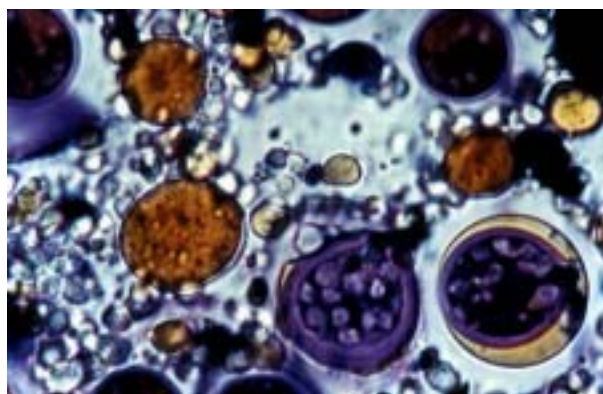




NREL/TP-580-24190

# A Look Back at the U.S. Department of Energy's Aquatic Species Program: Biodiesel from Algae



*Close-Out Report*

**A Look Back at the U.S. Department of Energy's Aquatic Species  
Program—Biodiesel from Algae**

July 1998

By

John Sheehan  
Terri Dunahay  
John Benemann  
Paul Roessler

Prepared for:

U.S. Department of Energy's  
Office of Fuels Development

Prepared by: the  
National Renewable Energy Laboratory  
1617 Cole Boulevard  
Golden, Colorado 80401-3393  
A national laboratory of the U.S. Department of Energy  
Operated by Midwest Research Institute  
Under Contract No. DE-AC36-83CH10093

## Executive Summary

From 1978 to 1996, the U.S. Department of Energy's Office of Fuels Development funded a program to develop renewable transportation fuels from algae. The main focus of the program, known as the Aquatic Species Program (or ASP) was the production of biodiesel from high lipid-content algae grown in ponds, utilizing waste CO<sub>2</sub> from coal fired power plants. Over the almost two decades of this program, tremendous advances were made in the science of manipulating the metabolism of algae and the engineering of microalgae algae production systems. Technical highlights of the program are summarized below:

### Applied Biology

#### *A unique collection of oil-producing microalgae.*

The ASP studied a fairly specific aspect of algae—their ability to produce natural oils. Researchers not only concerned themselves with finding algae that produced a lot of oil, but also with algae that grow under severe conditions—extremes of temperature, pH and salinity. At the outset of the program, no collections existed that either emphasized or characterized algae in terms of these constraints. Early on, researchers set out to build such a collection. Algae were collected from sites in the west, the northwest and the southeastern regions of the continental U.S., as well as Hawaii. At its peak, the collection contained over 3,000 strains of organisms. After screening, isolation and characterization efforts, the collection was eventually winnowed down to around 300 species, mostly green algae and diatoms. The collection, now housed at the University of Hawaii, is still available to researchers. This collection is an untapped resource, both in terms of the unique organisms available and the mostly untapped genetic resource they represent. It is our sincere hope that future researchers will make use of the collection not only as a source of new products for energy production, but for many as yet undiscovered new products and genes for industry and medicine.

#### *Shedding light on the physiology and biochemistry of algae.*

Prior to this program, little work had been done to improve oil production in algal organisms. Much of the program's research focused attention on the elusive "lipid trigger." (Lipids are another generic name for TAGs, the primary storage form of natural oils.) This "trigger" refers to the observation that, under environmental stress, many microalgae appeared to flip a switch to turn on production of TAGs. Nutrient deficiency was the major factor studied. Our work with nitrogen-deficiency in algae and silicon deficiency in diatoms did not turn up any overwhelming evidence in support of this trigger theory. The common thread among the studies showing increased oil production under stress seems to be the observed cessation of cell division. While the rate of production of all cell components is lower under nutrient starvation, oil production seems to remain higher, leading to an accumulation of oil in the cells. The increased oil content of the algae does not lead to increased overall productivity of oil. In fact, overall rates of oil production are lower during periods of nutrient deficiency. Higher levels of oil in the cells are more than offset by lower rates of cell growth.

---



### *Breakthroughs in molecular biology and genetic engineering.*

Plant biotechnology is a field that is only now coming into its own. Within the field of plant biotechnology, algae research is one of the least trodden territories. The slower rate of advance in this field makes each step forward in our research all the more remarkable. Our work on the molecular biology and genetics of algae is thus marked with significant scientific discoveries. The program was the first to isolate the enzyme Acetyl CoA Carboxylase (ACCase) from a diatom. This enzyme was found to catalyze a key metabolic step in the synthesis of oils in algae. The gene that encodes for the production of ACCase was eventually isolated and cloned. This was the *first* report of the cloning of the full sequence of the ACCase gene in *any* photosynthetic organism. With this gene in hand, researchers went on to develop the first successful transformation system for diatoms—the tools and genetic components for expressing a foreign gene. The ACCase gene and the transformation system for diatoms have both been patented. In the closing days of the program, researchers initiated the first experiments in metabolic engineering as a means of increasing oil production. Researchers demonstrated an ability to make algae over-express the ACCase gene, a major milestone for the research, with the hope that increasing the level of ACCase activity in the cells would lead to higher oil production. These early experiments did not, however, demonstrate increased oil production in the cells.

### **Algae Production Systems**

#### *Demonstration of Open Pond Systems for Mass Production of Microalgae.*

Over the course of the program, efforts were made to establish the feasibility of large-scale algae production in open ponds. In studies conducted in California, Hawaii and New Mexico, the ASP proved the concept of long term, reliable production of algae. California and Hawaii served as early test bed sites. Based on results from six years of tests run in parallel in California and Hawaii, 1,000 m<sup>2</sup> pond systems were built and tested in Roswell, New Mexico. The Roswell, New Mexico tests proved that outdoor ponds could be run with extremely high efficiency of CO<sub>2</sub> utilization. Careful control of pH and other physical conditions for introducing CO<sub>2</sub> into the ponds allowed greater than 90% utilization of injected CO<sub>2</sub>. The Roswell test site successfully completed a full year of operation with reasonable control of the algal species grown. Single day productivities reported over the course of one year were as high as 50 grams of algae per square meter per day, a long-term target for the program. Attempts to achieve consistently high productivities were hampered by low temperature conditions encountered at the site. The desert conditions of New Mexico provided ample sunlight, but temperatures regularly reached low levels (especially at night). If such locations are to be used in the future, some form of temperature control with enclosure of the ponds may well be required.

#### *The high cost of algae production remains an obstacle.*

The cost analyses for large-scale microalgae production evolved from rather superficial analyses in the 1970s to the much more detailed and sophisticated studies conducted during the 1980s. A major conclusion from these analyses is that there is little prospect for any alternatives to the open pond designs, given the low cost requirements associated with fuel production. The factors that most influence cost are biological, and not engineering-related. These analyses point to the need for highly productive organisms capable of near-theoretical levels of conversion of sunlight to biomass. Even with aggressive assumptions about biological productivity, we project costs for biodiesel which are two times higher than current petroleum diesel fuel costs.

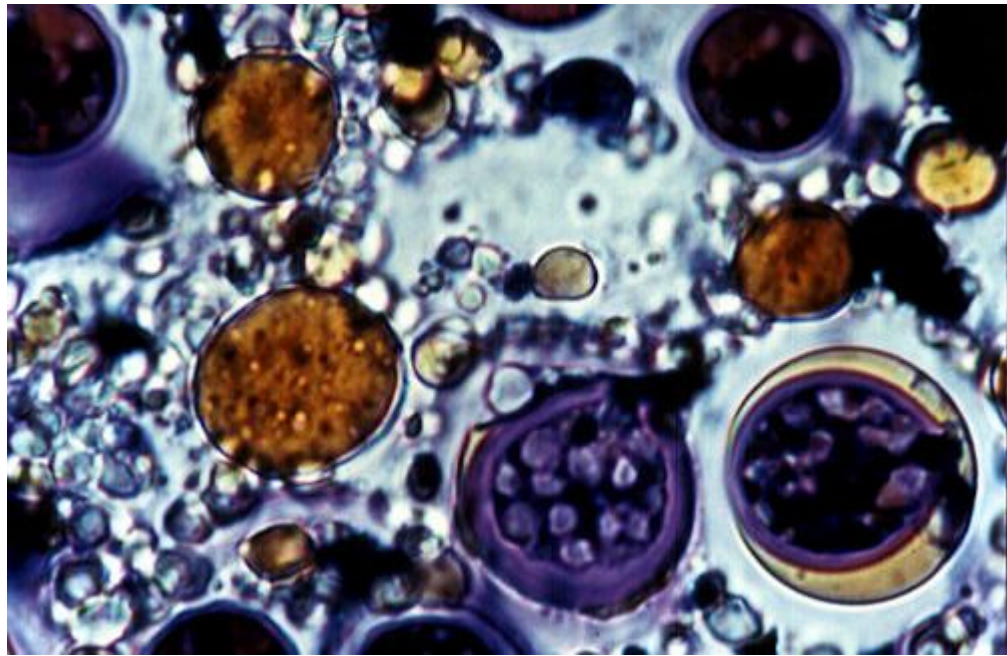


## Resource Availability

*Land, water and CO<sub>2</sub> resources can support substantial biodiesel production and CO<sub>2</sub> savings.*

The ASP regularly revisited the question of available resources for producing biodiesel from microalgae. This is not a trivial effort. Such resource assessments require a combined evaluation of appropriate climate, land and resource availability. These analyses indicate that significant potential land, water and CO<sub>2</sub> resources exist to support this technology. Algal biodiesel could easily supply several “quads” of biodiesel—substantially more than existing oilseed crops could provide. Microalgae systems use far less water than traditional oilseed crops. Land is hardly a limitation. Two hundred thousand hectares (less than 0.1% of climatically suitable land areas in the U.S.) could produce one quad of fuel. Thus, though the technology faces many R&D hurdles before it can be practicable, it is clear that resource limitations are not an argument against the technology.

# A Look Back at the U.S. Department of Energy's Aquatic Species Program:



## Biodiesel from Algae

*Part I:*

*Program Summary*

---

## Background

### Origins of the Program

This year marks the 20<sup>th</sup> anniversary of the National Renewable Energy Laboratory (NREL). In 1978, the Carter Administration established what was then called the Solar Energy Research Institute (SERI) in Golden, CO. This was a first-of-its kind federal laboratory dedicated to the development of solar energy. The formation of this lab came in response to the energy crises of the early and mid 1970s. At the same time, the Carter Administration consolidated all federal energy activities under the auspices of the newly established U.S. Department of Energy (DOE).

Among its various programs established to develop all forms of solar energy, DOE initiated research on the use of plant life as a source of transportation fuels. Today, this program—known as the Biofuels Program—is funded and managed by the Office of Fuels Development (OFD) within the Office of Transportation Technologies under the Assistant Secretary for Energy Efficiency and Renewable Energy at DOE. The program has, over the years, focused on a broad range of alternative fuels, including ethanol and methanol (alcohol fuel substitutes for gasoline), biogas (methane derived from plant materials) and biodiesel (a natural oil-derived diesel fuel substitute). The Aquatic Species Program (ASP) was just one component of research within the Biofuels Program aimed at developing alternative sources of natural oil for biodiesel production.

### Close-out of the Program

The Aquatic Species Program (ASP) was a relatively small research effort intended to look at the use of aquatic plants as sources of energy. While its history dates back to 1978, much of the research from 1978 to 1982 was focused on using algae to produce hydrogen. The program switched emphasis to other transportation fuels, in particular biodiesel, beginning in the early 1980s. This report provides a summary of the research activities carried out from 1980 to 1996, with an emphasis on algae for biodiesel production.

In 1995, DOE made the difficult decision to eliminate funding for algae research within the Biofuels Program. Under pressure to reduce budgets, the Department chose a strategy of more narrowly focusing its limited resources in one or two key areas, the largest of these being the development of bioethanol. The purpose of this report is to bring closure to the Biofuels Program's algae research. This report is a summary and compilation of all the work done over the last 16 years of the program. It includes work carried out by NREL researchers at our labs in Golden, as well as subcontracted research and development activities conducted by private companies and universities around the country. More importantly, this report should be seen not as an ending, but as a beginning. When the time is right, we fully expect to see renewed interest in algae as a source of fuels and other chemicals. The highlights presented here should serve as a foundation for these future efforts.

## What is the technology?

### Biological Concepts

Photosynthetic organisms include plants, algae and some photosynthetic bacteria. Photosynthesis is the key to making solar energy available in useable forms for all organic life in our environment. These organisms use energy from the sun to combine water with carbon dioxide (CO<sub>2</sub>) to create biomass. While other elements of the Biofuels Program have focused on terrestrial plants as sources of fuels, ASP was concerned with photosynthetic organisms that grew in aquatic environments. These include macroalgae, microalgae and emergents. Macroalgae, more commonly known as “seaweed,” are fast growing marine and freshwater plants that can grow to considerable size (up to 60m in length). Emergents are plants that grow partially submerged in bogs and marshes. Microalgae are, as the name suggests, microscopic photosynthetic organisms. Like macroalgae, these organisms are found in both marine and freshwater environments. In the early days of the program, research was done on all three types of aquatic species. As emphasis switched to production of natural oils for biodiesel, microalgae became the exclusive focus of the research. This is because microalgae generally produce more of the right kinds of natural oils needed for biodiesel (see the discussion of fuel concepts presented later in this overview).

In many ways, the study of microalgae is a relatively limited field of study. Algae are not nearly as well understood as other organisms that have found a role in today’s biotechnology industry. This is part of what makes our program so valuable. Much of the work done over the past two decades represents genuine additions to the scientific literature. The limited size of the scientific community involved in this work also makes it more difficult, and sometimes slower, compared to the progress seen with more conventional organisms. The study of microalgae represents an area of high risk and high gains.

These photosynthetic organisms are far from monolithic. Biologists have categorized microalgae in a variety of classes, mainly distinguished by their pigmentation, life cycle and basic cellular structure. The four most important (at least in terms of abundance) are:

- The diatoms (Bacillariophyceae). These algae dominate the phytoplankton of the oceans, but are also found in fresh and brackish water. Approximately 100,000 species are known to exist. Diatoms contain polymerized silica (Si) in their cell walls. All cells store carbon in a variety of forms. Diatoms store carbon in the form of natural oils or as a polymer of carbohydrates known as chrysolaminarin.
- The green algae (Chlorophyceae). These are also quite abundant, especially in freshwater. (Anyone who owns a swimming pool is more than familiar with this class of algae). They can occur as single cells or as colonies. Green algae are the evolutionary progenitors of modern plants. The main storage compound for green algae is starch, though oils can be produced under certain conditions.



- The blue-green algae (Cyanophyceae). Much closer to bacteria in structure and organization, these algae play an important role in fixing nitrogen from the atmosphere. There are approximately 2,000 known species found in a variety of habitats.
- The golden algae (Chrysophyceae). This group of algae is similar to the diatoms. They have more complex pigment systems, and can appear yellow, brown or orange in color. Approximately 1,000 species are known to exist, primarily in freshwater systems. They are similar to diatoms in pigmentation and biochemical composition. The golden algae produce natural oils and carbohydrates as storage compounds.

The bulk of the organisms collected and studied in this program fall in the first two classes—the diatoms and the green algae.

Microalgae are the most primitive form of plants. While the mechanism of photosynthesis in microalgae is similar to that of higher plants, they are generally more efficient converters of solar energy because of their simple cellular structure. In addition, because the cells grow in aqueous suspension, they have more efficient access to water, CO<sub>2</sub>, and other nutrients. For these reasons, microalgae are capable of producing 30 times the amount oil per unit area of land, compared to terrestrial oilseed crops.

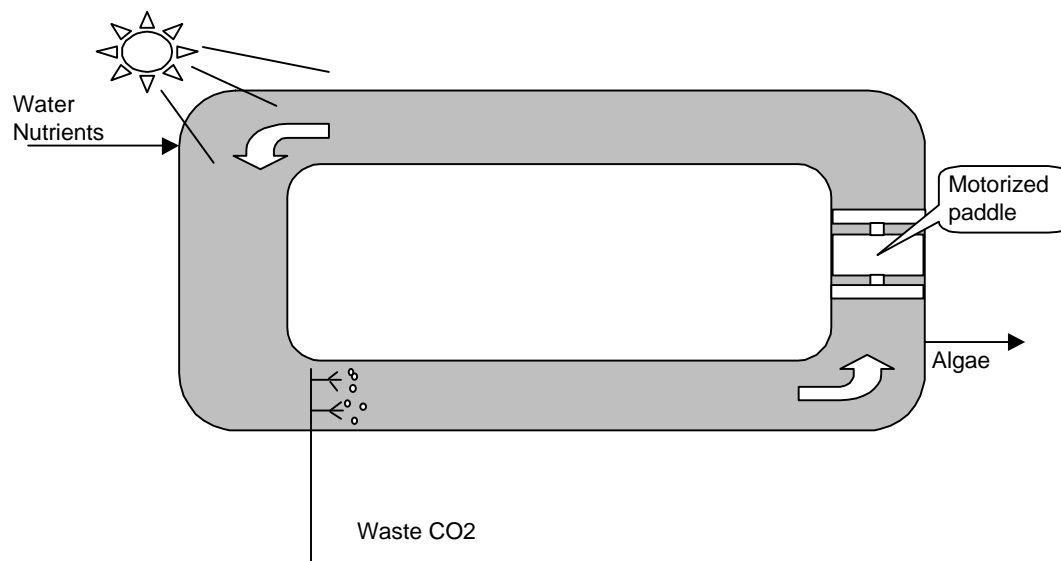
*Put quite simply, microalgae are remarkable and efficient biological factories capable of taking a waste (zero-energy) form of carbon (CO<sub>2</sub>) and converting it into a high density liquid form of energy (natural oil). This ability has been the foundation of the research program funded by the Office Fuels Development.*

### **Algae Production Concepts**

Like many good ideas (and certainly many of the concepts that are now the basis for renewable energy technology), the concept of using microalgae as a source of fuel is older than most people realize. The idea of producing methane gas from algae was proposed in the early 1950s<sup>1</sup>. These early researchers visualized a process in which wastewater could be used as a medium and source of nutrients for algae production. The concept found a new life with the energy crisis of the 1970s. DOE and its predecessors funded work on this combined process for wastewater treatment and energy production during the 1970s. This approach had the benefit of serving multiple needs—both environmental and energy-related. It was seen as a way of introducing this alternative energy source in a near-term timeframe.

In the 1980s, DOE's program gradually shifted its focus to technologies that could have large-scale impacts on national consumption of fossil energy. Much of DOE's publications from this period reflect a philosophy of energy research that might, somewhat pejoratively, be called "the quads mentality." A quad is a short-hand name for the unit of energy often used by DOE to describe the amounts of energy that a given technology might be able to displace. Quad is short for "quadrillion Btus"—a unit of energy representing 10<sup>15</sup> (1,000,000,000,000,000) Btus of energy. This perspective led DOE to focus on the concept of immense algae farms.

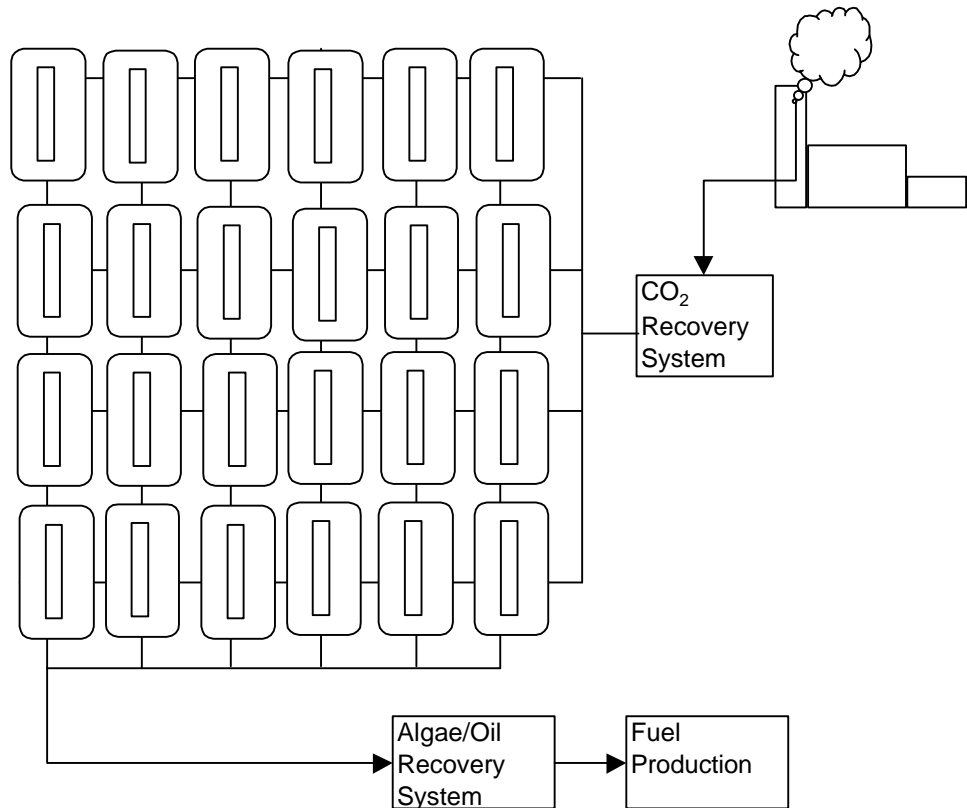
Such algae farms would be based on the use of open, shallow ponds in which some source of waste CO<sub>2</sub> could be efficiently bubbled into the ponds and captured by the algae (see the figure below).



The ponds are “raceway” designs, in which the algae, water and nutrients circulate around a racetrack. Paddlewheels provide the flow. The algae are thus kept suspended in water. Algae are circulated back up to the surface on a regular frequency. The ponds are kept shallow because of the need to keep the algae exposed to sunlight and the limited depth to which sunlight can penetrate the pond water. The ponds are operated continuously; that is, water and nutrients are constantly fed to the pond, while algae-containing water is removed at the other end. Some kind of harvesting system is required to recover the algae, which contains substantial amounts of natural oil.

The concept of an “algae farm” is illustrated on the next page. The size of these ponds is measured in terms of surface area (as opposed to volume), since surface area is so critical to capturing sunlight. Their productivity is measured in terms of biomass produced per day per unit of available surface area. Even at levels of productivity that would stretch the limits of an aggressive research and development program, such systems will require acres of land. At such large sizes, it is more appropriate to think of these operations on the scale of a farm.

There are quite a number of sources of waste CO<sub>2</sub>. Every operation that involves combustion of fuel for energy is a potential source. The program targeted coal and other fossil fuel-fired power plants as the main sources of CO<sub>2</sub>. Typical coal-fired power plants emit flue gas from their stacks containing up to 13% CO<sub>2</sub>. This high concentration of CO<sub>2</sub> enhances transfer and uptake of CO<sub>2</sub> in the ponds. The concept of coupling a coal-fired power plant with an algae farm provides an elegant approach to recycle of the CO<sub>2</sub> from coal combustion into a useable liquid fuel.



Other system designs are possible. The Japanese, French and German governments have invested significant R&D dollars on novel closed bioreactor designs for algae production. The main advantage of such closed systems is that they are not as subject to contamination with whatever organism happens to be carried in the wind. The Japanese have, for example, developed optical fiber-based reactor systems that could dramatically reduce the amount of surface area required for algae production. While breakthroughs in these types of systems may well occur, their costs are, for now, prohibitive—especially for production of fuels. DOE’s program focused primarily on open pond raceway systems because of their relative low cost.

*The Aquatic Species Program envisioned vast arrays of algae ponds covering acres of land analogous to traditional farming. Such large farms would be located adjacent to power plants. The bubbling of flue gas from a power plant into these ponds provides a system for recycling of waste CO<sub>2</sub> from the burning of fossil fuels.*

### Fuel Production Concepts

The previous sections have alluded to a number of potential fuel products from algae. The ASP considered three main options for fuel production:

- Production of methane gas via biological or thermal gasification.
- Production of ethanol via fermentation

- Production of biodiesel

A fourth option is the direct combustion of the algal biomass for production of steam or electricity. Because the Office of Fuels Development has a mandate to work on transportation fuels, the ASP did not focus much attention on direct combustion. The concept of algal biomass as a fuel extender in coal-fired power plants was evaluated under a separate program funded by DOE's Office of Fossil Fuels. The Japanese have been the most aggressive in pursuing this application. They have sponsored demonstrations of algae production and use at a Japanese power plant.

Algal biomass contains three main components:

- Carbohydrates
- Protein
- Natural Oils

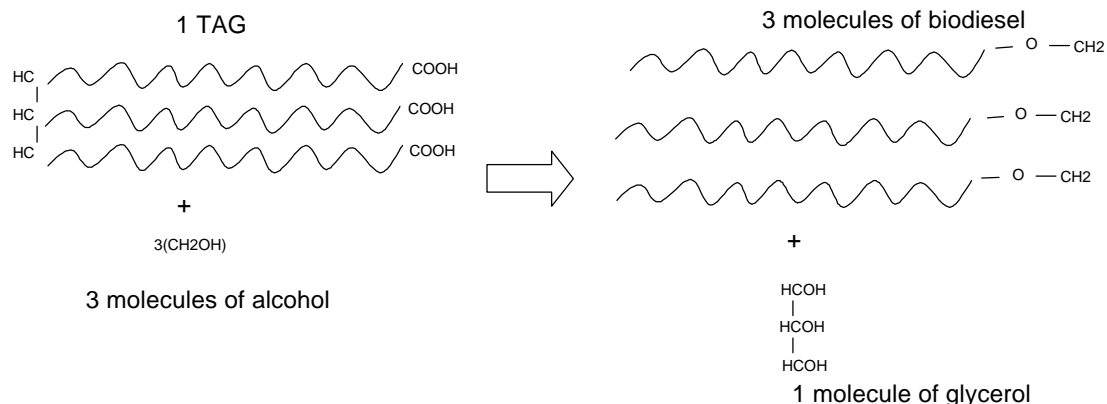
The economics of fuel production from algae (or from any biomass, for that matter) demands that we utilize all the biomass as efficiently as possible. To achieve this, the three fuel production options listed previously can be used in a number of combinations. The most simplistic approach is to produce methane gas, since the both the biological and thermal processes involved are not very sensitive to what form the biomass is in. Gasification is a somewhat brute force technology in the sense that it involves the breakdown of any form of organic carbon into methane. Ethanol production, by contrast, is most effective for conversion of the carbohydrate fraction. Biodiesel production applies exclusively to the natural oil fraction. Some combination of all three components can also be utilized as an animal feed. Process design models developed under the program considered a combination of animal feed production, biological gasification and biodiesel production.

The main product of interest in the ASP was biodiesel. In its most general sense, biodiesel is any biomass-derived diesel fuel substitute. Today, biodiesel has come to mean a very specific chemical modification of natural oils. Oilseed crops such as rapeseed (in Europe) and soybean oil (in the U.S.) have been extensively evaluated as sources of biodiesel. Biodiesel made from rapeseed oil is now a substantial commercial enterprise in Europe. Commercialization of biodiesel in the U.S. is still in its nascent stage.

The bulk of the natural oil made by oilseed crops is in the form of triacylglycerols (TAGs). TAGs consist of three long chains of fatty acids attached to a glycerol backbone. The algae species studied in this program can produce up to 60% of their body weight in the form of TAGs. Thus, algae represent an alternative source of biodiesel, one that does not compete with the existing oilseed market.

As a matter of historical interest, Rudolph Diesel first used peanut oil (which is mostly in the form of TAGs) at the turn of the century to demonstrate his patented diesel engine<sup>2</sup>. The rapid introduction of cheap petroleum quickly made petroleum the preferred source of diesel fuel, so much so that today's diesel engines do not operate well when operated on unmodified TAGs. Natural oils, it turns out, are too viscous to be used in modern diesel engines.

In the 1980s, a chemical modification of natural oils was introduced that helped to bring the viscosity of the oils within the range of current petroleum diesel<sup>3</sup>. By reacting these TAGs with simple alcohols (a chemical reaction known as “transesterification” already commonplace in the oleochemicals industry), we can create a chemical compound known as an alkyl ester<sup>4</sup>, but which is known more generically as biodiesel (see the figure below). Its properties are very close to those of petroleum diesel fuel.



Commercial experience with biodiesel has been very promising<sup>5</sup>. Biodiesel performs as well as petroleum diesel, while reducing emissions of particulate matter, CO, hydrocarbons and SO<sub>x</sub>. Emissions of NO<sub>x</sub> are, however, higher for biodiesel in many engines. Biodiesel virtually eliminates the notorious black soot emissions associated with diesel engines. Total particulate matter emissions are also much lower<sup>6,7,8</sup>. Other environmental benefits of biodiesel include the fact that it is highly biodegradable<sup>9</sup> and that it appears to reduce emissions of air toxics and carcinogens (relative to petroleum diesel)<sup>10</sup>. A proper discussion of biodiesel would require much more space than can be accommodated here. Suffice it to say that, given many of its environmental benefits and the emerging success of the fuel in Europe, biodiesel is a very promising fuel product.

*High oil-producing algae can be used to produce biodiesel, a chemically modified natural oil that is emerging as an exciting new option for diesel engines. At the same time, algae technology provides a means for recycling waste carbon from fossil fuel combustion. Algal biodiesel is one of the only avenues available for high-volume re-use of CO<sub>2</sub> generated in power plants. It is a technology that marries the potential need for carbon disposal in the electric utility industry with the need for clean-burning alternatives to petroleum in the transportation sector.*

### Why microalgae technology?

There are a number of benefits that serve as driving forces for developing and deploying algae technology. Some of these benefits have already been mentioned. Four key areas are outlined here. The first two address national and international issues that continue to grow in importance—energy security and climate change. The

remaining areas address aspects of algae technology that differentiate it from other technology options being pursued by DOE.

## Energy Security

Energy security is the number one driving force behind DOE's Biofuels Program. The U.S. transportation sector is at the heart of this security issue. Cheap oil prices during the 1980s and 1990s have driven foreign oil imports to all time highs. In 1996, imports reached an important milestone—imported oil consumption exceeded domestic oil consumption. DOE's Energy Information Administration paints a dismal picture of our growing dependence on foreign oil. Consider these basic points<sup>11</sup>:

- Petroleum demand is increasing, especially due to new demand from Asian markets.
- New demand for oil will come primarily from the Persian Gulf.
- As long as prices for petroleum remain low, we can expect our imports to exceed 60% of our total consumption ten years from now.
- U.S. domestic supplies will likewise remain low as long as prices for petroleum remain low.

Not everyone shares this view of the future, or sees it as a reason for concern. The American Petroleum Institute<sup>12</sup> does not see foreign imports as a matter of national security. Others have argued that the prediction of increasing Mideast oil dependence worldwide is wrong. But the concern about our foreign oil addiction is widely held by a broad range of political and commercial perspectives<sup>13</sup>.

While there may be uncertainty and even contention over when and if there is a national security issue, there is one more piece to the puzzle that influences our perspective on this issue. This is the fact that, quite simply, 98% of the transportation sector in the U.S. relies on petroleum (mostly in the form of gasoline and diesel fuel). The implication of this indisputable observation is that even minor hiccups in the supply of oil could have crippling effects on our nation. This lends special significance to the Biofuels Program as a means of diversifying the fuel base in our transportation sector.

*Our almost complete reliance on petroleum in transportation comes from the demand for gasoline in passenger vehicles and the demand for diesel fuel in commerce. Bioethanol made from terrestrial energy crops offers a future alternative to gasoline, biodiesel made from algal oils could do the same for diesel fuel.*

## Climate Change

CO<sub>2</sub> is recognized as the most important (at least in quantity) of the atmospheric pollutants that contribute to the “greenhouse effect,” a term coined by the French mathematician Fourier in the mid-1800s to describe the trapping of heat in the Earth's atmosphere by gases capable of absorbing radiation. By the end of the last century, scientists were already speculating on the potential impacts of anthropogenic

CO<sub>2</sub>. The watershed event that brought the question of global warming to the forefront in the scientific community was the publication of Revelle's data in 1957, which quantified the geologically unprecedented build-up of atmospheric CO<sub>2</sub> that began with the advent of the industrial revolution. Revelle<sup>14</sup> characterized the potential risk of global climate change this way:

*“Human beings are carrying out a large scale geophysical experiment of a kind that could not have happened in the past nor be produced in the future. Within a few centuries, we are returning to the atmosphere and the oceans the concentrated organic carbon stored in sedimentary rocks over hundreds of millions of years.”*

Despite 40 years of research since Revelle first identified the potential risk of global warming, the debate over the real impacts of the increased CO<sub>2</sub> levels still rages. We may never be able to scientifically predict the climatic effects of increasing carbon dioxide levels due to the complexity of atmospheric and meteorological modeling. Indeed, Revelle's concise statement of the risks at play in global climate change remains the best framing of the issue available for policy makers today. The question we face as a nation is how much risk we are willing to take on an issue like this. That debate has never properly taken place with the American public.

*As Revelle's statement implies, the burning of fossil fuels is the major source of the current build up of atmospheric CO<sub>2</sub>. Thus, identifying alternatives to fossil fuels must be a key strategy in reducing greenhouse gas emissions. While no one single fuel can substitute for fossil fuels in an all of the energy sectors, we believe that biodiesel made from algal oils is a fuel which can make a major contribution to the reduction of CO<sub>2</sub> generated by power plants and commercial diesel engines.*

### **The Synergy of Coal and Microalgae**

Many of our fossil fuel reserves, but especially coal, are going to play significant roles for years to come. On a worldwide basis, coal is, by far, the largest fossil energy resource available. About one-fourth of the world's coal reserves reside in the United States. To put this in perspective, consider the fact that, at current rates of consumption, coal reserves could last for over 200 years.

Regardless of how much faith you put in future fossil energy projections, it is clear that coal will continue to play an important role in our energy future—especially given the relatively large amounts of coal that we control within our own borders. DOE's Energy Information Administration estimates that electricity will become an increasingly large contributor to future U.S. energy demand. How will this new demand be met? Initially, low cost natural gas will grow in use. Inevitably, the demand for electricity will have to be met by coal. Coal will remain the mainstay of U.S. baseline electricity generation, accounting for half of electricity generation by the year 2010.

The long term demand for coal brings with it a demand for technologies that can mitigate the environmental problems associated with coal. While control technologies will be used to reduce air pollutants associated with acid rain, no technologies exist today which address the problem of greenhouse gas emissions. Coal is the most carbon-intensive of the fossil fuels. In other words, for every Btu of energy liberated by combustion, coal emits more CO<sub>2</sub> than either petroleum or

natural gas. As pressure to reduce carbon emissions grows, this will become an increasingly acute problem for the U.S.

One measure of how serious this problem could be is the absurdity of some of the proposals being developed for handling carbon emissions from power plants. The preferred option offered by researchers at MIT is ocean disposal, despite the expense and uncertainty of piping CO<sub>2</sub> from power plants and injecting the CO<sub>2</sub> in the ocean<sup>15</sup>.

Commonsense suggests that recycling of carbon would be more efficacious than deep ocean disposal. No one clearly understands the long-term effects of injecting large amounts of CO<sub>2</sub> into our oceans. Beyond these environmental concerns, such large-scale disposal schemes represent an economic sinkhole. Huge amounts of capital and operating dollars would be spent simply to dispose of carbon. While such Draconian measures may ultimately be needed, it makes more sense to first re-use stationary sources of carbon as much as possible. Algae technology is unique in its ability to produce a useful, high-volume product from waste CO<sub>2</sub>.

*Consumption of coal, an abundant domestic fuel source for electricity generation, will continue to grow over the coming decades, both in the U.S. and abroad. Algae technology can extend the useful energy we get from coal combustion and reduce carbon emissions by recycling waste CO<sub>2</sub> from power plants into clean-burning biodiesel. When compared to the extreme measures proposed for disposing of power plant carbon emissions, algal recycling of carbon simply makes sense.*

### **Terrestrial versus Aquatic Biomass**

Algae grow in aquatic environments. In that sense, algae technology will not compete for the land already being eyed by proponents of other biomass-based fuel technologies. Biomass power and bioethanol both compete for the same land and for similar feedstocks—trees and grasses specifically grown for energy production. More importantly, many of the algal species studied in this program can grow in brackish water—that is, water that contains high levels of salt. This means that algae technology will not put additional demand on freshwater supplies needed for domestic, industrial and agricultural use.

The unique ability of algae to grow in saline water means that we can target areas of the country in which saline groundwater supplies prevent any other useful application of water or land resources. If we were to draw a map showing areas best suited for energy crop production (based on climate and resource needs), we would see that algae technology needs *complement* the needs of both agriculture and other biomass-based energy technologies.

*In a world of ever more limited natural resources, algae technology offers the opportunity to utilize land and water resources that are, today, unsuited for any other use. Land use needs for microalgae complement, rather than compete, with other biomass-based fuel technologies.*



## Technical Highlights of the Program

### Applied Biology

#### *A unique collection of oil-producing microalgae.*

The ASP studied a fairly specific aspect of algae—their ability to produce natural oils. Researchers not only concerned themselves with finding algae that produced a lot of oil, but also with algae that grow under severe conditions—extremes of temperature, pH and salinity. At the outset of the program, no collections existed that either emphasized or characterized algae in terms of these constraints. Early on, researchers set out to build such a collection. Algae were collected from sites in the west, the northwest and the southeastern regions of the continental U.S., as well as Hawaii. At its peak, the collection contained over 3,000 strains of organisms. After screening, isolation and characterization efforts, the collection was eventually winnowed down to around 300 species, mostly green algae and diatoms. The collection, now housed at the University of Hawaii, is still available to researchers. This collection is an untapped resource, both in terms of the unique organisms available and the mostly untapped genetic resource they represent. It is our sincere hope that future researchers will make use of the collection not only as a source of new products for energy production, but for many as yet undiscovered new products and genes for industry and medicine.

#### *Shedding light on the physiology and biochemistry of algae.*

Prior to this program, little work had been done to improve oil production in algal organisms. Much of the program's research focused attention on the elusive "lipid trigger." (Lipids are another generic name for TAGs, the primary storage form of natural oils.) This "trigger" refers to the observation that, under environmental stress, many microalgae appeared to flip a switch to turn on production of TAGs. Nutrient deficiency was the major factor studied. Our work with nitrogen-deficiency in algae and silicon deficiency in diatoms did not turn up any overwhelming evidence in support of this trigger theory. The common thread among the studies showing increased oil production under stress seems to be the observed cessation of cell division. While the rate of production of all cell components is lower under nutrient starvation, oil production seems to remain higher, leading to an accumulation of oil in the cells. The increased oil content of the algae does not lead to increased overall productivity of oil. In fact, overall rates of oil production are lower during periods of nutrient deficiency. Higher levels of oil in the cells are more than offset by lower rates of cell growth.

#### *Breakthroughs in molecular biology and genetic engineering.*

Plant biotechnology is a field that is only now coming into its own. Within the field of plant biotechnology, algae research is one of the least trodden territories. The slower rate of advance in this field makes each step forward in our research all the more remarkable. Our work on the molecular biology and genetics of algae is thus marked with significant scientific discoveries. The program was the first to isolate

the enzyme Acetyl CoA Carboxylase (ACCCase) from a diatom. This enzyme was found to catalyze a key metabolic step in the synthesis of oils in algae. The gene that encodes for the production of ACCCase was eventually isolated and cloned. This was the *first* report of the cloning of the full sequence of the ACCCase gene in *any* photosynthetic organism. With this gene in hand, researchers went on to develop the first successful transformation system for diatoms—the tools and genetic components for expressing a foreign gene. The ACCCase gene and the transformation system for diatoms have both been patented. In the closing days of the program, researchers initiated the first experiments in metabolic engineering as a means of increasing oil production. Researchers demonstrated an ability to make algae over-express the ACCCase gene, a major milestone for the research, with the hope that increasing the level of ACCCase activity in the cells would lead to higher oil production. These early experiments did not, however, demonstrate increased oil production in the cells.

## Algae Production Systems

### *Demonstration of Open Pond Systems for Mass Production of Microalgae.*

Over the course of the program, efforts were made to establish the feasibility of large-scale algae production in open ponds. In studies conducted in California, Hawaii and New Mexico, the ASP proved the concept of long term, reliable production of algae. California and Hawaii served as early test bed sites. Based on results from six years of tests run in parallel in California and Hawaii, 1,000 m<sup>2</sup> pond systems were built and tested in Roswell, New Mexico. The Roswell, New Mexico tests proved that outdoor ponds could be run with extremely high efficiency of CO<sub>2</sub> utilization. Careful control of pH and other physical conditions for introducing CO<sub>2</sub> into the ponds allowed greater than 90% utilization of injected CO<sub>2</sub>. The Roswell test site successfully completed a full year of operation with reasonable control of the algal species grown. Single day productivities reported over the course of one year were as high as 50 grams of algae per square meter per day, a long-term target for the program. Attempts to achieve consistently high productivities were hampered by low temperature conditions encountered at the site. The desert conditions of New Mexico provided ample sunlight, but temperatures regularly reached low levels (especially at night). If such locations are to be used in the future, some form of temperature control with enclosure of the ponds may well be required.

### *A disconnect between the lab and the field.*

An important lesson from the outdoor testing of algae production systems is the inability to maintain laboratory organisms in the field. Algal species that looked very promising when tested in the laboratory were not robust under conditions encountered in the field. In fact, the best approach for successful cultivation of a consistent species of algae was to allow a contaminant native to the area to take over the ponds.

### *The high cost of algae production remains an obstacle.*

The cost analyses for large-scale microalgae production evolved from rather superficial analyses in the 1970s to the much more detailed and sophisticated studies conducted during the 1980s. A major conclusion from these analyses is that there is little prospect for any alternatives to the open pond designs, given the low cost requirements associated with fuel production. The factors that most influence cost are biological, and not engineering-related. These analyses point to the need for highly productive organisms capable of near-theoretical levels of conversion of sunlight to biomass. Even with aggressive assumptions about biological productivity, we project costs for biodiesel which are two times higher than current petroleum diesel fuel costs.

### **Resource Availability**

*Land, water and CO<sub>2</sub> resources can support substantial biodiesel production and CO<sub>2</sub> savings.*

The ASP regularly revisited the question of available resources for producing biodiesel from microalgae. This is not a trivial effort. Such resource assessments require a combined evaluation of appropriate climate, land and resource availability. These analyses indicate that significant potential land, water and CO<sub>2</sub> resources exist to support this technology. Algal biodiesel could easily supply several “quads” of biodiesel—substantially more than existing oilseed crops could provide. Microalgae systems use far less water than traditional oilseed crops. Land is hardly a limitation. Two hundred thousand hectares (less than 0.1% of climatically suitable land areas in the U.S.) could produce one quad of fuel. Thus, though the technology faces many R&D hurdles before it can be practicable, it is clear that resource limitations are not an argument against the technology.

### **A Brief Chronology of the Research Activities**

Part II of this report details the specific research accomplishments of the program on a year-to-year basis. In order to provide a consistent context and framework for understanding this detail, we have attempted to outline the major activities of the program as they unfolded over the course of the past two decades. The timeline on the following page shows the major activities broken down into two main categories—laboratory studies and outdoor testing/systems analysis. For the sake of clarity and brevity, many of the research projects and findings from the program are not presented here. Instead, only those findings that form a thread throughout the work are highlighted. There were many other studies and findings of value in the program. The reader is encouraged to review Part II of this report for a more comprehensive discussion of the research.

#### **Laboratory Studies**

The research pathway in the lab can be broken down into three types of activities:

- Collection, screening and characterization of algae.
- Biochemical and physiological studies of lipid production
- Molecular biology and genetic engineering studies

There is a logic to the sequence of these activities. Researchers first identified a need to collect and identify algae that met minimal requirements for this technology. Collection and screening occurred over a seven-year period from 1980 to 1987. Once a substantial amount of information was available on the types of oil-producing algae and their capabilities, the program began to switch its emphasis to understanding the biochemistry and physiology of oil production in algae. A natural next step was to use this information to identify approaches to genetically manipulate the metabolism of algae to enhance oil production.

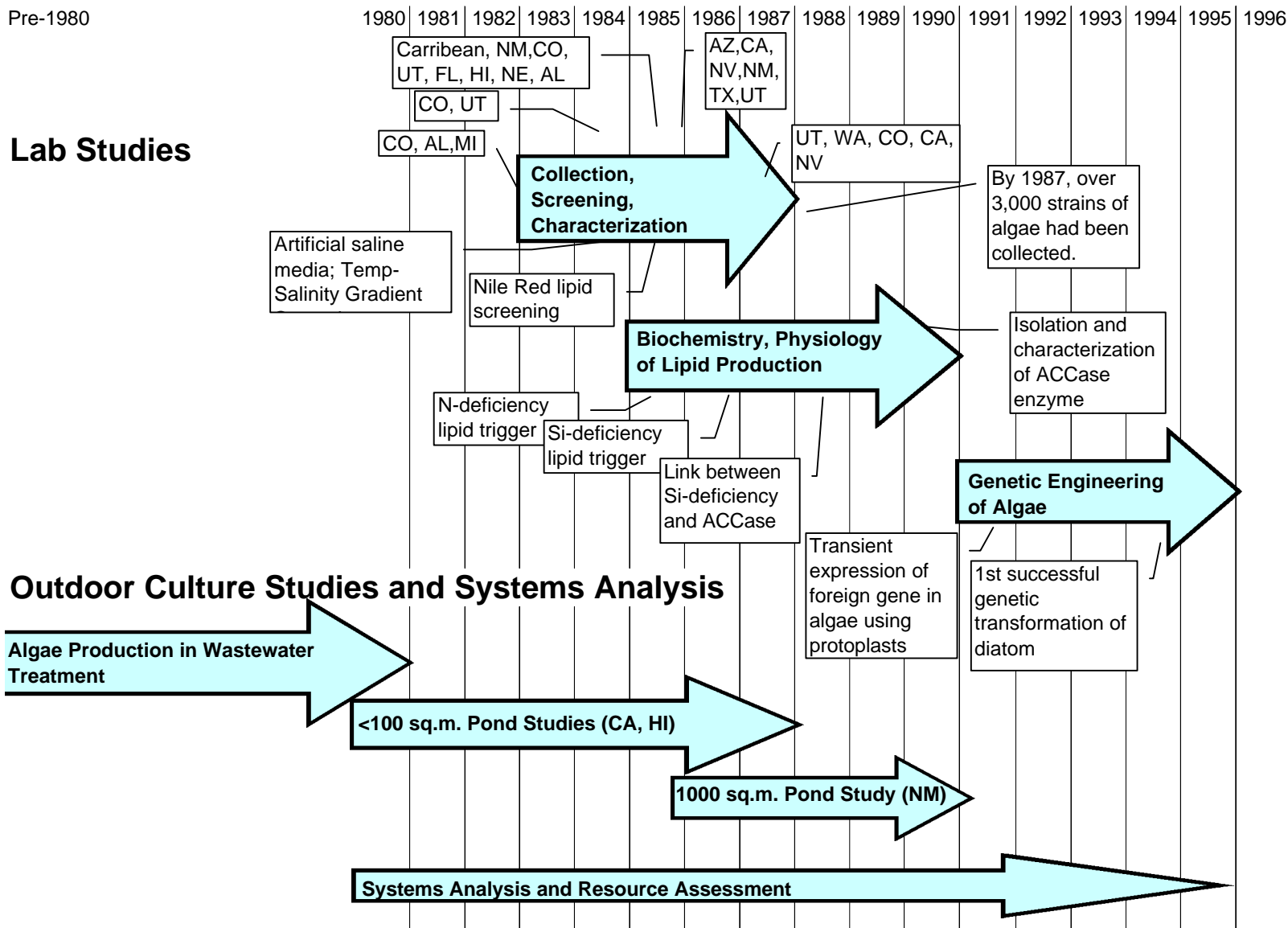
Algae collection efforts initially focused on shallow, inland saline habitats, particularly in western Colorado, New Mexico and Utah. The reasoning behind collecting strains from these habitats was that the strains would be adapted to at least some of the environmental conditions expected in mass culture facilities located in the southwestern U.S. (a region identified early on as a target for deployment of the technology). Organisms isolated from shallow habitats were also expected to be more tolerant to wide swings in temperature and salinity. In the meantime, subcontractors were collecting organisms from the southeastern region of the U.S. (Florida, Mississippi, and Alabama). By 1984, researchers in the program had developed improved tools and techniques for collecting and screening organisms. These included a modified rotary screening apparatus and statistically designed saline media formulations that mimicked typical brackish water conditions in the southwest. In 1985, a rapid screening test was in place for identifying high oil-producing algae. In the last years of the collection effort, the focus switched to finding algae that were tolerant to low temperature. This expanded the reach of the collection activities into the northwest. By 1987, the algae collection contained over 3,000 species.

As the collection efforts began to wind down, it became apparent that no one single species was going to be found that met all of the needs of the technology. As a result, about midway through the collection efforts, the program began studies on the biochemistry and physiology of oil production in algae in hopes of learning how to improve the performance of existing organisms. A number of ASP subcontractors struggled to identify the so-called “lipid trigger.” These studies confirmed observations that deficiencies in nitrogen could lead to an increase in the level of oil present in many species of algae. Observations of cellular structure also supported the notion of a trigger that caused rapid build up of oil droplets in the cells during periods of nitrogen depletion.

Pre-1980

## Lab Studies

## Outdoor Culture Studies and Systems Analysis

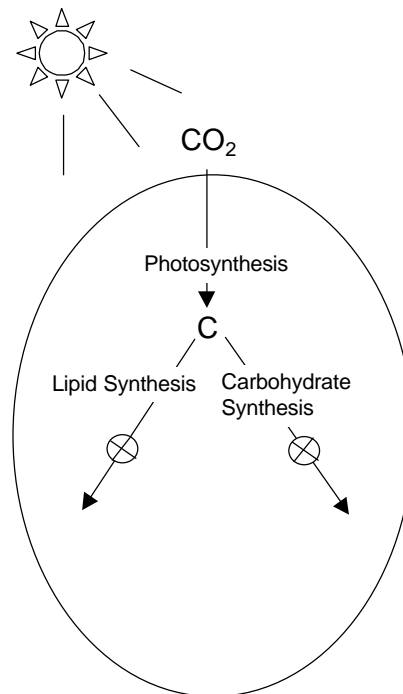


In the end, however, the studies conducted both by NREL researchers and program subcontractors concluded that no simple trigger for lipid production exists. Instead, we found that environmental stresses like nitrogen depletion lead to inhibition of cell division, without immediately slowing down oil production. It appeared that no simple means existed for increasing oil production, without a penalty in overall productivity due to a slowing down of cell growth. The use of nutrient depletion as a means of inducing oil production may still have merit. Some experiments conducted at NREL suggested that the kinetics of cell growth and lipid accumulation are very subtle. With a better understanding of these kinetics, it may be possible to provide a net increase in total oil productivity by carefully controlling the timing of nutrient depletion and cell harvesting.

In 1986, researchers at NREL reported on the use of Si depletion as a way to increase oil levels in diatoms. They found that when Si was used up, cell division slowed down since Si is a component of the diatoms' cell walls. In the diatom *C. cryptica*, the rate of oil production remained constant once Si depletion occurred, while growth rate of the cells dropped. Further studies identified two factors that seemed to be at play in this species:

1. Si-depleted cells direct newly assimilated carbon more toward lipid production and less toward carbohydrate production.
2. Si-depleted cells slowly convert non-lipid cell components to lipids.

Diatoms store carbon in lipid form or in carbohydrate form. The results of these experiments suggested that it might be possible to alter which route the cells used for storage (see schematic below):



Through the process of photosynthesis, algae cells assimilate carbon. There are numerous metabolic pathways through which the carbon can go, resulting in synthesis of whatever compounds are needed by the cell. These pathways consist of sequences of enzymes, each of which catalyzes a specific reaction. Two possible pathways for carbon are shown on the previous page. They represent the two storage forms that carbon can take.

Researchers at NREL began to look for key enzymes in the lipid synthesis pathway. These would be enzymes whose level of activity in the cell influences the rate at which oils are formed. Think of these enzymes as valves or spigots controlling the flow of carbon down the pathway. Higher enzyme activity leads to higher rates of oil production. When algae cells increase the activity of active enzymes, they are opening up the spigot to allow greater flow of carbon to oil production. Finding such critical enzymes was key to understanding the mechanisms for controlling oil production.

By 1988, researchers had shown that increases in the levels of the enzyme Acetyl CoA Carboxylase (ACCCase) correlated well with lipid accumulation during Si depletion. They also showed that the increased levels correlated with increased expression of the gene encoding for this enzyme. These findings led to a focus on isolating the enzyme and cloning the gene responsible for its expression. By the end of the program, not only had researchers successfully cloned the ACCCase gene, but they had also succeeded in developing the tools for expressing foreign genes in diatoms.

In the 1990s, genetic engineering had become the main focus of the program. While we have highlighted the successes of over-expressing ACCCase in diatoms, other approaches were also developed for foreign gene expression—in green algae as well as in diatoms. Another interesting sideline in the research involved studies aimed at identifying key enzymes involved in the synthesis of storage carbohydrates. Instead of over-expressing these enzymes, researchers hoped to inactivate them. Returning to our “spigot” analogy, this approach was like shutting off the flow of carbon to carbohydrates, in the hopes that it would force carbon to flow down the lipid synthesis pathway (again, see the schematic on the previous page). This work led to the discovery of a unique multifunctional enzyme in the carbohydrate synthesis pathway. This enzyme and its gene were both patented by NREL in 1996.

### **Outdoor Testing and Systems Analysis**

The first work done in earnest by DOE on demonstration of algae technology for energy production predates the Aquatic Species Program. In 1976, the Energy Research and Development Administration (before it was folded into DOE) funded a project at the University of California Berkeley’s Richmond Field Station to evaluate a combined wastewater treatment/fuel production system based on microalgae. Over the course of several years, the Richmond Field Station demonstrated techniques for algae harvesting and for control of species growing in open ponds.

By the time the Aquatic Species Program took on microalgae research, emphasis had already moved from wastewater treatment based systems to dedicated algae farm operations. From 1980 to 1987, the program funded two parallel efforts to develop large scale mass culture systems for microalgae. One effort was at the University of California, and it was based on a so-called “High Rate Pond” (HRP) design. The other effort was carried out at the University of Hawaii, where a patented “Algae

Raceway Production System” (ARPS). Both designs utilized open raceway designs. The HRP design was based on a shallow, mixed raceway concept developed at Berkeley in 1963 and successfully applied in wastewater treatment operations in California. The ARPS was really a variation on the same concept. Both efforts carried out their test work in ponds of 100 square meters or less. They studied a variety of fundamental operational issues, such as the effects of fluid flow patterns, light intensity, dissolved oxygen levels, pH and algae harvesting methods.

At the conclusion of the smaller scale tests conducted in California and Hawaii, the program engaged in a competitive bidding process to select a system design for scale up of algae mass culture. The HRP design evaluated at UC Berkeley was selected for scale-up. The “Outdoor Test Facility” (OTF) was designed and built at the site of an abandoned water treatment plant in Roswell, New Mexico. From 1988 to 1990, 1,000 square meter ponds were successfully operated at Roswell. This project demonstrated how to achieve very efficient (>90%) utilization of CO<sub>2</sub> in large ponds. The best results were obtained using native species of algae that naturally took over in the ponds (as opposed to using laboratory cultures). The OTF also demonstrated production of high levels of oil in algae using both nitrogen and silica depletion strategies. While daily productivities did reach program target levels of 50 grams per square per day, overall productivity was much lower (around 10 grams per square meter per day) due to the number of cold temperature days encountered at this site. Nevertheless, the project established the proof-of-concept for large scale open pond operations. The facility was shut down in 1990, and has not been operated since.

A variety of other outdoor projects were funded over the course of the program, including a three-year project on algal biodiesel production conducted in Israel. In addition, research at the Georgia Institute of Technology was carried out in the late 1980s. This work consisted of a combination of experimental and computer modeling work. This project resulted in the development of the APM (Algal Pond Model), a computer modeling tool for predicting performance of outdoor pond systems.

Two types of systems analysis were conducted frequently over the course of the program—resource assessments and engineering design/cost analyses. The former addresses the following important question: how much impact can algae technology have on petroleum use within the limits of available resources? Engineering designs provide some input to this question as well, since such designs tell us something about the resource demands of the technology. These designs also tell us how much the technology will cost.

As early as 1982, the program began to study the question of resource availability for algae technology. Initial studies scoped out criteria and methodology that should be used in the assessment. In 1985, a study done for Argonne National Lab produced maps of the southwestern U.S. which showed suitable zones for algae production based on climate, land and water availability. In 1990, estimates of available CO<sub>2</sub> supplies were completed for the first time. These estimates suggested that there was enough waste CO<sub>2</sub> available in the states where climate conditions were suitable to support 2 to 7 quads of fuel production annually. The cost of the CO<sub>2</sub> was estimated to range anywhere from \$9 to \$90 per ton of CO<sub>2</sub>. This study did not consider any regionally specific data, but drew its conclusions from overall data on CO<sub>2</sub> availability across a broad region. Also in 1990, a study was funded to assess land and water availability for algae technology in New Mexico. This study took a more regionally specific look at the resource question, but did so by sacrificing any

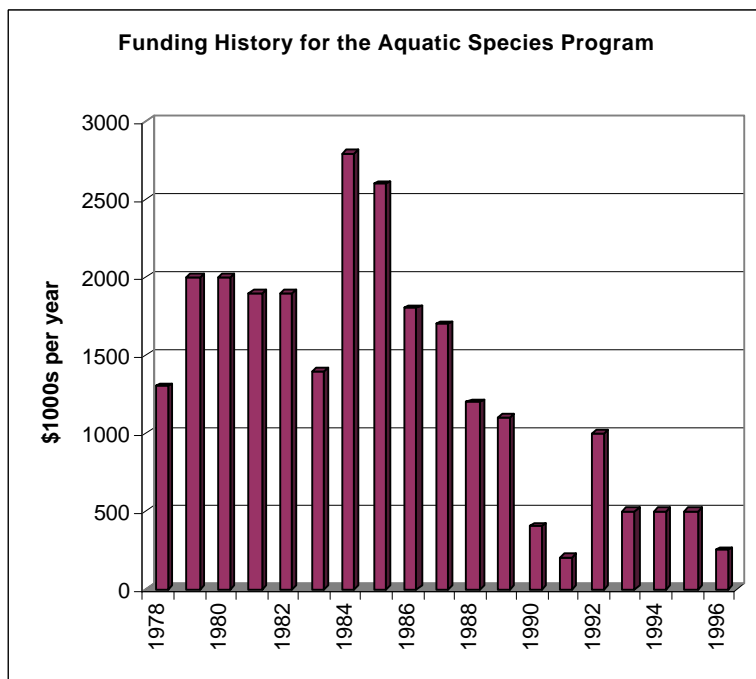


consideration of available CO<sub>2</sub> supplies. This last study sums up the difficulties faced in these types of studies. The results obtained on resource availability are either able to provide a complete, but general, perspective on resources or they are more detailed in approach, but incomplete in the analysis of all resources.

Engineering design and cost studies have been done throughout the course of the ASP, with ever increasing realism in the design assumptions and cost estimates. The last set of cost estimates for the program was developed in 1995. These estimates showed that algal biodiesel cost would range from \$1.40 to \$4.40 per gallon based on current and long-term projections for the performance of the technology. Even with assumptions of \$50 per ton of CO<sub>2</sub> as a carbon credit, the cost of biodiesel never competes with the projected cost of petroleum diesel.

## Program Funding History

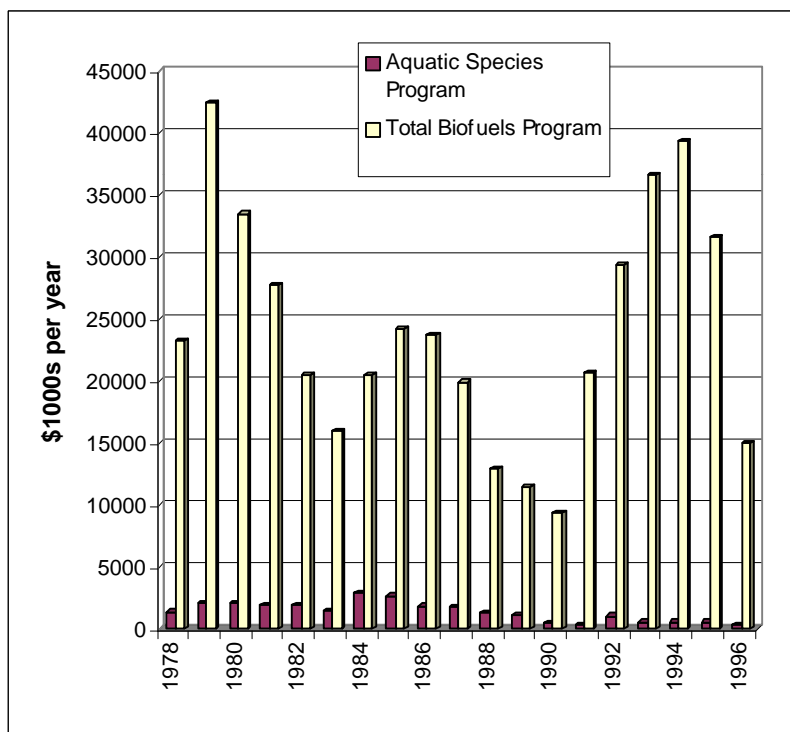
*Like all of the renewable fuels programs, the ASP has always been on a fiscal roller coaster*



In its heyday, this program leaped to levels of \$2 to \$2.75 million in annual funding. In most cases, these peaks came in sudden bursts in which the funding level of the program would double from one year to the next. After the boom years of 1984 and 1985, funding fell rapidly to its low of \$250,000 in 1991. The last three years of the program saw a steady level of \$500,000 (not counting FY 1996, which were mostly used to cover the cost of employee terminations). Ironically, these last three years were among the most productive in the history of the program (given the breakthroughs that occurred in genetic engineering). Though funding levels were

relatively low, they were at least steady—providing a desperately needed stability for the program. The years of higher spending are, for the most part, dominated by costly demonstration work (the tests carried out in California, Hawaii and culminating in New Mexico), engineering analysis and culture collection activities.

*High Return for a Small Investment of DOE Funds*



The total cost of the Aquatic Species Program is \$25.05 million over a twenty-year period. Compared to the total spending under the Biofuels Program (\$458 million over the same period), this has not been a high cost research program. At its peak, ASP accounted for 14% of the annual Biofuels budget; while, on average, it represented only 5.5% of the total budget. Given that relatively small investment, DOE has seen a tremendous return on its research dollars.

**Future Directions**

*Put less emphasis on outdoor field demonstrations and more on basic biology*

Much work remains to be done on a fundamental level to maximize the overall productivity of algae mass culture systems. The bulk of this work is probably best done in the laboratory. The results of this program’s demonstration activities have proven the concept of outdoor open pond production of algae. While it is important to continue a certain amount of field work, small scale studies and research on the

basic biological issues are clearly more cost effective than large scale demonstration studies.

#### *Take Advantage of Plant Biotechnology*

We have only scratched the surface in the area of genetic engineering for algae. With the advances occurring in this field today, any future effort on modifying algae to increase natural oil production and overall productivity are likely to proceed rapidly. The genetic engineering tools established in the program serve as a strong foundation for further genetic enhancements of algae.

#### *Start with what works in the field*

Select strains that work well at the specific site where the technology is to be used. These native strains are the most likely to be successful. Then, focus on optimizing the production of these native strains and use them as starting points for genetic engineering work.

#### *Maximize photosynthetic efficiency.*

Not enough is understood about what the theoretical limits of solar energy conversion are. Recent advances in our understanding of photosynthetic mechanisms at a molecular level, in conjunction with the advances being made in genetic engineering tools for plant systems, offer exciting opportunities for constructing algae which do not suffer the limitations of light saturation photoinhibition.

#### *Set realistic expectations for the technology*

Projections for future costs of petroleum are a moving target. DOE expects petroleum costs to remain relatively flat over the next 20 years. Expecting algal biodiesel to compete with such cheap petroleum prices is unrealistic. Without some mechanism for monetizing its environmental benefits (such as carbon taxes), algal biodiesel is not going to get off the ground.

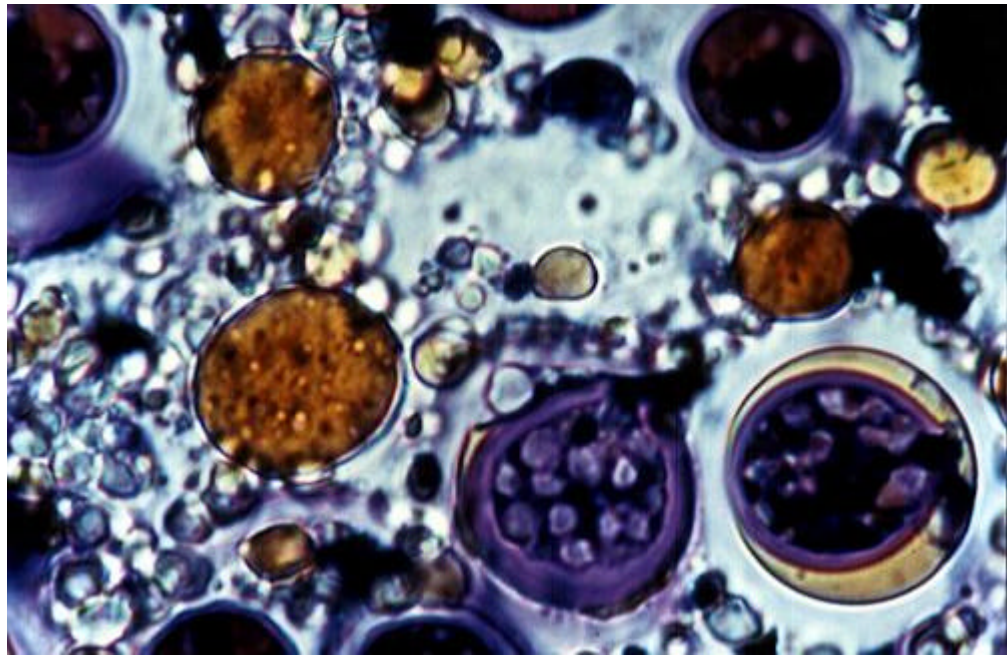
#### *Look for near term, intermediate technology deployment opportunities such as wastewater treatment.*

Excessive focus on long term energy displacement goals will slow down development of the technology. A more balanced approach is needed in which more near term opportunities can be used to launch the technology in the commercial arena. Several such opportunities exist. Wastewater treatment is a prime example. The economics of algae technology are much more favorable when it is used as a waste treatment process and as a source of fuel. This harks back to the early days of DOE's research.

## Footnotes

- <sup>1</sup> Meier, R.L. (1955) "Biological Cycles in the Transformation of Solar Energy into Useful Fuels." In *Solar Energy Research* (Daniels, F.; Duffie, J.A.; eds), Madison University Wisconsin Press, pp. 179-183.
- <sup>2</sup> Peterson, C. L. (1986) "Vegetable Oil as a Diesel Fuel: Status and Research Priorities," *Transactions of the ASAE*, pp 1413-1422. American Society of Agricultural Engineers, St. Joseph, MO.
- <sup>3</sup> Bruwer, J.; van D. Boshoff, B.; du Plessis, L.; Fuls, J.; Hawkins, C.; van der Walt, A.; Engelbrecht, A., (1980) "Sunflower Seed Oil As an Extender for Diesel Fuel in Agricultural Tractors," presented at the 1980 Symposium of the South African Institute of Agricultural Engineers.
- <sup>4</sup> Markley, K. (1961) "Chapter 9: Esters and Esterification," in *Fatty Acids: Their Chemistry, Properties, Production and Uses Part 2, 2nd Edition* (Markley, K.; ed.). Interscience Publications, New York.
- <sup>5</sup> European engine manufacturers have had very positive experience using rapeseed oil-derived biodiesel. In the U.S., engine manufacturers have expressed tentative support for blends of soy-derived biodiesel of up to 20%. See Alternative Fuels Committee of the Engine Manufacturers Association (1995) *Biodiesel Fuels and Their Use in Diesel Engine Applications* Engine Manufacturers' Association, Chicago, IL.
- <sup>6</sup> Graboski, M.; McCormick, R. (1994) *Final Report: Emissions from Biodiesel Blends and Neat Biodiesel from a 1991 Model Series 60 Engine Operating at High Altitude*. Colorado Institute for High Altitude Fuels and Engine Research. Subcontractor's report to National Renewable Energy Laboratory, Golden, CO.
- <sup>7</sup> FEV Engine Technology, Inc. (1994) *Emissions and Performance Characteristics of the Navistar T444E DI Diesel Engine Fueled with Blends of Biodiesel and Low Sulfur Diesel Fuel: Phase I final Report*. Contractor's report to the National Biodiesel Board, Jefferson City, MO.
- <sup>8</sup> Fosseen Manufacturing and Development, Ltd. (1994) *Emissions and Performance Characteristics of the Navistar T444E DI Diesel Engine Fueled with Blends of Biodiesel and Low Sulfur Diesel Fuel: Phase I final Report*. Contractor's report to National Biodiesel Board, Jefferson City, MO.
- <sup>9</sup> Peterson, C.; Reece, D. (1994) "Toxicology, Biodegradability and Environmental Benefits of Biodiesel," in *Biodiesel '94* (Nelson, R.; Swanson, D.; Farrell, J.; eds). Western Regional Biomass Energy Program, Golden, CO.
- <sup>10</sup> Sharpe, Chris, Southwest Research Institute (1998). Presentation on speciated emissions presented at the Biodiesel Environmental Workshop.
- <sup>11</sup> *Annual Energy Outlook 1996 with Projections to 2015*. U.S. Department of Energy, Energy Information Administration, DOE/EIA-0383(96), Washington, D.C. 1996.
- <sup>12</sup> *Reinventing Energy: Making the Right Choices*. The American Petroleum Institute, Washington, DC. 1996.
- <sup>13</sup> See Romm, J. *The Atlantic Monthly*, April 1996, pp 57-74.
- <sup>14</sup> Revelle, R.; Suess, H. *Tellus*, 9/1, pp 18-21, 1957.
- <sup>15</sup> Herzog, H., et al (1993) *The Capture, Utilization and Disposal of Carbon Dioxide from Fossil Fuel Power Plants*. Report to the U.S. Department of Energy DOE/ER-30194.

# A Look Back at the U.S. Department of Energy's Aquatic Species Program:



## Biodiesel from Algae

*Part II:*

*Technical Review*



## Table of Contents

<b>I.</b>	<b>INTRODUCTION.....</b>	<b>1</b>
<b>II.</b>	<b>LABORATORY STUDIES.....</b>	<b>5</b>
II.A.	COLLECTION, SCREENING, AND CHARACTERIZATION OF MICROALGAE	5
II.A.1.	<i>Collection, Screening, and Characterization of Microalgae by SERI In-House Researchers.....</i>	<i>5</i>
II.A.1.a.	Introduction.....	5
II.A.1.b.	Collection and Screening Activities - 1983.....	8
II.A.1.c.	Collection and Screening Activities - 1984.....	8
II.A.1.d.	Collection and Screening Activities - 1985.....	17
II.A.1.e.	Collection and Screening Activities - 1986 and 1987.....	19
II.A.1.f.	Development of a Rapid Screening Procedure for Growth and Lipid Content of Microalgae.....	21
II.A.1.g.	Statistical Analysis of Multivariate Effects on Microalgal Growth and Lipid Content.....	27
II.A.1.h.	Detailed Analyses of Microalgal Lipids.....	28
II.A.2.	<i>Collection, Screening, and Characterization of Microalgae: Research by SERI Subcontractors.....</i>	<i>32</i>
II.A.2.a.	Introduction.....	32
II.A.2.b.	Yields, Photosynthetic Efficiencies, and Proximate Chemical Composition of Dense Cultures of Marine Microalgae.....	33
II.A.2.c.	Selection of High-Yielding Microalgae from Desert Saline Environments.....	36
II.A.2.d.	Screening and Characterizing Oleaginous Microalgal Species from the Southeastern United States.....	40
II.A.2.e.	Collection of High Energy Strains of Saline Microalgae from Southwestern States.....	43
II.A.2.f.	Collection of High Energy Yielding Strains of Saline Microalgae from the Hawaiian Islands.....	45
II.A.2.g.	Characterization of Hydrocarbon Producing Strains of Microalgae.....	46
II.A.2.h.	Collection of High Energy Yielding Strains of Saline Microalgae from South Florida.....	48
II.A.2.i.	Collection and Selection of High Energy Thermophilic Strains of Microalgae.....	50
II.A.3.	<i>The SERI Microalgae Culture Collection.....</i>	<i>50</i>
II.A.3.a.	History of SERI Microalgae Culture Collection.....	51
II.A.3.b.	Current status of the SERI/NREL Microalgae Culture Collection.....	55
II.A.4.	<i>Collection and Screening of Microalgae—Conclusions and Recommendations.....</i>	<i>64</i>
II.B.	MICROALGAL STRAIN IMPROVEMENT	67
II.B.1.	<i>Physiology, Biochemistry, and Molecular Biology of Lipid Production: Work by SERI Subcontractors.....</i>	<i>67</i>
II.B.1.a.	Introduction.....	67
II.B.1.b.	Chrysophycean Lipids: Effects of Induction Strategy in the Quantity and Types of Lipids.....	68
II.B.1.c.	Genetic Variation in High Energy Yielding Microalgae.....	70
II.B.1.d.	Ultrastructure Evaluation of Lipid Producing Microalgae.....	75
II.B.1.e.	Improvement of Microalgal Lipid Production by Flow Cytometry.....	78
II.B.1.f.	Biochemical Elucidation of Neutral Lipid Synthesis in Microalgae.....	81
II.B.1.g.	Biochemical Elucidation of Neutral Lipid Synthesis in Microalgae.....	83
II.B.1.h.	Transformation and Somatic Cell Genetics for the Improvement of Energy Production in Microalgae.....	87
II.B.2.	<i>Physiology, Biochemistry, and Molecular Biology of Lipid Production: NREL In-House Researchers.....</i>	<i>95</i>
II.B.2.a.	Introduction.....	95



II.B.2.b.	Lipid Accumulation Induced by Nitrogen Limitation .....	96
II.B.2.c.	Studies on Photosynthetic Efficiency in Oleaginous Algae .....	97
II.B.2.d.	Lipid Accumulation in Silicon-Deficient Diatoms .....	98
II.B.2.e.	Isolation and Characterization of Acetyl-CoA Carboxylase from <i>C. cryptica</i> .....	102
II.B.2.f.	Cloning of the Acetyl-CoA Carboxylase Gene from <i>C. cryptica</i> .....	105
II.B.2.g.	Biochemistry of Lipid Synthesis in <i>Nannochloropsis</i> .....	108
II.B.2.h.	Biochemistry and Molecular Biology of Chrysolaminarin Synthesis .....	108
II.B.3	<i>Manipulation of Lipid Production in Microalgae via Genetic Engineering</i> .....	113
II.B.3.a.	Introduction .....	113
II.B.3.b.	Mutagenesis and Selection .....	114
II.B.3.c.	Development of a Genetic Transformation System for Microalgae .....	116
II.B.3.d.	Attempts to Manipulate Microalgal Lipid Composition via Genetic Engineering .....	137
II.B.3.e.	The Effect of Different Promoters on Expression of Luciferase in <i>Cyclotella</i> .....	139
II.B.4.	<i>Microalgal Strain Improvement – Conclusions and Recommendations</i> .....	142
<b>III.</b>	<b>OUTDOOR STUDIES AND SYSTEMS ANALYSIS.....</b>	<b>145</b>
III.A.	PROJECTS FUNDED BY ERDA/DOE 1976-1979 .....	145
III.A.1.	<i>Introduction</i> .....	145
III.A.2.	<i>Species Control in Large-Scale Algal Biomass Production</i> .....	147
III.A.3.	<i>An Integrated System for the Conversion of Solar Energy with Sewage-Grown Microalgae</i> ...	152
III.A.4.	<i>Large-Scale Freshwater Microalgal Biomass Production for Fuel and Fertilizer</i> .....	156
III.A.5.	<i>Other Microalgae Projects During the ERDA/DOE Period</i> .....	161
III.B.	THE ASP MICROALGAL MASS CULTURE .....	162
III.B.1.	<i>Introduction</i> .....	162
III.B.2.	<i>The ARPS Project in Hawaii, 1980-1987</i> .....	165
III.B.2.a.	Hawaii ARPS Project Initiation, 1980-1981 .....	165
III.B.2.b.	Second Year of the Hawaii ARPS Project, 1981-1982 .....	166
III.B.2.c.	Third Year of the Hawaii ARPS Project, 1982-1983 .....	169
III.B.2.d.	Fourth Year of the Hawaii ARPS Project, 1983-1984.....	170
III.B.2.e.	Fifth Year of the ARPS Project, 1984-1985.....	172
III.B.2.f.	Sixth Year of the Hawaii ARPS Project, 1985-1986.....	172
III.B.2.g.	Seventh Year of the Hawaii ARPS Project, 1986-1987 .....	173
III.B.2.h.	Hawaii ARPS Project, Conclusions.....	174
III.B.3.	<i>High Rate Pond (HRP) Operations in California, 1981-1986</i> .....	176
III.B.3.a.	HRP Design and Construction Phase, 1981 .....	176
III.B.3.b.	HRP Operations in California, Oct-Nov. 1982.....	179
III.B.3.c.	Continuing California HRP Pond Operations, 1983-1984 .....	179
III.B.3.d.	Completion of the California HRP Project, 1985-1986.....	185
III.B.4.	<i>The Israeli Microalgae Biodiesel Production Project</i> .....	190
III.B.5.	<i>Design and Operation of a Microalgae Outdoor Test Facility (OTF) in New Mexico</i> .....	193
III.B.5.a.	Facility Design and Construction. ....	193
III.B.5.b.	First Year OTF Experiments .....	195
III.B.5.c.	Full OTF System Operations .....	195
III.B.5.d.	<i>Conclusions</i> .....	198
III.B.6.	<i>The Effects of Environmental Fluctuation on Laboratory Cultures</i> .....	199
III.B.6.a.	Species Control and Productivity .....	199
III.B.6.b.	The Algal Pond Growth Model. ....	202



III.B.6.c.	Microalgae Competition under Fluctuating Conditions in the Laboratory.....	205
III.B.6.d.	Lipid Productivity of Microalgae .....	205
III.B.6.e.	Competition Studies with Continuous and Semicontinuous Cultures .....	208
III.C.	RESOURCE ANALYSES .....	211
III.C.1.	<i>Introduction</i> .....	211
III.C.2.	<i>The Battelle Columbus 1982 Resource Assessment Report</i> .....	212
III.C.3.	<i>The 1982 Argonne Study of CO<sub>2</sub> Availability</i> .....	212
III.C.4.	<i>The 1985 SERI Resource Evaluation Report</i> .....	213
III.C.5.	<i>The 1990 SERI Study on CO<sub>2</sub> Sources</i> .....	215
III.C.6.	<i>The 1990 SERI Study of Water Resources in New Mexico</i> .....	217
III.C.7.	<i>Conclusions</i> .....	219
III.D.	ENGINEERING SYSTEMS AND COST ANALYSES .....	219
III.D.1.	<i>Introduction</i> .....	219
III.D.2.	<i>The Algal Pond Subsystem of the “Photosynthesis Energy Factory”</i> .....	220
III.D.3.	<i>Cost Analysis of Microalgae Biomass Systems</i> .....	221
III.D.4.	<i>Cost Analysis of Aquatic Biomass Systems</i> .....	224
III.D.5.	<i>Microalgae as a Source of Liquid Fuels</i> .....	225
III.D.6.	<i>Fuels from Microalgae Technology Status, Potential and Research Requirements</i> .....	229
III.D.7.	<i>Design and Analysis of Microalgae Open Pond Systems</i> .....	233
III.D.8.	<i>Systems and Economic Analysis of Microalgae Ponds for Conversion of CO<sub>2</sub> to Biomass</i> .....	237
III.D.9.	<i>NREL Studies of Flue Gas CO<sub>2</sub> Utilization by Microalgae</i> .....	241
III.D.10.	<i>Conclusions</i> .....	245
<b>IV.</b>	<b>CONCLUSIONS AND RECOMMENDATIONS .....</b>	<b>248</b>
IV.A.	MICROALGAL STRAIN IMPROVEMENT .....	248
IV.A.1.	<i>Conclusions</i> .....	248
IV.A.2.	<i>R &amp; D Recommendations</i> .....	250
IV.A.2.a.	General Considerations .....	250
IV.A.2.b.	Maximum Efficiency of Photosynthesis.....	250
IV.A.2.c.	Overcoming Light Saturation, Photooxidation, and Other Limitations.....	252
IV.A.2.d.	Microalgal Strains for Mass Culture: Source and Genetic Improvements .....	253
IV.B.	MICROALGAL MASS CULTURE .....	255
IV.B.1.	<i>Conclusions</i> .....	255
IV.B.1.a.	Cost and Productivity Goals.....	255
IV.B.1.b.	Higher Value Byproducts and Coproducts.....	256
IV.B.1.c.	The Japanese R&D Program for Microalgae CO <sub>2</sub> Utilization.....	257
IV.B.1.d.	Resource Projections and Microalgae Biodiesel R&D.....	259
IV.B.1.e.	Summary of Major Conclusions from the ASP Microalgal Mass Culture Work.....	260
IV.B.2.	<i>R &amp; D Recommendations</i> .....	260
IV.B.2.a.	Biodiesel Production and Algal Mass Culture for Wastewater Treatment.....	260
IV.B.3.	<i>Conclusions</i> .....	261
<b>V.</b>	<b>BIBLIOGRAPHY .....</b>	<b>263</b>
V.A.	SERI/NREL/DOE REPORTS AND PUBLICATIONS .....	263
V.B.	ADDITIONAL REFERENCES .....	293
V.C.	PATENTS .....	294





## I. Introduction

Photosynthetic organisms, including plants, algae, and some photosynthetic bacteria, efficiently utilize the energy from the sun to convert water and CO<sub>2</sub> from the air into biomass. The Aquatic Species Program (ASP) at SERI<sup>1</sup> was initiated as a long term, basic research effort to produce renewable fuels and chemicals from biomass. It emphasized the use of photosynthetic organisms from aquatic environments, especially species that grow in environments unsuitable for crop production. Early in the program, macroalgae, microalgae, and emergents were investigated for their ability to make lipids (as a feedstock for liquid fuel or chemical production) or carbohydrates (for fermentation into ethanol or anaerobic digestion for methane production). Macroalgae (seaweeds) are fast-growing marine or freshwater plants that can reach considerable size; for example, the giant brown kelp can grow a meter in 1 day and as long as 60 m. Emergents are plants such as cattails or rushes that grow partially submerged in bogs or marshes. Macroalgae and emergents were found to produce small amounts of lipid, which function mainly as structural components of the cell membranes, and produce carbohydrate for use as their primary energy storage compound. In contrast, many microalgae, (microscopic, photosynthetic organisms that live in saline or freshwater environments), produce lipids as the primary storage molecule. By the early 1980s, the decision was made to focus ASP research efforts on the use of microalgal lipids for the production of fuels and other energy products. The studies on the growth and chemical composition of macroalgae and emergents will not be discussed in this report. However, interested readers are referred to reports by subcontractors J.D. Ryther, Harbor Branch Foundation, Florida (seaweeds), and D. Pratt, from the University of Minnesota, St. Paul (emergents) listed in the Bibliography.

Microalgae, like higher plants, produce storage lipids in the form of triacylglycerols (TAGs). Although TAGs could be used to produce a wide variety of chemicals, work at SERI focused on the production of fatty acid methyl esters (FAMES), which can be used as a substitute for fossil-derived diesel fuel. This fuel, known as biodiesel, can be synthesized from TAGs via a simple transesterification reaction in the presence of acid or base and methanol. Biodiesel can be used in unmodified diesel engines, and has advantages over conventional diesel fuel in that it is renewable, biodegradable, and produces less SO<sub>x</sub> and particulate emissions when burned. The technology is available to produce biodiesel from TAGs, and there are growing biodiesel industries both in the United States and Europe that use soybean or rapeseed oil as the biodiesel feedstock. However, the potential market for biodiesel far surpasses the availability of plant oils not designated for other markets. Thus, there was significant interest in the development of microalgal lipids for biodiesel production.

Microalgae exhibit properties that make them well suited for use in a commercial-scale biodiesel production facility. Many species exhibit rapid growth and high productivity, and many microalgal species can be induced to accumulate substantial quantities of lipids, often greater than 60% of

---

<sup>1</sup> The Solar Energy Research Institute (SERI) became the National Renewable Energy Laboratory (NREL) in 1990. In this report, the laboratory may be referred to as either SERI or NREL, depending on the time period during which the work being described was performed.



their biomass. Microalgae can also grow in saline waters that are not suitable for agricultural irrigation or consumption by humans or animals. The growth requirements are very simple, primarily carbon dioxide (CO<sub>2</sub>) and water, although the growth rates can be accelerated by sufficient aeration and the addition of nutrients. A brief overview of the characteristics of the major microalgal classes can be found in Section II.A.2.

A major undertaking by ASP researchers in the early stages of the program was to identify candidate microalgal species that exhibited characteristics desirable for a commercial production strain. Resource analyses carried out by SERI (discussed in Section III.C.) indicated that the desert regions of the southwestern United States were attractive areas in which to locate microalgal-based biofuel production facilities. This, in part, dictated the required strain characteristics. These characteristics included the ability of the strains to grow rapidly and have high lipid productivity when growing under high light intensity, high temperature, and in saline waters indigenous to the area in which the commercial production facility is located. In addition, because it is not possible to control the weather in the area of the ponds, the best strains should have good productivity under fluctuating light intensity, temperature, and salinity.

A multi-faceted effort was carried out to:

- isolate microalgae from a variety of saline habitats (including oceans, lakes, ponds, and various ephemeral water bodies),
- screen those isolates for the ability to grow under a variety of conditions,
- analyze the biochemical components of the strains (especially with respect to lipids), and
- determine the effects of environmental variables on the growth and lipid composition of selected strains.

This effort involved in-house researchers and subcontractors from academia, industry, and other government laboratories. Section II.A.1. documents the efforts of SERI in-house researchers in the area of microalgal strain isolation and screening. It also describes the methodologies developed and employed during the isolation, screening, and characterization phases of the work. Section II.A.2. describes parallel efforts conducted by SERI subcontractors. An account of the history and current status of the NREL Microalgae Culture Collection is presented in Section II.A.3.

Although the collection and screening efforts produced a number of viable candidate strains, no one algal strain was identified that exhibited the optimal properties of rapid growth and high constitutive lipid production. Many microalgae can be induced to accumulate lipids under conditions of nutrient deprivation. If this process could be understood, it might be possible to manipulate either the culture conditions, or to manipulate the organisms themselves, to increase lipid accumulation in a particular strain. Therefore, studies were initiated both at SERI and by



ASP subcontractors to study the biochemistry and physiology of lipid production in oleaginous (oil-producing) microalgae. Work performed by several ASP subcontractors was designed to understand the mechanism of lipid accumulation. In particular, these researchers tried to determine whether there is a specific “lipid trigger” that is induced by factors such as nitrogen (N) starvation. Subcontractors also studied ultrastructural changes induced in microalgae during lipid accumulation. They also initiated efforts to produce improved algae strains by looking for genetic variability between algal isolates, attempting to use flow cytometry to screen for naturally-occurring high lipid individuals, and exploring algal viruses as potential genetic vectors. The work performed by ASP subcontractors is described in Section II.B.1.

Although some of the efforts of the in-house SERI researchers were also directed toward understanding the lipid trigger induced by N starvation, they showed that silica (Si) depletion in diatoms also induced lipid accumulation. Unlike N, Si is not a major component of cellular molecules, therefore it was thought that the Si effect on lipid production might be less complex than the N effect, and thus easier to understand. This initiated a major research effort at SERI to understand the biochemistry and molecular biology of lipid accumulation in Si-depleted diatoms.

This work led to the isolation and characterization of several enzymes involved in lipid and carbohydrate synthesis pathways, as well as the cloning of the genes that code for these enzymes.

One goal was to genetically manipulate these genes in order to optimize lipid accumulation in the algae. Therefore, research was performed simultaneously to develop a genetic transformation system for oleaginous microalgal strains. The successful development of a method to genetically engineer diatoms was used in attempts to manipulate microalgal lipid levels by overexpressing or down-regulating key genes in the lipid or carbohydrate synthetic pathways. Unfortunately, program funding was discontinued before these experiments could be carried out beyond the preliminary stages.

Cost-effective production of biodiesel requires not only the development of microalgal strains with optimal properties of growth and lipid production, but also an optimized pond design and a clear understanding of the available resources (land, water, power, etc.) required. Section III reviews the R&D on outdoor microalgae mass culture for production of biodiesel, as well as supporting engineering, economic and resource analyses, carried out and supported by ASP during the 1980s and early 1990s. It also covers work supported by DOE and its predecessor agency, the Energy Research and Development Administration (ERDA), during the 1970s and some recent work on utilization of CO<sub>2</sub> from power plant flue gases.

From 1976 to 1979, researchers at the University of California-Berkeley used shallow, paddle wheel mixed, raceway-type (high-rate) ponds to demonstrate a process for the simultaneous treatment of wastewater and production of energy (specifically methane). Starting in 1980, the ASP supported outdoor microalgal cultivation projects in Hawaii and California, using fresh and seawater supplies, respectively, in conjunction with agricultural fertilizers and CO<sub>2</sub>. The two projects differed in the types of algae cultivated and the design of the mass culture system, with the project in California continuing to develop the high-rate pond design, and the Hawaii project studying an (initially) enclosed and intensively mixed system. From 1987 to 1990, an “Outdoor Test Facility” was designed, constructed and operated in Roswell, New Mexico, including two



1,000 m<sup>2</sup> high-rate ponds. This last project represented the culmination of ASP R&D in large-scale algal mass culture R&D. These studies are described in Section III.A. Some supporting laboratory studies and development of an “Algal Pond Model” (APM) are also reviewed at the end of that section. The conclusion from these extensive outdoor mass culture studies was that the use of microalgae for the low-cost production of biodiesel is technically feasible, but still requires considerable long-term R&D to achieve the high productivities required.

Section III.B. reviews the resource assessments, for water, land, CO<sub>2</sub>, etc., carried out by the ASP, primarily for the southwestern United States. These studies demonstrated the potential availability of large brackish and saline water resources suitable for microalgae mass cultures, large land and CO<sub>2</sub> resources. They suggest that the potential production of microalgae-derived biodiesel may represent more than 10% of U.S. transportation fuels, although full resource exploitation would be significantly constrained in practice. Several engineering and economic cost analyses were also supported by DOE and the ASP, and these are reviewed in Section III.C., including recent work by the ASP and DOE on power plant flue gas utilization for greenhouse gas (CO<sub>2</sub>) mitigation.

The overall conclusion of these studies was that in principle and practice large-scale microalgae production is not limited by design, engineering, or net energy considerations and could be economically competitive with other renewable energy sources. However, long-term R&D would be required to actually achieve the very high productivities and other assumptions made in such cost analyses. Section III.D. provides recommendations for future research that could make this technology commercially feasible.





## II. Laboratory Studies

### II.A. Collection, Screening, and Characterization of Microalgae

#### II.A.1. Collection, Screening, and Characterization of Microalgae by SERI In-House Researchers

##### II.A.1.a. Introduction

This chapter describes the research performed at SERI in the area of microalgal collection and screening. In addition to performing actual research in this area, SERI personnel were responsible for coordinating the efforts of the many subcontractors performing similar activities, and for standardizing certain procedures and analyses. These efforts ultimately resulted in the development of the SERI Microalgal Culture Collection, which is more fully described in Chapter II.A.3.

*Brief review of algal taxonomic groups and characteristics:*

For the purposes of this report, microalgae are defined as microscopic organisms that can grow via photosynthesis. Many microalgae grow quite rapidly, and are considerably more productive than land plants and macroalgae (seaweed). Microalgae reproduction occurs primarily by vegetative (asexual) cell division, although sexual reproduction can occur in many species under appropriate growth conditions.

There are several main groups of microalgae, which differ primarily in pigment composition, biochemical constituents, ultrastructure, and life cycle. Five groups were of primary importance to the ASP: diatoms (Class Bacillariophyceae), green algae (Class Chlorophyceae), golden-brown algae (Class Chrysophyceae), prymnesiophytes (Class Prymnesiophyceae), and the eustigmatophytes (Class Eustigmatophyceae). The blue-green algae, or cyanobacteria (Class Cyanophyceae), were also represented in some of the collections. A brief description of these algal groups follows.

- **Diatoms.** Diatoms are among the most common and widely distributed groups of algae in existence; about 100,000 species are known. This group tends to dominate the phytoplankton of the oceans, but is commonly found in fresh- and brackish-water habitats as well. The cells are golden-brown because of the presence of high levels of fucoxanthin, a photosynthetic accessory pigment. Several other xanthophylls are present at lower levels, as well as  $\beta$ -carotene, chlorophyll *a* and chlorophyll *c*. The main storage compounds of diatoms are lipids (TAGs) and a  $\beta$ -1,3-linked carbohydrate known as chrysolaminarin. A distinguishing feature of diatoms is the presence of a cell wall that contains substantial quantities of polymerized Si. This has implications for media costs in a commercial production facility, because silicate is a relatively expensive chemical. On the other hand, Si deficiency is known to promote storage lipid



accumulation in diatoms, and thus could provide a controllable means to induce lipid synthesis in a two-stage production process. Another characteristic of diatoms that distinguishes them from most other algal groups is that they are diploid (having two copies of each chromosome) during vegetative growth; most algae are haploid (with one copy of each chromosome) except for brief periods when the cells are reproducing sexually. The main ramification of this from a strain development perspective is that it makes producing improved strains via classical mutagenesis and selection/screening substantially more difficult. As a consequence, diatom strain development programs must rely heavily on genetic engineering approaches.

- Green Algae. Green algae, often referred to as chlorophytes, are also abundant; approximately 8,000 species are estimated to be in existence. This group has chlorophyll *a* and chlorophyll *b*. These algae use starch as their primary storage component. However, N-deficiency promotes the accumulation of lipids in certain species. Green algae are the evolutionary progenitors of higher plants, and, as such, have received more attention than other groups of algae. A member of this group, *Chlamydomonas reinhardtii* (and closely related species) has been studied very extensively, in part because of its ability to control sexual reproduction, thus allowing detailed genetic analysis. Indeed, *Chlamydomonas* was the first alga to be genetically transformed. However, it does not accumulate lipids, and thus was not considered for use in the ASP. Another common genus that has been studied fairly extensively is *Chlorella*.
- Golden-Brown Algae. This group of algae, commonly referred to as chrysophytes, is similar to diatoms with respect to pigments and biochemical composition. Approximately 1,000 species are known, which are found primarily in freshwater habitats. Lipids and chrysolaminarin are considered to be the major carbon storage form in this group. Some chrysophytes have lightly silicified cell walls.
- Prymnesiophytes. This group of algae, also known as the haptophytes, consists of approximately 500 species. They are primarily marine organisms, and can account for a substantial proportion of the primary productivity of tropical oceans. As with the diatoms and chrysophytes, fucoxanthin imparts a brown color to the cells, and lipids and chrysolaminarin are the major storage products. This group includes the coccolithophorids, which are distinguished by calcareous scales surrounding the cell wall.
- Eustigmatophytes. This group represents an important component of the “picoplankton”, which are very small cells (2-4  $\mu\text{m}$  in diameter). The genus *Nannochloropsis* is one of the few marine species in this class, and is common in the world’s oceans. Chlorophyll *a* is the only chlorophyll present in the cells, although several xanthophylls serve as accessory photosynthetic pigments.



- Cyanobacteria. This group is prokaryotic, and therefore very different from all other groups of microalgae. They contain no nucleus, no chloroplasts, and have a different gene structure. There are approximately 2,000 species of cyanobacteria, which occur in many habitats. Although this group is distinguished by having members that can assimilate atmospheric N (thus eliminating the need to provide fixed N to the cells), no member of this class produces significant quantities of storage lipid; therefore, this group was not deemed useful to the ASP.

#### *Collection and Screening of Microalgae: Programmatic Rationale*

The in-house collection effort was focused on collecting strains from inland saline habitats, particularly in Colorado, New Mexico, and Utah. The reasoning behind collecting strains from these habitats was that the strains would be adapted to at least some of the environmental conditions in mass culture facilities in the southwestern United States (i.e., high light intensity and high temperatures). They would also be well suited for growth in the saline waters available for use in such facilities. In addition, many of the aquatic habitats in this region are shallow, and therefore subject to large variations in temperature and salinity; thus, the strains collected in this region might be expected to better withstand the fluctuations that would occur in a commercial production pond. Cyanobacteria, chrysophytes, and diatoms often dominate inland saline habitats. The latter were of particular interest to the program because of their propensity to accumulate lipids. There had never been a large-scale effort to collect strains with this combination of characteristics; therefore, they were not available from culture collections.

The stated objectives<sup>2</sup> of the SERI culture collection and screening effort were to:

- Assemble and maintain a set of viable mono-specific algal cultures stored under conditions best suited to the maintenance of their original physiological and biochemical characteristics.
- Develop storage techniques that will help maintain the genetic variability and physiological adaptability of the species.
- Collect single species cultures of microalgae from the arid regions of Colorado, Utah, and New Mexico for product and performance screening.
- Develop media which are suitable for their growth.
- Evaluate each species for its temperature and salinity tolerances, and quantify growth rates and proximate chemical composition for each species over the range of tolerated conditions.

---

<sup>2</sup> Taken from the Proceedings of the April 1984 Aquatic Species Program Principal Investigators' Meeting.



Each objective was met during the course of research within the ASP. The following pages describe in detail the major findings of the work conducted by SERI researchers.

#### **II.A.1.b. Collection and Screening Activities - 1983**

The first collecting trips made by SERI researchers took place in the fall of 1983. Five saline hot springs in western Colorado were selected for sampling because of their abundant diatom populations, and because a variety of water types was represented. Water samples were used to inoculate natural collection site water that had been enriched with N (ammonium and nitrate) and phosphate (P) and then filter sterilized. Water samples were also taken for subsequent chemical analyses. The temperature and conductivity of the site water were determined at the time of collection. Conductivity ranged from 1.9 mmhos•cm<sup>-2</sup> at South Canyon Spring to 85.0 mmhos•cm<sup>-2</sup> (nearly three times the conductivity of seawater) at Piceance Spring. Water temperature at the time of collection ranged from 11° to 46°C.

In the laboratory, researchers tried to isolate the dominant diatoms from the enriched water samples. Cyanobacteria and other contaminants were removed primarily with agar plating. Approximately 125 unialgal diatom strains were isolated. The predominant genera found were *Achnanthes*, *Amphora*, *Caloneis*, *Camphylodiscus*, *Cymbella*, *Entomoneis*, *Gyrosigma*, *Melosira*, *Navicula*, *Nitzschia*, *Pleurosigma*, and *Surirella*.

A standardized lipid analysis protocol was not yet in place to screen these strains. However, many algal strains were known to accumulate lipids under conditions of nutrient stress. Microscopic analysis of cells grown under N-deficient conditions revealed lipid droplets in several of the strains, particularly in *Amphora* and *Cymbella*.

In addition to yielding several promising algal strains, this initial collection trip was useful for identifying areas for improving the collection and screening protocols. Some of these improvements were implemented for the 1984-collecting season, and are described in the next section.

#### **Publications:**

Barclay, W.R. (1984) "Microalgal technology and research at SERI: Species collection and characterization." *Aquatic Species Program Review: Proceedings of the April 1984 Principal Investigators' Meeting*, Solar Energy Research Institute, Golden, Colorado, SERI/CP-231-2341; pp. 152-159.

#### **II.A.1.c. Collection and Screening Activities - 1984**

The screening and characterization protocols used by SERI researchers were refined for the 1984 collecting season. Included in these refinements was the development of a modified "rotary screening apparatus", a standard type of motorized culture mixing wheel for 16x150-mm culture tubes. The rotating wheel was constructed of Plexiglas to allow better light exposure (see Figure II.A.1). The wheel was typically illuminated with a high-intensity tungsten stage lamp, and





could be placed inside a box behind a  $\text{CuSO}_4$ -water heat filter for temperature control. The Plexiglas wheel allowed all the cultures to receive equal illumination. Another technological advance used a temperature-salinity gradient table to characterize the thermal and salinity preferences and tolerances of the isolates.

#### *Development of artificial saline media.*

One of the most significant contributions made by SERI researchers during 1984 was the development of media that mimicked the saline water in shallow aquifers in the southwestern United States. This was an important undertaking because it allowed algal strains to be screened for growth in the types of water that would likely be available in an outdoor mass culture facility. To identify the major water types available in the southwestern United States, state and federal reports that described the chemical characteristics of water from 85 saline wells in New Mexico were studied. The data were statistically analyzed to identify the relationships between the various ionic constituents. (Data from wells deeper than 83 m was not used in this analysis, because the cost of pumping water from those depths was prohibitive.) R-mode factor analysis indicated that two factors were largely responsible for the differences between the waters examined (Barclay et al. 1988). The first factor, monovalent ion concentration, was responsible for 40% of the variance; the second factor, divalent ion concentration, for 30%. A plot of these factors against each other clearly delineated two primary water types, referred to as “Type I” and “Type II”. Type I waters were characterized by a low monovalent-to-divalent ion ratio (average value = 0.4), whereas Type II waters had a higher level of monovalent ions (monovalent-to-divalent ion ratio of 9.4). The major ions present in Type I water were  $\text{Na}^+$ ,  $\text{Cl}^-$ ,  $\text{Mg}^{2+}$ , and  $\text{Ca}^{2+}$ . The major ions of Type II water were  $\text{Na}^+$ ,  $\text{Cl}^-$ ,  $\text{SO}_4^{2-}$ , and  $\text{HCO}_3^-$ . Type II water is consequently termed a “sodium bicarbonate class” of water. Approximately three-fourths of the saline well waters were of the Type II variety, and one-fourth could be characterized as Type I.

The survey indicated that both types of water exhibited a range of conductivities; the researchers believed that the higher-conductivity waters resulted from evaporation of the lower conductivity waters. In addition, they recognized that the conductivity of the water in an outdoor production pond would increase with time because of the high rates of evaporation in the southwestern United States (as high as  $1 \text{ cm} \cdot \text{day}^{-1}$ ). Therefore, artificial media that covered a wide range of conductivities had to be developed. To this end, an experiment was conducted in which media that contained the salts typically present in low-conductivity Type I and Type II waters were allowed to evaporate with stirring at  $35^\circ\text{C}$ . Samples were removed at various times and filtered. The ions still dissolved in the waters were quantified using an inductively coupled plasma spectrometer and a high-performance liquid chromatograph. In this manner, media formulations were derived at SERI that covered a range of conductivities (from 10 to  $70 \text{ mmho} \cdot \text{cm}^{-1}$ ) for both media types. The media most commonly used were designated SERI Type I/10, Type I/25, Type I/55, Type I/70, Type II/10, Type II/25, Type II/55, and Type II/70, in which the number following the slash indicates the specific conductivity of the medium. The compositions of these media are given in Figure II.A.2.



In order to assess whether these media formulations accurately reflected the types of water in desert region surface waters, samples of the water at numerous algal collection sites in the southwestern United States were chemically analyzed. The relative compositions of the anionic and cationic constituents were then plotted on separate trilinear plots, which allowed a graphical representation of the various water samples relative to SERI Type I and Type II media (Figure II.A.3). This analysis indicated that Type I water has higher proportions of  $Mg^{2+}$  and  $Ca^{2+}$  than most surface waters examined, whereas Type II water was fairly representative of the sampled waters with respect to these cations. On the other hand, natural surface waters often had an anion composition similar to both SERI Type I and Type II media. The researchers concluded that these artificial media would serve well as standardized media for testing newly acquired strains, thereby allowing all ASP researchers (both in-house personnel and subcontractors) to screen strains for growth potential in waters similar to those that would be available for commercial production.

#### *Collection activities.*

Collecting trips made by SERI researchers in 1984 focused on shallow saline habitats, including ephemeral ponds, playas, and springs in the arid regions of Colorado and Utah. After collection, the water and sediment samples were kept under cool, dark conditions for 1 to 3 days until they could be further treated in the laboratory. The pH, temperature, conductivity, redox potential, and alkalinity of the collection site waters were determined, and water samples were taken for subsequent ion analysis. In the laboratory, the samples were enriched with 300  $\mu M$  urea, 30  $\mu M$   $PO_4$ , 36  $\mu M$   $Na_2SiO_3$ , 3  $\mu M$  NaFeEDTA, trace metals (5 mL/L PII stock, see Figure II.A.2), and vitamins. The enrichment tubes were then placed in the rotary screening apparatus (maintained at 25°C or 30°C) and illuminated at  $\sim 400 \mu E \cdot m^{-2} \cdot s^{-1}$ . Over a 5-day period, the illumination provided by the stage lamp was gradually increased to 1,000  $\mu E \cdot m^{-2} \cdot s^{-1}$ . The predominant strains present in the tubes were isolated as unialgal cultures by agar plating or by serial dilution in liquid media.

The isolated strains were then tested for their ability to grow in incubators at 25°C at 150–200  $\mu E \cdot m^{-2} \cdot s^{-1}$  in the standard media types described above, and in artificial seawater (termed “Rila Salts ASW,” using Rila Marine Mix, an artificial sea salt mixture produced by Rila Products, Teaneck, NJ). The strains that grew well in at least one of these media were further characterized with respect to growth on a temperature-salinity gradient table at a light intensity of 200  $\mu E \cdot m^{-2} \cdot s^{-1}$ . Thirty combinations of temperature (10° to 35°C) and salinity (10 to 70 mmho $\cdot cm^{-1}$ ) were included in this analysis, representing the ranges that might be expected in actual outdoor production systems. Once again, the cultures were enriched with nutrients to maximize growth rates. The cultures used to inoculate the test cultures were preconditioned by growth in the media at 17° and 27°C. The optical density at 750 nm ( $OD_{750}$ ) of the cultures was measured twice daily for 5 days, and the growth rates were calculated from the increase in culture density during the exponential phase of growth. A refinement of this method was to measure the growth rates in semicontinuous cultures, wherein the cultures were periodically diluted by half with fresh medium; this method provided more reproducible results than the batch mode experiments.



Figure II.A.3 gives an example of the type of growth data generated by the use of temperature-salinity gradient tables. The contour lines in the plot are interpolations indicating where a particular combination of temperature and salinity would result in a given growth rate. Many such plots were generated for various strains, and are shown in the culture collection catalogs and ASP annual reports.

Approximately 300 strains were collected from the 1984 trips to Utah and Colorado. Of these, only 15 grew well at temperatures  $\geq 30^{\circ}\text{C}$  and conductivities greater than  $5 \text{ mmho}\cdot\text{cm}^{-1}$ . Nine were diatoms, including the genera *Amphora*, *Cymbella*, *Amphipleura*, *Chaetoceros*, *Nitzschia*, *Hantzschia*, and *Diploneis*. Several chlorophytes (*Chlorella*, *Scenedesmus*, *Ankistrodesmus*, and *Chlorococcum*) were also identified as promising strains, along with one chrysophyte (*Boekelovia*).

Two strains isolated as a result of the 1984 collecting effort (*Ankistrodesmus sp.* and *Boekelovia sp.*) were characterized in greater detail using the temperature-salinity matrix described earlier. *Boekelovia* exhibited a wide range of temperature and salinity tolerance, and grew faster than one doubling $\cdot\text{day}^{-1}$  from 10 to  $70 \text{ mmho}\cdot\text{cm}^{-1}$  conductivity and from  $10^{\circ}$  to  $32^{\circ}\text{C}$ , exhibiting maximal growth of 3.5 doublings $\cdot\text{day}^{-1}$  in Type II/25 medium. Reasonable growth rates were also achieved in SERI Type I and ASW-Rila salts media (as many as 1.73 and 2.6 doublings $\cdot\text{day}^{-1}$ , respectively). *Ankistrodesmus* was also able to grow well in a wide range of salinities and temperatures, with maximal growth rates occurring in Type II/25 medium (3.0 doublings $\cdot\text{day}^{-1}$ ).

*Boekelovia* and *Ankistrodesmus* were also examined with regard to their lipid accumulation potential. Two-liter cultures were grown in media that contained high ( $600 \mu\text{M}$ ) and low ( $300 \mu\text{M}$ ) urea concentrations at a light intensity of  $200 \mu\text{E}\cdot\text{m}^{-2}\cdot\text{s}^{-1}$ . Half of each culture was harvested 2 days after the low-N culture entered stationary phase to determine the lipid content of N-sufficient cells and cells that were just entering N-deficient growth. After 10 days of N-limited growth, the remainder of the low-N culture was harvested. Lipids were extracted via a modification of the method of Bligh and Dyer (1959) and lipid mass was determined gravimetrically. The lipid content of *Boekelovia* was 27% of the organic mass in N-sufficient cells, increasing to 42% and 59% after 2 days and 10 days of N-deficiency, respectively. There was less effect of N starvation on the lipid content of *Ankistrodesmus*; the lipid content only increased from 23% in N-sufficient cells to 29% in cells that were N-deficient for 10 days.

In conclusion, research at SERI in 1984 led to the development of artificial media that mimicked the saline groundwater typically found in the desert regions of the southwestern United States. This allowed the strains isolated during collecting trips at various ionic concentrations to be systematically screened and provided standardized media that could be used in different laboratories performing ASP-sponsored research. Numerous strains were characterized with respect to growth at several temperatures and salinities using these new media.



*Publications:*

Barclay, W.; Johansen, J.; Chelf, P.; Nagle, N.; Roessler, R.; Lemke, P. (1986) "Microalgae Culture Collection 1986-1987." Solar Energy Research Institute, Golden, Colorado, SERI/SP-232-3079, 147 pp.

Barclay, B.; Nagle, N.; Terry, K. (1987) "Screening microalgae for biomass production potential: Protocol modification and evaluation." *FY 1986 Aquatic Species Program Annual Report*, Solar Energy Research Institute, Golden, Colorado, SERI/CP-231-3071; pp. 23-40.

Barclay, B.; Nagle, N.; Terry, K.; Roessler, P. (1985) "Collecting and screening microalgae from shallow, inland saline habitats." *Aquatic Species Program Review: Proceedings of the March 1985 Principal Investigators' Meeting*, Solar Energy Research Institute, Golden, Colorado, SERI/CP-231-2700; pp. 52-68.

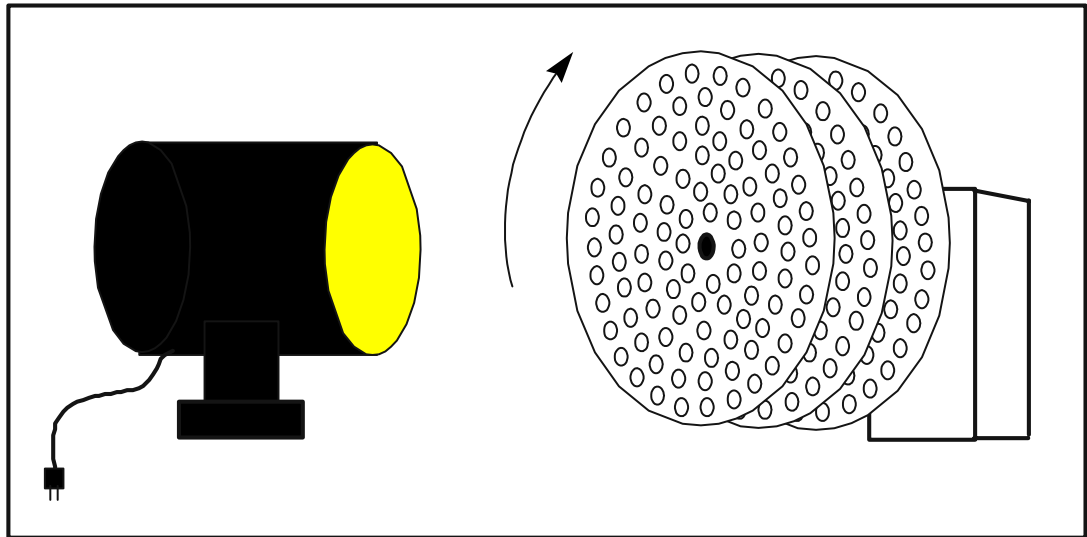
Barclay, W.R.; Nagle, N.J.; Terry, K.L.; Ellingson, S.B.; Sommerfeld, M.R. (1988) "Characterization of saline groundwater resource quality for aquatic biomass production: A statistically-based approach." *Wat. Res.* 22:373-379.

Sommerfeld, M.R.; Ellingson, S.B. (1987) "Collection of high energy yielding strains of saline microalgae from southwestern states." *FY 1986 Aquatic Species Program Annual Report*, Solar Energy Research Institute, Golden, Colorado, SERI/CP-231-3071; pp. 53-66.

*Additional References:*

Bligh, E.G.; Dyer, D.J. (1959) "A rapid method for total lipid extraction and purification." *Can. J. Biochem. Physiol.* 37:911-917.

Siver, P. (1983) "A new thermal gradient device for culturing algae." *British J. Phycol.* 18:159-163.



**Figure II.A.1.** Rotary screening apparatus used for microalgal screening.



SERI Type I Artificial Inland Saline Water					
Salt	Conductivity (mmho cm <sup>-1</sup> )				
	10	25	40	55	70
CaCl <sub>2</sub> .....	0	3,932	5,618	7,610	8,430
MgCl <sub>2</sub> ·6H <sub>2</sub> O .....	4,114	11,844	22,789	35,305	42,230
Na <sub>2</sub> SO <sub>4</sub> .....	0	2,925	3,310	3,705	3,620
KCl .....	194	407	662	960	1,186
NaHCO <sub>3</sub> .....	184	168	168	168	168
NaCl .....	2,118	3,845	9,132	13,023	16,039
CaSO <sub>4</sub> .....	1,686	0	0	0	0

SERI Type II Artificial Inland Saline Water					
Salt	Conductivity (mmho cm <sup>-1</sup> )				
	10	25	40	55	70
CaCl <sub>2</sub> .....	28	28	28	28	28
MgCl <sub>2</sub> ·6H <sub>2</sub> O .....	1,953	3,026	3,920	4,362	4,230
Na <sub>2</sub> SO <sub>4</sub> .....	2,671	5,870	15,720	23,305	28,360
KCl .....	466	965	2,028	3,044	3,673
NaHCO <sub>3</sub> .....	1,208	2,315	2,855	3,234	3,245
Na <sub>2</sub> CO <sub>3</sub> .....	231	876	1,234	1,492	1,527
NaCl .....	1,511	8,078	12,963	20,588	26,075

Suggested enrichments (mL/L) are:

Nitrogen source* (0.6M N) .....	1 mL
KH <sub>2</sub> PO <sub>4</sub> (0.6M) .....	1 mL
PII Trace Metals .....	5 mL
B <sub>12</sub> (1 mg L <sup>-1</sup> ) .....	1 mL
Thiamine-HCl (1 mg L <sup>-1</sup> ) .....	1 mL
Biotin (2 mg L <sup>-1</sup> ) .....	1 mL

\*Nitrogen source indicated for individual species, ammonium as NH<sub>4</sub>Cl, nitrate as KNO<sub>3</sub>.  
250-500 mg L<sup>-1</sup> Na<sub>2</sub>SiO<sub>3</sub>·9H<sub>2</sub>O should be added when cultivating diatoms in this medium.

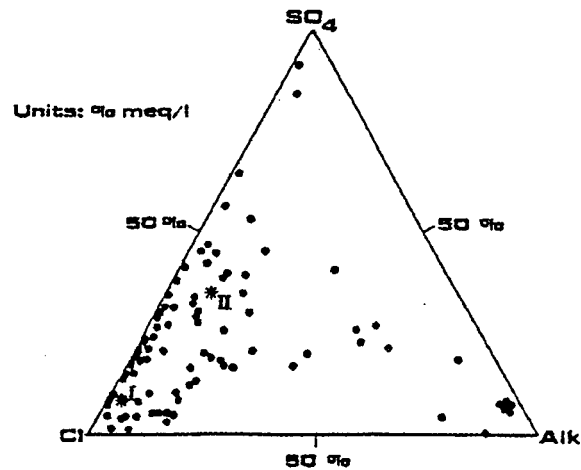
PII trace element stock (for 1 L):

Na <sub>2</sub> EDTA .....	6.0 g
FeCl <sub>3</sub> ·6H <sub>2</sub> O .....	0.29 g
H <sub>3</sub> BO <sub>3</sub> .....	6.84 g
MnCl <sub>2</sub> ·4H <sub>2</sub> O .....	0.36 g
ZnCl <sub>2</sub> .....	0.06 g
CoCl <sub>2</sub> ·6H <sub>2</sub> O .....	0.026 g

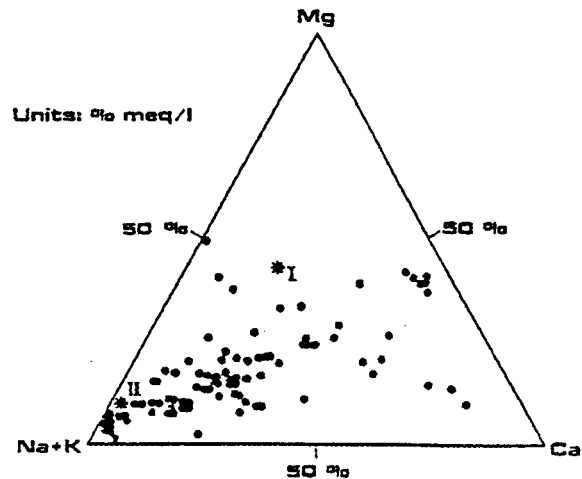
Adjust trace element stock solution to pH 7.8-8.0 with NaOH.

**Figure II.A.2.** Formulations for SERI Type I and Type II artificial inland saline waters.

Recipes for the preparation of Type I and Type II media at five different salinities, expressed as conductivity of the final solution. Formulas for these media were developed by statistical analysis of saline groundwater data for the state of New Mexico. For each salt, necessary additions in mg/L are listed. (Source: Barclay et al. 1986).

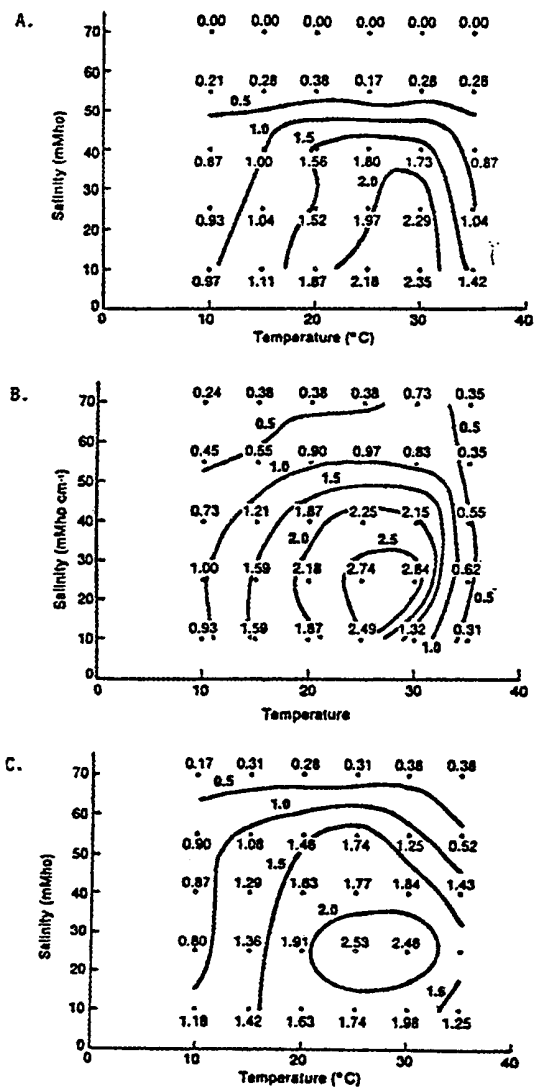


Relative anion composition for waters sampled for microalgae. Each dot represents a sampling site. Asterisks indicate relative anion composition of SERI Type I and II Media.



Relative cation composition for waters sampled for microalgae. Each dot represents a sampling site. Asterisks indicate relative cation composition of SERI Type I and II Media.

**Figure II.A.3.** Trilinear plots showing the ionic constituents of various water samples relative to SERI Type I and SERI Type II artificial saline media. (Source: Sommerfeld and Ellingson 1987.)



**Figure II.A.4. Growth contour plots.** Examples of growth contour plots generated from data obtained by the use of a temperature-gradient table. The contour lines represent interpolated values indicating where a particular combination of temperature and salinity would result in a given growth rate. The data shown, given as doublings•day) represent the exponential growth of *Monoraphidium* sp. (S/MONOR-2) in semicontinuous culture. Each point represents the mean of at least five separate daily growth rate determinations. (Source: Barclay et al. 1987).

- A: Type I inland saline water
- B: Type II inland saline water
- C: Seawater





#### II.A.1.d. Collection and Screening Activities - 1985

In 1985, the strain enrichment procedure utilizing the rotary screening apparatus described previously was modified to include incubation of samples in SERI Type I and Type II media (25 and 55  $\text{mmho}\cdot\text{cm}^{-1}$  conductivity) and in artificial seawater, in addition to the original site water. The cultures that exhibited substantial algal growth were further treated to isolate the predominant strains as unialgal (clonal) isolates. These strains were then tested for growth using the temperature-salinity matrix described earlier.

##### *Collection activities.*

Collection efforts by SERI researchers in 1985 again focused on shallow inland saline habitats. This time collecting trips were also made to New Mexico and Nebraska, in addition to Colorado and Utah. Eighty-six sites were sampled during the year, 53 of which were sampled in the spring. From these 53 sites, 17 promising strains were isolated. An analysis was conducted comparing the results of the new protocol with those that would have resulted from the protocol used in prior years. This analysis indicated that the revised protocol was in fact superior to the older protocol. For example, only six of the 17 strains selected via the new protocol would also have been selected using the old protocol. Only three of the 17 strains grew best in the artificial medium type that most closely resembled the collection site water; in fact, only six strains were even considered to grow well in the collection site water relative to growth in at least one of the artificial medium. This analysis clearly indicated the value of performing the initial screening and enrichment in a variety of relevant media. The results suggest that the shallow saline environments sampled probably contain a large number of species whose metabolism is arrested at any given time. In other words, the water quality of such sites varies greatly, depending on precipitation and evaporation, so probably only a few of the many species present are actively growing at any given time. This also may explain the wide range of salinities and temperatures tolerated by many of these strains.

##### *Growth rates.*

Six promising strains were analyzed in SERI Type I, Type II, and ASW (Rila) using the temperature-salinity gradient described previously. These included the diatoms *Chaetoceros muelleri* (CHAET14), *Navicula* (NAVIC1), *Cyclotella* (CYCLO2), *Amphora* (AMPHO1 and AMPHO2), and the chlorophyte *Monoraphidium minutum* (MONOR2). (NAVIC1 and CYCLO2 were actually collected from the Florida keys; the remaining strains were collected in Colorado and Utah.) All strains exhibited rapid growth over a wide range of conductivities in at least two media types. Furthermore, all strains exhibited temperature optima of 30°C or higher. Maximal growth rates of these strains, along with the optimal temperature, conductivity, and media type determined in these experiments are shown in Table II.A.1. (Higher growth rates were determined for some of these strains in subsequent experiments; see results presented in Barclay et al. [1987]). Temperature-salinity growth contours are provided for these strains in the 1986 ASP Annual Report (Barclay et al. 1986).

**Table II.A.1. Growth characteristics of various microalgal strains collected in 1985.**

Strain	Maximum Growth Rate (doublings • day <sup>-1</sup> )	Optimal Temperature (°C)	Optimal Conductivity (mmho • cm <sup>-1</sup> )	Optimal Medium Type (dependent on temperature and conductivity used)
AMPHO1	1.7	30	10-25	Type I, ASW
AMPHO2	2.48	30-35	40-70	Type I, Type II
CHAET14	2.87	35	25-70	Type II, ASW
CYCLO2	1.63	30-35	10-70	Type I, ASW
MONOR2	2.84	25-30	25	Type I, II, ASW
NAVIC1	2.77	30	10-40	Type I, Type II

Experiments were also conducted in an attempt to identify the chemical components of SERI Type I and Type II media most important for controlling the growth of the various algal strains. Bicarbonate and divalent cation concentrations were found to be important determinants in controlling the growth of *Boeckelovia sp.* (BOEKE1) and *Monoraphidium* (MONOR2). The growth rate of MONOR2 increased by more than five-fold as the bicarbonate concentration of Type II/25 medium was increased from 2 to 30 mM, and the growth of BOEKE1 by approximately 60% over this range. These results make sense, since media enriched in bicarbonate would have more dissolved carbon available for photosynthesis. An unexpected finding was that there was a decrease of nearly 50% in the growth rate of BOEKE1 as the divalent cation concentration increased from 5 mM to 95 mM (in Type I/10 medium containing altered amounts of calcium and magnesium). The effects of magnesium and calcium concentration on the growth of MONOR2 were less pronounced. These results indicate that matching the chosen strain for a particular production site to the type of water available for mass cultivation will be important.

#### *Lipid content.*

The lipid contents of several strains were determined for cultures in exponential growth phase and for cultures that were N-limited for 7 days or Si-limited for 2 days. In general, nutrient deficiency led to an increase in the lipid content of the cells, but this was not always the case. The highest lipid content occurred with NAVIC1, which increased from 22% in exponential phase cells to 49% in Si-deficient cells and to 58% in N-deficient cells. For the green alga MONOR2, the lipid content increased from 22% in exponentially growing cells to 52% for cells that had been N-starved for 7 days. CHAET14 also exhibited a large increase in lipid content in response to Si and N deficiency, increasing from 19% to 39% and 38%, respectively. A more modest increase occurred for nutrient-deficient AMPHO1 cells, whereas the lipid content of CYCLO2 was similar in exponential phase and nutrient-deficient cells, and actually decreased in AMPHO2 as a result of nutrient deficiency.



These results suggested that high lipid content was indeed achievable in many strains by manipulating the nutrient levels in the growth media. However, these experiments did not provide information on actual lipid productivity in the cultures, which is the more important factor for developing a commercially viable biodiesel production process. This lack of lipid productivity data also occurred with most of the ASP subcontractors involved in strain screening and characterization, but was understandable because the process for maximizing lipid yields from microalgae grown in mass culture never was optimized. Therefore, there was no basis for designing experiments to estimate lipid productivity potential.

#### Publications:

Barclay, B.; Nagle, N.; Terry, K. (1986) "Screening microalgae for biomass production potential: protocol modification and evaluation." *FY 1986 Aquatic Species Program Annual Report*, Solar Energy Research Institute, Golden, Colorado, SERI/SP-231-3071, pp. 22-40.

Barclay, W.R.; Terry, K.L.; Nagle, N.J.; Weissman, J.C.; Goebel, R.P. (1987) "Potential of new strains of marine and inland saline-adapted microalgae for aquaculture." *J. World. Aquaculture Soc.* 18:218-228.

#### II.A.1.e. Collection and Screening Activities - 1986 and 1987

SERI in-house algal strain collection and screening efforts during 1986-1987 were focused in three separate areas. First, detailed characterization of previously collected strains continued. Second, because the desert southwest sites targeted for biodiesel production facilities can be quite cool during the winter, a new effort to collect strains from cold-water sites was initiated. Finally, a strategy was developed and implemented to reduce the number of strains that had accumulated as a result of in-house and subcontracted research efforts, which allowed researchers to focus on the most promising strains.

##### *Strain characterization.*

Eight additional strains collected previously from warm-water sites that grew well during the initial screening procedures were characterized with respect to temperature and salinity tolerances, growth rates, and lipid content under various conditions. These strains were *Chaetoceros muelleri* (strains CHAET6, CHAET9, CHAET10, CHAET15, and CHAET39), *Cyclotella cryptica* (CYCLO4), *Pleurochrysis carterae* (PLEUR1), and *Thalassiosira weissflogii* (THALA2). Each strain was grown in a variety of temperature-salinity combinations by the use of a temperature-salinity gradient table. The maximal growth rate achieved under these conditions occurred with CHAET9, which exhibited a growth rate of 4.0 doublings•day<sup>-1</sup>. The remaining strains all had maximum growth rates that exceeded 1.4 doublings•day<sup>-1</sup>, and several grew at rates exceeding 2.5 doublings•day<sup>-1</sup> (i.e., CHAET6, CHAET10, and CHAET39). All had an optimal temperature of 30°C or higher, except for PLEUR1 and THALA2, which had optimal temperatures of 25°C and 28°C, respectively. Most of the strains grew well in a wide range of salinities (e.g., five of the eight strains exhibited a growth rate greater than one doubling•day<sup>-1</sup> at



conductivities between 10 and 70  $\text{mmho}\cdot\text{cm}^{-1}$ ). With respect to the effect of water type on growth, CHAET39, CYCLO4, and PLEUR1 grew best on SERI Type I medium. On the other hand, CHAET6, CHAET9, and CHAET10 grew best in SERI Type II medium, but also exhibited good growth on Type I medium and artificial seawater. CHAET15 and THALA2 achieved maximal growth rates on artificial seawater, and, along with PLEUR1, grew very poorly on Type II medium. These results again highlight the need to have a variety of algal strains available for the specific water resources that would be available for mass culture in various locations.

The lipid contents of these 10 strains were also determined for exponentially growing cells, as well as for cells that were grown under nutrient-limited conditions. Nitrogen deficiency led to an increase in the lipid contents of CHAET6, CHAET9, CHAET10, CHAET15, CHAET39, and PLEUR1. The mean lipid content of these strains increased from 11.2% (of the total organic mass) in nutrient-sufficient cells to 22.7% after 4 days of N deficiency. Silicon deficiency led to an increase in the lipid content of all strains (although in some cases the increase was small and probably not statistically significant). The mean lipid content of the eight strains increased from 12.2% in nutrient-sufficient cells to 23.4% in Si-deficient cells. A few strains were poor lipid producers, such as CHAET6, CYCLO4, and PLEUR1, which did not produce more than 20% lipid under any growth conditions.

#### *Cold water strain collection efforts.*

Most microalgal collection efforts carried out under the auspices of the ASP before 1987 focused on sites that were expected to naturally experience high temperatures; indeed, one subcontractor, Keith Cooksey (Montana State University) specifically searched for thermophilic strains isolated from hot springs. This was because the temperatures of production ponds in the southwestern United States during the prime growing season were expected to reach high levels; thus the production strains would have to thrive under such conditions. However, temperatures in this region are quite cool for several months of the year and can drop to below freezing at night. Consequently, an effort was initiated by SERI researchers to collect, screen, and characterize strains from cold-water habitats.

Four collecting trips were made between October 1986 and March 1987 to various inland saline water sites in Utah and eastern Washington, and to the coastal lagoon waters in southern California. Water samples were enriched with N, P, trace metals, and vitamins; artificial media were not used in the initial selection protocol for these experiments. The rotary screening apparatus was maintained at 15°C for the duration of the screening process by including a copper cooling coil inside the screening chamber. The cultures were incubated for 5-10 days, which is longer than for warm-water strains because of the slower growth at the cooler temperature. This procedure created a problem, however, in that many more strains survived the selection process than when 30°C was used as the selection temperature. As a consequence, separating strains from each other and identifying which were the best for further characterization were more difficult.



An interesting finding from the cold water strain collection project was that many species that predominate after the enrichment procedure were the same as the warm water species selected in previous collection efforts. The genera and species that were commonly found in both the cold water and warm water screening projects were *C. muelleri*, *Amphora coffeiformis*, *Cyclotella*, *Navicula*, and *Nitzschia*. However, some ochromonids and green coccoid algae were also isolated from the cold water collection effort; these types of alga were less commonly isolated during the warm-water selection procedures. Additional work would be needed to characterize these strains with respect to lipid production potential. Future work should look at the fatty acid profiles of oil found in the cold-water strains. Such cold-water organisms often contain high levels of polyunsaturated fatty acids, which would perform poorly as a feedstock for biodiesel because of their low oxidative stability and tendency to polymerize during combustion (Harrington et al. 1986).

#### Publications:

Johansen, J.R.; Doucette, G.J.; Barclay, W.R.; Bull, J.D. (1988) "The morphology and ecology of *Pleurochrysis carterae* var *dentata* nov. (Prymnesiophyceae), a new coccolithophorid from an inland saline pond in New Mexico, USA." *Phycologica* 27:78-88.

Johansen, J.; Lemke, P.; Barclay, W.; Nagle, N. (1987) "Collection, screening, and characterization of lipid producing microalgae: Progress during Fiscal Year 1987." *FY 1987 Aquatic Species Program Annual Report*, Solar Energy Research Institute, Golden, Colorado, SERI/SP-231-3206, pp. 27-42.

Johansen, J.R.; Theriot, E. (1987) "The relationship between valve diameter and number of central fultoportulae in *Thalassiosira weissflogii* (Bacillariophyceae)." *J. Phycol.* 23:663-665.

Tadros, M.G.; Johansen, J.R. (1988) "Physiological characterization of six lipid-producing diatoms from the southeastern United States." *J. Phycol.* 24:445-452.

#### Additional References:

Harrington, K.J. (1986) *Biomass* 9:1-17.

#### II.A.1.f. Development of a Rapid Screening Procedure for Growth and Lipid Content of Microalgae

By 1987, SERI researchers and subcontractors had collected approximately 3,000 algal strains. Most of these strains had not been well characterized, especially with respect to lipid production capabilities. As a consequence, work commenced on the development of a simple screening procedure to estimate the lipid contents of cells to determine which strains had the best potential as biofuel production organisms. Ideally, the procedure should be simple and reproducible so that it could be used as a standard method in numerous laboratories. The researchers hoped that such a screening tool would allow the size of the strain collection to be reduced to a manageable number (~200) representing the most promising strains.



*Development of a rapid screen for lipid content.*

In an attempt to develop a reproducible, easy-to-use screening procedure to identify algal strains with high lipid contents, Dr. Keith Cooksey (an ASP subcontractor at Montana State University) suggested that investigators explore the possibility of using the lipophilic dye Nile Red (9-diethylamino-5*H*-benzo{a}phenoxazine-5-one) to stain cells. Nile Red was first isolated from Nile Blue by Greenspan et al. (1985), who showed that Nile Red will fluoresce in a nonpolar environment and could serve as a probe to detect nonpolar lipids in cells. Nile Red permeates all structures within a cell, but the characteristic yellow fluorescence (approximately 575 nm) only occurs when the dye is in a nonpolar environment, primarily neutral storage lipid droplets. Earlier work within the ASP by Dr. Steve Lien had shown the utility of Nile Blue in microscopically assessing the lipid content of algal cells (Lien 1981). The active ingredient in these Nile Blue preparations may in fact have been Nile Red. Parallel efforts to develop a Nile Red staining procedure were carried out by SERI researchers and ASP subcontractors, notably Drs. Cooksey and Sommerfeld.

Cooksey et al. (1987) used the diatom *Amphora coffeiformis* to optimize the Nile Red staining procedure. The dye was dissolved in acetone and used at a concentration of 1 mg/mL of cell suspension. In this species, the fluorescence of the dye in live stained cells was stable for only 2-7 minutes; fluorescence measurements had to be completed rapidly to ensure consistent results. The kinetics of fluorescence in stained cells varied in different species, presumably due to differences in the permeability of cell walls to the stain, and differences in how the lipid is stored in the cells, i.e., as large or small droplets. Fixing the stained cells with formaldehyde or ethanol preserved the Nile Red fluorescence for 2 hours, but cells that were chemically fixed before Nile Red staining did not exhibit the characteristic yellow fluorescence. When Nile Red fluorescence was measured in algal cultures over time, the fluorescence increased as the culture became N deficient. The fluorescence level was linearly correlated with an increase in the total lipid content, determined gravimetrically, in a growing culture of algal cells. Fractionation of the lipids by silicic acid column chromatography demonstrated that the increase in lipid was due primarily to an increase in neutral lipids rather than in the polar lipids or glycolipids, which are found primarily in cell membranes.

Additional development of the Nile Red screening procedure occurred at SERI and at Milt Sommerfeld's laboratory at Arizona State University. The resultant protocol involved taking a fixed volume of a diluted algal culture (typically 4 mL), adding 0.04 mL of a Nile Red solution (0.1 mg/mL in acetone), and determining the fluorescence after 5 min using a fluorometer equipped with the appropriate excitation and emission filters.

Although the use of Nile Red allowed various microalgae to be rapidly screened for neutral lipid accumulation, interspecies comparisons may be subject to misinterpretation because of the species-specific staining differences described earlier. Nonetheless, before Nile Red was used, quantitating lipids from cells was very time consuming. It required the extraction of lipid from a large number of cells using organic solvents, evaporation of the solvent, and determination of the



amount of lipid by weighing the dried extract. Consequently, the use of Nile Red as a rapid screening procedure can still have substantial value.

*Screening for growth in high conductivity media.*

The estimation of lipid content using a simple procedure such as the Nile Red assay is clearly an important component of a rapid screening procedure for identifying promising strains, but an equally important component is a means to identify strains that grow rapidly under the expected culture conditions. Reports detailing the amount and types of saline groundwater available in the southwestern United States, along with data concerning the high rates of evaporation in this region, indicated that tolerance of algal strains to high conductivity (higher than  $50 \text{ mmho}\cdot\text{cm}^{-1}$ ) could be important. Therefore, an additional component of the secondary screening procedure developed to reduce the number of strains being maintained by ASP researchers. Algae were tested for the ability to grow at high conductivity ( $55 \text{ mmho}\cdot\text{cm}^{-1}$ , both Type I and Type II media), high temperature ( $30^\circ\text{C}$ ), and high light intensity (average of  $200 \mu\text{E}\cdot\text{m}^{-2}\cdot\text{s}^{-1}$ , 12 h light:12 h dark cycle) in cultures that were continually agitated via aeration. To prevent osmotic shock, strains were adapted to higher conductivities via a stepwise transfer into media with increasing conductivity at 2-day intervals. Tubes were used that could be placed directly in a spectrophotometer (i.e., 25 mm diameter, 50 mL volume), allowing the culture density to be measured without removing a sample. The tubes also held enough medium to allow samples to be taken for Nile Red lipid analysis (both for N-sufficient and N-deficient cells), and for ash-free dry mass determinations. The tubes were placed in a rack and illuminated by fluorescent lamps from below for the screening procedure. Optical density measurements were taken twice daily for 4 days during exponential growth to determine growth rates. Samples were removed for Nile Red fluorometric analysis during exponential growth and after 2 days (Arizona State University) or 4 days (SERI) of N deficiency.

This newly developed rapid screening protocol was subsequently used both in Milt Sommerfeld's laboratory and at SERI to screen many microalgal isolates. Keith Cooksey's laboratory also examined numerous strains using this procedure. Sommerfeld's laboratory examined approximately 800 strains that had been collected over the previous 2 years of the subcontract. Only 102 of these strains survived transfer into media having a conductivity of  $55 \text{ mmho}\cdot\text{cm}^{-1}$ . Of these strains, 40 grew in both Type I/55 and Type II/55 media, 42 grew only in Type I/55 medium, and 19 grew only in Type II/55 medium. The 10 fastest-growing strains, along with their preferred media, are shown in Table II.A.2.

**Table II.A.2 Fastest growing strains from Arizona State University collection.**

Strain	Genus	Class	Growth Rate (doublings•day <sup>-1</sup> )	Medium
OSCIL2	<i>Oscillatoria</i>	Cyanophyceae	4.23	I/55
OSCIL3	<i>Oscillatoria</i>	Cyanophyceae	3.50	I/55
CHLOC4	<i>Chlorococcum/ Eremosphaera</i>	Chlorophyceae	3.47	I/55
SYNEC5	<i>Synechococcus</i>	Cyanophyceae	3.25	II/55
ASU0735	<i>Oscillatoria</i>	Cyanophyceae	3.06	I/55
AMPHO46	<i>Amphora</i>	Bacillariophyceae	2.81	I/55
NANNO13	<i>Nannochloris</i>	Chlorophyceae	2.78	I/55
POLYC1	<i>Synechococcus</i>	Cyanophyceae	2.73	I/55
CHLOR23	<i>Chlorella</i>	Chlorophyceae	2.66	I/55
SYNEC3	<i>Synechococcus</i>	Cyanophyceae	2.51	II/55

The lipid production potential of these strains was evaluated by the use of the fluorometric Nile Red assay. In Type I/55 medium, 49 strains had a higher apparent lipid content after 2 days of N-deficient growth, whereas 13 strains had the same or lower apparent lipid levels in response to N deficiency. In Type II/55 medium, 42 strains had higher lipid levels, and 7 strains had lower or unchanged lipid levels as a consequence of N deficiency. Of note was that the mean lipid level in cells grown in Type II/55 medium was nearly twice that of Type I/55-grown cells.

The strains exhibiting the highest Nile Red fluorescence levels are shown in Table II.A.3. All of these strains are diatoms, confirming the propensity of this group to accumulate lipids.





**Table II.A.3. Strains from the Arizona State University collection having the highest Nile Red fluorescence.**

Strain	Genus	Class	Triolein equivalents (mg·L <sup>-1</sup> ) Exponential growth	Triolein equivalents (mg·L <sup>-1</sup> ) N-deficient growth
NITZS54	<i>Nitzschia</i>	Bacillariophyceae	8	1003
NITZS53	<i>Nitzschia</i>	Bacillariophyceae	17	934
NITZS55	<i>Nitzschia</i>	Bacillariophyceae	37	908
ASU3004	<i>Amphora</i>	Bacillariophyceae	9	593
NAVIC36	<i>Nitzschia</i>	Bacillariophyceae	61	579
AMPHO45	<i>Amphora</i>	Bacillariophyceae	39	308
FRAGI2	<i>Fragilaria</i>	Bacillariophyceae	6	304
AMPHO27	<i>Amphora</i>	Bacillariophyceae	38	235
NITZS52	<i>Nitzschia</i>	Bacillariophyceae	24	234

These researchers also ranked strains according to the estimated lipid productivity of rapidly growing cells, based on the calculated growth rates and estimated lipid contents of exponential phase cells. The top strains resulting from this analysis are shown in Table II.A.4. However, the optimal strategy for maximizing lipid yield in actual mass culture facilities may require an “induction” step (i.e., manipulation of the culture environment, possibly involving nutrient deficiency). The ranking of strains would obviously be very different in that case.



**Table II.A.4. Strains in the Arizona State University collection with the highest apparent lipid productivity during exponential growth, based on Nile Red staining.**

Strain	Genus	Class	Triolein equivalents (mg•L <sup>-1</sup> •day <sup>-1</sup> )
AMPHO27	<i>Amphora</i>	Bacillariophyceae	345
CHLOC4	<i>Eremosphaera/ Chlorococcum</i>	Chlorophyceae	117
SYNEC5	<i>Synechococcus</i>	Cyanophyceae	86
AMPHO46	<i>Amphora</i>	Bacillariophyceae	71
SYNEC4	<i>Synechococcus</i>	Cyanophyceae	64
AMPHO45	<i>Amphora</i>	Bacillariophyceae	63
NITZS55	<i>Nitzschia</i>	Bacillariophyceae	48
OOCYS9	<i>Oocystis</i>	Chlorophyceae	46
NITZS52	<i>Nitzschia</i>	Bacillariophyceae	45

SERI researchers also started to evaluate various strains by the rapid screening procedure. Initial work focused on 25 partially characterized strains. These strains were analyzed for growth and Nile Red fluorescence in exponentially growing cultures and in cultures grown under N-deficient conditions for 4 days. The results of the SERI and Sommerfeld laboratories cannot be compared directly, because Nile Red units are expressed differently and the time duration of N deficiency was not the same. The best strains of the 25 tested (based on the highest Nile Red fluorescence normalized to ash-free dry weight (AFDW) and rapid exponential growth) were determined to be CHAET9 (*muelleri*), NAVIC2 (*Navicula saprophila*), and NITZS12 (*Nitzschia pusilla*).

Twenty-eight strains of *Chaetoceros* were also examined using this screening protocol. The best strains identified were CHAET21, CHAET22, CHAET23, and CHAET25 (all *muelleri*). All but the latter strain were isolated from various regions of the Great Salt Lake in Utah.

The departure of Dr. Bill Barclay and Dr. Jeff Johansen from the ASP, along with a greater emphasis on genetic improvement of strains, marked the end of the in-house collection and screening work. As a consequence, many of the 3,000 strains collected by ASP researchers during the course of this research effort were never analyzed via this rapid screening protocol. Nonetheless, enough strains had been analyzed at SERI and at the laboratories of various subcontractors to obtain a substantial number of promising strains. The next step was to determine their ability to grow in actual outdoor mass culture ponds. This work is described in Section III of this report.



### Publications:

Berglund, D.; Cooksey, B.; Cooksey, K.E.; Priscu, L.R. (1987) "Collection and screening of microalgae for lipid production: possible use of a flow cytometer for lipid analysis." *FY 1986 Aquatic Species Program Annual Report*, Solar Energy Research Institute, Golden, Colorado, SERI/SP-231-3071, pp. 41-52.

Cooksey, K.E.; Guckert, J.B.; Williams, S.A.; Collis, P.R. (1987) "Fluorometric determination of the neutral lipid content of microalgal cells using Nile Red", *J. Microbiol. Methods* 6:333-345.

Johansen, J.; Lemke, P.; Barclay, W.; Nagle, N. (1987) "Collection, screening, and characterization of lipid producing microalgae: Progress during Fiscal Year 1987." *FY 1987 Aquatic Species Program Annual Report*, Solar Energy Research Institute, Golden, Colorado, SERI/SP-231-3206, pp. 27-42.

Lien, S. (1981) In *Proc. Brighton Int. Conf. On Energy from Biomass* (Palz, W.; Chartier, P.; and Hall, D.O., eds.), Applied Science Publishers, London, pp. 697-702.

Sommerfeld, M.; Ellingson, S.; Tyler, P. (1987) "Screening microalgae isolated from the southwest for growth potential and lipid yield." *FY 1987 Aquatic Species Program Annual Report*, Solar Energy Research Institute, Golden, Colorado, SERI/SP-231-3206, pp. 43-57.

### Additional References:

Greenspan, P.; Mayer, E.P.; Fowler, S.D. (1985) "Nile Red: A selective fluorescent stain for intracellular lipid droplets." *J. Cell Biol* 100:965-973.

Greenspan, P.; Fowler, S.D. (1985) *J. Lipid Res.* 26:787

#### II.A.1.g. Statistical Analysis of Multivariate Effects on Microalgal Growth and Lipid Content

As discussed earlier, environmental variables (particularly nutrient status) can have great effects on growth and the quantity and quality of lipids in microalgae. To determine the effects of several environmental variables alone and in combination on the growth and lipid contents of microalgae, a multivariate, fractional factorial design experiment was carried out with two promising diatoms, *Navicula saprophila* (NAVIC1) and *C. muelleri* (CHAET9). For these experiments, cells were grown in modified SERI Type II/25 medium in which the alkalinity was adjusted by adding sodium carbonate and sodium bicarbonate and the conductivity was adjusted by adding sodium chloride. Cultures were grown on the temperature gradient table described previously at  $200 \mu\text{E}\cdot\text{m}^{-2}\cdot\text{s}^{-1}$ . The following variables were tested in the multivariate analysis: conductivity (20 to 80  $\text{mmho}\cdot\text{cm}^{-1}$ ), temperature (17° to 32°C), N (urea) concentration (0 to 144  $\text{mg}\cdot\text{L}^{-1}$ ), sodium silicate concentration (0 to 500  $\text{mg}\cdot\text{L}^{-1}$ ), and alkalinity (8.8 to 88  $\text{meq}\cdot\text{L}^{-1}$ ). In these experiments, growth was measured by changes in AFDW and lipid was measured by the use of the Nile Red fluorometric assay.



The results indicated that the N content and conductivity of the medium were the most important variables affecting lipid content (Nile Red fluorescence) of both NAVIC1 and CHAET9. As N levels and conductivity increased, the amount of neutral lipid per mg of AFDW decreased. The interaction of N and conductivity was an important determinant of lipid content as well. Silicon level and alkalinity were more important factors in determining the lipid content for CHAET9 than for NAVIC1. N concentration was by far the most important factor in determining final cell mass for NAVIC1, and was a major factor for cell mass yield in CHAET9 (along with the interaction of conductivity and alkalinity, which had a large negative impact on growth). Alkalinity was a major factor for growth of both NAVIC1 and CHAET9. However, these experiments did not determine actual growth rates, but only the final cell yields; thus, how actual cell division rates compared with each other is not known.

These experiments indicate the importance of examining the interactions of environmental variables in determining the effects on growth and lipid production. However, the models generated by these kinds of experiments are specific for the strains being studied, and the results cannot necessarily be used to predict the effects of these variables on other strains. Furthermore, for such models to be truly predictive of growth and lipid production in an actual mass culture, much more sophisticated (and realistic) experimental setups would be required.

#### Publications:

Chelf, P. (1990) "Environmental control of lipid and biomass production in two diatom species." *J. Appl. Phycol.* 2:121-129.

#### II.A.1.h. Detailed Analyses of Microalgal Lipids

In addition to the in-house research being conducted in the area of strain collection and screening, there was an effort by Dr. Thomas Tornabene and others to characterize various strains via detailed lipid compositional analyses. Dr. Tornabene's laboratory at SERI (and later at the Georgia Institute of Technology) served as the focal point for the analysis of lipids in algal samples supplied by various researchers in the ASP. This section will describe the results of these analyses, and will provide details about the analytical methods used, as these methods were the most comprehensive used in the program. An early report by Tornabene et al. (1980) described the lipids that were present in the halophilic alga *Dunaliella* that had been isolated from the Great Salt Lake in Utah. The cells were grown to late logarithmic phase, harvested, and extracted with chloroform/methanol via the method of Bligh and Dyer (1959). Additional extraction by acetate buffer, followed by refluxing with an alkaline methanol/water mixture was then performed, followed by partitioning of lipids into petroleum ether. The extracted lipids were fractionated on the basis of polarity using silicic acid columns via differential elution with hexane, benzene, chloroform, acetone, and methanol. In this procedure, the lipids are eluted as follows:

1. hexane: acyclic hydrocarbons



2. benzene: cyclic hydrocarbons, polyunsaturated acyclic hydrocarbons, sterols, and xanthophylls
3. chloroform: mono-, di- and triacylglycerols, free fatty acids, and phaeophytin *a*
4. acetone: glycolipids, carotenoids, and chlorophyll *a* and *b*; and
5. methanol: phospholipids and chlorophyll *c*.

The various lipid classes were further analyzed via Si gel thin layer chromatography (both one- and two-dimensional), wherein lipids were detected via the use of iodine vapors (and autoradiography in the case of  $^{14}\text{C}$ -labeled lipids). In addition, lipids containing amino groups were detected via the ninhydrin reagent, and phospholipids were detected by the use of molybdate/ $\text{H}_2\text{SO}_4$ . Fatty acids were analyzed via gas chromatography using either flame ionization or mass spectroscopic detection after being converted to their methyl ester derivatives in the presence of methanolic HCl. The head groups of the polar lipids were identified via gas chromatography after being converted to alditol acetates. These and related methods were described by Tornabene et al. (1982).

These analyses indicated that lipids comprised 45%-55% of the total organic mass of *Dunaliella* cells. Based on the distribution of  $^{14}\text{C}$  after labeling the cells with  $^{14}\text{C}$ -bicarbonate, neutral lipids accounted for 58.5% of the lipid mass, whereas phospholipids and galactolipids were 22.9% and 10.9% of the lipid mass, respectively. Isoprenoid hydrocarbons (including  $\beta$ -carotene) and aliphatic hydrocarbons (in which the major components were tentatively identified as straight-chain and methyl-branched  $\text{C}_{17}$  and  $\text{C}_{19}$  hydrocarbons with various degrees of unsaturation) represented 7.0% and 5.2% of the lipids, respectively. The major fatty acids present were palmitic (20.6%), linolenic (12.5%), linoleic (10.7%) and palmitoleic (7.8%), but no attempt was made to ascertain whether any of these fatty acids predominated a particular lipid class. The high hydrocarbon content of this alga is rather atypical of most of the strains characterized in the ASP. These types of hydrocarbons would probably require catalytic conversion into a usable fuel source, which would perhaps limit their utility as a production organism.

A detailed analysis of the lipids present in the green alga *Neochloris oleoabundans* was also carried out by Tornabene (who was later to hold a position at the Georgia Institute of Technology), along with G. Holzer (Colorado School of Mines), S. Lien and N. Burris (SERI) (Tornabene et al. 1983). The strain used in this study was obtained from the University of Texas Algal Culture Collection, and reportedly contained substantial quantities of lipid when grown under N-deficient conditions. (However, this is a freshwater strain). Exponentially growing cells were transferred into a low-N medium, and after 5 to 7 days of growth in stirred cultures that were bubbled with 1%  $\text{CO}_2$  in air, the cells were harvested and the lipids were extracted. Analytical methods were similar to those described earlier, and included the use of pyrrolidine-acetic acid/mass spectrometry to determine the position of double bonds in the fatty acids. These analyses indicated that 35%-54% of the cellular dry weight was in the form of lipids in N-deficient cells. Neutral lipids accounted for more than 80% of the total lipids, and were



predominantly in the form of TAGs. Small amounts of straight-chain hydrocarbons and sterols were also found (one sterol was identified as a  $\Delta^7$  sterol, but low quantities of material made identification of the sterols difficult). A number of polar lipids were also quantified, but all polar lipids combined accounted for less than 10% of the lipid mass. The fatty acids that comprised the TAGs were present in the following proportions: 36% oleic (18:1  $\Delta^9$ ), 15% palmitic (16:0), 11% stearic (18:0), 8.4% iso-17:0 (an unusual fatty acid for microalgae), and 7.4% linoleic (18:2  $\Delta^9,12$ ). Other saturated and monounsaturated fatty acids were present in TAGs, but represented less than 5% each of the total fatty acids present. The high proportion of saturated and monounsaturated fatty acids in this alga is considered optimal from a fuel quality standpoint, in that fuel polymerization during combustion would be substantially less than what would occur with polyunsaturated fatty acid-derived fuel (Harrington, 1986).

Additional research carried out in Tornabene's laboratory (Ben-Amotz et al. 1985) examined the lipid composition of 7 algal species. Some were from existing culture collections and others were isolated by ASP researchers. The lipid contents of these strains were determined under conditions of N sufficiency, after 10 days of N deficiency, and under different salinity levels.

*Botryococcus braunii* has received considerable interest as a fuel production organism in other laboratories because of its high lipid content. This study confirmed the high lipid levels (55% of the organic mass for N-deficient cells). Most of this lipid was in the form of hydrocarbons, including  $C_{29}$  to  $C_{34}$  aliphatic hydrocarbons and a variety of branched and unsaturated isoprenoids. Glycerolipids were less abundant than the hydrocarbons, and were composed primarily of 16:0 and various  $C_{18}$  fatty acids. These data, coupled with the fact that this species grows very slowly (one doubling per 72 hours), indicated that *Botryococcus* would not function well as a feedstock for lipid-based fuel production.

The other species examined in this study were the chlorophytes *Ankistrodesmus*, *Dunaliella*, and *Nannochloris*, the diatom *Nitzschia*, and the chrysophyte *Isochrysis*. N deficiency led to an increase in the lipid content of *Ankistrodesmus* (from 24.5% to 40.3%), *Isochrysis* (from 7.1% to 26.0%), and *Nannochloris* (from 20.8% to 35.5%), but resulted in a decrease in the lipid content of *Dunaliella* (from 25.3% to 9.2%). Elevating the NaCl concentration of the medium had little effect on the lipid content of *Botryococcus* cells, but caused a slight decrease in the lipid content of *Dunaliella salina* (from 25.3% to 18.5% with an increase in [NaCl] from 0.5 to 2 M). Conversely, the lipid content of *Isochrysis* increased from 7.1% to 15.3% as the NaCl increased from 0.5 to 1 M. These results once again highlight the impact of culture conditions on the quantities of lipids present. However, as stated before, the most important characteristic of a lipid production strain is the overall lipid productivity for a given amount of time, which was not examined in this study.

The polar lipid composition of the strains examined in this study were typical of photosynthetic microalgae, and included phosphatidylcholine, phosphatidylinositol, phosphatidylethanolamine, phosphatidylglycerol, monogalactosyldiacylglycerol, and digalactosyldiacylglycerol.



Table II.A.5 indicates the major fatty acids (those at levels exceeding 5% of the total) present in these strains, both under N-sufficient and N-deficient growth conditions.

In conclusion, the work carried out by Tornabene's laboratory provided a detailed characterization of the lipids present in a variety of microalgae. No general conclusions could be made from the work except that the lipid composition of various microalgal strains can differ quite substantially. Because the nature of the lipids can have a large impact on the quality of the fuel product, characterizing the potential production strains is important to ensure that deleterious lipids (e.g., highly polyunsaturated fatty acids in the case of biodiesel fuel) are not present at high levels.

**Table II.A.5. Major fatty acids of various microalgae. (Fatty acids in bold are present at levels of 15% or higher)**

Strain	Nitrogen-sufficient cells	Nitrogen-deficient cells
<i>Ankistrodesmus</i>	16:0, 16:4, <b>18:1</b> , <b>18:3</b>	16:0, <b>18:1</b> , 18:3
<i>Botryococcus braunii</i>	<b>16:0</b> , <b>18:1</b> , 18:2, <b>18:3</b>	16:0, <b>18:1</b> , <b>18:3</b> , 20:5
<i>Dunaliella bardawil</i>	not determined	12:0, 14:0/14:1, <b>16:0</b> , <b>18:1</b> , 18:2, 18:3
<i>Dunaliella salina</i>	14:0/14:1, <b>16:0</b> , 16:3, 16:4, 18:2, <b>18:3</b>	<b>16:0</b> , 16:3, 18:1, 18:2, <b>18:3</b>
<i>Isochrysis sp.</i>	14:0/14:1, 16:0, 16:1, <b>18:1</b> , 18:3, <b>18:4</b> , 22:6	<b>14:0/14:1</b> , <b>18:1</b> , 18:2, 18:3, 18:4, 22:6
<i>Nannochloris sp.</i>	14:0/14:1, 16:0, 16:1, 16:2, 16:3, 20:5	not determined
<i>Nitzschia sp.</i>	14:0/14:1, 16:0, 16:1, 16:2, 16:3, 20:6	not determined

#### Publications:

Ben-Amotz, A.; Tornabene, T.G. (1983) "Chemical profile of algae with emphasis on lipids of microalgae." *Aquatic Species Program Review: Proceedings of the March 1983 Principal Investigators' Meeting*, Solar Energy Research Institute, Golden, Colorado, SERI/CP-231-1946, pp. 123-134.

Ben-Amotz, A.; Tornabene, T.G.; Thomas, W.H. (1985) "Chemical profiles of selected species of microalgae with emphasis on lipids." *J. Phycol.* 21:72-81.

Tornabene, T.G.; Holzer, G.; Peterson, S.L. (1980) "Lipid profile of the halophilic alga, *Dunaliella salina*." *Biochem. Biophys. Res. Comm.* 96:1349-1356.



Tornabene, T.G.; Ben-Amotz, A.; Hubbard, J.S. (1982) "Isolation, analysis and identification of lipids." SERI ASP Report prepared under contract XK-2-02149-01.

Tornabene, T.G.; Holzer, G.; Lien, S.; Burris, N. (1983) "Lipid composition of the nitrogen starved green alga *Neochloris oleoabundans*." *Enzyme Microb. Technol.* 5:435-440.

Tornabene, T.G. (1984) "Chemical profile of microalgae with emphasis on lipids." *Aquatic Species Program Review: Proceedings of the April 1984 Principal Investigators' Meeting*, Solar Energy Research Institute, Golden, Colorado, SERI/CP-231-2341, pp. 64-78.

Tornabene, T.G.; Benemann, J.R. (1985) "Chemical profiles on microalgae with emphasis on lipids." *Aquatic Species Program Review: Proceedings of the March 1985 Principal Investigators' Meeting*, Solar Energy Research Institute, Golden, Colorado, SERI/CP-231-2700, pp. 83-99.

**Additional References:**

Harrington, K.J. (1986) *Biomass* 9:1-17.

**II.A.2. Collection, Screening, and Characterization of Microalgae: Research by SERI Subcontractors**

**II.A.2.a. Introduction**

Included in this section are summaries of the research conducted by various subcontractors within the ASP who contributed to the collection, screening, and characterization of microalgal strains for potential use in biofuel production facilities. Initially, a variety of strain isolation and screening procedures were carried out by the various research groups, as there was no established protocol. This lack of uniformity in the screening protocols made comparing the results from one laboratory with those of another difficult, and meant that the criteria for selecting the best strains differed between the laboratories. At the same time, however, this arrangement provided the opportunity for new ideas regarding collecting and screening to be pursued, thereby allowing individual creativity in a manner that might be beneficial to the entire program.

Several subcontractors participated in the strain collection and screening effort. Dr. Bill Thomas and colleagues (Scripps Institution of Oceanography) collected a large number of strains from the desert regions of eastern California and western Nevada. Additional microalgal strains from desert waters in Arizona, New Mexico, California, Nevada, Utah, and Texas were obtained through the efforts of Dr. Milt Sommerfeld's laboratory at Arizona State University. Dr. Mahasin Tadros (Alabama A&M University) collected strains habitats in the southeastern United States (Alabama, Mississippi, and Florida). Additional strains from the Florida Keys and Everglades were collected by John Rhyther (Harbor Branch Foundation); Richard York (Hawaii Institute of Marine Biology) isolated a number of strains from the Hawaiian islands and surrounding waters. Certain environmental niches were focused on as well; Dr. Keith Cooksey (Montana State University) isolated several strains from thermal springs in Yellowstone National





Park; Dr. Ralph Lewin (Scripps Institution of Oceanography) focused on picoplanktonic algae (“floating” algae at the air-sea interface). The results of these efforts are described below.

**II.A.2.b. Yields, Photosynthetic Efficiencies, and Proximate Chemical Composition of Dense Cultures of Marine Microalgae**

**Subcontractor:** University of California, San Diego  
**Principal Investigator:** William H. Thomas  
**Period of Performance:** 1980 - 1983  
**Subcontract Number:** XK-0-9111-1

Work carried out under this subcontract represented one of the first attempts by an ASP subcontractor to characterize the productivity and lipid yields of various microalgae. Six algal strains (*B. braunii*, *Dunaliella primolecta*, *Isochrysis* sp., *Monallanthus salina*, *Phaeodactylum tricornutum*, and *Tetraselmis sueica*) were obtained from existing culture collections and analyzed with respect to lipid, protein, and carbohydrate content under various growth conditions. For these experiments, all cultures except for *B. braunii* were grown in natural seawater that was enriched with N, P, and trace metals. *B. braunii* was grown in an artificial seawater medium. Initial experiments to determine productivities of these species were performed using batch cultures in 9-L serum bottles. Of the strains tested, the highest growth rates were observed with *P. tricornutum* (Thomas strain) and *M. salina*.

Additional experiments were performed in plexiglas vessels that were 5 cm thick, 39 cm deep, and 24 cm wide (surface area ~940 cm<sup>2</sup>). The cultures were illuminated from the side with a 2,000-watt tungsten-halide lamp, which was placed behind a water/CuSO<sub>4</sub> thermal filter. In these experiments, the cultures were typically maintained for 40 to 90 days. In the early stages of an experiment, the cultures were maintained in a batch mode, and then converted to a continuous or semi-continuous dilution mode. Various culture parameters (including light intensity, dilution rate, and N status) were manipulated during the course of these experiments to determine their effects on the productivities and proximate chemical composition of the strains. The results of these experiments with each species tested are discussed below. These experiments are difficult to compare because the experiments were all carried out slightly differently (i.e., different light intensities, different culturing methods [batch, semi-continuous, and continuous], different means of obtaining N-deficient cultures, and inconsistent use of a CuSO<sub>4</sub> heat filter, which resulted in differences in light quality and culture temperature). Nonetheless, the general conclusions of this study are of interest.

*P. tricornutum* (Thomas strain):

This strain has been used for several past studies, and was concomitantly being tested in outdoor mass culture by another subcontractor (the University of Hawaii; principal investigator Dr. Edward Laws; discussed in Section III). Therefore, this strain was subjected to more extensive testing than the other strains in this subcontract. In one experiment reported for this strain, the



effects of light intensity on productivity were determined in batch cultures (i.e., in the Plexiglas culture apparatus described earlier without culture replacement and dilution). The maximum productivity observed for this strain ( $21$  to  $22$  g dry weight $\cdot$ m $^{-2}\cdot$ d $^{-1}$ )<sup>3</sup> was observed at a total daily illumination of 63-95 kcal (representing approximately 40%-60% of full sunlight in southern California during the summer). This value was slightly higher than the productivity observed with a total daily illumination of 70% full sunlight ( $17.1$  g dry weight $\cdot$ m $^{-2}\cdot$ d $^{-1}$ ). Productivities under N-limiting, continuous growth mode conditions were between 7 and 11 g dry weight $\cdot$ m $^{-2}\cdot$ d $^{-1}$ . Likewise, productivities under N-sufficient, continuous growth mode conditions were reduced relative to batch cultures.

In addition to measuring overall productivities, the levels of protein, carbohydrate, lipid, and ash were determined for cells grown under the various conditions described earlier. Illumination of the cultures from 40% to 70% of full sunlight did not have a large impact on the cellular composition. Growth of *P. tricornutum* cells under N-deficient conditions resulted in a reduction of the protein content from 55% (in N-sufficient cells) to 25% of the cellular dry weight. Carbohydrate content increased from 10.5% to 15.1%, and the mean lipid content increased from 19.8% to 22.2%, although these differences in carbohydrate and lipid contents did not appear to be statistically significant. At one stage of the experiment, however, a time course of N deficiency led to a consistent rise in lipid content from 19.9% to 30.8% over the course of 7 days. The actual rate of lipid production did not increase, however, because the overall productivity of the cultures was reduced under N-deficient growth.

#### *D. primolecta*:

The maximum productivity observed for this species ( $12.0$  g dry weight $\cdot$ m $^{-2}\cdot$ d $^{-1}$ ) occurred during continuous culture at 60% full sunlight under N-sufficient conditions. Doubling the light intensity lowered the productivity to  $6.1$  g dry weight $\cdot$ m $^{-2}\cdot$ d $^{-1}$ . The chemical composition of N-sufficient cells (as an average percentage of total cell dry weight) was 64.2% protein, 12.6% carbohydrate, and 23.1% lipid. After 7 days of growth under N-deficient conditions, the composition was 26.8% protein, 59.7% carbohydrate, and 13.7% lipid. Therefore, this alga accumulates carbohydrates rather than lipids in response to nutrient deficiency, limiting its usefulness as a lipid production strain.

#### *M. salina*:

This alga reportedly contained high levels of lipids when grown under N-deficient conditions. The highest productivity ( $13.9$  g dry weight $\cdot$ m $^{-2}\cdot$ d $^{-1}$ ) was observed under N-sufficient conditions at a light intensity of 50% full sunlight, although detailed experiments with regards to the effects of light intensity on productivity were not conducted. There was little difference in the lipid

---

<sup>3</sup>Reporting of productivities in g dry weight $\cdot$ m $^{-2}\cdot$ d $^{-1}$  derives from the goal of mass culturing the algae in shallow open ponds. The objective would be to maximize biomass produced per area of pond. However, it is often difficult to compare results between experiments when the data are reported in this manner, as factors such as culture depth and vessel design would significantly affect productivity of the cultures.



content of cells grown under N-sufficient and N-deficient conditions (20.7% and 22.1%, respectively).

*T. sueica*:

The highest productivity observed for this strain was 19.1 g dry weight•m<sup>-2</sup>•d<sup>-1</sup>, which occurred in N-sufficient batch cultures grown under a light intensity of 60% full sunlight. N deficiency resulted in a large increase in carbohydrate content (from a mean value of 10.7% to a mean value of 47.1%). On the other hand, protein content was reduced substantially (from 67.6% to 28.3%), and the lipid content decreased from 23.1% to 14.6% in response to N deficiency.

*Isochrysis* sp.(Tahitian strain T-ISO):

This strain is commonly used as a feed organism in aquaculture production systems. A productivity of 11.5 g dry weight•m<sup>-2</sup>•d<sup>-1</sup> was typical for batch cultures of this species, which was approximately 33% higher than the value recorded during semi-continuous growth (dilution of 0.15 L/d). Productivity was lowered during N-deficient growth to 5.5-7.6 g dry weight•m<sup>-2</sup>•d<sup>-1</sup>. This strain accumulated carbohydrate in response to N deficiency (from a mean value of 23.1% to 56.9%). Lipid content also increased slightly (from 28.5% to 33.4%), whereas protein content was reduced from 44.9% to 27.3%. The higher lipid content of N-deficient cells did not translate to higher lipid productivities, however, because of the lower overall productivity of the stressed cultures.

*B. braunii*:

Some very limited experiments were conducted with this species, which is known to accumulate hydrocarbons. A culture grown under a light intensity of 60% full sunlight had a productivity of only 3.4 g dry weight•m<sup>-2</sup>•d<sup>-1</sup>. The lipid content of these cells was 29% of the cellular dry weight; the N status of the cells was not reported, but it is assumed that the cells were grown under N-sufficient conditions.

*Overall Conclusions*

Of the species examined, *P. tricornutum* and *T. sueica* had the highest overall productivities. These species also had the highest lipid productivities, which were 4.34 and 4.47 g lipid•m<sup>-2</sup>•d<sup>-1</sup>, respectively. For both species, the maximal productivities were obtained in batch cultures, as opposed to semi-continuous or continuous cultures. Although the lipid contents of cells were often higher in response to N deficiency, the lipid productivities of all species tested were invariably lower under N deficiency because of an overall reduction in the culture growth rates. For the species tested under continuous or semi-continuous growth conditions, lipid productivities were reduced from 14% to 45% of the values measured for N-sufficient cultures.



The results also pointed to the importance of identifying strains that are not photoinhibited at light intensities that would occur in outdoor ponds. Finally, this work highlighted the fact that some microalgae accumulate carbohydrates during nutrient-deficient growth; such strains are clearly not acceptable for use as a feedstock for lipid-based fuel production.

#### Publications:

Thomas, W.H.; Seibert, D.L.R.; Alden, M.; Neori, A. (1981) "Effects of light intensity and nitrogen deficiency on yield, proximate composition, and photosynthetic efficiency of *Phaeodactylum*." *Proceedings of the Subcontractors' Review Meeting—Aquatic Species Program*, Solar Energy Research Institute, Golden, Colorado, SERI/CP-624-1228, pp. 33-58.

Thomas, W.H.; Seibert, D.L.R.; Alden, M.; Neori, A.; Eldridge, P. (1984a) "Yields, photosynthetic efficiency, and proximate composition of dense marine microalgal cultures. I. Introduction and *Phaeodactylum tricorutum* experiments." *Biomass* 5:181-209.

Thomas, W.H.; Seibert, D.L.R.; Alden, M.; Neori, A.; Eldridge, P. (1984b) "Yields, photosynthetic efficiency, and proximate composition of dense marine microalgal cultures. II. *Dunaliella primolecta* and *Tetraselmis suecica* experiments." *Biomass* 5:211-225.

(Also see references listed in the following section.)

#### II.A.2.c. Selection of High-Yielding Microalgae from Desert Saline Environments

**Subcontractor:** University of California, San Diego  
**Principal Investigator:** William H. Thomas  
**Period of Performance:** 1983 - 1986  
**Subcontract Number:** XK-2-02170-0-01

The work carried out under this subcontract represented one of the first efforts to collect microalgae from inland saline habitats and to screen those strains for rapid growth rates and lipid content. Collecting trips were made to eastern California and western Nevada, and initial culturing efforts were conducted at the Sierra Nevada Aquatic Research Laboratory near Mammoth Lakes, California, and the Desert Studies Center (Zzyzx Springs), which is near Baker, California. Various saline waters and soils were sampled during these collecting trips. The collection sites included Pyramid Lake, Black Lake, Owens Lake, Walker Lake, Saline Valley, Zzyzx Springs, Armagosa River, Sperry River, Harper Lake, and Salt Creek. The water samples were enriched with N, P, Si, and trace metals, then incubated under natural conditions. The algae that grew up were isolated by the use of micropipettes. Soil samples were placed in "Zzyzx medium" before algal isolation (see Thomas et al. [1986] for media compositions).

Diatoms, green algae, and cyanobacteria were the dominant types of algae isolated using these procedures. Of the 100 strains isolated, 42 were grown under standardized conditions in various



artificial media that were designed to mimic the water from which the strains were originally obtained. The pH of these various media formulations was typically high because of the presence of high levels of carbonate and bicarbonate, and the total dissolved solids ranged from approximately  $1.5 \text{ g}\cdot\text{L}^{-1}$  to over  $260 \text{ g}\cdot\text{L}^{-1}$ . The growth of the cultures was visually scored, and nine of the fastest growing strains were further analyzed with respect to growth under scaled-up conditions.

For larger scale cultures, 6 L of medium that was enriched with N (nitrate, urea, or ammonium), phosphate, trace metals, and vitamins were placed in 9-L serum bottles, and the cultures were illuminated with fluorescent bulbs at a light intensity of 18% full sunlight. To enhance growth, the cultures were bubbled with 1%  $\text{CO}_2$  in air, and more nutrients were added as the cell density of the cultures increased. The strains tested in this manner included *Nitzschia*, *Ankistrodesmus*, *Nannochloris*, *Oocystis* (two strains), *Chlorella* (three strains), and *Selenastrum*. The estimated productivities ranged from  $8.8 \text{ g dry weight}\cdot\text{m}^{-2}\cdot\text{d}^{-1}$  for *Nitzschia* S-16 (NITZS1<sup>4</sup>) grown in the presence of urea to  $45.8 \text{ g dry weight}\cdot\text{m}^{-2}\cdot\text{d}^{-1}$  for *Oocystis pusilla* 32-1, which was also grown with urea as the N source. (These productivity values were considered overestimates in that there was incidental side lighting of the flasks under the incubation conditions.) Also the productivity values did not always correlate with final biomass yield values, indicating that growth saturation was reached at different culture densities for the various strains. The maximum biomass yield was obtained with *O. pusilla* 32-1 ( $2.29 \text{ g dry weight}\cdot\text{L}^{-1}$ ). The results of these experiments indicated that certain strains had a clear preference for either urea or nitrate as the N source. Because urea is significantly less expensive than nitrate, these results have economic implications with respect to algal mass culture. However, the results regarding a preference for a particular N source were not always reproducible.

Additional experiments were carried out to assess the combined effect of temperature and salinity on the growth of several of the isolates. A thermal gradient table was used for these experiments in which the incubation temperature at six stations on the table varied between  $11^\circ\text{C}$  and  $35^\circ\text{C}$ . Salinities of the media were varied in five increments along the other axis (as much as twice that of the natural waters), leading to a total of 30 different combinations of temperature and salinity. Growth was determined via optical density measurements, and contour lines were drawn upon a matrix chart of the various temperature/salinity combinations. This approach was later used by other subcontractors and SERI in-house researchers to determine the optimal growth characteristics of numerous promising algal strains. Results from this analysis were reported for eight different strains. In general, the strains grew better at higher salinities, indicating their halophilic nature, and had temperature optima for growth between  $20^\circ\text{C}$  and  $30^\circ\text{C}$ . Of the strains tested, the Mono Lake isolate NITZS1 had the highest temperature optimum (between  $30$  and  $36^\circ\text{C}$ ).

The effect of light intensity on the growth of *Ankistrodesmus falcatus* 91-1 (ANKIS1, from Pyramid Lake) and *O. pusilla* 32-1 (from Walker Lake) was determined in 0.83-L cultures that were placed at varying distances from a tungsten lamp source. Neutral density filters were

---

<sup>4</sup>NREL Microalgae Culture Collection strain designations are provided when relevant.



placed between the light source and the cultures. This arrangement provided between 30% and 70% of full sunlight. For ANKIS1, maximum productivity ( $21.9 \text{ g dry weight}\cdot\text{m}^{-2}\cdot\text{d}^{-1}$ ) was attained when the cells were subjected to 50% full sunlight. At 30% full sunlight, the productivity fell off to  $14.7 \text{ g dry weight}\cdot\text{m}^{-2}\cdot\text{d}^{-1}$  (because of light limitation), and at 70% full sunlight, the productivity was reduced to  $19.0 \text{ g dry weight}\cdot\text{m}^{-2}\cdot\text{d}^{-1}$  (most likely because of photoinhibition). For *O. pusilla*, a maximum productivity of  $25.8 \text{ g dry weight}\cdot\text{m}^{-2}\cdot\text{d}^{-1}$  was also attained at 50% full sunlight, whereas productivity at 30% and 70% full sunlight was 18.7 and  $23.2 \text{ g dry weight}\cdot\text{m}^{-2}\cdot\text{d}^{-1}$ , respectively. These productivity values are believed to be more accurate than those reported in the preceding section because light was able to enter the culture vessels only from one side. The relative high densities of these cultures ( $>1 \text{ g dry weight}\cdot\text{L}^{-1}$ ) permitted the cells to tolerate higher light intensities than would be possible in less dense cultures, because of the self-shading of the cells.

Experiments were also conducted to determine the effects of varying the culture vessel width (i.e., culture depth) on overall productivities. ANKIS1 was grown in containers that were 5, 10, and 15 cm wide. The containers were illuminated with a tungsten lamp at 50% full sunlight, and were bubbled vigorously with 1%  $\text{CO}_2$  in air. The results of these experiments indicated that growth rate, when expressed as  $\text{g dry weight}\cdot\text{L}^{-1}\cdot\text{d}^{-1}$ , was highest in the 5-cm thick culture and lowest in the 15-cm thick culture. However, when productivities were expressed as  $\text{g dry weight}\cdot\text{m}^{-2}\cdot\text{d}^{-1}$ , which takes into account the actual surface area that is illuminated, the thicker cultures were more productive. For example, the volumetric productivities over 10 days were 0.72, 0.35 and  $0.31 \text{ g dry weight}\cdot\text{L}^{-1}\cdot\text{d}^{-1}$  for the 5-, 10-, and 15-cm thick cultures, respectively, whereas the corresponding areal productivities for these cultures were 41.1, 40.2, and  $52.7 \text{ g dry weight}\cdot\text{m}^{-2}\cdot\text{d}^{-1}$ . Because the economic constraints regarding an actual algal biodiesel production facility dictate the use of open pond systems, the areal productivity values are the more important consideration, although less water (and consequently less water handling) is required when dealing with more dense cultures. The productivities reported for these experiments may be overestimates of what these strains could achieve in outdoor mass culture because of the optimized mixing and aeration regime.

In the final year of this subcontract, additional collecting trips were taken to gather more microalgal strains. These strains, along with some that had been collected during earlier trips, were screened more rigorously than before. In this revised selection process, the strains were subjected to higher light intensities and higher temperatures, and the abilities of the strains to grow in “SERI standard media<sup>5</sup>” were investigated. This selection procedure resulted in the isolation of 41 additional strains. Initial screening of strains involved incubating the isolates at  $25^\circ\text{C}$  and  $30^\circ\text{C}$  under 40% full sunlight (provided by a 2000-W tungsten-halide lamp) in the SERI standard medium that most closely resembled the water from which they were originally isolated. Twelve of the strains that grew best under these conditions were then tested under the same temperature and light conditions in an early version of standard SERI media (Type I and Type II at low, medium, and high salinities; see media compositions in Thomas et al. [1985]).

---

<sup>5</sup>The development of the SERI standard media is discussed in Chapter II.A.1. The compositions of these media are given in Table II.A.1.



The results indicated that most of the strains had a definite preference for a particular medium type and level of salinity. The results also indicated some inconsistencies in the growth rates of cells grown in the two experiments. For example, *Chlorella* BL-6 (CHLOR2) grew very well in the preliminary experiments in Type II/low salinity medium ( $2.48 \text{ doublings} \cdot \text{d}^{-1}$ ), but grew much more poorly when grown in all five SERI media (including Type II/low salinity) in the second set of experiments. Conversely, *Chlamydomonas* HL-9 grew much more quickly in the second set of experiments than in the first set. The reasons for these discrepancies are unclear, as the culture conditions were essentially the same, and underscore the need to perform replicate experiments. Several marine microalgae were also tested for the ability to grow in SERI standard media. *Phaeodactylum tricornutum*, *Chaetoceros gracilis*, and *Platymonas* all grew well ( $>1.25 \text{ doublings} \cdot \text{d}^{-1}$ ) in at least one SERI medium. *Isochrysis* T-ISO was unable to grow in any SERI medium, however.

The combined effects of temperature and salinity on the growth rates of eight of these newly collected strains were determined by the use of a temperature-salinity gradient table. In general, the strains grew best in the range of salinity that was similar to that of the water from which they were originally isolated. The optimal temperature for growth was generally in the  $25^{\circ}\text{C}$  to  $35^{\circ}\text{C}$  range, although one *Chlorella* strain from Salt Creek grew well at  $40^{\circ}\text{C}$ . Based on the results of these experiments, two strains were selected for analysis of growth characteristics in larger scale (12 L) cultures at 50%-70% full sunlight. CHLOR2 achieved a productivity of  $55.5 \text{ g dry weight} \cdot \text{m}^{-2} \cdot \text{d}^{-1}$  under these conditions, and *Nannochloris* MO-2A had a productivity of  $31.9 \text{ g dry weight} \cdot \text{m}^{-2} \cdot \text{d}^{-1}$ .

This subcontract represented one of the first efforts in the ASP to collect and screen microalgal strains to identify suitable biofuel production strains. As a consequence, many of the screening and characterization protocols were still being developed; therefore, there is a substantial lack of uniformity in the testing of the various strains isolated. Nonetheless, a number of promising strains were isolated during the course of this research, and several methods were developed that helped establish standard screening protocols used by other ASP researchers.

#### Publications:

Thomas, W.H.; Gaines, S.R. (1982) "Algae from the arid southwestern United States: an annotated bibliography." *Report for Subcontract XK-2-0270-01*. Solar Energy Research Institute, Golden, Colorado, October 1982.

Thomas, W.H.; Seibert, D.L.R.; Alden, M.; Eldridge, P.; Neori, A.; Gaines, S. (1983b) "Selection of high-yielding microalgae from desert saline environments." *Aquatic Species Program Review: Proceedings of the March 1983 Principal Investigators' Meeting*, Solar Energy Research Institute, Golden, Colorado, SERI/CP-231-1946, pp. 97-122.

Thomas, W.H. (1983b) "Microalgae from desert saline waters as potential biomass producers." *Progress in Solar Energy* 6:143-145.



Thomas, W.H.; Seibert, D.L.R.; Alden, M.; Eldridge, P. (1984c) "Cultural requirements, yields, and light utilization efficiencies of some desert saline microalgae." *Aquatic Species Program Review: Proceedings of the April 1984 Principal Investigators' Meeting*, Solar Energy Research Institute, Golden, Colorado, SERI/CP-231-2341, pp. 7-63.

Thomas, W.H.; Tornabene, T.G.; Weissman, J. (1984d) "Screening for lipid yielding microalgae: Activities for 1983." *Final Subcontract Report*. Solar Energy Research Institute, Golden, Colorado, SERI/STR-231-2207.

Thomas, W.H.; Seibert, D.L.R.; Alden, M.; Eldridge, P. (1985) "Selection of desert saline microalgae for high yields at elevated temperatures and light intensities and in SERI Standard artificial media." *Aquatic Species Program Review: Proceedings of the March 1985 Principal Investigators' Meeting*, Solar Energy Research Institute, Golden, Colorado SERI/CP-231-2700, pp. 5-27.

Thomas, W.H.; Seibert, D.L.R.; Alden, M.; Eldridge, P. (1986) "Cultural requirements, yields and light utilization efficiencies of some desert saline microalgae." *Nova Hedwigia* 83:60-69.

#### **II.A.2.d. Screening and Characterizing Oleaginous Microalgal Species from the Southeastern United States**

**Subcontractor:** Alabama A&M University

**Principal Investigator:** Mahasin Tadros

**Period of Performance:** 1983 -

**Subcontract Number:** XK-3-03-50-1

The goal of this subcontract was to isolate and characterize strains of microalgae from the southeastern United States that have attributes desirable for a biodiesel production strain. During the first year of this work, field trips were made to several sites in Alabama to collect microalgal strains from a variety of habitats. Freshwater and brackish water strains were collected from rivers, lakes, estuaries, and ponds, and marine strains were collected from the waters surrounding Dauphin Island in the Gulf of Mexico. Collected samples were inoculated into various artificial media, including Bold's Basal Medium, Chu no. 10, and "f/2" (Barclay et al. 1986). Artificial sea salts were used in place of seawater for the saltwater media. For initial strain selection, the cultures were incubated at 29-30°C with shaking at a light intensity of 100 to 125  $\mu\text{E}\cdot\text{m}^{-2}\cdot\text{s}^{-1}$  provided by cool white fluorescent bulbs with a 14 h:10 h light:dark cycle. The fastest growing strains were isolated via micropipetting or by spreading samples on agar plates. In these preliminary experiments, the marine strains exhibiting the fastest growth were *Cyclotella* DI-35 (CYCLO1), *Hantzschia* DI-160 (NITZS2), and *Chlorococcum* DI-34. The freshwater strains exhibiting the fastest growth rates were *Chlorella* MB-31, *Scenedesmus* TR-84, *Ankistrodesmus* TR-87, and *Nitzschia* TR-114.





CYCLO1, *Nitzschia* TR-114, and *Scenedesmus* TR-84 were selected for more detailed growth analyses under various combinations of temperature, salinity, and light intensity. A temperature gradient table was employed for these experiments that was similar in design to the tables used by Dr. William Thomas (discussed earlier) and SERI researchers for screening purposes. Growth of standing cultures was determined by measuring final cell densities after 12 days of incubation. CYCLO1 achieved maximum cell density at a temperature of 30°C, a light intensity of 100  $\mu\text{E}\cdot\text{m}^{-2}\cdot\text{s}^{-1}$ , and a salinity of 15 ppt (parts per thousand). Growth was nearly as good at a light intensity of 200  $\mu\text{E}\cdot\text{m}^{-2}\cdot\text{s}^{-1}$  and a temperature of 35°C, and substantial growth occurred at a salinity of 32 ppt. Growth did not occur at 15° to 20°C. *Nitzschia* TR-114 achieved maximal cell density at 30°C, 15 ppt salinity, and 100  $\mu\text{E}\cdot\text{m}^{-2}\cdot\text{s}^{-1}$ ; growth was severely inhibited at 0 and 45 ppt salinity. Growth was similar at 100 and 200  $\mu\text{E}\cdot\text{m}^{-2}\cdot\text{s}^{-1}$  for this strain, although the higher light intensity seemed to increase the thermal tolerance of the cells. The freshwater strain *Scenedesmus* TR-84 grew best at 25°C, and grew increasingly slower as the salt concentration of the medium was increased.

The lipid contents of several strains isolated during the initial collecting trips were determined. For 14-day-old cultures that were reportedly N-limited (although no evidence is provided to support this), the lipid contents (as a percentage of the organic mass) were as follows: CYCLO1, 42.1%; *Nitzschia* TR-114, 28.1%; *Chlorella* MB-31, 28.6%-32.4%; *Scenedesmus* TR-84, 44.7%; *Ankistrodesmus* TR-87, 28.1%; and *Hantzschia* DI-160 (NITZS2), 66%.

Additional strains were collected the next year from intertidal waters near Biloxi, Mississippi and St. Joseph Bay, Florida. Preliminary screening experiments indicated that five strains (all of which were diatoms) had the best growth rates and lipid accumulation potential: *Navicula acceptata* (two strains, NAVIC6 and NAVIC8), *N. saprophila* (NAVIC7), *Nitzschia dissipata* (NITZS13), and *Amphiprora hyalina* (ENTOM3). These strains and CYCLO1 were grown semi-continuously in media with six different salinities at 25°, 30°, and 35°C. Cells were grown at light intensities of 80  $\mu\text{E}\cdot\text{m}^{-2}\cdot\text{s}^{-1}$  and 160  $\mu\text{E}\cdot\text{m}^{-2}\cdot\text{s}^{-1}$  (approximately 4% and 8% of full sunlight, respectively). The media were produced by adding various quantities of artificial sea salts to “f/2” medium; the resulting conductivities were <1, 10, 20, 35, 45, and 60  $\text{mmho}\cdot\text{cm}^{-1}$ . (Note: seawater is typically 35-45  $\text{mmho}\cdot\text{cm}^{-1}$ .) All strains exhibited more rapid growth under 160  $\mu\text{E}\cdot\text{m}^{-2}\cdot\text{s}^{-1}$  illumination than at 80  $\mu\text{E}\cdot\text{m}^{-2}\cdot\text{s}^{-1}$ ; and even higher growth rates might well have been obtained at light intensities greater than 160  $\mu\text{E}\cdot\text{m}^{-2}\cdot\text{s}^{-1}$ .

ENTOM3 grew best (2.0 to 2.3 doublings $\cdot\text{d}^{-1}$ ) at 30°C in media with conductivities of 20-60  $\text{mmho}\cdot\text{cm}^{-1}$ . Growth was better with urea or nitrate as the N source rather than with ammonium. The lipid content of nutrient-sufficient cells was 22.1% of the organic mass, and increased to 37.1% and 30.2% under Si-deficient and N-deficient conditions, respectively.

CYCLO1 achieved the highest growth rates (2.8 to 3.0 doublings $\cdot\text{d}^{-1}$ ) at 35°C between 10 and 35  $\text{mmho}\cdot\text{cm}^{-1}$ . Cells grew best with nitrate as a N source, followed by ammonium and then urea. The highest lipid content was observed in N-deficient cells (42.1%), but was also elevated in Si-deficient cells (38.6%) relative to nutrient-sufficient cells (13.2%).



NAVIC8 grew most rapidly ( $3.8 \text{ doublings} \cdot \text{d}^{-1}$ ) at  $35^\circ\text{C}$  and  $45 \text{ mmho} \cdot \text{cm}^{-1}$ . Nitrate and ammonium were more suitable N sources than urea. Lipid contents of 21.8%, 48.5%, and 32.4% were observed for cells grown under nutrient-sufficient, Si-deficient, and N-deficient conditions, respectively.

During the final year of this subcontract, additional promising strains were isolated. Included in this group was *Navicula* BB-324 (NAVIC9), which had a growth rate exceeding  $2.5 \text{ doublings} \cdot \text{d}^{-1}$  at  $30^\circ\text{C}$  in artificial seawater and SERI Types I/10, I/25, I/40, II/10, II/25, II/40, and II/55 media. *Navicula* SB-304 (NAVIC8) also exhibited excellent growth ( $1.5\text{-}3.0 \text{ doublings} \cdot \text{d}^{-1}$ ) in each medium. These two strains had Si starvation-induced lipid contents of 42.5% and 47.2%, respectively. Other notable strains were *Nitzschia* SB-307 (NITZS13), which had a maximal growth rate of  $2.5 \text{ doublings} \cdot \text{d}^{-1}$  and a lipid content of 45%-47% under nutrient-stressed conditions. *Amphiprora* BB-333 (ENTOM3), *Chaetoceros* BB-330 (CHAET66), and *Cylindrotheca* AB-204 also grew rapidly ( $2.3\text{-}6.0 \text{ doublings} \cdot \text{d}^{-1}$ ), with stress-induced lipid contents ranging from 16.5%-37.1%.

In conclusion, many promising strains were isolated as a result of this subcontract. The nutrient status of the cells again was played an important role in lipid accumulation. Furthermore, the nature of the N source included in the medium had a substantial impact on growth of the cultures. Several of these strains were further tested in outdoor mass culture, as described in Section III.

#### Publications:

Barclay, W.; Johansen, J.; Chelf, P.; Nagle, N.; Roessler, R.; Lemke, P. (1986) "Microalgae Culture Collection 1986-1987." Solar Energy Research Institute, Golden, Colorado, SERI/SP-232-3079, 147 pp.

Tadros, M.G. (1985) "Screening and characterizing oleaginous microalgal species from the southeastern United States." *Aquatic Species Program Review: Proceedings of the March 1985 Principal Investigators' Meeting*, Solar Energy Research Institute, Golden, Colorado, SERI/CP-231-2700, pp. 28-42.

Tadros, M.G. (1987a) "Screening and characterizing oleaginous microalgal species from the southeastern United States." *FY 1986 Aquatic Species Program Annual Report*, Solar Energy Research Institute, Golden, Colorado, SERI/SP-231-3071, pp. 67-89.

Tadros, M.G. (1987b) "Conclusion of the warm-water algae collection and screening efforts conducted in the southeastern United States." *FY 1987 Aquatic Species Program Annual Report*, Solar Energy Research Institute, SERI/SP-231-3206, pp. 58-74.

Tadros, M.G.; Johansen, J.R. (1988) "Physiological characterization of six lipid-producing diatoms from the southeastern United States." *J. Phycol.* 24:445-452.

**II.A.2.e. Collection of High Energy Strains of Saline Microalgae from Southwestern States**

**Subcontractor:** Arizona State University  
**Principal Investigator:** Milton Sommerfeld  
**Period of Performance:** 1985 - 1987  
**Subcontract Number:** N/A

The objectives of this subcontract were to collect microalgal strains from a variety of locations in the desert regions of the Southwestern United States and to screen them for their ability to grow under conditions in a commercial microalgal biodiesel facility. Studies were also conducted to optimize a fluorometric procedure for estimating cellular lipid content, and to use this method to screen some of the strains.

Collecting trips took place between April 1985 and June 1986. Water samples containing microalgae were collected from 125 sites in Arizona, California, Nevada, New Mexico, Texas, and Utah. Some samples were taken from saline surface waters in the regions of Arizona and New Mexico that were deemed suitable for microalgal mass culture, based in part on the availability of large quantities of saline groundwater (Lansford et al. 1987). Researchers believed that strains from these areas would be well adapted to the indigenous waters available for mass culture. These areas included the Palo Verde Irrigation District in Arizona, and the Pecos River Basin, the Crow Flats area, and the Tularosa Basin in New Mexico. The temperature, pH, specific conductance, and water depth were recorded at each collection site. Most of the waters sampled had a specific conductance exceeding  $2 \text{ mmho}\cdot\text{cm}^{-1}$ . Temperatures ranged from  $18^{\circ}\text{C}$  to  $45^{\circ}\text{C}$  (mean =  $26.9^{\circ}\text{C}$ ), pH ranged from 6.1 to 10.2 (mean = 8.0), and specific conductance ranged from  $0.45 \text{ mmho}\cdot\text{cm}^{-1}$  to  $474 \text{ mmho}\cdot\text{cm}^{-1}$  (mean =  $22.7 \text{ mmho}\cdot\text{cm}^{-1}$ ).

Planktonic algae were the primary type of alga collected, although neustonic and benthic forms were also collected when algal growth in such habitats was clearly visible. From these samples, more than 1,700 strains of microalgae were obtained. From these strains, approximately 700 unialgal cultures were established. Initial strain isolations were performed by streaking out samples onto 1.5% agar plates containing seawater, sterilized collection site water, or SERI Type I or Type II medium having a conductivity similar to that of the collection site water. In some cases, an enrichment step was performed before streaking out the cells, wherein the samples were placed in tubes on a rotary agitation wheel in liquid media at a light intensity of  $1500 \mu\text{E}\cdot\text{m}^{-2}\cdot\text{s}^{-1}$  (~75% of full sunlight) using a 12h:12h light:dark cycle.

Of the 700 unialgal cultures, 120 were identified taxonomically; 24 genera were represented in this group, including 60 chlorophytes, 40 diatoms, and 20 cyanophytes. The most common genera were *Dunaliella*, *Chlorococcum*, *Chlorosarcina*, *Amphora*, *Nitzschia*, *Navicula*, *Oscillatoria*, and *Chroococcus*. Initial screening typically involved visual assessment of growth at  $25^{\circ}\text{C}$  at  $200 \mu\text{E}\cdot\text{m}^{-2}\cdot\text{s}^{-1}$  in tubes containing SERI Type I/40 and Type II/40 media. Strains that grew the most rapidly were subjected to further characterization, including analysis of the effects



of temperature, salinity, light intensity, and N source on growth rates. Cultures were grown in several different media (SERI Types I and II media at various conductivities, and artificial seawater) at 30°C and 500  $\mu\text{E}\cdot\text{m}^{-2}\cdot\text{s}^{-1}$  using a 12h:12h light:dark cycle on a rotary screening apparatus. Thirty-one diatoms were tested under these conditions, and 11 exhibited growth rates exceeding one doubling $\cdot\text{d}^{-1}$ . The highest growth rate observed for a diatom under these conditions was 1.96 doublings $\cdot\text{d}^{-1}$  for *Amphora* ASU0308. Of the 50 chlorophyte species tested, 17 strains exhibited growth rates exceeding one doubling $\cdot\text{d}^{-1}$ ; the highest growth rate (2.58 doublings $\cdot\text{d}^{-1}$ ) was observed for a strain of *Dunaliella* (ASU0038). Of the strains that were tested for growth in all seven standard media, 80% of the cultures grew in the low salinity SERI Type I and Type II media and more than 50% of the strains grew in seawater. The highest growth rates were typically observed in SERI Type I/10 and Type II/10 media and seawater, although the mean growth rates of all strains combined at the highest salinities (70  $\text{mmho}\cdot\text{cm}^{-1}$ ) were 60% to 80% of the mean growth rates obtained at the lower salinities. Most of the strains were isolated from waters with specific conductances below 40  $\text{mmho}\cdot\text{cm}^{-1}$ , which may explain the lower growth rates in the media having higher salinities. A few strains, however, grew quite well in the higher salinity media. *Amphora* ASU0032 (AMPHO27), *Synechococcus* ASU0071 (CHLOC5), also referred to by the subcontractor as *Chroococcus*, and *Navicula* ASU0267 were the only strains that had a growth rate that exceeded one doubling $\cdot\text{d}^{-1}$  in Type II/70 medium. Certain strains had high growth rates in both Type I/70 and Type II/70 media; included in this group were the strains mentioned earlier along with *Synechococcus* ASU0075 (CHROC2) and *Dunaliella* ASU0038. Some strains were clearly euryhaline (i.e., able to tolerate a wide range of salinities), and could grow in all media tested (e.g., CHLOC5 had a growth rate that exceeded one doubling $\cdot\text{d}^{-1}$  in each of the seven media tested). Other strains were stenohaline, and grew much better at one particular salinity. Certain strains showed no real preference for SERI Type I versus SERI Type II medium, despite the very different ionic composition of these media types. Other strains exhibited a clear preference for one media type over the other (e.g., *Dunaliella* ASU0038 grew much better in SERI Type I medium or seawater than in SERI Type II medium). Twenty-eight of the strains tested had growth rates exceeding one doubling $\cdot\text{d}^{-1}$  in at least one media type, three strains had growth rates that exceeded two doublings $\cdot\text{d}^{-1}$ , and one strain (either *Eremosphaera* or *Chlorococcum* ASU0132 [CHLOC6] or ASU0048 [CHLOC4]) had a growth rate higher than three doublings $\cdot\text{d}^{-1}$ .

The proximate chemical compositions of 11 isolates were also determined in this study. Total lipid was determined by the Bligh-Dyer procedure (Bligh and Dyer 1959). Protein was determined by the heated biuret-Folin assay, and total carbohydrate was estimated by the phenol-sulfuric acid method (see Sommerfeld et al. [1987b] for details). Of the newly isolated strains tested, *Franceia* ASU0146 (FRANC1) had the highest lipid content under normal growth conditions (26.5% of the AFDW). The strains were not evaluated under nutrient-deficient conditions, which often increases the lipid content of microalgae. Because analyzing the lipid content of all the strains that had been isolated by this type of procedure would be very difficult, the strains were examined by the use of lipophilic dyes. The dyes Nile Blue A, Sudan Black B, Oil Red O, and Nile Red were used in conjunction with fluorescence microscopy to check for oil droplets within the cells. Inconsistent results were obtained when using the first three stains, but Nile Red appeared to give more reliable results. The stained cells were visually scored for the



presence of fluorescing lipid droplets. Additional work was carried out to develop a Nile Red staining procedure that could (in theory) provide a quantitative measure of lipid content by the use of a fluorometer. This latter work was discussed in Section II.A.1. along with the results of similar efforts carried out by SERI researchers and other subcontractors.

This subcontract was somewhat unusual in that many of the strains were collected from the actual areas in which the commercial microalgal biodiesel facilities could be. As a consequence, many of the strains that were isolated had characteristics that could make them good candidates for production strains. Additional results from this subcontract are presented in Section II.A.1.

#### Publications:

Sommerfeld, M.R.; Ellingson, S.B. (1987a) "Collection of high energy yielding strains of saline microalgae from southwestern states." *FY 1986 Aquatic Species Program Annual Report*, Solar Energy Research Institute, Golden, Colorado, SERI/SP-231-3071, pp. 53-66.

Sommerfeld, M.; Ellingson, S.; Tyler, P. (1987b) "Screening microalgae isolated from the southwest for growth potential and lipid yield." *FY 1987 Aquatic Species Program Annual Report*, Solar Energy Research Institute, Golden, Colorado, SERI/SP-231-3206, pp. 43-57.

#### Additional References:

Lansford, R.R.; Hernandez, J.W.; Enis, P.J. (1987) "Evaluation of available saline water resources in New Mexico for the production of micoralgae." *FY 1986 Aquatic Species Program Annual Report*, Solar Energy Research Institute, Golden, Colorado, SERI/SP-231-3071, pp. 227-248.

#### II.A.2.f. Collection of High Energy Yielding Strains of Saline Microalgae from the Hawaiian Islands

**Subcontractor:** Hawaii Institute of Marine Biology

**Principal Investigator:** Richard H. York, Jr.

**Period of Performance:** 1985

**Subcontract Number:** N/A

Microalgae were collected from a variety of sites in the Hawaiian islands, including ocean sites and inland saline habitats. The conductivity, dissolved oxygen content, pH, and temperature of each site was recorded. Individual cells were isolated via micropipetting and placed into glass tubes or fluorohalocarbon plastic bags containing either the original sample water, offshore seawater, SERI Type I medium, or SERI Type II medium. The plastic bags, which transmit the full visible solar spectrum, were placed in full sunlight without temperature control. This treatment was therefore believed to provide a good selection for strains that would be able to thrive under outdoor mass culture conditions. The glass tubes were incubated at 25°-26°C at 40  $\mu\text{E}\cdot\text{m}^{-2}\cdot\text{s}^{-1}$  under a 16h:8h light:dark regime; these conditions were less stressful than the outdoor



conditions, and therefore led to the recovery of less hardy strains. A large-scale outdoor enrichment culture was also prepared by pumping 1700 L of enriched seawater into a 5.5 m diameter open tank, then strains arising in this culture were isolated.

As a result of these procedures, 100 of the most rapidly growing strains were selected and maintained for further analysis. This group included members of the Chlorophyceae, Cyanophyceae, Bacillariophyceae, and Pyrrophyceae. Two strains, *Chaetoceros* SH 9-1 (CHAET38) and *Cyclotella* 14-89 (THALA6), were grown in outdoor cultures consisting of cells in 1-L fluorohalocarbon plastic bags. The highest growth rates measured for these strains were 2.12 doublings $\cdot$ d<sup>-1</sup> for CHAET38 and 1.43 doublings $\cdot$ d<sup>-1</sup> for THALA6. These growth rates were reported to correspond to 31 and 33 g dry weight $\cdot$ m<sup>-2</sup> $\cdot$ d<sup>-1</sup>, respectively, although how these values were derived is not clear.

#### Publications:

York, Jr., R.H. (1987) "Collection of high energy yielding strains of saline microalgae from the Hawaiian Islands." *FY 1986 Aquatic Species Program Annual Report*, Solar Energy Research Institute, Golden, Colorado, SERI/SP-231-3071, pp. 90-104.

#### II.A.2.g. Characterization of Hydrocarbon Producing Strains of Microalgae

**Subcontractor:** Scripps Institution of Oceanography  
**Principal Investigator:** Ralph A. Lewin  
**Period of Performance:** 1985 - 1986  
**Subcontract Number:** N/A

This subcontract focused on the collection and characterization of picoplanktonic algae, which are defined as algae (including the prokaryotic cyanophytes) that are very small (1-5  $\mu$ m) and that live on the surface of the water. In February 1985, water samples were taken from various sites in the Caribbean Sea, including sites near the U.S. Virgin Islands (St. John, St. Thomas, and St. Croix), Tortola, Puerto Rico, Curaçao, Panama, and the Florida Keys. 130 samples (250 mL each) were collected and filtered through a 3-8- $\mu$ m filter to remove larger cells. Smaller cells were collected on a 0.45  $\mu$ m nitrocellulose filter, which was rolled up and placed in the original sampling water that had passed through the filter. These samples were placed under natural lighting at 20°C to 25°C until transported to the laboratory. The filters were then transferred into a tube of sterile enriched seawater (containing additional N and other nutrients) and incubated at 25°C under continuous illumination from a fluorescent lamp at 30  $\mu$ E $\cdot$ m<sup>-2</sup> $\cdot$ s<sup>-1</sup>. In an attempt to stimulate lipid accumulation via nutrient deficiency, a portion of each culture was transferred after 4 weeks of growth to a fresh tube of unenriched seawater and then allowed to grow under the same conditions. After 4 more weeks, a film of cells was often observed floating on the surface of the cultures. Small samples of these cells were transferred to fresh enriched seawater. After incubation for an additional 2 weeks, the cells in these cultures were microscopically examined, and cultures that were dominated by diatoms, cyanophytes, and flagellates were



discarded, leaving approximately 60 cultures of small (1-5- $\mu\text{m}$ ) green cells. Unialgal cultures were established from these cells by isolating colonies on agar plates. Of these purified cultures, there were 14 isolates of *Stichococcus*, 21 isolates of *Nannochloris*, four strains of *Chlorella*, and several representatives of other genera. *Stichococcus*, *Nannochloris*, and *Chlorella* are all chlorophytes. Because cyanophytes typically do not accumulate lipids, they were eliminated from further study in this subcontract. The researchers anticipated that isolating strains in this manner would enrich for lipid-accumulating microalgae.

The isolated strains were tested for the ability to grow in freshwater; all the *Stichococcus* and *Chlorella* strains grew well in freshwater, suggesting perhaps a brackish water origin for these strains. Only six of the 21 *Nannochloris* strains could grow on non-marine media.

To quantitatively determine lipid content in the isolated strains, 1-L cultures were grown for 3 weeks in enriched seawater under continuous illumination at  $30 \mu\text{E}\cdot\text{m}^{-2}\cdot\text{s}^{-1}$ . The cultures were bubbled with 0.5%  $\text{CO}_2$  in air. Cells were harvested, frozen and lyophilized, and then extracted three times with a chloroform/methanol mixture (2:1 v/v). After the solvents evaporated, the lipid mass was determined gravimetrically and normalized to the cellular AFDW. The 13 *Stichococcus* strains had lipid contents ranging from 9% to 59% of the AFDW, with an average of 33%. The lipid contents of the 21 *Nannochloris* strains ranged from 6% to 63%, with an average of 31%. Data were not presented for the lipid contents of the four *Chlorella* strains, although three strains of the eustigmatophyte *Nannochloropsis* that were isolated from Qingdao, China were examined; for this genus, the lipid content ranged from 31% to 68%, with an average of 46%. These reported lipid contents may be slight overestimates, in that there was apparently no attempt to remove somewhat polar materials that may have also been extracted via the use of an aqueous washing step.

Some preliminary experiments were also conducted during the course of this subcontract regarding the growth of the eustigmatophyte *Nannochloropsis* (strain Nanno-Q, one of the Qingdao strains). This strain is euryhaline, and is able to grow in seawater as well as brackish water with one-tenth the salinity of seawater. The cells grew to a higher final yield with nitrate as the N source than with ammonium, and the lipid content rose substantially when the N source was initially supplied at levels below  $200 \mu\text{M}$  (as determined by the percentage of cells that were floating due to elevated lipid levels). A number of *Nannochloropsis* strains that had been obtained primarily from the Culture Collection of Marine Phytoplankton at Bigelow Laboratory (West Boothbay Harbor, Maine) were analyzed with respect to maximum cell yields after 4 weeks of growth at different temperatures. Most of the strains had temperature optima at or below  $25^\circ\text{C}$ , although one strain that had been collected near Long Island, New York had a temperature optimum of  $33^\circ\text{C}$ .

This subcontract examined a group of microalgae that had not received much attention in the ASP until that point. The small size of picoplanktonic algae could hinder harvesting efficiency in a mass culture facility, which would have a negative impact on the economics of biodiesel production. However, if the cells could be made to consistently float due to high lipid levels, this



property might facilitate harvesting. Outdoor testing of the most promising strains would help to evaluate this group of microalgae.

#### Publications:

Lewin, R.A. (1985) "Production of hydrocarbons by micro-algae; isolation and characterization of new and potentially useful algal strains." *Aquatic Species Program Review: Proceedings of the March 1985 Principal Investigators' Meeting*, Solar Energy Research Institute, Golden, Colorado, SERI/CP-231-2700, pp. 43-51.

Lewin, R.A.; Burrascano, C; Cheng, L. (1987) "Some picoplankton algae from the Caribbean region." *FY 1986 Aquatic Species Program Annual Report*, Solar Energy Research Institute, Golden, Colorado, SERI/SP-231-3071, pp. 105-121.

#### II.A.2.h. Collection of High Energy Yielding Strains of Saline Microalgae from South Florida

**Subcontractor:** Harbor Branch Foundation

**Principal Investigator:** John H. Ryther

**Period of Performance:** 1985 - 1986

**Subcontract Number:** N/A

The goal of the work performed under this subcontract was to collect and screen microalgal species from southern Florida. It emphasized collecting chromophytic algae (e.g., diatoms, chrysophytes, and prymnesiophytes), because this group of algae was known to often accumulate lipids. Collection trips were made in June and September 1985, and in February 1986 to the Florida Keys and the Everglades. Samples were taken from 123 sites, including various mangrove swamps, salt flats, canals, ditches, and shallow ponds. The basic physicochemical characteristics of the collection site waters were determined. The mean temperature was 29°-30°C both for sites in the Florida Keys and the Everglades. The mean conductivity of the water from the Keys (35.6 mmho•cm<sup>-1</sup>) was somewhat higher than that of the Everglades (25.7 mmho•cm<sup>-1</sup>), whereas the pH values were similar (~8). To select for the fastest growing microalgal strains in the water samples, the original samples were enriched with nitrate, trace metals, and vitamins, and incubated under continuous light (880 μE•m<sup>-2</sup>•s<sup>-1</sup>, or 45% of full sunlight) at 30°C. The strains that became dominant in the cultures were isolated into unialgal cultures via micropipetting, serial dilution, and spreading onto agar plates. As a consequence of these experiments, 61 unialgal cultures were produced.

Preliminary evaluation of the growth of these strains in various media was performed in test tubes containing enriched seawater, SERI Type I/25, Type I/40, Type II/25, and Type II/40 media. The test tubes were incubated at 30°C under constant illumination at 300 μE•m<sup>-2</sup>•s<sup>-1</sup>. Growth rates were determined by measuring the OD<sub>750</sub> every day for 5 days, and the final culture density was measured after 10 days. One hundred ten strains (including some strains already in





the Harbor Branch algal collection) were screened in this manner. In general, the strains that were newly isolated under the selection scheme outlined above grew more rapidly than the culture collection strains. Members of the Prymnesiophyceae, particularly coccolithophorids and ochromonads, tended to grow well in most media types, but the dinoflagellates isolated via these procedures did not grow well in the SERI standard media. Most species grew better in Type II medium than in Type I medium, although there were certainly exceptions to this. The highest growth rate ( $3.26 \text{ doublings} \cdot \text{d}^{-1}$ ) was observed with a strain of *Hymenomonas* HB152 (HYMEN3) in Type II/25 medium. Seven strains had growth rates that exceeded  $2 \text{ doublings} \cdot \text{d}^{-1}$  in at least one media type; included in this group were *Dunaliella* HB37 (DUNAL2), *Nannochloris* HB44 (NANNO2), a yellow green unicell HB54 (UNKNO4), *Chlorella* HB82 (CHLOR7) and HB87, *Pyramimonas* HB133 (PYRAM2), and HYMEN3. Nine strains had growth rates of at least one doubling  $\cdot \text{d}^{-1}$  in all five media (including *Chlorella* HB84 (CHLOR8) and HB97 (CHLOR9), *Nannochloris* HB85 (NANO3), and all the strains mentioned earlier in this paragraph except for HYMEN3).

Several of the most promising strains were examined in more detail; they were grown in a matrix of five different salinities ( $8\text{-}60 \text{ mmho} \cdot \text{cm}^{-1}$ ) at five different temperatures ( $15^{\circ}\text{-}35^{\circ}\text{C}$ ) by the use of a temperature-salinity gradient table, as described in previous sections. An artificial seawater medium (ASP-2) diluted with varying amounts of distilled water was used for these experiments. The cultures were exposed to constant illumination at  $180 \mu\text{E} \cdot \text{m}^{-2} \cdot \text{s}^{-1}$ . Each of the four strains tested (*Tetraselmis* HB47 [TETRA4], PYRAM2, UNKNO4, and an olive green unicell HB154 [UNKNO5]) exhibited excellent growth over a wide range of conditions. All these strains had a growth rate greater than one doubling  $\cdot \text{d}^{-1}$  between  $8$  and  $60 \text{ mmho} \cdot \text{cm}^{-1}$  and between  $20^{\circ}$  and  $35^{\circ}\text{C}$ . UNKNO4 had growth rates higher than  $1.5 \text{ doublings} \cdot \text{d}^{-1}$  between  $15$  and  $60 \text{ mmho} \cdot \text{cm}^{-1}$  and between  $20^{\circ}$  and  $35^{\circ}\text{C}$ .

A visual assessment of the lipid contents of the most rapidly growing strains was conducted by staining the cells with Nile Red, the stained cells were examined using fluorescence microscopy.

Based on this assessment (which was not carried out with nutrient-starved cells), TETRA5 and UNKNO4 had the highest estimated lipid contents. TETRA4, HYMEN2, PYRAM2, and UNKNO5 also appeared to accumulate substantial quantities of lipid.

#### Publications:

Rhyther, J.H.; Carlson, R.D.; Pendoley, P.D.; Jensen, P.R. (1987) "Collection and characterization of saline microalgae from South Florida." *FY 1986 Aquatic Species Program Annual Report*, Solar Energy Research Institute, Golden, Colorado, SERI/SP-231-3071, pp. 122-136.



**II.A.2.i. Collection and Selection of High Energy Thermophilic Strains of Microalgae**

**Subcontractor:** Montana State University

**Principal Investigator:** Keith E. Cooksey

**Period of Performance:** 3/86 - 4/87

**Subcontract Number:** XK-4-04136-04

The goal of this research was to develop a technique for rapidly screening microalgae for high lipid content, and to use this method to select microalgae with potential for liquid fuel production. Dr. Cooksey's laboratory initiated the development of the Nile Red lipid staining procedure, which is fully described in Section II.A.1.f. The Nile Red staining procedure was used to screen for high lipid strains of microalgae, first using cultures collected mainly from Florida and maintained at Montana State University, and in cultures containing diatoms freshly isolated from hot springs in Yellowstone National Park. Because algae to be used in outdoor mass culture in the desert southwest would be subject to high temperatures, the Florida strains, isolated at 28°C, were first tested for growth and lipid production at 35°C. Although some strains produced fairly high levels of lipid, most grew poorly. Some diatom strains were then isolated from the hot springs, based on the premise that they would be more likely to tolerate extremes of temperature and pH variation. In these cultures, Nile Red was used to screen the initial sample for lipid-producing strains. These cells were then cultured, made unialgal and axenic, and tested for growth rate and lipid production. The strains tested showed growth rates of 0.5 to 2 doublings/d and lipid contents of 9%-54%, similar to the properties of oil-producing algae isolated by other methods.

**Publications:**

Berglund, D.; Cooksey, B.; Cooksey, K.E.; Priscu, L.R. (1987) "Collection and screening of microalgae for lipid production: Possible use of a flow cytometer for lipid analysis." *FY 1986 Aquatic Species Program Annual Report*, Solar Energy Research Institute, Golden, Colorado, SERI/SP-231-3071, pp. 41-52.

Cooksey, K.E. (1987) "Collection and screening of microalgae for lipid production." *Final Subcontract Report to the Solar Energy Research Institute*, Solar Energy Research Institute, Golden, Colorado, May 1987, 42 pp.

Cooksey, K.E.; Guckert, J.B.; Williams, S.A.; Collis, P.R. (1987) "Fluorometric determination of the neutral lipid content of microalgal cells using Nile Red," *Journal of Microbiological Methods* 6:333-345.



### **II.A.3. The SERI Microalgae Culture Collection**

#### **II.A.3.a. History of SERI Microalgae Culture Collection**

The SERI Microalgae Culture Collection was first established in 1984 by Dr. Bill Barclay to provide a central repository for strains that were believed to have potential as biomass fuel production organisms. The intent was to provide documented and partially characterized microalgal strains to researchers interested in conducting biofuels research or in developing algal mass culture technologies. The publicly available collection was described in a series of Culture Collection Catalogs published between 1984 and 1987. It was initially limited to strains that had been characterized quite extensively with respect to growth properties and chemical composition, and that were believed to hold the most promise. These catalogs contain a wealth of information for many of these strains, often including photomicrographs, proximate chemical compositions, lipid contents of cells grown under various environmental conditions, growth characteristics in different media types and different temperatures, and the results of small-scale outdoor production pond trials. Furthermore, media compositions are provided in these catalogs.

The original 1984-1985 Microalgae Culture Collection Catalog listed the following criteria for selection of strains to be placed in the cataloged public collection (in descending order of importance):

- Energy yield (growth rate x energy content)
- Type of fuel products available from biomass (hydrocarbon, diesel, alcohol, methanol)
- Environmental tolerance range (temperature, salinity, pH)
- Performance in mass culture (highly competitive, predator resistant)
- Media supplementation requirements (addition of vitamins, trace minerals)
- Amount of culture and composition data available on the clone or strain
- Budget for the culture collection

Although conceptually sound, these criteria carried with them the requirement to characterize the strains fairly extensively before a decision could be made as to whether they should be included in the collection. This detailed characterization became increasingly difficult as the number of strains available increased. As a consequence, many strains were maintained that were not officially documented in the catalogs.

From the inception of the culture collection until the late 1980s, strains in the collection were provided free of charge to anyone who requested them, with the hope that the research conducted (and published) using these strains would increase the overall understanding of these organisms.



Many laboratories took advantage of this. In the first year after the publication of the SERI Microalgae Culture Collection Catalog, more than 100 cultures were shipped to various groups studying biofuels production, natural product discovery, aquaculture, and the general physiology, biochemistry, and molecular biology of microalgae. In the ensuing years, hundreds of additional cultures were provided to researchers free of charge. Then, in the early 1990s, concerns were raised by the SERI Legal Department that the cultures should be considered as valuable intellectual property, and a moratorium was placed on providing cultures to outside parties; this moratorium persisted until the ASP were eliminated in late 1995.

The SERI Microalgae Culture Collection consists almost exclusively of eukaryotic, single-celled microalgae. Included in the collection are members of several algal classes, with a predominance of chlorophytes (green algae) and diatoms. These two groups tended to dominate under the high temperature/high light screening and selection regimes used to identify good production strain candidates. Of the strains present in the final culture catalog produced (published in 1987, including an addendum), 26% were chlorophytes, 60% were diatoms, 8% were chrysophytes, and 6% were eustigmatophytes. The following pages list the strains described in each of the three culture collection catalogs published during the course of the ASP.

The first culture collection catalog (1984-1985) listed 11 strains, which included five chlorophytes, four diatoms, one chrysophyte, and one eustigmatophyte. Some of these strains were obtained from other culture collections, including the University of Texas algal culture collection. The strains listed in the original 1984-1985 catalog were as follows:

**Table II.A.6. Microalgal strains listed in the first SERI Culture Collection Catalog, 1984-1985.**

Species	Original SERI Strain Designation	Final SERI Strain Designation	Strain Alias	Collector
<i>Ankistrodesmus falcatus</i>	S/ANKIS-1	ANKIS1	Pyramid Lake 91-	W. Thomas
<i>Botryococcus braunii</i>	S/BOTRY-1	BOTRY1	UTEX #572	---
<i>Chaetoceros gracilis</i>	S/CHAET-1	CHAET1	CHGRA	R. York
<i>Chlorella</i> sp.	S/CHLOR-1	CHLOR1	S01	S. Lien
<i>Isochrysis galbana</i>	S/ISOCH-1	ISOCH1	Tahitian T-ISO	J.-L.
<i>Nannochloropsis salina</i>	S/NANNO-1	NANNP1	GSBSTICHO	J. Rhyther
<i>Nitzschia</i> sp.	S/NITZS-1	NITZS1	Mono Lake	D.
<i>Oocystis pusilla</i>	S/OOCYS-1	OOCYS1	Walker Lake	W. Thomas
<i>Phaeodactylum</i>	S/PHAEO-1	PHAEO1	TFX-1	---
<i>Phaeodactylum</i>	S/PHAEO-2	PHAEO2	BB	W. Thomas
<i>Platymonas</i> sp. (later <i>Tetraselmis suecica</i> )	S/PLATY-1	TETRA1	---	E. Laws



The next edition of the SERI Microalgae Culture Collection Catalog (1985-1986) included the following additional strains:

**Table II.A.7. Microalgal strains added to the SERI Culture Collection Catalog, 1985-1986.**

Species	Original SERI Strain Designation	Final SERI Strain Designation	Strain Alias	Collector
<i>Amphora coffeiformis</i>	S/AMPHO-1	AMPHO1	---	W. Barclay
<i>Boekelovia hooglandii</i>	S/BOEKE-1	BOEKE1	---	W. Barclay
<i>Chaetoceros</i> sp.	S/CHAET-2	CHAET14	SS-14	W. Thomas
<i>Chlorella ellipsoidea</i>	S/CHLOR-2	CHLOR2	BL-6	W. Thomas
<i>Chlorella</i> sp.	S/CHLOR-3	CHLOR3	SC-2	W. Thomas
<i>Cyclotella cryptica</i>	S/CYCLO-1	CYCLO1	DI-35	M. Tadros
<i>Monoraphidium</i> sp.	S/MONOR-1	MONOR1	Mom's Ranch	W. Barclay
<i>Monoraphidium</i> sp.	S/MONOR-2	MONOR2	---	W. Barclay
<i>Nannochloropsis</i> sp.	S/NANNO-2	NANNP2	Nanno-Q	R. Lewin
<i>Nitzschia dissipata</i>	S/NITZS-2	NITZS2	DI-160	M. Tadros

The 1986-1987 SERI Microalgae Culture Collection Catalog (including an addendum) added 29 more strains, bringing the total number of strains in the collection to 50. The 1986-1987 catalog included the following additional strains:

**Table II.A.8. Microalgal strains added to the SERI Culture Collection Catalog, 1986-1987.**

Species	Final SERI Strain Designation	Strain Alias	Collector
<i>Amphiprora hyalina</i>	ENTOM3	BB-333	M. Tadros
<i>Amphora</i> sp.	AMPHO27	MLS-1, ASU 0032	M. Sommerfeld
<i>Amphora</i> sp.	AMPHO28	GR-2, ASU 3001	M. Sommerfeld
<i>Chaetoceros muelleri</i>	CHAET6	NM-6	W. Barclay
<i>Chaetoceros muelleri</i>	CHAET9	UT-147	S. Rushforth
<i>Chaetoceros muelleri</i>	CHAET10	S/CHAET-4, UT-27	S. Rushforth



<i>Chaetoceros muelleri</i>	CHAET15	49-1A	W. Thomas
<i>Chaetoceros muelleri</i>	CHAET38	SH9-1	R. York
<i>Chaetoceros muelleri</i>	CHAET58	---	J. Johansen
<i>Chaetoceros muelleri</i>	CHAET61	---	S. Rushforth
<i>Chaetoceros muelleri</i>	CHAET63	---	S. Rushforth
<i>Cyclotella cryptica</i>	CYCLO2	F-1	P. Roessler
<i>Cyclotella cryptica</i>	CYCLO4	UT-65	W. Barclay
<i>Ellipsoidon</i> sp.	ELLIP1	70-01	R. Lewin
<i>Franceia</i> sp.	FRANC1	LCC-1, ASU 0146	M. Sommerfeld
<i>Nannochloris</i> sp.	NANNO2	HB44	R. Carlson
<i>Nannochloris</i> sp.	NANNO12	120-01	R. Lewin
<i>Navicula saprophila</i>	NAVIC1	F-2	P. Roessler
<i>Navicula acceptata</i>	NAVIC6	SB-264	M. Tadros
<i>Navicula</i> sp.	NAVIC7	BB 260	M. Tadros
<i>Navicula acceptata</i>	NAVIC8	SB-304	M. Tadros
<i>Navicula saprophila</i>	NAVIC24	---	J. Johansen
<i>Nitzschia dissipata</i>	NITZS13	SB-307	M. Tadros
<i>Nitzschia communis</i>	NITZS28	---	J. Johansen
<i>Pleurochrysis carterae</i>	PLEUR1	---	W. Barclay
<i>Tetraselmis</i> sp.	TETRA4	HB47	R. Carlson
<i>Thalassiosira weissflogii</i>	THALA2	CO-F15	W. Barclay
<i>Thalassiosira weissflogii</i>	THALA6	SH14-89	R. York
Unidentified Prasinophyte	GREEN3	---	J. Johansen



### II.A.3.b. Current status of the SERI/NREL Microalgae Culture Collection

Of the strains included in the most recent Culture Collection Catalog (the 1986-1987 edition, including the addendum), 37 are still viable. In addition, approximately 260 additional strains are part of the collection, but were never characterized well enough to be included in the catalog. All of these strains are in the process of being transferred to the University of Hawaii, where they will be maintained within the Center for Marine Biotechnology. The university intends to again make these strains available to the research community. A complete list of the strains still being maintained is included below:

**Table II.A.9. Current list of microalgal strains in the SERI Culture Collection**

Strain	Species	Class
ACHNA1	<i>Achnanthes orientalis</i>	Bacillariophyceae
ACHNA2	<i>Achnanthes orientalis</i>	Bacillariophyceae
AMPHO1	<i>Amphora coffeiformis</i>	Bacillariophyceae
AMPHO2	<i>Amphora coffeiformis</i>	Bacillariophyceae
AMPHO3	<i>Amphora coffeiformis</i>	Bacillariophyceae
AMPHO5	<i>Amphora coffeiformis</i>	Bacillariophyceae
AMPHO6	<i>Amphora coffeiformis</i>	Bacillariophyceae
AMPHO7	<i>Amphora delicatissima capitata</i>	Bacillariophyceae
AMPHO8	<i>Amphora coffeiformis punctata</i>	Bacillariophyceae
AMPHO10	<i>Amphora delicatissima</i>	Bacillariophyceae
AMPHO11	<i>Amphora coffeiformis</i>	Bacillariophyceae
AMPHO12	<i>Amphora coffeiformis punctata</i>	Bacillariophyceae
AMPHO13	<i>Amphora coffeiformis punctata</i>	Bacillariophyceae
AMPHO14	<i>Amphora coffeiformis</i>	Bacillariophyceae
AMPHO18	<i>Amphora coffeiformis</i>	Bacillariophyceae
AMPHO21	<i>Amphora coffeiformis linea</i>	Bacillariophyceae
AMPHO22	<i>Amphora coffeiformis</i>	Bacillariophyceae
AMPHO23	<i>Amphora delicatissima</i>	Bacillariophyceae
AMPHO24	<i>Amphora coffeiformis</i>	Bacillariophyceae
AMPHO25	<i>Amphora</i> sp.	Bacillariophyceae
AMPHO26	<i>Amphora coffeiformis tenuis</i>	Bacillariophyceae
AMPHO28	<i>Amphora coffeiformis</i>	Bacillariophyceae
AMPHO29	<i>Amphora coffeiformis</i>	Bacillariophyceae
AMPHO30	<i>Amphora coffeiformis</i>	Bacillariophyceae



Strain	Species	Class
AMPHO31	<i>Amphora coffeiformis</i>	Bacillariophyceae
AMPHO32	<i>Amphora coffeiformis</i>	Bacillariophyceae
AMPHO33	<i>Amphora delicatissima</i>	Bacillariophyceae
AMPHO34	<i>Amphora coffeiformis</i>	Bacillariophyceae
AMPHO35	<i>Amphora coffeiformis taylora</i>	Bacillariophyceae
AMPHO36	<i>Amphora coffeiformis taylora</i>	Bacillariophyceae
AMPHO37	<i>Amphora coffeiformis linea</i>	Bacillariophyceae
AMPHO38	<i>Amphora delicatissima</i>	Bacillariophyceae
AMPHO40	<i>Amphora delicatissima</i>	Bacillariophyceae
AMPHO46	<i>Amphora</i> sp.	Bacillariophyceae
ANKIS1	<i>Ankistrodesmus falcatus</i>	Chlorophyceae
BOROD2	<i>Borodinella</i> sp.	Chlorophyceae
BOTRY1	<i>Botryococcus braunii</i>	Chlorophyceae
CARB	---	---
CHAET1	<i>Chaetoceros muelleri</i>	Bacillariophyceae
CHAET3	<i>Chaetoceros gracilis</i>	Bacillariophyceae
CHAET5	<i>Chaetoceros muelleri</i>	Bacillariophyceae
CHAET6	<i>Chaetoceros muelleri</i>	Bacillariophyceae
CHAET7	<i>Chaetoceros muelleri</i>	Bacillariophyceae
CHAET9	<i>Chaetoceros muelleri</i>	Bacillariophyceae
CHAET10	<i>Chaetoceros muelleri</i>	Bacillariophyceae
CHAET11	<i>Chaetoceros muelleri</i>	Bacillariophyceae
CHAET14	<i>Chaetoceros muelleri</i>	Bacillariophyceae
CHAET15	<i>Chaetoceros muelleri</i>	Bacillariophyceae
CHAET17	<i>Chaetoceros muelleri</i>	Bacillariophyceae
CHAET18	<i>Chaetoceros muelleri</i>	Bacillariophyceae
CHAET19	<i>Chaetoceros muelleri</i>	Bacillariophyceae
CHAET20	<i>Chaetoceros muelleri</i>	Bacillariophyceae
CHAET21	<i>Chaetoceros muelleri</i>	Bacillariophyceae
CHAET22	<i>Chaetoceros muelleri</i>	Bacillariophyceae
CHAET23	<i>Chaetoceros muelleri</i>	Bacillariophyceae
CHAET24	<i>Chaetoceros muelleri</i>	Bacillariophyceae
CHAET30	<i>Chaetoceros</i> sp.	Bacillariophyceae
CHAET39	<i>Chaetoceros muelleri</i>	Bacillariophyceae





Strain	Species	Class
CHAET40	<i>Chaetoceros muelleri</i>	Bacillariophyceae
CHAET41	<i>Chaetoceros muelleri</i>	Bacillariophyceae
CHAET43	<i>Chaetoceros muelleri</i>	Bacillariophyceae
CHAET44	<i>Chaetoceros muelleri</i>	Bacillariophyceae
CHAET45	<i>Chaetoceros muelleri</i>	Bacillariophyceae
CHAET46	<i>Chaetoceros muelleri</i>	Bacillariophyceae
CHAET47	<i>Chaetoceros muelleri</i>	Bacillariophyceae
CHAET48	<i>Chaetoceros muelleri</i>	Bacillariophyceae
CHAET50	<i>Chaetoceros muelleri</i>	Bacillariophyceae
CHAET51	<i>Chaetoceros muelleri</i>	Bacillariophyceae
CHAET54	<i>Chaetoceros muelleri subsalsum</i>	Bacillariophyceae
CHAET55	<i>Chaetoceros muelleri subsalsum</i>	Bacillariophyceae
CHAET57	<i>Chaetoceros muelleri-trans</i>	Bacillariophyceae
CHAET58	<i>Chaetoceros muelleri muelleri</i>	Bacillariophyceae
CHAET59	<i>Chaetoceros muelleri subsalsum</i>	Bacillariophyceae
CHAET60	<i>Chaetoceros muelleri subsalsum</i>	Bacillariophyceae
CHAET62	<i>Chaetoceros muelleri subsalsum</i>	Bacillariophyceae
CHAET64	<i>Chaetoceros muelleri subsalsum</i>	Bacillariophyceae
CHAET66	<i>Chaetoceros muelleri</i>	Bacillariophyceae
CHAET67	<i>Chaetoceros</i> sp.	Bacillariophyceae
CHAET68	<i>Chaetoceros</i> sp.	Bacillariophyceae
CHAET69	<i>Chaetoceros</i> sp.	Bacillariophyceae
CHAET73	<i>Chaetoceros</i> sp.	Bacillariophyceae
CHAET75	<i>Chaetoceros</i> sp.	Bacillariophyceae
CHAET76	<i>Chaetoceros</i> sp.	Bacillariophyceae
CHAET78	<i>Chaetoceros</i> sp.	Bacillariophyceae
CHLOC1	<i>Chlorococcum</i> sp.	Chlorophyceae
CHLOC2	<i>Chlorococcum</i> sp.	Chlorophyceae
CHLOC3	<i>Chlorococcum</i> sp.	Chlorophyceae
CHLOC6	<i>Chlorococcum</i> sp.	Chlorophyceae
CHLOC7	<i>Chlorococcum</i> sp.	Chlorophyceae
CHLOC8	<i>Chlorococcum</i> sp.	Chlorophyceae
CHLOC10	<i>Chlorococcum</i> sp.	Chlorophyceae
CHLOC11	<i>Chlorococcum</i> sp.	Chlorophyceae



Strain	Species	Class
CHLOR1	<i>Chlorella</i> sp.	Chlorophyceae
CHLOR2	<i>Chlorella ellipsoidea</i>	Chlorophyceae
CHLOR3	<i>Chlorella</i> sp.	Chlorophyceae
CHLOR5	<i>Chlorella</i> sp.	Chlorophyceae
CHLOR6	<i>Chlorella</i> sp.	Chlorophyceae
CHLOR8	<i>Chlorella</i> sp.	Chlorophyceae
CHLOR9	<i>Chlorella</i> sp.	Chlorophyceae
CHLOR10	<i>Chlorella</i> sp.	Chlorophyceae
CHLOR11	<i>Chlorella</i> sp.	Chlorophyceae
CHLOR12	<i>Chlorella</i> sp.	Chlorophyceae
CHLOR13	<i>Chlorella</i> sp.	Chlorophyceae
CHLOR14	<i>Chlorella salina</i>	Chlorophyceae
CHLOR15	<i>Chlorella salina</i>	Chlorophyceae
CHLOR16	<i>Chlorella</i> sp.	Chlorophyceae
CHLOR17	<i>Chlorella</i> sp.	Chlorophyceae
CHLOR18	<i>Chlorella</i> sp.	Chlorophyceae
CHLOR20	<i>Chlorella</i> sp.	Chlorophyceae
CHLOR24	<i>Chlorella</i> sp.	Chlorophyceae
CHLOR27	<i>Chlorella</i> sp.	Chlorophyceae
CHOOC3	( <i>Chlorococcales</i> )	Chlamydoephyceae
CHOOC4	( <i>Chlorococcales</i> )	Chlamydoephyceae
CHOOC5	( <i>Chlorococcales</i> )	Chlamydoephyceae
CHOOC7	( <i>Chlorococcales</i> )	Chlamydoephyceae
CHOOC8	( <i>Chlorococcales</i> )	Chlamydoephyceae
CHOOC10	( <i>Chlorococcales</i> )	Chlamydoephyceae
CHOOC13	( <i>Chlorococcales</i> )	Chlamydoephyceae
CHOOC14	( <i>Chlorococcales</i> )	Chlamydoephyceae
CHOOC16	( <i>Chlorococcales</i> )	Chlamydoephyceae
CHROO1	<i>Chroomonas</i> sp.	Bacillariophyceae
CHRYS1	<i>Chrysosphaera</i> sp.	Bacillariophyceae
CHRYS2	Sarcinoid chrysophyte	Bacillariophyceae
CRICO1	<i>Cricosphaera</i> sp.	Bacillariophyceae
CRYPT1	<i>Cryptomonas</i> sp.	Bacillariophyceae
CYCLO1	<i>Cyclotella cryptica</i>	Bacillariophyceae



Strain	Species	Class
CYCLO6	<i>Cyclotella cryptica</i>	Bacillariophyceae
CYCLO8	<i>Cyclotella meneghiniana</i>	Bacillariophyceae
CYCLO9	<i>Cyclotella meneghiniana</i>	Bacillariophyceae
CYCLO10	<i>Cyclotella</i> sp.	Bacillariophyceae
CYCLO11	<i>Cyclotella cryptica</i>	Bacillariophyceae
DIATO1	<i>Navicula</i> sp. nov	Bacillariophyceae
DUNAL1	<i>Dunaliella</i> sp.	Bacillariophyceae
DUNAL2	<i>Dunaliella</i> sp.	Bacillariophyceae
ELLIP1	<i>Ellipsoidon</i> sp.	Eustigmatophyceae
ENTOM1	<i>Amphiprora hyalina</i>	Bacillariophyceae
EUSTI1	(Eustigmatophyte)	Eustigmatophyceae
EUSTI2	(Eustigmatophyte)	Eustigmatophyceae
EUSTI3	(Eustigmatophyte)	Eustigmatophyceae
EUSTI5	(Eustigmatophyte)	Eustigmatophyceae
EUSTI6	(Eustigmatophyte)	Eustigmatophyceae
EUSTI7	(Eustigmatophyte)	Eustigmatophyceae
EUSTI8	(Eustigmatophyte)	Eustigmatophyceae
EUSTI9	(Eustigmatophyte)	Eustigmatophyceae
EUSTI10	(Eustigmatophyte)	Eustigmatophyceae
EUSTI11	(Eustigmatophyte)	Eustigmatophyceae
EUSTI12	(Eustigmatophyte)	Eustigmatophyceae
EUSTI13	(Eustigmatophyte)	Eustigmatophyceae
EUSTI14	(Eustigmatophyte)	Eustigmatophyceae
EUSTI15	(Eustigmatophyte)	Eustigmatophyceae
EUSTI16	(Eustigmatophyte)	Eustigmatophyceae
EUSTI17	(Eustigmatophyte)	Eustigmatophyceae
EUSTI18	(Eustigmatophyte)	Eustigmatophyceae
EUSTI19	(Eustigmatophyte)	Eustigmatophyceae
EUSTI20	(Eustigmatophyte)	Eustigmatophyceae
EUSTI21	(Eustigmatophyte)	Eustigmatophyceae
EUSTI22	(Eustigmatophyte)	Eustigmatophyceae
EUSTI23	(Eustigmatophyte)	Eustigmatophyceae
FLAGE1	Flagellate	---
FLAGE2	Unknown flagellate	---



Strain	Species	Class
FLAGE3	<i>Pleurochrysis</i> sp.	---
FLAGE6	Green Flagellate	---
FRANC1	<i>Franceia</i> sp.	Chlorophyceae
GLECA2	<i>Gleocapsa</i> sp.	Cyanophyceae
GLOEO1	<i>Gloeothamnion</i> sp.	---
GREEN1	Green unicell	---
GREEN2	Green unicell	---
GREEN4	Green coccoid	---
GREEN6	Green coccoid	---
GREEN7	Green coccoid	---
GREEN8	Unknown green coccoid	---
GREEN9	Unknown green coccoid	---
GREEN10	Unknown green coccoid	---
GREEN11	Unknown green coccoid	---
HYMEN2	<i>Hymenomonas</i> sp.	Prymnesiophyceae
ISOCH1	<i>Isochrysis</i> aff. <i>galbana</i>	Prymnesiophyceae
MONOR1	<i>Monoraphidium</i> sp.	Chlorophyceae
MONOR2	<i>Monoraphidium</i> sp.	Chlorophyceae
MONOR3	<i>Monoraphidium</i> sp.	Chlorophyceae
MONOR4	<i>Monoraphidium minutum</i>	Chlorophyceae
NANNO2	<i>Nannochloris</i> sp.	Chlorophyceae
NANNO3	<i>Nannochloris</i> sp.	Chlorophyceae
NANNO5	<i>Nannochloris</i> sp.	Chlorophyceae
NANNO7	<i>Nannochloris</i> sp.	Chlorophyceae
NANNO8	<i>Nannochloris</i> sp.	Chlorophyceae
NANNO9	<i>Nannochloris</i> sp.	Chlorophyceae
NANNO10	<i>Nannochloris</i> sp.	Chlorophyceae
NANNO12	<i>Nannochloris</i> sp.	Chlorophyceae
NANNO13	<i>Nannochloris</i> sp.	Chlorophyceae
NANNP1	<i>Nannochloropsis salina</i>	Eustigmatophyceae
NANNP2	<i>Nannochloropsis</i> sp.	Eustigmatophyceae
NAVIC1	<i>Navicula saprophila</i>	Bacillariophyceae
NAVIC2	<i>Navicula saprophila</i>	Bacillariophyceae
NAVIC3	<i>Navicula saprophila</i>	Bacillariophyceae



Strain	Species	Class
NAVIC5	<i>Navicula saprophila</i>	Bacillariophyceae
NAVIC7	<i>Navicula saprophila</i>	Bacillariophyceae
NAVIC9	<i>Navicula pseudotenelloides</i>	Bacillariophyceae
NAVIC10	<i>Navicula biskanterae</i>	Bacillariophyceae
NAVIC12	<i>Navicula acceptata</i>	Bacillariophyceae
NAVIC13	<i>Navicula saprophila</i>	Bacillariophyceae
NAVIC14	<i>Navicula pseudotenelloides</i>	Bacillariophyceae
NAVIC15	<i>Navicula pseudotenelloides</i>	Bacillariophyceae
NAVIC16	<i>Navicula pseudotenelloides</i>	Bacillariophyceae
NAVIC17	<i>Navicula pseudotenelloides</i>	Bacillariophyceae
NAVIC20	<i>Navicula pseudotenelloides</i>	Bacillariophyceae
NAVIC21	<i>Navicula pseudotenelloides</i>	Bacillariophyceae
NAVIC22	<i>Navicula saprophila</i>	Bacillariophyceae
NAVIC23	<i>Navicula saprophila</i>	Bacillariophyceae
NAVIC24	<i>Navicula saprophila</i>	Bacillariophyceae
NAVIC26	<i>Navicula saprophila</i>	Bacillariophyceae
NAVIC28	<i>Navicula saprophila</i>	Bacillariophyceae
NAVIC31	<i>Navicula acceptata</i>	Bacillariophyceae
NAVIC32	<i>Navicula acceptata</i>	Bacillariophyceae
NAVIC33	<i>Navicula pseudotenelloides</i>	Bacillariophyceae
NAVIC35	<i>Navicula acceptata</i>	Bacillariophyceae
NEPHC1	<i>Nephrochloris</i> sp.	---
NEPHR1	<i>Nephroselmis</i> sp.	---
NITZS1	<i>Nitzschia pusilla monoensis</i>	Bacillariophyceae
NITZS3	<i>Nitzschia pusilla elliptica</i>	Bacillariophyceae
NITZS4	<i>Nitzschia alexandrina</i>	Bacillariophyceae
NITZS5	<i>Nitzschia quadrangula</i>	Bacillariophyceae
NITZS6	<i>Nitzschia pusilla monoensis</i>	Bacillariophyceae
NITZS7	<i>Nitzschia quadrangula</i>	Bacillariophyceae
NITZS9	<i>Nitzschia inconspicua</i>	Bacillariophyceae
NITZS10	<i>Nitzschia microcephala</i>	Bacillariophyceae
NITZS12	<i>Nitzschia pusilla</i>	Bacillariophyceae
NITZS13	<i>Nitzschia dissipata</i>	Bacillariophyceae
NITZS14	<i>Nitzschia communis</i>	Bacillariophyceae



Strain	Species	Class
NITZS17	<i>Nitzschia hantzschiana</i>	Bacillariophyceae
NITZS19	<i>Nitzschia inconspicua</i>	Bacillariophyceae
NITZS20	<i>Nitzschia inconspicua</i>	Bacillariophyceae
NITZS23	<i>Nitzschia intermedia</i>	Bacillariophyceae
NITZS24	<i>Nitzschia hantzschiana</i>	Bacillariophyceae
NITZS30	<i>Nitzschia hantzschiana</i>	Bacillariophyceae
NITZS35	<i>Nitzschia inconspicua</i>	Bacillariophyceae
NITZS37	<i>Nitzschia pusilla</i>	Bacillariophyceae
NITZS38	<i>Nitzschia pusilla</i>	Bacillariophyceae
NITZS39	<i>Nitzschia pusilla</i>	Bacillariophyceae
NITZS40	<i>Nitzschia pusilla</i>	Bacillariophyceae
NITZS43	<i>Nitzschia pusilla</i>	Bacillariophyceae
NITZS44	<i>Nitzschia frustulum</i>	Bacillariophyceae
NITZS45	<i>Nitzschia inconspicua</i>	Bacillariophyceae
NITZS49	<i>Nitzschia</i> sp.	Bacillariophyceae
OCHRO2	<i>Ochromonas</i> sp.	Chrysophyceae
OOCYS1	<i>Oocystis pusilla</i>	Chlorophyceae
OOCYS3	<i>Oocystis parva</i>	Chlorophyceae
OOCYS5	<i>Oocystis</i> sp.	Chlorophyceae
OOCYS9	<i>Oocystis</i> sp.	Chlorophyceae
OOCYS11	<i>Oocystis</i> sp.	Chlorophyceae
OOCYS14	<i>Oocystis</i> sp.	Chlorophyceae
OSCIL1	<i>Oscillatoria limnetica</i>	Cyanophyceae
OSCIL3	<i>Oscillatoria subbrevis</i>	Cyanophyceae
OSCIL8	<i>Oscillatoria</i> sp.	Cyanophyceae
OSCIL9	<i>Oscillatoria</i> sp.	Cyanophyceae
OSCIL10	<i>Oscillatoria</i> sp.	Cyanophyceae
OSCIL11	<i>Oscillatoria</i> sp.	Cyanophyceae
OSCIL12	<i>Oscillatoria</i> sp.	Cyanophyceae
OSCIL13	<i>Oscillatoria</i> sp.	Cyanophyceae
OSCIL14	<i>Oscillatoria</i> sp.	Cyanophyceae
OSCIL15	<i>Oscillatoria</i> sp.	Cyanophyceae
PAVLO2	<i>Pavlova</i> sp.	Chrysophyceae
PHAE01	<i>Phaeodactylum tricornutum</i>	Bacillariophyceae



Strain	Species	Class
PHAE02	<i>Phaeodactylum tricornutum</i>	Bacillariophyceae
PLATY1	<i>Platymonas</i> sp.	Chlorophyceae
PLEUR1	<i>Pleurochrysis dentata</i>	Prymnesiophyceae
PLEUR4	<i>Pleurochrysis dentata</i>	Prymnesiophyceae
PLEUR5	<i>Pleurochrysis</i> sp.	Prymnesiophyceae
PLEUR6	<i>Pleurochrysis</i> sp.	Prymnesiophyceae
PRYMN2	(Prymnesiophyte)	Prymnesiophyceae
PSEUD1	<i>Pseudoanabaena</i> sp.	Cyanophyceae
PSEUD4	---	---
PYRAM2	<i>Pyramimonas</i> sp.	Prasinophyceae
STICH1	<i>Stichococcus</i> sp.	Chlorophyceae
STICH2	<i>Stichococcus</i> sp.	Chlorophyceae
SYNEC1	<i>Synechococcus</i> sp.	Cyanophyceae
SYNEC3	<i>Synechococcus</i> sp.	Cyanophyceae
SYNEC5	<i>Synechococcus</i> sp.	Cyanophyceae
TETRA1	<i>Tetraselmis suecica</i>	Prasinophyceae
TETRA2	<i>Tetraselmis</i> sp.	Prasinophyceae
TETRA3	<i>Tetraselmis</i> sp.	Prasinophyceae
TETRA4	<i>Tetraselmis</i> sp.	Prasinophyceae
TETRA5	<i>Tetraselmis</i> sp.	Prasinophyceae
TETRA6	<i>Tetraselmis</i> sp.	Prasinophyceae
TETRA7	<i>Tetraselmis</i> sp.	Prasinophyceae
TETRA8	<i>Tetraselmis</i> sp.	Prasinophyceae
TETRA9	<i>Tetraselmis</i> sp.	Prasinophyceae
TETRA11	<i>Tetraselmis</i> sp.	Prasinophyceae
THALA6	<i>Thalassiosira weissflogii</i>	Bacillariophyceae
THALA7	<i>Thalassiosira weissflogii</i>	Bacillariophyceae
THALA14	<i>Thalassiosira weissflogii</i>	Bacillariophyceae
THALA15	<i>Thalassiosira weissflogii</i>	Bacillariophyceae
THALA16	<i>Thalassiosira weissflogii</i>	Bacillariophyceae
UNKNO1	---	---
UNKNO5	Unknown olive-green unicell	
UNKNO6	Unknown coccolithophorid	Prymnesiophyceae
UNKNO8	Unknown coccolithophorid	Prymnesiophyceae



Strain	Species	Class
UNKNO10	<i>Nitzschia</i> sp.	Bacillariophyceae
UNKNO24	---	---
UNKNO36	---	---
UNKNO52	---	Cyanophyceae
UNKNO58	---	---
VW291	---	---

#### Publications:

Microalgae Culture Collection 1984-1985. Solar Energy Research Institute, SERI/SP-231-2486; 59 pp.

Microalgae Culture Collection 1985-1986. Solar Energy Research Institute, SERI/SP-232-2863, 97 pp.

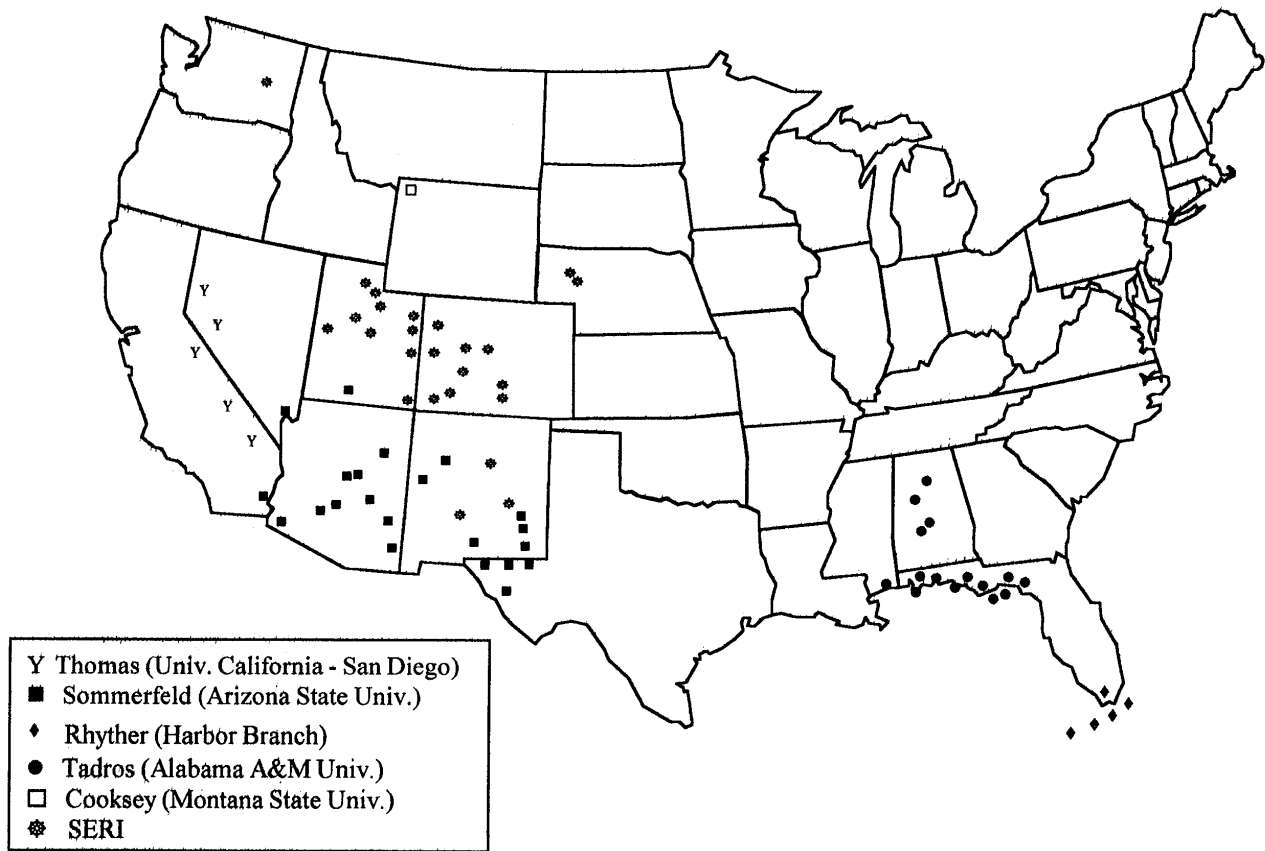
Barclay, W.; Johansen, J.; Chelf, P.; Nagle, N.; Roessler, R.; Lemke, P. (1986) "Microalgae Culture Collection 1986-1987." Solar Energy Research Institute, SERI/SP-232-3079, 149 pp.

Johansen, J.; Lemke, P.; Nagle, N.; Chelf, P.; Roessler, R.; Galloway, R.; Toon, S. (1987) "Addendum to Microalgae Culture Collection 1986-1987." Solar Energy Research Institute, SERI/SP-232-3079a, 23 pp.

#### II.A.4. Collection and Screening of Microalgae—Conclusions and Recommendations

The collection, screening, and characterization of microalgal strains represent a major endeavor of ASP researchers during the 1980s. More than 3,000 algal strains were collected from sites within the continental U.S. (Figure II.A.5.) and Hawaii or obtained from other culture collections. This was the first major collection of microalgae that emphasized strains suitable for cultivation in saline waters at high (or variable) temperatures, and with the potential for oil production. The establishment of the SERI Culture Collection as a genetic resource was a major accomplishment of the ASP; unfortunately a large proportion of the collection was lost due to funding cutbacks. However, the approximately 300 strains remaining in the collection will be transferred to the University of Hawaii, and should be available to interested researchers.





**Figure II.A.5.** Microalgae Collection Sites Within the Continental U.S.

The collection and screening effort resulted in a large number of strains that had many characteristics deemed important for a biodiesel production organism. In reviewing the many procedures used by ASP researchers, however, it is clear that a more consistent screening protocol might have yielded results that could be compared more meaningfully. Although these types of standard protocols were being developed near the end of the collection and screening effort, they were not consistently used. Furthermore, because an optimized microalgal-based biofuel production process was never fully developed, the screening protocols could not be based on an actual process. Therefore, whether the screening criteria used in the ASP were accurate predictors of good performance in a biodiesel production facility is not really known. For example, lipid productivity over a given amount of time is one of the most important factors in a production process. There were no clear guidelines as to whether lipid productivity in an outdoor pond was better in a continuous, steady-state process or in a multistage process involving substantial culture manipulation (e.g., nutrient level control, “ripening” tanks). This information is critical, and has a profound impact on the type of screening that should be conducted.



In addition to the need for a better understanding of the most economically feasible commercial biodiesel production process, additional information about the true constraints with regard to lipid properties (e.g., fatty acid chain length, degree of unsaturation, polar lipid constituents, etc.) there is a need for better information on the impact of lipid composition on fuel quality. The lipophilic dye Nile Red was used as a screening tool to rapidly assess the lipid contents of isolates, but in retrospect this technique probably does not provide the level of detail regarding lipid quality that may be necessary. Indeed, the variability in the ability of various strains to take up this dye is a major problem that must be recognized. With the rapid advances that have been made in recent years in automated high performance liquid chromatography and detection, this technique seems readily adaptable for use as a powerful screening tool.

For future screening endeavors, we recommend that an effort be made to naturally select strains at the locations that would likely be commercial microalgal production sites. In this manner, the algae would be exposed to the prevailing environmental conditions, particularly the indigenous waters. In small open-air vessels, the medium would be “inoculated” with a variety of indigenous strains, and a process of natural selection would occur such that the most competitive strains would dominate the cultures after a short while. Of course, the disadvantage of this method is that the dominant strains may not be good lipid producers. For this reason, genetically manipulating the dominant strains by classical or recombinant means may be necessary, such that they remain competitive and yet make acceptable amounts of lipid. Whether such manipulations can be made awaits further experimentation.

One thing that was clear from the collection and screening effort was that diatoms and green algae would most likely be well represented in a “natural selection” screen as described in the preceding paragraph. Therefore, future efforts should probably focus on developing sophisticated genetic engineering tools focused on these groups. Such tools could be transferable to many different species within these groups; such transfer would be facilitated by the fact that powerful methods for generating genetic sequence information are becoming routine.



## **II.B. Microalgal Strain Improvement**

### **II.B.1. Physiology, Biochemistry, and Molecular Biology of Lipid Production: Work by SERI Subcontractors**

#### **II.B.1.a. Introduction**

Eukaryotic algae, like all photosynthetic organisms, efficiently convert solar energy into biomass. The algal research program at SERI was designed as a long-term basic research effort to adapt or use photosynthesis and related metabolic pathways to produce renewable fuels and chemicals. Research at SERI under the Aquatic Species Program (Biodiesel) has focused on ways to increase the yield of oil from microalgae for cost-effective liquid fuel production. Initially, a large component of the research performed both by subcontractors and by SERI researchers was the collection of microalgal strains from saline environments in the desert southwest of the United States (a region targeted as a feasible location for large-scale microalgal culture), marine environments, and established culture collections. These organisms were then screened and numerous species were identified as candidates for biodiesel production; this research was described in Sections II.A. and II.B. of this report. However, no one species was identified that displayed the ideal combination of rapid growth, environmental tolerance, and high lipid production. Subsequent research efforts were directed toward understanding the biochemistry and physiology of lipid production in oleaginous microalgal strains, with the idea of using strain improvement technologies (breeding, cell fusion, genetic engineering, mutagenesis and selection) to develop algal strains with optimized traits for biodiesel production.

Early in the research program it became obvious the maximal lipid accumulation in the algae usually occurred in cells that were undergoing physiological stresses, such as nutrient deprivation or other conditions that inhibited cell division. Unfortunately, these conditions are the opposite of those that promote maximum biomass production. Thus, the conditions required for inexpensive biodiesel production, high productivity and high lipid content, appeared to be mutually exclusive.

To overcome this problem, research efforts were focused on understanding the biochemistry and physiology of lipid accumulation, with emphasis on understanding the “lipid trigger”, a mechanism that could induce production of large quantities of lipid under nutrient deprivation. In addition, research was directed toward understanding genetic variation within microalgal populations and to develop methods to screen for high-lipid subpopulations within algal cultures.

The knowledge of the biochemistry and physiology of lipid synthesis, combined with basic studies on microalgal molecular biology, was used in the later years of the project in attempts to use genetic engineering to develop microalgal strains with optimal properties of growth and lipid production.

Part II.B.2. of this report describes work by ASP subcontractors to understand the biochemistry and physiology of lipid accumulation in microalgae, including ultrastructural studies, the development of methods for screening for high lipid strains, and attempts to understand the biochemical lipid trigger. The research performed by SERI/NREL subcontractors on the physiology, biochemistry, and molecular biology of lipid production in oleaginous microalgae



took place during the second half of the 1980s and is presented here, roughly chronologically, according to the work performed by the individual subcontractors.

**II.B.1.b. Chrysophycean Lipids: Effects of Induction Strategy in the Quantity and Types of Lipids**

**Subcontractor:** Selma University

**Principal Investigator:** Shobha Sriharan

**Period of Performance:** 9/85 - 5/88

**Subcontract Number:** XK-5-05104-1

The purpose of the research performed by Dr. Sriharan and coworkers was to study the effects of nutrient deprivation and temperature on growth and lipid production in microalgae with potential for liquid fuel production. All the reports generated by this laboratory during the subcontract describe a virtually identical set of experiments performed on several species of microalgae. The benefit of this approach is that the productivity data can be compared between the species. However, the flaws in experimental design and reporting were carried through all experiments and reports.

The basic design for these experiments was to grow the algal cells in batch cultures in media that contained either “sufficient” or “deficient” levels of N or Si, and to test for algal growth rate, productivity, and lipid production. Cultures were grown at 20°C and at 30°C to test for the effect of temperature on growth and lipid induction. Exponentially growing cells were inoculated into fresh media containing high or low levels of Si or N. Growth was monitored by measuring the optical density of the culture, and the growth rate was reported as the number of cell doublings per day. The cells were harvested and processed to determine lipid content (reported as a percentage of the AFDW), and fatty acid composition under the various growth conditions.

The organisms studied were all diatoms, except for the chlorophyte *M. minutum* (which the authors initially reported to be a diatom, but they corrected this error in a later report). The diatoms tested were *Chaetoceros* SS-14, *C. muelleri* var *subsalsum*, *Navicula saprophila*, obtained from SERI, *Cyclotella* DI-35, *Cyclotella cryptica* Reimann, Lewin, and Guillard, and *Hantzchia* DI-60, obtained from M. Tadros at Alabama A&M University. All the organisms tested grew more rapidly at 30°C (versus 20°C) and in nutrient-sufficient media. A decrease in the total AFDW was reported for all strains grown in nutrient-deficient media compared to nutrient-sufficient cultures, and this was accompanied by an increase in the percentage of the AFDW made up of lipids.

The most dramatic increases in the lipid content of the cultures were seen under N-deficient conditions in cells grown at 30°C. In *C. cryptica*, the total lipids, as a percentage of AFDW, increased from 15% to 44%. In *Hantzschia*, lipids increased from 29% to 53%, and in *Navicula saprophila*, lipids increased from 26% to 44%. In all cases, the increase in total lipids was due to increases in both the neutral lipid and polar lipid fractions. In several cases, the ratio of neutral



lipids to polar lipids increased significantly in the nutrient-stressed cells (i.e., in *Hantzschia* and *C. muelleri* grown in Si-deficient media, and in *Navicula* grown in N-deficient media). Dr. Sriharan also presented data comparing the fatty acid profiles of lipids from diatoms grown under nutrient-sufficient and nutrient-deficient conditions. Although the data was incomplete, it indicated that changes in the fatty acid composition (lipid quality) did occur in nutrient-stressed cells, suggesting that nutrient deprivation can affect the lipid biosynthetic pathways.

In all cases nutrient-deficiency resulted in a decreased rate of cell growth and a decrease in total cell productivity. Therefore, an increase in lipid as a percentage of cell mass may not be economically advantageous for liquid fuel production from mass-cultured algae if the conditions that induce lipid accumulation also result in a significant drop in total biomass, and thus in total lipid produced. Although this was not discussed by Dr. Sriharan, the total effect of nutrient limitation on lipid content of the algal cultures could be estimated by multiplying the total biomass (AFDW) produced by the percentage of the AFDW attributable to lipid under nutrient-sufficient or nutrient-deficient conditions. In general, these calculations demonstrated an increase in lipid content of the cultures induced by nutrient stress, in the range of a 20% to 30% increase in total lipid.

The results reported here clearly suggest that algal productivity is increased under nutrient-sufficient conditions and at elevated temperatures. However, it is difficult to determine the validity of the data presented regarding nutrient-deprivation as a lipid trigger. Growth curves were not presented for the organisms studied. Therefore, it cannot be determined if the low nutrient levels limited growth throughout the period of the experiment, or whether the nutrients became depleted and the lipid effects correlated with a decrease in cell division, as reported elsewhere. It is also not clear at what point in the cell cycle the cells were harvested for determination of AFDW and lipid content, and how to compare the data for nutrient-sufficient and nutrient-deficient cells. In several experiments, the authors reported that the cultures were only harvested when lipid droplets were seen in the cells, although this would seem to bias experiments designed to test nutrient effects on lipid production. All in all, it is difficult to determine whether the experiments were badly performed, or just poorly reported.

In summary, the data presented by Dr. Sriharan was difficult to interpret for these reasons; however, several general conclusions can be made. Diatoms seem to be promising candidates for neutral lipid production. Many species produce constitutively high levels of lipid, and the level of lipid as a percentage of biomass can be increased by growing the cells under nutrient-limited conditions (the data presented here suggests that N-limitation may be more effective than Si-limitation). In addition, Dr. Sriharan's results suggest that nutrient-limitation may alter the lipid biosynthetic pathways in diatoms to increase lipid production and possibly affect lipid composition.



**Publications:**

Sriharan, S.; Bagga, D. (1987a) "Effects of induction strategies on *Chaetoceros* (SS-14), growth with emphasis on lipids." *FY 1986 Aquatic Species Program Annual Report*, Solar Energy Research Institute, Golden, Colorado, SERI/SP-231-3071, pp. 273-284.

Sriharan, S.; Bagga, D. (1987b) "Influence of nitrogen and temperature on lipid production in microalgae (*Hantzschia* DI-60)." *Energy from Biomass and Wastes X, Conference Proceedings*, (Klas, D.L., ed.), Institute of Gas Technology, Chicago, pp. 1689-1190.

Sriharan, S.; Bagga, D.; Sriharan, T.; Das, M. (1987) "Effect of nutrients and temperature on lipid production and fatty acid composition in *Monoraphidium minutum* and *Cyclotella* DI-35." *FY 1987 Aquatic Species Program Annual Report*, Solar Energy Research Institute, Golden, Colorado, SERI/SP-231-3206, pp. 108-126.

Sriharan, S.; Bagga, D.; Sriharan, T.P. (1988) "Algal lipids: Effect of induction strategies on the quantity and types of lipids produced." *Final Technical Report*, Solar Energy Research Institute, Golden, Colorado, 16 pp.

Sriharan, S.; Sriharan, T.P.; Bagga, D. (1989) "Lipids and fatty acids of diatom *Chaetoceros muelleri* var *subsalsum* and the control of their production by environmental factors." *Energy from Biomass and Wastes XII, Conference Proceedings*, (Klas, D.L., ed.), Institute of Gas Technology, Chicago, 10 pp.

Sriharan, S.; Bagga, D.; Nawaz, M. (1991) "The effects of nutrients and temperature on biomass, growth, lipid production, and fatty acid composition of *Cyclotella cryptica* Reimann, Lewin, and Guillard." *Appl. Biochem. Biotech.* 28/29:317-326.

Sriharan, S.; Bagga, D.; Sriharan, T.P. (1989) "Environmental control of lipids and fatty acid production in the diatom *Navicula saprophila*." *Appl. Biochem. Biotech.* 20/21:281-291.

Sriharan, S.; Bagga, D.; Sriharan, T.P. (1990) "Effects of nutrients and temperature on lipid and fatty acid production in the diatom *Hantzschia* DI-60." *Appl. Biochem. Biotech.* 24/25:309-316.

#### **II.B.1.c. Genetic Variation in High Energy Yielding Microalgae**

**Subcontractor:** City College of the City University of New York

**Principal Investigator:** Jane C. Gallagher

**Period of Performance:** 3/86 - 12/87

**Subcontract Numbers:** ZK-4-04136-5; ZK 4-04-136-04

The purpose of these studies was to investigate the intragenetic variability (e.g., between various isolates of a single species) in microalgae with potential for high lipid production. The rationale for this work with respect to the ASP is that variability within and between species of microalgae



has implications for algal collection strategies, for strain selection for high lipid producers, and for genetic manipulation of microalgae by classical breeding or genetic engineering.

Historically, microalgae have been classified based on morphological similarities. Previous studies by Dr. Gallagher and others (see Gallagher 1986) suggested significant physiological variability between isolates of a single species. In these studies, various isolates of a species grown under identical conditions (to control for environmentally induced changes in gene expression) often showed significant differences in characteristics such as nutrient uptake, growth rates, and pigment content. These results indicated that there may be inherent genetic differences between the individual strains. The studies by Dr. Gallagher compared electrophoretic banding patterns of specific proteins to obtain quantitative estimates of the genetic differences between isolates of two genera of oil-producing microalgae.

The organisms studied were *A. coffeiformis* (class Bacilliarophyceae) and *Nannochloropsis* spp. (class Eustigmatophyceae). The basic approach was to streak the isolated algae onto agar plates, then to pick single colonies and restreak the cells to ensure that each strain was unialgal. The isolates were propagated under identical growth conditions to minimize differences caused by environmentally induced changes in gene expression. Each strain was examined using light microscopy (LM) and scanning electron microscopy (SEM) to look for morphological differences and to confirm species identity. Crude protein extracts from each strain were separated by polyacrylamide gel electrophoresis. The gel was then stained to detect several specific enzymes, including phosphoglucose isomerase, hypoxanthine dehydrogenase,  $\alpha$ -ketoglutarate dehydrogenase, malate dehydrogenase,  $\alpha$ -hydroxybutarate dehydrogenase, and tetrazolium oxidase. (Dr. Gallagher also tried unsuccessfully to stain for several other enzymes. Poor staining may be a consequence of the location of these enzymes within cellular membranes in microalgae.) An extract from the diatom *Skeletonema costatum* (clone SKEL) was run on each gel to serve as an internal standard, and the migration pattern for each enzyme was reported as the ratio of the migration distance for the unknown *Amphora* or *Nannochloropsis* enzyme to the migration of the known enzyme from *Skeletonema*. An example of this type of experiment is shown in Figure III.B.1. This method allowed for detection of very small differences in the migration patterns of the various forms of the enzymes. These differences could result from subtle variations in protein charge or conformation due to one or several amino acid changes. Isolates that showed two bands for a specific enzyme were assumed to be heterozygous at that allele.

For the studies of *Amphora*, Dr. Gallagher obtained 47 isolates, 32 of which were isolated from a salt marsh in Woods Hole, Massachusetts, on the same day in August 1985. Another six strains had been isolated from the same site during the summers of 1979 or 1980 and maintained in culture, and five strains were obtained from laboratory cultures maintained by other investigators. It is unclear from Dr. Gallagher's reports how many of the 47 *Amphora* isolates were tested as described earlier.

All strains that were subsequently analyzed for enzyme banding patterns were first examined by LM and SEM. Microscopy confirmed that all the strains were *A. coffeiformis*, although some



variation was observed in the morphology of the frustule between strains, for example, in the presence or absence of costae (rib-like protrusions) or in the shape or number of punctae (holes). These changes were assumed to be due to genetic differences between the strains, as unialgal clones maintained in culture for 6-7 years did not show variations in frustule morphology between individuals. Genetic similarity was calculated based on the electrophoretic banding patterns using the statistical methods of Nei (1972). The zymograms indicated significant variation between isolates of the same species, even between strains isolated from the same site on the same day. These differences were not correlated with the extent of morphological variation, and some morphologically identical strains showed differences in the protein banding patterns.

For *Nannochloropsis*, 115 strains were obtained, all from culture collections. The electrophoretic banding patterns also indicated significant genetic diversity between strains, even between samples isolated from the same location. However, the zymogram data for *Nannochloropsis* was limited due to the high percentage of “null” alleles (no staining of some enzymes) in some isolates. It was unclear whether this was caused by undetermined genetic differences between the isolates (and between *Amphora* and *Nannochloropsis*), or due to difficulties in extraction of the proteins from *Nannochloropsis*. More data would be needed to fully analyze the genetic differences between isolates of this genus.

What are the implications of this research for the Aquatic Species Program? The significant amount of genetic diversity between individuals of a species, even when isolated from very similar locations, suggests that researchers involved in collecting microalgal strains as potential lipid producers should obtain more than one isolate from each site. In fact, these results suggest that it may be adequate to sample fewer sites to obtain a sufficiently varied collection of microalgal strains.

In a previous study (discussed in Gallagher 1985), Dr. Gallagher described experiments performed on isolates of the diatom *S. costatum* similar to those described here. The data suggested significantly less genetic variation between isolates of *Skeletonema*, even between strains isolated from different locations, than was seen between *Amphora* strains isolated from the same environment. This difference was attributed to the fact that *Amphora* is an attached, benthic organism that produces amoeboid gametes, whereas *Skeletonema* is planktonic, and produces swimming sperm. These “lifestyle” differences would result in lower potential for gene flow between *Amphora* populations, although the presence of heterozygotes indicates interbreeding among *Amphora* at localized sites. These observations suggest that benthic organisms may have greater genetic diversity than planktonic forms.

Based on the data in this study, Dr. Gallagher also concluded that breeding or genetic engineering of microalgae may be more successful using morphologically similar phenotypes, as her results suggest less diversity at the protein level between identical morphotypes. However, genetic engineering research during the past 15 years in other organisms indicates that cells can often express genes from very different species, so these differences between strains probably will not affect the expression of genes transferred between these similar organisms.





While working under the SERI subcontract, Dr. Gallagher also participated in a study that provided evidence that the carotenoid violaxanthin functions as a major light harvesting pigment in *Nannochloropsis* (Owens et al. 1987). Carotenoids generally are considered accessory pigments in photosynthetic organisms, involved primarily in photoprotection, fluorescence quenching, and light harvesting. *Nannochloropsis* is a member of the class Eustigmatophyceae, which are unusual in that they can contain violaxanthin as up to 60% of their total pigments. These authors used room temperature fluorescence excitation and emission data to provide the first evidence that violaxanthin can function in photosynthetic light harvesting.

Understanding the fundamental processes involved in microalgal photosynthesis is important to the ASP since light-driven photosynthesis results in the production of chemical reductants that drive the synthetic dark reactions; lipids are storage products that can be produced from excess photosynthate. One possible implication is that carotenoids absorb at different wavelengths than chlorophyll, absorbing green light that penetrates into the water column. This feature could be beneficial for mass culture of organisms, allowing denser cultures to grow in a deep raceway.

#### Publications:

Gallagher, J.C. (1986). "Population genetics of microalgae." In *Algal Biomass Technologies: An Interdisciplinary Perspective* (Barclay, W.; McIntosh, R., eds.), Beihefte zur Nova Hedwigia, Heft 83, Gebrüder Borntraeger, Berlin-Stugart, pp. 6-14.

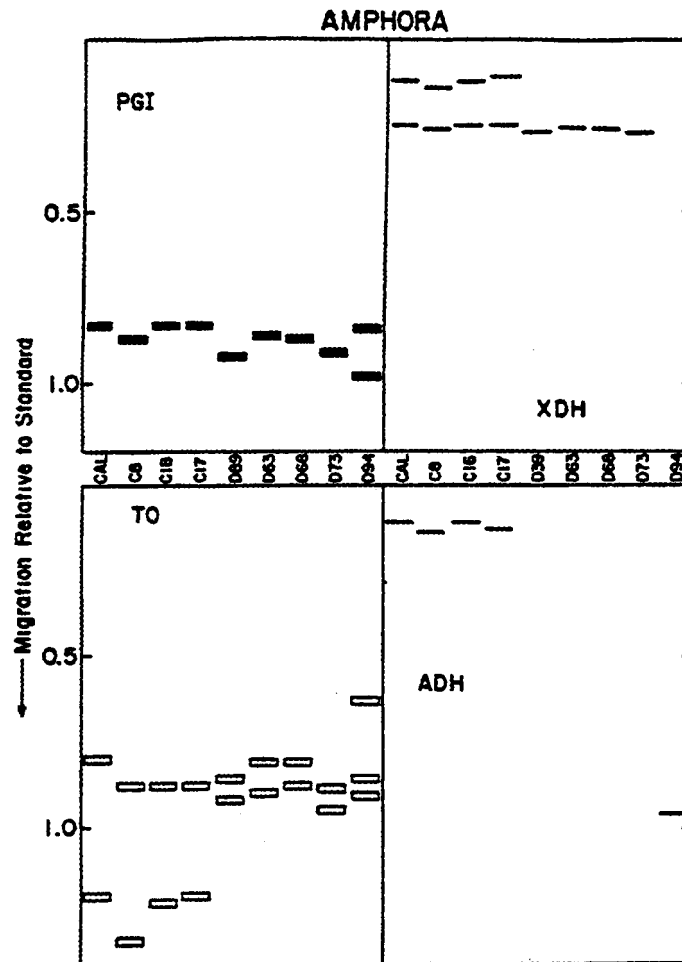
Gallagher, J. C. (1987a). "Patterns of genetic diversity in three genera of oil-producing microalgae" (abstr.), *FY 1987 Aquatic Species Program Annual Report*, (Johnson, D.A.; Sprague, S., eds.), Solar Energy Research Institute, Golden, Colorado, SERI/SP-231-3206, p. 209.

Gallagher, J.C. (1987b). "Genetic variation in oil-producing microalgae." *FY 1986 Aquatic Species Program Annual Report*, (Johnson, D.A., ed.), Solar Energy Research Institute, Golden, Colorado, SERI/SP-231-3071, p.331-336.

Owens, T.G.; Gallagher, J.C.; Alberte, R.S. (1987) "Photosynthetic light-harvesting function of violaxanthin in *Nannochloropsis* spp. (Eustigmatophyceae)." *J. Phycol.* 23:79-85.

#### Additional References:

Nei, M. (1972) *Amer. Natur.* 106:283.



**Figure II.B.1.** Drawing of representative gels showing the banding patterns of various enzymes from clones of *Amphora coffeiformis*.

All bands are graphed as a ratio of the distance travelled by protein bands in *Amphora* to the distance travelled by stand bands in *Skeletonema costatum*. **PGI**: phosphoglucose isomerase; **XDH**: hypoxanthine dehydrogenase; **TO**: tetrazolium oxidase; **ADH**: analine dehydrogenase. (Source: Gallagher 1987).

**II.B.1.d. Ultrastructure Evaluation of Lipid Producing Microalgae**

**Subcontractor:** Oak Ridge National Laboratory, Oak Ridge, Tennessee  
**Principal Investigator:** Jean A. Solomon  
**Period of Performance:** 10/84 - 11/86  
**Subcontract Number:** N/A

The goal of this project was to gain further understanding of the physiology of lipid accumulation in microalgae by examination of the ultrastructure of cells containing high levels of storage lipids. The questions that Dr. Solomon addressed were:

1. Where does the lipid accumulate within the cells; and
2. What other ultrastructural changes are seen in microalgae induced to accumulate lipid?

Three oleaginous microalgal strains were used in this study, *Ankistrodesmus fulcatus* (SERI strain ANKIS1; class Chlorophyceae), *Isochrysis* aff. *glabana* (ISOCH1, class Prymnesiophyceae), and *Nannochloropsis salina* (NANNO1, class Eustigmatophyceae). Ultrastructural changes were monitored by transmission electron microscopy (TEM). In this technique, cells are chemically fixed and embedded in a plastic resin. The resin is then cut into thin sections (70-100nm), stained with heavy metals, and viewed in an electron microscope. The first step was to develop adequate fixation and embedding techniques for the algal species to be studied. This is often problematic for microalgae, presumably due to the chemical and physical properties of the algal cell wall, which can act as barriers to penetration of the fixatives or resin. Dr. Solomon tested five fixation protocols (see Solomon 1985, p.74, Table 1), all variations of standard methods of fixation using glutaraldehyde and osmium tetroxide, dehydration with an organic solvent, embedding of the cells in an acrylic resin, and poststaining of the sections with uranyl acetate and lead citrate. Initially, Dr. Solomon reported that the best fixation of *Ankistrodesmus* and *Isochrysis* was achieved by exposing the cells briefly to glutaraldehyde and osmium simultaneously, followed by dehydration in acetone and embedding in Spurr's resin. However, a later report stated that *Ankistrodesmus* was better preserved by exposing the cells sequentially to glutaraldehyde and then osmium (in cacodylate buffer supplemented with sucrose as an osmoticum). Also, Araldite/Embed12 resin was used, as it appeared to provide better penetration into the cells. For *Isochrysis*, the initial protocol was also modified by adding sucrose. Fixation of *Nannochloropsis* was poor with any method used; the scaly cell wall of this organism seemed to provide a significant barrier to adequate penetration of fixatives and resins.

Nitrogen deprivation was used to trigger the production of lipids in the cells. The cells were grown in N-replete medium, then collected by centrifugation and resuspended in growth medium without added N. Samples were fixed immediately and at regular intervals during the following 13 days, and thin sections were cut and examined for ultrastructural changes by TEM.

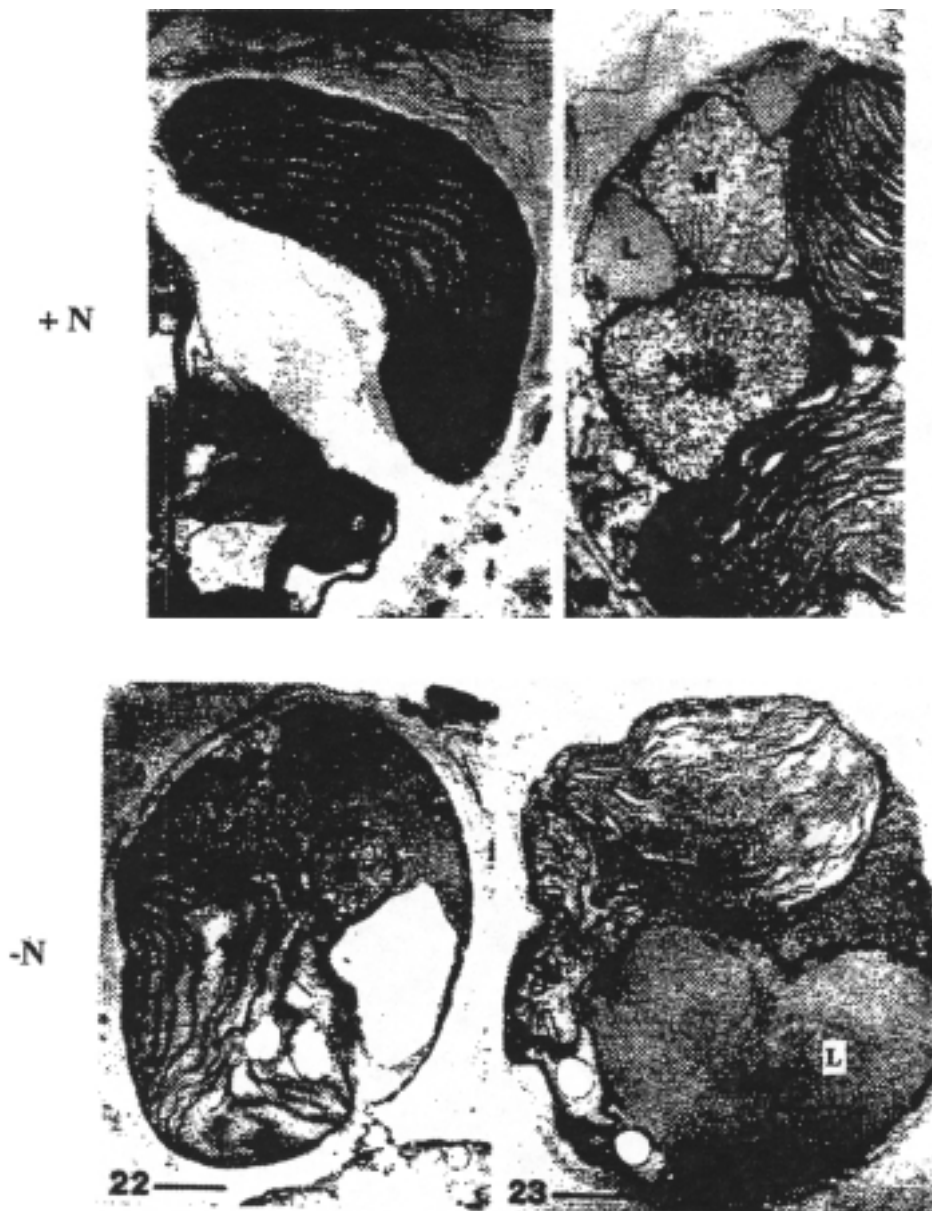


As expected, N deprivation resulted in the accumulation of lipid within the cells of all three microalgal species. The lipid appeared primarily as droplets within the cytoplasm, not within the chloroplast or other cellular organelles. The lipid droplets often appeared adjacent to a mitochondrion. In *Ankistrodesmus*, N-deficiency also produced an increased number of starch granules within the chloroplasts, and resulted in the formation of unusual membrane structures consisting of packed, concentric layers of double membranes within the cytoplasm. Whether these unusual structures were the site of excess lipid accumulation, or were structural artifacts of the fixation process, was unclear.

It is difficult to conclude much more about ultrastructural changes that might have been induced in these cells following N deprivation. The sample size was very small. One hundred-nm thick sections may represent less than 1/100th of the volume of a microalgal cell. In addition, only a few cells within a population can be examined easily by this technique. Finally, there is a high likelihood that the chemical fixation methods used in the study can create artifacts that are not related to actual cell structure. However, these studies supported the observation that significant levels of storage lipids can accumulate in the cytoplasm of microalgal cells exposed to N deficiency. Dr. Solomon's microscopic observations in *Ankistrodesmus* also suggested the presence of a discrete lipid trigger mechanism within each cell, as lipid did not appear to accumulate gradually within all cells of a population after N deprivation. Instead, individual cells appeared to accumulate large amounts of lipid during a 1-2 day period. This result was supported by the flow cytometric data also performed in Dr. Solomon's laboratory, which is described below.

**Publications:**

Solomon, J.A.; Hand, R.E.; Mann, R.C. (1986b) "Ultrastructural and Flow Cytometric Analyses of Lipid Accumulation in Microalgae: A Subcontract Report." Solar Energy Research Institute, Golden, Colorado, SERI/STR-231-3089.



**Figure II.B.2.** Electron micrographs of nitrogen-sufficient (top) and nitrogen-deficient (bottom) cells of *Nannochloropsis salina*.

Note the accumulation of large lipid droplets (L) in the cytoplasm in the nitrogen-deficient cells. The lipid often appeared adjacent to a mitochondrion (M). N: nucleus. C: chloroplast. Scale bars = 0.5  $\mu\text{m}$ . The numbers in the lower left corner of each figure are from the original publication (Solomon et al.1986b).



**II.B.1.e. Improvement of Microalgal Lipid Production by Flow Cytometry**

**Subcontractor:** Oak Ridge National Laboratory, Oak Ridge, Tennessee

**Principal Investigator:** Jean A. Solomon

**Period of Performance:** 12/86 - 11/87

**Subcontract Number:** DK-4-04142-01

The purpose of this project was to determine if flow cytometry could be used to select for subpopulations of high lipid-producing algae within an algal culture. Flow cytometry is a method that measures the light scattered or emitted by particles as they pass through a laser beam. Scattered light is believed to reflect the size, shape, and refractive properties of cells. Dr. Solomon initially used exponentially growing and nutrient-stressed cells of the chrysophycean alga *Boekelovia* to demonstrate that the extent of right-angle scatter, which indicates changes in internal cell morphology, can be correlated to the lipid content of microalgal cells.

In subsequent studies, a lipid-specific fluorescent dye, Nile Red (see work by Dr. Cooksey, described in Section II.A.1.f.), was used to stain intracellular lipids. Nile Red is excited at a wavelength of 488 nm, and emits yellow-green light at 520-580 nm. In contrast, chlorophyll autofluorescence can be measured at wavelengths greater than 630 nm. Therefore, in contrast to the scattered light data mentioned above, flow cytometric analyses of cells stained with Nile Red would be more specific for changes in lipid content. Preliminary experiments in which cells of *Boekelovia* were stained with Nile Red demonstrated that increased yellow green fluorescence could be correlated with increased numbers of lipid droplets in the cells, suggesting that this method could work to screen for cells with high lipid contents.

Of the three microalgal species analyzed by TEM (Section II.B.1.d.), only *Isochrysis* was found to be appropriate for flow cytometric analysis. The cells of this strain are small and spherical, the optimal shape for flow cytometric analysis, and take up Nile Red well. In contrast, *Ankistrodesmus* cells are long and thin (40 nm x 4 nm). *Nannochloropsis* did not take up the Nile Red dye, possibly because of cell wall properties that also prevented good chemical fixation for microscopy.

In the initial experiments, cells were screened for lipid content based on Nile Red fluorescence alone. Several improvements to this procedure were implemented during the course of the study. First, efforts were made to optimize the Nile Red staining protocol. The best staining was achieved using a concentration of 1 mg Nile Red in 1 mL of cell suspension. The solvent for the Nile Red stain was changed from heptane to acetone, due to interfering fluorescence from undissolved heptane droplets. Finally, the researchers found that the fluorescence signal from Nile Red is unstable and decays rapidly. However, the fluorescence level stabilizes after about 45 minutes, so all readings were taken at least 45 minutes after staining the cells with Nile Red.

Another important change was to measure the chlorophyll autofluorescence as well as Nile Red fluorescence. This ensured that only viable cells containing lipid and intact chloroplasts would



be analyzed. In addition, the amount of chlorophyll is an indication of cell size. Cell sorting based on the ratio of chlorophyll fluorescence to Nile Red fluorescence would normalize the results to account for differences in cell size and age and allow detection of individual cells with unusually high lipid levels resulting from natural genetic variation. A decrease in the ratio of chlorophyll to Nile Red fluorescence would indicate lipid accumulation.

In one set of experiments, *Isochrysis* cultures were stressed by transferring the cells into N-deficient media, then screened for lipid content using flow cytometry, either by lipid content alone (Nile Red fluorescence) or by monitoring the chlorophyll to Nile Red fluorescence ratios. The daughter cells containing high or low levels of lipid were recultured in N-replete medium for 1 week or 1 month, then subjected again to N deprivation, and resorted. The lipid content of the daughter population was compared to that of the parent cells. These experiments produced inconsistent results. In some cases, the population of daughter cells selected for their high lipid content showed a wider range of lipid contents than the parent cells; other sorts produced daughters without significant differences in lipid content from the parents. One interesting observation was the bimodal distribution of cells in all populations subjected to N stress. Cells fell into two classes with low or high chlorophyll-to-lipid ratios. This again supports the author's theory, discussed in the section on ultrastructural analysis of lipid accumulation, that cells respond as individuals to a lipid trigger, rather than gradually increasing the lipid content of the entire culture.

These results suggested that flow cytometry might be used to select for populations of high lipid algae if more was understood about the relationship of the physiological state of parent cells to lipid accumulation. Analysis of the growth of *Isochrysis* in N-replete media showed several phases, including a period of exponential growth that declined to a stationary phase. After about 2 weeks, the nutrients were depleted and the cells entered a stressed phase. A series of experiments was performed in which cells in various growth phases were stained with Nile Red and sorted based on lipid content alone (no chlorophyll measurements). The sorts on cells in exponential phase were usually not successful, but if the parent cells were in stationary phase or from very old cultures (stressed), the mean lipid content of the daughter population was about 20% higher than that of the parental cells. These results suggested that successful screening for high-lipid cells using flow cytometry was related to the cell cycle. The exponential cultures contained cells in all stages of cell growth and division. Cells that were preparing to divide would be larger and would be selected as high-lipid, so that the set of high lipid cells selected would actually contain only the largest and oldest cells, rather than high lipid genetic variants. Stationary or stressed populations are not actively dividing, so the cells are more uniform in size and sorting of the cells for high lipid should be more likely to identify true high lipid variants within the population.

The experiments using *Isochrysis* cultures in various growth stages as the parental population were repeated to test these assumptions. Cells were sorted based either on lipid levels alone (Nile Red fluorescence only) or using the ratio of chlorophyll to Nile Red fluorescence to control for cell size. The results presented in the available reports support the hypotheses. Sorting cells based solely on lipid content produced high-lipid daughter populations if the parent population



was in a stationary or stressed growth phase. Exponential cultures produced variable results. If the parental cells were sorted based on ratios of chlorophyll-to-lipid fluorescence, high-lipid populations could be produced from exponentially growing parent cultures.

These conclusions were based on very limited data. Only a few experiments were performed. In addition, several daughter cultures did not grow up after the sorting process, and failure of a growth chamber resulted in the loss of some cultures. The data were written up in only two technical reports to SERI, and it was difficult to determine the exact protocol used for each sorting experiment. However, the results of these studies are intriguing, and suggest that flow cytometry might be a viable method for screening for high lipid genetic variants within (or between) strains of oleaginous microalgae. The procedure would be limited to strains in which the cells are small and spherical. Dr. Solomon's data suggest the best results would be achieved by using stationary or stressed cells as the parent population. In addition, cells should be selected based on a low chlorophyll-to-Nile Red fluorescence ratio, which would indicate high-lipid levels with respect to cell size. However, it is interesting that high-lipid daughter strains were not produced in the experiments in which exponentially growing cells were transferred directly to N-deficient media; yet, cells allowed to gradually deplete their N supply to induce the stressed condition could be used successfully in a flow cytometric screen. This suggests either that lipid accumulation occurs by different mechanisms under these two conditions, or, more likely, that the stressed cells from very old cultures had all entered a similar metabolic state so that size and lipid contents would be more indicative of genetic differences.

#### Publications:

Solomon, J.A (1985) "Ultrastructure evaluation of lipid accumulation in microalgae." *Aquatic Species Program Review: Proceedings of the March 1985 Principal Investigators' Meeting*, Solar Energy Research Institute, Golden, Colorado, SERI/CP-231-2700, pp. 71-82.

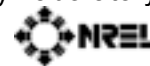
Solomon, J.A. (1987) "Flow cytometry techniques for species improvement." *FY 1986 Aquatic Species Program: Annual Report* (abstr.), Solar Energy Research Institute, Golden, Colorado, SERI/SP-231-3071, p. 252.

Solomon, J.A.; Hand, R.E.; Mann, R.C. (1986a) "Ultrastructural and flow cytometric analyses of lipid accumulation in microalgae." *Annual Report*, Oak Ridge National Laboratory, Oak Ridge, Tennessee, ORNL/M-258, 50 pp.

Solomon, J.A.; Hand, R.E.; Mann, R.C. (1986b) "Ultrastructural and Flow Cytometric Analyses of Lipid Accumulation in Microalgae: A Subcontract Report." Solar Energy Research Institute, Golden, Colorado, SERI/STR-231-3089.

Solomon, J.A.; Palumbo, A.V. (1987) "Improvement of microalgal strains for lipid production." *FY 1987 Aquatic Species Program: Annual report*, Solar Energy Research Institute, Golden, Colorado, SERI/SP-231-3206.



**II.B.1.f. Biochemical Elucidation of Neutral Lipid Synthesis in Microalgae**

**Subcontractor:** Montana State University  
**Principal Investigator:** Keith E. Cooksey  
**Period of Performance:** 1/86 - 10/87  
**Subcontract Numbers:** XK-5-05073-1; XK-6-05073-1

The goal of this research was to understand the biochemistry of lipid accumulation in microalgae, in particular, to provide information on the biochemical triggers that induce lipid synthesis. The Nile Red fluorescence technique developed by Dr. Cooksey's laboratory and at SERI (described above in Sections II.A.1.f. and III.B.1.e.) was used to study lipid accumulation in microalgae in response to N or Si depletion. Nile Red fluorescence was used to monitor the lipid levels in batch cultures of *Chlorella* over time. As the N became depleted, lipids accumulated in the cultures, predominately as triglycerides. The triglyceride levels began to increase before N was totally depleted from the medium. Microscopic examination showed that individual cells within the population began to accumulate lipid at different times, similar to results obtained by Dr. Solomon in *Isochrysis*. Dr. Cooksey concluded that lipid accumulation begins as the cells enter stationary phase and cell division ceases; the timing of this event would be different for individual cells within a population.

Dr. Cooksey's laboratory next performed a complex series of experiments designed to correlate media factors, (i.e., nitrate concentrations, pH, and carbon availability), with lipid accumulation in CHLOR-1. Cell growth and lipid accumulation were monitored in batch cultures, with cells grown in unbuffered Bold's medium, or media buffered at pH 7, 9, or 10. In unbuffered Bold's medium, the initial pH was 7, and increased to pH 8 by day 6, and up to pH 9.5 by day 9. The cells grew in all conditions, with the best growth at pH 9. Under all growth conditions, the level of nitrate in the media decreased, but never fell below 25% of the initial levels.

Accumulation of neutral lipids was monitored by Nile Red fluorescence. There was no lipid accumulation in cultures maintained at or below pH 9. However, in buffered medium with a pH  $\geq$  10, or in unbuffered medium that experienced an increase in pH during the growth period, the cultures generally showed a significant increase in lipid levels that was accompanied by a decrease in cellular growth rates.

Nutrient limitation, generally nitrate or silica, can trigger lipid accumulation in microalgae. Nutrient deprivation can cause a decrease in cell division, which presumably results in "targeting" of excess fixed carbon into storage lipids. The data obtained by Dr. Cooksey's laboratory suggested that a shift in pH, which has been correlated with decreased rates of cell division, could also trigger lipid accumulation. These data suggested that nutrient limitation might not directly affect biochemical pathways to enhance lipid synthesis; rather, lipid accumulation may be an indirect consequence of inhibition of a stage in the cell cycle. In other photosynthetic systems studied, the data indicated that cells synthesize triglycerides in the light and utilize these lipids as energy stores in the dark and during cell division. If division were

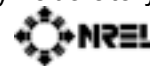


blocked, the rate of neutral lipid utilization would be slower than the rate of synthesis, so triglycerides would accumulate in the cells. To help test this hypothesis, Dr. Cooksey used light microscopy to examine cells grown in media with different pH ranges. Cultures grown at pH 7-9 consisted almost entirely of small, single cells. However, at pH 10 and higher, a large proportion of the cells was in the form of autosporangial complexes, i.e., their nuclei had divided, but the autospores had not separated. The specific effect of increased pH on cell division is not clear, although some evidence suggests that increased pH can lead to increased flexibility of the autospore wall, preventing individual cells from breaking free. Alternatively, increased pH could affect precipitation of media components, indirectly affecting the cell cycle.

Although the data presented here suggest that nutrient deprivation or increased pH may affect lipid levels simply as a consequence of decreased cell division, additional research by Dr. Cooksey's laboratory suggested that treatments that increase lipid accumulation may also affect the biochemistry of lipid biosynthesis. Analysis of the lipid classes present in the cells at the end of the 10-day growth period showed accumulation of triglycerides in cells at high pH, with a decrease in glycolipids and polar lipids. The nonpolar storage lipids predominantly contain 16- and 18-carbon saturated or monounsaturated fatty acids (16:0 and 18:1), which are considered "precursor" fatty acids in lipid biosynthesis. The polar lipids and glycolipids usually contain a higher proportion of polyunsaturated fatty acids. However, analysis of the fatty acid composition of the storage lipids showed that at higher pH, more of these precursor lipids were seen in the polar lipids and glycolipids. This suggests a switch in the lipid synthesis patterns that results in less desaturation of the fatty acids esterified to the polar lipids.

In summary, the finding that an increase in pH can also lead to lipid accumulation in cells before N is depleted suggested a method to uncouple lipid accumulation from nutrient deprivation, and provided another method to study the biochemistry of lipid accumulation in microalgae. The data from Dr. Cooksey's laboratory supported the premise that lipid triggers such as nutrient deprivation or pH increase affect lipid accumulation in microalgae by similar mechanisms, i.e., inhibition of cell division, leading to decreased utilization of storage lipid while new synthesis of lipid continues. However, he also proposed that different stresses may affect different stages of the cell cycle. As there is evidence that the different lipid classes (neutral lipids versus polar lipids) may be synthesized at different times during the cell cycle, this could affect the quality and the quantity of the lipids synthesized. For example, pH stress appears to block release of autospores (after DNA replication); N deprivation could have multiple effects on the photosynthetic machinery or on a number of biochemical pathways in the cell that could directly or indirectly affect lipid synthesis. R. Thomas, a graduate student working with Dr. Cooksey, found that treating the cells with monofluoroacetate (MFA) also decreased cell growth and caused neutral lipid accumulation. MFA inhibits the TCA cycle, presumably preventing TCA oxidation of fatty acids and thus increasing the pool of acetyl CoA for synthesis of new fatty acids. (Thomas suggested that MFA could be used as a trigger for lipid accumulation in algal ponds, with the caveat that MFA is toxic to all living systems).

Dr. Cooksey concluded that to understand the biochemistry of neutral lipid accumulation in microalgae, it would be necessary to understand cellular cycles of lipid synthesis and utilization



that are coupled to cell growth and division. It will also be important to consider not only factors that affect synthesis of storage lipid, but also to understand the metabolic shifts that result in production of membrane lipids or storage lipids.

#### Publications:

Cooksey, K.E. (1987) "Collection and screening of microalgae for lipid production." *Final Subcontract Report*, Solar Energy Research Institute, Golden, Colorado, May 1987, 42 pp.

Cooksey, K.E.; Guckert, J.B.; Thomas, R. (1989) "Triglyceride accumulation and the cell cycle in microalgae." *Aquatic Species Program Annual Report*, Solar Energy Research Institute, Golden, Colorado, pp. 139-158.

Cooksey, K.E.; Guckert, J.B.; Williams, S.A.; Collis, P.R. (1987) Fluorometric determination of the neutral lipid content of microalgal cells using Nile Red, *J. of Microbiol. Methods* 6:333-345.

Cooksey, K.E.; Williams, S.A.; Collis, P.R. (1987) "Nile Red, a fluorophore useful in assessing the relative lipid content of single cells," In *The Metabolism, Structure and Function of Plant Lipids*, (Stumpf, P.K; Williams, S.A.; Callis, R.P., eds.), Plenum Press, N.Y., pp. 645-647.

Guckert, J.B.; Cooksey, K.E.; Jackson, L.L. (1987) "Lipid solvent systems are not equivalent for analysis of lipid classes in the microeukaryotic green alga, *Chlorella*." Unpublished manuscript.

Guckert, J.B.; Cooksey, K.E. (1990) "Triglyceride accumulation and fatty acid profile changes in *Chlorella* (Chlorophyta) during high pH-induced cell cycle inhibition." *J. Phycol.* 26:72-79.

Thomas, R.M. (1990) "Triglyceride accumulation and the cell cycle in *Chlorella*." Masters Thesis, Montana State University, July 1990.

#### II.B.1.g. Biochemical Elucidation of Neutral Lipid Synthesis in Microalgae

**Subcontractor:** University of Nebraska  
**Principal Investigator:** Steven D. Schwartzbach  
**Period of Performance:** 3/87 - 3/88  
**Subcontract Number:** XK-5-05073-3

The goal of the research performed by Dr. Schwartzbach and coworkers was to understand the biochemistry and physiology of lipid accumulation in microalgae, in particular the biochemical responses to N deficiency as a trigger for lipid accumulation. Lipid biosynthesis is dependent on the availability of fixed carbon and the activity of enzymes involved in lipid synthesis. These experiments were directed at understanding how these processes are affected by N limitation in the algal cells.



The first set of experiments analyzed lipid synthesis in the eustigmatophytes *Nannochloropsis salina* and *Nanno Q*, two oleaginous strains from the SERI Culture Collection. Similar results were obtained for the two strains. The basic protocol was to inoculate the algal cells into media containing either non-limiting levels or low levels of nitrogen (0.1 mM NaNO<sub>3</sub>), and to monitor cell growth, chlorophyll content, and the lipid levels per cell and per culture volume. In cultures containing low N, cell division ceased after 50-60 hours, and the cells entered stationary phase as the N was depleted. In contrast, cells grown with sufficient N continued to divide. In the N-replete cultures, the lipid content of the individual cells remained constant, and there was a steady increase in the amount of lipid per mL of culture as the cell number increased. In contrast, the N-deficient culture showed a significant increase in the level of lipid per cell. However, the lipid content of the culture per mL (or percentage of the AFDW composed of lipid) did not change. In *N. salina*, lipid made up 26%-32% of the AFDW, and in *Nanno Q*, lipid was 23%-24% of the AFDW in cultures grown under N-replete and N-depleted conditions. These results indicate that N depletion causes the cells to stop dividing, while lipid synthesis continues. However, there is no net increase in lipid synthesis, and the trigger in these cells does not change the activity of enzymes involved in lipid biosynthesis. One caveat to these studies is that Dr. Schwartzbach measured only total lipid produced in the cells, including polar membrane lipids and nonpolar storage lipids; it is unclear from these studies and those described later whether N deficiency could differentially affect accumulation of the nonpolar lipids in these algae.

Another result from the studies on *Nannochloropsis* was that the level of chlorophyll in the cells declined rapidly in N depleted cells. Thus, N depletion would also presumably decrease photosynthetic efficiency and the availability of fixed carbon. The next set of experiments was designed to separate the effects of reduced photosynthetic efficiency from direct effects of N limitation on biosynthetic enzyme activities. To accomplish this, a series of experiments was performed using the eukaryotic green alga *Euglena gracilis* var. *bacillaris* Cori. *Euglena* can grow heterotrophically using ethanol as the sole carbon source. The growth of cells in the presence of externally supplied carbon (ethanol) should not be limited by decreased photosynthesis, so the rate of lipid synthesis would be solely limited by lipid biosynthetic capabilities.

*Euglena* is unique compared to most algae of interest to the ASP as potential producers of biodiesel. *Euglena* produces both lipid (primarily in form of the wax ester myristyl-miristate) and carbohydrate (the major product is paramylum, a  $\beta$ -1,3-glucan) as storage products. Using *Euglena*, a complicated series of experiments was conducted comparing the growth, lipid and carbohydrate content, and chlorophyll levels in algae under photosynthetic and heterotrophic growth conditions, as well as under aerobic and anaerobic conditions (Coleman et al. 1988b). Basically, cells were grown to N deficiency, then resuspended in fresh media containing either sufficient or limiting amounts of N. The new media also did, or did not, contain ethanol as a carbon source, and the cells were grown in the dark or in light.

As was seen with the *Nannochloropsis* strains, cell growth under N deficient conditions caused an increase in the levels of storage products (in this case, lipid plus carbohydrate) per cell. However, there was no net increase in total lipid/carbohydrate when measured as a percentage of



dry cell weight. This was true in cells grown autotrophically or heterotrophically. Nitrogen depletion caused the cells to stop dividing, but the storage products continued to accumulate in the cells at the same rate as in non-nitrogen limited cells. In addition, the proportion of carbohydrate and lipid was unchanged, thus there did not appear to be a N trigger effect, either directly or indirectly via carbon limitation, on the enzymes of the lipid or carbohydrate synthetic pathways. One caveat to this result was that in very old cultures, (i.e., 12 days after transfer of the cells to N-deficient media), the lipid as a percentage of the dry cell weight increased in all cultures. However, this was accompanied by a decrease in the total cell mass, and the lipids are apparently more stable than other cell components.

Growth of *Euglena* under N-deficient conditions resulted in loss of chlorophyll, as seen for *Nannochloropsis*. Dr. Schwartzbach also used two-dimensional gel electrophoresis to monitor changes in the levels of chloroplast and mitochondrial proteins under N-deficient conditions (Coleman et al., 1988a). Under photosynthetic growth conditions (high light), exposure of the cells to N-deficient conditions resulted in a decrease in the levels of 37 proteins identified as components of the chloroplast. Under low light conditions, there was little change in the population of chloroplast proteins. The degradation of the chloroplasts under low N conditions was presumably due to photooxidation of chlorophyll, accompanied by degradation of newly synthesized photosynthetic membrane proteins that could not assemble properly into the unstable chloroplast. Synthesis of chlorophyll requires N to form  $\delta$ -aminolevulinic acid, a chlorophyll precursor. Although photooxidation of chlorophyll occurs constantly in the light, synthesis of new chlorophyll molecules also occurs to replace the degraded molecules. However, if N levels are depleted, new chlorophyll cannot be produced, and photosynthetic efficiency decreases. This result is important with regard to biodiesel production. It suggests that there would be limitations on the amount of lipid that could be produced in outdoor ponds using N limitation as a trigger for lipid accumulation even if carbon was not limiting (i.e., for cells grown in outdoor ponds).

One process that affected the biosynthetic pathways in *Euglena* and resulted in an increase in the total lipid in the cultures was cell growth under anaerobic conditions with ethanol as a carbon source (lipids increased from 5-10% to 45% of the AFDW). Growth via anaerobiosis caused the activation of the oxygen-sensitive pyruvate dehydrogenase in the mitochondria. This led to increased levels of acetyl CoA in the mitochondria, which activates the mitochondrial fatty acid synthesis pathways. However, the increased flow of carbon to lipid synthetic pathways was accompanied by degradation of non-lipid components under anaerobic condition, including paramylum, the main storage carbohydrate, which resulted in a decrease in total cell mass. Dr. Schwartzbach estimated that if the anaerobic cells had increased in cell mass to the same extent as cells grown aerobically, the lipids would only compose 15% of the dry weight.

This observation that anaerobiosis could result in increased lipid yields by actually affecting the lipid biosynthetic pathway suggested that lipid synthesis could be increased by increasing the levels of the lipid precursors acetyl CoA and malonyl CoA. Little is known about lipid synthesis in algae, but data from other organisms suggested that pyruvate dehydrogenase and acetyl CoA carboxylase could function as regulatory enzymes in algal lipid synthesis. Understanding the biochemical factors that limit production of the lipid precursors could lead to biochemical or



genetic engineering strategies to increase the activity of these enzymes that could produce an organism with the ability to produce very high lipid levels. To this end, Dr. Schwartzbach initiated a project to isolate and characterize these enzymes from several algae, including *Euglena*, *N. salina*, *Nanno Q*, and *Monoraphidium 2* (Smith and Schwartzbach 1988). They reported some very preliminary information on protein extraction techniques and assay techniques for these enzymes. This work was a precursor to a major effort at SERI/NREL in the late 1980s through the end of project in 1996 to identify key enzymes in the algal biosynthetic pathways and to increase lipid levels by manipulating these pathways through genetic engineering (see Sections II.B.2. and II.B.3.).

In summary, although *Euglena* is not typical of the oleaginous microalgae targeted as potential biodiesel producers by the ASP, the data from Dr. Schwartzbach's laboratory point out the importance of understanding the biochemical mechanisms by which algae accumulate lipids. For *Euglena* and the *Nannochloropsis* strains described here, N deprivation does not seem to function as an actual trigger to induce biosynthesis of lipid. Rather, it acts as a block to cell division. Lipid synthesis continues by normal pathways, and lipid levels increase per cell, with no net accumulation in the culture. This result confirms the conclusions of Cooksey and coworkers. In addition, N deficiency also affects other cell processes, such as photosynthetic efficiency, which could affect lipid accumulation as the availability of fixed carbon is decreased.

#### Publications:

Coleman, L.W.; Rosen, B.H.; Schwartzbach, S.D. (1987a) "Environmental control of lipid accumulation in *Nannochloropsis salina*, *Nanno Q* and *Euglena*." *FY 1987 Aquatic Species Program Annual Report* (Johnson, D.A.; Sprague, S., eds.), Solar Energy Research Institute, Golden, Colorado, SERI/SP-231-3206, pp. 190-206.

Coleman, L.W.; Rosen, B.H.; Schwartzbach, S.D. (1987b) "Biochemistry of neutral lipid synthesis in microalgae." *FY 1986 Aquatic Species Program Annual Report* (Johnson, D.A., ed.), Solar Energy Research Institute, Golden, Colorado, SERI/SP-231-3071, p. 255.

Coleman, L.W.; Rosen, B.H.; Schwartzbach, S.D. (1988a) "Preferential loss of chloroplast proteins in nitrogen deficient *Euglena*." *Plant Cell Physiol* 29:1007-101. (Note: a preprint of this article was also submitted as a SERI Report, 47pp.)

Coleman, L.W.; Rosen, B.H.; Schwartzbach, S.D. (1988b) "Environmental control of carbohydrate and lipid synthesis in *Euglena*." *Plant Cell Physiol*. 29:423-432.

Smith, C.W.; Schwartzbach, S.D. (1988) "Preliminary characterization of pyruvate dehydrogenase and acetyl-CoA synthetase." Manuscript submitted as a report to SERI, 6 pp.

**II.B.1.h. Transformation and Somatic Cell Genetics for the Improvement of Energy Production in Microalgae**

**Subcontractor:** University of Nebraska; Oregon State University  
**Principal Investigator:** Russel H. Meints  
**Period of Performance:** 1/86 - 12/89  
**Subcontract Number:** XK-5-05073-2

By the mid-1980s, SERI researchers became convinced that optimal lipid production in microalgae could be achieved only by genetic manipulation of the cells to produce the desired traits. The overall goal of the research performed by Dr. Meints for SERI was to develop an algal virus system as a tool for the genetic manipulation of microalgae with potential for liquid fuel production. Viral vector systems had been used successfully to transfer DNA into other cell types. Dr. Meints' laboratory was preeminent in the field of algal viruses. The work performed from 1986 to 1989 was based on earlier studies from this laboratory on isolating and characterizing a unique group of viruses from symbiotic algae. Funding from SERI contributed to ongoing research on the algal viral system by Dr. Meints; much of this work was done in collaboration with Dr. James Van Etten, in the Department of Plant Pathology at the University of Nebraska. The list of publications at the end of this section includes articles produced before and after the period of the SERI subcontract. This information was included to give interested readers an overview of the work performed on this topic.

*Background:*

In the early 1980s, Dr. Meints and Dr. Van Etten were studying *Chlorella*-like green algae that live in a symbiotic relationship within cells of the protozoan *Hydra viridis*. They found that the algal cells could be excised from the hydra, which could exist free of the symbiont if given proper nutrients. However, it was not possible to culture the algae free of the hydra host. Further study demonstrated that when the algal cells were isolated from the host, virus particles rapidly began to multiply within the algae, resulting in lysis of the algal population within 24 hours. Ultrastructural and biochemical studies on this algal virus system produced the following results:

- The virus consisted of a large (approximately 190-nm), polygonal particle, containing 30 to 40 polypeptides, the most abundant of which was a 46 kDa glycoprotein, presumably associated with the viral capsid.
- The virus genome consists of about 130 kbp of double-stranded DNA.
- New virus particles were assembled in the cytoplasm of the algal cells and released upon lysis of the algal cell wall.

This virus, called HVCV (for *Hydra viridis Chlorella* virus), was one of the few viruses described in eukaryotic algae. HVCV might play a role in initiating or maintaining the symbiotic



relationship between the alga and its hydra host, possibly by altering the algal cell wall. Subsequent studies identified viruses in four other strains of *Hydra* obtained from commercial sources. The viruses fell into two classes, based on particle size, bouyant density, and DNA restriction patterns (HVCV-1, HVCV-2). In addition, a similar virus was isolated from symbiotic *Chlorella* from *Paramecium bursaria* (PBCV-1).

To facilitate the study of these viruses, it was desirable to identify an algal strain that could be cultured free of the hydra or *Paramecium* host, which was susceptible to infection by the virus. This would allow production of large quantities of the virus and the study of viral replication and development. Sixteen strains of culturable *Chlorella*, which had been isolated from invertebrates such as *Paramecium*, *Hydra*, *Stentor*, and sponges, plus two free-living strains, were obtained. Attempts were made to infect these *Chlorella* strains with all the virus strains described earlier. None of the HVCV viruses (from *Chlorella*-Hydra hosts) were able to infect any *Chlorella* strain tested. However, two culturable *Chlorella* strains originally isolated from *Paramecium* (*Chlorella* strains N1a and NC64) were infected with PBCV-1 (the *P. bursaia* *Chlorella* virus). The infection led to lysis of the algal cells and production of large amounts of infectious viral progeny. This result led to the development of a plaque assay system for the algal viruses, similar to a bacteriophage assay on bacterial lawns. The availability of this system, which caused synchronous infection of the algal cells and the production of large quantities of viral particles, allowed the researchers to characterize the virus biochemically. It also allowed researchers to study the regulation of viral gene expression and the effects of viral replication on algal physiology and gene expression. A large number of publications resulted from this research (see below). Several of the most interesting and possibly relevant findings are summarized here.

- The virus particles attach at one vertex of their polygonal capsid to receptor sites on the algal cell wall. A lytic enzyme produced by the virus degrades the wall at this site, and the viral DNA is released into the cell. Living algal cells are not required for virus attachment and wall degradation (viruses can attach to and degrade isolated wall fragments), but living cells are necessary for release of the viral DNA. Complete viral capsids are assembled in viral assembly sites within the cytoplasm and subsequently filled with DNA. Virus particles are released through holes produced at discrete locations in the algal cell wall.
- The plaque assay system was used to screen for other viruses that infect algae. Viruses that infect *Chlorella* strains N1a or NC64A were found to be very common in nature. The viruses all had similar features, including a large, polygonal capsid and dsDNA; however, some viruses were distinguishable based on plaque size, reactivity to anti-PBCV-1 antisera, variations in the DNA restriction patterns and the extent of nucleotide modification.
- The viruses are highly infectious and grow rapidly within the algal cells. Algal growth is inhibited rapidly following viral infection. Synthesis of host DNA and RNA is shut down, and the organellar and genomic DNA is degraded. Viral gene expression entails transcription of early and late genes, and may include





expression of overlapping genes or transcription of genes from both DNA strands. Analysis of DNA from some viral isolates showed that the viral DNA is modified to varying extents, primarily in the methylation of adenine and cytosine residues. The data suggested that the virus produces a unique restriction enzyme that is specific for non-methylated sequences for degradation of the host DNA. The virus also produces a corresponding methyltransferase, which recognizes the same sequence as the restriction endonuclease. The methyltransferase methylates newly synthesized viral DNA, protecting it from degradation in the next round of infection.

Dr. Meints received funding from SERI from 1986 through 1989. The overall goal of the SERI-funded research was to use the algal virus system to develop methods for genetically manipulating microalgae with potential for liquid fuel production. The research from Dr. Meints' laboratory is reviewed below with respect to the specific goals of the project.

*Isolation and characterization of natural hosts for the algal viruses.*

Water samples isolated from various sites were screened for the presence of algal viruses using the plaque assay. If viruses were not detected initially, an enrichment protocol was used in which a few algal cells were added to the water sample; after 48-72 hours the algal and cell debris were removed by centrifugation and the sample was reassayed for the presence of virus. Using these procedures, more than 50 individual algal viral isolates were identified. Although the viruses were all large polygonal particles with dsDNA genomes, analysis of the viral DNA by digestion with restriction endonucleases showed there were at least 15 different types of virus found. Sites that contained virus were further analyzed for the natural algal hosts; however, none were identified. It is unclear why the natural hosts could not be found. Dr. Meints proposed either that the viruses were propagated or maintained by some unknown mechanism, or, more likely, that the natural host was present in the sites tested at very low concentrations. This is possible in that each virus that infects an algal cell could produce 350 new virus particles, and that up to 100 algal cells can exist within a single *Paramecium*. Based on the density of viral particles isolated from the various sites, a single *Paramecium* with algal symbionts could theoretically sustain a virus population in 350 liters of water. Because a natural alga host for the viruses was not found, the goal of characterizing the viral host was dropped, and further screening efforts were discontinued.

In a separate, but related, series of experiments, Dr. Meints received 250 water samples collected by Dr. Ralph Lewin of the Scripps Institute in La Jolla, California. These were also screened for the presence of algal viruses, but viral particles were not found in any of Dr. Lewin's samples.

*Screening of the SERI algal collection for infection with the Chlorella viruses.*

Dr. Meints received a number of algal strains from Dr. Bill Barclay at SERI that were believed to have potential for biodiesel production. These included *Chlorella* 501 and *A. falcatus* (A record



of the precise number and identity of the strains sent to Dr. Meints could not be found). Growth conditions for these strains were optimized, and the algae were then tested for infection by the algal viruses. None of the SERI strains were susceptible to infection by any virus isolate tested. This project was discontinued in early 1987.

*Use of the lytic enzyme(s) produced by the virus for degradation of the host cell wall for the production of microalgal protoplasts.*

Infection of *Chlorella* N1a or NC64A by the algal viruses resulted in rapid lysis of the algal cells. Dr. Meints' laboratory developed methods to isolate the lytic enzymes and to use the lysin preparation to produce algal protoplasts (cells without cell walls). The protoplasts could be used in studies of somatic cell fusion (genetic improvement by fusion of two individuals with useful traits such as pH tolerance and high lipid production). Alternatively, the protoplasts could be used as targets in a genetic transformation system in which DNA plasmids are taken up directly into cells without walls.

A crude lysin preparation was produced by infecting *Chlorella* N1a with PBCV-1. After several lytic cycles (approximately 24 hours), the sample was centrifuged to remove cell debris and virus. Initially, the supernatant from this preparation was used directly to produce protoplasts from *Chlorella* N1a cells. Alternatively, lysin activity was precipitated from the supernatant with 65% ammonium sulfate. Cells were exposed to lysin in the presence of 1 M sorbitol as an osmoticum. (One interesting result from the protoplast studies is that algal strains exhibited significant differences in their sensitivities to osmotica commonly used for higher plant cells; i.e. mannitol, but not sorbitol, was toxic to *Chlorella* N1a. The sensitivity of individual algal strains to different osmotica will need to be determined empirically.) The cell wall of algal cells exposed to lysin was rapidly degraded over the entire cell surface, as judged by electron microscopy and staining of the cells with calcofluor white, which stains plant cell walls. The lysin preparation could be purified further by exposing the crude sample to an affinity matrix composed of algal cell wall fragments. Lysin activity was eluted by salt washes. Exposure of *Chlorella* N1a cells to this lysin sample resulted in degradation of the algal wall at specific sites; when the osmoticum was reduced to half strength, the alga protoplast was released through discrete holes in the wall. This result suggested the presence of more than one enzymatic activity in the crude lysin preparation.

Somewhat surprisingly, the protoplasts did not lyse when transferred to water. However, exposure of lysin-treated cells, but not untreated cells, to low concentrations of detergent caused the release of chlorophyll. The amounts of chlorophyll released from lysin-treated cells was used as a measure of the extent of protoplast formation in a cell sample. The protoplasts were viable, as judged by staining with fluorescein diacetate. Unfortunately, although some regeneration of the cell wall occurred, the lysin-treated cells never formed new colonies. Attempts to use the viral-lysin to produce protoplasts from other microalgal strains met with little success. A manuscript was prepared and submitted to SERI that described the progress made on the use of lysin to produce algal protoplasts, but the article was never published in a technical journal.



*Characterization of the chloroplast and mitochondrial genomes of microalgal strains.*

The goal of this research was to characterize the organellar genomes of *Chlorella* and other microalgae. As organellar DNA is thought to be highly conserved evolutionarily, the idea was to use similarities or differences between chloroplast or mitochondrial DNA as a measure of the taxonomic relatedness of algal strains. This information could be useful for experiments involving somatic cell fusion or gene transfer, as these procedures would likely have a higher chance of success between more closely related strains. Studies of the organellar genomes could also lead to the identification of promoters or replication origins that could be used to develop vectors for algal transformation. Due to the lack of significant progress on the first three goals, Dr. Meints concentrated the efforts of his laboratory on this project for the last 2 years of the subcontract.

The first step was to develop methods for isolation of chloroplast and mitochondrial DNA from *Chlorella* N1a. Based on protocols used for higher plants, Dr. Meints exploited the differences in the C/G content between chloroplast DNA and nuclear DNA to separate the two genomes using density gradient centrifugation. Chloroplast DNA was identified by hybridization with heterologous chloroplast DNA markers. The chloroplast genome of *Chlorella* N1a was found to be circular, containing approximately 120 kbp of DNA. A restriction map of the chloroplast genome was produced and several genes were localized on the map by hybridization with chloroplast gene sequences from maize. Most chloroplast genomes contain two inverted repeats, each of which contains a copy of the 23S, 16S, and 5S ribosomal RNA genes. These repeats are flanked by a short and long single copy DNA region. Although Dr. Meints initially reported that *Chlorella* N1a chloroplast DNA contained this inverted repeat structure (Meints 1987), a subsequent article reported that the chloroplast genome of *Chlorella* N1a contains only a single copy of the ribosomal RNA gene region (Schuster et al. 1990b). This result was confirmed by Dr. Meints via a recent personal communication. Although most other green algae, including other chlorellans, contain chloroplast DNA similar to that commonly seen in most higher plants, i.e., containing two inverted repeats, this unusual chloroplast structure has been seen in two legumes (peas, broad beans), conifers, some red algae, and in at least one other green alga, *Codium*.

Restriction analysis of chloroplast DNA from several exsymbiont and free-living strains of *Chlorella* showed variations between the strains that indicate genetic divergence and that suggest gene transfer and cell fusion between these species may be problematic. The results suggest that chloroplast DNA structure may be a useful taxonomic parameter, but more study is needed before definite conclusions on algal taxonomy or cell-cell compatibility based on chloroplast DNA structure can be made.

Isolating mitochondrial DNA from *Chlorella* N1a was technically problematic, and the mitochondrial genome isolated was first presumed to be a plasmid. Unlike some species in which mitochondrial DNA has a G/C content similar to that of nuclear DNA, in *Chlorella* N1a, the mitochondrial DNA had a low G/C content similar to that of chloroplast DNA, and the two genomes banded very closely on the density gradients. As with the chloroplast DNA,



heterologous probes were used to identify the mitochondrial DNA and to localize specific mitochondrial genes on the restriction map. The gene organization in the *Chlorella* N1a mitochondrial DNA was similar to that in higher plants, and distinct from the organization of mitochondrial genes in animals and fungi. It has been proposed that mitochondria in plants and green algae originated from a separate endosymbiotic event as compared to animals and fungi. This is supported by Dr. Meints' results.

Although not included in the original Statement of Work, Dr. Meints also reported under this task other related research efforts in his laboratory toward the development of a genetic transformation system for microalgae. Libraries were prepared from *Chlorella* N1a nuclear DNA and DNA from the algal virus. The goal of this project was to identify DNA sequences that could be used to develop transforming vectors, such as origins of replication, regulatory regions for gene expression, or algal genes to use in selectable marker systems. A library of the viral DNA was prepared in a lambda vector, which allowed for the sequencing of the viral genome and studies of viral gene structure and expression. This work led to several significant discoveries that were published after SERI funding stopped, including the cloning of the major viral capsid protein (Graves and Meints, 1992), and the identification of a viral gene promoter that also functioned in higher plants (Mitra and Higgins, 1994).

Dr. Meints' laboratory also made several attempts to produce a library of *Chlorella* nuclear DNA, with little success. This appeared to be due to modification (probably methylation) of the algal DNA that resulted in degradation of the DNA by the bacterial host used for library construction. Several ways around this problem were proposed, including the use of a yeast cloning system or the use of a bacterial host that did not contain the enzymes for degradation of methylated DNA. A cDNA library was produced successfully before the end of the SERI-funded research efforts.

Dr. Meints and his coworkers and collaborators produced a large quantity of data during the 4 years of SERI-funded research and during the following years. They made significant contributions to the study of the biology, biochemistry, and molecular biology of a eukaryotic algal virus, and to the biology and molecular biology of the algal hosts, particularly with respect to the algal organellar genomes. Unfortunately, because of the specificity of the virus/algal interactions, the results obtained were not directly applicable to the development of a transformation system for the oleaginous algal strains of interest to NREL. The research also generated some valuable technical information, regarding toxicity of microalgae to common osmotica, construction of genomic DNA libraries, and organellar genome isolation, which could be useful for further studies of algal molecular biology and the development of genetic engineering techniques. The studies of the algal virus also resulted in the identification of a new restriction endonuclease (Jin et al. 1994) and a new adenine methyltransferase (Stefan et al. 1991), as well as a viral promoter sequence that can function in plants (Mitra and Higgins 1994).

**Publications:**

- Anberg, S.M.; Meints, R.H. (1991) "Nucleotide sequence of the genes for ribulose-1,5-bisphosphate carboxylase/oxygenase large subunit and ribosomal protein S145 from a *Chlorella*-like alga." *J. Phycol.* 27:753-758.
- Graves, M.V.; Meints, R.H. (1992) "Characterization of the major capsid protein and cloning of its gene from algal virus PBCV-1." *Virology* 188:198-207.
- Graves, M.V.; Meints, R.H. (1992) "Characterization of the gene encoding the most abundant *in vitro* translation product from a virus infected *Chlorella*-like alga." *Gene* 113:149-155.
- Ivey, R.G.; Henry, E.C.; Meints, R.H. (1996) "A *Feldmania* algal virus has two genome size classes." *Virology* 220:267-.
- Jin, A.; Zhang, Y.; Van Etten, J.L. (1994) "New restriction endonuclease *CviRI* cleaves DNA at TG/CA sequences." *Nuc. Acids. Res.* 22:3928-.
- Krueger, S.K.; Ivey, R.G.; Meints, R.H. (1996) "A brown algal virus genome contains a ring zinc finger motif." *Virology* 219:307-.
- Lee, A. M.; Ivey, R.G.; Meints, R.H. (1995) "Characterization of a repetitive DNA element in a brown algal virus." *Virology* 212:474-.
- McCluskey, K.; Graves, M.V.; Mills, D.; Meints, R.H. (1992) "Replication of *Chlorella* virus PBCV-1 and host karyotype determination studies with pulse-field gel electrophoresis." *J. Phycol.* 28:846-850.
- Meints, R. (1987) "Studies of the chloroplast genome of exsymbiotic and free-living *Chlorella*." *FY 1987 Aquatic Species Program Annual Report*, Solar Energy Research Institute, SERI/SP-231-3206, pp. 210-228.
- Meints, R.H.; Burbank, D.E.; Van Etten, J.L.; Lamport, D.T.A. (1988) "Properties of the *Chlorella* receptor for the PBCV-1 virus." *Virology* 164:15-21.
- Meints, R.H.; Lee, K.; Burbank, D.E.; Van Etten, J.L. (1984) "Infection of a *Chlorella*-like alga with the virus PBCV-1: Ultrastructural studies." *Virology* 138:341-346.
- Meints, R.H.; Lee, K.; Van Etten, J.L. (1986) "Assembly site of the virus PBCV-1 in *Chlorella*-like alga: Ultrastructural studies." *Virology* 154:240-245.
- Meints, R.H.; Kennedy, J.; Ziegelbein, M.; Amberg, S.; Van Etten, J.L. (1988) "Production of protoplasts from *Chlorella*-like algae." Unpublished manuscript; submitted to SERI as a research report.



- Meints, R.H.; Schuster, A.M.; Van Etten, J.L. (1985) “*Chlorella* viruses.” *Plant Mol. Biol. Reports* 3:180-187.
- Meints, R.H.; Van Etten, J.L. (1991) “Eukaryotic Algae.” In *Microbial Ecology: Principles, Methods and Applications*, (Levin, M.A.; Seidler, R.J.; Rogul, M., eds.), McGraw-Hill, Inc. New York, pp. 883-888.
- Meints, R.H.; Van Etten, J.L.; Kuczmarski, D.; Ang, B. (1981) “Viral infection of the symbiotic *Chlorella*-like alga present in *Hydra viridis*.” *Virology* 113:698-703.
- Reisser, W.; Burbank, D.E.; Meints, S.M.; Meints, R.H.; Becker, B.; Van Etten, J.L. (1988) “A comparison of viruses infecting two different *Chlorella*-like green algae.” *Virology* 167:143-149.
- Schuster, A.M.; Burbank, D.E.; Meister, B.; Skrdla, M.; Meints, R.H.; Hattman, S.; Swinton, D.; Van Etten, J.L. (1986) “Characterization of viruses infecting a eukaryotic *Chlorella*-like green alga.” *Virology* 150:170-177.
- Schuster, J.A.; Graves, M.; Korth, K.; Ziegelbein, M.; Brumbaugh, J.; Grone, D.; Meints, R.H. (1990a) “Transcription and sequence studies of a 4.3 kbp fragment from a dsDNA eukaryotic alga virus.” *Virology* 176:515-523.
- Schuster, A.M.; Waddle, J.A.; Korth, K.; Meints, R.H. (1990b) “The chloroplast genome of an exsymbiotic *Chlorella*-like alga.” *Plant Mol. Biol.* 14:859-862.
- Skrdla, M.P.; Burbank, D.E.; Xia, T.; Meints, R.H.; Van Etten, J.L. (1984) “Structural proteins and lipids in a virus, PBCV-1, which replicates in a *Chlorella*-like virus.” *Virology* 135:308-315.
- Stefan, C.; Xia, Y.; Van Etten, J.L. (1991) “Molecular cloning and characterization of the gene encoding the adenine methyltransferase M.Cvir1 from *Chlorella* virus XZ-6E” *Nuc. Acids Res.* 19:307-.
- Van Etten, J.L.; Burbank, D.E.; Joshi, J.; Meints R.H. (1984) “DNA synthesis in a *Chlorella*-like alga following infection with the virus PBCV-1.” *Virology* 134:443-449.
- Van Etten, J.L.; Burbank, D.E.; Kuczmarski, D.; Meints, R.H. (1983) “Virus infection of a culturable *Chlorella*-like algae and development of a plaque assay.” *Science* 219:994-996.
- Van Etten, J.L.; Burbank, D.E.; Meints, R.H. (1986) “Replication of PBCV-1 in ultra-violet irradiated *Chlorella*.” *Intervirology* 26:115-120.
- Van Etten, J.L.; Burbank, D.E.; Schuster, A.M.; Meints, R.H. (1985) “Lytic viruses infecting a *Chlorella*-like alga.” *Virology* 140:135-143.



Van Etten, J.L.; Burbank, D.E.; Xia, Y.; Meints, R.H. (1983) "Growth cycle of a virus, PBCV-1, that infects *Chlorella*-like algae." *Virology* 126:117-125.

Van Etten, J.L.; Meints, R.H. (1991) "Viruses and virus-like particles of eukaryotic algae." *Microbiological Reviews* 55:586-620.

Van Etten, J.L.; Lane, L.; Meints, R.H. (1991) "Unicellular plants also have large dsDNA viruses." *Seminars in Virology* 2:71-77.

Van Etten, J.L.; Meints, R.H.; Burbank, D.E.; Kuczmarski, D.; Cuppels, D.A.; Lane, L.C. (1981) "Isolation and characterization of a virus from the intracellular green alga symbiotic with *Hydra viridis*." *Virology* 113:704-111.

Van Etten, J.L.; Meints, R.H.; Kuczmarski, D.; Burbank, D.E.; Lee, K. (1982) "Viruses of symbiotic *Chlorella*-like algae isolated from *Paramecium bursaria* and *Hydra viridis*." *Proc. Nat'l. Acad. Sci.* 79:3867.

Van Etten, J.L.; Schuster, A.M.; Meints, R.H. (1988) "Viruses of eukaryotic *Chlorella*-like algae." In *Viruses of Fungi and Simple Eukaryotes*, Mycology Series vol. 7 (Koltin, Y.; Leibowitz, M.J., eds.), Marcel Dekker, Inc., New York, pp. 411-428.

Van Etten, J.L.; Xia, Y.; Meints, R.H. (1987) "Viruses of a *Chlorella*-like green alga." In *Plant-Microbe Interactions II*, (Kosuge, T.; Nester, E.W., eds.), Macmillan Publishing Co., pp 307-325.

Van Etten, J.L.; Xia, Y.; Narva, K.E.; Meints, R.H. (1987) "*Chlorella* Algal Viruses." In *Extrachromosomal Elements in Lower Eukaryotes* (Fink, G.; et al., eds.), Plenum Press, New York, pp. 337-347.

Waddle, J.A.; Schuster, A.M.; Lee, K.; Meints, R.H. (1989) "The mitochondrial genome of the exsymbiotic *Chlorella*-like green alga N1a." *Aquatic Species Program Annual Report*, September 1989, Solar Energy Research Institute, Golden, Colorado, SERI/SP-231-3579, pp. 91-118.

Waddle, J.A.; Schuster, A.M.; Lee, K.; Meints, R.H. (1990) "The mitochondrial genome of an exsymbiotic *Chlorella*-like green alga." *Plant Mol. Biol.* 14:187-195

## **II.B.2. Physiology, Biochemistry, and Molecular Biology of Lipid Production: NREL In-House Researchers**

### **II.B.2.a. Introduction**

During the first few years of the ASP, in-house research efforts in the area of lipid biosynthesis focused on understanding the lipid trigger and the effects of N starvation on lipid synthesis and photosynthetic efficiency. It was also shown that lipid accumulation can be induced in diatoms by Si starvation, a major component of the diatom cell wall. During the second half of the 1980s



and early 1990s, a major component of the research at SERI/NREL was the study of lipid biosynthesis in the oleaginous diatom *C. cryptica*. This was primarily the work of Paul Roessler, who identified a key enzyme involved in lipid accumulation and isolated and characterized both the protein and the gene for the enzyme acetyl-CoA carboxylase from *Cyclotella*. Other research efforts at NREL examined related biosynthetic pathways, including synthesis of chrysolaminarin, a storage carbohydrate, and lipid processing reactions such as fatty acid desaturation. The basic biochemistry and molecular biology research formed the basis of the efforts to manipulate microalgal lipids by genetic engineering, which will be described in Section II.B.3.

One aspect of the algal research at SERI was the possibility of producing hydrogen by microalgae, for use as a gaseous fuel. During photosynthetic electron transport, electrons from reduced ferredoxin can be transferred to hydrogen ions to produce H<sub>2</sub>. This reaction is catalyzed by the enzyme hydrogenase. Unfortunately, hydrogenase is inhibited by molecular oxygen, a by-product of the photosynthetic reaction, making the practical application of this process difficult. There was a significant research effort at SERI in the early 1980s, primarily by Dr. Steve Lien and Dr. Paul Roessler, to understand the biochemistry of hydrogen production by microalgae. The work on hydrogenase was funded by the Hydrogen Program at DOE, not the ASP, and will not be included in this report. However, studies on hydrogen production by microalgae are ongoing at NREL (SERI) in the Center for Basic Sciences, and interested readers should contact Dr. Michael Seibert for more information.

#### **II.B.2.b. Lipid Accumulation Induced by Nitrogen Limitation**

As a result of the algal screening efforts by SERI subcontractors and in-house researchers, several algal species were identified as good candidates for biodiesel production during the early 1980s. This was facilitated by the development of a cytochemical staining technique for intracellular lipids that allowed researchers to visualize storage lipid droplets in algal cells (see Section II.A.1.f. and Lien 1981a). Two of the most promising candidates were the green alga *N. oleoabundans*, which showed a high lipid content and rapid growth, and a *Chlorella* strain (CHLS01) isolated from a local site.

First, a sensitive method to monitor nitrate levels in liquid cultures using ion chromatography was developed to study the effects of N limitation on lipid accumulation in these organisms. Algal growth, lipid content, and chlorophyll *a* content were measured in batch cultures of *N. oleoabundans* and CHLS01. Cell division and chlorophyll accumulation occurred rapidly in the cultures as long as N was present. When N was depleted, cell division stopped, although biomass accumulation continued for several days. The major portion of the new biomass was composed of lipids and storage oils. N depletion resulted in a rapid decrease in the level of chlorophyll *a* in the cultures, suggesting that the cells might metabolize chlorophyll during periods of nitrogen stress. There was also an increase in the ratio of carotenoid to chlorophyll and a significant decrease in the complexity of the intracellular membranes in N-starved cells. These last three observations indicated that the photophysiology of the cells was affected, suggesting that the lipid trigger could also directly or indirectly alter photosynthetic efficiency in the treated cells (discussed in more detail below).





### II.B.2.c. Studies on Photosynthetic Efficiency in Oleaginous Algae

SERI researchers Lien and Roessler (1986) tried a somewhat different approach to understand the processes affecting lipid accumulation (Lien and Roessler 1986). A recently published technical evaluation (Hill et al. 1984) identified two major requirements for economic feasibility of biodiesel production:

1. Photosynthetic efficiency (which can simply be thought of as the percentage of incident radiation that is converted into biomass) needs to be 18%, and
2. Algal biomass needs to consist of 60% lipid.

Because very high lipid production is usually correlated with stress conditions (nutrient deprivation) that result in decreased photosynthetic efficiency and decreased growth, the two conditions of high lipid and high productivity seemed to be mutually exclusive. To overcome this technical hurdle, Lien and Roessler initiated a study to help understand the effects of nitrogen deprivation and lipid accumulation on photosynthetic efficiency.

Three strains of oleaginous algae were used in this study: *Chlorella* CHLSO1, *Ankistrodesmus* sp., and a newly isolated chrysophyte strain Chryso/F-1. The cells were grown in batch culture and monitored for nitrate concentration, light levels in the culture, chlorophyll concentration, and yield of cell mass and lipid (including total, neutral, and polar lipids). Maximum energy efficiency occurred as the culture approached N depletion. At this point, the culture showed a maximum density of photosynthetic pigments (before chlorophyll degradation and after N depletion), but the light energy reaching the cells was decreased due to the higher culture density. Thus, photosynthetic efficiency (biomass produced per light energy input) was maximized and the individual cells suffered less photooxidative damage due to lower light exposure. After the N in the culture was depleted, cell mass continued to increase for a time, eventually leveling off. All cultures experienced a two- to three-fold increase in total lipid, primarily as non-polar lipid. The photosynthetic efficiency decreased over the duration of the batch culture. However, in the early stages after the N was depleted, the cultures showed a decrease in energy efficiency with respect to total cell mass (AFDW) and with respect to the non lipid cell components, while photosynthetic efficiency remained constant or increased slightly with respect to lipid accumulation. In addition, N deprivation caused an increase in the efficiency of neutral, storage lipid production and suppressed the efficiency of polar structural lipid production.

These studies provided interesting preliminary data on the energetics of cell mass and lipid accumulation in algae. Follow-up experiments were proposed, including investigations of the relationship between initial N concentration and photosynthetic efficiency and lipid production after N depletion, and studying the effects of N resupply after depletion to attempt to extend the period of lipid production. These experiments were not continued; however, the results described earlier suggest that understanding the timing or kinetics of lipid accumulation in microalgae will be essential to maximize lipid production in a mass culture facility. If N starvation is used to trigger lipid accumulation, the data suggest that maximal photosynthetic



efficiency with respect to lipid production (and probably the best time for harvesting lipid-producing cells), occurs just after the N is depleted from the cultures.

Another set of experiments directed at optimizing photosynthetic efficiency in algal ponds was performed by SERI researcher Dr. Ken Terry. Previous studies had indicated that algal cells grown under high-intensity flashing light can use that light energy more efficiently than cells grown under the same intensity under constant illumination. The evidence suggests that an algal cell can integrate absorbed light energy such that the photosynthetic efficiency achieved under intermittent light conditions is similar to that attained under constant light of the same average intensity. This flashing light, or photomodulation, effect can be mimicked in vertically-mixed algal ponds, as cells circulate to the surface and back down to the lower levels in the pond where they receive minimal light. Thus, the photosynthetic efficiency of algal cells grown in ponds may be increased in high light by using mixing strategies that optimize this photomodulation effect.

In order to better understand the effects of intermittent light on photosynthetic efficiency of microalgal cultures, Dr. Terry set up a system to measure photosynthetic rates and oxygen evolution in laboratory cultures of *Chlorella pyrenoidosa* and *Phaeodactylum tricorutum* under flashing light conditions. Intermittent light conditions were simulated by placing sectorized disks in front of a light source, and using this to illuminate exponentially growing cultures that had been placed in an oxygen electrode chamber. Photosynthesis was then measured under varying light/dark ratios (generated by changing the configuration of the disk) and light intensities. The data generated were used to calculate the percent “integration” of the incident light by the algal cultures. More rapid flashing led to greater integration, although lower flash frequencies produced higher levels of integration as the percentage of time the cells spent in the light decreased. Although these data were preliminary, they supported the proposal that photosynthetic efficiency in microalgal ponds could be enhanced by optimized vertical mixing strategies. However, increased photosynthetic efficiency might be compromised by increased losses to respiration as the cells spend increased time away from the surface, and the energy costs to achieve optimal mixing could be prohibitive.

Although Dr. Terry proposed follow-up studies using modulated light regimes that more closely mimic those seen in algal ponds, little further research on understanding photosynthetic efficiency in algal cultures was performed at SERI. Instead, the emphasis of the in-house research shifted to understanding the biochemistry and molecular biology of lipid accumulation.

#### **II.B.2.d. Lipid Accumulation in Silicon-Deficient Diatoms**

A note added to a chapter of the 1986 Annual Report (Lien and Roessler 1986) described preliminary data on the use of Si deficiency to trigger lipid accumulation in diatoms. Silicon is major component of diatom cell walls. Similar to the lipid trigger effect produced by N-deficiency, Si depletion also results in a decrease in cell growth and often is accompanied by an accumulation of lipid within the cells. However, Si (unlike N) is not a component of other cellular macromolecules (enzymes, membranes) or cell structures such as the photosynthetic



apparatus. Therefore, any changes in cellular biochemistry and lipid accumulation induced by Si deficiency might be more easily interpreted than changes induced by N starvation. This work initiated a series of experiments by Paul Roessler during the late 1980s and early 1990s on the biochemistry and molecular biology of lipid accumulation in Si-deficient diatoms.

The first set of experiments compared the effects of Si deficiency on lipid accumulation and cell physiology in several species of diatoms, including *C. cryptica* T13L, *Thalassiosira pseudonana*, and *Cylindrotheca fusiformis*. Exponentially growing cultures were transferred to media that contained either excess Si or limited levels of Si so that the media became Si deficient while the cells were still growing exponentially. Cell growth, chlorophyll *a* content, AFDW, lipid, and photosynthetic capacity were monitored under both conditions. In all three species, cell division decreased as soon as the Si was depleted in the media. However the species responded differently with respect to other physiological parameters. In *C. cryptica*, chlorophyll *a* synthesis was almost completely inhibited after 12 hrs in Si-depleted media; *C. fusiformis* showed little change in chlorophyll *a* synthesis after 72 hrs. *T. pseudonana* exhibited an intermediate effect, with some decrease in chlorophyll *a* synthesis noted after 36 hours without Si. The effect on photosynthetic capacity, measured as O<sub>2</sub> evolution, also varied between the three species. In *C. fusiformis* and *C. cryptica*, photosynthetic capacity decreased 33% and 58%, respectively, after 12 hours; *T. pseudonana* showed a steady decline in photosynthetic capability following Si-depletion. (However, photosynthetic capacity decreased in Si-replete cultures as well during the 72 hours time course of the experiment, presumably due to the increased ratio of antenna chlorophyll molecules versus reaction center molecules in the self-shaded, dense cultures).

The three species were also analyzed for accumulation of total biomass and lipid (Figure II.B.3.).

In *C. fusiformis*, biomass accumulation (measured as AFDW) for the duration of the experiment was similar in cultures with or without sufficient Si, although lipids made up a higher percentage of the AFDW in the Si-deficient cultures (26% versus 21% in Si-replete cells). In *T. pseudonana*, synthesis of cell mass and lipid was not affected until 36 hours after Si depletion. At this point, biomass and lipid accumulation rates decreased; however, there was little difference in the percentage of total lipid in the cells with or without Si at the end of the 72 hours experimental period. The situation with *C. cryptica* was very different. Twelve hours following Si depletion, there was a 38% decrease in the growth rate of these cells compared to the Si-replete culture. However, lipid synthesis continued at the same rate in the Si-deficient cells as in the Si-replete cells, resulting in a significant increase in the lipid content of the Si-starved cells. Interestingly, after these initial changes, the Si deficient cultures of *C. cryptica* showed little gain in total AFDW or lipid during the remaining 72 hours of the experiment.

In order to determine if Si deprivation affected the composition of the lipids produced, the lipids were extracted and analyzed for the percentage of polar versus neutral lipids present. In all three species, the Si-deficient cultures showed a significant increase in the level of neutral lipids, primarily TAGs. For example, the percentage of neutral lipids in Si-deficient cultures of *C. cryptica* was 64%, compared to 32% in Si-replete cultures. In *C. fusiformis*, the percentage of neutral lipids increased from 17%-20% to 57% in Si-deprived cultures.



Based on these studies, *C. cryptica* was identified as the best candidate for further studies on the biochemistry of lipid accumulation. To determine the effects of Si deficiency on the synthesis of the cell components, the levels of protein, carbohydrate, and lipid were examined at various times after Si was depleted in the cultures. During the first 12 hours, protein and carbohydrate synthesis decreased. Lipid accumulation continued at a rate similar to that of the Si-replete cultures. This resulted in an increase in lipid content of the Si deficient cells from 19% to 27%. This observation was confirmed in subsequent studies that followed the incorporation of newly assimilated carbon (as  $\text{H}^{14}\text{CO}_3^-$ ) into the various cell components. Si depletion resulted in a net decrease in the rate of photosynthesis and carbon assimilation, but the individual cell fractions were affected differently. For example, the rate of  $^{14}\text{C}$  accumulation into lipids decreased by 48% in the first 4 hours of Si-deprivation; the uptake of  $^{14}\text{C}$  into chrysolaminarin, the major carbohydrate storage product in diatoms, decreased 84%. Therefore, the increase in lipid content of Si-deficient cells was not due to an increase in the rate of lipid synthesis, but to a relative decrease in the rate of synthesis of protein and carbohydrate.

Pulse-chase experiments were performed to test whether Si deficiency also caused the conversion of non-lipid cellular components into lipids. In these experiments, Si-replete cells were labeled with  $\text{H}^{14}\text{CO}_3^-$  for 1 hour, then transferred into Si-deficient media without labeled bicarbonate. The amount of labeled carbon in the lipid fraction was determined at various times following transfer to Si-free media. This experiment showed that carbon was slowly redistributed from the nonlipid components of the cells into lipid under Si-deficient conditions, but not under Si-replete conditions. Therefore, the accumulation of lipids in diatoms in response to Si-deficiency is apparently due to two factors:

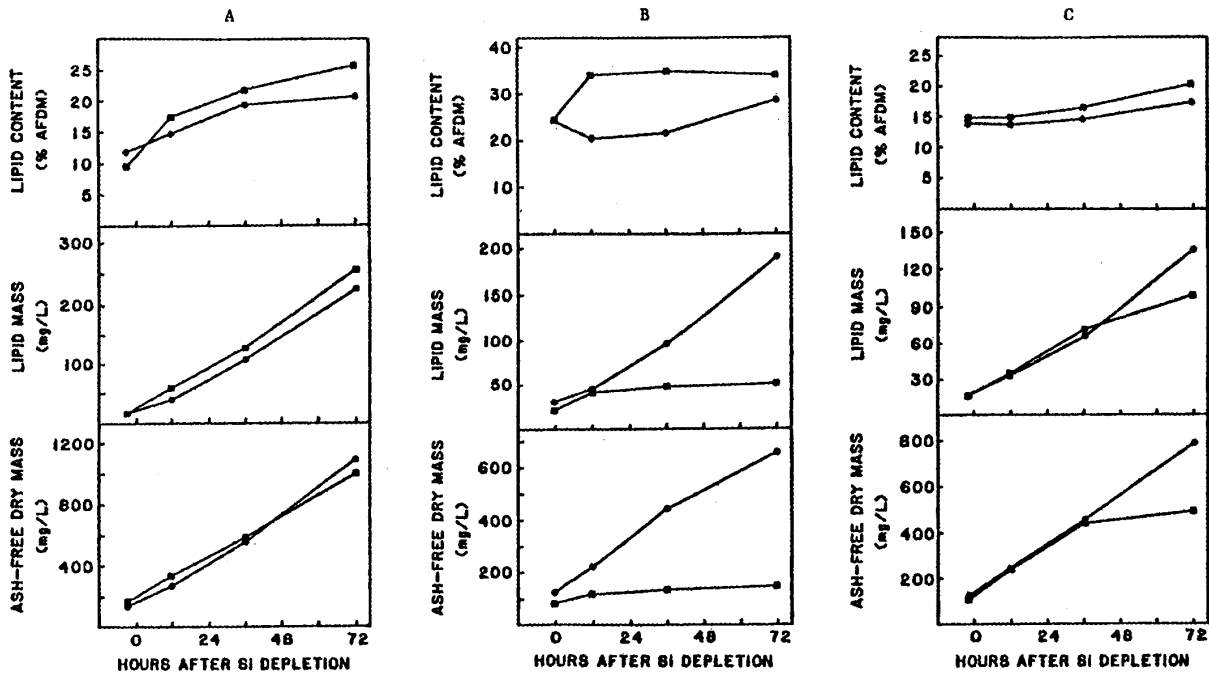
1. An increase in the proportion (but not the net amount) of newly assimilated carbon that is incorporated into lipids, resulting from a disproportionate decrease in the rate of lipid synthesis versus carbohydrate synthesis, and
2. A slow conversion of nonlipid cell material into lipids.

Fractionation of the lipids produced demonstrated that Si deprivation resulted in an increase in the proportion of total lipid as neutral lipids, primarily TAGs, from 43% to 63% after only 4 hours of Si deficiency. Analysis of the fatty acid composition of the accumulated lipids also showed changes induced by Si starvation. In Si-deficient cells, there was an increase in the proportions of mono- and unsaturated fatty acids (16:1, palmitoleic acid; 16:0, palmitic acid; and 14:0, myristic acid), and a reduction in the proportions of the three major polyunsaturated fatty acids, (16:3, 20:5, and 22:6). These results are consistent with the finding that the predominant fatty acids found in triacylglycerol storage lipids in *C. cryptica* are 16:1, 16:0, and 14:1. These shorter, more highly saturated fatty acids are also the most desirable substrates for conversion into fatty acid methyl esters (biodiesel), as they would be less likely to polymerize during combustion and “gum up” an engine.

Although Si depletion causes all diatoms tested to stop dividing, species responded differently with respect to continued accumulation of biomass and lipid. *C. cryptica* showed a rapid



response to Si-depletion, with a decrease in growth accompanied by a significant increase in the proportion of the biomass as lipid within 12 hours (the response to N starvation was usually much slower, as the cells could utilize internal N stores). This result again emphasizes the need to understand the kinetics of lipid accumulation in individual species under specific conditions for cost-effective lipid production in the ponds.



**Figure II.B.3.** Changes in lipid mass, ash-free dry mass, and lipid content in Si-deficient cultures of three diatoms.

A. *C. fusiformis* B. *C. cryptica* C. *T. pseudonana*.

Symbols: (■) Si-deficient cultures; (●) Si-replete cultures.



### II.B.2.e. Isolation and Characterization of Acetyl-CoA Carboxylase from *C. cryptica*

To better understand the processes involved in lipid accumulation in microalgae, and to identify potential molecular targets for genetic manipulation, studies were initiated to examine the effects of Si deficiency on the enzymatic pathways involved in lipid and carbohydrate synthesis in *C. cryptica*. One possibility is that the increased levels of storage lipid in cells exposed to Si starvation could result from shifts in the relative activities of one or more enzymes in the lipid biosynthesis pathway. Acetyl-coenzyme A (acetyl-CoA) is known to be the immediate precursor of fatty acid synthesis, but the source of this compound varies in different organisms. For example, in mammalian cells, acetyl-CoA used in cytosolic fatty acid synthesis is produced from citrate via the action of ATP citrate lyase. In plants, acetyl-CoA can be produced in the chloroplasts from pyruvate, catalyzed by pyruvate dehydrogenase. Alternatively, acetyl-CoA could be produced by the mitochondrial pyruvate dehydrogenase. In this case, the acetyl-CoA (which cannot diffuse across the organellar membranes) would be broken down to acetate and free CoA by acetyl-CoA hydrolase. Acetate would diffuse to the chloroplast and become incorporated into acetyl-CoA by the action of acetyl-CoA synthetase. Once acetyl-CoA is produced, it is then used as a substrate by acetyl-CoA carboxylase (ACCase) to produce malonyl CoA. Malonyl-CoA is a substrate for fatty acid synthase and this reaction is considered to be the first committed step in fatty acid synthesis.

These pathways had not previously been well-characterized in diatoms. To better understand the lipid synthesis pathways, Roessler first looked for the presence of these enzymes in extracts of *C. cryptica*, but found no citrate lyase activity. However, acetyl-CoA hydrolase, acetyl-CoA synthetase, and ACCase activity were all present. Enzyme activities were studied in Si-replete and Si-deficient cells (Figure II.B.4). The level of acetyl-CoA synthetase activity was similar under both conditions; however, the level of ACCase activity was two fold higher in Si-deficient cells after 4 hours, and four fold higher after 15 hours. Based on subsequent studies using protein synthesis inhibitors, the increased specific activity of the ACCase was believed to result from an increase in expression of the ACCase gene (Roessler 1988a; 1988c).

ACCase is a biotin-containing enzyme that catalyses the carboxylation of acetyl-CoA to form malonyl-CoA. This reaction entails two partial reactions: the carboxylation of biotin, followed by the transfer of the carboxyl group from biotin to acetyl-CoA. In bacteria, the enzyme is composed of four non-identical subunits. However, in eukaryotes, biotin binding, biotin carboxylation, and carboxyl-transfer all occur on a single large multifunctional protein; the functional ACCase occurs as a multimer of this polypeptide. ACCase had previously been shown to play a key regulatory role in the rates of fatty acid synthesis in both animal and plant systems. A project was initiated to isolate and characterize ACCase from *C. cryptica* to clarify the role of this enzyme in lipid accumulation induced by Si starvation, and to compare the microalgal enzyme with those isolated from plants, animals, yeast, and bacteria.

The enzyme was purified from *C. cryptica* by a combination of  $(\text{NH}_4)_2\text{SO}_4$  precipitation, gel filtration chromatography, and affinity chromatography based on the affinity of biotin to avidin. Consistent with ACCase enzymes isolated from other eukaryotes, *C. cryptica* ACCase was found

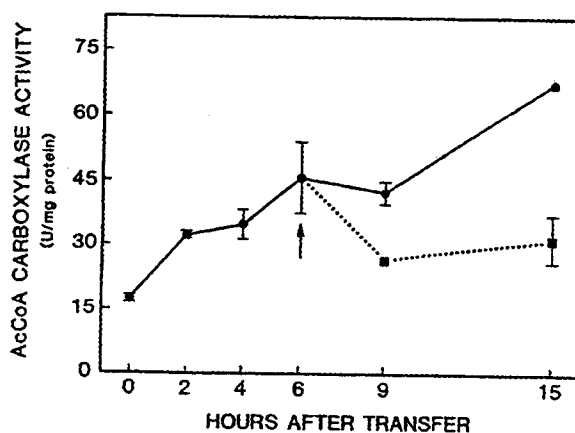


to consist of a homo-tetramer of 185 kDa subunits. The activity of the enzyme was assayed by the incorporation of  $^{14}\text{C}$  bicarbonate into malonyl-CoA, and other factors were identified that affect the stability and activity of the enzyme. As seen for other ACCases, the enzyme required a slightly alkaline pH for optimum activity (pH 8.2), although the enzyme was most stable when stored at pH 6.5. The enzyme was also stabilized by sulfhydryl reductants (i.e., dithiothreitol), citrate, NaCl, and KCl; divalent metal cations ( $\text{Mg}^{2+}$  or  $\text{Mn}^{2+}$ ) were required for activity. A number of cellular metabolites were also tested for their effects on ACCase activity. The enzyme was inhibited by products of the ACCase reaction, including malonyl-CoA, ADP, and  $\text{NaH}_2\text{PO}_4$ , and also by palmitoyl-CoA, but it was not affected by various glycolytic or photosynthetic intermediates or by free CoA. Two herbicides that inhibit ACCases from monocot plants were also had little or no effect on *C. cryptica* ACCase. Thus, the ACCase from this diatom was found to be similar to higher plant ACCase enzymes in that it is composed of multiple, identical, multifunctional subunits. In addition, the  $K_{\text{ms}}$  for the ACCase substrates (acetyl-CoA, MgATP, and bicarbonate) in *C. cryptica* were similar to those found in plant ACCase enzymes (Roessler 1989; 1990).



Enzyme	Enzyme activity $\pm$ SE (nmol·min <sup>-1</sup> ·mg protein <sup>-1</sup> )		Activity ratio deficient:replete
	Si-deficient cells	Si-replete cells	
UDPglucose pyrophosphorylase	418 $\pm$ 30	430 $\pm$ 29	0.97
Chrysolaminarin synthase	0.55 $\pm$ 0.02	0.80 $\pm$ 0.02	0.69
Acetyl-CoA synthetase	13.7 $\pm$ 1.3	14.5 $\pm$ 1.7	0.94
Acetyl-CoA carboxylase	32.3 $\pm$ 0.3	16.5 $\pm$ 1.3	1.96
Citrate synthase	112 $\pm$ 11	110 $\pm$ 11	1.02

*Note.* Enzyme activities were measured 4 h after transfer into a silicon-free or a silicon-replete medium. The results shown are the average of three separate experiments. Activity is expressed in terms of product formation for all enzymes except chrysolaminarin synthase, in which case activity is expressed in terms of UDPglucose utilization.



**Figure II.B.4.** Activity of various enzymes in Si-replete and Si-deficient *C. cryptica*.

A. (Top) - Activities of several enzymes in Si-replete and Si-deficient *C. cryptica* cells. There is no significant difference in the activities of UDPglucose pyrophosphorylase, acetyl-CoA synthetase, or citrate synthase in the cells under the two conditions. However, there is a relative increase in acetyl-CoA carboxylase activity, and a decrease in chrysolaminarin synthase activity in Si-deficient cells.

B (Bottom) - Graph showing the activity of ACCase in *C. cryptica* cells. Exponential-phase cells were transferred into Si-free media at 0 hr. At 6 hr, (arrow), the culture was split and 1.8 mM Na<sub>2</sub>SiO<sub>3</sub> was added to one culture. (●) Si-deficient cells; (■) Si-replete cells.

(Source: Roessler 1988a).





#### II.B.2.f. Cloning of the Acetyl-CoA Carboxylase Gene from *C. cryptica*

Work on the key role of ACCase in lipid biosynthesis in other plant and animal systems, suggested that this enzyme might be a viable target for genetic manipulation in order to increase lipid production in microalgae. This notion was further supported by the work at SERI that showed changes in ACCase activity in Si-starved *C. cryptica* cells.

The next step was to isolate the ACCase gene from a microalgal species. Although the ACCase gene had been isolated from yeast, rats, and the bacteria *E. coli*, the gene had not previously been isolated from any photosynthetic organism. In 1990 and 1991, Dr. Roessler took a sabbatical from SERI to work with Dr. John Ohlrogge at Michigan State University. Dr. Ohlrogge studies lipid biosynthetic pathways in higher plants. This work was partially funded by a Plant Biology Postdoctoral Fellowship to Paul Roessler from the National Science Foundation. The goal of this collaboration was to clone and characterize the ACCase gene from *C. cryptica*. To accomplish this task, the purified ACCase protein was first cleaved with cyanogen bromide (CNBr); the peptides generated were separated by SDS-PAGE, purified, and several of these peptides were analyzed to determine their amino acid sequence. (This work was done in collaboration with Calgene, a plant biotechnology company in Davis, California.)

The amino acid sequences were used to design degenerate oligonucleotide primers that were used in a polymerase chain reaction (PCR) to amplify an ACCase gene fragment from *C. cryptica*'s total DNA. A  $^{32}\text{P}$ -labeled RNA transcript was produced from the ACCase DNA and used to screen a genomic library of *C. cryptica* DNA. A 14 kb cloned fragment that hybridized to the ACCase probe was cleaved into smaller fragments that were subcloned, sequenced, and analyzed for the presence of open reading frames (ORFs) and non coding intron sequences. This analysis showed that the ACCase gene from *C. cryptica* contains approximately 6.3 kbp of coding sequence, separated by a 447 bp intron close to the 5' end, and a 73 bp intron just upstream from the biotin binding site. The protein predicted by this nucleotide sequence would contain 2,089 amino acids and have a molecular weight of 230 kDa. This is somewhat larger than the molecular weight of 185 kDa estimated by SDS-PAGE, discussed earlier. This discrepancy could be accounted for by inaccuracies inherent in using SDS-PAGE to estimate protein size, particularly for large proteins, and the probability of a signal sequence on the ACCase enzyme for targeting the protein to the chloroplast. Post-translational cleavage of the signal would result in a mature protein smaller than predicted from the primary DNA sequence.

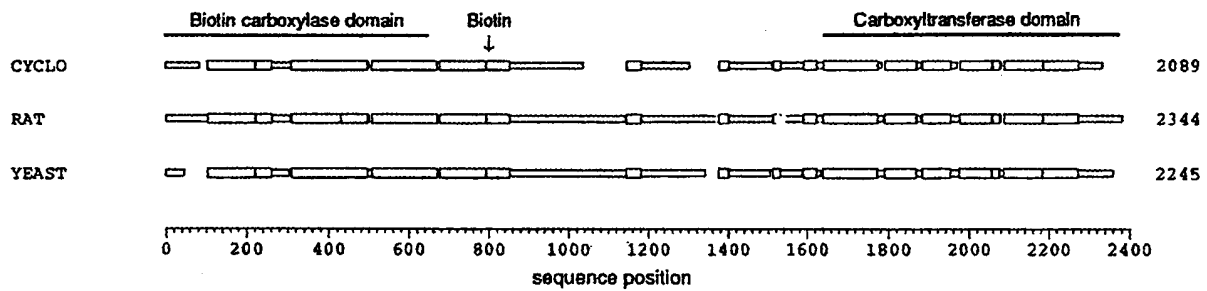
The deduced amino acid sequence of the ACCase from *C. cryptica* was compared with known sequences from yeast and rat (Figure II.B.5). The algal sequence showed approximately 50% identity with other sequences in the biotin carboxylase domain (at the amino terminus of the protein) and in the carboxyl transferase domain (at the carboxyl terminus of the sequence). However, the central portion of enzyme showed only about 30% identity with the yeast and rat enzymes, with most of the similarity in this region occurring in the biotin binding domain. This suggests that the central region of the protein probably functions primarily as a linker or spacer that moves the carboxylated biotin residue closer to the carboxyl transferase domain. The isolation of the ACCase gene from *C. cryptica* was an important step for the ASP; significantly



in that this was the first time a full-length sequence for an ACCase gene had been isolated from a photosynthetic organism. NREL was granted a patent on this gene in 1996, and there has been interest from at least one major plant biotechnology company in using this gene to manipulate oils and lipids in higher plants (Roessler and Ohlrogge 1993; Roessler et al. 1994).

The availability of the purified ACCase protein and the cloned ACCase gene allowed NREL researchers to study the effects of Si deficiency on ACCase gene expression. Southern blots, in which a fragment of the cloned ACCase gene was used as a probe to analyze *C. cryptica* DNA, indicated that there is probably only a single copy of the ACCase gene in *C. cryptica*. ACCase gene fragments were used to monitor mRNA levels in Si-deficient cells using the ribonuclease protection assay (RPA). ACCase mRNA levels increased 2.5-fold between 2 and 6 hours after the beginning of Si-deprivation as compared to Si-replete cells, but then decreased to the control level after 23 hours. Thus, Si concentration appears to affect ACCase gene expression at the level of gene transcription, possibly as a result of increased promoter activity and/or by altering the rates of mRNA degradation. ACCase activity was also measured in cell lysates from Si-starved cultures; enzyme activity increased steadily over 23 hours to a final level 4.5-fold higher than that of Si-replete cultures. The increased level of ACCase activity was correlated with an increase in the amount of ACCase protein, as determined by Western blotting using anti-ACCase polyclonal antibodies. Although Si deficiency caused the levels of ACCase mRNA and protein to increase, the kinetics of the two processes were different.

These results supported the hypothesis that diatoms could respond to Si deprivation by altering the activity of enzymes involved in lipid biosynthesis to partition more fixed carbon into storage lipids. If the activity of ACCase could be increased using mutation or genetic manipulation, it might be possible to produce a strain with constitutively high levels of TAG synthesis. This was a major premise of the genetic engineering experiments discussed in Section II.B.3.



**Figure II.B.5.** Schematic diagram indicating regions of similarity among the primary sequences of ACCase from *C. cryptica*, rat, and yeast. Regions ( $\geq 20$  amino acids) that are present in all three sequences and that exhibit statistically significant homology ( $p < 10^{-6}$ ) are indicated by thickened areas.

(Source: Roessler and Ohlrogge 1993).



### II.B.2.g. Biochemistry of Lipid Synthesis in *Nannochloropsis*

From 1992 to 1995, Dr. Jane Schneider worked at NREL with Dr. Roessler on a project funded by the United States–Israel Binational Agricultural Research and Development Fund. The research was performed in collaboration with Dr. Assaf Sukenik and other scientists at the Israel Oceanographic and Limnological Institute in Haifa. The goal of the research was to understand the biochemistry of lipid synthesis in the eustigmatophyte *Nannochloropsis* sp., particularly with respect to fatty acid desaturation pathways. There has been a significant amount of research on lipid synthesis pathways in higher plants, and the pathways have been assumed to be similar in lipogenic algae. However, unlike plants, nutrient deprivation produces major effects on the quantity and quality of lipids in algae; so there are likely to be significant differences in the biochemical pathways. In addition, like many algae, *Nannochloropsis* contains a high proportion of long fatty acids (i.e., C-20, C-22) with a high degree of unsaturation (20:5). These very long chain-polyunsaturated fatty acids (VLC-PUFAs) are important in aquaculture applications as they improve the nutritional quality of feed for fish and shellfish, and have nutritional and pharmaceutical applications for humans. Understanding the details of the biochemistry of lipid accumulation in microalgae could help researchers develop strategies for genetic manipulation of lipid synthesis pathways to affect not only the quantity but also the quality (chain length, degree of desaturation) of lipids produced for optimal biodiesel performance.

In one set of experiments, pulse-chase radiolabeling was used to study *de novo* synthesis of lipids in *Nannochloropsis*. Exponentially growing cells under low light were fed  $^{14}\text{C}$ -bicarbonate or acetate for 1 hour. The cells were then washed and allowed to grow in unlabeled medium. At various time points, cells were removed and lipids extracted. The substrates resulted in a different distribution of labeled carbon in the lipids and fatty acids. The work demonstrated the probable existence of two pools of malonyl-CoA used as substrates for fatty acid synthesis, and resulted in a new model for the sites of desaturation of fatty acids and the identification of a new acyltransferase activity in this organism. In another set of experiments, *Nannochloropsis* cells were mutagenized using UV light and screened for unusual fatty acid profiles using gas chromatography. This work resulted in the isolation of a mutant deficient in 20:5 fatty acids, probably due to a mutation affecting a desaturase enzyme that utilizes 20:4 fatty acids as substrate.

These experiments will not be described in detail here, primarily because the funding for this research did not come from DOE. In addition, it would require a lengthy discussion of the details of fatty acid synthesis and processing for the reader to understand the relevance of the findings. Readers interested in the details of this research are referred to the three publications that resulted from this research (Schneider and Roessler 1994; Schneider et al. 1995; Schneider and Roessler 1995).

### II.B.2.h. Biochemistry and Molecular Biology of Chrysolaminarin Synthesis

Another strategy that has been proposed to increase the proportion of lipid in algal cells is to limit the flow of newly assimilated carbon into other cellular pathways. Many diatoms, including



*C. cryptica*, can produce a significant amount of a storage carbohydrate called chrysolaminarin, a  $\beta$ -(1 $\rightarrow$ 3)-linked glucan. Although some data were available on the chemistry of this compound, the biochemical pathways involved in the synthesis of chrysolaminarin were not known. The synthesis of most storage polysaccharides involves the condensation of nucleoside diphosphate sugars; for example, starch is formed in plants from ADPglucose, and UDPglucose is used to form sucrose in plants and glycogen in mammalian cells. These reactions are catalyzed by nucleoside diphosphate sugar pyrophosphorylases, such as UDPglucose pyrophosphorylase (UGPase), which catalyzes the following reaction:

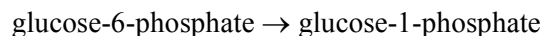


Roessler first looked for nucleoside diphosphate sugars pyrophosphorylases in cell-free extracts of *C. cryptica*, and identified significant amounts of UGPase activity. The enzyme activity was characterized to optimize *in vitro* assay conditions. The enzyme was activated in the presence of  $\text{Mn}^{2+}$  and  $\text{Mg}^{2+}$  but was not affected by 3-phosphoglycerate or inorganic phosphate; these chemicals are known to affect the activity of ADPglucose pyrophosphorylase in higher plants. Incubation of cell-free extracts with UDP[ $^{14}\text{C}$ ]glucose resulted in the incorporation of the labeled carbon into a  $\beta$ -(1 $\rightarrow$ 3)-glucan polymer, presumably chrysolaminarin, supporting the role of UGPase in chrysolaminarin synthesis in diatoms. Subsequent studies identified a second enzyme, UDPglucose: $\beta$ -(1 $\rightarrow$ 3)-glucan- $\beta$ -glucosyltransferase (also known as chrysolaminarin synthase), which catalyzes the synthesis of glucan using UDPglucose as substrate. The specific activity of both enzymes was examined in *C. cryptica* cells under Si-replete and Si-depleted conditions. The activity of UDPglucose pyrophosphorylase was similar under both conditions; however, the activity of chrysolaminarin synthase decreased by 31% in Si-deficient cells, suggesting that the partitioning of newly assimilated carbon into lipid may be partly due to decreased synthesis or inhibition of the chrysolaminarin synthase enzyme (Roessler 1987; 1988a).

Further research on UGPase in *C. cryptica* was put on hiatus for several years while the emphasis was on ACCase (discussed earlier) and on the development of genetic engineering protocols for microalgae (discussed in Section II.B.3.). However, the development of a successful genetic transformation system for *C. cryptica*, as well as advances in techniques that allow the down-regulation of particular genes (i.e., antisense RNA, ribozymes) generated a renewed interest in UGPase. NREL researcher Eric Jarvis spent 6 months working at Ribozyme Pharmaceuticals, Inc., a biotechnology company in Boulder, Colorado, learning about these new methods. Antisense RNA is a method in which a cell is transformed with a synthetic gene that produces an RNA sequence complimentary to a specific messenger RNA (mRNA). Although the exact mechanism is not clear, the antisense RNA prevents translation from its complimentary mRNA, effectively lowering the level of that particular protein in the cell. Ribozymes are also RNA molecules produced by synthetic genes that can bind to, and cleave, very specific RNA sequences. Ribozymes can be designed to degrade specific mRNA molecules, effectively decreasing expression of a specific gene.



In *C. cryptica*, chrysolaminarin can make up 20%-30% of the cell dry weight, and thus chrysolaminarin synthesis pathways presumably compete for newly fixed carbon with the pathways for lipid biosynthesis. Dr. Jarvis and Dr. Roessler proposed that inhibiting chrysolaminarin production by inhibiting one or more genes in the carbohydrate synthesis pathway could result in the flow of more carbon into lipid production. Based on the earlier studies on chrysolaminarin synthesis, Dr. Jarvis initiated an effort to isolate the UGPase gene from *C. cryptica* DNA. A fragment of the *C. cryptica* UGPase gene was first produced by the PCR using degenerate oligonucleotide primers based on conserved sequences from known UGPase genes from potato, human, yeast, and *Dictyostelium*. This fragment was cloned and sequenced; the derived amino acid sequence showed 37% identity with the corresponding sequence from potato UGPase, confirming that a *C. cryptica* UGPase gene fragment had been cloned. The cloned PCR product was then used as a probe to isolate a genomic DNA clone containing the entire *C. cryptica* UGPase gene from a lambda library. One clone contained a DNA segment with a single long open reading frame, the 5' end of which showed homology to known UGPase genes. Surprisingly, the 3' end of this DNA showed homology to known genes coding for the enzyme phosphoglucomutase (PGMase). In chrysolaminarin synthesis, PGMase catalyzes the following reaction:



The glucose-1-P produced in this reaction is the substrate for UGPase in the production of UDPglucose, an immediate precursor of chrysolaminarin, as described earlier. Although PGMase and UGPase are thought to catalyze successive steps in the chrysolaminarin biosynthesis pathway, this was the first report of a naturally occurring fusion of these two genes in any organism. The *C. cryptica* UGPase/PGMase gene, designated *upp1*, contained 3,640 bps, including 3 introns, and coded for a protein composed of 1,056 amino acids, with a molecular weight of 114.4 kd.

To confirm that the protein coded for by *upp1* actually catalyzes both the UGPase and PGMase reactions, the protein was isolated from extracts of *C. cryptica* by sequential column chromatography (ion exchange, hydroxylapatite, and gel filtration). The two enzyme activities co-eluted throughout the purification procedure, and all fractions containing UGPase/PGMase activity contained a 114 kd protein as determined by SDS-PAGE. These results supported the presence of both enzyme activities in *C. cryptica* on a single multifunctional protein. A patent submitted by NREL on this unique gene was allowed in October 1996. The research at NREL involving attempts to manipulate *upp1* gene expression to affect carbon partitioning in *C. cryptica* will be discussed in Section II.B.3. of this report.

#### Publications:

Bergeron, P.W., Corder, R.E., Hill, A.M., Lindsey, H.; Lowenstein, M.Z. (1983) *SERI Biomass Program Annual Technical Report*: 1982. Solar Energy Research Institute, Golden, Colorado, SERI/TR-231-1918, 83 pp.



Corder, R.E.; Hill, A.M.; Lindsey, H.; Lowenstein, M.Z.; McIntosh, R.P. (1984) *SERI Biomass Program FY 1983 Annual Report*, Solar Energy Research Institute, Golden, Colorado, SERI/TR-231-2159, 107 pp.

Hill, A.; Feinberg, A.; McIntosh, R.; Neenan, B.; Terry, K. (1984) "Fuels from microalgae: Technical status, potential, and research issues." *Solar Energy Research Institute Report*, SERI/SP-231-2550.

Jarvis, E.E.; Dunahay, T.G.; Brown, L.M. (1992) "DNA nucleoside composition and methylation in several species of microalgae." *J. Phycol.* 28:356-362.

Lien, S. (1981a) "Photobiological production of fuels by microalgae." In *Energy from Biomass: Proceedings of the First E.C. Conference* (Palz, W.; Chartier, P.; Hall, D.O., eds.), Applied Science Publishers, London, pp. 697-702.

Lien, S. (1981b) "Algal research at SERI: A basic research on photobiological production of fuels and chemicals in microalgae." *Proceedings of the July 1981 Subcontractors' Review Meeting, Aquatic Species Program*, Solar Energy Research Institute, Golden, Colorado, SERI/CP-624-1228, pp. 59-65.

Lien, S. (1982) "Studies on the production and accumulation of oil and lipids by microalgae." In *Proceedings of the SERI Biomass Program Principal Investigators' Review Meeting, Aquatic Species Program Reports*, June 23-25, 1982, Solar Energy Research Institute, Golden, Colorado, SERI/CP-231-1808, pp. 45-54.

Lien, S.; Roessler, P. (1986) "The energetics of biomass and lipid production by lipogenic microalgae under nitrogen deprivation." *Aquatic Species Program Review: Proceedings of the March 1985 Principal Investigators' Meeting*, Solar Energy Research Institute, Golden, Colorado, SERI/CP-231-2700, pp. 100-117.

Lien, S.; Spencer, K.G. (1983) "Algal oil production and lipid metabolism research." *Aquatic Species Program Review: Proceedings of the March 1983 Principal Investigators' Meeting*, Solar Energy Research Institute, Golden, Colorado, SERI/CP-231-1946, pp. 3-18.

Ohlrogge, J.; Jaworski, J.; Post-Beittenmiller, D.; Roughan, G.; Roessler, P.; Nakahira, K. (1993) "Regulation of flux through the fatty acid biosynthesis pathway." In *Biochemistry and Molecular Biology of Membrane and Storage Lipids of Plants* (Murata, N.; Somerville, C.R., eds.), American Society of Plant Physiologists, Rockville, Maryland, pp. 102-112.

Raymond, L.P. (1983a) "Aquatic biomass as a source of fuels and chemicals." *Conference report: First U.S.-China Conference on Energy, Resources, and Environment*. Beijing, People's Republic of China, Nov. 7-12, 1982. Solar Energy Research Institute, Golden, Colorado, SERI/TP-231-1699, 8 pp.



Roessler, P.G. (1987a) "Biochemical aspects of lipid accumulation in silicon-deficient diatoms." *FY 1986 Aquatic Species program Annual Report*, Solar Energy Research Institute, Golden, Colorado, SERI/SP-231-3071.

Roessler, P.G. (1987c) "Lipid accumulation in silicon-deficient diatoms." In *The Metabolism, Structure, and Function of Plant Lipids*, (Stumpf, P.K.; Mudd, M.B.; Nes, W.D., eds.), Plenum, Publishing Corp., pp. 649-651.

Roessler, P.G. (1987d) "UDPglucose pyrophosphorylase activity in the diatom *Cyclotella cryptica*. Pathway of crysolaminarin biosynthesis." *J. Phycol.* 23:494-498.

Roessler, P.G. (1988a) "Changes in the activities of various lipid and carbohydrate biosynthetic enzymes in the diatom *Cyclotella cryptica* in response to silicon deficiency." *Arch. Biochem. Biophys.* 267:521-528.

Roessler, P.G. (1988b) "Characteristics of abrupt size reduction in *Synedra ulna* (Bacillariophyceae)." *Phycologia* 27:294-297.

Roessler, P.G. (1988c) "Effects of silicon deficiency on lipid composition and metabolism in the diatom *Cyclotella cryptica*." *J. Phycol.* 24:394-400.

Roessler, P.G. (1989) "Purification and characterization of acetyl-CoA carboxylase from the diatom *Cyclotella cryptica*." *Aquatic Species Program Annual Report*, Solar Energy Research Institute, (Bollmeier, W.S.; Sprague, S., eds.), SERI/SP-231-3579, pp. 121-129.

Roessler, P.G. (1990) "Purification and characterization of acetyl-CoA carboxylase from the diatom *Cyclotella cryptica*." *Plant. Physiol.* 92:73-78.

Roessler, P.G.; Bleibaum, J.L.; Thompson, G.A.; Ohlrogge, J.B. (1994) "Characteristics of the gene that encodes acetyl-CoA carboxylase in the diatom *Cyclotella cryptica*." In *Recombinant DNA Technology II* (Bajpai, K.; Prokop, A., eds.), Ann. N.Y. Acad. Sci. 721:250-256.

Roessler, P.G.; Ohlrogge, J.B. (1993) "Cloning and characterization of the gene that encodes acetyl-coenzyme A carboxylase in the alga *Cyclotella cryptica*." *J. Biol. Chem.* 268:19254-19259.

Schneider, J.C.; Roessler, P. (1994) "Radiolabeling studies of lipids and fatty acids in *Nannochloropsis* (Eustigmatophyceae), an oleaginous marine alga." *J. Phycol.* 30:594-598.

Schneider, J.C.; Livine, A.; Sukenik, A.; Roessler P.G. (1995) "A mutant of *Nannochloropsis* deficient in eicosapentaenoic acid production." *Phytochem.* 40:807-814.

Schneider, J.C.; Roessler, P.G. (1995) "A novel acyltransferase activity in an oleaginous alga." In *Plant Lipid Metabolism* (Kader, L.C.; Mazliak, P., eds.), Kluwer Academic Publishers, the Netherlands, pp. 105-107.





Terry, K.L. (1984a) "Microalgal technology research at SERI: Modulated light photobiology." *Aquatic Species Program Review: Proceedings of the April 1984 Principal Investigators' Meeting*, Solar Energy Research Institute, Golden, Colorado, SERI/CP-231-2341, pp. 160-169.

Tornabene, T.G.; Holzer, G.; Lien, S.; Burris, N. (1983) "Lipid composition of the nitrogen starved green alga *Neochloris oleoabundans*." *Enzyme Microb. Technol.* 5:435-440.

Walsh, R.G. (1984) "Microalgal technology research at SERI: The biochemistry of lipid trigger mechanisms in microalgae—alteration of lipid metabolism during transition from rapid growth to rapid lipid accumulation." *Aquatic Species Program Review: Proceedings of the April 1984 Principal Investigators Meeting*, Solar Energy Research Institute, Golden, Colorado, SERI/CP-231-2341, pp. 170-183.

#### Patents:

Roessler, P.G; Ohlrogge, J.B., "Gene Encoding Acetyl-Coenzyme A Carboxylase", U.S. Patent 5,559,220, issued 9/24/96.

Jarvis, E.E.; Roessler, P.G. "Isolated-Gene Encoding an Enzyme with UDP-Glucose Pyrophosphorylase Activities from *Cyclotella cryptica*." Allowed 10/24/96.

### **II.B.3 Manipulation of Lipid Production in Microalgae via Genetic Engineering**

#### **II.B.3.a. Introduction**

The overall goal of the ASP was to cost-effectively produce biodiesel fuel from microalgal lipids. The early laboratory efforts focused on the characterization of microalgae with regard to traits deemed desirable for mass culture and fuel production, i.e., rapid growth, tolerance to environmental fluxes, and high production of TAG storage lipids. Although numerous promising organisms were identified, no individual strain demonstrated rapid growth with constitutively high lipid production. Although high lipid levels could be induced in many strains by starving the cells for an essential nutrient such as N or Si, the increase in lipid was accompanied by a decrease in cell division and total productivity.

During the late 1980s and 1990s, the direction of the laboratory research efforts at NREL shifted to the study of the biochemical pathways involved in lipid synthesis, with the goal of identifying targets for genetic manipulation. As discussed earlier, the desirable traits for biodiesel production (high productivity and high lipid content) were found to be mutually exclusive conditions in the organisms studied. Therefore, it was decided to use mutagenesis or genetic engineering to manipulate the algal biosynthetic pathways to produce algal strains with constitutively high lipid levels. Another possibility would be to engineer an organism in which lipid synthesis could be regulated by inducing or repressing key genes. Very little was known about the molecular biology of oleaginous microalgae and the genetic regulation of lipid biosynthesis pathways, so a concentrated research effort in this direction was deemed critical to



the success of the biodiesel project. Another reason for the shift to research on genetic manipulation of algae was more practical. Funding levels for ASP decreased during this period from the high funding levels in the mid-1980s that had allowed large numbers of subcontractors and the development of the Outdoor Test Facility in Roswell, New Mexico (Section II.B.5.). Laboratory experiments emphasizing biochemistry, molecular biology, and genetic engineering could be performed with a limited budget and few personnel.

This section of the report will describe the in-house research efforts at NREL to develop high lipid algae by genetically manipulating selected oleaginous strains. Microalgae generally reproduce asexually by simple fission. Many strains can also produce sexually, but the conditions required to induce algal sexual reproduction in the laboratory are not known for most species. Thus, genetic manipulation by classical “breeding” was not an option for the algae. The approaches explored at NREL were (1) mutagenesis and selection; and (2) genetic engineering. The information summarized in this report was taken from annual reports, scientific publications and meeting reports. No annual reports were generated by the ASP after 1993, and no quarterly reports after September 1995, so some of the most recent information presented was derived from the personal experience of Terri Dunahay and discussions with former coworkers (Paul Roessler and Eric Jarvis).

#### **II.B.3.b. Mutagenesis and Selection**

Work by SERI/NREL subcontractors in the early 1980s supported the idea that there is significant genetic variation within algal populations (i.e., Gallagher, Section II.B.1.c.). Therefore, one possible method for producing high lipid algal strains would be selection of natural genetic variants with desired traits, such as high lipid levels or increased tolerance to high salinity or temperature. The limiting factor to this approach has always been the difficulty of selecting for individuals exhibiting a desired trait among a large population of cells. The use of lipophilic dyes such as Nile Blue or Nile Red, coupled with flow cytometry, showed some potential for isolation of high lipid strains of microalgae (see work by Solomon and Cooksey, Sections II.B.1.e and f). It was not clear, however, that the variations detected in subpopulations of cells were the result of genetic variations that would be passed on to progeny.

An alternative approach is to induce genetic variation in a population of cells using mutagenesis. Again, the ability to select for the desired trait is a limiting factor, but the production of large numbers of mutants by artificial means is a proven method for generating organisms with heritable traits, often the result of a mutation within a single gene. As a prelude to the initiation of mutagenesis and selection experiments with oleaginous microalgae, NREL researcher Ruth Galloway performed a series of experiments designed to understand the factors required to produce mutants in microalgae. These included media requirements for growth, the ability to form colonies on agar plates, sensitivity to herbicides and other growth inhibitors, and the sensitivity of algal strains to mutagens such as UV light or fluorodeoxyuridine (Galloway 1990).

Nine algal strains from the SERI Culture Collection were tested, including organisms from three classes: the chlorophyceae (*M. minutum* MONOR1 and MONOR2), the eustigmatophyceae (*Nannochloropsis* (NANNP1 and NANNP2), and the bacilliarophyceae (*C. cryptica* T13L, C.



*mulleri* CHAET9, *Amphora* AMPHO17, *Nitzschia pusilla* NITSC12, and *N. saprophila* NAVIC1).

Growth of each strain was evaluated qualitatively after spotting the cultures onto media containing nitrogen or carbon sources, or after growing the cells under phototrophic, mixotrophic, or heterotrophic conditions. Cell growth was also evaluated in the presence of a large number of growth inhibitors including various antibiotics and herbicides. Although there was some variability between the algal strains, several generalizations could be made. Most strains could use either  $\text{NO}_3^-$  or  $\text{NH}_4^+$  as a nitrogen source. Mixotrophic growth on various carbon sources was more variable, and only AMPHO17, MONOR2, and CYCLOT13L were able to grow heterotrophically, using glucose as a carbon source. The ability to grow heterotrophically would be important for the isolation of photosynthetic mutants.

Predictably, antibiotics that inhibit bacterial cell wall synthesis such as ampicillin and carbenicillin did not inhibit the growth of the algal strains. Antibiotics that inhibit bacterial protein synthesis by binding to the 30S ribosome showed variation in their effects on algal growth. For example, all strains tested grew well on kanamycin and neomycin and showed no growth on erythromycin; while the growth response differed for the strains on spectinomycin and streptomycin. Whether this result was due to differences in 30S (organellar) ribosomal structure between the algal strains, to differences in uptake of the antibiotics by the individual strains, or to other factors that affect sensitivity, is unclear. All strains showed sensitivity to photosynthesis inhibitors diuron, metronidazol, and atrazine, and to the herbicide glyphosate (“RoundUp”), which affects the shikimic acid pathway. However, sensitivity varied between the strains to compounds that affect the enzyme acetolactate synthase and to chemicals that inhibit microtubule synthesis. (The details of these growth experiments can be found in Tables 2, 3, 4, 5, and 7 of Galloway 1990). Many of the growth inhibitors used in this study affect specific proteins in the target organism, and many of these proteins have been well characterized in a number of systems. Isolating the corresponding gene from an algal mutant using heterologous gene probes to characterize the mutation and/or to use the mutant gene as a selectable marker for transformation studies should be relatively easy.

Attempts were also made to generate mutants in the algal strains by exposing the cells to UV light or to fluorodeoxyuridine, followed by plating the cultures on toxic levels of various growth inhibitors. Using UV mutagenesis, streptomycin-resistant mutants were obtained in MONOR2, as well as glyphosate-resistant mutants in both strains of *Nannochloropsis*, sulfometuron methyl-resistant mutants in NANNP1, and atrazine-diuron-resistant mutants in NAVIC1. In addition, tunicamycin-resistant mutants of NAVIC1 were produced following treatment with fluorodeoxyuridine. Mutants were not obtained for the other diatoms, CYCLOT13L, CHAET9, or NITZS12, whether this was due to poor colony formation by these strains, inefficacy of the mutagen, or inappropriately high levels of the selective agent is not known. One interesting point was that the green algal strains, *Monoraphidium* and *Nannochloropsis*, produced mutants with traits thought to be due to recessive nuclear gene mutations (i.e., glyphosate resistance or photosynthesis mutants). On the other hand, in *Navicula*, the only diatom in which mutants were generated, the types of mutations produced were indicative of dominant mutations, i.e.,



atrazine/diuron resistance (resulting from a chloroplast gene mutation) or resistance to tunicamycin, an inhibitor of n-glycosylation. These results indicate that *Monoraphidium* and *Nannochloropsis* are probably haploid; the diatoms are diploid. Design of strategies for generation of algal mutants will have to consider the ploidy of the target organism. For example, generating nitrate reductase-deficient mutants for use in a genetic transformation system using homologous selectable markers (described in detail later) should be relatively simple in haploid strains, but would be much more difficult in diploids. For the diatoms, a better approach would be to utilize a dominant gene as a selectable marker, such as a mutant form of the enzyme acetolactate synthase (discussed later), or a heterologous gene such as the neomycin phosphotransferase II (NPTII). The latter gene confers drug resistance by inactivating antibiotics such as kanamycin or geneticin (G418).

In summary, the research performed by Dr. Galloway demonstrated the potential to produce algal mutants with a wide variety of phenotypes, particularly in the green algae, using simple mutagenesis and selection techniques. It would be important to first optimize and understand the growth conditions for the target strains. The conditions to be used for selection (inhibitor specificities and concentrations) should be determined for each strain. However, the generation of mutants will probably be more useful as a tool in developing selectable marker systems, rather than as a method to directly produce high lipid algal strains, primarily because there is no simple way to screen for high-lipid phenotypes. The use of mutagenesis to develop of homologous selectable marker systems for algal transformation will be discussed in detail later.

Mutagenesis and selection was used successfully in another study at NREL to generate mutants in one aspect of lipid synthesis, fatty acid desaturation (Schneider et al. 1995, described in Section II.B.2.g.). In this experiment, UV mutagenized cells of *Nannochloropsis* were allowed to form colonies, then grown in small-scale liquid cultures. Lipids were extracted from each sample and analyzed by gas chromatography for any significant alteration in the proportion of fatty acids. This project resulted in the identification of a mutant lacking in 20:5 fatty acids, apparently due to a mutation in a 20:4 desaturase. In this case, a simple screen was used to look for changes in a quantitative trait. This result suggests that, with the right method to screen for mutants with the desired properties, mutagenesis could result in microalgae with altered lipid compositions. However, this project was very labor intensive, with hundreds of colonies screened to identify a single mutant.

### **II.B.3.c. Development of a Genetic Transformation System for Microalgae**

#### *Introduction:*

During the past 2 decades, manipulation of organisms via genetic engineering has become routine in a number of animal, bacterial, fungal, and plant systems. However, before the research was done at NREL, very little work in this area had been done with microalgae. In fact, the only species for which there was a reproducible transformation system was the single-celled, flagellated green alga *C. reinhardtii*, which is studied extensively in laboratories as a model photosynthetic cell. The focus of the research in the ASP during the early 1990s was to develop



genetic transformation methods for microalgae with potential for biodiesel production. Based on the collection and screening efforts of the 1980s, this approach was considered to have the highest potential to produce organisms with high constitutive lipid levels, and to use genetic manipulation to understand the molecular regulation of lipid synthesis in the oleaginous algae. Studies on the biochemistry and molecular biology of lipid production in *C. cryptica* had identified acetyl-CoA carboxylase as a key regulatory enzyme in lipid synthesis (Section II.B.2.e.). One initial goal was to introduce additional copies of this gene into *C. cryptica* with the hope of increasing the activity of the enzyme and the flux of fixed carbon into lipid.

Several projects will be discussed in the following section of this report that were directed towards the development and use of genetic transformation systems in oleaginous microalgae. The initial approach was to use available promoters and marker genes that were reported to function in other eukaryotic systems. Various methods were also tried to get DNA into the cell, initially focusing on enzymatically removing the cell wall or perturbing the cell membrane using electroporation. Unsuccessful experiments represented a “Catch 22” scenario, as negative results could mean either the DNA was not getting into the cells, or the DNA entered but could not be expressed at detectable levels. Subsequent experiments were designed to increase the understanding of the processes involved in DNA uptake and expression and to increase the probability of obtaining transformants by developing methods for detecting rare transformation events within a population of cells.

The projects that will be discussed here include a basic study on the DNA composition of microalgal strains, with implications for the choice of reporter or marker genes used to monitor gene expression in transgenic algae. Other aspects of the research that will be discussed include:

- the use of the luciferase gene to monitor DNA uptake and expression in *Chlorella* protoplasts,
- attempts to develop heterologous and homologous genetic markers for algal transformation,
- the development of methods to introduce DNA into algal cells through the cell wall, and
- the successful development of a stable genetic transformation system for diatoms.

Once the methods were available to obtain genetic transformants, efforts were made to use the transformation system to manipulate lipid content in the algae by overexpressing or downregulating key genes. In addition, the transformation system was used to introduce a reporter gene under the control of various regulatory sequences, to better understand the regulation of gene expression in microalgae.

*Analysis of Microalgal DNA Composition:*

Several oleaginous microalgal strains had been identified as potential candidates for biodiesel fuel production. These organisms became the target of genetic engineering efforts to manipulate the lipid biosynthetic pathways. Before the work on genetic transformation of algae at NREL, very little information was available on the molecular biology of these organisms. One of the first steps was to develop techniques to isolate and purify DNA from these organisms. A desirable protocol would disrupt the cell wall using methods gentle enough to prevent shearing of the genomic DNA. This was not trivial for some species, such as *Monoraphidium*, which has a very resistant wall that contains sporopollenin. A method that worked for most species tested (described in Jarvis et al. 1992) was developed based on a protocol used to isolate yeast DNA (Hoffman and Winston 1987). The cells were suspended in buffer that contained 2% Triton X-100 and 1% SDS, then added to a tube that contained glass beads and an equal volume of phenol:chloroform:isoamyl alcohol (PCI). The cells were agitated for 1 minute using a vortex mixer. The DNA in the aqueous phase was purified by re-extraction with PCI, ethanol precipitation, and treated with RNase A. For some species, the DNA had to be purified further by using precipitation with hexadecyltrimethylammonium bromide (CTAB; Murray and Thompson 1980) to remove contaminating carbohydrates or by purifying the DNA on CsCl gradients. This procedure produced DNA that digested well with many common restriction endonucleases, but even highly purified DNA would not digest well with all restriction enzymes.

NREL researcher Eric Jarvis theorized that poor digestion of the DNA by some enzymes could be attributable to characteristics of the DNA. All DNA is composed of four nucleosides; deoxycytidine, deoxyguanosine, deoxythymidine, and deoxyadenosine, (abbreviated dC, dG, dT, dA); in double stranded DNA, dC is always paired with dG, and dT with dA. The percentage of each nucleoside (often represented as %GC) is variable between species. Restriction enzymes cut DNA at specific nucleotide sequences, generally recognizing 4-6 bp motifs. Therefore, the frequency of cutting by a particular enzyme will be affected by the total nucleotide composition of the DNA (i.e., an enzyme that recognizes CCGG would cut infrequently in an organism with a low %GC). The GC content is also reflected in the codon usage by each organism, as DNA with a high GC content would show a bias toward codons ending with G or C in the variable third position. DNA can also contain unusual modified nucleosides, including 5-hydroxymethyldeoxycytidine ( $hm^5dC$ ) and 5-hydroxymethyldeoxyuridine ( $hm^5dU$ ), although the biological significance is unclear. Another common modification is the presence of methylated nucleosides, in particular 5-methyldeoxycytidine ( $m^5dC$ ) and 6-methyldeoxyadenosine ( $m^6dA$ ). The degree of methylation has been associated with levels of gene expression. In addition, some microorganisms use DNA methylation as a defense mechanism, in that methylated DNA sequences are often not recognized by endonucleases from invading pathogens. Although the presence of methylated nucleosides is characteristic for some species, the degree of methylation can vary on a short time scale with changing environmental conditions. In contrast, the %GC and presence of modified nucleosides are characteristic for a particular organism. These characteristics only on an evolutionary time scale.



DNA was isolated from microalgae strains, including 10 species from 5 classes. The nucleoside composition was analyzed by reverse-phase HPLC and by digestion with restriction endonucleases. The results of the HPLC analysis are summarized in Table I.B.4-1. Although the diatoms showed a GC content typical for most eukaryotes (42%-48% GC), the GC content of the green algae (excepting *Stichococcus*) was significantly higher. In particular, *Monoraphidium* DNA contains 71% GC. The table also shows the presence of m<sup>5</sup>dC in the algal DNA. All species tested contained some level of this modified base, although once again *Monoraphidium* stands out with approximately 11% m<sup>5</sup>dC. The only other unusual feature was the presence of 12% hm<sup>5</sup>dU in the dinoflagellate *C. cohnii* (data not shown); dinoflagellates were not considered to be good candidates for biodiesel fuel production, so this observation was not explored further.

These data provided a good background for developing genetic transformation systems for these organisms. As mentioned above, the GC content of an organism can be reflected in the codon usage, suggesting that an organism with a high GC content such as *Monoraphidium* may not successfully express heterologous marker genes. This was found to be true for the green alga *Chlamydomonas*; successful transformation of this organism was achieved only by the use of homologous selectable markers (discussed in more detail later). Also, GC content should be considered when designing synthetic DNA probes based on protein sequences, i.e., for isolation of algal genes by PCR. In addition, DNA methylation can affect the ability to construct DNA libraries and to clone algal DNA, and may require the use of bacterial host strains that are insensitive to DNA methylation.

**Table II.B.1. DNA Nucleoside Composition of Several Microalgal Strains (Modified from Dunahay, et al, 1992, p .333 and Jarvis et al, 1992)**

Algal species	M <sup>5</sup> dC	5GC
Chlorophyceae		
<i>Chlamydomonas reinhardtii</i>	0.16	61.6
<i>Chlorella ellipsoidea</i>	1.48	51.6
<i>Monoraphidium minutum</i>	11.2	70.9
Bacillariophyceae		
<i>Cyclotella cryptica</i>	1.95	43.2
<i>Navicula saprophila</i>	0.20	46.2
<i>Nitzschia pusilla</i>	0.78	45.4



<i>Phaeodactylum tricornutum</i>	0.14	48.0
Charophyceae		
<i>Stichococcus</i> sp.	0.30	44.8
Prasinophyceae		
<i>Tetraselmis suecica</i>	3.32	57.5
Dinophyceae		
<i>Cryptocodinium cohnii</i>	1.54	43.7

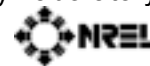
*Transient Expression of Luciferase in Chlorella ellipsoidea:*

The first step in transforming any organism is getting the foreign DNA inside the cell. For organisms with a cell wall, methods must be devised to either remove or permeabilize the wall, or to get DNA into the cell through the intact wall. Bacterial cell walls do not seem to represent a significant barrier to DNA uptake, and can be induced to take up foreign DNA simply by being washed in low osmotic medium and glycerol, followed by a brief heat shock. Cell walls can be removed enzymatically from yeast cells to form spheroplasts, or from plant cells to form protoplasts. These wall-less cells can be induced to take up DNA by chemically permeabilizing the cell membrane with polyethylene glycol and/or calcium. Alternatively, DNA can enter yeast spheroplasts or plant protoplasts via electroporation, a method in which a rapid, high voltage electric pulse is used to produce transient pores in a cell membrane.

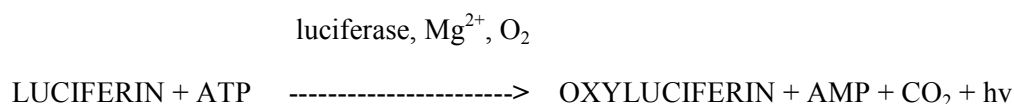
Based on their research backgrounds, NREL researchers tended to view microalgae as either single cell plants, or pigmented yeasts. In either case, the initial tendency was to try to produce wall-less algal cells as targets for transformation. There had previously been some reports of protoplast production in green microalgae of the genus *Chlorella* (Braun and Aach 1975; Berliner 1977). NREL researcher Eric Jarvis decided to attempt to introduce foreign DNA into *Chlorella* protoplasts, with the eventual goal of adapting these protocols for other algal strains with biodiesel production potential.

The production of a stably transformed line of cells involves several steps, including introducing the foreign DNA into the target cell, expressing the foreign gene, stabilizing (replicating) the new DNA by the host cell, and survival and proliferation of the genetically altered cells. Transient expression assays can be used to monitor and optimize just the first two of these processes, i.e., DNA entry and expressing a foreign gene in a population of cells, and thus can be useful intermediate steps in developing genetic transformation systems. Transient assays usually involve the introduction of a gene that codes for an enzyme detectable by a simple biochemical assay (often referred to as a reporter gene). Dr. Jarvis decided to use one such gene, the firefly luciferase gene, to monitor the entry and expression of foreign DNA into *Chlorella* protoplasts.





The alga used for these studies was *C. ellipsoidea* (strain CCAP 211/1a, obtained from the Culture Collection of Algae and Protozoa, Freshwater Biological Association, United Kingdom). Protoplasts were produced using a protocol adapted from Global and Aach (1985). The cells were grown to early stationary phase, then incubated overnight in 10 mg/mL Cellulysin, a crude commercial preparation of the cellulose-degrading enzyme cellulase. Protoplast production was monitored by sonication of the treated cells in water; generally about 80% of the cells were disrupted by this treatment and were considered to be protoplasts. A plasmid containing the luciferase gene driven by plant regulatory sequences was introduced in the protoplasts by mixing the cells with the plasmid DNA for 30 minutes in the presence of 50 mM CaCl<sub>2</sub> and 13% polyethylene glycol (mw 4000). The cells were washed and incubated in a regeneration medium overnight. The cells were then harvested and luciferase activity was monitored in crude protein extracts. Luciferase catalyzes the oxidation of luciferin with the production of a photon of light via the following reaction:



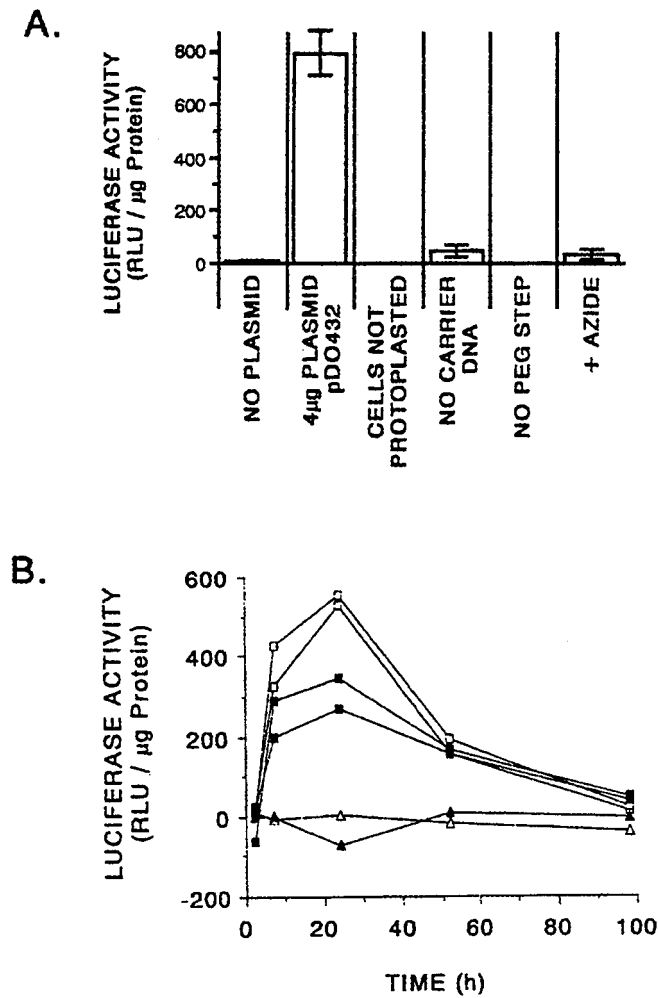
The light produced can be monitored using a scintillation counter or a luminometer.

The results of these experiments are shown in Figure II.B.6. Luciferase activity was detectable in protoplasts treated with the luciferase plasmid, but not in protoplasts that had not been exposed to plasmid or to polyethylene glycol. Intact cells did not take up the DNA. There was a significant decrease in luciferase expression when carrier DNA was left out of the transformation reaction (“carrier DNA” is usually sheared genomic DNA from calf thymus or salmon sperm that is added to reduce the effects of cellular nucleases on the added plasmid DNA). Monitoring of the luciferase activity over time showed that the activity was maximal at about 24 hours after exposing the protoplasts to the plasmid; expression decreased over time and was virtually undetectable after 80-100 hours. Unfortunately, attempts to regenerate the protoplasts into viable walled cells were unsuccessful.

These results were important as they demonstrated the first successful steps in developing a genetic transformation system for microalga, including the production of viable protoplasts, the introduction of DNA into the protoplasts, and the expression of a foreign gene by the algal cells. This last point was very significant, as homologous genes were required to achieve transformation in another green alga (*Chlamydomonas*). The dogma in the field was that heterologous gene expression in green algae would likely be unsuccessful due to codon biases resulting from high GC contents. The work resulted in a publication (Jarvis and Brown 1991), and was the basis for later studies in which the luciferase gene was used to monitor promoter activities in *Cyclotella* (discussed later). However, attempts to adapt this procedure to algal strains with significance to the biodiesel project were unsuccessful. The composition of microalgal cell walls is highly variable between species and even between isolates of the same species. Some unsuccessful efforts were made to determine the enzymatic conditions for wall degradation for several oleaginous algal strains. However, the conclusion, in the words of the



project manager at the time, was that this was “an endless pit of fruitless endeavor”, and the decision was made to explore other methods of introducing DNA into microalgal cells. In addition, although low levels of luciferase expression were achieved in *Chlorella*, the decision was made to pursue the development of selectable marker systems that would allow the isolation of very rare individual transformants within a population of microalgal cells. This will be discussed in the following section.



**Figure II.B.6.** Transient expression of firefly luciferase in *Chlorella ellipsoidea*.

A. (Top) - Histogram showing luciferase expression in protoplasts of *C. ellipsoidea*. Expression of the luciferase gene is expressed in relative light units (RLU), which are the net photons counted during a 5-min period. See text for explanation.

B. (Bottom) - Kinetics of luciferase expression in *C. ellipsoidea* protoplasts. Each symbol represents the result of a single assay. Control cultures were grown in the dark (▲) or light (△). Duplicate cultures of plasmid-treated protoplasts were also grown in either the dark (■) or light (□).

(Source: Jarvis and Brown 1991).



*Development of Homologous Selectable Markers for Monoraphidium and Cyclotella:*

Transient expression assays can be useful for the rapid assessment of DNA uptake and expression by cells as demonstrated by the expression of luciferase in *Chlorella* protoplasts, described earlier. However, attempts to produce similar results in other algal strains were unsuccessful. The problem with an experiment that produces no signal is that it is impossible to know if this is because the DNA did not get into the cell, or if the DNA entered the cell but was not expressed at detectable levels. In the latter case, poor expression could result from degradation of the foreign DNA, inappropriate regulatory signals, or differences in the codon usage.

One of the most promising organisms with regard to high lipid production and tolerance to environmental fluxes was the green alga *M. minutum* (strain MONOR2). However, MONOR2 DNA was shown to be highly unusual in GC content and degree of methylation. As mentioned elsewhere in this report, successful transformation of the green alga *C. reinhardtii*, which also has an elevated GC content, required the use of homologous selectable markers. The literature suggested that this unusual GC content would inhibit the expression of foreign genes, such as bacterial antibiotic resistance genes that had been used successfully as transformation markers in plant and mammalian systems. Based on this information, it was decided to attempt to develop homologous selectable markers for transforming MONOR2 and other strains with programmatic importance. Use of a selectable marker, in contrast to a transient expression assay, would allow the identification of very rare transformation events. Under the appropriate selection conditions, one transformed cell can be detected in a very large population of nontransformed cells, whereas in transient assays, a significant number of cells in a population must be expressing the foreign gene in order to detect the new enzymatic activity. The use of a homologous gene as a marker would greatly increase the chance for successful expression of the introduced gene, as there would be no problems associated with codon bias or foreign regulatory sequences. Although some success was achieved toward the development of a homologous selectable marker system, the emphasis of the research at NREL was shifted after the successful development of a transformation system for diatoms that used a chimeric selectable marker. A significant effort was put into the development of homologous markers, particularly for non-diatom species, from 1989 to 1994, so it is relevant here to summarize the progress made in this area.

The general protocol for developing a homologous selectable transformation system involves several steps. First, a mutation is created or identified in a specific gene. The gene should be essential for growth under “normal” conditions; however, the mutated strains will grow under modified growth conditions. This will allow for positive selection of transformed cells. Then the corresponding wild-type gene is isolated and inserted into a plasmid vector. The wild-type gene is introduced into the mutant cells, and transformants are detected by the ability to grow under the normal, defined growth conditions. In contrast to the transient assay described earlier, use of a selectable marker involves not only DNA entry and expression, but also stabilization of the new DNA in the cell and viability and growth of the newly transformed cells. Genes with good potential for use as selectable markers should not only code for a protein essential for growth



under defined conditions, but should also produce a protein that can be detected by a simple enzymatic assay. In addition, the use of a gene that has been well characterized in other systems will help isolate the gene from the species of interest and simplify the development of enzyme assays and growth conditions for isolating mutants and transformed cells.

Two genes that meet these criteria were targeted for the development of homologous selectable markers for MONOR2 and for *C. cryptica* T13L. One codes for the enzyme nitrate reductase (NR). NR had been used successfully to transform *Chlamydomonas* (Kindle et al. 1989) and several species of fungi (Daboussi et al. 1989) and methods were available to isolate NR mutants and selection of transformed strains. In addition, there was some interest at NREL in the role of nitrogen uptake and utilization in lipid accumulation, and isolating the wild-type NR gene would permit further investigation of these questions.

NR mutants can be isolated based on their resistance to chlorate. Cells with functional NR will take up chlorate along with nitrate and reduce the chlorate to the toxic compound chlorite. Therefore, cells with a mutation in the NR gene will be unable to grow using nitrate as the sole N source, but will be able to grow in the presence of chlorate, as long as urea or ammonium is added as an alternative N source. Using this scheme, several putative NR mutants grew from non-mutagenized cells of MONOR2 and *C. cryptica* T13L. Biochemical assays suggested that at least two of the MONOR2 mutants contained defects within the NR structural gene.

The next step was to isolate the wild-type gene from MONOR2 for complementation of the NR-minus mutants. A partial cDNA clone of NR from *Chlorella vulgaris* was obtained from Dr. Andrew Cannons (University of Southern Florida). Southern blot analysis indicated that the *Chlorella* DNA sequence showed significant homology to a sequence in MONOR2 genomic DNA. Degenerate primers for use in the PCR were designed based on conserved regions in the NR genes from three green algal species and several higher plants. A 700-bp PCR product was generated using MONOR2 genomic DNA as a template and confirmed to represent a fragment of the NR gene by sequence analysis. A MONOR2 genomic DNA library was constructed in a lambda phage vector. Although the library appeared to be representative of the algal genome in that it contained approximately 300,000 separate clones of about 20,000 bp each, repeated screening of the library with the NR gene fragment failed to produce any positive results. Two additional libraries were constructed, but again, screening with the MONOR2 NR sequence did not result in the isolation of a genomic NR sequence. It was concluded that the libraries were probably incomplete; i.e., they did not contain DNA representative of the total algal genome, possibly because of problems associated with the unusual composition of the MONOR2 DNA. This project was put on hold when successful transformation was achieved in *C. cryptica*, and had not been pursued further when the project was terminated in 1996.

A gene that encodes the enzyme orotidine-5'-phosphate decarboxylase (OPDase) was also targeted for use as a selectable transformation marker. OPDase is a key enzyme in the synthesis of pyrimidines. Organisms with defects in the OPDase gene will only grow if pyrimidines such as uracil are added to the growth medium. OPDase mutants can be selected by growing cells in the presence of the drug 5-fluoroorotic acid (FOA); OPDase converts FOA into a compound that



is toxic to the cells. Therefore, OPDase mutants would grow in the presence of FOA and require uracil; wild-type cells (or mutants transformed with the wild-type OPDase gene) would be susceptible to FOA and would require added uracil in the growth media. NREL researcher Eric Jarvis attempted to develop the OPDase system as a selectable marker for MONOR2. Cells were mutagenized by exposure to UV light, then grown in the presence of uracil and FOA. Putative OPDase mutants were identified as FOA-resistant colonies. Based on growth studies and spectrophotometric measurements of OPDase activity, one isolate of MONOR2 (3180a-1) was identified as a probable OPDase mutant for use as a host strain in the transformation system.

The next step, as for NR, was isolate the wild-type OPDase gene from MONOR2. OPDase had previously been isolated from several species and demonstrated significant sequence conservation between genes from different organisms. Dr. Jarvis made a number of attempts to isolate the OPDase gene from MONOR2 via PCR, using degenerate primers based on conserved OPDase gene sequences. Several PCR products were generated using this approach, but sequence analysis of the cloned DNA fragments resulted in no clones with homology to the OPDase gene. Why this approach did not work for OPDase is unclear, as this same PCR technique had been used to isolate a fragment of NR. A second approach, in which a MONOR2 genomic DNA library was screened for OPDase sequences using heterologous probes, was also unsuccessful.

By 1994, a transformation system had been developed for the diatoms using a chimeric gene as a selectable marker (discussed in the following section); however, there was still interest in producing a selectable marker system that would work for high lipid (although genetically recalcitrant) green algal strains, such as MONOR2. Work began on developing a new selectable marker system that used a mutated version of the acetolactate synthase (ALS) gene as a selectable marker. ALS is an enzyme involved in the synthesis of branched-chain amino acid such as leucine and valine. In plants, this enzyme is inhibited by sulfonylurea and imidazolinone herbicides. Previous work at NREL by Galloway (1990) showed that many microalgae are also sensitive to these herbicides. Eric Jarvis repeated these experiments for MONOR2 and demonstrated that these cells are sensitive to low levels of the sulfonylurea herbicides chlorsulfuron and sulfometural methyl. The approach was to isolate the wild-type gene for ALS from MONOR2, and then to produce a gene that encodes a herbicide-resistant form of the enzyme by site-directed mutagenesis. Degenerate primers were produced based on known ALS sequences and used, this time successfully, to isolate an ALS gene fragment from MONOR2 DNA. This sequence was used to screen the MONOR2 DNA libraries for a full-length ALS sequence, but once again, the screening efforts were unsuccessful.

The feeling among the NREL researchers was that the use of a homologous selectable marker system would still be the best approach for developing genetic transformation systems for some organisms, in particular, those with unusual DNA compositions, and for haploid organisms for which generation of mutants should be relatively straightforward. Despite the promise of *M. minutum* as a high lipid producer, it may have not been the best organism for these studies because of its highly unusual DNA properties and “tough” cell wall that complicated biochemical extractions and assays. Some of the cloning problems seen with this organism might have been



solved if time had permitted the generation of a cDNA library, or a new genomic DNA library using bacterial host strains optimized for use with highly modified or high GC DNA.

*Transformation of Chlamydomonas reinhardtii Using Silicon Carbide Whiskers:*

Based on the frustrating efforts to produce viable protoplasts from microalgae discussed earlier, efforts were initiated to develop other methods for introducing DNA into microalgal cells through the intact algal cell walls. At the time this research was going on, the only microalga for which there was a reproducible transformation system was *C. reinhardtii*. Early efforts to transform this organism were facilitated by the availability of wall-less cells, either genetic mutants (*cw-15*), or cells whose walls were degraded using autolysin, a species-specific cell wall-degrading enzyme produced during mating by *C. reinhardtii* gametes. High-frequency nuclear transformation was accomplished by agitating these wall-less cells in the presence of plasmid DNA, glass beads, and polyethylene glycol (Kindle 1990). This method was reported to work for walled cells, but at a very low frequency. DNA could also be introduced into walled cells of *Chlamydomonas* and into higher plant cells using microprojectile bombardment, or biolistics; however, this technique requires very expensive, specialized equipment. (This technique will be described in detail “Development of a Genetic Transformation System for the Diatoms *Cyclotella* and *Navicula*.”)

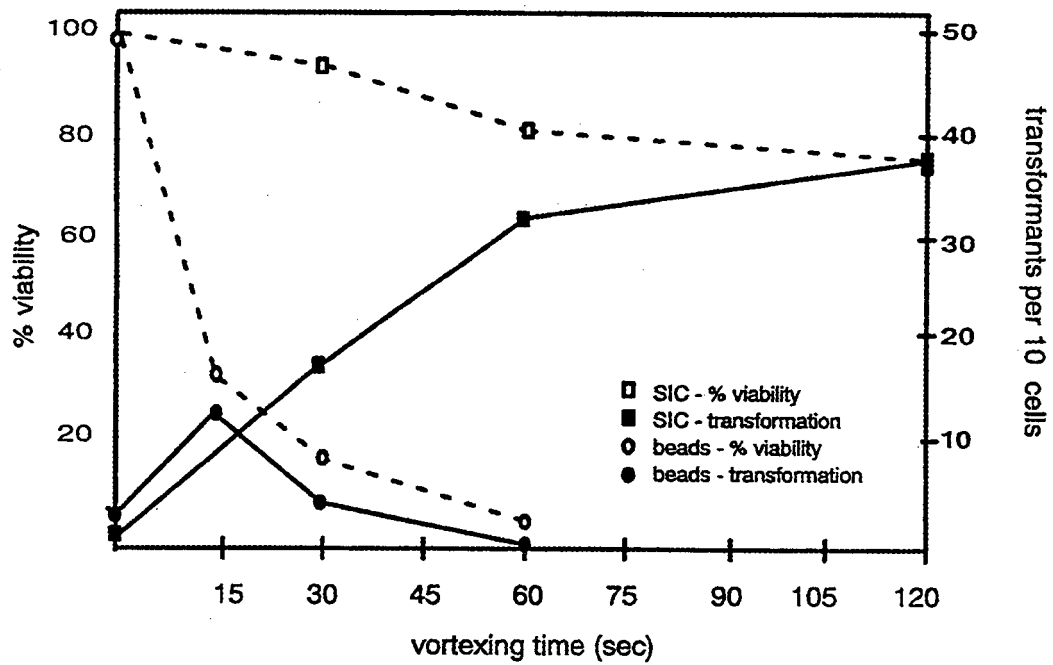
During the early 1990s, several reports demonstrated the feasibility of using silicon carbide whiskers (SiC) to mediate the entry of DNA into intact plant cells (Kaeppler et al. 1990; Asano et al. 1991). NREL researcher Terri Dunahay decided to try this approach to introduce DNA into intact algal cells. As reliable selectable markers were not yet available for any oleaginous microalgal strain, she decided to use *Chlamydomonas* as a model system. A strain of *C. reinhardtii* that contains a defect in the gene for nitrate reductase (CC2453 *nit1-305 mt*) was obtained from the *Chlamydomonas* Genetics Center at Duke University, Durham, North Carolina. These cells cannot use nitrate as a N source, but grow well in the presence of ammonia or urea. Kindle (1990) had shown previously that NR-deficient cells could be transformed with the *Chlamydomonas* wild-type gene for NR; transformed cells expressing the added DNA could be detected by their ability to grow on nitrate as the sole N source. A plasmid containing the wild-type NR gene from *Chlamydomonas* was obtained from Dr. P. Lefebvre at the University of Minnesota, St. Paul, Minnesota. A protocol for SiC-mediated transformation was developed based on the glass bead transformation protocol of Kindle (1990). Exponentially growing cells were washed once in  $\text{NH}_4^+$ -free medium, then suspended in the same medium with plasmid DNA, sterilized SiC whiskers, and polyethylene glycol (mw 8,000) to a final concentration of 4.5%-5.0% w/v. The samples were agitated using a vortex mixer for periods from 30 seconds to 10 minutes, then diluted into  $\text{NH}_4^+$ -free medium containing 0.6% agar (top agar) and plated onto agar plates that contained the same medium. Transformed colonies (containing a functional NR gene) appeared in 1-2 weeks.

Attempts to transform walled cells of *Chlamydomonas* using SiC were made in parallel with glass bead-mediated transformation to compare the two procedures. The results of a typical experiment are shown in Figure II.B.7. The number of transformants obtained using SiC varied



between experiments, but generally were in the range of 10-100 per  $10^7$  cells, comparable to transformation efficiency obtained with glass beads. Probably the most significant finding was the difference in cell viability after being agitated with either glass beads or SiC fibers. The viability of the cultures was greater than 80% even after agitation with SiC fibers for 10 minutes; only 10% of the cells survived agitation with glass beads for 60 seconds. The fact that SiC-mediated transformation appears to be a more “gentle” protocol than glass bead treatment may be important when adapting the transformation procedure to other species that may have different wall properties. This work resulted in two publications (Dunahay 1993; Dunahay et al. 1997). The second paper was a collaboration with Dr. Jonathan Jarvik at Carnegie Mellon University. Dr. Jarvik's laboratory adopted and refined the SiC protocol and now uses it routinely to generate transformants in *Chlamydomonas* strains with intact walls. After the initial development of the SiC protocol, there was some work at NREL to adapt this procedure for other algal strains of interest to the biodiesel project. Initially, no genetic markers for these strains were available; however, the viability of *Monoraphidium* and *Cyclotella* were tested following agitation with SiC; both strains showed high survival rates after extended agitation with SiC. However, the successful development of a transformation system for *Cyclotella* using biolistics (discussed later) precluded further work on SiC-mediated algal transformation. A few attempts were made to generate transformants of *Cyclotella* or *Navicula* using SiC once a selectable marker system was developed. Only one transformant was generated in one experiment. The silica frustule of the diatoms likely acts as a significant barrier to penetration by SiC fibers. SiC would probably work better for introducing DNA into non-diatom cells such as *Monoraphidium*; these cells are very small and may not be a good target for biolistics, but might be readily pierced by SiC fibers.





**Figure II.B.7.** Cell survival and transformation efficiency of intact *C. reinhardtii* following vortex mixing with SiC fibers or glass beads. (Source: Dunahay 1993.)



*Development of a Genetic Transformation System for the Diatoms Cyclotella and Navicula:*

Successful genetic transformation of microalgal strains with demonstrated potential for biodiesel fuel production was finally accomplished in 1994. Two factors that were critical in the development of the transformation system were:

- the cloning of the acetyl-CoA carboxylase gene from *C. cryptica*, and thus the availability of ACCase regulatory sequences to drive expression of a foreign gene in the diatoms, and
- the purchase by NREL of a microprojectile accelerator (also known as a particle gun) that can efficiently deliver DNA-coated gold or tungsten beads into walled cells.

Except for the transient expression of luciferase in *Chlorella* protoplasts, all previous attempts at NREL to transform microalgae had been unsuccessful. Whether the problem was the inability to deliver foreign DNA into the cells through the algal cell wall, or inefficient expression of the foreign gene, is not clear.

As discussed in the previous section of this report, a significant amount of work went into developing homologous selectable markers for microalgae, primarily for *Monoraphidium*. However, there were some attempts, mainly with diatoms, to use a heterologous antibiotic resistance gene as a selectable marker. The GC content of bacteria and diatoms are relatively similar; thus, codon bias should not prevent expression of a bacterial gene in the diatoms. The antibiotic kanamycin and its more potent analog G418, have been used extensively for genetic transformation in higher plants. These antibiotics function by binding to 30S ribosomes and inhibiting protein synthesis. Resistance to kanamycin or G418 can be induced in cells by expressing the bacterial gene neomycin phosphotransferase (*nptII*). This enzyme phosphorylates the antibiotic, preventing binding to the ribosome. Previous work at NREL (Galloway 1990) demonstrated that some algal strains are sensitive to kanamycin, suggesting that the kanamycin-G418/*nptII* system might be the basis of a successful transformation system for microalgae.

Further testing showed that most of the algal strains were sensitive to low concentrations of G418; however, the conditions for complete inhibition of cell growth had to be determined empirically for each strain. The required concentration of the antibiotic depended both on the osmoticum of the plating medium and on the plating density of the cells. For example, *C. cryptica* T13L grows well on both 10% and 50% ASW. When  $2 \times 10^6$  cells of T13L were plated on 50% ASW agar plates, the cells were resistant to  $50 \mu\text{g}\cdot\text{mL}^{-1}$  G418. The same number of cells plated onto 10% ASW plus  $50 \mu\text{g}\cdot\text{mL}^{-1}$  G418 showed no growth, yet  $3 \times 10^7$  cells produced a confluent lawn of colonies under the same conditions.

Early attempts to use the *nptII* gene as a selectable marker used a plasmid construct that had been used successfully for transformation in higher plants. This plasmid, pCaMVNeo, was obtained from Dr. Michael Fromm at the USDA Plant Gene Expression Center, Albany California.



pCaMVNeo contains the *nptII* gene driven by the cauliflower mosaic virus 35S ribosomal gene promoter (CaMV35S). Attempts were made to introduce pCaMVNeo into *C. cryptica* CYCLO1 by electroporation, and later into *C. ellipsoidea* or CYCLO1 by agitating the cells with glass beads or SiC fibers. No G418-resistant colonies were generated by these methods.

After the acetyl-CoA carboxylase (*acc1*) gene was cloned from *C. cryptica* T13L, NREL researcher Paul Roessler decided to try to use the 5'- and 3'-regulatory regions from this gene to drive expression of *nptII* in T13L. A plasmid (pACCNPT10) was constructed that contained a chimeric gene consisting of the coding region of the *nptII* gene flanked by 445 bp of the *acc1* 5' region (the putative promoter) and 275 bp of *acc1* coding region following the *nptII* stop codon, followed by the *acc1* 3' noncoding regions (the putative transcriptional terminator). To increase the chance of encompassing the entire *acc1* promoter, a second plasmid, pACCNPT5.1, was constructed that contained 819 bp of upstream sequence. In addition, all but 13 bp of the *acc1* coding region was removed from the 5' end of chimeric gene. Details of the plasmid constructions can be found in Dunahay et al. (1995), and plasmid maps are shown in Figure II.B.8.

DNA entry into the algal cells was accomplished using the DuPont/Bio-Rad PDS/1000He microprojectile accelerator. The process, called biolistics, had been used successfully for introducing DNA into walled cells of higher plants, fungi, bacteria, and *Chlamydomonas*. In this procedure, plasmid DNA is precipitated onto small tungsten or gold particles and accelerated into cells using a burst of helium pressure. Early versions of this device used a gun powder charge to accelerate the particles. Because of prohibitive costs and restrictive licensing agreements, a homemade version of the particle gun was designed and built at NREL. No transformants were generated using this device, but as these experiments were performed before the *acc1-nptII* chimeric plasmids were constructed, whether the device actually functioned as planned is unclear. Ultimately, a commercial microprojectile accelerator was purchased. This device was optimized for very simple operation and used helium pressure to propel the DNA-coated particles. These properties resulted in greater reproducibility between shots and decreased toxicity caused by gases generated during the explosive charge.

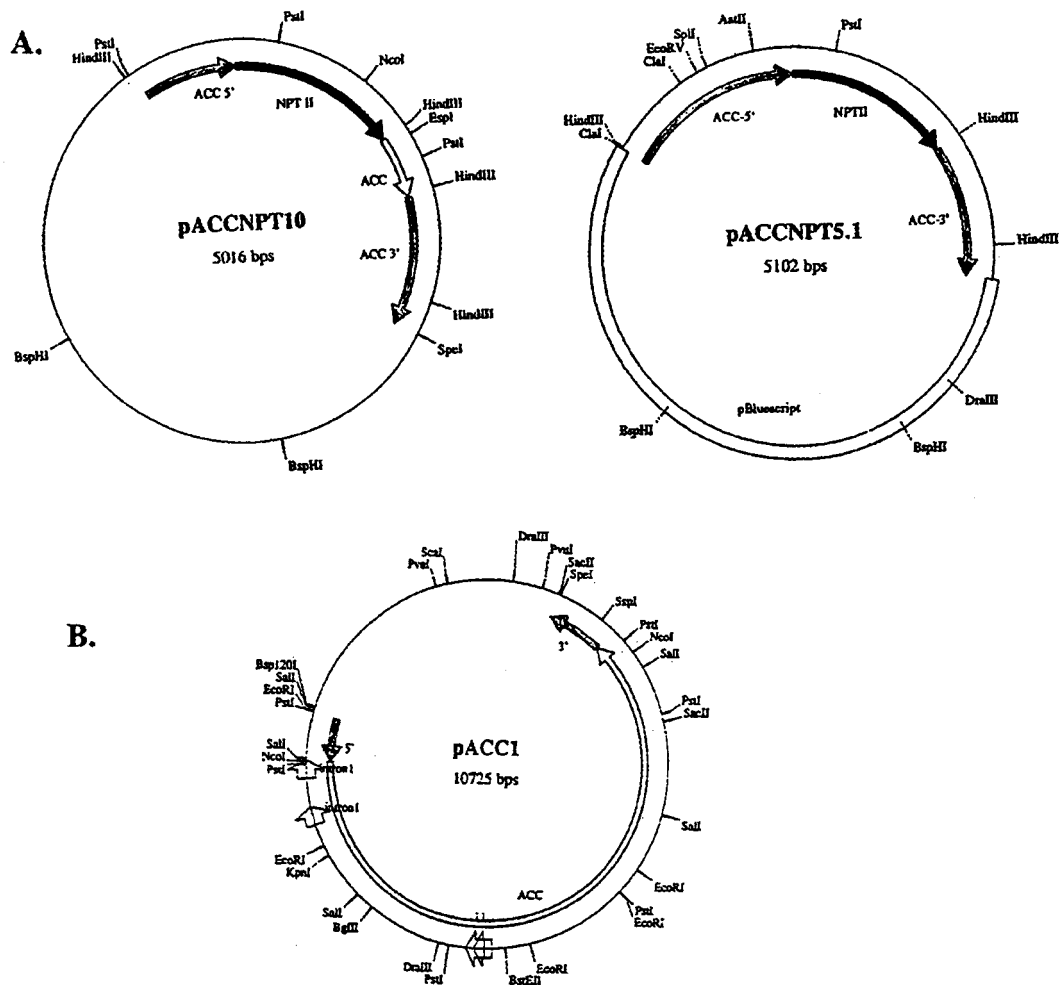
There was some initial skepticism on the part of at least one NREL researcher as to whether microprojectile bombardment would work to introduce DNA into diatoms through the Si frustule. However, the diatoms were transformed using the particle gun and the chimeric vectors in the first try. This turned out to be a simple and reproducible procedure (Figure II.B.9.). For each transformation, algal cells were harvested and spread in an approximate monolayer in the center of an agar plate containing growth medium and  $50 \mu\text{g}\cdot\text{mL}^{-1}$  ampicillin to inhibit bacterial growth. The plates were allowed to dry for 2 hours before bombardment. Just before bombardment, plasmid DNA was precipitated onto 0.5-1.0  $\mu\text{m}$  tungsten particles, which were then propelled into the cells using the microprojectile accelerator. The exact parameters used are described in Dunahay et al. (1995). The cells were incubated for 2 days under nonselective conditions to allow the cells to recover and express the *nptII* gene. The cells were then washed from the original plates and replated onto agar that contained the appropriate concentration of G418. G418-resistant colonies appeared in 7-10 days. These putative transformants were picked



from the plates and tested for continued resistance to G418. The presence of the foreign gene was tested by hybridizing the algal DNA with an *nptII* gene probe (Southern analysis). The cells were tested for the presence of the and for the NPTII protein by probing with an NPTII-specific antibody (Western blotting), Figures II.B.10 and II.B.11.

Both the pACCNPT10 and pACCNPT5.1 plasmids worked well to generate transformants in two strains of *C. cryptica* (T13L and CYCLO1), as well as in the diatom *N. saprophila* (NAVIC1). These two species belong to different orders (*C. cryptica* is a centric diatom, Order Centrales; *N. saprophila* is a pennate diatom, Order Pennales). Southern analysis indicated that the plasmid DNA was not replicating independently in the cells but had integrated into the host genome, presumably into the nuclear DNA. The chimeric gene integrated into one or more independent sites, often in form of tandem repeats. The *nptII* DNA remained stably integrated into the host genome for more than 1 year, even when the cells were grown under nonselective conditions.

The successful development of a genetic transformation system for the diatoms was a major achievement for the ASP. This was the first report of genetic transformation of any diatom species, and one of the few reports in which a heterologous gene was used as a selectable marker for stable nuclear transformation of an alga. The use of algal regulatory sequences to drive expression of the bacterial gene in diatoms apparently was a key factor in the successful development of a transformation protocol for these organisms. When the pCaMVNeo plasmid was introduced into diatoms via particle bombardment, no G418-resistant transformants were generated. However, when another plasmid that contains the CaMV35S promoter and the firefly luciferase gene were introduced into the diatoms by cotransformation with pACCNPT5.1, a number of transformants selected based on their resistance to G418 also expressed significant luciferase activity. This result suggests that even though microalgae can in some cases recognize and use foreign promoter sequences, homologous promoters may be necessary to drive expression of foreign selectable markers at levels high enough to overcome the selective pressure. The research that resulted in the development of a genetic transformation system for diatoms resulted in a publication (Dunahay et al. 1995) that was a finalist for the Provasoli Award for best publication in the *Journal of Phycology* for that year. In addition, a patent describing this technology was applied for and issued in August 1997. Diatoms represent a very large proportion of the world's biomass, and are responsible for nearly one-fourth of the net primary production. However, little is known about the biochemistry and molecular biology of these organisms. The availability of a genetic transformation system for diatoms could have a major impact on increasing the understanding of the basic biology of these organisms and should promote their use in biotechnological applications in addition to the intended goal of lipid production. The following section will describe the initial attempts to use the genetic transformation protocol to manipulate levels of storage lipids in *C. cryptica*.



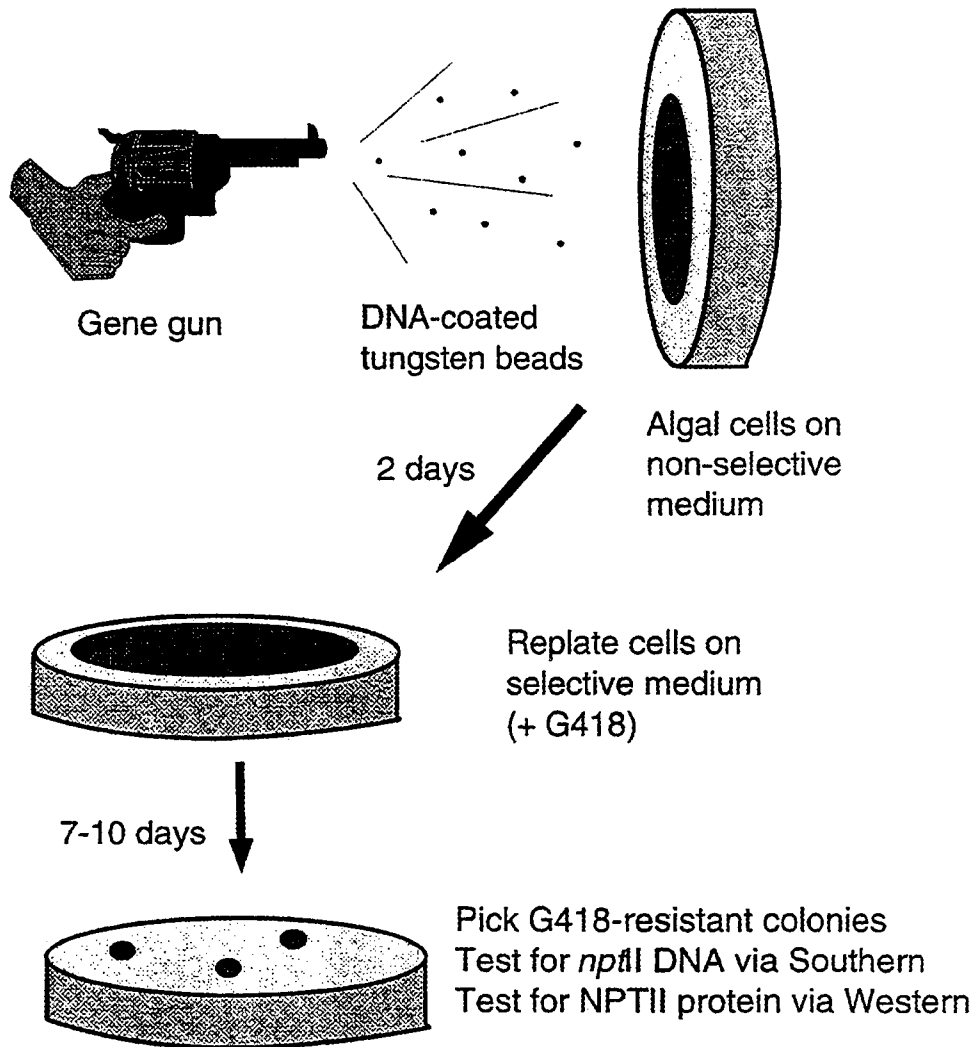
**Figure II.B.8.** Plasmid maps of pACCNPT10, pACCNPT5.1, pACC1

A. (Top) - Maps of plasmids containing the neomycin phosphotransferase gene (*nptII*) flanked by regulatory regions from the acetyl-CoA carboxylase gene from *C. cryptica*. Both plasmids worked well as expression vectors in the diatoms *C. cryptica* and *Navicula saprophila*.

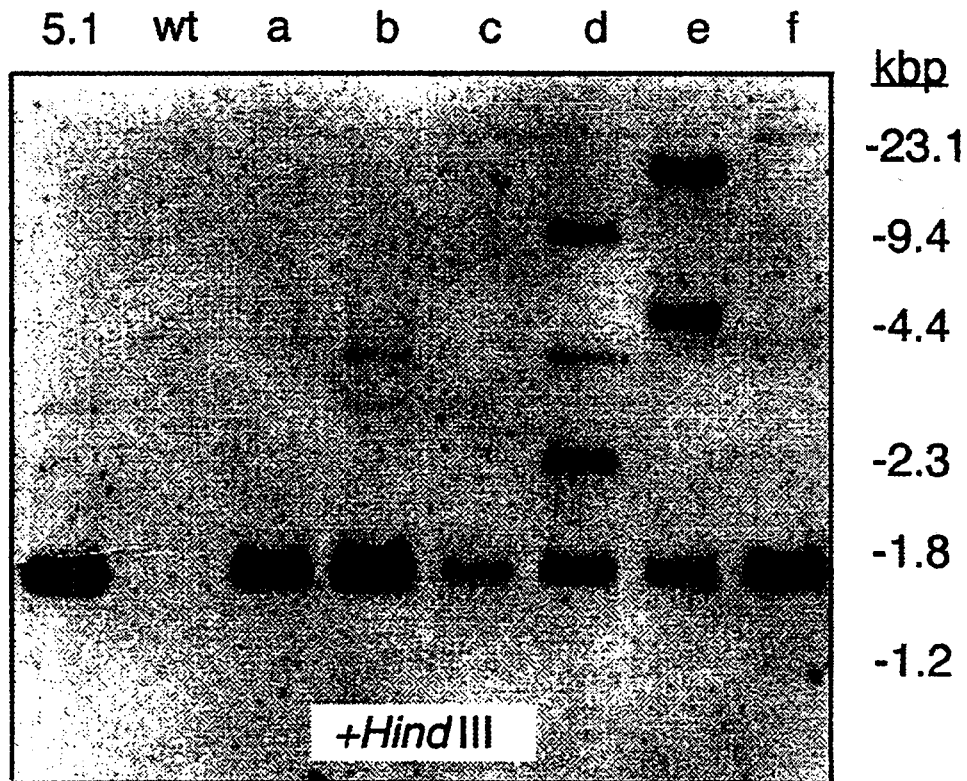
B. (Bottom) - Map of plasmid pACC1, containing the full-length genomic sequence of the acetyl-CoA carboxylase gene (*acc1*) from *C. cryptica*.

■ - *nptII* gene sequence; □ - *acc1* coding sequence; □ - *acc1* regulatory sequences

(Source: Dunahay et al. 1995; Roessler and Ohlrogge 1993).

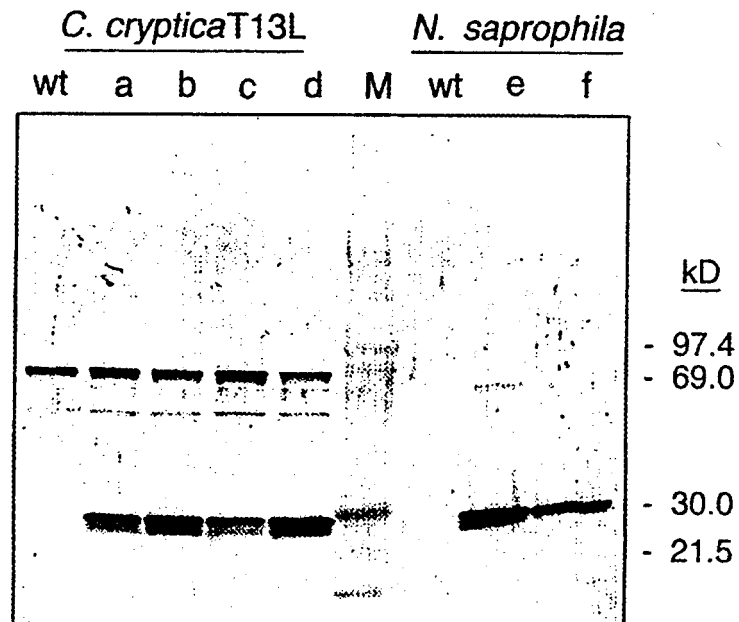


**Figure II.B.9.** Simplified schematic showing the protocol for transformation of diatoms by microprojectile bombardment (“gene gun”).



**Figure II.B.10.** Southern blot showing the presence of the *nptII* gene in transformed cells of *C. cryptica* T13L.

Cells of *C. cryptica* T13L were transformed with pACCNPT5.1 via particle bombardment as described in the text. DNA from wild-type cells (wt) or G418-resistant strains (lanes a-f) were digested with *Hind*III and hybridized to a digoxigenin-labeled *nptII* sequence. The lane designated “5.1” contains *Hind*III-digested pACCNPT5.1 as a control. The sizes of DNA fragments included as markers are indicated to the right. (Source: Dunahay et al. 1995).



**Figure II.B.11.** Western blot, showing the presence of the 30-kDa NPTII protein in transformed cells of *C. cryptica* T13L and *N. saprophila*.

In this example, *C. cryptica* and *N. saprophila* were transformed with pACCNPT10 and pACCNPT5.1, respectively. Crude cell extracts were separated on SDS-polyacrylamide gels, blotted onto a nitrocellulose filter, and NPTII protein was detected using anti-NPTII primary antibodies and alkaline phosphatase-conjugated goat anti-rabbit IgG secondary antibodies. The polyclonal antiNPTII antibody also recognizes a band of approximately 80 kDa in *C. cryptica*; however, the 30 kDa NPTII protein is seen only in the G418-resistant transformants. (Source: Dunahay et al. 1995).





### II.B.3.d. Attempts to Manipulate Microalgal Lipid Composition via Genetic Engineering

The overall goal of the studies on the biochemistry and molecular biology of lipid synthesis in microalgae was to increase the understanding of the lipid biosynthetic pathways and to identify enzymes that influence the rate of lipid accumulation and lipid quality. This information would be used to genetically manipulate the biosynthetic pathways for improvement in lipid production rates and to manipulate the nature of the lipids produced (i.e., the degree of fatty acid saturation and chain length) to optimize the production of biodiesel.

The development of a genetic transformation system for diatoms allowed NREL researchers to begin testing ways to manipulate microalgal biochemical pathways. The first target enzyme was ACCase. Previous studies at NREL had shown that increased lipid production in diatoms induced by Si starvation was accompanied by an increase in the activity of the ACCase enzyme. Therefore, it was logical to ask whether the activity of the enzyme could be increased in the cells by adding additional copies of the gene encoding ACCase (*acc1*), and, if so, would increased activity of the protein stimulate the production of lipids in the algal cells?

A full-length copy of the *C. cryptica acc1* gene had been cloned and characterized at NREL (see Section II.B.2.f). The plasmid containing this sequence was designated pACC1 (Figure II.B.8). Before the algal transformation system, attempts were made to express the algal gene in a bacterial system to ensure that the cloned gene encoded a functional ACCase enzyme and to test for the effects of overexpression. For expression of the *C. cryptica acc1* gene in *E. coli*, the introns were removed and the 5' terminus was replaced with the 5' end of the *E. coli*  $\beta$ -galactosidase gene, which included the inducible promoter region. This fusion gene was introduced into *E. coli*. The transformed cells were analyzed for the production of algal ACCase protein by probing blots of (Sodium Dodecyl Sulfate, SDS) polyacrylamide gels with an anti-ACCase antibody or with avidin conjugated to alkaline phosphatase. (Avidin binds to the biotin moiety in the functional ACCase protein.) The bacterial cells produced full-length algal ACCase, as well as a large number of shorter polypeptides recognized by the anti-ACCase antibody. Introducing the gene into other *E. coli* strains deficient in protease activity also produced these shortened peptides; therefore, they were presumed to be the result of truncated transcription or translation. The full-length ACCase protein was properly biotinylated in the transformed bacteria, but not as efficiently as in the *E. coli* native biotin-binding ACCase subunit. No effects were observed on lipid biosynthesis in the transformed *E. coli* strain. Attempts were also made to introduce the *C. cryptica acc1* gene into yeast, as expression in a eukaryotic system would more likely mimic the effects in algae, but these experiments were unsuccessful.

The next step was to introduce additional copies of the *acc1* gene in diatoms, with the goal of increasing the activity of the ACCase enzyme and then assaying the effects of ACCase overexpression on lipid accumulation. The plasmid containing the full-length *acc1* gene (pACC1) does not contain a selectable marker for transformation. Studies in other laboratories showed that nonselectable plasmids can be introduced into cells via cotransformation with a plasmid containing a selectable marker gene such as *nptII*. Although the exact mechanism for



this phenomenon is not clear, it is believed that during a given transformation procedure, a particular subpopulation of the cells becomes “transformation competent”. These cells may then take up multiple copies of DNA molecules present in the reaction. Introduction of pACC1 into the diatoms was mediated by microprojectile bombardment as described in a previous section, but with pACCNPT5.1 and pACC1 precipitated onto the tungsten beads in equimolar amounts. Transformed cells were selected based on their induced resistance to G418 and then screened for additional copies of the *acc1* wild-type gene using PCR and Southern analysis. Between 20% and 80% of the G418-resistant colonies contained *acc1* sequences in the cotransformation experiments. To facilitate the selection of transformants containing extra copies of the *acc1* gene, a plasmid was also constructed that contained both *acc1* and *nptII*, designated pACCNPT4; transformants generated using pACCNPT4 and selected for G418-resistance almost always contained the *acc1* gene as well.

Transformed cells containing additional *C. cryptica acc1* gene sequences were isolated in *C. cryptica* T13L, *C. cryptica* CYCLO1, and *N. saprophila* NAVIC1. Southern analysis indicated that the foreign DNA inserted into host genome, often in one or more random sites, and often in the form of tandem repeats. Several strains that contained one or more full-length sequences of the inserted *acc1* gene were analyzed further to test for ACCase overexpression. The CYCLO T13L transformants showed two to three fold higher ACCase activity than wild-type cells, and there was a corresponding increase in *acc1* gene transcript (mRNA) levels. However, preliminary analyses of the lipid composition of the cultures overexpressing *acc1* did not indicate a detectable increase in lipid levels. These results suggest that the lipid biosynthesis pathways may be subject to feedback inhibition, so that increased activity of the ACCase enzyme is compensated for by other pathways within the cells. It was hoped that expression of *C. cryptica* T13L *acc1* gene in other algal strains might overcome this inhibition. Numerous *N. saprophila* transformants were generated that contained full-length copies of the *C. cryptica acc1* gene; although *acc1* mRNA was detected using the RPA, the recombinant ACCase protein was not detected in any of the *N. saprophila* strains tested. Whether this result was due to inefficient translation of the mRNA, or degradation of the foreign protein due to improper biotinylation or targeting, is not known. Transformants were also generated in a second strain of *C. cryptica*, CYCLO1, but the program was discontinued before these strains could be analyzed fully.

NREL researcher Eric Jarvis took another approach to genetically manipulating algal pathways for increased lipid production. Previous research had resulted in the cloning and characterization of the *upp1* gene from *C. cryptica* (described in Section II.B.2.h.). This gene codes for a fusion protein containing the activities for UDPglucose pyrophosphorylase and phosphoglucomutase, two key enzymes in the production of chrysolaminarin. It was postulated that decreasing expression of the *upp1* gene could result in a decrease in the proportion of newly assimilated carbon into the carbohydrate synthesis pathways, and consequently increase the flow of carbon to lipids.

Two techniques that are becoming widely used for gene inactivation are ribozymes and antisense RNA. Dr. Jarvis spent 6 months working at Ribozyme Pharmaceuticals, Inc., a biotechnology company in Boulder, Colorado, learning about these new methods. Antisense RNA is a method



in which a cell is transformed with a synthetic gene that produces an RNA sequence complimentary to a specific mRNA. Although the exact mechanism is not clear, the antisense RNA prevents translation from its complimentary mRNA, effectively lowering the level of that particular protein in the cell. Ribozymes are also RNA molecules produced by synthetic genes that can bind to, and cleave, very specific RNA sequences. Ribozymes can be designed to degrade specific mRNA molecules, effectively decreasing expression of a specific gene.

Several ribozymes sequences designed to cleave *uppl* RNA were constructed based on computer predictions of the secondary structure of the target RNA. The ribozyme constructs were shown to specifically cleave the target RNA *in vitro*. The ribozyme sequences were then inserted into the pACCNPT10 vector in the untranslated *acc1* sequence between the *nptII* stop codon and the *acc1* termination sequence (see Figure II.B.8). *C. cryptica* T13L was transformed with these vectors as described earlier and transformants were selected based on acquired resistance to G418. Extracts were made of the transformed strains and analyzed for UGPase activity. Unfortunately, insertion of the ribozyme sequences did not result in detectable decreases in UGPase expression. Although these initial experiments were unsuccessful, gene inactivation technologies acquired during this project seemed a promising approach for manipulation of algal lipid synthesis pathways. At the time project funding was terminated, work was in progress to continue with the ribozyme experiments and to test antisense RNA constructs as an additional method for inactivating algal pathways.

#### **II.B.3.e. The Effect of Different Promoters on Expression of Luciferase in *Cyclotella***

Little is known about the regulation of gene expression in diatoms, partly because genetic transformation was not possible in this group of algae before NREL's transformation system was developed. The availability of this transformation system now allows the study of the roles of regulatory DNA sequences in gene expression. As a first step toward a better understanding of gene transcription in diatoms, NREL researchers Paul Roessler and Steve Milstrey used the firefly luciferase reporter gene (discussed earlier), to study the level of gene expression as controlled by various DNA regulatory sequences from the diatom *C. cryptica* and other organisms. They also used this system to try to define the regions of the ACCase gene promoter involved in the Si-depletion response.

Various plasmids were constructed in which different combinations of 5' regulatory DNA sequences (promoters) and 3' regulatory DNA sequences (terminators) were linked to the firefly luciferase gene (*luc*). The regulatory sequences used in this study included both the ACCase promoter and the UDP-glucose pyrophosphorylase/phosphoglucomutase promoters from *C. cryptica*. Also tested were the simian virus 40 (SV40) promoter, which drives high levels of gene expression in mammalian cells, and the cauliflower mosaic virus 35S RNA promoter (CaMV35S), which is a strong constitutive promoter in plants. These plasmids were introduced into *C. cryptica* via cotransformation with the selectable marker plasmid pACCNPT5.1 as described earlier. Approximately half of the transformed strains produced in this manner contained the *luc* gene, as determined by PCR analysis. Based on past results, it is expected that the plasmid DNA was integrated into the genome of the cells. Luciferase activities in randomly



chosen transformants (eight from each plasmid type) were determined by the use of a luminometer.

As expected, the promoter regions of both *C. cryptica* genes drove luciferase expression in the transformed *C. cryptica* cell at high levels. Less predictable was the finding that the SV40 mammalian promoter also drove luciferase expression in *C. cryptica* at relatively high levels (although lower than seen using the homologous promoters), but the CaMV35S promoter was much less effective. In most of the constructs used in this study, the 3' terminator regulatory region was from the *C. cryptica aac1* gene. Replacement of this sequence with the SV40 terminator did not affect the levels of luciferase expression driven by the *aac1* promoter, indicating that the source of the terminator sequence used may not be a critical determinant of gene transcription efficiency.

Previous results at NREL indicated that Si deficiency may affect the expression of the *aac1* gene in *C. cryptica* (see Section II.B.2.d.). To try to identify regions of the *aac1* promoter that might be responsive to Si levels, three plasmids that contained varying lengths of the *aac1* promoter region (900, 445, and 396 bp, respectively) fused to the *luc* gene were used to transform *C. cryptica*. Under Si replete conditions, the average luciferase activities of transformants containing these plasmids were very similar. Furthermore, the luciferase activity increased to the same extent (approximately twofold) 6 hours after transfer into Si-free medium. This suggests that the Si-responsive elements are either within the shortest (396-bp) promoter region tested or in a separate area of the genome.

These results indicate that the firefly luciferase gene can be expressed in recombinant *C. cryptica* cells, to provide a sensitive reporter system for analyzing gene expression and promoter function in diatoms. This and similar systems will likely be extremely useful for gaining a better understanding of the molecular biology of this important group of organisms.

#### Publications:

Brown, L.M.; Dunahay, T.G.; Jarvis, E.E. (1990) Applications of genetics to microalgae production. *Dev. Industrial Microbiology*, vol. 31 (*J. Industrial Microbiol.*, Suppl. No.5), pp. 271-274.

Dunahay, T.G. (1993) "Transformation of *Chlamydomonas reinhardtii* with silicon carbide whiskers." *Biotechniques* 15:452-460.

Dunahay, T.G.; Adler, S.A.; Jarvik, J.W. (1997) "Transformation of microalgae using silicon carbide whiskers." In *Methods in Molecular Biology*, vol. 62: *Recombinant Gene Expression Protocols* (Tuan, R., ed.), Humana Press, Totowa, New Jersey, pp. 503-509.

Dunahay, T.G.; Jarvis, E.E.; Dais, S.S.; Roessler, P.G. (1996) "Manipulation of microalgal lipid production using genetic engineering." *Appl. Biochem. Biotechnol.* 57/58:223-231.



Dunahay, T.G.; Jarvis, E.E.; Roessler, P.G. (1995) "Genetic transformation of the diatoms *Cyclotella cryptica* and *Navicula saprophila*." *J. Phycol.* 31:1004-1012.

Dunahay, T.G.; Jarvis, E.E.; Zeiler, K.G.; Roessler, P.G.; Brown, L.M. (1992) "Genetic engineering of microalgae for fuel production." *Appl. Biochem. Biotechnol.* 34/35:331-339.

Galloway, R.E. (1990) "Selective conditions and isolation of mutants in salt-tolerant, lipid-producing microalgae." *J. Phycol.* 26:752-760.

Jarvis, E.E. (1995) "Antisense RNA and ribozymes as tools for metabolic engineering." *Final Report DDF #07422041*, National Renewable Energy Laboratory, 13 pp.

Jarvis, E.E.; Brown, L.M. (1991) "Transient expression of firefly luciferase in protoplasts of the green alga *Chlorella ellipsoidea*." *Curr. Genet.* 19:317-321.

Jarvis, E.E.; Dunahay, T.G.; Brown, L.M. (1992) "DNA nucleoside composition and methylation in several species of microalgae." *J. Phycol.* 28:356-362.

Roessler, P.G. (1995) "Expression of an algal acetyl-CoA carboxylase gene in *E. coli*." In *Plant Lipid Metabolism* (Kader, J.-C.; Mazliak, P., eds.), Kluwer Academic Publishers, pp. 46-48.

Roessler, P.G.; Brown, L.M.; Dunahay, T.G.; Heacox, D.A.; Jarvis, E.E.; Schneider, J.C.; Talbot, S.G.; Zeiler, K.G. (1994) "Genetic engineering approaches for enhanced production of biodiesel fuel from microalgae." In *Enzymatic Conversion of Biomass for Fuels Production*, (Himmel, M.E.; Baker, J.; Overend, R.P., eds.), American Chemical Society, pp. 256-270.

Roessler, P.G.; Ohlrogge, J.B. (1993) "Cloning and characterization of the gene that encodes acetyl-coenzyme A carboxylase in the alga *Cyclotella cryptica*." *J. Biol. Chem.* 268:19254-19259.

#### Additional References:

Asano, Y.; Otsuki, Y.; Ugaki, M. (1991), "Electroporation-mediated and silicon carbide fiber-mediated DNA delivery in *Agrostis alba* L. (Redtop)." *Plant Sci.* 79:247-252.

Berliner, M.D. (1977) "Protoplast induction in *Chlorella vulgaris*." *Plant Sci. Lett.* 9:201-204.

Braun, E.; Aach, H.G (1975) "Enzymatic degradation of the cell wall of *Chlorella*." *Planta* 126:181-185.

Daboussi, M.J.; Djeballi, A.; Gerlinger, C.; Blaiseau, P.L.; Bouvier, I.; Cassan, M.; Lebrun, M.H.; Parisot, D.; Brygoo, Y. (1989) "Transformation of seven species of filamentous fungi using the nitrate reductase gene of *Aspergillus nidulans*." *Curr. Genet.* 15:453



Global, E.; Aach, H.G. (1985) “Studies of *Chlorella* protoplasts. II. Isolation and fusion of protoplasts from *Chlorella saccharophila* (Krüger) nadson strain 211-1a.” *Plant Sci.* 39:213-218.

Hoffman, C.S.; Winston, F. (1987) “A ten-minute DNA preparation from yeast efficiently releases autonomous plasmids for transformation of *Escherichia coli*.” *Gene* 57:267-272.

Kaeppler, H.F.; Gu, W.; Somers, D.A.; Rines, H.W.; Cockburn, A.F. (1990) “Silicon carbide fiber-mediated DNA delivery into plant cells.” *Plant Cell Rep.* 9:415-418.

Kindle, K. (1990) “High frequency nuclear transformation of *Chlamydomonas reinhardtii*.” *Proc. Nat. Acad. Sci. USA* 87:1228-1232.

Kindle, K.L.; Schnell, R.A.; Fernández, E.; Lefebvre, P.A. (1989) “Stable nuclear transformation of *Chlamydomonas* using the *Chlamydomonas* gene for nitrate reductase.” *J. Cell Biol* 109:2589-2601.

Murray, H.G.; Thompson, W.F. (1980), “Rapid isolation of high molecular weight plant DNA.” *Nuc. Acids Res.* 8:4321-4325.

#### Patents:

Dunahay, T.; Roessler, P.G.; Jarvis, E.E. “Method to Transform Algae, Materials Therefor and Products Produced Thereby”, U.S. Patent 5,661,017, issued 8/26/97.

#### II.B.4. Microalgal Strain Improvement – Conclusions and Recommendations

Previous to the research performed by researchers in the ASP at NREL, very little work had been done in the area of microalgal strain improvement, particularly with a goal of developing a commercial organism. Although much remains to be done, significant progress was made in the understanding of environmental and genetic factors that affect lipid accumulation in microalgae, and in the ability to manipulate these factors to produce strains with desired traits.

The evidence for a specific lipid trigger is not overwhelming. Interpreting exactly what is happening in the nutrient-deprived cells is difficult, particularly when cells are starved for N, as the lack of an important nutrient is likely to produce multiple and complex reactions in a cell. However, lipid accumulation in some algal species can be induced by nutrient limitation. Cell division slows or stops, and the cells begin to accumulate lipid as cytoplasmic droplets, formed primarily of neutral TAGs. The trigger hypothesis is supported by microscopic and flow cytometric evidence that showed that the lipid droplets do not form gradually within all cells in a population; rather, individual cells seem to sense the trigger and lipid accumulation occurs rapidly within the individual cells. However, lipid accumulation is always correlated with the cessation of cell division. Other factors that inhibit cell division, such as a pH shift, can also induce lipid accumulation in some strains. The evidence suggests that the rate of synthesis of all cell components, including lipids, proteins, and carbohydrates, is decreased in nutrient-stressed cells. However, the rate of lipid synthesis remains, at least for some strains of diatoms, higher



than the rate of protein or carbohydrate synthesis, resulting in a net accumulation of lipid in nutrient-starved cells. Another hypothesis is that cessation of cell division in nutrient-limited cells leads to decreased utilization of storage lipid while new synthesis of lipid continues, causing a net accumulation of lipid in the cells.

One of the most important findings from the studies on lipid accumulation in the microalgae is that, although nutrient stress causes lipid to increase in many strains as a percentage of the total biomass, this increase is generally accompanied by a decrease in total cell and lipid productivity. As discussed elsewhere in this report, economically viable production of algal lipids for fuel production will require optimization of productivity as well as a clear understanding of the kinetics of lipid accumulation, in order to harvest the cells at a time when lipid production is maximal.

In addition to the effect on total lipid production, nutrient deprivation seems to have other effects on the lipid biosynthetic pathways. Several laboratories reported that nutrient limitation also resulted in a change in the types of lipids seen in the algal cells, specifically, an increase in the ratio of neutral lipids (storage TAGs that are important in the production of biodiesel) as compared to the polar membrane lipids. It will be important to characterize this phenomenon further in any algal strain targeted for biomass production to maximize the desired lipid product.

The progress made by the ASP in the understanding of the biochemistry and molecular biology of lipid biosynthesis in algae, and the success in the area of algal genetic engineering are more clear cut. An enzyme that appears to play a key regulatory role in the synthesis of lipids in plants, and likely in algae, ACCase, was purified from the diatom *C. cryptica*. The gene that codes for this enzyme was then cloned; this was the first report of cloning a full-length ACCase sequence from any photosynthetic organism. Obtaining this gene was advantageous for two reasons:

1. The regulatory sequences from this gene were used to develop a genetic transformation system for diatoms, and
2. Having this gene (in combination with the transformation system) allowed researchers to test for the effects of overexpression of this enzyme on lipid accumulation.

The development of the transformation system for an oleaginous microalgal strain was a major goal of the ASP, and a significant effort was put into this project during the early 1990s. This was the first successful transformation of any non-green alga. The method was simple and reproducible, and should work for a variety of diatom strains, as long as the cells can form colonies on solid medium and are sensitive to one of the known selectable agents, such as G418 or kanamycin. Although little work is currently being done on the development of genetically engineered algal strains for commercial applications, the ability to transform these algae should have positive ramifications for the algal biotechnology community.



Preliminary experiments were also performed within the ASP to use this genetic transformation system to introduce genes into the algal cells, with the goal of manipulating lipid biosynthesis. Additional copies of the ACCase gene were introduced into cells of *C. cryptica* and *N. saprophila*. Although ACCase activity was increased in these cells, there was no detectable increase in lipid accumulation. The project was terminated before these experiments, and similar experiments designed to down-regulate genes involved in carbohydrate synthesis could be pursued further. This could be an interesting and possibly rewarding path for future research, if only to help in understanding the biochemical and molecular biological factors that affect lipid accumulation in these cells.

---





### **III. Outdoor Studies and Systems Analysis**

#### **III.A. Projects Funded by ERDA/DOE 1976-1979**

##### **III.A.1. Introduction**

The concept of microalgae biomass production for conversion to fuels (biogas) was first suggested in the early 1950s (Meier 1955). Shortly thereafter, Golueke and coworkers at the University of California–Berkeley demonstrated, at the laboratory scale, the concept of using microalgae as a substrate for anaerobic digestion, and the reuse of the digester effluent as a source of nutrients (Golueke et al. 1957; Golueke and Oswald 1959).

Oswald and Golueke (1960) presented a conceptual analysis of this process, in which large (40-ha) ponds would be used to grow microalgae. The algae would be digested to methane gas used to produce electricity. The residues of the digestions and the flue gas from the power plant would be recycled to the ponds to grow additional batches of algal biomass. Wastewaters would provide makeup water and nutrients. The authors predicted that microalgae biomass production of electricity could be cost-competitive with nuclear energy.

This concept was revived in the early 1970s with the start of the energy crisis. The National Science Foundation–Research Applied to National Needs Program (NSF-RANN) supported a laboratory study of microalgae fermentations to methane gas (Uziel et al. 1975). Using both fresh and dried biomass of six algal species, roughly 60% of algal biomass energy content converted to methane gas.

With the establishment of ERDA, the NSF-RANN activities were transferred to this new agency, which initiated a program in biomass fuels production. The Fuels from Biomass Program at ERDA funded a new project at Berkeley to develop a microalgae wastewater treatment and fuel production process. This project, started in 1976, was carried out at the Richmond Field Station of the University of California–Berkeley, and continued for about 4 years in parallel with several related projects. These projects included an ERDA-funded biophotolysis project (reviewed in Benemann et al. 1980), a NSF-RANN project on N-fixing blue-green algae (cyanobacteria) for fertilizer production (Benemann et al. 1977), and an EPA-funded project on algal bioflocculation in oxidation ponds (Koopman et al. 1978; 1980).

The initial objective of the ERDA microalgae fuels project was to develop methods by which particular species of microalgae could be maintained in open ponds used for wastewater treatment. There are many large (>100 ha) and many hundreds of smaller wastewater treatment pond systems in California and elsewhere in the United States. The problem addressed by this project was the removal (harvesting) of the algal biomass from the effluents. Not only did the algal biomass represent a potential resource for the production of biogas, but the algal solids discharged from the ponds were pollutants that resulted in eutrophication and dissolved O<sub>2</sub> reduction in the receiving bodies of waters. Thus, there was considerable interest in lower-cost and less energy-intensive microalgae harvesting technologies and wastewater treatment processes



in general. In the absence of cost-effective microalgae harvesting technologies, microalgae pond systems, although widely used, could not meet the increasingly stringent wastewater treatment plant discharge standards, specifically in regards to suspended solids (mainly algal cells). A process that could reduce algal solids in pond effluents would have a ready market and potential near-term applications.

This was the justification for the initial emphasis on wastewater treatment processes from microalgae production. However, the ERDA/DOE Fuels from Biomass Program soon shifted its emphasis towards large-scale biomass production systems, having multi-quad (quad =  $10^{15}$  Btu) impacts. This accounted, in part, for the early emphasis by this program on large-scale biomass “energy plantations” and even immense ocean energy farms, which some thought would provide solutions for the perceived U.S. energy crisis (Benemann 1980).

Large effects on U.S. energy supplies would probably not be plausible with wastewater treatment systems, which in aggregate represent a maximum potential of perhaps only one- or two-tenths of a quad of fuels (Benemann et al. 1998, in preparation), a fraction of 1% of U.S. energy needs. However, wastewater systems can arguably serve as an initial step in the long-term development of larger, stand-alone systems. Although this argument was controversial at the time, the University of California–Berkeley project continued to emphasize wastewater treatment systems in its R&D. However, the supporting economic analyses carried out by the ASP (see Section III.D.), started to focus on very large-scale, stand-alone systems. Section III.A. of this report reviews the algal mass-culture projects that were supported by ERDA and DOE before the ASP was initiated.

#### Publications:

Benemann, J.R. (1980) “Biomass energy economics.” *Intl. Energy Journal* 1:107-131.

Benemann, J.R.; Hallenbeck, P.C.; Weissman, J.C.; Murry, M.; Oswald, W.J. (1977) “Fertilizer production with nitrogen-fixing heterocystous blue-green algae.” *Final Report to the National Science Foundation*, Sanitary Eng. Res. Lab., Univ. Calif. Berkeley.

Benemann, J.R.; Koopman, B.L.; Weissman, J.C.; Eisenberg, D.M.; Goebel, R. P. (1980) “Development of microalgae harvesting and high rate pond technology.” In *Algal Biomass*, (Shelef, G.; Soeder, C.J., eds.), Elsevier, pp. 457-499.

Benemann, J.R.; Koopman, B. L.; Weissman, J.C.; Oswald, W.J. (1976) “Biomass production and waste recycling with blue-geen algae.” In *Microbial Energy Conversion*, (Schlegel, H.G.; Barnea, J., eds.), Gottingen, pp. 413-426.

Benemann, J.R.; Miyamoto, K.; Hallenbeck, P.C. (1980) “Bioengineering aspects of biophotolysis.” *Enzyme and Microbial Technology* 2:103-111.

Benemann, J.R.; Weissman, J.C.; Koopman, B.L.; Oswald, W.J. (1977) “Energy production with microalgae.” *Nature* 268:19-23.



Golueke, C.G.; Oswald, W.J. (1959) "Biological Conversion of light energy to the chemical energy of methane." *App. Microbiol.* 7:219-241.

Golueke, C.G.; Oswald, W.J.; Gotaas, H.B. (1957) "Anaerobic digestion of algae." *App. Microbiol.* 5:47-55.

Koopman, B.L.; Benemann, J.R.; Oswald, W.J. (1980) "Pond isolation and phase isolation for control of suspended solids concentration in sewage oxidation pond effluents." In: *Algal Biomass* (Shelef, G.; Soeder, C., eds.), Elsevier, pp. 135-162.

Koopman, B.L.; Thomson, R.; Yacksian, R.; Benemann, J.R.; Oswald, W.J. (1978) "Investigation of the pond isolation process for microalgae separation from woodland's pond effluents." *Report to the Univ. of Calif., Berkeley*, SERL Report No 78-5.

Meier, R.L. (1955) "Biological cycles in the transformation of solar energy into useful fuels." In: *Solar Energy Research*, (Daniels, F.; Duffie, J.A., eds.), Madison University Wisconsin Press, pp. 179-183.

Oswald, W.J.; Golueke, C.G. (1960) "Biological transformation of solar energy." *Adv. Appl. Microbiol.* 11:223-242.

Uziel, M.; Oswald, W.J.; Golueke, C.G. (1975) "Solar energy and conversion with algal bacterial systems." Univ. of California Berkeley, SERL Report to NSF/RANN/SE/GI-39216/Fr/75/5.

### **III.A.2. Species Control in Large-Scale Algal Biomass Production**

This project addressed the problem of the uncontrolled nature of the algal populations in wastewater treatment ponds. Because the dominant algal species found in a pond could range from small unicellular to large colonial or filamentous species, harvesting of the algae for biomass conversion would require a universally applicable harvesting technology, such as centrifugation or chemical flocculation, to enable the recovery of any algal type. However, these processes are very expensive (Golueke and Oswald 1965; see also Shelef 1984 for an ASP supported assessment, and Benemann and Oswald, 1996 for a recent review). If, however, algal species could be controlled in the ponds, then filamentous microalgae species might be grown that would be easier and cheaper to harvest using microstrainers. Microstrainers, which are rotating screens (typically 25 to 50  $\mu\text{m}$  openings) with a backwash, are already widely used for removing filamentous algae, mainly filamentous cyanobacteria (blue-green algae) from potable water supplies. Thus, the first objective of this project, initiated in 1976, was to investigate how to selectively cultivate filamentous microalgal species in waste treatment ponds (Benemann et al. 1977).

The first issue was that conventional waste treatment ponds are generally deep (2 m), and unmixed. Such ponds do not maximize algal productivity, nor do they provide a uniform hydraulic flow or physical-chemical environment. Thus, this project focused on the use of shallow, mixed, raceway-type ponds, the "high rate pond" of Oswald (1963), for microalgae



production and demonstration of algal species control in wastewater treatment. Initially four small (approximately 3 cm<sup>2</sup>) and, four larger (12 m<sup>2</sup>) rectangular, paddle wheel-mixed ponds were built and used. The Richmond Field station also had a large pilot-scale (0.25 ha) shallow high rate pond that was fed settled (primary effluent) municipal wastewater, available for this research.

A fundamental theory of species control was developed based on selective recycle of harvestable biomass (Figure III.A.1.). The concept is that harvesting filamentous algae and recycling part of the biomass back to the ponds (similar to the process of activated sludge), would favor the slower-growing filamentous algae over the faster-growing unicellular types (which would thus get washed out of the system). This theory was both mathematically proven and experimentally demonstrated in the laboratory in competition experiments with mixed cultures of *Chlorella* (a unicellular green alga) and *Spirulina* (a filamentous blue-green alga). Without biomass recycle *Chlorella* always out-competed *Spirulina*; with biomass recycle *Spirulina* could be made to dominate the culture (see also Weissman and Benemann 1978).

This process was also tested in outdoor ponds. Experiments with *Spirulina* grown on wastewater were not encouraging, as this species dominates only at high salinities and alkalinities. Thus, the first issue was the source of algal species for the experiments. A pond in the city of Woodland was found to have a dominant culture of the filamentous cyanobacterium *Oscillatoria*. It was decided to use this alga in the initial tests. First the alga was isolated from a small pond sample and grown in the laboratory. It was then inoculated into a small circular pond fed with settled Richmond algae. The results of the first experiment are shown in Figure III.A.2. The *Oscillatoria* culture grew, but the unicellular organisms grew faster. Only by completely harvesting the entire culture and recycling all of the biomass retained in the microstrainer (almost pure *Oscillatoria*), could the culture be maintained.

It was thought that perhaps the laboratory cultivation stage had selected for a laboratory-adapted strain that did not do well outdoors. A small microstrainer was taken to Woodland, and enough *Oscillatoria* biomass was collected and returned to the Richmond Field Station to inoculate one of the small circular ponds. The pond was diluted about one-third per day with wastewater, with about 40% of the algae harvest recycled. However, after a couple of weeks, a new algal species became dominant. This species, *Micractinium*, a colonial organism covered with large spines (thought to be a protection against zooplankton grazers), also was captured by the (26- $\mu$ m opening) fabric of the microstrainers and recycled. This gave a *Micractinium* competitive advantage over the unicellular forms, but also over the *Oscillatoria*. Several more inoculations of *Oscillatoria* gave similar results, with *Micractinium* dominating.

However, even *Micractinium* could not be stably cultured with recycling, as during apparently unfavorable conditions it washed out (probably due to loss of spines) and then was replaced by *Scenedesmus*. On the other hand, when conditions were favorable for *Micractinium*, biomass recycle helped the culture dominate the ponds faster, but, regardless of recycling, this alga replaced *Scenedesmus*. Thus, the theory worked in principle, but in practice selective biomass



recycle could be only one, and not a sufficient, tool for controlling microalgal species in such ponds.

Biomass productivities equivalent to a total solar energy conversion efficiency of about 2% (about 15 g/m<sup>2</sup>/d) were achieved for about 1-week periods. Effluents from the more harvestable cultures were below the EPA wastewater treatment system discharge limits of 30 ppm suspended solids (SS), with reductions of over 80% for ammonia and 50% for total organic C. A preliminary economic analysis was also presented (Benemann et al. 1977).

#### Publications:

Benemann, J.R.; Koopman, B.L.; Weissman, J.C.; Eisenberg, D.M.; Oswald, W.J. (1977b) "Species control in large scale microalgae biomass production. *Report to Univ. Calif. Berkeley, SERL 77-5, SAN/740-77/1* (April 1977, revised November 1997).

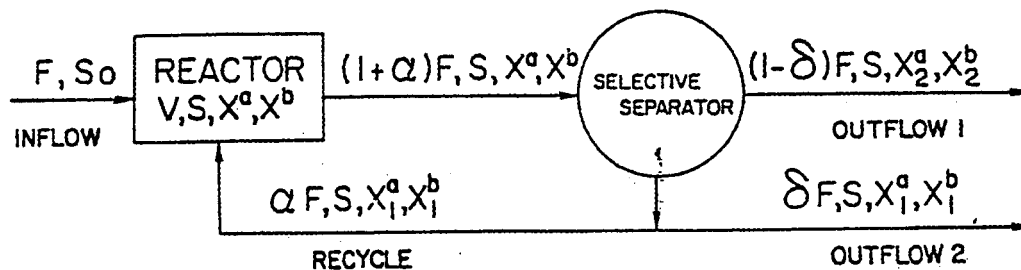
Benemann, J.R.; Oswald, W.J. (1966) "Systems and economic analysis of microalgae ponds for conversion of CO<sub>2</sub> to biomass." *Final Report to the Pittsburgh Energy Technology Center, Grant No. DE-FG22-93PC93204*.

Golueke, C.G.; Oswald, W.J. (1965) "Harvesting and processing sewage-grown planktonic algae." *J. Wat. Poll. Cont. Fe.* 37:471-498.

Oswald, W.J. (1963) "The high-rate pond in waste disposal." *Dev. Ind. Microbiol.* 4:112-125.

Shelef, G.A.; Sukenik, A.; Green, M. (1984) "Microalgae harvesting and processing: A literature review." *Report, Solar Energy Research Institute, Golden Colorado, SERI/STR-231-2396*.

Weissman, J.C.; Benemann, J.R. (1978) "Biomass recycling and species control in continuous cultures." *Bioeng. Biotech.* 21:627-648.



REACTOR MASS BALANCES:

$$\dot{S} = D(S_0 - S) - X^a \mu^a / y^a - X^b \mu^b / y^b$$

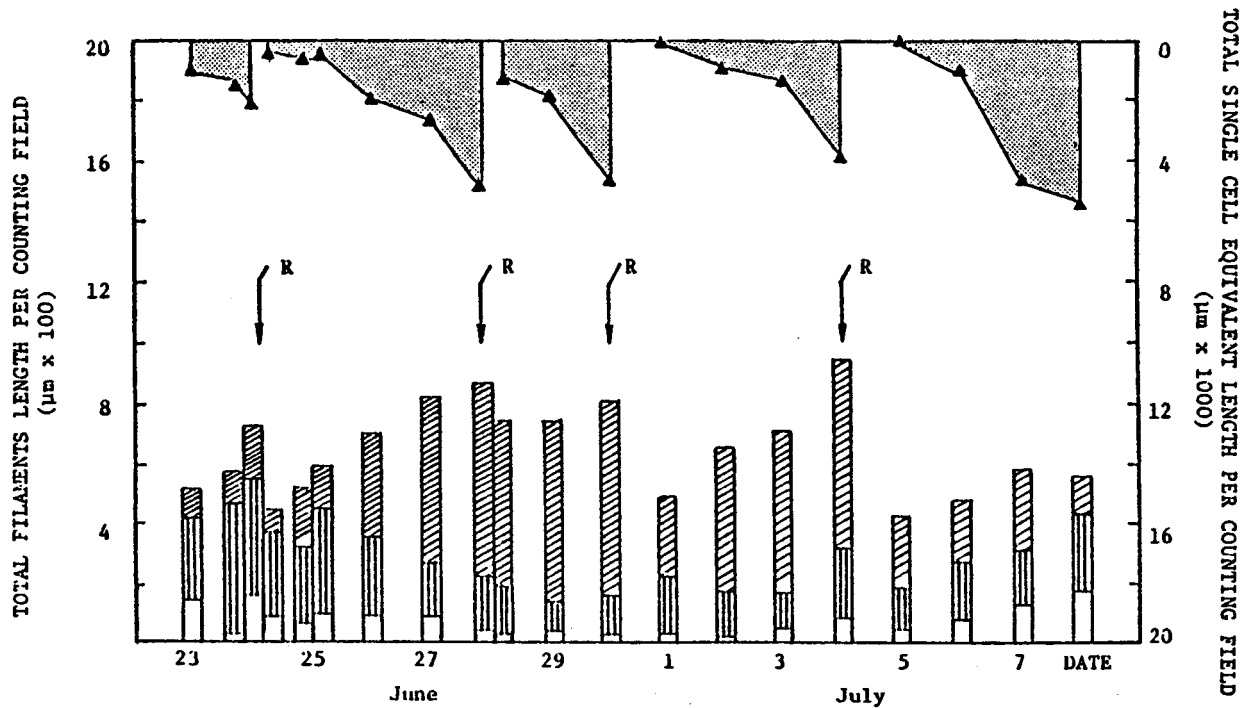
$$\dot{X}^a = X^a \mu^a - X^a (1 + \alpha - \alpha \beta^a) D = X^a \mu^a - X^a A^a D$$

$$\dot{X}^b = X^b \mu^b - X^b (1 + \alpha - \alpha \beta^b) D = X^b \mu^b - X^b A^b D$$

Completely mixed, continuous culture with one limiting nutrient (S), two competing species (a, b), and biomass recycle using a selective separator which favors the slower growing species "a". V = volume of reactor; F = volumetric inflow rate; D = dilution rate  $\equiv F/V$ ;  $S_0$  = influent concentration of limiting substrate; S = concentration of limiting substrate in reactor;  $X^i$ ,  $X_1^i$ ,  $X_2^i$  = concentration of species i in reactor, recycle stream and second outflow, and first outflow respectively;  $\mu^i$  = specific growth rate of species i =  $\mu_m^i S / (K_s^i + S)$ ;  $\alpha$  = ratio of recycle flow to inflow;  $\delta$  = ratio of second outflow ("product" stream) to inflow;  $\beta^i \equiv X_1^i / X^i$ ;  $\alpha \beta^i / (1 + \alpha)$  = ratio of cell mass recycled to cell mass coming out of reactor ( $0 < \alpha \beta^i / (1 + \alpha) < 1$ )  $A^i \equiv 1 + \alpha - \alpha \beta^i > 0$ ;  $Y^i$  = yield constant for species i. Since the separator favors species a,  $\beta^a > \beta^b$  and  $\beta^a > 1$ . A dot over a symbol indicates its

Figure III.A.1. Selection process through biomass recycle.

A theoretical model of selective cell harvesting and recycling resulting in dominance of the slower-growing over the faster-growing species. (Source: Benemann et al. 1978.)



**Figure III. A.2.** Initial experiment demonstrating the maintenance of *Oscillatoria* in outdoor ponds.

Maintenance of a culture of Napa *Oscillatoria* using selective recycle. Bars indicate the relative volume, concentration and filament length distribution of *Oscillatoria* (**white bar** height indicates filaments shorter than 150 µm; **vertical stripes** indicate filaments between 150 and 375 µm; **slashes** indicate filaments longer than 375 µm). Volumes of single algal cells were calculated on an equivalent concentration basis and are shown as triangles (shaded area, top). Vertical arrows marked **R** indicate when the culture was harvested with a microstrainer (30-µm opening fabric) and the captured algae (almost all *Oscillatoria*) returned to the pond. Experiments were carried out in a 3-m<sup>2</sup> circular pond mixed continuously at 3 cm/s. Settled raw sewage, supplemented with 100 ppm of bicarbonate was used as substrate. (Source: Benemann et al. 1977).



### III.A.3 An Integrated System for the Conversion of Solar Energy with Sewage-Grown Microalgae

During FY1976-1977, the project described in Section III.A.2. continued with the same overall objective: to determine what pond operating factors could allow control over algal species, and thus permit cultivation of algal types that allow low-cost harvesting by microstrainers. The biomass recycling process described earlier continued to be studied, using the 12-m<sup>2</sup> rectangular ponds and various pond operating strategies (mixing speeds, retention times, biomass recycle fraction), to test for their influence on microalgae species composition and productivity. Mainly the four 12-m<sup>2</sup> ponds were used, with some initial experiments with the large 0.25-ha pilot pond.

An extensive series of experiments was carried out in the small ponds, with daily analysis of suspended solids (SS) concentrations (the best measure of algal biomass, although some, 10%-15%, contributions from wastewater and bacterial solids could not be avoided). Other parameters measured, less frequently, were chlorophyll concentrations, BOD<sub>5</sub>, P, ammonia, and, microscopic algal counts, including cell dimensions. Experimental pond operating parameters tested included retention time (hydraulic dilution) and depth (though this was typically 25 cm), mixing speed, and biomass recycle ratios.

Both at short and long retention times the algal cultures invariably became unharvestable with microstrainers. Intermediate hydraulic retention times selected for larger colonial algal species that were more readily harvestable. However, long retention times also resulted in low productivities. There was an optimum residence time, which varied with depth of the culture and climatic variables that selected for harvestable cultures. However, biomass recycling was only marginally effective in improving biomass harvestability by microstraining. Mixing speeds  $\geq 15$  cm/s also improved harvestability by microstraining. Mixing speeds of 15 to 30 cm/s tended to induce algal flocculation.

Problems were encountered with zooplankton grazing of the algal cultures. Coarse (150- $\mu$ m) screens did not effectively remove the grazers. Shorter retention times reduced grazer pressures, but also made the cultures less harvestable by microstrainers. In all the ponds, *Scenedesmus* dominated in the winter and spring, and then was replaced with *Microactinium*. Loss of dominance correlated with the breakup of the colonies, which may have been related to zooplankton grazing. The best productivity was 13.4 g/m<sup>2</sup>/d, during a 10-month period, irrespective of harvest efficiency. For the most harvestable pond, productivity was only 8.5 g/m<sup>2</sup>/d (of which only 7.2 g/m<sup>2</sup>/d was harvested by the microstrainers). Clearly, optimizing for productivity and harvestability required quite different operating conditions. It was concluded that the use of microstrainer harvesting and biomass recycling was unlikely to lead to both a high algal productivity and effective harvesting process.

After growing and harvesting an algal culture on sewage, enough nutrients remain to grow a second crop of microalgae. Such a second crop would then deplete available N. Due to excess inorganic and organic phosphates in sewage, sufficient P remains after harvest of the second algal crop to allow cultivation of additional batches of N-fixing microalgae. Of course, due to C





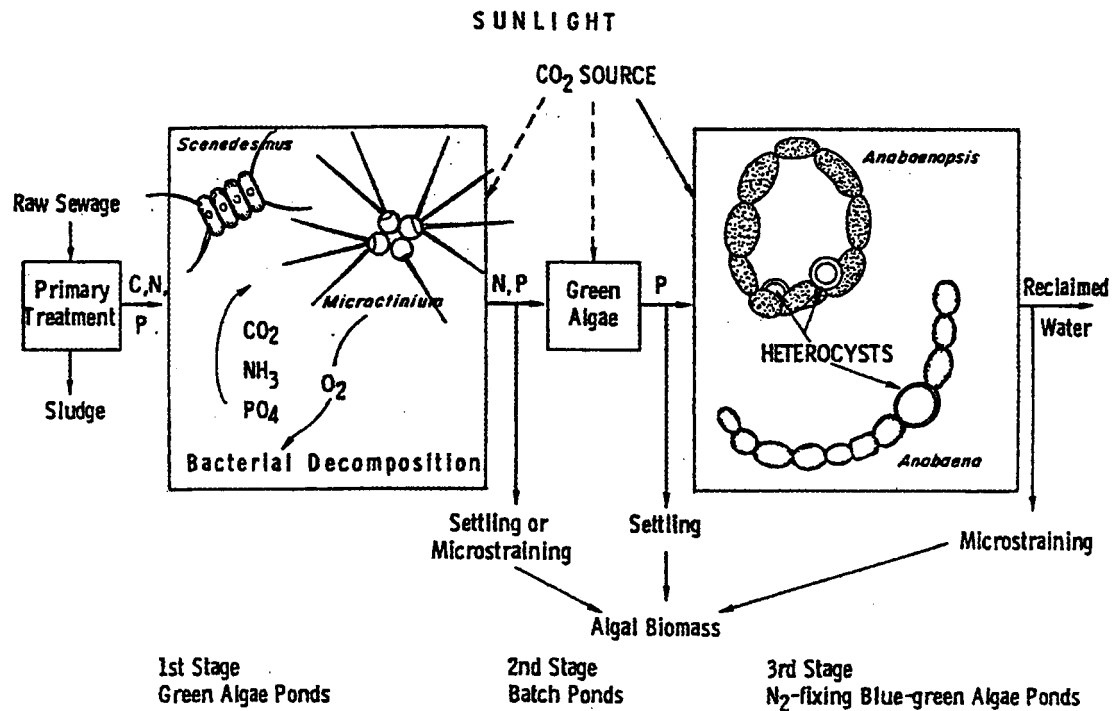
limitation, CO<sub>2</sub> must be supplied to these cultures. Such a process, which would achieve so-called tertiary wastewater treatment (nutrient removal) is shown schematically in Figure III.A.3., and was demonstrated during this project. Considerable problems were encountered with the secondary ponds (shown as a small box labeled “green algae” in Figure III.A.3.), due to culture instabilities, lack of sufficient algal removal in the first stage, grazers, etc. Figure III.A.4. shows a composite of the general results obtained, with a 7-day batch cultivation, at which point the culture settled quite well and, from its yellowish color was apparently N limited. The final, N-fixing, stage in this process was demonstrated under the following year's project and a NSF-RANN funded project (Benemann et al. 1977).

In May 1977, cultures were started in the 0.25-ha high rate pond. That pond, mixed (poorly) with centrifugal pumps located in a 2.5-m deep sump, exhibited rather poor hydraulics. Sewage supply limitations resulted in longer retention times than desired. Despite these and other operational problems, the results were “reasonably consistent with the smaller 12-m<sup>2</sup> ponds, both in productivity and harvestability responses to detention time” (Benemann et al. 1978). Productivities of 19 g/m<sup>2</sup>/d were observed over an 18-day campaign in summer, with a retention time of 3.5 days. Interestingly, zooplankton grazing was not as big a problem as with the smaller ponds.

These 0.25 ha pond algal effluents were also tested for settling, in a “pond isolation” experiment, in which cultures were removed from the pond and held for as long as 3 weeks in a settling pond. In one experiment, when the culture had been grown at a dilution rate at 0.22 day<sup>-1</sup>, it settled more than 90% in one day, while a culture grown at a dilution rate of 0.5 day<sup>-1</sup> required 3 weeks to settle. This suggested another approach to algal harvesting, which became the focus of the project described in Section III.A.4.

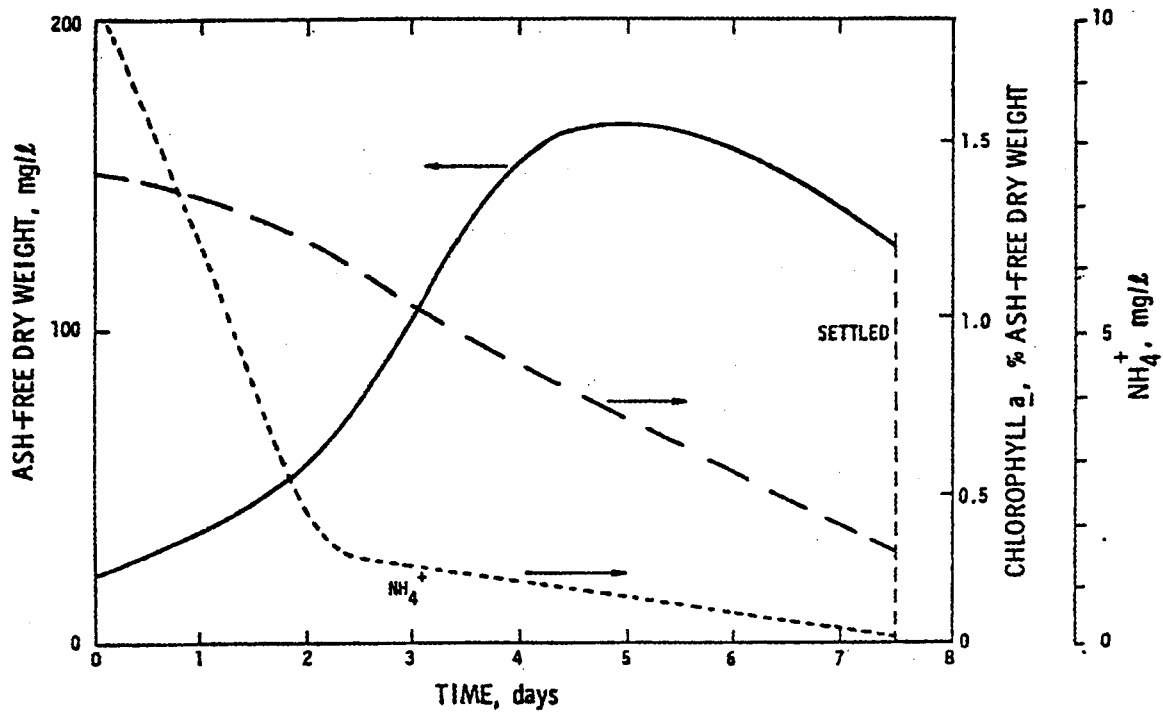
#### *Publications:*

Benemann, J.R.; Koopman, B.L.; Weissman, J.C.; Eisenberg, D.M.; Oswald, W.J. (1978) “An integrated system for the conversion of solar energy with sewage-grown microalgae.” *Report, Contract D(0-3)-34*, U.S. Dept. of Energy, SAN-003-4-2, June 1978.



**Figure III.A.3.** Process schematic for tertiary wastewater treatment with microalgae.

This schematic for an advanced wastewater treatment process uses a multi-stage pond system for complete organic waste degradation and nutrient removal. The initial wastewater treatment ponds are shown, followed by a smaller intermediate “green algae” pond for N depletion and a final pond for cultivating N-fixing blue-green algae and removing residual phosphates. CO<sub>2</sub> supplementation would be required in the last two ponds, and could increase productivity in the initial pond. (Source: Benemann et al. 1978.)



**Figure III.A.4.** Growth of microalgae on pond effluents.

Graph showing typical changes in density, chlorophyll *a* content and ammonia concentrations during batch growth of green microalgae on effluents from wastewater treatment ponds after settling of the primary culture. As the culture grew from the residual concentrations of about 20 mg to about 170 mg/L, ammonia concentrations and chlorophyll *a* levels decreased. A 4- or 5-day culture period appears to be optimal. (Source: Benemann et al. 1978.)



#### III.A.4. Large-Scale Freshwater Microalgal Biomass Production for Fuel and Fertilizer

This 2-year project (Benemann et al. 1979; Eisenberg et al. 1980) extended from the end of 1977 to Winter 1979. Initially the approach to establish microstrainable cultures using the 12-m<sup>2</sup> ponds, described in Section III.A.3., continued to be investigated. Essentially the same results as before were obtained: detention time was found to be the key environmental variable determining algal colony size (but not necessarily species composition) and a negative correlation was found between numbers of algal grazers and the large colonial algal types easy to harvest with microstrainers. Apparently the grazers preferentially consumed the smaller algae. Overall, the harvestability results with the microstrainers continued to be poor, so this line of research was abandoned during the initial period of this project.

Simultaneously with these studies, another project was being carried out under EPA sponsorship to study the settling of algae in the City of Woodland waste treatment ponds. This project used a “phase isolation” process, in which the algal cells were allowed to spontaneously settle when sewage inflow was stopped (Koopman et al. 1978, 1980). Although generally long times were required for this settling process (2-3 weeks), it was decided to investigate this general phenomenon of “bioflocculation” in high rate ponds. The process involved removing the algae from the paddle wheel-mixed ponds and placing them in a quiescent container, where they would spontaneously flocculate and rapidly settle. There are several apparently distinct mechanisms by which algae flocculate and then settle, including “autoflocculation”, which is induced by high pH in the presence of phosphate and divalent cations ( $Mg^{2+}$  and  $Ca^{2+}$ ), and flocculation induced by N limitation. Bioflocculation refers to the tendency of normally repulsive microalgae to aggregate in large flocs, that then exhibit a rather high sedimentation velocity. The mechanisms of bioflocculation involve extracellular polymers excreted by the algae, but the details remain to be investigated.

Settling tests were carried out with the cultures from the 12-m<sup>2</sup> ponds. As with microstrainer harvesting, detention time and mixing velocity were the most important variables in promoting a bioflocculating culture. The rather rapid settling of many of the cultures was very encouraging. Also, the initial experiments with the 0.25-ha pond demonstrated a fairly rapid (<24 h) bioflocculation process.

At this time (mid 1978), the 0.25-ha pond had been divided into two 0.1-ha high rate ponds mixed with paddle wheels, and the bioflocculation-settling process using these pilot ponds became the focus of further research. Two 32,000 L settling ponds, with concave bottoms as deep as 2.5 m, were constructed to test bioflocculation-settling with the effluents of these ponds at the pilot scale. In initial experiments the two ponds were operated in parallel with two smaller ponds, at similar dilution rates (and with the only difference that one set of ponds was screened to remove larger grazers). The results (summarized in Table III.A.1.) were reasonably reproducible between the ponds. Algal solids removal through bioflocculation, as measured by 24-h settling in an “Imhoff Cone,” was high, about 90%.



Additional experiments, with the ponds operated in parallel at 2.5- and 5-day retention times (during September 1978) again resulted in removal efficiencies of over 90% for both ponds, including the 32,000 L settling tanks, based on measurements of suspended solids and chlorophyll. However, the shorter retention-time pond had more than twice the productivity of the longer-retention time pond (15 versus 7 g/m<sup>2</sup>/d). Bioflocculation was established as the method of choice for algal harvesting, as it seemed to be achievable even with high productivity cultures. Culture settleability was routinely determined during all the experiments with the high rate ponds. Table III.A.2. summarizes productivity and settleability for more than 1 year for the two 0.1-ha ponds. The 24-h laboratory settling tests correlated well with settling in the large (32-m<sup>3</sup>) settling ponds. Overall, a settling efficiency of greater than 85% was achieved, if the better of the two ponds was selected, without compromise in productivity. Annual gross productivity averaged almost 20 g/m<sup>2</sup>/d, estimated at about 90% algal solids. In many cases bioflocculation removals were higher than 95% on a chlorophyll *a* basis, indicating almost complete sedimentation of the algal biomass.

One factor that had a major effect on bioflocculation was mixing speed. At very low mixing velocities, the cultures settled very poorly. This is not unexpected, as any settling algae would have dropped out of the photic zone and been replaced by suspended cells in the absence of continuous mixing. However, a more fundamental investigation of the bioflocculation phenomenon (well reported in the ecological and some physiological literature) remains to be carried out.

Another activity carried out during this project was the cultivation of N-fixing microalgae using the supernatant of secondary growth ponds (see Figure III.A.3.). One problem was that culture collection strains of N-fixing cyanobacteria inoculated into the N-deficient ponds quickly succumbed. However, when the N-deficient wastewater samples were incubated in sunlight for a few weeks, N-fixing strains, which were indeed culturable, appeared spontaneously. One strain, an *Anabaenopsis* sp., was successfully cultured over long periods. However, the productivity of N-fixing cultures was only about half of what was observed with green algae under similar conditions. That is understandable because of the high energy requirement of N-fixation, which is not desirable in biomass fuel production. However, use of such algae for phosphate removal from wastewaters is of interest.

This project also investigated the anaerobic digestion of algal biomass using both a large (1,400-L) and several smaller (20-L) digesters. Algae provided a good substrate for anaerobic digestion, although not as good as conventional sewage sludge based on the conversion of organic C to methane. However, attempts to regrow algae on the effluent of the digesters resulted in poor productivities, as some unidentified factor appeared to limit growth on the regenerated nutrients. This was not investigated further, but clearly requires some attention in the future.

As part of this project, the energy requirements for high-rate pond operations, in particular mixing, were studied. The shaft power input required for mixing followed closely the predicted cube power law, demonstrating the need to keep mixing velocities below 30 cm/s to avoid excessive power inputs. At 15 cm/s, power inputs were only about 1 kWh/d (for the 0.1-ha



pond), increasing to about 10 kWh/d at 30 cm/s. Motor efficiency at the higher velocity (67%) was twice that at the lowest velocities, not a deciding factor. Clearly, mixing speeds higher than 30 cm/s are impractical, at least for energy production systems.

An energy analysis of such a microalgae wastewater treatment process was quite promising, with the wastewater system being at least energy self-sufficient based on the requirements for sewage and algal pond effluent lift requirements, as well as algal pond mixing and other requirements. Such systems should be able to generate a net positive energy output if operated to maximize algal biomass through the addition of CO<sub>2</sub> (Figure III.A.3.).

Overall this project marked a major advance in this technology, as it demonstrated at the pilot plant scale a relatively low-cost and reasonably reliable microalgae harvesting process that does not unduly interfere with other objectives, in particular microalgae productivity. (See Benemann et al. [1980] and Eisenberg et al. [1980].)

**Publications:**

Benemann, J.R.; Weissman, J.C.; Eisenberg, D.M.; Goebel, R.P.; Oswald, W.J. (1979) "Large scale freshwater microalgae production for fuel and fertilizer." *Report to the Univ. of Calif. Berkeley*, SERL 79-3 (1979), Contract EY-76-S-03-0034.

Eisenberg, D.M.; Benemann, J.R.; Tiburzi, T.; Weissman, J.C.; Oswald, W.J. (1980) "Large scale freshwater microalgae production for fuel and fertilizer." *Report to the Univ. of Calif.*, Contract EY-76-S-03-0034.

Eisenberg, D.M.; Koopman, B.; Benemann, J.R.; Oswald, W.J. (1981) "Algal bioflocculation and energy conservation in microalgae sewage ponds." *Biotech. Bioeng. Symp.*, No. 11, pp. 429-449.



**Table III.A.1. Microalgae harvesting by bioflocculation: Small and large pond results.**

Comparison of performance between two 1,000-m<sup>2</sup> and two 12-m<sup>2</sup> ponds, operated under otherwise similar conditions except that one pond was screened to remove zooplankton and the other one was not so treated. Data averaged for July 1978. Note agreement in terms of productivity (grams VSS/m<sup>2</sup>/d, essentially some 90% AFDW algal biomass). (Source: Benemann et al. 1979.)

Pond	East 0.1 HA	M-3 12 sq m	West 0.1 HA	M-2 12 sq m
Experiment	Screened		Unscreened	
<b>Pond Environment</b>				
Insolation, Langleys/day	600			
Culture Temp. °C, AM	18	16	18	16
PM	26	26	26	26
Culture pH AM	9.5	8.6	9.4	8.5
PM	10.7	9.7	10.6	9.7
<b>Sewage</b>				
COD, mg/L	440			
Total N, mg/L	51			
<b>Loading and Pond Operation</b>				
Hydraulic d/θ, cm/day	5.9	6.6	5.8	6.6
Dilution Rate (θ/d) per day	0.33	0.33	0.29	0.33
Depth (d), cm	18	20	20	20
Mixing Velocity (M), cm/sec	19	12	19	12
<b>Culture Characteristics</b>				
VSS, mg/L	230	200	210	190
Chl. <u>a</u> , % of VSS	1.9	1.8	2.0	1.8
COD, mg/L	415	390	410	410
NH <sub>3</sub> -N, mg/L	3.5	7.3	4.6	8.7
Total N, mg/L	23	27	24	26
<b>Production</b>				
Grams VSS/sq m/day	14	13	12	13
Photosynthetic Efficiency, %	1.4	1.3	1.1	1.3
<b>Algae Removal Performance</b>				
Imhoff cone, } VSS	88	90	87	87
24-hr, } Chl. <u>a</u>	92	91	89	95
Removals, } COD	59	69	62	72



**Table III.A.2. Productivity and settleability of microalgae in the 0.1-ha high-rate ponds.**

Productivity (AFDW of suspended solids) averaged monthly. Varying hydraulic dilution rates and depths account for differences in productivities and harvestabilities between ponds. Algal biomass were estimated by microscopy at about 85% to more than 90% of AFDW productivity, the rest being waste derived solids. (Source: Benemann et al. 1979.)

Date	West Pond			East Pond		
	Total Production g/m <sup>2</sup> /day	24-hr Imhoff Cone* % removal	Harvestable Production g/m <sup>2</sup> /day	Total Production g/m <sup>2</sup> /day	24-hr Imhoff Cone* % removal	Harvestable Production g/m <sup>2</sup> /day
Sept 78	25.5	92	23.5	8.0	85	6.8
Oct	25.5	89	22.7	11.3	71	8.0
Nov	11.6	27	3.1	9.8	83	8.1
Dec	4.7	70	3.3	6.6	64	4.2
Jan 79	4.9	85	4.2	4.7	56	2.6
Feb	6.4	82	5.2	9.3	74	6.9
Mar	8.5	81	6.9	16.5	74	12.2
Apr	15.8	76	12.0	16.2	53	8.6
May	20.1	88	17.7	21.3	74	15.8
Jun	22.6	91	20.6	20.2	91	18.4
Jul	22.0	92	20.2	35.5	89	31.6
Aug	21.7	88	19.1	35.6	94	33.5
Sep	19.9	94	18.7	35.5	87	30.9
Oct	16.3	84	13.7	27.8	69	19.2

\* Imhoff Cone removals are 24-h laboratory settling tests, indicating percentage of algal biomass that spontaneously flocculate and settle ("bioflocculation") under quiescent conditions after the culture is removed from the mixed ponds.





### III.A.5. Other Microalgae Projects During the ERDA/DOE Period

During the 1975-1979 period, several other projects on microalgae fuels production were funded by ERDA/DOE, including the biophotolysis projects using heterocystous cyanobacteria, discussed earlier (see review by Benemann et al. 1980). Another biophotolysis project tested an optical fiber system for diffusing solar light into algal cultures, thereby overcoming the light saturation limitation to photosynthetic efficiencies (Manley 1979). This was shown to be impractical and was abandoned after only some very initial work. However, optical fiber photobioreactors are today the centerpiece of the 10-year, very large Japanese R&D program for microalgae CO<sub>2</sub> utilization (Section IV.B.1.c.).

In 1976, Lawrence Livermore National Laboratory (LLNL) established a well funded in-house project that was very similar to the University of California-Berkeley project, including the use of microstrainers for harvesting filamentous microalgae, biomass recycle, and even a biophotolysis component using heterocystous cyanobacteria (Jeffries et al. 1977; Timourian et al. 1997). This project failed to receive support from ERDA, and was disbanded in 1977.

Professor Harry Gregor at Columbia University was funded for 2 years to develop membrane systems for cross-flow filtration harvesting of microalgae. However, the membranes available at the time, the pressure drops required, and the fouling problems encountered made this approach impractical (Gregor and Gregor 1978).

At Woods Hole Oceanographic Institutions, Drs. John Ryther and Joel Goldman carried out extensive research on microalgae cultivation in outdoor ponds on mixtures of seawater-secondary sewage effluent. When Dr. Ryther relocated to the Harbor Branch Oceanographic Foundation in Florida in the late 1970s, he was supported by DOE and later the ASP for the production of freshwater plants (water hyacinths, etc.) and seaweeds (Ryther 1981; 1982; 1983), as well as for microalgae culture collection work (See Part II.A.2.). Dr. Goldman also wrote a review on the theoretical and practical aspects of microalgae cultivation under contract with DOE (Goldman 1979a,b). One conclusion was that the productivity of microalgae systems would be limited, because of the light saturation effect and other factors, to below 50 mt/ha/yr. Although the analysis was correct, it was a very conservative conclusion, making no allowance for productivity improvements caused by fundamental and applied R&D advances, as discussed in the remainder of this report.

#### Publications:

Benemann, J.R.; Miyamoto, K.; Hallenbeck, P.C. (1980) "Bioengineering aspects of biophotolysis." *Enzyme and Microbial Technology* 2:103-111.

Goldman, J.R. (1979a) "Fuels from solar energy photosynthetic systems—state of the art and potential for energy production." *Report to the U.S. Dept. of Energy* COOO-4141-241.

Goldman, J.R. (1979b) "Outdoor algal mass cultures. I. Applications. II. Theoretical Aspects." *Water Research* 13:1-19.



Gregor, H.P.; Gregor, C.D. (1978) "Synthetic membrane technology." *Sci. Amer.* 239:112-128.

Jeffries, T.W.; Mouthrop, P.H.; Timurian, H.; Ward, R.L.; Berger, B.J. (1977) "Biosolar production of fuels from algae." UCRL 52 177, November 16, 1976.

Manley, S. (1979) Unpublished Report to U.S. Department of Energy, for work in the laboratory of G. Pelofsky.

Ryther, J.H. (1981) "Cultivation of macroscopic marine algae." *Proceedings of the July 1981 Subcontractors' Review Meeting, Aquatic Species Program*, Solar Energy Research Institute, Golden Colorado, SERI/CP-624-1228, pp. 111-118.

Ryther, J.H. (1982) "Cultivation of macroscopic marine algae." *Proceedings of the June 1982 SERI Biomass Program Principal Investigators' Review Meeting, Aquatic Species Program Reports*, Solar Energy Research Institute, Golden, Colorado, SERI/CP-231-1808, pp 85-102.

Ryther, J.H. (1983) "Cultivation of macroscopic marine algae." *Proceedings of the March 1983 Principal Investigators' Meeting, Aquatic Species Program*, Solar Energy Research Institute, Golden, Colorado, SERI/CP-231-1946, pp. 79-88.

Timurian, R.; Ward, R.L.; Jeffries, T.W. (1977) "Growth of filamentous blue-green algae at high temperatures: a source of biomass for renewable fuels." *IZ Int. Seaweed Symp.*, Aug 20-27.

### **III.B. The ASP Microalgal Mass Culture**

#### **III.B.1. Introduction**

The long-term objective of the ASP was to develop microalgae liquid fuel production processes. Since its inception, the ASP supported laboratory R&D projects (Section II) and algal mass culture projects. However, for the most part, the laboratory and outdoor projects were not integrated into a strongly unified program. This reflects in large part the difficulty of such integration. Also, during the early stages of the ASP, too close an integration would have been restrictive, as it was not yet clear at the time which research approaches, production systems or algal strains would be best.

The extensive work on strain isolation, selection, characterization, etc., carried out by the ASP was used to a significant extent by the field projects, through the testing of a number of the isolates in algal mass cultures, specifically in the projects reviewed in this section. Unfortunately, the laboratory-level screening protocols had, in hindsight, relatively little predictive power for the ability of the strains to dominate and perform in outdoor ponds. Similarly, the laboratory work on the biochemistry, genetics and physiology of lipid biosynthesis, was difficult to apply to the goal of increasing lipid productivities in outdoor systems. Greater integration of laboratory and outdoor R&D is a challenge for any future microalgae R&D program.



The ASP initiated two outdoor projects in 1980, one in California using a paddle wheel-mixed raceway pond design (“high rate pond,” [HRP]), and another in Hawaii. The Hawaii project was to demonstrate a patented algal culture system, invented by then-ASP program manager, Dr. Larry Raymond (1981). This “Algal Raceway Production System” (ARPS) used very shallow flumes (<10 cm), rapid mixing by air lifts, covers with CuSO<sub>4</sub> filters to screen out harmful infrared radiation, and harvesting of the biomass by foam fractionation, among many other claimed attributes (Figure III.B.1.). Very high productivities were claimed. But a review of the work (Raymond 1979), in which *P. tricornutum* was grown in a 0.5-m<sup>2</sup> system, revealed that this projection derived from a single batch culture, and in fact, the last data point showed biomass density actually decreasing. Benemann et al. (1982a,b, see Section III.D.5.), carried out a comparative analysis of the ARPS and the HRP designs, concluding that the ARPS would be too expensive and energy intensive, compared to the HRP design. These two projects in California and Hawaii, carried out for more than 6 years each, are reviewed in this section, followed by descriptions of the ASP projects in Israel, New Mexico, and related projects.

**Publications:**

Raymond, L. (1979) “Initial investigations of a shallow layer algal production system.” *Am. Soc. Mech. Eng.*, New York.

Raymond, L. (1981) “Mass algal culture systems.” U.S. Patent 4,253, 271.

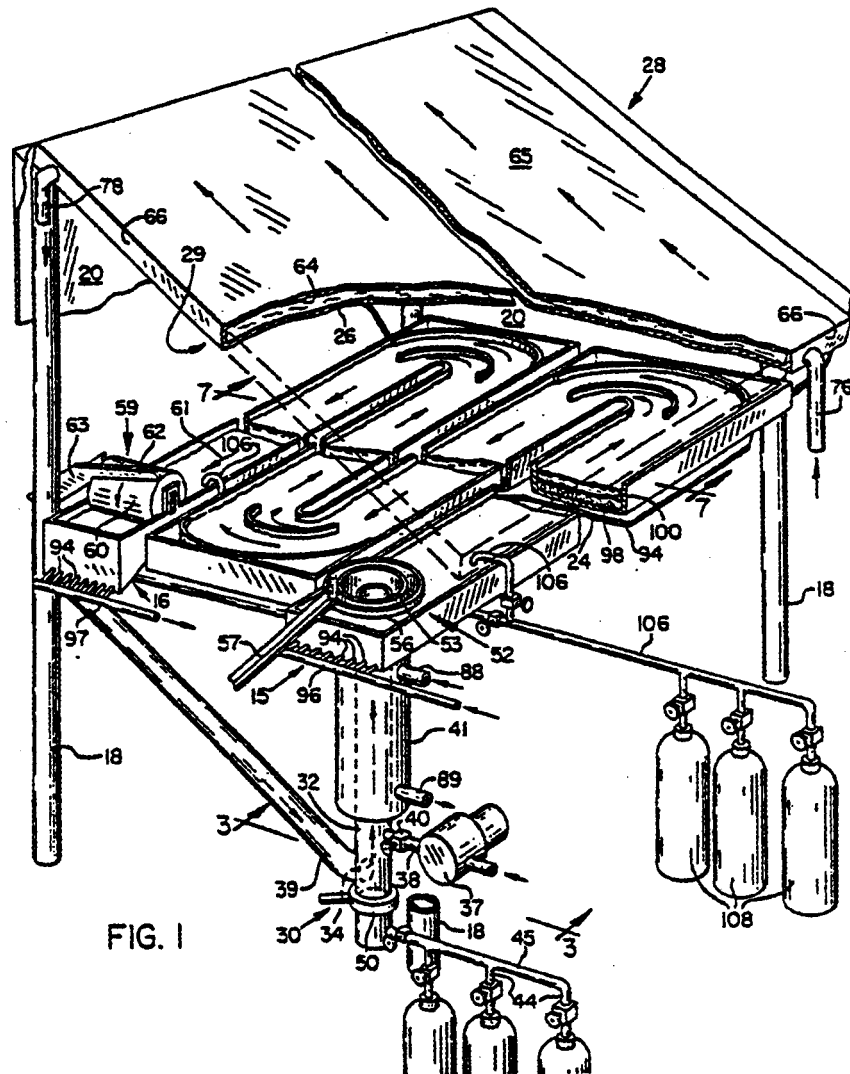


FIG. 1

**KEY PATENT CLAIMS**

- GAS LIFT PUMP MECHANISM FOR CIRCULATION, CARBONATION AND HARVESTING
- HEAT EXCHANGE FOR TEMPERATURE CONTROL
- FOAM FRACTIONATION / SKIMMING HARVESTING
- $\text{CaSO}_4$  SOLUTION IN COVER TO REMOVE INHIBITING IR.
- MIXING TO ACHIEVE FLASHING LIGHT EFFECT

Figure III.B.1. The algal raceway production system.

(Source: Raymond 1981.)



### **III.B.2. The ARPS Project in Hawaii, 1980-1987**

#### **III.B.2.a. Hawaii ARPS Project Initiation, 1980-1981**

As mentioned earlier, the concept for the ARPS project derived from the Raymond (1981) patent. The project was initiated in early 1980s, with construction of a single, 48-m<sup>2</sup> raceway system completed in early 1981 (Laws 1981). During this first year, chemostat experiments using two strains of *P. tricornutum* were carried out. The tests revealed large differences in protein and lipid productivity between the strains. This laboratory work also investigated cell harvesting by “foam fractionation” in which the foam formed by the aeration of the cultures via air lift mixing was collected and found to contain some 10-40 times the cell concentration of the liquid. However, the harvesting efficiency was not reported.

One difficulty noted in the laboratory experiments was the low cell densities achieved, compared with the original reports by Raymond for the ARPS system. Researchers tried to increase cell density by increasing the pond depth to 0.6 m, rather than 0.1 m as proposed by Raymond (1979). This resulted in other problems (low cell density, shading-see below), and the depth was again reduced to 30 cm. The laboratory experiments were extrapolated to predict an outdoor productivity of almost 130 mt/ha/yr, at least for the best *P. tricornutum* strain, similar to the Raymond prediction. However, this extrapolation was based on the invalid assumption that such laboratory growth rates can be used to predict outdoor productivities.

The initial work also studied the effect of CuSO<sub>4</sub> filters, concluding that although any productivity increases would be minor, installation of CuSO<sub>4</sub> filters is advisable in the ARPS, “as it would help manage overheating of the culture and store a potentially valuable by-product, heat.” Finally, the “flashing light” effect was investigated. The time constants (1 s light: 1 s dark), and low light intensities used were quite different from the classic flashing light effect of Kok (1953), which uses approx. 1-5 μsec high intensity light flashes, followed by about five times longer dark periods. Only small, “not particularly encouraging”, productivity increases were noted. Still, a 70% increase in productivity was predicted, though the basis for this was not stated.

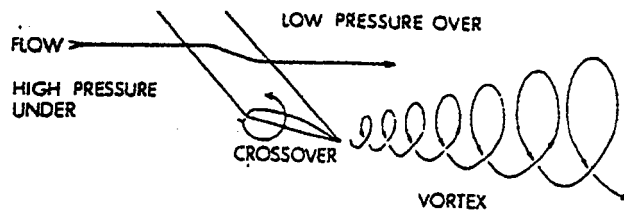
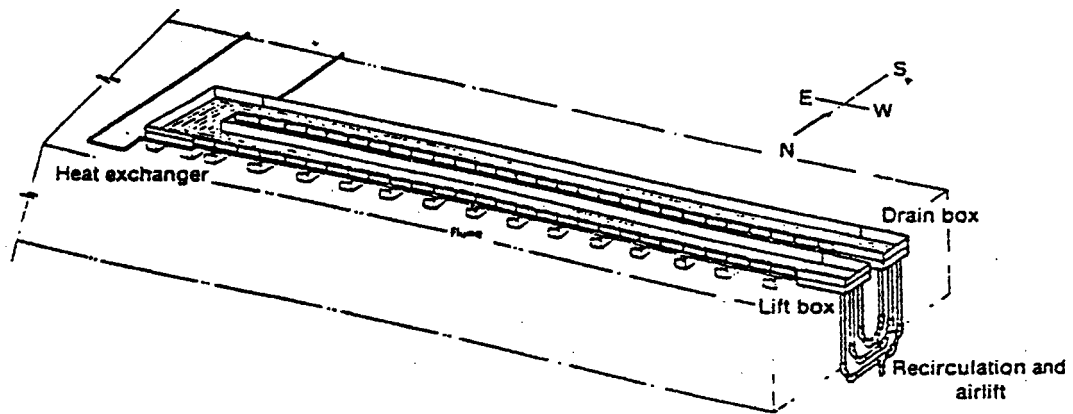
Laws (1981) also reported on initial results with the 48-m<sup>2</sup>, 0.6-m deep, airlift-mixed flume system. Cell densities were much lower than predicted, likely because of the great depth of the culture, which was later reduced. The report concluded that, assuming \$30,000/ha/yr production cost, a biomass production of 180 mt/ha/yr AFDW would allow oil production (with protein byproducts) competitive with fossil fuel. However, this productivity figure was extrapolated from the indoor chemostat work, and increased by one-third, as “effects of modulated blue light on the system will allow the extra production to be achieved,” so the reliability of this prediction is questionable.



### III.B.2 b. Second Year of the Hawaii ARPS Project, 1981-1982

The second year of this project emphasized the use of “flashing light to enhance algal mass culture production” (Laws, 1982; see also Laws et al. 1983). The basic idea was that a “foil array” in the pond culture would generate a vortex that would create organized mixing in the ponds, expected to result in exposure of the cells to regular dark-light cycles (Figure III.B.2.). Based on data in the literature, this effect would be predicted to increase overall productivity. These *a priori* arguments were not supported by the algal physiological literature (the flashing light productivity enhancements are observed at much shorter time constants), and neither were the hydraulic arguments plausible (organized mixing would be seen only in a small fraction of the pond volume). However, the key issue here is not the theory but the actual experimental results.

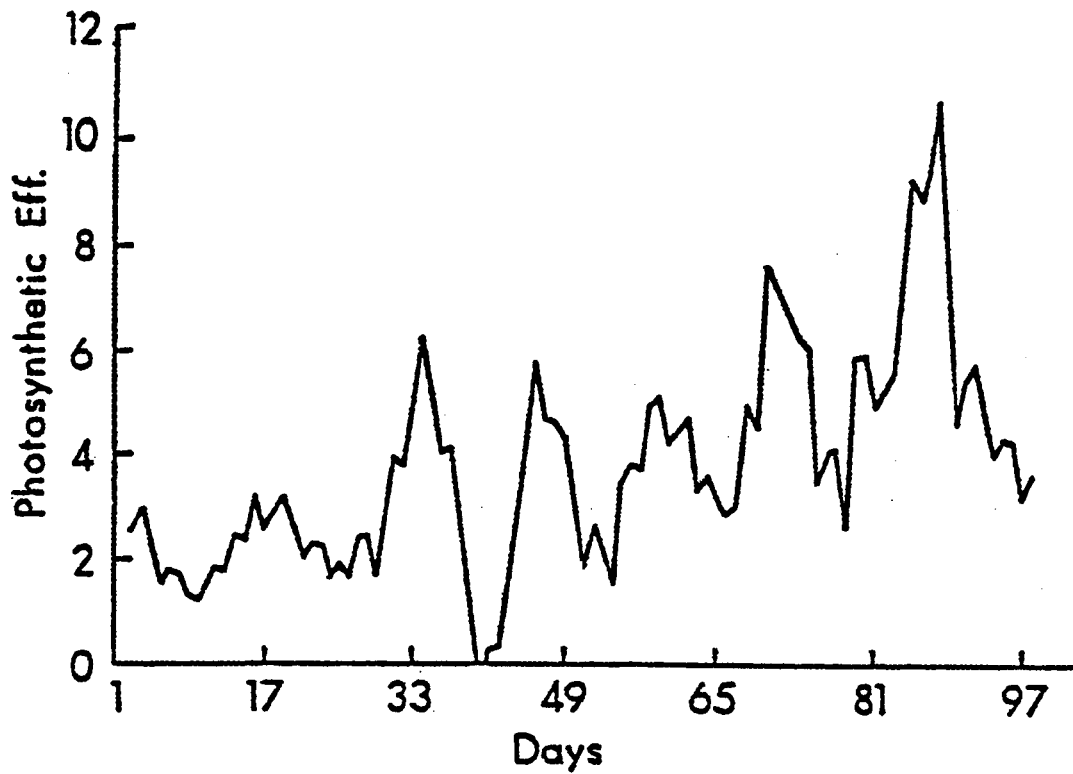
From November 1981 to January 1982, an average productivity of only about 3.3 g/m<sup>2</sup>/d was recorded for the 50-m<sup>2</sup>-flume reactor, a very low value for Hawaii, even in winter. After installation of the foils, productivities, from February to March 1982, increased to about 11 g/m<sup>2</sup>/d. This increase was attributed to the effect of the foils, though lack of a control did not allow isolation of this variable from other effects. Five-day running mean average photosynthetic efficiencies (PAR) are shown in Figure III.B.3. The author stated that productivity could be doubled with semi-continuous operations. One observation was infestation of the culture by algal predators, which could have been one reason for the rather large variability in productivities observed during this operation (Figure III.B.3.). However, day-to-day variability in productivities is a fact of outdoor pond microalgae cultivation, even in the best of cases.



**Figure III.B.2.** Hawaii ARPs with mixing foils

- a. (Top). Schematic of the 48-m<sup>2</sup> flume, showing heat exchangers, lift box, drain box and airlift mixer.
- b. (Bottom) Schematic of mixing resulting from foils inserted in the shallow flumes.

(Source: Laws 1982.)



**Five-Day Running Mean of Photosynthetic Efficiencies  
During First 100 Days of 1982 in 50-m<sup>2</sup> Flume**

Figure III.B.3. Five-day running productivity averages for the Hawaii system. (Source: Laws 1982.)





### III.B.2.c. Third Year of the Hawaii ARPS Project, 1982-1983

Laws and Terry (1983; see also Laws 1984a) reported on the further development of the ARPS. Four 9.2 m<sup>2</sup> experimental raceways were built to allow replication of experiments and testing of variables, again using *P. tricornutum*. These raceways were used in a multifactorial experimental design testing eight variables at two levels each:

1. depth (5 and 10 cm),
2. dilution rate (0.2 and 0.4 d<sup>-1</sup>),
3. night time temperatures (15° or 20°C),
4. flow rates (15 and 30 cm/s),
5. CuSO<sub>4</sub> filters (present and absence),
6. pH (8 and 9),
7. N source (ammonia and urea), and
8. salinity (15 and 35 ppt).

Sixteen runs (of 256 possible) in four sequential blocks were carried out, with the assumption apparently being that these variables are non-interacting and additive (probably a poor assumption for biological processes). No block-to-block controls were provided, which could have been affected by light intensity and other variables.

The ponds had been equipped with six sets of mixing foils, but rather surprisingly the presence or absence of the foils was not a variable tested. A complex data evaluation, in terms of “factor effects”, was presented, but no actual productivity data for any of the experiments are available. The authors concluded that “by far the most significant factor affecting biomass production” was culture depth, arguing that the “self-shading effects were more than offset by higher areal standing crops.” This was a rather puzzling conclusion as it is contrary to both theory and experience, which assumes that, everything else being equal, depth should not affect productivity. Of course, depth can affect pH, temperature, pO<sub>2</sub>, and other variables, which if not held constant will indeed affect productivity. But these should have been second-order effects, not the overriding factor in determining productivity.

Although no actual productivity data were reported, Laws (1984) stated that this factorial experiment demonstrated maximum productivities of about 25 g/m<sup>2</sup>/d, corresponding to an approximately 5% light conversion efficiency. The author claimed that this was 50% to 100% better than achieved with “conventional culture techniques,” though the basis for such extrapolations or comparisons was unclear.



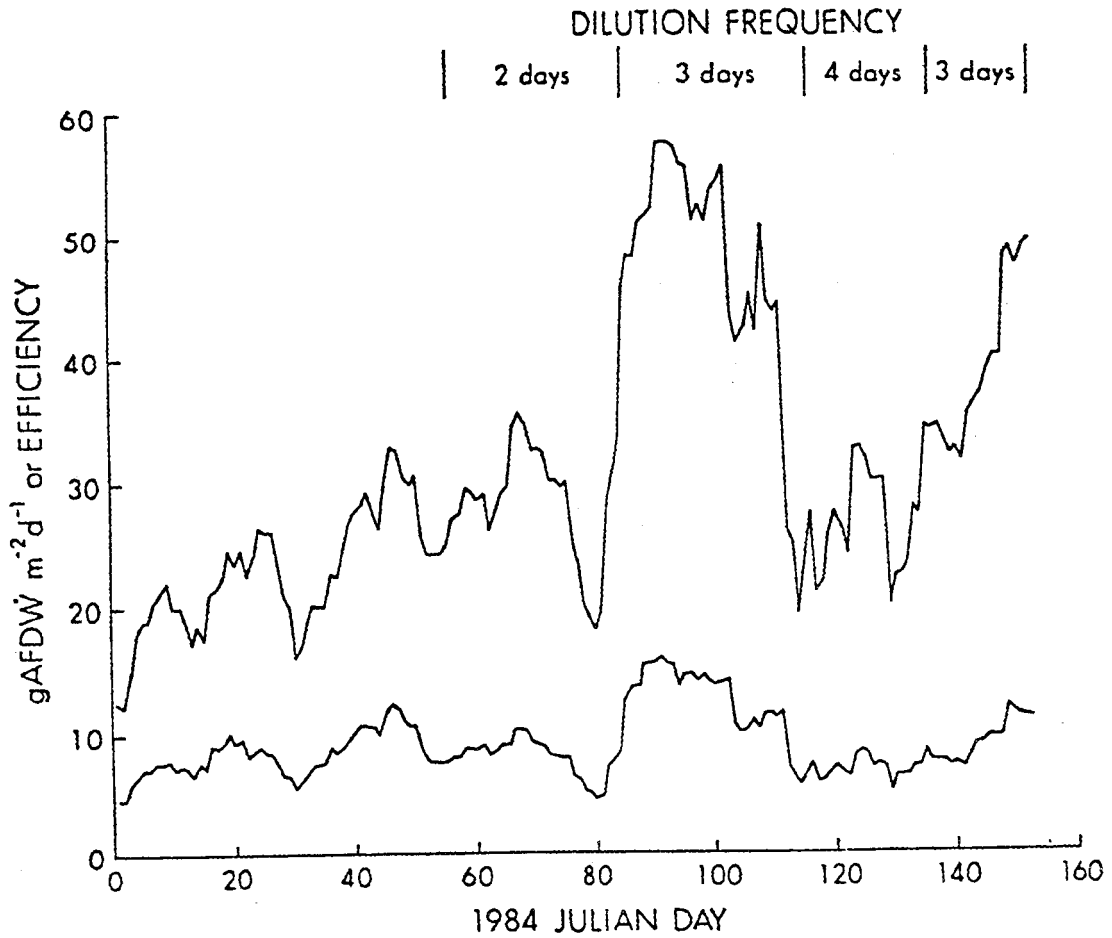
#### III.B.2.d. Fourth Year of the Hawaii ARPS Project, 1983-1984

During this year a number of experiments were carried out to determine productivity of the cultures as a function of several variables, this time studied independently (Laws 1984b,c; see also Laws et al. 1985). One task was to screen candidate species in the laboratory for possible growth outdoors. However, as the author concludes, “the fact that a given species grows well in the laboratory is no guarantee that it will perform well in an outdoor culture system.” One reason the project switched to different algal species was that the *P. tricornutum* strain used in the experiments described above was quite sensitive to even moderate (above 25°C) temperatures, and required temperature control (cooling) of the reactors. A *Platymonas* sp. was thus tested without temperature control in the outdoor flumes, at several dilution rates and maximal pH levels of 7 to 8. This strain showed a maximum productivity of about 26 g/m<sup>2</sup>/d, about the same as observed with *P. tricornutum* with temperature control.

Another question raised was the reproducibility of the data obtained with the flumes. During this year all four flumes were operated under identical conditions for two periods, resulting in very similar productivities (5% and 10% standard deviations in the two separate experiments). The *Platymonas* sp. strain was then inoculated into the larger (48 m<sup>2</sup>) flume which was operated at various depths. A depth of about 12-cm gave the best results, producing about 26 g/m<sup>2</sup>/d during February 1984.

One important experiment carried out, again with the *Platymonas* sp., was to determine the effects of N and P limitation on algal lipid content. Lipids increased from less than 20% to almost 40% of dry weight upon combined N and P limitation. However, no actual productivity data were reported for this 2-week experiment.

The major experiment carried out this year (Laws 1984b,c), was the cultivation of *Platymonas* in the 48-m<sup>2</sup> flume, over most of the year. One major variable was dilution, with the culture diluted every 2, 3, or 4 days. As seen in Figure III.B.4., maximal productivity (50 g/m<sup>2</sup>/d) was achieved by diluting the culture every 3 days. Further investigation of this phenomenon suggested that this was not an artifact, but a reproducible effect. Indeed, such a culture diluted every third day had twice the productivity on the third as on the first 2 days. This was a most unexpected, and controversial, result, and a major focus for the following years of this project.



Long term *Platymonas* production and photosynthetic efficiency results in 48m<sup>2</sup> flume. Data points are six-day running means

**Figure III.B.4.** Productivity as a function of dilution. (Source: Laws 1984.)



### III.B.2.e. Fifth Year of the ARPS Project, 1984-1985

In FY1984-85 (Laws 1985), the research was directed toward the study of more thermotolerant species. Algal strains collected by the ASP researchers in the southwestern United States were evaluated using the Type I and II waters (see Section II.A.1. for a description of SERI Type I and Type II media). Several species, including *Platymonas* sp. (used previously), *Amphora* sp., *C. gracilis*, and *Boekelovia* sp. were grown in the two water types, each at two salinities and at four temperatures (25° to 32°C), with the data reported as the number of doublings per day. One interesting, but unexplained, observation was that at higher temperatures there was a consistent shift, among all four algae, of maximum doubling rates to the higher salinity and Type II waters.

The small outdoor flumes were used to test this cultivation strategy. The cultures were diluted each third day, to a concentration of  $2 \times 10^6$  cells. The results were “consistent with those of earlier studies,” with solar conversion (PAR) efficiencies close to 10% (5% of total solar). The *C. gracilis* species was also tested, though at a 2-day dilution rate (requiring a one per day doubling time), with somewhat lower efficiencies (8%), though still rather high productivities. Also, *Tetraselmis suecica* was cultivated in the ponds with good results. Over a 78-day cycle, in spring 1984 and summer 1985, productivity was  $37 \pm 5$  g/m<sup>2</sup>/d, with a corresponding PAR efficiency of 9.1%.

Removing half the arrays had no significant effect on productivity; removing all foils reduced light conversion efficiencies from 8% to 5.5%. However, a major variable in such systems is the pO<sub>2</sub> in the ponds, which may well account for the difference observed. The higher mixing (e.g., power inputs) caused by the foils may have increased outgassing of O<sub>2</sub> from the pond enough to increase productivity, rather than to any flashing light effect. The reports of increased productivities caused by 3-day batch dilutions and foils remained controversial, and continued to be the major focus of this project.

### III.B.2.f. Sixth Year of the Hawaii ARPS Project, 1985-1986

Research during FY 1985-86 (Laws 1987a) elaborated on the two key findings mentioned earlier: effects of a 3-day dilution interval and of the foil arrays. The effects of foil arrays were tested over a 12-month period in the 48-m<sup>2</sup> flume with *Cyclotella* sp., a diatom, which, like *Chaetoceros*, is a good lipid producer. The experiment involved alternatingly operating the pond with and without the foils for 2-week periods. The presence of foils increased productivity by almost a third, similar to the prior experiments.

The dilution effect was investigated with *T. suecica*, also in the 48-m<sup>2</sup> flume, with similar results as before, in terms of both overall and maximal 3rd day productivity. However, solar conversion efficiencies were lower than observed in previous years, perhaps due to the approximately 3°C higher temperature during this year, compared to the previous one. The author speculated that this could have been close to the maximal permissible temperature for growth of *T. suecica*, and thus resulted in lower productivities.



However, the effect of dilution interval on production in the 48.4-m<sup>2</sup> flume was somewhat puzzling (Laws 1986). These findings were a subject of considerable discussion and controversy. One possible explanation was the measurement of actual biomass density, which varied from about 27-28 g/m<sup>2</sup> after dilution, to 80, 140, and 160 g/m<sup>2</sup> for the 2-, 3-, and 4-day dilutions periods, respectively. However, this was considered an “unlikely” explanation. Indeed, the highest productivity was observed on day 3, with a steep decline on day 4. However, 4-day cycle cells still had lower productivity on day 3. Some “lingering effect of exposure to supraoptimal density conditions” was speculated to account for this phenomenon. The classical technique for studying such phenomena is the P versus I curve. Such studies were carried out with *T. suecica* cultures grown in the smaller 9.2-m<sup>2</sup> flumes. However, as the author noted, the results were “somewhat discouraging” as there was no difference as a function of dilution intervals, and productivities were only about 24 g/m<sup>2</sup>/d, much lower than reported with the larger flumes. Thus, this issue remained as a major focus of this project.

### **III.B.2.g. Seventh Year of the Hawaii ARPS Project, 1986-1987**

During the final year of the Hawaii ARPS project (Laws 1987), the goal was to screen for additional algal species in the smaller flumes and to further study the effect of dilution intervals. Four species were tested in the 9.2-m<sup>2</sup> flumes: *Navicula* sp., *C. cryptica*, *C. gracilis*, and *Synechococcus* sp. From prior work (see earlier Section, and also Laws et al. 1986, 1987a), photosynthetic efficiencies of 9.1% were reported with *T. suecica*, during a 78-day period, and 9.6% for 122 days with *C. cryptica*. With the three other organisms listed above, somewhat lower efficiencies were noted during shorter time periods: 7.8 % for *Navicula* sp., 8.5% for *C. gracilis*, and 8.6% for *Synechococcus*. Somewhat “surprisingly” (their characterization), they observed that in a 2-day batch growth mode, initial cell concentrations ranging from about 50 to 400 mg/L (AFDW) had no major effect on productivity. For *C. cryptica*, at an initial concentration of 40 mg/L at a depth of 12 cm, this would give an areal cell density of about 5 g/m<sup>2</sup>. For an equal daily productivity of 30 g/m<sup>2</sup>/d, averaged over 2 days, this would require the cells to divide 2.5 times the first day, and once the second day. Not impossible, certainly, but somewhat problematic. There is indeed some likelihood that some systematic measurement error influenced their productivity measurements (John Ryther, private communications, circa. 1986).

This report also described lipid induction by Si limitation by *C. gracilis* and *C. cryptica*. In both microalgae Si limitation greatly reduced overall productivities, and lipid productivities, even though lipid contents increased. Laws (1987) concluded that lipid productivities would be maximized by maximizing total biomass production.

In the final paper, Laws et al. (1988), reported on long-term (13-month) production of *C. cryptica* in the large flume, with a 9.6% solar conversion efficiency reported with the foils and 7.5% without the foils, similar to earlier results with *T. suecica*. For 122 days, at optimal dilution (2-day batch cycle) productivity of about 30 g/m<sup>2</sup>/d was measured. This is, indeed, a high sustained productivity.



### III.B.2.h. Hawaii ARPS Project, Conclusions

This project evolved from one that focused on a demonstration of the ARPS concept using a single flume, to the investigation of fundamental issues in algal mass culture, using several smaller ponds and a simplified system design. In particular, this project reported very high productivities achieved by two methods: organized mixing in ponds (e.g., the foils), and optimal batch dilution (2- or 3-day intervals, depending on species). However, the basis for these productivity enhancements was speculative, and it proved difficult to demonstrate the reproducibility of these effects. The effects of foils could be better ascribed to degassing of oxygen from the ponds with foils (e.g., higher mixing power inputs) and the results from the 3-day dilution experiments to some uncontrolled factors, in addition to possible methodological problems (Laws et al. 1985; 1986a,b; 1987).

Laws (1989; see also Laws and Berning 1990) continued this research with Electric Power Research Institute funding for 1 year, moving the system to Kona, Hawaii. No significantly different information was produced. However, Laws concluded that lack of land area, and high costs, would make such a process impractical for fuel production in Hawaii.

#### Publications:

Cheng, E.D.H.; Dugan, G.L. (1996) "Low-energy mixing in algal culture raceways." *J. Energy Engineering*, December, pp. 100-107.

Kok, B. (1953) "Experiments in photosynthesis by *Chlorella* in flashing light." In *Algal Culture: From Laboratory to Pilot Plant* (Burlaw, J.B., ed.), Carnegie Inst. of Washington, Publ. 600, pp. 63-75.

Laws, E.A. (1981) "Year one progress report on algal production raceway project." *Proceedings of the July 1981 Subcontractors' Review Meeting, Aquatic Species Program*, Solar Energy Research Institute, Golden, Colorado, SERI/CP-624-1228, pp.1-32.

Laws, E.A. (1982) "Results from preliminary studies on the use of flashing light to enhance algal mass culture productivity." *Proceedings of the June 1982 SERI Biomass Program Principal Investigators' Review Meeting—Aquatic Species Program Reports*, Solar Energy Research Institute, Golden, Colorado, SERI/CP-231-1808, pp. 31-42.

Laws, E.A. (1984a) "Optimization studies in shallow algal mass culture flumes." *Proceedings of the April 1985 Principal Investigators' Meeting*, Solar Energy Research Institute, Golden, Colorado, SERI/CP-231-2341, pp. 108-131.

Laws, E.A. (1984b) "Research and development of shallow algal mass culture systems for the production of oils." *Final Report*, Solar Energy Research Institute, Golden, Colorado, SERI/STR-231-2496.



Laws, E.A. (1984c) "Research, development, and demonstration of algal production raceway (ARP) systems for the production of hydrocarbon resources." *Subcontractor Report to the Solar Energy Research Institute*, Golden, Colorado, SERI/STR-231-2206.

Laws, E.A. (1985) "Productivity optimization of saline microalgae grown in outdoor mass culture." *Proceedings of the March 1985 Principal Investigators' Meeting, Aquatic Species Program Review*, Solar Energy Research Institute, Golden, Colorado, SERI/CP-231-2700, pp. 162-178.

Laws, E.A. (1987) "Continuous microalgae production in shallow raceways at high productivity." *FY 1986 Aquatic Species Program Annual Report*, Solar Energy Research Institute, Golden, Colorado, SERI/SP-231-3071, pp. 209-225.

Laws, E.A. (1987) "Productivity optimization of saline microalgae grown in outdoor mass culture." *Final Report, Contract XK-4-4109-1*, Solar Energy Research Institute, Golden, Colorado.

Laws, E.A. (1989) *Final Report to the Electric Power Research Institute*.

Laws, E.A.; Berning, B.L. (1991) *Biotech. Bioeng.* 37:936.

Laws, E.A.; Lee, Y.K.; Tan, H.-M.; Hew, C.-S. (1985) "The effect of growth temperatures on the bioenergetics of photosynthetic algal cultures." *Biotech. Bioeng.* 27:555-561.

Laws, E.A.; Taguchi, S.; Hirata, J.; Pang, L. (1986) "High algal production rates achieved in a shallow outdoor flume." *Biotech. Bioeng.* 28:191-197.

Laws, E.A.; Taguchi, S.; Hirata, J.; Pang, L. (1988) "Optimization of microalgal production in a shallow outdoor flume." *Biotech. Bioeng.* 32:140-147.

Laws, E.A.; Terry, K.L. (1983) "Shallow algal mass culture system." *Proceedings of the March 1983 Principal Investigators' Meeting, Aquatic Species Program*, Solar Energy Research Institute, Golden Colorado, SERI/CP-231-1946, pp. 33-46.

Laws, E.A.; Terry, K.L.; Wickman, J.; Chalup, M.S. (1983) "Preliminary results from a simple algal production system designed to utilize the flashing light effect." *Biotech. Bioeng.* 25:2319-2336.

Raymond, L. (1979) "Initial investigations of a shallow layer algal production system." *Am. Soc. Mech. Eng.*, New York.

Terry, K.L. (1984b) "Modulated light photobiology." *Proceedings of the April 1984 Principal Investigators' Meeting, Aquatic Species Program*, Solar Energy Research Institute, Golden, Colorado, SERI/CP-231-2341, pp.160-169.



Terry, K.L. (1986) "Photosynthesis in modulated light: quantitative dependence on photosynthetic enhancement on the flashing rate." *Biotech. Bioeng.* 28:988.

### **III.B.3. High Rate Pond (HRP) Operations in California, 1981-1986**

#### **III.B.3.a. HRP Design and Construction Phase, 1981**

The project described in this section succeeded the projects reviewed in Section III.A. that took place at the University of California-Berkeley. That research group moved essentially intact (as Ecoenergetics, Inc., later renamed EnBio, Inc.) to Fairfield, California, some 30 miles north of Berkeley, with a pond system set up in nearby Vacaville.

The ASP funded this project starting in fall 1980. The objective was to demonstrate the HRP system using agricultural irrigation waters and fertilizers. The HRP was defined as a paddle wheel-mixed (approximately 10-20 cm/s), moderate depth (approximately 15-30 cm), algal production system. The R&D goal was to develop production technology for microalgae biomass with a high content of lipids. A detailed literature review concluded that the best option would be to use N limited (but not starved) batch cultures of green microalgae.

The plan view of the facility is shown in Figure III.B.5. The system consisted of four 200-m<sup>2</sup> and three 100-m<sup>2</sup> ponds, along with three deep harvesting ponds and four water and effluent storage ponds. This system thus provided considerable flexibility for the testing of a large number of variables and algal species, at a scale that would allow some confidence in the scale-up of the results. The units were lined with 20 mil PVC, to allow complete mass balances.

The report to the ASP describing this work (Benemann et al. 1981) provided considerable detail on the design of the system and the various considerations that went into selection of different design options and operating variables. For example, Table III.B.1. lists the calculations on which basis the carbonation requirements for the ponds were estimated.

After the facility was only partially constructed, the project was terminated by the ASP, as the Hawaii ARPS system, reviewed earlier, was deemed to have already demonstrated its superiority to the HRP design, even before any operations of either. However, after a hiatus of about 1 year, and with changes in the ASP management, funding for the California HRP project was reinstated in August 1982, and actual pond operations were initiated.







Table III.B.1. Microalgae pond carbonation requirements. (Source: Benemann et al. 1981.)

Quantity	Formula	Example*
X, aver. hourly prod. g/m <sup>2</sup> .hr	--	1.5
X <sup>P</sup> , peak hours prod. g/m <sup>2</sup> .hr	--	5
d, pond depth, cm	--	20
A, pond area, m <sup>2</sup>	--	200
Q, wt. fraction of C in algae	--	0.5
F, flow of CO <sub>2</sub> (ft <sup>3</sup> )/hr	--	50
E, carbonator efficiency	--	0.5
T, temp., °C	--	25
Peak hourly demand, m moles C/L.hr	8.3 QX <sup>P</sup> /d	1.0
Aver. hourly demand, m moles C/L.hr	8.3 QX/d	0.3
CO <sub>2</sub> influx, m moles C/L.hr	126.4 EF [298/(273+T)]/ad	0.8
V, linear mixing speed, cm/sec	--	10
L, pond length, m	--	30
R, recirculation time, hr	T = .056L/V	.16
ΔC, CO <sub>2</sub> influx/carbonation pas	(CO <sub>2</sub> influx) R	.07
pH av	--	8.0
A, alkalinity, meq/L	--	10
ΔpH	(f (pH avg A)	0.3



### III.B.3.b. HRP Operations in California, Oct-Nov. 1982

After this project was restarted, construction was completed and the first inoculation of algae into one of the 100-m<sup>2</sup> ponds was made on August 13, 1982, using a mixed *Micractinium-Scenedesmus* culture obtained from the Richmond wastewater ponds (Section III.A.). However, these algae settled out due to lack of flow deflectors, and the culture was soon dominated by a *Selenastrum* sp. Both biomass concentration and productivity were quite low. Without flow deflectors at the far end of the ponds (away from the paddle wheel) the hydraulics were so poor that the ponds exhibited almost zero productivity. This was due to the formation of large countercurrent eddies resulting in “dead zones,” where algal cells settled. After flow deflectors were installed, the pond was inoculated on September 21 with an almost pure culture of *Scenedesmus* that had arisen spontaneously in one of the 12-m<sup>2</sup> inoculum ponds. The culture remained well suspended and grew well (Benemann et al. 1983).

However, a similar inoculation into a 200-m<sup>2</sup> pond resulted in almost complete settling of the culture, caused by poor pond hydraulics, even with similar flow deflectors installed. This indicated that the hydraulics of the ponds are critical to the success of the process and further, that the hydraulics are not predictable from one scale to another, even within a factor of two. After two flow deflectors were installed around the bends in the 100-m<sup>2</sup> ponds, these ponds exhibited much improved hydraulics, with few eddies or settling of algal cells.

In contrast, similar deflectors did not improve hydraulics perceptibly in the 200-m<sup>2</sup> ponds. Only after two more flow deflectors were installed at the end nearest the paddle wheels were satisfactory hydraulics observed in these larger ponds. A quantitative study of flow velocities was undertaken using a flow meter. The results were counterintuitive: flow velocities are higher on the inside than the outside of the channels. Clearly, pond hydraulics must be customized for each pond size and design to obtain even mixing.

As expected, productivities were rather low in the initial experiments carried out during October and November 1982. Maximum productivities (measured for 2 days) were only about 9 g/m<sup>2</sup>/d and average productivities less than 5 g/m<sup>2</sup>/d. These initial experiments included assessment of species dominance, N limitations, and mixing velocities. Pond operations ceased by the end of November 1982.

### III.B.3.c. Continuing California HRP Pond Operations, 1983-1984

This project was a continuation of the project described in III.B.3.b. It was performed by a new company, Microbial Products, Inc. (EnBio was dissolved when John Benemann left in 1983 for the Georgia Institute of Technology). The pond system described earlier continued to be used for this project. The objective was to obtain long-term productivity data with a pilot-scale system and generally demonstrate the requirements of large-scale algal mass cultivation (Weissman 1984; Weissman and Goebel 1985, 1986).

The first challenge was to obtain microalgal species that could be grown on the fresh to slightly brackish water available at the site. The common experience is that either inoculated strains from



culture collections fail to grow in the outdoor ponds, or that they grow initially but become rapidly outcompeted by indigenous strains. A common practice is to make the best of a bad situation and cultivate the invading organisms. This was also the experience and approach of this project.

After inoculation of *Scenedesmus obliquus* strain 1450 from the SERI Culture Collection, a strain of *Scenedesmus quadricuada* invaded. This turned out to be the most successful organism, cultivated for 13 months in fresh water and an additional 3 months in brackish. After an *Oocystis* sp. (Walker Lake isolate) was inoculated, a *Chlorella* sp. became dominant and was maintained (or maintained itself) for 2 months under semi-continuous dilution. However, some strains provided by SERI researchers could be grown for at least a few months outdoors, including an *Ankistrodesmus falcatus* and a freshwater *Scenedesmus* sp. So2a.

Productivity for *S. quadricuada* grown semi-continuously which is harvested every few days (a “sequential batch” growth mode), averaged about 15 g/m<sup>2</sup>/d for the 8 month period of March through October, with monthly averaged solar conversion efficiency ranging from 1.2% to 2.2% (Figure III.B.6.). “Typical” real biomass density just before harvest ranged from 60 to 100 g/m<sup>2</sup>, except for May, which recorded the highest standing biomass (160 g/m<sup>2</sup>) and productivity (20 g/m<sup>2</sup>/d). The continuously diluted cultures (diluted during the entire light period) exhibited approximately 20% higher productivity.

From a large number (39) of experiments, a correlation of  $T_{\max}$ ,  $T_{\min}$ , and total insolation with productivity reduced the variance in the prediction of productivity by about 50% when using any single variable, but not in combination. This suggested that one of these three factors generally dominated (e.g., too high or too low a temperature or too little insolation). Similar experiments were carried out with the other microalgae in combination with the study of variables such as mixing speed, O<sub>2</sub> outgassing, CO<sub>2</sub> addition, and N limitation (for lipid induction).

The main conclusions of the extensive experimental program were:

1. Productivities of 15 to 25 g/m<sup>2</sup>/d were routinely obtained during the 8-month growing season at this location. However, higher numbers were rarely seen.
2. Continuous operations are about 20% more productive than semi-continuous cultures, but the latter densities are much higher, a factor in harvesting.
3. Culture collection strains fare poorly in competition with wild types.
4. Temperature effects are important in species selection and culture collapses, including grazer development.
5. Nighttime productivity losses increased to 10% to 20 % in July, when grazers were present; nighttime respiratory losses were high only at high temperatures.



6. There is a significant decrease in productivity in the afternoons, compared to the mornings, in the algal ponds.
7. Oxygen levels can increase as much as 40 mg/L, over 450% of saturation, and high oxygen levels limit productivity in some strains but not others. Oxygen inhibition was synergistic with other limiting factors (e.g., temperature).
8. Increasing TDS from 0.4 to 4 ppt decreased productivity, depending on strains.
9. Mixing power inputs were small at low mixing velocities (e.g., 15 cm/s) but increased exponentially. Productivity was independent of mixing speed.
10. The strains investigated in this study did not exhibit high lipid contents even upon N limitation.
11. The transfer of CO<sub>2</sub> into the ponds was more than 60% efficient, even though the CO<sub>2</sub> was transferred through only the 20-cm depth of the pond.
12. Harvesting by sedimentation has promise, but was strain specific and was increased by N limitation.
13. Initial experiments demonstrated that media recycle is feasible.
14. Project end input operating costs for large-scale production (@ \$50/mt CO<sub>2</sub>, 70% use efficiency, etc.) was \$130/mt of algae, of which half was for CO<sub>2</sub> and one-third for other nutrients, with pumping and mixing power only about \$10/mt.

This project answered a number of issues that had been raised about this process. One initially controversial observation was the finding that mixing speed had no effect on productivity (Figure III.B.7.). However, this experiment used a strain of *Chlorella* that did not settle, and care was taken to keep other parameters identical (in particular pH and pO<sub>2</sub> levels). Thus, the increased productivities seen in some experiments (e.g., those of Hawaii), could possibly be accounted for by differences other than those of mixing, such as changes in outgassing of O<sub>2</sub>.

From the perspective of large-scale biomass production, one conclusion from this research was that mixing power inputs make any mixing speed much above about 30 cm/s impractical, as the energy consumed would rapidly exceed that produced. The rate of mixing should only be between about 15 and 25 cm/s, sufficient to keep cells in suspension and transfer the cultures to the CO<sub>2</sub> supply stations in time to avoid C limitations in large-scale (>1-ha) ponds.

For low-cost production higher productivities would reduce capital, labor, and some other costs, but nutrient (e.g., CO<sub>2</sub>) related costs would not change. This suggested the need for low-cost CO<sub>2</sub>, and other nutrients, as well as a high CO<sub>2</sub> utilization efficiency. Efficient utilization of CO<sub>2</sub> appeared feasible based on the results obtained with even this unoptimized system.



Another major conclusion was that competitive strains would be required to maintain monocultures. The need for feedback from the outdoor studies to development of laboratory screening protocols was a major recommendation. Specifically, the relatively controllable parameters of CO<sub>2</sub>, pH, and O<sub>2</sub> were of interest in determining species survival and culture productivity. Also, harvesting was identified as a specific area for further research. Finally, lipid induction remained to be demonstrated. These were the general objectives during the final year of this project, described in Section III.B.3.d.

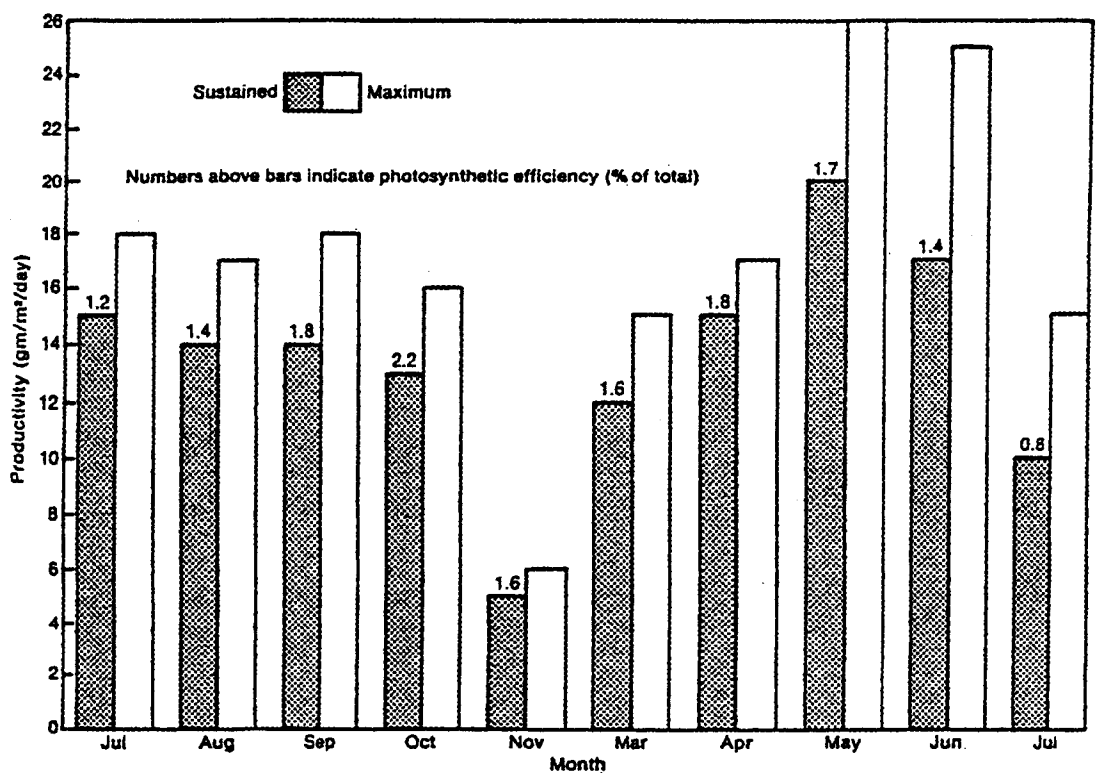


Figure III.B.6. Long-term productivity of *S. quadricauda* in freshwater (100-m<sup>2</sup> pond).

(Source: Weissman and Goebel 1985.)

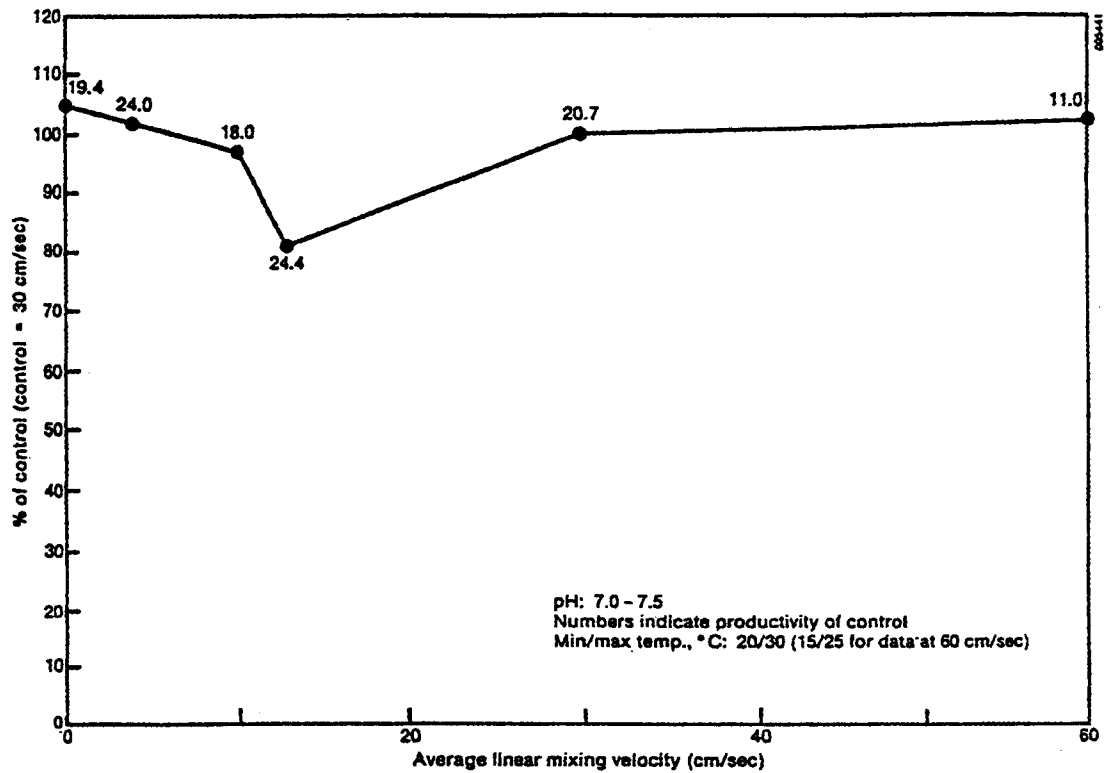


Figure III.B.7. *Chlorella* mixing velocity experiments.

Data from 3.5-m<sup>2</sup> ponds operated under constant pH and pO<sub>2</sub> levels and compared to a control culture operated at 30 cm/s mixing velocity. Numbers above the data points indicate productivity of the control. Max/min temperatures 20/30 °C (15/25 °C for the 60 cm/s data set). (Source: Weissman and Goebel 1986.)





### III.B.3.d. Completion of the California HRP Project, 1985-1986

Numerous microalgal strains were obtained from the SERI Culture Collection and tested in small-scale, 1.4-m<sup>2</sup>, ponds (Weissman and Goebel 1986; 1987). All strains could be grown quite successfully in these small units, although some, such as *Amphora* sp., did not survive more than 2 or 3 weeks before they were displaced by other algae. *Cyclotella* displaced *Amphora* under all conditions tested, even though *Amphora* was the most productive strain, producing 45 to 50 g/m<sup>2</sup>/d in short-term experiments. The green algae, e.g. *Chlorella* or *Nannochloropsis*, also could not be grown consistently. Their productivities were among the lowest, about 15 g/m<sup>2</sup>/d (similar to that in the prior year). Thus, one fundamental conclusion was that productivity is not necessarily correlated with dominance or persistence. However, these factors may be related to oxygen effects, as shown in later experiments.

Table III.B.2. summarizes the results of various experiments for the summer with small (3.5-m<sup>2</sup>) ponds and seven of the algal strains under different operating regimes, including controlling the oxygen tensions through degassing by air sparging.

A significant factor in pond operations was the oxygen level reached in the ponds, which influenced productivity and species survival. Ponds were operated with air sparging (and antifoam) to reduce DO levels, from typically 400% to 500% of saturation without air sparging, to 150% to 200% of saturation with sparging. Foaming, caused by air sparging, was still a problem in some cases, as with the *Cyclotella*. However this alga exhibited approximately the same productivity with or without sparging despite the 20%-30% opaque foam cover, suggesting some positive effect of the lower pO<sub>2</sub>. For other algal species productivity differences of 10% to 20% were noted, and for some (e.g., *C. gracilis*), no specific effect of high versus low DO was noted.

These outdoor results were reproducible enough to detect differences of greater than about 10% between treatments. The major result of this project was that productivities were 50% to 100% higher than the previous year, with some species of diatoms producing 30 to 40 g/m<sup>2</sup>/d (AFDW, efficiency about 6% to 9% of PAR, or 3% to 4.5% total solar). The green algae were, as mentioned earlier, less productive than the diatoms.

A more detailed study of oxygen effects was also carried out in the laboratory, avoiding the confounding factors of CO<sub>2</sub> supply, temperature, and light intensity. In general the diatoms were insensitive to high DO; most, but not all, of the green algal strains exhibited marked inhibition by high oxygen levels (Figure III.B.8.). None of the oxygen-sensitive algae could be grown outdoors, suggesting this as a major factor in species dominance and productivity.

Laboratory studies were also carried out at both high light intensity and high DO, to determine the synergism between these factors. Both the apparent maximum growth rate and dense culture productivity were determined for comparisons. Higher levels of DO intensified the inhibitory effects of higher light observed in some cases. This was true in particular for productivity, with growth rates also affected. Of course, the actual density of the culture is a major factor



determining productivity, and dense cultures avoid most, if not all, the deleterious effects of high light intensity. High O<sub>2</sub> and low CO<sub>2</sub> are other factors influencing the response to high light, with O<sub>2</sub> being more inhibitory at both low CO<sub>2</sub> and high light levels. High oxygen also affects chlorophyll content, although this effect is most pronounced at low light intensities where chlorophyll levels are 50% higher compared to high light intensities.

Outdoor experiments were carried out to determine the effect of low CO<sub>2</sub> (25 μM) and high (9-10) pH, which would be experienced in algal mass cultures, at least temporarily. Compared to the control cultures, one strain was not inhibited even at pH 10, two not at pH 9, and two were inhibited by about 33% at this pH, compared to the control at pH 8. Lowering pCO<sub>2</sub> also resulted in similar levels of inhibition for the other strains. A role for bicarbonate in growth at high pH was established from the data, with metabolic costs estimated at about one-third of productivity, a major factor. This requires further investigation.

One strain, a *Cyclotella* species, exhibited an increase of lipid content of more than 40% of dry weight upon Si limitation. However, lipid productivity (9 g/m<sup>2</sup>/d), was not significantly different between Si-deficient and the Si-sufficient controls, because of the high productivity of the Si-sufficient culture. Optimizing for lipid productivity was considered possible, but requires more detailed study.

Perhaps most important, the data and simulations also suggest that maximizing productivity at an acceptable CO<sub>2</sub>/pH combination from the perspective of outgassing and CO<sub>2</sub> loss from the ponds is possible, with operations above pH 8.0 required (for an alkalinity of 32 meq/L, higher for higher alkalinities) to avoid wasting of CO<sub>2</sub>.

Laboratory studies were also carried out during this project. These included a study of light conversion efficiencies that concluded that at low light intensities very high light conversion efficiencies can be achieved (near the theoretical maximum of about 10 photons/CO<sub>2</sub> fixed). However, these and other laboratories studies carried out during this project would require a much longer review than possible here.

Finally, this project investigated harvesting of microalgae cultures with both polymers and FeCl<sub>3</sub> (to enhance algal settling and sludge compaction) and cross-flow filtration. Organic flocculants at about 2 to 6 g/kg and FeCl<sub>3</sub> at about 15 to 200 g/kg of algal biomass (AFDW) were required to remove 90% or more of the algal cells. Because of the high cost of the organic flocculants, costs were comparable for both flocculants tested. The organic polymers were also deemed to have significant potential for improvement and optimization. Cross-flow filtration, though effective, was estimated to be too expensive. A cost analysis of such a harvesting process was also presented.

In conclusion, this project significantly advanced the state-of-the art of low-cost microalgae biomass production, and provided the basis for the Outdoor Test Facility, discussed in Section III.B.5., following the review of the ASP-supported project in Israel.

**Publications:**

Benemann, J.R.; Goebel, R.P.; Weissman, J.C. (1981) "Production of lipid hydrocarbon fuels and chemicals from freshwater microalgae." *Final Report, Contract Xb-0-9253-1*, Solar Energy Research Institute, Golden, Colorado.

Benemann, J.R.; Goebel, R.P.; Weissman, J.C. (1983) "Production of lipid hydrocarbon fuels and chemicals from freshwater microalgae." *Final Report*, Solar Energy Research Institute, Golden, Colorado (unpublished).

Benemann, J.R.; Goebel, R.P.; Weissman, J.C.; Augenstein, D.C. (1982a) "Microalgae as a source of liquid fuels." *Proceedings of the June 1982 SERI Biomass Program Principal Investigators' Review Meeting, Aquatic Species Program Reports*, Solar Energy Research Institute, Golden, Colorado, SERI/CP-231-1808, pp. 1-16.

Benemann, J.R.; Goebel, R.P.; Weissman, J.C.; Augenstein, D.C. (1983) "Production of liquid fuels and chemicals by microalgae." *Proceedings of the March 1983 Principal Investigators Meeting, Aquatic Species Program*, Solar Energy Research Institute, Golden, Colorado, SERI/CP-231-1946, pp. 19-32.

Weissman, J.C. (1984) "Cultivation of microalgae for liquid fuels." *Proceedings of the April 1984 Principal Investigators' Meeting, Aquatic Species Program*, Solar Energy Research Institute, Golden, Colorado, SERI/CP-231-2341, pp.132-149.

Weissman, J.C.; Goebel, R.P. (1985) "Design, fabrication, and operation of innovative microalgae culture experiments using open ponds." *Final Report, Subcontract XK-3-03135*, Solar Energy Research Institute, Golden, Colorado.

Weissman, J.C.; Goebel, R.P. (1985) "Production of liquid fuels and chemicals by microalgae." *Proceedings of the March 1985 Principal Investigators' Meeting, Aquatic Species Program*, Solar Energy Research Institute, Golden Colorado, SERI/CP-231-2700, pp.141-161.

Weissman, J.C.; Goebel, R.P. (1987) "Design and analysis of pond systems for the purpose of producing fuels." *Report to the Solar Energy Research Institute*, Golden, Colorado SERI/STR-231-2840.

Weissman, J.C.; Goebel, R.P. (1987) "Factors affecting the photosynthetic yield of microalgae." *FY 1986 Aquatic Species Program Annual Report*, Solar Energy Research Institute, Golden, Colorado, SERI/SP-231-3071, pp. 139-168.

Weissman, J.C.; Goebel, R.P.; Benemann, J.R. (1988) "Photobioreactor design: comparison of open ponds and tubular reactors." *Bioeng. Biotech.* 31:336-344.



Table III.B.2. Outdoor results summary for California pond operations.

Data from 3.5-m<sup>2</sup>ponds. (Source: Weissman and Goebel 1986.)

	Culture #	Dates	Days	Max Daily DO mg/l	Dilution Interval days	Productivity $\pm$ SDOH gm/m <sup>2</sup> /day	I- Ingy/day	PAR %	Lipid $\pm$ SDOH (n) %
Cyclotella sp. (S/CYCLD-1)	1	6/25-7/15	21	500	3	28.1 $\pm$ 0.5	664	6.0	27.1 $\pm$ 0.6 (3)
	2	6/13-7/15	33	500	3	29.6 $\pm$ 0.7	659	6.2	25.2 $\pm$ 4.5 (4)
	1	7/16-7/27	10	500	2	35.2 $\pm$ 1.6	600	8.3	23.1 $\pm$ 3.1 (6)
	2	7/16-7/27	10	150-300 <sup>2</sup>	2	37.6 $\pm$ 2.0	600	8.6	25.0 $\pm$ 2.4 (6)
	1	8/8 -8/14	6	500	2	28.2 $\pm$ 1.0	585	6.8	20.0 $\pm$ 3.0 (2)
	2	8/8 -8/20	12	500	2	26.0 $\pm$ 1.2	564	6.4	-
Chaetoceros gracilis (S/CHAET-1)	1	6/7 -7/15	39	500	3	22.5 $\pm$ 1.0	664	4.9	30.0 $\pm$ 4.8 (4)
	2	6/7 -7/15	39	150,300	3	25.6 $\pm$ 0.8	664	5.6	33.7 (1)
	1	7/16-7/21	6	500	2	29.1 $\pm$ 2.5	561	7.1	25.5 $\pm$ 3.1 (6)
	2	7/16-7/21	6	200 <sup>2</sup>	2	26.9 $\pm$ 3.6	561	6.6	26.2 $\pm$ 4.9 (7)
Chlorella pyrenoidosa (S/CHLOR-2)	1	6/22-7/15	24 <sup>1</sup>	300-500	3	13.1 $\pm$ 0.4	648	2.5	-
	2	6/22-7/15	24	150 <sup>2</sup>	3	14.1 $\pm$ 1.5	648	2.6	-
T. suecica (S/PLATY-1)	1	8/16-9/6	21	400-500	2-4	18.0 $\pm$ 1.5	510	4.3	20.4 $\pm$ 1.8 (2)
	2	8/20-9/6	17	140-190	2-4	20.3 $\pm$ 1.5	510	4.9	23.1 $\pm$ 5.0 (2)
Nannocloropsis BS-21	1	7/26-8/29	26 <sup>2</sup>	300-500	2-4	14.9 $\pm$ 0.8	582	3.4	20.4 $\pm$ 1.1 (2)
	2	7/26-8/29	29 <sup>1</sup>	150-200	2-4	15.4 $\pm$ 1.0	581	3.6	22.1 $\pm$ 1.6 (3)
Amphora sp. (S/AMPHO-1)	1	7/22-8-13	20	500	2	30.5 $\pm$ 1.5	608	6.7	-
	2	7/24-8/13	16	200-500	2	31.0 $\pm$ 2.1	596	6.9	19.4 $\pm$ 0.5 (2)
Chaetoceros sp. SS14 (S/CHAET-2)	1	8/6 -9/2	28	500,150-200	2	24.3 $\pm$ 2.6	544	6.0	21.0 $\pm$ 3.5 (4)
	2	8/6 -9/2	28	500	2	22.6 $\pm$ 2.4	544	5.6	21.7 $\pm$ 3.0 (3)

Kcal calculated from proximate composition, either 1) as measured or 2) determined as 50% protein, lipid as measured, and CHO by difference.

Temperature: Max 30-34°C, Min 16-20 °C

<sup>1</sup> Required re-inoculation

<sup>2</sup> Required re-inoculation twice

<sup>3</sup> Oxygen removal caused 20-30% coverage of surface with foam

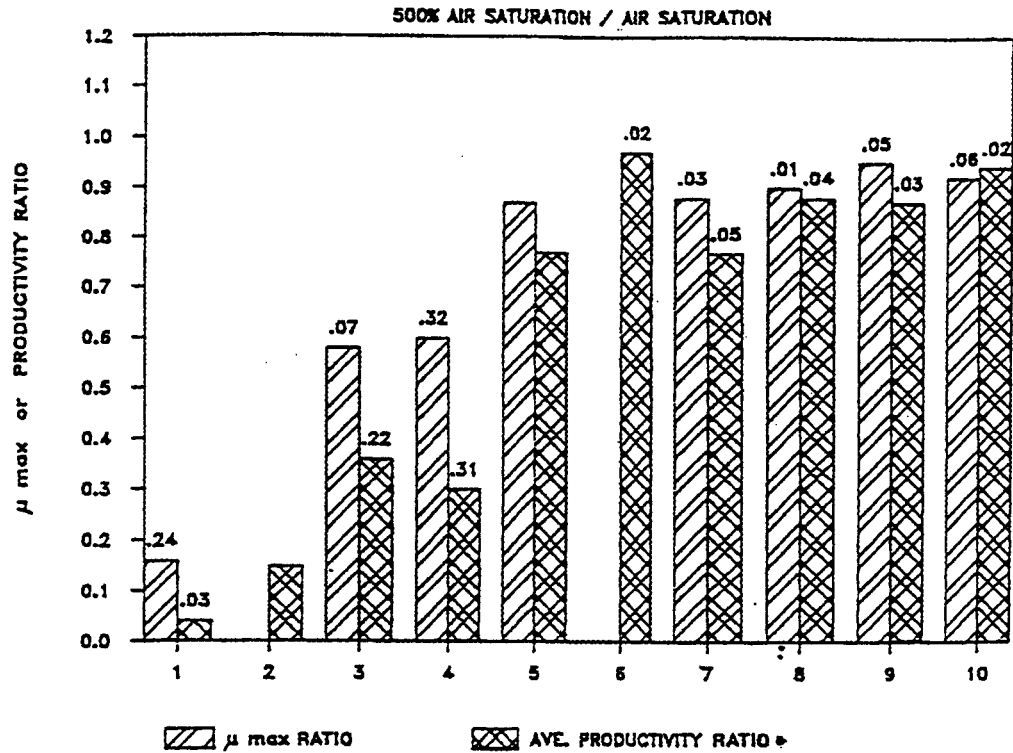


Figure 1. Oxygen Inhibition of Laboratory Algal Cultures

- |                                   |                            |
|-----------------------------------|----------------------------|
| 1. Nannocloropsis sp. 21          | 6. Scenedesmus quadricauda |
| 2. Oocystis sp. (S/OOCYS-1)       | 7. Chaetoceros gracilis    |
| 3. Tetraselmis suecica            | 8. Chaetoceros SS14        |
| 4. Chlorella ellipsoidea          | 9. Cyclotella sp.          |
| 5. Ankistrodesmus sp. (S/ANKIS-3) | 10. Amphora sp.            |

Figure III.B.8. Effects of oxygen tensions on laboratory algal cultures.

The numbers above bars are standard deviations of duplicates.

(Source: Weissman and Goebel 1986.)



#### III.B.4. The Israeli Microalgae Biodiesel Production Project

In the mid-1980s an algal mass culture project for biodiesel production was supported by the ASP in Israel (Arad 1984, 1985, 1986), as a cooperative project among the following groups:

1. Israel Oceanographic and Limnological Research Institute, with Dr. Ben-Amotz, who investigated lipid production at the laboratory and micropond scale;
2. Ben-Gurion University of the Negev, with Professor A. Richmond as Principal Investigator, investigating algal mass cultures with outdoor ponds, essentially of the HRP design.
3. Technion University, with Professor Gedaliah Shelef in charge of developing suitable microalgae harvesting technology.

During the first 2 years of the project Ben-Amotz (1984, 1985) screened laboratory cultures of unicellular algae isolated in Israel and elsewhere. Of a score of strains tested, *Nanochloropsis salina* and *B. braunii* were the highest lipid producers, with lipid content as high as 50% in semi-continuous nitrate-limited cultures. Other strains had lipid contents  $\leq 20\%$ . Lipid composition and chemical characteristics (e.g., hydrocarbon contents) were also determined for many cultures. *Nanochloropsis* sp., *P. tricornutum* and *C. gracilis* were studied in more detail in 0.5-Liter, pH-controlled chemostats for effects of temperature, light intensities, nutrients (Fe and nitrate), salinity and other parameters. The author concluded that “nitrogen limitation does not induce the production and accumulation of lipids,” but the “algae attain a low protein-carbohydrate ratio.” Previous reports in the literature describing lipid accumulation in algae induced by N limitation were attributed to trace element limitations. Actually, the data is typical of chemostat results, in which growth rate imposed by culture dilution do not allow lipid induction as is observed in batch or semi-continuous cultures.

During the final year of this project, Ben-Amotz (1986), optimized the growth of two cultures, *C. gracilis* and *Nannochloris atomus* in laboratory chemostats and in 0.35-m<sup>2</sup> outdoor “microponds.” The ponds were mixed by air sparging, which would reduce pO<sub>2</sub> levels. Maximal productivities of 40 g/m<sup>2</sup>/d were obtained with *C. gracilis* during June-August, and highest photosynthetic efficiency (9.5% PAR) was achieved in the fall (when productivity was 27.3 g/m<sup>2</sup>/d, AFDW). During the winter, productivity decreased by about half, but lipid contents in the N-sufficient algal cells increased almost as much, reproducing the low-temperature effect on lipid content seen in the laboratory cultures. Attempts were also made to increase lipid production by Si limitation, but this was unsuccessful due to rapid contamination with green algae.

The work by Professor Richmond and colleagues (1984; Boussiba et al. 1985, 1986), started with laboratory growth and lipid content experiments with more than a dozen algal strains. Outdoor cultivation was carried out for 2 years with small (2.5-m<sup>2</sup>, 12-cm deep) paddle wheel-mixed high rate ponds. Among other factors, the effects of culture density on productivity and lipid content



were studied, with the expected result that maximal productivity depended on the culture density (actually, on the areal concentration), but that this does not have major effects on lipid content. At the optimal density of 350 mg/L (45 g/m<sup>2</sup>), productivity in the summer was 24.5 g/m<sup>2</sup>/d and lipid content about 16% for *N. salina*, and somewhat higher (28.1 g/m<sup>2</sup>/d and 22 %) for *Isochrysis galbana* (both SERI Culture Collection strains). However, experiments with varying pond depths but constant areal biomass densities resulted in productivity differences of up to twofold, contrary to theory and expectations. Other factors (pO<sub>2</sub>, etc.) likely accounted for this. However, mixing speed had no significant effect on productivity. The authors stated: “These data reflect the complexity of the process of optimizing outdoor biomass production....”

Professor Shelef (1984a,b; Shelef et al. 1985) carried out experimental and engineering studies of algal harvesting. The major effort was on the use of chemical flocculants for affecting algal sedimentation. Much of the work focused on *I. galbana*, grown, as above, on seawater of various concentrations. As expected, the higher the ionic strength (salinity), the greater amounts of chemical flocculants (alum, ferric chloride, chitosan) were required to induce algal flocculation. Autoflocculation, achieved by interrupting the CO<sub>2</sub> supply, was also very effective. Other processes investigated were sand bed filtration, microstrainers (a 21 μm polyester weave allowed some 80%-90 % harvest efficiency), dissolved air flotation (after chemical flocculation, the method of choice for most commercial installations), and again, chemical “enforced” flocculation (recycling some of the precipitate to reduce flocculant needs). An economic analysis suggested various “allowable” flocculant costs for assumed biomass values. Overall, however, chemical flocculants are too expensive for biodiesel production.

During the final year of this project, a 100-m<sup>2</sup> pond was operated with *I. galbana* for 1 month (Arad 1986). In batch culture it took 12 days for the culture to enter stationary phase, and a productivity of 23.6 g/m<sup>2</sup>/d was measured for about 2 weeks after starting dilutions. The culture was harvested with FeCl<sub>3</sub> and alum using a dissolved air flotation unit from Technion. The flocculated algae had rather low lipid contents, compared to centrifuged algae. In conclusion, the Israeli project provided another dimension to the ASP effort, generally supporting the conclusions and results obtained by the U.S. work.

#### Publications:

Arad, S. (1984) “Development of outdoor raceway capable of yielding oil-rich halotolerant microalgae.” *Proceedings of the April 1984 Principal Investigators’ Meeting, Aquatic Species Program*, Solar Energy Research Institute, Golden, Colorado, SERI/CP-231-2341, pp. 184-185.

Arad, S. (1985) “Development of outdoor raceway for producing oil-rich halotolerant microalgae: An introduction.” *Proceedings of the March 1985 Principal Investigators’ Meeting, Aquatic Species Program*, Solar Energy Research Institute, Golden, Colorado, SERI/CP-231-2700, pp. 228-229.



Arad, S. (1987) "Integrated field-scale production of oil-rich microalgae under desert conditions." *FY 1986 Aquatic Species Program Annual Report*, Solar Energy Research Institute, Golden, Colorado, SERI/SP-231-3071, pp. 169-183.

Ben-Amotz, A. (1984) "Identification of oil rich strains." *Proceedings of the April 1984 Principal Investigators' Meeting, Aquatic Species Program*, Solar Energy Research Institute, Golden, Colorado, SERI/CP-231-2341, pp. 186-194.

Ben-Amotz, A. (1985) "Development of outdoor raceway capable of yielding oil-rich halotolerant microalgae." *Proceedings of the March 1985 Principal Investigators' Meeting, Aquatic Species Program*, Solar Energy Research Institute, Golden, Colorado, SERI/CP-231-2700, pp. 230-243.

Ben-Amotz, A. (1987) "Development of outdoor raceway capable of yielding oil-rich halotolerant microalgae." *FY 1986 Aquatic Species Program Annual Report*, Solar Energy Research Institute, Golden, Colorado, SERI/SP-231-3071, pp. 199-208.

Boussiba, S.; Vonshak, A.; Cohen, Z.; Abeliovich, A.; Kaplan, D.; Richmond, A. (1985) "Development of outdoor system for production of lipid-rich halotolerant microalgae." *Proceedings of the March 1985 Principal Investigators' Meeting, Aquatic Species Program*, Solar Energy Research Institute, Golden, Colorado, SERI/CP-231-2700, pp. 271-290.

Boussiba, S.; Vonshak, A.; Cohen, Z.; Richmond, A. (1987) "Development of outdoor system for production of lipid-rich halotolerant microalgae." *FY 1986 Aquatic Species Program Annual Report*, Solar Energy Research Institute, Golden, Colorado, SERI/SP-231-3071, pp. 184-198.

Richmond, A. (1984) "Development of outdoor system for production of lipid-rich halotolerant microalgae." *Proceedings of the April 1984 Principal Investigators' Meeting, Aquatic Species Program*, Solar Energy Research Institute, Golden, Colorado, SERI/CP-231-2341, pp. 184-185.

Shelef, G. (1984b) "Marine microalgae separation and harvesting." *Proceedings of the April 1984 Principal Investigators' Meeting, Aquatic Species Program*, Solar Energy Research Institute, Golden, Colorado, SERI/CP-231-2341, pp. 206-224.

Shelef, G.A.; Sukenik, A.; Green, M. (1984a) "Microalgae harvesting and processing: A literature review." *Report to the Solar Energy Research Institute*, Golden, Colorado, SERI/STR-231-2396.

Shelef, G.; Sukenik, A.; Sandbank, E. (1985) "Separation and harvesting of microalgae from saline media." *Proceedings of the March 1985 Principal Investigators' Meeting, Aquatic Species Program*, Solar Energy Research Institute, Golden, Colorado, SERI/CP-231-2700, pp. 244-270.





### **III.B.5. Design and Operation of a Microalgae Outdoor Test Facility (OTF) in New Mexico**

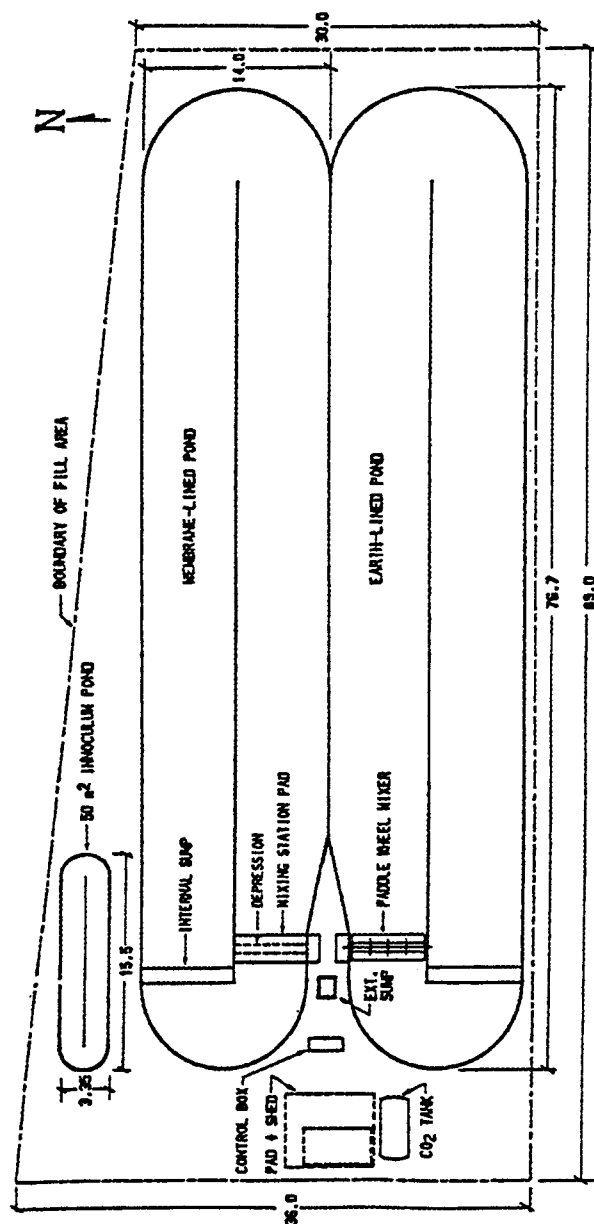
#### **III.B.5.a. Facility Design and Construction.**

After the above noted projects carried out in California, the ASP decided to hold a competition for the development of a larger process development outdoor test facility (OTF) located in the southwestern United States. Two independent designs and proposals were commissioned, one consisting of enclosed production units (Aquasearch, Inc., Dr. Mark Huntley, Principal Investigator); the other of open ponds, similar to the design tested in California (Microbial Products, Inc., J.C. Weissman, Principal Investigator). Microbial Products, Inc., won this competition, with a proposed facility consisting of two 1,000-m<sup>2</sup> ponds, one plastic lined and another unlined, as well as supporting R&D using six small, 3-m<sup>2</sup> ponds, continuing and extending the work carried out in the prior projects in California (Weissman and Goebel 1987. See Section III.D. for a discussion of this engineering /cost analysis. No report for the Aquasearch proposal is available.).

Although the proposal recommended establishing this facility in Southern California, the ASP selected a site in Roswell, New Mexico to establish the OTF. The project was located at an abandoned water research facility. Roswell has high insolation, abundant available flatland and supplies of saline groundwaters. The primary limitation of this site was temperature, which, in retrospect, turned out to be too low for more than 5 months of the year for the more productive species identified during the prior project.

The objective of the first year of the research at this new site was to initiate a species screening effort at this site with the small 3-m<sup>2</sup> ponds, which were installed while designing and constructing the larger facility. A major objective of this project was to identify cold weather-adapted strains (Weissman et al. 1987).

Building the large system required installation of two water pipelines of 1,300-m in length (15 and 7.5 cm, for brackish and fresh waters). The ponds were about 14 x 77 m, with concrete block walls and a central wooden divider. The paddle wheels were approximately 5-m wide, with a nominal mixing speed of 20 cm/s, and a maximum of 40 cm/s. Carbonation was achieved with a sump that allowed counterflow injection of CO<sub>2</sub>, to achieve high (90%+) absorption of CO<sub>2</sub>. One pond was plastic lined; the other had a crushed rock layer. The walls were cinder block. A 50-m<sup>2</sup> inoculum production pond was included. Figure III.B.9. shows an overview of the layout of the completed facility.



**Figure III.B.9.** Schematic of the microalgae OTF in Roswell, New Mexico.

(Source: Weissman and Goebel 1988.)



### III.B.5.b. First Year OTF Experiments

During the first year of the project (Weissman et al. 1988), all experimental work was carried out using the small ponds, which allowed essentially fully automatic operation and continuous dilution, as well as heating if needed. The objectives were to determine long-term productivity and stability for this site with previously studied and new species. Five of the strains inoculated into the 3-m<sup>2</sup> ponds were successfully cultivated, including two that derived from local isolates (one of which had invaded these ponds). Three of the culture collection strains could not be cultivated stably in the small ponds. Reproducibility of the experiments was tested, with the conclusion that differences between the different treatments should be judged significant only if these approached 20%.

Productivities in the summer month of August reached 30 g/m<sup>2</sup>/d for *C. cryptica* CYCLO1, but decreased to about half this level in September and October. At this point, *M. minutum* (MONOR2) was used, as this is a more cold-tolerant organism. By November productivity of MONOR2 fell to about 10 g/m<sup>2</sup>/d, and was very low (3.5 g/m<sup>2</sup>/d) in December in unheated ponds. Remarkably, despite these ponds freezing over repeatedly, the culture survived and exhibited some productivity. During August and September, productivities for CYCLO1 and *Amphora* sp. exhibited short-term excursions above 40 g/m<sup>2</sup>/d. Faulty data are not suspected.

A physical model of the pond environment developed by David Tillett at the Georgia Institute of Technology, combining climatic, design, operation, physico-chemical and biological process characteristics, was validated with temperature data from ponds in Roswell (see Section III.B.6).

The large-scale system was completed by the second year. Some problems were encountered: the spongy clay at the site did not compact well, resulting in an uneven pond bottom. This made it difficult to clean and drain the ponds, and resulted in settling and sedimentation of solids. Significant differences were noted between the lined (north) and unlined (south) ponds, in terms of mixing velocities, head losses, and roughness coefficients. In any case, power inputs at low mixing velocities (<30 cm/s) were relatively low (<0.1 w/m<sup>2</sup>). The efficiency of CO<sub>2</sub> injection into the ponds through the carbonation sumps (at approximately 0.6 to 0.9-m depth) was estimated at close to 90%. From the measured gas transfer coefficient, outgassing losses from the lined pond were estimated as approximately 10% depending on pH levels. Also, the unlined pond lost 0.3-0.4 cm/d more water due to percolation.

### III.B.3.c. Full OTF System Operations

Operation of the two large ponds (Weissman et al. 1989; Weissman and Tillett 1990, 1992) was initiated in August 1988. Ponds were inoculated with *T. suecica* and operated at relatively high mixing velocities (30 cm/s in the lined pond, 22 cm/s in the unlined pond) to reduce sedimentation. Productivities were only 11 and 10 g/m<sup>2</sup>/d, respectively, lower than in the small ponds, but with an unknown amount of algal biomass settling out. After loss of this alga, *M. minutum* was inoculated, and productivities were, again, somewhat lower in the larger than the smaller ponds.



Experiments were also carried out in the small pond, primarily to determine the best operating pH and pCO<sub>2</sub> range to help minimize CO<sub>2</sub> outgassing while maximizing productivity. At reduced CO<sub>2</sub> levels (higher pH) a decrease of 10% to 15% in productivity was observed with three algal species tested. Another variable tested was a 2- versus 3-day dilution routine, which had no significant effect. In addition, six cultures were examined for productivity in Si- or N-deficient media. Only one strain exhibited significantly higher total (AFDW) productivities with nutrient deficiency, but no lipid data were collected.

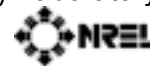
The conclusions from this work were, in brief:

1. Power for pond mixing is within the expected range, and quite low (<1 kW/ha).
2. Pond mixing should be in the 15-25 cm/s range, and pond depth 15-25 cm.
3. CO<sub>2</sub> utilization efficiencies of near 90% overall should be achievable with little compromise of productivity, through operation at an optimal pH/pCO<sub>2</sub> range.
4. Only preliminary 1,000-m<sup>2</sup> pond operations were carried out during this year, hampered by design and operational problems, which lowered expected productivities.
5. Large-scale pond productivities of 70 mt/ha/yr are realistic goals for this process, though probably not at this site because of low seasonal productivities.
6. Very high, 50 g/m<sup>2</sup>/d, single day, productivities were observed on some occasions.
7. The small-scale ponds can be used to screen strains and optimize conditions.

The final report (Weissman and Tillett 1992) in this series on the New Mexico OTF operations, reported on the demonstration of productivity for the two large ponds for 1 full year, continuation of the small-scale pond operations, and improvements in mixing and carbonation. One major improvement in the system was an automated data recording and operations system.

Mixing was improved by improving the flow deflectors and increasing operating depths from 15 to 22.5 cm, which is probably a better depth for large-scale systems. Culture instability was a problem, particularly in spring because of greater temperature fluctuations, and resulted in low average productivity of only 7 g/m<sup>2</sup>/d for March through May. In contrast, the average productivity was 18 g/m<sup>2</sup>/d for June through October, decreasing to 5-10 g/m<sup>2</sup>/d in November (depending on onset of cold weather), and only about 3 g/m<sup>2</sup>/d in the winter months.

Overall productivity, including 10%-15% down-time for the ponds for repairs and modifications, was 10 g/m<sup>2</sup>/d, only one-third of ASP goals (Table III.B.3.). Clearly the major limiting factor was temperature, as smaller systems in warm climates have achieved annual yields two to three



times as high. A major conclusion from this work is that scale-up is not a limitation with such systems. Climatic factors are the primary ones that must be considered in their siting.

A countercurrent flow injection system was installed in the sumps resulting in a carbonation system that was essentially 100% efficient in CO<sub>2</sub> transfer. Overall CO<sub>2</sub> utilization was higher than 90%. The unlined pond performed nearly as well as the lined pond, with minor decreases in productivity (10%-20%), CO<sub>2</sub> utilization efficiency (5%-10%) and a small increase in mixing power. The unlined pond consumed only 0.04 w/m<sup>2</sup>, allowing the entire 1,000-m<sup>2</sup> pond to be powered by the equivalent of a 40-w light bulb. Species stability in the lined and unlined pond exhibited no significant difference. This work clearly established the feasibility of using unlined ponds in microalgae cultivation. This was a critical issue, as plastic lining of ponds is not economically feasible for low-cost production.

In the small 3-m<sup>2</sup> systems, two variables were investigated: Si supply and pH. Both are major cost factors in pond operation, due to sodium silicate costs and CO<sub>2</sub> outgassing. They affect overall productivity as well as lipid production. For *Cyclotella*, for example, productivity was about 20 g/m<sup>2</sup>/d at pH 7.2 or 8.3, but only 15 g/m<sup>2</sup>/d at pH 6.2. As the higher pH range is preferred, where CO<sub>2</sub> outgassing is minimal, this demonstrates the feasibility of operating such cultures within the constraints of a large-scale production system. Si additions could be halved with only a modest decrease in productivity, suggesting that Si supply could be reduced, particularly if low Si-containing diatoms are cultivated. Also Si limitation can be used to induce lipid production, as was demonstrated during this project, with lipid biosynthesis increasing as soon as intracellular Si content dropped, with a 40% lipid content being achieved. However, overall, lipid productivity did not increase as CO<sub>2</sub> fixation limitation also set in. This remains as a major issue for the future (See also Section III.B.5.d.).

### Table III.B.3. Long Term OTF Results from 0.1-Ha Raceways.

(Source: Weissman and Tillett 1990.)

Pond Liner	CO <sub>2</sub> use (std.m <sup>3</sup> /d)	Dates	Productivity (gm afdw/m <sup>2</sup> /d)	Carbon Use Efficiency	Water Loss
YES	15.2	10/1/88-9/30/89	9.8	59	5.7 mm/d
NO	13.4	10/1/88-9/30/89	8.3	50	6.2 mm/d
NO	14.6	10/1/89-9/30/90	10.5	82	
YES	22.0	6/1/90-10/30/90	19	81	
NO	19.2	5/1/90-9/30/90	18	88	

Notes: std m<sup>3</sup>/d: standard cubic meters per day.

gm/afdwm<sup>2</sup>/d: grams of ash-free dry mass per square meter per day.

Pond liner: **YES** indicates a plastic lined pond; **NO** indicates an unlined (dirt bottom) pond.



#### III.B.5.d. **Conclusions**

The performance of the large-scale system improved considerably in all aspects during the 2 years of operations. The parallel use of the smaller-scale ponds helped guide this research, in particular in selecting algal strains and identifying operating characteristics. The high CO<sub>2</sub> utilization efficiency demonstrated in the small and large-scale ponds was another major accomplishment of this project.

The major limitation of this project was the overall low productivity in the large-scale ponds. This was due in large part to the adverse climatic conditions at this location, and the initial suboptimal nature of the large-scale pond operations. Even so, productivities were lower than anticipated, with annual average productivities only about one-third the projected productivities by the ASP that would be required for minimal economics (see Section III.D.). This must be a major ongoing objective for future research, first in terms of overcoming the lower temperature limitations on productivity, and second by relocating this type of process development to more favorable climatic sites. (See Section III.B.6. for a discussion of temperature effects.)

But perhaps the major limitation of this project was that it did not carry out a longer-term process development effort. Although 2 years of data were collected for the large-scale ponds, the rapid advances made suggested that further research would have allowed continued improvements in performance and increased understanding of the overall process in specific critical areas of culture maintenance.

The engineering evaluation of the operation of the 0.1-ha raceway ponds showed these systems to be potentially very efficient in terms of energy, water, nutrient and CO<sub>2</sub> utilization, and even basic construction cost inputs. Most important, the absence of liners did not significantly reduce pond performance (e.g., productivity). This was a major observation of this project, giving greater confidence in the engineering analysis and cost projections carried out by the ASP and DOE, discussed again in Section III.C.

A major uncertainty in this project was the nature of the species control achieved. A review of the data would suggest considerable success with species control, with several species cultivated successfully for relatively long periods. However, considerably more research will be required on this subject, as the tools were not available to allow a closer study of possible population dynamics (e.g., strain selection and even replacement) within the ponds. Thus, the subject of species control still requires considerable effort, as discussed further in the following section.

#### *Publications:*

Weissman, J.C.; Goebel, R.P. (1987) "Design and analysis of pond systems for the purpose of producing fuels." *Report to the Solar Energy Research Institute*, Golden, Colorado, SERI/STR-231-2840.



Weissman, J.C.; Tillett, D.T. (1989) "Design and operation of an outdoor microalgae test facility." *Aquatic Species Program, Annual Report* (Bollmeier, W.S; Sprague, S., eds.), Solar Energy Research Institute Golden Colorado, SERI/SP-231-3579, pp. 41-57.

Weissman, J.C.; Tillett, D.T. (1992) "Design and operation of an outdoor microalgae test facility: large-scale system results." *FY 1989-1990 Aquatic Species Project Report*, National Renewable Energy Laboratory, Golden, Colorado, NREL/MP-232-4174, pp 32-56.

Weissman, J.C.; Tillett, T.D.; Goebel, R. (1987) "Design and operation of an outdoor microalgae test facility." *FY 1987 Aquatic Species Program, Annual Report* (Johnson, D.A.; Sprague, S., eds.), Solar Energy Research Institute, Golden, Colorado, SERI/CP-231-3206, pp. 231-250.

Weissman, J.C.; Tillett, D.T.; Goebel, R.P. (1989) "Design and operation of an outdoor microalgae test facility." *Final Report to the Solar Energy Research Institute*, Subcontract XK-7-06113-1.

### **III.B.6. The Effects of Environmental Fluctuation on Laboratory Cultures**

#### **III.B.6.a. Species Control and Productivity**

In the time frame between the end of the California projects and before initiation of the Roswell project, John R. Benemann and Dr. David Tillett carried out a research project in support of these outdoor pond projects (Benemann and Tillett 1987, 1990). This project included studies of the effect of nutrient limitations, specifically N and Si, on lipid induction, the effects of fluctuating conditions (temperatures, O<sub>2</sub>, light) on culture dominance and productivity, and the development of a mathematical model of the algal pond environment. That "Algal Pond Model," (APM) could be used in designing experimental protocols and predicting culture performance.

A basic premise of this project was that the algal pond environment experienced by microalgal cells is characterized by relatively consistent and predictable fluctuations in a rather limited set of variables, specifically light intensity, temperature, pH/pCO<sub>2</sub>, and pO<sub>2</sub>. The first two are essentially uncontrolled, although somewhat predictable, variables. The second two factors are consequences of light and temperature, as well as the pond chemistry and hydraulics (outgassing), and algal productivity. Further, it was argued that some of these variables, such as the last three, could be well modeled, based on mass and heat balances and algal growth models.

One uncertainty is whether short-term (<0.1 h) light fluctuations caused by pond mixing, can be averaged over the time scales of interest (>1 h). With this assumption it would be possible to predict, and reproduce on a small-scale, the key environmental parameters of outdoor ponds to which microalgae likely would respond, determining productivity and culture stability.



Such “down-scaling” of parameters, as summarized in Table III.B.4., would allow more realistic modeling at the laboratory, or very small outdoor scale, of the conditions encountered by microalgae in large-scale ponds. And it would allow, in turn, more controlled and easily interpretable experiments on species productivity and even dominance. As one of its objectives, and in collaboration with the prior studies (Section III.B.5.; Weissman and Tillett 1989, 1992), this project resulted in the development of an APM. Many experiments were also conducted on species growth responses and competition under fluctuating environmental conditions. Finally, lipid productivity was investigated under conditions of nutrient limitation.





**Table III.B.4. Scale down parameters for microalgae culture.**

Feasibility of scaling pond environmental parameters to laboratory reactors.

(Source: Benemann and Tillett 1987.)

Quantity	Formula	Example*
X, aver. hourly prod. g/m <sup>2</sup> .hr	--	1.5
X <sup>P</sup> , peak hours prod. g/m <sup>2</sup> .hr	--	5
d, pond depth, cm	--	20
A, pond area, m <sup>2</sup>	--	200
Q, wt. fraction of C in algae	--	0.5
F, flow of CO <sub>2</sub> (ft <sup>3</sup> )/hr	--	50
E, carbonator efficiency	--	0.5
T, temp., °C	--	25
Peak hourly demand, m moles C/L.hr	8.3 QX <sup>P</sup> /d	1.0
Aver. hourly demand, m moles C/L.hr	8.3 QX/d	0.3
CO <sub>2</sub> influx, m moles C/L.hr	126.4 EF [298/(273+T)]/ad	0.8
V, linear mixing speed, cm/sec	--	10
L, pond length, m	--	30
R, recirculation time, hr	T = .056L/V	.16
ΔC, CO <sub>2</sub> influx/carbonation pas	(CO <sub>2</sub> influx) R	.07
pH av	--	8.0
A, alkalinity, meq/L	--	10
ΔpH	(f (pH avg A)	0.3



### III.B.6.b. The Algal Pond Growth Model.

The APM (Benemann and Tillett 1987, 1990; Tillett 1989) describes a shallow, paddle wheel-mixed pond system. It incorporated climatic, design, operational, physicochemical, and biological parameters and submodels to predict the pond, and algal culture, behavior. Simplifying assumptions in the model include the following:

- the pond exhibited no nutrient, biomass or temperature inhomogeneities (e.g., gradients),
- mixing was essentially plug flow for large systems and mixed tank behavior for smaller ones,
- CO<sub>2</sub> and O<sub>2</sub> outgassing can be estimated from measured gas transfer coefficients, and
- evaporation was 1.5 times pan A evaporation data, for example.

Climate input parameters were obtained from local U.S. climate stations in machine-readable form, including daily data on air temperatures (diurnal), relative humidity, rainfall, wind speed and total solar radiation. These data were then averaged over several years to provide daily and monthly average data sets. The use of such climate data is critical for predicting pond conditions at a particular site and location. Design variables included pond area, depth, mixing velocity, and length-to-width ratios. Physical inputs were the alkalinity of the media, the starting and ending pH for the carbonation station, and the outgassing coefficient. Finally, for a biological parameter a productivity assumption (from 20-40 g/m<sup>2</sup>/d, or a % maximum sunlight conversion efficiency) was used, along with C content, O<sub>2</sub> yield, heat of combustion, and saturating light intensity for photosynthesis (assuming simple light saturation, and application of the Bush equation).

The model included an energy balance (input sunlight, radiation, evaporation, air temperatures, etc.), which continuously predicted the pond temperature, based on pond depth, and ambient conditions. From the productivity assumption (on a diurnal basis) and a CO<sub>2</sub> outgassing coefficient for the ponds, the total inorganic C balance can be calculated based on alkalinity and pH as the major determinants of inorganic C in ponds. Like CO<sub>2</sub> (and pH, etc.), O<sub>2</sub> is also dependent on productivity, and outgassing. The model was written in Fortran (Tillett 1989).

The model was validated at the Roswell test site, with the 3-m<sup>2</sup> ponds, which were instrumented (for pH, DO, wind, air temperature, etc.) and a data acquisition system developed to obtain short- (< 1h) and long- (>1 d) term data. The model was also validated with the larger ponds. Measured and predicted pond temperatures agreed well, as seen in Figure III.B.10a for a diurnal data set for a heated and unheated small pond, and Figure III.B.10b for a single unheated pond for 2 weeks.

Simulations were also run for a larger, 1,000-m<sup>2</sup> earthen pond as built at Roswell (an arid and cool climate), which were then compared with a site in West Palm Beach, Florida (a humid,



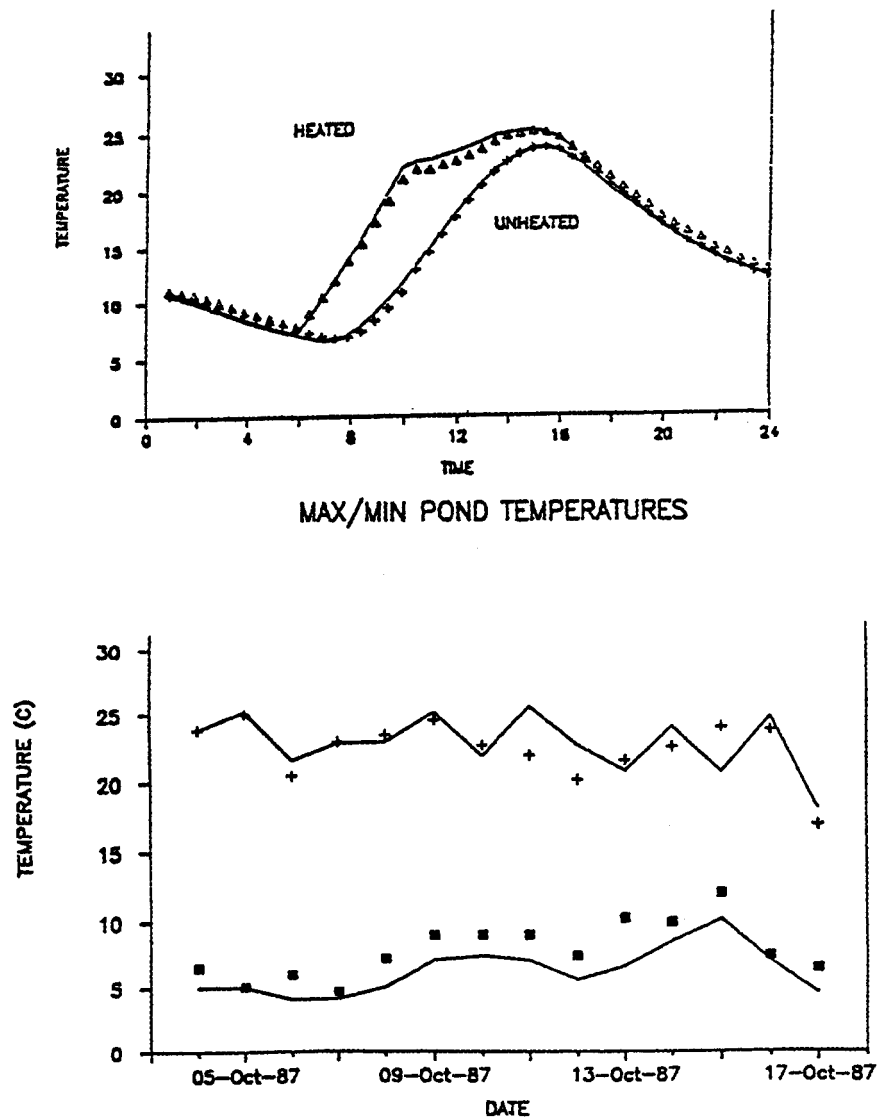
warm climate), using monthly average climate data. The model was exercised for 4 representative months of the year for both locations, and assuming ponds of 10, 20, 30 and 100-cm depth. (This last point was to demonstrate the limited effect of managing pond temperature extremes by depth.) Minimum water temperatures do not rise above 10°C for shallow ponds for most of the year in Roswell; they never drop below this level in West Palm Beach. Maximum summer temperatures seem to be only modestly higher in Florida than in New Mexico. These results point to low temperatures as a major factor in Roswell operations.

Only a limited attempt was made to verify the model in relation to productivity, by using a fitted  $I_k$  (saturating light intensity) parameter, as well as an assumed heat of combustion (5.7 Kcal/g) and biochemical conversion efficiency (from prior work by Weissman and Goebel 1987). Although the agreement between calculated and measured productivities was excellent (both gave about 15.3 g/m<sup>2</sup>/d), this was probably fortuitous, as the  $I_k$  actually used in the model was well below what had been previously measured with the same organism (*Monoraphidium* sp.). This requires further investigation.

One interesting use of the model was to predict CO<sub>2</sub> utilization and outgassing from various assumed pH, pCO<sub>2</sub> and alkalinity regimes. This is a central issue in the operation of algal pond systems, as these parameters must be used to optimize for productivity and overall CO<sub>2</sub> utilization efficiencies. The higher the pH and the lower the alkalinity, the greater the utilization efficiency. However, for CO<sub>2</sub> supply, pH must be decreased transiently. With moderate alkalinity (2.5-5 mM), and CO<sub>2</sub> requirements, the pH transients can be relatively small, allowing minimal outgassing even for seawater systems, resulting in predicted CO<sub>2</sub> use efficiencies of over 85%.

A final important parameter is dissolved O<sub>2</sub>, which was predicted to accumulate within 1 hour to a level of 210% of air saturation with a 30-cm deep culture and a productivity of 30 g/m<sup>2</sup>/d. Much higher concentrations would build up during the day, and are actually observed in ponds. This could be a major factor in reduced productivities in ponds (see Section III.B.5.).

This model is of sufficient detail and predictive value to minimally direct the laboratory and small-scale outdoor research in making these more representative of the outdoor pond environments. Laboratory applications are discussed in the following section.



**Figure III.B.10.** Comparison of measures and predicted pond temperatures in Roswell, New Mexico.

a.). Top: Comparison of measured and predicted diurnal temperature profiles for heated and unheated ponds. October 4, 1987.

b.). Bottom: A comparison of predicted (line) versus measured (symbols) maximum-minimum temperatures in miniponds using simplified inputs for Roswell, N.M.



### III.B.6.c. Microalgae Competition under Fluctuating Conditions in the Laboratory

A major issue in microalgae mass cultures is the understanding of the factors that determine species dominance. A considerable theoretical background can be gleaned from the ecological and ecophysiological literature, where this problem, as it applies to lotic systems (ponds, lakes, rivers, oceans) is the subject of an enormous literature (briefly reviewed in Benemann and Tillett [1987]). Fundamental to this is Hutchins' so-called "Paradox of the Plankton." Hutchins pointed out the fact that only a limited number of nutrients could limit algal growth, and thus, applying Liebig's Law of the Minimum, only a limited number (one per nutrient) of algal species that should be able to compete in any environment. Rather, we find literally hundreds, if not thousands of species and uncountable strains in even the smallest and most uniform of environments. Indeed, even Hutchins did not realize the greatness of microbial biodiversity in nature, hinted at by earlier work in clonal variations (See Section II.B.), but only recently revealed in ever-increasing detail using modern tools of molecular phylogenetics. The solution to the Paradox is that natural environments are not steady-state systems, but are exposed to periodic and random fluctuations in physical-chemical (let alone biotic) environmental parameters. These fluctuations allow for additional niches, allowing for organisms specialized in the exploitation of particular temporal combination of limiting factors. Also, non-steady-state conditions would select for different species and strains. For example, in a continuous cultivation using natural samples for inoculum into enriched media, the first algal species to appear and dominate are soon replaced by other species, which are slower growing but better at exploiting a light-limited (dense culture) environment.

Continuous algal cultures in 1-L vessels were set up in the laboratory, which allowed operations under fluctuating conditions of temperature, O<sub>2</sub> concentrations, and pH. In these experiments, several algal strains were inoculated together, then productivity and species dominance were observed for as long as 3 weeks (over 10 dilution times). In initial experiments, *Chlorella* and *Chaetoceros* co-dominated; *Cyclotella* was lost or greatly diminished, possibly because of different light spectral use of the two types of algae (greens and diatoms). Many other experiments were carried out, with fluctuating pH, dilution rates, and light intensities and even gas sparger types on the dominance of these and one additional algal strain (*Ankistrodesmus*). All these factors tended to affect species dominance, even the gas sparger, and the results were not clearly interpretable in terms of major dominance factors. One conclusion from these initial experiments was that several factors, alone and in combination, can determine species dominance.

### III.B.6.d. Lipid Productivity of Microalgae

The most fundamental assumption in microalgae biomass production for biodiesel fuels is that it will be possible to achieve near theoretical solar conversion efficiencies by overcoming the light saturation effect (see Section IV.A.2.c. for a brief discussion). The second most fundamental assumption is that it will be possible to achieve such very high productivities with microalgae cultures high in oils, approaching or even exceeding 50% of lipids by dry weight. This second assumption was tested by this project.



The concept of producing microalgae with a high oil content goes back almost 50 years, to work carried out, and even patented, by Sphoer and Milner (1949), who reported oil contents as much as 80% of the dry weight. Lipid content is affected by many parameters, but most particularly by N (and, for diatoms, Si) limitation, which can result in extraordinarily high lipid contents. However, it appeared from earlier work, and also from a survey of 30 species by Shiffrin and Chisholm (1981), that total productivity declined sharply upon nutrient limitation, resulting in a decline in total lipid productivity, although lipid content increased as a percentage of the cell mass. However, a re-analysis of the data suggested that the evidence for this was not clear-cut, as only rather widely spaced data points had been collected. In fact, an essential assumption in this field is that a “lipid trigger” activates lipid biosynthesis without necessarily reducing photosynthesis, at least for a transitory period (see Section II).

The experimental approach was to first grow the algal cultures under nutrient sufficiency and then to induce deficiency during batch cultivation, using light (single versus two-sided illumination of the 1-L flasks) as a second variable. In continuous cultures, the growth rates and cellular N contents were dependent on illumination, and there was only a modest increase in lipid content with decreasing cellular N content, with lipid culture productivity maximal at about 5% N biomass. The key experiment was the up-shifting of the light received by the culture (e.g., from single- to double-sided illumination). The results are shown in Figure III.B.11., which demonstrate that cells shifted to a higher light intensity start growing (AFDW increases) at the rate of the higher light level cultures. However, lipid productivity shoots up to a much higher rate than with either of the steadily illuminated cultures. In practical terms, this could be exploited by diluting cultures for lipid induction. This experiment demonstrated the possibility of producing high lipids content by nutrient limitation while achieving a substantial increase in overall lipid productivity. Experiments with continuously diluted cultures, however, did not exhibit such responses, indicating the necessity to carefully control and modulate conditions to maximize lipid production.

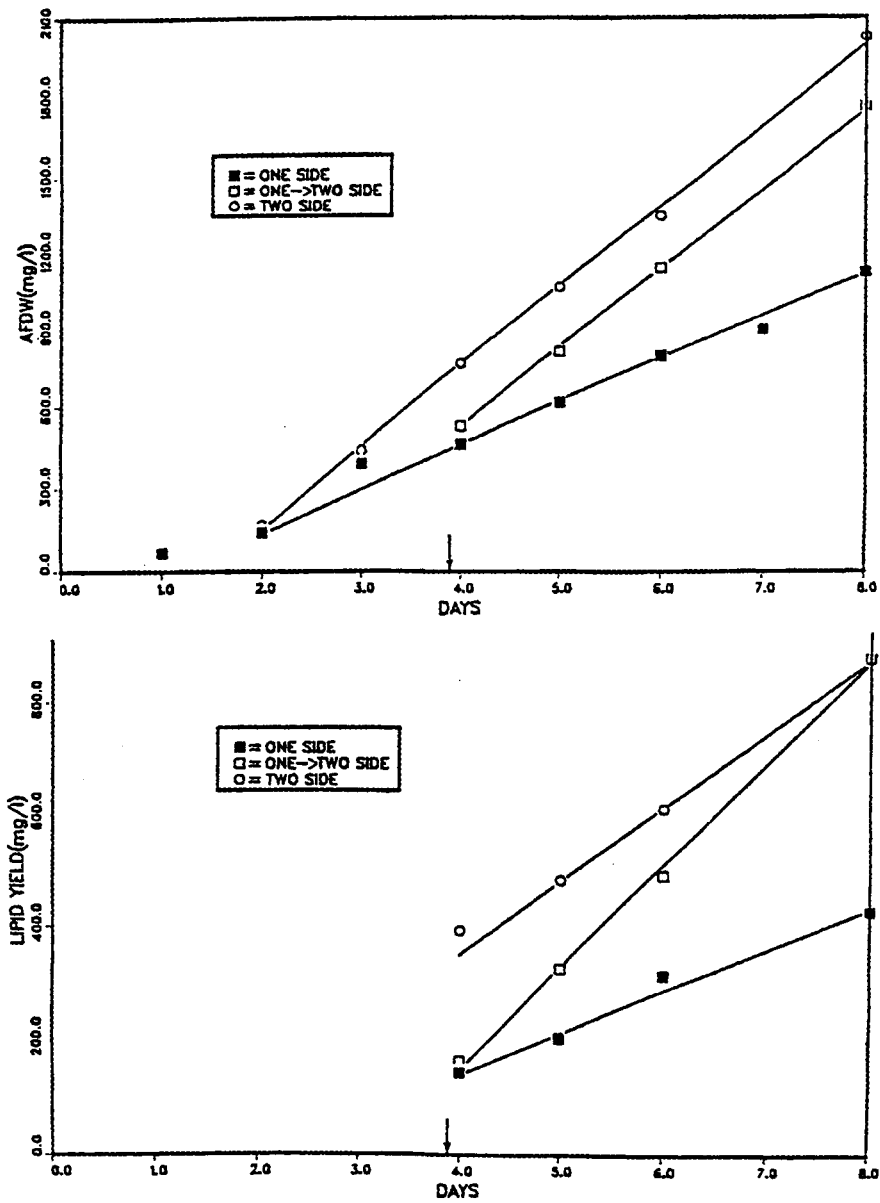


Figure III.B.11. Maximizing lipid productivity light shift-up.

A. Top. Biomass yield during light shift.

B. Bottom. Lipid yield during light shift.

(Source: Benemann and Tillett 1987.)



### III.B.6.e. Competition Studies with Continuous and Semicontinuous Cultures

A key underlying assumption in this work was that monoculture productivity is an indicator of competitiveness in mixed cultures. That is, the most productive culture will also be the most competitive. Another assumption is that productivity and competitiveness will be affected by fluctuations in environmental variables and cannot be predicted from single parameter variations or steady-state operations. Testing these hypotheses was a central objective of these experiments, which were carried out with continuous and then semicontinuous (once a day dilution) laboratory cultures (1-L bottles).

The continuous cultures were used to test productivity of several strains under simulated outdoor conditions (approximately sinusoidal diurnal temperature changes from 15°-32°C overnight, a 14-h constant light period, 0.6-0.7 d<sup>-1</sup> dilution, and 6-h gassing with pure O<sub>2</sub> rather than air). As in earlier studies, *Chlorella* and *Monoraphidium* exhibited higher productivities (250-300 mg/L/d) than the other strains tested (*Porphyridium*, *Ankistrodesmus*, and *Chaetoceros*, with some 150-200 mg/L/d productivity). Under constant conditions, similar ranking and differences were observed between the three fastest-growing strains. Mixed culture experiments between *Chlorella* and *Chaetoceros* were then carried out, with the results comparing fairly well with the APM results (Section III.B.6.b.). Figure III.B.12. shows experiments in which a 90/10 *Chaetoceros/Chlorella* mixed inoculum grew in continuous cultures, with cell species changing faster experimentally than in the model, which, however, predicts the overall trend. Overall results with these strains were in accord with prior experience (Weissman and Goebel 1985, 1988).

However, the continuous cultures proved logistically and experimentally very difficult, and the experimental design was switched to a simpler, once a day (before dawn), dilution. Fluctuating conditions were achieved primarily by timers and actuators (e.g., for O<sub>2</sub> versus air supply, for temperature control in the water baths). This allowed greater reproducibility and simultaneous operation of many more cultures, as many as 16 in four water baths, allowing collection of an extensive data set. The effects of constant versus fluctuating temperature, pO<sub>2</sub>, and light, on culture productivities and dominance in mixed cultures were studied. In summary, the overall result was that fluctuating temperature and other conditions had major effects and were different from those at constant temperature. Also, growth responses for unialgal cultures can predict the outcome of species competition experiments. Still, much more experimental work is required on these problems.

#### Publications:

Benemann, J.R.; Tillett, D. (1987a) "Effects of fluctuating environments on the selection of high yielding microalgae." *FY 1986 Aquatic Species Program Annual Report*, Solar Energy Research Institute, Golden, Colorado, SERI/SP-231-3071, pp. 285-300.





Benemann, J.R.; Tillett, D.M. (1987b) "Microalgae lipid production." In *Energy from Biomass and Wastes XI, Conference Proceedings*, (Klass, D.L., ed.), Institute of Gas Technology, Chicago.

Benemann, J.R.; Tillett, D.M. (1987c) "Effects of fluctuating environments on the selection of high yielding microalgae." *Final Report, Subcontract XK-4-04136-06*, Solar Energy Research Institute, Golden, Colorado.

Benemann, J.R.; Tillett, D.M. (1987d), "Effects of fluctuating environments on the selection of high yielding microalgae." *FY 1987 Aquatic Species Program Annual Report* (Johnson, D.A.; Sprague, S., eds.), Solar Energy Research Institute, Golden, Colorado, SERI/CP-231-3206, pp. 77-91.

Benemann, J.R.; Tillett, D.M. (1990) "Effects of fluctuating environments on the selection of high yielding microalgae." *Final Report, Subcontract XK 4-04136-06*, Solar Energy Research Institute. Golden, Colorado.

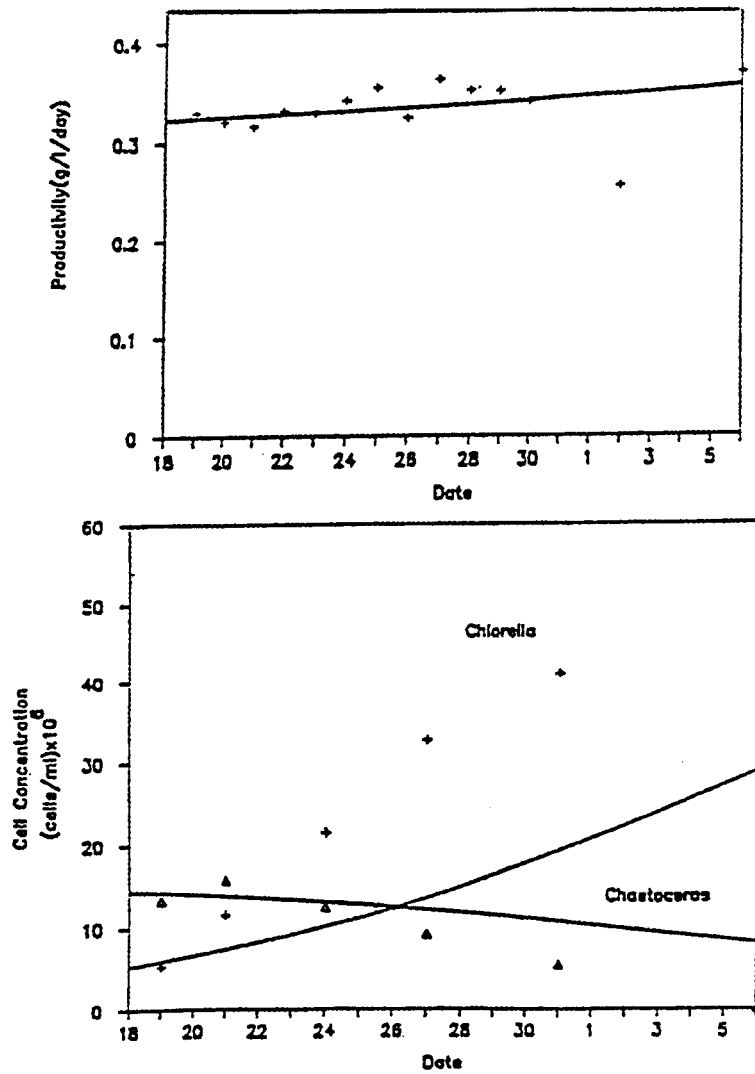
Benemann, J.R.; Tillett, D.M.; Weissman, J.C. (1987) "Microalgae biotechnology." *Trends in Biotechnology* 5:47-53.

Shifrin, N.S. (1984) "Oils from microalgae." In *Biotechnology for the Oils and Fats Industry* (Ratledge, C., et al., eds.), AOCS monograph 11.

Shifrin, N.S.; Chisholm, S.W. (1981) "Phytoplankton lipids: interspecific differences and effects of nitrate, silicate and light-dark cycles." *J. Phycol.* 17:374.

Sphoer, H.A.; Milner, H.W. (1956) "Production of protein, lipids and carbohydrates by cultures of algae." U.S. Patent 2,732,661.

Spoehr, H.A.; Milner, H.W. (1949) "The chemical composition of *Chlorella*; effect of environmental conditions." *Plant Physiol.* 24:120.



**Figure III.B.12.** Species competition between *Chaetoceros* and *Chlorella* in continuous cultures.

Mixed culture results for a 90/10 cell density mixture of *Chaetoceros* and *Chlorella*.

a.) Top: Culture productivity.

b.) Bottom: Species cell concentration (solid line represents model predictions).

(Source: Benemann and Tillett 1990.)



### III.C. Resource Analyses

#### III.C.1. Introduction

One major concern of the ASP, as for any renewable energy option being developed by DOE, is the resource potential for the technology. How large an impact will it have on future U.S. energy supplies, or, in today's units, fossil CO<sub>2</sub> or equivalent greenhouse gas reduction potential? This is required both by the mission of the DOE as well as the inherent need to justify budgetary decisions. However, potential contributions to fuel supplies should be only one, albeit an important, parameter in such an assessment. Other factors must also be considered, such as economics, time frame for implementation, and the possibility of success for the R&D effort. If large resource potential is the main criterion, this could result in focusing too many resources on a few technologies with a low probability of succeeding in practice.

Microalgal biodiesel is one of many different biomass energy options, extending from co-firing of wood in power plants to energy farms and a myriad of fuel conversion options (Hughes and Benemann 1997). One important attribute of microalgae systems is that they need not compete with other biomass alternatives, but must be able to use water and land resources generally not considered for crop production. Also, microalgae fuel production systems could meet other objectives, from waste treatment to salinity management. Resource potentials are important, and have been studied extensively by the ASP.

The ASP emphasized the production potential of microalgae in the southwestern United States. This choice was based in large part on the perspective that this area offered the best and largest resource potential for algal culture systems, including available saline water supplies, land area, sunlight, and CO<sub>2</sub> sources. Each of these resources individually was projected to have a potential of many quads (10<sup>15</sup> Btu) of energy, and overall potentials of several quads were projected (e.g., Chelf and Brown 1989). This certainly justified the emphasis by the ASP on this geographical area. In fact, a significant activity of the ASP was to document this resource potential. It was not a trivial task to assess these resource potentials. This required the development of suitable assessment techniques. This was a major accomplishment of the ASP, as reviewed in this section. However, estimating an actual resource potential is not a simple matter, as the juxtapositions of the requirements for microalgae production—water, land, CO<sub>2</sub>, and climate—are very difficult to quantitate, and would greatly reduce the resource potential estimated from single factor analyses.

#### Publications:

Hughes, E.; Benemann, J.R. (1997) "Biological fossil CO<sub>2</sub> mitigation." In *Proc. of the 3rd Int. Conf. on CO<sub>2</sub> Capture, Disposal and Reuse Utilization*, ICCDR-3, Mass. Inst. Tech., September 1996 (in press, 1997).



### III.C.2. The Battelle Columbus 1982 Resource Assessment Report

This report (Vignon et al. 1982), commissioned by the ASP, was the first comprehensive discussion of the resource requirements for microalgae production. It covered the criteria that should and could be used to identify available water, land and other resources, to estimate their relative importance, and to evaluate various legal, institutional, and other resource constraints. These issues were discussed at some length, focusing on the southwestern United States, although most of the discussion was of a rather general nature. For example, land and water rights issues are addressed, which are certainly important, but are difficult to extrapolate over large areas. Similarly, permits for such facilities will be very important, but will also involve site specific considerations.

The authors calculated various costs and energy inputs for water (seawater) pumping and transportation to arrive at permissible lift and distance criteria for water resources. Water lifting of some 75 m and pipeline distances of 6 km, with an approximately 1-m diameter pipeline, were estimated to cost about \$31 million for a 400-ha system. This estimate for water supply is as high as later estimates for the total cost of building and operating an entire microalgae production system (see Section III.B.5.), which puts some perspective on the limits of lift and distance for water supplies. This report did not arrive at a prediction for the resource base, but was an important early introduction to the complexities of such resource assessments.

#### Publications:

Vigon, B.W.; Arthur, M.F.; Taft, L.G.; Wagner, C.K.; Lipinsky, E.S.; Litchfield, J.H.; McCandlish, C.D.; Clark, R. (1982) "Resource assessment for microalgal/emergent aquatic biomass in the arid southwest." *Battelle Columbus Laboratory Report*, Solar Energy Research Institute, Golden, Colorado.

### III.C.3. The 1982 Argonne Study of CO<sub>2</sub> Availability

This report (Nelson 1982) was the first analysis of the availability of CO<sub>2</sub> specifically for microalgal mass culture. There was, and still is, considerable interest in CO<sub>2</sub> sources for EOR (enhanced oil recovery). Thus, a significant body of literature had developed in the preceding 5 years, particularly for the southwestern United States, where several small pipelines were built to deliver CO<sub>2</sub> for EOR. One study even considered the production of CO<sub>2</sub> from a power plant flue gas for such a purpose. The Argonne report concluded that there would be little extra available CO<sub>2</sub> for microalgae production until the time for EOR had passed, about the year 2020. Of course, since then declining oil prices, and increasing interest in CO<sub>2</sub> mitigation, have changed this situation. The report also concluded that flue gas sources would be a poor source for CO<sub>2</sub> for the microalgae ponds, as power plants were not generally located in a suitable area for microalgae cultivation. The authors also concluded that the delivery of pure CO<sub>2</sub> would be expensive, even after CO<sub>2</sub> became available after the EOR era.



*Publications:*

Nelson. (1982) “An Investigation of the availability of carbon dioxide for the production of microalgae lipids in the southwest.” *Report to the Argonne National Laboratory*, unpublished.

#### **III.C.4. The 1985 SERI Resource Evaluation Report**

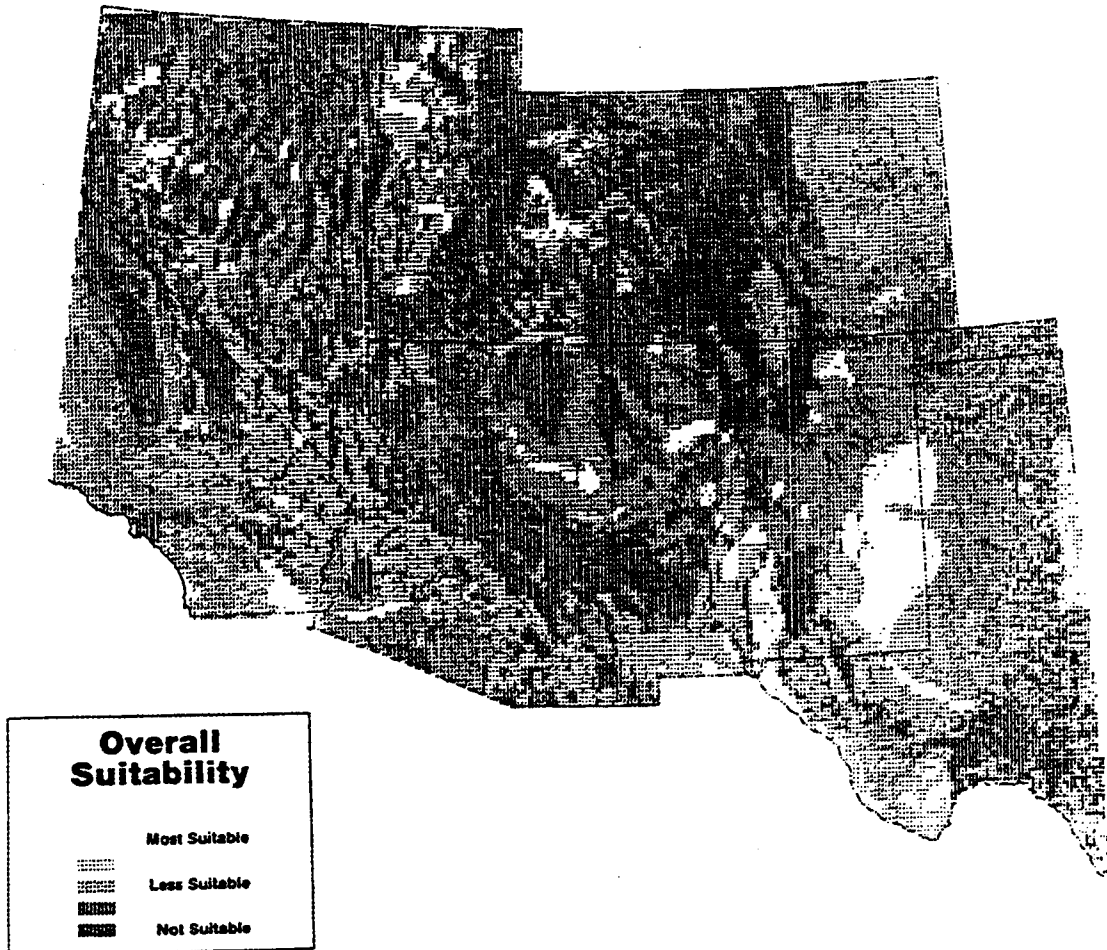
This study (Maxwell et al. 1985) assessed the availability and suitability of land, brackish water resources, and climate in the southwestern United States. The objective was to “stratify the Southwestern United States into zones of varying suitability for such [microalgal] systems.” The Battelle Columbus report discussed earlier (Vignon et al. 1982) was identified as a companion effort, although it was “not directly supportive of the stratification effort...” Climate, land resources, and water resources maps based on various process constraints and characteristics (e.g., freeze-free period, land slope, water depth) were overlaid to develop suitability maps. Because of insufficient water data, water supply was excluded from the final analysis. Available maps were also inadequate for land classification for slopes <10%.

This report includes an excellent discussion of the sources of maps and information about water, water rights, land ownerships, slopes, topography, climate, etc. Of course, in the dozen (or more) years since this research was carried out, the computer revolution has made access to this data easier or at least different. The report provides a very comprehensive review of the problem, and supplies a large amount of specific information. One interesting point is that microalgae systems will likely encroach on pasture and non-irrigated agricultural land; much of this land has low productivity and value, but is generally accessible and already generally serviced by roads and power.

A relative productivity map was developed for the southwestern United States, by combining frost-free days with insolation values. Many other such maps, including land suitability and water availability, were prepared, including a final overall suitability assessment (Figure III.C.1.). The authors proposed continuing such an assessment, pointing out the many limitations of the present study (such as water laws and rights issues) that required further studies. However, a point of diminishing returns is likely to be reached. It may be best to evaluate some very specific areas, even sites, for actual suitability for such a process. Indeed, any generic analysis may miss important details. For example, as indicated in Section III.B. from the experience at Roswell, New Mexico, that location is quite unsuitable for microalgae production, due to its short (approximately 200-day) growing season, although it appears in the overall suitability map (Figure III.C.1.). This was likely due to insufficiently restrictive temperature criteria (freeze-free days, etc.).

*Publications:*

Maxwell, E.L; Folger, A.G.; Hogg, S.E. (1985) “Resource evaluation and site selection for microalgae production systems.” *Report*, Solar Energy Research Institute, Golden, Colorado, SERI/TR-215-2484.



**Figure III.C.1.** Overall suitability map for microalgae culture in the Southwestern United States.

Zones of relative suitability for microalgae biomass production based on compositing of climate, land and water suitability maps. (Source: Maxwell et al. 1985.)



### III.C.5. The 1990 SERI Study on CO<sub>2</sub> Sources

The objective of this study (Feinberg and Karpuk 1990) was to examine CO<sub>2</sub> resources for microalgae production in the year 2010 and beyond. This report was a very comprehensive and authoritative source of information on this subject, from merchant CO<sub>2</sub> supplies and costs to potential competition from EOR for CO<sub>2</sub> sources. CO<sub>2</sub> recovery from existing processes was judged to be relatively low cost from ethanol and ammonia plants, and much more expensive from cement, refineries, or power plants.

After a detailed review of the options, the authors estimated that the potential CO<sub>2</sub> resource base was sufficient to support the annual production of roughly 2 to 7 quads of algal fuels. This corresponds to as much as 1.1 billion tons of CO<sub>2</sub> per year, at prices ranging from about \$9 to \$90/t CO<sub>2</sub>. However, this analysis lacks the spatial resolution of the earlier study; thus, the actual CO<sub>2</sub> availability (particularly of the low-cost supplies) was somewhat more speculative. Certainly CO<sub>2</sub> resources will be a major limiting factor in microalgae production technology. However, as CO<sub>2</sub> utilization has become a central objective of microalgae production systems, perhaps rather than looking at CO<sub>2</sub> as a limitation it should be considered a site-specific opportunity, where the other requirements for microalgae production are met (e.g., land, climate, water, infrastructure). Table III.C.1. summarizes the conclusions of this report regarding CO<sub>2</sub> costs and supplies.

#### *Publications:*

Feinberg, D.A.; Karpuk, M.E. (1990) "CO<sub>2</sub> sources for microalgae based liquid fuel production." *Report*, Solar Energy Research Institute, Golden, Colorado, SERI /TP-232-3820.

Karpuk, M. (1987) "CO<sub>2</sub> sources for fuels synthesis." *FY 1986 Aquatic Species Program Annual Report*, Solar Energy Research Institute, Golden, Colorado, SERI/SP-231-3071, pp. 269-275.

**Table III.C.1. Summary of Availability and Cost of CO<sub>2</sub> Sources**

(Source: Feinberg and Karpuk, 1990.)

CO <sub>2</sub> Source	Potential (10 <sup>6</sup> kg/y)	Estimated Cost (\$1986/mt)
<b>Concentrated, high pressure sources:</b>		
Liquid synthetic fuel plants	40	12 - 16
Gaseous synthetic fuel plants	220	
Gasification/combined cycle power plants	0-790	9-16
<b>Concentrated low-pressure sources:</b>		
Enhanced oil recovery	8-32	
Ammonia plants	9	9-16
Ethanol plants	<0.1	
<b>Dilute high pressure sources:</b>		
Non commercial natural gas	52-100	11-53
Refineries	13	54-95
<b>Dilute low pressure sources:</b>		
Anaerobic digestion (biomass/wastes)	230	11-84
Cement plants	26	51-84
Fossil steam plants	0-790	29-48
<b>TOTALS</b>	<b>600 - 2250</b>	





### III.C.6. The 1990 SERI Study of Water Resources in New Mexico

This study (Lansford et al. 1990) specifically addressed the saline groundwater water resources in New Mexico. The objective was to identify suitable areas where large (1,000-ha) microalgae facilities could be established based on land and water availability. This report did not consider CO<sub>2</sub> availability. Selection criteria developed by SERI, such as water quality, land slope, and climatic conditions, were used in this analysis. The groundwater resource information was reviewed for potential suitability for microalgae culture. Total gross water reserves of some 20 billion acre-feet were projected, of which about one-quarter was fresh water and the remainder of varying degrees of salinity. Freshwater sources would likely not be available in large quantities, as they would have higher value uses, would already be appropriated, or otherwise restricted. Thus, this report focused on saline groundwater sources. A first cut was by depth, likely well yields, size of reserves, and chemical composition. A detailed analysis of six groundwater basins of varying sizes and quality was then carried out. A qualitative analysis was carried out first, based on available data (Table III.C.2). Of these six, only two met all the criteria established by SERI for a microalgae facility, with the Tularosa Basin judged the best choice and Crows Flats next. For these regions, about 2.3 to 5 million acre-feet of useable water resources were identified as available. This report is an excellent example of the challenges of developing such a detailed resource analysis, to arrive at even an initial estimate for a single U.S. state, even after relaxing a key resource constraint (e.g., CO<sub>2</sub>).

#### Publications:

Lansford, R.; Hernandez, J.; Enis, P.J. (1987) "Evaluation of available saline water resources in New Mexico for the production of microalgae." *FY 1986 Aquatic Species Program Annual Report*, Solar Energy Research Institute, Golden, Colorado, SERI/SP-231-3071, pp. 227-248.

Lansford, R.; Hernandez, J.; Enis, P.J.; Truby, D.; Mapel, C. (1990) "Evaluation of available saline water resources in New Mexico for the production of microalgae." *Report*, Solar Energy Research Institute, Golden, Colorado, SERI/TP 232-3597, 83 pp.



Table III.C.2. Suitable water resources in New Mexico.

(Source: Landsford et al. 1990.)

**Qualitative Summary of Chosen Sites and Specific Criteria Used in Selection of Areas Suitable for Microalgae Production**

Criterion	Tularosa Basin		Crow Flats Basin	Estancia Basin		Pecos Basin	San Juan Basin	Tucumcari Basin
	Site A	Site B		Site A	Site B			
Supply of Unappropriated Groundwater	Available	Available	Available <sup>a</sup>	Available	Available	Limited Availability <sup>b</sup>	Available	Available
Depth to Saline Groundwater	Satisfactory	Satisfactory	Marginal to Satisfactory	Satisfactory	Satisfactory	N/A <sup>c</sup>	Marginal to Satisfactory	Marginal to Satisfactory
Potential Well-Yield	Marginal to Satisfactory	Marginal to Satisfactory	Satisfactory	Satisfactory	Satisfactory	Unsatisfactory	Unsatisfactory	N/A
Water Quality (TDS)	Satisfactory	Satisfactory	Marginal	Satisfactory	Marginal	Satisfactory	Satisfactory	Marginal
Adequate Reserves	Yes	Yes	Yes	Yes	Yes	Uncertain	Yes	No
Growing Season	Satisfactory	Satisfactory	Satisfactory	Unsatisfactory	Unsatisfactory	Satisfactory	Unsatisfactory	Marginal to Satisfactory
Land Slope	Satisfactory	Satisfactory	Satisfactory	Satisfactory	Satisfactory	N/A	N/A	N/A
Ownership	Majority is Private	Majority is Private	Majority is Federal	Majority is Private	Majority is Private	N/A <sup>d</sup>	N/A	N/A
Data Base Quality	Excellent	Excellent	Poor to Good	Good	Good	Poor	Good	Good
Further Study Recommended	Yes	Yes	Yes	No	No	Yes <sup>e</sup>	No	No

N/A = not available.

<sup>a</sup>Unappropriated water is available, but competition from agriculture is likely because water quality is suitable for agriculture.<sup>b</sup>Unappropriated water is available, but competition from existing uses may exclude microalgae production.<sup>c</sup>Data on depth to groundwater was available only for the Pecos Valley not the Pecos Basin.<sup>d</sup>Ownership was not described for the Pecos Basin. Ownership in the Pecos Valley was predominantly private.<sup>e</sup>Further study is recommended for the area around Ruswell if less than a 1000 ha facility is considered.



### **III.C.7. Conclusions**

The various ASP resources analyses indicated significant potential land, water, and CO<sub>2</sub> resources, even within the limited geographic area (the southwestern United States) that was the focus of the ASP. Several quads (10<sup>15</sup> Btu) of fuels were projected for the various available resources. Other areas, from Florida to California, could also be considered. Microalgae systems actually use fairly little water, compared to irrigated crop plants. In addition, many waste and saline water resources may be available and suitable for microalgae production. Many CO<sub>2</sub> sources are available, and algal ponds could be purposefully co-located with CO<sub>2</sub> sources, or even vice versa. This is already being done at a commercial microalgae facility in Hawaii. Finally, land is hardly a major limitation: two hundred thousand hectares, less than 0.1% of climatically suitable land areas in the United States, could, with maximal productivities, produce about 1 quad of fuels. Thus, although there are many practical limitations, which may make some earlier predictions optimistic, resource limitations should not be an argument against microalgae biodiesel systems.

### **III.D. Engineering Systems and Cost Analyses**

#### **III.D.1. Introduction**

One of the major accomplishments of the ASP was the development of detailed engineering/cost projections for large-scale microalgae biofuels production. These analyses generally supported the view that microalgae biomass production could be performed at sufficiently low cost as to plausibly become a renewable energy source, assuming however, that the rather ambitious R&D goals of the ASP could be met. A major conclusion from reviewing these studies is that most R&D goals for this technology are related to the algal cultures themselves (productivity, species control, and harvestability), rather than the engineering aspects, such as the ponds, CO<sub>2</sub> transfer, or biomass processing.

Historically, the first engineering and cost analysis for large-scale microalgae production of fuels was that of Oswald and Golueke (1960). These authors projected the costs of electricity generated from biogas (methane) obtained from the anaerobic fermentation of algal biomass. The algae were to be cultivated in very large (40-ha) raceway type ponds, mixed with pumps, and supplied with CO<sub>2</sub> from a power plant. Other nutrients would come from the digesters. Municipal wastewaters would be used as make up for water and nutrients (C, N, P, etc.). The ponds were to be of earthen construction, with a depth of about 30-cm. Harvesting was assumed to be by simple settling. Electricity costs were projected to be competitive with nuclear power. Although few details were provided, the general concept outlined in this early publication has remained essentially unchanged. Perhaps the greatest change is that biomass productivities thought to be achievable at that time were less than 50 mt/ha/yr of biomass, while current projections are roughly two to five times higher.

With the initiation of the ERDA/DOE funded projects at the University of California–Berkeley during the mid-1970s (Section III.A.), additional engineering and cost analyses were conducted



(Benemann et al. 1977). The early studies were based on large (8–20-ha) ponds, with multiple channels and mixing by recirculation pumps (the required deep concrete sumps and splash pads were a major cost factor). Both the settling pond for harvesting algae by sedimentation and a covered anaerobic lagoon were part of this initial design. Total systems costs were only about \$10,000/ha (somewhat over twice that in current dollars). Based on a projected yield of about 500 GJ/ha/y (10 GJ/t of algal biomass) of biogas, costs were projected at about \$3/GJ. Although optimistic, this study served as a starting point for more detailed later studies.

#### Publications:

Oswald, W.J.; Golueke, C.G. (1960) “Biological transformation of solar energy.” *Adv. Appl. Microbiol.* 11:223-242.

Benemann, J.R.; Baker, D.; Koopman, B.L.; Oswald, W.J. (1977) “A systems analysis of bioconversion with microalgae.” *Proc. Symposium Clean Fuels from Biomass and Wastes*, (Klass, D., ed.) Institute of Gas Technology, Chicago, pp. 101-126.

### III.D.2. The Algal Pond Subsystem of the “Photosynthesis Energy Factory”

A relatively detailed analysis of an algal wastewater treatment-energy production process was carried out by Benemann et al. (1977) as part of a larger study that examined a system integrating wastewater algal ponds with tree biomass production. The so-called “Photosynthetic Energy Factory” (InterTechnology Solar Corporation 1978) was to use the effluents of a waste treatment pond system to fertilize short-rotation trees for fuel farming. In turn, the power plant burning the woody biomass would provide CO<sub>2</sub> for the algal ponds.

A design of the algal pond subsystem was carried out by Benemann et al. (1978) for a typical municipal community of 50,000 people, generating approximately 18,000 m<sup>3</sup> of municipal wastewater per day. The assumption was that algal biomass would be grown up to the N growth potential of the wastewater, containing 65 mg/L of useable N (as organic N and ammonia). This required recycling about 5 to 7 tons of CO<sub>2</sub> per day from the power plant to the algal ponds. A temperate site with an average insolation of about 15 GJ/m<sup>2</sup>/d was assumed, with a solar conversion efficiency averaging only 2.7% of visible light (about 1.35% of total solar), somewhat higher in winter than summer. This is considerably lower than current assumptions.

This study, for the first time, took into consideration monthly variations in temperature, insolation and other parameters. Algal harvesting was assumed to be with microstrainers (this analysis was carried out while this option was still being investigated, see Section III.A.3.). This report also carried out the first, though preliminary, analysis of the mixing power required for such large algal ponds and of the transfer requirements for CO<sub>2</sub> to the algal culture. A 160-ha algal pond system was required to treat this wastewater flow year-round. This was about three times larger than a conventional oxidation pond system. Costs were projected to be competitive with conventional wastewater treatment systems.



Energy outputs were twice the energy inputs, based on digester gas production and requirements for pumping the wastewater, mixing the ponds, etc. The overall economics were very favorable because of the wastewater treatment credits.

Although this concept appeared favorable, in practice the relatively small scale of the locally available municipal wastes could supply only a small fraction of fertilizer needs for the very large (>10,000 ha) energy plantations being projected. It does, however, point to the potential of this technology in wastewater treatment.

#### *Publications:*

Benemann, J.R.; Koopman, B.L.; Baker, D.; Goebel, R.; Oswald, W.J. (1977) "Preliminary design of the algae pond subsystem of the photosynthesis energy factory." *Final Report to Inter-Technology Solar Corp.*, Sanitary Eng. Res. Lab., Univ. of Calif.-Berkeley.

InterTechnology/Solar Corp. (1978) "The photosynthesis energy factory: analysis, synthesis and demonstration." U.S. DOE HCP/T3548-01.

### **III.D.3. Cost Analysis of Microalgae Biomass Systems**

This report (Benemann et al. 1978) originated with a Request for Proposals (RFP) by ERDA for a "Cost Analysis of Algal Biomass Systems" which included both micro- and macroalgae. The contract was awarded to the Dyantech R/D Co., who subcontracted for the analysis of the microalgal work with CSO International, Inc. Although the RFP specified a minimum scale for such systems of "100 square miles," a single large unit was not feasible, and the analysis was carried out for individual modules of 800-ha. This system was to be independent of wastewater treatment and nutrients, which were deemed too small to provide "meaningful" energy supplies.

The first step in the analysis was to list 10 major sets of assumptions on which this process could be based (Table III.D.1.). These included

- essentially effortless species control,
- a yield of about 45 mt/ha/yr (20 t/ac/y),
- 4% N and 0.4% P in the algal biomass,
- 40 ha (100 ac) growth ponds with multiple channels, and
- harvesting by bioflocculation.

Month-by-month variations in biomass density, productivity, water and CO<sub>2</sub> utilization, etc. were estimated based on a typical southwestern United States location, with productivities ranging from a minimum of 6 to a maximum of 18 g/m<sup>2</sup>/d.



Based on these assumptions, designs of the various system components were carried out, and supporting calculations made for the subsystems, including earthworks, pumps to move and lift the water, the supply channels and piping required, transfer structures, settling ponds, ducting for CO<sub>2</sub>, etc. The algal biomass would be digested to methane gas, but this was not included in the analysis. Based on estimates for various components, total capital costs were estimated (in 1978 dollars) at about \$9,000/ha, without contingencies or engineering. Annualized costs, based on a 15% per annum capital charge, plus \$700/ha operating costs for labor and nutrients, assuming free CO<sub>2</sub>, were about \$2,000/ha, or about \$45/t biomass. As pointed out in the report, “the basis for choosing many of the design features was low cost, or, actually, the highest cost allowable.” Thus, this report was primarily useful in identifying the major design assumptions and cost centers for such a process.

This report was the first truly detailed analysis of such systems, though it still was, in many aspects, highly conceptual. It was used by Regan (1980) for a similar analysis of a large-scale algal (*B. braunii*) hydrocarbon production process in Australia, and served as the basis for subsequent analysis by DOE and the ASP.

*Publications:*

Benemann, J.R.; Persoff, P.; Oswald, W.J. (1978) “Cost analysis of microalgae biomass systems.” *Final Report prepared for the U.S. Dept. of Energy*, HCP/t1-605-01 Under Contract EX-78-X-01-1 605.

Regan, D.L. (1980) “Marine biotechnology and the use of arid zones.” *Search* 111:377-381.



Table III.D.1. Design assumptions for a microalgae production system.

(Source: Benemann et al. 1978.)

SUMMARY LIST OF ASSUMPTIONS

- I **ALGAE CULTIVATION:** Bioflocculating types of microalgae can be cultivated. No significant effort at species control need be undertaken. Mixed populations cultivated. No pest control.
- II **YIELD:** Yield is assumed to be 20 tons/acre/year (at 10,000 BTU/lb higher heating value) corresponding to somewhat less than 2% solar conversion efficiency in southern U.S. Losses resulting as a consequence of predation, disease or excretion of photosynthetic products are already subtracted.
- III **CHEMICAL COMPOSITION:** Algae contain 4% N, and 0.4% P. Major nutrient losses are 10% of N and 10 % of P (and other micronutrients) in the algal biomass produced per year (e.g. 160 lbs/acre/year N lost and 16 lbs/acre/year P lost.)
- IV **ALGAL DENSITY:** Yield is not significantly affected by operating ponds from -30% to +20% of algal densities specified by the yield and harvesting rate assumptions.
- V **WATER USE:** Water use is assumed to be 50% higher than calculated rates from class A pan evaporation minus precipitation data, to account for increased evaporation rates in growth ponds as well as evaporation in harvesting ponds, conveyance channels and minor percolation. Can use brackish, saline waste or sea water. Surge and equalization basins must be provided.
- VI **CLIMATE AND SITE:** Avoid cold and low insolation regions. Need cheap level land. Land costs are not considered.
- VII **GROWTH PONDS:** Channel width 200 ft, baffle height 18", earthwork height 24" with 2:1 sloping sides, growth ponds 100 acres (1,200 x 3,630 ft). Assumes self or clay sealing of ponds (no significant percolation).
- VIII **MIXING SYSTEM:** Paddlewheels, three sets per 100 acre growth pond. 0.2 ft/sec to 0.5 ft/sec mixing velocity. Assumes no erosion.
- XI **CARBONATION:** Need up to 5 M ft<sup>3</sup>/day of flue gas per 100 acre growth pond. Carbonation in covered paddlewheel stations and of return harvesting water.
- X **HARVESTING SYSTEM:** Use a pond isolation process which operates on a two day detention time (plus one day for fill and draw process). Assume up to ten-fold concentration and up to three successive stages of isolation.



#### III.D.4. Cost Analysis of Aquatic Biomass Systems

In 1978, Dynatech R/D Company prepared a report that analyzed the feasibility of using both macro- and microalgae systems, as well as other aquatic plants, for fuel production (Dynatech R/D Company 1978a). A major emphasis of this report was seaweed systems (“Ocean Farms”), as these were a major focus of the ERDA/DOE Fuels from Biomass Program at the time. This report concluded that macroalgae systems, based on open ocean giant floating seaweed farms, were technically and economically infeasible. The report also addressed the land-based microalgae systems, based on the report by Benemann et al. (1978) discussed in the previous section. The authors concluded that CO<sub>2</sub> supply from power plant stack gases required “prohibitively expensive” duct work, distribution and transfer systems. It recommended further development only of emergent higher aquatic plants, such as water hyacinths and marsh plants, which can use CO<sub>2</sub> from the air.

However, these conclusions were subjected to considerable critique. In response, a companion report was prepared that addressed “Reviewers’ Comments” (Dynatech R/D Co. 1978b). Although most of the comments related to the macroalgae systems, the conclusions regarding the microalgae process were also challenged, specifically with respect to CO<sub>2</sub> transfer. It was pointed out that CO<sub>2</sub> transport distances from the power plant to the ponds need not be longer than 10 km, as assumed in the Dynatech R/D Co. report and that CO<sub>2</sub> transfer into the ponds could be both efficient and of low-cost. In other respects, including water and nutrients supply and use, the Dynatech R/D (1978a) report concluded that overall “it appears that there is a high probability that land-based aquatic biomass growth systems can be designed which are technically feasible and for which growth energetics are quite favorable.” This conclusion did “not necessarily imply economic feasibility.”

Actually, the Dynatech R/D Co. (1978a) conclusions were more positive than the opinions of some participants in this project. For example, Goldman and Ryther (1977) had earlier rejected the concept of microalgae fuel production, because, among other arguments, the water and fertilizer resources for microalgae ponds would be prohibitive. However, Oswald and Benemann (1977) countered arguments, pointing out, for example, that such a simplistic analysis failed to consider water and nutrient recycling. In this connection, Goldman (1979a,b) also reviewed the fundamental and practical aspects of microalgae biomass production, including the productivity data with outdoor pond systems. As part of the Dynatech Report, DOE published a “Topical Analysis” of aquatic biomass systems (Goldman et al. 1977), a good review of the scientific basis at the time.

##### Publications:

Dynatech R/D Company, (1978a) “Cost analysis of aquatic biomass systems.” *Report prepared for the U.S. Dept. of Energy*, HCP/ET-4000-78-1, vol. 1.

Dynatech R/D Company, (1978b) “Reviewers comments on cost analysis of aquatic biomass systems.” *Report prepared for the U.S. Dept. of Energy*, HCP/ET-4000-78-2, vol. 2.





Goldman, J.C.; Ryther, J.H. (1977) "Mass production of algae: bioengineering aspects." In *Biological Energy Conversion* (Mitsui, A., et al., eds.), Academic Press, New York, pp. 367-378.

Goldman, J.C.; Ryther, J.H.; Waaland, R.; Wilson, E.H. (1977) "Topical report on sources and systems for aquatic plant biomass as an energy source." *Report to the U.S. Dept. of Energy*.

Oswald, W.J.; Benemann, J.R. (1977) "A critical analysis of bioconversion with microalgae." In *Biological Energy Conversion* (Mitsui, A., et al., eds.), Academic Press, New York, pp. 379-394.

### **III.D.5. Microalgae as a Source of Liquid Fuels**

After the ASP was established at SERI in the late 1970s, the emphasis switched from methane production to algal oils as the fuel product. This was based on the known ability of some microalgae species to accumulate large amounts of algal lipids, in particular under conditions of nutrient (mainly N and Si) limitations (See Section II and Section III.B.5.d.).

As discussed in Section III.A.1, initially the ASP set out to investigate both the HRP design described earlier and a patented, closed photobioreactor concept, the ARPS. In 1981, the DOE Office of Energy Research requested an in-depth engineering and cost analysis of both systems. However, by the time the final report was completed in 1982, the ARPS had already started to evolve toward a more standard design (Section II.B.2.), and the HRP project in California (Section III.B.3.) was re-instated. Thus, the comparative evaluation had become somewhat moot, and the final report (Benemann et al. 1982a) covered only the HRP system in detail, with the comparative HRP-ARPS analysis relegated to an unpublished appendix (Benemann et al. 1982b).

The HRP system followed quite closely on the earlier work of Benemann et al. (1978), but with some significant differences and much greater details for the engineering designs and cost estimates. As before, 40-ha earthwork ponds were used; however, this time with paddle wheel mixing. Productivities were now projected of 67.5 mt/ha/yr for an algal biomass containing 40% lipids (oils) by weight. This corresponded to about 90 mt/ha/yr for conventional algal biomass, yielding almost 160 barrels of crude oil/ha/yr. This was roughly twice as high as the prior study. Harvesting was again assumed to be by bioflocculation, followed by a centrifugation process to concentrate the biomass to a paste-like consistency. A solvent extraction process as used for soybean oil extraction was assumed, at three-time higher unit cost to account for the high-moisture in the paste. (However, as was pointed out, direct solvent extraction was unlikely to be feasible for such high moisture biomass.) As before, the residual biomass was to be anaerobically digested in covered ponds to produce methane gas, with the nutrients (and C) from the digester (and digester gas) recycled to the ponds.

A major emphasis in this report was the development of engineering designs for the CO<sub>2</sub> supply and transfer systems, a major point of criticism in the Dynatech R/D Co. (1978a) study. In fact, Mr. Don Augenstein, the author of the Dynatech R/D Co study, joined EnBio, Inc. and carried out the engineering designs and calculations for CO<sub>2</sub> supply systems for the present report. A



key assumption was that the CO<sub>2</sub> flue gas delivery pipe from the power plant was only 5 km long, at a cost of almost \$3 million (1982\$). The distribution piping system, including blowers and valves, was estimated at about \$2 million for the 800-ha plant. A detailed analysis of power requirements and CO<sub>2</sub> transfer issues was also carried out.

Several cases and scenarios were analyzed, including operations at high (8.0-8.5) pH and low (7.0-7.5) pH, CO<sub>2</sub> recycling from the methane produced, and the use of flue-gas and pure CO<sub>2</sub>. Flue gas CO<sub>2</sub> required much higher capital and operating costs; pure CO<sub>2</sub> required purchase of this nutrient. Various scenarios were analyzed for CO<sub>2</sub> sources, including purchase and combustion of coal (e.g., co-siting a power plant). Another major variable analyzed was the capital and operating costs factors, such as labor costs and overhead, utilities and fuel costs, land costs, factors for buildings and power supplies, contingencies and contracting, architect and engineering fees, and capital-related cost factors (taxes, insurances, depreciations, maintenance, and returns on investment). These factors made a larger difference in final costs than most of the engineering design cost estimates (e.g., pond construction costs, paddle wheels). Somewhat surprisingly, there appears to be no standardization for such general cost factors. For the “base case” analysis, assuming no recycling of nutrients from the digester and a low pH of operation, costs were nearly identical, at almost \$160/barrel oil, for pure CO<sub>2</sub> and flue gas utilization cases. The higher cost of pure CO<sub>2</sub> (@\$45/mt) balanced by the higher capital and operating costs of the flue gas delivery system.

The cost of oil at \$160/barrel was excessive, even for the projected rising fossil fuel prices. By recycling nutrients and operating at a higher pH (reducing CO<sub>2</sub> outgassing) and using lower cost (\$22/mt) CO<sub>2</sub>, overall costs could be reduced by about 20%-25%, to about \$115 for the pure CO<sub>2</sub> case, somewhat higher for the flue gas (coal) case (Table III.D.2.). This was a significant reduction, but still represented an excessive cost. This led to a reiteration of the entire engineering analysis, by using more optimistic engineering designs and estimates at each step, including, for example, a shorter flue gas delivery pipe. This resulted in a further capital costs reduction of about 25%. The capital cost related factors were also reduced, including power supply costs, building costs (to near \$1,000/ha), and return on total capital (from 15% to 10% per annum). With these most optimistic assumptions, final costs were reduced to as low as \$65/barrel of oil for a high pH flue gas case. Table III.D.2. summarizes these costs, for both for the conservative (base) case and optimistic cases. Updating these costs to roughly 1997 dollars would give, even under the optimistic case, costs for the oil of about \$100/barrel.

Other alternatives were also examined. Seawater systems were attractive if all the CO<sub>2</sub> required for algal growth were to be supplied by the seawater. For the assumed productivities, this would require a hydraulic retention time of 1 day, and thus much larger settling ponds and settling velocity for the algae, but could be cost-effective.

Another conclusion was that higher value byproducts were unlikely to significantly contribute to such systems, as their production (either in scale or objectives) would not be easily integrated with algal fuel production. The costs of methane and alcohol fuels from algal biomass (high in



carbohydrates, rather than lipids) would likely be similar to that of algal oil production. Indeed the issues were not the final processing, but the primary production of the biomass.

The authors identified four major research needs to achieve the objectives of high productivity in large-scale outdoor systems:

1. Photosynthetic efficiency for light energy and high lipid production.
2. Fundamentals of species selection and control in open pond systems.
3. Mechanisms (and control) of algal bioflocculation.
4. Effects of non-steady-state operating conditions on algal metabolism.

The appendix to this report (Benemann et al. 1982b), analyzed the ARPS system as proposed by Raymond (1979, 1981) that was in development at the time at the University of Hawaii (Section III.B.1.). First, a detailed historical review of microalgae systems designs was presented, which traced the evolution of the two concepts. The main report carried out a detailed and updated review of all prior cost analyses. The specific claims made for the ARPS systems were analyzed in detail. For example, the  $\text{CuSO}_4$ -filled cover was claimed to reduce harmful IR radiation, but this was not supported by the photosynthesis literature. Also, overheating would still be a major factor even with a  $\text{CuSO}_4$  cover, requiring a cooling process. In addition, the heated  $\text{CuSO}_4$  could not be plausibly used as a power source. Mixing power inputs would be prohibitive for this design. Increased productivities caused by a flashing light effect were not plausible. Most important, the costs for even the cover and liner for such a system would be prohibitive by themselves, without considering any other factors.

This study clearly identified the major difficulties associated with microalgal mass culture for fuel production. Only a very low-cost system, based on open ponds without plastic liners, mixed at low velocities, and using a very simple harvesting process, could be considered in such a process. But even with these rather favorable, though plausible, assumptions, costs would still be well above those for current, or projected, oil prices.

#### Publications:

Benemann, J.R.; Augenstein, D.C.; Weissman, J.C. (1982a) "Microalgae as a source of liquid fuels, appendix: technical feasibility analysis." *Final Report*, U.S. Department of Energy, unpublished, 126 pp.

Benemann, J.R.; Goebel, R.P.; Weissman, J.C.; Augenstein, D.C. (1982b) "Microalgae as a source of liquid fuels." *Final Report*, U.S. Department of Energy, 202 pp.

Raymond, L. (1979) "Initial investigations of a shallow layer algal production system." *Am. Soc. Mech. Eng.*, New York.

**Table III.D.2. Costs of microalgal biomass production.**

Productivity: 67.5 mt/ha/yr for 40% extractable lipid biomass (162 bbl oil/ha/yr).

System Description: Twenty 40-ha growth ponds, harvesting by settling, with C recycle from the digesters and use of either pure CO<sub>2</sub> delivered to the site for \$22/mt, or generation of CO<sub>2</sub> on site from coal at half this cost.

Cost Estimates: Figures in parenthesis next to capital and operating cost items refer to the factors used for the conservative and optimistic cases, respectively. Maintenance, insurance, taxes, (6% and 4.8%, respectively), based on total capital costs, except for land and working capital, which are also not depreciated. ROI (return on total capital) based on total capital, before taxes.

(Source: Benemann et al. 1982a.)

CAPITAL COSTS \$/ha	CONSERVATIVE CASE		OPTIMISTIC CASE	
	FLUE GAS	PURE CO <sub>2</sub>	FLUE GAS	PURE CO <sub>2</sub>
Water and Nutrient Supply		1,000		870
Earthworks & Berms		2,280		1,710
Paddlewheels		2,480		1,860
Settling Ponds		4,950		3,810
Centrifuges		6,930		3,470
Oil Extraction		3,710		3,710
CO <sub>2</sub> Supply	4,270	790	3,200	670
Electricity	2,560	2,215	930	805
Bldgs., Offsites (10%,7.5%)*	2,820	2,435	1,460	1,265
A&E and Contractors (20%,10%)*	6,200	5,360	2,090	1,810
Contingencies (10% for both)*	3,720	3,215	2,305	1,980
Land Costs		1,485		1,190
Working Capital (4, 3 months)*	3,180	3,000	1,335	1,485
<b>TOTAL CAPITAL COSTS</b>	<b>44,585</b>	<b>39,850</b>	<b>27,840</b>	<b>24,520</b>
<b>OPERATING COSTS \$/ha /yr</b>				
Labor and Overhead		1,760		1,410
Electricity (c10, 6.5/Kwhr)*	3,060	2,170	1,450	865
Water		740		495
CO <sub>2</sub> and Na <sub>2</sub> CO <sub>3</sub>	1,115	1,855	1,115	1,855
Nutrients (N,P)		320		250
Maintenance, Insurance, Taxes	2,450	2,130	1,210	1,040
Depreciation (10 Yr,15 Yr.)*	4,100	3,540	1,685	1,460
Return on Investment(15%,10%)*	6,840	5,980	2,785	2,450
<b>TOTAL OPERATING COSTS +ROI</b>	<b>20,385</b>	<b>18,495</b>	<b>10,400</b>	<b>9,830</b>
<b>\$/Barrel of oil</b>	<b>127</b>	<b>115</b>	<b>65</b>	<b>61</b>



### III.D.6. Fuels from Microalgae Technology Status, Potential and Research Requirements

In 1986, a report was generated by SERI ASP in-house researchers that analyzed factors and costs involved in microalgae biomass production systems (Neenan et al. 1986). The report reviewed the various system components and requirements for algal biomass production, and summarized and extended the available resource analyses for water, land, and most importantly, CO<sub>2</sub> required for large-scale microalgal biomass production. It also reviewed the various fuel product alternatives from microalgae biomass, including ethanol, methane, PVO (“pseudovegetable oil”), biodiesel (methyl ester fuels), and even gasoline, (see also Feinberg 1984).

Although generally following the HRP system concept and design described earlier, the authors raised a number of issues and questions. For example, they concluded that paddle wheel mixing was not “the optimal design,” although paddle wheel mixing was used in their analysis. Some modifications were made in the engineering analyses, such as replacing channel dividers by plastic fences, and the use of clay liners in the ponds. For harvesting, microstrainers or belt filters were used as primary harvesters, followed by centrifugation. However, the overall design and cost estimates were essentially based on the Benemann et al. (1982) analysis, including scale (860-ha of pond surface).

Using these inputs, an Algal Production and Economic Model was developed using various unit costs (costs of fertilizers, land, power, water, CO<sub>2</sub>, etc.) and design parameters (module size, depth, nutrient concentrations and losses, mixing velocities, etc.), financial factors, and operating parameters (retention times, algal biomass composition, growing seasons, efficiencies, etc.). As in the prior studies, the residues from the fuel extraction/processing would be converted to methane gas by anaerobic digestion. Schematics and process diagrams for the various processing options were developed. The reference case assumed a biomass with a 30% lipid content and a 17 g/m<sup>2</sup>/d average annual productivity (62.5 mt/ha/yr). The overall projected system costs for the reference case were \$43,283/ha of ponds and \$433/mt of algal biomass. This compares to \$39,850/ha and \$274/t in the “conservative” case of the Benemann et al. (1982) analysis (Table III.D.2., pure CO<sub>2</sub> case). That was for a somewhat higher productivity (67.5 mg/ha/yr) and lipid content (40% versus 30% in this study). It is difficult to extract the specific cost differences between these analyses. However, the cost routines and parameters used had larger effects on costs than the engineering estimates. For one example, in Neenan et al. (1986) water costs were 12% of overall costs, compared to less than 4% in Benemann et al. (1982).

Compared to a biomass cost of \$433/mt estimated for the reference case, the allowable feedstock costs for the various fuel options were calculated to be only somewhat above \$100/mt (and even less for ethanol). Table III.D.3. provides a summary of this analysis, for a 36,000 mt/y (33,000 t/y) microalgae biomass to fuels processing plant. The table provides capital and operating costs only for the fuel processing units, and derives an allowable algae cost, in \$/t. There is a large discrepancy between these estimates and the projected biomass production costs. This led to the conclusion that such a process “is currently not commercially viable.” In fact, the main and



coproduct credits in this analysis were projections for the year 2010, when diesel or methane was expected to cost some four times current (1998) costs (even without inflation adjustment). This makes the economics of this process even less attractive.

As in the prior analysis (Benemann et al. 1982a), a cost reduction and process improvement effort was undertaken and “attainability targets” developed. First, sensitivities were run for 13 resources (such as power costs and evaporation), 15 facility design parameters (e.g., culture depth and mixing), three biological parameters (such as growing season) and eight financial parameters (cost escalations, etc.). Taken one at a time, most factors did not reduce costs significantly (except for growing seasons, culture depth and source water CO<sub>2</sub> content). Although some of the results are difficult to interpret (for example, the large decrease in costs with increasing depth), the major conclusion was that no single parameter dominated costs sufficiently to achieve the goal of low-cost fuel production. Of course, several parameters in combination could do so. In particular, by increasing productivity to as high as 8% of total solar conversion efficiency and 50% lipids (50 g/m<sup>2</sup>d), and by assuming a capital investment of \$48,000/ha, an algal production cost of \$211/mt was estimated. Using this cost, the microalgae biomass fuel processing costs were again estimated, allowing calculation of allowable fuel product costs, of \$1.65/gal of biodiesel.

The fuel processing cost estimates, the major contribution of this report, were very preliminary and based on many assumptions. For example, the costs of the transesterification plant were rather high, and might be reduced in the future. But, as a central conclusion, productivity was again the most important parameter: increasing production efficiencies by a factor of about four decreased production costs by almost half. The report concluded with a detailed analysis of the “attainable” process improvements, emphasizing the need for achieving multiple cost reductions, in addition to significantly increased photosynthetic efficiencies. The report concluded that “aggressive research is need to fulfill the performance requirements defined by this analysis”.

*Publications:*

Feinberg, D.A. (1984) “Fuel options from microalgae with representative chemical compositions.” *Report*, Solar Energy Research Institute, Golden, Colorado, SERI/TR-231-2427.

Neenan, B.; Feinberg, D.; Hill, A.; McIntosh, R.; Terry, K. (1986) “Fuels from microalgae: Technology status, potential, and research requirements.” *Report*, Solar Energy Research Institute, Golden, Colorado, SERI/SP-231-2550, 158 pp.

**Table III.D.3. Costs of microalgal biofuels production: reference case.**

(Source: Neenan et al. 1986.)

Summary of reference capital, operating, and allowable feedstock costs for microalgae fuel processing options. Of the five fuel options, the first four produce a high (30%) lipid biomass; the last (ethanol) fermentable carbohydrate, representing only 13% of biomass weight.

Notes:

- Not including algae feedstock
- Process and cooling waters
- By-product prices: \$0.07/m<sup>3</sup> for CO<sub>2</sub> (captive use only), \$7.40/MMBtu for methane, fuel gas, or LPG, and \$13.30/MMBtu diesel fuel (exports)
- Main product prices: \$7.40/MMBtu for methane, fuel gas, LPG, and \$16.60 (\$1.75/gal) for gasoline and diesel fuel, \$1.20/gal for ethanol and \$1.75/gal for biodiesel (methyl ester) or PVO
- The value (\$/t) of the algal feedstock in producing the main and coproduct mixes. For example, for the ester fuel case, the facility would produce 2.1 million gallons of biodiesel in addition to some 600,000 GJ of methane and 760 t of glycerol for export (plus 11 million m<sup>3</sup> CO<sub>2</sub> and 2,400 tons N, recycled internally) at prices listed in c. and d. above.

Cost Category	Process				
	PVO	Ester Fuel	Gasoline	Methane	Ethanol
<b>Capital Costs (\$10<sup>6</sup>)</b>					
Main process unit	2.73	8.13	5.15	3.91	6.21
Glycerol by-product unit	—	1.32	—	—	—
Methane by-product unit	3.27	3.27	2.92	—	3.50
Subtotal	6.48	12.72	8.07	3.91	9.71
<b>Operating Costs (\$10<sup>3</sup>/yr)</b>					
Raw materials <sup>a</sup>	13	250	8	14	22
Electric power	141	145	137	187	159
Water <sup>b</sup>	13	28	10	21	35
Steam	54	46	70	0	111
Labor, maintenance, taxes	1188	1386	777	485	897
Depreciation	642	1313	844	440	1015
Return on investment	329	458	342	335	410
Subtotal (gross)	2380	3536	2188	(1482)	2649
<b>Credits from Product Sales<sup>c</sup> (\$10<sup>3</sup>/yr)</b>					
Carbon dioxide	(438)	(438)	(307)	(700)	(644)
Water	(13)	(13)	(11)	(15)	(13)
Nitrogen	(223)	(223)	(199)	(262)	(228)
Methane	(2026)	(2025)	(1540)	0	(2585)
LPG	0	0	(570)	0	0
Diesel	0	0	(388)	0	0
Glycerol	0	(782)	0	0	0
Main product <sup>d</sup>	(2484)	(2422)	(2363)	(3239)	(752)
Subtotal (credits)	(3184)	(3903)	(3378)	(4216)	(4222)
<b>Net operating cost<sup>a</sup></b>	<b>(2804)</b>	<b>(2367)</b>	<b>(3190)</b>	<b>(2734)</b>	<b>(1573)</b>
<b>Algae feed requirement (10<sup>3</sup> t/yr)</b>	<b>33</b>	<b>33</b>	<b>33</b>	<b>33</b>	<b>33</b>
<b>Allowable algae cost<sup>e</sup> (\$/t)</b>	<b>85</b>	<b>72</b>	<b>97</b>	<b>83</b>	<b>48</b>

**Table III.D.4. Costs of microalgae biofuels production: attainability cases.**

(Source: Neenan et al. 1986.)

Summary of Attainable Capital and Operating Costs for Fuel Processing Options.

Notes:

- a. Includes microalgae biomass feedstock production costs of \$211/mt
- b. Process and cooling waters
- c. By-product prices: \$0.07/m<sup>3</sup> for CO<sub>2</sub> (captive use only), \$7.40/MMBtu for methane, fuel gas, or LPG, and \$13.30/MMBtu diesel fuel (exports)
- d. Main product, million gallons/yr.

Cost Category	Process			
	PVO	Ester Fuel	Gasoline	Ethanol
<b>Capital costs (\$10<sup>6</sup>)</b>				
Main process unit	36.7	109.0	58.2	113.0
Glycerol by-product unit	—	17.7	—	—
Methane by-product unit	33.0	33.0	27.9	26.3
<b>Total</b>	<b>69.7</b>	<b>159.7</b>	<b>86.1</b>	<b>139.3</b>
<b>Operating costs (\$10<sup>6</sup>/yr)</b>				
Raw materials <sup>a</sup>	192.3	210.2	192.1	193.1
Electric power	3.4	3.7	4.0	2.1
Water <sup>b</sup>	0.2	1.3	0.2	2.3
Steam	4.1	3.5	4.1	14.2
Labor, maintenance, taxes	92.1	31.9	7.8	16.5
Depreciation	7.4	16.4	8.9	13.9
Return on investment	3.4	5.1	3.4	4.0
<b>Total (gross)</b>	<b>302.9</b>	<b>272.1</b>	<b>220.5</b>	<b>246.1</b>
<b>Credits from product sales<sup>c</sup> (\$10<sup>6</sup>/yr)</b>				
Carbon dioxide	(7.2)	(7.2)	(4.8)	(10.8)
Water	(0.3)	(0.3)	(0.3)	(0.2)
Nitrogen	(3.1)	(3.1)	(2.7)	(2.3)
Methane	(33.1)	(33.1)	(28.8)	(16.5)
LPG	0.0	0.0	(32.4)	—
Diesel	0.0	0.0	(22.1)	—
Glycerol	0.0	(59.2)	0.0	—
<b>Subtotal (credits)</b>	<b>(43.7)</b>	<b>(99.8)</b>	<b>(91.1)</b>	<b>(29.6)</b>
<b>Net operating cost</b>	<b>259.2</b>	<b>172.3</b>	<b>129.4</b>	<b>216.3</b>
<b>Fuel production<sup>d</sup></b>	<b>107.5</b>	<b>104.8</b>	<b>76.7</b>	<b>78.9</b>
<b>Main product cost (\$/gal)</b>	<b>2.40</b>	<b>1.65</b>	<b>1.70</b>	<b>2.75</b>





### III.D.7. Design and Analysis of Microalgae Open Pond Systems

This report (Weissman and Goebel 1987) originated from a competition held by the ASP for the development of a pilot plant (“test facility”) for microalgae production. As mentioned in Section III.A.4., two companies were selected to develop competing processes: Aquasearch, Inc., of San Diego, California, and Microbial Products, Inc., which had carried out the ASP pond project in California. The objectives were to arrive at cost projections for such a test facility, and also for scale-up costs of a future full-scale facility based on the selected process. Aquasearch, Inc., developed a concept for a closed system microalgae production process, using large plastic bag tubular reactors contained in a greenhouse. This system was not selected for further development, and no final report is available. Aquasearch, Inc. recently established in Hawaii a closed photobioreactor process for cultivating *Haematococcus pluvialis*, an alga high in astaxanthin.

This study further developed the concept of the HRP system for large-scale microalgae production, providing considerable additional detail, and performing extensive sensitivity analysis of various design options. A site was identified near Brawley, California, in the Imperial Valley, for locating a pilot plant and a full-scale system. Ample groundwater resources were available at this site. There was also significant water supply available from the Salton Sea, which is as saline as ocean water, although of different ionic composition. As discussed in Benemann et al. (1978), the Salton Sea is a potential source of saline water and land for more than 10,000 ha of algal ponds, as such ponds could help manage the salinity of this inland sea, a major problem. The report proposed building two 0.4-ha ponds to validate the process, as well as several smaller ponds for process development and inoculum production. A covered anaerobic lagoon was to be included to test the digestion of the algae and the recycling of nutrients to the algal ponds.

The design of these experimental and pilot plant-scale ponds was provided in great detail. A larger-scale, 400-ha, pond system was also designed and costed. This report presents the most detailed, comprehensive, and realistic cost estimates currently available for large-scale, low-cost microalgae biomass and fuels production.

Several significant advances were made in this design and analysis. Perhaps most importantly, the report presented a fundamental analysis of CO<sub>2</sub> supply and in-pond transfer issues, in combination with water chemistry and transit times between carbonation issues. The analysis concluded that CO<sub>2</sub> utilization efficiencies can overall be very high, more than 95%, within parameters that would allow high microalgae productivity. Another innovation was the use of small amounts of high molecular weight polymers to improve the flocculation, settling characteristics and harvesting efficiency of the basic bioflocculation process. The polymers can be used in very small amounts, without contributing a major cost to the overall process.

The base case (30 g/m<sup>2</sup>/d) capital costs were estimated at almost \$72,000/ha, without working capital, or almost twice as high as the prior effort (Benemann et al. 1982). This was due to higher costs for many components, such as earthworks, which were several-fold higher. Among other



things, higher costs were assumed for rough and fine (laser) grading, which depends on the type of site assumed to be available. Also the 1987 study estimated about \$5,000/ha to provide a 3-5 cm crushed rock layer, specified to reduce the suspension of silt from the pond bottom. There is, however, little evidence for a need for such erosion prevention, except perhaps for some areas around the paddle wheel and perhaps the turns. Further, the Weissman and Goebel (1987) study selected slipform poured concrete walls and dividers (baffles) as the design choice. For the curved portions of the walls and berms, the authors specified corrugated walls, with an average cost of about \$25/m. This resulted in a cost of over \$8,000/ha for the walls (perimeter central, etc.). Clearly, such design options and engineering specifications can result in very large differences in capital costs. For another example, in the present design, a power generation system was specified to produce electricity from the methane generated from the algal residues (at about 10% of total costs). This had not been included in the earlier study. Despite these higher costs, and perhaps because of them, this engineering design and cost analysis effort may be considered the most detailed and realistic one available.

Table III.D.5. summarizes two design cases (from more than a dozen presented in the report), with 30 and 60 g/m<sup>2</sup>/d average productivities. By using an annual capital charge of 25% (depreciation, return on investment, insurance, taxes), biomass costs of some \$273/mt and \$185/mt were estimated for the two productivity cases (Table III.D.5.). These costs were more than twice the cost derived from the “conservative” case in the earlier study (Benemann et al.1982), which used only the lower productivity. Note that this even included a significant credit for power production from the methane produced (most of which was used internally). Although this report is the most detailed and complete analysis of microalgae biomass production for fuels available, it can also be criticized for not attempting to examine cost reduction possibilities in the various design options, which would be required to make microalgae fuels production viable. Possible strategies for cost reduction were the objective of the study discussed in the following section.

#### *Publications:*

Weissman, J. C.; Goebel, R.P. (1987) “Design and analysis of pond systems for the purpose of producing fuels.” *Report*, Solar Energy Research Institute, Golden, Colorado, SERI/STR-231-2840.

**Table III.D.5. Capital and Operating Costs for an Open Pond System\***

(Source: Weissman and Goebel, 1987.)

\*Based on 400-ha system with nutrient and CO<sub>2</sub> recycle from anaerobic digesters.**A. CAPITAL COSTS**

CAPITAL COSTS (\$/ha )	112 mt/ha/y	224 mt/ha/y
<b>GROWTH PONDS</b>		
Earthworks	10,135	10,135
Walls & structural	8,304	8,304
Mixing system	4,919	4,919
Carbonation system	1,830	2,978
Instrumentation	500	500
Primary (settling ponds)	7,479	7,479
Secondary (centrifuges)	3,958	6,467
<b>SYSTEM-WIDE COSTS</b>		
Water supply/distrib.	4,426	4,426
CO <sub>2</sub> distribution	260	421
Nutrient supply	781	781
Salt disposal	833	833
Buildings (not for centf.)	573	573
Roads and drainage	521	521
Electrical distr./supply	1,924	2,215
Machinery	417	417
ENG. + CONTG. (25% above	11,715	12,742
LAND COSTS (\$1,250/ha)	2,500	2,500
GEN-SET (Eng.+ Cont. included)	8,250	16,500
ANAEROBIC DIGESTION	3,627	7,254
<b>TOTAL CAPITAL COSTS \$/ha</b>	<b>72,952</b>	<b>89,965</b>

**Table III.D.5. Capital and Operating Costs for an Open Pond System\***

(Source: Weissman and Goebel, 1987.)

\*Based on 400-Ha system with nutrient and CO<sub>2</sub> recycle from anaerobic digesters.**B. OPERATING COSTS (\$/ha/yr)**

OPERATING COSTS (\$/ha/yr)	112 mt/ha/y	224 mt/ha/y
CO <sub>2</sub> (2kg/kg biomass)	6,290	12,580
N (5.3% in biomass) as NH <sub>3</sub>	370	750
P superphosphate, Fe as FeSO <sub>4</sub>	530	1,070
Flocculants	1,120	2,250
Power mixing (10,730 kWh/ha)	700	700
1E Harvest (1,770 ")	120	120
2E Harvest (5,730 ")	370	600
Water Supply (8,750 ")	570	570
Other (1,562 kWh/ha)	110	110
Power Production (6.5 c/kWh)	(2,250)	(5,100)
Salt Disposal (\$67/mt)	1,130	1,130
Maintenance	1,970	2,940
Labor	1,390	1,390
TOTAL OPERATING	12,420	19,110
CAPITAL COST (25%/yr of total)	18,238	22,491
TOTAL COSTS (\$/ha/yr)	30,658	41,601
TOTAL BIOMASS COSTS (\$/mt)	273	185



### III.D.8. Systems and Economic Analysis of Microalgae Ponds for Conversion of CO<sub>2</sub> to Biomass

In recent years, there has been increasing interest in greenhouse gas mitigation technologies. As a consequence, there has been renewed interest in microalgae mass culture and fuels production from the perspective of CO<sub>2</sub> utilization. This is not a new concept, as Oswald and Golueke (1960) had previously emphasized the potential for microalgae systems to reduce and avoid CO<sub>2</sub> emissions and thus reduce the potential for global warming. Indeed, microalgae have a rather unique attribute: they can utilize concentrated CO<sub>2</sub> for growth, rather than the air-levels of CO<sub>2</sub> used by higher plants. This could allow the culture of microalgae on power plant flue gases, probably the only method for directly using such CO<sub>2</sub> sources. Of course, once the microalgae biomass is converted to, and used as fuel, this CO<sub>2</sub> is again released. However, an equivalent amount of fossil fuel is not burned and fossil CO<sub>2</sub> released into the atmosphere, reducing overall CO<sub>2</sub> emissions.

In the early 1990s, some ASP work at NREL was supported by the Pittsburgh Energy Technology Center, PETC (now FETC, Federal Energy Technology Center, see Section III.D.9.). PETC also contracted with the University of California-Berkeley to analyze microalgae systems for power plant flue gas utilization and CO<sub>2</sub> mitigation (Benemann and Oswald 1996). This report updated and extended the earlier cost analysis reviewed above. In particular it reanalyzed the assumptions on which these studies were based, and the costs for the various system components. For example, the costs of laser grading and earthworks were independently cost estimated through contacts with agricultural engineers with expertise in constructing rice paddies in northern California. Paddle wheel costs were based on the experience of the principal investigator (WJO) with large unit designs for waste treatment ponds. Pond walls and dividers were simple earthworks, much cheaper than the Weissman and Goebel (1987) design. Among the process innovations introduced was the use of a three-phase centrifuge to separate the algal lipids from the water and other biomass fractions. This provides a relatively straightforward method for lipid recovery (a major issue in prior studies) at only marginally higher costs than the centrifuge earlier specified for final concentration. However, overall this analysis was derivative of the prior studies.

Table III.D.6. summarizes the costs projected by this analysis. Both 20 and 60 g/m<sup>2</sup>/d productivities were assumed, with a high (40%) lipid biomass, equivalent to a 10% total solar conversion efficiency. Such very high productivities would clearly require a major R&D breakthrough. The theoretical approaches to such advances were reviewed. A reduction in light harvesting (“antenna”) pigments would increase the photosynthetic efficiencies at high light intensities. Microalgae with reduced antenna pigments would, however, not be very competitive in large-scale algal pond systems, and thus would be subject to contamination. However, nutrient limitation, required in any event to maximize lipid content in the algal cells, could be used as a strategy to limit such contaminants.



Both direct flue-gas utilization near the power plant and remote use of CO<sub>2</sub> captured from flue gas and piped to the algal ponds were considered. With projected oil prices of \$25/bbl and productivities of 5% solar conversion and 30 g/m<sup>2</sup>/d assumed to be achievable in the near-term, projected cost were \$77/mt to \$100/mt CO<sub>2</sub> avoided, similar to other direct flue gas mitigation options. With higher productivities (60 g/m<sup>2</sup>/d) and oil prices (\$35/bbl), CO<sub>2</sub> avoidance with microalgae costs could drop below \$10/mt CO<sub>2</sub>, a very competitive cost compared to other direct CO<sub>2</sub> mitigation options. The estimates for CO<sub>2</sub> mitigation are summarized in Table III.D.7.

This report also estimated the costs of providing a significant inoculum for the culture systems, taking as the example the cultivation of *B. braunii*. This would involve producing small amounts of inoculum under highly controlled laboratory conditions, then amplifying the cultures using increasingly larger, but less controlled and less expensive photobioreactors. Such a process would add some 10% to 30% to overall costs, depending on the amount and control over inoculum production desired. The microalgae industry and harvesting technologies were also reviewed in some detail.

A major emphasis in this report was the potential of microalgae CO<sub>2</sub> utilization during wastewater treatment, recapitulating the work since the 1950s by this group (Section III.B.). Indeed, with CO<sub>2</sub> mitigation being now the primary goal, rather than fuel production, what was before a cost could now add to the waste disposal credits of such systems. Microalgae wastewater treatment uses less energy, and thus fossil fuels, than conventional treatment processes, resulting in a reduction of greenhouse gas emissions. Wastewater treatment processes could provide a near-term pathway to developing large-scale microalgae production processes and could find applications around the world. With climate change a global problem, this now allows consideration of such international perspectives, even within a DOE-funded R&D program.

The applications of microalgae to CO<sub>2</sub> mitigation from power plants became a major focus of the ASP during the 1990s, as briefly reviewed in the following section.

#### Publications:

Benemann, J.R. (1993) "Alternative recommendation regarding biological CO<sub>2</sub> utilization R&D." In *The Capture, Utilization and Disposal of Carbon Dioxide from Fossil Fuel Power Plants* (Herzog, H., et al., eds.), U.S. Dept. of Energy, DOE/ER-30194/1, 56 pp.

Benemann, J.R.; Oswald, W.J. (1966) "Systems and economic analysis of microalgae ponds for conversion of CO<sub>2</sub> to biomass." *Final Report*, Pittsburgh Energy Technology Center, Grant No. DE-FG22-93PC93204.

Herzog, H., et al. (1993) "The capture, utilization and disposal of carbon dioxide from fossil fuel power plants." *Report*, U.S. Dept. of Energy, DOE/ER-30194, vol. 1 and 2.

Table III.D.6. Summary of cost analysis of microalgae CO<sub>2</sub> mitigation.

400-ha system, @ \$0.065/kWh for power sales.

(Source: Benemann and Oswald 1996.)

	CO <sub>2</sub>	Productivity Assumptions		
		30 g/m <sup>2</sup> /day Flue Gas	60 g/m <sup>2</sup> /day Flue Gas	
<b>Capital Costs, \$/ha</b>				
1. Site prep., levees, geotextile		6,000	6,000	
2. Mixing (paddle wheels)		5,000	5,000	
3. CO <sub>2</sub> sumps, supply, distrib.	4,300	10,000	4,300	13,000
4. 1 <sup>o</sup> Harvesting, Flocculation		9,000	10,000	
5. Centrifugation, Extraction		12,500	25,000	
6. Anaerobic digestion lagoon		3,250	6,500	
7. Gen-set (power generation)	8,700	—	17,400	—
8. Water, nutrient, waste		6,200	6,200	
9. Buildings, roads, electrical		4,500	5,500	
10. Eng. & Conting. (15% above)	8,900	8,500	12,800	11,500
11. Land Costs		2,000	2,000	
12. Working Capital (25% op. cost)	3,800	2,700	4,200	3,800
<b>Total Capital Investment</b>	<b>74,150</b>	<b>69,650</b>	<b>104,400</b>	<b>94,000</b>
<b>Operating Costs, \$/ha-yr</b>				
13. Power, all except CO <sub>2</sub>		1,870	2,370	
14. Power, flue gas supply	—	1,000	—	2,000
15. Nutrients, N,P, Fe		900	1,800	
16. CO <sub>2</sub> (@ \$40/mt)	7,400	—	7,400	—
17. Flocculant		1,000	2,000	
18. Labor + Overheads		3,000	4,000	
19. Waste Disposal		1,000	1,000	
20. Maint., Tax, Ins. (@ 5% Cap.)	3,400	3,250	4,900	4,400
21. Credit for Power or fuel	(3,400)	(1,150)	(6,800)	(2,300)
22. Total Net Operating Costs	15,170	10,870	16,670	15,270
23. Capital Charge (15%)	11,100	10,500	15,650	14,100
24. Total Annual Costs.	26,270	21,370	32,320	29,370
25. \$/mt biomass	241	196	148	135
26. \$/barrel algal oil	69	56	42	39



Table III.D.7. Greenhouse gas balances and mitigation costs.

400-ha system, @\$0.065/kWh.

(Source: Benemann and Oswald 1996.)

Item #	Productivity Assumptions			
	30 g/m <sup>2</sup> /day		60 g/m <sup>2</sup> /day	
	CO <sub>2</sub>	Flue Gas	CO <sub>2</sub>	Flue Gas
1. Gross Power Produced kWhr/ha-yr	52,000		104,000	
2. Net Power Exported kWhr/ha-yr	26,500	10,100	83,500	50,700
3. CO <sub>2</sub> mitigated from #2, mt/ha-yr	23	9	73	45
4. CO <sub>2</sub> due to fertilizers, etc. mt/ha-yr	5		10	
5. CO <sub>2</sub> mitigated before oil mt/ha-yr	18	4	63	35
5. Algal oil outputs barrel/ha-yr	380		760	
6. CO <sub>2</sub> mitigated from oil, mt/ha-yr	150		300	
7. Net CO <sub>2</sub> avoided, mt/ha-yr	168	154	363	335
8. Net CO <sub>2</sub> avoided, mt/barrel oil	0.44	0.40	0.48	0.44
9. \$/barrel algal oil (from Table 8.3)	69	56	42	39
10. Net cost of CO <sub>2</sub> avoided \$/mt				
for \$25/barrel oil	100	77.5	35	32
for \$35/barrel oil	77	52.5	14.5	9





### III.D.9. NREL Studies of Flue Gas CO<sub>2</sub> Utilization by Microalgae

The last major engineering-related activity carried out by the ASP was a PETC-funded study, both laboratory and process design, for microalgae biodiesel production using power plant flue gases. The general arguments for use of microalgae in CO<sub>2</sub> mitigation, from high productivity to relatively low water use were reviewed in several reports (Brown et al. 1991; Chelf et al. 1991). The authors concluded that the SO<sub>x</sub> and NO<sub>x</sub> impurities in flue gas would likely not have a major effect on algal cultures, and, indeed, that the NO<sub>x</sub> could not even provide the N requirements of the cultures. Prior work indicating an inhibitory effect of flue gases (for example Negoro et al. 1991) was probably due to the acidification of the media and resulting pH drop, because of excessive flue gas transfer.

To demonstrate that flue gases can be used for microalgae culture, NREL set up an experimental apparatus to supply controlled and measured amounts of such gases to the algal cultures. Figure III.D.1. shows a typical result, with no detectable difference between the simulated flue gas culture and the control gas (similar CO<sub>2</sub> levels, but without SO<sub>x</sub> and NO<sub>x</sub>). With almost 1,000 times more CO<sub>2</sub> than SO<sub>x</sub> in flue gas, alkalinity neutralization would not be a major problem except where high water reuse and low alkalinities in the water coincide. In general, flue gas supply to algal cultures should not present a major problem.

Aside from the experimental work, the ASP also carried out work on systems design and analysis for microalgae biodiesel production using power plant flue gases (Kadam 1994, 1995). The analysis was based on the production of essentially pure (liquified) CO<sub>2</sub> from the flue gases of a 500-MW power plant, using conventional amine scrubbing processes, and its supply to a 100-km remote microalgae production facility. Delivered costs were estimated at \$40.5/mt CO<sub>2</sub>. The microalgae pond system design was based on the prior effort of Neenan et al. (1986; see Section III.D.6.) and included site selection criteria for specific power plants in New Mexico. The summary of the system model inputs and outputs are provided in Table III.D.8., which summarizes current and long-term projections for such a process. Although there are some significant differences between this and other cost analyses (prior sections), overall these results agree that through long-term productivity increases such processes could achieve CO<sub>2</sub> mitigation costs competitive with other options. This places the focus on long-term efforts for productivity enhancements.

#### Publications:

Brown, L.M.; Zeiler, K.G. (1993) "Aquatic biomass and carbon dioxide trapping." *Energy Conv.Mgmt.* 34:1005-1013.

Chelf, P.; Brown, L.M.; Wyman, C.E. (1991) "Aquatic biomass resources and carbon dioxide trapping." *Biomass and Bioenergy* 4:175-183.

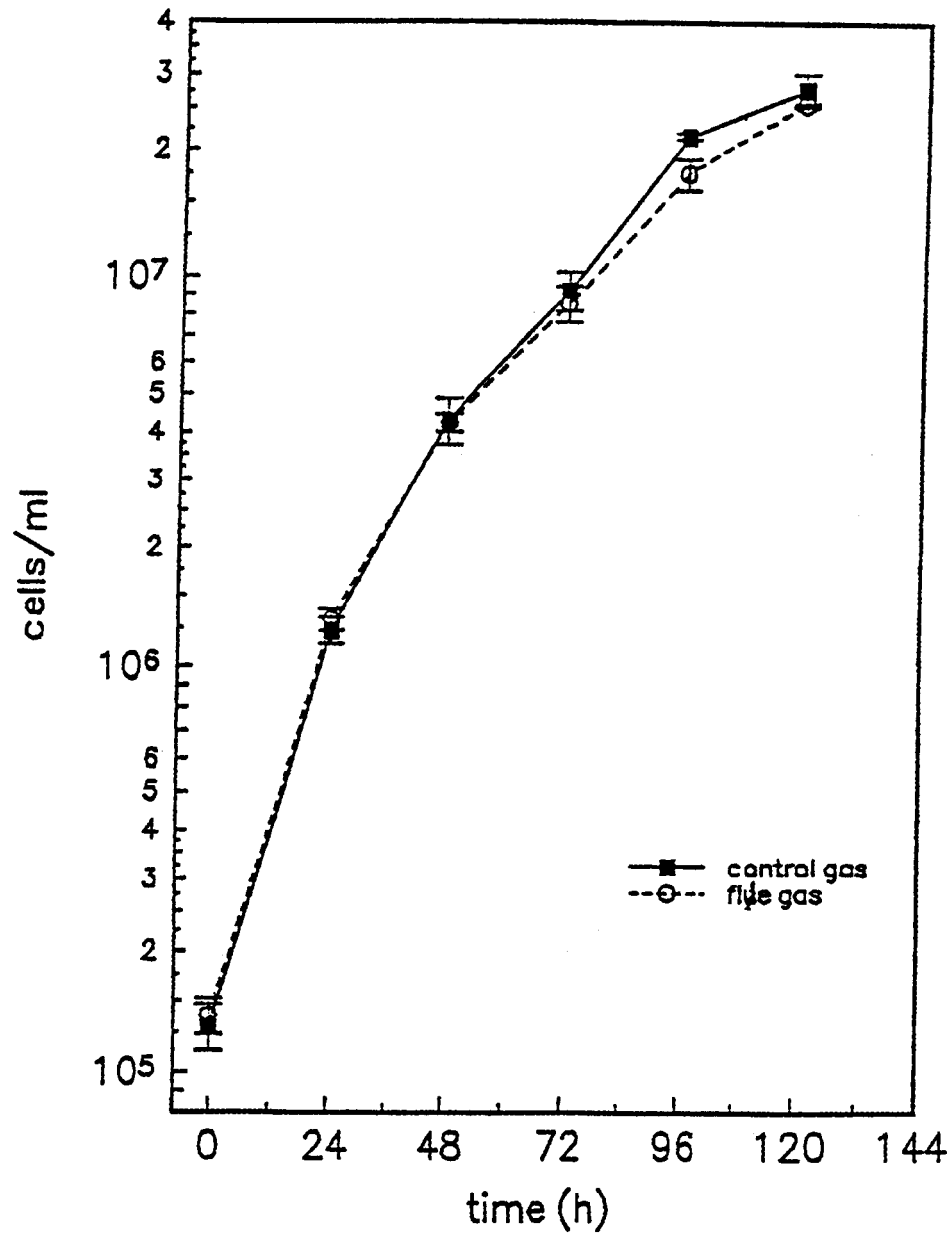
Kadam, K.L. (1994) "Bioutilization of coal combustion gases." *Draft Milestone Completion Report, Recovery & Delivery*, National Renewable Energy Laboratory, Golden, Colorado.



Kadam, K.L. (1995) "Power plant flue gas as a source of CO<sub>2</sub> for microalgae cultivation: technology and economics of CO<sub>2</sub> recovery & delivery." *Draft Report*, National Renewable Energy Laboratory, Golden, Colorado.

Kadam, K.L. (1997) "Power plant flue gas as a source of CO<sub>2</sub> for microalgae cultivation: economic impact of different process options." *Energ. Convers. Mgmt.* 38:S505-S510.

Zeiler, K.G.; Kadam, K.L. (1994) "Biological trapping of carbon dioxide." *Draft Milestone Completion Report*, National Renewable Energy Laboratory, Golden, Colorado.



**Figure III.D.1.** Effects of flue gas components on microalgal growth.

Growth of cells of *Monoraphidium minutum* exposed to 20 mL/min for 2 min 55 times during each 24-h period. (Source: Brown et al. 1994.)



**Table III.D.8. Summary of costs for microalgae CO<sub>2</sub> mitigation.**

Economic performance of processes with different maturities.<sup>1</sup>

(Source: Kadam 1995.)

	<b>Base Case Process (Current )</b>	<b>Improved Process I (Mid-Term)</b>	<b>Improved Process II (Long-Term)</b>
Cell concentration, g/L	0.8	1.0	1.2
Lipid content, % wt	30	45	50
Residence time, d	7	5.5	4
Operating season, d/yr	250	275	300
Productivity, g/m <sup>2</sup> /d	17.1	27.3	45
Photosynthetic efficiency, %	4.9	8.6	14.6
Algae cost, \$/t	399.7	282.5	209.5
Lipid cost, \$/bbl, \$/gal (unextracted)	186.3 / 4.44	87.7 / 2.09	58.6 / 1.40
Lipid cost, \$/bbl, \$/gal with CO <sub>2</sub> credit <sup>2</sup> (unextracted)	148.6 / 3.54	59.0 / 1.41	31.3 / 0.74
CO <sub>2</sub> cost, % of annual cost	16.4	26.6	37.9
CO <sub>2</sub> mitigation cost <sup>3</sup> , \$/t CO <sub>2</sub>	156.8	63.8	20.0

<sup>1</sup>CO<sub>2</sub> recovery cost = \$40/t

<sup>2</sup>CO<sub>2</sub> credit = \$50/t CO<sub>2</sub>

<sup>3</sup>Based on credit at the following rate: lipid = \$240/t, protein = \$120/t, carbohydrate = \$120/t



### III.D.10. Conclusions.

The cost analyses for large-scale microalgae production for fuels reviewed earlier evolved from the rather superficial analysis of the 1970s to the much more detailed and sophisticated studies during the 1980s, with some updates and advances during the present decade. The basic process did not change significantly from the conceptual designs first suggested by Oswald and Golueke (1960): very large open, shallow, unlined, mixed, raceway ponds. However, the design details have evolved significantly, and current engineering and cost analyses are much more realistic.

There are, of course, still some major uncertainties with these engineering studies. For the fundamental raceway design these are the issues of scale and the need for some type of pond lining. Current commercial microalgae production ponds are typically 0.25-0.5-ha in size, and are lined with plastics to prevent percolation and silt suspension and to allow pond cleaning. However, there are also examples of much larger and unlined raceway ponds in a commercial production facility, specifically the Earthrise Farms *Spirulina* plant in southern California, where two large (approximately 5-ha) unlined ponds are currently operating. Similar systems are also used in wastewater treatment. The City of Hollister wastewater treatment plant includes a single 7-ha raceway unlined pond mixed with an Archimedes screw. Even larger (>50 ha) unlined, unmixed ponds are also used for microalgae production in Australia for commercial production of *Dunaliella*, and in several countries in wastewater treatment. Thus, although some uncertainties remain (such as allowable channel width and wind fetch effects), in general the basic engineering designs and assumptions for the microalgae cultivation ponds appear well established.

For the harvesting, fuel processing, and media/nutrient recycling subsystem designs the cost analyses are perhaps less robust, based on often untested assumptions. However, overall, none of these appear to provide a likely major show stopper. Still, most of these issues require more R&D. One area where little work has been done is in the extraction of the algal oils. Although in the most recent studies the use of large three-phase centrifuges was recommended (Benemann and Oswald 1996), this requires further study.

Although no single design component or unit process in these engineering analyses has an overwhelming effect on costs, the cost projections are optimistic; therefore, there is relatively little scope for any further cost reductions. In most cases, engineering designs and specifications were based on the cheapest possible design and likely lowest costs. Also, the engineering design and system construction approaches were based on agricultural engineering practices, rather than those of chemical engineering, as agricultural materials and construction methods are more applicable, in addition to being of lower cost.

A major conclusion from the cost analyses is that there is little prospect for any alternative designs for microalgae production systems that would be able to meet the requirements of microalgae production for fuels. This is particularly true of closed photobioreactors, in which the culture is entirely enclosed, in greenhouses, plastic tubes or bags, or other transparent enclosures. The costs of even the simplest such system would likely be well above what is affordable for



fuel production processes. Even the simplest plastic sheeting cover over the ponds would much more than double total systems capital and operating costs. The simplest tubular photobioreactors are projected to have capital costs some ten times higher (e.g., \$50/m<sup>2</sup>) than open pond designs (Benemann 1998). And, despite many proponents of such closed photobioreactors, current commercial microalgae production systems use exclusively open pond cultures, even for very high-value microalgae products. The few attempts at large-scale (>1 t/yr) production of microalgae in closed systems have failed.

Of course, closed photobioreactors could have benefits in areas such as better control over environmental conditions (pH, temperature) and biological contaminants, and higher cell concentrations, reducing liquid handling and harvesting costs. Thus, it would be theoretically possible to grow algal strains not able to dominate in open ponds, at higher productivities and reduced harvesting costs, thereby making up for the higher costs of closed photobioreactors (which proponents assume to be only marginally higher than open pond systems). Closed systems of various types may find important applications in the production of the “starter culture” or inoculum that will be required to initiate and maintain large-scale open pond operations. This could be particularly important when genetically improved or genetically engineered algal strains are used.

At the other engineering design extreme are the very large (up to 100 ha) unmixed ponds used in the production of *Dunaliella* in Australia (and, until recently, also used for *Spirulina* production in Mexico). Such production processes are of even lower cost than the mixed raceway designs. However, due to hydraulic and CO<sub>2</sub> supply limitations (among others), productivities are maximally only a few g/m<sup>2</sup>/d, a small fraction of those required for microalgae fuels production. Thus, there seem to be few practical choices in the basic engineering design of a raceway pond system. Even the mixing options are restricted; paddle wheels are overall more economical, flexible, and suitable than the alternatives (e.g., Archimedes screws, recirculation pumps, or air-lifts).

However, the most important issues raised in these economic and engineering analyses are not the engineering designs, or even the cost estimates, but the biological assumptions on which such designs are based. These have changed dramatically during the past 2 decades in one major aspect: productivity. Productivity projections have escalated from less than 50 mt/ha/y in the initial studies (e.g., Benemann et al. 1977), to almost 300 mt/ha/y (on an equivalent heat of combustion basis) in the most recent extrapolations (Benemann et al. 1993). In terms of photosynthetic efficiency, these improvements are from about 2% total solar energy conversion to a near-theoretical 10% efficiency. This dramatic increase in projected productivities was based on two main factors: first the significant advances in the state-of-the-art during these 2 decades, with significantly higher productivities than originally anticipated being measured in outdoor systems. And second, the clear necessity to achieve very high efficiencies for any sunlight-to-fuels process. Although there are theoretical, and practical, approaches to achieving such high efficiencies, they will without a doubt require relatively long-term R&D efforts (see Section IV.A.2.).



Productivity, in terms of solar conversion efficiency, is only one of the objectives of future R&D in this field. A related issue is that much of this productivity must be in the form of algal lipids, suitable for utilization and upgrading to fuels. Although some progress was made in this area in the laboratory, through physiological and genetic means (see Section III.B.5.d.; also Section II), this still will require considerable research. Another area that will require significant research is the development of a low-cost harvesting process. Again, the engineering and economic realities constrict the choices to the lowest-cost option, which would appear to be a simple settling process, followed by further mechanical concentration and processing.

The major conclusion of these analyses is that microalgae production for fuels is currently not limited by engineering designs, but by the many microalgae cultivation issues, from species control in large outdoor systems to harvesting and lipid accumulation to overall productivity. Future R&D must focus on these biological issues as a primary research objective, in the quest for low-cost production processes.



## IV. Conclusions and Recommendations

### IV.A. Microalgal Strain Improvement

#### IV.A.1. Conclusions

From the early 1980s through the mid-1990s, there was a major effort by ASP researchers and contractors to identify or develop microalgal strains that demonstrated properties conducive to cost-effective biomass and lipid production. The characteristics deemed desirable in these strains include high productivity, high lipid content, competitiveness in outdoor culture, and tolerance to fluctuations in temperature and salinity. Although a number of strains were identified as possible candidates, no one strain was found to possess the optimal characteristics. As discussed elsewhere in this report, perhaps the most significant observation is that the conditions that promote high productivity and rapid growth (nutrient sufficiency) and the conditions that induce lipid accumulation (nutrient limitation) are mutually exclusive. Further research will be needed to overcome this barrier, probably in the area of genetic manipulation of algal strains to increase photosynthetic efficiency or to increase constitutive levels of lipid synthesis in algal strains.

The collection and screening efforts produced a number of significant findings. The SERI/NREL Microalgae Culture Collection was established as a valuable genetic resource and was the first microalgal collection that focused on organisms from brackish or saline environments. The organisms remaining in this collection (see Section II.A.3.) are being transferred to the University of Hawaii and should be available to interested researchers.

Although a number of algal strains were investigated for growth and lipid production properties, the best candidates were found in two classes, the Chlorophyceae (green algae) and the Bacilliarophyceae (diatoms). Organisms were identified in both classes that showed high productivity, ability to grow in large-scale culture, and lipid accumulation upon nutrient stress. However, in some ways the diatoms may turn out to be better candidate organisms for biofuels production. The highest lipid levels (40%-60% of the AFDW) were found in diatoms. Limiting the availability of Si, a major component of the diatom cell wall, can induce lipid accumulation in diatoms. In green algae, lipid accumulation is induced by N starvation. N is a component of many cellular molecules, and N limitation would induce a complex response, affecting photosynthesis, protein and nucleic acid synthesis, and other biochemical processes. In contrast, Si is not involved in most intracellular processes, so the response to Si limitation should be simpler to interpret and control. The disadvantage to diatom cultivation is the added cost of Si supplementation in the medium for optimal growth, although this could be minimized by the use of strains with lightly silicified walls. Some green algal strains, for example *M. minutum*, are advantageous for mass culture applications in that they can survive temperature fluctuations that are lethal for diatoms. We found however, that the properties that make these organisms very hardy, such as a very tough cell wall, also make their biochemical and molecular studies problematic. Despite these generalizations, the ideal organism(s) for a biofuels production facility will likely be different for each location, particularly for growth in outdoor ponds. The best approach will likely be to screen for highly productive, oleaginous strains at selected sites,





optimize growth conditions for large-scale culture, and optimize productivity and lipid production through genetic manipulation or biochemical manipulation of the timing of lipid accumulation in the selected strains. It is also likely that more than one strain will be used at a site, to maximize productivity at different times of the year.

Significant progress was made during the last 15 years in the understanding of lipid accumulation in the microalgae, although there is still much to be learned. Clearly microalgal cells can be induced to accumulate significant quantities of lipid when the medium is limited for an essential nutrient. However, the actual mechanism that triggers the accumulation is unclear. Lipid accumulation is correlated with the cessation of cell division. A simple explanation is that lipid synthesis continues in the non-dividing cells, but since no new membranes are being synthesized, the lipid is shunted into storage lipids. Alternatively, non-dividing cells are not utilizing cellular energy reserves as rapidly as dividing cells, so lipid accumulates as synthesis occurs more rapidly than utilization. Nutrient deprivation affects specific biochemical pathways, as lipid accumulation is accompanied by an increase in the proportion of storage lipids (TAGs) to polar membrane lipids, and Si deprivation in diatoms increases the expression of at least one gene involved in lipid synthesis, acetyl-CoA carboxylase. In general, nutrient deprivation induces lipid accumulation in cells and is accompanied by a decrease in total (and total lipid) productivity. However, studies of lipid accumulation suggest that an understanding of the kinetics of the process could be critical and could allow the identification of a stage where biomass productivity and lipid levels are optimal for maximal lipid accumulation.

Significant progress was also made in understanding the molecular biology of microalgae. Many of the green algae were found to contain DNA with unusually high GC ratios, and often with unusual modifications that would make these organisms more difficult as targets for genetic engineering. In contrast, the DNA content of diatoms is more typical of other eukaryotes. Work at NREL by ASP researchers resulted in the cloning and characterization of several genes involved in lipid and carbohydrate accumulation in diatoms, including the ACCase gene and a “fused” gene encoding the enzymes UDPglucose pyrophosphorylase and phosphoglucomutase. Isolation of these genes facilitated the development of a genetic transformation system for the diatoms. These genes were used in preliminary attempts to manipulate lipid production in these organisms. The successful development of the transformation system led to an increased understanding of the factors involved in introducing and expressing foreign genes in these organisms, and should facilitate the development of similar methods for other algal strains.

There is still much to be done in the area of microalgal strain development for lipid or biofuels production. A number of suggestions for possible research areas will be discussed in the following sections.



## **IV.A.2. R & D Recommendations**

### **IV.A.2.a. General Considerations**

The conclusions presented elsewhere in this report focus attention on the fundamental issue of how to maximize the overall productivities of microalgae systems and suggest that there still is considerable scope for improvements. The issue of productivity, in its various guises and aspects, from species control to lipid (oil) yield and harvesting, is therefore recommended as a central subject for any future U.S. R&D program in microalgae biodiesel production. Essentially, the focus would be on developing the microbial catalysts that can convert solar energy to a liquid fuel at high overall efficiency. This effort will require a relatively long-term R&D effort, which would, at least initially, be focused on the fundamental and early-stage applied research required for such a biocatalyst development effort.

This recommendation implies that engineering design, cost and resource analyses, and even outdoor pond operations, discussed in Section III, would be relatively minor parts of such a projected R&D program, at least initially. The argument is that most of the variables of large-scale microalgal culture can be scaled-down to very small-scale, even laboratory systems. This allows detailed investigation of the key parameters in maximizing productivities. At present the central issues in scale-up are those of algal species dominance and grazer control (and other biological invasions). However, at this point these are secondary to the necessity and priority of establishing a high benchmark for productivity and lipid induction, under physicochemical and other environmental conditions that would allow extrapolation to large-scale outdoor systems at typical locations.

Again, this will require a relatively long-term R&D effort to accomplish, although guideposts, such as efficiency goals, to the needed advances can be provided. One issue is how to select strains for genetic improvements. This is still a difficult choice, as a relatively large investment is required to develop any novel genetic system. On the other hand, selection of the best strains for such a targeted genetics development effort is still some time off. Thus, a parallel track is recommended: strain selection (screening and improvements) would be carried out alongside with genetic engineering studies to demonstrate productivity enhancements using microalgal strains with already well-developed genetic systems. Such improvements would be in the efficiency of photosynthesis, described next, and lipid productivities, extending the ASP research reviewed in Section II.

### **IV.A.2.b. Maximum Efficiency of Photosynthesis**

Many environmental factors affect the performance of the complex photosynthetic machinery in microalgae, reducing its efficiency to well below the maximum at which photosynthesis can perform. That maximum is dictated by the underlying mechanisms, biophysical constraints, and physiological adaptations. One objective of applied microalgal R&D would be to develop strains and techniques that achieve productivities as close as possible to the maximum.



However, somewhat surprisingly, there is still argument about the maximum limit for photosynthetic efficiencies. The arguments boil down to the mechanisms assumed and the many possible loss factors that may or may not be considered. Most researchers agree that an absolute minimum of eight quanta (photons) of light absorbed are required by the two-photosystem mechanism (Z-scheme) of photosynthesis to reduce one molecule of CO<sub>2</sub> (and closer to 10 to 12 quanta if the energy needs for CO<sub>2</sub> fixation and cell metabolism are considered). However, there have been many reports of higher efficiencies. For example, recently Greenbaum et al. (1995) reported that some algal mutants lacking one photosystem still fixed CO<sub>2</sub> (and produced H<sub>2</sub>), suggesting less than 8 (and as few as 4) quanta per CO<sub>2</sub> reduced. However, recent reports cast doubts on this interpretation, and the two-photosystem mechanism appears robust.

The maximum efficiency can be estimated at about 10% of total solar (Bolton 1996). Such efficiencies have been used in the projections for microalgae biodiesel production (see Section III.D.). However, high sunlight conversions are observed only at low light intensities. Under full sunlight, typically one-third or less of this maximal efficiency, biomass productivity is obtained, because of the light saturation effect.

Light saturation is simply the fact that algae, like many plants, can use efficiently rather low levels of light, typically only 10% of full sunlight (and often even less). Above this level, light is wasted. In fact, full sunlight intensities can damage the photosynthetic apparatus, a phenomenon known as photoinhibition. Light saturation and photoinhibition result from several hundred chlorophyll molecules collaborating in light trapping, an arrangement ideally suited for dense algal cultures, where on average a cell receives little light. However, exposed to full sunlight, the photosynthetic apparatus cannot keep up with the high photon flux and most of the photons are wasted, as heat and fluorescence, and can damage the photosynthetic apparatus in the process. One possibility, suggested by Neidhardt et al. (1998), is that photosynthetic productivity and light utilization could be maximized in microalgae by reducing the size of the light-harvesting antenna through mutation or genetic engineering. This is an interesting idea that will be discussed further in the next section.

#### Publications:

Bolton, J.R. (1996) "Solar photoproduction of hydrogen." *Report to the Int. Energy Agency, under Agreement on the Production and Utilization of Hydrogen*, IEA/H2/TR-96.

Greenbaum, E.; Lee, J.W.; Tevault, C.V.; Blankinship, S.L.; Metz, L.J. (1995) "Carbon dioxide fixation and photoevolution of hydrogen and oxygen in a mutant of *Chlamydomonas* lacking photosystem I." *Nature*, August 3rd, (1995).

Kok, B. (1953) "Experiments in photosynthesis by *Chlorella* in flashing light." In *Algal Culture: From Laboratory to Pilot Plant* (Burlaw, J.B., ed.), Carnegie Inst. of Washington, Publ. 600, pp. 63-75.



Kok, B. (1973) "Photosynthesis." *Proceedings of the Workshop on Bio Solar Hydrogen Conversion* (Gibbs, M., et al., eds.), September 5-6, Bethesda, Maryland, pp. 22-30.

Melis, A.; Neidhardt, J.; Bartoli, I.; Benemann, J.R. (1998) *Proc. Biohydrogen '97*.

Neidhardt, J.; Benemann, J.R.; Baroli, I.; Melis, A. (1998) "Maximizing photosynthetic productivity and light utilization in microalgae by minimizing the light-harvesting chlorophyll antenna size of the photosystems." *Photosynthesis Res.*, in press.

#### **IV.A.2.c. Overcoming Light Saturation, Photooxidation, and Other Limitations**

The problem of light saturation has been a subject of research in photosynthesis for almost 5 decades, with the report by Kok (1953) that microalgae cultures exposed to short (milliseconds) flashes of bright light, followed by longer periods of darkness, exhibited the same light conversion efficiencies as cultures exposed to the same total photon flux averaged for the entire period. The interpretation was straightforward: only a limited number of photons can be used per unit time, and the millisecond light/dark periods allow averaging high photon fluxes. A large body of literature has developed on this subject, including laboratory work by the ASP (Terry 1984, 1986; see also Section II). The mass culture work in Hawaii (Section III.B.2.), among many others, attempted to use this phenomenon to increase algal productivities. However, practical applications are not plausible because of the very short time periods involved. Another approach, central to the Japanese microalgae program (Section IV.B.1.c.), has been to diffuse light throughout the depth of the culture, using optical fibers, thus avoiding high a surface irradiance. But this approach is also not practical for biodiesel production because of the very high cost of the system.

A potential practical solution to the light saturation problem, and also probably to photoinhibition, has been recognized for many years (e.g., Kok 1973): reduce the number of chlorophyll molecules cooperating in photosynthesis (the so-called "antenna" chlorophylls) from a few hundred to a few dozen. This would allow the photosynthetic apparatus to absorb only as much light as it can use. The benefits of reduced absorption are that it would:

- reduce waste,
- limit photooxidative damage to the photosynthetic reaction center, and
- increase the overall productivity of an algal culture, by a factor of at least 3 (see Benemann and Oswald 1996 for a recent discussion).

However, it has only recently become possible to consider achieving this objective, through the detailed understanding of photosynthesis at the molecular level, and the development of genetic engineering tools that could now allow us to redesign the photosynthetic apparatus. Recent work by Melis et al. (1998) and Neidhardt et al. (1998) demonstrated, at the physiological level, the feasibility of obtaining high efficiencies and high light saturation levels with algal cultures. Much more research is required, but the molecular and genetic tools are available to achieve the



desired high photosynthetic efficiencies by algal mass cultures. Such tools can also be used to direct the flow of photosynthate to desired metabolic products, such as lipids (see Section II).

Future R&D should demonstrate the feasibility of genetically engineering an improved photosynthesis system using algae for which such genetic systems are already well established. Once proven, these techniques can then be transferred to strains suitable for mass culture.

#### **IV.A.2.d. Microalgal Strains for Mass Culture: Source and Genetic Improvements**

The immediate issue arises of how to isolate, select, improve, and maintain the algal strains required for large-scale, low-cost microalgae cultivation. The ASP spent considerable effort in this area, with the isolation, screening, maintenance, laboratory studies, outdoor cultivation, and genetic improvement of microalgal strains (see Section II). In general, laboratory results were not predictive of outdoor performance. In addition, the strains most successfully maintained outdoors were those that spontaneously arose in and then dominated the ponds, often for considerable periods. Indeed, one conclusion from the outdoor culture work was that strains maintained in laboratory culture are, in general, not very competitive in open ponds.

What was attempted in this context, the mass culture of specific, selected and productive algal strains in large open ponds for long periods of time, has only been accomplished in algal mass cultures in a few cases, and is still rare in most industrial or environmental microbiology applications. In the case of microalgae mass cultures, only a few strains, *Spirulina*, *Dunaliella*, *Scenedesmus*, and *Chlorella*, have been successfully mass cultured at a commercial or large (>0.1 ha) scale. In the most successful cases, *Spirulina* and *Dunaliella* are maintained in open ponds through the use of chemically selective media, containing high bicarbonate and high salinity, respectively. *Scenedesmus* was mass cultured at the pilot scale in Germany and Chekoslovakia, and other countries, with the cultures obtained from isolates that invaded and dominated the ponds. Commercial *Chlorella* production, using selected strains, has suffered from culture instabilities, requiring frequent inoculation and short production runs, greatly increasing the costs of the process. Thus, commercial-scale production of microalgae does not provide a good guide for this problem.

In the case of industrial microbiology, only the traditional fermentations (e.g., ethanol, vinegar, cheese production) use selected strains that can be inoculated into and maintained in the production system, which must be relatively “clean” to avoid rapid contamination, but do not need to be sterilized. In environmental and agricultural microbiology it has not yet been possible to inoculate desired microbes (e.g., pollutant degraders, N fixers) into the open environments and demonstrate their survival and efficacy.

Within this context, the demonstration of the ability to mass culture at least some algal strains on a relatively long-term and reliable basis by ASP-supported projects in California, Hawaii and New Mexico, must be considered a significant advance and accomplishment. These results provide a fundamental basis for future developments and improvements in this technology. However, a basic issue still to be resolved is the source of the microalgal strains to be used in



outdoor cultures. The results of the ASP Program suggest that one choice would be to allow the production system to self-select the organisms. Strains that naturally invade potential production sites could be screened for subtle combinations of fast growth, competitiveness in high densities, and adaptation to prevailing environmental conditions. In this context, most of the critical parameters—temperature, light intensity, pH fluctuations—can be modeled rather easily at a modest scale. Thus, it should be possible to select such strains in downscaled models that would allow much better control than possible in large ponds over the selective conditions desired.

One factor essentially impossible to model or scale down is the biotic environment itself, that is, invasions by other microalgae, predation by grazers, infection by viruses, and other obvious or hidden biological effects that result in decreased productivities or even loss of culture. However, it appears from the experience with outdoor ponds, that these biotic effects are usually consequences of, not fundamental reasons for, loss of culture competitiveness. Further, some techniques have been developed to counteract such problems, for example rotifer grazing. In general, these problems will have to be dealt with when the technology has advanced to the point where large-scale culture efforts can be justified. That is, after high productivity cultures can be demonstrated at smaller scales, starting with laboratory simulations.

It is thus recommended that small-scale systems, mimicking as much as possible the outdoor environment, be used as selection devices for microalgae strains suitable for outdoor algal mass cultures. Suitability for mass culture can be established at a relatively small scales (<200 m<sup>2</sup>). Such selected “wild type” algal strains, would, of course, not necessarily exhibit the high biomass and lipid productivities required for the purposes of biodiesel production. Thus, considerable R&D will be required to genetically improve such strains. The techniques used to increase photosynthetic efficiencies or to optimize lipid quantity or quality, achieved with laboratory strains, must then be applied to the isolated strains suitable for algal mass culture.

Thus the recommendation for future R&D in this field is for a parallel track effort:

1. Demonstrate the feasibility to achieve with laboratory systems the high solar conversion efficiencies and lipid productivities required for biodiesel production.
2. Isolate and study strains suitable for mass cultures, then apply the productivity enhancement techniques developed under laboratory conditions to these strains.



## **IV.B. Microalgal Mass Culture**

### **IV.B.1. Conclusions**

#### **IV.B.1.a. Cost and Productivity Goals**

The overall conclusion from this review of 2 decades of DOE and ASP R&D in microalgal mass culture for biodiesel and other renewable fuels, is that this technology still requires relatively long-term R&D for practical realization. The initial, rather optimistic, cost and performance projections have not been met, or when met, the performance expectation (e.g., for productivity) have been raised. This was due, in large part, to the following factors:

1. The expectations for the future costs of fossil fuels have declined.
2. The value of by-product credits for waste treatment, greenhouse gas mitigation, or higher value coproducts are either uncertain or relatively low.
3. The recent engineering designs and economic analyses have projected higher costs than earlier estimated, partly because of greater detail and realism, thus requiring higher productivities to achieve cost goals.
4. The actual productivity results of the outdoor experimental work were well below the projections on which the economic analyses are based.

In this concluding section, these issues are briefly addressed, followed by a discussion of future R&D needs and recommendations.

The expectation for the economics of alternative fuels is a moving and uncertain target. Energy prices have been falling in real terms for more than 20 years, since the last oil-shock of the late 1970s. Competing within current market realities is not plausible for most renewable energy technologies. Indeed, electric industry deregulation is removing price supports for such technologies as wood, wind, and geothermal power. The price of fossil fuels will probably start to reflect at least some of their externalities costs, including air pollution and greenhouse gases, and plausibly even a cost penalty to account for their non-sustainable nature. However, any projection of the future price or costs of fossil fuels, with which renewable fuels such as microalgae biodiesel would need to compete in the marketplace, is rather uncertain and arbitrary.

For example, the use of a C-tax of some \$50/t CO<sub>2</sub> has been suggested, based on a current tax in Norway. However, if this were applied to all fossil fuels currently consumed, equivalent to some 20 billion tons of CO<sub>2</sub> world wide, it would increase the energy sector of the world economy by \$1 trillion, more than tripling current expenditures on fossil fuels, a highly unlikely possibility. Perhaps a more modest tax of \$50/tC (approximately \$14/t CO<sub>2</sub>), would be a more appropriate upper bound for greenhouse gas mitigation penalties (e.g., credits for renewable energy sources).

At any rate, presently there is essentially no monetization of greenhouse gas mitigation, and any such figures are, at best, educated guesses.



However, greenhouse gas mitigation credits would likely be the overwhelming considerations in any future externalities cost accounting. Table III.D.7., summarized greenhouse gas credits required for microalgae systems, demonstrating the decisive effects of competitive fossil fuel costs on the necessary valuation of greenhouse gas mitigation. That table also demonstrates the major effect of productivity on the projected economics of such systems.

Another potential enhancement of microalgae biodiesel economics is in wastewater treatment. Here the technology and economics would be dominated by the competitive costs with an activated sludge plant, or other wastewater treatment processes, including conventional microalgae pond systems. The latter, known also as facultative or stabilization pond systems, naturally treat municipal wastewaters (sewage), liquid animal manures, food processing wastes, and even some industrial effluents. In current technology, with very few exceptions (e.g., the City of Sunnyvale, California) the algal biomass is not harvested, and thus it is discharged to the nearest body of water (river, lake, etc.), used for irrigation, groundwater recharge, or it settles to the bottom of the ponds. Such systems are not designed for maximizing biomass production. However, through conversion to high rate ponds, they provide a possible entry for introducing and demonstrating of microalgae biomass fuel production and CO<sub>2</sub> utilization. Of course, their economics would not be dictated, except marginally, by their waste treatment functions, and their impacts on U.S. greenhouse gas emissions and fuel resources would be modest, at most a fraction of 1% of U.S. energy consumption and greenhouse gas emissions.

To expand the economic base and potential of such systems, other higher value coproducts or byproducts have been considered from such systems and processes. This is discussed in the following section.

#### **IV.B.1.b. Higher Value Byproducts and Coproducts**

The problem with integrating microalgae biodiesel production with any high value coproducts or byproducts, such as pigments, vitamins, or specialty chemicals, is that these would be produced in very large amounts, saturating any likely markets. And, of course, the requirements for producing such high value products are quite different from the needs for biomass fuels. One example for coproducts comes from fuel ethanol production from corn, which is economically dependent on animal feeds (distillers dried grains), byproducts for economic viability, in addition to the more than \$1/gallon in subsidies. Indeed, only large byproduct markets, such as animal feeds, could be realistically considered in the context of biodiesel production. However, although it may be possible to coproduce proteins with algal lipids, such an optimization (e.g., for high protein feeds) is likely to be difficult. Another major problem, as in distillers dried grain, is the drying costs. Overall, higher-value feed coproducts cannot, and should not, be a major driving force in developing this technology.

Of course, the likely route for the future development of practical and commercial large-scale microalgae culture technology will be through development of specialty foods and animal feeds coproduction. For example, *Spirulina* with two farms in the United States, comprising more than 100-ha of ponds, is becoming a commodity product, with bulk prices declining by almost half





(from the high 20s to the mid teens in dollars per kg) during the past 2 years. If this trend were to continue, to below \$10/kg, this algal biomass could become a significant ingredient in aquaculture and other specialty animal feeds. Larger-scale systems for poultry feed production (microalgae high in xanthophylls, for example), or even cattle and hog feeds, could be foreseen, but require a decrease in costs (prices) to about \$1,000/ton.

But to be considered for fuel production, costs for microalgal biomass production would need to be reduced to the absolute minimum. This implies that productivities must significantly increase, and costs decrease from current levels. We argue that any future technology development effort for microalgae biodiesel production should exclude higher value byproducts or coproducts as a specific target. We believe that the needs of biodiesel production, specifically for high lipid productivities, must be the objectives of such a program. One exception is the combination of such a process with wastewater treatment, as there are few likely alternative uses for the biomass. The other is the utility of such processes in greenhouse gas mitigation, also the objective of the Japanese R&D program in microalgae CO<sub>2</sub> utilization, discussed briefly in the following section.

#### **IV.B.1.c. The Japanese R&D Program for Microalgae CO<sub>2</sub> Utilization**

In Japan, the Research for Innovative Technology of the Earth program (RITE) has carried out an extensive program for microalgal CO<sub>2</sub> utilization. The Ministry of International Trade and Industry (MITI) funds this program, through the New Energy Development Organization (NEDO). The program was established in 1990 as a 10-year effort, carried out by approximately two dozen private companies, with some supporting work at various national laboratories and academic institutions. The budget is generally stated to be approximately \$80 million (10 billion Yen) for 10 years; however, this is only for direct costs provided by RITE to the companies. If all indirect costs and supporting R&D at various institutes were to be included, this would easily double this budget. Also, microalgae-CO<sub>2</sub> capture related R&D has been going on at the Japanese electric utilities, projects that are not part of the MITI-NEDO-RITE program. Thus, perhaps it is no exaggeration to estimate that during the 1990s the Japanese government and private companies will have invested more than \$200 million (and perhaps closer to \$250 million) in this research.

Although the Japanese microalgae R&D program is very large, it can be summarized rather briefly. Contrary to the U.S. approach, the Japanese effort has focused on closed photobioreactors, and on higher-value products. The argument made for closed photobioreactors was that these would require less land area than open ponds, because of much higher productivities. The higher productivities were assumed to be possible by using optical fibers to diffuse light into the reactors, and by greater control over environmental conditions (such as the ability to supply high CO<sub>2</sub> levels to the cultures). Lower land requirements were also assumed to be possible with the optical fiber devices, although the land required for the concentrating mirrors was apparently not considered. The Japanese RITE program has yet to carry out, or at least report on, any technical, engineering, or economic analysis on such processes. A Japanese report (by researchers not part of the RITE program) to the IEA Greenhouse Gas R&D



Programme (IEA 1994) on microalgae “direct biofixation” of CO<sub>2</sub>, was based on prior U.S. engineering and cost analyses (Ikuta 1994), though they dried the algal biomass to replace coal.

The Japanese RITE program has presented some results on their microalgae genetics program and photobioreactor development (Murakami and Ikenouchi 1997; Usui and Ikenouchi 1975). But these add little detail to the development of this technology.

One major emphasis of the Japanese program has been on developing high-value coproducts, from animal feeds to antibiotics to specialty chemicals. Some are rather esoteric, such as algae-based paper and concrete additives. In brief, the Japanese RITE Biological CO<sub>2</sub> Fixation Program, and other Japanese R&D activities, perhaps in part by concentrating on such higher-value products, have not significantly advanced the technology for biofuels production or CO<sub>2</sub> utilization, despite large investments.

One exception is the work carried out by Mitsubishi Heavy Industries (MHI) and several electric utilities, in particular Tohoku Electric Co., near the northern city of Sendai, in the early 1990s. There, a small pond (approximately 3-m<sup>2</sup>) project was carried out on the mass culture of diatoms and green algae. These studies initially used algal strains obtained from the NREL culture collection, and then with strains that spontaneously appeared and dominated the cultures at this site (Negoro et al. 1992, 1993). Productivity data were obtained and were generally in accord with the work at Roswell, New Mexico. (Two authors of this report, Benemann and Weissman, were consultants to this project.)

Another interesting project was carried out by MHI and Tokyo Electric Power Co. (TEPCO), which demonstrated actual increased productivity in optical fiber bioreactors. However, the complication and costs of these devices resulted in this project shifting to more conventional, air-lift tubular reactors. Recently TEPCO-MHI released a publicity announcement of a major breakthrough in the production of ethanol from microalgae biomass. However, little specific technical information is available on this work.

*Publications:*

Ikuta, Y. (1994) “Design of a biological system for CO<sub>2</sub> fixation, in carbon dioxide utilization-direct biofixation.” *Report to the Int. Energy Agency Greenhouse Gas R&D Programme*.

Murakami, M.; Ikenouchi, M. (1997) “The biological CO<sub>2</sub> fixation and utilization project by RITE. 2. Screening and breeding of microalgae with high capability of fixing CO<sub>2</sub>.” *Energy Conver. Mgmt.* 38: Suppl. 493-498.

Negoro, M.; Shioji, K.; Ikuta, Y.; Makita, T.; Utiumi, M. (1992) “Growth characteristics of microalgae in high-concentrations of CO<sub>2</sub> gas: Effects of culture medium, trace components and impurities thereon.” *Biochem Biotech.* 34/35:681-692.



Negoro, M.; Hamasaki, K.A.; Ikuta, Y.; Makita, T.; Hirayama K.; Suzuki, S. (1993) "CO<sub>2</sub> fixation by microalgae photosynthesis using actual flue gas discharged from a boiler." *Biochem Biotech.* 39/40:643-653.

Usui, N.; Ikenouchi, M. (1997) "The biological CO<sub>2</sub> fixation and utilization project by RITE. 1. Highly effective photobioreactor system." *Energy Conver. Mgmt.* 38: Suppl. 487-492.

#### **IV.B.1.d. Resource Projections and Microalgae Biodiesel R&D**

There are several arguments for and against a U.S. microalgae biodiesel R&D program. One of the more important, and perhaps contentious, issues, is the potential impact of such technologies on U.S. energy supplies, specifically liquid transportation fuels. The review in Section III.C. of the NREL resource analyses for microalgae biodiesel concluded that there is a potential for production of several quads (10<sup>15</sup> Btu) of biodiesel fuels in the southwestern United States alone. However, as stated earlier, it will be difficult to find many locations where all the resources required for microalgae cultivation, flatland, brackish or waste waters, and low-cost CO<sub>2</sub> supplies, are all available in juxtaposition. And, as also pointed out, the southwestern United States is not the ideal climatic location for such systems. For both these reasons, the resource potential estimated by these resource studies must be significantly discounted.

In the case of utilization of power plant CO<sub>2</sub>, diurnal and seasonal factors would restrict direct CO<sub>2</sub> (e.g., flue gas) utilization to about one-third of the power plant CO<sub>2</sub>. Even with CO<sub>2</sub> capture and transportation (which greatly increases costs), only about half of the CO<sub>2</sub> would be useable. With most coal-fired power plants located in the north, or in otherwise unfavorable climates, only a rather small fraction of power plant CO<sub>2</sub> resources would likely be captured with microalgae systems in the United States.

A conservative estimate is that microalgae systems would be able to mitigate, directly or indirectly, perhaps only about 1% of current power plant CO<sub>2</sub> emissions, supplying an approximately equivalent amount of current transportation fuels. Herzog (1995) argued that such a potential, in fact, anything less than 10%, is not sufficient to justify a R&D effort, and that scarce resources should be devoted only to potentially high-impact technologies, such as the disposal of CO<sub>2</sub> in the oceans or geological formations. However, Benemann (1995) countered that such a resource-only argument is too limited, as it ignores the issue of economics and technological risks. For example, the technical feasibility of ocean disposal is far from established, and the costs of such a process are not currently constrained by credible engineering and economic analyses. A balanced R&D portfolio would need to account for such factors. Also, it is inherently more attractive to use and recycle CO<sub>2</sub>, thus increasing economic activity, rather than to bury it or dump it into oceans. In addition, microalgae CO<sub>2</sub> utilization could spin-off other technologies, as in the case of the ASP. Thus, although a decisive role for microalgae fuel production and greenhouse gas mitigation cannot be extrapolated, a modest R&D effort in this area is appropriate in the context of developing many such alternative technologies.



#### **IV.B.1.e. Summary of Major Conclusions from the ASP Microalgal Mass Culture Work**

This report cannot do justice to the extensive and long-term R&D effort in applied microalgae mass culture carried out by DOE and the ASP over a 20-year period. Here only a very brief summary of the major conclusions is provided to put into context the recommendations for future R&D, which follow.

Two major conclusions can be derived from the outdoor cultivation projects and engineering/economic analyses under the ASP, and can be briefly summarized:

1. There appear to be no fundamental engineering and economic issues that would limit the technical feasibility of microalgae culture, either in terms of net energy inputs, nutrient (e.g., CO<sub>2</sub>) utilization, water requirements, harvesting technologies, or general system designs.
2. Productivities, in terms of total biomass and algal lipids (oils) currently achieved during the ASP are substantially higher than those reported and even projected before the ASP, but still well below the theoretical potential, and the requirements for economical viability.

The first conclusion should not imply that all these issues and problems have been solved. It does, however, suggest that the immediate R&D needs are not for engineering designs or cost analysis, or even in the operation of large, outdoor algal mass culture systems. Rather, from the second conclusion, the emphasis of any R&D effort must be on more fundamental and early-stage applied research issues faced in developing very high productivity algal strains. Ideal strains would dominate the pond cultures, achieve near-maximal productivities, efficiently biosynthesize large amounts of lipids, and be easy to harvest.

Another conclusion from the DOE-ASP program is that the only plausible near- to mid-term application of microalgae biofuels production is integrated with wastewater treatment. In such cases the economic and resource constraints are relaxed, allowing for such processes to be considered with well below maximal productivities.

#### **IV.B.2. R & D Recommendations**

##### **IV.B.2 a. Biodiesel Production and Algal Mass Culture for Wastewater Treatment**

The laboratory work outlined earlier will be a relatively longterm effort. Even after the demonstration at the laboratory and small-scale (e.g., 1 m<sup>2</sup>) of the ability of genetically improved microalgae strains to exhibit high lipid productivities, many other factors and abilities are still required in algal mass culture. These, however, cannot be demonstrated in the laboratory. They include competitiveness, predation resistance, and harvestability. The issue thus arises of the need to carry out such algal mass culture research in parallel with the laboratory studies.



The outdoor projects of the ASP demonstrated the ability to mass culture microalgae under relatively unrestricted conditions (e.g., without a highly selective chemical environment), and to do so potentially at relatively low cost, as the inputs for power, nutrients, and water are rather modest. Considerable advances were also made in developing techniques for managing microalgae species in ponds, and demonstrating increasing biomass productivities. Of course, these subjects still require much more work. However, in the absence of improved microalgae strains, with the high total and lipid productivities required by the cost analyses, it would not be possible to make significant advances in this technology. Thus, a continuing emphasis on outdoor algal mass cultures, or on cost and resource analyses, is not recommended at this time. These accomplishments of the ASP now allow research to be focussed on the genetic work, as outlined above and in Section II, and to allow confident prediction of the ability to apply this research to mass culture systems. This is not to exclude some supporting outdoor studies, for example to verify the selection criteria used for the competitive strains for the genetic development. But, in general, the emphasis should be on genetics and strain improvements, not on outdoor culture technology development.

However, a strictly laboratory-based R&D program, may rapidly loose touch with the realities of the eventual applications. Thus, some outdoor mass culture R&D is recommended, specifically for near-term development and demonstration of a combined microalgae wastewater treatment—biodiesel production process. This recommendation is based on the potential for such systems to be developed and demonstrated rather quickly, and at relatively low cost. They would provide an early practical application of this technology, and justify the larger effort that would be required for the development of a significant microalgae-biodiesel industry. Benemann and Oswald (1996) present a detailed discussion of this approach.

#### **IV.B.3. Conclusions**

A microalgae biodiesel production system must be a solar conversion device, which operates at high efficiency and with minimal inputs at overall low cost. Cost constraints restrict consideration of such systems to the simplest possible devices, which are large unlined, open, mixed raceway ponds. Several decades of R&D in this field, in particular by the ASP, have revealed no plausible alternative to this basic design. Even some of the design details, such as the mixing devices (paddle wheels), depth (15-25 cm), mixing velocity (15-25 cm/s), CO<sub>2</sub> transfer (countercurrent sumps), and others are fixed by the engineering and economic constraints. The commercial experience with open mass culture ponds suggests that such systems require relatively little further engineering development. Certainly, it would be of interest to determine the practical limits of such systems. Can single raceway pond scales be larger than 5 ha? What are the wind effects in such large systems? But overall, the engineering and hardware for the low-cost mass culture of microalgae cannot be considered a major R&D need in this field.

Any effort toward the development of closed photobioreactors is probably too high risk in the present context. Although such devices could have a role in the buildup and production of



inoculum (starter cultures), they are not likely to be an essential or crucial component of large-scale, low-cost microalgae culture processes for energy production.

Any future R&D program for microalgae CO<sub>2</sub> capture and biofuels production must start with the development of the microalgae “biocatalysts.” The goal will be to construct strains via genetic engineering or other strain improvement methods that achieve very high solar conversion efficiencies and yield high lipid (oil) microalgal biomass, as required by the economic analyses. The central recommendation for a future R&D program is to emphasize such a biocatalyst development effort, building on the knowledge developed by the ASP. For a more near-term approach, there is a significant opportunity to develop and demonstrate microalgae biodiesel production as part of a wastewater treatment process; R&D in this area is also recommended. Finally, the international nature of the global warming problem now allows consideration of global impacts of such technologies. This could help justify a U.S., and an international, R&D effort, even if the impacts of microalgae biodiesel to future U.S. energy supplies were perceived to be modest.



## V. BIBLIOGRAPHY

### V.A. SERI/NREL/DOE REPORTS AND PUBLICATIONS

Anberg, S.M.; Meints, R.H. (1991) "Nucleotide sequence of the genes for ribulose-1,5-bisphosphate carboxylase/oxygenase large subunit and ribosomal protein S145 from a *Chlorella*-like alga." *J. Phycol.* 27:753-758.

Anderson, D.B.; Molton, P.M.; Metting, B. (1981) "Assessment of blue-green algae in substantially reducing nitrogen fertilizer requirements for biomass fuel crops." *Proceedings of the July 1981, Subcontractors' Review Meeting, Aquatic Species Program*, Solar Energy Research Institute, Golden, Colorado, SERI/CP-624-1228, pp. 69-73.

Arad, S. (1984) "Development of outdoor raceway capable of yielding oil-rich halotolerant microalgae." *Aquatic Species Program Review: Proceedings of the April 1984 Principal Investigators' Meeting*, Solar Energy Research Institute, Golden, Colorado, SERI/CP-231-2341, pp. 184-185.

Arad, S. (1985) "Development of outdoor raceway for producing oil-rich halotolerant microalgae: An introduction." *Aquatic Species Program Review: Proceedings of the March 1985 Principal Investigators' Meeting*, Solar Energy Research Institute, Golden, Colorado, SERI/CP-231-2700, pp. 228-229.

Arad, S. (1987) "Integrated field-scale production of oil-rich microalgae under desert conditions." *FY 1986 Aquatic Species Program Annual Report*; Solar Energy Research Institute, SERI/SP-231-3071; pp. 169-183.

Barclay, W.R. (1984) "Microalgal technology and research at SERI: Species collection and characterization." *Aquatic Species Program Review: Proceedings of the April 1984 Principal Investigators' Meeting*, Solar Energy Research Institute, Golden, Colorado, SERI/CP-231-2341, pp. 152-159.

Barclay, W.; Chelf, P.; Nagle, N. (1987) "Environmental control of lipid production in diatom cultures." *Abstract, FY 1986 Aquatic Species Program Annual Report*, Solar Energy Research Institute, Golden, Colorado, SERI/SP-231-3071, p. 250.

Barclay, W.; Johansen, J.; Chelf, P.; Nagle, N.; Roessler, P.; Lemke, P. (1986) "Microalgae culture collection, 1986-1987." Solar Energy Research Institute, Golden, Colorado, SERI/SP-232-3079, 149 pp.

Barclay, B.; Nagle, N.; Terry, K. (1986) "Screening microalgae for biomass production potential: protocol modification and evaluation." *FY 1986 Aquatic Species Program Annual Report*; Solar Energy Research Institute, Golden, Colorado, SERI/SP-231-3071, pp. 22-40.



Barclay, W.R.; Nagle, N.J.; Terry, K.L.; Ellingson, S.B.; Sommerfeld, M.R. (1988) "Characterization of saline groundwater resource quality for aquatic biomass production: a statistically-based approach." *Wat. Res.* 22:373-379.

Barclay, B.; Nagle, N.; Terry, K.; Roessler, P. (1985) "Collecting and screening microalgae from shallow, inland saline habitats." *Aquatic Species Program Review: Proceedings of the March 1985 Principal Investigators' Meeting*, Solar Energy Research Institute, SERI/CP-231-2700, pp. 52-68.

Barclay, W.R.; Terry, K.L.; Nagle, N.J.; Weissman, J.C.; Goebel, R.P. (1987) "Potential of new strains of marine and inland saline-adapted microalgae for aquaculture." *J. World. Aquaculture Soc.* 18:218-228.

Ben-Amotz, A. (1984) "Development of outdoor raceway capable of yielding oil-rich halotolerant microalgae." *Aquatic Species Program Review: Proceedings of the April 1984 Principal Investigators' Meeting*, Solar Energy Research Institute, Golden, Colorado, SERI/CP-231-2341, pp. 186-194.

Ben-Amotz, A. (1987) "Development of outdoor raceway capable of yielding oil-rich halotolerant microalgae" *FY 1986 Aquatic Species Program Annual Report*, Solar Energy Research Institute, SERI/SP-231-3071, pp. 199-208.

Ben-Amotz, A.; Tornabene, T.G. (1983) "Chemical profile of algae with emphasis on lipids of microalgae." *Aquatic Species Program Review: Proceedings of the March 1983 Principal Investigators' Meeting*; Solar Energy Research Institute, Golden, Colorado, SERI/CP-231-1946, pp. 123-133.

Ben-Amotz, A.; Tornabene, T.G.; Thomas, W.H. (1985) "Chemical profiles of selected species of microalgae with emphasis on lipids." *J. Phycol.* 21:72-81.

Benemann, J.R. (1980) "Biomass energy economics." *Intl. Energy Journal* 1:107-131.

Benemann, J.R. (1993a) "Alternative recommendation regarding biological CO<sub>2</sub> utilization R&D." In *The Capture, Utilization and Disposal of Carbon Dioxide from Fossil Fuel Power Plants* (Herzog, H., et al., eds.), U.S. Dept. of Energy, DOE/ER-30194/1, 56 pp.

Benemann, J.R. (1993b) "Utilization of carbon dioxide from fossil fuel-burning power plants with biological systems." *Energy Convers. Mgmt.* 34:999-1004.

Benemann, J.R. (1997) "CO<sub>2</sub> mitigation with microalgae systems." *Energy Convers. Mgmt.* vol. 38, Suppl., pp. S475-S.479.

Benemann, J.R.; Augenstein, D.C.; Weissman, J.C. (1982) "Microalgae as a source of liquid fuels, appendix: technical feasibility analysis." *Final Report to the U.S. Department of Energy*, unpublished, 126 pp.





Benemann, J.R.; Baker, D.; Koopman, B.L.; Oswald, W.J. (1977) "A systems analysis of bioconversion with microalgae." *Proc. Symposium Clean Fuels from Biomass and Wastes* (Klass, D., ed.), Institute for Gas Technology, Chicago, pp. 101-126.

Benemann, J.R.; Goebel, R.P.; Weissman, J.C. (1981) "Production of lipid hydrocarbon fuels and chemicals from freshwater microalgae." *Final Report, Contract Xb-0-9253-1*, Solar Energy Research Institute, Golden, Colorado.

Benemann, J.R.; Goebel, R.P.; Weissman, J.C. (1983) "Production of lipid hydrocarbon fuels and chemicals from freshwater microalgae." *Final Report*, Solar Energy Research Institute, Golden, Colorado (unpublished).

Benemann, J.R.; Goebel, R.P.; Weissman, J.C.; Augenstein, D.C. (1982a) "Microalgae as a source of liquid fuels." *Proceedings of the June 1982 SERI Biomass Program Principal Investigators' Review Meeting, Aquatic Species Program Reports*, Solar Energy Research Institute, Golden, Colorado, SERI/CP-231-1808, pp. 1-16.

Benemann, J.R.; Goebel, R.P.; Weissman, J.C.; Augenstein, D.C. (1982b) "Microalgae as a source of liquid fuels." *Final Report*, U.S. Department of Energy, 202 pp.

Benemann, J.R.; Goebel, R.P.; Weissman, J.C.; Augenstein, D.C. (1983) "Production of liquid fuels and chemicals by microalgae." *Aquatic Species Program Review: Proceedings of the March 1983 Principal Investigators' Meeting*, Solar Energy Research Institute, Golden, Colorado, SERI/CP-231-1946, pp. 19-32.

Benemann, J.R.; Koopman, B. L.; Weissman, J.C.; Oswald, W.J. (1976) "Biomass production and waste recycling with blue-green algae." In *Microbial Energy Conversion*, (Schlegel, H.G.; Barnea, J., eds.), Gottingen, pp. 413-426.

Benemann, J.R.; Hallenbeck, P.C.; Weissman, J.C.; Murry, M.; Oswald, W.J. (1977) "Fertilizer production with nitrogen-fixing heterocystous blue-green algae." *Final Report to the National Science Foundation*, Sanitary Eng. Res. Lab., Univ. Calif. Berkeley.

Benemann, J.R.; Koopman, B.L.; Baker, D.; Goebel, R.; Oswald, W.J. (1977) "Preliminary design of the algae pond subsystem of the photosynthesis energy factory." *Final Report to Inter-Technology Solar Corp.*, Sanitary Eng. Res. Lab., Univ. Calif. Berkeley.

Benemann, J.R.; Koopman, B.L.; Weissman, J.C.; Eisenberg, D.M.; Oswald, W.J. (1977b) "Species control in large scale microalgae biomass production." Report to Univ. Calif. Berkeley, SERL 77-5, SAN/740-77/1 (April 1977, revised November 1997.)

Benemann, J.R.; Koopman, B.L.; Weissman, J.C.; Eisenberg, D.M.; Goebel, R. P. (1980) "Development of microalgae harvesting and high rate pond technology." In *Algal Biomass*, (Shelef, G.; Soeder, C.J., eds.), Elsevier, pp. 457-499.



Benemann, J.R.; Koopman, B.L.; Weissman, J.C.; Eisenberg, D.M.; Oswald, W.J. (1978) "An integrated system for the conversion of solar energy with sewage-grown microalgae." *Report Contract D(0-3)-34*, U.S. Dept. of Energy, SAN-003-4-2, June 1978.

Benemann, J.R.; Miyamoto, K.; Hallenbeck, P.C. (1980) "Bioengineering aspects of biophotolysis." *Enzyme and Microbial Technology* 2:103-111.

Benemann, J.R.; Oswald, W.J. (1966) "Systems and economic analysis of microalgae ponds for conversion of CO<sub>2</sub> to biomass." *Final Report, Grant No. DE-FG22-93PC93204*, Pittsburgh Energy Technology Center.

Benemann, J.R.; Persoff, P.; Oswald, W.J. (1978) "Cost analysis of microalgae biomass systems." *Final Report Contract EX-78-X-01-1*, U.S. Dept. of Energy, HCP/t1-605-01.

Benemann, J.R.; Tillett, D. (1987a) "Effects of fluctuating environments on the selection of high yielding microalgae." *FY 1986 Aquatic Species Program Annual Report*, Solar Energy Research Institute, Golden, Colorado, SERI/SP-231-3071; pp. 285-300.

Benemann, J.R.; Tillett, D.M. (1987b) "Microalgae lipid production." In *Energy from Biomass and Wastes XI, Conference Proceedings* (Klass, D.L., ed.), Institute of Gas Technology, Chicago.

Benemann, J.R.; Tillett, D.M. (1987c) "Effects of fluctuating environments on the selection of high yielding microalgae." *Final Report*, Subcontract XK-4-04136-06, Solar Energy Research Institute, Golden, Colorado.

Benemann, J.R.; Tillett, D.M. (1987d), "Effects of fluctuating environments on the selection of high yielding microalgae." *FY 1987 Aquatic Species Program, Annual Report* (Johnson, D.A.; Sprague, S., eds.), Solar Energy Research Institute, Golden, Colorado, SERI/CP-231-3206, pp. 77-91.

Benemann, J.R.; Tillett, D.M. (1990) "Effects of fluctuating environments on the selection of high yielding microalgae." *Final Report*, Subcontract XK-4-04136-06, Solar Energy Research Institute, Golden, Colorado.

Benemann, J.R.; Tillett, D.M.; Weissman, J.C. (1987) "Microalgae biotechnology." *Trends in Biotechnology* 5:47-53.

Benemann, J.R.; Weissman, J.C.; Eisenberg, D.M., Goebel, R.P.; Oswald, W.J. (1979) "Large scale freshwater microalgae production for fuel and fertilizer." *Report to the Univ. Calif. Berkeley*, SERL 79-3 (1979) Contract EY-76-S-03-0034.

Benemann, J.R.; Weissman, J.C.; Goebel, R.P. (1983) "Production of liquid fuels and chemicals by microalgae." *Aquatic Species Program Review: Proceedings of the March 1983 Principal Investigators' Meeting*, Solar Energy Research Institute, Golden, Colorado, SERI/CP-231-1946, pp. 19-32.



Benemann, J.R.; Weissman, J.C.; Koopman, B.L.; Oswald, W.J. (1977) "Energy production with microalgae." *Nature* 268:19-23.

Bergeron, P. (1989) "The economic impact of brine disposal on algal fuel facilities." *Aquatic Species Program Annual Report* (Bollmeier, W.S.; Sprague, S., eds.), Solar Energy Research Institute, Golden, Colorado, SERI/SP-231-3579, pp. 21-37.

Bergeron, P.W.; Corder, R.E.; Hill, A.M.; Lindsey, H.; Lowenstein, M.Z. (1983). *SERI Biomass Program Annual Technical Report: 1982*. Solar Energy Research Institute, Golden, Colorado, SERI/TR-231-1918, 83 pp.

Berglund, D.; Cooksey, B.; Cooksey, K.E.; Priscu, L.R. (1987) "Collection and screening of microalgae for lipid production: Possible use of a flow cytometer for lipid analysis." *FY 1986 Aquatic Species Program Annual Report*, Solar Energy Research Institute, Golden, Colorado, SERI/SP-231-3071, pp. 41-52.

Bird, K.T.; Hanisak, M.D.; Ryther, J.H. (1981) "Changes in agar and other chemical constituents of the seaweed *Gracilaria tikvahiae* when used as a substrate in methane digesters." *Resources and Conservation* 6:321-327.

Bollmeier, W. (1989) "SERI Program Overview." *Aquatic Species Program Annual Report* (Bollmeier, W.S.; Sprague, S., eds.), Solar Energy Research Institute, Golden, Colorado, SERI/SP-231-3579, pp. 3-6.

Boussiba, S.; Vonshak, A.; Cohen, Z.; Abeliovich, A.; Kaplan, D.; Richmond, A. (1985) "Development of outdoor system for production of lipid-rich halotolerant microalgae." *Aquatic Species Program Review: Proceedings of the March 1985 Principal Investigators' Meeting*, Solar Energy Research Institute, Golden, Colorado, SERI/CP-231-2700, pp. 271-290.

Boussiba, S.; Vonshak, A.; Cohen, Z.; Richmond, A. (1987) "Development of outdoor system for production of lipid-rich halotolerant microalgae." *FY 1986 Aquatic Species Program Annual Report*, Solar Energy Research Institute, Golden, Colorado, SERI/SP-231-3071, pp. 184-198.

Brown, L.M. (1989) "Culture collection status." *Aquatic Species Program Annual Report* (Bollmeier, W.S.; Sprague, S., eds.), Solar Energy Research Institute, Golden, Colorado, SERI/SP-231-3579, pp. 61-69.

Brown, L.M. (1992) "Fuels from microalgae. Overview: Aquatic Species Project." *Aquatic Species Project Report, FY 1989-90*, (Brown, L.M.; Sprague, S., eds.), National Renewable Energy Laboratory, Golden, Colorado, NREL/MP-232-4174, pp. 1-6.

Brown, L.M.; Sprague, S. (1992) "Aquatic Species Project Report: FY 1991." *Report, April 1992*, National Renewable Energy Laboratory, Golden, Colorado, NREL/TP-422-4641, 30 pp.



Brown, L.M.; Sprague, S. (1993) "Biodiesel/Aquatic Species Project Report: FY 1992." *Report, May 1993*, National Renewable Energy Laboratory, Golden, Colorado, NREL/TP-422-5259, 32 pp.

Brown, L.M.; Dunahay, T.G.; Jarvis, E.E. (1989) "Strategies for genetic improvement of microalgae with ability to grow in outdoor mass culture." *Aquatic Species Program Annual Report* (Bollmeier, W.S.; Sprague, S., eds.), Solar Energy Research Institute, Golden, Colorado, SERI/SP-231-3579, pp. 85-89.

Brown, L.M.; Dunahay, T.G.; Jarvis, E.E. (1990). "Applications of genetics to microalgae production." *Dev. Industrial Microbiology*, vol. 31 (*J. Industrial Microbiol.*, Suppl. No.5), pp. 271-274.

Brown, L.M.; Sprague, S.; Jarvis, E.E.; Dunahay, T.G.; Roessler, R.G.; Zeiler, K.G. (1994) "Biodiesel from Aquatic Species Project Report: FY 1993." *Report, January 1994*, National Renewable Energy Laboratory, Golden, Colorado, NREL/TP-422-5726, 32 pp.

Brown, L.M.; Zeiler, K.G. (1993) "Aquatic biomass and carbon dioxide trapping." *Energy Conv. Mgmt.* 34:1005-1013.

Carlson, R.D.; Ryther, J.H.; Pendoley, P.D.; Jensen, P.R.; Blakeslee, M. (1986) "Collection and characterization of saline microalgae from south Florida." *Final Report*, Solar Energy Research Institute, Golden, Colorado, 51 pp.

Chelf, P. (1990) "Environmental control of lipid and biomass production in two diatom species." *J. Appl. Phycol.* 2:121-129.

Chelf, P.; Barclay, B.; Lemke, P. (1987) "Effect of environmental parameters on lipid production in *Navicula saprophila*." *FY 1987 Aquatic Species Program Annual Report* (Johnson, D.A.; Sprague, S., eds.), Solar Energy Research Institute, SERI/SP-231-3206, pp. 129-141.

Chelf, P.; Brown, L.M. (1989) "Microalgae mass culture and the greenhouse effect: Resources update." *Aquatic Species Program Annual Report* (Bollmeier, W.S.; Sprague, S., eds.), Solar Energy Research Institute, Golden, Colorado, SERI/SP-231-3579, pp. 9-15.

Chelf, P.; Brown, L.M.; Wyman, C.E. (1991) "Aquatic biomass resources and carbon dioxide trapping." *Biomass and Bioenergy* 4:175-183.

Chelf, P.; Brown, L.M.; Wyman, C.E. (1992) "Aquatic biomass resources and carbon dioxide trapping." *Aquatic Species Project Report, FY 1989-90* (Brown, L.M.; Sprague, S., eds.), National Renewable Energy Laboratory, Golden, Colorado, NREL/MP-232-4174, pp. 7-31.

Cheng, E.D.H.; Dugan, G.L. (1996) "Low-energy mixing in algal culture raceways." *J. Energy Engineering*, December, pp. 100-107.



Cheng, L.; Lewin, R.A. (1987) "Lipogenic picopleuston." *Abstract, FY 1987 Aquatic Species Program Annual Report* (Johnson, D.A.; Sprague, S., eds.), Solar Energy Research Institute, Golden, Colorado, SERI/SP-231-3206; p. 75.

Cohen, R.R.H. (1987) "Environmental effects on photorespiration in the diatom *Chaetoceros muelleri*." *Abstract, FY 1987 Aquatic Species Program Annual Report*, (Johnson, D.A.; Sprague, S., eds.), Solar Energy Research Institute, SERI/SP-231-3206, p. 155.

Coleman, L.W.; Rosen, B.H.; Schwartzbach, S.D. (1987a) "Environmental control of lipid accumulation in *Nannochloropsis salina*, *Nanno Q* and *Euglena*." *FY 1987 Aquatic Species Program Annual Report* (Johnson, D.A.; Sprague, S., eds.), Solar Energy Research Institute, Golden, Colorado, SERI/SP-231-3206, pp. 190-206.

Coleman, L.W.; Rosen, B.H.; Schwartzbach, S.D. (1987b) "Biochemistry of neutral lipid synthesis in microalgae." *Abstract, FY 1986 Aquatic Species Program Annual Report*, Solar Energy Research Institute, SERI/SP-231-3071, p. 255.

Coleman, L.W.; Rosen, B.H.; Schwartzbach, S.D. (1988a) "Preferential loss of chloroplast proteins in nitrogen deficient *Euglena*." *Plant Cell Physiol* 29:1007-101. (Note: a preprint of this article was also submitted as a SERI Report, 47 pp.)

Coleman, L.W.; Rosen, B.H.; Schwartzbach, S.D. (1988b) "Environmental control of carbohydrate and lipid synthesis in *Euglena*." *Plant Cell Physiol*. 29:423-432.

Cooksey, K.E. (1987) "Collection and screening of microalgae for lipid production." *Final Subcontract Report*, Solar Energy Research Institute, Golden, Colorado, May 1987, 42 pp.

Cooksey, K.E.; Guckert, J.B.; Thomas, R. (1989) "Triglyceride accumulation and the cell cycle in microalgae." *Aquatic Species Program Annual Report* (Bollmeier, W.S.; Sprague, S., eds.), Solar Energy Research Institute, Golden, Colorado, SERI/SP-231-3579, pp. 135-154.

Cooksey, K.E.; Guckert, J.B.; Williams, S.A.; Collis, P.R. (1987) "Fluorometric determination of the neutral lipid content of microalgal cells using Nile Red." *J. Microbiological Methods* 6:333-345.

Cooksey, K.E.; Williams, S.A.; Callis, P.R. (1987) "Nile Red, a fluorophore useful in assessing the relative lipid content of single cells." In *The Metabolism, Structure and Function of Plant Lipids* (Stumpf, P.K.; Williams, S.A.; Callis, R.P., eds.), Plenum Press, NY, pp. 645-647.

Corder, R.E.; Hill, A.M.; Lindsey, H.; Lowenstein, M.Z.; McIntosh, R.P. (1984) *SERI Biomass Program FY 1983 Annual Report*, Solar Energy Research Institute, Golden, Colorado, SERI/TR-231-2159, 107 pp.



Dubbe, D.R.; Pratt, D.C. (1987) "Sustained production of cattail for energy applications." *Energy from Biomass and Wastes X, Conference Proceedings* (Klass, D.L., ed.), Institute of Gas Technology, Chicago, pp. 363-383.

Dunahay, T.G. (1993) "Transformation of *Chlamydomonas reinhardtii* with silicon carbide whiskers." *Biotechniques* 15:452-460.

Dunahay, T.G.; Adler, S.A.; Jarvik, J.W. (1997) "Transformation of microalgae using silicon carbide whiskers." In *Methods in Molecular Biology, vol. 62: Recombinant Gene Expression Protocols* (Tuan, R., ed.), Humana Press, Totowa, New Jersey, pp. 503-509.

Dunahay, T.G.; Jarvis, E.E.; Dais, S.S.; Roessler, P.G. (1996) "Manipulation of microalgal lipid production using genetic engineering." *Appl. Biochem. Biotechnol.* 57/58:223-231.

Dunahay, T.G.; Jarvis, E.E.; Roessler, P.G. (1995) "Genetic transformation of the diatoms *Cyclotella cryptica* and *Navicula saprophila*." *J. Phycol.* 31:1004-1002.

Dunahay, T.G.; Jarvis, E.E.; Zeiler, K.G.; Nagle, N.; Brown, L.M. (1992a) "Genetic engineering of microalgae for fuel production." *Aquatic Species Project Report, FY 1989-90* (Brown, L.M.; Sprague, S., eds.), National Renewable Energy Laboratory, Golden, Colorado, NREL/MP-232-4174, pp. 57-119.

Dunahay, T.G.; Jarvis, E.E.; Zeiler, K.G.; Roessler, P.G.; Brown, L.M. (1992b) "Genetic engineering of microalgae for fuel production." *Appl. Biochem. Biotechnol.* 34/35:331-339.

Dynatech R/D Company (1978) "Cost analysis of aquatic biomass systems." *Report*, U.S. Dept. of Energy, HCP/ET-4000-78-1, vol. 1.

Dynatech R/D Company (1978) "Reviewers comments on cost analysis of aquatic biomass systems." *Report*, U.S. Dept. of Energy, HCP/ET-4000-78-2, vol. 2.

Eisenberg, D.M.; Benemann, J.R.; Tiburzi, T.; Weissman, J.C.; Oswald, W.J. (1980) "Large scale freshwater microalgae production for fuel and fertilizer." *Report to the Univ. of Calif.*, Contract EY-76-S-03-0034.

Eisenberg, D.M.; Koopman, B.; Benemann, J.R.; Oswald, W.J. (1981) "Algal bioflocculation and energy conservation in microalgae sewage ponds." *Biotech. Bioeng. Symp.* No. 11., pp. 429-449.

Ellingson, S.B.; Tyler, P.L.; Sommerfeld, M.R. (1989) "Characterization of growth and lipid yield in microalgae from the southwest using high salinity media." *Aquatic Species Program Annual Report* (Bollmeier, W.S.; Sprague, S., eds.), Solar Energy Research Institute, Golden, Colorado, SERI/SP-231-3579, pp. 71-81.

Feinberg, D.A., (1984) "Fuel options from microalgae with representative chemical compositions." *Report*, Golden, Colorado, SERI/TR-231-2427.



Feinberg, D.A.; Karpuk, M.E. (1989) "CO<sub>2</sub> sources for microalgae based liquid fuel production." *Aquatic Species Program Annual Report* (Bollmeier, W.S.; Sprague, S., eds.), Solar Energy Research Institute, Golden, Colorado, SERI/SP-231-3579, pp. 17-20.

Feinberg, D.A.; Karpuk, M.E. (1990) "CO<sub>2</sub> sources for microalgae based liquid fuel production." *Report, August 1990*, Golden, Colorado, SERI/TP-232-3820, 35 pp.

Gallagher, J.C. (1986) "Population genetics of microalgae." In *Algal Biomass Technologies: An Interdisciplinary Perspective* (Barclay, W.; McIntosh, R., eds.), Beihefte zur Nova Hedwigia, Heft 83, Gebrüder Borntraeger, Berlin-Stuttgart, pp. 6-14.

Gallagher, J.C. (1987a) "Patterns of genetic diversity in three genera of oil-producing microalgae." *Abstract, FY 1987 Aquatic Species Program Annual Report* (Johnson, D.A.; Sprague, S., eds.), Solar Energy Research Institute, Golden, Colorado, SERI/SP-231-3206, p. 209.

Gallagher, J.C. (1987b) "Genetic variation in oil-producing microalgae." *FY 1986 Aquatic Species Program Annual Report* (Johnson, D.A., ed.), Solar Energy Research Institute, Golden, Colorado, SERI/SP-231-3071, pp. 321-336.

Galloway, R.E. (1990) "Selective conditions and isolation of mutants in salt-tolerant, lipid-producing microalgae." *J. Phycol.* 26:752-760.

Goldman, J.R. (1979b) "Outdoor algal mass cultures. I. Applications; II. Theoretical Aspects." *Water Research* 13:1-19.

Goldman, J.R. (1979a) "Fuels from solar energy photosynthetic systems—state of the art and potential for energy production." *Report*, U.S. Dept. of Energy, COOO-4141-241.

Goldman, J.C.; Ryther, J.H. (1977) "Mass production of algae: bioengineering aspects." In *Biological Energy Conversion* (Mitsui, A., et al., eds.), Academic Press, New York, pp. 367-378.

Goldman, J.C.; Ryther, J.H.; Waaland, R.; Wilson, E.H. (1977) "Topical report on sources and systems for aquatic plant biomass as an energy source." *Report*, U.S. Dept. of Energy.

Golueke, C.G.; Oswald, W.J. (1965) "Harvesting and processing sewage-grown planktonic algae." *J. Wat. Poll. Cont. Fed.* 37:471-498.

Golueke, C.G.; Oswald, W.J. (1959) "Biological Conversion of light energy to the chemical energy of methane." *App. Microbiol.* 7:219-241.

Golueke, C.G.; Oswald, W.J.; Gotaas, H.B. (1957) "Anaerobic digestion of algae." *App. Microbiol.* 5:47-55.



Graves, M.V.; Meints, R.H. (1992) "Characterization of the major capsid protein and cloning of its gene from algal virus PBCV-1." *Virology* 188:198-207.

Graves, M.V.; Meints, R.H. (1992) "Characterization of the gene encoding the most abundant *in vitro* translation product from a virus infected *Chlorella*-like alga." *Gene* 113:149-155.

Gregor, H.P.; Gregor, C.D (1978) "Synthetic membrane technology." *Sci. Amer.* 239:112-128.

Guckert, J.B.; Cooksey, K.E. (1987) "Biochemical elucidation of neutral lipid synthesis in microalgae." *Abstract, FY 1986 Aquatic Species Program Annual Report*, Solar Energy Research Institute, Golden, Colorado, SERI/SP-231-3071, p. 253.

Guckert, J.B.; Cooksey, K.E. (1990) "Triglyceride accumulation and fatty acid profile changes in *Chlorella* (Chlorophyta) during high pH-induced cell cycle inhibition." *J. Phycol.* 26:72-79.

Guckert, J.B.; Cooksey, K.E.; Jackson, L.L. (1987a) "Biochemical elucidation of neutral lipid synthesis in microalgae: Report of a mechanism to induce neutral lipid accumulation and implications for increasing neutral lipid yields from microalgae." *FY 1987 Aquatic Species Program Annual Report* (Johnson, D.A.; Sprague, S., eds.), Solar Energy Research Institute, SERI/SP-231-3206, pp. 174-189.

Guckert, J.B.; Cooksey, K.E.; Jackson, L.L. (1987b) "Lipid solvent systems are not equivalent for analysis of lipid classes in the microeukaryotic green alga, *Chlorella*." *J. Microbiol. Meth.*, submitted, never published.

Habig, C.; DeBusk, T.A.; Ryther, J.H. (1984) "The effect of nitrogen content on methane production by the marine algae *Gracilaria tikvahie* and *Ulva* sp." *Biomass* 4:239-251.

Hanisak, M.D.; Ryther, J.H. (1986) "The experimental cultivation of the red seaweed *Gracilaria tikvahie* as an 'energy crop': An overview." In *Algal Biomass Technologies, An Interdisciplinary Perspective* (Barclay, W.R.; McIntosh, R.P., eds.), *Nova Hedwigia* 83:212-217.

Herzog, H., et al. (1993) "The capture, utilization and disposal of carbon dioxide from fossil fuel power plants." *Report to U.S. Dept. of Energy*, DOE/ER-30194, vol. 1 and 2.

Hill, A.M. (1982) "Cost budgeting for microalgae systems." *Proceedings of the June 1982 SERI Biomass Program Principal Investigators' Review Meeting, Aquatic Species Program Reports*, Solar Energy Research Institute, Golden, Colorado, SERI/CP-231-1808, pp. 17-30.

Hill, A.M. (1984) "Analysis and evaluation of the economics of microalgal fuel production." *Proceedings of the April 1984 Principal Investigators' Meeting, Aquatic Species Program*, Solar Energy Research Institute, Golden, Colorado, SERI/CP-231-2341, pp. 224-236.





- Hill, A.; Feinberg, A.; McIntosh, R.; Neenan, B.; Terry, K. (1984) "Fuels from microalgae: Technical status, potential, and research issues." *Report*, Solar Energy Research Institute, Golden, Colorado, SERI/SP-231-2550.
- Hon-Nami, K.; Hirano, A.; Kunito, S.; Suyuki Y.; Knoshita, K.; Ogushi, Y. (1997) "A new marine microalga cultivation in a tubular bioreactor and its utilization as an additive for paper surface improvement." *Energy Conv. Mgmt.* 38: Suppl. pp. 481-486.
- Hubka, W.F.; Browne, S.H. (1983) "Microalgal systems production and processing simulation." *Aquatic Species Program Review: Proceedings of the March 1983 Principal Investigators' Meeting*, Solar Energy Research Institute, Golden, Colorado, SERI/CP-231-1946, pp. 171-172.
- Hughes, E.; Benemann, J.R. (1997) "Biological fossil CO<sub>2</sub> mitigation." *Proc. of the 3rd Int. Conf. on CO<sub>2</sub> Capture, Disposal and Reuse Utilization*, ICCDR-3, Mass. Inst. Tech., September 1996 (in press, 1997).
- Ikuta, Y. (1994) "Design of a biological system for CO<sub>2</sub> fixation in carbon dioxide utilization—direct biofixation." *Report to the Int. Energy Agency Greenhouse Gas R&D Programme*.
- InterTechnology/Solar Corp. (1978) "The photosynthesis energy factory: analysis, synthesis and demonstration." U.S. DOE HCP/T3548-01.
- Ivey, R.G.; Henry, E.C.; Meints, R.H. (1996) "A *Feldmania* algal virus has two genome size classes." *Virology* 220:267.
- Jarvis, E.E. (1995) "Antisense RNA and ribozymes as tools for metabolic engineering." *Final Report DDF #07422041*, National Renewable Energy Laboratory, Golden, Colorado, 13 pp.
- Jarvis, E.E.; Brown, L.M. (1991) "Transient expression of firefly luciferase in protoplasts of the green alga *Chlorella ellipsoidea*." *Curr. Genet.* 19:317-321.
- Jarvis, E.E.; Dunahay, T.G.; Brown, L.M. (1992) "DNA nucleoside composition and methylation in several species of microalgae." *J. Phycol.* 28:356-362.
- Jeffries, T.W.; Mouthrop, P.H.; Timurian, H.; Ward, R.L.; Berger, B.J. (1977) "Biosolar production of fuels from algae." UCRL 52 177, November 16, 1976.
- Jin, A.; Zhang, Y.; Van Etten, J.L. (1994) "New restriction endonuclease CviRI cleaves DNA at TG/CA sequences." *Nuc. Acids. Res.* 22:3928-.
- Johansen, J.; Barclay, W. (1987) "Physiological variability within strains of *Chaetoceros muelleri*." *FY1986 Aquatic Species Program Annual Report*, Solar Energy Research Institute, Golden, Colorado, SERI/SP-231-3071, pp. 137-168.



Johansen, J.; Barclay, W.; Nagle, N. (1990) "Physiological variability within ten strains of *Chaetoceros muelleri* (Bacillariophyceae)." *J. Phycol.* 26:271-287.

Johansen, J.R.; Doucette, G.J.; Barclay, W.R.; Bull, J.D. (1988) "The morphology and ecology of *Pleurochrysis carterae* var *dentata* nov. (Prymnesiophyceae), a new coccolithophorid from an inland saline pond in New Mexico, USA." *Phycologica* 27:78-88.

Johansen, J.; Lemke, P.; Barclay, W.; Nagle, N. (1987). "Collection, screening, and characterization of lipid producing microalgae: Progress during Fiscal Year 1987." *FY 1987 Aquatic Species Program Annual Report* (Johnson, D.A.; Sprague, S., eds.), Solar Energy Research Institute, Golden, Colorado, SERI/SP-231-3206; pp. 27-42.

Johansen, J.R.; Theriot, E. (1987) "The relationship between valve diameter and number of central fultoportulae in *Thalassiosira weissflogii* (Bacillariophyceae)." *J. Phycol.* 23:663-665.

Johnson, D.A.; Sprague, S. (1987) "FY 1987 Aquatic Species Program Overview." *Report, November 1987*, Solar Energy Research Institute, Golden, Colorado, SERI/PR-231-3258, 22 pp.

Johnson, D.A.; Weissman, J.; Globel, R. (1989) "An outdoor test facility for the large-scale production of microalgae." *Energy from Biomass and Wastes XII, Conference Proceedings* (Klass, D.L., ed.), Institute of Gas Technology, Chicago, pp. 277-287.

Kadam, K.L. (1994) "Bioutilization of coal combustion gases." *Draft Milestone Completion Report, Recovery & Delivery*, National Renewable Energy Laboratory, Golden, Colorado.

Kadam, K.L. (1995) "Power plant flue gas as a source of CO<sub>2</sub> for microalgae cultivation: technology and economics of CO<sub>2</sub> recovery & delivery." *Draft Report to the National Renewable Energy Laboratory*, Golden, Colorado.

Kadam, K.L. (1997) "Power plant flue gas as a source of CO<sub>2</sub> for microalgae cultivation: economic impact of different process options." *Energ. Convers. Mgmt.* 38:S505-S510.

Karpuk, M. (1987a) "CO<sub>2</sub> sources for fuels synthesis." *FY 1986 Aquatic Species Program Annual Report* (Johnson, D.A.; Sprague, S., eds.), Solar Energy Research Institute, Golden, Colorado, SERI/SP-231-3206, p. 269.

Karpuk, M. (1987b) "CO<sub>2</sub> sources for fuels synthesis." *Abstract, FY 1986 Aquatic Species Program Annual Report*, Solar Energy Research Institute, Golden, Colorado, SERI/SP-231-3071, pp. 269-275.

Kok, B. (1953) "Experiments in photosynthesis by *Chlorella* in flashing light." In *Algal Culture: From Laboratory to Pilot Plant* (Burlaw, J.B., ed.), Carnegie Inst. of Washington, Publ. 600, pp. 63-75.



Kok, B. (1973) "Photosynthesis." *Proceedings of the Workshop on Bio Solar Hydrogen Conversion* (Gibbs, M., et al., eds.), September 5-6, Bethesda, Maryland, pp. 22-30.

Koopman, B.L.; Benemann, J.R.; Oswald, W.J. (1980) "Pond isolation and phase isolation for control of suspended solids concentration in sewage oxidation pond effluents." In *Algal Biomass* (Shelef, G.; Soeder, C., eds.), Elsevier, pp. 135-162.

Koopman, B.L.; Thomson, R.; Yacksian, R.; Benemann, J.R.; Oswald, W.J. (1978) "Investigation of the pond isolation process for microalgae separation from Woodland's pond effluents." *Report to the Univ. of Calif., Berkeley*, SERL Report No 78-5.

Kresovich, S.; Wagner, C.K.; Scantland, D.A.; Groet, S.S.; Lawhon, W.T. (1982) "The utilization of emergent aquatic plants for biomass energy systems development." *Report*, Solar Energy Research Institute, Golden, Colorado, SERI/TR-98281-03, 103 pp.

Krueger, S.K.; Ivey, R.G.; Meints, R.H. (1996) "A brown algal virus genome contains a ring zinc finger motif." *Virology* 219:307-.

Lansford, R.; Hernandez, J.; Enis, P.J. (1987) "Evaluation of available saline water resources in New Mexico for the production of microalgae." *FY 1986 Aquatic Species Program Annual Report*; Solar Energy Research Institute, Golden, Colorado, SERI/SP-231-3071, pp. 227-248.

Lansford, R.; Hernandez, J.; Enis, P.J.; Truby, D.; Mapel, C. (1990) "Evaluation of available saline water resources in New Mexico for the production of microalgae." *Report, August 1990*, Solar Energy Research Institute, Golden, Colorado, SERI/TP 232-3597, 83 pp.

Lee, A.M.; Ivey, R.G.; Meints, R.H. (1995) "Characterization of a repetitive DNA element in a brown algal virus." *Virology* 212:474-.

Laws, E.A. (1981) "Year one progress report on algal production raceway project." *Proceedings of the July 1981 Subcontractor's Review Meeting, Aquatic Species Program*, Solar Energy Research Institute, Golden Colorado, SERI/CP-624-1228, pp. 1-32.

Laws, E.A. (1982) "Results from preliminary studies on the use of flashing light to enhance algal mass culture productivity." *Proceedings of the June 1982 SERI Biomass Program Principal Investigators' Review Meeting, Aquatic Species Program Reports*, Solar Energy Research Institute, Golden, Colorado, SERI/CP-231-1808, pp. 31-42.

Laws, E.A. (1984a) "Optimization studies in shallow algal mass culture flumes." *Proceedings of the April 1984 Principal Investigators' Meeting*, Solar Energy Research Institute, Golden, Colorado, SERI/CP-231-2341, pp. 108-131.

Laws, E.A. (1984b) "Research and development of shallow algal mass culture systems for the production of oils." *Final Report*, Solar Energy Research Institute, Golden, Colorado, SERI/STR-231-2496.



Laws, E.A. (1984c) "Research, development, and demonstration of algal production raceway (ARP) systems for the production of hydrocarbon resources." *Subcontractor Report*, Solar Energy Research Institute, Golden, Colorado, SERI/STR-231-2206.

Laws, E.A. (1985) "Productivity optimization of saline microalgae grown in outdoor mass culture." *Aquatic Species Program Review: Proceedings of the March 1985 Principal Investigators' Meeting*, Solar Energy Research Institute, Golden, Colorado, SERI/CP-231-2700, pp. 162-178.

Laws, E.A. (1987) "Productivity optimization of saline microalgae grown in outdoor mass culture." *Final Report*, Solar Energy Research Institute, Golden, Colorado, Contract XK-4-4109-1.

Laws, E.A. (1987b) "Continuous microalgae production in shallow raceways at high productivity." *FY 1986 Aquatic Species Program Annual Report*, Solar Energy Research Institute, Golden, Colorado, SERI/SP-231-307, pp. 209-226.

Laws, E.A. (1989) *Final Report to the Electric Power Research Institute*.

Laws, E.A.; Berning, B.L. (1991) *Biotech. Bioeng.* 37:936.

Laws, E.A.; Lee, Y.K.; Tan, H.-M.; Hew, C.-S. (1985) "The effect of growth temperatures on the bioenergetics of photosynthetic algal cultures." *Biotech. Bioeng.* 27:555-561.

Laws, E.A.; Taguchi, S.; Hirata, J.; Pang, L. (1986) "High algal production rates achieved in a shallow outdoor flume." *Biotech. Bioeng.* 28:191-197.

Laws, E.A.; Taguchi, S.; Hirata, J.; Pang, L. (1988) "Optimization of microalgal production in a shallow outdoor flume." *Biotech. Bioeng.* 32:140-147.

Laws, E.A.; Terry, K.L. (1983) "Shallow algal mass culture system." *Proceedings of the March 1983 Principal Investigators' Meeting, Aquatic Species Program*, Solar Energy Research Institute, Golden Colorado, SERI/CP-231-1946, pp. 33-47.

Laws, E.A.; Terry, K.L.; Wickman, J.; Chalup, M.S. (1983) "Preliminary results from a simple algal production system designed to utilize the flashing light effect." *Biotech. Bioeng.* 25:2319-2336.

Lee, C.A.; McKim, T. (1981) "Water hyacinth wastewater treatment system." *Proceedings of the July, 1981, Subcontractors' Review Meeting, Aquatic Species Program*, Solar Energy Research Institute, Golden, Colorado, SERI/CP-624-1228, pp. 75-109.

Levine, L.S. (1982) "Biological and engineering parameters of algal mass culture." *Proceedings of the June 1982 SERI Biomass Program Principal Investigators' Review Meeting, Aquatic*



*Species Program Reports*, Solar Energy Research Institute, Golden, Colorado, SERI/CP-231-1808, pp. 43-44.

Lewin, R.A. (1980) "Tasks for the microbial geneticist in phycotechnology." In *Biotechnology for the Production of Chemicals and Fuels from Biomass*, Proceedings of the International Workshop, Vail, CO, 9/29/80-10/20/80, pp. 105-111.

Lewin, R.A. (1985) "Production of hydrocarbons by micro-algae; isolation and characterization of new and potentially useful algal strains." *Aquatic Species Program Review: Proceedings of the March 1985 Principal Investigators' Meeting*, Solar Energy Research Institute, Golden, Colorado, SERI/CP-231-2700; pp. 43-51.

Lewin, R.A.; Burrascano, C.; Cheng, L. (1987) "Some picoplankton algae from the Caribbean region." *FY 1986 Aquatic Species Program Annual Report*, Solar Energy Research Institute, Golden, Colorado, SERI/SP-231-3071, pp. 105-121.

Lewin, R.A.; Cheng, L. (1988) "Some lipogenic, eukaryotic, picoplankton algae from the Caribbean region." *Report*, Solar Energy Research Institute, Golden, Colorado.

Lien, S. (1981a) "Photobiological production of fuels by microalgae." In *Energy from Biomass: Proceedings of the First E.C. Conference* (Palz, W.; Chartier, P.; Hall, D.O., eds.), Applied Science Publishers, London, pp. 697-702.

Lien, S. (1981b) "Algal research at SERI: A basic research on photobiological production of fuels and chemicals in microalgae." *Proceedings of the July 1981 Subcontractors' Review Meeting, Aquatic Species Program*, Solar Energy Research Institute, Golden, Colorado, SERI/CP-624-1228, pp. 59-65.

Lien, S. (1982) "Studies on the production and accumulation of oil and lipids by microalgae." *Proceedings of the SERI Biomass Program Principal Investigators' Review Meeting, Aquatic Species Program Reports*, June 23-25, 1982, Solar Energy Research Institute, Golden, Colorado, SERI/CP-231-1808, pp. 45-54.

Lien, S.; Roessler, P. (1986) "The energetics of biomass and lipid production by lipogenic microalgae under nitrogen deprivation." *Aquatic Species Program Review: Proceedings of the March 1985 Principal Investigators' Meeting*, Solar Energy Research Institute, Golden, Colorado, SERI/CP-231-2700, pp. 100-117.

Lien, S.; Spencer, K.G. (1983) "Algal oil production and lipid metabolism research." *Aquatic Species Program Review: Proceedings of the March 1983 Principal Investigators' Meeting*, Solar Energy Research Institute, Golden, Colorado, SERI/CP-231-1946, pp. 3-18.

Lien, S.; Spencer, K.G. (1984) "Physiology of oil-producing microalgae in response to stress conditions." *Aquatic Species Program Review: Proceedings of the April 1984 Principal Investigators' Meeting*, Solar Energy Research Institute, SERI/CP-231-2341, pp. 79-107.



Lowenstein, M.Z. (1982) "FY 1982 Annual Report, Biomass Program Office." *November 1982 Draft Report*, Solar Energy Research Institute, Golden, Colorado, SERI/MR-231-1796.

Mack, R.W. (1984) "Comparative studies on the carbohydrate composition of marine macroalgae." *Aquatic Species Program Review: Proceedings of the April 1984 Principal Investigators' Meeting*, Solar Energy Research Institute, Golden, Colorado, SERI/CP-231-2341, pp. 2-7.

Manley, S. (1979) Unpublished Report to U.S. Department of Energy for work in laboratory of G. Pelofsky.

Maxwell, E.L.; Folger, A.G. (1982) "Resource assessment for saline aquatic biomass production systems." *Proceedings of the June 1982 SERI Biomass Program Principal Investigators' Review Meeting-Aquatic Species Program Reports*, Solar Energy Research Institute, Golden, Colorado, SERI/CP-231-1808, pp. 55-67.

Maxwell, E.L.; Folger, A.G.; Hogg, S.E. (1983) "Procedures for stratification of the U.S. Southwest for microalgae production systems based on climate, water, and land resources." *Aquatic Species Program Review: Proceedings of the March 1983 Principal Investigators' Meeting*, Solar Energy Research Institute, Golden, Colorado, SERI/CP-231-1946, pp. 135-154.

Maxwell, E.L.; Folger, A.G.; Hogg, S.E. (1985) "Resource evaluation and site selection for microalgae production systems." *Report*, Solar Energy Research Institute, Golden, Colorado, SERI/TR-215-2484.

McCluskey, K.; Graves, M.V.; Mills, D.; Meints, R.H. (1992) "Replication of *Chlorella* virus PBCV-1 and host karyotype determination studies with pulse-field gel electrophoresis." *J. Phycol.* 28:846-850.

McIntosh, R.P. (1985) "SERI Aquatic Species Program 1984 Annual Report." *March 1985 Report*, Solar Energy Research Institute, Golden, Colorado, SERI/PR-231-2659, 53 pp.

Meier, R.L. (1955) "Biological cycles in the transformation of solar energy into useful fuels." In *Solar Energy Research* (Daniels, F.; Duffie, J.A., eds.), Madison University Wisconsin Press, pp. 179-183.

Meints, R. (1987) "Studies of the chloroplast genome of exsymbiotic and free-living *Chlorella*." *FY 1987 Aquatic Species Program Annual Report* (Johnson, D.A.; Sprague, S., eds.), Solar Energy Research Institute, Golden, Colorado. SERI/SP-231-3206, pp. 210-228.

Meints, R.H.; Burbank, D.E.; Van Etten, J.L.; Lamport, D.T.A. (1988) "Properties of the *Chlorella* receptor for the PBCV-1 virus." *Virology* 164:15-21.

Meints, R.H.; Lee, K.; Burbank, D.E.; Van Etten, J.L. (1984) "Infection of a *Chlorella*-like alga with the virus PBCV-1: Ultrastructural studies." *Virology* 138:341-346.



- Meints, R.H.; Lee, K.; Van Etten, J.L. (1986) "Assembly site of the virus PBCV-1 in *Chlorella*-like alga: Ultrastructural studies." *Virology* 154:240-245.
- Meints, R.H.; Kennedy, J.; Ziegelbein, M.; Amberg, S.; Van Etten, J.L. (1988) "Production of protoplasts from *Chlorella*-like algae." Unpublished manuscript; submitted to SERI as a research report.
- Meints, R.H.; Schuster, A.M.; Van Etten, J.L. (1985a) "*Chlorella* viruses." *Plant Mol Biol. Reports* 3:180-187.
- Meints, R.H.; Schuster, A.M.; Van Etten, J.L. (1985b) "Characterization of viruses infecting *Chlorella*-like alga." *Abstract, FY1986 Aquatic Species Program Annual Report*, Solar Energy Research Institute, Golden, Colorado, SERI/SP-231-3071, p. 338.
- Meints, R.H.; Van Etten, J.L. (1991) "Eukaryotic Algae." In *Microbial Ecology: Principles, Methods and Applications* (Levin, M.A.; Seidler, R.J.; Rogul, M., eds.), McGraw-Hill, Inc., New York, pp. 883-888.
- Meints, R.H.; Van Etten, J.L.; Kuczmarski, D.; Ang, B. (1981) "Viral infection of the symbiotic *Chlorella*-like alga present in *Hydra viridis*." *Virology* 113:698-703.
- Melis, A.; Neidhardt, J.; Bartoli, I.; Benemann, J.R. (1998) *Proc. Biohydrogen '97*.
- Milne, T.A.; Evans, R.J. (1987) "Catalytic upgrading of whole algae and their components with shape-selective zeolites." *FY 1987 Aquatic Species Program Annual Report* (Johnson, D.A.; Sprague, S., eds.), Solar Energy Research Institute, SERI/SP-231-3206, pp. 264-265.
- Murakami, M.; Ikenouchi, M. (1997) "The biological CO<sub>2</sub> fixation and utilization project by RITE (2)—screening and breeding of microalgae with high capability of fixing CO<sub>2</sub>." *Energy Conver. Mgmt.* 38: Suppl. 493-498.
- Nagle, N.; Barclay, B. (1987) "The effects of light intensity on lipid production." *Abstract, FY 1986 Aquatic Species Program Annual Report*, Solar Energy Research Institute, Golden, Colorado, SERI/SP-231-3071, p. 251.
- Nagle, N.; Chelf, P.; Lemke, P.; Barclay, B. (1987) "Conversion of lipids through biological pretreatment." *FY 1987 Aquatic Species Program Annual Report* (Johnson, D.A.; Sprague, S., eds.), Solar Energy Research Institute, SERI/SP-231-3206, pp. 255-263.
- Nagle, N.; Chelf, P.; Lemke, P.; Barclay, B. (1989) "Conversion of lipids to liquid fuels by natural enzymatic pretreatment." *Energy from Biomass and Wastes XII, Conference Proceedings* (Klass, D.L., ed.), Institute of Gas Technology, Chicago, pp. 1107-1115.



- Nagle, N.; Lemke, P. (1989) "Microalgal fuel production processes: Analysis of lipid extraction and conversion methods." *Aquatic Species Program Annual Report* (Bollmeier, W.S.; Sprague, S., eds.), Solar Energy Research Institute, Golden, Colorado, SERI/SP-231-3579, pp. 157-164.
- Neenan, B. (1983) "Microalgae program element cost goals." *Aquatic Species Program Review: Proceedings of the March 1983 Principal Investigators' Meeting*, Solar Energy Research Institute, Golden, Colorado, SERI/CP-231-1946, pp. 69-77.
- Neenan, B.; Feinberg, D.; Hill, A.; McIntosh, R.; Terry, K. (1986) "Fuels from microalgae: Technology status, potential, and research requirements." *Report*, Solar Energy Research Institute, Golden, Colorado, SERI/SP-231-2550, 158 pp.
- Negoro, M.; Hamasaki, K.A.; Ikuta, Y.; Makita, T.; Hirayama K.; Suzuki, S. (1993) "CO<sub>2</sub> fixation by microalgae photosynthesis using actual flue gas discharged from a boiler." *Biochem Biotech.* 39/40:643-653.
- Negoro, M.; Shioji, K.; Ikuta, Y.; Makita, T.; Utiumi, M. (1992) "Growth characteristics of microalgae in high-concentrations of CO<sub>2</sub> gas. Effects of culture medium, trace components and impurities thereon." *Biochem Biotech.* 34/35:681-692.
- Neidhardt, J.; Benemann, J.R.; Baroli, I.; Melis, A. (1998) "Maximizing photosynthetic productivity and light utilization in microalgae by minimizing the light-harvesting chlorophyll antenna size of the photosystems." *Photosynthesis Res.*, in press.
- Nelson. (1982) "An investigation of the availability of carbon dioxide for the production of microalgae lipids in the southwest." *Report to the Argonne National Laboratory*, unpublished.
- Neushul, M. (1987) "Kelp genetics." *Abstract, FY 1986 Aquatic Species Program Annual Report*, Solar Energy Research Institute, Golden, Colorado, SERI/SP-231-3071, p. 337.
- Ohlrogge, J.; Jaworski, J.; Post-Beittenmiller, D.; Roughan, G.; Roessler, P.; Nakahira, K. (1993) "Regulation of flux through the fatty acid biosynthesis pathway." In *Biochemistry and Molecular Biology of Membrane and Storage Lipids of Plants* (Murata, N.; Somerville, C.R., eds.), American Society of Plant Physiologists, Rockville, Maryland, pp. 102-112.
- Oswald, W.J. (1963) "The high-rate pond in waste disposal." *Dev. Ind. Microbiol.* 4:112-125.
- Oswald, W.J.; Benemann, J.R. (1977) "A critical analysis of bioconversion with microalgae." In *Biological Energy Conversion* ( Mitsui, A., et al., eds.), Academic Press, New York, pp. 379-394.
- Oswald, W.J.; Golueke, C.G. (1960) "Biological transformation of solar energy." *Adv. Appl. Microbiol.*, 11:223-242.





Owens, T.G.; Gallagher, J.C.; Alberte, R.S. (1987) "Photosynthetic light-harvesting function of violaxanthin in *Nannochloropsis* sp. (Eustigmatophyceae)." *J. Phycol.* 23:79-85.

Pratt, D.C. (1981) "Wetland biomass production." *Proceedings of the July 1981, Subcontractors' Review Meeting, Aquatic Species Program*, Solar Energy Research Institute, Golden, Colorado, SERI/CP-624-1228, pp. 119-126.

Pratt, D.C. (1982) "Emergent aquatics: Stand establishment, management and species screening." *Proceedings of the June 1982 SERI Biomass Program Principal Investigators' Review Meeting, Aquatic Species Program Reports*, Solar Energy Research Institute, Golden, Colorado, SERI/CP-231-1808, pp. 69-84.

Pratt, D.C.; Andrews, N.J.; Garver, E.G.; Penko, M.; Read, P.E.; Zimmerman, E.S. (1982) "Emergent aquatics: stand establishment, management, and species screening." *Subcontract Report, Contract No. XK-1-1087-1*, Solar Energy Research Institute, Golden, Colorado, SERI/STR-231-1819, 56 pp.

Pratt, D.C.; Dubbe, D.R. (1983) "Wetland biomass production." *Aquatic Species Program Review: Proceedings of the March 1983 Principal Investigators' Meeting*, Solar Energy Research Institute, Golden, Colorado, SERI/CP-231-1946, pp. 55-67.

Pratt, D.C.; Dubbe, D.R.; Garver, E.G.; Linton, P.J. (1984) "Wetland biomass production: emergent aquatic management options and evaluations." *Final Subcontract Report, Contract No. XK-2-02094-01*, Solar Energy Research Institute, Golden, Colorado, SERI/STR-231-2383.

Radmer, R.; Behrens, P. (1987) "Temperature effects on microalgal photosynthetic efficiency." *FY 1986 Aquatic Species Program Annual Report*, Solar Energy Research Institute, Golden, Colorado, SERI/SP-231-3071, pp. 301-320.

Raymond, L. (1979) "Initial investigations of a shallow layer algal production system." *Am. Soc. Mech. Eng.*, New York.

Raymond, L. (1981) "Mass algal culture systems." U.S. Patent 4,253,271.

Raymond, L.P. (1983a) "Aquatic biomass as a source of fuels and chemicals." *Conference report: First U.S.-China Conference on Energy, Resources, and Environment*. Beijing, People's Republic of China, Nov. 7-12, 1982. Solar Energy Research Institute, Golden, Colorado, SERI/TP-231-1699, 8 pp.

Raymond, L.P. (1983) "The SERI microalgae research group." *Aquatic Species Program Review: Proceedings of the March 1983 Principal Investigators' Meeting*, Solar Energy Research Institute, Golden, Colorado, SERI/CP-231-1946, pp. 89-98.



Raymond, L.P. (1984) "Microalgal technology research at SERI." *Proceedings of the April 1984 Principal Investigators' Meeting, Aquatic Species Program*, Solar Energy Research Institute, Golden, Colorado, SERI/CP-231-2341, pp. 150-151.

Regan, D.L. (1980) "Marine biotechnology and the use of arid zones." *Search* 111:377-381.

Reisser, W.; Burbank, D.E.; Meints, S.M.; Meints, R.H.; Becker, B.; Van Etten, J.L. (1988) "A comparison of viruses infecting two different *Chlorella*-like green algae." *Virology* 167:143-149.

Rhyne, C. (1987a) "Nutritional requirements for maximal growth of oil producing microalgae." *Abstract, FY 1986 Aquatic Species Program Annual Report*, Solar Energy Research Institute, Golden, Colorado, SERI/SP-231-3071, p. 249.

Rhyne, C. (1987b) "Nutritional requirements for maximal growth of oil producing microalgae." *FY 1986 Aquatic Species Program Annual Report* (Johnson, D.A.; Sprague, S., eds.), Solar Energy Research Institute, Golden, Colorado, SERI/SP-231-3206, pp. 92-107.

Richmond, A. (1984) "Development of outdoor system for production of lipid-rich halotolerant microalgae." *Proceedings of the April 1984 Principal Investigators' Meeting, Aquatic Species Program*, Solar Energy Research Institute, Golden Colorado, SERI/CP-231-2341, pp. 195-205.

Ripin, M. (1983) "Systems overview of algal mass culture." *Aquatic Species Program Review: Proceedings of the March 1983 Principal Investigators' Meeting*, Solar Energy Research Institute, Golden, Colorado, SERI/CP-231-1946, pp. 155-169.

Roessler, P.G. (1987a) "Biochemical aspects of lipid accumulation in silicon-deficient diatoms." *FY 1986 Aquatic Species Program Annual Report*, Solar Energy Research Institute, Golden, Colorado, SERI/SP-231-3071, pp. 257-271.

Roessler, P.G. (1987b) "The effects of silicon deficiency on several enzymes involved in lipid and carbohydrate biosynthesis in *Cyclotella cryptica*." *FY 1987 Aquatic Species Program Annual Report* (Johnson, D.A.; Sprague, S., eds.), Solar Energy Research Institute, Golden, Colorado, SERI/SP-231-3206, pp. 159-173.

Roessler, P.G. (1987c) "Lipid accumulation in silicon-deficient diatoms." In *The Metabolism, Structure, and Function of Plant Lipids* (Stumpf, P.K.; Mudd, M.B.; Nes, W.D., eds.), Plenum, Publishing Corp., pp. 649-651.

Roessler, P.G. (1987d) "UDPglucose pyrophosphorylase activity in the diatom *Cyclotella cryptica*: Pathway of crysolaminarin biosynthesis." *J. Phycol.* 23:494-498.

Roessler, P.G. (1988a) "Changes in the activities of various lipid and carbohydrate biosynthetic enzymes in the diatom *Cyclotella cryptica* in response to silicon deficiency." *Arch. Biochem. Biophys.* 267:521-528.



Roessler, P.G. (1988b) "Characteristics of abrupt size reduction in *Synedra ulna* (Bacillariophyceae)." *Phycologia* 27:294-297.

Roessler, P.G. (1988c) "Effects of silicon deficiency on lipid composition and metabolism in the diatom *Cyclotella cryptica*." *J. Phycol.* 24:394-400.

Roessler, P.G. (1989) "Purification and characterization of acetyl-CoA carboxylase from the diatom *Cyclotella cryptica*." *Aquatic Species Program Annual Report* (Bollmeier, W.S.; Sprague, S., eds.), Solar Energy Research Institute, Golden, Colorado, SERI/SP-231-3579, pp. 121-134.

Roessler, P.G. (1990) "Purification and characterization of acetyl-CoA carboxylase from the diatom *Cyclotella cryptica*." *Plant. Physiol.* 92:73-78.

Roessler, P.G. (1995) "Expression of an algal acetyl-CoA carboxylase gene in *E. coli*." In *Plant Lipid Metabolism*", (Kader, J.-C.; Mazliak, P., eds.), Kluwer Academic Publishers, pp. 46-48.

Roessler, P.G.; Bleibaum, J.L.; Thompson, G.A.; Ohlrogge, J.B. (1994) "Characteristics of the gene that encodes acetyl-CoA carboxylase in the diatom *Cyclotella cryptica*." In *Recombinant DNA Technology II* (Bajpai, K.; Prokop, A., eds.), *Ann. N.Y. Acad. Sci.* 721:250-256.

Roessler, P.G.; Brown, L.M.; Dunahay, T.G.; Heacox, D.A.; Jarvis, E.E.; Schneider, J.C.; Talbot, S.G.; Zeiler, K.G. (1994) "Genetic engineering approaches for enhanced production of biodiesel fuel from microalgae." In *Enzymatic Conversion of Biomass for Fuels Production* (Himmel, M.E.; Baker, J.; Overend, R.P., eds.), American Chemical Society, pp. 256-270.

Roessler, P.G.; Ohlrogge, J.B. (1993) "Cloning and characterization of the gene that encodes acetyl-coenzyme A carboxylase in the alga *Cyclotella cryptica*." *J. Biol. Chem.* 268:19254-19259.

Ryther, J.H. (1981) "Cultivation of macroscopic marine algae." *Proceedings of the July 1981 Subcontractor's Review Meeting, Aquatic Species Program*, Solar Energy Research Institute, Golden, Colorado, SERI/CP-624-1228, pp. 111-118.

Ryther, J.H. (1982a) "Cultivation of macroscopic marine algae." *Proceedings of the June 1982 SERI Biomass Program Principal Investigators' Review Meeting, Aquatic Species Program Report*, Solar Energy Research Institute, Golden, Colorado, SERI/CP-231-1808, pp. 85-102.

Ryther, J.H. (1982b) "Cultivation of macroscopic marine algae and freshwater aquatic weeds." *Subcontract Report*, Solar Energy Research Institute, Golden, Colorado, SERI/TR-231-1820, 35pp.

Ryther, J.H. (1982c) "Cultivation of macroscopic marine algae." *Report*, Solar Energy Research Institute, Golden, Colorado, SERI/TR-98133-1A, 137 pp.



Ryther, J.H. (1982d) "Biomass production, anaerobic digestion, and nutrient recycling of small benthic or floating seaweeds." *Report*, Solar Energy Research Institute, Golden, Colorado, SERI/TR-98133-1B, 42 pp.

Ryther, J.H. (1983) "Cultivation of macroscopic marine algae." *Proceedings of the March 1983 Principal Investigators' Meeting, Aquatic Species Program*, Solar Energy Research Institute, Golden, Colorado, SERI/CP-231-1946, pp. 79-88.

Ryther, J.H. (1985) "Technology for the commercial production of macroalgae." In *Energy Applications of Biomass: Proceedings of the National Meeting on Biomass R&D for Energy Applications, Oct. 1-3, 1984, Arlington, Virginia* (Lowenstein, M.Z., ed.), Elsevier Applied Science Publishers, New York, pp. 177-188.

Ryther, R.H.; Carlson, R.D.; Pendoley, P.D.; Jensen, P.R. (1987) "Collection and characterization of saline microalgae from South Florida." *FY 1986 Aquatic Species Program Annual Report*, Solar Energy Research Institute, Golden, Colorado, SERI/SP-231-3071, pp. 122-136.

Ryther, J.H.; DeBusk, T.A. (1982) "Significance of carbon dioxide and bicarbonate-carbon uptake in marine biomass production." *Energy from Biomass and Wastes VI, Conference Proceedings* (Klass, D.L., ed.), Institute of Gas Technology, Chicago, pp. 221-233.

Ryther, J.H.; DeBusk, T.A.; Andrews, D.A.; Habig, C.; LaBaff, L.P.; Williams, L.D.; Falkner, B.E. (1982) "Cultivation of macroscopic marine algae." *Proceedings of the June 1982 SERI Biomass Program Principal Investigators' Review Meeting, Aquatic Species Program Reports*, Solar Energy Research Institute, Golden, Colorado, SERI/CP-231-1808, pp. 85-101.

Ryther, J.H.; DeBusk, T.A.; Blakeslee, M. (1984a) "Cultivation and conversion of marine macroalgae." *Final Subcontract Report*, Solar Energy Research Institute, SERI/STR-231-2360, 81 pp.

Ryther, J.H.; DeBusk, T.A.; Peterson, J.E. (1984b) "Studies of marine macroalgae: Saline desert water cultivation and effects of environmental stress on proximate composition." *Final Subcontract Report*, Solar Energy Research Institute, SERI/STR-231-2799, 64 pp.

Schneider, J.C.; Roessler, P. (1994) "Radiolabeling studies of lipids and fatty acids in *Nannochloropsis* (Eustigmatophyceae), an oleaginous marine alga." *J. Phycol.* 30:594-598.

Schneider, J.C.; Livine, A.; Sukenik, A.; Roessler P.G. (1995) "A mutant of *Nannochloropsis* deficient in eicosapentaenoic acid production." *Phytochem.* 40:807-814.

Schneider, J.C.; Roessler, P.G. (1995) "A novel acyltransferase activity in an oleaginous alga." In *Plant Lipid Metabolism* (Kader, L.C.; Mazliak, P., eds.), Kluwer Academic Publishers, the Netherlands, pp. 105-107.



Schuster, A.M.; Burbank, D.E.; Meister, B.; Skrdla, M.; Meints, R.H.; Hattman, S.; Swinton, D.; Van Etten, J.L. (1986) "Characterization of viruses infecting a eukaryotic *Chlorella*-like green alga." *Virology* 150:170-177.

Schuster, J.A.; Graves, M.; Korth, K.; Ziegelbein, M.; Brumbaugh, J.; Grone, D.; Meints, R.H. (1990a) "Transcription and sequence studies of a 4.3 kbp fragment from a dsDNA eukaryotic alga virus." *Virology* 176:515-523.

Schuster, A.M.; Waddle, J.A.; Korth, K.; Meints, R.H. (1990b) "The chloroplast genome of an exsymbiotic *Chlorella*-like alga." *Plant Mol. Biol.* 14:859-862.

Schwegler, B.R., Jr. (1983) "Water hyacinth production primary and advanced treatment of wastewater." *Final Subcontract Report*, Solar Energy Research Institute, Golden, Colorado, Subcontract No. XK-0-9245-1, SERI/STR-231-1886, 39 pp.

Schwegler, B.R.; McKim, T.W. (1982) "Water hyacinth wastewater treatment system." *Proceedings of the June 1982 SERI Biomass Program Principal Investigators' Review Meeting, Aquatic Species Program Report*, Solar Energy Research Institute, Golden, Colorado, SERI/CP-31-1808, pp. 103-113.

Shelef, G.A.; Sukenik, A.; Green, M. (1984a) "Microalgae harvesting and processing: a literature review." *Report*, Solar Energy Research Institute, Golden Colorado, SERI/STR-231-2396.

Shelef, G.A.; Sukenik, A.; Green, M. (1984b) "Marine microalgae separation and harvesting." *Proceedings of the April 1984 Principal Investigators' Meeting, Aquatic Species Program*, Solar Energy Research Institute, Golden Colorado, SERI/CP-231-2341, pp. 206-223.

Shelef, G.; Sukenik, A.; Sandbank, E. (1985) "Separation and harvesting of microalgae from saline media." *Proceedings of the March 1985 Principal Investigators' Meeting, Aquatic Species Program*, Solar Energy Research Institute, Golden Colorado, SERI/CP-231-2700, pp. 244-270.

Shifrin, N.S. (1984) "Oils from microalgae." In *Biotechnology for the Oils and Fats Industry* (Ratledge, C., et al., eds.), AOCS monograph 11.

Shifrin, N.S.; Chisholm, S.W. "Phytoplankton lipids: interspecific differences and effects of nitrate, silicate and light-dark cycles." *J. Phycol.*, 17:374.

Skrdla, M.P.; Burbank, D.E.; Xia, T.; Meints, R.H.; Van Etten, J.L. (1984) "Structural proteins and lipids in a virus, PBCV-1, which replicates in a *Chlorella*-like virus." *Virology* 135:308-315.

Smith, C.W.; Schwartzbach, S.D. (1988) "Preliminary characterization of pyruvate dehydrogenase and acetyl-CoA synthetase." Manuscript submitted as report to SERI, 6 pp.



Solomon, J.A (1985) "Ultrastructure evaluation of lipid accumulation in microalgae." *Aquatic Species Program Review: Proceedings of the March 1985 Principal Investigators' Meeting*, Solar Energy Research Institute, SERI/CP-231-2700, pp. 71-82.

Solomon, J.A. (1987) "Flow cytometry techniques for species improvement." *Abstract, FY 1986 Aquatic Species Program: Annual Report*, Solar Energy Research Institute, Golden, Colorado, SERI/SP-231-3071, p. 252.

Solomon, J.A.; Hand, R.E.; Mann, R.C. (1986a) "Ultrastructural and flow cytometric analyses of lipid accumulation in microalgae." *Annual Report*, Oak Ridge National Laboratory, Oak Ridge, Tennessee, ORNL/M-258, 50 pp.

Solomon, J.A.; Hand, R.E.; Mann, R.C. (1986b) "Ultrastructural and flow cytometric analyses of lipid accumulation in microalgae: A subcontract report." Solar Energy Research Institute, Golden, Colorado, SERI/STR-231-3089, 50 pp.

Solomon, J.A.; Palumbo, A.V. (1987) "Improvement of microalgal strains for lipid production." *FY 1987 Aquatic Species Program Annual Report* (Johnson, D.A.; Sprague, S., eds.), Solar Energy Research Institute, SERI/SP-231-3206, pp. 142-154.

Sommerfeld, M.R. (19xx) "Collection of high energy yielding strains of saline microalgae from southwestern states." *Report*, Solar Energy Research Institute, 52 pp.

Sommerfeld, M.R.; Ellingson, S.B. (1987a) "Collection of high energy yielding strains of saline microalgae from southwestern states." *FY 1986 Aquatic Species Program Annual Report*, Solar Energy Research Institute, Golden, Colorado, SERI/SP-231-3071, pp. 53-66.

Sommerfeld, M.; Ellingson, S.; Tyler, P. (1987b) "Screening microalgae isolated from the southwest for growth potential and lipid yield." *FY 1987 Aquatic Species Program Annual Report* (Johnson, D.A.; Sprague, S., eds.), Solar Energy Research Institute, Golden, Colorado, SERI/SP-231-3206; pp. 43-57.

Sphoer, H.A.; Milner, H.W. (1956) Production of protein, lipids and carbohydrates by cultures of algae." U.S. Patent 2,732,661.

Spoehr, H.A.; Milner, H.W. (1949) "The chemical composition of *Chlorella*; effect of environmental conditions." *Plant. Physiol.* 24:120.

Sriharan, S.; Bagga, D. (1987a) "Effects of induction strategies on *Chaetoceros* (SS-14), growth with emphasis on lipids." *FY 1986 Aquatic Species Program Annual Report*, Solar Energy Research Institute, Golden, Colorado, SERI/SP-231-3071, pp. 273-284.

Sriharan, S.; Bagga, D. (1987b) "Influence of nitrogen and temperature on lipid production in microalgae (*Hantzschia* DI-60)." *Energy from Biomass and Wastes X, Conference Proceedings* (Klass, D.L., ed.), Institute of Gas Technology, Chicago, pp. 1689-1190.



Sriharan, S.; Bagga, D.; Sriharan, T.; Das, M. (1987c) "Effect of nutrients and temperature on lipid production and fatty acid composition in *Monoraphidium minimum* and *Cyclotella* DI-35." *FY 1987 Aquatic Species Program Annual Report* (Johnson, D.A.; Sprague, S., eds.), Solar Energy Research Institute, SERI/SP-231-3206, pp. 108-126.

Sriharan, S.; Bagga, D.; Sriharan, T.P. (1988) "Algal lipids: Effect of induction strategies on the quantity and types of lipids produced." *Final Technical Report*, Solar Energy Research Institute, Golden, Colorado, 16 pp.

Sriharan, S.; Sriharan, T.P.; Bagga, D. (1989) "Lipids and fatty acids of diatom *Chaetoceros muelleri* var *subsalsum* and the control of their production by environmental factors." *Energy from Biomass and Wastes XII, Conference Proceedings* (Klass, D.L., ed.), Institute of Gas Technology, Chicago, 10 pp.

Sriharan, S.; Bagga, D.; Nawaz, M. (1991) "The effects of nutrients and temperature on biomass, growth, lipid production, and fatty acid composition of *Cyclotella cryptica* Reimann, Lewin, and Guillard." *Appl. Biochem. Biotech.* 28/29:317-326.

Sriharan, S.; Bagga, D.; Sriharan, T.P. (1989) "Environmental control of lipids and fatty acid production in the diatom *Navicula saprophila*." *Appl. Biochem. Biotech.* 20/21:281-291.

Sriharan, S.; Bagga, D.; Sriharan, T.P. (1990) "Effects of nutrients and temperature on lipid and fatty acid production in the diatom *Hantzshia* DI-60." *Appl. Biochem. Biotech.* 24/25:309-316.

Stefan, C.; Xia, Y.; Van Etten, J.L. (1991) "Molecular cloning and characterization of the gene encoding the adenine methyltransferase *M. CviRI* from *Chlorella* virus XZ-6E." *Nuc. Acids Res.* 19:307-

Suen, Y.; Hubbard, J.S.; Holzer, G.; Tornabene, T.G. (1987) "Total lipid production of the green alga *Nannochloropsis* sp. QII under different nitrogen regimes." *J. Phycol.* 23:289-296.

Tadros, M.G. (1985) "Screening and characterizing oleaginous microalgal species from the southeastern United States." *Aquatic Species Program Review: Proceedings of the March 1985 Principal Investigators' Meeting*, Solar Energy Research Institute, Golden, Colorado, SERI/CP-231-2700, pp. 28-42.

Tadros, M.G. (1987a) "Screening and characterizing oleaginous microalgal species from the southeastern United States." *FY 1986 Aquatic Species Program Annual Report*, Solar Energy Research Institute, Golden, Colorado, SERI/SP-231-3071, pp. 67-89.

Tadros, M.G. (1987b) "Conclusion of the warm-water algae collection and screening efforts conducted in the southeastern United States." *FY 1987 Aquatic Species Program Annual Report* (Johnson, D.A.; Sprague, S., eds.), Solar Energy Research Institute, Golden, Colorado, SERI/SP-231-3206, pp. 58-74.



Tadros, M.G.; Johansen, J.R. (1988) "Physiological characterization of six lipid-producing diatoms from the southeastern United States." *J. Phycol.* 24:445-452.

Taylor, J.H. (1983) "The Middle Atlantic Consortium on Energy Research (MACER) Progress Report for December, January, and February." *Aquatic Species Program Review: Proceedings of the March 1983 Principal Investigators' Meeting*, Solar Energy Research Institute, Golden, Colorado, SERI/CP-231-1946, pp. 49-53.

Terry, K.L. (1984a) "Microalgal technology research at SERI: Modulated light photobiology." *Aquatic Species Program Review: Proceedings of the April 1984 Principal Investigators' Meeting*, Solar Energy Research Institute, Golden, Colorado, SERI/CP-231-2341, pp. 160-169.

Terry, K.L. (1984b) "Modulated light photobiology." *Proceedings of the April 1984 Principal Investigators' Meeting, Aquatic Species Program*, Solar Energy Research Institute, Golden Colorado, SERI/CP-231-2341, pp.160-169.

Terry, K.L. (1986) "Photosynthesis in modulated light: quantitative dependence on photosynthetic enhancement on the flashing rate." *Biotech. Bioeng.* 28:988.

Terry, K.L.; Raymond, L.P. (1985) "System design for the autotrophic production of microalgae." *Enzyme Microb. Technol.* 7:474-487.

Thomas, R.M. (1990) "Triglyceride accumulation and the cell cycle in *Chlorella*." Masters Thesis, Montana State University, July 1990.

Thomas, W.H. (1982) "Laboratory selection of microalgae for maximum lipid and protein production." *Proceedings of the June 1982 SERI Biomass Program Principal Investigators' Review Meeting, Aquatic Species Program Reports*, Solar Energy Research Institute, Golden, Colorado, SERI/CP-231-1808, pp. 115-137.

Thomas, W.H. (1983b) "Microalgae from desert saline waters as potential biomass producers." *Progress in Solar Energy* 6:143-145.

Thomas, W.H.; Gaines, S.R. (1982) "Algae from the arid southwestern United States: an annotated bibliography." *Report for Subcontract XK-2-0270-01*, to the Solar Energy Research Institute, Golden, Colorado, October 1982.

Thomas, W.H.; Seibert, D.L.R.; Alden, M.; Eldridge, P. (1983a) "Yields, photosynthetic efficiencies, and proximate chemical composition of dense cultures of marine microalgae: A subcontract report." Solar Energy Research Institute, Golden, Colorado, SERI/STR-231-1896, 58 pp.

Thomas, W.H.; Seibert, D.L.R.; Alden, M.; Eldridge, P. (1984a) "Cultural requirements, yields, and light utilization efficiencies of some desert saline microalgae." *Aquatic Species Program*





Review: *Proceedings of the April 1984 Principal Investigators' Meeting*, Solar Energy Research Institute, Golden, Colorado, SERI/CP-231-2341; pp. 7-63.

Thomas, W.H.; Seibert, D.L.R.; Alden, M.; Eldridge, P. (1985) "Selection of desert saline microalgae for high yields at elevated temperatures and light intensities and in SERI Standard artificial media." *Aquatic Species Program Review: Proceedings of the March 1985 Principal Investigators' Meeting*, Solar Energy Research Institute, Golden, Colorado, SERI/CP-231-2700; pp. 5-27.

Thomas, W.H.; Seibert, D.L.R.; Alden, M.; Eldridge, P. (1986) "Cultural requirements, yields and light utilization efficiencies of some desert saline microalgae." *Nova Hedwigia* 83:60-69.

Thomas, W.H.; Seibert, D.L.R.; Alden, M.; Eldridge, P.; Neori, A.; Gaines, S. (1983b) "Selection of high-yielding microalgae from desert saline environments." *Aquatic Species Program Review: Proceedings of the March 1983 Principal Investigators' Meeting*, Solar Energy Research Institute, Golden, Colorado, SERI/CP-231-1946, pp. 97-122.

Thomas, W.H.; Seibert, D.L.R.; Alden, M.; Eldridge, P.; Neori, A.; Gaines, S. (1983c) "Microalgae from desert saline waters as potential biomass producers." In *Progress in Solar Energy, vol. 6, Biotechnology and Chemical Sciences Division*, American Solar Energy Society, Boulder, Colorado, pp. 143-145.

Thomas, W.H.; Seibert, D.L.R.; Alden, M.; Neori, A. (1981) "Effects of light intensity and nitrogen deficiency on yield, proximate composition, and photosynthetic efficiency of *Phaeodactylum*." *Proceedings of the Subcontractors' Review Meeting, Aquatic Species Program*, Solar Energy Research Institute, Golden, Colorado, SERI/CP-624-1228, pp. 33-58.

Thomas, W.H.; Seibert, D.L.R.; Alden, M.; Neori, A.; Eldridge, P. (1984b) "Yields, photosynthetic efficiency, and proximate composition of dense marine microalgal cultures. I. Introduction and *Phaeodactylum tricornutum* experiments." *Biomass* 5:181-209.

Thomas, W.H.; Seibert, D.L.R.; Alden, M.; Neori, A.; Eldridge, P. (1984c) "Yields, photosynthetic efficiency, and proximate composition of dense marine microalgal cultures. II. *Dunaliella primolecta* and *Tetraselmis suecica* experiments." *Biomass* 5:211-225.

Thomas, W.H.; Seibert, D.L.R.; Alden, M.; Neori, A.; Eldridge, P. (1984d) "Yields, photosynthetic efficiency, and proximate composition of dense marine microalgal cultures. III. *Isochrysis* sp. and *Monallantus salina* experiments and comparative conclusions." *Biomass* 5:299-316.

Thomas, W.H.; Tornabene, T.G.; Weissman, J. (1984e) "Screening for lipid yielding microalgae: Activities for 1983." *Final Subcontract Report*, Solar Energy Research Institute, Golden, Colorado, SERI/STR-231-2207.



Timurian, R.; Ward, R.L.; Jeffries, T.W. (1977) "Growth of filamentous blue-green algae at high temperatures: a source of biomass for renewable fuels." *IZ Int. Seaweed Symp.* Aug 20-27.

Tornabene, T.G. (1980) "Microbial production of hydrocarbons." *Proceedings, Bio-Energy '80: World Congress and Exposition*, Atlanta, GA, pp. 491-492.

Tornabene, T.G. (1984) "Chemical profile of microalgae with emphasis on lipids." *Aquatic Species Program Review: Proceedings of the April 1984 Principal Investigators' Meeting*, Solar Energy Research Institute, Golden, Colorado, SERI/CP-231-2341, pp. 64-78.

Tornabene, T.G.; Ben-Amotz, A.; Hubbard, J.S. (1982) "Isolation, analysis and identification of lipids." *Report, Subcontract XK-2-02149-01*, Solar Energy Research Institute, Golden, Colorado.

Tornabene, T.G.; Benemann, J.R. (1985) "Chemical profiles on microalgae with emphasis on lipids." *Aquatic Species Program Review: Proceedings of the March 1985 Principal Investigators' Meeting*, Solar Energy Research Institute, Golden, Colorado, SERI/CP-231-2700, pp. 83-99.

Tornabene, T.G.; Holzer, G.; Lien, S.; Burris, N. (1983) "Lipid composition of the nitrogen starved green alga *Neochloris oleoabundans*." *Enzyme Microb. Technol.* 5:435-440.

Tornabene, T.G.; Holzer, G.; Peterson, S.L. (1980) "Lipid profile of the halophilic alga, *Dunaliella salina*." *Biochem. Biophys. Res. Comm.* 96:1349-1356.

Usui, N.; Ikenouchi, M. (1997) "The biological CO<sub>2</sub> fixation and utilization project by RITE (1) highly effective photobioreactor system." *Energy Conver. Mgmt.* 38: Suppl. 487-492.

Uziel, M.; Oswald, W.J.; Golueke, C.G. (1975) "Solar energy and conversion with algal bacterial systems." Univ. of California-Berkeley, SERL Report to NSF/RANN/SE/GI-39216/Fr/75/5.

Van Etten, J.L.; Burbank, D.E.; Joshi, J.; Meints R.H. (1984) "DNA synthesis in a *Chlorella*-like alga following infection with the virus PBCV-1." *Virology* 134:443-449.

Van Etten, J.L.; Burbank, D.E.; Kuczmariski, D.; Meints, R.H. (1983) "Virus infection of a culturable *Chlorella*-like algae and development of a plaque assay." *Science* 219:994-996.

Van Etten, J.L.; Burbank, D.E.; Meints, R.H. (1986) "Replication of PBCV-1 in ultra-violet irradiated *Chlorella*." *Intervirology* 26:115-120.

Van Etten, J.L.; Burbank, D.E.; Schuster, A.M.; Meints, R.H. (1985) "Lytic viruses infecting a *Chlorella*-like alga." *Virology* 140:135-143.

Van Etten, J.L.; Burbank, D.E.; Xia, Y.; Meints, R.H. (1983) "Growth cycle of a virus, PBCV-1, that infects *Chlorella*-like algae." *Virology* 126:117-125.



Van Etten, J.L.; Meints, R.H. (1991) "Viruses and virus-like particles of eukaryotic algae." *Microbiological Reviews* 55:586-620.

Van Etten, J.L.; Lane, L.; Meints, R.H. (1991) "Unicellular plants also have large dsDNA viruses." *Seminars in Virology* 2:71-77.

Van Etten, J.L.; Meints, R.H.; Burbank, D.E.; Kuczmarski, D.; Cuppels, D.A.; Lane, L.C. (1981) "Isolation and characterization of a virus from the intracellular green alga symbiotic with *Hydra viridis*." *Virology* 113:704-111.

Van Etten, J.L.; Meints, R.H.; Kuczmarski, D.; Burbank, D.E.; Lee, K. (1982) "Viruses of symbiotic *Chlorella*-like algae isolated from *Paramecium bursaria* and *Hydra viridis*." *Proc. Nat'l Acad. Sci.* 79:3867.

Van Etten, J.L.; Schuster, A.M.; Meints, R.H. (1988) "Viruses of eukaryotic *Chlorella*-like algae." In *Viruses of Fungi and Simple Eukaryotes*, Mycology Series Vol. 7 (Koltin, Y.; Leibowitz, M.J., eds.), Marcel Dekker, Inc., New York, pp. 411-428.

Van Etten, J.L.; Xia, Y.; Meints, R.H. (1987) "Viruses of a *Chlorella*-like green alga." In *Plant-Microbe Interactions II* (Kosuge, T.; Nester, E.W., eds.), Macmillan Publishing Co., pp. 307-325.

Van Etten, J.L.; Xia, Y.; Narva, K.E.; Meints, R.H. (1987) "*Chlorella* algal viruses." In *Extrachromosomal Elements in Lower Eukaryotes* (Fink, G.; et al., eds.), Plenum Press, New York, pp. 337-347.

Vigon, B.W.; Arthur, M.F.; Taft, L.G.; Clark, R.; Wagner, C.K.; Lipinsky, E.S.; Scantland, D.A.; Kresovich, S. (1982a) "Resource assessment for microalgal/emergent aquatic biomass systems in the southwestern United States." *Proceedings of the June 1982 SERI Biomass Program Principal Investigators' Review Meeting, Aquatic Species Program Reports*, Solar Energy Research Institute, Golden, Colorado, SERI/CP-231-1808, pp. 139-149.

Vigon, B.W.; Arthur, M.F.; Taft, L.G.; Wagner, C.K.; Lipinsky, E.S.; Litchfield, J.H.; McCandlish, C.D.; Clark, R. (1982b) "Resource assessment for microalgal/emergent aquatic biomass in the arid southwest." *Battelle Columbus Laboratory Report*, Solar Energy Research Institute, Golden, Colorado.

Waddle, J.A.; Schuster, A.M.; Lee, K.; Meints, R.H. (1989) "The mitochondrial genome of the exsymbiotic *Chlorella*-like green alga N1A." *Aquatic Species Program Annual Report* (Bollmeier, W.S.; Sprague, S., eds.), Solar Energy Research Institute, Golden, Colorado, SERI/SP-231-3579, pp. 91-118.

Waddle, J.A.; Schuster, A.M.; Lee, K.; Meints, R.H. (1990) "The mitochondrial genome of an exsymbiotic *Chlorella*-like green alga." *Plant Mol. Biol.* 14:187-195.



Walsh, R.G. (1984) "Microalgal technology research at SERI: The biochemistry of lipid trigger mechanisms in microalgae—alteration of lipid metabolism during transition from rapid growth to rapid lipid accumulation." *Aquatic Species Program Review: Proceedings of the April 1984 Principal Investigators' Meeting*, Solar Energy Research Institute, Golden, Colorado, SERI/CP-231-2341, pp. 170-183.

Weissman, J.C. (1984) "Cultivation of microalgae for liquid fuels." *Proceedings of the April 1984 Principal Investigators' Meeting, Aquatic Species Program*, Solar Energy Research Institute, Golden, Colorado, SERI/CP-231-2341, pp.132-149.

Weissman, J.C.; Benemann, J.R. (1978) "Biomass recycling and species control in continuous cultures." *Bioeng. Biotech.* 21:627-648.

Weissman, J.C.; Goebel, R.P. (1985) "Design, fabrication, and operation of innovative microalgae culture experiments using open ponds." *Final Report, Subcontract XK-3-03135*, Solar Energy Research Institute, Golden, Colorado.

Weissman, J.C.; Goebel, R.P. (1985) "Production of liquid fuels and chemicals by microalgae." *Proceedings of the March 1985 Principal Investigators' Meeting, Aquatic Species Program*, Solar Energy Research Institute, Golden, Colorado, SERI/CP-231-2700, pp.141-161.

Weissman, J.C.; Goebel, R.P. (1987) "Design and analysis of pond systems for the purpose of producing fuels." *Report to the Solar Energy Research Institute*, Golden, Colorado, SERI/STR-231-2840.

Weissman, J.C.; Goebel, R.P. (1987) "Factors affecting the photosynthetic yield of microalgae." *FY 1986 Aquatic Species Program Annual Report*, Solar Energy Research Institute, SERI/SP-231-3071, pp. 139-168.

Weissman, J.; Goebel, R. (1989) "An outdoor test facility for the large-scale production of microalgae." *Energy from Biomass and Wastes XII, Conference Proceedings* (Klass, D.L., ed.), Institute of Gas Technology, Chicago, pp. 277-287.

Weissman, J.C.; Goebel, R.P.; Benemann, J.R. (1988) "Photobioreactor design: comparison of open ponds and tubular reactors." *Bioeng. Biotech.* 31:336-344.

Weissman, J.C.; Tillett, D.T. (1989) "Design and operation of an outdoor microalgae test facility." *Aquatic Species Program, Annual Report* (Bollmeier, W.S.; Sprague, S., eds.), Solar Energy Research Institute, Golden, Colorado, SERI/SP-231-3579, pp. 41-57.

Weissman, J.C.; Tillett, T.D.; Goebel, R. (1987) "Design and operation of an outdoor microalgae test facility." *FY 1987 Aquatic Species Program, Annual Report* (Johnson, D.A.; Sprague, S., eds.), Solar Energy Research Institute, Golden, Colorado, SERI/CP-231-3206, pp. 231-252.



Weissman, J.C.; Tillett, D.T. (1992) "Design and operation of an outdoor microalgae test facility: large-scale system results." *Aquatic Species Project Report, FY 1989-90* (Brown, L.M.; Sprague, S., eds.), National Renewable Energy Laboratory, Golden, Colorado, NREL/MP-232-4174, pp. 32-56.

Weissman, J.C.; Tillett, D.T.; Goebel, R.P. (1989) "Design and operation of an outdoor microalgae test facility." *Final Report*, Solar Energy Research Institute, Subcontract XK-7-06113-1.

York, Jr., R.H. (1987a) "Collection of high energy yielding strains of saline microalgae from the Hawaiian Islands." *Final Technical Report, Year 1*, Solar Energy Research Institute, Golden, Colorado, 15 pp.

York, Jr., R.H. (1987b) "Collection of high energy yielding strains of saline microalgae from the Hawaiian Islands." *FY 1986 Aquatic Species Program Annual Report*, Solar Energy Research Institute, Golden, Colorado, SERI/SP-231-3071, pp. 90-104.

York, Jr., R.H. (1987c) "Collection of high energy yielding strains of saline microalgae from the Hawaiian Islands." *Abstract, FY 1987 Aquatic Species Program Annual Report* (Johnson, D.A.; Sprague, S., eds.), Solar Energy Research Institute, Golden, Colorado, SERI/SP-231-3206, p. 76.

Zeiler, K.G.; Kadam, K.L. (1994) "Biological trapping of carbon dioxide." *Draft Milestone Completion Report*, National Renewable Energy Laboratory, Golden, Colorado.

## V.B. ADDITIONAL REFERENCES

Asano, Y.; Otsuki, Y.; Ugaki, M. (1991) "Electroporation-mediated and silicon carbide fiber-mediated DNA delivery in *Agrostis alba* L. (Redtop)." *Plant Sci.* 79:247-252.

Berliner, M.D. (1977) "Protoplast induction in *Chlorella vulgaris*." *Plant Sci. Lett.* 9:201-204.

Bligh, E.G.; Dyer, D.J. (1959) "A rapid method for total lipid extraction and purification." *Can J. Biochem. Physiol.* 37:911-917.

Braun, E.; Aach, H.G. (1975) "Enzymatic degradation of the cell wall of *Chlorella*." *Planta* 126:181-185.

Daboussi, M.J.; Djeballi, A.; Gerlinger, C.; Blaiseau, P.L.; Bouvier, I.; Cassan, M.; Lebrun, M.H.; Parisot, D.; Brygoo, Y. (1989) "Transformation of seven species of filamentous fungi using the nitrate reductase gene of *Aspergillus nidulans*." *Curr. Genet.* 15:453

Global, E.; Aach, H.G. (1985) "Studies of *Chlorella* protoplasts. II. Isolation and fusion of protoplasts from *Chlorella saccharophila* (Krüger) nadson strain 211-1a." *Plant Sci.* 39:213-218.



Greenbaum, E.; Lee, J.W.; Tevault, C.V.; Blankinship, S.L.; Metz, L.J. (1995) "Carbon dioxide fixation and photoevolution of hydrogen and oxygen in a mutant of *Chlamydomonas* lacking photosystem I." *Nature*, August 3.

Greenspan, P.; Mayer, E.P.; Fowler, S.D. (1985) "Nile Red: A selective fluorescent stain for intracellular lipid droplets." *J. Cell Biol.* 100:965-973.

Greenspan, P.; Fowler, S.D. (1985) "Spectrofluorometric studies of the lipid probe, Nile Red." *J. Lipid Res.* 26:781-.

Hoffman, C.S.; Winston, F. (1987) "A ten-minute DNA preparation from yeast efficiently releases autonomous plasmids for transformation of *Escherichia coli*." *Gene* 57:267-272.

Kaeppler, H.F.; Gu, W.; Somers, D.A.; Rines, H.W.; Cockburn, A.F. (1990) "Silicon carbide fiber-mediated DNA delivery into plant cells." *Plant Cell Rep.* 9:415-418.

Kindle, K. (1990) "High frequency nuclear transformation of *Chlamydomonas reinhardtii*." *Proc. Nat. Acad. Sci. USA* 87:1228-1232.

Kindle, K.L.; Schnell, R.A.; Fernández, E.; Lefebvre, P.A. (1989) "Stable nuclear transformation of *Chlamydomonas* using the *Chlamydomonas* gene for nitrate reductase." *J. Cell Biol* 109:2589-2601.

Mitra, A.; Higgens, D.W. (1994) "The *Chlorella* virus methyltransferase gene promoter is a strong promoter in plants." *Plant Mol Biol.* 26:85-93.

Murray, H.G.; Thompson, W.F. (1980), "Rapid isolation of high molecular weight plant DNA." *Nuc. Acids Res.* 8:4321-4325.

Nei, M. (1972) *Amer. Natur.* 106:283.

Siver, P. (1983) "A new thermal gradient device for culturing algae." *British J. Phycol.* 18:159-163.

## V.C. PATENTS

Dunahay, T.; Roessler, P.G.; Jarvis, E.E. "Method to Transform Algae, Materials Therefor and Products Produced Thereby." U.S. Patent 5,661,017, issued 8/26/97.

Jarvis, E.E.; Roessler, P.G. "Isolated-Gene Encoding an Enzyme with UDP-Glucose Pyrophosphorylase Activities from *Cyclotella cryptica*." Allowed 10/24/96.

Roessler, P.G.; Ohlrogge, J.B., "Gene Encoding Acetyl-Coenzyme A Carboxylase." U.S. Patent 5,559,220, issued 9/24/96.

# REPORT DOCUMENTATION PAGE

Form Approved  
OMB NO. 0704-0188

Public reporting burden for this collection of information is estimated to average 1 hour per response, including the time for reviewing instructions, searching existing data sources, gathering and maintaining the data needed, and completing and reviewing the collection of information. Send comments regarding this burden estimate or any other aspect of this collection of information, including suggestions for reducing this burden, to Washington Headquarters Services, Directorate for Information Operations and Reports, 1215 Jefferson Davis Highway, Suite 1204, Arlington, VA 22202-4302, and to the Office of Management and Budget, Paperwork Reduction Project (0704-0188), Washington, DC 20503.

1. AGENCY USE ONLY (Leave blank)		2. REPORT DATE  July 1998	3. REPORT TYPE AND DATES COVERED  Technical Report	
4. TITLE AND SUBTITLE  A Look Back at the U.S. Department of Energy's Aquatic Species Program: Biodiesel from Algae			5. FUNDING NUMBERS  BF886001	
6. AUTHOR(S)  J. Sheehan, T.G. Dunahay, J.R. Benemann, P.G. Roessler, J.C. Weissman				
7. PERFORMING ORGANIZATION NAME(S) AND ADDRESS(ES) National Renewable Energy Laboratory 1617 Cole Blvd. Golden, CO 80401-3393  U.S. Department of Energy  U.S. Department of Agriculture  Ecobalance, Inc.  Colorado School of Mines  Colorado Institute for Fuels and Engine Research			8. PERFORMING ORGANIZATION REPORT NUMBER	
9. SPONSORING/MONITORING AGENCY NAME(S) AND ADDRESS(ES) National Renewable Energy Laboratory 1617 Cole Blvd. Golden, CO 80401-3393			10. SPONSORING/MONITORING AGENCY REPORT NUMBER  NREL/TP-580-24190	
11. SUPPLEMENTARY NOTES				
12a. DISTRIBUTION/AVAILABILITY STATEMENT National Technical Information Service U.S. Department of Commerce 5285 Port Royal Road Springfield, VA 22161			12b. DISTRIBUTION CODE UC-1503	
13. ABSTRACT ( <i>Maximum 200 words</i> ) The Aquatic Species Program was a relatively small research effort intended to look at the use of aquatic plants as sources of energy. Its history dates back to 1978, but much of the research from 1978 to 1982 focused on using algae to produce hydrogen. The program switched emphasis to other transportation fuels, particularly biodiesel, beginning in the early 1980's. This report summarizes the research activities carried out from 1980 to 1996, with an emphasis on algae for biodiesel production.				
14. SUBJECT TERMS  biodiesel, algae, aquatic species, raceway ponds			15. NUMBER OF PAGES	
			16. PRICE CODE	
17. SECURITY CLASSIFICATION OF REPORT Unclassified	18. SECURITY CLASSIFICATION OF THIS PAGE Unclassified	19. SECURITY CLASSIFICATION OF ABSTRACT Unclassified	20. LIMITATION OF ABSTRACT  UL	

**For more information, contact:**

Michael Voorhies, Program Manager  
Office of Fuels Development  
U.S. Department of Energy  
Forrestal Building  
1000 Independence Avenue, SW  
Washington, D.C. 20585-0121

K. Shaine Tyson, Manager  
Biodiesel Project  
National Renewable Energy Laboratory  
1617 Cole Boulevard  
Golden, CO 80401-3393

John Sheehan  
Biotechnology Center for Fuels and  
Chemicals  
National Renewable Energy Laboratory  
1617 Cole Boulevard  
Golden, CO 80401-3393

Prepared for the  
U.S. Department of Energy (DOE)



by the National Renewable Energy Laboratory  
a U.S. Department of Energy national laboratory



Printed with renewable source ink on paper containing at least  
50% wastepaper, including 20% postconsumer waste.