

170

80

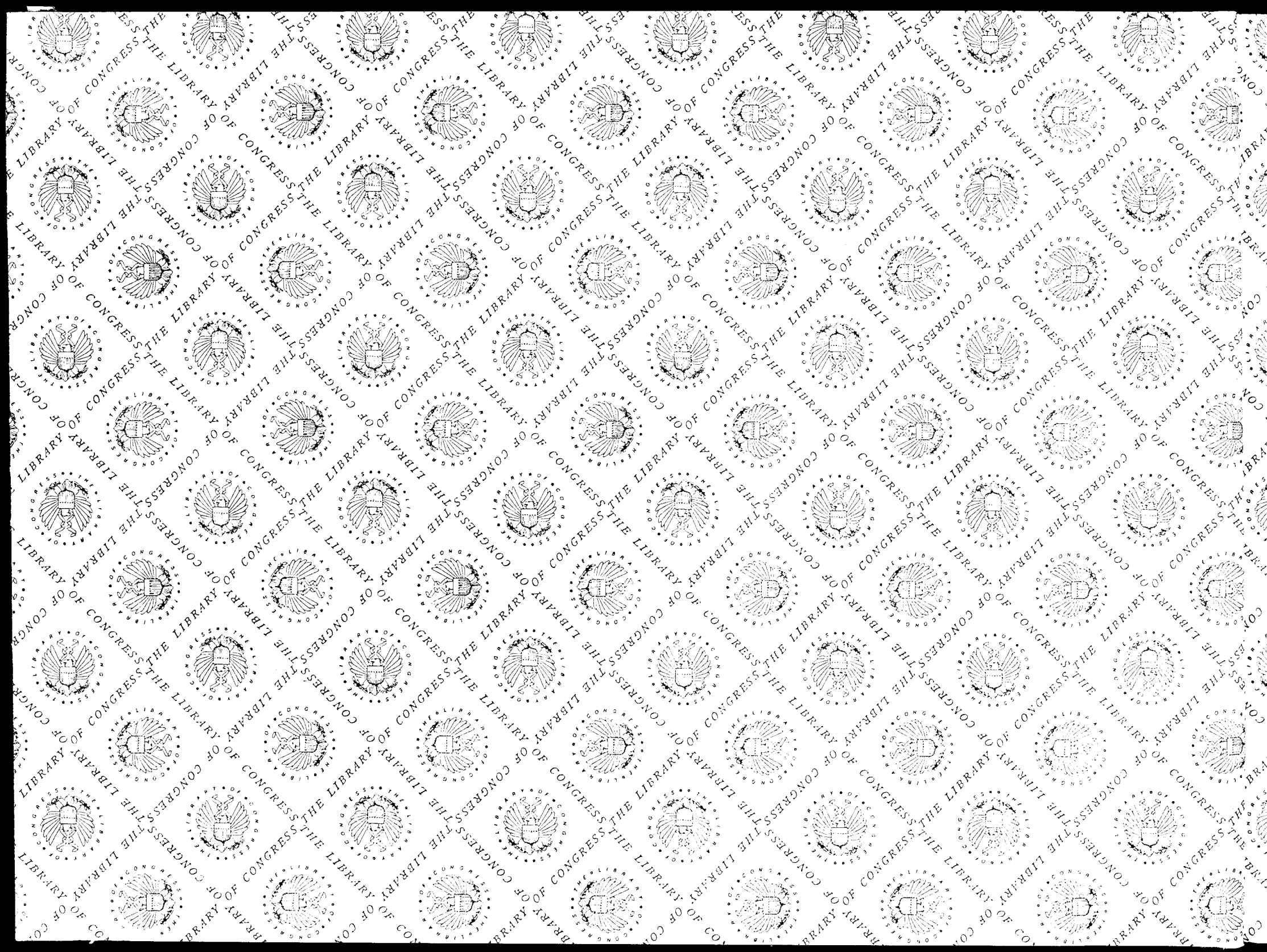

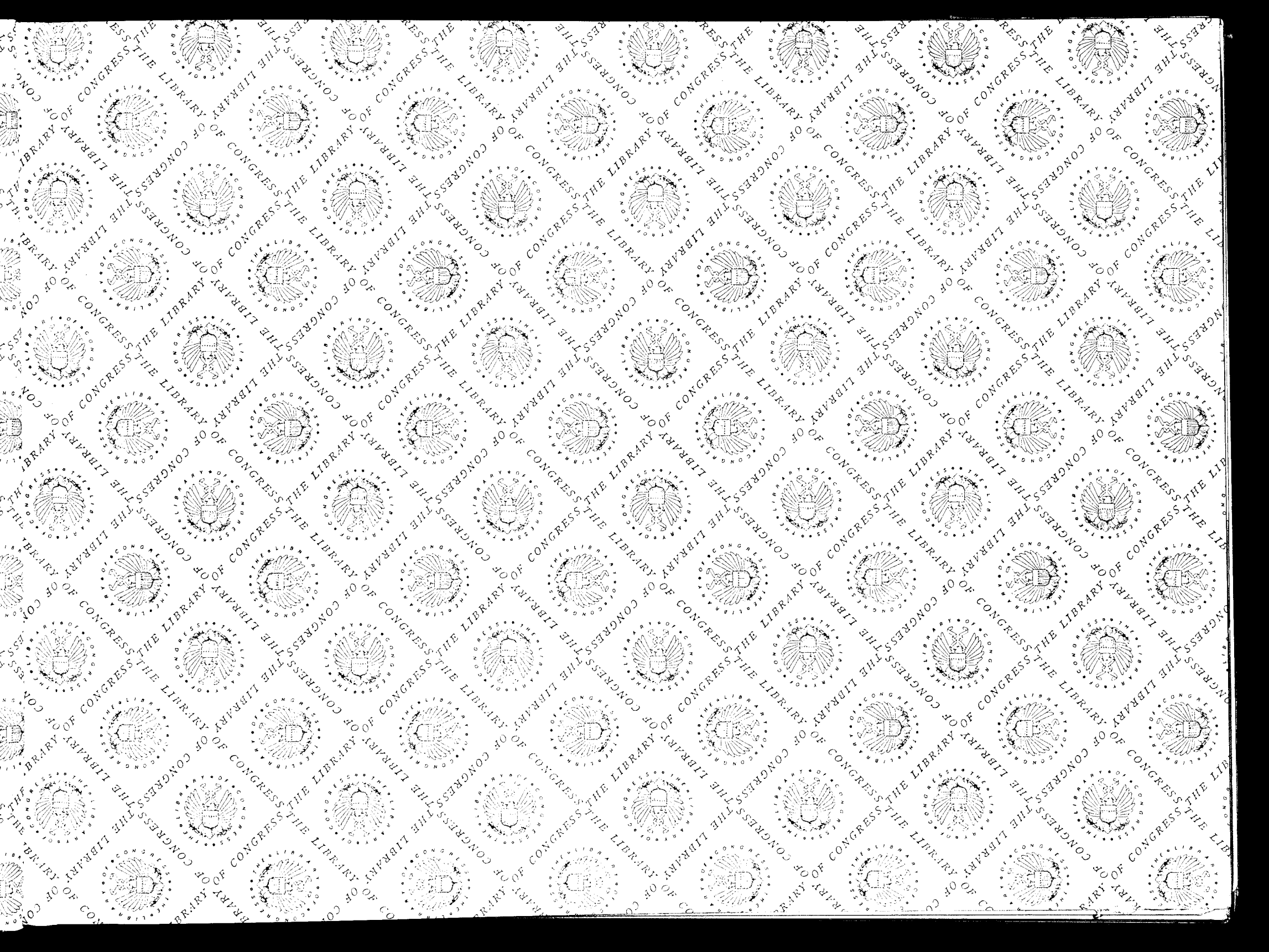



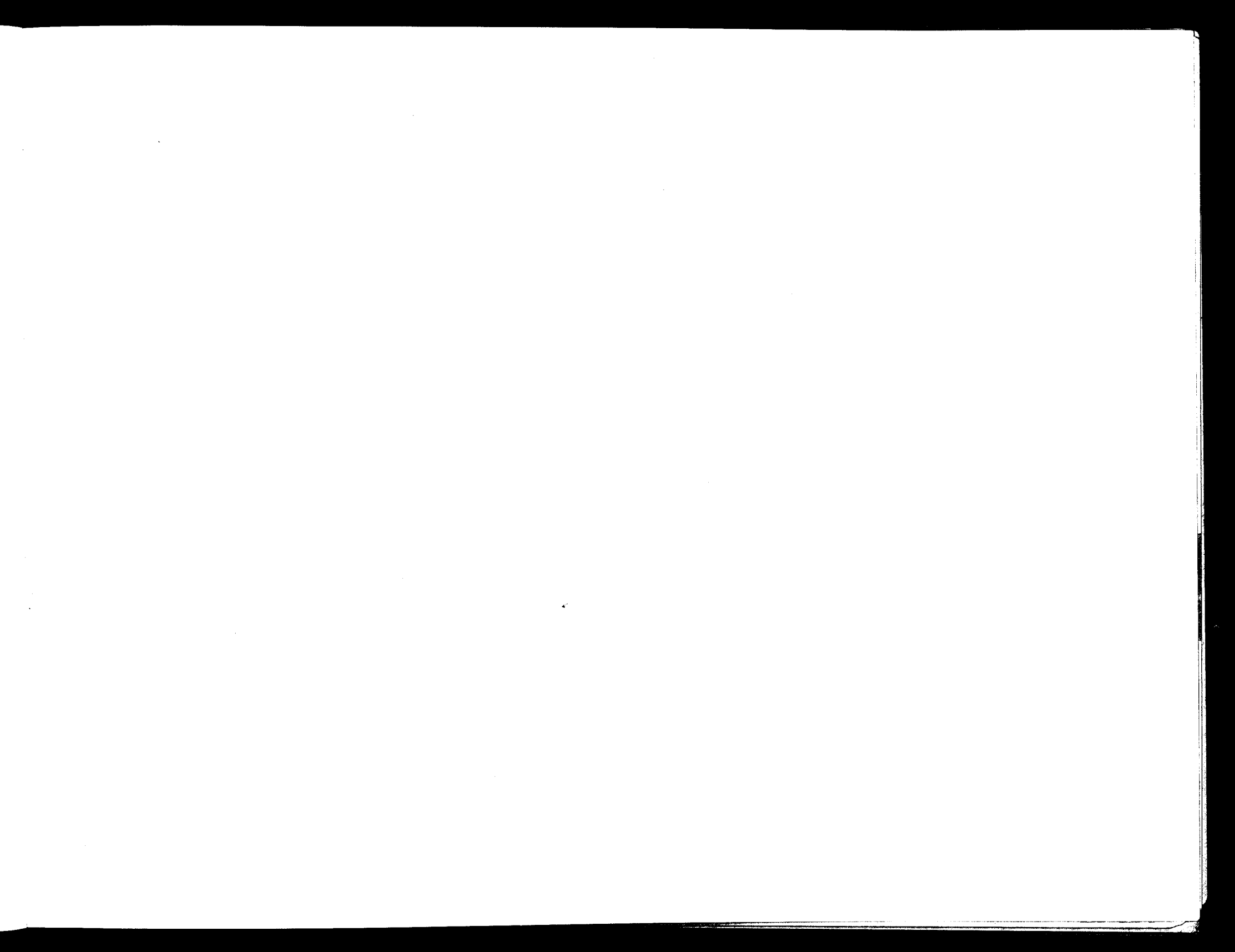



HOW TO DRAW

A PRACTICAL BOOK OF INSTRUCTION
IN THE ART OF ILLUSTRATION

422
1497

BY

LEON BARRITT

WITH NUMEROUS REPRODUCTIONS OF ORIGINAL DRAWINGS
BY AMERICA'S FAMOUS ILLUSTRATORS, CARTOONISTS
AND COMIC ARTISTS



NEW YORK AND LONDON

HARPER & BROTHERS PUBLISHERS

1904

LIBRARY OF CONGRESS

LIBRARY of CONGRESS
Two Copies Received
NOV 23 1904
COPYRIGHT ENTRY
Oct. 21, 1904
CLASS a XXc. No1
99718
COPY B.

NC 960
B3

Copyright, 1904, by HARPER & BROTHERS.
All rights reserved.
Published November, 1904.

TABLE OF CONTENTS

	PAGE		PAGE
LIST OF ARTIST CONTRIBUTORS	v	PERSPECTIVE	27
NOTE TO CONTRIBUTORS	vi	LANDSCAPE DRAWING	31
INTRODUCTION	vii	SPATTER WORK	31
PEN-AND-INK DRAWING	viii	WATER STUDIES	32
MATERIAL	1	COMICS	33
PRIMARY INSTRUCTION	2	CARTOONS	34
FIRST LESSON	4	WASH LAMP-BLACK DRAWING	37
LINE-WORK STUDIES	6	DISTEMPER DRAWING	38
RULES FOR DRAWING THE HEAD	7	DRAWING ON SILVER PRINTS	39
RULES FOR DRAWING THE EYE, EAR, AND MOUTH	8	LETTERING	40
RULES FOR DRAWING THE HANDS	9	HOW TO MAKE AN ELLIPSE	42
RULES FOR DRAWING THE FEET	10	TINT PAPERS	42
THE HUMAN FIGURE	11	SCALE FOR REDUCING DRAWINGS	43
MEASURING BY THE EYE	13	SHARPENING PENCILS	43
DRAWING FROM LIFE	14	NEWS AND STORY ILLUSTRATIONS	44
MEASUREMENTS OF HUMAN FIGURE	17	FOLIAGE STUDY	44
SHOE STUDIES	17	EXAMPLES OF THE WORK OF AMERICA'S MOST FAMOUS ILLUSTRATORS:	
DRAWING FROM LIFE—CHILDREN	18	NEWS	45
DRAWING FROM LIFE—DRAPERY	19	FICTION	61
STUDIES IN EXPRESSION	20	CARTOONS	75
ANIMAL DRAWING	22	COMICS	89

LIST OF ARTIST CONTRIBUTORS

NEWS ILLUSTRATIONS

	PAGE
E. FUHR	47
G. A. COFFIN	48
F. FOSTER LINCOLN	49
E. N. DART	50
E. FREDERICK	51
JOHN CARLETON BAKER	52
DAN SMITH	25, 53
W. H. LOOMIS	54
H. G. DART	55
CHARLES WRIGHT	56
L. A. SHAFER	57
PENRHYN STANLAWS	58
H. PRUETT SHARE	59, 60

FICTION ILLUSTRATIONS

C. D. WELDON	37
F. LUIS MORA	63
W. GRANVILLE SMITH	64
W. MORGAN	65
WM. G. KRIEGHOFF	66
WILLARD BONTE	67
E. V. NADHERNY	68
W. T. SMEDLEY	69
HOWARD PYLE	70
PETER NEWELL	71
A. B. FROST	38, 72
W. H. HYDE	73

CARTOONS

C. G. BUSH	77
W. A. ROGERS	78

CARTOONS—*Continued*

	PAGE
C. DE FORNARO	79
CH. NELAN	80
H. COULTAUS	81
T. S. SULLIVANT	82
HOMER DAVENPORT	83
F. T. RICHARDS	84
F. OPPER	85
C. S. RIGBY	86
LEON BARRITT	35, 87
THOMAS NAST	88

COMICS

WINSOR McCAY	91
T. E. POWERS	92, 93
FERDINAND LONG	94
WALT McDougall	95
R. F. OUTCAULT	96
R. DIRKS	97
F. OPPER	98
PAUL BRANSOM	99
HY. MAYER	100
F. M. FOLLETT	101
CARL SHULTZE	102
GEORGE McMANUS	103
GENE CARR	104
JAMES SWINNERTON	105
F. M. HOWARTH	106
W. P. BODFISH	107
WM. MARRINER	107
T. S. ALLEN	107



The publishers and author take pleasure in acknowledging their indebtedness to the many artists who have contributed examples of their work to this publication, thereby making it a work of comparison for many years to come.

INTRODUCTION

RECENT discoveries in the art of photography as applied to engraving have revolutionized the method of illustration, greatly reducing the cost over old wood-engraving methods, and placing the use of pictures within the reach of the most provincial journal. This, naturally, has opened a new and constantly increasing field for the illustrator. In consequence of this many young men and women who have not the opportunity to obtain personal instruction seek suggestions from men, like the author, engaged practically in the work. Having received hundreds of such communications from all parts of the country, it has suggested the idea that a publication would be welcomed that set forth in a simple, practical way the basic principles of illustration. Trusting that this endeavor may be found helpful, and bear abundant fruit, he respectfully subscribes himself,

THE AUTHOR.

PEN-AND-INK DRAWING

THE most popular and widely used method of illustration at the present time is that produced by pen and ink. These drawings to be commercially valuable must be made on white paper with black (India) ink. The reason for this is that the drawing being reproduced by photography must present a perfectly clean, sharp, black line, which for photographic purposes is best set forth on a pure white paper. The black lines of the drawing show white in the negative. If the line is drawn with a thin, gray ink it will photograph raggedly and present a weak, uncertain line in the negative; consequently thin, scratchy, weak lines must be avoided, or the reproduction will be unsatisfactory. Bear in mind that however delicate your line may be it must be black. The negative shows the drawing in reverse, that is, as before stated, the black lines will be white and all that is white will be black. This negative is then placed over a sheet of zinc, the surface of which is perfectly smooth, and which has been sensitized by photographic chemicals much the same as a sheet of paper is prepared to retain the image on a negative in ordinary photography. This is exposed to the action of sunlight or electric light, and the drawing is reproduced in black lines with a white background exactly as in the original. This zinc plate is then submitted to a bath of nitric acid, which eats away the white part and leaves the black line standing. The plate prior to the etching is prepared to resist the action of the acid in the parts desired in a way that is not necessary of detailed explanation here. The above facts are set forth to show the necessity for using white paper and black ink.

MATERIAL

PAPER

Plain white card-board, from one to three ply in thickness, is most commonly used. Of course, the better the quality the more easily erasures may be made if found necessary. In making an erasure use a sharp knife, and then go over it with a rubber eraser; this removes the fuzz, and burnish down with an ivory paper-cutter. The surface of the card-board once broken by an erasure never can be restored to its original finish, so in drawing over such a place great care will have to be taken to prevent the ink from spreading. The best plan in making a correction is to paste a piece of thin white paper on the part you desire to cover. Mounted Steinbach's and Whatman's hot pressed papers are also commonly used for pen drawing.

INK

"Higgins' non-waterproof" and French black are the most popular grades of ink used. These inks flow freely, and at the same time present a perfectly black line no matter how boldly or how finely made. Should the ink "thicken," it can be "thinned" by the addition of a little water. Care should be taken not to add too much water or the ink will become gray in color. These inks are made from India ink, and where the fluid ink is not obtainable a most excellent ink can be made by "grinding," as it is termed, the stick ink in a little earthen dish with water, adding the water and grinding the stick around in it until you obtain the desired color and quantity. Do not let the stick of ink stand in the water, as it will crack all to pieces. Should you desire to make a quantity of ink, break the stick up into small pieces and let it stand in a shallow saucer with just sufficient water to cover the particles, allowing it to stand for a few hours; then grind with a glass stopper, bottle, and keep corked when not in use. Should it thicken, add a little water and stir thoroughly.

White ink is made from Winsor & Newton, or any other moist water-color, by mixing a little water with it. As it dries

WHITE INK

very quickly it should be mixed only as required, and as it never flows very freely care will have to be used in its preparation.

GENS

Gillote's Nos. 170, 303, 404, and 290 are most used.

PENCILS

Faber's, Dixon's, and the Eagle are most popular among artists, although there are many other grades for which there is individual preference.

RUBBER ERASERS

The sponge rubber, together with two or three grades of the hard rubber erasers, are essential. Experience will soon show you what is best for your purpose.

BRUSHES

Red or black sable brushes of two or three small sizes will be found necessary for laying in a heavy body of color.

REDUCING-GLASS

A double concave spectacle lens (rough edge), costing about twenty cents at any optician's, will serve, and enable the student to see the effect of his drawing reduced half or one-third, according to the lens chosen.

MISCELLANEOUS NECESSITIES

Two drawing-boards of smooth, well-seasoned pine or other light wood, one 24 by 36 inches, and one 18 by 24 inches; a couple dozen thumb tacks; one ruling pen;* one pair dividers with ruling-pen and pencil attachment.

A T-square; one 36-inch straight-edge; one 24-inch straight-edge; one 24-inch ruler; two triangles, one with 14-inch angle and the other with a 6-inch angle; also one curve rule.

* The ink is put in a ruling-pen by first taking up the ink with an ordinary pen, and drawing it between the blades of the ruling-pen, care being taken not to allow the ink to get on the outer sides of the blades, as it is then apt to cause a blot as you draw the ruling-pen along the edge of the ruler.

PRIMARY INSTRUCTION

Practise drawing lines so as to form tints, beginning with the simple straight line at an angle of fifty degrees, as in writing. (See Fig. 1.)

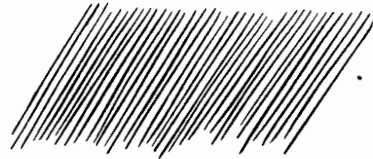

FIG 1

Then make them perpendicular. (See Fig. 2.)

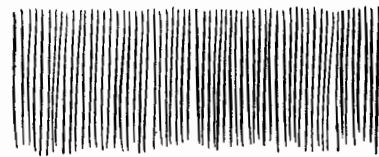

FIG 2

Then reverse the first angle. (See Fig. 3.)

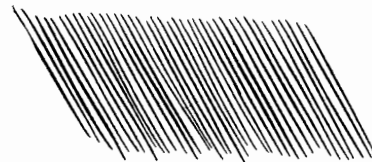

FIG. 3

Then combine the lines. (See Fig. 4.)

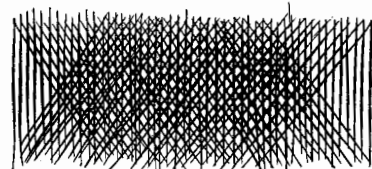

FIG. 4.

Change these combinations as you will, gradually lengthening the lines so as to obtain greater facility and freedom of stroke. Too great stress cannot be placed on the necessity for practise

in this work. Care should be taken to make the lines clean and strong from start to finish of the stroke. (See Fig. 5.) Not weak and broken, as in Fig. 6.



FIG. 5.



FIG. 6.

Always keep your work before you; work from the top down. (Fig. 1.)



FIG. 1.

Not from the bottom up. (Fig. 2.)

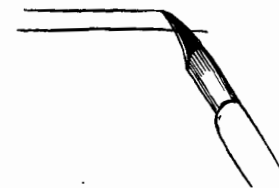

FIG. 2.

Work from left to right. (Fig. 3.)

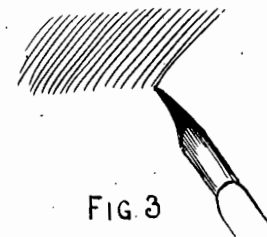
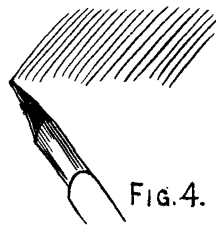

FIG. 3

PRIMARY INSTRUCTION

Not from right to left. (Fig. 4.)



Avoid cross hatching of lines as much as possible. Get your result by a bold line in the darkest shadows rather than to "niggle" over and over your picture to get the desired effect.

Study the work of our best illustrators, of which we present numerous examples for reference, but do not become a copyist; success cannot possibly be obtained in that way; but study from nature at all times, seeking to reproduce the humblest forms of nature's handiwork, and gradually attempt the more complicated. Use as a model at first a book, a pitcher, a vase, a leaf or flower, an orange or apple; then try to show by smooth, even tints the polished surfaces of the cube, and then the rough surfaces of the hewn stone. A tree stump with its rough bark sides is always a picturesque study; then try the tree with its spreading branches, and lastly the foliage. Imitate nature, acquire a style of your own. Do not pile up a mass of indifferent, unfinished sketches; that sort of thing will do for the practised artist, but not for the amateur. Whatever you undertake, do it just as well as you know how. Be patient, painstaking, care-

ful. Success can crown your effort in no other way. A man may be born with great natural aptitude for art, but destroy his opportunities for success by not submitting himself to proper training. So we would caution the beginner to apply himself to the mastery of little things, and he will then find himself better equipped for the battle with the greater problems.

No rule can be given by which a man may develop the power to create a picture unless it be hard work, close, intelligent observation, and a memory capable of retaining and applying what he acquires. The essential basis of creative art is a lively imagination. But there is a genius that is born, not made. It may, however, like imagination, be latent, and therefore developed.

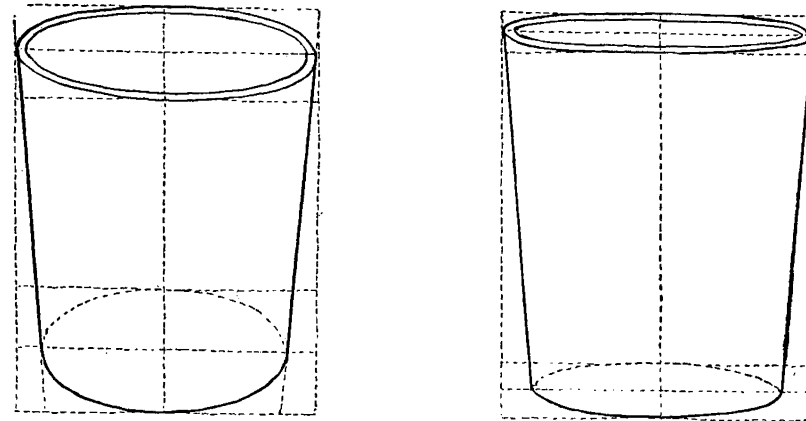

PERSPECTIVE STUDY OF A TUMBLER

PRIMARY INSTRUCTION

Practise drawing lines so as to form tints, beginning with the simple straight line at an angle of fifty degrees, as in writing. (See Fig. 1.)

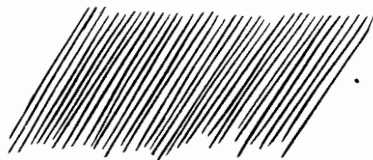

FIG 1

Then make them perpendicular. (See Fig. 2.)

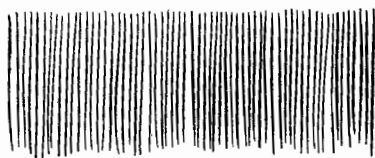

FIG 2

Then reverse the first angle. (See Fig. 3.)

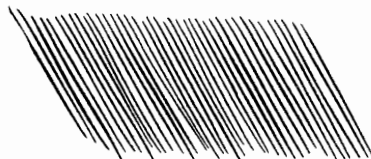

FIG. 3

Then combine the lines. (See Fig. 4.)

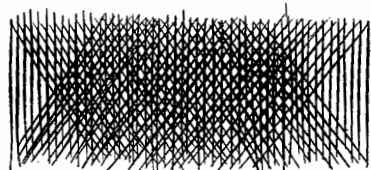

FIG. 4.

Change these combinations as you will, gradually lengthening the lines so as to obtain greater facility and freedom of stroke. Too great stress cannot be placed on the necessity for practise

in this work. Care should be taken to make the lines clean and strong from start to finish of the stroke. (See Fig. 5.) Not weak and broken, as in Fig. 6.

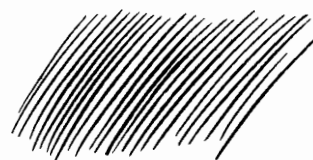

FIG. 5.



FIG. 6.

Always keep your work before you; work from the top down. (Fig. 1.)

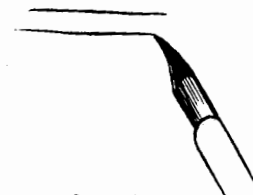

FIG. 1.

Not from the bottom up. (Fig. 2.)

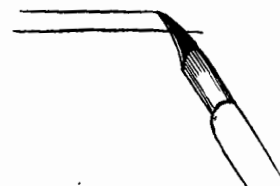

FIG. 2.

Work from left to right. (Fig. 3.)

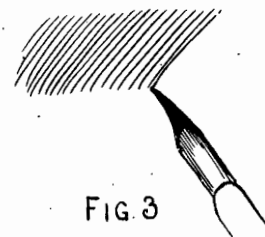

FIG. 3

PRIMARY INSTRUCTION

Not from right to left. (Fig. 4.)

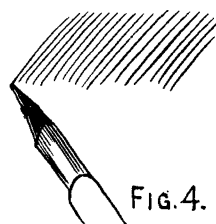

FIG. 4.

Avoid cross hatching of lines as much as possible. Get your result by a bold line in the darkest shadows rather than to "niggle" over and over your picture to get the desired effect.

Study the work of our best illustrators, of which we present numerous examples for reference, but do not become a copyist; success cannot possibly be obtained in that way; but study from nature at all times, seeking to reproduce the humblest forms of nature's handiwork, and gradually attempt the more complicated. Use as a model at first a book, a pitcher, a vase, a leaf or flower, an orange or apple; then try to show by smooth, even tints the polished surfaces of the cube, and then the rough surfaces of the hewn stone. A tree stump with its rough bark sides is always a picturesque study; then try the tree with its spreading branches, and lastly the foliage. Imitate nature, acquire a style of your own. Do not pile up a mass of indifferent, unfinished sketches; that sort of thing will do for the practised artist, but not for the amateur. Whatever you undertake, do it just as well as you know how. Be patient, painstaking, care-

ful. Success can crown your effort in no other way. A man may be born with great natural aptitude for art, but destroy his opportunities for success by not submitting himself to proper training. So we would caution the beginner to apply himself to the mastery of little things, and he will then find himself better equipped for the battle with the greater problems.

No rule can be given by which a man may develop the power to create a picture unless it be hard work, close, intelligent observation, and a memory capable of retaining and applying what he acquires. The essential basis of creative art is a lively imagination. But there is a genius that is born, not made. It may, however, like imagination, be latent, and therefore developed.

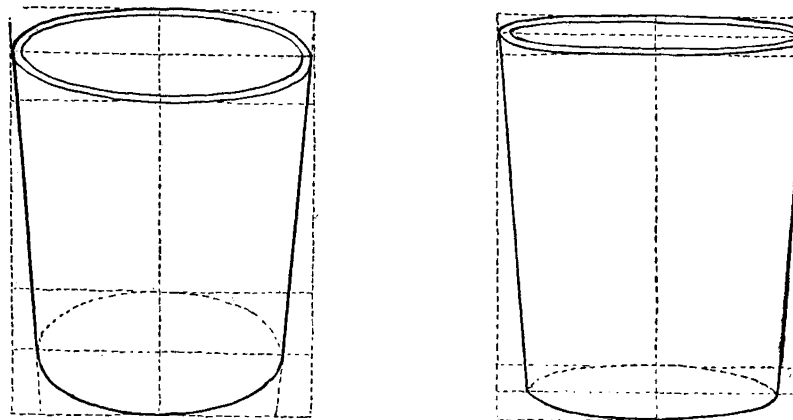

PERSPECTIVE STUDY OF A TUMBLER

FIRST LESSON

How can I learn to draw? That is a question often asked, and the answer is that if you have learned to write you can learn to draw. It does not follow, however, that because you have learned to write you have become a great writer. The same is true of drawing. You may master the principles of art, but their successful application depends upon the student.

The first step in art is to train the eye to proportions—as in the human figure we find it is eight heads high; or the head itself is four noses high; the space between the eyes is the width of an eye. Or, as we look at the sky-line of the city, or the horizon of the landscape, we may note that a church-spire is twice the height of some building near by, or, perchance, three times the height of some mountain on the distant landscape. The artist keeps these relative proportions of one object to another always in mind, and by constant practise, as in writing, they come as naturally and unconsciously to him as penmanship comes to the writer.

One of the simplest and best known methods for training the eye to proportions is the square, of which we give two examples—a block letter alphabet, and a series of simple objects—for the student to copy.

In laying out the scale of squares, measure off the four sides of your picture by rule, placing a dot at the scale of measure

you desire—quarter, half, inch or otherwise; then, using a hard pencil, rule off the squares. In drawing over the scale use a medium soft pencil, so that you can distinguish your picture lines from the pencil ruling of the squares.

In copying the alphabet the student will note that while all the letters are of the same height they are not all of the same width—the “A,” “M,” and “W” are wider.

In the second proportion scale of squares we have a series of objects. Note carefully the number of squares each occupies in width and height and the direction of the line through the squares. Practise copying these examples until you feel that you have the principle fully fixed in your mind, then practise drawing them without the squares. This is the very best possible training for the eye, and a basis for future freehand drawing. These imaginary lines or squares will be found to suggest themselves in everything you draw.

The scale of squares offers an infallible law for the drawing of two sides of an object alike, and for enlarging a picture. In enlarging a picture which, for illustration, we will presume you wish enlarged four times, lay out your original in quarter-inch squares, and your copy in half-inch squares, having, of course, as many squares in your copy as there are squares in the original. Then make your copy lines follow exactly the same course through each square of the enlargement as are shown in the original.

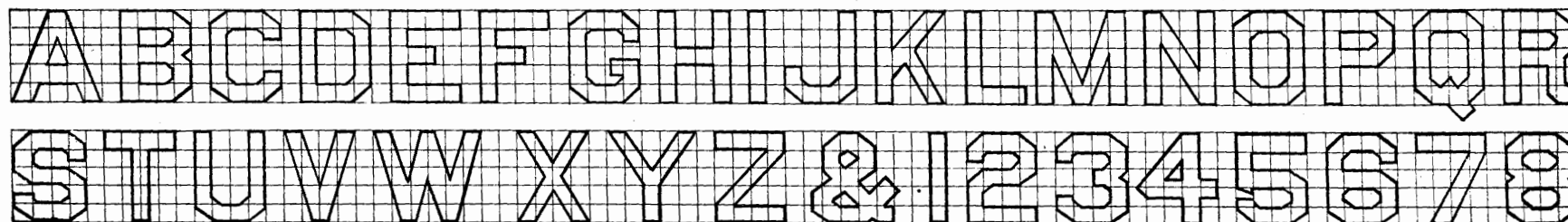

BLOCK LETTER STUDY

FIRST LESSON

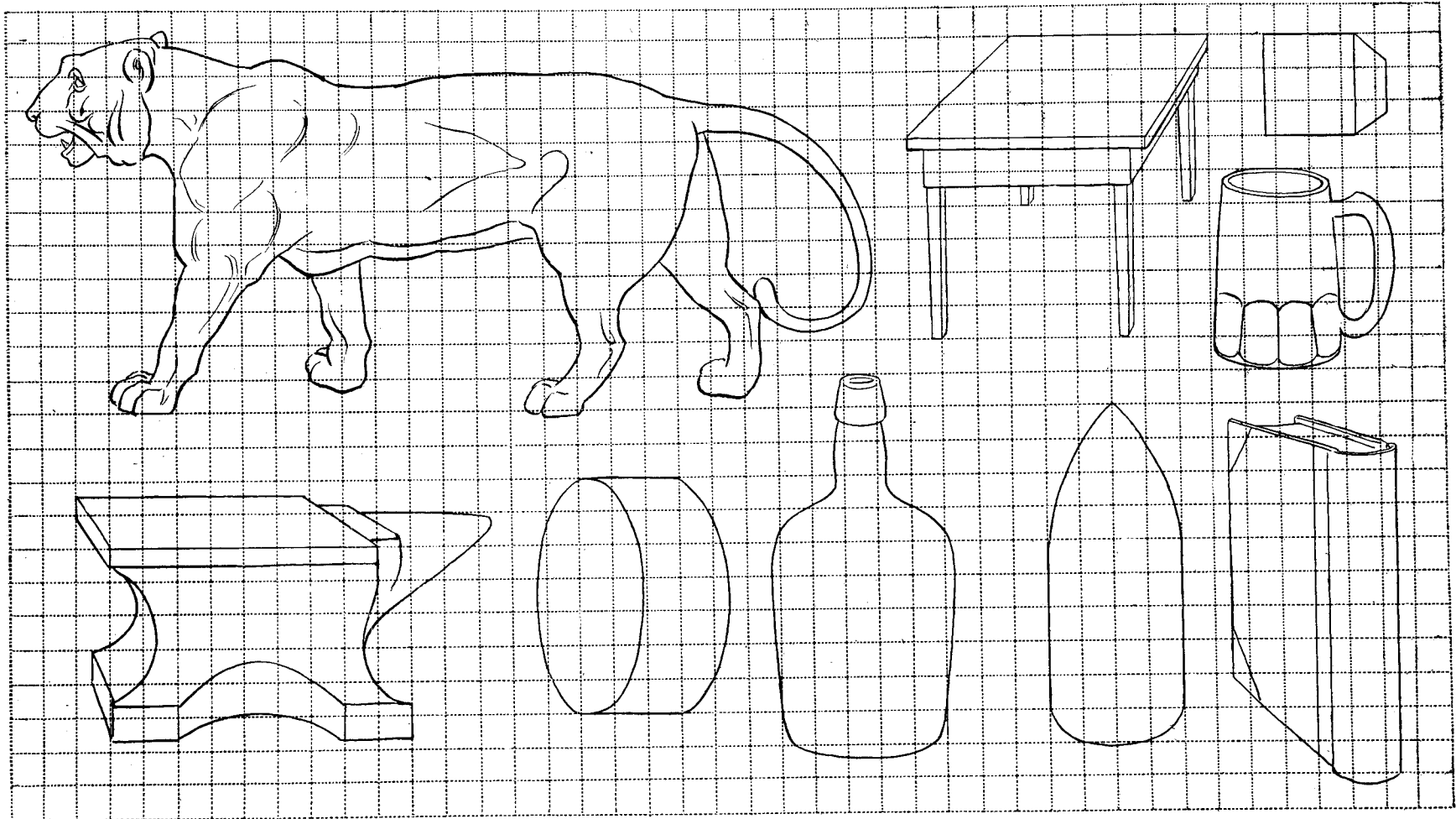

SCALE OF SQUARES

LINE-WORK STUDIES

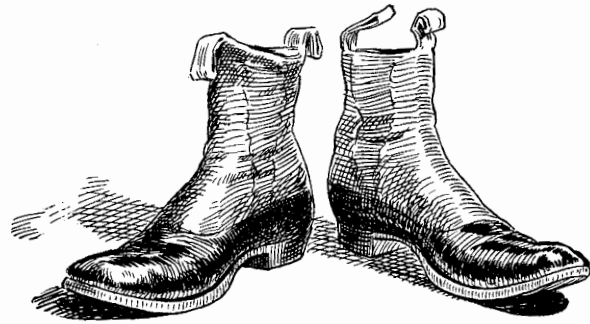

POLISHED SHOES

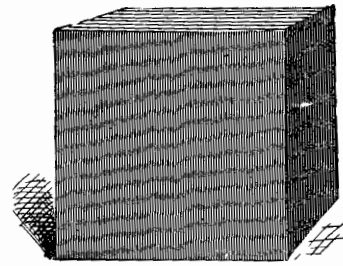

THE CUBE

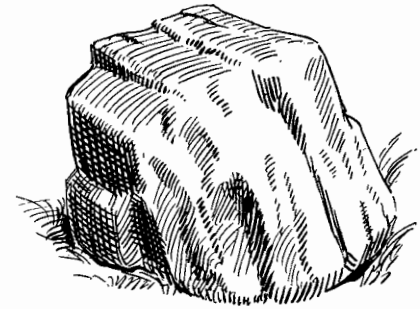

THE ROUGH STONE

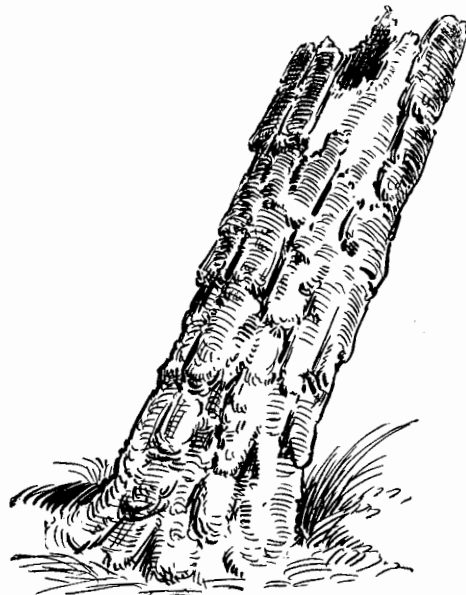

ROUGH BARK OF TREE

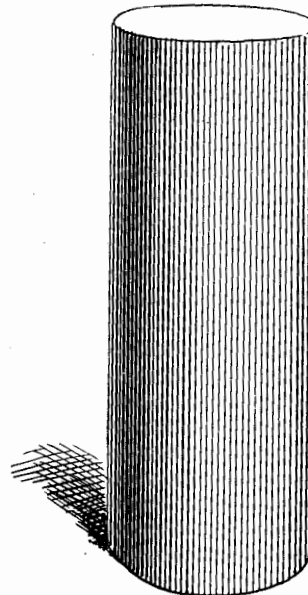

A SMOOTH ROUND COLUMN

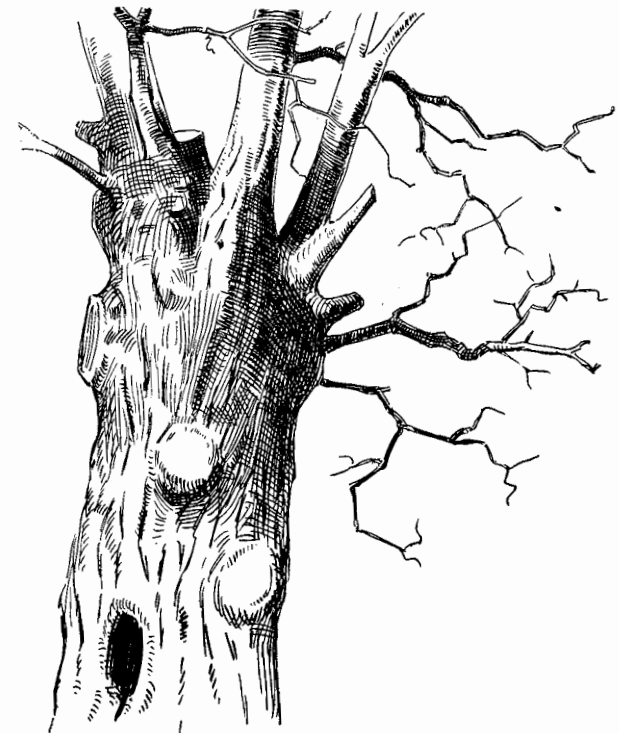

SMOOTH BARK OF TREE

STUDIES IN LINE EFFECTS—See p. 3

The Cube and the Column are both drawn with a ruling pen, the lines being made closer together, or thicker, to deepen the color where desired

HANDS

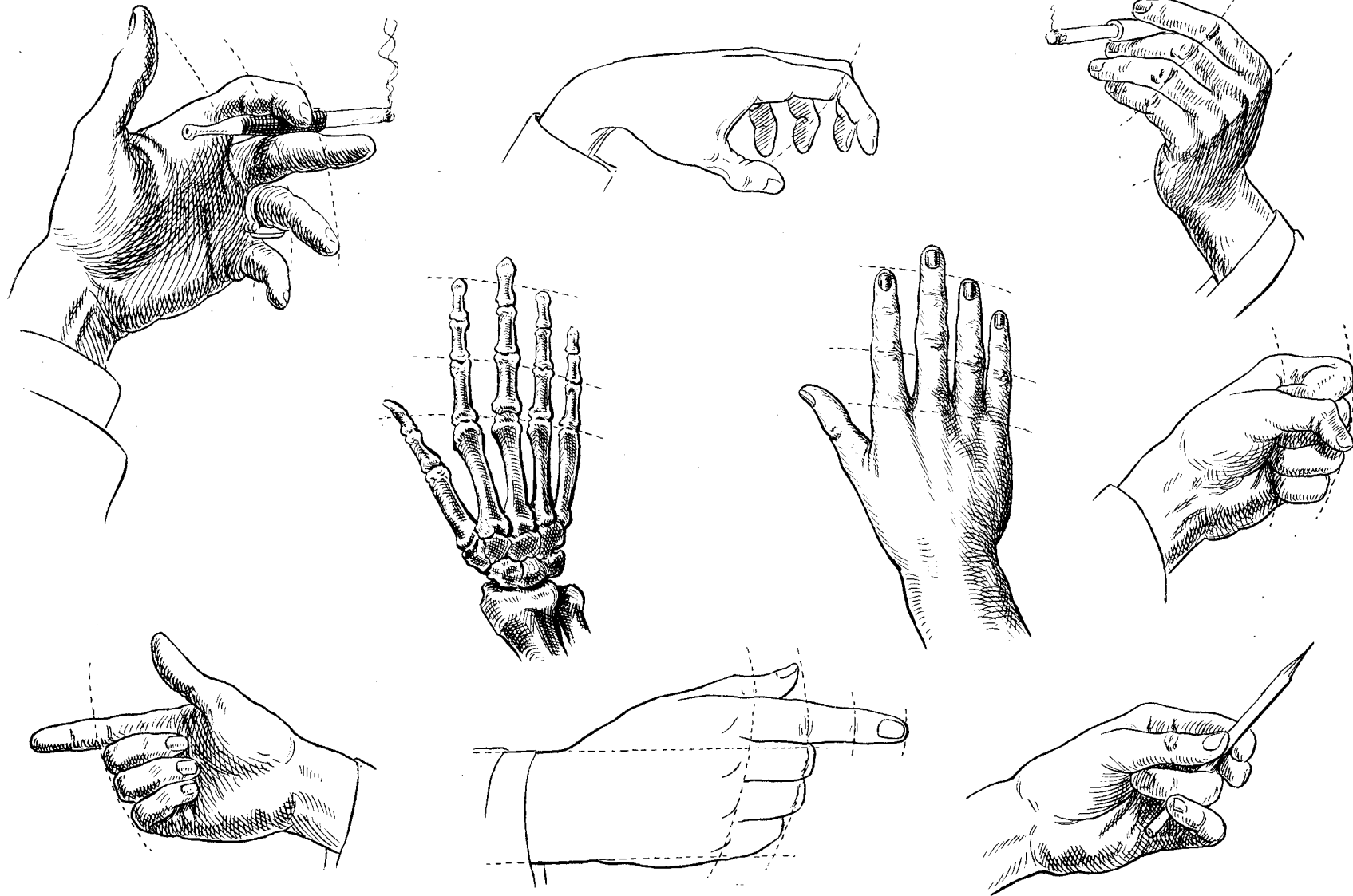

RULES FOR DRAWING THE HAND

THE HUMAN FIGURE

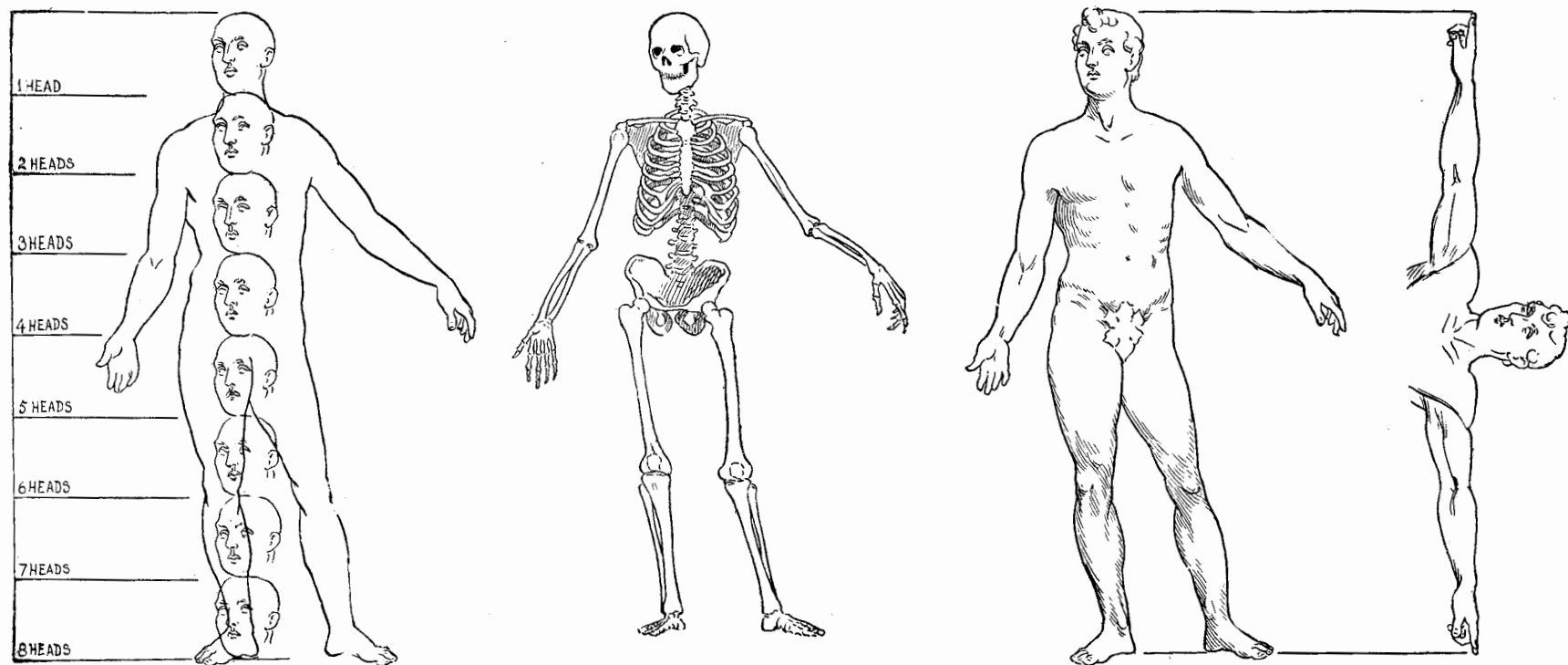

THE FIGURE IS EIGHT HEADS HIGH

THE SKELETON

THE ARMS FULLY EXTENDED EQUAL THE HEIGHT

(For other measurements see page 17)

It is not essential in a work of this primary character to go exhaustively into the subject of anatomy, yet a fair knowledge of the frame we build upon will not be found amiss. So we have introduced the skeleton complete and in part, in such a manner as will be most helpful to the student. By comparing the skeleton with the flesh-clothed examples, the reason why certain fixed laws govern the action of the human figure will be apparent. Copy these examples, and bear carefully in mind the measurements given, for their application constantly arises in figure draw-

ing. The relation of the head to the rest of the figure is most important, as it is the key, nine times out of ten, upon which the proportions of the rest of the figure are based.

If the student could obtain a human skeleton, or parts of it, particularly the head, hands, and feet, from some physician friend, to make studies of, it would be of inestimable value at this time. Draw the head, hands, and feet in every conceivable position, and then the skeleton as a whole, and when you commence drawing from life your knowledge of anatomy will be a great aid.

THE HUMAN FIGURE

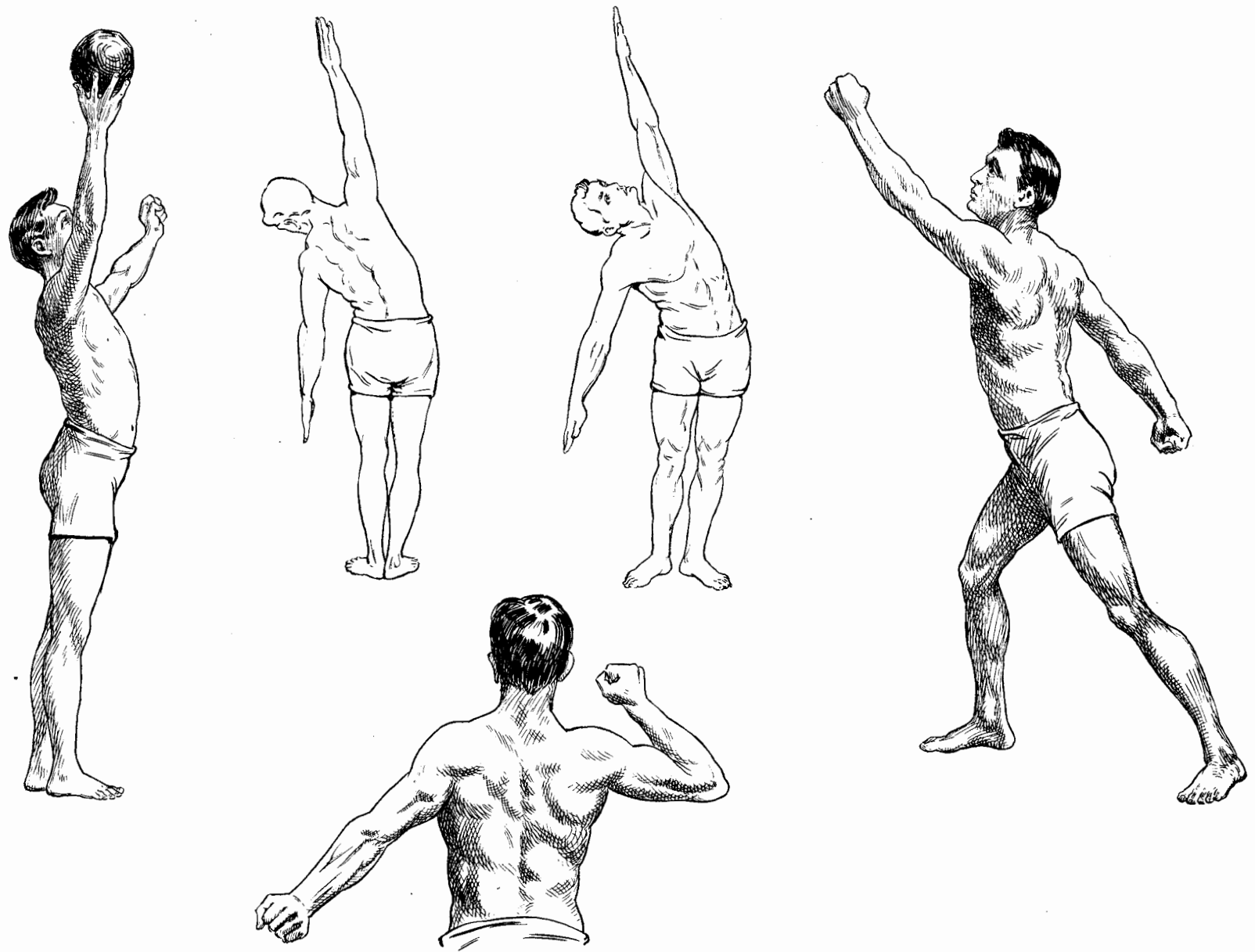

FIGURE STUDIES

MEASURING BY THE EYE

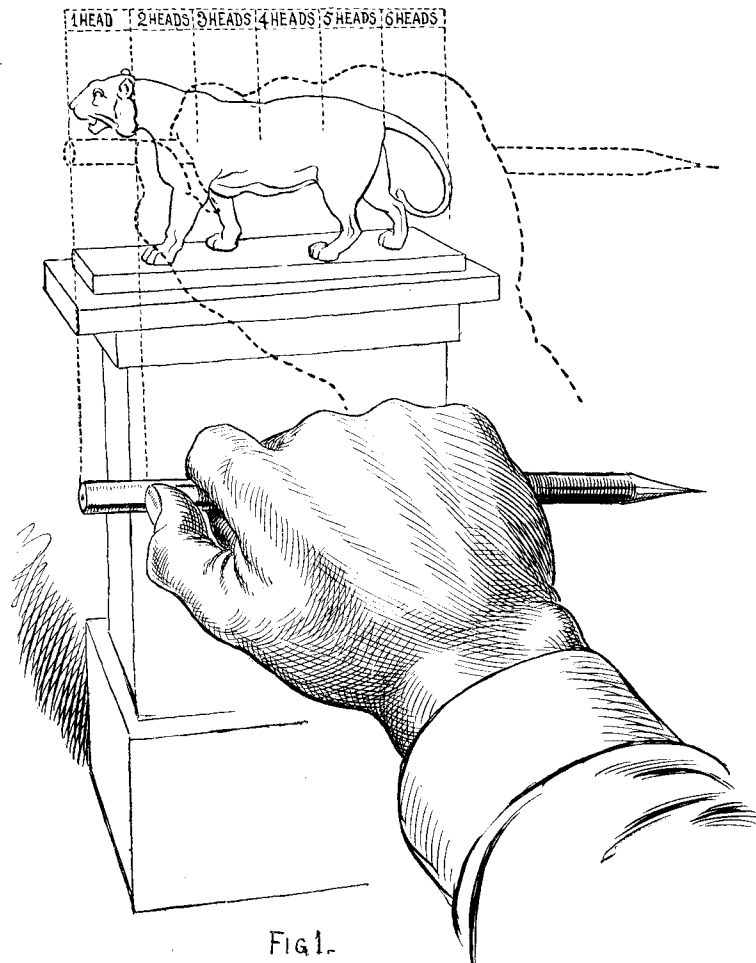
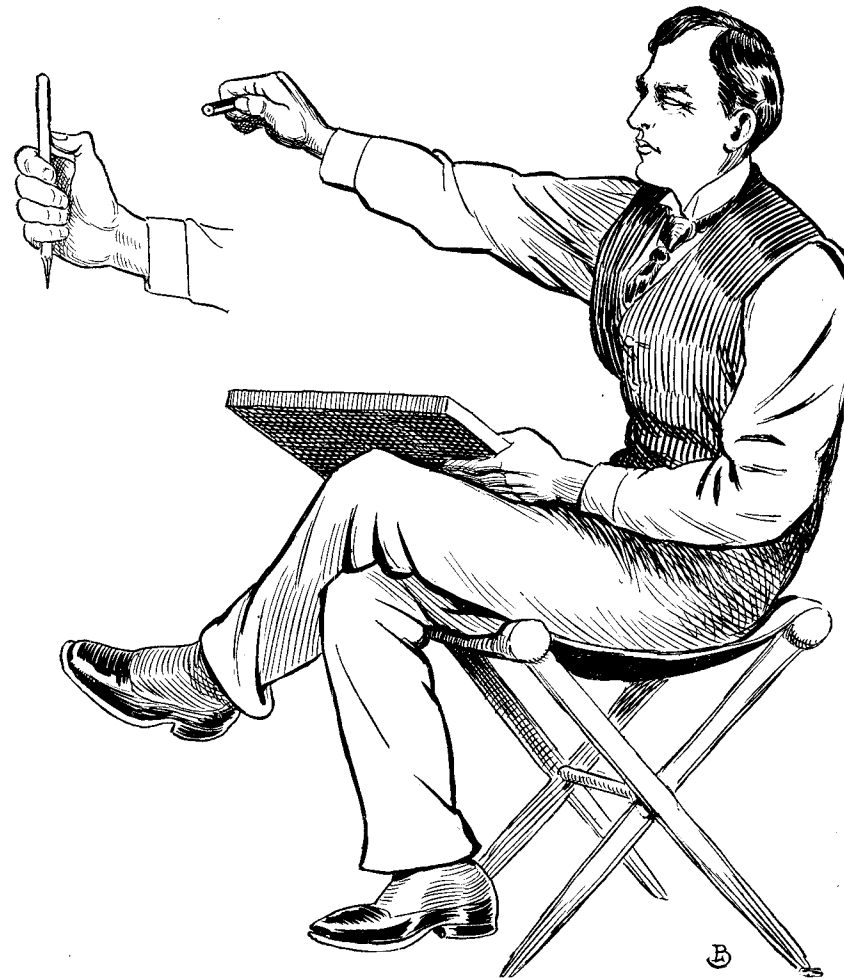

FIG. 1.



B

HOW TO MEASURE AN OBJECT BY THE EYE

The artist holds his body rigid and extends his right arm, pencil in hand, to its full length, and places his thumb against the pencil as a gauge—see engraving—he brings the pencil on a line with his eye and the object, and seeks to find some one part by which he can measure the rest. (See Fig. 1.) In this example he finds the tiger's head just six times the length of the body, that is from the end of the nose to the tail. This once

established, he applies the same head measure to the height, which is approximately three heads. These relative proportions being established, he proceeds to put in the details, still using the same scale of measurement. The artist, after long training in this method, abandons it, and depends largely upon his eye, but when in doubt as to the accuracy of his eye, he proves his drawing by the old pencil measurement.

DRAWING FROM LIFE

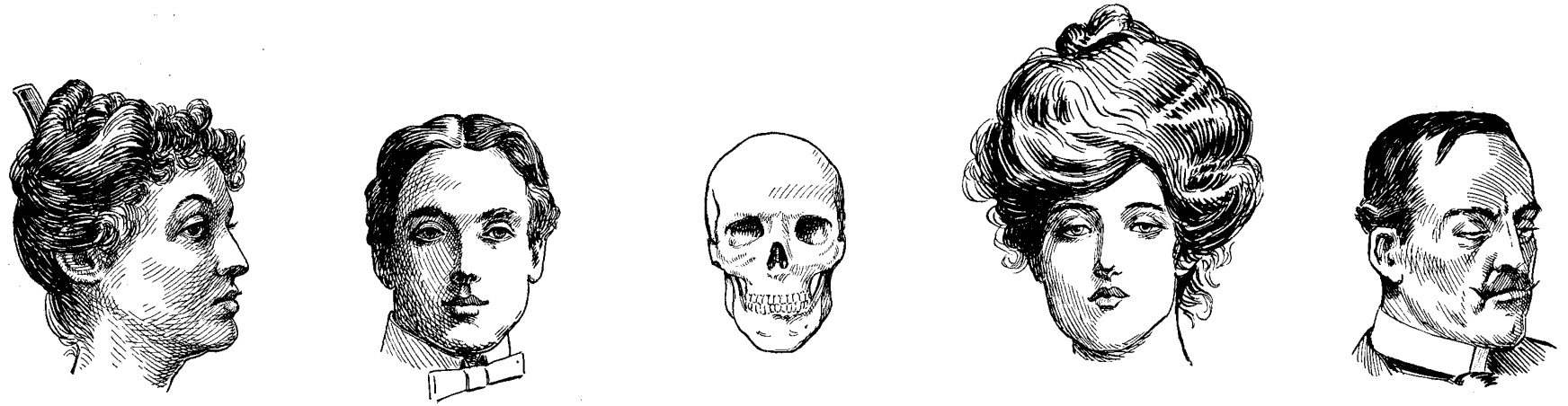

HEAD STUDIES

In drawing from life the artist finds one of his greatest pleasures. It is very fascinating work, and there is always something new to learn. Nature has not imparted all her secrets to man, and never will.

It is advisable for the beginner to select as his first model an elderly person, as they are more amenable to the exactions of posing than children, and their features being more strongly marked than a round, smooth-faced young person, the likeness can be more easily caught.

Pose the model in an easy sitting position, as you will then be enabled to work more leisurely, and without discomfort to the subject. However, should you pose the model standing, mark the outline of the feet in chalk on the floor, so that when they stop to rest, the position can be resumed with reasonable exactness, as before.

Pose the subject so that the light comes over your left shoulder, otherwise you will be working in your own light.

Use a medium soft pencil, and a good, smooth, white cardboard, or mounted Steinbach paper.

To more fully illustrate the method, and understandingly so

for the student, the drawings on page 15 have been prepared. We have now a practical demonstration of the "pencil measurement" to obtain proportions. The artist finds by his pencil measurements that the hat of the model is, in this instance, the best key to the rest of the figure. Having roughly blocked in the figure as there shown (Fig. 1), he proceeds to put in with pencil (Fig. 2) so much of the detail as he wishes. He then draws with pen and ink over the pencil-lines, and when finished, removes the pencil-marks with a soft eraser, and the drawing is completed, as in Fig. 3.

The attention of the student is drawn to the width of the model's shoulders; the hat, it will be seen, is practically the same width. In getting these measurements, the artist usually finds something by which he can locate each point of measurement. For instance, in Fig. 1 the "2d hat" measure line intersected the armpit; the 3d, the waist-line; the 4th, the fold in the drapery; the 5th, also a fold in the drapery; the 6th, the bottom of the dress.

Try to show by the modelling of the drapery the action of the figure beneath.

DRAWING FROM LIFE

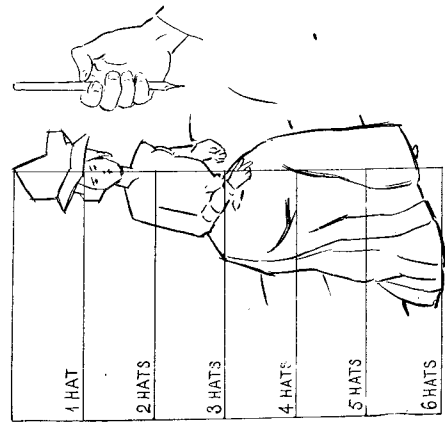

FIG. 1



FIG. 2



FIG. 3

STUDY OF A YOUNG LADY—See p. 14

DRAWING FROM LIFE

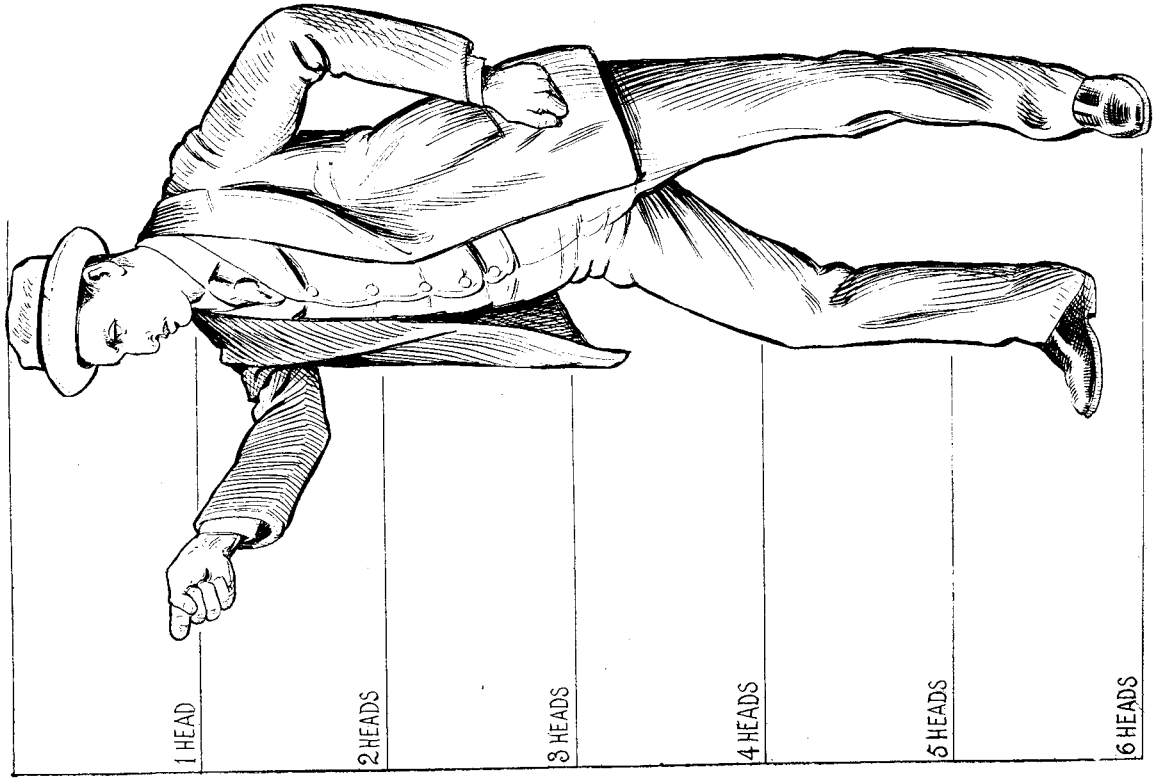

FIGURE 1.

STUDY OF A YOUNG MAN—See p. 17

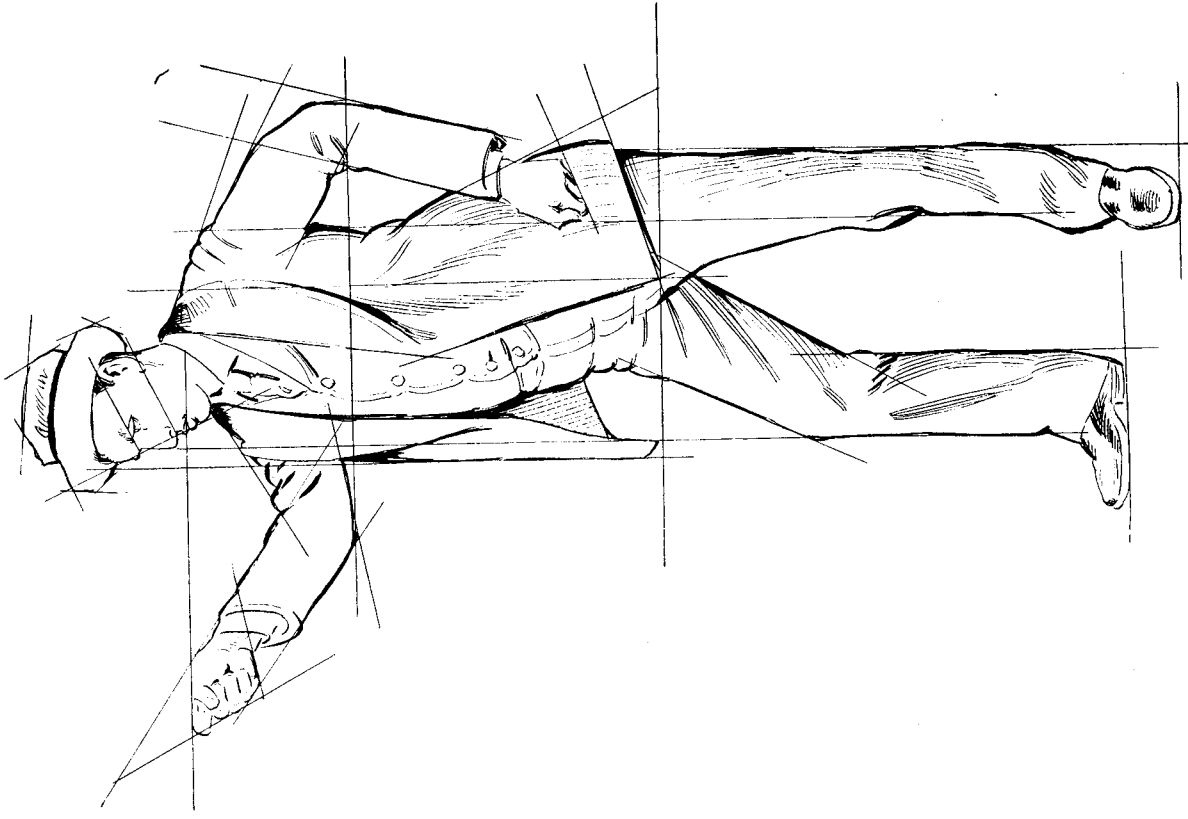

FIGURE 2

MEASUREMENTS OF HUMAN FIGURE—SHOE STUDIES

On page 16 another example of drawing from life will be found, in which the principle of obtaining the proportions of the model is further illustrated.

In this example the model's head and hat combined offer the best key to the figure, and to simplify the measurement will be called together "one head"; the figure by this measurement is six heads high. (See Fig. 1.)

In Fig 2 each one of the straight lines represents a pencil measurement, and actually represents the pencil as it was held by the artist at arm's-length on a line with his eye to obtain the various angles of the outline of the figure, and also the details of the drapery. Note especially the direction of each line, and be particular to note where the lines intersect, as by this means only is the artist enabled to obtain the proper proportions and action. Take a lead-pencil, lay it on each line, and you will have an actual demonstration as to how and why each line was put there. Note how the line from the back of the neck lines up with the hip; the one from the nose with the right knee; the one from the extended hand with the mouth; the one from the left shoulder passes on the inner side of the left leg. Having studied these methods carefully, and given them a practical application, their importance will soon be apparent.

The following measurements of the human figure are commonly accepted as the proper proportions for the perfect man:

Height, eight heads.

Shoulders, two heads wide.

Hips, two heads wide.

Arm, two and a half heads long.

Leg, three and a half heads long.

The arms fully extended equal the height.

The head from the chin to the crown is four times the length of the nose.

The ear and the nose are the same length.

The mouth is one third wider than the eye.

The head is five eyes in width.

The hand is the length of the face.

The foot is the length of the forearm.

Twice the breadth of the hand is its length.

The thumb is the length of the nose.

The quarter divisions of the body are as follows:

I. The armpits.

II. The bottom of the trunk.

III. The knees.

IV. The sole of the foot.



SHOE STUDIES

DRAWING FROM LIFE—CHILDREN

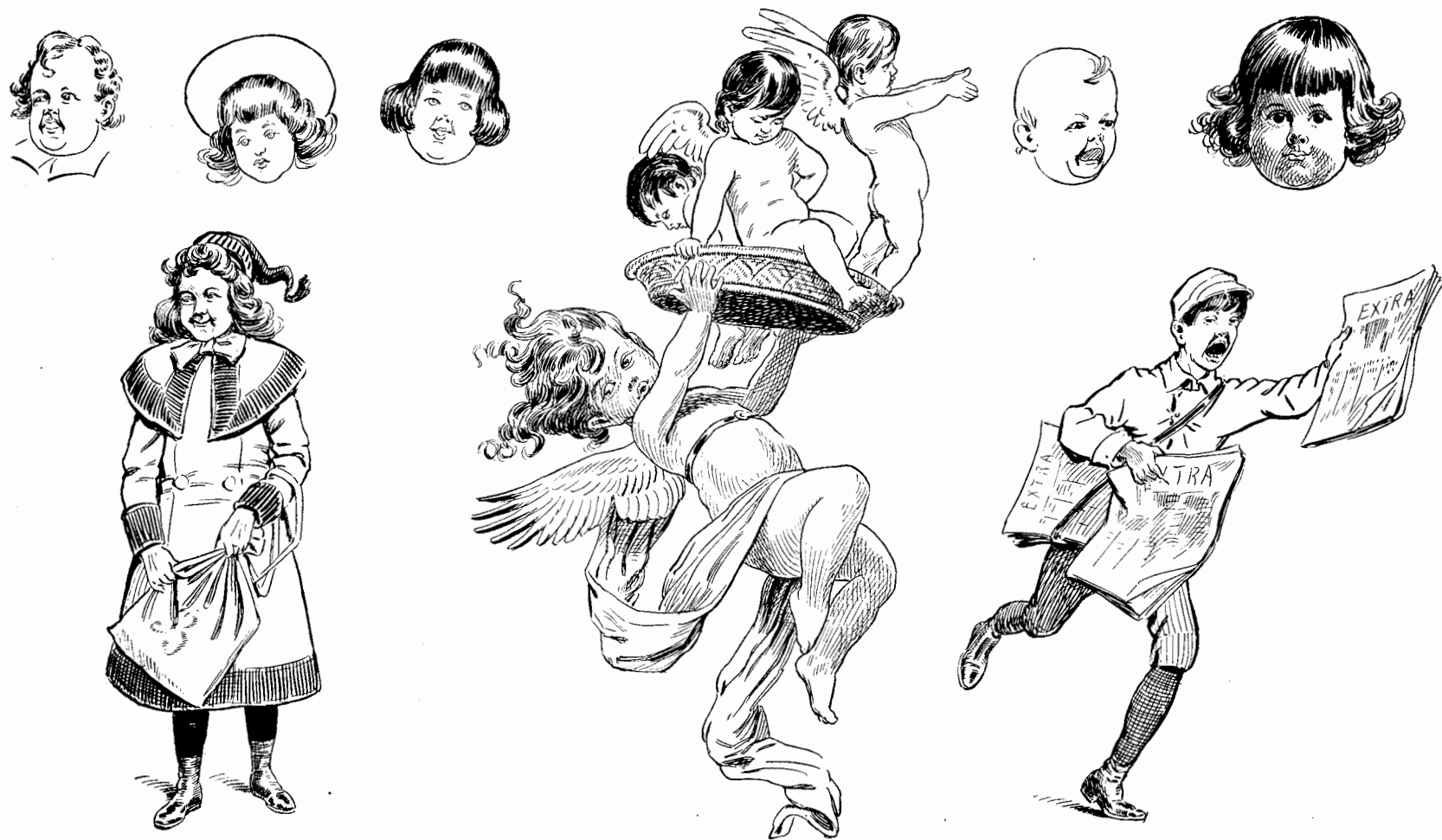

CHILDREN STUDIES

Children are, with rare exceptions, the most difficult models to work from, as posing is very trying and irksome to them. So we would not advise the amateur to attempt children unless he knows the temperament of his model pretty well. Otherwise he will find his patience taxed somewhat as well as that of his subject.

These are the average measurements of children:

A baby, three and a half heads.

At one year, four heads.

At three years, five heads.

At six years, six heads.

At sixteen years, seven heads.

DRAWING FROM LIFE—DRAPERY



DRAPERY STUDIES

Take any piece of clothing, a curtain or quilt, shawl, or whatever you may wish; drape it over a chair, or throw it carelessly upon a table. Then copy the action of the folds. It will be found most excellent practice, and very helpful to you when

you study from life. While there is no hard and fast rule for the pen-line in drapery, yet it is commonly drawn with the fold. The folds of the drapery should convey an impression of the action of the figure beneath.

STUDIES IN EXPRESSION

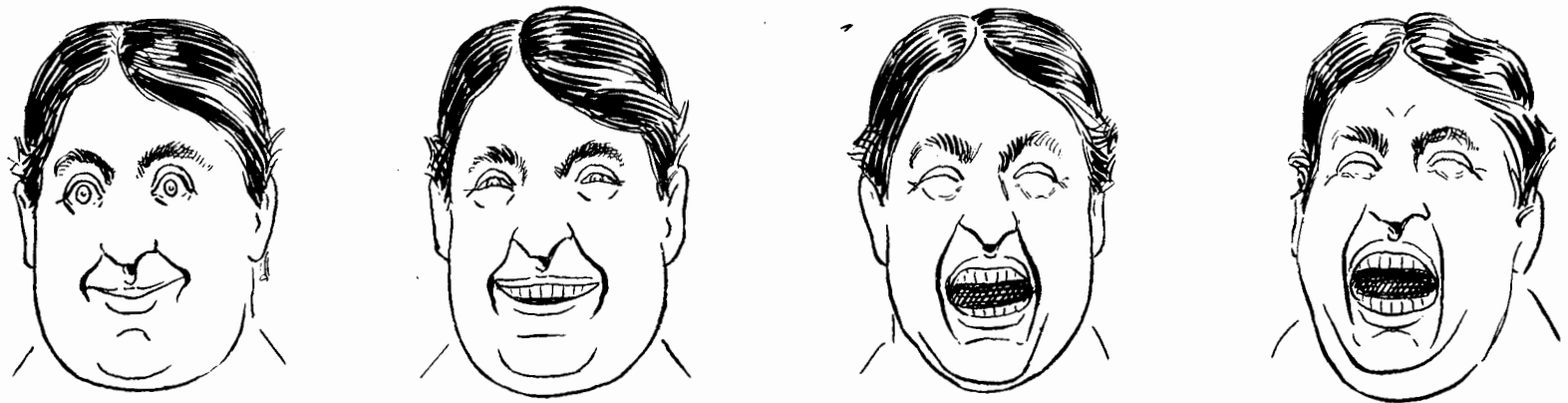
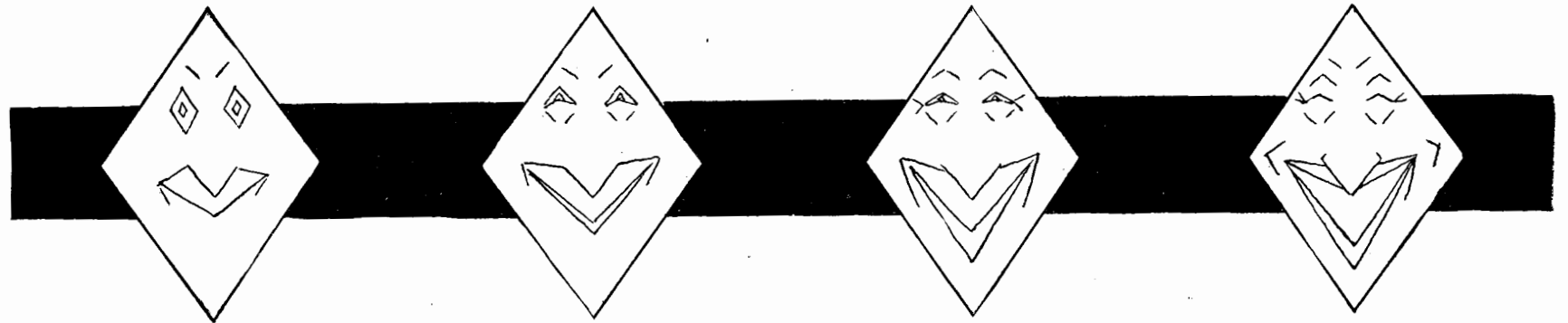

STUDIES IN EXPRESSION BY SIMPLE STRAIGHT LINES

When the student attempts to enter upon creative art, the necessity for a knowledge of how to express the gamut of human emotions as shown in the human face will be forced upon him. The simple studies here given in straight lines will be found not only amusing, but helpful to the student in developing his mind in that direction. By the straight line it will be seen that it is

possible to express almost every human emotion, and as a matter of practice we can suggest nothing better. Having copied the straight-line examples until you feel that you have the principle of expression thoroughly in mind, then copy the portraits below. It will be found most excellent practice to create expressions of your own by such departures from the examples here given as

STUDIES IN EXPRESSION

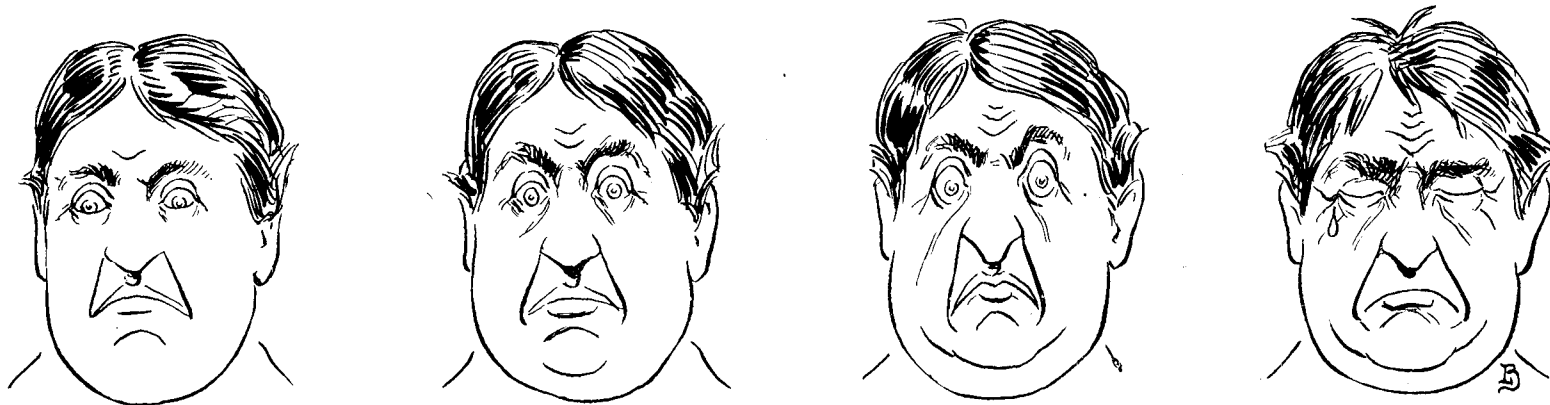
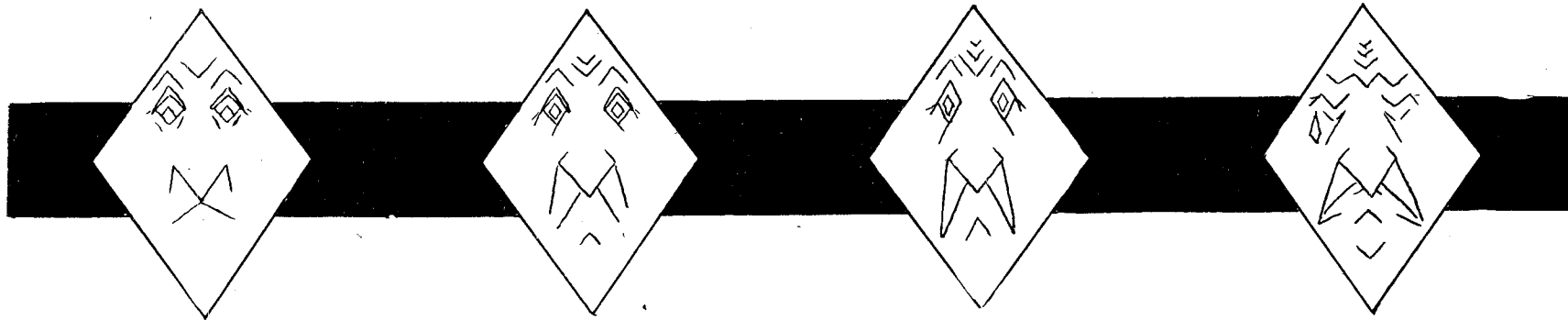

AND THEIR APPLICATION TO ACTUAL PORTRAITURE

your own mind suggests, as, for instance, by closing one eye and opening the other—making one side of the face in tears and the other smiling. Do not hesitate to make any radical departure from the rules here given, for it is only by so doing that you can possibly become self-reliant and creative. Don't be a simple copyist—let your own wings of fancy soar.

Beginners usually find that it is easier to draw the profile of the face than it is to draw the full front view, it being much easier to catch the expression where one has to deal with but one side of the face, and then the outlines of the nose and other features lend themselves more readily to a likeness; so we would advise that they practise drawing the full face view as much as possible.

ANIMAL DRAWING

This very beautiful example of the development of a drawing from the pencil-sketch to the finished drawing is specially commended to the student's consideration. Copy and study the details carefully. Note the clearness and cleanness of the lines, and the splendid action of the figures, and the snap given to the finished drawing in the boldness of the coloring. There is not a weak or vacillating line in the drawing anywhere. The composition is simplicity itself, yet there is all-sufficient detail. In study No. 1, the pencil-sketch, the student will note the suggestion of blocking—the square idea exemplified by a master hand. Too much care cannot be given in working out the pencil-sketch; that is the basis of the finished drawing, and if that is wrong the finished product must be. As David Crockett said: "Be sure you are right, then go ahead." This copy should be made free-hand, not traced, or measured by compass; the eye should be the only guide in attempting this design. A successful reproduction will be proof that your work in the past has not been in vain. In study No. 2 we have the first stage of inking. Go over the pencil-lines carefully, rounding off the suggestions of pencil blocking, where gracefulness of line is necessary, and having placed the drawing in outline, lay in the solid blacks on the figures and the cast shadows with the brush. This is the rule in all drawing work, from the darkest shadows to the lightest. The attention of the student is drawn to the very effective suggestion of fur-lines on the fawn. These are obtained by what is known as "splitting the brush." Take a small, red sable brush; dip it in the ink, and draw it lightly across a blank piece of cardboard—any old scrap piece will do—and as you approach the end of the stroke lift the brush so that it divides or splits, as it is termed, on the flattened end, into numerous tiny points. By gently stroking the brush while in this condition, as shown on the body of the fawn, a beautiful, soft furlike effect is given that is wellnigh impossible to attain with the pen, and, of course, very much more quickly. With a little practice charming results

No 1



CHILD AND FAWN STUDY

ANIMAL DRAWING

No 2



No 3



CHILD AND FAWN STUDY

ANIMAL DRAWING

are attained in this manner. The brush, by-the-way, is playing a more and more important part in so called pen-and-ink drawing, many artists using it almost entirely, as a substitute for the pen.

Study No. 3 is the finished drawing. Study the direction of the lines by which flatness or roundness in the modelling of the figure of the fawn are obtained. Care should be taken not to go over the lines until they are dry. Note the high lights, and try to preserve them in their delicate suggestion of softness. In the modelling of the drapery of the child's dress, preserve the direction of the lines and the coloring which convey the action of the figure beneath. In drawing the hair of the child, note that the direction of the line is always with the hair. In sketching it is allowable to put in a suggestion of shadows for the hair by making the pencil-line in any direction the artist may elect. This is simply a kind of shorthand drawing, but in the finished pen-work the direction of the line should always follow the direction of the hair.

By the clever coloring of the foliage in the background, the child's face is thrown into pleasing relief. The suggestion of trees and foliage in the background, the wreath of flowers on the child's head, the fawn, all go to make a charming composition of rural simplicity that is worthy of the student's most careful consideration as a study in composition.

Remove the pencil-lines with a soft sponge eraser when through inking. A hard, harsh rubber is apt to destroy the pen-lines, and take up color in such a way as to make the drawing gray.

There is probably nothing more difficult to draw than animals, as they are so restless. Of the domestic animals, the cow is probably the best subject, as it will frequently stand in one position for a long time. A sleeping cat or dog make good subjects. In attempting any animal subject, however, it is best to get the outline in the quickest way possible, and put in the detail afterwards. Make studies of the legs, feet, head, etc., of the subject which you can carry to any extreme of detail, and work them in your original outline at your leisure.



STUDIES IN ACTION

This is a very common method among artists for obtaining the action of men and animals quickly—the detail being worked in afterwards

ANIMAL DRAWING.



HORSE STUDY

The horse is modelled entirely by the brush, as described in the Child and Fawn Study, the outlines only being put in with the pen

ANIMAL DRAWING

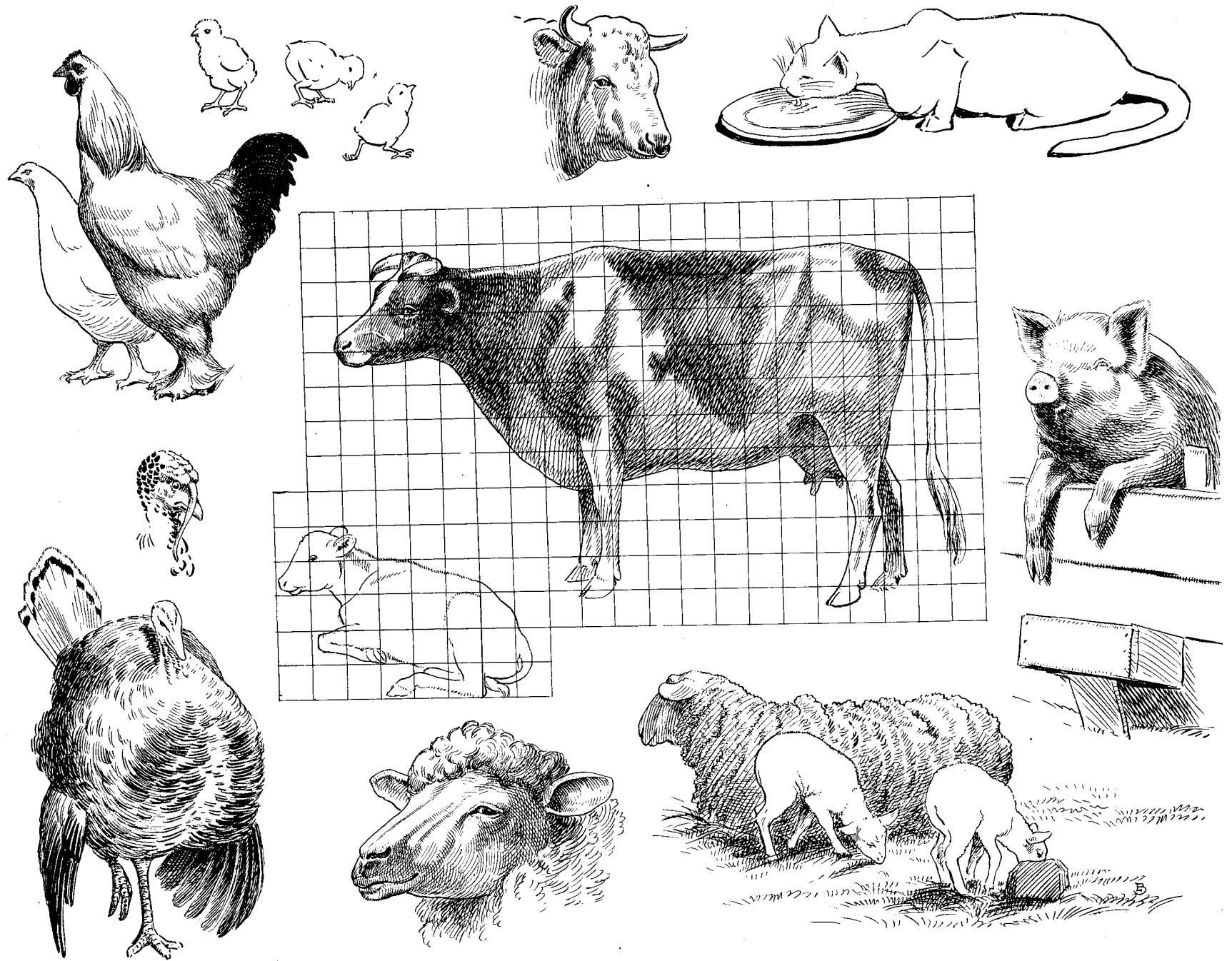

ANIMAL STUDIES

LIBRARY OF CONGRESS

PERSPECTIVE

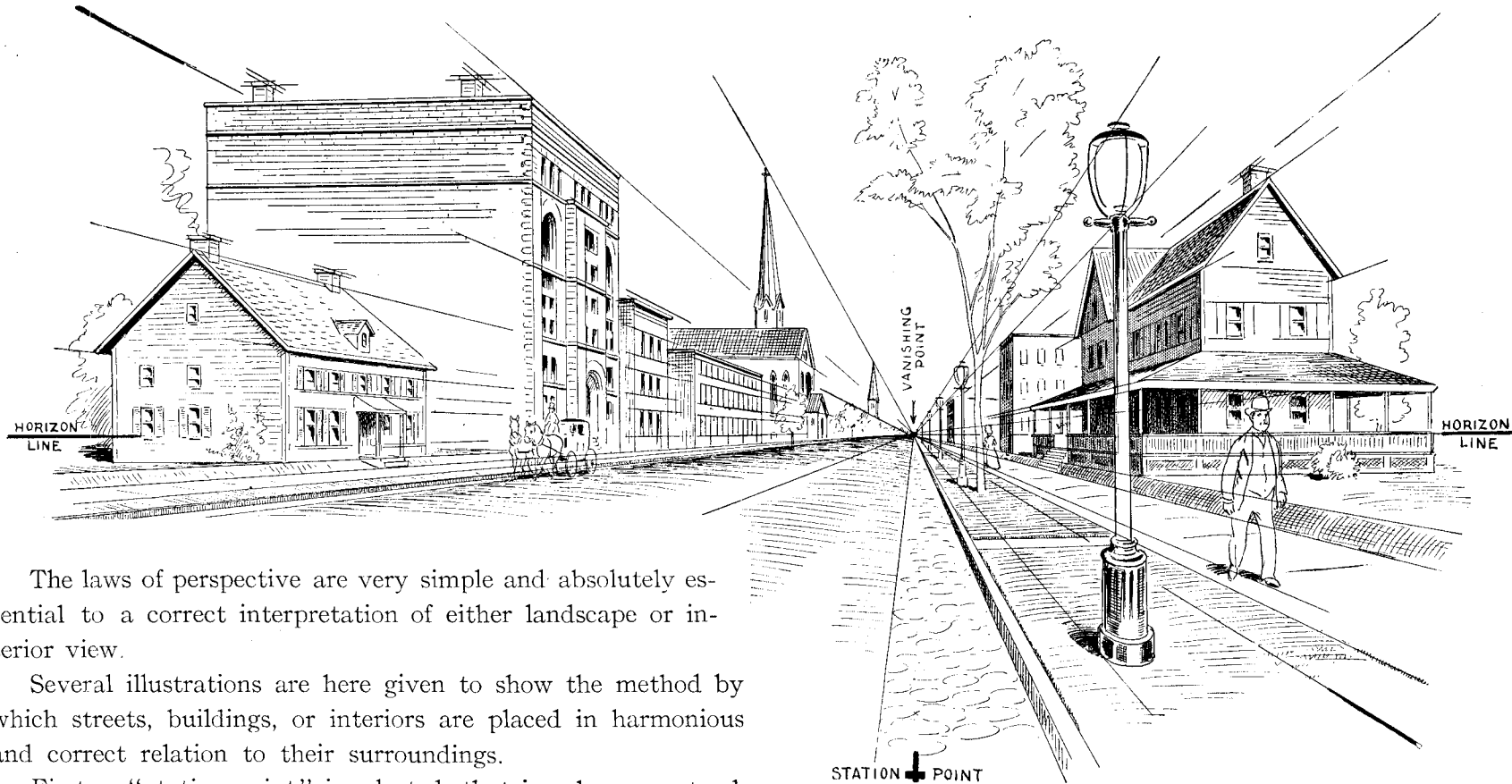

The laws of perspective are very simple and absolutely essential to a correct interpretation of either landscape or interior view.

Several illustrations are here given to show the method by which streets, buildings, or interiors are placed in harmonious and correct relation to their surroundings.

First, a "station point" is selected, that is, where we stand, and from which point the eyes see the picture disappear on the horizon—the "vanishing point." The horizon-line passes horizontally across the picture, and in practically a straight line, allowing, of course, for the variations in the sky-line of the landscape or buildings—to all intents and for our purposes we make it a straight line across the picture. To this line all the lines in the picture must converge to the "vanishing point." Reference to the example given in perspective studies Nos. 1 and 2 will more fully explain this than it is possible by text.

There may be, from the nature of the picture we desire to draw, two "vanishing points," as shown in perspective study

PERSPECTIVE STUDY NO. I

No. 3. The rules for placing a picture with two vanishing points in perspective are precisely the same as those by which we placed the preceding picture with one vanishing point in proper perspective. In these two examples we have all the laws of perspective, whether applied to landscape or interior view.

A reasonable knowledge of their application is absolutely essential to a correct interpretation of the relative proportion of objects to each other in a picture.

PERSPECTIVE

In placing a room in perspective, special care must be exercised if we desire to be absolutely correct. For instance, the placing of an ordinary square room in perspective will be found simple enough, but should we desire to show an open door (see perspective study No. 4), it will be found necessary to establish a vanishing point for that; and the same will be true of every other object in the room, if we move it away from the vanishing lines of the room.

It must be borne in mind, however, that the vanishing point in every instance must be at the same horizon level, and that the horizon level is the level of the eye.

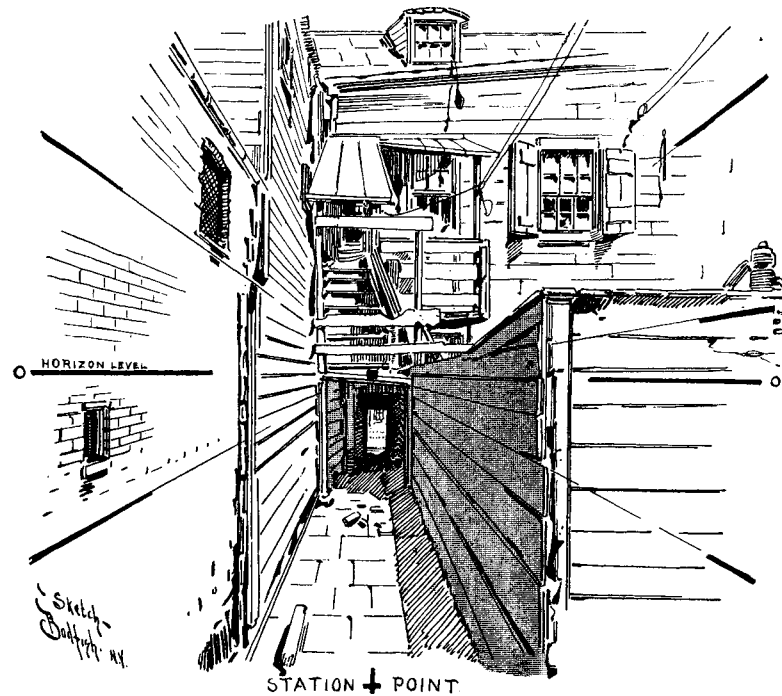

PERSPECTIVE STUDY NO. 2

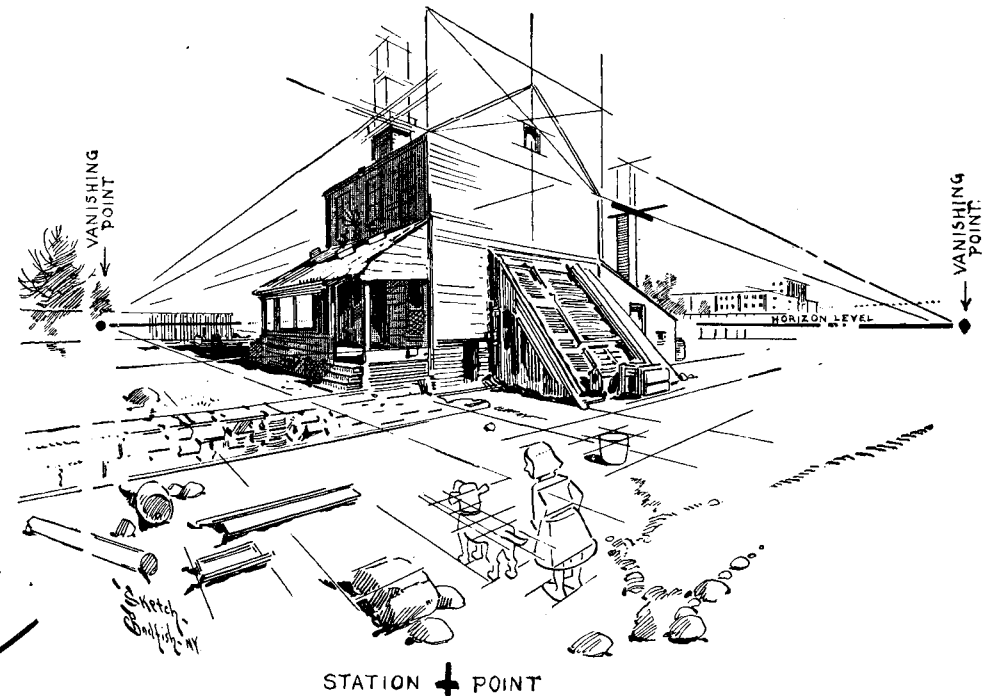

PERSPECTIVE STUDY NO. 3

In perspective study No. 3, we give an illustration of the method known as the "diagonal of the square," by which a room and its contents are placed in their exact relative proportion. The principle can also be applied to landscape drawing as well. The method, however, can best be demonstrated by using a room for our picture.

First. Determine upon the size of your picture. In this instance we have planned a room ten feet high with a floor twelve feet square.

Second. In Fig. 1 we have drawn a front elevation of the room, with a ground-plan of the floor below it. Fixing a vanishing point in the centre of the room, we then draw a line from each of the four corners of the picture to the vanishing point; these give the lines of perspective for the floor, ceiling, and side walls.

PERSPECTIVE

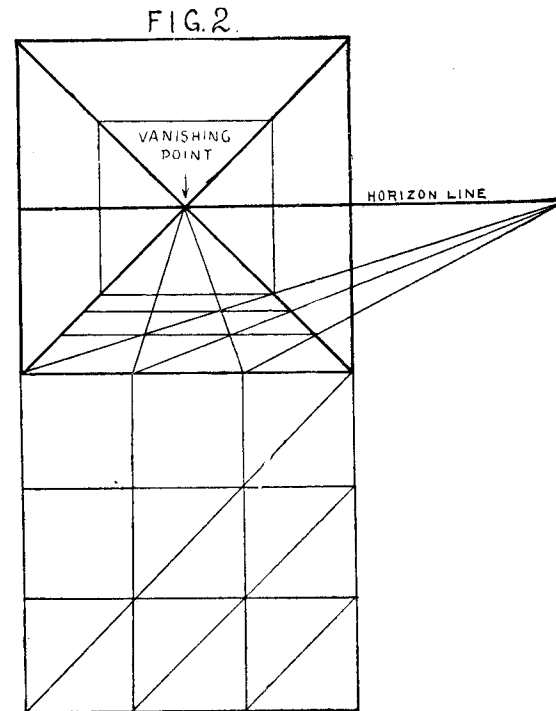
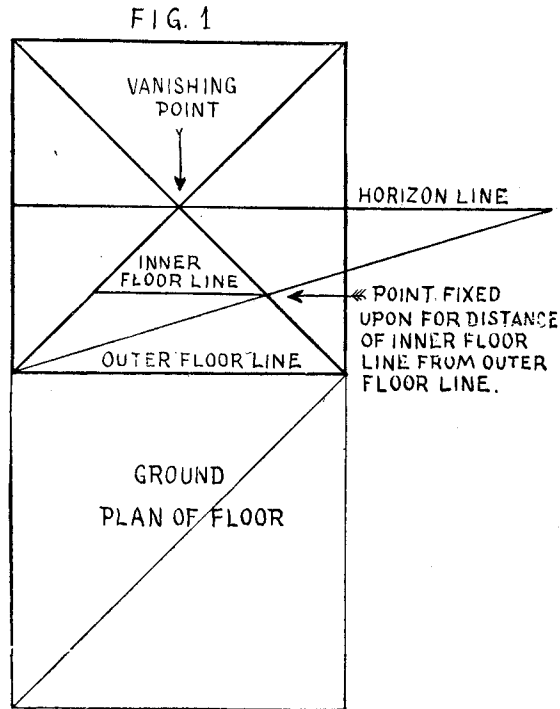

Third. Across the picture we now draw the horizon-line. This always intersects the vanishing point.

Fourth. The next important step is where to place the "inner" horizontal floor-line. We have the front and sides, now how shall we proceed to fix the proper distance at which to place the inner parallel line? This is wholly arbitrary with the artist, but is usually fixed at from one-fourth to one-sixth of the width of the picture. Having fixed this point, and drawn the line, as shown in Fig. 1, where it intersects with the side floor-lines leading to the vanishing point, we have the floor in complete and proper perspective. Draw a line diagonally from the lower left-hand corner of the floor in the picture to the upper right-hand corner, and then draw this line and also the horizon-line on out of the picture until they meet, and we have another

vanishing point upon which to base further subdivisions of the room.

Fifth. To fix the exact distance at which to draw the succeeding parallel lines of the floor (see Fig. 2), we draw a line from each point of the intersection of the squares at the lower edge of the picture to the vanishing point out of the picture, and where these lines cross the floor-line running from the right-hand lower corner to the inner vanishing point will be the exact point from which to draw each succeeding parallel line, so as to bring them in exact relative proportion. The lines of the floor running from you are obtained by starting at the same intersecting points at the lower edge of the picture, and drawing them to the vanishing point in the centre of the picture. This places the squares in the floor in their exact relative proportion.

PERSPECTIVE

FIG. 3.

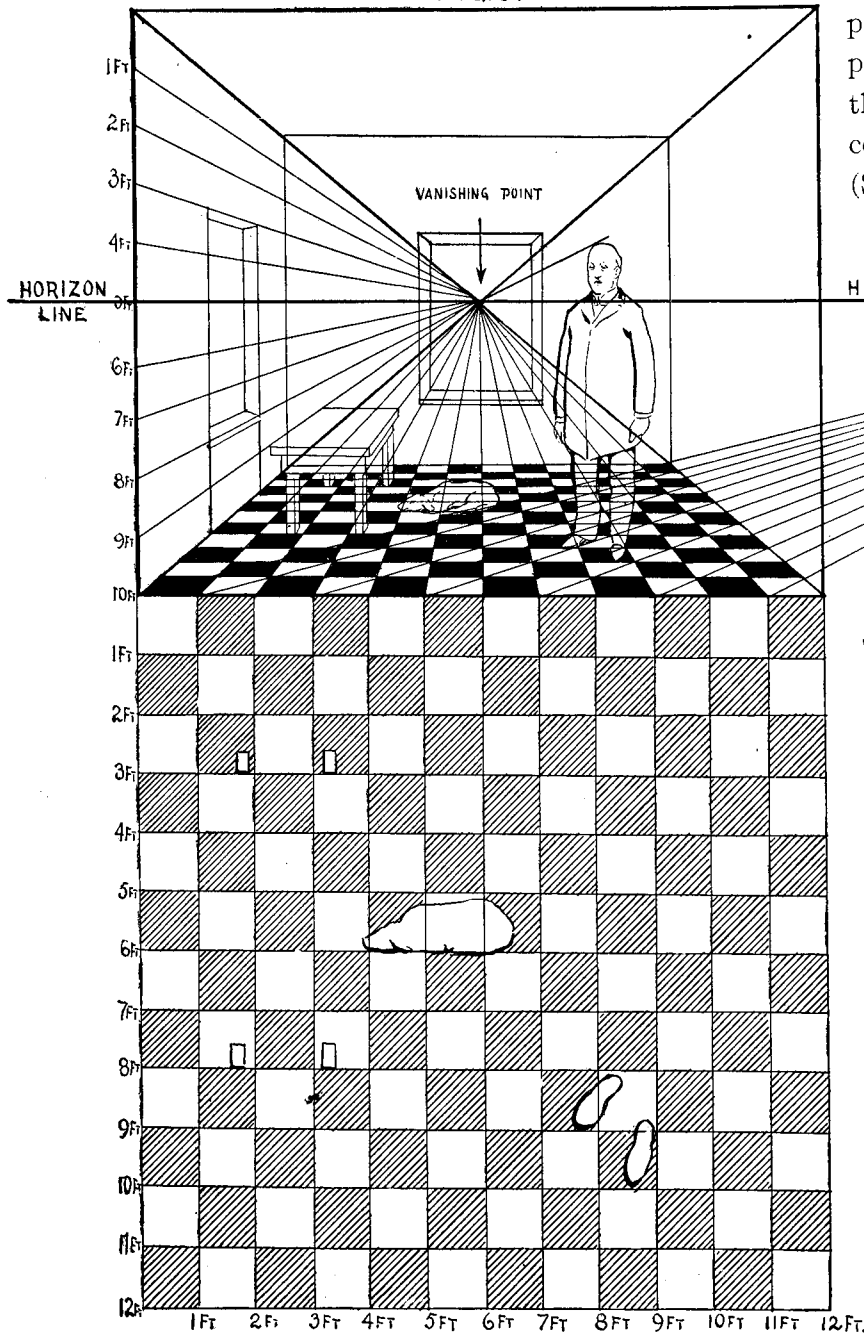

Sixth. The rear side wall-lines are obtained by drawing a perpendicular line from each corner of the inner floor-line to a point intersecting with the vanishing-point lines running from the upper right and left hand corners of the picture, and the ceiling-line by joining these lines at the top by a horizontal line. (See Fig. 2.) This places the room in complete perspective.

Seventh. In Fig. 3 we have the principle still further elaborated; by laying out the ground-plan of the floor into twelve square feet, and by marking on any square the location of an object, it is possible to show that object in this exact location, and

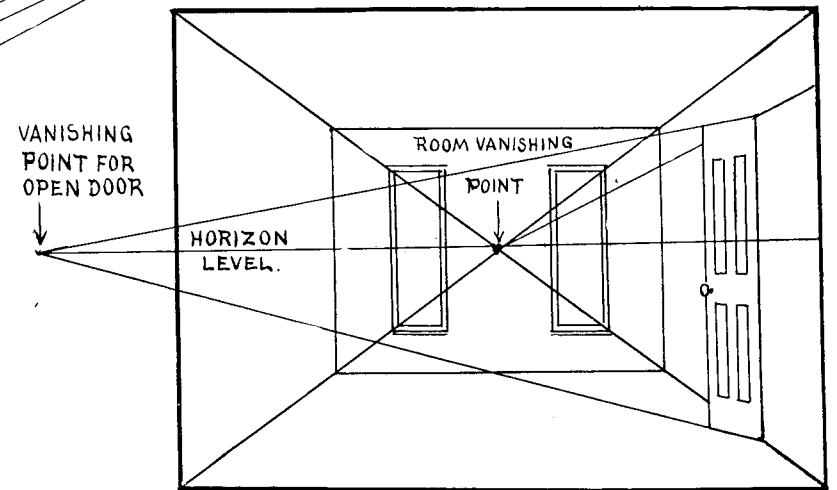
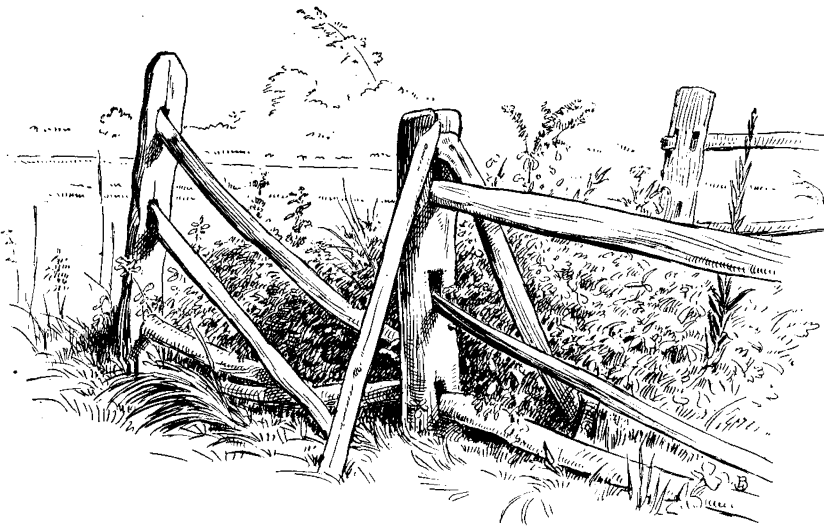

FIG. 4

in its proper relative proportion to the surroundings in the picture.

While in practical illustrative work the hard and exact laws of perspective are rarely applied, a knowledge of how to obtain exact results will be found very helpful in free-hand drawing, where one has to carry these rules in his mind's eye, as it were.

LANDSCAPE DRAWING—SPATTER WORK



RAIL-FENCE STUDY

Patient study of the little things in nature go far towards the mastery of the art of landscape drawing. Make careful and detailed studies of leaves, flowers, grasses, and their twigs, broken limbs, pieces of wood, logs, the bark of trees, then the tree itself. A stone wall with a bit of vine growing over it, or a rail fence, make a picturesque study. Having mastered to a reasonable degree these details, the landscape of which they all play an important part may then be attempted with some assurance of success.

It is permissible to leave out such unimportant parts of the landscape as would tend to destroy the picturesqueness of the view—an ugly tree, too dense foliage that might obstruct the view of a bit of water. And it is likewise permissible to add to the picture anything that would tend to make it more picturesque, as, for instance, a pretty bunch of grass, or a rock in the foreground, or even to add a tree. While these departures from the truths of nature are permitted, the student should not think that any wild distortion of trees and their surroundings allowable.

Care should be exercised in selecting the subject for a landscape study, to make it worthy of drawing. Will it make a picture? Does it compose well? Ask yourself these questions, and do a lot of thinking before you start your drawing.

Be particular as to the perspective, or you may find you have the river running up hill.

Seek first to find, as explained so fully in the chapter on figure-drawing, some one object in the landscape by which to measure the rest. It may be a tree, a barn, or a church-spire, or a bunch of trees. No set rule can be laid down for measuring up either a figure, or landscape; every subject approached is different, and the scale for measuring it must be found by the student in the subject before him.

Block in the hills, mountains, and rivers—the masses as they may be—note the directions of these general outlines by the pencil measurements. The same principle of obtaining the line directions apply here; then, being sure of the general composition, work in the detail. Here comes in the art of leaving out and putting in—what to see and what not to see.

SPATTER WORK

This is a method popular among artists for making backgrounds for decorative work, lettering, etc. Take a thin piece of card-board, cut out a section corresponding to the space you desire to cover in the drawing, making practically a stencil. Fasten this on the drawing with thumb-tacks, so it cannot be moved, and fully protect the rest of the drawing with sheets of paper. Then pour a little ink into a saucer, dip a tooth-brush into the ink, and draw the bristles over the edge of a knife blade, letting the "spatter" fly on to the "cut-out" on the drawing. With a little practice, at first on a blank sheet of paper, a novel and pleasing result will be obtained.

WATER STUDIES

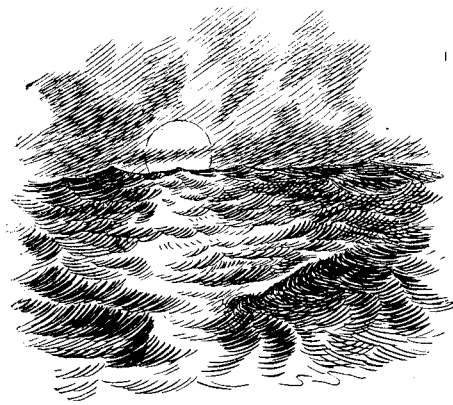

MOONLIGHT EFFECT

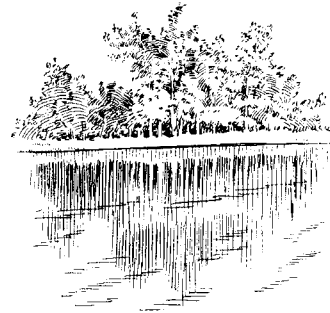

SMOOTH WATER

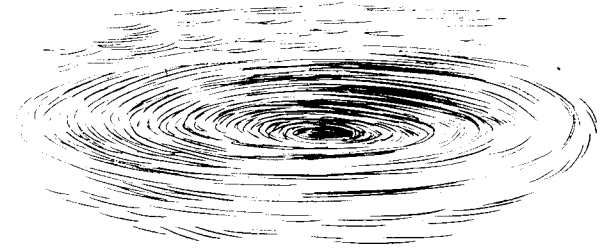

WHIRLPOOL

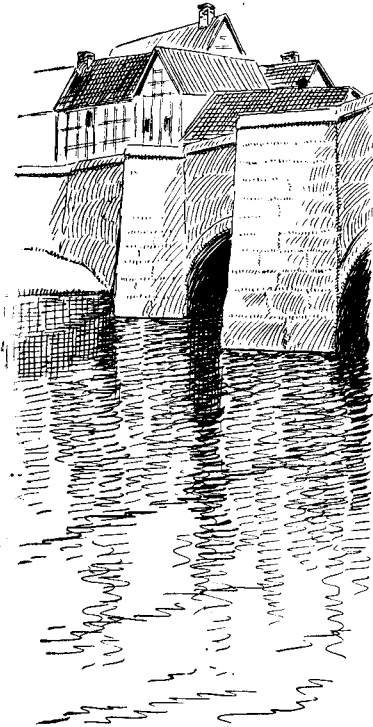

RIPPLING WATERS

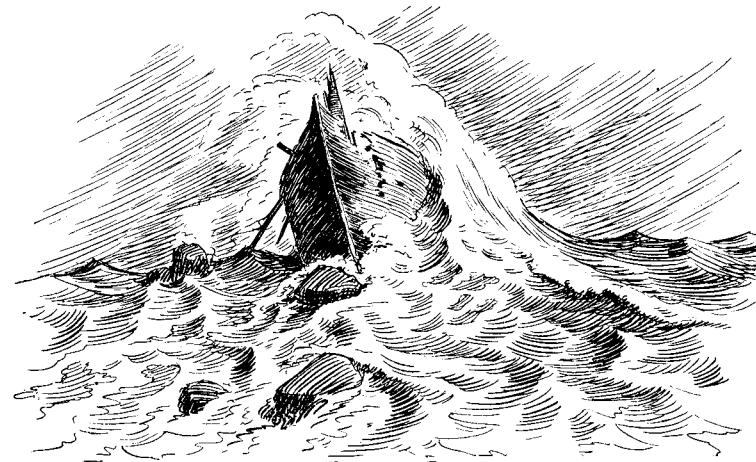

DASHING WAVES



BREAKERS

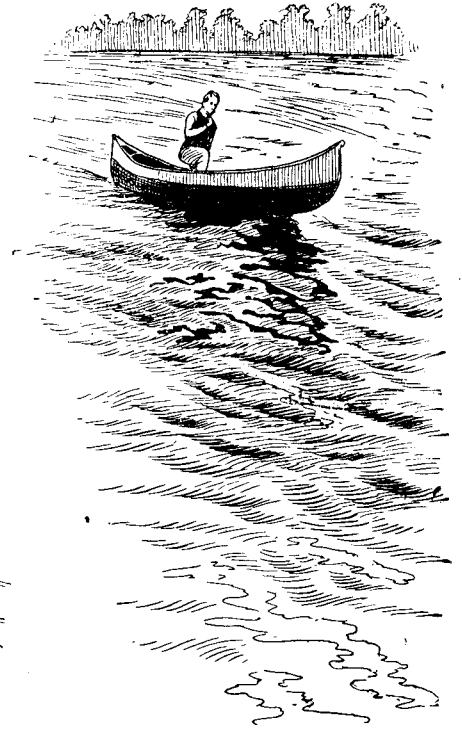

RAPIDS

WATER STUDIES

Showing the direction of the line necessary to obtain the desired action.

COMICS

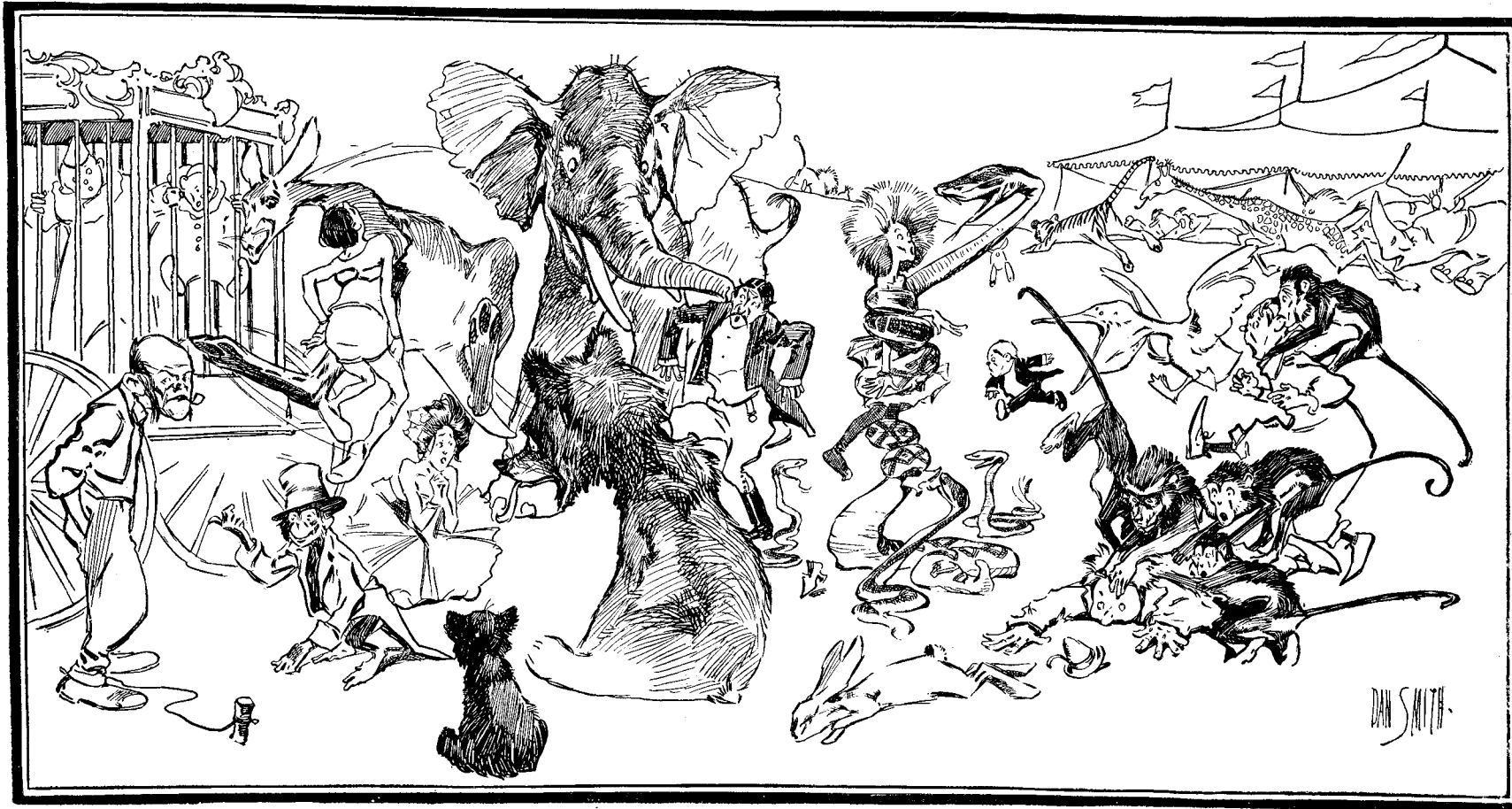

COMIC STUDY

One of the most promising fields for the young art student of to-day is that of "comics." There is nothing that appeals so strongly to the publisher as something that will create a laugh, something to amuse the young and the old—particularly the former. Most other fields of illustration have their seasons of depression, but this is not true of comics. They are in demand all the time. The popular demand is for those in series of not less than six or eight pictures, telling a story that is complete in that number or that may be continued indefinitely, as in the

case of "Buster Brown," by Outcault, in the *New York Sunday Herald*; or that of "Foxy Grandpa," in the *New York American*, by Shultz; or as by Levering, in *Harper's Weekly*, on leading topics of the day.

There can be no set rule laid down for the production of the comic. From the method of A. B. Frost to that of the popular grotesque exaggerations in drawing of Marriner there is a divergence as wide as the poles from each other; yet both provoke the laugh, and that is what is wanted.

CARTOONS

For many years the use of the cartoon was confined to weekly publications, but with the advent of photo-engraving it has become a feature of daily journalism the world over. For a time its use was confined to the sensational dailies, but the more conservative papers, both in this country and Europe, have awakened to the power and influence of the cartoon, so that there is to-day scarcely a daily paper of any standing in the world but has on its staff a cartoonist.

The cartoon is an illustrated editorial, and one to be successful as a cartoonist should be an omnivorous reader of contemporaneous history, as he finds it spread before him in the columns of the newspapers of the day, paying special attention to the editorial pages, of which he should be a most careful and faithful student at all times.

A cartoonist is not necessarily a good artist. But this fact should not deter the student who aims to be a cartoonist from putting forth every effort to acquire the very best knowledge of art that is possible, for the standard is being placed higher every day, and the cartoonist of the future cannot be too well armed for the fray. Many of the men who have attained wide reputations in this field at the present time have had little if any training in art, but at the same time it cannot be denied that the men who now command the best positions are men who have had an art training, or have succeeded in getting an art training after they had entered upon the work. To develop under such circumstances is a great handicap to the best effort, and it is best to get started right at the beginning, and it will be found to save you a world of discouragement later on.

The cartoonist should be fertile in ideas, have a keen sense of humor—for that appeals more strongly than anything else to readers—and the ability to execute his work with rapidity. He must do his work so as not to offend the advertisers of his paper, and great care must be exercised not to offend the religious readers, or to arouse racial prejudices.

“How do you go about it to produce a cartoon every day?” is almost invariably the first question asked the cartoonist by the novice. The answer is this: The artist, on arriving at his desk each day, finds the leading papers ready for his examination. Running these over carefully, he makes notes of the leading news features, and having concluded his reading, selects one, two, or three, as the case may be, of what he considers will be the best subjects for the next day's issue. These he develops as rapidly as possible in pencil, and submits them to the editor for selection. Having passed the editorial ordeal, he proceeds to finish the idea selected in ink.

Cartoons are mainly upon political topics, but when the political campaign is over the publishers want to get away from politics as much as possible, so leading news features become the order of the day. In metropolitan journalism, where one has the whole world to draw upon for material, it is not difficult to find one or more subjects worthy of consideration every day. Society, Wall Street, foreign news, etc., are constantly presenting some news phase that permits of cartooning.

The student will find in the examples given on pages 35 and 36, material for study in cartooning. In that of page 35 are presented the possibilities obtainable in using the portrait of one person on various types of men and animals. In this example the most striking character markings, which the cartoonist must seize upon, were the nose, mouth, eyes, and eyebrows, and the markings of the beard. So long as these are held, the likeness will be sufficiently well preserved for the cartoonist's purpose, and will, if the subject's portrait is one the public is at all familiar with, be at once recognized. The only limit there is to the application of this principle is the imagination of the artist.

The examples on page 36 should be carefully studied and copied, and where the missing head and parts of the bodies are indicated, fill them out as your imagination suggests they should be to make a good composition.

CARTOONS



STUDY IN CARICATURE

The same face being used in all the subjects

CARTOONS

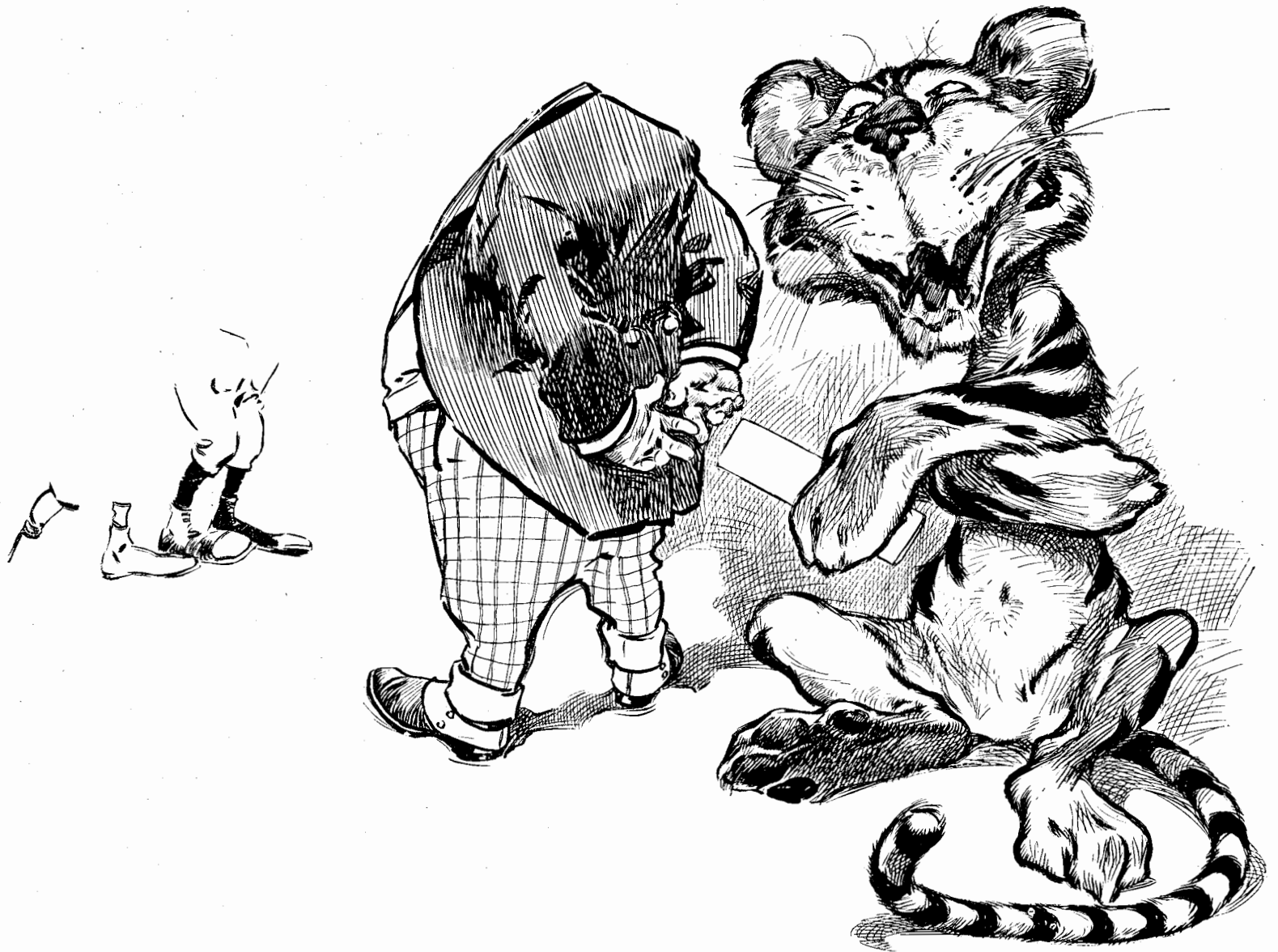

CARTOON STUDY

The student should copy this and fill in the missing head and parts of the bodies of the boys

WASH LAMP-BLACK DRAWING

Mounted Steinbach paper is commonly used for this purpose. Ivory-black water-color, to which water is added to obtain the desired shade, is the only color used. Having decided upon your design, lightly sketch it in with pencil, then place a little color in a saucer, and add sufficient water to make a wash that will cover the space desired. Commence by tipping the board towards you; then filling the brush with color, draw it across the top of the board from left to right. Immediately fill the brush again, and follow the edge of the preceding line across, taking up the little rivulet of color on the edge of the first line—which will have formed clear across the board by having tilted the board towards you—and repeat the operation until you have covered the space desired. Upon the success with which you have carried forward the wash will depend the success of your effort. Should you allow the preceding line to dry at any point, it will leave a bad spot in your tint and will be found difficult to overcome. The color must be kept running, as you will find by experience. A small piece of blotting-paper will be found useful to take up color when desired.

Practice will show the necessity of laying on the right density of color the first time. There is always a "life" and transparency to the first wash, that is lost if you go over the same spot many times. All water-color appears darker when first applied than when thoroughly dried. This is peculiarly true when using a drawing-paper that is very absorbent.

Don't be afraid of the color if it looks too dark, and avoid the temptation to make it darker when it is half dried, or you will find the brush taking up the color in spots, leaving almost bare paper—spots that you will find it difficult to cover.

Make your work clean and bold. Avoid "niggling," as the artists say.

Don't get too close to your work. Drop it frequently and stand off to get the effect impossible to obtain when it is less than an arm's-length away.



SPECIMEN OF A WASH DRAWING BY C. D. WELDON
(Reproduced from *Harper's Magazine*)

DISTEMPER DRAWING

Ivory black and Chinese white water-colors are used for distemper drawing. These mediums form a body of color, and require that the design you desire to draw should be laid in with strong pencil-lines, as the color soon covers the tracings of the pencil. Bristle brushes and red and black sable brushes are used in distemper drawing.

Any heavy card-board or canvas can be used for distemper work.

A combination of wash and distemper drawing is much in vogue among illustrators.

Wash and distemper drawings are also reproduced by a photographic process known as the "half-tone," a negative being made of the drawing through what is termed a screen, which throws the picture into minute squares of stipple running diagonally across the plate, which is then etched precisely the same as a line-drawing.

The combination of black and white produces a bluish tone, the values of which the photo-engraver has difficulty in reproducing, certain of the lighter tones being lost, and medium dark tones merging too suddenly into black. This may be overcome by the addition of a little sepia, which gives it a slight brownish tone.

What was said about working over a moist spot in a wash-drawing applies to distemper, and can only be done safely by the experienced. Care should also be taken in applying the second wash to do it quickly and with a light touch—to avoid picking up the color already placed, even when dry—greater than in the case of the transparent wash-drawing.

Beyond these elementary instructions there are numberless "tricks" in the handling of distemper that can only be acquired by patient experiment, but, once acquired, make it a most effective and interesting medium.



SPECIMEN OF A DISTEMPER DRAWING BY A. B. FROST

(Reproduced from *Harper's Magazine*)

DRAWING ON SILVER PRINTS

For this purpose, in newspaper-work, the photo it is desired to copy is enlarged by re-photographing, and making therefrom what is known as a "silver print." This is made on Clemmon's plain salted paper, which is then mounted on a piece of cardboard, for convenience in handling, and gives a perfectly smooth, firm surface for drawing upon. The artist then carefully traces the outlines of the subject, using the ordinary drawing-pens and India-ink, varying the pens, of course, according to the character of the lines desired. Draw in the deep shadows first, and gradually work out to the high lights. When the drawing is complete, the photo color (the silver) can be bleached away by pouring on it a saturated solution of bichloride of mercury. This eats the silver away, and leaves the pen-lines clean and sharp upon what will now be a perfectly white sheet of paper. This will dry quickly, when, by comparing the drawing with the original photo, he can proceed to touch it up where necessary.

The bleaching solution is made of equal parts of water and alcohol, to which is added sufficient bichloride of mercury to make it a saturated solution. As this "bleach" is a deadly poison, care must be taken in its use.

A photo of a building, a landscape, or any other subject, can, of course, be treated in this manner.

The process of drying the silver print after bleaching can be greatly hastened by waving it back and forth in the air. By this means the alcohol is more quickly evaporated.

The pen-and-ink portrait is not in much demand now except for advertising purposes and for provincial-journalism use, the half-tone portrait having displaced it. The half-tone portrait or view is made direct from the photograph, without practically any handwork upon it except what is necessary to make it fit the desired space, or to bring out some detail that may have been lost in the photograph, or to accentuate the high lights, and possibly to sharpen the outline.

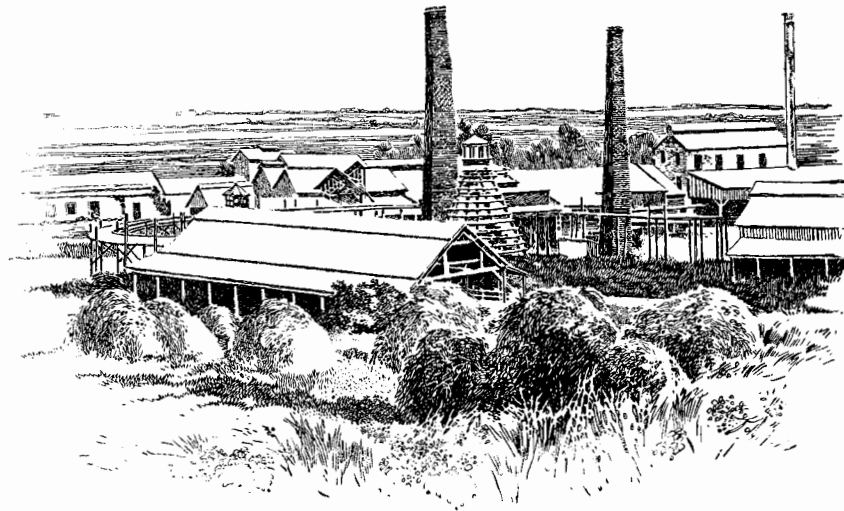

EXAMPLE OF BUILDINGS AND LANDSCAPE DRAWN ON SILVER PRINT



WILLIAM DEAN HOWELLS



DR. EDWARD EVERETT HALE

EXAMPLES OF PORTRAITS DRAWN ON SILVER PRINTS

LETTERING

In newspaper-work, particularly the Sunday supplements, lettering plays an important part, and the necessity for a general knowledge of the basic principles will be apparent.

There are four general styles of letters, upon which all others are based. They are the block, the Roman, Old English, and script letters, examples of which are here given. There are no hard and fast rules governing their making, and in submitting these examples we shall simply call attention to the general laws governing their construction and arrangement.

Block and Roman caps are all the same height, but not all the same width. "A," "M," and "W," from the nature of their construction, are made wider, so that they will look uniform with the rest of the letters. Should they be made the same in width as the other letters, they will appear cramped and heavy, and entirely out of keeping with the rest of the letters. In drawing a line of lettering, it is possible to make the spacing even more uniform than those set up from type. Type letters are made of necessity so that the letter sets on a square base, and when such letters as "W," "Y," "A," and "V" are used in conjunction, it is impossible to give them the proper spacing. Printers usually call the block letters "Gothic"; why this is we do not know.

The small or "lower-case" letters usually occupy two-thirds of the height of the caps.

Block letters are usually made by ruling off from four to six parallel lines equidistant, and then drawing perpendicular lines the same width apart, crossing the parallel lines, making a series of small squares, or blocks—hence the name block letter. (See example on page 41.) Each letter occupies the same number of squares in height and width, with the exception of "A," "M," and "W," as before noted, the space between the letters being the width of a square. The Roman and Old English letters are laid out on the same general plan of squares, so as to get them of equal height and width and of the desired spacing—all of which is a matter of taste with the artist.

Script letters are laid out by ruling off a series of parallel lines as in the block letter, but the perpendicular guide-line should be at an angle of at least forty-five to fifty degrees, so as to give the letter the proper slant.

By studying and practising the scale of square rule on page 4, with the suggestions here given, it should be possible for one to draw almost any scheme of lettering desired. Practice makes perfect, and with proficiency will come freedom of treatment, until, as in writing, the rules by which we first attained the art of writing are forgotten, and you will "letter" as you write, without thought of rules.

In drawing lower-case Old English letters (that is, the small letters), first draw five parallel lines of the desired height, as shown in the following example:

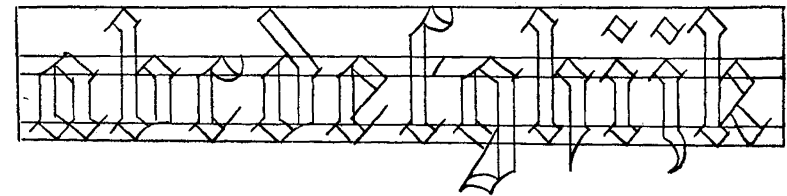

The two closely ruled parallel lines are for the spacing of the angle at the top and bottom of the letter, and the space between gives the uniformity of length to the perpendicular body-line. In drawing the letters fasten a ruler with thumb-tacks a few inches below the bottom line of your lettering, and parallel to it; then having made the proper spacing for the letters, place a tri-square against the ruler and draw in the perpendicular lines, moving the tri-square along from letter to letter; by this means each letter will be exactly perpendicular. The angles at the top and bottom of the letters are made in the same manner, perfectly uniform in their slant.

LETTERING

BLOCK LETTER ALPHABET

A B C D E F G H I J K L M N O P Q R S T U V W X Y Z &
a b c d e f g h i j k l m n o p q r s t u v w x y z \$ 1 2 3 4 5 6 7 8 9 0

SCRIPT LETTER ALPHABET

*A B C D E F G H I J K L M N O P Q R S T U V W X Y Z &
a b c d e f g h i j k l m n o p q r s t u v w x y z \$ 1 2 3 4 5 6 7 8 9 0*

ROMAN LETTER ALPHABET

A B C D E F G H I J K L M N O P Q R S T U V W X Y Z &
a b c d e f g h i j k l m n o p q r s t u v w x y z \$ 1 2 3 4 5 6 7 8 9 0

OLD ENGLISH ALPHABET

A B C D E F G H I J K L M N O P Q R S T U V W X Y Z &
a b c d e f g h i j k l m n o p q r s t u v w x y z \$ 1 2 3 4 5 6 7 8 9 0

HOW TO MAKE AN ELLIPSE—TINT PAPERS

Measure with compasses from A to B (see Fig. 1); then place compasses at C, and strike a circle as shown by dotted line from D to E, and where the circle intersects the horizontal line at D and E place pins (see Fig. 2), also one at C; stretch a thread from D to E passing over C, and tie ends together at C. Remove the pin at C; then holding a pencil perpendicularly describe the oval as here shown.

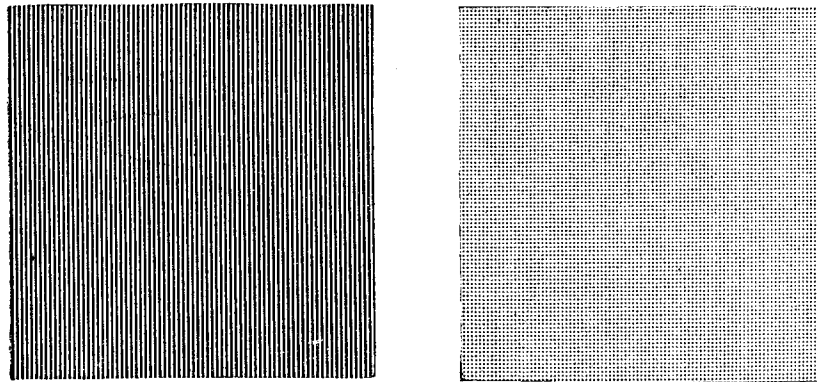

TINT AND STIPPLE PAPERS

As labor-saving mediums, tint and stipple papers find great favor. Two examples are here given. They come in a great variety of designs and are used for backgrounds and many other purposes. The tint papers come ready for use, but the Ross stipple papers have the designs embossed on them and are made available only by the pencil or crayon—very pretty effects are obtained by their use. The ruled tint papers are used for flat surface effects or in mechanical drawing, where gradations in the line are necessary to obtain rounding effects.

Tint and stipple effects are obtained also by the use of a mechanical device known as the Ben Day Process. This is commonly used in the newspaper or photo-engraving art departments, the artist indicating in blue pencil the part he desires stippled or tinted and the character of the tint or stipple desired.

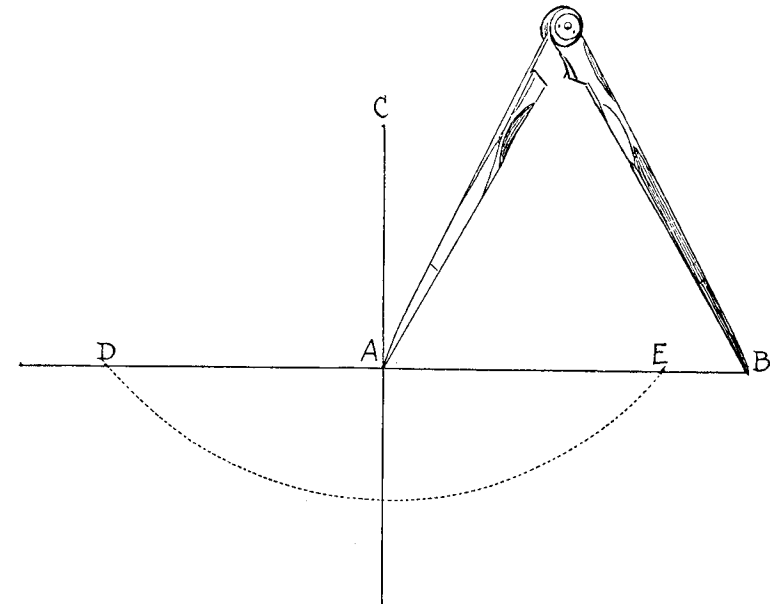

FIG. 1

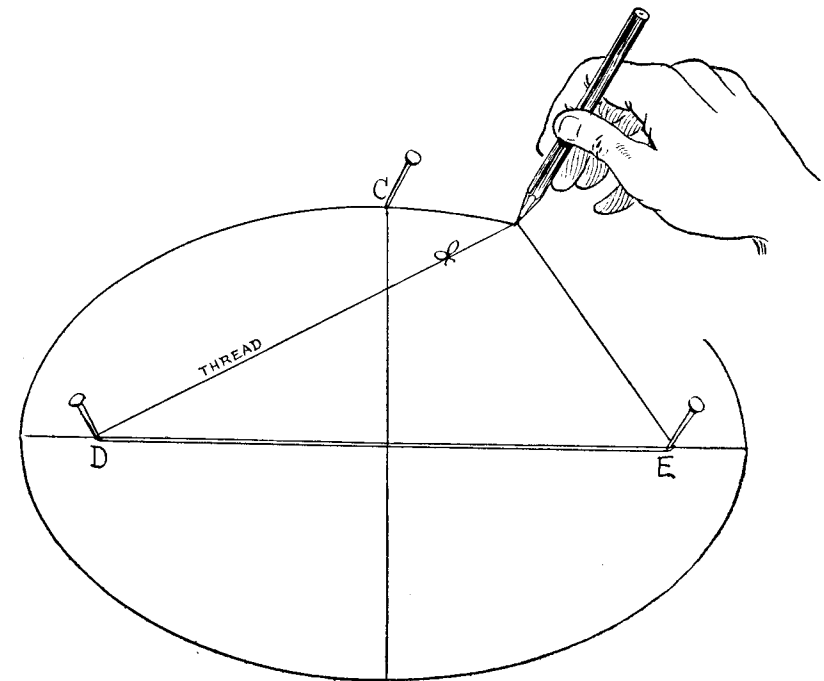

FIG. 2

SCALE FOR REDUCING DRAWINGS—SHARPENING PENCILS

Presume the space you desire to fill with a cut is 2 inches high by 3 inches in width; lay out this square in pencil as shown in Fig. 1.

Then draw a line from the lower left-hand corner, so as to intersect the upper right-hand corner, and carry it on as far as you wish, and square it as shown by the dotted lines.

A drawing made within the square of these dotted lines, and photographed down to the desired 3 inches in width, will be found to fit the space, 2 by 3 inches, absolutely. Should the drawing be oval in shape, obtain the square of the oval as shown in Fig. 2, and proceed exactly as before. Photography always reduces on the line of the angle as shown by the dotted line running from the upper right-hand corner to the lower left-hand corner.

Drawings for newspapers are usually made two or three times larger than desired when reduced. For magazines and weeklies, they are commonly made from five to ten times the

size desired. In the latter case the cuts receive so much better handling every way, with calendered paper, the best of inks, and slow printing, that it is possible to give a drawing most any reduction and yet get a good result. In newspaper-work, cheap paper and poor ink, combined with rapid press-work, require a reasonably open cut to get good results from.

The bolder a drawing is made in line, of course, the greater reduction it will stand. A little practical experience in the matter will show the artist what is required.

SHARPENING PENCILS

It is not always practicable to put a fine point on a lead-pencil with a knife, so the artist finds a common flat file a most excellent substitute, and with which the lead can be reduced to a most delicate point without breaking.

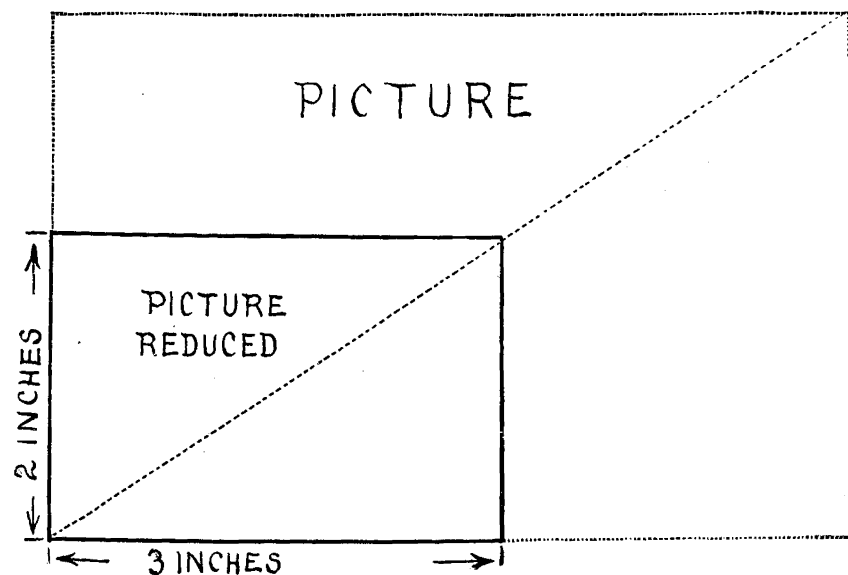

FIG. 1

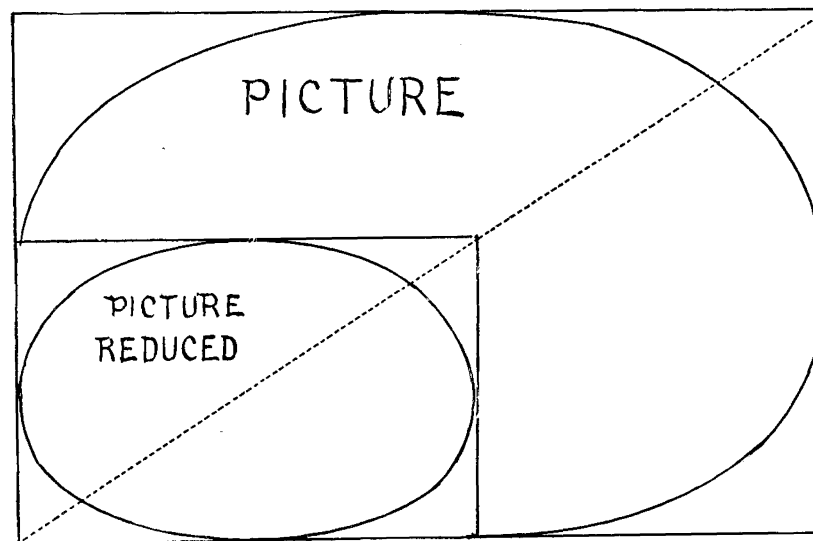

FIG. 2

NEWS AND STORY ILLUSTRATIONS—FOLIAGE STUDY

NEWS ILLUSTRATION

This is a field requiring the best type of artistic ability. The news artist must not only have the technical ability to transfer to paper the most striking scene in the drama of a court-room trial or a railway disaster, with decision, but at the same time must in the highest degree know what to leave out and what to put in. From the nature of the work oftentimes it is only possible to get the merest outline of suggestion, a short-hand memorandum, as it were, from which to make the finished drawing. This is frequently done with remarkable fidelity by men of experience. Then again, he must, in newspaper parlance, have a "nose for news"—that is, the ability to seize upon that which most fully and completely tells the story, and that will be most helpful to interpretation of the text.

STORY ILLUSTRATION

In story illustration the creative power is absolutely essential. The artist studies the text in detail, selecting for illustration that which is most striking and picturesque, keeping in mind that the pictures are not only to embellish the text, but to attract to its perusal. To do this he must enter fully into the spirit of the story, just as an actor enters into the character he interprets upon the stage.

In newspaper illustrative work, particularly in the Sunday supplements, what is known as "lay outs" are very artistically arranged for the dramatic and story feature pages. The artist is given a number of photographs which are to illustrate the story, and these he arranges within an artistic series of fancy bordered squares or ovals, leaving a space somewhere in the composition to introduce one or more striking figures in such a way as to convey the spirit of the story, and also leaving sufficient space across the top of the page for the lettering of the caption. This feature of illustrative work receives the atten-

tion of many of our most talented artists, and is often beautifully decorative and of the highest artistic merit.

In arranging a "lay out" for a page, the artist makes in pencil a dummy design of the whole page, about one-third larger than the actual page size, on heavy drawing card-board or mounted Steinbach paper, ruling off the columns just as they are in the paper. He then proceeds to arrange the squares, ovals, and general design, as before described, so that when reduced it will fit into the column measure of the paper exactly.

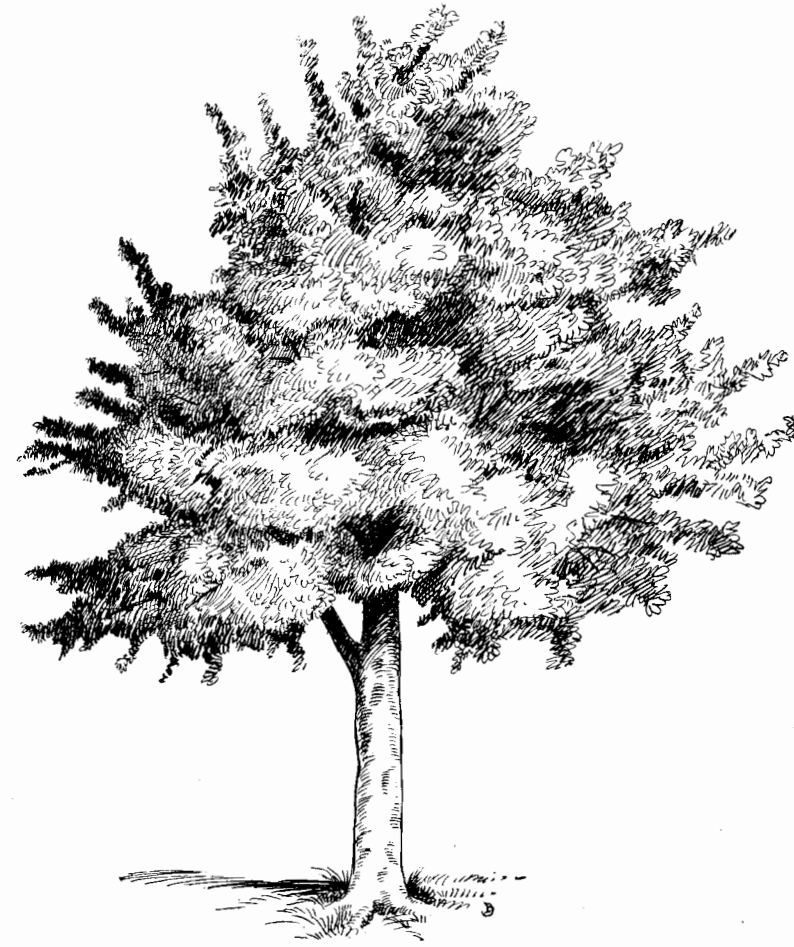

TREE AND FOLIAGE STUDY

NEWS ILLUSTRATIONS

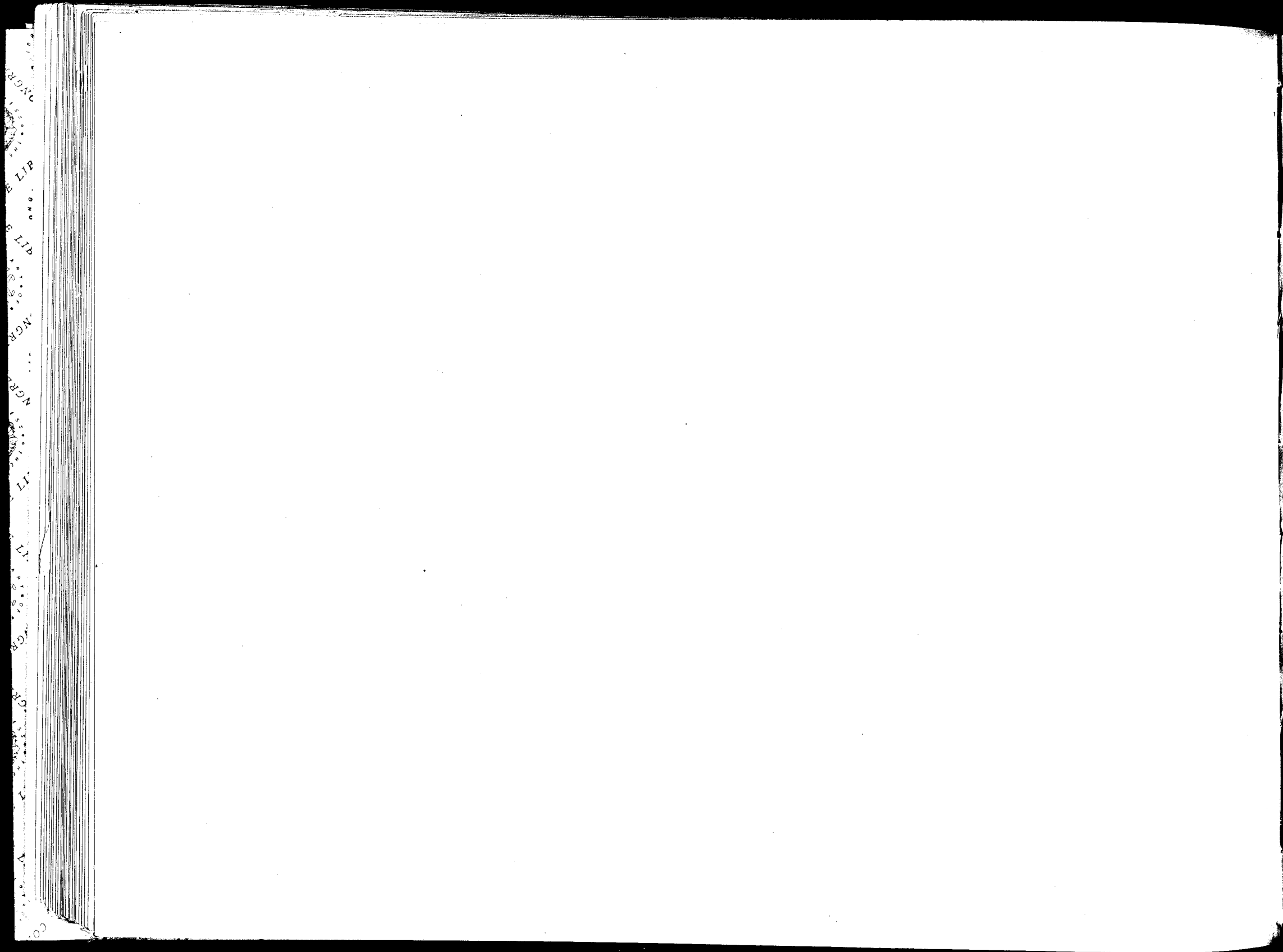

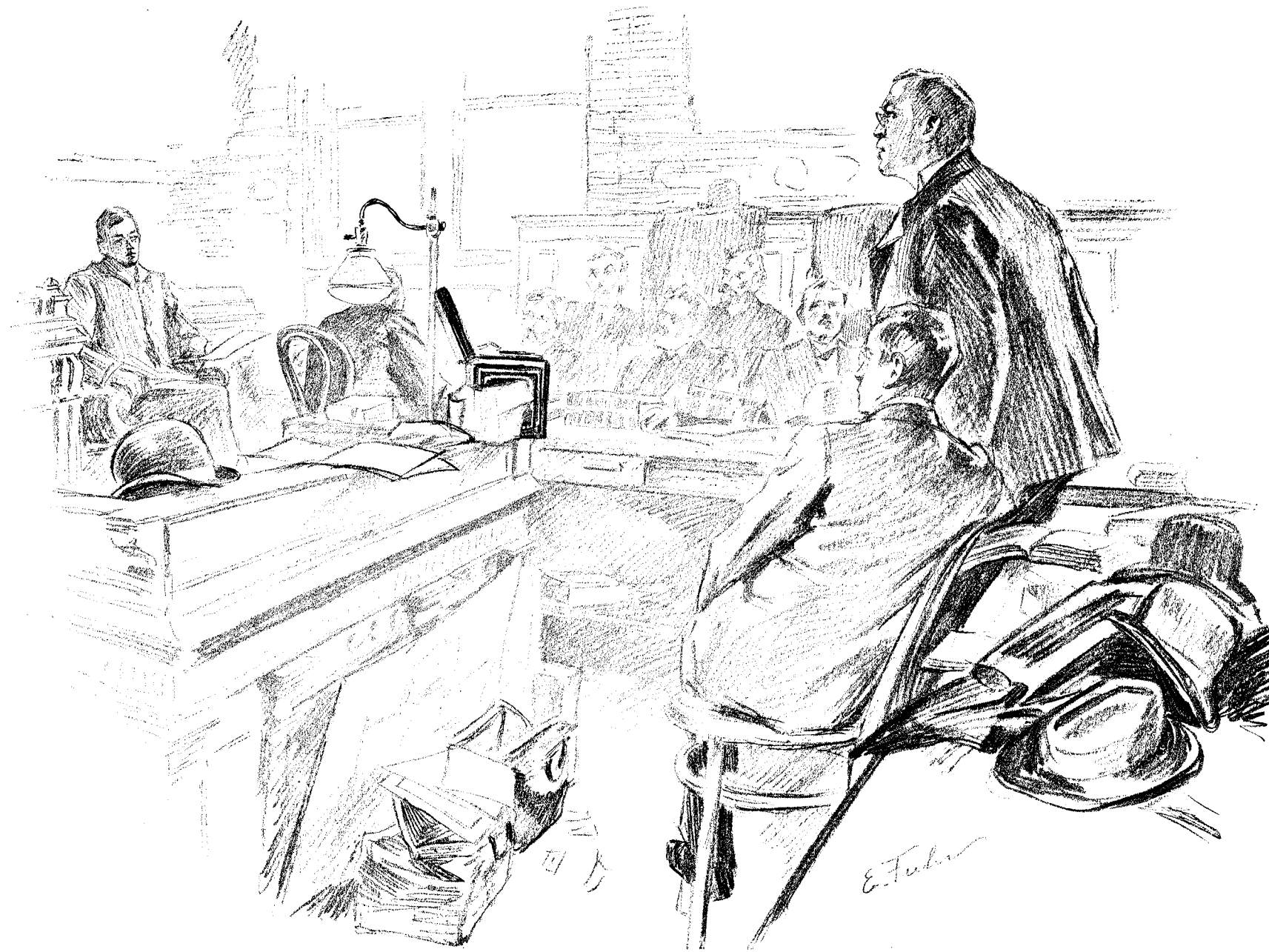

Permission of the New York World

A SCENE DURING THE PATRICK TRIAL
Reproduced directly from the pencil-sketch as made in the court-room

Drawn by E. FUHR

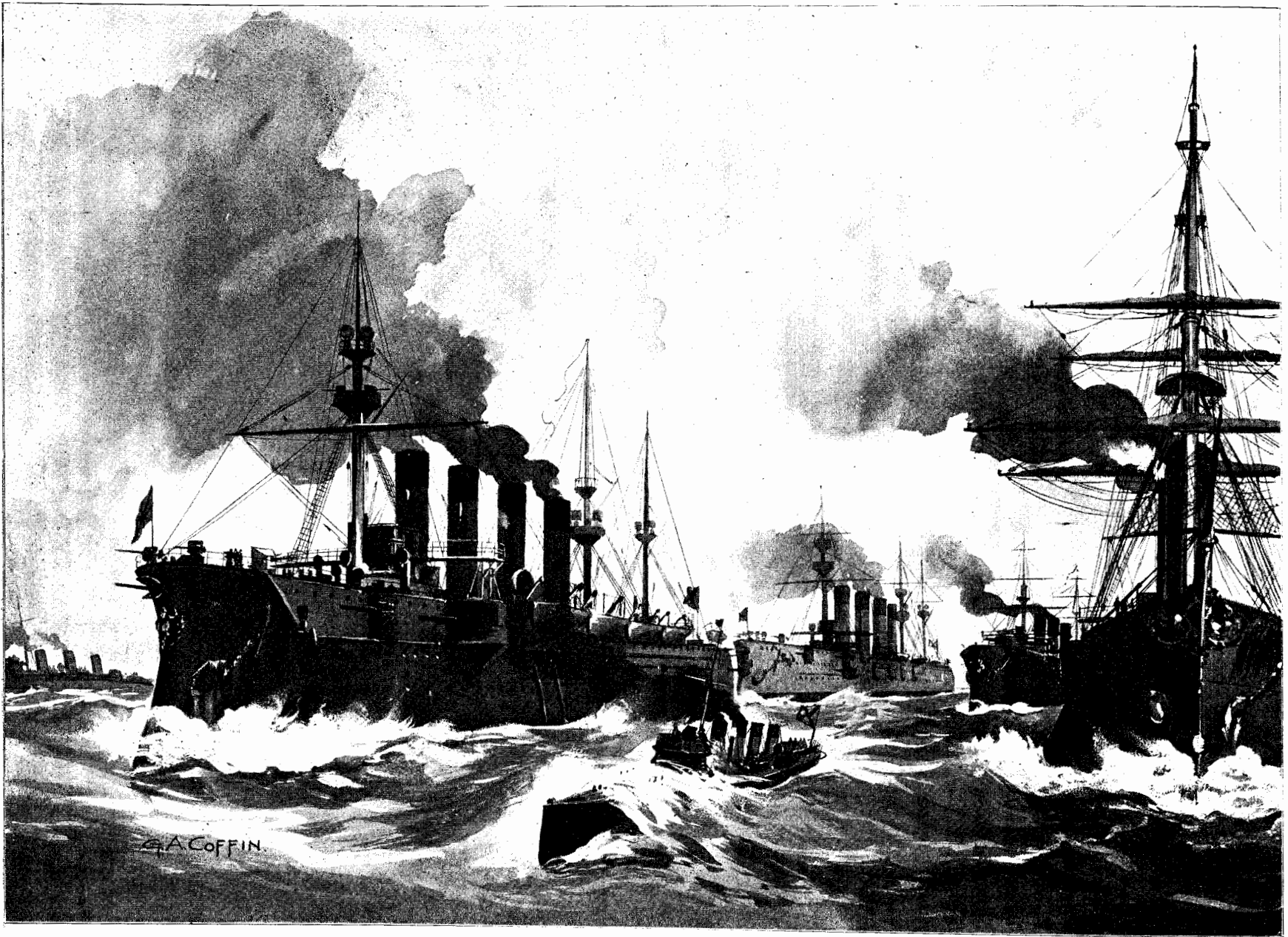

Permission of the *New York Herald*

RUSSIA'S VLADIVOSTOK FLEET

Drawn by G. A. COFFIN

NEWS

*EDWIN
HAWLEY.*

*ELIHU
ROOT.*

DANIEL J. SULLY.



E. Foster Lincoln

JOHN R. DOS PASSOS.

Drawn by F. FOSTER LINCOLN

Permission of the New York Herald

A COURT-ROOM SCENE
Reproduced from sketch as made in court-room

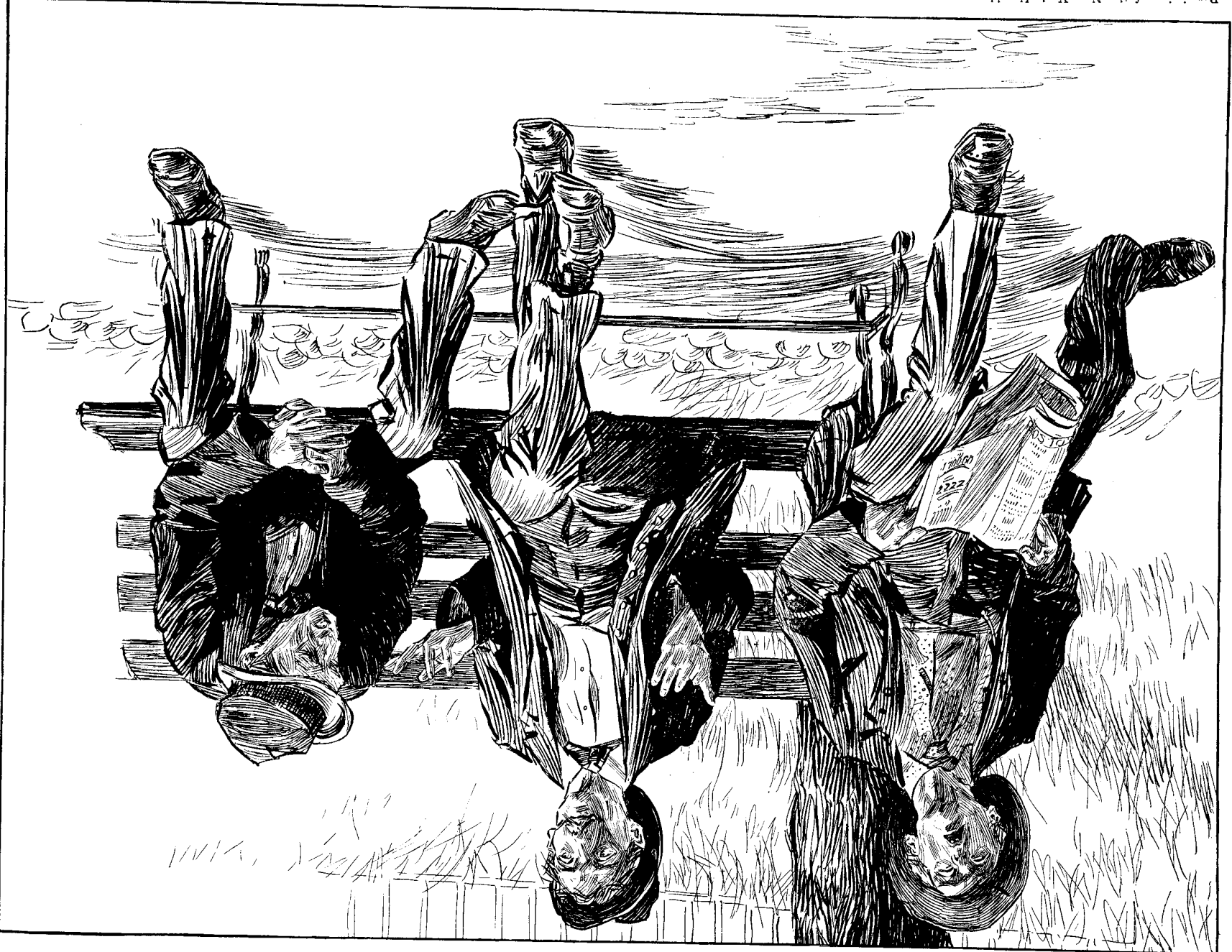

NEWS

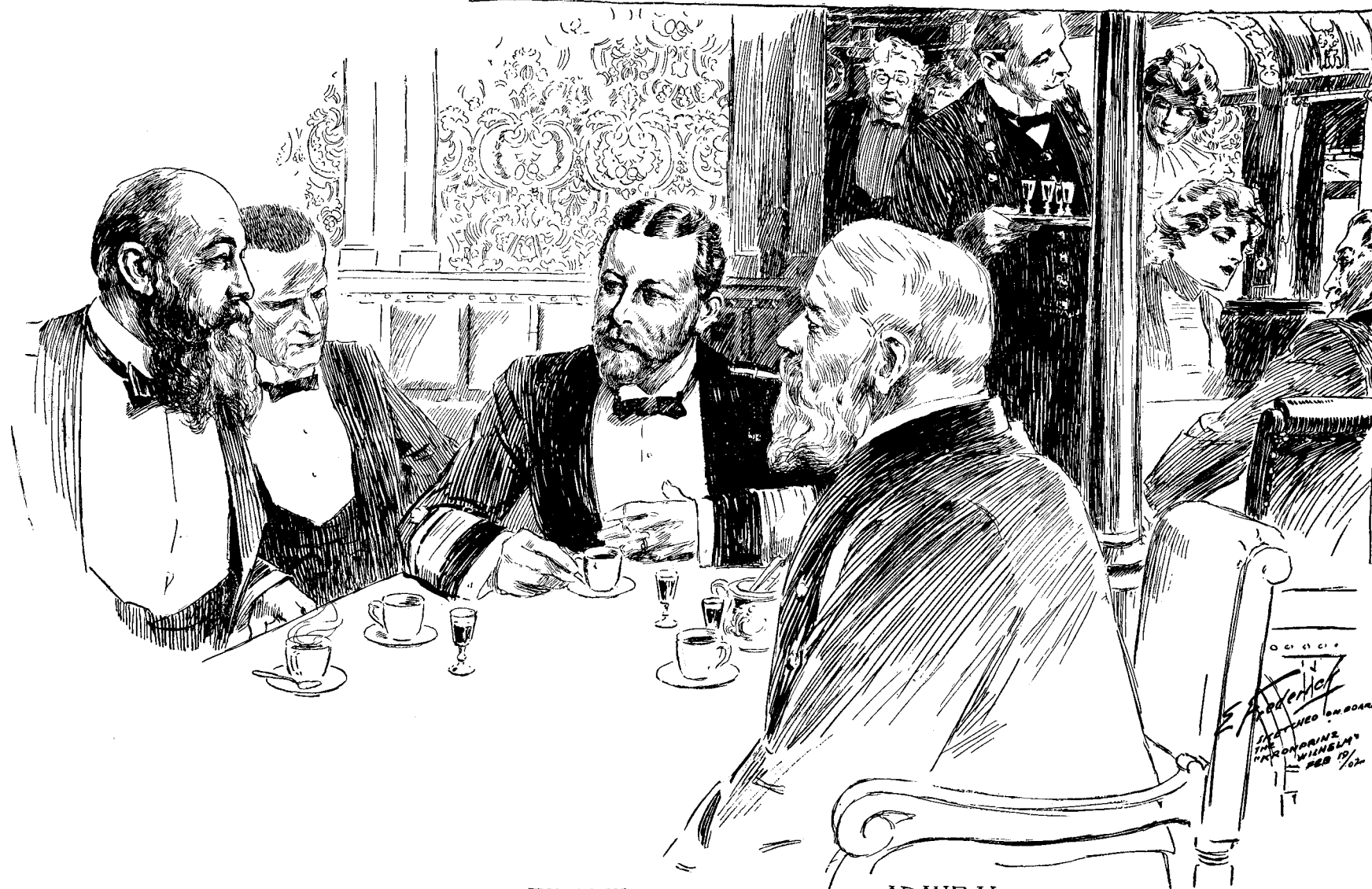

ADMIRAL
VON TIRPITZ

CAPTAIN
VON MUELLER

PRINCE
HENRY

ADMIRAL
SECKENDORFF

Permission of the New York American

PRINCE HENRY AND OFFICERS OF HIS SUITE IN "THE NAVAL CORNER OF THE SMOKING-ROOM"

Drawn by E. FREDERICK

NEWS



By Permission

WAGNER

Drawn by JOHN CARLETON BAKER

This drawing was made entirely with the brush, or "dry-point," as it is termed

NEWS.



Permission of the New York World

DESIGN FOR THEATRICAL PAGE "LAY-OUT"
Made entirely with the brush, or "dry-point"

Drawn by DAN SMITH

NEWS



JIM PARKER
from a Sketch
by MABEL
PARKER.

MABEL
PARKER

Permission of the New York World

A COURT-ROOM STUDY

Drawn by W. H. LOOMIS

NEWS

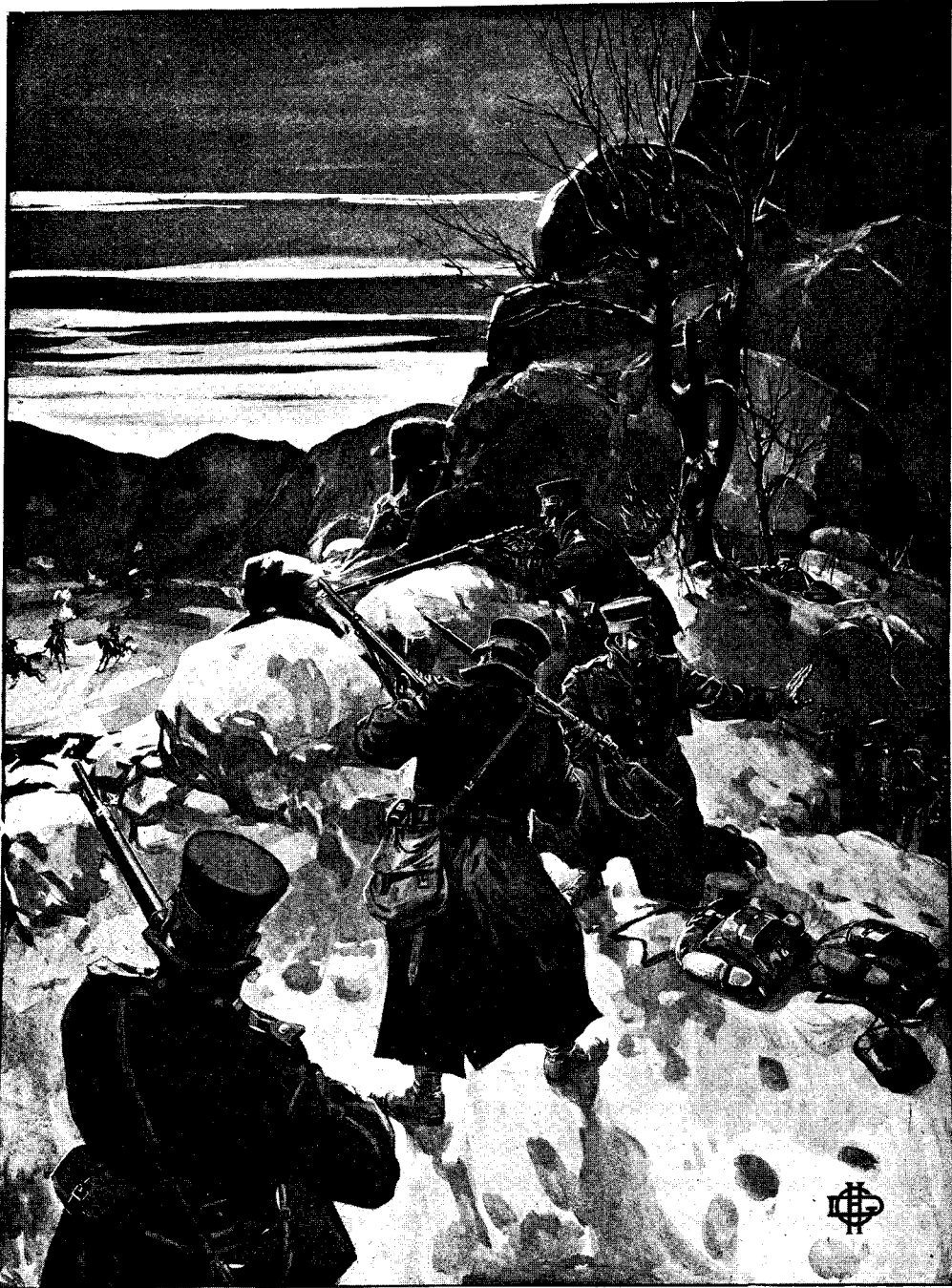

By Permission
JAPANESE ADVANCE-GUARD FIRING ON A PARTY OF COSSACK SCOUTS NEAR
YALO RIVER

NEWS

1776-WHEN WAR BLAZED 'ROUND NEW YORK 1781

A GLIMPSE OF THE NEWLY DISCOVERED DIARIES OF BARON VON CLOSEN, AN OFFICER OF ROCHAMBEAU'S ARMY.

WITH WASHINGTON AT KINGSBRIDGE, A HOT SKIRMISH "NEAR HARLEM" THE RAGGED CONTINENTALS, THE BELLES AND THE BEAUX OF REVOLUTIONARY DAY

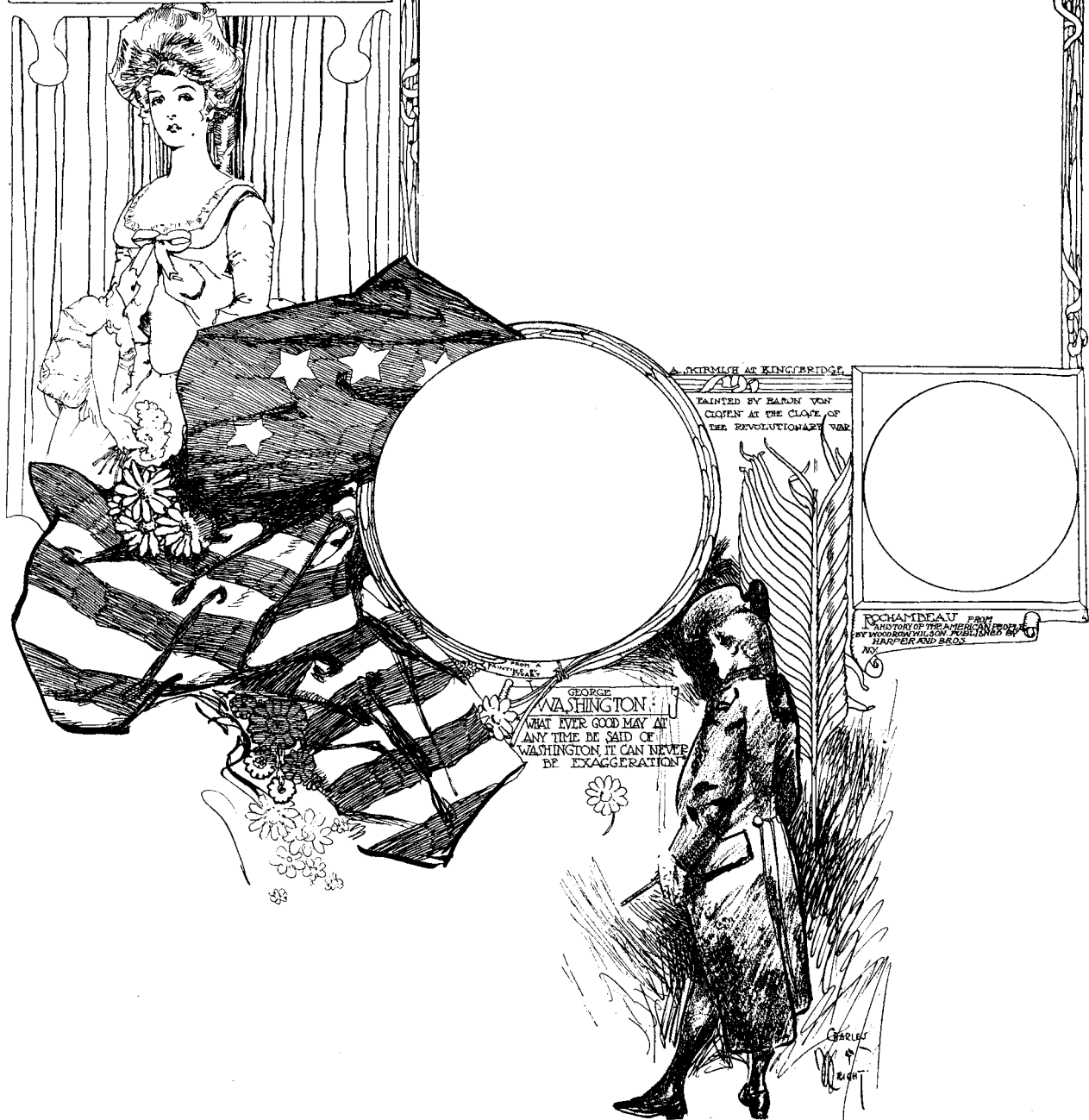

Permission of the New York Herald

A PAGE DESIGN "LAY-OUT"

Drawn by CHARLES WRIGHT

NEWS

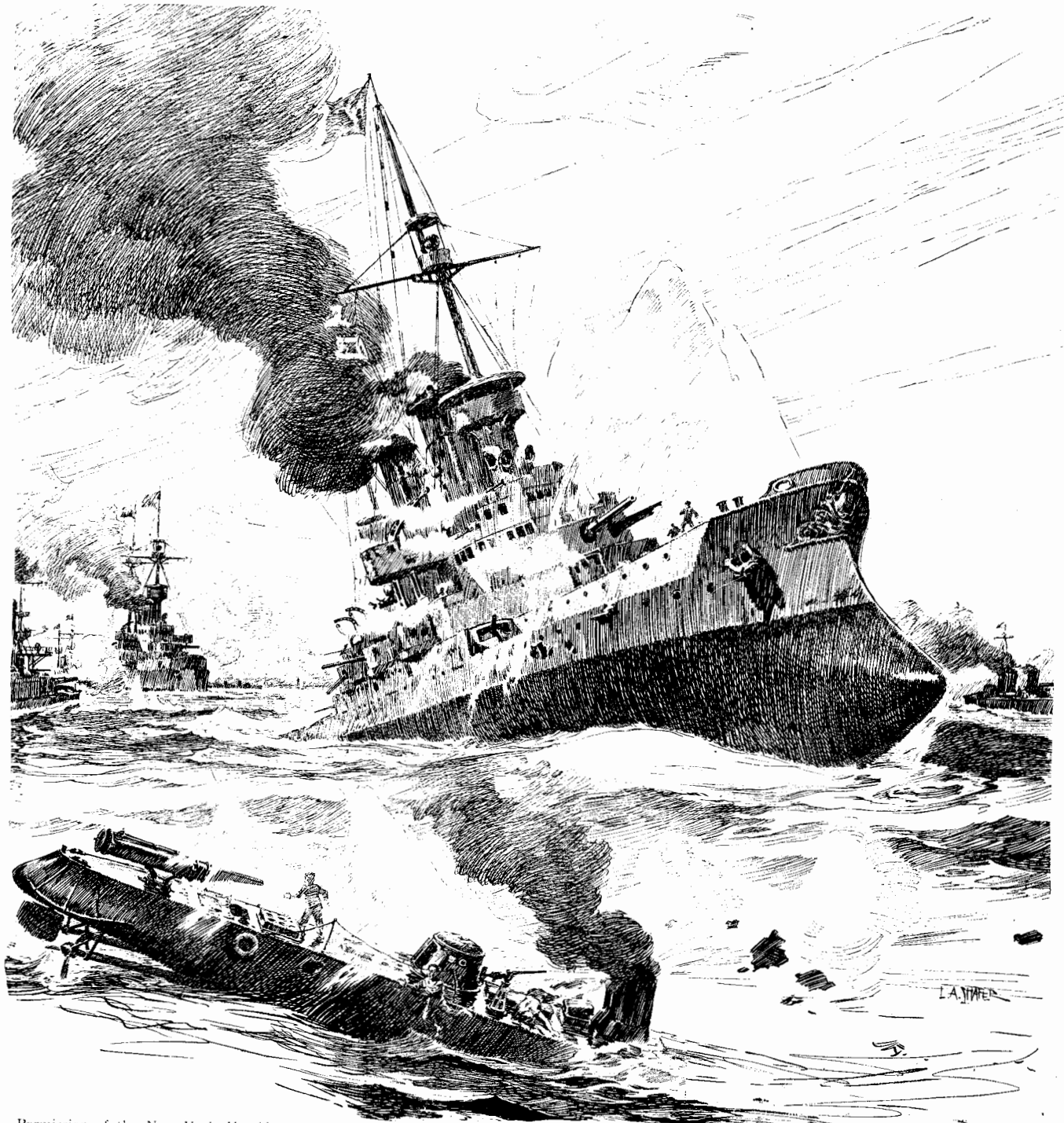

Permission of the New York Herald

Drawn by L. A. SHAFER

ILLUSTRATING THE TREMENDOUS EXPLOSIVE EFFECT OF A TORPEDO ON A BATTLE-SHIP



NEWS

NEWS



By Permission

Drawn by H. PRUETT SHARE

ON THE LIFE-LINE

NEWS

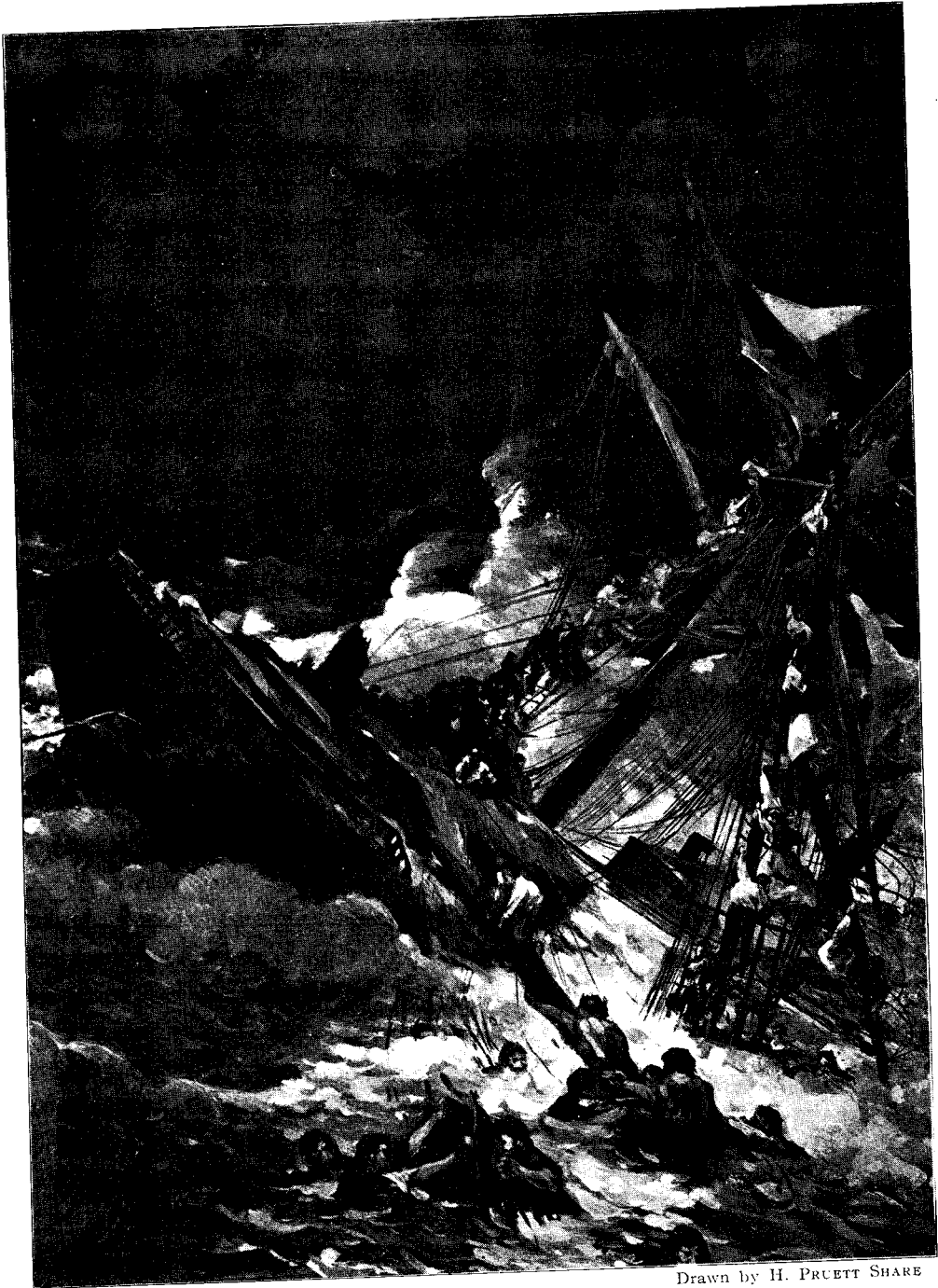

By Permission

Drawn by H. PRUETT SHARE

WRECK OF AN EMIGRANT SHIP

FICTION ILLUSTRATIONS

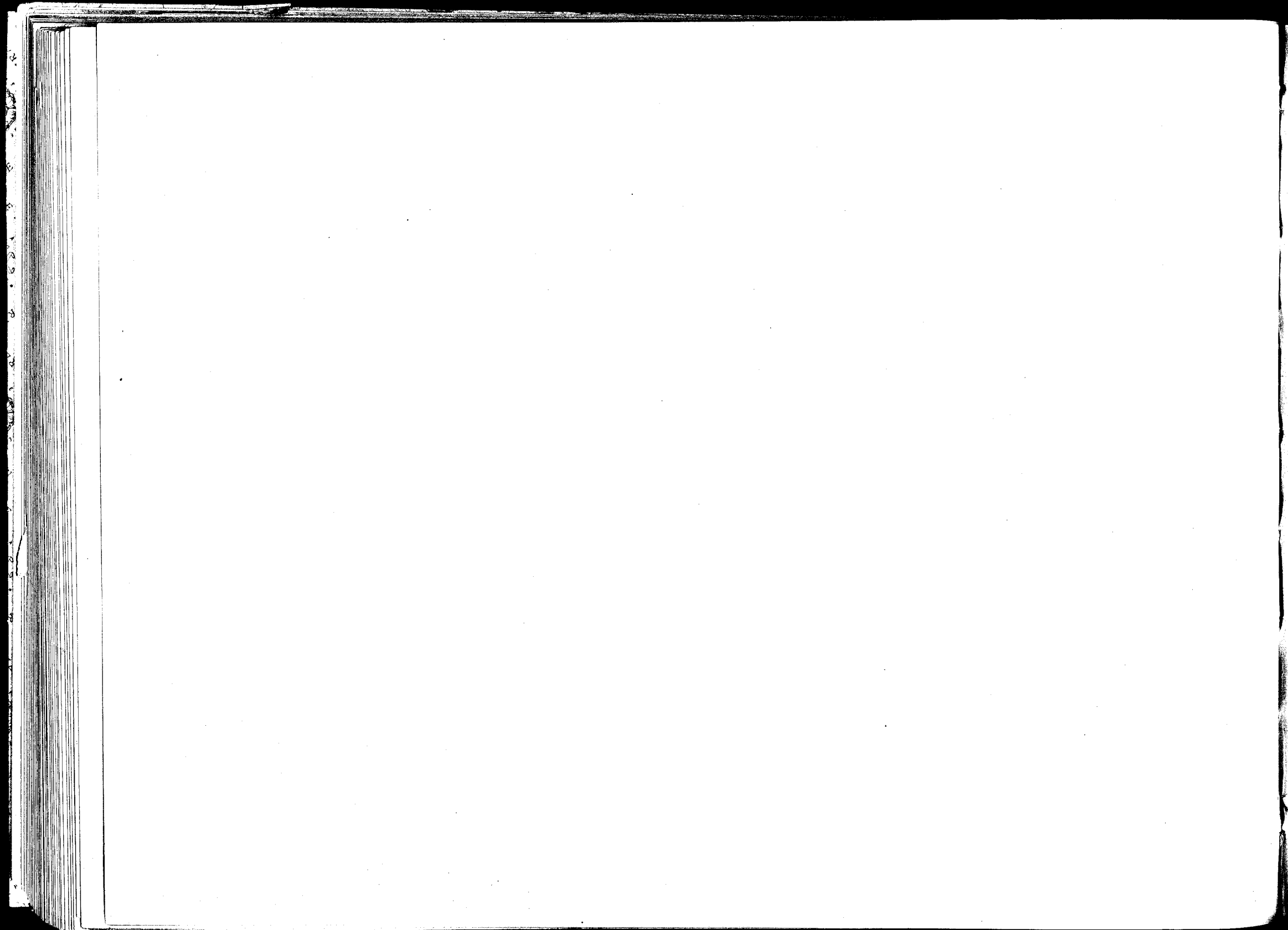

FICTION



Permission of *Harper's Weekly*

ILLUSTRATION FOR A SHORT STORY

Drawn by F. Luis Mora

FICTION

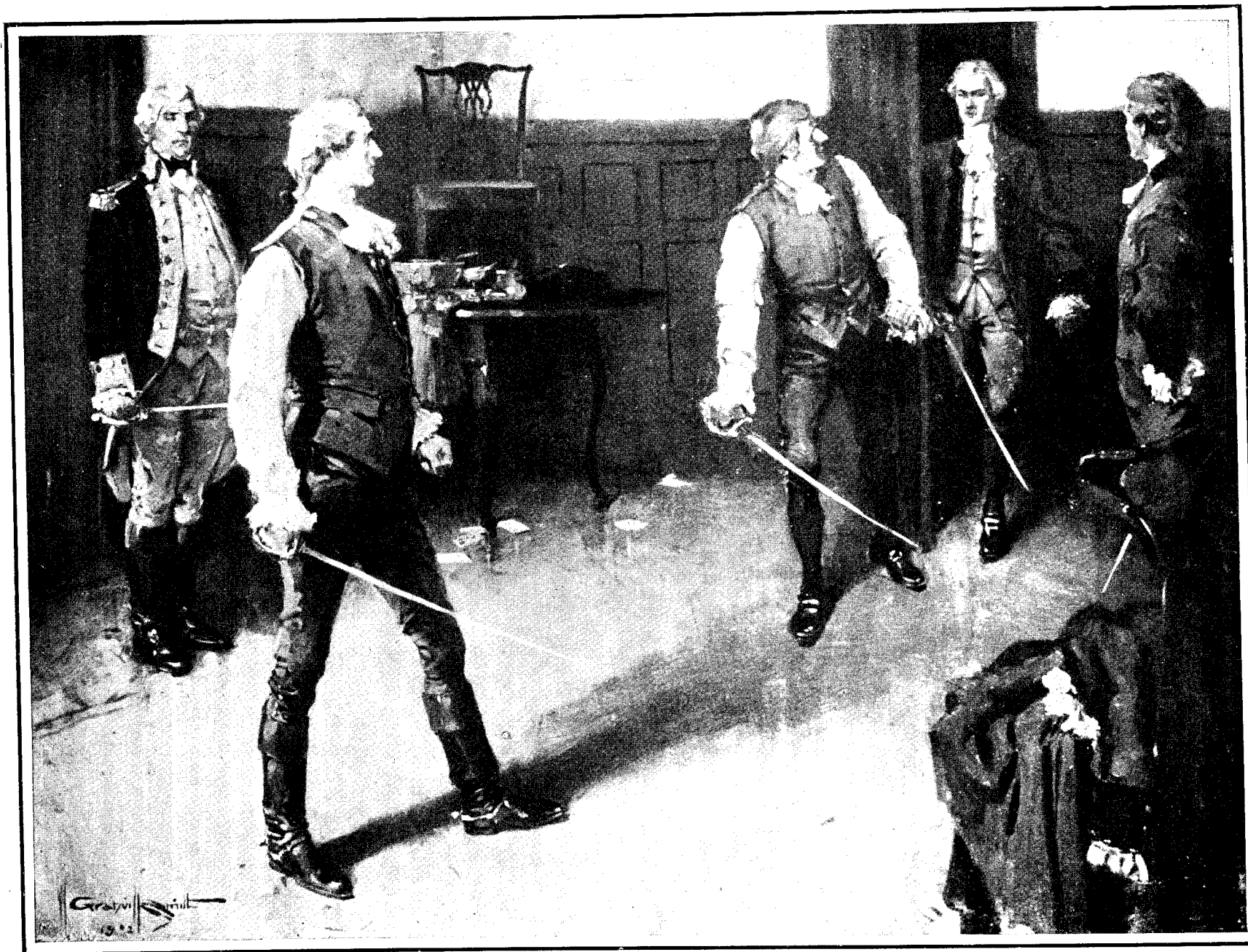

Permission of *Harper's Weekly*

ILLUSTRATION FOR A SHORT STORY

Drawn by W. GRANVILLE SMITH

FICTION

MAMMY'S BOY

BY
BROUGHTON
BRANDENBURG



"BANG!"

Permission of the New York Herald

BANG!
65

Drawn by W. MORGAN

FICTION

The Cry Of Mary

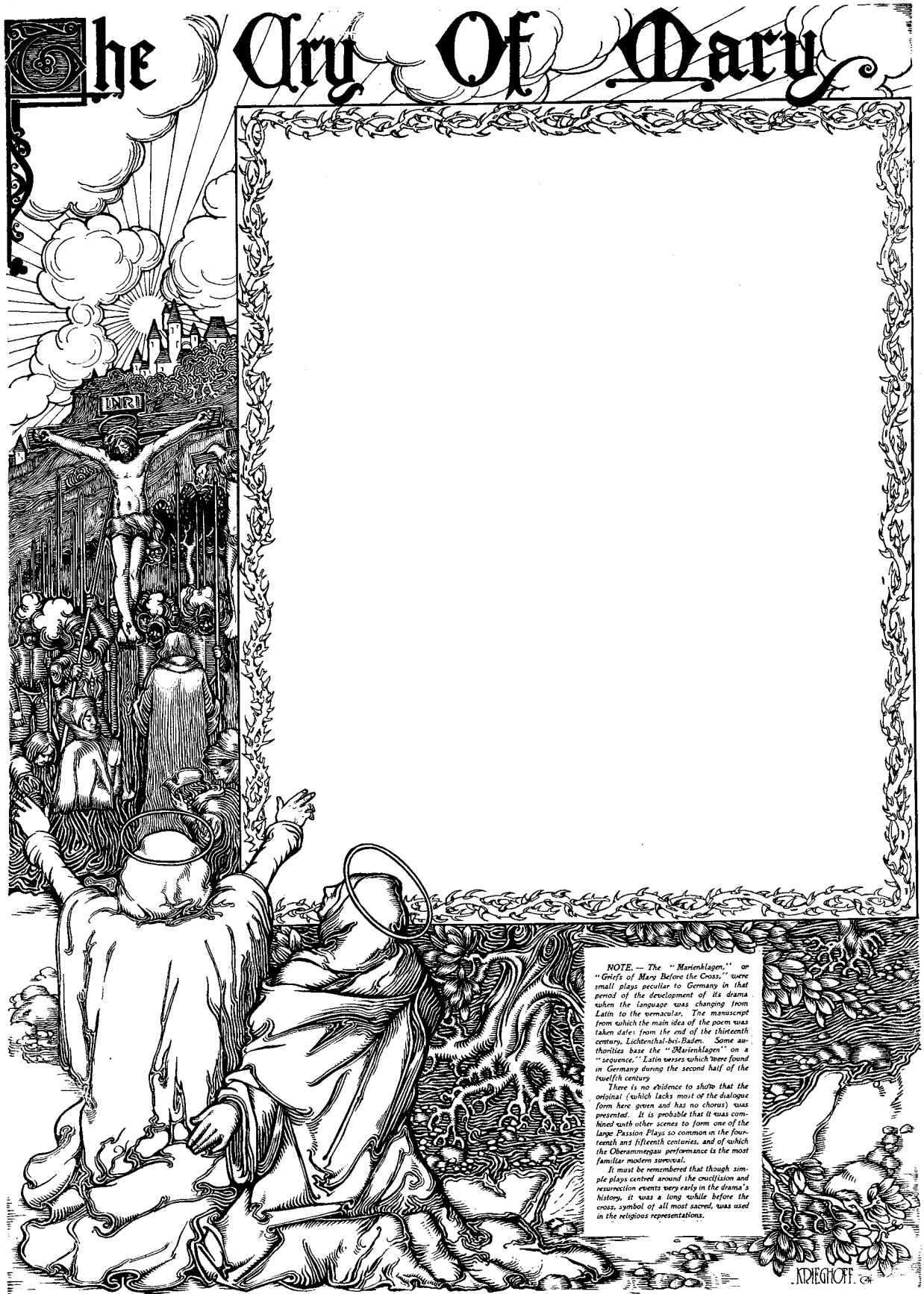

NOTE.— The "Marienklagen," or "Griefs of Mary Before the Cross," were small plays peculiar to Germany in that period of the development of its drama when the language was changing from Latin to the vernacular. The manuscript from which the main idea of the poem was taken dates from the end of the thirteenth century, Lichtenhal-bes-Baden. Some authorities base the "Marienklagen" on a "sequence," Latin verses which were found in Germany during the second half of the twelfth century.

There is no evidence to show that the original (which lacks most of the dialogue form here given and has no chorus) was presented. It is probable that it was combined with other scenes to form one of the large Passion Plays so common in the fourteenth and fifteenth centuries, and of which the Oberammergau performance is the most familiar modern survival.

It must be remembered that though simple plays centred around the crucifixion and resurrection events very early in the drama's history, it was a long while before the cross, symbol of all most sacred, was used in the religious representations.

KRIEGHOFF

Drawn by Wm. G. KRIEGHOFF

Permission of the New York Herald

AN EASTER PAGE DESIGN

FICTION



As deep as a house - as round as a cup
The King's great white horses
cannot draw it up.

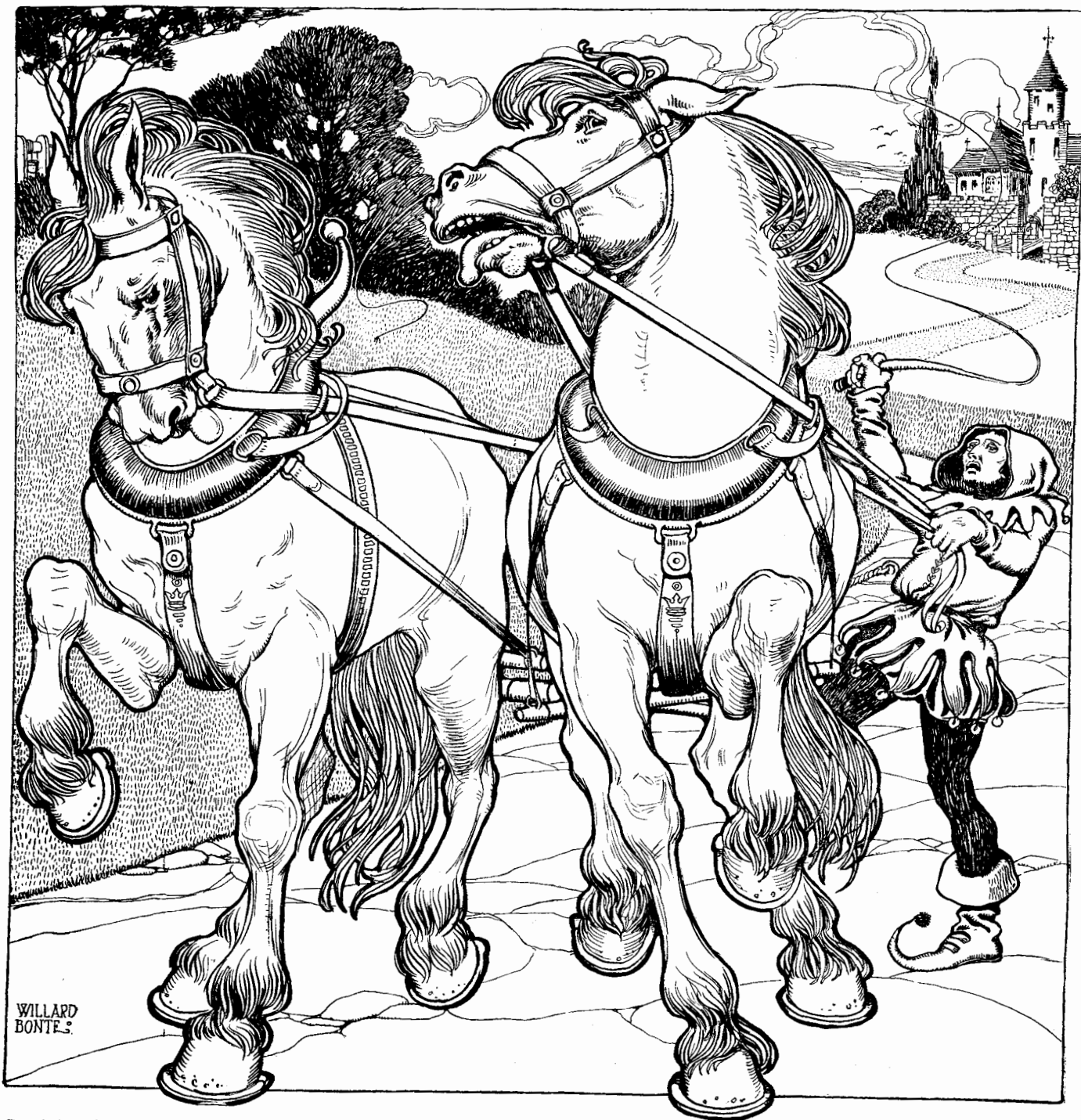

Permission of the New York Herald

A PUZZLE-PICTURE

Drawn by WILLARD BONTE

FICTION

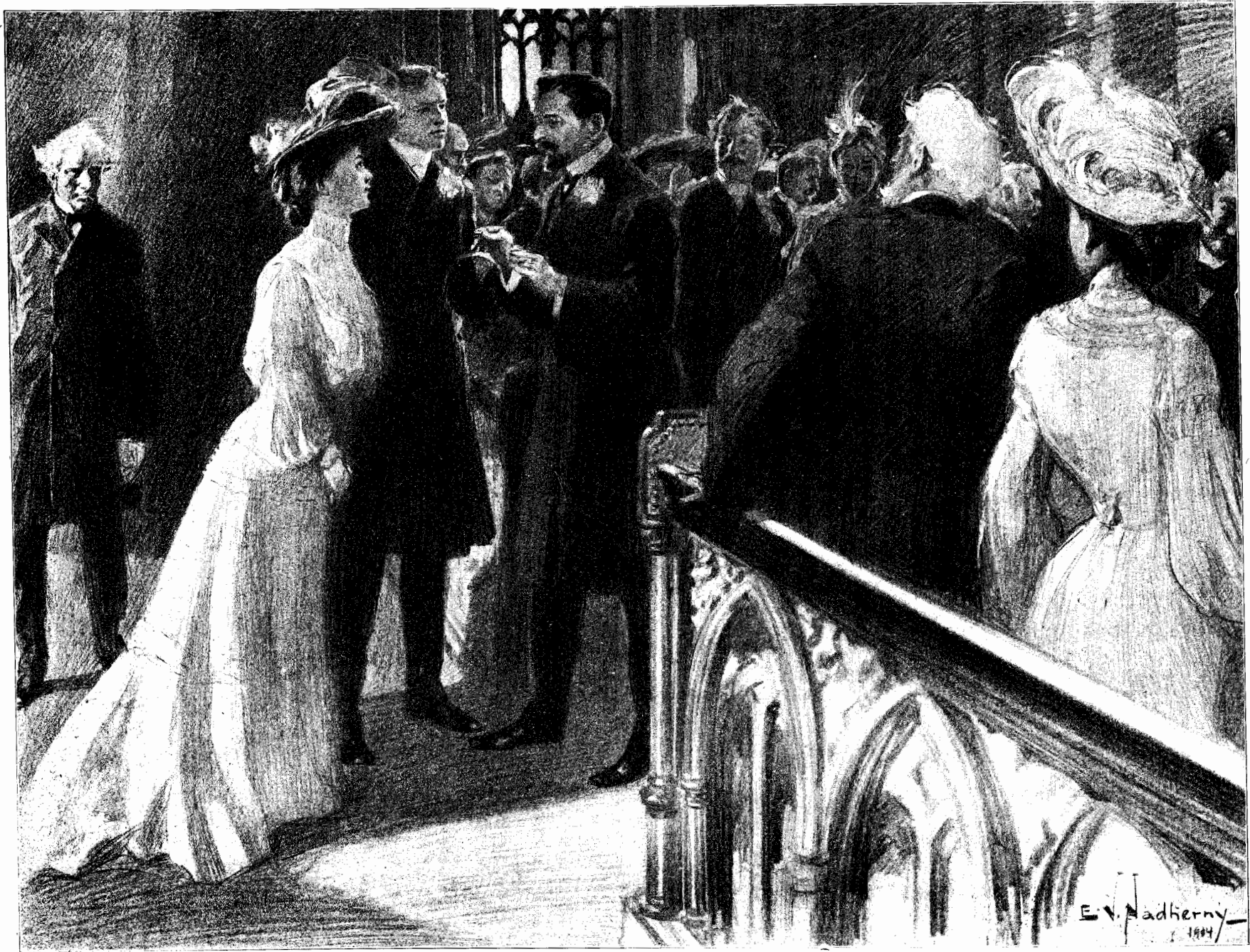

Permission of the New York *Herald*

ILLUSTRATION FOR STORY, "CUPID'S UNDERSTUDY"

Drawn by E. V. NABHERNY

FICTION

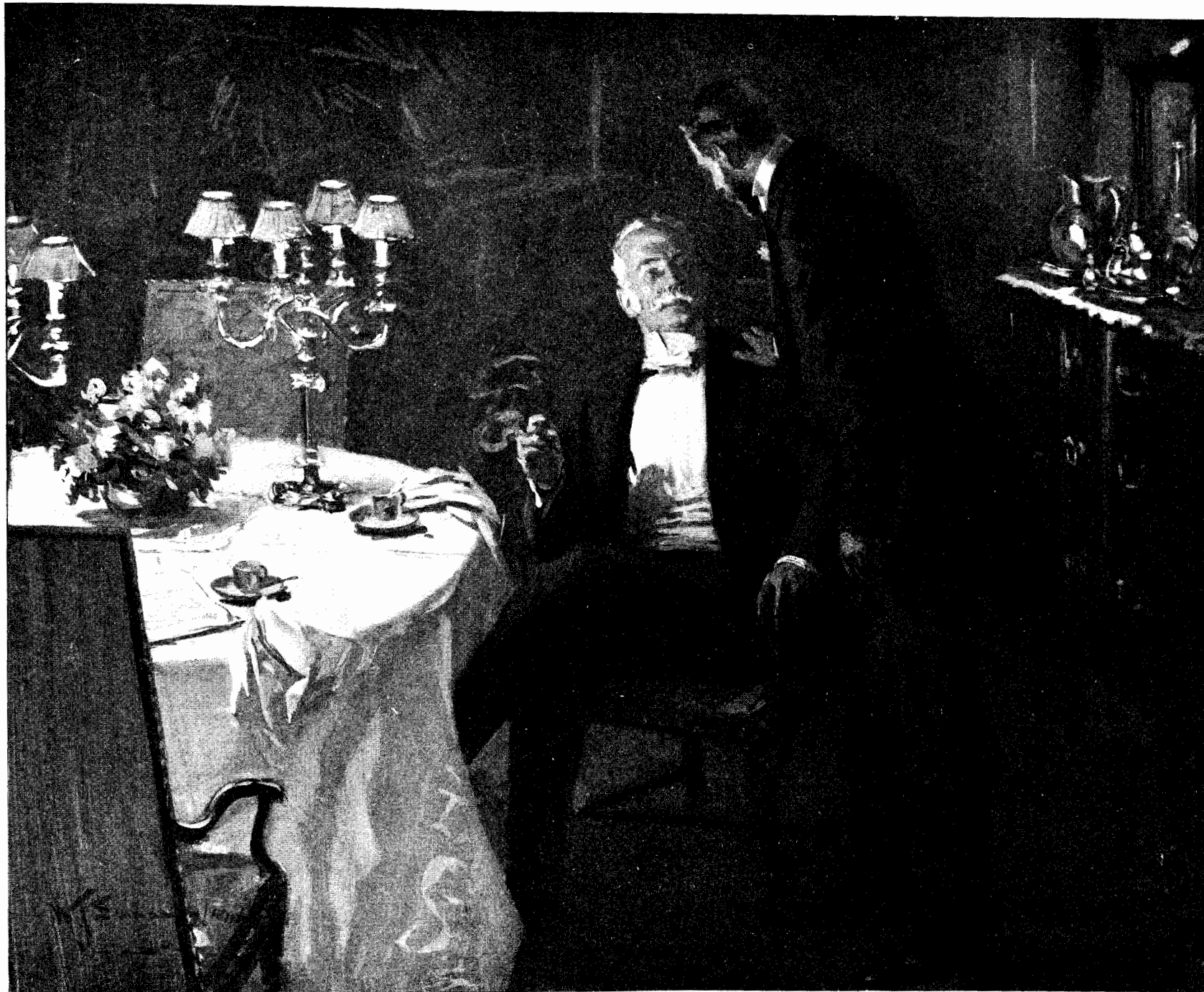

Permission of *Harper's Weekly*

ILLUSTRATION FOR A SERIAL STORY

Drawn by W. T. SMEDLEY

FICTION



Permission of *Harper's Weekly*

HEAD-PIECES FOR A SHORT STORY

Drawn by HOWARD PYLE

FICTION

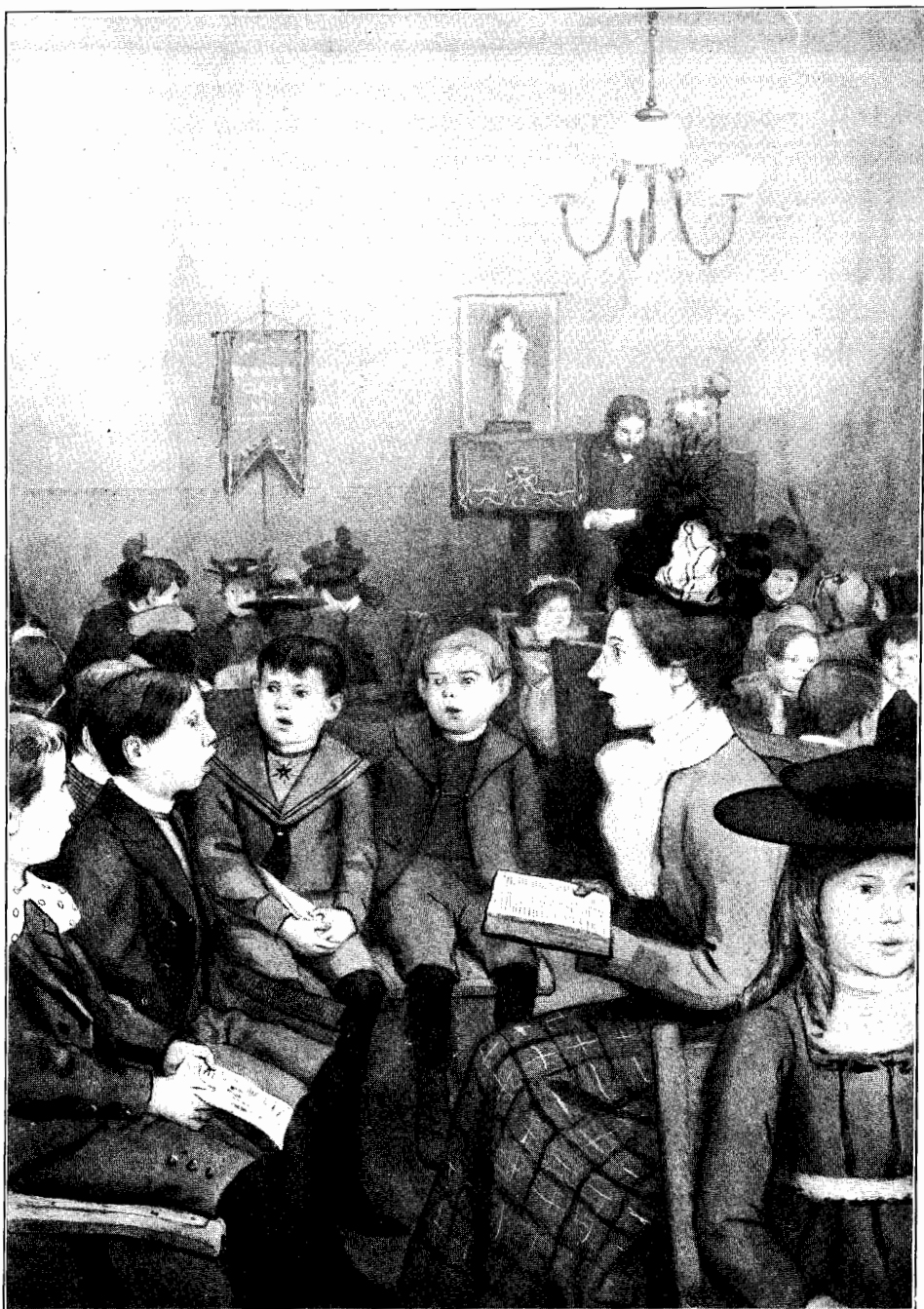

Permission of *Harper's Magazine*

Drawn by PETER NEWELL

ILLUSTRATION FOR A SHORT STORY

FICTION

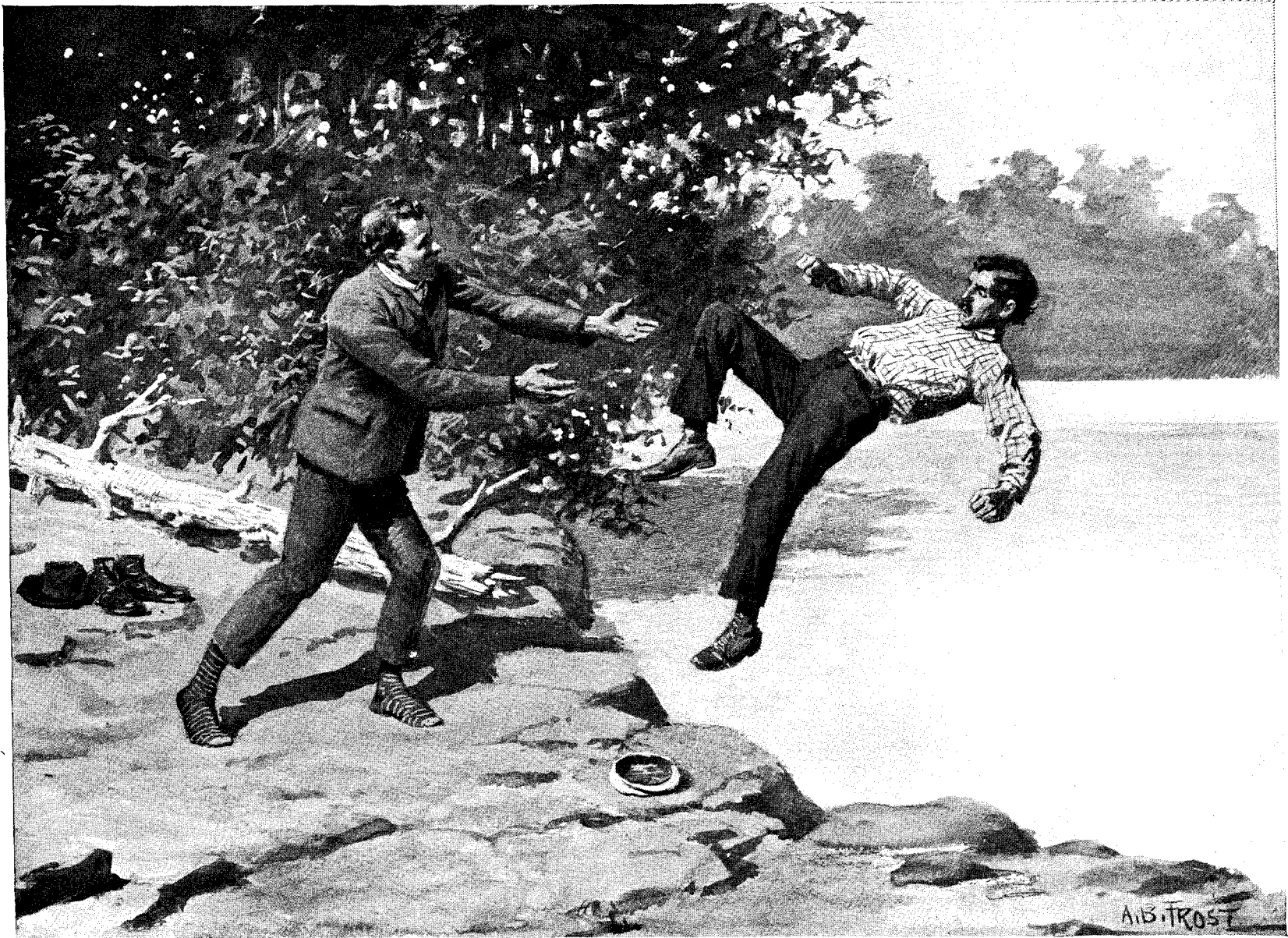

Permission of *Harper's Weekly*

ILLUSTRATION FOR A SERIAL STORY

Drawn by A. B. FROST

FICTION



Permission of *Harper's Weekly*

ILLUSTRATION FOR A SHORT STORY

Drawn by W. H. HYDE

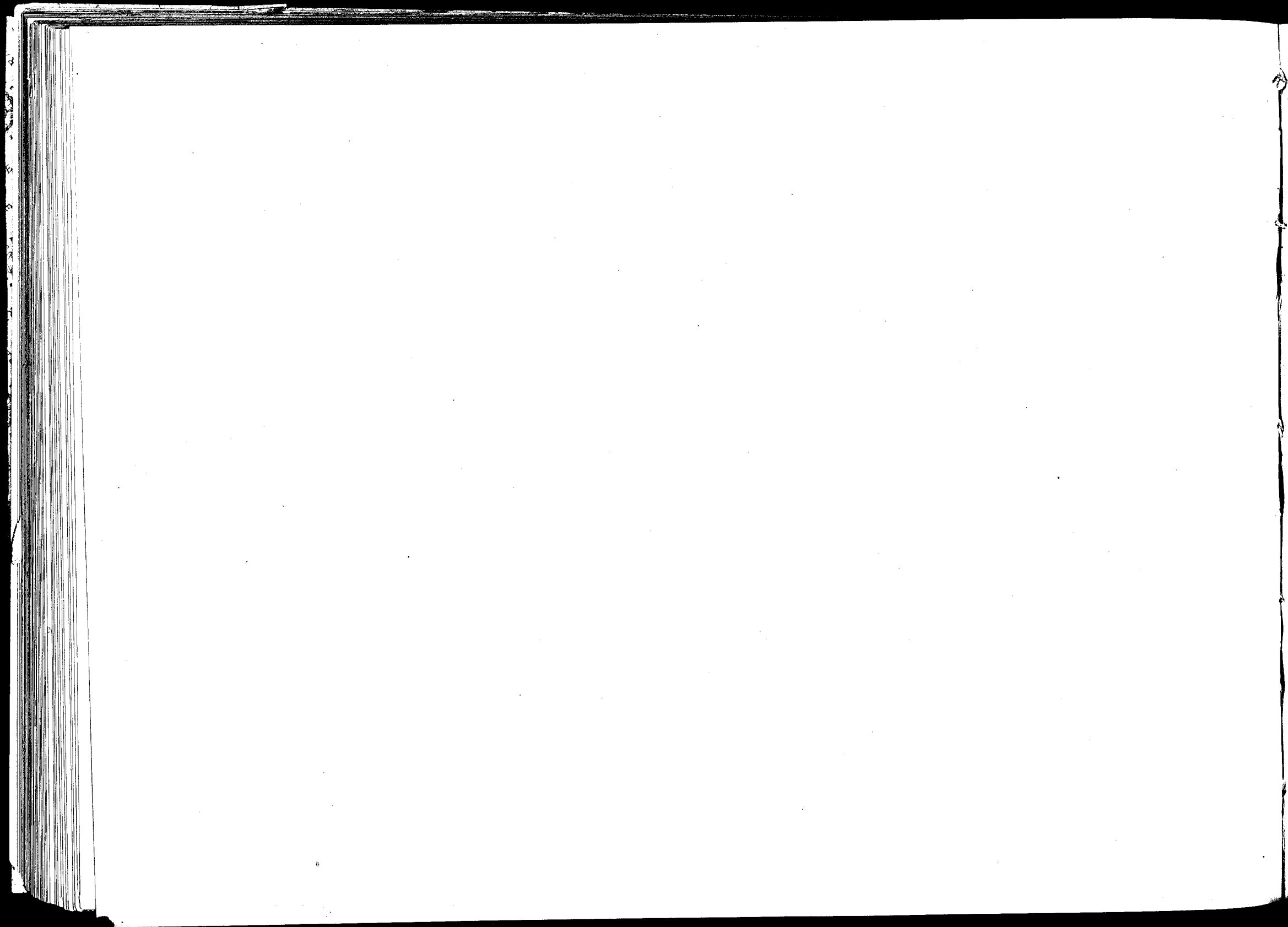

CARTOONS

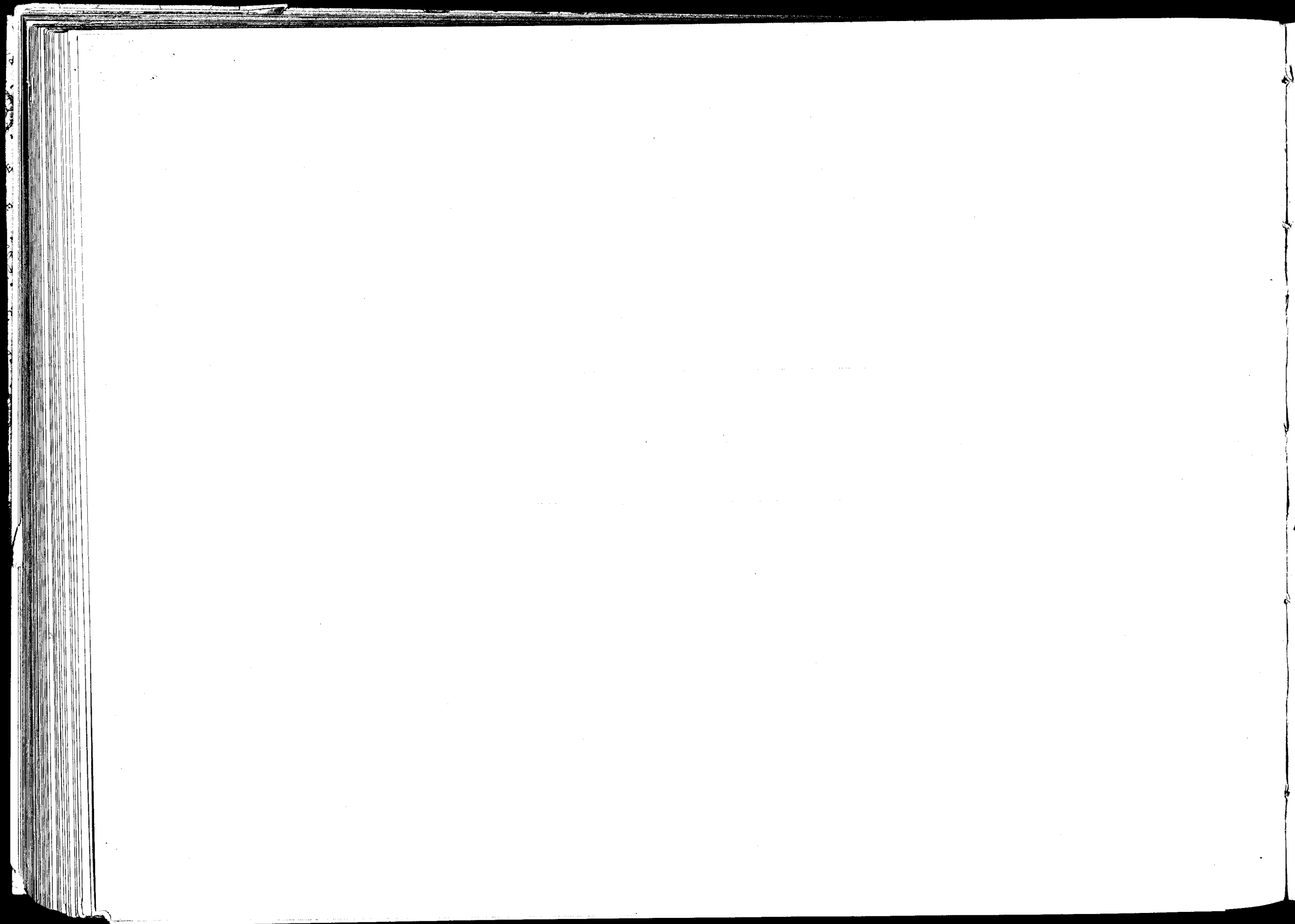

CARTOONS



Permission of the New York World

WE'VE HAD A ——— OF A TIME

Drawn by C. G. Bush

CARTOONS



Permission of Harper's Weekly

A CRITICAL MOMENT

Drawn by W. A. ROGERS

CARTOONS



Permission of the *Critic*

Drawn by C. DE FORNARO

CARTOONS



Permission of the New York Globe

Drawn by CH. NELAN

UNCLE SAM—"WE HAVE NO USE FOR YOU OR YOUR IMPLEMENTS"

CARTOONS



H. COULTAUS

Permission of the New York Evening Telegram

Drawn by H. COULTAUS

A PROMISING FLIRTATION

CARTOONS

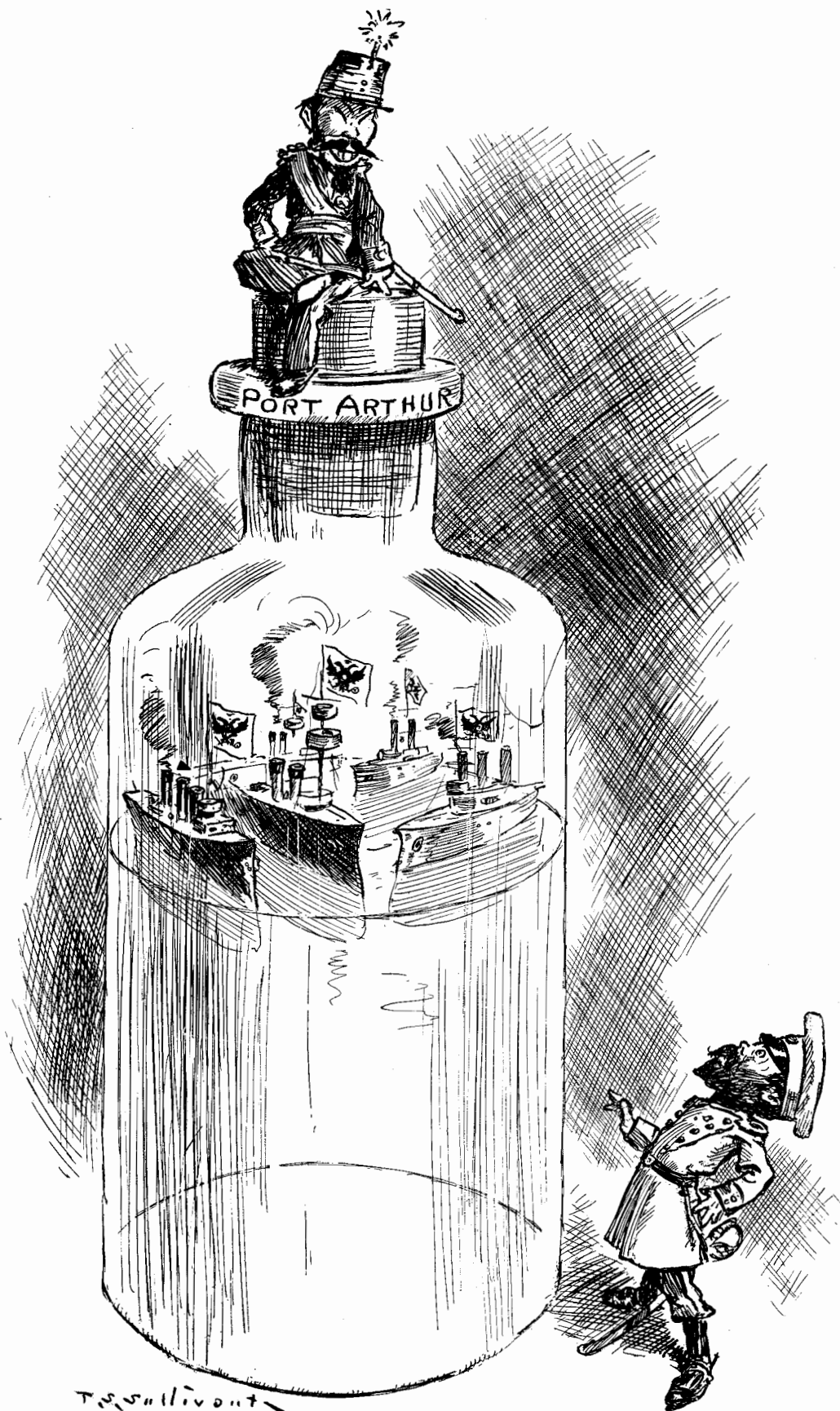

T. S. Sullivant

Permission of the New York American

WANTED, A CORKSCREW, APPLY TO NICHOLAS, ST. PETERSBURG

Drawn by T. S. SULLIVANT

CARTOONS



Permission of the New York American

THOMAS B. REED

Drawn by HOMER DAVENPORT

CARTOONS



F. T. RICHARDS

Permission of the New York Mail

WILLIAM J.—“GREAT KANSAS CITY! I THOUGHT I WAS THE ONLY 16 TO 1 MAN IN EXISTENCE”

Drawn by F. T. RICHARDS

CARTOONS

POPULAR PLAYS FOR THE PEOPLE—TEN NIGHTS IN A BAR-ROOM



Permission of the New York American

"FATHER, DEAR FATHER, COME HOME!"

Drawn by F. OPPER

CARTOONS



By Permission

PRESIDENT BENJAMIN HARRISON

Drawn by C. S. RIGBY

CARTOONS

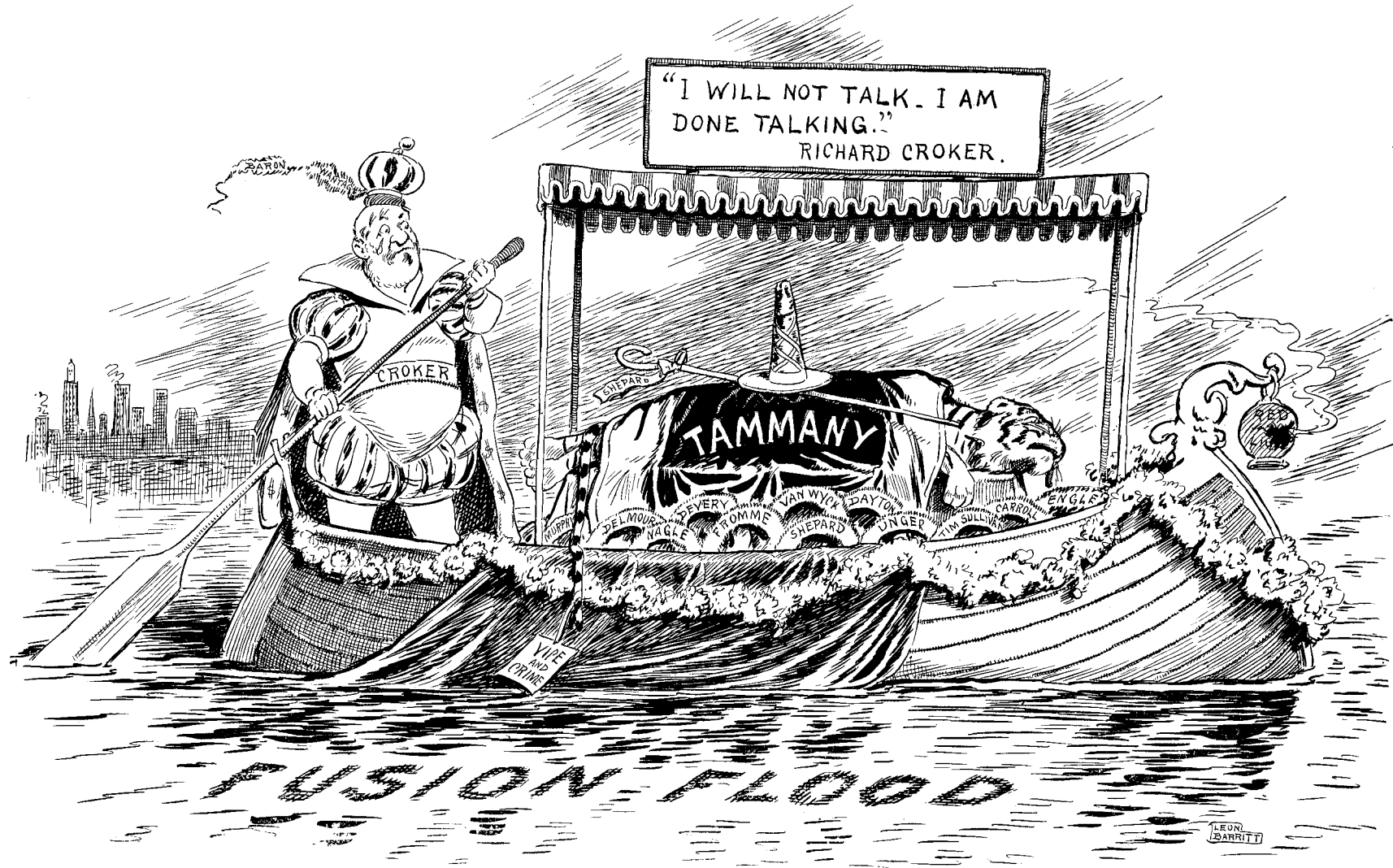

Permission of the New York Tribune

Drawn by LEON BARRITT

"Then rose the dumb old servitor,
And the dead steered by the dumb,
Went upward with the flood."
Tennyson's "Launcelot and Elaine"

CARTOONS

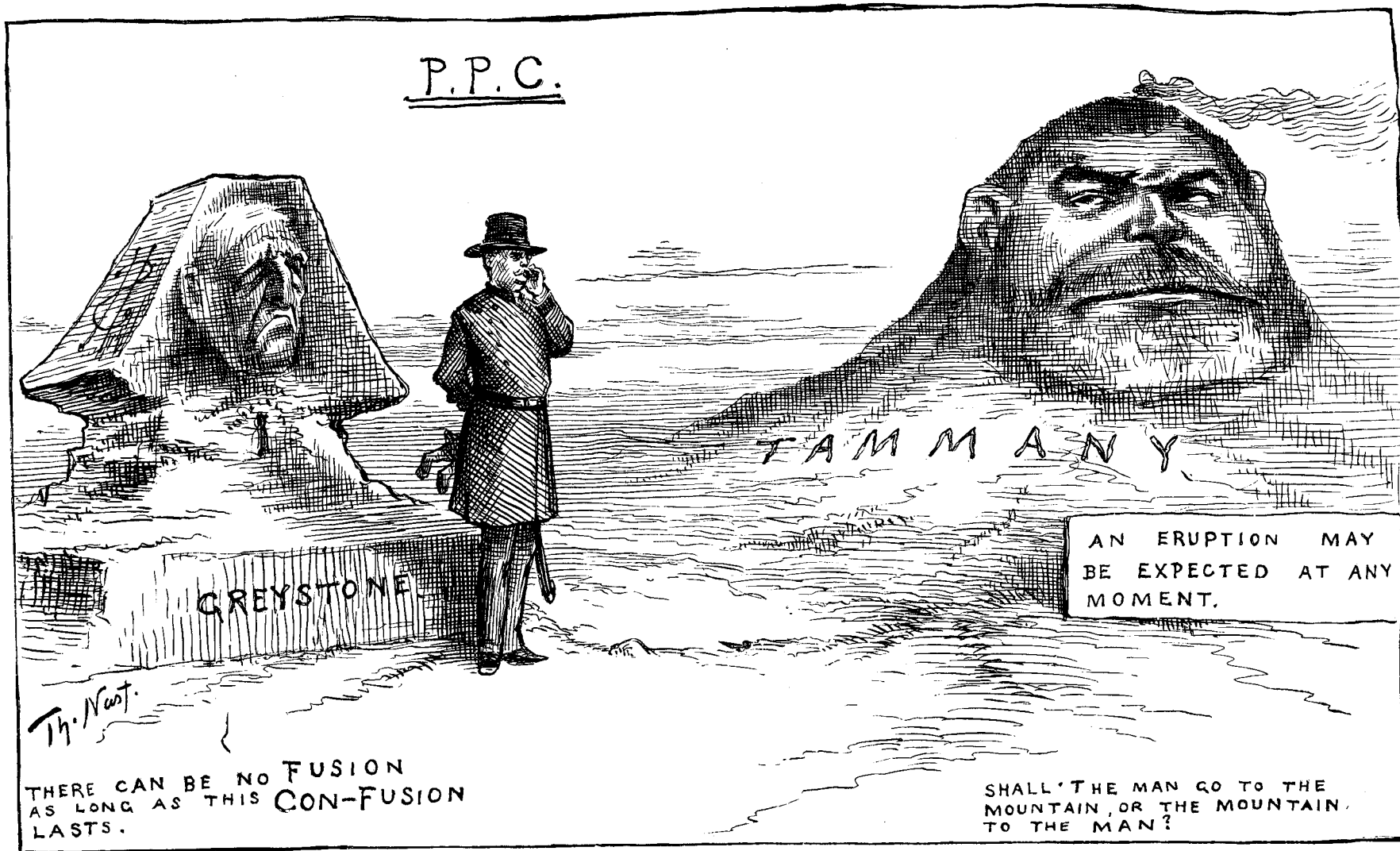

Permission of *Harper's Weekly*
DRAWN BY THOMAS NAST
SHOWING GENERAL HANCOCK, THE DEMOCRATIC CANDIDATE FOR PRESIDENT IN 1880, STANDING BEFORE THE GREYSTONE SPHINX (TILDEN) AND DEBATING WHETHER TO APPROACH THE TAMMANY MOUNTAIN (JOHN KELLY) OR TO AWAIT THE COMING OF THE MOUNTAIN TO HIM

COMICS

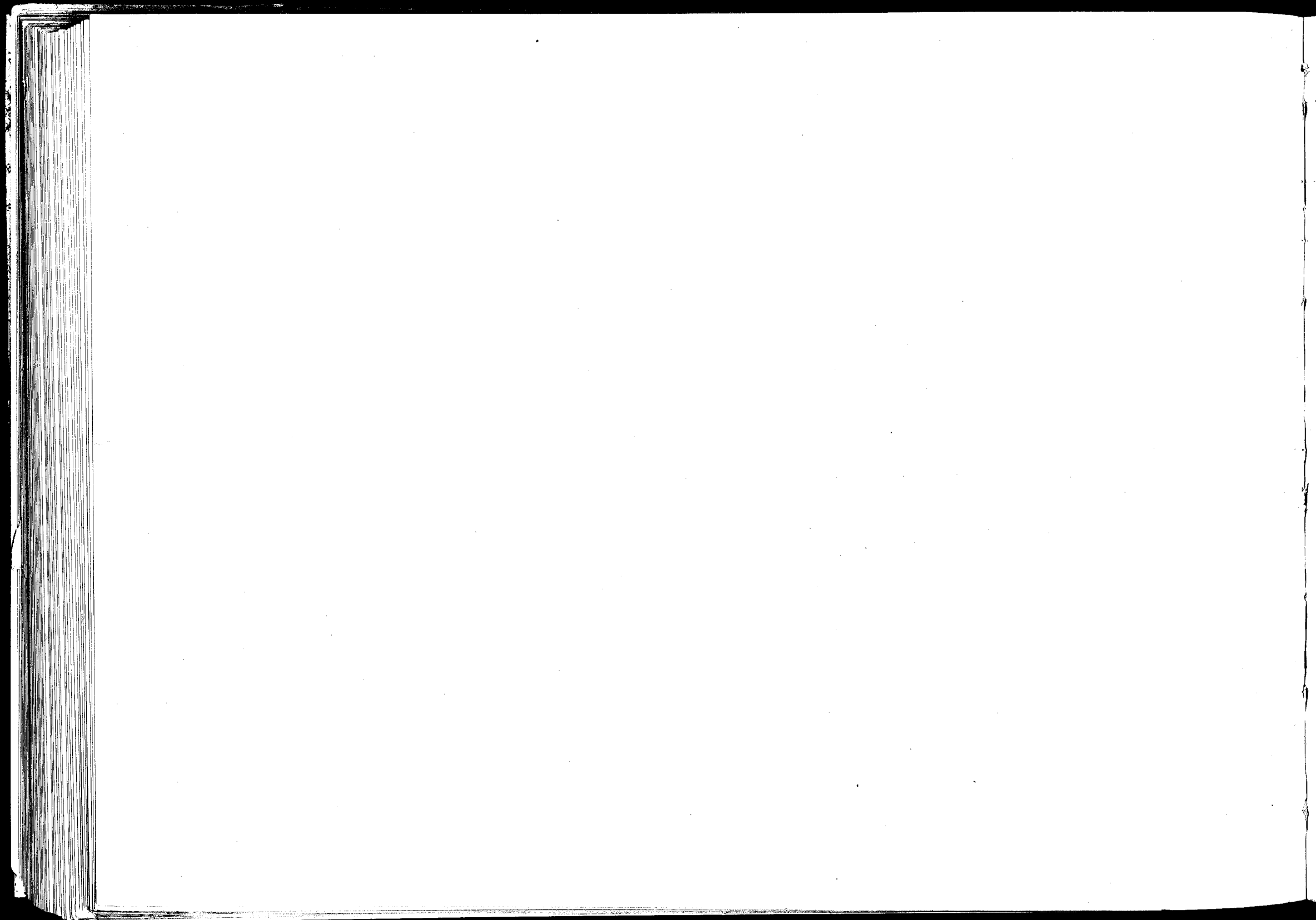

COMICS

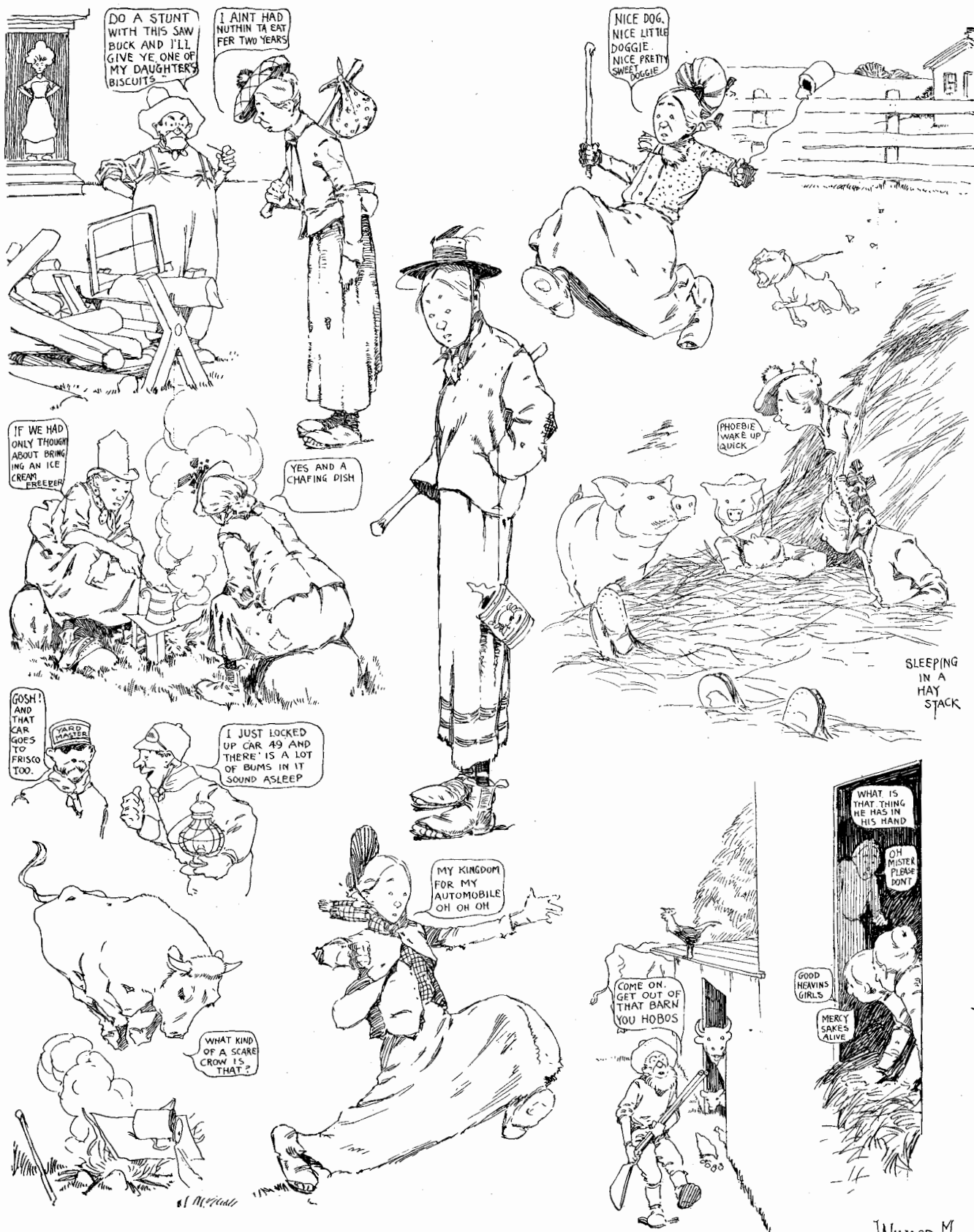

WINSOR McCay

Permission of the New York Herald

Drawn by WINSOR McCay

FASHIONABLE SCHOOL-GIRLS HAVE JOYS OF TRAMP LIFE

COMICS



Permission of the New York Evening World
 Drawn by T. E. POWERS
 MORAL—AN OUNCE OF INVENTION IS WORTH A POUND OF CURE,
 PROVIDING YOU DON'T STRIKE THE BRIDGE CRUSH

COMICS

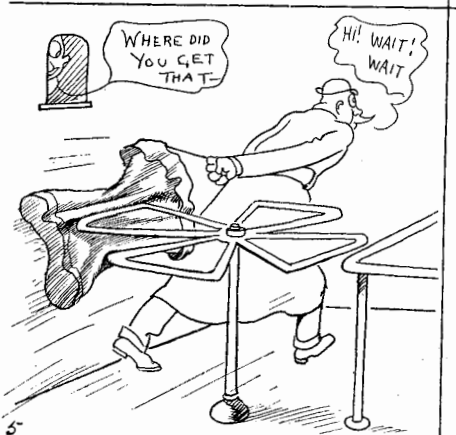
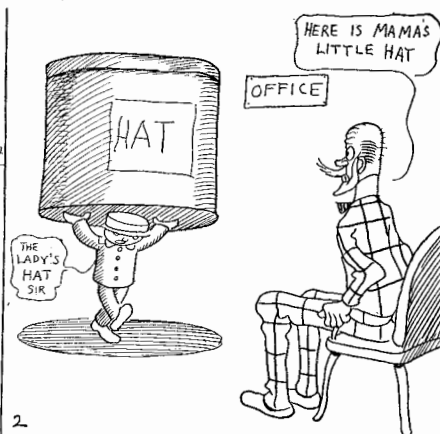

Permission of the New York Evening World
MORAL—DON'T BRING YOUR WIFE'S HAT HOME DURING CRUSH HOURS

T. F. POWERS

COMICS

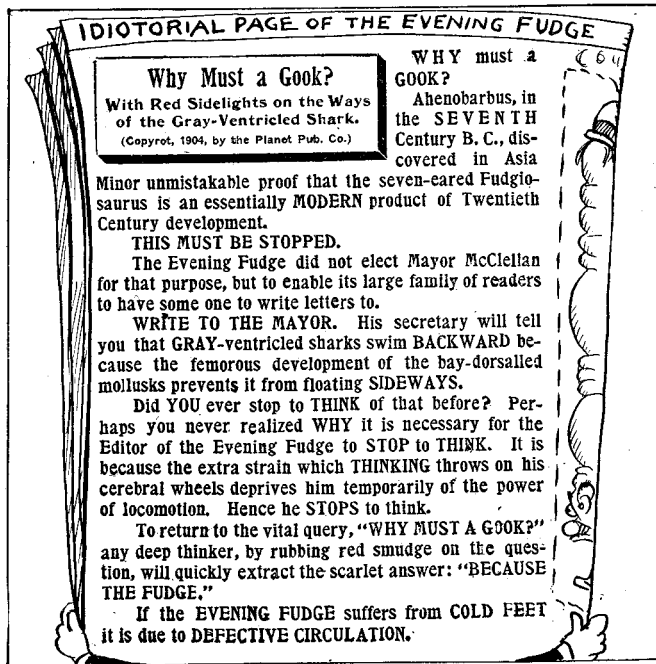
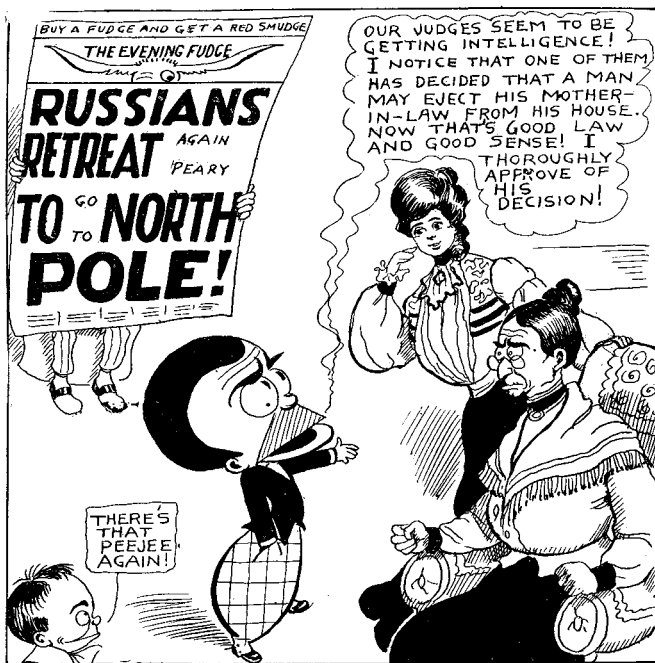

Permission of the New York Evening World

LITTLE MR. PEWEE

Drawn by FERDINAND LONG

COMICS

MCDUGALL'S CHILDREN

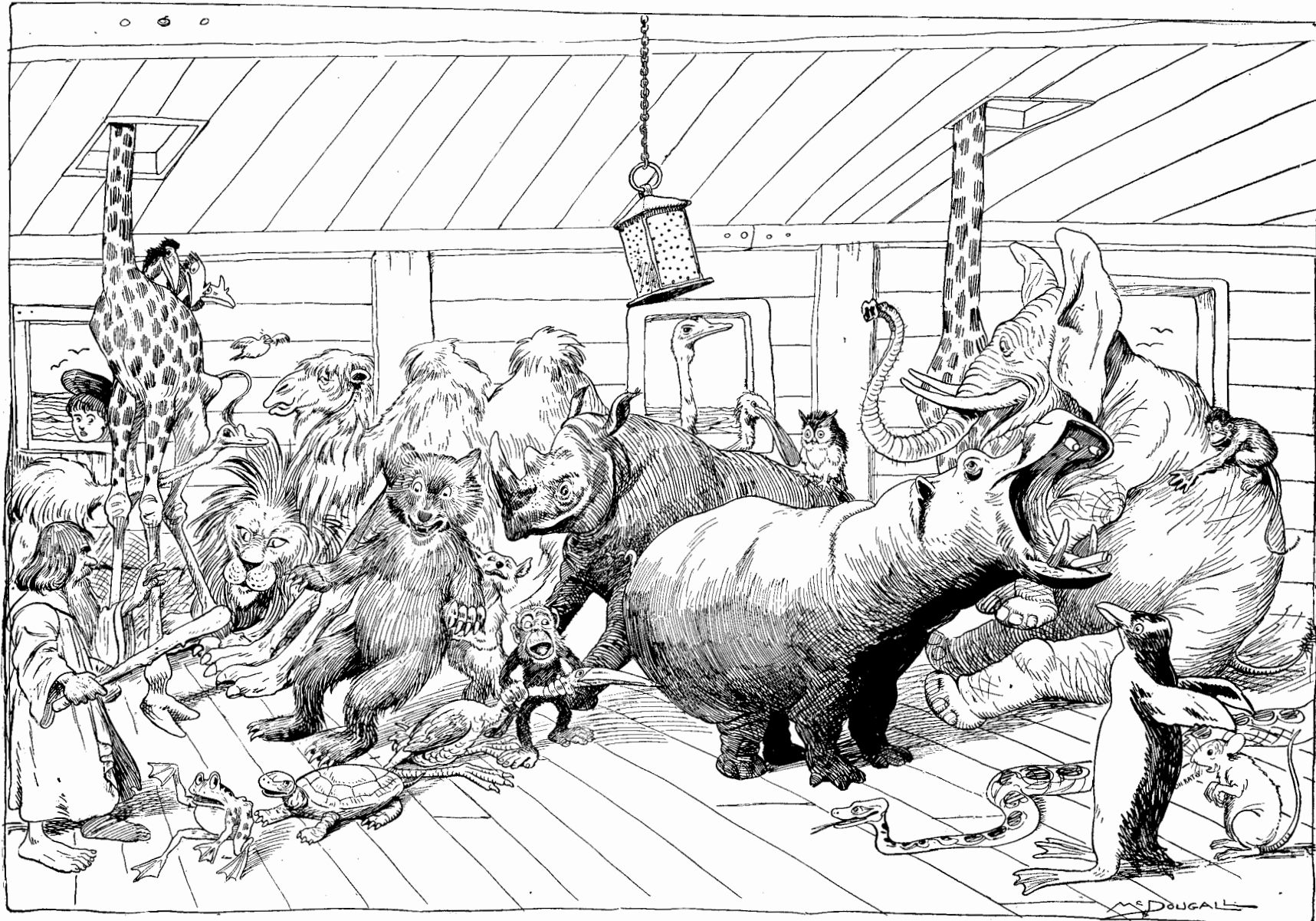

By Permission

THE ANIMALS SLID TOWARDS THE STERN

Drawn by WALT MCDUGALL

COMICS

BUSTER BROWN'S EUROPEAN TRIP.



"WELL, TIGER, I GUESS THE BROWN FAMILY IS GOING TO EUROPE."

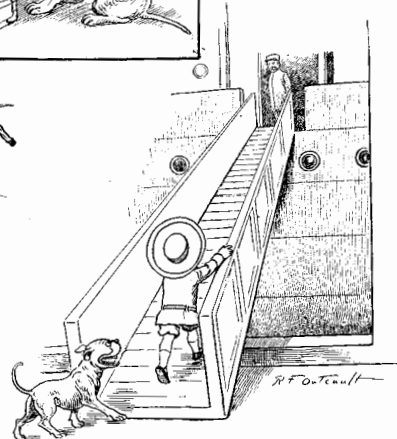
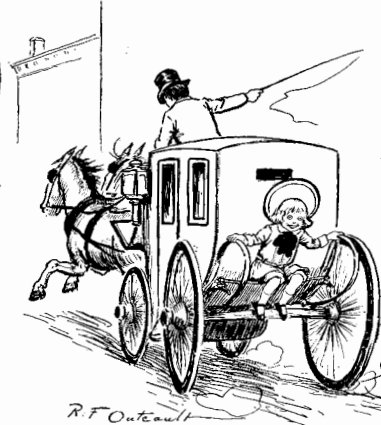
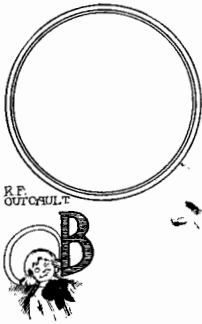

COMICS



Permission of the New York American

NO WONDER THE CAPTAIN DIDN'T FEEL WELL

Drawn by R. DIRKS

COMICS



Permission of the New York American

Drawn by F. OPPEN

HAPPY HOOLIGAN AT WORK AGAIN
He is hired to play the big drum in a German band

COMICS

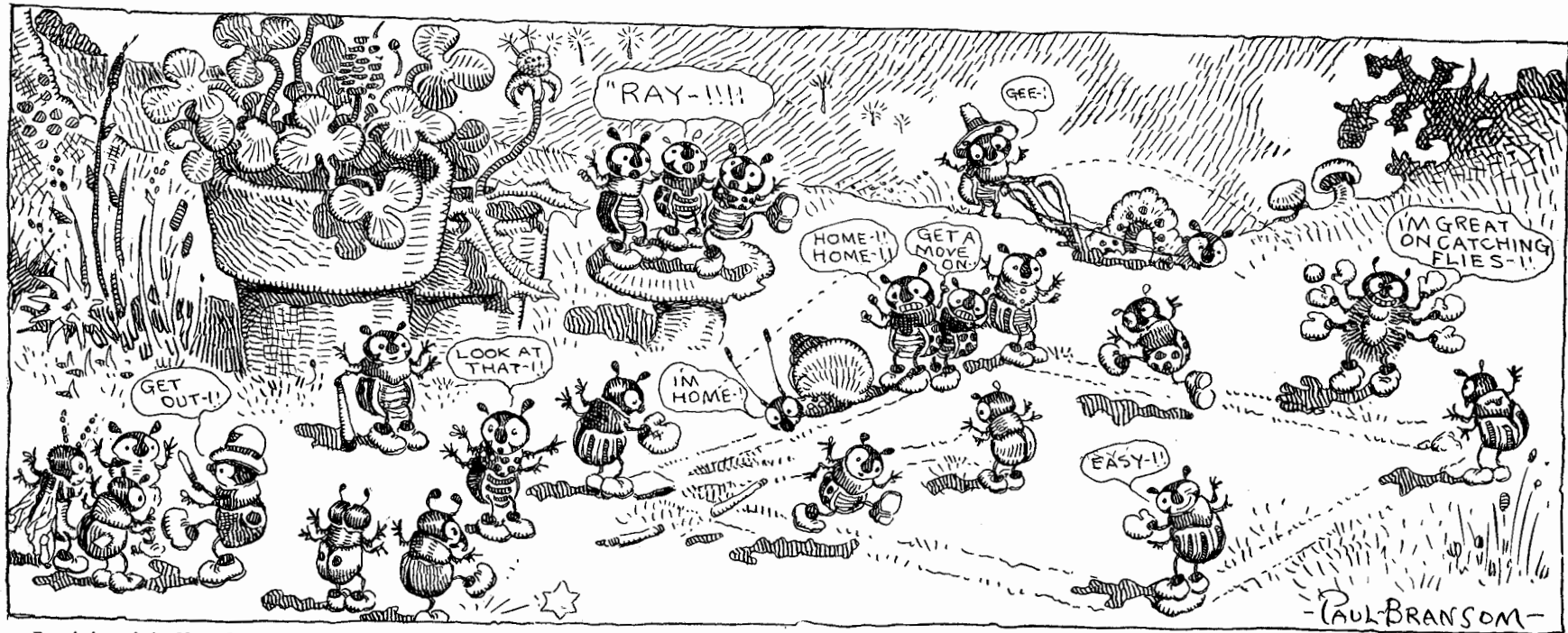

Permission of the New York Evening Journal

A BALL GAME IN BUGVILLE

Drawn by PAUL BRANSON

L. of G.

COMICS



1

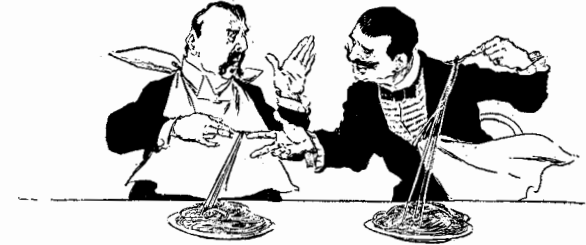

2

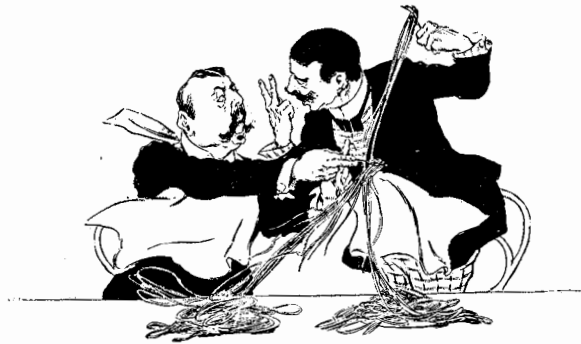

3



4

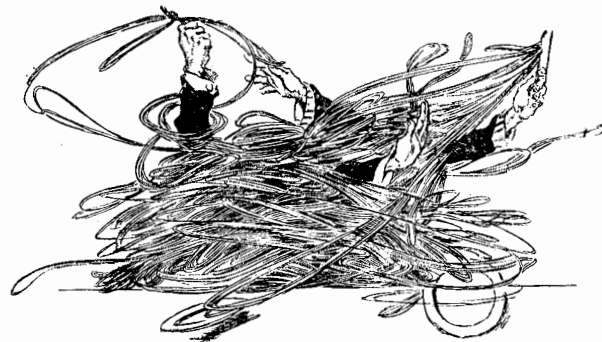

5

Permission of *Life*

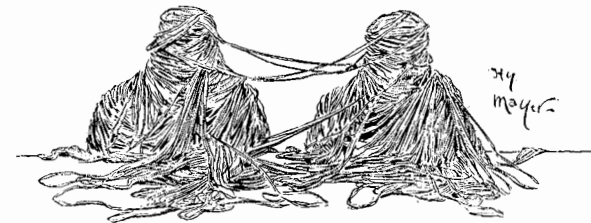

6

Drawn by HY MAYER

SPAGHETTI AND GESTICULATION
A tale of an Italian dinner

THE KID-PAPA GETS HIM A NEW VELOCIPÈDE.

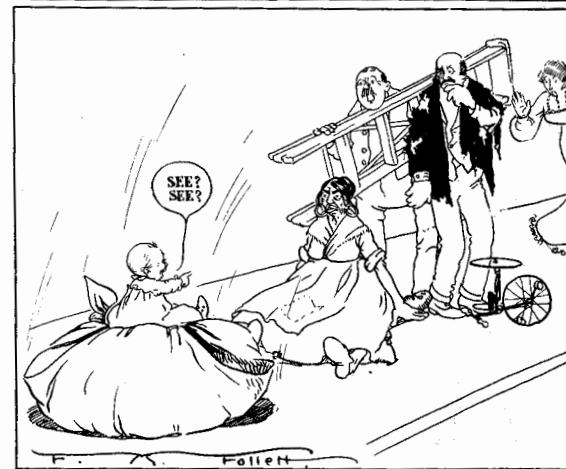
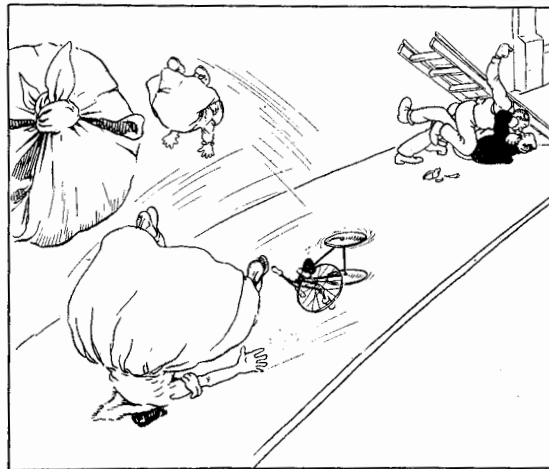
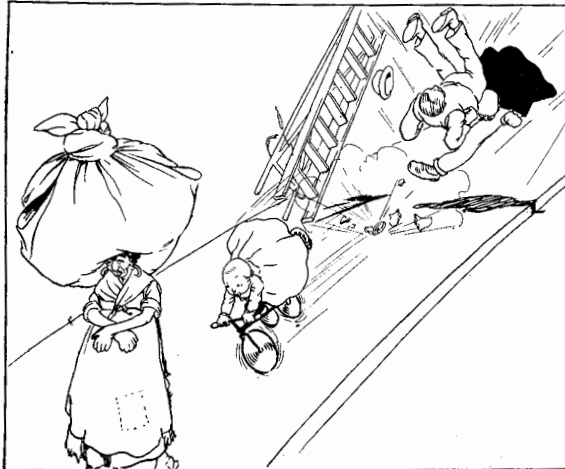
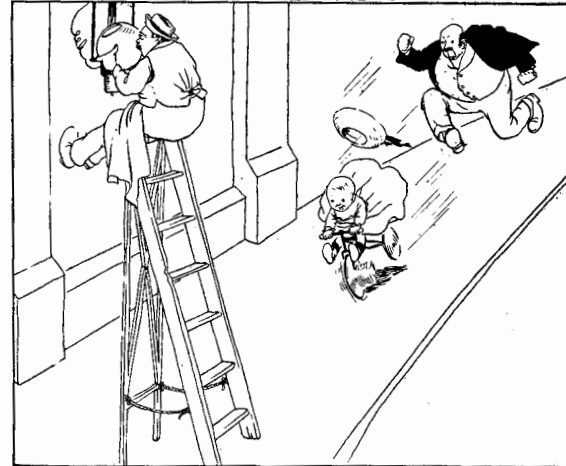
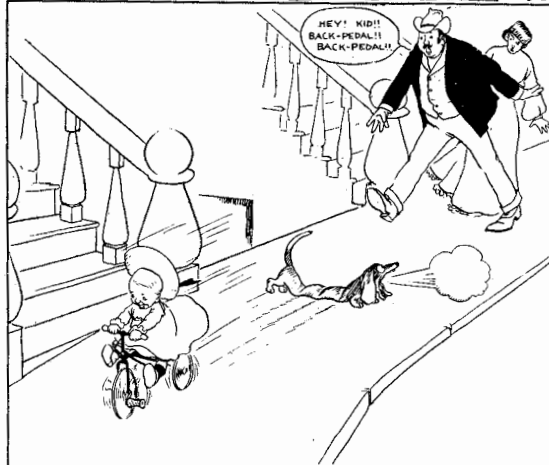
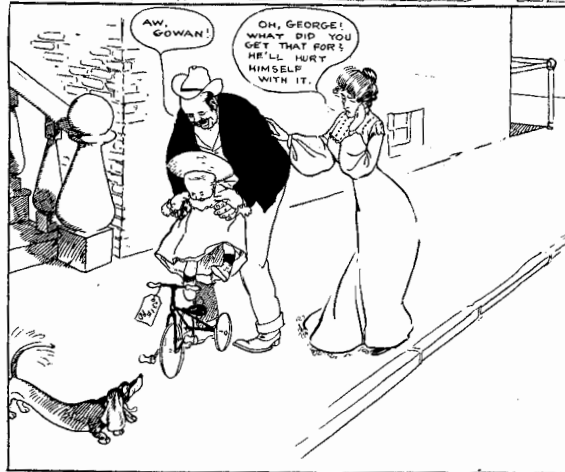

Permission of the New York World

Drawn by F. M. FOLLETT

FOXY GRANDPA

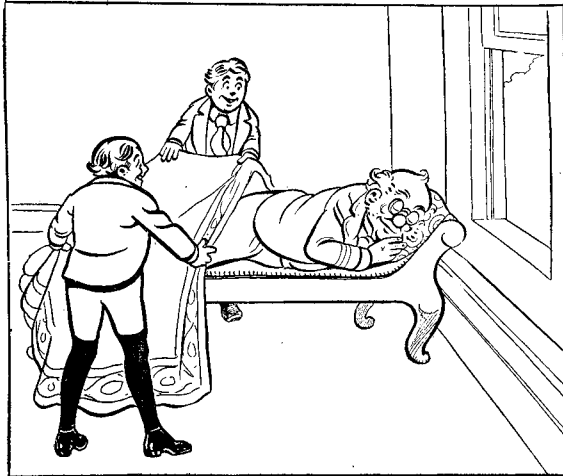

1. Boys—Grandpa's napping again; we are in luck; let's cover him with the rug.

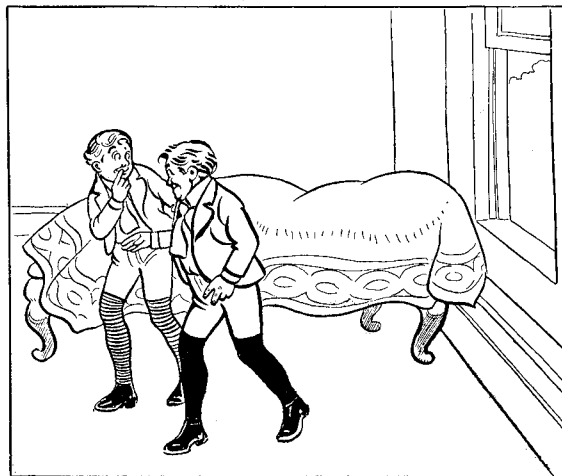

2. Boys—Now for a few more things to pile on

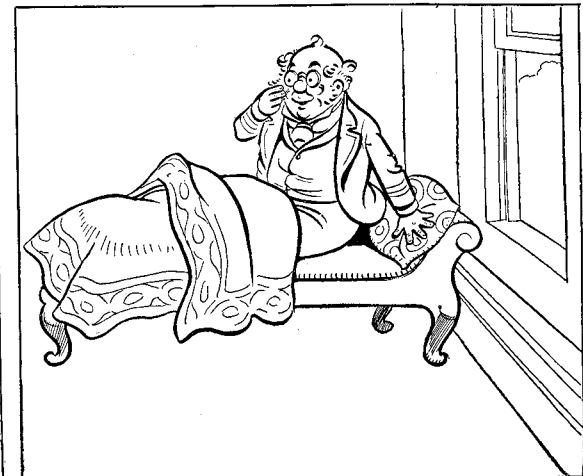

3. GRANDPA—Well, now, those boys must think me easily caught.



Permission of the New York American

4. Boys—Oh, say, this is too easy; pile them on gently.

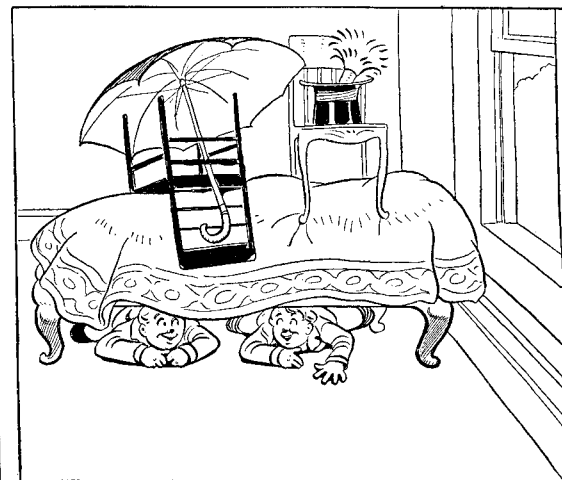

5. Boys—Now what a row there will be when grandpa awakens.

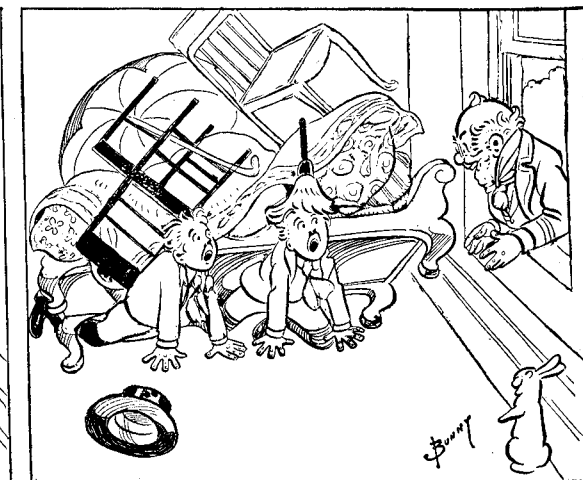

6. GRANDPA—Hello, boys! What are you doing under that sofa? Come out and let's have a little fun.

Drawn by CARL SHULTZE

PANHANDLE PETE AND THE GRATEFUL GOAT.

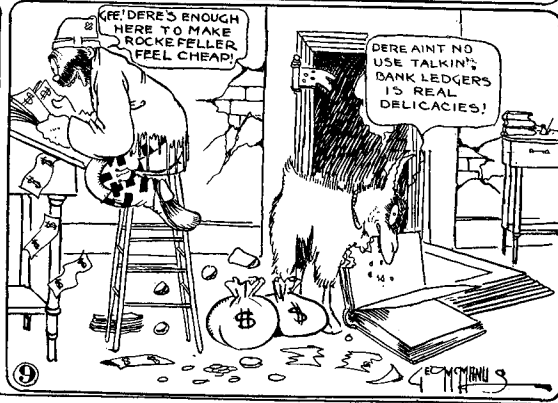
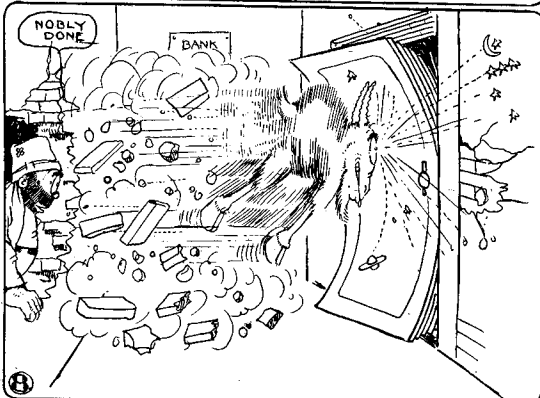
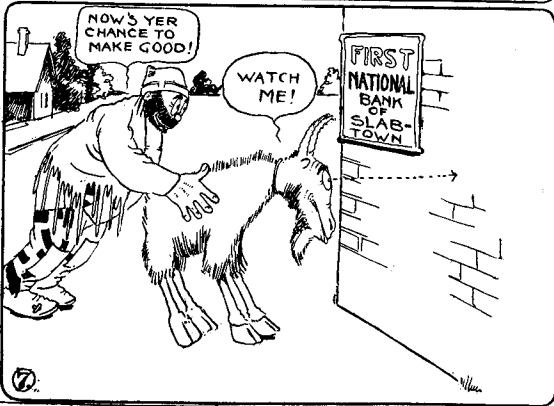
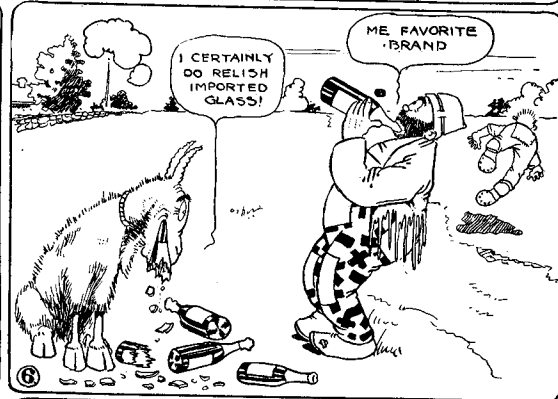
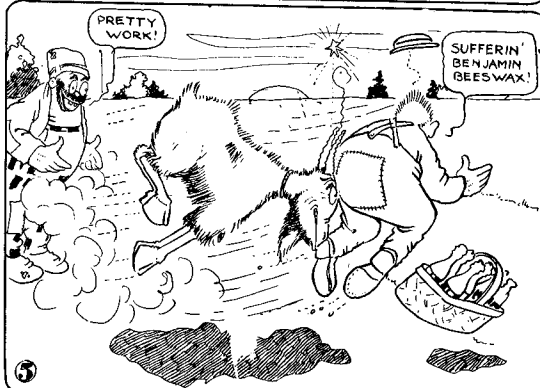
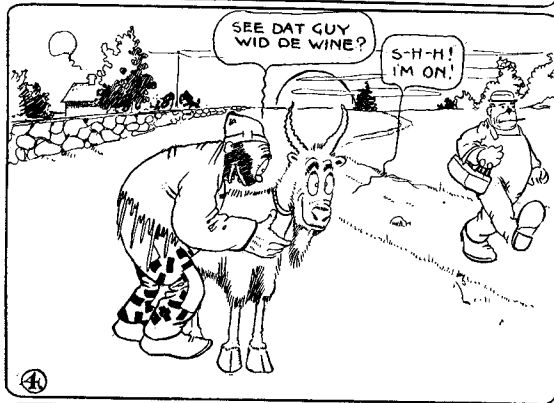
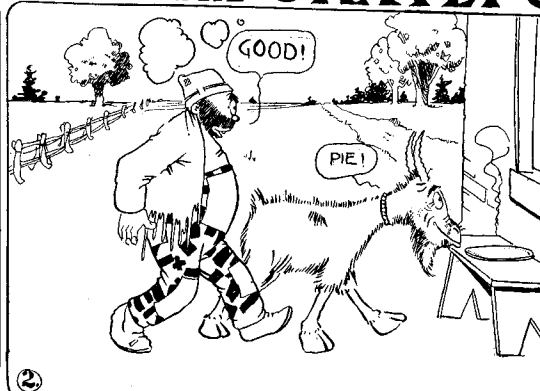

Permission of the New York World

Drawn by GEORGE McMANUS

LADY BOUNTIFUL'S WINSOME WILLIE TELLS OF WILLIAM TELL - by Gene Carr.

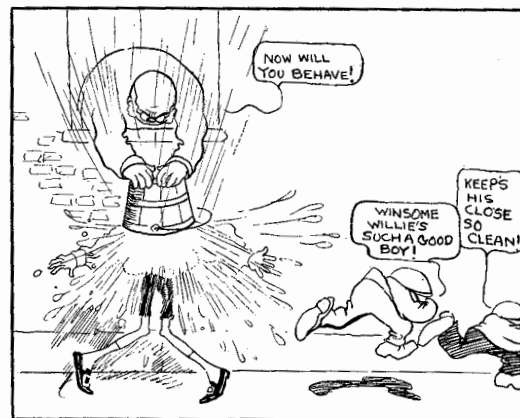
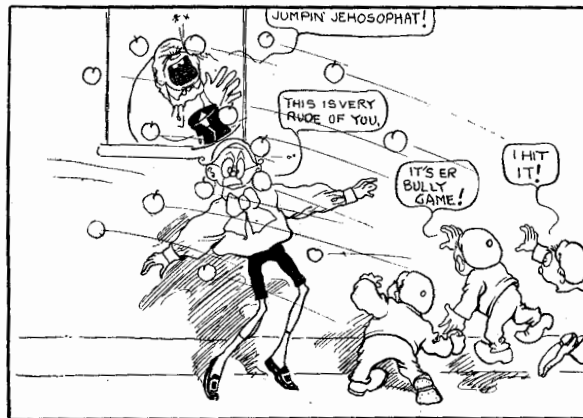
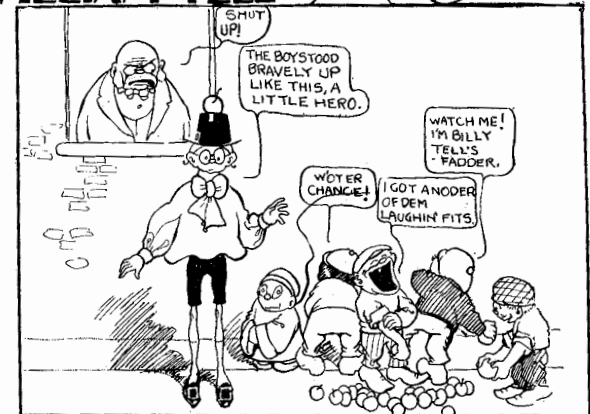
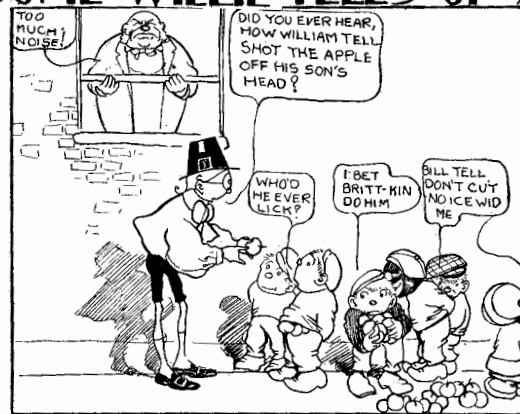
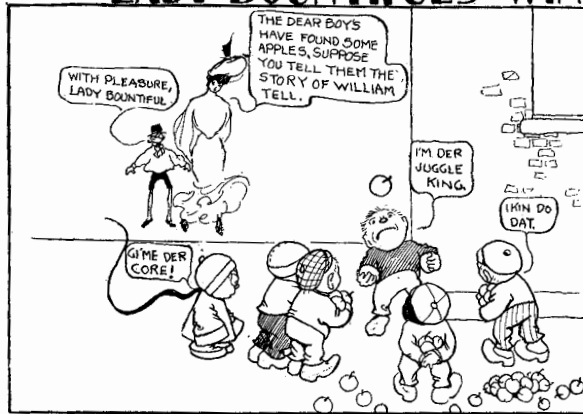

Permission of the New York World

Drawn by GENE CARR

COMICS

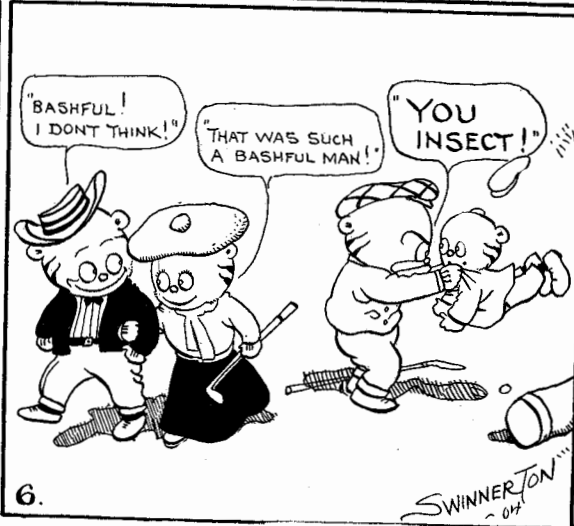
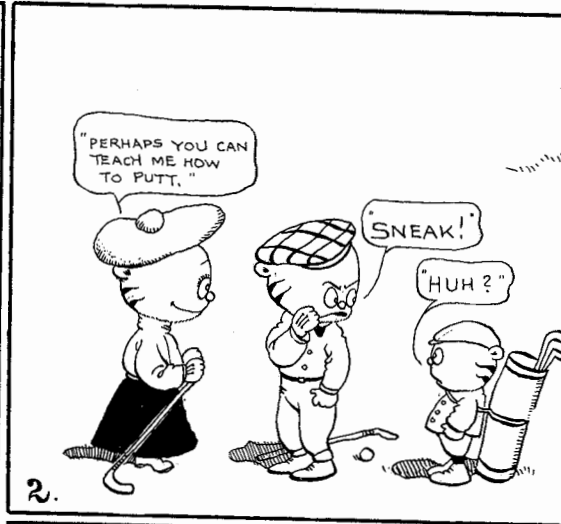
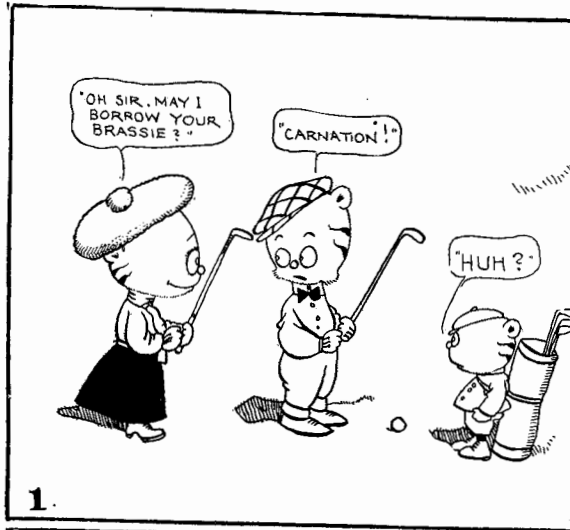

Permission of the New York American

MR. JACK—HE TRIES TO LOSE HIS CADDIE

Drawn by JAMES SWINNERTON

COMICS



1. BREATHLESS STRANGER—Say, mister, a murder has been committed in that first house around the corner. Hunt a policeman. I'm going for a doctor.

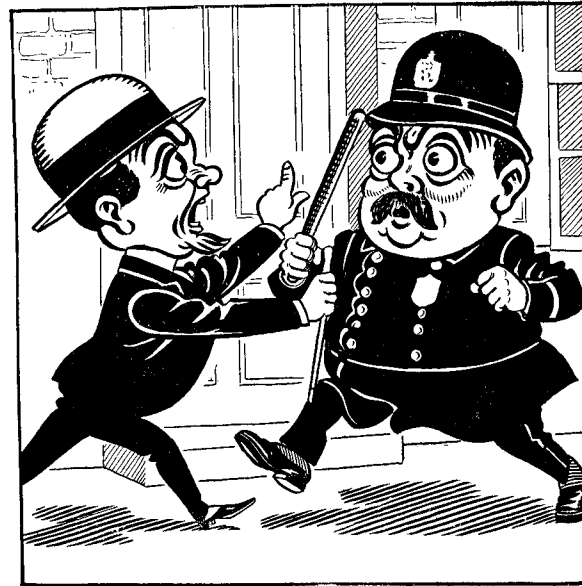

2. MR. E. Z.—You are just in time, Mr. Policeman. A murder has been committed in this house.
POLICEMAN—Gee! I was chasin' Nimble Finger Nick, the pickpocket; but a murder is of more importance.



3. LONE FEMALE (answering policeman's summons)—G'lang with you. There's been no murder committed in this house. I'm the only person who lives here, and I'm pretty much alive I guess. Some one's been playin' a joke on you, officer.



Drawn by F. M. HOWARTH

4. Come on, now. I see it all. You're a pal of Nimble Finger Nick. You invented that murder story to throw me off the chasc, that's what. All right; tell that to the captain. You don't fool with me the second time.

RD 156

COMICS

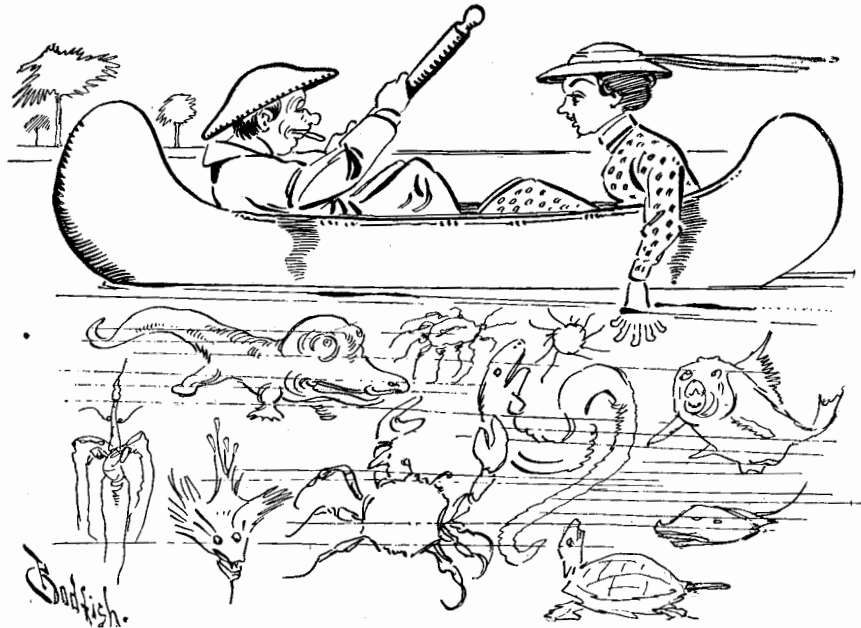

By Permission

Drawn by W. P. BODFISH

SHE—INDEED, I DO ENJOY BEING AWAY FROM ALL THOSE CREEPING, CRAWLING THINGS ON SHORE



By Permission

Drawn by WM. MARRINER

WHY SO CAST DOWN

KING UGLI-MUGG—I've just learned that one of the missionaries has died of the fever, and I'm afraid those we've eaten may have contracted the disease.



Permission of the New York Evening Journal

Drawn by T. S. ALLEN

ALLEN'S KIDS

See here, men, dis loidy has promised to be yer captain's bride, and I want yer ter swear to serve her wid yer life's blood same as me.

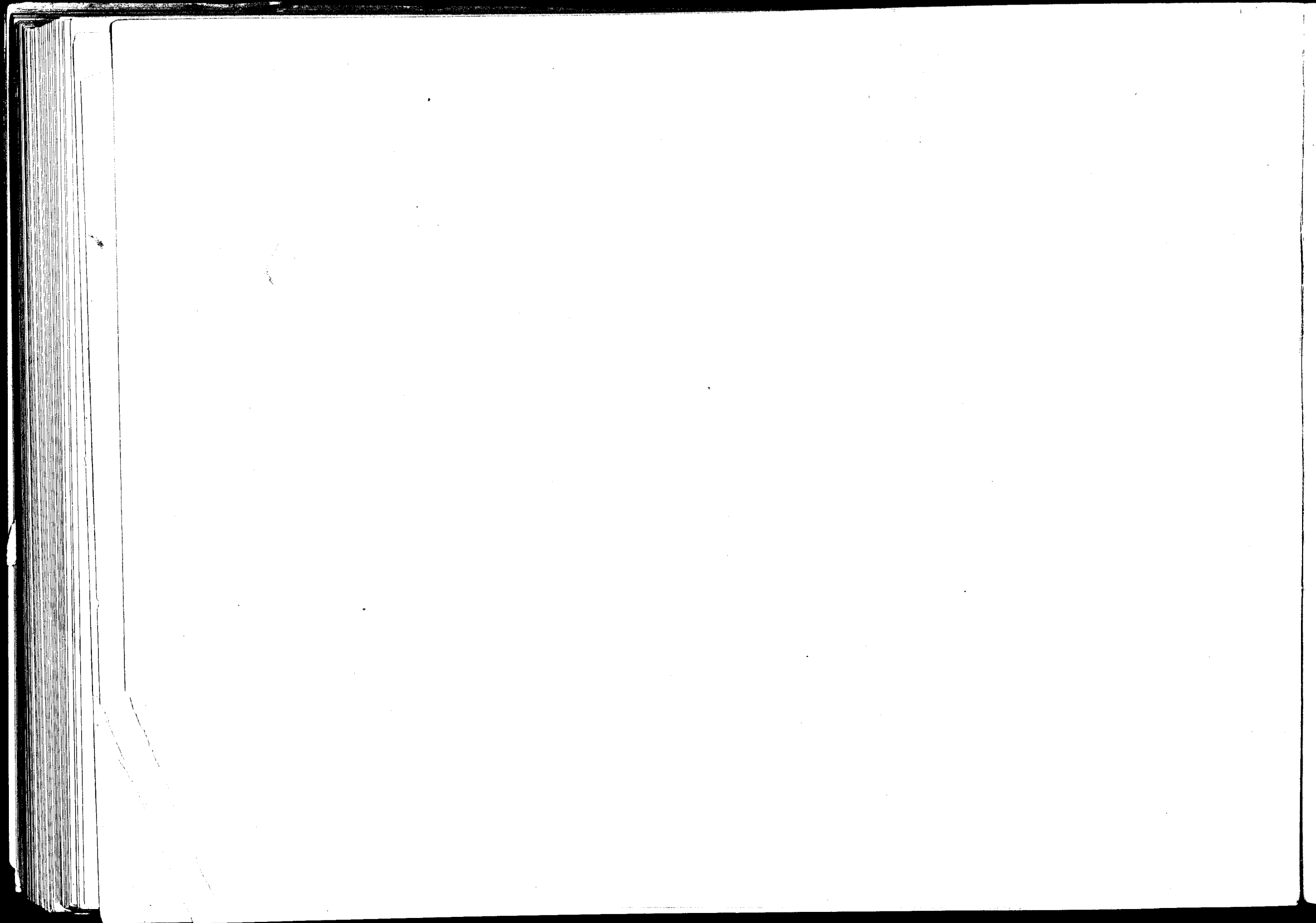

THE LIBRARY OF THE U.S. CONGRESS

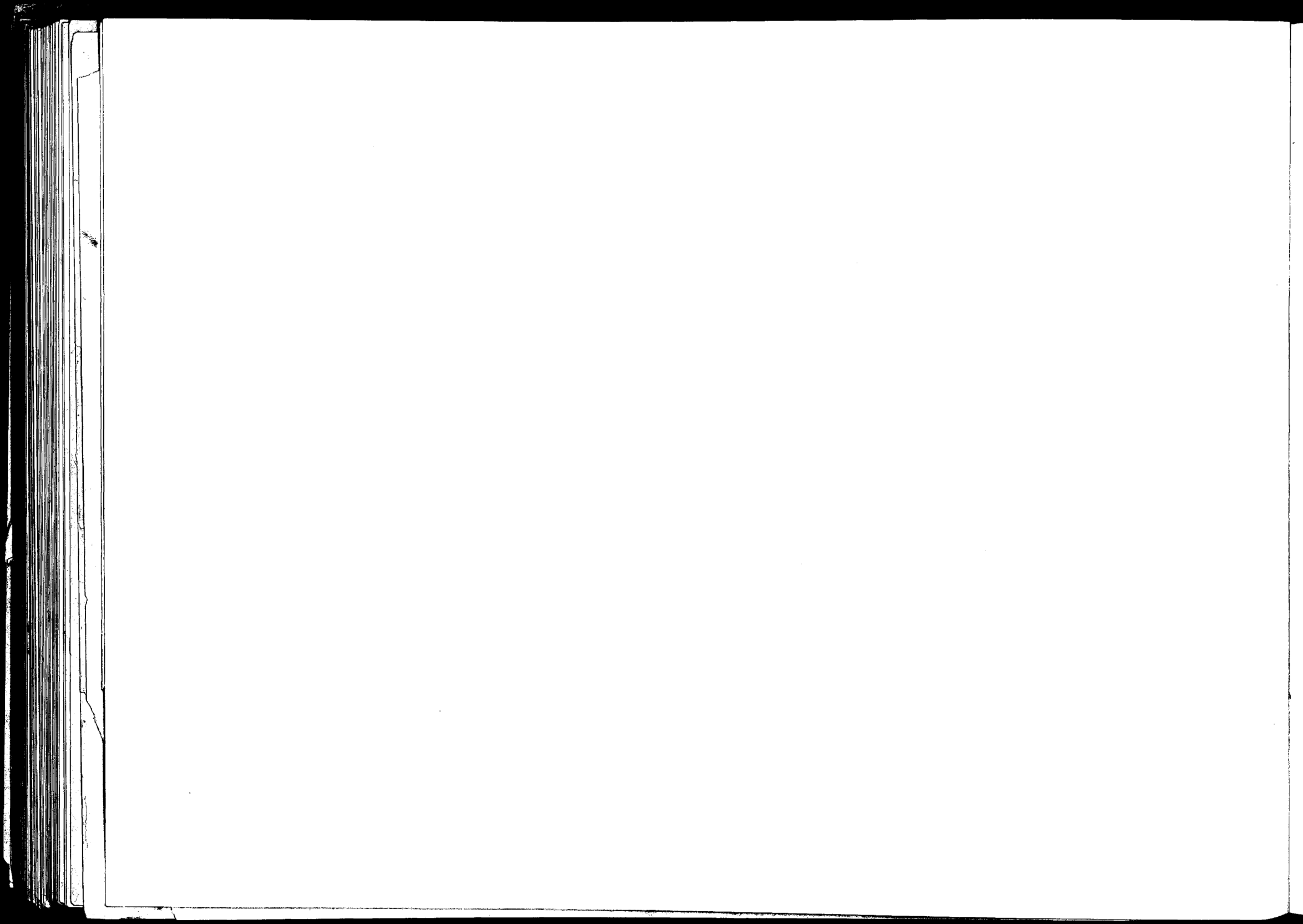

LIBRARY OF THE U.S. CONGRESS
PHOTODUPLICATION SERVICE
5101 MARSHFIELD DRIVE
FISHERS, N.C. 27834

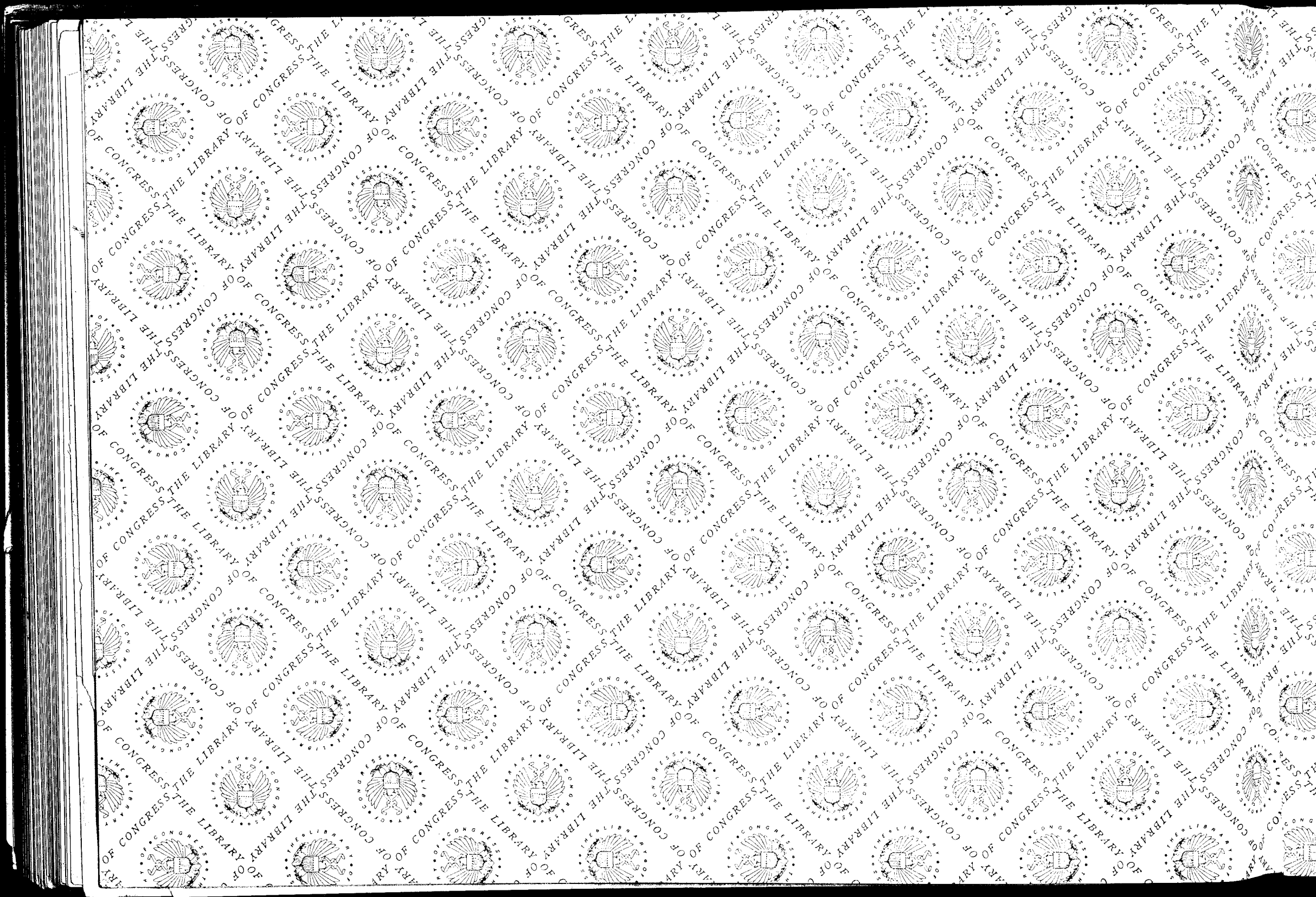

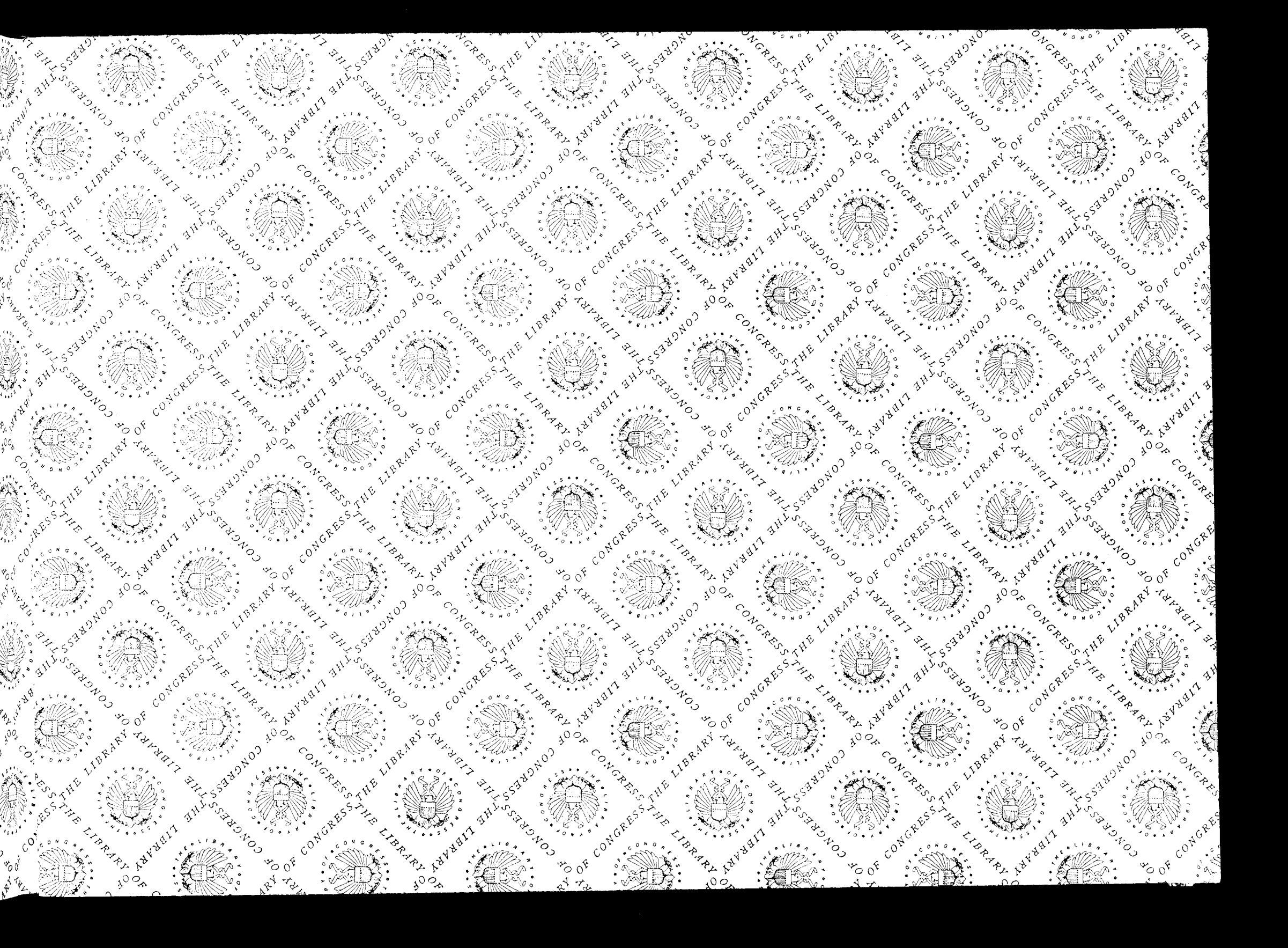

LIBRARY OF CONGRESS

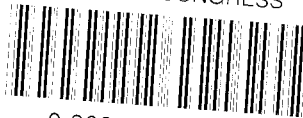

0 009 837 050 A