

# EMERGING INFECTIOUS DISEASES

EID  
Online  
[www.cdc.gov/eid](http://www.cdc.gov/eid)

A Peer-Reviewed Journal Tracking and Analyzing Disease Trends

Vol.11, No.12, December 2005

Zoonotic Diseases



# EMERGING INFECTIOUS DISEASES

EDITOR-IN-CHIEF

D. Peter Drotman

## EDITORIAL STAFF

### Founding Editor

Joseph E. McDade, Rome, Georgia, USA

### Managing Senior Editor

Polyxeni Potter, Atlanta, Georgia, USA

### Associate Editors

Charles Ben Beard, Ft. Collins, Colorado, USA

David Bell, Atlanta, Georgia, USA

Charles H. Calisher, Ft. Collins, Colorado, USA

Patrice Courvalin, Paris, France

Stephanie James, Bethesda, Maryland, USA

Takeshi Kurata, Tokyo, Japan

Brian W.J. Mahy, Atlanta, Georgia, USA

Martin I. Meltzer, Atlanta, Georgia, USA

David Morens, Bethesda, Maryland, USA

J. Glenn Morris, Baltimore, Maryland, USA

Tanja Popovic, Atlanta, Georgia, USA

Patricia M. Quinlisk, Des Moines, Iowa, USA

Gabriel Rabinovich, Buenos Aires, Argentina

Didier Raoult, Marseilles, France

Pierre Rollin, Atlanta, Georgia, USA

David Walker, Galveston, Texas, USA

J. Todd Weber, Atlanta, Georgia, USA

Henrik C. Wegener, Copenhagen, Denmark

### Copy Editors

Angie Frey, Thomas Gryczan, Ronnie Henry,

Anne Mather, Carol Snarey

### Production

Reginald Tucker, Ann Jordan, Maureen Marshall

### Editorial Assistant

Carolyn Collins

[www.cdc.gov/eid](http://www.cdc.gov/eid)

### Emerging Infectious Diseases

Emerging Infectious Diseases is published monthly by the National Center for Infectious Diseases, Centers for Disease Control and Prevention, 1600 Clifton Road, Mailstop D61, Atlanta, GA 30333, USA. Telephone 404-371-5329, fax 404-371-5449, email [eideditor@cdc.gov](mailto:eideditor@cdc.gov).

The opinions expressed by authors contributing to this journal do not necessarily reflect the opinions of the Centers for Disease Control and Prevention or the institutions with which the authors are affiliated.

All material published in Emerging Infectious Diseases is in the public domain and may be used and reprinted without special permission; proper citation, however, is required.

Use of trade names is for identification only and does not imply endorsement by the Public Health Service or by the U.S. Department of Health and Human Services.

∞ Emerging Infectious Diseases is printed on acid-free paper that meets the requirements of ANSI/NISO Z39.48-1992 (Permanence of Paper)

## EDITORIAL BOARD

Dennis Alexander, Addlestone Surrey, United Kingdom

Ban Allos, Nashville, Tennessee, USA

Michael Apicella, Iowa City, Iowa, USA

Barry J. Beaty, Ft. Collins, Colorado, USA

Martin J. Blaser, New York, New York, USA

David Brandling-Bennet, Washington, D.C., USA

Donald S. Burke, Baltimore, Maryland, USA

Jay C. Butler, Anchorage, Alaska

Arturo Casadevall, New York, New York, USA

Kenneth C. Castro, Atlanta, Georgia, USA

Thomas Cleary, Houston, Texas, USA

Anne DeGroot, Providence, Rhode Island, USA

Vincent Deubel, Shanghai, China

Ed Eitzen, Washington, D.C., USA

Duane J. Gubler, Honolulu, Hawaii, USA

Richard L. Guerrant, Charlottesville, Virginia, USA

Scott Halstead, Arlington, Virginia, USA

David L. Heymann, Geneva, Switzerland

Sakae Inouye, Tokyo, Japan

Charles King, Cleveland, Ohio, USA

Keith Klugman, Atlanta, Georgia, USA

S.K. Lam, Kuala Lumpur, Malaysia

Bruce R. Levin, Atlanta, Georgia, USA

Myron Levine, Baltimore, Maryland, USA

Stuart Levy, Boston, Massachusetts, USA

John S. MacKenzie, Perth, Australia

Tom Marrie, Edmonton, Alberta, Canada

John E. McGowan, Jr., Atlanta, Georgia, USA

Philip P. Mortimer, London, United Kingdom

Fred A. Murphy, Davis, California, USA

Barbara E. Murray, Houston, Texas, USA

P. Keith Murray, Ames, Iowa, USA

Stephen Ostroff, Honolulu, Hawaii, USA

Rosanna W. Peeling, Geneva, Switzerland

David H. Persing, Seattle, Washington, USA

Gianfranco Pezzino, Topeka, Kansas, USA

Richard Platt, Boston, Massachusetts, USA

Jocelyn A. Rankin, Atlanta, Georgia, USA

Mario Raviglione, Geneva, Switzerland

Leslie Real, Atlanta, Georgia, USA

David Relman, Palo Alto, California, USA

Nancy Rosenstein, Atlanta, Georgia, USA

Connie Schmaljohn, Frederick, Maryland, USA

Tom Schwan, Hamilton, Montana, USA

Ira Schwartz, Valhalla, New York, USA

Tom Shinnick, Atlanta, Georgia, USA

Patricia Simone, Atlanta, Georgia, USA

Bonnie Smoak, Bethesda, Maryland, USA

Rosemary Soave, New York, New York, USA

P. Frederick Sparling, Chapel Hill, North Carolina, USA

Jan Svoboda, Prague, Czech Republic

Bala Swaminathan, Atlanta, Georgia, USA

Robert Swanepoel, Johannesburg, South Africa

Phillip Tarr, St. Louis, Missouri, USA

Timothy Tucker, Cape Town, South Africa

Elaine Tuomanen, Memphis, Tennessee, USA

John Ward, Atlanta, Georgia, USA

David Warnock, Atlanta, Georgia, USA

Mary E. Wilson, Cambridge, Massachusetts, USA

# EMERGING INFECTIOUS DISEASES

A Peer-Reviewed Journal Tracking and Analyzing Disease Trends

Vol. 11, No. 12, December 2005



## On the Cover

Jan Brueghel the Elder (1568–1625).  
The Entry of the Animals  
into Noah's Ark (1613)  
Oil on panel (54.6 cm x 83.8 cm).  
The J. Paul Getty Museum, Los Angeles,  
California, USA (92.P8.82).  
Courtesy of the J. Paul Getty Museum

About the Cover p. 1991

## Introduction

**Role of Multisectoral Partnerships** .....1813  
N. Marano et al.

## Perspectives

**Framework for Classifying Disease Threats** .....1815  
A. Fenton and A.B. Pedersen  
Ecologic and evolutionary features of multihost pathogens determine the likelihood of emerging infectious diseases.

**Bushmeat Hunting, Deforestation, and Zoonoses** .....1822  
N.D. Wolfe et al.  
Integrating virology, ecology, and other disciplines enhances prediction of new emerging zoonoses.

**Human Granulocytic Anaplasmosis** .....1828  
J.S. Dumler et al.  
The unique niche of *Anaplasma phagocytophilum*, the neutrophil, has implications for pathogenetic mechanisms.

## Synopsis

***Francisella tularensis* in the United States** .....1835  
J. Farlow et al.  
Subpopulations A.I and A.II. of *Francisella tularensis* subsp. *tularensis* are associated with unique biotic and abiotic factors that maintain disease foci.

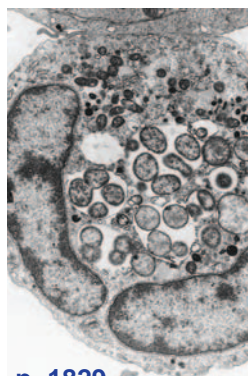

p. 1829



## Research

**Host Range and Emerging and Reemerging Pathogens** .....1842  
M.E.J. Woolhouse et al.  
Human pathogens are associated with a broad range of nonhuman hosts.

**Person-to-Person Transmission of Andes Hantavirus** .....1848  
V.A. Martinez et al.  
Two lineages are implicated in person-to-person transmission.

**European Bat Lyssaviruses, the Netherlands** .....1854  
W.H.M van der Poel et al.  
Genotype 5 lyssaviruses are endemic in the Netherlands and can cause fatal infections in humans.

**SARS-CoV Infection in a Restaurant from Palm Civet** .....1860  
M. Wang et al.  
Contact with food animals was associated with SARS-CoV infection in the People's Republic of China.

**Echinococcosis in Tibetan Populations** .....1866  
L. Tiaoying et al.  
This area has the highest prevalences of both forms of this disease in the world.

**Porcine and Human Noroviruses** ....1874  
Q.-H. Wang et al.  
Pigs may be reservoirs for human noroviruses, and porcine/human genogroup II recombinants could emerge.

**Viral Load Distribution in SARS Outbreak** .....1882  
C.M. Chu et al.  
Airborne transmission may have resulted in an outbreak of SARS in Hong Kong.

**Foot-and-Mouth Disease Virus Serotype O** .....1887  
N.J. Knowles et al.  
The PanAsia strain is spreading explosively in Asia and extending to parts of Africa and Europe.

# EMERGING INFECTIOUS DISEASES

A Peer-Reviewed Journal Tracking and Analyzing Disease Trends Vol. 11, No. 12, December 2005

***Bartonella henselae* in Porpoise Blood** .....1894  
R.G. Maggie et al.  
Bacterial DNA in porpoises suggests an emerging infectious disease in marine mammals.

***Salmonella* Typhimurium, Minnesota, 1997–2003** .....1899  
S.D. Wedel et al.  
Food animals are likely the primary reservoir of resistant *S. Typhimurium*.

**Postepizootic Persistence of Venezuelan Equine Encephalitis Virus** .....1907  
J.-C. Navarro et al.  
Etiologic subtype IC virus persists, 5 years after the apparent end of the major 1995 epidemic.

**Intergenogroup Recombination in Sapoviruses** .....1916  
G.S. Hansman  
Recombination event occurred between 2 different human sapovirus genogroups.

**Rabies Postexposure Prophylaxis, New York** .....1921  
J.D. Blanton et al.  
Bats are now the leading source of rabies post-exposure prophylaxis.

Another Dimension  
**The Enigma We Answer by Living** . . . .1927  
A.H. Deming

## Dispatches

- 1928 **Hunters Exposed to Simian Immunodeficiency Virus**  
M.L. Kalish et al.
- 1931 ***Bartonella quintana* from Cynomolgus Monkey**  
L.G. O'Rourke et al.
- 1935 **Passatempo Virus in Brazil**  
J. Leite et al.
- 1939 **Anthrax in Eastern Turkey**  
Z. Özkurt et al.
- 1942 **Methicillin-resistant Staphylococci in Companion Animals**  
K.E. Baptiste et al.
- 1945 **Phocine Distemper Outbreak, the Netherlands, 2002**  
J.M. Rijks et al.
- 1949 **Bat Nipah Virus, Thailand**  
S. Wacharapluesadee et al.
- 1952 **Cat-transmitted Sporotrichosis**  
A. Schubach et al.
- 1955 **Hemolytic Uremic Syndrome Risk and *E. coli* O157:H7**  
B. Tserenpuntsag et al.

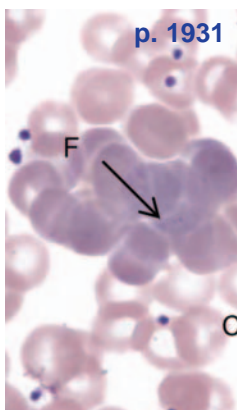

p. 1931



p. 1940

- 1958 **Hepatitis E Virus Transmission from Wild Boar Meat**  
T.-C. Li et al.
- 1961 **Human *Rickettsia felis* Infection, Canary Islands**  
J.-L. Pérez-Arellano et al.
- 1965 **MRSA in Pig Farming**  
A. Voss et al.
- 1967 ***Salmonella* and *Campylobacter* spp. in Seals**  
R.A. Stoddard et al.
- 1970 **Dogs and Rabies Transmission in China**  
X. Tang et al.

## Letters

- 1973 ***Echinococcus multilocularis* in Estonia**
- 1974 **Influenza Virus Infections in Racing Greyhounds**
- 1976 **Syngamioniasis in Tourist**
- 1977 **Human *Angiostrongylus cantonensis*, Jamaica**
- 1978 **Nipah Virus Strain Variation (Replies)**
- 1979 **Trichinellosis Outbreak**
- 1981 **Ciguatera Fish Poisoning, Canary Islands**
- 1983 **Human Rabies in China**
- 1984 **Resistant *S. Virchow* in Quail Products**
- 1985 **Vancomycin-resistant *Enterococcus faecium* Clone**
- 1987 **Rabies Vaccine Baits, Pennsylvania**
- 1989 **Salmonella Veterinary Clinic Outbreak**

## Book Review

- 1990 **Behind the Mask**  
M. Massoudi

## News & Notes

- About the Cover  
1991 **Painting from Life Nature's Unpredictable Menagerie**

# Role of Multisector Partnerships in Controlling Emerging Zoonotic Diseases

Nina Marano,\* Paul Arguin,\* Marguerite Pappaioanou,† and Lonnie King\*‡

This issue marks the second time that an issue of Emerging Infectious Diseases has been devoted to zoonotic diseases; the first zoonoses issue was published 1 year ago, in December 2004. The publication of this second theme issue attests to the frequency, visibility, and attention that these diseases are receiving. A year ago, we commented on several prevailing factors worldwide that facilitate the emergence of zoonotic infectious diseases, among them a growing human population, increased interaction between species, global climate changes, and rapid movement of people and animals (1). These factors continue to exert their influence, and we continue to see a plethora of emerging zoonotic infectious diseases.

In their book *Beasts of the Earth: Animals, Humans, and Disease*, Torrey and Yolken point out that domestic and international public health and animal health agencies have a long history of poor coordination and little effort to bridge the gulf between these 2 professional worlds (2). The authors suggest that we must learn to cooperate if we are to effectively combat emerging microbial threats. In the past year, improved cooperation has been evident. We have observed early detection and response to several important zoonotic diseases threatening the public's health. These responses were made possible by several strategic partnerships across human and animal health sectors—partnerships that have been long in the making.

As this issue goes to press, the year has been bracketed by several major natural disasters in 2 hemispheres—the tsunami in Southeast Asia, hurricanes in North America, and the earthquake in Pakistan and India. These events underscore the fragility of our society and the importance of working in partnerships to effectively protect and promote the health of all persons in challenging times. In the United States, understanding the potential threat for zoonotic disease outbreaks in natural disaster settings, local and state agencies and the Centers for Disease Control and Prevention (CDC) have worked in partnership

with nongovernmental and other federal agencies to augment surveillance systems to allow for early detection and response to potential rodent- and insect-borne infectious disease threats (3).

In between these events, the world detected and responded to a range of emerging microbial threats from all corners of the animal kingdom, including wildlife, captive wildlife in zoos, domestic poultry and livestock, and pet animals (4). Recurring reports have shown that H5N1 avian influenza in Southeast Asia is moving into eastern

## Guest Editors



Nina Marano

Dr Marano is the associate director of veterinary public health in the Division of Bacterial and Mycotic Diseases, CDC. She is responsible for promoting multi-sector partnerships to enhance detection, prevention, management, and control of emerging zoonotic diseases.



Paul Arguin

Dr Arguin is the acting chief of the Geographic Medicine and Health Promotion Branch and the zoonoses team leader in the Division of Global Migration and Quarantine, CDC. The team's mission is to prevent the introduction of zoonotic diseases into the country through imported animals and animal products.



Marguerite Pappaioanou

Dr Pappaioanou is professor of infectious disease epidemiology in the School of Public Health with a joint appointment in the College of Veterinary Medicine at the University of Minnesota. Her areas of interest are in emerging zoonotic infectious diseases, with a special interest in influenza viruses and in collaborative efforts that bridge public health and domestic animal and wildlife health sectors that address emerging zoonotic infectious diseases.

\*Centers for Disease Control and Prevention, Atlanta, Georgia, USA; †University of Minnesota, Minneapolis, Minnesota, USA; and ‡Michigan State University, East Lansing, Michigan, USA

Europe, and scientists are concerned that this virus could rapidly move across geographic regions through poultry, animal husbandry, and wild bird migration (5,6). Outbreaks of *Escherichia coli* have been detected in petting zoos (7). Lymphocytic choriomeningitis and West Nile virus have been transmitted through organ transplantation, and outbreaks of *Salmonella* spp. have been traced back to pet rodents (8–10). The world also witnessed the remarkable survival of a young woman with rabies in Wisconsin (11).

The articles in this special themed issue reflect emergence and reemergence of a wide array of known zoonotic pathogens, including lyssavirus, hantavirus, Rift Valley fever, methicillin-resistant *Staphylococcus aureus*, *Echinococcus* spp., norovirus, Nipah virus, and *Bartonella* spp., as well as pathogens for which the potential for spread to humans is yet unknown, such as canine influenza virus and porcine distemper virus (12–14).

How should we respond to these emerging disease challenges? This year has brought about renewed, and at times unprecedented, collaborations and partnerships to confront these health challenges. Wildlife, animal agriculture, and public health agencies worked together, often for the first time. They developed surveillance plans for monitoring wild birds for highly pathogenic avian influenza (HPAI), provided guidance for safely handling wild birds during these monitoring efforts, and created a comprehensive plan to combat avian flu in Southeast Asia. Such partnerships also facilitated collection of human and wild bird specimens for HPAI H5N1 surveillance in Southeast Asia, use of a survey instrument to evaluate state animal health–human health communication and coordination, and collaborations with industry for recommendations for safely handling pet rodents (15, N. Marano, unpub. data).

However, we need to respond further by calling for more multidisciplinary, integrated research that identifies the causes and factors leading to the emergence of zoonotic diseases and explores how to effectively prevent and control them (16). Avian influenza, in particular, has shown the importance of this research, as the results are vital to the health of both human and animal populations.

In 2006 we look forward to strengthening and nurturing essential collaborations between organization to improve human and animal health. One step will be the International Symposium on Emerging Zoonoses, organized by the World Animal Health Organization and CDC, to be held in Atlanta in March 2006.

This past year we have begun to come together. Let us do everything we can to continue in this direction, and the reward will be success in protecting and promoting human and animal health through effectively confronting zoonotic infectious diseases. This theme issue is an important component in this process.

## References

1. Marano N, Pappioanou M. Historical, new, and reemerging links between human and animal health. *Emerg Infect Dis.* 2004;10:2065–6.
2. Torrey EF, Yolken RH. *Beasts of the earth: animals, humans, and disease.* Piscataway (NJ): Rutgers University Press; 2005.
3. Centers for Disease Control and Prevention. Rapid health response, assessment, and surveillance after a tsunami—Thailand, 2004–2005. *MMWR Morb Mortal Wkly Rep.* 2005;54:61–4.
4. Lau SK, Woo PC, Li KS, Huang Y, Tsoi HW, Wong BH, et al. Severe acute respiratory syndrome coronavirus-like virus in Chinese horseshoe bats. *Proc Natl Acad Sci U S A.* 2005;102:14040–5.
5. The World Health Organization Global Influenza Program Surveillance Network. Evolution of H5N1 avian influenza viruses in Asia. *Emerg Infect Dis.* 2005;11:1515–21.
6. World Animal Health Organization. Highly pathogenic avian influenza in Mongolia in migratory birds. 2005 Aug 12 [cited 2005 Oct 11]. Available from [http://www.oie.int/eng/info/hebd/AIS\\_58.HTM#Sec4](http://www.oie.int/eng/info/hebd/AIS_58.HTM#Sec4)
7. Goode B, O'Reilly C. Final report. Outbreak of Shiga toxin producing *E. coli* (STEC) infections associated with a petting zoo at the North Carolina State Fair—Raleigh, North Carolina, November 2004. North Carolina Department of Health. [cited 2005 Oct 11]. Available from [www.epi.state.nc.us/epi/gcdc/ecoli/EColiReportFinal062905.pdf](http://www.epi.state.nc.us/epi/gcdc/ecoli/EColiReportFinal062905.pdf)
8. Centers for Disease Control and Prevention. Lymphocytic choriomeningitis virus infection in organ transplant recipients—Massachusetts, Rhode Island, 2005. *MMWR Morb Mortal Wkly Rep.* 2005;54:537–9.
9. Centers for Disease Control and Prevention. West Nile virus infections in organ transplant recipients—New York and Pennsylvania, August–September, 2005. *MMWR Morb Mortal Wkly Rep.* 2005;54:1–3.
10. Centers for Disease Control and Prevention. Outbreak of multidrug-resistant *Salmonella* Typhimurium associated with rodents purchased at retail pet stores—United States, December 2003–October 2004. *MMWR Morb Mortal Wkly Rep.* 2005;54:429–33.
11. Willoughby RE Jr, Tieves KS, Hoffman GM, Ghanayem NS, Amlie-Lefond CM, Schwabe MJ, et al. Survival after treatment of rabies with induction of coma [see comment]. *N Engl J Med.* 2005;352:2508–14.
12. Baptiste KE, Williams K, Williams NJ, Wattret A, Clegg PD, Dawson S, et al. Methicillin-resistant staphylococci in companion animals. *Emerg Infect Dis.* 2005;11:1942–4.
13. O'Rourke LG, Pitulle C, Hegarty BC, Kracyirik S, Killary KA, Grosenstein P, et al. *Bartonella quintana* in Cynomolgus monkey (*Macaca fascicularis*). *Emerg Infect Dis.* 2005;11:1931–4.
14. Yoon K-J, Cooper VL, Schwartz KJ, Harmon KM, Kim W-I, Janke BH, et al. Influenza virus infection in racing greyhounds [letter]. *Emerg Infect Dis.* 2005;11:1974–6.
15. Centers for Disease Control and Prevention. Interim guidance for protection of persons involved in U.S. avian influenza outbreak disease control and eradication activities. [cited 2005 Oct 11]. <http://www.cdc.gov/flu/avian/professional/protect-guid.htm>
16. Kuiken T, Leighton FA, Fouchier RA, LeDuc JW, Peiris JS, Schudell A, et al. Public health: pathogen surveillance in animals. *Science.* 2005;309:1680–1.

---

Address for correspondence: Nina Marano, Centers for Disease Control and Prevention, 1600 Clifton Rd, Mailstop C12, Atlanta GA, 30333, USA; fax: 404-639-3039; email: [nmarano@cdc.gov](mailto:nmarano@cdc.gov)

---

# Community Epidemiology Framework for Classifying Disease Threats

Andy Fenton\* and Amy B. Pedersen†

Recent evidence suggests that most parasites can infect multiple host species and that these are primarily responsible for emerging infectious disease outbreaks in humans and wildlife. However, the ecologic and evolutionary factors that constrain or facilitate such emergences are poorly understood. We propose a conceptual framework based on the pathogen's between- and within-species transmission rates to describe possible configurations of a multihost-pathogen community that may lead to disease emergence. We establish 3 dynamic thresholds separating 4 classes of disease outcomes, spillover, apparent multihost, true multihost, and potential emerging infectious disease; describe possible disease emergence scenarios; outline the population dynamics of each case; and clarify existing terminology. We highlight the utility of this framework with examples of disease threats in human and wildlife populations, showing how it allows us to understand which ecologic factors affect disease emergence and predict the impact of host shifts in a range of disease systems.

**M**odels of host-pathogen dynamics have typically assumed a single-host population infected by a single pathogen. However, most pathogens can infect several host species; >60% of human pathogens, >68% of wild primate parasites, and >90% of domesticated animal pathogens infect multiple host species (1–3). An interest in multihost pathogens is particularly timely, given that many of the most threatening current pathogens (e.g., HIV, West Nile virus, influenza virus, Ebola virus) are believed to have crossed species barriers to infect humans, domesticated animals, or wildlife populations (1,3–8). However, we do not know the host and pathogen characteristics that determine such host shifts and the likely characteristics of future emerging infectious diseases. To address this issue, 2 theoretical approaches have been adopted. The first,

using dynamic models, focuses on the host's perspective and ascertains how a shared pathogen affects the dynamics of 2 host populations (9–12). The second approach takes the pathogen's point of view and considers how combined host densities affect pathogen persistence within the community (13–15). However, as the number of studies grows, so does the terminology. Terms such as multihost pathogens, dead-end hosts, reservoir hosts, host shifts, and spillovers are frequently used, but often different phrases are used to describe the same phenomenon, and possibly more concerning, the same terminology may be used to describe strictly different phenomena.

This lack of consolidation makes it unclear how these different approaches relate in terms of understanding the mechanisms driving disease emergence. A need exists for a single, comprehensive framework that characterizes disease outcomes based on biologically meaningful processes. Recently, attempts have been made to reconcile these concepts, mainly by highlighting the role of reservoir hosts (13,16). Haydon et al. (13) proposed a conceptual model that assumed a target host species was exposed to a pathogen endemic in a second host species (or species complex). The outcome of infection then depended on the sizes of the populations and whether they were able to maintain the pathogen alone. This approach expanded the naive view that reservoirs are nonpathogenic, single-species populations and encompassed the complexity of pathogen-host communities observed in nature. However, focusing just on host density ignores many key features of emerging diseases. The likelihood of disease emergence will depend on highly dynamic processes determined by both between- and within-species transmission rates. Therefore, ecologic forces acting on both hosts and pathogens will influence the contact structure of the community and affect the likelihood and persistence of an emerging infectious disease in a new host.

---

\*Institute of Zoology, London, United Kingdom; and †University of Virginia, Charlottesville, Virginia, USA

We propose a conceptual framework to describe the configurations of a host-pathogen community that may lead to disease emergence in a target host. We develop our framework from a simple 2-host 1-pathogen model and establish thresholds for pathogen and host persistence based on the between- and within-species net transmission rates. We then consider what ecologic factors determine the location of various host-pathogen systems within the framework. Finally, we use a stochastic model to consider what characteristics of the hosts and pathogen define the dynamics and likelihood of an emerging infectious disease.

### Conceptual Framework of an Emerging Infectious Disease

We start by considering the assembly of a 2-host community infected by a single pathogen (15,17,18) where the pathogen is endemic within host population  $H_1$  such that individuals of  $H_1$  are either susceptible ( $S_1$ ) or infected ( $I_1$ ). We then assume a second target host population ( $H_2$ ) enters the community and can become infected by the pathogen (Figure 1A). Since the pathogen is well established in  $H_1$ , we assume  $S_1$  and  $I_1$  are unchanged by  $H_2$ ; thus, our model most closely resembles the asymmetric model of Dobson (15). In the terminology of Haydon et al. (12),  $H_1$  is a maintenance host species (or species complex) with the potential to be a disease reservoir for  $H_2$ .  $H_2$  may or may not be a maintenance host (see below). The model is

$$\frac{dS_2}{dt} = rH_2\left(1 - \frac{H_2}{K}\right) - (f_{22} + f_{12})$$

$$\frac{dI_2}{dt} = f_{22} + f_{12} - dI_2$$

(model 1)

where  $r$  is the reproductive rate,  $K$  the carrying capacity, and  $d$  the death rate of the infected hosts. The composite functions  $f_{22}$  and  $f_{12}$  describe the net within-species ( $H_2$  to  $H_2$ ) and between-species ( $H_1$  to  $H_2$ ) transmission rates, respectively. We assume density-dependent transmission and so these functions have the form  $f_{ij} = \beta_{ij} I_i S_j$ , where  $\beta_{ij}$  is the per capita transmission rate from species  $i$  to species  $j$ . Therefore, for example, the net rate of transmission from  $H_1$  to  $H_2$  ( $f_{12}$ ) depends on the size of the susceptible target population ( $S_2$ ), the size of the reservoir ( $I_1$ ), and the level of exposure and susceptibility of  $H_2$  ( $\beta_{12}$ ).

The target host population  $H_2$  has 4 possible outcomes: 1) uninfected, 2) infected but unable to sustain the pathogen, 3) infected and able to sustain the pathogen, or 4) infected and driven to extinction by the pathogen (Figure 1). These 4 outcomes are separated by 3 thresholds (Figure 1C): i) invasion threshold, ii) persistence threshold, and iii) host extinction threshold. The first 2 thresholds are analogous to established density-based thresholds in epidemiology; the first allows ecologic invasion of a pathogen, which subsequently dies out, and the second

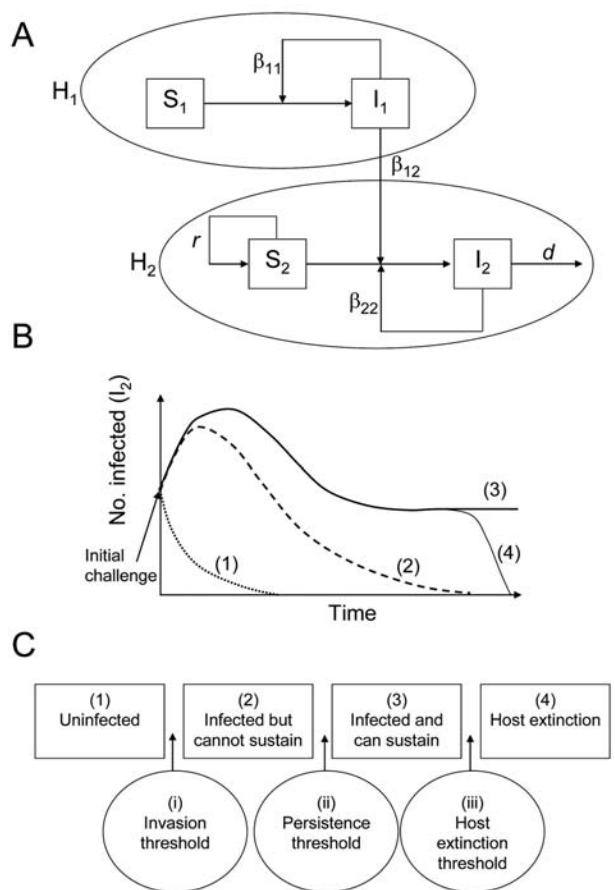

Figure 1. Emerging infectious disease framework. A) Schematic diagram of the multihost-pathogen community. B) Possible outcomes for a novel host,  $H_2$ , after an initial infection by a pathogen endemic in an existing host,  $H_1$ , where (1) the pathogen is unable to invade  $H_2$ , (2) the pathogen invades but cannot be sustained within  $H_2$ , (3) the pathogen invades and persists in  $H_2$ , and (4) the pathogen invades and drives  $H_2$  to extinction. C) Three thresholds separating the 4 possible outcomes: (i) the invasion threshold, (ii) the persistence threshold, and (iii) the host extinction threshold.

allows persistence of the pathogen (19). Here we combine these density effects with the per capita rates of infection to express these thresholds in terms of the magnitude of the net between- and within-species transmission rates ( $f_{12}$  and  $f_{22}$ , respectively).

### Community-Epidemiology Continuum

Infection of  $H_2$  by  $H_1$  and transmission within  $H_2$  are 2 separate processes determined by  $f_{12}$  and  $f_{22}$ . Different combinations of these parameters lead to the different outcomes described above, and all possible scenarios can be placed within a 2-dimensional continuum (Figure 2), with  $f_{12}$  on one axis (i.e., can  $H_2$  get infected from  $H_1$ ?) and  $f_{22}$  on the other (i.e., can  $H_2$  sustain infection?). We can then



divide the  $f_{12}-f_{22}$  parameter space into regions of different disease outcomes.

### Case 1: Spillover

In this case, the within- $H_2$  transmission rate is too low to sustain the pathogen ( $f_{22} \rightarrow 0$ ). The between-species transmission from  $H_1$  is also low ( $f_{12} \rightarrow 0$ ). Thus, although infections of  $H_2$  do occasionally occur, they are transient. This represents the case in which the pathogen is specialized to the endemic host and there is either very low exposure to  $H_2$  (an ecologic constraint, such as parasite transmission mode) or  $H_2$  is resistant to infection (a physiologic constraint). We recommend the term spillover to describe this form of cross-species infection. Previously, spillover has been used to describe a wide range of dynamics (20), but we recommend limiting its use to transient infections in a target host because of transmission from a reservoir host that is not self-sustaining in the target population.

The recent outbreak of West Nile encephalitis in the United States is such a spillover: the virus moved from bird populations ( $H_1$ ) to infect humans ( $H_2$ ), which are unable to transmit the pathogen ( $\beta_{22} = 0$ ) (21). Nevertheless, spillovers still represent a serious health concern; increases in the reservoir population may lead to dramatic increases in disease prevalence in the target host.

### Case 2: Apparent Multihost Pathogen

In this case, the within-species transmission rate for the target host is low, but the between-species transmission rate exceeds the invasion threshold, resulting in persistent infections in  $H_2$ . This case represents apparent multihost dynamics that differ from spillover dynamics in that the disease is nontransient in  $H_2$ , but the pathogen is sustained because of frequent between-species transmission from the disease-endemic host. Apparent multihost dynamics exist because the potentially high prevalence in the target host would give the appearance of a true multihost pathogen, but the lack of within-species transmission means the disease cannot be maintained in the absence of  $H_1$ . We recommend the term reservoir to describe  $H_1$  in both cases 1 and 2, in which the pathogen is permanently maintained in  $H_1$  and without between-species transmission ( $\beta_{12}$ ), the disease would not persist in the target host.

An example of an apparent multihost pathogen is rabies in side-striped jackals ( $H_2$ ) in Africa. Until a recent analysis (22), rabies was considered sustainable in the jackal population ( $H_2$ ), but detailed monitoring showed that rabies is not self-sustaining because of the density of the low susceptible jackal population ( $S_2$ ), and epidemics are frequently seeded from the domestic dog reservoir (high  $\beta_{12}$ ).

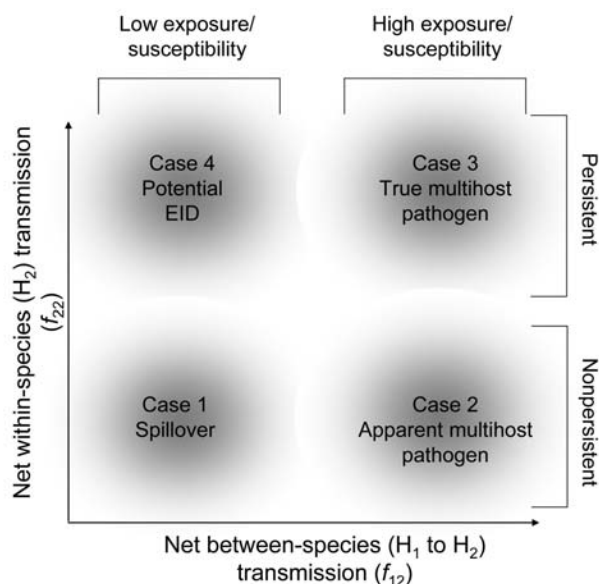

Figure 2. Community-epidemiology continuum, determined by the net between- $H_1$  and - $H_2$  transmission rate ( $f_{12}$ ) and the net within- $H_2$  transmission rate ( $f_{22}$ ). EID, emerging infectious disease.

### Case 3: True Multihost Pathogen

In this case, both the within- and between-species transmission rates are high. Thus, since the pathogen can independently persist in either host population in the absence of the other, following Haydon et al (13), both are considered maintenance hosts. This case represents a true multihost pathogen with substantial within- and between-species transmission. One example is brucellosis infections around Yellowstone National Park, where the pathogen can be endemically maintained in cattle, bison, and elk populations (23).

### Case 4: Potential Emerging Infectious Disease

In this case, the within- $H_2$  transmission rate is high, but the between-species transmission rate is very low ( $f_{12} \rightarrow 0$ ). Thus, the pathogen can persist in the target host ( $H_2$ ), but the net rate of between-species transmission is so low that  $H_2$  is rarely exposed to the disease. This case might occur when a disease is transmitted through close contact and thus has little chance of transmission between species. Similarly, the barrier to infection could be an ecologic factor, such as geographic isolation, which may be overcome by an anthropogenic change such as the introduction of exotic or invasive species. Thus, this case represents a potential emerging infectious disease in which the pathogen will become self-sustaining in  $H_2$  once the initial barrier to infection has been crossed. This case may be the region of greatest future concern since a single transmission event can have devastating consequences because of

the high rate of within-species transmission in the target host.

Recent examples of potential emerging infectious diseases that were realized include the emergence of HIV-1 and HIV-2 in human populations, in which the close-contact nature of the infection process prevented transmission of simian immunodeficiency virus (SIV) from primates to humans (6,24). Another example is severe acute respiratory syndrome-associated coronavirus in humans, in which the primary transmission event is believed to be the result of close human contact with civet cats in China. Once the infection was successful, it spread rapidly throughout the human population by direct contact (25).

### Factors Affecting Location of a Host-Pathogen Community

The location of a host-pathogen system within the continuum will be determined by characteristics of both host populations and the pathogen. For instance, the pathogen's transmission mode will greatly determine its likelihood of encountering new hosts (26). Parasites transmitted by close contact may have limited exposure to multiple species and thus transmission modes that decouple host-to-host contact (i.e., waterborne or soilborne transmission) will increase the opportunity for between-species transmission. Evidence from wild primates and humans shows that pathogens with direct contact transmission are associated with high host specificity (1,3). Therefore, host-pathogen systems should segregate along the  $f_{12}$  axis according to their transmission mode.

Furthermore, the evolutionary potential of a pathogen will affect its ability to infect a new host (2,27). Pathogens in taxa with high mutation rates, antigenic diversity, and short generation times may rapidly adapt to new hosts (28,29), and recent evidence suggests that RNA viruses are the most likely group to emerge in humans (26,30), possibly because of their high mutation rate (31). Thus, host-parasite systems may segregate along the  $f_{22}$  axis according to taxonomy. Similarly, the phylogenetic relationship between the reservoir and target host will have consequences for disease emergence; viruses are less likely to jump to new hosts as the phylogenetic distance between hosts increases (32).

However, host-pathogen systems are not static, and a community may move across the continuum either because of ecologic or evolutionary shifts of the host or pathogen (27). In particular, anthropogenic changes, such as environmental exploitation and the introduction of domestic animals into previously uninhabited areas, may increase exposure to the pathogen and drive such transitions. For instance, although transmission of SIV from chimpanzees to humans may have occurred on a number of distinct occasions (6), these spillovers remained isolated.

Only through various anthropogenic changes, including urbanization (increasing  $S_2$ ) and increased global travel (increasing  $\beta_{22}$ ) did the HIV pandemic take off in the 20th century.

In addition, pathogen evolution may greatly affect the likelihood of disease emergence by increasing the pathogen's basic reproductive ratio ( $R_0$ ) (18,26). For example, avian influenza has emerged several times in human populations since 1997. Typically, limited human-to-human transmission exists ( $\beta_{22} \approx 0$ ), so that although the avian reservoir ( $I_1$ ) and susceptible human populations ( $S_2$ ) are high, outbreaks are rare and isolated (i.e., occupying region 1 of the continuum). Only through recombination between strains and acquisition of human-specific respiratory epithelium receptors (thereby increasing  $\beta_{22}$ ) could the virus evolve sufficient transmissibility to be sustained in the human population, which poses the greatest risk for pandemics (33). These genetic changes could shift avian flu from being a spillover to becoming a true multihost parasite, which would have serious implications for human health.

### Stochastic Dynamics and Consequences for Vulnerable Host Populations

Theoretical and empiric evidence suggest that pathogens harbored by reservoir host populations are of particular concern because they can drive target hosts to extinction (34). Therefore, we must investigate population dynamic properties of different regions of the continuum and regions that pose the greatest risk for a target host. In a deterministic model, the invasion and persistence thresholds are the same and are determined by the pathogen's basic reproductive ratio ( $R_0$ ); if  $R_0 > 1$ , an initial infection can both become established and persist. As shown by Dobson (15),  $R_0$  for a pathogen in an asymmetric host community (with no back-transmission from the target host to the reservoir) is dominated by the largest within-species transmission term, which implies that infection dynamics in the 2 host populations are largely independent; once between-species transmission has occurred, infection in  $H_2$  is driven solely by within- $H_2$  transmission. However, in the stochastic reality of the natural world, an established infection may fade out, and reinfection from  $H_1$  could occur in the future (19). Therefore, we developed a stochastic analog of the above deterministic model to explore dynamics of the community-epidemiology continuum. The model was a discrete-time Monte Carlo simulation model, in which each event in model 1 (births, deaths, between- and within-species transmission) occurred probabilistically, and the next event was chosen at random based on those probabilities. The model was run 100 times for different combinations of within- and between-species transmission rates, and the infection status of the target host ( $H_2$ ) was measured

as the mean prevalence over time, the proportion of time the pathogen was absent from  $H_2$  (the proportion of time the pathogen faded out), and the proportion of runs in which the pathogen drove the host to extinction. This stochastic model is appropriate for exploring the dynamics of emerging infectious diseases not captured by continuous-time deterministic models, in particular when exposure of a target host to a pathogen from a reservoir is likely to occur at discrete intervals (27).

As in the deterministic case, low between- and within-species transmission prevents the pathogen from persisting in the target host (prevalence  $\approx 0$ , Figure 3A; proportion of time pathogen was absent  $\approx 100\%$ , Figure 3B). Increasing the exposure of  $H_2$  to the pathogen (i.e., increasing  $\beta_{12}$ ) leads to a gradual increase in both the prevalence of infection and the proportion of time the pathogen is present in  $H_2$ . This increase applies even if within- $H_2$  transmission is negligible ( $\beta_{22} \rightarrow 0$ ). Therefore, regular, high exposure to the pathogen from the reservoir can give the appearance of endemic infection, even if the pathogen cannot be sustained within the population (case 2: apparent multihost dynamics). Increasing the within- $H_2$  transmission rate ( $\beta_{22}$ ) from very low levels has little impact on the prevalence of infection or the proportion of time  $H_2$  is infected. Eventually, however, a point is reached at which increasing  $\beta_{22}$  suddenly allows the long-term persistence of the pathogen in  $H_2$ . At this point, the persistence threshold is reached and the pathogen becomes endemic in  $H_2$ , regardless of input from  $H_1$ . This threshold can be approximated from the deterministic model by setting  $\beta_{12} = 0$  and solving for  $R_0 = 1$ , which shows that  $\beta_{22}$  must be  $> (d + r)/K$  for the pathogen to persist in the absence of input from  $H_1$  (the horizontal line in Figure 3).

Increasing either between- or within-species transmission rates ( $\beta_{12}$  or  $\beta_{22}$ ) leads to a point when the host is driven to extinction (Figure 3C), which highlights the danger of an emerging infectious disease; even if  $H_2$  is a poor transmitter of the disease ( $\beta_{22} \rightarrow 0$ ), repeated exposure from  $H_1$  may be sufficient to drive the population to extinction. Analysis of the equivalent deterministic model (model 1) suggests that this threshold should be in the between-species transmission rate ( $\beta_{12}$ ) only (host extinction is not affected by  $\beta_{22}$ ) and is given by  $\beta_{12} > dr/(d - r)$  for  $H_2$  extinction to occur (shown by the vertical line in Figure 3). Thus, even if the probability that  $H_2$  will contract the pathogen is very low ( $\beta_{12} \rightarrow 0$ ), a single transmission event may spark an epidemic that completely decimates the population (region 3).

### Implications for Disease Control

The correct classification of the different regions of the community-epidemiology continuum are of more than just semantic importance; quantifying the between- and within-species transmission rates and the location of a host-pathogen system within the continuum are vital to determine the appropriate control strategy. Haydon et al. (13) proposed 3 means of controlling infection in a target-reservoir system: 1) target control, which is aimed at controlling infection within the target population; 2) blocking tactics, to prevent transmission between the reservoir and target host population; and 3) reservoir control, which suppresses infection within the reservoir. These 3 control strategies correspond to reducing the within- and between-species transmission rates ( $\beta_{22}$ ,  $\beta_{12}$ , and  $\beta_{11}$ , respectively). The benefits of each approach will vary according to the relative contributions different transmission processes

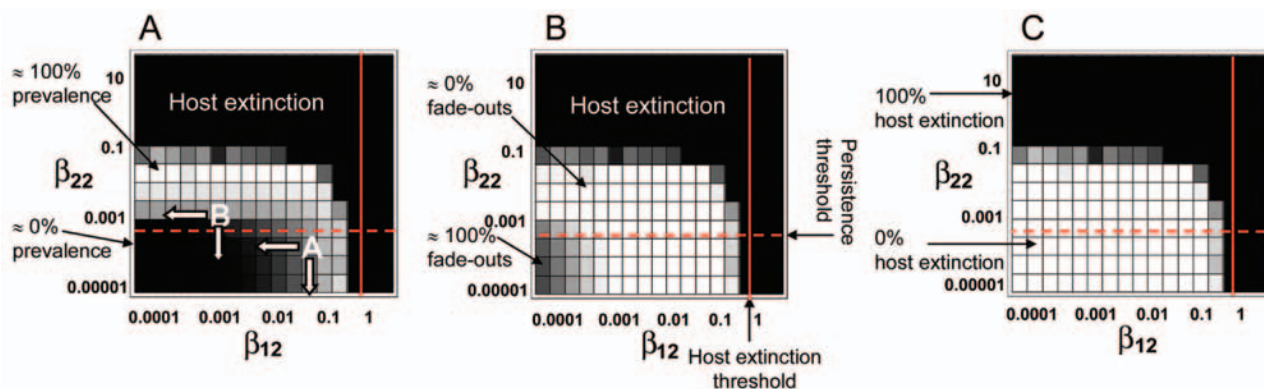

Figure 3. Stochastic model predictions of system behavior in  $\beta_{12}$ - $\beta_{22}$  parameter space. Each square represents the average of 100 simulation runs. Two measures of pathogen persistence are shown: A) Mean prevalence of infection in  $H_2$ , where black represents zero prevalence and white represents 100% prevalence, and B) Proportion of time in which the pathogen is absent (i.e., has faded out) from  $H_2$ , where white represents zero fade-outs (i.e., the pathogen is always present in  $H_2$ ) and black represents 100% fade-outs (i.e., the pathogen never infects  $H_2$ ). C) Probability of pathogen-driven host extinction, where black represents the case in which all runs resulted in host extinction and white the case in which none of the runs resulted in host extinction. The horizontal dashed lines are the deterministic approximation threshold. The points marked A and B in panel A and the associated arrows represent different control scenarios for 2-host pathogen systems located at different points within the continuum (see text for details).

make to the overall prevalence in the new host ( $H_2$ ). Our stochastic model showed that high exposure to the pathogen from the reservoir host can give the appearance of endemic infection in the target host, even if it cannot sustain the pathogen alone. In this case, the optimal control strategy is completely different from that used against a true multihost pathogen endemic in the target host. For a host-pathogen system in region 2 of the continuum (apparent multihost dynamics), where between-species transmission rates are high but within- $H_2$  transmission rates are low (point A in Figure 3A), the prevalence of infection in  $H_2$  may be very high, but mounting a target control program aimed at reducing within- $H_2$  transmission is unlikely to be effective (the vertical arrow from point A in Figure 3A). However, blocking control, which would reduce transmission from the reservoir to the target host, may drastically reduce prevalence (the horizontal arrow from point A in Figure 3A). Conversely, similar levels of prevalence in  $H_2$  may be observed for a host-pathogen system located in region 4 of the continuum (point B in Figure 3A) but because of fundamentally different processes. In this case, blocking tactics aimed at preventing transmission from the reservoir to the target host will be ineffectual (horizontal arrow from point B in Figure 3A), but target control may prove highly effective (vertical arrow from point B in Figure 3A). Therefore, establishing the initial location of a novel host-pathogen system within the community-epidemiology continuum and understanding the within- and between-species transmission rates are essential for optimizing vaccination and culling strategies to lessen the impact of disease.

## Conclusions

This report provides a conceptual framework to understand the ecologic characteristics of disease emergence based on between- and within-species transmission rates involving a potential disease reservoir population and a target host population. Using this framework, we outlined 4 possible cases of long-term disease dynamics in the target host and showed that these outcomes occupy different regions of a 2-dimensional continuum described by the net between- and within-species transmission rates. Furthermore, the development of the community-epidemiology framework allows us to clarify the wealth of terminology currently used to describe disease occurrence in host communities, based on an understanding of the underlying ecologic and epidemiologic processes. In particular, the much-overused terms reservoir and spillover can be seen to have explicit definitions, depending on whether the pathogen can be sustained within the target host population.

By explicitly considering how the ecologic and evolutionary characteristics of hosts and pathogens combine to affect the between- and within-species transmission rates,

and the subsequent consequences for disease occurrence in a novel host, this framework highlights that current human diseases, domestic and wild animal diseases, and the threats of emerging infectious diseases can be understood by a quantitative framework of the underlying transmission processes. Given that most parasites can infect multiple host species and the recent surge of emerging infectious diseases in wildlife and human populations, understanding the dynamics of disease persistence in novel hosts has never been more important.

## Acknowledgments

We thank S. Altizer for her enthusiasm about undertaking this project and helpful comments on the manuscript. We also thank J. Antonovics and M. Hood for comments on earlier drafts. This work was initiated at a workshop at Penn State University on the ecology and evolution of infectious diseases (Hudfest '03).

A.F. was funded by a fellowship from the National Environment Research Council.

Dr Fenton is a National Environment Research Council research fellow at the University of Liverpool. His research interests include the dynamics of host-parasite systems, emerging infectious diseases, and the evolution of parasite life-history strategies.

Dr Pedersen is a postdoctoral researcher in the Department of Biology at the University of Virginia. Her research interests include the ecology of wildlife diseases and multihost, multiparasite community dynamics.

## References

1. Taylor LH, Latham SM, Woolhouse MEJ. Risk factors for human disease emergence. *Philos Trans R Soc Lond B Biol Sci.* 2001;356:983–9.
2. Cleaveland SC, Laurenson MK, Taylor LH. Diseases of humans and their domestic mammals: pathogen characteristics, host range and the risk of emergence. *Philos Trans R Soc Lond B Biol Sci.* 2001;356:991–9.
3. Pedersen AB, Altizer S, Poss M, Cunningham AA, Nunn CL. Patterns of host specificity and transmission among parasites of wild primates. *Int J Parasitol.* 2005;35:647–57.
4. Daszak P, Cunningham AA, Hyatt AD. Emerging infectious diseases of wildlife: threats to biodiversity and human health. *Science.* 2000;287:443–9.
5. Roelke-Parker ME, Munson L, Packer C, Kock R, Cleaveland S, Carpenter M, et al. A canine distemper virus epidemic in Serengeti lions (*Panthera leo*). *Nature.* 1996;379:441–5.
6. Hahn BH, Shaw GM, DeCock KM, Sharp PM. AIDS as a zoonosis: scientific and public health implications. *Science.* 2000;287:607–14.
7. Dobson A, Foufopolous J. Emerging infectious pathogens of wildlife. *Philos Trans R Soc Lond B Biol Sci.* 2001;356:1001–12.
8. Williams ES, Yuill T, Artois M, Fischer J, Haigh SA. Emerging infectious diseases in wildlife. *Rev Sci Tech.* 2002;21:139–57.
9. Bowers RG, Begon M. A host-host-pathogen model with free-living infective stages, applicable to microbial pest control. *J Theor Biol.* 1991;148:305–29.

10. Begon M, Bowers RG. Host-host- pathogen models and microbial pest control: the effect of host self regulation. *J Theor Biol.* 1994;169:275–87.
11. Begon M, Bowers RG. Beyond host-pathogen dynamics. In: Grenfell BT, Dobson AP, editors. *Ecology of infectious disease in natural populations.* Cambridge (UK): Cambridge University Press; 1995. p. 478–509.
12. Greenman JV, Hudson PJ. Parasite-mediated and direct competition in a two-host shared macroparasite system. *Theor Popul Biol.* 2000;57:13–34.
13. Haydon DT, Cleaveland S, Taylor LH, Laurenson MK. Identifying reservoirs of infection: a conceptual and practical challenge. *Emerg Infect Dis.* 2002;8:1468–73.
14. Holt RD, Dobson AP, Begon M, Bowers RG, Schaub EM. Parasite establishment in host communities. *Ecol Lett.* 2003;6:837–42.
15. Dobson A. Population dynamics of pathogens with multiple host species. *Am Nat.* 2004;164:S64–78.
16. Ashford RW. When is a reservoir not a reservoir? *Emerg Infect Dis.* 2003;9:1495–6.
17. Holt RD, Pickering J. Infectious disease and species coexistence: a model of Lotka-Volterra form. *Am Nat.* 1985;126:196–211.
18. Gandon S. Evolution of multihost parasites. *Evolution.* 2004;58:455–69.
19. Davis S, Begon M, de Bruyn, Ageyev VS, Klassovskiy NL, Pole SB, et al. Predictive thresholds for plague in Kazakhstan. *Science.* 2004;304:736–8.
20. Gog J, Woodroffe R, Swinton J. Disease in endangered metapopulations: the importance of alternative hosts. *Proc Biol Sci.* 2002;269:671–6.
21. Campbell GL, Marfin AA, Lanciotti RS, Gubler DJ. West Nile virus. *Lancet Infect Dis.* 2002;2:519–29.
22. Rhodes CJ, Atkinson RPD, Anderson RM, Macdonald DW. Rabies in Zimbabwe: reservoir dogs and the implications for disease control. *Philos Trans R Soc Lond B Biol Sci.* 1998;353:999–1010.
23. Dobson A, Meagher M. The population dynamics of brucellosis in the Yellowstone National Park. *Ecology.* 1996;77:1026–36.
24. Gao F, Bailes E, Robertson DL, Chen Y, Rodenburg CM, Michael SF, et al. Origin of HIV-1 in the chimpanzee *Pan troglodytes troglodytes*. *Nature.* 1999;397:436–41.
25. Guan Y, Zheng BJ, He YQ, Liu XL, Zhuang ZX, Cheung CL, et al. Isolation and characterization of viruses related to the SARS coronavirus from animals in southern China. *Science.* 2003;302:276–8.
26. Woolhouse MEJ, Taylor LH, Haydon DT. Population biology of multihost pathogens. *Science.* 2001;292:1109–12.
27. Antia R, Regoes RR, Koella JC, Bergstrom CT. The role of evolution in the emergence of infectious diseases. *Nature.* 2003;426:658–61.
28. Whitlock MC. The red queen beats the jack-of-all-trades: the limitations on the evolution of phenotypic plasticity and niche breadth. *Am Nat.* 1996;148:S65–77.
29. Gupta S, Ferguson N, Anderson R. Chaos, persistence, and evolution of strain structure in antigenically diverse infectious agents. *Science.* 1998;280:912–5.
30. Holmes EC, Rambaut A. Viral evolution and the emergence of SARS coronavirus. *Philos Trans R Soc Lond B Biol Sci.* 2004;359:1059–65.
31. Drake JW, Charlesworth B, Charlesworth D, Crow JF. Rates of spontaneous mutation. *Genetics.* 1998;148:1667–86.
32. DeFilippis VR, Villarreal LP. An introduction to the evolutionary ecology of viruses. In: Hurst CJ, editor. *Viral ecology.* San Diego (CA): Academic Press; 2000. p. 126–208.
33. Webby RJ, Webster RG. Are we ready for pandemic influenza? *Science.* 2003;302:1519–22.
34. de Castro F, Bolker B. Mechanisms of disease-induced extinction. *Ecol Lett.* 2004;7:117–26.

Address for correspondence: Andy Fenton, School of Biological Sciences, Biosciences Building, Crown St, University of Liverpool, Liverpool L69 7ZB, UK; fax: 44-151-795-4408; email: a.fenton@liverpool.ac.uk



**ICEID  
2006**

**March 19-22, 2006  
Atlanta, GA USA**

*Which infectious diseases are emerging?  
Whom are they affecting?  
Why are they emerging now?  
What can we do to prevent and control them?*

**International Conference  
on Emerging Infectious Diseases**

Late-breaker Abstracts Submissions  
Due February 1  
See [www.iceid.org](http://www.iceid.org)



**International Symposium  
on Emerging Zoonoses  
Medical and Veterinary  
Partnerships To Address Global  
Challenges**

**March 22-24, 2006  
Marriott Marquis Hotel  
Atlanta Georgia USA**

**For Symposium agenda and registration  
information visit [www.isezconference.org](http://www.isezconference.org)**

# Bushmeat Hunting, Deforestation, and Prediction of Zoonotic Disease Emergence

Nathan D. Wolfe,\* Peter Daszak,† A. Marm Kilpatrick,† and Donald S. Burke\*

Understanding the emergence of new zoonotic agents requires knowledge of pathogen biodiversity in wildlife, human-wildlife interactions, anthropogenic pressures on wildlife populations, and changes in society and human behavior. We discuss an interdisciplinary approach combining virology, wildlife biology, disease ecology, and anthropology that enables better understanding of how deforestation and associated hunting leads to the emergence of novel zoonotic pathogens.

Approximately three fourths of human emerging infectious diseases are caused by zoonotic pathogens (1). These include agents responsible for global mortality (e.g., HIV-1 and -2, influenza virus) and others that cause limited deaths but result in high case-fatality rates and for which no effective therapies or vaccines exist (e.g., Ebola virus, hantaviruses, Nipah virus, severe acute respiratory syndrome [SARS]-associated coronavirus) (2). Despite the growing threat of zoonotic emerging infectious diseases, our understanding of the process of disease emergence remains poor. Public health measures for such diseases often depend on vaccine and drug development to combat diseases once pathogens have emerged. Indeed, many believe that predicting emergence of new zoonoses is an unattainable goal (3). Despite this, a growing trend in emerging disease research attempts to empirically analyze the process of emergence and move towards predictive capacity for new zoonoses. These studies track broad trends in the emergence of infectious diseases, analyze the risk factors for their emergence, or examine the environmental changes that drive them (4–6).

Many new zoonoses are viruses that emerge as human and domestic animal populations come into increasing con-

tact with wildlife hosts of potentially zoonotic pathogens (1). The risk for emergence of new zoonotic agents from wildlife depends largely on 3 factors: 1) the diversity of wildlife microbes in a region (the “zoonotic pool” [5]); 2) the effects of environmental change on the prevalence of pathogens in wild populations; and 3) the frequency of human and domestic animal contact with wildlife reservoirs of potential zoonoses. The first factor is largely the domain of virologists, particularly those analyzing evolutionary trends in emerging viruses (7). The last 2 factors are studied by wildlife veterinarians, disease ecologists, wildlife population biologists, anthropologists, economists, and geographers (4,8). Understanding the process of emergence requires analyzing the dynamics of microbes within wildlife reservoir populations, the population biology of these reservoirs, and recent changes in human demography and behavior (e.g., hunting, livestock production) against a background of environmental changes such as deforestation and agricultural encroachment. To fully examine zoonotic emergence, a multidisciplinary approach is needed that combines all of these disciplines and measures the background biodiversity of wildlife microbes. We use hunting and deforestation in Cameroon as an example to discuss the complex interactions between human behavior, demography, deforestation, and viral dynamics that underpin the emergence of diseases.

## Logging, Hunting, and Viral Traffic

Hunting of wildlife by humans is an ancient practice that carries a substantial risk for cross-species transmission. Despite the discovery of cooking  $\approx 1.9$  million years ago (9), the risk of zoonotic diseases emerging from hunting and eating wildlife is still of global importance because of increases in human population density, globalized trade, and consequent increased contact between humans and animals.

\*Johns Hopkins Bloomberg School of Public Health, Baltimore, Maryland, USA; and †Consortium for Conservation Medicine, New York, New York, USA

Deforestation of tropical forests is 1 cause of increasing contact between wildlife and hunters. However, the mechanics of disease emergence are complex. For example, clear-cut logging may be less likely to result in zoonotic emergence than selective extraction because of the relatively low contact rate between people and wildlife during clear-cutting. Because of the high costs of extraction and transportation, logging in central Africa generally involves selective extraction of high-value timber species. Selective extraction is also more likely to sustain natural diversity of wildlife than clear-cutting (10) and therefore to sustain the diversity of potentially zoonotic pathogens available to hunters. Selective logging generally involves constructing roads and transporting workers into relatively pristine forest regions. Although roads can bring health care to rural communities, they also provide increased contact between low-density, remote human populations and urban populations with access to international travel, which allows localized emergence events the potential for rapid global spread (11,12).

Building logging roads also leads to habitat fragmentation as forest edges along roads are degraded, which lowers the movement of wildlife between forest patches. This process may have 3 counteractive effects. First, as patch size decreases, smaller, more discrete, less dense populations of reservoirs result, some of which may be lowered below the threshold density of some potentially zoonotic microbes (13). In these cases, mathematical models of infectious diseases predict that the microbes will become extinct, lowering the risk for transmission to humans. Second, in some cases, the loss of vertebrate reservoir host species richness may result in increased abundance of highly competent reservoirs of some zoonotic agents, increasing the risk for transmission to humans. Although this phenomenon has only been demonstrated for 1 pathogen, *Borrelia burgdorferi*, the causative agent of Lyme disease (14), it may be more widespread. In this case, fragmentation increases the relative abundance of the highly competent reservoir, the white-footed mouse (*Peromyscus leucopus*) and results in a higher risk for infection to humans (14). Third, fragmentation due to road building may increase the functional interface between human populations and reservoir hosts. Historically, hunting activities radiated in a circular fashion from isolated villages, with decreasing impact at the periphery of the hunting range. Roads provide an increased number of points at which hunting activities can commence. Roadside transport means that hunters can lay traps and hunt at the same distance from roads. This changes the pattern of human contact from a circular pattern to a banded pattern surrounding developed roads, increasing the area in which hunting can be conducted with economic returns.

### **Anthropology of Bushmeat Hunting, Trade, and Consumption**

Different activities associated with bushmeat trade will involve different levels of risk for microbial emergence. Hunting (tracking, capturing, handling, sometimes basic field butchering, and transporting of the carcass) involves contact with potentially infected vectors, whereas distant consumption may not. Particularly high risks may be associated with hunting nonhuman primates, and even greater risks in hunting species such as chimpanzee, which are phylogenetically closest to humans. Butchering (opening, cutting, dressing, and preparing the carcass) is obviously more high risk for bloodborne pathogens than the transportation, sale, purchase, and eating of the butchered meat.

Research in medical anthropology has begun to examine indigenous theories of infectious disease (15) and the cultural contexts within which diseases emerge (16), but little data exist on local perceptions of health or other risks associated with hunting and eating bushmeat. Humans as well as other animals employ behavioral adaptations to avoid exposure to infections, yet the type of protective strategies that hunters might use and the effectiveness of such strategies remain unknown. For this reason, anthropologic studies of bushmeat should include not only the details of hunting, but also the transportation of meat to the village, the market, the kitchen, and onto the table. These practices are often articulated along lines of gender and ethnicity and within cultural contexts.

The demand for bushmeat in West and central Africa is as much as 4 times greater than that in the Amazon Basin (10). Estimates of the extraction rate in the Congo Basin suggest that >282.3 g of bushmeat per person per day may be eaten there, with a total of 4.5 million tons of bushmeat extracted annually (17). Expanded demand for bushmeat will likely lead to changes in the exposure of humans to potentially zoonotic microbes. Therefore, assessing the risk that bushmeat extraction and consumption poses to public health will include an assessment of the economy and geography of bushmeat demand and supply.

### **Case Study: Bushmeat Hunting in Cameroon**

A collaboration between Johns Hopkins University and the Cameroon Ministry of Health and Ministry of Defense is exploring emergence of infectious diseases in Cameroon (Figure). The ecologic diversity in Cameroon and the range of new and changing land-use patterns make it an ideal setting to examine the impact of environmental changes on novel disease transmission. Deforestation rates in Cameroon are high, with a loss of 800–1,000 km<sup>2</sup> forest cover per year and corresponding increase in road-building and expansion of settlements (18). Finally, Cameroon is representative of the region from which a range of notable

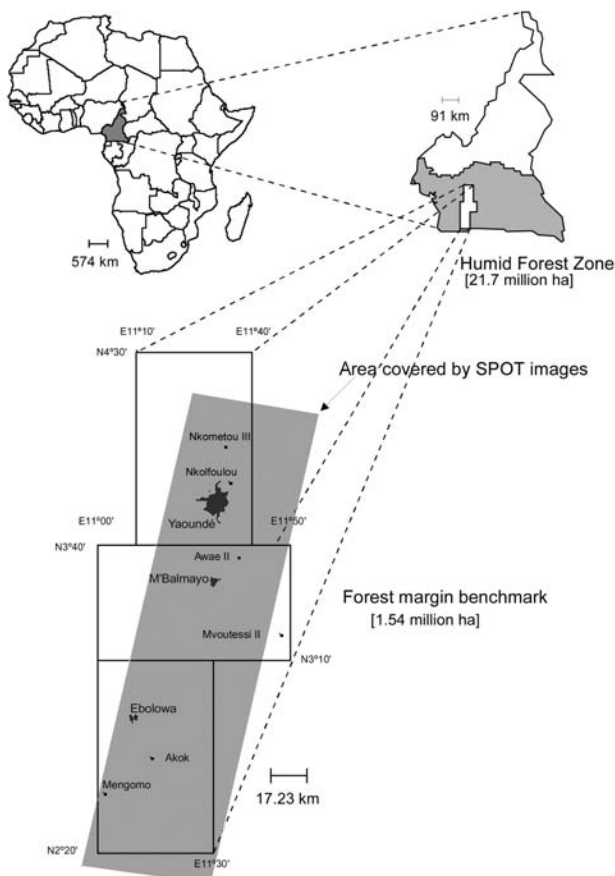

Figure. Location of the International Institute of Tropical Agriculture Humid Forest Benchmark Region, Cameroon. ha, hectares.

emerging infectious diseases, including HIV/AIDS, Ebola and Marburg viruses, and monkeypox, have emerged (Table).

A key factor driving the bushmeat trade in Cameroon is the large and growing urban demand for bushmeat in conjunction with the opening up of logging concessions in the East Province. The construction of the World Bank–funded Yaoundé–Douala truck road in the mid-1980s and the European Union–funded extension of this road to the border of the timber-rich East Province in 1992 dramatically reduced the cost of extracting timber and increased access to these areas for bushmeat hunters. One of the most important non-timber forest product activities within this region is the poaching of bushmeat by market hunters. The bushmeat market among households for sauce preparation in Yaoundé alone is estimated at ≈\$4 million annually (International Institute of Tropical Agriculture [IITA], unpub. data). A recently conducted consumption study showed that bushmeat plays an important dietary role among poor households and is not a

luxury product eaten mainly by the rich. Across income classes, the poorest 2 quantiles spent 16% and 17%, respectively, of their meat budgets on bushmeat versus 7% for the richest quantile and 9% overall (IITA, unpub. data). Finally, our work in Cameroon has shown that not only bushmeat hunters but also persons who keep various species of vertebrate pets or butcher and handle meat are at risk for zoonotic transmission due to bites, cuts, and other exposures to fluids or tissue (27).

### Viral Chatter and Globalized Emergence

The global emergence of a zoonotic pathogen such as SARS or HIV-1 and -2 requires 3 steps. First, the pathogen must be successfully transmitted between a wild reservoir and humans or their domestic animals. Several recently emerging zoonoses have achieved this stage without further transmission, e.g., Hendra virus. Second, the pathogen must be directly transmitted between humans. Finally, the pathogen must move from a local epidemic into the global population. Understanding and predicting the global emergence of pathogens require knowledge of the drivers of each of these steps or processes. These are, in fact, stages of emergence that have been described previously as invasion, establishment, and persistence of infectious diseases introduced into new host populations (8).

Evidence suggests that many pathogens are transmitted between their animal reservoirs and humans but fail to be transmitted from human to human or do so at rates that do not allow pathogen establishment within the human population. For example, sequence data from HIV-1 and HIV-2 suggest that as many as 10 prior transmission events into human populations occurred over the last century before this virus emerged globally (23). Recent data from our own field sites suggest that simian foamy viruses infect bushmeat hunters regularly, so far without evidence of human-to-human transmission (26). Other pathogens, such as avian influenza and Hendra viruses, which do not appear to be transmitted through bushmeat consumption, have also led to several small epidemics with little or no evidence of human-to-human transmission. We have termed this “viral chatter”, a seemingly common phenomenon of repeated transmission of nonhuman viruses to humans, most of which results in no human-to-human transmission (28). We hypothesize that this mechanism is common in viral emergence. High rates of viral chatter will increase the diversity of viruses and sequence variants moving into humans, increase the probability of transmission of a pathogen that can successfully replicate, and ultimately increase the ability of a human-adapted virus to emerge in a more widespread manner. In some cases this process may result in the evolution of a new viral strain (29) and may be a very common mechanism for viral emergence into the human population (23,28).



Table. Some zoonotic pathogens that have emerged in the Cameroon–Congo Basin region, 1970–2005\*

Pathogen or disease	Reservoir species	Outcome of transmission	Risk behavior	Confirmed or probable transmission routes					Ref.
				Body fluids	Bites/saliva	Organs/tissues	Feces/urine	Vectors (indirect)	
Arboviruses (dengue, yellow fever)	Various	Localized outbreaks	Human presence in region for habitation, work or leisure					X	(5,19,20)
Ebola	Unknown	Localized epidemics, short timescale	Hunting or wildlife necropsy	X	X	X	X		(21)
Monkeypox	Squirrels and others	Localized epidemics (at least four transmission cycles recorded)		X	X				(22)
HIV-1 and -2	Chimpanzee, sooty mangabe	Repeated single infections or localized outbreaks, followed by national then global emergence	Hunting & butchering nonhuman primates	X	X	X			(23)
Anthrax	Ungulates	Single infections or localized epidemics	Butchering or eating carcasses	X	X	X			
Salmonellosis	Range of nonhuman primates	Single infections	Keeping pets				X		(24)
Herpes B virus (did not emerge locally)	Range of non-human primates	Single infections	Keeping pets	X	X	X			(25)
Cutaneous leishmaniasis, Loa loa		Localized outbreaks	Logging/road-building, ecotourism, research		X		X	X	
Simian foamy viruses	Gorilla, mandarin, De Brazza's guenon, other unknown spp.	Exposure without replication, or replication in a single human	Hunting nonhuman primates	X	X	X	X		(26)
Chromomycosis			Wood collection		X		X	X	

\*Note that herpes B virus did not infect humans locally in the Cameroon–Congo basin.

Monkeypox and Nipah viruses are examples of the second stage towards global emergence. These viruses have shown limited human-to-human transmission in a number of relatively small epidemics before fading out (22,30). This phenomenon can be understood by using what mathematical modelers of disease dynamics refer to as the reproductive ratio ( $R_0$ ), which measures a pathogen's ability to cause an outbreak.  $R_0$  is the number of secondary cases in a population caused by a single case, assuming that all other members are susceptible (8). When  $R_0$  is  $>1$ , the pathogen will amplify within a population and cause an outbreak. In the environmental conditions in which monkeypox and Nipah viruses emerged,  $R_0$  was  $<1$ , and ultimately the epidemics faded out (22).

One of the crucial questions in disease emergence is: What environmental or evolutionary changes cause the  $R_0$  of wildlife viruses to rise above 1 in human populations? In mathematical models for density-dependent transmission,  $R_0$  is proportional to host density, so that there is a critical threshold of human population density (known as the threshold density,  $N_T$ ), below which a pathogen will

fade to extinction. Increasing densities of human populations in urban centers close to bushmeat hunting areas and the increasing rates of movement of people between village, town, and city, will increase  $R_0$  and the risk for new epidemic zoonoses. Alternatively, changes to human behavior that increase the transmission of viruses between people (e.g., sexual contact, injected drug use, or fluid contact by means of medical procedures) will increase  $R_0$  and may also assist in driving their emergence.

In the final stage of emergence, increased travel or migration facilitate the global spread of new zoonoses. For example, increased movements between villages or cities and higher between-person contact rates through increased numbers of sexual partners appear to have facilitated the early emergence of HIV/AIDS in Africa (12). This disease became a global pandemic following the expansion of road networks, changes in workforce demography, and increases in international air travel to central Africa and globally (12,23).

Our review suggests that predicting the emergence of new zoonoses will be a difficult but important task for

future medical research. This goal has been described as challenging or impossible by some researchers (3). However, we propose that it is now becoming possible to conduct the science of predicting emerging zoonoses and that far more attention should be paid to this approach than is currently given (31). We have previously proposed 3 criteria that can be used to predict which microbes are most likely to emerge (6). These include microbes that have a proven ability to 1) lead to human pandemics, 2) lead to zoonoses in (nonhuman) animal populations, and 3) mutate at high rates and recombine with other similar or dissimilar microbes. The high mutation rates of RNA viruses and their predominance within zoonotic emerging infectious diseases that are transmitted from human to human suggest that this group is a key candidate for future emergence (7). Simian foamy viruses are members of this group, and the high rates of viral chatter observed in Cameroon suggest a strong potential for their emergence as a human-to-human transmitted pathogen.

Little is known about the complexity of this process, but with  $\approx 75\%$  of human emerging infectious diseases classified as zoonoses (1), understanding the process is critical to global health. We propose that more attention be given to multidisciplinary studies at all stages of the process. For example, understanding how the rates of viral chatter respond to anthropogenic land-use changes (e.g., deforestation, mining) that affect the density of wildlife species and the prevalence of viruses that affect them will be critical for predicting hotspots of disease emergence. Second, understanding which viruses are likely to rapidly evolve in humans, rather than become dead-end hosts, will involve a combination of host immunologic and viral evolutionary traits (7,32). Studies of the characteristics of the zoonotic pool (i.e., the biodiversity of yet-to-emerge wildlife viruses [5]) may explain these events. Some strains within viral quasispecies may be able to infect and be transmitted between humans far more readily than others. Such complexity requires the collaboration of medical scientists with many other disciplines, including geography, ecologic and evolutionary biology, conservation biology, medical anthropology, and veterinary medicine.

Recent advances in a number of fields include some of direct relevance to predicting unknown zoonoses, among them modeling multihost disease dynamics in wildlife and humans (33), modeling the evolutionary dynamics of pathogens (34), insights into the phylogenetic characteristics of emerging pathogens (7,32), greater understanding of the environmental changes that drive emergence (4), risk assessments for pathogen transmission (35,36) and introduction (37), and major advances in the technology for microbial discovery (e.g., microarrays) and characterization (e.g., noninvasive sequencing) (38). A number of collaborative initiatives between veterinary medicine,

human medicine, and ecology have already begun (39,40), and our analysis suggests these should be strengthened by even wider collaboration. The fusion of these diverse, rapidly evolving fields will allow the first steps to be taken towards emerging disease research's ultimate challenge of predicting new zoonotic disease emergence.

### Acknowledgments

We thank the following researchers, who greatly assisted our study: Mpoudi Ngole Eitel, Jim Gockowski, Pia K. Muchaal, Christian Nolte, A. Tassy Prosser, Lisa M. Schloegel, Judith Ndong Torimiro, and Stephan F. Weise. We thank the staff of the Walter Reed Johns Hopkins Cameroon program for assistance with fieldwork and specimen processing, the government of Cameroon for permission to undertake the study, and the US Embassy, Yaoundé for their support.

The V. Kann Rasmussen Foundation provided core support to the Consortium for Conservation Medicine. Peter Daszak is supported by a National Institutes of Health (NIH)/National Science Foundation "Ecology of Infectious Diseases" award from the John E. Fogarty International Center of NIH, RO1 TW05869. A. Marm Kilpatrick is supported by NIAID contract #14-0131 and a grant from the Wilburforce Foundation.

This work was supported in part by a grant from the US Military HIV Research Program to D.S. Burke. N.D. Wolfe is supported by a grant from the National Institutes of Health (NIH) Fogarty International Center (K01 TW000003-05), the NIH Director's Pioneer Award Program (DP1-OD000370), the National Geographic Society Committee for Research and Exploration, and awards from the Johns Hopkins Bloomberg School of Public Health Center for a Livable Future, and Center for AIDS Research (NIH P30-AI42855).

Dr Wolfe is an assistant professor at Johns Hopkins Bloomberg School of Public Health. His work includes monitoring viral infections in bushmeat hunters in Cameroon and elsewhere.

### References

1. Taylor LH, Latham SM, Woolhouse MEJ. Risk factors for human disease emergence. *Philos Trans R Soc Lond B Biol Sci.* 2001;356:983–9.
2. Smolinski MS, Hamburg MA, Lederberg J. Microbial threats to health: emergence, detection and response. Washington: The National Academies Press; 2003.
3. Murphy FA. Emerging zoonoses. *Emerg Infect Dis.* 1998;4:429–35.
4. Daszak P, Cunningham AA, Hyatt AD. Emerging infectious diseases of wildlife—threats to biodiversity and human health. *Science.* 2000;287:443–9.
5. Morse SS. Examining the origins of emerging viruses. In: Morse SS, editor. *Emerging viruses.* New York: Oxford University Press; 1993. p. 10–28.
6. Burke DS. The evolvability of emerging viruses. In: Horsburgh CR, editor. *Pathology of emerging infections.* Washington: American Society for Microbiology; 1998. p. 1–12.

7. Moya A, Holmes EC, Gonzalez-Candelas F. The population genetics and evolutionary epidemiology of RNA viruses. *Nat Rev Microbiol*. 2004;2:279–88.
8. Anderson RM, May RM. The invasion, persistence and spread of infectious diseases within animal and plant communities. *Philos Trans R Soc Lond B Biol Sci*. 1986;314:533–70.
9. Wrangham RW, Jones JH, Laden G, Pilbeam D, Conklin-Brittain NL. The raw and the stolen: cooking and the ecology of human origins. *Current Anthropology*. 1999;40:567–94.
10. Fa JE, Juste J, Delval JP, Castroviejo J. Impact of market hunting on mammal species in Equatorial-Guinea. *Conservation Biology*. 1995;9:1107–15.
11. Robbins KE, Lemey P, Pybus OG, Jaffe HW, Youngpairoj AS, Brown TM, et al. U.S. Human immunodeficiency virus type 1 epidemic: date of origin, population history, and characterization of early strains. *J Virol*. 2003;77:6359–66.
12. Hooper E. *The river*. Boston: Little, Brown & Co.; 1999.
13. McCallum H, Dobson A. Detecting disease and parasite threats to endangered species and ecosystems. *Trends in Ecology and Evolution*. 1995;10:190–4.
14. LoGiudice K, Ostfeld RS, Schmidt KA, Keasing F. The ecology of infectious disease: effects of host diversity and community composition on Lyme disease risk. *Proc Natl Acad Sci U S A*. 2003;100:567–71.
15. Green EC. *Indigenous theories of contagious disease*. Walnut Creek (CA): Altamira Press; 1999.
16. Hewlett BS, Amola RP. Cultural contexts of Ebola in northern Uganda. *Emerg Infect Dis*. 2003;9:1242–8.
17. Fa JE, Peres CA, Meeuwig J. Bushmeat exploitation in tropical forests: an intercontinental comparison. *Conservation Biology*. 2002;16:232–7.
18. Gartlan S. *La conservation des écosystèmes forestiers du Cameroun*. Switzerland and Cambridge, UK: International Union for the Conservation of Nature; 1989.
19. Krippner R, von Laer G. First confirmed dengue-1 fever cases reported from Cameroon. *J Travel Med*. 2002;9:273–4.
20. Vicens R, Robert V, Pignon D, Zeller H, Ghisponi PM, Digoutte JP. Epidemic of yellow fever in North Cameroon in 1990—1st isolation of yellow fever virus in Cameroon. *Bull World Health Organ*. 1993;71:173–6.
21. Klenk H-D. *Marburg and Ebola viruses*. Current topics in microbiology and immunology. Berlin: Springer; 1999.
22. Jezek Z, Arita I, Mutombo M, Dunn C, Nakano JH, Szczeniowski M. Four generations of probable person-to-person transmission of human monkeypox. *Am J Epidemiol*. 1986;123:1004–12.
23. Hahn BH, Shaw GM, de Cock KM, Sharp PM. AIDS as a zoonosis: scientific and public health implications. *Science*. 2000;287:607–14.
24. Fox JG. Transmissible drug resistance in *Shigella* and *Salmonella* isolated from pet monkeys and their owners. *J Med Primatol*. 1975;4:165–71.
25. Ostrowski SR, Leslie MJ, Parrott T, Abelt S, Piercy PE. B-virus from pet macaque monkeys: an emerging threat in the United States? *Emerg Infect Dis*. 1998;4:117–21.
26. Wolfe ND, Switzer WM, Carr JK, Bhullar VB, Shanmugam V, Tamoufe U, et al. Naturally acquired simian retrovirus infections in central African hunters. *Lancet*. 2004;363:932–7.
27. Kalish ML, Wolfe ND, Ndongmo CB, McNicholl J, Robbins KE, Aidoo M, et al. Central African hunters exposed to simian immunodeficiency virus. *Emerg Infect Dis*. 2005;11:1928–30.
28. Wolfe ND, Switzer WM, Folks TM, Burkes DS, Heneine W. Simian retroviral infections in human beings—reply. *Lancet*. 2004;364:139–40.
29. Apetrei C, Marx PA. Simian retroviral infections in human beings. *Lancet*. 2004;364:137–8.
30. Hsu VP, Hossain MJ, Parashar UD, Ali MM, Ksiazek TG, Kuzmin I, et al. Nipah virus encephalitis reemergence, Bangladesh. *Emerg Infect Dis*. 2004;10:2082–7.
31. Daszak P, Tabor GM, Kilpatrick AM, Epstein J, Plowright R. Conservation medicine and a new agenda for emerging diseases. *Ann N Y Acad Sci*. 2004;1026:1–11.
32. Holmes EC. Error thresholds and the constraints to RNA virus evolution. *Trends Microbiol*. 2003;11:543–6.
33. Dobson A, Foufopoulos J. Emerging infectious pathogens of wildlife. *Philos Trans R Soc Lond B Biol Sci*. 2001;356:1001–12.
34. Boots M, Hudson PJ, Sasaki A. Large shifts in pathogen virulence relate to host population structure. *Science*. 2004;303:842–4.
35. Kilpatrick AM, Kramer LD, Campbell S, Alleyne EO, Dobson AP, Daszak P. West Nile virus risk assessment and the bridge vector paradigm. *Emerg Infect Dis*. 2005;11:425–9.
36. Linthicum KJ, Anyamba A, Tucker CJ, Kelley PW, Myers MF, Peters CJ. Climate and satellite indicators to forecast Rift Valley fever epidemics in Kenya. *Science*. 1999;285:397–400.
37. Kilpatrick AM, Gluzberg Y, Burgett J, Daszak P. A quantitative risk assessment of the pathways by which West Nile virus could reach Hawaii. *Ecohealth*. 2004;2:205–9.
38. Bailes E, Gao F, Bibollet-Ruche F, Courgnaud V, Peeters M, Marx PA, et al. Hybrid origin of SIV in chimpanzees. *Science*. 2003;300:1713.
39. Dierauf LA, Griffith G, Beasley V, Mashima TY. Conservation medicine: building bridges. *J Am Vet Med Assoc*. 2001;219:596–7.
40. Deem SL, Kilbourn AM, Wolfe ND, Cook RA, Karesh WB. Conservation medicine. *Ann N Y Acad Sci*. 2000;916:370–7.

Address for correspondence: Nathan D. Wolfe, Johns Hopkins Bloomberg School of Public Health, G15 N Wolfe St/E5038, Baltimore, MD 21205, USA; fax: 410-502-0530; email: [nwolfe@jhsph.edu](mailto:nwolfe@jhsph.edu)

Use of trade names is for identification only and does not imply endorsement by the Public Health Service or by the U.S. Department of Health and Human Services.

EMERGING INFECTIOUS DISEASES *online*

[www.cdc.gov/eid](http://www.cdc.gov/eid)

To receive tables of contents of new issues send an email to [listserv@cdc.gov](mailto:listserv@cdc.gov) with subscribe *eid-toc* in the body of your message.

# Human Granulocytic Anaplasmosis and *Anaplasma phagocytophilum*

J. Stephen Dumler,\* Kyoung-Seong Choi,\* Jose Carlos Garcia-Garcia,\* Nicole S. Barat,\*  
Diana G. Scorpio,\* Justin W. Garyu,\* Dennis J. Grab,\* and Johan S. Bakken†‡

Human granulocytic anaplasmosis is a tickborne rickettsial infection of neutrophils caused by *Anaplasma phagocytophilum*. The human disease was first identified in 1990, although the pathogen was defined as a veterinary agent in 1932. Since 1990, US cases have markedly increased, and infections are now recognized in Europe. A high international seroprevalence suggests infection is widespread but unrecognized. The niche for *A. phagocytophilum*, the neutrophil, indicates that the pathogen has unique adaptations and pathogenetic mechanisms. Intensive study has demonstrated interactions with host-cell signal transduction and possibly eukaryotic transcription. This interaction leads to permutations of neutrophil function and could permit immunopathologic changes, severe disease, and opportunistic infections. More study is needed to define the immunology and pathogenetic mechanisms and to understand why severe disease develops in some persons and why some animals become long-term permissive reservoir hosts.

Human granulocytic anaplasmosis (HGA) was first identified in 1990 in a Wisconsin patient who died with a severe febrile illness 2 weeks after a tick bite (1). During the terminal phases of the infection, clusters of small bacteria were noted within neutrophils in the peripheral blood (Figure 1), assumed to be phagocytosed gram-positive cocci. A careful review of the blood smear suggested the possibility of human ehrlichiosis, an emerging infection with similar bacterial clusters in peripheral blood monocytes among infected patients in the southeast and south-central United States. All blood cultures were unrevealing, and specific serologic and immunohisto-

chemical tests for *Ehrlichia chaffeensis*, the causative agent of human monocytic ehrlichiosis (HME) were negative. Over the ensuing 2 years, 13 cases with similar intraneutrophilic inclusions were identified in the same region of northwestern Wisconsin and eastern Minnesota (2). Aside from the bacterial clusters, common features among these persons included fever, headache, myalgia, malaise, absence of skin rash, leukopenia, thrombocytopenia, and mild injury to the liver.

In 1994, through application of broad range molecular amplification and DNA sequencing, the causative agent was recognized as distinct from *E. chaffeensis*. The agent was initially named HGE agent (1,2), although morphologic and serologic studies indicated a close or identical relationship to the veterinary pathogens of neutrophils, *E. equi* and *E. (Cytoecetes) phagocytophila*. During the process of classification of the human agent, phylogenetic studies showed taxonomic disarray among organisms broadly referred to as ehrlichiae, and a careful reorganization now places those bacteria previously classified as *E. phagocytophila*, *E. equi*, and the HGE agent into a different genus as a single species, *A. phagocytophilum* (Figure 2) (1,3). The fallout from the reclassification of these organisms is the proposal for a complete revision of the families *Rickettsiaceae* and *Anaplasmataceae*. Under the proposed revision, the tribe structure of the *Rickettsiaceae* would be abolished, and species in the *Ehrlichieae* tribe would be assigned to the family *Anaplasmataceae*, with several placed into the genera *Ehrlichia* (*Cowdria ruminantium*), *Anaplasma* (*E. equi*, *E. phagocytophila*, HGE agent, *E. platys*, *E. bovis*), and *Neorickettsia* (*E. sennetsu* and *E. risticii*). The genera *Ehrlichia* and *Anaplasma* possess all pathogens in the family that are transmissible by ticks and that generally infect peripheral blood cellular elements, including leukocytes, platelets, and erythrocytes.

\*Johns Hopkins University School of Medicine, Baltimore, Maryland, USA; †University of Minnesota at Duluth, Duluth, Minnesota, USA; and ‡St. Luke's Hospital, Duluth, Minnesota, USA

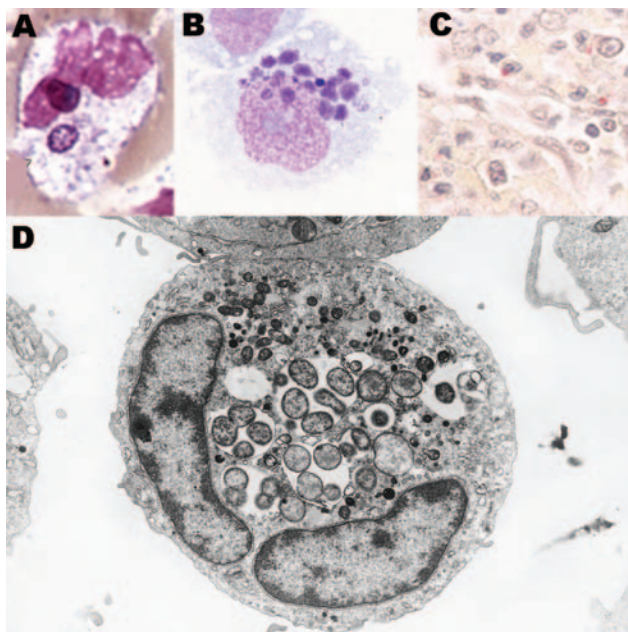

Figure 1. *Anaplasma phagocytophilum* in human peripheral blood band neutrophil (A, Wright stain, original magnification  $\times 1,000$ ), in THP-1 myelomonocytic cell culture (B, LeukoStat stain, original magnification,  $\times 400$ ), in neutrophils infiltrating human spleen (C, immunohistochemistry with hematoxylin counterstain; original magnification  $\times 100$ ), and ultrastructure by transmission electron microscopy in HL-60 cell culture (D; courtesy of V. Popov; original magnification  $\times 21,960$ ).

HGA is increasingly recognized as an important and frequent cause of fever after tick bite in the Upper Midwest, New England, parts of the mid-Atlantic states, northern California, and many parts of Europe, all areas where *Ixodes* ticks bite humans (4–6). The ecology of *A. phagocytophilum* is increasingly understood. The bacterium is maintained in a transmission cycle with *Ixodes persulcatus* complex ticks, including *I. scapularis* in the eastern United States, *I. pacificus* in the western United States, *I. ricinus* in Europe, and probably *I. persulcatus* in parts of Asia. Tick infection is established after an infectious blood meal, and the bacterium is transstadially but not transovarially passed (3). The major mammalian reservoir for *A. phagocytophilum* in the eastern United States is the white-footed mouse, *Peromyscus leucopus*, although other small mammals and white-tailed deer (*Odocoileus virginianus*) can also be infected. White-footed mice have transient (1–4 weeks) bacteremia; deer are persistently and subclinically infected. Human infection occurs when humans impinge on tick–small mammal habitats (4–7).

HGA is clinically variable, but most patients have a moderately severe febrile illness with headache, myalgia, and malaise. Among 10 clinical studies that describe the findings in HGA across North America and Europe and

that comprise up to 685 patients (Table), the most frequent manifestations are malaise (94%), fever (92%), myalgia (77%), and headache (75%); a minority have arthralgia or involvement of the gastrointestinal tract (nausea, vomiting, diarrhea), respiratory tract (cough, pulmonary infiltrates, acute respiratory distress syndrome [ARDS]), liver, or central nervous system (4–7). Rash is observed in 6%, although no specific rash has been associated with HGA and co-infection with *Borrelia burgdorferi*, which can cause simultaneous erythema migrans, is not infrequent. Frequent laboratory abnormalities identified in up to 329 patients include thrombocytopenia (71%), leukopenia (49%), anemia (37%), and elevated hepatic transaminase levels (71%).

Recent seroepidemiologic data suggest that many infections go unrecognized, and in endemic areas as much as 15% to 36% of the population has been infected (16,17). In Wisconsin, the yearly incidence of HGA from 1990 to 1995 was as high as 58 cases/100,000 in 1 county (Lyme disease incidence in the same region was 110 cases/100,000) (5). The overall yearly Connecticut incidence rate from 1997 to 1999 was 24 to 51 cases/100,000 population (18). Symptomatic infection in Europe appears to be rare; 66 cases have been reported, despite a median seroprevalence rate of 6.2% among 35 published reports, with rates as high as 21% in some European studies. Similarly, the median infection prevalence in European *I. ricinus* ticks is 3% (45 publications), a figure close to that observed among North American *I. scapularis* and *I. pacificus* ticks (median 4.7% among 42 publications).

What is unclear from these data is whether the discrepancy between the seroprevalence and symptomatic rate results from underdiagnosis of infection, asymptomatic serologic reactions, or even infections that produce cross-reactive serologic responses. In any case, symptomatic infection can occur often in tick-endemic regions and varies in severity from mild, self-limited fever to death. Severity sufficient for hospitalization is observed in half of symptomatic patients and is associated with older age, higher neutrophil counts, lower lymphocyte counts, anemia, the presence of morulae in leukocytes, or underlying immune suppression (5). Approximately 5%–7% of patients require intensive care, and at least 7 deaths have been identified (2,4,5,7,19), in which delayed diagnosis and treatment were risk factors. Severe complications include a septic or toxic shock–like syndrome, coagulopathy, atypical pneumonitis/acute respiratory distress syndrome (ARDS), acute abdominal syndrome, rhabdomyolysis, myocarditis, acute renal failure, hemorrhage, brachial plexopathy, demyelinating polyneuropathy, cranial nerve palsies, and opportunistic infections. At least 3 of the deaths resulted from opportunistic fungal or viral infections or hemorrhage that occurred immediately after

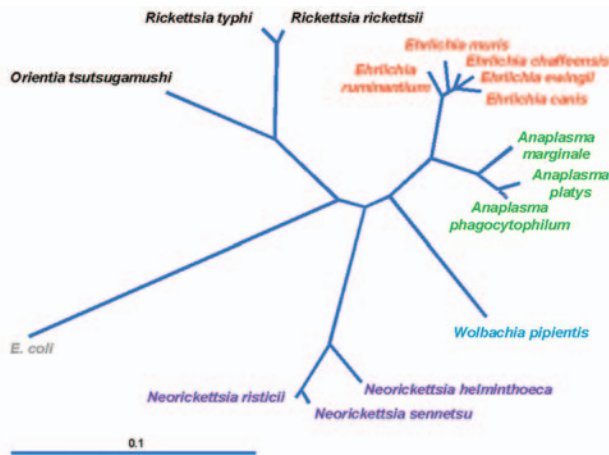

Figure 2. Current phylogeny and taxonomic classification of genera in the family Anaplasmataceae. The distance bar represents substitutions per 1,000 basepairs. *E. coli*, *Escherichia coli*.

HGA. In 2 cases, the patients had reasons for preexisting immunocompromise, which suggests that an intact immune system is important for recovery and that HGA further antagonizes immune dysfunction (2,4,5,7). Unlike results of animal observations (20), no evidence has shown *A. phagocytophilum* persistence in humans.

### Pathology of *A. phagocytophilum* Infections in Humans

Few histopathologic studies of HGA have been conducted. Of 7 patients with fatal cases, 3 died from opportunistic infections (2,4,5,7), including exsanguination

after ulcerative *Candida* esophagitis, ulcerative herpes simplex virus esophagitis with cryptococcal pneumonia, and invasive pulmonary aspergillosis. In 2 other deaths, the patients experienced myocarditis (likely viral) or generalized lymphadenopathy and mononuclear phagocyte system activation.

The pathologic changes in humans include perivascular lymphohistiocytic inflammatory infiltrates in multiple organs, hepatitis with infrequent apoptoses, normocellular bone marrow, mild lymphoid depletion, mononuclear phagocyte hyperplasia in spleen and lymph nodes, and, rarely, splenic necrosis. Hemophagocytosis is observed in bone marrow, liver, and spleen. Vasculitis has not been observed (4). By immunohistochemical tests, *A. phagocytophilum* is rarely identified; organisms were abundant in only 1 patient who died, rare in 2 patients, and not identified in 2 patients (2,4,5,19). Infected neutrophils are not generally associated with pathologic lesions, which suggests alternative mechanisms that do not involve direct bacteria-mediated injury.

Opportunistic infections and inflammatory changes in humans are not unexpected because similar findings occur in animals (19,21). In fact, tickborne fever (ruminant granulocytic anaplasmosis) induces diminished CD4 and CD8 peripheral blood counts, impaired mitogenic responses, impaired antibody responses, impaired neutrophil emigration, and defective phagocytosis and intracellular killing. Such in vitro findings are supported by clinical observations, which document that bacterial, fungal, and viral infections are frequent and generally worse in animals with tickborne fever (20). Disseminated staphylococcal infec-

Table. Metaanalysis of clinical manifestations and laboratory abnormalities in patients with human granulocytic anaplasmosis\*

Characteristics	All			North America		Europe	
	Median %†	Mean %	n‡	Mean %	n	Mean %	n
<b>Symptom or sign</b>							
Fever	100	92	480	92	448	98	66
Myalgia	74	77	514	79	448	65	66
Headache	89	75	378	73	289	89	66
Malaise	93	94	90	96	271	47	15
Nausea	44	38	256	36	207	47	49
Vomiting	20	26	90	34	41	19	49
Diarrhea	13	16	90	22	41	10	49
Cough	13	19	260	22	207	10	49
Arthralgias	58	46	497	47	448	37	49
Rash	3	6	685	6	289	4	53
Stiff neck	11	18	22	22	18	0	4
Confusion	9	17	211	17	207	0	4
<b>Laboratory abnormality</b>							
Leukopenia	38	49	329	50	282	47	47
Thrombocytopenia	71	71	329	72	282	64	47
Elevated serum AST or ALT§	74	71	170	79	123	51	47
Elevated serum creatinine	15	43	72	49	59	0	13

\*Data from references 5, 6, 8–15.

†Median percentage of patients with feature among all reports.

‡Number of patients with data available for metaanalysis.

§AST, aspartate aminotransferase; ALT, alanine aminotransferase.

tions that occur with tickborne fever kill  $\approx 2\%$  of field-raised sheep in the United Kingdom (20); louping ill, a tickborne viral encephalitis of goats is self-limited unless it occurs in conjunction with tickborne fever, when it is often fatal (20); bacterial and fungal secondary infections are more frequent in *A. phagocytophilum*-infected horses (21). A likely interpretation is that *A. phagocytophilum* is associated with perturbations in host inflammatory and immune system function. Impaired early inflammatory responses that might be induced by *A. phagocytophilum* could contribute to the pathogenesis of HGA, and early initiation of proinflammatory and immune responses depend on functionally competent neutrophils and mononuclear phagocytes.

### Pathogenesis of *A. phagocytophilum* Infections

*Anaplasma* species are small (0.2–1.0  $\mu\text{m}$  in diameter) obligate intracellular bacteria with a gram-negative cell wall (4), but lack lipopolysaccharide biosynthetic machinery (22). The bacteria reside in an early endosome, where they obtain nutrients for binary fission and grow into a cluster called a morula (Figure 1). Recent genomic studies demonstrated a type IV secretion apparatus, which could facilitate transfer of molecules between the bacterium and the host (23,24). *A. phagocytophilum* prefers to grow in myeloid or granulocytic cells and has been propagated in human HL-60 and KG-1 promyelocytic leukemia cells, THP-1 myelomonocytic cells, endothelial cell cultures, and tick cell cultures (3). HL-60 cells induced to differentiate into neutrophil-like cells cease to divide but enhance *A. phagocytophilum* growth. When differentiated into monocytic cells, HL-60 cells no longer support *A. phagocytophilum* growth.

*A. phagocytophilum* binds to fucosylated and sialylated scaffold proteins on neutrophil and granulocyte surfaces (25). The most studied ligand is PSGL-1 (CD162) to which the bacterium adheres at least in part through 44-kDa major surface protein-2 (Msp2) (26). Msp2 is probably part of an “adhesin complex” involving Msp2 oligomers with other membrane proteins. After internalization of bacteria, the endosome ceases to mature and does not accumulate markers of late endosomes or phagolysosomes (27). As a result, the vacuole does not become acidified or fuse to lysosomes. *A. phagocytophilum* divides until cell lysis or bacteria are discharged to infect other cells.

The range of described *A. phagocytophilum* proteins is limited, although the genome sequence should assist in defining bacterial structure and function. The most abundant protein in *A. phagocytophilum* is Msp2, encoded by a multigene family of at least 22 paralogs in the Webster strain genome and 52 or more paralogs in the HZ strain genome (28). Antigenic diversity among *A. phagocy-*

*tophilum* strains from different regions is increased by *msp2* gene conversion. Diversity is assumed to be driven by immune selection and may play an important role in persistence among reservoir hosts, but restricted *msp2* transcription and Msp2 expression over many passages and in tick cells suggest selection by fitness for new niches, a finding underscored by Msp2's role as an adhesin (26,28).

Aside from *msp2*, *ankA* is the most actively studied *A. phagocytophilum* component (24,29). This gene encodes a 153–160 kDa protein with at least 11 N-terminal ankyrin repeats and a C-terminus with several tandem repeats but no homology with other proteins. Anka sequences are diverse according to geographic origin, with relative conservation among North American strains and diversity among European bacteria. Whether *ankA* diversity relates to severity is not known. An interesting observation regarding Anka is its localization, where it forms a complex with chromatin in the infected granulocyte cell nucleus. Although little is known about whether Anka affects *A. phagocytophilum* survival or pathogenesis, it is currently the only protein of *A. phagocytophilum* known to be secreted by the bacterium, that passes through the bacterial and vacuolar membrane (presumably by the *A. phagocytophilum* type IV secretion mechanism [23]), through the cytoplasm and nuclear membrane, to find a nuclear target. Within the nucleus of infected neutrophils or HL-60 cells, Anka binds nuclear proteins and complexes to AT-rich nuclear DNA that lacks specific conserved sequences (29). Its mere presence in the nucleus of a cell in which gene transcription appears to be altered by infection compels further investigation of a direct pathogenetic role in regulation of eukaryotic gene expression.

### Animal Models and Immunopathogenicity

The discrepancy between bacterial load and histopathologic changes with HGA suggests that disease relates to immune effectors that inadvertently damage tissues. In vivo human cytokine responses are dominated by interferon- $\gamma$  (IFN $\gamma$ ) and interleukin-10 (IL-10), but lack tumor necrosis factor  $\alpha$  (TNF $\alpha$ ), IL-1 $\beta$ , and IL-4 (30), which suggests a role for macrophage activation in recovery and disease. A murine model shows a cytokine profile similar to that in humans and reproduces histopathologic lesions in infected humans, horses, and dogs (19). In this model, bacterial load peaks at day 7 and rapidly declines; IFN $\gamma$  peaks at day 10 and also declines in parallel. However, histopathologic injury, minimal at days 7–10, peaks by day 14, and then resolves. This pattern suggests a role for IFN $\gamma$  in histopathology and restriction of infection, which is confirmed since histopathologic lesions do not develop in IFN $\gamma$  knockout mice, but the mice have a 5- to 8-fold increase in bacteremia levels (31). In contrast, IL-10

knockout mice, which poorly restrict  $\text{INF}\gamma$  production, do not have increased bacteremia levels, yet histopathologic lesions are significantly worse than controls. The mechanisms of bacterial growth restriction seem clearly related to  $\text{INF}\gamma$  production, but the role of NOS2 (iNOS) in this process is unresolved. Activation of innate immune responses through TLR2, TLR4, MyD88,  $\text{TNF}\alpha$ , and CYBB does not contribute to control of *A. phagocytophilum*. Several murine models show no correlation between histopathologic injury and bacterial load. Likewise, infection of TLR2-, TLR4-, MyD88-,  $\text{TNF}\alpha$ -, and CYBB-knockout mice does not affect bacterial burden, yet abrogates inflammatory tissue lesions. Such findings support an immune triggering role for *A. phagocytophilum* as a mechanism for disease.

While  $\text{INF}\gamma$  and IL-10 are key markers or effectors of injury with *A. phagocytophilum* infection, their source is unclear. Infection of neutrophils and HL-60 cells differentiated into neutrophil-like cells produces striking quantities of CXC and CC chemokines, including IL-8, RANTES, MIP1 $\alpha$ , MIP1 $\beta$ , and MCP-1, but not  $\text{INF}\gamma$ , IL-10,  $\text{TNF}\alpha$ , IL-1 $\beta$ , or IL-4 (32), suggesting that *A. phagocytophilum* infection partially activates neutrophils. Akkoyunlu et al. demonstrated a decreased bacteremia with antibody blockade of chemokine receptors (CXCR2) and in CXCR2 knockout mice (33). This presumably provides a survival advantage to the bacterium by recruitment of new neutrophil host cells, increasing the blood concentrations of infected cells that can be acquired by tick bite. In spite of the increased bacteremia, no increase in histopathologic lesions is noted, confirming previous studies. The disadvantage of chemokine production to the host is that recruitment of inflammatory cells that are activated could produce  $\text{INF}\gamma$ -induced inflammation, leading to damage to tissues.

### Neutrophil Functional Changes with *A. phagocytophilum* Infection

Other notable alterations of neutrophil function and physiology are observed with *A. phagocytophilum* infection. *A. phagocytophilum* survives its initial encounter by detoxifying superoxide produced by neutrophil phagocyte oxidase assembly, perhaps by virtue of bacterial superoxide dismutase (23,34). Although not yet shown in infected neutrophils, infected HL-60 cells are unable to generate respiratory bursts because of reduced transcription of components of phagocyte oxidase, including gp91<sup>phox</sup> and Rac2 (35,36). Although this defect seems limited to the infected neutrophils and is a major mechanism that permits intracellular infection, the reduction in phagocyte oxidase may have other effects, including a reduction in local regulation of inflammation. This results from the inability of phagocyte oxidase to degrade inflammatory mediators

such as leukotrienes, complement, and perhaps other components. Another normal function of neutrophils is apoptosis, which regulates inflammation by programmed cell death of activated neutrophils usually within 24 to 48 hours. The induction of apoptosis by *A. phagocytophilum*-infected neutrophils is delayed  $\approx$ 24 hours (37) and also relates to maintained transcription of *bcl2* family genes and stabilization of the mitochondrial pathway that ultimately prevents procaspase 3 processing (37).

Infection by *A. phagocytophilum* results in significant disruption of normal neutrophil function, including endothelial cell adhesion and transmigration, motility, degranulation, respiratory burst, and phagocytosis. *A. phagocytophilum*-infected neutrophils and HL-60 cells are inhibited from binding to systemic and brain microvascular endothelial cells, even under conditions of low shear force (38). The adhesion defect results from the shedding of neutrophil PSGL-1 and L-selectin, which mediate the critical first step in inflammatory cell recruitment. This inhibited recruitment occurs despite the rapid mobilization of surface  $\beta$ 2-integrins (CD11b/CD18) and ICAM-1 (CD54), which ordinarily mediate the second phase of tight endothelial-cell binding. Thus, *A. phagocytophilum*-infected neutrophils are inhibited from transmigrating endothelial cell barriers in spite of stimulated motility. Selectin "shedding" occurs because infected cells degranulate, including an EDTA-inhibitable sheddase (metalloprotease),  $\beta$ 2-integrins, CD66b, and other inflammatory components such as matrix metalloproteases, which includes gelatinase (MMP9) (38,39). Engagement of opsonophagocytosis receptors and degranulation are usually accompanied by rapid cell death (apoptosis), but with *A. phagocytophilum*, degranulation occurs over a prolonged period, potentially exacerbating inflammation, especially with delayed apoptosis of infected neutrophils (36,39,40). After recruitment, chemotactic migration, and activation for respiratory burst, neutrophils are then activated for phagocytosis; however, this function is inhibited in vivo and in vitro, perhaps in part resulting from alterations of *rac2* expression and loss of important surface receptors (40). Altogether, the activated-deactivated phenotype of the *A. phagocytophilum*-infected neutrophil may benefit the bacterium by increasing concentrations of infected cells in the peripheral blood that are unresponsive to tissue recruitment and may have a prolonged lifespan. However, the cost to the host includes activation of neutrophils to participate in proinflammatory reactions while they are unable to act as microbicidal effectors or regulators of inflammation.

### Conclusions

Investigators of novel intracellular bacteria often address unanswered questions by investigating processes



shared with other bacteria or bacterial processes, or by investigating differences that have allowed the unique niche to become occupied. Since *A. phagocytophilum*, along with *E. ruminantium*, *E. ewingii*, and *Chlamydo-phila pneumoniae* are the only known bacteria to survive and propagate within neutrophils, it seems most relevant that investigation should focus on adaptations permissive for neutrophil infection. What is clear is that this new tick-borne infection has a great capacity to infect and cause disease in humans while maintaining a persistent subclinical state in animal reservoirs. The disease processes appear to be immune and inflammatory in nature, not directly related to pathogen burden, and result by the triggering of a detrimental and poorly regulated host response. Recent investigations have provided important phenotypic data on the range of functional changes among *A. phagocytophilum*-infected neutrophils and identified several compelling targets for study of fundamental pathogenetic processes. Important areas that still need intense study include the bacterial triggers of host innate and inflammatory response and the molecular and cellular mechanisms by which *A. phagocytophilum* influences cell function and ultimately causes injury to host cells, tissues, and organs. Perhaps by developing a more comprehensive understanding of the basic mechanisms underlying *A. phagocytophilum*-neutrophil/host interactions, we can appropriately target strategies for control and management.

Much of the work described in this article was supported by grants R01 AI44102, R01 AI41213, and R21 NS050711 from the National Institutes of Allergy and Infectious Diseases and the National Institute for Neurological Diseases and Stroke.

Dr Dumler is professor of pathology, Division of Medical Microbiology, at the Johns Hopkins University School of Medicine, Baltimore, Maryland. He has been studying the genera *Rickettsia*, *Ehrlichia*, and *Anaplasma* for over 25 years.

## References

- Chen S-M, Dumler JS, Bakken JS, Walker DH. Identification of a granulocytotropic *Ehrlichia* species as the etiologic agent of human disease. *J Clin Microbiol*. 1994;32:589-95.
- Bakken JS, Dumler JS, Chen SM, Eckman MR, Van Etta LL, Walker DH. Human granulocytic ehrlichiosis in the upper midwest United States. A new species emerging? *JAMA*. 1994;272:212-8.
- Dumler JS, Barbet AF, Bekker CP, Dasch GA, Palmer GH, Ray SC, et al. Reorganization of genera in the families *Rickettsiaceae* and *Anaplasmataceae* in the order *Rickettsiales*: unification of some species of *Ehrlichia* with *Anaplasma*, *Cowdria* with *Ehrlichia* and *Ehrlichia* with *Neorickettsia*, descriptions of six new species combinations and designation of *Ehrlichia equi* and 'HGE agent' as subjective synonyms of *Ehrlichia phagocytophila*. *Int J Syst Evol Microbiol*. 2001;51:2145-65.
- Walker DH, Dumler JS. Emergence of ehrlichioses as human health problems. *Emerg Infect Dis*. 1996;2:18-29.
- Bakken JS, Krueth J, Wilson-Nordskog C, Tilden RL, Asanovich K, Dumler JS. Clinical and laboratory characteristics of human granulocytic ehrlichiosis. *JAMA*. 1996;275:199-205.
- Aguero-Rosenfeld ME, Horowitz HW, Wormser GP, McKenna DF, Nowakowski J, Munoz J, et al. Human granulocytic ehrlichiosis (HGE): a case series from a single medical center in New York State. *Ann Intern Med*. 1996;125:904-8.
- Hardalo C, Quagliarello V, Dumler JS. Human granulocytic ehrlichiosis in Connecticut: report of a fatal case. *Clin Infect Dis*. 1995;21:910-4.
- Lotric-Furlan S, Petrovec M, Avsic-Zupanc T, Strle F. Human granulocytic ehrlichiosis in Slovenia. *Ann N Y Acad Sci*. 2003;990:279-84.
- Blanco JR, Oteo JA. Human granulocytic ehrlichiosis in Europe. *Clin Microbiol Infect*. 2002; 8:763-72.
- Bjoersdorff A, Wittesjo B, Berglun J, Massung RF, Eliasson I. Human granulocytic ehrlichiosis as a common cause of tick-associated fever in Southeast Sweden: report from a prospective clinical study. *Scand J Infect Dis*. 2002;34:187-91.
- Belongia EA, Gale CM, Reed KD, Mitchell PD, Vandermause M, Finkel MF, et al. Population-based incidence of human granulocytic ehrlichiosis in northwestern Wisconsin, 1997-1999. *J Infect Dis*. 2001;184:1470-4.
- Belongia EA, Reed KD, Mitchell PD, Chyou PH, Mueller-Rizner N, Finkel MF, et al. Clinical and epidemiological features of early Lyme disease and human granulocytic ehrlichiosis in Wisconsin. *Clin Infect Dis*. 1999;29:1472-7.
- Wallace BJ, Brady G, Ackman DM, Wong SJ, Jacquette G, Lloyd EE, et al. Human granulocytic ehrlichiosis in New York. *Arch Intern Med*. 1998;158:769-73.
- Lotric-Furlan S, Petrovec M, Avsic-Zupanc T, Strle F. Comparison of patients fulfilling criteria for confirmed and probable human granulocytic ehrlichiosis. *Scand J Infect Dis*. 2004;36:817-22.
- Bakken JS. Clinical diagnosis and treatment of human granulocytic anaplasmosis. In: Abstracts of the 4th International Conference on Rickettsiae and Rickettsial Diseases, Logrono, Spain, 2005 Jun 18-21. Abstract O-34.
- Bakken JS, Goellner P, Van Etten M, Boyle DZ, Swonger OL, Mattson S, et al. Seroprevalence of human granulocytic ehrlichiosis (HGE) and risk factors associated with infection among residents in northwestern Wisconsin. *Clin Infect Dis*. 1998;27:1491-6.
- Aguero-Rosenfeld ME, Donnarumma L, Zentmaier L, Jacob J, Frey M, Noto R, et al. Seroprevalence of antibodies that react with *Anaplasma phagocytophila*, the agent of human granulocytic ehrlichiosis, in different populations in Westchester County, New York. *J Clin Microbiol*. 2002;40:2612-5.
- Ildo JW, Meek JI, Carter ML, Magnarelli LA, Wu C, Tenuta SW, et al. The emergence of another tickborne infection in the 12-town area around Lyme, Connecticut: human granulocytic ehrlichiosis. *J Infect Dis*. 2000;181:1388-93.
- Lepidi H, Bunnell JE, Martin ME, Madigan JE, Stuen S, Dumler JS. Comparative pathology and immunohistology associated with clinical illness after *Ehrlichia phagocytophila*-group infections. *Am J Trop Med Hyg*. 2000;62:29-37.
- Brodie TA, Holmes PH, Urquhart GM. Some aspects of tick-borne diseases of British sheep. *Vet Rec*. 1986;118:415-8.
- Gribble DH. Equine ehrlichiosis. *J Am Vet Med Assoc*. 1969;155:462-9.
- Lin M, Rikihisa Y. *Ehrlichia chaffeensis* and *Anaplasma phagocytophilum* lack genes for lipid A biosynthesis and incorporate cholesterol for their survival. *Infect Immun*. 2003;71:5324-31.
- Ohashi N, Zhi N, Lin Q, Rikihisa Y. Characterization and transcriptional analysis of gene clusters for a type IV secretion machinery in human granulocytic and monocytic ehrlichiosis agents. *Infect Immun*. 2002;70:2128-38.

24. Caturegli P, Asanovich KM, Walls JJ, Bakken JS, Madigan JE, Popov S, et al. *ankA*: an *Ehrlichia phagocytophila* group gene encoding a protein antigen with ankyrin-like repeats. *Infect Immun.* 2000;68:5277-83.
25. Herron MJ, Nelson CM, Larson J, Snapp KR, Kansas GS, Goodman JL. Intracellular parasitism by the human granulocytic ehrlichiosis bacterium through the P-selectin ligand, PSGL-1. *Science.* 2000;288:1653-6.
26. Park J, Choi K-S, Dumler JS. Major surface protein 2 (Msp2) of *Anaplasma phagocytophilum* facilitates adherence to granulocytes. *Infect Immun.* 2003;71:4018-25.
27. Webster P, Ijdo JW, Chicoine LM, Fikrig E. The agent of human granulocytic ehrlichiosis resides in an endosomal compartment. *J Clin Invest.* 1998;101:1932-41.
28. Scorpio DG, Caspersen K, Ogata H, Park J, Dumler JS. Restricted changes in major surface protein-2 (*msp2*) transcription after prolonged in vitro passage of *Anaplasma phagocytophilum*. *BMC Microbiol.* 2004;4:1.
29. Park J, Kim KJ, Choi KS, Grab DJ, Dumler JS. *Anaplasma phagocytophilum* Anka binds to granulocyte DNA and nuclear proteins. *Cell Microbiol.* 2004;6:743-51.
30. Dumler JS, Trigiani ER, Bakken JS, Aguero-Rosenfeld ME, Wormser GP. Serum cytokine responses during acute human granulocytic ehrlichiosis. *Clin Diagn Lab Immunol.* 2000;7:6-8.
31. Martin ME, Caspersen K, Dumler JS. Immunopathology and ehrlichial propagation are regulated by interferon gamma (IFN $\gamma$ ) and interleukin-10 (IL-10) in a murine model of human granulocytic ehrlichiosis (HGE). *Am J Pathol.* 2001;158:1881-8.
32. Klein MB, Hu S, Chao CC, Goodman JL. The agent of human granulocytic ehrlichiosis induces the production of myelosuppressing chemokines without induction of proinflammatory cytokines. *J Infect Dis.* 2000;182:200-5.
33. Akkoyunlu M, Malawista SE, Anguita J, Fikrig E. Exploitation of interleukin-8-induced neutrophil chemotaxis by the agent of human granulocytic ehrlichiosis. *Infect Immun.* 2001;69:5577-88.
34. Carlyon JA, Abdel-Latif D, Pypaert M, Lacy P, Fikrig E. *Anaplasma phagocytophilum* utilizes multiple host evasion mechanisms to thwart NADPH oxidase-mediated killing during neutrophil infection. *Infect Immun.* 2004;72:4772-83.
35. Carlyon JA, Chan WT, Galan J, Roos D, Fikrig E. Repression of *rac2* mRNA expression by *Anaplasma phagocytophilum* is essential to the inhibition of superoxide production and bacterial proliferation. *J Immunol.* 2002;169:7009-18.
36. Choi K-S, Dumler JS. Early induction and late abrogation of respiratory burst in *A. phagocytophilum*-infected neutrophils. *Ann N Y Acad Sci.* 2003;990:488-93.
37. Ge Y, Yoshiie K, Kuribayashi F, Lin M, Rikihisa Y. *Anaplasma phagocytophilum* inhibits human neutrophil apoptosis via upregulation of *bfl-1*, maintenance of mitochondrial membrane potential and prevention of caspase 3 activation. *Cell Microbiol.* 2005;7:29-38.
38. Choi K-S, Garyu J, Park J, Dumler JS. Diminished adhesion of *Anaplasma phagocytophilum*-infected neutrophils to endothelial cells is associated with reduced leukocyte surface selectin expression. *Infect Immun.* 2003;71:4586-94.
39. Choi KS, Grab DJ, Dumler JS. *Anaplasma phagocytophilum* infection induces protracted neutrophil degranulation. *Infect Immun.* 2004;72:3680-3.
40. Garyu JW, Choi KS, Grab DJ, Dumler JS. Defective phagocytosis in *Anaplasma phagocytophilum*-infected neutrophils. *Infect Immun.* 2005;73:1187-90.

Address for correspondence: J. Stephen Dumler, The Johns Hopkins Medical Institutions 720 Rutland Ave, Ross 624, Baltimore, MD 21205, USA; fax: 443-287-3665; email: sdumler@jhmi.edu

# EMERGING INFECTIOUS DISEASES

Full text free online at  
[www.cdc.gov/eid](http://www.cdc.gov/eid)

The print journal is available at no charge to public health professionals

YES, I would like to receive Emerging Infectious Diseases.

Please print your name and business address in the box and return by fax to 404-371-5449 or mail to

EID Editor  
CDC/NCID/MS D61  
1600 Clifton Road, NE  
Atlanta, GA 30333

Moving? Please give us your new address (in the box) and print the number of your old mailing label here \_\_\_\_\_

---

# *Francisella tularensis* in the United States

Jason Farlow,\* David M. Wagner,\* Meghan Dukerich,\* Miles Stanley,\* May Chu,† Kristy Kubota,† Jeannine Petersen,† and Paul Keim\*

The causative agent of tularemia, *Francisella tularensis*, is a formidable biologic agent that occurs naturally throughout North America. We examined genetic and spatial diversity patterns among 161 US *F. tularensis* isolates by using a 24-marker multiple-locus variable-number tandem repeat analysis (MLVA) system. MLVA identified 126 unique genotypes. Phylogenetic analyses showed patterns similar to recently reported global-scale analyses. We observed clustering by subspecies, low genetic diversity within *F. tularensis* subsp. *holarctica*, and division of *F. tularensis* subsp. *tularensis* into 2 distinct subpopulations: A.I. and A.II. The 2 *F. tularensis* subsp. *tularensis* subpopulations also represent geographically distinct groups; A.I. occurs primarily in the central United States, and A.II. occurs primarily in the western United States. These spatial distributions are correlated with geographic ranges of particular vectors, hosts of tularemia, and abiotic factors. These correlates provide testable hypotheses regarding ecologic factors associated with maintaining tularemia foci.

Tularemia, also known as rabbit fever or deer-fly fever, is caused by the gram-negative intracellular pathogen *Francisella tularensis* (1). This bacterium was first identified in 1912 following reports of a plaguelike illness in ground squirrels in Tulare County, California (2). One of the most pathogenic microorganisms known, *F. tularensis* is currently listed as a category A select agent (3) because of its potential as a bioterrorism agent.

Since the discovery of this pathogen, 4 subspecies have been identified that exhibit distinct virulence and biochemical profiles as well as characteristic geographic distributions (4). Human disease is primarily associated with 2 *F. tularensis* subspecies: the highly virulent *F. tularensis* subsp. *tularensis* (type A), which is found only in North

America, and the moderately virulent *F. tularensis* subsp. *holarctica* (type B), which is endemic throughout the Northern Hemisphere (5). Although *F. tularensis* subsp. *novicida* was recently reported in Australia, it is endemic primarily in North America and rarely isolated (6). *F. tularensis* subsp. *mediasiatica* is reported only from central Asian republics of the former Soviet Union (7).

Although the incidence of human tularemia is rare in the United States, the distribution of the pathogen appears ubiquitous (8). From 1981 to 1987, ~60% of the cases reported in the United States occurred in Arkansas, Louisiana, Missouri, Oklahoma, or Texas (9). With the exception of localized outbreaks at Martha's Vineyard, Massachusetts, the central states of Arkansas, Missouri, Oklahoma, and South Dakota reported the highest incidence of the disease from 1990 to 2000 (8). Human tularemia incidence in the United States peaked in 1939 with 2,291 reported cases (5) and has since decreased to 100–200 cases annually (8).

In the United States, several blood-feeding arthropods serve as vectors for *F. tularensis*, including ticks (*Ixodidae*) and biting flies (*Tabanidae*) (5). Three ixodid tick species are important vectors in the United States: the American dog tick (*Dermacentor variabilis*), the Rocky Mountain wood tick (*D. andersoni*), and the Lone Star tick (*Amblyomma americanum*) (5). The deer fly (*Chrysops discalis*) was the first tularemia vector to be identified and is often associated with human disease in the western United States (10–12).

Tularemia infections have been documented in  $\geq 200$  species of mammals, as well as birds, reptiles, and fish (4). In North America, members of the family *Leporidae*, such as *Sylvilagus* spp. (cottontail rabbits) and *Lepus* spp. (hares), are important hosts (5). Despite these findings, the transmission cycle of *F. tularensis* is not well characterized because of the rare occurrence of natural outbreaks involving humans. As a result, ecologic and environmental

---

\*Northern Arizona University, Flagstaff, Arizona, USA; and †Centers for Disease Control and Prevention, Fort Collins, Colorado, USA

factors promoting the maintenance of tularemia foci in North America remain largely unknown.

We recently identified a major division within *F. tularensis* subsp. *tularensis* (13). This division consists of the split between the highly diverse A.I. isolates, which include the SCHU S4 strain, and the less diverse A.II. isolates, which include the *F. tularensis* species type strain ATCC 6223 (13). Since this division was not previously recognized, no studies have yet explored ecologic factors that may serve as the basis for this structure.

In this study, we examined genetic-spatial patterns among North American *F. tularensis* isolates to better understand how geography may shape their genetic repertoire. In an attempt to identify factors that may influence the maintenance of endemic tularemia foci in the United States, we examined correlations between observed genetic groupings that were identified by using multiple-locus variable-number tandem repeat analysis (MLVA) and biotic and abiotic variables.

## Methods

### Isolates of *F. tularensis* and MLVA Subtyping

We examined 161 *F. tularensis* isolates, 158 from the United States and 3 from Canada. Subspecies analyzed included 83 *F. tularensis* subsp. *tularensis*, 72 *F. tularensis* subsp. *holarctica*, and 6 *F. tularensis* subsp. *novicida*. The originating laboratories for a subset of these isolates (n = 80) is reported elsewhere (13). All additional isolates were provided by the Centers for Disease Control and Prevention in Fort Collins, Colorado. A detailed description of the MLVA typing system and its use in examining phylogenetic relationships within *F. tularensis* are reported elsewhere (13).

### Phylogenetic, Spatial, and Statistical Analyses

A neighbor-joining dendrogram was generated by using PAUP (Sinauer Associates Inc., Sutherland, MA, USA). Distribution maps were generated with ArcView 3.3 (Environmental Systems Research Institute, Inc., Redlands, CA, USA); host and vector distributions were based on previously published data (5,14,15). Rank Mantel analyses were performed (16) by using PRIMER software (Primer-E, Ltd., Plymouth, UK). Genetic group (A.I. or A.II.) or location (California or not California) were used as the categoric factors for analysis of similarities (ANOSIM) (17). Spatial analyses were performed by using county centroid data from a subset of isolates with known county of origin. Within this subset, 1 representative was included from each set of isolates known to be from the same host or epidemiologically linked. Isolates examined included 49 *F. tularensis* subsp. *holarctica*, 30 *F.*

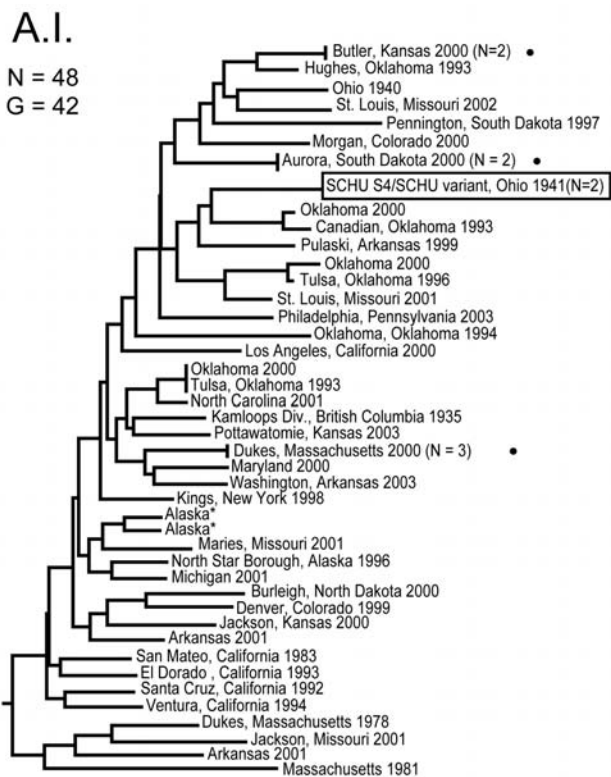

Figure 1. Genetic relationships among 48 North American *Francisella tularensis* subsp. *tularensis* A.I. subpopulation isolates based upon allelic differences at 24 variable number tandem repeat (VNTR) markers. County, state, and year of isolation are specified to the right of each branch or clade. G indicates number of distinct VNTR marker genotypes, dots indicate host-linked isolates, boxed designation indicates prominent *F. tularensis* subsp. *tularensis* laboratory strain SCHU S4, and asterisks indicate isolates with an unknown year of isolation.

*tularensis* subsp. *tularensis* subpopulation A.I., and 28 *F. tularensis* subsp. *tularensis* subpopulation A.II. A digital elevation model (Environmental Systems Research Institute, Inc.) was used to calculate mean elevation in each county of occurrence.

## Results

Neighbor-joining analysis of MLVA data identified 4 major genetic groups among the 161 North American *F. tularensis* isolates: *F. tularensis* subsp. *tularensis* subpopulation A.I., *F. tularensis* subsp. *tularensis* subpopulation A.II., *F. tularensis* subsp. *holarctica*, and *F. tularensis* subsp. *novicida* (Figures 1–5). The genetic groupings observed are consistent with the major genetics groups we described previously (13). In all cases, assignment of isolates to these genetic groups was consistent with their existing subspecies designations, which were based upon immunofluorescent, biochemical, and other molecular tests.

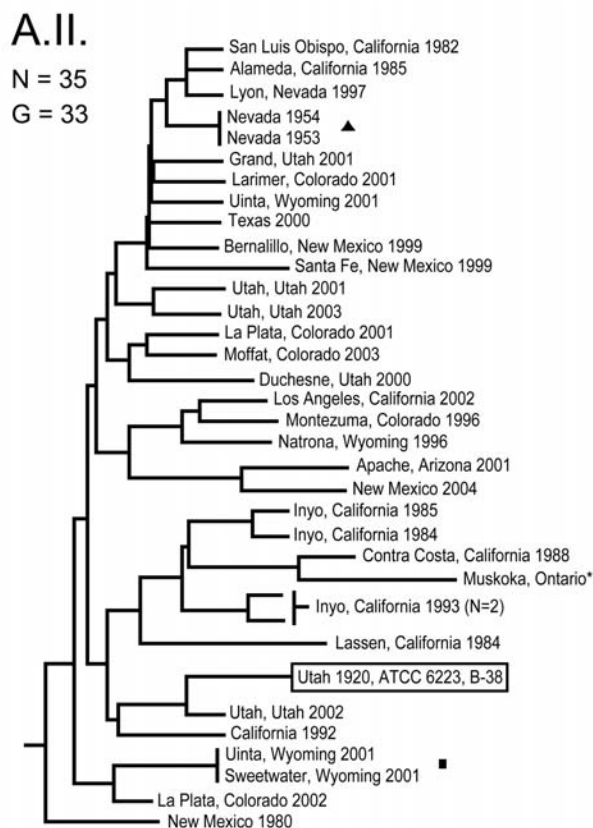

Figure 2. Genetic relationships among 35 North American *Francisella tularensis* subsp. *tularensis* A.II. subpopulation isolates based upon allelic differences at 24 variable number tandem repeat (VNTR) markers. County, state, and year of isolation are specified to the right of each branch or clade. G indicates number of distinct VNTR marker genotypes, triangle indicates epidemiologically linked isolate, asterisk indicates isolate with an unknown year of isolation, boxed designation indicates *F. tularensis* type strain B-38, and square indicates a set of genetically identical but epidemiologically unlinked isolates.

### Genetic Resolution

The MLVA typing system provided good genetic resolution (Figures 1–4). A total of 126 unique genotypes were observed among the 161 isolates. The average pairwise distance between isolates within the A.I. and A.II. subpopulations of *F. tularensis* subsp. *tularensis*, *F. tularensis* subsp. *holarctica*, and *F. tularensis* subsp. *novicida* was 0.324, 0.172, 0.144, and 0.310, respectively. MLVA provided complete discrimination among *F. tularensis* subsp. *tularensis* A.I. isolates, with the exception of 3 sets of isolates obtained from the same hosts (Figure 1). Among A.II. isolates, all but 2 sets of isolates were resolved by MLVA (Figure 2). Genetic resolution was poorest within *F. tularensis* subsp. *holarctica*; 14 sets of isolates were unresolved. Among these sets, only 2 were epidemiologically or host-linked, whereas many of the remaining 12

associated sets contain isolates from distant geographic locations (Figure 3).

### Geographic Distributions of Genetic Groups

The 4 genetic groups exhibited unique distributional patterns in geographic space (Figure 6). Isolates from *F. tularensis* subsp. *holarctica* were the most widespread, occurring in many of the lower 48 contiguous states, as well as British Columbia. With the exception of the 1920 Utah type strain (Utah 112) and 1 isolate from California, the other 4 *F. tularensis* subsp. *novicida* isolates were collected in southeastern states (Figures 4 and 6). The human incidence hotspot in the central United States (8) appears to be associated with the *F. tularensis* subsp. *tularensis* A.I. group (Figure 6). However, isolates from this group were also collected in Alaska, British Columbia, and California

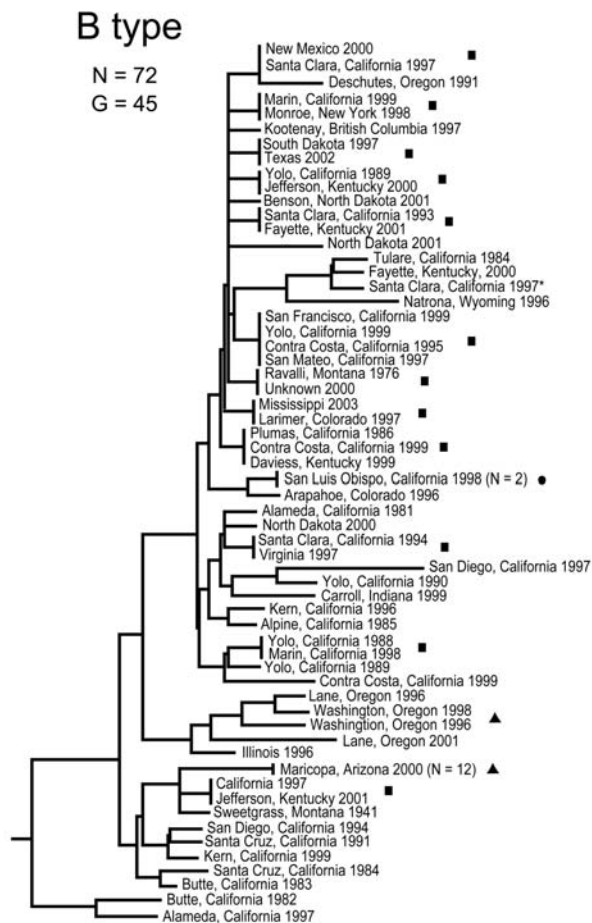

Figure 3. Genetic relationships among 72 North American *Francisella tularensis* subsp. *holarctica* B type isolates based upon allelic differences at 24 variable number tandem repeat (VNTR) markers. County, state, and year of isolation are specified to the right of each branch or clade. G indicates number of distinct VNTR marker genotypes, squares indicate genetically identical but epidemiologically unlinked isolates, asterisk indicates isolate with an unknown year of isolation, dot indicates a host-linked isolate, and triangles indicate epidemiologically linked isolates.

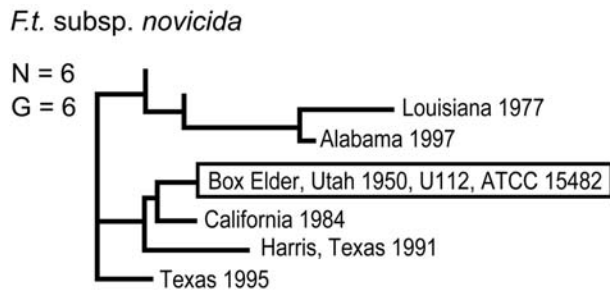

Figure 4. Genetic relationships among 6 North American *Francisella tularensis* subsp. *novicida* isolates based upon allelic differences at 24 variable number tandem repeat (VNTR) markers. County, state, and year of isolation are specified to the right of each branch or clade. G indicates number of distinct VNTR marker genotypes, and boxed designation indicates *F. tularensis* subsp. *novicida* type strain Utah 112 (U112).

(Figures 1 and 6). In contrast, isolates of the *F. tularensis* subsp. *tularensis* A.II. subpopulation were collected primarily in the western United States, although some were also collected in Ontario and Texas (Figures 2 and 6). California is the only state that had isolates from all 4 genetic groups (Figures 1–4 and 6).

#### Genetic-Geographic Correlations

Only within *F. tularensis* subsp. *tularensis* subpopulation A.II did genetic and geographic distances show a correlation ( $\rho = 0.340$ ,  $p = 0.0009$ ). No significant correlation was found between genetic and geographic distances within *F. tularensis* subsp. *tularensis* subpopulation A.I. ( $\rho = -0.009$ ,  $p = 0.5239$ ) or *F. tularensis* subsp. *holarctica* ( $\rho = 0.033$ ,  $p = 0.3328$ ).

#### *F. tularensis* subsp. *tularensis* A.I. and A.II. Subpopulations

Based on ANOSIM, A.I. and A.II. isolates form 2 distinct groups in geographic space ( $R = 0.336$ ,  $p < 0.001$ ). We found no evidence ( $R = -0.048$ ,  $p = 0.639$ ) that *F. tularensis* subsp. *tularensis* A.I. isolates from California ( $n = 5$ ) are genetically distinct from A.I. isolates found in the other 47 contiguous states ( $n = 23$ ).

The geographic distributions of the A.I. and A.II. subpopulations are associated with distinct abiotic and biotic factors, including known tularemia vectors and hosts. The mean elevation in counties where A.I. subpopulation genotypes were isolated was significantly lower (451.7 m, standard error [SE] 84.9;  $U = 211.5$ ,  $p < 0.001$ , by Mann-Whitney U test) than the mean elevation in counties where A.II. subpopulation genotypes were isolated (1,400.9 m, SE 175.2). The geographic distribution of A.I. isolates is closely associated with the distribution of the vectors *A. americanum* and *D. variabilis*; both *D. variabilis* and the A.I. isolates occur primarily in the central and eastern

United States but also in California (Figure 7A). The main geographic cluster of A.II. isolates is associated with the distributions of 2 known tularemia vectors, *D. andersoni* and *C. discalis* (Figure 7A). Finally, the main geographic distributions of A.I. and A.II. isolates are each associated with the distributions of different rabbit hosts, *S. floridanus* and *S. nuttallii*, respectively (Figure 7B).

#### Discussion

This study provides an ecogenetic analysis of *F. tularensis* in the United States and contributes new insights into this human health threat and potential biologic weapon. Our analyses categorized North American *F. tularensis* isolates into 4 previously recognized groups (13) and provided good genetic resolution within those groups (Figures 1–5). These findings indicate that MLVA is useful for examining continent-scale patterns of genetic diversity in *F. tularensis*. We focus here on a more detailed discussion of *F. tularensis* population structure on a continentwide scale and the ecologic correlates and associations of specific groups.

We observed relatively little genetic diversity within *F. tularensis* subsp. *holarctica* (Figure 3) despite analyzing samples from across North America (Figure 6). The genetic diversity that exists within this subspecies does not appear to be related to geographic distance. The lack of geographic differentiation, coupled with the low genetic diversity of *F. tularensis* subsp. *holarctica* in the United States, is consistent with rapid transmission of a recently emerged pathogen across great distances.

Unlike *F. tularensis* subsp. *holarctica*, the A.I. and A.II. subpopulations within *F. tularensis* subsp. *tularensis* are genetically distinct and geographically differentiated. The spatial distributions of these 2 subpopulations are associated with large differences in elevation, with A.I. occurring at lower elevations than A.II. Elevation alone is unlikely to influence the distribution of different groups within *F. tularensis* subsp. *tularensis*. We examined elevation because it is a single measurement that is highly

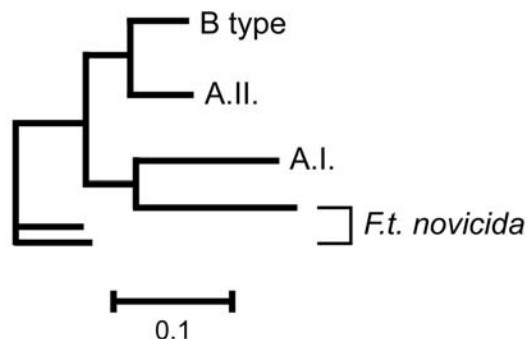

Figure 5. Phylogenetic relationships among subgroups A.I., A.II., B type, and *Francisella tularensis* subsp. *novicida* at 24 variable number tandem repeat markers. Scale bar represents genetic distance.

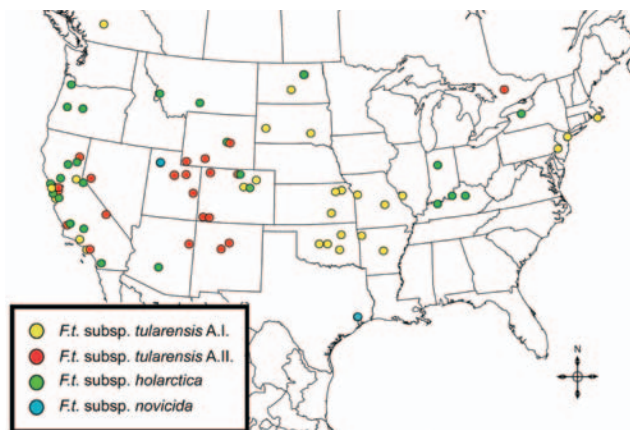

Figure 6. Spatial distribution of 125 *Francisella tularensis* isolates for which information on originating county was available. Locations (colored circles) correspond to county centroids. More than 1 subspecies was isolated from some counties in California (Alameda, Contra Costa, Los Angeles, San Luis Obispo, and Santa Cruz) and Wyoming (Natrona) (see Figures 1–3). In some cases, a single circle may represent instances where >1 sample of a given subspecies or genotypic group was isolated from a single county. Two isolates with county information, 1 from northern British Columbia and 1 from Alaska, are not shown.

correlated with other, more biologically relevant factors that may influence host and vector distributions, such as temperature, rainfall, and distribution of major vegetation types (18). The A.I. and A.II. subpopulations may have adapted to transmission and maintenance by specific vectors and hosts, leading to niche separation. This idea is supported by the striking association between the respective distributions of the A.I. and A.II. subpopulations and the distributions of specific tularemia vectors and hosts (Figure 7). Our results indicate that *S. floridanus* may be an important host for the A.I. subpopulation and *S. nuttallii* for the A.II. subpopulation (Figure 7B).

The A.I. and A.II. subpopulations within *F. tularensis* subsp. *tularensis* are associated with specific vector species, and movement of these vectors may have dispersed the pathogen across the United States. The distribution of the A.I. subpopulation is spatially correlated with *A. americanum* and the American dog tick *D. variabilis* (Figure 7A). The transport of dogs and, consequently, *F. tularensis*-infected *D. variabilis* may explain the lack of genetic-spatial correlation within this group, as well as the occurrence in California of both *D. variabilis* and the A.I. subpopulation of *F. tularensis* subsp. *tularensis*. Tularemia-infected *D. variabilis* could have been introduced into California through dogs during human westward migration in the 19th or 20th centuries. This hypothesis is consistent with the urban distribution of *D. variabilis* in California (19). Whatever the timing, A.I. isolates from California do

not form a genetic group that is distinct from other A.I. isolates, which is suggestive of multiple introductions to California from the eastern United States. In contrast, the information in Figure 7 suggests the primary focus of the *F. tularensis* subsp. *tularensis* A.II. subpopulation is in the western United States and that this focus is associated with the vectors *D. andersoni* and *C. discalis*.

The evolutionary linkage of the A.I. and A.II. subpopulations within *F. tularensis* subsp. *tularensis* may be ancient (Figure 8A). Large MLVA distances separate these types (13) and are equivalent to those separating other *F. tularensis* subspecies (Figure 5). The current spatial distribution and genetic distances distinguishing the A.I. and A.II. subpopulations may have been shaped by Pleistocene refugia. The greater diversity observed in the A.I. subpopulation is consistent with an older age, more rapid evolution in this focus, or a historical genetic bottleneck unique to the A.II. subpopulation that occurred after A.I.–A.II. separation. Evolutionary rates are accelerated in certain ecologic scenarios and retarded in others. However, if equal evolutionary rates between the A.I. and A.II. subpop-

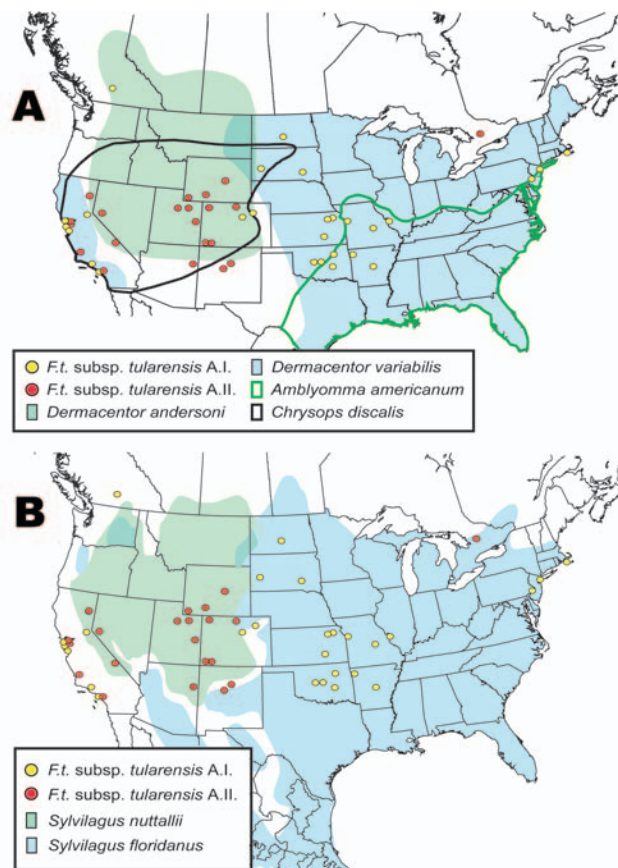

Figure 7. Spatial distributions of isolates from the A.I. and A.II. subpopulations of *Francisella tularensis* subsp. *tularensis* relative to A) distribution of tularemia vectors *Dermacentor variabilis*, *D. andersoni*, *Amblyomma americanum*, and *Chrysops discalis*; and B) distribution of tularemia hosts *Sylvilagus nuttallii* and *S. floridanus*.

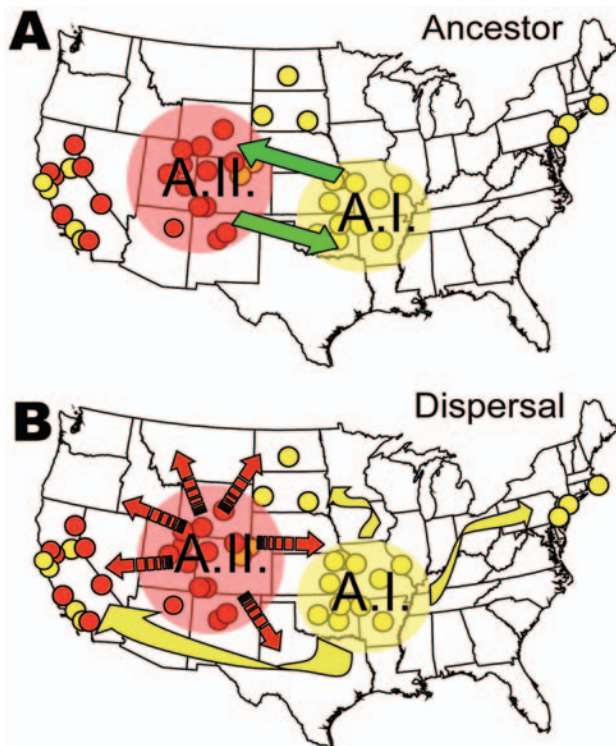

Figure 8. Genetic and spatial data of the A.I and A.II subpopulations of *Francisella tularensis* subsp. *tularensis* in the United States. A) Ancestral status of these 2 subpopulations is unclear; either could have founded the other, or a third unknown subpopulation could have been the ancestor. B) Highly restricted bacterial-endemic regions could now be breaking down because of human-mediated dispersal of the pathogen across the country. The small circles indicate the spatial distribution of the A.I and A.II isolates, as shown in Figure 6.

ulations are assumed, A.I. is older and may have been the founding population for A.II. More robust phylogenetic analysis that uses slowly evolving characters (20,21) should eventually root this relationship.

The lower Midwest tularemia focus (8) may have been a dispersal source for other A.I. populations in the United States. In this model (Figure 8B), continentwide dispersal may have occurred as recently as the advent of modern transportation (e.g., rail or automobile traffic). A locally robust population of *F. tularensis* subsp. *tularensis* A.I. may have been relatively isolated until European colonists dispersed this pathogen throughout the continent. The rapid and long-range dispersal of infected animals or vectors would be similar to an evolutionary radiation with little correlation to spatial parameters.

Such rapid dispersal also may be a function of the recent introduction of lagomorph species into these areas. In the first half of the 20th century, hundreds of thousands of rabbits and hares were shipped from central states to eastern states (5,22), and some of these shipments includ-

ed carcasses infected with *F. tularensis* (23). Before 1937, no cases of tularemia were reported from Massachusetts (5). These reports suggest that mass introductions of cottontail rabbits for sporting purposes ultimately may have helped shape the geographic distribution of this pathogen in the United States. Clearly, this anthropogenic factor played some role in dispersing the pathogen from the central regions of the United States to eastern regions where tularemia is now endemic.

The overall incidence of human tularemia infections in the United States appears to arise from areas where we showed the prevalence of the A.I. subpopulation of *F. tularensis* subsp. *tularensis*. Some of the main human incidence hotspots in the United States, Arkansas, Kansas, Massachusetts, Missouri, Oklahoma, and South Dakota (8), are all associated with A.I. (Figures 1 and 6). This distribution may be the result of a successful group within the *F. tularensis* subsp. *tularensis* A.I. subpopulation or favorable ecologic conditions that promote disease maintenance and transmission in this region.

## Conclusions

Our results confirm the presence of 2 distinct subpopulations within *F. tularensis* subsp. *tularensis* and indicate that these groups are geographically distinct and associated with unique biotic and abiotic factors. These findings are important because *F. tularensis* subsp. *tularensis* is most often associated with human tularemia in the United States. The ecologic correlates identified here provide a framework for developing testable hypotheses regarding niche separation between the A.I. and A.II. subpopulations and should inform future studies addressing the transmission dynamics and persistence of *F. tularensis* in North America.

## Acknowledgments

We thank Ken Gage and Joe Piesman for thoughtful discussions and Rommelle Vera-Tudela, Matt Van Ert, and Jim Schupp for technical assistance.

This work was supported by the Department of Homeland Security and the Cowden Endowment at Northern Arizona University.

Dr Farlow performed this work as a part of his dissertation requirements in the Keim Genetics Laboratory at Northern Arizona University. He completed his PhD in 2004 and is now a postdoctoral fellow at Arizona State University studying orthopoxviruses.

## References

- Hopla C, Hopla A. Tularemia. In: Beran G, Steele J, editors. Handbook of zoonoses. 2nd ed. Boca Raton (FL): CRC Press Inc.; 1994. p. 113–26.



2. McCoy G, Chapin C. *Bacterium tularensis*, the cause of a plague-like disease of rodents. Public Health Bull. 1912;53:17–23.
3. Rotz LD, Khan AS, Lillibridge SR, Ostroff SM, Hughes JM. Public health assessment of potential biological terrorism agents. Emerg Infect Dis. 2002;8:225–30.
4. Sjöstedt AB. *Francisella*. In: Brenner DJ, Krieg NR, Staley JT, Garrity GM, editors. The proteobacteria, part B. Bergey's manual of systematic bacteriology. 2nd ed. New York: Springer-Verlag; 2005. p. 200–10.
5. Jellison WL. Tularemia in North America, 1930–1974. Missoula (MT): University of Montana; 1974.
6. Hollis DG, Weaver RE, Steigerwalt AG, Wenger JD, Moss CW, Brenner DJ. *Francisella philomiragia* comb. nov. (formerly *Yersinia philomiragia*) and *Francisella tularensis* biogroup *novicida* (formerly *Francisella novicida*) associated with human disease. J Clin Microbiol. 1989;27:1601–8.
7. Olsufjev NG, Meshcheryakova IS. Subspecific taxonomy of *Francisella tularensis*. Int J Syst Bacteriol. 1983;33:872–4.
8. Hayes E, Marshall S, Dennis D, Feldman K. Tularemia—United States, 1990–2000. MMWR Morb Mortal Wkly Rep 2002;51:181–4.
9. Taylor JP, Istre GR, McChesney TC, Satalowich FT, Parker RL, McFarland LM. Epidemiologic characteristics of human tularemia in the southwest-central states, 1981–1987. Am J Epidemiol. 1991;133:1032–8.
10. Francis E, Mayne B. Experimental transmission of tularaemia by flies of the species *Chrysops discalis*. Public Health Rep. 1921;36:1738–46.
11. Klock LE, Olsen PF, Fukushima T. Tularemia epidemic associated with the deerfly. JAMA. 1973;226:149–52.
12. Hillman CC, Morgan MT. Tularemia—report of a fulminant epidemic transmitted by the deer fly. JAMA. 1937;108:538–40.
13. Johansson A, Farlow J, Larsson P, Dukerich M, Chambers E, Bystrom M, et al. Worldwide genetic relationships among *Francisella tularensis* isolates determined by multiple-locus variable-number tandem repeat analysis. J Bacteriol. 2004;186:5808–18.
14. Burgdorfer W. Ecology of tick vectors of American spotted fever. Bull World Health Organ. 1969;40:375–81.
15. Patterson BD, Ceballos G, Sechrest W, Tognelli MF, Brooks T, Luna L, et al. Digital distribution maps of the mammals of the Western Hemisphere [database on the Internet]. Arlington (VA): NatureServe; 2003 [cited 2004 Nov 21]. Available from <http://www.natureserve.org/getData/mammalMaps.jsp>
16. Mantel N. The detection of disease clustering and a generalized regression approach. Cancer Res. 1967;27:209–20.
17. Clarke KR. Non-parametric multivariate analyses of changes in community structure. Aust J Ecol. 1993;18:117–43.
18. Pikula J, Beklova M, Holesovska Z. Ecology of European brown hare and distribution of natural foci of tularaemia in the Czech Republic. Acta Vet Brno. 2004;73:267–73.
19. Rotramel GL, Schwan TG, Doty RE. Distribution of suspected tick vectors and reported cases of Rocky Mountain spotted fever in California. Am J Epidemiol. 1976;104:287–93.
20. Keim P, van Ert MN, Pearson T, Vogler AJ, Huynh LY, Wagner DM. Anthrax molecular epidemiology and forensics: using the appropriate marker for different evolutionary scales. Infect Genet Evol. 2004;4:205–13.
21. Pearson T, Busch JD, Ravel J, Read TD, Rhoten SD, U'Ren JM, et al. Phylogenetic discovery bias in *Bacillus anthracis* using single-nucleotide polymorphisms from whole-genome sequencing. Proc Natl Acad Sci U S A. 2004;101:13536–41.
22. Ayres JC, Feemster RF. Epidemiology of tularemia in Massachusetts with a review of the literature. N Engl J Med. 1948;238:187–94.
23. Belding DL, Merrill B. Tularemia in imported rabbits in Massachusetts. N Engl J Med. 1941;224:1085–7.

Address for correspondence: Paul Keim, Keim Genetics Laboratory, Department of Biological Sciences, Northern Arizona University, Flagstaff, AZ 86011-5640, USA; fax: 928-523-0639, email: [paul.keim@nau.edu](mailto:paul.keim@nau.edu)

Use of trade names is for identification only and does not imply endorsement by the Public Health Service or by the U.S. Department of Health and Human Services.

International Conference on  
Women and Infectious Diseases:  
Progress in Science and Action  
March 16-18, 2006  
Marriott Marquis Hotel  
Atlanta, Georgia, USA



The goal of the conference is to enhance prevention and control of infectious diseases among women worldwide, ensuring that these efforts address global inequalities.

- Diseases disproportionately affecting women across the life span
- Diseases occurring in populations but having distinct impact on women
- Diseases affecting pregnancy, birth, and infants
- Gender-specific interventions against infections in diverse populations of women
- Information-sharing of infectious disease science
- Collaboration between individuals and organizations around the globe
- Increased role for women in basic and applied science careers

More information is available at [www.womenshealthconf.org](http://www.womenshealthconf.org); email [omwh@cdc.gov](mailto:omwh@cdc.gov) or call 1-404-371-5308.

# Host Range and Emerging and Reemerging Pathogens

Mark E.J. Woolhouse\* and Sonya Gowtage-Sequeria\*

An updated literature survey identified 1,407 recognized species of human pathogen, 58% of which are zoonotic. Of the total, 177 are regarded as emerging or reemerging. Zoonotic pathogens are twice as likely to be in this category as are nonzoonotic pathogens. Emerging and reemerging pathogens are not strongly associated with particular types of nonhuman hosts, but they are most likely to have the broadest host ranges. Emerging and reemerging zoonoses are associated with a wide range of drivers, but changes in land use and agriculture and demographic and societal changes are most commonly cited. However, although zoonotic pathogens do represent the most likely source of emerging and reemerging infectious disease, only a small minority have proved capable of causing major epidemics in the human population.

A recent, comprehensive literature survey of human pathogens listed >1,400 different species (1), more than half known to be zoonotic, i.e., able to infect other host species (1,2). The survey data showed that those pathogens regarded as emerging and reemerging were more likely to be zoonotic than those that are not (1,3), confirming an association between these characteristics which had long been suspected (4,5), but which could not be formally demonstrated without denominator data as well as numerator data.

Here, we revisit these calculations, using updated information on the biology and epidemiology of recognized human pathogens. We pay close attention to possible differences between the major pathogen groups—viruses, bacteria, fungi, protozoa, and helminths. We also examine in detail the relationship between host range and pathogen emergence or reemergence, considering both the type and diversity of nonhuman hosts. We catalog the kinds of proximate factors or drivers that have been linked with pathogen emergence and reemergence and ask whether

these differ between the major pathogen groups or between zoonotic and nonzoonotic pathogens.

We focus mainly on pathogen diversity (as numbers of species) rather than on the effects of disease that they impose, noting that many diseases, e.g., infant diarrhea, can be caused by more than one species of pathogen. However, we comment on the transmissibility of pathogens once they have been introduced into the human population because transmissibility is an important determinant of the potential public health problem.

## Methods

We obtained counts of pathogen species from an updated version of the previously published database (1). As before, we defined a human pathogen as “a species infectious to and capable of causing disease in humans under natural transmission conditions.” We included pathogens that have only been reported as causing a single case of human disease and those that only cause disease in immunocompromised persons. We also included instances of accidental laboratory infection but excluded infections resulting from deliberate exposure in the laboratory. We added recently recognized pathogens listed online by the Centers for Disease Control and Prevention, the World Health Organization (WHO), ProMED, and elsewhere (6–9). We obtained taxonomic classifications online from the International Committee on Taxonomy of Viruses, the National Centre for Biotechnology Information, the CAB International Bioscience database of fungal names, and from standard texts (10–15).

Pathogen species were categorized as emerging or reemerging based on previously published reviews of the literature (1,3), again updated from online sources (6–8). A species was regarded as emerging or reemerging if any recognized variant fell into this category (e.g., *Escherichia coli* O157, H5N1 influenza A).

We considered the following pathogen groups: viruses (including prions), bacteria (including rickettsia), fungi

\*Centre for Infectious Diseases, University of Edinburgh, Edinburgh, United Kingdom

(including microsporidia), protozoa, and helminths. We did not consider ectoparasites (ticks and lice). Each group was further divided into subgroups (families) to test whether biases existed in numbers of emerging and reemerging species at this level. The viruses were also divided according to genome type (e.g., negative single-stranded RNA viruses).

We examined 3 aspects of host range, both for all pathogens combined and separately for each of the viruses, bacteria, fungi, protozoa, and helminths. First, we distinguished pathogen species according to whether they were known to be zoonotic, using the WHO definition “diseases or infections which are naturally transmitted between vertebrate animals and humans” (16). Note that this definition includes pathogens for which humans are the main host and other vertebrates are only occasional hosts, as well as the opposite, but excludes purely human pathogens that recently evolved from nonhuman pathogens, e.g., HIV. We then compared the fraction of emerging or reemerging species that were or were not zoonotic across the major pathogen groups and within each group by family.

Second, for all zoonotic species we identified the types of nonhuman vertebrate host they are known to infect, using the following broad categories: bats, carnivores, primates, rodents, ungulates, and other mammals and non-mammals (including birds, reptiles, amphibians, and fish). We excluded vertebrate intermediate hosts of parasites with complex life cycles. Host types were ranked by the number of zoonotic pathogen species associated with them, and rankings were compared by using Spearman rank correlation coefficient.

Third, we obtained a crude index of the breadth of host range by counting the number of the host types that each pathogen species is known to infect: 0 (i.e., not zoonotic), 1, 2, and 3 or more. We compared the fraction of emerging and reemerging species across these 4 classes.

For the emerging and reemerging pathogen species, we identified the main factors believed to drive their increased incidence, geographic range, or both, by conducting a systematic review of the emerging diseases literature. We allocated these drivers to 1 or more broad categories (Table). Note that although we chose categories that we considered to be useful and informative for our immediate purposes, and which were similar to those listed elsewhere (5), this is inevitably a subjective procedure and alternative categorizations may be equally valid. We then ranked the drivers (by number of emerging and reemerging pathogen species associated with each) and compared the ranking of drivers for the major pathogen groups and for zoonotic versus nonzoonotic pathogens.

For the zoonotic species, we distinguished those known to be transmissible between humans, allowing that this

Table. Main categories of drivers associated with emergence and reemergence of human pathogens

Rank*	Driver
1	Changes in land use or agricultural practices
2	Changes in human demographics and society
3	Poor population health (e.g., HIV, malnutrition)
4	Hospitals and medical procedures
5	Pathogen evolution (e.g., antimicrobial drug resistance, increased virulence)
6	Contamination of food sources or water supplies
7	International travel
8	Failure of public health programs
9	International trade
10	Climate change

\*Ranked by the number of pathogen species associated with them (most to least).

might be through an indirect route (e.g., a vector or an intermediate host), from those for which humans can only acquire infection (directly or indirectly) from a nonhuman source. For the transmissible zoonotic species, we further distinguished those that are sufficiently transmissible to cause major epidemics in human populations from those that cause only relatively minor outbreaks. This classification was intended to distinguish between pathogens with  $R_0 > 1$  in humans from those with  $R_0 < 1$ , where  $R_0$  is the basic reproduction number, i.e., the average number of secondary infections produced by a single primary infection introduced into a large population of previously unexposed hosts. Direct estimates of  $R_0$  are unavailable for most zoonotic pathogens.

Throughout the study, we quantified associations as the relative risk (RR) and tested for statistical significance using a standard  $\chi^2$  test (with correction for small expected values). Although these statistical analyses are susceptible to bias introduced by related species (e.g., several species of hantavirus exist, most of which are zoonotic and many of which are regarded as emerging or reemerging), the analysis at the family level is an indication of the extent of any such bias.

## Results

The survey of human pathogens produced a count of 1,407 human pathogen species, with 177 (13%) species regarded as emerging or reemerging (online Appendix, available at [www.cdc.gov/ncidod/EID/vol11no12/05-0997\\_app.htm](http://www.cdc.gov/ncidod/EID/vol11no12/05-0997_app.htm)). Of all pathogen species, 208 are viruses or prions, including 77 (37%) regarded as emerging or reemerging. For bacteria, the counts were 538 and 54 (10%), respectively; for fungi, 317 and 22 (7%), respectively; for protozoa, 57 and 14 (25%), respectively; and for helminths, 287 and 10 (3%), respectively. These numbers differ slightly from those previously published (1,3) as a result of adjustments to taxonomies and the discovery of previously unknown pathogen species. Clear differences

were found between the pathogen groups ( $\chi^2_4 = 154.3$ ,  $p < 0.001$ ), with viruses greatly overrepresented among emerging and reemerging pathogens and helminths underrepresented.

### Pathogen Taxonomy

More than 20 virus families contain human pathogens, with just 4, the *Bunyaviridae*, *Flaviviridae*, *Togaviridae*, and *Reoviridae*, accounting for more than half of the species affecting humans and, likewise, more than half of the emerging and reemerging species. Overall, no significant difference was found between the 9 largest families (pooling the remainder) in the fraction of species regarded as emerging or reemerging ( $\chi^2_9 = 14.9$ ,  $p = 0.09$ ). Nor were any significant differences found according to genome type, e.g., between RNA and DNA viruses ( $\chi^2_1 = 0.77$ ,  $p = 0.38$ ) or between positive and negative single-stranded RNA viruses ( $\chi^2_1 = 3.1$ ,  $p = 0.08$ ).

More than 60 bacteria families contain human pathogens; the enterobacteria and the mycobacteria account for the most species and for the most emerging and reemerging species. Overall, no significant difference was found between the 6 largest families (pooling the remainder) in the fraction of species regarded as emerging or reemerging ( $\chi^2_6 = 13.6$ ,  $p = 0.14$ ). Numbers of species of emerging and reemerging fungi, protozoa, and helminths were too small for meaningful comparisons between families, but no indication was found that emerging and reemerging species are concentrated in any particular taxa.

### Host Range

Of the 1,407 human pathogen species, 816 (58%) are known to be zoonotic. In comparison, of the 177 emerging or reemerging pathogens, 130 (73%) are known to be zoonotic. This corresponds to an RR of 2.0 and confirms the expectation that zoonotic pathogens are disproportionately likely to be associated with emerging and reemerging infectious diseases. This pattern varies somewhat across the different pathogen groups: for bacteria and fungi the association is strongest with RRs of 4.0 and 3.2, respectively; for viruses and protozoa, no obvious association was found, with RRs of 1.2 and 0.9, respectively; and for helminths (which are almost all zoonotic but very rarely emerging or reemerging), RR is 0.3. However, the numbers involved are small (particularly for protozoa and helminths), and these differences were not statistically significant ( $\chi^2_4 = 4.03$ ,  $p = 0.40$ ).

All the defined host types are potential sources of zoonotic infections, but differences occurred in their importance (ranked by number of pathogen species supported) across viruses, bacteria, fungi, protozoa, and helminths and no 1 type consistently dominates (Figure 1A), although ungulates are the most important overall, supporting over

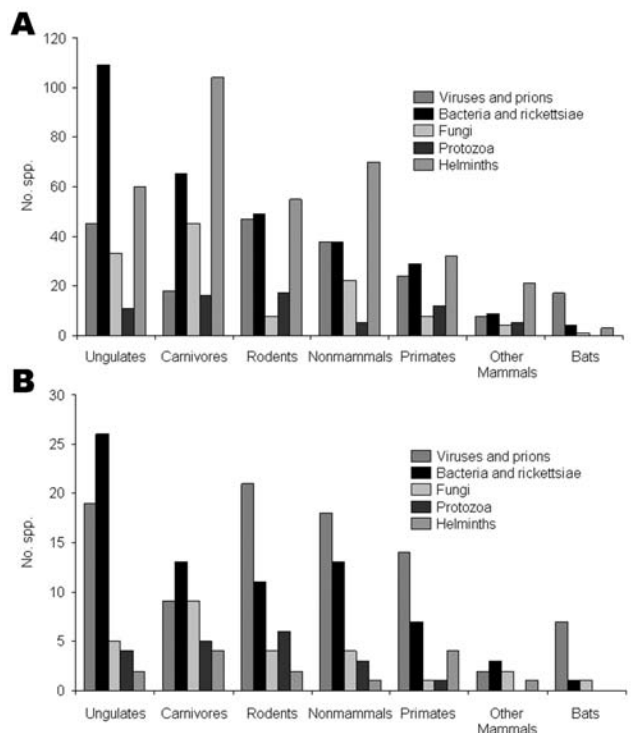

Figure 1. Numbers of species of zoonotic pathogens associated with different types of nonhuman host. Note that some pathogens are associated with >1 host. A) All zoonotic species. B) Emerging and reemerging zoonotic species only.

250 species of human pathogen. Emerging and reemerging pathogens show similar trends (Figure 1B), with ungulates again the most important overall, supporting over 50 species. In general, ranking of host types in terms of numbers of species correlates well both overall ( $r_s = 0.79$ ,  $n = 7$ ,  $p < 0.05$ ) and individually for each pathogen group. The general impression is that the emerging and reemerging zoonotic pathogens are not unusual in the types of nonhuman hosts they infect.

However, when the fraction of emerging and reemerging species is compared with the breadth of host range (as the number of host types other than humans), a pattern becomes apparent (Figure 2). Overall, the fraction tends to increase with host range: >40% of pathogens with the broadest host ranges (3 or more types of nonhuman host) are emerging or reemerging (exact  $p = 0.042$ ). However, this trend does not hold for the protozoa and helminths (although the numbers for these groups are small).

### Drivers of Emergence

We identified 10 main categories of drivers of emergence and reemergence and ranked these by the total number of pathogen species associated with them (Table). The

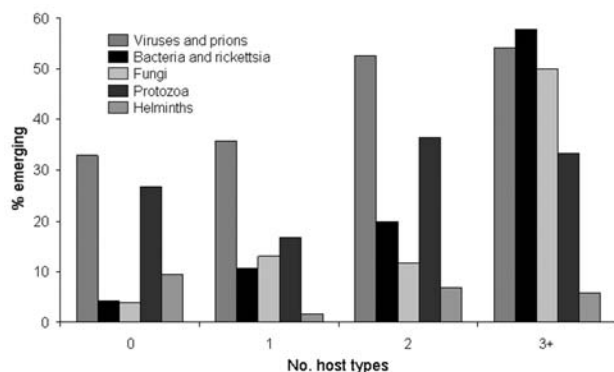

Figure 2. Relationship between breadth of host range (as number of nonhuman host types, as listed in Figure 1) and the fraction of pathogen species regarded as emerging or reemerging. A total of 122 zoonotic species (10 of them emerging or reemerging) for which the host range is unknown are omitted.

ranking of drivers across different categories of pathogen showed poor concordance (e.g., Spearman rank correlation for bacteria vs. viruses,  $r_s = 0.41$ ,  $n = 10$ ,  $p = 0.24$ ). The most striking discrepancies were as follows: 1) the marked association of emerging or reemerging fungi with hospitalization, poor population health, or both; 2) the greater importance of pathogen evolution and contaminated food and water and the lesser importance of international travel and changes in land use and agriculture for bacteria in comparison with viruses; 3) the greater importance of changing land use and agriculture for zoonoses than for nonzoonoses.

### Transmissibility

Overall, most zoonotic pathogens are either not transmissible (directly or indirectly) between humans at all (i.e., humans are a dead-end host) or are only minimally transmissible. Examples include rabies virus, Rift Valley fever virus, and *Borrelia burgdorferi* (the agent of Lyme disease). A small minority ( $\approx 10\%$ ) of pathogen species that are technically zoonotic are, in fact, spread almost exclusively from person to person (e.g., *Mycobacterium tuberculosis* or measles virus) or can do so once successfully introduced from a nonhuman source (e.g., some strains of influenza A, *Yersinia pestis*, or severe acute respiratory syndrome (SARS) coronavirus). However, a substantial minority of zoonotic pathogens (about 25%, i.e., 200 species) are capable of some person-to-person transmission but do not persist without repeated reintroductions from a nonhuman reservoir (e.g., *E. coli* O157, *Trypanosoma brucei rhodesiense*, or Ebola virus). This pattern is fairly consistent across the major pathogen groups.

### Discussion

Humans are affected by an impressive diversity of pathogens; 1,407 pathogenic species of viruses, bacteria, fungi, protozoa, and helminths are currently recognized. Of this total, 177 (13%) pathogen species are considered emerging or reemerging. This number must be viewed with some caution, given that these terms are still used somewhat subjectively. More rigorous definitions of emerging and reemerging have been proposed (5,17,18), but these are difficult to apply universally because they require long-term data on distributions and incidences which are available for only a small subset of infectious diseases (e.g., malaria [19] and tuberculosis [20]). Moreover, the counts of emerging and reemerging pathogen species reported here are subject to ascertainment bias. Despite these caveats, our results suggest that pathogens associated with emerging and reemerging diseases share some common features.

First, emerging and reemerging pathogens are disproportionately viruses, although they are not disproportionately different kinds of viruses. Numerically, RNA viruses dominate, comprising 37% of all emerging and reemerging pathogens. RNA viruses are also prominent among the subset of emerging pathogens that have apparently entered the human population only in the past few decades, such as HIV or the SARS coronavirus (21,22). A possible explanation for this observation is that much higher nucleotide substitution rates for RNA viruses permit more rapid adaptation, greatly increasing the chances of successfully invading a new host population (21,22).

Second, emerging and reemerging pathogens are not strongly associated with particular nonhuman host types, although emerging and reemerging pathogens more often are those with broad host ranges that often encompass several mammalian orders and even nonmammals. This pattern is consistent across the major pathogen groups. The determinants of host range in general remain poorly understood, but among viruses for which the cell receptor is known, an association exists between host range and whether the receptor is phylogenetically conserved (as measured by the homology of the human and mouse amino acid sequences) (23).

Emerging and reemerging pathogens have been likened to weeds (24), and that the associations reported above are likely reflecting underlying "weediness," that is, a degree of biologic flexibility that makes certain pathogens adept at taking advantage of new epidemiologic opportunities. This characteristic seems to be reflected in the broad range of drivers of the emergence or reemergence of pathogens, ranging from changes in land use and agriculture, through hospitalization to international travel. Although some drivers are numerically more important than others, the overall impression is that pathogens are exploiting almost any

change in human ecology that provides new opportunities for transmission, either between humans or to humans from a nonhuman source.

Even if a pathogen is capable of infecting and causing disease in humans, most zoonotic pathogens are not highly transmissible within human populations and do not cause major epidemics. The possible magnitude of an infectious disease outbreak is related to the basic reproduction number,  $R_0$  (Figure 3). For pathogens that are minimally transmissible within human populations ( $R_0$  close to 0), outbreak size is determined largely by the number of introductions from the reservoir. For pathogens that are highly transmissible within human populations ( $R_0 \gg 1$ ), outbreak size is determined largely by the size of the susceptible population. For pathogens that are moderately transmissible within human populations (corresponding to  $R_0 \approx 1$ ), notable outbreaks are possible (especially if multiple introductions occur), but the scale of these outbreaks is very sensitive to small changes in  $R_0$ . In other words, small changes in the nature of the host-pathogen interaction can lead to large increases (or decreases) in the scale of the public health problem (Figure 3). Such pathogens may be likely sources of emerging infectious disease problems in the future. However, we currently have no way of predicting whether a novel human pathogen will behave like rabies (frequently introduced into the human population, but not capable of causing major epidemics) or HIV (probably rarely introduced, but capable of causing a global

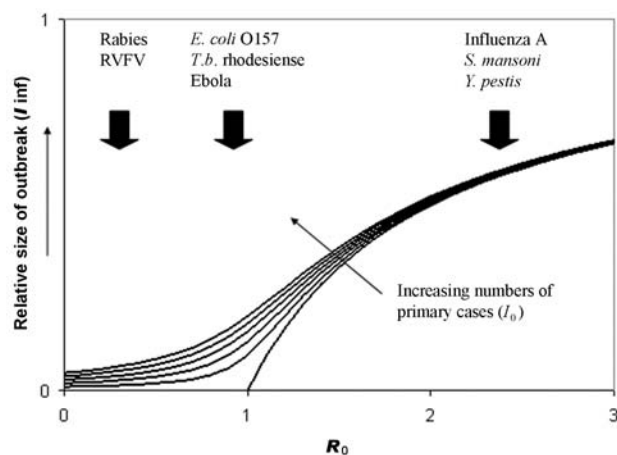

Figure 3. Expected relationship between outbreak size (as fraction of the population affected) and 2 key epidemiologic parameters:  $I_0$  is the number of primary cases of infection introduced into the human population from an external source such as a zoonotic reservoir (increasing in the direction indicated);  $R_0$  is the basic reproduction number, a measure of the transmissibility of the infection with the human population (see text). The curves are obtained from a modified version of the Kermack-McKendrick equation and show that expected outbreak size is particularly sensitive to small changes in  $I_0$  or  $R_0$  when  $R_0$  is close to 1. Examples of zoonotic pathogens with  $R_0 > 1$ ,  $R_0 < 1$  and  $R_0$  close to 1 are shown. RIVF, Rift Valley fever virus. (Reprinted with permission from [23]).

pandemic).

In conclusion, this study suggests that biologic and epidemiologic correlates of pathogen emergence or reemergence may be identified. However, the most striking feature of emerging and reemerging pathogens is their diversity (online Appendix). For this reason, surveillance and monitoring of infectious disease trends may have to be broadly targeted to be most effective. Given that three-fourths of emerging and reemerging pathogens are zoonotic, in many cases this targeting might usefully be extended beyond at-risk human populations to include populations of potential animal reservoirs.

### Acknowledgments

We thank Louise Taylor and Sophie Latham for their work on the original database and Ben Evans for his contribution to the updated database.

Dr Woolhouse is professor of infectious disease epidemiology in the Centre for Infectious Diseases at the University of Edinburgh. His research interests include foot-and-mouth disease, *E. coli* O157, scrapie, and sleeping sickness. He is an advisor to the UK government on issues relating to infectious disease epidemiology.

Dr Gowtage-Sequeira is a postdoctoral research assistant in the Division of Animal Health and Welfare at the University of Edinburgh. Her doctoral research, for the Institute of Zoology in London, was on the epidemiology of viral infections of canids in Namibia. She is currently studying the ecology of wild dogs in eastern Kenya.

### References

- Taylor LH, Latham SM, Woolhouse ME. Risk factors for human disease emergence. *Philos Trans R Soc Lond B Biol Sci.* 2001;356:983–9.
- Woolhouse MEJ, Taylor LH, Haydon DT. Population biology of multi-host pathogens. *Science.* 2001;292:1109–12.
- Cleaveland S, Laurenson MK, Taylor LH. Diseases of humans and their domestic mammals: pathogen characteristics, host range and the risk of emergence. *Philos Trans R Soc Lond B Biol Sci.* 2001;356:991–9.
- Morse SS. Factors in the emergence of infectious diseases. *Emerg Infect Dis.* 1995;1:7–15.
- Institute of Medicine. *Microbial threats to health: emergence, detection, and response.* Washington: National Academy Press; 2003.
- Centers for Disease Control and Prevention. Emerging infectious diseases. [cited 1 May 2005]. Available at <http://www.cdc.gov/ncidod/diseases/eid/index.htm>
- World Health Organization. Emerging diseases. Available at [http://www.who.int/topics/emerging\\_diseases/en/](http://www.who.int/topics/emerging_diseases/en/)
- ProMED. The ProMED-mail archives. [cited 1 May 2005]. Available at <http://www.promedmail.org>
- Ecker DJ, Sampath R, Willett P, Wyatt JR, Samant V, Massire C et al. The Microbial Rosetta Stone database: a compilation of global and emerging infectious microorganisms and bioterrorist threat agents. *BMC Microbiol.* 2005;5:19.

10. International Committee on the Taxonomy of Viruses. Index virum. [cited 10 May 2005]. Available at <http://life.anu.edu.au/viruses/Ictv/index.html>
11. National Center for Biotechnology Information. Taxonomy browser. [cited 10 May 2005]. Available at <http://www.ncbi.nlm.nih.gov/Taxonomy/taxonomyhome.html/>
12. CAB International Bioscience. Index fungorum. [cited 10 May 2005]. Available at <http://194.131.255.4/Names/Names.asp>
13. Collier L, Balows A, Sussman M, editors. Topley & Wilson's Microbiology and Microbial Infection, Volume 4. London: Arnold; 1998.
14. Schmidt GD, Roberts LS. Foundations of parasitology, 6th ed. London: McGraw-Hill; 2000.
15. Mayo MA. A summary of taxonomic recently approved by ICTV. Arch Virol. 2001;147:1655–63.
16. World Health Organization. Zoonoses: second report of the joint WHO/FAO expert committee. Geneva: The Organization; 1959.
17. Woolhouse ME, Dye C. Population biology of emerging and re-emerging pathogens —preface. Philos Trans R Soc Lond B Biol Sci. 2001;356:981–2.
18. World Organization for Animal Health. Terrestrial animal health code—2005. General definitions. [cited 1 Sep 2005]. Available at <http://www.oie.int>
19. Hay SI, Guerra CA, Tatem AJ, Noor AM, Snow RW. The global distribution and population at risk of malaria: past, present and future. Lancet Infect Dis. 2004;4:327–36.
20. Corbett EL, Watt CJ, Walker N, Maher D, Williams BG, Raviglione MC et al. The growing burden of tuberculosis: global trends and interactions with the HIV epidemic. Arch Intern Med. 2003;163:1009–21.
21. Burke DS. Evolvability of emerging viruses. In: Pathology of emerging infections 2, Nelson AM, Horsburgh CR, editors. Washington: American Society for Microbiology; 1998. p. 1–12.
22. Woolhouse MEJ, Haydon DT, Antia R. Emerging pathogens: the epidemiology and evolution of species jumps. Trends Ecol Evol. 2005;20:238–44.
23. Woolhouse MEJ. Population biology of emerging and re-emerging pathogens. Trends Microbiol. 2002;10:S3–7.
24. Dobson A, Foufopoulos J. Emerging infectious pathogens of wildlife. Philos Trans R Soc Lond B Biol Sci. 2001;356:1001–12.

Address for correspondence: M.E.J. Woolhouse, Centre for Infectious Diseases, University of Edinburgh, Ashworth Laboratories, Kings Buildings, West Mains Rd, Edinburgh EH9 3JT, UK; fax: 44-131-650-6564; email: [mark.woolhouse@ed.ac.uk](mailto:mark.woolhouse@ed.ac.uk)

**Zoonotic Diseases**

Search  
**EID**  
Online  
[www.cdc.gov/eid](http://www.cdc.gov/eid)

# Person-to-Person Transmission of Andes Virus

Valeria P. Martinez,\* Carla Bellomo,\* Jorge San Juan,† Diego Pinna,‡ Raul Forlenza,§ Malco Elder,¶ and Paula J. Padula\*

Despite the fact that rodents are considered to be the infectious source of hantavirus for humans, another route of transmission was demonstrated. Andes virus (ANDV) has been responsible for most of the cases recorded in Argentina. Person-to-person transmission of ANDV Sout lineage was described during an outbreak of hantavirus pulmonary syndrome in southwest Argentina. In this study, we analyzed 4 clusters that occurred in 2 disease-endemic areas for different ANDV lineages. We found new evidence of interhuman transmission for ANDV Sout lineage and described the first event in which another lineage, ANDV Cent BsAs, was implicated in this mechanism of transmission. On the basis of epidemiologic and genetic data, we concluded that person-to-person spread of the virus likely took place during the prodromal phase or shortly after it ended, since close and prolonged contact occurred in the events analyzed here, and the incubation period was 15–24 days.

The genus *Hantavirus* is a growing group of rodent-borne viruses of worldwide distribution that cause human diseases. *Hantavirus* is the only genus of the family *Bunyaviridae*, which comprises rodentborne viruses. Specific species of rodents are natural reservoirs for different hantavirus types. In America, hantaviruses are mainly carried by sigmodontine rodents. Hantavirus pulmonary syndrome (HPS) was first described in North America in 1993 (1,2), and then reported in several other countries of North, Central, and South America (3–9). Andes virus (ANDV) was characterized in Argentina in 1995 on the basis of specimens from a patient who died of HPS (3,10),

and Andes virus has been responsible for most HPS cases recorded in Argentina, Chile, and Uruguay (7).

Six different ANDV lineages have been reported to cause HPS in Argentina: ANDV Sout in the southwest region; ANDV Cent BsAs, ANDV Cent Lec, and ANDV Cent Plata in the central region; and ANDV Nort Orán and ANDV Nort Bermejo in the northwest region. The definition of these 6 lineages was previously established on the basis of nucleotide and amino acid differences (7,9). Although rodents are considered to be the infectious source for humans, another route of infection was demonstrated. Viral person-to-person transmission of ANDV Sout lineage was described for the first time during an HPS outbreak in southwest Argentina in 1996, in which 16 persons were involved (11–13), but in general, clusters of HPS cases are mainly attributed to a common source of rodent exposure. This mechanism of interhuman virus spread, which makes ANDV unique among the hantaviruses, is not the only exclusive feature of this virus. ANDV was the only American hantavirus isolated from human serum (14). Most importantly, ANDV was shown to be highly lethal in Syrian hamsters, and the characteristics of the disease closely resembled HPS in humans (15). Similar results have been recently obtained with Maporal virus (16).

We analyzed 4 case clusters of hantavirus infection and present new evidence for interhuman transmission of ANDV Sout lineage. We also describe the first event in which another lineage, ANDV Cent BsAs, has been implicated in this rare but already proven route of transmission.

## Materials and Methods

### Study Population

Thirteen HPS cases that occurred during the second half of 2002 in Argentina were analyzed in this study (Table 1). Cases were grouped in 4 clusters (C1–C4)

\*Instituto Nacional de Enfermedades Infecciosas ANLIS "Dr. C.G. Malbrán," Buenos Aires, Argentina; †Hospital de Infecciosas "F.J. Muñoz," Buenos Aires, Argentina; ‡Hospital Privado de La Comunidad, Mar del Plata, Argentina; §Dirección de Epidemiología del Gobierno de la Ciudad de Buenos Aires, Buenos Aires, Argentina; ¶Dirección de Epidemiología de la Provincia Neuquén, Neuquén, Argentina.



Table 1. Hantavirus pulmonary syndrome patients and their epidemiologic relationships, Argentina, 2002\*

Cluster/patient	Age, y	Date of onset	Date of death	Residence	Probable place of infection or risk activity
C1-f	41	7/10/02	7/16/02	BA City	Farm in LP (BA)
C1-s	14	8/8/02		BA City	Spent weekend at his father's house (Jul 13–14/02)
C2-d1	12	7/24/02	7/29/02	LP, rural area, (BA). El Peligro neighborhood.	Home
C2-d2	11	7/28/02		LP, rural area, (BA). El Peligro neighborhood.	Home
C2-s	NA			LP, rural area, (BA). El Peligro neighborhood.	Home
C2-m	40	8/04/02	8/15/02	LP, rural area, (BA). El Peligro neighborhood.	Home
C3-1	28	8/26/02		LP, rural area, (BA). Abasto neighborhood.	Home
C3-2	27	8/29/02		LP, rural area, (BA). Abasto neighborhood.	Home
C3-3	21	9/10/02		LP, rural area, (BA). Abasto neighborhood.	Home
C3-4	30	9/14/02		LP, rural area, (BA). Abasto neighborhood.	Home
C4-a	39	11/21/02		CI (RN)	Visited VA (NQ), Oct 20–30/02
C4-b	58	12/08/02		MP (BA)	Traveled by bus with C4-a from MP to NQ (11/23/02)
C4-c	38	12/31/02	1/02/03	MP (BA)	Several contacts with C4-b
NL-1	17	10/27/98		LP (BA)	Rural worker
NL-2	42	11/7/02	11/14/02	VA (NQ)	Rural worker. bitten by a rodent 9 days before the onset of symptoms
NL-3	22	12/8/02		VA (NQ)	Rural worker
NL-4	31	12/19/97		LO (NQ)	Housekeeper
NL-5	56	12/02/99	12/08/99	SM (NQ)	Rural worker

\*BA, Buenos Aires; NL, nonlinked cases; LP, La Plata City; NA, not available; CI, Cipolletti City; RN, Rio Negro Province; NQ, Neuquén; MP, Mar del Plata City; VA, Villa La Angostura City; LO, Loncopué City; SM, San Martín de los Andes City; NA, not available.

according to their known epidemiologic relationships. Samples from 12 of the 13 case-patients were available: we collected serum and clot samples from almost all patients; from patient C4-a, clot samples could not be obtained; from patient C2-d1, a hemoculture was available after death. A sample from the son in cluster 2 (C2-s) was not available. Serologic confirmation was performed on 11 serum specimens and on the hemoculture samples as previously described (17).

### Genetic Characterization

Ten clot samples and 1 serum sample were subjected to viral detection methods as described (7). For viral genetic characterization, a partial fragment of G2-encoding region from the M segment was analyzed: genomic positions 2717–2943 (G2). For cases sharing 100% nucleotide identity in G2 fragment, 1 or 2 additional regions were analyzed: positions 66–434 from G1-encoding region (G1); positions 1384–1795 for C4 and 1395–1809 for C1 from the S-noncoding region (S-NCR). All fragments were numbered in the antigenome-sense sequence relative to ANDV. The new sequences used in this manuscript have been submitted to GenBank (accession nos. DQ189092–DQ189095).

## Results

### Epidemiologic Findings

The cases were grouped into 4 clusters (Table 1), and the approximate geographic locations of the exposure sites are shown in Figure 1. Cluster 1 (C1) was a father-son pair (C1-f and C1-s). The first patient, C1-f, was a previously healthy veterinarian. He worked on a farm >65 km away from his home. He began working there 40 days before the onset of symptoms. He slept at the farm during the week and returned to his home on weekends. The first manifestation of his illness, abdominal pain and vomiting, began on a Wednesday. On the Friday of that week, he exhibited typical indistinguishable features of the prodromal phase. The following weekend, he remained in his house with his 2 sons. Although he was very ill, his younger son slept with him in the same bed; at that time, the prodromal phase was ending, since on the next Monday he began to experience progressive dyspnea. He sought medical attention but proceeded rapidly to pulmonary edema and shock. He died on Wednesday. His 2 sons had never visited his place of work, and they lived with their mother in another house in the city of Buenos Aires. Epidemiologists from Buenos Aires City reported that both houses were in urban areas,

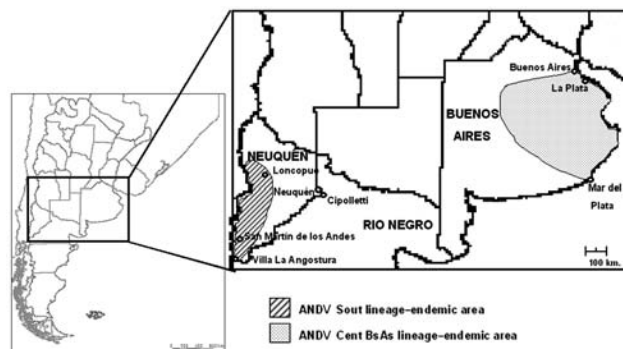

Figure 1. Location of residences and possible sites of exposure of hantavirus pulmonary syndrome patients in the provinces of Buenos Aires and Neuquén and Andes virus (ANDV)-endemic regions, 2002.

were in very good condition, and showed no evidence of rodents. Twenty-four days after the last contact with his sick father, fever developed in the younger son (C1-s) (Figure 2). Once immunoglobulin M antibodies to hantavirus was confirmed, he was hospitalized.

Cluster 2 (C2) was a rural cluster within a family of 5 that lived in a cabin. Rodent infestation of the house and surrounding areas was evident. The onset of symptoms of 3 of the 4 case-patients occurred during a 12-day period (Table 1). The mother in C2 (C2-m) began having symptoms when HPS was already confirmed in her 2 daughters (C2-d1 and C2-d2), but she did not seek medical consultation until 5 days later, when she was hospitalized and died.

Cluster 3 (C3), a rural cluster composed of 4 friends (cases C3-1 to C3-4), was similar to the previous cluster since all became ill during a period of 20 days (Table 1). They lived together in a cabin within the farm where they worked. Rodent infestation of the house and surrounding areas was also evident.

Cluster 4 (C4) involved a case-patient (C4-a) and a person he came into contact with (C4-b), and a third person who came into contact with C4-b. The index patient lived and worked in Neuquén City, where neither HPS cases nor rodent infestation had been registered. He traveled to Mar del Plata in the province of Buenos Aires, 1,005 km northeast of Neuquén City, where he remained for a few days while attending a meeting. His first symptoms (fever and myalgia) began before his return to Neuquén from Mar del Plata, 23 days after he returned from a vacation in Villa La Angostura, a small town surrounded by a wilderness area, 447 km southwest of Neuquén City (Figure 1). Two HPS cases were reported in 2002, and several infected rodents were captured previously. During the case-patient's 14-hour bus trip from Mar del Plata to Neuquén, he sat next to a man he did not know (C4-b). During the trip, a nonproductive cough, dyspnea, tachypnea, and headache developed,

and myalgia worsened. After their arrival in Neuquén, patient C4-b helped patient C4-a with his luggage and shared a taxicab with him. Patient C4-a was hospitalized 24 hours later. Patient C4-b spent 2 days in Neuquén (he never left the city). Fifteen days after the 14-hour bus trip to Neuquén City, patient C4-b became ill. He first experienced weakness and myalgia; vomiting and diarrhea developed 2 days later, and fever developed 6 days after the onset of the first symptoms. C4-b met a friend and co-worker (C4-c) 3 times during his prodromal phase; C4-c visited C4-b while he was hospitalized (Figure 2). Although C4-b did not have respiratory clinical symptoms, the chest radiograph showed interstitial infiltrates and Kurley B lines, and he had severe hypoxemia. The major clinical manifestations were weakness, gastrointestinal illness, and myalgia. An epidemiologic investigation led clinicians to suspect HPS. C4-c began to exhibit the first HPS symptoms 22 days after C4-b. C4-c had never left the province of Buenos Aires.

#### Viral Characterization

Nucleotide sequence comparisons of G2 fragment between sequences from the 11 cases, 5 nonlinked (NL) cases, and 5 previously published ANDV lineages are shown in Table 2. Comparisons in each of the 4 clusters showed 100% identity between cases in the same cluster. ANDV Cent BsAs lineage was characterized from C1, C2 (2/4 cases), and C3, while ANDV Sout was characterized from the 3 C4 cases, although C4-3 had never been to the southwestern part of the country. The 3 clusters from La Plata and NL-1 showed the highest similarity between them and showed significant differences with HPS cases from other places in Buenos Aires (Table 1).

#### Assessment of the Route of Transmission

Rodent transmission is the most common route of hantavirus infection. However, when a new HPS case is suspected, if rodent exposure was not evident, for interhuman

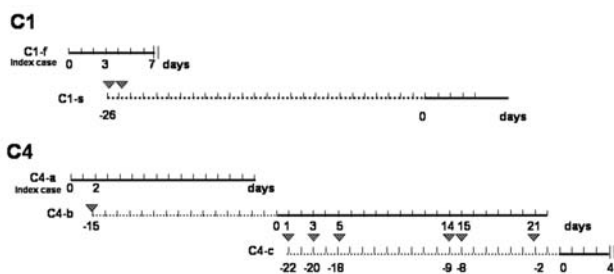

Figure 2. Contact events and incubation period of hantavirus pulmonary syndrome patients, Argentina, 2002. One line was drawn per case for C1 and C4; dotted lines represent the incubation period since the established moment of contact between contiguous case-patients. The onset of illness for each patient is indicated by day 0. Triangles indicate contacts between patients. || indicates day of death.

Table 2. Andes virus (ANDV) lineage identification by comparison of nucleotide sequence identity percentages between hantavirus pulmonary syndrome clustered cases and previously reported ANDV lineages\*

	ANDV Cent Plata	ANDV Cent Lech	ANDV Cent BsAs	ANDV Sout	ANDV Nort Orán	ANDV Nort Berm	C1-f/s	C2-d1/m	C3-1/2/3	C4-a/b/c	NL-1	NL-2	NL-3	NL-4	NL-5
ANDV Cent Plata		87.61	82.3	84.96	85.4	85.84	80.53	80.97	80.97	83.19	81.42	83.19	85.4	82.74	82.74
ANDV Cent Lech			82.74	82.3	84.51	88.05	83.19	82.74	82.74	80.53	84.07	80.53	82.74	80.9	81.42
ANDV Cent BsAs				80.97	84.07	81.86	94.69	95.58	95.58	83.3	95.13	83.3	81.42	81.42	81.86
ANDV Sout					84.86	80.97	81.42	80.97	80.97	96.02	81.86	96.02	98.67	94.69	95.58
ANDV Nort						85.84	84.07	82.74	82.74	82.3	84.07	82.3	85.4	85.4	81.86
ANDV Berm							82.3	81.42	81.42	80.09	82.74	80.09	82.3	82.3	79.65
C1-f/s								97.35	97.35	82.74	97.79	82.74	82.3	81.86	82.3
C2-d1/m									100	82.3	98.67	82.3	81.86	81.42	81.86
C3-1/2/3										82.3	98.67	82.3	81.86	81.42	81.86
C4-a/b/c											83.19	100	95.58	93.36	99.56
NL-1												83.19	82.74	82.3	82.74
NL-2													95.58	93.36	99.56
NL-3														95.13	95.13
NL-4															92.92
NL-5															

\*Comparisons were made on 226 nucleotides from the G2-coding region.

transmission to be suspected, one must 1) find an epidemiologic link with a previous case-patient (index case-patient); 2) confirm 100% viral nucleotide identity with the index patient in the fragments analyzed; and 3) assuming that the secondary patient could have been exposed to infectious rodents in the same or a different place than the index patient, determine the probability that both viral strains have 100% nucleotide identity in the fragments analyzed.

In C1, only C1-f had an evident rodent exposure. The only risk for C1-s was the close contact with C1-f during his prodromal phase. In C4, only C4-a had an evident risk of rodent transmission because he had visited a disease-endemic area. The only risky activity of C4-b was close contact with C4-a during the 14-hour bus trip. C4-c was in contact with C4-b at several times after the latter returned from Neuquén. All nucleotide fragment comparisons showed 100% identity for G1, G2, and S-NCR for C1 and C4. We analyzed viral variability in the areas of circulation of ANDV Cent BsAs and ANDV Sout lineages by comparing viral nucleotide sequences from previous HPS cases and found a positive correlation between geographic distance and genetic distance for each ANDV lineage (data not shown). Each ANDV lineage showed a significant degree of variability between the supposed sites of exposure in C1 for C1-f and C1-s and in C4 for C4-a and C4-b. In summary, C1-s, C4-b, and C4-c were infected by inter-human transmission.

**Discussion**

From July to December 2002, 31 HPS cases were reported in Argentina, 13 of which were included in this

study because they occurred as linked cases grouped in 4 clusters. Three of these clusters occurred in the province of Buenos Aires, where previous cases were isolated and sporadic (18). This is the first report of grouped HPS cases in this province. In contrast, such an occurrence is not rare in southern Argentina, where several clusters have been detected since the first HPS case was described in 1995. Three of these previous clusters occurred in the province of Neuquén. In the present study, we described 3 events of interhuman transmission: C1-f to C1-s, C4-a to C4-b, and C4-b to C4-c. Besides the complete identity of the fragments analyzed in each cluster, we conclude this mechanism took place based on the following facts: for C1, only C1-f was exposed to rodent infection in his work place (La Plata), and C1-s did not visit C1-f's work place. Similarly, in C4, C4-a was the only one of the 3 case-patients with epidemiologic risk of infection by rodent exposure during his vacation in Villa La Angostura. C4-b spent 2 days in Neuquén City, where HPS cases have never been reported. C4-c, who never left the province of Buenos Aires, could not have been infected by an endemic lineage from a place 1,300 km distant. Furthermore, 100% nucleotide identity was found between the C4 strain and NL-2, which confirmed the hypothesis that C4-a was exposed to ANDV in Villa La Angostura. In conclusion, C4 showed 2 links of the same chain of transmission. Notably, short or long periods between patients' onset of illness probably correspond to clusters with a common source of infection (C2) or to the occurrence of human transmission (C1 and C4) (Figure 2). The identical viral sequence in different HPS cases might be explained by exposure to the same viral variant within the local rodent populations, or in special situations,

by virus spread from person to person. Genetically differentiating between these 2 mechanisms of transmission is not possible in a small area, as in C2 and C3. However, geographically distant patients rarely share identical viral sequences; in these situations, if epidemiologic relationships between patients are shown, suspecting interhuman transmission is reasonable, as in C1 and C4.

This is the first report in which a lineage other than ANDV Sout, that is, ANDV Cent BsAs, was implicated in person-to-person transmission. This finding is relevant because ANDV Cent BsAs was responsible for most HPS cases in the province of Buenos Aires (18). Furthermore, the possibility that the other lineages can be spread by this mechanism cannot be discarded, and such an event could be expected in any of the 3 affected regions. A well-done epidemiologic investigation around each case is essential to accurately establish the mechanism of infection. The incubation period was 15 days for C4-b, and ranged from 24 to 26 days for C1-s and 18 to 22 days for C4-c. However, the oldest son of C1-f did not become infected, and taking into account that C1-s rested with C1-f in the same bed during the end of the prodromal phase, we speculate that close and prolonged contact is necessary to produce the infection. In C4, a unique close contact was established between 2 previously unknown persons, C4-a and C4-b, while C4-a exhibited early clinical manifestations of respiratory disease. In this event, the unique route of transmission was by means of small-particle infectious saliva or respiratory aerosols during the close contact between both persons, since C4-b was the only passenger of the bus in whom the illness developed. Recent experimental studies with sigmodontine rodents hosting ANDV investigated the hypothesis that saliva was one of the sources of infection within reservoir populations (19).

In summary, virus transmission from one person to another likely occurs during the prodromal phase or shortly after it ends. Previously published reports of person-to-person transmission did not provide details of clinical manifestation at the moment of contact, but several infections occurred while some HPS patients were initially hospitalized; other patients contracted the infection after being in contact with a recently symptomatic case-patient (12). Current evidence indicates that casual contacts with a person in early stages of HPS are not risky, but special consideration should be given to contacts with case-patients that occurred in confined places such as within vehicles or some work environments.

Since interhuman transmission of ANDV occurred in Argentina in 1996, the major question that clinicians have been facing is what to do about personal protection and patient isolation. The answer to physicians likely to encounter HPS patients is to follow the recommended

universal precautions. However, the findings presented here suggest that the most probable period of virus spread would be during the days before medical attention is sought. For this reason, the family or those who had close contact with an HPS patient during the prodromal phase seem to have more risk of interhuman infection than do clinicians. In the management of contacts of HPS cases caused by ANDV, epidemiologists usually give more relevance to serologic tests than to clinical surveillance. Whether serologic tests on specimens from asymptomatic contacts are worthwhile should be determined. Such results are usually misinterpreted since a negative serologic test result does not mean that the contact could not be incubating the infection, and a few days later, HPS symptoms could develop. This negative serologic result usually leads to delay in medical consultation. In our opinion, a strict clinical surveillance would be more valuable: contacts of HPS patients need to be monitored and advised to immediately look for medical evaluation as soon as fever or any other prodromal symptom develops. In this circumstance, a fast laboratory diagnosis is essential so virus spread can be avoided and early intensive care and treatment initiated. Patients with a confirmed diagnosis should be transferred to a unit skilled in intensive cardiopulmonary care. A previous study suggests that the earlier a patient is hospitalized, the higher the probability of survival (20). Unfortunately, effective vaccines, immunotherapeutic agents, and antiviral drugs for the prophylaxis or treatment of hantaviral infections are not available (21); thus far, results have been inconclusive regarding the usefulness of intravenous ribavirin in treating HPS (22).

Further studies will be necessary to understand more about this rare mechanism of virus spread. More information of virus variability of all the ANDV lineages will also help differentiate an instance of common rodent exposure from a new event of person-to-person transmission, especially in patients with a travel history.

#### Acknowledgments

We acknowledge the invaluable contributions of physicians and epidemiologists for their help in data collection and continued support, which made this research possible. We especially thank Alejandro Mendez and Eduardo Pasquinelli for technical assistance.

This research was supported in part by grant no. DPC/CD/078/03 from the Pan American Health Organization.

Ms Martinez is a doctoral candidate and virologist from Instituto Nacional de Enfermedades Infecciosas-ANLIS "Dr C.G. Malbrán." She has been actively involved in Latin American research projects and in national research programs for hantavirus in Argentina since 1997.

## References

- Duchin JS, Koster FT, Peters CJ, Simpson GL, Tempest B, Zaki SR, et al. Hantavirus pulmonary syndrome: a clinical description of 17 patients with a newly recognized disease. The Hantavirus Study Group. *N Engl J Med*. 1994;330:949–55.
- Khan AS, Khabbaz RF, Armstrong LR, Holman RC, Bauer SP, Graber J, et al. Hantavirus pulmonary syndrome: the first 100 US cases. *J Infect Dis*. 1996;173:1297–303.
- Lopez N, Padula P, Rossi C, Lazaro ME, Franze-Fernandez MT. Genetic identification of a new hantavirus causing severe pulmonary syndrome in Argentina. *Virology*. 1996;220:223–6.
- Johnson AM, Bowen MD, Ksiazek TG, Williams RJ, Bryan RT, Mills JN, et al. Laguna Negra virus associated with HPS in western Paraguay and Bolivia. *Virology*. 1997;238:115–27.
- Lopez N, Padula P, Rossi C, Miguel S, Edelstein A, Ramirez E, et al. Genetic characterization and phylogeny of Andes virus and variants from Argentina and Chile. *Virus Res*. 1997;50:77–84.
- Johnson AM, de Souza LT, Ferreira IB, Pereira LE, Ksiazek TG, Rollin PE, et al. Genetic investigation of novel hantaviruses causing fatal HPS in Brazil. *J Med Virol*. 1999;59:527–35.
- Padula PJ, Colavecchia SB, Martinez VP, Gonzalez Della Valle MO, Edelstein A, Miguel SD, et al. Genetic diversity, distribution, and serological features of hantavirus infection in five countries in South America. *J Clin Microbiol*. 2000;38:3029–35.
- Vincent MJ, Quiroz E, Gracia F, Sanchez AJ, Ksiazek TG, Kitsutani PT, et al. Hantavirus pulmonary syndrome in Panama: identification of novel hantaviruses and their likely reservoirs. *Virology*. 2000;277:14–9.
- Padula P, Della Valle MG, Alai MG, Cortada P, Villagra M, Gianella A. Andes virus and first case report of Bermejo virus causing fatal pulmonary syndrome. *Emerg Infect Dis*. 2002;8:437–9.
- Padula PJ, Sanchez AJ, Edelstein A, Nichol ST. Complete nucleotide sequence of the M RNA segment of Andes virus and analysis of the variability of the termini of the virus S, M and L RNA segments. *J Gen Virol*. 2002;83:2117–22.
- Enria D, Padula P, Segura EL, Pini N, Edelstein A, Posse CR, et al. Hantavirus pulmonary syndrome in Argentina. Possibility of person to person transmission. *Medicina (B Aires)*. 1996;56:709–11.
- Wells RM, Sosa Estani S, Yadon ZE, Enria D, Padula P, Pini N, et al. An unusual hantavirus outbreak in southern Argentina: person-to-person transmission? Hantavirus Pulmonary Syndrome Study Group for Patagonia. *Emerg Infect Dis*. 1997;3:171–4.
- Padula PJ, Edelstein A, Miguel SD, Lopez NM, Rossi CM, Rabinovich RD. Hantavirus pulmonary syndrome outbreak in Argentina: molecular evidence for person-to-person transmission of Andes virus. *Virology*. 1998;241:323–30.
- Galeno H, Mora J, Villagra E, Fernandez J, Hernandez J, Mertz GJ, et al. First human isolate of Hantavirus (Andes virus) in the Americas. *Emerg Infect Dis*. 2002;8:657–61.
- Hooper JW, Larsen T, Custer DM, Schmaljohn CS. A lethal disease model for hantavirus pulmonary syndrome. *Virology*. 2001;289:6–14.
- Milazzo ML, Eyzaguirre EJ, Molina CP, Fulhorst CF. Maporal viral infection in the Syrian golden hamster: a model of hantavirus pulmonary syndrome. *J Infect Dis*. 2002;186:1390–5.
- Padula PJ, Rossi CM, Della Valle MO, Martinez PV, Colavecchia SB, Edelstein A, et al. Development and evaluation of a solid-phase enzyme immunoassay based on Andes hantavirus recombinant nucleoprotein. *J Med Microbiol*. 2000;49:149–55.
- Martinez VP, Colavecchia S, Garcia Alay M, Suzuki B, Trincheri A, Busto S, et al. Hantavirus pulmonary syndrome in Buenos Aires Province [article in Spanish]. *Medicina (B Aires)*. 2001;61:147–56.
- Padula P, Figueroa R, Navarrete M, Pizarro E, Cadiz R, Bellomo C, et al. Transmission study of Andes hantavirus infection in wild sigmodontine rodents. *J Virol*. 2004;78:11972–9.
- Jenison S, Hjelle B, Simpson S, Hallin G, Feddersen R, Koster F. Hantavirus pulmonary syndrome: clinical, diagnostic, and virologic aspects. *Semin Respir Infect*. 1995;10:259–69.
- Jonsson CB, Milligan BG, Arterburn JB. Potential importance of error catastrophe to the development of antiviral strategies for hantaviruses. *Virus Res*. 2005;107:195–205.
- Mertz GJ, Miedzinski L, Goade D, Pavia AT, Hjelle B, Hansbarger CO, et al. Placebo-controlled, double-blind trial of intravenous ribavirin for the treatment of hantavirus cardiopulmonary syndrome in North America. *Clin Infect Dis*. 2004;39:1307–13.

Address for correspondence: Valeria P. Martinez, Av Velez Sarsfield 563-1281-Buenos Aires, Argentina; fax: 54-11-4301-3146; email: pmartinez@anlis.gov.ar



**Partners**  
in Information Access for  
the Public Health Workforce

*Your source for  
reliable public  
health information*

**http://PHPartners.org**

Brought to you by a collaboration  
of U.S. government agencies,  
public health organizations  
and health sciences libraries.

# European Bat Lyssaviruses, the Netherlands

Wim H.M. Van der Poel,\* Reina Van der Heide,\* Elisabeth R.A.M. Verstraten,† Katsuhisa Takumi,\* Peter H.C. Lina,‡ and Johannes A. Krampst†

To study European bat lyssavirus (EBLV) in bat reservoirs in the Netherlands, native bats have been tested for rabies since 1984. For all collected bats, data including species, age, sex, and date and location found were recorded. A total of 1,219 serotine bats, *Eptesicus serotinus*, were tested, and 251 (21%) were positive for lyssavirus antigen. Five (4%) of 129 specimens from the pond bat, *Myotis dasycneme*, were positive. Recently detected EBLV RNA segments encoding the nucleoprotein were sequenced and analyzed phylogenetically (45 specimens). All recent serotine bat specimens clustered with genotype 5 (EBLV1) sequences, and homologies within subgenotypes EBLV1a and EBLV1b were 99.0%–100% and 99.2%–100%, respectively. Our findings indicate that EBLVs of genotype 5 are endemic in the serotine bat in the Netherlands. Since EBLVs can cause fatal infections in humans, all serotine and pond bats involved in contact incidents should be tested to determine whether the victim was exposed to EBLVs.

European bat lyssaviruses (EBLVs) belong to the *Lyssavirus* genus of the *Rhabdoviridae* family and form a group of negative single-stranded RNA viruses with an almost worldwide distribution. The genus *Lyssavirus* can be divided into 7 genotypes, including EBLV1 as genotype 5 and EBLV2 as genotype 6 (1). EBLVs have been demonstrated in several bat species, and more bat species may be susceptible. The bite of an EBLV-infected bat may cause fatal encephalitis in humans; 4 fatal human cases have been reported. Three of the 4 viruses were typed genetically to be definitely EBLV (2). The most recent case was a 56-year-old bat worker in Scotland who was thought to have been bitten on his hand by a Daubenton's bat (3). Therefore, bat rabies is considered a

public health threat in countries where these viruses are endemic in bats. In the Netherlands, genotype 1 lyssaviruses were eradicated in the early 1990s, but EBLVs are endemic in several bat species; the serotine bat, *Eptesicus serotinus*, is considered the main reservoir of rabies in this country. If possible, bats involved in contact incidents are sent to the Central Institute for Animal Disease Control (CIDC), Lelystad, to be tested for lyssavirus. Rabies diagnosis is always performed within 24 hours and if necessary, rabies postexposure prophylaxis is administered to the patient according to World Health Organization recommendations.

To provide a picture of rabies incidence and distribution in native bat species in the Netherlands, data for bats tested for lyssavirus antigen at CIDC-Lelystad were collected and analyzed. To characterize the circulating EBLVs, reverse transcription–polymerase chain reaction (RT-PCR) amplification products of EBLV RNA were sequenced and analyzed phylogenetically.

## Materials and Methods

### Bat Specimens and Bat Data

In the Netherlands, surveillance of lyssaviruses in bats is ongoing. In 1984, it became mandatory to submit bats caught by animals or bats that were unable to fly to the CIDC-Lelystad Department of Virology for lyssavirus antigen testing. After 1987, surveillance began nationwide; since 1994, mainly bats involved in contact incidents and suspected of rabies infection have been submitted for testing. As part of this surveillance, from 1984 to 2003, brain tissue samples were collected from all submitted bats. Each year, >100 of these animals were tested for lyssavirus antigen. The locations where the bats were found were plotted by using 5 × 5 km grid allocations. In addition to location and date found, species, sex, and age were determined and recorded (by P.H.C.L.).

\*National Institute for Public Health and the Environment, Bilthoven, the Netherlands; †Central Institute for Animal Disease Control, Lelystad, the Netherlands; and ‡National Museum of Natural History, "Naturalis," Leiden, the Netherlands

The number of EBLV-positive bats was described by the binomial distribution prevalence that was specific to each sex-age group. This distribution produced a sequence of nested binomial models to test the effect of adding an extra group-specific prevalence to a simpler model by the likelihood ratio test. If the resulting deviance was greater than the 95th percentile of the chi-square distribution with 1 degree of freedom, the prevalence of the sex-age group was considered to be significantly different from the others.

### Detection of Lyssavirus Antigen

Detection of lyssavirus antigen was performed by standard fluorescent antibody test (FAT) as described (4), with modifications, using polyclonal fluorescein isothiocyanate-labeled rabbit anti-rabies nucleocapsid immunoglobulin G (IgG) (Diagnostics Pasteur, Marnes-la-Coquette, France). Positive controls, brain tissue smears from mice infected with genotypes 1 and 5 field virus, were incorporated in each test run. Duplicate smears were carefully and completely checked for fluorescence. From 1997 to 2003, all test results that were positive by FAT (n = 45) were confirmed by RT-PCR and sequenced.

### RT-PCR Analyses

To amplify EBLV-specific RNA, brain tissue samples (3 mm<sup>3</sup>) were put in 0.5 mL RNA extraction buffer. The RNA extraction was performed by using TRIzol (Invitrogen Life Technologies, Merelbeke, Belgium) according to the manufacturer's protocol. TRIzol was added to the brain tissue sample to a total volume of 1.0 mL. RT-PCR amplification was performed as described (5). Primer selection and Southern blot hybridizations of RT-PCR products were performed as described (6). To characterize the EBLVs, RT-PCR amplification products of all FAT-positive samples collected from 1997 to 2003 were confirmed by RT-PCR and sequenced later.

### EBLV RNA Sequence Analyses

Direct sequencing of the RT-PCR-amplified products of a 566-nucleotide (nt) fragment coding for the amino terminus of the nucleoprotein of EBLV and analyses of the nucleotide sequences were performed as described (7). This part of the genome was used to enable a comparison with sequences described by other lyssavirus researchers in Europe (7). PCR fragments were purified by QIAquick Purification Kit (Qiagen, Hilden, Germany) and then sequenced directly on both strands. Sequencing was performed on a Biosystems (ABI) 3700 DNA automated sequencer (Perkin Elmer-Applied Biosystems, Foster City, CA, USA) by using fluorescent dye-labeled dideoxynucleo terminators (BigDye Terminator Cycle Sequencing Ready Reaction, Perkin Elmer-Applied Biosystems, Warrington, UK). Nucleotide sequences were edited by

using Seq Ed (V1.03, Applied Biosystems), and aligned using Bionumerics (V2.5) (Applied Maths, Kortrijk, Belgium). To compare detected and historic sequences, phylogenetic trees were created based on cluster analyses and global alignment similarities of 396 nucleotide fragments of the N-gene encoding region (position in the genome nucleotide 46–441, numbered according to the CVS strain, GenBank accession no. D42112). The confidence values of the internal nodes were calculated by performing 100 bootstrap analyses (Bionumerics V2.5).

To allow the geographic relationship between homologous strains to be studied, sequences showing a high sequence homology were grouped by "cluster". All sequence "cluster" numbers were positioned on the country map to determine if sequences with high homogeneity originated from the same region.

## Results

### Detection of Lyssavirus Antigen

From 1984 to 2003, bats of 1 vagrant and 11 native species (Table 1) were tested for lyssavirus antigen. Lyssavirus was detected in 2 species only, the serotine bat and the pond bat, *Myotis dasycneme*. A total of 1,219 serotine bats and 129 pond bats were tested for lyssavirus antigen; 251 serotine bats and 5 pond bats were positive, which results in 21% and 4% prevalence, respectively. In the most common native bat species, the pipistrelle, *Pipistrellus pipistrellus*, EBLV was never detected (1,837 specimens tested). Approximately one third (32%) of all bats submitted for lyssavirus antigen testing were serotine bats (Table 1, Figure 1).

### EBLV RT-PCR and RNA Sequence Analyses

All FAT-positive bat brain tissue samples collected from 1997 to 2003 tested positive by PCR. Direct sequencing of the RT-PCR-amplified products of a 566-nt coding

Table 1. Investigated bats, the Netherlands, 1984–2003

Bat species	No. specimens tested	Lyssavirus antigen positive (%)
<i>Eptesicus serotinus</i>	1,219	251 (20.6)
<i>E. nilssonii</i>	1	0
<i>Myotis mystacinus</i>	18	0
<i>M. nattereri</i>	9	0
<i>M. daubentonii</i>	111	0
<i>M. dasycneme</i>	129	5 (3.9)
<i>Pipistrellus pipistrellus</i>	1,837	0
<i>P. nathusii</i>	256	0
<i>Nyctalus noctula</i>	61	0
<i>N. leisleri</i>	3	0
<i>Plecotus auritus</i>	214	0
<i>Vespertilio murinus</i>	6	0
Undetermined	9	0
Total	3,873	256

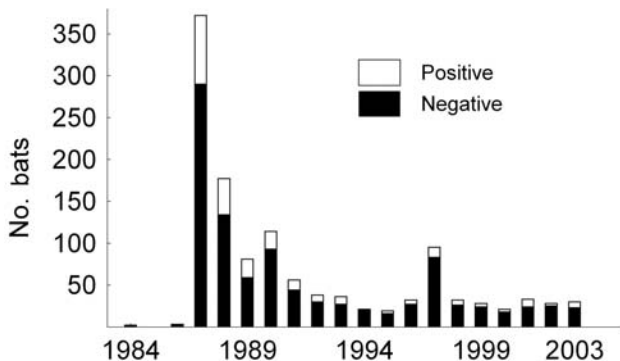

Figure 1. Number of submitted and lyssavirus antigen-positive samples from serotine bats, *Eptesicus serotinus*, collected in the Netherlands during the survey (1984–2003).

region of the amino terminus of the nucleoprotein resulted in homologies within subgenotypes EBLV1a (41 specimens) and EBLV1b (4 specimens) of 99.0%–100% and 99.2%–100%, respectively. Homologies with older EBLV bat isolates from the Netherlands were also within these ranges. Phylogenetic analyses did not show a significant change or shift in EBLV nucleoprotein encoding sequences over the years (Figures 2 and 3).

**Geographic Distribution, Age, and Sex**

The geographic origin of tested and EBLV-positive serotine and pond bats are depicted in Figures 4 and 5, respectively. The numbers of tested and EBLV-positive serotine bats per year are shown in Figure 1. High homology sequences detected in serotine bats did not show a clustering per year (Figure 2), but EBLV sequences that showed a high degree of homology seemed to have a geographic relationship for at least 2 lineages (clusters 2 and 4, Figure 3). Regarding age and sex, a significantly higher number of EBLV-infected serotine bats were found in the group of adult females, 25% EBLV positives (Table 2).

**Discussion**

From 1984 to 2003, the serotine bat appeared to be the main wildlife reservoir of EBLVs in the Netherlands, as in several other European countries (7). European bat lyssavirus incidence in serotine bats in the Netherlands was 21%. A much lower incidence of 4% was found in the pond bat. In the Netherlands, females of both the serotine bat and the pond bat usually dwell as maternity colonies in the summer; single males or male groups dwell in walls of houses and other buildings and occasionally in suitably quiet spaces like church lofts.

These practices may bring humans and pets in contact with diseased bats. Among pets, cats are the most common predators of building-dwelling bats. Most of the bats sub-

mitted for testing were prey of cats, many of the bats had been in direct contact with humans, and only a few were involved in biting incidents. Most of these bats were assumed to be diseased or exhausted, and therefore, the observed EBLV incidences in both bat species almost certainly are an overestimation of the incidence in healthy bat populations in the Netherlands. EBLV-positive cats were never identified, so the risk of infection seems to be very low for cats involved in bat contact.

The difference in the overall prevalence between the serotine bat and the pond bat is difficult to explain. The serotine bat and the pond bat are not related species. Differences in behavior or sensitivity to EBLV infection or disease may be underlying causes for the observed differences in EBLV prevalence in the 2 species. The patho-

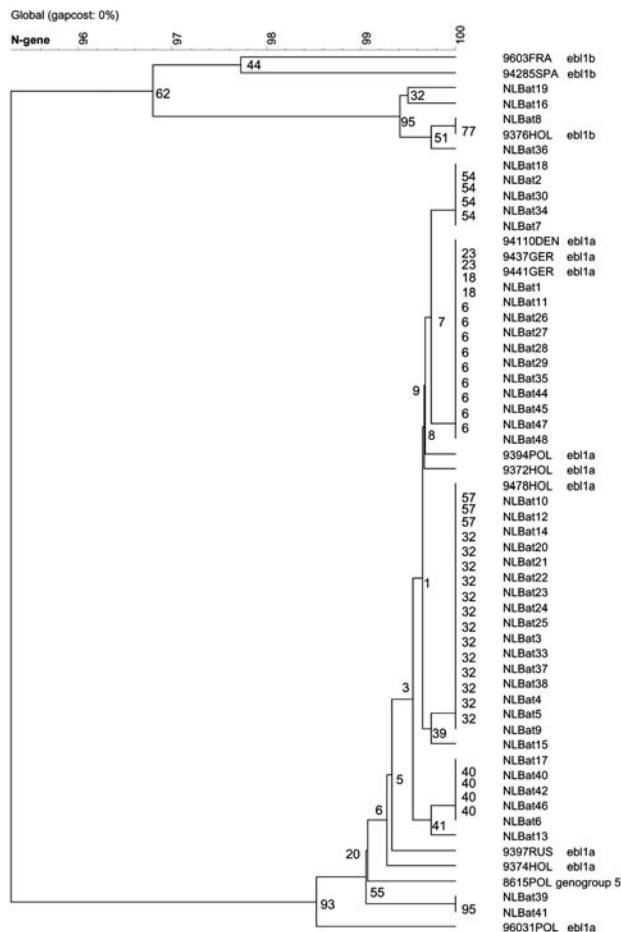

Figure 2. Phylogenetic tree of European bat lyssavirus (EBLV1) sequences detected in serotine bats in the Netherlands, 1997–2003, and historic EBLV sequences detected in bats in Europe. Tree calculated based on cluster analyses and global alignment similarities of 396 nucleotide fragments of the N-gene encoding region (position in the genome nucleotide 46–441, numbered according to the CVS strain, GenBank accession no. D42112). The confidence values of the internal nodes were calculated by performing 100 bootstrap analyses.



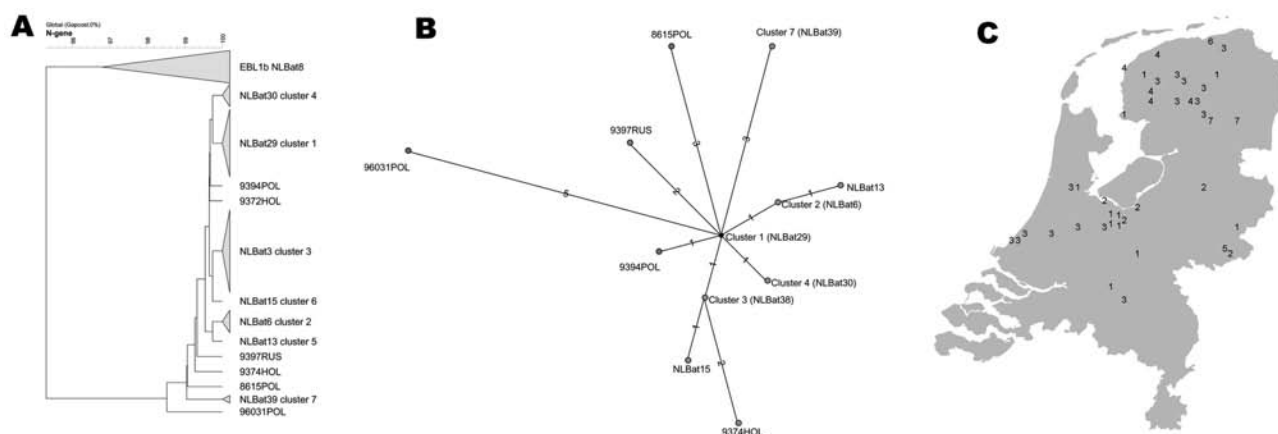

Figure 3. A) Phylogenetic tree of European bat lyssavirus 1 (EBLV1) sequences detected in serotine bats in the Netherlands, 1997–2003, and some historic sequences detected in bats in Europe. Analysis performed with maximum parsimony of representative DNA sequences of different EBLV1 sequences. B) Relationships between 7 different serotine bat EBLV1a sequence lineages (numbered “clusters” 1 to 7): maximum parsimony unrooted tree of representative EBLV1 sequences detected in serotine bats in the Netherlands and several historic sequences detected in other European countries (color coded country). C) Geographic distribution of the 7 different serotine bat EBLV1 lineages (numbered “clusters” 1 to 7) from 41 recently detected serotine bat isolates in the Netherlands.

genicity of EBLVs in natural hosts has not been extensively studied because bats are legally protected in most European countries (European Commission Directive 92/43/EEC on the Conservation of Natural Habitats and of Wild Fauna and Flora, 1992). Some European countries have even more strict regulations than those described in the European directive. Due to strict regulations on wildlife conservation in some countries, the study of EBLV infections in bats is hampered. Therefore, whether EBLVs normally cause fatal infections or induce an asymptomatic infection and virus persistence in individual bats is not known (8). Another possibility is that EBLVs induce infection with a long incubation period (i.e., months, years), because this can also lead to long-term maintenance of the virus within a specific species. Studies to elucidate this issue have not shown exclusive results (6).

Apart from the species, data including age, sex, and dates and locations the bats were found were also documented; these data enable us to show a clear picture of the geographic distribution of EBLVs in different bat species in the Netherlands (Figures 4A and B and Figure 5) for the first time. The serotine bat is relatively common and can be found throughout the country. The species is especially numerous in the northwest. In the south, the species is present almost everywhere but in rather low numbers. The pond bat is fairly common in the north and west. Both serotine bats and pond bats submitted for EBLV testing were concentrated more in the northern and the middle part of the country. This finding indicates the summer distribution and population density of both species in the Netherlands (9). During winter, the serotine bat hibernates

individually or in small groups in cavity walls of buildings usually not far from its summer roosts. The pond bat migrates to subterranean winter roosts which may be 20–300 km from its summer roosts. Hibernation of the pond bat in cavity walls of buildings has not yet been observed. The higher number (25%) of EBLV infections observed in adult female serotine bats is not surprising because adult females of this species live close together during their maternity period in the summer.

Forty-five FAT-positive bat brain tissue samples selected for EBLV sequence analysis tested positive by PCR. For these samples, the EBLV RT-PCR assay proved to be at least as sensitive as the FAT test system that is used for EBLV surveillance. Sequencing the RT-PCR-amplified products of the nucleoprotein-encoding region and subsequent sequence analyses resulted in exclusively EBLV1 subgenotype lineages. EBLV1a isolates showed a 99.0%–100% homology, whereas EBLV1b isolates in the Netherlands showed a 99.2%–100% homology. Homologies with older EBLV isolates from the Netherlands were also within these ranges (Figures 2 and 3).

Sequences from serotine bats with high homology for at least 2 EBLV1a lineages (clusters 2 and 4, Figure 3) originated from a defined geographic region in the Netherlands. This observation suggests that transmission of EBLVs in serotine bats over long distances within the country does not seem to play a major role in EBLV epidemiology. However, Davis et al. (10) recently suggested that transmission viral traffic may be established among bats in northern Europe because high homology strains were found across this entire region. For the EBLV1b lin-

eages, the possibility of geographic clustering of high homology sequences could not be determined because of the relatively low number of analyzed sequences.

EBLV sequences detected in native bats in the Netherlands showed little divergence and did not indicate an emergence of new EBLV strains, but this study confirms that the serotine bat is an EBLV1 reservoir. Since at least 4 fatal EBLV infections have been reported in

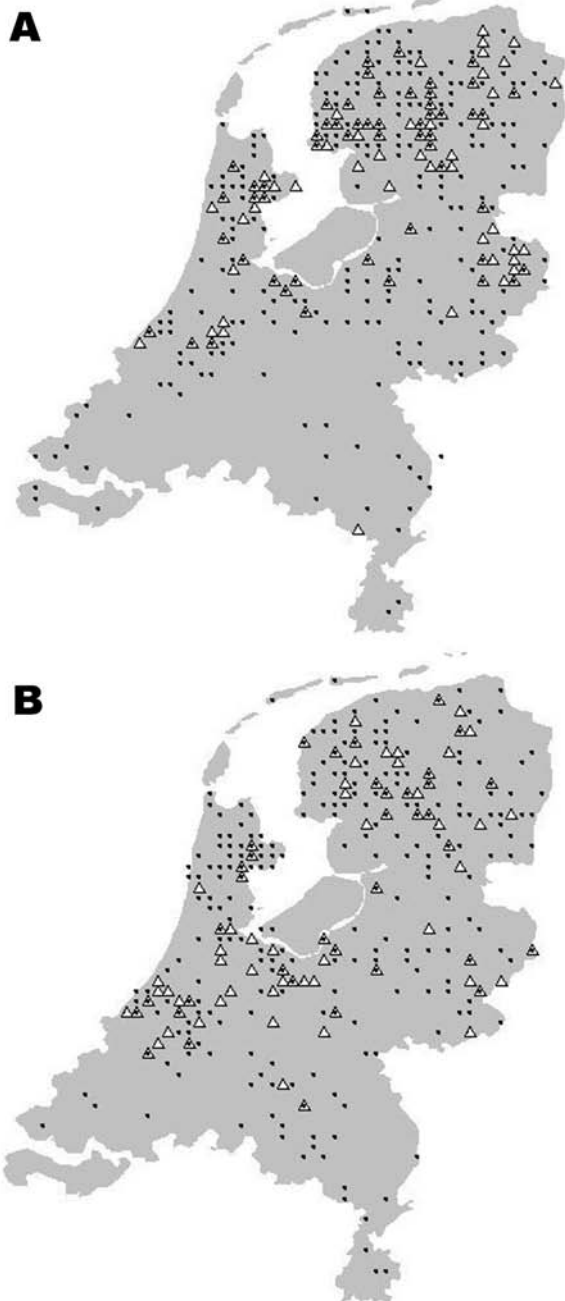

Figure 4. Location of serotine bat, *Eptesicus serotinus*, with positive (triangles) and negative (dots) test results for European bat lyssaviruses, the Netherlands; A)1984–1989; B)1990–2003.



Figure 5. Location of pond bat, *Myotis dasycneme*, with positive (triangles) and negative (dots) test results for European bat lyssaviruses, the Netherlands, 1984–2003.

humans in Europe in the last decade, the public health hazard of bat rabies in Europe should not be underestimated. Any contact with bats in Europe must be considered possible exposure, and biting incidents should be treated immediately with rabies postexposure prophylaxis. If possible, the involved bat should always be kept for lyssavirus testing. To prevent rabies transmission from bats, all bat handlers should be informed of the risks of rabies exposure and advised to be vaccinated. The continuing prevalence of EBLVs in serotine bats and pond bats in Europe and the risk of a fatal infection in humans should compel European countries to work together on bat lyssavirus surveillance.

Table 2. European bat lyssavirus–positive serotine bats by age and sex

Sex/age group	Examined	Positive	Prevalence (%)
Male/juvenile	22	6	27
Female/juvenile	35	4	11
Male/adult	684	132	19
Female adult*	438	108	25
Subtotal	1,178	250	21
Sex and age unknown	8	0	
Adult/unknown sex	24	1	4
Juvenile/unknown sex	8	0	
Total	1,219	251	21

\*Prevalence for this group was significantly higher than for the rest based on likelihood ratio test.

### Acknowledgments

We thank J.W. van der Giessen for contributions to the phylogenetic analysis and F. Lodder-Verschoor, R. Doornbos, and T. Pover for technical assistance.

This study was performed by order of and for the account of the Dutch Food and Product Safety Authority.

Dr Van der Poel is head of research on infection biology and virology in the Animal Sciences Group, Wageningen University Research, Lelystad, the Netherlands. His research interests include viral zoonoses.

### References

1. Badrane H, Bahloul C, Perrin P, Tordo N. Evidence of two *Lyssavirus* phylogroups with distinct pathogenicity and immunogenicity. *J Virol*. 2001;75:3268–76.
2. Fooks AR, Brookes SM, Johnson N, McElhinney LM, Hutson AM. European bat lyssavirus: an emerging zoonosis. *Epidemiol Infect*. 2003;131:1029–39.
3. Fooks AR, McElhinney LM, Pounder DJ, Finnegan CJ, Mansfield K, Johnson N, et al. Case report: isolation of a European bat lyssavirus type 2a from a fatal human case of rabies encephalitis. *J Med Virol*. 2003;71:281–9.
4. Dean DJ, Ableseth MK, Atanasiu P. The fluorescence antibody test. In: Meslin FX, Kaplan MM, Koprowski H, editors. *Laboratory techniques in rabies*. 4th ed. Geneva: World Health Organization; 1996. p. 88–95.
5. Heaton PR, Johnstone P, McElhinney LM, Cowley R, O'Sullivan E, Whitby JE. Hemi-nested PCR assay for detection of six genotypes of rabies and rabies-related viruses. *J Clin Microbiol*. 1997;35:2762–6.
6. Van der Poel WHM, Van de Heide R, Van Amerongen G, Van Keulen LJM, Bourhy H, Schaftenaar W, et al. Characterisation of a recently isolated lyssavirus in frugivorous zoo bats. *Arch Virol*. 2000;145:1919–31.
7. Amengual B, Whitby JE, King A, Cobo JS, Bourhy H. Evolution of European bat lyssaviruses. *J Gen Virol*. 1997;78:2319–28.
8. Botvinkin AD, Kuzmin IV, Chernov SM. The experimental infection of bats with lyssavirus serotypes 1 and 4. *Vopr Virusol*. 1992;37:215–8.
9. Kapteyn K, Mostert K. Atlas van de Nederlandse vleermuizen. Limpens H, Mostert K, Bongers W, editors. Utrecht: Stichting uitgeverij van de Koninklijke Natuurhistorische Vereniging; 1997.
10. Davis PL, Holmes EC, Larrous F, Van der Poel WH, Tjørnhøj K, Alonso WJ, et al. Phylogeography, population dynamics, and molecular evolution of European bat lyssaviruses. *J Virol*. 2005;79: 10487–97.

Address for correspondence: Wim H. Van der Poel, Animal Sciences Group, Wageningen University Research, PO Box 65 NL-8200 AB, Lelystad, the Netherlands; fax: 31-320-238961; email: wim.vanderpoel@wur.nl

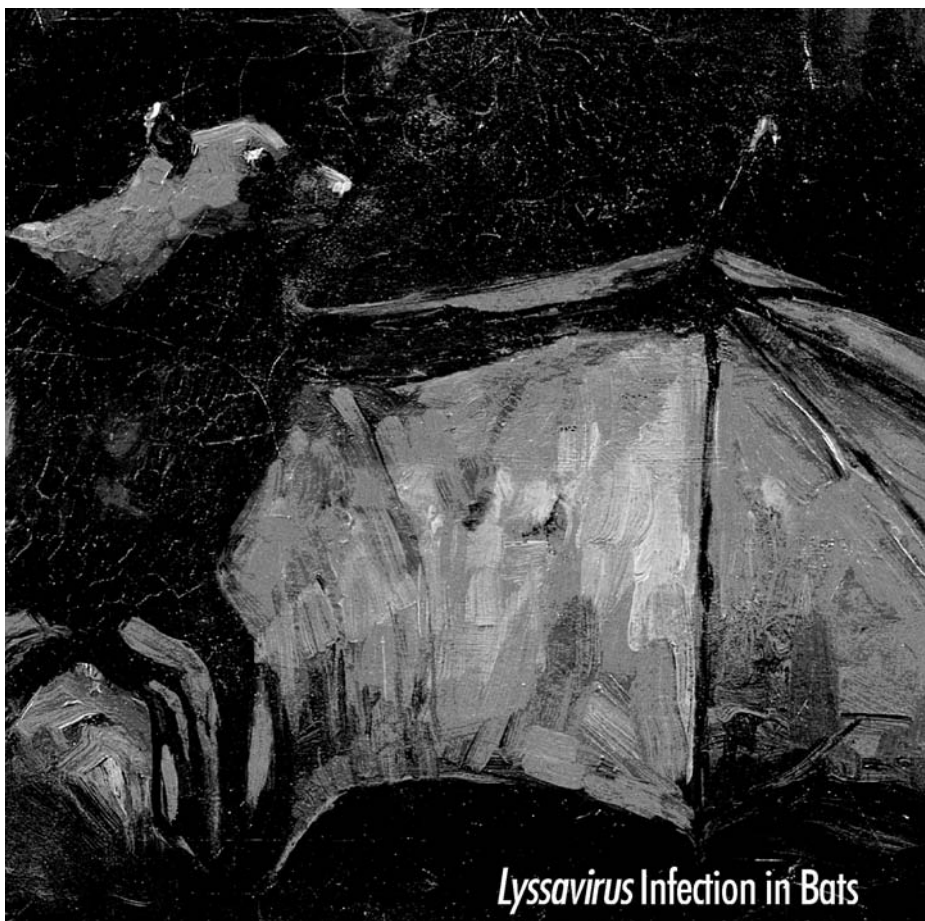

*Lyssavirus* Infection in Bats

Search  
**EID**  
 Online  
[www.cdc.gov/eid](http://www.cdc.gov/eid)

# SARS-CoV Infection in a Restaurant from Palm Civet

Ming Wang,<sup>\*1</sup> Meiyang Yan,<sup>††1</sup> Huifang Xu,<sup>\*1</sup> Weili Liang,<sup>††1</sup> Biao Kan,<sup>††1</sup> Bojian Zheng,<sup>§1</sup> Honglin Chen,<sup>§1</sup> Han Zheng,<sup>††</sup> Yanmei Xu,<sup>††</sup> Enmin Zhang,<sup>††</sup> Hongxia Wang,<sup>††</sup> Jingrong Ye,<sup>††</sup> Guichang Li,<sup>†</sup> Machao Li,<sup>†</sup> Zhigang Cui,<sup>††</sup> Yu-Fei Liu,<sup>\*</sup> Rong-Tong Guo,<sup>\*</sup> Xiao-Ning Liu,<sup>\*</sup> Liu-Hua Zhan,<sup>\*</sup> Duan-Hua Zhou,<sup>\*</sup> Ailan Zhao,<sup>††</sup> Rong Hai,<sup>††</sup> Dongzhen Yu,<sup>††</sup> Yi Guan,<sup>§</sup> and Jianguo Xu<sup>††</sup>

Epidemiologic investigations showed that 2 of 4 patients with severe acute respiratory syndrome (SARS) identified in the winter of 2003–2004 were a waitress at a restaurant in Guangzhou, China, that served palm civets as food and a customer who ate in the restaurant a short distance from animal cages. All 6 palm civets at the restaurant were positive for SARS-associated coronavirus (SARS-CoV). Partial spike (S) gene sequences of SARS-CoV from the 2 patients were identical to 4 of 5 S gene viral sequences from palm civets. Phylogenetic analysis showed that SARS-CoV from palm civets in the restaurant was most closely related to animal isolates. SARS cases at the restaurant were the result of recent interspecies transfer from the putative palm civet reservoir, and not the result of continued circulation of SARS-CoV in the human population.

The severe acute respiratory syndrome (SARS) epidemic emerged in 2003 in 6 municipalities in the Pearl River delta region in Guangdong, China. Early case-patients were more likely to be persons with occupational exposure to animals, such as animal sellers or restaurant cooks (1,2). Tracing the source of infection has been complicated, given the sporadic nature of index cases without a clear history of contact with animals. After the World Health Organization (WHO) declared the end of the SARS epidemic, 4 new cases of SARS were reported from December 16, 2003, to January 1, 2004, in Guangzhou in Guangdong Province. These cases were not linked to any

laboratory accidents. All patients had a temperature  $>38^{\circ}\text{C}$ , radiographic evidence of pneumonia, and serologic evidence of SARS infection. Fever lasted from 6 to 18 days (median 7), no mechanical ventilation was required, and the clinical course of the disease ranged from 21 to 24 days with full recovery. All 4 patients had community-acquired infections without any apparent epidemiologic link. A total of 257 contacts, including 113 close contacts, of these patients were observed for 2 weeks, with no secondary transmission identified. These patients had mild symptoms and no secondary transmission, which was remarkably different from patients in the 2003 epidemic.

Since potential reemergence of SARS leading to epidemic spread was possible, identification of the infectious source was a high priority. The S gene sequence of SARS-associated coronavirus (SARS-CoV) isolated from 2 of these 4 patients was found to be closely related to the sequence of virus isolated from palm civets (3). However, 1 of these patients reported no contact with palm civets or other animals in the preceding 2 months. The second patient was a 20-year-old waitress from a restaurant that served palm civets as food (4,5). Based on the virologic and epidemiologic findings, provincial officials took aggressive action on January 5, 2004, ordering a sweep through farms and food markets to destroy any animals that might harbor SARS-CoV. No additional SARS cases have since been reported. This information highlights the necessity for investigating restaurants as a possible source of infection, understanding that the virus can be transmitted from animals or environmental sources to humans, and clarifying the genetic basis of pathogenicity and infectivity of SARS-CoV from animal sources.

<sup>\*</sup>Guangzhou Municipal Center for Disease Control and Prevention, Guangdong, People's Republic of China; <sup>†</sup>National Institute for Communicable Disease Control and Prevention, Beijing, People's Republic of China; <sup>‡</sup>State Key Laboratory of Infectious Diseases Prevention and Control, Beijing, People's Republic of China; and <sup>§</sup>University of Hong Kong, Hong Kong Special Administrative Region, People's Republic of China

<sup>1</sup>These authors contributed equally to this article.

## Methods

### Specimen Collection

Serial nasopharyngeal, fecal, and serum specimens of patients were collected at hospitals by Guangzhou Municipal Centers for Diseases Control and Prevention. When possible SARS was diagnosed in the waitress on January 2, 2004, serum, throat and rectal swabs were obtained from all 6 palm civets at the restaurant. It was reported that the animals were purchased from Xinyuan live animal wholesale market in Guangzhou. Serum samples from employees of the restaurant were obtained on January 4. Persons with positive results provided additional samples as needed. All specimens were stored at  $-80^{\circ}\text{C}$ .

### Laboratory Diagnosis and Direct Sequencing of Primary Specimens

Serum samples were tested by enzyme-linked immunosorbent assay (ELISA), immunofluorescent antibody (IFA) test, and Western blot for specific immunoglobulin G (IgG) and IgM. Nasopharyngeal, throat, and rectal specimens were tested by reverse transcription–polymerase chain reaction for polyprotein (P) and nucleocapsid (N) genes of SARS-CoV. Gene sequences were determined directly from original samples. RNA was transcribed into cDNA (SuperScript, Invitrogen, Carlsbad, CA, USA) and subsequently used for PCR amplification. Complete spike (S) gene and whole genome sequencing of SARS-CoV virus was conducted by using 48 primer sets based on the sequence data of a SARS-CoV SZ3 isolate from palm civet (6) and an ABI 3730 Genetic Analyzer (Applied Biosystems, Foster City, CA, USA). Assembled genome sequences were compared with those of the first virus isolates of human (TOR2) and animal (SZ3) origin. Any nucleotide (nt) differences were double-checked and confirmed. Sequences from this study were deposited in GenBank (accession nos. AY572034–572038).

### Virus Isolation and Characterization

Samples from patients and animals were cultured in fetal rhesus kidney (FRhK-4) cells or Vero E6 cells for virus isolation as described (6,7). Cells with or without SARS-CoV virus infection were harvested and fixed in 2.5% glutaraldehyde (Electron Microscopy Sciences, Hatfield, PA, USA) for 4 h and post-fixed in 1% osmium tetroxide for 1 h. Cells were then transferred to a 1.5-mL tube and centrifuged at 1,000 rpm for 10 min. The supernatant was removed and a 2% agarose solution ( $55^{\circ}\text{C}$ – $60^{\circ}\text{C}$ ) was added to the cell pellet. After the agarose solidified,  $\approx 1$ -mm cubes containing the cell pellet were cut and dehydrated in graded ethanol. The cubes were then embedded in epoxy resin. Ultrathin sections (70 nm) were prepared and stained with uranyl acetate and lead citrate.

Sections were examined with a Philips (Eindhoven, the Netherlands) EM208S electron microscope.

### Phylogenetic Construction and Data Analyses

Nucleotide and amino acid sequences were aligned by using MegAlign version 6.0 (DNASTAR, Madison, WI, USA). A neighbor-joining tree with bootstrap values was constructed to estimate phylogenetic relationships among sequences. Nucleotide positions were numbered based on the TOR2 SARS virus isolate (GenBank accession no. NC\_004718) (8).

## Results

### Epidemiologic Findings of Patients

Epidemiologic investigations showed that 2 of the 4 recent SARS patients were linked with the restaurant serving palm civets as food. One patient was a 20-year-old waitress who became ill on December 26, 2003, with suspected SARS was diagnosed on January 2, 2004, and she was classified as a probable SARS patient by local health authorities on January 8, 2004 (4,5). She denied eating palm civet or being in close contact with them. However, palm civets were found in her work area and she often passed or stood a short distance from the animal cages. The other patient was a 40-year-old physician who ate at the restaurant on December 31, 2003, and first showed symptoms on January 7, 2004. His dining table was within 5 m of civet cages.

Serial serum samples from both patients were positive for IgG and IgM against SARS-CoV by ELISA, IFA, and Western blots. Positions 22907–23192 (286 bp) of the S gene were sequenced from a nasopharyngeal swab isolate from the waitress and from a fecal specimen from the physician (samples were obtained on January 5 and January 12, 2004, respectively). The 2 S gene sequence fragments were identical, but differed from all S gene sequences available on public databases. Attempts to isolate virus from these specimens by using Vero E6 cells were unsuccessful. Isolation of virus with the FRhK-4 cell line was not attempted because the volume of specimen from patients was limited.

### Epidemiologic and Etiologic Findings of the Restaurant

The restaurant is in a 2-story building in downtown Guangzhou. Eight animal cages containing 6 palm civets (*Paguma larvata*) were stacked (2 cages per stack) at the front door of the restaurant. The cages were approximately 1 m from the sidewalk and 2 m from the first row of dining tables on the ground floor of the restaurant. Pedestrians walking in the street and customers dining on the ground floor could easily see the animals in the cages.

Both P and N genes of SARS-CoV were found by nested PCR in all throat and rectal swab specimens from 6 palm civets (Table 1) (9). Three complete genome sequences and 2 complete S gene sequences of SARS-CoV were found in rectal or throat swab specimens from 5 of the 6 palm civets (Table 1) (10). The 286-bp S gene sequences from isolates from the waitress and the physician were identical to 4 of 5 S gene sequences from palm civets from the restaurant, but differed from other sequences available from public databases (Table 2). SARS-CoV virus was isolated from FRhK-4 cells cultured with a rectal swab specimen of a palm civet, but not from Vero E6 cells. Cytopathic effects (CPE) of SARS-CoV virus on FRhK-4 cells were visible 4 days after culture with a fecal swab sample. Electron microscopy showed typical morphologic features of SARS-CoV virus in a thin section of the infected cell. A complete genome sequence of the SARS-CoV isolated from a palm civet was determined directly from the original sample and submitted to GenBank (accession no. AY572034).

IgG antibodies against SARS-CoV were detected in 2 (5.1%) of 39 employees of the restaurant. This was higher than that observed in the control groups (1%–3%) (11). One employee tested positive for IgM against SARS-CoV in serum samples obtained on January 4 and January 13. Results became negative by January 17, 2004, with no illness or fever in the previous 2 months. This employee worked as a head waitress and often helped customers select palm civets from animal cages. A cook in the restaurant also tested positive for IgG antibody to SARS-CoV.

#### Nucleotide and Amino Acid Sequence Variations

Comparison of 5 complete S gene sequences (3,768 nt) from palm civets at the restaurant, 22 S gene sequences from SARS patients in the early 2003 epidemic, and 2 viruses isolated from palm civets in 2003 showed 60 nt polymorphisms. Only 5 signature nt variations (SNVs) were observed in the 5 complete S gene sequences from palm civets determined in this study, indicating that SARS-CoV sequences from civets at the restaurant were not different from those of the original animal SARS source. We also observed that 21 SNVs could be used to distinguish viruses with high pathogenicity and infectivity

from those with low pathogenicity and infectivity relative to clinical presentation and transmission events (Table 2).

Three of 5 complete S gene sequences from palm civets at the restaurant did not contain any of the 21 SNVs. The remaining 2 isolates (Civet014 and Civet020) had only 1 or 2 SNVs. In contrast, 11 of 22 SARS-CoV strains isolated from humans in Canada, Germany, and Vietnam had all 21 SNV mutations (Table 2). It should be noted that the first human SARS-CoV isolated, GD01, had 17 of 21 SNVs (Table 2). This virus caused severe infections in humans, but did not spread from Guangdong Province (12). Similar SNV patterns were observed in other isolates from patients at the beginning of the 2003 epidemic (13). Four isolates (ZS-A, SZ-B, SZ-C, and HGZ8L1-A) had 18 of 21 SNVs and were obtained from patients with contact histories traceable to some of the earliest independent cases, but with no further transmission recorded (13). Virus GZ02 had 17 SNVs. Another group of 2 early isolates, HSZ-B and HSZ-C, had 19 SNVs, in addition to an 82-nt deletion (13). Virus GZ60, which was isolated from nasopharyngeal aspirates of a healthcare worker at Guangdong Chest Hospital on February 18, 2003, had 18 SNVs (10). Guan et al. named this virus SARS-CoV sub-cluster A1, together with GD01 and GZ43 (10). None of the sequences of these early-phase isolates have been observed in the middle or later phase of the epidemic, suggesting these isolates had low or mild infectivity (13).

When deduced amino acid sequences were analyzed, 15 signature amino acid variations (SAAVs) were observed that could distinguish between viruses with low or high pathogenicity and infectivity. Three of the 5 recent SARS-CoV isolates from palm civets had no SAAVs, while viruses isolated from outbreaks in various countries had all 15 SAAVs (7,10,14,15). The isolates from the early phase of the 2003 epidemic (GD01, ZS-A, SZ-B, SZ-C, HGZ8L1-A, HSZ-B, HSZ-C, and GZ60) had 12 or 13 SAAVs (6,7,13). SARS-CoV SZ3 and SZ16 had 7 SAAVs mutations (6). The S protein sequence predicted for the first SARS case of 2003–2004 had only 3 SAAVs (13).

#### Genomic Differences

When the complete genome sequences of SARS-CoV determined in specimens from palm civets at the restaurant

Table 1. Detection of severe acute respiratory syndrome–associated coronavirus genes in palm civets\*

Palm civet	Nucleocapsid and polyprotein genes		Sequences detected (GenBank accession nos.)
	Throat swab specimen	Rectal swab specimen	
007	+	+	Complete genome (AY572034)
010	+	+	Complete genome (AY572035)
014	+	+	Spike gene (AY572036)
018	+	+	ND
019	+	+	Spike gene (AY572037)
020	+	+	Complete genome (AY572038)

\*Nucleocapsid and polyprotein genes were detected by nested reverse transcription–polymerase chain reaction. Spike gene sequences were determined from rectal swab isolates.+, positive; ND, not detected.

Table 2. Comparison of signature nucleotide variations in the spike (S) gene of SARS-CoV from various sources\*

Virus	Source	Signature nucleotide variation position of S gene†																				
		2	2	2	2	2	2	2	2	2	2	2	2	2	2	2	2	2	2	2	2	
		1	2	2	2	2	2	2	2	2	2	2	3	3	3	3	3	3	3	4	4	5
		9	5	5	5	8	8	9	9	9	9	9	3	3	3	4	7	7	8	5	9	0
		0	1	2	7	7	7	0	2	2	3	5	1	1	3	8	1	8	2	6	7	3
		7	7	2	0	4	5	6	7	8	0	1	6	7	0	5	9	5	3	6	8	1
Civet007	Civet, restaurant	T	G	G	C	T	T	C	G	A	G	G	T	T	A	C	G	T	G	C	G	C
Civet010	Civet, restaurant	T	G	G	C	T	T	C	G	A	G	G	T	T	A	C	G	T	G	C	G	C
Civet019	Civet, restaurant	T	G	G	C	T	T	C	G	A	G	G	T	T	A	C	G	T	G	C	G	C
Civet020	Civet, restaurant	T	G	G	C	T	C	C	G	A	G	G	T	T	A	C	G	T	G	C	G	C
Civet014	Civet, restaurant	T	G	G	C	T	C	C	A	A	G	G	T	T	A	C	G	T	G	C	G	C
Waitress	Patient 2, waitress									G	A	G	G									
Customer	Patient 4, customer									G	A	G	G									
GD03T0013	Patient 1	T	G	G	C	T	C	C	A	T	G	G	T	T	A	C	G	T	G	C	G	C
SZ3	Civet, market	C	G	G	C	C	C	T	A	A	A	G	G	C	T	C	C	C	G	C	G	T
SZ16	Civet, market	C	G	G	C	C	C	T	A	A	A	G	G	C	T	C	C	C	G	C	G	T
GZ60	Early phase	C	G	G	T	C	C	T	A	T	A	C	G	C	T	C	C	C	G	T	A	T
HGZ8L1-A	Early phase	C	G	G	T	C	C	T	A	T	A	C	G	C	T	T	C	C	G	T	A	T
ZS-A	Early phase	C	G	G	T	C	C	T	A	T	A	C	G	C	T	T	C	C	G	T	A	T
ZS-B	Early phase	C	G	G	T	C	C	T	A	T	A	C	G	C	T	T	C	C	G	T	A	T
ZS-C	Early phase	C	G	G	T	C	C	T	A	T	A	C	G	C	T	T	C	C	G	T	A	T
GD01	Early phase	C	G	G	T	C	C	T	A	T	A	C	G	C	T	T	C	C	G	C	A	T
GZ02	Early phase	C	G	G	T	C	C	T	A	T	A	C	G	C	T	T	C	C	G	T	G	T
HSZ-Bb	Early phase	C	A	A	T	C	C	T	A	T	A	C	G	C	T	T	C	C	G	T	G	T
HSZ-Bc	Early phase	C	A	A	T	C	C	T	A	T	A	C	G	C	T	T	C	C	G	T	G	T
HSZ-Cb	Early phase	C	A	A	T	C	C	T	A	T	A	C	G	C	T	T	C	C	G	T	G	T
HSZ-Cc	Early phase	C	A	A	T	C	C	T	A	T	A	C	G	C	T	T	C	C	G	T	G	T
GZ50	Middle phase	C	A	A	T	C	C	T	A	T	A	C	G	C	T	T	C	C	T	T	A	T
BJ01	Late phase	C	A	A	T	C	C	T	A	T	A	C	G	C	T	T	C	C	T	T	A	T
BJ03	Late phase	C	A	A	T	C	C	T	A	T	A	C	G	C	T	T	C	C	T	T	A	T
HKU-36871	Late phase	C	A	A	T	C	C	T	A	T	A	C	G	C	T	T	C	C	T	T	A	T
HKU-39849	Late phase	C	A	A	T	C	C	T	A	T	A	C	G	C	T	T	C	C	T	T	A	T
HKU-65806	Late phase	C	A	A	T	C	C	T	A	T	A	C	G	C	T	T	C	C	T	T	A	T
CUHK-W1	Late phase	C	A	A	T	C	C	T	A	T	A	C	G	C	T	T	C	C	T	T	A	T
CUHK-Su10	Late phase	C	A	A	T	C	C	T	A	T	A	C	G	C	T	T	C	C	T	T	A	T
Fra	Late phase	C	A	A	T	C	C	T	A	T	A	C	G	C	T	T	C	C	T	T	A	T
Tor2	Late phase	C	A	A	T	C	C	T	A	T	A	C	G	C	T	T	C	C	T	T	A	T
Urbani	Late phase	C	A	A	T	C	C	T	A	T	A	C	G	C	T	T	C	C	T	T	A	T

\*Blank spaces indicate information not available. Early, middle, and late phases indicate when virus was isolated from patients in various stages of the 2003 epidemic. SARS-CoV, severe acute respiratory syndrome.

†Numbers indicate position of signature nucleotide variations on the virus genome based on SARS-CoV Tor2 numbering. The 4 signature nucleotide variations in 286-bp S gene sequences for isolates from 2 restaurant-related patients were identical to 4 of 5 S gene sequences of palm civets at the restaurant.

(n = 3), animal markets (n = 2), and patients (n = 23) were compared, the 29-nt deletion (positions 27869–27897) was absent in all isolates from palm civets at the restaurant and at the market, but was present in 22 of 23 patient isolates. The only human isolate (GZ01) without the 29-nt deletion was from a patient in the 2003 epidemic. In addition to S gene sequences, another 42 SNVs were identified, of which 33 were located on the gene encoding P protein (open reading frame [ORF] ab), and on 9 other genes for uncharacterized proteins: ORF 3 (5 SNVs), membrane protein (2 SNVs), and N protein (2 SNVs). However, when complete genome sequences of SARS-CoV from palm civets at the restaurant were compared with those of isolates from palm civets from the market, only 37 SNVs were identified and located on genes encoding P protein (20 SNVs), S protein (11 SNVs), ORF 3a (3 SNVs), M

protein (1 SNV), and N protein (2 SNVs). All nucleotide changes were observed in virus sequences of palm civets from the market, but not in virus sequences of animal isolates from the restaurant.

**Phylogenetic Analysis**

Analysis of the S gene of SARS-CoV showed that viral isolates of animal origin clustered into 2 distinct groups. Group A is represented by SZ3 and SZ16, which were isolated from palm civets in 2003. Group B is represented by viruses found in palm civets at the restaurant (Figure) (6). Analysis of complete genome sequences showed the same relationships (data not shown). These most recent SARS patients were therefore infected by SARS-CoV that is most closely related to virus isolates from palm civets at the restaurant (Figure) (6).

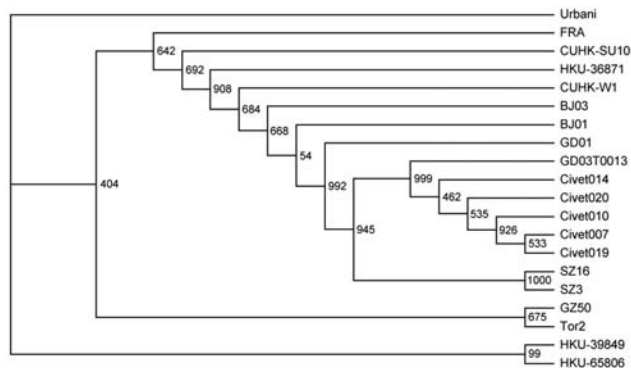

Figure. Phylogenetic relationships of severe acute respiratory syndrome (SARS) virus isolates based on the spike gene. The neighbor-joining tree was constructed by the neighbor-joining process with 1,000 bootstrap replicates. The origins of the sequences are as follows: Civet007, Civet010, Civet019, Civet020, and Civet014, palm civets from the restaurant; GD03T0013, the first SARS patient in 2004; SZ3 and SZ16, palm civets from a Shenzhen market in 2003; GZ60, HGZ8L1-A, ZS-A, ZS-B, ZS-C, and GD01, early phase isolates in 2003 without the 29-nucleotide (nt) deletion; GZ02, HSZ-Bb, HSZ-Bc, HSZ-Cb, and HSZ-Cc, early phase isolates from the 2003 epidemic with an 82-nt deletion; GZ50, HKU-36871, HKU-39849, HKU-65806, CUHK-W1, CUHK-Su10, BJ01, BJ03, Fra, Tor2, and Urbani, middle and late phase isolates from the 2003 epidemic.

## Discussion

The source of SARS-CoV, how it was introduced into humans, and where it may reemerge are critical questions related to disease control (16). Understanding the mode of transmission of SARS-CoV into humans is essential in designing appropriate prevention and control measures for future SARS epidemics. We provide the first direct evidence that SARS-CoV was transmitted from palm civets to humans, and that a restaurant serving palm civets positive for this virus was the source of infection for 2 of 4 confirmed SARS patients during the resurgence of SARS in the winter of 2003–2004 (6,17).

All 6 palm civets from the restaurant were positive for SARS-CoV. Partial S gene sequences were identical in both patients from this study and to 4 of 5 S gene sequences from palm civets from the restaurant, but different from more than 100 S gene sequences from SARS patients worldwide (6,10,12,13). That the restaurant was an infection source was further supported by serologic investigation of restaurant employees. Specific IgG was detected in 2 of 39 employees, 1 with a history of close contact with these palm civets. However, we lack evidence that eating civet could transmit the virus because the employees had not eaten palm civet before SARS developed. The patients most likely were infected by close exposure to animals carrying SARS-CoV in the restaurant. This situation may be similar to those earliest index cases

linked to markets or restaurants that occurred in winter of 2002–2003 (18). Results of PCR tests conducted by the WHO were positive for SARS-CoV in specimens from the bottom of animal cages and the kitchen of the restaurant (19).

Genome sequence analysis data strongly suggest that sporadic cases of SARS in Guangzhou in 2003–2004 were caused by SARS-CoV of animal origin. The 29-nt deletion was not observed in palm civets from the restaurant, but was present in almost all human isolates, and may have resulted from the adaptation and evolution of SARS-CoV in humans. SNVs in S gene sequences have been reported in several studies of the molecular evolution of SARS-CoV (6,7,12,13). The characteristic SNV pattern of S genes has 21 nt. SARS-CoV isolated from palm civets at the restaurant had 0, 1, or 2 SNVs. However, viruses from several provinces of China and other countries had all 21 SNVs (7,10,14,15). Viruses isolated in the early phase of the 2003 epidemic had 16–19 SNVs (6,7,13). The SZ3 and SZ16 isolates from palm civets in 2003 had 11 SNVs (6), while the S gene from the first case of SARS encountered in 2004 had only 3 SNVs (Table 2) (13). When the complete genomes of SARS-CoV from palm civets at the restaurant were compared with sequences of human isolates, 62 SNVs were identified. However, when the complete genome was compared with sequences of virus isolated from palm civets from animal markets in the 2003 epidemic, only 37 SNVs were identified.

Phylogenetic analysis of the S gene of SARS-CoV also showed that viruses from palm civets at the restaurant were more closely related to previously described viruses of animal origin, and these were more closely related to viruses isolated from patients during the early epidemic phase. Moreover, all SARS-CoV strains, including isolates from animal markets, had evolved from isolates in palm civets at the restaurant (Figure). Clearly, SARS cases contracted at the restaurant were the result of recent interspecies transfer from a putative palm civet virus reservoir, rather than the result of circulation of SARS-CoV in the human population.

SNV and phylogenetic analysis also suggest that the virus responsible for SARS infections in 2004 was not yet able to cause severe disease in humans. Minor clinical symptoms and no subsequent transmission have been recognized as features of the recent SARS infections. These findings support our observations that SARS-like illness did not develop in any of the 257 contacts of the 4 patients, or in any of the health care workers attending them. However, epidemiologic data can only provide clues to the biologic characteristics of the virus. Therefore, experimental infection using animal models is necessary to measure the relative pathogenic potential of various strains of SARS-CoV isolated from human and animals.



This work was supported by grant 2003AA208407 to J.X. from Ministry of Science and Technology, People's Republic of China and by grant U19 AI-51915 from the National Institutes of Health (USA).

Dr Wang is an epidemiologist at Guangzhou Center for Disease Control and Prevention, Guangdong Province, People's Republic of China. His main research interests are infectious diseases and the epidemiology of SARS.

## References

- Xu RH, He JF, Evans MR, Peng GW, Field HE, Yu DW, et al. Epidemiologic clues to SARS origin in China. *Emerg Infect Dis*. 2004;10:1030-7.
- Xu HF, Wang M, Zhang ZB, Zou XZ, Gao Y, Liu XN, et al. An epidemiologic investigation on infection with severe acute respiratory syndrome coronavirus in wild animal traders in Guangzhou. *Zhonghua Yu Fang Yi Xue Za Zhi*. 2004;38:81-3.
- Normile D. Infectious diseases. Viral DNA match spurs China's civet roundup. *Science*. 2004;303:292.
- World Health Organization. New case of laboratory-confirmed SARS in Guangdong, China: update 5. 2004. [cited 10 Sep 2004]. Available from [http://www.who.int/csr/don/2004\\_01\\_31/en/](http://www.who.int/csr/don/2004_01_31/en/)
- World Health Organization. Review of probable and laboratory-confirmed SARS cases in southern China: update 4. 2004. [cited 10 Sep 2004]. Available from [http://www.who.int/csr/don/2004\\_01\\_27/en/](http://www.who.int/csr/don/2004_01_27/en/)
- Guan Y, Zheng BJ, He YQ, Liu XL, Zhuang ZX, Cheung CL, et al. Isolation and characterization of viruses related to the SARS coronavirus from animals in southern China. *Science*. 2003;302:276-8.
- Zhong NS, Zheng BJ, Li YM, Poon, Xie ZH, Chan KH, et al. Epidemiology and cause of severe acute respiratory syndrome (SARS) in Guangdong, People's Republic of China, in February, 2003. *Lancet*. 2003;362:1353-8.
- Marra MA, Jones SJ, Astell CR, Holt RA, Brooks-Wilson A, Butterfield YS, et al. The genome sequence of the SARS-associated coronavirus. *Science*. 2003;300:1399-404.
- Yam WC, Chan KH, Poon LL, Guan Y, Yuen KY, Seto WH, et al. Evaluation of reverse transcription-PCR assays for rapid diagnosis of severe acute respiratory syndrome associated with a novel coronavirus. *J Clin Microbiol*. 2003;41:4521-4.
- Guan Y, Peiris JS, Zheng B, Poon LL, Chan KH, Zeng FY, et al. Molecular epidemiology of the novel coronavirus that causes severe acute respiratory syndrome. *Lancet*. 2004;363:99-104.
- Woo PC, Lau SK, Tsoi HW, Chan KH, Wong BH, Che XY, et al. Relative rates of non-pneumonic SARS coronavirus infection and SARS coronavirus pneumonia. *Lancet*. 2004;363:841-5.
- Ruan YJ, Wei CL, Ee AL, Vega VB, Thoreau H, Su ST, et al. Comparative full-length genome sequence analysis of 14 SARS coronavirus isolates and common mutations associated with putative origins of infection. *Lancet*. 2003;361:1779-85.
- The Chinese SARS Molecular Epidemiology Consortium. Molecular evolution of the SARS coronavirus during the course of the SARS epidemic in China. *Science*. 2004;303:1666-9.
- Peiris JS, Lai ST, Poon LL, Guan Y, Yam LY, Lim W, et al. Coronavirus as a possible cause of severe acute respiratory syndrome. *Lancet*. 2003;361:1319-25.
- Zeng FY, Chan CW, Chan MN, Chen JD, Chow KY, Hon CC, et al. The complete genome sequence of severe acute respiratory syndrome coronavirus strain HKU-39849 (HK-39). *Exp Biol Med* (Maywood). 2003;228:866-73.
- Keeler N, Lingappa J. Severe acute respiratory syndrome: public health response and clinical practice update for an emerging disease. *Curr Opin Pediatr*. 2004;16:61-9.
- Watts J. China culls wild animals to prevent new SARS threat. *Lancet*. 2004;363:134.
- Seto WH, Tsang D, Yung RW, Ching TY, Ng TK, Ho M, et al. Effectiveness of precautions against droplets and contact in prevention of nosocomial transmission of severe acute respiratory syndrome (SARS). *Lancet*. 2003;361:1519-20.
- Parry J. WHO confirms SARS in Chinese journalist. *BMJ*. 2004;328:65.

Address for correspondence: Jianguo Xu, National Institute of Communicable Diseases Control and Prevention, Chinese Center for Disease Control and Prevention, PO Box 5, Changping, Beijing 102206, People's Republic of China; fax: 86-10-6173-0233; email: xujg@public.bta.net.cn

Use of trade names is for identification only and does not imply endorsement by the Public Health Service or by the U.S. Department of Health and Human Services.

## Past Issues on SARS



[www.cdc.gov/eid](http://www.cdc.gov/eid)

# Echinococcosis in Tibetan Populations, Western Sichuan Province, China

Li Tiaoying,\* Qiu Jiamin,\* Yang Wen,\* Philip S. Craig,† Chen Xingwang,\* Xiao Ning,\*‡ Akira Ito,‡ Patrick Giraudoux,§ Mamuti Wulamu,‡ Yu Wen,\* and Peter M. Schantz¶

We screened 3,199 people from Shiqu County, Sichuan Province, China, for abdominal echinococcosis (hydatid disease) by portable ultrasound combined with specific serodiagnostic tests. Both cystic echinococcosis (CE) (*Echinococcus granulosus* infection) and alveolar echinococcosis (AE) (*E. multilocularis*) were co-endemic in this area at the highest village prevalence values recorded anywhere in the world: 12.9% were infected with one or the other form (6.8% CE and 6.2% AE). Prevalences of both CE and AE were significantly higher in female than male patients and increased with the age of the person screened. Pastoral herdsmen were at highest risk for infection (prevalence 19.0%). Prevalence of CE varied in 5 townships from 0% to 12.1%, whereas AE prevalence ranged from 0% to 14.3%. Risk factors associated with both infections included the number of owned dogs, frequency of contact with dogs, and sources of drinking water.

Human cystic echinococcosis (CE), caused by infection with the larval stage of *Echinococcus granulosus*, and alveolar echinococcosis (AE), caused by infection with the larval stage of *E. multilocularis*, are 2 of the most pathogenic zoonotic parasitic helminthic infections of humans in the Northern Hemisphere (1). Human CE occurs worldwide in association with herding, within which the main dog-sheep cycle for *E. granulosus* is transmitted (1). Human AE is a much rarer parasitic infection; transmission occurs in several regions of the Northern Hemisphere,

including the United States, Europe, Central Asia, Siberia, Japan, and China (2). In China, echinococcosis occurs mainly in western regions and provinces, including Xinjiang Uygur Autonomous Region, Qinghai Province, Gansu Province, Ningxia Hui Autonomous Region, and Sichuan Province (3). A previous pilot survey showed that human echinococcosis was prevalent in western Sichuan Province, situated on the eastern Tibetan Plateau, and that both human CE and AE were present. The average prevalence was 4.0%; CE accounted for 2.1% and AE 1.9% (4).

Shiqu County (longitude 97°20'00"–99°15'28" E and latitude 32°19'28"–34°20'40" N) is located in the north-west corner of Ganzi Prefecture in Sichuan Province (average altitude 4,200 m). The county covers 25,141 km<sup>2</sup>, located on the eastern part of the Tibetan Plateau. Grassland covers 83.5% of this treeless area, where the weather is cold (annual average temperature –1.6°C). Ethnic Tibetans comprise 98% of the total population; they are primarily involved with livestock production and herding. The total number of livestock is >630,000. In addition, a large number of dogs, including owned dogs and strays, exist in the area (5). We conducted a village-based community epidemiologic study of human echinococcosis from 2000 to 2002 in Shiqu County, Ganzi Tibetan Autonomous Region, Sichuan Province, to further understand the epidemiology of human AE in this region.

## Materials and Methods

The screening program was undertaken from 2000 to 2002; 26 villages in 5 townships in Shiqu County, were included (Figure 1). A total of 3,199 volunteers were self-selected after the purpose of the study was explained to the communities by local village leaders; volunteers were assured free diagnosis and chemotherapeutic treatment for echinococcosis, if indicated. Study participants ranged in

\*Sichuan Centers for Disease Control and Prevention, Chengdu, Sichuan Province, People's Republic of China; †University of Salford, Salford, United Kingdom; ‡Asahikawa Medical College, Asahikawa, Japan; §World Health Organization Collaborating Centre for the Prevention and Treatment of Alveolar Echinococcosis, Université de Franche-Comté, Besancon, France; and ¶Centers for Disease Control and Prevention, Atlanta, Georgia, USA



Figure 1. Study area in Sichuan Province, China.

age from 1 to 86 years (median 32 years). Fifty-two percent (1,660) were female patients, and 48% (1,539) were male patients. Persons of Tibetan ethnicity comprised 95% of the sampled population. The other participants listed their ethnicity as Han (4.5%), Hui (0.2%), or other (0.3%). Almost half of the participants (52.9%) raised livestock, including yaks, sheep, or goats, as the primary source of their income. Other listed occupations included student (19.1%), public servant (9.8%), preschooler (3.2%), illiterate child (2.0%), semifarmer (2.5%), farmer (1.1%), employee (2.2%), or other (7.3%).

#### Questionnaire

For each registered participant, a questionnaire designed to obtain information on demographics and animal ownership was completed. Questions mainly concerned occupation, education level, dog ownership and number, frequency of dog contact, fox hunting, drinking water source, and hygienic practices.

#### Screening and Diagnostic Criteria for Echinococcosis

All participants were examined by abdominal ultrasound; those with space-occupying lesions in the liver were asked to give venous blood samples to detect *Echinococcus* antibody by using enzyme-linked immunosorbent assay (ELISA) and immunoblot with *E. granulosus* hydatid cyst fluid as antigen (6–8), as well as

specific antibodies against *E. multilocularis* using ELISA and immunoblot with recombinant Em18 antigen (9,10). Diagnosis of human echinococcosis is mainly dependent on pathognomonic ultrasound images complemented by serum antibody confirmation of suspect CE/AE images (6,11). Investigators used the criteria for classification proposed by the World Health Organization Informal Working Group on Echinococcosis for CE (11), and the PNM system for classification of human AE, in which P stands for hepatic location of the parasite, N refers to extrahepatic involvement of neighboring organs, and M stands for absence or presence of distant metastases (12). CE Cases were defined as follows: 1) presence of characteristic cyst-like images detected on abdominal ultrasound and a positive ELISA result with hydatid cyst fluid antigen; 2) presence of pathognomonic cyst images detected on abdominal ultrasound, but negative by ELISA (Figure 2). In addition, CE cases, on the basis of the conformational features of cysts, were differentiated into 6 types (CL, CE1, CE2, CE3, CE4, and CE5) and subdiverted by size into 3 subtypes (small [s], medium [m], and large [l]) within each type. A case of AE was defined as follows: 1) presence of pathognomonic progressive AE type lesion detected on abdominal ultrasound, regardless of serologic results; 2) presence of calcified lesions, 1–3 cm in diameter, or nodular hyperechoic lesions detected on abdominal ultrasound and seropositive against recombinant Em18; and 3) presence of a calcified lesion (1–3 cm in diameter) detected by abdominal ultrasound and negative for antibodies to the recombinant Em18 antigen but positive by ELISA, with hydatid cyst fluid (Figure 3).

#### Statistical Analysis

All analyses were performed by using EpiInfo version 5.01a (Centers for Disease Control and Prevention, Atlanta, GA, USA). Statistical significance was set at  $p \leq 0.01$ .

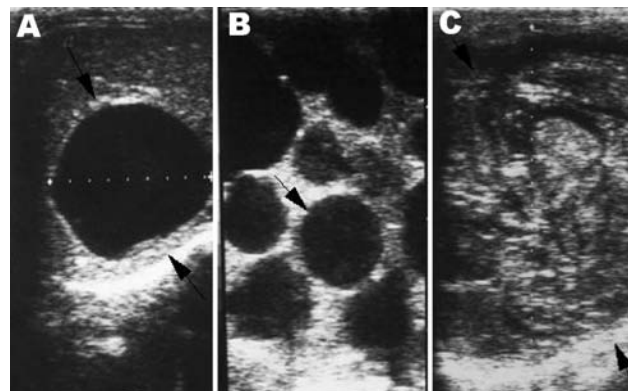

Figure 2. Lesions of cystic echinococcosis (CE) by abdominal ultrasound examination. A) CE lesion with distinct rim. B) Typical CE lesion with daughter cysts. C) Calcified CE lesion after chemotherapy.

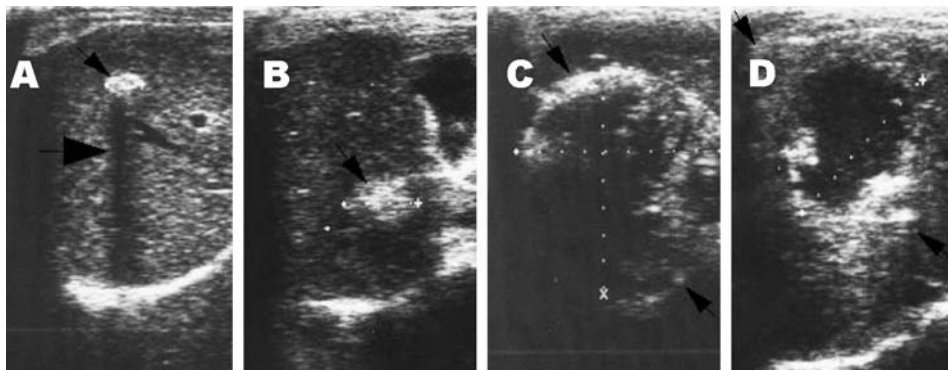

Figure 3. Lesions of alveolar echinococcosis (AE) by abdominal ultrasound examination. A) Calcified lesion: hyperechoic structure with a typical posterior shadow. B) Nodular hyperechoic lesion. C) Typical AE lesion: nonhomogeneous hyperechoic partially calcified area, without central necrosis. D) Typical AE lesion with central necrosis.

## Results

In this study, 84 (2.6%) of 3,199 participants examined by abdominal ultrasound scanning were determined to have an intrahepatic mass with a nonhomogeneous hyperechoic structure that contained scattered calcifications, and with irregular, poorly defined edges. A central necrotic cavity with a hypoechoic pseudoliquid structure and irregular borders was observed in 79 (2.5%) additional persons. In 53 of these participants the infiltrative lesions measured >10 cm in diameter and invaded or surrounded vascular structures, biliary structures, or both. In the other 26 persons, the lesions were nodular, were 3–5 cm in diameter at the longest dimension, and had calcifications. Calcified lesions, 1–3 cm in diameter, were observed in 20 persons. Thus, 163 persons were confirmed by ultrasound scanning to have AE infection, and 46 were suspected of having AE. Confirmatory serodiagnostic tests were performed in Japan and China, respectively. Serodiagnosis with the EgCF antigen in ELISA was positive in 93 of 94 persons with typical images of AE, 24 of 25 persons with nodular lesions, and 11 of 20 persons with calcified lesions. Additional serologic testing with the rEm18 antigen in

ELISA and immunoblot was positive in 101 of 102 persons with typical images of AE, 16 of 25 with nodular lesions, and 8 of 14 with calcified lesions (Table 1). Therefore, positive confirmatory serology in 35 study participants with a suspect AE image of a nodular lesion or calcified lesion indicated infection with AE. Another patient with a suspect AE image of a nodular lesion in the liver refused to give venous blood, so confirmatory serologic tests could not be performed on him, and this case was not counted in the AE category. Thus, of 46 study participants with a suspect AE image, 35 were finally diagnosed as having AE. A total of 198 (6.2%) of 3,199 persons studied were determined to be infected with AE on the basis of abdominal ultrasound images and confirmatory serologic results; 15 (38.5%) of 39 infected persons had inactive, or abortive AE lesions. Ninety-five single AE lesions were located in the right hepatic lobe, and 31 were in the left hepatic lobe. Involvement of both right and left hepatic lobes by a single lesion was observed in 17 patients. In 55 cases,  $\geq 2$  distinct foci were observed.

In addition, an ultrasound image of CE in the liver was detected in 216 (6.8%) of 3,199 study participants exam-

Table 1. Serologic results for screened study participants with a suspected lesion of alveolar (AE) or cystic (CE) echinococcosis at ultrasound examination\*

Ultrasound image	No. cases	Serology with rEm18		Serology with EgCF†	
		No. tested sera	No. positive sera	No. tested sera	No. positive sera
Typical image of AE‡	163	102	101	94	93
Image of suspected AE					
Nodular lesion	26	25	16	25	24
Calcified lesion	20	14	8	20	11
Image of CE					
CL	10	9	0	8	5
CE1	75	42	4	60	55
CE2	54	25	3	38	38
CE3	23	18	3	16	16
CE4	48	26	2	34	26
CE5	6	3	0	5	5
Total	425	264	137	300	273

\*27.5% of study population refused to provide blood samples for serology. The data only include those study participants with a suspected lesion of AE or CE; other abnormal findings observed at hepatic ultrasound examination, such as hemangioma, biliary cyst, and gallstone, are not presented.

†EgCF, *Echinococcus granulosus* hydatid cyst fluid.

‡Typical image of AE is a nonhomogeneous, hyperechoic structure with or without a central necrotic cavity.

ined. In 10 cases, ultrasound images showed unilocular, cystic lesions with uniform anechoic content, without visible cyst wall, all <5 cm; they were considered to be type CLs. Images characterized by unilocular, simple cyst with uniform anechoic content and visible cyst wall, some exhibiting a snowflake image (7 images <5 cm, 42 images ranging from 5 to 10 cm, and 26 images >10 cm) were observed in 75 patients; they were determined to be Type CE1 (7 CE1s, 42 CE1m, 26 CE1l); In 54 patients, images exhibited multivesicular or multiseptate cysts with a wheel-like appearance; others displayed unilocular cysts with daughter cysts with a honeycomb appearance. Eight of these images were <5 cm, 16 images were 5–10 cm, and 30 images were >10 cm; all of these images belonged to type CE2 (8 CE2s, 16 CE2m, 30 CE2l). In 23 cases, images were characterized by anechoic content with detachment of laminated membrane from the cyst wall, visible as a water-lily design; some had a unilocular cyst containing daughter cysts, but the whole cyst form was less rounded. Five of these cysts were <5 cm, 13 cysts were 5–10 cm, and 5 cysts were >10 cm; all were confirmed to be type CE3 (5 CE3s, 13 CE3m, 5 CE3l). In 48 cases, cysts had hyperechoic degenerative contents without daughter cysts. Seventeen of these cysts were <5 cm, 19 were 5–10 cm, and 12 cysts were >10 cm; these images belonged to type CE4 (17 CE4s, 19 CE4m, 12 CE4l). Cysts characterized by thick, calcified walls in an arch-shaped form with a cone-shaped shadow, were observed in 6 cases; 3 had images <5 cm, and 3 had cysts 5–10 cm in size; these were determined to be type CE5 (3 CE5s, 3 CE5m). In 18 cases,  $\geq 1$  cystic lesions were identified in the abdominal cavity in addition to the liver cysts. In 5 cases, additional cysts were found in the spleen; in 3 cases, additional cysts were found in the pelvic cavity; and in 1 case, a cyst was also found in the kidney. Serologic results in these study participants with CE at ultrasound examination are shown in Table 1. Serodiagnosis using the EgCF antigen in ELISA was negative in 16 of 161 persons with CE; 12 of 123 persons with CE were seropositive with rEm18 by ELISA and immunoblot (Table 1). No mixed infections were observed.

#### Distribution by Sex and Age

Of 414 persons with evidence of abdominal echinococcosis, 244 (CE = 134, AE = 110) were female patients, and 170 (CE = 82, AE = 88) were male. Thus, the prevalence of echinococcosis in female patients was 14.7% (244/1,660), and 11.0% (170/1,539) in male patients. Thus, prevalence in female patients was significantly higher than in males ( $\chi^2 = 9.46$ ,  $p < 0.01$ ). Compared with other older groups, the population <20 years of age had a lower infection prevalence (5.4%). In general, prevalence increased with age and reached a peak in the age group of >50 to  $\leq 60$  (Figure 4). The prevalence in the age group of

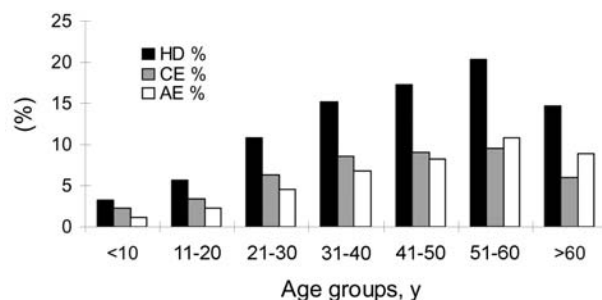

Figure 4. Human prevalences of echinococcosis by age groups. HD, hydatidosis; CE, cystic echinococcosis; AE, alveolar echinococcosis.

>10 to  $\leq 20$  years was significantly lower than in the age group of >20 to  $\leq 30$  years ( $\chi^2 = 10.20$ ,  $p < 0.01$ ). The youngest person infected with CE was 4 years of age, the oldest one was 79 years, and the average age of persons with CE was 39.0 years ( $n = 216$ ). The youngest persons with AE was 8 years of age, the oldest 80 years, and the average age of AE patients was 43.1 years ( $n = 198$ ) (Figure 5).

#### Village Prevalence

In this study 2,033 persons were screened for echinococcosis from 26 villages in the townships of Yiniu, Mengsha, Arizha, Xiazha, and Qiwu within Shiqu County; 226 infected cases were detected. The overall township prevalence of echinococcosis was 11.1% (range 7.4%–15.1%); 6.2% of patients were diagnosed with AE and 4.9% with CE disease. The highest village prevalences for AE and CE were 14.3% and 12.1%, respectively (Table 2).

#### Other Risk Factors

Occupation was a major risk factor. Herdsmen had the highest risk for echinococcosis infection, with a total prevalence of 19.0% (322/1,692,  $p < 0.01$ ); the AE prevalence was

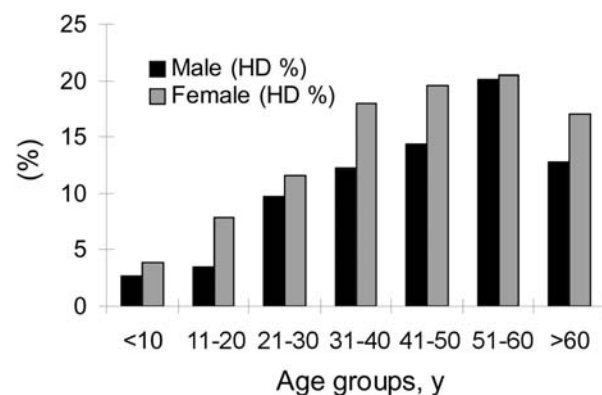

Figure 5. Prevalences of echinococcosis by sex and age groups. HD, hydatidosis.

9.5% (160/1,692), and the CE prevalence was 9.6% (162/1,692). Part-time herdsmen had a 12.7% prevalence of echinococcosis. Students and preschool children had a lower prevalence (2.8% and 3.0%), while illiterate adolescents were more heavily infected (14.3%) ( $\chi^2 = 21.17$ ,  $p < 0.01$ ) (Table 3).

A total of 2,811 of 3,199 persons examined answered the question about dog ownership. Of these, 496 said they did not own dogs; 2,315 (82.4%) persons had various numbers of dogs (range 1–9). Analysis indicated that the population without owned dogs had a total echinococcosis prevalence of 8.3% (41/496) (CE = 4.4%, AE = 3.8%). In contrast, persons who owned dogs had a total echinococcosis prevalence of 15.6% (360/2,315) (CE = 8.0%, AE = 7.5% [Table 4]).

To a certain extent, education can determine occupation choice and lifestyle. Our results implied that prevalence of echinococcosis had some relationship with the level of education. Among herdsmen, 1,469 (86.8%) of 1,692 were

illiterate; the prevalence in this subgroup reached 20.0% (293/1,469), the highest rate in the sampled population. The prevalence in self-identified literate herdsmen was 13.0% (29/223). Among illiterate adolescents, 14.3% were infected. Persons with only primary school education had a 6.0% (53/882) combined infection prevalence, and those with middle school education 9.1% (29/318). Persons with university education had an infection rate of 6.3% (17/268), and preschool children had an echinococcosis infection prevalence of 2.9% (3/105).

Fox hunting was also a risk factor. A total of 2,841 of 3,199 persons examined replied to the question about fox hunting. Results showed that the total prevalence of echinococcosis in populations who said that they neither hunted foxes nor kept fox skin products was 7.6% (29/384) (AE = 3.4%, CE = 4.2%), compared to a prevalence of 15.2% (368/2,427) (CE = 7.8% and AE = 7.4%) for persons who said they kept fox skin products that they had purchased, and 10% (3/30) (CE = 3 and AE = 0) in persons

Table 2. Prevalence of echinococcosis determined by abdominal ultrasound in 26 villages, Shiqu County\*

Township	Village	No. examined	No. cases (%)		Total
			AE	CE	
Yiniu	Benri1	88	9 (10.2)	3 (3.4)	12 (13.6)
	Benri2	77	4 (5.2)	0	4 (5.2)
	Benri3	57	5 (8.8)	0	5 (8.8)
	Jiefang1	64	5 (7.8)	4 (6.3)	9 (14.1)
	Jiefang2	83	11 (13.3)	2 (2.4)	13 (15.7)
	Yiniu1	137	12 (8.8)	6 (4.4)	18 (13.1)
	Yiniu2	87	10 (11.5)	1 (1.1)	11 (12.6)
	Subtotal	593	56 (9.4)	16 (2.7)	72 (12.1)
	Mengsha	Mengsha1	52	3 (5.8)	6 (11.5)
Mengsha2		39	0	2 (5.1)	2 (5.1)
Mengsha3		33	2 (6.1)	2 (6.1)	4 (12.1)
Xinrong1		95	12 (12.6)	7 (7.4)	19 (20.0)
Xinrong2		22	1 (4.5)	1 (4.5)	2 (9.1)
Xinrong3		30	2 (6.7)	3 (10.0)	5 (16.7)
Subtotal		271	20 (7.4)	21 (7.7)	41 (15.1)
Arizha	Arizha1	48	1 (2.1)	3 (6.3)	4 (8.3)
	Arizha2	33	2 (6.1)	4 (12.1)	6 (18.2)
	Arizha3	59	5 (8.5)	0	5 (8.5)
	Arizha4	62	5 (8.1)	1 (1.6)	6 (9.7)
	Arizha5	35	5 (14.3)	0	5 (14.3)
	Arizha6	44	3 (6.8)	2 (4.5)	5 (11.4)
	Arizha7	42	3 (7.1)	1 (2.4)	4 (9.5)
	Subtotal	323	24 (7.4)	11 (3.4)	35 (10.8)
Xiazha	Xiazha	266	10 (3.8)	13 (4.9)	23 (8.6)
	Ase	104	5 (4.8)	6 (5.8)	11 (10.6)
	Taxu	153	8 (5.2)	12 (7.8)	20 (13.1)
	Subtotal	523	23 (4.4)	31 (5.9)	54 (10.3)
Qiwu	Qiwu	219	2 (0.9)	16 (7.3)	18 (8.2)
	Getuo	78	0	3 (3.8)	3 (3.8)
	Juewu	26	1 (3.8)	2 (7.7)	3 (11.5)
	Subtotal	323	3 (0.9)	21 (6.5)	24 (7.4)
Total		2033	126 (6.2)	100 (4.9)	226 (11.1)

\*Calculations of village prevalence were based on a lower number of participants than the total study population because 1,166 study participants, including public servants, teachers, businessmen working in the area, and additional herdsmen from other townships in the vicinity of Shiqu County also participated in this survey. AE, alveolar echinococcosis; CE, cystic echinococcosis.

Table 3. Human prevalence of echinococcosis by patient occupation\*

Occupation	No. examined	No. cases (%)		
		CE	AE	Total
Herdsmen	1,692	162 (9.6)	160 (9.5)	322 (19.0)
Parttime herdsman	79	8 (10.1)	2 (2.5)	10 (12.7)
Farmer	35	0	1 (2.9)	1 (2.9)
Student	611	8 (1.3)	9 (1.5)	17 (2.8)
Public servant	315	11 (3.5)	9 (2.9)	20 (6.3)
Employee	69	3 (4.3)	0	3 (4.3)
Businessman	17	1 (5.9)	1 (5.9)	2 (11.8)
Preschooler	101	3 (3.0)	0	3 (3.0)
Illiterate child	63	8 (12.7)	1 (1.6)	9 (14.3)
Others	217	12 (5.5)	15 (6.9)	27 (12.4)
Total	3,199	216 (6.8)	198 (6.2)	414 (12.9)

\*CE, cystic echinococcosis; AE, alveolar echinococcosis.

who said they kept fox skin products that they obtained by hunting.

## Discussion

In this mass screening study of Tibetan communities, portable ultrasound examination combined with specific serologic tests was used for the diagnosis of both CE and AE. Survey results indicated that human echinococcosis is a serious public health problem for the inhabitants of this area, for whom a 12.9% overall prevalence was recorded. In comparison with reports on human echinococcosis in other areas, including other areas of China, the prevalence in northwest Sichuan Province was much higher for both CE and AE (1,3,12,13). The prevalence of CE was higher than in other recognized echinococcosis-endemic areas of the world, including North Africa, South America, Russia, and the Middle East (1,12,14,15). Previous ultrasound-based surveys for human AE have shown regional prevalences of <0.05% in continental Europe to 4% in Gansu Province in central northwest China (16,17). The most striking observation, however, was that both AE and CE were co-endemic in this area of Sichuan, with a prevalence of 6.8% for CE and 6.2% for AE. Only parts of Turkey, Central Asia, and Siberia have been identified as co-endemic for both human CE and AE (1,14).

In Shiqu County, China, analysis of human CE and AE indicated that prevalence of disease in female patients was significantly higher (14.7%) than in male patients (11.0%). According to traditional Tibetan custom, women are usu-

ally responsible for home chores, including feeding dogs, collecting yak dung for fuel, and milking livestock. Thus, women and girls may have more opportunity to be exposed to *Echinococcus*-infected dogs and the contaminated environment.

The infection prevalence for both CE and AE for persons in the age groups <20 years was markedly lower than those of other age groups. Prevalence reached a peak among the >50- to 60-year age group. The presence of CE or AE in persons as young as 4 and 8 years, respectively, indicates recent active transmission. In general, CE or AE infection increased with age. However, among persons >60 years of age prevalence of both AE and CE declined, a situation consistent with previous reports (4,15,18); this finding may be associated with early death of persons infected with forms of echinococcosis, particularly with AE. A recent analysis of the relative health impact of echinococcosis in these Tibetan communities showed that CE and AE caused an average of 0.8 disability-adjusted life years lost per person (19), which is an exceptional value.

This analysis showed that AE infection varied from 0% to 14.3% by village and that CE village prevalence ranged from 0% to 12.1%. A trend of gradual decrease in AE in villages from north to south (9.4% vs. 0.9% in the 5 townships surveyed) was observed.

Several factors may contribute to the high prevalence of human AE in this Tibetan population. High densities of small mammals are essential to maintaining the transmission cycle of *E. multilocularis*, and small mammal popula-

Table 4. Human prevalence of echinococcosis by patient ownership of dogs, Sichuan Province, China\*

No. owned dogs	No. examined persons	No. cases (%)		
		CE	AE	Total
0	496	22 (4.4)	19 (3.8)	41 (8.3)
1	889	67 (7.5)	65 (7.3)	132 (14.8)
2	835	61 (7.3)	66 (7.9)	127 (15.2)
3	414	38 (9.2)	29 (7.0)	67 (16.2)
≥4	177	19 (10.7)	14 (7.9)	33 (19.2)
Total	2,811	207 (7.4)	193 (6.9)	400 (14.2)

\*CE, cystic echinococcosis; AE, alveolar echinococcosis.

tions are also subject to ecologic changes, such as deforestation or pasture overgrazing (16,20–22). The involvement of dogs as well as foxes in transmission in eastern Tibet, together with lack of hygiene and probable contamination of the local peridomestic environment, seem to be additional major factors (23,24). For the 5 townships located in the central area of Shiqu County, the geographic conditions, apparent ecologic factors, life style, religion, livestock production, and dog ownership practices appear to be similar; however, human AE village prevalence was markedly variable. We had previously observed that local differences in small mammal abundance over time, possibly associated with overgrazing practices may contribute to variable township AE disease rates (22).

This survey disclosed that 86.8% of herdsmen were illiterate; 20% of them had either CE or AE disease. Consequently, improving the knowledge and awareness of the disease among the traditional nomadic population is imperative in any future control or prevention studies. Analysis indicated that both CE and AE risk was related to dog ownership ( $p < 0.01$ ), contact with dogs ( $p < 0.01$ ), source of drinking water, and general hygiene ( $p < 0.01$ ). While the role of domestic and working dogs as the major definitive host for *E. granulosus* is clear, such is not the case for *E. multilocularis*. Of particular interest therefore was the strong association between human AE risk and dog ownership or contact. Evidence from community studies in other parts of China (16), the United States (25), and Germany (26) increasingly show that the domestic dog plays a key role in the zoonotic risk for human AE.

Dogs are kept in large numbers by Tibetans and are used primarily to guard property and livestock. In this survey, 82.4% of the population owned dogs, and 21% owned >3 dogs. Buddhist practice forbids killing any animal, including dogs, and this practice leads to large numbers of stray dogs, which mainly gather around temples or townships, where they are fed by monks and herdsmen. Dogs also are predators of small mammals on adjacent pastures; these dogs are usually fed by herdsman with offal (including liver and lungs) of sheep and yaks during slaughtering season. Necropsy of intestines of stray dogs in 1995 in this region showed a 29.5% prevalence for *E. granulosus* and 11.5% for *E. multilocularis* (27,28). A recent diagnostic purgation study of dogs in this area demonstrated *E. multilocularis* prevalence of 12% and an *E. granulosus* prevalence of 8% (29). Foxes are the main sylvatic hosts of *E. multilocularis*, and both the Tibetan fox (*Vulpes ferrilata*) and the red fox (*V. vulpes*) are common on the Qinghai-Tibet plateau. A previous report showed a high prevalence of *E. multilocularis* in the Tibetan fox (59.1%) and red fox (57.1%) (28) in this area. Furthermore, Qiu et al. observed in 1995 the existence of *E. strobilae* in Tibetan foxes with morphologic characteristics distinct from *E. multilocularis*

adults but considered it to be a variant of *E. multilocularis*. These specimens and new samples have been shown to be a new species of taeniid cestode belonging to the genus *E. Rudolphi* (30). However, whether the new species is involved in the transmission of a third form of human echinococcosis in this region has yet to be determined.

This study was supported by the Ecology of Infectious Disease Program of the National Institutes of Health and National Science Foundation, USA (1R01 Two1565-01) and by the Sichuan Provincial Department of Health, China.

Dr Tiaoying is an assistant at the Institute of Parasitic Diseases, Sichuan Centers for Disease Control and Prevention. Her research interests include epidemiologic study, chemotherapy, and serodiagnosis of echinococcosis, particularly ultrasound diagnosis.

## References

- Schantz PM, Chai JJ, Craig PS, Echert J, Jenkins DJ, Macpherson CNL, et al. Epidemiology and control of hydatid disease. In: Thompson RCA, Lymbery AJ, editors. Echinococcosis and hydatid disease. Wallingford, UK: CAB International; 1995. p. 233–331.
- Kern P, Bardonnnet K, Renner E, Auer H, Pawlowski Z, Ammann RW, et al. European echinococcosis registry: human alveolar echinococcosis, Europe, 1982–2000. Emerg Infect Dis. 2003;9:343–9.
- Jiang C. Alveolar echinococcosis in China. Chin Med J. 1998;111:470–5.
- Qiu JM, Liu FJ, Schantz PM, Ito A, Delker C, He JG, et al. Epidemiological study on human hydatidosis in Tibetan region of Western Sichuan. Chinese Journal of Zoonoses. 2000;10:77–80.
- The committee of compiling Shiqu County annals. The Shiqu annals. Chengdu, Sichuan Province, China: Sichuan People's Press; 2000. p. 1–3.
- Bartholomot G, Vuitton DA, Harraga S, Snida Z, Giraudoux P, Barnish G, et al. Combined ultrasound and serologic screening for hepatic alveolar echinococcosis in central China. Am J Trop Med Hyg. 2002;66:23–9.
- Ito A, Ma L, Schantz PM, Gottstei B, Liu YH, Chai JJ, et al. Differential serodiagnosis for cystic and alveolar echinococcosis using fractions of *Echinococcus granulosus* cyst fluid (antigen B) and *E. multilocularis* protoscolex (Em18). Am J Trop Med Hyg. 1999;60:188–92.
- Mamuti W, Yamasaki H, Sako Y, Nakaya K, Nakao M, Lightowlers MW, et al. Usefulness of hydatid cyst fluid of *Echinococcus granulosus* developed in mice with secondary infection for serodiagnosis of cystic echinococcosis in humans. Clin Diagn Lab Immunol. 2002;9:573–6.
- Xiao N, Mamuti W, Yamasaki H, Sako Y, Nakao M, Nakaya K, et al. Evaluation of use of recombinant Em18 and affinity-purified Em18 for serological differentiation of alveolar echinococcosis from cystic echinococcosis and other parasitic infections. J Clin Microbiol. 2003;41:3351–3.
- Ito A, Sako Y, Yamasaki H, Mamuti W, Nakaya K, Nakao M, et al. Development of Em18-immunoblot and Em18-ELISA for specific diagnosis of alveolar echinococcosis. Acta Trop. 2003;85:173–82.
- World Health Organization. International classification of ultrasound images in cystic echinococcosis for application in clinical and field epidemiological settings. In PAIR, an option for the treatment of cystic echinococcosis. Geneva: The Organization; 2001. p. 23–9.



12. Eckert J, Gemmell MA, Meslin F-X, Pawlowski ZS. WHO/OIE manual on echinococcosis in humans and animals: a public health problem of global concern. Paris: World Health Organization/World Organization for Animal Health; 2001. p. 48–50.
13. Wang HL, Yin YC, Ma Z, Zhang CY, Zhang XP, Cheng RP, et al. A preliminary report on investigations of both cystic and alveolar forms of human hydatidosis of the liver in Xihou County, Ningxia Province. Chinese Journal of Parasitology and Parasitic Diseases. 1991;9:143–5.
14. Kovalenko F, Darchenkova N, Legonkov Y, Musaev G, Gudovsky L, Parshin V, et al. Hydatid diseases (cystic and alveolar) in Russia (1983–1997). Acta Parasitol. 2000;45:241–2.
15. Shambesh MK, Macpherson CN, Beesley WN, Gusbi A, Elsonosi T. Prevalence of human hydatid disease in north-west Libya: a cross-sectional ultrasound study. Ann Trop Med Parasitol. 1992;86:381–6.
16. Craig PS, Giraudoux P, Shi D, Bartholomot B, Garnish G, Delattre P, et al. An epidemiological and ecological study of human alveolar echinococcosis transmission in south Gansu, China. Acta Trop. 2000;77:167–77.
17. Romig T, Kratzer W, Kimmig P, Frosch M, Gaus W, Flegel WA, et al. An epidemiologic survey of human alveolar echinococcosis in south-western Germany. Am J Trop Med Hyg. 1999;61:566–73.
18. Bchir A, Larouze B, Soltani M, Hamdi A, Bouhaouala H, Ducic S, et al. Echotomographic and serological population-based study of hydatidosis in central Tunisia. Acta Trop. 1991;49:149–53.
19. Budke CM, Jiamin Q, Zinsstag J, Qian W, Torgerson PR. Use of disability adjusted life years in the estimation of the disease burden of echinococcosis for a high endemic region of the Tibetan Plateau. Am J Trop Med Hyg. 2004;71:56–64.
20. Giraudoux P, Quere JP, Delattre P, Bao G, Wang X, Shi D, et al. Distribution of small mammals along a deforestation gradient in southern Gansu, Central China. Acta Therapeutica. 1998;43:349–62.
21. Zhou HX, Chai SX, Craig PS, Delattre P, Quere JP, Raoul F, et al. Epidemiology of alveolar echinococcosis in Xinjiang Uygur autonomous region, China: a preliminary analysis. Ann Trop Med Parasitol. 2000;94:715–29.
22. Wang Q, Vuitton DA, Qiu J, Giraudoux P, Xiao Y, Schantz PM, et al. Fenced pasture: a possible risk factor for human alveolar echinococcosis in Tibetan pastoralist communities of Sichuan, China. Acta Trop. 2004;90:285–93.
23. Qiu JM, Liu FJ, Wang H, Ito A, Schantz PM. A survey of hydatid disease in Tibetan population in China: correlation of ultrasound and radiologic imaging and serologic result. Archivos Internacionales de la Hidatidosis. 1999;33:211–3.
24. Wang Q, Qiu JM, Schantz PM, He JG, Ito A, Liu FJ. Investigation of risk factors for development of human hydatidosis among households raising livestock in Tibetan areas of western Sichuan Province. Chinese Journal of Parasitology and Parasitic Diseases. 2001;19:93–6.
25. Rausch RL, Wilson JF, Schantz PM. A programme to reduce the risk of infection by *Echinococcus multilocularis*: the use of praziquantel to control the cestode in a village in the hyperendemic region of Alaska. Ann Trop Med Parasitol. 1990;84:239–50.
26. Kern P, Ammon A, Kron M, Sinn G, Sander S, Petersen LR, et al. Risk factors for alveolar echinococcosis in humans. Emerg Infect Dis. 2004;10:2088–93.
27. Qiu JM, Qiu DC, Luo CX, Zhu YB, Chen XW. Survey on infective agent of alveolar echinococcosis in Ganzi Prefecture and experimental research in animal. Chinese Journal of Zoonoses. 1989;5:38–40.
28. Qiu JM, Chen XW, Ren M, Lu CX. Epidemiological study on alveolar hydatid disease in Qinghai-Xizang Plateau. Journal of Practical Parasitic Diseases. 1995;3:106–8.
29. Budke CM, Campos-Ponce M, Qian W, Torgerson PR. A canine purgation study and risk factor analysis for echinococcosis in a high endemic region of the Tibetan Plateau. Vet Parasitol. 2005;127:43–9.
30. Xiao N, Qiu J, Nakao M, Li T, Yang W, Chen X, et al. *Echinococcus shiquicus* n. sp., a taeniid cestode from Tibetan fox and plateau pika in China. Int J Parasitol. 2005;35:693–701.

Address for correspondence: Qiu Jiamin, Department of Echinococcosis and Cysticercosis Control, Institute of Parasitic Diseases, Sichuan Centers for Disease Control and Prevention, Chengdu 610041, Sichuan Province, People's Republic of China; fax: 86-28-8543-8409; email: [giujiamin45@163.com](mailto:giujiamin45@163.com)

All material published in Emerging Infectious Diseases is in the public domain and may be used and reprinted without special permission; proper citation, however, is required.



Search  
past issues  
**EID**  
Online  
[www.cdc.gov/eid](http://www.cdc.gov/eid)

# Porcine Noroviruses Related to Human Noroviruses

Qiu-Hong Wang,\* Myung Guk Han,\* Sonia Cheetham,\* Menira Souza,\*  
Julie A. Funk,† and Linda J. Saif\*

Detection of genogroup II (GII) norovirus (NoV) RNA from adult pigs in Japan and Europe and GII NoV antibodies in US swine raises public health concerns about zoonotic transmission of porcine NoVs to humans, although no NoVs have been detected in US swine. To detect porcine NoVs and to investigate their genetic diversity and relatedness to human NoVs, 275 fecal samples from normal US adult swine were screened by reverse transcription–polymerase chain reaction with calicivirus universal primers. Six samples were positive for NoV. Based on sequence analysis of 3 kb on the 3' end of 5 porcine NoVs, 3 genotypes in GII and a potential recombinant were identified. One genotype of porcine NoVs was genetically and antigenically related to human NoVs and replicated in gnotobiotic pigs. These results raise concerns of whether subclinically infected adult swine may be reservoirs of new human NoVs or if porcine/human GII recombinants could emerge.

Noroviruses (NoVs) (family *Caliciviridae*, genus *Norovirus*) cause diarrhea in humans and animals (1–3). The NoV genome is 7.3–7.7 kb long with 3 open reading frames (ORFs) encoding a polyprotein that undergoes protease processing to produce several nonstructural proteins, including an RNA-dependent RNA polymerase (RdRp), a major capsid protein (VP1, capsid), and a minor capsid protein (VP2) (1,4,5). The capsid protein contains a conserved shell (S) and hypervariable protruding (P) domains (6). Noroviruses are genetically diverse and make up 27 genotypes within 5 genogroups, GI/1–8, GII/1–17, GIII/1–2, GIV, and GV, based on the capsid genes of 164 strains (7). Human NoVs cause an estimated 23 million cases of illness annually in the United States (8) and >90% of nonbacterial epidemic gastroenteritis worldwide (1). The low infectious dose, environmental resistance, strain diversity, shedding from asymptomatic

persons, and varied transmission vehicles render human NoVs highly contagious.

Norovirus RNA was detected by reverse transcription–polymerase chain reaction (RT-PCR) in 4 of 1,017 normal slaughtered pigs in Japan (9) and in 2 of 100 pooled pig fecal samples in the Netherlands (10). These porcine NoVs (Sw43/97/JP, Sw918/97/JP, and 34/98/NET) are genetically similar and are classified into GII (9,10), like most epidemic human NoVs (11–13). Also, the virus-like particles (VLPs) of Sw918 strain cross-react with antibodies against human GII but not GI NoVs (14). The close genetic and antigenic relationships between human and porcine NoVs raise public health concerns regarding their potential for zoonotic transmission and as reservoirs for emergence of new epidemic human strains.

Farkas et al. (14) reported that US swine sera react with Po/NoV/GII/Sw918 strain, but no direct detection of NoV from US swine has been reported. To detect porcine NoVs and assess their genetic diversity and relatedness to human NoVs, we screened 275 pig fecal samples from US swine by RT-PCR with a calicivirus universal primer pair p290/110 targeting the RdRp region (15,16), followed by sequencing the 3 kb on the 3' end of the genome for 5 NoV strains. Gnotobiotic pigs were inoculated with porcine NoVs to examine their infectivity and to produce convalescent-phase antiserum for antigenic analysis.

## Materials and Methods

Fecal samples (N = 275) were collected from December 2002 to June 2003 from finisher (10–24 weeks of age) pigs and gestating sows (≥1 year of age) from 3 Ohio swine farms (10, 60, and 32 samples), 1 Ohio slaughterhouse (83 samples), 1 Michigan swine farm (61 samples), and 2 North Carolina swine farms (8 and 21 samples). Fresh fecal samples were collected from individual pigs, placed into sterile containers, and stored frozen.

Sample RNA was extracted from 10% to 20% of fecal suspensions in sterile Eagle minimal essential medium

\*The Ohio State University, Wooster, Ohio, USA; and †The Ohio State University, Columbus, Ohio, USA

(EMEM, Invitrogen, Carlsbad, CA, USA) by using Trizol LS (Invitrogen). For some samples, RNA was concentrated and purified by using QIAamp Viral RNA Mini kit (Qiagen, Valencia, CA, USA).

RT-PCR was performed separately by using primer pair p290 (5'-GATTACTCCAAGTGGGACTCCAC-3') (15) and p110 (5'-ACDATYTCATCATCACCATA-3') (16) as previously described (15) but at 48°C for annealing (317 bp for NoV or 329 bp for sapovirus). To amplify the 3-kb 3' end fragment, cDNA was synthesized by SuperScript III First-Strand cDNA synthesis kit (Invitrogen) with primer VN<sub>3</sub>T<sub>20</sub> (5'-GAGTGACCGCGGCCGCT<sub>20</sub>-3'). PCR was then performed with TaKaRa Ex Taq polymerase (TaKaRa Mirus Bio, Madison, WI, USA) with primers p290 and VN<sub>3</sub>T<sub>20</sub>. Quantitative (endpoint titration) RT-PCR (17) was performed with primer pair PNV7 (5'-AGGTGGTGGCCGAGGAYCTCCT-3') and PNV8 (5'-TCACCATAGAAGGARAAGCA-3') targeting the RdRp (211 bp) of QW101 strain.

RT-PCR products were purified with the QIAquick Gel Extraction kit (Qiagen) before cloning into pCR2.1-TOPO (T/A) or PCR XL cloning kit (Invitrogen). Five clones of each sample were sequenced. DNA sequencing was performed with BigDye Terminator Cycle and 3730 DNA Analyzer (Applied Biosystems, Foster City, CA, USA).

Sequence editing was performed by Lasergene software package (v5, DNASTAR Inc., Madison, WI, USA). The Basic Local Alignment Search Tool (BLAST, <http://www.ncbi.nlm.nih.gov/BLAST>) was used to find homologous hits. Multiple sequence alignment was performed with ClustalW (v1.83) at DNA Data Bank of Japan (<http://www.ddbj.nig.ac.jp>). Phylogenetic and bootstrap (1,000 replicates) analyses were conducted by using MEGA (v2.1) (18). Identification of recombinants was performed by using the Recombinant Identification Program (RIP, <http://hivweb.lanl.gov/RIP/RIPsubmit.html>) (19). The classification and GenBank accession numbers of NoVs are listed in Table 1.

Four gnotobiotic pigs were maintained and euthanized as previously described (25,26). The inoculate was a 20% fecal filtrate (0.2 µm) in EMEM of the QW126 or QW144 (QW101-like, GII-18) strains or EMEM only (2 negative control pigs). One pig was inoculated with QW126 orally and intranasally at 9 days of age, and convalescent-phase antiserum LL616 was collected at postinoculation day (PID) 26. A second pig was inoculated with QW144 orally at 35 days of age and euthanized at PID 5.

Immune electron microscopy (IEM) was performed as described previously (27). For enzyme-linked immunosorbent assay (ELISA), the recombinant baculovirus-expressed human NoV VLPs and rotavirus VP2 and VP6 (2/6)-VLPs (negative control) (28) were CsCl-gradients purified. We coated 96-well microplates with VLPs (200

ng/well) in carbonate buffer (pH 9.6) and blocked with 5% nonfat dry milk in phosphate-buffered saline (PBS)-Tween 20 (0.05%). Serially diluted serum samples that included positive and negative controls were added to duplicate positive- and negative-coated wells, and the plates were incubated. After washing, horseradish peroxidase (HRP)-labeled goat anti-pig immunoglobulin G (IgG) (H + L) for pig sera or goat anti-human IgG + IgA + IgM (H + L) (KPL, Gaithersburg, MD, USA) for human serum was added. After incubation and washing, the substrate 3,3',5,5'-tetramethylbenzidine was added. The cutoff value was the mean absorbance of the negative coatings multiplied by 2.

Western blot was performed as described previously (29). Nitrocellulose membranes were incubated with pig convalescent-phase antiserum LL616 against porcine GII-18 NoV or negative control serum in PBS containing 4% nonfat dry milk followed by goat anti-pig IgG (H + L)-HRP conjugate.

## Results

Porcine NoVs were classified into 3 genotypes within GII based on the complete capsid sequences: 1 genotype with prototype Japanese strains Sw43 and Sw918 and 2 new genotypes. A total of 19 of 275 samples showed a potential positive band after agarose gel electrophoresis of the RT-PCR products of primer pair p290/110. Fourteen samples representative of each potentially positive farm or the slaughterhouse were sequenced. After performing BLAST search, we identified 6 NoVs (QW48, Michigan farm A; QW101, QW125, and QW126, Ohio farm B; and QW170 and QW218, Ohio slaughterhouse), 3 sapoviruses, and 5 sequences that had no significant hit in the database. Because the QW126 shared 99% nucleotide (nt) identity with the QW101 and QW125 strains in the 274-nt RdRp region, it was not sequenced further.

We sequenced the 3-kb 3' end of the genome containing the partial RdRp, VP1 and VP2 genes, and the 3' untranslated region of the 5 strains. The porcine NoVs represented 3 distinct clusters: 1) Sw43, Sw918, and QW48; 2) QW101 and QW125; and 3) QW170 and QW218, on the basis of the size of each gene and the ORF1-ORF2 overlap region (Table 2). Across the 3 kb, the QW101 and QW125 strains and the QW170 and QW218 strains shared 99% nt identity.

The amino acid identity of the predicted complete and S and P domains of the capsid protein of the 5 porcine NoVs, the previously reported porcine NoVs (Sw43 and Sw918), and representative human, bovine, and murine NoV strains is summarized in Table 3. In the complete capsid, the QW48 strain was most closely related to the porcine NoV prototype Sw43 strain (98% amino acid identity); the QW170 and QW218 strains shared the highest

## RESEARCH

amino acid identities (81%) to porcine Sw43 and Sw918 strains; the QW101 and QW125 strains showed the highest amino acid identity to human GII-3/Mexico (71.4%), then to human GII-6/Baltimore (71.0%), porcine QW218 (71.0%), and porcine Sw43 (70.6%) strains. The S and P

domains of these NoVs showed similar relationships. A neighbor-joining phylogenetic tree based on the amino acid sequences of the complete capsids (Figure 1) showed that QW48 grouped with Sw43 and Sw918 strains into GII-11 and that QW170 and QW218 formed a new

Table 1. Classification and GenBank accession numbers of norovirus (NoV) strains used for sequence analysis\*

Strain	Genus/genogroup-genotype	Abbreviation	GenBank accession no.
Hu/Norwalk/68/US	NoV/GI-1	Norwalk	M87661
Hu/Hawaii/71/US	NoV/GII-1	Hawaii	U07611
Hu/Melksham/89/UK	NoV/GII-2	Melksham	X81879
Hu/Snow Mountain/76/US	NoV/GII-2†	Snow Mountain	AY134748
Hu/Mexico/89/MX	NoV/GII-3	Mexico	U22498
Hu/Toronto/91/CA	NoV/GII-3	Toronto	U02030
Hu/SaitamaU18/97-99/JP	NoV/GII-3	SaitamaU18	AB039781
Hu/SaitamaU201/98/JP	NoV/GII-3	SaitamaU201	AB039782
Hu/Arg320/ARG	NoV/GII-3†	Arg320	AF190817
Hu/Camberwell/101922/94/AUS	NoV/GII-4	Camberwell	AF145896
Hu/Lordsdale/93/UK	NoV/GII-4	Lordsdale	X86557
Hu/Bristol/93/UK	NoV/GII-4	Bristol	X76716
Hu/MD145-12/87/US	NoV/GII-4	MD145	AY032605
Hu/Farmington Hills/02/US	NoV/GII-4	Farmington Hills	AY502023
Hu/Langen1061/02/DE	NoV/GII-4	Langen	AY485642
Hu/Hillingdon/93/UK	NoV/GII-5	Hillingdon	AJ277607
Hu/New Orleans 306/94/US	NoV/GII-5	New Orleans	AF414422
Hu/Baltimore/274/1993/US	NoV/GII-6	Baltimore	AF414408
Hu/SaitamaU3/97/JP	NoV/GII-6	SaitamaU3	AB039776
Hu/SaitamaU4/97/JP	NoV/GII-6	SaitamaU4	AB039777
Hu/SaitamaU16/97/JP	NoV/GII-6	SaitamaU16	AB039778
Hu/SaitamaU17/97/JP	NoV/GII-6	SaitamaU17	AB039779
Hu/Seacroft/90/UK	NoV/GII-6†	Seacroft	AJ277620
Hu/Leeds/90/UK	NoV/GII-7	Leeds	AJ277608
Hu/Gwynedd/273/94/US	NoV/GII-7	Gwynedd	AF414409
Hu/Amsterdam/98-18/98/NET	NoV/GII-8	Amsterdam	AF195848
Hu/SaitamaU25/97-99/JP	NoV/GII-8	SaitamaU25	AB039780
Hu/VA97207/97/US	NoV/GII-9‡	VA97207	AY038599
Hu/NLV/Erfurt/546/00/DE	NoV/GII-10	Erfurt	AF427118
Hu/Mc37/00-01/THA	NoV/GII-10†	Mc37	AY237415
Po/Sw43/97/JP	NoV/GII-11	Sw43	AB074892
Po/Sw918/97/JP	NoV/GII-11	Sw918	AB074893
<b>Po/MI-QW48/02/US</b>	<b>NoV/GII-11</b>	<b>QW48</b>	<b>AY823303</b>
Hu/Gifu/96/JP	NoV/GII-12‡	Gifu	AB045603
HU/Wortley/90/UK	NoV/GII-12†	Wortley	AJ277618
Hu/SaitamaU1/97-99/JP	NoV/GII-12†	SaitamaU1	AB039775
Hu/Fayetteville/98/US	NoV/GII-13	Fayetteville	AY113106
Hu/M7/99/US	NoV/GII-14	M7	AY130761
Hu/J23/99/US	NoV/GII-15	J23	AY130762
Hu/Tiffin/99/US	NoV/GII-16	Tiffin	AY502010
Hu/Neustrelitz260/00/DE	NoV/GII-16	Neustrelitz	AY772730
Hu/CS-E1/02/US	NoV/GII-17	CS-E1	AY502009
<b>Po/OH-QW101/03/US</b>	<b>NoV/GII-18</b>	<b>QW101</b>	<b>AY823304</b>
<b>Po/OH-QW125/03/US</b>	<b>NoV/GII-18</b>	<b>QW125</b>	<b>AY823305</b>
<b>Po/OH-QW170/03/US</b>	<b>NoV/GII-19‡</b>	<b>QW170</b>	<b>AY823306</b>
<b>Po/OH-QW218/03/US</b>	<b>NoV/GII-19‡</b>	<b>QW218</b>	<b>AY823307</b>
Bo/Newbury-2/76/UK	NoV/GIII-2	Newbury-2	AF097917
Hu/Alphatron/98-2/98/NET	NoV/GIV	Alphatron	AF195847
Mu/MNV-1/03/US	NoV/GV	MNV-1	AY228235

\*Classification is based on the capsid gene sequences. The 5 porcine NoV strains sequenced in this study are in **boldface**.

†Previously reported recombinants (20–24).

‡Potential recombinants found in this study.

Table 2. Sizes of the putative capsid protein VP1 and the minor capsid protein VP2, the overlap regions, and the 3' UTR of GII NoV\*

Species/genogroup-genotype/strain	ORF1-ORF2 overlap (nt)	VP1 (aa)	ORF2-ORF3 overlap (nt)	VP2 (aa)	3' UTR (nt)
Po/GII-11/Sw43	17	547	NA	NA	NA
Po/GII-11/Sw918	17	547	NA	NA	NA
Po/GII-11/QW48	17	547	1	253	57
Po/GII-18/QW101	20	557	1	275	48
Po/GII-18/QW125	20	557	1	275	48
Po/GII-19/QW170	17	548	1	254	51
Po/GII-19/QW218	17	548	1	254	51
Hu/GII-1/Hawaii	20	535	1	259	42
Hu/GII-2/Snow Mountain	20	542	1	259	45
Hu/GII-3/SaitamaU18	20	548	1	254	37
Hu/GII-4/MD145	20	539	1	268	46
Hu/GII-5/New Orleans	20	540	1	258	35
Hu/GII-6/SaitamaU3	20	550	1	259	54
Hu/GII-7/Gwynedd	20	540	1	257	68
Hu/GII-8/SaitamaU25	20	537	1	257	53
Hu/GII-9/VA97207	20	537	1	257	51
Hu/GII-10/Mc37	20	548	1	258	34
Hu/GII-12/SatamaU1	20	535	1	259	50
Hu/GI-1/Norwalk	17	530	1	212	66

\*UTR, untranslated region; NoV, norovirus; ORF, open reading frame; nt, nucleotide; aa, amino acid; NA, not available.

genotype (GII-19), which was closer to porcine than to human strains. However, QW101 and 125 formed a new genotype (GII-18) between human and porcine GII NoVs.

Further analysis of the predicted C-terminal  $\approx$ 260 amino acids of the RdRp region (Figure 2) showed similar grouping results for QW48, QW101, and QW125 strains but different for QW170 and QW218 strains, which were in the same cluster (GII-11) as Sw43, Sw918, and QW48 in the RdRp region. This finding suggested that a recombination event occurred between QW170/218-like and Sw43-like NoVs. The complete VP2 sequences of representative strains were also analyzed (data not shown). Results were similar to those of the capsid sequence classification.

A potential recombination event occurred between QW170/218-like and Sw43-like strains. To examine where the recombination occurred, we performed RIP analysis by placing the 3'-end RdRp and the capsid sequence of QW170 or QW218 as a query sequence and the corresponding sequences of Sw43 and QW101 as background sequences. The resulting diagram (Figure 3A) showed that QW170 had high similarity to Sw43 in the RdRp but not in the capsid region. This abrupt change happened in the RdRp-capsid junction region. Therefore, we performed

sequence alignments of the RdRp-capsid junction of NoVs, including the calicivirus genomic-subgenomic conserved 18-nt motif (20) (Figure 3B). Between Sw43, QW170, and QW218, all 18 nt were identical, but identities decreased downstream of this motif. QW170 and QW218 grouped with Sw43 with a high bootstrap value of 95 in the RdRp tree (Figure 2), whereas they segregated from Sw43 with the highest bootstrap value of 100 in the capsid tree (Figure 1). We could not clarify which was the parent or progeny strain.

The porcine NoVs replicated in gnotobiotic pigs. Two pigs were inoculated with QW101-like GII-18 porcine NoVs (QW126 and QW144 strains) to verify their replication in pigs as confirmed by quantitative RT-PCR and IEM and to produce convalescent-phase serum to examine antigenic reactivity with human NoVs. These 2 strains were confirmed as QW101-like porcine NoVs in both the RdRp (169-nt) and the capsid S domain (363-nt) regions by sequence analysis of the RT-PCR products (Q.H. Wang and L.J. Saif, unpub. data). They shared 99% and 100% amino acid identities to the QW101 strain in the 2 regions, respectively. Porcine NoV shedding, assessed by quantitative RT-PCR with primer pair PNV7/8, was detected at PID 3–5 (euthanized) after QW144 exposure, coincident

Table 3. Percentage amino acid identities of noroviruses within the capsid region

Strain	Complete capsid (S domain, P domain)					
	Po/GII*	Hu/GII†	Hu/GI/ Norwalk	Bo/GIII/ Newbury-2	Hu/GIV/ Alphatron	Mu/GV/MNV-1
QW48	96–98 (100, 94–97)	63–71 (77–85, 53–63)	43 (59, 36)	45 (62, 36)	53 (71, 42)	39 (58, 29)
QW101, QW125	70–70.6 (83, 63)	61–71.4 (77–86, 51–64)	42 (59, 35)	45 (62, 38)	54 (71, 44)	39 (58, 28)
QW170, QW218	81 (90, 74)	62–69 (77–82, 52–62)	43 (59, 36)	45 (61, 37)	53 (72, 40)	39 (60, 27)

\*Includes Sw43 and Sw918 strains.

†Includes Hawaii, Snow Mountain, Mexico, MD145, New Orleans, Baltimore, Gwynedd, Amsterdam, VA97207, Erfurt, Gifu, Fayetteville, M7, J23, and Neustrelitz strains.

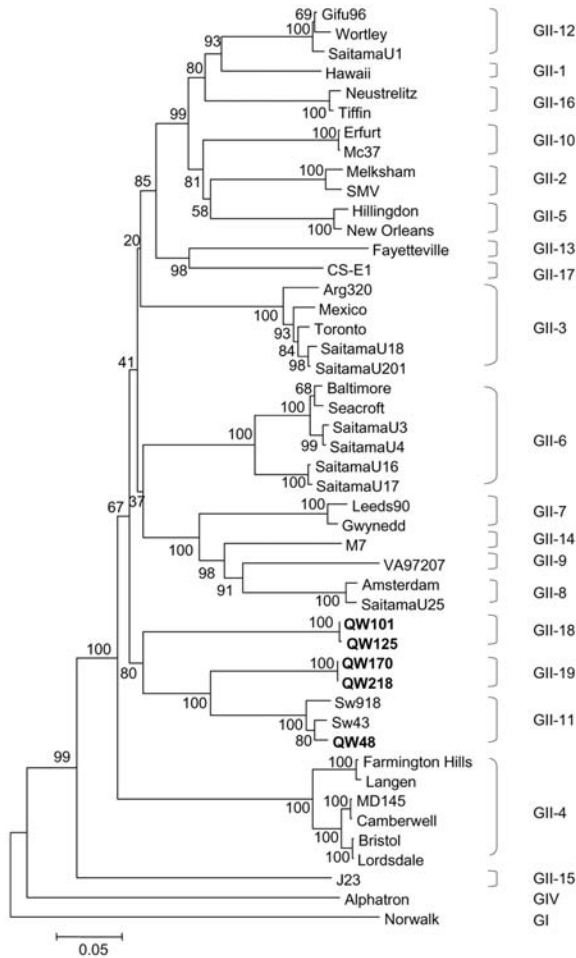

Figure 1. Neighbor-joining phylogenetic tree of genogroup II noroviruses (NoVs) based on the complete capsid region. The 5 newly identified porcine NoV strains are in **boldface**. Genogroups (G) and genotypes (numbers after G) are indicated. The human NoV GI-1/Norwalk and GIV/Alphatron strains were used as out-group controls.

with mild diarrhea. The RT-PCR-detectable units of the rectal swab RNA increased from negative at PID <2, 10<sup>3</sup> at PID 3–4, and 10<sup>4</sup> at PID 5 (large intestinal contents). Norovirus shedding was detected only at PID 5 without diarrhea after QW126 exposure. Examination of the intestinal contents of the pig inoculated with QW144 by IEM with pig convalescent-phase antiserum LL616 showed clumps of ≈32-nm NoV particles (Figure 4). The 2 control pigs had no virus shedding or diarrhea. Detailed studies of the pathogenesis of porcine NoVs in gnotobiotic pigs are in progress (S. Cheetham and L.J. Saif, unpub. data).

Antisera to QW101-like (QW126) porcine NoVs cross-reacted with VLPs of human GII NoVs in ELISA and Western blot. In ELISA (Table 4), the pig convalescent-phase antiserum (LL616) to QW101-like porcine NoV QW126 strain showed higher titers (1:400–1:800) to GII-

3/Toronto, GII-4/MD145, GII-4/HS66, and GII-6/Florida strains; a lower titer (1:100) to GII-1/Hawaii strain; and lowest titer (1:10) to GI-3/Desert Shield strain. In Western blot (Figure 5), the capsid proteins (59–60 kDa) of Toronto, MD145, HS66, and Florida strains, but not the Hawaii and Desert Shield strains, were detected by pig antiserum LL616 but not the negative control serum (data not shown). Thus, 1-way antigenic cross-reactivity exists between human NoV antigens and porcine NoV (GII-18) antiserum, with moderate cross-reactivity to human NoVs GII-3, 4, and 6; low cross-reactivity to GII-1; and very low cross-reactivity to GI-3.

**Discussion**

All porcine NoVs were detected from pigs without clinical signs (9,10). Subclinically infected pigs may be natural reservoirs for NoVs, and because porcine GII NoVs are genetically and antigenically related to human NoVs, concerns exist about their zoonotic potential. Whether human NoV strains similar to the QW101-like porcine NoVs circulate among people with occupational exposure to pigs is

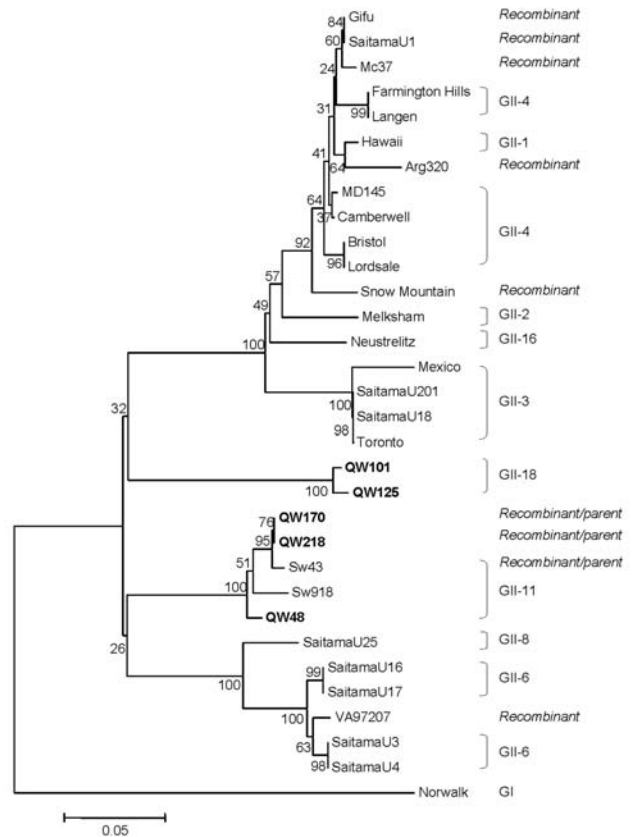

Figure 2. Neighbor-joining phylogenetic tree of genogroup II noroviruses (NoVs) based on the partial RNA-dependent RNA polymerase region (C-terminal 260–266 amino acids). The 5 newly identified porcine NoV strains are in **boldface**. Genogroups (G) and genotypes (numbers after G) are indicated. The human NoV GI-1/Norwalk and strain was used as outgroup control.

unknown, but such studies could provide information on the zoonotic potential of these porcine NoVs.

The RdRp-capsid junction region of NoVs contains a highly conserved 18-nt motif in genomic and subgenomic

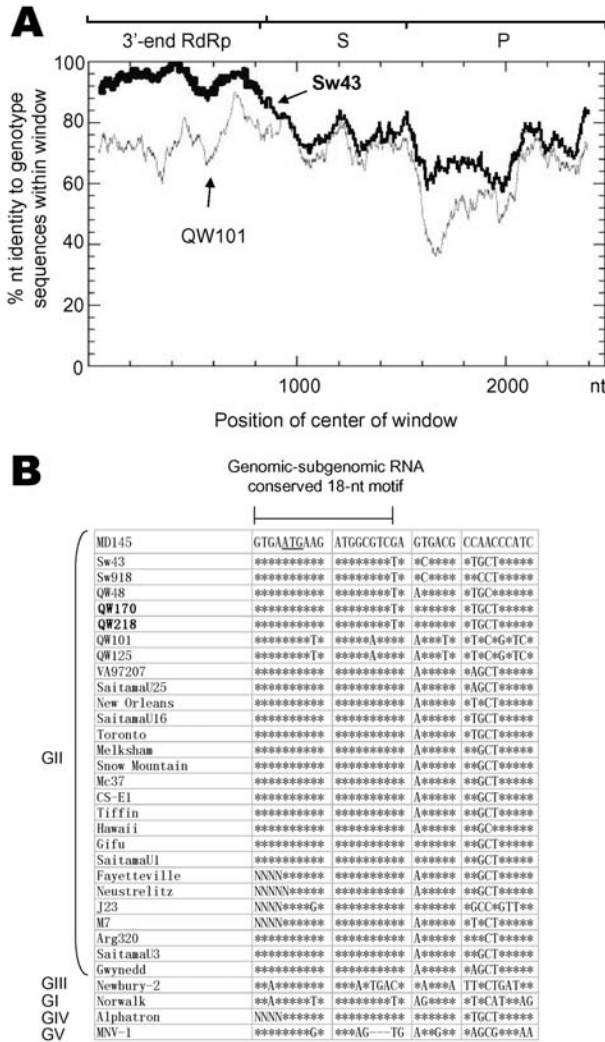

Figure 3. Identification of a potential recombination event between QW170 and Sw43 strains. A) Recombination Identification Program analysis of QW170 strain. At each position of the window, the query sequence (QW170) was compared to each of the background genotype representatives (GII-11/Sw43 and GII-18/QW101). When the query sequence is similar to the background sequences, the homologous regions are indicated as thick lines on the plot. Analysis parameters were window size of 100 and significance of 90%. The nucleotide positions of the 3'-end RNA-dependent RNA polymerase (RdRp) and the shell (S) and protruding (P) domains of the capsid protein are indicated. B) Sequence alignments of the RdRp-capsid junction region of noroviruses (NoVs). The genomic and subgenomic conserved 18-nucleotide (nt) motif is indicated by a horizontal line with 2 vertical bars. Asterisks indicate the identical residues to the sequence of the first line. Dashes represent gaps. The letter N indicates missing data on the residue. The start codon of open reading frame ORF 2 is underlined. Five NoV genogroups are indicated.

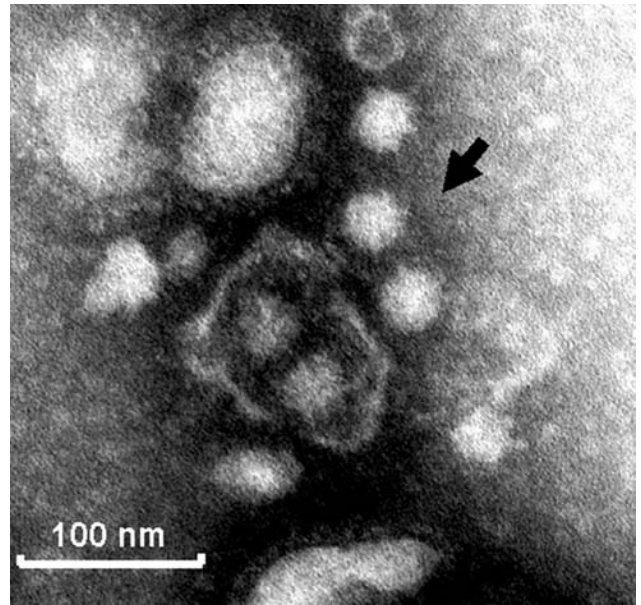

Figure 4. Immune electron micrograph of porcine noroviruses (NoVs). The diluted intestinal contents of a gnotobiotic pig euthanized on postinoculation day 5 to QW101-like porcine NoVs (QW144) were incubated with convalescent-phase serum LL616 from another gnotobiotic pig inoculated with QW101-like porcine NoVs (QW126) and visualized by negative staining with 3% phosphotungstic acid. The arrow indicates a small clump of NoV-like particles.

RNA that is believed to be a transcription start signal (1,20). All 18 nt were identical within each genogroup except for the Hu/GII/J23, Po/GII/QW101, and Po/GII/QW125 strains (Figure 3B, sequence alignments on other GI and GIII strains are not shown). This finding suggests that homologous recombination may occur within this motif between NoVs of different genotypes within the same genogroup. Recombinant human GII NoVs have been reported previously (20–24). To our knowledge, this study is the first identification of a potential recombinant between pig NoVs. At present, NoV recombinants have been detected exclusively between viruses within the same genogroup and within the same host species, but few animal NoVs have been sequenced (RdRp and capsid) for comparative analysis, especially those from animals in developing countries, where humans and animals may be in close contact.

The QW101-like porcine NoVs replicated in gnotobiotic pigs with fecal shedding, documented by quantitative RT-PCR and IEM. No cell culture system or animal disease models are available for human NoVs, which impedes the study of their pathogenesis, replication strategies, host immune responses, and preventive approaches. The infection of pigs with porcine NoVs may provide a new infection or disease model to study NoV infections.

## RESEARCH

Table 4. Antigenic cross-reactivity between human GII NoV antigens (VLPs) and a pig convalescent-phase antiserum against porcine GII NoVs, as determined by ELISA\*

Antiserum	ELISA antibody titer with each VLP antigen (genogroup-genotype)					
	Hawaii (GII-1)	Toronto (GII-3)	MD145 (GII-4)	HS66 (GII-4)	Florida (GII-6)	Desert Shield (GI-3)
HS66CS (positive control): human convalescent-phase antiserum to human HS66 (GII-4)	1:25,600	1:6,400	1:25,600	1:25,600	1:6,400	1:6,400
LL616: pig convalescent-phase antiserum to porcine QW126 (QW101-like, GII-18)†	1:100	1:800	1:400	1:400	1:400	1:10
LL368 (negative control): preinoculation serum‡	<1:10	<1:10	<1:10	<1:10	<1:10	<1:10
MM982 (negative control): preinoculation serum‡	<1:10	<1:10	<1:10	<1:10	<1:10	<1:10

\*NoV, norovirus; VLP, viruslike particle; ELISA, enzyme-linked immunosorbent assay.

†The QW126 shared 99% and 100% amino acid identities to the QW101 strain (GII-18) for a 169-bp segment in the RNA-dependent RNA polymerase region and a 363-bp segment in the capsid region, respectively.

‡LL368 and MM982 were sera from 2 gnotobiotic pigs before inoculation with porcine NoVs.

In this study, 1-way antigenic cross-reactivity occurred between antiserum to QW101-like porcine NoVs and the capsid proteins of human NoVs, with highest cross-reactivity to GII-3, 4, and 6 NoVs. This finding coincides with the finding that the QW101 strain shares high amino acid identity with GII-3 (71%), GII-6 (71%), and GII-4 (63%) NoVs.

In summary, 3 genotypes of porcine NoVs were detected in US swine. One genotype (QW101-like, GII-18) was genetically and antigenically most closely related to human GII NoVs. Potential recombinant porcine NoV strains were identified. The QW101-like NoVs infected gnotobiotic pigs, and NoV particles were evident in intestinal contents. These results raise questions of whether pigs may be reservoirs for emergence of new human NoVs or if porcine/human GII recombinants could emerge.

### Acknowledgments

We thank Kim Green and Steve Monroe for providing human NoV VLPs for ELISA, except for VLPs of GII-

4/HS66/01/US, and Duping Zheng for assistance in recombination analysis.

This work was supported by grants from the National Institute of Allergy and Infectious Diseases, National Institutes of Health (Grant R01 AI 49742); National Research Initiative, US Department of Agriculture (CGP Grant 1999 02009); and the Ohio Agricultural Research and Development Center (OARDC), Ohio State University (Graduate Student Research Enhancement Grant project 2002-114).

Dr Wang works in the Food Animal Health Research Program, Department of Veterinary Preventive Medicine, Ohio Agricultural Research and Development Center, Ohio State University. Her research involves diagnosis, epidemiology, and characterization of enteric calicivirus infections.

### References

- Green KY, Chanock RM, Kapikian AZ. Human caliciviruses. In: Knipe DM, Howley PM, editors. *Fields virology*. 4th ed. Philadelphia: Lippincott Williams & Wilkins; 2001. p. 841–74.
- Lopman B, Vennema H, Kohli E, Pothier P, Sanchez A, Negrodo A, et al. Increase in viral gastroenteritis outbreaks in Europe and epidemic spread of new norovirus variant. *Lancet*. 2004;363:682–8.
- Liu BL, Lambden PR, Gunther H, Otto P, Elschner M, Clarke IN. Molecular characterization of a bovine enteric calicivirus: relationship to the Norwalk-like viruses. *J Virol*. 1999;73:819–25.
- Pfister T, Wimmer E. Polypeptide p41 of a Norwalk-like virus is a nucleic acid-independent nucleoside triphosphatase. *J Virol*. 2001;75:1611–9.
- Belliot G, Sosnovtsev SV, Mitra T, Hammer C, Garfield M, Green KY. In vitro proteolytic processing of the MD145 norovirus ORF1 nonstructural polyprotein yields stable precursors and products similar to those detected in calicivirus-infected cells. *J Virol*. 2003;77:10957–74.
- Prasad BV, Hardy ME, Dokland T, Bella J, Rossmann MG, Estes MK. X-ray crystallographic structure of the Norwalk virus capsid. *Science*. 1999;286:287–90.
- Zheng DP, Ando T, Glass RI, Monroe SS. Norovirus classification and proposed strain nomenclature [abstract 4080]. Presented at the Second International Calicivirus Conference; Dijon, France; 2004 Nov 6–10.
- Mead PS, Slutsker L, Dietz V, McCaig LF, Bresee JS, Shapiro C, et al. Food-related illness and death in the United States. *Emerg Infect Dis*. 1999;5:607–25.

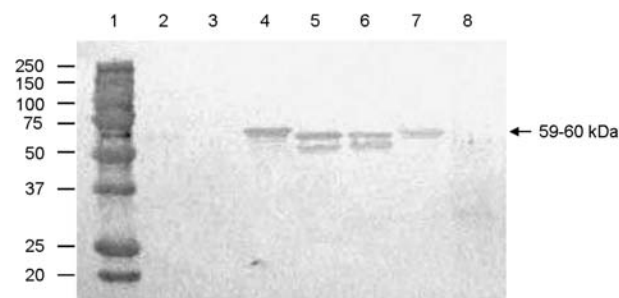
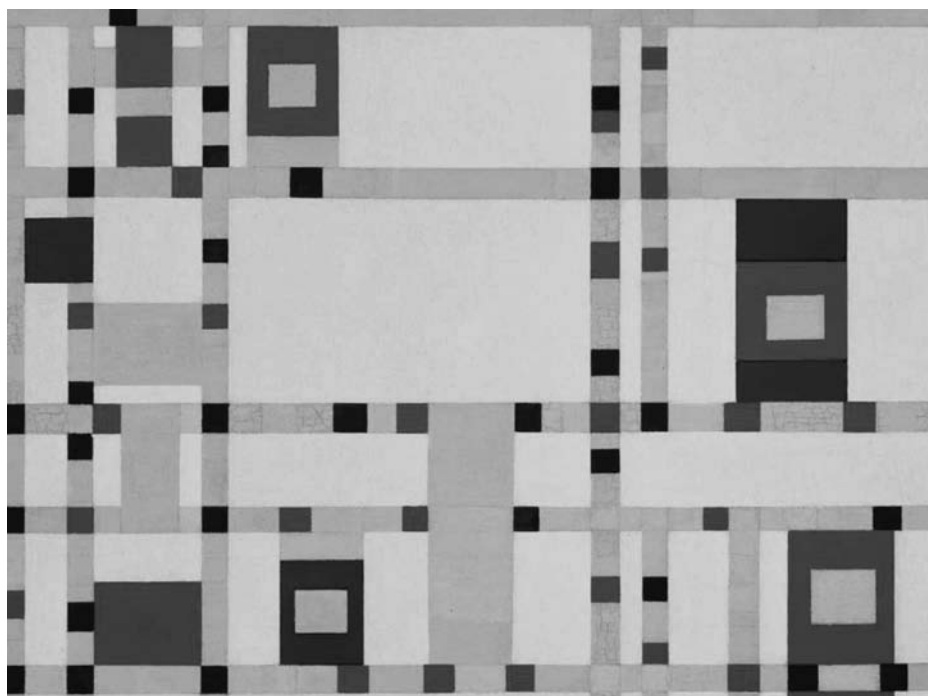

Figure 5. Antigenic cross-reactivity between human genogroup (G) II norovirus (NoV) capsid proteins and a pig convalescent-phase antiserum (LL616) against porcine QW101-like (GII-18) NoV was determined by Western blot. The CsCl-gradient purified viruslike particles (1,250 ng) were separated by sodium dodecyl sulfate 10% polyacrylamide gel electrophoresis, blotted onto nitrocellulose membranes, and tested with LL616. The sucrose-cushion (40%, wt/vol) purified Sf9 insect cell proteins acted as a negative control (lane 8). Lane 1, molecular weight marker (kDa); lanes 2–7, Hu/GI-3/Desert Shield, Hu/GII-1/Hawaii, Hu/GII-3/Toronto, Hu/GII-4/MD145, Hu/GII-4/HS66, and Hu/GII-6/Florida, respectively.



9. Sugieda M, Nagaoka H, Kakishima Y, Ohshita T, Nakamura S, Nakajima S. Detection of Norwalk-like virus genes in the caecum contents of pigs. *Arch Virol*. 1998;143:1215–21.
10. van der Poel WHM, Vinjé J, van der Heide R, Herrera MI, Vivo A, Koopmans MPG. Norwalk-like calicivirus genes in farm animals. *Emerg Infect Dis*. 2000;6:36–41.
11. Gallimore CI, Green J, Lewis D, Richards AF, Lopman BA, Hale AD, et al. Diversity of noroviruses cocirculating in the north of England from 1998 to 2001. *J Clin Microbiol*. 2004;42:1396–401.
12. Lopman BA, Reacher MH, van Duijnhoven Y, Hanon FX, Brown D, Koopmans M. Viral gastroenteritis outbreaks in Europe, 1995–2000. *Emerg Infect Dis*. 2003;9:90–6.
13. Widdowson MA, Cramer EH, Hadley L, Bresee JS, Beard RS, Bulens SN, et al. Outbreaks of acute gastroenteritis on cruise ships and on land: identification of a predominant circulating strain of norovirus—United States, 2002. *J Infect Dis*. 2004;190:27–36.
14. Farkas T, Nakajima S, Sugieda M, Deng X, Zhong W, Jiang X. Seroprevalence of noroviruses in swine. *J Clin Microbiol*. 2005;43:657–61.
15. Jiang X, Huang PW, Zhong WM, Farkas T, Cubitt DW, Matson DO. Design and evaluation of a primer pair that detects both Norwalk- and Sapporo-like caliciviruses by RT-PCR. *J Virol Methods*. 1999;83:145–54.
16. Le Guyader F, Estes MK, Hardy ME, Neill FH, Green J, Brown DW, et al. Evaluation of a degenerate primer for the PCR detection of human caliciviruses. *Arch Virol*. 1996;141:2225–35.
17. Lindesmith L, Moe C, Marionneau S, Ruvoen N, Jiang X, Lindblad L, et al. Human susceptibility and resistance to Norwalk virus infection. *Nat Med*. 2003;9:548–53.
18. Kumar S, Tamura K, Jakobsen IB, Nei M. MEGA2: molecular evolutionary genetics analysis software. *Bioinformatics*. 2001;17:1244–5.
19. Siepel AC, Halpern AL, Macken C, Korber BT. A computer program designed to screen rapidly for HIV type 1 intersubtype recombinant sequences. *AIDS Res Hum Retroviruses*. 1995;11:1413–6.
20. Katayama K, Shirato-Horikoshi H, Kojima S, Kageyama T, Oka T, Hoshino F, et al. Phylogenetic analysis of the complete genome of 18 Norwalk-like viruses. *Virology*. 2002;299:225–39.
21. Jiang X, Espul C, Zhong WM, Cuello H, Matson DO. Characterization of a novel human calicivirus that may be a naturally occurring recombinant. *Arch Virol*. 1999;144:2377–87.
22. Vinje J, Green J, Lewis DC, Gallimore CI, Brown DW, Koopmans MP. Genetic polymorphism across regions of the three open reading frames of “Norwalk-like viruses.” *Arch Virol*. 2000;145:223–41.
23. Hansman GS, Katayama K, Maneekarn N, Peerakome S, Khamrin P, Tonusin S, et al. Genetic diversity of norovirus and sapovirus in hospitalized infants with sporadic cases of acute gastroenteritis in Chiang Mai, Thailand. *J Clin Microbiol*. 2004;42:1305–7.
24. Lochridge VP, Hardy ME. Snow Mountain virus genome sequence and virus-like particle assembly. *Virus Genes*. 2003;26:71–82.
25. Meyer RC, Bohl EH, Kohler EM. Procurement and maintenance of germ-free swine for microbiological investigations. *Appl Microbiol*. 1964;12:295–300.
26. Guo M, Hayes J, Cho KO, Parwani AV, Lucas LM, Saif LJ. Comparative pathogenesis of tissue culture-adapted and wild-type Cowden porcine enteric calicivirus (PEC) in gnotobiotic pigs and induction of diarrhea by intravenous inoculation of wild-type PEC. *J Virol*. 2001;75:9239–51.
27. Ismail MM, Cho KO, Ward LA, Saif LJ, Saif YM. Experimental bovine coronavirus in turkey poults and young chickens. *Avian Dis*. 2001;45:157–63.
28. Yuan L, Geyer A, Hodgins DC, Fan Z, Qian Y, Chang KO, et al. Intranasal administration of 2/6-rotavirus-like particles with mutant *Escherichia coli* heat-labile toxin (LT-R192G) induces antibody-secreting cell responses but not protective immunity in gnotobiotic pigs. *J Virol*. 2000;74:8843–53.
29. Han MG, Wang Q, Smiley JR, Chang KO, Saif LJ. Self-assembly of the recombinant capsid protein of a bovine norovirus (BoNV) into virus-like particles and evaluation of cross-reactivity of BoNV with human noroviruses. *J Clin Microbiol*. 2005;43:778–85.

Address for correspondence: Linda J. Saif, Food Animal Health Research Program, Ohio Agricultural Research and Development Center, The Ohio State University, 1680 Madison Ave, Wooster, OH 44691, USA; fax: 330-263-3677; email: saif.2@osu.edu



Search  
**EID**  
 Online  
[www.cdc.gov/eid](http://www.cdc.gov/eid)

# Viral Load Distribution in SARS Outbreak

Chung-Ming Chu,\* Vincent C.C. Cheng,† Ivan F.N. Hung,† Kin-Sang Chan,\* Bone S.F. Tang,† Thomas H.F. Tsang,‡ Kwok-Hung Chan,† and Kwok-Yung Yuen†

An unprecedented community outbreak of severe acute respiratory syndrome (SARS) occurred in the Amoy Gardens, a high-rise residential complex in Hong Kong. Droplet, air, contaminated fomites, and rodent pests have been proposed to be mechanisms for transmitting SARS in a short period. We studied nasopharyngeal viral load of SARS patients on admission and their geographic distribution. Higher nasopharyngeal viral load was found in patients living in adjacent units of the same block inhabited by the index patient, while a lower but detectable nasopharyngeal viral load was found in patients living further away from the index patient. This pattern of nasopharyngeal viral load suggested that airborne transmission played an important part in this outbreak in Hong Kong. Contaminated fomites and rodent pests may have also played a role.

Severe acute respiratory syndrome (SARS) is a rapidly progressive pneumonia that affects all age groups in an epidemic manner. The number of cases worldwide has reached >8,000 with 774 deaths within a period of 9 months (1). A community outbreak affected 321 residents of a densely populated housing estate, the Amoy Gardens in Hong Kong, from March 20 to April 15, 2003 (2). This housing estate consists of 19 high-rise apartment blocks (A–S). Each block has 33 floors and 8 units per floor. Residents from 15 blocks were affected. The mechanism of the spread of SARS in Amoy Gardens has remained enigmatic. The suggestion has been made that virus-laden aerosols were forced from the sewage system by negative pressure of an exhaust fan in an airshaft into the dried U trap of the toilet in the bathroom of the index patient (3). Results of another study in which computer modeling was

carried out without virologic proof suggested that these contaminated aerosols were spread by natural air currents to other apartment units (4). Other means of spread might have been droplet transmission among residents or by rodent pests (5).

In a recent study, mice experiments demonstrated that viral load in respiratory specimens was proportional to viral inocula in patients infected with SARS-associated coronavirus (SARS-CoV) (6). We hypothesized that the initial nasopharyngeal viral load would be higher in patients residing near the index patient and lower in patients living further from the index patient. We analyzed the distribution of the initial SARS-CoV viral load by quantitative reverse transcription–polymerase chain reaction (RT-PCR) of nasopharyngeal aspirates of the first 79 SARS patients from Amoy Gardens admitted to our hospital. We also correlated the pattern of viral load with the geographic distribution of these patients from Amoy Gardens, which may indicate the mode of transmission in this point-source outbreak.

## Patients and Methods

From March 24 to March 29, 2003, the first 79 SARS patients who lived at Amoy Gardens were admitted to the United Christian Hospital in Hong Kong (Figure 1). Since Amoy Gardens was placed under active surveillance by the health authority soon after the first few cases of SARS were detected, these patients underwent frequent examinations and were admitted early in the course of their illness (7). Their initial clinical signs and symptoms and progress have been previously reported (7). We prospectively collected demographic, clinical, and laboratory data from these first 79 SARS patients from Amoy Gardens who were admitted to the hospital. The diagnosis of SARS was confirmed by World Health Organization clinical and laboratory diagnostic criteria. SARS was defined clinically by fever (temperature  $\geq 38^{\circ}\text{C}$ ), cough or shortness of breath,

\*United Christian Hospital, Hong Kong Special Administrative Region, People's Republic of China; †University of Hong Kong, Hong Kong Special Administrative Region, People's Republic of China; and ‡Department of Health, Hong Kong Special Administrative Region, People's Republic of China

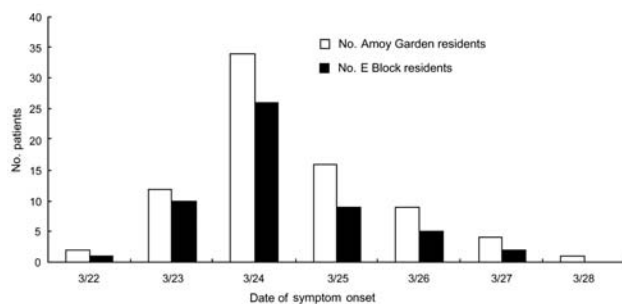

Figure 1. Numbers of patients in the initial outbreak of severe acute respiratory syndrome in Amoy Gardens admitted to United Christian Hospital, Hong Kong, 2003. The index patient visited Amoy Gardens on March 14 and March 19, 2003.

and new pulmonary infiltrates on chest radiographs or by high-resolution computed tomographic scans in the absence of an alternative diagnosis to explain the clinical manifestations. Positive SARS diagnostic findings included at least 1 of the following: confirmation by a positive PCR result for SARS-CoV, seroconversion by enzyme-linked immunosorbent assay or immunofluorescent antibody assay, or virus isolation in cell culture plus PCR confirmation (7).

Each apartment unit was coded according to block (A–H) and unit (1–8) (Figure 2). Patients in 26 different unit codes were affected. We retrospectively studied the viral loads of the first nasopharyngeal aspirate taken on the day of admission of the SARS patients who were admitted within the first 6 days of the epidemic. We examined the relationship between the viral loads and the distribution of the patients in Amoy Gardens. The index patient, who was responsible for transmitting the disease, stayed for 2 days (March 14 and 19, 2003) in block E unit 7 (E7, floor 16) and infected his brother (4), our first patient. The distance of the different block units from E7 was measured (Figure 2). Viral load was measured as previously described (7,8).

We compared the clinical characteristics and nasopharyngeal viral load of these patients in different blocks by chi-square test for categorical variables, Student t-test, or Mann-Whitney U test for continuous variables where appropriate. Correlation of nasopharyngeal viral loads in relation to the distance from the index patient was calculated by Spearman correlation. The patients were categorized into 5 subgroups according to the distance from the block of the index patient for further analyses: block E7, block E other than E7, blocks D and F, blocks C and G, and blocks A, B, and H. All statistical analyses were performed with SPSS version 12.0 software (SPSS Inc., Chicago, IL, USA). A 2-tailed  $p$  value  $<0.05$  was considered significant.

## Results

The number of patients in the initial outbreak of SARS in Amoy Gardens is shown in Figure 1. The demographic, clinical, and laboratory characteristics of patients residing in E block (where the index patient resided) and those residing in non-E blocks were compared (Table). Seventy-five patients (94.9%) were Chinese and 4 were Filipino. There were 38 male and 41 female patients. The mean (SD) age was 39.4 (11.5) years (range 20–72 years). Fifty-three patients (67.1%) were residents of E block; 10 (12.7%) were residents of E7 and 25 (31.6%) were residents of E8.

The relationships between viral load and distribution of patients from E7 and E8 are shown in Figure 3A and B, respectively. In E7, patients who resided within a few stories of the 16th floor had higher viral loads. For cases in neighboring E8, the distribution of patients and viral loads was random.

The median nasopharyngeal viral load in E block patients (5.09  $\log_{10}$  copies/mL) was much higher than in non-E block patients (0  $\log_{10}$  copies/mL) on admission ( $p < 0.001$ ). On admission, no statistically significant differences were found between E block patients and non-E block patients in terms of all demographic characteristics,

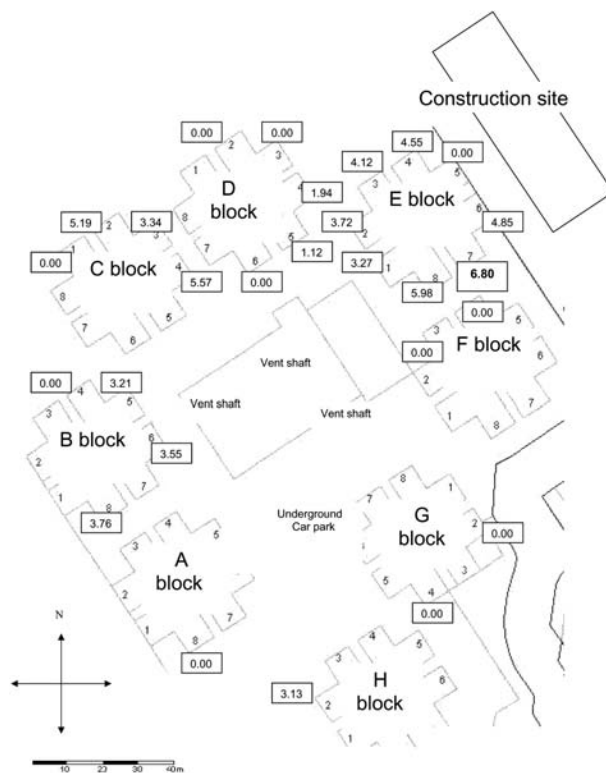

Figure 2. Scaled map of Amoy Gardens units and distribution of the median viral load ( $\log_{10}$  copies/mL) of the nasopharyngeal specimens (values in boxes) of patients in their respective residential blocks (index patient lived in E7).

## RESEARCH

Table. Demographic factors on admission of patients living in E block and non-E block of Amoy Gardens, Hong Kong\*

Factor	E block patients (n = 53)	Non-E block patients (n = 26)	p value
Age, y, mean (SD)	40.6 (11.9)	37.1 (10.6)	0.21†
Male:female ratio	25:28	13:13	0.81‡
Duration of symptoms to admission (days), mean (SD)	2.4 (1.2)	2.5 (1.2)	0.72†
Coexisting conditions including chronic hepatitis B, no. (%)	11 (19.6)	8 (30.8)	0.33‡
Chronic hepatitis B infection, no. (%)	5 (9.4)	5 (19.2)	0.22‡
Abnormal chest radiograph results, no. (%)	38 (71.7)	21 (80.8)	0.38‡
Multilobar involvement on initial chest radiograph, no. (%)	13 (24.5)	5 (19.2)	0.60‡
Day of collection of nasopharyngeal specimens after onset of symptoms, mean (SD)	3.2 (1.2)	3.3 (1.8)	0.74†
Quantitative RT-PCR result of nasopharyngeal specimens (log <sub>10</sub> copies/mL), median (IQR)	5.09 (3.50–6.59)	0 (0–3.57)	0.008§
Hemoglobin (g/dL), mean (SD)	13.3 (1.7)	13.8 (1.4)	0.24†
Neutrophil count (× 10 <sup>9</sup> /L), mean (SD)	5.2 (2.0)	5.3 (2.0)	0.77†
Lymphocyte count (× 10 <sup>9</sup> /L), mean (SD)	0.92 (0.6)	0.86 (0.4)	0.65†
Sodium (mmol/L), mean (SD)	138 (3)	138 (3)	0.91†
Potassium (mmol/L), mean (SD)	3.9 (3.6)	3.9 (3.0)	0.31†
Urea (mmol/L), mean (SD)	4.4 (1.4)	4.1 (1.0)	0.34†
Creatinine (μmol/L), mean (SD)	88 (16)	85 (12)	0.35†
Alanine aminotransferase (IU/L), mean (SD)	41 (49)	31 (19)	0.31†
Albumin (g/L), mean (SD)	40 (3)	40 (3)	0.85†
Creatinine kinase (IU/L), mean (SD)	197 (222)	190 (186)	0.89†
Lactate dehydrogenase (IU/L), mean (SD)	437 (190)	398 (107)	0.47†

\*SD, standard deviation; IQR, interquartile ratio; RT-PCR, reverse transcription–polymerase chain reaction.

†By Student *t* test.

‡By chi-square test.

§By Mann-Whitney U test.

initial radiographic findings, and baseline laboratory results (Table). The mean day of collection of nasopharyngeal specimens from E-block and non-E block patients did not differ significantly. Overall, the mean (SD) number of days from onset of symptoms to collection of nasopharyngeal samples was 3.22 (1.5), and no correlation was found between initial nasopharyngeal viral load and time elapsed from symptom onset date to the day of sample collection (Spearman  $\rho$  -0.16,  $p$  = 0.156).

Median viral loads of each unit of different blocks are shown in Figure 2. The initial nasopharyngeal load of patients was highly correlated with the distance in relation to the block of the index patient (Spearman  $\rho$  -0.63,  $p$  < 0.001, Figure 4). The percentage of specimens with a negative nasopharyngeal viral load in each block in order of patient distance from block E was as follows: block E (4/52) 7.7%; block D (4/7) 57.1%; block F (2/2) 100%; block C (1/6) 15.2%; block G (2/2) 100%; block A (1/1) 100%; block B (2/6) 33.3%; and block H (1/1) 100% ( $p$  = 0.04 by chi-square test). Subgroup analysis showed that patients in E7 and E8 had the highest median viral load, 6.80 and 5.98 log<sub>10</sub> copies/mL, respectively. Patients from these 2 units also accounted for 12.7% and 31.6% of the total number of patients, respectively. This pattern of distribution is strongly affected by the distance of the patients' units from the index patient (Figures 2 and 4). On the basis of a visual inspection of the layout of the units (Figure 2),

the direction in which patients' flats faced may also have influenced the viral load; patients in flats that faced away from the index patient's unit had a lower viral load.

The overall case death rate among the 79 patients was 24.1%. The highest rate was in block E, which accounted for 79% of all deaths, while the death rate in patients living in E7 (the same block as the index patient) was 70% (7 patients). This rate is significantly higher than in other units ( $p$  = 0.001 by  $\chi^2$  test). The index patient was one of the few patients from E7 who survived the disease.

## Discussion

In this study, a higher viral load was observed in patients who lived near the index patient than in those who lived further away. Amoy Gardens was placed under active surveillance during the SARS outbreak and the residents underwent frequent examinations. They were admitted to the hospital soon after any symptom of SARS developed, and nasopharyngeal specimens were collected at an early stage. Variation in collection time cannot explain the viral load distribution. The size of the viral inocula may have progressively decreased downstream. A recent study has demonstrated in mice that SARS-CoV viral load in the respiratory tract is proportional to viral inocula administered intranasally (6). Similarly, the degree of viremia is related to the size of the viral inoculum in HIV and hepatitis C virus infections in various models (9,10). Three patients

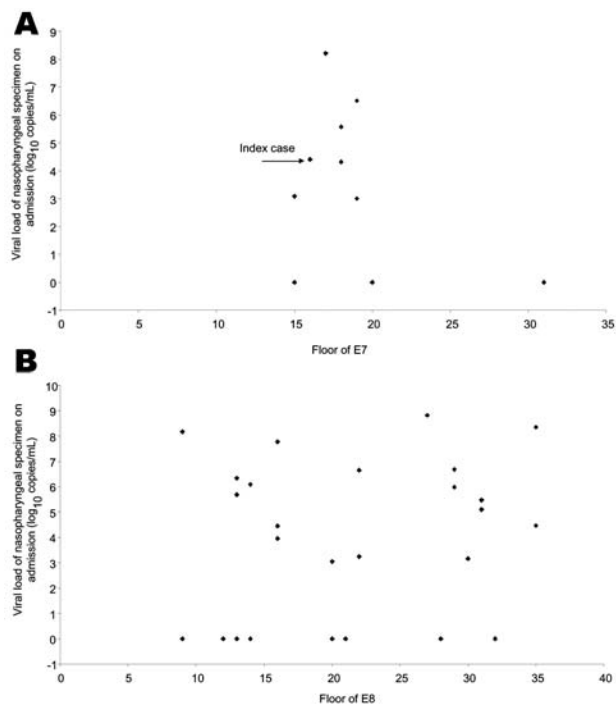

Figure 3. Distribution of viral load in nasopharyngeal specimens ( $\log_{10}$  copies/mL) of Amoy Gardens residents in E7 (A) and E8 (B).

from E7 and 12 patients from E8 had a higher viral load and more severe disease than the index patient in E7 (Figure 3). This finding can be explained by the fact that secondary case-patients had probably received higher viral inocula through droplets or close contact (11–14). The viral load gradually decreased in tertiary patients who lived further from the index case; dilution factors may have had an effect. Moreover, the shape of the U trap and the warm aerosol generated from the bathroom of the index patient caused the aerosol to circulate upwards, which may explain why only the upper floors of E7 were initially affected. Subsequently the virus-laden aerosols cooled and sank. At the same time, the virus was carried by a southwestward wind to E8 and other parts of Amoy Gardens. This scenario accounted for the higher rate and more widespread distribution of SARS patients in E8 than E7.

How SARS is transmitted is variously explained. In most cases, SARS is transmitted by direct contact with ill persons and spread of large droplets (15). In more distant transmission, airborne spread, contaminated fomites, and rodent pests can spread this disease (4,5,16). The initial viral load pattern in our study may help explain the different mechanisms involved in transmitting SARS in this outbreak. The highest nasopharyngeal viral load was detected in patients residing in E7 and E8, which were near the unit inhabited by the index patient. Direct contact transmission with the index patient and droplet spread by cough may

have occurred among patients living in block E. Rodent pests may have spread the virus in the same block or even to distant blocks. Transmission by contaminated fomites such as elevator door knobs or door handles would also lead to spread among patients in the same block.

The viral load of each patient correlated with the distance in relation to the index block (E7). However, more patients and higher viral load were found in patients living in block D than block F, in block C than block G, and in block B than blocks A and H, even though they were a similar distance from the index block (Figure 2). The attack rate was highest in block E, which accounted for 41% of the 321 SARS cases in Amoy Gardens, followed by block C (15%), block B (13%), and block D (13%). The remaining cases (18%) were distributed in 11 other blocks (2). This distribution pattern can be explained by airborne transmission as virus-laden aerosols circulated inside the complex and were driven by a southwestward wind from block E to blocks D, C, and B (4). Meteorologic data from The Hong Kong Observatory, Hong Kong Special Administrative Region showed that the prevailing wind direction on March 14 and March 19, 2003 was from the southwest. This pattern is consistent with a hypothesis of airborne transmission (17). Patients living in block D had a lower viral load than those in blocks B and C, even though they lived closest to the index patient. They may have been protected by a nearby construction site (Figure 2), which created a shield against the virus-laden draft. Patients from E7 living on floors 15–20 had higher viral loads than those living above or below them (Figure 3A). This distribution may be the result of a dilution effect as the virus-laden plume rose from the middle floors to the higher floors. Nonetheless, the airborne hypothesis is not possible to prove because simultaneous air sampling and analysis of the SARS viral load was not carried out.

Severity of illness did not differ between block E patients and non-E block patients when they were first seen at the hospital, despite higher viral load in block E patients. However, the death rate was higher in block E. We have previously demonstrated that patients with high

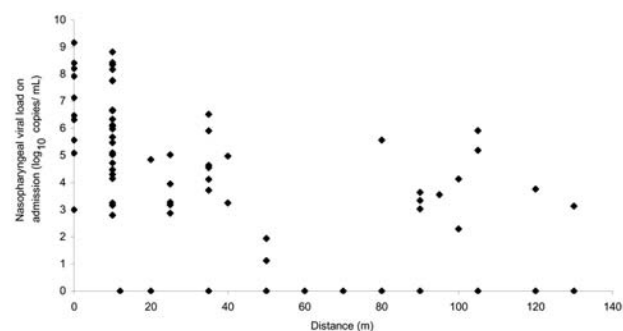

Figure 4. Correlation of nasopharyngeal viral load ( $\log_{10}$  copies/mL) in relation to the distance from the index unit (E7).

initial and peak viral loads in nasopharyngeal samples were more likely to show a less favorable disease course and lower survival rate (8,18). Patients living in E7 who had highest nasopharyngeal viral loads explains why their death rate was higher than for those living in other units. The dilution effect resulted in a decreased viral load as the disease spread to other units and in a lower death rate.

Our study was limited because we analyzed only data on the first 79 of 321 patients in Amoy Gardens with SARS. This limitation was the result of the rapid influx of patients who overwhelmed the capacity of our hospital; additional patients were admitted to other hospitals for treatment. Second, no human study has confirmed the relationship between the size of viral inocula and viral load. Host factors are important in this regard (9). Nevertheless, we believe that the patients we studied provide important information regarding initial viral loads and geographic factors. This situation involved different modes of transmission, including direct contact, droplets, airborne, contaminated fomites, and rodent pests. No single mechanism could explain such a major outbreak.

In conclusion, the overcrowded housing complex, unconnected pipes, a southwestward wind, rodent pests, and arrival of the SARS index patient all created an environment favorable for the transmission of this disease. Different modes of transmissions apparently had a part in this major outbreak. What actually took place will likely remain unsolved. Nevertheless, the possibilities of different modes of spread alert us to the importance of a multi-component infection control policy in future outbreaks of SARS-CoV infection, as well as in other respiratory viral infections.

### Acknowledgments

We thank the staff of the Department of Medicine and Intensive Care Unit, United Christian Hospital and Centre of Infection, University of Hong Kong, for excellent patient management and technical assistance. Part of this study was submitted by C-M Chu to the University of Hong Kong for fulfillment of the requirements for a doctor of medicine degree.

This study was supported by the Jessie and George Ho Charitable Foundation and the James Lau Emerging Infectious Diseases Fund.

Dr Chu is a pulmonologist at the United Christian Hospital in Hong Kong. His research interests include emerging infectious diseases.

### References

- World Health Organization. Summary of probable SARS cases with onset of illness from 1 November 2002 to 31 July 2003. [cited 22 Feb 2003]. Available from [http://www.who.int/csr/sars/country/en/country2003\\_09\\_23/en/](http://www.who.int/csr/sars/country/en/country2003_09_23/en/)
- Outbreak of severe acute respiratory syndrome (SARS) at Amoy Gardens, Kowloon Bay, Hong Kong: main findings of the investigation. [cited 22 Feb 2003]. Available from [http://www.info.gov.hk/info/ap/pdf/amoy\\_e.pdf](http://www.info.gov.hk/info/ap/pdf/amoy_e.pdf)
- World Health Organization. Final report: Amoy Gardens. WHO environmental investigation. 2003. [cited 22 Feb 2003]. Available from [http://www.iapmo.org/common/pdf/ISS-Rome/SARS\\_Amoy\\_Gardens\\_HK.pdf](http://www.iapmo.org/common/pdf/ISS-Rome/SARS_Amoy_Gardens_HK.pdf)
- Yu IT, Li Y, Wong TW, Tam W, Chan AT, Lee JL, et al. Evidence of airborne transmission of the severe acute respiratory syndrome virus. *N Engl J Med*. 2004;22:350:1731-9.
- Ng SK. Possible role of an animal vector in the SARS outbreak at Amoy Gardens. *Lancet*. 2003;362:570-2.
- Subbarao K, McAuliffe J, Vogel L, Fahle G, Fischer S, Tatti K, et al. Prior infection and passive transfer of neutralizing antibody prevent replication of severe acute respiratory syndrome coronavirus in the respiratory tract of mice. *J Virol*. 2004;78:3572-7.
- Peiris JS, Chu CM, Cheng VC, Chan KS, Hung IF, Poon LL, et al. Clinical progression and viral load in a community outbreak of coronavirus-associated SARS pneumonia: a prospective study. *Lancet*. 2003;361:1767-72.
- Chu CM, Poon LL, Cheng VC, Chan KS, Hung IF, Wong MM, et al. Initial viral load and the outcomes of severe acute respiratory syndrome (SARS). *CMAJ*. 2004;171:1349-52.
- Korthals Altes H, Ribeiro RM, de Boer RJ. The race between initial T-helper expansion and virus growth upon HIV infection influences polyclonality of the response and viral set-point. *Proc Biol Sci*. 2003;270:1349-58.
- Shata MT, Tricoche N, Perkus M, Tom D, Brotman B, McCormack P, et al. Exposure to low infective doses of HCV induces cellular immune responses without consistently detectable viremia or seroconversion in chimpanzees. *Virology*. 2003;314:601-16.
- Aaby P, Bukh J, Lisse IM, Smits AJ. Overcrowding and intensive exposure as determinants of measles mortality. *Am J Epidemiol*. 1984;120:49-63.
- Poulsen A, Qureshi K, Lisse I, Kofod PE, Nielsen J, Vestergaard BF, et al. A household study of chickenpox in Guinea-Bissau: intensity of exposure is a determinant of severity. *J Infect*. 2002;45:237-42.
- Poulsen A, Cabral F, Nielsen J, Roth A, Lisse IM, Vestergaard BF, et al. Varicella zoster in Guinea-Bissau: intensity of exposure and severity of infection. *Pediatr Infect Dis J*. 2005;24:102-7.
- Lienhardt C, Sillah J, Fielding K, Donkor S, Manneh K, Warndorff D, et al. Risk factors for tuberculosis infection in children in contact with infectious tuberculosis cases in the Gambia, West Africa. *Pediatrics*. 2003;111:e608-14.
- Seto WH, Tsang D, Yung RW, Ching TY, Ng TK, Ho M, et al. Effectiveness of precautions against droplets and contact in prevention of nosocomial transmission of severe acute respiratory syndrome (SARS). *Lancet*. 2003;361:1519-20.
- Dowell SF, Simmerman JM, Erdman DD, Wu JS, Chaovavanich A, Javadi M, et al. Severe acute respiratory syndrome coronavirus on hospital surfaces. *Clin Infect Dis*. 2004;39:652-7.
- Extract of meteorological observations for Hong Kong, March 2003. Hong Kong Observatory, The Government of the Hong Kong Special Administrative Region. [cited 27 Mar 2005]. Available from <http://www.hko.gov.hk/wxinfo/pastwx/metob200303.htm>
- Hung IF, Cheng VC, Wu AK, Tang BS, Chan KH, Chu CM, et al. Viral loads in clinical specimens and SARS manifestations. *Emerg Infect Dis*. 2004;10:1550-7.

Address for correspondence: Kwok-Yung Yuen, Department of Microbiology, University of Hong Kong, Queen Mary Hospital, Pokfulam Rd, Hong Kong Special Administrative Region, People's Republic of China; fax: 852-2855-1241; email: kyyuen@hkucc.hku.hk

---

# Pandemic Strain of Foot-and-Mouth Disease Virus Serotype O

Nick J. Knowles,\* Alan R. Samuel,\* Paul R. Davies,\* Rebecca J. Midgley,\*  
and Jean-François Valarcher\*

A particular genetic lineage of foot-and-mouth disease virus (FMDV) serotype O, which we have named the PanAsia strain, was responsible for an explosive pandemic in Asia and extended to parts of Africa and Europe from 1998 to 2001. In 2000 and 2001, this virus strain caused outbreaks in the Republic of Korea, Japan, Russia, Mongolia, South Africa, the United Kingdom, Republic of Ireland, France, and the Netherlands, countries which last experienced FMD outbreaks decades before (ranging from 1934 for Korea to 1984 for the Netherlands). Although the virus has been controlled in all of these normally FMD-free or sporadically infected countries, it appears to be established throughout much of southern Asia, with geographically separated lineages evolving independently. A pandemic such as this is a rare phenomenon but demonstrates the ability of newly emerging FMDV strains to spread rapidly throughout a wide region and invade countries previously free from the disease.

Foot-and-mouth disease virus (FMDV, family *Picornaviridae*, genus *Aphthovirus*) causes an acute vesicular disease of pigs and wild and domesticated ruminants such as cattle, water buffalo, sheep, goats, and deer (1). It can cause high death rates in young animals and production losses in adults and is considered to be the single most important constraint to world trade in live animals and animal products. Spread of FMDV is predominantly associated with the legal and illegal movement of infected animals or their products.

The Food and Agriculture Organization World Reference Laboratory for Foot-and-Mouth Disease (WRLFMD) is established within the high-security laboratory at the Institute for Animal Health, Pirbright, United Kingdom (2). From 2000 to 2004, WRLFMD received an annual average of 536 samples to diagnose FMD from regions of the world where the disease is endemic, pre-

dominantly Africa and Asia. Seven serotypes of FMDV exist: SAT 1, SAT 2, and SAT 3 are usually restricted to Africa; Asia 1 is restricted to Asia; and O, A, and C are present in Africa, Asia, and South America and occasionally Europe. In each of the last 5 years, serotype O has been isolated from >60% of the positive FMD samples received.

The economic consequences of FMD incursion into disease-free regions may be severe. For instance, in the first 3 months of the 1997 outbreak in Taiwan, >6,000 farms were affected, 4 million pigs were destroyed or died from the disease, and >21 million doses of vaccine were used (3). The cost of controlling the disease was estimated at US \$378.6 million. An additional \$1.6 billion was lost in export trade, and >65,000 jobs in pig farming and associated industries were lost (3). To control the FMD outbreak without using vaccination, animals were slaughtered on >10,000 farms in the United Kingdom in 2001; only one fifth of these animals were actually infected. Four million animals were slaughtered for control measures and 2.5 million more for animal health reasons (4). The direct and indirect losses were estimated at ≈£8 billion (5).

FMDV has a genome consisting of a single strand of positive-sense RNA. Consequently, the virus has a high mutation rate and may change, on a random basis, 1–8 nucleotides (nt) per replication cycle (6). Nucleotide sequencing of part or all of the genome region coding for the outer capsid polypeptide VP1 was first used to study the epidemiology of FMD by Beck and Strohmaier (7), who investigated the origin of outbreaks of types O and A in Europe over a 20-year period. Since then, genetic variability has been used to individually characterize strains of FMDV and track their movement across international borders (8), and a large number of epidemiologic studies have been published (9). Previously, on the basis of comparisons of partial VP1 sequences (≈170 nt at the 3' end of the gene) of FMD type O viruses, differences between 2 iso-

---

\*Institute for Animal Health, Pirbright, United Kingdom

lates within 4% have been suggested to indicate a recent common origin, whereas differences of  $\geq 15\%$  signify geographic isolation over many years (10), similar to the distinctions made between human polioviruses (11). Isolates with  $>85\%$  nt sequence identity have been placed within groups or topotypes, which tend to be restricted in their geographic distribution (10,12). The 10 topotypes have been named Europe-South America (Euro-SA), Middle East-South Asia (ME-SA), Southeast Asia (SEA), Cathay (CHY), West Africa (WA), East Africa 1 (EA-1), East Africa 2 (EA-2), East Africa 3 (EA-3), Indonesia-1 (ISA-1), and Indonesia-2 (ISA-2). The Indonesian topotypes, which have not been identified since 1983, are considered extinct.

Knowles et al. (13) described the emergence and spread of the PanAsia strain from 1990 to 2000 on the basis of comparisons of partial (and some complete) VP1 sequences from 60 virus isolates. This article extends the molecular epidemiology of this virus strain by comparing 188 complete VP1 sequences for FMDV type O viruses mostly isolated from 2000 to 2005 with published sequences of selected viruses from the previous decade and some reference virus strains (N = 151).

## Materials and Methods

### Viruses and Primers

The designation and origin of FMDV isolates studied are listed in online Appendix 1 (available from [http://www.cdc.gov/ncidod/EID/vol11no12/05-0908\\_app1.htm](http://www.cdc.gov/ncidod/EID/vol11no12/05-0908_app1.htm)).

Three alternative primer combinations were used for reverse transcription-polymerase chain reaction (RT-PCR): O-1C244F/NK61, O-1C272F/NK61, and O-1C283F/NK61, which have amplicon sizes of 1,181, 1,153, and 1,142 bp, respectively (Table). Forward and reverse primer amounts were 20 and 40 pmol, respectively. We used 4–6 internal sequencing primers to ensure coverage of the VP1 region on both DNA strands (Table).

### RT-PCR of vRNA

Total RNA was extracted from 460  $\mu\text{L}$  of a 10% epithelial suspension or cell culture supernatant by using RNeasy kits (Qiagen Ltd., Crawley, West Sussex, UK), according to the manufacturer's instructions, and resuspended in 50  $\mu\text{L}$  nuclease-free water. This RNA (5  $\mu\text{L}$ ) was used as the template in a 1-step RT-PCR (Ready-To-Go RT-PCR Beads; Amersham Pharmacia Biosciences, Chalfont St. Giles, Bucks, UK). The following thermal profile was used: 42°C for 30 min; 94°C for 5 min; 35 cycles of 94°C for 60 s; 60°C for 60 s; and 72°C for 90 s; followed by a final extension of 72°C for 5 min. PCR products were analyzed by electrophoresis on a 1.5% agarose-Tris-borate-EDTA gel containing 0.5  $\mu\text{g}/\text{mL}$  ethidium bromide. DNA weight markers (GeneRuler 100 bp DNA Ladder Plus, Ready-To-Use; Fermentas, Inc., Hanover, MD, USA) were run alongside the samples to facilitate product identification and quantification. Post-PCR removal of deoxynucleoside triphosphates and primers was achieved enzymatically by using ExoSAP-IT (USB Corporation, Cleveland, OH, USA), according to the manufacturer's instructions.

### Sequence Determination

PCR amplicons were sequenced by using the DTS Quick Start Kit (Beckman Coulter Inc., Fullerton, CA, USA) according to the manufacturer's instructions and with the sequencing primers listed in the Table. The sequencing reactions were run on a CEQ8000 Automated Sequencer (Beckman Coulter) according to the manufacturer's instructions. The sequences determined in this study have been submitted to the EMBL/GenBank/DBJ databases; accession numbers are shown in Appendix 1.

### Phylogenetic Analysis

An unrooted neighbor-joining tree was constructed by using MEGA version 3 (14). The robustness of the tree topology was assessed with 1,000 bootstrap replicates as implemented in the program.

Table. Oligonucleotide primers used for RT-PCR and cycle sequencing of FMDV strains\*

Primer	Primer sequence (5' → 3')	Sense	Location on FMDV genome		Use
			Gene	Position†	
ARS4	ACCAACCTCCTTGATGTGGCT	+	1C	2349–2369	RT-PCR
O-1C244F	GCAGCAAACACATGTCAAACACCTT	+	1C	2469–2494	RT-PCR
O-1C272F	TBGCRGGNCTYGCCAGTACTAC	+	1C	2497–2519	RT-PCR
O-1C283F	GCCCAGTACTACACACAGTACAG	+	1C	2508–2530	RT-PCR
NK61	GACATGTCTCCTGCATCTG	–	2B	3630–3649	RT-PCR
NK72	GAAGGGCCAGGGTTGGACTC	–	2A/2B	3558–3578	Sequencing
O-1C499F	TACGCGTACACCGCGTC	+	1C	2724–2740	Sequencing
O-1C583F	GACGGYGAYGCICTGGTCGT	+	1C	2808–2827	Sequencing
A-1C612F	TAGCGCCGGCAAAGACTTTGA	+	1C	2834–2854	Sequencing
O-1D296F	ACAACACCACCAACCCAAC	+	1D	3181–3199	Sequencing
O-1D628R	GTTGGGTTGGTGGTGGTGT	–	1D	3181–3199	Sequencing

\*RT-PCR, reverse transcription-polymerase chain reaction; FMDV, food-and-mouth disease virus.

†Position on the genome of O1/Kaufbeuren/FRG/66 (EMBL/GenBank accession no. X00871).



## Results and Discussion

Virus RNA was extracted from 188 FMDV type O viruses, and each VP1-coding region was successfully amplified by RT-PCR by using at least 1 of the 3 described primer sets. The complete VP1 sequences were determined by directly sequencing the amplicons. For all these isolates, the VP1 gene consisted of 633 nt coding for 211 amino acids (previously VP1 was considered to be 2 amino acids longer at its carboxyl-terminus; however, the VP1-2A cleavage site is actually between a conserved glutamine [VP1<sup>211</sup> in most type Os] and a variable residue [2A<sup>1</sup>, often a leucine in serotype O]) (15).

The 188 VP1 sequences we report were compared to 151 VP1 sequences previously published or awaiting publication (database accession numbers are listed in Appendix 1). A bootstrapped neighbor-joining tree containing all 339 sequences was constructed by using MEGA 3 (Figure 1). Figures 2–4 show various parts of the tree depicted in Figure 1 in greater detail. The bootstrap support for the 10 FMDV O topotypes was generally high (96%–100%; Figure 2). The topotype distributions of the 299 Asian FMDV type O viruses (including those reported elsewhere) were as follows: ME-SA (253), SEA (18), and Cathay (49) (Appendix 1). Additionally, 26 European viruses (from the United Kingdom, Ireland, and France) belonged to the ME-SA topotype. The PanAsia strain accounted for 168 (66%) of the 253 ME-SA isolates.

Some FMDV O topotypes had a more limited spread than the ME-SA topotype. Virus isolates from Hong Kong and the Philippines all fell within the Cathay topotype; all the recently isolated (2000–2004) Philippines isolates form a distinct lineage. This topotype was first introduced into the Philippines in 1994, probably from mainland China or Hong Kong (the only known places where it existed at that time). Earlier isolates from the Philippines (e.g., O/PHI/5/95) were closely related to Hong Kong viruses (Figure 2). This topotype was first seen in Vietnam in 1997 and continued to occur there until 2004 (Figure 2) but has not, as far as we know, spread to neighboring Southeast Asian countries. A Cathay topotype virus also spread to Taiwan in 1997, where it caused an extensive epidemic that lasted until at least 1999 (3) (Figure 2). Viruses belonging to the SEA topotype continue to be isolated throughout Southeast Asia (Figure 2; online Appendix 2; available from [http://www.cdc.gov/ncidod/EID/vol11no12/05-0908\\_app2.htm](http://www.cdc.gov/ncidod/EID/vol11no12/05-0908_app2.htm)), despite the recent introduction and widespread dissemination of the PanAsia strain. No examples of either of the Indonesian topotypes have been detected in the field since 1983.

Viruses belonging to the ME-SA topotype occur in many genetic sublineages (Figure 3). These were often initially found in India and subsequently spread to other geographic regions. The reference/vaccine strains (O<sub>3</sub>/IND/1/

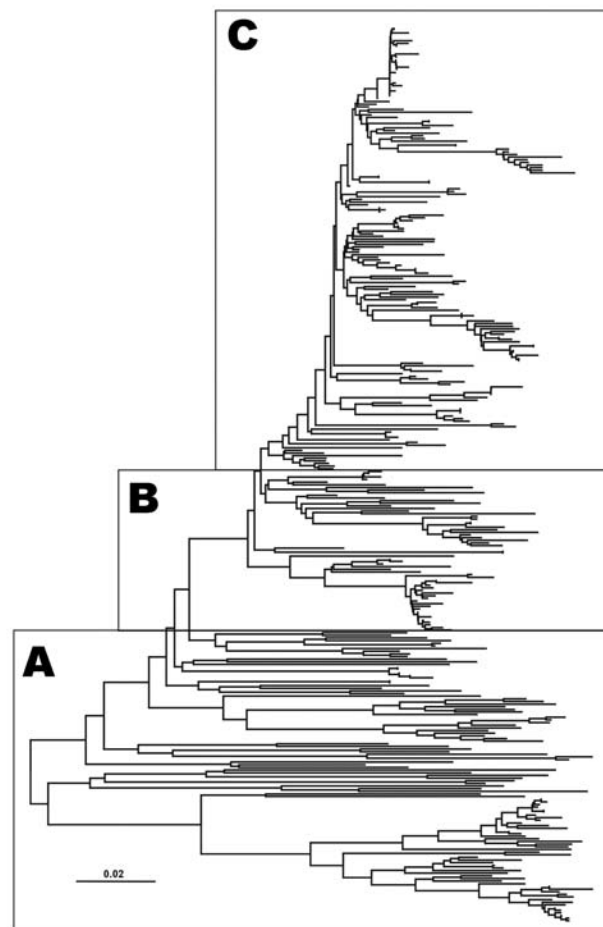

Figure 1. Midpoint-rooted neighbor-joining tree showing the relationships between the 339 VP1 sequences studied. Only the tree structure is shown; details of the boxes labeled A to C are shown in Figures 2–4.

62, O<sub>1</sub>/Manisa/TUR/69, O<sub>1</sub>/Sharquia/EGY/72, and O/IND/R2/75) all occur in a single lineage distinct from later isolates. The O<sub>3</sub>/IND/1/62 sequenced by Hemadri et al. (16) is different (9.6%) from the same strain that we and others sequenced (17,18) (all 3 sequences are identical, and the virus stocks probably all originated from WRLFMD), and the origin of these isolates requires further investigation. Two other reference/vaccine strains (O/Geshur/ISR/85 and O/Dalton/ISR/2/88) fall on another lineage but are not closely related to each other. Within the ME-SA topotype, several sublineages have been defined as strains, such as PanAsia, Ind2001, and Iran2001, on the basis of phylogenetic relationships and a nucleotide difference of <5% (9,16). However, these are artificial groupings, the edges of which become blurred as viruses evolve in different directions. For example, the nucleotide sequences of 2 viruses that are on the PanAsia lineage, O/VIT/1/2004 and

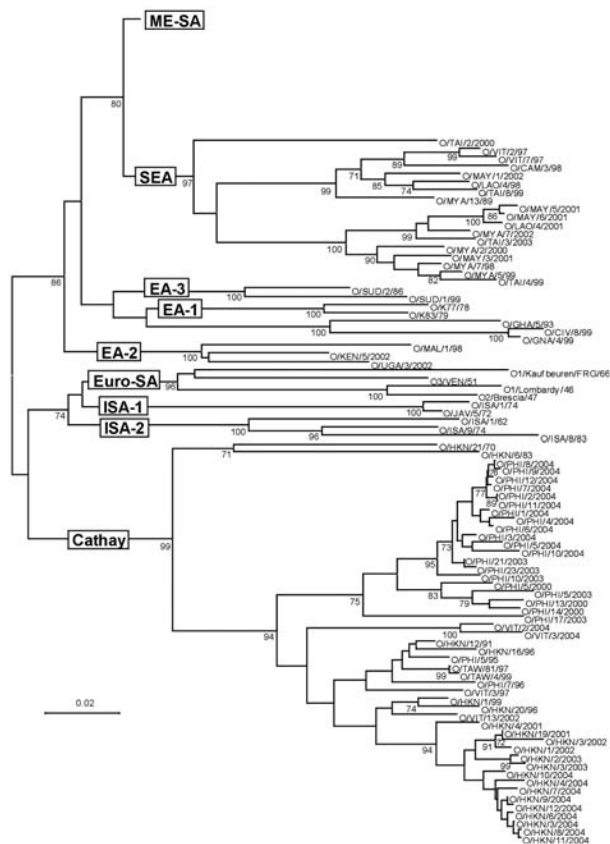

Figure 2. Midpoint-rooted neighbor-joining tree showing the Cathay, Europe-South America (Euro-SA), Indonesia-1 (ISA-1), Indonesia-2 (ISA-2), West Africa (WA), East Africa 1 (EA-1), East Africa 2 (EA-2), and East Africa 3 (EA-3) topotypes. Only bootstrap values  $\geq 70\%$  are shown.

O/BHU/27/2004, differ from O/TAW/2/99 by 5.4% and 5.0%, respectively, but differ from each other by 7.9%. Thus trying to define “strains,” particularly using percentage nucleotide relationships, may not be relevant, except in special circumstances, such as a pandemic caused by a cluster of closely related viruses.

Viruses that we consider part of the PanAsia strain (within the ME-SA topotype) are shown in Figure 4. Within the PanAsia strain, different sublineages can be distinguished despite some low bootstrap values. Some of them correspond to well-defined geographic areas in which these isolates have been collected through the years and show evolutionary relationships. Others are mixtures of FMDV isolates from different regions. In such cases, the phylogeny gives clues to the probable source of some isolates. The PanAsia strain shows a limited degree of variability of the VP1 gene during the outbreak in 2001 in the United Kingdom. Indeed, the degree of genetic variability of the VP1 gene of 24 isolates collected between the begin-

ning and the end of the outbreak was  $<1.29\%$ , and very few amino acid changes were observed (a maximum of 3 in any 1 sequence).

According to our current analysis, the PanAsia strain is an emergent sublineage of FMDV that, after several years in India, spread through southern Asia, the Middle East, and Europe. This strain apparently was confined to India for longer—and then spread much faster—than previously believed. In 1994, Samuel et al. (19) first noted the arrival of a new FMDV type O lineage in Saudi Arabia. Previously, we had considered this lineage to be part of the PanAsia strain (13). However, analysis of complete VP1 sequences with the neighbor-joining algorithm, rather than unweighted pair-group method analysis on partial VP1 sequences, indicated that these viruses, along with others isolated between 1994 and 1997 in Asia (except India), actually belong to 1 of 2 distinct lineages that we have termed Ind2001 and Iran2001 (Figure 3). Therefore, viruses that we would now classify as PanAsia first appeared in Bahrain, Iran, Lebanon, Kuwait, Saudi Arabia, and Yemen much later (i.e., in 1998); in Israel, Turkey, and the United Arab Emirates in 1999; and in Malaysia in 2000 (Figures 3 and 4; data not shown). In Nepal in 1990, viruses were found that were closely related to the earliest PanAsia isolates from India in the same year. However, from 1991 to 1996, only viruses belonging to non-PanAsia lineages of



Figure 3. Midpoint-rooted neighbor-joining tree showing the Middle East-South Asia (ME-SA) topotype (except the PanAsia strain). Only bootstrap values  $\geq 70\%$  are shown.



recorded outbreak in that country due to serotype O. In February 2001, FMD was diagnosed in the United Kingdom; by the end of July, >1,900 farms were affected. The PanAsia strain was responsible for these outbreaks (13,22,23). In late February 2001, the disease spread from the British mainland to Northern Ireland, and in March and April outbreaks of FMD type O were also reported in the Republic of Ireland (n = 1), France (n = 2), and the Netherlands (n = 26). In 2003, the PanAsia strain was detected for the first time in Afghanistan, Nepal, and Pakistan; however, because of lack of samples or sequencing data, the strain may have been present earlier. Since 2003, the PanAsia strain has not been detected in any new countries.

The PanAsia strain has not yet been detected in Africa (except South Africa in 2000) or South America, despite extensive unpublished sequence studies by ourselves; the Onderstepoort Veterinary Institute, South Africa (W. Vosloo, pers. comm.); and the Pan-American FMD Center, Brazil (I.E. Bergmann, pers. comm.). However, the PanAsia strain is present in many countries in which FMD is endemic and occurs in countries in which the incidence of FMD is sporadic.

The extent of this spread is unique for a single strain of FMDV, and its presence in most recent samples from the Middle East indicates that it has dominated and outcompeted the other strains of FMDV previously observed (19). While we acknowledge that the sampling of virus isolates is not random (i.e., the samples examined are those submitted to WRLFMD by some of the countries experiencing outbreaks), the same sampling technique has shown a marked increase in the number of isolations of the PanAsia lineage over the preceding years.

The appearance of the PanAsia virus in countries that have been FMD-free for many years shows that this strain is capable of spreading to countries where strict control measures are normally effective at preventing importation of animal pathogens. Whether this fitness to survive is related to particular features of the transmissibility of the virus strain or its ability to spread subclinically in certain breeds of animal, as found in Taiwan in 1999 or in Japan in 2000 (24), is not clear. The PanAsia virus strain has been isolated from a wide variety of host species, including cattle, water buffalo, pigs, sheep, goats, and gazelle (Qatar in 1999), and its ability to infect a wide range of species could be a contributing factor in its success. Within the PanAsia strain, differences in behavior of the virus, such as host species or virulence, remain unexplained on a genetic basis, according to comparison of the full genome sequences from viruses from this group (25). However, these characteristics can also be biased by practices such as vaccination, the animal population targeted for vaccination, or the animal species that are farmed in a particular area.

We have no evidence of increased or altered trade in the region that could explain the sudden spread of the PanAsia virus. Additionally, the lack of efficacy of existing FMDV vaccines does not seem to be responsible for the spread of this strain in countries in which vaccination is practiced. Indeed, antigenic matching analysis has shown good cross-reactivity between field isolates of the PanAsia strain and current vaccine strains such as O<sub>1</sub> Manisa (WRLFMD, data not shown), and this finding has been confirmed for O/UKG/2001 virus by cross-protection studies (26,27).

The spread of the PanAsia strain across most of Asia and into Europe and South Africa demonstrates how a newly evolved virus may become established, in spite of control measures at international borders. FMD in a previously disease-free country can seriously interfere with the local and export trade in susceptible animals and their products. A large outbreak of FMD in northern Europe or the United States could result in losses of several billion US dollars. The emergence of this strain of FMDV, and its spread within the territory bounded by Ireland in the west and Japan in the east, provides an example of the economic damage that can result. It also demonstrates the difficulty of containing such a transmissible virus within a defined region. The emergence of such strains highlights the necessity to constantly monitor and characterize field isolates responsible for outbreaks in FMD-endemic countries and the need for countries to be rapidly alerted so that appropriate control measures can be instituted. For this purpose, an international early warning system must be established to share information on the characteristics of the latest FMDV isolates in real time.

#### Acknowledgments

We acknowledge the work of Nigel Ferris and colleagues in receiving and serotyping the viruses submitted to WRLFMD.

This work was supported by the Department for Environment, Food and Rural Affairs, United Kingdom (Reference Laboratory contract and research grant no. SE 2921). The submission and serotyping of samples were supported by DEFRA and a grant from the European Commission for the Control of FMD.

Mr Knowles is a molecular virologist at the Institute for Animal Health. His research interests focus on the molecular epidemiology and evolution of picornaviruses of animals, particularly FMDV.

#### References

1. Thomson GR. Foot-and-mouth disease. In: Coetzer JAW, Thomson GR, Tustin RC, Kriek NPJ, editors. Infectious diseases of livestock with special reference to southern Africa. Vol. 2. Cape Town: Oxford University Press; 1994. p. 825-52.

2. Ferris NP, Donaldson AI. The World Reference Laboratory for Foot-and-Mouth Disease: a review of thirty three years of activity (1958–1991). *Rev Sci Tech*. 1992;11:657–84.
3. Yang PC, Chu RM, Chung WB, Sung HT. Epidemiological characteristics and financial costs of the 1997 foot-and-mouth disease epidemic in Taiwan. *Vet Rec*. 1999;145:731–4.
4. Scudamore JM, Harris, DM. Control of foot-and-mouth disease: lessons from the experience of the outbreak in Great Britain in 2001. *Rev Sci Tech*. 2002;21:699–710.
5. Thompson D, Muriel P, Russell D, Osborne P, Bromley A, Rowland M, et al. Economic costs of the foot-and-mouth disease outbreak in the United Kingdom in 2001. *Rev Sci Tech*. 2002;21:675–87.
6. Domingo E, Dopazo J, Rodrigo MJ, Rodriguez A, Saiz JC, Sabrino F. Aphthovirus evolution. In: Gibbs AJ, Calisher CH, Garcia-Arenal F, editors. *Molecular basis of virus evolution*. Cambridge (UK): Cambridge University Press; 1995. p. 310–20.
7. Beck E, Strohmaier K. Subtyping of European foot-and-mouth disease virus strains by nucleotide sequence determination. *J Virol*. 1987;61:1621–9.
8. Knowles NJ, Samuel AR. Molecular techniques in foot-and-mouth disease epidemiology. Towards livestock disease diagnosis and control in the 21st century: proceedings of an international symposium on diagnosis and control of livestock diseases jointly organized by the International Atomic Energy Agency and the Food and Agriculture Organization of the United Nations. Vienna, 1997 Apr 7–11. Vienna: International Atomic Energy Agency; 1998. p. 185–201.
9. Knowles NJ, Samuel AR. Molecular epidemiology of foot-and-mouth disease virus. *Virus Res*. 2003;91:65–80.
10. Samuel AR, Knowles NJ. Foot-and-mouth disease type O viruses exhibit genetically and geographically distinct evolutionary lineages (topotypes). *J Gen Virol*. 2001;82:609–21.
11. Rico Hesse R, Pallansch MA, Nottay BK, Kew OM. Geographic distribution of wild poliovirus type 1 genotypes. *Virology*. 1987;160:311–22.
12. Knowles NJ, Davies PR, Midgley RJ, Valarcher J-F. Identification of a ninth foot-and-mouth disease virus type O topotype and evidence for a recombination event in its evolution. Report of the Session of the Research Group of the Standing Technical Committee of EUFMD, Chania, Crete, Greece, 2004 Oct 12–15. Rome: Food and Agriculture Organization; 2004. Appendix 24, p. 163–72.
13. Knowles NJ, Samuel AR, Davies PR, Kitching RP, Venkataramanan R, Kanno T, et al. Emergence of a pandemic strain of foot-and-mouth disease virus serotype O. Report of the Session of the Research Group of the Standing Technical Committee of the European Commission for the Control of Foot-and-Mouth Disease, Borovets, Bulgaria, 2000 Sep 5–8. Rome: Food and Agriculture Organization; 2000. Appendix 1. p. 20–31.
14. Kumar S, Tamura K, Nei M. MEGA3: Integrated software for molecular evolutionary genetics analysis and sequence alignment. *Brief Bioinform*. 2004;5:150–63.
15. Birtley JR, Knox SR, Jaulent AM, Brick P, Leatherbarrow RJ, Curry S. Crystal structure of foot-and-mouth disease virus 3C protease. New insights into catalytic mechanism and cleavage specificity. *J Biol Chem*. 2005;280:11520–7.
16. Hemadri D, Tosh C, Sanyal A, Venkataramanan R. Emergence of a new strain of type O foot-and-mouth disease virus: its phylogenetic and evolutionary relationship with the PanAsia pandemic strain. *Virus Genes*. 2002;25:23–34.
17. Sangare O, Bastos AD, Marquardt O, Venter EH, Vosloo W, Thomson GR. Molecular epidemiology of serotype O foot-and-mouth disease virus with emphasis on West and South Africa. *Virus Genes*. 2001;22:345–51.
18. Carrillo C, Tulman ER, Delhon G, Lu Z, Carreno A, Vagnozzi A, et al. Comparative genomics of foot-and-mouth disease virus. *J Virol*. 2005;79:6487–504.
19. Samuel AR, Knowles NJ, Kitching RP, Hafez SM. Molecular analysis of foot-and-mouth disease type O viruses isolated in Saudi Arabia between 1983 and 1995. *Epidemiol Infect*. 1997;119:381–9.
20. Foot and mouth disease in the People's Republic of China. *OIE Disease Information*. 1999;12:76.
21. Foot and mouth disease in South Africa. *OIE Disease Information*. 2000;13(37):164–5.
22. Knowles NJ, Samuel AR, Davies PR, Kitching RP, Donaldson AI. Outbreak of foot-and-mouth disease virus serotype O in the UK caused by a pandemic strain. *Vet Rec*. 2001;148:258–9.
23. Samuel AR, Knowles NJ. Foot-and-mouth disease virus: cause of the recent crisis for the UK livestock industry. *Trends Genet*. 2001;17:421–4.
24. Sakamoto K, Yamakawa M, Kanno T, Murakami Y. Pathogenesis of O/JPN/2000 to susceptible animals. Report of the Session of the Research Group of the Standing Technical Committee of the European Commission for the Control of Foot-and-Mouth Disease, Borovets, Bulgaria, 2000 Sept 5–8. Rome: Food and Agriculture Organization; 2000. Appendix 2. p. 32–8.
25. Mason PW, Pacheco JM, Zhao Q-Z, Knowles NJ. Comparisons of the complete genomes of Asian, African and European isolates of a recent foot-and-mouth disease virus type O pandemic strain (PanAsia). *J Gen Virol*. 2003;84:1583–93.
26. Aggarwal N, Zhang Z, Cox S, Statham R, Alexandersen S, Kitching RP, et al. Experimental studies with foot-and-mouth disease virus, strain O, responsible for the 2001 epidemic in the United Kingdom. *Vaccine*. 2002;20:2508–15.
27. Cox SJ, Voyce C, Parida S, Reid SM, Hamblin PA, Paton DJ, et al. Protection against direct-contact challenge following emergency FMD vaccination of cattle and the effect on virus excretion from the oropharynx. *Vaccine*. 2005;23:1106–13.

---

Address for correspondence: Nick J. Knowles, Institute for Animal Health, Pirbright Laboratory, Ash Rd, Pirbright, Woking, Surrey, GU24 0NF, UK; fax: 44-148-323-2448; email: [nick.knowles@bbsrc.ac.uk](mailto:nick.knowles@bbsrc.ac.uk)

EMERGING INFECTIOUS DISEASES *online*

[www.cdc.gov/eid](http://www.cdc.gov/eid)

To receive tables of contents of new issues send an email to [listserv@cdc.gov](mailto:listserv@cdc.gov) with subscribe eid-toc in the body of your message.

# *Bartonella henselae* in Porpoise Blood

Ricardo G. Maggi,\* Craig A. Harms,\*† Aleta A. Hohn,‡ D. Ann Pabst,§ William A. McLellan,§ Wendy J. Walton,¶ David S. Rotstein,# and Edward B. Breitschwerdt\*

We report detection of *Bartonella henselae* DNA in blood samples from 2 harbor porpoises (*Phocoena phocoena*). By using real-time polymerase chain reaction, we directly amplified *Bartonella* species DNA from blood of a harbor porpoise stranded along the northern North Carolina coast and from a pre-enrichment blood culture from a second harbor porpoise. The second porpoise was captured out of habitat (in a low-salinity canal along the northern North Carolina coast) and relocated back into the ocean. Subsequently, DNA was amplified by conventional polymerase chain reaction for DNA sequencing. The 16S–23S intergenic transcribed spacer region obtained from each porpoise was 99.8% similar to that of *B. henselae* strain San Antonio 2 (SA2), whereas both heme-binding phage-associated *pap31* gene sequences were 100% homologous to that of *B. henselae* SA2. Currently, the geographic distribution, mode of transmission, reservoir potential, and pathogenicity of bloodborne *Bartonella* species in porpoises have not been determined.

**B**artonellosis is a newly emerging worldwide zoonotic disease (1,2) that can be caused by a spectrum of *Bartonella* species. These members of the alpha subdivision of the class Proteobacteria are gram-negative aerobic bacilli and comprise at least 20 species and subspecies. Infection with *Bartonella* species causes lymphadenopathy (3), disorders of the central nervous system (including encephalopathy, hemiplegia, epilepsy, and subcortical frontoparietal lesions) (4–7), bacillary angiomatosis and

bacillary peliosis (8), fever, adenitis, endocarditis (9–12), hepatosplenic involvement, cutaneous vasculitis, and osteomyelitis in domestic animals and humans (13–15).

*Bartonella* species have been isolated from numerous domestic and wild terrestrial animals, including cats, dogs, deer, cattle, lions, rabbits, and rodents (16–20). Because *Bartonella* spp. frequently induce persistent intravascular infections, particularly in reservoir hosts, attributing disease causation to *Bartonella* infection in animals or in human patients has been difficult, and satisfying Koch postulates for disease causation remains challenging (21).

Because conventional microbiologic techniques lack sensitivity, bartonellosis is usually diagnosed by using polymerase chain reaction amplification of organism-specific DNA sequences or serologic testing (1,22–25). Recently, a more sensitive isolation approach was developed by using *Bartonella* alpha Proteobacteria growth medium (BAPGM) followed by real-time polymerase chain reaction (PCR). This method has greatly facilitated the molecular detection or isolation of *Bartonella* species from the blood of sick and healthy animals (24). The relative sensitivity of diagnostic methods used to detect *Bartonella* species infection greatly influences the ability to establish disease causation. The use of these optimized microbiologic techniques facilitated the recognition of bloodborne *Bartonella* spp. infections in porpoises, as reported in this study.

We report real-time PCR detection of *B. henselae* SA2 DNA in porpoise blood samples. Harbor porpoises are cetaceans in the family *Phocoenidae* that are found alone or in small groups in coastal waters, bays, and estuaries in cold, temperate, and subarctic waters of the Northern Hemisphere (26). In the western Atlantic, they range from Baffin Island and Labrador in the north, extending as far south as North Carolina in the winter. Initially, blood samples were screened by using real-time PCR targeting the

\*North Carolina State University College of Veterinary Medicine, Raleigh, North Carolina, USA; †Center for Marine Sciences and Technology, Morehead City, North Carolina, USA; ‡National Marine Fisheries Service, Beaufort, North Carolina, USA; §University of North Carolina Wilmington, Wilmington, North Carolina, USA; ¶Virginia Aquarium and Marine Science Center, Virginia Beach, Virginia, USA; and #University of Tennessee College of Veterinary Medicine, Knoxville, Tennessee, USA

*Bartonella* 16S–23S RNA intergenic spacer (ITS) region, or the heme-binding phage-associated gene *pap31* (27). Preenrichment liquid BAPGM blood cultures were also screened by real-time PCR, after which conventional PCR was used to obtain DNA for sequencing and identifying *Bartonella* species to the strain level.

## Materials and Methods

### Sample Testing

Blood samples (anticoagulated with EDTA) were obtained from a live, stranded yearling female harbor porpoise (*Phocoena phocoena*) that required humane killing in northern North Carolina in May 2005 (MLC 001) and from a yearling male harbor porpoise. The male porpoise was captured out of habitat (in a low-salinity canal [3 parts salt per 1,000; by comparison, sea water contains 36 parts per 1,000] along the northern North Carolina coast) and relocated to the ocean in March 2005 (AAH 009). The samples were analyzed as follows. Following DNA extraction, real-time PCR (using DNA probes) and conventional PCR were used to screen for *Bartonella* DNA in each blood sample (23). A preenrichment culture was established from the original sample by using liquid BAPGM (24). After a 7-day incubation period, a sample was removed from the culture flask for conventional PCR and real-time PCR. In addition, sheep blood (used as blood supplement for preenrichment culture) and a sheep blood preenrichment BAPGM culture were screened for *Bartonella* DNA as a negative control at the time each porpoise sample was processed. *Bartonella* DNA was not detected in any control samples.

### Growth Medium

Preenrichment culture of EDTA-anticoagulated blood samples from the 2 porpoises tested in this study was performed as follows. A 1-mL aliquot of blood was added to 10 mL of BAPGM and incubated at 35°C in a 5% CO<sub>2</sub>, water-saturated atmosphere as previously described (24).

### DNA Extraction and PCR Screening of Blood and Blood Cultures

Screening for *Bartonella* species DNA was conducted by using conventional PCR and real-time PCR directly with EDTA-anticoagulated blood and from the 7-day postenrichment BAPGM blood culture samples. Gene sequencing was used to establish the species and strain classification. DNA was prepared by using the DNA Mini Kit (Qiagen, Valencia, CA, USA) from 200 µL of the blood sample and from 200 µL of preenrichment blood culture in BAPGM medium. After extraction, DNA concentration and quality were measured by using an absorbance ratio at 260:280 nm.

### Real-Time PCR Analysis

Real-time PCR screening for *Bartonella* species was performed as described previously (23). Scorpion 321 fluorescent probe 5'-FAM-CCG CGT TTT TCA AAG CCC ACG CGG-QUE-HEG-AGA TGA TGA TCC CAA GCC TTC TGG-3' and oligonucleotide 425as 5'-GGA TRA AYY RGW AAA CCT TYM YCG G-3' were used as sense and antisense primers, respectively, for screening of the *Bartonella* genus-specific ITS region. Identification of *Bartonella* species was conducted by using real-time multiplex PCR with species-specific fluorescent probes (Taqman, Applied Biosystems, Foster City, CA, USA) in conjunction with oligonucleotides 321s 5'-AGA TGA TGA TCC CAA GCC TTC TGG CG-3' and 421as 5'-GGA TRA AYY RGW AAA CCT TYM YCG G-3' as forward and reverse primers (Integrated DNA Technologies, Coralville, IA, USA), respectively. The species-specific fluorescent probe sequences (Taqman) used were 5'-FAM-CCA CCG TGG GCT TTG AAA AAC GCT-3' DBHQ1 for *B. henselae*, 5'-TexRed-GGG ACT TTA AGG AAG ACA CTT TTG TG-BHQ2-3' for *B. quintana*, 5'-ROX-TGC ACA AGC CTC TGA GAG GGA TGA ANG A-BHQ2-3' for *B. clarridgeiae*, and Cy3 5'-CTT TCY TGT AAG AGT GTA TTT TTT ATC TAA GA-BHQ2-3' for *B. vinsonii* subspecies *berkhoffii*. Real-time reactions were performed by using a SmartCycler II System (Cepheid, Sunnyvale, CA, USA) in 25-µL reaction volumes as described previously (23). Negative controls were prepared by using DNA extracted from sheep blood samples (the same used as blood supplement in BAPG liquid medium). PCR positive controls contained DNA from sheep blood samples spiked with *B. clarridgeiae* (ATCC 700095; American Type Culture Collection, Manassas, VA, USA), *Bartonella henselae* Houston-1 (ATCC 49882), *B. quintana* Fuller (ATCC VR-358), or *B. vinsonii* subsp. *berkhoffii* (ATCC 51672) DNA to a final concentration of 10 fg/µL. Real-time PCR conditions were a single hot-start cycle at 95°C for 30 s, followed by 55 cycles of denaturing at 94°C for 10 s, annealing at 58°C for 6 s (for *Bartonella*) or at 60°C for 6 sec (for the 4 *Bartonella* species), and final extension at 72°C for 10 s. Positive amplicons were detected by reading fluorescence at the appropriate wavelength.

### Conventional PCR Analysis

#### ITS Region

PCR screening of the *Bartonella* 16S–23S ITS region was performed on samples that were positive by real-time PCR, as described (24), when amplicon size allows preliminary species identification. Oligonucleotides 321s 5'-AGA TGA TGA TCC CAA GCC TTC TGG-3' and 983as 5'-TGT TCT YAC AAC AAT GAT GAT G-3' were used as forward and reverse primers, respectively. The ITS region

was amplified in a 25- $\mu$ L reaction volume that contained 8.5  $\mu$ L of molecular grade water (Epicentre, Madison, WI, USA) 0.5  $\mu$ L 10 mmol/L dNTP mixture, 2.5  $\mu$ L of 10 $\times$  PCR buffer, 2.5  $\mu$ L of 25 mmol/L MgCl<sub>2</sub>, and 0.7 units of Amplitaq Gold DNA polymerase (Applied Biosystems). The reaction mixture was completed by adding 0.25  $\mu$ L of 30  $\mu$ mol/L of each forward and reverse primer (Integrated DNA Technologies) and 10  $\mu$ L of DNA from each sample tested. PCR negative controls contained 10  $\mu$ L of DNA extracted from BAPGM (when testing BAPGM cultures) or 10  $\mu$ L of DNA extracted from sheep blood (when testing blood samples). Conventional PCR conditions were a single hot-start cycle at 95°C for 5 min, followed by 45 cycles of denaturing at 94°C for 45 s, annealing at 54°C for 45 s, and extension at 72°C for 45 s. Amplification was completed by an additional cycle at 72°C for 5 min. Products were analyzed by electrophoresis on 2% agarose gels and detected by staining with ethidium bromide and viewing under UV light. Amplicon products were sequenced to identify species strains.

#### ***pap31* Gene Amplification**

PCR species screening was performed by using primers designed to amplify a consensus sequence of the phage-associated gene *pap31* found in several species of the *Bartonella* genus (27). Oligonucleotides Pap31 1(s) 5'-GAC TTC TGT TAT CGC TTT GAT TT-3' and Pap31 688 (as) 5'-CAC CAC CAG CAA MAT AAG GCA T-3' were used as forward and reverse primers, respectively. Amplification of the *pap31* gene was performed in a 25- $\mu$ L final volume reaction as described above. PCR conditions for *pap31* gene amplification were a single hot-start cycle at 95°C for 5 min, followed by 45 cycles of denaturing at 94°C for 45 s, annealing at 58°C for 45 s, and extension at 72°C for 45 s. Amplification was completed by an additional cycle at 72°C for 5 min. Products were analyzed by electrophoresis on 2% agarose gels and detected by staining with ethidium bromide and viewing under UV light. Amplicons were sequenced to identify specific strains.

#### **Cloning and Sequencing of ITS and *pap31* Gene Amplicons**

*Bartonella* ITS and *pap31* DNA sequencing was performed for 2 positive amplicons for both the ITS and *pap31* gene to confirm the *Bartonella* species and strain. The amplified PCR products were cloned into the Plasmid pGEM-T Easy Vector System (Promega, Madison, WI, USA). Recombinants (white colonies) were selected on the basis of the right size of the insert in the plasmid using a plasmid miniprep procedure (Qiagen). Sequencing of plasmid inserts was done by Davis Sequencing, Inc. (Davis, CA, USA). Sequence analysis and alignment with

GenBank sequences were performed by using AlignX software (Vector NTI Suite 6.0, InforMax, Inc., Frederick, MD, USA) to identify bacteria at species and strain level.

## **Results**

#### **Blood and Preenrichment Blood Culture Real-Time PCR**

Following direct extraction from blood, *Bartonella* DNA was amplified from 1 (MLC 001) of the 2 porpoises. Real-time PCR amplification of *Bartonella* DNA was possible from the harbor porpoise stranded along the North Carolina coast, but not from the porpoise (AAH 009) that was captured and released until after the 7-day BAPGM enrichment period. Using a multiplex real-time PCR assay developed in the Vector-Borne Disease Diagnostic Laboratory at North Carolina State University, we identified *B. henselae* as the infecting species in both porpoises. *Bartonella vinsonii* subsp. *berkhoffii*, *B. clarridgeae*, and *B. quintana* DNA was not detected by using real-time PCR species-specific probes, which suggests that these species were not present in the original blood samples or in the preenrichment cultures. *Bartonella* DNA was not detected by real-time PCR in samples extracted from the sheep blood used as a negative control before and after preenrichment culture.

#### **Cloning and Sequencing**

The *Bartonella* species was confirmed by cloning and sequencing the 16S–23S ITS region and the *pap31* gene. The ITS and *pap31* DNA sequences from both porpoises were consistent with that of *B. henselae* strain San Antonio 2 (GenBank accession no. AF369529). The 16S–23S ITS sequence matches were 675/677 bp (99.7%) for MLC 001 and 676/677 bp (99.8%) for AAH 009. The ITS sequence from MLC 001 contained 2 bp insertions (a C and a T), at positions 45 and 675, respectively, when compared with the ITS GenBank sequences for *B. henselae* SA2. Sequences from AAH 009 contained only a C insertion at position 45. The *pap31* gene sequences derived from both porpoises matched 540/540 bp (100%) with *B. henselae* SA2 (GenBank accession no. AF308168).

## **Discussion**

We report the first detection of a *Bartonella* species from the blood of a cetacean, the detection of *B. henselae* from a nonterrestrial animal. This study was initiated by a request to use molecular diagnostic to evaluate blood from a stranded sick porpoise and from a porpoise captured out of its natural habitat.

MLC 001, a yearling female that was stranded in a remote location, may have been stranded for many hours before it could safely be reached and humanely killed. There was no evidence of fisheries interaction. The animal



was thin, and necropsy showed no food in its stomach. Few obvious gross lesions and parasites were noted. The degree of postmortem autolysis was more than would be expected in a freshly killed animal. This finding, with signs of cranial epaxial and caudal abdominal muscle hemorrhages and the friable condition of the muscle, suggests that the animal's condition likely deteriorated during stranding. Results of histopathologic examination were unremarkable and lesions known to be consistent with bartonellosis were not found.

AAH 009, found swimming in a low-salinity canal, had 2 lacerations (2.5 and 5 cm long) over the left dorsal trunk cranial to the dorsal fin, 1 of which extended the full thickness through the blubber, but was not bleeding. In addition, ≈8 clusters of pinpoint lesions were observed slightly cranial and dorsal to the lacerations, which may have been due to punctures or viral skin lesions. Assessment of the porpoise's behavior, body condition, and hematologic parameters indicated that it was not debilitated despite its unusual location. It was then tagged and released into the ocean. Molecular evidence of *Bartonella* infection was obtained by direct PCR on whole blood from MLC 001, and by using a recently improved diagnostic method that combines preenrichment blood culture (24) and real-time PCR in samples from AAH 009. An isolate was not obtained from either porpoise after application of the preenrichment BAPGM blood culture onto a blood agar plate.

Recently, various emerging or reemerging infectious diseases or infections of serious epizootic or zoonotic potential have been described in marine mammals (28–32). These include morbillivirus infection, brucellosis, toxoplasmosis, sarcocystosis, papillomavirus infection, and West Nile virus infection (29,31,33). As was the case for brucellosis, recognized as an emerging disease in a marine mammal in 1994 (34,35), bartonellosis may become an important emerging marine mammal infectious disease.

Current evidence indicates that all known *Bartonella* species are vector transmitted, with bites or scratches (cat scratch disease) providing an alternative means of transmission for *B. henselae* (2,20). The *B. henselae* SA2 sequence deposited in GenBank was amplified from an isolate derived from a human lymph node aspiration sample (9). Although exposed to rose thorns and cats, the patient did not recall an animal bite or scratch, and illness developed after a recent tick bite, which was attributed to *Amblyomma americanum*, based on the location and time of the year. Since the mode of infection was not established in these porpoises, the potential role of trauma, as induced by tooth raking, or transmission by biting marine invertebrates should be investigated.

As for many fastidious pathogens, difficulties associated with *Bartonella* detection and isolation have compromised efforts to define the role of these organisms in

disease causation. Enhancement of organism-specific DNA detection and isolation through the use of an optimized isolation medium such as BAPGM can aid in evaluating serodiagnostic assays and may advance understanding the diversity, adaptation, and epidemiology of this genus (24,36). Based on the recent use of BAPGM in the North Carolina State University Vector-Borne Disease Diagnostic Laboratory, we believe that chronic infection with *Bartonella* species can contribute to subtle clinical abnormalities or vague symptoms in companion and wild animals or in humans.

Angiomatosis, an important pathologic manifestation of *Bartonella* infection in immunocompromised persons (8,21), has been previously reported in bottlenose dolphins (37). Since angiomatous lesions are unusual pathologic lesions and *B. henselae* is a recently recognized cause of vasoproliferative lesions in humans (8,15), examination of angiomatous lesions from cetaceans for the presence of *B. henselae* should be a priority in future studies. In addition, the involvement of *Bartonella* species in disorders of the central nervous system and neurologic dysfunction in animals and humans (4–7) suggests that this genus should be considered in stranding events. Although *Bartonella* infection in the vasculature of reservoir hosts is generally not accompanied by pathologic changes, *Bartonella* spp. may become pathogenic in combination with severe stress, malnutrition, increased exposure to toxins, and concurrent infection with other organisms. PCR amplification directly from an extracted blood sample or from a preenrichment blood culture showed that both porpoises in this study were infected with *B. henselae* SA2. Since infection with *Bartonella* spp. has been documented in a marine mammal, the clinical impact, mode of transmission, pathology, and epidemiology are areas for additional inquiry.

#### Acknowledgments

We thank Gregory A. Lewbart for helpful discussions and review of this manuscript; Robert George, Larry J. Hansen, and Gretchen N. Lovewell for facilitating blood collection and testing; and the Virginia Aquarium and Marine Science Stranding Program and the University of North Carolina Wilmington Marine Mammal Stranding Program for assistance during the study.

This research was supported by the state of North Carolina. Funding for stranding responses and sample collection was provided in part by National Oceanic and Atmospheric Administration Fisheries John H. Prescott Marine Mammal Rescue Assistance Grant Program awards to D. Ann Pabst, William A. McLellan (NA03NMFS4390411), and Craig A. Harms (NA04NMF4390040).

Dr Maggi is a research postdoctoral associate in the Intracellular Pathogens Laboratory at North Carolina State University, College of Veterinary Medicine. His research

interests include development of novel/improved molecular, diagnostic, and culture methods for detection of *Bartonella* infections in humans and animals.

## References

- Boulouis HJ, Chang CC, Henn JB, Kasten RW, Chomel BB. Factors associated with the rapid emergence of zoonotic *Bartonella* infections. *Vet Res.* 2005;36:383–410.
- Breitschwerdt EB, Kordick DL. *Bartonella* infection in animals: carriership, reservoir, potential, pathogenicity, and zoonotic potential for human infection. *Clin Microbiol Rev.* 2000;13:428–38.
- Fournier PE, Robson J, Zeaiter Z, McDougall R, Byrne S, Raoult D. Improved culture from lymph nodes of patients with cat scratch disease and genotypic characterization of *Bartonella henselae* isolates in Australia. *J Clin Microbiol.* 2002;40:3620–4.
- Angibaud G, Balague JP, Lafontan JF. *Bartonella henselae* encephalopathy. *Presse Med.* 2005;34:297–8.
- Munana KR, Vitek SM, Hegarty BC, Kordick DL, Breitschwerdt EB. Infection of fetal feline brain cells in culture with *Bartonella henselae*. *Infect Immun.* 2001;69:564–9.
- Ogura K, Hara Y, Tsukahara H, Maeda M, Tsukahara M, Mayumi M. MR signal changes in a child with cat scratch disease encephalopathy and status epilepticus. *Eur Neurol.* 2004;51:109–10.
- Puligheddu M, Giagheddu A, Genugu F, Giagheddu M, Marrosu F. Epilepsia partialis continua in cat scratch disease. *Seizure.* 2004;13:191–5.
- Koehler JE, Quinn FD, Berger TG, LeBoit PE, Tappero JW. Isolation of *Rochalimaea* species from cutaneous and osseous lesions of bacillary angiomatosis. *N Engl J Med.* 1992;327:1625–31.
- Dolan MJ, Wong MT, Regnery RL, Jorgensen JH, Garcia M, Peters J, et al. Syndrome of *Rochalimaea henselae* adenitis suggesting cat scratch disease. *Ann Intern Med.* 1993;118:331–6.
- Breitschwerdt EB, Atkins CE, Brown TT, Kordick DL, Snyder PS. *Bartonella vinsonii* subsp. *berkhoffii* and related members of the alpha subdivision of the *Proteobacteria* in dogs with cardiac arrhythmias, endocarditis, or myocarditis. *J Clin Microbiol.* 1999;37:3618–26.
- Houpikian P, Raoult D. Blood culture-negative endocarditis in a reference center: etiologic diagnosis of 348 cases. *Medicine (Baltimore).* 2005;84:162–73.
- Znazen A, Rolain JM, Hammami N, Kammoun S, Hammami A, Raoult D. High prevalence of *Bartonella quintana* endocarditis in Sfax, Tunisia. *Am J Trop Med Hyg.* 2005;72:503–7.
- Ventura A, Massei F, Not T, Massimetti M, Bussani R, Maggiore G. Systemic *Bartonella henselae* infection with hepatosplenic involvement. *J Pediatr Gastroenterol Nutr.* 1999;29:52–6.
- Ledina D, Rincic J, Ivic I, Marasovic D, Ledina D. A child with *Bartonella henselae* osteomyelitis of the right humerus. *Acta Dermatovenerol Croat.* 2004;12:92–5.
- Spach DH, Koehler JE. *Bartonella*-associated infections. *Infect Dis Clin North Am.* 1998;12:137–55.
- Chang CC, Chomel BB, Kasten RW, Heller R, Kocan KM, Ueno H, et al. *Bartonella* spp. isolated from wild and domestic ruminants in North America. *Emerg Infect Dis.* 2000;6:306–11.
- Heller R, Riegel P, Hansmann Y, Delacour G, Bermond D, Dehio C, et al. *Bartonella tribocorum* sp. nov., a new *Bartonella* species isolated from the blood of wild rats. *Int J Syst Bacteriol.* 1998;48:1333–9.
- Heller R, Kubina M, Mariet P, Riegel P, Delacour G, Dehio C, et al. *Bartonella alsatica* sp. nov., a new *Bartonella* species isolated from the blood of wild rabbits. *Int J Syst Bacteriol.* 1999;49:283–8.
- Kordick DL, Swaminathan B, Greene CE, Wilson KH, Whitney AM, O'Connor S, et al. *Bartonella vinsonii* subsp. *berkhoffii* subsp. nov., isolated from dogs; *Bartonella vinsonii* subsp. *vinsonii*; and emended description of *Bartonella vinsonii*. *Int J Syst Bacteriol.* 1996;46:704–9.
- Kosoy MY, Regnery RL, Tzianabos T, Marston EL, Jones DC, Green D, et al. Distribution, diversity, and host specificity of *Bartonella* in rodents from the southeastern United States. *Am J Trop Med Hyg.* 1997;57:578–88.
- Jacomo V, Kelly PJ, Raoult D. Natural history of *Bartonella* infections (an exception to Koch's postulate). *Clin Diagn Lab Immunol.* 2002;9:8–18.
- Breitschwerdt EB, Hegarty BC, Maggi R, Hawkins E, Dyer P. *Bartonella* species as potential cause of epistaxis in dogs. *J Clin Microbiol.* 2005;43:2529–33.
- Maggi RG, Breitschwerdt EB. Potential limitations of the 16S-23S rRNA intergenic region for the molecular detection of *Bartonella* species. *J Clin Microbiol.* 2005;43:1171–6.
- Maggi RG, Duncan AB, Breitschwerdt EB. Novel chemically defined liquid medium for the growth, as single or composed culture, and the primary isolation of *Bartonella* species from blood and body fluids. *J Clin Microbiol.* 2005;43:2651–5.
- Robinson JL, Spady DW, Prasad E, McColl D, Artsob H. *Bartonella* seropositivity in children with Henoch-Schonlein purpura. *BMC Infect Dis.* 2005;5:21.
- Leatherwood S, Reeves RR. Whales and dolphins. San Francisco: Sierra Club Press; 1983. p. 262–6.
- Maggi RG, Breitschwerdt EB. Isolation of bacteriophage from *Bartonella vinsonii* subsp. *berkhoffii* and characterization of Pap 31 gene sequences from bacterial and phage DNA. *J Mol Microbiol Biotechnol.* 2005;9:44–51.
- Dierauf LA, Gulland MD, editors. CRC handbook of marine mammal medicine. 2nd ed. Boca Raton (FL): CRC Press; 2001.
- Godfroid J, Cloeckaert A, Liautard JP, Kohler S, Fretin D, Walravens K, et al. From the discovery of the Malta fever's agent to the discovery of a marine mammal reservoir, brucellosis has continuously been a re-emerging zoonosis. *Vet Res.* 2005;36:313–26.
- Dubey JP, Zarnke R, Thomas NJ, Wong SK, van Bonn W, Briggs M, et al. *Toxoplasma gondii*, *Neospora caninum*, *Sarcocystis neurona*, and *Sarcocystis canis*-like infections in marine mammals. *Vet Parasitol.* 2003;116:275–96.
- Dubey JP. Toxoplasmosis: a waterborne zoonosis. *Vet Parasitol.* 2004;126:57–72.
- Foster G, Jahans KL, Reid RJ, Ross HM. Isolation of *Brucella* species from cetaceans, seals and an otter. *Vet Rec.* 1996;138:583–6.
- Harvell CD, Kim K, Burkholder JM, Colwell RR, Epstein PR, Grimes DJ, et al. Emerging marine diseases: climate links and anthropogenic factors. *Science.* 1999;285:1505–10.
- Ross HM, Jahans KL, MacMillan AP, Reid RJ, Thompson PM, Foster G. *Brucella* species infection in North Sea seal and cetacean populations. *Vet Rec.* 1996;138:647–8.
- Ewalt DR, Payeur JB, Martin BM, Cummins DR, Miller WG. Characteristics of a *Brucella* species from a bottlenose dolphin (*Tursiops truncatus*). *J Vet Diagn Invest.* 1994;6:448–52.
- LaScola B, Raoult D. Culture of *Bartonella quintana* and *Bartonella henselae* from human samples: a 5-year experience (1993–1998). *J Clin Microbiol.* 1999;37:1899–1905.
- Turnbull BS, Cowan DF. Angiomatosis, a newly recognized disease in Atlantic bottlenose dolphins (*Tursiops truncatus*) from the Gulf of Mexico. *Vet Pathol.* 1999;36:28–34.

Address for correspondence: Edward B. Breitschwerdt, Department of Clinical Sciences, College of Veterinary Medicine, North Carolina State University, 4700 Hillsborough St, Raleigh, NC 27606, USA; fax: 919-513-6336; email: ed\_breitschwerdt@ncsu.edu

All material published in Emerging Infectious Diseases is in the public domain and may be used and reprinted without special permission; proper citation, however, is required.

---

# Antimicrobial-drug Susceptibility of Human and Animal *Salmonella* Typhimurium, Minnesota, 1997–2003

Stephanie D. Wedel,\* Jeffrey B. Bender,† Fe T. Leano,\* David J. Boxrud,\* Craig Hedberg,‡ and Kirk E. Smith\*

We compared antimicrobial resistance phenotypes and pulsed-field gel electrophoresis (PFGE) subtypes of 1,028 human and 716 animal *Salmonella enterica* serotype Typhimurium isolates from Minnesota from 1997 to 2003. Overall, 29% of human isolates were multidrug resistant. Predominant phenotypes included resistance to ampicillin, chloramphenicol or kanamycin, streptomycin, sulfisoxazole, and tetracycline (ACSSuT or AKSSuT). Most human multidrug-resistant isolates belonged to PFGE clonal group A, characterized by ACSSuT resistance (64%), or clonal group B, characterized by AKSSuT resistance (19%). Most animal isolates were from cattle (n = 358) or swine (n = 251). Eighty-one percent were multidrug resistant; of these, 54% were at least resistance phenotype ACSSuT, and 43% were at least AKSSuT. More than 80% of multidrug-resistant isolates had a clonal group A or B subtype. Resistance to ceftriaxone and nalidixic acid increased, primarily among clonal group A/ACSSuT isolates. Clonal group B/AKSSuT isolates decreased over time. These data support the hypothesis that food animals are the primary reservoir of multidrug-resistant *S. Typhimurium*.

Nontyphoidal salmonellae are a leading cause of acute gastroenteritis in the United States (1). *Salmonella enterica* serotype Typhimurium is the most common serotype isolated from humans (2). In the 1990s, multidrug-resistant (MDR) *S. Typhimurium* definitive phage type 104 (DT104) emerged in the United States; most isolates were resistant to ampicillin, chloramphenicol, streptomycin, sulfisoxazole, and tetracycline (resistance phenotype [R-type] ACSSuT) (3). *S. Typhimurium* R-type AKSSuT (with resistance to kanamycin) has also recently

emerged in the United States (4). Several studies have documented adverse health effects due to the increasing resistance observed in *S. Typhimurium* (5–9). These effects include an increased risk for infection with *S. Typhimurium* (5), increased risk for bloodstream infection (6), increased risk for hospitalization (6,7), treatment failures (8), and increased risk for death (9).

MDR *S. Typhimurium* strains have been well documented in food animals, as have MDR *S. Typhimurium* outbreaks in humans from animal contact or foods of animal origin (8,10–17). However, contemporaneous parallel data on resistance in human and animal *S. Typhimurium* isolates in the United States are limited (18), and an advisory panel has called for linking surveillance for bacterial resistance in animals and humans to further evaluate the human health effects of antimicrobial drug use in agriculture (19). The objectives of our study were to evaluate antimicrobial resistance and molecular subtyping data from all human clinical *S. Typhimurium* isolates received through statewide, population-based, active laboratory surveillance in Minnesota and to compare the human isolates to isolates from clinically ill animals in Minnesota identified by the Minnesota Veterinary Diagnostic Laboratory (MVDL).

## Methods

### Human and Animal Isolates

The Minnesota Department of Health (MDH) requires clinical laboratories to submit all *Salmonella* isolates to its public health laboratory as part of active, laboratory-based surveillance. MDH audits clinical laboratories to ensure complete reporting. Human *S. Typhimurium* isolates submitted to MDH from 1997 to 2003 were eligible for this study. Isolates that were part of an identified outbreak were excluded, except for the index case-isolate. Isolates from

---

\*Minnesota Department of Health, Minneapolis, Minnesota, USA; †University of Minnesota College of Veterinary Medicine, St. Paul, Minnesota, USA; and ‡University of Minnesota School of Public Health, Minneapolis, Minnesota, USA

secondary cases in household clusters and duplicate submissions from the same case also were excluded.

MVDL is a regional laboratory for veterinarians; pertinent diagnostic samples are cultured for *Salmonella* spp. Isolates are sent to the National Veterinary Services Laboratories (Ames, Iowa) for serotyping. Confirmed *S. Typhimurium* isolates are forwarded to MDH. *S. Typhimurium* isolates obtained from diagnostic specimens from sick animals cultured at MVDL from 1997 to 2003 were eligible for this study. Isolates from the same farm with the same pulsed-field gel electrophoresis (PFGE) subtype discovered within 1 year of the initial isolate collection date were excluded. Research animal submission, environmental sample, and non-Minnesota animal isolates were excluded.

### Study Populations

From 1997 to 2003, a total of 4,333 culture-confirmed cases of human salmonellosis were reported in Minnesota. *S. Typhimurium* was the most common serotype; it accounted for 1,193 (28%) cases overall (median 172 cases/year, range 124–201). Of the 1,193 human *S. Typhimurium* case-isolates, 1,028 (86%) were included in this study (Table 1).

A total of 716 animal isolates were included in this study (median 91/year, range, 67–150) (Table 1). Isolates represented 644 farms and animal owners and 72 of 87 Minnesota counties. Most isolates were of bovine (n = 358, 50%) or porcine (n = 251, 35%) origin. Cattle isolates decreased markedly over time: 106 isolates in 1997, 100 isolates in 1998, 49 isolates in 1999, 31 isolates in 2000,

29 isolates in 2001, 18 isolates in 2002, and 25 isolates in 2003. Conversely, swine isolates increased over time: 32 isolates in 1997, 27 isolates in 1998, 33 isolates in 1999, 22 isolates in 2000, 44 isolates in 2001, 39 isolates in 2002, and 54 isolates in 2003. The remaining isolates included 38 (5%) avian (5 turkey, 1 chicken, 7 unknown, and 25 miscellaneous species), 29 (4%) equine, 21 (3%) feline, 7 (1%) canine, and 12 (2%) other species.

### Isolate Testing

All *S. Typhimurium* isolates (including variant Copenhagen) submitted to MDH were confirmed as *S. Typhimurium* and subtyped by PFGE. PFGE patterns were compared by using BioNumerics software (Applied Maths, Sint-Martens-Latem, Belgium) with the Dice coefficient and a 1% band matching criterion (20). Patterns with no visible differences were considered indistinguishable. Subtypes for *S. Typhimurium* at MDH are designated with the prefix "TM" followed by a number (e.g., TM123). PFGE patterns are also submitted to the PulseNet national database. Antimicrobial susceptibility testing was performed with the disc diffusion method and interpretive standards of the National Committee for Clinical and Laboratory Standards (NCCLS) (21). Antimicrobial susceptibility was determined for ampicillin (A), chloramphenicol (C), kanamycin (K), streptomycin (S), sulfisoxazole (Su), tetracycline (T), cephalothin (Ct), ceftriaxone (Cr), ciprofloxacin (Cp), gentamicin (G), nalidixic acid (Na), and trimethoprim/sulfamethoxazole (Sxt). The Etest for MIC was performed on isolates with intermediate susceptibility to ceftriaxone by disc diffusion; MICs

Table 1. Multidrug-resistance phenotypes of *Salmonella enterica* serovar Typhimurium isolates from Minnesota residents and animals, 1997–2003\*

Resistance phenotype	No. isolates															
	1997		1998		1999		2000		2001		2002		2003		Total	
	Hu	An	Hu	An	Hu	An	Hu	An	Hu	An	Hu	An	Hu	An	Hu	An
At least pentaresistant	53	132	55	124	50	81	41	49	46	67	22	55	29	72	296	580
AKSSuT	14	76	15	72	11	38	5	18	5	13	2	5	1	10	53	232
ACSSuT	29	18	26	20	26	18	27	17	30	37	12	32	20	38	170	180
At least pentaresistant but not AC or AK	10	38	14	32	13	25	9	14	11	17	8	18	8	24	73	168
ACKSSuT	3	12	4	17	4	4	0	2	0	5	1	2	0	4	12	46
At least ACSSuT + Cr and/or Na†‡	1	3	0	3	0	3	4	1	5	1	2	4	3	8	15	23
At least AKSSuT + Cr and/or Na†‡	1	0	0	0	0	0	0	0	1	0	0	0	0	0	2	0
ACSSuT§ + ≥2 drugs	1	0	0	3	0	1	0	1	4	2	1	1	4	2	10	10
AKSSuT§ + ≥2 drugs	3	1	1	0	1	0	0	0	1	0	0	3	1	3	7	7
ACKSSuT + ≥1 drug	1	20	6	8	0	12	3	5	1	3	1	7	1	9	13	64

\*Hu, human; An, animal; A, ampicillin; C, chloramphenicol; K, kanamycin; S, streptomycin; Su, sulfisoxazole; T, tetracycline; Cr, ceftriaxone; Na, nalidixic acid.

†Resistance phenotype ACKSSuT isolates are included as ACSSuT but not AKSSuT.

‡Resistance phenotype ACSSuT accounted for 11 (61%) of 18 human ceftriaxone-resistant isolates, 10 (91%) of 11 human nalidixic acid-resistant isolates, 22 (88%) of 25 animal ceftriaxone-resistant isolates, and 2 (50%) of 4 animal nalidixic acid-resistant isolates. Seven human isolates and 1 animal isolate (from a turkey) were resistant to both ceftriaxone and nalidixic acid; all were multidrug resistant; and 6 of 7 human and the animal isolate were also at least ACSSuT. No isolates were resistant to ciprofloxacin.

§Resistance phenotype ACKSSuT not included as ACSSuT or AKSSuT.

were interpreted according to NCCLS criteria (21). An MIC of 48 µg/mL was considered resistant. Multidrug resistance was defined as resistance to  $\geq 5$  antimicrobial drugs.

PFGE data were analyzed by the first 3 tiers of criteria described by Tenover et al. (0, 1- to 3-, and 4- to 6-band differences) (22). Two primary PFGE subtype clusters that accounted for a large proportion of MDR isolates were identified on the basis of a  $\leq 3$ -band difference: 1) clonal group A (CGA), composed of subtypes  $\leq 3$  bands different from PFGE subtype TM5b, and 2) clonal group B (CGB), composed of subtypes  $\leq 3$  bands different from PFGE subtype TM54.

### Statistical Analysis

Resistance was analyzed in terms of R-types ACSSuT, AKSSuT, and ACKSSuT. R-type ACKSSuT isolates were included in analyses of “at least R-type ACSSuT” isolates, but not “at least R-type AKSSuT” isolates. Where indicated, ACKSSuT isolates were evaluated independently of ACSSuT. R-types were analyzed in terms of clonal group. The  $\chi^2$  test for trend was used to evaluate resistance trends (EpiInfo 6.04d, Centers for Disease Control and Prevention, Atlanta, GA, USA). Proportions were compared by using the  $\chi^2$  test. Uncorrected p value and exact 95% mid-p limits for the maximum likelihood estimate of the odds ratio (OR) were used. A p value  $\leq 0.05$  was considered significant.

## Results

### Human Isolates

Of the 1,028 *S. Typhimurium* isolates, 455 (44%) were resistant to  $\geq 1$  antimicrobial drug, and 296 (29%) were MDR (Table 1). Among MDR isolates, 217 (73%) were at least R-type ACSSuT, and 64 (22%) were at least AKSSuT (Table 2). The proportion of MDR isolates decreased from

32% in 1997 to 25% in 2003 ( $\chi^2$  for linear trend 6.3,  $p = 0.01$ ) (Figure 1). The proportion that were at least AKSSuT also decreased, from 10% in 1997 to 3% in 2003 ( $\chi^2$  for linear trend 17.7,  $p < 0.001$ ).

Eighteen (1.8%) isolates were resistant to ceftriaxone; all were MDR (Table 1). Ceftriaxone resistance was more prevalent from 2000 to 2003 (2.8%) than from 1997 to 1999 (0.6%) (OR 4.6, 95% confidence interval [CI] 1.4–20.0,  $p = 0.008$ ). Eleven (1.2%) isolates were resistant to nalidixic acid; all were MDR. Nalidixic acid resistance was more prevalent from 2000 to 2003 (1.8%) than from 1997 to 1999 (0.2%) (OR 9.2, 95% CI 1.5–200.8,  $p = 0.011$ ). Fifty-one (5%) isolates were resistant to trimethoprim-sulfamethoxazole. Of these, 34 (67%) were MDR, including 20 (39%) that were at least R-type ACSSuT and 6 (12%) that were at least AKSSuT. Forty-three (4%) isolates were resistant to gentamicin; of these, 23 (53%) were MDR.

We identified 271 unique PFGE subtypes among the 1,028 human *S. Typhimurium* isolates (median 63 subtypes/year, range 52–72). The 10 most common subtypes accounted for 509 (50%) isolates. CGA was composed of 31 PFGE subtypes. These subtypes accounted for 217 (21%) of all 1,028 human isolates, 188 (64%) of 296 MDR isolates, and 181 (83%) of 217 isolates that were at least R-type ACSSuT, including 12 isolates that were at least R-type ACKSSuT (Table 2, Figures 2 and 3).

CGB was composed of 20 subtypes and accounted for 81 (8%) of all 1,028 human isolates, 55 (19%) of 296 MDR isolates, and 51 (80%) of 64 isolates that were at least R-type AKSSuT (Table 2, Figures 2 and 3). The number of isolates with CGB subtypes decreased substantially from 2001 to 2003 (Figure 2).

### Animal Isolates

Overall, 640 (89%) of the 716 animal *S. Typhimurium* isolates were resistant to  $\geq 1$  antimicrobial drug, and 580

Table 2. Distribution of human and animal isolate resistance phenotypes in PFGE clonal groups, Minnesota 1997–2003\*

Clonal group†	No. isolates by resistance phenotype					Total
	At least ACSSuT‡	At least AKSSuT‡	At least ACKSSuT	Other resistance phenotypes	Pansusceptible isolates	
<b>Human isolates</b>						
Clonal group A	169	1	12	27	8	217
Clonal group B	1	51	1	23	5	81
Other	22	12	12	124	560	730
Total	192	64	25	174	573	1,028
<b>Animal isolates</b>						
Clonal group A	182	3	67	10	2	264
Clonal group B	1	227	21	27	2	278
Other	21	20	23	38	72	174
Total	204	250	111	75	76	716

\*PFGE, pulsed-field gel electrophoresis; A, ampicillin; C, chloramphenicol; K, kanamycin; S, streptomycin; Su, sulfisoxazole; T, tetracycline.

†Clonal groups are composed of subtypes that are  $\leq 3$  bands different from PFGE subtype TM5b (clonal group A) or  $\leq 3$  bands different from subtype TM54 (clonal group B).

‡Does not include ACKSSuT.

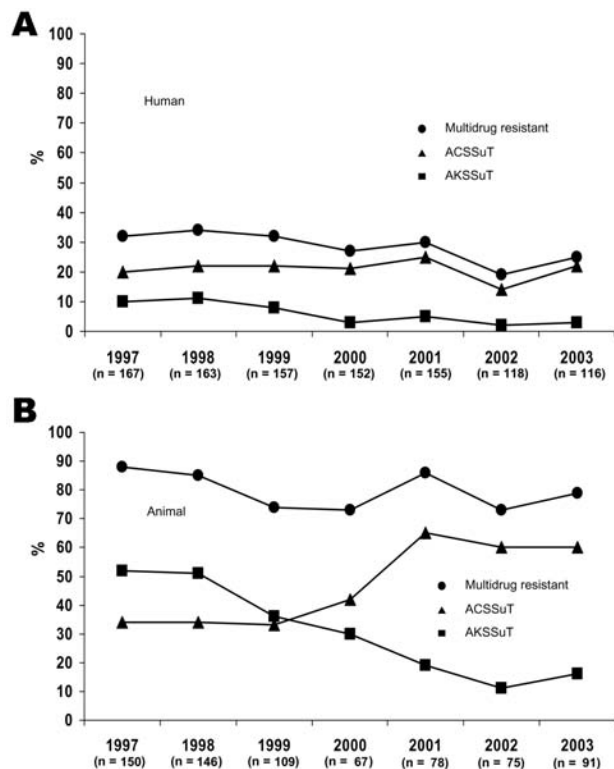

Figure 1. Percentage of *Salmonella enterica* serovar Typhimurium isolates from Minnesota humans (A) and animals (B) with multidrug resistance (i.e., resistance to  $\geq 5$  antimicrobial drugs), including resistance phenotypes (R-types) ACSSuT and AKSSuT, 1997–2003. A, ampicillin; C, chloramphenicol; K, kanamycin; S, streptomycin; Su, sulfisoxazole; T, tetracycline. R-type ACKSSuT is included as R-type ACSSuT but not AKSSuT.

(81%) were MDR (Table 1). Of the 580 MDR isolates, 315 (54%) were at least ACSSuT, and 250 (43%) were at least AKSSuT (Table 2). The proportion of isolates that were at least ACSSuT increased over time ( $\chi^2$  for linear trend 39.5,  $p < 0.001$ ). Conversely, the proportion that were at least AKSSuT decreased ( $\chi^2$  for linear trend 71.7,  $p < 0.001$ ) (Figure 1).

Of the 358 cattle isolates, 205 (57%) were at least R-type AKSSuT, and 101 (28%) were at least ACSSuT. The decrease in cattle isolates over time reflected a decrease in the number that were at least AKSSuT (Figure 2). In addition, the proportion of cattle isolates that were at least AKSSuT decreased significantly over time ( $\chi^2$  for linear trend 8.9,  $p = 0.003$ ).

Of the 251 swine isolates, 180 (72%) were at least R-type ACSSuT, and 30 (12%) were at least AKSSuT. The increase in swine isolates over time reflected an increase in the number that were at least ACSSuT (Figure 2). In addition, the proportion of swine isolates that were at least ACSSuT increased significantly over time ( $\chi^2$  for linear

trend 25.4,  $p < 0.001$ ). Nine (24%) of 38 avian isolates, 19 (66%) of 29 equine isolates, and 15 (71%) of 21 feline isolates were MDR.

Twenty-five (3.5%) animal isolates were resistant to ceftriaxone. Ceftriaxone resistance was more prevalent from 2000 to 2003 (5.1%) than from 1997 to 1999 (2.2%) (OR 2.4, 95% CI 1.0–5.7,  $p = 0.035$ ). Twelve ceftriaxone-resistant isolates were from cattle, and 10 were from swine. Four (0.6%) animal isolates were resistant to nalidixic acid, including 1 bovine isolate in 1997 and 3 turkey isolates in 2003. Eighty-one (11%) animal isolates were resistant to trimethoprim-sulfamethoxazole. Of these, 79 (98%) were MDR, and 62 (77%) were at least ACSSuT. Seventy-one (10%) animal isolates were resistant to gentamicin. Of these, 69 (97%) were MDR, and 44 (62%) were at least ACSSuT.

A total of 190 unique PFGE subtypes were identified among the 716 animal isolates (median 36 subtypes/year, range 31–47). Among animal isolates, CGA was composed of 48 PFGE subtypes. CGA accounted for 264 (37%) of all 716 animal isolates, 256 (44%) of 580 MDR isolates, and 249 (79%) of 315 isolates that were at least R-type ACSSuT, including 67 at least ACKSSuT isolates (Table 2, Figures 2 and 3). CGB was composed of 35 subtypes. CGB accounted for 278 (39%) of all 716 animal isolates, 250 (43%) of 580 MDR isolates, and 227 (91%) of 250 isolates that were at least R-type AKSSuT.

Distribution of PFGE subtypes differed by species and year (Figures 2 and 4). CGB subtypes occurred predominantly in cattle and accounted for 67% of cattle isolates. As with AKSSuT isolates, CGB subtype isolates were numerous in cattle from 1997 to 1998, but the number dropped markedly in 2002 and 2003 (Figure 2). CGA subtype isolates increased in swine from 2000 to 2003 and substantially outnumbered CGA cattle isolates during those years. CGA isolates in cattle were most common from 1997 to 1998 and then declined to a relatively stable, low level (Figure 2).

Of 9 MDR avian isolates, 5 were in CGA and 1 was in CGB. Of 19 MDR equine isolates, 4 were in CGA and 5 were in CGB. Of 15 MDR feline isolates, 8 were in CGA and 6 were in CGB.

#### Animal-Human Isolate Comparison

Combining the 1,028 human and 716 animal *S. Typhimurium* study isolates, 395 PFGE subtypes were identified. Sixty-six subtypes occurred both in animals and humans. These 66 subtypes represented 673 (65%) of human and 537 (75%) of animal isolates. Eighteen (27%) of shared subtypes were in CGA, and 12 (18%) were in CGB.

Combining the 296 MDR human isolates and the 580 MDR animal isolates, 183 PFGE subtypes were identified.

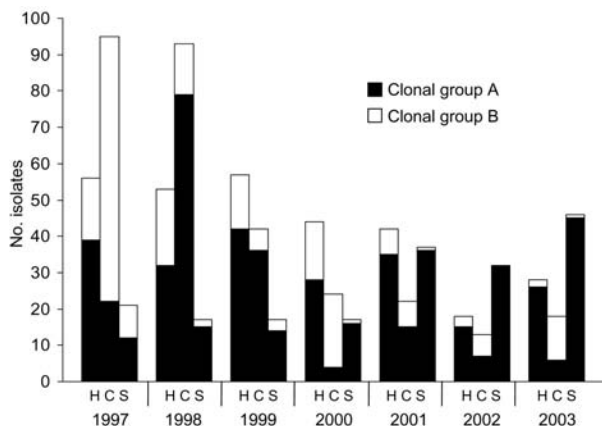

Figure 2. Distribution of *Salmonella enterica* serovar Typhimurium clonal group A pulsed-field gel electrophoresis (PFGE) subtypes and clonal group B PFGE subtypes among clinical isolates from humans and animals by species, Minnesota, 1997–2003. Clonal group A subtypes were  $\leq 3$  bands different from subtype TM5b by PFGE and were associated with resistance to ampicillin, chloramphenicol, streptomycin, sulfisoxazole, and tetracycline. Clonal group B PFGE subtypes were  $\leq 3$  bands different from subtype TM54 and were associated with resistance to ampicillin, kanamycin, streptomycin, sulfisoxazole, and tetracycline. H, C, and S indicate human, cattle, and swine isolates, respectively.

Of these subtypes, 31 occurred both among human and animal MDR isolates. These 31 subtypes represented 237 (80%) human MDR isolates and 442 (76%) animal MDR isolates. Eighteen of the 31 shared MDR subtypes were in CGA, and 7 were in CGB. Of the 296 MDR human isolates, 177 (60%) had a CGA subtype that also occurred among MDR animal isolates, and 51 (17%) had a CGB subtype that also occurred among MDR animal isolates. Of the 296 MDR human isolates, 243 (82%) belonged to CGA (64%) or CGB (19%). Of the 580 MDR animal isolates, 506 (87%) belonged to CGA (44%) or CGB (43%).

The 6 most common individual subtypes in animals, all of which were in CGA or CGB (Figure 3), were represented among human isolates (Figure 4). TM5b, the second most common animal subtype, was the most common human subtype. TM54, the most common animal subtype, was sixth in humans. TM123 was the third most common animal subtype and fifth in humans (Figure 4).

## Discussion

This study provides a comprehensive comparison of clinical human and animal *S. Typhimurium* isolates from the same area. Overall, 29% of human *S. Typhimurium* isolates in Minnesota were MDR. Isolates with at least R-types ACSSuT or AKSSuT made up almost all (95%) of MDR *S. Typhimurium* in humans. Resistance phenotypes that were at least ACSSuT predominated. The level of mul-

tidrug resistance in human isolates decreased from 1997 to 2003, corresponding to a decrease in R-type AKSSuT isolates. Resistance to at least ACSSuT was stable over time. The level of multidrug resistance observed in human isolates in Minnesota was slightly lower than that observed through the National Antimicrobial Resistance Monitoring System (NARMS) through 2002; however, multidrug resistance trends for *S. Typhimurium* generally paralleled NARMS findings (4,23).

Increasing resistance to ceftriaxone documented in human isolates in Minnesota indicated that ceftriaxone resistance continues to emerge in *S. Typhimurium* in the United States (13,24). The 1.8% resistance to nalidixic acid observed in human isolates from 2000 to 2003 was not substantially higher than the 1% resistance among NARMS isolates from 2000 to 2002 (23) but was significantly higher than that seen in our isolates from 1997 to 1999. Most of the isolates that were resistant to both ceftriaxone and nalidixic acid were from 2000 or later. Resistance to these antimicrobial agents, as well as gentamicin and trimethoprim-sulfamethoxazole, frequently occurred in isolates that were also resistant to  $\geq 5$  other antimicrobial drugs; this finding was true for all isolates that were resistant to ceftriaxone or nalidixic acid. Resistance to these clinically important antimicrobial drugs was associated most frequently with ACSSuT resistance rather than AKSSuT resistance.

The increasing resistance to ceftriaxone and nalidixic acid (an elementary quinolone) is of concern because extended-spectrum cephalosporins and fluoroquinolones are needed to treat serious *Salmonella* infections. Recent experiences in Denmark have shown treatment failures and excess deaths associated with quinolone-resistant *S. Typhimurium* (8,9). The addition of resistance to clinically useful antimicrobial drugs to already-pentaresistant R-types is added cause for concern because pentaresistant *S. Typhimurium* strains are more likely to cause infection (5) and adverse health outcomes (6,7) than drug-susceptible strains.

Despite the overall diversity observed among *S. Typhimurium* isolates by PFGE, human MDR isolates were highly clonal. Even when a relatively stringent definition of a clonal group ( $\leq 3$ -band difference) was used,  $>80\%$  of human MDR isolates composed 2 clonal groups. CGA isolates were characterized by ACSSuT resistance and represented most human MDR isolates. Of isolates from this study that were previously phage typed, those in CGA have all been in the DT104 complex (12,25,26). The clonal nature of ACSSuT/DT104 *S. Typhimurium* in the United States has been well documented (20,27).

CGB isolates were characterized by AKSSuT resistance. This group accounted for 19% of human MDR isolates overall but was more prevalent early in the study,

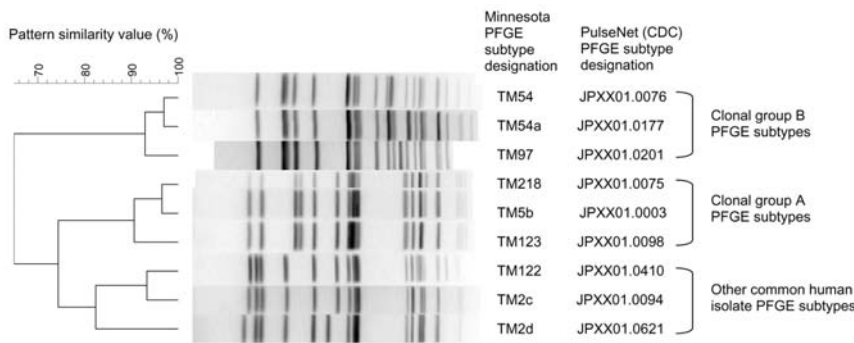

Figure 3. Pulsed-field gel electrophoresis (PFGE) patterns of common *Salmonella enterica* serovar Typhimurium subtypes observed among clinical isolates from humans and animals in Minnesota. The 3 clonal group B (CGB) PFGE subtypes represent the 3 most common CGB subtypes in animals and humans. The 3 clonal group A (CGA) PFGE subtypes represent the most common CGA subtypes in animals and humans. PulseNet designations are those used in the PulseNet national database of the Centers for Disease Control and Prevention (CDC).

after which a marked decline occurred. As with the ACSSuT/DT104 complex, AKSSuT isolates appear to be largely clonal in nature.

Most *S. Typhimurium* isolates from clinically ill animals in Minnesota were MDR, which emphasizes that MDR strains are prevalent animal pathogens (10). High resistance levels occurred in all species, throughout the state, and during the entire study period. As with humans, most MDR animal isolates were in either the CGA/ACSSuT (DT104) or CGB/AKSSuT clonal groups. PFGE subtypes found among human and animal MDR isolates were remarkably similar. This similarity is striking considering that Minnesota residents may be exposed to *S. Typhimurium* during travel or from food produced outside Minnesota.

Among animals, the CGB/AKSSuT clonal group was most common in cattle. The sharp decrease in CGB isolates in cattle was mirrored by a similar decrease in humans. The cause of this decrease in cattle is not known. The CGA/ACSSuT clonal group was distributed more evenly among all animal species but became more common in swine over time. The cause for the increase in swine CGA/ACSSuT isolates is not known.

MDR *S. Typhimurium* strains similar to those from our study have been recovered from food animals and retail meat products by other investigators, and multiple MDR *S. Typhimurium* outbreaks caused by foods of animal origin or animal contact have been documented (8,10,11,13–16,28,29). Our data provide additional evidence that food animals are the primary reservoir of MDR *S. Typhimurium* for humans; MDR *S. Typhimurium* that belong to CGA or CGB were documented in cattle or swine herds on hundreds of farms throughout Minnesota. Testing isolates with additional genetic subtyping methods and identifying resistance determinants would help further characterize the relationship between animal and human isolates (22,30). In addition, data on use of antimicrobial drugs in animal production (which are currently unavailable in the United States because requirements are lacking) would be helpful in assessing this issue.

Although the number of isolates was relatively small, the level of multidrug resistance was high in both cat and horse isolates. CGA/ACSSuT and CGB/AKSSuT isolates were observed in both species. The importance of these infections in companion animals has been demonstrated by recent MDR *S. Typhimurium* outbreaks in humans associated with small animal veterinary facilities, including a Minnesota outbreak of CGA/ACSSuT DT104 infections in persons who adopted infected kittens from a humane society (12).

The source of animal isolates for our study is a limitation in that *Salmonella* isolates from clinically ill animals overstate the level of antimicrobial resistance observed in isolates from healthy animals; therefore, strains from ill animals are not representative of strains carried by animals at slaughter (31,32). However, when we have evaluated *S. Typhimurium* isolates from other studies, the most prominent CGA and CGB subtypes from our study also have been found in healthy food animals or their environments. For example, TM5b and TM123 isolates were recovered

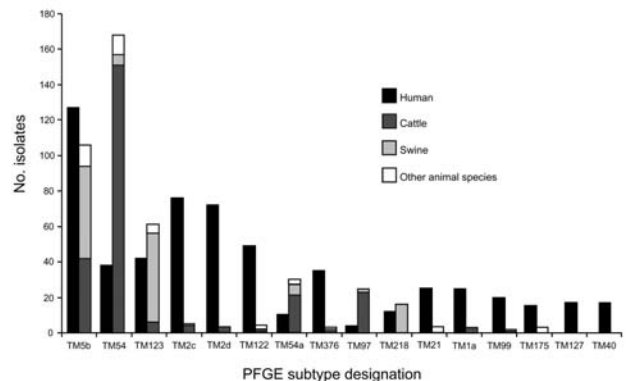

Figure 4. Frequency of pulsed-field gel electrophoresis (PFGE) subtypes that occurred  $\geq 15$  times among clinical human or animal *Salmonella enterica* serovar Typhimurium isolates in Minnesota, 1997–2003. Subtypes TM5b, TM123, and TM218 are part of clonal group A (subtypes  $\leq 3$  bands different from subtype TM5b). Subtypes TM54, TM54a, and TM97 are part of clonal group B (subtypes  $\leq 3$  bands different from subtype TM54).



from healthy, market-ready pigs at slaughter (J.B. Bender, unpub. data). Subtypes TM5b, TM123, and TM54 were represented among poultry isolates evaluated by Rajashekara et al. (28). In a study of *Salmonella* isolates on dairy farms in 4 states, including Minnesota, subtypes TM5b and TM54 were recovered from healthy dairy cows or environmental samples (33). Finally, MDR *S. Typhimurium* is present in the retail meat supply; in a recent study, almost all strains of *S. Typhimurium* recovered from ground meat (pork and chicken) were MDR phage types DT104 or DT208 (29).

Another limitation of our study was the underrepresentation of poultry isolates. Minnesota is a leading poultry producer; however, most poultry diagnostics are conducted by the Minnesota Poultry Testing Laboratory. This laboratory has documented DT104 in Minnesota poultry (28). In our study, 3 of 4 nalidixic acid-resistant animal isolates were from turkeys, even though very few turkey isolates were tested. The role of poultry as a potential reservoir for MDR *S. Typhimurium*, including nalidixic acid-resistant strains, should be more thoroughly evaluated.

We agree with other investigators that the emergence of multidrug resistance in *S. Typhimurium* is associated with the widespread dissemination of clonal groups (27,34). The changing trends of MDR *S. Typhimurium* in cattle versus swine observed in our study and the presence of MDR strains in poultry indicate that more study of individual subtypes and resistance determinants (including specific mobile genetic elements) is required to understand the movement of these strains within and between animal species. Improved biosecurity practices to interrupt dissemination are undoubtedly the key in controlling these strains (27).

The potential role of the selection pressure of antimicrobial drugs used in animal agriculture in the dissemination of MDR *S. Typhimurium* clonal groups must be considered. The ability of MDR *S. Typhimurium* strains to accumulate additional resistances allows them to survive under a wide range of conditions when antimicrobial agents are used. Use of antimicrobial drugs to which MDR *S. Typhimurium* strains are already resistant may increase the number of animals infected with these strains and the number of animals that manifest clinical illness. This use is inherently likely to contribute to increased dissemination, both within and between farms. Thus, we encourage the judicious use of all antimicrobial drugs in animals as well as in humans. In particular, the recommendation (19) that nonessential uses of specific antimicrobial drugs in food animals should be eliminated (e.g., the use of tetracyclines and penicillins for growth promotion and feed efficiency) has merit. MDR *S. Typhimurium* strains are serious pathogens in food animals and humans. Restricting conditions that favor their dissemination should return the

benefits of reduced incidence and severity of *S. Typhimurium* infections in both animals and humans.

### Acknowledgments

We thank laboratory staff at the University of Minnesota Veterinary Diagnostic Laboratory, John Besser and staff at the Minnesota Department of Health Public Health Laboratory for their work with *Salmonella* isolates for this project, and staff from the Minnesota Department of Health Acute Disease Investigation and Control Section, who participated in data collection for this project or reviewed this manuscript.

This work was supported in part through cooperative agreements with the Centers for Disease Control and Prevention (CDC) Emerging Infections Program, Foodborne Diseases Active Surveillance Network (FoodNet) (U50/CCU511190-10) and the CDC Epidemiology and Laboratory Capacity for Infectious Diseases Program (U50/CCU519683-04-4).

Ms Wedel is an epidemiologist in the Minnesota Department of Health, Foodborne, Vectorborne, and Zoonotic Diseases Unit. Her professional interests include foodborne diseases, zoonotic diseases, molecular epidemiology, and antimicrobial resistance of foodborne bacterial pathogens.

### References

1. Mead PS, Slutsker L, Dietz V, McCaig LF, Bresee JS, Shapiro C, et al. Food-related illness and death in the United States. *Emerg Infect Dis.* 1999;5:607–25.
2. Salmonellosis—technical information [monograph on the Internet]. 2003 Dec [cited 2005 Jan]. Available from [http://www.cdc.gov/ncidod/dbmd/diseaseinfo/salmonellosis\\_t.htm](http://www.cdc.gov/ncidod/dbmd/diseaseinfo/salmonellosis_t.htm)
3. Glynn MK, Bopp C, Dewitt W, Dabney P, Mokhtar M, Angulo FJ. Emergence of multidrug-resistant *Salmonella enterica* serotype Typhimurium DT104 infections in the United States. *N Engl J Med.* 1998;338:1333–8.
4. Rabatsky-Ehr T, Wichard J, Rossiter S, Holland B, Stamey K, Headrick ML, et al. Multidrug-resistant strains of *Salmonella enterica* Typhimurium, United States, 1997–1998. *Emerg Infect Dis.* 2004;10:795–801.
5. Glynn MK, Reddy V, Hutwagner L, Rabatsky-Ehr T, Shiferaw B, Vugia DJ, et al. Prior antimicrobial use increases the risk of sporadic infections with multidrug-resistant *Salmonella enterica* serotype Typhimurium: a FoodNet case control study, 1996–1997. *Clin Infect Dis.* 2004;38(Suppl 3):S227–36.
6. Varma JK, Mølbak K, Barrett TJ, Beebe JL, Jones TF, Rabatsky-Ehr T, et al. Antimicrobial-resistant nontyphoidal *Salmonella* is associated with excess bloodstream infections and hospitalizations. *J Infect Dis.* 2005;191:554–61.
7. Martin LJ, Fyfe M, Doré K, Buxton JA, Pollari F, Henry B, et al. Increased burden of illness associated with antimicrobial-resistant *Salmonella enterica* serotype Typhimurium infections. *J Infect Dis.* 2004;189:377–84.
8. Mølbak K, Baggesen DL, Aarestrup FM, Ebbesen JM, Engberg J, Frydendahl K, et al. An outbreak of multidrug-resistant, quinolone-resistant *Salmonella enterica* serotype Typhimurium DT104. *N Engl J Med.* 1999;341:1420–5.
9. Helms M, Vastrup P, Gerner-Smidt P, Mølbak K. Excess mortality associated with antimicrobial drug-resistant *Salmonella* Typhimurium. *Emerg Infect Dis.* 2002;8:490–5.

10. Akkina JE, Hogue AT, Angulo FJ, Johnson R, Petersen KE, Saini PK, et al. Epidemiologic aspects, control, and importance of multiple-drug resistant *Salmonella* Typhimurium DT104 in the United States. *J Am Vet Med Assoc.* 1999;214:790–8.
11. Cody SH, Abbott SL, Marfin AA, Schulz B, Wagner P, Robbins K, et al. Two outbreaks of multidrug-resistant *Salmonella* serotype Typhimurium DT104 infections linked to raw-milk cheese in northern California. *JAMA.* 1999;281:1805–10.
12. Wright JG, Tengelsen LA, Smith KE, Bender JB, Frank RK, Grendon JH, et al. Multidrug-resistant *Salmonella* Typhimurium in four animal facilities. *Emerg Infect Dis.* 2005;11:1235–41.
13. Fey PD, Safranek TJ, Rupp ME, Dunne EF, Ribot E, Iwen PC, et al. Ceftriaxone-resistant salmonella infection acquired by a child from cattle. *N Engl J Med.* 2000;342:1242–9.
14. Wall PG, Morgan D, Lamden K, Griffin M, Threlfall EJ, Ward LR, et al. Transmission of multi-resistant strains of *Salmonella* Typhimurium from cattle to man. *Vet Rec.* 1995;136:591–2.
15. Olsen SJ, Ying M, Davis MF, Deasy M, Holland B, Iampietro L, et al. Multidrug-resistant *Salmonella* Typhimurium infection from milk contaminated after pasteurization. *Emerg Infect Dis.* 2004;10:932–5.
16. Centers for Disease Control and Prevention. Multidrug-resistant *Salmonella* serotype Typhimurium—United States, 1996. *MMWR Morb Mortal Wkly Rep.* 1997;46:308–10.
17. Davis MA, Hancock DD, Besser TE, Rice DH, Gay JM, Gay C, et al. Changes in antimicrobial resistance among *Salmonella enterica* serovar Typhimurium isolates from humans and cattle in the Northwestern United States, 1982–1997. *Emerg Infect Dis.* 1999;5:802–6.
18. Swartz MN. Human diseases caused by foodborne pathogens of animal origin. *Clin Infect Dis.* 2002;34(Suppl 3):S111–22.
19. Facts about Antibiotics in Animals and the Impact on Resistance (FAAIR) Scientific Advisory Panel. Select findings and conclusions. *Clin Infect Dis.* 2004;34(Suppl 3):S73–7.
20. Ribot EM, Wierzbka RK, Angulo FJ, Barrett TJ. *Salmonella enterica* serotype Typhimurium DT104 isolated from humans, United States, 1985, 1990, and 1995. *Emerg Infect Dis.* 2002;8:387–91.
21. National Committee for Clinical Laboratory Standards. Zone diameter interpretive standards for *Enterobacteriaceae*. Wayne (PA): The Committee; 2003. p. 20–4.
22. Tenover FC, Arbeit RD, Goering RV, Mickelsen PA, Murray BE, Persing DH, et al. Interpreting chromosomal DNA restriction patterns produced by pulsed-field gel electrophoresis: criteria for bacterial strain typing. *J Clin Microbiol.* 1995;33:2233–9.
23. Centers for Disease Control and Prevention. National Antimicrobial Resistance Monitoring System (NARMS): enteric bacteria. 2002 annual report. 2004 [cited 2005 Sep 26]. Available from [www.cdc.gov/narms/annual/2002/2002ANNUALREPORTFINAL.pdf](http://www.cdc.gov/narms/annual/2002/2002ANNUALREPORTFINAL.pdf)
24. Dunne EF, Fey PD, Kludt P, Reporter R, Mostashari F, Shillam P, et al. Emergence of domestically acquired ceftriaxone-resistant *Salmonella* infections associated with AmpC beta-lactamase. *JAMA.* 2000;284:3151–6.
25. Bender JB, Hedberg CW, Boxrud DJ, Besser JM, Wicklund JH, Smith KE, et al. Use of molecular subtyping in surveillance for *Salmonella enterica* serotype Typhimurium. *N Engl J Med.* 2001;344:189–95.
26. Bender JB, Smith KE, Forfang J, Schaeffer L, Leano FT, Boxrud D, et al. Outbreak of multidrug-resistant *Salmonella* Typhimurium DT104 in a daycare [abstract #2219]. In: Abstracts of the 39th International Conference on Antimicrobial Agents and Chemotherapy; San Francisco, California; 1999 Sep 26–29. Washington: American Society for Microbiology; 1999. p. 695.
27. Davis MA, Hancock DD, Besser TE. Multiresistant clones of *Salmonella enterica*: the importance of dissemination. *J Lab Clin Med.* 2002;140:135–41.
28. Rajashekara G, Haverly E, Halvorson DA, Ferris KE, Lauer DC, Nagaraja KV. Multidrug-resistant *Salmonella* Typhimurium DT104 in poultry. *J Food Prot.* 2000;63:155–61.
29. White DG, Zhao S, Sudler R, Ayers S, Friedman S, Chen S, et al. The isolation of antibiotic-resistant salmonella from retail ground meats. *N Engl J Med.* 2001;345:1147–54.
30. Threlfall J, Hopkins KL, Ward LR. Diversification in *Salmonella* Typhimurium DT104 [letter]. *Emerg Infect Dis.* 2005;11:980–1.
31. Dargatz DA, Fedorka-Cray PJ, Ladely SR, Ferris KE, Green AL, Headrick ML. Antimicrobial susceptibility patterns of *Salmonella* isolates from cattle in feedlots. *J Am Vet Med Assoc.* 2002;221:268–72.
32. Wells SJ, Fedorka-Cray PJ, Dargatz DA, Ferris K, Green A. Fecal shedding of *Salmonella* spp. by dairy cows on farm and at cull cow markets. *J Food Prot.* 2001;64:3–11.
33. Fossler CP, Wells SJ, Kaneene JB, Ruegg PL, Warnick LD, Bender JB, et al. Prevalence of *Salmonella* spp. on conventional and organic dairy farms. *J Am Vet Med Assoc.* 2004;225:567–73.
34. Liebana E, Garcia-Migura L, Clouting C, Clifton-Hadley FA, Lindsay E, Threlfall EJ, et al. Multiple genetic typing of *Salmonella enterica* serotype Typhimurium isolates of different phage types (DT104, U302, DT204b, and DT49) from animals and humans in England, Wales, and Northern Ireland. *J Clin Microbiol.* 2002;40:4450–6.

Address for correspondence: Stephanie D. Wedel, Acute Disease Investigation and Control Section, Minnesota Department of Health, 625 Robert St N, PO Box 64975, St. Paul, MN 55164-0975, USA; fax: 651-201-5082; email: [stephanie.wedel@health.state.mn.us](mailto:stephanie.wedel@health.state.mn.us)

EMERGING INFECTIOUS DISEASES *online*

[www.cdc.gov/eid](http://www.cdc.gov/eid)

To receive tables of contents of new issues send an email to [listserv@cdc.gov](mailto:listserv@cdc.gov) with subscribe eid-toc in the body of your message.

---

# Postepizootic Persistence of Venezuelan Equine Encephalitis Virus, Venezuela

Juan-Carlos Navarro,\* Gladys Medina,† Clovis Vasquez,‡ Lark L. Coffey,§ Eryu Wang,§ Alexander Suárez,\*‡, Hernán Biord,# Marlene Salas,¶ and Scott C. Weaver§

Five years after the apparent end of the major 1995 Venezuelan equine encephalitis (VEE) epizootic/epidemic, focal outbreaks of equine encephalitis occurred in Carabobo and Barinas States of western Venezuela. Virus isolates from horses in each location were nearly identical in sequence to 1995 isolates, which suggests natural persistence of subtype IC VEE virus (VEEV) strains in a genetically stable mode. Serologic evidence indicated that additional outbreaks occurred in Barinas State in 2003. Field studies identified known *Culex (Melanoconion)* spp. vectors and reservoir hosts of enzootic VEEV but a dearth of typical epidemic vectors. Cattle serosurveys indicated the recent circulation of enzootic VEEV strains, and possibly of epizootic strains. Persistence of VEEV subtype IC strains and infection of horses at the end of the rainy season suggest the possibility of an alternative, cryptic transmission cycle involving survival through the dry season of infected vectors or persistently infected vertebrates.

Venezuelan equine encephalitis (VEE) is a reemerging, mosquito-borne viral disease of humans and equines (1). Equines serve as highly efficient amplification hosts for mosquito-borne transmission of 2 VEE virus (VEEV) epidemic subtypes, IAB and IC. Humans become infected primarily through the bites of the large numbers of mosquitoes that can be infected by viremic horses. Enzootic VEEV strains of variants ID and IE, closely related antigenically and genetically to each other and to variants IAB and IC, circulate in lowland tropical forests and swamps

among small mammals but are incapable of equine amplification to cause epidemics (2).

After a long period of inactivity from 1973 to 1992, recent outbreaks in Venezuela (3,4), Colombia (5), and Mexico (6) underscore the continued threat of VEE in the Americas. Because recent outbreaks have occurred sporadically, often with many intervening years of epidemic inactivity, the origin of strains of VEEV subtypes IAB and IC was enigmatic for many years. Of several hypotheses proposed (7), only 2 have been supported by antigenic and genetic comparisons of VEEV strains and experimental studies. The first hypothesis, suggested by sequence data, is that some epidemics that occurred between the first isolation of VEEV in 1938 and the last outbreak involving a strain of the IAB subtype in 1973 resulted from the use of incompletely inactivated vaccines produced from strains of VEEV subtype IAB (8). The lack of VEEV subtype IAB outbreaks since inactivated virus vaccines were replaced by the TC-83 attenuated vaccine strain (a subtype IAB virus) in the early 1970s also supports this hypothesis. The second hypothesis, supported by genetic studies, is that epizootic/epidemic (henceforth called epidemic) subtype IAB and IC VEEV strains arise through mutation from enzootic subtype ID VEEV strains (9). The strongest such evidence links a small, 1992-93 Venezuelan VEE outbreak caused by a subtype IC virus strain to sympatric strains of enzootic subtype ID virus (3,10).

The last major VEE epidemic began in April 1995 in the northern Venezuelan state of Falcon and spread throughout most of northern Venezuela and into La Guajira peninsula of northeastern Colombia to cause ≈75,000–100,000 human cases with ≈300 deaths (Figure 1) (4,5). Although the total number of equine cases was not reported, it was probably of a similar order of magnitude. The

---

\*Universidad Central de Venezuela, Caracas, Venezuela; †Instituto Nacional de Investigaciones Agropecuarias, Maracay, Venezuela; ‡Instituto Nacional de Higiene, Caracas, Venezuela; #Sociedad Venezolana de Ciencias Naturales, Venezuela; ¶Ministerio de Agricultura y Tierras, Barinas, Venezuela; and §University of Texas Medical Branch, Galveston, Texas, USA

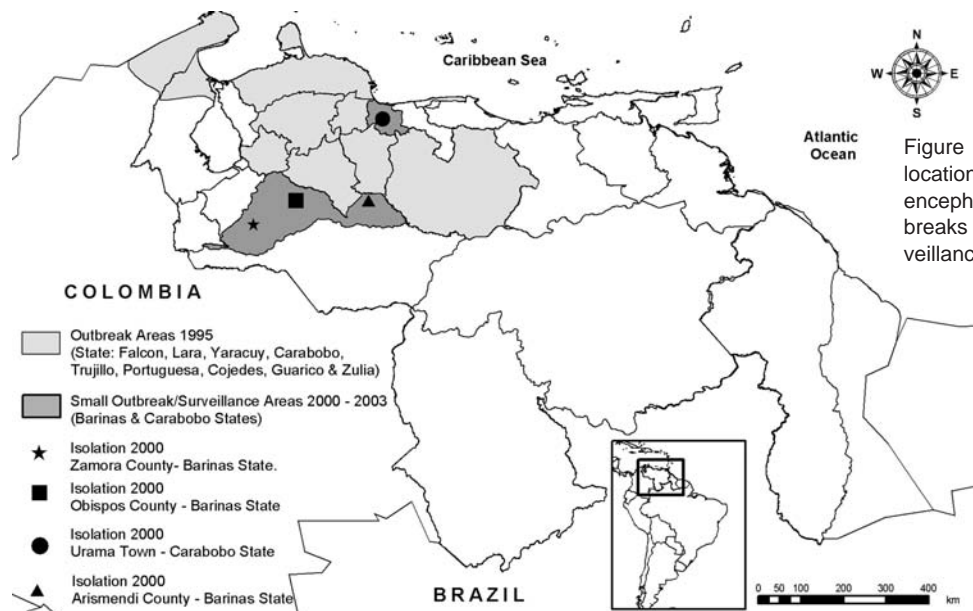

Figure 1. Map of Venezuela showing locations of the 1995 Venezuelan equine encephalitis outbreak and the small outbreaks of 2000 and 2003, along with surveillance study sites.

last equine and human cases were reported in December 1995 in Trujillo, Portuguesa, Cojedes, and Guarico States of Venezuela. After the apparent end of the 1995 outbreak, no confirmed epidemic or epizootic VEE occurred in South America for >4 years.

During December 1999 and February 2000, small, focal outbreaks of equine encephalitis were reported during the end of the rainy season and beginning of the dry season in Carabobo and Barinas States of Venezuela (Figure 1). Similar outbreaks occurred in Barinas State during October 2003. Clinical case descriptions, viral genetic studies, and preliminary surveillance in the region suggested persistence of VEEV subtype IC after 1995 in a cryptic transmission cycle.

## Materials and Methods

### Collection of Animal Samples

Arboviral surveillance was conducted in 2 regions of Barinas State: 1) Zamora and Obispos Counties and 2) Arismendi County (Figure 1). Four farms were studied in Zamora and Obispos Counties from April 2001 to October 2003: 1) El Relámpago (7°57'24"N, 70°59'20"W); 2) El Porvenir (7°49'–8°49'N; 70°37'–70°55'W); 3) La Grandeza (7°50'13"N, 70°44'25"W), and 4) Boca de Quiu (7°51'–57'N, 70°43'52"W). In Arismendi County, studies occurred in October 2003, at the end of the outbreak, on 4 farms: 1) Los Mesones (8°31'52"N, 68°21'49" W); 2) Mis Cantares (8°24'09"N, 68°17'93"W); 3) Don Eduardo (8°28'36"N, 68°21'94"), and 4) La Espuela (8°28'72"N, 68°21'68"W, including equines obtained from El Diamante). These farms, typical of the region, focus mainly on cattle production; equines are maintained for herding.

At each site, Syrian golden hamsters were exposed in *coquito* cages (11) for 7 days. Cages were suspended 1.2–1.5 m above the ground in transects at 20- to 25-m intervals, and hamsters were inspected and fed carrots daily. Blood samples were collected by cardiac puncture from moribund hamsters and from those surviving exposure; heart and spleen samples were then dissected and preserved in liquid nitrogen. The maintenance and care of animals complied with guidelines of the University of Texas Medical Branch and the Instituto Nacional de Higiene.

Parallel to the hamster transects, Sherman and Tomahawk traps were used for collecting small mammals, as described previously (12). Animals were bled by cardiac puncture and identified by using taxonomic keys (13,14).

### Mosquito Collections

Mosquitoes were collected with CDC light traps (15) baited with dry ice and suspended ≈1.5 m above the ground. Mosquitoes were identified by using taxonomic keys (16–19) and reference collections (20).

### Virus Isolations and Identification

Sera and tissues from equines, sentinel hamsters, and wild rodents were injected into 1- to 3-day-old mice or African green monkey kidney (Vero) cells for virus isolation. Viruses indicated by mouse deaths or cytopathic effects in cell culture were identified by hemagglutination inhibition (HI) tests. Subtypes of the VEEV isolates were determined by immunofluorescence by using monoclonal antibodies (MAbs), as described previously (21), and by amplifying by reverse transcriptase–polymerase chain reactions (RT-PCR) a portion of the PE2 envelope

glycoprotein precursor gene, followed by sequencing and phylogenetic analyses, as described previously (22).

### Genetic Analyses of Virus Isolates

The complete genomes or partial PE2 envelope glycoprotein precursor sequences of VEEV strains were amplified by RT-PCR using Superscript reverse transcriptase (BRL, Bethesda, MD, USA) and Pfu polymerase (Stratagene, La Jolla, CA, USA), as described previously (23). After electrophoresis, amplicons were extracted from 1% agarose gels and sequenced directly by using previously described primers (23) and the Applied Biosystems (Foster City, CA, USA) Prism automated DNA sequencing kit to produce consensus sequences. Genomic sequences, excluding the 5' terminal 20 nucleotides (nt) derived from the primer, or PE2 sequences, were submitted to the GenBank library under accession numbers AY973944 and AY986475. Sequences were aligned with homologous VEEV sequences in the GenBank library and analyzed by using neighbor-joining and maximum parsimony methods implemented in the PAUP 4.0 software package (24) and Bayesian methods with MrBayes 3 (25).

### Antibody Detection and Characterization

Serum samples were screened for VEEV antibodies by using HI with antigens prepared from the TC-83 attenuated virus vaccine strain and the South American eastern equine encephalitis virus strain C-49 (26). Antibodies from serum samples with titers  $\geq 1:20$  were confirmed by using 80% plaque reduction neutralization tests (PRNTs). To determine the VEEV subtypes that produced reactive sera, a blocking enzyme-linked immunosorbent assay (ELISA) with purified VEEV antigens and enzootic- or epidemic-specific MABs (21) was used, as described previously (27). Negative control serum specimens were obtained from animals in non-disease-endemic locations with no history of VEE.

## Results

### Description of Outbreaks

In February 2000, the Venezuelan Animal Health Service received a report of an equine encephalitis outbreak, consistent with VEE, on the Bella Vista farm in the Curito Abajo area of Zamora County, Barinas State. Simultaneously, another outbreak occurred on the Los Cerros farm in Obispos County (Figure 1). Five serum specimens were collected from stablemates of affected horses on the Bella Vista farm; 2 yielded VEEV isolates. One brain sample collected at necropsy during April 2000 on the Los Cerros farm yielded VEEV. Suspected VEE was reported in Obispos, Zamora, Pedraza, and Miranda municipalities before these VEEV isolates were confirmed

at the Instituto Nacional de Investigaciones Agropecuarias in April 2000. In addition, retrospective examination of epidemiologic records showed suspected VEE cases in Zamora County (Curito Abajo) since December 1999.

After the February 2000 outbreaks, 8 additional foci with 35 fatal equine cases were reported: 3 outbreaks in Zamora (15 deaths), 2 in Obispos (13 deaths), 2 in Pedraza (7 deaths), and 1 (no deaths) in Sucre County. Regional equine vaccination coverage with the strain TC-83 attenuated virus vaccine was 24% before the outbreaks, and additional vaccination initiated around all apparent foci in early 2000 increased coverage to 51%.

A geographically distant equine case consistent with VEE occurred in April 2000 in Carabobo State (Figure 1). The affected horse had been moved from south Guarico State (borders Obispos County of Barinas State) 10 days before onset of disease. Virus was isolated from its brain after euthanization and from the serum of a recently vaccinated stablemate. Another equine death had occurred on the same farm, but the horse had been incinerated before the cause of death could be confirmed.

Another outbreak consistent with VEE was reported in October 2003 in northeastern Barinas State around the town of Arismendi and along the nearby Guanare River basin (Figure 1). Because the affected farms were difficult to access and farmers did not initially report the cases to avoid equine quarantines, samples from affected horses were not obtained.

### Equine Serology

A total of 619 equine serum specimens from 8 different municipalities in Barinas State were tested for VEEV and eastern equine encephalitis virus (EEEV) antibodies by using HI (Table 1). Zamora and Pedraza municipalities showed the highest rates of VEEV seropositivity (44% and 48%, respectively); although vaccination was ongoing at the time of sampling, and some seropositivity undoubtedly resulted from vaccination, vaccine coverage of only  $\approx 24\%$  suggested that some horses were naturally infected. The blocking ELISA (27) cannot distinguish between strain TC-83 and subtype IC VEEV infections, so the

Table 1. Results of hemagglutination inhibition assays to detect Venezuelan equine encephalitis virus antibodies in horses

Municipality	No. serum samples tested	No. positive (%)
Obispos	199	46 (23)
Zamora	128	61 (48)
Bolivar	18	0
Pedraza	23	10 (44)
Barinas	172	37 (22)
Arismendi	9	0
Sucre	65	1 (2)
A. Arvelo Torrealba	5	1 (20)
Total	619	174 (28)

VEEV strain origins of equine antibodies could not be determined.

### Surveillance

To investigate circulation of VEEV, small mammals, known to be reservoir hosts of VEEV, and mosquitoes were trapped at 4 sites near the equine cases. Bovines  $\leq 2$  years of age that lived on the same farm for their entire life were bled as sentinels to detect recent VEEV circulation. The region of the first outbreak in 2000 included a part of Zamora and Obispos Counties, formerly included in the Ticoporo Forest Reserve (previously a rainforest, 8°12'N/70°56'W) between the Quiu and Michay Rivers, on the border between the western Llanos (plains and savannas) and the southern Andes Mountains. This area has been deforested for timber, cattle ranching, and crop farming, leaving only forest fragments and gallery forests with slopes of  $<1\%$  grade and an altitude of  $\approx 200$  m. The forested area decreased from 186,000 hectares (ha) in 1955 to 5,000 ha in 2002 (<http://www.tierramerica.net/2002/1124/ecobreves.shtml>).

The Barinas State rainy season is from April to December, and the dry season is from January to March, with mean temperatures of 22°C to 30°C. Annual precipitation averages 1,729–1,995 mm. The flora are typical of the Llanos and lowland Andean Mountains, including *Ceiba pentadra*, *Bombacopsis quinata*, *Spondia mombin*, *Chrysophyllum sericeum*, *Pouteria anibaefolia*, *Guazuma*

*tomentosa*, *Attalea maracaibensis*, and *Roystonea venezuela*. During the end of the rainy season, rivers flood adjacent lowland forests and generate habitat for water lettuce (*Pistia stratiotes*), a floating plant used as a breeding site by some *Culex* (*Melanoconion*) mosquito species.

The region of the second VEE outbreak in 2000 (Arismerendi County) also comprises lowland savannas in the Guanare River basin and includes extensive cattle production and fragmented forests resulting from deforestation. This part of Barinas State borders Guarico, Cojedes, and Portuguesa States to the north and northwest, and Apure State to the south (Figure 1). The flora is characteristic of lowland Llanos (95-m altitude) and flooded savannas: *Copernicia tectorum* (Llanos palms), *Hymenachne amplexicaulis*, *Leersia hexandra*, and *Luziola spruceana*. The climate is similar to that described above.

### Mammal Collections

A total of 130 small mammals were collected during 6,600 trap-nights, for a success rate of 1.9%. The captures and serologic data are shown in Table 2. The spiny rat (*Proechimys guairae*) and the cotton rat (*Sigmodon hispidus*), both belonging to known enzootic VEEV reservoir genera (12,28,29), as well as the cane mouse (*Zygodontomys brevicauda*), were abundant at most sites. No virus was isolated from wild mammals; HI antibodies to VEEV were detected in 4 (6.8%) of 58 *P. guairae*, 1 (25%) of 4 *Didelphis marsupialis*, and 1 (6.6%) of 15 *S.*

Table 2. Serologic results from equines, bovines, and wild mammals in regions of the 2000 and 2003 VEEV outbreaks\*

Location	Dates of collection	Species or common name	No. collected	Fraction HI seropositive	Fraction of HI-positive samples positive by PRNT	PRNT titers	
Obispos	May 2002	<i>Proechimys guairae</i>	10	0/10	NT	NT	
		<i>Zygodontomys brevicauda</i>	47	0/47	NT	NT	
Zamora	May 2003	<i>Akodon urichi</i>	2	0/2	NT	NT	
		<i>Oryzomys talamancae</i>	1	0/1	NT	NT	
		<i>Sigmodon hispidus</i>	13	0/13	NT	NT	
		<i>Zygodontomys brevicauda</i>	1	0/1	NT	NT	
		<i>Didelphis marsupialis</i>	2	0/2	NT	NT	
		<i>Proechimys guairae</i>	18	0/18	NT	NT	
		<i>Rattus rattus</i>	2	0/2	NT	NT	
		Bovines	4	0/4	NT	NT	
		June 2003	<i>Proechimys guairae</i>	6	1/6	0/1	<20
		Sep 2003	<i>Didelphis marsupialis</i>	1	1/1	0/1	<20
			<i>Proechimys guairae</i>	11	4/11	0/4	<20
			<i>Sigmodon hispidus</i>	1	1/1	0/1	<20
		Bovines	20	0/20	NT	NT	
Nov 2003	<i>Proechimys guairae</i>	10	0/10	NT	NT		
	<i>Sigmodon hispidus</i>	1	1/1	NT	NT		
Arismerendi	Oct–Nov 2003	Bovines	48	12/48	8/12	40–640	
Antonio Jose de Sucre/ Zamora	June 2003	<i>Proechimys guairae</i>	3	0/3	NT	NT	
		<i>Didelphis marsupialis</i>	1	0/1	NT	NT	
Totals		Wild mammals	130	7/130 (5%)	0/7	<20	
		Bovines	72	12/72 (17%)	8/12	40–640	

\*VEEV, Venezuelan equine encephalitis virus; HI, hemagglutination inhibition; PRNT, plaque reduction neutralization test; NT, not tested.

*hispidus*. However, HI titers were low ( $\leq 1:20$ ), and none was confirmed by PRNT ( $<20$ ). No EEEV-reactive antibodies were detected. These results suggest either very low VEEV antibody titers in some rodents or nonspecific HI reactivity.

### Bovine Serology

Bovines are effective VEE sentinels because they are naturally infected and seroconvert but no disease develops and they are not vaccinated (30). We bled cattle  $\leq 2$  years of age that had resided on the same farm for their entire life. The Zamora site showed no evidence of bovine seropositivity, with 0 of 4 positive for VEEV antibodies in May and 0 of 20 in September 2003 (Table 2). However, the Arismendi site had a 25% bovine VEEV seropositivity rate (12/48) from October to November 2003, and all positive serum samples were negative for EEEV. To determine whether the seropositive cattle were infected by enzootic or epidemic (subtype IC) VEEV strains, we used a blocking ELISA that distinguishes antibodies based on their ability to block the reaction of subtype-specific monoclonal antibodies (27). Five of the 8 PRNT-positive bovine serum specimens had consistently higher blocking activity against the enzootic virus-specific MAb, indicating exposure to enzootic VEE-complex alphaviruses (Table 3). However, 2 samples (166, 167) had similar blocking activities against both enzootic and epidemic virus-specific MAbs, which suggests either infection with both enzootic and epidemic VEEV phenotypes or nonspecific reactivity against 1 subtype.

### Mosquito Collections

Three CO<sub>2</sub>-baited CDC light traps were stationed for 2 consecutive days on each farm to assess possible VEEV

vectors as follows: May, June, and September–October, 2003 (Zamora County); October–November 2003 (Arismendi); and December 2003 (Obispos). These months correspond to the dry season and the rainy season. Maximum catches were obtained in December 2002 and November 2003, at the end of the rainy season. A total of 21 mosquito species and 5 unidentified taxa (to species level) were collected (Table 4). The most abundant species captured were *Cx. (Melanoconion) dunnii*, *Mansonia titillans*, *Cx. (Mel.) spissipes*, *Coquillettidia aribalzagae*, *Ae. scapularis*, *Cx. (Mel.) aikenii* sensu lato (*ocossa* and *panocossa*), and *Psorophora albipes*. Also, a large number of unknown *Cx. (Mel.)* spp. belonging to the *Melanoconion* Section were captured. No viruses were isolated from mosquitoes; however, 2 of the most abundant species, *Cx. ocosa* and *Cx. panocossa*, have been incriminated as enzootic VEEV vectors and *Ma. titillans* and *Ae. scapularis* were implicated as potential bridge vectors that may export VEEV from sylvatic, enzootic foci in Venezuela (31). However, typical epidemic vectors such as *Ae. taeniorhynchus* and *Ps. confinnis* were not present.

### Isolation and Genetic Analyses of VEEV Strains from Equines

Two equine brain specimens and 3 serum samples from stablemates yielded mouse deaths with CPE-inducing activity in brains. Antigenic analyses that used MAbs indicated that all isolates belonged to subtypes IAB/C. Four sequences of RT-PCR amplicons covering the PE2 gene were identical to the subtype IC strains 6119 and 3908 from the 1995 epidemic, and also to the subtype IC strains P676 and V198 from the 1962–64 epidemic (Table 5) (23). The exception was strain 254818, isolated from a stablemate of a deceased horse in Carabobo State after strain TC-

Table 3. Results of the blocking ELISA to determine VEEV subtypes producing seroconversion in HI- and PRNT-positive bovines from Arismendi municipality, Barinas State, Venezuela\*

Sample no.†	% inhibition of epizootic-specific MAb 1A3A–5 binding at indicated serum dilution			% inhibition of enzootic-specific MAb 1A1B–9 binding at indicated serum dilution		
	1:4	1:12	1:36	1:4	1:12	1:36
156	3.0	8.5	–5.0	52.4	17.8	–34.3
158	12.4	13.9	–3.6	27.0	–20.4	–37.0
166	35.6	12.5	6.2	30.7	42.7	–21.0
167	59.6	42.0	3.7	65.7	17.1	–9.9
172	–11.7	–15.4	–13.8	37.5	32.1	–19.0
175	8.2	5.0	2.1	48.5	21.5	–20.0
178	23.1	15.1	2.2	69.7	44.9	–5.9
204	–1.1	–10.8	–22.4	75.8	56.4	29.7
Negative control†	4.1	6.6	5.4	15.2	23.1	–5.7
Negative control†	9.4	14.1	12.0	8.0	14.5	15.6
Negative control†	5.8	11.4	11.3	17.5	23.2	11.0
Positive control†	18.8	9.5	–8.0	65.3	51.0	29.0
Positive control†	16.4	1.4	1.7	50.1	16.7	18.9

\*ELISA, enzyme-linked immunosorbent assay; VEEV, Venezuelan equine encephalitis virus; HI, hemagglutination-inhibition; PRNT, plaque reduction neutralization test; MAb, monoclonal antibody.

†Negative controls are bovine sera from locations with no history of VEE; positive controls are human sera from virus isolation–confirmed, subtype ID VEEV infections (note that the assay is species–independent).

## RESEARCH

Table 4. Mosquitoes collected in the regions affected by the 2000 and 2003 Venezuelan equine encephalitis outbreaks

Species	Study site			Total
	Zamora	Obispos	Arismendi	
<i>Culex (Melanoconion) dunnii</i>	133	924	25	1,082
<i>Cx. (Mel.) spissipes</i>	26	15		41
<i>Cx. (Mel.) pedroi*</i>	1			1
<i>Cx. (Mel.) theobaldi</i>	1			1
<i>Cx. (Mel.) ocozza*</i>		13	6	19
<i>Cx. (Mel.) panocossa*</i>		5		5
<i>Cx. (Mel.) sp. Mel Section</i>	24	120		144
<i>Cx. (Cux.) spp.</i>	800	132	45	977
<i>Psorophora albipes</i>	39	18		57
<i>Ps. ferox</i>	2	5		7
<i>Ps. lineata</i>	1			1
<i>Ps. cingulata</i>	7	3		10
<i>Aedes fulvus</i> †	2			2
<i>Ae. scapularis</i> †	6	44	9	59
<i>Uranotaenia calosomata</i>	17	5		22
<i>Trichoprosopon digitatum</i>	12	1		13
<i>Trichoprosopon sp.</i>		1		1
<i>Wyeomyia (Phoniomyia) sp.</i>	2			2
<i>Uranotaenia geometrica</i>	2			2
<i>Coquillettidia arribalzagae</i>	6		70	76
<i>C. nigricans</i>			5	5
<i>C. juxtamansonia</i>		7		7
<i>Mansonia titillans</i>		10	169	179
<i>Limatus asulleptus</i>		4		4
<i>Aedomyia squamipennis</i>			3	3
<i>Anopheles sp.</i>			2	2

\*Proven enzootic vectors of Venezuelan equine encephalitis virus.

†Suspected bridge vectors.

83 vaccination was initiated; this strain had a PE2 sequence identical to that of strain TC-83 (32), with the exception of a single nucleotide difference at genome position 8845 that encoded a Lys to Met change at E2 amino acid position 115.

To increase phylogenetic resolution, the complete genomes (excluding the 5' terminal 20 nt that incorporated PCR primers into amplicons) of representative strains from Carabobo (255010) and Barinas States (254934) were sequenced. The most closely related sequence to both isolates was strain 6119, isolated in May, soon after the beginning of the 1995 VEE epidemic in Falcon State. This strain differed from strains 255010 and 254934 by only 1 and 4 nt, respectively. Slightly more distantly related was strain 3908 from Zulia State in September 1995, followed by strains from the 1962–64 Venezuelan/Colombian epidemic. Only 1-nt difference among the year 2000 and 1995 VEEV isolates encoded an amino acid difference; strain 254934 had Lys at E2 position 199, whereas all other strains had Glu (Table 5).

Phylogenetic analyses that used all methods indicated that strain 6119 had a sequence identical to the predicted ancestor of strains 255010 and 254934, and branch lengths indicated interepidemic evolutionary rates of  $1.7\text{--}7.0 \times 10^{-5}$  substitutions/nucleotide/year. In contrast, during the

1995 outbreak, relative branch lengths of strains 6119 and 3908 indicated a faster evolutionary rate of  $2.0 \times 10^{-4}$  substitutions/nucleotide/year. Relative rate analyses of the 1962–64 epidemic clade resulted in similar estimates of intraepidemic evolution from  $2.2\text{--}4.4 \times 10^{-4}$  substitutions/nucleotide/year, similar to estimates of  $\approx 3 \times 10^{-4}$  substitutions/nucleotide/year for enzootic VEEV in Venezuela (23). These data indicate that the subtype IC VEEV strains persisted in Venezuela from 1995 to 2000 in a genetically stable manner, with ca. 10-fold slower rates of nucleotide substitution than are estimated to occur during epidemic or enzootic circulation.

## Discussion

Of 5 major hypotheses proposed to explain the source(s) of strains of subtypes IAB and IC responsible for all major VEE outbreaks (7), 2 are supported by previous studies: 1) several of the later VEE outbreaks caused by subtype IAB strains were probably initiated by the use of incompletely inactivated vaccines produced from early, wild-type, equine-virulent isolates (8,33); and 2) all subtype IAB and IC strains evolved independently from an enzootic lineage of subtype ID VEEV that circulates in western Venezuela, Colombia, and northern Peru (2,22). Johnson and Martin (7) also hypothesized that epidemic



Table 5. Sequence comparisons between the year 2000 VEEV virus equine isolates and those from the 1995 epidemic\*

Virus strain†	State of isolation	Horse sample	Date of collection	Passage history	Comparisons to 1995 strain 6119		Comparisons to 1995 strain 3908	
					nt differences‡	aa differences§	nt differences¶	aa differences#
254934	Barinas	Brain	Apr 10, 2000	sm-1	C1248T	–	A1443G	–
					G6325A	nsP4/V208I	T4975C	
					G9165A	E2/E199K	C5292T	–
					T10913C	–	T5475C	–
					C11237T	–	G6325A	nsP4/V208I
							A6498T	–
		G9159A	E2/E199K					
		C11237T	–					
255010	Barinas	Serum	Feb 20, 2000	sm-2	C1248T	–	A1443G	–
					T10913C	–	T4975C	–
					C11237T	–	C5292T	–
							T5475C	–
							A6498T	–
							G9159A	E2/E199K
		C11237T	–					
255005*	Barinas	Serum	Feb 20, 2000	sm-3	0	–	0	–
255057*	Carabobo	Brain	April, 2000	sm-1, V-1	0	–	0	–

\*VEEV, Venezuelan equine encephalitis virus; nt, nucleotide; aa, amino acid.

†Only partial PE2 envelope glycoprotein precursor gene sequences determined (817 nucleotides).

‡Strain 6119 residue is indicated first, followed by genome position and year 2000 strain residue.

§Strain 6119 residue is indicated first, followed by protein and amino acid position and year 2000 strain residue.

¶Strain 3908 residue is indicated first, followed by genome position and year 2000 strain residue.

#Strain 3908 residue is indicated first, followed by protein and amino acid position and year 2000 strain residue.

strains might persist between outbreaks in cryptic transmission cycles that have been overlooked, despite postepidemic surveillance in the affected areas of Colombia (11,12) and Venezuela (12,34,35).

We report the first direct evidence that supports postepidemic circulation of epidemic VEEV. During 2000 in western Venezuela, 5 years after the apparent end of the 1995 epidemic, 4 isolates of VEEV nearly identical to 1995 strains were associated with equine encephalitis in Barinas and Carabobo States. Viral sequences had undergone virtually no evolutionary change during the interepidemic period, in contrast to epidemic and enzootic virus circulation, in which a relatively steady rate of nucleotide substitutions, on the order of  $2-4 \times 10^{-4}$  substitutions/nucleotide/year, occurs (23,36). From 1995 to 2000, the subtype IC strain underwent an  $\approx 10$ -times slower evolution, which suggests less replication than normally occurs in rodent reservoir or equine amplification hosts and mosquitoes during horizontal transmission.

Our seroprevalence data from bovines also suggest that enzootic VEEV strains may have been circulating in the affected regions. Although we did not identify bovine serum that exhibited blocking activity solely against the epidemic virus-specific MAb, some samples reacted in both epidemic- and enzootic virus-specific ways. Larger samples of bovine and rodent serum are needed to more conclusively assess the subtype(s) of VEEV strains circulating in the region.

Although we could not identify the critical reservoir hosts and vectors that allow VEEV to persist in Barinas

State, the occurrence of equine cases at the end of the rainy season and beginning of the dry season suggests fundamental differences from normal epidemic or enzootic circulation. Epidemic VEEV generally occurs during the peak of the rainy season, when floodwater mosquitoes are abundant. Although mosquito surveillance was not conducted during the Barinas or Carabobo outbreaks, collections during the same season in 2001 indicated relatively small populations on the affected farms. Although our more recent mosquito collections included known enzootic VEEV vectors (Table 4), these mosquitoes are not known to transmit epidemic virus strains, and we did not detect VEEV antibodies in the rodents with which they are typically associated in sylvatic, enzootic foci. Typical epidemic vectors were not abundant in the affected regions. These results suggest the possibility that more xerophilic vectors other than mosquitoes might have been responsible for subtype IC VEEV maintenance and transmission to horses.

Ticks are susceptible to experimental infection by VEEV, although rates of oral and transtadial transmission tend to be low (37–39), and persistence for up to 171 days has been demonstrated. The effect of persistent tick infection on alphavirus genome stability has not been evaluated, but alphavirus infection of mosquitoes involves early replication for  $\approx 1$  week, followed by declining replication due to poorly understood modulating factors that probably include RNA interference (40). If similar mechanisms occur in infected ticks, long-term persistence could result in the levels of genetic stasis we observed in subtype IC VEEV from 1995 to 2000. To evaluate this hypothesis,

more extensive surveillance designed to identify the vector(s) and reservoir host(s) in Barinas State is ongoing.

Our results also call into question previous estimates of alphavirus evolutionary rates that suggested a laboratory source for the 1995 Venezuelan epidemic. The inconsistency between the genetic stasis observed in subtype IC strains isolated from 1962–1964 versus 1995, and rates of nucleotide substitution observed during enzootic or epidemic VEEV circulation, suggested a laboratory source for the 1995 outbreak (23). The common use in Venezuela of antigens prepared from a 1963 strain (P676), from which active virus was isolated, and its similarity to the predicted progenitor of the 1995 outbreak also supported this hypothesis of a laboratory origin. We consider it highly unlikely that the year 2000 Carabobo and Barinas outbreaks resulted from laboratory strains because of the following factors: 1) in Venezuela, wildtype epidemic VEEV strains have largely been replaced for antigen preparation by the strain TC-83 vaccine virus to minimize the possibility of a laboratory-initiated outbreak; 2) the 2000 isolates do not group phylogenetically with strain P676 as the 1995 strains do (Figure 2); and 3) unlike Falcon state, where the 1995 outbreak began, the locations of the 2000 outbreaks are far from the diagnostic and vaccine production laboratories that work with VEEV. Also, the Instituto Nacional de Investigaciones Agropecuarias, where the year 2000 VEEV strains were isolated, had not worked with subtype IC VEEV for many months. Furthermore, the isolation of

the strain TC-83 virus from a stablemate of the encephalitic horse at the Carabobo site during vaccination efforts argues against any laboratory contamination with a subtype IC strain. This evidence strongly suggests that the 2000 outbreaks involved naturally circulating VEEV strains that were maintained in a genetically stable state since 1995. Thus, based on genetic stasis and other factors, the previous conclusion that the 1995 outbreak may have had a laboratory origin, should be reevaluated. Since epidemic strains of VEEV can be maintained for at least 5 (1995–2000 or 2003) and possibly even 31 (1964–1995) years between epidemics, equine vaccination efforts and surveillance should be implemented continuously in Venezuela and Colombia.

### Acknowledgments

We thank Nelson Moncada, Napoleon León, Lisandro Carrasco, J.R. Salazar, Wenli Kang for field and laboratory technical assistance; Gabriela Rangel-Diaz for professional assistance; Juan Martinez for map design; Alba Carrillo, Edita de Torrealba, Reina Benitez, and Luis Salinas for field logistic assistance; and farm owners J. García, F. Pérez, J. Pérez and his wife, F. Umaña, D. Balza, O. Rojas, A. Bernal, L. Mora and Mora family, A. Sánchez, W. (Chicho) Nieves, and G. Hernández for their hospitality.

This research was funded by National Institutes of Health grant AI48807. L.L.C. was supported by the James W. McLaughlin Fellowship Fund.

Dr Navarro is an associate professor in the Universidad Central de Venezuela, Instituto de Zoología Tropical in Caracas, and also a guest researcher in the University of Texas Medical Branch Center for Biodefense and Emerging Infectious Diseases. His current research interests include vectorborne diseases, mosquito systematics and evolution, and eco-epidemiology of tropical and reemerging arboviruses, mainly VEEV.

### References

- Walton TE, Grayson MA. Venezuelan equine encephalomyelitis. The arboviruses: epidemiology and ecology, Vol. IV. Boca Raton (FL): CRC Press; 1988. p. 203–31.
- Weaver SC, Ferro C, Barrera R, Boshell J, Navarro JC. Venezuelan equine encephalitis. *Annu Rev Entomol.* 2004;49:141–74.
- Rico-Hesse R, Weaver SC, de Siger J, Medina G, Salas RA. Emergence of a new epidemic/epizootic Venezuelan equine encephalitis virus in South America. *Proc Natl Acad Sci U S A.* 1995;92:5278–81.
- Weaver SC, Salas R, Rico-Hesse R, Ludwig GV, Oberste MS, Boshell J, Tesh RB. Re-emergence of epidemic Venezuelan equine encephalomyelitis in South America. *VEE Study Group. Lancet.* 1996;348:436–40.
- Rivas F, Diaz LA, Cardenas VM, Daza E, Bruzon L, Alcalá A, et al. Epidemic Venezuelan equine encephalitis in La Guajira, Colombia, 1995. *J Infect Dis.* 1997;175:828–32.

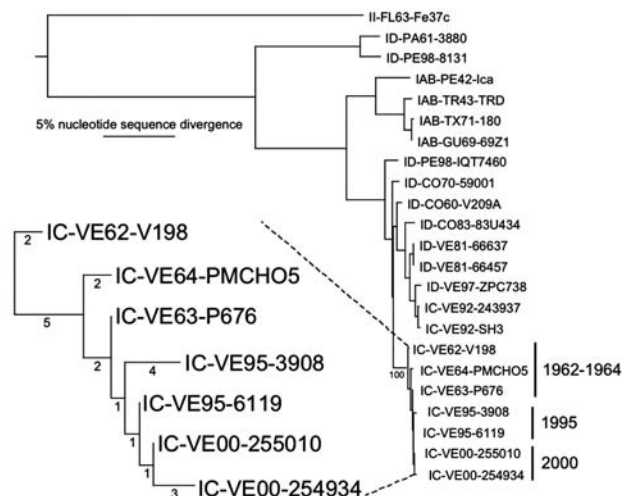

Figure 2. Phylogenetic tree generated from maximum parsimony analysis of genomic sequences of Venezuelan equine encephalitis virus (VEEV) strains 255010 and 254934 and homologous GenBank sequences from the 1962–64 and 1995 VEEV outbreaks, as well as other representative VEE complex alphavirus strains. Numbers indicate bootstrap values for groupings to the right. Enlargement on the lower left shows the 1962–64 and 1995–2000 clades, with numbers indicating nucleotide substitutions accompanying VEEV evolution.

6. Oberste MS, Fraire M, Navarro R, Zepeda C, Zarate ML, Ludwig GV, et al. Association of Venezuelan equine encephalitis virus subtype IE with two equine epizootics in Mexico. *Am J Trop Med Hyg.* 1998;59:100–7.
7. Johnson KM, Martin DH. Venezuelan equine encephalitis. *Adv Vet Sci Comp Med.* 1974;18:79–116.
8. Weaver SC, Pfeffer M, Marriott K, Kang W, Kinney RM. Genetic evidence for the origins of Venezuelan equine encephalitis virus subtype IAB outbreaks. *Am J Trop Med Hyg.* 1999;60:441–8.
9. Greene IP, Paessler S, Austgen L, Anishchenko M, Brault AC, Bowen RA, et al. Envelope glycoprotein mutations mediate equine amplification and virulence of epizootic Venezuelan equine encephalitis virus. *J Virol.* 2005;79:9128–33.
10. Wang E, Barrera R, Boshell J, Ferro C, Freier JE, Navarro JC, et al. Genetic and phenotypic changes accompanying the emergence of epizootic subtype IC Venezuelan equine encephalitis viruses from an enzootic subtype ID progenitor. *J Virol.* 1999;73:4266–71.
11. Dickerman RW, Cupp EW, Groot H, Alarcon AM, Cura E, Dickerman AW, et al. Venezuelan equine encephalitis virus activity in northern Colombia during April and May 1983. *Bull Pan Am Health Organ.* 1986;20:276–83.
12. Barrera R, Ferro C, Navarro JC, Freier J, Liria J, Salas R, et al. Contrasting sylvatic foci of Venezuelan equine encephalitis virus in northern South America. *Am J Trop Med Hyg.* 2002;67:324–34.
13. Fernández-Badillo A, Guerrero R, Lord R, Ochoa J, Ulloa G. Mamíferos de Venezuela. Lista y Claves para su identificación. Museo de Zoología Agrícola (MIZA-UCV), FAGRO. Caracas: Universidad Central de Venezuela; 1988.
14. Eisenberg JF. Mammals of the neotropics, Vol. 1. The northern neotropics. Vol. 1. Chicago: University of Chicago Press; 1989.
15. Chamberlain R, Sudia D. Methods for study of mosquitoes as virus hosts and vectors. *Methods Virol.* 1967;1:63–103.
16. Lane J. Neotropical Culicidae. Vol. 1. Sao Paulo: Sao Paulo University Press; 1953.
17. Sirivanakarn S. A review of the systematics and proposed scheme of internal classification of the New World subgenus *Melanoconion* of *Culex* (Diptera: Culicidae). *Mosquito Systematics.* 1982;14:265–333.
18. Pecor JE, Mallampalli VL, Harbach RE, Peyton EL. Catalog and illustrated review of the subgenus *Melanoconion* of *Culex* (Diptera: Culicidae). *Contributions of the American Entomological Institute* (Gainesville). 1992;27:1–228.
19. Sallum MAM, Forattini OP. Revision of the *Spissipes* section of *Culex* (*Melanoconion*) (Diptera: Culicidae). *J Am Mosq Control Assoc.* 1996;12:517–600.
20. Guimarães JH. 1997. Systematic database of diptera of the Americas south of the United States, family *Culicidae*. In: Fundação de Amparo a Pesquisa do Estado de Sao Paulo. Sao Paulo, Brazil; 1997.
21. Roehrig JT, Bolin RA. Monoclonal antibodies capable of distinguishing epizootic from enzootic varieties of subtype I Venezuelan equine encephalitis viruses in a rapid indirect immunofluorescence assay. *J Clin Microbiol.* 1997;35:1887–90.
22. Powers AM, Oberste MS, Brault AC, Rico-Hesse R, Schmura SM, Smith JF, et al. Repeated emergence of epidemic/epizootic Venezuelan equine encephalitis from a single genotype of enzootic subtype ID virus. *J Virol.* 1997;71:6697–705.
23. Brault AC, Powers AM, Medina G, Wang E, Kang W, Salas RA, et al. Potential sources of the 1995 Venezuelan equine encephalitis subtype IC epidemic. *J Virol.* 2001;75:5823–32.
24. Swofford DL. PAUP\*. Phylogenetic analysis using parsimony (\*and other methods). Version 4. Sunderland (MA): Sinauer Associates; 1998.
25. Ronquist F, Huelsenbeck JP. MrBayes 3: Bayesian phylogenetic inference under mixed models. *Bioinformatics.* 2003;19:1572–4.
26. Brault AC, Powers AM, Chavez CL, Lopez RN, Cachon MF, Gutierrez LF, et al. Genetic and antigenic diversity among eastern equine encephalitis viruses from North, Central, and South America. *Am J Trop Med Hyg.* 1999;61:579–86.
27. Wang E, Paessler S, Aguilar PV, Smith DR, Coffey LL, Kang W, et al. A novel, rapid assay for detection and differentiation of serotype-specific antibodies to Venezuelan equine encephalitis complex alphaviruses. *Am J Trop Med Hyg.* 2005;72:805–10.
28. Young NA, Johnson KM, Gauld LW. Viruses of the Venezuelan equine encephalomyelitis complex. Experimental infection of Panamanian rodents. *Am J Trop Med Hyg.* 1969;18:290–6.
29. Coffey LL, Carrara AS, Paessler S, Haynie ML, Bradley RD, Tesh RB, et al. Experimental Everglades virus infection of cotton rats (*Sigmodon hispidus*). *Emerg Infect Dis.* 2004;10:2182–8.
30. Walton TE, Johnson KM. Experimental Venezuelan equine encephalomyelitis virus infection of the bovine. *Infect Immun.* 1972;5:155–9.
31. Mendez W, Liria J, Navarro JC, Garcia CZ, Freier JE, Salas R, et al. Spatial dispersion of adult mosquitoes (Diptera: Culicidae) in a sylvatic focus of Venezuelan equine encephalitis virus. *J Med Entomol.* 2001;38:813–21.
32. Kinney RM, Johnson BJ, Welch JB, Tsuchiya KR, Trent DW. The full-length nucleotide sequences of the virulent Trinidad donkey strain of Venezuelan equine encephalitis virus and its attenuated vaccine derivative, strain TC-83. *Virology.* 1989;170:19–30.
33. Kinney RM, Tsuchiya KR, Sneider JM, Trent DW. Molecular evidence for the origin of the widespread Venezuelan equine encephalitis epizootic of 1969 to 1972. *J Gen Virol.* 1992;73:3301–5.
34. Walder R, Suarez OM, Calisher CH. Arbovirus studies in the Guajira region of Venezuela: activities of eastern equine encephalitis and Venezuelan equine encephalitis viruses during an interepizootic period. *Am J Trop Med Hyg.* 1984;33:699–707.
35. Walder R, Suarez OM, Calisher CH. Arbovirus studies in southwestern Venezuela during 1973–1981. II. Isolations and further studies of Venezuelan and eastern equine encephalitis, Una, Itaquí, and Moju viruses. *Am J Trop Med Hyg.* 1984;33:483–91.
36. Estrada-Franco JG, Navarro-Lopez R, Freier JE, Cordova D, Clements T, Moncayo A, et al. Venezuelan equine encephalitis virus, southern Mexico. *Emerg Infect Dis.* 2004;10:2113–21.
37. Linthicum KJ, Logan TM, Bailey CL, Gordon SW, Peters CJ, Monath TP, et al. Venezuelan equine encephalomyelitis virus infection in and transmission by the tick *Amblyomma cajennense* (Arachnida: Ixodidae). *J Med Entomol.* 1991;28:405–9.
38. Linthicum KJ, Gordon SW, Monath TP. Comparative infections of epizootic and enzootic strains of Venezuelan equine encephalomyelitis virus in *Amblyomma cajennense* (Acari: Ixodidae). *J Med Entomol.* 1992;29:827–31.
39. Linthicum KJ, Logan TM. Laboratory transmission of Venezuelan equine encephalomyelitis virus by the tick *Hyalomma truncatum*. *Trans R Soc Trop Med Hyg.* 1994;88:126.
40. Sanchez-Vargas I, Travanty EA, Keene KM, Franz AW, Beaty BJ, Blair CD, et al. RNA interference, arthropod-borne viruses, and mosquitoes. *Virus Res.* 2004;102:65–74.

Address for correspondence: Scott C. Weaver, Department of Pathology, University of Texas Medical Branch, Galveston, TX 77555-0609, USA; fax: 409-747-2415; email: sweaver@utmb.edu

All material published in *Emerging Infectious Diseases* is in the public domain and may be used and reprinted without special permission; proper citation, however, is required.

Use of trade names is for identification only and does not imply endorsement by the Public Health Service or by the U.S. Department of Health and Human Services.

# Intergenogroup Recombination in Sapoviruses

Grant S. Hansman,\* Naokazu Takeda,\* Tomoichiro Oka,\* Mitsukai Oseto,† Kjell-Olof Hedlund,‡ and Kazuhiko Katayama\*

Sapovirus, a member of the family *Caliciviridae*, is an etiologic agent of gastroenteritis in humans and pigs. Analyses of the complete genome sequences led us to identify the first sapovirus intergenogroup recombinant strain. Phylogenetic analysis of the nonstructural region (i.e., genome start to capsid start) grouped this strain into genogroup II, whereas the structural region (i.e., capsid start to genome end) grouped this strain into genogroup IV. We found that a recombination event occurred at the polymerase and capsid junction. This is the first report of intergenogroup recombination for any calicivirus and highlights a possible route of zoonoses because sapovirus strains that infect pig species belong to genogroup III.

The family *Caliciviridae* contains 4 genera, *Sapovirus*, *Norovirus*, *Lagovirus*, and *Vesivirus*. The sapovirus (SaV) and norovirus (NoV) strains are etiologic agents of gastroenteritis in humans, although animals such as pigs, cows, and mice can also be infected. SaV strains were originally detected by using electron microscopy, but today the most widely used method is reverse transcription–polymerase chain reaction (RT-PCR), which has a high sensitivity (1). Based on the capsid gene sequence, SaV can be grouped into 5 distinct genogroups (GI to GV) (2). Human SaV belong to GI, GII, GIV, and GV, whereas pig SaV belongs to GIII. The SaV GI, GIV, and GV genomes are believed to each contain 3 main open reading frames (ORFs), whereas the SaV GII and GIII genomes each have only 2 main ORFs (2). ORF1 encodes nonstructural proteins and the capsid protein, while ORF2 and ORF3 encode proteins of yet-unknown functions. Using complete genome sequence analysis, we recently identified the first recombinant (intra-genogroup) SaV

strains (3). Two SaV strains, Mc10 and C12, both belonging to GII, were identified as recombinants. Phylogenetic analysis of the nonstructural region (i.e., genome start to capsid start) grouped Mc10 and C12 together in 1 GII cluster (or genotype), while the structural region (i.e., capsid start to genome end) grouped Mc10 and C12 into distinct GII genotypes. Evidence suggested that the recombination site occurred at the polymerase and capsid junction on ORF1. This site is highly conserved among SaV strains, which suggests that the recombination event occurs when nucleic acids of parental strains come into physical contact in infected cells, e.g., during copy choice recombination (4), as we have recently described with recombinant NoV strains (5).

## Materials and Methods

We compared the complete genome sequences of 11 SaV strains to analyze suspected novel recombinant SaV strains. For this study, we sequenced the complete genomes of 4 SaV strains (Mc2, SK15, Ehime1107, and SW278). The Mc2 strain was isolated from a child with gastroenteritis in Chiang Mai, Thailand, in 2000 (6); SK15 was isolated from an adult with gastroenteritis in Sakai, Japan, in 2001 (unpub. data); Ehime1107 was isolated from an adult with gastroenteritis in Matsuyama, Japan, in 2002 (unpub. data); and SW278 was isolated from an adult with gastroenteritis in Solna, Sweden, in 2003 (7). The complete genome sequences were amplified and sequenced as described earlier (3). Phylogenetic analysis was performed by using the Genetyx program (Genetyx for the Macintosh version 13.0.5, Genetyx Corp., Tokyo, Japan) and ClustalX (Version 1.82; available from <http://www.embl.de/~chenna/clustal/darwin/>). Trees were drawn by using njplot (for the Macintosh; available from <http://pbil.univ-lyon1.fr/software/njplot.html>).

\*National Institute of Infectious Diseases, Tokyo, Japan; †National Institute of Environmental Studies, Ehime, Japan; and ‡Swedish Institute for Infectious Disease Control, Solna, Sweden

## Results

Based on the classification scheme of either the partial or complete capsid sequences in our previous studies, we grouped Manchester into GI; Bristol, Mc2, Mc10, C12, and SK15 into GII; PEC into GIII; and NK24 into GV (6,8,9). For this study and on the basis of the structural region (i.e., capsid start to genome end), we grouped Manchester into GI; Mc2, Bristol, Mc10, C12; and SK15 into GII; PEC into GIII; SW278 and Ehime1107 into GIV, and NK24 into GV (Figure 1). These genogroups were not maintained when we analyzed the nonstructural region (i.e., genome start to capsid start). We found that SW278 and Ehime1107 clustered into GII for the nonstructural region–based grouping but clustered into GIV for the structural region–based grouping. All genogroups were supported by bootstrap values (10), except for the structural region–based grouping of GI, which had a slightly lower value of 897. Nevertheless, these results indicate that the nonstructural region of SW278 and Ehime1107, i.e., a GII sequence, did not belong to a distinct genogroup, unlike their structural region, which belonged to a distinct genogroup (proposed as GIV). Comparisons of the complete genome sequences showed that SW278 and Ehime1107 shared >97% nucleotide identity and likely represented the same strain, although it was isolated from different countries; however, the lengths were different. Either SW278 or Ehime1107 had a 10-nucleotide insertion or deletion in the nontranslated region at the 3' terminus. A number of closely matching partial sequences to SW278 and Ehime1107, which included both the polymerase and capsid gene, were available on the database, which indicates the circulation of similar strains in other countries.

We next used SimPlot (available from <http://sray.med.som.jhmi.edu/SCRsoftware/simplot/>) with a window size of 100 and an increment of 20 bp (11) to further analyze these novel recombinant SW278 and Ehime1107 strains. We analyzed 7 complete genome SaV sequences. The Mc10 genome sequence was compared to C12, Bristol, Mc2, SK15, SW278, and Ehime1107. We observed a sudden drop in nucleotide similarity after the polymerase region for SW278 and Ehime1107 (Figure 2A). Nucleotide sequence analysis of the nonstructural region showed that SW278 and Ehime1107 shared between 74.0% to 77.6% nucleotide identity to the Mc2, C12, Mc10, and SK15 sequences, whereas analysis of the structural region showed that SW278 and Ehime1107 had only 54.0%–55.2% nucleotide identity to the Mc2, C12, Mc10, and SK15 sequences (Table); i.e., the nonstructural and structural regions of SW278 and Ehime1107 were >20% different. A similar result was observed with the nonstructural and structural regions of the already-established recombinant Mc10 and C12 strains, which had an 18.6% difference (3). When we analyzed the nonstructural

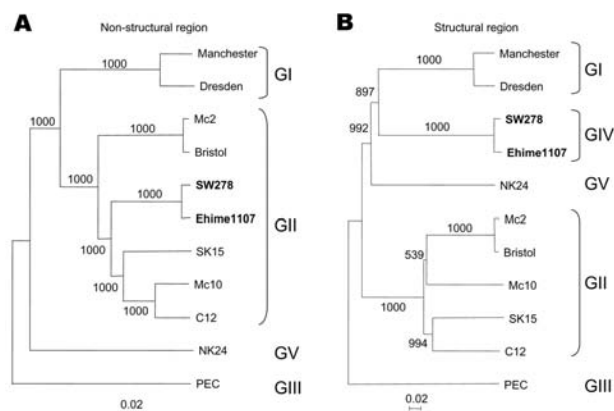

Figure 1. Phylogenetic analysis of (A) the nonstructural region (i.e., genome start to capsid start) and (B) the structural region (i.e., capsid start to genome end), showing the different genogroups. The numbers on each branch indicate the bootstrap values for the genotype. Bootstrap values  $\geq 950$  were considered significant for the grouping (10). The scale represents nucleotide substitutions per site. GenBank accession numbers are as follows: Mc10, AY237420; Manchester, X86560; Dresden, AY694184; SW278, DQ125333; Ehime1107, DQ058829; NK24, AY646856; C12, AY603425; Bristol, AJ249939; Mc2, AY237419; PEC, AF182760; and SK15, AY646855.

and structural regions of Mc2 and SK15, we found only a 1.5% difference. Likewise, all other SaV strains generally maintained their nucleotide identities over the complete genome (Table). This result can be best explained as a recombination event at the polymerase and capsid junction for the SW278 and Ehime1107 strains, i.e., the nonstructural region originated from a GII strain, and the structural region originated from a strain belonging to another genogroup. The SaV GI, GIV, and GV genomes are predicted to encode an ORF3, whereas the SaV GII and GIII genomes have 2 main ORFs. We found that SW278 and Ehime1107 each had an ORF3, which is predicted to encode a yet-unknown protein of 161 amino acids. Notably, the structural region–based grouping showed that GI, GIV, and GV grouped in 1 major branch, while GII and GIII represented 2 other branches. These data provide further evidence of the intergenogroup recombination for SW278 and Ehime1107 strains.

The SaV subgenomic RNA has not yet been identified, but for other caliciviruses the subgenomic RNA was identified (12–14). We recently provided evidence that the SaV viral protease was responsible for the cleavage of nonstructural and capsid proteins on ORF1 (15). Therefore, SaV replication may occur through at least 2 pathways: 1) the capsid protein was transcribed as a polyprotein on ORF1 and then cleaved, or 2) the capsid protein was transcribed as subgenomic RNA and then translated. The suspected recombination occurred at the highly conserved

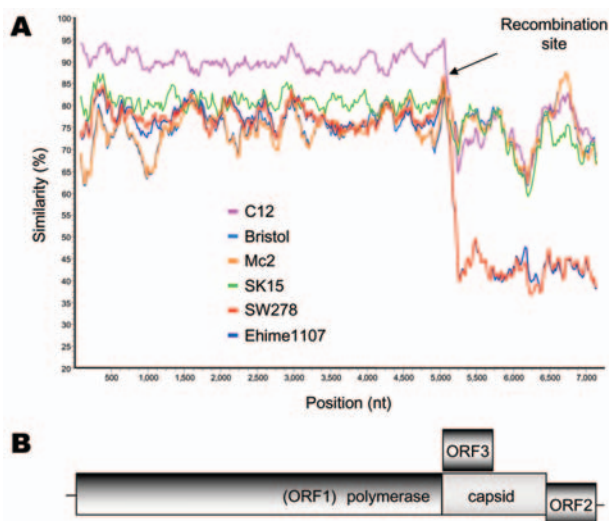

Figure 2. A) SimPlot analysis of 7 sapovirus (SaV) complete genome sequences. The Mc10 genome sequence was compared to C12, Bristol, Mc2, SK15, SW278, and Ehime1107 by using a window size of 100 bp with an increment of 20 bp. All gaps were removed. The recombination site is suspected to be located between the polymerase and capsid gene, as shown by the arrows. B) Genomic organization of the SaV GII and GIV strains.

polymerase and capsid junction for human SaV, as shown in Figure 3. Recombination is thought to occur when nucleic acids of the parental strains come into physical contact in infected cells, e.g., during copy choice recombination (4). These data suggest that recombinant SaV strains were formed either by full-length RNA template switching or full-length and subgenomic template switching.

**Discussion**

These results are noteworthy because this is the first report of intergenogroup recombination for any calicivirus. These findings provide evidence that zoonoses could occur within the *Sapovirus* genus because strains that infect pig

species belong to GIII. Furthermore, since the parent non-structural region of SW278 and Ehime1107 has not yet been identified, we could not rule out that the parents of SW278 and Ehime1107 came from a strain that infects animals. We have conducted a number of molecular epidemiologic studies using broad-range primers and found that GIV strains were infrequently compared to other genogroups (6,8,9,16,17). This finding suggests 1) the emergence and/or recombination of GIV strains from an animal reservoir, 2) a lower prevalence of GIV strains, though a number of similar sequences were identified in the United States, or 3) our primers were less sensitive in detecting variant GIV sequences. Nevertheless, further complete genome analysis of other SaV strains is needed to identify other recombinant strains and determine the extent of recombination in the *Sapovirus* genus. Although we cannot easily pinpoint where and when the recombination event took place, screening of animals with primers designed against human SaV strains may also help identify the potential parental strain(s) of these 2 novel recombinants.

**Conclusions**

To date, we have identified 4 different recombinant SaV strains, Mc10, C12, SW278, and Ehime1107. Collectively, these strains have 2 kinds of nonstructural sequences but 3 kinds of structural sequences (Figure 1). In addition, all nonstructural sequences belonged to GII. These data suggest that SaV could evade host immunity by readily changing their structural region (immunoreactive, i.e., capsid protein) and that GII strains (nonstructural-based grouping) are more capable of recombination than other genogroups. In 1999, Jiang et al. (18) identified the first naturally occurring human recombinant NoV, and several other strains were later described as recombinants (5,6,19–21). The site of genetic recombination for NoV was also between the polymerase and capsid genes. Human SaV and NoV strains cannot be cultivated, but the expression of the recombinant capsid

Table. Nucleotide identity (%) among sapovirus strains\*

Nonstructural region	Structural region									
	Ehime1107	SW278	Mc2	Mc10	C12	SK15	Dresden	Manchester	NK24	PEC
Ehime1107		96.9	54.6	55.1	54.4	55.2	58.3	58.8	58.3	51.0
SW278	97.5		54.6	55.2	54.0	54.7	58.1	58.3	58.3	50.8
Mc2	73.8	74.0		72.7	73.0	71.8	54.5	54.0	53.7	51.2
Mc10	77.5	77.6	74.4		71.5	71.1	55.3	54.6	55.2	50.7
C12	77.3	77.3	74.4	90.1		75.0	55.4	55.7	55.5	51.8
SK15	77.5	77.5	73.3	81.0	80.3		56.2	56.1	55.5	50.4
Dresden	62.6	62.7	63.3	63.0	63.1	62.4		92.9	57.3	52.5
Manchester	63.5	63.3	63.2	63.7	64.0	62.8	90.5		57.4	52.1
NK24	55.4	55.6	55.8	55.7	55.0	55.2	56.3	56.8		53.3
PEC	52.5	52.5	53.0	52.3	52.4	52.3	51.7	51.5	52.1	

\*Values on the lower left represent the nonstructural region, i.e., genome start to capsid start; values on the upper right represent the structural region, i.e., capsid start to genome end.

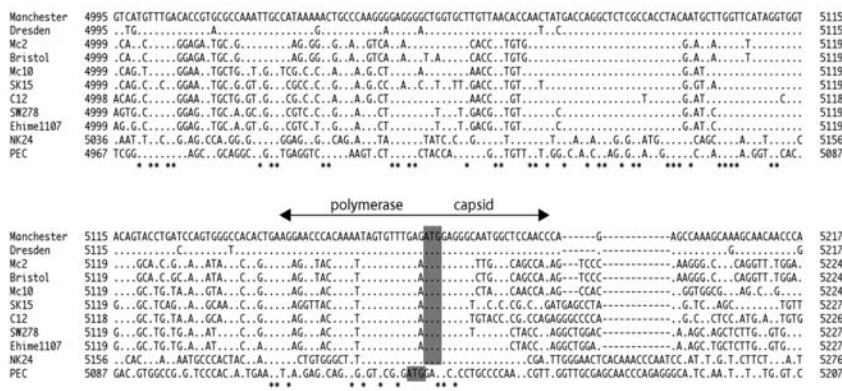

Figure 3. Nucleotide alignment of Manchester, Dresden, Mc2, Bristol, Mc10, SK15, C12, SW278, Ehime1107, NK24, and PEC sequences, showing the conserved polymerase and capsid junction. The asterisks represent conserved nucleotides. The shaded nucleotides represent the putative capsid start codons.

protein (rVP1) in a baculovirus expression system results in the self-assembly of viruslike particles (VLPs) that are morphologically similar to native SaV. In a recent study, we genetically and antigenically analyzed 2 recombinant NoV strains (strains 026 and 9912-02F) (17). When polymerase-based grouping was performed, these 2 strains clustered together, but when capsid-based grouping was performed, these 2 strains belonged in 2 distinct genotypes. When we compared the cross-reactivity of these VLPs with an antibody enzyme-linked immunosorbent assay (ELISA), the titers of 026 antiserum against 026 and 9912-02F VLPs were 1:2,058,000 and 1:512,000, respectively, a 4-fold difference, whereas the titers of 9912-02F antiserum against 9912-02F and 026 VLPs were 1:1,024,000 and 1:128,000, respectively, an 8-fold difference. These results demonstrated that 026 and 9912-02F likely represented distinct antigenic types, which correlated with the genetic analysis. The expression of SaV VLPs is also needed to determine the cross-reactivity among these recombinant strains, although our results have shown that GI and GV VLPs (capsid-based grouping) were antigenically distinct by an antibody and antigen ELISA (22), which suggests that these 2 recombinant strains are also antigenically distinct from GII strains. And finally, these results will have a major influence on the future phylogenetic classification of SaV strains. Therefore, the genetic classification of SaV strains needs to be addressed, and a consensus of prototype strains representing genogroups and genotypes should be established to avoid further grouping conflicts.

This work was supported by grants-in-aid from the Ministry of Education, Culture, Sports, Science and Technology, Japan, and a grant for research on reemerging infectious diseases from the Ministry of Health, Labour, and Welfare, Japan. G. Hansman received a fellowship from the Human Science Foundation of Japan.

Dr Hansman is a scientist at the National Institute of Infectious Diseases, Japan. His research interests include the epi-

demology, virus expression, and cross-reactivity of viruses that cause gastroenteritis in humans, particularly SaV and NoV.

### References

- Okada M, Shinozaki K, Ogawa T, Kaiho I. Molecular epidemiology and phylogenetic analysis of Sapporo-like viruses. *Arch Virol*. 2002;147:1445–51.
- Farkas T, Zhong WM, Jing Y, Huang PW, Espinosa SM, Martinez N, et al. Genetic diversity among sapoviruses. *Arch Virol*. 2004;149:1309–23.
- Katayama K, Miyoshi T, Uchino K, Oka T, Tanaka T, Takeda N, et al. Novel recombinant sapovirus. *Emerg Infect Dis*. 2004;10:1874–6.
- Worobey M, Holmes EC. Evolutionary aspects of recombination in RNA viruses. *J Gen Virol*. 1999;80:2535–43.
- Bull RA, Hansman GS, Clancy LE, Tanaka MM, Rawlinson WD, White PA. Norovirus recombination in ORF1/ORF2 overlap. *Emerg Infect Dis*. 2005;11:1079–85.
- Hansman GS, Katayama K, Maneekarn N, Peerakome S, Khamrin P, Tonusin S, et al. Genetic diversity of norovirus and sapovirus in hospitalized infants with sporadic cases of acute gastroenteritis in Chiang Mai, Thailand. *J Clin Microbiol*. 2004;42:1305–7.
- Johansson PJ, Bergentoft K, Larsson PA, Magnusson G, Widell A, Thorhagen M, et al. A nosocomial sapovirus-associated outbreak of gastroenteritis in adults. *Scand J Infect Dis*. 2005;37:200–4.
- Hansman GS, Natori K, Oka T, Ogawa S, Tanaka K, Nagata N, et al. Cross-reactivity among sapovirus recombinant capsid proteins. *Arch Virol*. 2005;150:21–36.
- Guntapong R, Hansman GS, Oka T, Ogawa S, Kageyama T, Pongsuwanna Y, et al. Norovirus and sapovirus infections in Thailand. *Jpn J Infect Dis*. 2004;57:276–8.
- Katayama K, Shirato-Horikoshi H, Kojima S, Kageyama T, Oka T, Hoshino F, et al. Phylogenetic analysis of the complete genome of 18 Norwalk-like viruses. *Virology*. 2002;299:225–39.
- Lole KS, Bollinger RC, Paranjape RS, Gadkari D, Kulkarni SS, Novak NG, et al. Full-length human immunodeficiency virus type 1 genomes from subtype C-infected seroconverters in India, with evidence of intersubtype recombination. *J Virol*. 1999;73:152–60.
- Herbert TP, Brierley I, Brown TD. Identification of a protein linked to the genomic and subgenomic mRNAs of feline calicivirus and its role in translation. *J Gen Virol*. 1997;78:1033–40.
- Morales M, Barcena J, Ramirez MA, Boga JA, Parra F, Torres JM. Synthesis in vitro of rabbit hemorrhagic disease virus subgenomic RNA by internal initiation on (-) sense genomic RNA: mapping of a subgenomic promoter. *J Biol Chem*. 2004;279:17013–8.
- Chang KO, Sosnovtsev SV, Belliot G, Kim Y, Saif LJ, Green KY. Bile acids are essential for porcine enteric calicivirus replication in association with down-regulation of signal transducer and activator of transcription 1. *Proc Natl Acad Sci U S A*. 2004;101:8733–8.

15. Oka T, Katayama K, Ogawa S, Hansman GS, Kageyama T, Ushijima H, et al. Proteolytic processing of sapovirus ORF1 polyprotein. *J Virol*. 2005;79:7283–90.
16. Hansman GS, Kuramitsu M, Yoshida H, Katayama K, Takeda N, Ushijima H, et al. Viral gastroenteritis in Mongolian infants. *Emerg Infect Dis*. 2005;11:180–2.
17. Hansman GS, Doan LT, Kguyen TA, Okitsu S, Katayama K, Ogawa S, et al. Detection of norovirus and sapovirus infection among children with gastroenteritis in Ho Chi Minh City, Vietnam. *Arch Virol*. 2004;149:1673–88.
18. Jiang X, Espul C, Zhong WM, Cuello H, Matson DO. Characterization of a novel human calicivirus that may be a naturally occurring recombinant. *Arch Virol*. 1999;144:2377–87.
19. Katayama K, Shirato-Horikoshi H, Kojima S, Kageyama T, Oka T, Hoshino F, et al. Phylogenetic analysis of the complete genome of 18 Norwalk-like viruses. *Virology*. 2002;299:225–39.
20. Lochridge VP, Hardy ME. Snow Mountain virus genome sequence and virus-like particle assembly. *Virus Genes*. 2003;26:71–82.
21. Vinje J, Green J, Lewis DC, Gallimore CI, Brown DW, Koopmans MP. Genetic polymorphism across regions of the three open reading frames of “Norwalk-like viruses.” *Arch Virol*. 2000;145:223–41.
22. Hansman GS, Natori K, Ushijima H, Katayama K, Takeda N. Characterization of polyclonal antibodies raised against sapovirus genogroup five virus-like particles. *Arch Virol*. 2005;150:1433–7.

Address for correspondence: Kazuhiko Katayama, Department of Virology II, National Institute of Infectious Diseases, 4-7-1 Gakuen, Musashi-murayama, Tokyo, 208-0011, Japan; fax: 81-42-561-4279; email: katayama@nih.go.jp

# EMERGING INFECTIOUS DISEASES

Tracking trends and analyzing new and reemerging infectious disease issues around the world

A peer-reviewed journal published by the National Center for Infectious Diseases

Vol. 5, No. 3, May–June 1999

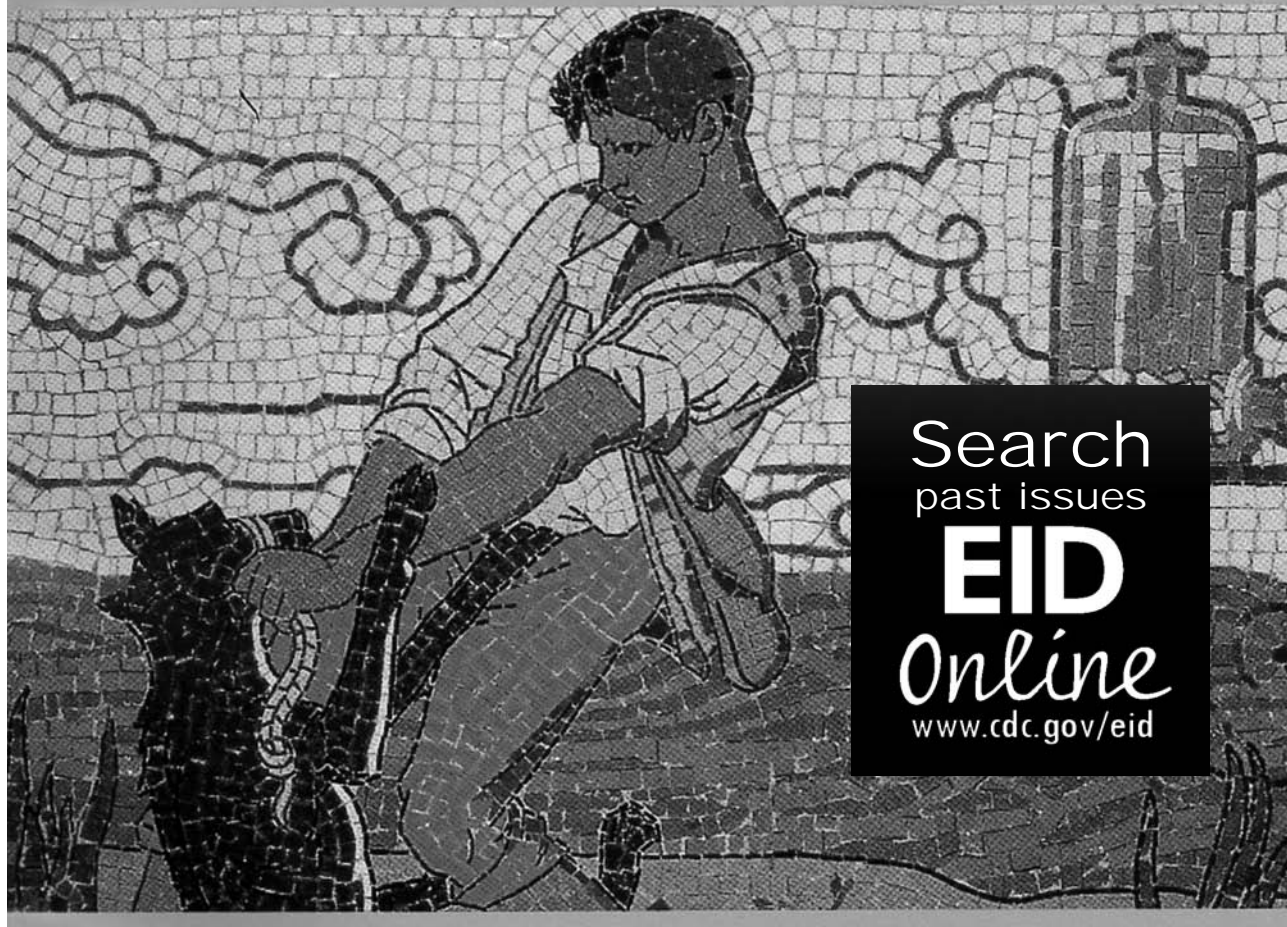



---

# Rabies Postexposure Prophylaxis, New York, 1995–2000

Jesse D. Blanton,\* Nadine Y. Bowden,\* Millicent Eidson,† Jeffrey D. Wyatt,‡ and Cathleen A. Hanlon\*

The epidemiology of human rabies postexposure prophylaxis (PEP) in 4 upstate New York counties was described from data obtained from 2,216 incidences of PEP recorded by local health departments from 1995 to 2000. Overall annual incidence for the study period was 27 cases per 100,000 persons. Mean annual PEP incidence rates were highest in rural counties and during the summer months. PEP incidence was highest among patients 5–9 and 30–34 years of age. Bites accounted for most PEP (51%) and were primarily associated with cats and dogs. Bats accounted for 30% of exposures, more than any other group of animals; consequently, bats have replaced raccoons as the leading rabies exposure source to humans in this area.

Combined with effective human rabies prophylaxis, canine rabies control programs were responsible for the steady decline of human rabies in the United States, from 20–25 annual cases in the 1940s to <3 annual cases in the 1990s (1–4). Although the current incidence of human rabies in the United States is negligible compared to that of other infectious diseases, the number of persons seeking rabies postexposure prophylaxis (PEP) is high; 18,238 persons received PEP in New York (excluding New York City) from 1993 to 1998 (5). No proven curative treatment has been documented for rabies once clinical disease begins (6). Human rabies can be prevented by following the Advisory Committee on Immunization Practices (ACIP) recommendations of local wound care and prompt administration of human rabies immune globulin (HRIG, 20 IU/kg) on day 0 and vaccine on days 0, 3, 7, 14, and 28 (7). For persons who have been previously

vaccinated, the recommended prophylaxis consists of a vaccine dose on days 0 and 3.

Studies addressing rabies PEP incidence indicate a rising trend since the 1970s. Estimates of annual PEP incidence in Georgia increased from 1.94 cases/100,000 in 1970 to an estimated 6.17 cases/100,000 from 1995 to 2001 (1, S.J. Onufrak, Source-specific risks among patients receiving rabies post-exposure prophylaxis in Georgia [master's thesis]. Atlanta: Emory University; 2003). At the national level, incidence was most recently estimated at 8.69 cases/100,000 in 1980 (8). Increases are probably attributable to an expanding raccoon rabies epizootic in the mid-Atlantic states and changes in PEP consideration after potential bat exposure (5). We describe demographic and animal exposure data associated with PEP in upstate New York several years after the establishment of the raccoon rabies variant and compare them with 1993–1994 data from the same area (9).

## Methods

Monroe and Onondaga Counties encompass the cities of Rochester and Syracuse and are predominantly urban-suburban with population densities of 422 and 232 persons/km<sup>2</sup>, respectively. Cayuga and Wayne Counties are predominantly rural-suburban, with population densities of 46 and 60 persons/km<sup>2</sup>, respectively. The 4-county region in western upstate New York is 7,086 km<sup>2</sup>, with an estimated human population of 1,369,407 (10).

We considered all PEP cases recorded on standardized reports by the 4 local health departments from 1995 to 2000. Data included patient demographics, animal characteristics, and exposure details. The report form was changed in 1998, with the addition of age, sex, treatment dates, and more detailed exposure information for bat-related PEP. Age and sex data were obtained directly from local health departments for PEP cases before 1998.

---

\*Centers for Disease Control and Prevention, Atlanta, Georgia, USA; †New York State Department of Health, Albany, New York, USA; and ‡University of Rochester School of Medicine & Dentistry, Rochester, New York, USA

Exposure source was defined as the suspected or confirmed rabid animal that directly or indirectly resulted in potential human exposure. Direct exposure consisted of a bite, scratch, or contamination of mucous membrane with potentially infectious material directly from a suspected rabid animal. Indirect exposure consisted of contact with potentially contaminated fomites (e.g., saliva from a pet's fur that comes into contact with open wounds or mucous membranes). Cases that lacked specific information about route of exposure were classified as unspecified. Cryptic or unspecified bat exposures consisted of discovering a bat in a room with a sleeping person, unattended child, mentally impaired person, intoxicated person, or someone otherwise unable to rule out contact. Rabies diagnostic results were obtained on animal cases from the New York State Department of Health Wadsworth Center Rabies Laboratory. Population data from the 2000 US census were used to calculate the incidence of PEP by county, age, and sex (10). Statistical analyses, including frequencies and chi-square tests, were performed with the SAS statistical package version 8.0 (SAS Institute Inc., Cary, NC, USA).

## Results

A total of 2,216 PEP cases were reported from the study area from 1995 to 2000, with 317–469 cases each year. Annual PEP incidence was 23–34 cases/100,000 during the 6-year period (average 27/100,000). The mean annual incidence for the urban counties of Monroe and Onondaga (319 residents/km<sup>2</sup>) was 23 cases/100,000 compared to 56 cases/100,000 in the rural counties of Cayuga and Wayne (52 residents/km<sup>2</sup>). No failures of PEP were recorded.

PEP cases tended to increase in the late spring/early summer; the highest number of PEP cases was seen in August/September in 1996 and 1997 and in July/August from 1998 to 2000 (Figure 1). Of 2,109 (95%) PEP cases for which sex data were available, 51% were male. The median age of PEP recipients was 27 years for men and 29 years for women. The mean annual incidence of PEP for men was 26 cases/100,000 and for women 24 cases/100,000. PEP incidence rates were highest in persons 5–9 years of age, followed by those 30–34 years of age (Figure 2). No significant differences among sex or age distributions and PEP were seen.

Wild animal exposures accounted for 1,081 PEP cases (49%), domestic animals accounted for 1,057 cases (48%), and species of exposure animal was not identified for 78 cases (3%) (Table 1). Bats accounted for 663 (61%) PEP cases related to wildlife exposures, while other sources of wildlife-related PEP included raccoons (250 cases), foxes (85 cases), skunks (46 cases), woodchucks (12 cases), opossums (6 cases), deer (5 cases), beavers, coyotes, and squirrels (3 cases each), and other wild species (5 cases). PEP from bat exposure was significantly associated with

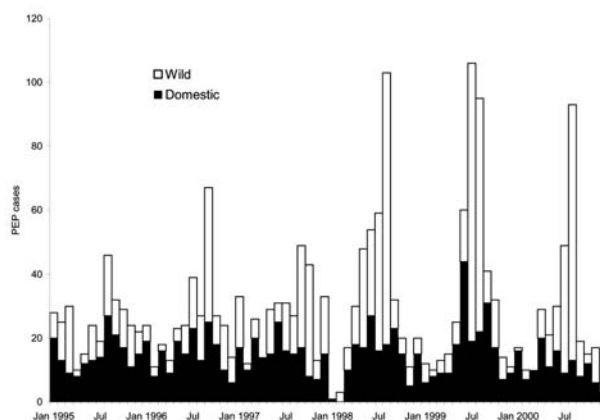

Figure 1. Human rabies postexposure prophylaxis (PEP) by month and species of exposure (domestic vs. wild), 4 upstate New York counties (Cayuga, Monroe, Onondaga, and Wayne), 1995–2000.

an urban setting ( $p < 0.001$ ). Among domestic animal exposures that resulted in PEP, 523 were attributed to cats, 498 to dogs, 19 to cattle, 11 to horses, 4 to ferrets, and 1 each to a pet rabbit and monkey.

Animals were not available for observation or testing for 66% of rabies PEP cases that resulted from exposure to cats and 89% that resulted from exposures to dogs. Of the dog-associated PEP, significantly ( $p < 0.001$ ) more of them (93%) occurred in urban counties compared to rural counties (Table 2). During the study period, only 16 (3%) dog-associated PEP cases involved dogs that were tested for rabies, and none were confirmed rabid. Among cats, 132 (25%) cat-associated PEP cases involved cats that were tested for rabies; of these, 110 PEP cases (83%) involved exposure to a confirmed rabid cat.

A total of 1,128 (51%) PEP cases were attributed to animal bite; 670 (30%) persons reported nonbite exposures,

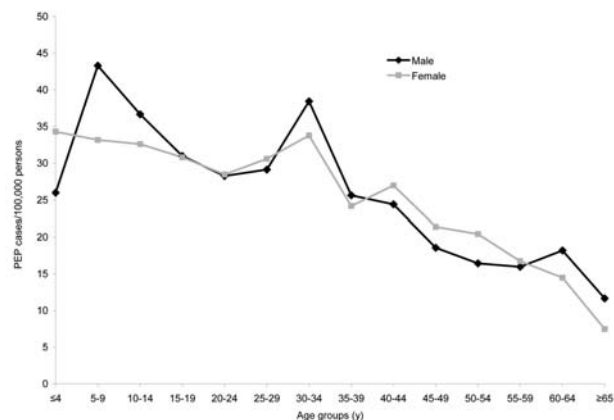

Figure 2. Human rabies postexposure prophylaxis (PEP) incidence by sex and age group, 4 upstate New York counties (Cayuga, Monroe, Onondaga, and Wayne), 1995–2000.

Table 1. Human rabies postexposure prophylaxis (PEP) by animal source, 4 counties, New York, 1995–2000\*

Animal source	Nonbite, n (%)					Total, n (%)
	Bite, n (%)	Direct			Unspecified§	
		Scratch	Saliva/NT†	Indirect‡		
Raccoon	48 (19)	16 (6)	65 (26)	120 (48)	1 (<1)	250 (11)
Bat (all species)	115 (17)	29 (4)	100 (15)	11 (2)	408 (62)	663 (30)
Other wild species¶	76 (45)	6 (4)	41 (24)	44 (26)	1 (1)	168 (8)
All wild species	239 (22)	51 (5)	206 (19)	175 (16)	410 (38)	1,081 (49)
Cat	367 (70)	64 (12)	89 (17)	3 (1)	0	523 (24)
Dog	493 (99)	0	3 (1)	0	2 (<1)	498 (22)
Other domestic species#	7 (19)	0	28 (78)	0	1 (3)	36 (2)
All domestic species	867 (82)	64 (6)	120 (11)	3 (<1)	3 (<1)	1,057 (48)
Unknown	22 (28)	4 (5)	19 (24)	28 (36)	5 (7)	78 (3)
Total	1,128 (51)	119 (5)	345 (16)	206 (9)	418 (19)	2,216 (100)

\*Data are from Cayuga, Monroe, Onondaga, and Wayne Counties.

†Direct contamination of an open wound or mucous membrane with potentially infectious material such as saliva or neural tissue (NT).

‡No known direct contact with a rabid or suspected rabid animal. Indirect exposure consisted of possible contact with saliva on an animal (i.e., pet dog or cat) or inanimate object from a suspected rabid animal that resulted in contamination of an open wound or mucous membrane.

§Unspecified contact indicates no exposure information was listed or exposure was indicated as unknown on data records. Unspecified exposure for bats includes being in the physical presence of a bat and not being able to rule out direct contact, particularly a bite. More people received PEP after unspecified exposure to bats than any other group of animals (p<0.001).

¶Includes beaver, coyote, chipmunk, deer, fox, mouse, opossum, otter, rat, skunk, squirrel, and woodchuck.

#Includes cow, ferret, horse, monkey, and rabbit.

and 418 (19%) reported exposure as unknown or unspecified (Table 1). Among nonbite-associated PEP recipients, 69% reported direct animal contact. Of the 1,106 bite-related PEP recipients that reported the species, 78% involved domestic animals. In 62% of potential exposures to bats, an exposure route was not described.

Exposure of only 1 person to a suspected rabid animal precipitated 1,336 (60%) PEP cases (Table 3). Exposure of a single person was more likely to be associated with a bite (p<0.001). Wild animal species accounted for 72% of group exposure PEP. The largest group occurred in June 1999, when 29 persons received PEP after exposure to a rabid cat.

Laboratory diagnosis of rabies was sought in 249 animals associated with 515 PEP cases (23%). Contact with a wild animal accounted for 348 cases (68%) where laboratory diagnosis was sought. Raccoons accounted for 176 (57%) of 309 PEP cases attributed to confirmed rabid wildlife. Nonbite exposures accounted for 366 (73%) of 501 PEP cases in which a laboratory diagnosis of rabies was obtained. Laboratory diagnosis of rabies in the exposing animal was significantly associated with nonbite exposure (p<0.001).

From 1998 to 2000, the time of PEP initiation in relation to exposure was available for 1,219 (98%) of 1,248 cases. The period between exposure and treatment varied from 0 to 115 days with a median of 3 days. Among persons with bite exposure, 199 (38%) of 528 began PEP the same day as exposure, while 14% of persons who reported a nonbite exposure received treatment the same day as exposure (p<0.001). Medians of 1 day for wild animal exposures and 2 days for domestic animal exposures were associated with bite exposures and 3 and 6 days, respectively, for nonbite exposures.

Of 1,248 PEP cases reported from 1998 to 2000, administration of PEP biologics was recorded as complete and appropriate (e.g., HRIG was given if indicated and the person completed all 5 vaccinations) in 1,035 (83%) cases. A total of 62 persons (5%) had received prior vaccination; 47 (76%) completed the appropriate course of treatment. Among rabies vaccination-naïve persons, 984 (85%) of 1,157 completed the appropriate course of treatment.

Table 2. Human rabies postexposure prophylaxis (PEP) by setting, 4 counties, New York, 1995–2000 \*

Animal source	Urban, n (%)	Rural, n (%)
Dog†	463 (93)	35 (7)
Cat	386 (74)	137 (26)
Other domestic‡	16 (44)	20 (56)
All domestic	865 (82)	192 (18)
Raccoon	162 (65)	88 (35)
Bat§	456 (69)	207 (31)
Fox	50 (59)	35 (41)
Skunk	28 (61)	18 (39)
Other wild¶	19 (51)	18 (49)
All wild	715 (66)	366 (34)
Total#	1,580 (74)	558 (26)
Annual rate/100,000	22.6	56.9

\*Rabies PEP cases reported to the health departments of 2 relatively urban counties, Onondaga and Monroe, and 2 relatively rural counties, Cayuga and Wayne.

†Human PEP cases from dog exposures were significantly higher in urban counties (p<0.001).

‡Other domestic animal exposures included 2 cows (10 cases), 3 ferrets (4 cases), 1 monkey (1 case), and 1 rabbit (1 case) in urban counties and 5 cows (9 cases) and 2 horses (11 cases) in rural counties.

§Human PEP cases due to bat exposures were significantly higher in urban counties (p<0.001).

¶Other wild animal exposures included 8 woodchucks (8 cases), 4 opossums (5 cases), 1 beaver (2 cases), 1 rat (1 case), 1 coyote (1 case), 1 mouse (1 case), and 1 otter (1 case) in urban counties and 5 deer (5 cases), 4 woodchucks (4 cases), 2 squirrels (3 cases), 2 coyotes (2 cases), 2 chipmunks (2 cases), 1 beaver (1 case), and 1 opossum (1 case) in rural counties.

#78 PEP cases excluded because animal source was missing.

## RESEARCH

Table 3. Human rabies postexposure prophylaxis (PEP) by group size, 4 counties, New York, 1995–2000

Characteristic	Group size, n (%)					
	1	2	3	4	5	>6
No.	1,336 (60)	284 (13)	159 (7)	192 (9)	55 (2)	190 (9)
No. sources	1,336 (83)	142 (9)	53 (3)	48 (3)	11 (1)	18 (1)
Route of exposure*						
Bite†	1,008 (75)	69 (24)	18 (11)	6 (3)	1 (2)	26 (14)
Nonbite	316 (24)	205 (72)	132 (83)	170 (89)	49 (89)	163 (86)
Unknown	12 (1)	10 (4)	9 (6)	16 (8)	5 (9)	1 (<1)
Source of exposure*						
Dog or cat	845 (63)	50 (18)	27 (17)	4 (2)	5 (9)	90 (47)
Other domestic species	5 (<1)	12 (4)	0	4 (2)	0	15 (8)
Raccoon	111 (8)	44 (16)	21 (13)	32 (17)	2 (4)	40 (21)
Bat	241 (18)	132 (46)	96 (60)	147 (76)	43 (78)	4 (2)
Other wild species	97 (7)	36 (13)	9 (6)	5 (3)	0	21 (11)
Unknown source animal	37 (3)	10 (3)	6 (4)	0	5 (9)	20 (11)
Mean age (y)	30.9	31.6	23.8	22.5	16.2	26.6

\*Route of exposure and source of exposure percentages calculated within group size to accommodate comparison.

†Bite exposure was significantly associated with single-person exposures vs. group exposures ( $p < 0.001$ ).

Information regarding treatment scheduling was not available for 29 (2%) PEP cases.

Information on vaccine scheduling was available for 724 (58%) of the 1998–2000 PEP cases. Administration schedules were correct for 605 (84%) persons. Six persons (1%) did not receive HRIG when it was indicated, and 9 (1%) previously vaccinated persons received HRIG, although it was not indicated. One person received 6 total vaccine doses. Adverse events were listed as either present or absent with no scale as to severity. In all, 63 persons (5%) reported adverse reactions to vaccine or to HRIG.

## Discussion

Epidemiologic characteristics of possible rabies exposure leading to PEP changed substantially in this 4-county upstate New York area from 1993 to 2000. The major changes were the animal species exposure source and type of exposure (Table 4). From 1995 to 2000, overall PEP incidence declined in this area to 27 cases/100,000 from a high of 43 cases/100,000 in the early 1990s (9). Although affected by complex factors, this may reflect increased knowledge about what constitutes an exposure from terrestrial mammals among the public and healthcare providers and how to avoid exposures.

Table 4. Human rabies postexposure prophylaxis (PEP), 4 counties, New York, 1993–2000

Characteristic	1993–1994*	1995–2000
PEP cases (annual mean)	1,173 (587)	2,216 (369)
Annual PEP incidence	32/100,000 urban, 123/100,000 rural	23/100,000 urban, 57/100,000 rural
Season	Summer to early autumn	Summer to early autumn, July–August for 1998–2000
Sex	55% male (47/100,000), 45% female (38/100,000)	51% male (27/100,000), 49% female (25/100,000)
Age (y)†	10–14 and 35–55	5–9 and 30–34
Exposure source (%)		
Wild	67	51
Raccoon	50	12
Bat	5	31
Other	12	8
Domestic	33	49
Cat	17	24
Dog	14	23
Other	2	2
Exposure type (%)		
Bite	30	51
Scratch	6	5
Direct‡	14	16
Indirect§	51	28
Group size	47% $\geq 2$ persons exposed	40% $\geq 2$ persons exposed

\*Data from Centers for Disease Control and Prevention (9).

†Age groups with highest annual incidence.

‡Direct exposure of saliva or neural tissue to wound or mucous membrane.

§Indirect exposure to saliva or neural tissue to wound or mucous membrane, includes unidentified exposures from 1995 to 2000.

In agreement with other recent studies, cats accounted for a majority of the exposures from domestic animals (9). Reinforced emphasis of responsible pet ownership and routine vaccination with specific attention to the ideal of maintaining cats indoors and up-to-date on their rabies vaccinations may help to reverse this trend. At this time, many states and localities do not require rabies vaccination in cats. New York established a statewide requirement for rabies vaccination for cats in 2002. Progress in this area would be further enhanced through tangible enforcement mechanisms.

The passive nature of PEP data collection is an inherent weakness in most studies addressing PEP incidence. The capture rate in this study is high because New York has a requirement for reporting all PEP cases and provided partial reimbursement to local health departments for uncovered expenses. However, some cases may not have been reported if costs were borne by the private sector.

Potential exposures to bats have replaced raccoons as the most common species leading to PEP (Figure 3). By 1998, bats had become the leading source of exposure for which PEP was sought in this area. Historically, bats have only accounted for 5% to 10% of PEP cases (1,8,9). Furthermore, most exposures to bats (62%) were cryptic or listed as unknown; in other words, the exposure could not be described as a bite from a bat or as direct or indirect contamination of an open wound or mucous membrane with infectious material from a bat.

One hypothesis in the debate surrounding cryptic bat exposure and subsequent human rabies is that a bite from a bat is dismissed as insignificant or is unrecognized by the person because of somnolence or other impairment. For example, 32 human rabies cases have been caused by bat rabies virus variants from 1980 to 2004, but only 5 patients reported a bite from a bat. However, a bat “encounter” was recalled in 75% of cases, sometimes by family members or associates. Moreover, bat bites do not typically require medical attention for trauma from the bite itself (Figure 4).

Recognizing a potential exposure by the patient and appropriate administration of PEP by healthcare professionals is critical to maintaining the low rates of human rabies deaths observed in the United States. Although the rate is low, the number of human rabies cases caused by bat-associated rabies virus variants rose from 2 during the 1980s to 20 during the 1990s. This apparent increase in bat-associated human rabies cases led to changes in the recommendations for PEP to be considered in situations where a bat is physically present, a bite cannot be ruled out, and rabies cannot be ruled out by testing the bat. This cautionary language was formalized in the 1999 update of ACIP recommendations for human rabies prevention and control (7). Although these recommendations have been criticized (11), they have been widely implemented in public health

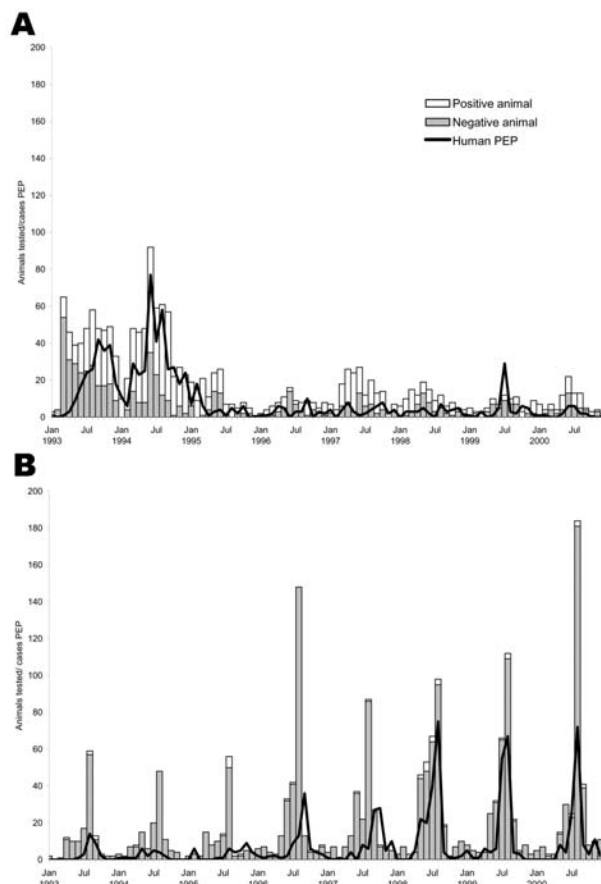

Figure 3. Human rabies postexposure prophylaxis (PEP) associated with raccoon (A) or bat (B) exposures and the number of raccoons or bats that tested positive or negative for rabies, 4 upstate New York counties (Cayuga, Monroe, Onondaga, and Wayne), 1993–2000.

practice. In addition to the ACIP recommendations, the public health response in New York consisted of updated rabies guidelines and an education campaign on bats and rabies during the late 1990s (7,12,13). Though these guidelines may have increased PEP, informed decision-making should always be used to reduce unnecessary PEP.

Despite increased educational emphasis on bats and rabies, public knowledge about the risk of rabies exposure from bats is lacking (13,14). A New York study documented that only 17%–26% of respondents knew that bats found in homes should not be immediately released (before considering the need to test the bat) (13). Additionally, a Colorado study found that at least a third of human encounters with bats that result in a possible exposure could have been prevented by adopting a “do not touch” approach to wildlife (15).

The deaths in 1993, 1994, and 1995 of 3 young girls in New York, Washington, and Connecticut and the death of

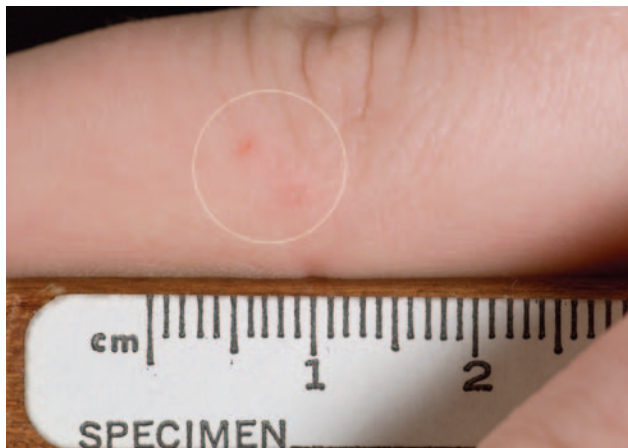

Figure 4. Wound inflicted by canine teeth of *Eptesicus fuscus* (big brown bat) while bat was being handled; picture taken same day as bite.

a New Jersey man in 1997 (16–19) caused by a bat rabies virus variant elicited mass media attention. Sudden increases in PEP after highly publicized rabies cases or exposures have been previously described (20,21). Local and national events that involve a potential rabies case may affect how persons and physicians assess the risk of an animal exposure, perhaps leading to use of PEP in an environment of heightened concern rather than in response to a true exposure (21,22).

The 1999 ACIP guidelines (currently in the nascent stages of another update), as well as the availability of expert consultation at the local, state, and national level, should be widely promoted among healthcare professionals responsible for advising patients and providing PEP. Ultimately, public education about bats and rabies may increase the number of persons who seek PEP. A balanced approach is necessary to curtail inappropriate PEP and avoid unnecessary human deaths, such as the recent California case in which a patient did not seek PEP after a bat bite (23). Similarly, the recent Wisconsin human rabies case resulting from a bat bite was preventable had the risk been understood and had PEP been sought and appropriately administered. Survivorship in this case provides a welcome but extremely rare exception to the paradigm of rabies as inevitably lethal (24). It does not alter the ultimate goal of absolute human rabies prevention.

#### Acknowledgments

We thank the public health professionals in the New York state public health system, including Hwa-Gan Chang, Barbara Wallace, Candace Noonan-Toly, and Yoichiro Hagiwara for maintenance of the rabies exposure reporting system; personnel from the 4 county health departments, specifically Lisa Jones, Nancy Bennett, Mary Anne Trupej, Linda Allen, Tam Cleveland,

Diane Rothermel, Deb Dolan, and Lynn Crane; Charles Trimarchi, Robert Rudd, and Richard Raczowski for providing detailed diagnostic data; and Charles Rupprecht for his leadership and assistance in the editorial process of this paper.

This research was supported in part by both an appointment to the Research Participation Program at the Centers for Disease Control and Prevention (CDC) administered by the Oak Ridge Institute for Science and Education and a grant from the CDC foundation.

Mr Blanton is a research scientist in the Viral and Rickettsial Zoonoses Branch at the Centers for Disease Control and Prevention in Atlanta. His interests include the epidemiology of rabies and other zoonotic diseases.

#### References

1. Currier RW, McCroan JE, Dreesen DW, Winkler WG, Parker RL. Epidemiology of antirabies treatment in Georgia, 1967–71. *Public Health Rep.* 1975;90:435–9.
2. Anderson LJ, Nicholson MB, Tauxe RV, Winkler WG. Human rabies in the United States, 1960 to 1979: epidemiology, diagnosis, and prevention. *Ann Intern Med.* 1984;100:728–35.
3. Noah DL, Drenzek CL, Smith JS, Krebs JW, Orciari L, Shaddock J, et al. Epidemiology of human rabies in the United States, 1980–1996. *Ann Intern Med.* 1998;128:922–30.
4. Messenger SL, Smith JS, Orciari LA, Yager PA, Rupprecht CE. Emerging pattern of rabies deaths and increased viral infectivity. *Emerg Infect Dis.* 2003;9:151–4.
5. Chang HH, Eidson M, Noonan-Toly C, Trimarchi CV, Rudd R, Wallace BJ, et al. Public health impact of reemergence of rabies, New York. *Emerg Infect Dis.* 2002;8:909–13.
6. Jackson AC. Human disease. In: Jackson AC, Wunner WH, editors. *Rabies*. San Diego: Academic Press; 2002. p. 232.
7. Centers for Disease Control and Prevention. Human rabies prevention—United States, 1999. Recommendations of the Advisory Committee on Immunization Practices. *MMWR Morb Mortal Wkly Rep.* 1999;48:1–24.
8. Helmick CG. The epidemiology of human rabies postexposure prophylaxis, 1980–1981. *JAMA.* 1983;250:1990–6.
9. Wyatt JD, Barker WH, Bennet NM, Hanlon CA. Human rabies post-exposure prophylaxis during a raccoon rabies epizootic in New York, 1993 and 1994. *Emerg Infect Dis.* 1999;5:415–23.
10. US Census Bureau. American FactFinder [database on the Internet]. [cited 2003 Feb]. Available from <http://factfinder.census.gov/home/saff/main.html>
11. Mlot C. Bat researchers dispute rabies policy. *Science.* 2000;287:2391–2.
12. Debbie JG, Trimarchi CV. Prophylaxis for suspected exposure to bat rabies. *Lancet.* 1997;350:1790–1.
13. Eidson M, Schmit K, Keegan M, Trimarchi CV, Tserenpuntsag B, Willsey A. Development and evaluation of bat rabies education materials. *Evidence-Based Preventive Medicine.* 2004;1:85–91.
14. Gibbons RV, Holman RC, Mosberg SR, Rupprecht CE. Knowledge of bat rabies and human exposure among United States cavers. *Emerg Infect Dis.* 2002;8:532–4.
15. Pape WJ, Fitzsimmons TD, Hoffman RE. Risk for rabies transmission from encounters with bats, Colorado, 1977–1996. *Emerg Infect Dis.* 1999;5:433–7.
16. Centers for Disease Control and Prevention. Human rabies—New York, 1993. *MMWR Morb Mortal Wkly Rep.* 1993;42:799–806.

17. Centers for Disease Control and Prevention. Human rabies—Connecticut, 1995. *MMWR Morb Mortal Wkly Rep.* 1996;45:207–9.
18. Centers for Disease Control and Prevention. Human rabies—Texas and New Jersey, 1997. *MMWR Morb Mortal Wkly Rep.* 1998;47:1–5.
19. Centers for Disease Control and Prevention. Human rabies—Washington, 1995. *MMWR Morb Mortal Wkly Rep.* 1995;44:625–7.
20. Leventhal A, Gandacu D. Transitory changes in public and physician behavior following the reappearance of human rabies in Israel. *Harefuah.* 2001;140:898–902.
21. McCombie SC. The politics of immunization in public health. *Soc Sci Med.* 1989;28:843–9.
22. Bell TA. Public health repercussions of a child's death from bat rabies. *Washington Public Health [serial on the Internet].* 1996 Feb [cited 2004 Feb 15]. available from: <http://healthlinks.washington.edu/nwcp/h/wph/batrabie.html>
23. Centers for Disease Control and Prevention. Human death associated with bat rabies—California, 2003. *MMWR Morb Mortal Wkly Rep.* 2004;53:33–5.
24. Centers for Disease Control and Prevention. Recovery of a patient from clinical rabies—Wisconsin, 2004. *MMWR Morb Mortal Wkly Rep.* 2004;53:1171–3.

---

Address for correspondence: Jesse Blanton, Viral and Rickettsial Zoonoses Branch, Division of Viral and Rickettsial Diseases, Centers for Disease Control and Prevention, Mailstop G33, 1600 Clifton Rd, Atlanta, GA 30333, USA; fax: 404-639-1564; email: [asi5@cdc.gov](mailto:asi5@cdc.gov)

All material published in *Emerging Infectious Diseases* is in the public domain and may be used and reprinted without special permission; proper citation, however, is required.

---

ANOTHER DIMENSION

## The Enigma We Answer by Living

**Alison Hawthorne Deming**

Einstein didn't speak as a child  
 waiting till a sentence formed and  
 emerged full-blown from his head.

I do the thing, he later wrote, which  
 nature drives me to do. Does a fish  
 know the water in which he swims?

This came up in conversation  
 with a man I met by chance,  
 friend of a friend of a friend,

who passed through town carrying  
 three specimen boxes of insects  
 he'd collected in the Grand Canyon—

one for mosquitoes, one for honeybees,  
 one for butterflies and skippers,  
 each lined up in a row, pinned and labeled,

tiny morphologic differences  
 revealing how adaptation  
 happened over time. The deeper down

he hiked, the older the rock  
 and the younger  
 the strategy for living in that place.

And in my dining room the universe  
 found its way into this man  
 bent on cataloguing each innovation,

though he knows it will all disappear—  
 the labels, the skippers, the canyon.  
 We agreed then, the old friends and the new,

that it's wrong to think people are a thing apart  
 from the whole, as if we'd sprung  
 from an idea out in space, rather than emerging

from the sequenced larval mess of creation  
 that binds us with the others,  
 all playing the endgame of a beautiful planet

that's made us want to name  
 each thing and try to tell  
 its story against the vanishing.

**From *Genius Loci* by Alison Hawthorne Deming**

Copyright 2005 by Alison Hawthorne Deming. Used by permission of Penguin, a division of Penguin Group (USA) Inc.

# Central African Hunters Exposed to Simian Immunodeficiency Virus

Marcia L. Kalish,\* Nathan D. Wolfe,†  
 Clement B. Ndongmo,\* Janet McNicholl,\*  
 Kenneth E. Robbins,\* Michael Aidoo,\*  
 Peter N. Fonjungo,\*‡ George Alemnji,‡  
 Clement Zeh,\* Cyrille F. Djoko,§  
 Eitel Mpoudi-Ngole,‡ Donald S. Burke,†  
 and Thomas M. Folks\*

HIV-seronegative Cameroonians with exposure to nonhuman primates were tested for simian immunodeficiency virus (SIV) infection. Seroreactivity was correlated with exposure risk ( $p < 0.001$ ). One person had strong humoral and weak cellular immune reactivity to SIVcol peptides. Humans are exposed to and possibly infected with SIV, which has major public health implications.

Two major public health priorities are ensuring the safety of the blood supply and preventing the emergence of new infectious diseases. Phylogenetic evidence shows that HIV-1 and HIV-2 were introduced into humans through independent cross-species transmission of simian immunodeficiency virus (SIV) strains from distinct, naturally infected, nonhuman primate (NHP) hosts. HIV-1 groups M, N, and O are believed to have arisen as 3 separate cross-species transmissions from chimpanzees, and each of the HIV-2 subtypes A–G was the result of independent transmissions from sooty mangabeys (*Cercocebus atys*) to humans. While laboratory exposure to NHPs has caused infections with SIV (1–3), no direct evidence has been seen of ongoing exposure to or infection with SIV in natural settings. Nevertheless, hunting and butchering wild NHPs for food, which expose humans to NHP blood and body fluids, are widespread in sub-Saharan Africa and may lead to ongoing transmission from any of the 33 species of NHP that are known to harbor their own unique SIV strains. Since ongoing lentivirus emergence would be of substantial importance to global public health, we looked for evidence of SIV in a unique collection of plasma from

persons with known levels of exposure to the blood and body fluids of NHPs (3).

## The Study

No commercial serologic assays can detect SIV infections in humans, and published assays for this purpose are not designed to detect a wide range of divergent SIV strains. To determine whether humans are infected with SIV, we developed a sensitive and specific SIV multiple antigenic peptide-based enzyme immunoassay (SMAP-EIA) for detecting *env* IDR (immunodominant region of gp41/gp36) and V3 antibodies to all of the SIV lineages for which *env* sequences were available, specifically SIVsm, SIVagm, SIVsyk, SIVcpz, SIVlhoest/SIVsun, SIVcol, SIVmnd and SIVdrl, SIVrcm, and SIVdeb (4). The SMAP-EIA also detects other SIV strains not represented by specific SIV lineage-based peptides.

This study was carried out under an approved protocol in accordance with guidelines set forth by the Centers for Disease Control and Prevention (CDC). We tested plasma samples from Cameroon that were seronegative for HIV-1 and HIV-2 by EIA. Cameroon has extensive HIV-1 genetic diversity, and rural bushmeat hunting is common (2). Plasma from 3 different groups in Cameroon was examined: 1) persons in remote villages who reported a high level of exposure to bodily fluids of NHPs through hunting NHPs, butchering NHPs, or keeping wild NHP pets ( $n = 76$ ) (2); 2) persons from the same villages who reported a low level of NHP exposure ( $n = 77$ ) (2); and 3) persons from a general population ( $n = 1,071$ ) from urban and rural areas in Cameroon where people may handle NHP meat but are unlikely to have repeated contact with the blood or body fluids of freshly killed animals. We tested the seroreactivity of these small-volume samples by using our SMAP-EIA. Of the samples that were reactive (optical density [OD]  $> 1.000$ ) to  $\geq 1$  of a panel of 9 SIV IDR MAPs (Figure 1), 17.1% were seroreactive in the high exposure group, 7.8% in the low exposure group, and 2.3% in the general group. The higher the risk for exposure to fresh NHP blood and body fluids, the greater the frequency of reactivity ( $p < 0.001$ ).

Only 1 of the plasma samples, with an IDR OD  $> 1$ , also reacted strongly to the homologous V3 peptide. This sample, which was from our general population, reacted to the SIVcol (*Colobus guereza*) MAPs in both IDR (OD = 1.250) and V3 (OD = 1.798). Since frozen viable cells were available from this person, we performed an interferon- $\gamma$  enzyme-linked immunospot (ELISPOT) assay to determine whether peripheral blood lymphocytes (PBLs) from this person recognized SIVcol peptides from *C. guereza*. Since no information is available about T-cell epitopes within the SIVcol genome, and the SIV strains from *C. guereza* are highly divergent from all known SIV

\*Centers for Disease Control and Prevention, Atlanta, Georgia, USA; †Johns Hopkins Bloomberg School of Public Health, Baltimore, Maryland, USA; ‡Project IRECAM (Investigation of Retroviruses in Cameroon), Yaoundé, Cameroon; and §Johns Hopkins Cameroon Program, Yaoundé, Cameroon



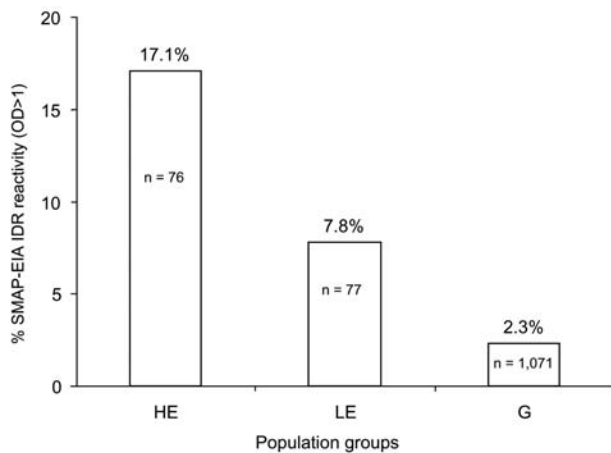

Figure 1. Simian immunodeficiency (SIV) multiple antigenic peptide–enzyme immunoassay (SMAP-EIA) seroreactivity trends to SIV immunodominant region (IDR) peptides in HIV-seronegative Cameroonian population groups with different levels of exposure (high exposure [HE], low exposure [LE], or general [G]) to nonhuman primates. OD, optical density.  $\chi^2$  linear trend 48.166,  $p < 0.001$ .

isolates (5), we designed a series of overlapping peptides (16-mers overlapping by 10) across the *gag* gene, on the basis of the only available *Colobus* sequence (5). Pools of 10 peptides were each tested in the ELISPOT assay. Low levels of T-cell reactivity to pools 71–80 and 81–86 of the *gag* peptides (10 $\times$  and 5 $\times$  background, respectively, and >25 spots/10<sup>6</sup> PBLs) and *env* V3 and IDR peptides (9 $\times$  and 6 $\times$  background, respectively) were observed with unfractionated PBLs (Figure 2). No reactivity was observed in PBLs from an HIV-1–seronegative African donor used as a negative control. Polymerase chain reaction (PCR) and reverse transcription–PCR amplifications from proviral DNA lysates, plasma from this sample, and cells from stimulated ELISPOT wells were performed with *pol* primers originally used to identify the *C. guereza* sequence (5) and with other primers specifically designed from the published *C. guereza* sequence. Despite a strong humoral (*env* IDR and V3) response and weak cellular (*gag*) immune reactivity (in the range of ELISPOT results reported from sex workers who were highly exposed to HIV but seronegative), we were unable to amplify any SIVcol nucleic acids. Seroreactivity without PCR amplification has been documented in those with occupational SIV exposures (1,2). Therefore, seroreactivity to SIVcol in this person may reflect exposure to nonviable or defective SIVcol, a nonproductive or cleared infection, or sequestering of virus in lymphatic tissues.

## Conclusions

Our data, taken together with previous reports of high prevalence of SIV in NHP bushmeat (6) and high levels of

NHP exposure (3), offer new evidence that persons who hunt and butcher wild NHPs are subject to ongoing exposure and potential infection with SIV. In a study of 16 SIV isolates from 5 different primate lineages, 12 were capable of infecting human monocyte-derived macrophages, and 11 were capable of replicating in human peripheral blood mononuclear cells (7), although cell tropism does not necessarily predict virus pathogenicity. Productive crossover infections may occur in low numbers in remote areas of Africa, but because of low population density and isolation, they do not have the opportunity to become epidemic strains and instead become dead-end infections. Ongoing transmission events may also be missed because serologic assays for detecting a broad range of SIVs are lacking or because monitoring is insufficient in populations with high levels of exposure to NHP blood and body fluids. We also have reason to believe that the frequency of SIV exposure and possible infection has increased during recent decades because of a combination of factors that have increased levels of NHP hunting (3); these factors include increased access to firearms, increased access to undisturbed NHP habitat from new logging roads, and increased demand for bushmeat in logging camps and rural and urban markets. New roads increase travel, increasing the probability that productive crossover SIV infections will emerge. Further surveillance for new, potentially successful, cross-species lentivirus transmission in Africa is needed to ensure a safe blood supply and prevent the spread of novel, emerging HIV infections.

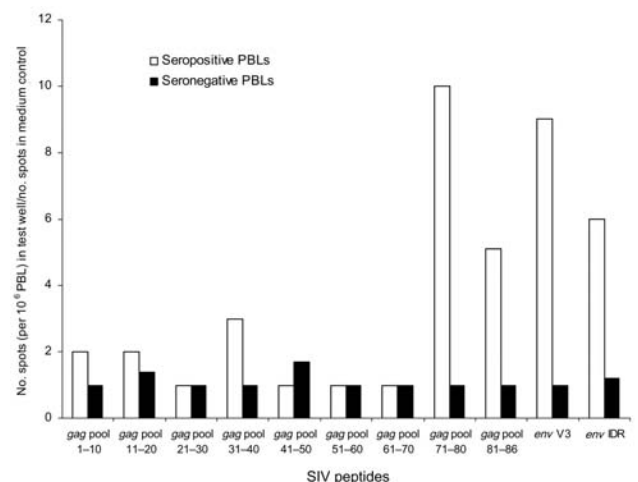

Figure 2. Interferon- $\gamma$  enzyme-linked immunospot reactivity stimulated with SIVcol peptides from the *env* and *gag* regions in peripheral blood lymphocytes (PBLs) from a person seropositive for both the SIVcol V3 and immunodominant region (IDR) peptides and a seronegative person from Africa (both men). To include both assays in a single graph, the number of spots per 10<sup>6</sup> PBLs for each pool of gag peptides was divided by the number of spots per 10<sup>6</sup> PBLs in the medium control. This value was expressed as the level of reactivity above background; i.e., the value 2 on the y-axis stands for 2 $\times$  the number of spots in the negative (medium) control.

### Acknowledgments

We thank Mark Rayfield and John Nkengasong for helping establish and implement variant protocol #1367 and Mbia Eloundou Agathe Feligie, Jose Esther Lyonga, and Eno Laura Takang for sample collection, processing, and basic serologic screening for HIV infection.

This work was supported in part by a grant from the US Military HIV Research Program to D.S. Burke. N.D. Wolfe is supported by a grant from the National Institutes of Health (NIH) Fogarty International Center (K01 TW000003-05), the NIH Director's Pioneer Award Program (DP1-OD000370), the National Geographic Society Committee for Research and Exploration, and awards from the Johns Hopkins Bloomberg School of Public Health Center for a Livable Future, and Center for AIDS Research (NIH P30-AI42855).

Dr Kalish is the associate chief for science, Laboratory Branch, Division of HIV/AIDS Prevention, National Center for HIV, STD, TB Prevention, at CDC. Her research interests include the evolution and molecular epidemiology of HIV, the study of unusual HIV variants and recombinant viruses, and investigations of atypical forms of HIV transmission of public health importance.

Use of trade names is for identification only and does not imply endorsement by the Public Health Service or by the U.S. Department of Health and Human Services.

### References

1. Khabbaz RF, Heneine W, George JR, Parekh B, Rowe T, Woods T, et al. Brief report: infection of a laboratory worker with simian immunodeficiency virus. *N Engl J Med.* 1994;330:172–7.
2. Khabbaz RF, Rowe T, Murphey-Corb M, Heneine WM, Schable CA, George JR, et al. Simian immunodeficiency virus needlestick accident in a laboratory worker. *Lancet.* 1992;340:271–3.
3. Wolfe ND, Prosser TA, Carr JK, Tamoufe U, Mpoudi-Ngole E, Torimiro JN, et al. Exposure to nonhuman primates in rural Cameroon. *Emerg Infect Dis.* 2004;10:2094–9.
4. Ndongmo CB, Switzer WM, Pau CP, Zeh C, Schaefer A, Pieniazek D, et al. A new multiple antigenic peptide-based enzyme immunoassay for the detection of SIV infection in nonhuman primates and humans. *J Clin Microbiol.* 2004;42:5161–9.
5. Courgnaud V, Pourrut X, Bibollet-Ruche F, Mpoudi-Ngole E, Bourgeois A, Delaporte E, et al. Characterization of a novel simian immunodeficiency virus from guereza colobus monkeys (*Colobus guereza*) in Cameroon: a new lineage in the nonhuman primate lentivirus family. *J Virol.* 2001;75:857–66.
6. Peeters M, Courgnaud V, Abela B, Auzel P, Pourrut X, Bibollet-Ruche F, et al. Risk to human health from a plethora of simian immunodeficiency viruses in primate bushmeat. *Emerg Infect Dis.* 2002;8:451–7.
7. Grimm TA, Beer BE, Hirsch VM, Clouse KA. Simian immunodeficiency viruses from multiple lineages infect human macrophages: implications for cross-species transmission. *J Acquir Immune Defic Syndr.* 2003;32:362–9.

Address for correspondence: Marcia L. Kalish, Centers for Disease Control and Prevention, 1600 Clifton Rd, Mailstop G19, Atlanta, GA 30333, USA; fax: 404-639-3254; email: mkalish@cdc.gov

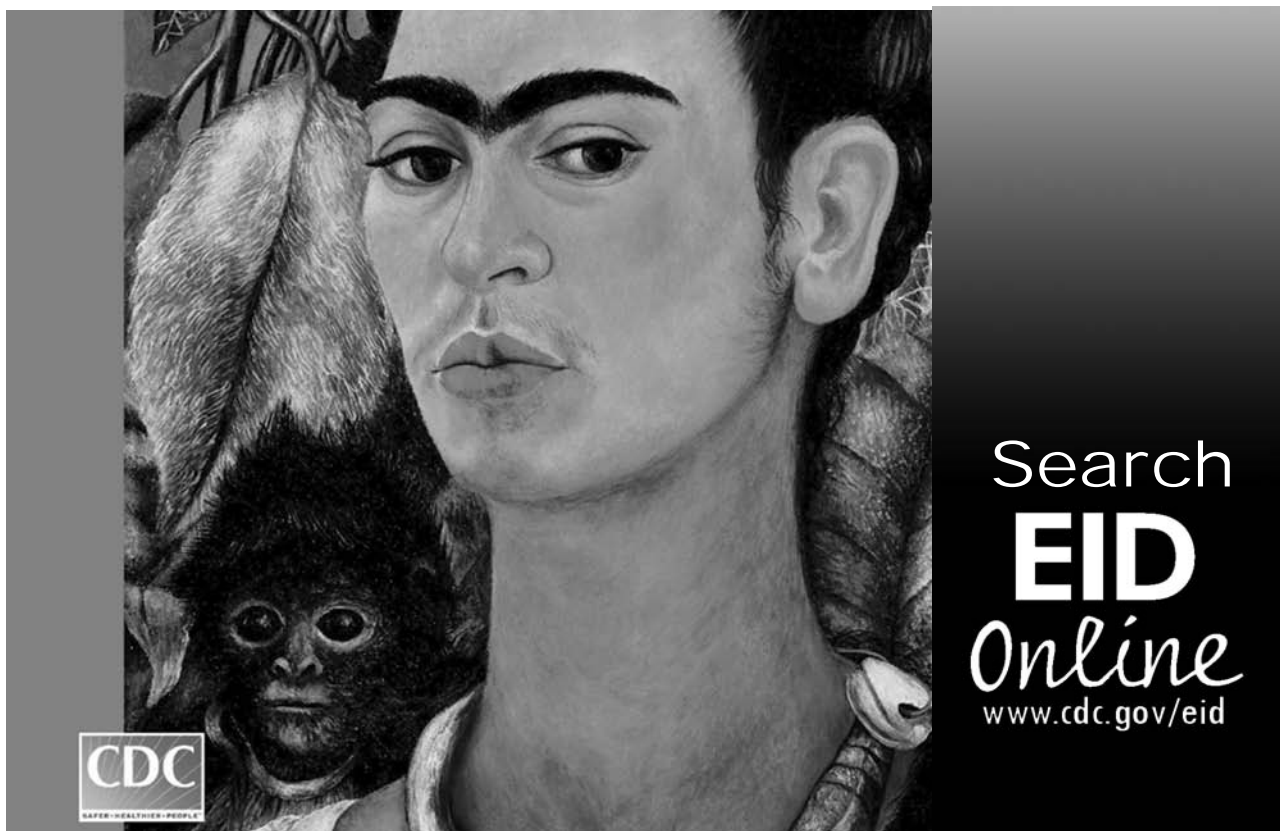



Search  
**EID**  
 Online  
[www.cdc.gov/eid](http://www.cdc.gov/eid)

# *Bartonella quintana* in Cynomolgus Monkey (*Macaca fascicularis*)

Laurie G. O'Rourke,\* Christian Pitulle,†  
Barbara C. Hegarty,† Sharon Kraycirik,†  
Karen A. Killary,‡ Paul Grosestein,‡  
James W. Brown,†  
and Edward B. Breitschwerdt†

We identified a *Bartonella quintana* strain by polymerase chain reaction amplification, cloning, and sequencing of DNA extracted from lysed erythrocytes and cultured colonies grown from peripheral blood collected from a captive-bred cynomolgus monkey (*Macaca fascicularis*). This report describes naturally acquired *B. quintana* infection in a nonhuman primate.

*Bartonella quintana*, transmitted by the human body louse (*Pediculus humanis*), is the etiologic agent for trench fever. Although Mooser experimentally infected a rhesus monkey with *B. quintana* >50 years ago, we report the first naturally occurring infection with *B. quintana* in a nonhuman primate (1).

A young adult female cynomolgus monkey (*Macaca fascicularis*), born October 1, 1998, in a breeding facility in Vietnam, was shipped on February 28, 2001, to Covance Inc. (Alice, TX, USA), where she was quarantined and acclimated by the vendor. On April 30, 2001, the monkey was shipped to Laboratory Animal Services, Novartis Pharmaceuticals Corporation (East Hanover, NJ, USA) and held in quarantine until released on June 15, 2001, for study and assigned an identification number of 1505. Numerous procedures, treatments, and screening tests were conducted by the vendor during the monkey's quarantine in Texas and before its arrival in New Jersey. These included the following: 1) vaccination against hepatitis A (genus *Hepatitisvirus*) and measles (genus *Morbillivirus*); 2) serologic testing for cytomegalovirus (subfamily *Betaherpesvirinae*; positive), herpesvirus B (family *Herpesviridae*, negative), simian type D virus (simian retrovirus; SRV-1, -2, and -3; negative), simian immunodeficiency virus (SIV, genus *Lentivirus*; negative), simian

T-lymphotropic virus (STLV, genus BLV-HTLV retroviruses; negative); 3) testing by polymerase chain reaction for SRV-1, -2, and -3 (negative); 4) Mantoux skin test for *Mycobacterium tuberculosis* (negative ×4); and 5) treatment for endoparasites with albendazole and ivermectin, for ectoparasites with insecticide dust, and for *Plasmodium* spp. with chloroquine and primaquine. During the course of routine microscopic review of no. 1505's peripheral blood collected pretest (July 9, 2001) and stained with Wright stain (Hema-Tek 2000, Bayer Corporation, Wright Stain Pak, Curtin Matheson Scientific Inc., Houston, TX, USA), erythrocytic morphologic changes (moderate to marked stomatocytosis, punctate discoloration, or polychromatophilic aggregation) suggestive of a hemotropic parasite were observed (Figure 1). Malarial parasites were

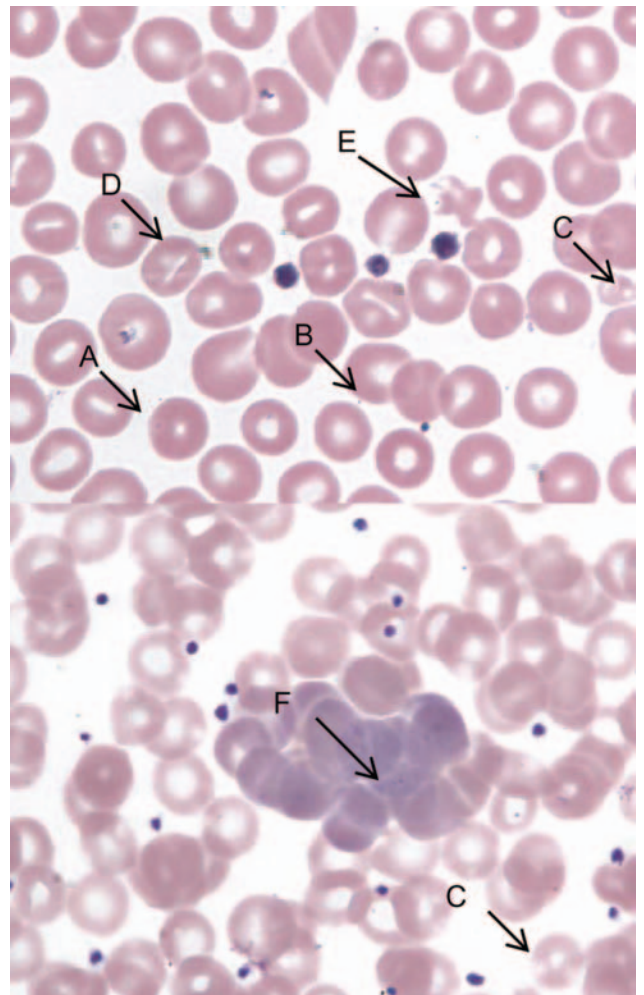

Figure 1. Peripheral blood film, Wright stain, 1,000× (oil immersion). A) Spherostomatocyte with suspect intracellular organism; B) suspect membrane-associated organism; C) microcytes with punctate discoloration; D) stomatocyte; E) poikilocyte with punctate discoloration and suspected membrane-associated organism; and F) aggregate of polychromatophilic erythrocytes and suspect intracellular organism at tip of arrow.

\*University College Dublin, Dublin, Ireland; †North Carolina State University, Raleigh, North Carolina, USA; and ‡Novartis Pharmaceuticals Corporation, East Hanover, New Jersey, USA

not observed. At the resolution of light microscopy ( $\approx 2 \mu\text{m}$ ), basophilic particles were identified in association with erythrocyte membranes, with less well-defined, pale-blue inclusions seen within erythrocytes. Mean corpuscular volume was increased (82.2 fL). Blood from the same K-EDTA collection tube was transferred to the Electron Microscopy Laboratory (Novartis) for both transmission electron microscopy (TEM) and scanning electron microscopy (SEM) evaluation. Although intra- and extra-erythrocytic bacterial organisms were confirmed by TEM, and SEM identified numerous pits, the morphologic characteristics were not unique identifiers for *Bartonella* spp. (Figure 2). Since the sample was discarded after aliquots were taken for electron microscopy, a new K-EDTA blood sample was collected for culture from monkey no. 1505 and sent on ice by overnight delivery to the Intracellular Pathogens Laboratory, North Carolina State University College of Veterinary Medicine. Clinical observations during the study dosing period were unremarkable, and no unusual lesions were observed at necropsy or during histologic examination of selected tissues.

### The Study

Approximately 1.5 mL K-EDTA blood received from Novartis was frozen ( $-80^{\circ}\text{C}$ ) and then thawed 1 week later after lysis of the erythrocytes. After centrifugation of the sample at  $3,000 \times g$  for 30 min, the pellet was resuspended in M199 (Cellgro, Mediatech, Inc., Herndon, VA, USA) containing 20% (vol/vol) fetal bovine serum, 22.5% (vol/vol) sodium bicarbonate, 100 mmol/L sodium pyruvate and GlutaMAX-1 (Gibco Life Technologies, Grand Island, NY, USA) and spread onto trypticase soy agar containing 5% (vol/vol) rabbit blood and chocolate agar (Becton Dickinson, Cockeysville, MD, USA), respectively. Plates were incubated at  $35^{\circ}\text{C}$  under 5%  $\text{CO}_2$  and monitored for up to 6 weeks.

Five hundred microliters phosphate-buffered saline (PBS) was added to 200  $\mu\text{L}$  blood (previously frozen at  $-80^{\circ}\text{C}$ ) and centrifuged at  $20,817 \times g$  for 6 min. The supernatant was removed, and the pellets were resuspended in

500  $\mu\text{L}$   $1 \times$  PBS followed by centrifugation for 6 min. After removing the supernatant, and resuspending the samples in 200  $\mu\text{L}$  PBS, we extracted DNA by using a QIAamp Blood Kit (Qiagen, Chatsworth, CA, USA) DNA from culture-grown *B. henselae* strain Houston-1, *B. vinsonii* subspecies *berkhoffii* (93CO-1), *B. elizabethae*, *B. clarridgeiae* (NCSU 94-F40), and *B. quintana* (ATCC VR-358) were used for all PCRs as control templates.

Amplification of the 16S rDNA and the 16S–23S intergenic spacer (ITS) regions was performed as described earlier (2,3). Amplification conditions for the citrate synthase gene (*gltA*) were the same as for the 16S–23S ITS region except that primers BhCS 1137n1 (5' AATG-CAAAAAGA ACAGTAAACA 3') and CS443f 2 (5' GCTATGTCTGCATTCTATCA 3') were used (4). Selective PCR amplifications for the 16S rDNA, 23S rDNA, and *rnpB* were performed as described (2).

After cloning, recombinant plasmid DNA for *gltA* and the 16S–23S ITS region was sequenced bidirectionally with the infrared fluorescently labeled primers M13Reverse (5' CAGGAAACAGCTATGACCATG) and T7 (5' TAATACGACTCACTATAGGCGA). The recombinant DNA carrying the genes for 23S rDNA, 16S rDNA, and *rnpB* was sequenced as described elsewhere (5). All sequences were aligned by using the multiple sequence alignment editor ALIGN-IR (LI-COR), and consensus sequences for every gene sequenced were determined. Consensus sequences were then used to identify the closest match within GenBank. To determine the exact phylogenetic relationship of the new isolate within the genus *Bartonella*, we analyzed an alignment that contained the sequences of 3 important phylogenetic markers, ribonuclease P RNA (RNase P RNA), 16S rDNA, and 23S rDNA, merged by catenation and organized by secondary structure elements, as described (5). Our dataset comprises 14 *Bartonella* strains (Table), including the 7 strains known to be human pathogens. We have also used the sequence information for the *gltA* as well as the 16S–23S rDNA ITS for sequence similarity analysis. Sequences have been deposited in GenBank with accession numbers AY484592

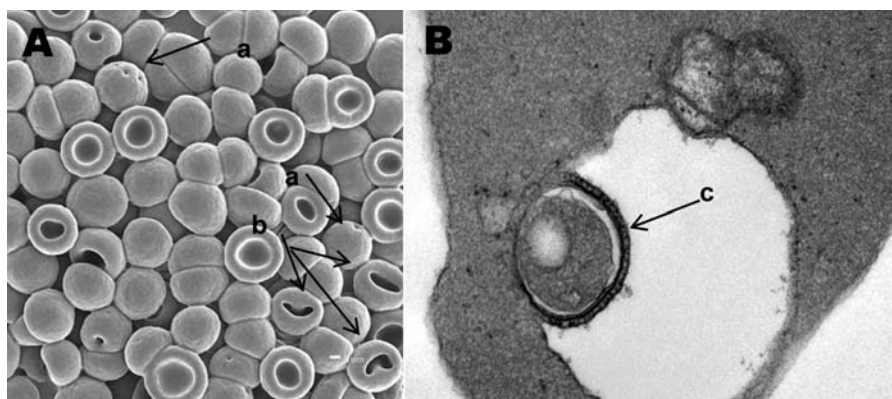

Figure 2. A) Electron microscopy scan of peripheral blood. B) Transmission electron microscopy scan of peripheral blood. a, membrane invaginations; b, stomatocytes and spherostomatocytes; c, erythrocyte with vacuole-enclosed suspect organism.

Table. Strains used for the phylogenetic analysis within genus *Bartonella*\*

Strain	16S rDNA	23S rDNA	<i>mpB</i>
<i>B. vinsonii</i> subsp. <i>arupensis</i> <sup>T</sup> (ATCC 700727)	AF214558	AF410937	AF441295
<i>B. clarridgeiae</i> strain NCSU 94-F40 <sup>T</sup> (ATCC 700095)	U64691	AF410938	AY033649
<i>B. doshiae</i> R18 <sup>T</sup> (ATCC 700133)	Z31351	AF410939	AF441294
<i>B. elizabethae</i> <sup>T</sup> (ATCC 49927)	L01260	AF410940	AY033770
<i>B. vinsonii</i> subsp. <i>berkhoffii</i> (93CO-1) <sup>T</sup> (ATCC 51672)	L35052	AF410941	AF375873
<i>B. grahamii</i> V2 NCTC 12860 <sup>T</sup> (ATCC 700132)	Z31349	AF410942	AF441293
<i>B. henselae</i> strain Houston-1 <sup>T</sup> (ATCC 49882)	M73229	AF410943	AY033897
<i>Bartonella</i> strain N40	AF204274	AF410944	AF441292
<i>Bartonella</i> strain deer 159/660/1	AF373845	AF410945	AF376051
<i>B. quintana</i> strain Fuller <sup>T</sup> (ATCC VR-358)	M11927	AF410946	AY033948
<i>B. bovis</i> (formerly <i>B. weissii</i> ) strain 99-BO1	AF291746	AF410947	AF376050
<i>B. vinsonii</i> subsp. <i>vinsonii</i> strain Baker <sup>T</sup> (ATCC VR-152)	Z31352	AF411589	AY033502
<i>B. bacilliformis</i> KC584	AF442955	L39095	AF440224
CMO-01-1	AY484592†	AY484593†	AY484594†

\*T, type strains. GenBank accession numbers for sequences of the 16S rDNA, 23S rDNA, and *mpB* are listed in corresponding columns.

†Accession numbers of sequence data determined in this study that were deposited into the GenBank database.

(16S rDNA), AY484593 (23S rDNA), AY484594 (RNase P RNA), and AY484595 (*gltA*).

On day 14 after blood plating, growth typical for members of the genus *Bartonella* was obtained. Sixty-two small to medium-sized, white, shiny, smooth, nonadherent colonies were detected on chocolate agar. By day 16 after plating, 43 colonies of similar appearance were evident on blood agar. The strain was designated *Bartonella* strain CMO-01-1.

DNA could be successfully extracted, and subsequent PCR reactions resulted in PCR products representing 23S rRNA, 16S rRNA, RNase P RNA, 16S-23S rDNA ITS sequence, and the citrate synthase gene. All products were successfully cloned and sequenced. Sequencing of multiple clones for each gene resulted in sequences that were >99% identical to existing sequences derived from *B. quintana*, with the exception of the 16S-23S rDNA ITS sequence (>98.4%) and *gltA* (98%). Initial BLAST search results showed that the sequences for the 23S rDNA, the 16S rDNA, RNase P RNA, 16S-23S rDNA ITS sequence, and *gltA* derived from strain CMO-01-1 best matched *B. quintana* sequences that have been reported to GenBank. The data could be reproduced by using DNA extracted from the K-EDTA blood sample or from pure colonies grown on both chocolate and blood agar.

Subsequent comprehensive phylogenetic analysis clearly identified the isolate CMO-01-1 as a close relative of *B. quintana* type strain "Fuller." The statistical support for this relationship is 100%, as indicated by the bootstrap values for the phylogenetic tree (Figure 3).

### Conclusions

Our findings support the close relationship of *B. quintana* and the new cynomolgus monkey isolate. The evolutionary distance (Figure 3) between *B. quintana* and the new isolate is similar to the evolutionary distance between

the 3 subspecies of *B. vinsonii*. The high degree of sequence identity for the 16S rDNA of our isolate to other *B. quintana* 16S rDNA sequences deposited in GenBank clearly identifies strain CMO-01-1 as *B. quintana*. However, the high degree of 16S rDNA sequence identity makes a discriminatory match within or below the species level impossible. We have therefore applied the combined use of the phylogenetic markers RNase P RNA, 16S

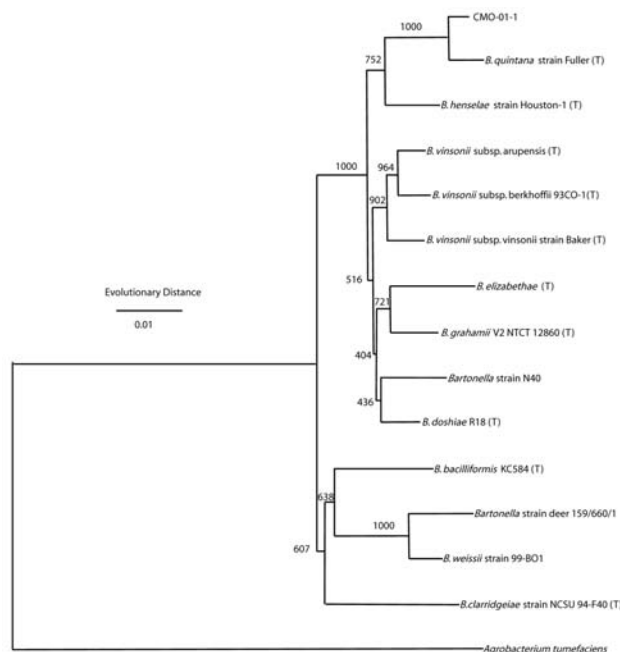

Figure 3. Phylogenetic tree of *Bartonella* species (Table) based on the combined RNase P RNA, 16S, and 23S rRNA sequence alignment. *Agrobacterium tumefaciens* serves as the outgroup in this tree. The tree shown was generated by using the neighbor-joining method. The horizontal axis is estimated evolutionary distance. The numbers shown at each node are the number of times that node appears among 1,000 bootstrapped trees. T, type strains.

rRNA, and 23S rRNA for a comprehensive phylogenetic analysis. The advantage of such an analysis within the genus *Bartonella* has been discussed by Pitulle et al. (2). We have used the same dataset (Table) as described earlier (2) but added the sequences derived from the isolate CMO-01-1. We therefore consider the new isolate a novel strain of *B. quintana*.

The 1.6% sequence dissimilarities of the 16S–23S rDNA ITS data derived from CMO-01-1 to published 16S–23S rDNA ITS sequences for *B. quintana* are phylogenetically insignificant. The 16S–23S rDNA ITS region is a highly sequence variable area within the bacterial genome that can differ to the extent seen in our study at or below the species level (3,5). The sequences determined in our study have the same length as the 16S–23S rDNA ITS sequence reported for *B. quintana*, which further supports our conclusion that CMO-01-1 is a strain of *B. quintana*.

The *gltA* sequence derived from the bacterial strain CMO-01-1 is 98% identical to that derived from *B. quintana*. This match was the highest within the genus *Bartonella*. The next closest match was *B. henselae* with 92% similarity. This degree of sequence identity also suggests that CMO-01-1 represents a strain of *B. quintana*.

Confinement practices used for monkey 1505 should have eliminated or substantially restricted possible exposure to insect vectors, such as the human body louse (*Pediculus humanis*). Neither an exposure date nor an arthropod vector was identified in this monkey. Chronic subclinical infection with *B. quintana* has been documented following experimental infection of monkeys (1) and in humans for *B. quintana* (5,6) and *B. bacilliformis* (7). Persistent infection was suspected but was not documented in this monkey because of the delay in bacterial identification. Bred and raised in outdoor facilities located in Southeast Asia, these primates often arrive in the United States with subclinical malaria, proof that exposure to mosquitoes and potentially other insects has occurred. *B. quintana* DNA has been recently found in ticks and fleas (8,9).

The reemergence of *B. quintana* infections in humans has expanded awareness of the organism's ability to induce persistent bacteremia in people with few symptoms (5,6,10,11). Because of the small number of infected erythrocytes needed to sustain infection, screening peripheral blood for organisms, even with confocal microscopy, has a

poor success rate (12). Our findings indicate that nonhuman primates may serve as a previously unrecognized reservoir for human *B. quintana* infection.

Dr O'Rourke is a veterinary clinical pathologist at the University College Dublin, Dublin, Ireland.

## References

- Mooser H, Weyer F. Experimental infection of *Macacus rhesus* with *Rickettsia quintana* (trench fever). *Proc Soc Exp Biol Med*. 1953;83:699–701.
- Pitulle C, Strehse C, Brown JW, Breitschwerdt EB. Investigation of the phylogenetic relationships within the genus *Bartonella* based on comparative sequence analysis of the *mpB* genes, 16S rDNA and 23S rDNA. *Int J Syst Evol Microbiol*. 2002;52(pt 6):2075–80.
- Houpikian P, Raoult D. 16S/23S rRNA intergenic spacer regions for phylogenetic analysis, identification, and subtyping of *Bartonella* species. *J Clin Microbiol*. 2001;39:2768–78.
- Birtles RJ, Raoult D. Comparison of partial citrate synthase gene (*gltA*) sequences for phylogenetic analysis of *Bartonella* species. *Int J Syst Bacteriol*. 1996;46:891–7.
- Brouqui P, Lascola B., Roux VR, Raoult D. Chronic *Bartonella quintana* bacteremia in homeless patients. *N Engl J Med*. 1999;340:184–9.
- Foucault C, Barrou K, Brouqui P, Raoult D. *Bartonella quintana* bacteremia among homeless people. *Clin Infect Dis*. 2002;35:684–9.
- Kosek M, Lavarello R, Gilman RH, Delgado J, Manguina C, Verastegui M, et al. Natural history of infection with *Bartonella bacilliformis* in a nonendemic population. *J Infect Dis*. 2000;182:865–72.
- Chang CC, Chomel BB, Kasten RW, Romano V, Tietze N. Molecular evidence of *Bartonella* spp. in questing adult *Ixodes pacificus* ticks in California. *J Clin Microbiol*. 2001;39:1221–6.
- Rolain J-M, Franc M, Davoust B, Raoult D. Molecular detection of *Bartonella quintana*, *B. koehlerae*, *B. henselae*, *B. clarridgeae*, *Rickettsia felis*, and in cat fleas, France. *Emerg Infect Dis*. 2003;9:338–42.
- Brouqui P, Raoult D. *Bartonella quintana* invades and multiplies within endothelial cells in vitro and in vivo and forms intracellular blebs. *Res Microbiol*. 1996;147:719–31.
- Spach DH, Kanter AS, Dougherty MJ, Larson AM, Coyle MB, Brenner DJ, et al. *Bartonella (Rochalimaea) quintana* bacteremia in inner-city patients with chronic alcoholism. *N Engl J Med*. 1995;332:424–8.
- Rolain JM, Foucault C, Guieu R, La Scola B, Brouqui P, Raoult D. *Bartonella quintana* in human erythrocytes. *Lancet*. 2002;360:226–8.

Address for correspondence: Edward B. Breitschwerdt, Intracellular Pathogens Laboratory, Department of Clinical Sciences, College of Veterinary Medicine, North Carolina State University, Raleigh, NC 27606, USA; fax: 919-513-6336; email: ed\_breitschwerdt@ncsu.edu

Search past issues of EID at [www.cdc.gov/eid](http://www.cdc.gov/eid)

# Passatempo Virus, a Vaccinia Virus Strain, Brazil

Juliana A. Leite,\* Betânia P. Drumond,\*  
Giliane S. Trindade,\* Zélia I.P. Lobato,\*  
Flávio G. da Fonseca,† João R. dos Santos,\*  
Marieta C. Madureira,‡ Maria I.M.C. Guedes,\*  
Jaqueline M.S. Ferreira,\* Cláudio A. Bonjardim,  
Paulo C.P. Ferreira,\* and Erna G. Kroon\*

Passatempo virus was isolated during a zoonotic outbreak. Biologic features and molecular characterization of hemagglutinin, thymidine kinase, and vaccinia growth factor genes suggested a vaccinia virus infection, which strengthens the idea of the reemergence and circulation of vaccinia virus in Brazil. Molecular polymorphisms indicated that Passatempo virus is a different isolate.

Since 1999, an increasing number of exanthemous outbreaks affecting dairy cattle and cow milkers in Brazil have been reported (1–3). These outbreaks were related to poxvirus infections, which resulted in economic losses to farmers and affected the health of humans and animals. Here we report a vaccinia virus (VACV) outbreak that emerged in March 2003 in the town of Passa-Tempo, Minas Gerais State, Brazil.

## The Study

The outbreak area is characterized by small rural properties with diverse crops, pasturelands, and surrounding fragments of Atlantic Forest. Its climate is tropical, with a relatively severe dry season, generally from April to September (4).

All dairy farms were similar, consisting of a main house with corrals and pasture fields generally with unsophisticated infrastructure. All milking was manually performed by milkers, typically without strict aseptic measures, which could have contributed to the spread of the virus among the herd and milkers. Cows exhibited lesions on teats and udders that resembled the clinical features observed during other Brazilian VACV outbreaks (1). Initial acute lesions were associated with a roseolar erythema with localized edema that led to the formation of vesicles. The vesicles rapidly progressed to papules and

pustules, which subsequently ruptured and suppurated. Typically, a thick dark scab followed, but the formation of large areas of ulceration was also common. The course of infection lasted from 3 to 4 weeks. Different stages of lesions were present, ranging from papules to vesicles, pustules, and crusts (Figure 1). Moreover, because of secondary infections, some cows had mastitis (Figure 1). Calves became infected, showing lesions on oral mucosa and muzzles (Figure 1). Several infected milkers reported lesions on their hands, which were apparently transmitted by unprotected contact with sick cattle (Figure 1). In addition, infected persons reported severe headache, backache, lymphadenopathy, and high fever.

For virus isolation, crusts were collected from 5 cows and 1 calf, macerated, and added to the chorioallantoic membrane of embryonated eggs (2). The whitish pockmarks produced on chorioallantoic membranes resembled VACV pocks, differing from the red hemorrhagic ones produced by cowpox virus (CPXV) (online Appendix Figure 1; available at [http://www.cdc.gov/ncidod/EID/vol11no12/05-0773\\_app1.htm](http://www.cdc.gov/ncidod/EID/vol11no12/05-0773_app1.htm)). Blood from affected animals was collected for neutralization assays (5). Serologic cross-reactivity of antibodies to VACV–Western Reserve (WR) strain was detected in all samples, and titers of these serum samples were  $\geq 640$  U/mL (data not shown).

Transmission electron microscopy of isolates (6) showed a morphologic pattern typical of orthopoxviruses (online Appendix Figure 2; available at [http://www.cdc.gov/ncidod/EID/vol11no12/05-0773\\_app2.htm](http://www.cdc.gov/ncidod/EID/vol11no12/05-0773_app2.htm)). No A-type inclusion body (ATI) was seen, reinforcing the conclusion that this virus was likely not a CPXV, but a VACV. Viral DNAs were extracted (6) and used as template for *ati* gene restriction fragment length polymorphism (RFLP) analysis (7). The *ati* RFLP patterns of all isolates were identical to those of Araçatuba virus (ARAV) (1) and other VACV strains previously isolated in our laboratory (unpub. data); they were similar to those of VACV–WR and completely different from those of CPXV–Brighton Red (BR) (online Appendix Figure 3; available at [http://www.cdc.gov/ncidod/EID/vol11no12/05-0773\\_app3.htm](http://www.cdc.gov/ncidod/EID/vol11no12/05-0773_app3.htm)). Since all isolates showed the same *ati* RFLP pattern, one was cloned, purified, titrated (1,6), and named Passatempo virus (PSTV).

To better identify this etiologic agent, *ha*, *tk*, and *vgf* genes were amplified by polymerase chain reaction with Taq polymerase (Promega, Madison, WI, USA) (6,8,9). Amplicons were cloned into pGEM-T vector (Promega). Three clones were sequenced 3 times in both orientations by the dideoxy method, using M13 universal primers and ET Dynamic Terminator for MegaBACE (GE Healthcare, Fairfield, CT, USA). The nucleotide (nt) sequences of *ha*, *tk*, and *vgf* were assembled by using the CAP3 Sequence Assembling Program (10) and deposited in GenBank

\*Universidade Federal de Minas Gerais, Belo Horizonte, Minas Gerais, Brazil; †Centro de Pesquisas René Rachou–Fundação Instituto Oswaldo Cruz, Belo Horizonte, Minas Gerais, Brazil; and ‡Instituto Mineiro de Agropecuária, Belo Horizonte, Minas Gerais, Brazil

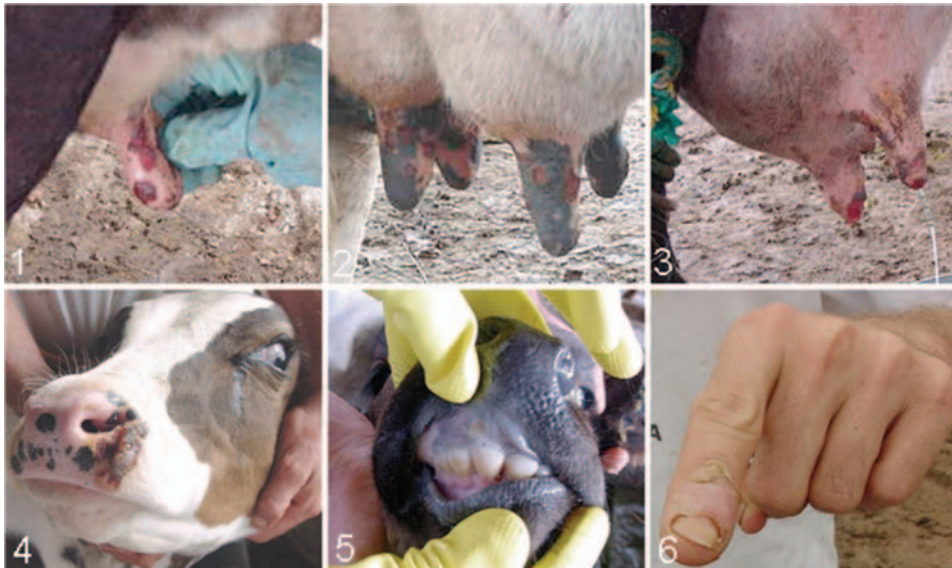

Figure 1. Lesions caused by Passatempo virus infection. Panels 1 and 2, ulcerative lesions on cows' teats; 3, mastitis caused by bacterial secondary infection; 4 and 5, lesion on calves' muzzle and oral mucosa; 6, lesions of dairy farm milker.

under accession numbers DQ070848, DQ085461, and DQ085462, respectively. The sequences and inferred amino acid sequences were aligned with those of orthopoxviruses by using the ClustalW 1.6 program (11).

PSTV *ha* gene sequence was compared to those of ARAV, Cantagalo virus (CTGV) (1,2), VACV-WR, CPXV-BR, VACV Instituto Oswaldo Cruz (VACV-IOC), and VACV Lister (VACV-LST). VACV-IOC and VACV-LST are vaccine strains used in the Brazilian smallpox eradication program (2,6). The PSTV *ha* gene sequences presented the same 18-nt deletion found in ARAV, CTGV, and VACV-IOC and shared more similarities to ARAV and CTGV homologous sequences. Additionally, 8 amino acid substitutions were unique to PSTV, ARAV, and CTGV. Since this characteristic was not observed in the vaccine strains, an independent origin is suggested. Moreover, PSTV HA differs from that of ARAV and CTGV by 1 and 2 amino acid substitutions, respectively (online Appendix Figure 4; available at [http://www.cdc.gov/ncidod/EID/vol11no12/05-0773\\_app4.htm](http://www.cdc.gov/ncidod/EID/vol11no12/05-0773_app4.htm)). The percentage of

identity between *ha*, *tk*, and *vgf* nucleotide sequences and inferred amino acid sequences of PSTV with CPXV-BR and other VACV strains are presented in the Table. For the *tk* gene that is highly conserved among VACV, the PSTV nucleotide sequence had 100% identity to ARAV, VACV-LST, and VACV-WR homologous sequences. Additionally, PSTV *vgf* gene had a 3-nt deletion, corresponding to nt 7,669–7,671 of VACV-WR, causing the loss of 1 isoleucine in a stretch of 4 found in the ARAV and VACV-WR VGF sequences (Appendix Figure 4). PSTV VGF also exhibited 2 amino acid substitutions when compared to ARAV VGF sequences.

The alignments were used to construct phylogenetic trees by the neighbor-joining method using the Tamura Nei model implemented in MEGA3 (12). Trees were rooted at midpoint, and 1,000 bootstrap replications were performed. A *tk* and *vgf* genes concatenated phylogenetic tree was constructed by placing PSTV together with VACV strains (data not shown). Regarding *ha* sequences, PSTV was clustered to ARAV and CTGV (Figure 2).

Table. Passatempo virus (PSTV), Araçatuba virus (ARAV), Cantagalo virus (CTGV), Vaccinia virus IOC (VACV-IOC), vaccinia virus Lister (VACV-LST), vaccinia virus Western Reserve (VACV-WR), and cowpox virus Brighton Red (CPXV-BR) *ha*, *tk*, and *vgf* genes and amino acid sequences\*†

PSTV	Identity among homologous sequences (%)					
	ARAV	CTGV	VACV-IOC	VACV-LST	VACV-WR	CPXV-BR
Genes						
<i>ha</i>	99.9	99.8	98.7	97.4	96.3	84.0
<i>tk</i>	100.0	—*	—*	99.8	100.0	98.0
<i>vgf</i>	98.6	—*	—*	98.0	98.6	95.7
Amino acids						
HA	99.7	99.3	96.6	95.0	94.0	79.9
TK	100.0	—*	—*	100.0	100.0	98.2
VGF	97.4	—*	—*	100.0	97.4	92.2

\*CTGV and VACV-IOC *tk* and *vgf* nucleotide and amino acid sequences are not available in the GenBank database.

†HA, hemagglutinin; TK, thymidine kinase; VGF, vaccinia growth factor.



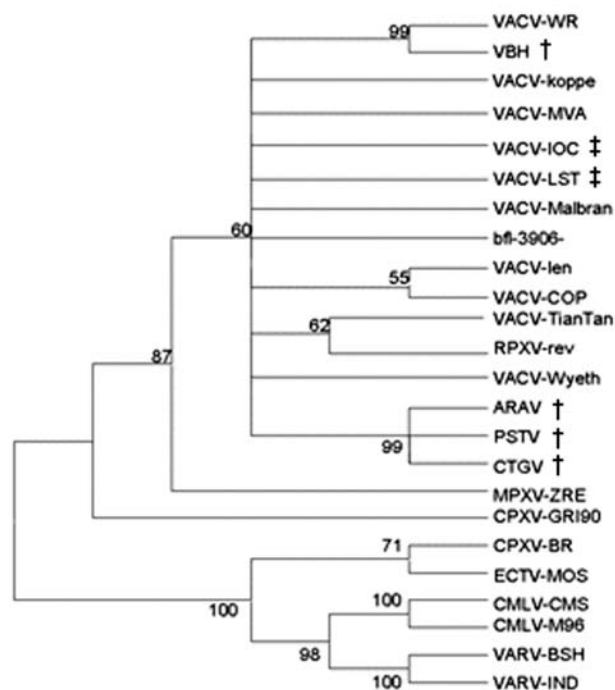

Figure 2. Consensus bootstrap phylogenetic tree based on the nucleotide sequence of *Orthopoxvirus ha* gene. The tree was constructed by the neighbor-joining method using the Tamura-Nei model of nucleotide substitutions implemented in MEGA3. The tree was midpoint-rooted, 1,000 bootstrap replicates were performed, and values >50% are shown. Nucleotide sequences were obtained from GenBank under accession numbers: PSTV (DQ070848), ARAV (AY523994), CTGV (AF229247), VACV-Wyeth (VZ99051), VACV-TianTan (U25662), VBH (AY542799), VACV-WR (AY243312), VACV-Koppe (AF375122), VACV-MVA (U94848), VACV-IOC (AF229248), VACV-LST (AF375124), VACV-len (AF375123), VACV-COP (M35027), bfl-3906 (AF375077), VACV-Malbran (AY146624), RPXV-rev (AF375118), CPXV-GRI90 (CVZ9904), CPXV-BR (AF482758), ECTV-MOS (AF012825), CMLV-CMS (AY009089), CMLV-M96 (AF438165), VARV-BSH (L22579), VARV-IND (X69198), MPXV-ZRE (AF380138). (†) indicates Brazilian VACV isolates and (‡) indicates Brazilian vaccine samples.

## Conclusions

The phylogenetic tree analysis suggested a strong phylogenetic relationship between PSTV and other Brazilian VACV strains. However, the *vgf* and *ha* gene analysis of PSTV, ARAV, and CTGV indicated that genetic heterogeneity exists among these viruses, which suggests that the *ha* gene deletion found in PSTV, ARAV, CTGV, and VACV-IOC could be a signature of New World or Brazilian VACV strains.

Additionally, that RFLP analysis showed a pattern identical with other Brazilian strains, similar to VACV-WR and different from CPXV, suggests that a cladogenesis event may have occurred. This conclusion is feasible considering that these viruses could be circulating in the wild since

smallpox vaccination or even before, going back to the colonization of South America, when cattle and other animals were brought to the New World without quarantine or inspection. The VACV variants buffalopox and rabbitpox have originated from VACV subspeciation (13).

That humans were also infected and that these persons were all milkers, phenomena that had been observed during other Brazilian VACV outbreaks, points to an occupational zoonosis. Although parapoxvirus infection has been placed in the category of occupational zoonosis, to our knowledge no other orthopoxviruses have been reported to cause an occupational hazard. Economic losses are also a matter of concern. In addition to the reduction in milk production, extra veterinary costs are due to the usual occurrence of secondary infections on cows' teats leading to mastitis. The reduction in milk production is a concern because Brazil is a major milk exporter. Therefore, the spread of these viruses could severely impact the country's economy. In this regard, the clinical features, widespread dissemination, and epidemiology of the etiologic agent of these outbreaks must be understood.

Since 1963, all Brazilian orthopoxvirus isolates have been characterized as VACV strains (3,6,14,15). The growing geographic distribution of these outbreaks (Figure 3)



Figure 3. Brazilian states where vaccinia viruses were isolated. ES, Espírito Santo State: Espírito Santo isolates in 2004 (unpublished); GO, Goiás State: Goiás isolates after 2001 (3); MG, Minas Gerais State: Belo Horizonte virus in 1993 (15), Minas Gerais isolates after 2001 (3), Passatempo virus in 2003; PA, Pará State: BeAn 58058 virus in 1963 (6); RJ, Rio de Janeiro State: Cantagalo virus in 1999 (2); SP, São Paulo State: SPAn232 virus in 1979 (14), Araçatuba virus in 1999 (1), São Paulo isolates after 2001 (3).

indicates that these viruses may be emerging as zoonotic pathogens of cattle. This fact is especially important because a growing human population has no vaccine-derived immunity to smallpox or other orthopoxviruses. This situation could create an opportunity for these viruses to disseminate in Brazil. In addition, the isolation of another VACV strain strengthens the hypothesis that VACV is circulating in the New World and that these viruses seem to be endemic of this region.

### Acknowledgments

We thank Angela S. Lopes, Ilda M.V. Gama, Daniela Lemos, and colleagues from the Laboratory of Virus for their excellent technical support and C. Jungwirth for providing VACV-WR and CPXV-BR used in this study. We also thank Rodrigo A.F. Redondo and Fabricio R. dos Santos for advice on the phylogenetic analysis, Olga Pfeilsticker for technical assistance on electron microscopy, and Denise Golgher for English review.

Financial support was provided by Conselho Nacional de Desenvolvimento Científico e Tecnológico (CNPq), Coordenação de Aperfeiçoamento de Pessoal de Nível Superior (CAPES), and Fundação de Amparo à Pesquisa do Estado de Minas Gerais (FAPEMIG). B.P. Drumond, G.S. Trindade, J.M.S. Ferreira, J.A. Leite, and M.I.M.C. Guedes received fellowships from CNPq or CAPES. C.A. Bonjardim, E.G. Kroon, F.G. da Fonseca, P.C.P. Ferreira and Z.I.P. Lobato are recipients of research fellowships from CNPq.

Ms Leite is a doctoral candidate at the Laboratory of Virus, Institute of Biological Sciences, Universidade Federal de Minas Gerais, Belo Horizonte-MG, Brazil. Her areas of research interest include virology, emergent viruses, molecular biology, and epidemiology.

### References

- de Souza Trindade G, da Fonseca FG, Marques JT, Nogueira ML, Mendes LC, Borges AS, et al. Araçatuba virus: a vaccinia like virus associated with infection in humans and cattle. *Emerg Infect Dis*. 2003;9:155–60.
- Damaso CR, Esposito JJ, Condit RC, Moussatche N. An emergent poxvirus from humans and cattle in Rio de Janeiro State: Cantagalo virus may derive from Brazilian smallpox vaccine. *Virology*. 2000;277:439–49.
- Nagasse-Sugahara TK, Kisielius JJ, Ueda-Ito M, Curti SP, Figueiredo CA, Cruz AS, et al. Human vaccinia-like virus outbreaks in Sao Paulo and Goias States, Brazil: virus detection, isolation and identification. *Rev Inst Med Trop São Paulo*. 2004;46:315–22.
- Morellato PC, Haddad CFB. The Brazilian Atlantic Forest. *Biotropica*. 2000; 32(4b Atlantic Forest Special Issue):786–92.
- Crouch AC, Baxby D, McCracken CM, Gaskell RM, Bennett M. Serological evidence for the reservoir hosts of cowpox virus in British wildlife. *Epidemiol Infect*. 1995;115:185–91.
- Fonseca FG, Lanna MC, Campos MAS, Kitajima EW, Peres JN, Golgher RR, et al. Morphological and molecular characterization of the poxvirus BeAn 58058. *Arch Virol*. 1998;143:1171–86.
- Meyer H, Ropp SL, Esposito JJ. Gene for A-type inclusion body protein is useful for a polymerase chain reaction assay to differentiate orthopoxviruses. *J Virol Methods*. 1997;64:217–21.
- da Fonseca FG, Silva RL, Marques JT, Ferreira PC, Kroon EG. The genome of cowpox virus contains a gene related to those encoding the epidermal growth factor, transforming growth factor alpha and vaccinia growth factor. *Virus Genes*. 1999;18:151–60.
- Ropp SL, Jin Q, Knight JC, Massung RF, Esposito JJ. PCR strategy for identification and differentiation of smallpox and other orthopoxviruses. *J Clin Microbiol*. 1995;33:2069–76.
- CAP3 Sequence Assembling Program. [accessed 18–22 Apr 2005]. Available from <http://deepe2.zool.iastate.edu/aat/ecap/cap.html>
- Thompson JD, Higgins DG, Gibson TJ. CLUSTAL W: improving the sensitivity of progressive multiple sequence alignment through sequence weighting, position-specific gap penalties and weight matrix choice. *Nucleic Acids Res*. 1994;22:4673–80.
- Kumar S., Tamura K, Nei M. MEGA3: integrated software for molecular evolutionary genetics analysis and sequence alignment. *Brief Bioinform*. 2004;5:150–163.
- The Universal Virus Database of the International Committee on Taxonomy of Viruses. Orthopoxvirus. [accessed 2 May 2005]. Available from <http://www.ictvdb.rothamsted.ac.uk/ICTVdB/58110000.htm>
- da Fonseca FG, Trindade GS, Silva RL, Bonjardim CA, Ferreira PC, Kroon EG. Characterization of a vaccinia-like virus isolated in a Brazilian forest. *J Gen Virol*. 2002;83:223–8.
- Trindade GS, da Fonseca FG, Marques JT, Diniz S, Leite JA, De Bodd S, et al. Belo Horizonte virus: a vaccinia-like virus lacking the A-type inclusion body gene isolated from infected mice. *J Gen Virol*. 2004;85:2015–21.

Address for correspondence: Erna G. Kroon, Laboratório de Vírus, Departamento de Microbiologia, Instituto de Ciências Biológicas, Universidade Federal de Minas Gerais. Av. Antônio Carlos, 6627, Caixa Postal 486, CEP: 31270-901, Belo Horizonte, MG, Brazil; fax: 55-31-3443-6482; email: kroone@icb.ufmg.br

All material published in *Emerging Infectious Diseases* is in the public domain and may be used and reprinted without special permission; proper citation, however, is required.

Search past issues of EID at [www.cdc.gov/eid](http://www.cdc.gov/eid)

# Anthrax in Eastern Turkey, 1992–2004

Züla Özkurt,\* Mehmet Parlak,\* Rustu Tastan,†  
Ufuk Dinler,‡ Yavuz S. Saglam,\*  
and Serhat F. Ozyurek§

We investigated animal and human anthrax cases during a 13-year period in eastern Turkey. From 1992 to 2004, a total of 464 animal and 503 human anthrax cases were detected. Most cases occurred in summer. Anthrax remains a health problem in eastern Turkey, and preventive measures should be taken.

Anthrax is an endemic zoonosis in Turkey, but the incidence of the disease has been decreasing. From 1960 to 1969, a total of 10,724 human cases were reported compared to 4,423 cases from 1980 to 1989. After 1990, the number of human anthrax cases was <300 annually (1). Animal anthrax cases have also been decreasing, and 277 cases were reported in 2001; 218 in 2002 and 72 in the first 8 months of 2003. We conducted this study to investigate the epizootiology and of epidemiology of anthrax during the 13-year period from 1992 through 2004 in eastern Turkey.

## The Study

Animal anthrax cases from the Institute of Veterinary Control and Research in Eastern Anatolia Region and human cases from the Department of Clinical Bacteriology and Infectious Diseases (in the tertiary hospital) and state health centers or hospitals (primary and secondary health care centers) from January 1992 to November 2004 were included. Data were collected from formal records.

A suspected case of cutaneous anthrax is characterized by a skin lesion evolving from a papule, through a vesicular stage, to a depressed black eschar; edema, erythema, or necrosis without ulceration may be present. A confirmed case is defined through positive smear or isolation of *Bacillus anthracis* in clinical specimens (2). *B. anthracis* isolates were identified on the basis of conventional methods such as gram-positive bacilli with spores seen in smear, the presence of a capsule, lack of motility, and catalase positivity.

In humans, the diagnosis of anthrax was based on clinical findings or microbiologic procedures, including Gram stain (short chains of capsulated gram-positive bacilli seen on a smear) and isolation of *B. anthracis* from a clinical

specimen (3). In animals, the diagnosis was made by examining the history, autopsy findings, and Gram stain or cultures from tissues (liver, spleen, lymph node, bone marrow, and ear) of a sick animal.

From the 13-year period January 1992–November 2004, a total of 464 animal and 503 human cases of anthrax were detected in eastern Turkey. Of 464 animal cases, 20 (4.3%) were sheep, and 444 (95.7%) were cattle. The mean number of cases was 35.6 per year in animals and 38.6 per year in humans. Anthrax cases in both humans and animals increased from 1993 to 1999 and decreased after 2000 (Figure 1).

Most animal (319 [68.7%]) and human (338 [67.2%]) cases occurred between July and October. Anthrax was seen most frequently in Erzurum and Kars, cities that are centers of animal commerce (Table).

All animal cases died. Most of the human cases were cutaneous anthrax (Figure 2) Only 2 cases (0.39%) died, one from meningitis, and the other from asphyxia due to extensive anthrax edema (4,5). The remaining patients recovered. All the patients had a history of exposure to anthrax-infected animals.

## Conclusions

Anthrax is endemic in the Middle East, some Asian countries, Africa, and South America. The disease has also been detected in Turkey (6–8). In eastern Turkey, most people live in rural areas and work in agriculture and stockbreeding. Animals usually graze in pasture from April through November. In this study, most anthrax cases were seen from April to November. Similar seasonal distribution has been observed in other studies (5,9–11).

The numbers of both animal and human anthrax cases in eastern Turkey increased from 1995 to 2000. Nevertheless, from 2000 until 2004, cases have been decreasing. Economic and social changes, strict animal vaccination programs, and education of farmers may have contributed to this trend. Anthrax was most commonly seen in Erzurum and Kars, which are centers of animal trade and have large international commercial roads.

Skinning, butchering a sick animal, and handling and eating contaminated meat are known risk factors for

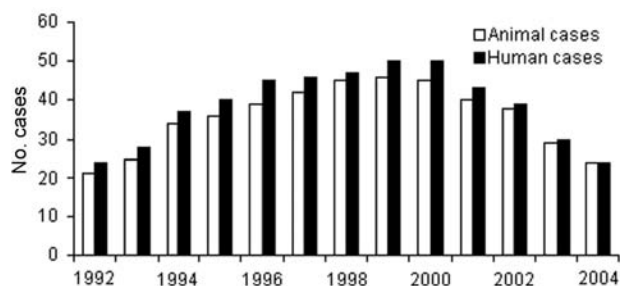

Figure 1. Annual distribution of anthrax cases.

\*Ataturk University, Erzurum, Turkey; †University of Kocaeli, Kocaeli, Turkey; ‡Institute of Veterinary Control and Research, Erzurum, Turkey; and §Health Directorate, Erzurum, Turkey

Table. Distribution of anthrax cases in cities, eastern Turkey

City	No. human cases	No. animal cases
Agri	35	28
Ardahan	45	39
Artvin	13	15
Bayburt	30	47
Erzincan	24	23
Erzurum	198	170
Igdir	31	29
Gumushane	24	19
Kars	103	94
Total	503	464

human anthrax (12). All patients in our study had a history of exposure to anthrax-infected animals. Although some patients had eaten infected meat, no gastrointestinal anthrax cases occurred, which may be due to the cooking methods these patients used (overcooking the meat). However, humans should not eat meat from a sick animal.

In this study, more anthrax cases occurred in humans than in animals. Several factors could account for this finding. First, sometimes sick animals have been butchered by humans and are not reported to veterinary institutions, so some animal cases are not recorded. Secondly, 1 sick animal can contaminate several persons who participate in the slaughtering procedure. Finally, because fewer resources are available for the veterinary infrastructure and reporting mechanisms than for the public health system, animal cases are probably underreported. Similar results have been reported in other studies (7,8). For example, Aydin et al. (8) detected 164 animal anthrax cases versus 327 human cases in 1993, and 50 animal cases versus 445 human cases in 1994. Kececi et al. (7) reported 17 animal versus 166 human anthrax cases in 1995. Otlu et al. (13) reported 45 animal cases versus 89 human anthrax cases in 2000–2001.



Figure 2. Cutaneous anthrax on eyelids. Photographer: Zülal Özkurt. Photograph taken with patient's permission.

In this study, most animal anthrax cases occurred in cattle. Several factors may account for this occurrence. First, more cattle than sheep are found in the region. Second, cattle graze in plains, but sheep graze in high plateaus and slopes, so cattle probably have more exposure to environmental anthrax risks than sheep (spores accumulate more in plains). Third, cattle have more economic value than sheep; as a result, sick cattle are reported to the veterinary service and recorded. But, when a sheep becomes ill, it is slaughtered before dying or buried immediately after death; its death is not reported to the veterinary service in rural areas. Aydin et al. (8) reported that 72.9% of anthrax cases occurred in cattle and 27.0% in sheep in the same region in 1994. Otlu et al. (13) detected 11 anthrax cases in sheep versus 34 anthrax cases in cattle in the same region in 2000.

Good surveillance, decontamination and disinfection procedures, and education are mandatory to reduce the incidence of anthrax. Employees should be educated about the disease to reduce the risk for disease. Controlling the disease in humans ultimately depends on controlling it in animals by effective surveillance and immunization. The carcasses of all animals that have died with a confirmed diagnosis of anthrax should be thoroughly cremated, and the remains should be deeply buried (14,15).

Dr Özkurt is an infectious specialist in the Department of Infectious Diseases, School of Medicine, Atatürk University, Erzurum, Turkey. Her primary research interests are hospital infections and zoonoses (brucellosis, Q fever, Crimean-Congo hemorrhagic fever, and anthrax).

## References

1. Doganay M, Sarbon. In: Topçu AW, Söyletir G, Doganay M, editors. *İnfeksiyon hastalıkları*. Istanbul: Nobel Tip Bookstore; 2002. p. 1533–42.
2. Centers for Disease Control and Prevention. Investigation of anthrax associated with intentional exposure and interim public health guidelines, October, 2001. *MMWR Morb Mortal Wkly Rep*. 2001;50:889–93.
3. Lew D. *Bacillus anthracis* (anthrax). In: Mandell GL, Bennet JE, Dolin R, editors. *Principles and practice of infectious diseases*. 5th ed. New York: Churchill Livingstone; 2000. p. 2215–20.
4. Tasyaran MA, Deniz O, Ertek M, Cetin K. Anthrax meningitis: case report and review. *Scand J Infect Dis*. 2002;34:66–7.
5. Kaya A, Tasyaran MA, Erol S, Ozkurt Z, Ozkan B. Anthrax in adults and children: a review of 132 cases in Turkey. *Eur J Clin Microbiol Infect Dis*. 2002;21:258–61.
6. Brachman PS. Anthrax. In: Evans AS, Brachman PS, editors. *Bacterial infections of humans: epidemiology and control*. 2nd ed. New York: Plenum; 1991. p. 75–86.
7. Kececi M, Aydin M. Zoonoses control programs in Turkey, country report. In: 11th session of the Joint Coordinating Committee of the Mediterranean Zoonoses Program. 1995 Sep 26–29, Istanbul, Turkey.
8. Aydin F, Finci E, Oltu S, Sahin M. Epizootiology and epidemiology of anthrax in Kars report [article in Turkish]. *Congress of International Veterinary Microbiology*; 1966. p. 48.

9. Kaya A, Tasyaran MA, Özkurt Z, Yılmaz S. Sarbon: 68 Olgunu n degerlendirilmesi. *Flora*. 1997;1:51-4.
10. Doganay M, Kökkaya A, Hah MM. Evaluation of 35 anthrax cases. *Microbiology Bulletin*. 1983;17:1-10. [article in Turkish].
11. Demirdag K, Ozden M, Saral Y, Kalkan A, Kilic SS, Ozdarendeli A. Cutaneous anthrax in adults: a review of 25 cases in the eastern Anatolian region of Turkey. *Infection*. 2003;31:327-30.
12. Mwenye KS, Siziya S, Peterson D. Factors associated with human anthrax outbreak in the Chikupo and Ngandu villages of Murewa district in Mashonaland East Province, Zimbabwe. *Cent Afr J Med*. 1996;42:312-5.
13. Otlu S, Sahin M, Genc O. Occurrence of anthrax in Kars district, Turkey. *Acta Vet Hung*. 2002;50:17-20.
14. Turnbull PCB, Hugh-Jones ME, Cosivi O. World Health Organization activities on anthrax surveillance and control. *J Appl Microbiol*. 1999;87:318-20.
15. Hugh-Jones ME, de Vos V. Anthrax and wildlife. *Rev Sci Tech*. 2002;21:359-83.

Address for correspondence: Zülal Özkurt, Department of Clinical Microbiology and Infectious Diseases, School of Medicine, Ataturk University, Erzurum, Turkey; fax: 90-442-316-6340; email: zozkurt@atauni.edu.tr

# EMERGING INFECTIOUS DISEASES



A Peer-Reviewed Journal Tracking and Analyzing Disease Trends

Vol.8, No.2, February 2002

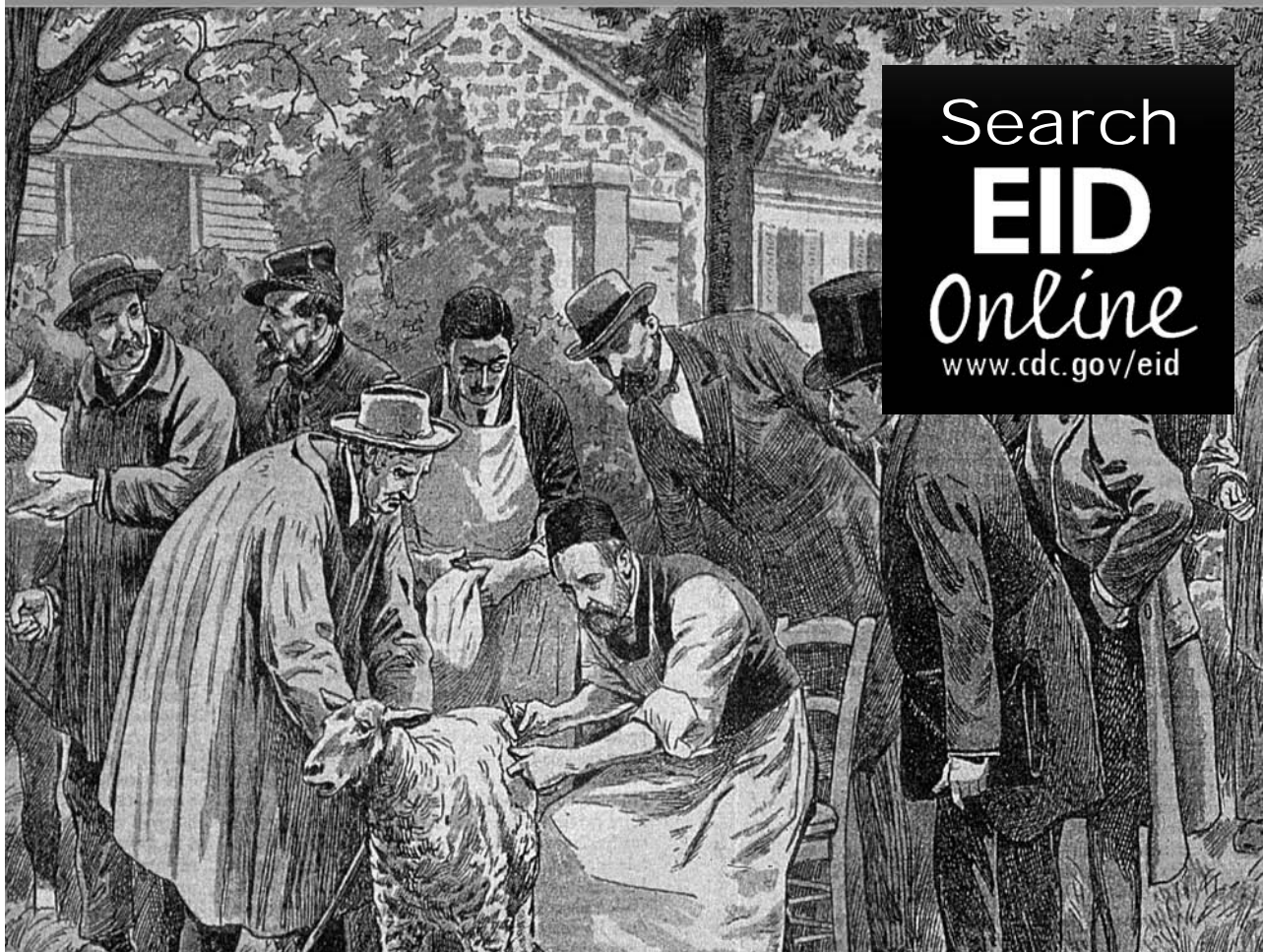

Search  
**EID**  
Online  
[www.cdc.gov/eid](http://www.cdc.gov/eid)

# Methicillin-resistant Staphylococci in Companion Animals

Keith E. Baptiste,\* Kerry Williams,†  
Nicola J. Williams,\* Andrew Wattret,\*  
Peter D. Clegg,\* Susan Dawson,\*  
John E. Corkill,† Turlough O'Neill,\*  
and C. Anthony Hart†

We determined the molecular characteristics of methicillin-resistant staphylococci from animals and staff at a small animal and equine hospital. Methicillin-resistant *Staphylococcus aureus* (MRSA) identical to human EMRSA-15 was found in dogs and hospital staff. In contrast, 5 distinct MRSA strains were isolated from horses but not from hospital staff.

Methicillin-resistant *Staphylococcus aureus* (MRSA) is among the most important causes of human healthcare associated infections. MRSA has also caused infections in dogs (1,2), and cases of human-to-dog transmission of MRSA in which dogs have acted as reservoirs for reinfection have been reported (3,4). MRSA and methicillin-resistant, coagulase-negative staphylococci (MR-CNS) have also been reported in horses (5), including outbreaks in equine hospitals (6). In these cases, MRSA was thought to be of human origin (6); however, a Japanese study could not definitively relate equine to human MRSA with pulsed-field gel electrophoresis (PFGE) (7). At a Canadian equine hospital and thoroughbred farm, both horses and staff were positive for MRSA, and 96% and 93% of isolates, respectively, were subtypes of a rare Canadian MRSA-5 clone (8).

Horses, dogs, and cats in the community; animals treated at the University of Liverpool's Small Animal Hospital (SAH) and Philip Leverhulme Equine Hospital (PLEH); and staff at those hospitals were screened for MRSA. The molecular characteristics of MRSA in these populations were investigated to determine the source and routes of transmission. Animal samples were also screened for MR-CNS.

## The Study

Swabs were taken from the anterior nares of dogs, horses, and staff; nasal surface of cats; perineum of dogs, cats, and horses; and the neck skin surface of horses. All diagnostic submissions from both of these hospitals were screened for MRSA. Swab specimens were directly inoculated onto mannitol salt agar (LabM, Bury, UK) with aztreonam (2 mg/L) and oxacillin resistance–screening agar (Oxoid, Basingstoke, UK) and incubated at 37°C for  $\leq 48$  h. Staphylococci were identified by colony shape, Gram stain, staphylase test (Oxoid), and API staph kit (MR-CNS only) (bioMérieux, Basingstoke, UK). The disk-diffusion method (Mast, Liverpool, UK) was used to determine the susceptibility of all isolates to oxacillin, methicillin, gentamicin, vancomycin, rifampicin, ciprofloxacin, co-trimoxazole, fusidic acid, and tetracycline, according to the British Society for Antimicrobial Chemotherapy guidelines, by using *S. aureus* ATCC 26923, EMRSA-15, and EMRSA-16 as controls (9).

Cell lysates of all methicillin-resistant staphylococci were prepared as described previously (10). Cell lysates were also prepared from 3 control strains, EMRSA-15, EMRSA-16, and the Canadian epidemic strain, CMRSA-5, previously found in horses and humans (8). The presence of the *mecA* gene was determined with polymerase chain reaction (PCR) by using a modified method adapted from Vanuffel et al. (11), with a conventional thermocycler. PCR to detect the *S. aureus femA* gene was used to confirm isolates as MRSA (12). For all MRSA and equine MR-CNS isolates, the *SCCmec* cassette and the *agr* operon were analyzed as described previously (13). All MRSA isolates were screened for the gene encoding Panton-Valentine leukocidin by using the method of Lina et al. (14); a positive control for this reaction was provided by the Scottish MRSA Reference Laboratory. Macrorestriction of the genome and PFGE were conducted on all MRSA isolates according to the protocol described by Murchan et al. (15) and included on each gel with EMRSA-15 and -16 and CMRSA-5.

Swabs taken from cats ( $n = 50$ ) and dogs ( $n = 55$ ) treated at the SAH and cats within the community (February–March 2004) were negative for MRSA. One cat was positive for methicillin-resistant staphylococci, and 4 dogs were positive for MR-CNS, all of which were confirmed by PCR to be carrying the *mecA* gene. However, 3 dogs with clinical infections (a joint infection in January 2004, pleuropneumonia in March 2004, and a wound infection in June 2004) were positive for MRSA at the site of infection. The dog with the joint infection was also positive for nasal and fecal carriage of MRSA; a student who treated the dog had an MRSA-positive nasal swab in April 2004. Eleven staff provided nasal swabs, of which 2 were positive for MRSA in January 2004 (Table). All MRSA

\*University of Liverpool, Leahurst, United Kingdom; and Royal Liverpool University Hospital, Liverpool, United Kingdom

Table. Isolate test results for methicillin-resistant *Staphylococcus aureus* (MRSA)\*

	No. sampled	No. samples positive for MRSA† (%)			Other (clinical)	No. samples positive for MR-CNS† (%)		
		Nasal	Perineum	Skin				
<b>Dogs</b>								
Clinical cases	3	1	1	1	Joint and pleural fluid, feces	NT	NT	NT
SAH	32	0	0	0		2 (6)	1 (0)	0
Community	22	0	0	0		1 (5)	0	0
<b>Cats</b>								
SAH	26	0	0	0		0	0	0
Community	24	0	0	0		1 (5)	1 (5)	0
SAH veterinary staff	11	3 (27)	NT	NT		NT	NT	NT
<b>Horses</b>								
Clinical cases	3	1	NT	1	Pleural and joint fluid	NT	NT	NT
PLEH	67	8 (12)	0	2 (3)		6 (9)	3 (5)	5 (8)
Community	40	0	0	0		12 (30)	0	1 (3)
PLEH Veterinary staff	12	0	NT	NT		NT	NT	NT

\*SAH, small animal hospital; PLEH, Philip Leverhulme Equine Hospital; NT, not tested; MR-CNS, methicillin-resistant, coagulase-negative staphylococci.  
†Some animals were positive for >1 body site.

isolates were resistant to ciprofloxacin but sensitive to all other antimicrobial drugs tested. All MRSA isolates were positive for the *mecA* and *femA* genes, carried the *SCCmec* type IV cassette, and were *agr* operon group 1 strains but were negative for *pvl* genes. PFGE showed that the human and dog clinical MRSA isolates were identical to the human epidemic strain, EMRSA-15 (Figure).

Of the 105 horses sampled, MRSA was isolated only from horses at PLEH. Of the 67 horses sampled at PLEH, 11 were positive (16%) for carriage and 3 had MRSA-associated clinical infections (pleuropneumonia, chronic septic arthritis, and chronic dermatitis). None of the isolates submitted from 12 staff members at the equine hospital were positive for MRSA. The horse MRSA isolates were resistant to gentamicin (100%), rifampicin (80%), ciprofloxacin (78%), fusidic acid (69%), co-trimoxazole (50%), and tetracycline (50%) but not to vancomycin. All MRSA isolates were positive for the *mecA* and *femA* genes and were *agr* group 1, except 2 that were *agr* group 2, but all were negative for the *pvl* genes. Like the human and dog isolates, all horse MRSA isolates except 3 (1 isolate had a variant of type II or III, and 2 isolates repeatedly failed to give PCR products for *SCCmec* cassettes), carried the *SCCmec* cassette type IV. MR-CNS was isolated from 19% of horses at the PLEH and 30% of horses in the community. All horse MR-CNS isolates (including those from PLEH) had different *SCCmec* cassettes than the MRSA isolates, and their banding patterns did not fully correspond to any of the known cassette types, giving a 209-bp band (types II and III) and a further band of 495 bp (type I). Twelve MRSA isolates from 7 horses were selected for PFGE based on differences in antibiogram and genes detected by PCR. This analysis showed 5 distinct strains. The same strain found in nasal samples, 1 skin sample from 3 horses, and 1 MRSA strain from a clinical case-patient were closely related to a nasal isolate from a differ-

ent horse. None of the horse MRSA strains were related to EMRSA-15, EMRSA-16, or CMRSA-5 as demonstrated in the Figure.

## Conclusions

This study documents MRSA transmission between humans and dogs; the same strain was found in 3 staff members and 3 dogs, all identical to the predominant human epidemic strain EMRSA-15. Two staff members and a student who treated 1 dog were positive for the same MRSA strain. Furthermore, MRSA was associated with clinical disease in 2 other dogs some months later; this finding could suggest a cycle of transmission between staff

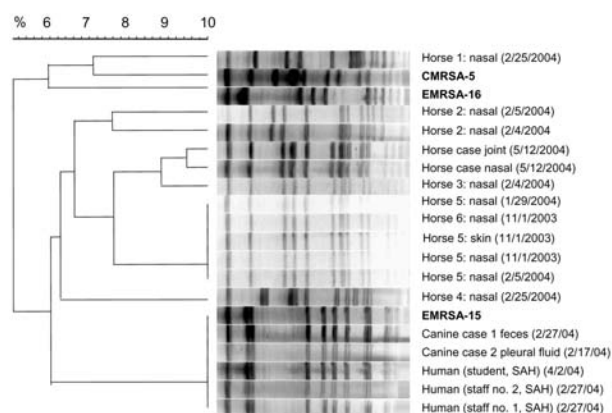

Figure. Dendrogram showing the pulsed-field gel electrophoresis patterns after macrorestriction of genomic DNA with *Sma*I of methicillin-resistant *Staphylococcus aureus* (MRSA) isolates from the small animal hospital (SAH) and the equine hospital. The dog and human isolates (SAH staff) were identical to the UK major epidemic strain EMRSA-15, and the equine MRSA isolates (5 distinct profiles) were unrelated to EMRSA-15, EMRSA-16, or CMRSA-5. Profiles were analyzed with Molecular Analyst software (Applied Maths, Inc., Sint-Martens-Latem, Belgium) by unweighted pair grouping by mathematical averaging clustering method with a 2% tolerance window and using the Dice coefficient.

and animals. However, the origin of MRSA in the first dog is unknown and could have originated in either staff or the dog in question, with dog-to-human transmission or vice versa. This study suggests that dogs can act as reservoirs of MRSA, which can pose a public health risk to owners and veterinary staff, as well as limit the options for antimicrobial drug treatment of MRSA infections. Staff in veterinary hospitals could have an increased risk of carrying MRSA because of contact with infected animals and antimicrobial drugs in their work environment.

Contrary to SAH results of this study and previous work in Canada, no evidence was seen of MRSA transmission between staff and horses at PLEH, nor were any isolates related to the predominant UK human epidemic strains or CMRSA-5. However, 5 different horse MRSA strains were identified with unknown sources. The fact that different SCC*mec* cassettes were found in horse MR-CNS isolates than in MRSA isolates does not suggest that methicillin resistance had transferred from MR-CNS to MRSA. Furthermore, the prevalence of MR-CNS in horses in the community is almost double that which was found in horses at PLEH. This could suggest that MR-CNS may compete well with methicillin-sensitive CNS in an environment where antimicrobial drugs are not present. These results imply that MRSA is present in the general horse population and may represent a reservoir of new or rare MRSA strains that could be transmitted to humans.

### Acknowledgments

We thank Caroline Janes, Katie Milner, Karl Faksvåg, Emily Talbot, Jane Devaney, and Jackie Jones for their assistance throughout this project; Derek Knottenbelt, Malcolm Bennett, and John Cox for their advice and encouragement; and the Canadian MRSA reference laboratory for supplying the CMRSA-5 strain.

We gratefully acknowledge the Research Development Fund, University of Liverpool, for their financial support of this project.

Dr Baptiste is a lecturer of veterinary public health and epidemiology in the Department of Veterinary Pathology, Faculty of Veterinary Sciences, University of Liverpool. His current research interests include associations and origins of antimicrobial drug-resistant bacteria in animals.

### References

- Tomlin J, Pead MJ, Lloyd DH, Howell S, Hartmann R, Jackson HA, et al. Methicillin-resistant *Staphylococcus aureus* infections in 11 dogs. *Vet Rec.* 1999;144:60–4.
- Boag A, Loeffler A, Lloyd DH. Methicillin-resistant *Staphylococcus aureus* isolates from companion animals. *Vet Rec.* 2004;154:11.
- Manian FA. Asymptomatic nasal carriage of mupirocin, methicillin-resistant *Staphylococcus aureus* (MRSA) in a pet dog associated with MRSA infection in household contacts. *Clin Infect Dis.* 2003;36:e26–8. Epub 2003 Jan 6.
- van Duijkeren E, Wolfhagen MJHM, Box ATA, Heck MEOC, Wannet WJB, Fluit AC. Human-to-dog transmission of methicillin-resistant *Staphylococcus aureus*. *Emerg Infect Dis.* 2004;10:2235–7.
- Hartmann FA, Trostle SS, Klohn AA. Isolation of methicillin-resistant *Staphylococcus aureus* from a postoperative wound infection in a horse. *J Am Vet Med Assoc.* 1997;211:1558–61.
- Seguin JC, Walker RD, Caron JP, Kloos WE, George CG, Hollis RJ, et al. Methicillin-resistant *Staphylococcus aureus* outbreak in a veterinary teaching hospital: potential human-to-animal-transmission. *J Clin Microbiol.* 1999;37:1459–63.
- Shimizu A, Kawano Y, Yamamoto C, Kakutani O, Anzai T, Kamada M. Genetic analysis of equine methicillin-resistant *Staphylococcus aureus* by pulsed-field gel electrophoresis. *J Vet Med Sci.* 1997;59:935–7.
- Weese JS, Archambault M, Willey BM, Dick H, Hearn P, Kreiswirth BN, et al. Methicillin-resistant *Staphylococcus aureus* in horses and horse personnel, 2000–2002. *Emerg Infect Dis.* 2005;11:430–5.
- Andrews JM, BSAC Working Party on Susceptibility Testing. BSAC standardized disc susceptibility testing method. *J Antimicrob Chemother.* 2001;48(Suppl 1):43–57.
- Senna JPM, Pinto CA, Carvalho LPS, Santos DS. Comparison of pulsed-field gel electrophoresis and PCR analysis of polymorphisms on the *mec* hypervariable region for typing methicillin-resistant *Staphylococcus aureus*. *J Clin Microbiol.* 2002;40:2254–6.
- Vannuffel P, Gigi J, Ezzedine H, Vandercam B, Delmee M, Wauters G, et al. Specific detection of methicillin-resistant *Staphylococcus* species by multiplex PCR. *J Clin Microbiol.* 1995;33:2864–7.
- Francois P, Pittet D, Bento M, Pepey B, Vaudaux P, Lew D, et al. Rapid detection of methicillin-resistant *Staphylococcus aureus* directly from sterile or non-sterile clinical samples by a new molecular assay. *J Clin Microbiol.* 2003;41:254–60.
- Corkill JE, Anson JJ, Griffiths P, Hart CA. Detection of elements of the staphylococcal cassette chromosome (SCC) in a methicillin-susceptible (*mecA* gene negative) homologue of a fucidin-resistant MRSA. *J Antimicrob Chemother.* 2004;54:229–31.
- Lina G, Piemont Y, Godail-Gamot F, Bes M, Peter MO, Gauduchon V, et al. Involvement of Panton-Valentine leukocidin-producing *Staphylococcus aureus* in primary skin infections and pneumonia. *Clin Infect Dis.* 1999;29:1128–32.
- Murchan S, Kaufmann ME, Deplano A, Ryck R, Struelens M, Zinn CE, et al. Harmonisation of pulsed field gel electrophoresis protocols for epidemiological typing of strains of methicillin-resistant *Staphylococcus aureus*: a single approach developed by consensus in 10 European laboratories and its application for tracing the spread of related strains. *J Clin Microbiol.* 2003;41:1574–85.

Address for correspondence: Nicola Williams, Department of Veterinary Pathology, Faculty of Veterinary Science, Chester High Rd, Leahurst, United Kingdom CH64 7TE; fax: 44-151-794-6005; email: njwillms@liverpool.ac.uk

Use of trade names is for identification only and does not imply endorsement by the Public Health Service or by the U.S. Department of Health and Human Services.



---

# Phocine Distemper Outbreak, the Netherlands, 2002

Jolianne M. Rijks,\*†‡ Marco W.G. Van de Bildt,‡  
Trine Jensen,§ Joost D.W. Philippa,‡  
Albert D.M.E. Osterhaus,\*†‡ and Thijs Kuiken\*†‡

During the 2002 phocine distemper epidemic, 2,284 seals, primarily harbor seals (*Phoca vitulina*), were found stranded along the Dutch coast. Stranding pattern varied with age, sex, state of decomposition, wind, and location. Cumulative proportion of deaths (54%) was comparable to that in the first reported epidemic in 1988.

---

Marine mammal morbilliviruses are among the most pathogenic infectious agents to emerge in wildlife. Phocine distemper virus (PDV) infection (1–3) was considered responsible for the deaths of ≈18,000 seals in Europe in the first recorded outbreak in 1988 (4), and of ≈22,000 seals in the second outbreak in 2002 (5,6). We examined the effect of different variables on the dynamics of the 2002 PDV epidemic in the Netherlands. This epidemic started 6 weeks after the first cases were noted on Anholt Island, Denmark (5). Subsequently, the disease spread east to Germany and Denmark, and west to Belgium, France, the United Kingdom, and Ireland (6). We also compared the epidemiologic characteristics of the 1988 and 2002 PDV epidemics in the Netherlands.

Seal strandings were reported to a central telephone service. Live stranded seals were rehabilitated or euthanized. Dead stranded seals were collected for necropsy during which species, sex, standard body length, and state of decomposition were determined. Seals were divided into age categories, based on sex and standard body length (7): male juveniles (age ≤1 yr; length ≤95 cm), subadults (1 yr < age ≤4 yr; 95 cm < length ≤140 cm), or adults (age >4 yr; length >140 cm); female juveniles (age ≤1 yr; length ≤90 cm), subadults (1 yr < age ≤3 yr; 90 cm < length ≤130 cm), or adults (age >3 yr; length >130 cm) (Table 1). Of 1,315 seals that underwent necropsy, complete data were obtained for 1,096 harbor seals (*Phoca vitulina*) (Table 1). These seals originated from the entire Dutch coast, except from the islands Rottumeroog and Rottumerplaat, where they were buried; from the island of Texel, where they were collected for a different study; and

from the mainland coasts of North Holland and South Holland, where only a few seals were submitted for necropsy (Table 1, Figure 1A). Because seals on which a necropsy was performed represented 56%–73% of the stranded seals in the remaining locations (Table 1, Figure 1A) and had a similar-shaped epidemic curve to that of stranded seals (online Appendix Figure 1; available at [http://www.cdc.gov/ncidod/EID/vol11no12/05-0596\\_app1.htm](http://www.cdc.gov/ncidod/EID/vol11no12/05-0596_app1.htm)), they were considered representative of stranded seals. The daily wind factor was calculated by multiplying average daily wind force at Den Helder, North Holland (obtained from the Royal Netherlands Meteorological Institute [KNMI]), with its coefficient. Coefficients were positive for winds north of the line west-southwest–east-northeast, negative for winds south of this line, and ranged from 0, when the wind direction was parallel to this line, to 4, when at right angles to it. To analyze the effect of spring tide, the number of strandings on the day of spring tide and the 2 subsequent days was compared to the number of strandings on other days. We used the  $\chi^2$  test for categorical comparisons and linear trends, and Mann-Whitney U and Kruskal-Wallis tests for temporal scales, with pairwise comparison for the variables that showed significant overall effect (SPSS for Windows, SPSS Inc., Chicago, IL, USA). For stranded seals with missing observations, age category, sex, and state of decomposition were imputed by using data on seals that underwent necropsy and had been stranded in the same location and on the same or closest weekly date.

Between June 16, 2002, when the Dutch index case was found on Vlieland, and the end of November 2002, when the stranding rate returned to preepidemic levels, 2,284 seals (2,154 dead, 130 live) were stranded along the Dutch coast (Figure 1B, Table 1). Almost all (2,279 of 2,284) were identified as harbor seals, and the remaining 5 as gray seals (*Halichoerus grypus*), despite recently increased gray seal numbers in the Netherlands and their likely exposure to PDV. This finding is consistent with experimental findings that PDV infection is more pathogenic for harbor seals than for gray seals (9). At gross necropsy, ≈80% of harbor seals had pulmonary consolidation consistent with PDV infection, while about 50% had either immunoglobulin M to morbillivirus by serology, morbillivirus-specific nucleic acid by reverse-transcription polymerase chain reaction (PCR), or both (unpub. data). This PCR fragment corresponded to that of PDV by phylogenetic analysis (5). Together these results confirm PDV infection as the primary cause of the epidemic. The rapid course of the epidemic, high cumulative proportion of deaths, and involvement of all age categories (Table 1) fit with a virgin soil epidemic and correspond with lack of preexisting specific immunity to PDV in most of the seals (5,6).

---

\*Dutch Wildlife Health Center, Rotterdam, the Netherlands; †Faculty of Veterinary Medicine, Utrecht, the Netherlands; ‡Erasmus Medical Center, Rotterdam, the Netherlands; and §Royal Veterinary and Agricultural University, Frederiksberg, Denmark

Table 1. Age and sex distribution of harbor seals stranded during 2002 phocine distemper virus epidemic in the Netherlands

Stranding location	Coastline (km)*	No. stranded	No. that underwent necropsy†	Harbor seals					
				Juvenile‡		Subadult‡		Adult‡	
				M	F	M	F	M	F
Texel	57	281	–	–	–	–	–	–	–
Vlieland	41	303	198	25	35	86	123	11	23
Terschelling	67	338	190	42	36	92	134	17	17
Ameland	49	279	156	22	22	87	96	34	18
Schiermonnikoog	29	331	219	33	31	82	101	52	32
Rottumeroog and Rottumerplaat	14	172	–	–	–	–	–	–	–
Friesland mainland	93	217	159	8	21	57	66	27	38
Groningen mainland	80	194	138	18	34	28	50	24	40
North Holland	124	97	–	–	–	–	–	–	–
South Holland	36	18	–	–	–	–	–	–	–
Zealand	116	51	36	–	–	–	–	–	–
Total	706	2,284	1,096	148	179	432	570	165	168

\*Source: ref. (8).

†These are harbor seals for which complete data were obtained. Seals from Texel, Rottumeroog and Rottumerplaat, North Holland, and South Holland were excluded because of the small proportions that underwent necropsy.

‡Age category and sex for stranded seals with missing observations were imputed by using those of seals that were stranded in the same location and on the same or closest weekly date.

Age and sex affected temporal distribution of strandings. The median stranding date varied significantly among age categories ( $p \leq 0.001$ ). The date was significantly earlier for subadults than for juveniles and adults ( $p \leq 0.05$ ; Figure 1B). Subadults display considerably more social play than seals in other age categories, especially in early summer (10). In contrast, juveniles and their mothers are relatively more separated from other seals during the lactation period, are more sedentary, and have fewer new contacts (11,12). The median stranding date for males was significantly earlier than that for females in juveniles ( $p \leq 0.001$ ), subadults ( $p \leq 0.001$ ), and adults ( $p \leq 0.001$ )

(online Appendix Figure 2; available at [http://www.cdc.gov/ncidod/EID/vol11no12/05-0596\\_app2.htm](http://www.cdc.gov/ncidod/EID/vol11no12/05-0596_app2.htm)). The average change in the number of individually identified seals hauled out between consecutive days is significantly higher for males than for females (12), and both subadult and adult males have the longest and most aggressive interactions with each other (13). These behavioral differences suggest that contact rates and intensity of contact with other seals, including seals with PDV infection, were higher for subadults at the start of the epidemic than for juveniles and adults, and higher for males than females, thus increasing the risk and severity of infection.

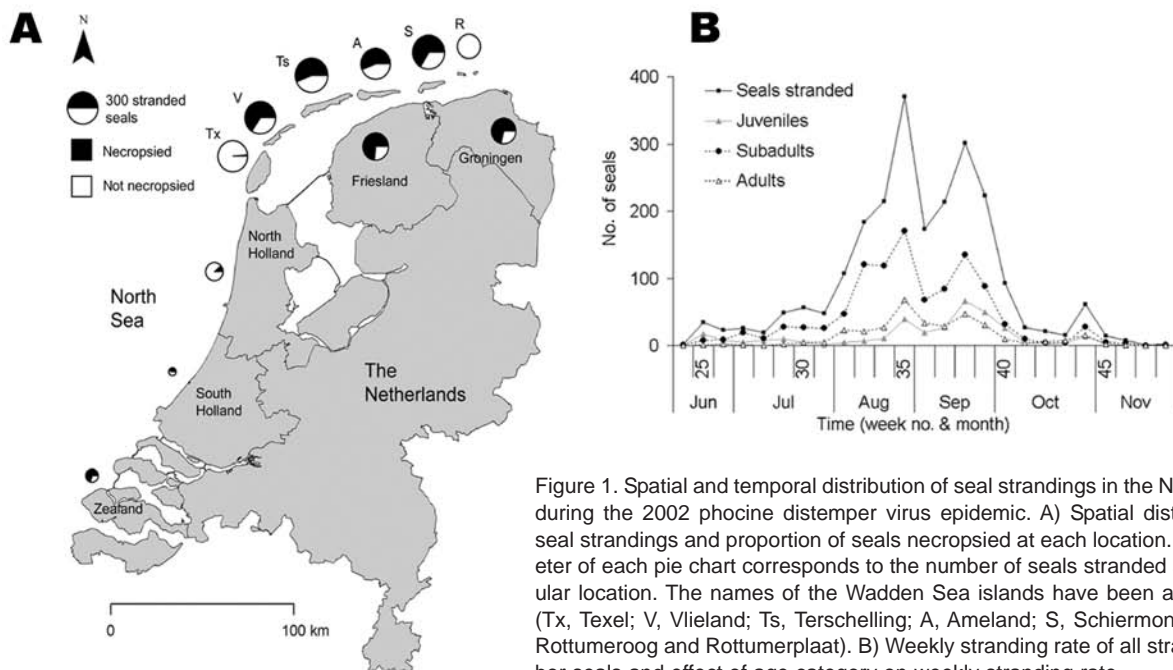

Figure 1. Spatial and temporal distribution of seal strandings in the Netherlands during the 2002 phocine distemper virus epidemic. A) Spatial distribution of seal strandings and proportion of seals necropsied at each location. The diameter of each pie chart corresponds to the number of seals stranded at a particular location. The names of the Wadden Sea islands have been abbreviated (Tx, Texel; V, Vlieland; Ts, Terschelling; A, Ameland; S, Schiermonnikoog; R, Rottumeroog and Rottumerplaat). B) Weekly stranding rate of all stranded harbor seals and effect of age category on weekly stranding rate.

Alternatively, the above patterns may be linked to age-related and sex-related differences in the effects of contaminants. The contaminant levels in the tissues of seals that died in the 1988 PDV epidemic were considered sufficiently high to cause immunosuppression and thus to increase the severity of the PDV outbreak (14). Pollutant levels in tissues of seals that died during the 2002 PDV epidemic have yet to be reported.

Age affected geographic distribution of strandings. The proportion of stranded seals of each age category varied significantly among Wadden Sea locations ( $p \leq 0.001$ ). The highest proportions of juveniles and adults stranded at mainland Groningen (Table 1), which includes Eemsmond, a core breeding area. The highest proportion of subadults stranded on Vlieland (Table 1) in the western part of the Dutch Wadden Sea, an area assumed to have an influx of migrating young seals (15). The number of seals stranded per kilometer of coastline varied significantly among locations for juveniles ( $p \leq 0.001$ ), subadults ( $p \leq 0.001$ ), and adults ( $p \leq 0.001$ ), with 2.2 to 3.1 more seals stranded per kilometer of coastline on Schiermonnikoog, an island in the eastern part of the Dutch Wadden Sea, than would be expected had the seals been evenly distributed per km coast (Table 1). This coincides with the summer distribution of harbor seals in the Dutch Wadden Sea, which is highly skewed toward the east (15,16). Within each age category, the proportion of males to females varied significantly among locations only for adults ( $p \leq 0.001$ ). Ameland had the highest proportion of adult males, and Vlieland the lowest (Table 1).

Location affected the temporal distribution of strandings. The median stranding date varied significantly among locations ( $p \leq 0.001$ ); that for Zeeland (week 39) was significantly later than that for all Wadden Sea locations (weeks 35–37) (online Appendix Figure 3; available at [http://www.cdc.gov/ncidod/EID/vol11no12/05-0596\\_app3.htm](http://www.cdc.gov/ncidod/EID/vol11no12/05-0596_app3.htm)). This is likely because seals in Zeeland are fewer and more widely dispersed than in the Wadden Sea, so the chance of the virus spreading is lower.

Wind appeared to have a confounding effect on stranding rate: periods of southerly wind corresponded with decreased overall stranding rates, e.g., in weeks 33 and 36, and the opposite for northerly winds (Figure 2A). This is probably because dead seals floated in the top water layer, which shows parallel drift to surface winds. A similar effect of wind on strandings has been shown for seabirds (17). Spring tide did not affect stranding rate ( $p > 0.05$ ).

State of decomposition (as a measure of length of time between death of a seal and its detection) also had a confounding effect on stranding rate. From July to October, the overall proportion of decomposed seals differed significantly among months ( $p \leq 0.001$ ) and increased significantly with time ( $p \leq 0.001$ ) (Figure 2B). This finding is

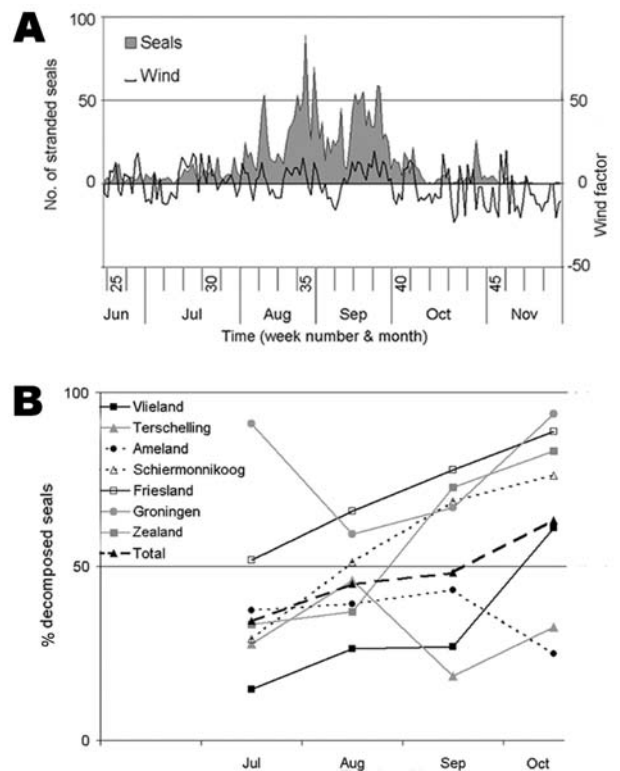

Figure 2. Effects of environmental variables on seal strandings in the Netherlands during the 2002 phocine distemper virus epidemic. A) Effect of wind direction and force on temporal distribution of stranded seals. Stranding rate of seals is expressed as number of seals reported per day. The wind factor is a function of wind force and wind direction. Negative wind factors correspond to southerly winds. B) Effect of state of decomposition on temporal distribution of stranded harbor seals, overall and per location. Percentages of decomposed seals are expressed per month.

probably because recovery of seal carcasses was not 100% so that, as the epidemic progressed, a higher proportion of stranded carcasses consisted of seals that had died before the previous shore survey. These findings show that over time stranding rate became a less accurate estimate of mortality rate, as observed in 1988 (18). The proportion of decomposed carcasses varied significantly by location ( $p \leq 0.001$ ), with high proportions of decomposed carcasses on the mainland coasts of Friesland and Groningen and on Schiermonnikoog (online Appendix Figure 4; available at [http://www.cdc.gov/ncidod/EID/vol11no12/05-0596\\_app4.htm](http://www.cdc.gov/ncidod/EID/vol11no12/05-0596_app4.htm)).

The timing of deaths and cumulative proportion of deaths of the 2002 PDV epidemic were similar to those characteristics in 1988 (Table 2). A difference, however, was that the index case was detected  $\approx 1$  month later in 2002 than in 1988. The similarity between estimated cumulative proportion of deaths in 1988 (53% of the population) and 2002 (54%) suggests that the pathogenic-

Table 2. Comparison of overall characteristics of the 1988 and 2002 phocine distemper virus epidemics, the Netherlands

Variable	1988	2002
Date index case	May 22*	Jun 16
Date median case	Sep 4*	Sep 2
Central epoch (d)	115*	93
No. found stranded	417*	2,284
No. counted in preepidemic year	966†	3,595‡
No. counted in postepidemic year	535†	2,365‡
Average annual population growth in preepidemic years (%)	8§	19¶
Estimated cumulative proportion of deaths (%)#	53	54

\*Source: ref. (4).

†Source: Report "Compilatie van gegevens over zeehonden en zeehondenopvang in de Nederlandse Waddenzee" (available at [http://www.waddenzee.nl/fileadmin/content/Dossiers/Natuur\\_en\\_Landschap/pdf/zeehondenplatform\\_compilatiebericht.pdf](http://www.waddenzee.nl/fileadmin/content/Dossiers/Natuur_en_Landschap/pdf/zeehondenplatform_compilatiebericht.pdf))‡Source: Wadden Sea Newsletters 2001-3 and 2003-2 (available at <http://www.waddensea-secretariat.org>).

§Source: ref. (19).

¶Source: ref. (15).

#Calculated as follows: [(number of live seals counted in preepidemic year + average annual growth in preepidemic years) - (number of live seals counted in postepidemic year - average annual growth in preepidemic years)] / (number of live seals counted in preepidemic year + average annual population growth in preepidemic years).

ity of PDV for the harbor seal population has not changed noticeably. However, more detailed examination of the genetic composition of both the virus and the harbor seal is needed to exclude changes in the host-pathogen relationship.

### Acknowledgments

We thank the volunteers who searched the Dutch coast daily for stranded seals; the staff at the Seal Research and Rehabilitation Center in Pieterburen for logistical support; V.O.P. Containers for providing the location to perform necropsies of the seals; the staff of the Dutch Ministry of Agriculture, Nature and Food Quality (LNV-Noord) for providing access to and help with the centralized seal registration data; the Common Wadden Sea Secretariat and the Trilateral Seal Expert Group for international coordination of the outbreak; Fiona Read for her help with geographic coordinates; Xavier Harduin for help in entering and analyzing data; Robin Huisman for help with the Geographic Information Systems program; and Hans Heesterbeek, Rik de Swart, and Cock van Duijn for reviewing the manuscript at different stages of development.

This study received financial support from the Dutch Ministry of Agriculture, Nature and Food Quality.

Ms Rijks is a veterinarian at the Erasmus Medical Center in Rotterdam, the Netherlands. Her research interests include the effect of infectious diseases on wild animal populations and the relationship between wildlife health and development aid.

### References

- Osterhaus ADME, Vedder EJ. Identification of virus causing recent seal deaths. *Nature*. 1988;335:20.
- Mahy BWJ, Barrett T, Evans S, Anderson EC, Bostock CJ. Characterization of a seal morbillivirus. *Nature*. 1988;336:115.
- Cosby SL, McQuaid S, Duffy N, Lyons C, Rima BK, Allan GM, et al. Characterization of a seal morbillivirus. *Nature*. 1988;336:115-6.
- Dietz R, Heide-Jørgensen M-P, Härkönen T. Mass deaths of harbor seals (*Phoca vitulina*) in Europe. *Ambio*. 1989;18:258-64.
- Jensen T, van de Bildt M, Dietz HH, Andersen TH, Hammer AS, Kuiken T, et al. Another phocine distemper outbreak in Europe. *Science*. 2002;297:209.
- Müller G, Wohlsein P, Beineke A, Haas L, Greiser-Wilke I, Siebert U, et al. Phocine distemper in German seals, 2002. *Emerg Infect Dis*. 2004;10:723-5.
- McLaren IA. Growth in pinnipeds. *Biol Rev*. 1993;68:1-79.
- Camphuysen CJ. Oil pollution and oiled seabirds in the Netherlands, 1969-97: signals of a cleaner sea. *Sula*. 1997;11:41-156.
- Harder T, Willhaus T, Frey H-R, Liess B. Morbillivirus infections of seals during the 1988 epidemic in the Bay of Heligoland: III. transmission studies of cell culture-propagated phocine distemper virus in harbour seals (*Phoca vitulina*) and a grey seal (*Halichoerus grypus*): clinical, virological and serological results. *J Vet Med B*. 1990;37:641-50.
- Renouf D, Lawson JW. Quantitative aspects of harbour seal (*Phoca vitulina*) play. *J Zool, Lond*. 1987;212:267-73.
- Traut IM, Ries EH, Donat B, Vareschi E. Spacing among harbour seals (*Phoca vitulina vitulina*) on haul-out sites in the Wadden Sea of Niedersachsen. *Z Säugetierkunde*. 1999;64:51-3.
- Godsell J. Herd formation and haul-out behaviour in harbour seals (*Phoca vitulina*). *J Zool, Lond*. 1988;215:83-98.
- Sullivan RM. Agonistic behavior and dominance relationships in the harbor seal, *Phoca vitulina*. *J Mamm*. 1982;63:554-69.
- Ross PS, De Swart RL, Reijnders PJH, Van Loveren H, Vos JG, Osterhaus ADME. Contaminant-related suppression of delayed-type hypersensitivity and antibody responses in harbor seals fed herring from the Baltic Sea. *Environ Health Perspect*. 1995;103:162-7.
- Ries EH, Traut IM, Brinkman AG, Reijnders PJH. Net dispersal of harbour seals within the Wadden Sea before and after the 1988 epizootic. *J Sea Res*. 1999;41:233-44.
- Leopold MF, van der Werf B, Ries EH, Reijnders PJH. The importance of the North Sea for winter dispersal of harbour seals *Phoca vitulina* from the Wadden Sea. *Biol Conserv*. 1997;81:97-102.
- Camphuysen CJ, Heubeck M. Marine oil pollution and beached bird surveys: the development of a sensitive monitoring instrument. *Environ Pollut*. 2001;112:443-61.
- Hall AJ, Pomeroy PP, Harwood J. The descriptive epizootiology of phocine distemper in the UK during 1988/89. *Sci Total Environ*. 1992;115:31-44.
- Reijnders PJH, Ries EH, Tougaard S, Nørgaard N, Heidemann G, Schwarz J, et al. Population development of harbour seals *Phoca vitulina* in the Wadden Sea after the 1988 virus epizootic. *J Sea Res*. 1997;38:161-8.

Address for correspondence: Thijs Kuiken, Institute of Virology, Erasmus MC Rotterdam, PO Box 1738, 3000 DR Rotterdam, the Netherlands; fax: 31-10-408-9485; email: t.kuiken@erasmusmc.nl

The opinions expressed by authors contributing to this journal do not necessarily reflect the opinions of the Centers for Disease Control and Prevention or the institutions with which the authors are affiliated.

# Bat Nipah Virus, Thailand

Supaporn Wacharapluesadee,\*  
Boonlert Lumlertdacha,† Kalyanee Boongird,‡  
Sawai Wanghongsa,‡ Lawan Chanhome,†  
Pierre Rollin,§ Patrick Stockton,§  
Charles E. Rupprecht,§ Thomas G. Ksiazek,§  
and Thiravat Hemachudha\*

Surveillance for Nipah virus (NV) was conducted in Thailand's bat population. Immunoglobulin G antibodies to NV were detected with enzyme immunoassay in 82 of 1,304 bats. NV RNA was found in bat saliva and urine. These data suggest the persistence of NV infection in Thai bats.

Nipah virus (NV) caused a major outbreak in swine and humans in Malaysia from September 1998 to April 1999 that led to 265 human cases with 105 deaths and the culling of >1 million swine (1). The genesis of the outbreak was suggested to be associated with bats (2,3). NV and Hendra virus (HV) are members of the *Paramyxoviridae* family in the genus *Henipavirus* (4). A seroepidemiologic study in Malaysia implicated 4 fruit bat species, *Pteropus hypomelanus*, *P. vampyrus*, *Cynopterus brachyotis*, *Eonycteris spelaea*, and an insectivorous bat, *Scotophilus kuhlii* (2). NV was also identified and isolated from bat urine samples of *P. hypomelanus* (5). Unlike NV's first appearance in Malaysia, in outbreaks in Bangladesh, infection may have been contracted by eating fruits contaminated with bat saliva, and transmitted from person to person (6). Antibodies to NV antigen were detected in 2 *P. giganteus* adult females from Bangladesh (6). Recently, antibodies to NV and virus isolation were successfully demonstrated in *P. lylei* from Cambodia (7).

Thailand is bordered by Malaysia to the south and Cambodia to the southeast. No NV infections in humans have been reported in Thailand. Surveillance in swine by enzyme-linked immunosorbent assay (ELISA) showed negative results (8). Estimates suggest ≈112 bat species in Thailand; 18 are fruit bats and 94 are insectivorous bats (9). Given that NV has caused several outbreaks in the region, obtaining baseline data for surveillance and planning for future public health assessment of its impact are essential.

\*Chulalongkorn University Hospital, Bangkok, Thailand; †Thai Red Cross Society, Bangkok, Thailand; ‡Ministry of Natural Resources and Environment, Bangkok, Thailand; and §Centers for Disease Control and Prevention, Atlanta, Georgia, USA

## The Study

From March 2002 to February 2004, a total of 17 trips were made to 15 sites in 9 provinces in central, eastern, and southern Thailand (Figure). Bats were caught and blood samples were collected as previously described (10). Of 12 bat species collected, 6 were frugivorous and 6 were insectivorous (Figure). Seventy-one percent (932) of 1,304 samples were from *Pteropus* bats and 66% (857) were from *P. lylei*. Saliva and urine were obtained by swabbing and stored in tubes with 1.0 mL of NucliSens lysis buffer containing guanidine thiocyanate (bioMérieux, Boxtel, the Netherlands) for transporting. Liquid from ≈10 individual samples from the same species, colony, and time of capture was saved into the same pool. A total of 142 pools each were collected from 1,286 saliva and 1,282 urine specimens. The pooled specimens were frozen at -70°C until analysis.

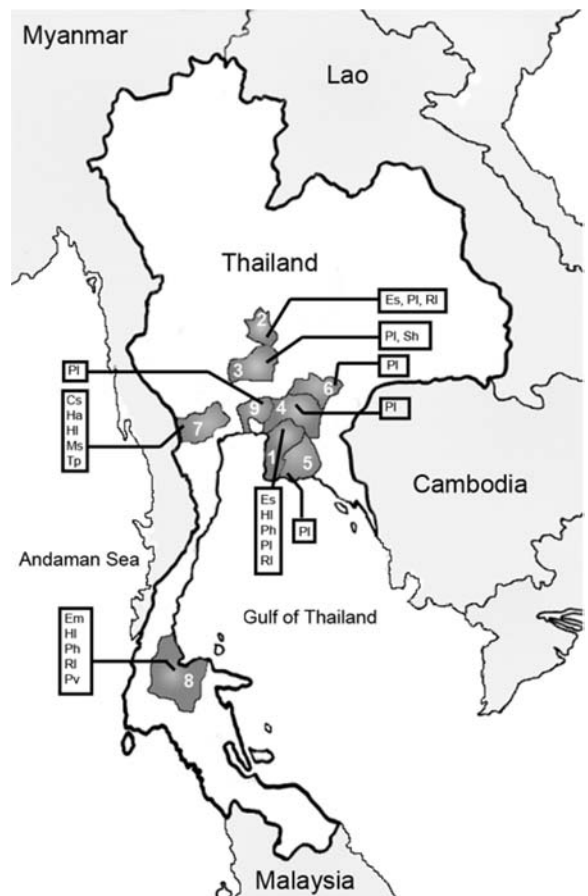

Figure. Locations in Thailand where bats have been captured. 1 = Chon Buri, 2 = Sing Buri, 3 = Ayutthaya, 4 = Cha Choeng Sao, 5 = Ra Yong, 6 = Pra Chin Buri, 7 = Ratcha Buri, 8 = Surat Thani, 9 = Bangkok. Species analyzed: Cs = *Cynopterus sphinx*, Em = *Emballonura monticola*, Es = *Eonycteris spelaea*, Ha = *Hipposideros armiger*, HI = *Hipposideros larvatus*, Ms = *Megaderma spasma*, Ph = *Pteropus hypomelanus*, PI = *P. lylei*, Pv = *P. vampyrus*, Rs = *Rousettus leschenaulti*, Sh = *Scotophilus heathi*, Tp = *Tadarida plicata*.

Immunoglobulin G (IgG) antibodies to NV were assayed by indirect ELISA at Chulalongkorn University Hospital, with a protocol developed by the Centers for Disease Control and Prevention (CDC), Atlanta, Georgia. Serum samples were heated to 56°C and titrated at 4 dilutions (1:100, 1:400, 1:1,600, and 1:6,400). Of the 1,054 serum specimens tested, 82 (7.8%) from 4 species—*P. hypomelanus* (n = 4), *P. lylei*, (n = 76), *P. vampyrus* (n = 1), and *Hipposideros larvatus* (n = 1)—were NV IgG antibody-positive (titer  $\geq$ 1:400) with 43 at a titer of 1:400; 30 at 1:1,600, and 9 at 1:6,400. *P. lylei* contained higher serum antibody titers than other species (9 of 76 at 1:6,400, 29 of 76 at 1:1,600) (Table).

Total RNA was extracted from saliva and urine according to manufacturer's protocol. A RNA plasmid was introduced as an internal control RNA in the duplex reverse transcription-polymerase chain reaction (RT-PCR) as previously described (11). NV nucleoprotein (N)-specific primers used for reverse transcription and first-round PCR were: NPIF, 5' CTT GAG CCT ATG TAT TTC AGA C 3'; NPIR, 5' GCT TTT GCA GCC AGT CTT G 3'. The internal primers for nested PCR were previously described (1). This process allowed an internal control to be visualized as the upper (323 bp) bands and NV product as lower bands (227 bp). Single-step RT-PCR was performed by using the One Step RT-PCR kit (Qiagen Inc., Valencia, CA, USA) followed by nested PCR. The PCR product was sized by gel electrophoresis in 2% agarose. Only samples showing both the 323-bp internal control and 227-bp NV-specific bands, or only a NV-specific band, were considered positive; those showing only the internal control band were considered negative. Those showing no band were tested again and judged to contain enzyme inhibitors if no band

was shown on repetition. All samples with positive results were tested again without the positive control, and the sequence of amplified product was determined by using internal primer.

The sensitivity of the duplex system is not notably altered by incorporation of the internal control RNA (data not shown). Samples from a saliva pool of *H. larvatus* from site 1 in Chon Buri Province and another pool of *P. lylei* from site 3 in Chon Buri Province were duplex nRT-PCR positive. All 6 positive duplex nRT-PCR urine pools were collected from *P. lylei* captured from 3 different sites, 1 from Cha Choeng Sao, 1 from Bangkok, and 4 from site 3 in Chon Buri. The 181-nucleotide (nt) sequences of the N gene obtained from 1 saliva pool of *H. larvatus* was identical to those reported from Malaysia (accession no. NC\_002728). The sequences of 1 saliva pool from *P. lylei* and 6 urine pools from *P. lylei* were identical to those reported from Bangladesh (AY988601) with 13 divergent nt (92% identity) from Malaysia. The nucleotide changes at positions 1397, 1407, and 1481 resulted in amino acid substitutions (with 94% identity to Malaysia, 56 of 59) from isoleucine to valine, glycine to glutamic acid, and asparagine to aspartic acid at codons 429, 432, and 457 of N protein, respectively. Nine divergent nucleotides among Thai, Bangladesh, and Cambodia (AY858110) did not result in amino acid differences.

## Conclusions

This study reports the evidence of NV infection in Thai frugivorous and insectivorous bats demonstrated by IgG antibodies to NV in serum samples and NV RNA in urine and saliva. Antibodies against NV were detected in *P. hypomelanus*, *P. vampyrus*, *P. lylei*, and *H. larvatus*. NV

Table. ELISA, PCR saliva, and PCR urine results for Nipah virus from 12 bat species, Thailand, 2002–2004\*

Species	Total bats	ELISA		PCR saliva‡		PCR urine‡	
		No. analyzed	No. positive (%) †	No. analyzed	No. pool positive/total	No. analyzed	No. pool positive/total
<b>Frugivorous</b>							
<i>Cynopterus sphinx</i>	34	10	0	34	0/5	34	0/5
<i>Eonycteris spelaea</i>	64	54	0	64	0/7	64	0/7
<i>Pteropus hypomelanus</i>	36	26	4 (15.4)	36	0/6	35	0/6
<i>P. lylei</i>	857	813	76 (9.3)	845	1/87	845	6/87
<i>P. vampyrus</i>	39	39	1 (2.6)	39	0/4	39	0/4
<i>Rousettus leschenaulti</i>	11	4	0	6	0/3	6	0/3
<b>Insectivorous</b>							
<i>Emballonura monticola</i>	14	12	0	14	0/2	14	0/2
<i>Hipposideros armiger</i>	88	6	0	88	0/10	88	0/10
<i>H. larvatus</i>	95	74	1 (1.3)	94	1/10	91	0/10
<i>Megaderma spasma</i>	13	0	0	13	0/2	13	0/2
<i>Scotophilus heathi</i>	3	3	0	3	0/1	3	0/1
<i>Tadarida plicata</i>	50	13	0	50	0/5	50	0/5
<b>Total</b>	<b>1,304</b>	<b>1,054</b>	<b>82 (7.8)</b>	<b>1,286</b>	<b>2/142</b>	<b>1,282</b>	<b>6/142</b>

\*ELISA, enzyme-linked immunosorbent assay; PCR, polymerase chain reaction.

†ELISA positive: titer  $\geq$ 1:400.

‡10 individual samples (saliva or urine) from the same species, colony, and the time of capture were saved into the same pool.

infections in the first 2 species were similar to those reported in Malaysia (2). *P. lylei* was the only bat species found NV-infected among 14 species tested in Cambodia (7). An earlier report demonstrated a correlation between ELISA and neutralization tests with 87% sensitivity and 99% specificity (7). These data support our ELISA results as a firstline screening tool to investigate NV infection in countries that do not have a BSL-4 facility in which to perform neutralization assays. The finding of unusually high antibody titers from *P. lylei* suggests that NV circulates mainly in this bat species in Thailand and Cambodia (7).

Although serum neutralization tests were not conducted, NV RNA was demonstrated in saliva and urine from *P. lylei* and saliva of *H. larvatus*. Determining PCR positivity by naked eye observations for the presence of a 227-bp fragment is not likely the most sensitive method (our detection limit is 0.37 pg total RNA/ $\mu$ L); therefore, some low-positive samples might be missed. Increasing the volume of sample tested by using a plastic sheet method in urine collection may overcome such problems (12).

Southern blot analysis is also useful for PCR confirmation; however, sensitivity may not be markedly improved as previously reported in the case of rabies (13). We used a nested PCR method because less RNA was required initially and because of a shorter turnaround time. Confirmation was achieved by direct sequencing of amplified products. Taken together, our current ELISA and PCR data are sufficient to conclude that Thai bats were naturally infected with NV. Higher numbers of PCR-positive samples in *P. lylei* may be due to a bias in species collection. Alternatively, in the serologic study, *P. lylei* may be the most prevalent infected species. Sequence analysis of the short 181-nt sequence suggests that  $\geq 2$  strains of NV are circulating in Thai bats. More sequence data are required to confirm this hypothesis. Finding NV RNA in saliva of *H. larvatus*, may indicate the insectivorous bat as another reservoir or this may be only an accidental spillage.

We believe that NV infection is prevalent in Thai fruit bats as previously reported in Malaysia and Cambodia (2,7). Countrywide surveillance is needed to clarify the epidemiology of NV infection in Thailand as it relates to host, seasonal, and geographic attributes.

#### Acknowledgments

We thank our colleagues at Chulalongkorn University, the Thai Red Cross Society, the Ministry of Natural Resources and Environment, and the Special Pathogens Branch and Viral and Rickettsial Zoonoses Branch of CDC for their input and expertise. We also thank Chantanee Buranathai and Kaw Bing Chua for critical comments.

This research was approved by the Ministry of Natural Resources and Environment and supported in part by a grant

from Thailand Research Fund and Department of Livestock, Ministry of Agriculture and Cooperatives. S.W., B.L., and T.H. received funding support from the National Center for Genetic Engineering and Biotechnology, National Science and Technology Development, Thailand.

Ms Wacharapluesadee is head of the Molecular Biology Laboratory for Neurological Diseases, Chulalongkorn University Hospital. Her areas of interest are the diagnosis, pathogenesis, and pathophysiology of viral encephalitis.

#### References

1. Chua KB, Bellini WJ, Rota PA, Harcourt BH, Tamin A, Lam SK, et al. Nipah virus: a recently emergent deadly paramyxovirus. *Science*. 2000;288:1432–5.
2. Yob JM, Field H, Rashdi AM, Morrissy C, van der Heide B, Rota P, et al. Nipah virus infection in bats (order *Chiroptera*) in peninsular Malaysia. *Emerg Infect Dis*. 2001;7:439–41.
3. AbuBakar S, Chang LY, Ali AR, Sharifah SH, Yusoff K, Zamrod Z. Isolation and molecular identification of Nipah virus from pigs. *Emerg Infect Dis*. 2004;10:2228–30.
4. Wang LF, Yu M, Hansson E, Pritchard LI, Shiell B, Michalaki WP, et al. The exceptionally large genome of Hendra virus: support for creation of a new genus within the family *Paramyxoviridae*. *J Virol*. 2000;74:9972–9.
5. Chua KB, Koh CL, Hooi PS, Wee KF, Khong JH, Chua BH, et al. Isolation of Nipah virus from Malaysian Island flying-foxes. *Microbes Infect*. 2002;4:145–51.
6. Hsu VP, Hossain MJ, Parashar UD, Ali MM, Ksiazek TG, Kuzmin I, et al. Nipah virus encephalitis reemergence, Bangladesh. *Emerg Infect Dis*. 2004;10:2082–7.
7. Reynes J-M, Counor D, Ong S, Faure C, Seng V, Molia S, et al. Nipah virus in Lyle's flying foxes, Cambodia. *Emerg Infect Dis*. 2005;11:1042–7.
8. Damrongwatanapokin S. Situation and surveillance of Nipah virus infection of pigs in Thailand. In: Proceedings of the challenge of infectious diseases in the 21st century. Chiangmai, Thailand; 2005 Jun 15–17. Bangkok, Thailand: Bureau of General Communicable Diseases, Department of Disease Control; 2005. p. 172–87.
9. Boonkird K, Wanghongsa S. Diversity of bats in Thailand. In: Compilation of 2003 research, progressive reports and essays on wildlife ecology. Bangkok, Thailand: Wildlife Research Division, Department of National Park, Wildlife and Plant Conservation; 2004. p. 183–96.
10. Lumlerdaecha B, Boongird K, Wanghongsa S, Wacharapluesadee S, Chanhome L, Khawplod P, et al. Survey for bat lyssaviruses, Thailand. *Emerg Infect Dis*. 2005;11:232–6.
11. Echevarria JE, Avellon A, Juste J, Vera M, Ibanez C. Screening of active lyssavirus infection in wild bat populations by viral RNA detection on oropharyngeal swabs. *J Clin Microbiol*. 2001;39:3678–83.
12. Chua KB. A novel approach for collecting samples from fruit bats for isolation of infectious agents. *Microbes Infect*. 2003;5:487–90.
13. Smith J, McElhinney LM, Heaton PR, Black EM, Lowings JP. Assessment of template quality by the incorporation of an internal control into a RT-PCR for the detection of rabies and rabies-related viruses. *J Virol Methods*. 2000;84:107–15.

Address for correspondence: Supaporn Wacharapluesadee, Molecular Biology Laboratory for Neurological Diseases, Department of Medicine, Chulalongkorn University Hospital, Rama 4 Rd, Bangkok 10330, Thailand; fax: 662-6523122; email: spwa02@yahoo.com

# Cat-transmitted Sporotrichosis, Rio de Janeiro, Brazil

Armando Schubach,\*  
Tânia Maria Pacheco Schubach,\*  
Mônica Bastos de Lima Barros,\*  
and Bodo Wanke\*

Sporotrichosis is an emerging zoonosis in Rio de Janeiro, Brazil. From 1998 to 2003, 497 humans and 1,056 cats with culture-proven sporotrichosis were studied. A total of 421 patients, 67.4% with a history of a scratch or bite, reported contact with cats that had sporotrichosis.

Sporotrichosis is caused by *Sporothrix schenckii*, a dimorphic fungus widely found in nature (1). Davies and Troy (2) reviewed 48 cases of feline sporotrichosis published over a period of 40 years. Little is known about feline sporotrichosis or the role of cats as a source of infection because reports are scarce. Human sporotrichosis has been related sporadically to scratches or bites by animals (3).

Since the 1980s, the role of felines in transmission of the mycosis to humans has gained attention among animal owners, veterinarians, and caretakers (2). Epidemics involving a large number of persons or wide geographic areas are rare and have been related to an environmental source of infection (4,5). No epizootics have been reported.

From 1987 to 1997, before the current emergence of sporotrichosis in Brazil, only 13 cases of human sporotrichosis had been recorded at the Evandro Chagas Clinical Research Institute (IPEC) in Rio de Janeiro (6). In 1998, the first year of the current outbreak, 9 patients with human sporotrichosis were observed, 3 of whom reported scratches by cats with cutaneous lesions (7). Since then, cats with clinically suspected sporotrichosis or human cases of this disease have been studied systematically.

## The Study

The study protocol was reviewed and approved by the research ethics committee and the institutional review board of the Center for Biological Evaluation and Care of Research Animals of the Oswaldo Cruz Foundation. The patient inclusion criterion for humans and cats in this study was isolation of *S. schenckii* in culture. All human patients were treated at the outpatient clinic of IPEC, and the animals were seen at the veterinary outpatient clinic of IPEC.

From 1998 to 2001, 178 human (8) and 347 feline (9) cases of sporotrichosis were reported to IPEC. Additionally, 101 apparently healthy cats that lived with other cats with sporotrichosis were identified and followed up for 1 year. All data were collected by review of medical charts and recorded on a standardized form.

Most human cases treated at IPEC came from outlying neighborhoods of greater metropolitan Rio de Janeiro, an area with low socioeconomic conditions. Of 178 patients, 156 reported home or professional contact with cats with sporotrichosis, and 97 reported a history of cat scratch or bite. The patients had an age range of 5 to 89 years (median 39). One hundred twenty-two (68%) were women. Housewives (30%) and students (18%) were the 2 most frequently affected groups; 5% of patients were veterinarians.

Fifty-two (28.6%) of the 170 patients showed a positive result on a leishmanin skin test. Of these patients, 38 came from areas with active transmission of American tegumentary leishmaniasis (ATL) (10).

We evaluated 148 cats with sporotrichosis for the presence of *S. schenckii*. The fungus was isolated from all cutaneous lesions, 47% (n = 71) of nasal cavity swabs, 33% (n = 79) of oral cavity swabs, and 15% (n = 38) of nail fragment pools (11). *S. schenckii* was isolated from the oral and or nasal cavities of 10 of 101 apparently healthy cats that lived with other cats with sporotrichosis.

Coinfection with feline immunodeficiency virus (FIV) or feline leukemia virus (FeLV) was demonstrated in 21.8% of 142 tested cats with sporotrichosis. Antibodies against FIV were detected in 28 cats, FeLV antigen in 2 cats, and both FIV and FeLV in 1 cat (9).

A broad spectrum of clinical signs and symptoms was observed in 347 cats with sporotrichosis, ranging from subclinical infection and a single cutaneous lesion with spontaneous regression to fatal systemic forms. The cutaneous-lymphatic form was observed in only 19.3% of the cats, while mucosal involvement of the upper respiratory and digestive tracts was observed in 34.9% and multiple cutaneous lesions in 39.5% (9).

We reviewed published data on an ongoing epidemic of zoonotic sporotrichosis in Rio de Janeiro, Brazil. In the first year of this outbreak, 9 cases of human disease and 1 case of animal disease were diagnosed at IPEC. The incidence of sporotrichosis increased so much that by December 2003 a total of 497 humans and 1,056 cats with culture-proven sporotrichosis had been recorded (IPEC, unpub. data) (Figures 1 and 2). A total of 421 patients reported contact with cats that had sporotrichosis; 284 of these patients had a history of a scratch or bite. This finding represents the largest epidemic of this mycosis as a zoonosis. Isolation of the fungus from the nails and oral cavity of cats suggests that transmission can occur through a scratch or bite. In addition, infection may be transmitted

\*Evandro Chagas Clinical Research Institute, Rio de Janeiro, Brazil



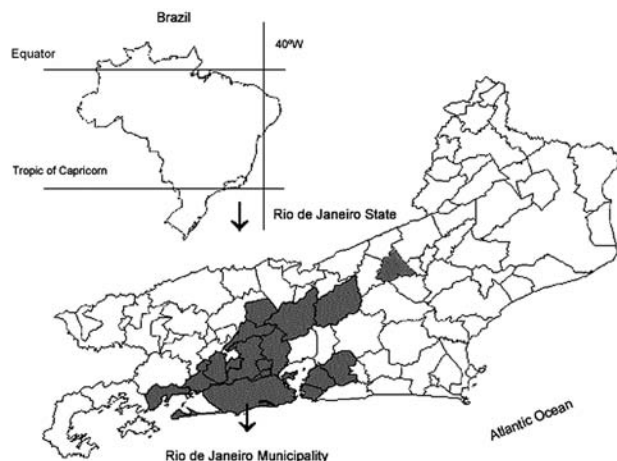

Figure 1. Map of Brazil and the state of Rio de Janeiro showing municipalities (shaded areas) where human and feline cases of sporotrichosis were diagnosed from 1998 to 2003.

through secretions because fungus was isolated from nasal fossae and cutaneous lesions and yeastlike elements were visualized in histologic sections of cutaneous biopsy specimens (3,9,12). The large proportion of housewives among the human patients suggests that this group is the most heavily exposed to the fungus because they care for cats. Molecular typing of *S. schenckii* strains isolated from humans and animals reinforces this hypothesis (13).

## Conclusions

The primary differential diagnosis for sporotrichosis was cutaneous leishmaniasis, especially in cases from areas endemic for ATL. In these cases, a diagnosis based only on clinical findings and positive leishmanin skin test result could lead to incorrect treatment and unnecessary control measures (10). In addition to cutaneous infection as a transmission route, the current epidemic also appears to have a strong respiratory component because the frequency of respiratory signs and pulmonary and nasal

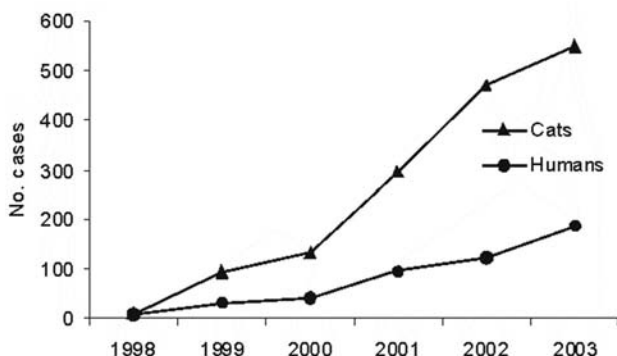

Figure 2. Number of human and feline cases of sporotrichosis diagnosed at the Instituto de Pesquisa Clínica Evandro Chagas, Rio de Janeiro, Brazil, 1998–2003.

mucosal lesions was high and because *S. schenckii* was isolated from nasal swabs collected in vivo and from the lungs of autopsied cats (9,11,12).

Some investigators believe that the severity of feline sporotrichosis is related to immunosuppression caused by coinfection with FIV or FeLV (2). However, no association with FIV/FeLV-related immunodeficiency was observed (12).

The present series consisted mainly of cats with chronic cutaneous lesions whose owners sought specialized care at a reference center. In transmission areas, many cases of subclinical infection and spontaneous cure may have gone undetected. Since reporting sporotrichosis cases is not mandatory, assessing its occurrence and distribution is difficult, and the incidence may have been underestimated. The absence of a feline sporotrichosis control program and various feline behavior factors (e.g., frequent cat fights in the neighborhoods) may have contributed to the spread of the mycosis.

For public health purposes and to control the current epidemic, an effective and viable therapeutic regimen for cats is necessary. In addition, public awareness programs on sporotrichosis prophylaxis are required. These will encourage responsible ownership, neutering, cremation of dead cats, confinement of cats inside the home, limiting the number of cats per household, regular cleaning of dwellings, proper health care for the animals, and general public health measures such as basic sanitation, regular garbage collection, and cleaning of empty lots.

## Acknowledgments

We thank Virgílio Ferreira da Silva, Thais Okamoto, Fabiano Borges Figueiredo, Sandro Antonio Pereira, Dilma Ferreira Monteiro, Isabella Vianna Pellon, Isabele Barbiere dos Santos, Luiz Rodrigo de Paes Leme, Roseli Lopes Pereira, Paulo Cezar Fialho Monteiro, Rosani Santos Reis, Rodrigo de Almeida Paes, Márcia dos Santos Lazéra, Rosely Maria Zancopé-Oliveira, Maria Clara Gutierrez Galhardo, Antonio Carlos Francesconi do Valle, Mariza Matos Salgueiro, Brenda Regina de Siqueira Hoagland, Keyla Belizia Feldman Marzochi, João Soares Moreira, Claudia Maria Valette Rosalino, Magdala Louvain Fabri, Ana Cristina Martins, Márcio Sued, Jorge Luiz Nunes da Silva, Italia Mazzei Portugal, Tullia Cuzzi, Leonardo Pereira Quintella, Fátima Conceição-Silva, Mauricio Andrade Perez, Sônia Regina Lambert Passos, Maria José Conceição, and Mauro Célio de Almeida Marzochi for their assistance in this study.

This study was partially supported by the Program to Support Strategic Health Research, FIOCRUZ, and the Brazilian National Research Council.

Dr Armando Schubach is a clinical researcher at the Zoonoses Division, Evandro Chagas Clinical Research Institute, Oswaldo Cruz Foundation, in Rio de Janeiro. His research

interests include the diagnosis, epidemiology, and therapeutics of sporotrichosis and leishmaniasis.

## References

1. Kwon-Chung K, Bennet J. Sporotrichosis. In: Kwon-Chung K, Bennet J, editors. *Medical mycology*. 1st ed. Philadelphia: Lea & Febiger; 1992. p. 707–29.
2. Davies C, Troy GC. Deep mycotic infections in cats. *J Am Anim Hosp Assoc*. 1996;32:380–91.
3. Kauffman CA. Sporotrichosis. *Clin Infect Dis*. 1999;29:231–6.
4. Brown R, Weintraub D, Simpson M. Timber as a source of sporotrichosis infection. In: Proceedings of the Transvaal Mine Medical Officers' Association. Sporotrichosis infection on mines of the Witwatersrand. Johannesburg: The Transvaal Chamber of Mines; 1947. p. 5–33.
5. Dixon DM, Salkin IF, Duncan RA, Hurd NJ, Haines JH, Kemna ME, et al. Isolation and characterization of *Sporothrix schenckii* from clinical and environmental sources associated with the largest U.S. epidemic of sporotrichosis. *J Clin Microbiol*. 1991;29:1106–13.
6. de Lima Barros MB, Schubach TM, Galhardo MC, de Oliveira Schubach A, Monteiro PC, Reis RS, et al. Sporotrichosis: an emergent zoonosis in Rio de Janeiro. *Mem Inst Oswaldo Cruz*. 2001;96:777–9.
7. Schubach TM, Valle AC, Gutierrez-Galhardo MC, Monteiro PC, Reis RS, Zancopé-Oliveira RM, et al. Isolation of *Sporothrix schenckii* from the nails of domestic cats (*Felis catus*). *Med Mycol*. 2001;39:147–9.
8. Barros MB, Schubach Ade O, do Valle AC, Gutierrez Galhardo MC, Conceicao-Silva F, Schubach TM, et al. Cat-transmitted sporotrichosis epidemic in Rio de Janeiro, Brazil: description of a series of cases. *Clin Infect Dis*. 2004;38:529–35.
9. Schubach TM, Schubach A, Okamoto T, Barros MB, Figueiredo MB, Cuzzi T, et al. Evaluation of an epidemic of sporotrichosis in cats: 347 cases (1998–2001). *J Am Vet Med Assoc*. 2004;224:1623–9.
10. de Lima Barros MB, Schubach A, Francesconi-do-Valle AC, Gutierrez-Galhardo MC, Schubach TM, Conceicao-Silva F, et al. Positive Montenegro skin test among patients with sporotrichosis in Rio de Janeiro. *Acta Trop*. 2005;93:41–7.
11. Schubach TM, de Oliveira Schubach A, dos Reis RS, Cuzzi-Maya T, Blanco TC, Monteiro DF, et al. Positive Montenegro skin test among patients with sporotrichosis in Rio de Janeiro, Brazil. *Mycopathologia*. 2002;153:83–6.
12. Schubach TM, Schubach Ade O, Cuzzi-Maya T, Okamoto T, Reis RS, Monteiro PC, et al. Pathology of sporotrichosis in 10 cats in Rio de Janeiro. *Vet Rec*. 2003;152:172–5.
13. Reis R, Schubach T, Guimarães A, Monteiro P, Zancopé-Oliveira R. Molecular typing of *Sporothrix schenckii* strains isolated from clinical specimens in Rio de Janeiro, Brazil. In: Abstracts of the 14th Congress of the International Society of Human and Animal Mycology; Buenos Aires, Argentina; May 8–12, 2000; Abstract 498. International Society of Human and Animal Mycology; 2000.

Address for correspondence: Armando Schubach, Fundação Oswaldo Cruz, Instituto de Pesquisa Clínica Evandro Chagas, Serviço de Zoonoses, Av. Brasil 4365, CEP 21040-900 Rio de Janeiro, RJ, Brazil; fax: 55-21-3865-9541; email: armando@ipecc.fiocruz.br

## etymologia

### *Eptesicus fuscus*

[ep'tes-ə-kəs fəs-kəs]



The big brown bat. From the Greek *epten*, "I fly," plus *oikos*, "house," and the Latin *fuscus*, "dusk." A nocturnal, insectivorous bat, *Eptesicus fuscus* females separate after mating into maternity colonies that are frequently found in attics of buildings or other manmade locations, since they prefer warmer temperatures in which to raise their young.

**Figure.** Photograph courtesy of Ivan Kuzmin.

**Sources:** McElhinny T. A mammalian lexicon. [cited 2005 Oct 13]. Available from <http://www.msu.edu/~mcelhinn/zoology/mammalwords.htm>; Webster's Third New International Dictionary (unabridged). Springfield (MA), 1993; and wikipedia.org.

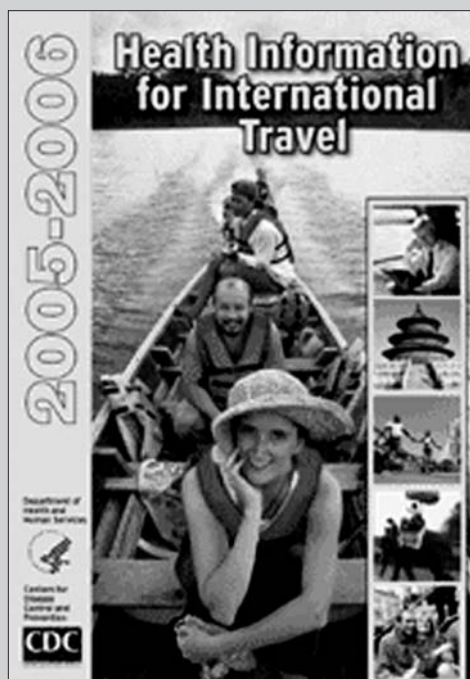

For more information visit  
<http://www.cdc.gov/travel/yb/index.htm>

---

# Hemolytic Uremic Syndrome Risk and *Escherichia coli* O157:H7

Boldtsetseg Tserenpuntsag,\* Hwa-Gan Chang,†  
Perry F. Smith,\*† and Dale L. Morse\*†

We reviewed medical records of 238 hospitalized patients with *Escherichia coli* O157:H7 diarrhea to identify risk factors for progression to diarrhea-associated hemolytic uremic syndrome (HUS). Data indicated that young age, long duration of diarrhea, elevated leukocyte count, and proteinuria were associated with HUS.

---

In the United States, *Escherichia coli* O157:H7 causes ≈73,000 infections and 60 deaths annually (1). Infection progresses to hemolytic uremic syndrome (HUS) in 2% to 15% of cases (2). In studies of *E. coli* O157:H7 outbreaks, female sex, young age, elevated leukocyte count, antimicrobial drug use, vomiting, and fever have been reported as risk factors for HUS (3–11). Previously, a possible association between HUS and female sex, young age, and prolonged duration of diarrhea was shown in a study that evaluated the New York state surveillance system for postdiarrheal HUS (12). This report extends that study to investigate hospitalized patients with *E. coli* O157:H7 infection to assess potential risk factors for progression of infection to HUS by using a case-control study.

## The Study

Medical charts of all persons who were hospitalized and reported with confirmed cases of *E. coli* O157:H7 to the New York State Department of Health's Communicable Disease Surveillance System (CDSS) in 1998 and 1999 were reviewed according to a standardized survey form. A HUS case was defined as occurring in a patient with acute diarrhea who was hospitalized with *E. coli* O157:H7 infection and in whom confirmed or probable postdiarrheal HUS developed. A confirmed HUS case was defined as occurring in a patient with a clear history of acute diarrhea who showed the following signs: hemolytic anemia with microangiopathic changes, renal insufficiency (creatinine level  $\geq 1.0$  mg/dL in a child  $< 13$  years of age or  $\geq 1.5$  mg/dL in an adult, or  $\geq 50\%$  increase over baseline), and thrombocytopenia (platelet count  $< 150,000/\mu\text{L}$ ). A probable HUS case was defined as occurring in a patient

with acute diarrhea with all the above signs except microangiopathic changes in the blood smear. Controls were hospitalized patients with *E. coli* O157:H7 infection without HUS. Demographic, clinical, and laboratory characteristics were abstracted from medical charts. Statistical analysis was performed by using SAS software (SAS Institute, Cary, NC, USA). A multiple logistic regression analysis was performed to identify factors associated with development of HUS.

In 1998 and 1999, the CDSS received reports of 1,170 cases of *E. coli* O157:H7 infection. Of these, 255 patients (21%) were hospitalized and 238 (93%) had medical charts available for review. Thirty-six (15%) patients were confirmed ( $n = 29$ ) or probable ( $n = 7$ ) HUS case-patients, and 202 *E. coli* O157:H7-infected patients without HUS were identified as controls. The risk of HUS was highest among children  $< 5$  years of age, compared with patients  $> 65$  years (odds ratio [OR] 4.9, 95% confidence interval [CI] 2.2–11.8). Sixty-nine percent of HUS patients were female compared with 61% of controls (OR 1.5, 95% CI 0.8–3.4). The hospital stay was significantly longer for HUS patients than controls (median hospital stay 13 vs. 3 days). Five HUS patients (14%) died, including 2 children  $< 5$  years of age, compared with 2 controls (1%).

Forty percent of all patients had vomiting, and 85% had bloody stool. These factors were not significantly different between patients and controls. Eleven (31%) case-patients and 78 (38%) controls were treated with antimicrobial drugs (not significant). Antimicrobial treatment was reported in 11 patients before the diagnosis of HUS: 6 received antimicrobial drugs primarily for other conditions (e.g., urinary tract infection, otitis media, venous line sepsis), 1 had treatment stopped once *E. coli* O157:H7 was diagnosed, and we could not tell whether drug regimens were completed or discontinued in 4 patients. HUS patients were more likely than non-HUS controls to have fever (OR 3.2, 95% CI 1.6–6.5). The duration of diarrhea before hospitalization was significantly longer for HUS patients than for non-HUS controls (median 4 vs. 2 days).

Proteinuria and hematuria were observed significantly more often among the case-patients. Twenty-three (64%) patients had proteinuria at admission, whereas 37 (18%) controls were admitted with proteinuria (OR 7.8, 95% CI 3.6–17). Hematuria at admission was reported in 23 (64%) patients and 57 (28%) controls (OR 4.5, 95% CI 2.1–9.4). Twenty-nine (81%) HUS patients vs. 90 (44%) controls had leukocyte counts  $\geq 13,000/\mu\text{L}$  (OR 5.2, 95% CI 2.2–12.3) at admission (Table 1). Factors associated with HUS in univariate analysis (age  $< 5$  years, outbreak case, fever, hematuria, proteinuria, leukocytosis at admission, and duration of diarrhea before hospitalization  $> 3$  days) were included in the multivariate analysis. The following variables were associated with HUS development in the

---

\*University at Albany, Albany, New York, USA; and †New York State Department of Health, Albany, New York, USA

multivariate analysis: proteinuria (OR 6.7, 95% CI 1.9–24.1), duration of diarrhea before hospitalization >3 days (OR 6.2, 95% CI 2.2–17.4), age <5 years (OR 5.9, 95% CI 1.9–17.6), and leukocyte count  $\geq 13,000/\text{mL}$  (OR 4.4, 95% CI 1.6–12.6). Factors such as outbreak involvement, hematuria and fever were not associated with HUS development (Table 2).

### Conclusions

This study provides additional information on potential risk factors for progression of *E. coli* O157:H7 infection to HUS, but unlike other studies, this study used hospitalized

rather than outpatient controls. Our data confirmed previous differences in risk for HUS development by age group (3–5). Women and girls have been reported to be at increased risk for HUS development in several studies (10,11), but our study showed no significant increased risk. Several studies have suggested that administration of antimicrobial agents increases risk for HUS development (5,6,9,13), but no significant relationship was observed between HUS and the use of antimicrobial drugs in our sample.

Although reports (5,7) have demonstrated a higher incidence of HUS among patients with bloody diarrhea, fever,

Table 1. Characteristics of hospitalized *Escherichia coli* O157:H7 patients by HUS case status, New York, 1998–1999\*

Characteristic	Total (N = 238) n (%)	HUS (n = 36) n (%)	Non-HUS (n = 202) n (%)	OR (95% CI)	p value
Age (y)					
0–4	34 (14)	18 (49)	16 (8)	4.9 (2.2–11.8)	<0.001
5–14	52 (22)	6 (17)	46 (23)	1.1 (0.4–3.1)	
15–65	96 (40)	6 (17)	90 (44)	0.6 (0.2–1.7)	
>65	56 (24)	6 (17)	50 (25)	1.0	
Sex					
Female	147 (62)	25 (69)	122 (61)	1.5 (0.8–3.4)	0.33
Male	91 (38)	11 (31)	80 (39)	1.0	
Outcome					
Dead	7 (3)	5 (14)	2 (1)	16.1 (2.9–86.8)	0.001
Alive	231 (97)	31 (86)	200 (99)	1.0	
Outbreak					
Yes	49 (21)	15 (42)	34 (17)	3.6 (1.6–7.5)	0.01
No	189 (79)	21 (58)	168 (83)	1.0	
Hospital stay (d)					
>4	121 (51)	31 (86)	90 (45)	7.7 (2.8–20.6)	0.001
1–4	117 (49)	5 (14)	112 (55)	1.0	
Bloody stool					
Yes	203 (85)	30 (84)	173 (86)	0.8 (0.3–2.4)	0.77
No	35 (15)	6 (16)	29 (14)	1.0	
Fever					
Yes	71 (30)	19 (53)	52 (26)	3.2 (1.6–6.5)	0.009
No	167 (70)	17 (47)	150 (74)	1.0	
Vomiting					
Yes	96 (40)	14 (39)	82 (40)	0.9 (0.4–1.9)	0.84
No	142 (60)	22 (61)	120 (60)	1.0	
Antimicrobial drug use					
Yes	89 (37)	11 (31)	78 (38)	0.7 (0.3–1.5)	0.38
No	149 (63)	25 (69)	124 (62)	1.0	
Proteinuria at admission					
Yes	60 (25)	23 (64)	37 (18)	7.8 (3.6–17.0)	<0.001
No	178 (75)	13 (36)	165 (82)	1.0	
Hematuria at admission					
Yes	80 (34)	23 (64)	57 (28)	4.5 (2.1–9.4)	<0.001
No	158 (66)	13 (36)	145 (72)	1.0	
Leukocyte count at admission					
$\geq 13,000/\mu\text{L}$	119 (50)	29 (81)	90 (44)	5.2 (2.2–12.3)	<0.001
$< 13,000/\mu\text{L}$	119 (50)	7 (19)	112 (56)	1.0	
Duration of diarrhea before hospitalization					
>3 days	70 (29)	24 (67)	46 (23)	6.7 (3.1–14.6)	<0.001
$\leq 3$ days	168 (71)	12 (33)	156 (77)	1.0	

\*HUS, hemolytic uremic syndrome; OR, odds ratio; CI, confidence interval.

Table 2. Multiple logistic regression analysis of risk factors associated with HUS, New York, 1998–1999\*

Characteristic	No. patients (%) (n = 36)	No. controls (%) (n = 202)	Adjusted OR (95% CI)
Proteinuria	23 (64)	37 (18)	6.7 (1.9–24.1)
Duration of diarrhea before hospitalization >3 d	24 (67)	46 (23)	6.2 (2.2–17.4)
Age <5 y	18 (50)	16 (8)	5.9 (1.9–17.6)
Leukocytes >13,000/ $\mu$ L	29 (81)	90 (44)	4.4 (1.6–12.6)
Outbreak case	15 (42)	34 (17)	1.7 (0.6–4.9)
Hematuria	23 (64)	57 (28)	1.4 (0.4–4.9)
Fever	19 (53)	52 (26)	1.1 (0.4–3.1)

\*HUS, hemolytic uremic syndrome; OR, odds ratio; CI, confidence interval.

or vomiting, our multivariate analysis did not show a significant association between these characteristics and HUS. Since only hospitalized patients with severe diarrhea were studied, some symptoms (bloody stool, fever, or vomiting) might have been reported more often than in the general population with *E. coli* O157:H7 infection. As a result, some significant associations might have been missed. Buteau et al. (14) reported that a diarrheal prodrome <3 days is an independent predictor of HUS development in children with *E. coli* O157:H7 infection; however, our study suggested that prolonged diarrhea (>3 days) may increase the risk of HUS.

Our analysis was consistent with results of other studies that found patients with elevated leukocyte counts to be at higher risk for developing HUS (5–8,14). Patients with leukocytes  $\geq$ 13,000/ $\mu$ L at admission in our study had 5 times the risk of HUS. Protein and occult blood in urine were described as risk factors for HUS in a study in Japan (15). In the current study, proteinuria at admission was also a risk factor for HUS. However, HUS had already developed in most of these patients by the time of hospitalization, and we could not determine whether these factors preceded HUS development.

In summary, patients hospitalized for *E. coli* O157:H7 infection, those <5 years of age with >3 days of diarrhea, leukocytes  $\geq$ 13,000/ $\mu$ L, and proteinuria should be monitored closely for further complications. Nine (25%) of the HUS patients had 4 risk factors, 11 (31%) patients had 3 risk factors, and 10 (28%) had 2 risk factors. In comparison, none of the controls had these 4 risk factors, 4 (2%) had 3 risk factors, and 47 (23%) had 2 risk factors. Identifying potential risk factors may allow clinicians to develop treatment interventions to prevent progression to HUS.

Ms Tserenpuntsag is a DrPH student majoring in epidemiology at the State University of New York at Albany. Her research interests include infectious disease epidemiology.

## References

- Mead PS, Slutsker L, Dietz V, McCaig LF, Bresee JS, Shapiro C, et al. Food-related illness in the United States. *Emerg Infect Dis.* 1999;5:607–25.
- Dundas S, Todd WT, Stewart AI, Murdoc PS, Chaudhuri AKR, Hutchinson SJ. The central Scotland *Escherichia coli* O157:H7 outbreak: risk factors for hemolytic uremic syndrome and death among hospitalized patients. *Clin Infect Dis.* 2001;33:923–31.
- Griffin PM, Ostroff SM, Tauxe RV, Greene KD, Wells JG, Lewis JH, et al. Illnesses associated with *E. coli* O157:H7 infections: a broad clinical spectrum. *Ann Intern Med.* 1988;109:705–12.
- Griffin PM, Tauxe RV. The epidemiology of infections caused by *E. coli* O157:H7, other enterohemorrhagic *E. coli* and associated hemolytic uremic syndrome. *Epidemiol Rev.* 1991;13:60–98.
- Pavia AT, Nichols CR, Green DP, Tauxe RV, Mottile S. Hemolytic uremic syndrome during an outbreak of *Escherichia coli* O157:H7 infections in institutions for mentally retarded persons: clinical and epidemiologic observations. *J Pediatr.* 1990;116:544–51.
- Bell BP, Griffin PM, Lozano P, Christie DL, Kpbayashi JM, Tarr PI. Predictors of hemolytic uremic syndrome in children during a large outbreak of *Escherichia coli* O157:H7 infections. *Pediatrics.* 1997;100:E12.
- Ikeda K, Ida O, Kimoto K, Takatorige T, Nakanish N, Tatara K. Predictors for the development of haemolytic uremic syndrome with *Escherichia coli* O157:H7 infections: with focus on the day of illness. *Epidemiol Infect.* 2000;124:343–9.
- Kawamura N, Yamazaki T, Tamai H. Risk factors for the development of *Escherichia coli* O157:H7 associated with hemolytic uremic syndrome. *Pediatr Int.* 1999;41:218–22.
- Carter AO, Borczyk AA, Carlson JA, Harvey B, Hockin JC, Karmali MA, et al. A severe outbreak of *Escherichia coli* O157:H7—associated hemorrhagic colitis in a nursing home. *N Engl J Med.* 1987;317:1496–1500.
- Cimolai N, Carter JE, Morrison BJ, Anderson JD. Risk factors for the progression of *Escherichia coli* O157:H7 enteritis to the hemolytic uremic syndrome. *J Pediatr.* 1990;116:589–92.
- Rowe PC, Walop W, Lior H, Mackenzie AM. Hemolytic anemia after childhood *Escherichia coli* O157:H7 infection: are females at increased risk? *Epidemiol Infect.* 1991;106:523–30.
- Chang HH, Tserenpuntsag B, Kacica M, Smith PF, Morse DL. Hemolytic uremic syndrome in New York. *Emerg Infect Dis.* 2004;10:928–31.
- Wong CS, Jelacic S, Habeeb RL, Watkins SL, Tarr PI. The risk of hemolytic-uremic syndrome after antibiotic treatment of *Escherichia coli* O157:H7 infections. *N Engl J Med.* 2000;342:1930–6.
- Buteau C, Proulx F, Chaibou M, Raymond D, Clermont MJ, Mariscalco MM, et al. Leukocytosis in children with *Escherichia coli* O157:H7 enteritis developing the hemolytic uremic syndrome. *Pediatr Infect Dis J.* 2000;19:642–7.
- Joh K. Predictive indicators for progression to severe complications (hemolytic-uremic syndrome and encephalopathy) and their prevention in enterohemorrhagic *Escherichia coli* infection. *Nippon Rinsho.* 1997;55:700–5.

Address for correspondence: Hwa-Gan Chang, New York State Department of Health, Corning Tower Building, Room 1143, Empire State Plaza, Albany, NY 12237, USA; fax: 518-474-4880; email: hgc04@health.state.ny.us

# Hepatitis E Virus Transmission from Wild Boar Meat

Tian-Cheng Li,\* Katsumi Chijiwa,†  
 Nobuyuki Sera,† Tetsuya Ishibashi,†  
 Yoshiki Etoh,† Yuji Shinohara,‡ Yasuo Kurata,‡  
 Miki Ishida,§ Shigeru Sakamoto,¶  
 Naokazu Takeda,\* and Tatsuo Miyamura\*

We investigated a case of hepatitis E acquired after persons ate wild boar meat. Genotype 3 hepatitis E virus (HEV) RNA was detected in both patient serum and wild boar meat. These findings provided direct evidence of zoonotic foodborne transmission of HEV from a wild boar to a human.

**H**epatitis E virus (HEV), a causative agent of human hepatitis E, is a single-stranded positive-sense RNA virus recently classified as the sole member of the genus *Hepevirus* in the family *Hepeviridae* (1,2). HEV is transmitted primarily by the fecal-oral route through contaminated drinking water. However, recent studies have demonstrated that various animal species have serum antibodies to HEV, suggesting that hepatitis E is a zoonotic disease (3). In Japan, 4 hepatitis E cases have been linked directly to eating raw deer meat (4), and several cases of acute hepatitis E have been epidemiologically linked to eating undercooked pork liver or wild boar meat (5,6). These cases provide convincing evidence of zoonotic food-borne HEV transmission. We report direct evidence of HEV transmission from a wild boar to a human.

## The Study

A 57-year-old woman came to Iizuka Hospital on March 12, 2005, with malaise and anorexia. Although she was a healthy hepatitis B virus carrier and negative for serologic markers of hepatitis A and C, testing upon admission showed elevated levels of liver enzymes (alanine aminotransferase 752 IU/L, aspartate aminotransferase 507 IU/L, and  $\gamma$ -glutamyl transpeptidase 225U/L). A serum sample collected on March 16 was positive for both immunoglobulin M (IgM) and IgG antibodies to HEV when tested by an antibody enzyme-linked immunosorbent assay using recombinant viruslike particles (7). This

led to the diagnosis of hepatitis E. The hepatitis was typical, acute, and self-limiting, and the patient recovered by the end of March.

The patient's husband traditionally hunted boar for food 3 or 4 times a year, and she had eaten boar meat on 2 occasions. With her husband, she ate the meat as part of a hot pot on December 28, 2004, 11 weeks before her illness, and again, grilled, on January 19, 2005, along with 10 other people (including her husband) 8 weeks before her illness. Disease did not develop in the other 10 people. Except for this wild boar meat, the patient had not eaten meat or liver from other wild animals. Since she had not traveled abroad in the past 30 years, transmission must have occurred in Japan. Two portions of meat from the wild boar (meats 1 and 2) eaten on December 28, 2004, and 1 portion from the other wild boar (meat 3) eaten on January 19, 2005, remained and were frozen.

Juice was obtained from the sliced meat by centrifugation at  $10,000 \times g$  for 15 min. The supernatant was used for RNA extraction. A nested reverse transcription-polymerase chain reaction (RT-PCR) was conducted to amplify part of open reading frame 2 (ORF2), which corresponds to nucleotides (nt) 5939–6297 of the genotype 1 HEV genome (GenBank D10330), with external sense primer HEV-F1 (5'-TAYCGHAAYCAAGGHTGGCG-3') and antisense primer HEV-R2 (5'-TGYTGTTTRTCR-TARTCCTG-3'). A nested PCR was conducted with internal sense primer HEV-F2 (5'-GGBGTBGCNGAGGAGG-AGGC-3') and internal antisense primer HEV-R1 (5'-CGACGAAATYAATTCTGTGTCG-3'). This procedure allows amplification of HEV 1, 3, and 4 genotypes. A PCR product of 359 bp including the primer sequences was obtained from meat 3 by nested PCR. However, meats 1 and 2 were negative. HEV RNA was not detected in the patient's serum by the same amplification method. This may have resulted from an extremely small amount of RNA.

New primers for the nested RT-PCR were designed for a region within the 359 base region based on the meat 3 sequences, which corresponded to nt 5983–6243. The first PCR was performed with external sense primer HEV-WB-F1 (5'-ACCTCTGGCCTGGTAATGCT-3') and antisense primer HEV-WB-R2 (5'-GAGAAGCGTATCAGCAAG-GT-3'). The nested PCR was performed with internal sense primer HEV-WB-F2 (5'-TATTCATGGCTCTCCTGTCA-3') and internal antisense primer HEV-WB-R1 (5'-ACAGTGTCAGAGTAATGCCT-3'). These primers allowed amplification of 281 nt, including the primer sequences from the patient serum collected on March 16, 2005. In contrast, meats 1 and 2 were negative with these new primers.

To further analyze the RNA in the patient serum and meat 3, RNA genomes encoding an entire ORF2 were

\*National Institute of Infectious Diseases, Tokyo, Japan; †Fukuoka Institute of Health and Environmental Sciences, Fukuoka, Japan; ‡Tagawa Health, Welfare, and Environment Office, Fukuoka, Japan; §Fukuoka Prefectural Government, Fukuoka, Japan; and ¶Iizuka Hospital, Fukuoka, Japan

amplified as overlapping segments, nucleotide sequences were determined, and phylogenetic analysis was carried out with avian HEV as an outgroup. Avian HEV is a causative agent of chicken hepatitis-splenomegaly syndrome (8). Two sequences, 1 from the patient (DQ079629) and the other from meat 3 (DQ079630), were classified into genotype 3 (Figure). Only 1 nt difference was observed in the 1,980 nt of the entire ORF2; the nucleotide sequence identity was 99.95%. The difference was not accompanied by any amino acid changes. These data demonstrated that HEV infection was transmitted from the wild boar meat to the patient on January 19, 2005.

## Conclusions

Currently, deer, pig, and wild boar are suspected sources of foodborne zoonotic transmission of HEV in Japan, and genotypes 3 and 4 of HEV are believed to be indigenous (4–6,9,10). Direct evidence for transmission of genotype 3 HEV from animals to humans was observed in acute hepatitis in 4 persons who had eaten uncooked deer meat that contained  $\approx 10^7$  copies of HEV RNA (4). However, the rare finding of HEV antibody-positive deer in Japan suggest that deer are not the major zoonotic reser-

voir of HEV in this country (11). In contrast, high antibody-positive rates in domestic pig and wild boar, including HEV genotypes 3 and 4, have been frequently detected, suggesting that persons who eat uncooked meat are at risk for infection with HEV (12,13). This report is the first to provide direct evidence of zoonotic foodborne genotype 3 HEV transmission from wild boar to a human.

## Acknowledgments

We thank Tomoko Mizoguchi for secretarial assistance.

This study was supported in part by grants on emerging and reemerging infectious diseases, hepatitis, and food safety from the Ministry of Health, Labor and Welfare, Japan.

Dr Li is a senior researcher at National Institute of Infectious Diseases in Tokyo, Japan. His research focuses on epidemiology, expression of viral proteins, and the three-dimensional structure of hepatitis E virus.

## References

- Purcell RH, Emerson SU. Hepatitis E virus. In: Knipe DM, Howley PM, editors. *Fields virology*. Fourth ed. Philadelphia: Lippincott Williams & Wilkins; 2001. p. 3051–61.
- Emerson SU, Anderson D, Arankalle A, Meng XJ, Purdy M, Schlauder GG, et al. Hepatitis E virus. In: Fauquet CM, Mayo MA, Maniloff J, Desselberger U, Ball LA, editors. *Virus taxonomy: eighth report of the ICTV*. London: Elsevier/Academic Press; 2004. p. 851–5.
- Meng X-J. Zoonotic and xenozoonotic risks of the hepatitis E virus. *Infect Dis Rev*. 2000;2:35–41.
- Tei S, Kitajima N, Takahashi K, Mishiro S. Zoonotic transmission of hepatitis E virus from deer to human beings. *Lancet*. 2003;362:371–3.
- Yazaki Y, Mizuo H, Takahashi M, Nishizawa T, Sasaki N, Gotanda Y, et al. Sporadic acute or fulminant hepatitis E in Hokkaido, Japan, may be food-borne, as suggested by the presence of hepatitis E virus in pig liver as food. *J Gen Virol*. 2003;84:2351–7.
- Matsuda H, Okada K, Takahashi K, Mishiro S. Severe hepatitis E virus infection after ingestion of uncooked liver from a wild boar. *J Infect Dis*. 2003;188:944.
- Li TC, Yamakawa Y, Suzuki K, Tatsumi M, Razak MA, Uchida T, et al. Expression and self-assembly of empty virus-like particles of hepatitis E virus. *J Virol*. 1997;71:7207–13.
- Haqshenas G, Shivaprasad HL, Woolcock PR, Read DH, Meng XJ. Genetic identification and characterization of a novel virus related to human hepatitis E virus from chickens with hepatitis-splenomegaly syndrome in the United States. *J Gen Virol*. 2001;82:2449–62.
- Tamada Y, Yano K, Yatsuhashi H, Inoue O, Mawatari F, Ishibashi H. Consumption of wild boar linked to cases of hepatitis E. *J Hepatol*. 2004;40:869–70.
- Masuda JI, Yano K, Tamada Y, Takii Y, Ito M, Omagari K, et al. Acute hepatitis E of a man who consumed wild boar meat prior to the onset of illness in Nagasaki, Japan. *Hepatol Res*. 2005;31:178–83.
- Sonoda H, Abe M, Sugimoto T, Sato Y, Bando M, Fukui E, et al. Prevalence of hepatitis E virus (HEV) infection in wild boars and deer and genetic identification of a genotype 3 HEV from a boar in Japan. *J Clin Microbiol*. 2004;42:5371–4.
- Meng XJ, Halbur PG, Shapiro MS, Govindarajan S, Bruna JD, Mushahwar IK, et al. Genetic and experimental evidence for cross-species infection by swine hepatitis E virus. *J Virol*. 1998;72:9714–21.

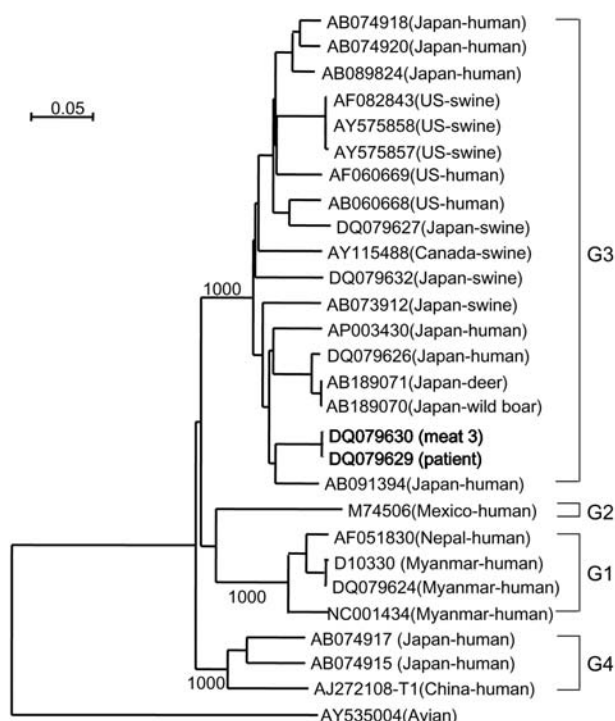

Figure. Phylogenetic tree of hepatitis E virus (HEV) reconstructed with avian HEV as an outgroup. Nucleotide sequences of the entire open reading frame 2 were analyzed by the neighbor-joining method. The bootstrap values correspond to 1,000 replications. The 2 nucleotide sequences characterized in this study are shown in **bold**. The horizontal scale bar at the top left indicates nucleotide substitutions per site.

13. Takahashi M, Nishizawa T, Miyajima H, Gotanda Y, Iita T, Tsuda F, et al. Swine hepatitis E virus strains in Japan form four phylogenetic clusters comparable with those of Japanese isolates of human hepatitis E virus. *J Gen Virol.* 2003;84:851–62.

Address for correspondence: Tatsuo Miyamura, Department of Virology II, National Institute of Infectious Diseases, 4-7-1 Gakuen, Musashimurayama, Tokyo, 208-0011, Japan; fax: 81-42-565-4279; email: tmiyam@nih.go.jp

# EMERGING INFECTIOUS DISEASES

A Peer-Reviewed Journal Tracking and Analyzing Disease Trends

Vol.9, No.12, December 2003



Disease emergence and control

Search  
**EID**  
*Online*  
www.cdc.gov/eid



---

# Human *Rickettsia felis* Infection, Canary Islands, Spain

Jose-Luis Pérez-Arellano,\*†<sup>1</sup>

Florence Fenollar,‡<sup>1</sup> Alfonso Angel-Moreno,\*†

Margarita Bolaños,\*† Michele Hernández,\*†

Evora Santana,\*† Marion Hemmersbach-Miller,\*†

Antonio-M Martín,\*† and Didier Raoult‡

We report the first cases of human infection by *Rickettsia felis* in the Canary Islands. Antibodies against *R. felis* were found in 5 adsorbed serum samples from 44 patients with clinically suspected rickettsiosis by Western blot serology. Fleas from 1 patient's dog were positive for *R. felis* by polymerase chain reaction.

*Rickettsia felis* is an intracellular bacterium (genus *Rickettsia*, spotted fever group [SFG]) (1,2). Its biological cycle involves the cat flea (*Ctenocephalides felis*) as the main vector (3). *R. felis* has been found in *C. felis* and *C. canis* in the Americas, Europe, Africa, Asia, and Oceania (1,3–6). Human disease caused by *R. felis* was unknown until 1994 (4). Since then, *R. felis* infection has been reported in Mexico (3 patients) (7), Germany (1 patient) (8), Brazil (2 patients) (1), and France (2 patients) (1). The clinical manifestations of the disease include high fever, rash, and elevation of liver enzymes (1,4,7). Exposure to fleas or to flea-prone animals is sometimes recorded (7,8).

On the Canary Islands (Atlantic islands of Spain), autochthonous cases of murine typhus have been reported (9). Although we suspected that some patients with a clinical picture of murine typhus actually had *R. felis* infection, we were not able to confirm this hypothesis. Therefore, 44 serum samples from 44 patients from the Canary Islands with suspected murine typhus were sent to the Unité des Rickettsies in Marseille, France, for specific serologic tests. Here, we describe the first 5 human infections caused by *R. felis* on the Canary Islands.

## The Study

Forty-four patients were recruited for a prospective study of fever of intermediate duration (i.e., fever without

focal symptoms lasting 7–28 days). Demographic, clinical, and laboratory data were collected for all patients. Chest radiographs and blood and urine cultures were taken. Antibodies against *R. typhi* were tested by direct immunofluorescence test (bioMérieux, Marcy L'Etoile, France) in the Canary Islands. Among the 44 patients, 24 showed a positive serologic result. Antibodies against other agents (*Coxiella burnetii*, *R. conorii*, *Leptospira* spp., Epstein-Barr virus, cytomegalovirus, HIV, and hepatitis B virus) were also tested; all were negative.

To search for evidence of infection with *R. felis*, all serologic results were confirmed by microimmunofluorescence (MIF) in France, as previously described (10). Systematic testing of SFG rickettsia antigens present in Europe and Africa was performed in parallel. The MIF procedure was followed by the use of Western blot and cross-adsorption studies. An immunofluorescence assay was considered positive if immunoglobulin G (IgG) titers were >1:64 or if IgM titers were >1:32. When cross-reactions were noted between the rickettsial antigens, the analysis comprised 3 steps. First, a rickettsial antigen was considered to represent the agent of infection when IgG or IgM antibody titers against this antigen were  $\geq 2$  serial dilutions higher than titers of IgG or IgM antibody against other rickettsial antigens (11). Second, when the difference in titers between *R. felis* and other antigens was <2 dilutions, Western blot assays were performed. A rickettsial antigen was considered the agent of infection when sera reacted only against the specific protein of this antigen. Expected molecular masses of the specific proteins were  $\approx 125$  kDa for *R. typhi* and 31 kDa for *R. felis*. Finally, when Western blot assays were not diagnostic, cross-adsorption studies were performed, as previously described (12). Specific diagnosis criteria after cross-adsorptions studies included a Western blot assay that showed exclusive reactivity with specific proteins of a sole agent. If reactivity with the 2 tested agents was still observed, diagnosis of an indeterminate rickettsial disease was made. With this strategy, patients were classified by 3 types: *R. felis* infection, *R. typhi* infection, and indeterminate rickettsial disease.

Five fleas from the dog of 1 *R. felis*-infected patient were tested by polymerase chain reaction (PCR) (3). DNA was extracted and amplified with primers that targeted the citrate synthase sequence, as previously described (3). For negative controls, we used sterile water and infection-free fleas previously tested in our laboratory; both negative controls were tested after every 7 samples. Amplicons were separated by electrophoresis on 1% agarose gels and then purified by using a QIAquick PCR purification kit (Qiagen, Hilden, Germany), as described by the manufac-

---

\*Hospital Universitario Insular de Las Palmas, Canary Islands, Spain; †Universidad de Las Palmas de Gran Canaria, Canary Islands, Spain; and ‡Université de la Méditerranée, Marseille, France

<sup>1</sup>These authors contributed equally to this article.

turer. PCR products were sequenced by using the d-rhodamine terminator-cycle sequencing kit (PE Applied BioSystems, Courtabeuf, France), as described by the manufacturer. The sequences obtained were compared with those available in the GenBank DNA database by using the program Basic Local Alignment Search Tool (BLAST, version 2.0, National Center for Biotechnology Information (<http://www.ncbi.nlm.nih.gov/BLAST/>)).

A rickettsial infection was diagnosed by using MIF for 31 of the 44 patients: 5 patients with the final diagnosis of *R. felis* infection, 13 with the diagnosis of *R. typhi* infection, and 13 with the diagnosis of indeterminate rickettsioses (Table). The diagnosis of *R. felis* infection was based on Western blot results on adsorbed sera for all

patients. All the antibodies of these patients were removed when the *R. felis*-adsorbed sera were analyzed with *R. typhi* and *R. felis* antigens, whereas antibodies to *R. felis* remained when the *R. typhi*-adsorbed sera were analyzed.

Western blots performed with unadsorbed and adsorbed sera are represented in the Figure. Features of patients are indicated in the online appendix ([http://www.cdc.gov/ncidod/EID/vol11no12/05-0711\\_app.htm](http://www.cdc.gov/ncidod/EID/vol11no12/05-0711_app.htm)). Some differences were found between groups. The interval between the beginning of clinical signs and symptoms and evaluation was significantly more prolonged in the *R. felis* group than others. In the *R. typhi* group, odynophagia, cough, and rash were more frequent. When we compared biologic data, no difference was observed between *R. typhi* and

Table. Clinical, epidemiologic, and biological data between *Rickettsia felis* group, *R. typhi* group, and indeterminate rickettsiosis group

Characteristic	<i>R. felis</i>	<i>R. typhi</i>	Indeterminate	p value
No.	5	13	13	—
Mean age, y*	45 (16)	29 (14)	40 (17)	NS†
Sex (M/F)	5/0	10/3	12/1	NS‡
Contact with dogs or cats§	4/5	11/13	11/13	NS‡
Interval between clinical picture and evaluation, d¶	12 (9.5–14)	9 (8.5–10.2)	9 (7.9–13.4)	<0.05#
Fever§	5/5	13/13	13/13	NS‡
Maximal temperature (°C)*	39.3 (0.8)	39.6 (0.5)	39.4 (0.5)	NS†
Headache§	4/5	12/13	13/13	NS‡
Conjunctivitis§	1/5	3/13	2/13	NS‡
Arthralgia/myalgia§	4/5	6/13	5/13	NS‡
Odynophagia§	0/5	6/13	0/13	0.01‡
Dry cough§	3/5	8/13	2/13	0.04‡
Nausea/vomiting§	0/5	2/13	1/13	NS‡
Abdominal pain§	1/5	1/13	0/13	NS‡
Rash§	0/5	9/13	6/13	0.03‡
Past or actual tick bite§	1/5	2/13	1/13	NS‡
Hepatomegaly§	1/5	6/13	5/13	NS‡
Splenomegaly§	0/5	3/13	2/13	NS‡
Anemia (hemoglobin <13 mg/dL)	0/5	3/13	1/13	NS
Normal blood leukocyte counts (4,000–10,000/μL)	5/5	10/13**	11/13††	NS‡
Normal platelet counts (150,000–400,000/μL)	4/5	11/12‡‡	11/13‡‡	NS‡
Normal ratio prothrombin time (0.8–1.2)	4/4	10/13	11/13	NS‡
Normal ESR (<10 mm/h)	1/4	11/12	3/11	NS‡
Normal creatinine blood level (62–106 μmol/L)	5/5	11/13	10/13	NS‡
Normal sodium blood level (136–144 mmol/L)	2/4	10/13	10/12	NS‡
Elevated AST (>35 IU/L)	4/5	8/13	5/12	NS‡
Mean AST (U/L)	123	254	72	0.01§§
Elevated ALT (>45 IU/L)	5/5	8/13	6/12	NS†
Mean ALT (U/L)¶¶¶	185 (71–374)	354 (55–1,368)	86 (34–292)	<0.01§§§
Elevated GGT (>55 IU/L)	2/5	3/13	4/12	NS‡
Elevated total serum protein concentration (>80 g/L)	0/5	0/12	1/12	NS‡
Elevated gamma globulin concentration (>13 g/L)	2/5	5/12	8/10	NS‡

\*Data are expressed as mean (SD). Samples are distributed normally and have similar SD. NS, nonsignificant; ANOVA, analysis of variance test; ESR, erythrocyte sedimentation rate; AST, aspartate aminotransferase; ALT, alanine aminotransferase; GGT, gamma-glutamyl transpeptidase.

†ANOVA.

‡ $\chi^2$  test.

§No. patients with these epidemiologic or clinical data/no. patients evaluated.

¶Data are expressed as median and 95% confidence intervals;  $\geq 1$  samples have a non-gaussian distribution.

#Significant differences between *R. felis* and *R. typhi* groups ( $p < 0.05$ ) with Dunn test.

\*\*Leukopenia in 1 patient (3,700/μL), leukocytosis in 2 patients (11,500/μL and 16,000/μL).

††Leukopenia in 2 patients.

‡‡All patients with an abnormal platelet count presented with thrombocytopenia in all cases.

§§ANOVA; all cases.

¶¶¶Data are expressed as mean (range values). Samples are distributed normally and have similar SD.

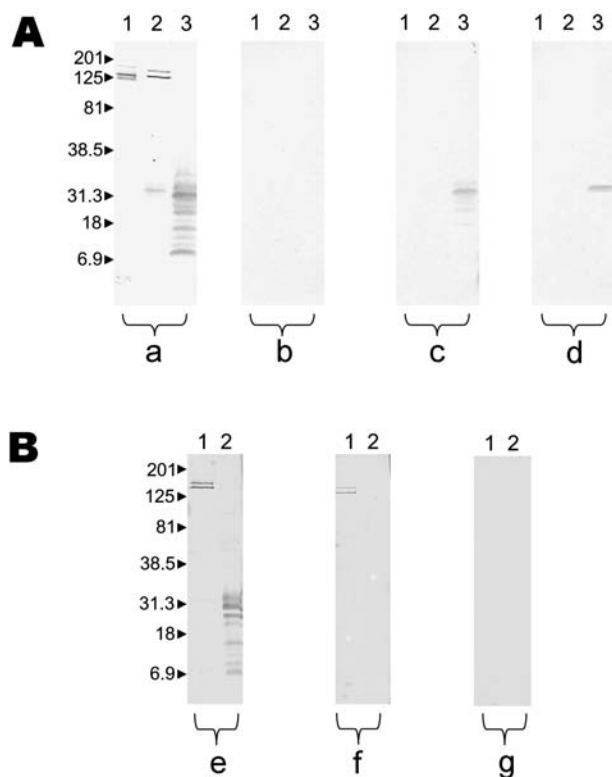

Figure. Results of Western blot performed with serum samples from patient 5 with *Rickettsia felis* infection and patient 10 with *R. typhi* infection. Molecular masses (in kilodaltons) are given to the left of panels. A) Patient with *R. felis* infection; a, untreated serum analyzed by using *R. conorii* (lane 1), *R. typhi* (lane 2), and *R. felis* (lane 3); b, *R. felis*-adsorbed serum analyzed by using *R. conorii* (lane 1), *R. typhi* (lane 2), *R. felis* (lane 3); all antibodies were removed; c, *R. typhi*-adsorbed serum analyzed by using *R. typhi* (lane 1) and *R. felis* (lane 2); antibodies to *R. felis* remained; d, *R. conorii*-adsorbed serum analyzed by using *R. conorii* (lane 1), *R. typhi* (lane 2), *R. felis* (lane 3); antibodies to *R. felis* remained. B) Patient with murine typhus; e, untreated serum analyzed by using *R. typhi* (lane 1) and *R. felis* (lane 2); f, *R. felis*-adsorbed serum analyzed by using *R. typhi* (lane 1) and *R. felis* (lane 2); antibodies to *R. typhi* remained; g, *R. typhi*-adsorbed serum analyzed by using *R. typhi* (lane 1) and *R. felis* (lane 2); all antibodies were removed.

*R. felis* groups, except for milder hypertransaminasemia in the latter group. Finally, 2 PCR products were obtained and sequenced from 2 fleas. Both sequences were 100% similar to *R. felis* citrate synthase gene in GenBank accession no. AF210692. No fleas were positive for *R. typhi*. Amplification was unsuccessful in all negative controls.

## Conclusions

In the past 10 years, application of molecular tools has resulted in discovery of several new species of pathogenic rickettsiae, including *R. felis*. Since then, this bacterium was cultivated, and its genome was sequenced (1,13). Its

pathogenic role was recently demonstrated in patients with serologic evidence of infection in Brazil, France, and Germany (1). *R. felis* DNA has also been detected in sera in Texas, Mexico, Brazil, and Germany (1,4,8,14). Autochthonous human rickettsioses that occur in the Canary Islands include murine typhus; SFG infections have never been reported (9). We diagnosed 5 cases of acute *R. felis* infection (15). The clinical picture is globally similar to murine typhus (4). However, the *R. felis* infection in our study seemed to be milder, and no skin rash was observed. The incidence of *R. felis* infection in the Canary Islands is probably underestimated; therefore, serologic tests for *R. felis* should be performed in patients with prolonged fever or suspected rickettsioses.

Cross-reactions in serologic testing for *R. felis* are unpredictable (3). In our study, patients with *R. felis* infection more frequently had high antibody titers (IgM >1:32 and IgG >1:64) to *R. conorii* and *R. typhi* (2 of 5 patients) than did patients with *R. typhi* infection (0 of 13). On the basis of *R. felis* data, we conclude that patients with *R. felis* infection may have no cross-reactivity with other rickettsiae, cross-reactivity with SFG rickettsiae, or cross-reactivity with both SFG rickettsiae and *R. typhi*. Genetic support for cross-reactivity with *R. conorii* is plausible because most membrane proteins of SFG and *R. felis* are extremely close (surface cell antigen [Sca] family). Genome analysis showed that several genes were present in *R. felis* and *R. typhi* and absent for other SFG, which could explain the cross-reactivity between *R. felis* and *R. typhi* (13). Finally, if <2-fold differences in IgG/IgM titers between *R. felis* and other SFG and typhus group rickettsiae are observed, only Western blot and cross-adsorptions will allow a specific diagnosis once reactivity has disappeared after adsorption with *R. felis* antigen. By contrast, a band of ~31 kDa for the *R. felis* antigen persists after adsorption with *R. conorii* and *R. typhi*.

## Acknowledgments

We thank Kelly Johnston and Silpak Biswas for reviewing the manuscript.

This research was supported in part by a grant from the Canary Foundation of Investigation and Health.

Dr Pérez-Arellano is chief of the Infectious Diseases and Tropical Medicine Service and professor in the Department of Medical and Surgical Sciences, Health Sciences Faculty, University of Las Palmas de Gran Canaria. His main research interests are imported and emerging infectious diseases.

## References

1. Raoult D, La Scola B, Anea M, Fournier PE, Roux V, Fenollar F, et al. A flea-associated *Rickettsia* pathogenic for humans. *Emerg Infect Dis.* 2001;7:73–81.

2. La Scola B, Meconi S, Fenollar F, Rolain JM, Roux V, Raoult D. Emended description of *Rickettsia felis* (Bouyer et al. 2001), a temperature-dependent cultured bacterium. *Int J Syst Evol Microbiol*. 2002;52:2035–41.
3. Rolain JM, Franc M, Davoust B, Raoult D. Molecular detection of *Bartonella quintana*, *B. koehlerae*, *B. henselae*, *B. clarridgeiae*, *Rickettsia felis*, and *Wolbachia pipientis* in cat fleas, France. *Emerg Infect Dis*. 2003;9:338–42.
4. Schriefer ME, Sacci JB Jr, Dumler JS, Bullen MG, Azad AF. Identification of a novel rickettsial infection in a patient diagnosed with murine typhus. *J Clin Microbiol*. 1994;32:949–54.
5. Parola P, Sanogo OY, Lerdthusnee K, Zeaiter Z, Chauvancy G, Gonzalez JP, et al. Identification of *Rickettsia* spp. and *Bartonella* spp. in from the Thai-Myanmar border. *Ann N Y Acad Sci*. 2003;990:173–81.
6. Kelly PJ, Meads N, Theobald A, Fournier PE, Raoult D. *Rickettsia felis*, *Bartonella henselae*, and *B. clarridgeiae*, New Zealand. *Emerg Infect Dis*. 2004;10:967–8.
7. Zavala-Velazquez J, Ruiz-Sosa J, Sanchez-Elias R, Becerra-Carmona G, Walker D. *Rickettsia felis* in Yucatan. *Lancet*. 2000;9235:1079–80.
8. Richter J, Fournier P, Petridou J, Häussinger D, Raoult D. *Rickettsia felis* infection acquired in Europe and documented by polymerase chain reaction. *Emerg Infect Dis*. 2002;8:207–8.
9. Hernandez CM, Angel-Moreno A, Santana E, Bolanos M, Frances A, Martin-Sanchez MS, et al. Murine typhus with renal involvement in Canary Islands, Spain. *Emerg Infect Dis*. 2004;10:740–3.
10. Teyssie N, Raoult D. Comparison of Western blot immunoblotting and microimmunofluorescence for diagnosis of Mediterranean spotted fever. *J Clin Microbiol*. 1992;30:455–60.
11. Raoult D, Fournier P, Fenollar F, Jensenius M, Prioe T, De Pina J, et al. *Rickettsia africae*, a tick-borne pathogen in travelers to Sub-Saharan Africa. *N Engl J Med*. 2001;344:1504–10.
12. La Scola B, Rydkina L, Ndiokubwayo JB, Raoult D. Serological differentiation of murine typhus and epidemic typhus using cross-adsorption and western blotting. *Clin Diag Lab Immunol*. 2000;7:612–6.
13. Ogata H, Renesto P, Audic S, Robert C, Blanc G, Fournier PE, et al. The genome sequence of *Rickettsia felis* identifies the first putative conjugative plasmid in an obligate intracellular parasite. *PLoS Biology*. 2005;3:248.
14. Zavala-Velazquez JE, Zavala-Castro JE, Vado-Solis I, Ruiz-Sosa JA, Moron CG, Bouyer DH, et al. Identification of *Ctenocephalides felis* fleas as a host of *Rickettsia felis*, the agent of a spotted fever rickettsiosis in Yucatan, Mexico. *Vector Borne Zoonotic Dis*. 2002;2:69–75.
15. La Scola B, Raoult D. Laboratory diagnosis of rickettsioses: current approaches to diagnosis of old and new rickettsial diseases. *J Clin Microbiol*. 1997;35:2715–27.

Address for correspondence: D. Raoult, Unité des Rickettsies, CNRS UMR 6020, Faculté de Médecine, Université de la Méditerranée, 27 Bd Jean Moulin, 13385 Marseille CEDEX 05, France; fax: 33-4-91-38-77-72; email: Didier.Raoult@medecine.univ-mrs.fr

All material published in Emerging Infectious Diseases is in the public domain and may be used and reprinted without special permission; proper citation, however, is required.



Search  
past issues  
**EID**  
Online  
[www.cdc.gov/eid](http://www.cdc.gov/eid)

---

# Methicillin-resistant *Staphylococcus aureus* in Pig Farming

Andreas Voss,\*† Frans Loeffen,\* Judith Bakker,\*  
Corne Klaassen,† and Mireille Wulf\*

We conducted a study among a group of 26 regional pig farmers to determine the methicillin-resistant *Staphylococcus aureus* prevalence rate and found it was >760 times greater than the rate of patients admitted to Dutch hospitals. While *spa*-type t108 is apparently a more widespread clone among pig farmers and their environment, we did find other *spa*-types.

---

Methicillin-resistant *Staphylococcus aureus* (MRSA) has become a major nosocomial pathogen, highly prevalent in many European countries and throughout the world (1). In the Netherlands, the prevalence of MRSA among clinical isolates is still <1%, among the lowest in Europe (1). This low prevalence is probably best explained by the national policy that entails strict screening and isolation of all persons who are considered at high risk for MRSA when admitted to a hospital. This high-risk population has essentially consisted of patients admitted to or treated in foreign hospitals. As a result of this policy for all healthcare institutions, the prevalence of MRSA in the Dutch community is extremely low as well. In a recent study among ≈10,000 patients admitted to 4 Dutch hospitals, 23% carried *S. aureus*, but only 0.03% of the isolates were methicillin-resistant (2).

In July 2004, we unexpectedly found MRSA in the preoperative screening cultures of a 6-month-old girl before thoracic surgery. Neither the girl nor her family (parents, 1 sister) had a history of traveling or admission to a foreign hospital. In the following months, the girl remained colonized with MRSA during consecutive decolonization attempts. Subsequently, the girl's parents were found to be positive for MRSA. The family lived on a farm and raised pigs.

To further investigate pig farming as a possible source of MRSA in Dutch patients, we screened a selection of pigs owned by the MRSA-positive farmer, and other regional pig farmers in November 2004. In January and

February 2005, 2 new cases of MRSA were identified, one in a pig farmer from a different region and one in the son of a veterinarian who worked mostly with pigs. Subsequently, the strain was also isolated from the veterinarian and from a nurse in the hospital unit to which the son was admitted.

Although the aforementioned cases were unrelated in time and location, they shared some features. In all the cases, other family members were MRSA-positive, decolonization was repeatedly unsuccessful, and genotyping performed in the National Institute of Public Health and Environment (RIVM, Bilthoven, the Netherlands) showed the strains were not typeable by pulsed-field gel electrophoresis (PFGE) with restriction endonuclease *SmaI* (the standard method).

## The Study

Initially, the nares of 10 pigs were cultured. All were negative for MRSA. At a later stage, the perineum of 30 pigs was cultured; 1 was positive for MRSA. The regional pig farmers were screened (throat and nares) during a monthly professional meeting that happened to be on the farm of the MRSA-positive family, at the time of investigation. With the exception of this meeting, the farmers had no further epidemiologic links, other than being from the southeastern region of the Netherlands. Six (23%) of the 26 farmers were colonized with MRSA.

As mentioned above, all MRSA isolates were resistant to digestion with restriction-endonuclease *SmaI*, when typing with PFGE was attempted. To ensure that we did not falsely classify a pig-related staphylococcal species as MRSA, the identification of all isolates was confirmed by testing for the presence of a *S. aureus*-specific DNA element as well as the *MecA* gene, according to the methods of Reischl et al. (3). To compare the MRSA isolates, we performed random amplified polymorphic DNA analysis with primers Eric II (5'-AAG TAA GTG ACT GGG GTG AGC G-3'), RW3A (5'-TCG CTC AAA ACA ACG ACA CC-3'), D14307 (5'-GGT TGG GTG AGA ATT GCA CG-3') and *spa*-typing.

Overall, 3 different MRSA strains were identified. The isolates of the girl (case-patient A), her parents, and the pig from their farm were identical with random amplified polymorphic DNA and belonged to *spa*-type t108. Furthermore, one of the regional pig farmers screened during the meeting, the pig farmer from a different region (case-patient B), the young boy (case-patient C), as well as his father and the nurse who treated the boy, were colonized with the same strain (Table). Three of the regional pig farmers shared *spa*-type 567. The isolate from the remaining MRSA-positive regional farmer showed a *spa*-type not previously described (Table).

---

\*Radboud University Medical Centre, Nijmegen, the Netherlands; and †Canisius-Wilhelmina Hospital, Nijmegen, the Netherlands

Table. Molecular typing of methicillin-resistant *Staphylococcus aureus* isolates

Case-patients	Date of culture	Random amplified polymorphic DNA type	<i>Spa</i> -type
Patient A (girl)	Jul 2004	A	108
Regional farmer 1 (father of patient A)	Aug 2004	A	108
Mother of patient A	Nov 2004	A	108
Pig	Feb 2005	A	108
Patient B (farmer, different region)	Jan 2005	A	108
Patient C (boy)	Feb 2005	A	108
Father (veterinarian) of patient C	Feb 2005	A	108
Nurse of patient C	Feb 2005	A	108
Regional farmer 2	Nov 2004	Not done	108
Regional farmer 3	Nov 2004	Not done	567
Regional farmer 4	Nov 2004	Not done	567
Regional farmer 5	Nov 2004	Not done	567
Regional farmer 6	Nov 2004	Not done	943

### Conclusions

Recently, MRSA has been found in horses and in persons who take care of them (4). Human carriage has also been linked to colonized companion cats and dogs (5,6). While Lee et al. (7) reported an MRSA isolation frequency of 0.6% in major food animals, but did not find MRSA in 469 samples from pigs, Armand-Lefevre et al. (8) described *S. aureus* (methicillin-susceptible and -resistant) carriage among pigs and pig farmers. Although the authors showed that both farmers and pigs carried methicillin-sensitive *S. aureus* and MRSA and that both groups shared certain multilocus sequence typing, the isolates came from separate, nonrelated collections.

Here we demonstrate transmission of MRSA between an animal and human (pig and pig farmer), between family members (pig farmers and their families), and between a nurse and patient in the hospital. The unexpected high frequency of MRSA among the group of regional pig farmers (>760 × higher than in the general Dutch population) indicates that their profession might put them at risk for MRSA colonization. Overall, we found 3 different MRSA strains, including a new *spa*-type. Therefore, we expect that multiple strains are present in the pig population and the pig farmers. The strain with *spa*-type t108 appears to be more prevalent and widespread, given that the strain spread from animal to human, between family members, between patient and nurse, and among pig farmers from different regions.

Further research on a larger scale is needed to see if these observations hold true in other regions. If so, pig farming poses a significant risk factor for MRSA carriage in humans that warrants screening wherever pig farmers or their family members are admitted to a hospital.

Dr Voss is a consultant microbiologist and head of infection control at the Canisius-Wilhelmina Hospital and professor of infection control at the Radboud University Medical Centre. His primary research interests are nosocomial infections, including multidrug-resistant nosocomial pathogens such as MRSA.

### References

1. Tiemersma EW, Bronzwaer SL, Degener JE, Lyytikäinen O, Schrijnemakers P, Bruinsma N, et al. Methicillin-resistant *Staphylococcus aureus* in Europe, 1999–2002. *Emerg Infect Dis.* 2004;10:1627–34.
2. Wertheim HF, Vos MC, Boelens HA, Voss A, Vandenbroucke-Grauls CM, Meester MH, et al. Low prevalence of methicillin-resistant *Staphylococcus aureus* (MRSA) at hospital admission in the Netherlands: the value of search and destroy and restrictive antibiotic use. *J Hosp Infect.* 2004;56:321–5.
3. Reischl U, Linde HJ, Metz M, Leppmeier B, Lehn N. Rapid identification of methicillin-resistant *Staphylococcus aureus* and simultaneous species confirmation using real-time fluorescence PCR. *J Clin Microbiol.* 2000;38:2429–33.
4. Weese JS, Archambault M, Willey BM, Dick H, Hearn P, Kreiswirth BN, et al. Methicillin-resistant *Staphylococcus aureus* in horses and horse personnel, 2000–2002. *Emerg Infect Dis.* 2005;11:430–5.
5. Duquette RA, Nuttall TJ. Methicillin-resistant *Staphylococcus aureus* in dogs and cats: an emerging problem? *J Small Anim Pract.* 2004;45:591–7.
6. Cefai C, Ashurst S, Owens C. Human carriage of methicillin-resistant *Staphylococcus aureus* linked with pet dog. *Lancet.* 1994;344:539–40.
7. Lee JH. Methicillin (oxacillin)-resistant *Staphylococcus aureus* strains isolated from major food animals and their potential transmission to humans. *Appl Environ Microbiol.* 2003;69:6489–94.
8. Armand-Lefevre L, Ruimy R, Andreumont A. Clonal comparison of *Staphylococcus aureus* isolates from healthy pig farmers, human controls, and pigs. *Emerg Infect Dis.* 2005;11:711–4.

Address for correspondence: Andreas Voss, Canisius-Wilhelmina Hospital, (C-70), PO Box 9015, Nijmegen, 6500 GS, the Netherlands; fax: 31-24-365-7516; email: a.voss@cwz.nl

All material published in *Emerging Infectious Diseases* is in the public domain and may be used and reprinted without special permission; proper citation, however, is required.

Use of trade names is for identification only and does not imply endorsement by the Public Health Service or by the U.S. Department of Health and Human Services.

# *Salmonella* and *Campylobacter* spp. in Northern Elephant Seals, California

Robyn A. Stoddard,\*† Frances M.D. Gulland,†  
E. Rob Atwill,\* Judy Lawrence,† Spencer Jang,\*  
and Patricia A. Conrad\*

*Campylobacter* and *Salmonella* spp. prevalence and antimicrobial drug sensitivity were determined in northern elephant seals that had not entered the water and seals that were stranded on the California coast. Stranded seals had a higher prevalence of pathogenic bacteria, possibly from terrestrial sources, which were more likely to be resistant.

A limited number of surveys have shown that pinnipeds (seals, sea lions, and walruses) can be infected with zoonotic enteric bacteria, including *Salmonella* and *Campylobacter* spp. and that some strains are resistant to antimicrobial drugs (1–3). Because both *Salmonella* and *Campylobacter* spp. are important zoonotic organisms, their presence in marine mammal feces raises concerns regarding risks to human health associated with exposure to coastal waters and marine mammals. Another concern is that these bacteria in marine mammals may reflect pollution of the California coast by feces from terrestrial sources, including sewage and runoff that contain domestic animal waste. To address these concerns, more detailed data on bacterial pathogen distribution along the California coast are needed.

Northern elephant seals (*Mirounga angustirostris*) are born on various California beaches and do not leave the beaches for several months after birth (4). Once the seals leave their natal beaches, they are at sea for most of their lives other than during breeding and the annual molt or if they are found “stranded” (if poor health or injury prevents them from leaving the shore) (5). We investigated the prevalence and antimicrobial drug sensitivity of *Salmonella* and *Campylobacter* spp. in northern elephant seals at different sites in California to ascertain the distribution of these bacteria in pinnipeds and determine their potential effect on marine mammal and human health.

## The Study

In February and March of 2003 and 2004, 165 northern elephant seals, which had been recently weaned and had never entered the water, were sampled on their natal beaches at 3 colonies in California (Figure). From February to July in 2003 and 2004, 195 juvenile northern elephant seals were found stranded live along the California coast, rescued, and brought to The Marine Mammal Center (TMMC), Sausalito, California, for rehabilitation. At TMMC, seals were physically restrained and examined, and rectal swabs with Cary-Blair transport medium (BD Diagnostics, Franklin Lakes, NJ, USA) were collected for bacterial culture. Animals were not treated until after sampling.

*Salmonella enterica* was isolated, identified with standard procedures (6), and stored at  $-80^{\circ}\text{C}$  in Microbank bead vials (Pro-Lab Diagnostics, Austin, TX, USA) until it was tested for antimicrobial drug susceptibility. *Salmonella* isolates were sent to the National Veterinary Services Laboratory (Ames, IA, USA) for serotyping. Antimicrobial drug susceptibility was performed with broth microdilution according to the Sensititre user manual and National Committee for Clinical Laboratory Standards (NCCLS) guidelines (7) for amikacin, amoxicillin-clavulanic acid, ampicillin, cefazolin, ceftiofur, cefprozime, chloramphenicol, enrofloxacin, gentamicin, tetracycline, ticarcillin-clavulanic acid, and trimethoprim-sulfamethoxazole. *Campylobacter* spp. were selected by

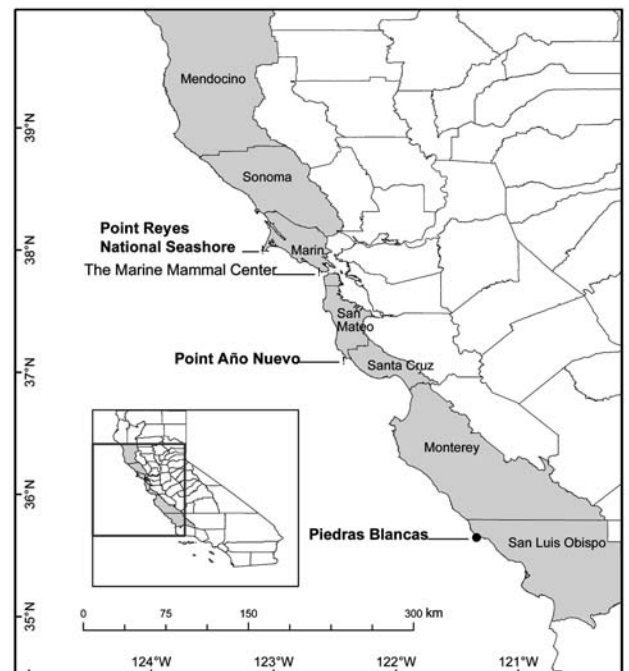

Figure. Location of The Marine Mammal Center (TMMC), rescue range of TMMC (shaded), and northern elephant seal rookeries (Point Reyes National Seashore, Point Año Nuevo, Piedras Blancas) where seals were sampled along the California coastline.

\*University of California, Davis, California, USA; and †The Marine Mammal Center, Sausalito, California, USA

using Campy-CVA agar (Hardy Diagnostics, Santa Maria, CA, USA) that was incubated under microaerophilic conditions at 37°C for 48 to 96 h, identified by using standard procedures (8), and stored at -80°C in Microbank bead vials until they were tested for antimicrobial drug susceptibility. *Campylobacter* isolates were tested for susceptibility to ciprofloxacin, doxycycline, erythromycin, and gentamicin according to previously described techniques (9,10). Odds ratios were compared among the different bacteria and seal populations by using mixed- or fixed-effects logistic regression, with geographic location as the random effect and seal rookery as the fixed effect (11). A forward-stepping algorithm was used, and terms with  $p < 0.05$ , based on the Wald statistic, were included in the final model.

*Salmonella* spp. were isolated from 3 (1.8%) of 165 natal-site elephant seals and 72 (36.9%) of 195 stranded seals. Stranded seals were 41× more likely to test positive for *Salmonella* spp. than natal-site seals (odds ratio [OR] 40.9,  $p < 0.001$ , 95% confidence interval [CI] 7.7–218). All 3 *Salmonella* isolates from the natal-site seals were serotype Typhimurium and were sensitive to all antimicrobial drugs tested (Table 1). Eighty-three *Salmonella* isolates of 5 different serotypes, Newport, Saint Paul, Montevideo, Typhimurium, and Reading, were collected from 72 stranded seals; Newport was the most common serotype. Eleven stranded seals were positive for 2 different serotypes. Only 4 *Salmonella* Newport isolates from stranded seals were resistant to antimicrobial drugs; 3 isolates were resistant to ampicillin, with intermediate resistance to ticarcillin-clavulanic acid, and 1 isolate was resistant to amoxicillin-clavulanic acid and cefazolin.

On the basis of biochemical analysis, *Campylobacter jejuni*, *C. lari*, and an unknown *Campylobacter* sp. were isolated from both groups of elephant seals (Table 2). *C. jejuni* was the most common *Campylobacter* species isolated, followed by *C. lari* and the unknown *Campylobacter* sp. (Table 2). One natal-site seal and 8 stranded seals were infected with 2 *Campylobacter* spp. Stranded seals were 6.0× more likely to test positive for *Campylobacter* spp. than natal-site seals (OR 5.97,  $p < 0.001$ , 95% CI 4.2–8.4).

Table 1. Serotypes and antimicrobial drug resistance\* of *Salmonella* spp. isolated from natal-beach and stranded northern elephant seals, California, 2003–2004

Serotype	No. resistant isolates/total (%)	
	Natal-beach seals	Stranded seals
Newport	0/0	4/42 (9.5)
Saint Paul	0/0	0/17
Montevideo	0/0	0/15
Typhimurium	0/3	0/2
Reading	0/0	0/7
All serotypes	0/3	4/83 (4.8)

\*Intermediately resistant or resistant to  $\geq 1$  antimicrobial drugs.

Stranded seals were 4.3× more likely to be positive for *C. jejuni* (OR 4.33,  $p < 0.001$ , 95% CI 1.8–10.6), 7.2× more likely to be positive for *C. lari* (OR 7.2,  $p < 0.001$ , 95% CI 2.4–21.4), and 22× more likely to be positive for the unknown *Campylobacter* sp. (OR 21.9,  $p = 0.003$ , 95% CI 2.9–164) than natal-site seals. Ciprofloxacin was the only antimicrobial drug to which isolates were resistant (intermediate or complete); resistance was detected in both groups of seals but was more common in stranded seals (Table 2).

## Conclusions

Prevalence of *Salmonella* and *Campylobacter* spp. was higher in juvenile northern elephant seals that became stranded along the coast of central California than in seals on their natal beaches that had never entered the water. A potential explanation for this difference is that stranded seals may have harbored bacteria but were not shedding them while they were in good health on their natal beaches. Infections with some pathogenic bacteria may be asymptomatic, but animals may intermittently shed bacteria, especially if stressed (12,13). Stress and malnutrition can suppress immunity, which makes an individual animal more susceptible to infection and prolongs existing infection (14). Another possible explanation for the higher prevalence in stranded seals is that stranded animals are more susceptible to infection, because of stress or malnutrition, by pathogens in the environment from terrestrial sources, such as contaminated freshwater and sewage outfall. The fact that isolates from stranded seals tend to be resistant supports this possibility.

Table 2. Prevalence and antimicrobial resistance\* of *Campylobacter* spp. isolated from natal-beach and stranded northern elephant seals, California, 2003–2004

Species	Natal-beach		Stranded†	
	Positive seals/ total (%)‡	Resistant isolates/ total (%)	Positive seals/ total (%)‡	Resistant isolates/ total (%)
<i>Campylobacter jejuni</i>	17/165 (10.3)	0/16§	54/194 (27.8)	2/54 (3.7)
<i>C. lari</i>	5/165 (3.0)	2/5 (40.0)	26/194 (13.4)	8/23§ (34.8)
Unknown <i>Campylobacter</i> sp.	1/165 (0.6)	0/1	23/194 (11.9)	12/20§ (60.0)
All <i>Campylobacter</i> spp.	22/165 (13.3)		94/194 (48.5)	

\*Intermediately resistant or resistant to  $\geq 1$  antimicrobial drugs.

†The presence of *Campylobacter* spp. was not determined for 1 stranded seal because other bacteria overgrew on the plate.

‡Number of seals positive can be fewer than total number of *Campylobacter* isolates because multiple *Campylobacter* spp. were isolated from some seals.

§Not all isolates were tested for susceptibility because of contamination or lack of growth after freezing.



The cause of the higher prevalence of pathogenic bacteria in stranded juvenile northern elephant seals should be determined, especially if animals are infected by pathogenic bacteria from terrestrial sources contaminating the marine environment. Coastal freshwater runoff is associated with a high risk for infection of southern sea otters (*Enhydra lutris nereis*) with *Toxoplasma gondii* in California and might also be a risk factor for infection of elephant seals with pathogenic fecal bacteria (15). Further studies to identify environmental risk factors for infection of elephant seals with *Campylobacter* and *Salmonella* spp. and genetic fingerprinting of these isolates may help determine the sources of these bacteria.

### Acknowledgments

We thank Michelle Caudle, Denise Greig, Barbara Byrne, Pat Morris, Brian Hatfield, Rich Walker, Dan Costa, Sarah Allen, Brent Stewart, staff of the University of California Reserve System, the rangers of Año Nuevo State Reserve, and staff of the Point Reyes National Seashore.

This project was supported by the Wildlife Health Center, University of California, Davis; the Prescott Marine Mammal Rescue Assistance Grant Program; and the West Coast Center for Oceans and Human Health (WCCOHH) as part of the National Oceanic and Atmospheric Administration Oceans and Human Health Initiative, WCCOHH publication no. 4. WCCOHH is part of the National Marine Fisheries Service's Northwest Fisheries Science Center, Seattle, Washington. Samples were collected under MMPA permits numbers 87-1593-01, 373-1575, and 486-1506.

Dr Stoddard is a research fellow at TMMC, Golden Gate National Recreation Area, Sausalito, California. Her research interests are marine mammals as indicators of fecal bacterial contamination in the marine environment, including pathogenic bacteria and antimicrobial drug-resistant commensal bacteria such as *Escherichia coli*.

### References

- Smith WA, Mazet JA, Hirsh DC. *Salmonella* in California wildlife species: prevalence in rehabilitation centers and characterization of isolates. *J Zoo Wildl Med.* 2002;33:228–35.
- Foster G, Holmes B, Steigerwalt AG, Lawson PA, Thorne P, Byrer DE, et al. *Campylobacter insulaenigrae* sp. nov., isolated from marine mammals. *Int J Syst Evol Microbiol.* 2004;54:2369–73.
- Johnson SP, Nolan S, Gulland FM. Antimicrobial susceptibility of bacteria isolated from pinnipeds stranded in central and northern California. *J Zoo Wildl Med.* 1998;29:288–94.
- Le Boeuf BJ, Laws RM. Elephant seals: an introduction to the genus. In: Le Boeuf BJ, Laws RM, editors. *Elephant seals: population ecology, behavior, and physiology.* Berkeley (CA): University of California Press; 1994. p. 1–26.
- Wilkinson DM. Report to assistant administrator for fisheries: program review of the Marine Mammal Strandings Networks. Silver Springs (MD): US Department of Commerce, National Marine Fisheries Services; 1991.
- Bopp CA, Brenner FW, Fields PI, Wells JG, Strockbine NA. *Escherichia*, *Shigella*, and *Salmonella*. In: Murray PR, Baron EJ, Jorgensen JH, Pfaller MA, Tenover FC, Tenover FC, editors. *Manual of clinical microbiology.* Washington: ASM Press; 2003. p. 654–71.
- National Committee for Clinical Laboratory Standards. Performance standards for antimicrobial disk and dilution susceptibility tests for bacteria isolated from animals, approved standards; NCCLS document M31-A2. Wayne (PA): The Committee; 2002.
- Nachamkin I. *Campylobacter* and *Arcobacter*. In: Murray PR, Baron EJ, Jorgensen JH, Pfaller MA, Tenover FC, Tenover FC, editors. *Manual of clinical microbiology.* Washington: ASM Press; 2003. p. 902–14.
- McDermott PF, Bodeis SM, Aarestrup FM, Brown S, Traczewski M, Fedorka-Cray P, et al. Development of a standardized susceptibility test for *Campylobacter* with quality-control ranges for ciprofloxacin, doxycycline, erythromycin, gentamicin, and meropenem. *Microb Drug Resist.* 2004;10:124–31.
- National Committee for Clinical Laboratory Standards. MIC testing supplemental tables; NCCLS document M100-S13 (M7). Wayne (PA): The Committee; 2003.
- StataCorp. *Stata cross-sectional time series, reference manual: release.* College Station (TX): StataCorp; 2003. p. 32–140.
- Clegg FG, Chiejina SN, Duncan AL, Kay RN, Wray C. Outbreaks of *Salmonella* Newport infection in dairy herds and their relationship to management and contamination of the environment. *Vet Rec.* 1983;112:580–4.
- Jones K, Howard S, Wallace JS. Intermittent shedding of thermophilic campylobacters by sheep at pasture. *J Appl Microbiol.* 1999;86:531–6.
- Amati L, Cirimele D, Pugliese V, Covelli V, Resta F, Jirillo E. Nutrition and immunity: laboratory and clinical aspects. *Curr Pharm Des.* 2003;9:1924–31.
- Miller MA, Gardner IA, Kreuder C, Paradies DM, Worcester KR, Jessup DA, et al. Coastal freshwater runoff is a risk factor for *Toxoplasma gondii* infection of southern sea otters (*Enhydra lutris nereis*). *Int J Parasitol.* 2002;32:997–1006.

Address for correspondence: Robyn A. Stoddard, Department of Pathology, Microbiology, and Immunology, School of Veterinary Medicine, University of California, Davis, CA 95616, USA; fax: 530-752-3349; email: rastoddard@ucdavis.edu

All material published in Emerging Infectious Diseases is in the public domain and may be used and reprinted without special permission; proper citation, however, is required.

Search past issues of EID at [www.cdc.gov/eid](http://www.cdc.gov/eid)

# Pivotal Role of Dogs in Rabies Transmission, China

Xianchun Tang,\*<sup>1</sup> Ming Luo,†<sup>1</sup> Shuyi Zhang,\*  
Anthony R. Fooks,‡ Rongliang Hu,†  
and Changchun Tu†

The number of dog-mediated rabies cases in China has increased exponentially; the number of human deaths has been high, primarily in poor, rural communities. We review the incidence of rabies in China based on data from 1950 and 2004, obtained mainly from epidemiologic bulletins published by the Chinese Ministry of Health.

Rabies is a zoonotic disease that causes severe destruction to the central nervous system and is usually fatal. Asia reports the highest global incidence: human rabies cases there account for >80% of the worldwide total. In Bangladesh, India, and Pakistan, >40,000 persons die of rabies each year; transmission from a dog bite is reported in 94% to 98% of cases (1). The numbers of human cases are still considered to be conservative estimates, however, since underreporting of rabies is widespread in developing countries. In recent years, China has reported the second highest rates of illness and death from human rabies worldwide. From 1950 to 2004, ≈103,200 persons died of rabies throughout the country in 4 reported epidemic waves that occurred at 10-year intervals: 1956–1957, 1965–1966, 1974–1975, and 1982–1983. The most severe epidemic occurred from 1980 to 1990 and resulted in 55,367 human deaths (2). After 1990, the number of reported human rabies cases declined annually, and the lowest number of cases was reported in 1996 (n = 159), largely as a result of increased awareness of risk. Since 1997, the fatality rate has increased exponentially (3); the number of human rabies deaths peaked in 2003–2004. The reported number of human rabies deaths, from 2001 to 2004 were 854, 1,159, 1,980, and 2,651, respectively, which corresponds to increases of 91%, 36%, 71%, and 34% from the previous year. In addition, the number of affected regions has expanded rapidly, and in 2003, human rabies cases were reported in 190 counties, of which 30 recorded their first epidemic. The current trend shows that the fifth epidemic

wave of rabies that began in the 1990s is gaining momentum as a serious human epidemic.

The disease is predominantly distributed in the southern provinces of China, bordered by the Yangtze River. Relatively fewer cases occur in northern China, largely as a result of population demographics. The human-to-dog ratio in southern China is substantially greater than in northern China, and the potential risk for exposure to a rabid dog is therefore enhanced. From 1996 to 2002, rabies predominantly affected 5 southern provinces, Guangxi, Hunan, Jiangxi, Guangdong, and Jiangsu, with human deaths accounting for >70% of the national total (Figure, Table) (3–8). In 2003, 7 provinces reported twice the number of human rabies cases than reported in 2002. Further analysis showed that the death rate in men was 1–2.5 times higher than in women and that the death rate for adolescents and children was higher than that for adults; 68.6% rabies cases were reported in patients <30 years of age (5–8). These data reaffirmed our understanding of rabies in other developing regions, especially in parts of Africa and Asia, where rabies is universally recognized as a disease of poor, rural communities, often of the disadvantaged, and principally of young adults and children.

Numerous wildlife species are natural reservoirs of rabies virus and are known, on rare occasions, to act as a source of transmission to humans. In China, however, the domestic dog (*Canis familiaris*) plays a pivotal role in rabies transmission; 85%–95% of human rabies cases are ascribed to dog bites, and 50%–70% of human rabies cases are reported in rural areas. Animal rabies surveillance in 2004 showed that brain tissue specimens collected from 5 (1.76%) of 283 healthy looking dogs from rural areas of 13 cities in Guangxi province tested positive for rabies virus by reverse transcriptase polymerase chain reaction followed by virus isolation (Q. Liu, pers. comm.). In early 2005, 6 dog rabies cases in rural areas of 5 counties of Chongqing, southwest China, were reported to our laboratory. These rabid dogs were not vaccinated and had bitten 15 dogs and 52 people. From their brain tissues 6 rabies virus isolates were obtained.

Owned dogs do not have to be registered in China, and the number of dogs has been estimated at 80–200 million. In rural areas, low vaccination coverage of dogs is widespread, largely because of poor awareness of rabies and the high cost of vaccination. Rural dogs are not leashed and always have free movement in these regions, thereby increasing the risk for human exposure to rabies. More importantly, people injured by dog bites in rural areas do not receive qualified and sufficient postexposure prophylaxis as recommended by the World Health Organization because rabies immunoglobulin is expensive, awareness of

\*Chinese Academy of Science, Beijing, People's Republic of China; †Academy of Military Medical Sciences, Changchun, People's Republic of China; and ‡Veterinary Laboratories Agency (Weybridge), Surrey, United Kingdom

<sup>1</sup>These authors contributed equally to this article.

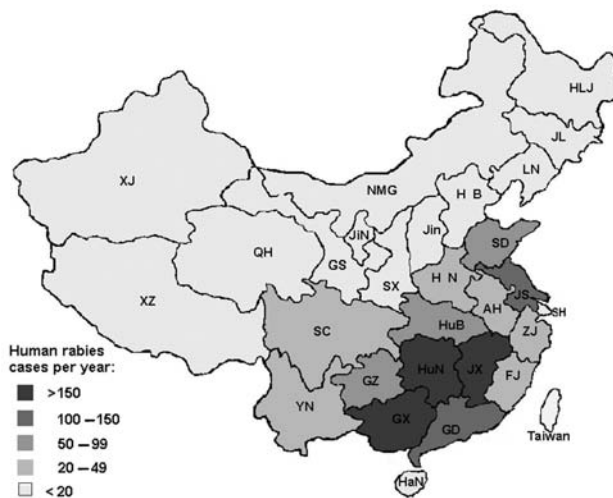

Figure. Human rabies epidemic in China by location, 1996–2000.

prophylaxis is poor, and access to medication is not convenient. One study showed that 244 (88.7%) of 275 human rabies patients reported in Guangxi Province from 1996 to 2000 were not treated with immediate postexposure prophylaxis. Only 31 patients (11.3%) were treated properly; 16 received a completed vaccination regimen (6).

In addition to the prevalence of rabies in dogs, the disease was also reported in other domestic animals, livestock, and wildlife, including cattle, pigs, sheep, foxes, sika deer, rats (9–11), and bats. In 1999, a total of 300 bats not identified to species were captured in Nanning, the capital city of Guangxi province, and their brain tissues were subjected to reverse transcription–polymerase chain reaction and virus isolation to detect a bat lyssavirus. The brain tissues of 3 bats tested positive, resulting in the isolation of live virus by using the mouse inoculation test (T. Luo, pers. comm.). In 2002, the first report of human rabies in China caused from the bite of a bat was reported. A staff member at a television broadcasting station in Tonghua County in northeast Jilin Province was bitten by a bat on the left side of his face when he picked up a telephone on the evening of July 17, 2002. Twelve days later, on July 29, he reported that his face felt numb, and he had

a severe headache. On July 31, the patient had a fever with a body temperature of 41°C–42°C. He also reported feeling nauseated and faint and said his upper body was painful and sore. The patient also showed characteristic clinical symptoms of rabies, including a fear of both wind and light. He was hospitalized in Changchun General Hospital, Jilin Province, on August 1, 2002, with a clinical diagnosis of rabies and died the next day, 16 days after the exposure and 4 days after he showed clinical symptoms. This was the first reported case of bat rabies virus in China although the species of the bat was never identified; the tissue samples from the bat and the viral isolates were discarded.

Comprehensive research studies have not been carried in China on the ecology, molecular epidemiology, and genetic diversity of rabies virus strains circulating in different provinces. In 2002, a study demonstrated that the viruses isolated in China from humans and domestic animals were genotype 1 strains of classic rabies virus (12).

The prevention and control of rabies in China would be advanced with the establishment of a veterinary administration that specializes in rabies control. This administration would need financial resources to support diagnostic, surveillance, and vaccination campaigns in animals.

Vaccinating domestic dogs in rural areas would substantially reduce the numbers of human rabies cases. For this goal to be achieved, a government-funded registration and licensing for all dogs would have to be compulsory and vaccination and sterilization of owned dogs in rural areas would have to be implemented and regular vaccination of dogs in urban areas continued. If the medical infrastructure in rural areas is strengthened by educating more professional healthcare workers and improving the availability of biological products, especially vaccines and rabies immunoglobulin for human use in postexposure prophylaxis regimens, China would be able to realize the goal of the World Health Organization to reduce by half the number of human rabies cases worldwide by 2015.

This work was supported a grant from the Ministry of Agriculture of the People's Republic of China to C.T. (grant no.

Table. The 5 Chinese provinces with the highest number of rabies cases, 1996–2002

Province	1996	1997	1998	1999	2000	2001	2002
Jiangsu	11	23	15	39	42	48	100
Jiangxi	8	28	60	79	160	192	160
Hunan	17	31	43	78	111	311	300
Guangdong	11	20	29	35	14	76	144
Guangxi	51	49	40	23	79	138	204
Total of 5 provinces	98	151	187	254	406	765	908
National total	163	230	238	341	465	891	1,191
% of national total	60.12	65.65	78.57	74.49	87.31	85.86	76.24

2004-070102). A.R.F. was funded by the Department for Environment, Food and Rural Affairs (DEFRA, project SEV3500) and by The Royal Society (RS, grant 16572), United Kingdom.

X.T. and S.Z. were supported by the Ministry of Science and Technology of China (2005CB523004).

Dr Tang is assistant research professor at the Institute of Zoology, Chinese Academy of Science, Beijing. His research is focused on detection and identification of bat viruses and the molecular epidemiology of rabies virus in China.

## References

1. World Health Organization Department of Communicable Disease Surveillance and Response. Strategies for the control and elimination of rabies in Asia. Geneva: The Organization; 2001.
2. Yu Y, editor. Rabies and rabies vaccine. Beijing: Medical Press of China; 2001. p. 127–42.
3. Tang Q, Zhao X, Tao X. Analysis on current situation of human rabies in China. Chinese Journal of Epidemiology. 2001;1:8–10.
4. Hu J, Wang Z. Epidemic analysis of rabies in Jiangsu Province in last 40 years. Modern Preventive Medicine. 1997;24:315–6.
5. Chen H, Tang Y. Analysis on the epidemiology of rabies from 1986 to 2000 in Jiangxi Province. Disease Surveillance. 2002;17:23–4.
6. Zhang L, Yang J, Liu W, Wang X, Wu X. Analysis on the epidemiology of rabies from 1996 to 2000 in Guangxi Province. Guangxi Journal of Preventive Medicine. 2001;7:210–2.
7. Guo S, Li J. The epidemiological features of human rabies in recent 50 years in Hunan Province. China Tropical Medicine. 2002;2:94–6.
8. Zhen K, Luo H. Analysis on the epidemiology of rabies from 1990 to 1996 in Guangdong Province. Guangdong Journal of Health and Epidemic Prevention. 1998;24:25–6.
9. Liu D, Qi J, Ding G. Epidemiological investigation on rabies of wild animals in Hunan Province. Hunan Journal of Animal Science and Veterinary Medicine. 1995;1:24.
10. Hou S, Hu J, Cui J, Liu J, Bu R, Yang S. Etiological study of rabies in sika deer. Bulletin of Veterinary College People's Liberation Army. 1986;6:341–9.
11. Hou A, Zhou X, Zhang G, Hou S, Li J, Yang S. Studies on prevention of rabies in scalper cattle in Nanyang district of Henan province. Bulletin of Veterinary College People's Liberation Army. 1991;11:209–14.
12. Xu G, Li K, Wu J, De Mattos CA, Zheng X, Xue J, et al. Sequence analysis of N genes of 19 rabies virus street isolates from China. Chinese Journal of Virology. 2002;18:48–51.

Address for correspondence: Changchun Tu, Military Veterinary Research Institute, Academy of Military Medical Sciences, 1068 Qinglong Rd, Changchun, 130062, China; fax: 86-431-796-0009; email:changchun\_tu@hotmail.com



Measurable Indicators

Search  
past issues

**EID**

Online

[www.cdc.gov/eid](http://www.cdc.gov/eid)

## *Echinococcus multilocularis* in Estonia

**To the Editor:** Alveolar echinococcosis (AE) caused by *Echinococcus multilocularis* is one of the most important emerging zoonoses in Europe. The fatality rate is >90% in untreated patients (1). In Europe, the distribution range of the zoonotic tapeworm *E. multilocularis* has expanded over the last few decades, and the parasite attracts increasing awareness as a public health issue (2–5). In 2003, AE was added to the list of zoonoses to be monitored in the member states of the European Union, according to Directive 2003/99/EC.

This is the first report of *E. multilocularis* in Estonia, which extends its northern distribution in Europe. Results of examinations of 17 red foxes shot in the eastern (Võnnu and Rāpina) and western (Hiiumaa) districts of Estonia from February to December 2003 were included in this study. We examined the intestinal tracts by the sedimentation and counting technique as described (1). *Echinococcus* adult stages were found in 5 foxes (29.4%). Two foxes, infected with 3 and 5 adult worms, were from the Rāpina district; 2 foxes, infected with 66 and 133 worms, were from the Võnnu district; and 1 fox, infected with the highest number of worms (927), was from the Hiiumaa District. The worms were retrieved, counted, washed, and stored in 90% ethanol until DNA purification. The parasites were identified as *E. multilocularis*, based on the most important morphometric parameters of adult stages (length of worms, number of proglottids, terminal proglottids in percentage of total worm length, position of genital pore, and form of uterus) (2).

To confirm the taxonomic status of the worms, polymerase chain reaction (PCR) was conducted, followed by

restriction fragment length polymorphism (RFLP) analysis and direct sequencing of a portion of the NADH dehydrogenase subunit I (ND1) gene of the mtDNA. A total of 6 specimens of *E. multilocularis* were used for genetic analysis. Total genomic DNA was extracted with the High Pure PCR Template Preparation Kit (Roche Molecular Biochemicals, Mannheim, Germany) according to manufacturer's instructions. PCR-RFLP was performed as described by Gonzalez et al. (6). The RFLP pattern of *E. multilocularis* isolates differed from that of *E. granulosus*. Diagnostic cleavage at the locus Eg9 of *E. multilocularis* with the enzyme *CfoI* is able to distinguish *E. multilocularis* and its closest relative *E. granulosus* (Figure, lanes 3 and 4 vs. lane 10). All 6 specimens of *E. multilocularis* produced identical results. A 426-bp fragment of the mitochondrial ND1 gene was amplified with the primers NDfor2-AGTTTCGTAAGGGTCCTAATA and NDrev2-CCCCTAATACTCCCTTTC using the BD Advantage 2 PCR Kit (Becton Dickinson Biosciences, Franklin Lakes, NJ, USA) as described (7). DNA cycle sequencing was performed by using the DYEnamic ET

Terminator Cycle Sequencing Kit (Amersham Pharmacia Biotech, Piscataway, NJ, USA). Sequences were resolved on an ABI PRISM 377 automated DNA sequencer (Applied Biosystems, Foster City, CA, USA).

All analyzed *E. multilocularis* specimens had identical sequences. The ND1 sequence of *E. multilocularis* from Estonia was submitted to GenBank under accession no. AY855918. The nucleotide sequences obtained were compared with those in the GenBank sequence database. The sequence of the Estonian isolate was identical with other *E. multilocularis* sequences deposited under accession nos. AJ32907, AJ32908, AJ32909, and AJ32910 from Poland (7) and AY389984 from China (Yang JK et al., unpub. data), and differed considerably from the sequences of the most closely related species, *E. granulosus*. For phylogenetic analysis, the ND1 sequences of 7 *E. multilocularis*, 24 *E. granulosus*, 1 *Taenia solium*, 1 *E. vogeli*, and 1 *E. oligarthrus* isolates were included and MrBayes 3.04b (8) was used for the Bayesian estimation of phylogeny, applying the GTR+I+G substitution model that best fitted the data (determined with Modeltest 3.06) (9). Searches were conducted with

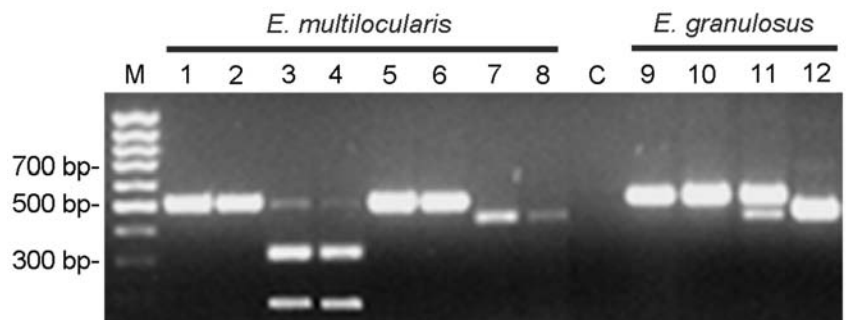

Figure. Diagnostic polymerase chain reaction (PCR) restriction fragment length polymorphism analysis for *Echinococcus multilocularis* (lanes 1–8, 2 specimens in parallel) and *E. granulosus* (lanes 9–12, 1 specimen). Lane M: Gene Ruler 100-bp DNA ladder; lane C: negative control without DNA; lanes 1 and 2: amplification of *E. multilocularis* DNA with Eg9 PCR; lanes 3 and 4: amplification of *E. multilocularis* DNA with Eg9 PCR, followed by cleavage with enzyme *CfoI*; lanes 5 and 6: amplification of *E. multilocularis* DNA with Eg9 PCR, followed by cleavage with enzyme *RsaI*; lanes 7 and 8: amplification of *E. multilocularis* DNA with Eg16 PCR; lane 9: amplification of *E. granulosus* DNA with Eg9 PCR; lane 10: amplification of *E. granulosus* DNA with Eg9 PCR, followed by cleavage with enzyme *CfoI*; lane 11: amplification of *E. granulosus* DNA with Eg9 PCR, followed by cleavage with enzyme *RsaI*; lane 12: amplification of *E. granulosus* DNA with Eg16 PCR.

4 simultaneous Markov chains over 2 million generations, sampled every 100 generations, and ended with a calculation of a 50% majority rule consensus tree. On the phylogenetic tree, sequences of Estonian isolate group together with those of other *E. multilocularis* isolates from different countries and were clearly separated from those of all other species (data not shown). The results of genetic analysis confirmed morphologic identification of *E. multilocularis*.

This study reports a new location of *E. multilocularis* in Europe. Estonia is the northernmost country on the mainland of the continent where *E. multilocularis* has been described. Because no studies have been published on the occurrence of *E. multilocularis* in Estonia in either foxes or rodents, whether this report identifies a stable endemic area or whether the parasite has expanded its range recently cannot be determined. Although a limited number of foxes were examined, the occurrence of *E. multilocularis* appears to be frequent and widespread in Estonia, which poses a risk for putatively parasite-free adjacent countries in Fennoscandia.

#### Acknowledgments

We thank Isam Sadula Saeed for confirming the morphologic diagnosis of *E. multilocularis*.

Funding was provided by Estonian Ministry of Education (target-financing grant 0181432) and Environmental Investment Centre (target-financing grant 04-04-9/415).

#### Epp Moks,\* Urmas Saarma,\*† and Harri Valdmann\*

\*University of Tartu, Tartu, Estonia; and  
†Estonian Biocentre, Tartu, Estonia

#### References

1. Kern P, Bardonnnet K, Renner E, Auer H, Pawlowski Z, Amman RW, et al. European Echinococcosis Registry: human alveolar echinococcosis, Europe, 1982–2000. *Emerg Infect Dis.* 2003;9:343–9.
2. Eckert J, Gemmell MA, Meslin FX, Pawlowski ZS, editors. WHO/OIE Manual on echinococcosis in humans and animals: a public health problem of global concern. Paris: World Health Organization for Animal Health (Office International des Epizooties) and World Health Organization; 2001.
3. McManus DP, Zhang W, Li J, Bartley PB. Echinococcosis. *Lancet.* 2003;362:1295–304.
4. Sréter T, Széll Z, Egyed Z, Varga I. *Echinococcus multilocularis*: an emerging pathogen in Hungary and Central Eastern Europe? *Emerg Infect Dis.* 2003;9:384–6.
5. Mazeika V, Paulauskas A, Balciuskas L. New data on the helminth fauna of rodents of Lithuania. *Acta Zool Lit.* 2003;13:41–7.
6. Gonzalez LM, Daniel-Mwambete K, Montero E, Rosenzvit MC, McManus DP, Carate T, et al. Further molecular discrimination of Spanish strains of *Echinococcus granulosus*. *Exp Parasitol.* 2002;102:46–56.
7. Kedra AH, Swiderski Z, Tkach VV, Rocki B, Pawlowski J, Pawlowski Z. Variability within NADH dehydrogenase sequences of *Echinococcus multilocularis*. *Acta Parasitol.* 2000;45:353–5.
8. Ronquist F, Huelsenbeck JP. MrBayes 3: Bayesian phylogenetic inference under mixed models. *Bioinformatics.* 2003;19:1572–4.
9. Posada D, Crandall KA. MODELTEST: testing the model of DNA substitution. *Bioinformatics.* 1998;14:817–8.

Address for correspondence: Harri Valdmann, Department of Integrative Zoology, University of Tartu, Vanemuise 46, 51014, Tartu, Estonia; fax: 372-7-375-830; email: Harri.Valdmann@ut.ee

## Influenza Virus Infection in Racing Greyhounds

**To the Editor:** Influenza is globally the most economically important respiratory disease in humans, pigs, horses, and fowl (1). Influenza virus is known for its continuous genetic and antigenic changes, which impeded effective influenza control (1,2). More importantly, emergence of a new subtype by genetic reassortment or interspecies transmission is of great concern for preventing influenza epidemics and pandemics (1). Recently, influenza outbreaks have occurred in species (feline and canine) that historically do not carry influenza virus (3,4), which alerted both regulatory and scientific communities to expansion of the host range of influenza virus. We report an outbreak of respiratory disease by influenza virus infection in Iowa racing greyhounds after influenza outbreaks in Florida in 2004.

In mid-April, an influx of racing greyhounds into Iowa greyhound tracks resulted in outbreaks of respiratory disease within the track compounds. The disease was characterized by rapid onset of fever and cough, rapid respiration, and hemorrhagic nasal discharge. The illness rate was almost 100% in both race-track compounds, although the death rate was <5%. Most affected dogs recovered, yet many died of hemorrhagic pneumonia. Therapeutic administration of broad-spectrum antimicrobial drugs reduced the severity of the disease but could not control it.

Tissue samples from 4 animals that died of severe pneumonia were submitted to the Iowa State University Veterinary Diagnostic Laboratory. The animals represented 2 different racing tracks located in eastern and western Iowa. On gross examination, lungs exhibited extensive red to red-

#### Instructions for Emerging Infectious Diseases Authors

**Letters.** Letters commenting on recent articles as well as letters reporting cases, outbreaks, or original research are welcome. Letters commenting on articles should contain no more than 300 words and 5 references; they are more likely to be published if submitted within 4 weeks of the original article's publication. Letters reporting cases, outbreaks, or original research should contain no more than 800 words and 10 references. They may have 1 figure or table and should not be divided into sections. All letters should contain material not previously published and include a word count.

black discoloration with moderate to marked palpable firmness. Mild fibrinous pleuritis was also noted. Microscopically, lung sections were characterized by severe hemorrhagic interstitial to bronchointerstitial pneumonia. Patchy interstitial change with alveolar septal thickening, coagula of debris in alveoli, and associated atelectasis were evident. Focally extensive pyogranulomatous bronchointerstitial pneumonia with dilatation of airways by degenerate cells and debris was observed. Scattered vasculitis and vascular thrombi were apparent.

Microbiologic testing for conventional viral and bacterial agents did not show any important pathogens except *Streptococcus equi* subsp. *zoepidemicus* from lung tissues of all animals examined. Two of the 4 lung samples were positive for influenza A virus by a real-time reverse transcription-polymerase chain reaction (RT-PCR) (5). Viral pneumonic lesions of both lungs were positive for immunohistochemistry (IHC) with monoclonal antibody specific for the nucleoprotein of influenza A virus (6) and with antigen-capturing enzyme-linked immunosorbent assay (*Directigen Flu A*, Becton-Dickinson, Sparks, MD, USA). Bronchioalveolar lavage samples from the 2 positive lungs were also positive by RT-PCR for influenza A virus.

Virus isolation was attempted; the influenza virus in canine lungs was unexpected since no influenza virus infection in dogs had been reported, except a recent communication at a meeting of veterinary diagnosticians (4). A virus that was able to agglutinate rooster erythrocytes was isolated in Madin-Darby canine kidney cells from lung and bronchioalveolar lavage fluid of 1 of the 2 animals in which influenza virus was detected by IHC and RT-PCR. Isolates were determined by RT-PCR to be influenza A virus of H3 subtype. The US Department of Agriculture National

Veterinary Services Laboratory (Ames, IA) subtyped the virus isolates (A/Canine/Iowa/13628/2005) as H3N8 by using hemagglutination-inhibition assay and neuraminidase-inhibition assay.

Sequencing hemagglutinin (HA) and neuraminidase (NA) genes of both isolates showed 100% and 99.8% identity, respectively, between the 2 isolates. Phylogenetically, the HA gene (GenBank accession no. DQ146419) of the isolates was genetically close (96%–98% nucleotide homology) to the HA gene of recent H3N8 equine influenza viruses (7). The NA gene (DQ146420) of the isolates also showed 96%–98% homology with the NA gene of recent H3N8 equine influenza viruses. Internal genes remain to be sequenced.

In conclusion, recent outbreaks of hemorrhagic pneumonia and associated deaths in Iowa racing greyhounds were primarily due to infection by an H3N8 influenza virus genetically and antigenically similar to equine influenza viruses. This conclusion can be supported by a previous report of fatal hemorrhagic pneumonia by H3N8 virus infection in racing greyhounds in Florida (4). The fact that greyhounds in 2 different racetracks, which are in geographically remote sites in Iowa, simultaneously died of the disease without the involvement of sick horses suggests that the influenza virus isolate is likely a canine-adapted strain and able to perpetuate and spread among dogs. While influenza virus infection was likely responsible for the disease outbreaks, the contribution that *S. zoepidemicus* might have made to the disease and the severity of clinical manifestations remains to be further evaluated since the bacterium has been implicated in respiratory disease and septicemia-associated problems in many different animal species (8,9).

#### Acknowledgment

We thank staff in Virology and Bacteriology Sections at the Iowa State

University Veterinary Diagnostic Laboratory for their timely and excellent technical assistance in laboratory testing.

**Kyoung-Jin Yoon,\***

**Vickie L. Cooper,\***

**Kent J. Schwartz,\***

**Karen M. Harmon,\* Won-Il Kim,\***

**Bruce H. Janke,\* Jody Strohbehn,†**

**Darcey Butts,‡ and Joe Troutman§**

\*Iowa State University, Ames, Iowa, USA;

†Strohbehn Veterinary Clinic, Council Bluffs, Iowa, USA;

‡Glenwood Veterinary Clinic, Glenwood, Iowa, USA; and

§Dubuque Greyhound Track, Dubuque, Iowa, USA

#### References

1. Wright PF, Webster RG. Fields virology. In: Knipe DM, Howley PM, Griffin DE, Lamb RA, Martin MA, Roizman B, et al. (editors). Orthomyxoviruses. Philadelphia: Lippincott Williams & Wilkins; 2001. p. 1533–79.
2. Webster RG, Bean WJ, Gorman OT, Chambers TM, Kawaoka Y. Evolution and ecology of influenza A viruses. *Microbiol Rev.* 1992;56:152–79.
3. Keawcharoen J, Oraveerakul K, Kuiken T, Fouchier RA, Amonsin A, Payungporn S, et al. Avian influenza H5N1 in tigers and leopards. *Emerg Infect Dis.* 2004;10:2189–91.
4. Dubovi EJ, Craford CW, Donis RO, Castleman WL, Stephenson I, Gibbs EPJ. Isolation of equine influenza virus from racing greyhounds with fatal hemorrhagic pneumonia. In: Proceedings of the 47th Annual Meeting of American Association of Veterinary Laboratory Diagnosticians; 2004 October; Greensboro, North Carolina. p. 158.
5. Harmon KM, Krauss S, Yoon K-J. Development of a PCR-based differential test for H1N1 and H3N2 swine influenza viruses. In: Proceedings of the 42nd Annual Meeting of American Association of Veterinary Laboratory Diagnosticians; 1999 October; San Diego, California. p. 44.
6. Vincent LL, Janke BH, Paul PS, Halbur PG. A monoclonal-antibody-based immunohistochemical method for the detection of swine influenza virus in formalin-fixed, paraffin-embedded tissues. *J Vet Diagn Invest.* 1997;9:191–5.
7. Macken C, Lu H, Goodman J, Boykin L. Options for the control of influenza IV. In: Osterhaus ADME, Cox N, Hampson AW (editors). The value of a database in surveillance and vaccine selection. Amsterdam: Elsevier Science; 2001. p. 103–6.

8. Wood JL, Newton JR, Chanter N, Mumford JA. Association between respiratory disease and bacterial and viral infections in British racehorses. *J Clin Microbiol*. 2005;43:120–6.
9. Gillespie JH, Timoney JF, editors. The genera *Staphylococcus* and *Streptococcus*. In: Hagan and Bruner's infectious diseases of domestic animals. 7th ed. Ithaca (NY): Comstock/Cornell University Press; 1981. p. 164–80.

Address for correspondence: Kyoung-Jin Yoon, Iowa State University, Department of Veterinary Diagnostic and Production Animal Medicine, College of Veterinary Medicine, 1600 South 16th St, Ames, IA 50011, USA; fax: 515-294-6619; email: kyoon@iastate.edu

## Syngamioniasis in Tourist

**To the Editor:** *Mammomonogamus laryngeus* (*Syngamus laryngeus*) is a nematode parasite found in the larynx of tropical mammals (1), especially cattle and cats and occasionally humans (2). We report a case in a 65-year-old Caucasian man who visited Brazil from July 20 to September 9, 2004. The patient stayed in Rio de Janeiro and Ilhéus in northern Brazil. He ate local food, including salads, raw vegetables and fruits, and drank what he assumed was safe water.

Upon return to Portugal in September 2004, the patient experienced a cough and fever. He was seen in an emergency service and chest radiograph indicated infiltration in the left inferior lobe, the right basal hilum, and right apex. A complete blood count revealed a leukocyte count of 9,700/mm<sup>3</sup>, 81% polymorphonuclear leukocytes and 2.1% eosinophils. He was treated with antimicrobial drugs; a week later a radiograph showed bronchovascular markings. The patient failed to follow recommendations and in mid-October, he returned to the hospital

with a persistent cough and expectoration.

In late November the patient had a persistent cough with hemoptysis. He was given antimicrobial drugs; a computed tomographic scan showed an infiltration, a sequela to pneumonia, localized in the left superior lobe. Symptoms persisted, and bronchofibrosopic examination in January 2005 showed thickening of the bilateral bronchovascular bundles and discrete diffuse inflammation in the bronchial mucosa. A Y-shaped worm, moving and wrapped in viscous, bloody mucus, was seen around the right medial bronchus. A worm was seen in the left main bronchus and, upon closer examination, a male and female worm in copula were seen. The worms removed with forceps and identified as *M. laryngeus* (Figure). Eggs from the female were characteristic of the species.

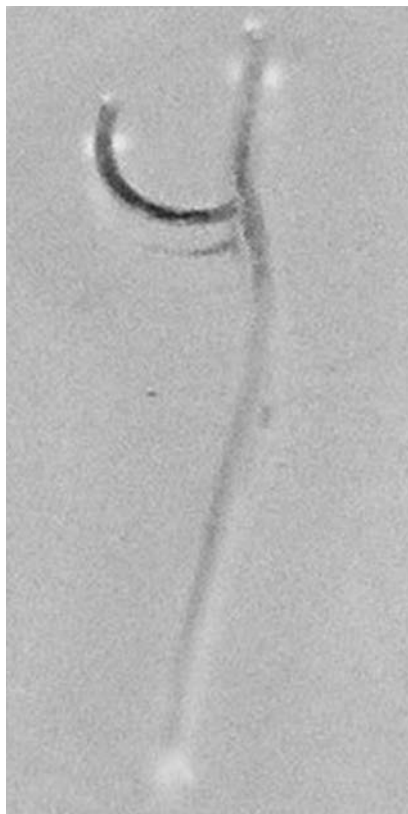

Figure. Male and female *Mammomonogamus laryngeus* recovered from the bronchial mucosa.

The patient was treated with albendazole 200 mg, 3×/day for 3 days, followed by mebendazole 100 mg, 3×/day for 3 days. The cough and hemoptysis clinically improved and abated by early February.

The genus *Mammomonogamus* consists of 2 major species, *M. laryngeus* and *M. nasicola*. The former is a parasite of the laryngotracheal region of bovids and felines, and the latter is found in the nasal fossa of bovids. *M. laryngeus* and *M. nasicola* belong to the family *Syngamidae* that contains the gapeworm of birds, *S. trachea*.

Possibly 100 human infections (3), most caused by *M. laryngeus*, have been reported from the Caribbean Islands and South America, especially Brazil, with other reports from Australia, Canada, the United States, France, United Kingdom (4), the Philippines (2), Thailand (5), and Korea (6). Many of the cases reported outside of the Caribbean and South America were usually acquired while the patient was visiting areas where *M. laryngeus* was endemic. Naturally infected ruminant host are found in tropical America, India, Africa, Malaysia, the Philippines, and Vietnam (7).

*M. laryngeus* is blood red; the males are joined permanently to the female and are characteristically Y shaped (Figure). The males are ≈3 mm and the females are ≈10 mm in length. The mouth opening is wide, and the buccal capsule is cup-shaped with 8–10 small teeth. The worms attach to the mucosa of the larynx in animals and cause bronchitis and cough.

The means of transmission of *M. laryngeus* is unknown but it is assumed to be similar to that of *S. trachea*, which is acquired by ingesting an embryonated egg, hatched larvae, or a paratenic host such as earthworms, snails, or arthropods. The patient in our case could have been infected by eating contaminated raw vegetation or drinking contaminated water while traveling through Brazil.



The life cycle of *M. laryngeus* is not completely known, but it is assumed to be similar to *S. trachea*, which penetrates the intestinal wall and migrates through the body of the animal to the tracheolaryngeal region (8). Eggs produced are deposited in the tracheal mucosa, swallowed, and pass in the feces.

Chronic cough and fever are the major symptoms associated with *M. laryngeus* in humans, with occasional reports of hemoptysis when the worms are in the bronchus. Worms in the larynx may cause irritation and a crawling or scratching sensation. Symptoms of asthma have been reported, and leukocytosis and eosinophilia may occur. Our patient had respiratory symptoms, persistent cough, and hemoptysis, without leukocytosis or eosinophilia.

The diagnosis of parasitosis is usually made by finding expectorated worms or visualizing by bronchoscopy and removal by forceps. Eggs may be found in sputum or feces. In our case, eggs were not found in sputum or feces.

The worms are coughed up by the patient or removed with forceps during bronchoscopy. When anti-helminthics such as mebendazole and albendazole have been used, patients have reported improvement.

Although mammomonogamiasis may not be considered an emerging parasitosis, physicians should be aware of the condition especially in patients with pulmonary symptoms who visited disease-endemic areas.

**Jose C. da Costa,\* M.L. Delgado,\*  
Paulo Vieira,\* Abel Afonso,†  
Bebiana Conde,‡  
and John H. Cross‡**

\*National Institute of Health, Porto, Portugal; †Hospital Center Vila Real-Peso da Regua, Porto, Portugal; and ‡Uniformed Services University of the Health Sciences, Bethesda, Maryland, USA

The opinions expressed by authors contributing to this journal do not necessarily reflect the opinions of the Centers for Disease Control and Prevention or the institutions with which the authors are affiliated.

## References

1. Anderson RC, Chabaud AG, Willmott S, editors. CIH keys to the nematode parasites of vertebrates, no.7. Keys to the genera of the superfamily *Strongyloidea*. Farrham Royal, Bucks, England: Commonwealth Agricultural Bureau; 1980.
2. Beaver PC, Jung RC, Wayne E. Clinical parasitology. Philadelphia: Lea and Febiger; 1984.
3. Nosanchuk JS, Wade SE, Landolf M. Case report of and description of parasite in *Mammomonogamus laryngeus* (human syngamosis). J Clin Microbiol. 1995;33:998-1000.
4. Cunnac M, Magnaval JF, Cayarci D, Leophonte P. A propos de 3 cas de syngamose humaine en Guadeloupe. Rev Pneumol Clin. 1988;44:140-2.
5. Pipitogool V, Chaisiri K, Visetsuspakarn P, Srigan V, Maleewong W. *Mammomonogamus (syngamus) laryngeus*. First case report in Thailand. Southeast Asian J Trop Med Public Health. 1992;23:336-7.
6. Kim HY, Lee SM, Joo JE, Na MJ, Ahn MH, Min DY. Human syngamosis: the first case in Korea. Thorax. 1998;53:717-8.
7. Acha PN, Szyfres B. Mammomonogamiasis. Zoonosis and communicable diseases common to man and animals. Washington (DC): Pan American Health Organization; 2003. Scientific and Technical Publication No. 580.
8. Severo LC, Conci LMA, Camargo JJP, Andre-Alves MR, Palombini BC. Syngamosis: two new Brazilian cases and evidence of possible pulmonary cycle. Trans R Soc Trop Med Hyg. 1988;82:467-8.

Address for correspondence: John Cross, Uniformed Services University of the Health Sciences, 4301 Jones Bridge Rd, Bethesda, MD 20814, USA; fax: 301-295-1971; email: jcross@usuhs.mil

## Human *Angiostrongylus* *cantonensis*, Jamaica

**To the Editor:** *Angiostrongylus cantonensis* is the most common cause of eosinophilic meningoen- cephalitis worldwide (1). The para-

site's presence has been well documented in Jamaica in rats (definitive host) and a variety of mollusks (intermediate hosts); infections occur in humans sporadically on the island. However, the mode of transmission of infections to humans in Jamaica, where raw or undercooked mollusks are not usually eaten, is not well understood (2).

An outbreak of *A. cantonensis* occurred among American medical students vacationing in Jamaica in 2000. An epidemiologic investigation identified the probable source of infection (Caesar salad), but no biologic contaminant was determined (2). During a field investigation of *A. cantonensis*, we spoke with local farmers and vendors to identify possible routes of food contamination. While our observations were preliminary and anecdotal in nature, our findings provide valuable insight into local transmission and control of this parasite.

Humans can become infected by eating the intermediate hosts, slugs and snails, of *A. cantonensis*. Freshwater shrimp serve as paratenic hosts and reservoirs of infection for humans, both naturally and experimentally (3,4). Most reports of Jamaican eating practices indicate that terrestrial snails and slugs are not eaten and that shrimp and other meats are always eaten well cooked (5). However, during interviews with a farmer near Mavis Bank, a rural area outside of Kingston, and fishermen at the Coronation Market, Jamaica's largest fresh produce market, we discovered that freshwater and saltwater shrimp, as well as mussels (paratenic hosts), are occasionally eaten raw. Freshwater shrimp or mussels are eaten, particularly by men, directly from rivers and streams, and freshwater and saltwater bait shrimp are eaten by fishermen.

In Jamaica, molluscicides are routinely applied to growing vegetables such as cabbage, lettuce, and bok choy to keep snails and slugs away,

although this practice is not effective. Snails and slugs withdrew from produce after the molluscicide was applied to surrounding vegetation, but returned after several days. We purchased a lettuce head that had been reportedly treated with molluscicides at the Coronation Market and found a small slug inside. The role of produce in transmitting *A. cantonensis* is still unclear; humans may become infected by inadvertently consuming small slugs or other infected hosts or by consuming produce directly contaminated with larvae. Infections in slugs have not been found in previous studies conducted on the island (2). Regardless, the use of molluscicides to limit human infection from produce is an ineffective strategy.

At the Coronation Market, vendors repeatedly used a bucket of water to rinse vegetables before displaying them. This practice could transmit *A. cantonensis* in 2 ways. First, if free larvae are deposited on vegetables in either the slime or feces of mollusks, cross contamination can occur. Second, dead or decaying intermediate hosts may release larvae into water (6). If infected mollusks were rinsed from vegetables into the buckets, the water could become contaminated with larvae. While cross-contamination by common wash buckets has not been implicated in an outbreak of a parasitic infection, it has been linked to outbreaks of other infectious agents (7,8).

Vendors at venues such as Coronation Market primarily buy produce to sell. These vendors typically purchase their produce from intermediaries who purchase and transport it from farms in outlying areas. As a consequence, many vendors are unsure of the farm or region from which their produce came. This practice makes it difficult, if not impossible, for health officials and researchers to isolate and link etiologic agents with particular produce items or regions and complicates the investigation of any foodborne infection.

*A. cantonensis* is an important parasitic agent in Jamaica for which a definitive route of infection is often not found. We found that potential paratenic hosts are occasionally eaten raw. Because of the high prevalence of *A. cantonensis* infection in mollusks in certain parts of Jamaica, consumption of raw, infected shrimp may be a source of sporadic angiostrongyliasis on the island. Control of *A. cantonensis* is complicated because of the apparent ineffectiveness of molluscicides, the potential for cross-contamination of produce at markets, and the difficulty of tracking produce and other products to their source.

**Cecelia A. Waugh,\* Shira Shafir,†  
Matthew Wise,†  
Ralph D. Robinson,\*  
Mark L. Eberhard,†  
and John F. Lindo\***

\*University of West Indies, Kingston, Jamaica; and †Centers for Disease Control and Prevention, Atlanta, Georgia, USA

#### References

1. Kliks MM, Palumbo NE. Eosinophilic meningitis beyond the Pacific Basin: the global dispersal of a peridomestic zoonosis caused by *Angiostrongylus cantonensis*, the nematode lungworm of rats. *Soc Sci Med*. 1992;34:199–212.
2. Lindo JF, Waugh C, Hall J, Cunningham-Myrie C, Ashley D, Eberhard ML, et al. Enzootic *Angiostrongylus cantonensis* in rats and snails after an outbreak of human eosinophilic meningitis, Jamaica. *Emerg Infect Dis*. 2002;8:324–6.
3. Alto W. Human infections with *Angiostrongylus cantonensis*. *Pac Health Dialog*. 2001;8:176–82.
4. Wallace GD, Rosen L. Studies on eosinophilic meningitis. 2. Experimental infection of shrimp and crabs with *Angiostrongylus cantonensis*. *Am J Epidemiol*. 1966;84:120–31.
5. Lindo JF, Escoffery CT, Reid B, Codrington G, Cunningham-Myrie C, Eberhard ML. Fatal autochthonous eosinophilic meningitis in a Jamaican child caused by *Angiostrongylus cantonensis*. *Am J Trop Med Hyg*. 2004;70:425–8.
6. Cross JH. Angiostrongylosis. In: Palmer SR, Soulsby EJJ, Simpson DIY, editors. *Zoonoses*. Oxford: Oxford University Press; 1998. p. 774–81.
7. Centers for Disease Control and Prevention. Hepatitis A outbreak associated with green onions at a restaurant—Monaca, Pennsylvania, 2003. *MMWR Morb Mortal Wkly Rep*. 2003;52:1155–7.
8. Wachtel MR, Charkowski AO. Cross-contamination of lettuce with *Escherichia coli* O157:H7. *J Food Prot*. 2002;65:465–70.

Address for correspondence: Cecelia Waugh, Department of Life Sciences, University of the West Indies, Mona, Kingston 07, Jamaica, West Indies; fax: 876-977-1075; email: cecelia.waugh@uwimona.edu.jm

## Nipah Virus Strain Variation

**To the Editor:** AbuBakar et al. described strain variation in Nipah virus during the 1998–1999 outbreak in Malaysia (1). They found an isolate from pigs in Perak, as well as from a flying fox, that differed markedly from pig and human isolates from the main epidemic in southern Malaysia. AbuBakar et al. proposed that this finding indicates 2 separate spillover events from bats to pigs occurred, the first in Perak in 1998 and the second in southern Malaysia in 1999. However, investigations at the time of the outbreak showed that many pigs were moved from Perak onto southern farms in early 1999. We suggest that successive spillovers of the pig population in the north can also explain the observed strain differences between northern and southern isolates.

A model from experimental studies and active farm data demonstrate that Nipah virus may have circulated repeatedly and become endemic within 1 or several large pig farms in Perak (J.R.C. Pulliam, unpub. data), which is consistent with the occurrence of human cases in Perak before the 1998–1999 outbreak. Evolution of the virus population in pigs, fol-

lowed by the reintroduction in Perak of the original strain from bats and its subsequent southward movement in infected pigs, would explain observed strain differences. Models suggest that evolution of the virus within pig populations would result in lower death rates but prolonged illness. Although the pig-adapted virus strain may have circulated on both northern and southern farms, sampling biases in favor of the more virulent strain would be expected in areas of high death rates, which would explain the observed genetic relationships between sequenced isolates.

We suggest that pigs be experimentally infected with the Perak strain of Nipah virus to determine whether differences exist in illness and death caused by this virus. Further sequencing of virus from archived pig samples will clarify with greater confidence whether multiple strains circulated in both regions.

#### Acknowledgments

This work is published as part of a collaboration with the Australian Biosecurity Cooperative Research Center for Emerging Infectious Disease.

Funding for the Henipavirus Ecology Research Group is provided by a National Institutes of Health/National Science Foundation 'Ecology of infectious diseases award' (R01-TW05869) from the John E. Fogarty International Center.

**Juliet R.C. Pulliam,\*  
Hume E. Field,† Kevin J. Olival,‡  
and the Henipavirus Ecology  
Research Group§<sup>1</sup>**

\*Princeton University, Princeton, New Jersey, USA; †Queensland Department of Primary Industries, Brisbane, Queensland, Australia; ‡Columbia University, New York, New York, USA; and §Consortium for Conservative Medicine, New York, New York, USA

#### Reference

1. AbuBakar S, Chang LY, Ali AR, Sharifah SH, Yusoff K, Zamrod Z. Isolation and molecular identification of Nipah virus from pigs. *Emerg Infect Dis.* 2004;10:2228–30.

Address for correspondence: Juliet R.C. Pulliam, Department of Ecology and Evolutionary Biology, Princeton University, 102 Guyot Hall, Princeton, NJ 08544, USA; fax: 609-258-1334; email: pulliam@princeton.edu

<sup>1</sup>A full list of members of this group is available at [www.henipavirus.org](http://www.henipavirus.org)

**In response:** Pulliam et al. (1) presented a model to help explain the observed Nipah virus (NV) strain differences reported earlier by AbuBakar et al. (2). The model is built around an assumption that NV was endemic in several pig farms in the north of Malaysia and that a subsequent reintroduction of the original NV caused the fatal encephalitis outbreak in 1998.

While the model is plausible, that NV infection was endemic among pigs before the 1998 outbreak is difficult to imagine in the absence of verifiable evidence. As with any virus that crosses species, NV would likely have caused severe infection, and what happened in 1998 is a classic example. Before NV could have evolved, become less virulent, and subsequently become endemic, it would have been first introduced to pigs. This initial introduction would have caused an outbreak, but no such outbreaks were reported before 1998. Furthermore, the life span of pigs reared in farms is relatively short before they are sent to the markets, which limits the time in which NV evolution could take place. Slaughtering these pigs would also

have caused infection among abattoir workers and pork handlers. At present, the finding of 2 different NV strains from 2 different outbreak foci favors the suggestion that 2 possibly overlapping NV outbreaks occurred in Malaysia in 1998. Further investigation of NV archived materials would shed further light into the possible origin of NV in the 1998 Malaysia outbreaks.

**Sazaly AbuBakar\***

\*University Malaya, Kuala Lumpur, Malaysia

#### References

1. Pulliam JRC, Field HE, Olival KJ, and the Henipavirus Ecology Research Group. Nipah virus strain variation. *Emerg Infect Dis.* 2005;11:1978–9.
2. AbuBakar S, Chang L-Y, Mohd Ali AR, Sharifah SH, Yusoff K, Zamrod Z. Isolation and molecular identification of Nipah virus from pigs. *Emerg Infect Dis.* 2004;10:2228–30.

Address for correspondence: Sazaly AbuBakar, University Malaya, Department of Medical Microbiology, Faculty of Medicine, Kuala Lumpur 50603, Malaysia; fax: 603-7967-5757; email: sazaly@um.edu.my

## Trichinellosis Outbreak

**To the Editor:** Trichinellosis is a zoonotic disease caused by the nematode *Trichinella*. Although now uncommon as a result of public health control measures, trichinellosis outbreaks have been reported in the United States (1), Europe (2,3), Mexico (4), Thailand (5), Canada (6), Lebanon (7–10), and elsewhere.

In Israel, the disease is rare because most Jewish and Muslim citizens avoid eating pork. Until 1997, only 6 small outbreaks were reported in humans; they occurred mostly in

the Christian Arab population. However, from 1998 to 2004, 10 similar trichinellosis outbreaks involving 200 Thai migrant agricultural workers occurred. The workers all took part in festive meals whose main dish was uninspected wild boar, hunted in the Upper Galilee in northern Israel, near the Lebanese border. Wild boar was also the source of several large outbreaks that were reported from 1975 to 1997 in southern Lebanon (7–10).

We report an outbreak among a group of 47 male Thai workers (mean age 32 years). The workers participated in a festive meal where the implicated wild boar meat was served. Two weeks later, 26 of them had symptoms of trichinellosis. Serologic tests were performed on all 47 workers 2–4 weeks after they ate the infected meat (first time point), 6 and 8 weeks later (second time point), or both. The specimens were tested for immunoglobulin G antibodies to *Trichinella spiralis* with the LMD Elisa kit lot 9910231 (Alexon-Trend, Ramsey, MN, USA). According to the kit insert, absorbance readings  $\geq 0.3$  optical density (OD) units are positive.

A case-patient was defined as a worker who had  $\geq 1$  of the following symptoms of trichinellosis: muscle soreness, edema of upper eyelids, fever, ocular symptoms, gastrointestinal symptoms, maculopapular rash, or pulmonary symptoms. Workers with no clinical symptoms were divided into 2 subgroups. Asymptomatic case-patients were workers with  $\geq 1$  positive serologic test result with or without elevated absolute eosinophil count. Nonpatients were workers whose serologic results remained negative during the 2 months of study, with normal absolute eosinophil count.

At the onset of symptoms, 2 weeks after the meal, 26 patients arrived at the emergency room of Barzilai Hospital, Ashkelon, with abdominal pain with various degrees of myalgia (23 [88%]), fever (3 [11%]), periorbital edema (11 [42%]), headache (12

[46%]), rash (9 [34%]), and cough (1 [4%]). Only 1 patient did not seroconvert during the 2-month study.

Of 18 symptomatic patients, 13 (72%) were positive at the first time point (mean  $\pm$  standard deviation [SD] OD  $0.87 \pm 0.80$ ; in another 4 patients, seroconversion was observed at the second time point. At this second time point, 21 persons were tested, and 20 (95%) were positive (OD  $2.89 \pm 1.16$ ). Five patients showed moderate eosinophilia ( $1.0\text{--}5.0 \times 10^9$  cells/L), and 4 patients had marked eosinophilia ( $>5.0 \times 10^9$  cells/L). No direct correlation was observed between severity of symptoms, degree of eosinophilia, and antibody levels (OD).

Of the 21 asymptomatic workers, 7 did not have cases of trichinellosis, and 14 (67%) had  $\geq 1$  positive sample. At the first time point, 12 workers were tested; 7 (58%) were positive (OD  $0.64 \pm 0.91$ ). At the second time point, seroconversion was observed in 4 other workers. At this time, 14 persons were tested; 10 (71%) were positive (OD  $1.76 \pm 1.62$ ). In this group, 1 person had moderate eosinophilia, and 2 had marked eosinophilia.

All the persons who ate the infected meat were treated with mebendazole, 5 mg/kg twice a day for 5 days. All symptomatic patients recovered.

Epidemiologic investigation indicated that 1 large piece of meat was put in boiling water for just a few minutes before being eaten. The meat that remained from the meal was examined microscopically, and encysted *Trichinella* larvae were identified (Figure).

The attack rate in this outbreak was higher (85%) than that in other published outbreaks. One explanation for this high rate could be that our case definition was broader and included any exposed person who had a positive serologic result during the 2-month study period. Moreover, all those who ate the investigated meal gave at least 1 blood sample. In other outbreaks, only samples from acute symptomatic patients were taken (8), the follow-up was incomplete because some patients did not return for convalescent-phase serologic testing (8), or not all the affected persons were studied (7).

This outbreak demonstrates the need to increase awareness and knowledge of trichinellosis and its epidemiologic features among medical personnel, public health teams, and workers. Health education and promotion are important for migrant workers, who should be reached and informed about how to prevent trichinellosis.

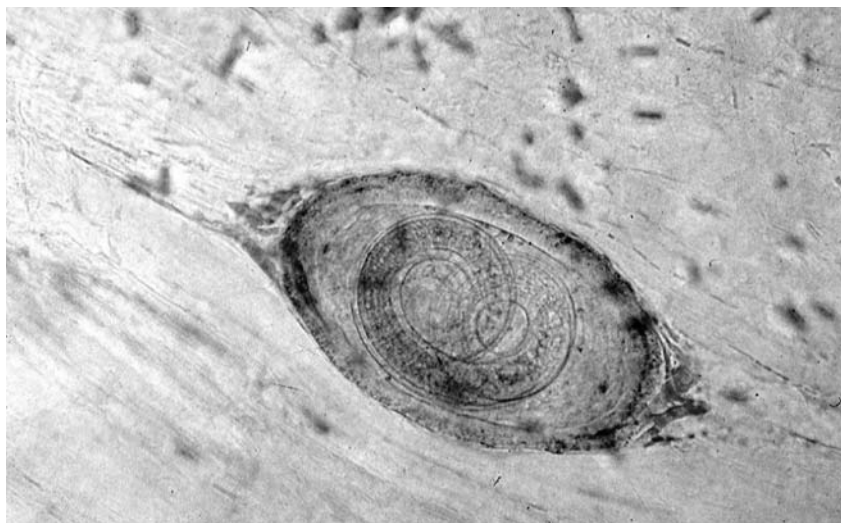

Figure. *Trichinella* larvae in a sample of infected meat (light microscopy,  $\times 100$ ).

### Acknowledgment

We thank Heather Schnur for her editorial help.

**Esther Marva,\* Alex Markovics,†  
Michael Gdalevich,\* Nehama Asor,\*  
Chantal Sadik,\* and  
Alex Leventhal\***

\*Ministry of Health, Jerusalem, Israel; and  
†Kimron Veterinary Institute, Beit-Dagan,  
Israel H2

### References

- Roy SL, Lopez AS, Schantz PM. Trichinellosis surveillance—United States, 1997–2001. *MMWR Morb Mortal Wkly Rep.* 2003;52:SS1–6.
- Desenclos JC. Pork related trichinellosis: emergence of a new mode of transmission? *Euro Surveill.* 1999;4:77.
- Djordjevic M, Bacic M, Petricevic M, Cuperlovic K, Malakauskas A, Kapel CM, et al. Social, political and economic factors responsible for the reemergence of trichinellosis in Serbia: a case study. *J Parasitol.* 2003;89:226–31.
- Zamora-Chavez A, O-Cavazos ME, Bernal-Rendón RM, Berrones Espericaeta D, Vazquez Antona C. Acute trichinosis in children. Intrafamilial epidemic outbreaks in Mexico City. *Bol Med Hosp Infant Mex.* 1990;47:395–400.
- Khamboonruang C, Nateewatana N. Trichinosis: a recent outbreak in northern Thailand. *Southeast Asian J Trop Med Public Health.* 1975;6:74–8.
- Schellenberg RS, Tan BJ, Irvine JD, Stockdale DR, Gajadhar AA, Serhir B, et al. An outbreak of trichinellosis due to consumption of bear meat infected with *Trichinella nativa* in 2 northern Saskatchewan communities. *J Infect Dis.* 2003;188:835–43.
- Haim M, Efrat M, Wilson M, Schantz PM, Cohen D, Shemer J. An outbreak of *Trichinella spiralis* infection in southern Lebanon. *Epidemiol Infect.* 1997;119:357–62.
- Olaison L, Ljungstrom I. An outbreak of trichinosis in Lebanon. *Trans R Soc Trop Med Hyg.* 1992;86:658–60.
- Blondheim DS, Klein R, Ben-Dror G, Schick G. Trichinosis in southern Lebanon. *Isr J Med Sci.* 1984;20:141–4.
- Matossian RM, Rebeiz J, Stephan E. Serodiagnosis by fluorescent antibody staining of an outbreak of trichinosis in Lebanon. *Ann Trop Med Parasitol.* 1975;69:387–92.

Address for correspondence: Esther Marva, Ministry of Health – Central Laboratories, POB 34410, Jerusalem, Israel 91342; fax: 972-2-655-1866; email: esther.marva@eliav.health.gov.il

## Ciguatera Fish Poisoning, Canary Islands

**To the Editor:** Ciguatera outbreaks usually occur in the area between 35° north and 35° south latitude, mainly in the Caribbean, Indo-Pacific islands, and the Indian Ocean (1–5) (Figure). Occasionally, ciguatera poisoning has been reported outside disease endemic areas, such as the Bahamas, Canada, or Chile, but no case had been described in the West African region until now. European and Spanish cases have been rarely described and are mainly associated with seafood imported from disease-endemic regions (6).

Ciguatera fish poisoning is a clinical syndrome caused by eating contaminated fish (1). The causative toxins of its clinical manifestations are ciguatoxins (7). These toxins are transmitted by dinoflagellates of the species *Gambierdiscus toxicus*, which lives adhered to damaged coral reefs in tropical seas (2). Herbivorous fish species accumulate toxins in their musculature, liver, and viscera after ingesting dinoflagellates. Larger marine carnivores eat contaminated fish and concentrate ciguatoxins (1,2).

More than 425 species of fish are associated with ciguatera poisoning in humans. The most commonly implicated fish are barracuda, red snapper, grouper, amberjack, sea bass, surgeonfish, and moray (eel) (2,3). In January 2004, 2 fishermen captured a 26-kg amberjack (local name: Medregal Negro; scientific name:

*Seriola Rivoliana*) while scuba diving along the coast of the Canary Islands, Spain. The fishermen filleted the fish and stored fillets in a household freezer. Within a few days, one of the fishermen and 4 family members consumed some fish, and neurologic and gastrointestinal symptoms developed within 30 minutes to 28 hours. The 5 family members sought treatment at the emergency room of Hospital de Fuerteventura and the Outpatient Clinic of Infectious Diseases and Tropical Medicine Service of Hospital Insular de Las Palmas.

The 5 family members exhibited a combination of gastrointestinal (diarrhea [4 persons], nausea/vomiting [3 persons], metallic taste [1 person]), cardiologic (heart rhythm disturbances [2 persons]), systemic (fatigue [5 persons], itching [3 persons], dizziness [1 person]), and neurologic manifestations (myalgia [3 persons], peripheral paresthesia [3 persons], perioral numbness [2 persons], and reversal of hot and cold sensations [3 persons]), which is pathognomonic of ciguatera poisoning). These clinical observations and laboratory data were collected from a prospective questionnaire filled in by physicians at the patients' first visits. No hematologic or biochemical abnormalities were detected in any patient. Based upon the symptomatic profiles, relationships of the patients, and their common dietary histories, ciguatera intoxication was diagnosed in all. None of the patients required hospitalization. The neurologic and gastrointestinal symptoms resolved over several weeks, but intermittent recurrence of some symptoms, at lower intensities, was noted for several months.

A portion of the implicated fish was recovered from freezer storage at the fisherman's home. A solid-phase membrane immunobead assay with a monoclonal antibody directed against Pacific ciguatoxins and related polyether toxins was used to detect ciguatoxins or other antigenically related

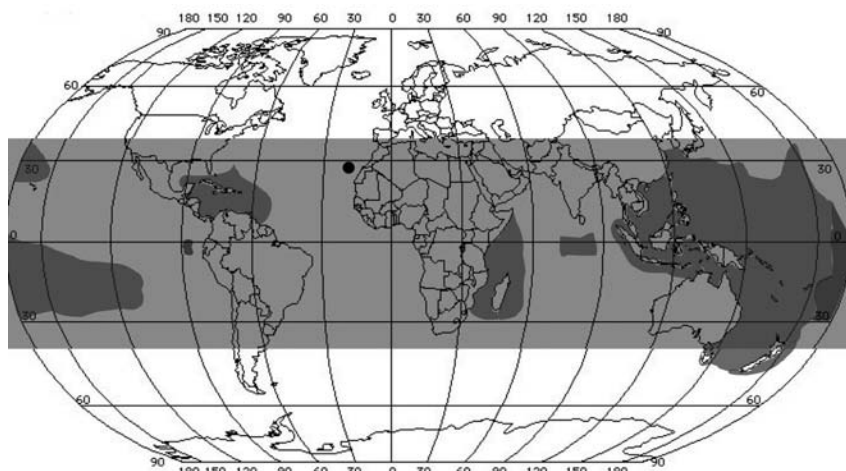

Figure. Worldwide distribution of ciguatera. Gray indicates coral reef regions located between 35° north and 35° south latitudes; darker gray indicates disease-endemic areas of ciguatera; black circle indicates Canary Islands (latitude 28°06' north, longitude 15°24' west). Source: refs. 4 and 5.

substances in fish tissues. Results were positive.

A 150-g sample of the fish was delivered to the US Food and Drug Organization's Gulf Coast Seafood Laboratory, Dauphin Island, Alabama, USA, for sodium channel-specific *in vitro* assay (8) and liquid chromatography-mass spectrometry (LC/MS/MS) analysis. Assay results were positive and the ciguatoxin content of the fish sample was estimated to be 1.0 ppb (ng/g). Caribbean ciguatoxin (CCTX-1: MH+ m/z 1141.6) was confirmed by LC/MS/MS by using multiple reaction monitoring (9). The amount of ciguatoxin in the fish tissue estimated by *in vitro* assay was low, and close to the limit the LC/MS/MS method can detect. At least 2 additional toxins were detected in the fish sample by *in vitro* assay of liquid chromatography fractions. We cannot rule out the possibility that these toxins represent new ciguatoxinlike structures unique to the eastern Atlantic. Further studies are necessary to elucidate all toxins implicated in this outbreak.

Classic symptoms of ciguatera developed in our patients after eating a fish they captured in the Canary

Islands, which are not in the ciguatera-endemic zone (Figure). The preliminary results of this outbreak investigation suggest the presence of ciguatoxins or ciguatoxinlike structures in fish from temperate waters of the eastern Atlantic. Ciguatera poisoning is a matter of public health concern and residents of coastal West Africa and the regional island archipelagos could be a new community at risk for this seafood intoxication syndrome. We emphasize that ciguatera poisoning is a debilitating disease, and therapeutic intervention strategies are very limited (10).

#### Acknowledgments

We thank Ana Gago, for her collaboration in analytical procedures and Isaías Naranjo for his editorial assistance in preparing the manuscript.

**Jose-Luis Pérez-Arellano,\*†**  
**Octavio P. Luzzardo,\***  
**Ana Pérez Brito,‡**  
**Michele Hernández Cabrera,\*†**  
**Manuel Zumbado,\***  
**Cristina Carranza,\*†**  
**Alfonso Angel-Moreno,\*†**  
**Robert W. Dickey,§**  
**and Luis D. Boada\***

\*University of Las Palmas de Gran Canaria, Las Palmas de Gran Canaria, Spain; †Hospital Universitario Insular de Gran Canaria (Canary Health Service), Las Palmas de Gran Canaria, Spain; ‡Hospital de Fuerteventura, Puerto del Rosario, Spain; and §Gulf Coast Seafood Laboratory (Food and Drug Administration), Dauphin Island, Alabama, USA

#### References

1. Ting JY, Brown AF. Ciguatera poisoning: a global issue with common management problems. *Eur J Emerg Med.* 2001;8: 295-300.
2. Caplan CE. Ciguatera fish poisoning. *CMAJ.* 1998;159:1394.
3. Pearn J. Neurology of ciguatera. *J Neurol Neurosurg Psychiatr.* 2001;70:4-8.
4. Juranovic LR, Park DL. Foodborne toxins of marine origin: ciguatera. *Rev Environ Contam Toxicol.* 1991;117:51-94.
5. Lewis RJ. The changing face of ciguatera. *Toxicol.* 2001;39:97-106.
6. Puente S, Lago M, Subirats M, González Lahoz JM. Ciguatera: un caso importado. *Med Clin (Barc).* 1995;104:357.
7. Glaziou Ph, Legrand AM. The epidemiology of ciguatera fish poisoning. *Toxicol.* 1994;32:863-73.
8. Dickey R, Jester E, Granade R, Mowdy D, Moncreiff C, Rebarchik D, et al. Monitoring brevetoxins during a *Gymnodinium breve* red tide: comparison of sodium channel specific cytotoxicity assay and mouse bioassay for determination of neurotoxic shellfish toxins in shellfish extracts. *Nat Toxins.* 1999;7:157-65.
9. Pottier I, Hamilton B, Jones A, Lewis RJ, Vernoux JP. Identification of slow and fast-acting toxins in a highly ciguatoxic barracuda (*Sphyrna barracuda*) by HPLC/MS and radiolabelled ligand binding. *Toxicol.* 2003;42:663-72.
10. Pérez CM, Vásquez PA, Perret CF. Treatment of ciguatera poisoning with gabapentin. *N Engl J Med.* 2001;344: 692-3.

Address for correspondence: José-Luis Pérez-Arellano, Infectious Diseases and Tropical Medicine Service, Department of Medical and Surgical Sciences, Health Sciences Faculty, University of Las Palmas de Gran Canaria, PO Box 550, 35080 Las Palmas de Gran Canaria, Spain; fax: 34-928-45-1413; email: jlperez@dcmq.ulpgc.es

The opinions expressed by authors contributing to this journal do not necessarily reflect the opinions of the Centers for Disease Control and Prevention or the institutions with which the authors are affiliated.

## Human Rabies in China

**To the Editor:** Rabies has occurred in China for >2,000 years and was first described in ≈556 BC (1). Since 1950, human rabies has been a class II notifiable disease in China, and the annual number and distribution of human rabies cases have been archived. We examined the archived data from 1950 to 2004 and analyzed epidemiologic characteristics.

During the 55-year period, 108,412 human rabies cases were recorded in China. The Figure shows the number of annual cases from 1950 to 2004; 3 major epidemics of human rabies in China are apparent. In the early 1950s, only a few cases occurred; the first peak occurred from 1956 to 1957 with ≈2,000 cases each year. Then the number of cases declined during subsequent years and was relatively constant throughout the 1960s. By 1969, the number of cases increased again to ≈2,000. This ascending phase continued throughout the 1970s and 1980s. The second epidemic peaked in the early 1980s. In 1981, 7,037 cases were recorded, the largest number of cases in a single year during the 55-year period. During the 1980s, 55,367 cases were reported (>5,000 cases annually), representing >50% of the 108,412 cases seen during the entire period. In the early 1990s, the number of human cases decreased dramatically from 3,520 in 1990 to 159 in 1996. However, this downward trend reversed its course in 1998, and annual cases have increased gradually since then. In 2004, a total of 2,651 cases were reported, an increase of >16 fold when compared with the numbers in 1996. This third rabies epidemic apparently has not yet peaked.

The compiled data also showed substantially more rabies cases in the summer and autumn than in the spring and winter. Similar seasonality was reported in animals (2), indicating the pattern of transmission from animals to humans. Rabies patients range in age from infancy to >65 years of age. The ratio of male to female victims is 68 to 32. Although human rabies has been reported in almost all provinces, 15 provinces have had >1,000 cumulative cases each. These provinces are Hunan, Guangdong, Sichuan, Guangxi, Guizhou, Hubei, Jiangxi, Shandong, Henan, Anhui, Jiangsu, Hebei, Fujian, Yunnan, and Liaoning. These 15 provinces account for >93% of the total cases. Four provinces (Hunan, Guangdong, Sichuan, and Guangxi) have had >7,000 cumulative cases each.

Most of the human patients were infected with rabies by dog bites. The number of dogs has increased gradually in China since the late 1970s. Now ≈70% of households in Guangxi, Guizhou, and Jiangsu, and Hunan, where the most cases were recorded in recent years, have ≥1 dog (data not shown). However, the rate of dog vaccination remains ≈3%.

The rabies epidemics in China since 1950 may be partially explained by dog population dynamics. The first major epidemic subsided at the end of the 1950s and the beginning of the

1960s, coinciding with pet reduction policy. The second major epidemic peaked in the late 1970s and early 1980s, when economic reforms were initiated in China and the dog population increased dramatically. Population immunity may also play a role in these cyclic epidemics. However, neither the dramatic decline of rabies cases in the early part of 1990s nor the initiation of the third epidemic around the turn of the millennium could be explained simply by dog population dynamics. Other factors may include untimely and inappropriate postexposure treatment (3,4) and the existence of healthy carrier dogs (5–7). Wounds of 118 of 178 patients were not treated; 60 of the patients washed the wounds with soap and water. A total of 129 (72%) patients did not receive vaccine. Of the remaining 49 (28%) patients, 35 received vaccination in a timely manner. Two of the 178 patients received antirabies serum intramuscularly. Among the 49 patients who received postexposure vaccination, 30 did not complete the immunization requirements. Healthy carriers have been detected, and rabies virus antigen was found in 25 (10%) of 248 brain specimens from healthy dogs collected from Guangxi, Guizhou, and Jiangsu (data not shown) in 1 study. Further investigation is needed to confirm these findings.

In summary, rabies remains a public health problem in China. Strategies to control and prevent human rabies include public education and awareness about rabies, pet vaccination programs, elimination of stray animals, and enhanced postexposure management. In addition, the large number of rabies cases should encourage rabies prophylaxis for foreign travelers before they visit China, particularly those who might travel to rural areas.



Figure. Annual rabies cases reported in China from 1950 to 2004

Yong-Zhen Zhang,\* Cheng-Long Xiong,\* Dong-Lou Xiao,\* Ren-Jie Jiang,† Zhao-Xiao Wang,‡ Ling-Zhu Zhang,§ and Zhen F. Fu¶

\*Chinese Center for Disease Control and Prevention, Beijing, China; †Yancheng Municipal Center for Disease Control and Prevention, Yanchen, China; ‡Guizhou Center for Disease Control and Prevention, Guiyang, China; §Guangxi Center for Disease Control and Prevention, Nanning, China; and ¶University of Georgia, Athens, Georgia, USA

## References

1. Wang XJ, Huang JT. Epidemiology. In: Yu YX, editor. Rabies and rabies vaccine. Beijing: Chinese Medicine Technology Press; 2001. p. 127–44.
2. Gylys L, Chomel BB, Gardner IA. Epidemiological surveillance of rabies in Lithuania from 1986 to 1996. *Rev Sci Tech*. 1998;17:691–8.
3. Centers for Disease Control and Prevention. Human rabies prevention—United States, 1999; recommendations of the Advisory Committee on Immunization Practice (ACIP). *MMWR Recomm Rep*. 1999;48(RR-1):1–21.
4. Chhabra M, Ichhpujani RL, Tewari KN, Lal S. Human rabies in Delhi. *Indian J Pediatr*. 2004;71:217–20.
5. Hu JY, Xu TQ, Wu ZM, Si Y, Zhao LL, Shen RH, et al. A study on the epidemiological characteristics and the preventive measures of rabies in Shanghai [article in Chinese]. *Chin J Epidemiol*. 2001;22:11–13.
6. Du F, Huang MT, Liang FP, Luo HM, Wen JH, Chen DR, et al. Investigation on rabies virus in dogs in Guangdong [article in Chinese]. *Chin J Zoonoses*. 1992;8:39–41.
7. Fekadu M, Shaddock JH, Chandler FW, Baer GM. Rabies virus in the tonsils of a carrier dog. *Arch Virol*. 1983;78:37–47.

Address for correspondence: Yong-Zhen Zhang, Institute for Infectious Disease Control and Prevention, Chinese CDC, Liuzi 5, Changping 102206, Beijing, 102206, China; fax: 86-10-61739457; email: yongzhenzhang@sohu.com



## Resistant *Salmonella* Virchow in Quail Products

**To the Editor:** *Salmonella* spp. resistant to multiple antimicrobial agents have emerged worldwide in recent years, but clinical relevance varies with the agent to which resistance evolves. Fluoroquinolones are often the drug of choice to treat gastrointestinal infections in humans, and resistance to this class of antimicrobial agents is associated with increased illness and death (1). Resistance to fluoroquinolones has emerged worldwide during the last decade. *Salmonella* isolates resistant to oxyiminocephalosporins because they produce extended-spectrum  $\beta$ -lactamases (ESBLs) have emerged worldwide since 1992. This emergence has caused concern since cephalosporins are drugs of choice to treat salmonellosis in children, to whom fluoroquinolones must not be administered because of toxicity issues. In Denmark, the first ESBL-producing isolate of animal origin from a *Salmonella enterica* serovar Heidelberg isolated from a boar imported from Canada in 2003 was reported (2), but such isolates have not previously been reported in food products.

On October 15, 2003, the Danish Institute for Veterinary Research, the national reference laboratory, received 3 *Salmonella* isolates found in quails imported from France. *Salmonella* isolates found at any importer's laboratory in Denmark are submitted to the reference laboratory for further analyses. The quails were in the importer's storage room at the time of sampling; sampling was performed routinely by the importer's own laboratory. At the reference laboratory, the isolates were serotyped as *S. enterica* serovar Virchow and found resistant to ampicillin, ceftio-

fur, cephalothin, nalidixic acid, and tetracycline and with reduced susceptibility to ciprofloxacin (MICs >0.125  $\mu$ g/mL) (3). Polymerase chain reaction detection and sequencing (4) showed that the  $\beta$ -lactam resistance was mediated by *bla*<sub>CTX-M-9</sub>. Pulsed-field gel electrophoresis was performed by using *Xba*I and *Bln*I as restriction enzymes according to the PulseNet protocol (5), and all 3 isolates had the same profile.

On October 23, the importer was informed of the laboratory's findings and the increased risk associated with salmonella isolates simultaneously resistant to quinolones and cephalosporins. Based on this information, the importer withdrew the product from the supermarkets on October 24. Recently, *S. enterica* Virchow with *bla*<sub>CTX-M-9</sub> has also been reported in poultry, poultry products, and humans in France (6), as well as humans in Spain (7) and the United Kingdom (8). The isolates from France were also resistant to nalidixic acid; the isolates we have obtained from fresh quails imported from France are possibly related to these isolates.

The global food-products trade is expected to increase in the future. Thus, attempts to improve food safety must emphasize detection of antimicrobial drug-resistant bacteria in imported food products. Furthermore, international agreements that limit contamination with drug-resistant bacteria and resistance genes at the primary production site are necessary to ensure consumer safety (9). International agreements must be based on antimicrobial-resistance data and early reports of emerging problems. Recently, the World Health Organization (WHO) launched the Global Salm Surv program (10) to isolate and identify antimicrobial resistance to *Salmonella* globally.

Many national and international rules, as well as marketing and consumer factors, regulate the interna-



tional trade of food products and live animals. Large international corporations may also affect international trade. For example, McDonald's Corporation has issued a global policy for antimicrobial drug use in food animals that specifies requirements for their food product suppliers. Local groceries or supermarkets may also impose their own standards nationally. We are aware of only 1 product withdrawal related to antimicrobial resistance, the quail imported from France.

No international standards exist for managing food safety problems related to antimicrobial resistance. However, in 2003 the Food and Agriculture Organization of the United Nations, WHO, and the World Organisation for Animal Health jointly hosted a workshop with a panel of experts to scientifically assess resistance risks related to nonhuman use of antimicrobial drugs (9). The panel's purpose was also to provide recommendations to the Codex Alimentarius Commission for future risk management of antimicrobial drug resistance (9). Imposing restrictions on products with combinations of resistance, such as simultaneous resistance to quinolones and cephalosporins in *Salmonella*, as reported in this study, would be a good first step towards managing antimicrobial drug-resistance risks.

**Frank M. Aarestrup,\*  
Henrik Hasman,\*  
and Lars Bogø Jensen\***

\*Danish Institute for Food and Veterinary Research, Copenhagen V, Denmark

## References

- Helms M, Simonsen J, Mølbak K. Quinolone resistance is associated with increased risk of invasive illness or death during infection with *Salmonella* serotype Typhimurium. *J Infect Dis.* 2004;190:1652-4.
- Aarestrup FM, Hasman H, Olsen I, Sørensen G. International spread of *bla*(CMY-2)-mediated cephalosporin resistance in a multiresistant *Salmonella enterica* serovar Heidelberg isolate stemming from the importation of a boar by Denmark from Canada. *Antimicrob Agents Chemother.* 2004;48:1916-7.
- Aarestrup FM, Lertworapreecha M, Evans MC, Bangtrakulnonth A, Chalermchaikit T, Hendriksen RS, et al. Antimicrobial susceptibility and occurrence of resistance genes among *Salmonella enterica* serovar Weltevreden from different countries. *J Antimicrob Chemother.* 2003;52:715-8.
- Hasman H, Mevius D, Veldman K, Olesen I, Aarestrup FM.  $\beta$ -Lactamases among extended-spectrum beta-lactamase (ESBL) resistant *Salmonella* from poultry, poultry products and human patients in The Netherlands. *J Antimicrob Chemother.* 2005;56:115-21.
- Ribot EM, Wierzbica RZ, Angulo FJ, Barrett TJ. *Salmonella enterica* serotype Typhimurium DT104 isolated from humans, United States, 1985, 1990, and 1995. *Emerg Infect Dis.* 2002;8:387-91.
- Simarro E, Navarro F, Ruiz J, Miro E, Gomez J, Mirelis B. *Salmonella enterica* serovar Virchow with CTX-M-like beta-lactamase in Spain. *J Clin Microbiol.* 2000;38:4676-8.
- Weill FX, Lailler R, Praud K, Kerouanton A, Fabre L, Brisabois A, et al. Emergence of extended-spectrum-beta-lactamase (CTX-M-9)-producing multiresistant strains of *Salmonella enterica* serotype Virchow in poultry and humans in France. *J Clin Microbiol.* 2004;42:5767-73.
- Batchelor M, Hopkins K, Threlfall EJ, Clifton-Hadley FA, Stallwood AD, Davies RH, et al. *bla*(CTX-M) genes in clinical *Salmonella* isolates recovered from humans in England and Wales from 1992 to 2003. *Antimicrob Agents Chemother.* 2005;49:1319-22.
- World Health Organization. Geneva: 1st Joint FAO/OIE/WHO expert workshop on non-human antimicrobial usage and antimicrobial resistance: scientific assessment. Geneva: The Organization; 2003 [cited 1 Mar 2005]. Available from [http://www.who.int/foodsafety/publications/micro/en/a\\_mr.pdf](http://www.who.int/foodsafety/publications/micro/en/a_mr.pdf)
- World Health Organization. Global Salm Surv (GSS). Geneva: The Organization; 2004 [cited 1 Mar 2005]. Available from <http://www.who.int/salmsurv/en/>

Address for correspondence: Frank M. Aarestrup, Danish Institute for Food and Veterinary Research, Bülowsvej 27, DK-1790 Copenhagen V, Denmark; fax: 45-72-34-60-01; email: faa@dfvf.dk

## Vancomycin-resistant *Enterococcus faecium* Clone in Swine, Europe

**To the Editor:** The use of antimicrobial agents for growth promotion (AGP) in food-producing animals has been extensively debated because of the risk of establishing a reservoir of antimicrobial resistance genes or antimicrobial-resistant organisms of potential relevance for human health. This concern has motivated the progressive ban of the use of different AGP in the European Union, which began in 1997 with avoparcin and will end in 2006 (1). Worldwide trade of living animals for food production or breeding and of meat products enables multidrug-resistant pathogens to spread across national borders.

Intercontinental dissemination of antimicrobial-resistant bacteria associated with food animals has been described for particular clones such as *Salmonella enterica* Typhimurium DT104 or *Escherichia coli* O157:H7 and for transferable genetic elements such as the genomic island SG1 or the streptococcal plasmid pRE25 (2). Vancomycin-resistant enterococci (VRE) in European farms were initially associated with the intensive use of avoparcin; however, the persistence of VRE in food animal environments after years of avoparcin withdrawal indicates that coselection by further antimicrobial or other agents, increased fitness of strains, and mobile genetic elements cannot be ruled out (1-3).

A specific clone was recently detected among vancomycin-resistant *E. faecium* (VREF) isolated from different swine farms in Denmark and Switzerland and from a healthy Danish woman without antimicrobial drug exposure who ate pork, chicken, and beef (4,5). Since Portugal and

Spain maintain commercial trade of food-producing swine (living or meat products) between them and with other European countries, including Denmark (<http://www.dgv.min-agricultura.pt/dgv.nsf>), we investigated a possible relationship among VREF swine fecal isolates from Portugal and Spain and compared these isolates with the Swiss/Danish clone. We studied 3 VREF from a Figueira da Foz slaughterhouse in central Portugal (1997–1998) and 3 VREF isolates from 3 Spanish slaughterhouses in Valencia, Lugo, and Murcia in eastern, northern, and southern Spain, respectively (1998–2000). These isolates were recovered in the course of previous surveillance studies (C. Novais/I. Herrero, unpub data). Antimicrobial susceptibility was tested for 13 antimicrobial agents by using the agar dilution method (6). Clonal relationships were analyzed by pulsed-field gel electrophoresis (PFGE) and characterization of *purK* alleles by amplification and further sequencing (6,7; [mlst.net\). Species identification, genes coding for antimicrobial resistance genes or for putative virulence traits, and the backbone structure of Tn1546 were analyzed by polymerase chain reaction followed by sequencing when necessary \(6,8\). Broth and filter mating were performed by using \*E. faecium\* GE1 as recipient strain \(6\).](http://efaecium.</a></p>
</div>
<div data-bbox=)

Following criteria published elsewhere (6), the VREF isolates studied were considered a single clone (0–4 bands difference by PFGE). Some vancomycin-susceptible *E. faecium* swine isolates (VSEF) from Spain and Switzerland showed an *Sma*I-PFGE pattern closely related to that of VREF isolates (data not shown; [4]).

Representative VREF of each country harbored the allele 9 of the housekeeping gene *purK*, previously found among *E. faecium* isolates from swine and healthy persons (7). All VREF isolates were resistant to glycopeptides (*vanA*), erythromycin [*erm(B)*], and tetracycline. Two Spanish isolates were also highly resistant to streptomycin and

kanamycin [*aph(3')-IIIa*] (Table). All VREF isolates tested carried a Tn1546 type D, previously found in isolates from food-producing animals (8). This element showed alterations in *orf1* and a G-T point mutation in the position 8234 at *vanX*. Transfer of vancomycin resistance was detected for the Swiss (4), Spanish, and Portuguese isolates and was associated with erythromycin resistance in all cases. Tetracycline resistance was also transferable in the Spanish strains. No virulence traits were detected.

We describe the simultaneous occurrence of a VREF strain among swine in 4 distant European countries for at least a 4-year period. Tn1546 type D has been largely described in European swine isolates, which indicates stability of this particular type among the high diversity of Tn1546 described to date (8). The finding of a group of genetically closely related strains, which include both VSEF and VREF isolates and which harbor a particular *purK* allele previously

Table. Features of vancomycin-resistant *Enterococcus faecium* swine isolates from European countries\*

Isolate	PFGE	<i>purK</i>	Antimicrobial drug susceptibility (mg/L)*†													Resistance genes†	Mating‡
			VC	TC	AMP	TET	ER	CP	CL	GM	KM	SM	LIN	DA	NIT		
Portugal§																	
7S4	A	9	>256	256	<2	64	32	<0,5	8	<256	1,000	<256	2	1	64	<i>vanA</i> <i>erm(B)</i>	10 <sup>-4</sup>
8S1	A3	ND	>256	256	<2	32	>32	<0,5	16	<256	<256	<256	2	1	64	<i>vanA</i> <i>erm(B)</i>	10 <sup>-8</sup>
35S2	A4	ND	>256	256	<2	64	>32	<0,5	8	<256	<256	<256	2	0.5	32	<i>vanA</i> <i>erm(B)</i>	ND
Spain¶																	
S1	A1	9	>256	128	<2	>64	>32	<0,25	8	<256	>2,000	>2,000	2	1	64	<i>vanA</i> <i>erm(B)</i> <i>aphIII</i>	10 <sup>-5</sup>
S2	A2	ND	>256	128	<2	64	>32	<0,25	8	<256	<256	<256	2	2	64	<i>vanA</i> <i>erm(B)</i>	10 <sup>-4</sup>
S8	A1'	ND	>256	128	<2	>64	>32	<0,25	8	<256	>2,000	2,000	2	0.5	64	<i>vanA</i> <i>erm(B)</i> <i>aphIII</i>	10 <sup>-5</sup>
Switzerland#																	
4D	A	9	>256	64	<2	64	>32	<0,25	<4	<256	<256	<256	2	4	64	<i>vanA</i> <i>erm(B)</i>	10 <sup>-5</sup>

\*PFGE, pulsed-field gel electrophoresis; VC, vancomycin; TC, teicoplanin; AMP, ampicillin; TET, tetracycline; ER, erythromycin; CP, ciprofloxacin; CL, chloramphenicol; GM, high level of resistance to gentamicin; KM, high-level resistance to kanamycin; SM, high-level resistance to streptomycin; LIN, linezolid; DA, daptomycin; NIT, nitrofurantoin; ND, not done. All isolates were Tn1546 type D.

†Antimicrobial resistance or resistance genes detected in transconjugants appear underlined.

‡Conjugation frequency is expressed as transconjugants per donors.

§First 2 isolates were collected in 1997; third in 1998.

¶S1 was isolated in 1998; S2, 1999; and S8, 2000.

#Isolate was collected in 1999.

associated with *E. faecium* swine strains, might mirror wide dissemination of a host-specific clone more prone than others to acquire and spread different antimicrobial resistance, as reported for human clinical *E. faecium* isolates (9). Since enterococci from swine are able to colonize in the human gut (5,7) and isolates harboring *purK-9* can be recovered from hospitalized patients with severe infections (10), specific swine enterococcal strains might represent a risk for antimicrobial resistance spread in the clinical setting. Further analyses need to be performed to understand the role of international animal movements, animal feed, and colonized farmers in the spread of this particular strain and to assess whether this clone shows an increased fitness in the porcine intestine when compared to other *E. faecium* strains.

C. Novais was supported by a fellowship from Fundação para a Ciência e Tecnologia (SFRH/BD/3372/2000).

**Carla Novais,\* Teresa M. Coque,†  
Patrick Boerlin,‡  
Inmaculada Herrero,§  
Miguel A. Moreno,§  
Lucas Dominguez,§  
and Luísa Peixe\***

\*REQUIMTE at Universidade do Porto, Porto, Portugal; †Hospital Universitario Ramón y Cajal, Madrid, Spain; ‡University of Guelph, Ontario, Canada; and §Universidad Complutense de Madrid, Madrid, Spain

## References

1. Phillips I, Casewell M, Cox T, Groot B, Friis C, Jones R, et al. Does the use of antibiotics in food animals pose a risk to human health? A critical review of published data. *J Antimicrob Chemother.* 2004;53(Suppl 1):28–52.
2. Teuber M. Veterinary use and antibiotic resistance. *Curr Opin Microbiol.* 2001;4:493–9.
3. Johnsen PJ, Østerhus JI, Sletvold H, Sorum M, Kruse H, Nielsen K, et al. Persistence of animal and human glycopeptide-resistant enterococci on two Norwegian poultry farms formerly exposed to avoparcin is associated with a widespread plasmid-mediated *vanA* element within a polyclonal *Enterococcus faecium* population. *Appl Environ Microbiol.* 2005;71:159–68.
4. Boerlin P, Wissing A, Aarestrup F, Frey J, Nicolet J. Antimicrobial growth promoter ban and resistance to macrolides and vancomycin in enterococci from pigs. *J Clin Microbiol.* 2001;39:4193–5.
5. Hammerum A, Lester C, Neimann J, Porsbo L, Olsen K, Jensen L, et al. A vancomycin-resistant *Enterococcus faecium* isolate from a Danish healthy volunteer, detected 7 years after the ban of avoparcin, is possibly related to pig isolates. *J Antimicrob Chemother.* 2004;53(Suppl 3):547–9.
6. Novais C, Coque TM, Sousa JC, Baquero F, Peixe L. Local genetic patterns within a vancomycin-resistant *Enterococcus faecalis* clone isolated in three hospitals in Portugal. *Antimicrob Agents Chemother.* 2004;48:3613–7.
7. Homan WL, Tribe D, Poznanski S, Li M, Hogg G, Spalburg E, et al. Multilocus sequence typing scheme for *Enterococcus faecium*. *J Clin Microbiol.* 2002;40:1963–71.
8. Woodford N, Adebisi AMA, Palepou MFI, Cookson B. Diversity of VanA glycopeptide resistance elements in enterococci from humans and animals. *Antimicrob Agents Chemother.* 1998;42:502–8.
9. Willems RJL, Top J, van Santen M, Robinson A, Coque TM, Baquero F, et al. Global spread of vancomycin-resistant *Enterococcus faecium* from distinct nosocomial genetic complex. *Emerg Infect Dis.* 2005;11:821–8.
10. Coque TM, Willems RJ, Fortun J, Top J, Diz S, Canton R, et al. Population structure of *Enterococcus faecium* causing bacteremia in a Spanish university hospital: setting the scene for a future increase in vancomycin resistance? *Antimicrob Agents Chemother.* 2005;49:2693–700.

Address for correspondence: Luísa Peixe, REQUIMTE, Laboratório de Microbiologia, Faculdade de Farmácia, Universidade do Porto, Rua Aníbal Cunha, 4050-030 Porto, Portugal; fax: 351-2-200-3977; email: lpeixe@ff.up.pt



## Rabies Vaccine Baits, Pennsylvania

**To the Editor:** Oral rabies vaccine (ORV) programs control rabies in terrestrial reservoir species by distributing vaccine in baits (1). The current US-licensed ORV consists of a rabies virus glycoprotein gene inserted into the thymidine kinase gene of an attenuated strain of the Copenhagen vaccinia virus (V-RG) (2). Safety experience includes extensive animal studies (2,3) in which significant adverse effects were seen only with parenteral (but not mucosal) exposure of nude mice to V-RG (4). Usage monitoring (4,5) found only 1 human adverse complication to date (6).

We report our experience monitoring pet and human exposure to V-RG as part of a multiagency federal-state cooperative program that distributed 1,710,399 V-RG-laden baits from August 11, 2003, to September 17, 2003, over 25,189 km<sup>2</sup> of western Pennsylvania (human population ≈3 million). The baits consisted of a vaccine-filled plastic sachet surrounded by a fishmeal polymer. Workers distributed these baits on the ground from vehicles or by air from fixed-wing aircraft using conveyor belts. Aircraft did not release baits when over homes or other areas where humans or pets were likely to be present. Given the limitations of dispersing 1,421,517 baits at a frequency of 75 to 150 baits/km<sup>2</sup> from 200 m in the air, human habitat could not be totally avoided.

Each bait was printed with a toll-free phone number. Phone calls were routed to a local or district health department where an ORV-specific form adapted from the Ohio State Health Department was used to collect uniform information about bait contact.

During the 2003 campaign, Pennsylvania health departments and districts received 105 reports from persons who found 190 baits. This rate of reporting, 6.1 per 100,000

baits, is in the midrange of other published reports (0.12–50 per 100,000 baits) (5,6).

Of the 105 reports, 69 involved persons who picked up or had other skin contact with baits, and 8 reported likely contact with vaccine. Four involved persons who were hit by baits from the air. Seventy reports involved a pet or pets. In 66 reports, the pet was a dog. In 56 reports, a dog picked up the bait in its mouth. Eight of these dogs ate the bait, and another 6 ruptured the plastic sachet.

The only definite human exposure to vaccine occurred when a dog ruptured a bait and contaminated its owner's hands. Seven reports of possible human contact with vaccine involved 10 persons. No documented adverse reactions were associated with any definite or potential human exposures.

Of the 7 reports of possible human vaccine exposures, 3 incidents (4 persons) involved owners who put hands or fingers in a dog's mouth to retrieve a bait, 1 incident involved a dog that licked 2 children right after rupturing the bait, and 2 incidents (3 persons of whom 2 were children) involved picking up a potentially ruptured bait.

The final possible exposure to vaccine involved 1 of 4 persons hit by a bait. This person reported that after being struck, pink liquid spilled out of the bait. The bait was examined by program personnel and appeared to be intact. The other 3 persons (including 1 child) hit by baits did not report vaccine contact or injury.

One uninsured person, who was sent to a hospital emergency room because of potential vaccine exposure to the eye, signed out against medical advice to avoid receiving a bill. This person was seen by a family nurse practitioner 2 weeks later. Results of an examination were normal, and the person refused to have blood drawn for rabies or vaccinia titers.

Eleven children were involved in 9 credible incidents. In addition to the

previously described children, 6 children picked up intact baits. We received 2 noncredible reports: a child with a dog ate a bait and a child licked a bait. In the first case, the child was in a different city at the time the alleged incident occurred, and in the second case, the caller refused to supply any information that could be used to validate the episode.

Posters, brochures, a press conference, and press releases have been used to educate the public to take precautions (for example, wash exposed skin and never remove bait from an animal's mouth) necessary to protect the most vulnerable. Callers were asked questions to determine their ORV awareness. Seventy-nine callers (75%) did not know about ORV activities, and 75 (71%) did not know what the bait was before speaking with us. Those who did know about the program had most often learned about ORV programs through paid radio announcements in neighboring Ohio.

Modifications for 2004 included an increase in media outreach in smaller markets and increased hand baiting. We received fewer reports (51, or 2.9 per 100,000 baits) of persons finding baits in 2004.

#### Acknowledgments

We thank the many dedicated employees of the Allegheny County Health Department, Erie County Department of Health, Pennsylvania Department of Agriculture, Pennsylvania Department of Health, US Centers for Disease Control and Prevention, and the US Department of Agriculture (Animal and Plant Health Inspection Service–Wildlife Services), as well as Renee Groner, Anita Lukacs, Joan McMahon, Karen Martin, David Myers, Joan O'Dair, Doug Range, Bruce Schmucker, Jason Suckow, Craig Swope, and Carol Teacher for their work with the rabies ORV program.

Virginia M. Dato\*  
and Charles Rupprecht†

\*Pennsylvania Department of Health, Pittsburgh, Pennsylvania, USA; and †Centers for Disease Control and Prevention, Atlanta, Georgia, USA

#### References

- Rupprecht CE, Hanlon CA, Slate D. Oral vaccination of wildlife against rabies: opportunities and challenges in prevention and control. *Dev Biol (Basel)*. 2004;119:173–84.
- Hanlon CA, Niezgoda M, Shankar V, Niu HS, Koprowski H, Rupprecht CE. A recombinant vaccinia-rabies virus in the immunocompromised host: oral innocuity, progressive parenteral infection, and therapeutics. *Vaccine*. 1997;15:140–8.
- Rupprecht CE, Hanlon CA, Cummins LB, Koprowski H. Primate responses to a vaccinia-rabies glycoprotein recombinant virus vaccine. *Vaccine*. 1992;10:368–74.
- United States Department of Agriculture, Animal and Plant Health Inspection Service. Monitoring report. Calendar year 2003 for environmental assessment. Oral vaccination to control specific rabies virus variants in raccoons, gray foxes, and coyotes in the United States. Riverdale (MD): The Department; 2003.
- McGuill MW, Kreindel SM, DeMaria A Jr, Robbins AH, Rowell S, Hanlon CA, et al. Human contact with bait containing vaccine for control of rabies in wildlife. *J Am Vet Med Assoc*. 1998;213:1413–7.
- Rupprecht CE, Blass L, Smith K, Orciari LA, Niezgoda M, Whitfield SG, et al. Human infection due to recombinant vacciniarabies glycoprotein virus. *N Engl J Med*. 2001;345:582–6.

Address for correspondence: Virginia M. Dato, Division of Infectious Disease Epidemiology, Bureau of Epidemiology, Pennsylvania Department of Health, Southwest District Office, 514 Pittsburgh State Office Building, 300 Liberty Ave, Pittsburgh, PA 15222, USA; fax: 412-565-7582; email: vdato@state.pa.us



## Salmonella Typhimurium Veterinary Clinic Outbreak

**To the Editor:** The Emerging Infectious Diseases 2004 issue on zoonotic diseases (volume 10, number 12) included a careful and comprehensive description of a *Salmonella enterica* serovar Typhimurium outbreak associated with a veterinary clinic in New York (1). In the outbreak, 2 cats and 1 dog had dental procedures performed, and the 3 owners, 2 clinic technicians, and a friend of an affected owner all contracted with salmonellosis caused by the same strain. An isolate was obtained from an animal, but a source for the *Salmonella* outbreak was not identified.

I get 1 or 2 phone calls each year from veterinarians in Canada regarding recurrent problems of salmonellosis in their clinics, though rarely with human infections. The advice I give the veterinarians, which stops the problem, is to stop using clindamycin as a routine prophylactic agent when carrying out dental procedures. The marked disruption of the colonic anaerobic microflora by oral clindamycin will reduce the number of *Salmonella* organisms required to establish infection to very few. In vet-

erinary journals, advertising for clindamycin focuses on its use in prophylaxis of infections after dental procedures such as cleaning, scaling, and extractions. Veterinary practitioners typically respond to my advice with initial disbelief because it challenges use of a procedure that is seen as standard in veterinary practice.

That "all 3 animal patients were treated after the [dental] procedure with a prophylactic course of clindamycin" is the most meaningful factor in this outbreak, but this point was not commented on by the authors. The apparently increasing use in North American dogs and cats of biologically appropriate raw foods diets, in other words raw meat, may be exacerbating the problem since most such diets are contaminated with *Salmonella* spp. (2). In addition, *Clostridium difficile* infection is increasingly recognized as a common cause of diarrhea in dogs (3) and might also develop in some animals treated with clindamycin, just as it does in humans.

A number of antimicrobial drugs are likely to be as effective as clindamycin for dental prophylaxis, if indeed any antimicrobial drug is truly needed, and these are considerably less likely to produce what is probably the side effect described in this report. Moreover, a canine dentistry text states, "Most routine dental cleaning

procedures do not require antibiotic administration. The American Dental Association, the American Academy of Oral Medicine, and the Council on Scientific Affairs advise against the routine use of antibiotics for dental cleaning procedures" (4). The case reported by Cherry et al. probably supports this recommendation.

**John F. Prescott\***

\*University of Guelph, Guelph, Ontario, Canada

### References

1. Cherry B, Burns A, Johnson GS, Pfeiffer H, Dumas N, Barrett D, et al. *Salmonella* Typhimurium outbreak associated with veterinary clinic. *Emerg Infect Dis*. 2004;10:2249-51.
2. Joffe DJ, Schlesinger DP. Preliminary assessment of the risk of *Salmonella* infection in dogs fed raw chicken diets. *Can Vet J*. 2002;43:441-2.
3. Weese JS, Staempfli HR, Prescott JF, Kruth SA, Greenwood SJ, Weese HE. The roles of *Clostridium difficile* and enterotoxigenic *Clostridium perfringens* in diarrhea in dogs. *J Vet Intern Med*. 2001;15:374-8.
4. DuPont GA. Prevention of periodontal disease. Canine dentistry. *Vet Clin North Am Small Anim Pract*. 1998;28:1129-45.

Address for correspondence: John F. Prescott, Department of Pathobiology, University of Guelph, Guelph, Ontario N1G 2W1, Canada; fax: 519-767-0809; email: prescott@uoguelph.ca

The image shows a screenshot of the CDC Emerging Infectious Diseases Journal homepage. The browser window displays the URL <http://www.cdc.gov/eid>. The page content includes a search bar, a navigation menu, and a list of articles under the heading "EMERGING INFECTIOUS DISEASES". A large, stylized graphic with the text "SEARCH EID ONLINE" is overlaid on the right side of the screenshot. Below the screenshot, the URL [www.cdc.gov/eid](http://www.cdc.gov/eid) is printed in a large, bold font.

## Behind the Mask: How the World Survived SARS, the First Epidemic of the 21st Century

Timothy J. Brookes  
and Omar A. Khan

American Public Health  
Association, Washington, DC  
ISBN: 087553046X  
Pages: 262; Price: US \$27.00

Behind the Mask: How the World Survived SARS, the First Epidemic of the Twenty-First Century recounts the outbreak of Severe Acute Respiratory Syndrome (SARS) that swept through much of the world, especially Asia, in 2003. The author does a superb job of telling the reader about what was occurring before SARS appeared, what happened during the outbreak, and what efforts are underway to prevent its return. The author has blended research results and interviews with frontline staff, particularly healthcare providers, into 20 nicely interlaced chapters. The stage for this commentary is a timeline of events, starting November 16, 2002, with the first known case of SARS in Guangdong Province, China, and ending in December 2003–January 2004 with 4 cases of SARS and the slaughtering of ≈10,000 civets in

Guangdong Province. Where possible, the author avoided the use of medical terms and jargon and provides helpful lay translations where their use was unavoidable. As a result, the book is accessible to readers both inside and outside the healthcare arena.

The information presented in the book is, for the most part, current and accurate; different views and beliefs are presented when necessary. There are minor typographical mistakes as well as a few incorrect statements, such as in Chapter 1, page 6, where the author refers to past public health efforts to eradicate viruses. The author states that smallpox virus and poliovirus have both been eradicated and that both are now bioterrorism agents. However, despite tremendous progress through efforts of many governments and public and private entities, poliovirus has yet to be eradicated and is not regarded as a bioterrorism agent at this time.

With regard to SARS, however, the author successfully portrays the human side of the outbreak response—a response heralded as unparalleled by many of the involved officials. Dr Carlo Urbani, the World Health Organization (WHO) physician in Vietnam who worked tirelessly and who was an eventual casualty of SARS, is among the many heroes who are featured in this book. Lesser-known facts, such as the thought processes that led to identifying

SARS, are also provided. For example, before the SARS coronavirus was shown to be the causative agent, the outbreak was thought to be caused by either avian influenza or chlamydia. The reader is made aware of all of the challenges posed by the SARS virus, such as the delay in recognizing that there was an outbreak, the difficulties in diagnosing and reporting the disease and obtaining specimens, the breadth and scope of national and international collaboration and coordination, and not knowing the causative agent.

This book does a nice job of giving readers a flavor of the experiences faced by persons at WHO, persons at the country ministry level, individual healthcare providers, and SARS patients. I highly recommend this book, especially to anyone who was not directly involved in the SARS outbreak response; they too can share the experience of the global community response to a disease that was first recognized in 1 province of China.

Mehran S. Massoudi\*

\*Centers for Disease Control and Prevention, Atlanta, Georgia, USA

Address for correspondence: Mehran S. Massoudi, Centers for Disease Control and Prevention, 1600 Clifton Rd NE, Mailstop K20, Atlanta, Georgia 30333, USA; fax: 770-488-6450; email: MMassoudi@cdc.gov



Search  
past issues  
**EID**  
Online  
[www.cdc.gov/eid](http://www.cdc.gov/eid)



**Jan Brueghel the Elder (1568–1625).** The Entry of the Animals into Noah's Ark (1613) (detail). Oil on panel (54.6 cm × 83.8 cm). The J. Paul Getty Museum, Los Angeles, California, USA (92.P8.82). Courtesy of the J. Paul Getty Museum

## Painting from Life Nature's Unpredictable Menagerie

Polyxeni Potter\*

“On his journeys Bruegel did many views from nature, so it was said of him when he traveled through the Alps that he had swallowed all the mountains and rocks and spat them out again, after his return, onto his canvases and panels, so closely was he able to follow nature here and in his other works” (1). This brilliant legacy, become familial burden, framed the life and work of Jan Brueghel the Elder, Pieter Bruegel’s<sup>1</sup> son, and his sons after him. Always measured against the original, “Peasant” Bruegel, descendants in this legendary family held their own, each making a mark, all painstakingly distinguishing themselves through the choice of subject matter and niceties of style.

Jan Brueghel hardly knew his father. Orphaned soon after his birth in Brussels, he studied with Pieter Goetkind and Gillis van Coninxloo in Antwerp, learned watercolor painting from his grandmother Mayken Verhulst, and flourished under the patronage of great collector Cardinal Federigo Borromeo in Rome and Milan. Although he grew up copying his father’s works, he was influenced little by them or those of his brother, Pieter Brueghel the Younger,

called “Hell” Brueghel for his fiery depictions of afterlife (2).

Art in the Low Countries during the 1600s was dominated by the Brueghel family, who worked in Antwerp amidst political and social change. The spread of humanism affected popular tastes, favoring mythological over religious themes in the visual arts. And with commissions by the church, court, and nobility on the decline, painting specialties (genre, still life, landscape) appealing to patrons of more modest means became popular. The Brueghels so excelled in the new specialties that they created a trend for their generation, a bridge between the technical refinement of Flemish primitive art and the expansive imagination seen later in the work of Peter Paul Rubens and his followers (3).

Jan became known as “Flower” Brueghel, even though he started painting flowers late in his career. Tulips, hyacinths, marigolds, nasturtiums, and sunflowers were as new in Europe as the artistic genre they embellished. With a modern insistence on painting from nature, the artist traveled far to find flora for his lush scenes. Botanical

\*Centers for Disease Control and Prevention, Atlanta, Georgia USA

<sup>1</sup>Spelling without “h” adopted in 1559. Sons maintained “h” in spelling of their names.

specimens of various seasons often appeared together in bucolic Eden-like scenes that earned him another name, "Paradise" Brueghel. As was the custom, figures in his scenes were sometimes painted by other artists. Rubens, a close friend, was a frequent collaborator, as with Madonna in a Wreath of Flowers for which Brueghel painted the iconic wreath. Jan Brueghel II (1601–1678) and Ambrosius Brueghel (1617–1675) continued the tradition of flower still life long after their father's death of cholera in Antwerp.

Jan Brueghel painted on various media, among them copper, an innovation learned during his tenure in Italy and exploited to full advantage in hundreds of paintings. The smoothness of copper allowed the brush to glide on the surface without the interruption or absorption characteristic of wood or canvas surfaces. Close-up forms were painted with visible brushstrokes of thick paint, distant ones with fluid, thinly diluted paint. Even the minutest figures in the artist's tightly structured compositions were distinguishable (4). Meticulous attention to detail and ability to control the brush and create surfaces of exquisite refinement and sheen earned Jan his most common name, "Velvet" Brueghel.

The Entry of Animals into Noah's Ark, on this month's cover, was methodically assembled. The sprawling backdrop was filled with detailed vegetation, for which the artist had become famous and which secured his legacy during his lifetime. The scene teemed with nature's creatures, domestic and wild, from the tiniest to the most imposing, painted from life at Infanta Isabella's menagerie of exotic animals in Brussels (5). Reminiscent of other Jan Brueghel paintings of animals in nature, the tableau reflected the interest and curiosity about natural history sparked by discovery of the New World and its exotic plant and animal life.

Affection and concern for animals were also central to ark lore and its countless interpretations. When biblical balance and harmony broke down and precipitated the flood, animals were invited to the ark, as if world survival

would have been unthinkable without them. Assembled in this unreal scene in their most realistic attire, they seemed unaware of the importance of the occasion. Oblivious to the clouds building in the horizon, many strayed from the shepherded line moving toward the ark in the far distance. Distracted, churlish, and unruly, they seized a moment of human inattention to wander off into mayhem.

Jan Brueghel's rendition of biblical survival seems allegorical of emerging zoonoses. As in this animal-human gathering, in nature, balance and harmony are imperiled by irregularity or unpredictable biological behavior for which no host defenses are immediately available. And like shepherding skills, existing protective mechanisms can be overwhelmed by unexpected turns. Biological and social systems and infrastructures prove inadequate against new agents and modes of transmission and demand new measures and approaches; among them, multisector alliances able to bridge the gap in public health response between recognition and control of new hazards to humans and animals (6,7). Above all, closely following nature, proven to make better art, also makes better defense against emerging diseases.

#### References

1. The great masters. London: Quantum Publishing Ltd.; 2003.
2. The family Van Haelst/Van Aelst. [cited 2005 Oct]. Available from [http://www.euronet.nl/~qim\\_tdm/Van%20Haelst/PCvanAelst.htm](http://www.euronet.nl/~qim_tdm/Van%20Haelst/PCvanAelst.htm)
3. Broos B. The Mauritshuis. London: Scala Publications; 1994.
4. Antwerp artists and the practice of painting on copper. [cited 2005 Oct]. Available from <http://www.cix.co.uk/~neastaugh/Articles/Volume-1/0/0.htm>
5. The entry of the animals into Noah's ark. [cited 2005 Oct]. Available from <http://www.getty.edu/art/collections/objects/o1034.html>
6. Marano N, Arguin P, Papaioanou M, King L. Role of Multisector partnerships in controlling emerging zoonotic diseases. *Emerg Infect Dis.* 2005;11:1813–4.
7. Potter P. "One medicine" for animal and human health. *Emerg Infect Dis.* 2004;10:2269–70.

Address for correspondence: Polyxeni Potter, EID Journal, Centers for Disease Control and Prevention, 1600 Clifton Rd NE, Mailstop D61, Atlanta, GA 30333, USA; fax: 404-371-5449; email: PMP1@cdc.gov

## The Public Health Image Library (PHIL)



The Public Health Image Library (PHIL), Centers for Disease Control and Prevention, contains thousands of public health-related images, including high-resolution (print quality) photographs, illustrations, and videos.

PHIL collections illustrate current events and articles, supply visual content for health promotion brochures, document the effects of disease, and enhance instructional media.

PHIL Images, accessible to PC and Macintosh users, are in the public domain and available without charge.

Visit PHIL at <http://phil.cdc.gov/phil>.



# EMERGING INFECTIOUS DISEASES

## Upcoming Issue

### Special reports on influenza

H5N1 Outbreaks and Enzootic Influenza

Influenza Pandemics of the 20th Century

1918 Influenza: The Mother of All Pandemics

Swine Influenza A Outbreak at Fort Dix, NJ  
(January – February 1976)

Reflections on Influenza in 1976

Influenza Pandemic Periodicity, Virus Recycling,  
and the Art of Risk Assessment

Swine Flu and the Fog of Epidemics

Vaccines and Antiviral Drugs in Pandemic Preparedness

Making Better Influenza Virus Vaccines

Vaccines for Pandemic Influenza

Pandemic Influenza Threat and Preparedness

Influenza and the Origin of the Phillips Collection

Economics of Neuraminidase Inhibitor Stockpiling Strategies

Estimating Influenza Hospitalization among Children

Influenza, Winter Olympiad, 2002

Complete list of articles in the January issue at  
<http://www.cdc.gov/ncidod/eid/upcoming.htm>

### Upcoming Infectious Disease Activities

#### December 5–9, 2005

National Viral Hepatitis Prevention  
Conference

Hyatt Regency Hotel on Capitol Hill  
Washington, DC, USA

<http://www.nvhpc.com>

#### December 10–14, 2005

American Public Health Association  
133rd Annual Meeting and Exposition  
Philadelphia, PA, USA

<http://www.apha.org>

#### December 11–15, 2005

ASTMH 54th Annual Meeting  
Hilton Washington Hotel and Towers  
Washington, DC, USA

Contact: 847-480-9592 or

[astmh@astmh.org](mailto:astmh@astmh.org)

<http://www.astmh.org>

### 2006

#### February 5–9, 2006

13th Conference on Retroviruses  
and Opportunistic Infections  
Colorado Convention Center

Denver, CO, USA

<http://www.retroconference.org>

#### March 16–18, 2006

International Conference on Women  
and Infectious Diseases: Progress in  
Science and Action

Marriott Marquis Hotel

Atlanta, GA, USA

Contact 404-371-5308 or

[omwh@cdc.gov](mailto:omwh@cdc.gov)

<http://www.womenshealthconf.org>

#### March 19–22, 2006

International Conference on  
Emerging Infectious Diseases 2006  
Marriott Marquis Hotel

Atlanta, GA, USA

Contact 202-942-9330 or

[iceid@asmusa.org](mailto:iceid@asmusa.org)

<http://www.iceid.org>

#### March 22–24, 2006

International Symposium on  
Emerging Zoonoses

Medical and Veterinary Partnerships  
To Address Global Challenges

Marriott Marquis Hotel

Atlanta, GA, USA

Contact 202-942-3-9330

<http://www.isezconference.org>

# EMERGING INFECTIOUS DISEASES

EID  
Online  
www.cdc.gov/eid

A Peer-Reviewed Journal Tracking and Analyzing Disease Trends

Vol.11, No.11, November 2005

Avian Influenza

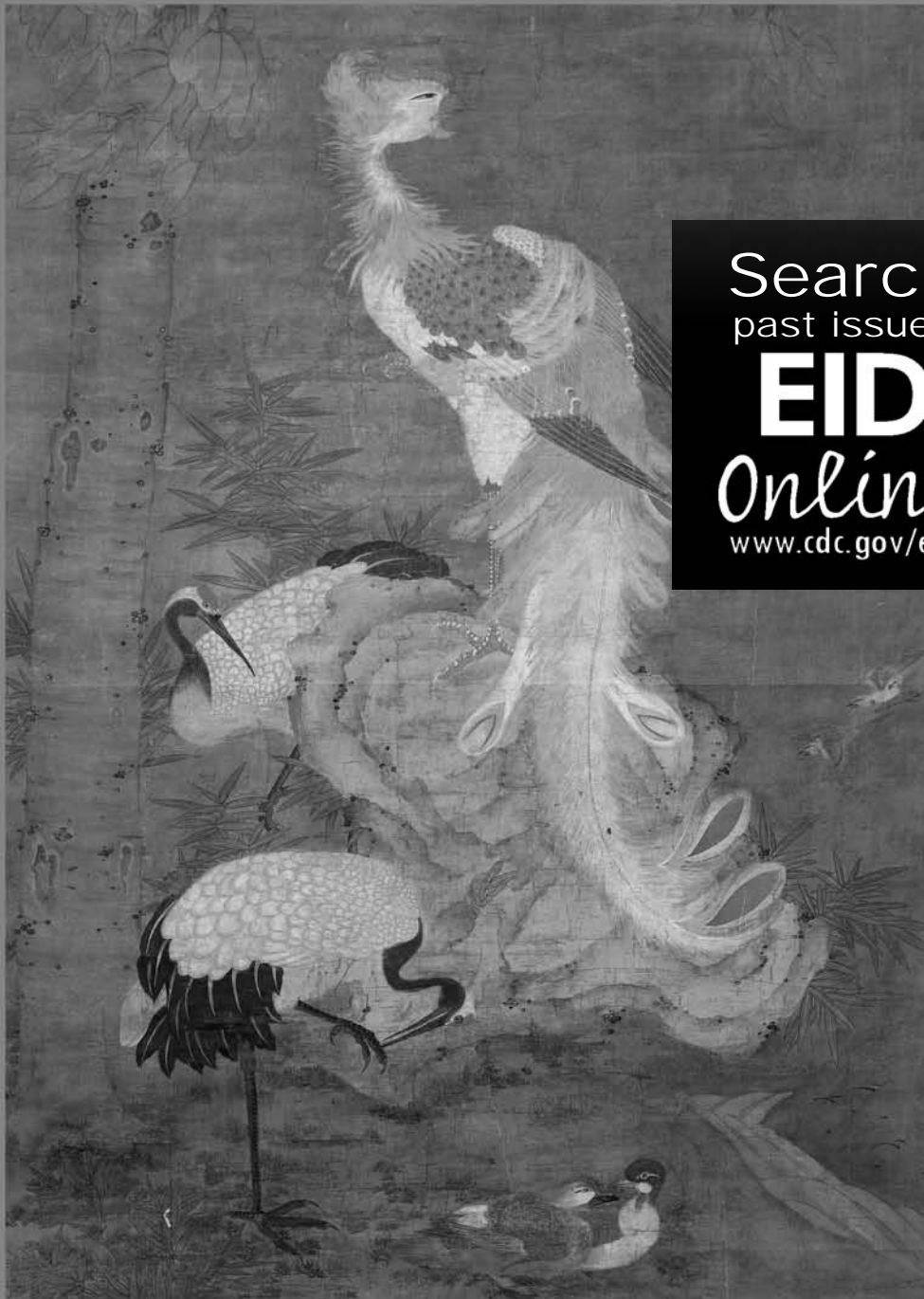

Search  
past issues

**EID**  
Online  
www.cdc.gov/eid



## Editorial Policy and Call for Articles

Emerging Infectious Diseases is a peer-reviewed journal established expressly to promote the recognition of new and reemerging infectious diseases around the world and improve the understanding of factors involved in disease emergence, prevention, and elimination.

The journal is intended for professionals in infectious diseases and related sciences. We welcome contributions from infectious disease specialists in academia, industry, clinical practice, and public health, as well as from specialists in economics, social sciences, and other disciplines. Manuscripts in all categories should explain the contents in public health terms. For information on manuscript categories and suitability of proposed articles see below and visit <http://www.cdc.gov/eid/ncidod/EID/instruct.htm>.

Emerging Infectious Diseases is published in English. To expedite publication, we post articles online ahead of print. Partial translations of the journal are available in Japanese (print only), Chinese, French, and Spanish (<http://www.cdc.gov/eid/ncidod/EID/trans.htm>).

## Instructions to Authors

**Manuscript Preparation.** For word processing, use MS Word. Begin each of the following sections on a new page and in this order: title page, keywords, abstract, text, acknowledgments, biographical sketch, references, tables, figure legends, appendixes, and figures. Each figure should be in a separate file.

**Title Page.** Give complete information about each author (i.e., full name, graduate degree(s), affiliation, and the name of the institution in which the work was done). Clearly identify the corresponding author and provide that author's mailing address (include phone number, fax number, and email address). Include separate word counts for abstract and text.

**Keywords.** Include up to 10 keywords; use terms listed in Medical Subject Headings Index Medicus.

**Text.** Double-space everything, including the title page, abstract, references, tables, and figure legends. Indent paragraphs; leave no extra space between paragraphs. After a period, leave only one space before beginning the next sentence. Use 12-point Times New Roman font and format with ragged right margins (left align). Italicize (rather than underline) scientific names when needed.

**Biographical Sketch.** Include a short biographical sketch of the first author—both authors if only two. Include affiliations and the author's primary research interests.

**References.** Follow Uniform Requirements ([www.icmje.org/index.html](http://www.icmje.org/index.html)). Do not use endnotes for references. Place reference numbers in parentheses, not superscripts. Number citations in order of appearance (including in text, figures, and tables). Cite personal communications, unpublished data, and manuscripts in preparation or submitted for publication in parentheses in text.

Consult List of Journals Indexed in Index Medicus for accepted journal abbreviations; if a journal is not listed, spell out the journal title. List the first six authors followed by "et al." Do not cite references in the abstract.

**Tables and Figures.** Create tables within MS Word's table tool. Do not format tables as columns or tabs. Send graphics in native, high-resolution (200 dpi minimum) .TIF (Tagged Image File), or .EPS (Encapsulated Postscript) format. Graphics should be in a separate electronic file from the text file. For graphic files, use Arial font. Convert Macintosh files into the suggested PC format. Figures, symbols, letters, and numbers should be large enough to remain legible when reduced. Place figure keys within the figure. For more information see EID Style Guide ([http://www.cdc.gov/ncidod/EID/style\\_guide.htm](http://www.cdc.gov/ncidod/EID/style_guide.htm)).

**Manuscript Submission.** Include a cover letter indicating the proposed category of the article (e.g., Research, Dispatch) and verifying that the final manuscript has been seen and approved by all authors. Complete provided Authors Checklist. To submit a manuscript, access Manuscript Central from the Emerging Infectious Diseases web page ([www.cdc.gov/eid](http://www.cdc.gov/eid)).

## Types of Articles

**Perspectives.** Articles should be under 3,500 words and should include references, not to exceed 40. Use of subheadings in the main body of the text is recommended. Photographs and illustrations are encouraged. Provide a short abstract (150 words), a one-sentence summary of the conclusions, and a brief biographical sketch of first author. Articles in this section should provide insightful analysis and commentary about new and reemerging infectious diseases and related issues. Perspectives may also address factors known to influence the emergence of diseases, including microbial adaptation and change, human demographics and behavior, technology and industry, economic development and land use, international travel and commerce, and the breakdown of public health measures. If detailed methods are included, a separate section on experimental procedures should immediately follow the body of the text.

**Synopses.** Articles should be under 3,500 words and should include references, not to exceed 40. Use of subheadings in the main body of the text is recommended. Photographs and illustrations are encouraged. Provide a short abstract (150 words), a one-sentence summary of the conclusions, and a brief biographical sketch of first author—both authors if only 2. This section comprises concise reviews of infectious diseases or closely related topics. Preference is given to reviews of new and emerging diseases; however, timely updates of other diseases or topics are also welcome. If detailed methods are included, a separate section on experimental procedures should immediately follow the body of the text.

**Research Studies.** Articles should be under 3,500 words and should include references, not to exceed 40. Use of subheadings in the main body of the text is recommended. Photographs and illustrations are encouraged. Provide a short abstract (150 words), a one-sentence summary, and a brief biographical sketch of first author—both authors if only 2. Report laboratory and epidemiologic results within a public health perspective. Explain the value of the research in public health terms and place the

findings in a larger perspective (i.e., "Here is what we found, and here is what the findings mean").

**Policy and Historical Reviews.** Articles should be under 3,500 words and should include references, not to exceed 40. Use of subheadings in the main body of the text is recommended. Photographs and illustrations are encouraged. Provide a short abstract (150 words), a one-sentence summary of the conclusions, and brief biographical sketch. Articles in this section include public health policy or historical reports that are based on research and analysis of emerging disease issues.

**Dispatches.** Articles should be no more than 1,200 words and need not be divided into sections. If subheadings are used, they should be general, e.g., "The Study" and "Conclusions." Provide a brief abstract (50 words); references (not to exceed 15); figures or illustrations (not to exceed 2); tables (not to exceed 2); and a brief biographical sketch of first author—both authors if only 2. Dispatches are updates on infectious disease trends and research. The articles include descriptions of new methods for detecting, characterizing, or subtyping new or reemerging pathogens. Developments in antimicrobial drugs, vaccines, or infectious disease prevention or elimination programs are appropriate. Case reports are also welcome.

**Commentaries.** Thoughtful discussions (500–1,000 words) of current topics. Commentaries may contain references but no figures or tables.

**Another Dimension.** Thoughtful essays, short stories, or poems on philosophical issues related to science, medical practice, and human health. Topics may include science and the human condition, the unanticipated side of epidemic investigations, or how people perceive and cope with infection and illness. This section is intended to evoke compassion for human suffering and to expand the science reader's literary scope. Manuscripts are selected for publication as much for their content (the experiences they describe) as for their literary merit.

**Letters.** Letters commenting on recent articles as well as letters reporting cases, outbreaks, or original research are welcome. Letters commenting on articles should contain no more than 300 words and 5 references; they are more likely to be published if submitted within 4 weeks of the original article's publication. Letters reporting cases, outbreaks, or original research should contain no more than 800 words and 10 references. They may have 1 figure or table and should not be divided into sections. All letters should contain material not previously published and include a word count.

**Book Reviews.** Short reviews (250–500 words) of recently published books on emerging disease issues are welcome. The name of the book, publisher, and number of pages should be included.

**Announcements.** We welcome brief announcements (50–150 words) of timely events of interest to our readers. (Announcements may be posted on the journal Web page only, depending on the event date.)

**Conference Summaries.** Summaries of emerging infectious disease conference activities are published online only. Summaries, which should contain 500–1,000 words, should focus on content rather than process and may provide illustrations, references, and links to full reports of conference activities.