



**RI** 9655

---

REPORT OF INVESTIGATIONS/2001

---

# **Geomechanics of Reinforced Cemented Backfill in an Underground Stope at the Lucky Friday Mine, Mullan, Idaho**

**Department of Health and Human Services**  
Centers for Disease Control and Prevention  
National Institute for Occupational Safety and Health



**Report of Investigations 9655**

**Geomechanics of Reinforced Cemented Backfill  
in an Underhand Stope at the Lucky Friday Mine,  
Mullan, Idaho**

**T.J. Williams, D.K. Denton, M.K. Larson, R.L. Rains, J.B. Seymour, and  
D.R. Tesarik**

U.S. DEPARTMENT OF HEALTH AND HUMAN SERVICES  
Public Health Service  
Centers for Disease Control and Prevention  
National Institute for Occupational Safety and Health  
Pittsburgh Research Laboratory  
Pittsburgh, PA

July 2001

## ORDERING INFORMATION

Copies of National Institute for Occupational Safety and Health (NIOSH)  
documents and information  
about occupational safety and health are available from

NIOSH–Publications Dissemination  
4676 Columbia Parkway  
Cincinnati, OH 45226-1998

FAX: 513-533-8573  
Telephone: 1-800-35-NIOSH  
(1-800-356-4674)  
E-mail: [pubstaft@cdc.gov](mailto:pubstaft@cdc.gov)  
Web site: [www.cdc.gov/niosh](http://www.cdc.gov/niosh)

*This document is the public domain and may be freely copied or reprinted.*

---

Disclaimer: Mention of any company or product does not constitute endorsement by NIOSH.

## CONTENTS

Page

Abstract .....	1
Introduction .....	2
Mining method .....	2
Description and placement of instruments .....	3
Mining and monitoring procedures .....	6
In-mine observations and data analysis .....	8
Closure readings .....	8
Tests of cemented backfill specimens .....	9
Backfill pressure readings .....	11
Instrumented rock bolts .....	11
Rock bolt load cells .....	12
Backfill temperature .....	13
Truss loads .....	13
Conclusions .....	16
Acknowledgments .....	16
References .....	16
Appendix A: Results of unconfined compression tests of backfill .....	18

## ILLUSTRATIONS

1. Location of Lucky Friday Mine, Coeur d'Alene Mining District, Idaho .....	2
2. Intersection truss system .....	3
3. Rock bolts instrumented with load cells .....	4
4. Wall closure instrument locations .....	5
5. Location of instruments in 5660-05-level intersection .....	6
6. Longitudinal projection of Lucky Friday Mine .....	7
7. Cut sequence for 5660 and 5750 sublevels showing location of instrumented intersection .....	8
8. Gap and backfill closure versus time .....	9
9. Thrust-fault-type fill failure, November 4, 1997 .....	9
10. Backfill closure as a function of time .....	10
11. Compressive test of cemented sandfill, stress/strain curve .....	10
12. Backfill closure versus backfill pressure, West 2 .....	11
13. Calibration curve showing relationship between frequency and load on instrumented rock bolts .....	12
14. Backfill closure versus rock bolt load, East 2 .....	12
15. Closure sequence in backfill .....	14
16. Temperatures recorded on rock bolts in backfill and in mine atmosphere .....	15
17. Load cells at truss four-way bracket .....	15
18. Backfill failure at four-way bracket .....	15
19. Data from instrumented bolts in truss .....	15

## TABLES

1. Original stope width .....	9
2. Closure readings .....	10
3. Loads on instrumented bolts and load cells for three cuts of mining .....	12
4. Load readings on trusses and rock bolts during intersection failure .....	16

## UNIT OF MEASURE ABBREVIATIONS USED IN THIS REPORT

cm	centimeter	ft	foot
hr	hour	in	inch
Hz	hertz	lb	pound
kg	kilogram	psi	pound per square inch
km	kilometer	°F	degree Fahrenheit
kN	kilonewton		
kPa	kilopascal	°	degree
MPa	megapascal	%	percent
m	meter		
N	newton		
°C	degree Celsius		

# GEOMECHANICS OF REINFORCED CEMENTED BACKFILL IN AN UNDERHAND STOPE AT THE LUCKY FRIDAY MINE, MULLAN, IDAHO

By T.J. Williams,<sup>1</sup> D.K. Denton,<sup>1</sup> M.K. Larson,<sup>1</sup> R.L. Rains,<sup>2</sup> J.B. Seymour,<sup>1</sup> and D.R. Tesarik<sup>3</sup>

---

## ABSTRACT

Because backfill has occasionally collapsed into an active working area, posing a hazard to miners, engineers from the Spokane Research Laboratory of the National Institute for Occupational Safety and Health and Hecla Mining Co. installed instruments in a cemented, backfilled, stope-ramp intersection at Hecla's Lucky Friday Mine, Mullan, ID. The purpose was to measure stress and strain changes in the backfill and reinforcing members during undercut mining. The instruments were monitored for 6 months while three successive cuts were mined below the intersection. Readings showed induced loads up to 3450 kPa (500 psi) in the backfill as stope walls converged 2.5 to 12 cm (1 to 5 in). The backfill then deformed against the top and bottom plates of the 2-m- (6-ft-) long vertical rock bolts installed as reinforcement, producing loads to 177 kN (40,000 lb) on the rock bolts.

We hypothesize that a compressive zone was created in the backfill that allowed the backfill to remain stable as long as the compressive zones from adjacent rock bolts overlapped. This hypothesis is presented in graphical form.

Of particular interest was the effect of loading on trusses installed to augment the vertical rock bolts and wire mesh typically installed in backfill. Data from the instruments indicate that wall closure perpendicular to the vein induced loads in truss legs parallel to the vein and in the rock bolt driven through the center of the truss, but, because they are designed to function under tension, truss legs perpendicular to the vein supplied insignificant support as a result of compressional forces from wall closure. Based on this study, use of trusses was discontinued, and an alternative support system of wood beams and posts was installed as needed to ensure the safety of miners working beneath the backfill in stope-ramp intersections.

---

<sup>1</sup>Mining engineer.

<sup>2</sup>Geologist.

<sup>3</sup>Mechanical engineer, Spokane Research Laboratory, National Institute for Occupational Safety and Health, Spokane, WA.

## INTRODUCTION

Mining-induced wall closure in cemented, backfilled underhand stopes at Hecla Mining Co.'s Lucky Friday Mine in Mullan, ID, can cause the backfill to fracture. These fractures generally do not pose a hazard to miners working in the stopes beneath the backfill because any broken material is contained by wire mesh and Dywidag<sup>4</sup> rock bolts used for backfill reinforcement. Still, some collapses of backfill have occurred in stope-ramp intersections as the backfill was undercut.

Options for improving miner safety while miners are working under backfill include placement of a layer of low-modulus backfill above a reinforced cemented sill, installation of deformable plastic sheets along the centerline of the stope (Fredericksen et al. 1993; Krauland and Stille 1993), or placement of additional support to reinforce the backfill. The latter option was chosen by Hecla, and in addition to vertical rock bolts, trusses manufactured by Western Support Systems, Salt Lake City, UT, were installed in the four-way ramp-stope intersections.

To monitor the effectiveness of the trusses and to compare stresses in the truss-supported backfill with stresses previously recorded in stopes without truss systems, engineers from the Spokane Research Laboratory (SRL) of the National Institute for Occupational Safety and Health (NIOSH) and Hecla Mining Co. mounted instruments on both bolts and trusses. The instruments included vibrating-wire strain gauges and load cells on the rock bolts and the legs of the trusses, earth pressure cells in the cemented backfill, and string potentiometers across the stopes. Redundancy was designed into the instrumentation plan to overcome known instrument survival problems associated with deformation of the fill and to provide sufficient data to interpret the interaction of the individual support components.

In addition, cylinders of wet backfill material were collected during filling of the instrumented stope. The cylinders were cured in a room where humidity and temperature were controlled. They were then tested for 7- and 28-day unconfined compressive and splitting tensile strengths.

## MINING METHOD

The Lucky Friday Mine (figure 1) uses a mechanized underhand cut-and-fill mining method to mine lead-silver ore from a steeply dipping, 2.4-m- (8-ft-) wide vein at a depth exceeding 1.6 km (1 mile) (Scott 1990). In the underhand mining method, the mined-out stope is backfilled with reinforced, cemented mill tailings following each cut, which provides a safe stope back or roof for the following cut. Approximately 10% cement by weight is added to the mill tailings to strengthen the backfill rapidly so that mining of the following cut can resume under the backfill without a long wait. This amount of cement has been selected after years of experience in balancing miner safety, cost of the cement, and the need to start mining the following cut soon after backfill placement.

Approximately 70% of the stope height is backfilled, leaving a 1-m (3-ft) gap between the bottom of the previous fill and the top of the new fill. The backfill is delivered from the surface in a pastelike consistency, which lowers water content, thereby increasing the final strength of the backfill (Brackebusch 1994). Backfill reinforcement consists of 2- or 2.4-m- (6- or 8-ft-) long Dywidag rock bolts driven vertically on 1.2-m (4-ft) centers into loose muck on the floor. When the end of the rock bolt driven into the loose muck is exposed during mining of the following cut, chain link fencing, a bearing plate, and a nut are installed for ground support.<sup>5</sup> The high horizontal in situ stresses at the Lucky Friday Mine (Whyatt and Beus 1995; Whyatt et al. 1995) result in rapid closure of the wall rock in the mined-out portion

of the vein, and this wall closure is the main factor affecting the stability of the backfill.

Each mining cut is 3.3 m (11 ft) high and 2 to 3 m (6 to 10 ft) wide and extends approximately 75 m (250 ft) along the vein to each side of an access ramp (slot). The broken ore is stored in a muck bay on the opposite side of the vein from the access slot. This creates a four-way intersection. Thus the backfill may span a distance of up to 9 m (30 ft) diagonally.

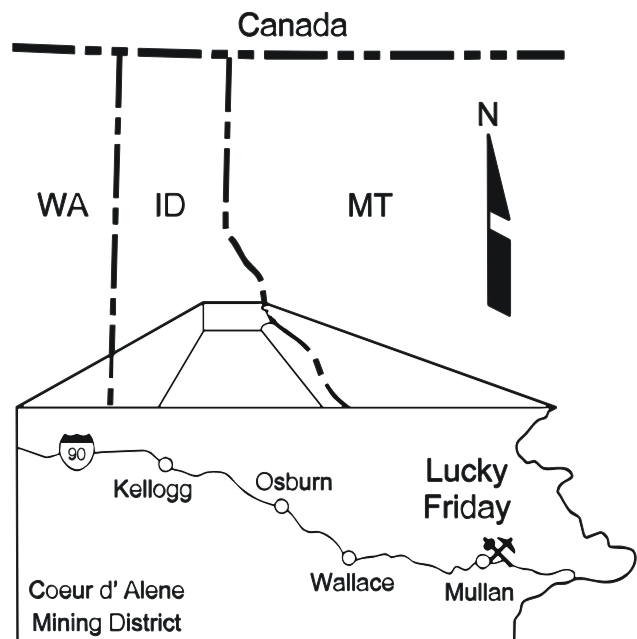

Figure 1.—Location of Lucky Friday Mine, Coeur d'Alene Mining District, Idaho.

<sup>4</sup>Mention of specific products and manufacturers does not imply endorsement by the National Institute for Occupational Safety and Health.

<sup>5</sup>The Garpenberg Mine in Sweden (Krauland and Stille 1993) and the Henty Mine in Western Tasmania, Australia (Henderson et al. 1998), use similar reinforcement with their undercut-and-fill mining methods.

## DESCRIPTION AND PLACEMENT OF INSTRUMENTS

Although stope wall closure and fill pressure had been monitored previously at the mine (Williams et al. 1992; Hedley 1993), loads on backfill reinforcement had not been. Thus, the instrumentation plan was designed to determine closure of the backfilled mine openings, pressure in the backfill, strength of the backfill, and induced loads on the truss and rock bolts placed in the backfill. Because support is provided by mechanical interaction among these elements, a complete evaluation of the engineering parameters of each element was needed to determine how the whole system functioned. Failures of the instruments from deformation and breakup of the backfill were anticipated; therefore, redundant systems were used.

A four-way truss was installed at the center of the intersection in addition to the vertical rock bolts typically used as reinforcement. The truss was constructed using No. 7 Dywidag rock bolts having a minimum yield strength of 160 kN (36,000 lb). It consisted of one vertical rock bolt, four legs angled 15° to 20° from the horizontal, one four-way horn bracket, and four stirrup U-bolts bent upward at 25° from the horizontal. The horizontal legs consisted of two or three rock bolts joined together with couplings so that the ends of the legs lay outside the intersection into the east and west sides of the stope along the vein and into the slot and the muck bay (figure 2).

Instrumented No. 7 Dywidag rock bolts were obtained from Roctest, Plattsburgh, NY, to measure induced load on the rock bolts used for backfill reinforcement. Roctest installed a vibrating-wire strain gauge and thermister in one end of each rock bolt. These instrumented rock bolts were placed at the ends of all the truss legs. They were also used to replace some of the vertical rock bolts throughout the stope. All instrumented

rock bolts were installed so that the instrumented end was in the backfill to protect the instruments from blasting as the next cut was mined.

ALC10 rock bolt load cells were also obtained from Roctest to provide redundant readings on the vertical rock bolts and the truss. Load cells were the only instruments that could be used to obtain load readings at the junction of the stirrup and the horizontal legs at the truss bracket because blasting at this location would have destroyed the instrumented rock bolt wires. The load cells were installed on the lower end of instrumented rock bolts (figure 3) and on the truss legs after mining had passed. The load cells survived better than the instrumented rock bolts because the wires were not subjected to backfill deformation.

At various locations, wall-to-wall closure was measured in three different vertical positions (figure 4). A closure plane in the 1-m (3-ft) gap above the backfill was measured with string potentiometers. Another closure plane across the backfill was measured with string potentiometers inside collapsible steel casings, and a closure plane in the new stope cut was measured with a tape extensometer. All closure readings were taken between 15- by 15-cm (6- by 6-in) bearing plates on 1.2-m- (4-ft-) long rock bolts to achieve as much accuracy as possible.

Compressional loads in the backfill were measured with 690 kPa, 23-cm- (1000 psi, 9-in-) diam Model 3500 earth pressure cells from Geokon, Inc., Lebanon, NH. Each earth pressure cell had a backfill wall closure instrument, a gap wall closure instrument, and an instrumented vertical rock bolt installed at the same location.

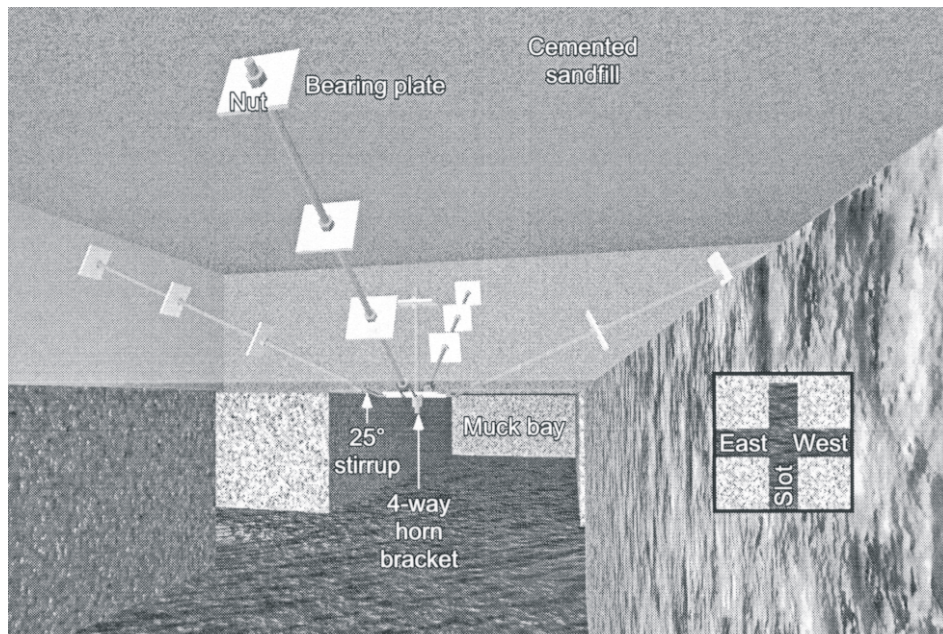

Figure 2.—Intersection truss system.



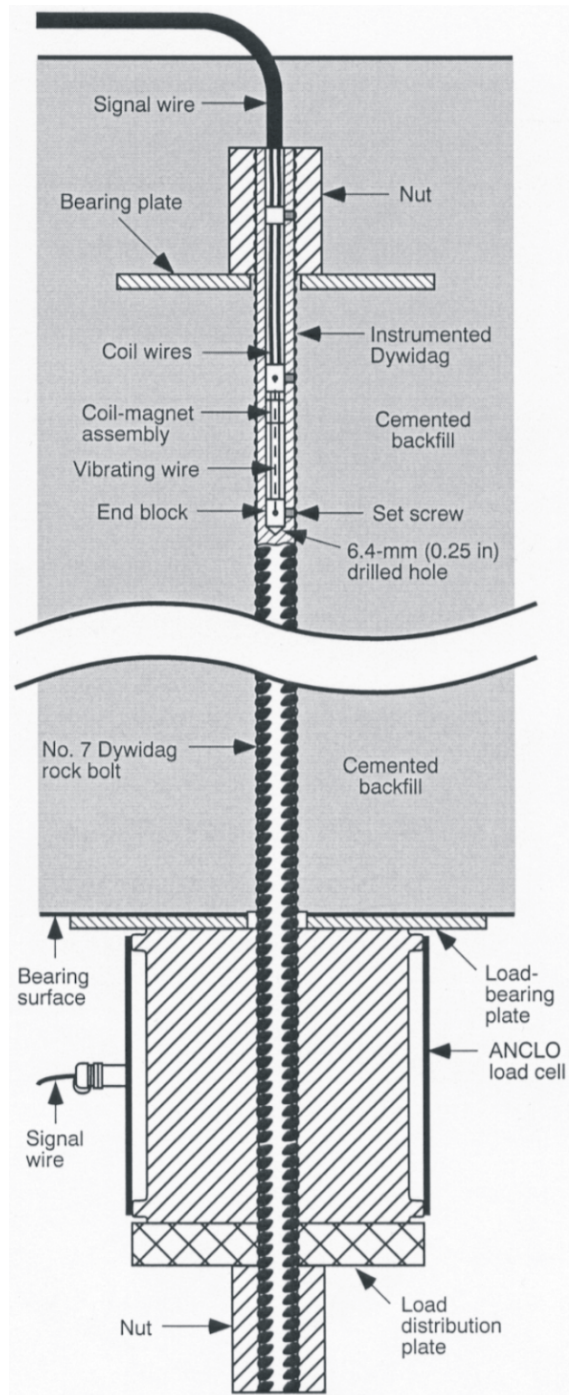

Figure 3.—Rock bolts instrumented with load cells.

Figure 5 shows the location and types of instruments installed in the intersection.

A CR10 datalogger manufactured by Campbell Scientific, Inc., Logan, UT, was chosen because of its ability to record information from a number of instrument types (Seymour et al.

1998; Larson et al. 1995; Larson and Maleki 1996), including vibrating-wire strain gauges and thermistors, load cells, pressure transducers, and voltage potentiometers. An Excel spreadsheet was used for data analysis.

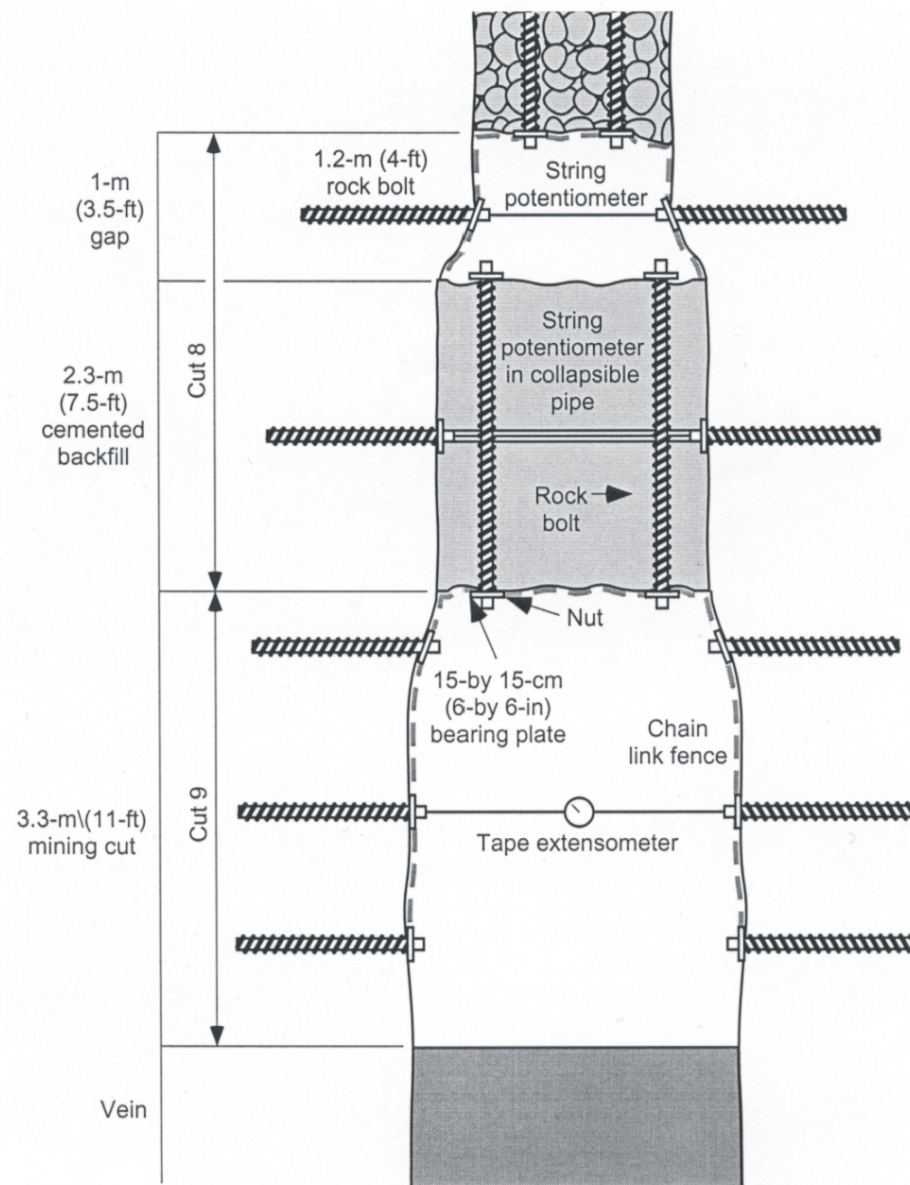

Figure 4.—Wall closure instrument locations.

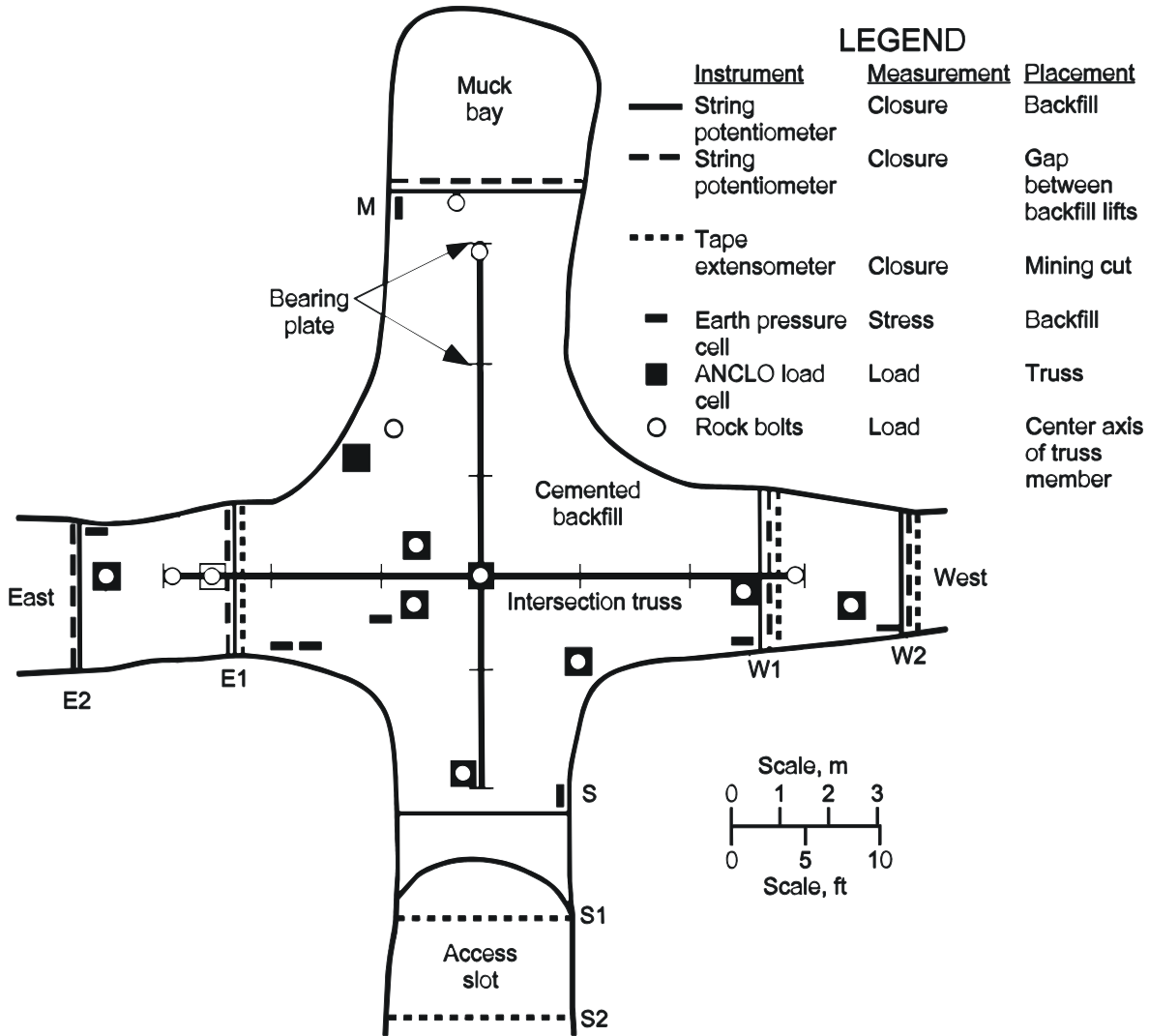

Figure 5.—Location of instruments in 5660-05-level intersection.

## MINING AND MONITORING PROCEDURES

After the instruments were calibrated at SRL, they were installed in the mined-out cut 8 of the 5660-05 stope prior to placement of the backfill. Figure 6 is a longitudinal projection of the Lucky Friday Mine with the test stope location shown in the lower west corner. Figure 7 is an expanded view showing the cut sequence for the 5660 and 5750 sublevels and the location of the instrument site. On October 15, 1997, the intersection was backfilled with 2.3 m (7.5 ft) of cemented mill tailings so that the truss legs were completely covered. Because the stope was only filled for 2.3 m (7.5 ft) of its 3.3-m (11-ft) height, additional string potentiometers were installed wall-to-wall in the gap on October 16. The datalogger was then moved

to a position in the gap between the fills so it would not be damaged by blasting during mining of cut 9.

The instruments were initially monitored hourly, then every 2 hr, and by the end of the project, every 12 hr. The monitoring rate was changed to lengthen the time the system would operate without having to retrieve the data storage canister.

Mining the next cut (5660-05 stope, cut 9) began by blasting the bottom of the cut 8 ramp on October 20. The load cells were installed on the exposed ends of the rock bolts on October 29 after mining had proceeded far enough so that the instrument wires would not be damaged by blasting. The mine installed a 3-m- (10-ft-) long cap across the west side of the intersection in

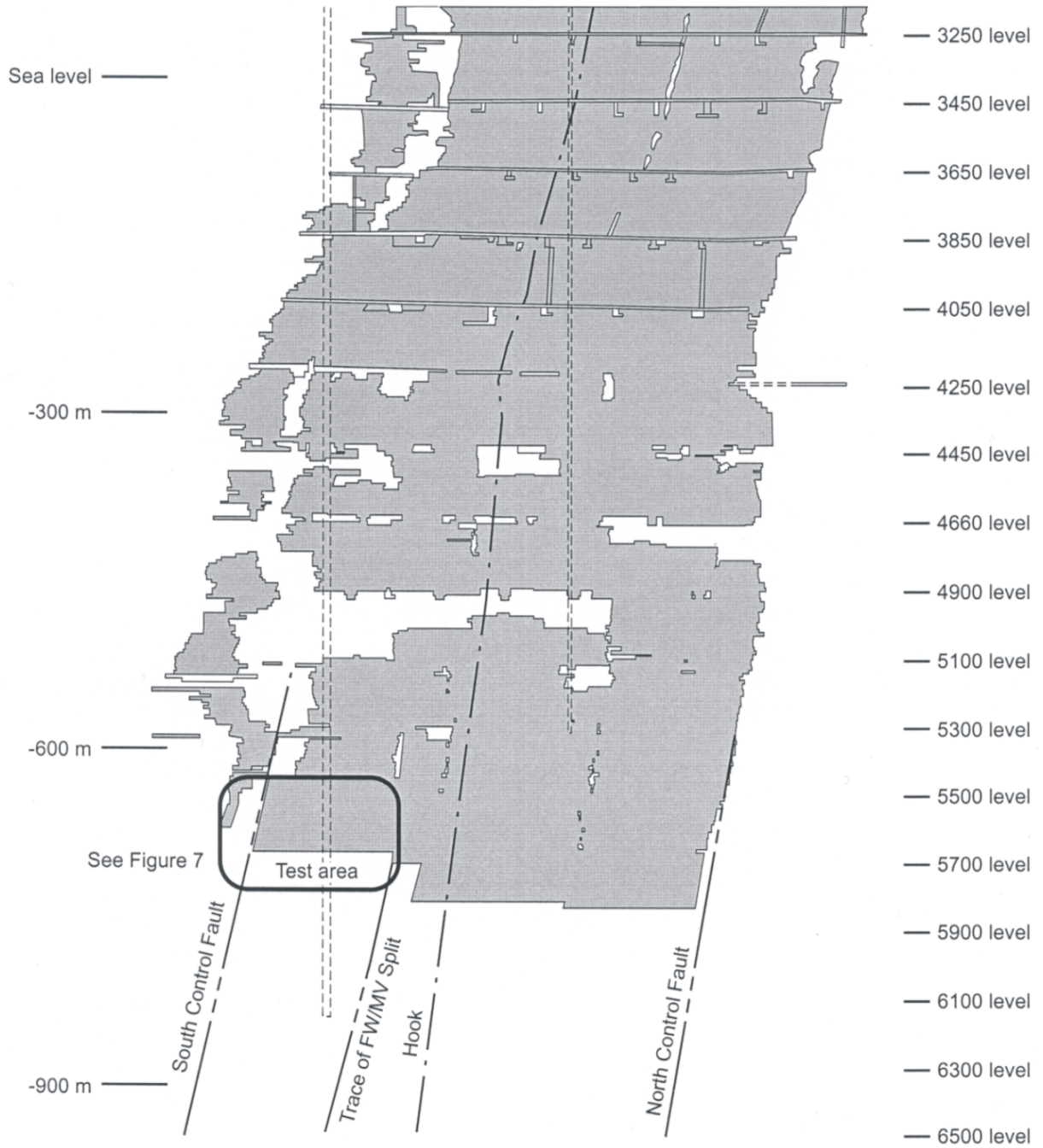

Figure 6.—Longitudinal projection of Lucky Friday Mine.



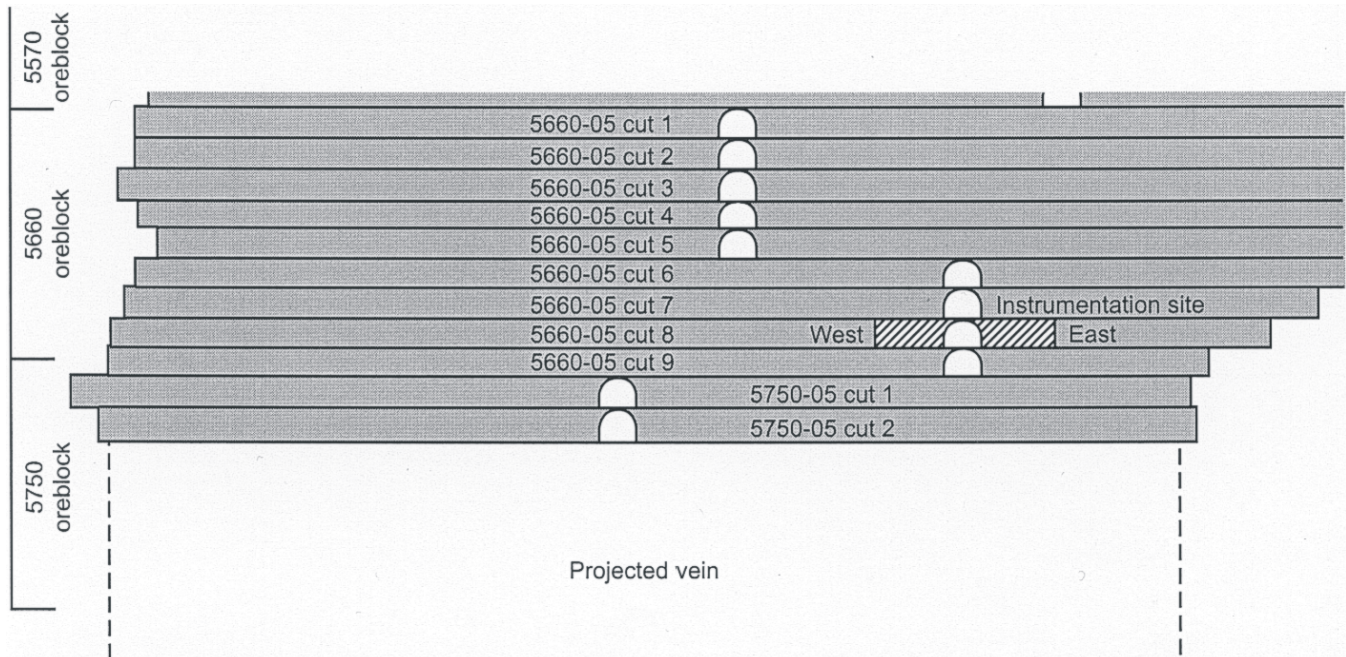

Figure 7.—Cut sequence for 5660 and 5750 sublevels showing location of instrumented intersection.

cut 9 to protect miners from a possible fill collapse following the collapse of a 3-m (10-ft) section of the wall in the northwest intersection corner that exposed 1.5 m (5 ft) of the side of the fill. This was 3.7 m (12 ft) from the West 1 instrument location, so the collapse did not affect instrument readings. Later, another cap was installed across the muck bay side of the intersection when a crack in the backfill was noticed there. Monitoring the instruments continued to April 2, 1998, during mining of three successive cuts below the instrumented backfill location.

Changes in the truss leg readings on March 1, 1998, indicated that the intersection had failed. Visual inspection revealed that the northwest corner of the intersection had collapsed on to the top of the cut 9 fill in the same area where the stope wall had failed during mining of cut 9. At this time, the active mining face was 9 m (30 ft) below with two backfill horizons between it and the failed backfill, so the failure posed no hazard to the miners.

## IN-MINE OBSERVATIONS AND DATA ANALYSIS

### CLOSURE READINGS

Stope wall closure readings were taken in the mining cut, across the backfill, and in the gap above the backfill between rock bolts to determine horizontal convergence of the stope walls as mining progressed. The closure instruments showed that the walls of the slot and vein were converging, but that the walls of the muck bay were not moving.

String pots placed in the backfill showed the vein walls had converged an average of 7.9 cm (3.1 in) during mining of cut 9 on the 5660 level, 8.9 cm (3.5 in) during mining of cut 1 on the 5750 level, and 8.0 cm (3.2 in) during mining of cut 2 on the 5750 level. At the same time, vein closure measured by string pots in the gap area averaged 14.0 cm (5.5 in) for cut 9 on the 5660 level, 11.5 cm (4.5 in) for cut 1 on the 5750 level, and 9.7 cm (3.8 in) for cut 2 on the 5750 level. Increased amounts of closure across the gap were caused by a lack of support for the walls in this area. Gap closure also began 1 or more days

before closure in the backfill (figure 8), a further indication that the backfill was supplying wall support. The amount of overall wall closure would probably be the same, but the backfill supplied enough support so that fractures in the stope walls closed before the backfill started to yield. There were no borehole closure extensometers in the walls, so this hypothesis could not be confirmed.

In the active mining area, a tape extensometer recorded an average of 9.4 cm (3.7 in) of convergence across the vein and 7.6 cm (3.0 in) across the slot. Closure measurements in the active mining area began after mining was at least 9 m (30 ft) past the instrument locations; therefore, these measurements do not represent total closure related to mining of this cut.

A thrust-fault-type of fracture (figure 9) was noticed at the top of the backfill while retrieving the CR10's data canister on November 4, 1997. The failure went across the intersection and into the east and west headings along the vein. Both 2- and 2.4-m- (6- and 8-ft-) long vertical rock bolts had been placed in

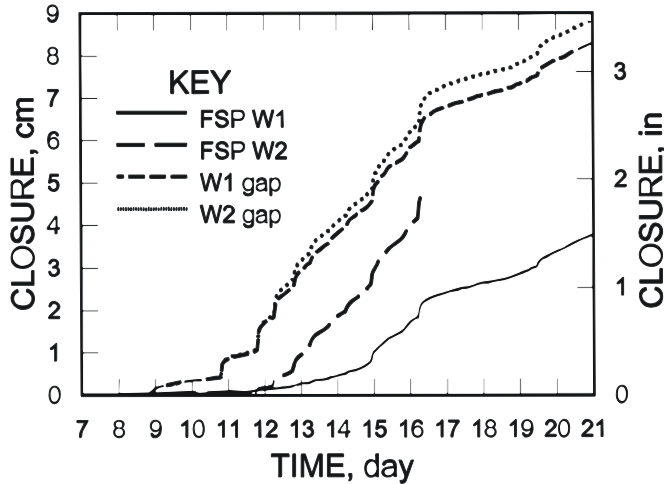

Figure 8.—Gap and backfill closure versus time.



Figure 9.—Thrust-fault-type failure, November 4, 1997.

the area. Failure appeared to be above the 2-m (6-ft) rock bolts, but blocked by the 2.4-m (8-ft) rock bolts, the ends of which were just visible at the top of the fill.

This failure was caused by convergence of the vein walls on the backfill. At this time, there had been 2.5 to 7.6 cm (1 to 3 in) of horizontal closure across the vein in the backfill and 7.6 to 15 cm (3 to 6 in) in the gap above the instrumented backfill.

Fracturing of the backfill caused upward buckling that gradually reduced the gap between the backfills over time. Buckling continued until the initial 1-m (3.5-ft) vertical gap was reduced to less than 0.3 m (1 ft) before the backfill from cut 7 collapsed onto the instrumented cut 8 backfill. Table 1 is a summary of original stope widths, and table 2 shows closure readings for the three mining cuts. Figure 10 shows backfill closure as a function of time for three mining cuts. Total closure includes

some rapid closure as the cut was mined past the instruments and more gradual time-dependent closure resulting from all previous mining in the area.

Table 1.—Original stope widths.

Location	m	in
West 1	34.5	136
West 2	25.4	100
East 1	27.4	108
East 2	36.6	144
Muck bay	39.6	156
Slot 2	30.0	118
West 1	52.1	205
West 2	35.6	140
East 1	37.1	146

**TESTS OF CEMENTED BACKFILL SPECIMENS**

At the time the stope was backfilled, samples of the fill were collected for compressive and tensile strength tests. The 7-day unconfined compressive strengths ranged from 1703 to 2744 kPa (247 to 398 psi), with an average of 2082 kPa (302 psi), while 28-day unconfined compressive strengths ranged from 2654 to 3902 kPa (385 to 566 psi) and averaged 3254 kPa (472 psi). The laboratory tests agreed with the 2757-kPa (400-psi) ultimate strength recorded across the vein at approximately 15 days.

Movement of the platen head of the compression test machine was also recorded to determine an apparent modulus for the 7- and 28-day compressive tests. Figure 11 is an example of the stress-strain curve for the tests. The modulus for the samples is calculated between the 20% and 50% strength values because this is the straight line portion of the curve and most representative of the true response of the backfill. The equation used is —

$$20-50 \text{ modulus} = (50\% \text{ strength} - 20\% \text{ strength}) \div (50\% \text{ strain} - 20\% \text{ strain}).$$

The five samples tested at 7 days had a range of apparent modulus from 593 to 2013 MPa (86,000 to 292,000 psi) with an average of 1041 MPa (151,000 psi). Apparent modulus for the 28-day tests ranged from 1172 to 1641 MPa (170,000 to 238,000 psi) and averaged 1370 MPa (198,700 psi).

Seven-day tensile strengths ranged from 441 to 551 kPa (64 to 80 psi) and averaged 496 kPa (72 psi), while the 28-day tests ranged from 537 to 579 kPa (78 to 84 psi) and averaged 551 kPa (80 psi). These strengths are consistent with other tests recently conducted on samples of cemented fill from the Lucky Friday Mine. Appendix A provides a summary of recent tests.

Table 2.—Closure readings.

Instrument and location	5660 level, cut 9		5750 level, cut 1		Cuts 9 + 1		5750 level, cut 2		Cuts 9+1+2	
	cm	in	cm	in	cm	in	cm	in	cm	in
Muck bay	0.10	0.04	0	0	0.10	0.04			0.10	0.04
Backfill string pots:										
West 1	7.77	3.06	11.28	4.44	19.05	7.5	12.19	4.8	3.24	12.3
West 2	+4.65	+1.83								
East 1	12.14	4.78								
East 2	3.78	1.49	6.63	2.61	10.16	4.1	3.81	1.5	14.22	5.6
Muck bay	0.08	0.03	0.10	0.04	0.18	0.07				
Gap string pots:										
West 1	12.4	4.88	11.05	4.35	23.44	9.23				
West 2	11.33	4.46								
East 1	16.36	6.44	11.86	4.67	28.22	11.11	9.68	3.81	37.90	14.92
East 2	15.80	6.22								
Slot 1	8.71	3.43								
Tape extensometer:										
Slot 2	6.55	2.58								
West 1	9.12	3.59								
West 2	12.47	4.89								
East 1	6.76	+2.66								

+ = Quit working.

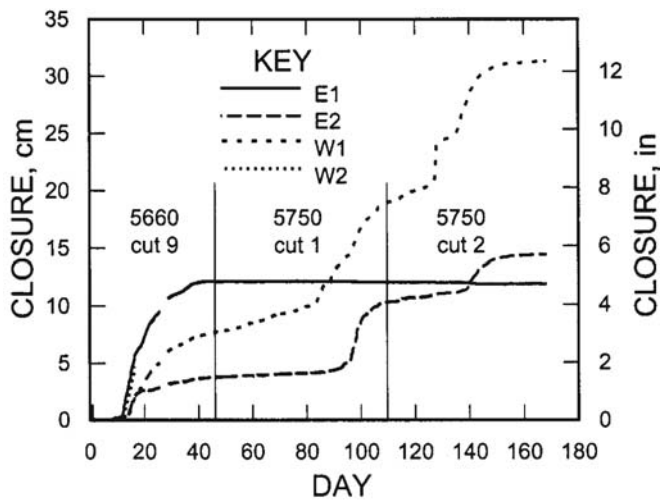

Figure 10.—Backfill closure as a function of time.

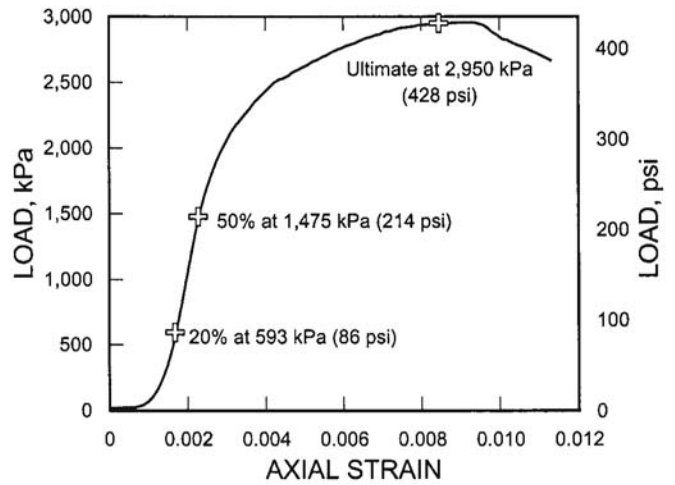

Figure 11.—Compressive test of cemented sandfill, stress/strain curve.

## BACKFILL PRESSURE READINGS

Model 3500 earth pressure cells from Geokon, Inc., were placed in the cemented backfill to monitor pressure as the walls closed. The backfill pressure increased rapidly as wall closure commenced (figure 12). The readings peaked with mining of cut 9, after which backfill pressure dropped as each subsequent cut was completed. Peak pressures ranged from a low of 793 kPa (115 psi) in the intersection to 4178 kPa (606 psi) at West 2; the average across the vein was 2757 kPa (400 psi) at 15 days. The data collected in the mine were within the range of the data collected in the laboratory (7-day unconfined compressive strength of 2082 kPa [302 psi] and 28-day unconfined compressive of 3254 kPa [472 psi]).

The 20-50 moduli determined at locations E1, E2, W1, and W2 were 681, 1513, 2361, and 5095 MPa (98,760, 219,400, 342,400, and 738,800 psi), respectively, and averaged 2412 MPa (349,800 psi). Strain was determined by dividing measured wall closure by the original opening width. These modulus values were documented 8 to 12 days after the backfill had been poured and as mining of the following cut passed the instrument locations. These data show that the ultimate strength of the cemented backfill was surpassed by loading induced by the large amounts of wall closure experienced in the stope. Thus, rock bolt reinforcement is needed to maintain the integrity of the backfill so that it will be safe for miners to work under.

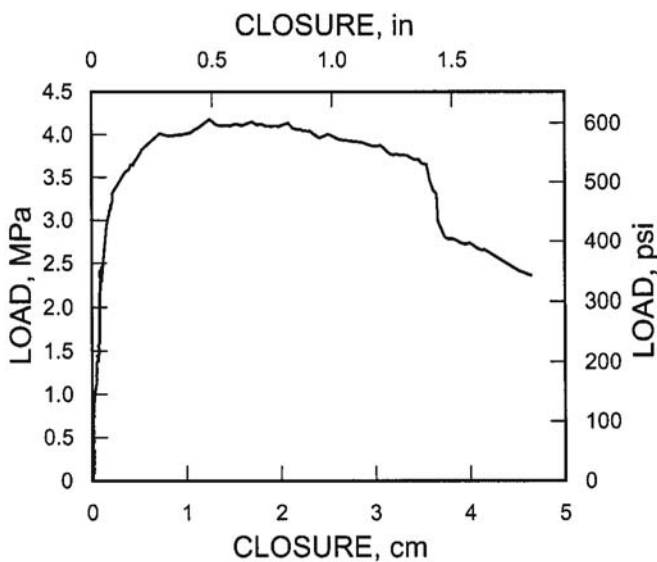

Figure 12.—Backfill closure versus backfill pressure, West 2.

Broken backfill was observed in the chain link below the backfill, and backfill heaving was seen in the gap at the top. The backfill eventually broke up to where it could no longer carry load and support itself. It then collapsed onto the backfill below it. When these collapses occurred, they presented no danger to miners because mining was usually two or more cuts below, and two or more intact backfill horizons were between the miners and the collapsed fill remained.

## INSTRUMENTED ROCK BOLTS

The vibrating-wire instrumented rock bolts and load cells were initially calibrated in a Tinius-Olsen testing machine at SRL to 53 kN (12,000 lb); however, readings recorded at the mine with the instrumented rock bolts using the 27-N/Hz (6-lb/Hz) calibration indicated that the yield and ultimate strengths of the rock bolts had been exceeded.

To determine if the initial readings were accurate or if this were a calibration problem, two instrumented rock bolts were tested in tension to failure. The instrumented rock bolts yielded at 160 kN (36,000 lb) and failed between 209 and 221 kN (47,000 and 49,900 lb) at the gauge location.

These tests showed that the hole drilled for the vibrating wire did not affect the yield strength of the bolt, but that it did reduce ultimate strength from 240 to 215 kN (54,000 to 48,450 lb). The slope of gauge response was linear between 8.9 and 124 kN (2000 and 28,000 lb) at 27 N/Hz (6 lb/Hz). Gauge response was then rapidly reduced to 2 N/Hz (0.45 lb/Hz). At 142 kN (32,000 lb), the gauges failed before the yield point of the rock bolts was reached. Figure 13 shows calibration load versus gauge response frequency for the bolts tested to failure. These tests showed that the vibrating-wire gauges installed in the end of the bolts were inadequate for this application and any future tests should use a gauge with a higher load range. The data were reanalyzed using this calibration curve.

Load on six of the nine instrumented rock bolts placed vertically in the backfill exceeded 142 kN (32,000 lb), which was the limit of the vibrating-wire gauge. Information from most of the instrumented rock bolts was eventually lost because deformation of the backfill apparently broke many of the signal wires in the backfill.

The data showed that the vertical reinforcing rock bolts in the backfill did a good job of resisting backfill deformation and provided a safe back for miners to work under. Initial loads began at zero and increased over time, indicating a direct relationship to wall closure.



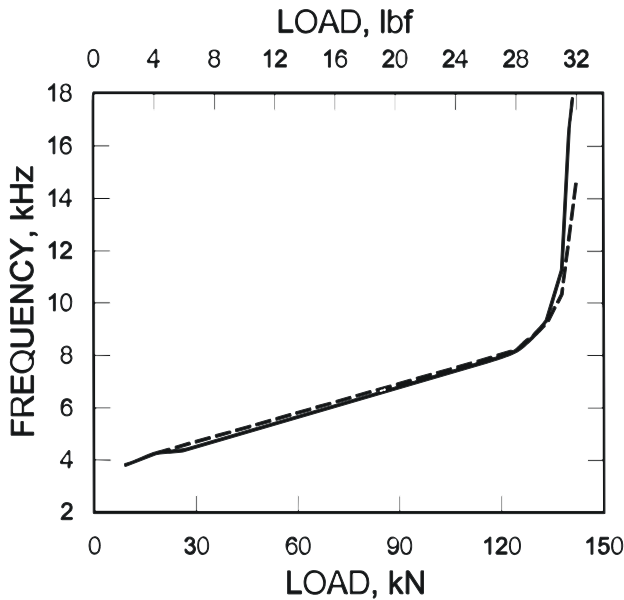

Figure 13.—Calibration curve showing relationship between frequency and load on instrumented rock bolts.

**ROCK BOLT LOAD CELLS**

Data from the rock bolt load cells indicated that the vertical rock bolts were under loads from 41 to 179 kN (9300 to 40,300 lb) after cut 9 was mined except in the muck bay, where loads ranged from 2.9 to 19.1 kN (660 to 4300 lb). Loads on the vertical rock bolts along the vein dropped as cuts were subsequently mined. This drop was probably a result of the continued breaking up of the backfill as the walls closed. Figure 14 shows the relationship of rock bolt load to backfill closure at East 2. The data indicate rock bolt load leveling off and

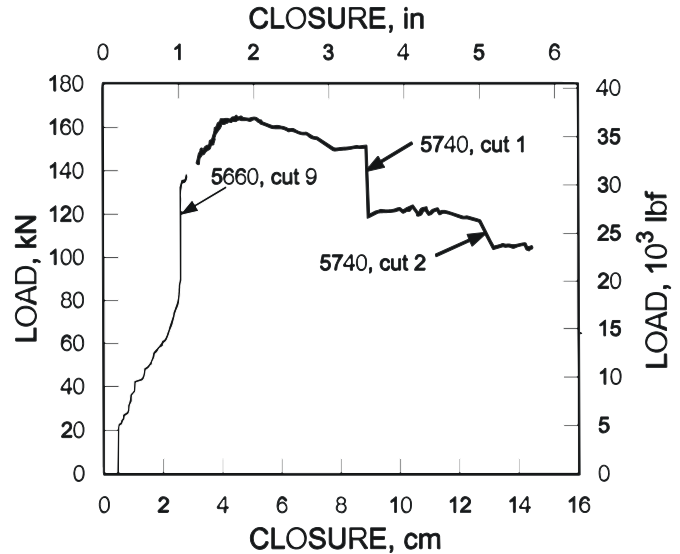

Figure 14.—Backfill closure versus rock bolt load, East 2.

decreasing as closure continued following each mining cut. This drop was probably caused by backfill failure around the rock bolt bearing plates as the walls converged. Inspection of the bottom of the backfill revealed bags of broken backfill in the chain link fencing between the rock bolt plates. Visual observation of the top of the 2.4-m- (8-ft-) long vertical rock bolts also confirmed that the 15- by 15-cm (6- by 6-in) bearing plates resisted backfill deformation and transferred load to the rock bolt.

Table 3 is a summary of the loads recorded on the instrumented rock bolts and load cells. The readings of 164 and 179 kN (36,900 and 40,300 lb) are the only ones exceeding the yield strength of the rock bolt at 160 kN (40,900 lb); the rest were below the yield strength. This is important because it

Table 3.—Loads on instrumented bolts and load cells for three cuts of mining.

Location	5660-05, cut 9				5750-05, cut 1				5750-05, cut 2			
	Bolt		Load cell		Bolt		Load cell		Bolt		Load cell	
	kN	lb	kN	lb	kN	lb	kN	lb	kN	lb	kN	lb
Vertical bolts:												
Slot	+142	+32,000	102	22,900			44.3	9,960			35.1	7,890
Muck bay	8.9	1,990	0.9	194	6.7	1,510	1.8	400	2.9	655	10.1	2,270
West 1	63.1	14,200	42.5	9,340	503	11,300	34.1	7,680			25.3	5,700
West 2	+142	+32,000	116	26,200			19.4	4,370			9.9	2,230
East 1	+142	+32,000	179	40,300			157	35,400			133	30,000
East 2	+142	+32,000	157	35,500	+142	+32,000	122	27,600			104	23,400
Intersection A	+142	+32,000			+142	+32,000			+142	+32,000		
Intersection B	103	23,200	164	36,900	53.3	12,000	1.8	408	43.3	9,740		
Truss bolts:												
Slot			31.4	7,060			35.8	8,060			5.4	1,220
Muck bay	-2.5	-570	12.5	2,810	8.7	1,960	19.1	4,300		5,170	2.8	660
West	19.9	4,480	23.7	5,330	6.5	1,460	41.7	9,370		6,320	159	35,800
East	36.0	8,100	4.3	960	20.1	4,530	48.3	10,860			63.1	14,200
Center	+142	+32,000	113	25,600	+142	+32,000	104	23,500	+142	+32,000		

+ = Out of range or quit working.

indicates that the yield strength of the rock bolts was not being exceeded.

Figure 15 is an idealized drawing of how the instrumented rock bolts interacted with the cemented backfill in the vein portion of the stope as mining progressed. This interpretation is based on conventional theories of rock bolt reinforcement that state that tensioned rock bolts create a self-supporting compressive arch across the opening (Lang 1961; Hoek and Brown 1980; Stillborg 1986; Brady and Brown 1993). The illustration is also based on visual observations, closure measurements, and load readings on the vertical rock bolts gathered during this project. Initially, in stage 1, there is no wall closure, pressure in the backfill, or load on the reinforcing rock bolts. Then forces in the backfill, created as the bearing plates resist backfill deformation caused by wall closure, form a cone of compression in the backfill (stage 2). The backfill is self-supporting until the backfill breakup progresses to the point where the overlap of the cones of compression between adjacent vertical rock bolts is eliminated (stage 3). The backfill then collapses because of gravity.

### BACKFILL TEMPERATURE

The instrumented bolts and two of the earth pressure cells had temperature sensors attached in case large temperature fluctuations required that calculations be made to compensate for these fluctuations. The sensors on the bolts were on the end of the bolt with the strain gauge, and the temperature readings reflected the position of the gauge with respect to the surface of the sandfill. The readings from the 2.4-m- (8-ft-) long rock bolts in the intersection were lower than the other readings because the ends of these bolts were exposed to the air. Figure 16 shows average temperatures for the bolts in the backfill and those in the intersection. The 47.2 °C (117 °F) in-fill temperature at day 2 was the highest temperature recorded in the backfill and stemmed from the heat of hydration of the cemented backfill. The 32.2 °C (90 °F) recorded on the IA, IB, and IC rock bolts was air temperature in the unventilated area above the backfill. The data show that no temperature compensation was required for the strain gauges because loads were significantly higher than the temperature compensation. The data also give an indication of the heat load to the ventilation system from the heat of hydration of the cemented backfill.

### TRUSS LOADS

Immediately after installation on day 14 and during mining of cut 9 on the 5660 level, the load cell on the vertical rock bolt in the center of the truss took on loads to 116 kN (26,000 lb), while the load cells on the horizontal leg showed loads from 0.4 to 33.4 kN (100 to 7500 lb) (figure 17). Loads on the horizontal legs remained fairly constant until day 87, at which time cut 1 from the 5750 level was being mined past the instrument locations 6 m (20 ft) below.

On February 15, 1998 (day 122), load on the horizontal legs increased suddenly while load on the vertical leg decreased.

Visual inspection on February 18 showed that the backfilled intersection of cut 7 had slumped onto the top of the instrumented backfill. It was noticed that the yoke of the slot leg of the cut 7 truss had come off the horn bracket (figure 18) and supplied no support at all. Then, between 6:00 p.m. on February 28 (day 136) and 6:00 a.m. on March 1, the load cells on the four horizontal legs of the truss showed sudden increases of 6.7, 7.6, 9.3, and 19.1 kN (1500, 1700, 2100 and 4300 lb). The next readings (12 hr later at 6:00 p.m. on March 1) showed that loads on the east and west legs of the truss had increased from 111 and 80 kN (25,000 and 18,000 lb) to 178 and 165 kN (40,000 and 37,000 lb), respectively, while loads on the slot and muck bay legs had dropped from 53 and 49 kN (12,000 and 11,000 lb) to 13.3 and 2.7 kN (3000 and 600 lb), respectively.

Load on the vertical instrumented rock bolt in the truss also showed an increase from 35.6 kN (8000 lb) to the 142-kN (32,000-lb) limit of the vibrating-wire strain gauge on day 12 as cut 9 on the 5660-05 level was mined under the intersection. At approximately the same time, the instrumented rock bolts on the east and west truss leg ends reached loads of 60.9 and 27.7 kN (13,687 and 6236 lb), respectively. These loads then gradually leveled off at 36.5 and 19.6 kN (8200 and 4400 lb).

After day 87, the instrumented rock bolts showed decreases in load on the east and west legs and an increase on the muck bay leg, while the load cells all showed an increase in load. Readings from the rock bolt on the east leg of the truss stopped shortly after, probably as a result of backfill deformation cutting the signal wire.

At day 136, the two remaining instrumented rock bolts on the muck bay leg and the west leg also recorded sudden increases in load similar to, but of a lower magnitude than, those of the load cells at the truss bracket. Readings from the instrumented rock bolt on the west truss leg stopped on day 142 after cut 2 from the 5750 level had mined under. Figure 19 is a graph of data for all three mining cuts.

Data from both the load cells and instrumented bolts indicate that a major redistribution of load was taking place in the intersection during this 18-hr period. Table 4 is a summary of the readings over the 18-hr period for the rock bolt load cells and the instrumented rock bolts. The truss legs along the vein functioned as expected, but the legs extending into the muck bay and slot failed to hold load and were ineffective.

Visual inspection of the intersection on March 3 showed that the backfill in the northwest corner of the intersection had collapsed onto the backfill in cut 9, but that the truss was still above the backfill. It was not possible to determine how far the failure extended along the west side of the stope, but it is thought that, based on instrument response, failure was limited to the first 3 m (10 ft) of the west side. The 3-m- (10-ft-) long cap placed here probably stopped further collapse, but the area was not accessible to confirm this belief. The weight of the backfill from cut 7 on top of the instrumented backfill and continued wall closure from mining in cut 2 on the 5750-05 level caused the intersection to collapse. The collapse was not hazardous to miners because there were two intact backfilled cuts between the collapse and the active mining area.

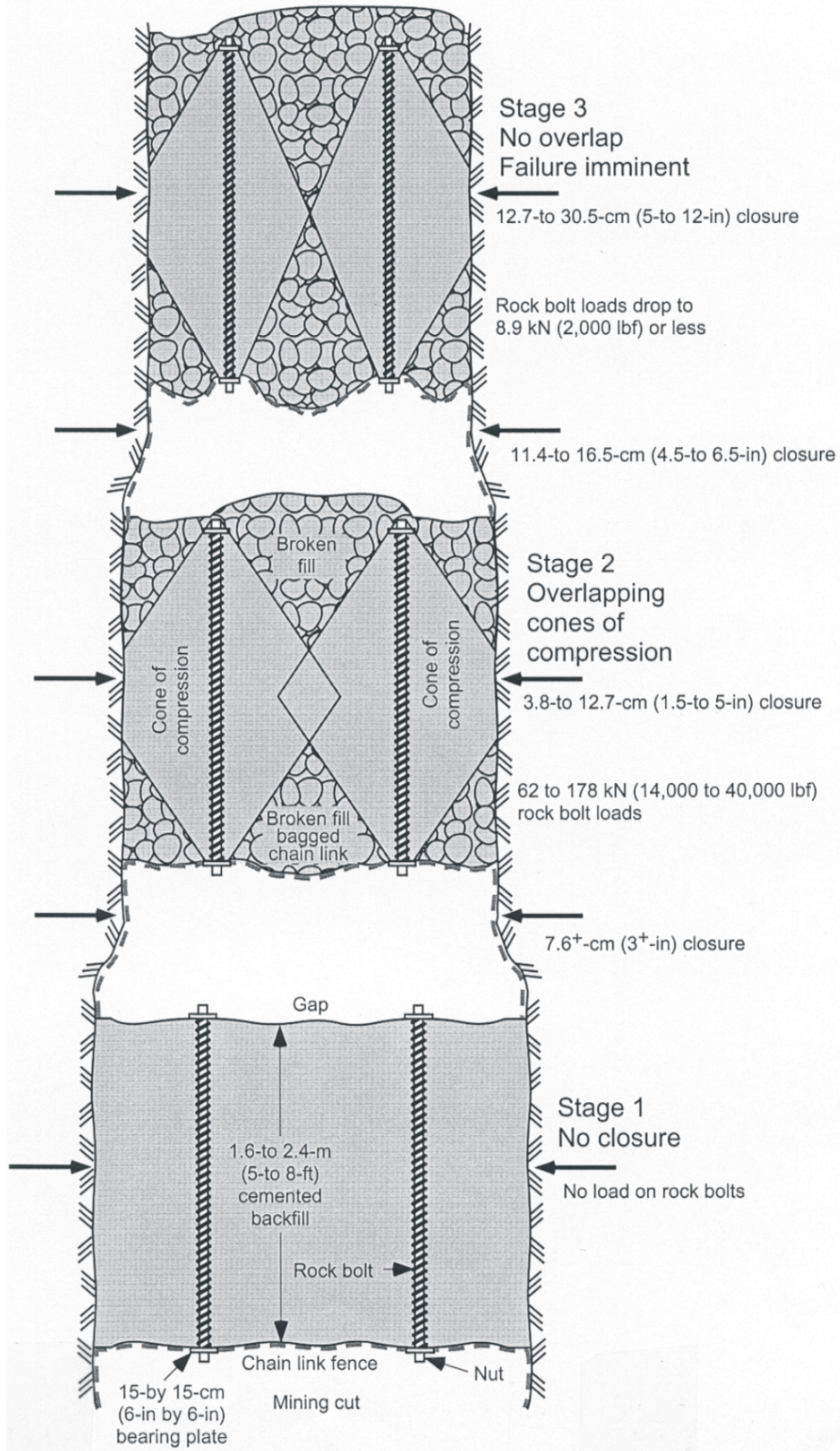

Figure 15.—Closure sequence in backfill.



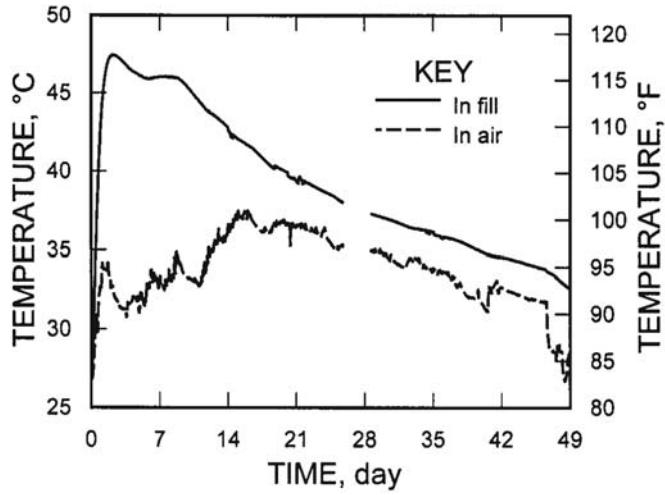

Figure 16.—Temperatures recorded on rock bolts in backfill and in mine atmosphere.

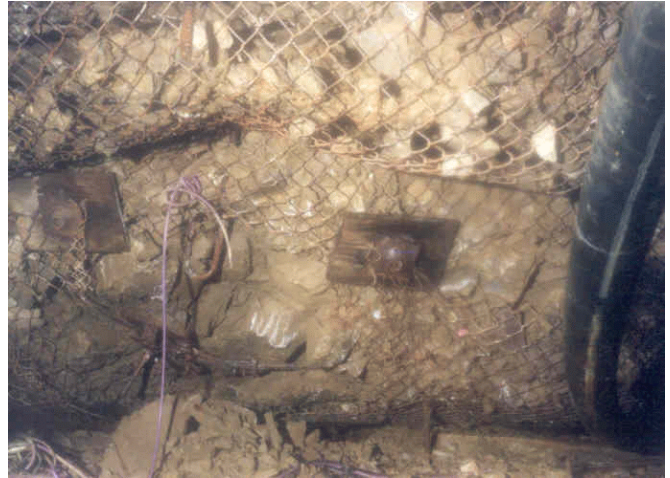

Figure 18.—Backfill failure at four-way bracket.



Figure 17.—Load cells at truss four-way bracket.

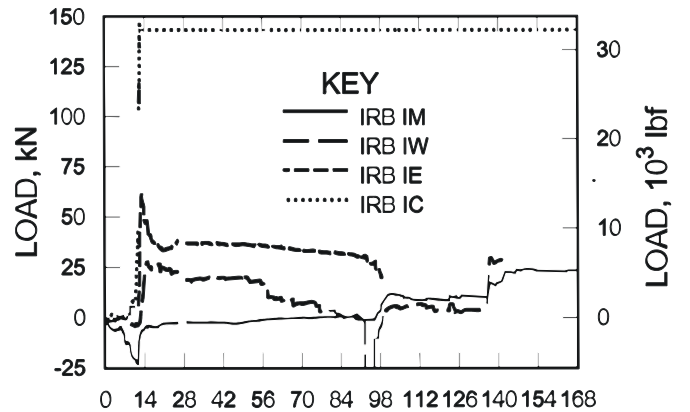

Figure 19.—Data from instrumented bolts in truss.

Table 4.—Pressure readings on truss and rock bolts during intersection failure.

Instrument	February 28, 6:00 p.m.		March 1, 6:00 a.m.		March 1, 6:00 p.m.	
	kN	lb	kN	lb	kN	lb
Load cells:						
IS truss .....	46.7	10,489	53.7	12,075	13.6	3,064
IM truss .....	42.4	9,533	50.2	11,288	2.9	644
IW truss .....	62.7	14,095	81.8	18,398	165	37,067
IE truss .....	104	23,485	114	25,584	180	40,539
IC truss, vertical .....	89.6	20,144	75.4	16,943	2.9	650
Instrumented bolt:						
IM truss .....	10.0	2,242	12.4	2,783	17.1	3,847
IW truss .....	6.9	1,555	17.4	3,911	29.2	6,558
Load cell on vertical bolt:						
W1 .....	33.7	7,578	29.2	6,560	23.7	5,321
W2 .....	13.0	2,920	8.3	1,875	8.5	1,908

## CONCLUSIONS

An extensive instrumentation project carried out in the intersection area of cut 8 of the 05 stope on the 5660 level of the Lucky Friday Mine showed that the intersection truss installed to provide additional support did not function fully because closure across the vein reduced the effectiveness of the horizontal truss legs in the slot and muck bay. Data from the instruments indicated that wall closure induced loads in the truss legs parallel to the vein and in the vertical rock bolts, but that insignificant support was supplied by the truss legs perpendicular to the vein. Therefore, the mine staff decided to use an alternative support system of wood beams and posts to ensure the safety of miners working beneath the backfill.

Project data also showed that some rock bolts placed vertically in the backfill for reinforcement were taking loads past their

yield strength of 160 kN (36,000 lb). This is the first documentation of mining-induced loads on rock bolts in backfill at the Lucky Friday Mine. The instruments also documented for the first time significant closure across the slot and an almost total lack of wall rock movement in the muck bay. All instruments recorded changes as mining of subsequent cuts passed by the instrument locations.

An interpretation of the interaction among wall closure, backfill deformation, and induced loads in the vertical rock bolts in the cemented backfill is presented in figure 15 and indicates how the reinforced backfill support system may work. This knowledge is important for designing backfill support systems for other mines to ensure the safety of miners working in underhand stopes.

## ACKNOWLEDGMENTS

Clyde Peppin, chief engineer at the Lucky Friday Mine, purchased instruments and coordinated activities at the mine. Doug Bayer, rock mechanics engineer, helped install the instruments and supplied information on mining sequences. Frank Reed, mine production foreman, was very patient and helpful when researchers were working around the miners in the stope.

This work could not have been completed without the help of a number of support staff at the Spokane Research Laboratory. In particular, Paul Pierce and Mike Jones helped with building the closure instruments; their work is greatly appreciated.

## REFERENCES

- Brackebusch, F. W. Basics of Paste Backfill Systems. *Min. Eng.*, Oct. 1994, pp. 1175-1178.
- Brady, B. H. G., and E. T. Brown. *Rock Mechanics for Underground Mining*, 2nd ed. Chapman and Hall, 1993, 571 pp.
- Fredericksen, A., N. Krauland, H. Stille, and S. Stromberg. Improved Undercut-and-Fill Mining at the Garpenberg Mine. In *Minefill 93*, ed. by H. W. Glen (Johannesburg, S. Afr., Sept. 1993). Symp. Ser. S13, S. Afr. Instit. of Min. and Metall., Johannesburg, S. Afr., 1993, pp. 17-23.
- Hedley, D. G. F. Properties of Cemented Paste Backfill at Hecla's Lucky Friday Mine. Report on Stiff Backfill Project of Canadian Rockburst Research Project. April 1993, 13 pp. Available from author.
- Henderson, A., G. Jardine, and C. Woodall. The Implementation of Paste Fill at the Henty Gold Mine. In *Minefill 98, Proceedings of the Sixth International Symposium on Mining with Backfill*, ed. by M. Bloss (Brisbane, Australia, April 14-16, 1998). Aust. Inst. of Min. and Metall. Pub. Series 1/98, 1998, pp. 299-304.
- Hoek, E., and E. T. Brown. 1980. Underground Excavations in Rock. *Inst. Min. and Metall.*, London, UK.
- Krauland, N., and H. Stille. Rock-Mechanics Investigations of Undercut-and-Fill Mining at the Garpenberg Mine. In *Minefill 93*, ed. by H. W. Glen (Johannesburg, S. Afr., Sept. 1993). Symp. Ser. S13, S. Afr. Instit. of Min. and Metall., Johannesburg, S. Afr., 1993, pp. 47-54.
- Lang, T. A. Theory and Practice of Rock Bolting. *Trans.* 1961, vol. 220, pp. 333-348.
- Larson, M. K., and H. Maleki. Geotechnical Factors Influencing a Time-Dependent Deformation Mechanism Around an Entry in a Dipping Seam. In *Proceedings, 15th International Conference on Ground Control in Mining*, ed. by L. Ozdemir, K. Hanna, K. Y. Harnam, and S. Peng (Golden, CO, Aug. 13-15,

1996). CO School of Mines, 1996, pp. 699-710.

Larson, M., B. Stewart, M. Stevenson, M. King, and S. Signer. A Case Study of a Deformation Mechanism Around a Two-Entry Gateroad System Involving Probable Time-Dependent Deformation. In *Proceedings of 14th International Conference on Ground Control in Mining*, ed. by S. S. Peng (Morgantown, WV, Aug. 1-3, 1995). Dept. of Mining Engineering, WV Univ, 1995, pp. 295-304.

Scott, D. F. Relationship of Geologic Features to Rock Bursts, Lucky Friday Mine, Mullan, Idaho. In *Rockbursts and Seismicity in Mines. Proceedings of the 2nd International Symposium on Rock Bursts and Seismicity in Mines*, ed. by C. Fairhurst (Minneapolis, MN, June 8-10, 1988). Balkema, 1990, pp. 401-406.

Seymour, B., D. Tesarik, M. Larson, and J. Shoemaker. Stability of Backfilled Cross-Panel Entries During Longwall Mining. In *Proceedings of*

*17th International Conference on Ground Control in Mining*, ed. by Syd S. Peng (Morgantown, WV, Aug. 4-6, 1998). Dept. of Mining Engineering, WV University, 1998, pp. 11-20.

Stillborg, B. Professional User's Handbook for Rock Bolting. Trans Tech Publi. Series on Rock and Soil Mechanics, vol. 15, 1986.

Whyatt, J. K., and M. J. Beus. In Situ Stress at the Lucky Friday Mine (In Four Parts): 1. Reanalysis of Overcore Measurements From 4250 Level. U.S. Bur. Mines Rep. of Invest. 9532, 1995, 26 pp.

Whyatt, J. K., T. J. Williams, and W. Blake. In Situ Stress at the Lucky Friday Mine (In Four Parts): 4. Characterization of Mine In Situ Stress Field. U.S. Bur. Mines Rep. of Invest. 9582, 1995, 26 pp.

Williams, T. J., J. K. Whyatt, and M. E. Poad. Rock Mechanics Investigations at the Lucky Friday Mine (In Three Parts): 1. Instrumentation of an Experimental Underhand Longwall Stope. U.S. Bur. Mines Rep. of Invest. 9432, 1992, 26 pp.

## APPENDIX A: RESULTS OF UNCONFINED COMPRESSION TESTS OF BACKFILL

Sample designation	Type of sample	Date of placement	Location
A .....	Cored	Jan. 14, 1997	5660-05 ramp-stope intersection cut
B .....	In situ	Mar. 11, 1997	5660-05 east (left) side of stope cut
C .....	In situ	Oct. 10, 1997	5660-05 ramp-stope intersection cut
D .....	Cored		5500-01 ramp stope intersection cut

Specimen series	Curing time, days	Compressive strength, psi			Coefficient of variation, %
		Average	Range		
			Minimum	Maximum	
Sample type A:					
1 .....	43	628.7	577.5	685.1	5.3
2 .....	45	632.0	571.2	694.9	6.4
Sample type B:					
1 .....	14	450.6	414.3	477.4	5.7
2 .....	28	499.8	469.2	530.3	4.8
3 .....	90	613.2	575.4	698.0	7.4
Sample type C:					
1 .....	7	302.8	247.7	398.8	18.0
2 .....	28	472.4	385.7	556.2	14.7
Sample type D:					
1 .....	?	249.6	241.3	263.1	3.4



***Delivering on the Nation's Promise:***  
*Safety and health at work for all people*  
*Through research and prevention*

For information about occupational safety and health topics contact NIOSH at:

1-800-35-NIOSH (1-800-356-4674)

Fax: 513-533-8573

E-mail: [pubstaft@cdc.gov](mailto:pubstaft@cdc.gov)

[www.cdc.gov/niosh](http://www.cdc.gov/niosh)

**DHHS-(NIOSH) Publication No. 2001-138**