

LABORATORY EVALUATION OF A CANOPY AIR CURTAIN FOR CONTROLLING OCCUPATIONAL EXPOSURES OF ROOF BOLTERS

G.V.R. Goodman
Pittsburgh Research Laboratory
National Institute for Occupational Safety
and Health
Pittsburgh, PA 15236 USA

J. A. Organiscak
Pittsburgh Research Laboratory
National Institute for Occupational Safety
and Health
Pittsburgh, PA 15236 USA

ABSTRACT

In the United States, respirable coal mine dust exposures are limited to a 2 mg/m^3 time weighted average for a working shift. If the silica content of the sample exceeds 5 percent, the 2 mg/m^3 standard is reduced according to 10) (% silica) to limit silica dust exposures to $100 \text{ }\mu\text{g/m}^3$. Examinations of dust sampling data collected by the federal coal mine inspectorate showed that roof bolter occupations continue to be at risk for overexposure to respirable silica dust. Testing at the Pittsburgh Research Laboratory of the National Institute for Occupational Safety and Health assessed the effectiveness of a canopy air curtain for controlling occupational exposures to respirable silica and coal dusts. Initial testing found that zones of higher velocity airflow shrank as distance beneath the canopy increased. This suggested that protection from occupational dust exposures would likely decrease as distance beneath the canopy increased. Further testing revealed that coal dust reduction efficiencies were most affected by changes in interference air velocity and, to a lesser extent, changes in canopy air quantity. However, respirable silica dust percentages under the canopy were not affected by such changes and, in fact, were not significantly different from silica percentages measured outside the canopy. This implied that the air curtain was equally effective on both respirable coal and respirable silica dust particles.

KEYWORDS

Coal mine dust, engineering controls, silica dust, underground mining, coal mining

INTRODUCTION

The Federal Coal Mine Health and Safety Act (the Act) limits the respirable dust exposure of mine workers to a time weighted average of 2.0 mg/m^3 for a working shift (U.S. Government Printing Office, 1999). If the respirable dust sample contains more than 5 percent silica by weight, the dust standard is reduced according to the formula 10) (% silica). This maintains silica dust levels at or below $100 \text{ }\mu\text{g/m}^3$.

In the United States, coal mine dust samples are collected using constant flow pumps to pull dust-laden air through a 10-mm nylon cyclone preseparator at a rate of 2.0 liters/minute. This deposits the respirable mass onto pre-weighed 37-mm filters. The Act stipulates that the calculated dust concentration be multiplied by 1.38 to convert it to an equivalent concentration measured with a British Mining Research Establishment sampling device.

Data from the Mine Safety and Health Administration revealed that more than 3200 respirable dust samples

were collected at roof bolting occupations in 1998. Of these, more than 12 percent of the samples exceeded the 2 mg/m^3 standard for respirable dust while 25% of the samples exceeded the $100 \text{ }\mu\text{g/m}^3$ level for respirable silica dust (MSHA, 1999). Clearly, roof bolters occupations continue to be at risk for overexposure to respirable silica dust.

Previous work showed that several operational factors contributed to this increased risk. Higher levels of silica dust were measured at the roof bolter when this machine operated in the return air of the continuous mining machine. Besides exposures from silica dust generated during cutting and loading cycles, exposures often increased when the mining machine cut rock (Organiscak *et al.*, 1990; Kok *et al.*, 1985). Exposures also increased when dumping the dust collector box, although this source was very controllable with proper care and attention. Respirable silica levels generated during bolting could vary considerably depending upon the condition of the dry collection system. Both studies showed, however, that

these collection systems were very effective when properly maintained.

One means to limit downwind exposures is use of a filtered air supply. Placed on the underside of the bolter canopy, the filtered air supply or canopy air curtain (CAC) can blow a constant stream of fresh, filtered air over the breathing zone of the bolter operator. Such devices were previously developed under contract with the U.S. Bureau of Mines and were investigated for dust reduction performance (Donaldson Company, Inc., 1975). When placed under the canopy of a continuous miner, dust reductions varied from 30 to 75 percent, depending upon the length of time the operator spent beneath the air curtain. However, this air curtain design did not allow adequate headroom beneath the operator's canopy. A second-generation CAC was developed later that improved both headroom and distribution of airflow around the operator's head (Donaldson Company, Inc., 1985). Laboratory testing of this improved device showed an 89% reduction in respirable dust. Work conducted by the Mining Research and Development Establishment (MRDE) in Great Britain showed that reductions in operator exposure suffered when the external or interference air velocity exceeded 0.51 m/sec (MRDE, 1981). High interference air velocities could overwhelm the airflow of the CAC and push dust under the canopy. Subsequent work in lower airflow headings showed dust reductions of 73% in underground trials (MRDE, 1983).

Due to the lower velocities common in bolter work places, the air curtain may be a viable means of controlling occupational exposures at roof bolter positions. This work evaluates the effectiveness of a canopy air curtain system for controlling exposures to both respirable coal and silica dusts. Relationships are also defined between the protection provided by the air curtain and variables such as interference air velocity and canopy airflow. The effects of velocities emanating from the canopy and their impacts on the protection of a bolter operator situated beneath this canopy are evaluated.

EXPERIMENTAL DESIGN

The canopy air curtain was tested in a full-scale facility at the Pittsburgh Research Laboratory. This facility simulated a bolter heading 1.93 meters high, 5.49 meters wide, and 12.19 meters deep (Figure 1). This heading was ventilated by a brattice curtain hung 91.4 cm from the left side of the simulated heading. The main gallery fans drew from 2.83 to 5.66 cubic meters per second (m^3/s) of ventilation airflow through this curtain. A continuous recording anemometer was placed behind the ventilation curtain 7.01 m from the curtain mouth and 1.14 m above the floor to measure this airflow.

The canopy air curtain is constructed of a square steel frame 43.2 cm wide by 43.2 cm long. Air enters this device at one side of the frame and passes along an intake plenum and through a honeycomb flow straightener to disperse the air along the intake side of the curtain equally. The airflow then enters another honeycomb flow straightener before exiting through a perforated steel plate. The perforations were 2.38-mm diameter holes drilled on 6.35-mm centers. The perforated plate was roughly 40.6 cm by 40.6 cm.

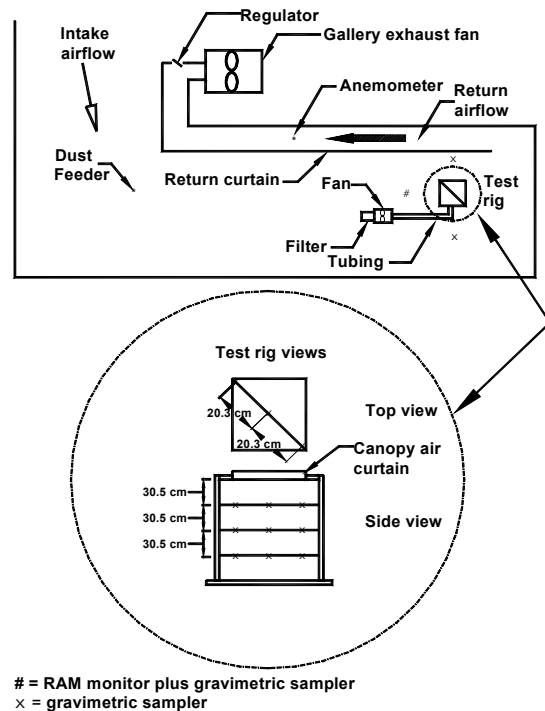

Figure 1. Experimental setup

The air curtain was mounted 1.63 m above the floor on a wooden test rig placed 1.02 m from the return curtain and 91.4 cm from the curtain mouth. A 5.6 kW (7.5 hp) centrifugal fan was connected to the air curtain with 20.3-cm diameter metal ducting. This fan generated airflow quantities of 0.094, 0.188, and 0.283 m^3/s that were checked with 10-point pitot tube traverses in a straight run of the ducting. Because this fan provided more air than required for this study (0.944 m^3/s at 3.72 kPa static pressure), air was bled as needed behind the return curtain. Static pressures across the canopy were 0.22 kPa, 0.45 kPa, and 1.04 kPa at flows of 0.094, 0.188, and 0.283 m^3/s , respectively.

A Donaldson Company (Minneapolis, MN, USA) ECG11-2501 Konepac filter was attached on the inlet side of the fan to filter dust from the air being supplied to the air curtain. This filter was selected due to its high efficiency (99.9% for particles less than 200 μm) and low initial pressure restriction (0.44 kPa at 0.283 m^3/s) (Donaldson Company, Inc., 1987).

Initial evaluations of the canopy air curtain defined velocity profiles at distances of 30.5, 61.0, and 91.5 cm beneath the perforated plate. Air curtain quantities of 0.094, 0.188, and 0.283 m³/s were used. Velometer measurements were made on a preset grid pattern of 7.6-cm increments (Figure 2). These evaluations were made without the presence of gallery airflow (interference airflow) to more easily define practical limits of protection with the air curtain.

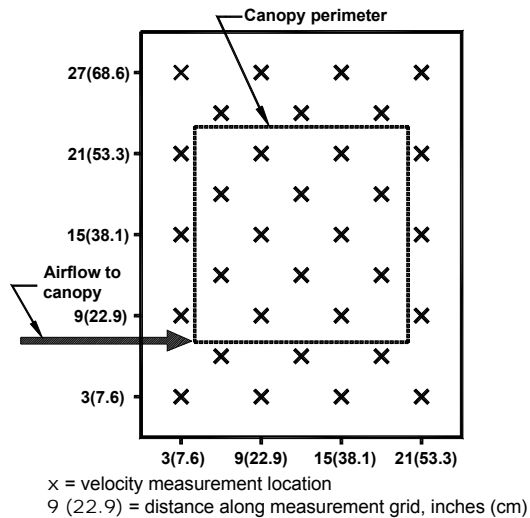

Figure 2. Velocity measurement grid

Subsequent testing evaluated the ability of the air curtain to reduce dust exposures for personnel working beneath this device. A mixture of silica dust in coal dust was used for this testing. Samples of this silica-coal mixture sent to an independent laboratory for bulk analysis showed that the feed dust averaged 13.0 ± 0.9 percent silica. This dust was introduced into the test gallery 12.19 m upwind of the canopy air curtain to simulate dust flow from a continuous miner working upwind of a roof bolter. Respirable coal dust levels surrounding the air curtain averaged 4.01 ± 0.14 mg/m³ for all tests while respirable silica dust levels averaged 6.19 ± 0.36 percent.

Dust samples were taken by constant flow sampling pumps pulling dust-laden air through 10-mm nylon cyclone separators at a rate of 2.0 liters/min to deposit the respirable mass onto preweighed 37-mm filters. All filters were subsequently weighed and dust levels calculated. Selected filters were sent to an independent laboratory for P-7 silica analysis (MSHA, 1973).

For this testing, three gravimetric dust samplers each were placed 30.5 cm, 61.0 cm, and 91.5 cm beneath the canopy air curtain. In each set of three, one sampler was placed directly beneath the center of the perforated plate with the remaining two samplers placed 20.3 cm away along a diagonal line drawn between two opposite corners (Figure 1). Three samplers were also placed

away from the air curtain to measure surrounding or environmental dust levels. One was placed 1.52 meters in front of the air curtain, one was placed 91.4 cm to the left side of the test rig, and the final sampler placed 91.4 cm to the right of the test rig. These three samplers were situated 1.07 m above the floor. Finally, one RAM (Realtime Aerosol Monitor, GCA Corp., Bedford, MA) was placed 1.52 m in front of the air curtain and 1.07 m above the floor to monitor dust levels during testing.

To provide robust assessments of the protection provided by the canopy air curtain, wide ranges were selected for both interference air velocities and canopy air flows. Gallery air quantities of 2.83 m³/s and 5.66 m³/s were selected corresponding to interference velocities of 0.32 m/s and 0.64 meters per second (m/s), respectively, around the air curtain test rig. Air quantities supplied to the canopy air curtain ranged from 0.094 to 0.283 m³/s. Tests were conducted for each combination of interference air velocity and canopy air flow. Five replicates were made to assess the potential error in each combination. Two interference air velocities combined with two canopy air quantities defined the four corners of the experimental design square. The presence of curvature or non-linearity was defined between the dependent variable of dust reduction and the independent variables of interference air velocity and canopy air flow. To evaluate potential curvature, five replicates were run at the middle point of each independent variable. The middle point was defined by a gallery flow of 4.25 m³/s, corresponding to an interference velocity of 0.48 m/s, and an air curtain air flow of 0.189 m³/s. Tests were run for 50 minutes to provide measurable dust quantities for all samples.

The dust concentration at each point beneath the canopy was the average of all replicates for that set of conditions. Dust levels outside the canopy were calculated by averaging the three exterior dust measurements for all replicates of a specific set of conditions. The average protection efficiency was then calculated as one minus the ratio of dust concentration beneath the canopy to concentration outside the canopy, multiplied by 100.

ANALYSIS OF TEST DATA

Air Curtain Velocities

Tests of velocities were made at 30.5, 61.0, and 91.5 cm beneath the perforated plate with the canopy air curtain operating at 0.094, 0.188, and 0.283 m³/s. With 0.094 m³/s supplied to the air curtain, the velocity profile 30.5 cm beneath the curtain is shown in figure 3. Nearly one-half of the area beneath the air curtain received between 1.0 and 1.5 m/s airflow. Air flow from the centrifugal fan, entering at a corner of the air curtain, led to the higher flow velocities in this area. The opposite corner of the air curtain, representing the furthest distance from the inlet, was a region of low air

velocity. As distance beneath the canopy increased, the zone of higher velocity air shrank noticeably, although it remained beneath the center of the canopy. Zones of lower velocity air then covered most the area beneath the air curtain. This suggested that, although protection from occupational dust exposures likely decreased as distance beneath the canopy increased, zones of increasing protection were found beneath the center of the canopy.

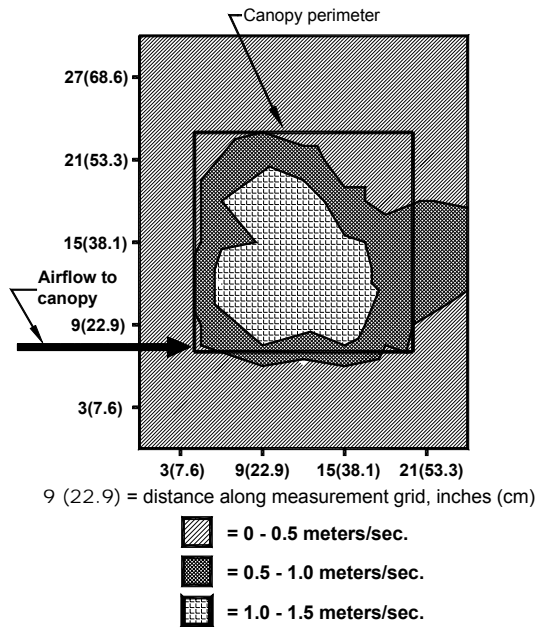

Figure 3. Velocity contours for canopy flow = 0.094 m³/s, 30.5 cm beneath canopy

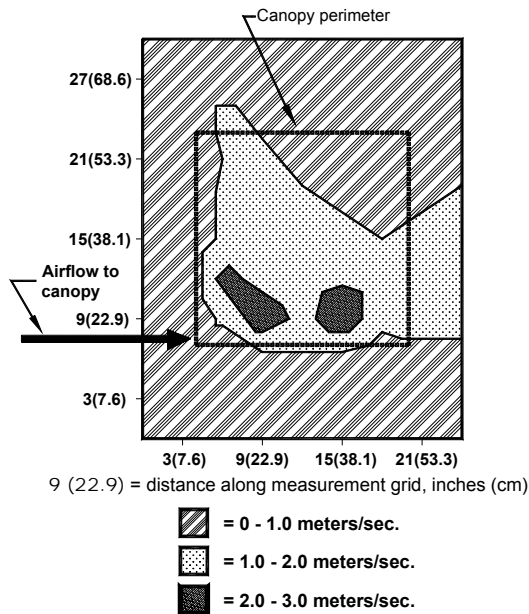

Figure 4. Velocity contour for canopy flow = 0.283 m³/s, 30.5 cm beneath canopy

As air curtain flow increased to 0.283 m³/s, zones of higher air velocity appeared near the inlet. At a distance of 30.5 cm beneath the canopy, velocities exceeding 1.0 m/s were present beneath a large portion of the area under the canopy (Figure 4). However, velocities diminished with distance from the inlet and with distance beneath the canopy implying that, despite higher canopy air curtain flows, zones of decreased protection could remain.

Dust Reductions With Air Curtain

Testing initially measured dust reduction efficiencies at the extreme points of the test matrix; that is, air curtain flows of 0.094 and 0.283 m³/s and interference air velocities of 0.32 and 0.64 m/s. Subsequent testing then determined the presence of any curvature or non-linearity between canopy air flow, interference air velocity, and dust reduction potentials. This involved repeated testing at the center point of the matrix; that is, an air curtain flow of 0.188 m³/s and an interference air velocity of 0.48 m/s. Table 1 gives mean dust reduction efficiencies and 95% confidence levels for distances of 30.5, 61.0, and 91.5 cm below the air curtain. Higher efficiencies signify increased protection from exterior dust concentrations.

Not surprisingly, the data showed that, for each combination of canopy flow and interference velocity, efficiencies were highest when sampling close to the canopy and that these efficiencies decreased rapidly with distance. This was expected given the high velocities found near the canopy and their rapid decrease at greater distances.

Table 1. Mean reduction efficiencies and 95% confidence limits.

Air curtain flow (m ³ /s)	Interference air velocity (m/s)	Reduction efficiencies (%)		
		30.5 cm	61.0 cm	91.5 cm
0.094	0.32	56.6 ± 2.9	42.7 ± 6.7	29.4 ± 16.1
0.094	0.64	28.5 ± 20.7	-19.9 ± 12.8	-22.2 ± 7.6
0.283	0.32	62.1 ± 5.5	52.5 ± 5.0	47.1 ± 14.8
0.283	0.64	25.2 ± 4.5	-2.6 ± 13.8	-9.9 ± 9.5
0.188	0.48	40.5 ± 7.9	28.5 ± 16.2	6.9 ± 11.1

Notes:

1. samples for each combination of air curtain flow and air velocity.
2. Negative efficiencies are increases in dust concentrations.

ANOVA analyses defined variabilities in dust reduction efficiencies through the contributions of canopy air flow, interference air velocity, and the

interaction of these two variables. Comparing the average reduction at the extreme points of the test matrix to the average reduction at the center point gave the error associated with curvature or non-linearity (Myers and Montgomery, 1995). The ANOVA tables are given in table 2 for average dust reduction efficiencies at 30.5, 61.0, and 91.5 cm beneath the air curtain.

These analyses show that changes in interference air velocity significantly affected dust reduction efficiencies for all distances beneath the canopy. Changes in air curtain quantity were significant at 61.0 and 91.5 cm beneath the canopy, yet insignificant at 30.5 cm beneath the canopy. Perhaps, canopy efficiency was maximized at this distance. The AB interaction of the two independent variables was not significant at any distance showing that the effect of each variable was independent of the magnitude of the other. Finally, these ANOVA analyses showed that for distances of 30.5 and 61.0 cm beneath the canopy, dust reduction efficiencies varied linearly with air curtain quantity and interference air velocity. Curvature in the relationship was detected only at the extreme distance of 91.5 cm beneath the canopy. However, very few instances are envisioned where a roof bolter operator would work this far beneath the air curtain. Most work time would be spent within 61.0 cm of this device and the effects of curvature between the test variables were insignificant at this distance.

The impacts of increasing curtain airflow and interference air velocity were evaluated by comparing average dust levels with each variable at the low level to dust levels with that variable at its high level. Hypothesis testing then assessed the significance of the difference between these mean dust levels. With the null hypothesis being no difference in mean dust levels, *t*-tests were used to accept or reject this assumption. Two tails were specified to account for any increase or decrease in dust level due to change in variable level. Subsequent analyses constructed 95 percent confidence intervals for the difference in mean dust levels. An interval containing zero means that the difference in mean dust levels was not statistically significant at this level of confidence.

Increasing air curtain quantity from 0.094 m³/s to 0.283 m³/s generally resulted in statistically significant improvements in efficiency and, consequently, improved protection from exterior dust levels. The ranges of improvements in figure 5 show that for a low interference air velocity of 0.32 m/s, significant improvements in efficiency were seen at 30.5 and 61.0 cm below the canopy (p<0.05). The improvement at 91.5 cm was not significant (p>0.05). Efficiency improved at the high interference air velocity (0.64 m/s) only for 61.0 and 91.5 cm below the canopy. No significant change in efficiency was seen at 30.5 cm (p>0.10).

Figure 5 shows that increasing air curtain quantity led to small or even negative changes in efficiency at

30.5 cm beneath the canopy. This is consistent with the ANOVA analysis in table 2 showing that air curtain quantity was not a significant influence on canopy efficiency at 30.5 cm. For other distances, however, increases in canopy air curtain quantity generally led to statistically significant increases in efficiency.

Table 2. Summary of ANOVA results for air curtain sampling.

Source of variation	Sum of Squares	Degrees of freedom	F-ratio
---------------------	----------------	--------------------	---------

30.5 cm beneath air curtain

A (air curtain quantity)	6.16	1	0.08
B (interference air velocity)	5276.05	1	64.22 [#]
AB (interaction)	95.66	1	1.16
Curvature	27.25	1	0.33
Error	1232.34	15	
Total	6637.46	19	

61.0 cm beneath air curtain

A (air curtain quantity)	913.546	1	12.966 [#]
B (interference air velocity)	17344.283	1	246.161 [#]
AB (interaction)	69.006	1	0.979
Curvature	42.172	1	0.599
Error	1056.886	15	
Total	19425.893	19	

91.5 cm beneath air curtain

A (air curtain quantity)	1127.551	1	15.125 [#]
B (interference air velocity)	14758.201	1	197.969 [#]
AB (interaction)	34.716	1	0.466
Curvature	518.746	1	6.959 [#]
Error	1118.216	15	
Total	17557.43	19	

Note:

Critical F-value: $F_{0.05,1,15} = 4.54$

[#] = significant at 95% level of confidence

Increasing interference air velocity, however, from 0.32 to 0.64 m/s led to statistically significant reductions in efficiency at all sampling locations (Figure 6). This was most evident at locations 61.0 and 91.5 cm below the air curtain where mean reductions in efficiencies ranged from -52% to -63%. The effects were much less at a distance of 30.5 cm from the canopy where mean reductions in efficiencies ranged from -28% to -36%. Comparing absolute magnitudes of changes in figure 5 to those in figure 6 suggests that changes in interference air velocity, rather than changes in air curtain quantity, had a much greater impact on air curtain efficiency. This is supported by the ANOVA results of Table 2.

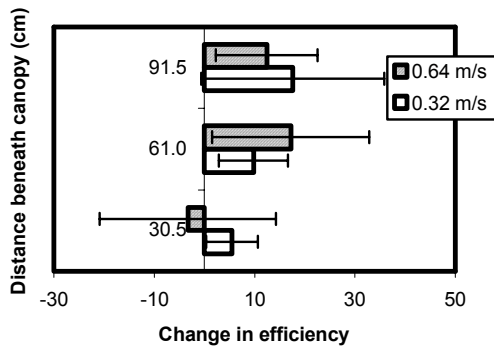

Figure 5. Effects of changing air curtain quantity (mean changes and 95% confidence limits shown)

These analyses imply that use of a canopy air curtain on a roof bolter would be most effective in areas of low air velocity such as bolting faces. In areas of higher interference air velocity, the protection offered by the device likely would be compromised. Furthermore, higher canopy airflow, such as that used in this work, led to little improvement in efficiency. Perhaps smaller capacity and, therefore, quieter fans may be as effective as larger fans.

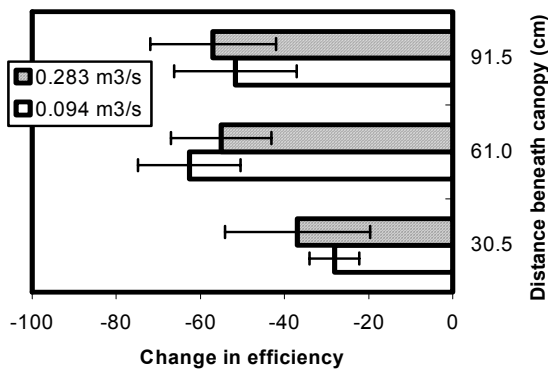

Figure 6. Effects of changing interference air velocity (mean changes and 95% confidence limits shown)

Average dust concentrations and efficiencies were calculated using the average of three samplers situated beneath the air curtain. The previous assessment showed that the highest velocity air streams existed below the center of the air curtain and that these velocities diminished toward its periphery. Center efficiencies were calculated in table 3 and found much higher than the efficiencies across the entire air curtain.

ANOVA analyses of centerline efficiencies showed trends similar to those found with the average efficiencies. Interference air velocity significantly affected average efficiency at all distances from the air curtain. Air curtain quantity, again, was significant only at distances of 61.0 and 91.5 cm beneath the canopy. No evidence was found of interaction between the variables of air curtain quantity and interference air velocity, nor any evidence of non-linearity between these variables.

Table 3. Mean reduction efficiencies and 95% confidence limits beneath center of air curtain.

Air curtain flow (m³/s)	Interference air velocity (m/s)	Reduction efficiencies (%)		
		30.5 cm	61.0 cm	91.5 cm
0.094	0.32	89.5 ± 1.9	55.6 ± 11.5	33.6 ± 18.2
0.094	0.64	64.6 ± 41.8	-19.9 ± 15.3	-21.8 ± 10.5
0.283	0.32	90.2 ± 8.0	77.2 ± 5.1	57.4 ± 22.4
0.283	0.64	73.7 ± 12.2	12.7 ± 36.8	-4.4 ± 7.4
0.188	0.48	88.3 ± 6.6	28.5 ± 16.2	6.9 ± 11.1

- 1.5 samples for each combination of air curtain flow and air velocity.
- Negative efficiencies are increases in dust concentration.

Efficiencies calculated using three samplers beneath the air curtain were much less than center efficiencies. However, these average efficiencies presented a more realistic picture of the actual dust reduction potentials. During roof bolting, the bolter operator likely will be moving beneath the canopy, rather than staying beneath the center. An efficiency calculated from three samplers establishes a lower limit on protection from an external dust source. Improved protection is, of course, available by staying beneath the center of the air curtain.

Out of five total tests run with each combination of canopy air curtain flow and interference air velocity, filters from three of these tests were selected for subsequent silica analyses. ANOVA analyses showed that respirable silica percentages at distances of 30.5, 61.0, and 91.5 cm beneath the CAC were not significantly affected by changes in either air curtain quantity or interference air velocity. Subsequent pairwise comparisons revealed no significant difference

between silica contents under the canopy and silica contents outside the canopy (Figure 7).

This implies that the canopy air curtain was equally effective on both respirable coal and respirable silica dust particles. If the canopy air curtain was selective in its control of either dust particle, then silica percentages under the the canopy would have been significantly different from percentages outside the canopy.

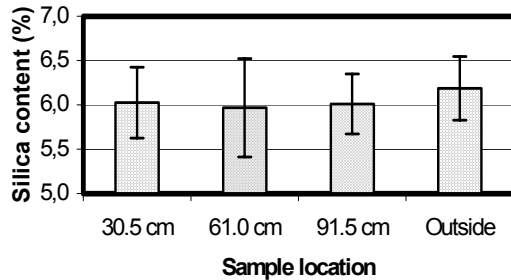

Figure 7. Average silica dust percentages with 95% confidence limits

Although silica percentages did not change under the canopy, coal dust concentrations generally decreased. Therefore, silica dust concentrations also decreased for samples under the canopy. The canopy air curtain provided similar control of both respirable coal and respirable silica dusts.

SUMMARY

Data collected from the Mine Safety and Health Administration show that roof bolting occupations continue to be at risk for overexposure to respirable silica dust. One means proposed to limit exposures is the use of a canopy air curtain to provide a constant flow of filtered air over the breathing zone of the bolter operator. This laboratory work evaluated the effectiveness of such a system for limiting respirable coal and silica dust exposures.

Initial evaluations of velocity profiles beneath the canopy showed that higher velocity air streams existed near the inlet to the air curtain and that these velocities diminished with distance from the inlet. With increasing distance beneath the canopy, the zone of high velocity air shrank noticeably, although it was still present beneath the center of the canopy.

Subsequent testing showed that dust reduction efficiencies were highest for those locations close to the canopy and that these values decreased rapidly with distance beneath the canopy. ANOVA analyses revealed that changes in interference air velocity significantly affected dust reduction efficiencies while changes in canopy air flow did not always lead to significant changes. No interactive effects were found between interference airflow and canopy air quantity. Similar

results were found when considering only the higher, centerline dust reduction efficiencies. A final analysis showed that respirable silica dust percentages were not significantly affected by changes in either canopy air flow or interference air velocity. In fact, silica contents of samples under the canopy were not significantly different from those outside the canopy. Due to reductions in respirable coal dust levels under the canopy, however, silica dust concentrations decreased under the canopy.

REFERENCES

- Donaldson Company, Inc., 1975, "Develop and Test Canopy Air Curtain Devices," Contract Report No. H0232067, U.S. Bureau of Mines, Pittsburgh, PA
- Donaldson Company, Inc., 1987, "Improved Canopy Air Curtain Systems," Contract Report No. J0318014, U.S. Bureau of Mines, Pittsburgh, PA
- Kok, E.G., Adam, R.F.J., and Pimentel, R.A., 1985, "Control of Respirable Quartz on Continuous Mining Sections," Contract Report No. J0338078, U.S. Bureau of Mines, Pittsburgh, PA
- Mine Safety and Health Administration (MSHA), 1973, "Standard Method No. P-7, Infrared Determination of Respirable Quartz in Respirable Coal Mine Dust," Internal Document, U.S. Department of Labor, Pittsburgh, PA
- Mine Safety and Health Administration (MSHA), 1999, Respirable Coal Mine Quartz Dust Data, available from the MSHA Technology Center, Dust Division, Pittsburgh, PA, USA 15236
- Mining Research and Development Establishment (MRDE), 1981, "Studies of Air Curtain Technology with Particular Application to the Provision of Clean Air for Underground Mines," Final Report, ECSC Project 7251-17/8/085
- Mining Research and Development Establishment (MRDE), 1983, "Application of Air Curtains and Other Methods for Controlling Ventilation and Providing Clean Air at the Workplace," Final Report, ECSC Project 7256-13/039/08
- Myers, R.H. and Montgomery, D.C., 1995, Response Surface Methodology. John Wiley and Sons, Inc., New York.
- Organiscak, J.A., Page, S.J., and Jankowski, R.A., 1990, "Sources and Characteristics of Quartz Dust in Coal Mines," Information Circular 9271, US Bureau of Mines, Pittsburgh, PA
- U.S. Government Printing Office, 1999, Mineral Resources. Code of Federal Regulations Title 30, Parts 70 and 75