



**CDC**  
Workplace  
Safety and Health

# *Proceedings of the First American Conference on Human Vibration*



DEPARTMENT OF HEALTH AND HUMAN SERVICES  
Centers for Disease Control and Prevention  
National Institute for Occupational Safety and Health

National Institute for  
Occupational Safety and Health  
**NIOSH**

Proceedings of the  
First American Conference on Human Vibration

June 5-7, 2006

Waterfront Place Hotel  
Morgantown, West Virginia, U.S.A.

Ren Dong, Ph.D.  
Kristine Krajnak, Ph.D.  
Oliver Wirth, Ph.D.  
John Wu, Ph.D.

Engineering and Control Technology Branch  
Health Effects Laboratory Division  
Morgantown, West Virginia, U.S.A.

Department of Health and Human Services  
Centers for Disease Control and Prevention  
National Institute for Occupational Safety and Health

## Disclaimer

Mention of any company or product does not constitute endorsement by NIOSH. In addition, citations to Web sites external to NIOSH do not constitute NIOSH endorsement of the sponsoring organizations or their programs or products. Furthermore, NIOSH is not responsible for the content of these Web sites. The findings and conclusions in this report have not been formally disseminated by the National Institute for Occupational Safety and Health and should not be construed to represent any agency determination or policy.

This document is in the public domain and may be freely copied or reprinted.

## ORDERING INFORMATION

To receive documents or other information about occupational safety and health topics, contact NIOSH at

NIOSH – Publications Dissemination  
4676 Columbia Parkway  
Cincinnati, OH 45226-1998

Telephone: 1-800-35-NIOSH (1-800-356-4674)  
Fax: 513-533-8573  
E-mail: [pubstaft@cdc.gov](mailto:pubstaft@cdc.gov)

Or visit the NIOSH Web site at [www.cdc.gov/niosh](http://www.cdc.gov/niosh)

DHHS (NIOSH) Publication No. 2006-140  
June, 2006

## Foreword

It is my pleasure to welcome the *First American Conference on Human Vibration* to Morgantown, West Virginia. This meeting showcased the most recent research regarding the physiological effects of vibration. It explored the etiology of vibration-induced disorders and illuminated opportunities for their diagnoses, treatment, and prevention.

Vibration-induced disorders, such as work-related Reynaud's disease, are serious and potentially disabling. They may result in loss of feeling and interfere with one's ability to work. NIOSH has long sought strategies to prevent vibration-induced disorders. In 1983 the Institute published a Criteria Document describing the risk of vibration syndrome from the use of hand-held machinery. Since that time the body of knowledge in this field has continued to expand. We now better understand the risk faced by workers who drive on or off road vehicles, operate marine or aircraft, or are exposed to continuous building vibration.

This conference provided us with a historic opportunity to exchange information regarding this critical occupational health issue. The agenda promised a rich and diverse scientific program as researchers and medical professionals from around the world have gathered to examine human responses to hand-transmitted vibration and whole-body vibration.

NIOSH is pleased to have hosted the first U.S. conference to examine human vibration, and I would like to thank the many scientific presenters from both the U.S. and abroad who have come to share their work with us. Together, we will advance the science further and achieve safer and healthier workplaces.

I congratulate you on a successful conference.

A handwritten signature in black ink, appearing to read "J. Howard". The signature is fluid and cursive, with a large initial "J" and a long, sweeping underline.

John Howard, MD  
Director, National Institute for Occupational Safety and Health

## Acknowledgments

The convening of the First American Conference on Human Vibration was supported by the Health Effects Laboratory Division of the National Institute for Occupational Safety and Health (NIOSH). Many thanks to Frank J. Hearl (Chief of Staff, NIOSH) for delivering the opening address. Assistance with the organization of the conference was provided by Jamie Long (West Virginia University -- Continuing Education) and Barbara Elbon, Thomas McDowell, Daniel Welcome, and Christopher Warren (NIOSH). Editing, cover design, graphics, and layout were provided by Kimberly Clough Thomas (NIOSH). Tanya Headley (NIOSH) provided assistance with the final editing.

## ACHV Organizing Committee

Ren Dong<sup>1</sup>  
Chuanfang Jin<sup>4</sup>  
Kumar Kittusamy<sup>2</sup>  
Kristine Krajnak<sup>1</sup>  
Alan Mayton<sup>3</sup>  
Oliver Wirth<sup>1</sup>  
John Wu<sup>1</sup>

<sup>1</sup> Health Effects Laboratory Division, National Institute for Occupational Safety and Health

<sup>2</sup> Spokane Research Laboratory, National Institute for Occupational Safety and Health

<sup>3</sup> Pittsburgh Research Laboratory, National Institute for Occupational Safety and Health

<sup>4</sup> School of Medicine, West Virginia University

## Board of Scientific Advisors (in alphabetical order)

Nabih Alem (US Army Research Lab)  
Farid Amirouche (University of Chicago)  
Thomas Armstrong (University of Michigan)  
Paul-Emile Boileau (IRSST, Canada)  
Martin Cherniack (University of Connecticut)  
Anthony Brammer (National Research Council Canada)  
Ren Dong (NIOSH)  
Thomas Jetzer (Occupational Medicine Consultants)  
Bernard Martin (University of Michigan)  
Robert Radwin (University of Wisconsin, Madison)  
Subhash Rakheja (Concordia University, Canada)  
Douglas Reynolds (University of Nevada, Las Vegas)  
Danny Riley (Medical College of Wisconsin)  
Susanne Smith (US Air Force Research Lab)  
David Wilder (University of Iowa)  
Donald Wasserman (Human Vibration Consultant)  
Jack Wasserman (University of Tennessee, Nashville)

## Table of Contents

Introduction	1
Keynote Presentations	2
Podium Presentations	11
Session I: Exposure I	11
Session II: Health Effects I	24
Session III: Biodynamics I	37
Session IV: Health Effects II	50
Session V: Health Effects III	63
Session VI: Epidemiology, Standards Applications, and Prevention I	76
Session VII: Biodynamics II	89
Session VIII: Vibration Reduction and Machine Testing	103
Session IX: Epidemiology, Standards Applications, and Prevention II	116
Poster Presentations	129
Index of Authors	170

## Introduction

Vibrations caused by power tools, machinery, vehicles, and heavy equipment are a ubiquitous feature of modern work environments. In the U.S., an estimated six million workers are in occupations exposed to whole-body vibration and more than one million workers are in occupations exposed to hand-transmitted vibration (U.S. Bureau of Labor Statistics, 2004). Since Alice Hamilton's seminal report in 1918 on vibration-induced hand disorders in quarry stonecutters, the potential health risks associated with prolonged and repeated vibration exposure have been well recognized and documented. Efforts to understand the exposure risk factors and adverse health effects of occupational vibration exposure have waxed and waned over the years. Despite numerous studies and technological advances in vibration measurement and control, the exposure risks and etiology of the adverse health effects are not well understood. Human exposure to vibration remains a major risk factor associated with vascular, neural, and musculoskeletal disorders.

The First American Conference on Human Vibration (ACHV) was held in Morgantown, West Virginia, June 5-7, 2006. It was organized by the Health Effects Laboratory Division of the National Institute for Occupational Safety and Health and West Virginia University Department of Continuing Education. This conference provided a unique opportunity for a multidisciplinary group of national and international experts to exchange current information on all aspects of segmental and whole-body vibration exposures. The attendees included industrial hygienists, engineers, physicians, epidemiologists, scientists, psychologists, physiologists, health and safety specialists, consultants, students, and other individuals from Government, industry, and academic institutions from the U.S., Canada, and more than seven other countries.

Four keynote lectures and more than 60 papers were presented at this conference. Topics included vibration exposure measurement and quantification, biodynamic responses of whole-body and hand-arm system, subjective perceptions of vibration, physiological and pathological mechanisms, health effects, clinical diagnoses, epidemiological studies, prevention effectiveness, standard development and implementation. Presentations also described recent technological advances that may improve vibration measurement, tool and vehicle seat designs and tests, personal protection devices, and clinical diagnosis and assessment methods.

The ACHV was intended to prompt the convening of future, biennial conferences on human vibration in North America. We hope that the publication of these conference proceedings will help encourage new research and technological advances so that the health hazards associated with occupation vibration exposures will be significantly reduced.

Ren Dong  
Kristine Krajnak  
Oliver Wirth  
John Wu

Morgantown, West Virginia

## Keynote Speakers

### Michael J. Griffin

Michel Griffin, BSc., Ph.D., is the head of the multi-disciplinary Human Factors Research Unit in the Institute for Sound and Vibration Research at the University of Southampton in England. Professor Griffin is the Chairman of the British Standards Institution Sub-Committee concerned with human response to mechanical vibration and shock. He is also a member of relevant committees of the International Organization for Standardization and the European Committee for Standardization. Professor Griffin has particular research interests in biodynamics, human performance, ride comfort in vehicles, vibration-induced injuries, and motion sickness.



### Setsuo Maeda and Neil J. Mansfield

Setsuo Maeda, Dr.Eng., Dr.Med.Sci. is the Director of Department of Hazard Assessment at Japan National Institute of Occupational Safety and Health in Kawasaki, Japan. His research interests include human response to multi-axis whole-body vibration and multi-axis hand-arm vibration. Neil Mansfield, B.Eng., Ph.D., is a Senior



Lecturer in the Department of Human Sciences at Loughborough University in the U.K. He is Technical Director of OPERC hand-arm vibration test centre (HAVTEC) and heads the Vibration, Biomechanics and Noise research group of Loughborough University's Environmental Ergonomics Research Centre. He has worked in the area of human response to vibration and noise for 15 years as a consultant.

### Hisataka Sakakibara

Hisataka Sakakibara, M.D., Ph.D. is a Professor at Nagoya University School of Health Sciences in Nagoya, Japan. His major research focuses on the pathophysiological effects of hand-arm vibration.



### Chris Nelson

Chris Nelson, Ph.D. is a Specialist Inspector (Noise and Vibration) with the U.K.'s Health and Safety Executive (HSE). He has recently been involved with the development of British legislation, and supporting guidance, to implement the European vibration directive. He is also convener of the ISO and CEN working groups on hand-arm vibration. Prior to joining the HSE, Chris spent some years involved in research and consultancy work at the Institute of Sound and Vibration Research, Southampton University, gaining a Ph.D. for his study of vibration-induced white finger in dockyard employees. He then joined the Institute of Naval Medicine as Head of Acoustics and Vibration, moving to the HSE in 1997.





## Keynote Presentation

### HEALTH EFFECTS OF VIBRATION – THE KNOWN AND THE UNKNOWN

Michael J. Griffin

Institute of Sound and Vibration Research, University of Southampton, U.K.

#### Introduction

Science involves the study of the nature and behaviour of natural things and the knowledge we obtain about them. Scientific endeavour leads to the unfolding of new knowledge and adjustments to our understanding and our behavior. To indicate that we ‘know’ something may merely mean we do not feel able to, or that we do not wish to, disagree with others who claim to know; or it may mean we have either heard about it, or studied it, or understand part of it, or accept that it is true, or have seen evidence to be convinced of its veracity. What do we ‘know’ about the health effects of vibration?

There are many unknowns in the field of human responses to vibration. Not all would agree on what is known and what is unknown. This paper seeks to summarize what we know that we know, what it is sometimes claimed that we know, and what we know that we do not know about the relation between exposures to vibration and our health. It also speculates on what we do not know that we do not know.

#### Hand-transmitted vibration

##### *What we know we know*

We know that exposures to hand-transmitted vibration result in various disorders of the hand, including abnormal vascular and neurological function. Not all frequencies, or magnitudes, or durations, of hand-transmitted vibration cause the same effects.

##### *What we may claim to know*

To enable exposures to be reported and compared, they are ‘measured’ and ‘evaluated’ using defined (e.g. standardised) procedures. This involves identifying what is to be measured and specifying how it is expressed by one (or a few) numbers. Summarising a vibration exposure in a single value involves assuming the relative importance of components within the vibration (e.g. different magnitudes, frequencies, directions, and durations), so standards define ‘weightings’ for these variables. The importance of the weighted values may also be suggested, allowing ‘assessments’ according to a criterion (e.g. the probability of a specific severity of a specific disease).

Standards for the measurement and evaluation of hand-transmitted vibration define a frequency weighting and time dependencies that allow the severity of vibration exposures to be assessed and the probability of finger blanching to be predicted<sup>1</sup>.

##### *What we do not know*

We do not know that the frequency weighting in current standards reflects the relative importance of different frequencies and axes of vibration in producing any specific disorder. We do not know whether the energy-based daily time-dependency inherent in  $A(8)$  reflects the relative importance of vibration magnitude and daily exposure duration. Consequently, the relation between  $A(8)$  and the years of exposure to develop finger blanching, as in an appendix to ISO 5349-1 (2001), is not well-founded.

We do not know, or at least there is no consensus on, the full extent of the disorders caused by hand-transmitted vibration (e.g. vascular, neurological, muscular, articular, central), or the pathogenesis of any specific disorder caused by hand-transmitted vibration, or the roles of other factors (e.g. ergonomic factors, environmental factors, or individual factors). We know that acute

exposures to hand-transmitted vibration cause both vascular and neurological changes analogous to the changes seen in those occupationally exposed to hand-transmitted vibration, but we do not yet know how the acute changes relate to the chronic disorders.

### **Whole-body vibration**

#### *What we know we know*

We know that many persons experience back pain and that some of these are exposed to whole-body vibration. We know that in the population at large, occupational exposures to whole-body vibration are not the main cause of back problems, and that ergonomic factors (e.g. lifting and twisting) and personal factors are often involved. We know vibration and shock can impose stresses that could supplement other stresses.

#### *What we may claim to know*

Measurement methods and evaluation methods have been defined in which the frequencies, directions and durations are weighted so as to predict the relative severity of different vibrations and indicate the magnitudes that might be hazardous <sup>2</sup>.

#### *What we do not know*

We are not able to predict the probability of any disorder from the severity of an exposure to whole-body vibration. We do not know whether there is any disorder specific to whole-body vibration, or what disorders are aggravated by exposure to whole-body vibration. We do not know the relative importance of vibration and other risk factors in the development of back disorders.

### **Discussion**

Providing guidance to others involves compromises – a perceived need, or other argument, may outweigh the cautious interpretation of scientific evidence. Standards for measuring and evaluating human exposures to vibration use uncertain frequency weightings and time dependencies but allow legislation for the protection of those exposed <sup>3</sup>. The standards may appear useful, but it is prudent to distinguish between standards and knowledge – between what is accepted to reach a consensus and what can be accepted as proven. Standards may guide actions but not understanding.

Where reducing risk solely involves reducing vibration magnitude or exposure duration, ill-founded evaluation methods will not increase risk. Where prevention involves a redistribution of vibration over frequencies or directions, or balancing a change in magnitude with a change in duration, an inappropriate evaluation method can increase risk. For example, the hand-transmitted vibration frequency weighting, which may be far from optimum, implies that gloves give little beneficial attenuation, whereas a different weighting might indicate that gloves can be a useful means of protection <sup>4</sup>.

What do we not know that we need to know? Not all appreciate the benefits of placing more reliance on traceable data than on consensus. Traceability is fundamental to quality systems but deficient in current standardization. Standards can comfort their users – justifying actions without resort to understanding – while concealing assumptions that may prevent the minimization of the risks of injury from exposures to vibration.

### **References**

1. International Organization for Standardization (2001) Mechanical vibration - measurement and evaluation of human exposure to hand-transmitted vibration - Part 1: General requirements. ISO 5349-1.
2. International Organization for Standardization (1997) Mechanical vibration and shock - evaluation of human exposure - to whole-body vibration. Part 1: general requirements. ISO 2631-1.
3. Griffin, M.J. (2004) Minimum health and safety requirements for workers exposed to hand-transmitted vibration and whole-body vibration in the European Union; a review. *Occupational and Environmental Medicine*; 61, 387-397.
4. Griffin, M.J. (1998) Evaluating the effectiveness of gloves in reducing the hazards of hand-transmitted vibration. *Occupational and Environmental Medicine*, 55, (5), 340-348.

## Keynote Presentation

### EVALUATION OF WHOLE-BODY VIBRATION COMFORT

Setsuo Maeda, National Institute of Industrial Health, Kawasaki, Japan  
Neil J Mansfield, Loughborough University, Loughborough, U.K

#### Introduction

The purpose of using experimental subjective and/or perception methods is: (a) to understand human subjective impressions of the physical characteristics of vibration; (b) to determine the relationship between the subjective perception of some aspect of the vibration and an evaluation index of the physical vibration characteristics; and (c) the establishment of target values for design of vibration environments in terms of human sensation of vibration characteristics. In order to understand the relationship between a physical measure of the mechanical vibration and the subjectively perceived aspect of the vibration environment, experimental methods shown in Table 1 have been used<sup>1</sup>.

Table 1. Psychophysical methods.

Constant measurement methods	Constant stimulus method Method of adjustment Method of limits Adaptive psychological method
Subjective scaling methods	Interval scale Paired comparison method Category judgment method Proportional scale Magnitude estimation

The constant measurement methods of Table 1 are mainly used for measurement of the threshold of human sense. The subjective scaling methods are mainly used for obtaining subjective (or proportional) scaling between the perceived quantity and physical quantity.

In this review, the fundamental approach of experimental methods for obtaining the target values used in the design of vibration environments, and the different findings between the subjectively perceived methods for evaluating human response to vibration characteristics and the physical quantity of the vibration environment are summarized.

#### Fundamentals of Subjective Scaling

The relationship between the experimental psychological methods for providing target values in the design of the vibration environments and the physical quantities is illustrated in Fig. 1. Vehicle mechanical vibration can be characterized using many metrics, and these can be considered the ‘input’ to the human. In order to predict subjective responses to the vibration, it is necessary to link the characteristics of the source of vibration and human reactions, the ‘output’.

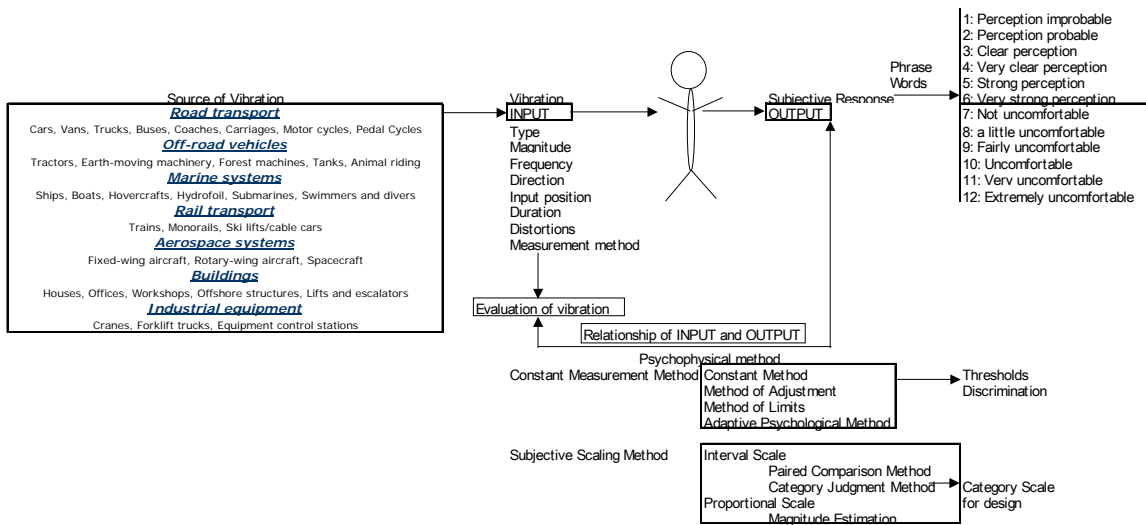

Fig.1 Relationship between vibration and subjective responses.

The constant measurement methods are usually used when the aim of the research is to understand human sensation in response to changes in the nature of the vibration (e.g. changes in frequency). The constant method uses an array of predetermined stimuli at discrete magnitudes above and below the expected threshold; the method of adjustment allows the experimental subject to control the magnitude such that they can set it to their threshold; the method of limits alternates the magnitude between detection and non-detection thresholds; adaptive methods use stimuli with magnitudes which step up and down, crossing the threshold, in response to subjective responses. In all of these cases the threshold could be absolute perception or some form of difference threshold.

Subjective scaling, such as using interval scales or proportional scales, has usually been used when the aim of the research is to understand human sensation in response to changes in the perceived magnitude of vibration. Paired comparisons requires subjects to choose one of two stimuli (e.g. greater intensity); category judgment requires subjects to select from a range of text descriptors (e.g. describing levels of discomfort); magnitude estimation requires subjects to give a numerical score to each stimulus. Some methods are used that try to combine qualities from more than one technique (e.g. Borg CR-100).

Each experimental method works in a different way and has its own advantages and disadvantages. Therefore, researchers must carefully choose the most appropriate experimental method. It is also essential to include enough information for readers to understand and assess the methods used when presenting and publishing results.

It will be necessary to conduct new experiments for the design of vehicles in the future, possibly requiring new psychophysical approaches. For example, new methods might be required to investigate the relationship between the human biodynamic response and subjective responses to multi-axis whole-body vibration.

## Reference

1. Guilford J.P. (1954) Psychometric methods. McGraw-Hill, New York.

## **Keynote Presentation**

### **SOME ASPECTS OF PATHOGENESIS OF VIBRATION-INDUCED WHITE FINGER**

Hisataka Sakakibara  
Nagoya University School of Health Sciences, Nagoya, Japan

#### **Introduction**

Although the pathophysiology of vibration-induced white finger (VWF) is still under discussion, evidence has been accumulated to understand the underlying mechanism.

VWF is pathophysiologically characterized by an enhanced vasospastic response to cold, which can result from an imbalance between vasoconstriction and vasodilation in the digital arteries in response to cold (i.e., vasoconstriction-dominant). The imbalance is supposed to be due to faults in vascular vessels and sympathetically mediated vascular tone.

#### **Enhanced vasospastic response to cold**

Structural factors for enhanced vasoconstriction (and vasodilation)

- Narrowing of arterial lumen with medial smooth muscle hypertrophy.

Possible functional factors for enhanced vasoconstriction

- Increased sympathetic nervous activity to cold (e.g., norepinephrine)
- Increased release of endothelin-1 (ET-1; an endothelial-dependent vasoconstrictor) from the endothelium
- Increased reactivity of alpha2-adrenoreceptors to cold

Possible functional factors for decreased vasodilation

- Decreased release of nitric oxide (NO; an endothelial-dependent vasodilator) from the endothelium
- Decreased release of calcitonin gene-related peptide (CGRP; a vasodilatory neuropeptide) from sensory afferents

The question is how their interrelations or imbalances among them are.

#### **Vibration and arterial damage**

The next question is, how does hand-arm vibration exposure induce such pathophysiological changes in VWF patients? Recent morphological evidence from animal experiments shows that vibration acceleration stress (including shear stress) and smooth muscle contraction contribute to arterial damage of smooth muscle and endothelial cells. The vibration-induced arterial damage is frequency-amplitude-dependent.

Repeated vibration exposure may damage smooth muscle cells to medial hypertrophy leading to lumen narrowing and injure endothelial cells to impaired vasodilation, resulting in vasospastic response to cold. The enhanced vasospastic response might in turn exaggerate vasoconstriction in response to cold.

### References

Sakakibara H. (1998). Pathophysiology and pathogenesis of circulatory, neurological, and musculoskeletal disturbances in hand-arm vibration syndrome. In: Pelmear PL, Wasserman DE (eds) *Hand-Arm Vibration, A Comprehensive Guide for Occupational Health Professionals* (Second Edition), Beverly Farms, OEM Press.

Herrick AL (2005). Pathogenesis of Raynaud's phenomenon. *Rheumatol.* 44, 587-596.

Curry BD, Govindaraju SR, Bain JLW, Zhang LL, Yan J-G, Matloub HS, Riley DA (2005). Evidence for frequency-dependent arterial damage in vibrated rat tails. *Anat. Record Part A* 284A, 511-521.

## **Keynote Presentation**

# **EUROPEAN LEGISLATION AND STANDARDISATION FOR THE CONTROL OF RISKS FROM VIBRATION AT WORK**

Chris Nelson  
Health and Safety Executive, United Kingdom

## **Introduction**

Two pieces of European Union (EU) legislation together establish requirements for protection against risks from vibration at work. The vibration directive<sup>1</sup> specifies duties of employers to protect workers from risks from exposure to vibration; the machinery directive<sup>2</sup>, specifies duties of manufacturers and suppliers regarding the safety of machinery marketed in the EU. This paper discusses both directives and the standardisation programmes that support them. It also addresses the implementation of these requirements in Great Britain.

### **Employers' duties: the vibration directive**

This directive requires employers to assess and control risks to health and safety arising from hand-arm vibration (HAV) and whole-body vibration (WBV). Member States were required to implement the directive in national legislation by 6 July 2005.

Employers are required to eliminate vibration risk at source, or reduced to a minimum. The duties include: assessing risk and exposure; planning and implementing the necessary risk control measures; providing and maintaining suitable work equipment; providing workers with information and training on risks and their control; and monitoring and reviewing the effectiveness of the risk control programme. Daily exposure exceeding a specified action value triggers a requirement for a programme of technical and organisational measures to minimise vibration exposures and the resulting risk, and the provision of health surveillance. Exposures above a specified limit value are prohibited.

When conducting their risk assessments, employers are required to “assess and, if necessary, measure” the vibration exposure of workers, for comparison with the action and limit values. Vibration measurement in the workplace is not expected in all cases and the use of vibration information from equipment manufacturers is specifically mentioned. This provides a link with the machinery directive (see below).

### **Manufacturers' and suppliers' duties: The machinery directive**

The machinery directive, first introduced in 1989, is intended to remove barriers to trade. It puts duties on manufacturers and suppliers who place machinery on the European market to design their products to eliminate or reduce risks to health and safety and to warn the user of any residual risks, providing information required for safe use (for example, operator training, maintenance and selection of consumables). There are specific requirements for minimising risk from vibration in the design and construction of the machine and, in the case of hand-held, hand-

guided and mobile machines, for declaring the vibration emission. If the declared emission of a machine is representative of the vibration in real-world use, it can be adequate to inform the user of residual vibration risks.

### **Standards supporting the two directives**

The vibration directive contains two annexes (for HAV and WBV respectively) which define the metrics for daily vibration exposure by reference to ISO 5349-1:2001 for HAV and ISO 2631-1:1997 for WBV. The European Standards bodies (CEN and CENELEC) have no mandate from the European Commission to produce any standards in support of the vibration directive. However, CEN had, in 2001, adopted both parts of ISO 5349, and has also chosen to prepare a new standard providing guidance on assessing daily WBV exposures using the “A(8)” method.

The machinery directive is supported by a set of harmonized standards, mostly prepared by CEN and CENELEC under a work programme mandated by the European Commission. Where appropriate, this is done in partnership with ISO so that the relevant international standard is used to support the directive in Europe. The harmonized standards define safety requirements for various categories of machine (including the provision of user information); conformity with the relevant standard carries a presumption of conformity with the directive. The standards include test codes for vibration emission; some of those dealing with hand-operated equipment do not adequately describe the vibration in typical use and require revision.

### **Controlling risks from vibration at work in Great Britain**

Both directives are implemented as regulations in the British legal system and are enforced by the Health and Safety Executive (HSE). HSE’s work programme includes targeted inspections of high-risk activities (currently focusing on construction, foundries and steel fabrication) to ensure that HAV risks are properly controlled. Visits to tool manufacturers and suppliers are also undertaken, to secure improved provision of information on vibration risks. This front-line work is supported by the production of guidance material and activities to communicate HSE’s messages on preventing vibration-related ill-health<sup>3</sup>.

### **References**

1. European Parliament and the Council of the European Union (2002) Directive 2002/44/EC on the minimum health and safety requirements regarding the exposure of workers to the risks arising from physical agents (vibration). Official Journal of the European Communities, OJ L177, 6.7.2002, 13.
2. Council of the European Union (1998) Council Directive 98/37/EC on the approximation of the laws of the Member States relating to machinery. Official Journal of the European Communities, OJ L207, 23.7.98, 1-46.
3. HSE’s vibration web pages. [www.hse.gov.uk/vibration](http://www.hse.gov.uk/vibration)



## Podium Presentations

### Session I: Exposure I

Chairs: Subhash Rakheja and Logan Mullinix

<b>Presenter</b>	<b>Title</b>	<b>Page</b>
D.D. Reynolds University of Nevada - Las Vegas	Using an air bladder seat shock isolation system to protect military vehicle occupants from mine blasts.	12
P.É. Boileau Laurentian University	Vibration spectral class characterization of long haul dump mining vehicles and seat performance evaluation.	14
J. Kim University of Cincinnati	Time-frequency analysis of hand-transmitted vibration of impact tools using wavelet transform.	16
N. J. Mansfield Loughborough University	Variation in the vibration emission of rotary hammer drills under simulated work-site conditions.	18
D. R. Peterson University of Connecticut Health Center	Device for measuring daylong vibration exposure and grip force levels during hand-tool use.	20
B. Evanhoff Washington University School of Medicine	Challenges and uncertainties in measuring hand vibration in field studies.	22

# USING AN AIR BLADDER SEAT SHOCK ISOLATION SYSTEM TO PROTECT MILITARY VEHICLE OCCUPANTS FROM MINE BLASTS

Douglas D. Reynolds, Qunli Liu, Tarek Deeb  
Center for Mechanical & Environmental Systems Technology,  
University of Nevada Las Vegas, Las Vegas, Nevada, U.S.A.

## Introduction

Landmines are a great threat to military vehicles and their occupants. Mine blasts can completely destroy vehicles and kill all the occupants or disable the vehicle and leave the occupants severely injured. Injuries sustained during a landmine blast come from fragmentation that enters the vehicle through a hull breach, hot gasses expanding through the vehicle, or shock created from the extreme pressure of the blast (Lafrance, L.P. 1998). Mitigating the high acceleration experienced by the occupants during survivable mine blasts is the focus of the research being addressed in this paper.

## Method

The objective of the project reported in this paper was to prove the feasibility that pneumatic seat technologies that employ light-weight, foam-filled, inflatable air bladder seats and seat backs can be used to protect the crews of lightweight combat vehicles against the detrimental and injurious effects of mine blasts. This protection includes reducing the shock energy experienced by seated vehicle crews during mine blast initiation and at vehicle slam-down to below potentially injurious levels. Figure 1 shows a schematic representation of the proposed lightweight, foam-filled, inflatable mine blast attenuating seat. It will consist of specially designed interconnected seat and seat back lightweight, foam-filled, air bladders that are supported by a rigid frame.

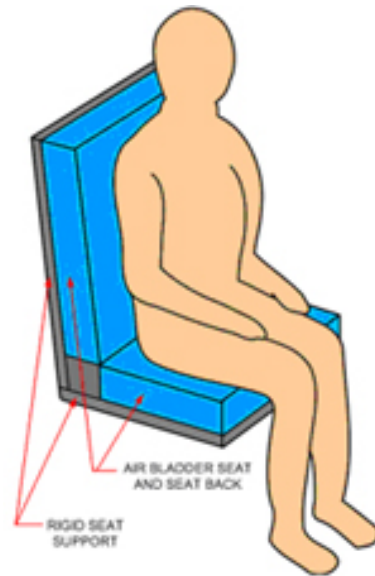

**Figure 1** Schematic of Lightweight, Foam-Filled Inflatable Mine Blast Attenuating Seat

## Results

Air gun tests and finite element analyses were conducted to determine the effectiveness of a light-weight, foam-filled, inflatable air bladder seat shock isolation system in isolating a vehicle occupant from the injurious effects of a mine blast. Figures 2 through 5 show analytical and experimental results associated with a 65.8 kg mass resting on an inflatable air bladder that is exposed to a shock input.

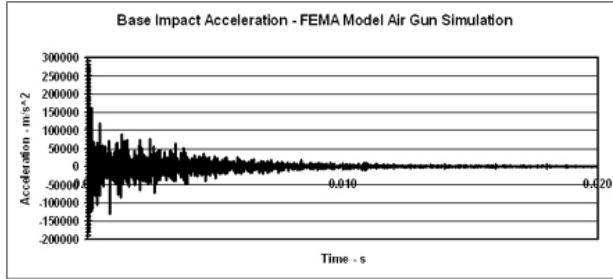

**Figure 2** Simulated Air Gun Test Shock Input

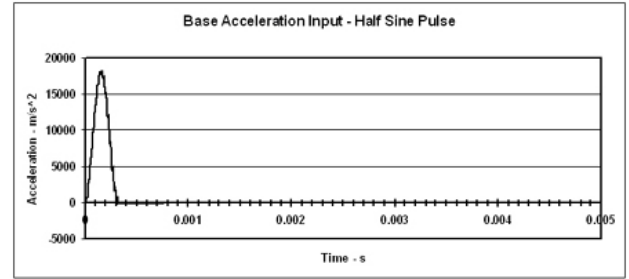

**Figure 3** 0.32 ms 8,000 m/s<sup>2</sup> Half-Sine Shock Input

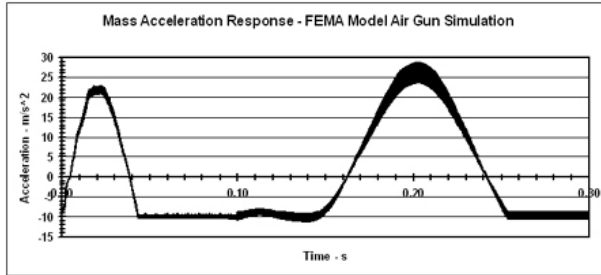

**Figure 4** Supported Mass Acceleration – Air Gun Simulation

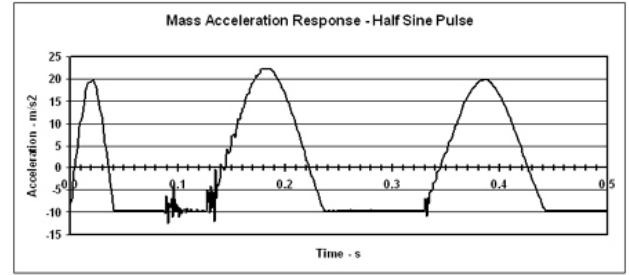

**Figure 5** Supported Mass Acceleration – 0.32 ms 18,000 m/s<sup>2</sup> Half-Sine Pulse Input

### Discussion

Table 1 shows that seat bladder reduced the peak acceleration response of the 65.8 kg mass relative to the peak shock input acceleration by three orders of magnitude for the air gun test and the half-sine shock pulse simulation.

The seat bladder shock isolation system has the potential when properly and fully developed to significantly reduce the injurious effects of mine blast shock inputs to seated individuals in lightweight combat vehicles.

**Table 1** Seat Bladder Shock Attenuation Results

	Support Mass Impact Acceleration	65.8 kg mass Peak Acceleration	65.8 kg Mass Acceleration/Support Mass Acceleration
	m/s <sup>2</sup>	m/s <sup>2</sup>	
<b>20 psi Air Gun Tank Pressure Simulated Air Gun Test</b>	34,000	47	0.001
<b>0.32 ms Half Sine Pulse Seat Impact</b>	28,000	25	0.001
	18,000	23	0.001

### References

Lafrance, L.P., 1998, “Mine Blast Protection Systems for Military Support.” American Society of Mechanical Engineers, vol. 361 pp. 305-309.

# VIBRATION SPECTRAL CLASS CHARACTERIZATION OF LONG HAUL DUMP MINING VEHICLES AND SEAT PERFORMANCE EVALUATION

P.-É. Boileau<sup>1</sup>, J. Boutin<sup>1</sup>, T. Eger<sup>2</sup> and M. Smets<sup>2</sup>

<sup>1</sup>Institut de recherche Robert-Sauvé en santé et en sécurité du travail (IRSST),  
Montréal, Canada

<sup>2</sup>School of Human Kinetics, Laurentian University, Sudbury, Canada

## Introduction

Long-haul dump (LHD) vehicles used in underground mining are known to expose workers to important levels of whole-body vibration<sup>1</sup>. These vehicles are generally designed without suspension and may be categorized as small or large LHDs depending on whether their respective load capacities are lower or larger than 3.5 cubic yards. While the majority of older vehicles are equipped with a rigid or unsuspended seat, more recent LHDs often incorporate a suspension seat.

The objective of this study was to define the vibration spectral characteristics of most commonly encountered large and small LHD vehicles operating in mining operations. This was done in an effort to categorize the vehicles in terms of vibration spectral classes to be reproduced on a laboratory whole-body vibration simulator to assess the vibration attenuation performance of a typical LHD suspension seat.

## Methods

Vertical vibration measured at the seat attachment point of 8 small and 8 large LHD vehicles operating underground in typical mining operations under loaded and unloaded conditions was considered as the basis for defining the spectral classes. By regrouping the data collected for each LHD vehicle size and load condition, the overall distribution of acceleration power spectral density (PSD) of measured floor vibration was determined over the 0.5 to 20 Hz frequency range. Mean and envelopes of maximum and minimum values of PSD spectra were computed to define the spectral classes, along with the corresponding values of frequency weighted rms acceleration determined in accordance to the ISO 2631-1 standard<sup>2</sup>. These spectra were further used to calculate the displacements needed to drive a whole-body vibration simulator consisting of a platform supported by two servo-hydraulic actuators having a total stroke of  $\pm 100$  mm. For validation purposes, the vibration acceleration spectra measured on the simulator were compared with the target spectra representing the spectral classes. Finally, the vibration transmissibility characteristics of a typical suspension seat were determined under sine sweep excitation using both a rigid mass load and a human subject having a mass of 62 kg and 85 kg, respectively. The SEAT value, representing the ratio of seat to base frequency-weighted rms acceleration, was further measured under each of the defined LHD vibration spectral classes by loading the seat with an 85 kg subject. Tests were repeated three times and the mean SEAT values were determined to assess the seat's ability to reduce exposure to whole-body vibration in LHD vehicles.

## Results

Three spectral classes applicable to both loaded and unloaded conditions were defined as shown in Figure 1: one for large and two for small LHDs. The influence of load on frequency-weighted rms acceleration was found to be negligible for large and Class I small LHDs, while a shift of the peak acceleration PSD to lower frequencies was noted for the loaded vehicles. The influence of load was found to be more important for Class II small LHDs. Table 1 provides a

comparison of frequency weighted,  $a_w$ , and unweighted,  $a$ , accelerations and dominant frequencies for the mean, maximum and minimum spectra associated with the different spectral classes. These were reproduced on a vibration simulator and used to assess the performance of a typical LHD suspension seat. The results obtained suggest that the seat cannot provide attenuation of the vibration at the dominant frequencies of the vehicles which range from 2.6 to 3.4 Hz. The measured SEAT values ranging from 1.25 for large LHDs to 1.35 for Class II small LHDs confirm that the seat is not adapted to these vehicles.

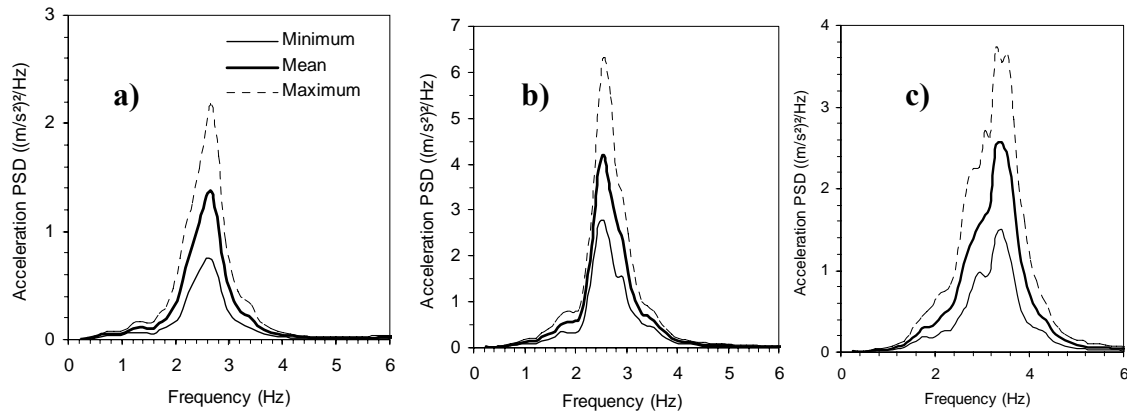

**Figure 1 : Vibration spectral classes :a) Large LHDs; b) small LHDs Class I; c) small LHDs Class II**

**Table 1: Characteristics of the spectral classes for large and small LHDs.**

Spectrum	Large LHDs		Small LHDs-Class I		Small LHDs-Class II	
	a	$a_w$	a	$a_w$	a	$a_w$
Minimum ( $ms^{-2}$ )	0.89	0.62	1.63	1.16	1.38	1.13
Mean ( $ms^{-2}$ )	1.20	0.85	2.03	1.45	1.88	1.55
Maximum ( $ms^{-2}$ )	1.52	1.09	2.45	1.76	2.36	1.95
Dominant frequency	2.7 Hz		2.7 Hz		3.4 Hz	

### Discussion

The vibration measured in LHD vehicles can be categorized into three spectral classes, two of which apply to small LHDs. In general, small LHDs lead to much higher vibration levels than large LHDs and the spread of values is more important, particularly for class II vehicles for which the dominant vibration frequency is considerably higher than that of the other categories. Laboratory evaluation of a typical suspension seat recommended for use in these vehicles has shown that it is more likely to provide amplification of whole-body vibration under normal operating conditions.

### Acknowledgment

The authors would like to extend their gratitude to the WSIB of Ontario and IRSST for funding this part of the research project.

### References

1. Village, J., Morrison, J., Leong, D. (1989). Whole-body vibration in underground load-haul-dump vehicles, *Ergonomics*. 32(10), 1167-1183.
2. International Standard ISO 2631-1 (1997). Mechanical vibration and shock-Evaluation of human exposure to whole-body vibration-Part 1: General requirements.

# TIME-FREQUENCY ANALYSIS OF HAND-TRANSMITTED VIBRATION OF IMPACT TOOLS USING ANALYTIC WAVELET TRANSFORM

Jay Kim,<sup>1</sup> Daniel E. Welcome,<sup>2</sup> Ren G. Dong,<sup>2</sup>

Won Joon Song,<sup>1</sup> Charles Hayden<sup>2</sup>

<sup>1</sup>Mechanical, Industrial and Nuclear Engineering Department  
University of Cincinnati, Cincinnati, Ohio, U.S.A.

<sup>2</sup>National Institute for Occupational Safety and Health  
Morgantown, West Virginia, U.S.A.

## Introduction

Prolonged, extensive exposure to hand-transmitted vibration could cause a series of vibration-induced disorders in the vascular, sensorineural, and musculoskeletal structures of the human hand-arm system, which have been collectively called hand-arm vibration syndrome (HAVS).<sup>1</sup> To assess the risk of HAVS the international standard ISO 5349-1 (2001)<sup>1</sup> recommends using the root-mean-square (rms) acceleration of the measured vibration with a frequency weighting. While a few epidemiological studies have reported results consistent with the predictions made according to the recommendation, many other studies have reported results with large discrepancies.<sup>2</sup> This may be partially attributed to the time-averaging effect involved in calculation of the frequency components, especially for impact type tools. Because the spectral characteristics of impact tools change dramatically with time, a time-frequency (T-F) analysis can provide better characterizations of such highly transient vibrations. The analytic wavelet transform (AWT) is an ideal T-F analysis tool because it possesses the advantages of both the Fourier transform and the wavelet transform.<sup>3</sup> The objective of this study was to explore the application of the AWT method for characterizing the impact tool vibrations and assessing their exposure risk.

## Methods

Five tools (two chipping hammers, two riveting hammers, and one concrete cutting saw) were used in this study. The saw vibration was measured when it was used to cut a section of road pavement during a repair. The vibrations on the other tools were measured by the procedure specified in ISO 8662-2 (1992).<sup>4</sup> A sampling rate of 16,386 Hz was used in the measurement. The AWT and Fourier analysis were applied to these signals and to identify their characteristics.

## Results

Figure 1 compares the T-F characteristics of the accelerations measured from the relatively steady concrete saw and a riveting hammer. The frequency weighting specified in ISO 5349-1<sup>1</sup> was applied in the calculations. The comparison clearly shows that the two tools have completely different T-F characteristics.

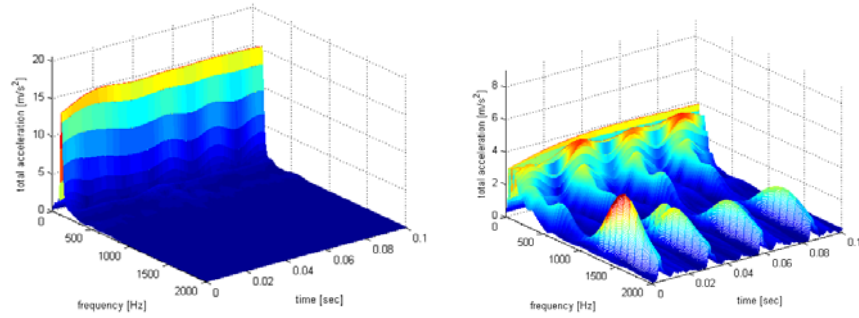

Figure 1: T-F characteristics of a concrete saw (left) and a riveting hammer (right).

Figure 2 compares the frequency-weighted and un-weighted 1/3 octave band spectra of the tools used in Figure 1. The spectra, especially in weighted forms, are not as strikingly different as those in Figure 1.

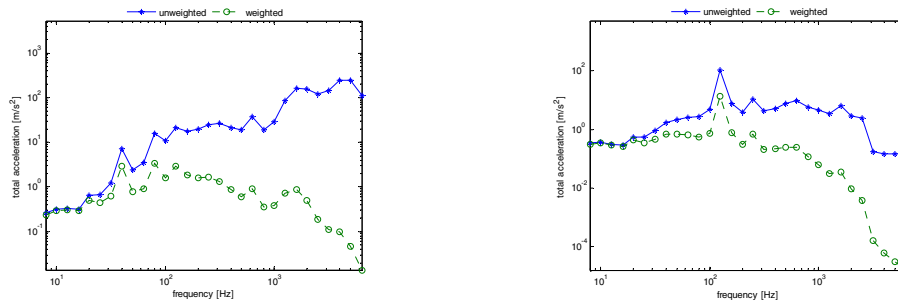

Figure 2: 1/3 octave band spectra of a concrete saw (left) and a riveting hammer (right).

## Discussion

The frequency-weighted spectrum such as shown in Fig. 2 is used as the basis to calculate the vibration exposure dose in the standardized method.<sup>1</sup> The time averaging effect evens out the effect of sharp peaks that can be observed in Fig. 1. The health effects or thresholds of vibration exposure may be non-linear with respect to vibration magnitude, which may not be fully taken into account by the standard time-averaging- based method. The time-frequency-weighted acceleration can be calculated from the T-F spectra shown in Figure 1. Because the temporal changes of the frequency components can also be taken into account, the T-F method is believed to be a better approach than the conventional method for assessing the risk of impact vibration exposure.

## References

1. ISO 5349-1, 2001: Mechanical vibration - measurement and evaluation of human exposure to hand-transmitted vibration - part 1: General requirements. Geneva, Switzerland: International Organization for Standardization.
2. Griffin, M., Bovenzi, M., Nelson, C.M., 2003. Dose-response patterns for vibration-induced white finger. *Occup Environ Med* 60:16-26.
3. Kulkarni, P., Zhu, X., Kim, J. and Hayden, C., 2004 *Proceedings of NOISECON 2004*, Baltimore, MD. 306-312 Time-frequency characteristics of high-intensity, fast transient noise from power tools by analytic wavelet transform.
4. ISO 8662-2, 1992: Hand-held portable power tools - Measurement of vibrations at the handle - part 2: Chipping hammer and riveting hammers. Geneva, Switzerland: International Organization for Standardization.

# VARIATION IN THE VIBRATION EMISSION OF ROTARY HAMMER DRILLS UNDER SIMULATED WORK-SITE CONDITIONS

Neil J Mansfield

Environmental Ergonomics Research Centre, Loughborough University, Loughborough, U.K.

## Introduction

Tool manufacturers are required to provide declarations of vibration emission values in order to sell their tools within Europe. To ensure that users can compare results obtained from different manufacturers, the declared values must be obtained using a methodology as specified in the relevant test code (such as in the ISO 8662 series of standards). In most cases, the vibration emission values obtained using test codes under-estimate the vibration that an operator will be exposed to when using the tool on a work-site. A further problem with manufacturers' data is that usually only a single value is provided for a tool. This is despite many factors affecting the vibration emission, including inserted tool type, work piece, operator technique, tool condition. New improved test codes are in the process of being developed.

In order to provide guidance to users on how to interpret manufacturers' data, a Draft CEN Technical Report (Draft CEN/TR 15350 (2005)) was developed. Part of the CEN/TR provides multiplication factors for combinations of task and tool type. For example, data obtained from electrical hammer drills (tested according to EN 60745-2-6:2003) should be multiplied by 2, for hammering applications, in order to obtain an estimate of the vibration emission during work.

In response to concerns from industry, the UK trade association OPERC have, in collaboration with hire companies and tool manufacturers, established a freely accessible online database of tool emission values based on independent tests carried out under simulated work-site conditions. This paper reports some of the data obtained from electrical hammer drills, highlighting the range of emission values that can be obtained for a tool. Data from many other tool types are also included in the database.

## Methods

Tri-axial hand-arm vibration was measured at both handles of each of 19 electrical hammer drills, in accordance with ISO 5349-1 (2001). Each tool was measured with three experienced operators and at least 5 runs were completed for each operator. Tools were tested using a range of appropriate new bits from 4 to 40 mm diameter. The minimum number of bits for a tool was 3; the maximum number was 29. 146 tool / bit combinations are reported here, representing about 2200 individual 6-axis measurements. Operators were required to drill vertically into a concrete block with a compressive strength after 28 days of 40 N/mm<sup>2</sup>. Two drills (1 and 15) were battery powered; others were powered using a 110V transformer supply.



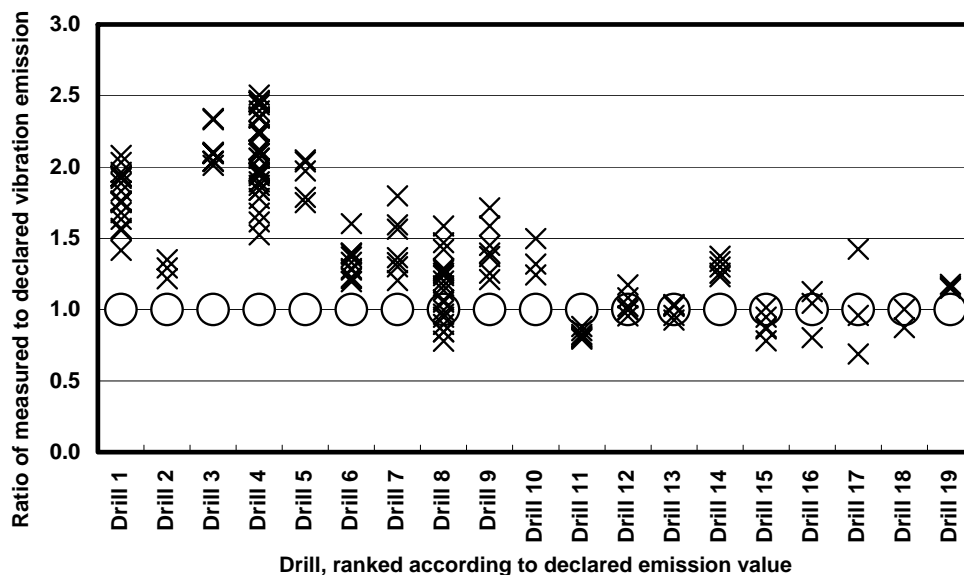

**Fig 1.** Ratio of measured emission to declared emission for 19 tools.

### Results and Discussion

The relationship between the measured vibration and the declared vibration is illustrated in Fig 1. For those tools declaring vibration emission values less than 10 m/s<sup>2</sup> (Drills 1-10), work-site data were generally greater than declared values; for those tools declaring vibration emission values greater than 10 m/s<sup>2</sup> (Drills 11-19), work-site data were generally similar to declared values. Thus, if the scaling factors are used, those tools reporting higher but closer to simulated work-site values would be penalized.

In agreement with individual tool trends, there was a positive correlation between vibration emission and drill diameter (Fig 2,  $p < 0.01$ , Pearson). This indicates that provision of specific tool / bit data should improve applicability of risk assessments.

### Acknowledgements

Data in this abstract were drawn from the HAVTEC database ([www.operc.com](http://www.operc.com)). The contributions of Dr David Edwards and Dr Andrew Rimell are acknowledged.

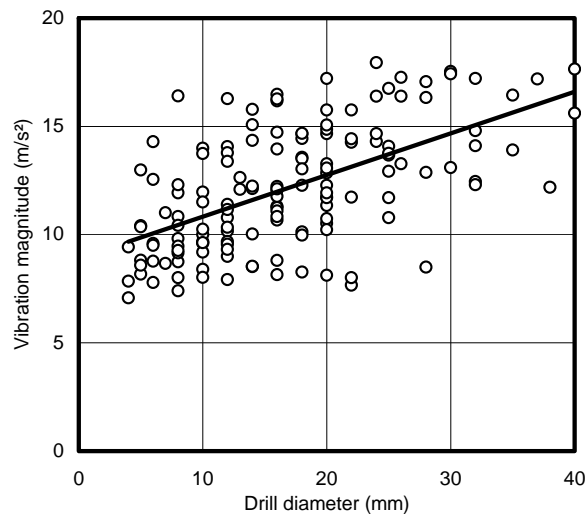

**Fig 2.** Relationship between drill diameter and vibration magnitude

### Reference

Draft CEN/TR 15350 (2005), *Mechanical vibration – Guideline for the assessment of exposure to hand-transmitted vibration using available information including that provided by manufacturers of machinery.*

# **DEVICE FOR MEASURING DAYLONG VIBRATION EXPOSURE AND GRIP FORCE LEVELS FOR DURING HAND-TOOL USE**

D. R. Peterson, A.J. Brammer, M.G. Cherniack  
Biodynamics Laboratory, University of Connecticut Health Center, U.S.A.

## **Introduction**

Over the past two decades, there have been significant reductions in industrial exposures to hand-arm vibration, especially when specific tools and work processes have been redesigned to incorporate anti-vibration and ergonomic principles. Nevertheless, Hand-Arm Vibration Syndrome (HAVS) remains a significant occupational health problem as disease symptoms continue to occur even when vibration exposure levels believed to incur low risks have been reached<sup>2</sup>. This inconsistency may be related to the methodology that is typically used to estimate workday vibration exposure levels, involving laboratory and/or very short duration field measurements coupled with estimates of overall eight-hour tool operation times determined from brief observations of tool tasks and/or self-reported surveys. One solution is to use small, commercially-available, personal vibration dosimeters to calculate, record, and display long-duration vector sums and energy equivalents of vibration. However, since these devices are attached to the worker and require tool-mounted accelerometers, they are incompatible with the worker performing normal duties involving putting down or changing tools. In addition, these commercial systems do not allow for the characterization of the transmission of vibration to the hand such as monitoring the mechanical coupling between the hand and the tool handle (e.g., grip forces). O'Boyle and Griffin showed that variations in applied force can alter vibration transmission characteristics by 50% or more indicating that the measurement of grip force is essential for modeling vibration transmissibility and vibration exposures<sup>5</sup>. In summary, a need exists for the development of a method and device that will more accurately characterize workday-long vibration exposures.

## **Methods**

A portable, light-weight, Vibration Exposure Monitor (VEM) system was developed to record user-specific tool-operating times, vibrations, and grip forces throughout all, or a representative part, of a workday. It monitors frequency weighted and unweighted accelerations from a palm-mounted uni-axial accelerometer (Model 352C22, PCB Piezotronics, Depew, NY) and calculates exposure levels using the root-mean-square (RMS) and higher power mean values, such as the root-mean-quad (RMQ) and the root-mean-oct (RMO). Grip forces are also monitored using a palm-mounted force sensor (Model 400, Interlink Electronics, Camarillo, CA) from which average grip force levels and exerted grip extrema are calculated.

At the core of the VEM system is a commercially available, battery-powered microcomputer (Tattletale, Model 8v2, Onset Computer, Onset, MA) with one megabyte of memory and eight analog channels using 12-bit sampling at a single-channel maximum of 100 kHz. Analog signal processing (i.e., anti-aliasing, with cutoffs at 4 and 1250 Hz, and ISO 5349-1<sup>3</sup> frequency weighting) is accomplished using custom circuitry that is directly interfaced with the microcomputer. An embedded C-based protocol governs the data collection from each channel

at a 3 kHz sampling frequency and performs all vibration and grip force calculations. The entire VEM system, including the ICP-type accelerometer, is powered using three 9 V batteries and can provide measurements for up to 12 hours, while retaining data in the RAM for up to 72 hours.

## Results

Measures of acceleration and grip were validated through laboratory studies involving an electro-dynamic shaker outfitted with a handle and actual power tools. The frequency response of the palm-mounted sensors was measured at a 100 N grip and showed a flat response up to 3 kHz. Results for weighted and unweighted vibration and grip force are presented in Fig. 1 for a 65-minute window of debrushing operations during forestry work.

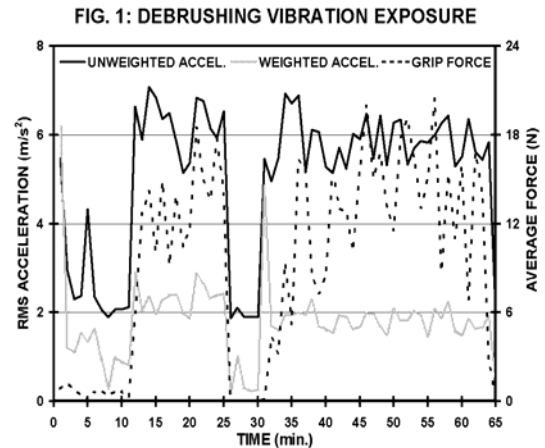

## Discussion

Given the nature of the root-mean and averaged calculations, the measurements made using the VEM system only provide estimates of the time histories of accelerations entering the hands and for the grip forces exerted throughout the workday. These estimates have been seen to be more accurate than traditional methods and can be used to assist in the subsequent construction of vibration exposure metrics for the development of exposure-response relationships as described in ISO 5439-2<sup>4</sup> and more complex metrics involving biologically plausible models of tissue burden and dose<sup>1</sup>. These metrics may also assist in determining why deviations from ISO's energy-based exposure-response models occur.

## References

1. Brammer, AJ, Peterson, DR, Cherniack, MG. (2001). Characterizing Exposure to Hand-Transmitted Impacts. Intl. Cong. of Occ. Health, Gothenburg, Sweden
2. Burström L, Hagberg M, Lundström R, Nilsson T. (2004). Relation Between Hand-arm Vibration Exposure And Symptoms Among Workers Within a Heavy-Engineering Production Workshop. 10th Intl. Conf. on Hand-Arm Vib., Las Vegas
3. ISO 5349-1 (2001). Mechanical vibration – Measurement and assessment of human exposure to hand-transmitted vibration – Part 1: General guidelines. ISO, Geneva, Switzerland.
4. ISO 5349-2 (2001). Mechanical vibration -- Measurement and evaluation of human exposure to hand-transmitted vibration -- Part 2: Practical guidance for measurement at the workplace. ISO, Geneva, Switzerland.
5. O'Boyle MJ, Griffin MJ. (2004). Transmissibility and Dynamic Stiffness of Glove Materials and the Apparent Mass of the Hand. 10th Intl. Conf. on Hand-Arm Vib., Las Vegas

# CHALLENGES AND UNCERTAINTIES IN DESIGNING FIELD STUDIES TO MEASURE HAND VIBRATION

Dale AM, Standeven J, Evanoff B  
Washington University School of Medicine, St. Louis, Missouri, U.S.A.

## Introduction

We encountered several areas of methodologic uncertainty during development of a data collection method for use with vibrating hand tools in metal assembly. A local manufacturer sought our assistance designing a data collection method for evaluating and predicting risks of upper extremity disorders associated with use of vibrating hand tools. Current methods of vibration measurement are described in ISO 5349 [2]. However, the complexity of measuring vibration along with other exposures such as force and posture has limited the number of workplace-based studies of upper extremity disorders that have included direct measurements of vibration. Data from this preliminary study was used to look at two issues: a comparison of vibration values between production and non-production workers when performing the same task, and a comparison of worker ratings of vibration comfort to direct measurement of tool vibration.

## Methods

Eight experienced production workers used each of six metal fastening tools to install fasteners. Vibration was collected by 3 tri-axial accelerometers, one attached to the tool handle following ISO 5349 recommended locations, one attached to the hand dorsum on the 3<sup>rd</sup> knuckle and one to the thumb side of the wrist. Data sampling rate was 10,000 samples/second. Hand grip and feed forces were obtained using a Novel pressure sensing mat on the palm. Each trial consisted of installing 10 fasteners per tool for each of the 6 tools. The test set-up placed the wrist in the position typically used by the operator during production. Each worker documented subjective comfort and effort ratings on a seven point scale following each series of fastener installations. One series of testing was completed by three non-production workers inexperienced in fastener installation to simulate use of alternative employees for data gathering. Vibration data for each trial were acquired, digitized, and stored using LabView. The X, Y, & Z axes were used to calculate the vector sum response for each tri-axial accelerometer. The tool data were digitally filtered following ISO recommendations. Calculated data consisted of the mean RMS over the tool's on-time, the starting and breaking peak impulses, and the peak of the frequency response.

## Results

Production workers (n=8) were right hand dominant males with a mean age of 55 years and normal hand strength (mean right grip = 106 lbs). Non-production workers (n=3) had similar characteristics.

We found large and statistically meaningful differences in hand force during tool use between production and non-production workers (mean production workers = 9.77 lbs, mean non-production workers = 43.30 lbs,  $p = 0.0001$ ). Vibration values obtained from the hand also showed a statistically meaningful difference (mean in production workers = 0.67 Gs, mean in non-production workers = 1.48Gs,  $p = 0.0014$ , figure 1). Experienced worker ratings of comfort during tool use demonstrated a moderate correlation with measured vibration ( $r=0.63$ ). Worker ratings trended with direct recordings from the tool handle as shown in figure 2.

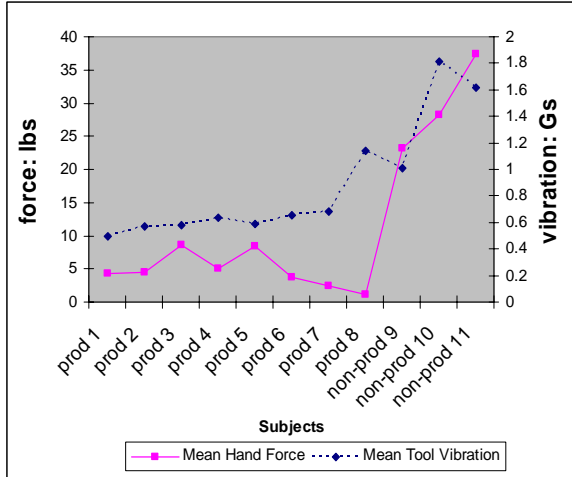

Figure 1. Comparison of hand force and vibration in production and non-production workers.

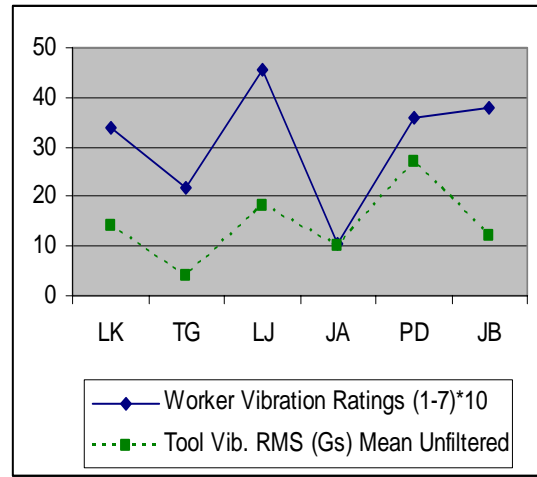

Figure 2. Comparison of worker ratings to vibration values produced for six different tools.

### Discussion

This study highlights some of the issues that should be considered during vibration field studies. The striking differences in hand force and vibration between production and non-production workers suggest that vibration measures should be performed in the worker population actually using the tools. As workers become more adept at operating tools, they may use less hand force to perform a task, thus affecting vibration values. In our study, workers who were not experienced with daily use of the tools used higher hand force resulting in unreliable vibration values. The conditions of the field study should mimic real work conditions as much as is feasible, and deviations from normal work conditions should be considered when interpreting study results.

Our results also showed that worker ratings of tool vibration had reasonable correlation to measured vibration [1, 3]. This indicates that at least in a qualitative sense, experienced workers can estimate the magnitude of the vibration incurred during tool operation of familiar tools. Field studies may use worker rating data to identify problems or document the effectiveness of interventions. These data may supplement direct measures, particularly in large cohorts where direct measures on all subjects are impractical. Development of methods to estimate vibration under realistic work conditions will greatly enhance our ability to better understand the relationship between vibration and upper extremity disorders.

### References

1. Annett, J, 2002, Subjective rating scales: science or art? *Ergonomics*, 45(14), 966-987.
2. International Organization for Standardization (ISO). Mechanical and evaluation of human exposure to hand transmitted vibration. Geneva 2001. ISO 5349-1 and 5349-2.
3. Latko, W.A., Armstrong, T.J., Foulke, J.A., Herrin G.D., Ranbourn, R.A., and Ulin, S.S., 1997, Development and evaluation of an observation method for assessing repetition in hand tasks. *American Industrial Hygiene Association Journal*, 58, pp. 278-285.

## Podium Presentations

### Session II: Health Effects I

Chairs: Suzanne Smith and Oliver Wirth

<b>Presenter</b>	<b>Title</b>	<b>Page</b>
K.A. Rider University of Michigan	Ride motion effects on the accuracy of rapid pointing tasks	25
T.W. McDowell NIOSH	The effects of vibration on psychophysical grip and push force-recall accuracy	27
A. Mayton NIOSH	Comfort evaluation for mine shuttle car seat designs	29
Y. Nakashima ISUZU Advance Engineering Center	A method of evaluating vehicle seat vibration with consideration of subjective judgment	31
M. Morioka University of Southampton	Perception thresholds for lateral vibration at the hand, seat, and foot	33
S. Wilson University of Kansas	Neuromotor habituation as a mechanism for vibration induced low back pain	35

# RIDE MOTION EFFECTS ON THE ACCURACY OF RAPID POINTING TASKS

Kevin A. Rider, Bernard J. Martin  
University of Michigan, Ann Arbor, Michigan, U.S.A.

## Introduction

Reaching movements are planned and subsequently executed [1] using visual and somatosensory feedbacks [2], where absence of visual feedback is known to increase endpoint variability [3]. Visual occlusion decreases the ability to make rapid online compensatory movements, which results in initial radial deviations that are highly correlated with radial dispersion at the target. Perturbations of rapid, visually-guided reaches are compensated on-line and result in endpoint dispersions poorly correlated with initial deviations, emphasizing the strong effect of visual feedback in temporally-constrained reaching tasks. In control conditions (no vibration), these uncompensated, rapid reaches serve as estimates of the individual's intended trajectory. When ride motion is present, trajectories of rapid, visually-occluded reaches provide a measure of the natural biodynamic response of the cantilevered spine-arm-hand linkage. These intended movement trajectories and the biodynamic response (vibration feedthrough) are used to predict the effect of ride motion on the performance of rapid reaching tasks. Goals of this study are to investigate the influences of vehicle motion on human reaching and pointing, and to reveal movement strategies used in visually-occluded reaching tasks.

## Methods

A six degree of freedom human-rated Ride Motion Simulator (RMS) was used to generate a dynamic vehicle environment. Participants performed discrete, rapid pointing tasks to targets presented on three touchpanel displays under stationary and random whole-body vibration. Reach instructions included *successfully* reaching identical circular targets ( $\varnothing = 0.25''$ ) with the right index fingertip *as fast as possible*. Targets were presented on resistive-touch displays mounted approximately 60 cm from the participant's nasion. The touchpanel displays were located in the forward and lateral directions at eye level, and forward at  $45^\circ$  of elevation. These displays measured the spatial error of the reach destination. A ten-camera VICON motion capture system recorded the upper body kinematics of the participant. Reflective markers were placed on the participant's torso, head, and arms. Initial kinematics of the fingertip (i.e. time and magnitude peak tangential velocity) and tangential velocity at target were used to estimate the planned endpoint of the reach.

## Results and Discussion

Ride motion resulted in increased endpoint variability compared to reaches performed in the stationary condition. Reaches to the elevated touchpanel consistently resulted in the largest variability across all motion conditions, suggesting that a vehicle occupant would not be capable of accurately activating a control in that location. Principal axes of endpoint ellipses were along and perpendicular to the direction of fingertip movements. Example graphs of endpoint variability with ellipses containing 95% of the data points are shown in Figure 1. These ellipses

might be used to enhance vehicle cockpit designs, where controls and displays could be shaped and oriented within the vehicle with respect to the operator and the probable reach direction.

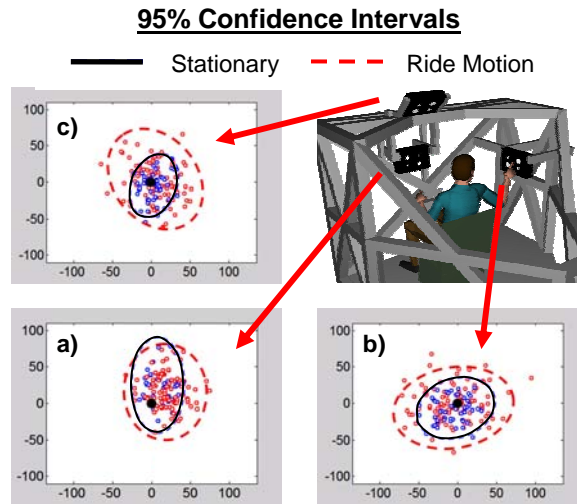

**Figure 1.** Comparison of 95% confidence ellipses of endpoint variability due to ride motion.

Analysis of the endpoint accuracy is illustrated using the circular representation in Figure 2a, where the deviations at peak velocity (PV, Figure 2b) are correlated with the deviations at the target (Figure 2c) with respect to the mean trajectory. If visual feedback mechanisms are not being utilized, then the dispersion of fingertip positions at PV (Figure 2b) should be replicated at the target. However, figure 2c shows that the actual endpoint dispersion at the target are poorly correlated ( $R^2 = 0.07$ ) to values at PV for visually-occluded reaches, suggesting the interaction of proprioceptive feedback control.

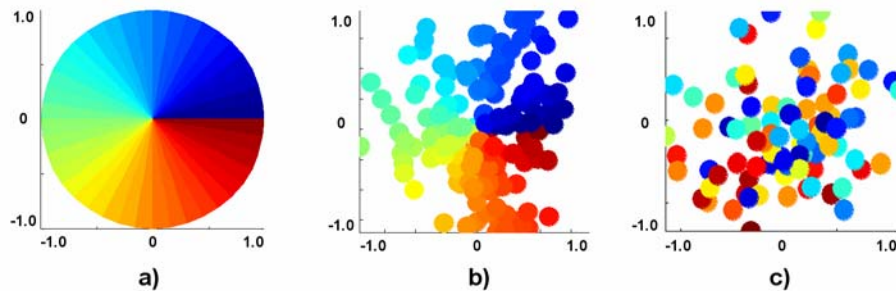

**Figure 2.** a) Illustration of the radial deviation of fingertip position at peak velocity (b, relative to the mean path) and reach endpoints (c, relative to the target center).

## References

Bernstein N (1967) In: The coordination and regulation of movements. Oxford, New York: Pergamon Press.

Van Beers R, Sittig A, van der Goin J (1996) "Localization of a seen finger is based exclusively on proprioception and visual position information," *Exp Brain Res* 111: 253-261.

Keele S, Posner M (1968) "Processing of visual feedback in rapid movements," *J Exp Psych* 77: 155-158.



# THE EFFECTS OF VIBRATION ON PSYCHOPHYSICAL GRIP AND PUSH FORCE-RECALL ACCURACY

TW McDowell<sup>1</sup>, SF Wiker<sup>2</sup>, RG Dong<sup>1</sup>, DE Welcome<sup>1</sup>

<sup>1</sup>National Institute for Occupational Safety and Health, Morgantown, West Virginia, U.S.A.

<sup>2</sup>West Virginia University, Morgantown, West Virginia, U.S.A.

## Introduction

Workers using vibrating hand tools have the potential for developing health problems associated with repeated forceful actions and exposures to hand-transmitted vibration. Hand-arm vibration syndrome (HAVS) and other hand-arm system disorders have been associated with such exposures.<sup>1-2</sup> To better assess health risks, comprehensive evaluations of these exposures must include quantitative assessments of hand-tool coupling forces; unfortunately, no standardized method for quantifying hand forces exists. Handle instrumentation may be ill-suited for some field environments. Psychophysical force-recall techniques may provide alternatives to handle instrumentation. A thorough understanding of the effects of vibration and other factors on force-recall accuracy and reliability is important before such methods are applied in risk assessments.

## Methods

In this study, the effects of vibration and other factors on the accuracy of psychophysical force-recall were explored in two experiments. Twelve male subjects participated in the first experiment. The second experiment employed 20 participants (10 female, 10 male). In each experiment, participants applied specific grip and push forces to an instrumented handle mounted on a shaker system. Participants were exposed to sinusoidal vibration at frequencies that ranged from 0 Hz to 250 Hz. Three levels of applied force (low: grip = 15 N/push = 25 N, medium: grip = 30 N/push = 50 N, and high: grip = 45 N/push = 75 N) and two levels of vibration magnitude (low: ANSI 4-8-hr limit and high: ANSI <0.5-hr limit)<sup>3</sup> were examined. During the vibration exposure period, participants were provided with visual feedback while they attempted to “memorize” the applied grip and push forces. At the conclusion of the vibration exposure/force memorization period and a controlled rest period, the participants tried to duplicate the grip and push forces on a non-vibrating handle without the aid of visual feedback. The effects of different vibration frequencies, vibration magnitudes, and grip and push force levels were tested in a random order from trial to trial.

## Results

Participants tended to overestimate grip and push forces. Depending on exposure conditions, error means ranged from 2 N to 10 N. The ANOVA revealed that force-recall errors for exposures between 31.5 Hz and 63 Hz were significantly higher than those at other vibration frequencies ( $p < 0.05$ ). The frequency effect is depicted in Figure 1. Error means were greater when participants were exposed to the higher vibration magnitude (mean = 9.1 N, 95% CI = 8.2-10.1 N) when compared with the lower vibration magnitude (mean = 4.9 N, 95% CI = 3.9-5.8 N) ( $p < 0.05$ ). The effect of vibration magnitude is shown in Figure 2. The average error for

females (4.9 N, 95% CI = 4.0-5.8 N) was significantly less than that for males (8.3 N, 95% CI = 7.4-9.2 N) ( $p < 0.05$ ). The effects of force level were mixed.

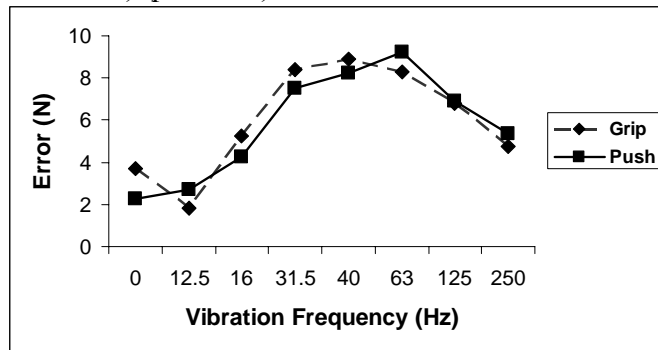

Figure 1. Grip and push force-recall error means plotted against vibration frequency across all conditions of the two experiments.

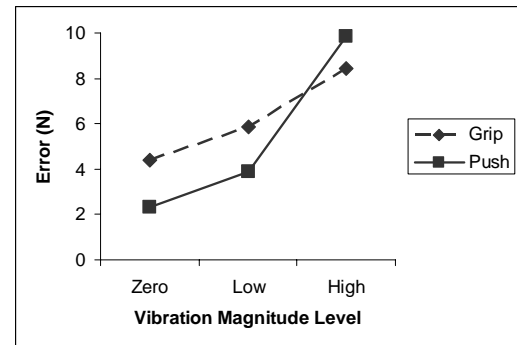

Figure 2. Force-recall error as a function of against vibration magnitude (Low = ANSI 4-8-hr limit, High = ANSI <0.5-hr limit)<sup>3</sup> and exertion type.

## Discussion

Overall, recalled force errors were relatively small over the range of operationally-relevant hand-handle coupling forces and vibration exposure conditions. Vibration exposure significantly affected grip and push force-recall accuracy. This result is consistent with previous research.<sup>4-5</sup> The vibration effect was particularly pronounced with vibration exposures between 31.5 Hz and 63 Hz. This frequency range coincides with that of hand-arm system resonance.<sup>6-7</sup> The effect of vibration was greater at higher levels of vibration magnitude. This force-recall technique shows promise as an alternative to expensive and fragile force-sensing instrumentation. For example, to account for anticipated force-recall errors due to vibration effects, weighting functions can be developed to yield accurate force estimates. Once refined, this psychophysical force-measuring technique can be incorporated into various risk assessments of hand-transmitted vibration.

## References

1. Griffin, M.J. and Bovenzi, M. (2001). The diagnosis of disorders caused by hand-transmitted vibration: Southampton workshop 2000. *Int Arch Occup Environ Health*. 75, 1-5.
2. NIOSH. (1997). *Musculoskeletal disorders and workplace factors: A critical review of epidemiologic evidence for work-related musculoskeletal disorders of the neck, upper extremity, and low back*, NIOSH publication 97-141. U.S. Department of Health and Human Services, National Institute for Occupational Safety and Health, Cincinnati, OH.
3. ANSI. (2002). *ANSI S3.34, 2002: Guide for the measurement and evaluation of human exposure to vibration transmitted to the hand*. American National Standards Institute (ANSI), New York.
4. Nowak, D.A., Rosenkranz, K., Hermsdorfer, J. and Rothwell, J. (2004). Memory for fingertip forces: Passive hand muscle vibration interferes with predictive grip force scaling. *Exp Brain Res*. 156, 444-450.
5. Cafarelli, E. and Kostka, C.E. (1981). Effect of vibration on static force sensation in man. *Exp Neurol*. 74, 331-340.
6. Kihlberg, S. (1995). Biodynamic response of the hand-arm system to vibration from an impact hammer and a grinder. *Int J Ind Ergo*. 16, 1-8.
7. Dong, R.G., Schopper, A.W., McDowell, T.W., Welcome, D.E., Wu, J.Z., Smutz, W.P., Warren, C. and Rakheja, S. (2004). Vibration energy absorption (VEA) in human fingers-hand-arm system. *Med Eng Phys*. 26, 483-492.

# COMFORT EVALUATION FOR MINE SHUTTLE CAR SEAT DESIGNS

Alan Mayton<sup>1</sup>, Christopher Jobes<sup>1</sup>, N. Kumar Kittusamy<sup>2</sup>, Farid Amirouche<sup>3</sup>

<sup>1</sup>NIOSH, Pittsburgh Research Laboratory, Pittsburgh, Pennsylvania, U.S.A.

<sup>2</sup>NIOSH, Spokane Research Laboratory, Spokane, Washington, U.S.A.

<sup>3</sup>Vehicle Technology Laboratory, University of Illinois at Chicago, Illinois, U.S.A.

## Introduction

Industrial equipment exposes individuals to whole-body vibration (WBV) and mechanical shock. This exposure can negatively impact their health, safety, comfort, and working efficiency and performance. Accordingly, proper seat design is an important consideration in reducing the adverse effects of WBV exposure to vehicle operators. Since the human body is sensitive to low frequency WBV, ride quality is a basic and important element of good seat design. When designing a suitable seat, it is essential to understand vibration exposure environment of workers and how well they can tolerate this environment [1]. This is particularly true in the mining industry.

Mayton et al. [2] reported on a low-coal shuttle car seat design that underwent limited, yet successful underground mine trials. Building on this work, a follow-up study compared NIOSH and existing seat designs on low- and mid-coal seam shuttle cars. The NIOSH seat designs included viscoelastic foam, which has properties similar to those found in a mechanical spring/damper suspension system. The seats also included an adjustable lumbar support and a fore-aft seat adjustment. The NIOSH seat designs contrast with the existing seat design, which have little or no lumbar support and include inexpensive foam padding of the type commonly used in furniture.

This paper will focus on the seat designs for the mid-coal seam shuttle car and compare subjective comfort data collected from five vehicle operators with ISO 2631 – based reduced comfort boundary (RCB) analysis of recorded vibration levels.

## Methods

Experimental data were collected using three different tools: triaxial accelerometers, pre-amplifiers, and filters connected to a data recorder; a visual analog scale (VAS); and a short questionnaire.

Researchers recorded quantitative or objective vehicle vibration data to determine the input and output acceleration at the operator cab floor and operator seat interface. Qualitative or subjective data, collected with the VAS, allowed researchers to obtain the operators' immediate impressions of shock, vibration, and discomfort levels for the vehicle ride on each of the seat designs. Each shuttle car operator made six round trips with the vehicle each seat. The shuttle car operator marked the VAS on the first, third, and sixth round trip of the trials for each seat. A round trip consisted of traveling to the coal face with *no load* and returning to the load discharge location with a *full load* of coal.

## Results

Total overall average ratings for the five vehicle operators of the mid-coal seam shuttle car, showed that operators sensed from 45 to 87% less discomfort with NIOSH seat designs compared to the existing seat design. Using a 95% CI, researchers computed a strong positive correlation for discomfort.

Figure 1 illustrates the RCB analysis method for one of two NIOSH seat designs.

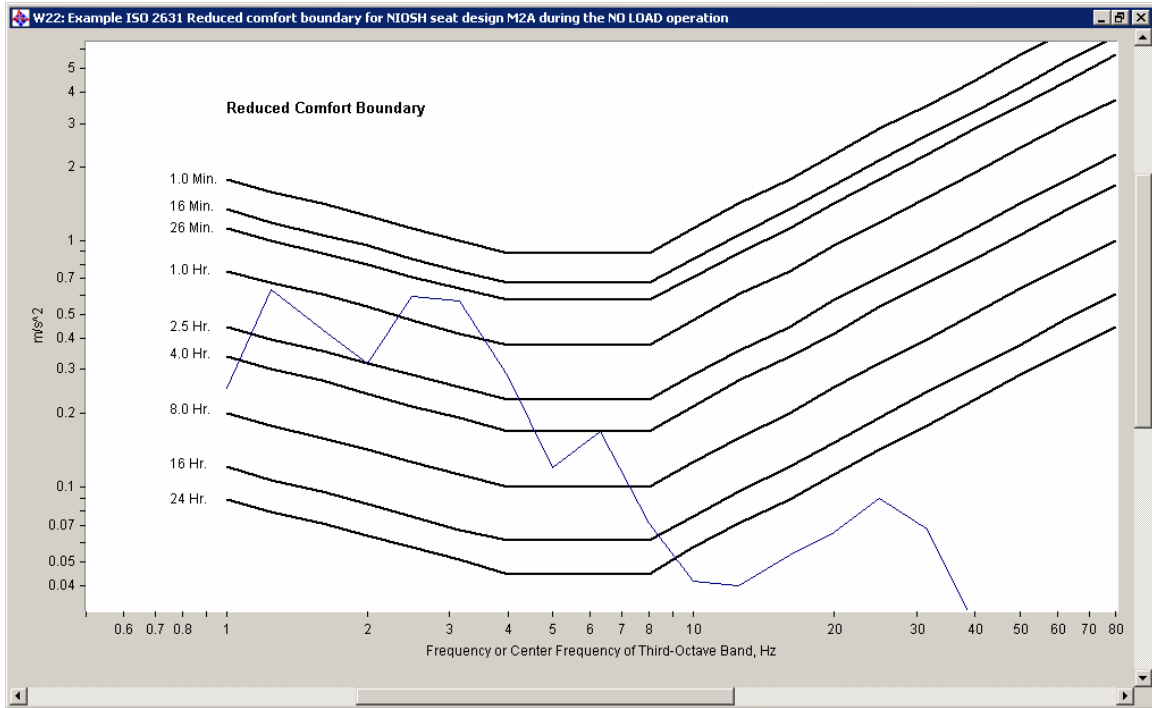

**Figure 1. ISO 2631 RCB analysis for NIOSH seat design during *no load* operation.**

### Discussion

The RCB analysis during *no-load* operation showed that NIOSH seat designs, compared to the existing seat design, generally provided an increase in allowable exposure time for the vehicle operator, in the 4 to 8 Hz range. During *full-load* operation, the RCB analysis showed little difference in allowable exposure time for either the NIOSH or the existing seat designs. The natural frequency of the vehicle decreases for *full-load* operation as shown by the equation,  $\omega = \sqrt{k/m}$  where,  $\omega$  is the natural frequency,  $k$  is the spring constant, and  $m$  is the mass. Foam- or air-filled tires provide primary damping or attenuation of jars/jolts when the vehicle mass is increased with the *full load* of coal. Seat performance in attenuating of jars/jolts is thus secondary. The RCB acceleration-based analysis appears inadequate for correlating operator perceptions of discomfort. Vehicle operators' perceptions of discomfort are based more on the energy they sense transmitted to their bodies through the seat from the floor of the vehicle. So, the use of the absorbed power analysis reported by Mayton et al. [3], on the other hand, may provide a better means of correlating operator perceptions of vibration energy rather than the acceleration levels of the ISO 2631 RCB method.

### References

1. Amirouche F., Xu P., and E. Alexa (1997). Evaluation of dynamic seat comfort and driver's fatigue. SAE 971573, 12 pp.
2. Mayton A., Merkel R., and S. Gallagher (1999). Improved seat reduces jarring/jolting for operators of low-coal shuttle cars. *Min. Eng.* vol. 51, no.12, pp. 52-56.
3. Mayton A., Amirouche F., and C. Jobes (2005). Comparison of seat designs for underground haulage vehicles using the absorbed power and ISO 2631-1 (1985)-based ACGIH threshold limits methods. *Int. J. Heavy Vehicle Systems*, vol. 12, no.3, pp. 225-238.

# A METHOD OF EVALUATING VEHICLE SEAT VIBRATION WITH CONSIDERATION OF SUBJECTIVE JUDGMENT

Yumi Nakashima, ISUZU Advanced Engineering Center, Fujisawa, Japan  
Setsuo Maeda, National Institute of Industrial Health, Kawasaki, Japan

## Introduction

Vibration magnitude and frequency of the z-axis vehicle seat are time-variant, which are influenced by not only vehicle vibration characteristics themselves but also road surfaces, speeds and the human body. There is little in the current reporting about evaluating and analyzing automobile seat vibration that focuses on the time-variant.

Yaguchi et al.<sup>1</sup> has proposed a method to evaluate automobile seat vibration that is based on judgments using a subjective mental state. Their method focuses on the time-variant magnitude of the peak frequency on a power spectrum density. However, their method has no consideration of all the frequency contents of the discomfort, nor comparison between different peak frequency vibrations. Suzuki<sup>2</sup> has emphasized that the vehicle vibration should be judged by a series of vibration stimuli to evaluate, because the vehicle vibration is time-variant, which isn't a matter of the relationship between a single vibration stimulus and a subjective response. He clarified that the human sensation to the vehicle vibration discomfort changes every moment showing the relationship between the frequency-weighted r.m.s. acceleration calculated every 5 seconds and the category judgment to vehicle vibration discomfort every 5 seconds. However, his study doesn't show what parameter connects to the subjective final judgment to vehicle vibration.

Therefore, we applied the method similar to ISO10056<sup>3</sup> considering the time-variant to the vehicle seat z-axis vibration evaluation. The new method for the vehicle seat vibration considering the time-variant was examined on the hypothesis that the final subjective evaluation must be conducted from the judgment summarizing a series of vibration stimuli.

## Methods

The vibration bench system, which reproduces the movement of a vehicle floor, was used for the experiment with the single-axis (vertical direction) four-post road simulator system, which is usually used for a car, as shown in Fig.1. The experiment was done on the right side of the vibration bench using the floor vibration which was 5.5 minutes,  $0.822 \text{ m/sec}^2$  (Wk) over the range 0.5-20Hz with 4 male subjects (age ave21.5, SD0.5, weight ave75kg, SD7.91kg, height ave166.8cm, SD5.2cm) and 4 suspension seats. As Fig.2 shows, subjects evaluated the degree of discomfort every 5 seconds to each seat vibration measuring the seat z-axis vibration acceleration.

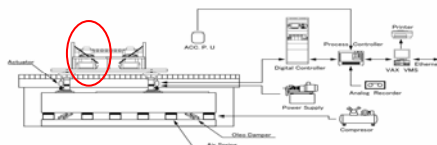

Fig1. Road simulator system



Fig 2. Right side of vibration bench system

## Results

Fig.3 shows the discomfort evaluated every 5 seconds by 4 subjects matched up to frequency-weighted r.m.s. acceleration calculated every 5 seconds. Other seats also had the same tendency. As Table1 shows, evaluations by ISO2631-1<sup>4</sup> didn't fit final judgments by each subject. Table2 shows statistical parameters from cumulative distribution histogram of frequency-weighted r.m.s. acceleration calculated every 5 seconds applied the method of ISO10056. Seat A and Seat B had larger frequency weighted r.m.s. acceleration of the 90% band range than Seat C and Seat D. Seat A, which had the least discomfort, as judged by most of the subjects, had smaller values over all than Seat B had.

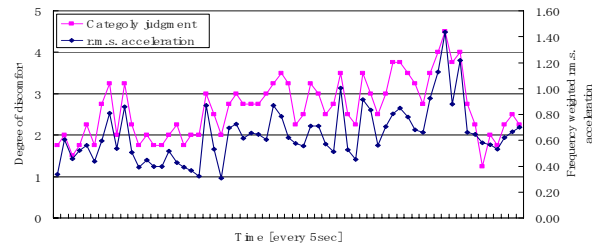

Fig.3 Seat A results of Frequency weighted r.m.s. accelerations and category judgments every 5 seconds.

Table 1. Evaluations by ISO2631-1 and subjective final judgments

	Seat A	Seat B	Seat C	Seat D	Least Discomfort seat
Subject1	0.694	0.675	0.665	<b>0.65</b>	Seat A
Subject2	0.673	0.728	<b>0.647</b>	0.66	—
Subject3	0.674	0.743	0.688	<b>0.638</b>	Seat A
Subject4	<b>0.645</b>	0.76	0.626	0.647	Seat A
Average	0.671	0.727	0.656	<b>0.649</b>	
SD	0.017	0.032	0.023	0.008	

Table 2. Statistical parameters of Wk r.m.s. acceleration cumulative distribution histogram

	Seat A	Seat B	Seat C	Seat D
Average	0.647	0.697	0.647	0.631
SD	0.216	0.244	0.166	0.191
Max	<b>1.456</b>	<b>1.552</b>	1.274	1.351
99%tile	<b>1.425</b>	<b>1.525</b>	1.225	1.325
95%tile	<b>1.045</b>	<b>1.17</b>	0.975	1
5%tile	<b>0.362</b>	<b>0.375</b>	0.416	0.375
1%tile	<b>0.287</b>	<b>0.3</b>	0.375	0.312
Min	<b>0.27</b>	<b>0.28</b>	0.36	0.294
80%band	<b>0.5</b>	<b>0.604</b>	0.416	0.45

## Discussion

It was shown that the human sensation of discomfort to vehicle seat vibration changes every moment influenced by the time-variant seat vibration. It clarified the new evaluation and analysis method for seat vibration that was based on the hypothesis that the final judgment was conducted from summarizing a series of time-variant vibration stimuli. An additional study is required to investigate the applicability to different types of vehicle vibration using a larger number of subjects.

## References

1. Yaguchi E, Yanagishima T, Akatsu Y, Hanai T and Kato K (1994) Whole-Body Vibration and Ride Comfort, Inter-noise94, 905-910
2. Hiroaki Suzuki (1997) A study on the vibrational factors determining the riding comfort of railway vehicle, The Japanese Journal of Ergonomics Vol33, NO.6, 349-355
3. International Organization for Standardization (2001) Mechanical vibration – Measurement and analysis of whole-body vibration to which passengers and crew are exposed in railway vehicles. ISO10056
4. International Organization for Standardization (1997) Mechanical vibration and shock-Evaluation of human exposure to whole-body vibration Part1: General requirements. ISO2631-1.

# PERCEPTION THRESHOLDS FOR LATERAL VIBRATION AT THE HAND, SEAT, AND FOOT

Miyuki Morioka and Michael J. Griffin  
Human Factors Research Unit

Institute of Sound and Vibration Research, University of Southampton, Southampton, U.K.

## Introduction

Discomfort, annoyance, or interference with activities due to exposure to vibration is only expected if the vibration exceeds the threshold for the perception of vibration. When there is more than one vibration input to the body (e.g. at the hands, seat and feet), the sensation is first experienced at the location with greatest sensitivity. Knowledge of differences in the thresholds of perception for vibration at the hand, seat, and feet should assist the identification of sources of discomfort caused by vibration.

Perception thresholds for vibration have been determined in several studies, but only a few studies have investigated perception thresholds in the horizontal direction for hand-transmitted vibration<sup>1, 6</sup> or whole-body vibration<sup>4-5</sup>, and there has been little consideration of perception thresholds for the foot resting on a vibrating surface.

This study determines absolute thresholds for the perception of sinusoidal lateral vibration, examining the effect of vibration frequency (8 to 315 Hz for the hand and foot; 2 to 315 Hz for the seat) and the effect of input location (the hand, the seat and the foot).

## Methods

Three groups of twelve males aged between 20 and 29 years participated in the experiment. Subjects in each group attended an experiment to determine perception thresholds for lateral vibration via either a rigid handlebar (30 mm diameter) at the left hand (left hand), or a rigid contoured seat (250 mm x 150 mm), or a footrest at the left foot (30.5 mm x 10.5 mm with 10-degree inclination). For the non-exposed hand (right hand) or foot (right foot), a stationary handle and footrest with the same dimensions as the vibrating handle and footrest were provided so that the same body posture was adopted among the three groups of subjects.

An up-down (staircase) algorithm was employed to determine thresholds in conjunction with a three-down one-up rule. A single test stimulus (2.0 seconds) was presented with a cue light illuminated during this period. The task of the subjects was to indicate whether they perceived the vibration stimulus or not. The threshold was calculated from the mean of the last two peaks and the last two troughs, omitting the first two reversals.

## Results

The median absolute thresholds of the 12 subjects determined at each frequency for the hand, seat and foot are shown in Figure 1. A frequency dependence of the threshold contours within the investigated frequency range is evident, with similar shape to the threshold contours

determined in other research<sup>3-6</sup>. Among the three locations (hand, seat and foot), the thresholds between 25 and 63 Hz did not differ significantly. The seat was the most sensitive to lateral vibration at 8 and 10 Hz among the three locations (Mann-Whitney,  $p < 0.05$ ). The hand was less sensitive to lateral vibration than the seat and foot at 12.5, 16 and 20 Hz (Mann-Whitney,  $p < 0.05$ ), but more sensitive than the seat and foot at frequencies greater than 100 Hz (Mann-Whitney,  $p < 0.05$ ).

## Discussion

It is evident from Figure 1 that the vibration threshold contours derived from the present study are inconsistent with the reciprocals of the relevant frequency weightings (e.g.  $W_h$ ,  $W_b$ , and  $W_d$ ) in current standards<sup>1-2</sup>, indicating greater sensitivity at high frequencies relative to low frequencies than implied by the standards for predicting perception thresholds at the hand, the seat, and the foot.

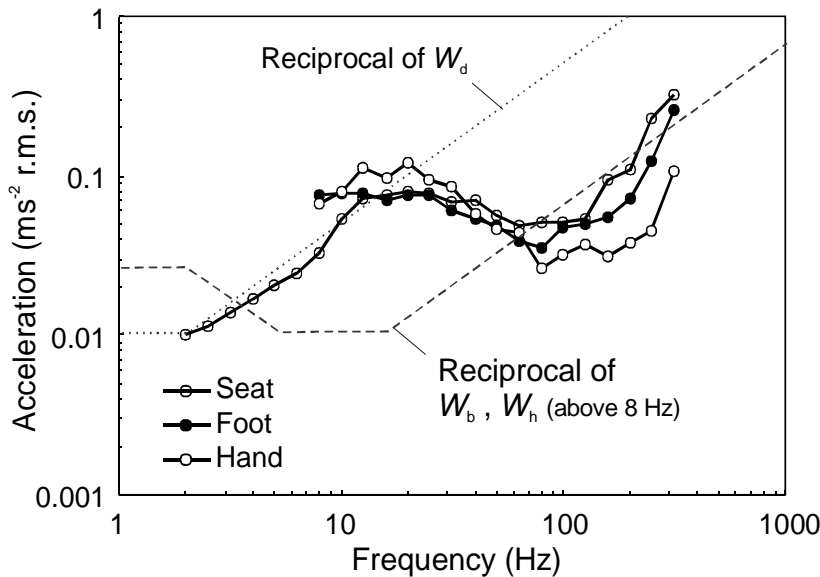

**Figure 1** Median perception threshold contours for lateral vibration at the hand, seat and foot. The reciprocals of  $W_b$ ,  $W_d$ , and  $W_h$  frequency weightings<sup>1-2</sup> normalized to 0.01  $\text{ms}^{-2}$  r.m.s. are overlaid.

## References

1. International Organization for Standardization (2001) Mechanical vibration – Measurement and assessment of human exposure to hand-transmitted vibration – Part 1: General guidelines, ISO 5349-1.
2. International Organization for Standardization (1997) Mechanical vibration and shock – Evaluation of human exposure to whole-body vibration – Part 1: General requirements, ISO 2631-1.
3. Miwa, T. (1967a) Evaluation methods for vibration effects. Part 3: Measurements of threshold and equal sensation contours on hand for vertical and horizontal sinusoidal vibrations, *Industrial Health* 5, 213-220.
4. Miwa, T. (1967b) Evaluation methods for vibration effect Part 1. Measurements of threshold and equal sensation contours of whole body for vertical and horizontal vibrations, *Industrial Health*, 2, 183-205.
5. Parsons, K.C., and Griffin, M.J. (1988) Whole-body vibration perception thresholds, *Journal of Sound and Vibration*, 121 (2) 237-258.
6. Reynolds, R.R., Standlee, K.G., and Angevine, E.N. (1977) Hand-arm vibration, Part III: Subjective response characteristics of individuals to hand-induced vibration, *Journal of Sound and Vibration* 51, 267-282.1.



# NEUROMOTOR HABITUATION AS A MECHANISM FOR VIBRATION INDUCED LOW BACK PAIN

Sara E. Wilson and Lu Li

Mechanical Engineering, University of Kansas, Lawrence, Kansas, U.S.A.

## Introduction

Occupational exposure to whole body vibration has long been associated with increased incidence of low back pain and low back injuries<sup>1</sup>. A number of studies have investigated transmissibility of seat pan vibration<sup>5, 6</sup>. While transmissibility has been well researched, the mechanism by which vibration may induce injury has not been thoroughly studied. Winter et al. identified increased reflex response delay after vibration exposure and speculated that muscular fatigue may be the cause of this increase<sup>9</sup>. However, a mechanism has yet to be demonstrated completely.

A potential mechanism that may explain the increased risk is neuromotor habituation. Muscle spindle organs have been shown in the extremities to be sensitive to muscle and tendon vibration. Rapid length changes in muscle have been shown to result in kinesthetic illusions as the regular firing of the muscle spindles is interpreted as muscle lengthening<sup>4, 7</sup>. These illusions have also been demonstrated in the paraspinal musculature<sup>2</sup>. With removal of vibration, research in the extremities has demonstrated increased positioning errors, probably due to neuromotor habituation<sup>8</sup>.

In this research, it has been hypothesized that neuromotor habituation after exposure to occupational vibration will increase positioning errors. It is further hypothesized that these errors can be shown to be linked to increased reflex response time. Such increased reflex response time could, in turn, decrease spinal stability and increase low back injury risk.

## Methods

Both positioning error and sudden load response were measured before and after exposure to 20 minutes of 5 Hz, 0.223 m/s<sup>2</sup> RMS seat pan vibration. Subjects were asked to sit on an unpaddinged seat without a backrest. Throughout the whole body vibration period, subjects were instructed to put their hands on a stable hand rest and feet on an adjustable stable footrest. The subjects were instructed to assume a comfortable and relax sitting posture for the duration of the exposure.

Positioning error was measured using an active-active reposition sense protocol. Electromagnetic markers (Motionstar, Ascension Tech, Burlington, VT) were used to track trunk motion. With markers attached to the skin at the T10 vertebra, the S1 vertebra and manubrium, trunk flexion (the angle from vertical of the line connecting T10 and S1) and lumbar curvature (the difference in inclination of the T10 and S1 markers) were tracked. In the reposition sense protocol, subjects were asked to maintain an upright trunk flexion and to rotate their pelvis and lumbar curvature to assume a target lumbar curvature. In the protocol subjects completed training trials, where they were asked to match their lumbar curvature using a visual display, and assessment trials, where they were asked to reproduce the lumbar curvature from memory. After two initial training trials, training trials and assessment trials were alternated for a total of 3 assessment trials. Reposition error was defined as the absolute difference between the target lumbar curvature and the lumbar curvature the subject assumed during the assessment trials.

For sudden loading trials, subjects were asked to stand on a force plate with their pelvis fixed with a belt. A sudden impulse load was applied by dropping a weight of 4.5 kg a height of 10 cm. The weight applied a sudden flexion moment through a chest harness. Electromyographic (Delsys, Boston, MA) data was recorded from the erector spinae, rectus abdominus and internal and external oblique muscle groups. Trunk motion was collected with the electromagnetic sensors.

A simulink model (MATLAB, Natick MA) was created in which the trunk was modeled as an inverted pendulum and muscle reflex response was modeled as a feedback with a detection threshold, a fixed time delay, and a linear gain. Overall trunk stiffness and trunk inertia from Cholewicki et al. were used<sup>3</sup>. An increase in positioning errors was modeled as an increase in detection threshold.

## Results

Both reposition error and erector spinae muscle activity delay were found to increase significantly after exposure to vibration, returning close to baseline after approximately 20 minutes. This pattern was also reflected in the significant increase after vibration in trunk flexion in response to sudden loading.

By increasing detection threshold for reflex response in the model, it was possible to show that changes in the detection threshold (position error) would indeed increase response delays and increase trunk flexion. It was shown that altering gain did not change these delays suggesting that muscular fatigue may not explain the data.

## Discussion

From the model, it can be predicted that loss in proprioception (position sense) can lead to increased muscle response times and increased trunk flexion in response to a sudden load. This was also demonstrated experimentally. This association supports the hypothesis that neuromotor habituation from vibration can lead to loss in proprioception and in turn alter low back stabilization. Future work will examine occupational factors such as seating configuration and vibration frequency on these neuromotor changes.

## References

1. Bernard, B. P. (Ed.) (1997) Musculoskeletal disorders and workplace factors, Washington, D.C., U.S. Department of Health and Human Services.
2. Brumagne, S., Lysens, R., Swinnen, S. & Verschueren, S. (1999) Effect of paraspinal muscle vibration on position sense of the lumbosacral spine. *Spine*, 24, 1328-31.
3. Cholewicki, J., Simons, A. P. & Radebold, A. (2000) Effects of external trunk loads on lumbar spine stability. *J Biomech*, 33, 1377-1385.
4. Cordo, P., Gurfinkel, V. S., Bevan, L. & Kerr, G. K. (1995) Proprioceptive consequences of tendon vibration during movement. *J Neurophysiol*, 74, 1675-88.
5. Griffin, M. J. (1990) Handbook of human vibration, London, England, Academic Press Limited.
6. Pope, M. H., Magnusson, M. & Wilder, D. G. (1998) Kappa Delta Award. Low back pain and whole body vibration. *Clin Orthop*, 241-8.
7. Roll, J. P. & Vedel, J. P. (1982) Kinaesthetic role of muscle afferents in man, studied by tendon vibration and microneurography. *Exp Brain Res*, 47, 177-90.
8. Wierzbicka, M. M., Gilhodes, J. C. & Roll, J. P. (1998) Vibration-induced postural posteffects. *J Neurophysiol*, 79, 143-50.
9. Wilder, D. G., Aleksiev, A. R., Magnusson, M. L., Pope, M. H., Spratt, K. F. & Goel, V. K. (1996) Muscular response to sudden load. A tool to evaluate fatigue and rehabilitation. *Spine*, 21, 2628-39.

## Podium Presentations

### Session III: Biodynamics I

Chairs: Douglas Reynolds and Farid Amirouche

<b>Presenter</b>	<b>Title</b>	<b>Page</b>
B. Valero University of Illinois at Chicago	Pneumatic active suspension design for heavy seats and operator ride comfort	38
Y. Aldien Concordia University	Hand forces-dependent modeling of the hand-arm under $z_h$ -axis vibration	40
J. Wu NIOSH	Dynamic responses of a fingertip to vibration 3D finite element analysis	42
H.P. Wölfel Darmstadt University of Technology	Numerical models and hardware dummies for simulating whole-body vibration of human – an overview	44
S. Pankoke Wölfel Beratende Ingenieure GmbH + Co	Simulation of human motion, muscle forces and lumbar spine stresses due to whole-body-vibration: An application of the dynamic human model CASIMIR for the development of commercial Vehicles and passenger cars	46
R.G. Gibson BNNTechnologies	A case study of whole-body vibration exposures associated with ordinary passenger and recreational vehicles	48

# **PNEUMATIC ACTIVE SUSPENSION DESIGN FOR HEAVY VEHICLE SEATS AND OPERATOR RIDE COMFORT**

Bertrand Valero<sup>1</sup>, Farid Amirouche<sup>1</sup>, Alan Mayton<sup>2</sup>

<sup>1</sup>Vehicle Technology Laboratory, University of Illinois at Chicago, Illinois, U.S.A.

<sup>2</sup>NIOSH, Pittsburgh, Pennsylvania, U.S.A.

## **Introduction**

Handling of heavy vehicles such as tractors, trucks and buses require a large roll stiffness which causes large high accelerations at the seat level during impacts. To provide comfort and minimize the energy transfer from the chassis and the seat a pneumatic active seat suspension is proposed. An active seat suspension design and control algorithm under development at the University of Illinois at Chicago, UIC, is being developed and tested. Preliminary results are presented in this paper.

The design of a passive suspension typically consists of optimizing the value of two parameters: the stiffness and the damping of the suspension. The general dynamic performance of the suspension is limited to the conditions under which these parameters were obtained. A change in the input conditions might lead to poor suspension and an amplification of the vibration transmitted to the body. The focus of this paper is a robust, semi-active suspension system with a variable controlled damping and using the body response an index measure to minimize the acceleration at the interface of the seat and operator.

A summary of existing suspensions, such as MR and ER fluids, and spring loaded and dual valve shock absorbent will be discussed to highlight the need of a semi-active pneumatic suspension system design.

## **Methods**

A model of the proposed suspension was developed in MATLAB (Simulink) and different control strategies for the valve position in relation to the cylinder pressure tested. The effects of stiffening and softening resulting from pressure changes in the cylinder were examined. The vertical accelerations of the seat was computed for different control strategies and configurations of the suspension and compared to the response of a passive seat suspension.

A lump -mass model was created to represent the human body including the head, the upper, middle and lower torso as well as the legs. The connective forces between body segments were modeled through modal analysis techniques from previous experiments at the Vehicle Technology Laboratory. ISO standards and absorbed power were used to evaluate the different configuration of the seat suspension system in relation to the dynamic response of the operator.

## **Results**

Initial results of the semi-active suspension system show a significant reduction in the RMS value of the acceleration of the seat. A reduction of the total absorbed power by the operator is expected to provide an insight into the control strategies adapted in the active suspension.

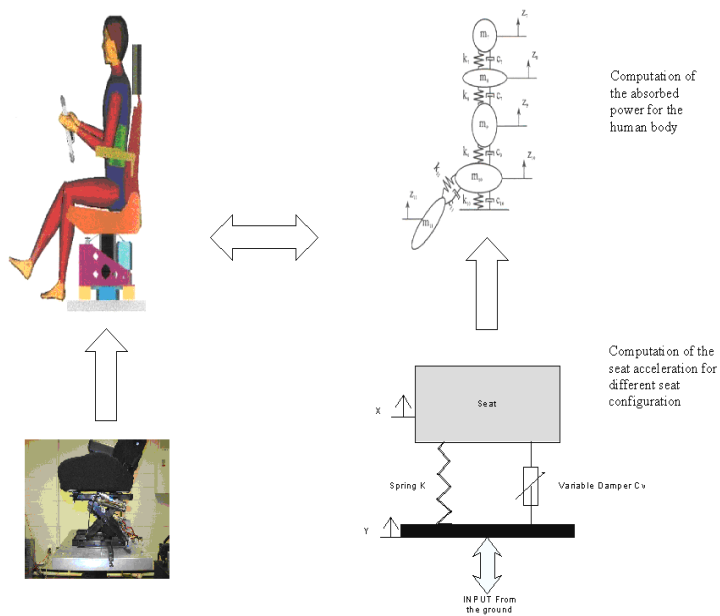

Figure 1 : Scheme of the general method applied in the study

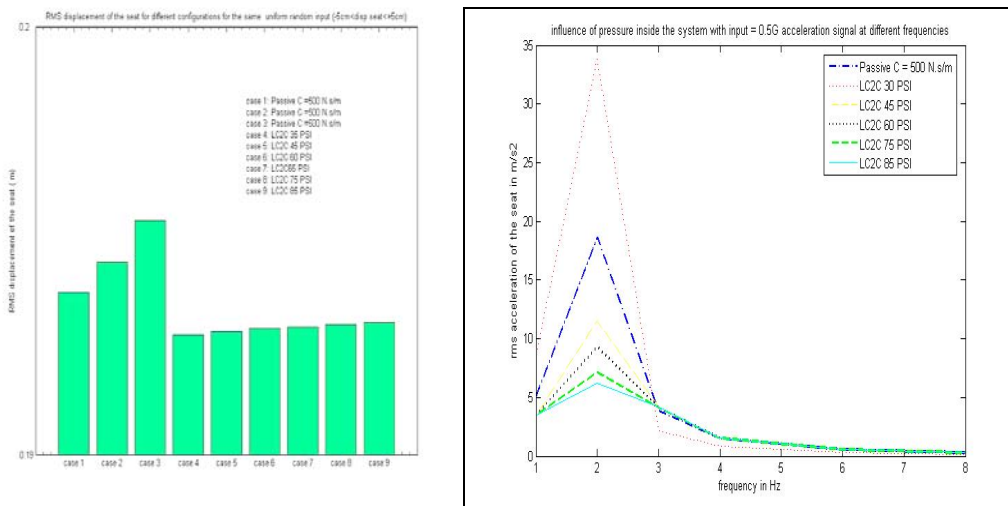

Figure 2 : RMS Acceleration of the seat for different configuration of the suspension

### References

1. F.M.L. Amirouche, *Computational Methods in Multibody Dynamics*. Practice Hall,
2. F.M.L. Amirouche, *Advanced Topics in Seat Suspension Design and Human Body Vibration Control*. SAE Seminars, 1998
3. F.M.L. Amirouche, L. Palkovics and J. Woodrooffe, *Optimal driver seat suspension design for heavy trucks*, International Journal of Vehicle Design, 1992

# HAND FORCE-DEPENDENT MODELING OF THE HAND-ARM UNDER $Z_H$ -AXIS VIBRATION

Y. Aldien<sup>1</sup>, S. Rakheja<sup>1</sup>, P. Marcotte<sup>2</sup>, P.-E. Boileau<sup>2</sup>

<sup>1</sup>CONCAVE Research Center, Concordia University, Montréal, Canada

<sup>2</sup>Institut de recherche Robert-Sauvé en santé et en sécurité du travail, Montréal, Canada

## Introduction

A number of biodynamic models of the hand-arm system have evolved on the basis of measured driving-point mechanical impedance (DPMI) responses to facilitate analyses of the coupled hand-tool system [1]. The parameter identifications in such models are based upon minimization of an error function of the model and the target impedance data, which may not yield a unique solution. Consequently, a number of model structures and parameter sets could be realized that would equally satisfy the target curve. Moreover, the vast majority of the reported models exhibit acute deficiencies due to excessive static deflections of model masses, presence of a low frequency mode and very light masses in the order of 1.2- 4.8 grams. The models also do not characterize the dependency of the biodynamic responses on many factors, namely the hand forces, hand-arm posture and vibration intensity. This study aims at development of a hand-arm biodynamic model with considerations of the hand forces, and both the DPMI and power absorption measures, to enhance the uniqueness of the model.

## Methods

Two different model structures are chosen for identifying the model parameters on the basis of measured DPMI and absorbed power characteristics of the hand-arm system under  $z_h$ -axis vibration over a range of hand-grip and push forces. Owing to the strong influence of the hand-handle coupling forces, the models were initially derived for fixed hand forces, namely 30 N grip and 50 N push forces, as suggested in the ISO 10068 standard [2]. The equations of motion for the model are formulated and solved to compute both the DPMI and absorbed power responses. A constrained minimization function comprising weighted errors of both the DPMI and absorbed power is formulated and solved to identify the parameters. Alternate functions corresponding to different combinations of hand forces are then applied to identify hand-force dependent model parameters.

Variations in the model parameters are investigated as functions of the grip, push and coupling forces through linear regression analysis. Regression-based models are formulated for deriving the hand-handle forces dependent model parameters. The validity of the model is also examined under selected combinations of hand forces.

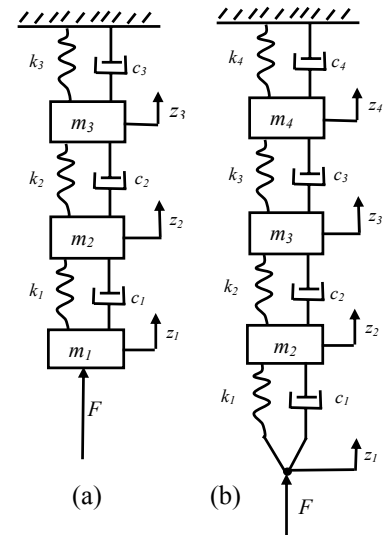

Fig. 1: hand-arm vibration models

## Results and Discussions

Comparisons of models results with the measured data suggested that both model structures could predict the DPMI as well as absorbed power reasonably well, when variations in the hand forces are neglected. The model with the visco-elastic interface (b), however, provided relatively poor agreements and large static deflection under a static push force. The model stiffness and damping parameters identified on the basis of measured responses for nine different combinations of hand forces revealed linear variations with the hand forces, particularly the coupling force. The model masses, however, revealed only minimal sensitivity to variations in the hand forces. The resulting relationships between the model parameters and the coupling force ( $CF$ ) were thus used to formulate a hand force-dependent mechanical-equivalent model of the human hand-arm system using model (a). These relationships suggest linear increase in stiffness and damping coefficients with increasing coupling force, and assume the general form:

$$k_i = a_1 CF + a_0; \text{ and } c_i = b_1 CF + b_0 \text{ for } i=1,2,3$$

where  $a_0$ ,  $a_1$ ,  $b_0$  and  $b_1$  are constant coefficients. Multiple linear regressions between parameters and the grip and push forces ( $F_g$  and  $F_p$ ) as independent variables, were also performed, which resulted in higher correlation factors ( $>0.88$ ). These are expressed as:

$$k_i = a_2 F_p + a_1 F_g + a_0; \text{ and } c_i = b_2 F_p + b_1 F_g + b_0 \text{ for } i=1,2,3$$

Comparisons of model responses with the measured data revealed reasonably good agreements in both the DPMI and absorbed power magnitudes for the hand forces combinations considered. Consideration of parameters as functions of grip and push forces would also be more desirable than that based upon the coupling force only.

While the DPMI magnitude is known to exhibit negligible sensitivity to variations in excitation magnitude, the absorbed power increases considerably under a higher vibration magnitude. The validity of the resulting model under different magnitudes of excitation was thus explored by comparing the model results with the data acquired under  $a_{h,w} = 2.5$  and  $5 \text{ m/s}^2$ . The model results revealed reasonably good agreements with measured absorbed power and the DPMI under both levels of excitations.

The vibration properties of the proposed models could be considered appropriate in view of the practical issues related to model implementation, namely static deflection, damping ratio and resonant frequencies. The eigen-frequencies of the proposed model also revealed good agreements with the frequencies corresponding to the peaks observed in the DPMI magnitude data, while the static deflections of masses were relatively small.

## References

- [1] Rakheja, S., Wu, J.Z., Dong, R.G., Schopper, A.W. and Boileau, P.E. 2002: A comparison of biodynamic models of human hand-arm system for applications to hand-held power tools, *Journal of Sound and Vibration*, 249, pp. 55-82.
- [2] ISO 10068, 1998: Mechanical vibration and shock – Free, mechanical impedance of the human hand-arm system at the driving point, *International Standard Organization*, Geneva, Switzerland.

# DYNAMIC RESPONSES OF A FINGERTIP TO VIBRATION - 3D FINITE ELEMENT ANALYSIS

John Z. Wu, Kristine Krajnak, Daniel E. Welcome, Ren G. Dong  
National Institute for Occupational Safety and Health, Morgantown, West Virginia, U.S.A.

## Introduction

Although the exact mechanisms underlying vibration white finger (VWF) are not clear, it has been speculated that VWF is associated with variations of the blood flow patterns due to the physical damage and/or degeneration in neural and vascular tissue caused by vibration loading [1]. Excessive dynamic deformation of the soft tissues in the fingertip under vibration loading is believed to induce multiple occupation-related hand/finger disorders. However, the in vivo distributions of the dynamic stress/strain of the tissues in the fingertip under vibration conditions have not been studied because they cannot be measured experimentally to date. The goal of this study is to analyze, theoretically, the location and frequency-dependent dynamic deformation of the soft tissue in the fingertip during vibration exposures.

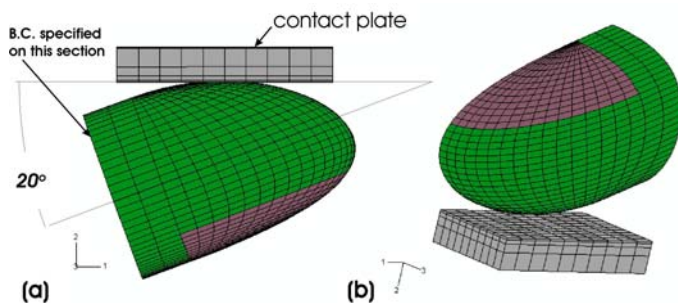

**Figure 1:** FE model of the fingertip in contact with a flat surface. (a): side view. (b): perspective view. The fingertip is in contact with a flat plate with a contact angle of 20°.

## Methods

The fingertip considered in the model is the distal phalanx, the portion from the distal end of the fingertip to the distal interphalangeal (DIP) joint articulation (Fig. 1). The external shape of the fingertip was determined using a smooth mathematical surface fitting to the observed fingertip shapes. The fingertip surface was then scaled to the dimensions of a typical male index finger: length 25 mm, width 20 mm, and height 18 mm. The fingertip was approximated to be symmetric, such that only a half of the fingertip was considered in the FE modeling. The fingertip was assumed to be composed of outer and inner skin layers, subcutaneous tissue, bone, and nail. The soft tissues (inner skin layer and subcutaneous tissues) were assumed to be nonlinearly elastic and viscoelastic, while the bone, nail, and outer skin layer were considered as linearly elastic. The simulations were conducted using a displacement-controlled protocol in two stages. First, the fingertip was statically pre-compressed. The contact plate was first displaced towards the finger to achieve a predetermined value of tissue deformation (i.e., 0.5, 1.0, 1.5, and 2.0 mm). Second, the steady-state dynamics responses of the fingertip were analyzed using a linear perturbation procedure. The fingertip was subjected to a continuous harmonic excitation (magnitude 0.5 mm) from the contact interface. The dynamic analysis was performed in a frequency domain ranging from 16 to 2000 Hz. The frequency-dependent distributions of the vibration magnitude and dynamic strain magnitudes in the soft tissues are investigated.

## Results

Typical simulation results for the frequency-dependent distributions of the vibration magnitude in the soft tissues are shown in Fig. 2 (figures show the results with a pre-compression of 2.0 mm). The vibration magnitude at the contact surface is 0.5 mm (specified) for all frequencies, while the vibration magnitudes in the soft tissues are location- and frequency-dependent. It is clear that the fingertip has a major resonance around 125 Hz, at which the vibration magnitudes in the soft tissues are over four times greater than that of the contact plate (0.5 mm). It is interesting to observe that, at this resonant frequency (125 Hz), the soft tissues at the tip has the maximal vibration magnitude while the regions near the contact



interface participate less in the vibrations. For frequencies greater than 250 Hz, the vibrations tend to be concentrated in the tissues near the contact interface.

## Discussion

The present simulation results show that the effects of vibration on soft tissue are region dependent, with the soft tissues near the nail bed displaying much less dynamic deformation than those in the finger pad, close to the point of contact with the vibrating source. In addition, no resonance of the fingernail was observed in the frequency range of power tools. Based on the current results, one would speculate that alterations in blood flow in the fingertips would be more prevalent, and occur earlier in the soft tissue of the fingerpad than in the vessels round the nail bed. These model predictions on the dynamic deformation distribution within the tissues are consistent with the physiological data collected from workers with VWF [2,3]. We have also examined the effects of compression on finger vibration mode. The fingertip was found to have a major resonance around 100 Hz, which increases with increasing pre-compression. These simulation results are consistent with the experimental observations of the mechanical impedance of the fingertip [4]. The modal shapes of the fingertip at the resonances cannot be determined experimentally at this time. Our results indicated that this resonant mode (around 100 Hz) of the fingertip is associated with amplified vibration at the tip (Fig. 2). Thus, exposure to vibration frequencies close to the resonance may result in an increase in blood vessel deformation at the very tip of the finger, making these frequencies more likely to induce injury.

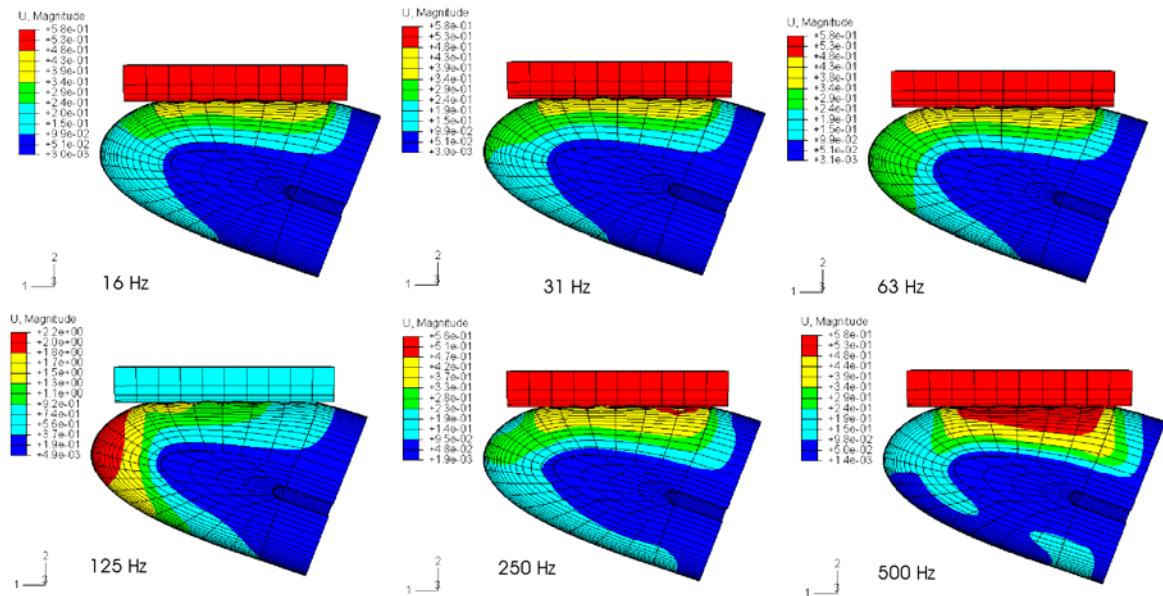

**Figure 2:** The distributions of the vibration magnitude in the longitudinal section for six different vibration frequencies ( $f= 15.6, 31.3, 62.5, 125, 250,$  and  $500$  Hz). The fingertip is pre-compressed by  $2.0$  mm before being subjected to harmonic vibrations (magnitude  $0.5$  mm).

## References

- [1] Herrick, A. (2005). Pathogenesis of Raynaud's phenomenon. Rheumatology, Oxford.
- [2] Mirbod, S., Yoshida, H., Jamali, M., Miyashita, K., Takada, H., Inaba, R., Iwata, H. (1998). Ind Health, 36:171–8.
- [3] Kaji, H., Bossnev, W., Honma, H., Yasuno, Y., Kobayashi, T., Saito, K., Fujino, A. (1995). Cent Eur J Public Health, 3S:34–6.
- [4] Dong, R.G., Wu, J.Z., McDowell, T. W., Welcome, D.E., Schopper, A.W. (2005). J Biomech, 38: 1165–75.

# NUMERICAL MODELS AND HARDWARE DUMMIES FOR SIMULATING WHOLE-BODY VIBRATION OF HUMAN - AN OVERVIEW

Horst Peter WÖLFEL

Department of Structural Dynamics, Darmstadt University of Technology, Germany

## Introduction

The goal of biodynamic models is to simulate the vibration behaviour of the human body. In combination with experimental studies biodynamical models can be a powerful tool for the analysis of the effects of vibration exposure on health [1] and comfort. This paper gives an overview of the state of the art of biodynamic whole-body vibration models of humans, addressing both numerical models and hardware dummies.

## Method

Two approaches are distinguished, the phenomenological and the anatomical, as illustrated in Figure 1.

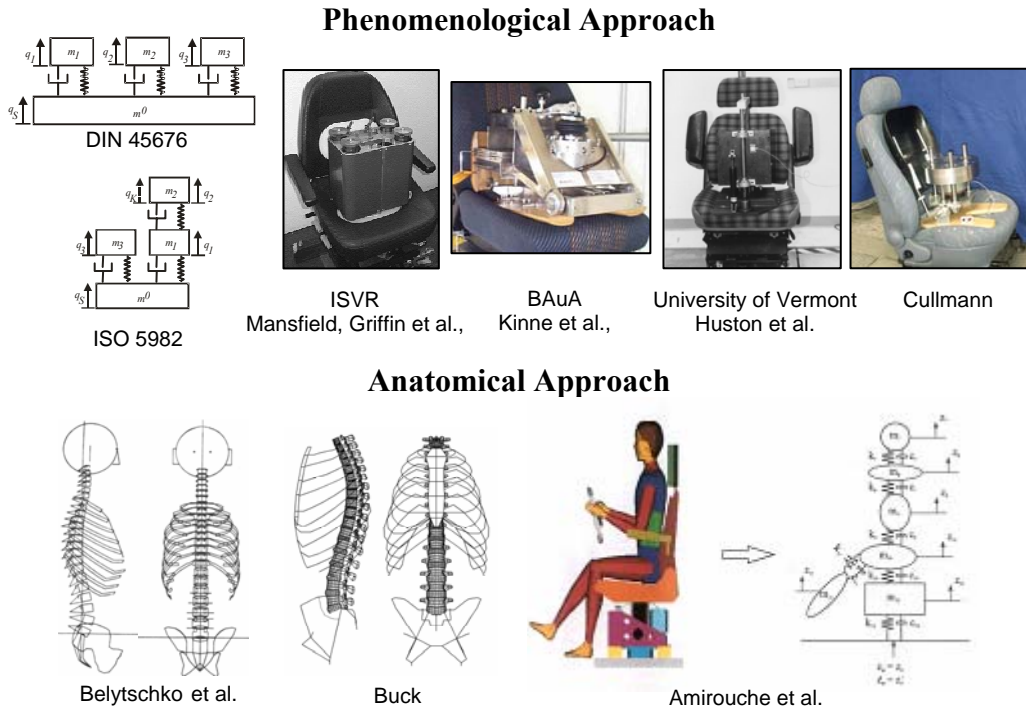

Figure 1: Two modelling approaches.

Phenomenological models aim to reproduce the vibration behaviour of humans with respect to particular physical quantities, chiefly the driving-point impedance at the interface to the seat, and partly with respect to other transfer functions. Discrete systems of masses, springs, and dampers with several degrees of freedom whose topology and parameters are determined by structure- and parameter identification methods are used in the sense that the functions derived from measurements are reproduced as well as possible. This paper provides an evaluation of this methodology and defines its range of application as well as its limits.

The aim of anatomical models, on the other hand, is to simulate numerically all quantities potentially relevant for the evaluation of vibration behaviour, as well as to calculate those unknown quantities not accessible from experimentation, e.g., the loading of the lumbar spine.

The basis for these models is human anthropometry and physiology [2]. Multi-body systems and finite element models are utilised as mathematical models. Because of the complexity of the claim, the validation of anatomical models with the help of experiments on test persons is important. This paper gives an overview of various types of anatomy-based models, their range of application, and the current trends in this field.

Two types of hardware vibration dummies have been developed so far: Passive and active dummies. Both types of dummies aim to reproduce the driving-point impedance at the interface to the seat. Passive dummies consist of a system of masses, springs and dampers. They are based on phenomenological models. Active dummies additionally use an actuator to meet given response functions in a more flexible way.

### **Results**

There is a broad variety of biodynamic models used to simulate human whole-body vibrations [3]. The use of these models requires a critical check of the biodynamic properties employed to describe the models, as well as how they were validated [4]. This is most important for numerical models, but also valid for hardware dummies.

In order to accurately simulate motions and loads numerically, including the effects on health and comfort sensations of an individual exposed to vibration, a high level of research is essential. In particular, this necessitates the extension and systematisation of the experimental database needed for the validation of spatial vibration behaviour, and to what extent the dependence of the factors of posture, anthropometric properties, age, gender and potential pre-damage can be systematically calculated.

For anatomy-based models, there is an urgent need for research on the modelling of the lumbar spine, especially with regard to the development of damage models, the modelling of muscles, the influence of muscle activity, and finally the modelling of the inner organs and soft tissue involved in the man-seat interface.

### **Conclusion**

Numerical biodynamic models are needed for any systematic analysis of the relationship between vibration exposure, health and comfort. But the range of their application must be carefully limited to the range in which they are validated. Numerical models and hardware dummies will help to support the development of technical systems for the reduction of vibration impact.

### **References**

- [1] ISO 2631-1 (1997) Mechanical vibration and shock – Evaluation of human exposure to whole-body vibration – Part 1: General requirements.
- [2] BUCK B., WÖLFEL H.P. (1998) Dynamic three-dimensional finite element model of a sitting man with a detailed representation of the lumbar spine and muscles. *Computer Methods in Biomechanics & Biomedical Engineering* – 2, Gordon and Breach Science Publishers, ISBN 90-5699-206-6, 379-386.
- [3] SEIDEL H., GRIFFIN M.J. (2001) Modelling the response of the spinal system to whole-body vibration and repeated shock. *Clinical Biomechanics* 16 Suppl. No. 1, S3-S7.
- [4] GRIFFIN M.J. (2001) The validation of biodynamic models. *Clinical Biomechanics* 16 Suppl. No. 1, S81-S92.
- [5] CULLMANN A., WÖLFEL H.P. (2001) Design of an active vibration dummy of sitting man. *Clinical Biomechanics* 16 Suppl. No. 1, S64-S72.

# **SIMULATION OF HUMAN MOTION, MUSCLE FORCES AND LUMBAR SPINE STRESSES DUE TO WHOLE-BODY-VIBRATION: APPLICATION OF THE DYNAMIC HUMAN MODEL CASIMIR FOR THE DEVELOPMENT OF COMMERCIAL VEHICLES AND PASSENGER CARS**

Steffen Pankoke and Alexander Siefert  
Wölfel Beratende Ingenieure GmbH + Co., Höchberg, Germany

## **Introduction: Occupant modeling**

In the development of commercial vehicles as well as of passenger cars, the effects of vehicle vibrations on operating safety, health and comfort can only be predicted by numerical simulation when appropriate occupant models are available. Such models must be based on human anatomy and have dynamic properties of real humans in order to achieve realistic results. Since human dynamic behavior depend on posture and percentile, the occupant model needs to be adjustable to these parameters with respect to geometry and dynamic properties [1,2].

## **Dynamic Human Finite-Element-Model CASIMIR**

CASIMIR is a non-linear, dynamic finite-element-model of the human body. It consists of a dynamic model of the upper torso with head, neck, shoulders and arms as well as of a dynamic model of the lower extremity with pelvis and legs. The most important part is the lumbar area with dynamic non-linear models of the lumbar spine and of back and abdominal musculature. The frequency-dependent characteristics of the intervertebral discs and the effects of muscle activation and non-linear frequency-dependent muscle properties are included. In the latest stage of development, CASIMIR has been equipped with a compliant model of the body surface in the contact areas to the seat. This results in a very realistic transmission of static and vibrational forces into the human body, see fig. 1. Intense model verification and validation has been performed in all stages of model development, starting with validation of small components like intervertebral disc, ending with validation of whole-body-vibrations using measurements of the dynamic mass / mechanical impedance [4]. For an in-detail examination of stresses in the vertebral bodies and discs, a non-linear submodel of the lumbar spine with an increased number of degrees of freedom can be coupled to the whole-body-model, enabling the researcher to examine local effects of vibrations and single shocks on the lumbar materials.

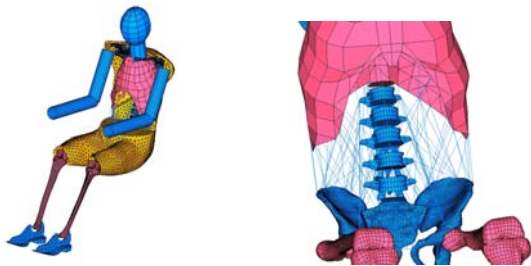

Fig. 1: Dynamic human model CASIMIR



Fig. 2: CASIMIR f05, m50, m95

Since it is well known that human dynamic behavior is significantly affected by anthropometric data and posture, CASIMIR can be individualized to the anthropometric status of single individuals or to the mean values for specific percentile groups. Furthermore, posture can be adjusted to the seating conditions applicable to a specific vehicle. Posture modification capabilities include the variation of the lumbar lordosis [3].

### Static Seating: Muscle Activation and Static Forces in the Lumbar Spine

Due to non-linearities of human body and seat a qualified simulation of the static seating procedure is a prerequisite of any simulation of dynamic responses of the human body and seat. During static seating simulation, the human model takes the desired posture on the seat, muscles are activated in order to maintain this posture and thus the non-linear biomaterials of the human body as well as the non-linear foam materials in common seats of commercial vehicles and passenger cars are loaded in an appropriate trim point. This ensures automatic selection of the correct tangent stiffness for the succeeding vibration analysis. A static seating simulation gives a number of valuable results with respect to the human body:

- muscle activation / muscle forces: ergonomic judgment of the body posture
- static forces and static stresses: relevant for damage in the vertebral discs
- pressure distribution (comfort, fig. 3) and H-point-location (package, safety)

### Multiaxial Dynamic Excitation: Motions, Forces and Stresses

After static seating simulation, dynamic excitations in multiple axes (x,y,z) can be applied on the human model or the model of the occupied seat (seat + human). Usually, an excitation is selected that is typical for the seat slide (or the seat surface) of the specific vehicle under investigation. For commercial vehicles with higher amplitudes of excitation, a non-linear solution procedure has to be applied while comfort simulations may be covered with linearised procedures. Results to be analysed are motions of the body with respect to operational safety of commercial vehicles, dynamic forces in the musculature with respect to operational performance and dynamic forces / stresses (with submodel) in the lumbar spine with respect to health, fig. 4.

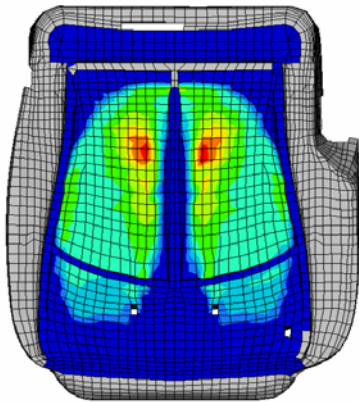

Fig. 3: Static seat pressure

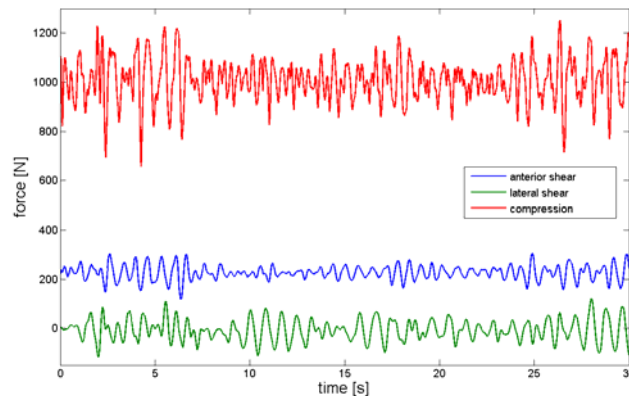

Fig. 4: Dynamic disc forces, spinal level L4L5

### References

- [1] Pankoke, S.; Hofmann, J.; Wölfel, H. P.: *Determination of vibration-related loads by numerical simulation*, Clinical Biomechanics 16 Supplement No. 1 (2001)
- [2] Seidel, H.; Blüthner, R.; Hinz, B.: *Application of Finite-Element-Models to Predict Forces Acting on the Lumbar Spine during Whole Body Vibration*, Clinical Biomechanics 16 Supplement No. 1 (2001)
- [3] Pankoke, S.; Siefert, A.; Breitfeld, Th.: *Numerical Simulation of Seat Vibrations in Luxury-Class Automobiles: Application of the Finite-Element-Man-Model CASIMIR*, VDI-Berichte Nr. 1912, VDI Verlag Düsseldorf, 2005
- [4] Hofmann, J.; Pankoke, S.; Wölfel, H.P.: *Individualisierbares FE-Modell des sitzenden Menschen zur Berechnung der Beanspruchungen bei dynamischer Anregung – Ganzkörpermodell und Submodell LWS*, Editor: German Federal Inst. Occupational Safety & Health, Dortmund/Berlin 2003

# **A CASE STUDY OF WHOLE-BODY VIBRATION EXPOSURES ASSOCIATED WITH ORDINARY PASSENGER AND RECREATIONAL VEHICLES**

Robert G. Gibson and Joel D. Gibbons  
BBN Technologies, Arlington, Virginia, U.S.A.

## **Introduction**

Measurements and analyses were conducted of whole-body vibration aboard seven commercially available passenger and/or recreational vehicles: sedan; sport-utility vehicle (SUV); pickup truck; moving truck; motorcycle; all-terrain vehicle (ATV); and boat. The purpose of the testing was to measure and assess whole-body vibration exposure in a range of typical vehicle environments in order to gain understanding of typical exposure levels characteristic of activities of daily living.

Vehicle models tested (and model year) were: Ford Taurus (1995); Jeep Cherokee Sport (2000); Toyota Tundra SR5 (2002); Ford F-350 (1997); Harley-Davidson Electra Glide Classic (2004); Yamaha Kodiak 400 4x4; and Steiger Craft Model 21 Montauk. All vehicles were tested with their standard factory-installed seats and were operated under a range of normal operating conditions and speeds typical of intended vehicle use.

## **Methods**

The measurement, processing, analysis, and exposure assessment methods follow the guidance of generally accepted, national and international consensus standards relevant to the evaluation of whole-body vibration, including ISO 2631-1 [1] and ANSI S3.18 [2].

Seats were instrumented with low-mass triaxial accelerometers mounted in seat pads. Accelerometers used in the test are specified to have flat frequency response over the frequency range of 0.5 to 80 Hz, and all accelerometers were recently calibrated traceable to the National Institute of Standards and Technology (NIST). Seat pads were installed following guidance in the relevant standards [1, 2], with sensitive axes of the accelerometers following the standard coordinate system with respect to the seated occupant. (The x-axis represents fore-aft motion; the y-axis represents side-to-side motion; and the z-axis represents vertical motion with respect to the occupant.)

Vibration data processing and analysis, including filtering, sampling, frequency-weighting, averaging, summation, and determination of basic and additional metrics followed procedures in the relevant standards [1, 2]. Digitized time series data were acquired and stored using a PC-based data acquisition system. Whole-body vibration exposure analyses were conducted via post-processing. During data processing, recorded periods of seat acceleration that were identified and verified as resulting from occupant-induced motion rather than vehicle motion were excluded prior to exposure analysis.

The basic evaluation metric for whole-body vibration is the frequency-weighted root-mean-square (r.m.s.) acceleration,  $a_w$ . The primary additional evaluation metric is the fourth-power

vibration dose value, VDV. The VDV measured for a period of time can be normalized to a standard eight-hour time period using a standardized calculation process.

Testing of on-road vehicles was conducted on public roads. The routes included a variety of road surfaces and features that are typical of road travel in urban, suburban and/or rural areas. Testing of the ATV was conducted off-road, on rural trails. Testing of the boat was conducted in a bay and estuary in calm conditions with waves of less than one foot. The total duration of vibration measurements during vehicle operations ranged from approximately 1½ hours for the ATV and boat to approximately 4½ hours for the SUV.

## Results

Results of basic and additional exposure metrics are summarized in the table below. Basic r.m.s. acceleration is expressed in  $m/s^2$ . Measured VDV for the duration of the test and VDV normalized to an 8-hour exposure period ( $VDV_8$ ) are expressed in  $m/s^{1.75}$ .

Vehicle	$a_{wx}$	$a_{wy}$	$a_{wz}$	$VDV_x$	$VDV_y$	$VDV_z$	$VDV_{8x}$	$VDV_{8y}$	$VDV_{8z}$
Sedan	0.27	0.21	0.38	4.6	3.8	7.4	6.2	5.2	9.9
SUV	0.14	0.20	0.33	2.9	3.9	6.8	3.4	4.6	7.9
Pickup Truck	0.16	0.19	0.30	3.0	3.8	6.3	3.7	4.7	7.8
Moving Truck	0.22	0.21	0.53	3.8	3.5	11.3	5.2	4.8	15.4
Motorcycle	0.23	0.87	0.61	4.8	14.5	13.9	5.9	17.8	17.1
ATV	0.69	0.67	1.02	9.2	8.9	14.2	14.2	13.7	21.7
Boat	0.66	0.47	1.01	10.0	8.2	22.0	15.0	12.3	33.1

## Discussion

Measurements and exposure analyses conducted in accordance with consensus standards may be compared with guidance for the assessment of whole-body vibration and impact with respect to health, as published in Annex B of the standards [1, 2], in order to address questions regarding potential health effects of vehicle operation.

It is also instructive to compare whole-body vibration exposures determined for these typical passenger and recreational vehicles with exposures measured in other vehicle types, including those driven by professional operators, and with other occupational exposures to whole-body vibration and impact. Comparisons may also be made with exposure assessments of vehicles measured by other investigators, in accordance with relevant standards, for example, locomotives and road vehicles, e.g., as reported in [3].

## References

1. International Organization for Standardization (1997). Mechanical vibration and shock – Evaluation of human exposure to whole-body vibration – Part 1: General Requirements, ISO 2631-1:1997.
2. American National Standards Institute (2002). Nationally Adopted International Standard, Mechanical vibration and shock – Evaluation of human exposure to whole-body vibration – Part 1: General Requirements, ANSI S3.18-2002.
3. Fries, R.H., N.K. Cooperrider, and R.E. Larson (1993). Locomotive and Road Vehicle Ride Quality Assessments, *ASME Rail Transportation*, RTD Vol. 6, pp. 219-227.

## Podium Presentations

### Session IV: Health Effects II

Chair: Paul-Emile Boileau

<b>Presenter</b>	<b>Title</b>	<b>Page</b>
M. Cherniack, University of Connecticut Health Center	Prospective studies of vibration exposed cohorts: Hand-arm vibration International Consortium (HAVIC)	51
T. Jetzer	Clinical Surveillance for HAVS	53
J.-G. Yan Medical College of Wisconsin, Milwaukee	Characteristic neuropathological changes in vibration injury: An experimental study	55
J.-G. Yan Medical College of Wisconsin, Milwaukee	Measuring physical and biochemical changes following long periods of work-related vibration.	57
K. Krajnak NIOSH	Acute vibration exposure shifts the current perception threshold of A $\beta$ fibers in a rat-tail model of vibration	59
S. Govindaraju Medical College of Wisconsin, Milwaukee	Acute effects of vibration on rat-tail nerves	61



**PROSPECTIVE STUDIES OF VIBRATION EXPOSED COHORTS: HAND-ARM VIBRATION INTERNATIONAL CONSORTIUM (HAVIC)**

M Cherniack<sup>1</sup>, AJ Brammer<sup>1,2</sup>, R Lundstrom<sup>3</sup>, JD Meyer<sup>1</sup>, TF Morse<sup>1</sup>, G Neely<sup>4</sup>, T Nilsson<sup>4,5</sup>, D Peterson<sup>1</sup>,  
E Toppila<sup>6</sup>, N Warren<sup>1</sup>,

<sup>1</sup>Ergonomics Technology Center, University of Connecticut Health Center, U.S.A., <sup>2</sup>Institute for Microstructural Sciences National Research Council Ottawa, Canada, <sup>3</sup>University Hospital Department of Biomedical Engineering and Informatics, Umeå, Sweden, <sup>4</sup>National Institute of Working Life Department of Work and the Physical Environment, Umeå, Sweden, <sup>5</sup>Department of Occupational and Environmental Medicine, Sundsvall, Hospital, Sundsvall, Sweden, <sup>6</sup>Department of Physics Finnish Institute of Occupational Health, Helsinki, Finland

**Introduction**

HAVIC is a collaboration of investigators from North America, Sweden, and Finland having a scientific mandate from NIOSH, to study the exposure response relationship between vibratory tool exposure and adverse health effects. Five cohorts, the Suomossalmi forest workers cohort, Volvo truck cab workers, Connecticut shipyard workers, and matriculating dental hygiene students and experienced dental hygienists have been under study. In the case of shipyard workers, there was survey and tool exposure data from 1988, although detailed subject testing was only available within the timeframe of the study. The truck cab assembly workforce was an inception cohort that had been followed from 1994 along with age-matched controls. The Finnish forest workers had cumulative health data on a cohort (n=52) that had been studied from 1976. For a subset of these subjects, there was detailed tactometry testing in 1990, 1995, and 2003. Accordingly, there was historical as well as new prospective data for the industrial cohorts. The Suomossalmi cohort was reassembled only for our study, which precluded follow-up evaluation and because of retirement is almost certainly the last time this historic group will be studied. The study features are:

- Characterization of the exposure response relationship for hand-arm vibration through a study design, incorporating multiple cohorts, some having existing historical data,
- Selection of cohorts to include different types of vibration: oscillatory (forest workers) impact (truck cab workers), high frequency (dental hygienists) and mixed (shipyard workers),
- Inclusion of two inception cohorts: dental hygiene students and Swedish truck cab workers,
- Methods for multi-site and historical integration

A description follows.

	<b>Participants</b>	<b>Design</b>	<b>Duration</b>	<b>Populations</b>	<b>Health Assessment</b>	<b>Exposure Assessment</b>
<i>HAVIC</i>	North America, Sweden, Finland	Longitudinal, historical data inclusion, variable re-test intervals	2000-2006	217 shipyard worker; 56 automotive workers/34 controls; 61 forestry workers; 94 dental hygienists/ 56 trainees	Questionnaire, Physical exam, cold challenge test, tactometry, segmental nerve conduction	Diaries , questionnaire, data logging, simulation, biomechanical analysis (PATH)

**Methods**

The study included surveys, physical evaluation, and a selection of battery of “best tests” (cold challenge plethysmography, multi-frequency tactometry, segmental sensory nerve conduction velocity [SNCV]<sup>1,2,3</sup>) applied across groups to quantify responses to exposure. Exposure monitoring included exposure characterization through daylong data logging at the individual level. Workers at each site were instrumented with a microcomputer-based Vibration Exposure Monitoring (VEM) system, developed at the Biodynamics Laboratory of UCHC and about the size of a police walkie-talkie, to record user-specific tool-operating times, vibrations, and grip forces throughout all, or a representative part, of their workday. More specifically, data logging methods involved the direct monitoring of work cycles, involving tool operation time and measures of tool vibration, namely the root-mean-square (RMS), root-mean-quad (RMQ), and root-mean-oct (RMO), and grip forces, each calculated per minute. For this study, the questionnaire was homogenized with other vibration studies<sup>4,5,6</sup>. Cross-translation was directed by the multi-lingual investigators, and then reviewed by the study team. To extend comparability with future international studies, questions were also added from the Vibration Network (VINET) draft questionnaire, the product of a European

consortium sponsoring uniform questionnaire development. During the initial shipyard evaluation and piloting, we unexpectedly found a segment specific temperature/velocity relationship<sup>3</sup>. Members of the HAVIC consortium concluded that conventional nerve conduction warming techniques could no longer be justified, where there was such excessive variable instability, particularly where vascular dysfunction was a potentially powerful covariate. The protocol was amended and external warming was replaced by exercise-based whole body warming consistent with the methodology of Wallin (2002).

### Results

There was high workforce volatility. When the shipyard was studied in 1988, there was a full-time grinding department sub-group of 460 workers, of whom 71% had vascular symptoms, and 84% had hand paresthesias. Significant organizational changes took place. By 2001, there were only 31 full-time grinders; the overall production workforce had decreased from 7624 to 1708, and there was limited cohort overlap. There was also progressive exposure modification through changes and changes in work organization. The Swedish inception cohort had declined from 148 to 56 members over 10 years without a high rate of turnover, apparently due to the tendency of younger workers to seek different opportunities even within a stable cohort. The problems of symptom instability in shorter-term measures and minimum observation periods ( $\geq 5$  years for Suomossalmi and Volvo) to see effects with our most sensitive stable measure (vibrotactometry), add an additional complication to prospective study design.

There are interesting results related to exposure monitoring. In Figure 1, data logged tool operating time is graphed against energy equivalent hand absorption. At the individual level, the association is weak. In Figure 2, there is little correspondence between self report of exposure, data logged exposure, diary based exposure accounting, and observation by a skilled observer.

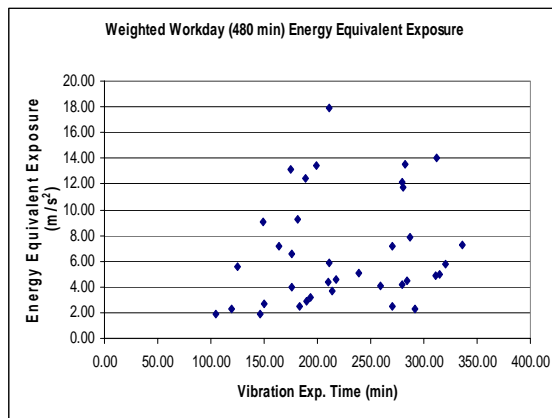

Fig. 1 Exposure magnitude and time

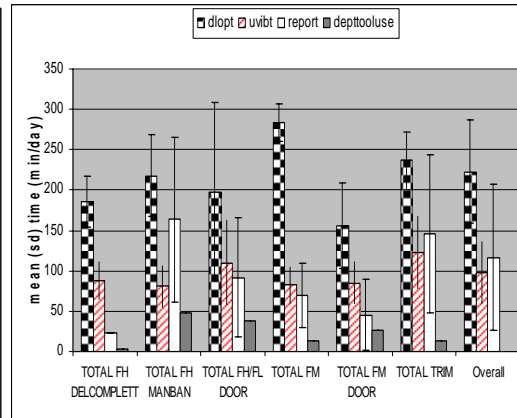

Fig.2 Exposure assessment: different modalities

### Discussion

To date, the results demonstrate the importance of exposure monitoring methods. Mixed longitudinal designs or repeated cross-sections have advantages over traditional prospective cohort construction for studies of this type.

### References

1. Sakakibara H, et al. Digital nerve conduction velocity as a sensitive indication of peripheral neuropathy in vibration syndrome. *Am J Indus Med* 1994;26:359-366.
2. Sakakibara H, et al. Affected segments of the median nerve detected by fractionated nerve conduction measurement in vibration-induced neuropathy. *Indus Health* 1998; 36:155-159.
3. Cherniack M, et al., Segmental Nerve Conduction Velocity in Vibration Exposed Shipyard Workers. *Int Arch Occup Environ Health* 2004; 77(3): 159-176.
4. Koskimies K, et al. Vibration syndrome among Finnish forest workers between 1972 and 1990. *Int Arch Occup Environ Health* 1992; 64:251-56.
5. Letz Ret al. cross-sectional epidemiologic survey of shipyard workers exposed to hand-arm vibration. *Br J Indus Med* 1993; 49:53-62.
6. Gemne G., Ed. Stockholm Workshop 86. Symptomatology and Diagnostic Methods in the Hand-Arm Vibration Syndrome. *Scand J Work Environ Health* 1987; 13S:265-388.
7. Sanden H, et al. Bicycle ergometer test to obtain adequate skin temperature when measuring nerve conduction velocity. *Clin Neurophysiol* 2005;116:25-27.

# CLINICAL ASSESSMENT AND CHARACTERISTICS OF MEN AND WOMEN EXPOSED TO HIGH LEVEL OF HAND-ARM VIBRATION

Thomas Jetzer<sup>1</sup> and Douglas Ketcham<sup>2</sup>

<sup>1</sup>Occupational Medicine Consultants, Minneapolis, Minnesota, U.S.A.

<sup>2</sup>Hospital Radiology Department, St. Paul, Minnesota, U.S.A.

## Introduction

While the neurological and vascular aspects of Hand-Arm Vibration Syndrome (HAVS) has been generally accepted as a medical condition, the medical criteria and the clinical findings used to establish the diagnosis has been more difficult to bring to consensus. The criteria was first quantified by the Taylor-Palmear scale.<sup>1</sup> This criteria was subsequently modified in 1986 at the 1<sup>st</sup> Stockholm Workshop<sup>2,3</sup> to included more acceptance for the neurological effects that characterized the predominate findings in some workers. The relationship between hand-arm vibration and Carpal Tunnel Syndrome was defined in NIOSH 97-141<sup>4</sup>.

While the aforementioned documents have defined the clinical entities associated with hand-arm vibration exposure, agreement on the clinical findings and test to confirm the diagnosis has been more difficult to bring to consensus. Clinicians assessing HAVS has relied on a number of varied neurological and vascular tests. The neurological testing has focused on assessing damage to the sensory capability of the fingers for the neurological component including tests to measuring ability to sense vibration, cold or other end point finger sensor functions. However, the vascular testing has been traditionally focused on the ability to either measure vascular function or to reproduce the vascular blanching that occurs in HAVS with cold water provocation. Recent assessment of this testing in the United Kingdom Coal Miner's study has questioned the value of this testing especially in reviews by McGeoch.<sup>5</sup> In an attempt to provide some type of definitive testing to substantiate vascular damage from hand-arm vibration exposure, angiography is an alternative or adjunct to cold water provocation testing.

The standards that have been established to predict the level, type and incidence of HAVS have been based on clinical studies and reports that have essentially been all male populations. However, the recent entry of women into more vibration intensive jobs has brought about the exposure of some women to high levels of vibration previously only previously experienced by men. However, there have been only few studies that look at HAVS in women<sup>6</sup>. Although exposed the same vibration levels, it has not been clear that the latency and type of pathology of HAVS in women will be the same as for men.

The purpose of this study is to look at recent case studies of men and women exposed to jobs with high levels of hand-arm vibration with extensive clinical testing for both the neurological and vascular components of HAVS as well as other associated upper extremity conditions such as Carpal Tunnel Syndrome.

## Methods

Clinical cases referred for evaluation with neurological testing including, vibrometry, Simmes-Weinstein mono filaments, 2 point discrimination, Purdue peg board testing and nerve conduction testing. Vascular testing included Allen's testing, Doppler studies of both upper extremities, cold water provocation testing and angiograph. Additional laboratory blood work and clinical examination was done to rule out alternative disease conditions that could confound results such as diabetes, collagen-vascular disease, etc.<sup>8</sup>

## Results

Although the study was too small for statistical significance, review of the cases show that when exposed to the same high levels of hand arm vibration, women develop HAVS symptoms sooner than might be expected and early onset of Carpal Tunnel Syndrome.. In contrast men take longer to develop the same symptoms and are more likely to develop other finding such as tendonitis before they develop the constellation of symptoms and findings found in women.

Comparison of the vascular testing techniques indicates that the angiography can be helpful in confirming the vascular damage from hand-arm vibration exposure in both men and women. Furthermore, angiography may help localize areas of damage from specific exposure. The study proved to be too small to compare the effectiveness the various vascular testing techniques but suggest that further study is warranted.

## Discussion

The study shows that there is a suggestion that present standards for the latency of HAVS and other vibration related disorders may be different for women then for men. Also review of clinical cases shows that angiography is useful tool in confirming and defining the level of vascular pathology in case of significant HAVS. Further enlarged studies to confirm both of these findings are recommended.

## References

1. Taylor, W and Pelmear, P., eds. *Vibration White Finger in Industry*. London Academic Press, 1975
2. Gemne, G., Pykkom, L. Taylor, W. Pelmear P. L., *The Stockholm Workshop Scale for the Classification of Cold-Induced Raynaud's Phenomenon in the HAV*, Scand. J. Work. Environ. Health, 1987: 13:275-278
3. Bramer, A. J., Taylor, W., Lundborg. G *Sensoineuroal Stages of the HAVS*, Scand. J. Work. Environ. Health 1987 13: 279-283
4. *Musculoskeletal Disorder of the Workplace*, US Dept of Health and Human Services, CDC, Natl. Institute for Occupational Health, NIOSH Publ No 97-141 Chapter 5 c, July 1997
5. *McGeoch, K.L., et al., A Medical Assessment Process for a Large Number of Miners and Ex-Miners with Compensation Claims for HAVS*, 10<sup>th</sup> HAVS Conference, Las Vegas, June 2004
6. *Bylund, S H., Women Injured by Hand-Arm Vibration-Who Cares?* 10<sup>th</sup> HAVS Conference, Las Vegas, June 2004

# CHARACTERISTICS OF VIBRATION INJURIES IN PERIPHERAL NERVES

Ji-Geng Yan<sup>1</sup>, Hani S. Matloub<sup>1</sup>, Lin-Ling Zhang<sup>1</sup>, James R. Sanger<sup>1</sup>, Danny A. Riley<sup>2</sup>  
<sup>1</sup>Department of Plastic Surgery, <sup>2</sup>Department of Cell Biology, Neurobiology, and Anatomy,  
Medical College of Wisconsin, Milwaukee, Wisconsin, U.S.A.

## Introduction

This experimental study was done to determine pathological feature of vibration injury to the peripheral nerves in the hind limbs of rats exposed to 7 days of vibration.

## Materials and Methods

**Animals:** Twenty four male Sprague-Dawley rats weighing 350-400 grams were randomly divided into two groups: sham control group and vibrated group. To document vibration-induced changes in the experimental model, the sciatic nerve was used because it contains both motor and sensory fibers and is relatively superficial in the posterior thigh.

**Customized Vibrating Platform:** The hind limbs of the rats in the vibrated group were exposed to vibration in a custom-built vibrating apparatus consisting of two platforms: a smaller vibrating platform on which the hind limbs of the rat are secured, and a larger platform on which the remainder of the body rests. The vibration parameters (frequency 43.5 Hz, amplitude 1.5mm, acceleration 4.75G, velocity 6cm/sec., and displacement of 3.0mm) of this model were measured.

**Methods:** Rats were anesthetized with 35mg/kg of intraperitoneal Nembutal (phenobarbital) and their hind limbs fixed to the vibrating platform by Velcro loops. Both hind limbs rest on the vibrating platform while the remainder of the body rests on the larger platform. The rats were vibrated 4 hours a day, for 7 days, with close monitoring of the vibration parameters. The 4-hour duration of hazardous vibration was based on recommendations from the British Standards Institution. The sciatic nerve of rats not exposed to vibration, but similarly anesthetized and secured to the vibrating platform, acted as controls. At the end of seven days of exposure to vibration, nerves from both the vibrated rats and the control rats were harvested after perfusion of the lower half of the body using glutaraldehyde as described below.

**Neural Fixation:** The aorta was cannulated, and the inferior vena cava was nicked and the animal was initially perfused with 0.9% buffered sodium chloride. This was followed by perfusion of a filtered mixture of 3% glutaraldehyde and 3% paraformaldehyde fixation solution. The tissue was subjected to post fixation by routine. The neural tissue was then submitted for light and electron microscopy.

## Results

While light microscopy showed minimal histological differences between vibrated (n=12) and control nerves (n=12), the changes revealed by electron microscopy were dramatic. These included thickening of the epineurium, as well as thickening of the myelin sheath as compared with normal nerve. Also, the axon plasma was detached from the myelin sheaths, and many vacuoles were seen between the myelin laminae(Fig.1); These changes were found in all vibrated animals, and in the whole segment of each vibrated nerve. Myelin balls, consisting of

destroyed myelin rolled into wool-like threads, were located inside the myelin layers (Fig. 2); Axonal damage was seen in both myelinated and nonmyelinated axons (Fig. 3). In addition, nonmyelinated axons were edematous. An interesting finding was the circumferential disruption of several myelin layers, leaving a large circular space around the impacted myelin with central axonal constriction, this characteristic finding, giving the appearance of a finger ring, was found in every vibrated nerve (Fig. 4). Many microtubes and microfilaments were ruptured or had disappeared (Fig. 2-4).



Fig. 1



Fig. 3

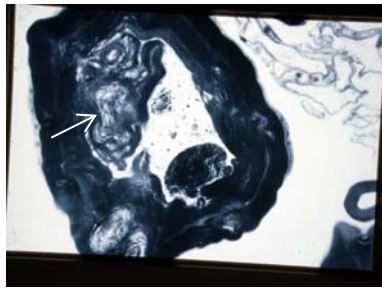

Fig. 2

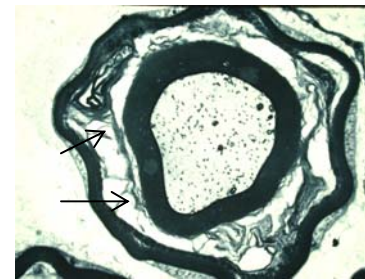

Fig. 4

**Fig. 1.** Arrow indicates a big vacuole in myelin laminae; **Fig 2.** Arrow indicated a huge myelin ball, wool-like thread consisting of destroyed myelin; **Fig. 3** Axonal plasmadamage was seen in both myelinated ( arrow ) and nonmyelinated axons ( arrow head); **Fig. 4.** Arrows showed a large circular space between the myelin layers.

### Discussion

The vibrated nerves show definite pathologic changes in the form of axonal damage and myelin fragmentation<sup>1-4</sup>. We therefore conclude: Myelin disruption, myelin balls, myelin “finger ring” changes, and axonal de-attachment are identifiable characteristics of the neuropathological changes due to vibration injury. Further research to identify the hazardous components of vibration (amplitude, frequency, etc.) is in progress in our laboratory.

### References

1. Bovenzi M, Giannini F, Rossi S. Vibration-induced multifocal neuropathy in forestry workers: electrophysiological findings in relation to vibration exposure and finger circulation. *Int Arch Occup Environ Health.* 2000;73(8):519-527.
2. Tseng HM, Yu HS, Ho ST, Yao TH. Vibration syndrome—pathophysiological and electron microscopic studies. *Kashsiung J Med Sci.* 1986;2:732-744.
3. Brammer AJ, Pyykko I. Vibration-induced neuropathy. Detection by nerve conduction measurements. *Scand J Work Environ Health.* 1987;13(4):317-322.
4. Dahlin LB, Necking LE, Lundstrom R, Lundborg G. Vibration exposure and conditioning lesion effect in nerves: an experimental study in rats. *J Hand Surg (Am).* 1992;17(5):858-861.

# MEASURING PHYSIOLOGICAL AND BIOCHEMICAL CHANGES IN WORK-RELATED VIBRATION

Ji-Geng Yan<sup>1</sup>, Hani S. Matloub<sup>1</sup>, Lin-Ling Zhang<sup>1</sup>, James R. Sanger<sup>1</sup>, Yuhui Yan<sup>1</sup>, Danny A. Riley<sup>2</sup>, Michael Agresti<sup>1</sup>, David Rowe<sup>1</sup>, Paula Galaviz<sup>1</sup>, Judith Marchant-Hanson<sup>1</sup>, Scott Lifchez<sup>1</sup>

<sup>1</sup>Department of Plastic Surgery, <sup>2</sup>Department of Cell Biology, Neurobiology, and Anatomy, Medical College of Wisconsin, Milwaukee, Wisconsin, U.S.A.

## Introduction

Until now there has been controversy about which tests should be performed to diagnose early Hand-Arm Vibration Syndrome (HAVS). Initial screening questions, especially about tingling and numbness, routinely given to patients prior to examinations proved to be a very important tool in the diagnostic process<sup>1, 4</sup>. However, standardized tests that are simple, quick, valid and reliable are needed to support a diagnosis of HAVS. **Purpose:** To find the most valid and reliable tests to diagnose HAVS.

## Material and Methods

Five major tests were performed on Group I and Group II. Group I: Control group of 12 volunteers including students, nurses, secretaries and physicians with no history of using vibrating tools (age 20 to 50y, mean age 38.5y; 5 male, 5 female.) Group II: 12 workers (age 17 to 65y, mean age 39y; 9 male, 3 female) were sent by a local trade union with a history of using vibrating power tools on their jobs for varying amounts of time (mean 12.2y, from 0.5 to 35y.) Pre-enrollment survey showed that each had more than 4 complaints commonly associated with use of vibrating tools (including numbness, tingling, weakness, pain, finger color or nail changes, temperature change, and difficulty moving.)

1. Sensory nerve conductive tests: Amplitude and nerve conductive velocity (NCV) were evaluated. 2. Cold Stress-Temperature recovery time tests were done on the index finger of the dominant hand following these steps: Confirm water bath is within 4-5° C. Place the finger temperature probe on pad of the index finger of the dominant hand. Record temperature every 15 seconds. Place subject's hand in the cold- water bath for exactly five minutes. Record temperature every 15 seconds for ten minutes. 3. Blood test: Venous blood was taken by a 21-gauge needle with the yellow collection tube adapter. S-ICAM, Sera Thrombomodulin, Norepinephrine levels were evaluated by Henderson Research Centre, Canada. 4. Finger Sensory Evaluation: Semmes-Weinstein monofilament test and 2-point discrimination tests were performed on bilateral fingers. 5. Digital blood pressure test: blood pressure was measured in bilateral index fingers.

## Results

1. Median nerve sensory conductive amplitude from palm to wrist :  
GI: mean  $96 \pm 31 \mu\text{m}$ ; GII: mean  $43 \pm 30 \mu\text{m}$ ; for dominant hands.  
GI vs GII:  $P < 0.001$

Motor nerve conductive velocity (NCV) from elbow to wrist:

GI: mean  $60.8 \pm 8.5$  m/s; GII: mean  $48.3 \pm 5.9$  m/s; GI vs GII:  $P < 0.001$

2. Cold-Stress Test: Temperature Recovery Rate (TRR) = T before test / T after 10 minutes. GI: mean:  $85.36\% \pm 14.22$  GII: More three years of using vibrating tools was a critical point, with vibration for 3 years, the TRR was 70% and as time of use increased, the correlation to TRR also increased. Two subjects' TRR was 52% with 15 and 35 years of using vibrating tools.
3. Sera Chemical Test: A. sICAM: Standard Reference Range is 132.5-344.2 ng/mL. GII: The value of 3 workers  $> 344.2$  ng/mL (385.2, 346.4 and 381.4), Positive rate was 25.0%; B. Norepinephrine: Standard Reference Range is 0.8-3.4; 4 workers' value was  $< 0.8$  nmol/L (0.5, 0.7, 0.3, 0.6). Positive rate was 33.3%.
4. Hand Sensory Evaluation:
  - A. Semmes-Weinstein monofilament test: Standard criterion: Normal: 1.65-2.83; Diminished light touch: 3.22-3.61; Diminished protective sensation: 3.84-4.31; Loss of protective sensation: 4.59-6.65. Results: 3 workers (3.5 years) were normal; 9 workers ( $> 5$  years) were diminished. Positive rate was 66.98%.
  - B. Two-point discrimination test: Normal is  $< 6$  mm. GI: 119/120 tested fingers were less than 6 mm; GII: 20/120 were  $< 6$  mm. Positive rate was 16.7 %.
5. Digital blood pressure test: Normal cut-off point:  $< 70$  mmHg was abnormal. Results: GI: none was  $< 70$ ; GII: 8/23 fingers (n=23, index fingers in both hands, 1 n/a); positive rate was 35%.

## Conclusions

1. Semmes-Weinstein monofilament test is a sensitive and simple test to assess HAVS. 2. Cold stress test gave a lower positive rate but did indicate later damage; however, it causes patient discomfort. 3. Sensory nerve conductive and NCV were useful but need a control group value. 4. The S-ICAM increased in 25%, and NE decreased in 33% of vibrated workers. 5. Digital BP test and 2-point discrimination test both have cut-off point value; they could be used to differentiate HAVS from simple carpal tunnel syndrome.

## References

1. Cederlund R, Iwarsson S, Lundborg G. Hand function tests and questions on hand symptoms as related to the Stockholm workshop scales for diagnosis of hand-arm vibration syndrome. *J Hand Surg [Br]*. 2003 Apr;28(2):165-171.
2. Coughlin PA, Chetter IC, Kent PJ, Kester RC. The analysis of sensitivity, specificity, positive predictive value and negative predictive value of cold provocation thermography in the objective diagnosis of the hand-arm vibration syndrome. *Occup Med (Lond)*. 2001 Mar;51(2):75-80.
3. Coughlin PA, Bonser R, Turton EP, Kent PJ, Kester RCA comparison between two methods of aesthesiometric assessment in patients with hand-arm vibration syndrome. *Occup Med (Lond)*. 2001 Jun;51(4):272-277.
4. Elms J, Poole K, Mason H. A screening questionnaire for HAVS? *Occup Med (Lond)*. 2005 Mar;55(2):139-141.



# ACUTE VIBRATION EXPOSURE SHIFTS THE CURRENT PERCEPTION THRESHOLD OF A $\beta$ FIBERS IN A RAT TAIL MODEL OF VIBRATION

Kristine M. Krajnak

National Institute for Occupational Safety and Health, Morgantown, West Virginia, U.S.A.

## Introduction

Occupational exposure to hand-arm vibration through the use of powered hand tools can result in reductions in tactile sensitivity, grip strength and manual dexterity. In fact, even acute exposures to vibration cause shifts in vibrotactile thresholds in exposed fingers (2,4,5). Although reductions in tactile sensitivity after acute vibration exposures are transient, cellular changes associated with this shift in sensitivity could lead to the more permanent reductions in tactile sensitivity that are a common symptom of hand-arm vibration syndrome (HAVS).

## Methods

Animals. Male Sprague Dawley rats (6 weeks of age) were used for all experiments. Animals were housed in AAALAC accredited facilities, and all procedures were approved by the NIOSH Animal Care and Use Committee and were in compliance with the CDC guideline for care and use of laboratory animals. Vibration exposures were performed by restraining rats in a Broome-style restrainer, and securing their tails to the vibration platform using 6 mm wide straps that were placed over the tail every 3 cm. Restraint control animals were treated in an identical manner except that the tail platform was set on isolation blocks instead of a shaker.

Tail temperature and current perception thresholds (CPTs). Rats were exposed to 4 h of tail vibration (125 Hz, 49 m/s<sup>2</sup>), or restraint. Tail temperature was collected prior to and immediately following the exposure using an infra-red camera. Sensory neuron function was assessed by measuring CPTs with a Neurometer (Neurotron, Baltimore, MD). Transcutaneous nerve stimulation was applied to the C10 region of the tail. Three frequencies were used to test specific fiber types (5 Hz – C, 250 Hz - A $\delta$ , and 2000 Hz – A $\beta$ ). The intensity of the stimulus was automatically increased in small increments until the rat flicked its tail. Tests at each frequency were repeated until the animals displayed 2 responses that were within 2 CPT (or 0.02 mA) of each other (2-4 tests/animal). CPT tests were performed prior to the exposure, immediately following the exposure, and 24 h after the exposure.

Data Analyses. Temperatures were analyzed using a one-way ANOVA with animal as a random variable. ANCOVAs were used to analyze the CPTs at each frequency. Temperature at the time of the CPT test was used as a covariate, and animal was used as a random variable

## Results

Tail temperatures declined between pre and post exposure ( $F(1,25) = 62.85$ ,  $p < 0.001$ ; mean  $\pm$  sem pre  $25.96^{\circ}\text{C} \pm 0.42$ , post  $20.71^{\circ}\text{C} \pm 0.77$ ), but were back to baseline levels by 24 h after the exposure in both groups of rats. The ANCOVAs demonstrated that exposure to a single bout of vibration did not alter sensitivity of C (5Hz) or A $\delta$  (250 Hz) fibers to stimulation.

However, at 2000 Hz ( $A\beta$  fibers), restrained animals displayed an increased sensitivity to the stimulus following exposure (i.e., lower CPT value,  $F(1, 28) = 23.71, p < 0.001$ ). In contrast, the CPT was significantly higher in vibrated rats immediately following the exposure, indicating that the  $A\beta$  fibers were less sensitive to stimulation. However, 24 h later, the CPT at 2000 Hz returned to pre-exposure values (Figure 1A-C). At 5 Hz, there were no group differences in pre to post CPT values. However, about one third of the animals did display a post exposure increase in CPT values. The increased CPT in this subset of animals accounts for the large variability in the post exposure measure at 5 Hz. None of the CPT values were affected by temperature. (Figures 1D-F).

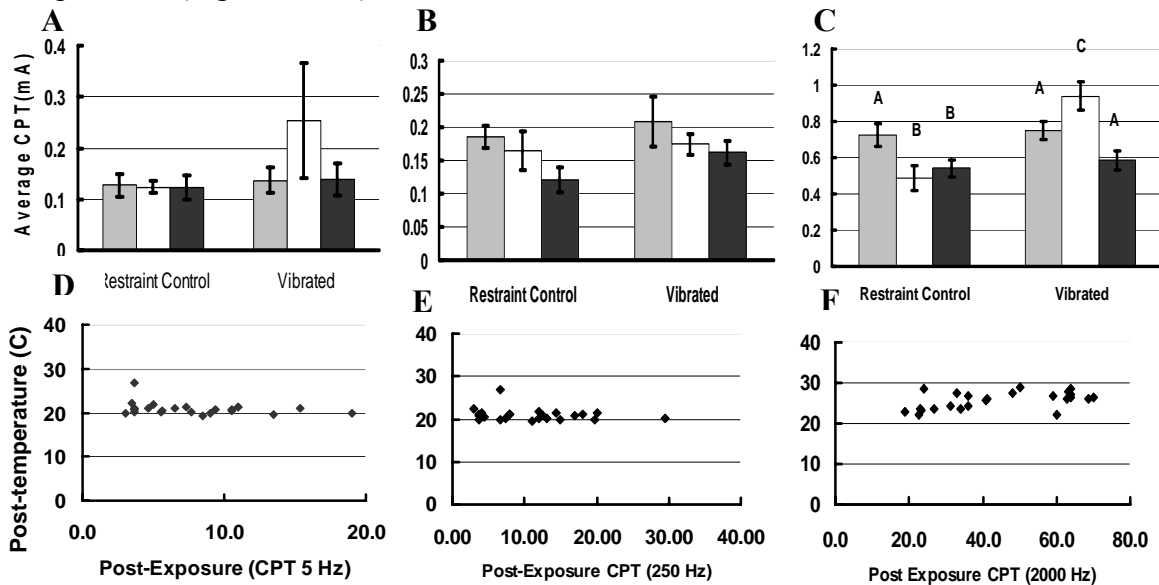

**Figure 1.** CPT measures (mA) at 5 (A), 250 (B) and 2000 Hz (C), and correlations between temperature and CPT values (D-F). Bars represent the means  $\pm$  sem. Gray bars are pre-exposure, white immediately after exposure and black 24 h after exposure. In 1-C, different letters are significantly different from each other ( $p < 0.05$ ).  $R^2$  values for the correlation between temperature and CPT are 0.085 for 5 Hz, 0.042 for 250 Hz and 0.009 for 2000 Hz.

## Discussion

- Exposure to a single bout of vibration results in a transient reduction in the sensitivity of the  $A\beta$  fibers to stimulation. This shift in sensitivity is comparable to the transient shift in vibrotactile thresholds seen in humans after an acute vibration exposure (2,4,5).
- The vibrotactile test is affected by the skin temperature of the subject (1,3). The results of this study demonstrate that the CPT is not affected by skin temperature. In addition, the CPT allows the tester to determine which nerve fiber subtype is affected. Thus, the CPT may serve as reasonable test for diagnosing vibration-induced changes in tactile sensitivity.

## References

1. Ide H, et al., Effect of Skin Temperature on Vibrotactile Sensitivity. In: *Med Biol Engin Com*, 1985, p. 306-310.
2. Kihlberg S, et al., Acute effects of vibration from a chipping hammer and a grinder on the hand-arm system. *Occup Environ Med* 52: 731-737, 1995.
3. Klinenberg E, et al., Temperature effects on vibrotactile sensitivity threshold measurements: implications for carpal tunnel screening tests. *J Hand Surg* 21: 132-137, 1996.
4. Lundstrom R, Johansson, R. Acute Impairment Of The Sensitivity Of Skin Mechanoreceptive Units Caused By Vibration Exposure Of The Hand. *Ergonomics*: 687-698, 1986.
5. Maeda S and Griffin MJ. The growth and recovery of vibrotactile TTs caused by hand-transmitted repetitive shocks of various waveforms. *Central European Journal of Public Health* 3: 57-61, 1995.

# ACUTE EFFECTS OF VIBRATION ON RAT-TAIL NERVES

Sandya Govindaraju, Brian Curry, James Bain, Danny Riley  
Department of Cell Biology, Neurobiology & Anatomy  
Medical College of Wisconsin, Milwaukee, Wisconsin, U.S.A.

## Introduction

Hand arm vibration syndrome (HAVS) affects industrial workers exposed to long term hand-transmitted vibration from powered-tools. Peripheral neuropathy is a major component of the symptom complex of HAVS. Long term exposure to vibration causes myelin damage in peripheral nerves and reduces nerve conduction velocities in rats<sup>1</sup>. This study addresses the effects of acute vibration at constant acceleration of  $49 \text{ m/s}^2$  on myelinated fibers in peripheral nerves in Sprague-Dawley male rats using the 'rat-tail vibration model,' which simulates hand-transmitted vibration<sup>2</sup>.

## Methods

Male Sprague-Dawley rats (~300 g) were assigned to vibration groups: 1 hr continuous vibration at 60 Hz; 4 hr continuous exposure at frequencies of 30, 60, 120 or 800 Hz; immediate and 24 hr following a 4-hr cumulative exposure of continuous and intermittent vibration at 60 Hz. Unanesthetized rats were restrained in cages on a nonvibrating platform with their tails placed on a vibrating stage accelerated by a B&K motor type 4809 and vibrated. Intermittent vibration was delivered in bouts of 10 min vibration alternating with 5 min rest periods repeated over 6 hr. Sham controls were restrained without vibration. After vibration exposure, the rats were anaesthetized, and the ventral nerve trunks from the proximal tail segment 7 were fixed in glutaraldehyde, embedded in epon-araldite and sectioned at  $0.5 \mu\text{m}$  thickness and stained with toluidine-blue for morphological quantitative analysis. The total number of myelinated axons in each cross-section of the nerve was counted using the Image J software. Myelin damage was identified by focal increase in area and intensity of toluidine-blue staining and unraveling of the myelin sheath. Statistical analysis for comparing sham and the different vibration groups was done using Dunnett's test. Animal treatment and all surgical procedures were approved by the institutional review board and compiled with the Laboratory Animal Welfare Act.

## Results

The rats tolerated continuous vibration very well and exhibited no behavioral signs of stress. When exposed to intermittent vibration, there was increased vocalization, a startle reflex at the beginning of each bout of vibration, deposition of porphyrin around the eyes and transient hypersensitivity to touch.

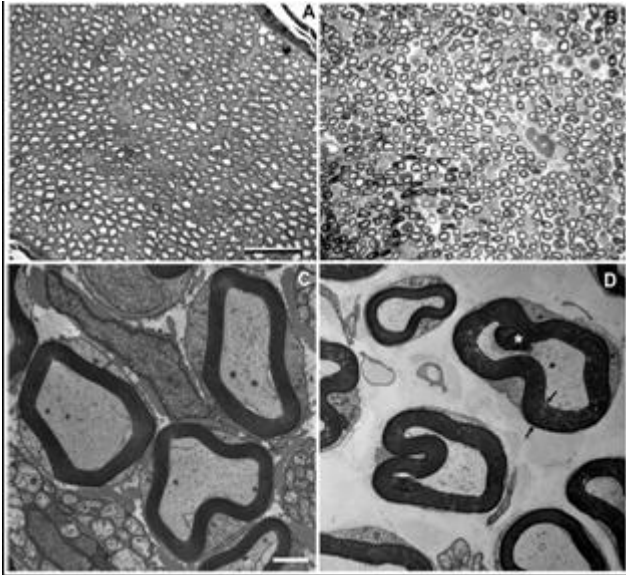

Fig 1: A. The semithin cross section of the tail nerve from a sham control rat demonstrates that the myelin is evenly stained with toluidine blue. B. When vibrated, the myelin stains darker and exhibits focal thickening. C. At the electron microscopic level, the myelin membranes are compact, except for tiny foci of separation in the sham-vibrated control nerves. D. Vibrated nerves exhibit larger and more extensive areas of separation of the myelin membranes (arrows), and frequently the myelin sheaths show decompaction (\*). Bar in A equals 40  $\mu\text{m}$  for A, B. Bar in C equals 0.5  $\mu\text{m}$  for C, D.

Table 1: There was an average of  $1187 \pm 50$  myelinated axons in the ventral tail nerve at the level of segment 7. The numbers of myelinated fibers showing delamination are expressed as % of total fibers  $\pm$  SEM. All vibration groups were significantly different from the sham vibrated,  $*p < 0.05$ . CI- Continuous immediate, CS- Continuous 24 hr survival, II- Intermittent immediate, IS- Intermittent 24 hr survival.

Exposure	Myelin disruption %
Sham, 4hrs, CI	$5.0 \pm 0.6$
60Hz, 1hr, CI	$15.6 \pm 2.2^*$
30Hz, 4hr, CI	$24.5 \pm 3.4^*$
120Hz, 4hr, CI	$28.0 \pm 1.7^*$
800Hz, 4hr, CI	$16.9 \pm 1.6^*$
60Hz, 4hr, CI	$28.6 \pm 1.8^*$
60Hz, 4hr, CS	$36.2 \pm 1.8^*$
60Hz, 4hr, II	$47.7 \pm 1.9^*$
60Hz, 4hr, IS	$45.3 \pm 5.7^*$

## Discussion

1. Vibration exposure duration as short as 1 hr at 60 Hz can cause myelin disruption.
2. Damage is not limited to a single frequency.
3. Frequent rest periods do not reduce, but exacerbate, damage as evidenced by increased myelin disruption and transient hypersensitivity.

## References

1. Chang KY, Ho ST, Yu HS. Vibration induced neurophysiological and electron microscopical changes in rat peripheral nerves. *Occup Environ Med* 1994; 51:130-135.
2. Curry BD, Bain JL, Yan JG, Zhang LL, Yamaguchi M, Matloub HS, et al. Vibration injury damages arterial endothelial cells. *Muscle Nerve* 2002; 25:527-534.

*Supported by the Medical College of Wisconsin and in part by NIOSH grant R01 OH003493*

## Podium Presentations

### Session V: Health Effects III

Chairs: Thomas Jetzer and Danny Riley

<b>Presenter</b>	<b>Title</b>	<b>Page</b>
T. Xia University of Iowa, Iowa City	Seated human response to simple and complex impacts	64
D. Wilder University of Iowa, Iowa City	Response to sudden load by patients with back pain	66
B. Martin University of Michigan	Upper body joint coordination under vibration	68
Y. Satou Kurume University School of Medicine	Effects of short-term exposure to whole-body vibration on wakefulness levels	70
R.V. Maikala, Liberty Mutual Institute for Safety	Regional cerebral oxygenation and blood volume responses in healthy women during seated whole-body vibration (WBV)	72
Alice, Turcot Direction de Santé Publique Chaudière-Appalaches	Health perception in workers exposed to hand-arm vibration: Prerequisite for putting in place an effective preventative program in the workplace	74

# SEATED HUMAN RESPONSE TO SIMPLE AND COMPLEX IMPACTS

D Wilder, T Xia<sup>1</sup>, J Ankrum, K Spratt<sup>2</sup>

Iowa Spine Research Center, Biomedical Engineering Department,

<sup>1</sup>University of Iowa, Iowa City, Iowa, U.S.A.

<sup>2</sup>Orthopaedics, Dartmouth College, Hanover, New Hampshire, U.S.A.

## Introduction

The human lumbar spine is inherently an unstable structure and requires sophisticated neuromuscular control to maintain its stability and for performing physical tasks. As a consequence, it is important to understand the potential health effects on human operators of mechanical stimuli such as shock and vibration.<sup>1</sup> Impact applied to a vehicle operator combines the risk of sudden, unexpected load with the mechanical stress of the seated posture.<sup>2</sup> Because many work environments contain the potential for multiple, unexpected impacts, it is important to understand how the trunk muscles respond to complex conditions. We believe the results have implications for isolation design and standards development.

## Methods

Muscle activity was recorded during simple and complex impacts, applied randomly and without warning, while subjects sat on an air-suspension truck seat located on a man-rated 6-DOF motion platform (Rexroth-Hydraudyne). Simple (single) impacts consisted of 100 ms quarter-sine jolts in the side-to-side (L and R) and vertical upward (V) directions with peak amplitude at 0.4 g. Complex impacts consisted of combinations of two simple (single) impacts in sequence (LV, RV, VL, VR), separated by 100 ms. Twelve right-handed males ( $23.7 \pm 7.8$  years old) were tested without a blindfold under 2 posture conditions (supported while leaning back and unsupported, sitting upright) and 2 seat suspension conditions (present or absent). Each type of impact was repeated three times under each posture and suspension condition, resulting in 84 impacts in total. Surface EMG signals from the left and right erector spinae (ES), rectus abdominis (AR), external obliques (EO) and internal obliques (IO) were recorded and transformed to 25ms RMS values. The response time, defined as the time the muscle activity exceeded the mean + 2 STD of the pre-impact resting period, peak response amplitude, and time were then derived. A mixed-model repeated measures analysis of variance was used to evaluate statistical significance, where type I error rate was set at .05.

## Results

One question we asked of these data was whether there were differences in responses related to simple single strike impacts (L, R, or V) and complex, double-strike impacts (LV, RV, VL, VR). There are 21 possible combinations of comparisons of simple and complex impacts to each other. The differences found are listed in Table 1.

Table 1. Number of significant contrasts in muscle response to different impact types (the format below is: Peak response amplitude (response start time, time at peak response))

Comparison	Muscle Groups				Total
	ES	AR	EO	IO	
Simple vs. Simple	1 (0, 0)	0 (0, 0)	1 (0, 1)	3 (2, 2)	5 (2, 3)
Simple vs. Complex	3 (3, 4)	2 (0, 0)	1 (3, 1)	5 (5, 6)	11 (11, 11)
Complex vs. Complex	0 (3, 2)	0 (0, 0)	0 (2, 0)	2 (4, 5)	2 (9, 7)
Total	4 (6, 6)	2 (0, 0)	2 (5, 2)	10 (11, 13)	18 (22, 21)

The contrast between impact types shows differences in the muscles. Overall differences occurred more often in the Simple vs. Complex comparisons. The analysis also showed that posture had a significant effect but the suspension had little effect.

### Discussion

These results corroborated prior work showing that the back muscles play an important role in balancing the trunk in seated impact environments and confirmed that abdominals and external obliques are less able to discriminate between impact types and are likely unable to respond effectively. This study shows, for the first time, that the behavior of the internal obliques is more sensitive than that of the erectors to impact types. Just as a bent beam has one side under tension and the other side under compression, the act of sitting for a human lengthens the posterior aspect of the body and shortens the anterior aspect. During sitting, the lengthened (posterior) muscles are more sensitive and the passively shortened and hence, loose anterior muscles are less sensitive. In the standing posture, all trunk muscles play a role in postural control, however in the sitting posture, a demand on the internal obliques was observed. Long-term exposure to this unbalanced condition may retrain the muscles and control system in an undesirable fashion. Concern about responses to a complex strike is because the first impact may displace the body and the second may further destabilize it, especially with the first strike being an asymmetric impact. These results suggest that a single strike from the side may not be a simple mechanical stimulus, as has traditionally been hypothesized, because it is asymmetric and fundamentally different from a vertical strike. There was one limitation of the study. The low level of the impacts might have contributed to a lack of suspension effect.

**Acknowledgements** This project entitled “Reducing Injury Risk from Jolting/Jarring on Mobile Equipment” was partially supported by CDC order # S0265112 from the NIOSH-Spokane Research Lab, Centers for Disease Control and Prevention. This investigation was conducted in a facility constructed with support from The University of Iowa vice president for Research and the University of Iowa, College of Engineering. Assistance was provided by Logan Mullinix (CVGrp, Columbus, OH) in determining subject impact exposure and in supplying a KAB seat.

### References

1. Wilder DG, Pope MH (1996) Epidemiological and aetiological aspects of low back pain in vibration environments - an update. *Clinical Biomechanics*, 11(2):61-73
2. Wilder DG, Aleksiev AR, Magnusson ML, Pope MH, Spratt KF, Goel VK (1996) Muscular response to sudden load: A Tool to Evaluate Fatigue and Rehabilitation. *Spine* 21:2628-2639

# RESPONSE TO SUDDEN LOAD BY PATIENTS WITH BACK PAIN

D Wilder<sup>1</sup>, T Xia, R Gudavalli<sup>2</sup>, E Owens<sup>2</sup>,

<sup>1</sup>The University of Iowa, Iowa City, Iowa

<sup>2</sup>Palmer Center for Chiropractic Research, Davenport, Iowa

## Introduction

As mechanical shock and vibration environments evolve, it is important to understand their potential effect on human operators. Human beings are sophisticated mechanisms comprised not only of passive components with mass, damping, and stiffness characteristics, but also of components that can actively affect apparent mass, stiffness, and damping. Because the lumbar spine can exhibit local, short-column buckling, stability of the human trunk depends on the responsiveness of the neuromuscular control system.<sup>1-2</sup> We have been evaluating the ability of patients with back pain to respond to a series of sudden loads. We believe the results have implications for isolation design and standards development.

## Methods

153 patients, aged 21 to 55, presenting with back pain agreed to enroll in a research study that randomly assigned them to one of three treatment arms: high velocity low amplitude spinal manipulation, low velocity variable amplitude spinal manipulation, or wait for 2 weeks and then be randomized to one of the above groups. Response to sudden load testing was one of a battery of baseline evaluations performed upon entry into the study and prior to treatment. EMG electrodes were attached to the skin over the paraspinal muscles of the standing participant bilaterally 3 cm from midline at the L3 level. While standing upright on a force plate (Bertec), participants were fitted with a strap around their back and hooked to a load cell in front of their chest. An accelerometer was rigidly attached to the load cell. Impact was applied to the chest using a cord attached to a falling weight. The weight's fall distance was varied between 9 and 13 inches to account for the size of the subject. The subject was blindfolded and wore headphones playing white noise to prevent cueing of when the weight was dropped to apply the load. Hence, although the participant knew a load was about to be applied, he or she did not know the instant it would occur. Just before the weight was dropped, a 4 second data collection process was started for the two EMG electrodes, load cell, accelerometer, and force plate. The load drop was repeated 6 times, at irregular intervals, over a period of 2 minutes. The raw data thus collected was reduced to obtain several values: 1) length of time from the pull on the harness to the beginning of the response of the left and right paraspinal muscles (LES, RES), 2) time and magnitude of the maximum response, 3) force and acceleration experienced at the chest, and 4) the time and magnitude of the center of pressure location (COP). A general linear model was used to evaluate the results.

## Results

For the EMG data, of the 1,824 observations made, 90% of them indicated a response. Prior to the sudden load, resting muscle activity was different between left and right sides ( $p=0.0001$ ) and between males and females ( $p=0.0001$ ). Female subjects began to respond to the sudden load within 92 to 110 ms and males from 101 to 109 ms. Females exhibited more variation in starting



their responses than did males. Females began to respond to the second sudden load significantly sooner (92 ms) than the males (109 ms) with  $p=0.0027$ , otherwise they were similar to the males. There was no significant effect of sudden load trial (1<sup>st</sup>, 2<sup>nd</sup>, 3<sup>rd</sup>, etc) on the amount of time taken to create the peak EMG response to the sudden load (179-193 ms LES, 186-198 ms RES), but the muscle side responding more quickly had a trend of an effect ( $p=0.0568$ ). Peak muscle response was not affected by gender, but was affected by trial. The first peak response differed significantly from the rest (2<sup>nd</sup>  $p=0.0108$ , 3<sup>rd</sup>-6<sup>th</sup>  $p<0.0001$ ). Thereafter, only the peak response at trial 2 was different from that at trial 6 ( $p=0.0498$ ). Females exhibited greater variation in their peak responses than did males. The females experienced significantly lower forces at the chest during the sudden pull than did the males (121.1 v 131.4 N,  $p<0.0001$ ). The females experienced significantly larger accelerations at the chest during the sudden pull than did the males (1.76 v 1.39  $\text{ms}^{-2}$ ,  $p<0.0001$ ). In response to the sudden load, subjects counteracted the overturning moment by shifting forward the center of pressure (COP) under their feet. The shift was larger in the first trial (84mm) and decreased over the trials (79, 77.2, 75.4, 74.7, and 73.7 mm). The time to shift the COP forward was smallest in the first trial (388.0 ms), increased up to the 5<sup>th</sup> trial (433.4, 444.1, 480.6, and 488.4 ms), and then decreased slightly by the 6<sup>th</sup> trial (486.5 ms).

## Discussion

In a study trying to predict who would respond well to different chiropractic treatment methods, baseline data were obtained on patients that provide insight into the response of people with back pain to sudden loads applied at the chest. The primary observation is that people take finite amounts of time to respond to a sudden load. People are able to adapt to some aspects of exposure to a train of sudden loads: adjusting back muscle activity magnitude, and the speed and magnitude of changing the center of pressure in order to stabilize their stance. There is however, no significant adaptation of the time the back muscles take to respond to the load. Although efforts were made to adjust the suddenly applied load according to subject size, the females presented a more compliant and faster moving trunk to the loading device. In summary, although people with back pain can make some adaptations to a train of similar impacts, their first response is always unique. It always takes a certain amount of time to respond to various aspects of sudden load. The reciprocals of the above response times provide insight into some of the observed psychophysical and mechanical sensitivities to vibration and repetitive mechanical shock.

**Acknowledgements** Under the leadership of Dr. William Meeker, this project entitled: Predicting Patients' Response to Spinal Manipulation, was supported by Grant Number U19 AT002006 from the National Center for Complementary and Alternative Medicine (NCCAM). This investigation was conducted in a facility constructed with support from Research Facilities Improvement Program Grant Number C06 RR15433-01 from the National Center for Research Resources, National Institute of Health. Several others were also vital to this project: Mr. Lance Corber of the Office of Data Management for organizing the biomechanical data, Dr. Maria Hondras, Project Manager, Caelyn Nagle, Josh Myers, several other assistants in data collection and management, recruitment assistants, and clinicians.

## References

1. Wilder DG, Pope MH, Frymoyer JW (1988) The biomechanics of lumbar disc herniation and the effect of overload and instability. American Back Society Research Award. *J Spinal Disorders* 1(1):16-32
2. Wilder DG, Aleksiev AR, Magnusson M, Pope MH, Spratt K, Goel V (1996) Muscular response to sudden load: A tool to evaluate fatigue and rehabilitation. *Spine* 21(22):2628-2639

# UPPER BODY JOINT COORDINATION UNDER VIBRATION

Jueun Lee, Jong-Hwa Yoon, K. Rider, Bernard J. Martin

## Introduction

Whole body vibration is known to affect movement accuracy [1], however little is known about changes in the organization of movement and movement strategies used to limit the influences of perturbations. The specific aim of this work is to analyze the motion and coordination of upper body segments of seated operators performing reaching tasks under whole-body sinusoidal vibration exposure and simulated vehicle ride motion. The long-term objective is to model reach coordination and predict the dynamic behavior of the upper body motion under vehicle vibration exposure.

## Method

The reach task consisted of pointing with the right hand index finger to targets located on touch screens placed in front of the subject, 45° overhead and 90° to the right in the mockup cabin of an HMMWV placed on a 6 DOF ride motion simulator. The task was performed under stable (no vibration) and vibration (sinusoidal vibration or simulated ride motion) conditions. A motion capture system was used to record kinematic data of reflective markers to recreate body link trajectories. Joint angles (torso, shoulder and elbow; Figure 1) were then computed using quaternions. Coordination between body links was defined as a) the joints angle-versus-angle relationships between the upper arm and lower arm, and b) the joint motion onset relationships between torso, upper arm and lower arm in the time domain.

## Results

**Angle-versus-angle relationships.** The relationship between upper arm vs. lower arm angle and torso vs. upper arm angle for a far forward reaching movement in the stable (solid lines) and vibration conditions (dotted lines) are illustrated in Figure 2. Fig 2A compares the control condition with a 4 Hz lateral vibration while Fig 2B compares the control condition with a 6 Hz vertical vibration. It appears that under vibration exposure the reduced upper arm extension is compensated by an increase in torso flexion. This effect is seen in the last phase of the movements (encircled areas). In addition, the lower arm extension is delayed under 6 Hz vertical vibration (Fig 2B left panel).

**Time of joint motion onset.** The timing relationship between torso, upper arm and lower arm is largely a function of the target to be reached. Examples of delays between body links are illustrated in Figure 3. The control condition is compared to a 6 Hz vertical vibration for three

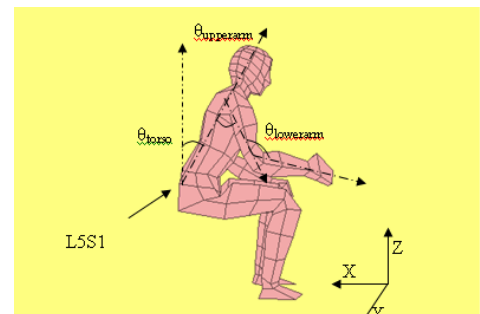

Figure 1. Angle definitions

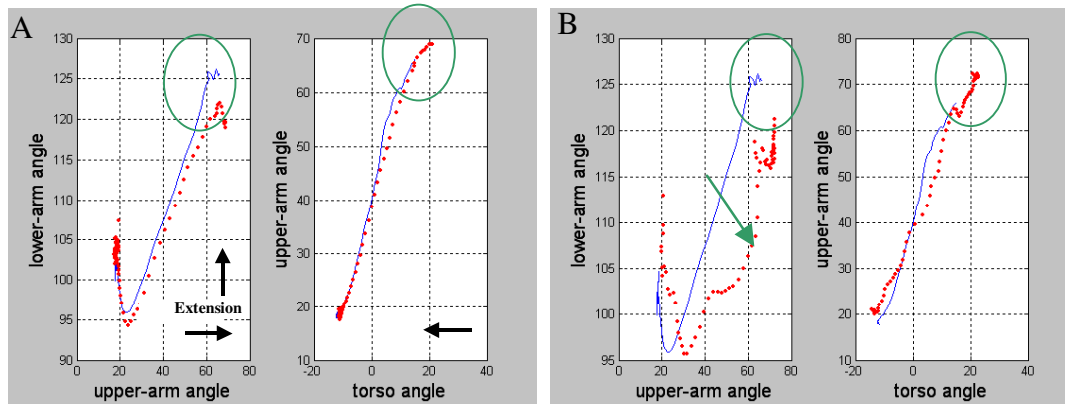

Figure 2. Angle-versus-angle relationships for a far forward reach in two vibration conditions. A: lateral direction, 4 Hz, 0.2g vibration. B: vertical direction, 6 Hz, 0.2g. [control: solid line; vibration: dotted line]

subjects reaching to a lateral target. For this target, the upper arm moves first in the control condition while the torso moves first under vibration exposure.

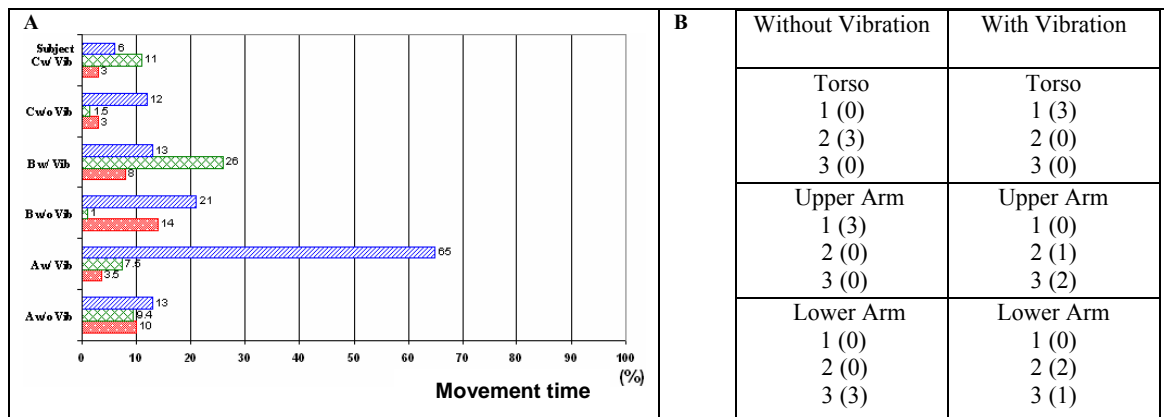

Figure 3. Timing of movement onsets for a lateral near reach. A) movement onset times (torso: dotted bar; upper arm: bar with the x; lower arm: diagonal bar); B) order of movement onset.

## Discussion

Overall the results indicate that the movement strategies (magnitude and timing of joint movements) change under vibration exposure; however, these strategies are dependent on movement direction. It is assumed that the forward flexion of the torso may be used to reduce the influence of vibration on the perturbation of the arm movement.

## Reference

Gauthier, G.M., Roll, J.P., Martin, B., Harlay, F. (1981) Effects of whole-body vibration on sensory motor system performance in man. *Aviat Space Environ Med* 52(8): 473-479.

# EFFECTS OF SHORT-TERM EXPOSURE TO WHOLE-BODY VIBRATION ON WAKEFULNESS

Yuka Satou, Hideo Ando, Tatsuya Ishitake  
Department of Environmental Medicine, Kurume University School of Medicine,  
Kurume, Japan

## Introduction

Whole-body vibration occurs when the body is supported on a surface which is vibrating. Occupational exposures to whole-body vibration mainly occurs in the transportation industry, but also in association with other industrial process. Epidemiological studies have frequently indicated an elevated health risk for the spine in workers exposed to whole-body vibration. With regarding to train or bus operators, a fall of drivers' wakefulness level because of fatigue is often pointed out. This decrease in wakefulness results in an increase of the occurrence of accidents. However, a study of how whole-body vibration affects people's level of wakefulness has not been done. To test the hypothesis that exposure to whole-body vibration has a certain effects on level of wakefulness, the change of a subjective wakefulness level and changes of electroencephalogram (EEG) were observed under experimental exposure to short-term whole-body vibration.

## Methods

Subjects are ten healthy male university students, with an average age of  $20.7 \pm 1.8$  years old, and they are all nonsmokers. Using the equipment (CV-300, AKASHI) of whole-body vibration generator, we consider an exposure environment of actual driver work, so that set the frequency and the acceleration level as 10 Hz and  $0.6\text{ms}^{-2}$  r.m.s.. The subjects were exposed to whole-body vibration in the seated position and exposure time was fixed for 12 minutes. Subjective wakefulness level was evaluated using the questionnaire of VASS (Visual Analog Sleepiness Scale) and KSS (The Kwansai Gakuin Sleepiness Scale). For the electroencephalogram (EEG) measurement, it was equipped with the electrodes based on the International ten-twenty electrode system (C3-A2, O1-A2, O2-A1). EEG activity in the alpha frequency band (8 – 12 Hz) is one of the most typical physiological indicator which represent the transition from wakefulness to sleepiness. AAT (Alpha Attenuation Test) which repeats three times each opened and closed eye for 1 minute was performed in a seating position with directions of the researcher in the beginning, in the middle and in the end of exposure to whole-body vibration. For analysis, power spectral analysis was conducted over the last 6 min of EEG, and wakefulness levels were defined as the ratio of mean alpha power during eyes closed versus eyes opened. The laboratory was kept at room temperature ( $21 \pm 1.0$  degrees C), humidity was  $50 \pm 5\%$ , noise level was 63.6 dB (A) eq, and illumination 510 lx. Each experiment was started around 10:00 am to minimize the effect of biorhythm.

## Results

VASS and KSS increased and subjective level of wakefulness decreased from pre- to post exposure in all subjects, regardless of exposure. Using the AAT as an objective wakefulness measure also showed that wakefulness levels were reduced at the post-exposure test in all subjects. However, wakefulness level was almost constant in the case without exposure to whole-body vibration and in the case with exposure to whole-body vibration fell down largely, and it was rising after that. Moreover, the case with exposure to whole-body vibration was a significant difference from the case without exposure to whole-body vibration.

## Discussion

It is difficult to simulate the exact environment that drivers are exposed to in transportation vehicles in the laboratory. However, in this study, exposure to whole-body vibration was simulated so that the effects on wakefulness could be measured. We demonstrate that wakefulness levels changes with exposure to whole-body vibration. Based on these results we suggest that attention should be focused on reducing whole-body vibration exposure. This may decrease the risk of accidents caused by a driver's vibration-induced reduction in wakefulness levels.

## References

- Nishiyama K (2005) Review of Studies on the Effects of Human Exposure to Whole-Body Vibration and the Problem of Updating the Relevant Exposure Limits. *J Sci Labour* 81, 72-84 (in Japanese).
- Palmer K, Griffin M, Pannett B. (2000) Prevalence and Pattern of occupational exposure to whole body vibration in Great Britain-findings from a national survey. *Occup Environ Med* 57, 229-236.
- Palmer K, Griffin M, Syddal H. (2003) The relative importance of whole body vibration and occupational lifting as risk factors for low-back pain. *Occup Environ Med* 60, 715-721.
- Johanning E. (1991) Back disorders and health problems among subway train operators exposed to whole-body vibration. *Scand J of Work Environ and Health* 17, 414-419.
- Mizukami N, Satou K, Kuramata T, Sawa M (2003) Experimental Study on the Relationship Between Cardiovascular Fitness and Arousal Level in monotonous Work Under Prolonged Restrained Condition. *Jpn Transportation Med* 57,1-7 (in Japanese).
- Ishihara K, Saito T, Miyata Y(1982) Sleepiness scale and an experimental approach. *Jpn J of Psychol* 52,362-365 (in Japanese).
- Michimori A, Stone P, Claudio S (1994) Relationship between the Alpha Attenuation Test, Subjective Sleepiness and Performance Test. *Proceeding of 10th Symposium on Human Interface* 233-236 (in Japanese).

# REGIONAL CEREBRAL OXYGENATION AND BLOOD VOLUME RESPONSES IN HEALTHY WOMEN DURING SEATED WHOLE-BODY VIBRATION (WBV)

Rammohan V. Maikala<sup>1</sup>, Yagesh N. Bhambhani<sup>2</sup>

<sup>1</sup>Liberty Mutual Research Institute for Safety, Hopkinton, Massachusetts, U.S.A.

<sup>2</sup>Faculty of Rehabilitation Medicine, University of Alberta, Edmonton, Canada

## Introduction

Landstrom et al. (1985) suggested the possibility of cortical activation during exposure to WBV, however, it is not known how cerebral physiology (oxygenation and blood volume) responds in healthy women during different vibration frequencies. This study examined the role of backrest support and handgrip work on cerebral oxygenation and blood volume responses, during exposure to seated WBV.

## Methods

Fourteen women (age:  $23.9 \pm 3.5$  years) were randomly exposed to three frequencies of WBV (3, 4.5 and 6 Hz at approximately  $0.9g_{r.m.s}$  in the vertical direction) on a customized vibrating base (Advanced Therapy Products, Inc., USA) in a seated posture on three separate days. On the first day, the subjects completed an aerobic fitness test until volitional exhaustion on an arm cranking ergometer (Cybex, MET 300, USA).

Each WBV session lasted 30 min (6 min baseline without WBV, 8 min WBV ‘with’ or ‘without’ backrest support, and 4 min recovery from WBV, 8 min WBV with ‘opposite’ backrest condition, and 4 min recovery following WBV). During 8 min WBV exposure ‘with’ and ‘without’ backrest support, subjects performed maximal voluntary rhythmic handgrip contractions with their right hand for 1 min using a dynamometer. To obtain regional oxygenation and blood volume responses, a NIRS sensor (MicroRunman, NIM, Inc., PA, USA) was placed on the anterior right frontal lobe just below the hair and close to fronto-temporalis region (Maikala et al. 2005).

## Results

Baseline oxygenation and blood volume values were recorded during recovery from each WBV session of ‘with’ and ‘without’ backrest support. The physiological change in oxygenation and blood volume during each frequency (3, 4.5, and 6 Hz) for both *backrest* (‘with’ and ‘without’ a backrest) and *workload* (WBV only and WBV combined with rhythmic handgrip contractions) was calculated as the difference between the maximum values identified for each WBV condition of *backrest* and *workload* and baseline values (Maikala et al. 2005).

Three-way analysis of covariance with repeated measures (*frequency*, *backrest*, and *workload*) with a fully crossed design was used to evaluate the differences in the oxygenation and blood volume responses (measured in optical density [od] units). Peak oxygen uptake during

arm cranking was treated as the covariate. No three- or two-way interactions were significant ( $P > 0.05$ ). Only the main effects: *frequency* and *workload* reached statistical significance ( $P < 0.05$ ). Significant differences were observed in the oxygenation change between 3 and 6 Hz ( $0.0003 \pm 0.04$  od *versus*  $0.065 \pm 0.09$  od,  $P = 0.022$ ), but not between 3 and 4.5 Hz ( $0.030 \pm 0.06$  od,  $P = 0.102$ ) and 4.5 and 6 Hz ( $P = 0.206$ ). Corresponding comparisons for the blood volume changes were significant: between 3 and 4.5 Hz ( $0.017$  od  $\pm 0.12$  *versus*  $0.07 \pm 0.06$  od,  $P = 0.008$ ) and 3 and 6 Hz ( $0.100 \pm 0.09$  od,  $P = 0.004$ ), but not between 4.5 and 6 Hz ( $P = 0.247$ ). Physiological changes were similar ‘with’ and ‘without’ backrest support (oxygenation:  $0.031 \pm 0.07$  od *versus*  $0.030 \pm 0.07$  od,  $P = 0.79$ ; blood volume:  $0.063 \pm 0.07$  od *versus*  $0.062 \pm 0.12$  od,  $P = 0.80$ ). Compared to WBV only condition, changes were higher during rhythmic handgrip contractions (oxygenation:  $0.020 \pm 0.07$  od *versus*  $0.042 \pm 0.07$  od,  $P = 0.000$ ; blood volume: ( $0.048 \pm 0.06$  od *versus*  $0.078 \pm 0.12$  od,  $P = 0.015$ )). Subjects’ aerobic fitness influenced the oxygenation and blood volume responses during WBV ( $P < 0.05$ ).

## Discussion

Compared to sitting without WBV, cerebral region showed increase in both oxygenation and blood volume responses at each frequency of WBV, implying an increase in neuronal activity due to WBV. Highest oxygenation and blood volume responses were observed during exposure to 6 Hz, suggesting women respond differently compared to men between the frequencies of 3 and 6 Hz (Maikala et al. 2005). An increase in response during handgrip contractions suggest that exposure to WBV in combination with physical activity might lead to much greater increase in cerebral activity due to functional motor stimulation. During vibration, Weinstein et al. (1988) suggested an increase in axonal transport due to direct stimulation of the brain, similar to the mechanism occurring during peripheral nerve injury, and the current evidence from exposure to WBV in different experimental conditions suggest that, increased neuronal activity subsequently results in increased perfusion to the pre-frontal cortex.

## References

- Landstrom, U., and Lundstrom, R. (1985). Changes in wakefulness during exposure to whole-body vibration. *Electroencephalogr Clin Neurophysiol* 61, 411-415.
- Maikala, R.V., King, S., and Bhambhani, Y.N. (2005). Regional Cerebral oxygenation and blood volume responses to seated whole-body vibration. *Eur J Appl Physiol*. 95, 447-453.
- Weinstein J., Pope M., Schmidt R., and Seroussi, R. (1988). Neuropharmacologic effects of vibration on the dorsal root ganglion – An Animal Model. *Spine* 13, 521-525.

# **HEALTH PERCEPTION IN WORKERS EXPOSED TO HAND-ARM VIBRATION: PREREQUISITE FOR PUTTING IN PLACE AN EFFECTIVE PREVENTIVE PROGRAM IN THE WORKPLACE**

Alice Turcot

Institut national de santé publique du Québec, Direction de Santé Publique Chaudière-Appalaches, Barbara Tessier, Direction de Santé Publique Chaudière-Appalaches, Maria Alzate, Suzanne Bédard, Christian Bélanger, CSSS Montmagny-L'Islet

## **Introduction**

Knowledge of risks from exposure to hand-arm vibrations is usually presented by clinicians and researchers from a medical and engineering point of view. There is a strong need to develop innovative health promotion programs for exposed workers. Risk perceptions by vibration exposed workers and HAVS (hand-arm vibration syndrome) affected workers are less well known. In 1983, Brubaker demonstrated that 75% of studied fellers thought that whitening of the fingers was part of the job and/or an unrelated nuisance, while only 25% believed it was a disease. <sup>1</sup>Grounds also showed that even though there were a very high number of forestry workers with white fingers, none considered quitting because of their condition. <sup>2</sup> It seems that many workers hesitate to declare the illness or believe they are less affected than they really are, perhaps from fear of losing their jobs and livelihood. <sup>3</sup> Risk awareness, on the part of exposed workers and their employers, as well as knowledge and acceptance of available preventive solutions are necessary steps before installing adequate preventive measures, whether organizational, behavioral or environmental. Workers need to understand fully the hazards and risks in order to be able to make informed decisions under uncertain conditions. <sup>4</sup> Prerequisites include the following: workers knowledge about the risk, their attitude towards it, which in turn, can be influenced by values, needs and interests. Also, knowledge and attitudes towards safety behaviour, organizational or environmental barriers must be taken into account. Our research focuses on these key elements, which help bridge the gap between health promotion research and practice.

## **Methods**

A descriptive exploratory study is in progress with workers exposed to hand-arm vibrations. It uses qualitative methods that include focus group discussions with workers exposed to hand-arm vibrations, as well as individual interviews with other key informants (employers, health care professionals). An open-ended questionnaire was developed to collect qualitative data on perceived risks and solutions to prevent or reduce HAVS. Based on an integrated theoretical framework related to known determinants of behavior change, the analysis will focus on the following<sup>5</sup>:

- 1) knowledge of health effects, safety, well-being and/or quality of life
- 2) related beliefs about individual susceptibility and severity of consequences
- 3) attitude and values related to hand-arm vibration exposure
- 4) knowledge and attitudes towards exposure reduction, as well as perceptions of barriers and facilitating factors for these measures, in the workplace environment or otherwise.



## Results

Preliminary research results indicate that several obstacles exist that need to be addressed, when putting in place preventive measures in the workplace. These include obstacles from the point of view of workers, employers, and health care professionals. We will present the underlying concepts and the theoretical framework necessary for setting up HAVS preventive programs in the workplace as well as the preliminary results of the research.

## Discussion

We highlight the importance of taking into account determinants of behavioral change within a theoretical framework, while respecting the workers' and employers' perspective, when setting up HAVS preventive programs. "Health professionals must consult the people who are the intended target of health programs to determine their needs, problems, and aspirations concerning quality of life. If professionals do not take this vital step, health policies will remain sterile technocratic solutions to problems that may not exist or that hold a low priority in the minds of the people."<sup>6</sup>

## References

---

<sup>1</sup> Brubaker R et al., (1983), Vibration white finger disease among tree fellers in British Columbia, *Journal of Occup. Med.*, 25, no.2, 403-408.

<sup>2</sup> Grounds MD, (1964), Raynaud's phenomenon in users of chain saw, *Med J Aust*, 22, 279-272 cité in Pykkö et al, (1982), Longitudinal study of Vibration Syndrome in Finnish forestry workers, *Vibration effects on the hand and arm in industry*, Wiley Interscience, 157-167.

<sup>3</sup> Gemne G et al., 1983, The Stockhom Workshop scale for the classification of cold-induced Raynaud's phenomenon in the hand-arm vibration syndrome ( revision of the Taylor-Pelmeare scale), *Scand J Work Environ Health*, 13, 275-278.

<sup>4</sup> Nicholson PJ, ( 2000), Communicating occupational and environmental issues, *Occup.Med.* 50, 226-230.

<sup>5</sup> Committee on Communication for Behaviour Change in the 21st Century: Improving the Health of Diverse Populations, ( 2002) Board on Neuroscience and Behavioral Health, The National Academic Press, Washington, DC.

<sup>6</sup> Green Lawrence, Kreuter Marshall, (1991), *Health promotion planning, An educational and Environmental Approach.*

## Podium Presentations

### Session VI: Epidemiology, Standards Applications, and Prevention I

Chairs: Bernard Martin and Paul-Emile Boileau

<b>Presenter</b>	<b>Title</b>	<b>Page</b>
J.J. Gordon GMH Engineering	Shock and impact on North American locomotives evaluated with ISO 2631 Parts 1 and 5	77
D.D. Reynolds University of Nevada – Las Vegas	Revision of ANIS S3.34 (2.70-2006) – Guide for the measurement and evaluation of human exposure to vibration transmitted to the hand	79
R. Stayner RMS Vibration Test Laboratory	Standard tests for suspended seats – Can these contribute to protection against whole-body vibration? – Commentary on historical development and current work in CEN/TC231/WG9 (seating)	81
E. Gillin Construction Safety Association of Ontario	Evaluation of scraper operator exposure to whole-body vibration in the construction industry: A task analysis	83
J.-C. Chen University of North Carolina Chapel Hill	Characteristics of whole-body vibration frequencies and low back pain in urban drivers	85
H.-K. Jang Institute for Advanced Engineering	Investigation into the uncertainty in measurements and evaluation of hand-transmitted vibration	87

# SHOCK AND IMPACT ON NORTH AMERICAN LOCOMOTIVES EVALUATED WITH ISO 2631 PARTS 1 AND 5

Neil K. Cooperrider, Consulting Engineer  
John J. Gordon, GMH Engineering

## Introduction

The International Organization for Standardization (ISO) standard ISO 2631 [1,2] provides three methods for evaluation of human exposure to vibrations that contain occasional shocks or impacts. Part 1 of the standard specifies the running r.m.s. or maximum transient vibration method (MTVV) and the fourth power vibration dose value (VDV). Part 5 of the standard provides a method of computing the stress in the lumbar spine for humans exposed to multiple shocks. Alem et al [3] have reported application of these methods to data for tactical ground vehicles. This paper reports and compares VDV and spinal stress evaluations of more than 90 hours of vibration and shock measurements on North American locomotives engaged in through freight operations.

The measurements evaluated in this paper were obtained for full crew shifts on 19 freight locomotive runs on mainline track in locations from New York to California. The shifts ranged in duration from 187 minutes to 497 minutes. The average speeds for the shifts were from 21.0 mph to 54.6 mph. All measurements were made on locomotives hauling freight trains in regular revenue service.

## Data Acquisition and Processing

The results reported here were computed using test data acquired from a tri-axial seat pad, accelerometer at a sample rate of 400Hz with an anti-aliasing filter corner frequency of 100Hz. The V DVs and the lateral and longitudinal spinal stress values were computed directly from the acquired test data according to the procedures specified and described in [1] and [2]. The vertical spinal stress values were computed by converting the as-acquired test data to a sample rate of 160Hz for input to the vertical spine model, as required in [2]. The conversion of the test data from the as-acquired sample rate of 400Hz to the required sample rate of 160Hz involved up sampling or interpolating the test data to an equivalent sample rate of 800Hz, band limiting the resultant data with a low-pass filter corner frequency of 60Hz and finally down sampling or decimating the 800Hz data to a sample frequency of 160Hz.

## Discussion

The vertical V DVs computed according to [2] for the 19 shifts ranged from 2.68 to 9.33  $\text{m/s}^{1.75}$ . In all but one case, the vertical values were greater than the values for the lateral or longitudinal directions. Note that the health guidance in [1] puts the lower boundary of the health guidance caution zone at a V DV value of 8.5 and the upper boundary at 17  $\text{m/s}^{1.75}$ . The daily equivalent static compression dose computed following [2] ranged from 0.123 to 0.434 MPa. Health guidance provided in [2] states that there is a low probability of an adverse health effect if the daily dose is less than 0.5 MPa.

The daily equivalent static compression dose is plotted against the vertical VDV for the 19 shifts in Figure 1. As expected, a linear correlation of the spinal stress with VDV is evident in the graph. Also note that although the highest VDV values exceed the lower health guidance boundary, all the compression dose values are well below the boundary for low probability of an adverse health effect with daily exposure over a lifetime of work.

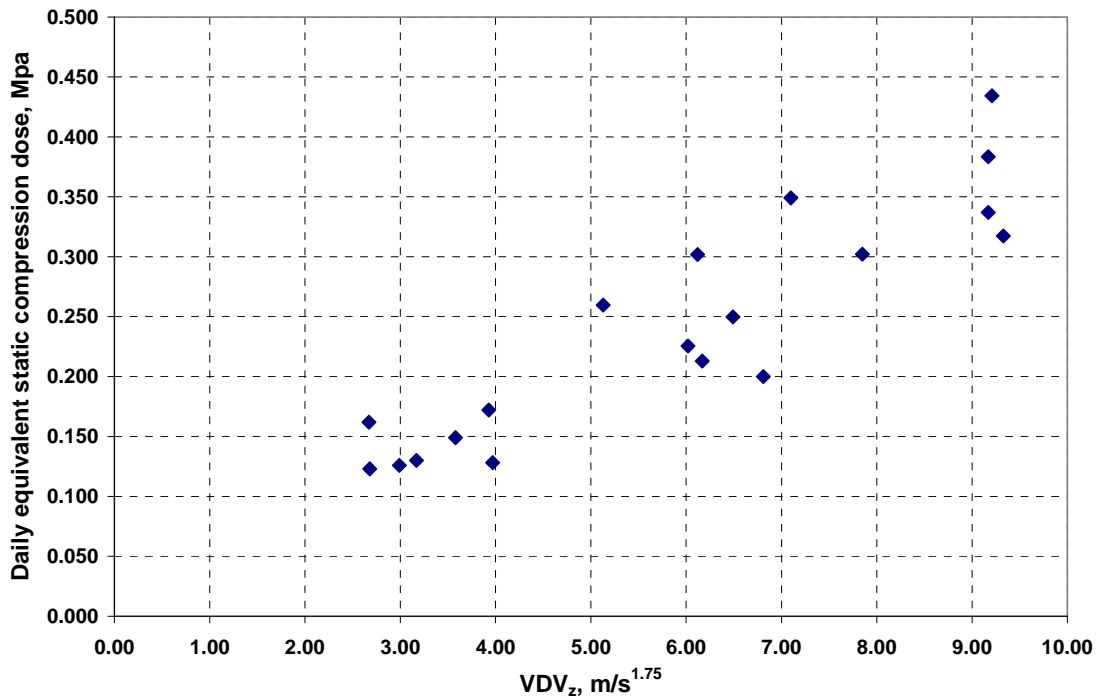

Figure 1. Daily static compression dose vs Vertical Vibration Dose Value

### Conclusions

Evaluation of the data collected in the studies reported here following ISO 2631 suggests that the shock and impact exposure for locomotive crew members presents a low probability for an adverse health outcome. These results also indicate that, for locomotive shock and vibration, the health guidance for the VDV given in Part 1 of the standard is more stringent than the health guidance for spinal stress in Part 5.

### References

1. International Organization for Standardization. (1997). Mechanical vibration and shock-Evaluation of human exposure to whole body vibration-Part 1: General requirements. ISO2631-1:1997
2. International Organization for Standardization. (2004). Mechanical vibration and shock-Evaluation of human exposure to whole body vibration-Part 5: Method for evaluation of vibration containing multiple shocks. ISO2631-5:2004.
3. Alem, N., Hiltz, E., Breaux-Sims, A. and B. Bumgardner. ( 2004). Evaluation of New Methodology for Health Hazard Assessment of Repeated Shock in Military Tactical Ground Vehicles. NATO RTO-Applied Vehicle Technology Symposium. RTO-AVT-110. Paper 7. pp 1-18.

# REVISION OF ANSI S3.34 (2.70-2006) – GUIDE FOR THE MEASUREMENT AND EVALUATION OF HUMAN EXPOSURE TO VIBRATION TRANSMITTED TO THE HAND

Douglas D. Reynolds  
Center for Mechanical & Environmental Systems Technology  
University of Nevada Las Vegas, Las Vegas, Nevada, U.S.A.

## Introduction

Intense vibration can be transmitted to the hands and arms of workers who use hand-held percussive or vibrating devices, tools, and work pieces. Continued habitual exposure to vibration directed to the hands can cause patterns of various symptoms associated with hand-arm vibration syndrome (HAVS). The International Organization for Standardization (ISO) first published ISO 5349 in 1986.<sup>3</sup> This standard specified methods for measuring and evaluating vibration directed into the hands from hand-held vibrating devices, tools, and work pieces. The American National Standards Institute (ANSI) published ANSI S3.34 the same year.<sup>1</sup> This standard was modeled after ISO 5349-1986 and specified methods for assessing exposure to hand-arm vibration.

The Parliament of the European Union has issued the European Union Human Vibration Directive-2002/44/EC, which specifies vibration daily exposure action values (DEAV) of 2.5 m/s<sup>2</sup> and daily exposure limit values (DELV) of 5.0 m/s<sup>2</sup>. These values have generally been accepted by medical experts, scientists, and engineers in governmental agencies, research institutions, and industry in the USA and other countries.<sup>2</sup> When they are achieved, they will reduce the potential for the development of symptoms related to HAVS among workers exposed to hand-arm vibration.

Significant improvements in measurement and analysis instrumentation, miniature and subminiature accelerometers, and medical diagnostic and assessment protocols have been introduced since 1986 when ANSI S3.34 was first published. In response to these improvements and the introduction of the EU Human Vibration Directive, ANSI Working Group S2.39 developed the revision to ANSI S3.34, which has now been published as ANSI S2.70-2006.<sup>2</sup>

## Method

ANSI S2.70 specifies the use of the hand-arm vibration measurement procedures outlined in ISO 5349, Parts 1 and 2.<sup>2,4,5</sup> It requires the measurement of ISO frequency-weighted acceleration values in three mutually orthogonal axes of vibration. These values are then vectorially added to obtain the vibration total value,  $a_{hv}$ :

$$a_{hv} = \sqrt{a_{hwx}^2 + a_{hwy}^2 + a_{hwz}^2} \quad (1)$$

where  $a_{hwx}$ ,  $a_{hwy}$ , and  $a_{hwz}$  are the measured r.m.s. ISO frequency-weighted acceleration values in the x, y, and z directions, respectively. If multiple vibration exposure events are experienced during a work day, the overall vibration total value is obtained from:

$$a_{hv} = \sqrt{\frac{1}{T} \sum_{i=1}^n (a_{hvi}^2 T_i)} \quad (2)$$

where  $a_{hvi}$  is the vibration total value of the  $i^{\text{th}}$  operation,  $T_i$  is time duration in hours of the  $i^{\text{th}}$  operation,  $n$  is the total number of operations, and  $T$  is total time in hours associated with the  $n$

operations. Finally, the daily vibration exposure value,  $A(8)$ , standardized to an 8-hour reference period, is obtained from:

$$A(8) = a_{hv} \sqrt{\frac{T}{T_0}} \quad (3)$$

where  $T_0$  is the reference duration of 8 h.

ANSI S2.70 defines a value of  $A(8)$  equal to  $2.5 \text{ m/s}^2$  as the Daily Exposure Action Value (DEAV).<sup>2</sup> The DEAV represents the health risk threshold to hand-transmitted vibration. “Health risk threshold is defined as the dose of hand-transmitted vibration exposure sufficient to produce abnormal signs, symptoms, and laboratory findings in the vascular, bone or joint, neurological, or muscular systems of the hands and arms in some exposed individuals.”<sup>2</sup> ANSI S2.70 recommends that a program be designed to reduce worker exposure to hand-transmitted when  $A(8)$  exceeds the DEAV to reduce health risks.

ANSI S2.70 defines a value of  $A(8)$  equal to  $5.0 \text{ m/s}^2$  as the Daily Exposure Limit Value (DELV).<sup>2</sup> Workers who are exposed to hand-transmitted vibration at or above this level are expected to have a high health risk. “High health risk is defined as the dose of hand-transmitted vibration exposure sufficient to produce abnormal signs, symptoms, and laboratory findings in the vascular, bone or joint, neurological, or muscular systems of the hands and arms in a high proportion of exposed individuals.”<sup>2</sup> ANSI S2.70 recommends that workers not be exposed to  $A(8)$  values above the DELV.

## Discussion

ANSI S2.70 is a timely and needed revision of ANSI S3.34. It gives the U.S. a modern standard that is in agreement with ISO 5349, Parts 1 and 2 and that has vibration assessment criteria that are accepted by medical experts, scientists, and engineers in governmental agencies, research institutions, and industry in the USA and other countries. ANSI S2.70 gives guidance for vibration exposure and health risks assessments, specifies methods for mitigating health risks associated with hand-transmitted vibration, and gives guidance for worker training and medical surveillance.

## References

1. ANSI S3.34 (1986), Guide for the Measurement and Evaluation of Human Exposure to Vibration Transmitted to the Hands. American National Standards Institute.
2. ANSI S2.70 (2006), Guide for the Measurement and Evaluation of Human Exposure to Vibration Transmitted to the Hands. American National Standards Institute.
3. ISO 5349 (1986), Mechanical vibration — Measurement and evaluation of human exposure to hand-transmitted vibration. International Organization for Standardization
4. ISO 5349 (2001), Mechanical vibration – Measurement and evaluation of human exposure to hand-transmitted vibration – Part 1: General requirements. International Organization for Standardization.
5. ISO 5349 (2001), Mechanical vibration – Measurement and evaluation of human exposure to hand-transmitted vibration – Part 2: Practical guidance for measurement at the workplace. International Organization for Standardization.

# STANDARD TESTS FOR SUSPENDED SEATS – CAN THESE CONTRIBUTE TO PROTECTION AGAINST WHOLE-BODY VIBRATION? – COMMENTARY ON HISTORICAL DEVELOPMENT AND CURRENT WORK IN CEN/TC231/WG9 (SEATING)

Richard Stayner  
RMS Vibration Test Laboratory, Ludlow, U.K.

## Introduction

Suspended seats perform two functions: Reduce effect of occasional large bumps; Reduce more continuous vibration at a lower level. The former needs high damping. The latter needs low damping. For most mobile work machines the inevitable compromise is generally better than a simple cushion seat, because that amplifies vibration at around 4 Hz which is a sensitive frequency for human vertical WBV.

Why have standard tests for seat suspensions?

- Seat suspensions are non-linear so any measure of performance depends on operating conditions. For comparison these need to be defined.
- Seat manufacturers need benchmarks for product development;
- Machine makers choose dynamic characteristics appropriate to their products;
- Occupational health specialists wish to control operator exposure to

Standard tests should be representative, repeatable and reproducible. These requirements are reviewed in relation to the history of seat test standards and the current position.

## Current position and history

The current position is that we have standard tests for seats for agricultural tractors, earthmoving machinery, industrial (fork-lift) trucks. These tests comprise measurement of vibration transmission and of the rate of damping.

Current standards developed as the technology developed, starting around 1960:

1. Test on machine driven over standard surface<sup>1</sup>.
2. Test on shaker reproducing standard surface.
3. Shaker input replaced by representative spectrum<sup>2</sup>.
4. Human subject replaced by dynamic dummy. (Not yet settled).

## Are standard tests representative?

The development process has gradually moved seat tests further from reality. 4 hr samples of work exposure suggest that seats do not **on average** provide large reductions of vertical WBV<sup>3</sup>. For **specific magnitudes** of vibration they can work well. For low vibration, performance is reduced by friction and for severe vibration by length of travel. Recent work has led to a new test to quantify how a suspension controls over-travel<sup>9</sup>.

### **Are standard tests repeatable?**

Tests involving driving a machine were never very repeatable, because the input could not be controlled very closely. Shaker tests can have very repeatable inputs, e.g. KAB Seating has just run a review that shows consistency over a ten year period.

### **Are standard tests reproducible?**

In Europe, inter-laboratory tests gave unacceptable inconsistencies. Dynamic dummies are being trialled to replace human subjects, but even with these there can be 25% difference between laboratories. Current work of CEN Seating WG is aimed at comparing how different laboratories interpret the standard specifications, with the aim of improving these specifications. Then with dummies we should have reproducibility.

### **Comments**

We have standard tests for seat suspensions that are repeatable. Work is in hand to try to make them more reproducible. The question remains: How helpful are such standard tests in protecting workers against harmful effects that are associated with WBV?

### **References**

1. Matthews, J. (1966) Ride comfort for tractor operators IV: Assessment of ride quality of seats. J. agric. Engng. Res. 11 (1), 44-57.
2. ISO 7096 (2000) Earthmoving machinery – Laboratory evaluation of operator seat vibration. International Standards Organization, Geneva.
3. Scarlett, A.J., Price, J.S., Semple, D.A. and Stayner, R.M. (2005) Whole-body vibration on agricultural vehicles: evaluation of emission and estimated exposure levels. Research Report 321, Health and Safety Executive, ISBN 0-7176-2970-8.



# EVALUATION OF SCRAPER OPERATOR EXPOSURE TO WHOLE-BODY VIBRATION IN THE CONSTRUCTION INDUSTRY: A TASK ANALYSIS

E.K. Gillin<sup>1</sup>, A.Cann<sup>1</sup>, P. Vi<sup>2</sup>, T. Eger<sup>4</sup>, M. Hunt<sup>1</sup>, A. Salmoni<sup>3</sup>

<sup>1</sup>Doctoral Program in Rehabilitation Sciences, University of Western Ontario, Canada

<sup>2</sup>Construction Safety Association of Ontario, Canada

<sup>3</sup>School of Kinesiology, University of Western Ontario, Canada

<sup>4</sup>School of Human Kinetics, Laurentian University, Ontario, Canada

## Introduction

Kittusamy (Kittusamy & Buchholz, 2004) state that there have been few studies conducted to assess exposure to whole-body vibration (WBV) in the construction industry. They suggest that there is very little reliable data from the construction industry that characterizes exposure levels to various hazards including WBV or the health outcomes from such exposure and that there is a need for more exposure data. In a recent exploratory study of heavy construction equipment Cann (Cann, Salmoni, Vi, & Eger, 2003) looked at vibration levels for 14 different types of construction equipment. Eight of the 14 pieces of equipment tested exposed operators to levels of WBV that exceeded the recommended limits for an 8-hour period when comparing the measured VDV to the ISO 2631-1 standards. The purpose of the present research was not only to test a larger number of scrapers but also to investigate scraper operator exposure to whole body vibration (WBV) separately for each task.

## Methods

33 scrapers were evaluated for WBV in a variety of residential and road construction projects. Testing equipment consisted of triaxial accelerometers that allowed vibration data collection in all three orthogonal axes, with the x-axis positioned to measure vibration in the anterior-posterior direction, the y-axis in the medial-lateral direction, and the z-axis in the vertical direction. Root mean square accelerations (aRMS), vibration dose value (VDV), crest factor, and maximum transient vibration values (MTVV) were derived from this software and exported to an Excel™ spreadsheet for later data analysis.

Test sessions for each piece of equipment lasted for approximately 20 minutes until at least three work cycles had been completed. Tasks included: idling while waiting for a bulldozer to push the scraper through the scraping phase, scraping, traveling loaded with dirt, dumping and traveling empty.

## Results

Task breakdown by time reveals 25% of the work cycle was spent traveling fully loaded with dirt, 19% dumping, 21% traveling unloaded, 17% idling and 18% scraping. Calculation of aRMS vector sums gave values of 2.55 m/s<sup>2</sup> during loaded transport, 2.46 m/s<sup>2</sup> during dumping, 2.31 m/s<sup>2</sup> during unloaded travel, 0.55 m/s<sup>2</sup> during idling and 1.46 m/s<sup>2</sup> during scraping (see Table 1). The highest acceleration values recorded were found in the z-axis during fully loaded transport reaching an average aRMS over three work cycles of 2.55 m/s<sup>2</sup>.

Table 1: Summary of WBV aRMS from the x,y,z axes  $n=33$

<i>aRMS (m/s<sup>2</sup>)</i>	<i>Loaded</i>	<i>Dump</i>	<i>Unloaded</i>	<i>Idle</i>	<i>Scrape</i>	<i>Overall</i>
X (m/s <sup>2</sup> )	0.97	0.94	0.88	0.23	0.60	0.81
Y (m/s <sup>2</sup> )	1.04	0.99	0.95	0.21	0.59	0.86
Z (m/s <sup>2</sup> )	1.55	1.49	1.39	0.32	0.83	1.28
Vector Sum (m/s <sup>2</sup> )	2.55	2.46	2.31	0.55	1.46	2.12

## Discussion

The overall vector sum aRMS values exhibit accelerations well beyond the Commission of European Communities (CEC) recommended 8 hour levels. In a review of European Union whole body vibration exposure standards Griffin confirms the 8 hour action limit to be 0.5 m/s<sup>2</sup> and the 8 hour exposure limit of 1.15 m/s<sup>2</sup> (Griffin, 2004). Results are consistent with whole body vibration measurements from previous work. Accelerations are repeatedly in excess of maximal exposure limits recommended by ISO. This leads one to conclude that all scrapers will expose the operator to excessive levels of whole body vibration that may lead to injury or illness. There are researched methods that a scraper operator can do to decrease this risk. First, they can decrease speed while traveling loaded, dumping and unloaded. Second, they can ensure that tire pressure is at optimal levels. Third, they can maintain a healthy posture while driving. However, the effect of such risk reducing factors is minimal. The solution to harmful vibration does not lie in wasting more money testing construction equipment to determine that it is exposing the user to potentially higher than recommended levels of vibration. The solution lies in the engineer's hands. Attacking this problem through better seat design is thought to enable a decrease of over 50% (Griffin, 1990). In addition, improving vehicle suspension, cab vibration absorption and engine mounts keeps solutions at the source of the problem versus at the operator.

## Acknowledgements

The authors would like to thank the Workplace Safety and Insurance Board of Ontario for its generous grant and workers who participated in this research.

## References

- Cann, A. P., Salmoni, A. W., Vi, P., & Eger, T. R. (2003). An exploratory study of whole-body vibration exposure and dose while operating heavy equipment in the construction industry. *Appl Occup Environ Hyg*, 18(12), 999-1005.
- Griffin, M. J. (1990). Vibration and human responses. In *Handbook of Human Vibration* (pp. 7). London: Academic Press Inc.
- Griffin, M. J. (2004). Minimum health and safety requirements for workers exposed to hand-transmitted vibration and whole-body vibration in the European Union; a review. *Occup Environ Med*, 61(5), 387-397.
- ISO. (1997). *Mechanical Vibration and Shock-Evaluation of Human Exposure Whole-Body Vibration-Part 1: General Requirements*. Geneva: Switzerland: International Organization for Standardization.
- Kittusamy, N. K., & Buchholz, B. (2004). Whole-body vibration and postural stress among operators of construction equipment: a literature review. *J Safety Res*, 35(3), 255-261.

# CHARACTERISTICS OF WHOLE-BODY VIBRATION FREQUENCIES AND LOW BACK PAIN IN URBAN TAXI DRIVERS

Jiu-Chiuan Chen<sup>1,2</sup>, Wen-Ruey Chang<sup>3</sup>, Britt H. Hatfield<sup>2</sup>, David C Christiani<sup>2</sup>

<sup>1</sup>Department of Epidemiology, University of North Carolina, School of Public Health, Chapel Hill, North Carolina, U.S.A.

<sup>2</sup>Occupational Health Program, Department of Environmental Health, Harvard School of Public Health, Boston, Massachusetts, U.S.A.

<sup>3</sup>Liberty Mutual Research Institute for Safety, Hopkinton, MA, U.S.A.

## Introduction

Occupational exposures to whole-body vibration (WBV) at different frequency domains may differentially affect human comfort and the musculoskeletal system. Under this presumption, a frequency-based weighting scheme has been adapted in many widely accepted standards for WBV measurement. However, there is very little human data showing a direct link between WBV frequency and musculoskeletal disorders. We conducted an epidemiologic study to examine the association between WBV frequency and prevalence of low back pain (LBP) and to identify determinants of specific frequencies associated with LBP in urban taxi drivers.

## Methods

The WBV frequency data were collected from 247 professional drivers (aged 44.6±8.3) who participated in an exposure validation study<sup>1</sup> of the Taxi Drivers' Health Study (TDHS) in 2000.<sup>2</sup> In accordance with the ISO 2631-1 (1997) methods, we measured the frequency-weighted acceleration over drivers' seat surface, under conditions representing randomly assigned destinations. We developed a WBV record-replay system at the Liberty Mutual Research Institute (LMRI) in Hopkinton, MA, USA. This system includes two tri-axial accelerometers (PCB Piezotronics, NY, USA), one RD-130T PCM data recorder (TEAC, Tokyo, Japan), and one LMWBV meter 2.0 (LMRI, MA, USA). Only the vertical axis of seat-surface WBV frequency was used in this study. To characterize the WBV frequency curve, we manually identified the presence of any peak within each of the following frequency range: <4, 4-10, 10-20, and >20 Hz. Information about the operating vehicles and driving environment was either collected from the vehicle registration record (manufacturer, year of make, transmission, engine size, etc.) or directly measured (wheel-base length, seat inclination, etc.). Structured interviews were conducted by an occupational physician to gather information on LBP that had led to medical attention or absence from driving in past year. We used multiple logistic regression to estimate the prevalence odds ratio (OR) associated with the presence of each index peak frequency, adjusting for age, body mass index, professional seniority, daily driving hours, seat inclination, and the intensity of predicted root-mean-square WBV exposure in m/sec<sup>2</sup>. For any revealed WBV frequency that was associated with LBP, we constructed a multiple logistic regression model to identify the personal and vehicle characteristics associated with the presence of WBV peak within the indicated frequency range.

## Results

Of the 236 (96% of 247) all male drivers who had WBV frequency data, 47% complained LBP in the past year. Of all classifiable frequency curves, the proportion of having an identifiable peak, respectively for <4, 4-10, 10-20, and >20 Hz, was 71%, 93%, 47%, and 56% respectively. Drivers whose frequency curves did not reveal the presence of peak frequency < 4Hz had the lowest LBP prevalence (37%). Results of multiple logistic regression showed positive associations between the presence of peak frequency <4 (p=0.06) or 4-10Hz (p=0.35) and increased 1-year prevalence of LBP, with estimated prevalence OR=1.98 (95% confidence [CI]: 0.98-4.01) and 1.74 (95%CI: 0.54, 5.59). No positive associations were found with the presence of peak frequency either at 10-20 or >20Hz. As average driving speed increased, the probability of having a low-frequency (<4Hz) peak on WBV curve increased in a quadratic-linear manner (p<0.001). Other significant determinants of the presence of a WBV peak frequency <4Hz included: engine size <1500c.c. (OR=1.72, 95%CI: 1.46, 9.70) and manufacturer (p<0.001). Our preliminary analyses did not suggest any statistically significant associations with other vehicle or drivers' characteristics.

## Discussion

This was the first epidemiologic study linking LBP with WBV frequency profile obtained by directly measuring frequency during the exposure. Our preliminary analyses indicated that the presence of a low-frequency (<4Hz) WBV peak was associated with higher 1-year prevalence of LBP. Although we noted a positive association with the presence of a WBV peak near the resonance frequency of 4-6 Hz, the limited variability of the WBV frequency curve across the 4-10 Hz range, probably as a result of applying the ISO 2631-1 (1997) frequency weighting function, might have precluded the possibility of finding any statistically significant association. We also identified driving speed, engine size, and manufacturer as the most significant determinants of the presence of a low-frequency (<4Hz) WBV peak. Further analyses will examine the association of LBP with the estimated intensity of each WBV peak, and also to identify the determinants of any peak WBV intensity that correlates, if any, with LBP in urban taxi drivers. If the positive association between low-frequency (<4Hz) WBV and LBP was further confirmed, experimental research should look into the biomechanical effects and other pathophysiological changes related to WBV exposure at this frequency range.

## References

1. Chen JC, Chang WR, Shih TS, et al. Using "exposure prediction rules" for exposure assessment: an example on whole-body vibration in taxi drivers. *Epidemiology* 2004; 15:293-9.
2. Chen JC, Dennerlein JT, Shih TS, et al. Knee pain and driving duration: a secondary analysis of the Taxi Drivers' Health Study. *Am J Public Health* 2004; 94:575-81.

# INVESTIGATION INTO THE UNCERTAINTY IN MEASUREMENTS AND EVALUATION OF HAND-TRANSMITTED VIBRATION

Han-Kee Jang, Chi-Mun Song, Seok-In Hong, Seok-Hyun Choi  
Institute for Advanced Engineering, Yongin, Korea

## Introduction

Accurate measurement and evaluation of hand-transmitted vibration from a power tool is an important issue for tool manufacturers, because they are obliged to develop low-hazard power tools for workers. The International Standard ISO 5349<sup>(1)</sup> dictates a systematic procedure for the measurement and evaluation of hand-transmitted vibration. However, the uncertainty in this measurement is too large for manufacturers to apply such data to the design and modification of power tools. There can be several sources of this uncertainty in such measurements; e.g., operator-dependent, power tool-dependent, and operational conditions (see Table 1). For a manufacturer to characterize the exposure of a power tool's use to a given level of vibration, the relationship between these uncertainty factors and the measured vibration must be elucidated. In this study, we investigated the effect of several factors on the uncertainty in measurements.

Table 1. The possible sources of an uncertainty in a measurement.

Tool	Operator	Operating condition	Instrumentations
Tool Grit/Tip/Insert Installation	Stature and weight Muscular strength	Posture Applying forces	Accelerometer Data processing device

## Methods

In this study, some of the factors in Table 1 were selected for examination, and their effect on the measured variation was quantitatively investigated. Three tools from the same manufacturer were sampled at random in our experiments, and each of five of the same type of insert (disks or tips) was installed into each tool. Although each of the tools and inserts were of the same design and were made by the same production process, they differed from one to another, which can be a source of the variation in the measured vibration.

Three human subjects participated in our experiments, which were carried out as stated in ISO 5349. The subjects were asked to maintain their posture, and the applied force was kept as constant as possible. The applied force was monitored using an indirect method, where vibration energy was displayed in real time during the experiment using a three-axis accelerometer attached to the work piece at a specified point. The appropriate range of the applied force was predetermined to cover the range of real work operations. The engineering tolerance between the inner diameter of a grit disk and the outer diameter of the tool shaft leads to an eccentricity of the mass at the center of the disk. The degree of eccentricity varies with installation, and this is another source of uncertainty. In our study, the effect of this eccentricity was investigated by carrying out repeated assembly and disassembly of an insert.

Human exposure levels of hand-transmitted vibration were measured in 45 combinations of the three subjects using three tools of the same make, and five inserts of the same make for each of the three types of tool studied: a 7” and a 4” grinder, and a die grinder. Each measurement was performed following the procedure listed in ISO 5349. Data acquisition for each case was made over a period of five minutes involving five repeated one-minute measurements.

## Results

Table 2 shows the variation in human exposure levels to hand-transmitted vibration,  $a_{hv}$ , for the selected factors. For example, the 7” grinder showed a variation of 13.7% for our subjects using the 15 tool and insert combinations. For the three types of tool, the effect of the variation among the tools, which was closely related to the quality of the product, was the most dominant factor. Variations in the vibration according to subject varied from 11.7% to 13.7%, which seems reasonable, because the applied force was monitored and controlled during the measurement. Variations according to the insert are possibly caused by irregularities in the insert and/or installation. Variations in the measurements according to installation were investigated in a separate experiment.

Table 2. Variations in human exposure levels of hand-transmitted vibration with different tools, inserts, and subjects.

	Factor		
	Subject	Tool	Insert
7” Grinder (plus grit grinding wheel) grinding stainless steel	13.7%	40.3%	14.7%
4” Grinder(plus grit grinding wheel) grinding stainless steel	11.7%	18.6%	9.5%
Die grinder (plus rotary cutter) grinding stainless steel	13.4%	18.9%	16.4%

## Discussion

We have investigated the effect of several factors on the uncertainty in measurements of hand-transmitted vibration. Among the three major factors studied, the variation according to the tool used was the most dominant factor, even though this was limited. The variation according to subject showed a consistent value of 11.7% to 13.7% for the three types of tool studied. The variations according to insert had two causes: one was due to the irregularities between the inserts, and the other was due to the eccentricity of the rotation, which is currently under further investigation.

To compare human exposure levels to vibration in different tools, which is necessary for the selection of better tools, more research into the effect of the factors that influence the uncertainty should be carried out.

## Reference

ISO 5349-1, 2001, Mechanical vibration—Measurement and evaluation of human exposure to hand-transmitted vibration Part 1: General requirements, International Organization for Standardization, Geneva.

## Podium Presentations

### Session VII: Biodynamics II

Chairs: John Wu and Kumar Kittusamy

<b>Presenter</b>	<b>Title</b>	<b>Page</b>
P.W. Johnson University of Washington	A portable measurement system for the assessment of time weighted and impulsive exposures to whole body vibration	90
S. Mandapuram Concordia University	Influence of back support conditions on the absorbed power of seated occupants under horizontal vibration	91
A. Pranesh, Concordia University	A multi-body dynamic biomechanical model of a seated human exposed to vertical whole-body vibration	93
S.K. Patra Concordia University	Assessments and refinements of an anthropodynamic manikin for seating dynamics applications	95
R. McCormick MB Dynamics	A novel 3-D hand-arm vibration test system and its preliminary evaluations	97
T. Keller Spectral Dynamics	Multi-axis hand-arm vibration testing & simulation at the National Institute of Industrial Health, Kawasaki, Japan	99
D. Welcome NIOSH	A pilot study of the transmissibility of the rat tail compared to that of the human finger	101

# **A PORTABLE MEASUREMENT SYSTEM FOR THE ASSESSMENT OF TIME WEIGHTED AND IMPULSIVE EXPOSURES TO WHOLE BODY VIBRATION**

Peter W. Johnson and Jim Ploger  
University of Washington, Department of Environmental and Occupational Health Sciences,  
Seattle, Washington, U.S.A.

## **Introduction**

Bus drivers represent a large segment of the US transportation industry and research has shown an association between exposure to Whole Body Vibration (WBV) and the high rates of low back disorders. Impulsive WBV exposures have been recognized as a risk factor for low back injury and new guidelines exist for their measurement and assessment (ISO 2631, Part 5). Methods to accurately and better characterize the impulsiveness of WBV along with the temporal patterns of the exposures are needed. The development of a hardware and software system to measure continuous TWA and raw, impulsive WBV exposures and the design of a subsequent study are presented.

## **Methods**

Using two Larson Davis HVM 100 as accelerometer amplifiers, small external batteries, and a Pocket-PC (PDA) with 1 Gb of compact flash memory, we can collect up to 16 channels of data for a full day 600 Hz. Tri-axial WBV exposures will be measured and characterized at the frame of the bus and at the driver/seat interface (seatpad accelerometer). Using a repeated measures design, 20 bus drivers will drive on selected routes which include both city streets and highways, and within and between subject components of variability and exposure determinants related to the bus, bus seat, the bus driver, and the route will be identified. Global Positioning System (GPS) data will also be collected and integrated with the WBV exposure data to facilitate the identification of the location, velocity and type of road associated with high average TWA and impulsive WBV exposures. This system may be used to develop administrative (alter speed and/or route of bus, systematically vary type of routes) and/or engineering controls (identify and trigger the need for street repair) to reduce high WBV exposures.

## **Results**

Our portable Pocket-PC based data acquisition system is up and running and we can collect seven channels of WBV data (seat pan tri-axial accelerometer, bus frame tri-axial accelerometer and GPS data) continuously for a full shift. The software analysis of the data is complex but nearing completion. We have incorporated the vibration dose calculations from ISO 5321, Part 5 and have obtained a Matlab-based routine to appropriately weight the continuous signals.

## **Discussion**

In summary, the measurement of WBV is complex but new technologies open avenues of collecting and assessing WBV exposures that were previously not possible. The standardization of impulsive WBV exposure assessment methods is needed to further the discipline and better enable comparisons across studies.



# INFLUENCE OF BACK SUPPORT CONDITIONS ON THE ABSORBED POWER OF SEATED OCCUPANTS UNDER HORIZONTAL VIBRATION

S. Mandapuram<sup>1</sup>, S. Rakheja<sup>1</sup>, Shiping. Ma<sup>1</sup>, P.-É. Boileau<sup>2</sup>

<sup>1</sup>Concordia University, Montréal, QC, Canada

<sup>2</sup>IRSST, Montréal, QC, Canada

## Introduction

The absorbed power ( $P_{Abs}$ ) has been suggested as a better measure of human responses to whole-body vibration, since it relates to the cumulative energy dissipated by the body exposed over a given duration. Moreover, unlike the other measures, the  $P_{Abs}$  can adequately account for the intensity of exposure. Although, the vast majority of off-road vehicles impose considerably severe vibration along the horizontal axes, the vast majority of studies on biodynamic response characterization consider only vertical vibration. Only a few studies have reported  $P_{Abs}$  responses of the seated human body exposed to horizontal vibration and the major contributing factors [1]. This study aims to characterize the  $P_{Abs}$  responses of seated human subjects to horizontal (uncoupled  $x$ - and  $y$ -axis) vibration as functions of the vibration intensity, subject mass, seat height and the, type of back support.

## Methods

Experiments were conducted using a rigid seat with an adjustable backrest inclination and seat height. The seat was installed on a horizontal vibration simulator and the forces at the seat base and the backrest were measured by three-axis force plates. Two single-axis accelerometers were installed on the seat back and the platform, oriented along the axis of motion. The experiments were performed using three different seat heights (350, 390 and 410 mm), back support conditions (NB- no back support and sitting erect; Wb0- Upper body supported against a vertical back support; and WbA- back supported against an inclined backrest, while sitting relaxed) and three different magnitudes of broad band excitations in the 0.5-10 Hz frequency range (0.25, 0.5 and 1  $m/s^2$  rms acceleration under  $x$ -axis and  $y$ -axis, applied independently). A total of 8 healthy adult male volunteers with total body mass ranging from 59.4 kg to 92 kg and aged between 21-51 years took part in the experiments. The subjects were seated with their hands in lap, and feet supported on the moving platform for each posture. Each measurement was repeated 2 times, while the data were analysed using a bandwidth of 50 Hz and frequency resolution of 0.0625 Hz.

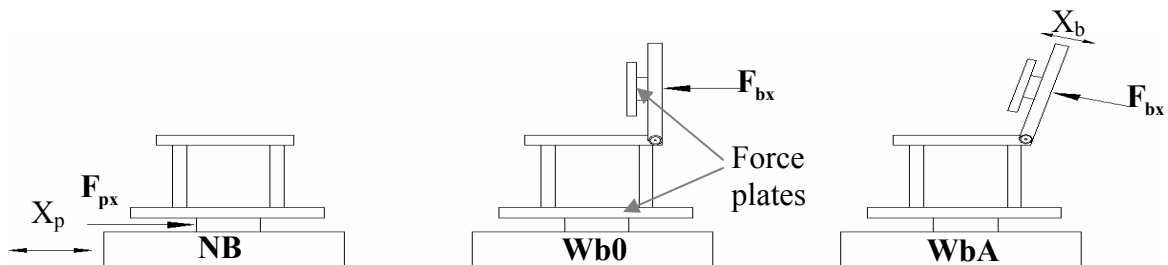

Fig 1: Back support conditions used in the study.

The data were analyzed to derive the absorbed power characteristics of the body at both seat pan and backrest interfaces, while the coherence among the measured forces and accelerations were

particularly monitored. The  $P_{Abs}$  of the seated body subjected to  $x$ - and  $y$ -axis vibration were computed in the one-third octave bands, while the total power was derived through integration of the real component of the force and velocity cross-spectrum under each test condition.

## Results and Discussions

The measured absorbed power responses suggested significant inter-subject variability, irrespective of the experimental condition employed, while the total  $P_{Abs}$  showed nearly quadratic relation with the excitation magnitude. The seat-buttock interface  $P_{Abs}$  responses obtained for all the subjects seated assuming the NB posture and exposed to  $x$ - and  $y$ -axis vibration consistently revealed distinct peaks in the bands with center frequencies of 0.63 and 1.25 Hz. These frequencies are comparable with those observed from reported studies on  $P_{Abs}$  and APMS responses [1, 2]. The  $P_{Abs}$  responses revealed strong influences of the back support condition, apart from the vibration intensity under  $x$ -axis vibration, while the effect of seat height was observed to be small. Under  $y$ -axis vibration, the contributions due to back support were relatively small (Fig. 2).

Sitting with inclined back support (WbA) resulted in the peak  $P_{Abs}$  response in the 2.5-4 Hz bands under  $x$ -axis vibration, while the magnitude of the peak in the 0.63 Hz band diminished most significantly. The  $P_{Abs}$  derived at the backrest also revealed similar trends in magnitude and the corresponding frequency under  $x$ -axis vibration. The magnitude of the peak  $P_{Abs}$  measured at the back rest was around 50-60% of that measured at the seat pan, suggesting important interactions of the upper body with the backrest (Fig. 2). The WbA posture showed lower power absorption by the body when compared to that with the Wb0 posture, which can be attributed to more stable upper body posture when supported by an inclined backrest. Total  $P_{Abs}$  derived from the seat pan and the backrest measurements under  $x$ -axis motions showed good correlations with the body mass ( $r^2 > 0.8$  and  $0.7$ , respectively). The intermittent loss of contact of the upper body with the backrest resulted in relatively lower correlation with the body mass

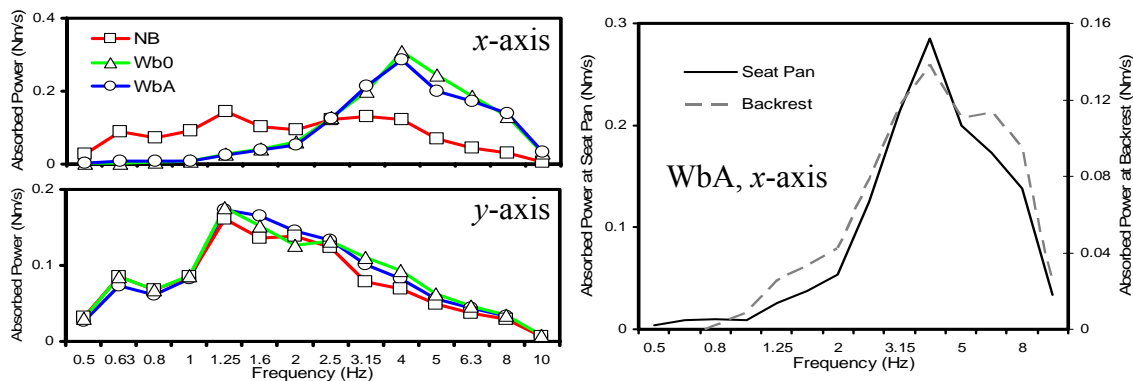

Fig. 2: Influence of back support condition on the absorbed power responses.

## References

1. R. Lundström and P. Holmlund (1998) Absorption of energy during whole-body vibration exposure. *Journal of Sound and Vibration* 215(4), 789-799.
2. S. Mandapuram, S. Rakheja et al (2005) Influence of back support conditions on the apparent mass of seated occupants under horizontal vibration. *Industrial Health*, (43), 421-435.

# A MULTI-BODY DYNAMIC BIOMECHANICAL MODEL OF A SEATED HUMAN EXPOSED TO VERTICAL WHOLE-BODY VIBRATION

A. Pranesh<sup>1</sup>, S. Rakheja<sup>1</sup>, R. Demont<sup>2</sup>

<sup>1</sup>CONCAVE Research Center, <sup>2</sup>Department of Exercise Science  
Concordia University, Montréal, Québec, Canada

## Introduction

Ethical concerns of in-vivo procedures and poor repeatability of non-invasive techniques have been major limitations in estimating vibration-induced spine loads through experiments. The biodynamic models of seated human body exposed to whole-body vibration (WBV) have evolved for defining the frequency-weightings, enhancement of human responses to WBV, and developing anthropodynamic manikins for seating assessment activities. The widely reported mechanical-equivalent models, solely based on through- or to-the-body biodynamic response functions, do not seem to resemble the biomechanical structure and do not yield information on the dynamic loading and deflections of segments of concern, namely the spine. On the other hand, biomechanical models with representative anatomical structure and anthropometry are being attempted to simulate segmental movements and the coupling effects, using Finite elements (FE) or multi-body dynamics (MBD) formalisms, which could provide important insights into the inter-vertebral forces [1]. While the FE models pose considerable complexities primarily related to characteristics of the bio-material properties, the MBD technique with discrete rigid bodies offers the flexibility to create multi-segment models with relative ease and lower computational cost. In this study, a preliminary multibody dynamic model of a seated human body exposed to WBV along the vertical direction is formulated using MSC/ADAMS software. The model validity is demonstrated by comparing selected responses with the available measured data.

## Methods

The seated human is represented by nine rigid body segments, including: head, neck, thoracic and lumbar torso, pelvis, hands and thighs, as shown in Fig. 1. The rigid bodies are coupled through different rotational and translational joints, some of which are force elements to allow vertical translations and sagittal-plane rotations of the segments. The measurements of transmission of vertical vibration through-the-body generally require subjects to voluntarily maintain a vertical head position to reduce head-accelerometer orientation errors. The head-neck-shoulder joint is thus considered to be rigid. The shoulders are assumed to be rigidly attached to the thoracic segment.

The torso is made up of three (upper, middle and lower) segments connected by visco-elastic revolute and translational joints to permit relative pitch and vertical motions. The forces and torques generated by the joints are derived assuming linear stiffness and damping properties, which were identified from published studies. The pelvis is connected to the rigid seat by similar elements representing the visco-elastic properties of the buttock tissues. The two thighs are rigidly connected to the pelvis, while the segment masses are chosen from the anthropometric data for the 50<sup>th</sup> percentile male subject.

The initial model parameters for the joints were obtained from [2]. The model was analyzed to determine the force-motion relationship at the buttock-seat interface expressed in terms of

apparent mass (AM) and through-the-body vibration transmission, expressed in terms of seat-to-head acceleration transmissibility (STHT), under a swept-sine vertical acceleration. Normal mode analysis was also performed to study the segment motions and resonant frequencies.

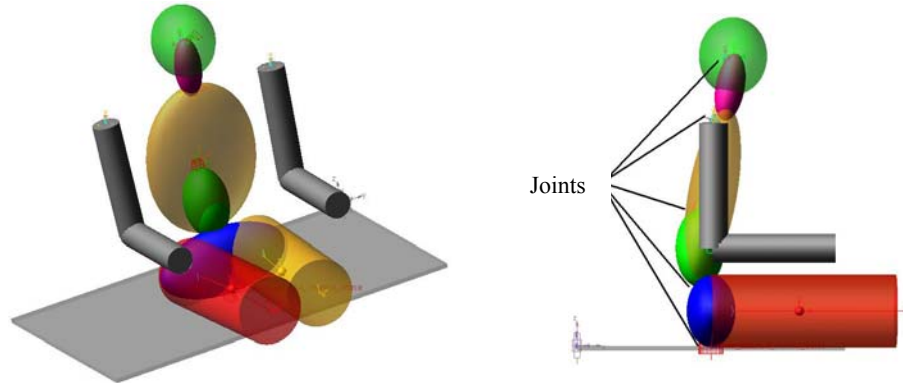

Fig. 1: A multi-body formalism of the seated body.

## Results and Discussion

The model validity was initially examined by comparing the AM and STHT magnitude and phase responses with those reported in ISO 5982 [3] and Paddan and Griffin [4]. The results showed poor agreements between the model and reported responses, while the frequencies corresponding to the peak magnitudes were quite close. Normal mode analysis revealed two significant modes: upper-body pitch near 2 Hz, thoracic translation and pitch about the lumbar near 6.6 Hz. Both the AM and STHT responses showed peak magnitude near 4 Hz, while a relatively smaller magnitude peak was observed near 2 Hz. These frequencies agree well with those observed from the biodynamic responses under vertical and horizontal WBV, respectively. The discrepancies in the response magnitudes, however, suggested the need for verification and/or identification of suitable parameters for all the joints. An optimization-based parameter identification technique is thus applied with limit constraints around the reported values to enhance the validity of the model. The results suggest that the model parameters could be identified to match the AM and STHT responses, reasonably well. The feasibility of the resulting model in predicting the relative movements of segments and spine loads could then be explored.

## References

1. Fritz, M. (1998) Three-dimensional biomechanical model for simulating the response of the human body to vibration stress. *IEEE Med. Bio. Eng. and Comp.*, 36, 686–692.
2. Amirouche, F.M.L., Ider, S.K., (1988). Simulation and analysis of a biodynamic model subjected to low accelerations—a correlation study. *J. of Sound and Vibration*, 123 (2), 281–292.
3. International Organization for Standardization ISO 5982 (2001). Mechanical vibration and shock – Range of idealized values to characterize seated-body biodynamic response under vertical vibration.
4. Paddan, G.S., Griffin, M.J. (1998). A review of the transmission of translational seat vibration to the head. *J. of Sound and Vibration*, 215 (4), 863–882.

# ASSESSMENTS AND REFINEMENTS OF AN ANTHROPODYNAMIC MANIKIN FOR SEATING DYNAMICS APPLICATIONS

S.K. Patra<sup>1</sup>, S.Rakheja<sup>1</sup>, P.E.Boileau<sup>2</sup>, H.Nelisse<sup>2</sup>, A. Natani<sup>3</sup>

<sup>1</sup>CONCAVE Research Center, Concordia University, Canada

<sup>2</sup>Institut de recherche Robert-Sauvé en santé et en sécurité du travail du Québec, Canada

<sup>3</sup>Indian Institute of Technology, Mumbai, India

## Introduction

The current laboratory methods for assessing the vibration attenuation performance of seats involve repetitive trials with a number of human occupants, and raise certain ethical concerns. Moreover, the measurements with human subjects yield considerable variability in the data. Alternatively, several anthropodynamic manikins have been developed for effective assessments of the coupled seat occupant system [1]. The effectiveness of a manikin in predicting the response of a coupled seat-occupant system lies in its ability to reproduce the biodynamic response of the seated human body in terms of force-motion relationship at the body-seat interface, such as apparent mass (APMS). A number of prototype manikins have thus been developed on the basis of biodynamic characteristics of vertical vibration-exposed seated occupants of different body masses in the vicinity of 5<sup>th</sup>, 50<sup>th</sup> and 95<sup>th</sup> percentile male population. This study concerns with the analysis of a passive prototype manikin to enhance its ability to reproduce the idealized APMS response characteristics of the vibration-exposed seated human subjects defined in ISO-5982[2] for mean body masses of 55, 75 and 98 kg.

## Methods

The APMS responses of a prototype anthropodynamic passive manikin were thoroughly characterized in the laboratory under different excitations and body mass configurations. The manikin was designed with sufficient flexibility to configure mechanical-equivalent models corresponding to seated body masses of 55, 75 and 98 kg, by adding/removing specified masses and springs (1). The manikin, configured for a specific body mass, was positioned on a rigid seat without a backrest, which was fixed to the force platform of a whole-body vertical vibration simulator. The simulator was programmed to synthesize random vertical vibration with flat acceleration power spectrum in the 0.4-20 Hz frequency range with two different magnitudes: 1 and 2 m/s<sup>2</sup> overall *rms* acceleration. The total static and dynamic forces of the manikin to and the seat were measured using the force platform, while a single axis accelerometer was installed on the seat pan to measure acceleration due to vertical excitation. The measured data was appropriately corrected for the rigid seat inertia force, and the apparent mass



and (Fig.

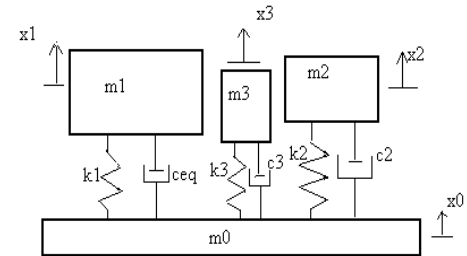

Fig. 1: A pictorial view and mathematical model of the manikin

characteristics of the manikin were derived using the 50 Hz bandwidth and the frequency resolution of 0.0625 Hz. A mathematical model of the manikin was also developed upon considerations of the components properties, and the motions due to various linkages. A linear three-DOF model was formulated to compute the APMS responses for different mass configurations (Fig. 1). A constrained optimization-based parameter identification method was applied for identifying desired components properties such that the manikin could accurately reproduce the idealized APMS responses of the seated human occupants for the three body masses.

## Results and Discussions

Figure 2(a) illustrates the measured APMS magnitude responses of the manikin for three mass configurations under  $2 \text{ m/s}^2$  excitation. The magnitude peaks occur near 4, 4.8 and 4.5 Hz respectively for the 55, 75 and 98 kg masses. Comparisons of the measured data with the standardized responses in ISO-5982 [2] revealed that the APMS responses of the manikin for 55 and 75 kg masses lie within the lower and upper bounds of the idealized range defined in the standard. For the 98 kg configuration, the measured magnitude exceeded the upper bound near the primary resonant frequency. Moreover, the primary resonant frequencies corresponding to 75 and 98 kg configurations deviated considerably from those of the idealized values. The manikin also provided extremely poor prediction of the APMS responses under lower excitation levels, which was attributed to relatively high damper seal friction. The results attained from the optimization based parameter identifications suggested that the response predictions of the manikin could be considerably enhanced through only minor refinements of the component properties. As an example, Fig. 2(b) shows comparisons of the measured and idealized responses for the 75 kg mass with that of the refined design.

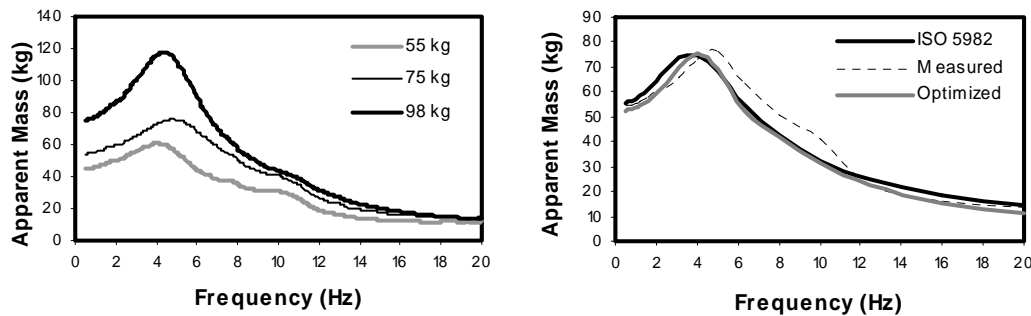

Fig. 2: (a) Measured APMS responses of the manikin; (b) comparisons of measured and standardized responses with that of the refined design (75 kg).

## References

- [1] Toward, M.G.R., 2000 “Use of an Anthropodynamic dummy to measure seat dynamics”, 35<sup>th</sup> UK Group Meeting on Human Response to Vibration. University of Southampton, Southampton, U.K.
- [2] International Standard 5982, 2001 “Mechanical Vibration and Shock-range of idealized values to characterize seated-body biodynamic response under vertical vibration”.

# A NOVEL 3-D HAND-ARM VIBRATION TEST SYSTEM AND ITS PRELIMINARY EVALUATIONS

Ren G. Dong<sup>1</sup>, Dan E. Welcome<sup>1</sup>, Richard McCormick<sup>2</sup>

<sup>1</sup>National Institute for Occupational Safety and Health, Morgantown, West Virginia, U.S.A.

<sup>2</sup>MB Dynamics, Cleveland, Ohio, USA

## Introduction

Vibration exposure at workplaces is generally multi-axial. The health effects of vibration exposure also likely depend on the vibration direction. Therefore, there is a wide interest in the simulation of multi-axial vibration in laboratory experiments. Advances in technology have led to the development of a new 3-D test system for studying hand-transmitted vibration exposure and health effects. The purposes of this paper are to introduce the system and to present the results of its preliminary evaluations.

## Test System

As shown in Figure 1, the system is basically composed of three vibration generators, a multi-axis vibration control system, instrumented handle, handle fixture, and shaker-fixture linkages (stingers).

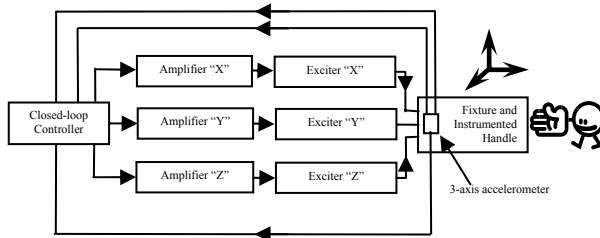

Figure 1: System block diagram

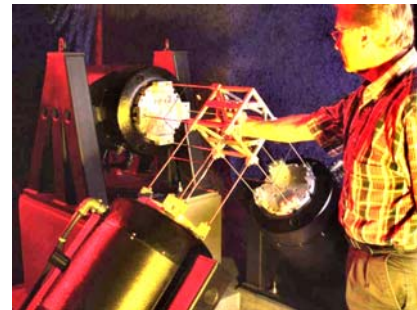

Figure 2: Configuration of the 3-D system

Figure 2 shows the array of three vibration generators (MB Dynamics, Energizer BLACK-500 lbs) and their associated support bases and foundation developed by MB Dynamics (Cleveland, USA), which create the 3-axis simultaneous motion. These electrodynamic exciters are powered by power amplifiers which provide current proportional to the analog drive signal from a controller. The controller (JAGUAR Multi-Input/Multi-Output closed-loop vibration controller) was provided by Spectral Dynamics, San Jose, California, USA). NIOSH-designed instrumented handle was equipped on the system.

## System Evaluation Methods

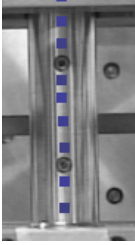

Figure 3:  
Vibration  
Distribution  
measurement

Several preliminary experiments have been performed to examine the characteristics of the system and its performance. A laser vibrometer (Polytec PI, H-300) was used to examine the distribution of sinusoidal acceleration on the handle vibrating at 2g in three directions, as shown in Figure 3a. The system was used to simulate 3-D sinusoidal vibration, a broadband random vibration from 7.5 Hz to 500 Hz, and a cutting saw vibration spectrum.

## Evaluation Results

Figure 4 shows the distribution of the vibration on the handle. The maximum difference of the distribution along the handle longitudinal direction in the frequency range (<500 Hz) of concern was less than 9%.

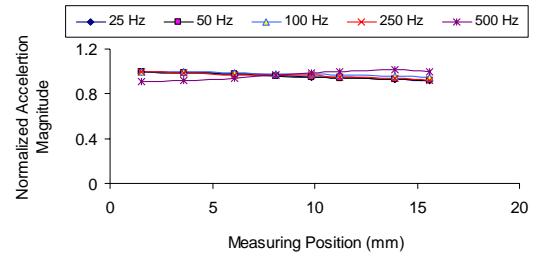
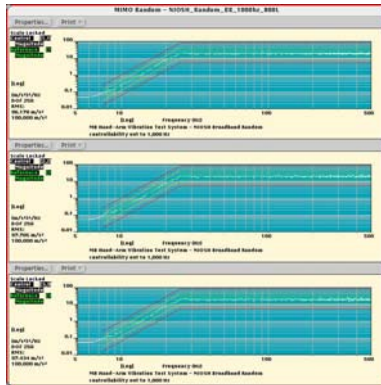

Figure 4: Vibration distribution on the handle

As an example, Figure 5 (a) and (b) display the Control and Drive plots demonstrating full performance. Overall noise levels due to the 10 g's RMS vibration on each axis exceeded 96 dBA in a 52 dBA ambient environment absent the vibration.



(a) Control signal



(b) Drive signal

Figure 5: System performance

## Conclusion

These preliminary results suggest that it is acceptable to use the 3-D test system to simulate the sinusoidal, broadband random, and time-history vibrations.



## **MULTI-AXIS HAND-ARM VIBRATION TESTING & SIMULATION AT THE NATIONAL INSTITUTE OF INDUSTRIAL HEALTH, KAWASAKI, JAPAN**

Setsuo Maeda, National Institute of Industrial Health, Kawasaki, Japan  
Tony Keller, Spectral Dynamics, Inc., San Marcos, California, U.S.A.

### **Introduction**

Hand-Arm Vibration Syndrome (HAVS) was identified as early as 1918 in Bedford, Indiana in the U.S. Since then much research work has been done around the world in the areas of medical, epidemiological, engineering and legal aspects of HAVS. In Japan, much of the pioneering work in this field has been performed by Dr. Setsuo Maeda and his staff at the National Institute of Industrial Health (NIIH) in Kawasaki. Most recently, reports of work done by this group and by Dr. Ren Dong<sup>1</sup> of NIOSH in the U.S., as well as many other suppliers and Japanese practitioners were presented at the 13<sup>th</sup> Japan Group Meeting on Human Response to Vibration held in Osaka<sup>2</sup> during August 3-5, 2005.



**Patient grasping test handle at NIIH, Japan**

The laboratory at NIIH has been at the forefront of much of the testing technology and instrumentation verification involved in the latest HAVS research which is taking place. An example of this is the recently installed 3-axis vibration simulator in the NIIH laboratory. What follows is a brief description of this system and some results obtained to date.

## Methods

Specific methods of measurement and analysis were under development as this abstract was prepared. The presentation may include actual patient response data if it is available at that time.

## Results

Results of simultaneous X, Y, Z controlled excitation, like this example, are given.

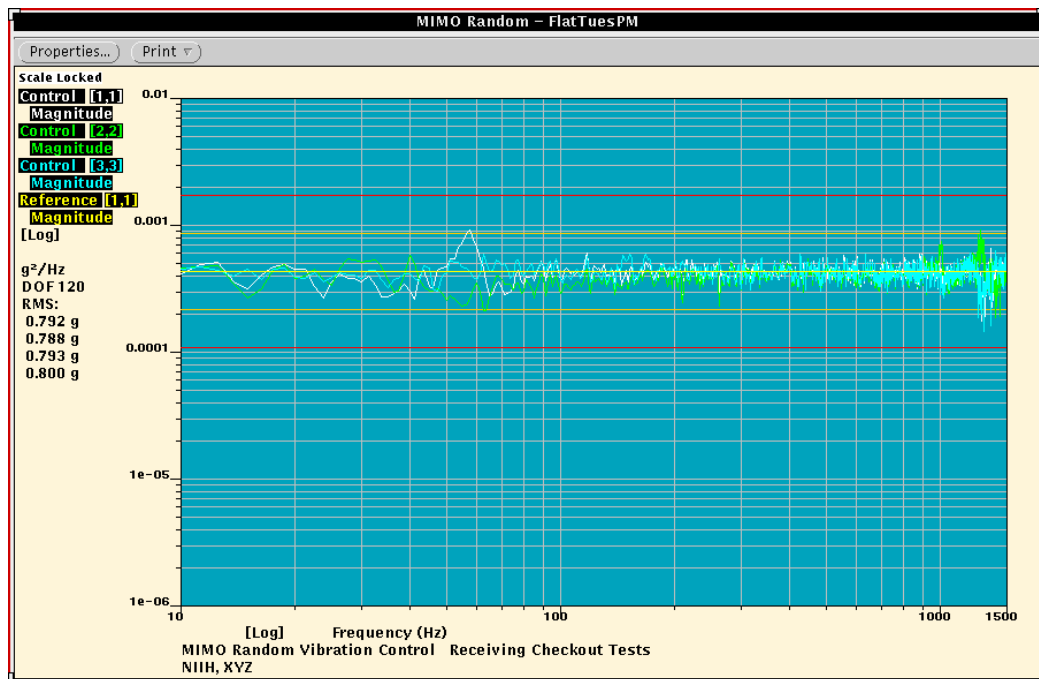

X, Y, Z Responses controlled from 10 to 1,500 Hz

## Discussion

Development is continuing on a modified special handle with embedded Force and Acceleration transducers to understand fully the patient HAVS responses.

## References

1. Maeda, S, and Dong, R.G. (2004). Measurement of hand-transmitted vibration exposure. Proceedings of the 10<sup>th</sup> International Conference on Hand-Arm Vibration, Las Vegas, NV, USA.
2. Keller, T (2005). Some aspects of multi-shaker/multi-axis MIMO. 13<sup>th</sup> Japan Group Meeting on Human Response to Vibration; Osaka, Japan, 3-5 August, 2005 (JGHRV)

# A PILOT STUDY OF THE TRANSMISSIBILITY OF THE RAT TAIL COMPARED TO THAT OF THE HUMAN FINGER

Dan Welcome, Ren G. Dong, Kristine M. Krajnak  
National Institute for Occupational Safety and Health, Morgantown, West Virginia, U.S.A.

## Introduction

Continual occupational exposure to vibrating hand tools can damage the neural, vascular and other soft tissues of the fingers. Rat tail models have been developed to investigate the biological responses of the tissues to vibration.<sup>1-2</sup> However, the biodynamic response of the tail relative to that of the human fingers has not been characterized. The objective of this pilot study was to compare the transmissibilities of rat tails measured via a scanning laser vibrometer to those of human fingers gripping a handle.

## Methods

In Part I of this experiment, four male Sprague Dawley rats (6 weeks old) were exposed to discrete 5g-rms sinusoids of 32, 63, 125, 160, 250, and 500 Hz. The rats were restrained in Broome-style restrainers with their tails constrained without compression to an exposure platform via elastic straps as shown in Figure 1. The platform was attached to a vertically vibrating shaker. The vibration was measured for the array of points shown in Figure 1 using a scanning laser vibrometer (Polytec) and the transmissibility calculated for each point on the tail relative to the reference points on the platform.

In Part II, three male human subjects were exposed at the frequencies specified in Part I - with the addition of 1000 Hz - at a magnitude at the ANSI <0.5-hr limit up to 63 Hz, after which the acceleration was held constant at 5g-rms. The subjects gripped an instrumented handle at 20 N as shown in Figure 2. The transmissibility was calculated relative to the reference points on the handle.

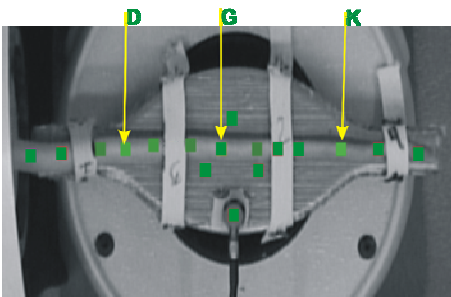

**Fig. 1.** Index points for tail. D is closest to the rat body.

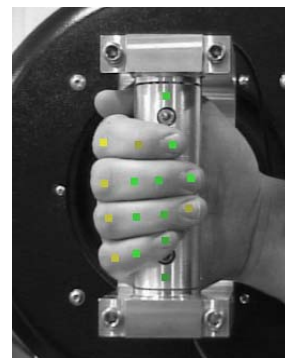

**Fig. 2.** Experimental set-up for Part II.

## Results

Figure 3 shows the transmissibility calculated at the nails of the index, middle and ring fingers of the human subjects. Figure 4 shows a comparison of the transmissibilities of the three most active points on the rat tail with the mean response of all of the tips of the human fingers.

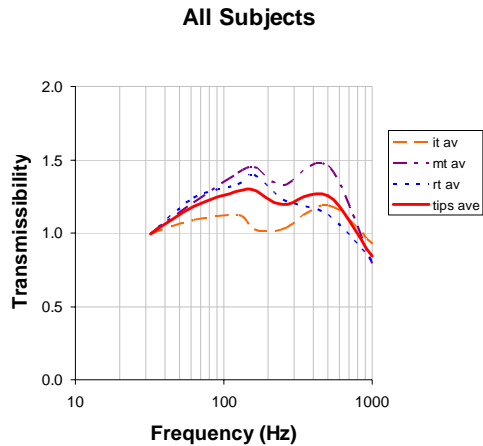

**Fig. 3.** Transmissibility at middle (mt), and index (it) finger nails.

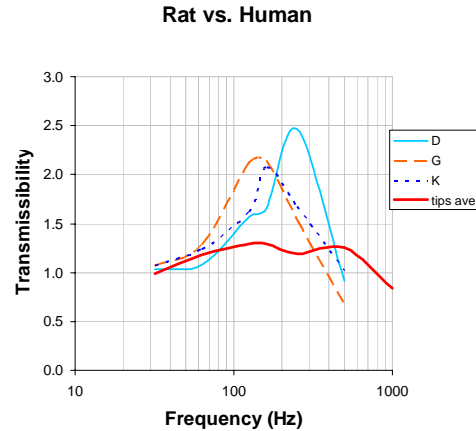

**Fig. 4.** Comparison of frequency ring (rt) responses of the tail model and the average for the finger nails.

## Discussion

As shown in Figure 3, the finger nails tend to show similar frequency responses with comparable first resonances around 125-160 Hz and a second peak at 500 Hz, albeit with varying levels of amplification. The fingers are larger with more mass and damping, while the tail is also stiffer. The rat has considerably higher amplification at all of the most active points. Therefore the rat tail may offer an accelerated model for the investigation of the physiological response to vibration while having similar resonant frequencies to the finger tip.

## References

1. Curry et al. (2002). Vibration injury damages arterial endothelial cells. *Muscle & Nerve* 25, 527-34.
2. Krajnak et al. (In press). Acute vibration increases  $\alpha_{2C}$ -adrenergic smooth muscle constriction and alters thermosensitivity of cutaneous arteries. *J. Appl. Physiol.*

## Podium Presentations

### Session VIII: Vibration Reduction and Machine Testing

Chairs: Jack Wasserman and Alan Mayton

<b>Presenter</b>	<b>Title</b>	<b>Page</b>
S.D. Smith Air Force Research Laboratory Wright-Patterson AFB	Seat cushion and posture effects in military propeller aircraft vibration environments	104
A.M. Dale Washington University School of Medicine	Comparison of anti-vibration interventions for use with fastening tools in metal	106
L. Skogsberg Atlas Copco Tools & Assembly Systems	Vibration control on hand-held industrial power tools	108
M. Persson Atlas Copco Tools & Assembly Systems	Vibration emission measurement methods for grinders	110
R. Kadam Virginia Tech University	Computational simulation of a pneumatic chipping hammer	112
P. Marcotte, Institut de Recherche Robert- Sauvé en Santé et en Sécurité du Travail	Design of a test bench to evaluate the vibration emission values of jackleg rock drills	114

# SEAT CUSHION AND POSTURE EFFECTS IN MILITARY PROPELLER AIRCRAFT VIBRATION ENVIRONMENTS

Suzanne D. Smith<sup>1</sup>, and Jeanne A. Smith<sup>2</sup>

<sup>1</sup>Air Force Research Laboratory, <sup>2</sup>General Dynamics AIS  
Wright-Patterson AFB, Ohio, U.S.A.

## Introduction

Annoyance, fatigue, and musculoskeletal pain have been reported during prolonged exposures to propulsion-generated vibration in military propeller aircraft<sup>1</sup>. The objective of this study was to determine the vibration mitigation properties of selected seat cushions and the effects of occupant seating posture during exposure to higher frequency multi-axis vibration associated with military propeller aircraft.

## Methods

A Navy E-2C Hawkeye crew seat was mounted onto the Six Degree-of-Freedom Motion Simulator (SIXMODE). Six seat pan cushion configurations were tested during exposure to an E-2C vibration signal collected in the field<sup>1</sup>. Seat pan cushions 1 – 5 were used with the original E-2C seat back cushion. Cushion configuration 6 included seat pan cushion 5 with a prototype seat back cushion. Triaxial accelerometer pads were mounted onto the seat pan and seat back cushions to measure the vibration entering the human. Data were collected for seven subjects seated upright with their backs in contact with the seat (back-on) and not in contact with the seat (back-off). Spectral analysis techniques were used to analyze data at the two dominant frequencies associated with the propulsion system (propeller rotation frequency (PRF) ~18.5 Hz, and blade passage frequency (BPF) ~73.5 Hz). Overall accelerations were also calculated between 1 and 80 Hz. Vibration Total Values (VTVs) were calculated using the weighted seat pan and seat back (back-on only) accelerations and compared to the comfort reactions given in ISO 2631-1: 1997<sup>2</sup>.

## Results

In general, the highest accelerations observed at the seat pan occurred in the fore-and-aft (X) direction at both the PRF and the BPF for all cushions and both postures. The most pronounced effect was at the BPF in the X direction, where all configurations showed significantly lower seat pan accelerations than configuration 1 (original E-2C cushion) with the back-on posture. Configuration 5 was the exception with the back-off posture (Fig. 1A, Repeated Measures ANOVA,  $P < 0.05$ ). The most pronounced effect of posture occurred at the PRF in the X direction, where all cushion configurations showed significantly lower seat pan accelerations with the back-off posture (Fig. 1B).

All configurations except configuration 2 showed similar VTVs as compared to Configuration 1 (Fig. 2,  $P < 0.05$ ). Configuration 2 tended to show the lowest weighted acceleration levels. The overall VTVs (back-on only, Fig. 2B) showed significantly higher accelerations as compared to both the back-on and back-off seat pan point VTVs (Figs. 2A &

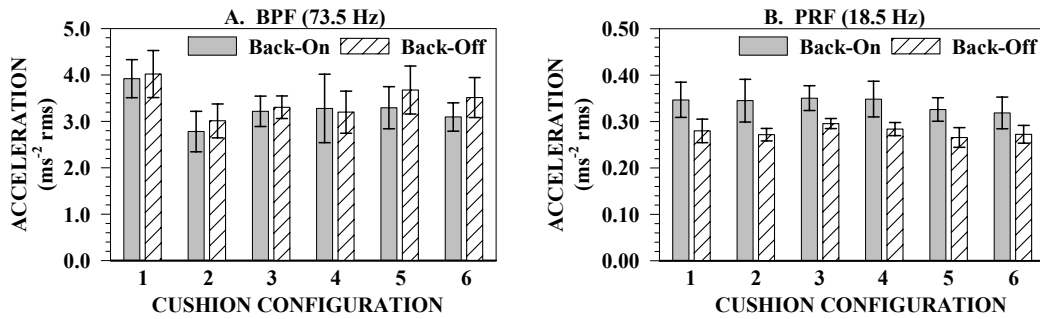

Figure 1 Mean Seat Pan X Accelerations +/- One Standard Deviation at the A. BPF and B. PRF

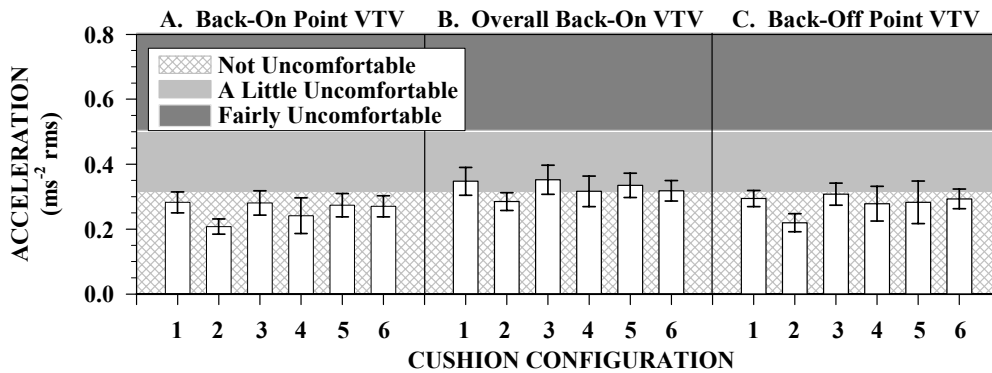

Figure 2 Mean VTVs +/- One Standard Deviation

2C) (Paired t-test,  $P < 0.05$ ). Configurations 3, 4, & 6 showed significantly higher back-off point VTVs (Fig. 2C) as compared to the back-on point VTVs (Fig. 2A). Figures 2B & 2C suggest that, in several instances, vibration would be considered at least “a little uncomfortable.”

## Discussion

The psychophysical effects reflected in the VTVs indicated that the occupants may only perceive a reduction in the vibration with Configuration 2, regardless of the unweighted results. It is noted that the ISO comfort reactions are based on public transport and may not reflect aircrew comfort perception during prolonged exposures. Posture, relative to sitting in contact with the seat back (back-on), does appear to have a significant effect on the vibration. Although not shown, the highest unweighted seat back vibration occurred in the vertical direction, while the highest weighted seat back vibration was estimated to be in the X direction (back-on). These results render it difficult to determine an appropriate strategy for reducing discomfort by mitigating higher frequency vibration through seat cushion design alone. Newer seat designs (active or semi-active vibration isolation systems) may improve seating comfort during prolonged vibration exposures.

## References

1. Smith, S.D. (2006). Seat vibration in military propeller aircraft: characterization, exposure assessment, and mitigation. *Aviation, Space, and Environ. Med.* 77, 32-40.
2. International Organization for Standardization (1997). Mechanical vibration and shock – evaluation of human exposure to whole-body vibration – part 1: general requirements. ISO 2631-1: 1997.

*(Approved for public release; distribution unlimited. AFRL/WS-06-0257 31 Jan 2006)*

# COMPARISON OF ANTI-VIBRATION INTERVENTIONS FOR USE WITH FASTENING TOOLS IN METAL

Dale AM, Standeven J, Evanoff B  
Washington University School of Medicine, St. Louis, Missouri, U.S.A.

## Introduction

Tool manufacturers continue to incorporate new designs to the internal mechanism of tools in order to decrease the vibration that is delivered to the hand during operation. Modification of some tools to minimize tool vibration is not easily resolved through internal tool design. For this reason, vibration damping materials applied between the tool and the hand are a simple alternative. The damping materials may be applied to the area of the tool directly contacted by the operator or in a glove containing a vibration absorbing pad. These interventions are developed specifically to damp vibration but are not necessarily produced and tested under the same work conditions that a company may expose their workers. Therefore, it is important to test the value of the proposed interventions for the specific applications. This study evaluates the effectiveness of anti-vibration interventions currently in use at a local manufacturing company.

## Methods

The design of this study evaluates the vibration energy produced at the tool handle and from the back of the operator's hand. Each operator performed a series of fastener installations in metal using several interventions and one series with no intervention as a control. Four of the interventions were gloves containing anti-vibration material and the fifth intervention was an anti-vibration material wrapped around the tool handle. The protocol for wrapping the tool handle was developed and is part of the equipment procedure at this manufacturing company. Test conditions mimicked production work conditions including similar materials, fasteners and technique for installation. Vibration values were collected using 3 tri-axial accelerometers with one firmly glued to the tool handle close the hand grip as recommended by ISO 5349. A second accelerometer was placed on the top of the pistol shaped tool. The third accelerometer was attached to the back of the hand close to the third knuckle using double sided tape.

## Results

Preliminary results for 3 volunteers show a difference between the vibration values of the control condition (mean hand vibration on bare hand = 1.77 Gs) compared to all of the interventions ( $p=.0001$  using Mixed Procedure, Tests of Fixed Effects).

The graph below shows individual trials for each subject for each condition. Glove 3 with the air bladder insert shows large variability between subjects (Range = 0.84-3.33 Gs). The other interventions show much less variability both within subjects and between subjects indicating consistent response with use of the intervention.



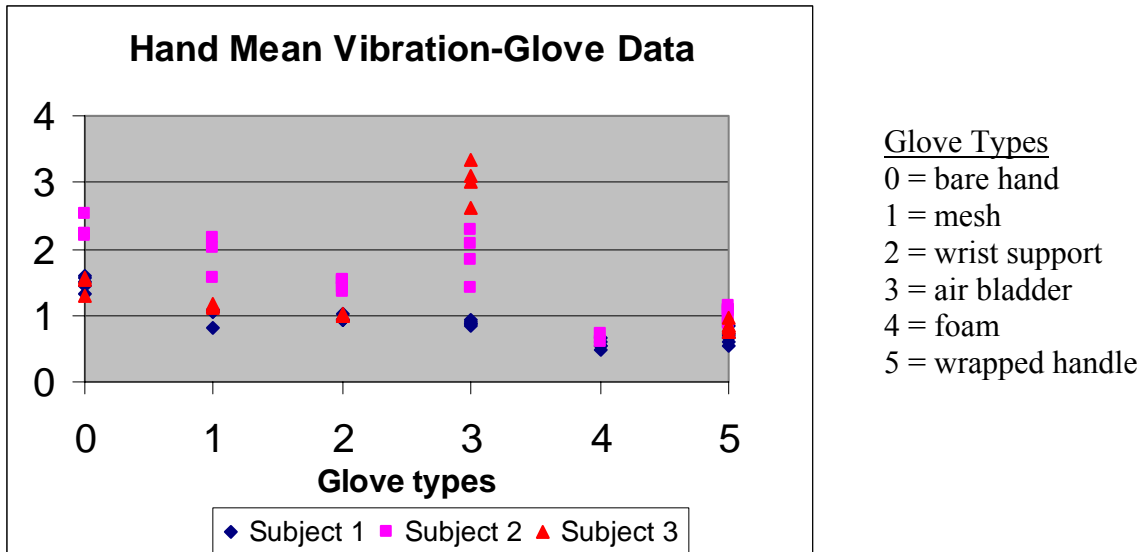

### Discussion

All interventions showed less vibration energy produced at the level of the hand compared to the control condition. Thus providing an interface between the operators hand and vibration source decreased the energy directed to the operator. Three of the gloves produced a beneficial response with minimal variation. Intervention glove 3 containing the air bladder provided less consistent beneficial effects due to the large variability in response. This device requires the operator to manually pump the air bladder to the desired level. The manufacturer recommends pumping the air bladder 50 repetitions prior to the initial use and a few additional pumps each day the glove is used. The amount of air delivered to the glove for this pilot was determined by the personal preference of the subjects and resulted in large variability in vibration output.

Intervention 5 consists of a Viscolas™ material wrapped over a tool handle, and held in place with shrink wrap. The manufacturing company developed this method to provide protection to the workers with a durable wrap that was cosmetically pleasing. The lowered vibration values for the Viscolas™ wrapped handle compared to the control indicates the method of wrapping the handle is protective to the operator.

Since both the gloves and the Viscolas™ wrap on the handle of the tool measured lower vibration values, work conditions and behaviors of the workers should be considered to determine the recommended intervention. Use of gloves to minimize vibration exposures requires the operator's consistent use of the glove during all tool use. Wrapping the handle of a tool to protect a worker from vibration exposures does not depend upon a worker's behavior for effectiveness. Assuming all areas of the tool encountered by the hand are covered with the Viscolas™ material, every time the worker grasps the tool, the hand is protected. Since three of the gloves in the study are fingerless, the anti-vibration material will not protect the exposed skin. Operators cannot manipulate small fasteners with full fingered gloves. Recommendations for anti-vibration materials for use in a work force should consider the work methods and behaviors of the operators. In determining a recommended intervention for a particular manufacturing process, it is important to test the real physical conditions as well as the typical behaviors of the workers.

# VIBRATION CONTROL ON HAND-HELD INDUSTRIAL POWER TOOLS

Lars Skogsberg

Product Ergonomics, Atlas Copco Tools & Assembly Systems, Stockholm, Sweden

## Introduction

Work with hand-held power tools can be found in most industries all over the world. This type of work exposes the operators to different kind of loads like gripping-forces, feed-forces, exposure to vibration and noise, holding hot or cold surfaces and the exposure to dust. Designing a power tool with good ergonomics is a matter of finding the best compromise. As a simple example, increasing the mass is not acceptable because it will increase the forces needed to handle the tool. At the same time increased mass will in most cases reduce the vibrations.

Vibration disorders related to the use of hand-held power tools has been known and reported since long. It is therefore essential that low vibrating tools are developed and used. The new vibration regulations in Europe, based on the Physical Agents (Vibration) Directive, have put increased focus on the vibration control in industry.

### Forces acting on the tool cause vibration

Tools for industrial use must be of very robust design to withstand the very hard use they are exposed to. Industrial tools are therefore normally designed with the main parts made of metal. From a vibration point of view this means that most tools can be regarded as rigid bodies, especially because the dominating frequency normally is equal to the rotational frequency of the tool spindle or the blow frequency for a percussive tool. These frequencies are with few exceptions below 200 Hz. Handles however can not always be regarded as rigidly connected to the tool. There are several examples of weak suspensions designed to reduce vibration transmitted to the hands of the operator. There are also examples of designs where the handles just happened to be non-rigidly connected and in some cases even in resonance within the frequency region of interest. Oscillating forces act on the tool and the result is vibration.

### Design principals

In all cases forces are the source of vibration. This leads to the three basic principles to control vibration:

- **Control the magnitude of the vibrating forces.** Examples are the balancing unit on a grinder or the differential piston in a chipping hammer.
- **Make the tool less sensitive to the vibrating forces.** Examples can be when the mass of the guard on a grinder is rigidly connected to the tool to increase the inertia of the tool.
- **Isolate the vibrations in the tool from the grip surfaces.** Examples are vibration-dampening handles on grinders or pavement breakers, the air-spring behind the blow-mechanism in a riveting hammer or the mass spring system in a chipping hammer.

### **Control the magnitude of the vibrating forces**

For rotating machinery the balance of the rotating parts is essential. The inserted tools that will be mounted on the tool spindle often give major contribution to the unbalance of the rotating parts. This is a problem because the tool manufacturer has no control over the inserted tools. The only thing that can be done is to design flanges and guides to fine tolerances as close as possible to the tolerance interval for the inserted tool.

Limiting the power of the tool will in most cases also reduce vibration but that is not a possible route because lower power leads to increased usage-time to get the job done and that would negatively affect the daily exposure.

### **Make the tool less sensitive to the vibrating forces**

A tool will be less sensitive to oscillating forces when mass and or inertia is increased. To increase mass can be questioned from an ergonomic perspective. In some cases when a small increase in mass give a big increase in inertia it might still be a good solution. The tool can be regarded as a rigid body suspended in weak springs. Therefore it will move around its centre of rotation. The perpendicular distance between the forces acting and the centre of rotation will determine how the pattern of movement will be. By altering this distance the movement of the tool can be controlled.

### **Isolate the vibration in the tool body from the grip surfaces**

To isolate the handles from the vibration in the tool body is the most common thing to do. Modern chain saws and breakers are examples where this principal have been successfully applied. The mass spring system must be designed to have the excitation frequency from the vibration well above the systems resonance. This requires a certain mass in the handles or the spring need to be very soft. A correlated problem is when mass is moved from the body of the tool to the handles. The reduced mass will make the tool-body more sensitive to the vibrating forces and the vibration amplitude in the body will increase.

## **Summary**

An industrial powertool can in most cases be regarded as a rigid body. The handles are not always part of this rigid body.

- Forces acting on this rigid body are the source of vibration. The forces are either forces from the process or process independent e.g. unbalances in rotating parts.
- There are three basic principals for vibration control. Control the magnitude of the vibrating forces. Make the tool less sensitive to the forces. Isolate the vibration in the tool body from the grip surfaces.
- All three principals are used in vibration control on power tools either one by one or combined on the same tool.

# VIBRATION EMISSION MEASUREMENT METHODS FOR GRINDERS

Magnus Persson  
Atlas Copco Tools & Assembly Systems, Stockholm, Sweden

## Introduction

ISO8662-4, “Hand-held portable power tools - Measurement of vibrations at the handle - Part 4: Grinders” is under revision. The new revision shall harmonize ISO 20643 “Mechanical vibration - Hand-held and hand-guided machinery - Principles for evaluation of vibration emission” which, among others, requires measurements in three directions and declared values related to the upper quartile of real-use vibration.

To get the most suitable test method, a round robin test was made for evaluation of the two test methods proposed by the ad-hoc group working with this standard revision.

## Methods

Seven laboratories measured the vibration from four grinders of different sizes, with and without autobalancing units. The laboratories come from universities, health & safety laboratories and grinder manufacturers.

Two measurement methods are evaluated with respect to repeatability and reproducibility:

1. Grinding on a well-defined mild steel bar with depressed center wheels according to detailed test instructions. The test sequence starts and ends with 10 seconds of running the grinder in the air, when measuring the unbalance contribution to the vibration coming from the unbalance of the grinding wheel. Between these runs the average vibration during 60 seconds of grinding is measured. Three operators do five grinding tests per grinder.
2. Measurements using an aluminum unbalance disc similar to the one defined in ISO8662-4. Each operator runs the grinder four times, between each run the unbalance is moved 180 degrees to avoid variations caused by the play between the test wheel and the spindle. The averaging time is 10 seconds. Each grinder is tested by three operators.

Repeatability is the spread within a lab between operators and over short time period for one machine and reproducibility is the spread between laboratories and over longer time periods for one machine. Instrumentation and transducer location are chosen according to ISO8662-4 and circulated test instructions.

## Results

Both the repeatability and reproducibility is poor for the real grinding test, see figure 1. The coefficient of variation for repeatability is approximately 40% higher for the grinding test and the coefficient of reproducibility is 60% higher for the grinding test than for the unbalance disc test.

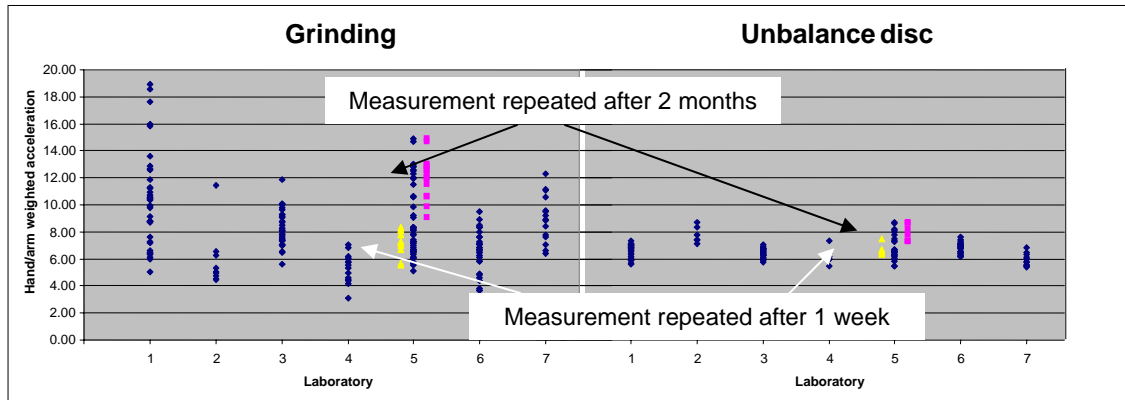

**Figure 1. Example of result from grinding test and unbalance disc test. The grinding test shows a larger spread between test runs, operators, and laboratories and over time.**

The unbalance disc test gives vibration values corresponding to the upper quartile of the real grinding test for grinders without autobalancing units. This is one requirement in the revised vibration measurement standard. Grinders with autobalancing unit gives lower values for the unbalance disc test, therefore they require additional grinding tests to fulfill this requirement.

### Discussion

Unbalance disc test is proven to be the most accurate method for measuring vibrations from grinders, with one exception; grinders with autobalancing units. The result from this study also shows that it is extremely time consuming to get reliable field vibration measurements on grinders. The result is varying depending on many factors that are difficult to control; feed force, grinding wheel quality, work piece etc. The unbalance disc test gives values with good repeatability and reproducibility which well correspond to the upper quartile of the vast amount of grinding measurements made in this study. Thus, it is recommended to use the declared value according to ISO 8662-4 when assessing the vibration emission from grinders instead of doing field measurements. When using emission values from manufacturers, it is important to verify that the value is measured according to appropriate ISO-standard.

### References

1. ISO 8662-4 1994(F). *“Hand-held portable power tools – Measurements of vibrations at the handle – Part 4: Grinders.* ISO.
2. ISO 20643 2005(E). *“Mechanical vibration – Hand-held and hand-guided machinery – Principles for evaluation of vibration emission”.* ISO.
3. Smeatham D (2003). *Supporting research for the ad hoc working group for ISO 8662-4, Grinders.* NV/03/01, HSL, UK

# COMPUTATIONAL SIMULATION OF A PNEUMATIC CHIPPING HAMMER

Rahul Kadam, Kyle Schwartz, Marty Johnson, Ricardo Burdisso  
 Vibration and Acoustics Labs, Virginia Tech, Blacksburg, Virginia, U.S.A.

## Introduction

Occupational exposure to hand transmitted vibration (HTV) arises from the hand held powered tools extensively used in the mining and construction industry such as rock drills, chipping hammers, chain saws etc. Regular exposure to HTV is the major cause of a range of permanent injuries to human hands and arms which are commonly referred to as hand-arm vibration syndrome (HAVS). In addition to this, the percussive tools generate overall sound power levels in excess of 110dBA in most cases. Such a high sound power level greatly exceeds the maximum permissible exposure limit (PEL) of organizations such as National Institute for Occupational Safety and Health (NIOSH) and the Occupational Safety and Health Administration (OSHA). Long term occupational exposure to this noise has been diagnosed as the main reason for permanent hearing loss in the operators. It is therefore important to develop an understanding of the mechanisms which lead to these high vibration and sound levels and in order to do this a detailed computational model of a pneumatic chipping hammer has been made.

This paper presents a nonlinear computational model of a pneumatic chipping hammer. In order to better understand the dynamics of the chipping hammer, the hammer was subdivided into components that are shown in figure 1 (a) (based on a chipping hammer manufactured by Atlas-Copco). The hammer mainly consisted of a center body, a moving piston and a chisel. Compressed air is used to drive the piston inside of a cylinder and on the downward stroke this piston impacts the chisel to create the hammer effect. The machine has one pneumatic valve and this valve regulates the air supply either to the upper chamber or to the lower chamber. The valve changes according to the relative pressures in the two chambers and the supply pressure. There are also twelve different exhaust ports at two positions along the cylinder labeled upper ports and lower ports. As the piston moves the ports can be closed or open (allowing exhaust).

Fundamentally, the computational model was made up of two different sub-models, a

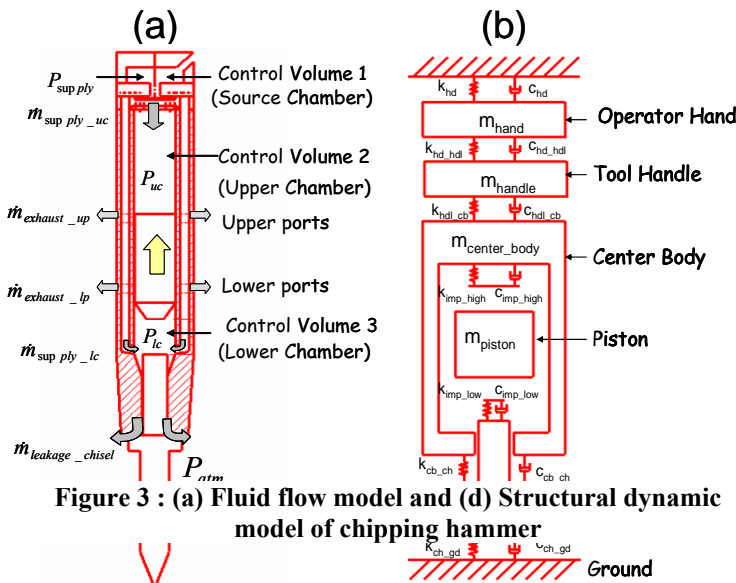

Figure 3 : (a) Fluid flow model and (b) Structural dynamic model of chipping hammer

fluid model and a structural dynamic model as shown in Figure 3 (a) and (b) respectively. The first sub-model takes into consideration the fluid dynamics of the machine since the hammer is driven by compressed air. Equations for the mass flow rate through bleed orifices (assuming an isentropic process)<sup>1</sup> is used to determine the mass flow into and out of the upper and lower chambers. From this the pressures in the two chambers and consequently the forcing on the piston can be calculated. The second sub-model deals with modeling the structural

components of the chipping hammer. The structural model consists of various lumped masses<sup>2</sup>, each representing a specific component of the chipping hammer as well as the ground and operator's hand. The impact dynamics were also incorporated by connecting the piston and the chisel with a non-linear spring. The fluid flow and structural models were then coupled together using a time domain, state space formulation to compute the displacements of each component, the pressures in the chambers, the impact forces and the jet velocities from the exhaust ports. The computational model was then validated using experimental obtained vibration levels and exhaust velocities.

## Results

Figure 4 (a) and (b) show the experimental and computational exhaust velocities from the upper and lower exhaust ports respectively. There is a very good match between the exhaust jet velocities measured during lab tests and the exhaust jet velocities calculated from the computational model. Also the tool impact frequency measured from lab tests is approximately 27 Hz which is very close to the tool impact frequency calculated from the computational model (32Hz). Keeping in mind the nonlinear nature of the fluid flow model, these can be considered as good results. However, further refinement of the fluid flow model will be continued in the near future. The structural dynamic response of the computational model will be discussed at the time of presentation.

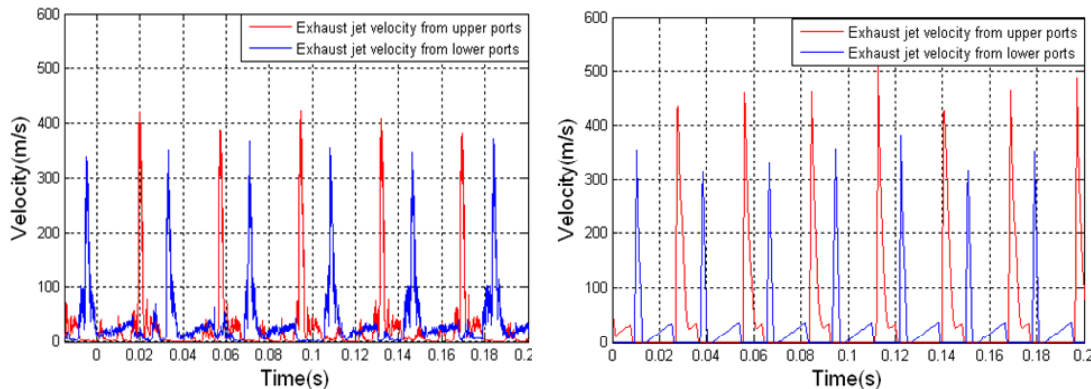

**Figure 4 : Exhaust jet velocities (a) experimental results, (b) computational results**

This model provides a unique opportunity to evaluate different vibration and noise control techniques and consequently to help determine the best possible control method. The model would avoid the need for extensive laboratory testing which is time consuming as well as expensive.

## References

1. Y T Wang, R Singh, H C Yu, D A Guenther, "Computer Simulation of a Shock-Absorbing Pneumatic Cylinder", *Journal of Sound and Vibration* (1984) 93(3), 353-364
2. E. V. Golycheva, V. I. Babitsky and A. M. Vepruk, "Dynamic Correction of in Handheld Electro-Pneumatic Percussion Machines", *Journal of Sound and Vibration* (2003) 259(4), 829-843

# DESIGN OF A TEST BENCH TO EVALUATE THE VIBRATION EMISSION VALUES OF JACKLEG ROCK DRILLS

Pierre Marcotte<sup>1</sup>, Sylvain Ouellette<sup>2</sup>, Jérôme Boutin<sup>1</sup>, Paul-Émile Boileau<sup>1</sup>, Gilles Leblanc<sup>2</sup>, and Rémy Oddo<sup>3</sup>

<sup>1</sup>Institut de recherche Robert-Sauvé en santé et en sécurité du travail, Montréal, Canada

<sup>2</sup>CANMET Mining and Mineral Sciences Laboratories, Val-d'Or, Canada

<sup>3</sup>Groupe d'Acoustique de l'Université de Sherbrooke, Sherbrooke, Canada

## Introduction

Jackleg rock drills are widely used in the mining industry and are known to generate high levels of hand-arm vibration which contribute to the development of the hand-arm vibration syndrome for exposed miners.<sup>1-3</sup> To reduce the vibration levels, a prototype of an antivibration handle was developed as part of a previous study.<sup>4</sup> To provide some bench marking for this handle prototype and to follow the evolution of its performance over time, a test bench was developed to characterize the vibration emission values of jackleg drills under controlled operating conditions. As the current ISO 8662 series of standards could not apply directly to this type of tool, there was a need to design and validate a test bench to evaluate the vibration emission values of jackleg drills, while taking into account the conditions specific to the operation of this type of tool.

## Methods

A test bench including an energy absorber, was developed for testing jackleg drills based on the ISO 8662-3 standard<sup>5</sup>. The energy absorber was bolted to a 3300 kg concrete block to ensure tool stability. A pictorial view of the device is given in Figure 1. For validation purposes, acceleration measurements at the handle of a conventional jackleg drill were taken simultaneously along the three axes ( $x_h$ ,  $y_h$  and  $z_h$ ) in an underground rock drilling operation as well as on the test bench. The handle accelerations were measured for three different jackleg angles ( $13^\circ$ ,  $28^\circ$  and  $43^\circ$ ) determined with respect to the floor. Moreover, each measurement was repeated at least three times to assess the data repeatability.



Figure 5. Jackleg drill (right) with the energy absorber (left)

## Results

As a preliminary validation of the test bench, Figure 2 provides a comparison of the frequency weighted rms acceleration spectrum measured along the  $z_h$ -axis, for both underground drilling and operation on the test bench ( $28^\circ$  jackleg angle in both cases). It is shown that the vibration measured on the handle of a jackleg drill operating on the test bench is representative of that recorded during typical rock drilling operations, despite the fact that some harmonics of the percussion frequencies are generated with a higher amplitude on the test bench. Table 1 provides



a comparison of the overall frequency-weighted rms accelerations measured for all three jackleg angles. It is shown that the test bench provides comparable values of overall acceleration for all three axes, with much lower variation coefficients (COV) on the test bench, suggesting a higher measurement repeatability. In addition, it was verified that the measurements obtained on the test bench were reproducible, by ensuring that similar frequency-weighted rms accelerations could be obtained after completely reinstalling the jackleg drill on the test bench.

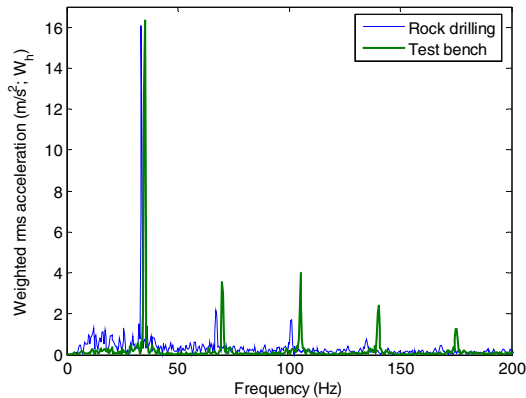

Figure 2. Comparison of vibration frequency spectrum measured on the test bench and while drilling ( $z_h$  percussion axis)

Table 1. Comparison of frequency weighted rms accelerations measured for three different jackleg angles on the test bench and while drilling.

$m/s^2 (w_h)$   
COV (%)

		x axis	y axis	z axis	Total
13 deg	Bench	10.66 0.84	5.33 5.33	20.72 1.72	23.90 1.41
	Drilling	12.80 44.19	6.18 2.21	24.30 3.52	28.41 11.69
28 deg	Bench	9.51 1.98	5.15 2.03	19.90 0.79	22.65 0.73
	Drilling	9.64 8.96	6.18 29.70	22.70 13.13	25.44 13.33
43 deg	Bench	11.46 1.32	5.52 0.54	18.74 0.48	22.65 0.60
	Drilling	8.78 11.62	4.92 7.27	19.73 6.73	22.16 7.35

## Discussion

The validation of a test bench to characterize the vibration emission values of jackleg rock drills has been presented. Preliminary results have shown that the test bench provides a good representation of the vibration measured during rock drilling operations, while providing a better repeatability of the acceleration values. Thus the test bench appears to be applicable to characterize the vibration emission values of jackleg drills.

## Acknowledgements

The authors wish to acknowledge the financial support provided by SOREDEM .

## References

1. Lindstrom, I.M. (1977). Vibration injury in rock drillers, chisellers and grinders. Proceeding of the international occupational hand-arm conference, Cincinnati, DHHS (NIOSH), publication No. 77-170, 77-84.
2. Iwata, H. (1968). Effects of rock drills on operators. Part 2. Survey and examination on Raynaud's phenomenon. *Industrial Health* 6, 37-47.
3. Pelmeur, P.L., Roos, J., Leong, D. and Wong, L. (1987). Cold provocation test results from a 1985 survey of hard-rock miners in Ontario. *Scandinavian Journal of Work, Environment & Health* 13, 343-347.
4. Oddo, R., Loyau, T., Boileau, P.E. and Champoux, Y. (2004). Design of a suspended handle to attenuate rock drill hand-arm vibration: model development and validation. *Journal of Sound and Vibration* 275, 623-640.
5. International Organization for Standardization (1992). Hand-held portable power tools – Measurement of vibrations at the handle – Part 3: Rock drills and rotary hammers. International Standard, ISO 8662-3.

## Podium Presentations

### Session IX: Epidemiology, Standards Applications, and Prevention II

Chairs: David Wilder and Kristine Krajnak

<b>Presenter</b>	<b>Title</b>	<b>Page</b>
U. Kaulbars BG Institute for Occupational Safety (BGIA)	Risk assessment of hand-arm vibration by estimate, taking the example of hand-guided stone-working machines	117
T. Eger Laurentian University	Whole-body vibration exposure and driver posture evaluation during the operation of LHD vehicles in underground mining	119
R. Larson Exponent, Inc.	Measurement and evaluation of vibration exposure for locomotive crew members	121
J. Wasserman University of Tennessee	Environmental effects on truck driver ISO 2631 acceleration exposure	123
M.S. Contratto Caterpillar, Inc.	Evaluation of the capability of seat suspension to reduce the operator exposure to vibration in track type tractors	125
N.K. Kittusamy NIOSH	Musculoskeletal symptoms among operators of heavy mobile equipment	127

# **RISK ASSESSMENT OF HAND-ARM VIBRATION BY ESTIMATE, TAKING THE EXAMPLE OF HAND-GUIDED STONE-WORKING MACHINES**

Uwe Kaulbars  
BG Institute for Occupational Safety (BGIA), Sankt Augustin, Germany

## **Introduction**

Vibration measurements at the workplace are often complicated and expensive. The assessment of the risk in conformity with EC Directive 2002/44/EC “Vibration” (which lays down the minimum requirements of laws in Europe for occupational safety and health) can therefore be carried out on the basis of an estimate based on information from manufacturers as well as by measurement conforming to ISO 5349.

The characteristic values (emission values) determined by manufacturers in laboratory conditions may deviate from the exposure values measured at source at the workplace. Equally, deviations may arise as a result of the delay in the changeover of test methods from the single axis of measurement to the total vibration value for the three axes of measurement conforming to ISO 20643.

To prevent faulty estimates, the manufacturer’s information has to be corrected by a tool-related factor in accordance with CEN/TR 15350. By taking the example of masonry and stone working machines, the empirically determined tool-related correction factor is checked and confirmed.

## **Methods**

Vibration measurements were carried out in accordance with ISO 5349 in practical application conditions on 10 selected typical eccentric and orbital sanders, concrete and disc grinders as well as on wall chasers and stone saws.

## **Results**

The total vibration value obtained for the investigated tools ranged from  $a_{hv} = 3.6 \text{ m/s}^2$  to  $a_{hv} = 11.6 \text{ m/s}^2$ . When the values from the practical measurements are compared with the manufacturer’s vibration values, the underestimation of the risk occurring in some cases can be largely compensated for by the tool-related factors conforming to CEN/TR 15350 (see Figure 1).

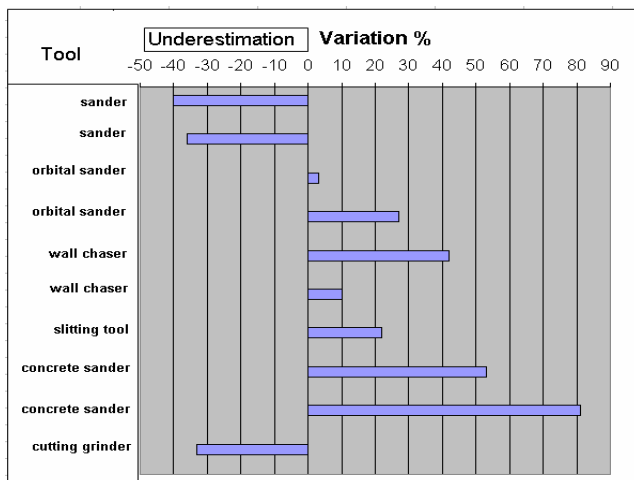

Figure 1.  
Variation of the estimated vibration values from the values obtained in practice after correction.

### Discussion

The risk assessment can be carried out on the basis of an estimate based on information from manufacturers. The procedure is presented with reference to examples. In three of the ten investigated cases, there was slight underestimation after correction. However, these variations lie within the accuracy range achievable with workplace measurements.

### References

1. CEN/TR 15350 - Mechanical vibration – Guideline for the assessment of exposure to hand-transmitted vibration using available information including that provided by manufacturers of machinery (in preparation)
2. ISO20643, Publication date: 2005-02 Mechanical vibration - Hand-held and hand-guided machinery - Principles for evaluation of vibration emission
3. ISO 5349-1, Publication date: 2001-05 Mechanical vibration - Measurement and evaluation of human exposure to hand-transmitted vibration - - Part 1: General requirements- Part 2: Practical guidance for measurement in the workplace
4. DIRECTIVE 2002/44/EC OF THE EUROPEAN PARLIAMENT AND OF THE COUNCIL of 25 June 2002 on the minimum health and safety requirements regarding the exposure of workers to the risks arising from physical agents (vibration) (sixteenth individual Directive within the meaning of Article 16(1) of Directive 89/391/EEC) Official Journal of the European Communities No. L 177/13 6.7.2002

# WHOLE-BODY VIBRATION EXPOSURE AND DRIVER POSTURE EVALUATION DURING THE OPERATION OF LHD VEHICLES IN UNDERGROUND MINING

T. Eger<sup>1</sup>, J. Stevenson<sup>2</sup>, S. Grenier<sup>1</sup>, P.-É. Boileau<sup>3</sup>, M. Smets<sup>1</sup>, and VibRG<sup>4</sup>

<sup>1</sup>School of Human Kinetics, Laurentian University, Sudbury, ON, Canada

<sup>2</sup>School of Physical and Health Education, Queen's University, Kingston, ON, Canada

<sup>3</sup>IRSST, 505 De Maisonneuve West, Montréal, QC, Canada

<sup>4</sup>Vibration Research Group (Laurentian University, IRSST, Queen's University, University of Western Ontario, MASHA and CSAO)

## Introduction

Load-haul dump vehicles (LHDs) are used to move waste rock and ore in underground mining operations. The LHD is designed for bi-directional operation and the driver sits sideways to the direction of travel. LHD operators have higher reports of low back pain and neck discomfort than other mobile equipment operators who do not sit sideways in the vehicle, but are exposed to whole-body vibration (WBV)<sup>1</sup>.

Exposure to WBV is linked with reports of lower-back pain, neck problems and spinal degeneration<sup>2,3</sup>. Static sitting postures, sitting with the neck and back twisted, and sitting with the back in an unsupported posture are also linked with an increased risk of developing back pain<sup>4</sup>. The objective of this study was to determine typical vibration exposure levels and driving postures for LHD operators.

## Methods

Whole-body vibration exposure was measured at the seat-pan, in accordance with the ISO 2631-1 standard<sup>5</sup>, on seven LHD vehicles with a 10 yard bucket haulage capacity. Vibration data were recorded with a Biometrics™ DataLog II (P3X8) and stored on a 128 Mb Simpletech™ multimedia card. Comparisons were made to the ISO 2631-1 Health Guidance Caution Zone (HGCZ) in order to determine potential injury risk.

Operator posture was monitored with three digital video cameras which were secured inside each operator's cab to the top left corner, top right corner and back right corner. Reflective tape was placed on each driver's shoulders, head, and back in several locations and in several locations on the vehicle seat in order to aid in posture coding. Posture coding was performed with 3DMatch v4.50 multiple video view analysis feature. Vibration measurement and posture recording occurred simultaneously for 60 minutes while the LHD operator performed typical duties.

## Results and Discussion

Results indicate LHD operators may be exposed to whole-body vibration levels putting them at risk for injury (Table 1). According to ISO 2631-1 the frequency weighted acceleration values corresponding to the lower and upper limits of the HGCZ (for an 8 hr exposure duration) are 0.45 and 0.90 m/s<sup>2</sup> respectively<sup>5</sup>. Six of the seven vehicles showed exposure levels within the HGCZ defined for 8 hours.

Preliminary video analysis indicated LHD operators were exposed to potentially harmful levels of WBV while adopting asymmetric postures (Table 2). For example, one LHD operator (Figure 1) worked with his neck twisted greater than 40 degrees for 93 % of a 60 minute work cycle. According to the Swedish National Work Injury Criteria, neck rotation should be less than 15 degrees if the motion is required for greater than 80% of the work time<sup>6</sup>. Results of this study highlight the need to further examine the contribution of non-neutral working postures and

WBV exposure in or above the ISO 2631-1 HGCZ given the development of higher than average levels of low back and neck injuries amongst LHD operators.

Table 1: Summary of frequency weighted acceleration (multiplying factor k for health evaluation applied) and the equivalent 8h frequency weighted acceleration (vibration cycle of 7 hours within an 8 hour work day) values for typical underground LHD operation. The axis associated with the dominant value is shown in bold.

Mine & Model	Duration (min.)	$aw_x$ (m/s <sup>2</sup> )	$aw_y$ (m/s <sup>2</sup> )	$aw_z$ (m/s <sup>2</sup> )	$a_v$ (m/s <sup>2</sup> )	$a_8$ (m/s <sup>2</sup> )
1 -B	68	0.51	0.45	<b>0.69</b>	1.18	0.60
1 -A (1)	70	0.70	0.47	<b>0.81</b>	1.44	0.70
1 -A (2)	78	0.68	0.51	<b>1.01</b>	1.56	0.83
2 -F	124	<b>0.67</b>	0.45	0.63	1.30	0.41
2 -C	117	0.69	0.58	<b>1.12</b>	1.68	0.75
3 -C	66	0.65	0.56	<b>0.78</b>	1.43	0.69
3 -H	70	<b>0.61</b>	0.56	0.56	1.29	0.49

Table 2: Postures adopted along with the percentage of time spent in each posture during a 60 minute monitoring duration, for a typical LHD operator.

Posture Adopted	% time adopted
Neutral neck rotation (< 15 degrees of rotation)	3
Mild neck rotation (15 - 40 degrees of rotation)	4
Severe neck rotation (>40 degrees of rotation)	93
Neutral trunk rotation (< 15 degrees of rotation)	97
Mild trunk rotation (15 – 30 degrees of rotation)	3
Severe trunk rotation (> 30 degrees of rotation)	0
Neutral trunk flexion (< 15 degrees of flexion)	93
Mild trunk flexion (15-30 degrees of flexion)	7
Severe trunk flexion (>30 degrees of flexion)	0
Neutral trunk lateral bend (< 15 degrees of bend)	86
Moderate trunk lateral bend (15–30 degrees of bend)	14
Severe trunk lateral bend (> 30 degrees of bend)	0



Figure1. Typical posture adopted by LHD drivers.

### Acknowledgment

Funding for this research was provided by the Workplace Safety and Insurance Board of Ontario with support from the Mines and Aggregates Safety and Health Association of Ontario and the Ontario Mining Industry.

### References

1. Mines and Aggregates Safety and Health Association (2004). Mobile Equipment Operator Injury Statistics (1997-2002). North Bay, ON, CND.
2. Thalheimer, E. (1996). Practical approach to measurement and evaluation of exposure to whole-body vibration in the workplace. *Seminars in Perinatology*, 20(1), 77-89.
3. Scutter, S., Turker, K., & Hall, R. (1997). Headaches and neck pain in farmers. *Australian Journal of Rural Health*, 5(1), 2-5.
4. Reid-Bush, T. & Hubbard, R. (2000). Biomechanical design and evaluation of truck seats. *Society of automotive engineers* (200-01-3406) pp 37-43.
5. International Standard ISO 2631-1 (1997). Mechanical vibration and shock-Evaluation of human exposure to whole-body vibration-Part 1: General requirements.
6. Eklund, J., Odenrick, P., & Zettergen, S., (1994). Head posture measurements among work vehicle drivers and implications for work and workplace design, *Ergonomics*, 37(4), 623-639.

# MEASUREMENT AND EVALUATION OF VIBRATION EXPOSURE FOR LOCOMOTIVE CREW MEMBERS

Robert Larson, Christine Raasch, Janine Pierce  
Exponent, Inc.

## Introduction

The vibration and impact environment for crew members on locomotives has been investigated in a series of studies conducted by Exponent Failure Analysis Associates (Exponent) beginning in 1990. Locomotive cab vibration and impact levels were measured on a variety of locomotive models operating over many different track sections across the Union Pacific, Burlington Northern Santa Fe, CSX, Norfolk Southern, and CONRAIL systems. The comfort and health implications of exposure to the measured locomotive vibration levels were evaluated by comparison with the human vibration exposure boundaries given in the International Standards Organization (ISO) standard 2631-1:1997, the British Standard 6841:1987, European Union (EU) Directive 2002/44/EC, measurements made by Exponent on various commercial and recreational vehicles, and vibration exposure measurement data found in the literature.

## Methods

Initially, vibration levels experienced by locomotive crews were measured and recorded at incremental speeds covering the range of normal train operation. In 2003, a method of measuring the vibration exposure continuously by means of a digital recorder was developed, allowing the vibration level over the entire run or crew shift to be analyzed. For each seating location measured, acceleration was recorded on the seat surface beneath the ischial tuberosities (pelvis) of the seated crew member and on the cab floor directly under the seat. At each of the locations, triaxial accelerometers were used to measure the vibration along the longitudinal, lateral, and vertical axes. Since the vibration environment varies throughout the route, and locomotive vibration levels have been found to be primarily speed dependent, a speed sensor was used to continuously measure the speed of the train.

To evaluate the recorded vibrations levels, the data was divided into two-minute segments, which were each processed per the 1997 ISO standard for weighted RMS vibration levels and Vibration Dose Values (VDV). Additionally, PSDs and 1/3 Octave RMS values were calculated to determine the frequency content of the vibration. For each two-minute segment, the average speed of the locomotive was calculated to allow for correlation with the recorded vibration exposure values. The resulting exposure values for the entire run were calculated by combining the data from all of the two-minute segments.

Since introducing the continuous method of recording acceleration, 23 seating locations have been recorded on 11 locomotives traveling 11 different routes across various parts of the United States. One of the routes was a shift of 'yard work', traveling back and forth in a rail yard coupling train cars together.

## Results

A guide to interpreting weighted acceleration values with respect to health is given in Annex B of the 1997 ISO standard. A health guidance caution zone is defined to indicate the

level of vibration where a health risk could exist. The figure below shows the caution zone from the ISO standard as the area between the dashed lines. The dotted lines represents an alternative caution zone, also defined in the 1997 ISO standard, that is based on an estimated Vibration Dose Value (eVDV) and a health guidance caution zone range of 8.5 to 17  $\text{m/s}^{1.75}$ . Also shown are the data points representing the exposure levels for all 23 measurements in all three directions. In all cases, the weighted rms accelerations measured were below both caution zones defined in ISO 2631.

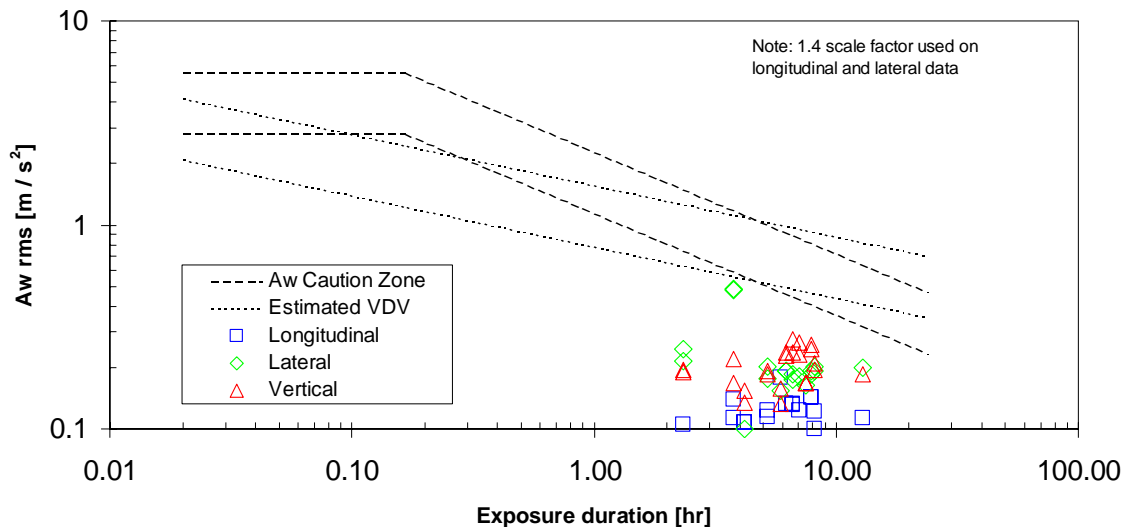

To put the locomotive vibration exposure level in perspective, the results were compared to the levels measured on heavy trucks, light and medium duty trucks, a van and a motorcycle. The locomotive vibration levels were also compared to levels reported for various vehicles found in the literature. The vibration environment on locomotives was found to be comparable to commercial on-road vehicles and below many commercial off-road vehicles and recreational vehicles.

To evaluate the effect of transient vibration and shock, a VDV was calculated for all of the measurements. The VDV's calculated for locomotive crew members averaged  $4.6 \text{ m}\cdot\text{s}^{-1.75}$  with the highest value at  $6.1 \text{ m}\cdot\text{s}^{-1.75}$ . These values are well below the action level of  $15 \text{ m}\cdot\text{s}^{-1.75}$  defined in the British Standard (BS 6841:1987), the EU Directive 'action value' of  $9.1 \text{ m}\cdot\text{s}^{-1.75}$ , and the EU 'exposure limit' of  $21 \text{ m}\cdot\text{s}^{-1.75}$ .

## Discussion

The vibration exposure experienced during locomotive operation was found to be consistently below the health guidance caution zones defined in the ISO whole body vibration exposure standard. The Vibration Dose Value measure of vibration exposure, which is an additional measure that is more sensitive to occasional shocks, was found to be less than the action levels of the British Standard and the EU Directive.



## **Environmental Effects on Truck Driver ISO 2631 Acceleration Exposure**

Jack Wasserman, Logan Mullinix, Kelly Neal, Shekhar Khanal, Don Wasserman

### **Introduction**

This paper presents current finding on truck driver average exposure to acceleration for several different manufacturer's cab-over trucks on a variety of roads in different countries. The predominant time, for this aspect of the study has been spent in the area around London, England and Warsaw, Poland.

The ECE directive 2002/44/EC has provided specific guidelines for vehicle operators 8 hour average acceleration exposure. The primary considerations have been on truck design including the air-ride driver's seat. The truck manufacturers have produced truck cabs that have some separate suspension from the truck frame. The truck seat manufacturers have been producing air-ride suspension seats for the cab. Both of these designs have had the objective of meeting the ECE directive and providing the vehicle drivers with some degrees of comfort.

This paper will provide some information on the ability of the vehicles to operate on a variety of roads and meet the objectives.

### **Method**

The primary method for evaluation of the driver's exposure has been the use of a seat pad attached to the driver's seat. Although this sensor system provides the critical information for the driver, an understanding of the reasons for the values requires additional measurements.

The initial study in England used both driver and passenger seat pads, as shown in Figure 1, as well as triaxial accelerometers mounted on the base of the seat. The latest studies used significantly more transducers to better understand the relative rotations and translations on the truck frame, the cab, and the driver.



Figure 1 Triaxial Acceleration Seat Pad

The data was processed to produce the average accelerations for the X - axis, Y - axis, and Z – axis based on data for 360 seconds or longer. The time length is required by the ISO 2631 standard for reasonable accuracy.

## Results

The data has shown road situations that have exceeded the  $0.5 \text{ m/s}^2$  but not to exceed the  $1.15 \text{ m/s}^2$  for extended periods of time. Comparisons between loaded and unloaded trucks and between different drivers have been done for certain situations. The major aspects related more to the road quality than the particular manufacturer for a vehicle or a seat. As can be seen in Figure 2, the driver's seat generally has lower values than the passenger's seat.

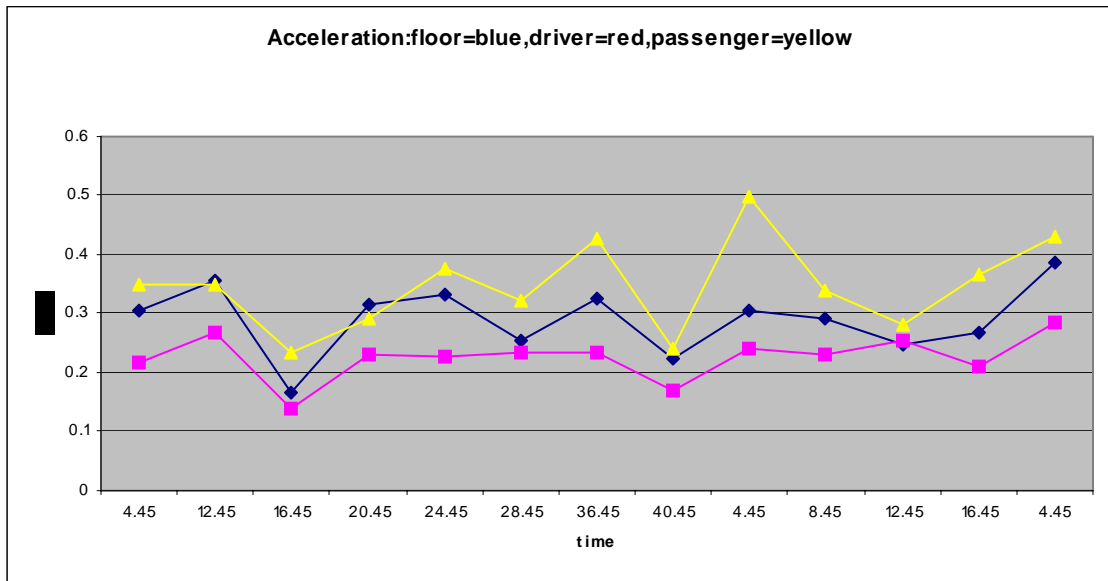

Figure 2 Comparison of Seating during time.

## Conclusions

The initial results have shown that the dominant effects of the levels of acceleration expose have related to the quality of the roads and the truck speed. Continued testing is planned for the future to further understand the potential risks to the drivers and to allow a better process for assessment and design of truck seats.

# EVALUATION OF THE CAPABILITY OF SEAT SUSPENSION TO REDUCE THE OPERATOR EXPOSURE TO VIBRATION IN TRACK TYPE TRACTORS.

Michael S. Contratto, Engineering Specialist, Caterpillar, Inc.  
Tom Brodersen, Director - R and D, Sears Seating  
Dave Marshall, R & D Manager, KAB Seating

## Introduction

The European Union (EU) completed a new directive 2002/44/EC<sup>1</sup> called the Physical Agents Directive (PAD) that establishes action and limit values for hand-arm and whole body vibrations. The directive specifies that:

*“...workers shall not be exposed above the exposure ‘limit value’.”*<sup>1</sup>

and

*“...once the exposure action values ... are exceeded, the employer shall establish and implement a programme of technical and/or organisational measures intended to reduce to a minimum exposure to mechanical vibration and the attendant risks...”*<sup>1</sup>

The PAD limit value is effective for new machines starting July 6, 2007 and for used machines by at least July 6, 2010. These requirements apply to the users of machines, but machine manufacturers will be challenged to provide machines and information to help the users comply with the directive.

Caterpillar manufactures machines with the goal of enabling our customers to comply with all regulations dealing with health and safety. Caterpillar designs all of our machines to provide a safe, comfortable and productive work environment. This study was to determine if seat suspensions could provide a reduction in the vibration environment experienced by operators of Caterpillar mid sized (<50,000KG) Track Type Tractors

## Methods

Seat manufacturers were asked to provide seat suspensions that provide improved isolation over and above current seat suspension. Each supplier was provided with ride profiles and was asked to demonstrate the vibration reduction on a shaker table. Two suppliers provided suspensions that were compared with the current seat suspension in a field study. Three full factorial experiments were conducted. The first experiment was to evaluate overall suspension performance for four operations. The second experiment was to determine the benefit of the adjustable vertical damper at three different levels and the third experiment was to determine the effect of the fore/aft and side/side isolators. Six operators were used for the study. Acceleration was measured at the seat base and at the operator seat pad. Both the transfer function and the ISO 2631 RMS ride values were used to determine the seat suspension's effectiveness of isolating the operator from vibration. A structured questionnaire was used to determine the operators' subjective assessment of the seat suspensions.

## Results

There was significant operator-to-operator variability in the vertical direction (>35%), however there was little variability in the fore/aft and side/side direction based on seat base

acceleration. There was significant variation in the vertical vibration levels for all four operations; slot dozing, ripping, cross v-ditch, and roading. Roading showed much lower fore/aft and side/side vibration levels than the other operations. Slot dozing showed lower side/side vibration levels than other operations but was similar to roading. The fore/aft and side/side levels appear to be a function of the ground profile.

The seat suspensions demonstrated reductions in the ISO Ride values for the vertical direction in the shake table test however they did not show any significant reduction during the field operations. The exception was during the roading operations where the advance seat suspensions showed measurable reductions. The damper settings again showed significant differences during the shake test but had little or no effect during the field test. The fore/aft isolator did not provide a statistically significant reduction in the ISO ride values however the Side/Side isolator did provide a 20% reduction.

The seat suspensions did provide an improvement in the operator subjective evaluation of the machine vibration environment. In the vertical directions, the operators felt the advanced suspension provide a slight improvement. The fore/aft isolator provided a significant improvement in the vibration environment. This occurred despite the fact that the isolators provided no statistically significant improvement in the ISO ride values. The side/side isolator did provide a slight improvement in the operator perception of the vibration environment.

## Discussion

Seat suspensions tested will not provide a significant reduction in the ISO RMS ride values for the current generation of construction machines however they do provide a significant improvement in the operator subjective opinion of the machine vibration environment. This may imply that the methodology used in the European Union (EU) directive 2002/44/EC may not be appropriate for evaluating operator comfort in construction machines. The basis of the ISO weighting curves are human response testing in a seated position without foot pedals, seat backs, arm rests and control contact. The operator seated position in construction machines may change how the human responds to vibration and perceives vibration. Further work is required to understand the effect of foot pedals, back rests, arm rest and control contact on the operator perception of the vibration environment.

## References

- <sup>1</sup>EEC, (2002) Directive 2002/44/EC of the European Parliament and of the Council of 25th June 2002 on the minimum health and safety requirements regarding the exposure of workers to the risks arising from physical agents (vibration). (Sixteenth individual Directive within the meaning of Article 16(1) of Directive 89/391/EEC). Official Journal of the European Communities, L177, pp13-20, 6th July 2002.
- Griffin MJ, (1990). *Handbook of human vibration*. Academic Press Ltd London. ISBN 0-12-303040-4.
- International Standard ISO 2631 (1974). Guide for the evaluation of human exposure to whole body vibration. International Organisation for Standardisation, Geneva.
- International Standard ISO 2631 (1997). Mechanical vibration and shock, Evaluation of human exposure to whole-body vibration-part1: general requirements. International Organisation for Standardisation, Geneva.
- International Standard, BS EN ISO 7096:2000. Laboratory evaluation of operator seat vibration. International Organisation for Standardisation, Geneva.
- ISO 11112 Earth-moving machinery – Operator’s seat – Dimensions and requirements. International Organisation for Standardisation, Geneva.
- ISO 3411 Earth-moving machinery – Human physical dimensions and minimum operator space envelope. International Organisation for Standardisation, Geneva.

# MUSCULOSKELETAL SYMPTOMS AMONG OPERATORS OF HEAVY MOBILE EQUIPMENT

N. Kumar Kittusamy

National Institute for Occupational Safety and Health, Spokane Research Laboratory,  
Spokane, Washington, U.S.A.

The purpose of this study was to assess the adequacy of the cab design and to determine the percentage of musculoskeletal symptoms among operators of mobile equipment used in mining and construction. A questionnaire was designed to assess demographics, work information, job history, and musculoskeletal symptoms in operators of heavy mobile equipment. Information concerning equipment included design of the seat/chair, levers, pedals, bothersome vibration, quality of ingress/egress from the equipment, proper preventative maintenance and repairs, and age of the equipment. The body regions that were evaluated included the neck, middle/upper back, low-back, shoulder/upper-arm, elbow/forearm, wrist/hand, hip, knee, and ankle/foot. Five hundred and eighty six operators completed the questionnaire. The results indicate that these workers are at risk for developing musculoskeletal disorders, and the need to quantify risk factors (i.e., whole-body vibration and static sitting postures).

## Introduction

Kittusamy and Buchholz<sup>(1)</sup> estimated that there are currently 540,000 operators of heavy mobile equipment, who are generally referred to as operating engineers, in the United States. Their estimate also shows that ninety percent of the operating engineers are involved in performing excavating and paving work, whereas the remaining 10% are crane operators and all of these operating engineers are exposed to whole body vibration. Two important risk factors for musculoskeletal disorders among operators of heavy earth-moving equipment are static sitting and whole body vibration,<sup>(2,3)</sup> where long term exposure to these risk factors have been associated with low back pain, disc degeneration, sciatic pain, and muscle fatigue.<sup>(4)</sup>

## Methods

A work and health questionnaire was designed to assess demographics, work information, job history and musculoskeletal symptoms in operators of heavy mobile equipment. Self-administered work and health questionnaires were distributed to operating engineers by the International Union of Operating Engineers training centers in several states within the United States of America. The operators who attended their regularly scheduled training classes, from December 2001 to May 2005, at the training centers were requested to complete the questionnaire during their training session. The participation was voluntary, but participation was highly encouraged by the training officers. All of the participants were briefed about the purpose of the study and they signed an informed consent form.

## Results

Five hundred and eighty six operators out 598 (98%) completed the questionnaire from 6 different local unions in 8 different states. A majority of the participants were male (91%). A majority of the operators (72%) were journey level. The ages of the operators ranged from 18 to 68 years. The majority of the operators (>65%) indicated that the cab (i.e., seat/chair, levers and pedals) was adequately designed for their job. Some of the operators reported that they were not bothered by vibration and that the quality of egress from the equipment was good. Most of the operators (>80%) indicated that proper maintenance and repairs were performed on their equipment. The classification of equipment as being old or new was almost identical.

The prevalence of musculoskeletal symptoms in the total population was 58.5%. Three body regions that received the highest total percent of symptoms categorized as somewhat severe or higher, included the knee, shoulder/upper-arm, and the low back.

## Summary

The current study is in agreement with the prevalence of musculoskeletal symptoms in various body regions as reported by Zimmerman et al.<sup>(5)</sup> Also, similar results were observed in a pilot study of operators of heavy construction equipment that further reiterate the findings in the current study<sup>(6)</sup>.

Construction workers are often afflicted with musculoskeletal symptoms that compromise their health and well-being. However, there have been few formal studies of the nature and potentially preventable causes of these symptoms. The results from this study indicate that the operators are at risk for developing musculoskeletal disorders, the need to quantify risk factors (i.e., whole-body vibration and static sitting postures), and develop engineering controls to reduce the exposure levels.

## References

1. Kittusamy, N.K. and Buchholz, B., 2004. Whole body vibration and postural stress among operators of construction equipment: A literature review. *Journal of Safety Research*, **35**: 255-261.
2. Boshuizen H.C., Hulshof C.T.J. and Bongers P.M., 1990. Long- term sick leave and disability pensioning due to back disorders of tractor drivers exposed to whole- body vibration. *International Archives of Occupational and Environmental Health*, **62**: 117-122.
3. Kittusamy N.K., 2002. Ergonomic risk factors: A study of heavy earthmoving machinery operators. *Professional Safety-Journal of the American Society of Safety Engineers*, Oct , 38-45.
4. Dupuis H. and Zerlett G., 1987. Whole-body vibration and disorders of the spine. *International Archives of Occupational and Environmental Health*, **59**: 323-336.
5. Zimmerman, C.L., Cook, T.M. and Rosecrance, J.C., 1997. Operating engineers: Work-related musculoskeletal disorders and the trade, *Applied Occupational and Environmental Hygiene*, **12**: 670-680.
6. Kittusamy, N.K., 2003. Reports of Musculoskeletal Symptoms among Operators of Heavy Construction Equipment: A Pilot Study, *American Industrial Hygiene Conference and Exposition*, Dallas, TX.

## Poster Presentations

<b>Presenter</b>	<b>Title</b>	<b>Page</b>
D. Wilder University of Iowa,	Head-trunk motion increase with arm-rest controls	130
L.Frey Law, University of Iowa	Arm and should muscle activity are greater with steering wheel vs. seat mounted controls	132
E.J. Wolf VA Medical Center	Evaluation of powered wheel-chairs with suspension and exposure to whole-body vibration.	134
N. Hosoya Saitama University	Establishment of biodynamic response measurement system of hand-arm	136
J. Wasserman University of Tennessee	Training simulators extend laboratory testing techniques for WBV analysis	138
D.E. Welcome NIOSH	Instrumented handles for studying hand-transmitted vibration exposure	140
R.G. Dong NIOSH	A novel theory: ellipse of grip force	142
S.D. Smith Wright-Patterson Air Force Base	Chest transmissibility characteristics during exposure to single- and combined-axis vibration	144
K. Harrer Naval Medical Center San Diego	A field study: Measurement and evaluation of whole-body vibration for MH-60S pilots	146
A. Joshi University of Missouri-Rolla	Modeling of hand-arm vibration	148
E. Johannig Occupational and Environmental Life Science	Railroad locomotive whole-body vibration study – Vibration, shocks and seat ergonomics	150
T. Jetzer Occupational Medicine Consultants	Clinical assessment and characteristics of men and women exposed to high-level of hand-arm vibration	152
D. Riley Medical College of Milwaukee	Acute effects of vibration on the rat-tail artery	154
O. Wirth NIOSH	Effects of repeated vibration exposures in muscle tissue	156
C. Johnson NIOSH	Vibration exposure reduced nitric oxide concentrations in the ventral artery of the rat tail	158
S. Waugh NIOSH	Acute vibration induces oxidative stress and changes in transcription in soft tissue of rat tail	160
Z.-M. Li University of Pittsburgh	Visualization of multi-digit manipulation mechanics	162
M. J. Jorgensen Wichita State University	Use of TUNGSTEN to reduce vibration exposure in aircraft manufacturing.	164
S. L. Tillim Bonsil Technologies, LLC	Handle design for optimal hand function.	166
J. P. Dickey University of Guelph	Vibration time and rest time during sinusoidal vibration experiments: Do these factors affect comfort ratings?	168

## HEAD-TRUNK MOTION INCREASE WITH ARM-REST CONTROLS

D Wilder, S Rahmatalla, M Contratto+, T Xia, L Frey-Law, G Kopp+, N Grosland  
University of Iowa, Iowa City, Iowa, U.S.A., +Caterpillar, Inc., Peoria, Illinois, U.S.A.

### Introduction

Heavy equipment manufacturers have made a long-term commitment to minimize operator vibration exposure for comfort, performance, and health reasons. Domestic and international guidelines/standards and EC laws dictate exposure limits based on measurement of vibration at the interface between the seat and the operator's buttocks using seat-pad accelerometry.<sup>1-4</sup> This is historically based on the assumption that the only major source of vibration is transmitted through the seat pan. However, vibration may also be imparted to the head and neck via the steering wheel and/or arm-rest controls and a relatively rigid upper body.<sup>5</sup> Unfortunately, little is known regarding the influence of arm position on head and neck motion. The purpose of this study was to investigate relative head and trunk motions during riding simulations of large construction equipment, using three different arm control options.

### Methods

Five typical heavy equipment ride files were "played back" through a man-rated Servo Test 6-degree-of-freedom vibration system. An 8-camera Vicon motion capture system operating at 200 frames per second, recorded the motion of reflective surface markers on 5<sup>th</sup>, 50<sup>th</sup>, and 95<sup>th</sup> percentile right-handed male subjects, using 3 seat and control configurations (steering wheel (SW), floor mounted armrest controls (FM), seat-mounted armrest controls (SM)). Two trials were performed for each ride and seat control combination (each trial: 60 sec of 6-dof and 60 sec of vertical vibration). The relative motions (change in distances) from the marker over the xiphoid process (caudal end of sternum) to markers over each shoulder, each mid-clavicle, the presternal notch, and to each of four markers on a tight band around the head were calculated (12,001 frames, 6-dof motion only). As a rigid body control, distances between markers on the head band were also monitored. The standard deviation (SD) of the 12,001 distances between pairs of markers was normalized by the mean (L) of the associated distances producing: SD/L which was used as a measure of motion. Error assessments were also performed by analyzing the motion between relatively fixed markers (on the headband). A repeated measures analysis of variance was used to evaluate the results. While five ride files were used, only one ride file containing significant lateral acceleration components was analyzed for comparing the effects of two armrest controls versus use of a steering wheel for this part of our study.

### Results

Values of SD/L between the points on the relatively rigid head band were consistently small and similar to each other for all conditions with one exception due to treatment (SM v SW,  $p=0.0145$ ). SD/L between the markers over the xiphoid process and the presternal notch, another region that should be relatively rigid, were also similar to each other for all conditions. Use of floor-mounted, arm rest controls versus a steering wheel produced a significant increase in the value of SD/L between the xiphoid process and: the right shoulder marker (92%,  $p=0.0316$ ), the right mid-clavicle marker (47%,  $p=0.0478$ ), and the right-front marker on the head band (28%,  $p=0.0182$ ). Use of floor-mounted, arm rest controls versus seat-mounted, arm rest controls



produced a significant increase in the value of SD/L between the xiphoid process and the right-back marker on the head band (14%,  $p=0.0467$ ).

### Discussion

During a pilot study to assess the efficacy of a motion capture system in whole-body vibration studies, the authors observed a large increase in head-trunk relative motion due to the use of armrest controls, raising a concern about an increased likelihood of injuries. With the use of a steering wheel, the trunk and arms can behave as active dampers, attenuating horizontal motions and maintaining a stable platform for the head-neck system (an inverted pendulum). Armrest controls more rigidly couple the shoulders, via the upper arms, to a vibration source and bypass the damping provided by the entire arm, potentially increasing the risk of motion-related musculoskeletal problems in the neck and upper trunk. While armrests may reduce arm and shoulder fatigue and reduce the effect of the vibrating trunk mass on the lower back, they may do so at the expense of increased motion at the neck and shoulders. The vibration community needs to consider the effect of and attenuation of vibration from sources other than the seat pan. The authors urge the standards and law making communities to consider vibration sources in addition to those at the operator's seat pan.

### Acknowledgements

This study was funded by Caterpillar, Inc. of Peoria, IL and was conducted at Sears Manufacturing of Davenport, IA with the help of Mike Drinkall and Jason Boldt. Dean Macken of the Engineering Design and Prototyping Center at the College of Engineering at The University of Iowa helped a great deal with design and setup of specialized equipment. Brad Parker, of the Center for Computer-Aided Design at The University of Iowa provided vital help with computer hardware and software. The study was conducted through the Center for Computer-Aided Design (directed by Karim Abdel-Malek at The University of Iowa), where one of its goals is to optimize the Digital Human.

### References

1. ANSI S3.18 2002/ISO 2631-1:1997 Nationally Adopted International Standard (NAIS): Mechanical vibration and shock - Evaluation of human exposure to whole body vibration Part 1: General requirements. *Acoustical Society of America, Melville, NY, 2002-05-13*.
2. European Commission (2002). Directive 2002/44/EC of the European Parliament and of the Council of 25 June 2002 on the minimum health and safety requirements regarding the exposure of workers to the risks arising from physical agents (vibration) (sixteenth individual Directive within the meaning of Article 16(1) of Directive 89/391/EEC) *Official Journal of the European Communities L177(45)13-19, 7 June 2002*
3. ISO 2631-1:1997(E) 2<sup>nd</sup> Ed 1997-05-01 Corrected and Reprinted 1997-07-15: Mechanical vibration and shock – Evaluation of human exposure to whole-body vibration – Part 1: General Requirements, *International Standards Organization, Geneva, Switzerland, 1997-07-15*.
4. ISO 2631-5:2004(E) 1<sup>st</sup> Ed 2004-02-15: Mechanical vibration and shock – Evaluation of human exposure to whole-body vibration – Part 5: Method for evaluation of vibration containing multiple shocks, *International Standards Organization, Geneva, Switzerland, 2004-02-15*.
5. National Research Council and the Institute of Medicine (2001) Biomechanics. Chapter 6 in: Musculoskeletal Disorders and the Workplace: Low Back and Upper Extremities. Panel on Musculoskeletal Disorders and the Workplace. Commission on Behavioral and Social Sciences and Education. National Academy Press, Washington, DC, pp219-286.

## **ARM AND SHOULDER MUSCLE ACTIVITY ARE GREATER WITH STEERING WHEEL VS. SEAT MOUNTED CONTROLS**

L Frey Law, S Rahmatalla, D Wilder, N Grosland, T Xia, T Hunstad, M Contratto+, G Kopp+  
University of Iowa, Iowa City, Iowa, U.S.A., +Caterpillar, Inc., Peoria, Illinois, U.S.A.

### **Introduction**

Chronic whole-body vibration exposure, as expected in large construction and mining vehicles, has been associated with neck and back pain and injury.<sup>1</sup> While work has been done towards gaining a better understanding of the relationship between vibration and shock and muscle activity of the back musculature<sup>2</sup>, relatively little information regarding the activity of neck, shoulder and upper arm muscles is known. Today's equipment designs must conform to domestic and international standards, however these standards do not specifically address the vibration exposure in the head and upper quarter. Further it is not well known how the control configuration within a vehicle (e.g. steering wheel versus arm controls) influences muscle voluntary and reflex activity levels. Greater muscle activity may lead to greater muscle fatigue – which in turn may be associated with greater risk of injury.<sup>2</sup> Thus, muscle contractions needed to maintain static postures as well as those resulting reflexively should be considered during an analysis of seating position. Unfortunately, little is known regarding the influence of arm position on head and neck muscle function. The purpose of this study was to investigate the relative muscle activities of 5 neck, shoulder, and upper arm muscles during riding simulations of large construction equipment, using three different arm control options.

### **Methods**

Five typical heavy equipment ride files were “played back” through a man-rated Servo Test 6-degree of freedom (dof) vibration system. Each ride was repeated using 3 seat and control configurations (steering wheel (SW), floor mounted arm-rest controls (FM), seat mounted arm-rest controls (SM)). Two trials were performed for each ride and seat control combination (each trial: 60 sec of 6-dof and 60 sec of vertical vibration). Five channels of surface electromyography (EMG) of the right-side cervical erector spinae muscles (neck extensors), sternocleidomastoid (neck flexor), upper trapezius (shoulder elevator), biceps brachii (elbow flexor) and triceps brachii (elbow extensor) muscles were collected throughout each ride (~2min) using pre-amplified (10x), 1 cm silver bar electrodes, with 1 cm fixed inter-electrode distances (Delsys, Inc). Further analog amplification was set at 10k (1k for one subject), and sampled at 1000Hz using a 12-bit DAQ card and Labview 7.1 software (National Instruments). A total of 7 right-handed male subjects were tested, but only 5 had complete EMG data sets to analyze for this sub-study. EMG was analyzed using root mean square (RMS, in mV) of 20 ms moving windows, and then averaged across the entire trial for a measure of mean total muscle activity (voluntary and reflexive). The muscle activity to maintain the static posture was estimated as the mean RMS EMG over a 1 sec interval just prior to and/or after completion of the ride. Repeated Measures ANOVAs were used to test for with-in subject differences using  $\alpha = 0.05$ .

## Results

The upper trapezius and triceps brachii muscles were significantly more active (mean EMG muscle activity) while using the steering wheel controls than for either the floor mounted or seat mounted arm rest controls. Whereas, the floor mounted arm controls tended to produce greater activity in the biceps brachii. Overall, the seat mounted controls resulted in the lowest mean EMG levels across all five muscles. No significant differences were observed in the neck flexor (sternocleidomastoid) or the neck extensor (erector spinae) muscles across control configurations.

## Discussion

This pilot study suggests that muscle activity is indeed influenced by arm control postures. In our companion study on relative neck and shoulder motion, we indicate greater relative motion with the armrest control configurations. Interestingly, in this study we observed greater static and dynamic muscle activity with the steering wheel configuration. The arms may behave as active dampers particularly when the control configuration is not mounted to the seat (SW or FM), potentially attenuating head and neck motions. However, it is not entirely clear as to whether the greater relative motion or the potential for greater muscle fatigue over time may be the most problematic for equipment operators. Certainly the risk of injury may depend on the type of injury considered, e.g. overuse muscle injury versus repetitive motion joint pathology. There may be trade-offs between the potential for reduced fatigue associated with arm-rest controls, which is supported by our observations of decreased mean muscle activity, and the potential for greater apparent muscle and joint stiffness associated with tonic muscle activity – and thereby reduced motions. These preliminary results would suggest that the vibration community needs to consider the effect of and attenuation of vibration in the upper quarter considering the influence of postural muscle activity with different arm control configurations on the transmissibility of vibration into the head and neck.

## Acknowledgements

This study was funded by Caterpillar, Inc. of Peoria, IL and was conducted at Sears Manufacturing of Davenport, IA with the help of Mike Drinkall and Jason Boldt. At the University of Iowa, Dean Macken of the Engineering Design and Prototyping Center in the College of Engineering assisted with design and setup of specialized equipment, and Brad Parker, of the Center for Computer-Aided Design (CCAD) provided vital help with computer hardware and software. The study was conducted through CCAD (directed by Karim Abdel-Malek) where one of its goals is to optimize the Digital Human.

## References

1. Pope, M. H., Wilder, D. G. & Magnusson, M. L. (1999) A review of studies on seated whole body vibration and low back pain. *Proceedings of the Institution of Mechanical Engineers. Part H - Journal of Engineering in Medicine*, 213, 435-46.
2. Wilder, D., Magnusson, M. L., Fenwick, J. & Pope, M. (1994) The effect of posture and seat suspension design on discomfort and back muscle fatigue during simulated truck driving. *Appl Ergon*, 25, 66-76.

# **EVALUATION OF POWERED WHEELCHAIRS WITH SUSPENSION AND EXPOSURE TO WHOLE-BODY VIBRATION**

Erik J. Wolf, Rory A. Cooper, Michael L. Boninger  
VA R&D Center of Excellence for Wheelchairs and Related Technologies, VA Medical Center,  
Pittsburgh, Pennsylvania, U.S.A.  
Departments of Bioengineering and Rehabilitation Science and Technology, University of  
Pittsburgh, Pittsburgh, Pennsylvania, U.S.A.

## **Introduction**

Although wheelchair users are regularly subjected to whole-body vibrations little research has been conducted to assess these vibrations or attempt to reduce them [2,3,5]. Most of the wheelchair and whole-body vibration research done to this point has been conducted on manual wheelchairs. Van Sickle et al showed that manual wheelchair propulsion over a simulated road course produces vibration loads that exceed the ISO 2631-1 standards for the fatigue-decreased proficiency boundary at the seat of the wheelchair as well as the head of the user [6]. In a study by Boninger et al [1], 66% of wheelchair users reported neck pain since acquiring their wheelchair. One of the key reasons believed to be the cause of pain, was the exposure to whole-body vibration. Kwarciak et al [4] and Wolf et al [7] performed similar studies using two methods of analysis to evaluate vibrations on suspension and non-suspension wheelchairs while descending curbs of varying heights. Both studies revealed no significant difference in the abilities of the wheelchairs to reduce the amounts of vibrations transferred to the wheelchair user. Although the efforts of wheelchair companies to reduce the amounts of whole-body vibration transmitted to wheelchair users through the addition of suspension systems is encouraging, the technology is not yet ideal. Additionally, the research to date has focused on manual wheelchairs exclusively, while little attention has been shown to powered wheelchairs.

## **Methods**

This study includes the use of two suspension electric powered wheelchairs: The Quickie S-626 and the Invacare 3G Torque SP Storm Series. Each subject tested all of the configurations of the suspension wheelchairs. These included the Invacare with suspension, the Quickie with suspension set to three settings (most stiff, least stiff, and 50% stiffness), and both wheelchairs with solid inserts to act as non-suspension wheelchairs. Sixteen able bodied subjects have been recruited for this study so far. In each of the configurations of the wheelchairs, the subjects traversed an Activities of Daily Living (ADL) course. Vibrations were collected from a tri-axial accelerometer attached to a seat plate beneath the cushion during driving over the activities course. A mixed model ANOVA was used to determine if there were differences between suspensions based on Vibration Dose Value (VDV).

## **Results**

Statistical analyses of the VDV data revealed significant differences between the six different suspensions over each of the obstacles in the activities of daily living course. Post-hoc analyses revealed that for each of the obstacles, significant differences existed between the Invacare suspension and the Invacare solid insert. For the Quickie power wheelchair the solid insert setting was not significantly different from the most-stiff setting for each of the obstacles

except the smooth surface. The solid insert setting was significantly different than the lowest and mid stiffness settings for all of the obstacles except the smooth surface and the deck surface.

Table 1 – Average and total VDV values ( $\text{m/s}^{1.75}$ ) for each suspension setting

	Invacare Insert	Invacare Suspension	Quickie Insert	Quickie Least Stiff	Quickie Mid-Stiff	Quickie Most Stiff
Deck	0.23	0.26	0.25	0.23	0.23	0.25
Door	1.07	0.72	0.81	0.56	0.51	0.77
Curb	2.45	1.56	2.87	1.41	2.06	2.78
Dimple	0.69	0.61	0.69	0.59	0.58	0.68
Smooth	0.14	0.11	0.14	0.12	0.12	0.15
Carpet	1.00	0.83	1.16	0.71	0.70	1.02
Total VDV	<b>2.55</b>	<b>1.65</b>	<b>2.91</b>	<b>1.55</b>	<b>2.10</b>	<b>2.87</b>

### Discussion

Although most of the suspension systems are capable of reducing the amounts of vibration transmitted to the users, the exception being the Quickie S-626 with the most-stiff suspension setting (this setting was not significantly different from the solid insert setting for all obstacles except the smooth surface), the results of the vibration dose values seem to indicate that they may not reduce them enough to reduce probability of injury in powered wheelchair users. When examining the total VDV over the entire activities of daily living course, in relation to the Health Guidance Caution Zone (HGCZ), there is not significant time allowed before WBVs are considered dangerous.

The information on the transmissions of vibrations from different suspension systems can lead to improvement in their design and function allowing powered wheelchairs to adequately reduce the amount of whole-body vibrations experienced by their users. Future research should investigate vibrations experienced by wheelchair users in real environments over extended periods of time.

### References

1. Boninger, M.L., Cooper, R.A., Fitzgerald, S.G., Lin, J., Cooper, R.A., Dicianno, B., Liu, B. (2003) Investigating Neck Pain in Wheelchair Users. Amer J Phys Med Rehabil, 82(3), 197-202.
2. Cooper, R.A., Wolf, E., Fitzgerald, S.G., Boninger, M.L., Ulerich, R., Ammer, W.A., (2003) Seat and Footrest Accelerations in Manual Wheelchairs With and Without Suspension, Archives of Physical Medicine and Rehabilitation, 84(1), 96-102
3. DiGiovine, C., Cooper, R.A., Wolf, E., Fitzgerald, S., Boninger, M., Guo, S. (2003). Whole-body vibration during manual wheelchair propulsion with selected seat cushions and back supports. IEEE Trans on Rehab. 11(3), 311-322.
4. Kwarcia, A.M., Cooper, R.A., Wolf, E.J. (2002). Effectiveness of Rear Suspension in Reducing Shock Exposure to Manual Wheelchair Users During Curb Descents, RESNA Proceedings, 365-367.
5. Tai, D., Cooper, R.A., DiGiovine, M.M., Boninger, M.L. (1998). Analysis of Vibrations During Manual Wheelchair Propulsion. Saudi J of Disabil Rehabil, 4(3), 186-191.
6. VanSickle, D., Cooper, R.A., Boninger, M., DiGiovine, C. (2001). Analysis of vibrations induced during wheelchair propulsion. Jour of Rehab R&D, 38, 409-421.
7. Wolf, E.J., Cooper, R.A., Kwarcia, A. (2002) Analysis of Whole-Body Vibrations of Suspension Manual Wheelchairs: Utilization of the Absorbed Power Method, RESNA Proceedings, 303-305

# ESTABLISHMENT OF AN EXPERIMENTAL SYSTEM FOR MEASURING BIODYNAMIC RESPONSE OF HAND-ARM

Naoki Hosoya, Saitama University, Saitama, Japan  
Setsuo Maeda, National Institute of Industrial Health (NIIH), Kawasaki, Japan

## Introduction

This paper addresses establishment of an experimental system for measuring biodynamic response (BR) of hand-arm system at the NIIH in Japan. BR measurement system at the NIIH is nearly equivalent to NIOSH installed system. The feasibility of the system is examined through the apparent mass (AM) measurement of the empty handle and a set of calibration masses.

## Apparatus

The grip force was measured by using the handle shown in Fig. 1. The handle has two force sensors (KISTLER, 9212) and one accelerometer (PCB, 356A12). A low-pass filter with 5 Hz cut-off frequency was used to the grip force from measured force signal. Figure 2 shows BR measurement system in this study. The push or pull force at the handle was measured by using the force plate (KISTLER, 9286AA). The grip force and the push / pull force were displayed on a monitor. The shaker (IMV, VE-100S) is used to vibrate the hand-arm system along the forearm axis ( $Z_h$  direction) (ISO 10068, 1998; ISO 5349-1, 2001). In most situations force actions for operating tools are expressed by grip, push, pull and combined these actions. These actions can be simulated in the test system. AM was obtained by performing H1 estimator in the PULSE™ system (B&K, 3109) and it is denoted at the one-third octave band center frequencies.

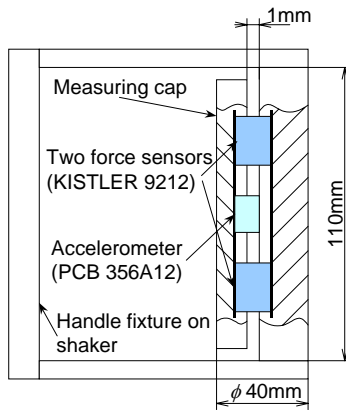

Fig. 1 Instrumented handle of the system

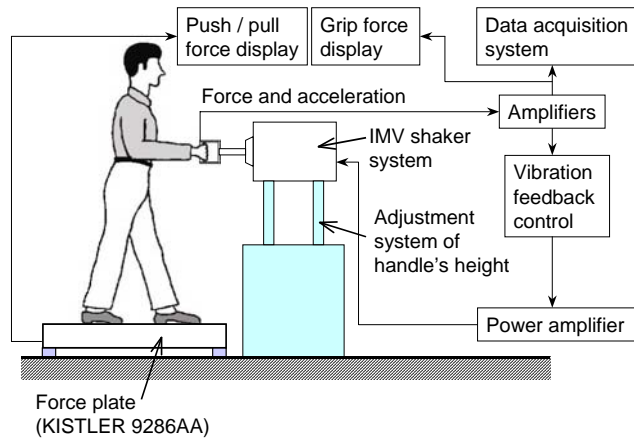

Fig. 2 Measurement system at the NIIH

## Methods

In order to investigate the reliability of the system, AM measurement of the handle was performed. It is assumed that the handle is rigid in the upper limit of adoptive frequency range in this study. This assumption is validated in AM measurement of the empty handle. A pseudo-random vibration in the frequency range of 10 to 1,250 Hz was used and its amplitude is  $1.0 \text{ (m/s}^2\text{)}^2\text{/Hz}$  with a flat power spectral density (PSD) in the experiment.

Measured AM includes the mass effect of the measuring cap in a subject experiment. Compensated apparent mass  $AM_c(\omega)$  is obtained by Eq. (1) <sup>1-2</sup>.

$$AM_c(\omega) = AM_{total}(\omega) - AM_{cap}(\omega) \quad (1)$$

where  $AM_{total}(\omega)$  is measured response with the mass of the measuring cap and BR of a subject,  $AM_{cap}(\omega)$  is the response of measuring cap in an empty handle test. In this study it is assumed that  $AM_{total}(\omega)$  is the response with attached small piece of metal to the measuring cap by adhesive tape. Eight pieces (1, 2, 3, 4, 5, 10, 15 and 20g) of metal were used in the experiment.

### Results and Discussions

The measured AM of the empty handle differences between measured and true values are less than 3%. Since resonant frequency is higher enough frequency range of measurement (12.5 – Hz), the assumptions seem to hold in the frequency range of measurement. The calibrations of the measuring cap's mass shown in Fig. 3. The measured pieces of generally agree with the true mass value. measured mass values of over 10g are than the true mass value in the high frequency range (>600Hz).

The amplification of the response seems increases with the increase in the metal mass. This is likely because each piece of metal is resiliently attached to the measuring cap by adhesive tape and the metal and tape form a local 1D system. The resonant frequency of the system reduces with the increase in the mass value. This further supports the validity of the measurement system and the mass cancellation method.

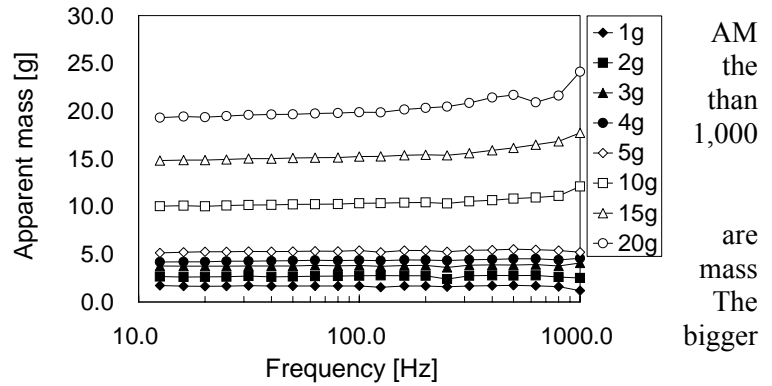

Fig. 3 Mass compensation results

### Conclusions

Throughout the course of this study, several conclusions are obtained as follows:

- (1) A BR experimental system for measuring biodynamic response of hand-arm system and vibration exposure tests was established in NIIH.
- (2) The instrumented handle of the system was validated through the AM measurement.
- (3) The mass of the measuring cap in the AM measurement was well compensated by the mass cancellation method, which confirms its validity.

### Acknowledgements

The authors acknowledge the assistance of staff at NIOSH, Dr. Dong, R. G. and Mr. Welcome, D. E. Their help is greatly appreciated.

### References

1. Dong R. G., McDowell T. W., Welcome D. E., Wu J. Z. (2004). Biodynamic response of Human Fingers in a Power Grip Subjected to a Random Vibration. *Journal of Biomechanical Engineering (Transactions of the ASME)*, **126**: pp.446-456.
2. Dong R. G., Wu J. Z., McDowell T. W., Welcome D. E., Schopper A. W. (2005). Distribution of mechanical impedance at the fingers and the palm of the human hand, *Journal of Biomechanics* **38**, pp.1165-1175.

## Training Simulators Extend Laboratory Testing Techniques for WBV Analysis

Jack Wasserman  
Logan Mullinix  
Shekar Khanal  
Gretchen Hinton  
Don Wasserman

### Introduction

Human testing has always been a needed way to provide information on the effects of vehicle vibration, however, the manner of testing has not reflected the real situations of driver's hands on a steering wheel and a seat with back support and driving tasks. The typical system have used a standard sinusoidal excitation rather than the typical types of road – truck excitations

The new truck driver training simulators provide the combination of road roughness, speed effects, cab environment and individual tasks. The system has a full six axis simulation potential. The simulators have the protection of the individual by a combination of two ways for the individual to stop the motion as well as an operator with visual capability who can stop the testing. The closed simulator, shown in Figure 1, has the potential for providing motion during the operation.



Figure 1 Mark III Truck Simulator



## Plan Objectives

The current project is to evaluate the levels and distribution available from a standard truck driver training simulator. The simulator has a combination of regular routs and “rough” routs.

The system will be operated with a combination of triaxial seat pads and floor accelerometers for comparison to the date collected from the trucks in Europe

## Results

Comparisons of the truck testing data will be provided as part of the planning for future research activity. Initial testing has been done on the vibration exposure for the operator of the simulator when the roads are “rough”. The actual rms weighted value for vertical acceleration was  $0.254 \text{ m/s}^2$ . The 1/3 Octave spectrum shown in Figure 2 is from driver’s seat in England. This seat showed significant loading in the 4 Hz. band. The simulator does have some loading in this area, but it is much lower.

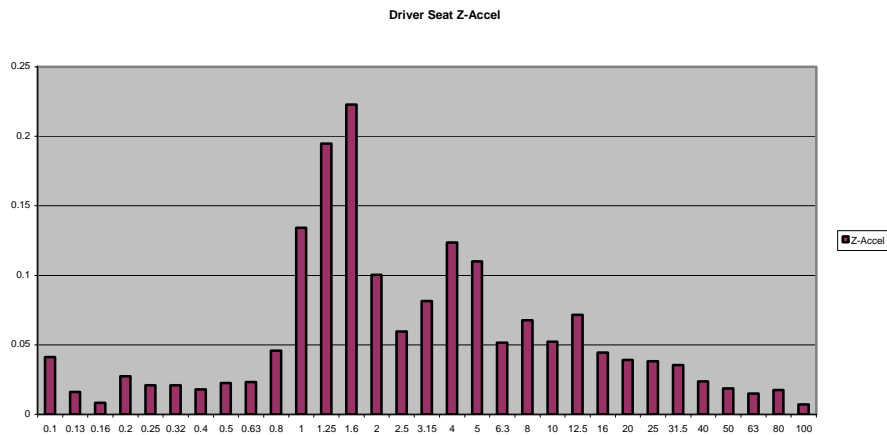

Figure 2 Driver’s Seat 1/3 Octave Z –Axis Acceleration

For testing purposes, the values in the 4 – 8 Hz region may need to be increased to the normal band level.

# INSTRUMENTED HANDLES FOR STUDYING HAND-TRANSMITTED VIBRATION EXPOSURE

Dan E. Welcome and Ren G. Dong

National Institute for Occupational Safety and Health, Morgantown, West Virginia, U.S.A.

## Introduction

Instrumented handles or dynamometers are widely used to measure hand forces and/or the biodynamic response of hand-arm system. To study hand-transmitted vibration exposure, six generations of instrument handles were constructed or initially developed by researchers in ECTB/HELD/NIOSH. This presentation provided a summary of these handles. Their basic characteristics, limitations, and usefulness are described, which may help their appropriate applications and further improvements.

## Six Designs of Instrumented Handles

**Handle 1:** The conceptual design is recommended in ISO 10819 (1996)<sup>1</sup> for glove test. The grip force is measured by detecting bending strains on a measuring beam in the handle. A special handle fixture was designed to connect the handle to a shaker. Except the screws, the handle and fixture were made from aluminum.

**Handle 2:** The design is based on the principle of shear strain measurement.<sup>2-3</sup> Both grip and push forces can be measured simultaneously using this handle. This handle was directly designed for a simulated vibrating tool.

**Handle 3:** This design is basically composed of a handle base, a measuring cap, and two charge-based sensors (Kistler 9212) sandwiched between the base and cap. The handle was also made from aluminum. The fixture for Handle 1 was also used with this handle. This generation of handle has three different handle diameters (30, 40, and 50mm).<sup>4</sup>

**Handle 4:** This design is an improvement from Handle 3. The handle fixture was totally redesigned and it was much stiffer than the previous one. The aluminum measuring cap was replaced with a magnesium cap.

**Handle 5:** The basic structure of this handle is the same as that for Handle 3. However, the piezoelectric sensors were replaced with two strain gage based sensors (Interface SML-50).

**Handle 6:** This handle includes two measuring caps, four piezoelectric sensors, and a handle centre base. The handle fixture was the same as that with Handle 4.

## Methods for Handle Examinations

The static and dynamic characterizations were performed using the methods reported by Dong et al.<sup>5-6</sup>

## Results and Discussion

**Handle 1:** The static force measurement depended on the hand grip location on the handle. Its natural frequency was less than 200 Hz.<sup>5,6</sup> Because the transmissibility of gloves may not vary significantly with the applied grip force, this handle may be acceptable for glove test. However, the force measurements with this handle may not be reliable.

**Handle 2:** The static force measured with this handle was insensitive to the hand acting location. However, when the handle was vibrating, the force signals could be totally distorted. For this reason, it was not used for vibration studies.

**Handles 3 and 4:** The static force measurements with these handles were independent of the hand grip location.<sup>6</sup> The resonant frequency of the early version was about 1,450 Hz and the latest was about 1,900 Hz. These handles have been extensively used for both static and biodynamic measurement up to 1,000 Hz.<sup>4,6</sup> The experimental data measured with the handle have been used to develop biodynamic models. A sample model, together with its parameters, is shown in Fig. 1. The modelling results agree excellently with the experimental data, as shown in Fig. 2. The natural frequencies (29 Hz and 208 Hz), the damping ratios (0.29 and 0.73), and the potential static deformations of the hand-arm system in the possible hand force range are also very reasonable. Without the reliable and accurate experimental data, it is impossible to establish such a model.

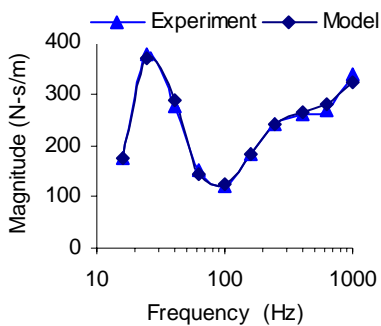

Fig. 2: Comparison of modeling and experimental impedance data (50 N grip-only) ( $r = 0.993$ ).

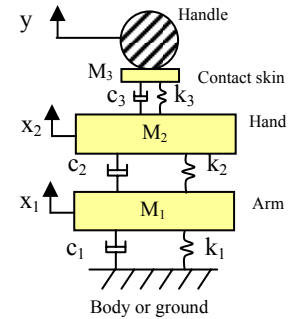

Fig. 1: A 3-DOF model ( $M_1=1.2320$  kg;  $M_2=0.1774$  kg;  $M_3=0.0338$  kg;  $k_1 = 1.5$  kN/m;  $k_2 = 48.5$  kN/m;  $k_3=252.8$  kN/m;  $c_1=54$  N-s/m;  $c_2=104$  N-s/m;  $c_3=231$  N-s/m.)

**Handle 5:** Piezoelectric force sensor can have a significant zero-drift problem. The handle equipped with such a sensor may not be suitable for a long duration force measurement. The handle equipped with strain gauge sensors has no such a problem. However, because the sensor is not as stiff as the charge-based sensor, the handle resonance was at about 900 Hz. It has been used for studying hand force recall.<sup>7</sup>

**Handle 6:** Except for Handles 2 and 6, the other handles cannot simultaneously measure both grip and push forces. The push force is usually measured using a force plate in the experiment. The dynamic responses distributed on the fingers and palm can only be measured separately using Handles 3-5. Handle 6 was developed to overcome the deficiencies. Its natural frequency was about 1,450 Hz.

## References

1. ISO 10819 (1996): Mechanical vibration and shock - Hand-arm vibration - Method for the measurement and evaluation of the vibration transmissibility of gloves at the palm of the hand. Geneva, Switzerland, International Organization for Standardization.
2. Pronk CAN and Niesing R (1981). Measuring hand grip force using an application of stain gages. Medical, Biological Engineering and Computing 19: 127-128
3. Radwin RG, Masters G, and Lupton FW (1991). A linear force summing hand dynamometer independent of point of application. Applied Ergonomics 22(5): 339-345.
4. Welcome DE, Rakheja S, Dong RG, Wu JZ, Schopper AW 2004. Relationship between the grip, push and contact forces between the hand and a tool handle. Inter. J. of Ind. Erg. 34(6): 507-518.
5. Dong RG, Rakheja S, Smutz WP, Schopper AW, Caporali S (2003). Dynamic characterization of the simulated tool handle and palm-adapter used for assessment of vibration performance of gloves. Journal of Testing and Evaluation 31(3): 234-246.
6. RG Dong, DE Welcome, TW McDowell, JZ Wu (In press) Measurement of Biodynamic Response of Human Hand-Arm System. Journal of Sound and Vibration.
7. McDowell, TW, Wiker, SF, Dong, RG, Welcome, DE, and Schopper, AW. (2006). Evaluation of Psychometric Estimates of Vibratory Hand-Tool Grip and Push Forces. Inter. J. of Ind. Erg. 36(2): 119-128.

# A NOVEL THEORY: ELLIPSE OF GRIP FORCE

Ren G. Dong, Dan E. Welcome, Chris Warren, Chun L. Dong, Thomas W. McDowell,  
John Z. Wu

National Institute for Occupational Safety and Health, Morgantown, WV, U.S.A.

## Introduction

Hand forces are important factors for risk assessment of hand-arm vibration syndrome (HAVS).<sup>1</sup> Grip force is one of the most important force components in the operation of powered hand tools. A considerable number of studies on grip force have been reported. It is well known that the grip force applied on a cylindrical handle is not uniformly distributed on each axis across the center of the handle cross-section.<sup>2</sup> Therefore, maximum and minimum orientations of grip force exist around the handle. Such orientations have not been clearly identified. In a recently proposed international standard (ISO/CD 15230, 2005),<sup>3</sup> it is stated that “the direction of the main gripping force is generally parallel to the z-axis defined in ISO 8727.”<sup>4</sup> This assertion is questionable, and further examinations are required. The objective of this study was to establish a fundamental theory on the distribution of the grip force around cylindrical handles.

## Methods

As shown in Fig. 1, the grip force is defined as a vector composed of normal and shear components ( $F_N$  &  $F_T$ ) in this study. Fig. 2 shows the hand coordinate system defined in this study, together with the ISO systems.<sup>1,4</sup> Based on this novel grip force definition, we derived four fundamental properties and a theorem. More significantly, we formulated a novel hypothesis: similar to Mohr’s circle of stress, the normal and shear components can be represented approximately using an ellipse on the plane of the two force coordinates, as shown in Fig. 3.

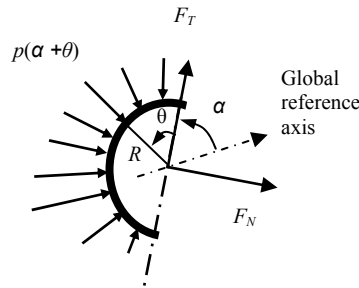

Fig. 1 Grip force definition

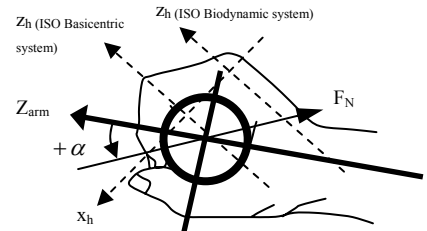

Fig. 2: Hand coordinate systems ( $Z_h$  &  $x_h$ : ISO system.<sup>1,4</sup>  $Z_{arm}$ : forearm z-axis.  $F_N$ : grip normal force at  $\alpha$  deg.

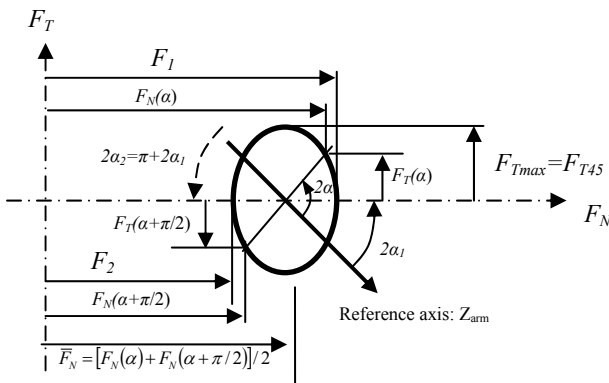

Fig. 3: A novel hypothesis: ellipse of grip force.

Based on this novel grip force definition, we derived four fundamental properties and a theorem. More significantly, we formulated a novel hypothesis: similar to Mohr’s circle of stress, the normal and shear components can be represented approximately using an ellipse on the plane of the two force coordinates, as shown in Fig. 3. The maximum and minimum grip normal forces are termed as the first principal grip force ( $F_1$ ) and the second principal grip normal force ( $F_2$ ), respectively. Their corresponding orientations are termed as the first principal grip angle ( $\alpha_1$ ) and the second principal grip angle ( $\alpha_2$ ).

A series of experiments were conducted to test this hypothesis. Twelve

subjects participated in the experiment. Three cylindrical handles (30, 40, and 48 mm) were used. Each of them was equipped with a flexible contact pressure sensor (TekScan, Model #5101-100). Fig. 4 shows the measurement setup and hand grip posture. Each subject was required to align the hand mark (on  $Z_{arm}$  axis) with the handle mark and to apply the maximum and medium (50%) grip forces on the handle.



**Fig. 4:** Test setup & hand posture

## Results and Discussion

Fig. 5 shows an example of the experimental results. Table 1 provides comparisons of the elliptical model predictions and the test data. The results strongly support the hypothesis. This study also found that the maximum grip pressure around the handle is distributed in the finger contact area. On the 40 mm handle, the first principal force is more than 40% of the second principal force ( $t$ -test:  $p < 0.001$ ). The maximum force is located in the finger contact orientation at approximately  $27^\circ$  from the  $Z_{arm}$ -axis that is about  $29^\circ$  from the hand  $z_h$ -axis defined in ISO 5349-1 or ISO 8727. It is significantly greater than that on the  $Z_{arm}$ -axis ( $t$ -test:  $p < 0.001$ ). The maximum force on the 30 mm handle moves further from the  $Z_{arm}$ -axis, and that on the 48 mm handle moves closer to this axis. Therefore, even if the  $z_h$ -axis in the basiocentric system defined in ISO 8727 could align with the  $Z_{arm}$ -axis in the operations of some tools, the above-mentioned statement in ISO/DIS 15230 (2005) is generally invalid. The proposed theory can be used to improve the standard and to develop a more effective method for grip force measurement.

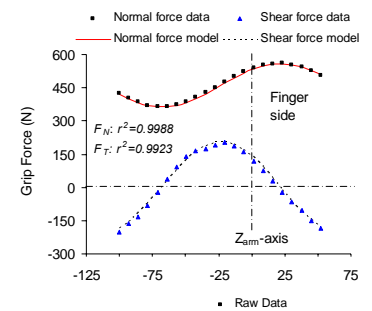

**Fig. 5:** Data comparisons

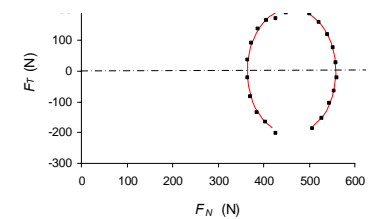

**Table 1:** Modelling and test data for 40 mm handle

Ellipse Parameters	$\alpha_1 - \alpha_2$ (deg.)	$F_{T45} / F_{Tmax}$	$(F_1 - F_2) / F_{Tmax}$	$r^2$ -value for $F_N$ fitting	$r^2$ -value for $F_T$ fitting
Mean	89.4	0.9741	0.9313	0.9937	0.9642
SD	5.8	0.0286	0.0767	0.0082	0.0425
Theory	90.0	1.0000		1.0000	1.0000

## References

- ISO 5349-1, 2001: Mechanical vibration - measurement and evaluation of human exposure to hand-transmitted vibration - part 1: General requirements. Geneva, Switzerland: International Organization for Standardization.
- Edgren CS, Radwin RG, Irwin CB (2004). Grip force vectors for varying handle diameters and hand sizes. HUM FACTORS 46 (2): 244-251.
- ISO/DIS 15230, 2005. Mechanical vibration and shock - Coupling Forces at the Machine-Man Interface for Hand-Transmitted Vibration. Geneva, Switzerland: International Organization for Standardization.
- ISO 8727, 1997. Mechanical vibration and shock - Human exposure-Biodynamic coordinate systems. Geneva, Switzerland: International Organization for Standardization.

# CHEST TRANSMISSIBILITY CHARACTERISTICS DURING EXPOSURE TO SINGLE- AND COMBINED-AXIS VIBRATION

Suzanne D. Smith,<sup>1</sup> Stephen E. Mosher<sup>2</sup>

<sup>1</sup>Air Force Research Laboratory, <sup>2</sup>General Dynamics AIS  
Wright-Patterson AFB, Ohio, U.S.A.

## Introduction

Ground, air, and water vehicles can expose humans to substantial multi-axis vibration. Multiple input/multiple output relationships or models exist for estimating frequency response functions of linear systems<sup>1, 2</sup>. These relationships have been applied by some investigators to evaluate the effects of occupied seat vibration<sup>3, 4</sup>. Using a multiple input/single output model, this study investigated the effects of single- and combined-axis vibration in the fore-and-aft (X), lateral (Y), and vertical (Z) directions on vibration transmission to the human chest. Frequency response functions (transmissibilities) were estimated and compared for the back-on and back-off postures.

## Methods

A rigid seat with seat back was mounted onto the Six Degree-of-Freedom Motion Simulator (SIXMODE). A flat acceleration vibration signal was generated between 2 and 40 Hz at 1.0 ms<sup>-2</sup> rms in the single and combined X, Y, Z, XY, XZ, YZ, and XYZ axes. The signals were shifted in time so that the combined inputs were not fully correlated. Lightweight triaxial accelerometers were used to measure accelerations at the seat base (input) and at the bony manubrium of the chest (output). The maximum of nine frequency response functions ( $H(\omega)$ ) or transmissibilities were estimated from the auto- and cross-spectra. The system transfer matrix for the XYZ inputs and chest Z output is

$$\begin{bmatrix} H_{xZ} \\ H_{yZ} \\ H_{zZ} \end{bmatrix} = \begin{bmatrix} P_{xx} & P_{xy} & P_{xz} \\ P_{yx} & P_{yy} & P_{yz} \\ P_{zx} & P_{zy} & P_{zz} \end{bmatrix}^{-1} \begin{bmatrix} P_{xZ} \\ P_{yZ} \\ P_{zZ} \end{bmatrix} \quad (1)$$

where  $P_{xZ}$ ,  $P_{yZ}$ , and  $P_{zZ}$  are the cross-spectra between the three inputs at the seat base and the Z output at the chest, respectively, and  $P_{xx}$ ,  $P_{xy}$ , ...  $P_{zz}$  are the auto- and cross-spectra between the input signals ( $\omega$  not shown in Eq. 1). Equation 1 can be similarly written for the chest X and Y outputs. Matlab<sup>®</sup> was used to estimate the auto- and cross-spectral densities for calculating the transmissibilities, ordinary coherences (for single inputs), partial coherences, and multiple coherences.

## Results

Figure 1 illustrates the major chest transmissibilities observed for the two postures. Vertical vibration showed a consistent influence on the chest X response (Chest X/Z), most likely causing chest pitch. Some chest Z responses were observed with X-axis inputs, but the results were variable and difficult to interpret. In general, other factors besides the known inputs did not affect the transmissibilities shown in Figure 1 (Repeated Measures ANOVA,  $P < 0.05$ ). This was

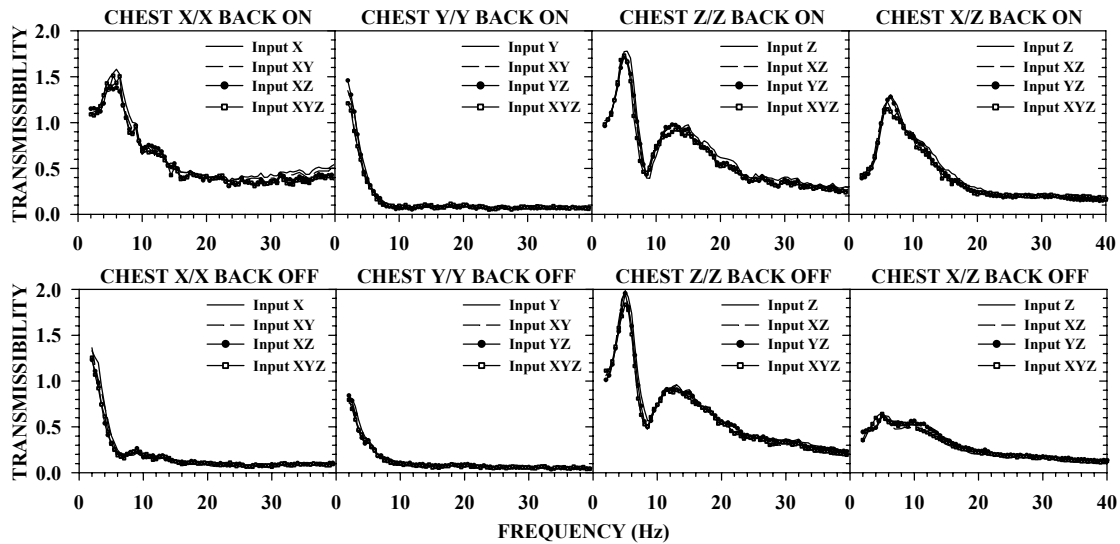

Figure 1 Mean Chest Transmissibilities from Nine Subjects (4 Females, 5 Males)

reflected by the relatively high partial coherences, particularly associated with the primary peak responses (majority PCoh>0.85). More variable coherences were noted among the subjects for Chest X/Z for the XZ and XYZ inputs, the lowest mean value being  $0.75 \pm 0.14$ . Regardless of the input, the back-off posture showed the elimination of the 4-6 Hz peak in Chest X/X, the significant reduction in the peak frequency for Chest X/Z, and the significant reductions in the Chest Y/Y and Chest X/Z transmissibilities (Fig. 1, Paired t-test,  $P < 0.05$ ).

## Discussion

Lower partial coherences would suggest that the chest responses were not fully accounted for by a linear relationship to the known inputs. This could occur due to chest pitch, which was expected to some extent with both the X and Z inputs. Except for a few cases, the partial coherences were relatively high. The seating posture was found to have a significant effect on the chest multi-axis biodynamics. Specifically, coupling with the seat back promoted the influence of vertical vibration on the chest X response, causing higher upper torso motion in the X direction at a peak coincident with whole-body resonance ( $\sim 4-6$  Hz, as observed in Chest Z/Z). When contact with the seat back was removed, these effects were reduced and the peak chest X motions appeared dampened at higher frequencies. The chest X motion with the back off appeared to be more influenced by lower frequency vibration associated with relatively higher seat displacement ( $\sim 2$  Hz).

## References

1. Bendat, J.S. and Piersol, A.G. (1993). *Engineering Applications of Correlation and Spectral Analysis*. New York, J. Wiley.
2. Newland, D.E. (1984). *An Introduction to Random Vibrations and Spectral Analysis*. 2<sup>nd</sup> ed., New York, Longman Inc.
3. Qui, Y. and Griffin, M.J. (2004). Transmission of vibration to the backrest of a car seat evaluated with multi-input models. *J. Sound and Vibration*. 274, 297-321.
4. Smith, S.D., Smith, J.A., Newman, R.J., and Loyer, C.M. (2003). Multi-axis vibration transmission characteristics of occupied suspension seats. Proceedings of 38<sup>th</sup> United Kingdom Conference on Human Response to Vibration, Institute of Naval Medicine, Gosport, England, 17-19 Sep.

# **A FIELD STUDY: MEASUREMENT AND EVALUATION OF WHOLE BODY VIBRATION FOR MH-60S PILOTS**

Kristin Harrer, Nancy Estrada, Carol Lavery, Jane Nowell, Cathy Jennings,  
Naval Medical Center San Diego  
Debra Yniguez, COMHSCWINGPAC

## **Introduction**

Pilots of the MH-60S helicopter are exposed to continuous whole body vibration (WBV). Pilot fatigue is a growing operational concern due to the increased frequency of extended durations of missions (6-8+hours) in support of Operations Iraqi Freedom and Enduring Freedom. Endurance aspects of the currently used rotary wing seating systems were not optimized for the longer missions and wide range of pilot anthropometric measurements, which is now typical of naval aviation. The current seating systems were designed primarily to meet crashworthiness requirements, not for the wide range of pilot anthropometry or to mitigate WBV. Albeit, an issue, pilot fatigue and reduced mission effectiveness are also critical concerns.

Current Hazard Reports indicated that pain in pilots' legs and backs begin two to four hours into the flight and increase with time. Mission readiness also decreases with an increase in flight duration due to the constant distraction of pilots shifting in their seats while trying to get comfortable. Froom, et al [2] reported a dose-response relationship between the length of military helicopter flights and back discomfort. He also concluded that this pain is typically dull, over the lower back, and its prevalence and intensity are dependent on the total flight hours of exposure.

## **Methods**

This study evaluated WBV produced in the pilot seating systems onboard the MH-60S. The purpose of the study was to test and compare the effectiveness of two different seat cushions, the current seat cushion versus an anti-vibration seat cushion. Both seat cushions were measured for acceleration levels averaged over five-minute intervals using a triaxial seat pad accelerometer. The recordings were completed for a 3-hour straight and level flight. A frequency analysis from 0-80 hertz (Hz) was conducted on all acceleration measurements to determine the dominant axis and frequency of the pilots' vibration exposure. The results were then compared to the applicable Threshold Limit Values (TLVs) established by the American Conference of Governmental Industrial Hygienists (ACGIH) [1] and the International Organization for Standardization (ISO) 2631.1 [3] to determine the MH-60S pilots' permissible exposure time for both seat cushions.

## **Results**

The results of the study showed that for both seat cushions the vibration levels of the z-axis at 16 Hz had the shortest allowable exposure duration, according to the ACGIH TLVs. In the z-axis at 16 Hz, the MH-60S's current seat cushion's acceleration levels indicated an exposure time limit of approximately 6 hours, while the anti-vibration seat cushion's acceleration levels pierced the 8-hour exposure time limit curve. This is shown in the graph below.



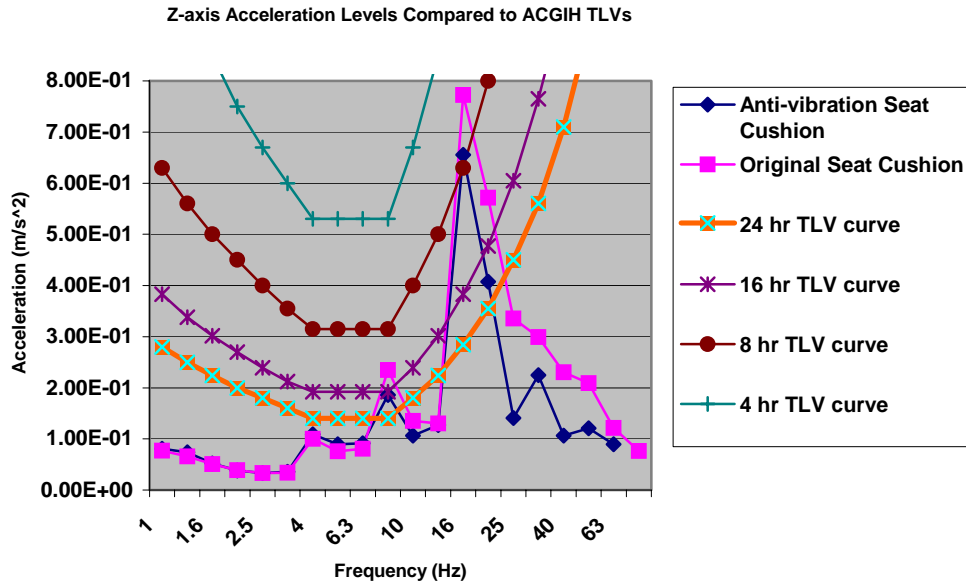

When compared to the ISO standard, the acceleration levels are  $0.86 \text{ m/s}^2$  and  $0.73 \text{ m/s}^2$  for the current and anti-vibration seat cushions, respectively.

### Discussion

While the anti-vibration seat cushion's acceleration levels were slightly lower than the current seat cushion's levels, the helicopter pilots are still overexposed to WBV. Since the average flight during a deployment or mission could last up to 8 hours, the current exposure places the pilots at an unacceptable risk of injury, lack of mission readiness, and possible equipment damage. In the future, helicopters will be outfitted with auxiliary fuel tanks, enabling even longer flights.

Additional research should be conducted to include a larger sample size, evaluate specific flight profiles other than straight and level flights, and perform transmissibility studies aboard the MH-60S targeting specific portions of the human body. Additionally, extensive follow-up epidemiological studies should be performed for Navy helicopter pilots to evaluate the incidence rates of back injury and their relationship to whole body vibration exposure.

### References

1. American Conference of Governmental Industrial Hygienists (2005). Whole-body vibration. In: Threshold limit values, TLVs and biological exposure indices for 2005, pp. 126-133. ACGIH, Cincinnati, Ohio.
2. Froom, P, Hanegbi, R., Ribak, J., Gross, M. (1987). Low back pain in a AH-1 Cobra helicopter. *Aviation Space Environmental Medicine* 58: 315-8.
3. International Organization for Standardization (1997). Mechanical Vibration and shock – Evaluation of human exposure to whole-body vibration – Part 1: General requirements. ISO 2631-1. International Organization for Standardization, Geneva.

# MODELING OF HAND-ARM VIBRATION

Akul Joshi, Robert Guttenberg, Ming C. Leu  
Department of Mechanical and Aerospace Engineering  
University of Missouri-Rolla, U.S.A.

Susan L. Murray  
Department of Engineering Management and Systems Engineering  
University of Missouri-Rolla, U.S.A.

## Introduction

The aerospace and automotive industries are facing a significant risk for cumulative trauma disorders from high-repetition, long-duration tasks. Additional risk factors such as shocks, vibrations and sustained uncomfortable postures oftentimes contribute to musculoskeletal, neurological injuries associated with the hand-arm system. The power tools used for the operation reduce the comfort and working efficiency of the operators, thus lowering their health and safety and the quality of operation. This paper investigates the fastening operation on the assembly line of a major aerospace company for quantifying hand-arm vibrations with the objective of developing a dynamic model of the hand-arm system. The model will be used to ascertain the effect of the various risk factors on the quality of the operation.

## Experiment Setup

A system of three tri-axial accelerometers is used to collect vibrations entering the hand-arm system and their positioning follows the ISO-5349 standard. Reaction force during the operation is measured using a force sensor. The posture of the hand-arm system is measured using two goniometers and one torsionmeter. The pilot study conducted has two subjects and one pistol-grip power tool. The experiment setup and positions of various sensors is depicted in Figure 1.

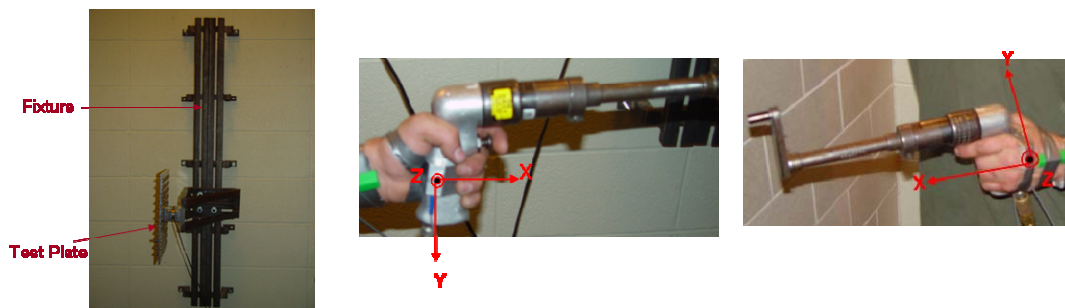

Figure 1: Experiment setup and position of various sensors

## Analysis Method

The analysis consists of transmissibility of vibrations and frequency weighted acceleration based on the recommendations of the ISO-5349 standard [1,2]. The transmissibility [3] was deduced in frequency domain after measuring data in time domain from the

accelerometers mounted on the tool and third meta-carpel of the primary hand of the operator. The ISO frequency weighting function was utilized to calculate the frequency weighted r.m.s values of acceleration for the power tool to get the probability of finger blanching. The transmissibility is calculated as follows:

$$\text{Transmissibility} = T = \frac{A_h(\omega)}{A_t(\omega)} = \frac{\sqrt{A_{hx}^2(\omega) + A_{hy}^2(\omega) + A_{hz}^2(\omega)}}{\sqrt{A_{tx}^2(\omega) + A_{ty}^2(\omega) + A_{tz}^2(\omega)}}$$

Where  $A_h(\omega)$  and  $A_t(\omega)$  are frequency weighted r.m.s accelerations measured by the hand and tool accelerometers, respectively. The frequency weighted 8-hour equivalent r.m.s acceleration is given by:

$$A(8) = a_{fwrms} \sqrt{\frac{t}{t_0}}$$

Where  $a_{fwrms}$  - the frequency is weighted r.m.s acceleration and  $t$  is the operation time.

### Conclusion and Future Work

The transmissibility was found to be consistent for all trials for a subject. The frequency range for ( $T \geq 1$ ) is approximately 5-200 Hz and the lower bound of the frequency range for ( $T \leq 0.1$ ) is about 300 Hz. The average number of years taken to induce 10% probability of finger blanching was found to be about 20 years for the subjects and tool studied.

The transmissibility analysis will be used for deriving the dynamic model of the hand-arm system. The model generated would be used to determine the energy input to the hand-arm system for various postures and tools. Computer simulation software to assist the designer in evaluating operator ergonomics and manufacturability during the design phase for future tools/fixtures will be developed based on this study.

### Acknowledgement

This work is supported by the Air Force Research Laboratory under the Contract FA8650-04-C-5704.

### References

1. ISO-5349 (2001) Mechanical vibration -- Measurement and evaluation of human exposure to hand-transmitted vibration -- Part 1: General requirements.
2. ISO-5349 (2001) Mechanical vibration -- Measurement and evaluation of human exposure to hand-transmitted vibration -- Part 2: Practical guidance for measurement at the workplace.
3. Reynolds, D. D., Angevine, E. N., 1977, Hand-arm vibration. Part II: vibration transmission characteristics of the hand and arm, *Journal of Sound and Vibration*, 51(2), 255-265.

# RAILROAD LOCOMOTIVE WHOLE-BODY VIBRATION STUDY: VIBRATION, SHOCKS AND SEAT ERGONOMICS

E. Johanning<sup>1</sup>, S. Fischer<sup>2</sup>, E Christ<sup>2</sup>  
B. Gores<sup>2</sup>, R. Lührman<sup>1</sup>

<sup>1</sup>Occupational and Environmental Life Science, Albany, NY, U.S.A.

<sup>2</sup>BG Institute for Occupational Safety and Health (BGIA), Alte Heerstrasse Sankt Augustin,  
Germany

## Introduction

North American railroad locomotive operators (engineers and conductors) are exposed to multi-axis vibration and shocks (1, 2). A recent epidemiological survey showed a prevalence of serious type of neck and lower back disorders nearly double that of a control group (3). Ergonomic working conditions are important co-factors in a vibration and shock exposure risk assessment (4, 5). The goal of this study is to illustrate typical work stations (cabs and seats) in US/Canadian type locomotives and assess shock related exposure risk by calculations of the new proposed shock risk indicators according to the new ISO 2631-5 (2004) (6).

## Methods

Locomotive cab and seat inspections were conducted and operators' activities were assessed by a trained observer. Field measurements (n=50) were obtained during normal revue service following generally accepted guidelines (ISO 2631 (1)). A sub-sample of n=20 locomotives were selected for the calculation of proposed shock indicators (ISO 2631 (5)).

## Results

There has been little change in basic locomotive cab and seat design in the U.S.. Two locomotive cab design concepts are used: the Association of American Railroad (AAR) Control Stand and in newer series wide-body locomotives the "Control Consol" (Figures 1-2), with varying seating conditions, but frequently subjecting the operator to an awkward body posture in addition to the vibration and shock exposure.

**[Fig 1]** Traditional cab and seat design ("American Standard Control Stand")

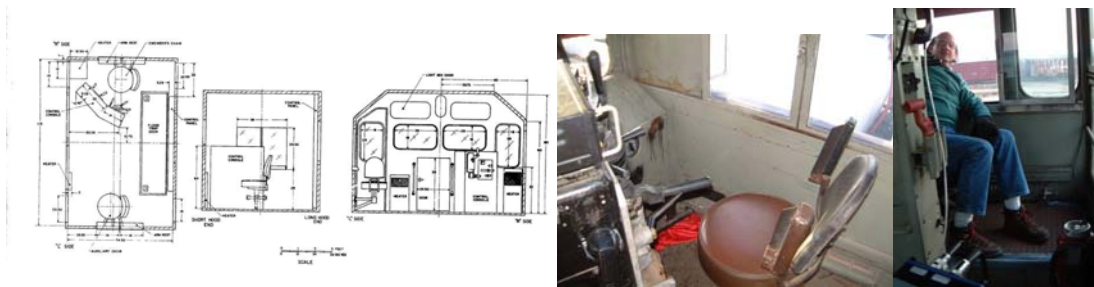

**Fig 2)** Modern "Control Consol" in "wide body" locomotive cab and seating

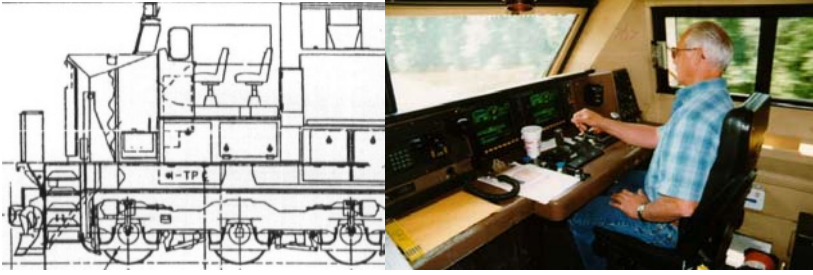

The results of the vibration and shock measurement of the basic x, y, z-axis ( $a_{w\text{ rms}}$ ) and vector sum ( $a_v$ ) ranges were 0.07- 0.19, 0.13-0.4, 0.14-0.5 and 0.27 – 0.65, respectively. The ranges of the “shock” indicators  $MTVV/a_w$  and  $VDV/(a_w \cdot T^{1/4})$  were (x,y,z): 3.2-7.6, 2.9- 9.4, 3.3-10 and 1.44-2.3, 1.37-1.71, 1.44-1.94 and exceeded in a number of cases the critical values given by ISO 2631 (1). The daily equivalent static compression dose  $S_{ed}$  range was 0.11 to 0.79, mean 0.32 and the R-factor range was 0.12 to 0.92, mean 34, suggesting possible conflicting shock exposure risk information.

### Discussion

Different shock indicator values were computed based on both ISO standards. Although, the new ISO 2631-5 method for evaluation of vibration containing multiple shocks suggests in our calculations possibly a low exposure risk other data and experience suggest an underestimation error relying solely on this indicator. We propose considering a combined sum score, in an overall risk assessment, that includes ergonomic co-factors such as awkward body posture, cab and seat design, and other environmental factors.

### References

1. Sorainen, E. & Ryttonen, E. 1999, "Whole-body vibration of locomotive engineers", *Am.Ind.Hyg.Assoc.J.*, vol. 60, no. 3, pp. 409-411.
2. Johanning, E., Fischer, S., Christ, E., Gores, B., & Landsbergis, P. 2002, "Whole-body vibration exposure study in U.S. railroad locomotives--an ergonomic risk assessment 14", *AIHA.J.(Fairfax., Va.)*, vol. 63, no. 4, pp. 439-446.
3. Johanning, E., Landsbergis, P., Fischer, S., & Luhrman, R. 2004, "Back Disorder and Ergonomic Survey Among North American Railroad Engineers", *Transportation Research Record: Journal of the Transportation Research Board*, vol. 1899, pp. 145-155.
4. (U.S.) John A.Volpe National Transportation System Center 1998, *Human factors guidelines for locomotive cabs*, U.S. Department of Commerce, National Technical Information Service, Springfield, VA.
5. Johanning, E. 2000, "Evaluation and management of occupational low back disorders", *American Journal of Industrial Medicine*, vol. 37, no. 1, pp. 94-111.
6. International Organization for Standardization (ISO) 2004, *Mechanical Vibration and Shock - Evaluation of Human Exposure to Whole-Body Vibration. Part 5: Method for Evaluation of Vibration Containing Multiple Shocks (ISO 2631-5)*, ISO, Geneva, 1st ed. [Standard].

# **CLINICAL ASSESSMENT AND CHARACTERISTICS OF MEN AND WOMEN EXPOSED TO HIGH LEVEL OF HAND-ARM VIBRATION**

Thomas Jetzer and Douglas Ketcham  
Occupational Medicine Consultants, Minneapolis, Minnesota, U.S.A.  
United Hospital Radiology Department, St. Paul, Minnesota, U.S.A.

## **Introduction**

While the neurological and vascular aspects of Hand-Arm Vibration Syndrome (HAVS) has been generally accepted as a medical condition, the medical criteria and the clinical findings used to establish the diagnosis has been more difficult to bring to consensus. The criteria was first quantified by the Taylor-Palmear scale.<sup>1</sup> This criteria was subsequently modified in 1986 at the 1<sup>st</sup> Stockholm Workshop<sup>2,3</sup> to include more acceptance for the neurological effects that characterized the predominate findings in some workers. The relationship between hand-arm vibration and Carpal Tunnel Syndrome was defined in NIOSH 97-141<sup>4</sup>.

While the aforementioned documents have defined the clinical entities associated with hand-arm vibration exposure, agreement on the clinical findings and test to confirm the diagnosis has been more difficult to bring to consensus. Clinicians assessing HAVS has relied on a number of varied neurological and vascular tests. The neurological testing has focused on assessing damage to the sensory capability of the fingers for the neurological component including tests to measuring ability to sense vibration, cold or other end point finger sensor functions. However, the vascular testing has been traditionally focused on the ability to either measure vascular function or to reproduce the vascular blanching that occurs in HAVS with cold water provocation. Recent assessment of this testing in the United Kingdom Coal Miner's study has questioned the value of this testing especially in reviews by McGeoch.<sup>5</sup> In an attempt to provide some type of definitive testing to substantiate vascular damage from hand-arm vibration exposure, angiography is an alternative or adjunct to cold water provocation testing.

The standards that have been established to predict the level, type and incidence of HAVS have been based on clinical studies and reports that have essentially been all male populations. However, the recent entry of women into more vibration intensive jobs has brought about the exposure of some women to high levels of vibration previously only previously experienced by men. However, there have been only few studies that look at HAVS in women<sup>6</sup>. Although exposed the same vibration levels, it has not been clear that the latency and type of pathology of HAVS in women will be the same as for men.

The purpose of this study is to look at recent case studies of men and women exposed to jobs with high levels of hand-arm vibration with extensive clinical testing for both the neurological and vascular components of HAVS as well as other associated upper extremity conditions such as Carpal Tunnel Syndrome.

## Methods

Clinical cases referred for evaluation with neurological testing including, vibrometry, Simmes-Weinstein mono filaments, 2 point discrimination, Purdue peg board testing and nerve conduction testing. Vascular testing included Allen's testing, Doppler studies of both upper extremities, cold water provocation testing and angiograph. Additional laboratory blood work and clinical examination was done to rule out alternative disease conditions that could confound results such as diabetes, collagen-vascular disease, etc.<sup>6</sup>

## Results

Although the study was too small for statistical significance, review of the cases show that when exposed to the same high levels of hand arm vibration, women develop HAVS symptoms sooner than might be expected and early onset of Carpal Tunnel Syndrome.. In contrast men take longer to develop the same symptoms and are more likely to develop other finding such as tendonitis before they develop the constellation of symptoms and findings found in women.

Comparison of the vascular testing techniques indicates that the angiography can be helpful in confirming the vascular damage from hand-arm vibration exposure in both men and women. Furthermore, angiography may help localize areas of damage from specific exposure. The study proved to be too small to compare the effectiveness the various vascular testing techniques but suggest that further study is warranted.

## Discussion

The study shows that there is a suggestion that present standards for the latency of HAVS and other vibration related disorders may be different for women then for men. Also review of clinical cases shows that angiography is useful tool in confirming and defining the level of vascular pathology in case of significant HAVS. Further enlarged studies to confirm both of these findings are recommended.

## Bibliography

1. Taylor, W and Pelmeur, P., eds. *Vibration White Finger in Industry*. London Academic Press, 1975
2. Gemne, G., Pyykkom, L. Taylor, W. Pelmeur P. L., *The Stockholm Workshop Scale for the Classification of Cold-Induced Raynaud's Phenomenon in the HAV*, Scand. J. Work. Environ. Health, 1987: 13:275-278
3. Bramer, A. J., Taylor, W., Lundborg. G *Sensoineuroal Stages of the HAVS*, Scand. J. Work. Environ. Health 1987 13: 279-283
4. *Musculoskeletal Disorders fo the Workplace*, US Dept of Health and Human Services, CDC, Natl. Institute for Occupational Health, NIOSH Publ No 97-141 Chapter 5 c, July 1997
5. McGeoch, K.L., et al., *A Medical Assessment Process for a Large Number of Miners and Ex-Miners with Compensation Claims for HAVS*, 10<sup>th</sup> HAVS Conference, Las Vegas, June 2004
6. Bylund, S H., *Women Injured by Hand-Arm Vibration-Who Cares?* 10<sup>th</sup> HAVS Conference, Las Vegas, June 2004

# ACUTE EFFECTS OF VIBRATION ON THE RAT-TAIL ARTERY

Sandya Govindaraju, Brian Curry, James Bain, Danny Riley  
Department of Cell Biology, Neurobiology and Anatomy  
Medical College of Wisconsin, Milwaukee, Wisconsin, U.S.A.

## Introduction

Acute vibration causes vasoconstriction in naïve human subjects<sup>1</sup>. Vibration-induced decrease in skin perfusion has also been reported in the rat-tail vibration model<sup>2</sup>. After vibration exposure, rat-tail arteries demonstrate vacuoles in smooth muscle cells, similar to that caused by pharmacological vasoconstrictors<sup>3</sup>. This study addressed the effects of different frequencies, durations and patterns of vibration on lumen size and vacuole formation using the rat-tail vibration model in male Sprague-Dawley rats (~300 g).

## Methods

The different groups were: 4-hr continuous vibration at 30, 60, 120 and 800 Hz; continuous exposure durations of 5 min, 1 hr and 4 hr at 60 Hz; and 4-hr cumulative exposure of 60 Hz delivered intermittently in cycles of 10 min on and 5 min off. Acceleration was set at 49 m/s<sup>2</sup> r.m.s. for all frequencies. Unanesthetized rats were restrained in cages on a nonvibrating platform with their tails placed on a vibrating stage driven by a B&K motor (4809). The sham control animals were also placed in the vibration apparatus but not vibrated. Room temperature was controlled at 25 ± 1°C. Ventral arteries from proximal tail segments 7 were immersion fixed in aldehydes, embedded in epon-araldite and sectioned (0.5 µm) for morphological analysis. Vascular lumen sizes were measured as the percent ratio of the lumen perimeter to internal elastic membrane length using Image J software (NIH). The number of vacuoles in the smooth muscle layer of each artery section was counted.

## Results

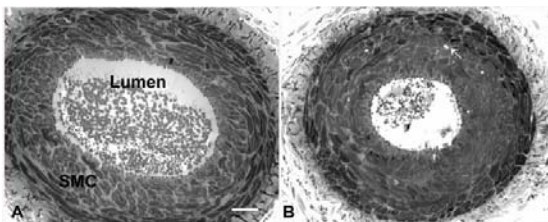
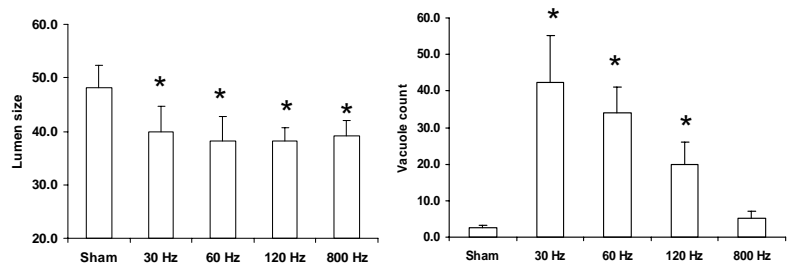

Fig 1: Semithin sections of arteries. A. Sham control. B. 4-hr vibration 60 Hz. In vibrated arteries, the lumen decreases in size, and smooth muscle cells (SMC) exhibit vacuoles (arrow). Bar equals 40 µm for each panel.

Fig 2: Bar graphs of lumen size and vacuole count when vibrated for 4 hrs at 30, 60, 120 and 800 Hz. \* significantly different from sham, p<0.05.





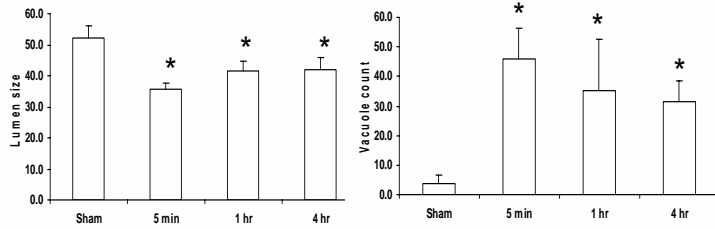

Fig 3: Bar graphs of lumen size and vacuole count when vibrated for 5 min, 1 hr and 4 hrs at 60 Hz. \* significantly different from sham,

p<0.05.

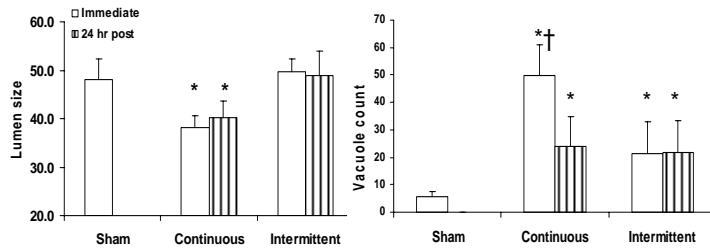

Fig 4: Bar graphs of lumen size and vacuole count when vibrated continuously or intermittently for 4 hrs at 60 Hz and examined immediately or 24 hr after exposure. \* significantly different from sham, † significantly different from other vibrated groups, p<0.05.

## Discussion

1. Vasoconstriction is induced by vibration at 30, 60, 120 and 800 Hz.
2. Vibration exposure of 60 Hz for 5 min is sufficient to cause vasoconstriction and generate smooth muscle cell vacuoles.
3. The decrease in lumen size persists at least 24 hrs after cessation of 60 Hz continuous vibration.
4. Both patterns of vibration, continuous and intermittent, cause the formation of smooth muscle cell vacuoles.

## References

1. Bovenzi M, Griffin MJ, Ruffell CM. Vascular responses to acute vibration in the fingers of normal subjects. *Cent Eur J Public Health* 1995; 3 Suppl:15-18.
2. Curry BD, Bain JL, Yan JG, Zhang LL, Yamaguchi M, Matloub HS, et al. Vibration injury damages arterial endothelial cells. *Muscle Nerve* 2002; 25:527-534.
3. Curry BD, Govindaraju SR, Bain JL, Zhang LL, Yan JG, Matloub HS, et al. Nifedipine pretreatment reduces vibration-induced vascular damage. *Muscle Nerve* 2005; 32:639-646.

*Supported by the Medical College of Wisconsin and in part by NIOSH grant R01 OH003493*

## **EFFECTS OF REPEATED VIBRATION EXPOSURES IN MUSCLE TISSUE**

Oliver Wirth, Stacey Waugh, Claud Johnson, G. Roger Miller, Kristine M. Krajnak  
National Institute for Occupational Safety and Health, Morgantown, West Virginia, U.S.A.

### **Introduction**

Workers exposed to vibrating hand tools are at risk of developing symptoms such as cold-induced vasospasms, loss of tactile sensitivity, and loss of grip strength in the fingers and hands. These symptoms are known collectively as vibration white finger (VWF) or hand-arm vibration syndrome (HAVS). Symptoms of VWF or HAVS are in part due to repeated and prolonged peripheral vasoconstriction[1, 2]. The reduction in blood flow that occurs with vasoconstriction can result in oxygen deprivation (hypoxia) in soft tissues, such as nerves and muscle, and lead to functional and structural changes in these tissues. The present study examined muscle tissue to determine if vibration-induced changes in transcript levels and protein concentrations result in enhanced vasoconstriction and hypoxia. Manual dexterity was also assessed intermittently to determine if vibration-induced changes in cellular factors are accompanied by performance deficits.

### **Methods**

An animal model was developed to study the biological and functional changes that occur in response to repeated segmental vibration exposures. In this model, the right paw of intact rats was exposed to a platform vibrated at a frequency 250 Hz and amplitude of  $49 \text{ m/s}^2$  to simulate the vibration characteristics of hand-held grinders. Three groups of 8 rats each were studied: a vibration-exposed group, an exposure-control group, and a cage-control group. Exposure sessions, with or without vibration, were conducted 4 hr/day, 5 days/week for 5 weeks.

Manual dexterity was assessed intermittently during the 5-week exposure period with the Montoya stair-case test[3], which quantifies the rat's ability to reach for, grasp, and retrieve small food pellets placed below the rat on different levels or steps. Following the 5-week exposure period, the flexor muscles of the right forelimb were collected for analysis of gene expression, protein concentrations, and immunohistochemistry.

### **Results**

Vibration-exposure resulted in an approximate 2-fold increase in the expression of  $\alpha 2C$  and  $\alpha 1D$  receptor transcripts in flexor muscles (Figure 1). These receptors mediate norepinephrine-induced vasoconstriction in smaller arteries. Vibration-exposure also resulted in an approximate 2-fold increase in hypoxia-induced factor-1 $\alpha$  (HIF-1 $\alpha$ ), a transcription factor that is expressed in response to tissue hypoxia. Western analyses demonstrated that restraint caused a decrease in  $\alpha 1$ -receptor protein concentrations in the flexor, but vibration-exposure prevented the restraint-induced reduction (Figure 2). Immunohistochemistry performed on flexor muscles (not shown) demonstrated that  $\alpha 1$  receptors are primarily located in arteries; maintained levels of these receptors could contribute to prolonged vasoconstriction following repeated vibration exposure. The staircase test showed some performance improvement, or a training effect, in manual dexterity for the control groups but not the vibration-exposed group (Figure 3).

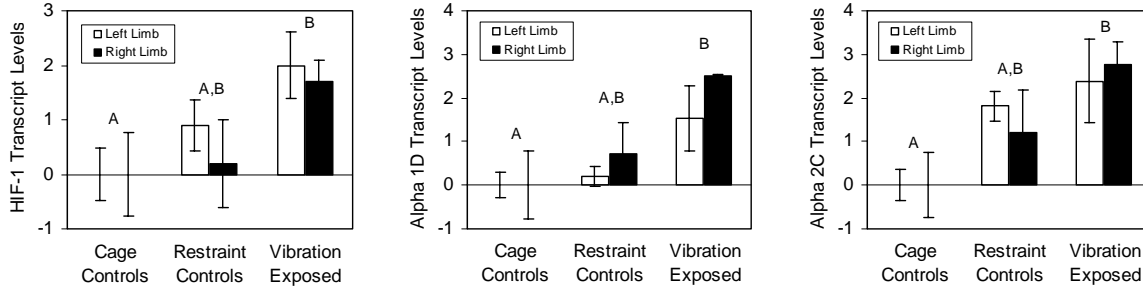

Figure 1. Relative gene transcript levels, expressed as mean fold change ( $\pm$ SE) in critical threshold from cage controls, for *a2c*, *a1a/d*, and *HIF-1a* in the left and right (exposed) limbs. Right limb is not significantly different from left; with right and left combined, A is significantly different from B.

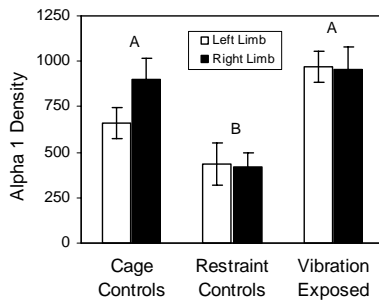

Figure 2. Mean relative optical density ( $\pm$ SE) of  $\alpha 1$  proteins in the right flexor muscles as determined by western blot analysis.

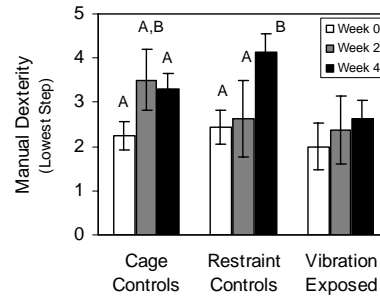

Figure 3. Staircase test of manual dexterity in the right limb (mean  $\pm$  SE; higher = better dexterity).

## Discussion

Results are consistent with the notion that vibration causes increased vasoconstriction in the vasculature, and subsequent damage or loss of function may be associated with hypoxia. Similar changes in transcript levels in both right and left limbs in the vibration-exposed group are consistent with reports of vibration-induced sympathetic vasoconstriction responses in contralateral (nonexposed) limbs[4]. Results also support the hypothesis that vibration-induced disturbances in motor control, manual dexterity, or loss of strength might be linked to hypoxia. A better understanding of these mechanisms can lead to the identification of early indicators of injury and improved methods for diagnosis and treatment of VWF or HAVS.

## References

1. Griffin, M.J., *Handbook of Human Vibration*. 1990, San Diego: Academic Press.
2. Pyykko, I. and G. Gemne, *Pathophysiological aspects of peripheral circulatory disorders in the vibration syndrome*. *Scand J Work Environ Health*, 1987. **13**(4): p. 313-6.
3. Montoya, C.P., et al., *The "staircase test": a measure of independent forelimb reaching and grasping abilities in rats*. *Journal of Neuroscience Methods*, 1991. **36**(2-3): p. 219-28.
4. Bovenzi, M., M.J. Griffin, and C.M. Ruffell, *Acute effects of vibration on digital circulatory function in healthy men*. *Occupational & Environmental Medicine*, 1995. **52**(12): p. 834-41.

# VIBRATION EXPOSURE REDUCES NITRIC OXIDE CONCENTRATIONS IN THE VENTRAL ARTERY OF THE RAT TAIL

Claud Johnson and Kristine M. Krajnak  
National Institute for Occupational Safety and Health, Morgantown, WV 26501

## Introduction

Vibration transmitted to the upper limb by the chronic use of hand tools can result in cold-induced vasospasms finger blanching and cyanosis, similar to that seen with Raynaud's phenomenon (4). These vasospasms, commonly referred to as vibration white finger (VWF), are in part the result of an increased sensitivity of peripheral arteries to the vasoconstricting effects of norepinephrine (e.g., (1-3)). However, alterations in vasodilating factors could also contribute to vasospasms. The goal of these studies was to determine if exposure to a single bout of vibration alters concentrations of the vasodilator, nitric oxide (NO), in a rat tail model of vibration. To determine if vibration exposure alters NO, we exposed animals to a single bout of vibration and measured concentrations of the synthetic enzymes, nitric oxide synthetase (NOS)-1 and NOS-3 in the ventral tail artery. We also directly assessed arterial concentrations of NO using a nitrate/nitrite assay.

## Methods

*General apparatus.* Animals were placed in Broome-style restrainers, and their tail was secured to a vibrating or stable platform. Rats were exposed to a single 4 h bout of tail vibration (125 Hz, acceleration of 49 m/sec<sup>2</sup> r.m.s.) or restraint control. Animals were euthanized with an overdose of pentobarbital (100 mg/kg) and the ventral tail artery was dissected and frozen.

*Experiment 1:* Male Sprague Dawley rats (6 weeks old, n = 32) were used for all exposures. All animals were maintained in AAALAC accredited facilities, and all procedures were approved by the NIOSH Animal Care and Use Committee, and were in compliance with the CDC Regulations for the Care and Use of Laboratory Animals. Animals were euthanized 1 or 24 h after the completion of the exposure. Western analyses were performed on total proteins (80 µg/lane) isolated from the C16-18 artery segments. Band densities were detected by chemiluminescence and quantified using Scion Image, and analyzed using 2-way ANOVAs.

*Experiment 2. Nitrate/nitrite concentrations..* Male Sprague Dawley rats (n = 24, 6 weeks of age) were maintained and exposed as described above. All animals were euthanized 24 h after the exposure and the ventral artery was collected. Nitrate/nitrite concentrations were measured in ventral artery tissue homogenates using the nitrate/nitrite colorimetric Assay Kit (Caymen).

## Results

Analyses of band densities revealed that there was an effect of time ( $F(1, 17) = 6.03, p < 0.03$ ) on NOS-1 protein in arteries exposed to vibration, with NOS levels being lower in arteries collected 24 h after the exposure than arteries collected 1 h after the exposure. Although NOS-1 proteins concentrations were slightly lower in control arteries collected 24 h after an exposure than arteries collected 1 h after exposure, post-hoc contrasts indicated they were not significantly different than 1 h controls. In contrast, NOS-1 band densities from arteries collected 24 h after the exposure were lower than those collected 1 h after the exposure ( $p < 0.01$ ; Figure 1). NOS-3

protein concentrations in the ventral artery were not affected by vibration exposure. Exposure to vibration also resulted in a significant decrease in nitrate/nitrite concentrations (an estimate of NO concentrations) in the ventral tail arteries of rats when compared to cage controls ( $F(1, 17) = 5.07, p < 0.03$ ; Figure 2).

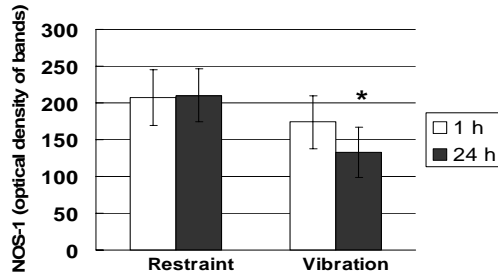

**Figure 1.** NOS-1 concentrations in the ventral tail artery (mean  $\pm$  sem). \* represents less than 24 h restraint control and 1 h vibration exposed.

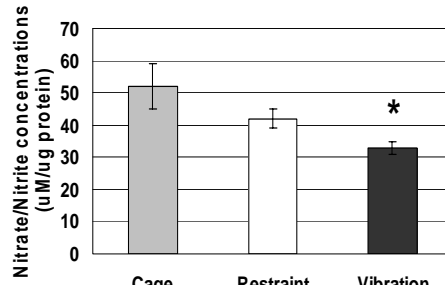

**Figure 2.** Nitrate/Nitrite concentrations in the ventral tail artery (mean  $\pm$  sem). \* is less than cage control,  $p < 0.03$ .

### Discussion

- NOS-1, the neuronal form of the enzyme, stimulates NO production by nerve and smooth muscle cells. NOS-1 was reduced in ventral artery homogenates collected 24 h after a vibration exposure. This suggests that NO production by nerves and/or smooth muscle may be reduced in vibration exposed animals.
- The reduction in NOS-1 protein concentrations was associated with a reduction in NO concentrations in the ventral artery. Reductions in NO may prevent or delay re-dilation of the ventral artery after a vibration-induced constriction.
- NOS-3, the endothelial form of the enzyme, was not altered by vibration exposure, suggesting that endothelial mediated vasodilation may be unchanged after a single exposure to vibration.

### References

1. Curry BD, Govindaraju SR, Bain JL, Zhang LL, Yan JG, Matloub HS and Riley DA. Nifedipine pretreatment reduces vibration-induced vascular damage. *Muscle Nerve*, 2005.
2. Krajnak K, Dong RG, Flavahan S, Welcome DE and Flavahan NA. Acute vibration increases  $\alpha_{2c}$ -adrenergic smooth muscle constriction and alters thermosensitivity of cutaneous arteries. *Journal of Applied Physiology*, in press.
3. Lindblad LE and Ekenvall L. Alpha 2-adrenoceptor inhibition in patients with vibration white fingers. *Kurume Med J* 37 Suppl: S95-99, 1990.
4. Stoyneva Z, Lyapina M, Tzvetkov D and Vodenicharov E. Current pathophysiological views on vibration-induced Raynaud's phenomenon. *Cardiovasc Res* 57: 615-624, 2003.

# ACUTE VIBRATION INDUCES OXIDATIVE STRESS AND CHANGES IN TRANSCRIPTION IN SOFT TISSUE OF RAT TAILS

Stacey Waugh<sup>1</sup>, Stephen S. Leonard<sup>2</sup>, G. Roger Miller<sup>1</sup>, Kristine M. Krajnak<sup>1</sup>

<sup>1</sup>Engineering and Control Technology Branch, <sup>2</sup>Pathology and Physiology Research Branch, National Institute for Occupational Safety and Health, Morgantown, West Virginia, U.S.A.

## Introduction

Repeated exposure to hand-arm vibration through the use of vibrating hand tools can result in the development of the disorder known as hand-arm vibration syndrome (HAVS; (1,3)). One of the hallmark symptoms of HAVS is cold-induced peripheral vasospasms that result in finger blanching (4). Although the vascular and neural pathology associated with vasospasms has been described, little is known about cellular mechanisms leading to this damage (4). To understand how vibration may alter vascular and neural physiology and anatomy, rats were exposed to a single bout of tail vibration and the molecular responses of neural and vascular tissues were measured to determine if there are immediate or sustained effects of vibration that may underlie longer term changes in physiology.

## Methods

Experiment 1. Male Sprague Dawley rats (n = 32, 6 weeks of age) were housed in AAALAC accredited facilities. All procedures were approved by the NIOSH Animal Care and Use Committee and were in compliance with the CDC guidelines for care and use of laboratory animals. Vibration exposures were performed by restraining rats in Broome-style restrainers, and securing their tails to a vibration platform using 6 mm wide straps that were placed over the tail every 3 cm. Restraint control rats were treated in the same manner, except that the tail platform was mounted on isolation blocks and not on a shaker. The vibration exposure was 125 Hz, 49 m/s<sup>2</sup>, for 4 h. Rats were euthanized with an overdose of pentobarbital (100 mg/kg) 1 h or 24 hours after the exposure. RTqPCR was used to measure transcript levels for endothelin 1 (ET-1), the 3 forms of nitric oxide synthetase (NOS) NOS-1, NOS-2, NOS-3 and norepinephrine receptor subtypes 1D, 2A, 2C, in artery tissue, and to measure calcitonin gene-related peptide (CGRP) and nitric oxide synthase-1 (NOS-1) in ventral nerves. Data were analyzed using 2-way ANOVAs.

Experiment 2. Male Sprague Dawley rats (n =24, 6 weeks of age) were maintained as described above. Animals were exposed to a single bout of restraint or vibration. Another group of animals served as cage controls. All animals were euthanized 24 h after the exposure, and tail arteries were isolated and frozen. Reactive oxygen species (ROS) were measured using electron spin resonance spectroscopy (ESR). Arteries were homogenized over ice in 1 ml of PBS with protease inhibitor cocktail, using a tissue tearer (Biospecs Products Inc. Racine, WI USA). The sample was split into two 0.5 ml samples. One set had PBS and the spin label hydroxyl-TEMPO [0.1 mM] added while the other set had hydroxyl-TEMPO [1.0 mM] plus the specific hydroxyl radical scavenger, dimethylthiourea (DMTU), added to confirm the presence of the hydroxyl radical. Samples were vortexed and then placed in a flat cell for ESR analysis. The ESR spectrometer settings were: receiver gain, 6.32 x 10<sup>2</sup>; time constant, 0.02 s; modulation amplitude, 1.0 G; scan time, 20 sec; magnetic field, 3490 ± 100 G (2). Data were analyzed using 1-way ANOVAs.

A

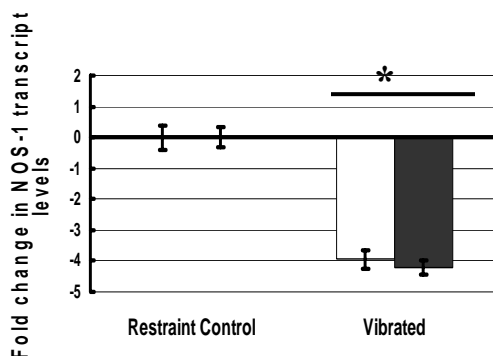

## Results

B

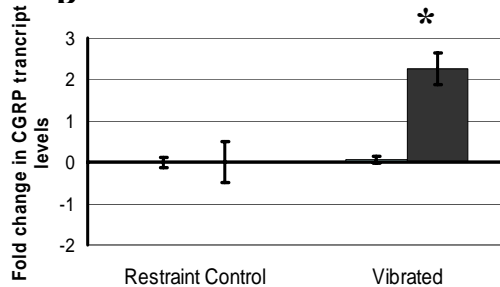

**Figures 1A-B.** Fold changes in NOS-1(A) and CGRP (B) in the ventral tail arteries rats exposed to a single bout of vibration or restraint. The data are expressed as fold changes in transcript levels (mean  $\pm$  sem) from the time matched controls. White bars represent transcript levels from tissue collected 1 h after the exposure and black bars represent transcript levels from tissue collected 24 h after the exposure (\* different from time matched restraint control,  $p < 0.05$ ). Exposure to vibration resulted in a reduction in NOS-1 transcript levels (main effect of exposure  $F(1, 26) = 6.67, P < 0.02$ ) and an increase in CGRP transcript levels in nerve tissue collected 24 h after the exposure ( $p < 0.05$ ).

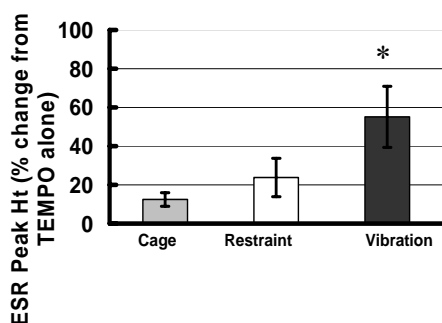

**Figure 2.** ROS measured using ESR. Acute vibration exposure resulted in an increase in hydroxyl radicals. The data to the left represent the ESR peak height when both TEMPO and DMTU were added to homogenates from the tail artery. The data are presented as the percent increase in peak height between TEMPO + DMTU and TEMPO alone. (mean  $\pm$  sem;  $p < 0.05$ , different from cage and restraint controls;  $F(1, 20) = 8.68, p < 0.002$ ).

## Discussion

- Nitric oxide (NO) is a potent vasodilator produced by nerves and arteries. Vibration-induced reductions in the neural form of NOS, NOS-1, may result in reductions in NO synthesis and contribute to a prolonged noradrenergic-induced vasoconstriction.
- Increases in oxidative stress can result in a reduction in NOS activity. Acute exposure to vibration increase ROS in the arteries. This increase in ROS in arteries (and potentially nerves) may result in a reduction in NOS activity and NO production.
- The increase in CGRP transcript levels, which are not seen until 24 h after the exposure, may act to relieve the vibration induced vasoconstriction.

## References

1. Griffin MJ. *Handbook of Human Vibration*. San Diego: Academic Press, 1990.
2. Machida Y, et al., *Am J Physiol Heart Circ Physiol* 284: H449-H455, 2003.
3. Palmer KT, et al., *Occup Environ Med* 58: 279-280, 2001.
4. Stoyneva Z, et al., *Cardiovasc Res* 57: 615-624, 2003.

# VISUALIZATION OF MULTI-DIGIT MANIPULATION MECHANICS

Zong-Ming Li, Shouchen Dun

Hand Research Laboratory, Department of Orthopaedic Surgery, University of Pittsburgh,  
Pittsburgh, Pennsylvania, U.S.A.

## Introduction

Manipulation of hand-held objects in 3D space is a complex task. Understanding how individual digits interact with a hand-held object provides helpful information for hand tool designers, researchers, clinicians, and occupational therapists. At the object-digit interface, the contact mechanics can be represented by three force and three torque components. Six-component force/torque transducers can register all the three forces and three torques at the digit-object interface, and therefore are advantageous in the study of manipulation mechanics. The large number of force and torque signals from multiple force/torque transducers are difficult to interpret and therefore making experimental research of manipulation a challenging task. The purpose of this study was to develop a 3D visualization tool for the investigation of the contact mechanics at the object-digit interfaces during manipulation tasks.

## Methods

A 3D stick-figure hand model was created based on digitized 23 anatomical landmarks of the hand. Five miniature 6-component force/torque transducers ( $4 \times$  Nano17 for the fingers,  $1 \times$  Mini40 for the thumb, ATI Industrial Automation, NC) were used to record force and torque data at the tips of individual digits. Thirty channels of force/torque signals from the transducers were collected by a 16-bit analogue-digital converter (PCI-6031, National Instrument, Austin, TX) installed in a computer. The transducers were mounted on a custom-made rectangular aluminum handle for object manipulation. Coordinate frames were established at each transducer, on the handle, and at the base of the MicroScribe digitizer. To visualize the force vectors at the digit-tips, the coordinates of the hand landmarks in the MicroScribe coordinate frame and the force vectors in local transducer coordinate frames were transformed to a common coordinate frame defined on the handle. One healthy right-handed, male subject participated in the experimental study. During the tests, the participant sat in a chair by a testing table. The forearm was strapped to an arm holder in neutral rotation position. The instrumented handle was fixed on the testing table by a C-clamp through an adapting plate. With the hand of the subject gripped on the instrumental handle, the landmarks of the instrumented handle and the transducers, as well as the anatomical landmarks of the hand were digitized using the MicroScribe digitizer for the purpose of coordinate frame establishment and transformation as described above. The subject performed three different maximum isometric voluntary contraction tasks: (1) grasping, (2) rotating in pronation, and (3) lifting.

## Results

The 3D hand model and representative force vector clusters in a single trial of grasping, rotating, and lifting tasks are shown in Figure 1. Each cluster was formed by displaying all the 3D force vectors during the period of “stabilized” maximum effort in a trial. The magnitude and



orientation of the force vectors of individual digits were strongly dependent on the task. Compared to the grasping and lifting tasks where forces were more evenly distributed among 4 fingers, forces in the rotating tasks were more concentrated on the two radial fingers, which was an advantageous strategy to produce pronation torque. In the grasping tasks, there was a trend that the force vectors of the four fingers converged. During the rotating tasks, there was a trend that the lower was the finger, the greater the projection angle, and the force vectors of the thumb pointed towards the ulnar aspect (-24.7 degrees). Therefore, the force vectors of individual digits tended to form a force couple to generate pronation torque. During the lifting tasks, the force vectors of all digits pointed upwards to generate maximal resultant uplifting force.

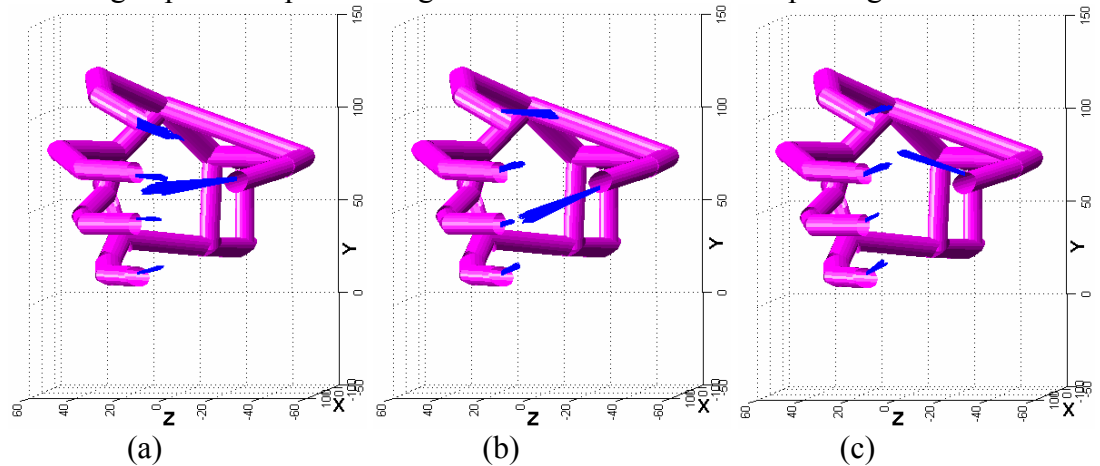

*Figure 1. Three-dimensional hand model and representative force vector clusters at the digit-tips in tasks of (a) grasping, (b) rotating in pronation, and (c) lifting. Note that the magnitudes of all the force clusters within a task were equally scaled to achieve a reasonable visualization effects.*

## Discussion

The employment of 6-component force/torque transducers enabled us to construct 3D force vectors at the digit-object interfaces. Our preliminary results showed that during 5-digit manipulation, the human subject tended to maximize task efficiency by utilizing different force coordination strategies for different tasks. Complex force vector coordination patterns during manipulation tasks could be directly perceived through visualization. The 3D visualization tool developed in the current study could provide expedient and intuitive understanding of the mechanical interaction at the object-digit interfaces and the coordination among multiple digits. It could potentially be an effective tool for the understanding of human hand control and ergonomic designs that involve the usage of multiple digits. Further development of the current visualization tool will focus on incorporating kinematic data synchronized with force/torque measurement so that a relationship of the dynamic hand motion and manipulation mechanics could be established. The integration of force/torque data and kinematic data not only provides a dynamic visualization of grasping mechanics, but also allows for more advanced biomechanical studies such as the calculation of joint torques and muscle/tendon forces.

# USE OF TUNGSTEN TO REDUCE VIBRATION EXPOSURE IN AIRCRAFT MANUFACTURING

Michael J. Jorgensen, Khurram S. Khan, and Anoop Polsani  
Industrial and Manufacturing Engineering Department, Wichita State University  
Wichita, KS, U.S.A.

## Introduction

Riveting operations in aircraft manufacturing involves the use of power tools for manually drilling holes for the rivets, power drills for the setting of the holes for the rivets, as well as rivet guns to drive and set the rivets. To close the rivet, the rivet is driven against a metallic bar commonly called a “bucking bar”. The bucking bars are typically held firmly to increase the quality of the riveting, as well as keep the bucking bar from “dancing” against the metal piece being riveted. Thus, employees in aircraft manufacturing involved in riveting are exposed to hand-arm vibration from several sources, and epidemiological evidence suggests that vibration-related musculoskeletal disorders are associated with long term exposure to riveting tasks in the aircraft manufacturing of aircraft.<sup>1,2</sup> Recently, tungsten technology has been introduced into aircraft manufacturing for bucking bars, which are heavier than traditional steel bucking bars of the same size. Rivet guns with tungsten pistons instead of steel pistons have also recently been introduced with the objective of reducing vibration exposure to the riveter. The objective of this study was to assess vibration characteristics of steel and tungsten bucking bars and rivet guns to identify the combination that simultaneously reduced the combined exposure to both the “riveter” and “bucker”.

## Methods

Vibration (10g tri-axial accelerometer, Biometrics S2-10G-MF Series 2) was measured from eight experienced employees using seven different rivet guns on size 6 rivets, with the same person bucking for all subjects. Vibration was also measured on two different bucking bars for these same eight subjects, with the same person driving the rivets using the various rivet guns. The rivet guns consisted of three E4 steel piston guns with different RPMs (Guns A-E4, B-E4, C-E4), an E4 vibration dampened rivet gun (Gun D-E4D), an E3 steel piston rivet gun (Gun E-E3) and an E3 and E4 tungsten piston rivet guns (Guns F-E3T and G-E4T). The bucking bars were made of 90% tungsten (1694g) and cold-rolled steel (843g), and were the same shape and size. A two-way repeated measures analysis of variance was performed on the vibration (mean frequency weighted resultant acceleration) on both the rivet gun side and the bucking bar side, and mean rankings were used to assess the vibration simultaneously for the rivet gun and bucking bars to investigate which combinations provided the lowest vibration exposure.

## Results

Frequency weighted resultant acceleration was significantly lower on the E3 tungsten (F-E3T) rivet gun than the E4 steel piston (B-E4) and the E4 tungsten piston (G-E4T) rivet guns (Figure 1). When measuring vibration on the bucking bar, the E4 (A-E4) steel piston rivet gun resulted in lower vibration on the bucking bars than the E4 tungsten piston (G-E4T) and E4 vibration dampened (D-E4D) rivet guns (Figure 2). Additionally, use of tungsten bucking bars resulted in a 35% decrease in resultant frequency weighted acceleration than when using steel bucking bars.

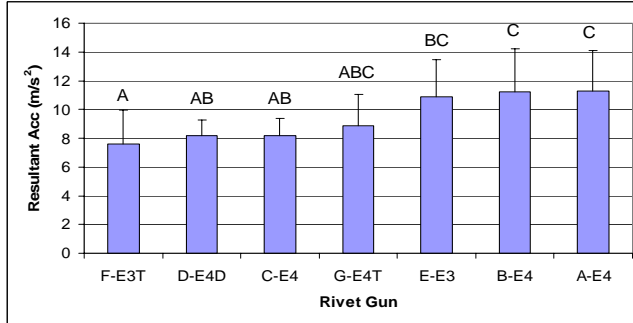

Figure 1. Resultant vibration measured on the rivet gun

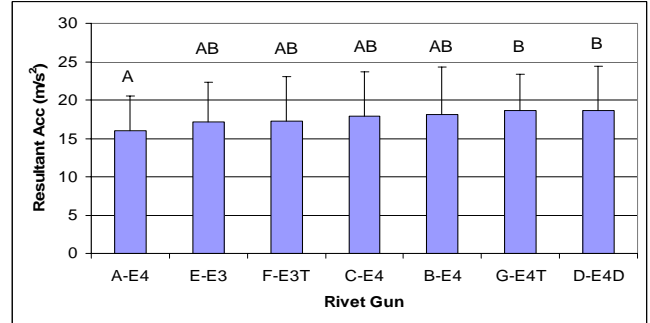

Figure 2. Resultant vibration measured on the bucking bar as a function of rivet gun used.

### Discussion

Differences in vibration magnitudes were observed, however, the differences depended on whether the vibration was measured from the rivet gun or on the bucking bar. The vibration measured on the rivet guns indicated that the E3 (F-E3T) and E4 (G-E4T) tungsten piston rivet guns resulted in lower magnitudes, whereas E4 steel piston guns (B-E4 and A-E4) had higher magnitudes. Using tungsten bucking bars substantially decreased the vibration to the “buckers” compared to using steel bucking bars. However, the rivet guns that produced the lowest vibration to the riveter (dampened: D-E4D; tungsten: G-E4T) resulted in the highest vibration experienced on the bucking bar (Figure 3). Using the rankings on vibration levels for the tungsten bucking bar and different rivet guns to assess vibration exposure to the “riveters” and “buckers” simultaneously, using the E3 tungsten piston rivet gun (F-E3T) appears to reduce the vibration levels when considering both the riveting side and bucking bar side simultaneously when driving size 6 rivets. In conclusion, use of tungsten technology has the potential to reduce vibration exposure to riveters and buckers in certain riveting tasks.

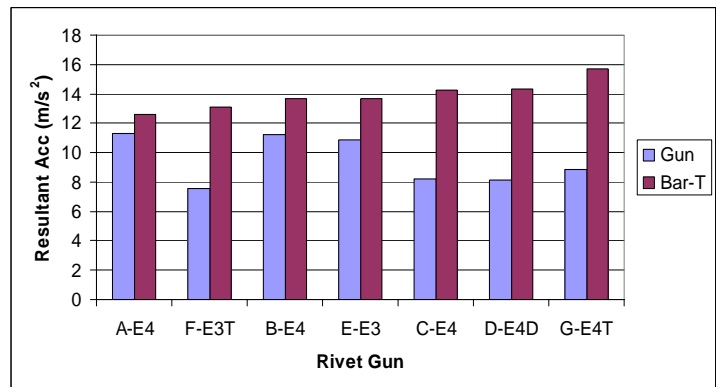

Figure 3. Resultant vibration measured on the rivet gun and the tungsten bucking bar.

### References

1. Engstrom, K. and Dandanell, R. 1986, Exposure conditions and Raynaud’s phenomenon among riveters in the aircraft industry, *Scandinavian Journal of Work, Environment & Health*, 12, 293-295.
2. Burdorf, A., Monster, A. 1991, Exposure to vibration and self-reported health complaints of riveters in the aircraft industry, *Annals of Occupational Hygiene*, 35(3), 287-298.

## HANDLE DESIGN FOR OPTIMAL HAND FUNCTION

Stephen L. Tillim

Bonsil Technologies, LLC, Boulder Creek, California, U.S.A.

Tubular Handles can negatively affect the contents of the carpal tunnel. Years of injuries from grasping handles for tools and machines can cause carpal tunnel syndrome, tendonitis and wrist joint injuries. They can cause inability to use a hand and resulted in the longer absences from work than injuries from falls, accidents or fires.<sup>1</sup>

Cylindrical, tubular and rectangular handles are rolled flat structures. They place the hand on a rolled flat surface where the ends of the middle and ring fingers overlap the index and small fingers. They are pulled along a series of lines that contact the end joint of the index finger, the middle bones of the middle and ring fingers and the end bone of the small finger. Cylinders are pulled diagonally in the hand toward the carpal tunnel (CT) area. Gripping in this manner tenses asymmetric muscle groups in the forearm.

Handles could work better if they do not place pressure on the CT and conform to the natural function or neutral hand position where the hand rests or dangles at the side of the body, the finger tips form a diagonal, the palm and fingers form a cup, the thumb rests between the index and middle fingers and the wrist is mildly extended. However, handles designed for the neutral position are pulled by diagonally oriented fingers into the valley between the thenar and hypothenar muscles where they can compress the median nerve and tendons exiting the CT.

Seven principles for handles that do not place pressure on the carpal tunnel and employ optimal hand position are presented. First, handles should align the ends of the fingers parallel to the horizontal crease and not diagonally. Second, handles should extend from the cupped fingers to meet the muscles at the base of the thumb on the radial side of the hand and extend further on the other or ulnar side to meet a portion of the small muscles. Third, handles should have a recess on the proximal side to prevent contacting or placing pressure on the carpal tunnel. Fourth, handle design should be based on hand measurements in a position of function. Fifth, handles should come in sizes. Sixth, handles should be placed on tools to maintain the wrist and elbow in neutral position. The seventh is handles should support the maximum area of the hand and absorb, but not direct, vibration to the carpal tunnel. These principles led to prototypes and patents for handles for gripping, pinching and squeezing<sup>2,3,4</sup>.

The poster will illustrate and explain the principles Bonsil handles. Research, with existing tools, is needed to substantiate claims made for the Bonsil handle.

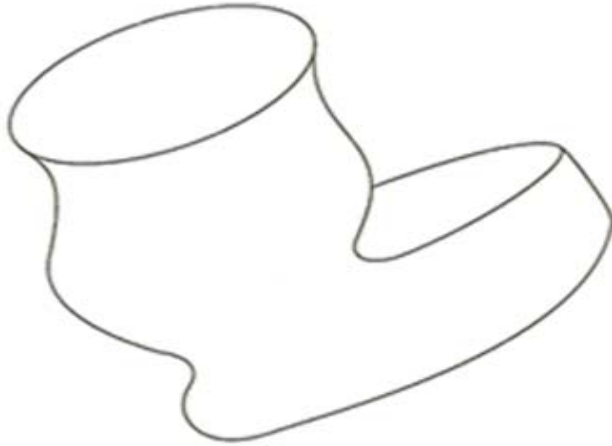

Figure 1

Figure 1 illustrates a large Bonsil handle. The upper section of handles for hammers will have a smaller radius than large power tools. Handles that support the upper body, such as crutches, canes and bicycles will have longer front to back lengths and shorter side to side lengths. The ulnar section extends further for supportive handles than for handles gripped like hammers.

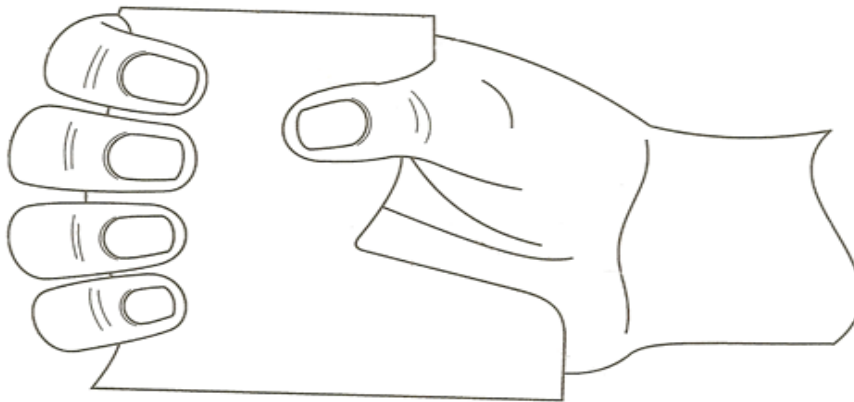

Figure 2

Figure 2 illustrates a hand wrapped around the Bonsil handle. Note, aligning the fingers preserves the cups formed by the fingers and palm. The thumb opposes the space between the index and middle fingers for strongest potential grip. The ulnar extension balances radial and ulnar grip. The CT area is not touched.

### References

1. Repetitive Motion Results in Longest Work Absences. [www.bls.gov.opub/ted/2004/mar/wk5/arto2.htm](http://www.bls.gov.opub/ted/2004/mar/wk5/arto2.htm)
2. US Patent 6,988,295 HANDLE/GRIP AND METHOD FOR DESIGNING THE LIKE
3. US Patent 6,944,914 HANDLE AND FORCEPS/TWEEZERS AND METHOD AND APPARATUS FOR DESIGNING THE LIKE
4. US Patent 7,010,835 PARALLEL HANDLE SYSTEM AND METHOD FOR DESIGNING A PARALLEL HANDLE SYSTEM

## VIBRATION TIME AND REST TIME DURING SINUSOIDAL VIBRATION EXPERIMENTS: DO THESE FACTORS AFFECT COMFORT RATINGS?

James P. Dickey<sup>1</sup>, Michele L. Oliver<sup>2</sup>, Natasha K. Lee Shee<sup>1</sup>, Paul-Émile Boileau<sup>3</sup>, Tammy R. Eger<sup>4</sup>, Lana M. Trick<sup>5</sup>, Vibration Research Group<sup>6</sup>

<sup>1</sup>Human Health and Nutr. Sci, University of Guelph, Guelph, Ontario, Canada

<sup>2</sup>School of Engineering, University of Guelph, Guelph, Ontario, Canada

<sup>3</sup> Institut de recherche Robert Sauvé en Santé et en Sécurité du Travail (IRSST), Montreal, Quebec, Canada

<sup>4</sup>School of Human Kinetics, Laurentian University, Sudbury, Ontario, Canada

<sup>5</sup>Department of Psychology, University of Guelph, Guelph, Ontario, Canada

<sup>6</sup>(University of Guelph, Laurentian University, IRSST, University of Western Ontario, Mines and Aggregates Safety and Health Association, Ontario Forestry Safe Workplace Association and Construction Safety Association of Ontario).

### Introduction

Industrial exposure to whole-body vibration is associated with injury and discomfort. Certain industries, notably mining, construction, and forestry, involve complex 6 degrees of freedom vibration. Laboratory-based studies of vibration are essential for controlled and systematic evaluation of the human responses to vibration<sup>2</sup>. The purpose of this pilot study was to evaluate whether the duration of the vibration exposure, and rest between vibrations, significantly influence the subjective ratings of comfort during laboratory-based studies of vibration.

### Methods

**Subjects:** The cumulative vibration dose was calculated, and was below the health guidance caution zone recommended by International standards<sup>3</sup>. The experimental procedures were approved by the University of Guelph Research Ethics Board. Ten adult subjects participated in this pilot experiment. All subjects completed the entire experimental paradigm; no subjects complained of pain during or after the experiment.

**Experimental Design:** The experiment consisted of four blocks of vibration exposures; either 15 or 20 seconds of vibration (1 df:Z axis, 3 df:XY plane, 3df:YZ plane, or 6 df) alternating with either 5 or 10 seconds rest. The order of presentation of the four blocks was randomized. Each of the blocks was composed of 37 individual sinusoidal vibration exposures in randomized sequence. This abstract focused on ten identical trials, (6.3 Hz vertical vibration, 0.55 m/s<sup>2</sup> RMS) interspersed within each block, in order to assess whether the subjects' comfort ratings systematically varied between the 15 or 20 vibration exposures, the 5 or 10 second rest between vibrations, or within each block. The experiment involved 43 minutes of vibration within the 62 minute experiment.

**Vibration Apparatus:** A commercial parallel robotic platform was used to apply the specific vibration exposures (R2000, Parallel Robotics Systems Corporation, Hampton, New Hampshire). The subjects sat on a passenger seat from a 1992 Honda Accord that was rigidly mounted to the robotic platform (Figure 1). This robotic system performed the specific vibration exposures operating under closed-loop displacement control. A custom-written Matlab program automated the testing sequence.

**Comfort Measures:** Subjective feelings of comfort were verbally reported following each vibration exposure (during the rest period). The comfort scale was modelled after a previously published 9 point continuous comfort scale<sup>1</sup> which provided the greatest reliability and discrimination between different vibration intensities among 14 scales, but was modified to enable verbal reports (0 = "zero discomfort" & 8 = "max. discomfort").

**Statistical Analysis:** The raw comfort scale values for the ten identical vibration trials in each of the four blocks were analyzed using a three-way ANOVA.

## Results

Figure 2 illustrates each of the subjects' comfort ratings for the ten repeated trials, collapsed across blocks of vibration duration. Statistical analysis did not observe significant interactions or main effects.

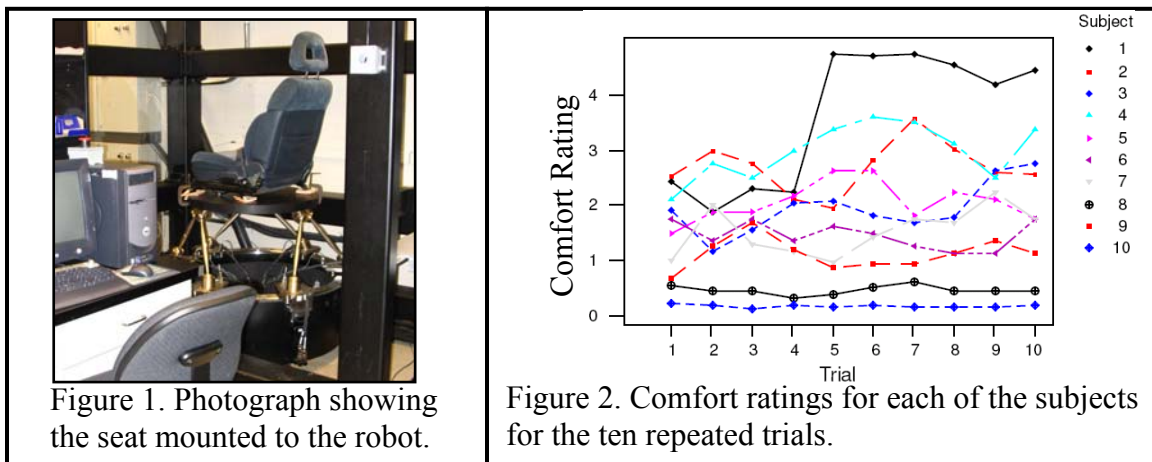

## Discussion

We did not observe statistically significant differences in comfort between the 15 or 20 second vibration exposures, or the 5 vs10 second rest durations. In addition, the comfort ratings did not vary systematically within the blocks of vibration. It appears that the one hour experiment duration did not result in systematic changes in reported comfort. This information is helpful for designing future laboratory-based vibration experiments.

**Acknowledgements:** Support provided by the Workplace Safety and Insurance Board of Ontario. The authors are grateful to the subjects for their participation.

## References

1. Dempsey, T.K., Coates, G.D. and Leatherwood, J.D. (1977). An Investigation of Ride Quality Rating Scales. NASA Technical Paper 1064.
2. Fairley, T.E. and Griffin, M.J. (1988). Predicting the Discomfort Caused by Simultaneous Vertical and Fore-And-Aft Whole-Body Vibration. *Journal of Sound and Vibration* 124, 141-156.
3. ISO 2631-1 (1997). Mechanical vibration and shock – Evaluation of human exposure to whole-body vibration- Part 1: General requirements, International Organization for Standardization, Switzerland.

## Index of Authors

Agresti, M.	57
Aldien, Y.	40
Alzate, M.	74
Amirouche, F.	29, 38
Ando, H.	70
Ankrum, J.	64
Bain, J.	61, 154
Bedard, S.	74
Belanger, C.	74
Bhambhani, Y.N.	72
Boileau, P.-É.	14, 40, 91, 95, 114, 119, 168
Boninger, M.L.	134
Boutin, J.	14, 114
Brammer, A.J.	20, 51
Brodersen, T.	124
Burdisso, R.	112
Cann, A.	83
Chang, W.-R.	85
Chen, J.-C.	85
Cherniack, M.G.	20, 51
Choi, S.-H.	87
Christ, E.	150
Christiani, D.C.	85
Contratto, M.	66, 124, 130, 132
Cooper, R.A.	134
Cooperrider, N.K.	77
Curry, B.	61, 158
Dale, A.M.	22, 106
Deeb, T.	12
Demont, R.	93
Dickey, J.	168
Dong, C.L.	142
Dong, R.	1, 16, 27, 42, 97, 101, 140, 142
Dun, S.	162
Eger, T.	14, 83, 119, 168
Estrada, N.	146
Evenoff, B.	22, 106
Fischer, S.	150
Frey-Law, L.	66, 130, 132
Galaviz, P.	57
Gibbons, J.D.	48
Gibson, R.G.	48
Gillin, E.K.	83
Gordon, J.J.	77
Gores, B.	150
Govindaraju, S.	61, 154
Grenier, S.	119
Griffin, M.J.	2, 3, 33
Grosland, N.	66, 130, 132

Guttenberg, R.	148
Harrer, K.	146
Hatfield, B.H.	85
Hayden, C.	16
Hinton, G.	138
Hong, S.-I.	87
Hosoya, N.	136
Howard, J.	iv
Hunstad, T.	132
Hunt, M.	83
Ishitake, T.	70
Jang, H.-K.	87
Jennings, C.	146
Jetzer, T.	53, 152
Jobes, C.	29
Johanning, E.	150
Johnson, C.	156, 158
Johnson, M.	112
Johnson, P.W.	90
Jorgensen, M.J.	164
Joshi, A.	152
Kadam, R.	112
Kaulbars, U.	117
Keller, T.	99
Ketcham, D.	53, 152
Khan, K.	164
Khanal, S.	123, 140
Kim, J.	16
Kittusamy, N.K.	29, 126
Kopp, G.	66, 130, 132
Krajnak, K.M.	1, 42, 59, 101, 156, 158, 160
Larson, R.	123
Lavery, C.	146
Leblanc, G.	114
Lee, J.	68
Lee Shee, N.	168
Leonard, S.S.	160
Leu, M.C.	152
Li, L.	35
Li, Z.-M.	162
Lifchez, S.	57
Liu, Q.	14
Luhrman, R.	150
Lundstrom, R.	51
Ma, S.	91
Maeda, S.	2, 5, 31, 99, 136
Maikala, R.V.	72
Mandapuram, S.	91
Mansfield, N.	2, 5, 18
Marcotte, P.	40, 114



Marshall, D.	124
Martin, B.J.	25, 68
Matloub, H.S.	55, 57
Mayton, A.	29, 38
Merchant-Hanson, J.	57
Meyer, J.D.	51
McCormick, R.	97
McDowell, T.W.	27, 142
Miller, G.R.	156, 160
Morioka, M.	33
Morse, T.F.	51
Mosher, S.E.	144
Mullinix, L.	123, 138
Murray, S.L.	148
Nakashima, Y.	31
Natani, A.	95
Neal, K.	123
Neely, G.	51
Nelisse, H.	95
Nelson, C.	2, 9
Nilsson, T.	51
Nowell, J.	146
Oddo, R.	114
Oeullette, S.	114
Oliver, M.	168
Pankoke, S.	46
Patra, S.K.	95
Persson, M.	110
Peterson, D.R.	20, 51
Pierce, J.	121
Ploger, J.	90
Polsani, A.	164
Pronesh, A.	93
Raasch, C.	121
Rahmatalla, S.	66, 130, 132
Rakheja, S.	25, 40, 91, 93, 95
Reynolds, D.	12, 79
Rider, K.A.	25, 68
Riley, D.A.	55, 57, 61, 154
Rowe, D.	57
Sakakibara, H.	2, 7
Salmoni, A.	83
Sanger, J.R.	55, 57
Satou, Y.	70
Schwartz, K.	112
Siefert, A.	44
Skogsberg, L.	108
Smets, M.	14, 119
Smith, J.A.	104
Smith, S.D.	104, 144
Song, C.-M.	87
Song, W. J.	16
Spratt, K.	64

Standeven, J.	22, 106
Stayner, R.	81
Stevenson, J.	119
Tessier, B.	74
Tillim, S.	166
Toppila, E.	51
Trick, L.	168
Turcot, A.	74
Valero, B.	38
Vi, P.	83
Warren, C.	142
Warren, N.	51
Wasserman, D.	123, 138
Wasserman, J.	123, 138
Waugh, S.	156, 160
Welcome, D.E.	16, 27, 40, 97, 101, 140, 142
Wiker, S.F.	27
Wilder, D.	64, 66, 130, 132
Wilson, S.	35
Wirth, O.	1, 156
Wolf, E.J.	134
Wolfel, H.P.	44
Wu, J.	1, 42, 142
Xia, T.	64, 66, 130, 132
Yan, J-G	55, 57
Yan, Y.	57
Yniquez, D.	146
Yoon, J.-H.	68
Zhang, L-L	55, 57