

Effect of Scrubber Operation on Airflow and Methane Patterns at the Mining Face

C.D. Taylor, J. E. Chilton, E. Hall, and R.J. Timko

U.S. Department of Health and Human Services, Centers for Disease Control and Prevention, National Institute for Occupational Safety and Health, Pittsburgh Research Laboratory, Pittsburgh, PA, USA

ABSTRACT: The National Institute for Occupational Safety and Health (NIOSH) has conducted research to determine the influence of mining machine-mounted scrubbers on airflows and methane concentrations at the face when blowing ventilation systems are used. Tests were conducted in a full-scale ventilation gallery with a model mining machine that simulated airflow created by a dust scrubber. During the tests, ultrasonic anemometers were used to measure airflow speed and direction at several locations near the face. For the same test conditions, methane was released from the face and gas concentrations were measured at 21 locations above the machine using fixed point methanometers. Changes in airflow speed and direction are correlated with scrubber airflow and the measured methane distribution above the mining machine. The research results showed that operation of machine-mounted scrubbers improved face ventilation when blowing ventilation is used by increasing both the intake flow and the quantity of air reaching the face.

1 INTRODUCTION

Effective face ventilation requires that the intake air delivered to the end of the tubing or brattice must reach the face. For cuts deeper than 6.1 m (20 ft), as little as 5 pct of the air delivered to the end of the curtain reaches the face (Thimons 1999). The amount of air delivered generally decreases as the curtain setback distance increases. Flooded bed scrubbers are widely used on continuous miners to reduced airborne dust levels during cutting. Previous research by Volkwein (1986), Gillies (1982), and Taylor (1996, 1997) showed that scrubber operation increases the quantity of air reaching the face. The increased airflow can result in lower methane levels. However, the mechanisms whereby scrubber operation increases face airflows are not clearly understood.

The objective of the current work is to use a full-scale model of a mining machine at a simulated mining face to examine how scrubber use affects face airflow and methane concentrations. Ultrasonic anemometers were used to measure airflow near the face with and without a scrubber operating. Changes in methane concentrations resulting from use of the scrubber were determined by releasing methane at the face and measuring the methane concentrations above the machine.

2 TEST PROCEDURES

2.1 Gallery and mining machine

Testing was conducted in NIOSH's Pittsburgh Research Laboratory, Ventilation Test Gallery. One side of the "L shaped building" is designed to model an underground mining entry, which is 5 m (16.5 ft) wide by 2.1 m (7 ft) high (Fig. 1). A 1.2 m (3.5 ft) wide by 12.2 m (40 ft) long box was built along the right side of the face to simulate an uncut slab of coal. The resulting entry simulated a 4 m (13 ft) wide box cut.

A brattice and wood curtain constructed 0.6 m (2 ft) from the left side of the entry directed airflow toward the face for the scrubber evaluation tests. The curtain setback distance for all the tests was 10.5 m (35 ft). The intake flow quantity was calculated by multiplying the velocity times 1.3 m^2 (14 ft^2), the cross-sectional area of the airflow pathway behind the curtain. Regulator door openings were adjusted to deliver the desired flows of 1.9 or 2.8 m^3/s (4000 or 6000 ft^3/min) to the end of the curtain.

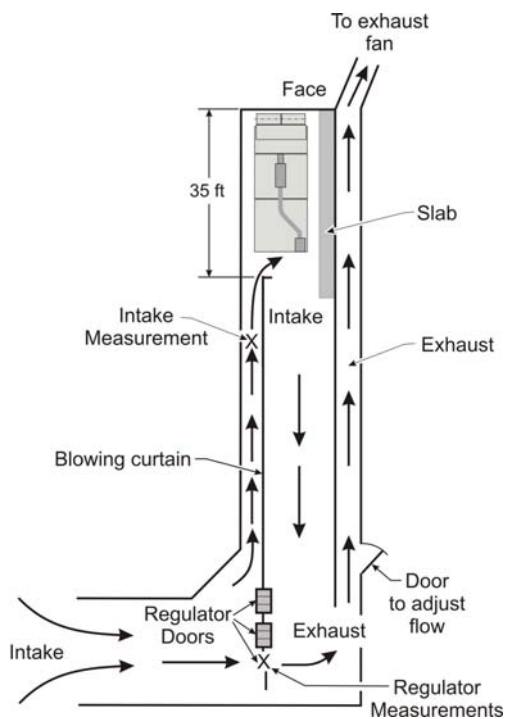

Figure 1. NIOSH ventilation test gallery.

A full-scale model continuous miner was located at the center of the entry to simulate a mining machine at a box-cut face (Fig. 2). The continuous miner model includes a simulated scrubber system that consists of the following:

- Two inlet openings 25 by 36 cm (10 by 14 in), one on each side of the mining machine, and 2.7 m (9 ft) from the front edge of the cutting drum.
- An exhaust opening 38 by 38 cm (15 by 15 in) at the right rear of the machine chassis. Louvers over the exhaust opening direct the airflow away from the face.
- Ducting to provide flow between the inlets and exhaust openings.
- An axial fan to move the air from the scrubber inlet openings to the exhaust.

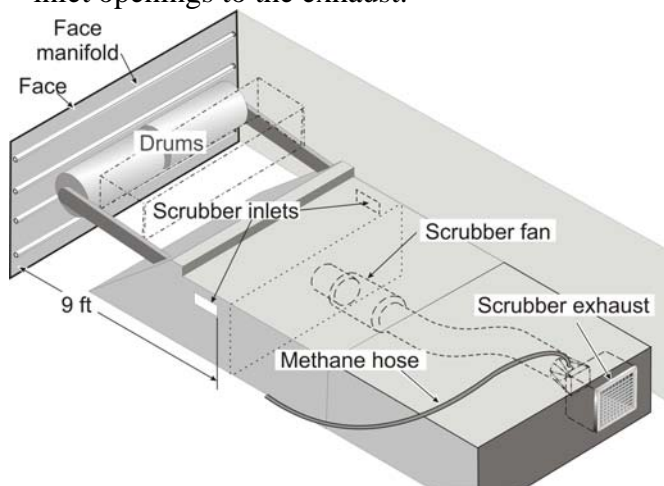

Figure 2. Continuous miner model used in ventilation gallery.

Scrubber airflow is adjusted by inserting orifice plates with different size openings into the ducting, just upstream of the fan.

2.2 Airflow Measurement

Two, three-axis anemometers (Windmaster) and one, single-axis anemometer (Solent), manufactured by Gill Instruments Ltd. Great Britain (Disclaimer: Mention of any company or product does not imply endorsement by NIOSH), were used to make the airflow measurements. Both instruments measure velocities of 0.01 m/s (2 ft/min) and greater. Airflow measurements were made at seven locations as marked in Fig. 3. The single-axis instrument measures flow in the direction in which the instrument is oriented. An arrow on top of the instrument indicates the direction of the flow measurement. Behind the curtain, the single-axis anemometer was aligned with the airflow that is directed toward the face.

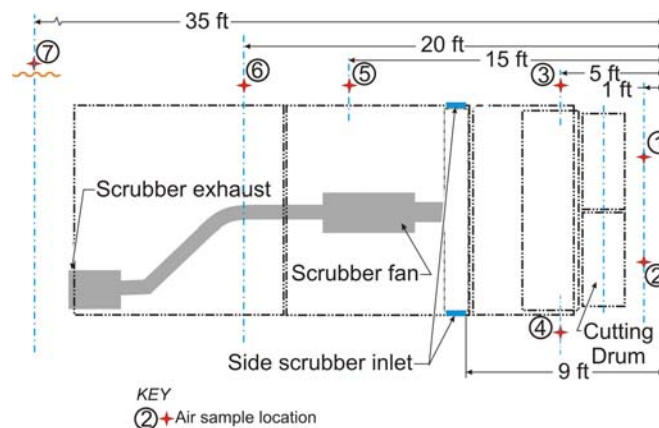

Figure 3. Ventilation gallery airflow sampling locations.

The three-axis instruments were used to measure flow velocity between the curtain and the face where flow direction frequently changes. The instruments were positioned vertically so the flow velocity measurements were made only in a plane parallel to the top and bottom of the entry (Fig. 4). The vector components in this horizontal plane, measured by the anemometer, were used to calculate flow in the horizontal plane in the direction of the flow. Although the three-axis instrument also measures flow in the vertical direction, velocities were only calculated for the airflow in a horizontal plane.

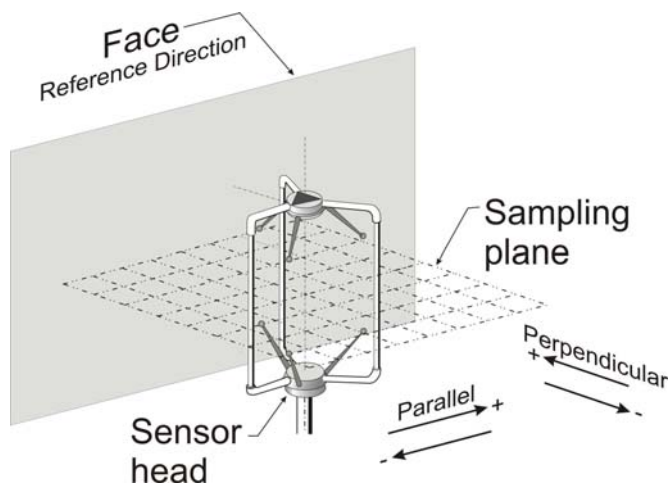

Figure 4. Vertically mounted three-axis anemometer sensor head.

To simplify the comparison of velocities measured between the curtain and the face, measurements with the three-axis anemometers were calculated to give flow velocities either perpendicular or parallel to the face. Specifically, velocities perpendicular to the face were determined for locations 3-6. By convention, if the airflow was toward the face it was positive, and away from the face it was negative (Fig. 4). Velocities parallel to the face were determined for locations 1 and 2. The sign for flow parallel to the face was positive to the right and negative to the left.

The three-axis sensor heads at locations 1 and 2 were positioned 61 cm (2 ft) from the roof and at locations 3-6 the sensor heads were 30 cm (1 ft) from the roof. The sensor head for the one-axis instrument (location 7) was located at the center point behind the curtain.

All anemometers were programmed to record average airflow data once a second. A software program (ANEMVENT 2003) written by NIOSH recorded the three-axis instruments data, and Hyper Terminal software (Hilgraeve, Inc.) was used to record data from the single-axis instrument. Data was transferred to EXCEL spreadsheets for analysis. The average velocities were calculated for the duration of each test (2 to 3 minutes).

2.3 Methane Measurements

To evaluate the distribution of methane concentrations over the mining machine, natural gas (approximately 96 pct methane) was released into the gallery through four connected horizontal 3.7 m (12 ft) long by 3.8 cm (1½ in) diameter copper pipes. Holes were drilled 2 mm (0.06 in) in diameter and 6.3 cm (2½) apart on top and bottom of each pipe. The four pipes were equally-spaced vertically, and located 0.1 m (4 in.) away from the face to provide a relatively uniform release of gas.

Methane concentrations were measured at 21 locations above the mining machine (Fig. 5). All 21 locations were 43 cm (17 in) from the roof. A vacuum pump pulled air samples through plastic tubing from each of the sampling locations to one of 15 heat-of-combustion methane sensors. Fifteen locations (1-15) were monitored simultaneously. Tests were then repeated to obtain data for locations 16-21.

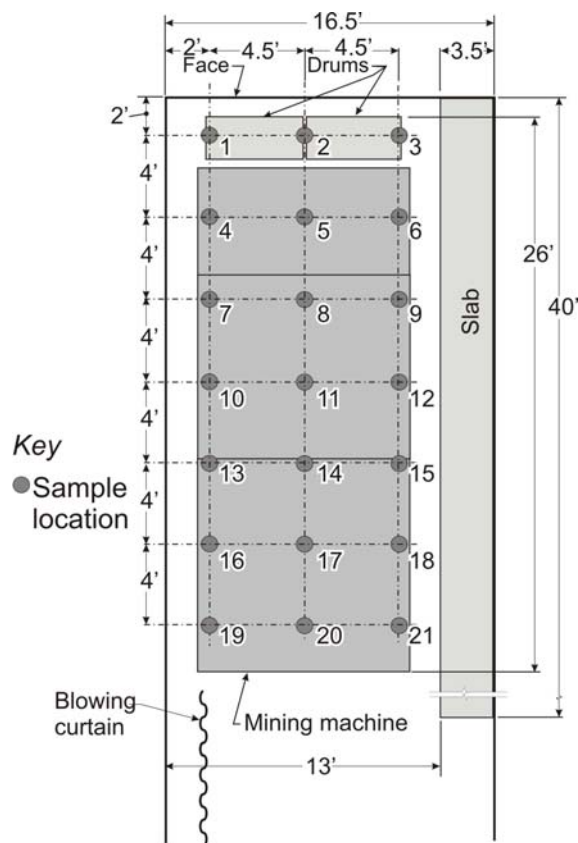

Figure 5. Ventilation gallery methane sampling locations above mining machine.

To allow the methane and air to mix thoroughly, methane was released into the gallery for 5 minutes before making gas measurements. A constant flow rate [approximately 0.01 m³/s (21 ft³/min)] was monitored and maintained by passing the gas through a rotameter. For some tests, however, the gas flow was reduced to prevent concentrations in the gallery from exceeding 2.5 pct. For the reduced flow tests, methane concentrations were adjusted by using the ratio of the flows. After mixing, methane concentrations were measured for the next 5 minutes. The concentrations were recorded once every second. Data was downloaded to a computer via an analog-to-digital conversion board using commercial data acquisition software. Average concentrations were then calculated for each sampling location.

2.4 Test Conditions

Airflow and methane readings were taken for the following six operating conditions:

- Scrubber off, intake flow $1.9 \text{ m}^3/\text{s}$ ($4000 \text{ ft}^3/\text{min}$)
- Scrubber off, intake flow $2.8 \text{ m}^3/\text{s}$ ($6000 \text{ ft}^3/\text{min}$)
- Scrubber flow $1.9 \text{ m}^3/\text{s}$ ($4000 \text{ ft}^3/\text{min}$), intake flow $2.8 \text{ m}^3/\text{s}$ ($6000 \text{ ft}^3/\text{min}$)
- Scrubber flow $1.9 \text{ m}^3/\text{s}$ ($4000 \text{ ft}^3/\text{min}$), intake flow $1.9 \text{ m}^3/\text{s}$ ($4000 \text{ ft}^3/\text{min}$)
- Scrubber flow $2.8 \text{ m}^3/\text{s}$ ($6000 \text{ ft}^3/\text{min}$), intake flow $2.8 \text{ m}^3/\text{s}$ ($6000 \text{ ft}^3/\text{min}$)
- Scrubber flow $2.8 \text{ m}^3/\text{s}$ ($6000 \text{ ft}^3/\text{min}$), intake flow $1.9 \text{ m}^3/\text{s}$ ($4000 \text{ ft}^3/\text{min}$)

Tests were repeated for each of the six test conditions, and the results averaged for each set of conditions.

3 RESULTS AND DISCUSSION

3.1 Airflow Measurement Results

As described above, airflow velocities were calculated for flows moving either parallel or perpendicular to the face. The velocities of the airflow as it moved parallel to the face (locations 1 and 2) are shown in Figures 6-7. With the scrubber operating the velocities varied from 0.07 to 0.18 m/s (15 to 35 ft/min). Without the scrubber, velocities were practically zero. In most cases velocities increased when the intake airflow volume was increased.

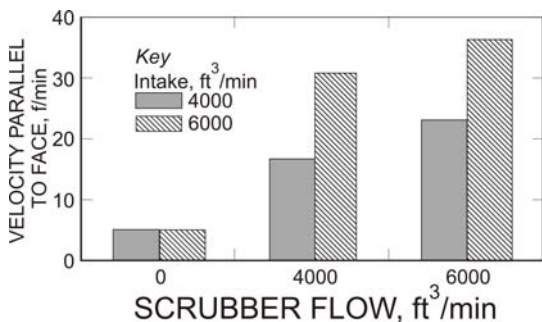

Figure 6. Airflow parallel to face (Location 1).

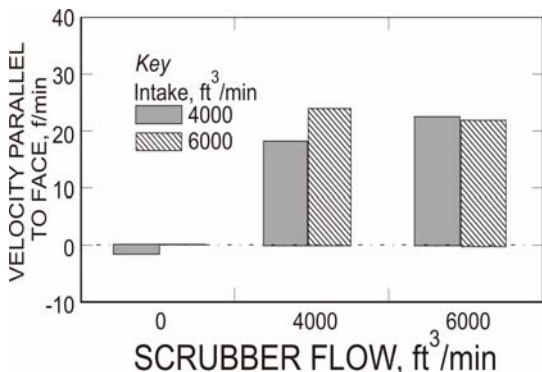

Figure 7. Airflow parallel to face (Location 2).

With no scrubber, the air moved toward the face on the right side of the machine and away from the face on the left side of the machine. With the scrubber operating, airflow directions were reversed on each side of the machine. Although directions were reversed, the flow velocities were similar on the right side of the machine, with and without the scrubber operating. Increasing the scrubber flow decreased airflow velocities moving toward the left side of the face.

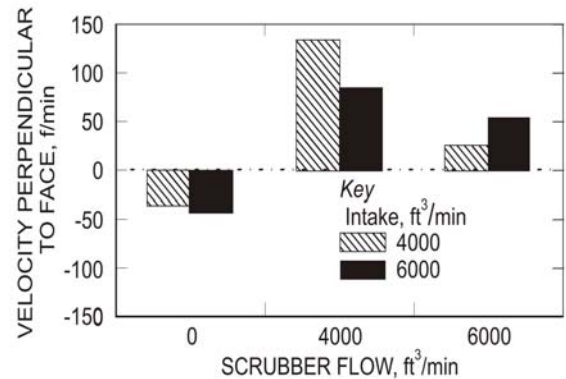

Figure 8. Airflow perpendicular to face (Location 3).

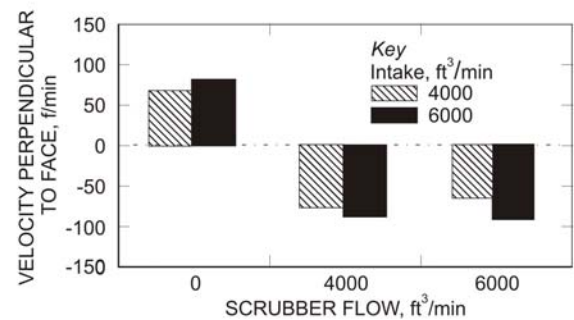

Figure 9. Airflow perpendicular to the face (Location 4).

Figures 10 and 11 show the airflow velocities measured at locations 3 and 5-7 along the left side of the entry. These locations correspond to distances of 1.5 m (5 ft), 4.6 m (15 ft), 6.1 m (20 ft), and 10.7 (35 ft) from the face. Airflow velocities decreased as air moved away from the curtain. With the scrubber off, velocities 4.6 m (15 ft) from the face had decreased to practically zero. Increasing either the intake or scrubber airflows increased air velocities, except at sampling location 3, which was 5 feet from the face. At this location, the flow velocity is reduced because a portion of the air moving toward the face is drawn into the scrubber inlet, which is just outby location 3.

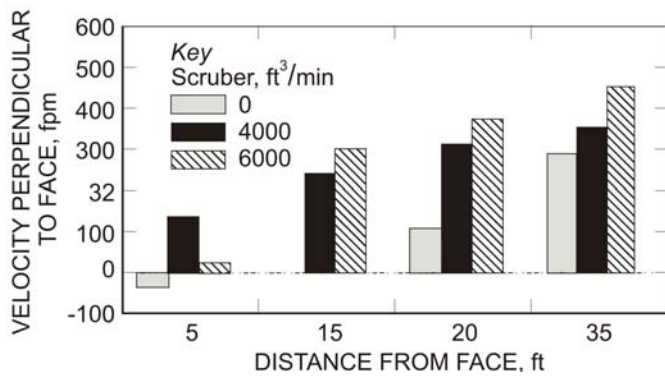

Figure 10. Left side airflow perpendicular to face (4000 ft³/min intake).

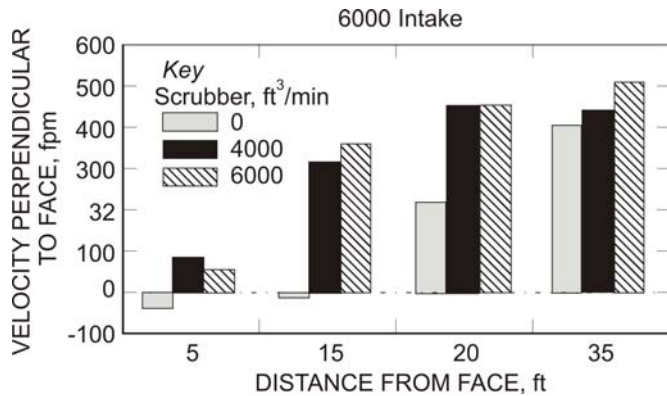

Figure 11. Left side airflow perpendicular to face (6000 ft³/min intake).

Flow velocities at the end of the curtain increased when the scrubber was turned on. A test was conducted to evaluate the source of the increased flow. Two of the three regulator doors were closed and the third left completely open (Fig. 1). An outside door was opened enough to adjust intake flows to either 1.9 m³/s (4000 ft³/min) or 2.8 m³/s (6000 ft³/min) behind the blowing curtain.

For each intake flow, the airflow velocity was measured at the end of the curtain and at the regulator door opening with the scrubber operating. The air quantities were determined by multiplying the measured velocities by either the area behind the curtain or the area of the regulator opening. The same airflow measurements were made at the end of the curtain and at the regulator door opening, but with the scrubber operating with the following conditions:

- Scrubber flow 1.9 m³/s (4000 ft³/min), intake flow 2.8 m³/s (6000 ft³/min)
- Scrubber flow 2.8 m³/s (6000 ft³/min), intake flow 1.9 m³/s (4000 ft³/min)

In each case with the scrubber operating, the airflow behind the curtain increased and the flow at the regulator door decreased (Fig.12). The flow quantity measured at the end of the curtain was 24 to 51 percent greater than the flow quantity measured at the regulator door. The additional airflow at

the end of the curtain could be due either to additional intake airflow diverted from the flow at the regulator doors, or air leaking from the return to the intake side of the blowing brattice.

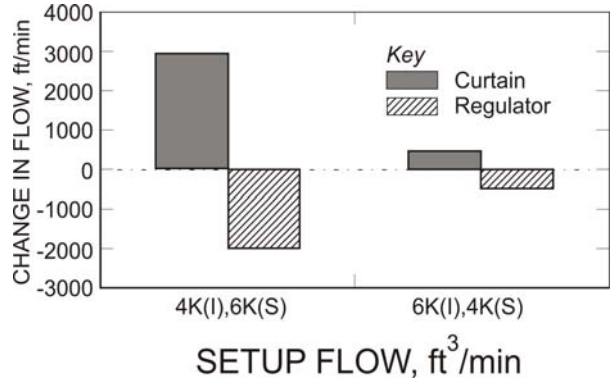

Figure 12. Airflow changes measured behind the curtain and at the regulator door due to scrubber use.

3.2 Methane Measurement Results

Methane concentrations measured above the mining machine are shown in Figures 13 and 14 for 1.9 m³/s (4000 ft³/min) and 2.8 m³/s (6000 ft³/min) intake airflows. The distribution of the methane over the mining machine indicates airflow patterns that are distinctly different for the various intake and scrubber flow combinations. The methane concentrations measured over the mining machine were higher closer to the face where the gas was released, and lower on the left side of the machine where the curtain was located. The highest concentrations generally occurred in the corner of the face opposite the blowing curtain. Operation of the scrubber reduced methane levels at most of the sampling locations.

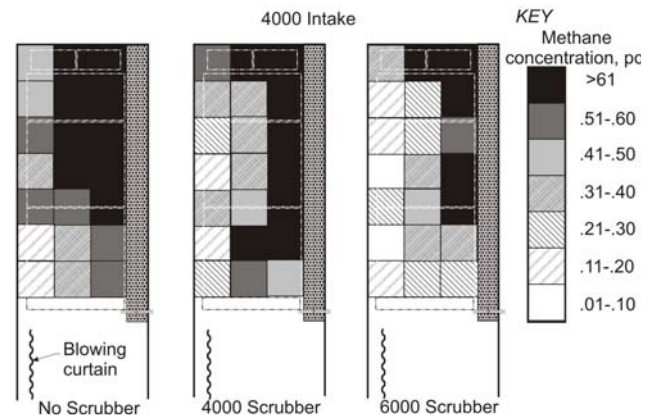

Figure 13. Methane concentrations above mining machine (4000 ft³/min intake flow).

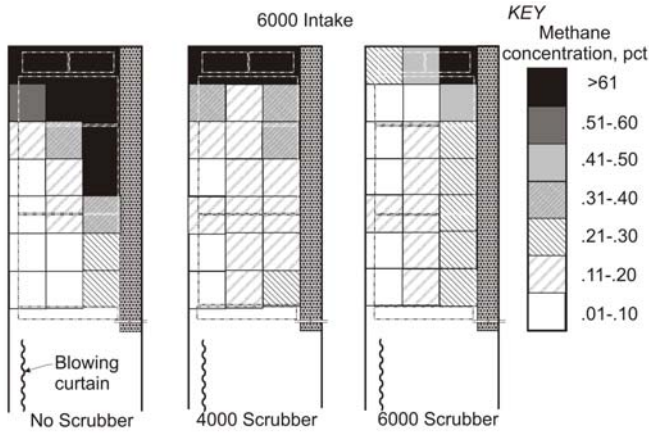

Figure 14. Methane concentrations above mining machine (6000 ft³/min intake flow).

The methane sampling locations (Fig. 5) were arranged in seven rows with three locations in each row. The methane concentrations were averaged for each of the seven rows of samples to evaluate how concentrations varied with distance from the face. The averages for each row were plotted versus the distance from the face (Figs. 15-16). For example, rows 1 and 7 correspond to distances of 0.6 m (2 ft) and 7.9 m (26 ft), respectively, from the face. With or without the scrubber operating, methane concentrations generally decreased as sampling distance from the face increased. The concentrations decreased faster when the scrubber was on, and intake airflow was higher (i.e. 6000 cfm).

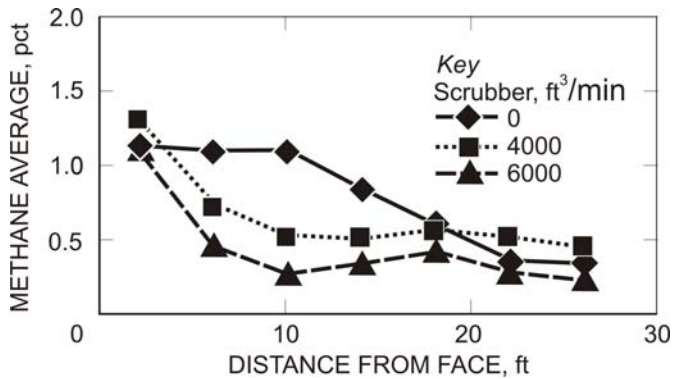

Figure 15. Methane concentrations with distance from face (4000 ft³/min intake).

Methane released from the pipe manifold simulated methane liberation at the mining face. Some of the gas liberated at the face will pass through the scrubber and be exhausted in the direction of the entry return. Part of the gas from the scrubber exhaust, however, can move back toward the face and over the machine. A test was conducted to

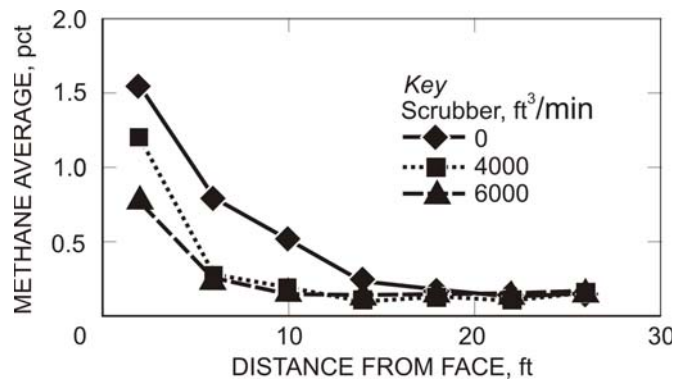

Figure 16. Methane concentration with distance from face (6000 ft³/min intake).

determine how methane from the scrubber exhaust would affect methane levels over the machine. A 3.8-cm (1 1/2 in) inner diameter hose was placed in the scrubber ducting, just upstream of the scrubber outlet, to inject methane into the scrubber airflow (Fig. 2). The maximum possible methane flow [0.016 m³/s (34 ft³/min)] was used to obtain a minimum gas concentration in the ventilation airflow needed for detection using the methane monitors. Test conditions included:

- Intake flow of 2.8 m³/sec (6000 ft³/min) and a scrubber flow of 1.9 m³/sec (4000 ft³/min), and
- Intake flow of 1.9 m³/sec (4000 ft³/min) and a scrubber flow of 2.8 m³/sec (6000 ft³/min).

After allowing time for the gas and air to mix, methane concentrations were measured at methane sampling locations 16 to 21 (Fig. 5). Methane from the scrubber exhaust was present above the machine for both test conditions. Higher concentrations were measured when scrubber flow was greater than the intake airflow (Fig. 17).



Figure 17. Methane from scrubber exhaust.

4 CONCLUSIONS

Scrubber operation increased the airflow velocity behind the blowing curtain and at all sampling locations along the intake side of the entry. Consequently, airflow volumes reaching the face were greater when the scrubber was on. Scrubber operation also affected flow direction. With the scrubber on, air drawn into the scrubber reduced flow velocities at sampling locations in by the inlets, especially when the intake airflow was $1.9 \text{ m}^3/\text{s}$ ($4000 \text{ ft}^3/\text{min}$). However, airflows in by the inlets were still higher and methane concentrations were lower than when the scrubber was off. With no scrubber operating, air moved from right to left across the face and reversed when the scrubber was on.

Changes in airflow velocities and direction due to scrubber operation affected methane concentrations measured above the mining machine. Methane concentrations generally were lower at most sampling locations when the scrubber was turned on. Methane concentrations were reduced the most on the left side of the face where air velocities were highest. Regardless of whether the scrubber was operating or not, methane concentrations decreased as distance from the face increased. The concentrations decreased more quickly when the scrubber was operating and the intake airflow was $1.9 \text{ m}^3/\text{sec}$ ($4000 \text{ ft}^3/\text{min}$).

Methane levels closest to the face (locations 1-3) were also affected by airflow direction. Concentrations were higher with the scrubber off because the right to left flow interfered with the movement of air to the return side of the entry. With the scrubber on, velocities decreased as the air moved from left to right across the face. The direction of the flow and the reduction in velocity resulted in higher methane concentrations at the right corner of the face.

Because the scrubber operation increased airflow behind the curtain, more air was directed toward the face. This study showed that part of this air was intake air drawn up behind the curtain. The remainder of the increase in intake airflow most likely came from return air that was drawn through openings in the blowing curtain.

Test results showed that methane in the scrubber exhaust can move back over the mining machine. More methane passed back over the machine when the scrubber flow was greater than the intake airflow. For the conditions tested, any gas from the scrubber exhaust would have had only a small effect on methane levels at the face. Moreover, the increase in intake airflow reaching the face due to scrubber operation would have further reduced methane gas from the scrubber exhaust.

5 DISCLAIMER

The findings and conclusions in this report are those of the authors and do not necessarily represent the views of the National Institute for Occupational Safety and Health.

REFERENCES

- Gillies, A.D.S. 1982, Studies in improvements to coal face ventilation with mining machine –mounted dust scrubber systems, SME-AIME Annual Meeting, Preprint No. 82-24, 13 pp.
- Taylor C. D., Rider, J. P., & Thimons E.D. 1996. Changes in face methane concentrations using high capacity scrubbers with exhausting and blowing ventilation, In: Proceedings of the SME Annual Meeting, Phoenix, Arizona, Preprint 96-167.
- Taylor, C.D., Rider, J.P. & Thimons, E.D. 1997. Impact of unbalanced intake and scrubber flows on methane concentrations. In: Proceedings of the 6th International Mine Ventilation Congress, Pittsburgh, PA, Chapter 27, pp. 169-172.
- Taylor, C.D., Timko, R. J., Senk, M.J. and Lusin, A. 2003. Measurement of airflow in a simulated underground mine Environment using an ultrasonic anemometer. In Proceedings of the SME Annual Meeting, Cincinnati, Ohio Preprint 03-065, 6 pp.
- Taylor, C.D., and Zimmer, J. A. 2001, Effects of water sprays and scrubber exhaust on face methane concentrations. In : Proceedings of 7th International Mine Ventilation Congress, Krakow, Poland, Chapter 65, pp. 465-470.
- Thimons, E. D., Taylor and Zimmer. 1999. Ventilating the box cut of a two-pass 40 ft extended cut. *J. Mine Vent S.A.*, Vol 52, No. 3, 8 pp.
- Volkwein, J.C. and Thimons E.D., 1986, "Extended Advance of Continuous Miner Successfully Ventilated With a Scrubber in a Blowing Section," SME Fall Meeting, SME Preprint 86-308, 4 pp.