

EVALUATION OF IYONI II METHANOMETERS

Joseph E. Chilton, Charles D. Taylor, and Robert J. Timko
National Institute for Occupational Safety and Health/Pittsburgh Research
Lab
Pittsburgh, PA USA

1 ABSTRACT

No regular monitoring of methane is required in areas outby the mining face. Methane ignitions that have occurred in mine outby areas indicate the need to provide better protection to workers. Handheld methane monitors are now used by some miners to make periodic measurements of methane at the working face. The IYONI II gas detector which is incorporated into a miner's cap lamp and worn on a miner's helmet can continuously provide an alarm signal whenever methane levels exceed a set level. Tests were conducted to evaluate the performance characteristics of this methane detector by measuring response times with methane gas supplied through a calibration fixture or adaptor. Other response time tests were performed with the detector in an environmental test box. Performance was also evaluated in a full scale test gallery where face methane emission and underground ventilation were simulated. Procedures for calibration by response time measurement of the IYONI II detector have been developed. In limited testing, the IYONI II detector was found to reliably detect the presence of 1 percent by volume methane.

2 INTRODUCTION

The highest methane concentrations in gassy coal mines are most likely to occur near active mining faces. Methane in air mixtures can be ignited if the methane concentrations are between 5 and 15 pct by volume. To assure the safety of underground miners who work in the face areas, Federal Law (30CFR 75.323) requires that methane levels in working mine face areas be continuously monitored by methane detection devices on mining machines and also measured with a portable monitor at 20-minute intervals. Methane concentrations must be maintained below 1 pct by fresh air ventilation.

Methane gas can also accumulate in areas outby the face due to slow liberation in poorly ventilated areas, a sudden outburst of gas from the seam, or a migration of gas from worked-out areas. No regular monitoring for methane is required in these areas. When working in or traveling through these outby areas, workers can be exposed to ignitable mixtures of methane without any warning. A recent methane ignition that occurred at a battery charging station with a roof fall indicates the need to monitor methane concentrations at locations outby the

face.¹

Assuring that workers in very gassy mines are not exposed to potentially explosive levels of methane is possible only if methane concentrations are monitored in all areas where miners work. It is not practical to place methane monitors in all outby areas where workers may work or travel. Handheld monitors are normally only used by some workers for periodic measurements of methane near the working face. Other workers could also carry handheld methane monitors or be equipped with a person wearable device. The IYONI gas detector is designed to be worn by miners and provide them with an alarm whenever methane levels exceed a predetermined limit. It is designed to alert them with both visual and aural alarms when methane concentrations are excessive.

The purpose of these tests was to evaluate the performance of the IYONI II gas detector. After developing and evaluating a calibration procedure, the instrument was also examined in an environmental test box and a simulated mine environment.

3 THE IYONI II GAS DETECTOR

Two IYONI II² combustible gas detectors were obtained from GfG (Pty) Ltd, South Africa through GfG Instrumentation, Ann Arbor MI. The combustible gas detector is designed to be worn by a miner and is powered by a standard Willard cap lamp battery. The detector, which is housed inside a modified miners cap lamp headpiece, continuously monitors methane levels as long as the cap lamp is operating. The IYONI instruments tested were equipped with both methane and carbon monoxide detectors. Only the methane function was evaluated during these tests.

The manufacturer did not provide schematics of the detector's electronic circuitry. The figure 1 schematic is based on written documentation provided by the manufacturer and information obtained during this study. A catalytic heat of combustion-type sensor is used, connected in a Wheatstone bridge arrangement, where the signal from the bridge is proportional to the concentration of methane gas in air that passes over the sensor head. A potentiometer is used to adjust an operational amplifier that increases the magnitude of this signal. The increased signal voltage is compared to a constant reference voltage. An alarm is generated when the signal voltage becomes greater than the reference voltage.

1 MSHA Fatalgram for the 9/23/2001 coal mining accident can be found at www.msha.gov.

2 Reference to specific products does not imply endorsement by NIOSH

IYONI- II Methane Cap Lamp Alarm

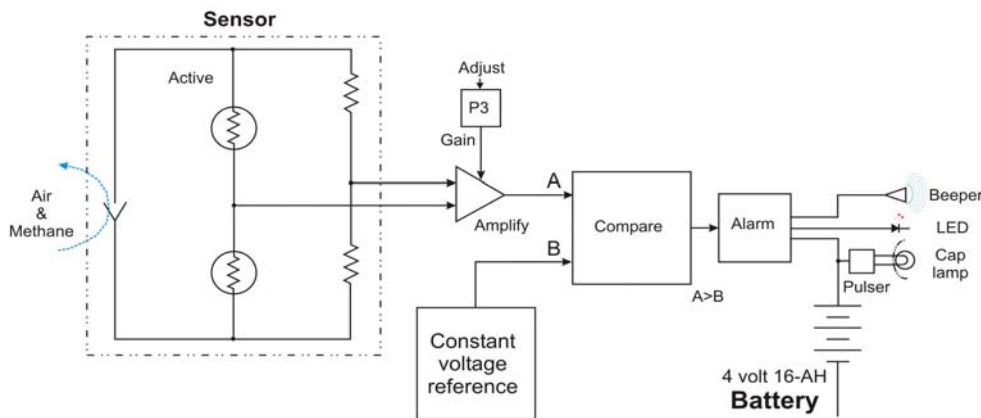

Figure 1. IYONI functional schematic

4 CALIBRATION PROCEDURE

The performance of this type of instrument is based on setting the calibration and evaluating response time measurements. Normally gas detector devices are calibrated by comparing the instrument readout to a known concentration of calibration gas. Instrument response time is determined by measuring the time required for the instrument output to change from a steady state reading in pure air to a steady state reading when exposed to a calibration gas of known concentration.

The IYONI instrument has no visual readout. The only way to indicate gas concentration is the alarm signal. The procedure used for measuring the performance of the IYONI is based on the application of a gas of known methane concentration and measurement of the elapsed time between application of the gas and generation of the signal. Although this procedure focuses on a response time measurement, it is called a calibration of the IYONI instrument in this document.

Figure 2 illustrates the equipment used to calibrate the IYONI instrument. Calibration gas was directed to the cap lamp sensor head through the manufacturer-supplied calibration adaptor. The flow was controlled and monitored using a pressure regulator and rotameter. The cap lamp with the integral methane alarm was inserted directly into the calibration adaptor.

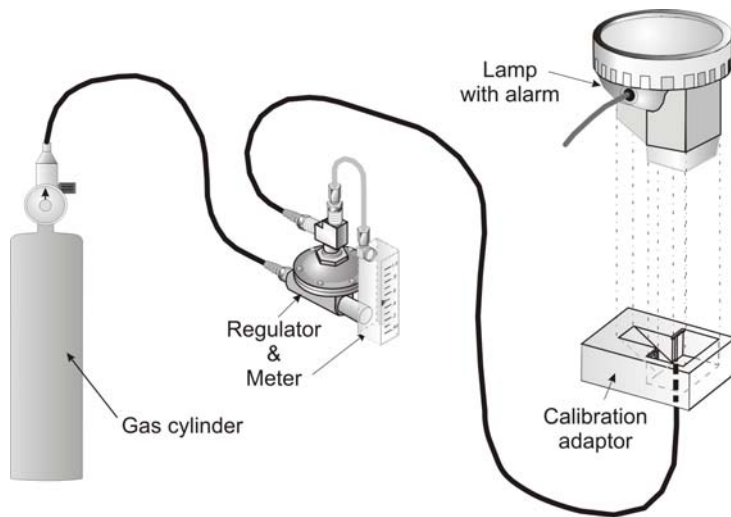

Figure 2. IYONI Calibration Equipment

A potentiometer in the methane alarm was adjusted to vary the amplifier gain until the response time was between 15 and 25 seconds. When the response time for one percent gas was between 15 and 25 seconds the instrument was considered calibrated.

4.1 Revised Calibration Procedure

The above outlined calibration method, provided by the manufacturer, was reviewed, tested, and modified. The authors then used the revised procedure as given below.

The cap lamp was turned on for a minimum warm-up of ten minutes prior to calibrating the sensor. Before the sensor was placed in the calibration adaptor, the 1 pct methane in air calibration gas was turned on for 1 to 2 seconds to purge any air contained within the tubing, pressure regulator and flow meter. With the adaptor inverted, the cap lamp with sensor was firmly inserted into the adaptor, the regulator valve was turned on, and a digital timer started. The response (elapsed) time was recorded when the alarm signals (buzzer and flashing lamp) were activated. The test gas flow was then discontinued and the sensor head removed from the adaptor.

Waiting 10 minutes after the initial test, the response time was rechecked. The second elapsed time should be a value within ± 3 seconds of the first reading. If not, a third measurement is taken after waiting an additional 10 minutes. The results of all the

Readings were averaged. If the average alarm time is greater than 25 seconds, the

instrument must again be calibrated to reduce the response time.³

To adjust the instrument gain and change the response time, a small plastic cover with an o-ring must be removed from the back of the alarm. The screw holding the cover in place is removed using a TORX screwdriver with a T8 tip. When removing this cover, its orientation relative to the instrument case should be noted. When the cover is removed, two calibration potentiometer screws are visible. The correct screw for adjusting the methanometer gain can be determined by placing the cap lamp in the adaptor. A hole over the correct screw is marked with methane “CH₄” marking. Gain is adjusted using a flat blade screwdriver to turn the screw in 1/8 to 1/4 turn increments. Rotating the potentiometer screw clockwise will decrease the response time. Conversely, turning the potentiometer counterclockwise will increase the response time.

After adjusting the gain potentiometer, and before making additional response time measurements, the potentiometer cover must be replaced in its original orientation. The potentiometer cover screw is tightened enough to slightly compress the o-ring that seals the cover to the back of the instrument. If, after adjusting the potentiometer and making response time measurements, the average response time is not between 15 and 30 seconds, the instrument must be recalibrated. Instrument response time should be checked at least once each week.

5 EVALUATION OF FACTORS AFFECTING INSTRUMENT PERFORMANCE

Several factors could affect IYONI instrument performance. The effects of these factors on instrument response times are discussed below.

5.1 Instrument Gain Setting and Methane Concentration

Although the output voltage cannot be read directly from the IYONI instrument, test results showed that response time increases when the instrument gain is decreased. Changing the gain varies the magnitude of the sensor signal. Turning the gain potentiometer adjustment screw clockwise increases response time and turning it counterclockwise decreases the response time. Figure 3 illustrates the relative effects of varying instrument gain on the signal output voltage.

³ A shorter response time results in alarm signals at lower methane concentrations. A longer response time decreases the protection provided to workers by delaying the time required for an alarm when there are higher concentrations.

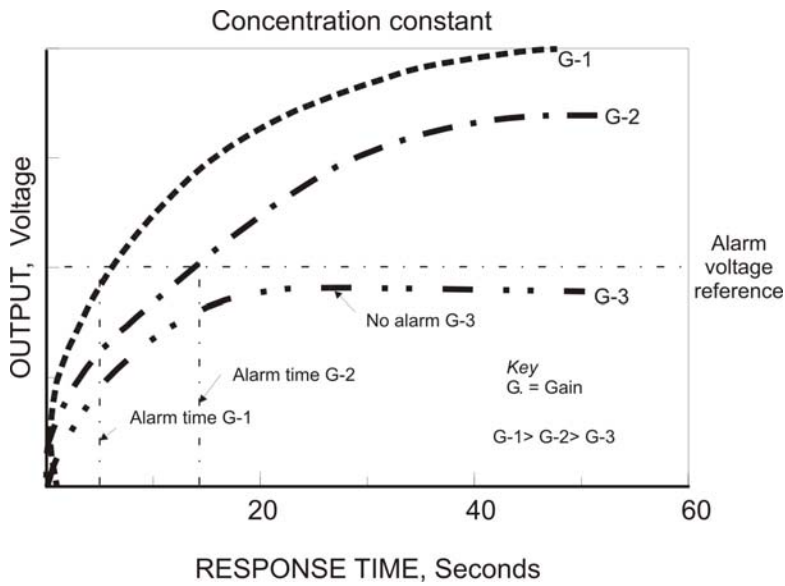

Figure 3. IYONI Gain Effect on Response Time (Concentration Constant)

Similarly, decreasing the concentration of methane gas passing over the sensor head increases the response time (See figure 4).

Using 1.0 pct methane calibration gas, the instrument gains were adjusted until the response times for IYONI Units 1 and 2 were 20 and 18 seconds respectively. With no further adjustment to the gain setting, response times were measured using 0.6, 0.8, 1.2 and 2.5 pct methane in air calibration gas. The data recorded in figure 5 and table 1 show that response times decreased as the methane concentration increased.

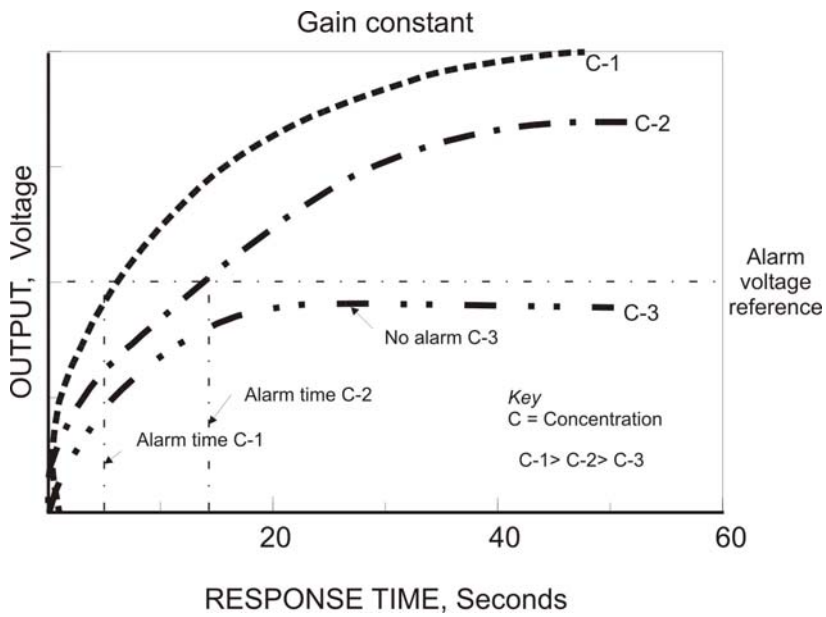

Figure 4. IYONI Concentration Effect on Response Time (Gain Constant)

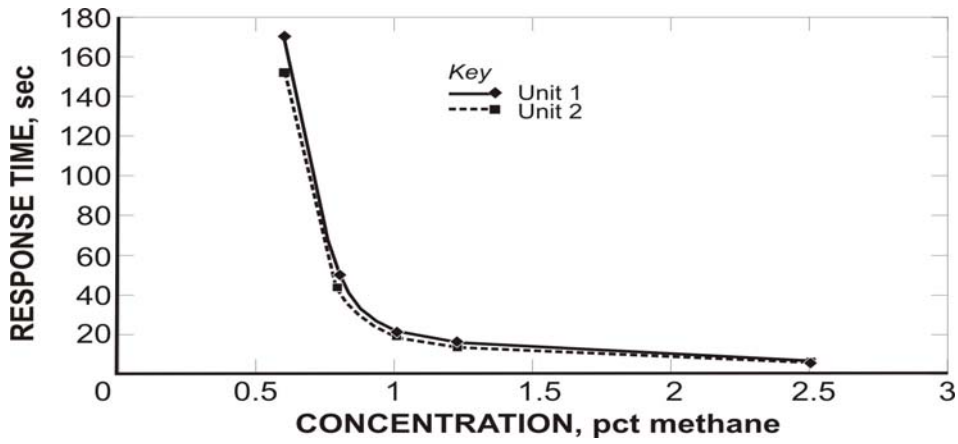

Figure 5. Methane Concentration Effect on Alarm Response

Table 1. Effect of Methane Concentration on Response Times

Methane, pct	Unit 1 avg. response, sec	Unit 2 avg. response, sec
--------------	---------------------------	---------------------------

0.59	170	152
0.79	50	43
1.00	20	18
1.20	14	13
2.50	5	5

5.2 The effect of measurement frequency on instrument response time

During response time measurements, heat is generated within the sensor head when the sensor element is exposed to methane. As soon as methane is removed, the sensor head begins to cool. If the time interval between tests is short, heat that has been retained from the prior test may affect subsequent response time measurements.

Tests were conducted to examine how the length of time between measurements affected response times. Consecutive measurements were made at intervals of 1, 10, and 2 minutes. The response times generally decreased as the time intervals between measurements decreased (see figure 6 and table 2). Response times, obtained at 1-minute time intervals, decreased steadily. Results of other tests showed that the differences for consecutive readings were smallest when the time interval between measurements was a minimum of 10 minutes.

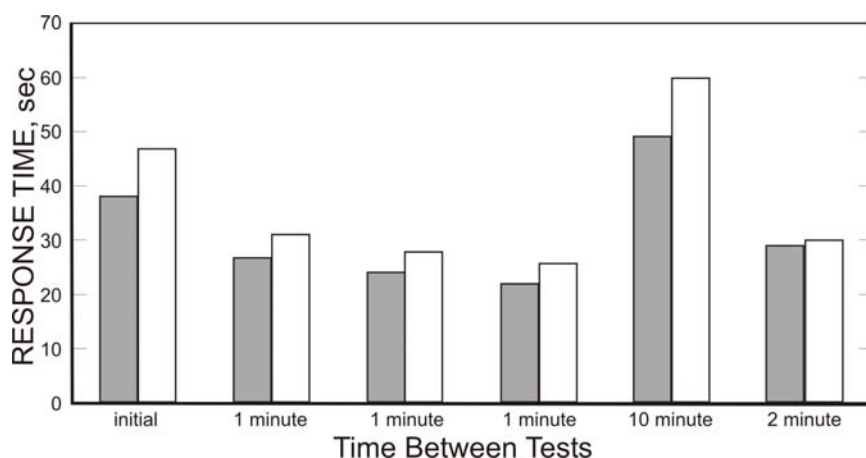

Figure 6. Times between tests

Table 2. Time intervals and instrument response

Interval, min	Unit 1 response time, sec	Unit 2 response time, sec
Initial	38	47
1	27	31
1	24	28
1	22	26

10	49	60
2	29	30

5.3 Methane flow rate

The heat generated by sensor head methane combustion is a function of the methane quantity that passes over the sensor. The methane quantity can be changed by either increasing the concentration of the methane in the air mixture or by increasing the flow rate of the gas.

To determine the effect of flow rate on response time, 1 pct methane gas was directed through the calibration adaptor at rates of 0.30, 0.50 and 0.85 lpm (liter per minute). Methane flow through the calibration adaptor was limited by a pressure regulator and monitored with an in-line rotameter. Two response time measurements were made for each flow rate. The response times decreased as the flow rate increased (See figure 7 and table 3).

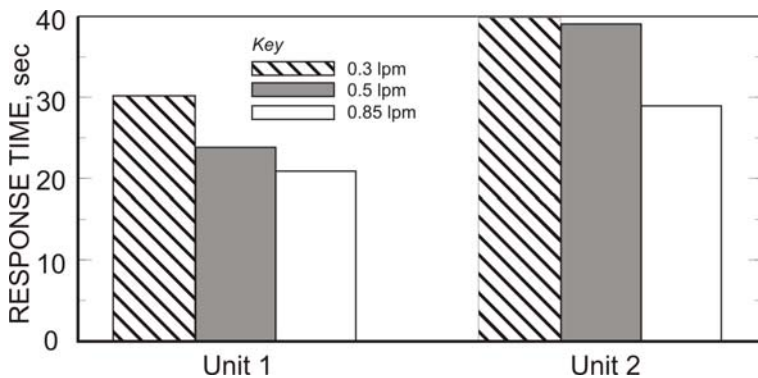

Figure 7. Test Gas Flow Effects on Alarm Time

Table 3. Flow rate effects

Methane flow rate, lpm	Unit 1 response time, sec	Unit 2 response time, sec
0.30	30	40
0.50	24	39
0.85	21	29

5.4 Sensor head cover orientation

For the sensor to measure gas concentration, methane must first reach the sensor element by

moving from the surrounding environment and passing through the sensor head. The sensor head design, including the location of the opening in the sensor head body, affects the time required for the gas to move through the sensor head (Reference 1). In general, the more direct the path through the sensor head, the shorter the response time.

One opening in the body of the IYONI instrument is adjacent to the methane sensor head (See figure 8). A second opening in the body provides access to the potentiometer screw, which is used to adjust instrument gain. During use, this opening is covered and sealed with a plastic cover.

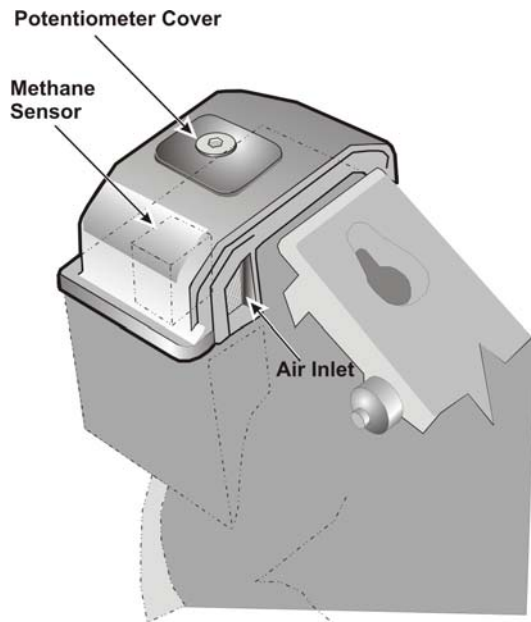

Figure 8. IYONI Alarm Mounted on Cap Lamp

When the cover is removed, additional air can enter the sensor head through this opening. With each instrument set at either a low or high gain setting, response times were measured with the cover on and off. For both gain settings, response times were shorter when the cover was off. (See figure 9 and table 4).

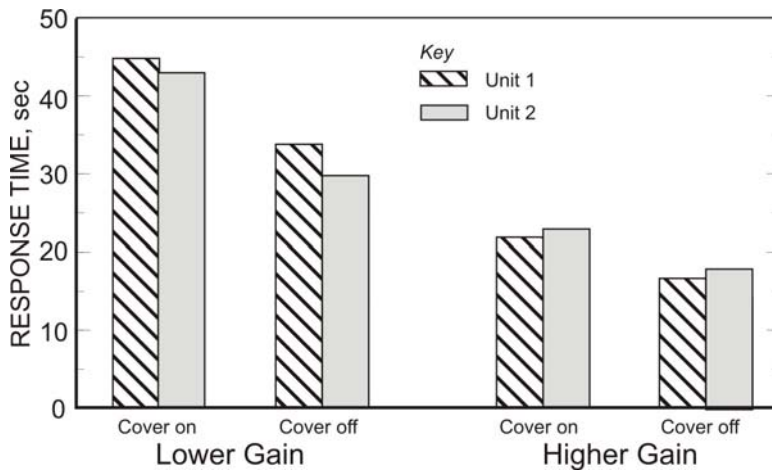

Figure 9. Effect of Instrument Cover on Response Times

Table 4. Instrument Cover Effect

Instrument cover location/Gain	Unit 1 response time, sec	Unit 2 response time, sec
On/Low	45	43
Off/Low	34	30
On/High	22	23
Off/High	17	18

IYONI engineers designed the potentiometer cover to be installed in one specific orientation. To determine if there was enough leakage to affect the response time, the cover was rotated 90° from its normal position. Response times were shorter when the cover was installed in the rotated position suggesting test gas leakage around the cover.

5.5 Battery voltage

The IYONI instrument is powered by a cap lamp battery that provides a nominal 4 volts. The effect of voltage on response time measurements was evaluated. A variable power supply was used to supply voltages between 3.4 and 4.38 volts to the IYONI instrument. Table 5 shows the measured response times versus the supply voltages. For this range of voltages the response times for a given unit did not vary significantly.

Table 5. Voltage effects

Supply voltage, vdc	Unit 1 response time, sec	Unit 2 response time, sec
4.38	18	32
4.38	20	36
4.00	18	39
3.80	20	--
3.60	21	39
3.40	20	41

5.6 Exposing the sensor head to methane

Before the IYONI can measure a gas concentration, methane must move from the surrounding environment into the sensor head. Airflow patterns around the sensor head could have an effect on the time required for the methane to reach the sensor element. However, the calibration adaptor, which covers part of the sensor head, during response time measurements probably, minimizes any effects ambient airflow has on response time measurements. Tests were conducted to compare how applying calibration gas directly to the sensor head versus placing the sensor head in an atmosphere containing a known concentration of methane affects response time measurements.

A box was built to hold the IYONI instruments, including the cap lamp battery. The box (See figure 10), made of 19 mm (0.75-in) thick plywood had inside dimensions of 35.6

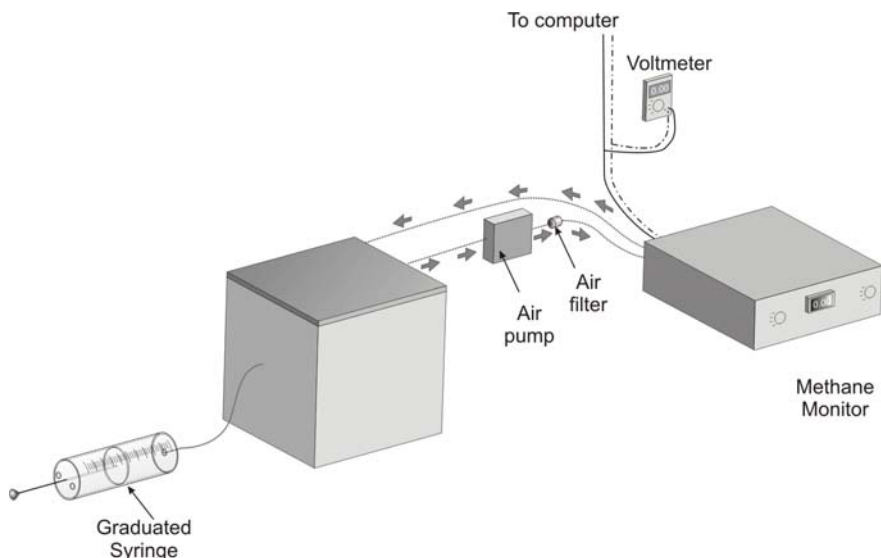

Figure 10. Box Test for Response Times

by 35.6 by 35.6 cm (14 by 14 by 14 in). A bracket, inside of the box, was used to hold the IYONI sensor head. The box lid, which was removed to insert and position sampling instrument, had a neoprene seal to isolate the test atmosphere within the box from the surrounding air. A 2.3 kg (5 lb) weight was placed on top of the lid to compress the seal and further reduce leakage.

Using a graduated 1500 cc Hamilton plastic (acrylic) Super syringe, a measured gas quantity of 99.3-pct methane was introduced into the box at a rate of 2 to 4 sec per syringe volume. The gas quantities were varied to provide concentrations between 0.6 and 2.5 pct within the test box. The approximate methane volumes introduced into the box to achieve the desired methane concentrations are shown in Table 6.

Table 6. Methane volumes and resulting box methane concentrations

Methane volume released, cc	Resulting methane concentration, pct
-----------------------------	--------------------------------------

269	0.6
360	0.8
450	1.0
540	1.2
1124	2.5

The methane concentrations in the box were continuously monitored using a Horiba Model PIR-2000 infrared gas analyzer (See figure 10). A MSA Flowlite air pump, operating at 1.5 lpm, moved air from the box, through the analyzer gas cell, and then returned it back to the box. To minimize air transport time, the connecting tubing was kept as short as practical, in this case approximately 61-cm (24-in). An in-line filter, placed between the MSA pump and the Horiba analyzer inlet, prevented airborne particles from entering the gas cell.

Two 4-inch axial air fans, mounted within and attached to the bottom of the box, mixed the air and methane and created a turbulent airflow typical of flow in an underground mine entry. Methane injected into the box mixed quickly with the air. Measurements with the Horiba indicated that the methane concentration increased and reached a relatively constant concentration within 4 sec.

The elapsed time between injection of the gas and the IYONI alarm signal was measured with a digital stopwatch. A 13-cm (5-in) long, 6-mm (0.25-in) diameter piece of round glass rod was inserted through the side of the box and used to observe the blinking cap lamp light when the instrument was in alarm mode. It was also possible to hear the audible alarm signal outside the box when the instrument alarmed within the box.

The response times measured by applying the calibration gas through the calibration adaptor and applying test gas in the box are plotted on figures 11 and 12 for both units. The alarm response times measured in the test box and with the calibration adaptor were similar for methane concentrations between 0.6 and 2.5 pct.

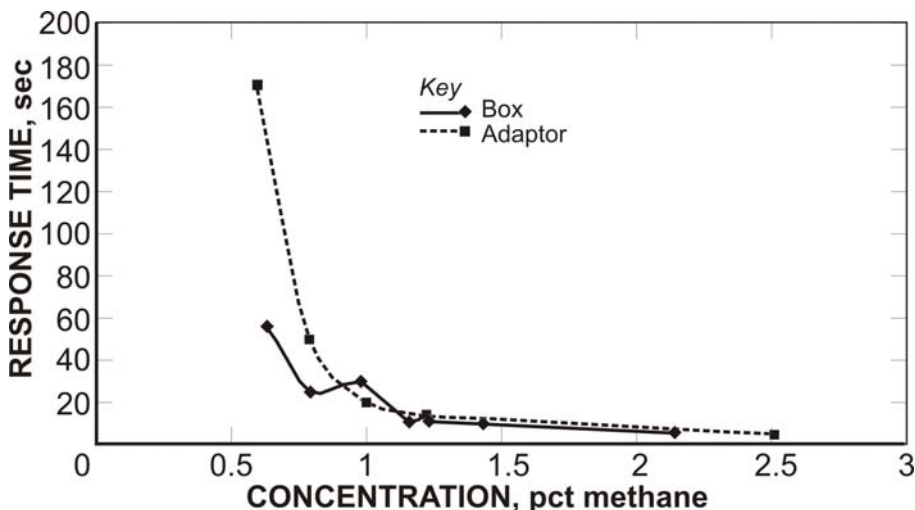

Figure 11. IYONI Unit 1 Box and Adaptor Tests

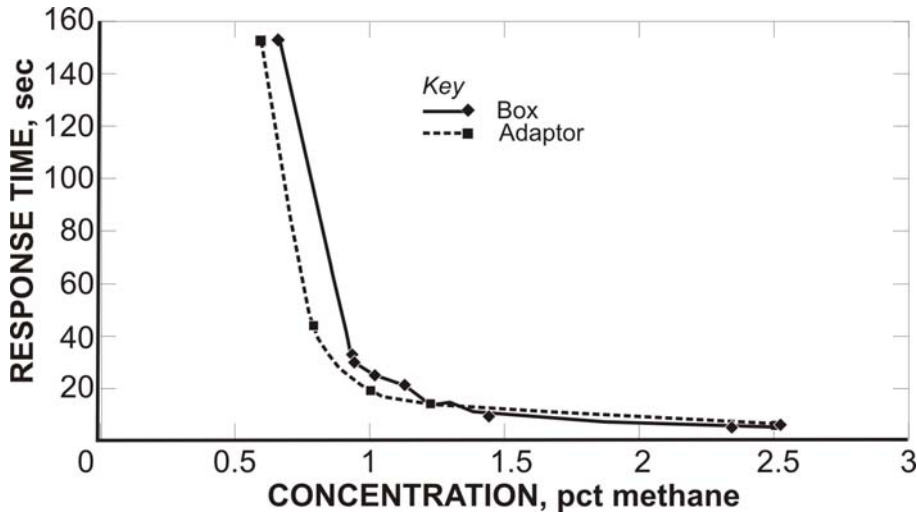

Figure 12. IYONI Unit 2 Box and Adaptor Tests

6 ALARM STABILITY /REPEATABILITY OF MEASUREMENTS

Calibration of machine-mounted methane monitors used in coal mines must be examined at least once every 31 days (30CFR 75.342 (a) (4)). Periodic checks of calibration are needed to determine instrument accuracy. On seven working days between March 21 and April 4 response time measurements were made daily with both IYONI methane sensors to check the variability of response time measurements over time (See figure 13). Both sensors were calibrated on March 21 and no further changes were made to instrument gain

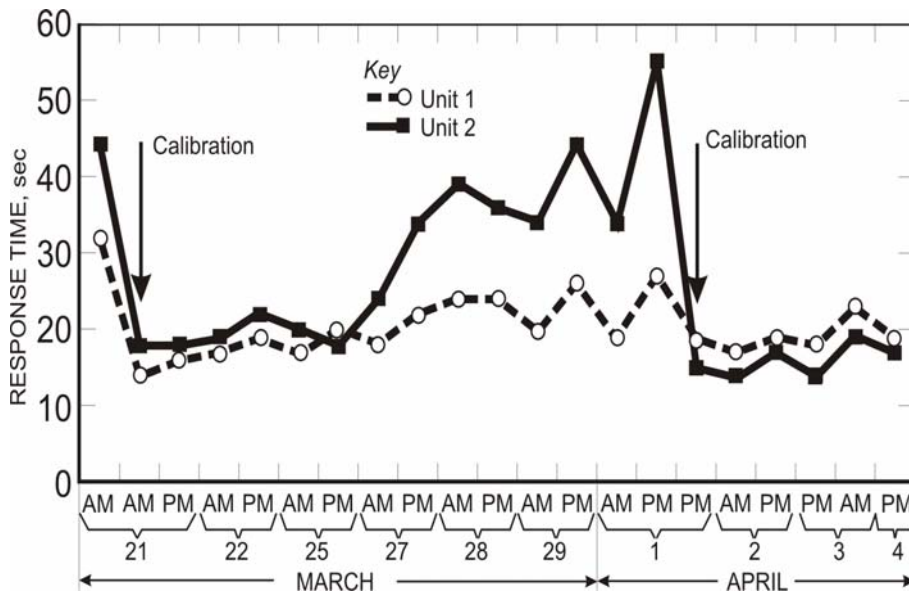

Figure 13. Response Time Repeatability

until April 1. On most days, 2 or more measurements were made in the morning and afternoon and the results were averaged. The time interval between readings was 10 minutes and the standard calibration procedure was used to apply the calibration gas to the sensor head.

Following calibration on March 21, response times increased for both units. On April 1, both instruments were calibrated and the response times reduced by adjusting the instrument gain.

7 EVALUATION IN A VENTILATION TEST GALLERY

Tests were conducted in the Pittsburgh Research Laboratory's Ventilation Test Gallery to evaluate the IYONI instrument under ventilation conditions similar to those found near the face in an underground mine. An experimenter entered the gallery wearing a miner's cap and belt. The IYONI instrument was worn on the cap and the battery was attached to the belt.

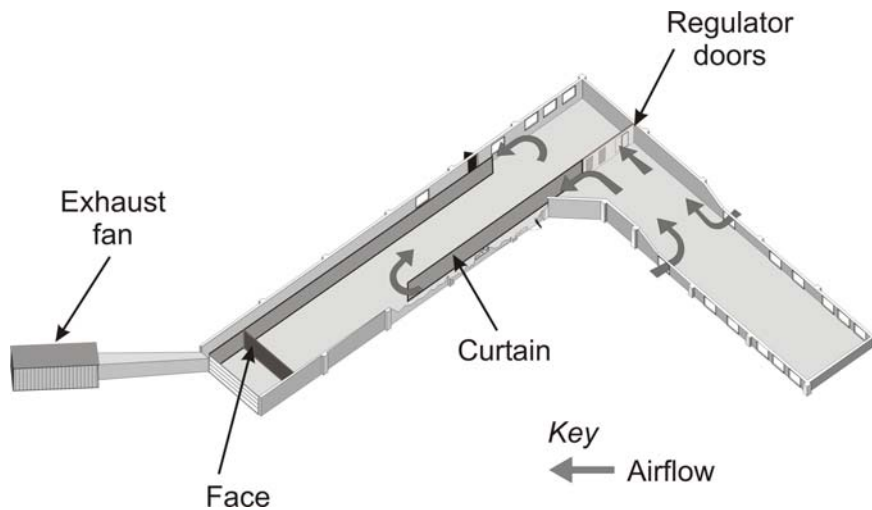

Figure 14 Ventilation Test Gallery

The test gallery (figure 14) was used to simulate a 5-m (16.5-ft) wide entry with a 2.1-m (7-ft) high roof. A Joy Manufacturing electric powered exhaust fan pulled approximately $5.9 \text{ m}^3/\text{s}$ (12,500 cfm) of air from the gallery. An air flow of $4.7 \text{ m}^3/\text{s}$ (10,000 cfm) was directed toward the mining face using a blowing brattice that was constructed 0.6-m (2-ft) from the left side of the entry. The end of the curtain was 10.7-m (35-ft) back from the face. The average air speed measured with a vane anemometer at the end of the curtain was approximately 3.6 m/s (715 fpm) over the 1.3-m^2 (14-ft^2) inlet area.

Simulated methane liberation at the face was accomplished by releasing methane from a natural gas distribution line through four, 3.7-m (12-ft) long horizontal copper pipes that were equally spaced vertically and located 10-cm (4-in) from the face. 1.6-mm (0.06-in) diameter holes were drilled 51-mm (2-in) apart through the tops and bottoms of each of the pipes to provide a relatively uniform release of gas across the face area.

During testing, methane levels were continuously monitored by a Bacharach Model CE 130 monitoring system with gas sampling positions at four locations 30-cm (1-ft) from the roof and face and equally spaced across the face. Natural gas volumetric flow into the gallery was monitored with a rotameter. The gas was turned on and off before and after each test. The flow rate for the 93 pct pure methane was $0.02 \text{ m}^3/\text{s}$ (33 cfm). For safety, personnel were not permitted in the gallery unless methane concentrations at the face were 2 pct or less, as measured at the four face sampling locations. Also for safety, all electrical power to circuits within the gallery, including lights and outlets, was turned off during testing.

After establishing methane gas flow, an experimenter entered the gallery wearing the IYONI sensor and carrying an Industrial Scientific Company Model MDU420 combustible gas monitor. The MDU420 is an infrared instrument that uses a pump to draw air through an inlet port into the infrared sensing chamber. A visual readout gives methane concentration. Polyethylene tubing, attached to the inlet port of the MDU420, was extended to a location on the helmet approximately 1 inch from the IYONI sensor head.

Before the test, the IYONI instrument was calibrated as previously described using 1 pct calibration gas. The measured response time was 24 seconds. Accuracy of the Model MDU420 instrument was checked by applying 1 pct calibration gas.

Two measurement locations were selected in the gallery. Location 1 was 7.6-m (25-ft) back from the face, approximately 0.6-m (2-ft) from the left side of the entry, and 3.0-m (10-ft) in by the blowing brattice. Methane concentrations were essentially zero at this location. Location 2 was 7.6-m (25-ft) from the face and 0.6-m (2-ft) from the right side of the entry. Methane levels varied at this location.

During the tests, a researcher stood at one of the locations and faced the gas release manifold. Using a hand-held two-way radio, information was transmitted to personnel outside the gallery regarding the current sampling location, the methane concentration obtained from the Model 420 visual readout, and the time when the IYONI alarm signal turned on or off.

Table 7 below compares methane readings obtained by the Industrial Scientific Model 420 instrument to the IYONI II alarm status; on or off. Alarm-on readings varied from 0.7-to 1.2-pct methane. Readings when the alarm turned off varied from 0.0-to 0.7 pct methane. The IYONI alarm activated when carried to the right side of the entry where the measured methane concentration was 0.7 pct or greater. The alarm was de-activated when the IYONI was carried to the left side of the entry where the methane levels were lower.

Table 7. Comparing measured methane values to IYONI alarm status

Measured methane values, pct	IYONI alarm status
0.9	On
0.5	Off
0.9	On
0.0	Off
0.7	On
0.0	Off
1.2	On
0.7	Off
0.8	On

8 DISCUSSION

8.1 Visual and Aural Alarm Signals

As previously noted, the IYONI instrument gives both aural and visual alarms when the signal output exceeds a reference signal. The sound level generated by the instrument was measured using a Bruel and Kjaer sound level meter. With the sound meter set 0.3-m (1-ft) from the IYONI instrument, the alarm was activated by applying 2.5 pct methane gas from a cylinder. The following sound level readings were taken for the two instruments. Unit 1

sound intensity was 60 to 64 dB at a frequency of 6300 Hz and 50 dB at 3150 Hz. Unit 2 sound intensity was 65 to 68 dB at a frequency of 6300 Hz and 71 dB at 3150 Hz. The highest decibels were measured when the inlets to the alarm sensors were directed at the microphone. It is unlikely that the alarm could be heard when working near mining equipment having background noise levels often 85 dB or higher.

Detection of the visual alarm depends on observing the blinking of the cap lamp. The rate at which the light blinks is rapid. A photoresistor powered with a 0.375 volts power supply was used to measure the cap lamp light blink rate during the alarm mode. Both units had alarm light durations of 2-s on and 0.14 to 0.16-s off. This rapid blink rate can be easily detected when there is no background light or the light is observed directly by a second individual. However, if there is background light or the head-mounted unit is moved rapidly due to the actions of the worker, the blinking alarm may not be immediately detected by the wearer.

9 CONCLUSION

The response times measured for each of the two instruments tested are typical of those measured for other diffusion limited methane alarms using heat of combustion sensor heads. Any increases in response time beyond these measured ranges could indicate deterioration in instrument performance and the need to provide routine maintenance, repair, or replace the instrument sensor.

Wearing a methane monitor, such as the IYONI could improve worker safety in all underground work areas of gassy mines if the monitor, when exposed to higher methane concentrations, would provide a warning signal in time to evacuate workers and/or allows workers to reduce methane concentrations to safe levels by improving local ventilation. The IYONI instrument does not provide a direct reading of methane concentrations and, therefore, cannot be used to determine compliance with underground methane standards. To assure compliance with methane standards, actual concentrations must be confirmed using an approved hand-held methane detector.

The IYONI units tested comply with SABS 1515-1 and are used in RSA mines as flammable gas warning devices. These units are not presently approved for use underground in U. S. mines. They will require Mine Safety and Health Administration approvals for use in U. S. underground coal mines. The units tested were purchased by NIOSH for use only in their laboratories. In limited testing, the IYONI II detector was found to reliably detect the presence of 1 percent by volume methane.

10 REFERENCES

Taylor CD, Chilton JE and Mal T [2002]. Evaluating Performance Characteristics of Machine-Mounted Methane Monitors by Measuring Response Time. Proc. of the North American/9th U.S. Mine Ventilation Symposium, Kingston, Ontario, Canada, June 8-12, pp 315-321.

