

REPORT OF THE DEPARTMENT OF THE ARMY REVIEW  
OF THE  
PRELIMINARY INVESTIGATIONS INTO THE MY LAI INCIDENT (U)

VOLUME III

EXHIBITS

BOOK 4 - MISCELLANEOUS DOCUMENTS

14 MARCH 1970

# CONTENTS

Exhibit No.	Title	Page
M-1	<u>Life</u> Magazine, pages 36-45.....	1
M-2	Military Assistance Command, Vietnam (MACV), "9 Rules".....	9
M-3	MACV Card, "Enemy in your Hands".....	11
M-4	MACV Card, "Guide for Commanders".....	13
M-5	English Translation - Document from LT Tan to Quang Ngai Province Chief.....	15
M-6	Americal Division Log, dated 16 March 1968.....	(III-3)*
M-7	Congratulatory Message from MG Koster, 19 March 1968.....	19
M-8	III MAF Force Order 5820.1, "War Crimes In- vestigation".....	(III-2)*
M-9	Americal Letter, 24 March 1968, Subj: "Safe- guarding of Noncombatants".....	(III-2)*
M-10	MAJ Watke's Letter to his Wife, dated 16 March 1968, plus Envelope.....	23
M-11	MAJ Watke's Letter to his Wife, dated 17 March 1968, plus Envelope.....	25
M-12	MAJ Watke's Letter to his Wife, dated 18 March 1968, plus Envelope.....	27
M-13	COL Henderson's Letter to GEN Westmoreland, 10 December 1969.....	29
M-14	TF Barker Log, 16 March 1968.....	(III-3)*
M-15	Memo for Record, Extract of Journal Entries, 11th Infantry Bde, 17 and 21 March 1968	

---

\*Indicates location in volume and book.

Exhibit No.	Title	Page
	(Concerning COL Henderson's Movements).....	(III-3)*
M-16	TF Barker Log, 14, 15, 17 & 18 March 1968.....	(III-3)*
M-17	11th Infantry Bde TRIDENT, Volume 1, Number 7, 22 March 1968.....	33
M-18	Memorandum, Subj: Interview with Mrs. Dorothy M. Barker, 19 December 1969, with 4 Inclo- sures.....	37
M-19	Roster, Co C, 1st Bn, 20th Infantry, 18 April 1968, corrected as of 16 March 1968.....	(III-3)*
M-20	Memo for Record, Subj: Tape Recording Tran- script, 17 December 1969, with 2 Inclosures: (1) Transcript of Tape Recording from TF Barker TOC, 16 March 1968, and (2) Legend for Call Signs.....	43
M-20A	Tape Recording Transcript as Revised by CPT Lewellen and Annotated with Sequence Numbers and Times.....	73
M-21	CPT Livingston's Letter to his Wife, 16 March 1968.....	111
M-22	CPT Livingston's Letter to his Wife, 16 March 1968.....	113
M-23	Americal News Sheet, Vol 1, Number 332, 17 March 1968.....	115
M-24	Roster, Co B, 4th Bn, 3d Infantry, 31 October 1967, corrected as of 16 March 1968.....	(III-3)*
M-25	Organizational Chart, Quang Ngai Sector.....	119
M-26	Organizational Chart, Quang Ngai Province.....	121
M-27	Organizational Chart, CORDS, Quang Ngai.....	123
M-28	LT Tan's Letter to COL Khien, Quang Ngai Prov- ince Chief, 28 March 1968.....	125
M-29	LT Tan's Letter to Province Chief, 11 April 1968, found in files of Son Tinh District....	127

---

\*Indicates location in volume and book.

Exhibit No.	Title	Page
M-30	Signed Statement by Angel M. Rodriguez, 14 April 1968.....	129
M-31	Census Grievance Report, 18 March 1968.....	131
M-32	Postal Message Directive from COL Toan to the Quang Ngai Sector to Conduct an Investiga- tion, 14 April 1968.....	133
M-33	VC Propaganda Broadcast, an Inclosure to Memo for CG, 2d ARVN Div.....	135
M-34	Son Tinh District Chief's Letter to Quang Ngai Province Chief, 11 April 1968, Obtained from Files of Quang Ngai Province.....	141
M-34A	Copy of M-34 with Handwritten Notation by COL Khien.....	143
M-35	VC Propaganda Leaflet, Dated 28 March 1968.....	145
M-36	Memo for COL, CG, 2d ARVN Div, 12 April 1968....	153
M-37	Letter of Appreciation Dated 14 March 1968, to All Members of Adv Team 2 - "Summary of Progress".....	163
M-38	Historical Summary - III MAF.....	(III-3)*
M-39	Recommendation for Award, 13 June 1968, OPN HOAI.....	167
M-40	COMUSMACV Message, 240125Z, December 1969, Subj: Letter from COMNAVFORV, Dated 23 De- cember 1969 (U) (Copy of Letter dated 23 De- cember 1969 and Annotated Map).....	175
M-41	Informal Register Maintained by 1SG Dahner, B/4-3 Inf, Listing KIA and WIA.....	183
M-42	Orders and Related Papers for Award of Bronze Star with "V" Device, SP4 Lawrence Colburn....	185
M-43	Recommendation for and Approval of Award, SP4 Glenn U. Andreotta.....	193
M-44	Recommendation for and Approval of Award, WO1 Hugh C. Thompson, Jr.....	197

\*Indicates location in volume and book.



Exhibit No.	Title	Page
M-45	DA IG Letter, Subject: Request for Assistance, dated 13 August 1968, with 1st and 2d Indorsements.....	211
M-46	11th Inf Bde Journal, 0001 Hours, 16 March 1968 to 2400 Hours, 19 March 1968.....	(III-3)*
M-47	Paragraph 38, Special Orders Number 34, HQ Americal Division, 3 February 1968 (Award of CIB to Members of B/4-3) (Extract).....	227
M-48	COMUSMACV Message, 211531Z, February 1968, to VMAC, Subj: Mistreatment of Detainees and PW (U).....	(III-3)*
M-49	Mr. Do Dinh's Letter to 1LT District Chief, Son Tinh District, Subj: Report of the Allied Operation of 16 March 1968.....	231
M-50	S-5 Log, 11th Bde, 18 March 1968.....	(III-3)*
M-51	Journal of Psy Ops, USC BS 7178, Quang Ngai Province, 1-20 March 1968, with copy of map listing areas of operations.....	234
M-52	Memorandum for LTG William R. Peers, Subj: Interview with Mr. Ronald L. Haeberle, 22 January 1970.....	237
M-53	11th Inf Bde, XIOP, Letter, 1 November 1967, Subj: Preparation for Overseas Movement (POM).....	(III-2)*
M-54	Americal Division, AVDF-GC, Letter, 7 December 1967, Subj: Phased Schedule of 11th Lt Inf Bde (U).....	(III-2)*
M-55	Training Memorandum 350-2, HQ, 11th Inf Bde (Record Copy, Undated) (Training of 11th Bde in RVN on Arrival).....	(III-2)*
M-56	11th Inf Bde Tactical SOP (Extracts).....	(III-2)*
M-57	Preliminary Instructions to Witnesses.....	243
M-58	Release No. 113-68-75, Info Office, 11th Infantry Bde, by SP5 Jay A. Roberts.....	245

\*Indicates location in volume and book.

Exhibit No.	Title	Page
M-59	11th Inf Bde TRIDENT, Vol I, Number 11, 19 April 1968.....	249
M-60	"Americal News Sheet," Vol I, Number 333, 18 March 1968.....	253
M-61	News Release, Number 76-68, Office of Informa- tion, MACV, 16 March 1968.....	255
M-62	Southern Cross (Americal Division Publica- tion), Vol I, Number 4, 1 August 1968 (Extract).....	259
M-63	HQ, Americal Division, Letter, 13 June 1969, Subj: Order of Battle Summary (U).....	(III-3) *
M-64	"Americal News Sheet," Vol I, Number 334, 19 March 1968.....	265
M-65	"Americal News Sheet," Vol I, Number 335, 20 March 1968.....	267
M-66	Americal Division Artillery Field SOP, 1 Dec- ember 1967.....	(III-2) *
M-67	Gunnery Checklist, Americal Division, 5 Feb- ruary 1968.....	(III-2) *
M-68	Artillery Items for Command Emphasis, Americal Division Artillery, 12 October 1967.....	(III-2) *
M-69	Americal Division Message, AVDF-GC 6660, 2 Dec- ember 1967, Subj: Reporting.....	(III-2) *
M-70	Investigation of Artillery Incidents, TF Ore- gon, 7 May 1967.....	(III-2) *
M-71	TF Oregon Message, AVDF-AT 2859, July 1967, Subj: Reporting and Investigation of Erratic Artillery Rounds.....	(III-2) *
M-72	Message, Knowles to Matheson, Linnell, Wear and Young, July 1967, Subj: Double Check Proced- ure for Artillery Units.....	(III-2) *

---

\*Indicates location in volume and book.

Exhibit No.	Title	Page
M-73	TF Oregon Message, AVDF-AT 1483, May 1967, Subj: Orientation and Training in Ar- tillery Techniques.....	(III-2) *
M-74	6th Bn, 11th Arty Combat SOP, 18 November 1967.....	(III-2) *
M-75	Memo for Record, Re: TF Oregon/Americal Division, Artillery Incident Reports, April 1967 - February 1968, 17 January 1970.....	271
M-76	CORDS, I Corps, PSA Conference, 23 February 1968, Notes.....	275
M-77	GO 2224, Americal Division, 27 April 1968, Assumption of Command (Young).....	277
M-78	GO 2401, Americal Division, 8 May 1968, As- sumption of Command (Koster).....	279
M-79	GO 2965, Americal Division, 3 June 1968, As- sumption of Command (Young).....	281
M-80	GO 3343, Americal Division, 22 June 1968, Assumption of Command (Gettys).....	283
M-81	General Information for Witnesses Appearing be- fore Interview Team C.....	285
M-82	GEN Westmoreland's Letter to GEN Cao Van Vien, 21 February 1968.....	287
M-83	Letter from Mr. Ronald L. Ridenhour, 29 March 1969.....	289
M-84	Letter from Mr. Ronald L. Ridenhour, 19 Jan- uary 1970.....	295
M-85	Diary Extracts of Mr. Partsch, 15-18 March 1968.....	299
M-86	Diary Extracts of Mr. Partsch, 29 February and 3 May 1968.....	301
M-87	11th Inf Bde INTSUM 76-68, 151900 H to 161900 March 1968.....	(III-3) *

---

\*Indicates location in volume and book.

Exhibit No.	Title	Page
M-88	<u>Stars and Stripes</u> , 18 March 1968 (Extract, page 6).....	305
M-89	COMUSMACV Message to Americal Division, 161425 March 1968, Congratulatory Message.....	307
M-90	Letter of Commendation from 11th Bde to CO, C/1-20 Inf, 27 March 1968.....	309
M-91	Message from COMUSMACV, Subj: Guidance for Commanders in Vietnam, December 1967.....	(III-2)*
M-92	MACV Computer Summary, Subj: Large Scale Operations, 1st Quarter 1968.....	(III-3)*
M-93	Handbook for Military Support, February 1968 (Extracts).....	315
M-94	MACV Individual Replacement Packet, with MFR, 20 January 1970 (Extract).....	(III-1)*
M-95	MACV Command Center Log, 0001 to 2400 16 March 1968 (Extract).....	(III-3)*
M-96	MACV Command Center Log, 17 March 1968.....	(III-3)*
M-97	Message from CG, USARV to CG, Americal Division, Subj: Reorganization, 9 September 1968.....	(III-1)*
M-98	HQ, USARV Memo for Record, Subj: Inquiry Concerning Alleged Massacre - My Lai, 17 April 1969.....	359
M-99	HQ Americal Division Letter, Subj: ROI to CG, USARV, Attn: IG, 25 May 1969.....	363
M-100	Copy of M-99 with Annotation.....	365
M-101	Message, 23 May 1969, from COL Donaldson, Americal Division to COL Henderson (True Copy)....	367
M-102	GO 1841, HQ, Americal Division, 9 April 1968, Subj: Award of Purple Heart to COL Henderson.....	369

---

\*Indicates location in volume and book.

Exhibit No.	Title	Page
M-103	SO 45, HQ Americal Division, 14 February 1968, Subj: Assignment of LTC Barker as CO, TF Barker (Extract).....	371
M-104	HQ, Americal Division TOC Log, 130001 June to 132400 June 1968 (Extract Item 8).....	(III-3)
M-105	TF Oregon Field SOP, 21 March 1967.....	(III-2)
M-106	Americal Division Combat SOP, 15 April 1968.....	(III-2)
M-107	HQ, 11th Inf Bde Unit Order 13, 15 March 1968, Subj: Assumption of Command, Henderson.....	375
M-108	HQ, 11th Inf Bde Historical Document, Subj: History 1 January to 31 December 1968.....	(III-3)
M-109	HQ, 11th Inf Bde Letter, Subj: PFC Carter, with Casualty Report, 6 April 1968.....	379
M-110	Memo For Record, Subj: Low Level Recon to Identify Sites Previously Indicated by CWO Thompson, 1 January 1970, with Addendum, 8 January 1970.....	383

Miscellaneous documents are continued in Book 5.

---

\*Indicates location in volume and book.

EXHIBIT M-1, LIFE MAGAZINE

Early in the conduct of hearings, a copy of LIFE Magazine, dated 5 Dec 69, pages 36 to 42, was entered into the record. The purpose was solely for identification of the photographs; the accompanying article was not referred to as part of the exhibit. This was done prior to the receipt of the color photographs taken at My Lai (4) on 16 March 1968 by Mr. Ronald Haeberle. Color photographs which correspond to those appearing in LIFE Magazine have been received and entered into evidence as follows:

LIFE Page No.	Exhibit No.
36	P-29
37	P-40
38 (Upper)	P-41
38 (Lower)	P-38
39	Not Available to Inquiry
40 (Upper)	P-33
40 (Lower)	P-35
41	P-39
42	P-34

Exclusive pictures, eyewitness accounts

# The Massacre at Mylai



Sprinting for cover, men of Company C left the helicopters that ferried them in for the assault on Mylai

The action at Mylai received only a passing mention at the weekly Saigon briefing in March of 1968. Elements of the Americal Division had made contact with the enemy near Quangnai city and had killed 128 Vietcong. There were a few rumors of civilian deaths, but when the Army looked into them—a month after the incident—it found nothing to warrant disciplinary measures. The matter might have ended there except for a former GI, Ron Ridenhour, now a California college student. After hearing about Mylai from former comrades, he wrote letters to congressmen warning that “something rather dark and bloody” had taken place. Now an officer has been charged with murder of “an unknown number of Oriental human beings” at Mylai, and 24 other men of Company C, First Battalion, 20th Infantry are under investigation. Congressmen are demanding to know what happened at Mylai, who ordered

it, and whether or not U.S. troops have committed similar acts in Vietnam.

Because of impending courts-martial, the Army will say little. The South Vietnamese government, which has conducted its own investigation, states that Mylai was “an act of war” and that any talk of atrocities is just Vietcong propaganda. This is not true. The pictures shown here by Ronald Haerberle, an Army photographer who covered the massacre, and the interviews on the following pages confirm a story of indisputable horror—the deliberate slaughter of old men, women, children and babies. These eyewitness accounts, by the men of Company C and surviving villagers, indicate that the American troops encountered little if any hostile fire, found virtually no enemy soldiers in the village and suffered only one casualty, apparently a self-inflicted wound. The people of Mylai were simply gunned down.

“Guys were about to shoot these people,” Photographer Ron Haerberle remembers. “I yelled, ‘Hold it,’ and shot my picture. As I walked away, I heard M16s open up. From the corner of my eye I saw bodies falling, but I didn’t turn to look.”

Photographed by RONALD L. HAEBERLE







Haeberle found the bodies above on a road leading from the village. "Most were women and babies. It looked as if they tried to get away."

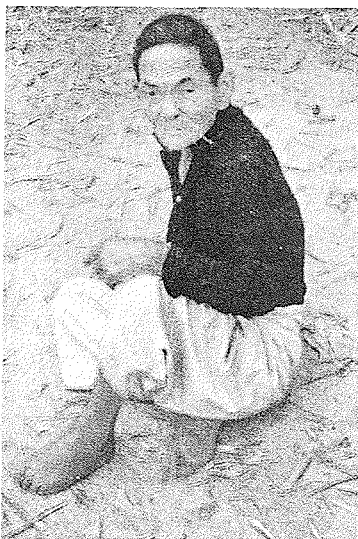
"When these two boys were shot at," says Haeberle, "the older one fell on the little one, as if to protect him. Then the guys finished them off."



4



"This man was old and trembling so that he could hardly walk. He looked like he wanted to cry. When I left him I heard two rifle shots."



## 'The order was to destroy Mylai and everything in it'

*These photographs and the first detailed eyewitness account of Mylai were brought to light by Joseph Eszterhas, a reporter for the Cleveland Plain Dealer. He helped prepare the following article, based on his own interviews with Photographer Ron Haeberle and reports from LIFE Correspondents Dale Wittner, John Saar, Tom Flaherty and Reg Bragonier and Stringers Kent Demaret and Jane Estes.*

On the day before their mission the men of Company C met for a briefing after supper. The company commander, Captain Ernest Medina, read the official prepared orders for the assault against Mylai and spoke for about 45 minutes, mostly about the procedures of movement. At least two other companies would also participate. They, like Company C, were elements of Task Force Barker, named for its commander, Lt. Colonel Frank Barker, who was to die in action three months later. But only Company C would actually enter the cluster of huts known as Mylai 4.

"Captain Medina told us that this village was heavily fortified," recalls one of his squad leaders, Sgt. Charles West. "He said it was considered extremely dangerous and he wanted us to be on our toes at all times. He told us there was supposed to be a part of the 98th NVA Regiment and the 48th VC Battalion there. From the intelligence that higher levels had received, he said, this village consisted only of North Vietnamese army, Vietcong, and VC families. He said the order was to destroy Mylai and everything in it."

Captain Medina was a stocky, crew-cut, hard-nosed disciplinarian whom his men called "Mad Dog Medina." Men respected him: to Charles West he was one of "the best officers I've known." Most of them had served under Medina since the company had formed the previous year in Hawaii as C Company, First Battalion, 20th Infantry, 11th Light Infantry Brigade.

"As far as I'm concerned, Charlie Company was the best company to ever serve in Vietnam," says West. "Charlie Company was a company, not just a hundred and some men they call a company. We operated together or not at all: We cared about each and every individual and each and every individual's problems. This is the way that we were taught by Captain Medina to feel toward each other. We were like brothers."

Mylai 4 was one of nine hamlets, each designated by a number, which were clustered near the village of Songmy, a name sometimes used also for the hamlets. The men of Company C called the area "Pinkville" because it was colored rose on their military maps and because these fertile coastal plains long had been known as Vietcong territory. Pinkville was only seven miles northeast of the provincial capital of Quangnai, where, during the Tet offensive only a month before, Vietcong and North Vietnamese troops had boldly occupied portions of the city. Soon Company C would use the name Pinkville not only for the entire area but for the single hamlet Mylai 4.

Company C had seen its first real combat in

the previous weeks, all of it around Pinkville. A couple of weeks before, sniper fire from across the river had killed one man. His buddies believed the fire had come from Mylai 4. Two weeks before, enemy land mines had killed five men and wounded 22. Several days before, in a hamlet near Mylai 4, a booby trap made from an unexploded artillery shell had killed one of the GIs' favorite squad leaders, Sgt. George Cox.

"I was his assistant squad leader," recalls Charles West. "On the way back to camp I was crying. Everybody was deeply hurt, right up to Captain Medina. Guys were going around kicking sandbags and saying, 'Those dirty dogs, those dirty bastards.'"

At the briefing, says West, "Captain Medina told us we might get a chance to revenge the deaths of our fellow GIs." Afterward the men held a memorial service for George Cox, but the ritual of mourning was more like a pep rally for the forthcoming action.

"Captain Medina didn't give an order to go in and kill women or children," says West. "Nobody told us about handling civilians, because at the time I don't think any of us were aware of the fact that we'd run into civilians. I think what we heard put fear into a lot of our hearts. We thought we'd run into heavy resistance. He was telling us that here was the enemy, the enemy that had been killing our partners. This was going to be our first real live battle, and we had made up our minds we were going to go in and with whatever means possible wipe them out."

Shortly after sunrise on March 16, 1968, a bright, clear, warm day, the helicopters began lifting approximately 80 men of Company C from the base camp at Landing Zone Dottie and delivering them 11 kilometers away in the paddies west of Mylai 4.

Army Photographer Sgt. Ron Haeberle and SP5 Jay Roberts, both of the 31st Public Information Detachment, came in on the second helicopter lift. Haeberle, who had been drafted out of college, had only a week left on his tour in Vietnam. Neither man had seen much action. They had volunteered for this operation because the word was out that it would be "a hot one." The squad the two were assigned to was getting its orders by walkie-talkie from Captain Medina. Haeberle was carrying three cameras—one for the Army, two of his own. (He turned in his black-and-white film to the Army. The Army took no action at that time but apparently intends to use the film as evidence in the court-martial proceedings.) Roberts, a college student who had volunteered for the draft, took pad and pencil. Their

CONTINUED

## 'You don't call

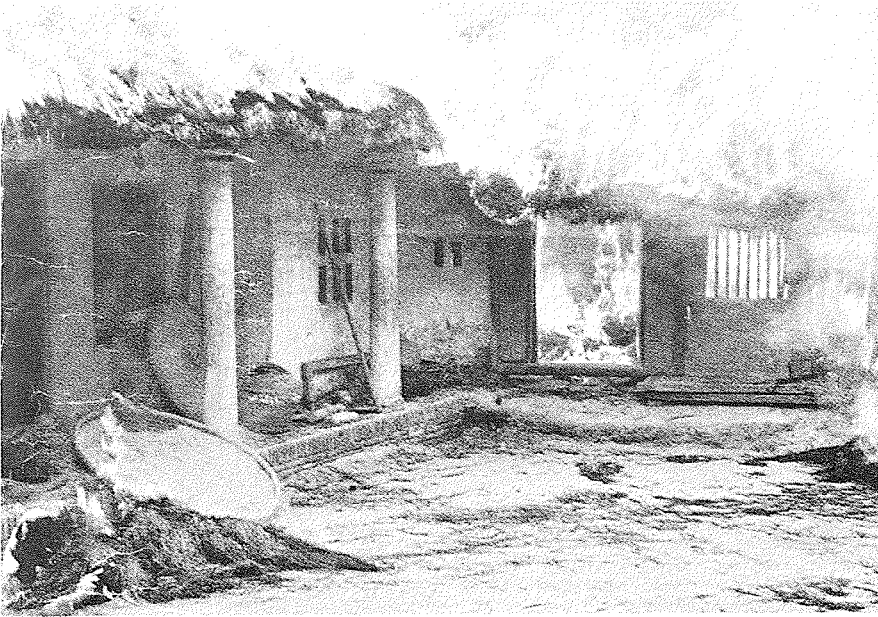
CONTINUED

mission was to prepare news releases and a report for the brigade newspaper.

"We landed about 9 or 9:30 in a field of elephant grass," says Varnado Simpson, then a 19-year-old assistant platoon leader from Jackson, Miss. Gunships had prepped the area with Miniguns and grenade launchers. It was clear and very warm and it got warmer. "Our landing zone was the outskirts of town, on the left flank. There were about 25 of us and we went directly into the village. There wasn't any enemy fire. We'd come up on a hoo'ch, we'd search it to see if there was someone in it. If there was no one in it, we'd burn it down. We found people in some, and we took some back to the intelligence people for questioning. Some ran, we tried to tell them not to run. There were about 15. Some stopped. About five or six were killed."

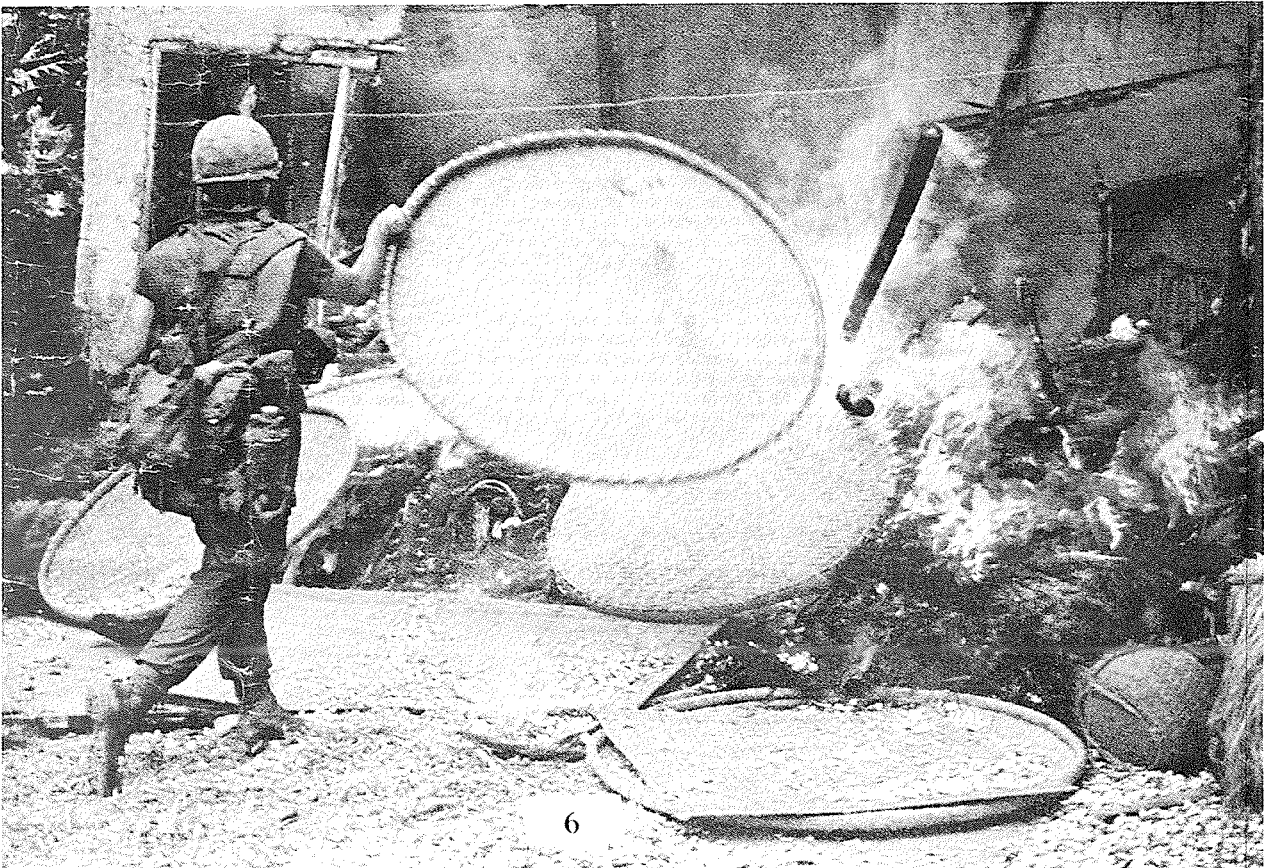
Haeberle and Roberts moved through the rice fields toward a hill in back of the village area. Haeberle was with 10 or 15 GIs when he saw a cow and heard shots at the same time. The shooting was straight ahead. A GI shot a cow and then others kept pumping bullets into the cow until the cow finally fell.

"Off to the right," says Haeberle, "a wom-



Haeberle remembers that the body in front of a burning house (*above*) kept twitching and that one GI commented, "He's got ghosts in him."

Intent on destroying everything that might be of use to the Vietcong, a soldier (*below*) stokes a fire with the baskets used to dry rice and roots.





## them civilians—to us they were VC'

an's form, a head, appeared from some brush. All the other GIs started firing at her, aiming at her, firing at her over and over again. She had slumped over into one of those things that stick out of the rice paddies so that her head was a propped-up target. There was no attempt to question her or anything. They just kept shooting at her. You could see the bones flying in the air chip by chip. Jay and I, we just shook our heads."

"There were a whole lot of Vietnamese people that I especially liked," recalls Sgt. Charles West of his year in Vietnam. "Most of them were at this orphanage I used to visit frequently after I came off field duty. I'd go down there and the people would try to teach me more of the Vietnamese language and they would explain a lot of customs that I wanted to know something about."

Charles West led his squad of 13 men through the rice paddies and heard the sound of gunfire. They were coming down a sharply winding trail and were keeping a close watch for booby traps. They turned a curve in the trail and there, 25 feet ahead of them, were six Vietnamese, some with baskets, coming toward them. "These people were running into us," he says, "away from us, running every

which way. It's hard to distinguish a mama-san from a papa-san when everybody has on black pajamas." He and his squad opened fire with their M16s. Then he and his men kept going down the road toward the sound of the gunfire in the village.

"I had said in my heart already," says West, "and I said in my mind that I would not let Vietnam beat me. I had two accomplishments to make. The first was to serve my government and to accomplish my mission while I was in Vietnam. My second accomplishment was to get back home."

"There was a little boy walking toward us in a daze," says Haerberle. "He'd been shot in the arm and leg. He wasn't crying or making any noise." Haerberle knelt down to photograph the boy. A GI knelt down next to him. "The GI fired three shots into the child. The first shot knocked him back, the second shot lifted him into the air. The third shot put him down and the body fluids came out. The GI just simply got up and walked away. It was a stroboscopic effect. We were so close to him it was blurred."

"The people who ordered it probably didn't think it would look so bad," says Sgt. Michael

A. Bernhardt, who asserts he refused to take part in the killings.

As he entered the village, Bernhardt recalls, a plane was circling above, warning the people in Vietnamese to leave. "Leaflets were dropped ahead of time, but that doesn't work with the Vietnamese people. They have very few possessions. The village we went into was a permanent-type village. It had hard walls, tile roofs, hard floors and furniture. The people really had no place to go. The village is about all they have. So they stay and take whatever comes.

"It was point-blank murder. Only a few of us refused. I just told them the hell with this, I'm not doing it. I didn't think this was a lawful order."

"To us they were no civilians," says Varnado Simpson. "They were VC sympathizers. You don't call them civilians. To us they were VC. They showed no ways or means that they wasn't. You don't have any alternatives. You got to do something. If they were VC and got away, then they could turn around and kill you. You're risking your life doing that work. And if someone kills you, those people

CONTINUED

"This man and two little boys popped up from nowhere," says Haerberle. "The GIs I was with opened up, then moved in close to finish them."





PHOTOGRAPH © R.L. HAEBERLE



SP4 VARNADO SIMPSON

**Someone will always be pointing a finger at me and saying, 'He was one of them'**

Varnado Simpson of Jackson, Miss. hasn't forgotten the old woman and the child, dead in a smoldering doorway. "We saw a man running away from us, but he had a weapon. There were two running along with him. What else was there to do? Run up and beg them to stop? I had orders to shoot anyone that ran. They were about 20 yards away. I couldn't see the child. I used my M16 . . . I noticed it was a woman and child when I walked over. It's hard to tell what they are

from the back. . . . The man? He got away.

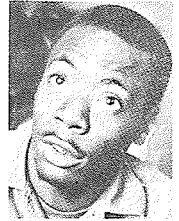
"They can't punish me for that. Big officials are saying it doesn't matter that we were under orders, we're still guilty—but I don't see that. If you're under orders, you're going to be punished for not doing it and punished if you do. I didn't like what happened, but I didn't decide."

Simpson's grandmother saw this picture and said quietly, "Lord, have mercy."

## 'They might have been wild



EX-PFC. CHARLES GRUVER



EX-SGT. CHARLES WEST

CONTINUED

aren't going to feel sorry for you."

Lt. William Calley Jr.'s platoon was the first to arrive in the center of Mylai. "There was about 40, 45 people that we gathered in the center of the village," ex-Pvt. Paul Meadlo told CBS News. "And we placed them in there, and it was like a little island, right there in the center of the village, I'd say.

"Men, women, children. Babies. And we all huddled them up. We made them squat down, and Lieutenant Calley came over and said, you know what to do with them, don't you? And I said yes. So I took it for granted that he just wanted us to watch them. And he left, and came back about 10 or 15 minutes later, and said how come you ain't killed them yet? And I told him that I didn't think you wanted us to kill them, that you just wanted us to guard them. He said, no. I want them dead. He stepped back about 10, 15 feet, and he started shooting them. And he told me to start shooting. So I started shooting, I poured about four clips into the group.

"I fired them on automatic—you just spray the area and so you can't know how many you killed 'cause they were going fast.

"We're rounding up more, and we had about seven or eight people. And we was going to throw them in the hootch and well, we put them in the hootch and then we dropped a hand grenade down there with them. And somebody holed up in the ravine, and told us to bring them over to the ravine, so we took them back out, and led them over too—and by that time, we already had them over there, and they had about 70, 75 people, all gathered up. So we threw ours in with them and Lieutenant Calley told me, he said, Meadlo, we got another job to do. And so we walked over to the people, and he started pushing them off and started shooting . . . off into the ravine. It was a ditch. And so we started pushing them off and we started shooting them, so altogether we just pushed them all off, and just started using automatics on them. Men, women, and children.

"And babies. And so we started

shooting them, and somebody told us to switch off to single shot so that we could save ammo. So we switched off to single shot, and shot a few more rounds."

"There was no expression on the American faces," says Haerberle. "I couldn't believe it. They were destroying everything. They were doing it all very businesslike. The Vietnamese saw the Americans but didn't run. They kept on walking until the GIs saw them and started shooting. Some of the people started pulling their animals off the road and hiding behind trees. The GIs were opening up with M16s, machine guns and grenade launchers. The grenade launcher made a KAPLOW sound."

Pfc. Charles Gruver of Tulsa, Okla., was the first eyewitness to report what he had seen to his old friend Ron Ridenhour, the man who set off the new Army investigation by writing to congressmen. Gruver says he had been in other operations around Mylai, "but we had never killed civilians before. We had never been under orders to wipe things out before."

Gruver told Ridenhour of seeing a small boy, about three or four years old: "The boy was clutching his wounded arm with his other hand while blood trickled between his fingers. He just stood there with big eyes staring around like he didn't understand. Then the captain's RTO [radio operator] put a burst of 16 [M16] fire into him."

"On other missions," says Sgt. West, "the GIs would take their fruit and maybe a can of pork and beans and give the rest to the Vietnamese people. I always thought it would be a treat if I could give them my pears or my peaches or something like that. The people seemed like they appreciated it.

"Just about anywhere we went on an operation we always had kids following us, and most of the kids we would know by name. In a lot of cases I could actually say the people were actually looking out for us. Kids would meet us two or three miles outside a village. We didn't have to use



## NINE RULES

FOR PERSONNEL OF US MILITARY  
ASSISTANCE COMMAND, VIETNAM

The Vietnamese have paid a heavy price in suffering for their long fight against the communists. We military men are in Vietnam now because their government has asked us to help its soldiers and people in winning their struggle. The Viet Cong will attempt to turn the Vietnamese people against you. You can defeat them at every turn by the strength, understanding, and generosity you display with the people. Here are nine simple rules:

DISTRIBUTION — 1 to each member of the  
United States Armed Forces in Vietnam

## NINE RULES

- 1 Remember we are guests here: We make no demands and seek no special treatment.
- 2 Join with the people! Understand their life, use phrases from their language and honor their customs and laws.
- 3 Treat women with politeness and respect.
- 4 Make personal friends among the soldiers and common people.
- 5 Always give the Vietnamese the right of way.
- 6 Be alert to security and ready to react with your military skill.
- 7 Don't attract attention by loud, rude or unusual behavior.
- 8 Avoid separating yourself from the people by a display of wealth or privilege.
- 9 Above all else you are members of the U S Military Forces on a difficult mission, responsible for all your official and personal actions. Reflect honor upon yourself and the United States of America.

EXHIBIT M-2

KEY PHRASES.



<u>ENGLISH</u>	<u>VIETNAMESE</u>
Halt	Đứng lại
Lay down your gun	Buông súng xuống
Put up your hands	Đưa tay lên
Keep your hands on your head	Đưa tay lên đầu
I will search you	Tôi khám ông
Do not talk	Đừng nói chuyện
Walk there	Lại đây kia
Turn Right	Xây bên phải
Turn Left	Xây bên trái

" The courage and skill of our men in battle will be matched by their magnanimity when the battle ends. And all American military action in Vietnam will stop as soon as aggression by others is stopped.

21 August 1965

Lyndon B. Johnson

THE ENEMY IN YOUR HANDS

AS A MEMBER OF THE US MILITARY FORCES, YOU WILL COMPLY WITH THE GENEVA PRISONER OF WAR CONVENTIONS OF 1949 TO WHICH YOUR COUNTRY ADHERES. UNDER THESE CONVENTIONS :

YOU CAN AND WILL

DISARM YOUR PRISONER  
IMMEDIATELY SEARCH HIM THOROUGHLY  
REQUIRE HIM TO BE SILENT  
SEGREGATE HIM FROM OTHER PRISONERS  
GUARD HIM CAREFULLY  
TAKE HIM TO THE PLACE DESIGNATED BY YOUR COMMANDER

YOU CANNOT AND MUST NOT

MISTREAT YOUR PRISONER  
HUMILIATE OR DEGRADE HIM  
TAKE ANY OF HIS PERSONAL EFFECTS WHICH DO NOT HAVE SIGNIFICANT MILITARY VALUE  
REFUSE HIM MEDICAL TREATMENT IF REQUIRED

AND UNAVAILABLE

ALWAYS TREAT YOUR PRISONER HUMANELY

THE ENEMY IN YOUR HANDS

1. HANDLE HIM FIRMLY, PROMPTLY, BUT HUMANELY.

The captive in your hands must be disarmed, searched, secured and watched. But he must also be treated at all times as a human being. He must not be tortured, killed, mutilated, or degraded, even if he refuses to talk. If the captive is a woman, treat her with all respect due her sex.

2. TAKE THE CAPTIVE QUICKLY TO SECURITY

As soon as possible evacuate the captive to a place of safety and interrogation designated by your commander. Military documents taken from the captive are also sent to the interrogators, but the captive will keep his personal equipment except weapons.

3. MISTREATMENT OF ANY CAPTIVE IS A CRIMINAL OFFENSE. EVERY SOLDIER IS PERSONALLY RESPONSIBLE FOR THE ENEMY IN HIS HANDS.

It is both dishonorable and foolish to mistreat a captive. It is also a punishable offense. Not even a beaten enemy will surrender if he knows his captors will torture or kill him. He will resist and make his capture more costly. Fair treatment of captives encourages the enemy to surrender.

4. TREAT THE SICK AND WOUNDED CAPTIVE AS BEST YOU CAN.

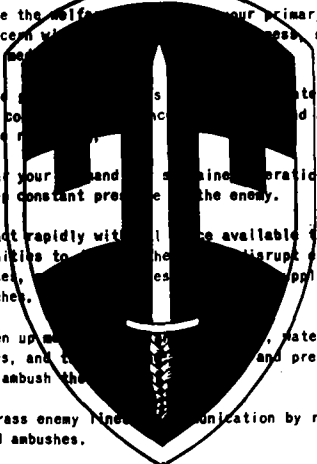
The captive saved may be an intelligence source. In any case he is a human being and must be treated like one. The soldier who ignores the sick and wounded degrades his uniform.

5. ALL PERSONS IN YOUR HANDS, WHETHER SUSPECTS, CIVILIANS, OR COMBAT CAPTIVES, MUST BE PROTECTED AGAINST VIOLENCE, INSULTS, CURIOSITY, AND REPRISALS OF ANY KIND.

Leave punishment to the courts and judges. The soldier shows his strength by his fairness, firmness, and humanity to the persons in his hands.

EXHIBIT M-3

GUIDANCE FOR COMMANDERS IN VIETNAM

- 
1. Make the welfare of your primary concern. Use mail, and mail.
  2. Give your men intelligence, communication and accurate information.
  3. Gear your operations: keep constant pressure on the enemy.
  4. React rapidly with all available opportunities to disrupt enemy bases, caches, and supply caches.
  5. Open up air, water--ways, and land and prepared to ambush the enemy.
  6. Harass enemy lines of communication by raids and ambushes.
  7. Use your firepower with care and discrimination, particularly in populated areas.

8. Capitalize on psywar opportunities.
9. Assist in "revolutionary development" with emphasis on priority areas and on civic action wherever feasible.
10. Encourage and help Vietnamese military and paramilitary units; involve them in your operations at every opportunity.
11. Be smarter and more skillful than the enemy; stimulate professionalism, alertness and tactical ingenuity; seize every opportunity to enhance training of men and units.
12. Keep your officers and men well informed, aware of the nine rules for personnel of MACV, and mindful of the techniques of communist insurgency and the role of free world forces in Vietnam.
13. Maintain an alert "open door" policy on complaints and a sensitivity to detection and correction of malpractices.
14. Recognize bravery and outstanding work.
15. Inspect frequently units two echelons below your level to insure compliance with the foregoing.

MACV 68-4

22/7/66



[REDACTED]

Son Tinh, 28 March 1968

Quang Ngai Province  
Son Tinh District

No. 181/HC/ST/M

FROM: 1LT Tran Ngoc Tan  
Son Tinh District Chief

TO: Quang Ngai Province Chief

SUBJECT: Confirmation of Allied Troops Shooting at the Residents of Tu Cung Hamlet, Coordinates BS 721795

It is respectfully reported that:

On 19 March 1968, an element of the US Forces (unspecified, because this District Headquarters had not been notified of the operation) conducted an operation at Tu Cung Hamlet (BS 721795), Son My Village, Son Tinh District. It was reported that when the element entered the hamlet, one of its members was killed and some others wounded by a VC booby-trapped mine. At this time the VC opened up fiercely from their positions in the hamlet. Meanwhile, the US troops used intense firepower while moving in with artillery and air support, inflicting injuries on a number of hamlet residents because the VC mingled with the population.

Observation by this Headquarters:

The Tu Cung Hamlet and the two neighboring hamlets, e.g., My Lai (BS 737800) and Van Thien (BS 794804), in Son My Village had become insecure since 1964, so the administrative authorities of these areas had been forced to flee to Son Long (BS 638756), leaving these hamlets under VC control. Casualties were unavoidably caused to the hamlets residents during the firefight, while the local administrative authorities were not present in the area. The enemy may take advantage of this incident to undermine, through fallacious propaganda, the prestige of the RVNAF, and frustrate the Government's rural pacification efforts.

Respectfully yours,

(Signed and Sealed)

Copies to:  
S2 and S3, Quang Ngai Sector HQ

EXHIBIT M-5

[REDACTED]

Sơn-Tĩnh, ngày 30 tháng 3 năm 1938

TỈNH QUẢNG-NHAI,  
QUẬN HẢI-CHIÊN SƠN-TỈNH.

Số 18 / 432/ST/M

TRUNG-ĐỘI TRINH-TRƯỞNG  
QUẬN-HƯỚNG QUẬN SƠN-TỈNH.

Định sẵn

TRUNG-ĐỘI TRINH-TRƯỞNG TỈNH QUẢNG-NHAI.

Trích-yếu : V/v xét nhận quân-đội đồng-minh bản người  
tại vùng hành quân từ-cung 721/83.721/93

Trên trung kính trình Trung-Đội Tỉnh-Quảng

Trong ngày 10 tháng 3 năm 1938, quân-đội Sơn-Tĩnh  
(thông số đơn-vị nào, vì cuộc hành-quan này trên tới lãnh  
đạo thành phố) đã hành-quan vào ấp từ-cung 721/83,  
721.795 thuộc xã Sơn-Tĩnh, quận Sơn-Tĩnh. Được biết khi  
quân-đội Sơn-Tĩnh tiến vào ấp có một binh-sĩ vốn năm 16  
tuổi thường và vài quan phạm khác bị thương. Đồng thời  
hơn 100 địch tử trong ấp dẫn ra rất nhiều. Có lẽ vì thế  
quân-đội Sơn-Tĩnh đã dùng hỏa-lựu càng phá-binh và phá-cố  
yên-tĩnh đã tiến vào ấp có gây thiệt hại cho một số thường  
dân vì 16 lính trên chúng trong ấp đó.

Nhơn xét của Quận Sơn-Tĩnh :

Ấp từ-cung và các ấp lân-cận như lý-lại 721/83  
755.800, Vạn-Thị 721/83, 704.804 thuộc xã Sơn-Tĩnh đã nhận  
an-minh từ năm 1934. Chính-quyền xã ấp tận củ con vùng  
Sơn-Tĩnh 721/83, 638.754 đã trú ngụ, hoạt động trên  
ấp 16 lính soát vì phòng-thủ. Vì thế sự giao tranh không  
lên quá trình khởi chốt chốt vì đem đến của cả hai bên.  
Về hình-quyền địa phương (xã ấp) cũng không hiện diện  
đó không thể được. Tuy-nhiên, thực lực địa phương tuyên-truyền,  
cộng-dân có thể nhận một cốt lõi giữa uy-tín quân-đội  
cộng-minh trở ngại cho chủ-trương bình-định xã ấp.

HÀO KINH GIỚI :

- ĐƠN/ST/QUC/P.2 & P.3 :

Thẩm tra

Trên-trung,

Exhibit M-6 is published in Volume III,  
Book 3, Reports.

**EXHIBIT M-6**

SECURITY CLASSIFICATION			
UNCLASSIFIED			
FORM	BOOK	MULTI	SINGLE
1985		M	
PRECEDENCE			
ROUTINE			
INFO			

DTG

FROM: CG, AMERICAL DIV, CHL

TO: CG, 11TH LT INF BDE, DFC

CO, 123D AVN BN, CHL (courier)

UNCLASSIFIED AVDF-CC 2577 KOSIVE BRADS

SUBJECT: CONGRATULATORY MESSAGE

1. I WOULD LIKE TO PASS ON THE FOLLOWING MESSAGE FROM GEN WBSHORELAND:

OF DISCASSINE CORNACI NORTHEAST OF QUANG NGAI CITY ON 16 MARCH DEALT WITH HERBY BLOW. CONGRATULATIONS TO OFFICERS AND MEN OF C/1-20 INF AND B/4-3 INF FOR OUTSTANDING ACTION.

2. I ADD MY CONGRATULATIONS FOR THE GREAT WORK AND AGGRESSIVENESS EXHIBITED BY THE ABOVE MENTIONED COMPANIES AND TO ALL OTHERS PARTICIPATING IN THIS OPERATION.

SPECIAL INSTRUCTIONS			
DISTRIBUTION			
C/S	SI	SI	CS
4			3
CS	ACTIV	NO	ACC
AVM	C/A	CCC	C/OP
1			
CMC	C/O	COMPT	S
10	MA	PROV	S
3/A	3/RG	SSD	T/ADM
			DET
		9TH	RT/AD
		ART	
		AMC	IS
			TR
COORDINATION			
SECTION		OFFICE	
UNIT/ACC		SERIES	
CLEANING OFFICER			
<i>[Signature]</i>			
DATE	TIME		
19	0702Z		
MONTH	YEAR		
MAR	68		
PAGE NO.	NO. OF PAGES		
1	1		

TYPER NAME AND TITLE	PHONE
GROSBIE E. SAINT MAJ, GS ASST GS	603

SIGNATURE
<i>[Signature]</i>
TYPED (or stamped) NAME AND TITLE
V.H. GENEL, 1LT, AGC, ASST AG

SECURITY CLASSIFICATION	DEGRADING INSTRUCTIONS
UNCLASSIFIED	

EXHIBIT M-7

1. I WOULD LIKE TO PASS ON THE FOLLOWING MESSAGE FROM GEN WESTMORELAND:

OP MUSCATINE CONTACT NORTHEAST OF QUANG NGAI CITY ON 16 MARCH DEALT ENEMY HEAVY BLOW. CONGRATULATIONS TO OFFICERS AND MEN OF C/1-20 INF AND B/4-3 INF FOR OUTSTANDING ACTION.

2. I ADD MY CONGRATULATIONS FOR THE TEAM WORK AND AGGRESSIVENESS EXHIBITED BY THE ABOVE MENTIONED COMPANIES AND TO ALL OTHERS PARTICIPATING IN THIS OPERATION.

Exhibit M-8 and Exhibit M-9 are published  
in Volume III, Book 2, Directives.

EXHIBIT M-8  
EXHIBIT M-9

EXTRACT OF EXHIBIT M-10

(MAJ Watke's letter, 16 March 1968)

16 March 1968

\* \* \* \* \*

A new operation began this morning in our area of the division operational area so it meant we had an early rise. The briefing started at 0615 and we took off at 0700. We had a large number of people exit from the assault area but only one man had a weapon and we did not get him. About an hour after we came on station we observed what we thought was a mortar. We inserted the infantry on top of the hill. It was so rough we couldn't land the aircraft. We finally inserted only one squad and they did find 40 mortar rounds but no tube. We inserted a demolition team and they (mortars) were blown in place. It was a good operation because the infantry battalion in the area will not search this hill.

We just had an OH-23 clip a tree so the blade is probably shot. It really doesn't bother me except that the blade are near impossible to obtain. At this very moment we have no flyable 23's. Maintenance has just examined our ship & we do require a new blade. We have just located a large homemade antenna, so we are dispatching a slick to call in artillery.

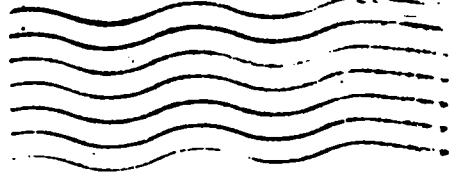
\* \* \* \* \*

A TRUE EXTRACT COPY:

*H. L. Coop*  
H. L. COOP  
MAJ, AGC

EXHIBIT M-10

Maj F.W. Watke 074588  
Aero Scout Co. 123 Avn Bn  
APO S.F. 96374



VIA AIR MAIL

Mrs F.W. WATKE  
17 Wilson Drive  
Columbus, Ga. 31903



EXTRACT OF EXHIBIT M-11

(MAJ Watke's letter, 17 March 1968)

17 March 1968

\* \* \* \* \*

I did not go to the field location with the company today but I did have a full day. I attended the routine company briefing at 0645. The battalion meeting at 0730 and a meeting with Gen Young, the Asst Div Cmdr over an incident in the field yesterday. It did not involve my unit but some of my people were witnesses. I did go to church although I was a little late (as usual). This afternoon I and the battalion Commander, L/Col Holliday flew to Duc Pho to talk to the brigade commander reference my unit and its capabilities. Upon my return I met with all my newly assigned personnel. Originally I talked with each one as he joined us but now I'm not around enough so the XO has taken this chore. We occasionally get into our little division paper.

\* \* \* \* \*

A TRUE EXTRACT COPY:


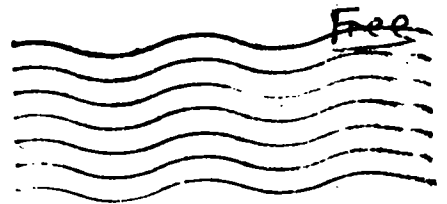
  
H. L. COOP  
MAJ, AGC

EXHIBIT M-II

Maj F.W. Watke 074508  
Aero Scout Co. 123 Aw 8N  
APO S.F. 96374



VIA AIR MAIL

Mrs F.W. Watke  
17 Wilson Drive  
Columbus, Ga. 31903

EXTRACT OF EXHIBIT M-12

(MAJ Watke's letter, 18 March 1968)

18 March 1968

\* \* \* \* \*

\* \* \* \* \*

I had a meeting today at 9AM with L/Col Holliday, Gen Young, Col Henderson, CO of 11th Bde and L/Col Barker, CO of an infantry battalion. My people observed an unfortunate act the other day and I reported it. Col Henderson has been directed to investigate it and make a report to the Commanding General. I didn't make any friends but my conscience is clear.

\* \* \* \* \*

A TRUE EXTRACT COPY:


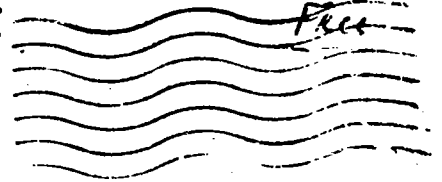
  
H. L. COOP  
MAJ, AGC

EXHIBIT M-12

Maj F. W. Watke 074588  
Aero Scout Co 123 Avn BN  
APO S.F. 96374



VIA AIR MAIL

MRS F. W. WATKE  
17 WILSON DRIVE  
COLUMBUS, GA 31903

[REDACTED]

10 December 1969

The Chief of Staff  
United States Army  
Washington, D. C. 20310

Dear General Westmoreland:

1. Following the My Lai operation 16 March 1968, I conducted a command inquiry based upon an eyewitness report which suggested that noncombatants had possibly been killed by "wild shooting" of ground troops and gunships and by command channel reports that twenty noncombatants had been killed by artillery and gunship fire. This inquiry was initiated by me without guidance or knowledge of any higher headquarters. Consequently, the depth of the inquiry was based solely upon my judgment. I did not treat it lightly; however, I was unable to produce a single additional witness or a thread of evidence to substantiate the eyewitnesses report. An effort to conduct a sweep in the objective area on 17 March 1968, which could possibly have more positively identified cause of noncombatant deaths and shed additional light on the subject was aborted. Following the initial inquiry and again as a part of the formal report of investigation, I advised my Division Commander that irresponsible acts of killing noncombatants did not occur. I currently maintain that conviction. This judgment was mine alone, and I am unwilling to share the responsibility with anyone. I informed the Board of Investigation, headed by Lieutenant General Peers, of this position at the conclusion of my testimony on 2 December 1969.

2. I continue to maintain the highest admiration, confidence, and faith in the integrity, fighting qualities and courage of the officers and men, 11th LIB, present during the alleged incident.

3. In the interest of strengthening the American people's confidence in its Army, and to halt a growing disenchantment within the Army junior officer corps, a speedy decision is urgently needed. Consequently, I urge that the Army announce its findings even though the current investigation proceeds and that the responsibility without qualification be assigned solely to me. I, of course, defer to the Army the manner and substance of such announcement.

Respectfully,

ORAN K. HENDERSON  
Colonel, Infantry

EXHIBIT M-13

[REDACTED]

Exhibit M-14, Exhibit M-15, and Exhibit M-16  
are published in Volume III, Book 3, Reports.

EXHIBIT M-14

EXHIBIT M-15

EXHIBIT M-16



# 11TH INFANTRY BRIGADE



# IRIDENI

VOLUME 1 NUMBER 7

MARCH 22, 1963

## JOINT EFFORT BY US, RVN BUILDS NEW CLASSROOMS

A new wing capable of housing 150 to 200 students was dedicated last week in the village of Duc Pho.

The wing, product of a six-week program undertaken by the 29th Civil Affairs Co.'s 4th Platoon and the people of Duc Pho, contains six new classrooms for the high school.

On hand for the dedication ceremony held in the school compound were CPT Nguyen, Dai Uy of Duc Pho; the village council; MAJ Carl R. Smith, MACV II Leader, and the officers and men of the CA platoon. COL Oban K. Henderson, 11th Infantry Brigade commanding officer, also attended the dedication, as well as representatives of the Americal Division's G-5 section.

Guest of honor for the occasion was CPT Wyckliffe T. Watson, CA platoon commander, for (SCHOOL Cont. on Page 4)

## TF BARKER CRUSHES ENEMY STRONGHOLD

For the third time in recent weeks 11th Brigade infantrymen of Task Force Barker raided a Viet Cong stronghold known as "Pinkville", six miles northeast of Quang Ngai.

"Jungle Warriors," together with artillery and helicopter support hit the village of My Lai last Friday morning. Contacts throughout the morning and early afternoon resulted in 128 enemy killed, 13 suspects detained and three weapons captured.

A Task Force Barker company of the 1st Battalion, 20th Infantry conducted a combat assault west of My Lai and quickly killed one VC while moving away from the LZ. "Shark" gunships from the 174th Aviation Company killed four more enemy during the assault.

"Aero Scout" helicopters from the 123d Aviation Company were supporting the infantrymen and killed two enemy. The "War Lords" also located 40 60mm mortar rounds.

The infantry company, led by CPT Ernest Medina, engaged and killed 14 VC and captured three M1 rifles, a radio and enemy documents, while moving towards the village. One of the ten suspects apprehended by the company told an interpreter that 35 VC had moved into the village two hours earlier.

As the "Warriors" moved through the marshes a mile west of My Lai they counted 69 enemy bodies killed by ground troops and a battery of the 6th Battalion, 11th Artillery. The battery, commanded by CPT Steven Gambel, fired on the enemy from a location three miles to the (BARKER Cont. on page 3)



## ENEMY BULLET BREAKS INTO SOLDIER'S WALLET

Specialist Four George Ruckman is walking around with a hole in his wallet, instead of a Purple Heart on his chest.

The hole is a souvenir left by the Viet Cong when they ambushed two trucks carrying a platoon from LZ Liz to a petrol mission. SP4 Ruckman, commo chief for "E" Company, 3d Battalion, 1st Infantry, was riding on the back of the seat in the lead truck when they were attacked.

He described the action: "A hand grenade went off between the trucks, injuring some of the personnel in the second truck. As we called for a medic, small arms fire began coming in. I felt a sharp sting in my rear, and thought it was fragment from the grenade because everybody was yelling they'd been hit by frags." (RUCKMAN Cont. on Page 3)

\* \* \* \*

## COMMAND INFORMATION

Rabies is an acute, deadly virus, transmitted in the saliva of a rabid animal. Everywhere we go in Vietnam we find dogs, monkeys and other animals that could be rabid.

Dogs and monkeys abound in the field, and many units keep them as mascots.

Although we usually associate rabies with dog bites, the disease can be transferred by a friendly lick on broken skin.

Rabies is a very common disease in Vietnam, and any animal that bites a human should be considered rabid until proven otherwise. Rabid animals will usually appear to be sick, may act in an unusual manner, and should be avoided.

Rabies in man is always fatal, if not treated by medical facilities. If bitten, immediate first aid by washing the wound with soap and water is an effective way to help prevent rabies, but is not a substitute for medical care. The animal should be delivered to the veterinary facility alive if possible for quarantine and examination. If it is absolutely necessary to kill the animal it should not be shot in the head since that would make the necessary examination of the brain impossible.



Despite popular belief, the treatment for rabies is not worse than the disease itself. A suspected case of rabies, immediately reported for medical treatment is handled with little discomfort to the patient and very safely.

We cannot eliminate completely the carriers of rabies, but we can avoid the disease. Immunize animals to rabies, stay away from animals which you suspect may be rabid, and report any suspected rabies for medical attention.

## PORKERS AID RVN FARMERS

As part of its continuing program of agricultural improvement, the 29th Civil Affairs Co.'s 4th Platoon, located at LZ Bronco, distributed 32 purebred pigs to 32 farmers in the Duc Pho area.

The pigs, according to 1LT Thomas G. Jones, will be used for breeding a superior grade of stock by the villagers. "Most of the pig stock in Duc Pho, and that matter, is unsuitable for efficient domestic use," LT Jones said. "These pigs should improve the stock greatly."

Plan for the breeding program is, according to LT Jones, to have each villager who is given a pig return one of the pigs from the first litter the new pig produces to the CA platoon. These, in turn, will be given to other (PIGS Cont. on Page 4.)

(H)APLAIN'S  
FLAG

By Chaplain (MAJ) Carey

TWO DIED FOR ME

An overloaded ship, running before a storm, suffered severe damage. Obviously it would have to be abandoned. When lifeboats were counted however it was discovered that there was not room for all the passengers and crew.

Someone suggested lots be cast to see who would have the privilege of a lifeboat seat, and who would remain behind to face certain death.

Among those who lost was a wicked sailor. When he heard his fate, he turned deathly pale, and was heard to mutter, "Lost...Lost eternally!"

Suddenly he was picked up bodily and thrown unceremoniously into the last lifeboat as it was lowered over the side. The man who did it called after him, "You're not ready to die, but I am; so I'm willing to offer my life for yours just to be sure I meet you in Heaven!"

The speaker was an old sailor who had often testified to the young man about the Lord.

In years of faithful service that followed, he was often heard to say, "For me, TWO HAVE DIED!"

There may be some unsaved individual who will not have such a last minute reprieve. Prepare now, the reward is ever so great: ETERNAL HAPPINESS!

Brigade Commander  
Information Officer  
TRIDENT OIC  
News Chief  
Editor

COL ORAN K. HENDERSON  
1LT JOHN W. MOODY  
2LT ARTHUR J. DUNN  
SFC JOHN STONICH  
SP5 JAY A. ROBERTS

Staff Reporters: SP4's James Ford, Dean Pohland, Kevin Howe and PFC's Kenneth Ainslie and Lawrence Mollner

The TRIDENT is published weekly under the supervision of the IO, 11th Infantry Brigade as an authorized publication. This publication is solely for personnel in the 11th Infantry Brigade and may not be duplicated or released to the news media. Opinions expressed herein do not necessarily represent those of the Department of the Army.



## RUCKMAN

(CONT. FROM PAGE 1)

But when he checked for possible injury, he found one big bruise and one hole in his wallet.

The bullet had first hit the radio strapped to the back of SP4 George McMurty, radio telephone operator for "E" Co., who was riding in the rear of the truck. It then ricocheted off the side bar of the truck, the front bar of the trunk bed, and was stopped by Ruckman's wallet.

"It didn't hit any money," he said, "but it went through my ration card, a picture of my girl and some other papers I was carrying." He is still carrying the bullet that did the damage...in his wallet, of course.

## ENEMY GAINS ADVANTAGE WITH "LOST" U.S. WEAPONS

Few items of equipment are as important to the individual soldier as his personal weapon.

Nevertheless, weapons, like other pieces of issued equipment have a way of getting lost or stolen.

Since April, 1967, soldiers of the Americal Division have lost nearly 100 weapons through theft or misplacement, a loss, in money alone, of \$11,155.

According to Americal Division spokesmen, this monetary loss, through Reports of Survey, has been largely recovered by holding the responsible soldiers liable for their value.

In a recent letter on control and safeguarding of small arms, Major General Samuel W. Koster stated that: "What concerns me even more than the cost of these weapons and the effort required to replace them is that there is a strong possibility that these weapons may eventually end up in the hands of the enemy."

He noted that investigations have shown that "neglect or carelessness is the proximate cause." Gen. Koster added: "This is an indication that there is insufficient command emphasis placed on the safeguarding of personal weapons, particularly in such areas as post exchanges, mess halls and clubs."

He concluded that: "Effective immediately, whenever a weapon is lost or stolen, I desire that a letter from the commander concerned be addressed to me, explaining the circumstances of the loss or theft, and what actions had been taken prior to and after the loss. I expect all levels of command to give their personal attention to the security of weapons."

(BARKER Cont. from page 1) north. A platoon of "Barker's Bastards" from the 4th Battalion, 3d Infantry was airlifted into a position south of My Lai. The unit, led by 2LT Tom Willingham, engaged an unknown number of enemy along the beach one half mile south of the village. When contact was broken 30 Viet Cong lay dead.

Early in the afternoon the platoon observed enemy soldiers escaping into a tunnel complex. Eight of the enemy were killed and web gear, hand grenades, and small arms ammunition was recovered.

The three recent engagements by the 11th Brigade in the My Lai-Pinkville area has cost enemy forces a total of 276 men.

## CHILDREN SPAN LANGUAGE BARRIER

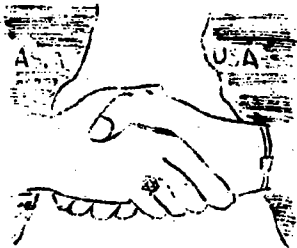
Tiny hands are reaching half way across the world to create a better understanding between two nations, the United States and Vietnam.

The hands belong to 34 Vietnamese children and children of a first grade school class in Saint Louis Park, Minnesota. Language is no barrier. In describing the people, customs, dress, and other aspects of each country hand drawings by the children, condensed into scrapbooks, are to be exchanged between the groups.

All pictures are explained with English words but the Vietnamese children go one step further and put the Vietnamese translation under the English word.

The exchange project was initiated by SP4 Howard Goldberg of Headquarters and Headquarters Company, who works in the Brigade S-5 Section. Goldberg is an English teacher at the Catholic Orphanage in Duc Pho, Vietnam where he gives one hour lessons to children between seven and eleven years of age six days a week.

While thinking of some ways to make the classes more interesting he came up with the idea of having each pupil make an individual scrapbook. A letter to Mr. Robert M. Dougherty, Principal of St. Louis Park's Aquila Elementary School, out-



lined Goldberg's exchange of ideas and the first grade teachers were enthused. Crayons, dictionaries and other supplies were quickly donated and shipped to Goldberg for use by the Vietnamese children.

Scrapbooks have already been completed by Goldberg's class and will soon be on their way to Minnesota and the students of Aquila Elementary School. Work by the American students has been started and according to (TINY HANDS Cont. on pg 4)

## SCHOOL

(CONT FROM PAGE 1)  
whom the high school wing was named.

The building program, according to 1LT Thomas G. Jones of the CA Platoon, is geared "to involve the Vietnamese people as much as possible in these projects. The village council usually contracts labor from a local building firm and we supply the materials for building." These materials, he said, come from the brick factory in Duc Pho run by the 29th CA Co., and surplus or scrap lumber.

Two other school building projects under this program are presently underway, including the nearly-completed Duc Pho Elementary School and beginning construction on the Pho Bienh Elementary School.

## BRIGADE NCO RECALLS DAYS OF MULES AND SEMAPHORES

"Twenty-nine years ago infantry weapons were carried on pack mules. Only the company commander and first sergeant rode horseback. Everyone else walked."

SFC Julius S. Cross, now in an Army that travels by helicopter or armored personnel carrier at a moment's notice, hasn't forgotten what it was like when he entered the Army. He began his career as a farrier for Co. I of the 38th Infantry at Ft. Douglas, Utah. His job was shoeing and caring for the company's mules and horses.

(SCHOOL Cont. from pg. 1)  
villagers under the same plan.

"We hope to have a continually expanding program," LT Jones said.

Other agricultural projects undertaken by the platoon in a joint effort with the villagers include a rabbit breeding program and the introduction of high-yield, hybrid strains of rice to improve the local crop.

Now assistant operations sergeant for 3rd Bn., 1st Inf., SGT. Cross began active duty in Feb., 1940.

"There was no basic training system. I was assigned specifically to the company. An NCO was appointed by the first sergeant to give us boot training. We were given general training necessary for a unit, plus training in our individual field. I was given instruction in the Army method of caring for animals."

"The only radio communication we had was between battalion and regiment. Commo between smaller units was carried out by semaphore, a system using flags; and at night, Morse code using lights. We also had runners to carry written messages."

Throughout the years, SFC Cross has been able to watch the service change from a horse-powered Army to a highly mobile and fast-hitting force.

(TINY HANDS Cont. from pg 3)  
Mr. Dougherty they will be forwarded to SP4 Goldberg when they are finished.

So a little bit of crayon, pieces of paper, bits of string and many youthful imaginations are being put together to bring two nations, already fighting side by side, into closer harmony.

## POINTERS FOR 'POINT' HOPEFULS

Enlisted men serving with the U.S. Army have an opportunity to attend the U.S. Military Academy at West Point - if they apply and qualify.

This "gateway to the Point" is the U.S. Military Academy Preparatory School, located at Ft. Belvoir, Va. Application to the school is limited to enlisted men on active duty who have been nominated for an appointment to West Point, can present academic credentials that predict success at the preparatory school, show that they have no disqualifying physical defects and have enough time remaining in service to carry them through July of the year following enrollment in the school.

Applicants must be citizens of the U.S., of good moral character, be at least 17 and no more than 22 years old on July 1 of the year the applicant plans to enter the USMA, be unmarried and not previously married, be a high school graduate and medically qualified.

The school provides a 10-month course in academic subjects and physical training to prepare men to attend the Academy. Policies and procedures for enrollment are outlined in AR 350-55. Further information may be obtained by writing the Commandant, U.S. Military Academy Preparatory School, Ft. Belvoir, Va. 22060, or by seeing your re-enlistment NCO.



19 December 1969

MEMORANDUM FOR: LTG WILLIAM R. PEERS

SUBJECT: Interview with Mrs. Dorothy M. Barker

1. Upon receiving the verbal order from COL Franklin, I departed for Hollywood, Florida, on 15 December 1969 to interview Mrs. Dorothy M. Barker, wife of LTC Frank A. Barker - deceased.
2. The purpose of this interview was to obtain Mrs. Barker's permission to peruse the personal effects of LTC Barker and determine if there were any documents, letters, etc., that made reference to Task Force Barker's combat assault on My Lai (4) on 16 March 1968. Also to ascertain if there was any evidence to prove or indicate that LTC Barker made an investigation of this incident.
3. About 152030 Dec 69, I met with Mrs. Barker in her residence at 1618 Madison Street, Hollywood, Florida, and informed her of the purpose of my visit. Mrs. Barker made available to me two cardboard boxes containing LTC Barker's personal effects and gave me her permission to look through them. Perusal of these items did not produce any report of investigation that was conducted by LTC Barker. Attached as Inclosures 1 - 4 are the only documents found that could be of some significant value.
4. Mrs. Barker also agreed to let me hear the the three tape recordings that were in LTC Barker's personal effects but stated that her tape recorder was broken and would borrow one from a friend. Taking into consideration that it was late in the evening and Mrs. Barker had to work and go to school the next day, it was decided to postpone the playing of the tapes until the following day.
5. At 161900 December 1969, I met Mrs. Barker at her residence as agreed and played the tapes. All three tapes were personal in nature and had no bearing on the My Lai (4) incident.

EXHIBIT M-18

6. Mrs. Barker was very cooperative and willing to release any documents that would be pertinent to this inquiry. She assured me that I had seen all of the documents and related papers that she possessed. She further stated that LTC Barker did not mention My Lai (4) or an investigation when she last saw him in Hawaii while he was on R&R from 28 April to 4 May 1968. I thanked Mrs. Barker for her assistance and cooperation and departed.

*Edward F. Zychowski*  
EDWARD F. ZYCHOWSKI  
Major, MPC  
Investigating Officer

- 4 Incl
1. S.O. 45, dtd 14 Feb 68, HQ, Americal Div
  2. Ltr of Commendation, dtd 27 Mar 68
  3. Vol I, No 7 -- 11th Inf Bde "Trident" newspaper
  4. 11th Inf Bde Combat Action Report, dtd 28 Mar 68

S.O. 45, dated 14 February 1968, HQ, Americal Division is published as Exhibit M-103.

Letter of Commendation, dated 27 March 1968, is published as Exhibit M-90.

Congratulatory Message from MG Koster is published as Exhibit M-7.

Vol I, No 7 -- 11th Inf Bde "Trident" newspaper is published as Exhibit M-17.

11th Inf Bde Combat Action Report, dated 28 March 1968, is published as Exhibit R-2.

Exhibit M-19 is published in Volume III,  
Book 3, Reports.

EXHIBIT M-19

21 January 1970

MEMORANDUM FOR RECORD

SUBJECT: Tape of Captain Lewellen

1. The original tapes (2 rolls) belonging to Captain Charles R. Lewellen were received this date.
2. Per my instructions, Captain Lewellen executed a statement to the effect that these tapes were recorded on 16 March 1968 at LZ Dottie (Incl 1).
3. Per my instructions, Captain Lewellen improved our original transcription (Exhibit M-20) to include the "background" conversations within the TOC. These are indicated by capital letters (Incl 2).
4. Two copies of this tape are being made for retention in our files, and the original tape will be returned to Captain Lewellen.

2 Incl  
as

  
JAMES H. PATTERSON  
Lieutenant Colonel, Armor

DEPARTMENT OF THE ARMY  
Headquarters and Headquarters Company, The School Brigade, USAIS  
Fort Benning, Georgia 31905

C-E-R-T-I-F-I-C-A-T-E

I certify that the two enclosed tapes marked TAPE Number 1 and TAPE Number 2 are the original two tapes recorded by me on 16 March 1968 at LZ Dottie, Republic of Vietnam. The tapes were recorded on a TOSHIBA tape recorder model GT-500P. at 1 7/8 inches per second.



CHARLIE R. LEWELLEN  
CPT, Infantry  
Commanding



STATION

MESSAGE

(Coyote 3)

They will be controlled by Coyote Six.  
The artillery has been informed of this  
change. Over.

Dolphin Lead

This is Dolphin Lead. Roger. Thank You.

Coyote 3

Helix Three Three. Coyote Three. Over.

Helix 33

Helix Three Three. Up your push. I'll be  
in your area in about five minutes.

Coyote 3

This is Coyote Three. Roger. Out.

(Helix 33)

Three Three. Radio Check.

(Sane Drank Delta Mike)

This is Delta Mike. Loud and Clear. Over.

(Helix 33)

Roger. Same.

(Dolphin Lead)

This is Lead. Commo check. Fox Mike.

(Alpha Two)

Alpha Two

(Alpha Three)

Alpha Three)

WHAT'S HIS CALL SIGN?

(Alpha Trail)

Alpha Trail.

(Alpha Four)

Alpha Four.

HOW 'BOUT LET'S CALL TWO AND \_\_\_\_\_

NONE: Alpha Two, Alpha Three, Alpha Trail,  
and Alpha Four appear to be lift ships  
answering FM commo check from Dolphin Lead.

Coyote 6

Coyote Six. Over.

THE LIMA ZULU \_\_\_\_\_

(Dolphin Lead)

This is Lead. Go ahead.

Coyote 6

This is Coyote Six. Time 0722. Over.

(Dolphin Lead)

This is Lead. Roger.

Coyote 23	Correction Coyote Three. Coyote Two Three. (garble) - Two Two. Over.
(Coyote 65)	This is Six Five. Roger. Thank You. Out.
(Coyote 6)	This is Six. Over.
(Dolphin Lead)	This is Lead.
Coyote 6	Dolphin Lead. Coyote Six. Over.
(Dolphin Lead)	This is Lead. Go ahead.
Coyote 6	This is Coyote Six. Recommend landing to the north. Over.
(Dolphin Lead)	This is Lead. Roger.
Warlord Alpha Lead	Coyote Three. Coyote Three. This is War- lord Alpha Lead.
Coyote 65	Coyote Six Five. Go ahead.
Warlord Alpha Lead.	Roger. This is Warlord Alpha Three - Alpha Lead. We'll be in our area in approx- imately fifteen minutes on the recon.
(Coyote 65)	This is Six Five. Real fine. Anything futher. Over.
(Warlord Alpha Lead)	Negative. We'll stay up here so we can advise you of anything we spot. Appreciate if you'd let us know if anything goes off different than planned.
(Coyote 65)	Six Five. Certainly will.
Coyote 3	Warlord Lead. Coyote Three. Second LZ will be stepped up approximately six zero minutes. Over.
(Warlord Alpha Lead)	Roger. Second LZ will be stepped up six zero minutes. Thank you very much.
Coyote 6	Helix Three Three. Coyote Six. Over.
Coyote 6	Helix Three Three. Coyote Six. Over.

Helix 33 Helix Three Three. Over.

Coyote 6 This is Coyote Six. You realize the gun target line from LZ Uptight to LZ? Over.

Helix 33 Three Three. Affirmative.

Dolphin Lead Coyote Six. This is Dolphin Lead.

Coyote 6 This is Coyote Six. Over.

Coyote 6 Coyote Six. Over.

Dolphin Lead This is Dolphin Lead. We're three minutes out at this time.

Coyote 6 This is Coyote Six. Roger. No restrictions on door gunners.

(Dolphin Lead) This is Lead. Roger.

Dolphin Lead This is Dolphin Lead. If you're not on your marking run at this time I can just go right on in and land. I see the LZ. Do you have to put smoke in it.

Coyote 6 This is Coyote Six. Roger. Waiting for completion of last round of artillery. As soon as it's complete I'll go in for the mark.

(Dolphin Lead) This is Lead. Roger. Save us a lot of time if you didn't mark. I see the LZ now at this time to the west of the white smoke from the artillery.

Coyote 6 This is Coyote Six. That's affirm. Over.

Dolphin Lead Dolphin Lead. Is the artillery stopped?

Coyote 6 This is Coyote Six. Roger. Rounds complete. Over.

Dolphin Lead This is Lead. Roger.

(Helix 33) I still see artillery coming in there.

Dolphin Lead Coyote Six. This is Dolphin Lead.

Coyote 6 This is Coyote Six. Over.

Dolphin Lead This is Dolphin Lead. We're out of the LZ. LZ appeared to be cold.

Coyote 6 Coyote Six. Thank you. Out.

Coyote 6 Coyote Six Five. Coyote Six. Over.

(Coyote 65) Six Five. Go ahead.

Coyote 6 Coyote Six. Touchdown 0730. LZ appeared to be cold. Over.

(Coyote 65) Six Five. Thank you. Out.

Warlord Alpha Lead In the vicinity of the first LZ. This is Warlord Lead. We'll be turning to the south of the road. We have a Dink with a weapon we're getting at this time.

HA HA HA

Shark 6 This is Shark Six. Roger. Understand you will be to the south of the road and say again the part about the weapon.

(Warlord Alpha Lead) Ah. Roger. We've got a Dink with a weapon down here that we're getting at this time. If you'd stay north and we'll stay south and out of your way.

(Shark 6) Roger. We're going to be working north of this road.

(Warlord Alpha Lead) Roger. We'll stay south.

AH SHOOT, THAT'S ONE DINK.

(Helix 33) Three Three. There is also one running down the road toward the east. Three Three. It's just to the left of you.

Shark 6 Warlord Lead. This is Shark Six..

Warlord Lead This is Warlord Lead. Go ahead.

(Shark 6) Roger. I'm going to come a little bit on your side of the road. We've got one with a weapon over here.

(Warlord Lead) Roger. Go get him.

(Shark 6) Roger. It's just about fifty meters right over here.

Coyote 6 Six. Over. This is Coyote Six. You sat it seems to be hot. Did you receive fire when you first went in. Over.

(Dolphin Lead) This is Lead. Negative reported fire from any of the slicks. Over.

(Helix 33) I got a couple of them down here right under me if the Shark could come down here.

Warlord Alpha Lead This is Warlord. We've got one rocket run in progress now if you'll just stay where you are we'll go past you.

COYOTE 3 THIS IS COYOTE THREE. OVER.  
AH BRAVO WHAT ARE YOU DOING.

Dolphin Lead Coyote Two Three. This is Dolphin Lead.

Coyote 23 This is Coyote Two Three.

Dolphin Lead This is Dolphin Lead. Ah...we gonna be able to pick up all the pax on this last lift?  
COME ON TWO THREE.

Coyote 23 Ah...Coyote Two Three. Yes. Over.

Warlord Alpha Lead Warlord Alpha Lead.

Helix 33 Warlord. This is Helix Three Three.

(Warlord Alpha Lead) Roger. Just trying to tell Shark Lead where that smoke is there, we got a couple of Dinks with weapons. Ah...we got a Low bird out there looking at HER. Appreciate if they didn't put any fire in that general area.

(Helix 33) Helix Three Three. Some of 'em are escaping back toward the ocean down this road.

Helix 33 Ah...Roger.

Coyote 23 Dolphin Lead. This is Coyote Two Three. Over

(Dolphin Lead) Two Three. This is Lead.

(Coyote 23) Lead. This is Two Three. You got 'em all. Over.

(Dolphin Lead) This is Lead. Roger.

Coyote 23                      Coyote Three. This is Coyote Two Three. Lift off...Second Lift Off completed 0738.

(Coyote 65)                     Six Five. Thank you. Out.

(Coyote 6)                      Charlie Six. Ah...Coyote Six. Probaly on the wrong push. Over.

Coyote 6                        Coyote Six. Over.

(Dolphin Lead)                 Coyote Six. This is Lead.  
ANSWER HIM COYOTE SIX.

(Dolphin Lead)                 Coyote Six. This is Lead.

(Warlord Alpha Lead)          Coyote Six. This is Warlord. Go ahead.

Dolphin Lead                   Coyote Six. This is Dolphin Lead. Approximately four minutes out at this time.

(Coyote 6)                      Roger.

Coyote 6                        This is Coyote Six. Over.

Shark 6                         Coyote Six. Shark Six. If you'll look out to the east of the first LZ we dropped a couple of red smokes out here in a rice paddy: we just killed two Dinks that got weapons, hand gernades and all the web gear in the world right out here in this rice paddy.

Coyote 6                        This is Coyote Six. Roger. Thank you much. Out Break. Charlie Six. Coyote Six. Over.

Shark 6                         Coyote Six. Shark Six. We also killed another man to the south of the Lima Zulu. Ah...had a weapon and all the web gear in the world on him also. We'll go back over there as soon as this next lift is in and mark his location also (pause)

                                      Shark Six. Did you monitor.  
PUT THEM ALL LIEUTENANT IN THE SAME COORDENATES.

Dolphin Lead                    This is Lead (garbled)...Pop smoke please.  
(garbled)

DOLPHIN LEAD                    BRAVO SIX GOLB. DOLPHIN LEAD.

BRavo 6 GOLF  
DOLPHIN LEAD

LEAD. BRAVO SIX GOLF. OVER.

THIS IS DOLPHIN LEAD. WOULD YOU POP SMOKE ON  
THE LZ PLEASE.

Dolphin Lead  
Dolphin Lead

Coyote Six. This is Bravo - - This is Dolphin Lead.  
This is Dolphin Lead. On that second sortie into  
the first LZ we received fire coming out of one  
of the villages. The Sharks are over checking  
it out now.

HELLO

DOLPHIN LEAD  
(BRAVO 6)

THIS IS DOLPHIN LEAD. GO.

ARE YOU GOING TO LAND FROM THE SOUTH TO NORTH?

HELLO

DOLPHIN LEAD  
DOLPHIN LEAD  
Dolphin Lead

DOLPHIN LEAD. ROGER.

BRAVO SIX. DOLPHIN LEAD. ROGER.

This is Dolphin Lead. The ships that have their  
rotating beacons on at this time only have five  
people on board. Can you send one more pack out  
to them?

Warlord Alpha Lead

This is Alpha Lead. Roger. Directly to the south  
of the LZ we had two Dinks with weapons both of  
them KIA now. Ah..we are reconning now along the  
peninsula checking the people out that are  
di di - ing the area and they are going out fast.  
You've got the area to the south and to your  
west we're just covering it now.

Coyote 6  
(Shark 6)

This is Coyote Six. Thank You much. Out.

If you'll look almost due south of the LZ you  
will see some white smoke and also some red smoke,  
at this location in a ditch right where the red  
smoke is we've got a Dink with a weapon and a whole  
bunch of web gear on and in the general location  
of the white smoke we got a couple of ammo boxes  
and some more stuff that he threw down.

The red smoke is right on the Dink and the white smoke is right on the ammo boxes so if you could get somebody down there and police 'em up.

(Dolphin Lead)

Six. I can take seven on all the aircraft except three. That'll be six aircraft that will on... that will have seven on board.

Coyote 6

Six Five. This is Coyote Six. Over.

PROTECTOR TOC

(Coyote 65)

Six Five. Go ahead.

PROTECTOR TOC

Coyote 6

This is Coyote Six. All of Charlie's elements are on the ground. They've had negative contact as of yet. However, gunships have killed a total of six VC with weapons; and Charlie Six is sending elements out to police up the weapons. Over.

THEY HAVE KILLED SEVEN \_\_\_\_\_

Coyote 65

This is Coyote Six Five. Roger on that. Total of seven for the gunships. Over counting warlord's Over.

Coyote 6

This is Coyote Six. That's affirmative.

MAKE IT FIFTEEN FOR ALPHA.

(Coyote 65)

This is Six Five. That's Roger of that. Also we now have a total of fifteen. Over.

HAY-8 OKAY CHARLIE SIX.

Coyote 6

This is Coyote Six. You have a total of what? Over.

Coyote 65

This is Coyote Six Five. Charlie Six has now a total of fifteen. Over.

THE LINE WENT OUT AT 0740 \_\_\_\_\_

Coyote 6

This is Coyote Six. Fifteen what. Over.

(Coyote 65)

Victor Charlies. Over

Coyote 6

This is Coyote Six. Roger. Out.



Coyote 6 (Charlie Six. This is) Coyote Six. Over.  
Understand you have fifteen Victor Charlies is  
that correct? Over.

Coyote 6 Coyote Six. Roger. How many weapons so far  
if any. Over.

( ) (garble). @G AHEAD.

Coyote 6 This is Coyote Six. Roger. Out.

Rawhide 3 Coyote Six. This is Rawhide Three Over.

Coyote 6 This is Coyote Six. Over.

Rawhide 3 Rawhide Three. We've got quite a few people  
that are really moving out on this road going  
southwest from the first Lima Zulu. Over.

Coyote 6 This is Coyote Six. Roger. I'll get somebody  
on that. Warlord is checking to the south. I'll  
have him also check to the west. Over.

Rawhide 3 This is Rawhide Three. Roger. Out.

Warlord Alpha Lead This is Warlord Alpha Lead. Roger, I monitored.  
The road to the southwest of the first Lima Zulu.  
Is that affirmative.

Coyote 6 This is Coyote Six. That's affirmative. Out.

(Warlord Alpha Lead) Roger.

Dolphin Lead Bravo Six. This is Lead. Roger, I monitored that.  
We'll have to see what happens on this next  
sortie when we come back in and see just what  
the heck we have and we'll make a determination  
at that time. Ah...Dolphin Lead. We'll have  
to wait until we return from this sortie and  
see how many people we can take and we'll make  
a determination then as to whether we'll make  
another sortie or not.

Rawhide 3 This is Rawhide Three. Over.

Warlord 3 This is Warlord Three. Go ahead.

Rawhide 3 This is Rawhide Three. When you get a chance to check out those people down to the southwest. You will be able to see our ship orbiting over them. Over.

(Warlord Alpha Lead) This is Warlord Alpha....(transmission broken)

Warlord 3 This is Warlord Three. Over.

Warlord 6 This is Warlord Six. Go ahead.

( ) COYOTE \_\_\_\_\_

RAWHIDE 3 WARLORD SIX. RAWHIDE THREE. OVER.

Coyote 6 Coyote Six. Charlie Six, you calling me? Over.

(Shark 6) Te ahead.

(Shark 6) THAT SONY SHORTWAVE RADIO

Roger. I'm over here with the one to the east at this time. I'm going to throw one more smoke over here and then I'll go back and mark the other one over there.

Shark 6 (Char'ie) Six. This is Shark Six. Can you see my white smoke over here to the east of the LZ. Out here in this ditch over here.

Coyote 6 ---Coyote Six. Over

Rawhide 3 Warlord Six. Rawhide Three. Over.

Warlord Alpha Lead This is Rawhide Three. Just to the west of where that smoke went down, three of 'em together. One or two of them with out their shirts on. They're in black. Over.

(Warlord Alpha Lead) Ah..Roger. We got the Skeeter over them how giving them a check.

Coyote 6 Dolphin Lead. Coyote Six. Over.

Dolphin Lead Coyote Six. This is Dolphin Lead. Go ahead.

Coyote 6 Dolphin Lead. Coyote Six. Artillery prep is started. Shou'd go as scheduled. You should touch down 0815. Over.

(Dolphin Lead)

This is Lead. Roger.

(Warlord Alpha Lead)

Request Three come over to check people.

We got one down here that is surrendering. He's taking all his clothes off. Standing by if you want to come down and pick him up. PICK HIS ASS UP. I'm ready to pop the two white smokes on the highway. We got your Dink down here, he's stripped down. He is standing with his hands over his head.

Rawhide 3

This is Rawhide Three. Over.

COME ON NOW. MAJOR MCKNIGHT HAS TO GET IN ON IT.

This is Rawhide Three. Over.

Warlord Alpha Lead

Rawhide Three. This is Warlord Alpha Lead. Roger We have your Dink now at this time. He is stripped down and got his hands over his head. ~~He~~<sup>HE</sup> tried to run once and we caught him again. He's down on the road if you want to come down and pick him up..He's stopped and ready.

Rawhide 3

This is Rawhide Three. Roger. We're on our way in at this time. There were two others that were going along with him. Did you manage to get them also. Over.

(Warlord Alpha Lead)

Negative. We got two of them now at this time.

Rawhide 3

Rawhide Three. Roger. Out

Shark 6 Alpha

Charlie Six Alpha. Shark Six Alpha. If you can see where the green smoke dropped right back to the south of that along in a ditch in there. There's one we just zapped a little while ago I'd like the troops to check him out.

Coyote 6

Dolphin Lead. Coyote Six, Over. Dolphin Lead Coyote Six. Over.

RIGHT NOW \_\_\_\_\_

(BRAVO SIX)

BRAVO SIX. \_\_\_\_\_

(Dolphin Lead) This is Lead. I had to make a go around because the artillery was still shooting while I was on my aprosch and didn't want to land in there when it was going.

Coyote 6 This is Coyote Six. Roger. Rounds Complete now. You want me to go in and mark now. Over.

Dolphin Lead This is Lead. That's affirm.

Coyote 6 This is Coyote Six. Roger. Out. Dolphin Lead, Coyote Six. LZ marked. Over.

Dolphin Lead This is Dolphin Lead, Roger identify violate.

Coyote 6 Coyote Six. Roger. Out.

Coyote 6 (Charlie Six). This is Coyote Six, you calling me Over.

(Dolphin Lead) (Bravo) Six. Go (Garble)

Dolphin Lead Tallyho yellow.

0815

(Dolphin Lead) Roger. The ones with roasting beacons on will take six, the rest take seven. Go. Go ahead and pop smoke.

COYOTE 3 CHARLIE EIGHT ONE, COYOTE THREE. OVER.

Warlord Alpha Lead This is Warlord Alpha Lead. Coyote Six, this is Warlord Alpha Lead.

Coyote 6 This is Coyote Six. Over.

Warlord Alpha Lead Roger. This is Warlord Alpha Lead. We will be putting appreximately two one (21) people on Hill 85, to your south. We've got a mortar position and ammo spotted on top.

Coyote 6 This is Coyote Six. Roger. We've had mortars in that area before. Go in and get them. Out.

CHARLIE 81 THIS IS CHARLIE EIGHT ONE. OVER.

(Warlord Alpha Lead) Roger.

Dolphin Lead This is Dolphin Lead.

CHARLIE 81

CHARLIE EIGHT ONE. CHARLIE SIX SAYS HE AH

This is Dolphin Lead. This completes the lift  
Ah..only one problem we had and that was that  
the artillery didn't get shut off in time.  
MINE SWEEPS AND THE PEOPLE KNOW WHERE TO COME  
OUT

Coyote Six. This is Dolphin Lead.

Coyote 6

This is Coyote Six. Over.

Dolphin Lead

This is Dolphin Lead. This completes your lift  
for this morning. We only had one problem and  
that was that the artillery didn't get shut  
off in time.

Coyote 6

This is Coyote Six. That's affirmative. They  
were about a minute late cutting off. We'll try  
to do better next time. Over.

Dolphin Lead

This is Dolphin Lead. Roger, other than that that it  
was a good lift.

(COYOTE 65)

0827 LZ COLD. OVER.

WE HAVE COMPLETED TWO LIFTS. OVER.

(Coyote 6)

(Charlie) Six. I'm heading back to refuel. Have  
you had any contact down there yet. Over

(COYOTE 65)

THIS IS SIX FIVE.

Coyote 6

Coyote Six. Roger, dig deep. Take your time  
and get'em out of those holes. Over.

Coyote 6

Coyote Six. Is that eight..ah eight four KIS's  
Over.

(Coyote 6)

Roger. Out

Coyote 6

Six Five. This is Coyote Six. Over.

Coyote 65

This is Coyote Six Five. Go ahead.

Coyote 6

This is Coyote Six. Returning to your location  
to refuel. I'll stop down in the TOC and bring  
you up to date. Over.

Coyote 65

This is Six Five. Roger, I'll have a vehicle up to meet you. Over.

Coyote 6

Coyote Six. Out.

Shark 6

Coyote Six. Shark Six.

DOES HE WANT BLAKLEY? I'LL GET HIM.

(Shark6)

Six. Ah..these two people we killed with weapons and the web gear over just northeast of LZ. We dropped smoke on them awhile ago and your people were within a hundred meters of it now then they've left the area and are going the other direction. Do you want us to drop down there and pick up this stuff.

HELL YES, GO GET IT. COME ON CHARLIE SIX.

They might drag these people off if you don't hustle.

( )

BRAVO SIX.

We've got a white smoke burning on it right now if you can look over where we're circling you'll see a white smoke.

(Shark6)

It will have to be in the next five minutes because we are running awful low on fuel.

COYOTE SIX IS CALLING, I KNOW COYOTE SIX IS NOT READING ME.

Coyote 3

This is Coyote Three. Go Over.

(Shark 6)

We are covering the Charlie element. They're going over to pick up some Binks that had some weapons and web gear and stuff. Understand there are facilities there at Lima Zulu Dettie to pick up some POL.

Coyote 6

Shark Six. This is Coyote Six. Over.

Coyote 3 Shark Six. This is Coyote Three. Affirmative, we can refuel and rearm you here at Dottie. Over.

Shark 6 This is Shark Six. Roger. We can stay a bit longer that way and won't have to head back down south. We can give them a little bit more cover.

Coyote 3 This is Coyote Three. Roger. We can refuel you and rearm you and be glad to. Over.

(Shark 6) Roger. Understand.

Shark 6 Charlie Six. Shark Six. Were you trying to contact me?

This is Shark Six. Go ahead.

Shark Six. Go ahead.

Rawhide 3 Shark Six. Rawhide Three. Over.

Shark 6 Alpha (Bravo Six) This is Shark Six Alpha. We'll be right over.

RAWHIDE 3 CHARLIE SIX. RAWHIDE THREE. OVER.

(RAWHIDE 3) YOU'RE COMING WITH YOUR ELEMENT.

(Shark 6) Dropped red smoke over there on location at this time. There is two little small rice paddies right together and there is one laying in each one of them.

Shark 6 Alpha (Bravo Six). Shark Six Alpha. Go ahead

( ) 792 Roger. We'll do.

KEEP THE DOOR SHUT.

Helix 33 Helix Three Three.

YOU KNOW WE POSTED FOURTEEN AMHILE AGO.

(CHARLIE 81) RIGHT 0.9 UP 1.7. OVER.

(Shark 6) Six. Roger I believe we are above your location at this time. If you give us a direction and approximate distance from your location. Do you desire that we just give you some VR or would you like to put a little ordance in there.

This small wood line just almost due west of you there approximately about 400-500 meters.

(Shark 6) Six. Go ahead. Roger. We'll go down and check this wood line out at this time.

Coyote 65 Lobe Six Five. This is Coyote Six Five.

Lobe 65 Lobe Six Five. Over

CHARLIE 81 THIS IS CHARLIE EIGHT ONE. ROGER OUT. BREAK \_\_\_\_\_

Coyote 65 This is Six Five. Request a Dustoff Over.

Lobe 65 This is Lobe Six Five. Roger Send it Over.

CHARLIE 81 COYOTE THREE. CHARLIE EIGHT ONE. OVER.

COYOTE 3 COYOTE THREE. OVER.

(CHARLIE 81) BRAVO SIX NEEDS A DUSTOFF. HAS ONE KIA AND ONE LITTER. ROSTER NUMBER 00\_\_. COORDINATES 733793.

CHARLIE CHARLIE COYOTE SIX FIVE. CHARLIE CHARLIE NOTE: Charlie Char'ie is the Command and Control aircraft.

COYOTE 3 THIS IS COYOTE THREE. ROGER THAT. NOW THAT'S ONE KIA. I WOULD LIKE TO KNOW HOW THEY WERE WOUNDED. OVER.

CHARLIE 81 THIS IS CHARLIE EIGHT ONE. THAT WAS POOPY TRAPS. OVER.

Coyote 65 Pick up point 719807. Requestor Coyote Alpha Six. Number of patients two. Litter. US. Nature of injuries unknown. Wounded by beehy trap. Category urgent. Condition of pick up sight unknown. Will secure.

TELL BRIGADE WE'RE MOVING OFF THEIR NET AND LEAVE ONE ON DUSTOFF NET.

Charlie 81 This is Charlie Eight One Roger. Coyote Three said they were on their way. Over.

Shark 6 Alpha This is Shark Six Alpha. We got yellow smoke on the bunker down there were that Dink's at. I'm pretty sure he might be your boy. He is decorated RVN, red scarf and stuff like that on what I could see of him.



Helix 33 Three Three. Over (Repeated).

(Warlord Alpha Lead) Helix Three. What sector are you trying to call?

(Helix 33) We got an ARVN moving into this little village. And there is a troop coming in from the south - er - from the north

ARE YOU TALKING ON DUSTOFF FRRQ?

Warlord Alpha Lead This is Warlord. Go ahead Helix.

Helix 33 I'm being fired at I'm certain from the village.

Warlord Alpha Lead Roger. Say again your last.

(Helix 33) There is a troop speaking in from the north side of this village.

NO, BOOBY TRAPS \_\_\_\_\_

(Warlord Alpha Lead) Roger. We've got our people right now on the ground over here at this Hill 85. The ARVN outpost and digging out some mortar tubes right now we'll send him over in that area to check him out as soon as possible.

Coyote 6 This is Coyote Six. Over.

Warlord Alpha Lead This is Warlord Alpha Lead. Go ahead.

Coyote 6 Warlord Alpha Lead. Coyote Six. Did you say you were digging out some mortar tubes. Did you actually get some tubes. Over

Warlord Alpha Lead This is Warlord Alpha Lead. That's affirmative. We are digging out mortar tubes and a few rounds of sixty mortar and eighty mortar.

Coyote 6 This is Coyote Six. Roger. How many tubes do you know of.

(Warlord Alpha Lead) Roger. We've got two at this time. They're still going through the area.

Coyote 6 This is Coyote Six. Roger. Are they sixty mike mikes. Over.

(Warlord Alpha Lead) Ah..that's affirmative.

Coyote 6 Coyote Six. Roger. Out Break. Coyote Six  
Five. Coyote Six Over.

(Coyote 65) Six.Five. Monitored that from Warlord. I  
sure would like to know about the location. Over.

Coyote 6 This is Coyote Six. Roger. I'll give you that.  
(Warlord Alpha Lead) Sitting on top of Hill 85. If you've go it Six Five.

Coyote 6 This is Coyote Six. Roger. Location is Hill 85.

CHARLIE 81 CHARLIE EIGHT ONE. ROGER. OUT.  
718778. Generally in that area. Over.

(Coyote 65) Six Five. Good copy. Two mortar tubes  
vicinity 718-778. Over.

Coyote 6 This is Coyote Six. Roger. Sixty mike mike tubes.  
Roger out.

Coyote 6 Coyote Six. Over.

Shark 6 Alpha Coyote Six. Shark Six Alpha. Were you trying to  
contact me?  
YOU ALSO COUNTED \_\_\_\_\_

Shark 6 Bravo Six, Shark Six Alpha. Were you trying to  
contact me?

(Warlord Alpha Lead) Charlie Bird over the ARVN fort. They are going  
to blow some mortar tubes or mortar rounds in  
NO WE'RE NOT \_\_\_\_\_  
there that they've stacked up. You might kinda  
back off a little bit.

Coyote 6 Six Coyote Six. Over.

Coyote 6 Coyote Six. Where do you want to fire the mortars? over.

(Coyote 6) Wait. Out.

Coyote 6 (Bravo) Six. Coyote Six. Go ahead with that firing,  
no problem with that, Over.

Coyote 6 Coyote Six, you have permission to fire the  
mortars in that area. Over.

Coyote 6

Charlie Charlie

DUSTOFF 252

(Charlie Charlie)

( )

Coyote 6

(Coyote 6)

Coyote 6

CHARLIE 81

Coyote 6

(CHARLIE 81)

Warlord Alpha Lead

Coyote 6

Roger. We'll stay west of that. Over.

(Bravo) Six. Charlie Charlie - - (Bravo) Six

Charlie Charlie. Shark Six will be refueling for about one zero and rearming. Be back on station in 'bout one zero. He's wondering what the nature of your problem is.

COYOTE BRAVO SIX. DUSTOFF TWO FIVE TWO.

Roger, Shark Six is wondering what your problem is. He's refueling and rearming at this time. Be back out there in about one zero to help you out and he'd like to know what you're requesting him for and a...a...like to advise that your radio is very weak.

ROGER. CONTACT ME \_\_\_\_\_

Bravo Six. Coyote Six. Over. Recommend you change batteries. You were coming in very weak. Shark Six wants to know what kind of assistance you need. Over.

Six, you asked Shark Six for some help. He went to refuel and he'll be back and he wants to know what kind of assistance you need. What's your problem there Over.

Coyote Six. Roger, if you're putting mortar fire in you probably won't need Shark Six. Has the Dustoff picked up your man yet? Over.

THIS IS CHARLIE EIGHT ONE. WAIT OUT. BREAK.

Roger, Dustoff is on the way but you better hold on your mortar fire till you get the Dustoff in there. Over.

ROGER. OUT. BREAK.

Warlord Alpha Lead

This is Coyote Six. Over.

Warlord Alpha Lead Roger, this is Warlord Alpha Lead. Cancel that two mortar tubes. Make that two zero sixty millimeter, six~~ty~~ six mike mike mortar rounds, and we're calling EOD in now to destroy 'em.

Coyote 6 This is Coyote Six. Roger. negative on mortar tubes, is that right? Over.

(Warlord Alpha Lead) That's affirmative. We just got the rounds didn't get the tubes.

Coyote 6 This is Coyote Six. Roger. Out.

Coyote 6 Coyote Six. Over.

(Coyote 65) This is Six Five. Go ahead.

Coyote 6 This is Coyote Six. Did you monitor Warlord's transmission. Over.

(Coyote 65) Six Five. Negative.

Coyote 6 To scratch the two sixty millimeter mortars it was a...a...only mortar rounds. Over

Coyote 65 This is Coyote Six Five. Roger on That, Did he give you the number of rounds? Over.

Coyote 6 He gave me a...this is Coyote Six. He gave me a number. I think it was two zero. Over.

(Coyote 65) This is Six Five. Roger. Anything further. Over.

WHAT NO TUBES?

Coyote 6 Coyote Six. Negative. Out.

CHARLIE 81 CHARLIE EIGHT ONE. OVER.

Warlord Alpha Lead This is Warlord Alpha Lead. Go ahead.

Coyote 6 This is Coyote Six. Could you tell me again how many sixty millimeter rounds you picked up. Over.

(Warlord Alpha Lead) That was two zero. I say again, two zero. We got them all stacked up now we're going to blow them with an EOD team from Dottie.

Coyote 6 This is Coyote Six. Thank you Out.

Coyote 3 Coyote Six, Coyote Three. Over.

Coyote 6 Three Coyote Six. Over.

Coyote 3 This is Coyote Six (Three mistakenly identified himself as six here) We have a..Charlie Six reports that a great number of people are moving just southwest of My Lai (4) coordinates 715795. Request somebody check them out. Over.

( ) ROGER. AH.....

Coyote 6 This is Coyote Six. Roger. Out. Break. Warlord, Warlord Alpha Lead. Coyote Six. Over.

(Warlord Alpha Lead) Go ahead. we a..Can you give us the coordinates again and the direction and we'll go ahead and check them out.

Coyote 6 This is Coyote Six. Roger. Direction is south Ah..to the southwest. I'll get coordinates again. Break, Coyote Three, Coyote Six. Over.

(Coyote 65) This is Six Five. Over.

Coyote 6 This is Coyote Six. Say again those coordinates. Over.

(Coyote 65) This is Six Five. 715795. Over.

Coyote 6 Coyote Six. 715795. Right

(Coyote 65) This is Six Five. That's affirmative. Over

Coyote 6 Six. That is not southwest, but we got the coordinates. Out. Break. Warlord, this is Coyote Six. Over.

(Warlord Alpha Lead) This is Warlord. We monitored and we will check both the coordinates and to the southwest of your area.

Coyote 6 Coyote Six. Thank you.

(Same Drank Delta Mike) Push for about zero five. Over.

Coyote 6 This is Coyote Six. Roger. Anything further? WE GOT ABOUT TWENTY.

Helix 33 This is Three Three. Over.

Six. Helix Three Three. Over.

Coyote 6 Six. Over.

Helix 33 Roger. I'm going back and Helix Three Two will be up shortly.

Coyote 6 Coyote Six. Roger. Thank you. Out.

COYOTE 6 SIX. ROGER. WHAT DIRECTION IS \_\_\_\_\_ FROM YOU. OVER.

Coyote 6 He's on his way back to your area. He'll be contacting you. He's on his way back now. Over

Shark 6 Charlie Six. Shark Six.

Warlord Alpha Lead Warlord Alpha Lead. Those are our troops our friendly troops. We've spotted mortar tubes on them and we are getting them out.

Shark 6 Charlie Six. Shark Six. Fox Mike.

Shark 6 Refuel at this time. If you have anything for us here let us know at this time or else we're going to be heading on back down south.

Coyote 6 Six. This is Coyote Six. Over.

Coyote 6 Coyote Six. Over. Were you able to police up those weapons Shark talked to you about and the man they killed? Over.

Coyote 6 Roger. Out.

Charlie 81 Charlie Eight One. Over.

Coyote 6 Landed next to and keep working east. Over.

Shark 6 Roger. This is Shark Six. There is a whole lot of movement out to the southwest here along the main trail that runs out here. The majority of them look like women and children and farmers. However, there could be some military age males mixed in with them. Other than that the villages look like they are pretty well evacuated and we don't see any more movement at this time so we are going to head on back down south and if you need us today just give us a call.

Coyote 6 This is Coyote Six. Thank you much. Out

Sane Drank Delta Mike This is Sane Drank Delta Mike. Over.

Coyote 6 This is Coyote Six. Over.

Sane Drank Delta Mike This is Delta Mike. Do you have somebody firing a mortar here on the beach. Over.

Coyote 6 This is Coyote Six. We have a mortar down in the beach area. He's going to fire. I don't think he's fired yet. Over

Sane Drank Delta Mike This is Delta Mike. I spotted two rounds looks like maybe sixty mike mike. In the vicinity of coordinates 742785. Over.

Coyote 6 Coyote Six. Roger I'll check it out.

Coyote 6 (Bravo) Six. Coyote Six. Over.

Coyote 6 Coyote Six. Have you begun to fire your mortars yet. Over.

Coyote 6 Roger. Did your Dustoff come in yet. Over.

Coyote 6 Delta Mike. Coyote Six. Over.

Sane Drank Delta Mike This is Delta Mike. Over. I copied. Be advised we also have one eighty-one mike mike if you need us. Over.

Coyote 6 This is Coyote Six. Roger.

Coyote 6 Brave Six. Coyote Six. Over.

Coyote 6 Coyote Six. this reminder, you got Sane Drank Delta Mike out there who can help you out in that are a. over.

Sane Drank Delta Mike Sane Drank Delta Mike. Roger. Out.

News Boy India 20 This is news Boy India Two Zero. Over.  
HE WAS AS I UNDERSTAND IT \_\_\_\_\_

Sane Drank Delta Mike This is Delta Mike. Over.

News Boy India Two Zero This is Two Zero. I'm about two zero minutes from you location. Over.

Sane Drank Delta Mike This is Delta Mike. Come on in. Over.

News Boy India Two Zero This is News Boy India Two Zero. Roger. Out.

(Coyote 6) Shark is going south. You got Delta Mike out there. I think he can cover that area for you.

Sane Drank Delta Mike Mike, If you want I'll open the beach for relieving otherwise I'll stay here. I'm about 600 yards off now. Over.

News Boy India Two Zero This is Two Zero. Whatever you think. If you think you ought to stay in there, we'll come in. Over.

(Sane Drank Delta Mike) Mike. We're right off the beach now. There's a lot of small arms fire coming from that direction on the beach. Is that your people. Over.  
TAPER GIVE ME POINTER TRAINS, PLEASE.

(Coyote 6) Three W H A down there. Is that Correct. Over.

(Coyote 6) Very weak. Say again, then change batteries. Over.

Coyote 6 Coyote Six. Reger. I can come in and pick them up if you'll pop smoke for us and secure a place for us. Over.

(Sane Drank Delta Mike) Delta Mike. Can you tell me where the nearest friendlies are in relation to my position. Over.

(Sane Drank Delta Mike) Reger. Thank you. Out.

Coyote 6 (Bravo) Six Coyote Six. Tallyho Violet smoke. Over.  
IS HE GOING IN TO PICK THEM UP.

Coyote 6 Coyote Six. Have the wounded sittin' there. Over.

Coyote 6 Coyote Six. Over.

(Coyote 65) This is Six Five. Are you going into Bravo's area to pick up wounded. Over.

Coyote 6 This is Coyote Six. That's affirmative. Over.

Coyote 65 This is Six Five. Reger, we requested Dustoff. Just wanted to cancel it out. Over.

Coyote 6 Coyote Six. Reger. Out.

(Warlord Alpha Lead) You get somebody out in the area where these I'll say there's about eight or nine Dinks laying in there with web gear and everything. Somebody ought to police up the gear.



Coyote 6

(Warlord Alpha Lead)

This is Coyote Six. Give me coordinates. Over.

Roger, it's just below the - er - Hill 85.

Just to the North of Hill 85 where we first get 'em just to the south of your first LZ and along the road there. There's about, eh, ten fifteen Dinks all spread out over the field that we get when they were di di-ing to the south. The gunships shot 'em. We'd like to know if there's somebody in the area to pick up this web gear, 'cause right now we're just keeping people from stealing it.

Coyote 6

(Warlord Alpha Lead)

This is Coyote Six. I'll get somebody down there.

Roger.

Charlie 81

Charlie Eight One. Over.

Charlie 81

Charlie Eight One. Over.

Charlie 81

Charlie Eight One. Over.

Coyote 6

Charlie Six. This is Coyote Six Over.

Coyote 6

Charlie Six. This is Coyote Six Over.

Coyote 6

Six. Warlord has got some people he wants you to check out. Just to the south of your LZ. Contact him and send some people down there. there's some VC there with web equipment and so on that have been killed. Over.

(Warlord Alpha Lead)

Roger. We are over the area at this time if you have us in sight we're just at the north base of the hill along the road. We'll be off your frequency for the next ten -- one zero minutes. We'll be peppering smoke at the different locations where these bodies are.

(Warlord Alpha Lead)

The bodies that we get before. They've got web gear, weapons and everything, and it's probably a good idea to get it off them before someone comes up and uses them.

\_\_\_\_\_ TIED UP AND THERE ARE THREE OF THEM.

( ) COYOTE SIX FIVE. COYOTE SIX FIVE.

(Warlord Alpha Lead) Reger. We'll be peppin' smoke on the different bodies in the area.

Coyote 6 Coyote Six. Over.

Coyote 65 Coyote Six Five.

Coyote 6 Coyote Six. I'm goin' to jump off the chopper here at Dettie and this chepper' ll go ahead north and take these wounded. Over.

Coyote 65 Six Five. Reger, be advised Sabre Six is at our location.

Coyote 6 This is Coyote Six. Reger. Out.

(News Boy India Two Zero) We are heading on our way down the coast. You get any messages you want to pass - want us to pass on to Movement Control at An Khe.

Sane Drank Delta Mike This is Sane Drank Delta Mike. I'm gonna come out to a mile. Over.

News Boy India Two Zero This is Two Zero. Over.

Sane Drank Delta Mike Mike. I'm gonna come out to a mile. Over.

Premo 687 This is Premo 687.

Coyote 65 This is Coyote Six Five. Over.

CHARLIE 81 OUT. BREAK. BRAVO SIX. CHARLIE EIGHT ONE. \_\_\_\_\_

Coyote 65 GOT THAT? I'LL WRITE IT UP.

Coyote 65 This is Coyote Six Five. Over.

Premo 687 This is Premo 687 we're approximately zero five out of your location with the LNO.

(Coyote 65) This is Six Five. Real Fine. Over.

Coyote 3 Three Two. Coyote Three. Over.

(Helix 32) Reger, Do you have any artillery firing into the area at this time. sh.. into the CA area.

Coyote 3 This is Coyote Three. Negative, however all three units down in that area have eighty one

Mike mikes with them. I don't know whether they're firing them or not. Over.

(Helix 32)

Roger, I just saw something impact over here on the beach. It's probably what it is.

Coyote 3

This is Coyote Three. Swift boats are out there and they have an eighty-one mike mike also. Over.

(Helix 32)

Roger. Thank you.

DO WE HAVE ANYBODY HERE THAT CAN START \_\_\_\_\_

(Coyote 65)

This is Six Five. Charlie Charlie. Come on in to the pad and sit down and relax.

(Charlie Charlie)

Roger. Sounds Good.

Charlie 81

Charlie Eight One. Brave Six would like to know whether you can get him some ammo out. He'll send what he needs in a few minutes. Over.

Coyote 3

This is Coyote Three. Roger, tell him to give me the number and type ammo he needs. Over.

Charlie 81

Charlie Eight One. Roger, Out. Bravo.....

LEGEND FOR CALL SIGNS

TF BARKER

Coyote 3	MAJ Calhoun
Coyote 6	LTC Barker
Coyote 23	PZ Control LZ Dottie
Coyote 65	NCS MSG Johnson
Coyote Alpha 6	Company A
Coyote Bravo 6	Company B
Coyote Charlie 6	Company C
Coyote Charlie 81	81MM Mortars LZ Uptight

AIR CRAFT

Helix 32	Forward Air Controllers
Helix 22	
Warlord Alpha Lead	Aero Scouts 123d Avn Bn
Shark 6	Gun Ships 174th Avn Co
Dolphin Lead	2, 3, 4, 5, Lift Ships 174th Avn Co
Skeeter	H-23 helicopter 123d Avn Bn
Rawhide 3	11th Inf Bde S-3 MAJ McKnight
Dust Off	Med Evac Helicopter

U. S. NAVY

Sane Drank Delta Mike	Swift Boat
News Boy India Two Zero	Swift Boat

MIC

Saber 6	CG Americal Div
Lobo 65	NCS 4th Bn 3d Inf 11th Inf Bde

Incl 2

TIME\*

NO.

STATION

MESSAGE

REMARKS

1	Coyote 3	They will be controlled by Coyote Six. The artillery has been informed of this change. Over.
2	Dolphin Lead	This is Dolphin Lead. Roger. Thank you.
3	Coyote 3	Helix Three Three. Coyote Three. Over.
4	Helix 33	Helix Three Three. Up your push. I'll be in your area in about five minutes.
5	Coyote 3	This is Coyote Three. Roger. Out.
6	Helix 33	Three Three. Radio Check.
7	Sane Drank Delta Mike	This is Delta Mike. Loud and Clear. Over.
8	Helix 33.	Roger. Same.
9	Dolphin Lead	This is Lead. Commo check. Fox Mike.
10	Alpha Two	Alpha Two.
11	Alpha Three	Alpha Three.
11A		WEAT'S HIS CALL SIGN?
12	Alpha Trail	Alpha Trail.
13	Alpha Four	Alpha Four.
13A		HOW 'BOUT LET'S CALL TWO AND _____.
14	Coyote 6	NOTE: Alpha Two, Alpha Three, Alpha Trail, and Alpha Four appear to be lift ships answering FM commo check from Dolphin Lead. Coyote Six. Over.
14A		THE LIMA ZULU _____

EXHIBIT M-20A

\*Deduced time has asterik. considered accurate within ± 5 minutes.

REMARKS

MESSAGE

NO.

STATION

TIME

15	Dolphin Lead	This is Lead. Go ahead.
16	Coyote 6	This is Coyote Six. Time 0722. Over.
17	Dolphin Lead	This is Lead. Roger.
18	Coyote 23	Correction Coyote Three. Coyote Two Three. (garble) - Two Two. Over.
19	Coyote 65	This is Six Five. Roger. Thank you. Out.
20	Coyote 6	This is Six. Over.
21	Dolphin Lead	This is Lead.
22	Coyote 6	Dolphin Lead. Coyote Six. Over.
23	Dolphin Lead.	This is Lead. Go ahead.
24	Coyote 6	This is Coyote Six. Recommend landing to the north. Over.
25	Dolphin Lead	This is Lead. Roger.
26	Warlord Alpha Lead	Coyote Three. Coyote Three. This is Warlord Alpha Lead.
27	Coyote 65	Coyote Six Five. Go ahead.
28	Warlord Alpha Lead	Roger. This is Warlord Alpha Three - Alpha Lead. We'll be in our area in approximately fifteen minutes on the recon.
29	Coyote 65	This is Six Five. Real fine. Anything further. Over.
30	Warlord Alpha Lead	Negative. We'll stay up here so we can advise you of anything we spot. Appreciate if you'd let us know if anything goes off different than planned.

REMARKS

MESSAGE

STATION

NO.

TIME

31 Coyote 65 Six Five. Certainly will.

32 Coyote 3 Warlord Lead. Coyote Three. Second LZ will be stepped up approximately six zero minutes. Over.

33 Warlord Alpha Lead Roger. Second LZ will be stepped up six zero minutes. Thank you very much.

34 Coyote 6 Helix Three Three. Coyote Six. Over.

35 Coyote 6 Helix Three Three. Coyote Six. Over.

36 Helix 33 Helix Three Three. Over.

37 Coyote 6 This is Coyote Six. You realize the gun target line from LZ Uptight to LZ? Over.

38 Helix 33 Three Three. Affirmative.

39 Dolphin Lead Coyote six. This is Dolphin Lead

40 Coyote 6 This is Coyote Six. Over.

41 Coyote 6. Coyote Six. Over.

42 Dolphin Lead This is Dolphin Lead. We're three minutes out at this time.

43 Coyote 6 This is Coyote Six. Roger. No restrictions on door gunners.

44 Dolphin Lead This is Lead. Roger.

45 Dolphin Lead This is Dolphin Lead. If you're not on your marking run at this time I can just go right on in and land. I see the LZ. Do you have to put smoke in it?

\*0727

REMARKS

MESSAGE

STATION

NO.

TIME

46	Coyote 6	This is Coyote Six. Roger. Waiting for completion of last round of artillery. As soon as it's complete, I'll go in for the mark.
47	Dolphin Lead	This is Lead. Roger. Save us a lot of time if you didn't mark. I see the LZ now at this time to the west of the white smoke from the artillery.
48	Coyote 6	This is Coyote Six. That's affirm. Over.
49	Dolphin Lead	Dolphin Lead. Is the artillery stopped?
*0729	Coyote 6	This is Coyote Six. Roger. Rounds complete. Over.
51	Dolphin Lead	This is Lead. Roger.
52	Helix 33	I still see artillery coming in there.
53	Dolphin Lead	Coyote Six. This is Dolphin Lead.
54	Coyote 6	This is Coyote Six. Over.
0730	Dolphin Lead	This is Dolphin Lead. We're out of the LZ. LZ appeared to be cold.
56	Coyote 6	Coyote Six. Thank you. Out.
57	Coyote 6	Coyote Six Five. Coyote Six. Over.
58	Coyote 65	Six Five. Go ahead.
59	Coyote 6	Coyote Six. Touchdown 0730. LZ appeared to be cold. Over.
60	Coyote 65	Six Five. Thank you. Out.



REMARKS

MESSAGE

STATION

NO.

TIME

In the vicinity of the first LZ. This is Warlord Lead. We'll be orbiting to the south of the road. We have a Dink with a weapon we're getting at this time.

HA HA HA

This is Shark Six. Roger. Understand you will be to the south of the road and say again the part about the weapon.

Ah. Roger. We've got a Dink with a weapon down here that we're getting at this time. If you'd stay north and we'll stay south and out of your way.

Roger. We're going to be working north of this road.

Roger. We'll stay south.

AH SHOOT. THAT'S ONE DINK.

Three Three. There is also one running down the road toward the east. Three Three. It's just to the left of you.

Warlord Lead. This is Shark Six.

This is Warlord Lead. Go ahead.

Roger. I'm going to come a little bit on your side of the road. We've got one with a weapon over here.

Roger. Go get him.

Warlord Alpha Lead

61A

Shark 6

Warlord Alpha Lead

Shark 6

Warlord Alpha Lead

65A

Helix 33

Shark 6

Warlord Lead

Shark 6

Warlord Lead

\*0731

REMARKS

MESSAGE

STATION

NO.

TIME

71	Shark 6	Roger. It's just about fifty meters right over here.
72	Coyote 6	Six. Over. This is Coyote Six. You said it seems to be hot. Did you receive fire when you first went in. Over.
73	Dolphin Lead	This is Lead. Negative reported fire from any of the sick. Over.
74	Helix 33	I got a couple of them down here right u me if the Shark could come down here.
75	Warlord Alpha Lead	This is Warlord. We've got one rocket ru in progress now if you'll just stay where you are we'll go past you.
76	Coyote 3	THIS IS COYOTE THREE. OVER. AH BRAVO WHAT ARE YOU DOING?
77	Dolphin Lead	Coyote Two Three. This is Dolphin Lead.
78	Coyote 23	This is Coyote Two Three.
79	Dolphin Lead	This is Dolphin Lead. Ah...w gonna be able to pick up all the pax on this last lift?
79A		COME ON TWO THREE.
80	Coyote 23	Ah...Coyote Two Three. Yes. Over.
81	Warlord Alpha Lead	Warlord Alpha Lead.
82	Helix 33	Warlord. This is Helix Three Three.
83	Warlord Alpha Lead	Roger. Just trying to tell Shark Lead where that smoke is there' we got a couple of Dinks with weapons. Ah...we got a low bird out there looking at HER. Appreciate if they didn't put any fire in that general area.

REMARKS

MESSAGE

STATION

NO.

TIME

Helix Three Three. Some of 'em are escaping back toward the ocean down this road.

Ah...Roger.

Dolphin Lead. This is Two Three. Over.

Two Three. This is Lead.

Lead. This is Two Three. You got 'em all. Over.

This is Lead. Roger.

Coyote Three. This is Coyote Two Three. Lift off...Second lift off completed 0738.

Six Five. Thank you. Out.

Charlie Six. Ah...Coyote Six. Probably on the wrong push. Over.

Coyote Six. Over.

Coyote Six. This is Lead.

ANSWER HLM COYOTE SIX.

Coyote Six. This is Lead.

Coyote Six. This is Warlord Go ahead.

Coyote Six. This is Dolphin Lead. Approximately four minutes out at this time.

Roger.

This is Coyote Six. Over.

84 Helix 33

85 Helix 33

86 Coyote 23

87 Dolphin Lead

88 Coyote 23

89 Dolphin Lead

90 Coyote 23

91 Coyote 65

92 Coyote 6

93 Coyote 6

94 Dolphin Lead

94A

95 Dolphin Lead

96 Warlord Alpha Lead

97 Dolphin Lead

98 Coyote 6

99 Coyote 6

0738

\*0743

TIMENO.STATIONMESSAGEREMARKS

100	Shark 6	Coyote Six. Shark Six. If you'll look out to the east of the first LZ we dropped a couple of red smokes out here in a rice paddy; we just killed two Dinks that got weapons, hand grenades and all the web gear in the world right out here in this rice paddy.
101	Coyote 6	This is Coyote Six. Roger. Thank you much. Out. Break. Charlie Six. Coyote Six. Over.
102	Shark 6	Coyote Six. Shark Six. We also killed another man to the south of the Lima Zulu. Ah...had a weapon and all the web gear in the world on him also. We'll go back over there as soon as this next lift is in and mark his location also (pause). Shark Six. Did you monitor.
102A		PUT THEM ALL LIEUTENANT IN THE SAME COORDINATES.
103	Dolphin Lead	This is Lead (garbled)...Pop smoke please. (garbled)
*0747	Dolphin Lead	Bravo Six Golf. Dolphin Lead.
104	Dolphin Lead	Lead. Bravo Six Golf. Over.
105	Bravo 6 Golf	This is Dolphin Lead. Would you pop smoke on the PZ please?
106	Dolphin Lead	Coyote Six. This is Bravo--This is Dolphin Lead.
107	Dolphin Lead	This is Dolphin Lead. On that second sortie into the first LZ we received fire coming out of one of the villages. The Sharks are over checking it out now.
108	Dolphin Lead	
108A		HELLO

MESSAGE

STATION

NO.

TIME

109	Dolphin Lead	This is Dolphin Lead. GO.
110	Bravo 6	Are you going to land from the south to north?
110A		HELLO
111	Dolphin Lead	Dolphin Lead. Roger.
112	Dolphin Lead	Bravo Six. Dolphin Lead. Roger.
113	Dolphin Lead	This is Dolphin Lead. The ships that have their rotating beacons on at this time only have five people on board. Can you send one more pack out to them?
114	Warlord Alpha Lead	This is Alpha Lead. Roger. Directly to the south of the LZ we had two Dinks with weapons both of them KIA now. Ah...we are reconning now along the peninsula checking the people out that are <u>di di - ing</u> the area and they going out fast. You've got the area to the south and to your west;we're just just covering it now.
115	Coyote 6	This is Coyote Six. Thank you much. Out.
116	Shark 6	If you'll look almost due south of the LZ you will see some white smoke and also some red smoke, at this location in a ditch right where the red smoke is we've got a Dink with a weapon and a whole bunch of web gear on and in general location of the white smoke we got a couple of ammo boxes and some more stuff that he threw down. The red smoke is right on the Dink and the white smoke is right on the ammo boxes so if you could get somebody down there and police 'em up.

01

TIME                      NO.                      STATION                      MESSAGE                      REMARKS

117                      Dolphin Lead  
 Six. I can take seven on all the aircraft except three. That'll be six aircraft that will on...that will have seven on board.

118                      Coyote 6  
 Six Five. This is Coyote Six. Over.

118A  
 PROTECTOR TOC.

119                      Coyote 65  
 Six Five. Go ahead.

119A  
 PROTECTOR TOC

\*0755                      Coyote 6  
 This is Coyote Six.. All of Charlie's elements are on the ground. They've had negative contact as of yet. However, gunships have killed a total of six VC with weapons; and Charlie Six is sending elements out to police up the weapons. Over.

120A  
 THEY HAVE KILLED SEVEN

121                      Coyote 65  
 This is Coyote Six Five. Roger on that. Total of seven for the gunships. Over. Counting Warlord's. Over.

122                      Coyote 6  
 This is Coyote Six. That's affirmative.

122A  
 MAKE IT FOURTEEN FOR ALPHA.

123                      Coyote 65  
 This is Six Five. That's Roger of that. Also we now have a total of fifteen. Over.

123A  
 HAY-8 OKAY CHARLIE SIX.

124                      Coyote 6  
 This is Coyote Six. You have a total of what? Over.

REMARKS

MESSAGE

STATION

NO.

TIME

125 Coyote 65 This is Coyote Six Five. Charlie Six has now a total of fifteen. Over.

125A THE LINE WENT OUT AT 0740 \_\_\_\_\_

126 Coyote 6 This is Coyote Six. Fifteen what. Over.  
127 Coyote 65 Victor Charlies. Over.

128 Coyote 6 This is Coyote Six. Roger. Out.  
129 Coyote 6 (Charlie Six. This is) Coyote Six. Over. Understand you have fifteen. Victor Charlies, is that correct? Over.

130 Coyote 6 Coyote Six. Roger. How many weapons so far, if any? Over.

131 (garble). Go ahead.

132 Coyote 6 This is Coyote Six. Roger. Out.

133 Rawhide 3 Coyote Six. This is Rawhide Three. Over.

134 Coyote 6 This is Coyote Six. Over.

135 Rawhide 3 Rawhide Three. We've got quite a few people that are really moving out on this road going southwest from the first Lima Zulu. Over.

136 Coyote 6 This is Coyote Six. Roger. I'll get somebody on that. Warlord is checking to the south. I'll have him also check to the west. Over.

REMARKS

MESSAGE

STATION

NO.

TIME

TIME	STATION	NO.	MESSAGE	REMARKS
	Rawhide 3	137	This is Rawhide Three. Roger. Out.	
	Warlord Alpha Lead	138	This is Warlord Alpha Lead. Roger. I monitored. The road to the southwest of the first Lima Zulu. Is that affirmative?	
	Coyote 6	139	This is Coyote Six. That's affirmative. Out.	
	Warlord Alpha Lead	140	Roger.	
	Dolphin Lead	141	Bravo Six. This is Lead. Roger. I monitored that. We'll have to see what happens on this next sortie when we come back in and see just what the heck we have and we'll make a determination at that time. Ah...Dolphin Lead. We'll have to wait until we return from this sortie and see how many people we can take and we'll make a determination then as to whether we'll make another sortie or not.	
	Rawhide 3	142	This is Rawhide Three. Over.	
	Warlord 3	143	This is Warlord Three. Go ahead.	
	Rawhide 3	144	This is Rawhide Three. When you get a chance to check out those people down to the southwest, you will be able to see our ship orbiting over them. Over.	
	Warlord Alpha Lead	145	This is Warlord Alpha... (transmission broken)	
	Warlord 3	146	This is Warlord Three. Over.	
	Warlord 6	147	This is Warlord Six. Go ahead.	
	Coyote	148	Coyote	
	Rawhide 3	149	Warlord Six. Rawhide Three. Over.	

\*0805



REMARKS

MESSAGE

STATION

NO.

TIME

Coyote Six. Charlie Six, you calling me?  
Over.

Go ahead.

THAT SONY SHORTWAVE RADIO

Roger. I'm over here with the one to the east at this time. I'm going to throw one more smole over here and then I'll go back and mark the other one over there.

(Charlie) Six. This is Shark Six. Can you see my white smoke over here to the east of the LZ? Out here in this ditch over here?

--Coyote Six. Over.

Warlord Six. Rawhide Three. Over.

This is Rawhide Three. Just to the west of wjere that smoke went down, three of 'em together. One or two of them without their shirts on. They're in black. Over.

Ah...Roger. We got the Skeeter over them now giving them a check.

Dolphin Lead. Coyote Six. Over.

Coyote Six. This is Dolphin Lead. Go ahead.

Dolphin Lead. Coyote Six. Artillery prep is started. Should go as scheduled. You should touch touch down 0815. Over.

This is Lead. Roger.

150 Coyote 6

151 Shark 6

151A

152 Shark 6

153 Shark 6

154 Coyote 6

155 Rawhide 3

156 Warlord Alpha Lead.

157 Warlord Alpha Lead

158 Coyote 6

159 Dolphin Lead

160 Coyote 6

161 Dolphin Lead

0808

\*0808



REMARKS

MESSAGE

STATION

NO.

TIME

Request Three come over to check people. We got one down here that is surrendering. He's taking all his clothes off. Standing by if you want to come down and pick him up. PICK HIS ASS UP. I'm ready to pop the two white smokes on the highway. We got your Dink down here; he's stripped down. He is standing with his hands over his head.

This is Rawhide Three. Over.

COME ON NOW. MAJOR MCKNIGHT HAS TO GET IN ON IT.

This is Rawhide Three. Over.

Rawhide Three. This is Warlord Alpha Lead. Roger. We have your Dink now at this time. He is stripped down and got his hands over his head. He tried to run once and we caught him again. He's down on the road if you want to come down and pick him up... He's stopped and ready.

This is Rawhide Three. Roger. We're on our way in at this time. There were two others that were going along with him. Did you manage to get them also? Over.

Negative. We got two of them now at this time.

Rawhide Three. Roger. Out.

162 Warlord Alpha Lead

162A

163 Rawhide 3

163A

164 Warlord Alpha Lead

165 Rawhide 3

166 Warlord Alpha Lead

167 Rawhide 3

\*0810

TIME

NO.

STATION

MESSAGE

REMARKS

168	Shark 6 Alpha	Charlie Six Alpha. Shark Six Alpha. If you can see where the green smoke dropped right back to the south of that along in a ditch in there. There's one just zapped a little while ago. I'd like the troops to check him out.
169	Coyote 6	Dolphine Lead. Coyote Six, Over. Dolphin Lead. Coyote Six. Over.
169A		RIGHT NOW _____
170	(Bravo 6)	Bravo Six _____
0812	Dolphin Lead	This is Lead. I had to make a go round because the artillery was still shooting while I was on my approach and didn't want to land in there when it was going.
172	Coyote 6	This is Coyote Six. Roger. Rounds complete now. You want me to go in and mark now? Over.
173	Dolphin Lead	This is Lead. That's affirm.
174	Coyote 6	This is Coyote Six..Roger. Out. Dolphin Lead, Coyote Six. LZ marked. Over.
175	Dolphin Lead	This is Dolphin Lead. Roger. Identify violet.
176	Coyote 6	Coyote Six. Roger. Out.
177	Coyote 6	(Charlie Six) This is Coyote Six. You calling me? Over.

07

REMARKS

MESSAGE

STATION

NO.

TIME

178	Dolphin Lead	(Bravo) Six. Go (garble)
179	Dolphin Lead	Tallyho yellow.
179A		0815
180	Dolphin Lead	Roger. The ones with rotating beacons on will take six, the rest take seven. Go. Go ahead and pop smoke.
181	Coyote 3	Charlie Right One, Coyote Three. Over.
182	Warlord Alpha Lead	This is Warlord Alpha Lead. . Coyote Six, this is Warlord Alpha Lead.
183	Coyote 6	This is Coyote Six. Over.
184	Warlord Alpha Lead	Roger. This is Warlord Alpha Lead. We will be putting approximately two one (21) people on Hill 85, to your south. We've got a mortar position and ammo spotted on top.
185	Coyote 6	This is Coyote Six. Roger. We've had mortars in that area before. Go in and get them. Out.
186	Charlie 81	This is Charlie Eight One. Over.
187	Warlord Alpha Lead	Roger.
188	Dolphin Lead	This is Dolphin Lead.
189	Charlie 81	Charlie Eight One. Charlie Six says he _____ ah_____

∞  
∞

REMARKS

MESSAGE

STATION

NO.

TIME

This is Dolphin Lead. This completes the lift. Ah...only one problem we had and that was that the artillery didn't get shut off in time.

MINE SWEEPS AND THE PEOPLE KNOW WHERE TO COME

OUT \_\_\_\_\_

Coyote Six. This is Dolphin Lead.

This is Coyote Six. Over.

This is Dolphin Lead. This completes your lift for this morning. We only had one problem and that was that the artillery didn't get shut off in time.

This is Coyote Six. That's affirmative. They were about a minute late cutting off. We'll try to do better next time. Over.

This is Dolphin Lead. Roger. Other than that, it was a good lift.

0827 LZ cold. Over.

WE HAVE COMPLETED TWO LIFTS. OVER.

(Charlie) Six. I'm heading back to refuel. Have you had any contact down there yet? Over.

This is Six Five.

190 Dolphin Lead

190A

191 Dolphin Lead

192 Coyote 6

193 Dolphin Lead

194 Coyote 6

195 Dolphin Lead

196 Coyote 65

197 Coyote 6

198 Coyote 65

0827

CO  
CO

REMARKS

MESSAGE

STATION

NO.

TIME

Coyote Six. Roger. Dig deep. Take your time and get 'em out of those holes. Over.

Coyote Six. Is that eight..ah eight four KIA's? Over.

Roger. Out.

Six Five. This is Coyote Six. Over.

This is Coyote Six Five. Go ahead.

This is Coyote Six. Returning to your location to refuel. I'll stop down in the TOC and bring you up to date. Over.

This is Six Five. Roger. I'll have a vehicle up to meet you. Over.

Coyote Six. Out.

Coyote Six. Shark Six.

DOES HE WANT BLAKLEY? I'LL GET HIM.

Six. Ah...these two people we killed with weapons and the web gear over just northeast of LZ. We dropped smoke on them awhile ago and your people were within a hundred meters of it; now then they've left the area and are going the other direction. Do you want us to drop down there and pick up this stuff?

HELL YES, GO GET IT. COME ON CHARLIE SIX.

They might drag these people off if you don't hustle.

\*0829

201

202

203

204

\*0830

Coyote 65

206

207

207A

208

208A

209

00

REMARKS

MESSAGE

STATION

NO.

TIME

\*0832  
 ↓  
 210 ( )  
 211 (Shark 6)  
 212 Shark 6  
 212A

COYOTE SIX IS CALLING, I KNOW COYOTE SIX IS NOT READING ME.

This is Coyote Three. Go. Over.

We are covering the Charlie elem-at. They're going over to pick up some Dinks that had some weapons and web gear and stuff. Understand there are facilities there at Lima Zulu Dottie to pick up some POL.

Shark Six. This is Coyote Six. Over.

Shark Six. This is Coyote Three. Affirmative. We can refuel and rearm you here at Dottie. Over.

This is Shark Six. Roger. We can stay a bit longer that way and won't have to head back down south. We can give them a little bit more cover.

This is Coyote Three. Roger. We can refuel you and rearm you and be glad to. Over.

Roger. Understand.

Charlie Six. Shark Six. Were you trying to contact me?

REMARKS

MESSAGE

STATION

NO.

TIME

This is Shark Six. Go ahead.

Shark Six. Go ahead.

Shark Six. Rawhide Three. Over.

(Bravo Six) This is Shark Six Alpha. We'll be right over.

Charlie Six. Rawhide Three. Over.

You're coming with your element.

Dropped red smoke over there on location at this time. There is two little small rice paddies right together and there is one laying in each one of them.

(Bravo Six) Shark Six.Alpha. Go ahead.

792 Roger. We'll do.

KEEP THE DOOR SHUT.

Helix Three Three.

YOU KNOW WE POSTED FOURTEEN AWHILE AGO.

Right 0.9 up 1.7. Over.

Six. Roger. I believe we are above your location at this time. If you give us a direction and approximate distance from your location. Do you desire that we just give you some VR or would you like to put a little ordance in there? This small wood line just almost due west of you there approximately about 400-500 meters.

Shark 6

Shark 6

Rawhide 3

Shark 6 Alpha

Rawhide 3

Rawhide 3

Shark 6

Shark 6 Alpha

( )

229A

Helix 33

230A

(Charlie 81)

(Shark 6)

221

222

223

224

225

226

227

228

229

229A

230

230A

231

232

\*0835



TIME

NO.

STATION

MESSAGE

REMARKS

0840	233	(Shark 6)	Six. Go ahead. Roger. We'll go down and check this wood line out at this time.
	234	Coyote 65	Lobo Six Five. This is Coyote Six Five.
	235	Lobo 65	Lobo Six Five. Over.
	236	Charlie 81	This is Charlie Eight One. Roger out. Break _____
	237	Coyote 65	This is Six Five. Request a Dust-off. Over.
	238	Lobo 65	This is Lobo Six Five. Roger. Send it. Over.
	239	Charlie 81	COYOTE THREE. CHARLIE EIGHT ONE. OVER.
	240	Coyote 3	COYOTE THREE. OVER.
	241	Charlie 81	BRAVO SIX NEEDS A DUSTOFF. HAS ONE KIA AND ONE LETTER. ROSTER NUMBER 00____ COORDINATES 733793.
	242	Charlie Charlie	COYOTE SIX FIVE. CHARLIE CHARLIE. NCTE: Charlie Charlie is the Command and Control aircraft.
	243	Coyote 3	THIS IS COYOTE THREE. ROGER THAT. NOW THAT'S ONE KIA. I WOULD LIKE TO KNOW HOW THEY WERE WOUNDED. OVER..
	244	Charlie 81	THIS IS CHARLIE EIGHT ONE. THAT WAS BOOBY TRAPS. OVER.

REMARKS

MESSAGE

STATION

NO.

TIME

0845	245	Coyote 65	'Pick up point 719807. Requestor Coyote Alpha Six. Number of patients two. Litter. US. Nature of injuries unknown. Wounded by booby trap. Category urgent. Condition of pick up sight unknown. Will secure.
	246		TELL BRIGADE WE'RE MOVING OFF THEIR NET AND LEAVE ONE ON DUSTOFF NET.
	247	Charlie 81	This is Charlie Eight One. Roger. Coyote Three said they were on their way. Over
	248	Shark 6 Alpha	This is Shark Six Alpha. We got yellow smoke on the bunker down there where that Dink's at. I'm pretty sure he might be your boy. He is decorated RVN, red scarf and stuff like that on what I could see of him.
	249	Helix 33	Three Three. Over. (Repeated)
	250	Warlord Alpha Lead	Helix Three. What sector are you trying to call?
	251	Helix 33	We got an ARVN moving into this little village. And there is a troop coming in from the south - er - from the north.
	251A		ARE YOU TALKING ON DUSTOFF FREQ?
	252	Warlord Alpha Lead	This is Warlord. Go ahead, Helix.
	253	Helix 33	I'm being fired at. I'm certain from the village.
	254	Warlord Alpha Lead	Roger. Say again your last.
	255	Helix 33	There is a troop sneaking in from the north side of this village.
	255A		NO, BOOBY TRAPS _____

REMARKS

MESSAGE

STATION

NO.

TIME

256 Warlord Alpha Lead  
Roger. We've got our people right now on the ground over here at this Hill 85. The ARVN outpost and digging out some mortar tubes right now; we'll send him over in that area to check his out as soon as possible.

257 Coyote 6  
This is Coyote Six. Over.

258 Warlord Alpha Lead  
This is Warlord Alpha Lead. Go ahead.

259 Coyote 6  
Warlord Alpha Lead. Coyote Six. Did you say you digging out some mortar tubes? Did you actually get some tubes?. Over.

260 Warlord Alpha Lead  
This is Warlord Alpha Lead. That's affirmative. We are digging out mortar tubes and a few rounds of sixty mortar and eight mortar.

261 Coyote 6  
This is Coyote Six. Roger. How many tubes do you know of?

262 Warlord Alpha Lead  
Roger. We've got two at this time. They're still going through the area.

263 Coyote 6  
This is Coyote Six. Roger. Are they sixty mike mikes? Over.

264 Warlord Alpha Lead  
Ah...that's affirmative.

265 Coyote 6  
Coyote Six. Roger. Out Break. Coyote Six Five. Coyote Six. Over.

266 Coyote 65  
Six Five. Monitored that from Warlord. I sure would like to know about the location. Over.

267 Coyote 6  
This is Coyote Six. Roger. Location is Hill 85.

\*0855

TIMENO.STATIONMESSAGEREMARKS

Warlord Alpha Lead

Sitting on top of Hill 85. If you've got it Six Five.

269 Coyote 6

This is Coyote Six. Roger. Location is Hill 85.

270 Charlie 81

Charlie Eight One. Roger. Out.

271 (Coyote 6)

718778. Generally in that area. Over.

272 Coyote 65

Six Five. Good copy. Two mortar tubes vicinity 718-778. Over.

273 Coyote 6

This is Coyote Six. Roger. Sixty mike mike tubes. Roger out.

274 Coyote 6

Coyote Six. Over.

275 Shark 6 Alpha

Coyote Six. Shark Six Alpha. Were you trying to contact me?

275A

YOU ALSO COUNTED \_\_\_\_\_

276 Shark 6

Bravo Six, Shark Six Alpha. Were you trying to contact me?

277 Warlord Alpha Lead

Charlie Bird over the ARVN fort. They are going to blow some mortar tubes or mortar rounds in.

277A

NO WE'RE NOT \_\_\_\_\_

(277)

there that they've stacked up. You might kinda back off a little bit.

278 Coyote 6

Six Coyote Six. Over.

279 Coyote 6

Coyote Six. Where do you want to fire the mortars? Over.

280

(Coyote 6)

Wait. Out.

REMARKS

MESSAGE

STATION

NO.

TIME

(Bravo) Six. Coyote Six. Go ahead with that firing. No problem with that. Over.

Coyote Six, you have permission to fire the mortars in that area. Over.

Roger. We'll stay west of that. Over.

(Bravo) Six. Charlie Charlie -- (Bravo) Six about one zero and rearming. Be back on station in 'bout one zero. He's wondering what the nature of your problem is.

Coyote Bravo Six. Dustoff Two Five Two.

Roger. Shark Six is wondering what your problem is. He's refueling and rearming at this time. Be back out there in about one zero to help you out and he'd like to know what you're requesting him for and a... a...like to advise that your radio is very weak.

Roger. Contact me.

Bravo Six. Coyote Six. Over. Recommend you change batteries. You were coming in very weak. Shark Six wants to know what kind of assistance you need. Over.

Six, you asked Shark Six for some help, He went to refuel and he'll be back and he wants to know what kind of assistance you need. What's your problem there? Over.

281 Coyote 6

282 Coyote 6

283 Coyote 6

284 Charlie Charlie

\*0905  
to  
\*0910

285 Dustoff 252

286 (Charlie Charlie)

287 ( )

288 Coyote 6

289 Coyote 6

REMARKS

MESSAGE

STATION

NO.

TIME

290	Coyote 6	Coyote Six. Roger, if you're putting mortar fire in you probably won't need Shark Six. Has the Dustoff picked up your man yet? Over.
291	Charlie 81	This is Charlie Eight One. Wait out. Break.
292	Coyote 6	Roger. Dustoff is on the way but you better hold on your mortar fire till you get the Dustoff in there. Over.
293	(Charlie 81)	Roger. Out. Break.
294	Warlord Alpha Lead	Warlord Alpha Lead.
295	Coyote 6	This is Coyote Six. Over.
296	Warlord Alpha Lead	Roger. This is Warlord Alpha Lead. Cancel that two mortar tubes. Make that two zero sixty millimeter, sixty mike mike mortar rounds, and we're calling EOD in now to destroy 'em.
297	Coyote 6	This is Coyote Six. Roger. Negative on mortar tubes, is that right? Over.
298	Warlord Alpha Lead	That's affirmative. We just got the rounds, didn't get the tubes.
299	Coyote 6	This is Coyote Six.. Roger. Out.
300	Coyote 6	Coyote Six. Over.
301	(Coyote 65)	This is Six Five. Go ahead.
302	Coyote 6	This is Coyote Six. Did you monitor Warlord's transmission? Over.
303	(Coyote 65)	Six Five. Negative.

CO  
OO

TIMENO.STATIONMESSAGEREMARKS

304	Coyote 6	To scratch the two sixty millimeter mortars it was a...a...only mortar rounds. Over.
305	Coyote 65	This is Coyote Six Five. Roger on that. Did he give you the number of rounds? Over.
306	Coyote 6	He gave me a...this is Coyote Six. He gave me a number. I think it was two zero. Over.
307	(Coyote 65)	This is Six Five. Roger. Anything further? Over.
307A		WHAT NO TUBES ?
308	Coyote 6	Coyote Six. Negative. Out.
309	Charlie 81	Charlie Eight One. Over.
310	Warlord Alpha Lead	This is Warlord Alpha Lead. Go ahead.
311	Coyote 6	This is Coyote Six. Could you tell me again how many sixty millimeter rounds you picked up. Over.
312	Warlord Alpha Lead	That was two zero. I say again, two zero. We got them all stacked up now; we're going to blow them with an EOD team from Dottie.
313	Coyote 6	This is Coyote Six. Thank you. Out.
314	Coyote 3	Coyote Six, Coyote Three. Over.
315	Coyote 6	Three, Coyote Six. Over.

REMARKS

MESSAGE

STATION

NO.

TIME

316	Coyote 3	This is Coyote Six (three mistakenly identified himself as six here) We have a... Charlie Six reports that a great number of people are moving just southwest of My Lai (4) coordinates 715795. Request somebody check them out. Over.
317	( )	Roger. Ah.....
318	Coyote 6	This is Coyote Six. Roger. Out. Break. Warlord, Warlord Alpha Lead. Coyote Six. Over.
319	(Warlord Alpha Lead)	Go ahead. We a...Can you give us the coordinates again and the direction and we'll go ahead and check them out.
320	Coyote 6	This is Coyote Six. Roger. Direction is south. Ah...to the southwest. I'll get coordinates again. Break, Coyote Three, Coyote Six. Over.
321	(Coyote 65)	This is Six Five. Over.
322	Coyote 6	This is Coyote Six. Say again those coordinates. Over.
323	(Coyote 65)	This is Six Five. 715795. Over.
324	Coyote 6	Coyote Six. 715795. Right?
325	(Coyote 65)	This is Six Five. That's affirmative. Over.
326	Coyote 6	Six. That is not southwest, but we got the coordinates. Out. Break. Warlord, this is Coyote Six. Over.
327	(Warlord Alpha Lead)	This is Warlord. We monitored and we will check both the coordinates and to the southwest of your area.



<u>TIME</u>	<u>NO.</u>	<u>STATION</u>	<u>MESSAGE</u>	<u>REMARKS</u>
	328	Coyote 6	Coyote Six. Thank you.	
	329	(Sane Drank Delta Mike)	Push for about zero five. Over.	
	330	Coyote 6	This is Coyote Six. Roger. Anything further?	
	330A		WE GOT ABOUT TWENTY.	
	331	Helix 33	This is Three Three. Over.	
	332	Coyote 6	Six. Helix Three Three. Over.	
	333	Helix 33	Six. Over.	
	334	Coyote 6	Roger. I'm going back and Helix Three Two will be up shortly.	
	335	Coyote 6	Coyote Six. Roger. Thank you. Out.	
	336	Coyote 6	Six. Roger. What direction is _____ from you? Over.	
	337	Shark 6	He's on his way back to your area. He'll be contacting you. He's on his way back now. Over.	
	338	Warlord Alpha Lead	Charlie Six. Shark Six.	
	339	Shark 6	Warlord Alpha Lead. Those are our troops, our friendly troops. We've spotted mortar tubes on them and we are getting them out.	
	340	Shark 6	Charlie Six. Shark Six. Fox Mike.	
	*0915 to *0920		Refuel at this time. If you have anything for us here let us know at this time or else we're going to be heading on back down south.	
	341	Coyote 6	Six. This is Coyote Six. Over.	

REMARKS

MESSAGE

STATION

NO.

TIME

342	Coyote 6	Coyote Six. Over. Were you able to police up these weapons Shark talked to you about and the man they killed? Over.
343	Coyote 6	Roger. Out.
344	Charlie 81	Charlie Eight One. Over.
345	Coyote 6.	Landed next to and keep working east. Over.
346	Shark 6	Roger. This is Shark Six. There is a whole lot of movement out to the southwest here along the main trail that runs out here. The majority of them look like women and children and farmers. However, there could be some military-age males mixed in with them. Other than that the villages look like they are pretty well evacuated and we don't see any more movement at this time so we are going to head on back down south and if you need us today just give us a call.
347	Coyote 6	This is Coyote Six. Thank you much. Out.
348	Sane Drank Delta Mike	This is Sane Drank Delta Mike. Over.
349	Coyote 6	This is Coyote Six. Over.
350	Sane Drank Delta Mike	This is Delta Mike. Do you have somebody firing a mortar here on the beach? Over.
351	Coyote 6	This is Coyote Six. We have a mortar down in the beach area. He's going to fire. I don't think he's fired yet. Over.

TIME

STATION

MESSAGE

REMARKS

Sane Drank Delta Mike

This is Delta Mike. I spotted two rounds; looks like maybe sixty mike mike. In the vicinity of coordinates 742785. Over.

353 Coyote 6

Coyote Six. Roger. I'll check it out.

354 Coyote 6

(Bravo) Six. Coyote Six. Over.

355 Coyote 6

Coyote Six. Have you begun to fire your mortars yet? Over.

356 Coyote 6

Roger. Did your Dustoff come in yet? Over.

357 Coyote 6

Delta Mike. Coyote Six. Over.

Sane Drank Delta Mike.

This is Delta Mike. Over. I copie Be advised we also have one eighty-one mike mike if you need us. Over.

359 Coyote 6

This is Coyote Six. Roger.

360 Coyote 6

Bravo Six. Coyote Six. Over.

361 Coyote 6

Coyote Six. This reminder, you got Sane Drank Delta Mike out there who can help you out in that area. Over.

Sane Drank Delta Mike

Sane Drank Delta Mike. Roger. Out.

363 News Boy India 20

This is News Boy India Two Zero. Over.

363A

HE WAS AS I UNDERSTAND IT \_\_\_\_\_

Sane Drank Delta Mike

This is Delta Mike. Over.

365 News Boy India 20

This is Two Zero. I'm about two zero minutes from your location. Over.

REMARKS

MESSAGE

STATION

NO.

TIME

366	Sane Drank Delta Mike	This is Delta Mike. Come on in. Over.
367	News Boy India 20	This is News Boy India Two Zero. Roger. Out.
368	Coyote 6	Shark is going south. You got Delta Mike out there. I think he can cover that area for you.
369	Sane Drank Delta Mike	Mike. If you want, I'll open the beach for relieving, otherwise I'll stay here. I'm about 600 yards off now. Over.
370	News Boy India 20	This is Two Zero. Whatever you think. If you think you ought to stay in there, we'll come in. Over.
371	(Sane Drank Delta Mike)	Mike. We're right off the beach now. There's a lot of small arms fire coming from that direction on the beach. Is that your people? Over.
371A		TAPER GIVE ME POINTER TRAINS, PLEASE.
372	(Coyote 6)	Three W H A down there. Is that correct? Over.
373	(Coyote 6)	Very weak. Say again, then change batteries. Over.
374	Coyote 6	Coyote Six. Roger. I can come in and pick them up if you'll pop smoke for us and secure a place for us. Over.
375	(Sane Drank Delta Mike)	Delta Mike. Can you tell me where the nearest friendlies are in relation to my position? Over.
376	(Sane Drank Delta Mike)	Roger. Thank you. Out.
377	Coyote 6	(Bravo) Six Coyote Six. Tallyho Violet smoke. Over.

0943

REMARKS

MESSAGE

STATION

NO.

TIME

IS HE GOING TO PICK THEM UP.?

Coyote Six. Have the wounded sittin' there. Over.

Coyote Six. Over.

This is Six Five. Are you going into Bravo's area to pick up wounded? Over.

This is Coyote Six. That's affirmative. Over.

This is Six Five. Roger, we requested Dustoff. Just wanted to cancel it out. Over.

Coyote Six. Roger. Out.

You got somebody out in the area where these I'll say there's about eight or nine Dinks laying in there with web gear and everything. Somebody ought to police up the gear.

This is Coyote Six. Give me coordinates. Over.

Roger, it's just below the er - Hill 85. Just to the North of Hill 85 where we first got 'em just to the south of your first LZ and along the road there. There's about, oh, ten, fifteen Dinks all spread out over the field that we got when they were di-di-ing to the south. The gunships shot 'em. We'd like to know if there's somebody in the area to pick up this web gear, 'cause right now we're just keeping people from stealing it.

This is Coyote Six. I'll get somebody down there.

377A

378 Coyote 6

379 Coyote 6

380 (Coyote 65)

381 Coyote 6

382 Coyote 65

383 Coyote 6

384 (Warlord Alpha Lead)

385 Coyote 6

386 (Warlord Alpha Lead)

387 Coyote 6

0943

REMARKS

MESSAGE

STATION

NO.

TIME

388	(Warlord Alpha Lead)	Roger.
389	Charlie 81	Charlie Eight One. Over.
390	Charlie 81	Charlie Eight One. Over.
391	Charlie 81	Charlie Eight One. Over.
392	Coyote 6	Charlie Six. This is Coyote Six. Over.
393	Coyote 6	Charlie Six. This is Coyote Six. Over.
394	Coyote 6	Six. Warlord has got some people he wants you to check out. Just to the south of your LZ. Contact him and send some people down there. There's some VC there with web equipment and so on that have been killed. Over.
395	(Warlord Alpha Lead)	Roger. We are over the area at this time if you have us in sight we're just at the north base of the hill along the road. We'll be off your frequency for the next ten--one zero minutes. We'll be popping smoke at the different locations where these bodies are.
396	(Warlord Alpha Lead)	The bodies that we got before. They've got web gear, weapons and everything, and it's probably a good idea to get it off them before someone comes up and uses them.
396A		<u>          </u> TIED UP AND THERE ARE THREE OF THEM.
397	( )	Coyote Six Five. Coyote Six Five.

398 (Warlord Alpha Lead)

Roger. We'll be popping smoke on the different bodies in the area.

399 Coyote 6

Coyote Six. Over.

400 Coyote 65

Coyote Six Five.

\*0950

401 Coyote 6

Coyote Six. I'm goin' to jump off the chopper here at Dottie and this chopper'll go ahead north and take these wounded. Over.

402 Coyote 65

Six Five. Roger, be advised Sabre Six is at our location.

403 Coyote 6

This is Coyote Six. Roger. Out.

404 (News Boy India 20)

We are heading on our way down the coast. You got any messages you want to pass - want us to pass on to Movement Control at An Khe?

405 Sane Drank Delta Mike

This is Sane Drank Delta Mike. I'm gonna come out to a mile. Over.

406 News Boy India 20

This is Two Zero. Over.

407 Sane Drank Delta Mike

Mike. I'm gonna come out to a mile. Over.

408 Premo 687

This if Premo 687.

409 Coyote 65

This is Coyote Six Five. Over.

410 Charlie 81

Out. Break. Bravi Six. Charlie Eight One

410A

GOT THAT? I'LL WRITE IT UP.

411 Coyote 65

This is Coyote Six Five. Over.

REMARKS

MESSAGE

STATION

NO.

TIME

This is Premo 687. We're approximately zero five out of your location with the LNO.

This is Six Five. Real fine. Over.

Three Two. Coyote Three. Over.

Roger. Do you have any artillery firing into the area at this time? Ah...into the CA area?

This is Coyote Three. Negative, however, all three units down in that area have eighty-one mike mikes with them. I don't know whether they're firing them or not. Over.

Roger, I just saw something impact over here on the beach. It's probably what it is.

This is Coyote Three. Swift boats are out there and they have a eighty-one mike mike also. Over.

Roger. Thank you.

DO WE HAVE ANYBODY HERE WHO CAN START?

This is Six Five. Charlie Charlie. Come on in to the pad and sit down and relax.

Roger. Sounds good.

Charlie Eight One. Bravo Six would like to know whether you can get him some ammo out. He'll send what he needs in a few minutes. Over.



TIME

NO.

STATION

MESSAGE

REMARKS

423

Coyote 3

This is Coyote Three. Roger, tell him to give me the number and type ammo he needs. Over.

424

Charlie 81

Charlie Eight One. Roger. Out. Bravo.....

EXTRACT OF EXHIBIT M-21

(CPT Livingston's Letter to His Wife, 16 March 1968)

Saturday 16 March 68

Dear Betz,

\*\*\*\*\* Well its been a long day, saw some nasty sights. I saw the insertion of infantrymen and were they animals. The [y] preped the area first, then a lot of women and kids left the village. Then a gun team from the shark[s], a notorious killer of civilians, used their minny guns, people falling dead on the road. I've never seen so many people dead in one spot. Ninety-five percent were women and kids. We told the grunts on the ground of some injured kids. They helped them al[l-]right. A captain walked up to this little girl, he turned away took five steps, and fired a volly of shots into her. This Negro sergeant started shooting people in the head. Finally our OH23 saw some wounded kids, so we acted like medivacs[medevacs]. Another kid whom the grunts were going "take care of" was next on our list. The OH23 took him to Quang Nai[Ngai] hospital. We had to do this while we held machine guns on our own troops - American troops. I'll tell you something it sure makes one wonder why we are here. I can also see why they hate helicopter pilots. If I ever here a shark open his big mouth I'm going to shove my fist into his mouth. We're trying to get the captain and sergeant afore mentioned reprimanded. I don't know if we will be successful, but we're trying. Enough for that.

\*\*\*\*\*

Brian

A TRUE EXTRACT COPY:


  
H. L. COOP  
Major, AGC

EXHIBIT M-21

EXTRACT OF EXHIBIT M-22

(CPT Livingston's Letter to His Wife, 19 March 1968)

19 March 68

Dear Betz,

\*\*\*\*\*

\*\*\*\*\* You remember I told you about the massacre I witnessed, well I read a follow-up story in the paper. The article said I quote "The American troops were in heavy combat with an unknown number of V. C. Two Americans were killed, seven wounded, and 128 V. C. killed." That[']s a bunch of bull. I saw four V. C., that is, those with weapons, and the amazing thing about that, is two of them got away. It made me sick to watch it.

\*\*\*\*\*

Brian

A TRUE EXTRACT COPY:


  
H. L. COO  
Major, AGC

EXHIBIT M-22

## MIRACLE WEATHER REPORT

Scattered cloudiness throughout Monday. Winds variable at 3-5 knots per hour. Scattered rain in the afternoon. High Monday 88. Low Monday night 72.



Volume 1 Number 332 Sunday March 17, 1968

### AMERICALL DIVISION NEWS

CHU LAI (AMERICALL IO) — A combat assault into a hot LZ started the day off right for infantrymen in the Task Force Barker area of Operation Muscatine yesterday. By mid-afternoon when the enemy broke contact Americal's 11th Brigade soldiers with support from artillery and gunships had killed 128 Viet Cong. The 128 enemy dead was the largest enemy body count recorded by the 11th Brigade for a 24 hour period since they took control of Operation Muscatine. It also is the largest number killed by the "Jungle Warriors" in one day's fighting since they became a part of the Americal Division.

Other enemy contacts in the Americal's area of southern I Corps resulted in 20 enemy soldiers killed in Operation Wheeler/Wallowa and one enemy death recorded near Chu Lai. Five Americal soldiers were killed and 17 wounded and evacuated for treatment yesterday.

For the third time in recent weeks 11th Brigade infantrymen in Task Force Barker raided a Viet Cong stronghold known as "Pinkville" six miles northeast of Quang Ngai.

"Jungle Warriors", together with artillery and helicopter support, hit the village of My Lai early yesterday morning. Contacts throughout the morning and early afternoon resulted in 128 enemy killed, 13 suspects detained and three weapons captured.

A Task Force Barker company of the 1st Battalion, 20th Infantry conducted a combat assault west of My Lai and quickly killed one VC while moving away from the LZ. "Shark" gunships from the 174th Aviation Company killed four more enemy during the assault.

"Aero Scout" helicopters from the 123rd Aviation Company were supporting the infantrymen and killed two enemy. The "War Lords" also located 40 60mm mortar rounds.

The infantry company led by CPT Ernest Medina (Schofield Barracks, Ha), of the 1st Battalion, engaged and killed 14 VC and captured three M-1 rifles, a radio and enemy documents while moving toward the village. One of the ten suspects apprehended by the company told an interpreter that 35 VC had moved into the village two hours earlier.

As the "Warriors" moved through the marshes a mile west of My Lai they counted 69 enemy bodies killed by a battery of the 6th Battalion, 11th Artillery. The battery commanded by CPT Steven Gamble (Portsmouth, N.H.), fired on the enemy from a location approximately three miles to the north.

A platoon of "Barker's Bastards" from the 4th Battalion, 3rd Infantry was airlifted into a position south of My Lai. The unit led by 2LT Thomas K. Willingham (Clark, N.J.), engaged an unknown number of enemy along the beach one half mile south of the village. When contact was broken 30 Viet Cong lay dead.

Early in the afternoon a platoon observed enemy soldiers escaping into a tunnel complex. Eight of the enemy were killed and web gear, hand grenades, and small arms ammunition was recovered. Three additional suspects were detained in the Operation Muscatine area 11 miles northwest of Quang Ngai.

Elements of Americal's 196th Brigade killed 20 enemy troops and captured seven weapons, including two Chicom

(Continued On Page 2 Column 1.)

EXHIBIT M-23

## AMERICAL DIVISION NEWS (Continued From Page 1)

light machine guns as action picked up throughout the "Chargers" area of Operation Wheeler/Wallowa yesterday.

A company of the 2nd Battalion, 35th Infantry commanded by CPT Robert S. Henderson (Reno, Nev), found the bodies of ten NVA soldiers that had been killed by artillery fire. Continuing its search and destroy operation the company discovered two huts containing the two Chi-com light machine guns, three packs, 53 rounds of 40mm ammunition, two trip flares and two ponchos.

Members of a company of the 1st Battalion, 6th Infantry commanded by CPT Dan E. Prether (Bibbcock, Texas), killed three VC in two separate encounters. Another company of the 6th Battalion, led by CPT James T. Price (Fayetteville, N.C.), received two incoming hand grenades while on a sweeping operation. The infantrymen returned the fire and killed one VC. A reconnaissance element of the 1st Battalion, found one LAW and 100 rounds of 7.62mm ammunition hidden in a cave.

In other "Charger" action a company of the 3rd Battalion, 21st Infantry killed two enemy soldiers in two separate incidents. CPT John T. Thomason's (Severna Park, Md), company of the 3rd Battalion killed one VC and found the body of another killed by small arms fire. Another 21st Infantry company commanded by CPT Jose R. Feliciano (Baltimore, Md), killed one VC and found a loaded pistol during a search and destroy mission.

An Americal Division Long Range Reconnaissance Patrol killed one NVA and captured a pistol and some documents. A company of the 4th Battalion, 31st Infantry commanded by CPT Daniel R. Mellon (Fairbanks, Alaska) captured two more enemy weapons, an M-1 carbine and an AK-47 with three magazines.

In other Operation Wheeler/Wallowa action, units of Americal's 1st Squadron, 1st Cavalry operating around Tam Ky detained three suspects during search and destroy missions yesterday.

One enemy was killed by an Americal

198th Brigade unit operating south of Chu Lai yesterday.

The lone Viet Cong kill occurred in the afternoon when a patrol from the "Brave and Bold" engaged three VC ten miles southeast of here. Officials reported that the area nearby was constantly mined and booby trapped by the Viet Cong.

Americal's 14th Aviation Battalion flew 1.138 sorties, carried 1,447 combat troops and hauled 274 tons of cargo in support of the division yesterday,

## AMERICAL NEWS SHEET

MG S.W. Koster, Commanding General

MAJ Patrick H. Dionne, IO

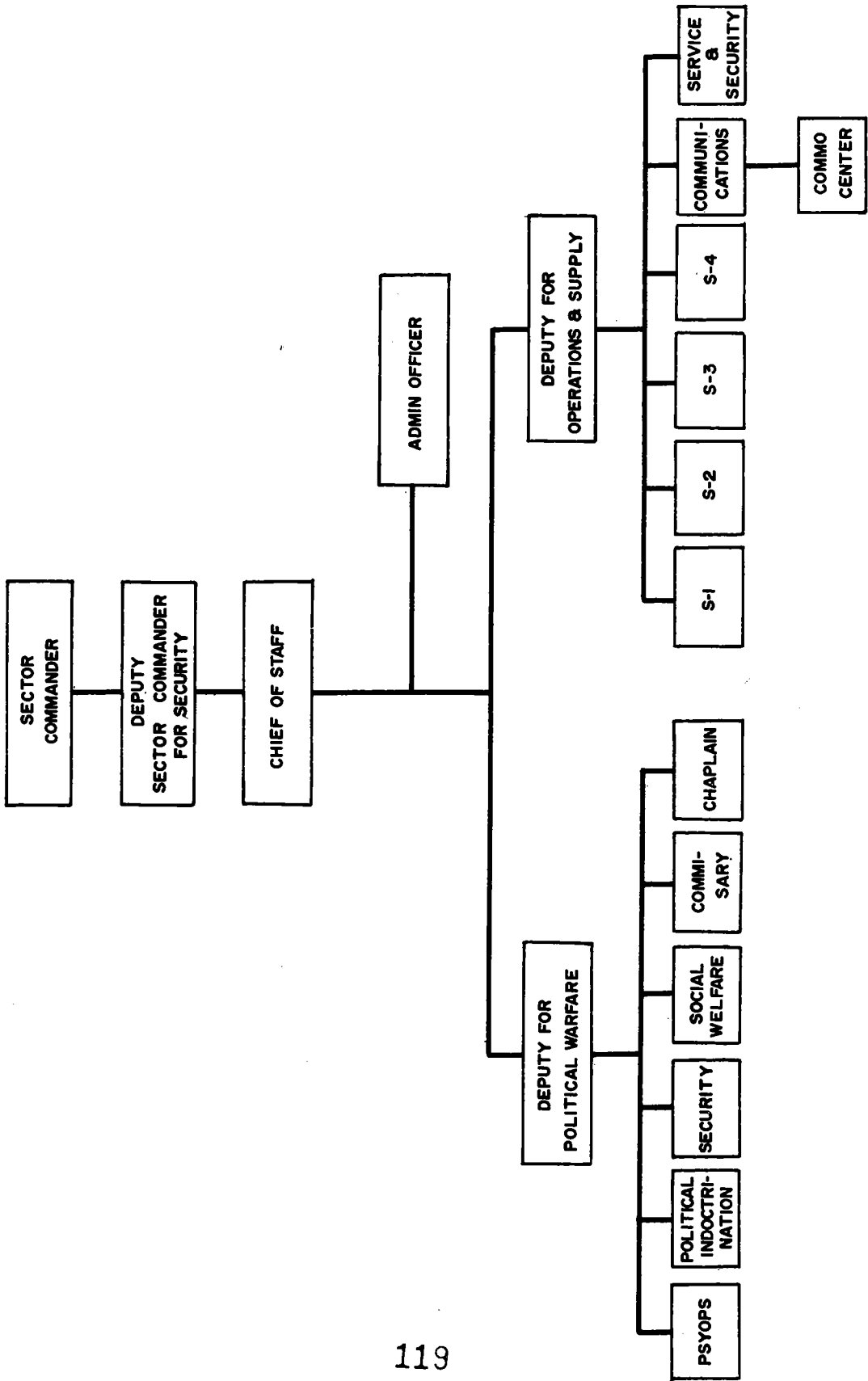
Telephone: Chu Lai 3212 or 2414

This News Sheet is published daily under the supervision of the IO, Americal Division as an authorized army publication. This News Sheet is solely for personnel in the Americal Division and may not be duplicated or released to the news media.

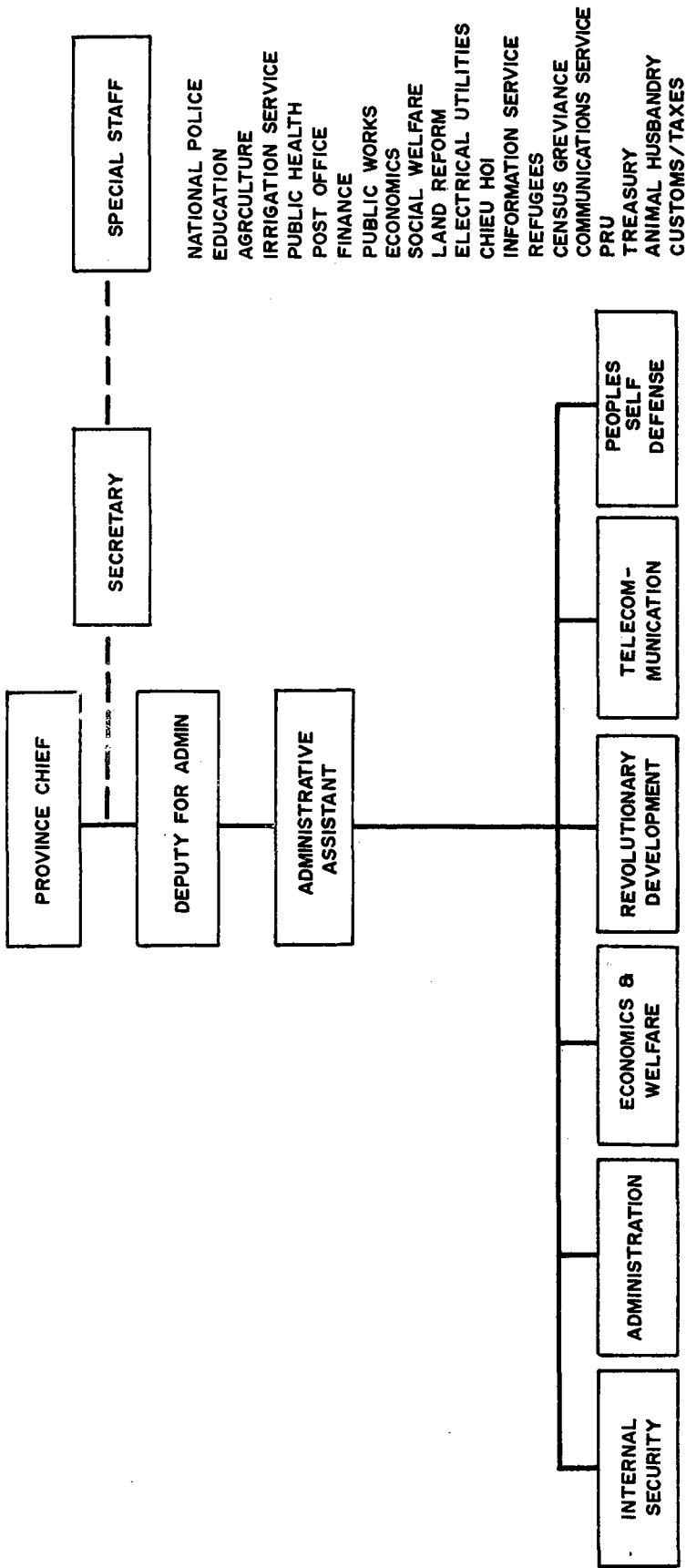


Exhibit M-24 is published in Volume III,  
Book 3, Reports.

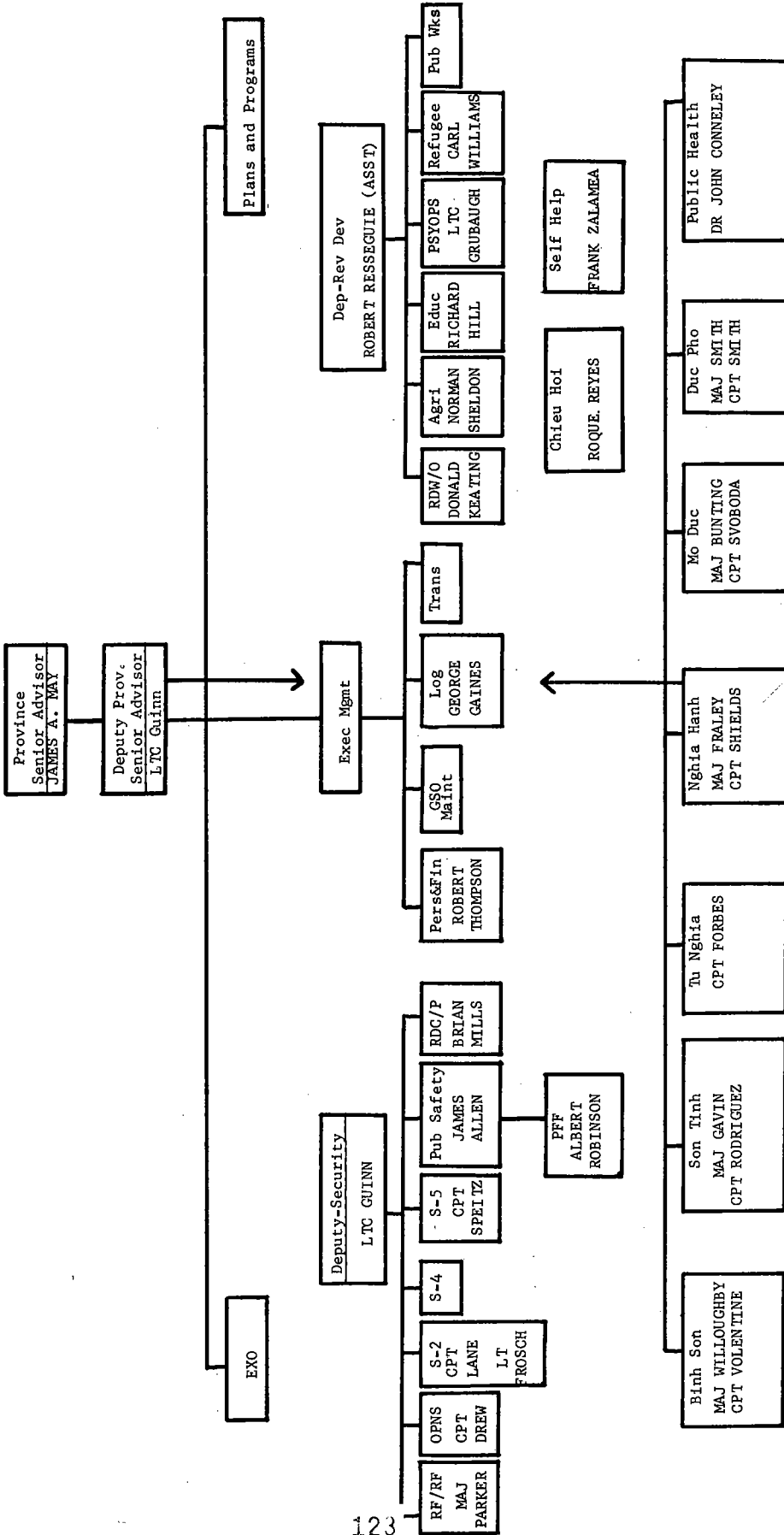
# ORGANIZATION CHART QUANG NGAI SECTOR 1968



# PROVINCE HEADQUARTERS QUANG NGAI 1968







Son Tinh, 28 March 1968

Quang Ngai Province  
Son Tinh District

No. 181/HC/ST/M

FROM: 1LT Tran Ngoc Tan  
Son Tinh District Chief

TO: Quang Ngai Province Chief

SUBJECT: Confirmation of Allied Troops Shooting at the Residents  
of Tu Cung Hamlet, Coordinates BS 721795

It is respectfully reported that:

On 19 March 1968, an element of the US Forces (unspecified, because this District Headquarters had not been notified of the operation) conducted an operation at Tu Cung Hamlet (BS 721795), Son My Village, Son Tinh District. It was reported that when the element entered the hamlet, one of its members was killed and some others wounded by a VC booby-trapped mine. At this time the VC opened up fiercely from their positions in the hamlet. Meanwhile, the US Troops used intense firepower while moving in with artillery and air support, inflicting injuries on a number of hamlet residents because the VC mingled with the population.

Observation by this headquarters:

The Tu Cung Hamlet and the neighboring hamlets, e.g., My Lai (BS 737800) and Van Thien (BS 794804), in Son My Village had become insecure since 1964, so the administrative authorities of these areas had been forced to flee to Son Long (BS 638754), leaving these hamlets under VC control. Casualties were unabridably caused to the hamlets residents during the firefight, while the local administrative authorities were not present in the area. The enemy may take advantage of this incident to undermine, through fallacious propaganda, the prestige of the RVNAF, and frustrate the Government's rural pacification efforts.

Respectfully yours,

TRAN-NGOC-TAN  
(signed)  
(sealed)

Copies to:  
S2 and S3, Quang Ngai Sector HQ

A true translation to the best of my knowledge, Saigon, Republic  
of Vietnam, 7 January 1970.

  
BILLY M. STANBERRY

Lieutenant Colonel, U. S. Army

EXHIBIT M-28

Sơn-Tĩnh, ngày 28 tháng 03 năm 1968

TỈNH QUẢNG-NGÃI  
QUẬN HÀNH-CHÁNH SƠN-TỈNH

Số: 181 /HC/ST/M

Trung-Ủy **TRẦN-NGỌC-TẤN**  
QUẬN TRƯỞNG QUẬN SƠN-TỈNH

Kính-Gởi :

TRUNG-TÁ TỈNH TRƯỞNG TỈNH QUẢNG-NGÃI

TRÍCH-YẾU : V/v xác nhận Quân-đội Đồng-Minh bắn người tại vùng hành quân Tư-Cung TBD, BS.721.795.

Trân trọng kính trình Trung-Tá Tỉnh Trưởng,

Trong ngày 19 tháng 3 1968 Quân-đội Hoa-Kỳ (không rõ Đơn-vị nào, vì cuộc hành-quân này Quận tôi không được thông-báo) đã hành quân vào Ấp Tư-Cung TBD, BS.721.795 thuộc Xã Sơn-Mỹ, Quận Sơn-tĩnh. Được biết khi Quân-đội Hoa-Kỳ tiến vào Ấp có 1 binh-sĩ vượt mìn VC tử thương và vài quân-nhân khác bị thương. Đồng thời hỏa lực địch tử trong Ấp bắn ra rất nhiều. Có lẽ vì thế Quân-đội Hoa-Kỳ đã dùng hỏa-lực cũng pháo-binh và phi-có yểm trợ đe dọa vào Ấp có gây thiệt hại cho một số hương dân vì VC lan tron chung trong Ấp đó.

Nhận-xét của Quận Sơn-tĩnh :

Ấp Tư-Cung và các Ấp lân cận như Kỳ-lại TBD, BS.735.800, Vạn-Thiện BS.704.804 thuộc Xã Sơn-Mỹ đã mất an-ninh từ năm 1964. Chính-quyền Xã Ấp tản cư đến vùng Sơn-long TBD, BS.638.754 để trú an, Toàn khu vực trên do VC kiểm soát và phòng thủ, vì thế sự giao tranh không làm sao tránh khỏi chét chóc vì bom đạn của cả 2 bên mà chính quy quyền địa phương (Xã Ấp) cũng không hiện diện để kiểm kê được. Tuy-nhiên theo luận điệu tuyên-truyền, Cộng-sản có thể xuyên tạc cốt làm giảm uy tín Quân-đội Đồng-minh trở ngại cho chủ-trương bình-dịnh Xã Ấp./-

Trân trọng

**TRẦN-NGỌC-TẤN**

(Ký tên)

(đóng dấu)

SAO KÍNH GỬI :

BCH/TK/QNG/P.2+P.3

"Thần tượng"

Republic of VN  
Quang Ngai Province  
Son Tinh District

Son Tinh, 11 April 1968  
Number 190/CT/ST

FROM: District Chief, Son Tinh

TO: Lieutenant Colonel Province Chief, Quang Ngai

SUBJECT: Allied Operation at Son My assembled and killed civilians

On 16 March 1968 an American Army unit conducted a mop-up operation at Tu Cung and Co Luy hamlets of Son My Village, Son Tinh District. At About 10 o'clock on the above day, the American unit encountered a VC mine and received fire from Tu Cung hamlet. One American soldier was killed and a number of others wounded.

In response the operational forces attacked the village, assembled the people and shot and killed more than 400 people at Tu Cung hamlet, and 90 more people in Co Luy hamlet of Son My Village. While the VC were withdrawing from the Hamlet, 48 VC and more than 52 guerillas and self defense soldiers were wounded by helicopter gun ships.

Subsector comments.

Tu Cung and Co Luy are two areas of Son My Village that have long been held by the VC. The district forces lack the capability of entering the area. Therefore, allied units frequently conduct mop-up operations and bombing attacks freely in the area. But the basic position of the report of the Son My village committee is that although the VC cannot be held blameless for their actions in the 16 March 1968 operation, the Americans in anger killed too many civilians. Only one American was killed by the VC, however the allies killed near 500 civilians in retaliation.

Really an atrocious attitude if it cannot be called an act of insane violence. Request you intervene on behalf of the people.

Respectfully

1st Lt Tran Ngoc Tan  
District Chief

Copies to:  
2nd ARVN Div Hq.  
MACV Quang Ngai Sector  
Major U.S. Advisor, Son Tinh Subsection  
(Courtesy Copy)

A TRUE TRANSLATION TO THE BEST OF MY KNOWLEDGE, HEADQUARTERS,  
DEPARTMENT OF THE ARMY - 6 FEBRUARY 1970

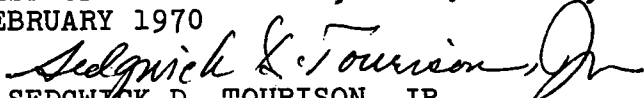
  
SEDGWICK D. TOURISON, JR.  
WARRANT OFFICER, USA

EXHIBIT M-29

VIỆT-NAM CỘNG-HÒA

TỈNH QUẢNG-NGÃI  
QUẬN SƠN-TỈNH.

Sơn-tỉnh, ngày 11 tháng 04 năm 1968

SỐ: \_\_\_/QT/ST

\*\*\*\*\*

QUẬN-TỈNH SƠN-TỈNH.

Kính-gởi: TRUNG-TÁ TỈNH-TRƯỞNG QUẢNG-NGÃI

Trích-yếu: v/v Đồng-Minh hành-quân tại Xã Sơn-Nỹ đã tập trung đồng-bào đến giết chết.

Trân-trọng kính trình Trung-Tá,

Trong ngày 16 tháng 3 năm 1968, đơn-vị lực-quân Hoa-kỳ đã mở cuộc hành-quân tạo-thành Việt-Cộng tại các ấp Tư-Cung, Cổ-lũy thuộc Xã Sơn-mỹ, huyện Sơn-tỉnh, cuộc hành-quân tiếp-diễn đến khoảng 10 giờ ngày trên, đơn-vị Hoa-kỳ đã bị Việt-Cộng còng từ ấp Tư-cung bắn ra và đâm phải mìn VC làm CI binh-sĩ Hoa-kỳ tử-thương và số khác trọng thương.

Vì thế, lực-lượng hành-quân dùng hỏa-lực tấn-công vào ấp, dọn dẹp tập-trung đồng-bào bắn chết trên 400 người tại ấp Tư-cung và 90 người khác tại ấp Cổ-lũy Xã Sơn-mỹ. Cùng thời VC rút lui khỏi Ấp đã bị tập trung và trong bắn chết 40 tên và hơn 52 tên cán bộ Tự-quản và lực-lịch Việt-Cộng bị thương tại vùng hành quân nơi trên.

Nhận xét Chi Khu :

Vùng Tư-Cung và Cổ-lũy là 2 ấp liền thuộc xã Sơn-Nỹ đã bị Việt-Cộng chiếm từ lâu. Các vị lực-lượng cơ-hội quân xen như bát khã xâm phạm. Vì thế, đơn-vị đồng - quân đã mở hay tạo thành và oanh-kiệt bị đe. Những căn cứ vào báo cáo của Hội-đồng xã Sơn-Nỹ, trong cuộc hành-quân của Hoa-kỳ ngày 16 tháng 3 năm 1968 vừa qua đã làm thiệt hại bắn chết thường dân quá nhiều, đành rằng không thể sang tha cộng-sản.

Tuy nhiên chỉ một binh-sĩ Hoa-kỳ tử-thương vì Việt-Cộng mà Đồng-Minh đã giết chết gần 500 thường dân để thường mạng.

Thật là một thái-độ tàn nhẫn nếu không gọi là cuồng n. bạo, thiếu tình nhân loại !!

Kính xin Trung-Tá can thiệp để dân được nhờ ./-

Trân trọng,

MAO HINH GỎI :

- Bộ Tư-Lệnh SD/2/BB/P2
- Thái Bộ PACV/QNG
- Chiếu-Té Cố vấn Hoa-Kỳ Chi Khu Sơn-Tỉnh  
( Kính trình ở đây )

S T A T E M E N T

14 April 1968

THIS STATEMENT IS IN REFERENCE TO LETTER FROM THE SON TINH DISTRICT CHIEF TO THE QUANG NGAI PROVINCE CHIEF, SUBJECT: ALLIED FORCES GATHERED PEOPLE OF SON-MY VILLAGE FOR KILLING, DATED 11 APRIL 1968.

THE SON TINH DISTRICT CHIEF RECEIVED A LETTER FROM THE VILLAGE CHIEF OF SON-MY VILLAGE CONTAINING THE COMPLAINT OF THE KILLING OF 490 CIVILIANS INCLUDING CHILDREN AND WOMEN BY AMERICAN TROOPS. THE VILLAGE CHIEF ALLEGED THAT AN AMERICAN UNIT OPERATING IN THE AREA ON 16 MARCH 1968 AND KILLED THESE CIVILIANS WITH THEIR OWN PERSONAL WEAPONS. THE INCIDENT TOOK PLACE IN THE HAMLETS OF TU-CONG AND CO-LUY LOCATED IN THE EASTERN PORTION OF SON TINH DISTRICT. ACCORDING TO THE VILLAGE CHIEF THE AMERICAN UNIT GATHERED 400 CIVILIANS IN TU-CUNG HAMLET AND KILLED THEM. THEN MOVED TO CO-LUY HAMLET. AT THIS LOCATION THE UNIT GATHERED 90 MORE CIVILIANS AND KILLED THEM.

THE SON-MY VILLAGE CHIEF FEELS THAT THIS ACTION WAS TAKEN IN REVENGE FOR AN AMERICAN SOLDIER KILLED BY SNIPER FIRE IN THE VILLAGE.


THE LETTER WAS NOT GIVEN MUCH IMPORTANCE BY THE DISTRICT CHIEF BUT IT WAS SENT TO THE QUANG NGAI PROVINCE CHIEF. LATER THE SON TINH DISTRICT CHIEF WAS CALLED AND DIRECTED BY THE 2D DIVISION COMMANDER, COLONEL TOAN, TO INVESTIGATE THE INCIDENT AND PREPARE A REPORT. THE DISTRICT CHIEF PROCEEDED TO INTERVIEW THE SON-MY VILLAGE CHIEF AND GOT THE SAME INFORMATION THAT I HAVE DISCUSSED ABOVE. THE DISTRICT CHIEF IS NOT CERTAIN OF THE INFORMATION RECEIVED AND HE HAS TO DEPEND ON THE WORD OF THE VILLAGE CHIEF AND OTHER PEOPLE LIVING IN THE AREA.

THE TWO HAMLETS WHERE THE INCIDENT IS ALLEGED TO HAPPEN ARE IN A VC CONTROLLED AREA SINCE 1964.

ANGEL M. RODRIQUEZ  
CPT, INF  
Asst Dist Advisor, Son Tinh

EXHIBIT M-30

A TRUE COPY:

  
H. L. COOK  
MAJ, AGC

18 March 68

REPUBLIC OF VIET NAM

letter report

Report of results Son My Village, Tu Cung hamlet, Son Tinh District:

About 7 AM 15 Mar 68, an operation conducted by allied forces was conducted in Tu Cung hamlet.

A Force composed of District VC and local guerillas (strength unknown) opposed the Allied operation.

After a fierce battle the allies killed 320 people at subhamlet Thuan Yen and Binh Dong.

27 people were killed at My Lai. Among this number was a hamlet security chief named Le Van Gia.

At Co Luy Hamlet 80 people young and old were killed. The total civilians and guerillas killed during the last 3 days 227, including young and old.

At this time the Allied operation is continuing and the force is now located at Co Luy in Son My Village.

Presented for CSG Chief, Quang Ngai

Completed at 1600 Hrs 18 Mar 68

CSG Cadreman

Phong Duc \_\_\_\_\_  
(Last name not legible)

A TRUE TRANSLATION TO THE BEST OF MY KNOWLEDGE, CHU LAI, REPUBLIC OF VIETNAM, 3 JANUARY 1970

  
BILLY M. STANBERRY  
Lieutenant Colonel, United States Army

ĐP. 38-B.4-m

10/11/54

Trình báo đơn thỉnh cầu thành lập trường tiểu học  
nhằm các lớp tiểu học tại xã Hòa Bình -

Điền - xã 4/6 - Các lớp tiểu học hiện nay ở đơn vị -

Tại ấp Tân Long thuộc xã Hòa Bình, huyện Hòa Bình  
tỉnh Quảng Ngãi -

Nếu các trường tiểu học này 15 tháng 5 năm 1954  
một cuộc hành quân do quân đội đồng minh  
trở về.

Một là ngày tháng hiện nay là do việc  
đã có (không rõ quân số) của đồng đội với  
lực lượng đồng minh -

Các học sinh giao thừa đã biết các  
trường đồng minh đã hạ số 320 người tại các  
thôn Tân - Yên và Minh - Bình -

Mà số học sinh báo tại này - tại 17 người  
trong số đó có 1 học sinh sinh viên ở trường  
Tân Lê - Văn - Giã -

Tại ấp Cổ - Tân, họ 80 người lớn nhỏ.  
Số học sinh báo ở đây cũng như các học  
sinh ở trường này báo ngày xưa 127 người lớn  
nhỏ -

Hiện nay các học sinh hành quân của đồng minh  
còn đang chờ đợi và chờ đợi tại ấp  
Cổ - Tân thuộc xã Hòa Bình -

Này xin trình bày trường tiểu học  
trung tâm huyện để biết lý do mà các  
thần thầy -

Lập xong vào hồi 16 giờ - 18-3  
Bản bộ phụ trách

132 Ông. C. C. D. -

Trần Văn Thọ  
14  
1/3



POSTAL MESSAGE

FROM: G-2, Tactical Zone 12.  
TO: Quang Ngai Sector


Message Number 1242/18

Reference report number 190/CK/ST, dated 11 April 1968 from Son Tinh District, Subject: Report that an American unit operation at Son My Village on 16 Mar 68 where near 500 civilians were assembled, shot and killed.

Request Sector conduct another investigation. In event report is not true, instruct Son Tinh District to rectify the above report. If correct, report to G-2, 2nd Division; this headquarters will intervene.

KBC 4.277, 15 April 1968  
COL Nguyen Van Toan  
CG 2nd ARVN Div, 12 Tactical Zone  
Signed LTC Pham Cao Dong Chief of Staff

A TRUE TRANSLATION TO THE BEST OF MY KNOWLEDGE, CHU LAI, REPUBLIC OF VIETNAM  
1 JANUARY 1970



BILLY M. STANBERRY  
Lieutenant Colonel, United States Army

B U D - 1 1 2

QUY CHẾ : ...

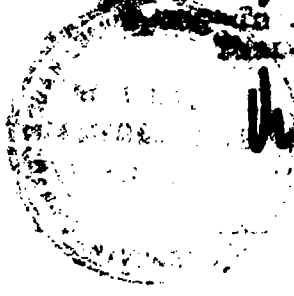
MỠ : ...

1202

Tham chiến pháo-trình số 104/XX/01 ngày 11/4/68 của Quân Sơn-Tĩnh + Bắc-cấp địa-vị Hoa-Kỳ hình-quả tại địa-ban-ỹ ngày 16/3/68 đã tập-trung bắn chết gần 900 người dân +

Yêu-cầu Quý Tiểu-Khu cho điều tra lại + Trường hợp không đúng sự thật + chỉ-thị Quân-Sơn-Tĩnh đính chính pháo-trình trên + Báo cáo pháo-trình về Bộ-Tổng-Lệnh Sư-Đoàn 2 tháng 2 để an-thiết +

1202.277, ngày 13 tháng 4 năm 1968  
Thư-Lệnh Sư-Đoàn 2/ĐB Khu I CT  
Đã-đọc và đồng-ý  
Thư-Lệnh Sư-Đoàn 2/ĐB Khu I CT  
Đã-đọc và đồng-ý



Handwritten signature

CS (Peers Inquiry)

12 March 1970

MEMORANDUM FOR RECORD

SUBJECT: Translation of Vietnamese Document

1. Exhibit M-33 is an English Translation of a Vietnamese (VC) document that accompanied Major Pham Van Pho's 12 April 1968 memorandum to Colonel Toan, CG, 2d ARVN Division (Exhibit M-36).
2. To provide the most accurate English translation of Vietnamese documents, a verification of the translations was accomplished.
3. The translation by WO Sedgwick D. Tourison is considered to be the most accurate and is therefore considered to be Exhibit M-33.

2 Incl

1. English translation
2. Vietnamese document

  
JAMES H. PATTERSON  
Lieutenant Colonel, Armor

Script for Megaphone

THE AMERICAN DEVILS SHOW THEIR TRUE FORM

(Use together with the leaflets: "Force the American pirates to repay this blood debt")

- - - - -

The American imperialists provoked an aggressive war by invading the Southern part of our country, but they stubbornly maintained they came to help our people, calling themselves our "friends."

When they first came to the South, they attempted to find a way to conceal their savage aggression. They issued directives to the American soldiers that they must maintain good relations with our people. Their psychological warfare offices also issued what was called the "9 Disciplines" in which the general ideas were "respect women, respect the customs of the Vietnamese people," etc. and etc.

When the American soldiers just set foot on this ground, they showed they were "refined and polite" exact in business dealings, even going so far as to sometimes paying more than the normal price, and carefully reimbursing for damages. Then there were places where the people were allowed to come into the posts, places where they went into the hamlets to give medical examinations and give the people medicine. The Americans newspapermen produced pictures of American soldiers shaking hands with the Vietnamese, kissing children and giving them candy, American medics wearing Red Cross armbands examining the people...these were all well known pictures taken in the places these soldiers were stationed. These flattered people believed the Americans were good friends, honest, polite and warm. How couldn't one help but be happy being an ally with a prosperous friend who was also so good.

However, there comes a time when the curtain must come down at the end of the play. If, in order to become good actors and to become more talented, a play is allowed to continue on and on, it will become offensive. All the more reason for this play which flatters the people to be rubbed out quicker than any other.

It could be argued that this play would become more "enjoyable," more "flavorable," if the Americans were only able to have a few more victories each year. Unfortunately, each year, the army and the people of the South are making them suffer a more painful defeat with each passing day. For that reason, these flattered people are being awakened early. At the present time, the American soldiers can no longer hide anything. They have become audacious and revealed the characteristics of every aggressive Army. On sweep operations there is a daily increase in the plundering, killing and rape. They have showed their animal savagery, their American "culture." In Saigon

one would take his penis out of his pants, place a dollar on it, and force the young girls selling things to them, to take it. American soldiers chased girls in all the public places: on the beach, on the street...disregarding the looks of the passers by. In the areas they stationed troops, they searched the civilians in order to steal their money, rings, watches, and ear rings...even going so far as to be able to distinguish true gold from the fake, and then not taking the fake.

Their senseless acts during the first part of the recent spring offensive showed they were like seriously wounded animals, becoming more insane and more ferociously cruel, loosing all sence of human behavior. They rained bombs and bullets on refugee areas in each city, especially in Hue, Saigon and Bentre. According to their own confirmation, up to 70% of the buildings in Hue were destroyed. Tens of thousands of our countrymen were killed or left homeless. Western news papermen and radio stations acknowledged that the destruction of civilian buildings in the southern cities was due to the American bombs and bullets, the reason being the American firepower was stronger than that of the Liberation Army. English newspapermen said: The American bombing directly on the cities, especially Saigon, will be condemned by public opinion. These American actions are too much. Japanese public opinion said: The Americans will be isolated and lose people's sympathy when they bomb cities, and will cause a wave of anti-American feeling in the South. Ignore public opinion and international public opinion protests. Even now the public opinion of the Americans allies is not sympathetic to the American's continuing to close their eyes and continue to commit their crimes.

Recently, during their sweep operation on March 15, 1968, in Son Tinh, the American pirates insanely used automatic rifles and all other types of weapons to kill 500's of our people in Tinh Khe Village (that is, Son My). A large number of these were women and children with newborn infants, many pregnant women and even women ready to give birth. They opened fire as soon as they saw anyone, killing nearly all the livestock, burning the people's houses. 26 families were completely wiped out to the last person.

The ferocious American devils have thrown off their clothing to show their cruel form.

Our people have only one choice, that is to strike them dead.

By now our Vietnamese soldiers and officers have surely seen the true face of the Americans. How many times they fled leaving them to fight the Liberation Army troops and didn't even provide a single round of mortar fire for support, even though they were right beside them. There have even been times when they dropped bombs on the bodies of puppet troops to destroy them completely. They often placed artillery and mortar fire on them.

The role of the puppet troops being cannon fodder is quite clear. Anyone who doubts this should look at the 39th Ranger Battalion presently

being pushed out to the Khe Sanh area, to lie in front of the American Marines. This Battalion was given the name "Resigned to Death." However, the resignation to death here is not in the name of the fatherland as with the liberation soldiers but is rather to insure the lives of the 6000 American soldiers there.

There, that's American culture, that's what good friends are like.

How can one accept these assassins? Are these allies, these who have murdered our countrymen, spilling the same Vietnamese blood, red like the blood flowing in all our veins?

What are you waiting for but to take the Americans guns and fire them into their heads to avenge our countrymen to repay the country and save my honour and life.

Now is the best time of all: HE WHO HOLDS AN AMERICAN GUN SHOULD AIM AT THE AMERICANS HEADS AND PULL THE TRIGGER!

A TRUE TRANSLATION TO THE BEST OF MY KNOWLEDGE, WASHINGTON, D. C., 12 MARCH 1970:

*Sedgwick D. Tourison*  
SEDGWICK D. TOURISON  
W1, MI  
OACSI, HQ DA

(đùng phối hợp với truyện đơn :  
"Bất giặc Mỹ trả món nợ máu này"

Để quốc Mỹ gây chiến tranh xâm lược miền Nam nước ta, nhưng lại leo lẻo là sang để giúp nhân dân ta, tự gọi là "bạn" của nhân dân ta.

Khi mới bước chân vào miền Nam chúng cũng cố tìm cách che dấu cái dã tâm xâm lược ấy. Chúng ra những chỉ thị cho binh lính Mỹ là phải giữ mối quan hệ tốt với nhân dân ta. Cơ quan tâm lý chiến của chúng con đề ra cái gọi là "9 điều kỳ mật" trong đó có những điểm nêu đại ý là "phải tôn trọng phụ nữ, tôn trọng phong tục tập quán của người VN" vv... và vv...

Lính Mỹ lúc mới đặt chân lên đất này cũng cố tỏ ra là con người "hào hoa lịch sự", mua bán song phẳng, thậm chí có khi trả tiền nhiều hơn giá thị trường, làm hư hỏng cũng bồi thường cẩn thận. Đôi thì nơi thì để nhân dân lên đôn, nơi thì xuống tận thôn xóm khám bệnh, cho thuốc nhân dân. Báo chí Mỹ đưa lên những hình ảnh lính Mỹ bắt tay người VN, hôn hít và cho kẹo trẻ em, y tá Mỹ đeo băng hồng thập tự khám bệnh cho dân... và huyền hoang đó là những hình ảnh quen thuộc ở nơi chúng ta đóng quân. Những trò mị dân kia đã làm cho một số binh sĩ nhẹ dạ đã cho Mỹ đúng là một ông bạn tốt, chân thành, tử tế, thương người. Được là đồng minh với 1 ông bạn có tiền của, lại có lòng tốt như vậy chẳng sung sướng lắm sao?

Nhưng đã là trò thì bất cứ màn trò nào cũng phải tới lúc hạ màn. Cho dù diễn viên có khéo léo, tài nghệ có cao đến đâu, thì diễn mãi một trò cũng trở thành trò trên. Huống hồ là cái trò mị dân lại càng mau "lộ tẩy" hơn trò nào hết.

Cái trò này lẽ ra có thể diễn "xôm" hơn, "mùi" hơn, nếu như Mỹ mỗi năm chỉ đánh được ít nhiều thắng lợi nào đó. Khốn nỗi mỗi năm chúng bị quân dân miền Nam đánh cho ngay càng thua đau hơn. Cho nên cái trò mị dân sớm càng bị vạch mặt hơn. Đến nay thì lính Mỹ không còn che dấu gì nữa, chúng đã trắng trợn để lộ tất cả những tính cách điển hình của bất cứ một đội quân xâm lược nào. Đi cần, những hành động cướp bóc, tàn sát, hiếp dâm ngày càng nhiều, chúng đã để lộ tất cả những dã tâm thú vật, những "văn minh" nước Mỹ của chúng. Ở Sài Gòn có tên đã kéo đường vật của chúng ra ngoài quân, đặt đồng đô la lên để bắt chỉ em bán hàng cho chúng phải cầm lấy. 5 lính Mỹ đã chơi gái ở mọi nơi công cộng : bãi biển, ngoài đường .. bất kể con mắt của người qua lại. Ở vùng chúng đóng quân, chúng khám xét đồng bao để lấy từng đồng bạc, từng cái nhân, đồng hồ, đôi bông... thậm chí còn biết phân biệt vàng giả thì không lấy.

Trước những thảm bại vô cùng nặng nề của chúng trong đợt tấn công vừa qua chúng như con thú dữ bị thương nặng, càng rầy rụa điên cuồng, càng tỏ ra tàn ác dã man, mất hết nhân tính. Chúng đã đem bom đạn trút bừa bãi xuống các vùng đông dân cư trong các thành phố, nhất là ở Huế, Sài Gòn, Bến Tre. Ở Huế theo chúng xác nhận, có đến 70% nhà cửa bị phá hủy. Hàng vạn đồng bào ta bị chết hoặc ở trong cảnh màn trời chiếu đất. Báo chí và đài phát thanh phương tây cũng phải thừa nhận là những thiệt hại nhà cửa của dân chúng trong các thành phố ở miền Nam là do bom đạn Mỹ bởi vì Mỹ có hỏa lực mạnh hơn quân giải phóng. Báo chí Anh nói : việc Mỹ ném bom ngay xuống các

thành phố, nhất là Saigon, sẽ bị dư luận lên án, Mỹ hành động như thế là hơi quá. Dư luận Nhật thì nói : Mỹ sẽ bị cô lập và mất căn tính trong khi ném bom các thành phố, sẽ gây nên một làn sóng bài Mỹ ở miền Nam. Bất chấp dư luận dư luận thế giới phản đối, ngay dư luận đồng minh của Mỹ cũng không đồng tình Mỹ vẫn nhắm mắt bưng tai tiếp tục hành động tội ác của chúng.

Gần đây trong cuộc can ngày 15/3/68 ở Sơn Tịnh, giặc Mỹ đã điên cuồng dùng Trung Liên và tất cả các loại vũ khí khác bắn giết hàng 500 đồng bào ta tay không ở xã Tịnh Khê (tức Sơn Mỹ). Số đông những người này là đàn bà con nít, có những em nhỏ mới sinh, có nhiều bà mẹ mang thai, và có cả những bà gần tới ngày sinh. Chúng đã bắn khi nhìn thấy một ai, giết hầu hết trâu bò gia súc, đốt phá nhà cửa của đồng bào. 26 gia đình đã bị chúng tàn sát hết, không còn một người.

Con quỷ dữ Mỹ đã vứt bỏ tấm áo thầy tu để hiện nguyên hình tàn ác dã man của nó.

Nhân dân ta chỉ còn một con đường là đập cho nó chết hẳn thì nó mới hết dây dưa, cắn quanh cắn quẩn.

Anh em sĩ quan binh lính người Việt đến lúc này hẳn đã rõ bộ mặt thực của Mỹ rồi. Biết bao lần chúng đã bỏ mặc cho họ ăn đon của quân giải phóng mà không hề bắn chi viên đến một trái cối, mặc dầu chúng ở ngay bên cạnh. Thậm chí có lần chúng dội bom thẳng xác chết của lính ngự để thủ tiêu luôn, có nhiều lần bắn pháo, cối ngay đội hình của họ.

Cái địa vị làm bia đỡ đạn của lính ngự đã quá rõ ràng. Có ai ngờ vực thì hãy nhìn vào Tiểu Đoàn biệt động 39 hiện đang bị đẩy ra đóng vùng khe sanh, án ngữ phía trước cho bọn lính thủy đánh bộ Mỹ thì rõ. Cũng cho Tiểu Đoàn này cái tên là "Quyết tử". Nhưng quyết tử đây không phải là để cho tổ quốc quyết sinh như các chiến sĩ giải phóng, mà là để giữ lấy sinh mạng cho 6.000 lính Mỹ ở đây.

Đó, cái văn minh Mỹ, cái lòng tốt của ông bạn là thế.

Có thể nào thừa nhận bọn sát nhân, bọn tàn sát đồng bào ruột thịt của mình làm đổ giống máu Việt Nam, cũng đổ như giống máu chảy trong huyết quản mình, là đồng minh không?

Còn chờ đợi gì nữa mà không đem ngay súng Mỹ bắn vào đầu Mỹ, trả thù cho đồng bào, rửa nhục cho đất nước, cứu vinh dự và tính mạng cho bản thân?

Lúc này hơn lúc nào hết :

SÚNG MỸ TRONG TAY ĐÓ

HÃY NHẢM TRÚNG ĐẦU MỸ

XIẾT CÒ!



Republic of VN  
Quang Ngai Province  
Son Tinh District

Son Tinh, 11 April 1968  
Number 190

From: District Chief, Son Tinh

To: Lieutenant Colonel Province Chief, Quang Ngai

SUBJECT: Allied operation at Son My assembled and killed Civilians

On 16 March 1968 an American Army unit conducted a mopping-up operation at Tu Cung and Co Luy hamlets of Son Tinh Village. At About 10 o'clock on the above day, the American unit encountered a VC mine and received fire from Tu Cong hamlet. One American soldier was killed and a number of others wounded.

In response the operational forces attacked the village, assembled the people and shot and killed more than 400 people at Tu Cung hamlet, and 90 more people in Co Luy hamlet of Son My Village. While the VC were withdrawing from the Hamlet, 48 VC and more than 52 guerillas and self defense soldiers were wounded by helicopter gun ships.

Subsector comments.

Tu Cung and Co Luy are two areas of Son My Village that have long been held by the VC. The district forces lack the capability of entering the area. Therefore, allied units frequently conduct mop-up operations and bombing attacks freely in the area. But the basic position of the report of the Son My village committee is that although the VC cannot be held blameless for their actions in the 16 March 1968 operation, the Americans in anger killed too many civilians. Only one American was killed by the VC, however the allies killed near 500 civilians in retaliation.

Really an atrocious attitude if it cannot be called an act of insane violence. Request you intervene on behalf of the people.

Respectfully

1st Lt Tran Ngoc Tan  
District Chief

Copies to  
2nd ARVN Div Hq.  
MACV Quang Ngai Sector

A TRUE TRANSLATION TO THE BEST OF MY KNOWLEDGE, CHU LAI, REPUBLIC OF VIETNAM  
1 JANUARY 1970

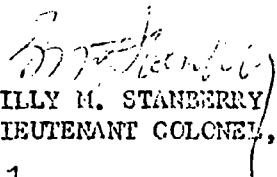
  
BILLY M. STANSBERRY  
LIEUTENANT COLONEL, UNITED STATES ARMY

EXHIBIT M-34

VIỆT-NAM CỘNG-HÒA

TỈNH QUẢNG-NGÃI  
QUẬN SƠN-TỊNH.

◆◆◆◆◆

Sơn-tĩnh, ngày 11 tháng 04 năm 1968

SỐ: 142 /CT/ST

QUẬN-TRƯỞNG SƠN-TỊNH.

Kính-gởi: TRUNG-TÁ TỈNH-TRƯỞNG QUẢNG-NGÃI

Trích-yếu: v/v Đồng-Minh hành-quân tại Xã Sơn-Mỹ đã tập trung đồng-bào đến giết chết.

Trân-trọng kính trình Trung-Tá,

Trong ngày 16 tháng 3 năm 1968, đơn-vị lực-quân Hoa-kỳ đã mở cuộc hành-quân tạo-thành Việt-Cộng tại các Ấp Tư-Cung, Cồ-lũy thuộc Xã Sơn-mỹ, Quận Sơn-tĩnh, cuộc hành-quân tiếp-diễn diễn đến khoảng 10 giờ ngày trên, đơn-vị Hoa-kỳ đã bị Việt-Cộng còng từ ấp Tư-cung bắn ra và đâm phải mìn VC. làm OI binh-sĩ Hoa-kỳ tử-thương và số khác trọng thương.

Vì thế, lực-lượng hành-quân dùng hỏa-lực tấn-công vào ấp, đoạn tập-trung đồng-bào bắn chết trên 400 người tại ấp Tư cung và 90 người khác tại ấp Cồ-lũy Xã Sơn-mỹ. Đồng thời VC rút lui khỏi Ấp đã bị trực thăng và-trang bắn chết 48 tên và hơn 52 tên cán bộ Tự-quản và du-kích Việt-Cộng bị thương tại vùng hành-quân nói trên.

Nhận xét Chi Khu :

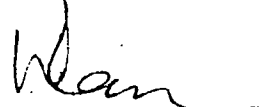
Vùng Tư-Cung và Cồ-lũy là 2 Miền thuộc xã Sơn-Mỹ đã bị Việt Cộng chiếm từ lâu. Nơi này lực lượng cơ-hữu Quận xem như bet khê xem phạ. Vì thế đơn vị đồng-minh thường hay tạo thanh và oanh-kiích tự do. Nhưng căn cứ vào báo cáo của Hội-đồng xã Sơn-Mỹ, trong cuộc hành-quân của Hoa-kỳ ngày 16 tháng 3 năm 1968 vực qua đã hăng tiết và bắn chết thương đến quá nhiều, đành rằng không thể dung tha cộng-sản.

Tuy nhiên chỉ một binh sĩ Hoa-kỳ tử thương vì Việt-Cộng mà Đồng-Minh đã giết chết gần 500 thường dân để thường mạng.

Thật là một thái-độ tàn nhẫn nếu không gọi là cuồng m. bạo, thiếu tình nhân loại !!

Kính xin Trung-Tá can-thiệp để dân được nhờ ./-

Trân trọng,



AD TỈNH GỬI :

BỘ TƯ-ỆNH 30/2/BP/BC

Thư Bộ 10/GV/ONG

Chiếu-Té Cố vấn Hoa-Kỳ Chi Khu Sơn-Tĩnh

(Kính trình đồng)

16 February 1970

NOTE FROM COL WHALEN

The handwriting on the document is that of COL Khien, formerly the Quang Ngai Province Chief.

It is in the best of his recollection the same data as that on the copy that was noted at a previous interview.

He received the data from a US Advisor -- he doesn't remember but thinks that it was the G-2 Advisor --

Present were LTC Stanberry  
Mr. Wells  
COL Wilson  
Quang Tri

W

VIỆT-NAM CÔNG-HOÀ

LIÊN-HỢP CHUNG-NGÀI

Sơn-tĩnh, ngày II tháng 4 năm 1968

Số : 192/CT/ST

QUẢN-TRƯỞNG SƠN-TỈNH

Yêu cầu ĐƠN-VỊ TỈNH-TRƯỞNG QUẢNG-NGÀI

Trích-viên.- V/v Đồng-minh hành quân tại xã Sơn-mỹ đã tập-trung đông-bào bắn giết chết.

Trân-trọng kính trình Trung-Tả,

Trong ngày 16 tháng 3 năm 1968, đơn-vị Lục-quân Hoa-kỳ đã mở cuộc hành quân tảo-thanh Việt-cộng tại các ấp Tư-cung, Cồ-lũy thuộc xã Sơn-mỹ, quận Sơn-tĩnh. Cuộc hành quân tiếp-diễn đến khoảng 10 giờ ngày trên, đơn-vị Hoa-kỳ đã bị VC. từ ấp Tư-cung bắn ra và đâm phải mìn VC. làm 01 binh-sĩ Hoa-kỳ tử thương và số khác trọng thương.

Vì thế, lực-lượng hành quân dùng hỏa-lực tấn-công vào ấp, đoạn tập-trung đông-bào bắn chết trên 400 người tại ấp Tư-cung và 90 người khác tại ấp Cồ-lũy xã Sơn-mỹ. Đồng thời VC, rút lui khỏi ấp đã bị trực-thăng võ-trang bắn chết 48 tên và hơn 52 tên Cáo-bộ tự-quan và du-kích VC. bị thương tại vùng hành quân nói trên.

Nhấn-rất Chi-khu.-

Vùng Tư-cung và Cồ-lũy là 2 miền thuộc xã Sơn-mỹ đã bị VC chiếm từ lâu. Đối với lực-lượng cơ-biểu Quận xem như bất khả xâm phạm. Vì thế đơn-vị Đồng-minh thường hay tảo-thanh và canh-kích tự-địa. Nhưng sẵn-cú vào báo-cáo của Hội-đồng xã Sơn-mỹ, trong cuộc hành quân của Hoa-kỳ ngày 16 tháng 3 năm 1968 vùng này đã hứng tiết và bắn chết thương dân quá nhiều, đáng rằng không thể đứng thờ-cộng-án.

Tuy nhiên, chỉ 01 binh-sĩ Hoa-kỳ tử thương vì Việt-cộng mà Đồng-minh đã giết chết gần 500 thường dân để thương nặng.

Thật là một thái-độ tàn-nhân nếu không gọi là cường-bạo, thiếu tình nhân-loại !!

Kính xin Trung-Tả can thiệp để dân được nhờ ./-

SÁC KINH GỢI :

- Bộ Tư-lệnh SP/2/BB/P2 .

- Phái-bộ MACV/QNG .

'Kính trình tường' ./-



Trân-trọng,

*[Handwritten signature]*

*operation  
- 100k force  
CO A - 128 VC killed  
Document & munitions*

**TOP SECRET**

*Information  
provided by American  
advisor*

*MACV/SP/2/BB/P2*

*10-20*

*42/7-68*

The following is a full translation of a three page notice issued by the QUANG NGAI (P) National Liberation Front Committee, dtd 28 Mar 68:

N O T I C E

Concerning the Crimes Committed by U S Imperialists and Their Lackeys

Who Killed more than 500 Civilians of TINH KHE (V), SON TINH (D)

---

The morning of 16 March 1968 was a quiet morning, just like every other morning, with the people of TINH KHE Village about to start another laborious day of production and struggle. Suddenly, artillery rounds began pouring in from NUI RAM Mountain, BINH LIEN and QUANG NGAI Sub-Sector. XOM LANG Sub-Hamlet of TU CUNG Hamlet and XOM GO Sub-Hamlet of CO LUY Hamlet were pounded by artillery for hours. After the shelling, nine helicopters landed troops who besieged the two small sub-hamlets. The U S soldiers were like wild animals, charging violently into the hamlets, killing and destroying. They formed themselves into three groups: one group was in charge of killing civilians, one group burned huts and the third group destroyed vegetation and trees and killed animals. These American troops belonged to the 3d Brigade of the 82d Division which had just come to Viet Nam and suffered a defeat in the Spring. Wherever they went, civilians were killed, houses and vegetation were destroyed and cows, buffalo, chickens and ducks were also killed.

They even killed old people and children; pregnant women were raped and killed. This was by far the most barbaric killing in human history.

At XOM LANG Sub-Hamlet of TU CUNG Hamlet, they routed all the civilians out of their bunkers and herded them, at bayonet point, into a group near a ditch in front of Mr. NHIEU's gate (Mr. NHIEU was 46 years old). About 100 civilians who squatted in a single line were killed instantly by bursts of automatic rifle fire and M79 rounds. Bodies were sprawled about, blood was all over. Among those killed were 60 year old men and newly born babies still in their mother's arms. Most of them were children from 1 to 14 years old.

EXHIBIT M-35

Badly wounded children who were screaming were shot to death.

Some entire families were massacred. Inhabitants were killed inside bunkers, in the gardens of their homes or in the alleys of the hamlet. Mr. HUONG THO, 72 years old, was beaten, his beard was cut, and he was pushed into a well and shot with automatic rifle fire until his body submerged. NGUYET, 12 years old, after being raped, was bayoneted in the vagina and rest of her body. PHAN THI MUI, 15 years old, was raped and then burned to death in a rice bowl. The entire seven members of Mr. LE LY's family were killed, including the youngest 4 year old nephew and 70 year old Mr. LY. The only survivor of the family was a married daughter who lived somewhere else and returned to the hamlet after the massacre, to cry, holding her beloved relatives' bodies in her arms. (She set up an altar at her father's burned house and prayed for her seven dead relatives.) Neighbors set up altars for families that had no surviving relatives.

The total number of civilians killed at XOM LANG Sub-Hamlet was 2060, including old people, children, women and young people.

At XOM GO Sub-Hamlet of CO LUY Hamlets, American pirates blew up and burned every hut and tossed grenades into civilian shelters. The sand was soaked with blood; beheaded bodies lay sprawled on the ground. People died without enough time to utter a word! Mothers holding sons' bodies! Grandmothers holding grandsons' bodies. They died unjustly. Fifteen people were killed inside Mr. LE's shelter. They even killed pregnant women. VO THI HAI, who had given birth to a child the night before, was raped and killed, leaving behind a newly-born baby with no milk, with no one to suckle it. NGUYEN THI NGON, 32 years old, near the end of her pregnancy, was mutilated inside her bunker, exposing the stirring, unborn baby. While 30 year old VO THI PHU was feeding her baby, they snatched her baby away and raped her. Later, both were burned to death.

Mrs. KHEO, 65 years old, was shot to death by the bunker entrance and her body was tossed onto the burning fire. Mr. DUONG, 85 years old, was marched out of the bunker when they came. They marched him to every bunker, showing him the sights of the barbaric killings. They offered him poisoned candy, but he caught the bad smell and didn't eat the candy. They searched him and found nothing and released him.

At this place, American pirates killed 92, wounded 10, burned 304 huts, destroyed 78 bunkers and destroyed and burned civilian property worth 900,000 piastres.

Civilian laborers who had come to work or to visit relatives at TU CUNG Hamlet and CO LUY Hamlet were also massacred.

Thus, on 16 March 1968, the U S pirates and their lackeys massacred a total of 502 people at TU CUNG Hamlet and CO LUY Hamlet of TINH KHE Village and wounded 50 who survived the first bursts of automatic rifle fire. Among the dead were 67 old people, 170 children, 137 women. All huts, trees and animals were completely burned and destroyed.

This is by far the most typical of the barbaric massacres committed by the U S Imperialists against our People.

Like the other earlier massacres by American and Korean pirates at PHUONG DINH, SON TINH; VAN HA, (MO DUC) PHU THO, (NGHIA HANH) BINH HOA, (BINH SON) PHO MINH, (DUC PHO) the TINH KHE Village massacre was the worst crime committed by the U S Imperialists and their lackeys before their complete defeat.

The Heavens will not tolerate this! The blue ocean waters will not wash away the hatred. These murders are even more savage than Hilter of TAN THUY HOAN (Translator's Note: TAN THUY HOAN was the Chinese emperor who ordered hundreds of thousands of civilians to build the Great Wall, which resulted in thousands of deaths.)

Shamefully defeated, confused, the enemy is like a wild animal just before dying, due to our thunderous Spring attack. They have become excited and crazy, hoping to shake our spirit and the heroic tradition of our people. QUANG NGAI is the province of proud BA TO, uprising TRA BONG, BA GIA, VAN TUONG, the province of glorious victories that scared the enemy.

With deep hatred in their hearts, the people of TINH KHE, as well as the people and armed forces of QUANG NGAI Province, have turned their sufferings and hatred into a rising, vengeful force.

After the massacre, the people of TINH KHE Village wiped away their tears, hate deep in their hearts, and bravely rebuilt their homes, clearing away all traces of tragedy, growing potatoes, rice.

Immediately after the massacre, TINH KHE guerrillas and other village guerrillas killed 31 enemy soldiers on 17 and 19 March 1968, including 17 Americans. TINH KHE guerrillas personally killed 8 Americans on 17 March. The armed forces of the province have forced the enemy to pay their bloody debt.

During the 15 days from 13 March to 28 March 68, Local Force and QUANG NGAI guerrillas fought many battles, killing 298 enemy soldiers, including 20 Americans, and captured much equipment.

The massacre of the 500 civilians of TINH KHE has increased our hatred. We must attack continuously, rising up to make the enemy pay their debts!

28 March 1968

National Liberation Front Committee  
of QUANG NGAI Province







... (faded text) ...

... (faded text) ...

... (faded text) ...

... (faded text) ...

... (faded text) ...

... (faded text) ...

Ngày 25 tháng 3 năm 1954

ĐẠI BIỂU HỘI ĐỒNG QUẢN LÝ QUÂN QUẢN QUẢN

12 April 1968

MEMO FOR COL CG, 2dARVN Div

SUBJECT: An American Unit Operating in East Son Tinh on 16 Mar 68, Shot and Killed More Than 400 Civilians.

In a propaganda leaflet the VC have used the operation conducted by an American unit at Son My (Son Tinh) on 15 March 1968, saying that the US unit assembled, shot and killed 500 people (including men and women, young and old.) Their objective is to incite the people against the US military.

On this matter, the Son Tinh District Chief has confirmed the following:

On 16 Mar 68 US unit conducted an operation at Son My (East Son Tinh area, considered by Son Tinh subsector to be an insecure area). At 1000 hours the US unit received fire from Tu Cong hamlet and also hit a mine. One US was killed and a number wounded.

After that the US unit assaulted the hamlet, assembled the people, then shot and killed over 400 people in Tu Cong hamlet and 90 people in Co Luy hamlet.

Attached is a copy of the VC propaganda leaflet and the report of the Son Tinh District Chief.

KBC 4.277, 12 April 1968  
Major Pham Van Pho  
G-2

Margin notes made by General (then Colonel) Toan on this document as follows:

Quang Ngai Sector Review this investigation. If there is nothing to it, have the District rectify report -- If it is true, link-up with the Americal Division to have this stopped.

A TRUE TRANSLATION TO THE BEST OF MY KNOWLEDGE, CHU LAI, REPUBLIC OF VIETNAM  
1 JANUARY 1970

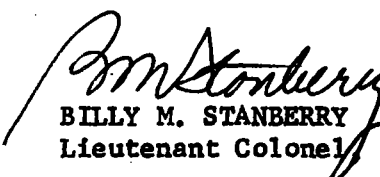
  
BILLY M. STANBERRY  
Lieutenant Colonel, United States Army

EXHIBIT M-36

ĐẠI TÁ TU LỆNH SU ĐOÀN 2 BB

ĐỀ - MỤC :--Đơn vị Mỹ hành quân tại khu vực Đông Sơn Tĩnh ngày 16/3/68 đã bắn chết trên 400 người dân.

Trân trọng kính trình ĐẠI TÁ :

Trong một tài-liệu (truyền đơn) của VC đã nêu lên cuộc hành quân của đơn vị Mỹ tại xã Sơn-Mỹ (Sơn-Tĩnh) ngày 15/3/68, nói rằng đơn vị Mỹ đã tập trung dân chúng (gồm Nam phụ lão ấu) rồi bắn chết tất cả 500 người. Mục đích để gây cảm phẫn giữa đồ g báo với-Quân Đội Mỹ;

Việc này Ông Quận trưởng Sơn-tĩnh đã xác nhận như sau :

Ngày 16/3/68 đơn vị Hoa-Kỳ hành-quân tại xã Sơn Mỹ (phía Đông Sơn-tĩnh khu vực này CK/Sơn-tĩnh coi là vùng bất an hoàn toàn). Lúc 10 giờ đơn vị Hoa-Kỳ bị VC từ Ấp Tr-cung giết mìn và bắn ra làm cho 1 binh sĩ Mỹ tử thương và một số bị thương.


Sau đó đơn vị Hoa-Kỳ dùng hỏa lực tấn công vào ấp, đem tập trung đồng bào lại rồi bắn chết trên 400 người dân tại Ấp Tr-cung và 90 người tại ấp Cờ Lũy.

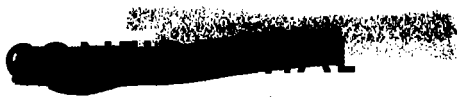
Kính trình ĐẠI TÁ tham tường. Xin đính kèm truyền đơn

KBC. 2.277, ngày 12 tháng 4 năm 1968  
(hiệu Tá PHAM VĂN PHỔ)  
Trưởng Phòng 2



*Tấn đ*  
*12-4*  
*Leo*  
*a.*  
*TRẦN NGUYỄN*  
*Kem diện tra VC và tờ trình của Ông Quận Trưởng SƠN TỈNH.*  
*lại - Nên khg có*  
*thì Quận Sơn Tĩnh phải*  
*Cải chính - Nên có liên*  
*lạc với SĐ Americal chuẩn dít*





Broadcast                    American Evil Appears  
 (Coordinate this broadcast with leaflets: "Let American  
 Enemy Pay This Bloody Debt.")

American imperialists make Vietnam aggressive war, but he said that he came here to "help" our people and he calls himself as our friend.

When he arrives in South Vietnam he tries to hide his bad aggressive ambition. He told his troopers to respect Vietnamese people and make good relationship with them. His psyops also give troops "commandments" whose contents are "Have to respect women and Vietnamese traditions and customs."

When American troops had just arrived in Vietnam, they tried to show themselves as "Honorable gentlemen" selling or buying fair and square, even, paying higher than market prices. When they destroyed something, they paid for it with money. Then some posts allowed people to come, and doctors were sent to some where to give people medical aid. American press shows some pictures of Americans and Vietnamese shaking hands - Americans kiss Vietnamese people and give them candies - or Americans with Red Cross signs at their arms give medical aid to Vietnamese people ... and they boast that this is one of familiar pictures around American troops locations.

This demagegy makes some ARVN troops believe Americans are good friends. How happy it is if we have such good and rich friends!

But any play has to end, although the actors are skillful, but they play only one act, they will become soon unskillful - and the play will become a bad one. So the damagegy will become "true", "unmask", easier than any plays.

The role can be played more beautifully if U.S. troops collect more victories every year, but they are beaten more heavily by our people year by year. So the demagegy is unmasked more easy. Now, U.S. troops can not hide anything, they have shown all bad ambition which belongs to any aggressive troops. In sweep operations, they loot people's properties, destroy everything, rape women, they have shown their animal ambition, their civilization. In Saigon one American had put his penis outside his pants, and one dollar was put on it, which he paid to a girl. U.S. troops play girls every public areas: beach, roadside ... they do not care about people passing by. In U.S. troop locations, they search people to get piaster, gold rings, watches, ear rings, they are so cunning that they do not pick up false gold

Due to their great defeats in the recent Spring, they are like wild wounded animal, the more they wriggle, the more bad actions are done - definitely inhuman doings. They had dropped bombs at random onto pepluous areas and cities such as HUE, SAIGON, BEN TRE. They confirmed that 90% of houses were destroyed in HUE City. Thousands of our people were killed or homeless. Western newspapers and radio stations also confirmed that all the damages of houses in South Vietnam cities came from American bombs and ammo because U.S. has more fire power than NLF troops. British newspapers said Americans



[REDACTED]

bombed cities, especially Saigon City, it would be condemned by opinion it was too much when Americans did that. Japanese public opinion said: America would be isolated and lose appreciation when they bomb South Vietnamese cities. It would make an anti-American wave in the South Vietnam, unless the world public opinion protested, and also there was not a unanimity of Allies. Americans still close their eyes, shut their ears to perform their cruel acts.

A sweep operation was conducted on 15 Mar 68 recently in SON TINH. Crazy American enemy used light machineguns and all kinds of weapons to kill our innocent civilian people in TINH KHE Village (SON MY (V)). Most of them were women, kids, there were some just born babies and pregnant women. They shot everything they saw, they killed all domestic animals, they burned all people's houses. There were 26 families killed completely - no survivors.

The fierce devil Americans dropped down their priest covers to become barbarous, and cruel.

American wolf forget their good sheeps' appearance. They opened mouth to eat, drink our people blood with all their animal barbarity.

Our people have only one way, it is to kill them so they can not bite around anymore.

Vietnam officers, soldier brothers, it is about time to know the true face of Americans. There were so many times they forget you when you were bitten by NLF's troops but they have never fired any mortar round to support you. Even they are right beside you and they also dropped bombs on puppet dead bodies to suppress and sometimes they mortared right on your formation.

The position of puppet troops as their targets are so clear. Any one still doubt, just look at the 39th Ranger Battalion stationed in KHE SANH area. They used the unit as an obstacle in the front for American Marines, you already knew they offered this battalion as "ready to die" but it doesn't mean the same as the meaning of "die for fatherlands" as NLF soldiers, they said that because they wanted to protect 6000 American troops there.

So it is the American civilization it is the good of friend as you see them - a murdered, killed your blood people - made a vietnamese blood stream running as blood in our own bodies - as an allied or not?

What are you waiting for! Use right American guns to shoot right their heads in order to avenge our people, to wash out insult to our nation and save your proud and your own life.

This time: more than ever before  
American guns are in your hands  
Point to American heads and shoot!

A TRUE TRANSLATION TO THE BEST OF MY KNOWLEDGE, CHU LAI, REPUBLIC OF VIETNAM

1 JANUARY 1970.

[REDACTED]

*Billy M. Stanberry*  
BILLY M. STANBERRY  
Lieutenant Colonel, US Army

(đúng phối hợp với truyện đơn :  
"Bất giác Mỹ trả món nợ máu này"  
-----

Để quốc Mỹ gây chiến tranh xâm lược miền Nam nước ta, nhưng lại leo lên là sang để giúp nhân dân ta, tự gọi là "bạn" của nhân dân ta.

Khi mới bước chân vào miền Nam chúng cũng cố tìm cách che dấu cái dã tâm xâm lược ấy. Chúng ra những chỉ thị cho binh lính Mỹ là phải giữ mối quan hệ tốt với nhân dân ta. Cơ quan tâm lý chiến của chúng còn đề ra cái gọi là "9 điều kỷ luật" trong đó có những điểm nêu đại ý là "phải tôn trọng phụ nữ, tôn trọng phong tục tập quán của người VN" vv... và vv...

Lính Mỹ lúc mới đặt chân lên đất này cũng cố tỏ ra là con người "hào hoa lịch sự", mua bán song phẳng, thậm chí có khi trả tiền nhiều hơn giá thị trường, làm hư hỏng cũng bồi thường cẩn thận. Rồi thì nơi thì để nhân dân lên đôn, nơi thì xuống tận thôn xóm khám bệnh, cho thuốc nhân dân. Báo chí Mỹ đưa lên những hình ảnh lính Mỹ bắt tay người VN, hôn hít và cho kẹo trẻ em, y tá Mỹ đeo băng hồng thập tự khám bệnh cho dân... và huyền hoang đó là những hình ảnh quen thuộc ở nơi chúng đóng quân. Những trò mị dân kia đã làm cho một số binh sĩ nhẹ dạ đã cho Mỹ đúng là một ông bạn tốt, chân thành, tử tế, thương người. Được là đồng minh với 1 ông bạn có tiền của, lại có lòng tốt như vậy chẳng sung sướng lắm sao?

Nhưng đã là trò thì bất cứ màn trò nào cũng phải tới lúc hạ màn. Cho dù diễn viên có khéo léo, tài nghệ có cao đến đâu, thì diễn mãi một trò cũng trở thành trò trên. Huống hồ là cái trò mị dân lại càng mau "lộ tẩy" hơn trò nào hết.

Cái trò này lẽ ra có thể diễn "xôm" hơn, "múi" hơn, nếu như Mỹ mỗi năm chỉ đánh được ít nhiều thắng lợi nào đó. Khốn nỗi mỗi năm chúng bị quân dân miền Nam đánh cho ngày càng thua đau hơn. Cho nên cái trò mị dân sớm càng bị vạch mặt hơn. Đến nay thì lính Mỹ không còn che dấu gì nữa, chúng đã trắng trợn để lộ tất cả những tính cách điển hình của bất cứ một đội quân xâm lược nào. Đi cần, những hành động cướp bóc, tàn sát, hiếp dâm ngày càng nhiều, chúng đã để lộ tất cả những dã tâm thú vật, những "văn minh" nước Mỹ của chúng. Ở Sài Gòn có tên đã kéo dương vật của chúng ra ngoài quần, đặt đồng đô la lên để bắt chị em bán hàng cho chúng phải cầm lấy. Ở lính Mỹ đã chơi gái ở mọi nơi công cộng : bãi biển, ngoài đường .. bất kể con mắt của người qua lại. Ở vùng chúng đóng quân, chúng khám xét đồng bào để lấy từng đồng bạc, từng cái nhẫn, đồng hồ, đôi bông... thậm chí còn biết phân biệt vàng giả thì không lấy.

Trước những thảm bại vô cùng nặng nề của chúng trong đợt đầu xuân vừa qua chúng như con thú dữ bị thương nặng, càng rầy rụa điên cuồng, càng tỏ ra tàn ác dã man, mất hết nhân tính. Chúng đã đem bom đạn trút bừa bãi xuống các vùng đông dân cư trong các thành phố, nhất là ở Huế, Sài Gòn, Bến Tre. Ở Huế theo chúng xác nhận, có đến 70% nhà cửa bị phá hủy. Hàng vạn đồng bào ta bị chết hoặc ở trong cảnh màn trời chiếu đất. Báo chí và đại phát thanh phương tây cũng phải thừa nhận là những thiệt hại nhà cửa của dân chúng trong các thành phố ở miền Nam là do bom đạn Mỹ bởi vì Mỹ có hỏa lực mạnh hơn quân giải phóng. Báo chí Anh nói : việc Mỹ ném bom ngay xuống các



thành phố, nhất là Saigon, sẽ bị dư luận lên án, Mỹ hành động như thế là hơi quá. Dư luận Nhật thì nói : Mỹ sẽ bị cô lập và mất căn tính trong khi ném bom các thành phố, sẽ gây nên một làn sóng bài Mỹ ở miền Nam. Bất chấp dư luận dư luận thế giới phản đối, ngay dư luận đồng minh của Mỹ cũng không đồng tình Mỹ vẫn nhắm mắt bưng tai tiếp tục hành động tội ác của chúng.

Gần đây trong cuộc can ngày 15/3/68 ở Sơn Tịnh, giặc Mỹ đã điên cuồng dùng Trung Liên và tất cả các loại vũ khí khác bắn giết hàng 500 đồng bào ta tay không ở xã Tịnh Khê (tức Sơn Mỹ). Số đông những người này là đàn bà con nít, có những em nhỏ mới sinh, có nhiều bà mẹ mang thai, và có cả những bà gần tới ngày sinh. Chúng đã bắn khi nhìn thấy một ai, giết hầu hết trâu bò gia súc, đốt phá nhà cửa của đồng bào. 26 gia đình đã bị chúng tàn sát hết, không còn một người.

Con quỷ dữ Mỹ đã vứt bỏ tấm áo thầy tu để hiện nguyên hình tàn ác dã man của nó.

Nhân dân ta chỉ còn một con đường là đập cho nó chết hẳn thì nó mới hết dấy dựa, cản quạnh cản quán.

Anh em sĩ quan binh lính người Việt đến lúc này hẳn đã rõ bộ mặt thực của Mỹ rồi. Biết bao lần chúng đã bỏ mặc cho họ ăn đon của quân giải phóng mà không hề bắn chi viên đến một trái cối, mặc dầu chúng ở ngay bên cạnh. Thậm chí có lần chúng dội bom thẳng xác chết của lính ngụy để thủ tiêu luôn, có nhiều lần bắn pháo, cối ngay đội hình của họ.

Sải địa vị làm bia đỡ đạn của lính ngụy đã quá rõ ràng. Có ai ngờ vực thì hãy nhìn vào Tiểu Đoàn biệt động 39 hiện đang bị đẩy ra đóng vung khe sanh, ăn ngủ phía trước cho bọn lính thủy đánh bộ Mỹ thì rõ. Cũng cho Tiểu Đoàn này cái tên là "Quyết tử". Nhưng quyết tử đây không phải là để cho tổ quốc quyết sinh như các chiến sĩ giải phóng, mà là để giữ lấy sinh mạng cho 6.000 lính Mỹ ở đây.

Đó, cái văn minh Mỹ, cái lòng tốt của ông bạn là thế.

Có thể nào thừa nhận bọn sát nhân, bọn tàn sát đồng bào ruột thịt của mình làm đổ giòng máu Việt Nam, cũng đổ như giòng máu chảy trong huyết quản mình, là đồng minh không?

Còn chờ đợi gì nữa mà không đem ngay súng Mỹ bắn vào đầu Mỹ, trả thù cho đồng bào, rửa nhục cho đất nước, cứu vinh dự và tính mạng cho bản thân?

Lúc này hơn lúc nào hết :

SÚNG MỸ TRONG TAY ĐÓ  
HÃY NHẦM TRÚNG ĐẦU MỸ

XIẾT CÒ!

Republic of VN  
Quang Ngai Province  
Son Tinh District

Son Tinh, 11 April 1968  
Number 190/CT/ST

FROM: District Chief, Son Tinh

TO: Lieutenant Colonel Province Chief, Quang Ngai

SUBJECT: Allied operation at Son My assembled and killed Civilians

On 16 March 1968 an American Army unit conducted a mopping-up operation at Tu Cung and Co Luy hamlets of Son Tinh Village. At About 19 o'clock on the above day, the American unit encountered a VC mine and received fire from Tu Cung hamlet. One American soldier was killed and a number of others wounded.

In response the operational forces attacked the village, assembled the people and shot and killed more than 400 people at Tu Cung hamlet, and 90 more people in Co Luy hamlet of Son My Village. While the VC were withdrawing from the Hamlet, 48 VC and more than 52 guerillas and self defense soldiers were wounded by helicopter gun ships.

Subsector comments.

Tu Cung and Co Luy are two areas of Son My Village that have long been held by the VC. The district forces lack the capability of entering the area. Therefore, allied units frequently conduct mop-up operations and bombing attacks freely in the area. But the basic position of the report of the Son My Village committee is that although the VC cannot be held blameless for their actions in the 16 March 1968 operation, the Americans in anger killed too many civilians. Only one American was killed by the VC, however, the allied killed near 500 civilians in retaliation.

Really an atrocious attitude if it cannot be called an act of insane violence. Request you intervene on behalf of the people.

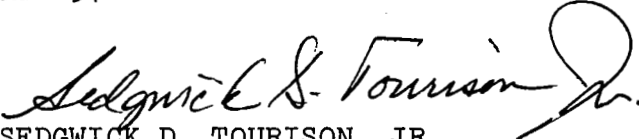
Respectfully

1st Lt Tran Ngoc Tan  
District Chief

Copies to:  
2nd ARVN Div Hq.  
MACV Quang Ngai Sector  
(Courtesy Copy)

Note: 1 - Stamp at top of page - "VUNG LEN DIET CONG" ' "Rise up & kill the communists". 2.- Stamp midway down page in left hand margin - "TOI - KHAN" - Top Priority

A TRUE TRANSLATION TO THE BEST OF MY KNOWLEDGE, HEADQUARTERS,  
DEPARTMENT OF THE ARMY - 7 FEBRUARY 1970

  
SEDGWICK D. TOURISON, JR.  
WARRANT OFFICER, USA

VIỆT - MIỀN BẮC - HOÀ  
TỈNH QUẢNG - NGÃI  
QUẬN SƠN - TỈNH

Sơn-tỉnh, ngày 11 tháng 4 năm 1968

Số : 190/CT/ST

QUẢN-TRƯỞNG H. P. TỈNH

Kính gửi : QUẢN-TRƯỞNG QUẢNG-NGÃI

Trích-yếu. - v/v Địch-minh hành quân tại xã Sơn-mỹ đã tập-trung đông-bào sơn giết chết.

Trân-trọng kính trình Trung-Tổ,

Trong ngày 16 tháng 3 năm 1968, đơn-vị Địch-quân Hoa-kỳ đã mở cuộc hành quân tảo-thanh Việt-cộng tại các ấp Tư-cung, Cồ-lũy thuộc xã Sơn-mỹ, quận Sơn-tỉnh. Cuộc hành quân tiếp-diễn đến khoảng 10 giờ ngày trên, đơn-vị Hoa-kỳ đã bị VC. từ ấp Tư-cung bắn ra và đem phải mất VC. làm 01 binh-sĩ Hoa-kỳ tử thương và số khác trọng thương.

Vì thế, lực-lượng hành quân dùng hỏa-lực tấn-công vào ấp, đoạn tập-trung đông-bào bắn chết trên 400 người tại ấp Tư-cung và 90 người khác tại ấp Cồ-lũy xã Sơn-mỹ. Đồng thời VC. rút lui khỏi ấp đã bị trực-thăng y-cơ-trang bắn chết 48 tên và hơn 52 tên Cấn-bộ tự-quen và du-kích VC. bị thương tại vùng hành quân nói trên.

Nhận-xét Chi-khu.

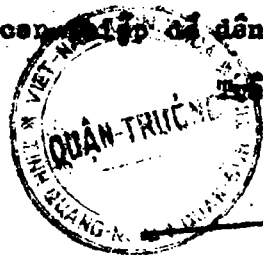
Vùng Tư-cung và Cồ-lũy là 2 miền thuộc xã Sơn-mỹ đã bị VC. chiếm từ lâu. Đối với lực-lượng cơ-hữu Quận xem như bất khả xâm phạm. Vì thế đơn-vị Địch-minh thường hay tảo-thanh và oanh-kích tự-độc. Nhưng căn-cứ vào báo-cáo của Hội-đồng xã Sơn-mỹ, trong cuộc hành quân của Hoa-kỳ ngày 16 tháng 3 năm 1968 vừa qua đã hăng tiết và bắn chết thương dân quá nhiều, đến nỗi không thể đếm the cộng-sản.

Tuy nhiên, chỉ 01 binh-sĩ Hoa-kỳ tử thương vì Việt-cộng mà Địch-minh đã giết chết gần 500 thường dân để thường mạng.

Thật là một thái-độ tàn-nhân nếu không gọi là cuồng-bạo, thiếu tình nhân-loại !!

Kính xin Trung-Tổ can thiệp để dân được nhờ ./-

Trân-trọng,



*[Handwritten signature]*

SÁC KÍNH GỢI :

- Bộ Tư-lệnh SB/2/BB/P2 .
- Phối-bộ MACV/QNG .

'Kính trình tường' ./-

Trang, TRẦN-NGỌC-TÂN

TOI KHU

10-20  
12/7-68

OFFICE OF THE SENIOR ADVISOR  
ADVISORY TEAM 2  
APO 96260

MACTN-2DSA

14 March 1968

SUBJECT: Appreciation

TO: All Members of Advisory  
Team 2 and Attached or  
Supporting US Elements

1. On the eve of my departure for a new assignment, I wish to express my deep appreciation to each of you for your loyal and skillful support.

2. In our preoccupation with the details of daily work we tend to dwell on things that go wrong and to overlook real accomplishments. I think, however, that within the 12th DTA commendable progress was made during the past year -- at least from the military point of view.

3. Specific indications of this progress are as follows:

a. In 1967 nearly 7000VC were KIA (body count) by the 2D Division and associated RF/PF units. In 1968 by the end of February ARVN Forces in the 12th DTA accounted for an additional 2065 VC KIA's -- a 40% upsurge in the rate at which enemy personnel have been destroyed.

b. In 1966 the ratio of VC to ARVN killed was about 3 to 1. In 1967 it was over 5 to 1. So far in 1968 it is running just under 7 to 1.

c. In 1967 the number (1438) of Hoi Chanh in the 12th DTA exceeded that for 1966 by nearly 50%.

d. For the first time the 2D Division became training conscious. The program needs much improving, but it does represent a start. A small unit leadership course was begun at the Division Training Center. More than 300 squad and platoon leaders have attended and have returned to their units with increased effectiveness.

e. On 31 January 1968 the ARVN Forces in the 12th DTA repulsed the VC Tet Offensive with decisive results. On that one day we accounted for 1223 VC KIA (confirmed), 111 VCC, and 444 weapons captured. I have not heard of any division -- US, Korean, or ARVN -- which has had better results in a single day's action.

f. Although the Tet Offensive disrupted the RD Program, I believe it drove many indifferent Vietnamese citizens to side positively against the VC. I think the disruption is temporary and that with

SUBJECT: Appreciation

continued strong military pressure on the communist forces, we will see increased progress in pacification as a long term result.

3. Finally, I believe that our cause in Vietnam is just and proper. Communism is an evil menace to all things we Americans stand for. We should fight it with every resource at our disposal, whenever and wherever we can. If we heed the dissenters and doves who capture the headlines of our misguided press, at some dismal point in the future our nation would be forced to accept communist slavery without a fight and without a choice. You can be proud of the part you are playing to insure that such a day never comes.



CARL C. ULSAKER

Colonel, Infantry

Senior Advisor

Exhibit M-38 is published in Volume III,  
Book 3, Reports.

X

20 June 1968

Senior Advisor  
Advisory Team #2  
APO 96260

COMMUNIST  
ACT: MACAG-1D  
APO 96222

Senior Advisor  
Quang Ngai Province  
APO 96260

NGUYEN DINH HOAI

LT/239.314

MAJ

N/A

Headquarters, Quang Ngai Province

N/A

Bronze Star

X

N/A

LT/239.314

MAJ

N/A

Deputy For Security  
Headquarters, Quang Ngai Province

X

None

None

I

IX

N/A

John Green  
David Hacking  
Jerome D. Reed

02028583  
01031394  
02101511

LTC  
MAJ  
MAJ

Advisory Team #2  
Advisory Team #2  
Advisory Team #2

N/A

Son Tinh District, Quang Ngai Province

13 June 1968

0750 hrs

Terrain was flat and consisted of flooded and unflooded rice fields. Positions were located as to provide excellent cover for the enemy and clear fields of fire. The weather was hot and humid.

Estimated two reinforced companies of the 18th Local Force Battalion. Unit has mortar, automatic, and recoilless weapon capability. Morale is known to be high because of the long period of time the 18th Battalion has remained in the area. Enemy had been firing on two RF companies operating in eastern Son Tinh for three days.

Enemy casualties:

167

EXHIBIT M-39



Unit morale was good. Staff morale was excellent. Friendly casualties were: None. This was a rescue mission following the loss of one UH1D Helicopter and one C-2 fixed wing in which eight U.S. personnel perished.

Two RF companies were moving toward the crash site.

## XI

At approximately 0750 hours, 13 June 1968, a helicopter (UH1D) with seven passengers aboard and one C-2 Air Force observer aircraft with only the pilot aboard, crashed in the vicinity of BS 723801. When these aircraft crashed, Major Hoai, his sector staff, and three U.S. Advisors, LTC Green, MAJ Hacking, and MAJ Reed, were located at BS 704703, controlling an operation. When it was known that the two aircraft had crashed, Major Hoai, without hesitation contacted his two companies and ordered them to move toward the crash site. At the same time Major Hoai, the aforementioned advisors, and eleven men moved toward the crash site. Major Hoai's actions were voluntary and without his support the danger of three advisors moving alone in this area would have been greatly magnified because the crash site and the route to the site were in VC controlled territory. While moving to the crash site, the relief force of 15 men was as much as 700 meters in front of the two relief companies and highly vulnerable to ambush, as the small vanguard force moved across rice fields, a river which was at least five and one-half feet deep, and through an area that had not been penetrated by Free World Forces in at least three months. Although no fire was received by this small relief force, VC strength of approximately two companies (continued)

Aircraft site was secured until U.S. Forces arrived.

Acting Deputy Senior Advisor  
Quang Ngai Province

Province Senior Advisor  
Quang Ngai Province, APO 96260

1. Proposed Citation
2. Witness statement-Major Hacking
3. Witness Statement-Major Reed
4. Biographical Sketch-Major Hoai

JOHN GREEN, LTC, Inf  
Assistant Sector Advisor

was revealed when an American Force attempted to remove the aircraft from the area. Major Heald's personal courage was an inspiration to all present. His disregard for his personal safety and his deep concern to reach and secure the crash site before the Viet Cong arrived will always be remembered by the advisors who accompanied him and the American Forces that later arrived on the scene.

C-I-T-A-T-I-O-N

By direction of the President, under the provisions of Executive Order 11046, the Bronze Star Medal with "V" Device is awarded to: Major Nguyen Dinh Hoai, AF/239.314, Vietnamese Army, for heroism in connection with military operations against a hostile force. Major Hoai is cited for valor while serving as Deputy for Security, Quang Ngai Province, Republic of Vietnam. On 13 June 1968, Major Hoai volunteered himself and his staff of eleven men to accompany three US Advisors, on an emergency mission through hostile territory to a site, also in hostile territory, where two US aircrafts had crashed. Without regard for his personal safety, Major Hoai moved with his small force to the crash site through open terrain which afforded many excellent ambush sites, and across the Dien Dien River where the water level forced some of his men to swim. Major Hoai's concern to aid anyone that might have been wounded in the aircrafts and to secure the site before the Viet Cong arrived inspired his men and the advisors to move three kilometers in forty minutes. Major Hoai's forces were first to reach the crash site and security was established until American forces arrived. The Vietnamese companies which followed the relief column engaged an estimated Viet Cong company which was maneuvering to a position to attack the near exhausted vanguard. During this engagement four Viet Cong were killed and Viet Cong forces withdrew.

EYE WITNESS STATEMENT

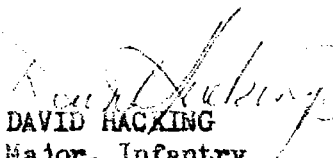
At approximately 0750 hours, 13 June 1968 a report was received, that a UH1D helicopter and a O2 observation aircraft had crashed in the vicinity of BS 723801.

Major Hoai, immediately radioed instructions to two of his RF rifle companies to divert them from their assigned objectives, to the crash site, with the mission of securing the downed aircraft.

Major Hoai then collected his sector staff, a total of eleven men and 3 US advisors and moved from his CP location, vicinity BS 704703, directly across country to the crash site.

Throughout the cross country movement Major Hoai, encouraged the entire group and inspired both US and Vietnamese personnel by his disregard for his own personal safety, and obvious concern for the fate of the downed personnel. Upon reaching the crash site Major Hoai directed the emplacement of security forces, and organized a search of the area surrounding the downed O2 aircraft. He discontinued the search, only after he was convinced that the pilots body was not recoverable by his meager forces.

Major Hoai's determination to reach the crash site as rapidly as possible, caused him to move directly through an area known to be infested with Viet Cong. His display of stamina, courage and professional ability were remarkable and in keeping with the best traditions of any army.

  
DAVID HACKING  
Major, Infantry  
04031394

EYE WITNESS STATEMENT

On 13 June 1968 at approximately 0750 hours a collision occurred involving an American helicopter and an O2 aircraft. Quang Ngai Sector Staff and MACV Advisors were, at the time of the crash, engaged in an operation in that area. Our immediate concern, after being informed of the crash, was the protection of the area and evacuation of any survivors. Without hesitating, Major Noel volunteered his sector staff, and security section to accompany us to the area. With complete disregard for his own personal safety he lead the relief force to the area of the downed aircraft. His timely directions to the small security force played a large role in our being able to reach the area safely. His display of courage was an inspiration to all of us in the small security force. His action reflected great credit upon his countryman, his unit.

*Jerome D. Reed*  
JEROME D. REED  
Maj, Arty  
054004511

BIOLOGICAL SKETCH

NAME: NGUYEN BINH HOAI

ID CARD NUMBER: 48/239.314

BORN: 2 Aug 1927, Hue City

SCHOOLING: University Hue (1943)  
Dalet Military Academy (1951)

MILITARY SERVICE: Assigned to Operations Officer  
Province Headquarters

DECORATIONS: National order of Vietnam Knight or Fifth Class.  
Army Distinguished Service Order 2nd Class.  
3(three) Gallantry Cross with Palm.  
3(three) Gallantry Cross with Golden Star.  
7(seven) Gallantry Cross with Silver Star.  
Staff Service Honor First Class.  
Viet-Nam Campaign Medal.  
Armed Forces Service Medal.  
Gerd with Gallantry Color.

was revealed when an American Force attempted to remove the aircrafts from the area. Major Hoel's personal courage was an inspiration to all present. His disregard for his personal safety and his deep concern to reach and secure the crash site before the Viet Cong arrived will always be remembered by the advisors who accompanied him and the American Forces that later arrived on the scene.

LTC BROWN  
PEERS' GROUP

TOP

DEPARTMENT OF THE ARMY  
STAFF COMMUNICATIONS DIVISION

DA IN  
239430

INFO  
SEC  
ACC

VZCZCSCD139 QS#A131  
DTTCZYUW RHMSMVA6133 3580155-CCCC--RUEADWD.  
ZNY CCCCC  
O 240125Z DEC 69  
FM COMUSMACV

TO DA  
BT

C O N F I D E N T I A L 70272 (IG) ATTN: (SGS)  
PEERS INQ  
SUBJ: LETTER FROM COMNAVFORV, DTD 23 DEC 69 (U)  
1. (C) REF LETTER IS FWD FOR YOUR INFO: QUOTE,  
FROM: COMMANDER U.S. NAVAL FORCES, VIETNAM  
TO: COMMANDER U.S. MILITARY ASSISTANCE COMMAND, VIETNAM  
ATTN: DEPUTY INSPECTOR GENERAL  
SUBJ: PEERS INQUIRY (U)

REF: (A) TELCON CUL WHALEN, COMUSMACV/LT WALLIN,  
COMNAVFORV 17 AND 18 DEC 69.  
(B) COMUSMACV LTR MACIG-DEP OF 19 DEC.69

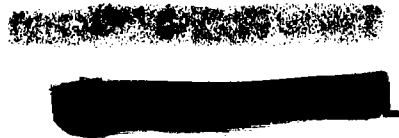
- (C) VTF 115 MSG 190001Z MAR 68
- (D) PVF 20 MSG 160930Z MAR 68
- (E) PCF 20 MSG 161945Z MAR 68
- (F) PCF 81 MSG 170905Z MAR 68
- (G) PCF 81 MSG 171705Z MAR 68

- (H) USS EPPERSON 171040Z MAR 68
  - (I) USS EPPERSON 172050Z MAR 68
- ENCL: (1) ANNOTATED CHART OF QUANG MGA I AREA

1. (C) IN COMPLIANCE WITH REF (A) & (B), THE FOLLOWING INFO IS FORWARDED:

A. REF (C) IS AN UPREP-5 REPORT WHICH STATES, INTER ALIA, THAT ON 16 & 17 MAR 68, PCF 81 PROVIDED A BLOCKING FORCE FOR A COASTAL SWEEP BY TASK FORCE BARKER

DA IN 239430





DEPARTMENT OF THE ARMY  
STAFF COMMUNICATIONS DIVISION

DA IN

239430

UNITS (PARA SIM PERTAINS).

B. DURING THE PERIOD 161600H-170335H MAR 68, PCF 20

FILED TWO SPOT REPORTS, REF (D) & (E), THE SUBSTANCE OF WHICH IS AS FOLLOWS:

(1) AT ANNOTATION 1, ENCLOSURE (1), FROM 161600H-161700H, PCF 20 SIGHTED 10 SAMPANS WITH SEVERAL MALES AND CHILDREN ABOARD. THERE WERE NO WOMEN ABOARD. SIX OF THE SAMPANS WERE BOARDED AND DIRECTED TO BEACH. THE VIETNAMESE APPEARED TO HAVE BEEN INNOCENT CIVILIANS BUT WERE TURNED OVER TO TF BARKER AS POSSIBLE SOURCES OF AREA INTELLIGENCE. NONE OF THE DETAINEES WERE SUB-

SEQUENTLY CLASSIFIED AS POSSIBLE VC BY VIETNAMESE NATIONAL POLICE.

(2) PCF 20 FIRED H&I MISSIONS AS REQUESTED BY TF

BARKER FROM 162305H-162330H AND FROM 170315H-170335H TO ANNOTATION NO 2. FOUR ROUNDS OF 81 MM WP AND 13 ROUNDS OF 81MM HE WERE EXPENDED. NO ROUND DAMAGE ASSESSMENT WAS REPORTED.

C. DURING THE PERIOD 170630H-142355H MAR 68, PCF 81 FILED TWO SPOT REPORTS, REF (F) & (G), AS FOLLOWS:

(1) PCF 81 PROVIDED BLOCKING FORCE AT ANNOTATION

NO3 AS TF BARKER SWEEP SOUTH FROM ANNOTATION NO. 4, DESTROYING BUNKERS AND SUPPORT AREAS. DURING THIS PERIOD, TF BARKER REPORTED SEVERAL VC KIA AND MANY DETAINEES.

DEPARTMENT OF THE ARMY  
STAFF COMMUNICATIONS DIVISION

DA IN

239430

PCF 81 EXPERIENCED NO INFILTRATION BY SEA AND EXPENDED  
NO ORDNANCE.

(2) FROM 172339H-172355H, PCF 81 FIRED H&I AS RE-

QUESTED BY TF BARKER, AT ANNOTATION NO 5, EXPENDING 6 ROUNDS  
81 MM HE AND 4 ROUNDS 81MM WP. THE RESULTS OF THESE  
MISSIONS WERE UNKNOWN.  
D. DURING THE PERIOD 16-17 MAR 68, USS EPPERSON (DDO

719) FIRED IN SUPPORT OF 2D ARVN DIV REF (H) AND (J)  
PERTAIN. TWO MISSIONS WERE FIRED AT ANNOTATIONS 6 & 7  
WHICH WERE IDENTIFIED AS VC ASSEMBLY POINTS, DAMAGE ASSES-

SMENT INCLUDED 12 STRUCTURES DESTROYED AND 10 STRUCTURES  
DAMAGED. A TOTAL OF 113 FIVE INCH SHELLS WERE EXPENDED.  
FOUR OTHER MISSIONS WERE FIRED BUT ALL WERE OUTSIDE OF A  
FIVE MILE RADIUS OF BS 7576.

2. (C) UNITS CORRESPONDING TO THE CALL SIGNS CITED IN

REF (A) AND (B) ARE AS FOLLOWS:

A. SAME DING, DELTA MIKE-OPERATIONAL CALL SIGN  
FOR THE PCF OPERATING IN MARKET TIME AREA 20, THE CAPE

BATANGAN AREA. "MIKE" IN THE CALL SIGN INDICATES THE  
HIGHER NUMBERED PCF IN THE AREA. RECORDS SHOW THAT THIS

WAS PCF 81.

B. NEWS BOY INDIA. TWO ZERO-THE ADMINISTRATIVE CALL  
SIGN OF PCF 20.

S/EMMETT H. HODD

T/EMMETT H. HODD

CHIEF OF STAFF UNQUOTE.

2: ENCLOSURE REFERS TO MAP: 1:50,000 QUANG NGAI SHEET  
673988 SERIES L7014, ANNOTATION NO. 1BS750812, NO. 2BS744770,

NO. 3BS735749, NO. 4BS731789, NO. 5BS781825, NO. 6BS743672, NO.  
7BS731704

DA IN 239430

Page 3





**DEPARTMENT OF THE NAVY**

**U. S. NAVAL FORCES, VIETNAM  
FPO SAN FRANCISCO 96626**

FF5-16/34:jmk

3000

Ser 0769

23 DEC 1969

**CONFIDENTIAL**

**From:** Commander U. S. Naval Forces, Vietnam  
**To:** Commander U. S. Military Assistance Command, Vietnam  
(Attn: Deputy Inspector General)

**Subj:** Peers Inquiry (U)

**Ref:** (a) TELCON COL WHALEN, COMUSMACV/LT WALLIN, COMNAVFORV 17 and 18 December 1969  
(b) COMUSMACV ltr MACIG-DEP of 19 December 1969  
(c) CTF 115 msg 190001Z March 1968  
(d) PCF 20 msg 160930Z March 1968  
(e) PCF 20 msg 161945Z March 1968  
(f) PCF 81 msg 170945Z March 1968  
(g) PCF 81 msg 171705Z March 1968  
(h) USS EPPERSON 171040Z March 1968  
(i) USS EPPERSON 172050Z March 1968

**Encl:** (1) Annotated Chart of Quang Ngai Area

1. (C) In compliance with references (a) and (b), the following information is forwarded:

a. Reference (c) is an OPREP-5 report which states, inter alia, that on 16 and 17 March 1968, PCF 81 provided a blocking force for a coastal sweep by Task Force BARKER units (paragraph 21M pertains).

b. During the period 161600H-170335H March 1968, PCF 20 filed two spot reports, references (d) and (e), the substance of which is as follows:

(1) At annotation #1, enclosure (1), from 161600H-161700H, PCF 20 sighted 10 sampans with several males and children embarked. There were no women embarked. Six of the sampans were boarded and directed to the beach. The Vietnamese appeared to have been innocent civilians but were turned over to TF BARKER as possible sources of area intelligence. Nine of the detainees were subsequently classified as possible VC by Vietnamese National Police.

(2) PCF 20 fired H&I missions as requested by TF BARKER from 162305H-162330H and from 170315H-170335H at annotation #2. Four rounds of 81MM WP and 13 rounds of 81MM HE were expended. No gun damage assessment was reported.

c. During the period 170630H-172355H March 1968, PCF 81 filed two spot reports, references (f) and (g), as follows:

**GROUP 4**

**DOWNGRADED AT 3 YEAR INTERVALS,  
DECLASSIFIED AFTER 12 YEARS**

**CONFIDENTIAL**

CONFIDENTIAL

(1) PCF 81 provided blocking force at annotation #3 as TF BARKER swept south from annotation #4, destroying bunkers and support areas. During this period, TF BARKER reported several VC KIA and many detainees. PCF 81 experienced no exfiltration by sea and expended no ordnance.

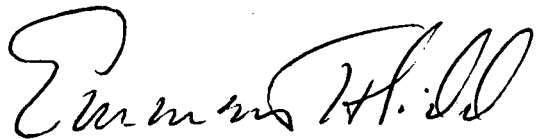
(2) From 172339H to 172355H, PCF 81 fired H&I as requested by TF BARKER, at annotation #5, expending 6 rounds 81MM HE and 4 rounds 81MM WP. The results of these missions were unknown.

d. During the period 16-17 March 1968, USS EPPERSON (DD 719) fired in support of 2nd ARVN Division. References (h) and (i) pertain. Two missions were fired at annotations #6 and #7 which were identified as VC assembly points. Damage assessment included 12 structures destroyed and 10 structures damaged. A total of 113 five inch shells were expended. Four other missions were fired but all were outside of a five mile radius of BS 7575.

2. (C) Units corresponding to the call signs cited in references (a) and (b) are as follows:

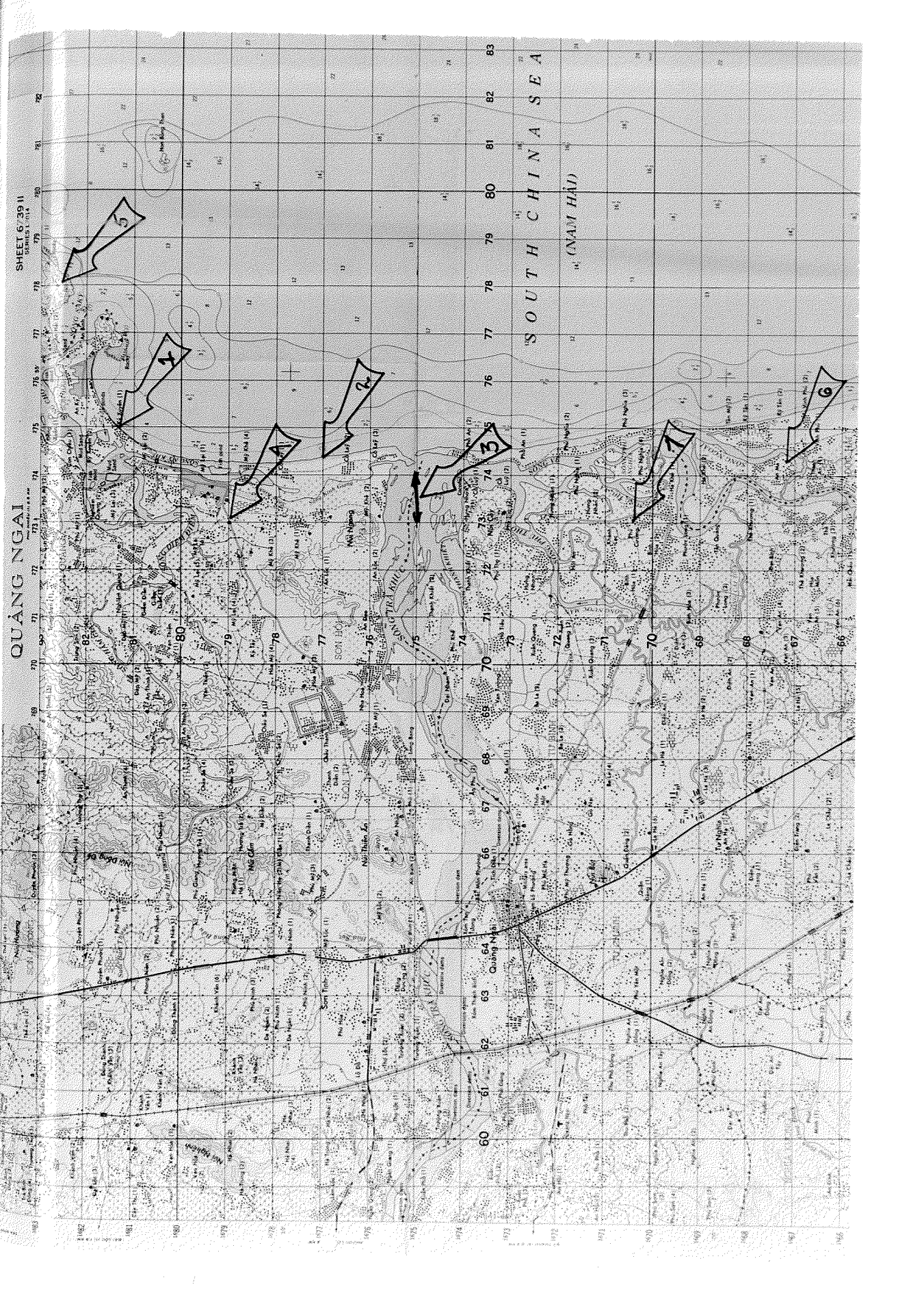
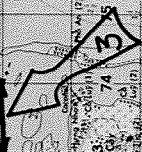
a. Sane Drink Delta Mike - Operational call sign for the PCF operating in Market Time Area 2D, the Cape Batangan area. "Mike" in the call sign indicates the higher numbered PCF in the area. Records show that this was PCF 81.

b. News Boy India, Two Zero - The administrative call sign of PCF 20.



EMMETT H. TODD  
CHIEF OF STAFF

SOUTH CHINA SEA  
(NAM HÃI)



KIA

1.	ELEHORN	3
2.	COLLICCHIO	3
3.	DERBRADSKY	2
4.	WESTER	3
5.	WILLIAMS, HT	3
6.	WALKER, C	W
7.	POMEROY	W
8.	RUSO	1
9.	WYATT, J.	2
10.	COCHRAN	2
11.	MILUS	1
12.	MOSS FORD	1
13.	WALKER, L	1
14.	GARCIA	1
15.	SMITH, MICHAEL	2
16.	SNITCHLER	2
17.	ROAR	W

KIA

18.	THOMAS, W. A	1
19.	LEWIS	3

91

WIA

1.	WILLIAMS, A	1
2.	WISE	2
3.	JEFFERS	2
4.	GONZALES <sup>SANCHEZ</sup>	2
5.	WILLEY	2
6.	FEGLEY	2
7.	JORDEN	3
8.	GUTHRIE	3
9.	LIAS	1
10.	ROSS	2
11.	WHITLEY	2
12.	COCHRAN	2
13.	CROW	2
14.	BROWN CHARLES	3
15.	CRESSENTI	3
16.	WILLIAMS, HT.	3

WIA

17.	WILLINGHAM, H.	3
18.	SPRAGGINS	1
19.	<u>POMEROY</u>	W
20.	BOMAN	2
21.	MENDOZA	2
22.	WOOD, D.	2
23.	BLECHER	2
24.	HACKER	2
25.	McKINNEY	2
26.	LEE (MED)	2
27.	RAYSER	2
28.	WILBURN	2
29.	AISTAKLAND	W
30.	PETER	1
31.	WINSTON	3
32.	HOSKINS	1

WIA

33.	HAEKSTEN	1
34.	GONZALES, S	1
35.	STEINBERGER	1
36.	WALTERS	2
37.	REED, B	2
38.	WILBURN	2
39.	CANTU	2
40.	GUNTA	2
41.	TRAVERSA	2
42.	SHIFLEY	2
43.	BLECHER	2
44.	HITCHMAN	2
45.	MERCER	2
46.	SMITH, MICHAEL	2
47.	MEALLS	3
48.	CYBALLER	2

49.	WILLINGHAM HT.	1
50.	JONES, H.	1
51.	<u>GARCIA</u>	1
52.	WILLIAMS, A.	1
53.	STRACHAN	1
54.	SILVA	1
55.	PIERCE	1
56.	GERDEL	1
57.	<u>WALKER, L</u>	1
58.	ANISPAENER	2
59.	TRAVERSA	2
60.	KROEGER	1
61.	<u>THOMAS W. A.</u>	1
62.	PLACK	1
63.	JENKINS	1
64.	BREITENSTEIN	1





**RECOMMENDATION FOR DECORATION FOR VALOR OR MERIT  
(USARV Reg 672-1)**

*Old page*

THRU: Commanding Officer 123rd Avn. Bn. APO SF 96374	TO: Commanding General Americal Division APO SF 96374	FROM: Commanding Officer Aero-Scout Co. 123rd Avn. Bn. APO SF 96374
--	---	--

1. NAME: (Last, First, MI) Andrectta, Glenn U.	2. SN: DA 1770-000 ESR: 492-52-57411	3. GRADE: SP/4 E-4	4. BRANCH: (MOS-WO&EM) 67N20
---	---	-----------------------	------------------------------------

5. AGE: 20 (Nearest Year)	6. CATEGORY 1-Y PERSONNEL: <input type="checkbox"/> YES <input checked="" type="checkbox"/> NO	7. MONTHS IN VN: (Nearest Month) 5 24	8. POSTHUMOUS AWARD: <input checked="" type="checkbox"/> YES <input type="checkbox"/> NO
------------------------------	--	---	---

9. ORGANIZATION AT TIME OF ACTION Aero-Scout Co., 123rd Avn. Bn. APO SF 96374	10. ACTION OF FINAL APPROVING AUTHORITY: <input type="checkbox"/> APPROVAL <input type="checkbox"/> DISAPPROVAL <input type="checkbox"/> UPGRADE <input type="checkbox"/> DOWNGRADE
---	---

11. AWARD INDIVIDUAL IS RECOMMENDED FOR

<input type="checkbox"/> DSC	<input type="checkbox"/> ACM*V*	<input type="checkbox"/> SERVICE	FOREIGN/OTHER AWARD  NONE
<input type="checkbox"/> SS	<input type="checkbox"/> IM	<input type="checkbox"/> ACHIEVEMENT	
<input type="checkbox"/> DFC	<input type="checkbox"/> BS		
<input type="checkbox"/> SM	<input type="checkbox"/> AM		
<input checked="" type="checkbox"/> BS*V*	<input type="checkbox"/> ACM	<input type="checkbox"/> OAK LEAF CLUSTER	

(For Air Medal Only Attach USARV Form 131)

DATES OF SERVICE - MERIT: DATES OF ACTION - VALOR: xxxxx 16 March 1968	13. DEROS: 12 Nov 68	14. CURRENT ORGANIZATION: YTA
--	-------------------------	----------------------------------

15. PREVIOUS AWARDS (PF & HIGHER)

DECORATION	DATE OF ACTION OR SERVICE	AUTHORITY
NONE		

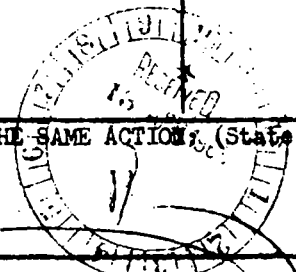
16. OTHERS RECOMMENDED FOR AN AWARD FOR THE SAME ACTION: (State name and award)

SP/4 Lawrence Colburn BS\*U\*

17. NAMES OF EYEWITNESSES

WO-1 Hugh C. Thompson Jr.

**BSV**



18. NARRATIVE DESCRIPTION: (For all awards describe in detail what individual did to warrant decoration. For valor awards describe in detail the mission, terrain, weather, enemy conditions and friendly casualties. Use plain bond paper for continuation sheet if necessary).

Specialist Fourth Class Glenn U. Andreotta, RA 17701280, United States Army, distinguished himself on 16 March 1968 while serving as crew chief on a OH-23 G helicopter in connection with military operations against a hostile force in the Republic of Vietnam. The helicopter, assigned to the Aero-Scout Company of the 123rd Aviation Battalion, was on a mission providing aerial reconnaissance for Task Force Barker. While flying over the village of Ky La SP/4 Andreotta spotted thirteen children hiding in a bunker located between friendly forces and hostile forces engaged in a heavy fire fight. At this time a UH-1B gun ship that was flying cover for the OH-23 G aircraft landed and the children were put into the gun ship and evacuated to a secure area thus saving the lives of the Vietnamese children. After SP/4 Andreotta's aircraft took off he spotted a wounded Vietnamese child. The aircraft was landed and he picked up the wounded child and carried him to the aircraft. The child was taken to the Vietnamese hospital located in the town of Quang Ngai where his wounds were treated.

SP/4 Andreotta's willingness to risk his life for innocent children and his bravery in action reflect great credit upon himself, his unit, the Medical Division and the United States Army.

*[Faint, mostly illegible text and markings, possibly bleed-through or administrative notes.]*

19. ENCLOSURES		20. INDIVIDUAL INITIATING RECOMMENDATION	
1. Proposed Citation	NAME, GRADE, & POSITION	SIGNATURE AND DATE	
1. Eyewitness Statement	FREDERIC W. WATKE	<i>Frederic W. Watke 10 April 68</i>	
	Maj., INF.		
	COMMANDING		
RECOMMENDATION OF YOUR COMMAND			
APPROVAL <input type="checkbox"/>		DISAPPROVAL <input type="checkbox"/>	
OTHER <input type="checkbox"/>			
NAME, GRADE, & POSITION		SIGNATURE & DATE	
JOHN L. HOLLADAY		<i>John L. Holladay 11 April 68</i>	
LTC., ARMOY			
Commanding			

OK DM

ANDREOTTA / SP 4 / BS "V" POSTHUMOUS

For heroism in connection with military operations against a hostile force in the Republic of Vietnam. Specialist Four Andreotta distinguished himself by exceptionally valorous actions on 16 March 1968 while serving ~~with~~ with the Aero-Scout Company of the 123d Aviation Battalion. On that date, he was serving as crew chief aboard a helicopter which was flying a reconnaissance mission over the village of My La for Task Force Barker. As the aircraft was passing over the area, Specialist Andreotta observed 15 children hiding in a bunker between ground forces engaged in a heavy fire fight. As the pilot landed the helicopter, Specialist Andreotta <sup>(UNDES. TATIANGAY)</sup> left the aircraft and went to the aid of the children. ~~He immediately proceeded to the bunker and~~

~~and placed the children aboard his helicopter for evacuation to a secure area.~~  
 At that time, an armed helicopter which was flying in support of his aircraft landed nearby and Specialist Andreotta placed the children aboard for evacuation to a secure area. After ~~his~~ his aircraft took off, Specialist Andreotta observed a wounded Vietnamese child. Once again the aircraft landed and Specialist Andreotta, without regard for his own safety, left the craft, picked up the wounded child and carried the child to his helicopter. <sup>They</sup> ~~The helicopter~~ then flew the child to ~~the~~ hospital for treatment.

Specialist Four Andreotta's personal bravery, unselfish concern for the lives of the young children and decisive actions in the face of enemy fire were in keeping with the highest traditions of the military service and reflected great credit upon himself, the Americal Division, and the United States Army.

PROPOSED CITATION

BY DIRECTION OF THE PRESIDENT, UNDER THE PROVISIONS OF EXECUTIVE ORDER 11046, 24 AUGUST 1962, A BRONZE STAR MEDAL FOR HEROISM IN CONNECTION WITH MILITARY OPERATIONS AGAINST A HOSTILE FORCE IN THE REPUBLIC OF VIETNAM IS AWARDED TO SPECIALIST FOURTH CLASS GLENN U. ANORECOTTA, RA 1770128, UNITED STATES ARMY WHO DISTINGUISHED HIMSELF BY EXCEPTIONALLY HUMANITARIAN AND VALOROUS ACTS ON 16 MARCH 1968 WHILE SERVING AS CREW CHIEF ON A OH-23 G HELICOPTER ASSIGNED TO THE AERC-SCOUT COMPANY OF THE 123RD AVIATION BATTALION. WHILE FLYING OVER THE VILLAGE OF MY LA ON A RECONNAISSANCE MISSION FOR TASK FORCE BARKER SP/4 ANORECOTTA SPOTTED FIFTEEN CHILDREN HIDING IN A BUNKER BETWEEN GROUND FORCES ENGAGED IN A HEAVY FIRE FIGHT. HIS AIRCRAFT LANDED AND SP/4 ANORECOTTA GOT THE CHILDREN OUT OF THE BUNKER. AT THIS TIME A UH-1B GUN SHIP THAT WAS FLYING COVER FOR OH-23 G AIRCRAFT LANDED AND THE CHILDREN WERE PUT INTO THE GUN SHIP AND EVACUATED TO A SECURE AREA THUS SAVING THE LIVES OF THE CHILDREN. AFTER SP/4 ANORECOTTA'S AIRCRAFT TOOK OFF HE SPOTTED A WOUNDED VIETNAMESE CHILD. THE AIRCRAFT LANDED AND HE PICKED THE WOUNDED CHILD UP AND CARRIED THE CHILD TO THE AIRCRAFT. THE CHILD WAS TAKEN TO THE VIETNAMESE HOSPITAL LOCATED IN THE VILLAGE OF QUANG NGAI AND TREATED FOR HIS WOUNDS. SP/4 ANORECOTTA'S PERSONAL COURAGE AND DECISIVENESS UNDER FIRE, ESPECIALLY DURING THE RESCUE OF THE WOUNDED CHILD, ARE IN KEEPING WITH THE HIGHEST TRADITIONS OF THE MILITARY SERVICE AND REFLECT GREAT CREDIT UPON HIMSELF, HIS UNIT, THE AMERICAN DIVISION, AND THE UNITED STATES ARMY.

## EYEWITNESS STATEMENT

On 16 March 1968 SP/4 Glenn U. Andreotta, RA 17701280, United States Army was flying as crew chief in an OH-23 G helicopter assigned to the Aero-Scout Company, 123rd Aviation Battalion, on a mission providing aerial reconnaissance for Task Force Barker. While flying over the village of My La SP/4 Andreotta spotted fifteen children hiding in a bunker located between friendly forces and hostile forces engaged in a heavy fire fight. His aircraft landed and SP/4 Andreotta got the children out of the bunker. At this time a UH-1B gun ship that was flying cover for the OH-23 G aircraft landed and the children were put into the gun ship and evacuated to a secure area thus saving the lives of the children. After SP/4 Andreotta's aircraft took off he spotted a wounded Vietnamese child. The aircraft was landed and he picked the wounded child up and carried the child to the aircraft. The child was taken to the Vietnamese Hospital located in the town of Quang Ngai and treated.

During the whole incident SP/4 Andreotta was able to keep his composure and his bravery and professionalism were instrumental in saving the lives of sixteen innocent children.

*Hugh C. Thompson Jr*  
HUGH C. THOMPSON JR.  
WO-1, AVN.  
AIRCRAFT COMMANDER

DEPARTMENT OF THE ARMY  
HEADQUARTERS AMERICAL DIVISION  
APO San Francisco 96374

GENERAL ORDERS  
NUMBER 2137

23 April 1968

AWARD OF THE BRONZE STAR MEDAL

1. TC 320. The following AWARD is announced posthumously.

ANDREOTTA, GLENN U. RA17701280 (SSAN 492-52-5741), SPECIALIST FOUR E4,  
United States Army, Aero-Scout Company, 123d Aviation Battalion APO 96374

Awarded: Bronze Star Medal with "V" Device

Date action: 16 March 1968

Theater: Republic of Vietnam

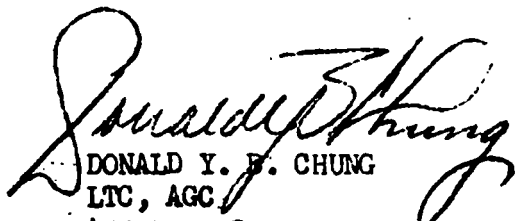
Reason: For heroism in connection with military operations against a hostile force in the Republic of Vietnam. Specialist Four Andreotta distinguished himself by exceptionally valorous actions on 16 March 1968 while serving with the Aero-Scout Company of the 123d Aviation Battalion. On that date, he was serving as crew chief aboard a helicopter which was flying a reconnaissance mission over the village of My La for Task Force Barker. As the aircraft was passing over the area, Specialist Andreotta observed 15 children hiding in a bunker between ground forces engaged in a heavy fire fight. As the pilot landed the helicopter, Specialist Andreotta unhesitatingly left the aircraft and went to the aid of the children. At that time, an armed helicopter which was flying in support of his aircraft landed nearby and Specialist Andreotta placed the children aboard for evacuation to a secure area. After his aircraft took off, Specialist Andreotta observed a wounded Vietnamese child. Once again the aircraft landed and Specialist Andreotta, without regard for his own safety, left the craft, picked up the wounded child and carried the child to his helicopter. They then flew the child to a hospital for treatment. Specialist Four Andreotta's personal bravery, unselfish concern for the lives of the young children and decisive actions in the face of enemy fire were in keeping with the highest traditions of the military service and reflected great credit upon himself, the Americal Division, and the United States Army.

Authority: By direction of the President under the provisions of Executive Order 11046, 24 August 1962.

FOR THE COMMANDER:

OFFICIAL:

NELS A. PARSON, JR.  
Colonel, GS  
Chief of Staff

  
DONALD Y. F. CHUNG  
LTC, AGC  
Adjutant General

GENERAL ORDERS NUMBER 2137, dated 23 April 1968, DEPARTMENT OF THE ARMY,  
HEADQUARTERS, AMERICAN DIVISION APO San Francisco 96374 (Cont)

DISTRIBUTION:

- 25 AVDF-AGD
- 2 AVDF-AGA
- 2 AVDF-JC
- 1 CO, Aero-Scout Co, 123d Avn Bn
- 1 CO, 123d Avn Bn ATTN: S1
- 1 CG, AMERICAN DIVISION
- 1 CG, USARV-ATTN: AG Awards

SPECIAL DISTRIBUTION:

- 1 USA Pers Svc Support Center  
ATTN: AGPE-F  
Fort Benjamin Harrison, Ind. 46216

DEPARTMENT OF THE ARMY  
HEADQUARTERS AMERICAL DIVISION  
APO San Francisco 96374

GENERAL ORDERS  
NUMBER 2585

14 May 1968

AWARD OF THE BRONZE STAR MEDAL

1. TC 320. The following AWARD is announced.

COLBURN, LAWRENCE RA18975748 (SSAN 557-46-6882), SPECIALIST FOUR E4,  
United States Army, Aero-Scout Company, 123d Aviation Battalion APO  
96374

Awarded: Bronze Star Medal with "V" Device

Date action: 16 March 1968

Theater: Republic of Vietnam

Reason: For heroism in connection with military operations against a hostile force in the Republic of Vietnam. Specialist Four Colburn distinguished himself by exceptionally valorous actions on 16 March 1968 while serving as a gunner on a OH-23G helicopter. On that date, his helicopter was flying a reconnaissance mission over the village of My La for Task Force "Barker" when the crew chief spotted 15 children hiding in a bunker between ground forces engaged in a heavy fire fight. After his helicopter landed, Specialist Colburn jumped to the ground and immediately removed the children from the bunker. After the gunship which was flying cover for his aircraft landed, he helped place the children aboard and they were evacuated to a secure area. After his ship was airborne, Specialist Colburn spotted a wounded Vietnamese child lying in an exposed area between the two forces. After his helicopter landed, Specialist Colburn quickly rushed to the wounded child, picked him up, and carried him to the helicopter. Specialist Four Colburn's personal bravery, unselfish concern for his fellow man, and devotion to duty are in keeping with the highest traditions of the military service and reflect great credit upon himself, the Americal Division and the United States Army.

Authority: By direction of the President under the provisions of Executive Order 11046, 24 August 1962.

FOR THE COMMANDER:

OFFICIAL:

NELS A. PARSON, JR.  
Colonel, GS  
Chief of Staff

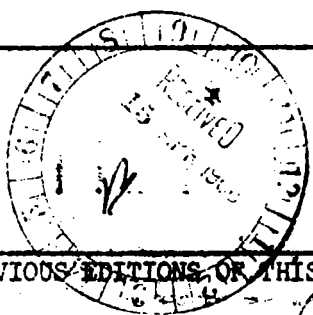
  
DONALD Y. B. CHUNG  
LTC, AGC  
Adjutant General

EXHIBIT M-43



**RECOMMENDATION FOR DECORATION FOR VALOR OR MERIT**  
(Submit In Three Copies)

<b>THRU: Commanding Officer</b> 123rd Avn. Bn. APO SF 96374	<b>TO: Commanding General</b> Americal Division APO SF 96374	<b>FROM: Commanding Officer</b> Aero-Scout Co. 123rd Avn. Bn. APO SF 96374	
1. NAME (Last, First, MI) Colburn, Lawrence NMI	2. SN: RA 18975748 SSAN: 557-46-4892	3. GRADE: SP/4	4. BRANCH: (MOS-WO & EM) 11B2F
5. AGE (Nearest Year) 20	6. CATEGORY 1-Y PERSONNEL: <input type="checkbox"/> YES <input checked="" type="checkbox"/> NO	7. MONTHS IN VN: (Nearest Month) 4	8. POSTHUMOUS AWARD: <input type="checkbox"/> YES <input checked="" type="checkbox"/> NO
9. ORGANIZATION AT TIME OF ACTION Aero-Scout Co., 123rd Avn. Bn. APO SF 96374 CODE		10. ACTION OF FINAL APPROVING AUTH <input type="checkbox"/> APPROVAL <input type="checkbox"/> DISAPPROVAL <input type="checkbox"/> UPGRADE <input type="checkbox"/> DOWNGRADE	
11. AWARDS INDIVIDUAL IS RECOMMENDED FOR			
<input type="checkbox"/> DSC <input type="checkbox"/> ACM "V" <input type="checkbox"/> SERVICE <input type="checkbox"/> SS <input type="checkbox"/> LM <input type="checkbox"/> DFC <input type="checkbox"/> BS <input type="checkbox"/> ACHIEVEMENT <input type="checkbox"/> SM <input type="checkbox"/> AM <input checked="" type="checkbox"/> BS "V" <input type="checkbox"/> ACM <input type="checkbox"/> AM "V" <input type="checkbox"/> PH <input type="checkbox"/> OAK LEAF CLUSTER (For Air Medal Only Attach USARV Form 131)			FOREIGN/OTHER AWARD  NONE
12. DATES OF SERVICE - MERIT: DATE(S) OF ACTION: <del>xxx</del> VALOR: 16 Mar 68	13. DEROS: 4 Dec 68	14. CURRENT ORGANIZATION: Aero-Scout Co., 123rd Avn. Bn. APO SF 96374	
15. PREVIOUS AWARDS (PH & Higher)			
DECORATION	DATE OF ACTION OR SERVICE	AUTHORITY	
NONE			
16. OTHERS RECOMMENDED FOR AN AWARD FOR THE SAME ACTION: (State Name and award)			
SP/4 Glenn U. Andreotta <b>BS "V"</b>			
17. NAMES OF EYEWITNESSES:  WO-1 Hugh C. Thompson			



USARV FORM 157-R (Revised 22 Dec 66) PREVIOUS EDITIONS OF THIS FORM ARE OBSOLETE

WITNESS STATEMENT

On 16 March 1968 SP/4 Lawrence Colburn, RA 189757406, United States Army was flying as a gunner in an OH-23 G helicopter assigned to the Aero-Scout Company, 123rd Aviation Battalion, on a mission providing aerial reconnaissance for Task Force Barker. While flying over the village of My La SP/4 Anoreotta, the aircraft's crew chief, spotted fifteen children hiding in a bunker located between friendly forces and hostile forces engaged in a heavy fire fight. SP/4 Colburn's aircraft landed and he got the children out of the bunker. At this time the UH-1B gun ship that was flying cover for the OH-23 G aircraft landed and the children were put into the aircraft and evacuated to a secure area. After SP/4 Colburn's aircraft took off a wounded Vietnamese child was spotted. The aircraft landed and he helped pick up the wounded child and carry him to the aircraft. The child was taken to the Vietnamese Hospital located in the town of Quang Ngai and treated for his wounds.

Without SP/4 Colburn's great courage and intense professionalism the lives of sixteen innocent children may very well have been lost.

*Hugh C. Thompson Jr*

HUGH C. THOMPSON  
NO-1, AVN.  
AIRCRAFT COMMANDER

PROPOSED CITATION

BY DIRECTION OF THE PRESIDENT, UNDER THE PROVISIONS OF EXECUTIVE ORDER 11046, 24 AUGUST 1962, A BRONZE STAR MEDAL FOR HEROISM IN CONNECTION WITH MILITARY OPERATIONS AGAINST A HOSTILE FORCE IN THE REPUBLIC OF VIETNAM IS AWARDED TO SPECIALIST FOURTH CLASS LAWRENCE COLBURN, RA 18975748, UNITED STATES ARMY, WHO DISTINGUISHED HIMSELF BY EXCEPTIONALLY VALOROUS ACTS ON 16 MARCH 1968 WHILE SERVING AS A GUNNER ON A OH-23 G HELICOPTER ASSIGNED TO THE AERO-SCOUT COMPANY OF THE 123rd AVIATION BATTALION. WHILE FLYING OVER THE VILLAGE OF MY LA ON A RECONNAISSANCE MISSION FOR TASK FORCE BARKER SP/4 ANORSOTTA, THE AIRCRAFTS CREW CHIEF, SPOTTED FIFTEEN CHILDREN HIDING IN A BUNKER BETWEEN GROUND FORCES ENGAGED IN A HEAVY FIRE FIGHT. THE AIRCRAFT LANDED AND SP/4 COLBURN GOT THE CHILDREN OUT OF THE BUNKER. AT THIS TIME THE UH-1B GUN SHIP THAT WAS FLYING COVER FOR THE OH-23 G AIRCRAFT LANDED AND THE CHILDREN WERE PUT INTO THE GUN SHIP AND EVACUATED TO A SECURE AREA. AFTER SP/4 COLBURN'S SHIP TOOK OFF HE SPOTTED A WOUNDED VIETNAMESE CHILD. THE AIRCRAFT LANDED AND HE HELPED PICK UP THE WOUNDED CHILD AND CARRY HIM TO THE HELICOPTER. THE CHILD WAS TAKEN TO THE VIETNAMESE HOSPITAL LOCATED IN THE TOWN OF QUANG NGAI AND HIS WOUNDS TREATED. SP/4 COLBURN'S BRAVERY AND GAIN UNDER FIRE, ESPECIALLY DURING THE RESCUE OF THE WOUNDED CHILD, ARE IN ACCORD WITH THE HIGHEST TRADITIONS OF THE MILITARY SERVICE AND REFLECT GREAT CREDIT UPON HIMSELF, HIS UNIT, THE AMERICAN DIVISION, AND THE UNITED STATES ARMY.

DEPARTMENT OF THE ARMY  
Headquarters, Americal Division  
APO San Francisco 96374

GENERAL ORDERS  
NUMBER 3601

1 July 1968

AWARD OF THE DISTINGUISHED FLYING CROSS

1. TC 320. The following Award is announced.

THOMPSON, HUGH C JR W3157206 (SSAN 254-58-5661), WARRANT OFFICER W1, Aero Scout Company, 123d Aviation Battalion APO 96374

Awarded: Distinguished Flying Cross

Date action: 16 March 1968

Theater: Republic of Vietnam

Reason: For heroism while participating in aerial flight as evidenced by voluntary actions above and beyond the call of duty. Warrant Officer Thompson distinguished himself by exceptionally valorous actions on 16 March 1968 in the Republic of Vietnam while serving as a pilot of an observation aircraft with the 123d Aviation Battalion. On that date, Warrant Officer Thompson's aircraft was performing a reconnaissance and screening mission for friendly forces near Quang Ngai. After spotting approximately 15 young children who were trying to hide in a bunker between Viet Cong positions and advancing friendly forces, Warrant Officer Thompson landed his helicopter near the children and moved them to a secure area. Only moments later, he located a wounded Vietnamese child, caught in the intense cross fire. Disregarding his own safety, he again landed his helicopter and evacuated the wounded child to the Quang Ngai hospital. Warrant Officer Thompson's heroic actions saved several innocent lives while his sound judgement greatly enhanced Vietnamese-American relations in the operational area. Warrant Officer Thompson's commendable display of personal heroism, unselfish concern for others, and avid devotion to duty are in keeping with the highest traditions of the military service and reflect great credit upon himself, the Americal Division, and the United States Army.

Authority: By direction of the President under the provisions of the Act of Congress, approved 2 July 1926.

FOR THE COMMANDER:

OFFICIAL:

NELS A. PARSON, JR.  
Colonel, GS  
Chief of Staff

JOHN K. SACKETT  
1LT, AGC  
Asst AG

EXHIBIT M-44

GENERAL ORDERS NUMBER 3501, dated 1 July 1966, DEPARTMENT OF THE ARMY,  
HEADQUARTERS, AMERICAL DIVISION APO San Francisco 96374 (Cont)

**DISTRIBUTION:**

25-AVDF-AGE  
2-AVDF-AGA  
2-AVDF-IC  
2-3a Indiv Conc  
1-AVDF-AGERO  
0-AVDF-AGER  
1-CG, Aero Sct Co, 123d Avn Bn  
1-CG, 123d Avn Bn ATTN: SI  
1-CG, AMERICAL DIVISION  
1-CG, USAFV ATTN: AG Awards

**SPECIAL DISTRIBUTION:**

1-TAGO ATTN: AGPF-F  
(for official personnel file)  
0-USA Pers Svc Support Center  
ATTN: AGPE-F  
Fort Benjamin Harrison, Ind. 46248

3601

1 JUL

RECOMMENDATION FOR DECORATION FOR VALOR OR MERIT

(Submit In Six Copies)

THRU: Commanding Officer Aero Scout Co 123d Avn Bn APO 96374	TO: Commanding General America Division APO 96374	FROM: Commanding Officer Aero Scout Co 123d Avn Bn APO 96374
---	---	---

4. NAME (Last, First MI) Thompson, Hugh G. Jr.	SSN: 254-58-5661 M3157206	3. GRADE: WO1	4. BRANCH: AVN
---	------------------------------	------------------	-------------------

5. AGE: (NEAREST YEAR) 25	6. CATEGORY 1-Y PERSONNEL YES/NO NO	7. MONTHS IN VIETNAM (NEAREST MONTH) 4	8. POSTHUMOUS AWARD YES/NO NO
---------------------------------	---	--	----------------------------------

9. ORGANIZATION AT TIME OF ACTION: Aero Scout Co, 123d Avn Bn CODE: E-1	10. ACTION OF FINAL APPROVING AUTHORITY APPROVAL _____ DISAPPROVAL _____ UPGRADE _____ DOWNGRADE _____
---	--

11. AWARD INDIVIDUALS IS RECOMMENDED FOR:

<input type="checkbox"/> DSC	<input type="checkbox"/> ACM "V"	<input type="checkbox"/> SERVICE	FOREIGN/OTHER AWARD  NONE
<input type="checkbox"/> SS	<input type="checkbox"/> LM	<input type="checkbox"/> ACHIEVEMENT	
<input checked="" type="checkbox"/> DFC	<input type="checkbox"/> BS	<input type="checkbox"/> OAK LEAF CLUSTER	
<input type="checkbox"/> SM	<input type="checkbox"/> AM		
<input type="checkbox"/> BSM "V"	<input type="checkbox"/> ACM		
<input type="checkbox"/> LM "V"	<input type="checkbox"/> FH		

(FOR AIR MED. L ONLY ATTACH USARV FORM 131)

12. DATES OF SERVICE MERIT: DATE(S) OF ACTION <u>XX</u> VALOR: 16 March 1968	13. DEROS 26 Dec 68	14. CURRENT ORGANIZATION: Aero Scout Company 123d Avn Bn APO 96374
--	------------------------	--

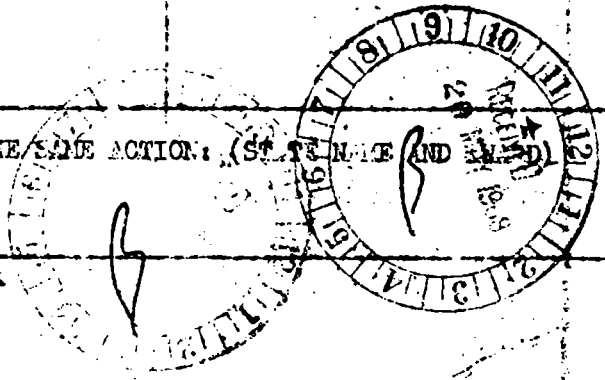
15. PREVIOUS AWARDS (PURPLE HE REHIGHET)

DECORATION:	DATE OF ACTION OR SERVICE	AUTHORITY
RAM	UNK	Submitted by previous unit

16. OTHERS RECOMMENDED FOR AWARD FOR THE SAME ACTION: (STATE NAME AND GRADE)

Andretta, Glenn V. BS "V"  
Colburn, Lawrence BS "V"

17. NAMES OF EYEWITNESSES:  
SP4 Lawrence Colburn



18. NARRATIVE DESCRIPTION: (For all awards describe in detail what individuals did to warrant decoration. For valor award describe in detail the mission, terrain and weather, enemy conditions, and friendly casualties. Use plain bond paper for continuation sheet if necessary.)

Warrant Officer Hugh C. Thompson Jr., W3157206, United States Army, distinguished himself by exceptionally valorous actions while engaged in military operations against a hostile force in the Republic of Vietnam. WO Thompson was piloting an OH-23 observation helicopter as a part of an Aero Scout reconnaissance team screening for elements of task force Barker, approximately 10 miles northeast of Quang Ngai, Republic of Vietnam. Viet Cong snipers had been spotted to the front of advancing friendly elements. Approximately 15 children were spotted by him, hiding in a partially destroyed bunker between friendly and hostile forces. Unhesitatingly he landed his helicopter and supervised moving of the children to an area where one of his armed helicopter escort aircraft could fly them to a secure area. Only moments later he spotted a wounded Vietnamese child, landed and evacuated the child to a nearby hospital. His courage and selfless devotion to duty saved a number of innocent lives and greatly enhanced Vietnamese-American relations. His valorous actions are in keeping with the highest traditions of military service and reflect great credit upon himself, his unit, the Americal Division and the United States Army.

19. INCLOSURES: 20. INDIVIDUAL INITIATING RECOMMENDATION

Eyewitness statement  
Proposed Citation

NAME, GRADE & POSITION

CLYDE P WILSON, MAJ, INF, CMDG

SIGNATURE & DATE:

*Clyde P. Wilson*  
2 May 68

21. RECOMMENDATION OF THRU COMMAND:

RECOMMEND:

APPROVAL

DISAPPROVAL

OTHER

NAME, GRADE & POSITION

JOHN L HOLLADAY, LTC, ARMOR, CMDG

SIGNATURE & DATE

*John L Holladay*  
3 May 68

OK DM

For heroism while participating in aerial flight as evidenced by ~~voluntary~~ voluntary actions above and beyond the call of duty. Warrant Officer Thompson distinguished himself by exceptionally valorous actions on 16 March 1968 in the Republic of Vietnam while serving as a pilot <sup>OF AN</sup> ~~of an~~ observation aircraft with the 123rd ~~Aviation~~ Aviation Battalion. On that date, Warrant Officer Thompson's aircraft was performing a reconnaissance and screening mission for friendly forces near Quang Ngai. ~~He~~ <sup>AFTER (approximately)</sup> spotted <sup>ing</sup> 15 young children who were trying to hide in a bunker between Viet Cong positions and advancing friendly forces, ~~completely~~ ~~completely~~ ~~disregard~~ ~~for~~ ~~his~~ ~~own~~ ~~safety~~, Warrant Officer Thompson landed his helicopter near the children and moved them to an area where an accompanying helicopter could land and move them to a secure area. Only moments later, he located a wounded Vietnamese child, <sup>CAUGHT in the INTENSE cross fire.</sup> ~~and~~ ~~immediately~~ <sup>(regarding his own safety, he again)</sup> landed his helicopter and evacuated the ~~the~~ wounded child to the Quang Ngai hospital. Warrant Officer Thompson's ~~brave~~ ~~brave~~ heroic actions ~~and~~ ~~previously~~ saved several innocent lives while his sound judgement greatly enhanced Vietnamese-American relations in the operational area. Warrant Officer Thompson's commendable display of personal heroism, unselfish concern for others, and avid devotion to duty are in keeping with the highest traditions of the military service and reflect great credit upon himself, the Americal Division, and ~~the~~ the United States Army.



PROPOSED CITATION

BY DIRECTION OF THE PRESIDENT, UNDER THE PROVISIONS OF THE ACT OF CONGRESS, APPROVED 2 JULY 1926, A DISTINGUISHED FLYING CROSS IS AWARDED TO WARRANT OFFICER HUGH C. THOMPSON JR., W3157206, UNITED STATES ARMY, FOR HEROISM WHILE PARTICIPATING IN AERIAL FLIGHT EVIDENCED BY VOLUNTARY ACTION ABOVE AND BEYOND THE CALL OF DUTY. WARRANT OFFICER THOMPSON DISTINGUISHED HIMSELF BY EXCEPTIONALLY VALOROUS ACTIONS ON 16 MARCH 1968 WHILE SERVING AS A PILOT ON AN OBSERVATION AIRCRAFT PERFORMING A RECONNAISSANCE AND SCREENING MISSION FOR FRIENDLY FORCES NEAR QUANG NGAI, REPUBLIC OF VIETNAM. HE SPOTTED APPROXIMATELY 15 YOUNG CHILDREN WHO WERE TRYING TO HIDE IN A BUNKER BETWEEN VIET CONG POSITIONS AND ADVANCING FRIENDLY FORCES. SHOWING COMPLETE DISREGARD FOR HOSTILE FIRE, WARRANT OFFICER THOMPSON LANDED HIS HELICOPTER NEAR THE CHILDREN AND MOVED THEM TO AN AREA WHERE AN ACCOMPANYING ARMED HELICOPTER COULD LAND AND MOVE THEM TO A SECURE AREA. ONLY MOMENTS LATER HE LOCATED A WOUNDED VIETNAMESE CHILD AND AGAIN UNHESITATINGLY LANDED HIS HELICOPTER, AND EVACUATED THE WOUNDED CHILD TO QUANG NGAI HOSPITAL. WARRANT OFFICER THOMPSON'S FEARLESS ACTIONS IN ALL PROBABILITY SAVED SEVERAL INNOCENT LIVES, AND HIS COURAGE AND SOUND JUDGMENT GREATLY ENHANCED VIETNAMESE-AMERICAN RELATIONS IN THE OPERATIONAL AREA. WARRANT OFFICER'S THOMPSON'S COURAGE AND DEVOTION TO DUTY WERE IN KEEPING WITH THE HIGHEST TRADITIONS OF THE MILITARY SERVICE AND REFLECT GREAT CREDIT UPON HIMSELF, THE AMERICAN DIVISION, AND THE UNITED STATES ARMY.

S-T-A-T-E-M-E-N-T

Warrant Officer Hugh C. Thompson distinguished himself by heroism while flying an OH-23G helicopter on 16 March 1968. His mission was to fly low level and recon ahead of advancing elements of friendly ground forces. Sniper fire had been received forward of friendly units and while flying towards it, Warrant Officer Thompson noticed a number of children trying to hide in an old bunker between the friendly and enemy forces. Unhesitatingly he landed his helicopter and directed movement of the children to an area where an accompanying armed helicopter could land and move them to safety. He had just taken off again when he saw a wounded Vietnamese boy. Without hesitation or regard for Viet Cong fire, he landed and picked up the child and flew him to the ARVN hospital at Quang Gnai City several minutes away.

*Lawrence M. Colburn*  
LAWRENCE M. COLBURN  
SP4E4, RA18975748  
Co B, 123d Avn Bn

AVDF-AGD THOMPSON, Hugh C. 1st Ind  
W3 157 206 (2 May 68)  
SUBJECT: Recommendation for Decoration for Valor or Merit


DA, Headquarters, Americal Division, APO 96374 14 May 68

TO: Commanding Officer, 123d Aviation Battalion, APO 96374

1. Returned without action.
2. Request resubmission of recommendation with letter of explanation stating reason for the delay.

FOR THE COMMANDER:

- 2 Incl
1. STATEMENT (Sp4 Colburn)
  2. Proposed Citation

  
EARL J. DAMATO  
CPT, AGC  
Asst Adjutant General

AVDF-ABK Thompson, Hugh C. 2nd Ind  
W3 157 206 (2 May 68)  
SUBJECT: Recommendation for Decoration for Valor or Merit

Commanding Officer, 123rd Aviation Battalion, APO 96374 18 May 68

TO: DA, Headquarters, Americal Division, APO 96374

1. The reason for the delay in submission of this recommendation is probably not justified. The date of valor was 16 March 1968 but WO Thompson's role in the action was not known until a much later date. WO Thompson recommended SP4 Andreotta and SP4 Colburn for awards for this same action. On 8 April 1968 SP4 Andreotta was killed by hostile action and his recommendation for award was then given priority for submission by the awards and decoration clerk. As this award was being processed we realized that WO Thompson's actions needed to be investigated to see if he merited an award. SP4 Colburn was interviewed and it was found that an award was appropriate. Necessary action was then initiated and the recommendation was submitted.

AVEF-AEK (2 May 68) 2nd Ind 18 May 1968

SUBJECT: Recommendation for Decoration for Valor or Merit

2. It is felt that an appropriate award should be recommended for a deserving person when it becomes known to the commander. In this case it was not known until a later date and appropriate action was then taken.

FOR THE COMMANDER:



BOBBY L. LOVE

Cpt AGC

Adjutant



AWARDS WORKSHEET

NAME THOMPSON, HUGH C. JR. GRADE WO1 SN 03157266 BR/MOS AVN  
 UNIT AERO-SCOUT CO, 123D AVN BN DEROS 26 DEC 68

DATE ACTION/PERIOD OF SVC 16 MAR 68

RECOMMENDED AWARD DISTINGUISHED FLYING CROSS

RECOMMENDATIONS: RECOMMENDER: CLYDE P. WILSON, MAJ, INF, CMDC

INTERMEDIATE COMMANDER JOHN L. HOLLADAY, LTC, RECOMMENDS APPROVAL

OTHER AWARDS APPROVED IN THE REPUBLIC OF VIETNAM (DSC) (SS) (DFC) (SM)  
 (BSM \_\_\_\_\_ OLC) (ARCOM \_\_\_\_\_ OLC) (PH \_\_\_\_\_) (AM \_\_\_\_\_ OLC)

RECOMMENDATIONS AND COMMENTS OF BOARD MEMBERS:

COMMENTS \_\_\_\_\_

	APPROVED	DISAPPROVED	DOWNGRADE TO	UPGRADE TO
1. <u>COL JONES</u>	: _____ :	: _____ :	: _____ :	: _____ :
2. <u>LTC BAXLEY</u>	: <u>R</u> :	: _____ :	: _____ :	: _____ :

AWARDS WORKSHEET

NAME THOMPSON, HUGH C. JR. GRADE WO1 SN W3157208 BR/MOS AVN  
 UNIT AERO-SCOUT CO, 123D AVN BN DEROS 26 DEC 68

DATE ACTION/PERIOD OF SVC 16 MAR 68

RECOMMENDED AWARD DISTINGUISHED FLYING CROSS

RECOMMENDATIONS: RECOMMENDER: CLYDE P. WILSON, MAJ, INF, CMDG

INTERMEDIATE COMMANDER JOHN L. HOLLADAY, LTC, RECOMMENDS APPROVAL

OTHER AWARDS APPROVED IN THE REPUBLIC OF VIETNAM (DSC) (SS) (DFC) (SM)  
 (BSM \_\_\_\_\_ OLC) (ARCCM \_\_\_\_\_ OLC) (PH \_\_\_\_\_) (AM \_\_\_\_\_ OLC)

RECOMMENDATIONS AND COMMENTS OF BOARD MEMBERS:

COMMENTS \_\_\_\_\_

	APPROVED	DISAPPROVED	DOWNGRADE TO	UPGRADE TO
1. <u>COL JONES</u>	: _____ :	: _____ :	: _____ :	: _____ :
2. <u>LTC BAILEY</u>	: _____ :	: _____ :	: _____ :	: _____ :
3. <u>LTC HOOD</u>	: _____ :	: <u>NOV</u> :	: <u>AM</u> :	: _____ :
ACTION BY CG	: _____ :	: _____ :	: _____ :	: _____ :

**DFC**

AMERICAL Div Form , 120A dtd 17 Apr 68 , Replaces Americal Div Form 120A, dtd 23 Dec 67

# DISPOSITION FORM

(AR 340-15)

REFERENCE OR OFFICE SYMBOL

SUBJECT

AVDF-AGPRO

Decorations

TO AG AWARDS

FROM

Chief, Off Rcds Br

DATE 6 May 68

CMT1

1. The following previous awards (Purple Heart or higher) have been awarded to WO1 Hugh C. Thompson W3 157 206 254-58-5661.

DECORATION(S)

DATE OF ACTION / SVC

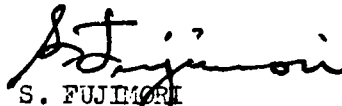
AUTHORITY

NONE

NONE

NONE

2. This action ~~is~~ (is not) in contravention of AR 600-31.

  
S. FUJIMORI  
CW3, USA  
Chief, Off Rcds Br

209



AVDF-IG 2d Ind  
SUBJECT: Request for Assistance

DA, HQ, Americal Division, APO 96374 30 Aug 1968

TO: Commanding General, United States Army, Vietnam, ATTN: AVHIG  
APO 96375

1. An inquiry was conducted by this office as directed. PFC Ebinger was not available for interview, having rotated back to CONUS on 11 August 1968 for early release from active duty to attend college.

2. The results of the inquiry indicated the following concerning the allegations made by PFC Ebinger:

a. Ball point pens were available in ample quantities in 4th Battalion 3d Infantry throughout the period in question.

b. In early June, elements of his battalion were conducting combat operations in an area infested with leeches. Leech repellent was ordered by the Battalion S-4 and was received by his unit within two days. The Battalion Sergeant Major delivered the repellent to the troops in the field. After delivery, no complaints were received from members of PFC Ebinger's company regarding lack of repellent.

c. Interviews with officers and NCO's of the battalion indicated no knowledge of any officer allowing a native farmer to be used as a point man in crossing a mined area, nor was there any indication of torturing any captives by this unit or its personnel.

d. During the period in question, there were no reported incidents of rape by members of PFC Ebinger's Company.

3. Five commissioned officers and two non-commissioned officers of PFC Ebinger's former battalion were interviewed for this inquiry. Unavailable for this inquiry was Captain Earl Nichols, his Company Commander in Vietnam from December 67 to 28 May 1968, who died as a result of a helicopter accident on 13 June 1968.

2 Incl  
nc

CARROLL E. SWAIN  
LTC, IG  
Inspector General

EXHIBIT M-45

DEPARTMENT OF THE ARMY  
OFFICE OF THE INSPECTOR GENERAL  
Washington, D.C. 20315

IG-ARA Ebinger, John, Jr.

SUBJECT: Request for Assistance

13 Aug 1968

Commanding General  
United States Army, Vietnam  
ATTN: Inspector General  
APO San Francisco 96375

1. Reference is made to the attached letter, dated 30 July 1968, to President Johnson from PFC John C. Ebinger, Jr., Company B, 4th Battalion, 3d Infantry, 11th Brigade, Americal Division, APO San Francisco 96217. (Incl 1)
2. The referenced correspondence, concerning alleged improper conditions in his unit, mistreatment of captured personnel, and related matters, is forwarded for appropriate inquiry and action. Acknowledgement of receipt has been made. (Incl 2)
3. In view of Presidential interest, request this office be informed of your findings and provided with information upon which to base a reply, by not later than 12 September 1968. Your report should reflect an interview with PFC Ebinger.

FOR THE INSPECTOR GENERAL:

FELDER L. FAIR  
Colonel, IG  
Chief, Assistance and  
Reviews Branch

AVHIG Ebinger, John, Jr. 1st Ind  
(13 August 1968)  
SUBJECT: Request for Assistance

HEADQUARTERS, UNITED STATES ARMY, VIETNAM, APO 96375 19 August 1968

TO: Inspector General, Americal Division, APO 96374

1. Forwarded for inquiry and appropriate action.
2. It is requested that information upon which to base a reply be furnished this office by not later than 4 September 1968. Your report should reflect an interview with PFC Ebinger.

2 Incl  
nc

B. H. KERR  
Colonel, IG  
Inspector General

W. P. ...  
H. L. ...

July 30, 1968

To: Lyndon B. Johnson  
President of The United States

Dear Sir

I have never written to such a high official before but I got so mad at a recent article where you were described as a "lame duck" President I had to write to you and tell you how I feel. I sincerely hope you get a chance to read this because it is important at least to me.

There is no such thing as a "lame duck" President. If a person is elected to a public office he has an obligation to the people of this nation to fulfill his duties in the best way he knows how until his term of office is up. It's as if his duties don't end six months before his term of office is up just because he he isn't running for reelection. He has a responsibility to do his duties until his successor is sworn in.

214

I just turned 22 this year so this will be my first Presidential election

True enough, that this is true for many other people in the U.S. but I can't see myself voting for people that I had no choice in nominating.

Mr. Humphrey will be the Democratic candidate, this he did without entering any of the primaries. It is true you withdrew from the Presidential race late but how can a man the people (majority not minority) didn't pick be a contender for the President. The same runs or holds true for Mr. Nixon. Why is this sort of thing allowed in the U.S. in this day and age?

I am in Vietnam right now. It's an LZ or Landing Zone barely 37 miles south of Danang. My unit is moving, but where we is rather quiet right now. I am writing in Red pen because nothing else is available. I have seen why there are few pens available also why when the field troops need beach repellent and it is ordered by S-4 (Battalion Supply) but they only get a small amount and it is taken by the SGT MAJOR of the Battalion and that's the last anyone 215 sees of it. Also many things that a

Here like a captain giving his okay to a group of men torturing a captive farmer used as a point man in a mined area when they are finished using him. There are many things like this and worse going on. This is why many people turn v.c. again. They are against us but not <sup>the</sup> communists what are they to do fight what he thinks is the lesser of the two evils. If a soldier raped one of your daughters would you want to kill him. Most people would and it is being done many ~~2~~ times every day by soldiers. Can you or anyone higher up do anything about this kind of conduct in this war? anything you might say on the subject would greatly be appreciated.

Yours very Truly  
John Etinger Jr.  
Co B 4BN 3 INF  
11<sup>th</sup> INF (LIGHT) Bde  
AMERICAN DIVISION  
APO SAN FRANCISCO 962

MEMO ROUTING SLIP		NEVER USE FOR APPROVALS, DISAPPROVALS, CONCURRENCES, OR SIMILAR ACTIONS		ACTION	
1 TO	LTC J -	INITIALS	CIRCULATE		
		DATE	COORDINATION		
2			FILE		
			INFORMATION		
3			NOTE AND RETURN		
			PER CON-VERSATION		
4			SEE ME		
			SIGNATURE		
REMARKS					
<p>See memo w/co clk, SP4          Nakas, B 4/3 Inf, ETC          stated d/a 11 Aug 68          per para 35 50 200<sup>th</sup> Hq.</p> <p>Do you want to see          anyone else from the unit?</p>					
FROM		DATE		PHONE	
[Signature]		26/3/5 Aug			

DD FORM 95  
1 OCT 60

Replaces DD Form 94, 1 Feb 50 and DD Form 95,  
1 Feb 50 which will be used until exhausted.

PPC-Japan

### Summary of Interview

LTC Alvin E. Adkins, A CofS G-2, and formerly the Battalion Commander of the 4th Battalion, 3d Infantry, was interviewed and stated in substance the following:

LTC Adkins commanded the 4th Battalion, 3d Infantry on its arrival in Vietnam during December 1967. He commanded the battalion until 31 May 1968 when he was replaced by LTC Barker who was killed in a helicopter accident in June 1968. LTC Adkins recalled that CPT Michel, B Company Commander, was also killed in the same accident. No incidents of alleged rape or mistreatment to a captured farmer were reported during the period LTC Adkins commanded the battalion. Also, there was no requirement for leech repellent. Subordinate unit commanders were informed to question the local populace about locations of mines and booby traps and watch their movements through the area very carefully. The philosophy behind this was that if the Vietnamese knew of mines and booby traps in the area he would avoid them. On one occasion, LTC Adkins related an incident where local force V.C. influenced local villagers to make allegations of rape against soldiers of his unit. Upon checking it out there was no case. This is a common practice of the V.C. in effort to summon hostility toward American troops and improve support for them. CPT Michel's reputation and character were such that rape or mistreatment of captured personnel would not have been condoned in his unit.



### Summary of Interview

CPT Jimmy Davis, Commanding Officer, Company B, 4th Battalion, 3d Infantry was interviewed on 27 August 1968 and stated in substance the following:

Captain Davis assumed command of Company B on 28 May 1968 replacing Captain Earl Michels, who became the Battalion S-2. On 13 June 1968, Captain Michels was killed as a result of a helicopter accident. PFC Ebinger was assigned to the company until mid-August 1968 when he rotated to the United States. PFC Ebinger was never in the field on combat operations during the period 28 May to mid-August 1968. He was assigned to the Battalion Trains performing duty with the supply element. PFC Ebinger was known to be a complainer and constantly maintained temporary profiles restricting performance in his MOS 11B. Captain Davis does not recall any incidents as alleged by PFC Ebinger. The unit has had an adequate supply of ball point pens and leech repellent. No complaints have been received regarding shortages of the aforementioned.

## Summary of Interview

Captain Davis Shanks, Battalion Surgeon, 4th Battalion, 3d Infantry was interviewed on 28 August 1968 and stated in substance the following:

Captain Shanks arrived in Vietnam with the battalion in December 1967. Shortly after arrival, B Company performed a combat operation for approximately a five day duration. PFC Ebinger was a part of this combat operation. Upon completion of the operation, PFC Ebinger came to the Battalion Surgeon and claimed that his ankle was giving him trouble. A thorough evaluation of his case resulted in granting a temporary profile. This started a chain of problems with PFC Ebinger's physical condition. On several other occasions he managed to secure other temporary profiles for his ankle, feet and legs. Before leaving the battalion for rotation to the United States, an intensified check was being conducted to determine whether Ebinger had forged the signatures and dates on some of his temporary profile forms.

Since EM's application for early discharge was approved, the alleged forgery was not pursued further. No incidents of alleged rape or mistreatment of a captured farmer had been reported during the period the unit has been in Vietnam. Treatment of Viet Cong and other prisoners of war within Medical Support Operations had been equal to that received by United States soldiers.

### Summary of Interview

Captain George Bryant III, Battalion S-4, 4th Battalion, 3d Infantry, was interviewed on 28 August 1968 and stated in substance the following:

Captain Bryant was the Service Platoon Leader of the battalion from December 1967 to 20 June 1968 when he assumed duty as the Battalion S-4. Captain Bryant does not recall that at anytime ball point pens were in short supply. The unit has always had sufficient quantity of leech repellent. During combat operations in leech infested areas for the period 2 July to 31 July, the battalion was issued experimental leech repellent along with questionnaires. Sufficient quantity was available for troops actually participating in Combat Assault Operations. The repellent was disseminated by the Battalion Sergeant Major who monitored submission of the completed questionnaires. During this period no complaints were received indicating a lack of leech repellent. Personnel located at LZ Baldy had no requirement for leech repellent since leeches were not in the immediate area. To the best of Captain Bryant's knowledge there has been no reported incidents of rape or mistreatment to a captive farmer during the period he has served with the battalion.

### Summary of Interview

1/LT Bruce Kendrick, Aide de Camp, Headquarters Americal Division and formerly a platoon leader Company E, 4th Battalion, 3d Infantry was interviewed on 28 August 1968 and stated in substance the following:

LT Kendrick was a member of the 4th Battalion, 3d Infantry for the period June 1967 - June 1968 and served with the unit in Vietnam from December 1967 to June 1968. LT Kendrick knew Captain Michels and based on his character and reputation could not believe that the allegations as stated happened. Captain Michels was killed in a helicopter accident in June 1968. LT Kendrick could not recall any incidents involving rape or mistreatment of captives during his tour with the unit. He recalls that his unit had no problems with the procurement of leech repellent or ball point pens.

### Summary of Interview

First Sergeant Wilhelm Dahner, First Sergeant, Company B, 4th Battalion, 3d Infantry was interviewed on 27 August 1968 and stated in substance the following:

Sergeant Dahner was PFC Ebinger's First Sergeant from December 1967 when Company B arrived in Vietnam to August 1968. PFC Ebinger rotated to the United States on 11 August 1968 after receiving an "early out" to return to college. PFC Ebinger participated in one combat operation with his unit in December 1967 for a period of five days. On returning to base camp, PFC Ebinger obtained a temporary profile and was assigned to the supply element in the Battalion Trains Area where he remained until rotating. PFC Ebinger was a chronic complainer and performed his duties in hardly a satisfactory manner. Sergeant Dahner does not recall any incidents as alleged by PFC Ebinger. In early June, elements of the battalion were conducting combat operations in an area infested with leeches. Requests were given to the S-4 to procure leech repellent and the repellent was received in about two days. On arrival the Sergeant Major delivered the repellent to troops in the field. This was the first requirement the unit had for leech repellent since arrival in Vietnam. No complaints were received from members of the company regarding lack of repellent once it had been delivered to the units' field locations.

### Summary of Interview

S/Sgt Edward Vann, Re-Supply Sergeant, 4th Battalion, 3d Infantry, was interviewed on 28 August 1968 and stated in substance the following:

S/Sgt Vann was associated with Ebinger for approximately 15 months as members of the same battalion. Upon arrival in Vietnam in December 1967, the unit participated in a five day combat operation. At the completion of this operation, PFC Ebinger secured a temporary profile and was assigned duty with the re-supply element of the battalion. Ebinger's performance in the supply element was satisfactory. For a 30 day period in July 1968, Ebinger was located at LZ Baldy. Units operating in the area of LZ Baldy had a requirement for leech repellent. Experimental leech repellent was issued with questionnaires to be completed by individual soldiers. The Battalion Sergeant Major assumed the responsibility for issue to troops engaged in combat operations and monitoring completion of the questionnaires. The leech repellent was delivered to field combat locations by the Sergeant Major. No complaints were received indicating a shortage of the repellent and there was always a sufficient quantity on hand. Personnel located at LZ Baldy had no requirement for leech repellent since leeches were not present in the immediate area. Sergeant Vann has no knowledge of any reported incidents of alleged rape or mistreatment to a captured farmer. It is believed that Ebinger's allegations are basically untrue or based on distorted information because he was not in the field long enough to know exactly what was going on.

Exhibit M-46 is published in Volume III,  
Book 3, Reports.

DEPARTMENT OF THE ARMY  
HEADQUARTERS MEDICAL DIVISION  
APO San Francisco 96374

Jad  
3 February 1968

SPECIAL ORDERS  
NUMBER 34

E X T R A C T

38. TC 322. Ur AR 672-5-1 fol indiv Co B 4th Bn 3d Inf awd COMBAT  
INFANTRYMAN BADGE (3d Award).

<u>NAME</u>	<u>ASN</u>	<u>SSAN</u>	<u>GRADE</u>	<u>MOS</u>
DAHNER, WILHELM	RA369498E1	361-16-8645	1SG E8	11C50

Ur AR 672-5-1 fol indiv Co B 4th Bn 3d Inf awd COMBAT INFANTRYMAN BADGE  
(1st Award).


MICHLES, EARL R	CF102674	431-66-4457	CPT	71542
COCHRAN, ROY B	05331399	241-66-543E	1LT	1542
SPRAGGINS, JOHN B	05331353	237-74-9980	1LT	1542
CARTER, DAVID S	05344512	559-66-0702	2LT	1542
ROSS, ROBERT L	05347350	189-38-0272	2LT	1542
WILLIAMS, MAURICE T <i>TC P</i>	RA14650331	265-56-926E	rSG E7	11B40
MC CLOUD, FRANKLIN A <i>(S)</i>	RA16685434	309-40-9255	SSG E6	11B40
VANN, EDWARD O	RA53350103	744-04-1914	SSG E6	11C40
WESTER, WILBURN E <i>2 (SW)</i>	RA34834986	254-30-4E21	SSG E6	11B40
WYATT, JAMES E	RA17435150	4E6-3E-3015	SSG E6	11B40
BRADDOCK, JAMES A <i>2</i>	RA12771139	144-40-1575	SGT E5	11B40
CARDINES, HENRY D	US50012431	576-44-9786	SGT E5	11B40
CONGLETON, LAWRENCE	RA15750599	316-46-3742	SGT E5	11B40
JORDAN, LOREN H	US55984633	4E8-54-4262	SGT E5	11B40
LIAS, RAY L	RA18656413	450-68-4683	SGT E5	11B40
MARSHALL, BARRY P	RA12767726	056-36-9350	SGT E5	11C40
PODEBRADSKY, ANTHONY	US55881248	399-50-9891	SGT E5	11B40
REED, BOBBY E	US55991488	496-50-2364	SGT E5	11B40
BEST, WILLIE R	US51598875	242-68-8700	Sr4 E4	11C20
CABALLERO, ROBERT	US56823924	549-6E-8950	Sr4 E4	11C20
CRESCENTE, RAFAEL A	US51609197	0E7-36-572E	Sr4 E4	11B20
EASTENLING, RONALD J	US51827975	277-46-5063	Sr4 E4	11B20
GARCIA, CRESENCIO	US54719532	465-68-5567	Sr4 E4	11320
GELMEYER, ROBERT W	US56456860	3E8-44-1344	Sr4 E4	11C20
GONZALEZ, ESTEVEN P	US54E14372	360-32-2662	Sr4 E4	11320
HATCH, LARRY L <i>RT0</i>	US54811439	358-40-7652	Sr4 E4	11B20
HOOTON, DONALD R	US5496093E	376-44-2E02	Sr4 E4	11B20
HUFFMAN, CECIL W	RA1E748797	448-42-3662	Sr4 E4	11C20
ISAACS, RALPH D	RA67029433	404-6E-820E	Sr4 E4	11E20
JONES, WALTER	RA25149466	247-72-2910	Sr4 E4	11B20
KLEIN, GARY A	US558E1288	395-42-7080	Sr4 E4	11B20
LINKOUS, RODNEY V	RA19E93402	527-80-063E	Sr4 E4	11B20
LITTLE, KING D	RA11564904	214-50-6735	Sr4 E4	11B20
MORGAN, CARL E	RA10985117	404-70-0016	SP4 E4	11C20
MYERS, LUTHER C	RA11819535	116-40-5443	Sr4 E4	11C20
PARKER, HARVEY E <i>2</i>	US52E09971	20E-34-E099	Sr4 E4	11B20
RIMES, ROBERT A	US55E96395	270-46-1183	Sr4 E4	11B20
SCHINDLER, DAVID R <i>2</i>	RA16947593	317-44-1145	SP4 E4	11B20
SCHREINER, STEVEN A	US51606381	194-3E-31E2	SP4 E4	11B20
SERLS, DAVID A	RA12769607	157-34-9654	Sr4 E4	11B20
TAYLOR, LARRY H	RA1686E363	491-54-0066	SP4 E4	11B20
TITTLE, RAY E	RA157583E1	194-38-3182	Sr4 E4	11B20
TRUJILLO, THOMAS E	US54377252	569-64-7982	SP4 E4	11B20



✓ WHITTAKER, BRICE E	US54962565	380-50-2914	Sr4 E4	11B20
✓ ASKEW, WALTER A	US63002731	261-82-6795	PFC E3	11B10
✓ AWBREY, GERALD C -	US54509297	465-72-2501	PFC E3	11B10
BREITENSTEIN, PETER	US56706869	558-68-7131	PFC E3	11B10
CANTU, GILBERT	RA15957994	NONE	PFC E3	11B10
✓ COLLICCHIO, PETER	US52748997	071-38-7187	PFC E3	11B10
✓ DUFF, EDWARD E <i>CR</i>	US55943611	315-48-4371	PFC E3	11C10
FERNANDEZ, MARIO J	US67083968	263-82-8926	PFC E3	11B10
✓ GLEGHORN, JERRY <i>(K/A) 2</i>	US43665015	940-46-6774	PFC E3	11B10
✓ GUTHRIE, JIMMY W	US54385781	585-05-9869	PFC E3	11B10
HALL, HOMER C	US53451559	257-64-4645	PFC E3	11B10
HAYES, PETER J	RA11814568	064-38-3244	PFC E3	11B10
HOLMES, LARRY G	US55943619	303-52-7345	PFC E3	11B10
HOSKINS, JOHNNY E	US67082967	259-74-4079	PFC E3	11B10
HOUGHTONK, DANIEL R	US52967111	113-38-3659	PFC E3	11C10
✓ INGALLS, VINCENT C	US54960306	381-44-1826	PFC E3	11B10
JONES, MARVIN B	US54963733	383-46-6771	PFC E3	11B10
KINGSBY, DAVID L	US56454757	393-44-3251	PFC E3	11B10
MADISON, JOE	US53701864	261-64-7604	PFC E3	11B10
✓ MAHR, MICHAEL D	US51591672	102-38-3334	PFC E3	11B10
MC FARLAND, PERCY L	US54564035	428-88-5323	PFC E3	11C10
MC CURRY, WILLIAM A	RA12886850	263-68-9585	PFC E3	11B10
MC KENNEY, WILLIE J	US53701886	264-74-0299	PFC E3	11B10
MICHENER, MORRIS G	US52676652	233-76-2797	PFC E3	11B10
MILLER, STEPHEN M	US53811545	409-76-0975	PFC E3	11B10
MILUS, EDWARD L	US54440703	463-80-3182	PFC E3	11B10
MORRIS, JAMES L	US53452391	258-74-1037	PFC E3	11C10
✓ NAVARRE, GEORGE G	US54963235	375-44-0682	PFC E3	11B10
✓ NEVINS, CHARLES	RA67158472	312-52-4282	PFC E3	11B10
ROMEROY, DAVID K	US56587053	490-46-7583	PFC E3	11C10
QUINTANILLA, MARTIN	RA16990763	499-54-0958	PFC E3	11B10
SCHMIDT, CLETUS F	US56543285	508-66-3371	PFC E3	11B10
SNITCHLER, HOWARD W	US53701417	133-38-5581	PFC E3	11B10
STEINBRECHER, WESLEY	US54966545	306-42-4426	PFC E3	11B10
STRACHAN LEO J	RA14969888	266-92-3671	PFC E3	11B10
TIMMER, EDWARD G	RA16923175	484-60-6289	PFC E3	11B10
THARP, WILLIAM E	US51830751	288-40-7890	PFC E3	11C10

FOR THE COMMANDER:

OFFICIAL:

  
F. H. GENEL  
2LT, AGC  
Asst AG

NELS A. PARSON, JR  
Colonel, GS  
Chief of Staff

DISTRIBUTION:

162-2 Ea Indiv conc

45-AVDF-AGA

243-AVDF-AG&R

243+10-AVDF-AGD

5-CG, USARV, ATTN: AG Awards

5-CG, Americal Div APO 96374

5-Co B 4th Bn 3d Inf 11th LIA APO 96217

Exhibit M-48 is published in Volume III,  
Book 1, Directives.

EXHIBIT M-48

Son Tinh District  
Son My Village  
NR 116 Admin Office

REPUBLIC OF VIET NAM

Administrativ e Council Son My Village

TO: 1LT District Chief, Son Tinh District

SUBJECT: Report of the Allied Operation of  
16 March 68

Concerning the allied operation conducted  
16 March 1968 at Tu Cung and Co Luy hamlets of  
Son My village:

Margin notes in pen:

Thuan Yen	19
My Khe	3
Trung Binh	4
Binh Tay	3
Binh Dong	23

Results: Allies: 1 killed, 2 WIA (at  
Thuan Yen subhamlet, Tu Cung hamlet).

Viet Cong: 48 killed, 52 wounded (including  
guerillas, cadre from subhamlet, hamlet, village  
and district).

Civilians: Tu Cung 480  
Co Luy 90

Total: 570 civilians

Besides persons killed, animals, property  
and houses were 90% destroyed.

For information of the District Chief.

Son My 22 March 1968

signed

Mr. Do Dinh Luyen  
Chairman Village Council  
(also Village Chief)

Translator's Note:

Subhamlets of Tu Cung Hamlet are:

Thuan Yen  
Binh Tay  
Binh Dong  
Truong Hoa  
Truong An

Above total is 52 -- same as number of VC reported wounded.

A true translation to the best of my knowledge, Saigon, Republic  
of Vietnam, 7 January 1970.


  
BILLY M. STANBERRY  
Lieutenant Colonel, U. S. Army

EXHIBIT M-49

QUỐC LÃI  
SỐ 116/VAC

VIỆT NAM CỘNG HÒA

-----

ỦY BAN HÀNH CHÍNH XÃ SƠN HỮU

**Nhiệm vụ:** Trung úy quân trưởng quân sự.

**Thích ứng:** V/V Báo cáo dụng cụ của quân đội đồng minh.

Trong cuộc, Hành quân do quân sự của quân đội đồng minh ngày 10/3/1960 tại xã Sơn Hữu, huyện Sơn Hữu, tỉnh Sơn Hữu.

- Ước giờ 13
- Nếu khác 3
- Tổng số 4
- Phải trả 3
- Phải lấy 23

**Tên quân:** Bông mìn: tử thương, vụ bị thương.

**Viết quân:** 40 quân bị thương, 10 quân bị chết.

**Thích ứng:** 10 quân bị thương.

**Ước giờ:** 13 giờ.

Thời gian về nhà của quân sự, số quân bị thương 10/10.

Hạt quân trong việc thích ứng của quân sự.



03/1960

*signed*

Exhibit M-50 is published in Volume III,  
Book 3, Reports.

**FOR OFFICIAL USE ONLY**

PSYCHOLOGICAL OPERATIONS IN THE VICINITY OF BS 7178, QUANG NGAI PROVINCE

1 - 20 MARCH 1968

Date	Location (Coordinates)	Leaflet		Broadcasts					
		Number	Number Dropped	Title	Aerial	Ground	Duration	Tape Number	Title
1 Mar 68	BS 685805				X		20 min	T-7-141C-68	Unite with the GVN to Build Economical Powerful Vietnam
2 Mar 68	BS 7081				X		20 min	T-7-317-68	Surrender to the Just Cause of the GVN
4 Mar 68	BS 7081	7-242-68	100,000	Reward for VC Weapons	X		30 min	T-7-317-68	Surrender to the Just Cause of the GVN
11 Mar 68	BS 7386	7-111-68	150,000	(Unknown)	X		20 min	T-7-310-68	The People of South Vietnam Will Never Support a Communist Government
	BS 7384	Chieu Hoi Mixture Number Four	300,000	Chieu Hoi	X		40 min	(Unknown)	Anti-VC
13 Mar 68	BS 6982	Chieu Hoi Mixture Number Four	250,000	Chieu Hoi	X		30 min	T-7-146-68	Chieu Hoi
		Chieu Hoi Mixture Number Four		(Addressed to VC Infiltration Troops)					
		7-330-68		These Planes Will Destroy You					
		7-236-68							
	BS 7280	(Unknown)	150,000	Chieu Hoi					
14 Mar 68	BS 7090	Chieu Hoi Mixture Number Four	100,000	Chieu Hoi	X		30 min	T-7-146-68	Chieu Hoi
		Chieu Hoi Mixture Number Four							
	BS 7092	Chieu Hoi Mixture Number Two	100,000	Chieu Hoi	X		20 min	T-7-117C-68	The Viet Cong Kill Innocent People
18 Mar 68	BS 7685	7-335-68	100,000	(Unknown)	X		30 min	T-7-7&8C-68	Your Choice, Return to GVN or Die
20 Mar 68	BS 7486	SP 2392	50,000	Chieu Hoi	X		10 min	T-7-118C-68	(Unknown)

NOTE: The above information was derived from Exhibit B-3 and the 7th PSYOP Battalion, Da Nang, Republic of Vietnam.

EXHIBIT M-51

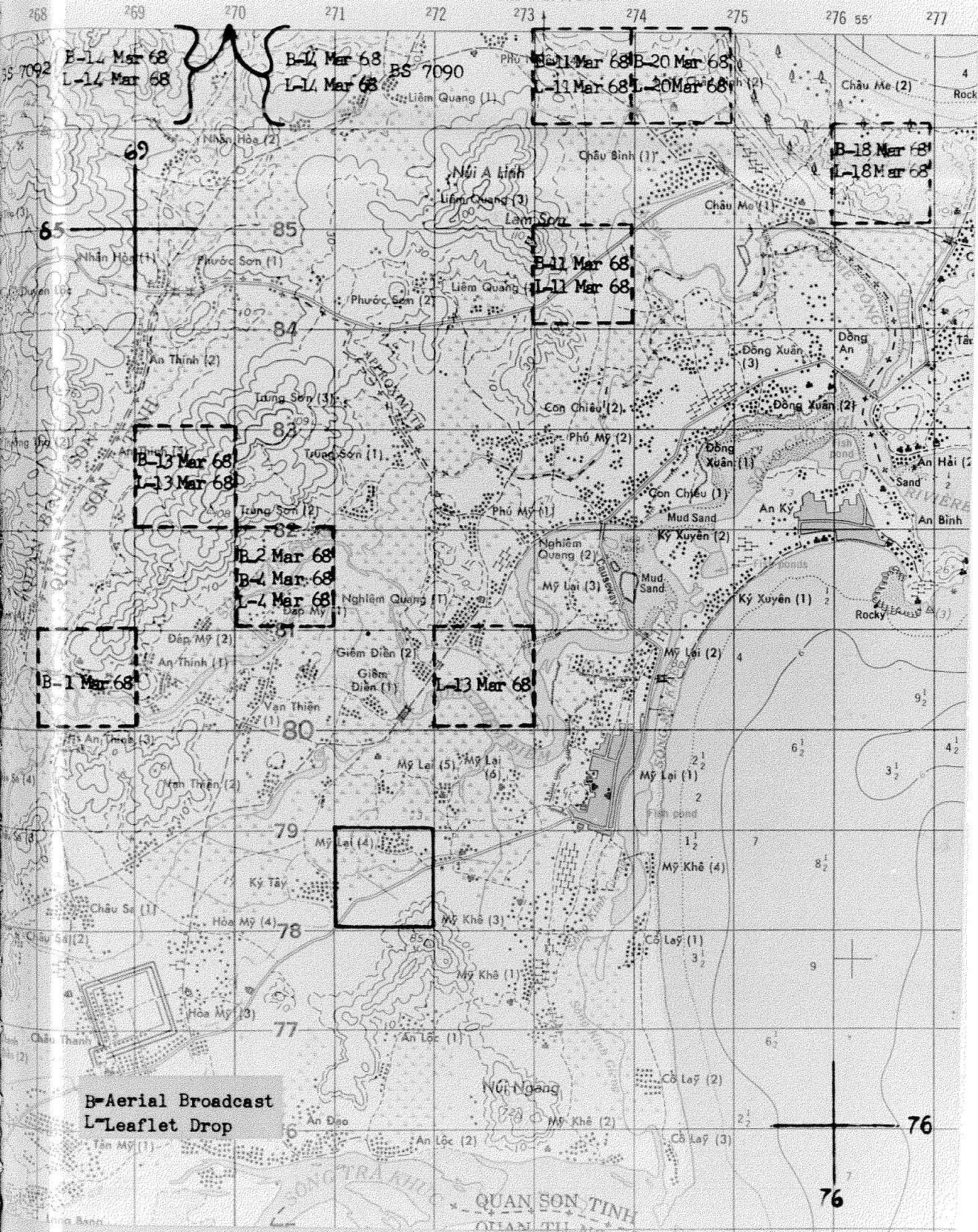
FOR OFFICIAL USE ONLY

# QUẢNG NGAI

SHEET 6739 II

SFRIFS 17014

PHU NHIEU (1) 2.5 KM.



B-14 Mar 68  
L-14 Mar 68

B-17 Mar 68  
L-17 Mar 68

B-11 Mar 68  
L-11 Mar 68

B-20 Mar 68  
L-20 Mar 68

B-18 Mar 68  
L-18 Mar 68

B-11 Mar 68  
L-11 Mar 68

B-13 Mar 68  
L-13 Mar 68

B-2 Mar 68  
B-4 Mar 68  
L-4 Mar 68

L-13 Mar 68

B-1 Mar 68

B-Aerial Broadcast  
L-Leaflet Drop

76

76

22 January 1970

MEMORANDUM FOR: LTG WILLIAM R. PEERS

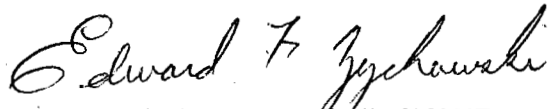
SUBJECT: Interview With Mr. Ronald L. Haeberle

1. Between 1330 - 1600 hours on 19 January 1970 and 1115 - 1240 hours on 20 January 1970, I met with Mr. Ronald L. Haeberle at the Premier Industrial Corporation, Cleveland, Ohio, his place of employment. His counsel was not present.
2. The purpose of this visit was to obtain from Mr. Haeberle the numerical sequence in which he took the pictures (Exhibits P-26 to P-42) when he accompanied Company C, 1st Battalion, 20th Infantry, 11th Infantry Brigade, on a combat assault on My Lai (4) on 16 March 1968.
3. After telephonically receiving the film number and description of each slide from a representative of Life Magazine, Mr. Haeberle looked through the exhibits that I provided him until he found the picture described. The picture was then marked with the film sequence number. A total of 17 film numbers and their description plus one unnumbered film which fit the description of Exhibit #39 were relayed in this manner. Assuming that Mr. Haeberle used a 20-picture roll of film and Life Magazine has 18 of his slides in their possession, two slides are unaccounted for.
4. Mr. Haeberle stated that Exhibit P-28 was not taken on this roll of film. This picture was taken of an unknown area and is not related to My Lai (4). He further stated that Exhibit P-39, (the unnumbered film) was taken somewhere between slide 7 through 12 and could be one of the three missing slides 8, 10 or 11. Mr. Haeberle's film number 20 is a picture of the old Vietnamese man shown in Exhibit P-2 and P-3 except that he is looking at the camera.
5. Mr. Haeberle stated that the representative of Life Magazine who provided the film numbers from the slides was Mr. Gerald Moore, Associate Editor, Life Magazine, New York City, New York.
6. Attached as Inclosure 1 is the sequence in which Mr. Haeberle took the pictures and the comparable exhibit number.



7. Exhibit P-188 is another aerial photograph of My Lai (4) and the surrounding area on which Mr. Haeberle indicated the possible route he traveled on 16 March 1968 and the approximate area in which he took the photographs (Exhibits P-29 through P-42). A comparison between this aerial photograph and the one completed on 17 January 1970 shows a change in his route of travel and the location of Exhibit P-38.

8. At the termination of our meeting, Mr. Haeberle signed the aerial photograph prepared on 17 January 1970 and the one completed on 20 January 1970.



EDWARD F. ZYCHOWSKI  
Major, MPC  
Investigating Officer

1 Incl  
as

<u>HAEBERLE PHOTO</u>		<u>EXHIBIT</u>	<u>REMARKS</u>
1	-	P-26	
2	-	P-27	
3	-	P-29	
4	-	P-30	
5			Single Chopper (Gunship) in the air
6	-	P-31	
7A	-	P-38	
8			Missing - unknown picture
9	-	P-32	
10			Missing - unknown picture
11			Missing - unknown picture
12A	-	P-35	
13	-	P-34	
14A	-	P-33	
15A	-	P-37	
16	-	P-42	
17	-	P-41	
18A	-	P-40	
19	-	P-36	
20			This is a picture of the old Viet- namese man shown in Exhibits P-2 and P-3
		P-28	Unknown area - not taken on this roll of film
		P-39	Unnumbered film - taken somewhere between slides 7 - 12

Incl # 1

Exhibit M-53, Exhibit M-54, Exhibit M-55, and Exhibit M-56 are published in Volume III, Book 2, Directives.

EXHIBIT M-53

EXHIBIT M-54

EXHIBIT M-55

EXHIBIT M-56

This investigation was directed jointly by the Secretary of the Army and the Chief of Staff, United States Army, for the purpose of determining facts and making findings and recommendations concerning:

- (1) the adequacy of prior investigations and inquiries into, and subsequent reviews and reports within the chain of command, of what is now commonly referred to as the My Lai incident of 16 March 1968;
- (2) possible suppression or withholding of information by any person who had a duty to report and to furnish information concerning this incident.

This investigation is not being conducted to investigate all facts and circumstances of what happened at My Lai. It is directed to those specific purposes just stated. GEN Peers has had made available to him and has reviewed prior official statements obtained in other official investigations of the My Lai incident.

Your testimony will be taken under oath. A verbatim transcript will be prepared. A tape recording is being made in addition to the verbatim notes being taken by the reporter.

Although the general classification of the report will be confidential, it is possible that testimony, or parts of it, may later become a matter of public knowledge.

There are several persons in the room who may ask you questions. These individuals are assistants and they are authorized to ask questions. However, GEN Peers has the responsibility of weighing the evidence and making the findings and recommendations.

You are requested to not discuss your testimony with others

**EXHIBIT M-57**

except in the performance of duty or as you may be required so to do before a competent judicial, legislative, or administrative body. You are cautioned that, if you are subject to the order issued by the military judge in the general court-martial case of United States v. Calley, your appearance here in no way changes the applicability and effect of that order.

You may be requested to appear before a Special Subcommittee of the House Armed Services Committee. This Committee is looking into the entire incident of My Lai and your appearance and instructions before the Peers Inquiry in no way restricts your appearance before the House Armed Services Committee. You will be notified prior to your departure if you are to appear before the Committee.

Release No. 113-68-75

FOR IMMEDIATE RELEASE:

RUNNING BATTLE

MACOI REP 4706 I CORPS DANANG RVN	INFORMATION OFFICE 11TH INFANTRY BRIGADE MARINE "MARAC" DIVISION APO San Francisco 96217
CLEARED FOR RELEASE	
NOT CLEARED FOR RELEASE	

AM-4-68-343

By SFS JAY A. ROBERTS

CHU LAI, Vietnam (MARACAL IO)—For the third time in recent weeks, the Americal Division's 11th Brigade infantrymen from Task Force Barker raided a Viet Cong stronghold known as "Hickville" six miles northeast of Quang Ngai, killing 128 enemy in a running battle.

The action occurred in the coastal town of Ky Lai where, three weeks earlier, another company of the brigade's Task Force Barker fought its way out of a VC ambush, leaving 80 enemy dead.

The action began as units of the task force conducted a combat assault into a known Viet Cong stronghold. "Shark" gunships of the 174th Aviation Company escorted the troops into the area and killed four enemy during the assault. Other choppers from the 123d Aviation Battalion killed two enemy.

"The combat assault went like clockwork," commented LTC Frank Barker, New Haven, Conn., the task force commander. "We had two entire companies on the ground in less than an hour."

A company led by CPT Ernest Medina, Schofield Barracks, Hawaii, killed 14 VC minutes after landing. They recovered two M1 rifles, a carbine, a short-wave radio and enemy documents.

(MORE)

EXHIBIT M-58

....AND ENEMY DOCUMENTS. 2-2-2

The attack on the village accounted for 69 enemy killed, some of which were attributed to supporting artillery fire. A suspect told the interpreter that a large VC force had spent the night in the village.

Another platoon of "Jungle Warriors" was airlifted to an area south of the village along the beach. This unit, under 2LT Thomas Billingham, Clark, N.J., immediately ran into enemy fire. When the VC fled, they left 30 dead. The platoon then continued to move up the beach where they saw an enemy soldier slipping into a tunnel. The tunnel turned out to be an enemy underground complex, where the platoon killed eight VC. The tunnels housed a VC hospital and storage area which contained web gear, hand grenades and small arms ammunition.

The swiftness with which the units moved into the area surprised the enemy. After the battle, the 11th Brigade "Warriors" moved into the village, searching each hut and tunnel. CPT Medina directed the search and worked with an interpreter to obtain information from the villagers. They were told that American and South Vietnamese troops would remain in this area to keep the village free of Viet Cong.

# Men Of Task Force Barker Kill 128 VC In Running Battle

**CHU LAI, (AMERICAL-10)**— For the third time in recent weeks, men of Task Force Barker, 11th Light Infantry Brigade raided a Viet Cong stronghold known as "Pink-village" six miles northeast of Quang Ngai, killing 128 enemy in a running battle.

The action occurred in the coastal town of My Lai where three weeks earlier another company of the brigade's task force fought its way out of an ambush, leaving 80 VC dead. The action began as units of the task force swept into the stronghold.

A task force company led by Capt. Ernest Medina killed 14 VC minutes after landing. They recovered three weapons,

a shortwave radio and enemy documents.

The ground attack and supporting artillery fire accounted for 69 enemy dead. One detailed suspect told the interpreter that a large VC force had spent the night in the village.

Another platoon of infantrymen was airlifted to a area south of the village along the beach and immediately ran into enemy fire. The enemy fled, leaving 30 dead.

The platoon continued to move up the beach, where they saw enemy soldiers slipping into tunnels. Eight VC were killed, and the tunnel complex was found to be a hospital and storage area.

After the battle, the unit

moved through the village, searching huts and tunnels and using an interpreter to question the villagers.

Welfare authorities, refugees are being moved from temporary shelters to a permanent refugee settlement at Petrus Ky.

The work of resettling homeless refugees will not be quickly accomplished. To judge the scope of the task, it took 42 months prior to the Tet offensive to resettle or return to their homes a total of 1,520,233 refugees. The current total is slightly higher than that figure.

## Repetition Emphasized In PsyOps Programs

**LAI KHE, (1st INF-10)**— Successful Psychological Operations (PsyOps) play an increasingly important role in support of elements of the 1st Infantry Division.

Recently, a new phase of PsyOps was carried out by members of the G-5 section of the 1st INF and the 6th Psycho-

South Vietnam.

In addition, PsyOps attempts to stimulate interest and participation in government affairs by the people of Vietnam. PsyOps also emphasizes that the United States and other Free World powers will withdraw once aggression is defeated.



# 11TH INFANTRY BRIGADE TRIDENT

VOLUME 1 NUMBER 11

APRIL 19, 1968

## "REGULARS" HEIST VC HARDWARE

Elements of the 11th Infantry Brigade recently concluded a combat operation eight miles southwest of Quang Ngai city, into an area normally included in an adjoining ARVN area of operation.

Persistent intelligence reports of VC supply channels and caches in the area brought the 1st Bn, 20th Inf sweeping into the foothills, supported by APCs of the Brigade's armored troop and helicopter gunships from Primo Aviation Ltd. and the 174th Aviation Company.

After a week of fighting, the situation report of Operation Norfolk Victory reads like a hardware shopping list as "Sykes' Regulars" companies uncovered large VC munitions.

Tunnel and bunker caches have yielded 131 individual and crew served weapons including two complete mortars, more than 4,000 small arms and crew served weapons rounds, and 3,000 pounds of other types of explosives. They also uncovered a graveyard containing the bodies of 27 VC killed during the week by small arms and artillery fire.

In addition, enemy base camps discovered by the "Regulars" have revealed VC classrooms, hospitals, medical supplies as well as combat and administration supplies and VC mine and booby trap manufacturing equipment. An abandoned VC compound rigged with barbed wire was destroyed in the same area.

(NORFOLK Cont. on page 3)

## WEAPONS CACHES HIGHLIGHT WARRIORS' WEEK

In a week of continuous contact with the enemy, the Jungle Warriors of the 11th Brigade amassed 77 kills, captured 250 weapons, and collected large amounts of munitions.

A unit of the 3d Battalion, 1st Infantry, led by CPT Robert Dickson, spent two days clearing a large tunnel complex NW of Duc Pho. Detecting the presence of enemy in the tunnel, the company threw in grenades to persuade them to come out. When no enemy appeared, PFC Clarence Brown was sent in to search the tunnel. He spent most of the first day in clearing the complex. When three tunnel (WRAP-UF Cont. on page 3)



## TFB FILLED MUSCATINE VOID

The 11th Infantry Brigade's main body was in Vietnam less than a month when it was given control of Operation Muscatine. This added responsibility called for two battalion-sized elements. One of these maneuver elements was the 4th Battalion, 3d Infantry and the other was a composite of one company from each of the Brigade's battalions.

On January 22 a convoy consisting of A Co., 3d of the 1st; B Co. "Old Guard"; C Co. "Sykes' Regulars" and staff from HHC 11th Brigade rolled from LZ Carentan to become Task Force Barker. In its brief 78 day history, TFB compiled an impressive record for itself and the 11th Brigade.

TFB, commanded by and named for LTC Frank Barker boasts 401 Viet Cong killed and 33 weapons captured. Besides its outstanding military accomplishments, TFB carried out many successful civil affairs and medical aid programs in and around their operational area.

The task force con- (BARKER Cont on Page 4)

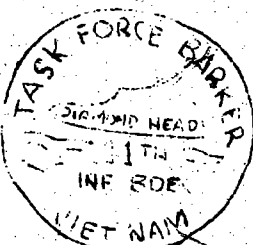


EXHIBIT M-59

Pages 2 and 3 not applicable.

(NR.F-UF Cont. from page 3)  
47 mortar rounds, 30 rockets, 5 anti-tank weapons, 29 M79 rounds, 25 hand grenades, and 10,740 rounds of small arms and machine gun ammunition. In addition, Vietnamese turned over two claymore mines, two Bangalore torpedoes, and an M1 carbine.  
\* \* \* \* \*

## TASK FORCE BARKER

(CONT FROM PAGE 1)  
ducted three major combat operations. These offensive sweeps cost the enemy a total of 276 men killed in the My Lai area.

The first of these actions was on February 12. During this battle TFB proved itself capable of coping with numerically superior enemy forces. They destroyed a major enemy rest area and killed 78 enemy during a joint Army, Navy and Army of the Republic of Vietnam operation.

It was in this battle that the courageous "Dirty Dozen" was born. Commanded by 1LT John Spraggins, 12 volunteers from B Co., "Old Guard" assaulted a heavily reinforced and numerically superior enemy force cutting down 44 of the estimated 100. "Charlie" fled.

### FIFTEEN AWARDS

Other displays of heroism by "Dolphins" from the 174th Aviation Co., AFCs from E Trp, 1st Cavalry, and other Barker companies received 15 awards for individual bravery as a direct result of the enemy encounter.

In late February, infantry and cavalry units of TFB, supported by the brigade's "Fishes Aviation Ltd," "Sharks," and four air strikes by Air Force F-105 Thunderchiefs, encountered the remnants of a Battalion-sized enemy force. In the four-hour engagement near the village of My Lai, a total of 68 enemy dead were left on the battle field and five weapons were captured.

### 128 KILLS

In a large combat assault on March 16, TFB landed two companies simultaneously on opposite sides of a known VC stronghold. During the heavy fighting that ensued 128 enemy were killed and forty 60mm mortar rounds, three rifles, a radio, enemy documents, and numerous supplies were captured. The fighting took place in an area known as "Pinkville," six miles northeast of Quang Ngai.

The task force and supporting engineers from B Company, 39th Engineers established Z Dottie as a refueling and rearming heliport for the Operation Muscatine tactical area.

## "HOI CHANHS" TURN IN VC CHIEF

"Hoi Chanhs" - Viet Cong defectors - led the Recon Platoon, 3d Bn, 1st Inf, in an operation north of Duc Pho which netted 10 suspects and one enemy killed. The dead soldier was later identified as a local guerrilla chief; he had valuable documents on his person.

The first Hoi Chanhs, Nguyen Thiep, turned himself and his M1 rifle in to local authorities and said that he had narrowly escaped capture by 3d of the 1st's C Co the day before.

Thiep took the platoon to the hamlet of An Tho. He pointed out the location of two camouflaged positions harboring six men.

After an ARVN interpreter, SGT Vu Van Thuong, failed to talk them into surrendering, a member of the platoon threw a grenade into the position, wounding one of the three suspects inside.

The three men in the other hole surrendered after hearing the explosion.

The platoon leader, 1LT John F. Nolan, who has since assumed command of B Co, 3d of the 1st, questioned the suspects with Thuong, and one of them volunteered to lead the platoon to more VC in the nearby hamlet of Phan That.

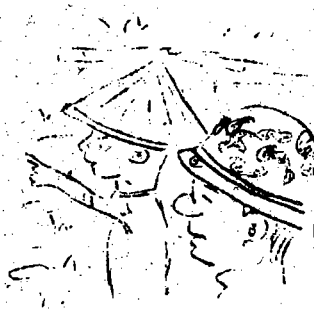
As the platoon moved out of An Tho, they received fire, and SSG Patrick J. Hardy, spotted two suspects running toward Phan That.

With the cry of "Dink running!" he alerted the other members of the platoon and gave chase.

The platoon came in to the village and the informer led the men to a hole containing four suspects. As the platoon was trying to get the suspects to come out, SSG John R. Yount noticed brush moving near the entrance to a nearby bunker. Motioning to Hardy to assist him, he

covered the bunker's entrances.

When the four suspects had been captured, the informer was sent into the bunker, but stopped when two shots were fired. SSG Yount, who was covering the other entrance, threw a grenade in and followed after the explosion.



Inside, he discovered a dead VC, a cal. .45 pistol and a map case containing documents. Later investigation revealed the dead VC to be a district chief.

Nolan commented later: "If Yount hadn't seen those bushes move, the district chief would not have been discovered. He (the district chief) showed a definite will to resist."

# AMERICAL

news



sheet

## MIRACLE WEATHER REPORT

Partly cloudy Tuesday with little change foreseen. Winds variable at 10 knots per hour. High Tuesday 90. Low Tuesday night 73.

Vol. 1 No. 332 Monday March 18, 1968

### Americal Units Kill 43 In Action Yesterday

PHU LAI (AMERICAL-10) --- Americal Division forces recorded 43 enemy kills in fighting throughout southern I Corps yesterday. Americal units reported three infantrymen killed and 11 wounded and evacuated for treatment.

Elements of Americal's 196th Brigade killed 18 enemy and captured one 60mm mortar tube in contacts throughout the "Chargers" area of Operation Wheeler/Wallowa yesterday.

A company of the 3d Battalion, 21st Infantry commanded by CPT Robert E. Coringan Jr. (Arlington, VA.) killed two VC with 81mm mortar fire. A unit of the 21st Infantry killed one VC on a search and destroy mission. CPT Cecil H. Oxford's (Corpus Christi, Tex.) company of the 3d Battalion, found one NVA that had been killed by an air strike.

Members of a company of the 2d Battalion, 1st Infantry commanded by CPT Jose R. Feliciano (Balt, Md.) killed two VC and found one 60mm mortar tube while on a search and destroy mission.

A 1st Battalion, 6th Infantry company commanded by CPT Robert D. Leinen Sr. (Auburn, N.Y.) found and evacuated 1,200 pounds of rice. Another 6th Infantry company led by CPT James T. Price (Fayetteville, N.C.) killed one VC. Other elements of the 6th Infantry killed two NVA.

CPT Larry R. Byer's (Des Moines, Wash.) company of the 4th Battalion, 31st Infantry adjusted artillery on three NVA. One NVA was killed by the rounds fired by a battery of the 3d Battalion, 82nd Artillery. The company later killed one NVA soldier.

"P" Troop, 17th Cavalry was credited with one enemy kill and a 2nd Battalion,

35th Infantry company engaged eight NVA and killed four. "C" Troop 7th Squadron, 17th Cavalry recorded two VC kills while flying in general support of the "Chargers" yesterday.

Units of Americal's 1st Squadron, 1st Cavalry reported an enemy body count of eight yesterday in Operation Wheeler/Wallowa near Tam Ky.

A troop of the 1st Cavalry on a search and destroy mission north of Tam Ky picked up one of the enemy kills. A tank commanded by SSG Bobby L. Ward (Duganville, Tex.) was responsible for the enemy kill.

Another unit of the Cavalry on a search and destroy mission nine miles northwest of Tam Ky discovered a mass grave containing seven NVA bodies. Platoon SGT Gil I. Martinez (Killeen Tex.) along with SGT James M. Wanner (Grand Rapids, Mich.) discovered the grave site.

"Jungle Warriors" of Americal's 11th Brigade killed 10 enemy soldiers in the Duc Pho area and six in Operation Muscatine yesterday.

Action tapered off in the Operation Muscatine area after Saturday's heavy contact in which 128 VC were killed. "Jungle Warrior" soldiers of Task Force Barker continued to push through paddies northeast of Quang Ngai and killed six VC yesterday.

A company commanded by CPT Earnest Medina (Schofield Barricks, Ha.) killed three VC and detained two suspects while searching villages and tunnels. Another unit of "Barkers Bastards" led by CPT Earl Michles (Pocahontas, Ark) of the 4th Battalion, 3rd Infantry killed a VC in the same area. Another 3rd Infantry

EXHIBIT M-60

AMERICAL (Continued)

unit killed two VC later in the day.

Units of the 11th Brigade's 3rd Battalion, 1st Infantry conducted a combat assault eight miles north of Duc Pho yesterday. A company led by CPT Joe Rhinehart (Canton, N.C.) discovered a large tunnel complex and killed five VC. Another 1st Infantry company found the body of a VC killed by artillery. Earlier in the day a unit discovered a large VC base camp with several foxholes and bunkers. Although they found some supplies, the enemy had evacuated the area. The unit is led by CPT Robert Dickson (Decatur, Ga).

A company of the 1st Battalion, 20th Infantry killed three VC late Sunday night. Yesterday a 20th Infantry company discovered the body of a VC killed by artillery.

One enemy soldier was reported killed in Americal's 198th Brigade's area of operations yesterday.

A company of the 1st Battalion, 52nd Infantry reported killing the enemy when the infantrymen fired on movement outside their night perimeter. The VC body was recovered at daybreak yesterday.

In operations north of Chu Lai a unit of the 1st Battalion, 46th Infantry reported finding a booby trapped anti-tank mine. It had been buried on a trail frequently used by track vehicles in that area.

Americal's 14th Aviation Battalion flew 1,328 sorties, carried 1,961 combat troops and hauled 313 tons of cargo in support of the division yesterday.

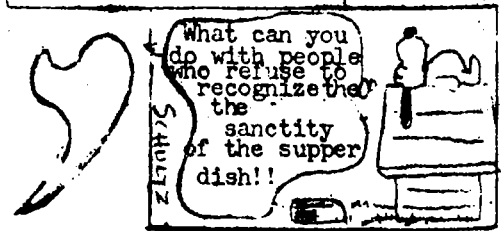
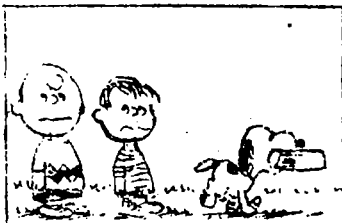
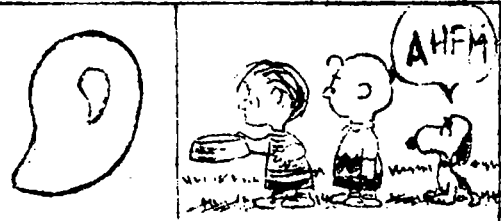
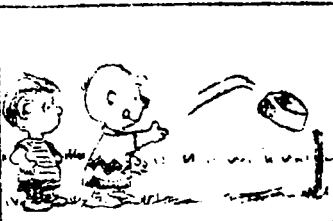
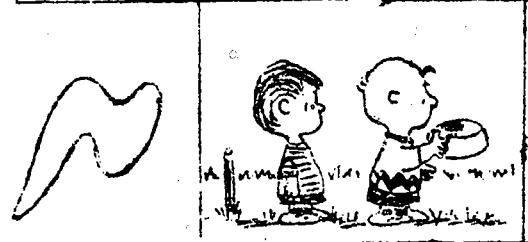
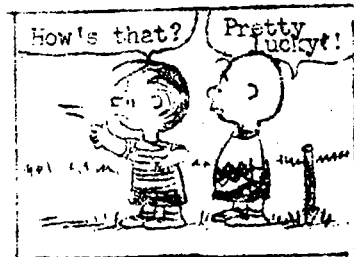
AMERICAL NEWS SHEET

MG S.W. Koster, Commanding General

LTC Patrick H. Dionne, IO

Telephone: Chu Lai 3212 or 2414

This News Sheet is published daily under the supervision of the IO, Americal Division as an authorized Army Publication. This News Sheet is solely for Personnel in the Americal Division and may not be duplicated or released to the news media.



# NEWS RELEASE

Office of Information  
United States Military Assistance Command Vietnam  
APO San Francisco 96222

RELEASE NUMBER 76-68

16 MARCH 1968

## MACV COMMUNIQUE

In the first major contact of the multi-division operation QUYET THANG, initiated on 11 March west and north of Saigon, U.S. cavalrymen and ARVN 25th Infantry Division soldiers killed 81 enemy yesterday. No U.S. soldiers were killed and ARVN casualties were light in the engagement 19 miles northwest of Saigon.

In an unrelated action 14 miles northwest of the capital, troopers from the U.S. 25th Infantry Division discovered a grave containing 18 enemy dead.

In an action today, AMERICAL Division forces have killed 128 enemy near Quang Ngai City. Helicopter gunship and artillery missions supported the ground elements throughout the day. Contact continues at last report.

In the northern-most province of Quang Tri, 1st Air Cav Division soldiers discovered a cache yesterday containing 560 rounds of 60mm mortar rounds. The enemy has been using this type round

WTW

(MORE)

EXHIBIT M-61



The ARVN force also captured 1 crew-served and 3 individual weapons, 10,000 rounds of small arms ammunition, 13 anti-tank mines and 13 bangalore torpedoes.

There were no ARVN casualties during the operation.

(END BACKGROUND)

\* \* \*

4. NAVFORV (GO CONG PROVINCE) - (DELAYED REPORT) - A U.S. Navy SEAL team on an area reconnaissance 48 km (30 miles) south of Saigon Wednesday night made contact with approximately 70 enemy and killed 16 of them.

The patrol made contact with the enemy at 2200. The enemy force was in an area that contained a bunkered campsite and several barracks-type structures.

While exchanging fire with the enemy, the patrol directed U.S. Navy helicopter gunships into the enemy camp. The patrol was extracted from the area at 0315 Thursday morning.

While killing the 16 enemy, 4 U.S. Navymen were wounded.

\* \* \*

5. OPERATION MUSCATINE (QUANG NGAI PROVINCE) - Thus far, 128 enemy have been killed in an engagement between elements of the AMERICAL Division's 11th Light Infantry Brigade and an enemy force of unknown size. The action is taking place in an area 9 km (6 miles) northeast of Quang Ngai City.

This morning at 0750, a company from the brigade made contact with the enemy force when the company entered an area that had been subjected to artillery preparatory fires.

WTW

(MORE)

Another company from the brigade, also involved in the search and destroy mission, was inserted into the area at 0910 approximately 3 km (2 miles) east-northeast of the point of original contact.

As the companies moved toward each other sweeping the area, they engaged the enemy in sporadic contacts throughout the day.

During the course of the engagement, the infantrymen were supported by Army artillery and helicopter gunships.

At last report the contact was continuing.

\* \* \*

6. OPERATION SCOTLAND (QUANG TRI PROVINCE) - SCOTLAND Marines and ARVN troops received more than 230 rounds of mixed enemy mortar and artillery fire yesterday. Casualties as a result of all hostile action in the operation were reported as light.

\* \* \*

6a. PROVCORPSV (QUANG TRI PROVINCE) - This morning about 0600 the Marine combat base at Dong Ha received more than 15 rounds of 140mm mortar fire. Casualties were light. No material damage was reported.

\* \* \*

WTFJ



# Wedding Bells and Chopper Pads For Couple

By SP4 MIKE KEISEY  
Staff Writer

**CHU LAI**—A whirlwind three-month courtship was brought to a dramatic close here July 13 as the happy bride and groom flew off into the sunset in a helicopter with a crew that wore ties instead of armored vests.

CPT Patricia H. Mann, 24, of Wash-

ington, D.C., a nurse at the 2nd Surgical Hospital here, became the bride of CW2 Don Sewell, 22, of San Antonio, Tex., a pilot who brings wounded soldiers to her hospital, in the first military wedding to be conducted at Chu Lai.

Sewell, a helicopter pilot with the 54th Med. Co. (Air Amb.), met his bride at a party given by his unit last April.

(Continued on Page 8)



**NEWLYWEDS EMBARK**—CW2 Don Sewell reads his wife Patricia for a boost into their "honeymoon helicopter," as the pilot falls on their heads. Asking is the chopper crew, dressed in ties instead of armored vests. (Photo by Sp4 Bill Guertant, Photo Editor)

## SOUTHERN D C R O S S AMERICAL DIVISION

259

Vol. 1, No. 4

CHU LAI, VIETNAM

August 1, 1968

### New Enemy Threats

# Homeless In Son Tra Start Reconstruction

**SON TRA**—Some 2,000 P.V., an organization which victims of a Viet Cong terror attack on this fish-

ing hamlet have started the agonizing rebuilding process under the shadow of renewed enemy threats.

They are being assisted in their efforts to restore what

I know of has left the village. They're right behind the government on this and have been giving us excellent cooperation all the way," said 1LT F.A. Martheau, of Biddisford, Me.

Another platoon member. First priority on the reconstruction list is homes. A total of 42 10-family housing units

EXHIBIT M-62

# Fifth 'Jungle Warriors' Battle Enemy In Southern Quang Ngai

LZ BRONCO—June marked the halfway point of the 11th Inf. Bde's first year in Vietnam.

The past seven months have seen the "Jungle Warriors" hit the enemy hard and often, both in major battalion-sized operations and in the slow but steady attrition of daily sweeps through his area.

The soldiers of the brigade have killed more than 1,500 of the enemy, including 15 North Vietnamese regulars, and have captured more than 1,450 individual rifles, pistols, carbines and sub-machineguns, and 39 crew-served mortars and machineguns.

Viet Cong supply lines have also been hurt. Combat sweeps through the brigade's area of operations, from Binh San in the north to Sa Huynh in the south, east from the South China Sea to the western mountains, have yielded 82 tons of captured Communist rice and 178.5 tons of salt, hidden in secret supply caches.

The first major operation undertaken in this area was Operation Muscatine by the men of the 4th Bn, 3rd Inf, when the "Old Guard" occupied LZ Sue near Quang Ngai last Jan. 10, taking over from the 198th Inf. Bde, and the 3rd Bde, 4th Inf. Div.

They were soon reinforced by Task Force Barker, a unit composed of three rifle companies, one from each battalion in the brigade.

Operation Muscatine involved some of the largest encounters with the Viet Cong in the "Warriors" fledgling history. In March, Task

Force Barker troops twice engaged a Viet Cong battalion near the village My Lai on the coast east of Quang Ngai, and killed a total of 196 enemy soldiers.

When Task Force Barker was disbanded after 78 days, it had accounted for 401 of the 1,000-plus enemy killed in the six months of fighting in the Muscatine area.

In early April, the "Old Guard" started again during Operation Norfolk Victory, uncovering a cache of more than 150 weapons and 1,000 pounds of explosives—the largest single cache yet captured by brigade forces.

This same operation saw the soldiers of the 1st Bn, 20th Inf, "Sykes' Regulars" kill 27 Viet Cong and capture more than 125 crew-served and individual weapons, as well as 3,000 pounds of explosives.

The battalion later distinguished itself in the battle for Nui Hoac ridge, when two of its companies were assigned to the 196th Inf. Bde, in Operation Wheeler/Wallowa action near Tam Ky.

The "Regulars" were also instrumental in the sinking of an enemy trawler off the coast near Duc Pho last March, when they made a forced night march to the beach to trap the ship as it was chased ashore by Navy swiftboats and gun-ship helicopters of the 174th Avn. Co.

The crew of the trawler was forced to scuttle its ship, destroying an estimated 3,000 individual weapons. The 3rd Bn, 1st Inf, has seen some of the

hardest day-to-day fighting of any brigade unit, locating and killing enemy groups attempting to infiltrate the Mo Duc-Duc Pho area. The "Always First" played a major part in Operation Chatterhoochee Swamp, when 25 enemy were killed and 17 weapons captured in the dense jungles southwest of Quant Ngai.

In April, the 4th Bn, 21st Inf, "Gimlets" arrived in Vietnam and have since been operating in the southern sector of the brigade's area of operations. To date, they have captured more than 100 tons of enemy salt and rice.

In all operations, the brigade's infantrymen have been able to rely on quick, accurate and devastating fire by the "On Time" 6th Bn, 11th Arty., with its 105 mm howitzer batteries spread throughout the brigade area. The unit was especially effective during the two battles of My Lai, when its fast-firing cannoniers blasted nearly 100 of the total kills.

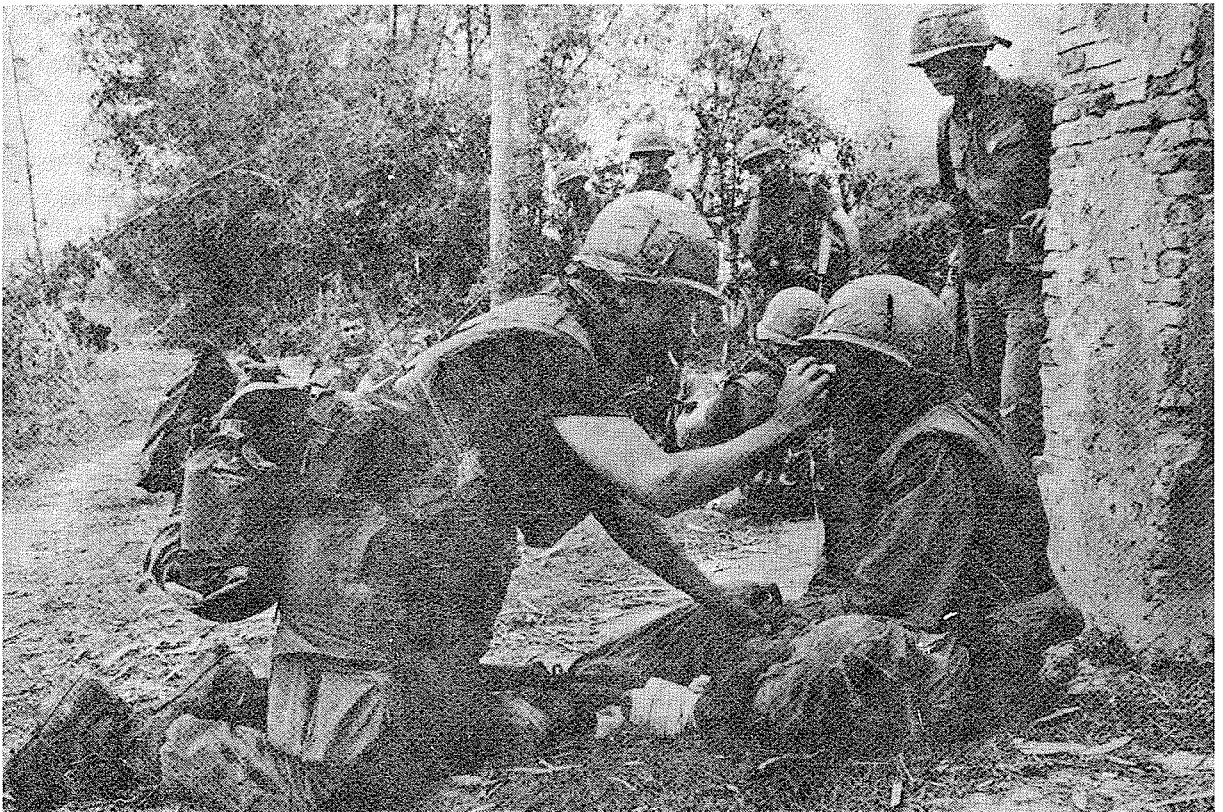
"Sharks" and "Dolphins" of the 174th Avn. Co. at LZ Bronco, and the brigade's own Primo Aviation Ltd, have done yeomen's work throughout the campaign, flying troops to combat, flying cover with their gunships, finding the enemy through day and night reconnaissance missions and picking up the wounded from the battlefield.

On July 1, the "Jungle Warriors" second anniversary, COL Oran K. Henderson, brigade commander, asked the men of his command to "meet the challenges of the future with the brigade's traditional gallantry, devotion and unselfishness."





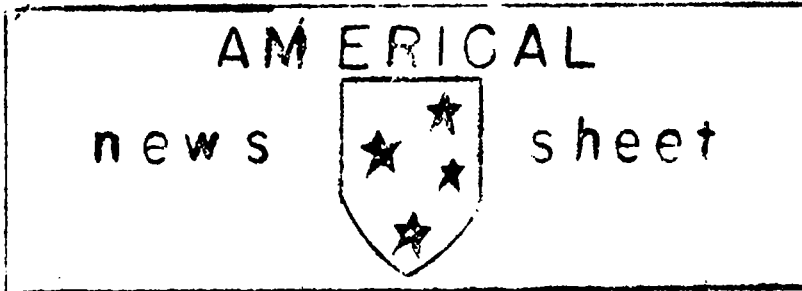
**Soldier Searches For Enemy Weapons**



**Task Force Barker Medic Treats Wounded As Chopper Is Called**

Exhibit M-63 is published in Volume III,  
Book 3, Reports.

EXHIBIT M-63



MIRACLE WEATHER REPORT.

Partly Cloudy Wednesday with little change foreseen. Winds variable at 5 knots per hour. High Wednesday 90. Low Wednesday night 72.

Vol. 1 No. 334 Tuesday March 19, 1968

AMERICAL DIVISION NEWS

CHU LAI (AMERICAL-IO)—Forces of the Americal Division reported 29 enemy killed and 12 individual weapons captured in a day that saw fighting throughout southern I Corps. Americal units suffered three soldiers killed and 13 wounded and evacuated for further medical care.

Enemy contacts in the 196th area of Operation Wheeler/Wallowa resulted in 11 enemy killed by units of the Americal's "Charger" Brigade.

A company of the 4th Battalion, 31st Infantry commanded by CPT Larry R. Byers (Des Moines, Wash) found graves containing four NVA bodies while on a search and destroy mission. The graves also contained two Chicom hand grenades, one NVA gas mask and two AK-47 magazines. Another company of the battalion commanded by CPT Daniel R. Mellon (Fairbanks, Alaska) spotted 21 VC moving north of the company's position. Artillery was called in killing three VC.

Members of a company of the 1st Battalion, 6th Infantry commanded by CPT Jan E. Prather (Lubbock, Tex) killed one VC and captured 2,000 pounds of rice which was evacuated to "Charger Hill". Another 6th Infantry company led by CPT Robert D. Leinen, Sr. (Auburn, N.Y.) found a complex of bunkers and trenches containing 718 rounds of carbine ammunition, 248 rounds of 30 caliber ammunition, 14 NVA uniforms, two VC flags, assorted web gear, medical supplies and documents.

In the only other actions of the day, a company of the 2nd Battalion, 1st Infantry, commanded by CPT Jose R. Feli-

ciano (Baltimore, Md) killed two evading VC. A company of the 3rd Battalion, 21st Infantry commanded by CPT James F. Hughs (Pacific Grove, Calif) called artillery on two VC, killing one.

In other Wheeler/Wallowa Operation action near Tam Ky elements of Americal's 1st Squadron, 1st Cavalry reported killing seven VC.

A troop of the 1st Cavalry was responsible for four of the Viet Cong killed as cavalrymen conducted a reconnaissance mission seven miles northwest of Tam Ky. "C" Troop, 7th Squadron, 17th Cavalry flying in support of the troop recorded three VC kills.

"Jungle Warriors" of Americal's 11th Brigade killed ten VC, detained 14 suspects and captured 13 weapons in action in the Duc Pho and Operation Muscatine areas yesterday.

Infantrymen of the 3rd Battalion, 1st Infantry encountered an estimated 50 VC in bunkers and tunnels late yesterday. Two separate contacts resulted in nine enemy killed, ten suspects detained and 11 weapons captured.

Action 13 miles northwest of Duc Pho began late Sunday for the company of the "Always First" Battalion commanded by CPT Robert Dickson (Decatur, Ga.). As the unit moved to a night position, they received small arms and automatic weapons fire. The company returned fire with negative results. Yesterday morning the company again received enemy fire and detained five suspects in the troublesome area. One of the suspects told the company that there were a large number of VC in the area and five weapons were hidden nearby.

(Continued Page 2 Column 1)

EXHIBIT M-64

AMERICAN DIVISION (MIRACLE)  
(CONTINUED FROM PAGE 1 COLUMN 2)

A force commanded by Cpt Michael Hayes (Columbus, Ga) engaged three VC killing one and detaining two. Three weapons--a K-44 and two M-1 rifles were also captured. The unit continued to search the area and come upon the bunkers and tunnels. The ensuing fire-fight lasted over an hour and the "Warriors" pushed close enough to throw hand grenades into the enemy positions. When contact broke eight enemy were dead, two had been detained and five K-44s, two carbines, and a BAR were captured. One other suspect was detained for questioning north of Duc Pho.

One evading VC was killed in the morning five miles southeast of Duc Pho by a company of the 1st Battalion, 20th Infantry. The "Syke's Rogulars" unit led by CPT Sario Carvalho (Ewa Beach, Ha) also captured a Walther P-38 pistol.

Four suspects were detained in the Operation Muscatine area yesterday. A company from the 4th Battalion, 3rd Infantry found and evacuated 3,000 pounds of rice.

A reconnaissance helicopter from "Primo Aviation Limited", the brigade's aviation section, spotted ammunition cans and other camouflaged field equipment ten miles northwest of Duc Pho. Automatic weapons fire and grenades were used to destroy the enemy cache.

One enemy soldier was killed in Americal's 198th Brigade area yesterday during light and scattered activity.

The command and control ship of the 1st Battalion, 46th Infantry spotted two VC seven miles west of Chu Lai and killed one.

Civic action soldiers of the "Brave and Bold" treated 367 Vietnamese during two area medical visits yesterday.

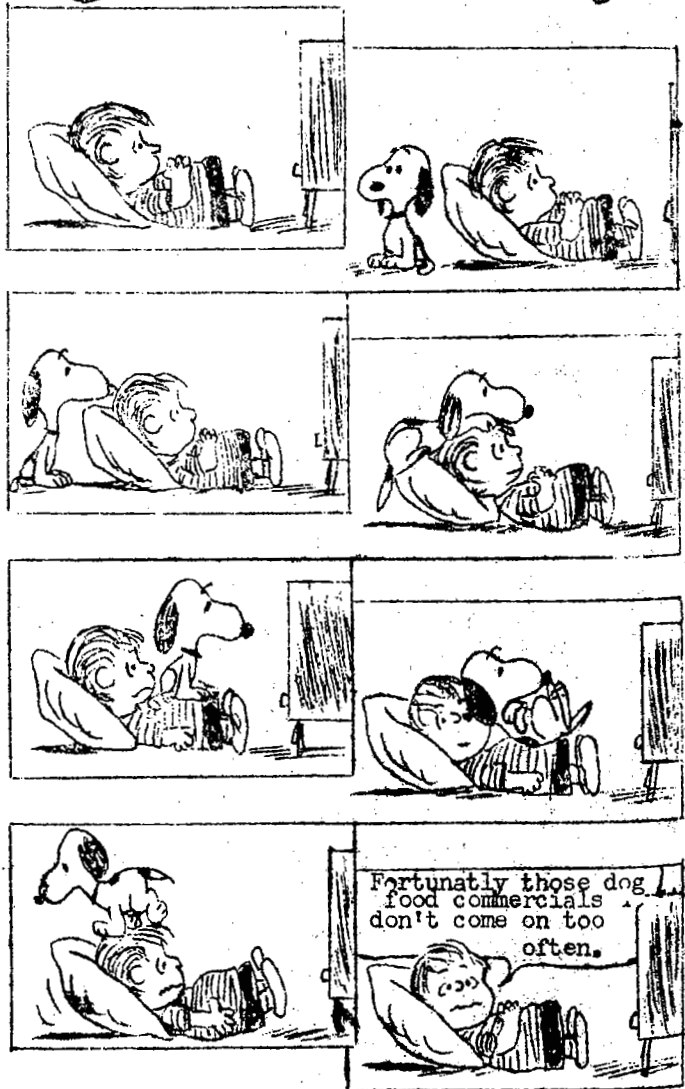
Americal's 14th Aviation Battalion flew 1,338 sorties, carried 1,413 combat troops and hauled 183 tons of cargo in support of the division yesterday.

AMERICAN NEWS SHEET

MG S.W. Koster, Commanding General  
LTC Patrick H. Dionne, IO

Telephone: Chu Lai 3212 or 2414

This News Sheet is published daily under the supervision of the IO, Americal Division as an authorized Army Publication. This News Sheet is solely for personnel in the Americal Division and may not be duplicated or released to the news media.



# AMERICAL

news



sheet

Vol. 1 No. 335 Wednesday March 20, 1968

## AMERICAL DIVISION NEWS

CHU LAI (AMERICAL-10) -- A lull in fighting was reported by Americal forces yesterday as division units recorded 14 Viet Cong killed and two individual weapons captured. Two Americal soldiers were killed and 19 wounded and evacuated for treatment.

PSYOPS aircraft dropped 3.5 million leaflets throughout the division yesterday. Eleven tactical air strikes were flown in support of Americal forces resulting in four structures, 16 automatic weapons positions destroyed and 30 meters of trench opened-up.

Enemy activity tapered off yesterday as elements of Americal's 196th Brigade killed five VC throughout their area of Operation Wheeler/Wallowa. In two MEDCAPs yesterday "Charger" soldiers treated 288 Vietnamese.

A company of the 3d Battalion, 21st Infantry commanded by CPT Cecil H. Oxford (Corpus Christi, Tex.) killed one VC who was carrying an M-26 hand grenade and some documents. Another company of the "Gimlets" led by CPT Dennis A. Leach (Fairmont, Minn.) destroyed an automatic weapons position and 30 meters of trench.

An Americal Long Range Reconnaissance Patrol killed one VC after receiving automatic weapons fire and another patrol called in artillery to account for another kill. An observation aircraft spotted an enemy position and called for artillery which accounted for one kill. "C" Troop 7th Squadron, 17th Cavalry was responsible for one VC kill while flying in general support of ground units.

Americal's 1st Squadron, 1st Cavalry recorded five enemy kills in Operation Wheeler/Wallowa near Tam Ky yesterday.

A troop of the 1st Cavalry on a search and destroy mission 12 miles

## MIRACLE WEATHER REPORT

Cloudy Thursday morning becoming partly cloudy in the afternoon. Winds southeasterly at 10 knots per hour. High Thursday 90. Low Thursday night 73.

northeast of Tam Ky killed one VC and "C" Troop, 7th Squadron, 17th Cavalry's gunships killed the other four while flying in close support of the troop.

In Americal's 198th Brigade area of operations a company of the 1st Battalion, 52nd Infantry set a hasty ambush and killed two VC. While searching the area they discovered one M-1 rifle and several hand grenades. They also captured a small amount of enemy medical supplies earlier in the day.

MEDCAP teams of the "Brave and Bold" treated 289 Vietnamese yesterday.

Americal's 11th Brigade soldiers recorded two enemy killed, 31 suspects detained and one weapon captured during operations yesterday.

An aerial reconnaissance helicopter of the brigade's "Primo Aviation Limited", piloted by CW-3 Gil Honda (Honolulu, Ha.), killed a VC in the evening while returning from a mission two miles north of Mo Duc. The Viet Cong's M-1 carbine along with several hand grenades and assorted web gear were captured.

The "Jungle Warriors" other kill occurred in the morning when a 3rd Brigade, 1st Infantry company engaged a VC 10 miles northwest of Duc Pho. The unit led by CPT Ronald Tumelson (Red Bluff, Calif) continued to search the area and detained 10 suspects. Sixteen additional suspects were also apprehended by the "Always First" Battalion, and five punji pits were destroyed.

Five more suspects were detained by brigade elements in the Duc Pho and Operation Muscatine areas.

The 14th Aviation Battalion flew 1,020 sorties, carried 2,394 combat troops and hauled 969 tons of cargo in support of the Americal Division yesterday.

EXHIBIT M-65



CONGRATULATORY MESSAGE FROM GENERAL WESTMORELAND

Operation Muscatine contact north-east of Quang Ngai city on 16 March dealt enemy heavy blow. Congratulations to officers and men of C/1/20 Inf and B/4/3 Inf for outstanding action.

RESIDENT COURSES

The Americal Division Education Center will again offer residence credit courses from the University of Maryland. There will be two three credit hour courses in Term 4: Anthropology 1, Introduction to Anthropology and History 22, History of the United States from 1865 to present. The term will run from 1 April to 25 May. Registration will be 25-30 March. Space will be limited and names are now being accepted. Contact the Americal Education Center today. Bldg AN-2, Tel. Chu Lai 2311).

ALL THE NEWS THAT  
FITS WE PRINT.

AMERICAN NEWS SHEET

MG S.W. Koster, Commanding General  
LTC Patrick H. Dionne, IO  
Telephone: Chu Lai 3212 or 2414  
This News Sheet is published daily under the supervision of the IO, Americal Division as an authorized Army publication. This News Sheet is solely for personnel in the Americal Division and may not be duplicated or released to the news media.

S  
N  
O  
O  
P  
Y





Exhibit M-66, Exhibit M-67, Exhibit M-68, Exhibit M-69, Exhibit M-70, Exhibit M-71, Exhibit M-72, Exhibit M-73, and Exhibit M-74 are published in Volume III, Book 2, Directives.

EXHIBIT M-66

EXHIBIT M-67

EXHIBIT M-68

EXHIBIT M-69

EXHIBIT M-70

EXHIBIT M-71

EXHIBIT M-72

EXHIBIT M-73

EXHIBIT M-74

17 January 1970

MEMORANDUM FOR RECORD

RE: Task Force Oregon/Americal Division, Artillery Incident Reports April 1967 - February 1968

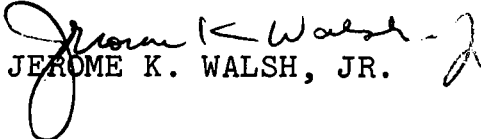
In the course of his testimony on 16 January 1970, Colonel Mason J. Young, Jr., Div Arty Commander of Task Force Oregon and Americal Division from April 1967 until 31 March 1968, produced a file folder said to contain copies of all reports of investigations of artillery incidents which he received before completing his tour in Vietnam. Examination of the file indicates that a total of 38 reports of investigation were submitted during the period. Of this total, 23 involved U. S. casualties, 1 involved a Vietnamese interpreter assigned to a U. S. unit, 1 involved ARVN casualties, 10 involved Vietnamese civilian casualties only, and 3 involved only property damage (2 civilian areas, one barracks). All reports covered ground based artillery except for one incident involving rocket fire from a HU 1 aircraft.

	<u>DATE OF INCIDENT</u>	<u>CASUALTIES/DAMAGE</u>
1.	25 Apr 67	"Friendly areas" no casualties
2.	30 Apr 67	4 U. S. personnel wounded
3.	7 May 67	U. S. barracks - no casualties
4.	27-28 Apr 67	1 "friendly" civilian killed, 5 wounded
5.	7 May 67	1 U. S. killed, 6 wounded
6.	27 May 67	5 U. S. wounded
7.	11 Jun 67	3 U. S. killed, 21 wounded
8.	3 Jun 67	no casualties
9.	16 Jun 67	1 civilian wounded; village near Route 1

EXHIBIT M-75

10.	7 Jul 67	1 civilian woman killed
11.	25 Jul 67	1 U. S. wounded
12.	3 Aug 67	3 U. S. killed when aircraft hit; 2 civilians on ground killed in crash
13.	3 Sep 67	1 civilian killed
14.	17 Sep 67	1 U. S. killed, 2 wounded
15.	29 Sep 67	8 U. S. wounded
16.	3 Oct 67	1 civilian woman and 6 water buffalo
17.	26 May 67	3 U. S. wounded
18.	26 Oct 67	1 U. S. killed, one wounded
19.	8 Nov 67	4 civilians killed, 14 wounded
20.	2 Nov 67	1 U. S. killed, 3 wounded
21.	17 Nov 67	2 U. S. killed, 3 wounded
22.	21 Nov 67	1 VN interpreter with U. S. Inf Co wounded
23.	16 Nov 67	1 U. S. killed, 6 wounded
24.	6 Oct 67	HU 1 firing rockets - 1 civilian killed, 2 wounded
25.	21 Nov 67	1 U. S. killed, 6 wounded
26.	8 Dec 67	2 U. S. wounded
27.	17 Dec 67	destroyed house and wounded 2 VN civilians (N.B., "friendly village")
28.	12 Dec 67	4 ARVN killed, 9 wounded
29.	23 Dec 67	2 U. S. wounded
30.	19 Dec 67	2 civilians killed inside ARVN No Fire Zone
31.	23 Dec 67	2 U. S. wounded
32.	5 Jan 68	5 U. S. wounded

33.	18 Jan 68	1 U. S. killed, 1 wounded
34.	19 Jan 68	3 U. S. killed, 6 wounded
35.	5 Feb 68	5 U. S. wounded
36.	9 Feb 68	2 U. S. wounded
37.	14 Feb 68	3 U. S. wounded
38.	18 Feb 68	3 U. S. wounded

  
JEROME K. WALSH, JR.



CORDS, I Corps, PSA Conference, 23 February 1968

NOTES

1. Lt. General Cushman, CG, III MAF

General Cushman congratulated those present and said the civilians did a magnificent job in the recent Tet offensive. He reported good news from Hue, saying the Marines had completed their portion of retaking the city. He noted however, that the enemy may be planning another offensive similar to the Tet attacks. The first order of battle for the civilian effort now should be psychological operations, telling the people that ARVN and FWMAF scored a big victory. The confidence of the people must be restored and they must be convinced that the United States has no intention of giving up or of negotiating. The second priority should be on reconstruction, that is, taking care of the newly generated refugees and restoring civilian government to the province and lower levels. The refugees should be fed to show the government's concern and ability to care for them.

General Cushman stated that military operations are continuing and that more US troops are being brought into I Corps. We want an offensive spirit, he noted. ARVN must get the RD support battalions out again and energize the DIOCC, which can lead operations to seize the many VC infrastructure who surfaced during the recent Tet offensive. It will take another four days of concentrated engineering work to repair the broken bridges in the Phu Loc area in order to begin to reopen Highway One from Danang to Hue. Khe Sonh is difficult to supply, receiving incoming rounds, and the subject of a few ground probes, but it is receiving heavy air support. There are still two NVA Divisions around Khe Sanh and four to five enemy regiments near Quang Tri City. He noted that few CAP's were attacked because the enemy went for bigger objectives, i.e., the cities. In general, the countryside was bypassed in the assault in order to surprise the cities and provincial and district capitals. In response to a question, General Cushman noted that he knew of no defections of ARVN or other friendly units or officers anywhere in Vietnam.

\* \* \* \* \*



EXHIBIT M-76

~~CONFIDENTIAL~~

6. James May, PSA - Quang Ngai

The situation is manageable. There is some forward motion and there will be more. Officials have been reassured about the real intention of the US Government. Public administration is in its usual low state. The Province Chief was obviously shaken by the Tet experience and is now more amenable to advice. He led the complaints about inadequate US reaction to the attack. The curfew is from 1900 to 0700. The commodities are now being released, following convincing the Province Chief that this was indeed the emergency for which he was saving the supplies. Primary schools reopened. The three Bns. designated for RD support are still under division control and will probably and appropriately remain there for awhile, being used in clearing operations. Col. Toan is performing well as the Division Commander. Between 250 and 300 RDPG are armed. Because the Americal Division has shifted its resources northward, there has been a shortage of friendly troops in the province. The CAP's are doing very well. The old problem of RF/PF allocation shortages continues.

The VC still hold major portions of the province, for example, in Nghia Hanh District. There is less security in the hamlets than previously and the VC are there and recruiting. Twenty-five of the 40 in-province RD teams are in their assignments, though as many as 20 out of the 25 may not be remaining in their hamlets at night. Five teams are used to work with refugees and five are used to defend provincial RD headquarters. The remainder are employed in the defense of district headquarters. Of the 25 in their RD hamlets, 13 are in 1968 assignments and 12 in 1967, i.e., the same disposition as before Tet. The PSA is pushing the proposal to move the provincial jail to Ly Son Island to eliminate the problem of recurring successful attacks that free the prisoners.

\* \* \* \* \*

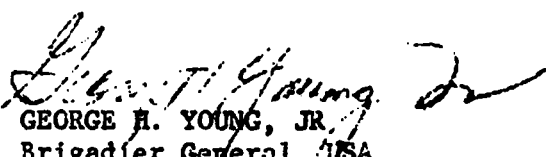
DEPARTMENT OF THE ARMY  
HEADQUARTERS AMERICAL DIVISION  
APO San Francisco 96374

GENERAL ORDERS  
NUMBER 2224

27 April 1968

1. TC 355. The undersigned assumes command.

Organization: Americal Division APO San Francisco 96374  
Authority: Paragraph 15a, AR 600-20

  
GEORGE H. YOUNG, JR.  
Brigadier General, USA  
Acting Commander

DISTRIBUTION:

A Plus  
15-HQ, USARV  
5-COMUSMACV  
5-CG, III MAF  
7-CINCUSARPAC  
2-CINCUSARPAC, ATTN: Historian File  
30-ΔVDF-AGA

SPECIAL DISTRIBUTION:

3-DOSPER, DA, ATTN: Gen Off Br  
3-TAG, DA ATTN: AGPF

EXHIBIT M-77

DEPARTMENT OF THE ARMY  
HEADQUARTERS AMERICAL DIVISION  
APO San Francisco 96374

GENERAL ORDERS  
NUMBER 2401

8 May 1968

1. TC 355. The undersigned assumes command.

Organization: Americal Division APO San Francisco 96374  
Authority: Paragraph 12b, AR 600-20

  
S. W. KOSTER  
Major General, USA  
Commanding

**DISTRIBUTION:**

A-Plus  
15-HQ, USARV  
5-COMUSMACV  
5-CG, III MAF  
7-CINCUSARPAC  
2-CINCUSARPAC, ATTN: Historian File  
30-AVDF-AGA

**SPECIAL DISTRIBUTION:**

3-DGSPER, DA, ATTN: Gen Off Br  
3-TAG, DA, ATTN: AGPF



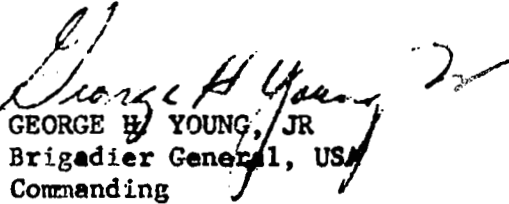
DEPARTMENT OF THE ARMY  
HEADQUARTERS AMERICAL DIVISION  
APO San Francisco 96374

GENERAL ORDERS  
NUMBER 2965

3 June 1968

1. TC 355. The undersigned assumes command.

Organization: Americal Division APO San Francisco 96374  
Authority: Paragraph 12b, AR 600-20

  
GEORGE H. YOUNG, JR.  
Brigadier General, USA  
Commanding

DISTRIBUTION:

A Plus  
15-HQ, USARV  
5-COMUSMACV  
5-CG, III MAF  
7-CINCUSARPAC  
2-CINCUSARPAC, ATTN: Historian File  
30-AVDF-AGA

SPECIAL DISTRIBUTION:

3-DOSPER, DA, ATTN: Gen Off Br  
3-TAG, DA ATTN: AGPF

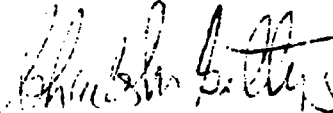
DEPARTMENT OF THE ARMY  
HEADQUARTERS AMERICAL DIVISION  
APO San Francisco 96374

GENERAL ORDERS  
NUMBER 3343

jad  
23 June 1968

1. TC 355. The undersigned assumes command.

Organization: Americal Division APO San Francisco 96374  
Authority: Paragraph 12b, AR 600-20



CHARLES M. GETTYS  
Major General, USA  
Commanding

**DISTRIBUTION:**

A-Plus  
15-HQ, USARV  
5-COMUSMACV  
5-OG, XII MAF  
7-CINCSAREAC  
2-CINCSAREAC, ATTN: Historian File  
30-AVDF-AGA

**SPECIAL DISTRIBUTION:**

3-DCOPER, DA, ATTN: Gen Off Br  
3-TAG, DA, ATTN: AGPF

GENERAL INFORMATION FOR WITNESSES APPEARING BEFORE INTERVIEW TEAM C

The Peers Inquiry was directed jointly by the Secretary of the Army and the Chief of Staff for the purpose of determining facts and making recommendations concerning the My Lai (4) incident of 16 March 1968. In conducting his investigation, General Peers determined that it was necessary to have a complete insight into the overall ground and air operation in the Son My Village area during the period 16--18 March 1968. He therefore appointed this board, referred to as Interview Team C, to question personnel of B Co, 4/3d and prepare a complete description of the unit operation. You may expect GEN Peers and other members of his board to join this group and participate in the interview.

Your testimony will be taken under oath. A verbatim transcript will be prepared. A tape recording is being made in addition to the verbatim notes being taken by the reporter.

Although the general classification of the report will be CONFIDENTIAL, it is possible that testimony, or parts of it, may later become a matter of public knowledge.

During this interview the board will follow a chronological sequence of questioning. The first series of questions will be concerned with training just prior to and after arrival in RVN. The second series will inquire into the briefing prior to the combat assault and the third series will concern the operations on 16, 17 and 18 March 1968, in that order. The final questions will concern prior investigations or inquiries into the Task Force operation on 16 March.

EXHIBIT M-81





Mr. Ron Ridenhour  
1416 East Thomas Road #104  
Phoenix, Arizona

March 29, 1969

Gentlemen:

It was late in April, 1968 that I first heard of "Pinkville" and what allegedly happened there. I received that first report with some skepticism, but in the following months I was to hear similar stories from such a wide variety of people that it became impossible for me to disbelieve that something rather dark and bloody did indeed occur sometime in March, 1968 in a village called "Pinkville" in the Republic of Viet Nam.

The circumstances that led to my having access to the reports I'm about to relate need explanation. I was inducted in March, 1967 into the U. S. Army. After receiving various training I was assigned to the 70th Infantry Detachment (LRP), 11th Light Infantry Brigade at Schofield Barracks, Hawaii, in early October, 1967. That unit, the 70th Infantry Detachment (LRP), was disbanded a week before the 11th Brigade shipped out for Viet Nam on the 5th of December, 1967. All of the men from whom I later heard reports of the "Pinkville" incident were reassigned to "C" Company, 1st Battalion, 20th Infantry, 11th Light Infantry Brigade. I was reassigned to the aviation section of Headquarters Headquarters Company 11th LIB. After we had been in Viet Nam for 3 to 4 months many of the men from the 70th Inf. Det. (LRP) began to transfer into the same unit, "E" Company, 51st Infantry (LRP).

In late April, 1968 I was awaiting orders for a transfer from HHC, 11th Brigade to Company "E," 51st Inf. (LRP), when I happened to run into Pfc "Butch" Gruver, whom I had known in Hawaii. Gruver told me he had been assigned to "C" Company 1st of the 20th until April 1st when he transferred to the unit that I was headed for. During the course of our conversation he told me the first of many reports I was to hear of "Pinkville."

EXHIBIT M-83

"Charlie" Company 1/20 had been assigned to Task Force Barker in late February, 1968 to help conduct "search and destroy" operations on the Batangan Peninsula, Barker's area of operation. The task force was operating out of L. F. Dottie, located five or six miles north of Quang Nhai city on Viet Nameese National Highway 1. Gruver said that Charlie Company had sustained casualties; primarily from mines and booby traps, almost everyday from the first day they arrived on the peninsula. One village area was particularly troublesome and seemed to be infested with booby traps and enemy soldiers. It was located about six miles northeast of Quang Nhai city at approximate coordinates B.S. 728795. It was a notorious area and the men of Task Force Barker had a special name for it: they called it "Pinkville." One morning in the latter part of March, Task Force Barker moved out from its firebase headed for "Pinkville." Its misaion: destroy the trouble spot and all of its inhabitants.

When "Butch" told me this I didn't quite believe that what he was telling me was true, but he assured me that it was and went on to describe what had happened. The other two companies that made up the task force cordoned off the village so that "Charlie" Company could move through to destroy the structures and kill the inhabitants. Any villagers who ran from Charlie Company were stopped by the encircling companies. I asked "Butch" several times if all the people were killed. He said that he thought they were, men, women and children. He recalled seeing a small boy, about three or four years old, standing by the trail with a gunshot wound in one arm. The boy was clutching his wounded arm with his other hand, while blood trickled between his fingers. He was staring around himself in shock and disbelief at what he saw. "He just stood there with big eyes staring around like he didn't understand; he didn't believe what was happening. Then the captain's RTO (radio operator) put a burst of 16 (M-16 rifle) fire into him." It was so bad, Gruver said, that one of the men in his squad shot himself in the foot in order to be medivac-ed out of the area so that he would not have to participate in the slaughter. Although he had not seen it, Gruver had been told by people he considered trustworthy that one of the company's officers, 2nd Lieutenant Kally (this spelling may be incorrect) had rounded up several groups of villagera (each group consisting of a minimum of 20 persons of both sexes and all ages). According to the story, Kally then machine-gunned each group. Gruver estimated that the population of the village had been 300 to 400 people and that very few, if any, escaped.

After hearing this account I couldn't quite accept it. Somehow I just couldn't believe that not only had so many young American men participated in such an act of barbarism, but that their officers had ordered it. There were other men in the unit I was soon to be assigned to, "E" Company, 51st Infantry (LRP), who had been in Charlie Company at the time that Gruver alleged the incident at "Pinkville" had occurred. I became determined to ask them about "Pinkville" so that I might compare their accounts with Pfc Gruver's.

When I arrived at "Echo" Company, 51st Infantry (LRP) the first men I looked for were Pfc's Michael Terry and William Doherty. Both were veterans of "Charlie" Company, 1/20 and "Pinkville." Instead of contradicting "Butch" Gruver's story they corroborated it, adding some tasty tidbits of information of their own. Terry and Doherty had been in the same squad and their platoon was the third platoon of "C" Company to pass through the village. Most of the people they came to were already dead. Those that weren't were sought out and shot. The platoon left nothing alive, neither livestock nor people. Around noon the two soldiers' squad stopped to eat. "Billy and I started to get out our chow," Terry said, "but close to us was a bunch of Vietnamese in a heap, and some of them were moaning. Kally (2nd Lt. Kally) had been through before us and all of them had been shot, but many weren't dead. It was obvious that they weren't going to get any medical attention so Billy and I got up and went over to where they were. I guess we sort of finished them off." Terry went on to say that he and Doherty then returned to where their packs were and ate lunch. He estimated the size of the village to be 200 to 300 people. Doherty thought that the population of "Pinkville" had been 400 people.

If Terry, Doherty and Gruver could be believed, then not only had "Charlie" Company received orders to slaughter all the inhabitants of the village, but those orders had come from the commanding officer of Task Force Barker, or possibly even higher in the chain of command. Pfc Terry stated that when Captain Medina (Charlie Company's commanding officer Captain Ernest Medina) issued the order for the destruction of "Pinkville" he had been hesitant, as if it were something he didn't want to do but had to. Others I spoke to concurred with Terry on this.



It was June before I spoke to anyone who had something of significance to add to what I had already been told of the "Pinkville" incident. It was the end of June, 1968 when I ran into Sargent Larry La Croix at the USO in Chu Lai. La Croix had been in 2nd Lt. Kally's platoon on the day Task Force Barker swept through "Pinkville." What he told me verified the stories of the others, but he also had something new to add. He had been a witness to Kally's gunning down of at least three separate groups of villagers. "It was terrible. They were slaughtering the villagers like so many sheep." Kally's men were dragging people out of bunkers and hootches and putting them together in a group. The people in the group were men, women and children of all ages. As soon as he felt that the group was big enough, Kally ordered an M-60 (machine-gun) set up and the people killed. La Croix said that he bore witness to this procedure at least three times. The three groups were of different sizes, one of about twenty people, one of about thirty people, and one of about forty people. When the first group was put together Kally ordered Pfc Torres to man the machine-gun and open fire on the villagers that had been grouped together. This Torres did, but before everyone in the group was down he ceased fire and refused to fire again. After ordering Torres to recommence firing several times, Lieutenant Kally took over the M-60 and finished shooting the remaining villagers in that first group himself. Sargent La Croix told me that Kally didn't bother to order anyone to take the machine-gun when the other two groups of villagers were formed. He simply manned it himself and shot down all villagers in both groups.

This account of Sargent La Croix's confirmed the rumors that Gruver, Terry and Doherty had previously told me about Lieutenant Kally. It also convinced me that there was a very substantial amount of truth to the stories that all of these men had told. If I needed more convincing, I was to receive it.

It was in the middle of November, 1968 just a few weeks before I was to return to the United States for separation from the army that I talked to Pfc Michael Bernhardt. Bernhardt had served his entire year in Viet Nam in "Charlie" Company 1/20 and he too was about to go home. "Bernie" substantiated the tales told by the other men I had talked to in vivid, bloody detail and added this. "Bernie" had absolutely refused to take part in the massacre of the villagers

of "Pinkville" that morning and he thought that it was rather strange that the officers of the company had not made an issue of it. But that evening "Medina (Captain Ernest Medina) came up to me ("Bernie") and told me not to do anything stupid like write my congressman" about what had happened that day. Bernhardt assured Captain Medina that he had no such thing in mind. He had nine months left in Viet Nam and felt that it was dangerous enough just fighting the acknowledged enemy.


Exactly what did, in fact, occur in the village of "Pinkville" in March, 1968 I do not know for certain, but I am convinced that it was something very black indeed. I remain irrevocably persuaded that if you and I do truly believe in the principles, of justice and the equality of every man, however humble, before the law, that form the very backbone that this country is founded on, then we must press forward a widespread and public investigation of this matter with all our combined efforts. I think that it was Winston Churchill who once said "A country without a conscience is a country without a soul, and a country without a soul is a country that cannot survive." I feel that I must take some positive action on this matter. I hope that you will launch an investigation immediately and keep me informed of your progress. If you cannot, then I don't know what other course of action to take.

I have considered sending this to newspapers, magazines, and broadcasting companies, but I somehow feel that investigation and action by the Congress of the United States is the appropriate procedure, and as a conscientious citizen I have no desire to further besmirch the image of the American serviceman in the eyes of the world. I feel that this action, while probably it would promote attention, would not bring about the constructive actions that the direct actions of the Congress of the United States would.

Sincerely,

/s/ Ron Ridenhour

A TRUE COPY

  
C. D. LYNN  
MAJ, AGC

Ronald L. Ridenhour  
Claremont Men's College  
Claremont, California  
January 19, 1970

The Honorable Eugene J. McCarthy  
U.S. Senate  
Washington, D.C.

Dear Sir:

As you might guess, I have been following the developments of the My Lai case with interest. There is one area of the investigation that I find deeply disturbing: the failure of the Army to bring charges against any of the officers of Task Force Barker other than Lieutenant Calley, and especially the Army's failure to bring charges against the company commander of "Charlie Company", Captain Ernest Medina. After comparing Captain Medina's public statements concerning the incident with my combat experience in Vietnam, my personal knowledge of American combat operations there, and my private conversations about the incident with members of "Charlie Company", I find many flagrant inconsistencies in his story. So many, in fact, that even in my most beneficent moments, I cannot help doubting both his integrity and his innocence. Those same inconsistencies cast grave doubt on the innocence in this affair of Colonel Frank A. Barker, commanding officer of Task Force Barker.

(1) Captain Medina maintained that his intelligence sources had informed him that there would be no civilians in the village at the time that the attack was scheduled because they would all be at the market place. Anyone with much experience in Vietnam knows that this is simply not done. Vietnamese civilians do not desert their villages just to go the market. In my four months as a door-gunner with "Primo", 11th Brigade Aviation, I flew over literally hundreds of Vietnamese villages at low altitude (100-200 feet) before 7:30 in the morning. I never once saw a village which showed obvious signs of habitation that was deserted. In each of those villages the majority of the people were women and children of all ages--none of whom looked particularly blood-thirsty. If Captain Medina did receive such a report, he was foolish--at best--to take it at face value.

EXHIBIT M-84

(2) Captain Medina maintained that from the information supplied to him by his intelligence sources, he expected to be outnumbered 2-to-1 by a well armed enemy who would be fighting from fortified positions. It is commonly accepted military theory the world over that an attacking force, attacking a well armed enemy who is fighting from fortified positions, must have a manpower superiority ratio of at least 3-to-1 if it is to be successful. Given this, If Captain Medina accepted his alleged intelligence reports at face value, then he ordered his company to assault My Lai knowing that they were outnumbered 6-to-1 under the conditions. The three minute artillery barrage that preceded "Charlie Company's" attack on the village seems hardly sufficient as a counterbalance against the enemy's alleged superior forces.

(3) "Charlie Company" assaulted the village a platoon at a time. It appears that that was the plan of battle, since the company was helicopterborne a platoon at a time to a position less than 200 yards from the village, in clear view of the village. If Medina's company was to be outnumbered 2-to-1, then what kind of odds would a platoon have, a platoon that was landing within easy rifle range of where the enemy was believed to be?

(4) Captain Medina claims that he entered the village only after the shooting stopped, or about three hours after the attack began. I flew many missions in "Primo" in support of infantry companies, and in all frankness, I must admit that the sight of the commanding officer of an infantry company lagging so far behind his company that he did not know what they were doing, especially when there was very obviously a great deal of shooting going on, is beyond both the realm of my experience and the limit of my imagination.

(5) The body count reported by Task Force Barker on the day in question was 128. Enemy weapons captured on that day have been reported as either 5 or 7. Since the ratio of weapons-captured to enemy-killed in an engagement with an enemy unit typically runs from 1-to-3 to 1-to-5, Captain Medina's statement that he saw only 20 to 28 bodies of dead civilians appears to deserve much closer scrutiny.

(6) Captain Medina maintains that the woman he shot was reported to him as a VC with a weapon. Medina said that the helicopter pilot who reported her position to him marked it with smoke. In order for a chopper to mark a position that exact with any accuracy, it would have to fly at a reduced rate of speed and at a very low altitude--less than 200 feet, probably much closer to 100

feet. A helicopter flying in such a manner is very vulnerable to ground fire. In addition, it should be understood that there is a great deal of emphasis placed on "body count" by the U.S. military in Vietnam. As a result of this there is an intense competition between American units for enemy kills. Taking these points into account, I cannot believe that a chopper pilot would expose himself, his crew, and his ship to this kind of danger--flying almost directly overhead an armed enemy at less than 200 feet--just to mark that enemy's position for ground troops. The normal procedure, at least from my experience, would have been for the chopper to have killed the woman if she was armed and had not thrown down her weapon and moved well away from it. If she was not armed in the first place, a chopper might conceivably have marked her position as Captain Medina said. If a helicopter did indeed mark the woman's position for Medina, I cannot believe that she was armed, nor that the pilot told him that she was.

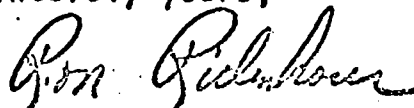
(7) Any combat operation undertaken by a combat unit in Vietnam must first be okayed by headquarters of the division under whose command it comes. The plans of the operation must be specific as to time, place, concept of operation, and plan of battle. Let me illustrate how extensive division control is. In Long Range Patrol a six-man team would be assigned a reconnaissance mission in a specific area. This area would usually be four map grid squares (1/25,000), or an area 2000 meters long and 2000 meters wide. If for some reason the team leader wanted to work outside the bounds of that area, he had to radio for permission before he could do so. That permission had to come from division headquarters for a six-man reconnaissance team. There is no doubt in my mind that whatever the mission was that was planned for Hy Lal on the morning of March 16, 1968, Americal Division Headquarters knew of it.

(8) One question remains that I think is of crucial importance. Where was Lieutenant Colonel Frank A. Barker on the morning of March 16, 1968? The picture of Colonel Barker that has thus far unfolded is that of an aggressive young officer considered an excellent battle commander by his peers. A good battle commander is, by definition, a man who is in touch with and in command of the battlefield situation at all times. The American military machine in Vietnam has a universally applied solution to the "how" of accomplishing this. Battalion and brigade commanders oversee the conduct of their units' operations while flying directly overhead the operations in a "command and control", or "charlie-charlie", helicopter. In addition to the unit commander, a "charlie-charlie" will contain various members

of the unit's command staff (usually 2-to-4 officers and a senior NCO). (I might add that these "charlie-charlies" fly at an altitude of 1500 feet to 2000 feet unless the enemy is known to have 50 caliber machine-guns or anti-aircraft weapons in the area. What is happening on the ground is quite identifiable from that altitude.) It would be extremely unusual if a battalion or task force commander was not overhead when his unit was assaulting a position that was believed to be held by the enemy, especially if it was believed to be held by large elements of an enemy battalion. It would be even more unusual if the task force commander was not overhead when his task force or any element of it was engaged in an action from which they were reporting a large number of enemy casualties, as was the case at My Lai. I can only conclude that Colonel Barker was almost certainly in the air over My Lai in the early morning of March 16, 1968. If, as Captain Medina contends, the shooting in the village lasted for over three hours, then it is extremely unlikely that Colonel Barker or his staff could have been unaware of what was happening below.

After considering these points, I find it difficult to believe that Lieutenant William Calley is the only officer of the American unit involved in the incident at My Lai who should be charged with criminal misconduct. The facts listed here and the questions they raise make it imperative that the actions of Captain Ernest Medina, his superior, Colonel Frank A. Barker, and any other officers connected to the bloody incident at My Lai be thoroughly investigated. If these men are innocent of any wrong-doing, then the results of the investigation must be made public through a thoroughly documented report that is above reproach. If they are not, then they must be brought to trial for their role in this infamous incident. To do otherwise would be a blatant betrayal of those ideals America has long championed and for which so many Americans have given their lives. I respectfully implore you to do everything in your power to insure that such a travesty does not occur.

Sincerely yours,



Ronald L. Kidder

Mar 15 Fri. got up at 5 a.m. ate chow had police call after that. Had garbage detail sure get a kick out of that. Brought mess garbage down and they even ate that. Just sitting around now cleaning weapons and took another bath at the stream. Had meeting hole company said we are going to really hit something tomorrow going to hit 4 places its a hot place.


Mar 16 Sat. got up at 5:30 left at 7:15 we had 9 choppers. 2 lifts first landed had mortar team with us. We started to move slowly through the village shooting everthing in sight children men and women and animals. Some was sickening. There legs were shot off and they were still moving it was just hanging there. I think there bodies were made of rubber. I didn't fire a round yet and didn't <sup>kill</sup> ~~hit~~ anybody not even a chicken I couldn't. We are know suppose to push through 2 more it is about 10 a.m. and we are taken a rest before going in. We also got 2 weapons M1 and a carbine our final destition is the Pinkville suppose to be cement bunkers we killed about 100 people after a while they said not to kill women and children. Stopped for chow about 1 P.M. we didn't do much after that. We are know setting up for the night 2 oompanies B and someone else we are set up in part of a village and rice patties had to dig foxhole area is pretty level are mortars are out with us. Are serving hot chow tonite I looked in my pack for dry socks and found out they were stolen from the time we were out in the field the name of the villages are My Lai 4, 5, and 6. I am know pulling my guard for night. 1 1/2 hours I am with the 1st squad had pop and beer. Sky is a little cloudy but it is warm out.

Mar 17 Sun: got up at 6:30 foggy out. We didn't go to Pinkville went to My Lai 2, 3, and 4 no one was there we burned as we pushed. We got 4 VC and a nurse. Had documents on them yesterday we took 14 VC. We pushed as far as the coast to the South China Sea there was a village along the coast also a lot of sailboats we stayed there for about an hour we went back about 2 kilometers to set up camp its in a graveyard actually we didn't pull guard but awake most of the night.

Mar 18 Mon: moved back to another area 1 VC said he would take us to a tunnel he took us all over didn't find any after that we met with other platoons as we were going 2 guys hit mines there flack jackets saved them not hurt bad TREVINO and GONZALEZ. We got with company and CA out to Dottie there is a lot of fuss on what happened at the village a Gen was asking questions. There is going to be an investigation on MEDINA. We are not supposed to say anything. I didn't think it was right but we did it but we did it at least I can say I didn't kill anybody. I think I wanted to but in another way I didn't.

\* \* \* \* \*

I certify that the above is a true and exact copy of my diary through the period 15-17 March 1968 to the best of my knowledge. Prepared at Washington, DC this 30th day of January 1970.

  
THOMAS R PARTSCH



Feb 29. Thur got bad headache up at 5:30 a.m. our plt going out A.P.C's went to village really ruffed the people up. The guys got 2 girls. its cloudy a little warm stopped for chow at 11 a.m. headed back. Walked 5 clicks got here and said we are going to have an inspection Cap going to do it general said it was a mess had to guard 3 plt bunker. They went on ambush.

May 3 Friday My birthday 21 today. We are suppose to leave at 6:30 go to some valley they are not sure where they suppose to go. BEERS didn't tell them where he wants them to go. We may climb 953. We went down to the valley we took a path all the way down. When we got down to the bottem the first element saw some gooks running they shot but missed. We took left flank and when we went about 200 meters SCHIEL saw 3 of them hidding in the brush one woman 2 men they had food and medical supplies. Some of the guys messed with the girl went down further into the villey some huts were there. We all ransacked the places and messed with the girls tore there clothes off and screwed them. Sal beat up one. We left and came up a hill to break for chow and also to set up for night I took some pictures of the people. Is sure hot out. Our plt went out first we walked through the same village. 3 and 2 squads saw something in the bushes. TRAVAMO was walking on a path and a VC with pack on jumped out he had a 79 so he couldn't shot and he ducked into the bushes we found him under a hole in a small path of water it looked like he was dead but wasn't we got 2 grenades (homemade) a bunch of papers a radio and a Russian flag. KING has them. We had an interpretor come in and he is know asking him questions. Came back to hill have ambush over in the same area got a letter from mom. Nothing happened on the ambush.

EXHIBIT M-86

\* \* \* \* \*

I certify that the above is a true and exact copy of my diary through the period 29 February 1968 and 3 May 1968 to the best of my knowledge prepared at Washington D.C. this 30th day of January 1970:

Thomas R. Partsch

THOMAS R. PARTSCH

Exhibit M-87 is published in Volume III,  
Book 3, Reports.

EXHIBIT M-87

Following article is from the Three Star Edition of the Pacific Stars and Stripes of 18 March 1968:

## U.S. TROOPS SURROUND REDS, KILL 128

S&S Vietnam Bureau

SAIGON -- U.S. infantrymen killed 128 Communists in a bloody day-long battle Saturday six miles northeast of Quang Ngai City on South Vietnam's central coast.

The battle was touched off shortly after 8 a.m. when a company from the 11th Light Inf. Brigade ran into heavy contact as they moved into an area following a U.S. Artillery bombardment.

Within an hour after the company became locked in heavy fighting with the unknown size Communist force, another company from the brigade was sent in two miles northeast of the battle.

The two companies began moving toward each other, encountering sporadic enemy contact throughout the day, until the enemy broke off the contact in the late afternoon.

U.S. casualties for the fighting were put at two killed and 10 wounded.

(Meanwhile, in the war's biggest allied operation -- a massive attempt to clear the Viet Cong from five provinces around Saigon -- the count of enemy dead rose to 474 after the first six days, AP reported.)

(The combined U.S. and South Vietnamese force, totaling more than 50,000 men, also has taken 114 prisoners, and captured 226 enemy weapons, U.S. headquarters reported.)

(American casualties so far, headquarters said, were 28 killed and 211 wounded. The South Vietnamese, without giving specific figures, termed their casualties light.)

Eighty-one Communists were killed Friday 19 miles northwest of Saigon in the first major battle of the massive operation Quyet Thang which kicked off on March 11.

The battle reportedly began at about 10 a.m. when a troop of armored vehicles from the U.S. 11th Armored Cav. Regt. was taken under fire by an estimated enemy battalion in an area six miles southwest of Cu Chi.

Almost immediately, U.S. Army helicopter gunships began attacking the Communist positions with rockets and machine-gun fire, and heavy artillery shells began crashing down on the enemy.

U.S. Air Force jets arrived a short time later and bombed and strafed the Reds.

Shortly before 2 p.m. units from the Vietnamese 25th Inf. Div. arrived on the scene to reinforce the U.S. armor, and the two units began pressing the attack against the enemy until the Reds withdrew at sundown.

A CERTIFIED TRUE COPY:

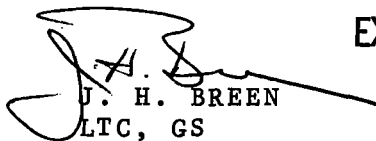
  
J. H. BREEN  
LTC, GS  
Executive Officer,  
Peers Inquiry

EXHIBIT M-88

NRANZCZOSAA7517VA 0030P

# FOR

PP RUMSAM  
LE RUMSAM 23530 11061450  
ZNR 00000 20A 0P00  
P 101425Z MAR 68 27F-G  
FM COMUSMACV  
TO RUMHIC/CG AREA 100L DAV  
INFO RUMSAK/CG 110 00AF

BT  
UNCLASSIFIED 0754Z FROM GEN WESTINGFLAW FOR  
MG KOSTER, INFO LTG CUSHMAN  
SLEW: CONGRATULATIONS MESSAG  
OF HUSCOWINE CONTACT NORTHEAST OF QUANG NGAI CT Y ON 16 MARCH  
LEANT ENEMY HEAVY BLW. CONGRATULATIONS TO OFFICERS AND MEN TO  
C/1/22 145 AND 14/4/3 INF FOR OUTSTANDING ACTION  
BT

FROM  
ORIGINATION AT  
SET FILE

FOLDER  
15 MAR 68

EXHIBIT M-89

COPY 2 OF 6 COPIES

APC	CS	DC/S	S-1	S-2	S-3	S-4	S-5	Compt.	Adl.	Chap.	OOD
COC	Dist.O.	Emb.	Engr.	PL.Serv.	NO Comd.	SNRP	LEGAL	INTO	Postal	Project	TRSO
Ops.	Spl. Serv.	Sup.	Serv.								

307

96217

XICO

27 March 1968

SUBJECT: Letter of Commendation

THRU: Commanding Officer  
Task Force Barker  
11th Infantry Brigade  
APO 96217

THRU: Commanding Officer  
1st Battalion, 20th Infantry  
11th Infantry Brigade  
APO 96217

TO: Commanding Officer  
Company C  
1st Battalion, 20th Infantry  
11th Infantry Brigade  
APO 96217

1. I wish to add my personal congratulations to those already stated by General Westmoreland and Major General Koster for the outstanding action, team work and aggressiveness exhibited by your unit.

2. The success of this operation and the praiseworthy role of units of the 11th Infantry Brigade directly reflect your expert guidance, leadership and devotion to duty. The quick response and professionalism displayed during this action has again enhanced the Brigade's image in the eyes of higher commands.

XICO

27 March 1968

SUBJECT: Letter of Commendation

3. Please convey my sincere appreciation to those personnel responsible for a job well done.

1 Incl  
Message Extract

ORAN K. HENDERSON  
Colonel, Infantry  
Commanding

**EXTRACT MESSAGE FROM MAJOR GENERAL KOSTER**

**SUBJECT CONGRATULATORY MESSAGE**

1. I WOULD LIKE TO PASS ON THE FOLLOWING MESSAGE FROM GEN WESTMORELAND:  
OP MUSCATINE CONTACT NORTHEAST OF QUANG NGAI CITY ON 16 MARCH DEALT  
ENEMY HEAVY BLOW. CONGRATULATIONS TO OFFICERS AND MEN OF C 1/20 INF  
AND B 4/3 INF FOR OUTSTANDING ACTION.
2. I ADD MY CONGRATULATIONS FOR THE TEAM WORK AND AGGRESSIVENESS  
EXHIBITED BY THE ABOVE MENTIONED COMPANIES AND TO ALL OTHERS PARTICI-  
PATING IN THIS OPERATION.

**Inclosure 1**



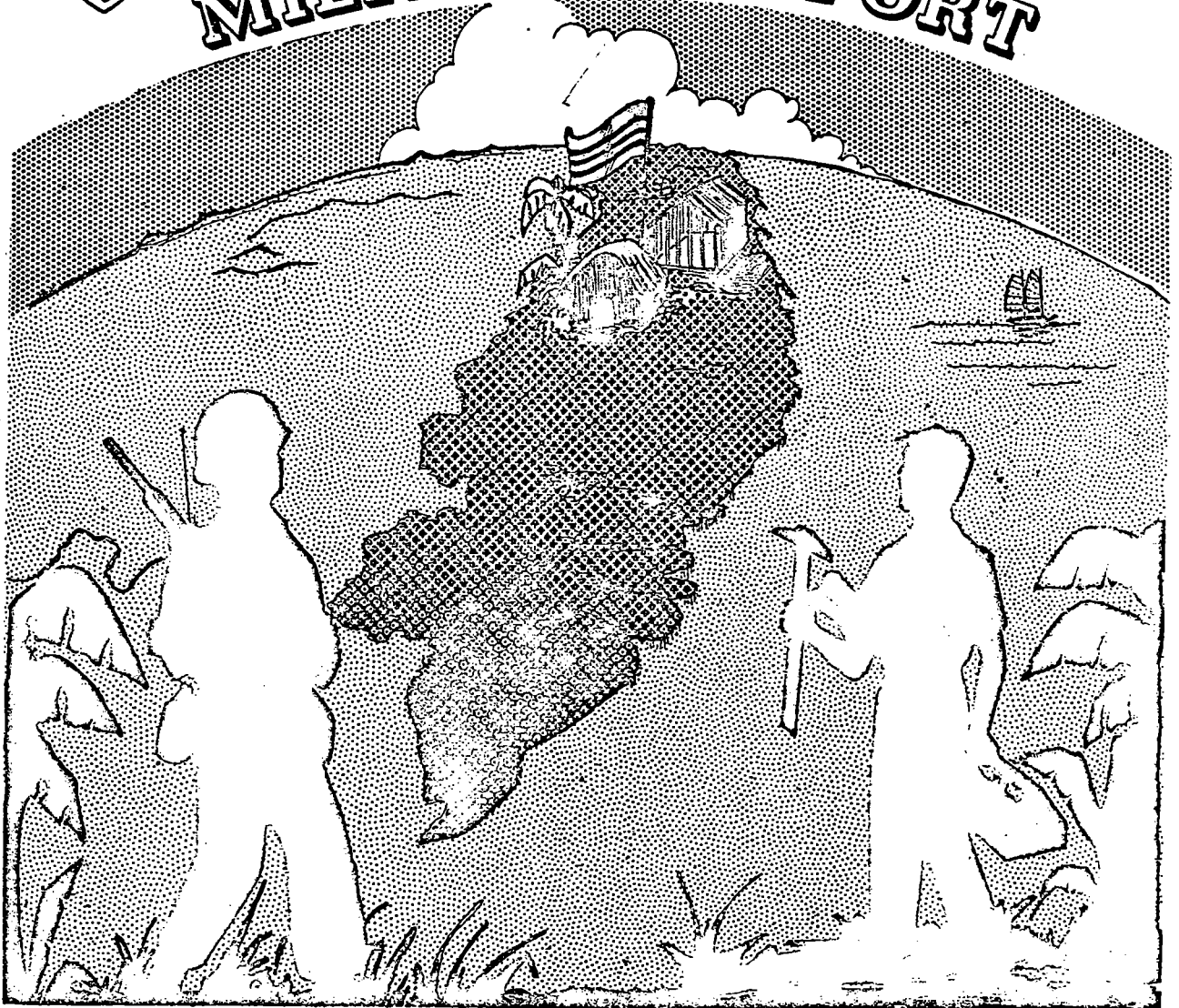
Exhibit M-91 is published in Volume III,  
Book 1, Directives. Exhibit M-92 is  
published in Volume III, Book 3, Reports.

EXHIBIT M-91  
EXHIBIT M-92

EXTRACT  
**HANDBOOK**

**FOR**

**MILITARY SUPPORT**



**OF**

**PACIFICATION**

HEADQUARTERS  
UNITED STATES MILITARY ASSISTANCE COMMAND, VIETNAM  
APO San Francisco 96222

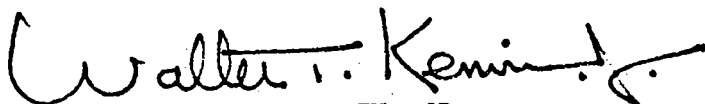
FOREWORD

The "Handbook for Military Support of Pacification" has been developed as a basic reference document designed for use by United States forces, Republic of Vietnam Armed Forces, and Free World Military Assistance Forces operating in the Republic of Vietnam. Prior to its publication, it was distributed in draft form to the field for a three month evaluation and has been completely coordinated with the Joint General Staff, Republic of Vietnam Armed Forces. In the near future, the handbook will be published in the Vietnamese language by The Republic of Vietnam Armed Forces.

In view of the recent dynamic changes in the government of Vietnam and the pacification program, it is considered that the publication of this handbook at this time is especially appropriate.

The handbook will be revised periodically by this headquarters. New pages will be distributed for insertion into the handbook when appropriate. Recommended changes or suggestions for improvement should be forwarded to Commander, United States Military Assistance Command, Vietnam, ATTN: MACJ3, APO 96222.

FOR THE COMMANDER:



WALTER T. KERWIN, JR.  
Major General, United States Army  
Chief of Staff

## TABLE OF CONTENTS

		Paragraph	Page
CHAPTER 1.	INTRODUCTION	1-3	1-2
CHAPTER 2.	CONCEPTS AND OBJECTIVES OF PACIFICATION	4-21	3-10
Section I	Background	4-16	3-5
Section II	Concepts and Objectives	17-21	5-10
CHAPTER 3.	ORGANIZATION	22-29	11-33
Section I	General	22	11
Section II	GVN Organization	23-26	11-26
	General	23	11
	Civilian Functional Organization	24	12-17
	National Police Field Force Organization	25	17-21
	Military Functional Organization	26	21-26
Section III	US Organization	27-29	26-33
	General	27	26-27
	Civil Operations and Revolutionary Develop- ment Support (CORDS) Staff Element Organization	28	27-31
	US Military Organization	29	31-33
CHAPTER 4.	US AND VIETNAMESE RELATIONSHIPS AND COORDINATION	30-50	34-41
Section I	General	30-31	34
Section II	Provincial Level	32-37	34-37
Section III	DTA Level	38-41	37-38
Section IV	CTZ Level	42-46	38-40
Section V	Operational Coordination	47-50	40-41
CHAPTER 5.	TACTICS AND TECHNIQUES	51-63	42-54
Section I	General	51-52	42
Section II	Tactics	53-55	42-43
Section III	Techniques	56-63	43-54
	General	56	43-44
	Patrolling	57	44-46
	Cordon and Search	58	46-50
	Combined Cordon and Search Techniques	59	50
	Hamlet Festival	60	51
	Go Team	61	51-52
	County Fair	62	52
	Combined Action Program	63	52-54
CHAPTER 6.	TRAINING	64-74	55-58
Section I	General	64-65	55
Section II	Mobile Training Team Operations	66-74	55-58
Section III	Future Trends	75	58-59

TABLE OF CONTENTS - (Continued)

		Page
ANNEX A	RD Hamlet Criteria	A-1 thru A-2
ANNEX B	The Hamlet Festival	B-1 thru B-3
ANNEX C	Glossary of Terms and Abbreviations	C-1 thru C-5

## CHAPTER 3

### ORGANIZATION

#### Section I

##### GENERAL

22. This chapter discusses the many governmental agencies, military and civilian, Vietnamese and United States, which are participating in or supporting pacification. Although each major agency is discussed separately, it must be borne in mind continually that there is a complex interaction between all of these separate agencies at every level of the military or civil government. At some levels, military and civilian functions blend and the same individual is responsible for both. The primary task of the United States agencies in Vietnam is to advise, support and assist the GVN counterpart agencies. The US Mission Agency which has primary military and civilian responsibility for support of pacification is USMACV. It is necessary to keep the distinction between military and civil responsibilities in mind during the discussion that follows, as it will assist in determining who and what agency has primary responsibility for a given function and in what channels it operates.

#### Section II

##### GVN ORGANIZATION

##### 23. GENERAL.

The government of Vietnam is in a transition stage at this time in that an elected constitutional structure has just come into being. The present government cannot be divided simply into "civil organization" and "military organization". The military government of Vietnam had by its very nature introduced military officers into every level of the government. Many of them occupied then, and will occupy in the future, governmental positions concerned only with civilian functions. Others now occupy positions concerned only with military functions. However, there remain many whose job assignments combine military and civilian functions in a single office. This is not only a characteristic of the present government but is a foreseeable long term trend, as many of the most able and experienced Vietnamese administrators are in uniform. It is important to understand the distinction between the purely military line officer and the officer whose responsibilities include both military and civilian functions, as the actual responsibility may vary considerably from apparent rank.

## 24. CIVILIAN FUNCTIONAL ORGANIZATION:

a. Presently, the top echelon of the Government of the Republic of Vietnam is essentially civilian in character, although military or former military personnel presently occupy some of the top-ranking and policy-making positions. Currently, this echelon consists of the President, Vice President, and the Ministers of Defense, Interior, and Revolutionary Development. Below the top echelon, the majority of the governmental employees are civilian. Elections recently completed in September and October 1967, represented final steps toward constitutional government which had its beginning in September 1966. During that month the newly elected Constituent Assembly was convened.

b. The Constituent Assembly set about drafting a constitution which was unanimously approved in March 1967. The form of government ordained in the constitution is a modified presidential system. The constitution calls for a President as Chief of State who will designate a Prime Minister and a Cabinet to implement the government's policies and manage the affairs of the nation. It also provides for a two chamber legislature known as the National Assembly.

c. An independent judiciary is established with the highest legal authority vested in the Supreme Court. An Inspectorate is provided for by appointment. This body of representatives has the duty of guarding against corruption and other acts harmful to the national interest at all levels of government and in public and private agencies.

d. Revolutionary development councils composed of both military and civil representatives function at national through district level. At the national level, the Central RD Council (CRDC) develops policies and manages the overall program. Its organization is shown at Figure 3-1. Many civil activities are administered initially by the Ministry of Revolutionary Development to provinces and districts until they are taken over by the appropriate technical ministry. The activities of technical ministries are administered directly to the province from the ministry. Military activities are administered by the Ministry of Defense through subordinate RVNAF echelons to province and district levels. Regional, provincial, DTA, and district RD councils review RD activities and ensure that the military and civil aspects are coordinated. The CRDC has the following specific duties:

- (1) To determine the basic RD policy.
- (2) To examine and approve all RD plans and programs.

e. The CRDC has a Permanent Bureau. The chief is the Secretary General of the CRDC who is also the Minister of RD. The

# CENTRAL REVOLUTIONARY DEVELOPMENT COUNCIL

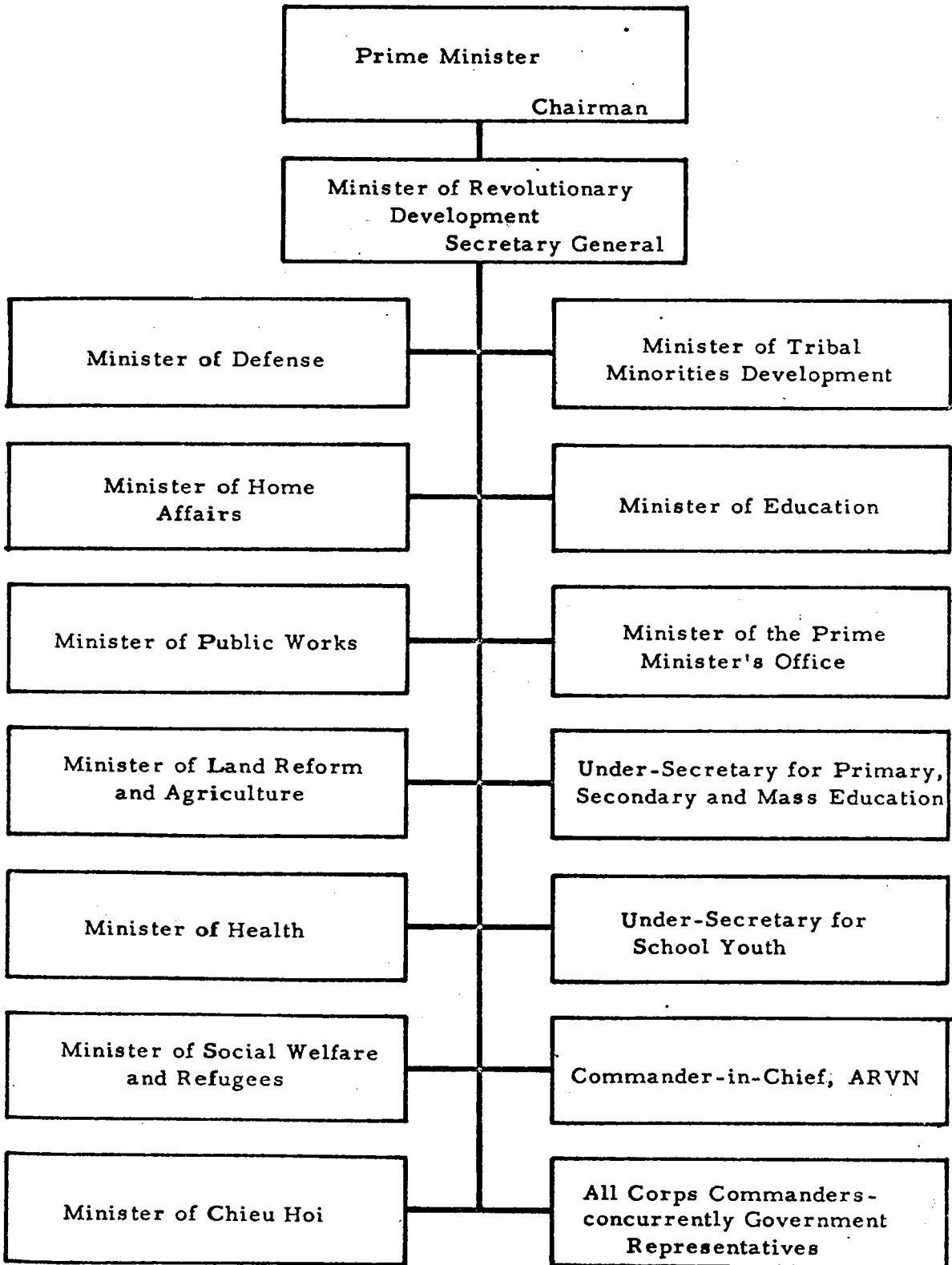


Figure 3-1



permanent bureau which is, for all practical purposes, the Ministry of RD, acts as an executive agency for the CRDC, and as such, executes all decisions made by the CRDC and coordinates with all ministries to assure smooth operation. Regional, provincial, DTA, and district RD councils also have permanent bureaus which function in much the same way. See Figure 3-2.

f. The corps commander has civil as well as military responsibilities, is responsible for governmental functions within a region, and is concurrently the GVN regional representative. The region boundaries correspond to the military corps boundaries known as Corps Tactical Zones (CTZ). The corps commander is assisted in his civil functions by a Deputy for Civilian and Territorial Affairs, and by regional deputies from the ministries in Saigon.

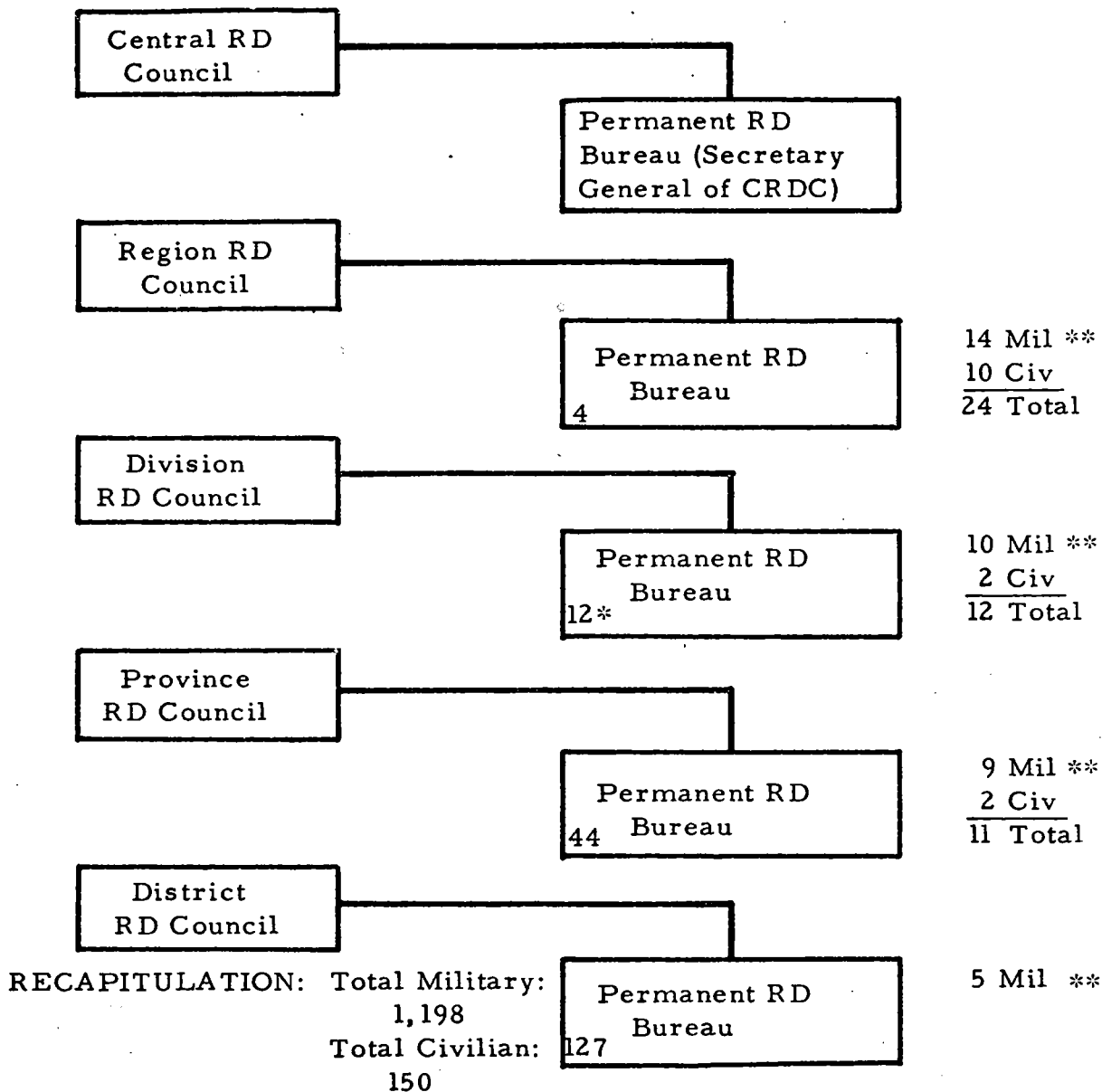
g. The commander of the Division Tactical Area (DTA) has limited responsibilities pertaining to civilian governmental functions. His role is discussed more fully in paragraph 38.

h. The province chief is the "key" man for success of the pacification program. He is responsible for developing a province pacification plan containing a detailed RD plan. Further, he is responsible for the control of all civil and military resources to be applied in support of pacification. Each technical ministry has a service representative in each province, but the province chief is, as an individual, responsible for all government functions within his province. The province chiefs are supervised through Region/CTZ for some functions, directly by Region/CTZ for other functions, and directly from the central government for others. The technical ministries give guidance directly to the service chiefs. This gives rise, on occasion, to policy conflicts which must be resolved by the province chief or higher authority.

i. The main operational element for the civil aspects of RD is the RD cadre group which is composed of 59 RD cadre (Fig 3-3). As soon as the required degree of military security is established, the RD cadre groups are introduced into the hamlet and begin the task of organization and development. The RD cadre group consists of three main elements:

- (1) Staff (7 men) responsible for:
  - (a) Command and Control.
  - (b) Coordination.
  - (c) Reporting.

# GVN REVOLUTIONARY DEVELOPMENT COUNCILS



(\*Figure on Div Bureaus includes CMD and 24th Special Tactical Zone (Rung Sat Special Zone has no RD council). Permanent Bureaus are authorized for 124 districts and three autonomous cities where priority revolutionary development activities are taking place.)

(\*\*The JGS has requested RVNAF Force Structure spaces for these billets. MACV J3 has stated that the spaces should be filled by civilians.)

Figure 3-2

# THE 59-MAN REVOLUTIONARY DEVELOPMENT CADRE GROUP

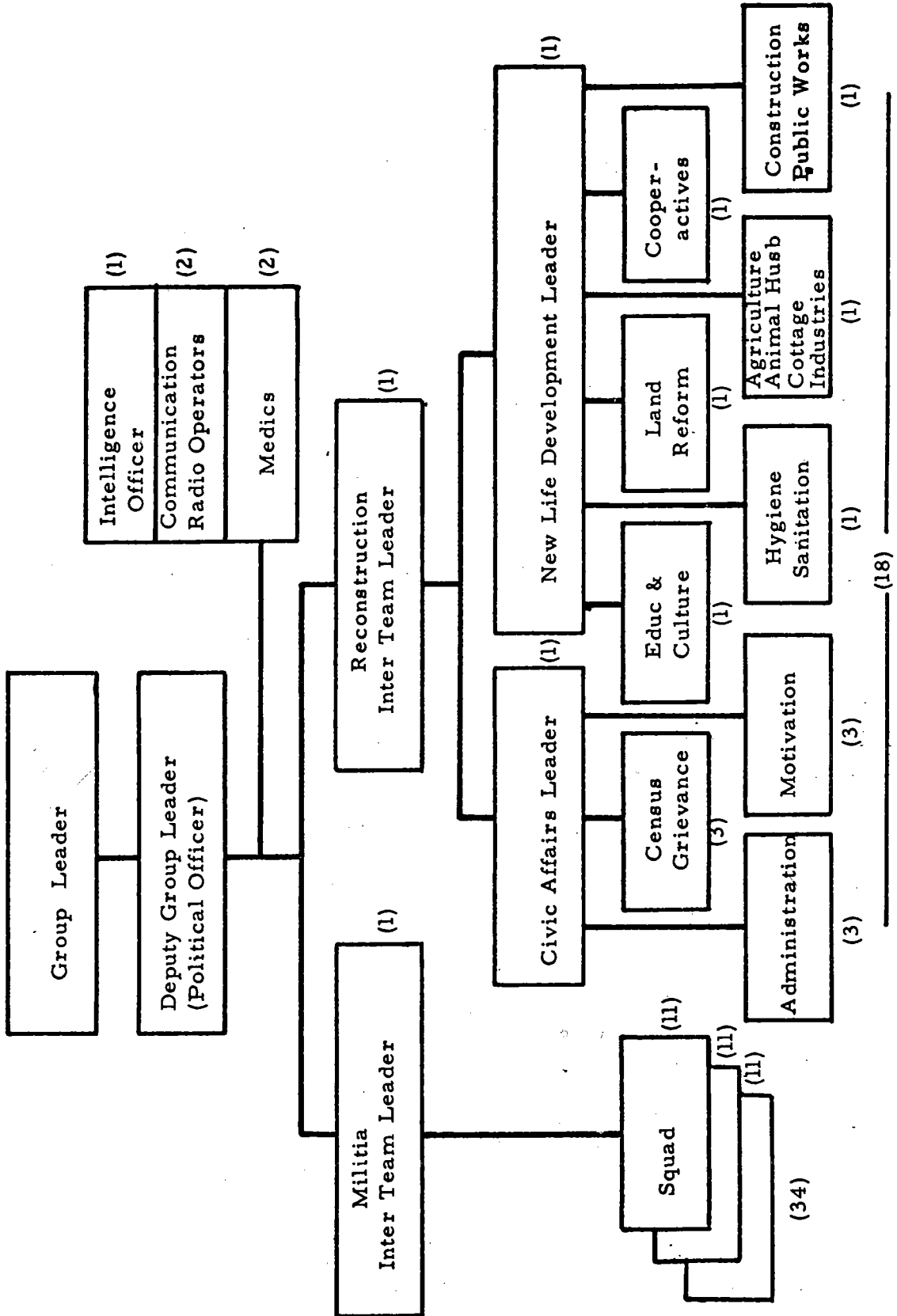


Figure 3-3

(2) Reconstruction Inter-Team (18 men) responsible for:

- (a) Studying and improving the political, cultural, social and economic situation.
- (b) Determining the aspirations of the people.
- (c) Planning self-help projects.
- (d) Motivating and assisting the people to build their own hamlet.

(3) Militia Inter-Team (34 men) responsible for:

- (a) Making security plans to protect the RD cadre and the hamlet inhabitants.
- (b) Coordinating with the Census Grievance unit of the reconstruction inter-team to discover and eliminate the VC infrastructure.
- (c) Organizing and training the Revolutionary Development Peoples Groups (RDPG) as self-defense forces.

j. The basic RD cadre group may be augmented by technical cadre from any GVN ministry in order to give proper emphasis or additional assistance in developmental areas outside the competence of the RD cadre group. For example, textile, fisheries, lumber products, ceramic products; these and other special problems might require specialized cadre skills applicable only in a limited geographical area and/or for a limited period of time. The province chief in these cases may request technical augmentation of his RD cadre group from the appropriate ministry in Saigon.

k. The RD cadre group operates under the operational control of the province chief, principally within the hamlets, to establish initial government administration, organize the people for self-defense, and initiate simple economic and social development projects to win the confidence and loyalty of the people. A Provincial Revolutionary Development Cadre Group (Fig 3-4) provides the province chief with a planning and control group to assist him in the execution of his responsibilities.

## 25. NATIONAL POLICE FIELD FORCE ORGANIZATION.

a. The National Police Field Force (NPFF) is a component of the GVN National Police. It consists of lightly armed tactical elements, whose major function is, in collaboration with the Special

# PROVINCIAL REVOLUTIONARY DEVELOPMENT CADRE GROUP

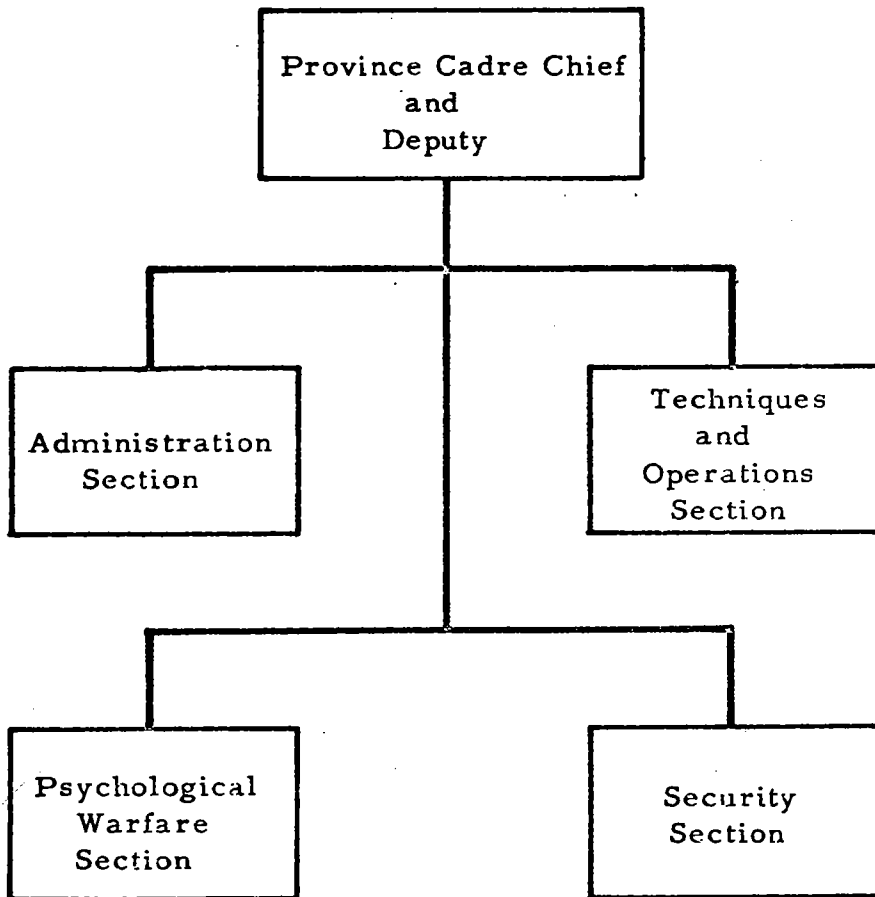


Figure 3-4

Police Branch, to eliminate the VC infrastructure in the district, village, and hamlet. Once this task is discharged, the NPDF has the primary responsibility of preventing VC resurgence and the ultimate mission of safeguarding the extension of other National Police presence into the rural area. The NPDF operates within the direct line of National Police command and supports other local police elements. The basic NPDF operating unit is the company.

b. Command of the NPDF is exercised by Commander, NPDF, who is an Assistant Director General of NPDF. Necessary staff is provided by the Directorate General of National Police.

c. Every member of the NPDF is fully trained as a policeman and is further trained in the counterinsurgency aspects of military operations. The internal administration, logistical support, and disciplinary functions of the NPDF are designed to support tactical operations as well as to carry out their primary mission of VC infrastructure eradication in collaboration with the Special Police Branch.

d. Extending the supervisory and reporting capability of Headquarters NPDF in Saigon, the Commander, NPDF, is represented at the headquarters of regions and provinces by officers of NPDF attached to the offices of the Regional Chief of Police and Province Chief of Police respectively. The duty of these officers is to ensure continuous and adequate logistic and administrative support from Headquarters NPDF; to keep Commander, NPDF continuously informed on all aspects of the status of his companies; and to ensure a proper working relationship between NPDF company commanders and the province/district administration. In particular, they ensure that the NPDF field elements are used only for those purposes for which they have been provided; i. e., VC infrastructure eradication and necessary field operations at the village level. NPDF are not responsible for providing the personal security of province or district chiefs; their equipment is not to be diverted to non-NPDF elements; nor should they be used as scouts for ARVN/RF/PF tactical operations.

e. It is the prerogative of the province chief to decide which districts will employ NPDF as part of his province plan. He may decide that:

(1) The local security has so deteriorated that NPDF will be withdrawn because they cannot handle the local situation.

(2) The local security has so improved that NPDF operations will pass to the uniformed National Police.

f. It is the responsibility of the Province Chief of Police to ensure that the police administrative and intelligence machinery

cooperate and coordinate with all other government agencies (particularly the armed forces).

g. It is the task of the NPFF representative at Province Headquarters to ensure that the NPFF companies are operationally effective.

h. Relationships - District Chief/District Chief of Police/NPFF Company Commander.

(1) The district chief will decide in which villages of his district the NPFF platoons will be deployed. Subsequent redeployment will reduce the operational effectiveness of the NPFF, depending on the intelligence posture, familiarity with the area, and the degree of rapport established with the local population.

i. Relationship - Village Chief/NPFF Platoon Commander. The NPFF Platoon Commander will work in close and cordial association with the village chief of the village to which his platoon is assigned. However, the village chief has no authority over the Platoon; and the Platoon Commander has no authority over the Village Chief. The relationship of NPFF is collaboration with the village and hamlet authorities.

j. Organization:

(1) The basic NPFF unit is the company.

(2) Normal deployment calls for one company to each "task district" (a district selected by the province chief for NPFF operations). A task district will contain several "task villages", which have been selected by the District Chief for NPFF operations.

(3) The company is a flexible sized unit. The number of platoons will vary with the number of task villages in the district.

(4) The allocation of companies to a province will vary with the number of task districts in the province.

(5) Weapons. Although there is a nationally established TOE, allocation of weapons within a platoon is at the discretion of platoon leader who may decide to group all shotguns, or all BARs or all rifles, or any combination appropriate to his task. Similarly, unless otherwise directed, the squad leader may group his weapons.

(6) Vehicles. The allocation of vehicles provides for

one truck, 1/4 ton (Jeep) per platoon and one for company headquarters. In addition, the company headquarters is authorized two trucks, 1 1/2 ton.

k. The Public Safety Division, MACCORDS, is responsible for providing advisors to the NFFF as well as programming the support provided to the NFFF by the United States.

## 26. MILITARY FUNCTIONAL ORGANIZATION.

a. The Joint General Staff, Republic of Vietnam Armed Forces (JGS/RVNAF) is the senior Vietnamese military headquarters in Vietnam. The Deputy Chief of the JGS, RVNAF assists the Chief of JGS in all matters pertaining to RVNAF and directs RVNAF's support of RD and Pacification programs. The Deputy is also the commander and responsible to the Chief for all matters pertaining to RF and PF affairs.

b. The Republic of Vietnam Armed Forces (RVNAF) includes the regular Army (ARVN), Air Force (VNAF), Navy (VNN), Marine Corps (VNBC) and the Regional Force and the Popular Force (RF/PF). The basic missions of VNAF and VNN are to provide support to ARVN. The battalions of the VNBC, along with ARVN airborne battalions, normally in general reserve, will be allocated to the operational control of a corps commander for specific operations. Normally, RF units are under the command of the province chief/sector commander and PF platoons are under the command of the district chief/subsector commander. The military command echelon below the JGS/RVNAF is the corps.

c. In his military role, the corps commander is responsible for all military operations within his assigned area of responsibility.

### d. ARVN.

(1) The general mission of the ARVN, at corps level and below, is to plan and execute military operations in support of the joint military effort, and to support the RF/PF and civil pacification effort at province level.

(2) Below corps level, ARVN is organized along conventional US lines into divisions, regiments and battalions (Figure 3-5). Divisions are assigned military responsibility for division tactical areas (DTA). Subordinate elements of the division may be assigned tactical areas of responsibility (TAOR) for providing military support of pacification. The boundaries between DTAs and the designation of TAORs are normally based on the provincial political boundaries.

(3) Division, regimental and battalion headquarters are dispersed within the DTA, sited in the large towns and cities. Although



# ORGANIZATION OF THE RVNAF

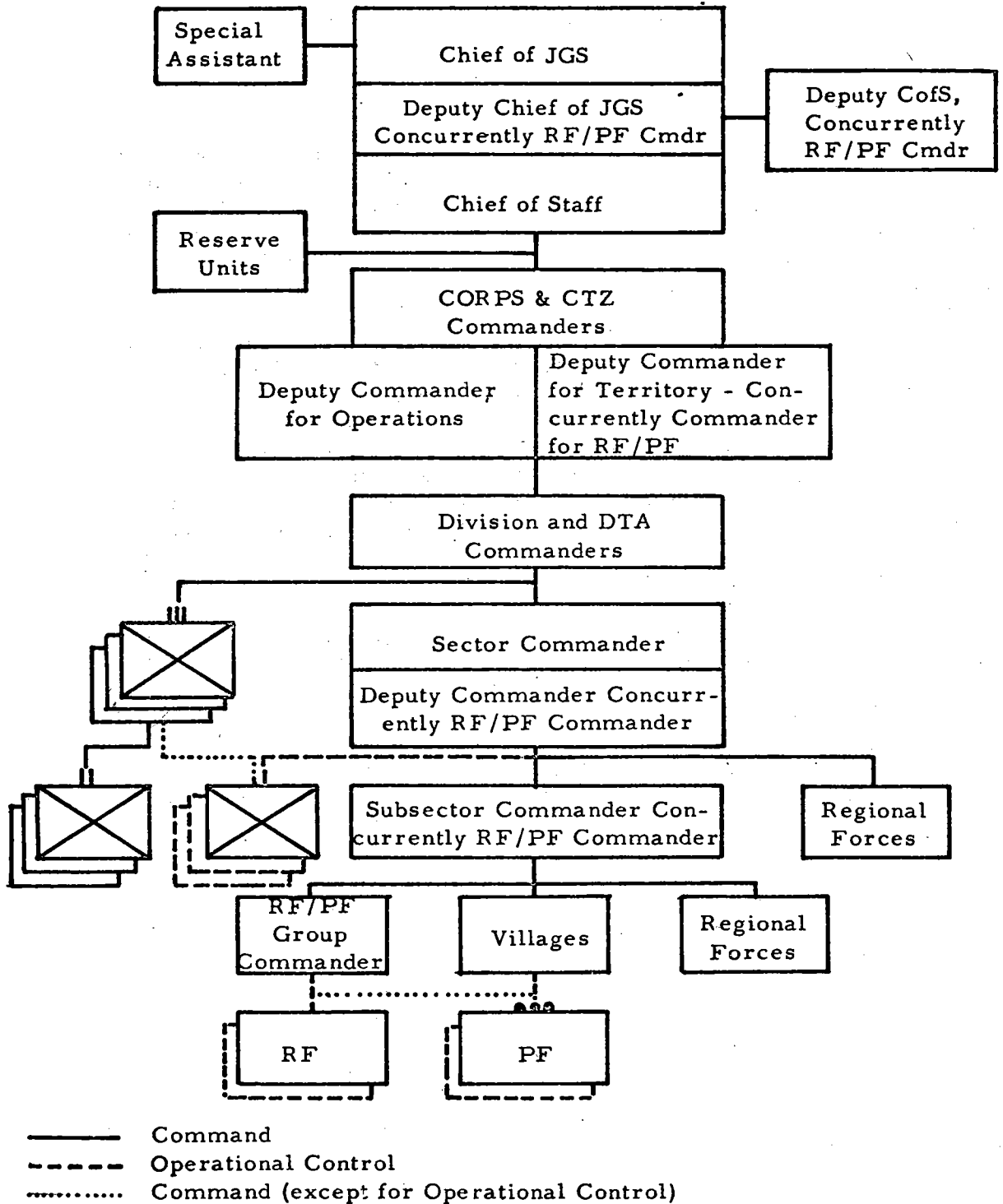


Figure 3-5

physically located within provinces and districts, ARVN tactical units remain within the ARVN chain of command unless higher authority has directed otherwise. Therefore, the normal relationship between commanders of ARVN units and the province/district chief is mutual liaison and coordination. However, when assigned to provide territorial security for pacification, ARVN units normally will be placed under the operational control of the sector commander who may also be the province chief.

e. Regional Force/Popular Force.

(1) An RVNAF reorganization study recently completed and approved by both MACV and JGS/RVNAF calls for modification of the RVNAF organizational structure. Charts in this handbook dealing with RF/PF reflect the current organization and, in so far as possible, the pending changes as known at the time of publication.

(2) The mission of Popular Force (PF) platoons operating in a contiguous belt or zone outside the hamlet or village is to conduct night saturation patrols and to establish and maintain outposts, thus providing local security for RD. The Popular Forces organize civic groups to participate in local security in rural areas, support the Pacification Program and assist in the protection of vital highways and key installations when Regional Forces (RF) are not available. The RF company operating throughout another belt contiguous to that of the PF, but more distant from the hamlet or village, has a similar mission of providing local security to RD. Regional Forces will also protect villages, hamlets, population resources, communications systems and other fixed installations when Popular Forces are not available.

(3) The Regional Force/Popular Force (RF/PF) is the military organization specifically established for assignment to the command of the sector and subsector commanders. Although RF/PF is within the RVNAF command structure, its function more nearly approximates that of militia rather than that of regular forces (Fig 3-6). It can be seen from the subparagraph above that its mission is more locally oriented than the mission of ARVN. Its organization and equipment is considerably lighter than that of a corresponding ARVN organization, consequently its combat firepower and effectiveness are not comparable to an equivalent ARVN organization. In spite of these limitations, the RF/PF has consistently demonstrated its capability in the field. RF/PF collectively constitute approximately one-half of the manpower in the Vietnamese Armed Forces.

(4) As the general rule, the Regional Force is province oriented while the Popular Force is district oriented. This does not, however, preclude inter-district or inter-provincial combat operations or limited duty station transfers for RF personnel. A typical provincial organization is shown at Figure 3-7. The number of RF companies will vary from province to province, depending upon size, population and priority of the province. The same applies to the number of PF platoons assigned to a district.

# RF/PF ORGANIZATION

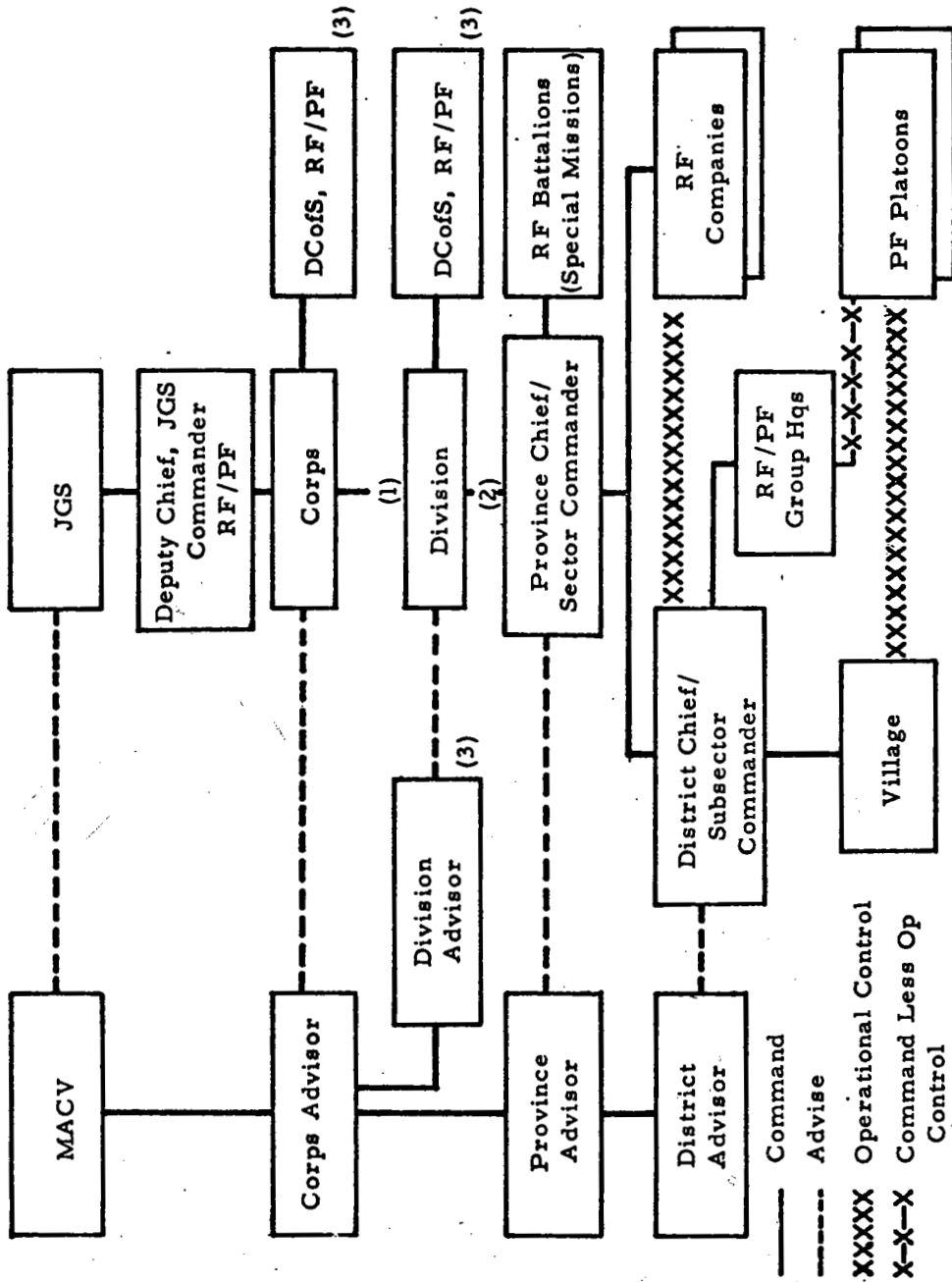


Figure 3-6

NOTE: (1) Upon reorganization of RVNAF in CY68, the corps commander deals directly with the province chief on matters of RD.  
 (2) No responsibility for supervision of RF/PF administration, training or logistics beginning in the first half of CY68.  
 (3) To be deleted in the first half of CY68.

# RF/PF ORGANIZATION WITHIN A PROVINCE/SECTOR

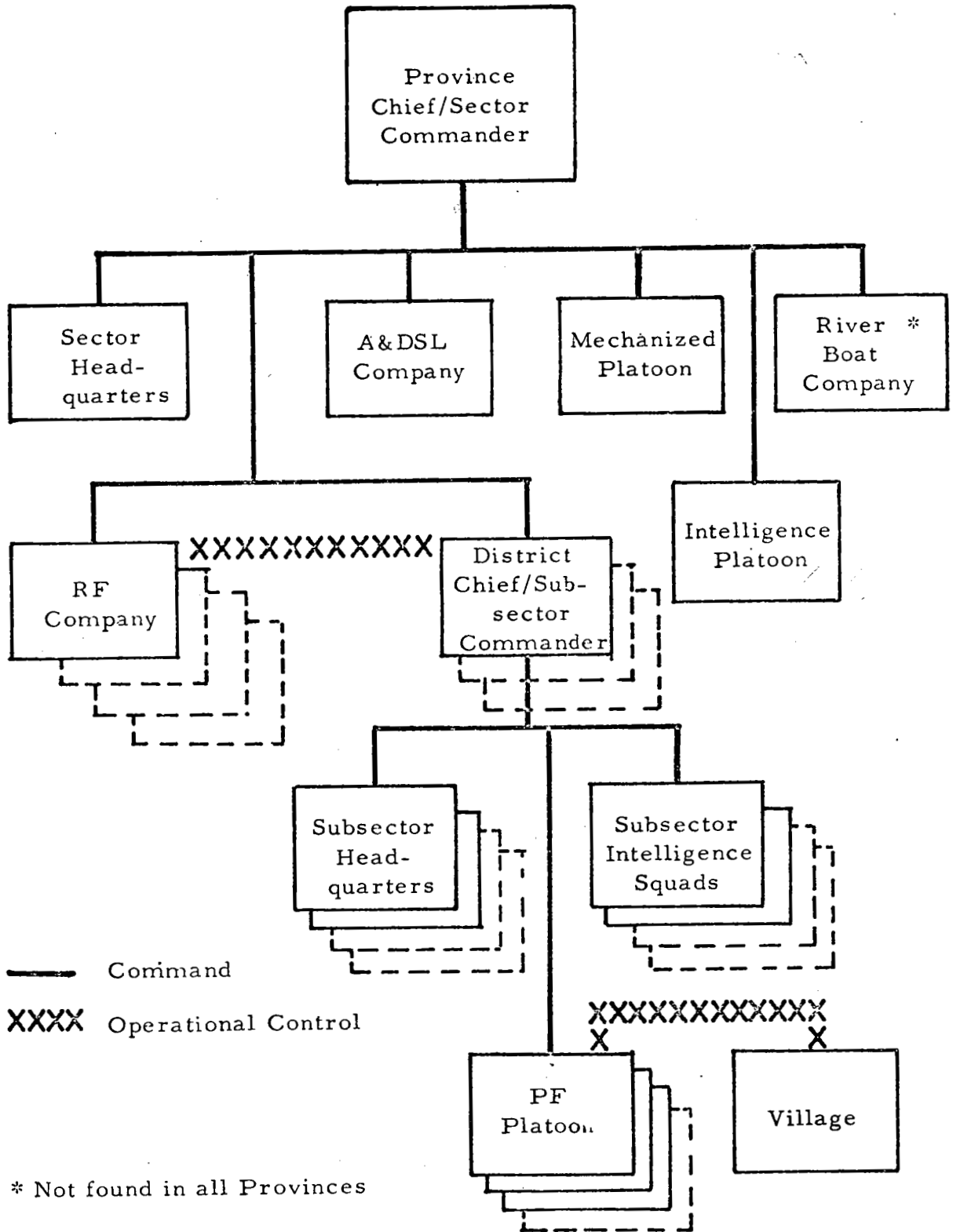


Figure 3-7

(5) PF platoons usually are assigned as village or hamlet security forces. They also are used for Line of Communications (LOC) and bridge security, for maintaining outposts, intelligence and security patrols, and night and day ambushes. Generally, the PF is assigned to the command of the subsector commander, but is supported logistically by the province Administrative and Direct Support Logistical Company (A&DSL CO).

(6) RF units are assigned to the sector commander. He may retain operational control or may place them under the operational control of the subsector commander. The sector commander may employ multi-company formations and conduct combat operations over a relatively long period of time. In some cases the sector commander will employ one or two RF companies as a province reaction force. In addition, the RF is used normally for the defense of the more critical outposts and forward operating bases within the sector. RF battalions, while subordinate to the sector commanders, are assigned special missions by the corps.

f. Paramilitary Forces. The Civilian Irregular Defense Group (CIDG) forces are paramilitary forces under Vietnamese Special Forces (LLDB) command. The LLDB are advised and supported by the US Army Special Forces (USASF). Since many of the missions, tasks and operations of these forces are classified, a discussion of the CIDG program in this handbook is not possible. The reader may refer to Annex K (Employment of CIDG) to the Combined Campaign Plan 1968, AB 143, for a more detailed discussion of CIDG forces and their employment.

### Section III

#### US ORGANIZATION

##### 27. GENERAL.

a. The Ambassador of the United States is the personal representative of the President of the United States to the Government of South Vietnam. He is the senior member of the US Mission, and is responsible for the conduct of all United States Governmental activities in Vietnam.

b. The Embassy, Joint United States Public Affairs Office (JUSPAO), United States Agency for International Development (USAID), Office of Special Assistant to the Ambassador (OSA), and US Military Assistance Command - Vietnam (USMACV) are the United States Government Agencies presently in Vietnam. Collectively, they comprise the US Mission which is identified as the US Country Team.

c. The Embassy provides facilities and staff to support the Ambassador and is responsible for all exchanges between the US Government and the RVN at the national level.

d. JUSPAO is organized to meet the specific public affairs requirements imposed by United States interests in Vietnam.

e. USAID is responsible for assisting and advising on the development of the civilian economy. It provides advice and support over the entire spectrum of nonmilitary assistance in Vietnam.

f. USMACV is charged with the dual responsibility for providing military assistance support to the Republic of Vietnam Armed Forces (RVNAF) and, as a subordinate unified command under the Commander in Chief, Pacific (CINCPAC), for the command of US military forces committed to assist the RVN. By agreement, COMUSMACV coordinates the activities of the military forces contributed by other Free World Nations in support of the RVN.

g. The top coordinating body is the US Mission Council. The council is also the senior advisory body to the Ambassador. The senior officer or senior member of each US agency is a member of the Mission Council.

28. CIVIL OPERATIONS AND REVOLUTIONARY DEVELOPMENT SUPPORT (CORDS) STAFF ELEMENT ORGANIZATION.

a. The Commander, USMACV (COMUSMACV) has the responsibility to provide single manager direction of all US civil/military pacification activities in the RVN. The Deputy to COMUSMACV for Civil Operations and Revolutionary Development Support (CORDS) is responsible to COMUSMACV for discharging these duties. Specifically, he is charged by COMUSMACV with supervising the formulation and execution of all policies and programs, military and civilian, which support the RVN's pacification program.

b. The Assistant Chief of Staff, CORDS, is assigned the following responsibilities:

(1) Advise COMUSMACV, MACV staff elements, and all US civilian agencies on all aspects of US civil/military support for the RVN pacification program.

(2) Develop joint and combined plans, policies, concepts, and programs concerning US civil/military support for pacification, in conjunction with RVN authorities.

(3) Supervise the execution of plans and programs for US civil/military support of pacification.

(4) Provide advice and assistance to the RVN, including the Ministry of Revolutionary Development (MORD), RVNAF, Joint General Staff (JGS), and other RVN agencies on US civil/military support for pacification including US advisory and logistical support.

(5) Develop requirements for military and civil assets (US and RVN) to support pacification.

(6) Serve as the contact point for sponsoring agencies for RD programs. Maintain liaison with supporting agencies in representing their interest in civil non-RD programs and activities in the field. Maintain ~~direct~~ operational communications with field elements for these programs.

(7) Be responsible for program coordination with the various US mission civil agencies in the planning and implementing of community development and nation building activities.

(8) Provide a MACV focal point for economic warfare including population and resources control and for civic action by US forces.

(9) Evaluate all civil/military pacification activities including the provision of territorial security for pacification by US/FWMAF/RVN military forces and report on the progress, status, and problems of pacification support.

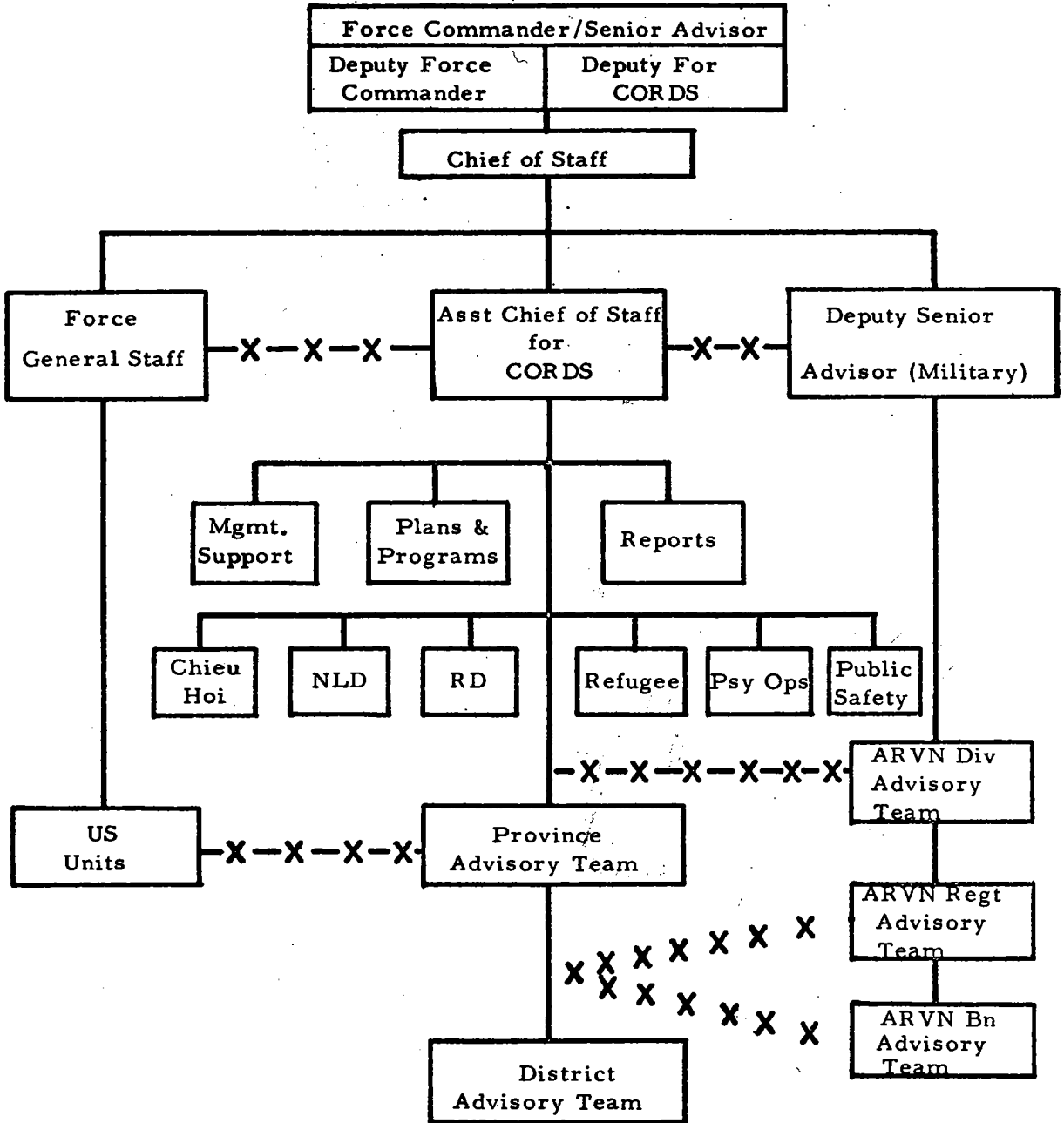
(10) Act on all pacification support policy matters pertaining to subordinate echelons.

(11) Direct advisory relationships with the RVN on pacification matters.

(12) Exercise overall staff monitorship, in conjunction with the other HQ MACV staff agencies in their areas of primary staff interest, for the RF/PF Advisory Group in all matters related to the pacification effort.

c. Region/CTZ: The staff element organization for CORDS conforms generally to Figure 3-8 allowing for differences in the situation in the various regions or Corps Tactical Zones (CTZ), provinces, and districts.

# REGION/CTZ CORDS ORGANIZATION



**X-X-X** Coordination--Military and CORDS matters.  
**XXXX** Operational Control when unit assigned on RD direct support mission.

Figure 3-8



(1) The Deputy for Civil Operations and Revolutionary Development Support to the Force Commander/Senior Advisor (SA) in all the corps is a civilian. He is charged with supervising the formulation and execution of all military and civil plans, policies, and programs which support the RVN's pacification program including civic action performed by US units.

(2) The Deputy Senior Advisor (DSA) assists the Deputy for CORDS in all matters relating to RVNAF military support for pacification.

(3) The Assistant Deputy for CORDS at region/CTZ level is a civilian. He heads an integrated civil/military staff which parallels the MACCORDS organization. He also directs headquarters based RD-related and non-RD technical programs.

d. Province.

(1) An integrated military/civilian advisory team is assigned to each province.

(2) The province senior advisor is the province team chief. He may be military or civilian. The province senior advisor is chosen by the Force Commander/Senior Advisor and his deputy for CORDS, with the concurrence of the Deputy COMUSMACV of CORDS. If the province senior advisor is military, the deputy province senior advisor must be civilian and vice versa.

(3) The province senior advisor receives operational direction from the Deputy for CORDS to the Force Commander/Senior Advisor. Province teams receive military administrative and logistical support from the ARVN division advisory teams.

(4) Where ARVN units are in direct support of pacification in a province, advisors to these units will be under the operational control of the province senior advisor.

(5) The province senior advisor serves as principal advisor to the province chief. However, technical advice will be given to the province chief or his representative by the most qualified member of the province team. The province senior advisor must be made aware of the advice given and will establish policies to which this advice will conform.

e. District.

(1) The district advisory team is an integrated military/civilian team.

(2) The district team advises the district chief on military/civil matters and implements all US military/civil support programs within the district.

(3) The district senior advisor is the district team chief. He is selected by the province senior advisor with the concurrence of the Deputy for CORDS to the Force Commander/SA. The district senior advisor and the deputy senior advisor may be either military or civilian. If one is military, the other must be civilian if there is a civilian representative present at district level.

## 29. US MILITARY ORGANIZATION.

a. USMACV is the US mission agency charged with the responsibility for military support of pacification. By exercising its influence through advisory channels, MACV guides and advises ARVN in the execution of that part of its mission related to the military support of pacification. By virtue of its operational command authority over US military components and operational control over Free World Military Assistance Forces (FWMAF), MACV assigns missions to its subordinate commanders which contribute to or directly support the pacification effort.

### b. US Military Advisory Organization:

(1) US advisory detachments are provided to the RVNAF regular forces down to battalion or equivalent level (Fig 3-9). The advisory chain of command parallels the RVNAF chain of command. The organization of the US advisory detachment also provides for an independent communication capability which parallels that of ARVN, extending from USMACV through corps, division and regiment to battalion.

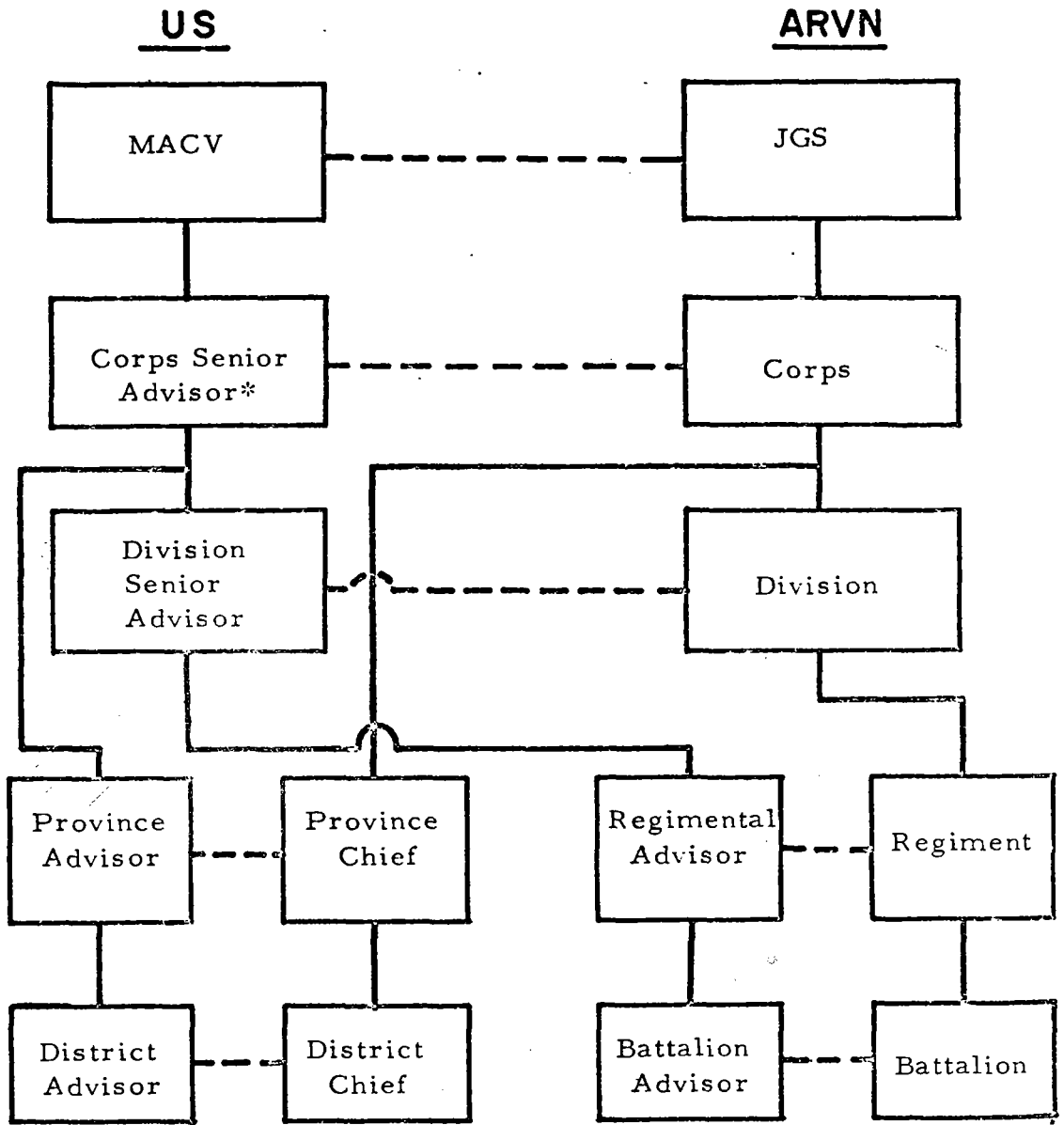
(2) The US Force Commander in I, II and III CTZ also functions as the Senior Advisor. This dual responsibility of the CG, III MAF, CG, I FFORCEV and CG, II FFORCEV allows effective coordination between RVNAF and US/FWMAF units conducting combat operations in support of pacification. IV Corps, which does not have a corresponding US tactical commander, has only a Senior Advisor and advisory detachment.

(3) Within each corps the senior advisor at each echelon is responsible for the US military advisory effort in the geographical area encompassed by his counterpart commander. The province senior advisor is supervised by the corps senior advisor of the corps in which the province is located.

### c. US/FWMAF:

(1) COMUSMACV exercises operational command through the

# ARVN/US ADVISOR ORGANIZATION



\* CG, III MAF is I Corps SA  
 CG, I FFORCEV is II Corps SA  
 CG, II FFORCEV is III Corps SA  
 SA, IV Corps is IV Corps SA

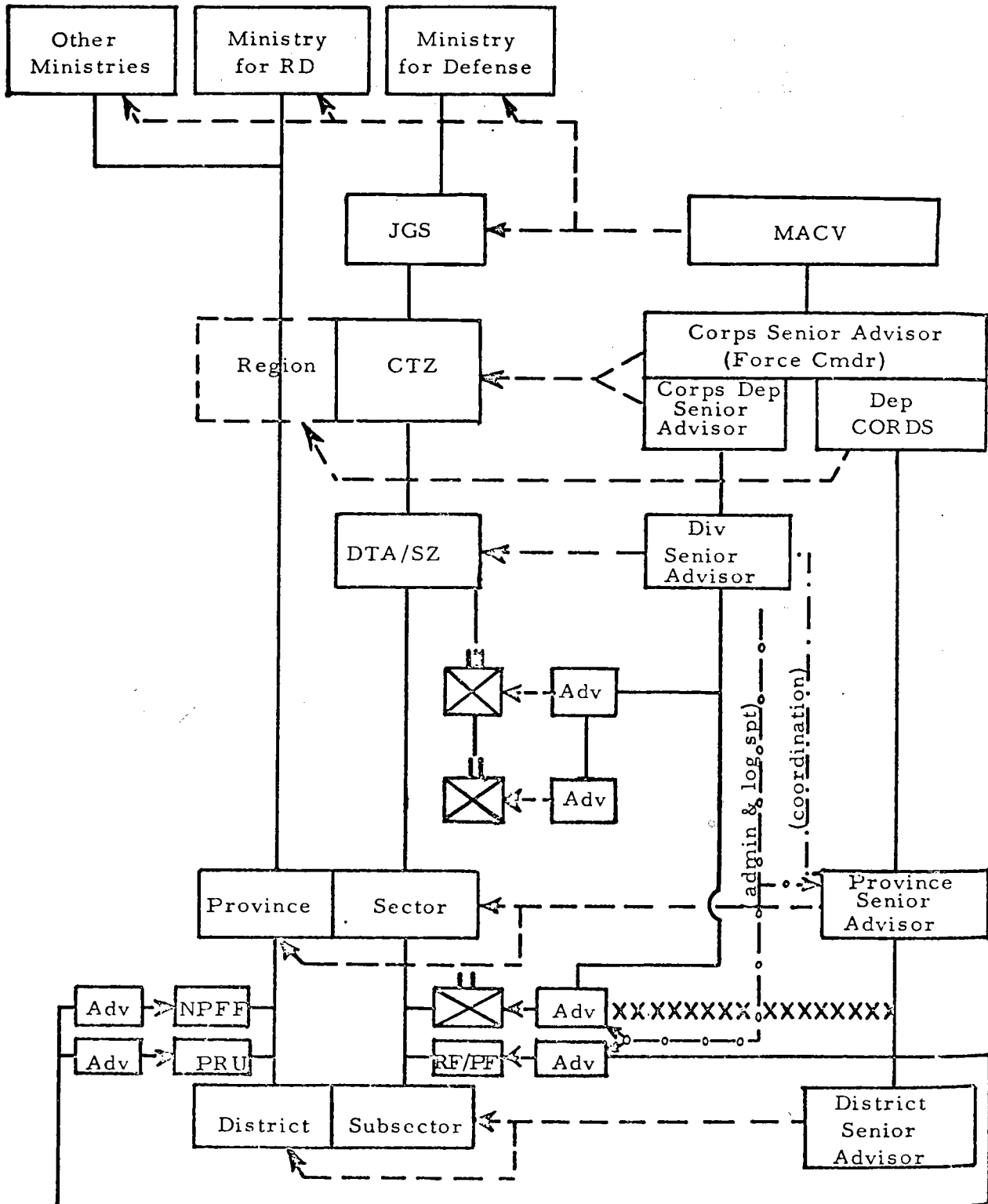
————— Command  
 - - - - - Advice

Figure 3-9

service component commanders over all US forces in the RVN. The FWMAF maintain their national identity, but by agreement are under the operational control of COMUSMACV.

(2) The primary responsibility of US/FWMAF is the destruction of VC/NVA main force units and neutralization of VC/NVA base areas. US/FWMAF will also conduct military operations in support of RD within assigned Tactical Areas of Responsibility (TAOR) and in the vicinity of US/FWMAF base areas.

# US ADVISORY ORGANIZATION



————— Command  
 - - - - - Advise  
 XXXXX OPCON

Figure 4-1

## CHAPTER 5

### TACTICS AND TECHNIQUES

#### Section I

##### GENERAL

51. In Chapter 1, Section II, the concepts and objectives of pacification were discussed. The overall strategic concept includes these separate but mutually supporting tasks:

a. Military Offensive. US/FWMAF have been assigned primary responsibility for conducting the military offensive to defeat the VC/NVA main force units. RVNAF participates in this task when possible in conjunction with their primary task of military support of pacification. It should be noted that in IV CTZ, RVNAF currently has the primary task for the military offensive as well as the support of pacification.

b. Revolutionary Development. RVNAF and GVN civil elements conduct this task with RVNAF having the primary responsibility for providing territorial security for RD. US/FWMAF is assigned this responsibility when directed by COMUSMACV. This task is conducted in three phases which are clearing, securing, and developing.

c. Nation Building. Government of Vietnam civil elements conduct this task with assistance of US/FW civil agencies to complete the development of a nation-wide political, economic and social institutions necessary for a viable, free noncommunist Republic of Vietnam.

52. This chapter will present certain of the tactics and techniques applicable to operations of the military offensive and those in support of pacification when US/FWMAF/RVNAF are supporting a GVN/US civil effort. In all cases, military operations should be so conducted as to be integrated fully with civil pacification objectives.

#### Section II

##### TACTICS

53. US/ARVN doctrine and tactics are being reviewed continuously to determine their adequacy and effectiveness in the combat environment of Vietnam. This continual review has proved that combat doctrine as published and taught in US service schools is valid for application in Vietnam. The "Handbook for US Forces in Vietnam", April 1967, is a valuable source of tactical guidance in concentrated form to augment the standard doctrinal sources. Additionally, "Combat Tips" and

"Lessons Learned" are published by the various headquarters from time to time to update doctrine and to disseminate information on successful combat tactics and techniques. This body of doctrine is valid for and applicable to the conduct of the military offensive and military operations in support of pacification. In actuality, military support of pacification is a unit mission, not a special and identifiable military maneuver. In order to accomplish this mission, units will employ standard tactics and techniques adapted as necessary to meet the requirements of terrain, enemy forces, and rules of engagement.

54. In the initial phase of pacification, offensive operations are conducted to clear the area. By definition, an area is cleared when organized VC/NVA main force and guerrilla units have been destroyed or evicted. During this phase, the clearing forces normally will operate in company and battalion size operations, although regiment or division size operations may be required initially, depending on VC/NVA capabilities and probable reaction. Later, when the VC/NVA cannot operate in large formations, the clearing force will be able to operate correspondingly in smaller formations covering larger areas. Saturation patrolling, day and night operations, and search and destroy operations will be conducted to locate, engage, and destroy remaining main force and local guerrilla units. Psychological operations will be conducted in support of these activities with emphasis on persuading the VC/NVA military and civil cadres to defect from the VC/NVA cause and rally to the GVN. In coordination with province officials, short term, high impact civic action projects are accomplished. The area will be outposted to give surveillance and early warning of enemy movements. Larger scale operations will move outward to the perimeter of the area undergoing clearing and/or in adjacent areas, in order to prevent the VC/NVA from reentering. During clearing, military operations will be oriented on the enemy within a designated area.

55. In securing an area, continued emphasis is placed on small unit operations (company and platoon), outposting, day and night ambushes, and security missions. Military operations are oriented on providing area security, but are characterized by aggressive offensive operations throughout the area. Psychological operations, particularly in civic actions, are intensified. Securing continues until the VC capability is reduced to individual terrorist activities.

58. CORDON AND SEARCH.

a. The CORDON AND SEARCH may be used alone or may be integrated with the County Fair, Hamlet Festival or Go Team, which will be discussed later. The concept of the CORDON AND SEARCH operation is to form a blockade around the target area - usually a hamlet - prevent movement into or out of the target area with one force, and then conduct a detailed search with a separate force. The CORDON AND SEARCH is most effective when the cordon is established silently and under the cover of darkness. This frequently will entrap draft evaders, deserters, and local guerrillas or VC local forces who have spent the night in the hamlet; therefore, the cordoning forces must maintain surveillance and be prepared to engage enemy forces inside the perimeter as well as outside the perimeter.

b. Although the cordoning force may be ARVN, US, or FWMAF, the searching force should always be Vietnamese. They may be ARVN, RF/PF or NFFF. The searching force should receive special training on the tactics and techniques of conducting a search, should be organized into search teams, each with specific assigned tasks, and should be briefed on the specific area or hamlet to be searched. Whenever possible, aerial photographs or a sand table should be used



during the briefing, in order that each team leader knows and understands his responsibilities.

c. For the purpose of the following discussion, a sizeable searching force is assumed, i.e., an RF company. The actual searching force may be considerably smaller, but the principles still apply. Each man, team, squad, or platoon must be selected for, trained for, and preferably rehearsed for a specific job during a specific search phase. The search will produce proper results only when it is well coordinated and carefully controlled during execution. The search should be as thorough as time permits: a sloppy or halfhearted search does not achieve satisfactory results.

d. The search operation can be divided into two phases - first, the sweep, and second, the deliberate search. Prior to initiating the sweep, the searching force moves as close as possible to the objective before detection. If possible, movement will be made under the cover of darkness, maintaining light and noise discipline.

e. Sweep.

(1) The sweep phase should be conducted rapidly, taking advantage of the element of surprise. The purpose of the sweep is to inspect rapidly the objective area, seize arms, ammunition, or other contraband before it can be hidden; detect any obvious booby traps; immobilize the population; and apprehend any suspected persons for further questioning. The sweep must be executed rapidly and decisively. The physical layout and the availability of approaches to the objective area may require that the sweep be conducted only from one point. It will be more effective, however, if a converging sweep can be initiated from two or more approaches.

(2) The sweep phase is terminated when the entire objective area has been given a visual inspection or when resistance or the threat of resistance by entrapped VC forces is encountered. Sweep forces always must be prepared for offensive combat if resistance develops.

f. Organization for the sweep should include the following functional teams, which may consist of from two or three men to a squad in strength:

(1) Command Group: Maintains overall command and control over the search operation. Maintains communication with the commander of the cordoning force and with the overall commander for the operation.

(2) Sub-Command Group: If two or more search sectors are established, each should have a senior NCO or an officer in charge.

The commander should maintain radio communications with the search force commander. He should control directly the fire support team.

(3) Fire Support Team: This team consists of a minimum of one automatic rifle or light machine gun, with crew. It displaces as required under control of the commander or sub-commander so as to be prepared to provide supporting fires to search teams if opposition is encountered. If converging sectors of search are being used, care must be exercised to preclude endangering friendly personnel.

(4) Search Teams: This team conducts a rapid visual search of each habitation and its surrounding ground. During the sweep, emphasis is on maintaining speed, to search as rapidly as possible to detect contraband or apprehend suspicious persons before they can be hidden. If such are located, they should be taken immediately to the command group for safe keeping by only one or two of the search team while the balance of the team continues the search. The search team should be equipped with signs, marking tape, or other means of marking booby traps or mines for later destruction. The location of mines, booby traps, tunnels, and underground bunkers should be reported immediately to the command group.

(5) Loud Speaker Team: A portable bull horn or loud speaker is considered essential for establishing rapid and positive control of the population. If possible, a minimum of one loud speaker per search sector under the immediate control of the commander/sub-commander should be provided.

g. Tunnels and bunkers normally will not be searched during the sweep however, surveillance of entrances must be maintained. Smoke or CS may be placed inside for immediate flushing action. If an extensive network of tunnels is detected, the search commander may consider this to be a sufficient threat so as to require a suspension of the sweep and an initiation of a deliberate search, which includes tunnel flushing and destruction/denial operations. If significant opposition is encountered, the cordoning force may reinforce the searching force and reduce the hamlet by normal combat action.

h. Deliberate Search.

(1) Upon completion of the sweep, the deliberate search phase of the search operation is initiated. This phase is characterized by a detailed and methodical search of the entire objective area. The search force is organized into functional teams, each of which has received training and is equipped to carry out a specific search procedure.

(2) Mines and booby traps must be located, marked and neutralized or destroyed.

(3) Tunnels that have been by-passed and kept under surveillance during the sweep phase are flushed with CS or smoke; either may cause personnel inside to come out and also will assist in detecting additional tunnel entrances. Considerable success has been experienced employing tunnel search teams which actually make a detailed search of the tunnel complex to kill or capture the enemy and capture weapons, documents, and other supplies.

(4) Each house or hut receives a methodical search. Walls and roofs are tapped or probed to detect hiding places or contraband. Floors are probed. A few bucketfuls of water spread evenly over the floor frequently will detect buried objects, as recently disturbed earth is more porous than the packed earth and absorbs water faster. Flagstones or hearth stones are examined carefully for evidence of being removable and, if in doubt, are lifted and the area beneath probed. Again, water poured over the area will be absorbed more rapidly between stones that have been disturbed. Family altars are examined carefully but with consideration for the religious sensitivities of the inhabitant. Sleeping platforms are dismantled and searched, the earth probed. Frequently, glazed pottery jugs are dug in beneath the sleeping platforms, to be used for hasty shelter or storage. These jugs are lifted and the interior of the hole examined and probed. Conventional mine sweeping gear or other metallic detectors may be used to sweep the walls and roof, but the usual amount of random metal - tie wires, nails and scrap - usually gives a high percentage of false reading. Exterior and interior measurements are taken to determine if walls or partitions of unusual thickness are present. Bagged rice is probed or, if possible, weighed on an improvised beam scale to determine if any contraband is hidden inside.

(5) The outside area is examined carefully to detect evidence of buried objects, particularly around and under bushes and trees. Tree trunks are tapped with a hammer or rock to locate hidden openings. Caches frequently are located on platforms hidden by the foliage on the tree limbs. Wells must be inspected carefully by a search team member physically descending inside; tunnels frequently are constructed exiting into well shafts. Fish weirs and holding ponds must be examined carefully for underwater entrances to caves or tunnels. Grave sites should be examined carefully but with consideration for the religious sensitivities of the local inhabitant.

(6) Care must be exercised to return the searched area to its normal state of order and repair as in those cases where no evidence of enemy complicity is found.

i. Added details which must be considered are that:

(1) The search force commander must allocate tasks and areas to ensure that the entire area is subjected to a detailed search.

(2) The senior member of the family, preferable the male member, should be inside the house with the search team during the search. This will tend to discourage looting by the search team. After the search has been completed, the search force commander assembles the hamlet elders and determines if any looting was done by the search teams.

(3) During the deliberate search of the area, interrogation teams assemble the inhabitants, conduct a documentation inspection, and as appropriate, conduct a detailed interrogation of selected subjects.

59. COMBINED CORDON AND SEARCH TECHNIQUES.

a. Three specific variations of cordon and search have been developed in Vietnam. Each of these utilize both US and Vietnamese personnel. Although these techniques may be used during support of RD, they are used primarily during clearing operations. These techniques are:

(1) The Hamlet Festival.

(2) The Go Team.

(3) The County Fair.

b. Basically, the three techniques are similar in that all include the cordoning of the hamlet selected for the operation, a search of the hamlet by GVN forces, and finally, conduct of PSYOP for the purpose of evidencing GVN concern for the people of the area. First, the Hamlet Festival concept will be described in brief. Then the Go Team and County Fair will be covered, pointing out the significant differences which require amplification.

c. Annex B describes the Hamlet Festival layout and task organization and functions of the RVNAF teams of the Hamlet Festival conceived and employed by the 1st US Infantry Division. The physical layout and the task organization shown in the annex are idealized; both may vary according to terrain, equipment available, and mission requirements.

## 60. HAMLET FESTIVAL.

a. The Hamlet Festival operation conceptually includes three components: the external cordon of military forces; the search force, always Vietnamese; and the Hamlet Festival force, also Vietnamese. These operate as a permanent task force under a combined staff of US and GVN personnel. It is used most profitably where military security and GVN civil influence are planned to be permanent.

b. In the actual operation, the military force moves in under cover of darkness and establishes a cordon around the hamlet: the search force then enters. As the search force enters, VC, ARVN deserters, and other illegal residents will attempt to escape: the cordon force will apprehend them. The searchers, normally RF/PF or NPFF units, assemble all males and females in the 15-45 age bracket and screen them. Search techniques are discussed in paragraph 58.

c. As this search is being conducted, the remaining hamlet residents are assembled for a Hamlet Festival. The purpose of this phase of the operation is to subject the people to intensive propaganda for the purpose of indicating to them that there does exist concern for their welfare on the part of the GVN. Food, clothing, agricultural advice, medical attention, all these are utilized as material evidences of the GVN concern. In addition, ID cards and family identity books are issued and lectures and entertainment are provided.

## 61. GO TEAM.

a. The Go Team differs from the Hamlet Festival in these respects:

(1) A combined staff for the operation is not required.

(2) The purpose of the operation is not to establish a permanent GVN presence, but rather to assist the progress of a military operation by clearing hamlets in the operation area and by providing evidence of GVN concern for the people even though adequate security is not available for the introduction of revolutionary development teams.

b. The operation of the team is similar to the conduct of the Hamlet Festival, except that a formal festival layout is not used. The Go Team consists of:

(1) Police or RF/PF units who conduct the search and elicit intelligence.

(2) A specially trained Vietnamese team which operates

with the US unit and assists in conducting night ambushes and patrols.

(3) Hoi Chanh, if available, who operates in the same manner as in the Hamlet Festival.

(4) PSYWAR/CA personnel who also operate in the same manner as in the Hamlet Festival.

(5) The intelligence team which gathers and confirms information and attempts to recruit informants and agents for future use.

(6) Medical personnel who attend to the simple medical needs of the people and thus provide a very tangible example of GVN interest.

c. Upon completion of the search and the Go Team's function, the entire operation moves on. The Go Team operation usually can be accomplished in a single day. It is most important in the Go Team operation that the people fully understand that the GVN presence is only temporary so that they do not needlessly expose themselves to the threat of later VC reprisal.

## 62. COUNTY FAIR.

The County Fair is much like the Hamlet Festival but is on a lesser scale. It falls half-way between Hamlet Festival and the Go Team. US units provide the tactical cordon within which GVN teams similar in composition and mission to the Go Teams, carry out their operation. The County Fair may be used in clearing operations in areas in which the GVN does not intend immediately to maintain its presence permanently, but desires to prepare the population for later assimilation. No attempts are made to obtain a commitment to GVN by the population at the time of the County Fair.

## 63. COMBINED ACTION PROGRAM.

a. The Combined Action Program, bringing together US Marines in III MAF and Vietnamese Popular Forces into wholly integrated units of platoon size, was initiated in August 1965. From a modest beginning of one Combined Action Platoon at Phu Bai in August 1965, the program had grown by May 1967, to 75 platoons. The program has exhibited strength and promise from the start. Villages with a Combined Action Platoon have moved rapidly toward a condition of peace and stability. A clear evidence of a Combined Action Platoon's effectiveness is the fact that the VC have never been able to re-establish control over a village protected by a Combined Action Platoon. In order to provide for effective operations and the orderly expansion of the Combined

Action Program and to ensure its integration into the Revolutionary Development Campaign Plan, items of joint policy have been agreed to between the I ARVN Corps and III MAF. These policy items are directive in nature and are distributed in a Vietnamese translation of this instruction to the military units of I ARVN Corps.

b. The basic Combined Action unit is the Combined Action Platoon (CAP) composed of one PF platoon equipped according to the TOE with a combat strength of 35 PF soldiers, and a Marine rifle squad of 14 Marines plus one Navy corpsman. The PF platoon retains its basic organization, while the Marines become advisors to the entire platoon, with the Marine squad leader serving as the advisor to the Vietnamese platoon leader. The individual Marines are integrated into the PF squads. Within the CAP, command relationships are on a coordination and cooperation basis between the PF platoon leader and the Marine squad leader. The Marine squad leader does not command the PF element of the CAP, nor does the PF platoon leader command the Marine squad.

c. The Missions/Tasks of the CAP are to:

(1) Destroy the VC infrastructure within the village or hamlet area of responsibility.

(2) Provide public security and help maintain law and order.

(3) Protect the friendly political/social infrastructure.

(4) Protect bases and communication lines within the village and hamlets in which they are located by conducting day and night patrols and ambushes in their assigned areas.

(5) Contribute to combined operations with RF and other PF, ARVN or FWMAF in their area of activity.

(6) Participate in civic action and conduct propaganda against the VC.

(7) Participate and assist in RD activities to the maximum extent possible with the accomplishment of the foregoing missions/tasks.

d. The subsector commander (district Chief) exercises control over the CAP through the Combined Action Team (CAT) located at subsector headquarters. The Combined Action Team is composed of a VN section of 1 or 2 officers and the necessary enlisted personnel and one or more

Combined Action Company Headquarters of 1 Marine officer and 5 enlisted USMC; plus liaison personnel from FWMAF units as required, such as artillery liaison and fire support coordination personnel. The CAT is designed to evolve into a complete operations center for the subsector commander to direct and coordinate the security efforts of CAPs, PF platoons, and RD cadre groups in the district with ARVN, FWMAF units, and RD campaign activities. The actions of the CAT include all matters necessary to accomplish the missions set forth in subparagraph c above.

e. The activation of a CAP or the relocation of the Marine element of a CAP mutually determined by CG, I Corps and CG, III MAF is based upon recommendations made by subsector commanders forwarded through ARVN or III MAF Combined Action Program channels. In general, CAP locations are selected to contribute directly to the accomplishment of the RD Campaign Plan, to provide defense of the LOCs, and to solve particular security problems unique to a given district such as those caused by the influx of refugees.

f. The training objective of the CAP is to enhance combat effectiveness of the PF platoon as soon as feasible in order to relocate the USMC squad in another hamlet/village area. Subsector commanders, insofar as practicable, attempt to keep the PF platoons in the same hamlet for a sufficient period of time to accomplish this training objective. All members of PF platoons assigned for duty in a CAP have completed basic military training. Additional on-the-job training is conducted by the Marine squad leader, operating in coordination with the PF platoon leader. Additional training guidance is provided from time to time to the elements of the CAP through the I Corps and III MAF Combined Action Program channels. Marine/Naval personnel assigned to the Combined Action Program as replacements or to form new CAPs attend the Combined Action School in DaNang or Phu Bai prior to such assignment.

g. The Combined Action Program is still in the development stage, but it is anticipated that shortly, certain platoons will have progressed to the point at which the Marine squad can be withdrawn and moved to a new area. It is estimated that the Marine squad will spend from six to twelve months with each PF platoon. Results of the program to date are the quantum jump in efficiency of the reinforced platoons and the consequent proportional increase in the degree of security that they are able to provide.



## DISTRIBUTION

<p>S</p> <p>2 - SJS</p> <p>2 - J1</p> <p>2 - J2</p> <p>1 - J31</p> <p>1 - J32</p> <p>1 - J33</p> <p>150 - J34</p> <p>2 - COC</p> <p>3 - COC (JOD)</p> <p>2 - J4</p> <p>2 - J5</p> <p>2 - J6</p> <p>150 - MACCORDS</p> <p>1 - MACDC</p> <p>1 - MACSA</p> <p>100 - MACT</p> <p>1 - MACOI</p> <p>2 - MACSOG</p> <p>2 - FWMAO</p> <p>50 - FWMAO (AFV)</p> <p>12 - FWMAO (ROK-V)</p> <p>2 - FWMAO (NZV Force)</p> <p>2 - FWMAO (MAGROC-V)</p> <p>2 - FWMAO (RMTAGOV)</p> <p>2 - FWMAO (PHILCAG)</p> <p>1 - Combined Studies</p> <p>1 - ACTIV</p> <p>5 - OSD/ARPA</p> <p>1 - Mil History</p> <p>2 - AFTU</p> <p>2 - NRDU</p> <p>1 - USAHAC</p> <p>10 - Cdr, 7th AF</p> <p>4 - MATTLO</p> <p>50 - CG, III MAF</p> <p>400 - CG, USARV (175 each to I FFORCEV and II FFORCEV)</p> <p>10 - Each Chief, AF Adv Gp; Chief, US Naval Adv Gp; Railway Security Adv Det</p> <p>300 - Each SA, I, II, III &amp; IV Corps (3 to each Sr Adv down to and including Bn and subsector level)</p>	<p>30 - Each SA, CMD, Abn Div, RF/PF, Marine Adv Gp (3 to each Sr Adv down to and including Bn and subsector level)</p> <p>5 - Each SA I, II, III, IV &amp; V ALC</p> <p>5 - COMNAVFORV</p> <p>15 - CO, 5th SFG (Abn)</p> <p>5 - JGS, J3</p> <p>200 - JGS, Central Training Agency</p> <p>10 - Chairman, JCS</p> <p>10 - CSA</p> <p>5 - CSAF</p> <p>10 - CNO</p> <p>10 - CMC</p> <p>10 - ACSI</p> <p>5 - DCSOPS</p> <p>25 - SACSA</p> <p>20 - ACTIV Ln Off, ACSFOR</p> <p>5 - CINCPAC</p> <p>5 - CINCPACAF</p> <p>14 - CINCAL</p> <p>5 - CINCLANT</p> <p>1 - USCINCEUR</p> <p>2 - CINCSTRIKE</p> <p>2 - USCINCSO</p> <p>5 - CINCLANTFLT</p> <p>10 - CINCUSAREUR</p> <p>5 - CINCUSARPAC</p> <p>2 - HQ USAFSTRIKE</p> <p>2 - HQ USARSTRIKE</p> <p>5 - US Army Forces Southern Command</p> <p>14 - CG, USARAL</p> <p>2 - CG, 1st US Army</p> <p>2 - CG, 3rd US Army</p> <p>2 - CG, 4th US Army</p> <p>2 - CG, 5th US Army</p> <p>2 - CG, 6th US Army</p> <p>2 - CG, 7th US Army</p> <p>2 - CG, 8th US Army</p> <p>5 - CG, XVIII Abn Corps</p> <p>5 - CG, III Corps</p> <p>5 - CG, 82d Abn Div</p> <p>5 - CG, 1st Armd Div</p> <p>5 - CG, 2d Armd Div</p>
--	---

**DISTRIBUTION:**

5 - CG, 5th Mech Div  
15 - CG; USACDC  
2 - CG, USACDEC  
1 - CO, USACDCIA  
3 - COMPHIBPAC  
3 - COMPHIBTRAPAC  
3 - COMPHIBTRALANT  
5 - COMUSMACTHAI  
2 - COMUSJAPAN  
10 - CHMAAGCHINA  
2 - CHMAAGJAPAN  
2 - CHPROVMAAGKOREA  
2 - CHMILTAGINDONESIA  
2 - CHMEDTBURMA  
2 - Chief, ARPA RDFU (THAI)  
10 - Chief, JUSMAG, PHIL  
12 - JFK Center SW  
5 - Defense Document Center  
3 - CO, Seal Tm 1  
3 - CO, Seal Tm 2  
7 - COMRIVFLOT ONE  
6 - COMCOSRON ONE  
6 - COMRIVRON FIVE  
2 - COMDT, NWC  
5 - COMDT, AFSC  
2 - COMDT, ICAF  
5 - COMDT, USAWC  
2 - COMDT, Air War College  
2 - President, Naval War College  
5 - COMDT, USAINTS  
5 - COMDT, USAARMS  
10 - COMDT, USAIS  
5 - COMDT, USAAVNS  
2 - COMDT, USA Jungle Warfare Sch  
2 - COMDT, PMG Sch  
2 - COMDT, USA Trans Sch  
2 - COMDT, USA Sig Sch  
2 - COMDT, USMC Sch  
2 - COMDT, USN Amph Sch  
12 - COMDT, USA CA Sch  
2 - COMDT, USAPHS  
2 - COMDT, USAQMS  
6 - COMDT, USASWS  
2 - COMDT, USAAD Sch  
5 - COMDT, USAAMS  
2 - COMDT, USACMLCS  
2 - COMDT, USAOGMS  
2 - COMDT, USAOC&S  
2 - COMDT, USAES  
5 - COMDT, USACGSC  
5 - COMDT, USARPAC Intell Sch  
2 - Supt, USNA  
2 - Supt, USNPGS  
3 - Supt, USMA  
2 - Supt, USAFA  
5 - USA Sch of Americas  
2 - CO, NAVPHILBSCOL CORO  
5 - MAI  
1 - Dir, US Air Univ Library  
1 - Dir, Special Air Warfare Sch

Exhibit M-94 is published in Volume III, Book 1, Directives. Exhibit M-95 and Exhibit M-96 are published in Volume III, Book 3, Reports. Exhibit M-97 is published in Volume III, Book 1, Directives.

EXHIBIT M-94

EXHIBIT M-95

EXHIBIT M-96

EXHIBIT M-97



DEPARTMENT OF THE ARMY  
HEADQUARTERS, UNITED STATES ARMY VIETNAM  
PO BOX 23000, SAN FRANCISCO 96375

AVHIG

17 April 1969

MEMORANDUM FOR RECORD

SUBJECT: Preliminary Inquiry Concerning Alleged Massacre of All Vietnamese Residents of My Lai (BS 728795) by US Soldiers.

1. On 12 April 69, a backchannel message was received from DA indicating that an ex-member of HHC, 11th Light Inf Bde, Americal Division, alleged Vietnamese residents of Pinkville (referred to by US Soldiers as Pinkville and identified as My Lai) were ruthlessly slaughtered by members of Co C, 1/5 Inf in early March 1968 at approximate coordinates of BS 728795. GEN Wheeler is in possession of a xerox copy of letter from the complainant, and other copies are drifting around the Congress. DA requests information concerning validity of the allegations, and requests views of LTJG Mildren and MG Jones on what action should be taken (EXHIBIT A).
2. On 14 Apr 69 the USAFV CofS directed a preliminary inquiry be made to determine if there is substance to the allegations (EXHIBIT B).
3. On 13 and 14 April 1969 at Chu Lai, RVN, Colonel H. K. Whitaker conducted a preliminary inquiry. Upon arrival at Americal Division Headquarters, the CofS, Colonel J. W. Donaldson and the CG, MG C. M. Gettys were briefed. Colonel Whitaker briefed Colonel Donaldson before departure.
4. MG Gettys has been CG, Americal Div, since June 68 and stated the alleged incident had never been brought to his attention. Colonel Donaldson commanded the 11th Light Inf Bde from Oct 68 until recently and had no information regarding the allegations. Both stated they knew of no investigations ever having been conducted concerning the alleged incident.
5. a. Task Force Barker was a task organization composed of the following elements of the 11th AIB:
  - Co A, 3/1 Inf
  - Co B, 4/3 Inf
  - Co C, 1/20 Inf
- b. Above units were reinforced by Artillery, Army Aviation and

EXHIBIT M-98

AVN19

SUBJECT: Preliminary Inquiry Concerning Alleged Massacre of All Vietnamese residents of My Lai (BS 728795) by US Soldiers

surveillance forces. The operation order outlining the organization and mission of the TF is attached (EXHIBIT C).

c. It was determined that reference to Co C, 1/5th Inf in the DA Message is erroneous and should read "Co C, 1/20th Inf." With the exception of 2LT Kally, the participants/witnesses listed in the DA Message were members of Co C, 1/20 Inf at the time of alleged incident.

6. a. An examination of the Daily Journals, G3 Operation, Americal Division, revealed a significant military action conducted by TF Barker occurred in the My Lai (Pinkville) area on 16 Mar 68 (EXHIBIT D). It is assumed this is the action to which the complainant refers.

b. There was a previous military action conducted by TF Barker in the My Lai area (BS 728795). However a review of the Combat After Action report revealed that Co C, 1/20 Inf was not committed to this action (EXHIBIT E).

c. A review of the Combat After Action report regarding the 16 Mar 68 military action revealed that an estimated enemy local force was in the vicinity of the My Lai (BS 728795) area. The area was noted as a VC stronghold, saturated with VC and VC sympathizers and heavily mined and booby trapped. A combat assault was initiated by TF Barker at 0730H, 16 Mar 68, to locate and destroy the enemy forces and fortifications. By 1630H, 16 Mar 68, the surviving enemy elements had broken contact by infiltrating with civilians leaving the area, or by going into the extensive tunnel systems. Enemy losses during this action were heavy, with 128 KIA and 11 VCS CIA. The civilian population supporting the VC in the area numbered approximately 200. This created a problem in population control and medical care of those civilians caught in fires of opposing forces. However, the Infantry units on the ground and helicopters were able to assist the civilians leaving the area and in caring for and/or evacuating the wounded (EXHIBIT F).

d. The map and overlay showing the disposition of enemy and friendly forces is at EXHIBIT G.

e. The Combat After Action report mentioned in c above, adequately described the concept, execution, and results of the military action (EXHIBIT F). In addition, the Americal Division news release of the military action gives an account of the events (EXHIBIT H). This release was dispatched to the USAFV-IO, and referred to the Saigon Office for clearance and possible release to the Press. It could not be determined whether the Press used the information.

7. An examination of records at the Americal Div AG Office revealed that all participants/witnesses listed in the DA Message are in COMUS. Names to

~~CONFIDENTIAL~~

AVNIG

SUBJECT: Preliminary Inquiry Concerning Alleged Massacre of All Vietnam  
Residents of My Lai (BS 728795) by US Soldiers

include their last known COMUS assignment were obtained (ANNEX 1). 2. Kelly could not be identified, however, a 2LT Thomas K. Wittingham participated in the operation and was a platoon leader in Co B, 4/3 Inf. The investigating officer could not identify any personnel currently assigned to the Americal Division Headquarters who would have been participants in the TF Barker operation. However, it was determined that the following personnel by virtue of their duty assignments while in AVN should have knowledge of the operation.

a. LTC E. D. Beers, CACSFOP, Wash, D. C. LTC Beers was in Command of 1/20th Inf from 1 Jul 66 to 5 Jul 68.

b. Major J. R. Bell, HQ, 29th Inf Bde, APO SF 96557. MAJ Bell was XO of 1/20th Inf during the period of the alleged incident.

c. Major P. L. Clifford, HQ, USARPAC, GI, APO SF 96558. MAJ Clifford was XO, 1/20th from 4 Apr - 15 Sep 68.

8. LTC Albert L. Russell, CO4277, Americal Division Liaison Office to HQ, III MAF, stated that he assumed command of the 4/3 Inf and TF Barker on 19 Jun 68 as a result of LTC Barker being killed. He stated that when he assumed command he heard rumors that stateside newspapers carried stories of the TF Barker operation of 16 Mar 68 which resulted in an investigation with everyone being exonerated. However, he has no first hand knowledge of this being factual. A check within USARPAC Headquarters and Americal Division failed to verify this.

9. a. Although the DA Message indicates there is the possibility that the alleged incident may have been the subject of a previous investigation, the investigating officer could not substantiate that any type of an investigation had been conducted. The Americal Division CG, CofS, G-1, AG, IO, IG, G-2, G-3, G-5, SJA, and Historian had no knowledge of the alleged incidents ever being investigated, and a review of their files failed to reveal any investigation was ever requested or accomplished.

b. A review of all files of the IG, USARPAC Headquarters was accomplished with negative results. In addition, a check of files by the USARPAC ACoFS G2, ACoFS G-3, ACoFS G-5, AG, IO, PM and SJA was accomplished with negative results.

c. An informal check by the Chief of Investigation Division, MACV-IG also met with negative results.

10. The entire Bantangan Peninsula of RVN which includes the My Lai area has a history of being a VC stronghold. A joint US/ARVN operation

~~CONFIDENTIAL~~

[REDACTED]

AVHIG

SUBJECT: Preliminary Inquiry Concerning Alleged Massacre of All Vietnamese Residents of My Lai (BS 728795) by US Soldiers

(Bolmariner/Russell Beach) commenced in Jan 69 with the purpose of clearing the area of VC and to pacify the peninsula. This operation continues and at present the ARVN forces are operating in the My Lai area with the mission of pacifying the area.

11. An examination of all available documents concerning the alleged incident reveals that the complainant has grossly exaggerated the military action in question. No evidence could be uncovered which would substantiate the allegations. Participants/witnesses listed in the DA Msg were not available for interrogation. In view of this it is recommended that USARV recommend OTIG, DA, arrange to interview pertinent witnesses/participants to determine if the allegations have substance.

LIST OF TABS

- A - DA Msg WDC5977
- B - Directive
- C - Opn Order
- D - Journal
- ✓ E - Cbt Action Rept 23 Feb 68
- F - Cbt Action Rept 16 Mar 68
- G - Map w/overlay
- H - News release
- I - Address of Witnesses

*Howard K. Whitaker*  
HOWARD K. WHITAKER  
Colonel, IG



**DEPARTMENT OF THE ARMY**  
**HEADQUARTERS AMERICAL DIVISION**  
**APO SAN FRANCISCO 96374**

AVDF-IG

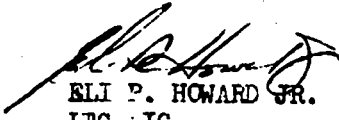
25 May 1969

SUBJECT: Report of Investigation

Commanding General  
United States Army, Vietnam  
ATTN: AVHIG - Col Whittaker  
APO 96375

1. Reference, your special inquiry, 13-14 April 1969.
2. A copy of the attached report of investigation was discovered this date and is forwarded to you for your information and such action as you deem appropriate.

1 Incl  
as

  
ELI P. HOWARD JR.  
LTC, IG  
Inspector General

REGRADED UNCLASSIFIED WHEN SEPARATED  
FROM CLASSIFIED INCLOSURE.

*Read by  
I & C Div  
on 4 Jun 69*

**EXHIBIT M-99**



AVHF-12

25 May 1969

**SUBJECT: Report of Investigation**

Commanding General  
United States Army, Vietnam  
ATTN: AVHIG - Col Whittaker  
APO 96375

1. Reference, your special inquiry, 13-14 April 1969.
2. A copy of the attached report of investigation was discovered this date and is forwarded to you for your information and such action as you deem appropriate.

1 Incl  
as

*PH*  
ELI P. HOWARD JR.  
ITC, IG  
Inspector General

REGRADED UNCLASSIFIED WHEN SEPARATED  
FROM CLASSIFIED INCLOSURE.

*MPK*  
*Office of S provided copy of Incl 1 25 May 69.*  
*Incl 1 obtained from S2 files 11 B Side*  
*EW*

365

EXHIBIT M-100

[REDACTED]

PRECEDENCE: OPERATIONAL IMMEDIATE

DTG: 230215Z MAY 69

FROM: COL DONALDSON, C/S AMERICAL DIVISION

TO: COL HENDERSON, USARHAW

ZEM

UNCLAS E F T O ACD 461

1. A THOROUGH SEARCH OF DIVISION HEADQUARTERS FILES AND 11TH INFANTRY BRIGADE FILES HAS FAILED TO PRODUCE THE INFORMAL INVESTIGATION YOU REQUESTED.
2. WITH REFERENCE TO THE VIETNAMESE DECORATIONS THAT WERE PRESENTED TO YOU BY PRESIDENT THIEU, THE NECESSARY PAPERWORK WAS MAILED TO USARPAC BY USARV ON 15 MAY.
3. SORRY I COULD NOT HELP YOU MORE ON THE FIRST SUBJECT. BEST REGARDS.

5 Feb 1970

I certify that the above message is quoted in its entirety.

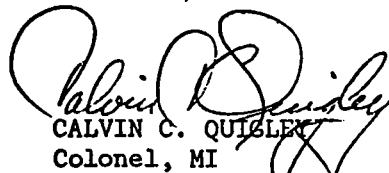
  
CALVIN C. QUIGLEY  
Colonel, MI  
Commanding, USASSG

EXHIBIT M-101

DEPARTMENT OF THE ARMY  
HEADQUARTERS AMERICAL DIVISION  
APO San Francisco 96374

GENERAL ORDERS  
NUMBER 1841

9 April 1968

AWARD OF THE PURPLE HEART  
(THIRD OAK LEAF CLUSTER)

1. TC 320. The following AWARD is announced.

PERSON, ORAN K. 084369 (SSAN 307-14-6649), COLONEL, INFANTRY, United States Army, Headquarters and Headquarters Company, 11th Infantry Brigade 96217

Awarded: Purple Heart (3d Oak Leaf Cluster)

Date Action: 21 March 1968

Theater: Republic of Vietnam

Reason: For wounds received in connection with military operations against a hostile force.

Authority: By direction of the President under the provisions of Executive Order 11046, 25 April 1962.

FOR THE COMMANDER:

OFFICIAL:

NELS A. PARSON, JR.  
Colonel, GS  
Chief of Staff

  
DONALD Y. B. CHUNG  
Lieutenant General

DISTRIBUTION:

- 5 AVDF-AGD
- 2 AVDF-ACA
- 2 AVDF-IO
- 2 In. Indiv Gene
- 1 AVDF-AGPRO
- 1 CO, NHC, 11th Inf Bde
- 1 CO, 11th Inf Bde ATTN: S1
- 1 CG, AMERICAL DIVISION
- 1 CG, USARV ATTN: AG Awards

OFFICIAL DISTRIBUTION:

- 1 TAGO, DA ATTN: AGPF-F  
(for official personnel file)

DEPARTMENT OF THE ARMY  
HEADQUARTERS AMERICAL DIVISION  
APO San Francisco 96374

wgb  
14 February 1968

SPECIAL ORDERS  
NUMBER 45

E X T R A C T

39. TC 253. Fol DY MSG/REL announced.

BARKER, FRANK A. JR. 0989282 (SSAN 040-20-3485) LTC INF 51542 HHC 11th LIB  
Dy asg: CO, Task Force Barker (1542)  
Dy rel fr: S-3 (2162)  
Eff date: 22 Jan 68

CALHOUN, CHARLES C. 085405 (SSAN 248-46-0319) MAJ INF 71543 HHC 11th LIB  
Dy asg: XO/S-3, Task Force Barker (1542/2162)  
Dy rel fr: S-1 (2260)  
Eff date: 22 Jan 68

ANDERSON, WILLIS B. 0999030 (SSAN 337-14-4103) MAJ ARTY 1983 HHC 123d Avn Bn  
Dy asg: Avn Safety Off (7423)  
Dy rel fr: NA  
Eff date: 27 Dec 67

FOR THE COMMANDER:

OFFICIAL:



L. W. CUNNINGHAM  
2LT, AGC  
Asst AG

NELS A. PARSON, JR  
Colonel, GS  
Chief of Staff

DISTRIBUTION:

- 15-5 ea indiv conc
- 45-AVDF-AGA
- 9-AVDF-AGPRO
- 9-AVDF-FC
- 5-HHC 11th LIB APO 96217
- 5-HHC 123d Avn Bn Americal Div APO 96374

Exhibit M-104 is published in Volume III,  
Book 3, Reports. Exhibit M-105 and Exhibit  
M-106 are published in Volume III, Book 2,  
Directives.

EXHIBIT M-104  
EXHIBIT M-105  
EXHIBIT M-106

DEPARTMENT OF THE ARMY  
HEADQUARTERS 11TH INFANTRY BRIGADE  
APO San Francisco 96217

UNIT ORDERS  
NUMBER 13

15 March 1968

1. TC 355. The undersigned assumes command.

Organization/Unit: 11th Infantry Brigade  
Americall Division  
APO San Francisco 96217

Authorization: Para 12b AR 600-20

*Oran K. Henderson*  
ORAN K. HENDERSON  
Colonel, Infantry  
Commanding

**DISTRIBUTION:**

A plus  
5 - CG, Americal, ATTN: AVDF-AGA

Exhibit M-108 is published in Volume III,  
Book 3, Reports.

DEPARTMENT OF THE ARMY  
Headquarters, 11th Infantry Brigade, Americal Division  
APO San Francisco 96217

XIFE

6 April 1968

SUBJECT: PFC Herbert L. Carter

Commanding General  
Americal Division  
ATTN: AVIF-AGPA  
APO 96374

1. Reference is made to telecon between Mr. Buxton, your office, and Major Lankis pertaining to alleged failure to report casualty of subject EM on 16 March 1968.

2. A thorough investigation was made by the undersigned to determine the reason for alleged failure to report subject casualty. All records this headquarters indicate that casualty was telephonically reported to Casualty Branch, AG on 16 March 1968 and USAFV Forms 130R forwarded as normal.

3. The reason why your headquarters is not in receipt of same cannot be determined. However, it is still the responsibility of this headquarters to insure that all casualties are promptly and accurately reported. To preclude future incidents of this nature, more stringent checks and closer supervision of casualty reporting procedures have since been initiated.

FOR THE COMMANDER:

WILLIAM R. DANKIS  
Major, Infantry  
Adjutant



U.S. ARMY CASUALTY REPORT FORMAT

TO BE SUBMITTED on all casualties. USED ONLY to insure submission of complete information telephonically or electrically in standard sequence for hostile casualties, seriously ill, missing and death reports.

Report submitted by: DAVID M STORMS 1LT Co C 1/20 16 1200 Mar 68

(Name, Grade, Unit, Date and Time)

TYPE OF REPORT: FRIAR

A. CARTER HERBERT L.

(Last Name, First Name, MI)

B. US 67 183 349

(Service Number)

C. PLC E-3

(Rank & Pay Grade)

(Branch - Officers Only)

(Indicate by using the letter "P" if individual is promotable posthumously). See AR 600-200.

D. 16 1020 Mar 68

(Date and Hour of Incident)

11B10

(IMAS)

E. (1) a. GSW (L) foot

(Diagnosis)

b. GOOD

(Prognosis)

(2) A. 2nd Surg Hosp Chu Lai RVN APO 96374

(Where hospitalized or treated to include APO address).

(3) Circumstances: While member of combat mission being conducted in vicinity

(Geographical Location or Grid Coordinates & Proof)

of grid coordinates BS 716788, individual received GSW hostile in left foot.

F. NEG

(Race)

G. Co C 1st Bn 20th Inf 11th LIA Amsal Div APO SF 96217

(Organization and Address)

H. (Next of Kin - Name, Relationship, Address and Date of DA Form 41)

(Next of Kin to be notified:

YES

NO

I. \_\_\_\_\_  
(Base Pay) (Additional Pay Codes) (BFED)

J. \_\_\_\_\_

(Cause of death - Hostile or Non-Hostile - if previously reported as missing, the estimated time of death).

K. \_\_\_\_\_  
(Status of remains - Indicate location of remains if recovered)

L. \_\_\_\_\_  
(Date tour commenced in the Republic of Vietnam)

M. \_\_\_\_\_  
\_\_\_\_\_  
\_\_\_\_\_  
(Decorations awarded or pending)

N. \_\_\_\_\_  
(Line of Duty Status - Applicable only to non-hostile reports)

O. \_\_\_\_\_  
(Religion - If deceased, indicate whether ministrations were received prior death: YES NO UNKNOWN).

P. \_\_\_\_\_  
(SGLI) (Date DA Form 3054 mailed to DA Cas Br in cases of death reports)

Q. \_\_\_\_\_  
(Date of Birth)

R. \_\_\_\_\_  
(If FUNCH report enter statement that allotments will not be discontinued).

REMARKS: \_\_\_\_\_  
\_\_\_\_\_  
\_\_\_\_\_  
\_\_\_\_\_  
\_\_\_\_\_  
\_\_\_\_\_  
\_\_\_\_\_

1 January 1970

MEMORANDUM FOR RECORD

SUBJECT: Low Level Reconnaissance to Identify Sites Previously Indicated by Chief Warrant Officer Thompson

1. On 31 December 1969 arrangements were made with the Americal Division for the low level reconnaissance as indicated by the title above. The flight was conducted starting from Chu Lai at 0800, 1 January 1970. It consisted of one LOH piloted by Captain Gary E. Hickman, D Company, 1st Squadron, 1st Cavalry, Americal Division, with Chief Warrant Officer Hugh C. Thompson flying in the copilot seat to direct Captain Hickman and with Lieutenant General Peers accompanying as an observer. A second LOH with guns provided close-in security; two Huey Cobra gunships flew close in escort; and one Huey command and control aircraft commanded by Major General Lloyd B. Ramsey, Commanding General of the Americal Division, was over the area and directed the operation. Mr. MacCrate flew with General Ramsey in the command and control aircraft. The low level reconnaissance was conducted at altitudes of 30-100 feet and on occasion as low as five to ten feet. All sites were located on an aerial photo and subsequently replotted and identified on the attached aerial photo certified by CWO Thompson.

2. The first objective was the area of the bodies on highway 521 indicated by numbers 8 and 9 and of the general areas where smoke grenades had been dropped to indicate wounded civilians as shown by the x's. The next point of reference was item number 1 where CWO Thompson observed a captain shoot a woman on the ground. CWO Thompson was positive of this location and indicated that the spot on the map would be within five to eight feet of the exact location. The flight then proceeded to attempt to locate the ditch. After considerable low level reconnaissance and hovering, CWO Thompson indicated with almost absolute assurance that the ditch was located as shown by number 2. He further located the spot where he had landed his H23 helicopter and talked to a colored sergeant who had walked over to the aircraft from approximately 30 meters to the east as shown by number 4. CWO Thompson also indicated that when he lifted off the sergeant proceeded southwest where he last observed him pointing his M-16 in the direction of the ditch. The final area reconnoitered was the bunker/hootch area in which several women and children had been observed running and the area in which he had the encounter with an American lieutenant. These are indicated by the numbers 5 and 6. Number 7 indicates where Millians landed his gun ship on two occasions to lift out the women and children and fly them to an area on highway 521 southwest of My Lai (4).

1 January 1970

SUBJECT: Low Level Reconnaissance to Identify Sites Previously  
Indicated by Chief Warrant Officer Thompson

4. Subsequent to the initial flight, another flight was made to re-check the previous positions. These were again verified. In addition CWO Thompson pointed out an area in the southeast portion of My Lai (4) Hamlet where he observed a group of bodies lying in a courtyard in the vicinity of a large home. He also pointed out the area in which he observed a VC running toward a hedgerow and took him under fire. This is indicated by number 10 on the annotated aerial photo.

5. Following this, a high level flight was made of Hill 85 to identify the area where CWO Thompson had sighted the 40 rounds of 60 mm mortar which were subsequently destroyed by the ground platoon of the Aero Scout Company. After this, a high level flight was made of the area of My Khe 3, 1, and 2, and Co Lai 1, 2, and 3, generally the operation areas of Company C, 1st of the 20th, and B Company, 4th of the 3d, on 17 March 1968.

6. The planning and arrangements made by the Americal Division were outstanding in every respect. The Division and all personnel concerned are to be highly complimented.



W. R. PEERS  
Lieutenant General, USA

1 Incl  
as

8 Jan 70

ADDENDUM TO: Low Level Reconnaissance to Identify Sites  
Previously Indicated by Chief Warrant Officer  
Thompson

Subsequent to the aerial reconnaissance on 1 January 1970 and the ground reconnaissance made by LTG Peers, Mr. MacCrate, and Mr. Walsh on the morning of 3 January 1970, CWO Thompson was requested to make a re-check on the location of the ditch. As a result of his reconnaissance on 4 January 1970, CWO Thompson has adjusted the location of the ditch on the photograph and has marked this as point 2 - Ditch Location Adjusted.



W. R. PEERS  
Lieutenant General, USA

Inclosure to Low Level Reconnaissance to Identify Sites  
Previously Indicated by Chief Warrant Officer Thompson:

INDEX

<u>Site Number</u>	<u>Identification</u>
1	Saw Capt with woman
2 and 2a	Ditch with bodies
3	Set down
4	First saw colored NCO. Talked to him at 3. NCO then went to ditch at 2.
5	Bunker and hootches with women and children.
6	Meeting and discussion with LT.
7	Spot where gunship sat down.
8	Sighted dead woman - Exhibit P-32.
9	Bodies on Road 5 to 10.
10	VC ran into hedgerow.
11	Wounded marked by smoke.
12	Bodies in courtyard of large house - 3 to 5.

