

HISTORIC STRUCTURE REPORT

FINAL REPORT

JUNE 2004

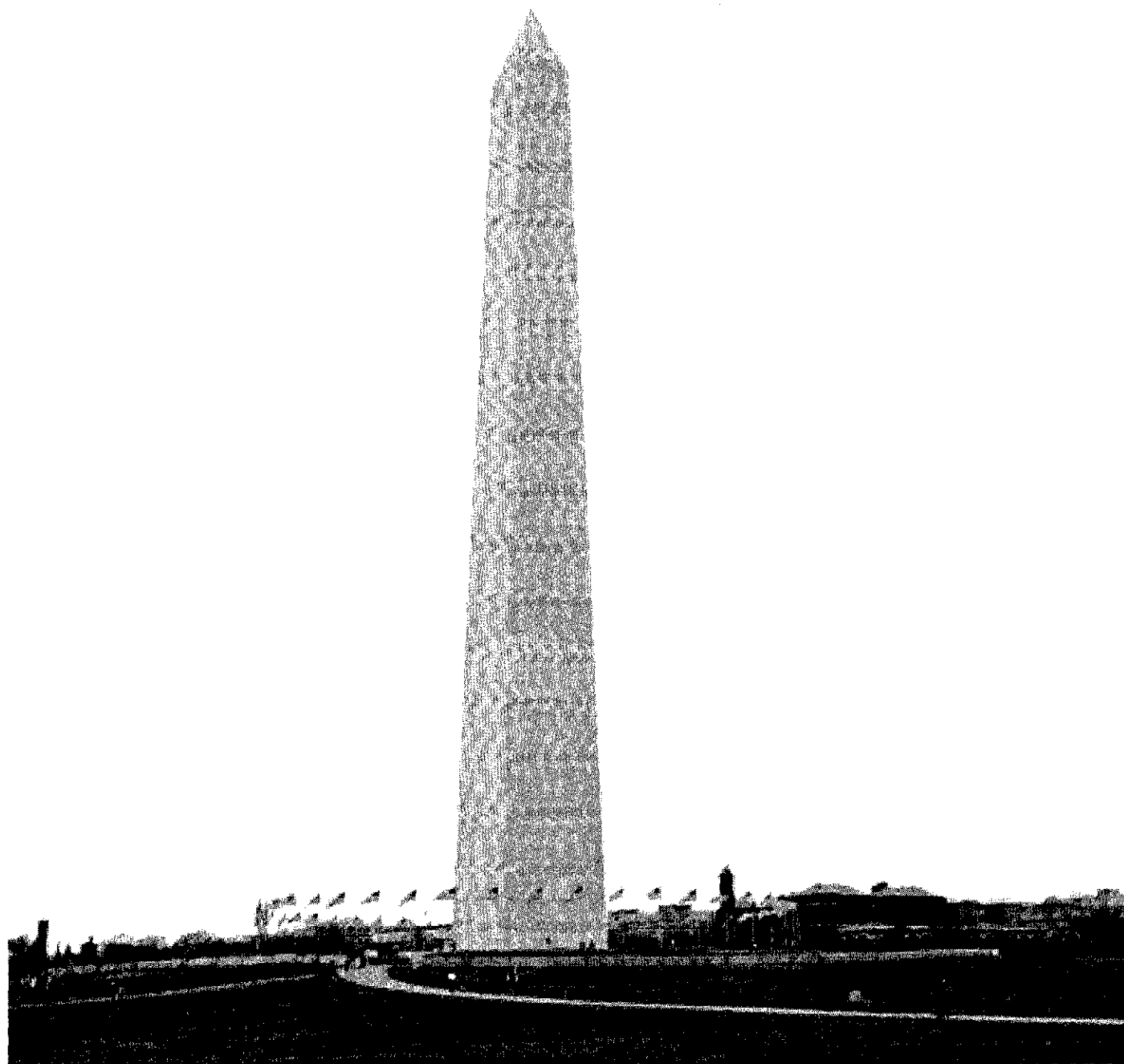

WASHINGTON MONUMENT AND
ASSOCIATED STRUCTURES

VOLUME III – SURVEY LODGE

1
2
3
4
5
6
7
8
9
10
11
12
13
14
15
16
17
18
19
20
21
22
23
24
25

807 10-34
V.3

WASHINGTON MONUMENT AND ASSOCIATED STRUCTURES
HISTORIC STRUCTURE REPORT

VOLUME III – SURVEY LODGE

FINAL REPORT

PREPARED FOR
National Park Service
Denver Service Center
AND
National Park Service
National Capital Region

PREPARED BY
John Milner Associates, Inc.

ARCHITECTS • ARCHEOLOGISTS • PLANNERS • LANDSCAPE ARCHITECTS
535 NORTH CHURCH STREET
WEST CHESTER, PENNSYLVANIA 19380
(610) 436-9000

IN ASSOCIATION WITH

Grunley-Walsh Joint Venture
11910 PARKLAWN DRIVE, SUITE U
ROCKVILLE, MARYLAND 20852
(301) 881-8081

TASK ORDER #25, MODIFICATION 3

NPS CONTRACT No. 1443CX3059980901

June 2004

TECHNICAL INFORMATION CENTER
DENVER SERVICE CENTER
NATIONAL PARK SERVICE

COVER ILLUSTRATION: The Washington Monument and grounds today (John Milner Associates, Inc., 2003).

PUBLICATION CREDITS: Information in this publication may be copied and used, with the condition that full credit is given to the authors and the National Park Service.

UNITED STATES DEPARTMENT OF THE INTERIOR MISSION STATEMENT: As the Nation's principal conservation agency, the Department of the Interior has responsibility for most of our nationally owned public lands and natural resources. This includes fostering sound use of our land and water resources; protecting our fish, wildlife and biological diversity; preserving the environmental and cultural values of our national parks and historical places; and providing for the enjoyment of life through outdoor recreation. The Department assesses our energy and mineral resources and works to ensure that their development is in the best interest of all people by encouraging stewardship and citizen participation in their care. The Department also has a major responsibility for American Indian reservation communities and for people who live in island territories under U.S. administration.

CREDITS

NATIONAL PARK SERVICE

NATIONAL CAPITAL REGION

Steve Lorenzetti, Chief, Resource Management

Rebecca Stevens, Regional Historical Architect

Anthony Donald, Historical Architect

Lori McConnell, Cultural Resource Specialist

GRUNLEY-WALSH JOINT VENTURE

Cleo A. Kimbembe, Project Manager

JOHN MILNER ASSOCIATES, INC.,

ALEXANDRIA, VIRGINIA

John Mott, Project Director

Jerrie Ott, Historical Intern Architect

Sarah Goode, Historian

WEST CHESTER, PENNSYLVANIA

Peter Benton, Project Manager

Philip Yocum, Historical Architect

Jeanette DiStefano, Desktop Publishing

PHILADELPHIA, PENNSYLVANIA

Lori Aument, Historical Conservator

ACKNOWLEDGMENTS

Several organizations and individuals have assisted John Milner Associates, Inc. in the preparation of this Historic Structure Report. We would like to thank the staff of the National Park Service, National Capital Region, for their assistance and guidance. The administrative staff for the Washington Monument was very helpful in coordinating the field survey and providing access to the facilities.

We would also like to thank James P. Reger, Ph.D., Principal Geologist, Maryland Geological Survey, for his insight on Maryland marble, its inclusions, and its possible sources of discoloration.

TABLE OF CONTENTS

CHAPTER ONE – MANAGEMENT SUMMARY

1.1 Executive Summary	1-1
1.1.1 Introduction.....	1-1
1.1.2 Scope	1-1
1.1.3 HSR Methodology	1-2
1.1.4 Historical Summary	1-4
1.1.5 Evaluation of Significance	1-6
1.1.6 Summary of Condition and Integrity	1-7
1.1.7 Recommendations for Treatment and Use.....	1-8
1.2 Administrative Data	1-9
1.2.1 Names and Location of Structures	1-9
1.2.2 Proposed Treatment of the Structure	1-9
1.2.3 Related Studies and Documents.....	1-10
1.2.4 Cultural Resource Data	1-11
1.3 Recommendations for Future Research	1-11

PART I – DEVELOPMENTAL HISTORY

CHAPTER TWO – HISTORICAL BACKGROUND AND CONTEXT

2.1 1886–1923: Power Plant for Washington Monument	2-1
2.2 1924–Present: Offices and Chlorination Plant	2-3
2.3 Evaluation of Significance	2-4

CHAPTER THREE – CHRONOLOGY OF DEVELOPMENT AND USE

3.1 1886–1923: Power Plant for Washington Monument	3-1
3.1.1 1886–1901: Boiler House.....	3-1
3.1.2 1901–1923: Power House.....	3-3
3.2 1924–Present: Offices and Chlorination Plant	3-5

CHAPTER FOUR – PHYSICAL DESCRIPTION

4.1 General Description	4-1
4.2 Site	4-1
4.3 Survey Lodge – Exterior	4-2
4.4 Utility Shed	4-5

4.5 Survey Lodge – Interior	4-5
4.5.1 First-Floor Level	4-6
4.5.1.1 <i>Entry Vestibule (Visitor Contact Station)</i>	4-6
4.5.1.2 <i>Rest Rooms</i>	4-6
4.5.1.3 <i>Corridor</i>	4-6
4.5.1.4 <i>North Office</i>	4-7
4.5.1.5 <i>Park Manager Office</i>	4-7
4.5.1.6 <i>West Office</i>	4-7
4.5.1.7 <i>Passage</i>	4-7
4.5.1.8 <i>South Office</i>	4-7
4.5.1.9 <i>Stair</i>	4-7
4.5.2 Basement Level	4-8
4.5.2.1 <i>Corridor</i>	4-8
4.5.2.2 <i>Staff Break Room</i>	4-8
4.5.2.3 <i>Rest Rooms</i>	4-9
4.5.2.4 <i>Staff Locker Room</i>	4-9
4.5.2.5 <i>North Storage Room</i>	4-9
4.5.2.6 <i>East Storage Room</i>	4-10
4.5.3 Attic	4-10

CHAPTER FIVE – CONDITION ASSESSMENT

5.1 General Condition	5-1
5.2 Methodology	5-1
5.3 Site	5-1
5.3.1 Southeast (Main Entry Approach)	5-2
5.3.2 Northwest	5-2
5.3.3 Northeast	5-2
5.4 Survey Lodge – Exterior	5-2
5.4.1 Southeast Façade	5-3
5.4.2 Southwest Façade	5-3
5.4.3 Northwest Façade	5-5
5.4.4 Northeast Façade	5-6
5.4.5 Roof	5-7
5.5 Utility Shed	5-8
5.6 Survey Lodge – Interior	5-8
5.6.1 First-Floor Level	5-9
5.6.1.1 <i>North Office</i>	5-9
5.6.1.2 <i>Passage</i>	5-9
5.6.1.3 <i>Stair</i>	5-9
5.6.2 Basement Level	5-9
5.6.2.1 <i>Corridor</i>	5-10
5.6.2.2 <i>Staff Break Room</i>	5-10

5.6.2.3 Rest Rooms	5-10
5.6.2.4 Staff Locker Room.....	5-10
5.6.2.5 North Storage Room	5-10
5.6.2.6 East Storage Room.....	5-11
5.6.3 Attic.....	5-11

CHAPTER SIX – EVALUATION OF INTEGRITY

6.1 Character-Defining Features	6-1
6.2 Integrity	6-2
6.2.1 Location and Setting	6-2
6.2.2 Design, Materials, and Workmanship.....	6-2
6.2.3 Feeling and Association	6-3

PART II

CHAPTER SEVEN – TREATMENT AND USE

7.1 Ultimate Treatment and Use.....	7-1
7.2 Requirements for Treatment	7-2
7.3 Alternatives for Treatment	7-4
7.3.1 Restoration of Survey Lodge	7-4
7.3.2 Rehabilitation of Survey Lodge	7-5
7.3.3 Preservation of Survey Lodge.....	7-6

APPENDICES

Appendix A – Scope of Work.....	A-1
Appendix B – Annotated Chronology	B-1

BIBLIOGRAPHY

Bibliography	Bib.-1
--------------------	--------

LIST OF FIGURES

CHAPTER ONE: MANAGEMENT SUMMARY

- Figure 1.1: Site location map.
Figure 1.2: Site vicinity map.
Figure 1.3: Washington Monument Grounds building and structures.

CHAPTER TWO: HISTORICAL BACKGROUND AND CONTEXT

- Figure 2.1: Washington Monument Boiler House Sections, Elevations and Details, 1886. ([Architectural Drawing] File 74-21-7; NCP 807; RG 79; Cartographic and Architectural Records LICON, Special Media Archives Division, National Archives at College Park, College Park, Md.)
- Figure 2.2: Washington Monument Boiler House Plans, Sections and Elevations, 1886. ([Architectural Drawing] File 74-21-8; NCP 807; RG 79; Cartographic and Architectural Records LICON, Special Media Archives Division, National Archives at College Park, College Park, Md.)
- Figure 2.3: Power House Washington Monument Showing Proposed Addition for Electric Motors, 1898. (*Annual Report Upon the Improvement and Care of the Public Buildings and Grounds, and Care and Maintenance of the Washington Monument in the District of Columbia, by Theo. A Bingham, Capt. Corps of Engineers, Col. U.S.A., Being Appendix C of the Annual Report of the Chief of Engineers for 1898*, Washington, D.C.: GPO, 1898.)
- Figure 2.4: Plan Showing Present Boiler House in Dotted Lines and Proposed Addition in Full Lines, 1898. ([Architectural Drawing] File 74-21-3; NCP 807; RG 79; Cartographic and Architectural Records LICON, Special Media Archives Division, National Archives at College Park, College Park, Md.)
- Figure 2.5: Proposed Fireproof Vault Survey Lodge Washington Monument Grounds, 7 March 1946. ([Architectural Drawing] File 807_84242; Technical Information Center, Denver Service Center, National Park Service.)
- Figure 2.6: Ca. 1909–1932 photograph of the Survey Lodge. (Prints and Photographs Division, LC-USZ62-107739, Library of Congress, Washington, D.C.)
- Figure 2.7: July 7, 1932, photograph of a survey crew outside the Survey Lodge. Note the metal screens over the windows and the hexagonal asphalt shingle roof (NPS-NCR Collection).
- Figure 2.8: Proposed Chlorinating Plan for Condensing Water Tunnel, 2 September 1939, this alternative not built. ([Architectural Drawing] File 74-21-9; NCP 807; RG 79; Cartographic and Architectural Records LICON,

Special Media Archives Division, National Archives at College Park, College Park, Md.)

- Figure 2.9: Chlorinating Plant Survey Lodge – Washington, D.C., Approved 2 February 1940. ([Architectural Drawing] File 74-20-10, NCP 807; RG 79; Cartographic and Architectural Records LICON, Special Media Archives Division, National Archives at College Park, College Park, Md.)
- Figure 2.10: Architectural Plans, Remodel Survey Lodge Washington Monument Grounds, 3 August 1989. (Drawing 807_80116, Sheet 3 of 25, Drawing A2, Denver Service Center, National Park Service.)

CHAPTER THREE: CHRONOLOGY OF DEVELOPMENT AND USE

- Figure 3.1: Washington Monument Boiler House Sections, Elevations and Details, 1886. ([Architectural Drawing] File 74-21-7; NCP 807; RG 79; Cartographic and Architectural Records LICON, Special Media Archives Division, National Archives at College Park, College Park, Md.)
- Figure 3.2: Washington Monument Boiler House Plans, Sections and Elevations, 1886. ([Architectural Drawing] File 74-21-8; NCP 807; RG 79; Cartographic and Architectural Records LICON, Special Media Archives Division, National Archives at College Park, College Park, Md.)
- Figure 3.3: Plan Showing Present Boiler House in Dotted Lines and Proposed Addition in Full Lines, 1898. ([Architectural Drawing] File 74-21-3; NCP 807; RG 79; Cartographic and Architectural Records LICON, Special Media Archives Division, National Archives at College Park, College Park, Md.)
- Figure 3.4: Roof for Addition to Washington Monument Boiler House, 1900. ([Architectural Drawing] File 74-21-6; NCP 807; RG 79; Cartographic and Architectural Records LICON, Special Media Archives Division, National Archives at College Park, College Park, Md.)
- Figure 3.5: July 7, 1932, photograph of a survey crew outside the Survey Lodge. ([Photograph], 7 July 1932; NPS-NCR Collection.)
- Figure 3.6: Proposed Chlorinating Plan for Condensing Water Tunnel, 2 September 1939, this alternative not built. ([Architectural Drawing] File 74-21-9; NCP 807; RG 79; Cartographic and Architectural Records LICON, Special Media Archives Division, National Archives at College Park, College Park, Md.)

Figure 3.7: Chlorinating Plant Survey Lodge – Washington, D.C., Approved 2 February 1940. ([Architectural Drawing] File 74-20-10, NCP 807; RG 79; Cartographic and Architectural Records LICON, Special Media Archives Division, National Archives at College Park, College Park, Md.)

Figure 3.8: Remodel Survey Lodge Washington Monument Grounds, 3 August 1989. (Drawing 807_80116, Sheet 3 of 25, Drawing A2, Architectural Plans, Denver Service Center, National Park Service.)

CHAPTER FOUR: PHYSICAL DESCRIPTION

Figure 4.1: Survey Lodge site plan

Figure 4.2: Lodge site at southeast façade, view to west.

Figure 4.3: Decorative cast-metal phone booths at southeast corner of lodge.

Figure 4.4: Pedestrian path to basement entry, view to southeast.

Figure 4.5: Lodge site north of utility shed, view to west.

Figure 4.6: Southeast elevation.

Figure 4.7: Historic granite entry stair has been incorporated in surrounding planting bed.

Figure 4.8: Southeast elevation with current entry on left and historic entry on right.

Figure 4.9: Southwest elevation with 1901 stucco addition.

Figure 4.10: Mechanical vault roof.

Figure 4.11: Basement areaway, view to southeast.

Figure 4.12: Basement areaway roof and handrail with chimney base on right, view to northeast.

Figure 4.13: Northwest elevation, view to south.

Figure 4.14: Alternating-board wood fence is scribed to stone building wall, view to southwest.

Figure 4.15: Northeast elevation, view to west.

Figure 4.16: Flat-seam metal roof between slate roof gables, view to northeast.

- Figure 4.17: Built-in metal roof gutter, view to northeast.
- Figure 4.18: Cupola, view to southeast.
- Figure 4.19: Utility shed, view to southeast.
- Figure 4.20: Utility shed roof, view to northeast.
- Figure 4.21: First floor plan.
- Figure 4.22: Basement floor plan.
- Figure 4.23: Entry vestibule (visitor contact station), view to east.
- Figure 4.24: Entry vestibule (visitor contact station), view to south.
- Figure 4.25: Passage, view to north with original marble and granite exterior building walls. This space was enclosed in the 1901 addition, and a new doorway cut. The doorway has been reduced in size with the installation of red brick.
- Figure 4.26: Passage, view to northeast with tongue-in-groove wood ceiling scribed to stone building wall.
- Figure 4.27: South office, view to southeast.
- Figure 4.28: Stair, view to northwest from first-floor landing. Note arched-head panel at stair window. This is the only building window with a head panel instead of interior trim.
- Figure 4.29: Stair, view to northeast from basement floor landing.
- Figure 4.30: Basement corridor, view to northeast into staff locker room.
- Figure 4.31: Staff break room, view to north.
- Figure 4.32: Staff locker room, view to southeast with arched doorway into east storage room.
- Figure 4.33: North storage room, view to northwest.
- Figure 4.34: Attic, view to northeast.

CHAPTER FIVE: CONDITION ASSESSMENT

- Figure 5.1: Asphalt service drive north of lodge, view to the southeast with serious cracking and previous patches evident.
- Figure 5.2: Lower sash of double-hung wood window with granite sill, northwest elevation. Note paint deterioration and loose pegs in the window, and drips of paint on the granite sill.
- Figure 5.3: Southwest elevation and attached chimney, view to the southeast. Splashing rain is encouraging biological growth above the areaway roof, and ferrous fasteners on the roof deck are beginning to rust.
- Figure 5.4: Detail of southwest elevation with ferrous staining under attached pivoting metal arm. The stucco has spalled, revealing the red brick back-up of the 1901 addition, and two penetrations are visible.
- Figure 5.5: Detail of southwest elevation at south corner with open and improperly tooled mortar joints. The red brick back-up of the 1901 addition is visible at the edge of the stucco in some locations.
- Figure 5.6: Attached chimney, view to the south. The granite belt course has spalled, and the metal chimney cap has stained the granite cornice.
- Figure 5.7: Detail of southwest elevation with severe stucco cracking and spots of ferrous staining at window head.
- Figure 5.8: Detail of steel structure at northwest areaway roof with failing paint and rust bloom. The K-type hanging gutter and downspout are also experiencing paint failure.
- Figure 5.9: Light fixtures under areaway roof supporting bird nests.
- Figure 5.10: Detail of northwest elevation with significant biological growth under previous location of window air-conditioning unit. Ferrous staining and paint spatters are also visible at the granite window sill and water table.
- Figure 5.11: Lower sash of double-hung wood window with granite sill, northwest elevation. Note the line of paint at the masonry opening, drips of paint on the granite sill, and the remains of an anchor from a previously removed security screen.
- Figure 5.12: Northeast elevation with significant biological growth on underside of rock-faced finish marble and granite water table.
- Figure 5.13: Detail of door at northeast elevation with damage to center rail.

- Figure 5.14: Detail of through-cornice downspout disconnected from rain leader at south end of southeast elevation. The downspout is clogged with branches and foliage.
- Figure 5.15: Cupola, view to the west with black sealant and failing paint.
- Figure 5.16: Gutter and downspout at southwest corner of areaway roof. Gutter is clogged with branches and foliage and contains standing water. Ferrous fasteners in the roof deck are beginning to rust and stain the galvanized steel. In the background, stucco patches adjacent to the attached chimney are visible.
- Figure 5.17: First floor plan conditions.
- Figure 5.18: Basement floor plan conditions.
- Figure 5.19: Detail of paint failure and water infiltration at concrete ceiling of north storage room. The painted concrete and brick wall at this location has also eroded and is showing signs of rust bloom from embedded ferrous elements.
- Figure 5.20: Detail of paint failure and water infiltration at concrete ceiling of staff break room.
- Figure 5.21: Detail of painted concrete floor at door of staff locker room. A large crack beginning at the door frame runs across the opening to an adjacent wall, and the paint has eroded in high-traffic areas.
- Figure 5.22: Detail of metal ramp at basement entry to handicapped lift with paint failure and rust bloom at perimeter. Also note the soiling and wear at the adjacent wall and door frame.
- Figure 5.23: Staff locker room, view to the northeast with metal access door to historic steam tunnel. The door is currently welded closed and the welds have severely rusted.
- Figure 5.24: Attic, view to the southwest with remains of whitewash and deteriorated mortar under granite cornice.
- Figure 5.25: Attic, view to the northwest with plastic containers catching water from rain-dampened wood purlins and sheathing.



CHAPTER ONE
MANAGEMENT SUMMARY

1
2
3
4
5
6
7
8
9
10
11
12
13
14
15
16
17
18
19
20
21
22
23
24
25
26
27
28
29
30
31
32
33
34
35
36
37
38
39
40
41
42
43
44
45
46
47
48
49
50
51
52
53
54
55
56
57
58
59
60
61
62
63
64
65
66
67
68
69
70
71
72
73
74
75
76
77
78
79
80
81
82
83
84
85
86
87
88
89
90
91
92
93
94
95
96
97
98
99
100

CHAPTER ONE

MANAGEMENT SUMMARY

1.1 EXECUTIVE SUMMARY

1.1.1 INTRODUCTION

The Washington Monument in Washington, D.C., is the United States of America's primary memorial to the nation's first president, George Washington. As a powerful symbol of the nation's capital, the Monument is one of the city's most heavily visited sites. The Monument Grounds are situated at the monumental core of the capital city and have been the site of significant public events, ceremonies, and demonstrations for over a century. In November 2001, the National Park Service (NPS) initiated a design process that would have resulted in the construction of a new visitor facility and permanent security improvements in order to protect the Washington Monument and its visitors, while improving the visitor experience, preserving the monument structure, improving accessibility, and retaining public activities on the grounds.

1.1.2 SCOPE

The NPS retained Grunley-Walsh Joint Venture, LLC (Grunley-Walsh) of Rockville, Maryland, with the design team of Hartman-Cox Architects of Washington, D.C., and Olin Partnership of Philadelphia, Pennsylvania, to prepare conceptual design plans for a new visitor facility and permanent security improvements. The proposed visitor facility was designed to be a below-grade structure, entered on 15th Street through the existing Monument Lodge, which would be modified with an addition on the west. The new below-grade visitor facility was to be connected to a below-grade pedestrian concourse through which visitors would access the Washington Monument. Permanent security improvements included an underground security screening facility, a landscaped vehicle-barrier system of low-walled terraces and walkways, removal of the above-ground queuing area and the present interim security building from the monument plaza, subtle regrading of the monument's knoll, rehabilitation of the monument plaza, and removal of the 16th Street parking lot.

Conceptual plans for the visitor facility, security improvements, and the associated landscape design were granted preliminary approval by the National Capital Planning Commission (NCPC) in the spring of 2003. The planning and review processes were continuing throughout the preparation of this report, with construction of the approved design to be implemented by Grunley-Walsh.

In February 2003, John Milner Associates, Inc. (JMA) of West Chester and Philadelphia, Pennsylvania, and Alexandria and Charlottesville, Virginia, was retained by Grunley-Walsh to prepare the joint Historic Structure Report (HSR) and Cultural Landscape Report (CLR) for the

Washington Monument and Grounds. The HSR and CLR were required as part of a Programmatic Agreement between the National Park Service and the Advisory Council on Historic Preservation, for the purposes of understanding the architectural resources in order to inform decisions relating to the proposed visitor facility and security improvements. The two documents build upon historic research and documentation previously conducted by Oehrlein & Associates Architects and Robinson & Associates, Inc. of Washington, D.C. Because of the immediate need for implementation of the visitor facility and security improvements, the reports were to be completed by the fall of 2003. However, in October 2003, plans for the proposed underground security screening facility were under reconsideration and the completion date for this report was pushed back to June 2004. The landscape improvements were scheduled to move ahead as planned.

The HSR was commissioned to address both the Washington Monument and its associated structures, the Washington Monument Lodge (hereinafter referred to as the Monument Lodge) and the Survey Lodge, that are located within the Washington Monument Grounds (see figures 1.1, 1.2 and 1.3). The goals of the HSR are to:

- Develop historical background for the Washington Monument, Monument Lodge, and Survey Lodge;
- Determine the developmental history and use for the buildings, and document changes as they evolved from early design development through the present day;
- Document through a combination of narrative and graphics the existing conditions of the buildings; and
- Provide preferred treatment recommendations for managing the historic resources.

The HSR for the Washington Monument and Associated Structures has been prepared in three volumes: Volume I – Washington Monument, Volume II – Monument Lodge, and Volume III – Survey Lodge. The companion Washington Monument Grounds CLR addresses the site.

1.1.3 HSR METHODOLOGY

This HSR has been prepared in accordance with the guidance offered in the most recent versions of various federal standards documents, many of which are cited for their relevance in the scope of work for the project:

- *NPS Director's Order Number 28: Cultural Resource Management Guidelines*
- *Secretary of the Interior's Standards for the Treatment of Historic Properties with Guidelines for Preserving, Rehabilitating, Restoring, and Reconstructing Historic Buildings (1995)*
- *Uniform Federal Accessibility Standards (UFAS) or the Americans with Disabilities Act Accessibility Guidelines (ADAAG), whichever provides greater accessibility*
- *NPS Director's Order Number 10A: Standards for Design and Construction (1997)*
- *National Register Bulletin 15: How to Apply the National Register Criteria for Evaluation*

- Preservation Brief No. 17: *Architectural Character: Identifying the Visual Aspects of Historic Buildings as an Aid to Preserving Their Character* (1999)
- *Chicago Manual of Style*, 14th ed.

The HSR for the Andrew Johnson Homestead, prepared by the NPS, the HSR for Buildings 32, 33, and 33A at Harpers Ferry National Historical Park, prepared by Laura L. Simpkins, and the CLR for the Lincoln Memorial, prepared by the NPS, served as models for report preparation, organization, and format.

Team members representing Grunley-Walsh, the NPS, and John Milner Associates met in the Alexandria offices of JMA on February 13, 2003, to discuss the project, its scope, schedules, and specific administrative procedures. The scope of work for the HSR is included in Appendix A: Scope of Work.

Historical research in support of the HSR focused on the consolidation of materials provided by the NPS. These materials, gathered by Oehrlein & Associates Architects and Robinson & Associates, Inc., were supplemented with limited additional investigation by JMA. In the spring of 2002, Robinson & Associates visited document repositories (online or in person) and reviewed books, reports, documents, maps, drawings, and photographs and copied or borrowed those sources relevant to the project. The collected documents were provided to the JMA team by the NPS. Research conducted by Robinson & Associates focused on information available at the archives at the Library of Congress, Prints and Photographs Division; Martin Luther King Library, Washingtoniana Division, Historical Photo Collection; National Archives and Record Administration, Cartographic Division, Record Group (RG) 79, Still Pictures Division, RG 42, RG 66, and RG 328; Smithsonian Archives, Washington Monument Files; Historical Society of Washington, D.C., CHS Photo Collection; and NPS, National Capital Region files, National Capital Region electronic drawing files, National Capital Region digital photographs, and the "Lockwood" files held at the Jefferson Ranger Library, National Capital Parks - Central.

Subsequently, JMA conducted a thorough review and analysis of the documents provided from these sources to support the historical findings documented in the HSR. Each item was reviewed for information relative to the history and development of the Washington Monument, Monument Lodge, and Survey Lodge. JMA conducted limited directed research in April and May 2003 to answer specific questions related to the structures. This research included a review of contextual sources at the Library of Congress, selected resources focusing on construction contracts and development of recreation within RG 42 of the National Archives, and annual reports from the Corps of Engineers, Office of Public Buildings and Public Parks, and the National Park Service available at the U.S. Department of Interior Library. Online reviews of National Capital Planning Commission documents were also conducted.

JMA conducted field investigations during the months of March, May, and June 2003. The Washington Monument, Monument Lodge, and Survey Lodge were surveyed to verify the existing conditions information provided by the NPS and to assess the historical development, physical condition, and integrity of each structure. Field investigations included survey of readily accessible areas and documentation of conditions on historic drawings and field sketches. No

destructive materials testing or fabric investigations were carried out. The structures were photographed using color as well as black-and-white film.

The documentation of existing conditions was developed through cross-referenced narrative, graphic, and photographic materials and organized in accordance with the framework established in the NPS Cultural Resource Management Guideline, Chapter 8: Management of Historic and Prehistoric Structures, and *The Secretary of the Interior's Standards for the Treatment of Historic Properties with Guidelines for Preserving, Rehabilitating, Restoring, and Reconstructing Historic Buildings*. Existing conditions documentation was subsequently prepared through the review of existing architectural drawings and historic photographs; examination of available park documents, park files, and NPS reports; field investigations; and review of photographs taken in the field. Photographs of architectural features were used to consider and illustrate the various architectural characteristics of the historic structures included in this report. These representative photographs support the narrative descriptions of key architectural features and are referenced in the text. A binder containing all of the existing conditions photographs and negatives has been provided to the NPS to supplement the representative photographic coverage included in the report. Black-and-white photographs of the Washington Monument, Monument Lodge, and Survey Lodge documenting primary architectural features have been provided as the archival record of the historic structures prior to the implementation of security improvements.

1.1.4 HISTORICAL SUMMARY

In 1791, Pierre L'Enfant proposed a site for an equestrian monument to George Washington at the western terminus of the National Mall to be the central focus of the monumental core of his urban design for the nation's new capital city. The statue was never commissioned. In 1833, the Washington National Monument Society was founded to remedy the lack of an appropriate memorial to George Washington in the nation's capital. The society raised funds and elected to hold a design competition for a suitable monument in 1836. Several designs were submitted, including one by notable architect Robert Mills, but the society did not select a design at this time. Fund-raising continued, and in 1845 the society selected a design by Robert Mills at an estimated cost of \$200,000. Mills's design called for a 600-foot obelisk surrounded by a 250-foot-diameter, 100-foot-tall pantheon. Construction of the monument was begun in 1848, but temporarily halted in 1854 due to a lack of funds.

The monument remained partially complete until after the Civil War, when interest in its construction as a symbol of a re-united nation was renewed. Funding appropriations were slow in coming during the period of Reconstruction; however, the enthusiasm for the Centennial celebrations provided motivation for completion of the monument, and ownership was transferred to the federal government in 1876. The Army Corps of Engineers was commissioned to study the integrity of the foundations, and structural modifications were begun in 1878. Lt. Col. Thomas Lincoln Casey was appointed by the Joint Commission as Engineer in Charge of the project. The foundation-strengthening work was completed in 1880, and construction resumed on the obelisk that same year. Casey developed an internal iron structure for the monument to support the work platforms and the steam-powered hoist. Casey also altered the

final height of the Washington Monument and adjusted the proportions of the pyramidion to conform to those of known ancient Egyptian obelisks. The final design was a 500-foot obelisk culminating in a 55-foot steeply pitched pyramidion. The Washington Monument sits atop a grassy knoll with land gently sloping to every side along the banks of the Potomac River. Though it appears natural, this graceful hillock is the result of a large amount of fill brought to and sculpted on the site to support the foundation of the monument.

The Washington Monument was dedicated in 1885 and opened to the public in October of 1888. Since that time to the present, it has served as a major tourist attraction in the nation's capital. Subsequent repair renovation campaigns have been undertaken to maintain the integrity of the monument and improve visitor comfort and safety. Major exterior restoration was performed in 1934, 1964, and 1997–2000. The interior public spaces were substantially modified in 1904, 1913, 1958, 1974–1976, 1992, and 1997–2000. The original steam-powered elevator was replaced in 1901 with an electric elevator. The elevator was subsequently renovated in 1925, 1958, and 1997–2000.

The Monument Lodge, constructed as a waiting room and comfort station for Washington Monument visitors, is located 480 feet to the east of the monument along 15th Street. The design for the Monument Lodge by architect William M. Poindexter was accepted in 1887, constructed in 1888, and the building opened to the public in January of 1889. The exterior was styled as a rusticated Greek temple with rock-faced marble- and granite-masonry rubble from the construction of the Washington Monument, which is laid in a random-coursed ashlar pattern. The building originally contained a waiting room, keeper's room, archive room, and public men's and women's toilets. The toilet rooms were expanded in 1911–1917 and again in 1931. The waiting room was renovated in 1910–1911 and 1943. An outdoor concession stand was added to the west façade in 1948. In 1963, the outdoor concession stand was replaced with a larger enclosed concession addition. The Monument Lodge interior was renovated in 1971 and 1995. The Monument Lodge continues to serve as a gift shop, food-vending facility, and comfort station.

The Survey Lodge, originally constructed to house the steam-generating plant for the Washington Monument elevator, is located approximately 750 feet southwest of the monument. From the date of its completion in 1886 until 1923, the Survey Lodge, then known as the Boiler House, housed a steam boiler that provided steam to the Washington Monument via pipes housed in an underground tunnel. The steam was used to power the steam elevator in the monument. Like the Monument Lodge, the Survey Lodge is constructed of refuse marble and granite from the Washington Monument construction site. The original structure was ell-shaped, but in 1901, the Survey Lodge was expanded to its present rectangular form. It was enlarged to house the steam-powered electric dynamo for the new electric elevator installed in the monument. In 1923, the electric power source for the monument elevator was converted to the local public electric utility, eliminating the need for the steam-generating boiler in the Survey Lodge. The building acquired the name Survey Lodge after its use by survey crews of the National Park Service in the 1930s. Roof repairs were made in 1932 and again in the 1960s. In the 1970s, the Survey Lodge was converted to the headquarters for Mall Operations of National

Capital Parks – Central. A major rehabilitation project, including a complete renovation of the interior, was undertaken in 1989 and completed in 1993.

1.1.5 EVALUATION OF SIGNIFICANCE

Each component of the Washington Monument, including the Washington Monument Grounds, the Washington Monument, the Monument Lodge, and the Survey Lodge, has been evaluated for significance by JMA. The detailed significance evaluation for the Washington Monument Grounds can be found in a companion to this document, the Washington Monument Grounds CLR. The detailed significance evaluations for the Washington Monument, the Monument Lodge, and the Survey Lodge are located in their individual HSRs. The following is a summary of the findings contained in the above-referenced CLR and HSR documents.

The Washington Monument Grounds appear to possess national-level significance as a historic designed landscape under National Register Criterion C within the areas of Architecture, Community Planning and Development, Engineering, and Landscape Architecture for the period 1791 through 1943. As noted in the existing National Register Documentation for the property, the site derives its primary significance from its role as the nation's foremost memorial to its first president and from the pivotal role the monument and its site play in the urban design of the nation's capital. This significance extends from the initial conception of the National Mall area through the completion of the Jefferson Memorial in 1943.

Preliminary investigations into the history of the Washington Monument Grounds have also suggested that the site is likely significant within the areas of Politics/Government and Social History, as a social and political forum and a national meeting ground for expressing American rights and freedoms, with the monument serving as a symbolic backdrop. Further investigation into the extent of the area and contexts associated with use as a political forum will be required to fully determine the areas, periods, and aspects of this significance. It is possible, however, that the significance of the site as a national gathering space may extend to the present day due to the ongoing nature and importance of these uses. As such, the site would meet the eligibility requirements of Criterion Consideration G for events and associations that are less than fifty years old. The Washington Monument Grounds also appear to be significant at a local level in the area of Recreation/Entertainment for the role the site has played over many decades in providing passive and active recreational opportunities for D.C.-area residents and visitors alike.

The Washington Monument appears to possess significance under National Register Criterion C within the area of architecture as an example of the early-nineteenth-century movement to commemorate prominent Americans, as embodying the principles of Egyptian Revival architecture in its spare obelisk form, as an engineering milestone, and for its association with its designers, Robert Mills and Thomas Lincoln Casey. The Washington Monument is listed on the National Register of Historic Places. The 1980 documentation form indicates that the monument is significant in the areas of Architecture, Engineering, Landscape Architecture, and Commemoration. The Washington Monument is also a National Historic Civil Engineering Landmark. The Washington Monument is listed as a critical element of the larger National Mall area property as listed on the National Register of Historic Places in 1994 in the L'Enfant-

McMillan Plan for the City of Washington. This nomination indicates that the National Mall area is significant under Criteria A, B, and C in the areas of Community Planning and Development, Landscape Architecture, Politics/Government, and Transportation for the period 1790–1943.

The existing National Register documentation for the Washington Monument establishes a period of significance of 1848–1889. As a result of the research and analysis conducted as part of this HSR, it is recommended that this period of significance be expanded to include the period 1848–1914. This period includes the original construction period of the Washington Monument along with the construction of important interior features, such as the first-floor lobby with its marble wainscoting and terrazzo floor.

The Monument Lodge appears to possess significance under National Register Criterion C within the area of Architecture for its significance as an early comfort station and visitor center prototype. It embodies period architectural characteristics in its style: a Greek temple form with Victorian embellishments, and its method of construction: a marble- and granite-clad brick structure with a vaulted masonry roof. It is also significant as the work of William Poindexter, a prominent local architect of the late-nineteenth century. The Monument Lodge appears to be a contributing element of the Washington Monument, due to its historical association, physical relationship, and function as a support facility for those working in and visiting the Washington Monument. The existing National Register documentation for the Washington Monument, including the Monument Lodge, establishes a period of significance of 1848–1889. As a result of the research and analysis conducted as part of this HSR, it is recommended that this period of significance be expanded to include the period 1888 to 1910. This period includes the construction of the Monument Lodge and the addition of important interior features, such as the terrazzo floors and marble wainscoting in 1910.

The Survey Lodge appears to possess significance under National Register Criterion C within the area of Architecture. Constructed in the period of 1886–1901, the Survey Lodge is an example of an aesthetically designed mechanical building. It was built to support the function of the Washington Monument and is linked to the monument through its location on the Monument Grounds, through its use of waste materials from the monument's construction, and through its historic function providing steam for the monument's elevator engines. The existing National Register Documentation for the Washington Monument, including the Survey Lodge, establishes a period of significance of 1848–1889. As a result of the research and analysis conducted as part of this HSR, it is recommended that this period of significance be expanded to include the period 1886 to 1901. This period includes the construction of the Survey Lodge and the addition in 1901 to accommodate the electric dynamo and generator to power the new electric elevator of the Washington Monument.

1.1.6 SUMMARY OF CONDITION AND INTEGRITY

The Survey Lodge is a low, one-story building, rectangular in shape, with an attached chimney that conveys its historic function as the power source for the Washington Monument elevator. The construction details and materials that define the character of the Survey Lodge include

simple two-over-two double-hung windows, slate gable roofs, simple carved granite lintels, and stone masonry construction. The exterior details and overall character of the Survey Lodge closely reflect the building's appearance in 1901, when it was expanded to its present size, though not all materials are original. A modern utility shed was constructed to the northwest of the lodge as part of a major renovation project in 1989. That project included the complete renovation of the interior of the Survey Lodge, leaving no original interior finishes or features.

The Survey Lodge, its attached utility shed, and the surrounding hardscape features of the lodge building site are all currently in good condition. The historic exterior masonry and slate roof of the lodge, its modern interior finishes, and the utility shed only require maintenance-level repairs to ensure their continued preservation. The concrete walkways on the Survey Lodge site, along with site features such as pedestal-mounted telephones and picnic tables, also require only maintenance-level repairs. The Survey Lodge is in good condition overall and its exterior retains a high level of integrity in its feeling and association as a late-nineteenth-century aesthetically designed mechanical/utility structure on the grounds of the Washington Monument.

1.1.7 RECOMMENDATIONS FOR TREATMENT AND USE

The most recent National Park Service planning document that directly addresses the treatment of the Survey Lodge, the 1973 "Comprehensive Design Program and Engineering Feasibility Report," calls for the retention of the Survey Lodge and the remodeling of its office space to "increase privacy and amenities and to improve appearance."¹ Subsequent documents submitted by the National Park Service (NPS), and approved by the National Capital Planning Commission (NCPC), make no direct recommendations for the treatment of the Survey Lodge other than showing it on plans as retained.² The lodge's surrounding circle drive and nearby pedestrian pathways, though, are shown to be reconfigured in these documents. No indication of how these items would be reconfigured appears in the approved plans, but the purpose of all proposed work is to improve security, visitor flow, and accessibility, while retaining recreational areas and preserving the quality of the cultural landscape.

In 1989, the Survey Lodge underwent a massive rehabilitation campaign that restored exterior masonry and windows, reconstructed the historic slate roof and cupola, and renovated the entire interior of the building. The structure now serves as the Headquarters of Mall Operations for the Park Service and contains a visitor contact station, handicapped accessible restrooms, offices and facilities for Park Service staff, and storage space. The approved ultimate treatment of the lodge is retention of the existing structure.

Based on the findings of this HSR, it is recommended that the existing historic elements on the exterior of the Survey Lodge be preserved in order to maintain the building's excellent exterior integrity. To increase the integrity of the building setting, it is recommended that the wood-and-metal utility shed to the northwest of the lodge be removed and its functions relocated. On the interior of the Survey Lodge, no historic finishes remain; however, extant historic masonry load-bearing walls should be preserved. It is recommended that the interior finishes be upgraded and repaired as needed to provide adequate and attractive facilities for Park Service staff and visitors. Any future changes contemplated to the Survey Lodge should be included in a Visitor

Experience and Resource Protection (VERP) framework implemented for all resources within the Washington Monument Grounds.

Preserving the Survey Lodge in its current form would require maintenance-level activities to ensure the continued good condition of the historic building. The lodge would continue its current use as a center of administration for Park Service Mall Operations and as a visitor contact point for those visiting surrounding monuments and memorials. Preservation of the lodge would include sensitive repair of historic character-defining features, materials, and finishes. The exterior masonry would be maintained with appropriate cleaning, repointing, and repairs. The wood windows, doors, frames, and cupola would be sustained with appropriate repairs and regularly scheduled painting. The existing historic roof truss system would be preserved during any future roofing work. Mechanical, electrical, and plumbing systems could be upgraded in a sensitive manner with the intent of improving energy efficiency, and to meet code and facility requirements. Interior office and rest-room spaces would continue to be updated as needed. The current integrity of the Survey Lodge, excellent on the exterior though poor on the interior, would be maintained.

Preservation of the Survey Lodge would retain all of the existing character-defining features of the structure, maintain and repair the existing historic fabric, replace deteriorated non-historic elements, and upgrade systems as required. This treatment would be in compliance with NPS policy and, in conjunction with other projects within the grounds of the Washington Monument, would meet NPS management objectives. Preservation is by far the preferred treatment option for the future of the Survey Lodge.

1.2 ADMINISTRATIVE DATA

1.2.1 NAMES AND LOCATION OF STRUCTURES

The Washington Monument, the Washington Monument Lodge, and the Survey Lodge are located in the Washington Monument Grounds. The site is positioned within Washington, District of Columbia, immediately west of the National Mall. The Washington Monument Grounds are typically defined as District Reservation 2, a roughly 106-acre area bounded by 14th Street on the east, Constitution Avenue on the north, 17th Street on the west, and the Tidal Basin on the South. For the purpose of the joint HSR/CLR, the study area has been slightly modified to include approximately 75 acres bounded by 14th and 17th Streets, and Constitution and Independence Avenues.

The Washington Monument stands on an elevated grassy knoll in the southeast quadrant of the study area. The Washington Monument Lodge is located approximately 480 feet east of the Washington Monument adjacent to 15th Street. The Survey Lodge is located approximately 750 feet southwest of the Washington Monument near Independence Avenue.

1.2.2 PROPOSED TREATMENT OF THE STRUCTURE

Proposed Treatment for the Survey Lodge: No Proposed Treatment Found.
No proposed treatment statement was found in the following documents:

- NPS. *Development Concept Plan*. 1993
- National Park Service. "Washington Monument Permanent Security Improvements Environmental Assessment." Washington, D.C., April 2002.
- NPS. *Decision Notice and Finding of No Significant Impact – Washington Monument Permanent Security Improvements Environmental Assessment (FONSI)*. July 2002.
- NPS. "Revised Development Concept Plan." January 9, 2003.

1.2.3 RELATED STUDIES AND DOCUMENTS

The Washington Monument has been the subject of significant historical documentation including numerous drawings, photographs, reports, studies, documents, and papers. For the purpose of this HSR, the documents specifically related to the history of the Washington Monument, Monument Lodge, and the Survey Lodge, and the proposed visitor facility and security modifications were the primary references and are listed in the Bibliography. Key documents directly related to this HSR include the following:

- Historic American Building Survey, National Park Service, U. S. Department of the Interior. Washington Monument, No. DC-428. Aaron V. Wunsch. Washington, D.C., 1994.
- National Park Service. *A General History of the West Potomac Park and Washington Monument Grounds Cultural Landscapes*. Scott G. Shultz. Washington, D.C., 1995.
- National Park Service. *Decision Notice and Finding of No Significant Impact – Washington Monument Permanent Security Improvements Environmental Assessment*. Washington, D.C., July 2002.
- National Park Service. *National Register of Historic Places Inventory – Nomination Form, Washington Monument*. Donald C. Pfanz. Washington, D.C., 1980.
- National Park Service. *Preliminary Opinion of the Design Proposal as it Relates to the Washington Monument Grounds Cultural Landscape*. Regional Historical Landscape Architect, Regional Historian, National Capital Region, and Chief, Division of Resource Management, National Capital Parks – Central. Washington, D.C., July 15, 2002.
- National Park Service. *Preliminary Opinion of the Design Proposal as it Relates to the Washington Monument Lodge*. Regional Chief Historical Architect, National Capital Region, and Chief, Division of Resource Management, National Capital Parks – Central. Washington, D.C., July 19, 2002.
- National Park Service. *Preliminary Research Findings – Cultural Landscape Report – Washington Monument Grounds*. Oehrlein & Associates Architects with Robinson & Associates, Inc. Washington, D.C., June 10, 2002.
- National Park Service. *Preliminary Research Findings – Historic Structures Report – Washington Monument Lodge*. Oehrlein & Associates Architects with Robinson & Associates, Inc. Washington, D.C., June 10, 2002.

- National Park Service. *Washington Monument Permanent Security Improvements Environmental Assessment*. Washington, D.C., April 2002.
- National Park Service. *Washington Monument – Proposed Renovation of Entry Level Lobby*. Notter Finegold & Alexander, Inc., April 1991.

1.2.4 CULTURAL RESOURCE DATA

The Washington Monument, the Washington Monument Lodge, the Survey Lodge, and the Washington Monument Grounds are administered by the National Park Service (NPS) as part of National Capital Parks – Central. The NPS inventory of National Register properties is called the List of Classified Structures (LCS). Each LCS structure is assigned a unique identification number. The identification numbers for the structures evaluated in the HSR are as follows:

- Washington Monument – LCS ID No. 00212000
- Washington Monument Lodge – LCS ID No. 100069
- Survey Lodge – LCS ID No. 100069

The Washington Monument, including the Monument Grounds, the Washington Monument, the Washington Monument Lodge, the Survey Lodge, and associated site features, was listed on the National Register of Historic Places on May 19, 1981. The 1980 National Register Documentation indicates that the Washington Monument is nationally significant for its architecture and engineering between 1848 and 1889, within the areas of Architecture, Landscape Architecture, Engineering, and Commemoration. The Washington Monument Lodge and the Survey Lodge are included in the 1980 National Register Documentation.

1.3 RECOMMENDATIONS FOR FUTURE RESEARCH

Additional avenues for research related to the Survey Lodge include the review of studies and documents that were identified during the preparation of the HSR but not made available by the NPS or were outside of the scope of work for this report. The location and assembly of these documents would assist future research. The following documents have been identified for future study:

- Thomas Lincoln Casey Papers on the Washington Monument, at the Society for the Preservation of New England Antiquities (SPNEA), for information on the construction of the Washington Monument, the Monument Lodge, and the Survey Lodge.
- Documents related to the Decision Notice and Finding of No Significant Impact for the 1989 renovations to the Survey Lodge.
- Review of Record Group 42 of the National Archives, College Park, Md., for annual and quarterly reports for the National Park Service – National Capital Region for information on the development of the Washington Monument, the Monument Lodge, and the Survey Lodge.

- Recent construction documents or memoranda (1970–present) from National Park Service – National Capital Region files and Denver Service Center files relating to recent work at the Washington Monument, the Monument Lodge, and the Survey Lodge.
- Field notes, photographs, and other documents pertaining to the 1997–2000 restoration work at the Washington Monument in the National Park Service – National Capital Region and/or National Capital Parks – Central files.
- Interviews with National Park Service staff involved in 1997–2000 restoration work at the Washington Monument.

Archeological investigations are not included in the scope of this HSR. Although the Washington Monument Grounds are in great part covered with fill, there is some potential for both prehistoric and historic archeological resources. Refer to the companion Washington Monument Grounds CLR for a more-detailed discussion of potential archeological investigations.

ENDNOTES

¹ Hartman-Cox Architects, “Comprehensive Design Program and Engineering Feasibility Report,” 20 September 1973: 1.

² National Park Service, U.S. Department of the Interior, “Development Concept Plan and Alternatives, Washington Monument Grounds, Washington, D.C.,” September 1981, revised 1989; NPS-NCR Collection; National Park Service, U.S. Department of the Interior, “Phases of Implementation for Grounds Improvement and Accessibility, Washington Monument Grounds,” May 1993; National Park Service, U.S. Department of the Interior, “Washington Monument Grounds Revised Development Concept Plan and Preliminary Site and Building Plans for Visitor and Security Improvements,” 9 January 2003; NCPC File No. 1303/6152; National Park Service, U.S. Department of the Interior, “Washington Monument Permanent Security Improvements Environmental Assessment,” April 2002.

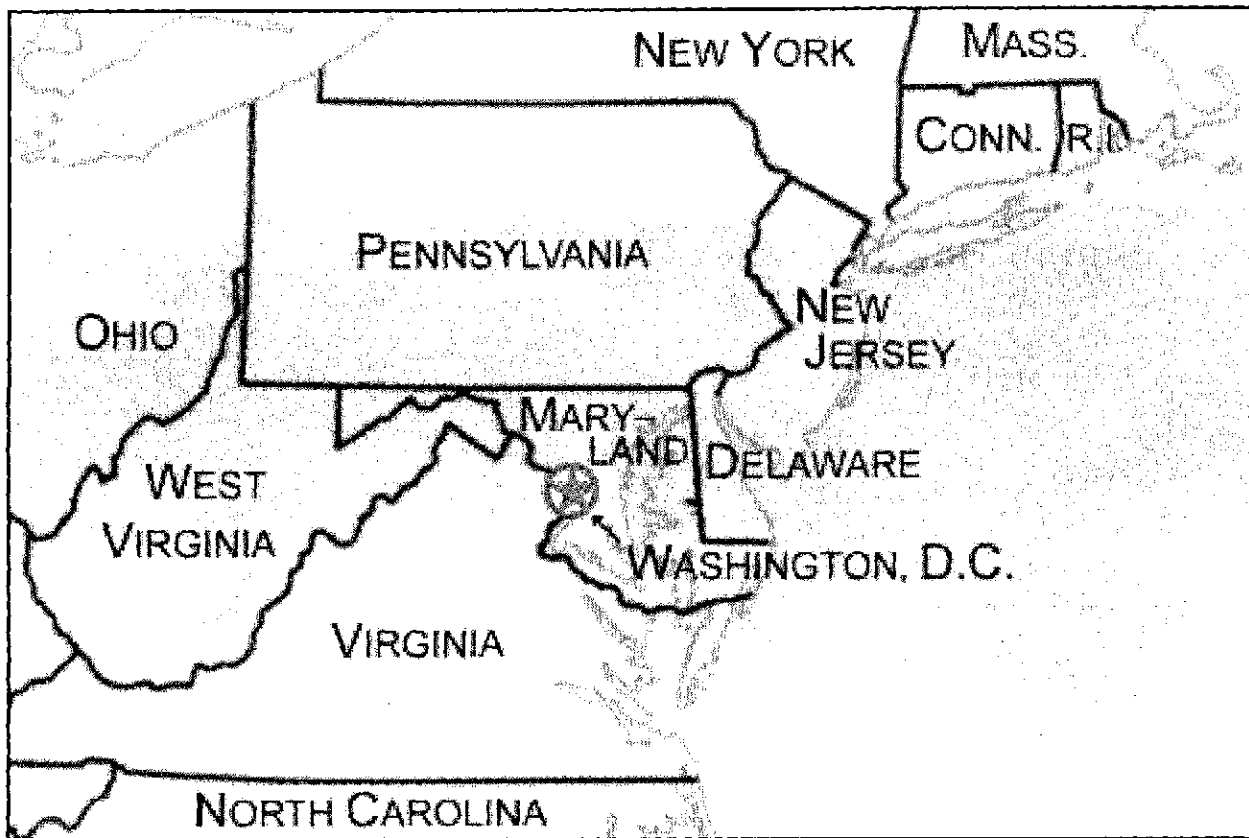

Figure 1.1: Site location map.

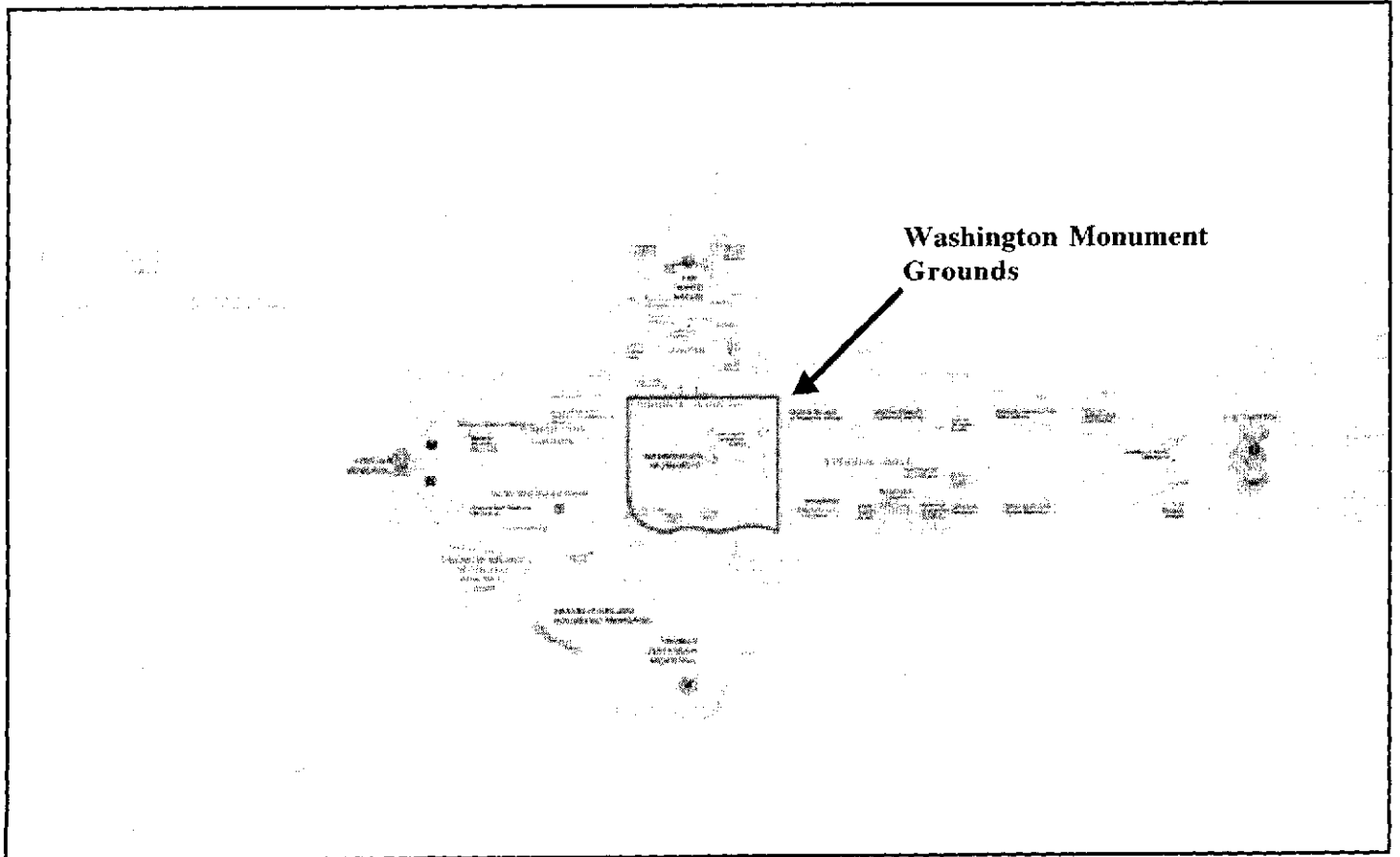
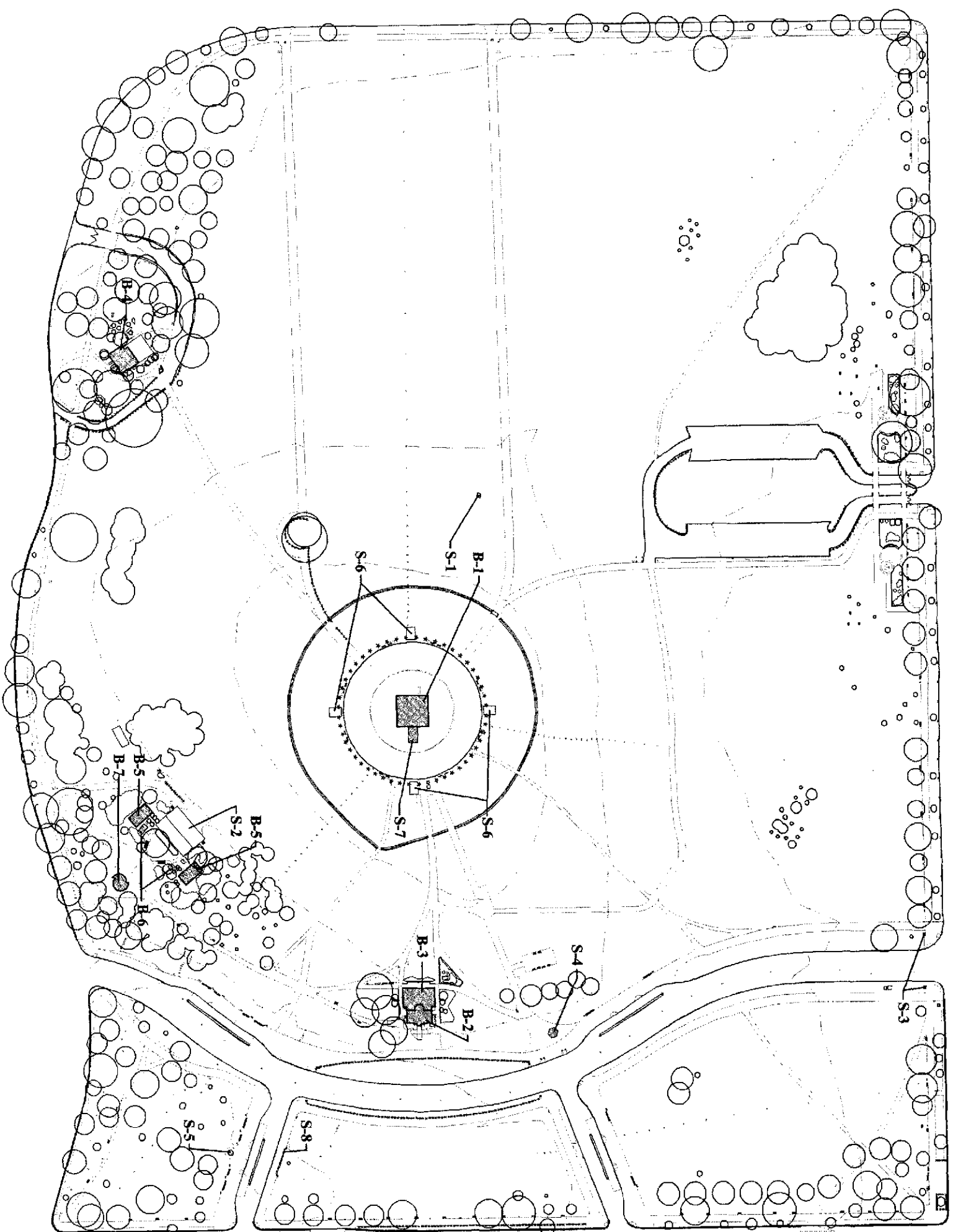

Figure 1.2: Site vicinity map.



- Buildings & Structures**
- B-1 Washington Monument
 - B-2 Monument Lodge
 - B-3 Monument Lodge addition
 - B-4 Survey Lodge
 - B-5 Sylvan Theatre dressing rooms
 - B-6 Sylvan Theatre sheds
 - B-7 Comfort station
 - S-1 Jefferson Pier survey marker
 - S-2 Sylvan Theatre stage
 - S-3 Bulfinch gateposts (2)
 - S-4 Ticket kiosk
 - S-5 Bus tour kiosk
 - S-6 Light vaults
 - S-7 Monument entry station
 - S-8 Granite retaining wall

- Legend**
- Building
 - - - Contour
 - Fence
 - ▤ Jersey barriers
 - Road
 - ◊ Stump
 - Sidewalk
 - Tree

Figure 1.3: Washington Monument Grounds building and structures.



Part I – Developmental History

CHAPTER TWO
HISTORICAL BACKGROUND AND CONTEXT



CHAPTER TWO

HISTORICAL BACKGROUND AND CONTEXT

2.1 1886–1923: POWER PLANT FOR WASHINGTON MONUMENT

During the second phase of construction for the Washington Monument, 1876–1888, there were many auxiliary buildings on the monument grounds, including stonecutting sheds, blacksmith shops, hoists, railroad spurs, and numerous other structures. The power source for the hoists and machinery was a steam engine and boiler located in separate small houses in the western side of the monument's earthen embankment.¹

Even though the exterior and structure of the Washington Monument was largely completed at its dedication on February 21, 1885, additional work was needed before opening the monument and its grounds for public visitation. As part of the transformation of the Washington Monument Grounds from a construction site into a public park, buildings, such as the stonecutting sheds, the carpenter shop, and the blacksmith shop, were removed from the grounds. While the elevator engine temporarily remained on the west side of the monument,² the new Boiler House, with its tall chimney that would detract from the park-like setting of the monument, was to be sited away from the monument.

The new location for the Boiler House, now known as the Survey Lodge, was at the edge of the Washington Monument Grounds near the banks of the Potomac River, 750 feet southwest of the monument. This was a sufficient distance so that the tall boiler exhaust chimney would not intrude on the monument's surroundings and the experience of monument visitors.³

It appears that the Boiler House was designed by the Office of the Engineer in Charge of the Washington Monument, most likely by Lt. Col. Thomas Lincoln Casey's Assistant Engineers Capt. George W. Davis and Bernard L. Green. Designing the Boiler House would have fit within their responsibilities, as the Boiler House was a utilitarian building, not requiring the talents of an architect. However, Casey signed the final plans for the Boiler House and presumably closely oversaw the work of his assistants.

Thomas Lincoln Casey, son of Brigadier General Silas Casey, graduated first in the West Point class of 1852, where he taught engineering in the late 1850s. Casey served as military engineer in the Washington Territory, where he constructed wagon roads through virgin forest and during the Civil War built fortifications on the Maine coast, including completing Fort Knox on the Penobscot River.⁴

Thomas Lincoln Casey and Bernard R. Green were major builders in post-Civil War Washington, D.C. Casey had first worked with Green, a civilian engineer, during his work in Maine during the Civil War. When Casey was appointed head of the Office of Public Buildings and Parks in 1877, he hired Green as his assistant. Besides the Washington Monument, Casey and Green worked on several large government construction projects, including the State, War, and Navy Building, where they constructed the north wing for one-third the cost of the east wing built earlier under O. E. Babcock.⁵ In July 1888, Casey was promoted to Brigadier General⁶ and appointed Chief of Engineers of the U.S. Army, a post he held until May 1895. Casey and Green supervised construction of the Library of Congress beginning in 1888; Casey continued as construction supervisor until his death in 1896, with Green succeeding him in this position.⁷

Even though it was a purely mechanical building with no public-use component, its location on the Washington Monument Grounds required that the Boiler House be aesthetically designed. While the Boiler House does not fit within an established architectural style, its use of materials in a variety of colors and textures is typical of the late-nineteenth century. Other parks of the late-nineteenth century included aesthetically designed secondary buildings, such as Prospect Park's Concert Grove House (1874) and Central Park's Dairy (1870s). These had a public-use component to their program. It is rare to find aesthetically designed service buildings with no public component; these were typically simple, utilitarian structures, with little or no architectural detailing, often of less-permanent materials.

The Boiler House was designed to have minimal intrusion upon the surrounding landscape and not detract from the Washington Monument. As part of this, the mass of the building was minimized through the sinking of the boiler pit and coal vault into the ground. By necessity, the chimney extended above the surrounding tree line. The intrusion of the Boiler House was lessened by using "White Marble and Granite, to be obtained from the waste of the stock used in building the Monument" with quarry-faced marble walls contrasting with smooth-finished granite water tables, sills, and other masonry details.⁸ This new Boiler House contained two coal-fired boilers, a 90-ton coal vault, ash vault, and workroom with toilet, as will be discussed further in the following chronology of development and use (see figures 2.1 and 2.2). William Bradley, contracted to build the Boiler House, completed construction of the structure on June 30, 1886.⁹

While the visual connection between the Boiler House and Washington Monument was minimized through the Boiler House's design and surrounding vegetation, the physical connection between the two was hidden below ground. Linking the Boiler House and Washington Monument engine house was a brick tunnel, which supplied live steam to the elevator's engine, removed exhaust from the elevator engine to the Boiler House chimney, and carried water-supply pipes to the Boiler House and Washington Monument.¹⁰

As elevator technology improved and the number of visitors to the Washington Monument steadily increased, it became apparent that the original steam-powered Washington Monument elevator was inefficient. Also, the long distance that the steam traveled from the Boiler House to the elevator engine decreased its efficiency. Electric elevators offered greater efficiency, increased speed, improved control of acceleration and deceleration, and increased safety.¹¹ With

the large numbers of visitors and heavy use that the Washington Monument elevator received, it is no surprise that the Office of Public Buildings and Public Parks wanted to upgrade their system to ensure the safety and comfort of the visiting public. By 1898, plans were made to replace the existing steam engine with an electric engine and dynamo, to be housed in a small addition within the ell of the Boiler House (see figure 2.3). It was not until November 1900 that a satisfactorily priced bid was received for the new generating unit. By the end of June 1901, the addition housing the new power plant was completed and the new machinery installed (see figure 2.4).¹² This addition retained the same aesthetic principles as the original structure, using the same materials and basic design features. The electricity produced by this generating plant was also intended to provide an independent power source for lighting the Washington Monument Grounds, Executive Mansion Grounds, and potentially the Executive Mansion.¹³

After this addition, the Boiler House is referred to as the Power House. The two boilers that had formerly provided steam for the elevator engine remained in the Power House and were used in part to power the electric generator located in the new addition.¹⁴

In 1923, the Washington Monument was rewired to receive electricity from the local power and light company for light, power, and heat.¹⁵ This change in power source for the monument meant the discontinuation of the use of the Power House as a power generator. It is not apparent what new use the building acquired, but in 1926 the "old power plant for the Monument" was re-assigned to the Design and Construction Division of the Office of Public Buildings and Public Parks (OPB&PP), apparently for use as offices.¹⁶

This shift in function meant that the Power House no longer directly served the needs of the Washington Monument. Its distant location from the monument, as well as its sitting amidst trees, a feature since at least 1923,¹⁷ kept the Boiler House from having a direct visual relationship with the monument. With the discontinuation of use as a power source, the brick tunnel connecting the Power House and Washington Monument was no longer used and the physical connection between the two buildings was severed. Not until 1942 does a direct path, pedestrian or vehicular, appear between the Washington Monument and the Survey Lodge.¹⁸ Roads through the Washington Monument Grounds had passed by the Boiler House as early as 1889,¹⁹ and the Boiler House was encircled c. 1902 by a spur of 16th Street.²⁰

2.2 1924–PRESENT: OFFICES AND CHLORINATION PLANT

On August 10, 1933, the Office of Public Buildings and Public Parks of the National Capital (OPB&PP), and all the lands under its control, were reorganized as part of the National Park Service in the Department of the Interior.²¹ As the National Park Service assumed responsibility for the Washington Monument Grounds, there were some accompanying changes in use. The former Power House appears to have become a Survey Lodge, housing the crews who surveyed parks within the National Capital Region.²² This increased activity in the National Capital Region parks was a result of increasing depression-era government employment projects. As early as September 1933, two Civilian Conservation Corps (CCC) camps were set up to serve the National Capital Parks. By 1942, there were a total of ten CCC camps in the Washington, D.C., area. Numerous parks were developed and renovated by the CCC and other Works Projects Administration projects.²³ Some of this work presumably included surveying the parks of the

National Capital Parks, whether they were new or existing. The CCC and others relieved the backlog of park development work that had occurred during earlier periods of funding shortfalls. A 1946 floor plan shows the ground floor of the Survey Lodge with rooms for drafting, survey, equipment, and record storage (see figures 2.5, 2.6, and 2.7).²⁴

In 1939, plans were made to transform the upper (ground) level of the boiler room into a chlorinating plant for the condensing water tunnel (see figures 2.8 and 2.9).²⁵ It appears that at least some aspects of this plan were carried out, but the full extent and purpose of this chlorinating plant was not discovered as part of this report.²⁶

In the 1970s, the Survey Lodge became the Mall Operations Office for the National Park Service. This office managed the monuments and memorials of the National Mall area, including the Washington Monument. This functional change restored the original service relationship between the Survey Lodge, then the Boiler House, and the Washington Monument. The Survey Lodge currently houses a visitor contact station, handicapped-accessible rest rooms, offices and facilities for Park Service staff, and storage space.²⁷

Through the various development plans made for the Washington Monument Grounds, including the 1973 Washington Monument Visitor Facility Comprehensive Design Program, the 1981 Development Concept Plan, the 1989 revisions to the 1981 Development Concept Plan, and the current 1993 Development Concept Plan, it has been recommended that the Survey Lodge retain its function as offices for the National Park Service.²⁸ In order to maintain this function, the Survey Lodge underwent an extensive rehabilitation from 1989 to 1993 to repair termite damage and modernize conditions. Original yet missing features, such as the slate roof and cupola, were reconstructed as part of this project (see figure 2.10).²⁹

2.3 EVALUATION OF SIGNIFICANCE

Based on the evaluation made as part of this HSR and earlier evaluations, the Survey Lodge on the Washington Monument Grounds appears to possess significance under National Register Criterion C within the area of Architecture for its significance as an aesthetically designed mechanical building. The Survey Lodge is included in the National Register of Historic Places documentation for the Washington Monument. This documentation does not include a determination of contributing or non-contributing status. Other elements included in the Washington Monument National Register documentation include the Washington Monument, the Washington Monument Grounds, and the Monument Lodge.³⁰ The Survey Lodge appears to be a contributing element of the Washington Monument, due to its historical association, physical relationship, and function as a support facility for those working at and visiting the Washington Monument.

The Evaluation of Significance for the Washington Monument Grounds can be found in a companion to this document, the *Washington Monument Grounds Cultural Landscape Report*, submitted to the National Park Service by John Milner Associates in 2003. The significance evaluations for the Washington Monument and the Monument Lodge are located in their individual Historic Structure Reports, also companions to this document. The existing National

Register documentation for the Washington Monument, including the Survey Lodge, establishes a period of significance of 1848–1889. As a result of the research and analysis conducted as part of this HSR, it is recommended that this period of significance be expanded to include the period 1886 to 1901. This period includes the construction of the Survey Lodge and the addition in 1901 to accommodate the electric dynamo and generator to power the new electric elevator of the Washington Monument.

Constructed in the period of 1886–1901, the Survey Lodge is an example of an aesthetically designed mechanical building. It is part of an ensemble of structures directly associated with the Washington Monument as historic service structures. It was built to support the function of the Washington Monument and is linked to the monument through its location on the Monument Grounds, through its use of waste materials from the monument's construction, and through its historic function providing power, steam until 1901 and electricity until 1923, for the monument's elevator engines.

While the Survey Lodge does not fit within a defined architectural style, it includes elements that are typical of late-nineteenth-century architecture, such as the variety of texture and color in the exterior stone work. The gable ends with their partial cornice returns and the octagonal cupola with its attached pilasters and articulated bell roof are characteristic of the Classical Revival styles of the late-nineteenth century.

The Survey Lodge is a rare surviving example of an aesthetically designed mechanical building. Its use of permanent materials, such as stone and slate, marked a departure from the temporary buildings built to serve the Washington Monument during its construction and also the majority of mechanical buildings built during this period. Most other mechanical buildings of this period are simple, utilitarian buildings lacking in such architectural detail. The Survey Lodge's fine architectural details belie its utilitarian purpose.

The location of the Survey Lodge on the grounds of the prominent Washington Monument led to its aesthetic design and also its siting. During completion of the monument and grounds, the boilers for the elevator's steam engine were moved from directly west of the monument to their current location, where distance would render the necessary tall chimney less obtrusive upon the grounds and the monument visitor's experience.

It appears that the Boiler House was designed by the Office of the Engineer in Charge of the Washington Monument, most likely by Lt. Col. Thomas Lincoln Casey's Assistant Engineers Capt. George W. Davis and Bernard L. Green. Designing the Boiler House would have fit within their responsibilities, as the Boiler House was a utilitarian building not requiring the talents of an architect. However, Casey signed the final plans for the Boiler House and presumably closely oversaw the work of his assistants.

Thomas Lincoln Casey and Bernard R. Green were major builders in post-Civil War Washington, D.C. Casey had first worked with Green, a civilian engineer, during his work in Maine during the Civil War. When Casey was appointed head of the Office of Public Buildings and Parks in 1877, he hired Green as his assistant. Besides the Washington Monument, Casey and Green worked on several large government construction projects, including the State, War,

and Navy Building, where they constructed the north wing for one-third the cost of the east wing built earlier under O. E. Babcock.³¹ In July 1888, Casey was promoted to Brigadier General³² and appointed Chief of Engineers of the U.S. Army, a post he held until May 1895. Casey and Green supervised construction of the Library of Congress beginning in 1888; Casey continued as construction supervisor until his death in 1896, with Green succeeding him in this position.³³

ENDNOTES

Abbreviations:

E 484	Letters Received, Entry 484; Records of the Joint Commission for Completion of the Washington Monument, 1876–1892
GPO	Government Printing Office, Washington, D.C.
NAB	National Archives Building, Washington, D.C.
NCP 807	National Capital Parks, Group 807, Washington Monument
NPS-NCR	National Park Service – National Capital Region
RG 42	Records of the Office of Public Buildings and Public Parks of the National Capital, Record Group 42
RG 79	Records of the National Park Service, Record Group 79

¹ Thomas Lincoln Casey, Engineer in Charge of the Washington Monument, to Joint Commission for Completion of the Washington Monument, "Report of Operations Upon Completion of the Washington Monument for the Month of June 1880," July 1880; E 484; RG 42; NAB.

² The existing engine house was enlarged and altered so that its new iron, copper, and concrete roof would not project above the ground level of the new hill being formed around the base of the monument. (Thomas Lincoln Casey, Engineer in Charge of the Washington Monument, and James B. Haliday and William A. Wilson, "Articles of Agreement," 15 March 1886; Contracts, Entry 512; Records of the Engineer in Charge, 1876–1892; Records of the Joint Commission for the Completion of the Washington Monument, 1876–1892; RG 42; NAB.)

³ Thomas Lincoln Casey, Engineer in Charge of the Washington Monument, to Brig. Gen. J. C. Duane, Chief of Engineers, "Report of Operations Upon the Washington Monument for the Year 1886," 20 December 1886; E 484; RG 42; NAB.

⁴ Louis Torres, "To the Immortal Name and Memory of George Washington," *The United States Army Corps of Engineers and the Construction of the Washington Monument* (Washington, D.C.: GPO, 1984).

⁵ Albert E. Cowdrey, *A City for the Nation: The Army Engineers and the Building of Washington, D.C., 1790–1967* (Washington, D.C.: Historical Division, Office of Administrative Services, Office of the Chief of Engineers, 1979).

⁶ From the records for construction of the Washington Monument, it appears that Casey was promoted to a full Colonel from Lieutenant Colonel.

⁷ U.S. Army Corps of Engineers, "Brigadier General Thomas Lincoln Casey," <http://www.hq.usace.army.mil/history/coe2.htm>, accessed 25 June 2003.

⁸ Thomas Lincoln Casey, Engineer in Charge of the Washington Monument, "Advertisement and Specifications for Boiler House at the Washington Monument," 3 October 1885; Contracts, Entry 512; Records of the Engineer in Charge, 1876-1892; Records of the Joint Commission for the Completion of the Washington Monument, 1876-1892; RG 42; NAB.

⁹ Thomas Lincoln Casey, Engineer in Charge of the Washington Monument, to Joint Commission for Completion of the Washington Monument, "Report of Operations Upon Completion of the Washington Monument for the Month of June 1886," 2 July 1886; v. 4, p. 282; Letters Sent, Entry 495; Records of the Engineer in Charge, 1876-1892; Records of the Joint Commission for the Completion of the Washington Monument, 1876-1892; RG 42; NAB. Bradley had been awarded the \$6,994.58 contract for construction of the Boiler House on October 22, 1885 (Casey, "Report of Operations Upon the Washington Monument for the year 1886").

¹⁰ Casey, "Report of Operations Upon the Washington Monument for the Year 1886."

¹¹ Museum for the Preservation of Elevating History, "Major Components," <http://www.theelevatormuseum.org/d/d.htm>, accessed July 22, 2003.

¹² Theodore A. Bingham, *Annual Report upon the Improvement and Care of the Public Buildings and Grounds, and Care and Maintenance of the Washington Monument in the District of Columbia*, by Theo. A. Bingham, Capt., Corps of Engineers, Col., U.S.A., being Appendix DDD of the Annual Report of the Chief of Engineers for 1901 (Washington, D.C.: GPO, 1901).

¹³ Theodore A. Bingham, *Annual Report upon the Improvement and Care of the Public Buildings and Grounds, and Care and Maintenance of the Washington Monument in the District of Columbia*, by Theo. A. Bingham, Capt., Corps of Engineers, Col., U.S.A., being Appendix CCC of the Annual Report of the Chief of Engineers for 1898 (Washington, D.C.: GPO, 1898).

¹⁴ The boilers served this function during at least 1901-1904.

¹⁵ War Department, U.S. Army Corps of Engineers, *Annual Report to the Chief of Engineers, U.S. Army* (Washington, D.C.: GPO, 1923).

¹⁶ U. S. Grant, 3d, Director, "General Order No. 67, Office of Public Buildings and Public Parks," 17 June 1926; U.S. Department of the Interior Library, Washington, D.C.

¹⁷ *National Geographic*, June 1923; File 13193, Washingtoniana Collection, Martin Luther King Library, Washington, D.C.

¹⁸ U.S. Department of the Interior, National Capital Parks, Planning and Construction Division, "Washington Monument Grounds, Proposed Walks," 25 June 1942; [Architectural Drawing] File 807_84208; Technical Information Center, Denver Service Center, National Park Service.

¹⁹ In the 1889 plan of the Washington Monument Grounds, 16th Street enters the grounds at B Street N and follows a curvilinear path south and around the Washington Monument before intersecting 14th Street. "Plan of Washington Monument Ground, showing the surface grade to be formed under the present contract," 1889; [Architectural Drawing] File 44-49; NCP 807; RG 79; Cartographic and Architectural Records LICON, Special Media Archives Division, National Archives at College Park, College Park, Md.

²⁰ Theodore A. Bingham, "Plan for the Improvement of the West Side of Monument Park," in *Annual Report upon the Improvement and Care of the Public Buildings and Grounds, and Care and Maintenance of the Washington Monument in the District of Columbia*, by Theo. A. Bingham, Capt., Corps of Engineers, Col., U.S.A., being Appendix DDD of the Annual Report of the Chief of Engineers for 1902 (Washington, D.C.: GPO, 1902).

²¹ Barry Mackintosh, *The National Parks: Shaping the System* (Washington, D.C.: National Park Service, 2000, web-only edition, http://www.cr.nps.gov/history/online_books/mackintosh1/index.htm, accessed 16 April 2003).

²² "Survey Lodge 'The Boiler House,'" n.d.; NPS-NCR Collection.

²³ Cornelius W. Heine, *A History of National Capital Parks* (Washington, D.C.: U.S. Department of the Interior, National Park Service, National Capital Parks, 1953; http://www.cr.nps.gov/history/online_books/nace/adhi.htm, accessed August 19, 2003.)

²⁴ U.S. Department of the Interior, National Park Service, National Capital Parks, Engineering Division, "Proposed Fireproof Vault Survey Lodge Washington Monument Grounds," 7 March 1946; [Architectural Drawing] NCP File 807_84242; NPS-NCR Collection.

²⁵ "Proposed Chlorinating Plant for Condensing Water Tunnel," 2 September 1939; [Architectural Drawing] File 74-21-9; NCP 807; RG 79; Cartographic and Architectural Records, LICON, Special Media Archives Division, National Archives at College Park, College Park, Md.

²⁶ In this letter, Mr. Ward asks permission to cut through a roadway in connection with the work he is doing on the chlorination plant at the Survey Lodge. It includes no further information on Mr. Ward's involvement with the chlorination plant. Heman S. Ward, to Superintendent, National Park Service, 13 May 1940; NPS-NCR Collection; Hartman-Cox Architects, *Visitor Facility for the Washington Monument, Washington D.C. Comprehensive Design Program and Engineering Feasibility Design Program*, 20 September 1973; NPS-NCR Collection.

²⁷ "Survey Lodge 'The Boiler House,'" n.d.; NPS-NCR Collection.

²⁸ Hartman-Cox Architects, *Visitor Facility*, 20 September 1973; National Capital Parks - Central, "Development Concept Plan and Alternatives, Washington Monument," September 1981; National Park Service, "Development Concept Plan: Washington Monument Grounds (Revisions to the 1981 Development Concept Plan)," April 1989.

²⁹ Aaron V. Wunsch, *Washington Monument, HABS No. DC-42* (Washington, D.C.: U.S. Department of the Interior, National Park Service, Historic American Buildings Survey, 1994).

³⁰ Donald C. Phanz, "Washington Monument." *National Register - Documentation of Existing National Register Property* (Washington, D.C.: Department of the Interior, National Park Service, 1980).

³¹ Albert E. Cowdrey, *A City for the Nation: The Army Engineers and the Building of Washington, D.C., 1790-1967* (Washington, D.C.: Historical Division, Office of Administrative Services, Office of the Chief of Engineers, 1979).

³² From the records for construction of the Washington Monument, it appears that Casey was promoted to a full Colonel from Lieutenant Colonel shortly before his promotion to Chief of Engineers.

³³ U.S. Army Corps of Engineers, "Brigadier General Thomas Lincoln Casey," <http://www.hq.usace.army.mil/history/coe2.htm>, accessed 25 June 2003.

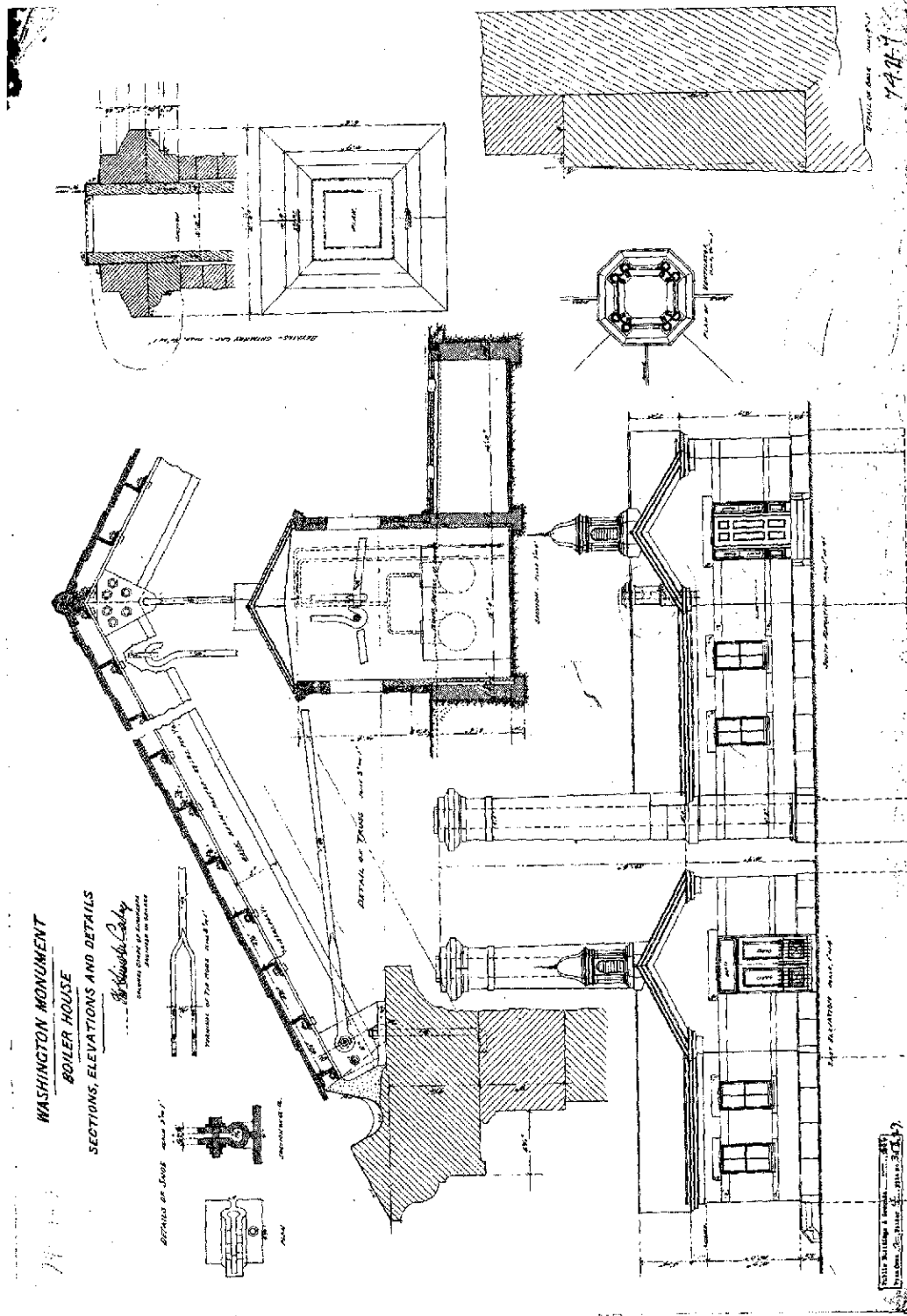

Figure 2.1: Washington Monument Boiler House Sections, Elevations and Details, 1886. ([Architectural Drawing] File 74-21-7; NCP 807; RG 79; Cartographic and Architectural Records LICON, Special Media Archives Division, National Archives at College Park, College Park, Md.)

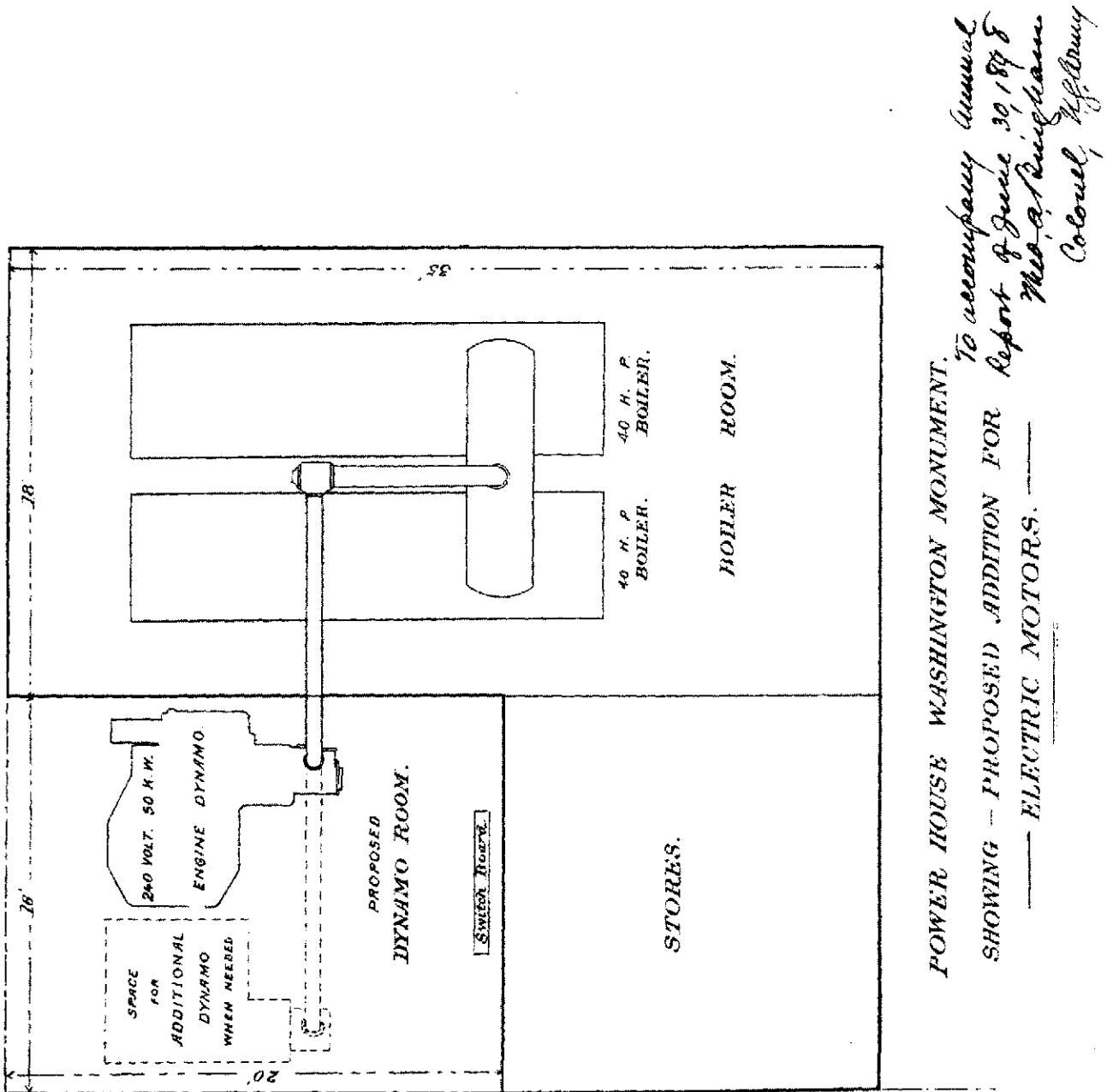

Figure 2.3: Power House Washington Monument Showing Proposed Addition for Electric Motors, 1898. (Annual Report Upon the Improvement and Care of the Public Buildings and Grounds, and Care and Maintenance of the Washington Monument in the District of Columbia, by Theo. A Bingham, Capt. Corps of Engineers, Col. U.S.A., Being Appendix C of the Annual Report of the Chief of Engineers for 1898, Washington, D.C.: GPO, 1898.)

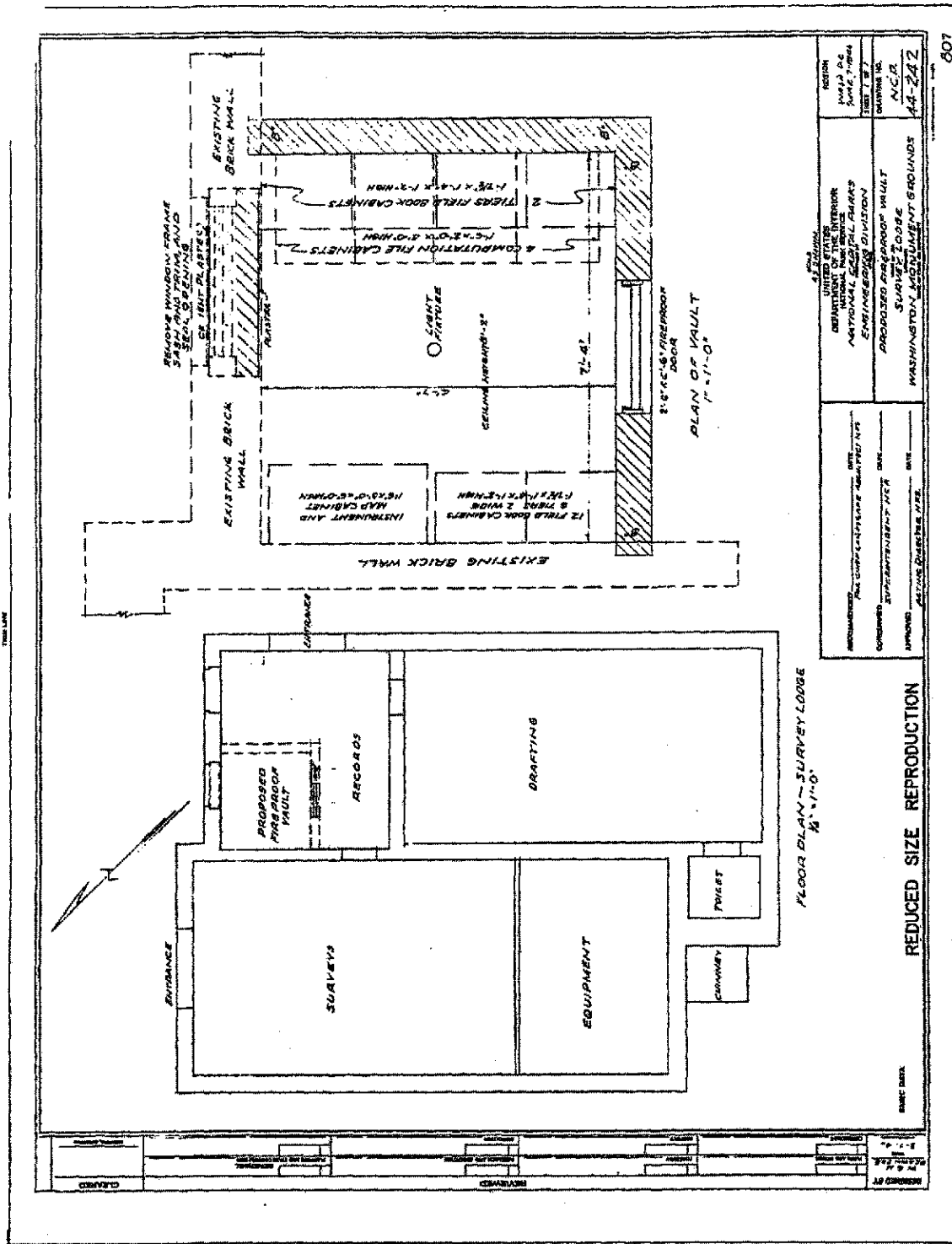

Figure 2.5: Proposed Fireproof Vault Survey Lodge Washington Monument Grounds, 7 March 1946. ([Architectural Drawing] File 807_84242; Technical Information Center, Denver Service Center, National Park Service.)



Figure 2.6: Ca. 1909-1932 photograph of the Survey Lodge (Prints and Photographs Division, LC-USZ62-107739, Library of Congress, Washington, D.C.)



Figure 2.7: July 7, 1932, photograph of a survey crew outside the Survey Lodge. Note the metal screens over the windows and the hexagonal asphalt shingle roof (NPS-NCR Collection).

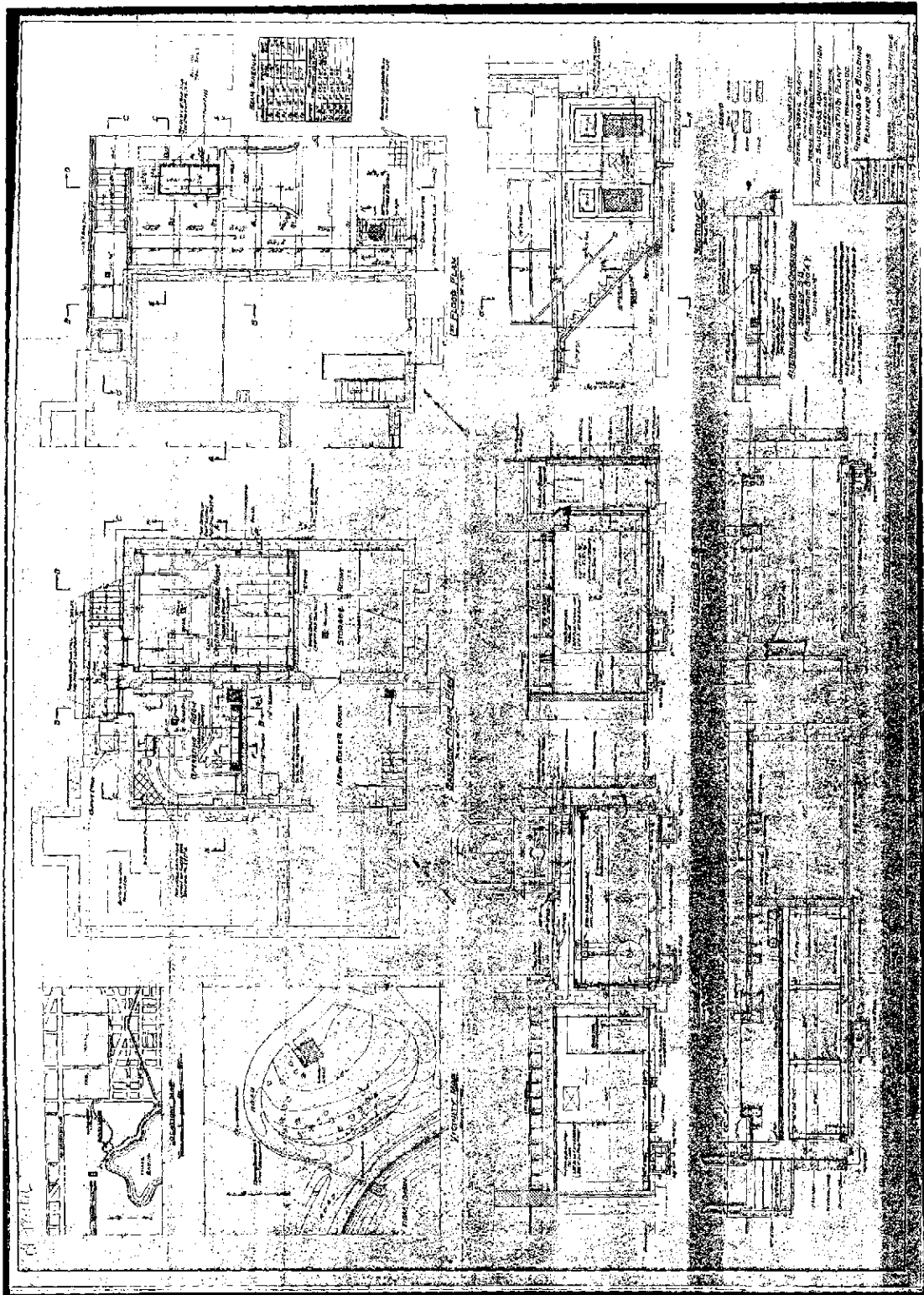

Figure 2.9: Chlorinating Plant Survey Lodge – Washington, D.C., Approved 2 February 1940.
([Architectural Drawing] File 74-20-10, NCP 807; RG 79; Cartographic and Architectural Records
LICON, Special Media Archives Division, National Archives at College Park, College Park, Md.)

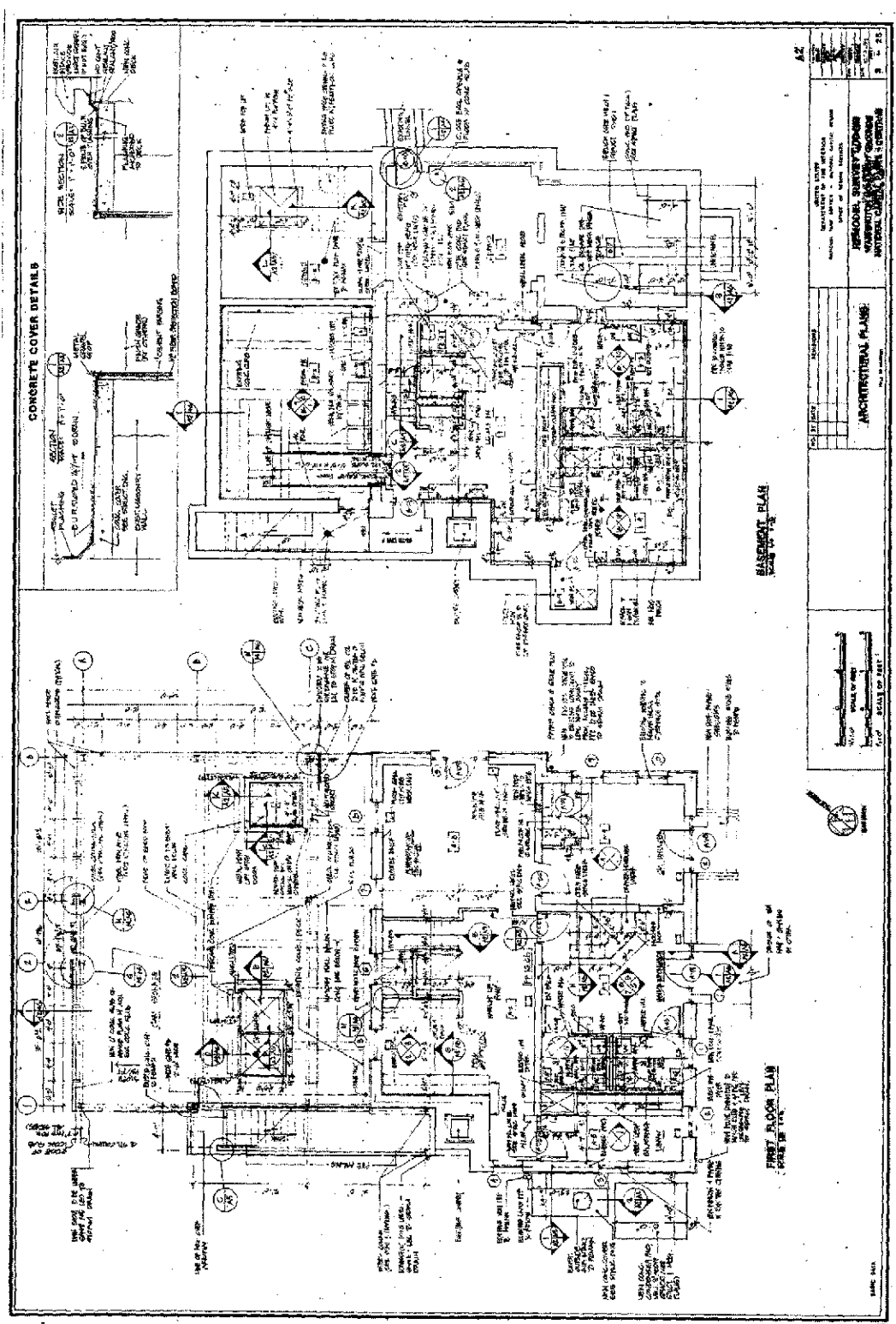

Figure 2.10: Architectural Plans, Remodel Survey Lodge Washington Monument Grounds, 3 August 1989. (Drawing 807_80116, Sheet 3 of 25, Drawing A2, Denver Service Center, National Park Service.)

1
2
3
4
5
6
7
8
9
10
11
12
13
14
15
16
17
18
19
20
21
22
23
24
25
26
27
28
29
30
31
32
33
34
35
36
37
38
39
40
41
42
43
44
45
46
47
48
49
50
51
52
53
54
55
56
57
58
59
60
61
62
63
64
65
66
67
68
69
70
71
72
73
74
75
76
77
78
79
80
81
82
83
84
85
86
87
88
89
90
91
92
93
94
95
96
97
98
99
100

Part I - Developmental History

CHAPTER THREE
CHRONOLOGY OF DEVELOPMENT AND USE

1
2
3
4
5
6
7
8
9
10
11
12
13
14
15
16
17
18
19
20
21
22
23
24
25
26
27
28
29
30
31
32
33
34
35
36
37
38
39
40
41
42
43
44
45
46
47
48
49
50
51
52
53
54
55
56
57
58
59
60
61
62
63
64
65
66
67
68
69
70
71
72
73
74
75
76
77
78
79
80
81
82
83
84
85
86
87
88
89
90
91
92
93
94
95
96
97
98
99
100

CHAPTER THREE

CHRONOLOGY OF DEVELOPMENT AND USE

Sited approximately 750 feet to the southwest of the Washington Monument, the Survey Lodge has supported the functions of the Washington Monument from its construction in 1886 almost uninterrupted to the present day. The original 1886 ell-shaped structure was constructed as a Boiler House for the monument and housed two coal-fired boilers, connected to the monument's engine room through a steam tunnel, which fueled the monument's elevator steam engine. In 1901, the original ell-shaped structure was expanded to its current rectangular footprint to accommodate a new electric dynamo and engine for the elevator and became known as the Power House. When the monument was connected to the public power supply in 1923, the Power House became redundant. Starting in 1926, the building served the staff of the Office of Public Buildings and Public Parks, and later the National Park Service, in some capacity. The structure became known as the Survey Lodge in the 1930s when it was home to the National Park Service survey crews. During the 1940s–1970s, parts of the Survey Lodge may also have served as a chlorination plant. From the 1970s to the present, the Survey Lodge has provided support facilities for Mall Operations staff of the National Park Service. The Survey Lodge underwent an extensive rehabilitation in 1989–993 that involved renovation of the interior and restoration of the exterior for its current use as a staff office and visitor contact facility.

3.1 1886–1923: POWER PLANT FOR WASHINGTON MONUMENT

From the date of its completion in 1886 until 1923, the Survey Lodge, known as the Boiler House from 1886–1900 and the Power House from 1901–1923, provided the energy that fueled the Washington Monument elevator. The construction history of the Boiler House was intimately tied to the mechanics of the elevator in the monument, which dictated the use of the structure during 1886–1923. From 1886 to 1901, the original 1886 ell-shaped structure provided space for the two coal-fired boilers that fueled the monument's elevator steam engine, housed in the monument's engine room. In 1901, the Boiler House became known as the Power House when the original ell-shaped structure was expanded to its current rectangular plan in order to house a new electric dynamo and engine for the monument's new electric-powered elevator.

3.1.1 1886–1901: BOILER HOUSE

Thomas Lincoln Casey, Engineer in Charge of the completion of the Washington Monument, contracted William Bradley on October 22, 1885, to construct the Boiler House and Coal Vaults at a cost of \$6,994.58.¹ The Boiler House, completed June 30, 1886, was a one-story ell-shaped masonry structure with a substantial chimney, and an iron-truss-supported, slate-shingled, cross-gabled roof with a cupola-shaped ventilator (see figures 3.1 and 3.2).² The structure was sited with the interior of the ell facing south. The main chimney projected from the west end of the southwest elevation. The interior of the Boiler House contained a full basement, with a two-story

boiler room, an ash vault in the basement to the east, a workroom above the ash vault, and a 90-ton capacity, sub-grade coal vault to the northwest, located outside the footprint of the above-grade structure.

The Boiler House was constructed on stone footings with stone foundation walls. All of the exterior walls, excepting those of the ash and coal vaults, were of double masonry construction, lined with brick on the interior and stone on the exterior, with an air space in between. The ash and coal vault areas had a single masonry wall. According to the 1885 specifications, the masonry walls below ground were to have "good smooth faces on both sides, using the stone to be obtained from the refuse Marble and Granite at the monument. Joints to be close, thoroughly filled and pointed on both sides with mortar."³ Above ground, the exterior masonry was constructed of "White Marble and Granite, to be obtained from the waste of the stock used in building the monument, and now lying on the ground near the base."⁴ The exterior masonry consisted of "broken white marble ashlar, with pitched joints and quarry faces, jointed with set square, no stone to exceed 10 inches by 18 inches in size, all quoins to be selected of the large sizes and laid with rustic bond." In contrast to the marble, the water table course, window and door sills and heads, door steps, two belt courses, and cornice were built of granite with a patent bush-hammered finish.⁵ The masonry was laid and pointed with a hydraulic cement mortar. Joints in the marble were tooled to a 3/8-inch-wide, raised, half-round joint; the granite was to be laid with "close, neat joints, well pointed and lined with a grooving tool."⁶ The interior of the main chimney was lined with brick leaving an air space between the brick and exterior masonry with header bricks that tied into the masonry at short intervals. The chimney capstones were anchored down and clamped together with an iron plate.

The southeast elevation contained three bays: two window bays at the west ell and the main entrance to the Boiler House at the east portion of the ell. Each window bay contained a two-over-two, double-hung window in a box frame fitted with Morris sash locks. Three granite steps with low cheek walls led to the main entrance comprised of a six-raised-panel door hung on bronze hinges between two-light sidelights. The front door was fitted with a "suitable gong bell."⁷ The southwest façade had two bays: a two-over-two double-hung window at the east portion of the ell while the west portion of the ell was dominated by the large chimney. The northwest façade was punctuated by four two-over-two double-hung windows. The northeast façade was divided in three bays: two two-over-two double-hung windows to the east and an overlook into the boiler room to the west consisting of double glazed doors with a single transom light. A wrought-iron guardrail blocked access to this overlook.

The cross-gable roof was supported on cast-iron trusses formed with two iron strut beams bolted together at the peak and stabilized with a tie-rod tie beam. The horizontal tie-rod tie beam was kept in tension by a hooked, vertical iron tie-rod. The vertical tie-rod was bolted at the top end to the peak while the bottom hooked onto the center of the horizontal tie beam. The trusses were set in shoes and anchored to the top of the exterior walls. Iron purlins were bolted to the strut beams. The 10-inch by 18-inch by 1/4-inch-thick, split Bangor slates were attached directly to the iron roof purlins with copper wire. The wood ridge pole was covered with six-pound sheet lead. Built-in gutters and roof valleys were flashed with tin. The roof was drained by through-gutter, 3-inch corrugated, galvanized-iron downspouts at the west and south. The boiler pit was ventilated through a ventilator located over the east end of the boiler pit. The galvanized-sheet-

iron ventilator was housed in an octagonal wood cupola decorated with half-round pilasters at each of the corners and topped with a metal, articulated bell roof. A smaller chimney was located at the inner corner of the ell to vent the toilet in the workroom below.

The sub-grade coal vault roof was spanned by a series of segmental brick arches supported on 10½-inch iron I-beams. At grade on the exterior, the coal vault roof was edged with granite curbing and topped with asphalt laid flush with the top of the curb.

The interior of the Boiler House was dominated by the boiler-room space, occupying two stories from basement to roof in the northwest portion of the ell. The remaining portion of the ell on the east was occupied by an ash vault at the basement level and a workroom on the first floor. The workroom had a small toilet and closet on the northwest wall and stairs that led down to the boiler room on the northeast. The interior partition walls were brick, with the exception of closet walls, which were plaster on lath. The plaster of the workroom walls, a lime plaster reinforced with ox hair, was applied directly onto the masonry or lath. The workroom floor was framed with 2-by-12-inch floor joists, reinforced with one row of bridging, and covered with tongue-and-groove wood flooring. The ceiling in the workroom was plaster applied to wood lath nailed to wood ceiling joists. The interior of the workroom was most likely finished with a calcimine paint.⁸ The toilet, located in the west corner of the workroom, was fitted out with a porcelain hopper water closet with flush tank and a 15-inch porcelain wash basin. The plumbing was a mixture of 5-inch terracotta pipe and 4- and 2-inch cast-iron pipe. The stairs were constructed of Georgia or North Carolina pine with an ash newel post.

In the basement, the walls of the boiler room were finished with whitewash.⁹ The floors of the coal vault and boiler room were paved with bricks in a herringbone pattern, laid on edge in a bed of sand. In the ash vault, the floors were brick, also in a herringbone pattern, but laid flat. Joints in the brick paving were grouted with a cement mortar. The doorway between the boiler room and the coal vault had sliding wood doors hung from overhead iron tracks.

The boiler pit was equipped with two coal-fired boilers, which created the steam that fueled the steam engine located in the engine house of the monument. The live and exhaust steam was run through pipes laid in an underground steam tunnel connecting the boiler and engine houses. The steam tunnel was constructed by Haliday and Wilson, contractors, who were simultaneously laying the flagstone paving on the first-floor level of the Washington Monument. The tunnel, which was 3 feet wide and 4 feet 3 inches tall with a concrete floor and brick vault and side walls, was completed in June 1886. The steam tunnel entered the boiler pit at the north corner. Contractor John Lyon set the boilers and laid the pipes in October 1886 under a contract worth \$3,996.80.¹⁰ A 1½-inch-diameter water pipe was run to the tunnel near its center and from there branched to provide both the boiler and engine houses with water.¹¹ The intended pressure units for the original boilers are not known; however, in 1902, it was noted that the boiler pressure was reduced from 80 to 70 pounds per square inch (psi).¹²

3.1.2 1901-1923: POWER HOUSE

By 1898, plans were being laid to replace the inefficient steam engine powering the monument elevator with an electric dynamo, housed in an addition to the Boiler House.¹³ An 1878 text noted that steam engines of the period required five times the theoretical energy required to perform a unit of work because of heat loss. Steam boilers alone only utilized three-fourths of the

energy from burning coal, losing one-fourth to heat loss.¹⁴ The situation was exacerbated at the monument by the 800 feet of pipe carrying steam between the boiler pit and the elevator engine. It was reported that one boiler was utilized almost solely to keep these pipes hot.¹⁵ Much of the energy was lost through condensation of steam in these pipes and through the inefficiency of the old steam engine. In 1900, it was estimated that it would be cheaper to produce energy on site rather than connect to a private company, especially considering that the closest public electricity connection was 2,000 feet from the monument.¹⁶

The new electric dynamo and generator would be installed in an addition to the Boiler House, thereby removing the long distance between the boiler and engine in the previous arrangement. The motor, condenser, and air pump for the new electric elevator system would be housed in the monument engine room, renamed the motor room. Funds were appropriated and bids tendered in 1900. The old steam elevator was removed and construction in both the Washington Monument and Boiler House, soon to be known as the Power House, proceeded.¹⁷

In 1901, an addition was constructed within the interior ell of the 1886 structure for the new electric dynamo and engine creating the present rectangular footprint (see figures 3.3 and 3.4). The southeast wall of the 1901 addition, constructed of a masonry wall with brick backup on the interior, was made flush with the east ell of the 1886 structure. The southwest wall of the addition, constructed of brick and covered with stucco, projected past the chimney, terminating at the southeast side of the chimney. It is probable that masonry from the 1886 structure was salvaged for use in the southeast façade, as there is no color change in the stones of the 1886 and 1901 constructions. It is assumed that there was not enough salvage material to cover the stuccoed southwest wall. The small chimney on the east portion of the ell was probably also dismantled at this date. The completed southeast façade now had four bays: three new windows in the new addition and the existing doorway on the east from the 1886 construction. The southwest façade had one window in the new addition.

The gable roof with iron-truss construction was continued in the 1901 addition. The new addition was covered with a new end gable roof that paralleled the 1886 roof, creating a valley between the two peaks. Slates were attached directly onto the purlins as in the earlier construction.

On the interior, the new addition offered one large, two-story space for the new machinery. A new toilet was tucked into the west corner next to the 1886 chimney.

The Power House was routinely refinished and the equipment overhauled. At least one of the original boilers continued to fuel the electric dynamo and engine from 1901–1904. In 1904, the two original boilers were replaced with 80-horsepower, horizontal-return, tubular boilers.¹⁸ A cement apron for handling the ashes from the boiler room was built at the southwest side of the Power House in 1907–1908.¹⁹ The asphalt roof over the coal vault was replaced with a cement roof in 1910–1911.²⁰ The Power House retired from its role as a power generator for the monument in 1923 when the monument and grounds were connected to the public power-supply system.

3.2 1924–PRESENT: OFFICES AND CHLORINATION PLANT

After 1923, the role of the now redundant Power House is unclear. In 1926, the Design and Construction Division of the Office of Public Buildings and Public Parks was given “the old power plant for the Monument,” apparently for office space.²¹ As part of the reorganization of government lands in 1933, the old power plant came under the administration of the National Park Service. The building acquired the name Survey Lodge after its use by survey crews of the National Park Service in the 1930s.²² Around 1932, the slate roof and cupola ventilator were removed and a hexagonal-tab asphalt-shingle roof was installed (see figure 3.5).²³ At some date prior to 1940, wood floors and stairs were installed in order to divide the formerly open boiler pit and electric dynamo areas into two floors.

There were proposals to convert the structure into a chlorinating plant in 1939. An approved 1940 plan shows an operating room equipped with chlorinators, located in the southwest third of the former boiler pit basement, and a chlorine storage room equipped with cradles for drums, located in the southwest half of the coal vault (see figures 3.6 and 3.7). Contractor Heman S. Ward was working on the chlorination plant in May of 1940.²⁴ Some alterations that are shown in the 1940 drawings were made and remain today. These include the construction of the concrete stair and basement entrance, located at the west corner of the Survey Lodge, and installation of the trap door opening, now skylight, over the coal vault.²⁵ Other alterations shown in the 1940 drawings were removed during later renovations. These include quarry tile laid in the basement floors and a brick partition wall erected at the basement level of the boiler room. It is not clear how long the chlorination plant was in operation; by 1973, the Washington Monument Visitor Facility Comprehensive Design Program recommended removal of the chlorination tanks, which were presumably no longer in use.²⁶

Little is known of the use and condition of the Survey Lodge from 1940–1985. A second three-tab asphalt-shingle roof was installed at the Survey Lodge in the 1960s.²⁷ An additional window was installed on the southwest façade at some point between 1939–1988. In the early 1970s, the Survey Lodge was converted to the National Park Service Mall Operations Office in order to house support staff who oversaw and managed the monuments and memorials on the mall.²⁸ By the 1980s, the lodge was also serving as a visitor contact center.

In 1985, a report on the Survey Lodge recommended immediate measures to halt ongoing damage to wood floor joists by termites. The termite infestation was well established at this point and had compromised the structural integrity of the wooden floors and beams.²⁹ By 1987, it was recognized that the Survey Lodge would have to be abandoned due to structural deterioration if repairs were not made. The wood floors, though temporarily shored in 1985, were almost completely destroyed by termite damage. No other accommodation existed for Mall Operations staff and temporary trailers were required during rehabilitation of the lodge.³⁰

A rehabilitation project began in 1989 and was not complete until early 1993 (see figure 3.8). The 1960s asphalt roofing tiles were removed, the sheathing was repaired, and a new slate-shingle roof was installed over the original iron-truss system. The cupola was reconstructed based on historic documentation. The easternmost window bay on the southeast façade, adjacent to the 1886 entrance, was converted into the main entrance doorway. The original 1886 entrance was no longer used as a main entrance. The interior work included complete removal of wood

floor systems, repair and replacement of window and door framing, removal of deteriorated plaster from masonry, and removal of the wood stairs added c. 1940. The interior was completely retrofitted with new concrete floors, stairs, and modern finishes (the new finishes are described in detail in Chapter 4 of this report). The site was improved with new walks and landscaping. A steel column and beam utility shed with alternating wood board walls and a corrugated galvanized steel gable roof was constructed in 1989 to the northwest of the Survey Lodge, over the former coal vault. The utility shed is used to store maintenance equipment, supplies, and vehicles. The rehabilitated Survey Lodge currently provides office space, lockers, a break room, and maintenance storage for Mall Operations staff and volunteers, as well as providing rest room facilities and park information for visitors.

ENDNOTES

Abbreviations:

- E 484 Letters Received, Entry 484: Records of the Joint Commission for Completion of the Washington Monument, 1876–1892
- NAB National Archives Building, Washington, D.C.
- RG 42 Records of the Office of Public Buildings and Public Parks of the National Capital, Record Group 42
- RG 79 Records of the National Park Service, Record Group 79

¹ Thomas Lincoln Casey, Engineer in Charge of the Washington Monument. "Advertisement and Specifications for Boiler House at the Washington Monument." 3 October 1885; Contracts, Entry 512; Records of the Joint Commission for Completion of the Washington Monument; RG 42; NAB.

² Col. Thomas Lincoln Casey, Engineer in Charge of the Washington Monument, to Brig. Gen. J.C. Duane, Chief of Engineers, "Report of Operations Upon the Washington Monument for the Year 1886," 20 December 1886; E 484; RG 42; NAB.

³ Casey, "Specifications for Boiler House," 2.

⁴ Casey, "Specifications for Boiler House," 1.

⁵ A patent bush-hammered finish indicated a surface texture of stone dressed with short, parallel scoring lines with 4–8 cuts in 7/8-inch: used especially on granite. Originally cut with a patent hammer with a head holding a series of adjustable chisels. From *Dictionary of Building Preservation*, Ward Bucher, ed. (New York: John Wiley & Sons, Inc., 1996): 327.

⁶ Casey, "Specifications for Boiler House," 2–3.

⁷ Casey, "Specifications for Boiler House," 6.

⁸ Oswald H. Ernst, "Appendix BBB: Annual Report upon the Improvement and Care of the Public Buildings and Grounds, and Care and Maintenance of the Washington Monument in the District of Columbia" in *Annual Report of the Chief of Engineers for 1892*, Washington, D.C.: GPO, 1892.

⁹ John M. Wilson and Oswald H. Ernst, "Appendix CCC: Annual Report upon the Improvement and Care of the Public Buildings and Grounds and Care and Maintenance of the Washington Monument in the District of Columbia" in *Annual Report of the Chief of Engineers for 1893*, Washington, D.C.: GPO, 1893.

¹⁰ Cascy to Duane, "Report of Operations," 20 December 1886.

¹¹ Thomas Lincoln Casey, Engineer in Charge of the Washington Monument, to Joint Commission for Completion of the Washington Monument, "Report of Operations Upon Completion of the Washington Monument for the Month of October 1886," 3 November 1886; E 484; RG 42; NAB.

¹² William A. Craig, Custodian, to Theodore A. Bingham, Major, Corps of Engineers, "Report of Operations on the Washington Monument for the month ending November 30th, 1902," 1 December 1902; Monthly Reports of Operations, Entry 538; Records of the Custodian, 1879-1929; Records of the Engineer in Charge of the Monument, 1879-1929; RG 42; NAB.

¹³ Col. Theodore A. Bingham, "Appendix CCC: Annual Report upon the Improvement and Care of the Public Buildings and Grounds, and Care and Maintenance of the Washington Monument in the District of Columbia" in *Annual Report of the Chief of Engineers for 1898*, Washington, D.C.: GPO, 1898.

¹⁴ See Robert H. Thurston, *A History of the Growth of the Steam-engine*, New York: Appleton and Co., 1878.

¹⁵ Theodore A. Bingham, "Appendix CCC Annual Report upon the Improvement and Care of the Public Buildings and Grounds, and Care and Maintenance of the Washington Monument in the District of Columbia" in *Annual Report of the Chief of Engineers for 1899*, Washington, D.C.: GPO, 1899.

¹⁶ G.W. Baird, Commander (Chief Eng.) U.S.N. Superintendent, to Col. Bingham, 14 April 1900; RG 42; NAB.

¹⁷ Col. Theodore A. Bingham, "Appendix HHH: Annual Report upon the Improvement and Care of the Public Buildings and Grounds, and Care and Maintenance of the Washington Monument in the District of Columbia" in *Annual Report of the Chief of Engineers for 1900*, Washington, D.C.: GPO, 1900; Theodore A. Bingham, "Appendix DDD: Annual Report upon the Improvement and Care of the Public Buildings and Grounds, and Care and Maintenance of the Washington Monument in the District of Columbia" in *Annual Report of the Chief of Engineers for 1901* (Washington, D.C.: GPO, 1901).

¹⁸ William A. Craig, Custodian of the Washington Monument, to Col. Chas. S. Bromwell, "Report of Operations at the Washington Monument for Month of August 1904," 1 September 1904; Monthly Reports of Operations, Entry 538; Records of the Custodian, 1879-1929; Records of the Engineer in Charge of the Monument, 1879-1929; RG 42; NAB.

¹⁹ Bingham, *Annual Report*, 1900; Maj. Charles S. Bromwell, "Appendix GGG: Annual Report upon the Improvement and Care of the Public Buildings and Grounds, and Care and Maintenance of the Washington Monument in the District of Columbia" in *Annual Report of the Chief of Engineers for 1908*, Washington, D.C.: GPO, 1908.

²⁰ Maj. Spencer Cosby, "Appendix EEE: Annual Report upon the Improvement and Care of the Public Buildings and Grounds, and Care and Maintenance of the Washington Monument and the Highway Bridge Across the Potomac River, Washington, District of Columbia" in *Annual Report of the Chief of Engineers for 1911*, Washington, D.C.: GPO, 1911.

²¹ U. S. Grant, 3d, Director, "General Order No. 67, Office of Public Buildings and Public Parks," 17 June 1926; U.S. Department of the Interior Library, Washington, D.C.

²² "Survey Lodge 'The Boiler House,'" n.d.; NPS-NCR Collection.

²³ Assistant to the Regional Historic Architect, to Chief of Maintenance Division, 4 November 1991; NPS-NCR Collection.

²⁴ Heman S. Ward, to Superintendent, National Park Service, 13 May 1940; NPS-NCR Collection.

²⁵ See "Chlorinating Plant Survey Lodge - Washington, D.C.," Approved 2 February 1940; [Architectural Drawing] File 74-20-10, NCP 807; RG 79; Cartographic and Architectural Records LICON, Special Media Archives Division, National Archives at College Park, College Park, Md.

²⁶ Hartman-Cox Architects, "Visitor Facility for the Washington Monument, Washington D.C. Comprehensive Design Program and Engineering Feasibility Design Program," 20 September 1973; NPS-NCR Collection.

²⁷ Assistant to the Regional Historic Architect, to Chief of Maintenance Division, 4 November 1991; NPS-NCR Collection.

²⁸ "Survey Lodge 'The Boiler House,'" n.d.; NPS-NCR Collection.

²⁹ Carol DiSalvo, Center for Urban Ecology, to Superintendent Central, National Park Service, 10 May 1985; NPS-NCR Collection.

³⁰ 1987 Development/Study Package Proposal No. 138, 3 December 1987; NPS-NCR Collection.

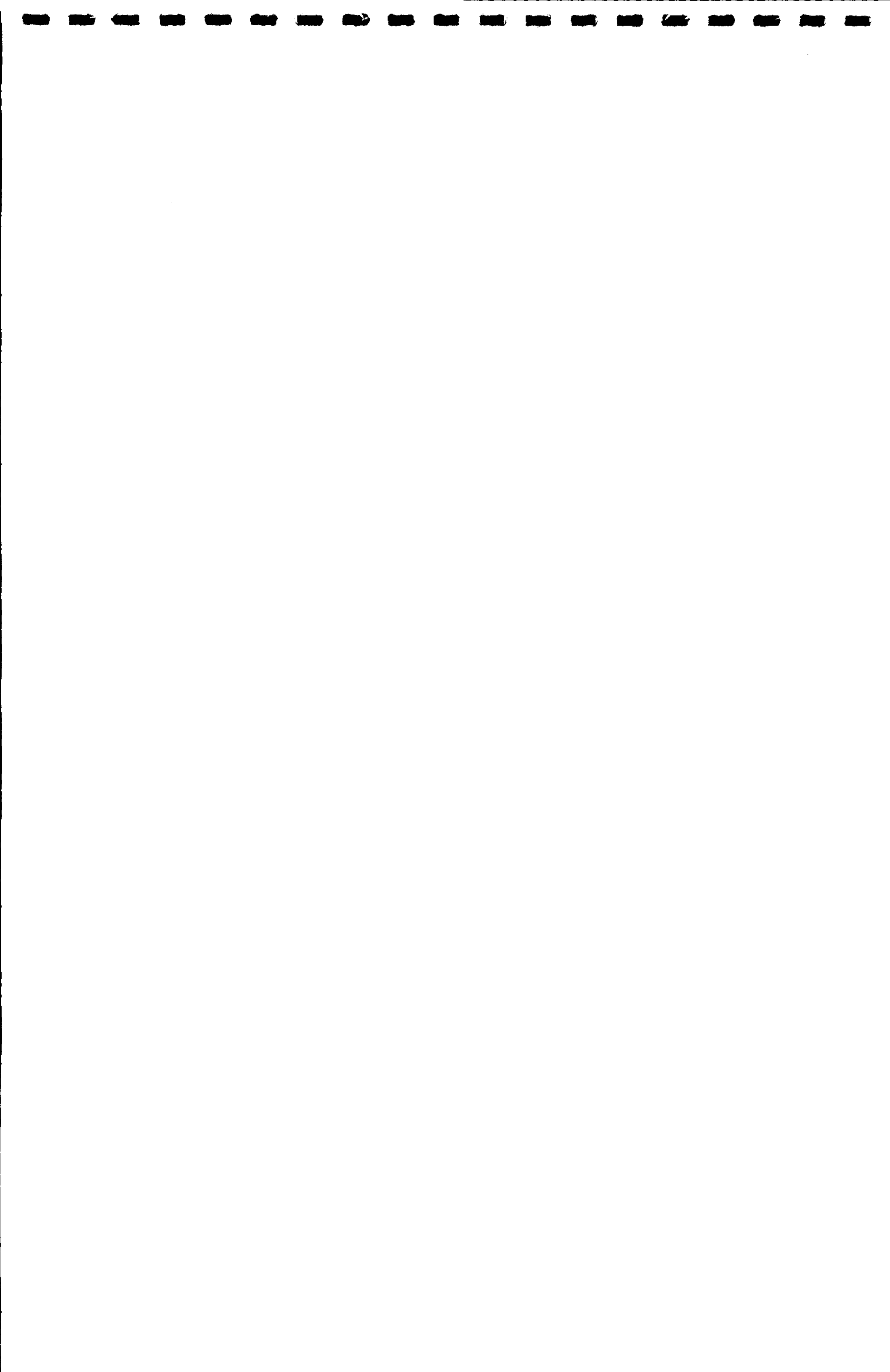

7421-8

WASHINGTON MONUMENT
BOILER HOUSE

PLANS, SECTIONS AND ELEVATIONS

Scale 1/4" = 1'-0"

Shelburne Cady
ARCHITECT

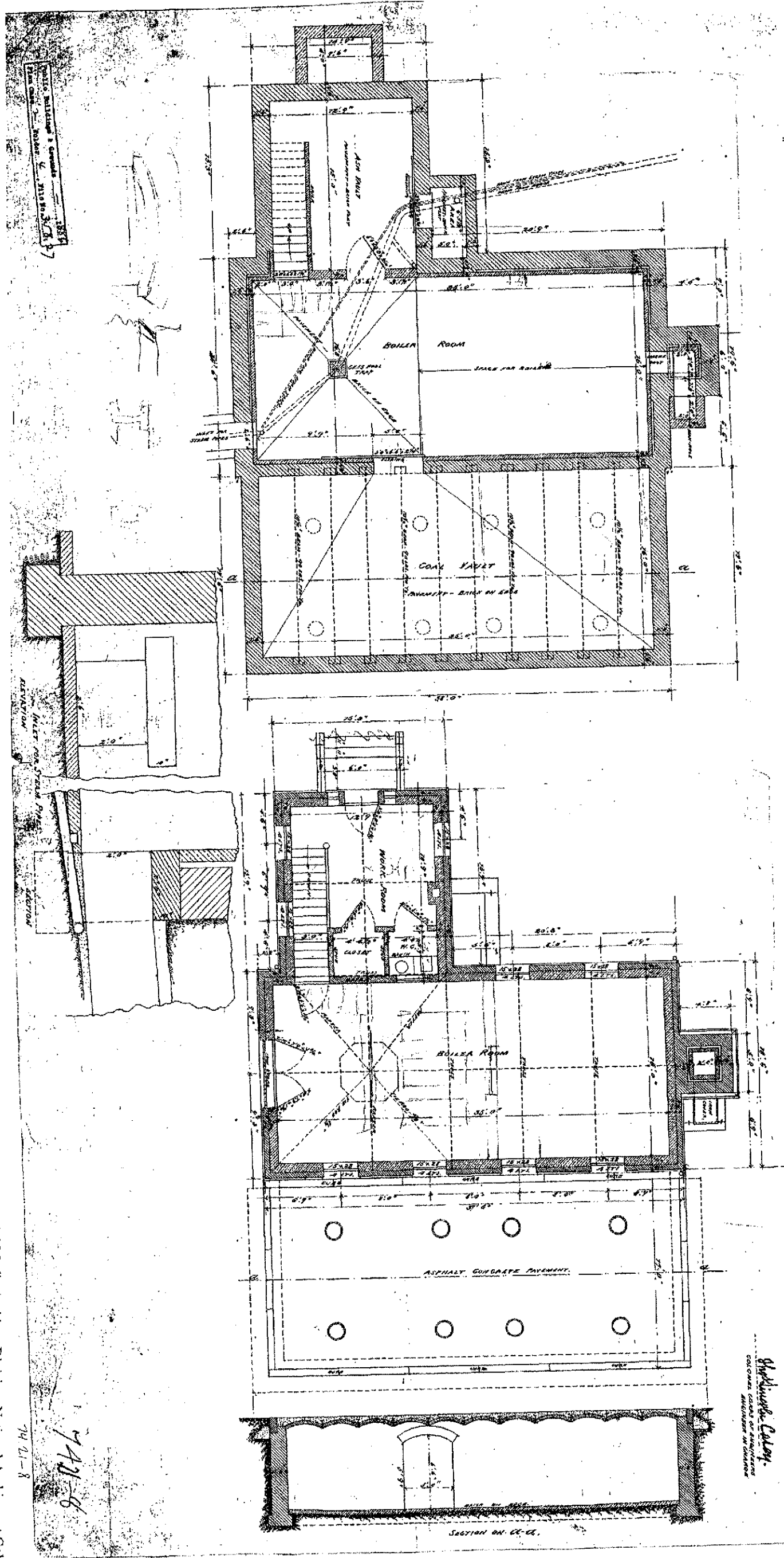

7421-8

Figure 3.2: Washington Monument Boiler House Plans, Sections and Elevations, 1886. (Architectural Drawing] File 74-21-8; NCP 807; RG 79; Cartographic and Architectural Records LICON, Special Media Archives Division, National Archives at College Park, College Park, Md.)

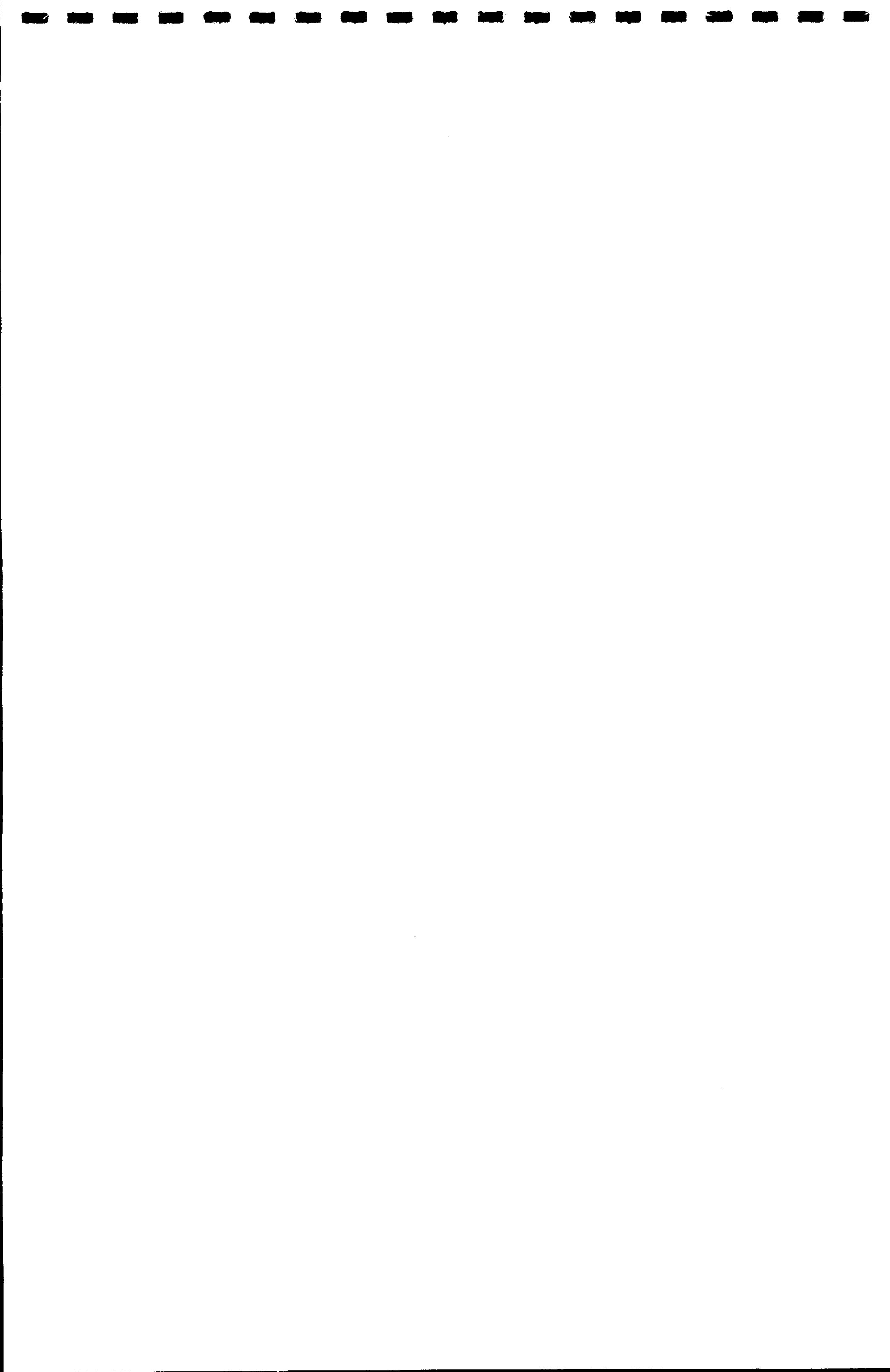

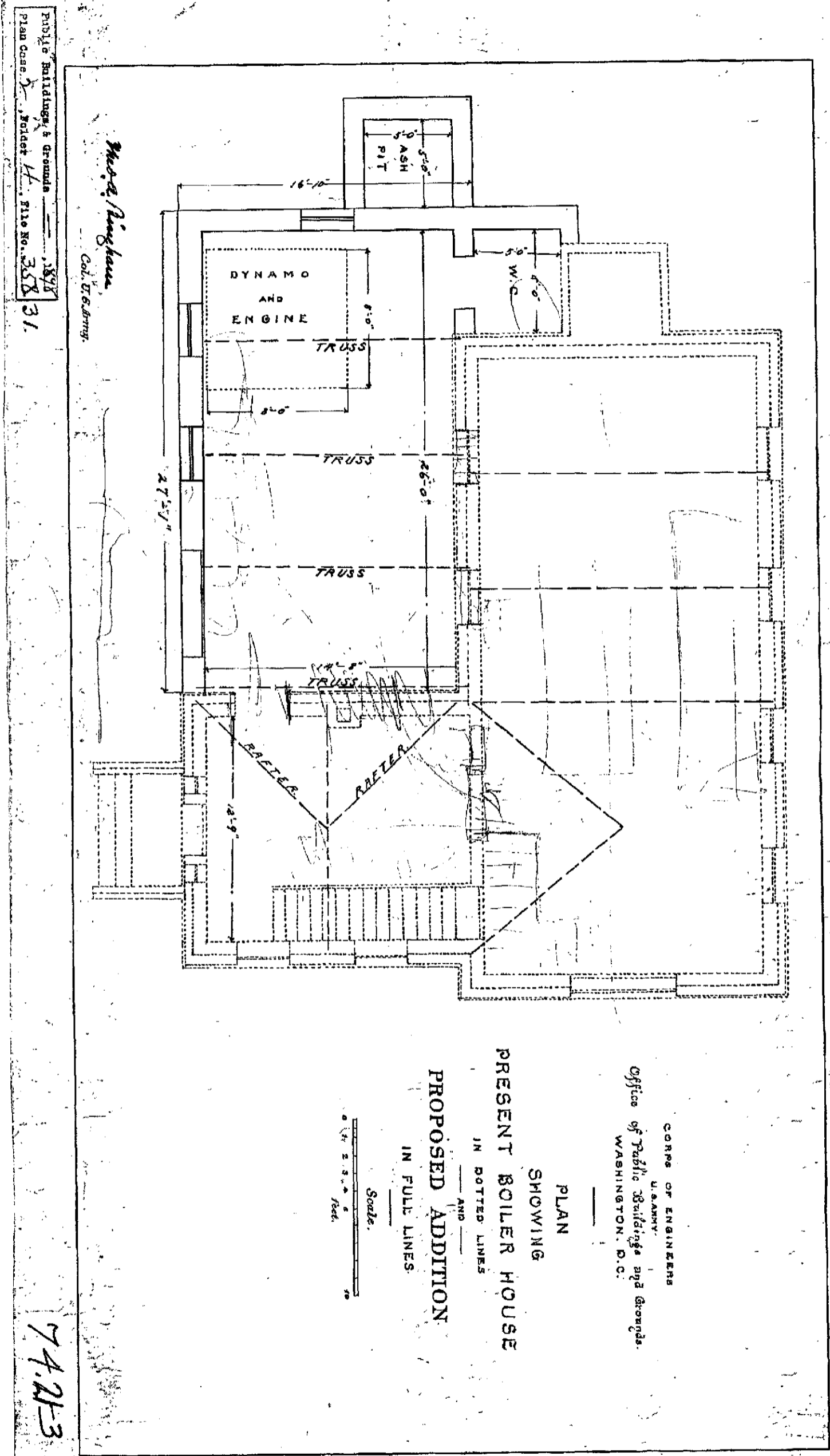

CORPS OF ENGINEERS
 U.S. ARMY
 Office of Public Buildings and Grounds
 WASHINGTON, D.C.

PLAN
 SHOWING
 PRESENT BOILER HOUSE
 IN DOTTED LINES
 AND
 PROPOSED ADDITION
 IN FULL LINES.

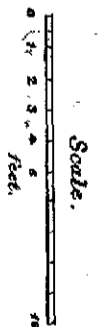

Figure 3.3: Plan Showing Present Boiler House in Dotted Lines and Proposed Addition in Full Lines, 1898. (Architectural Drawing | File 74-21-3; NCP 807; RG 79; Cartographic and Architectural Records IICON, Special Media Archives Division, National Archives at College Park, College Park, Md.)

74.21-3



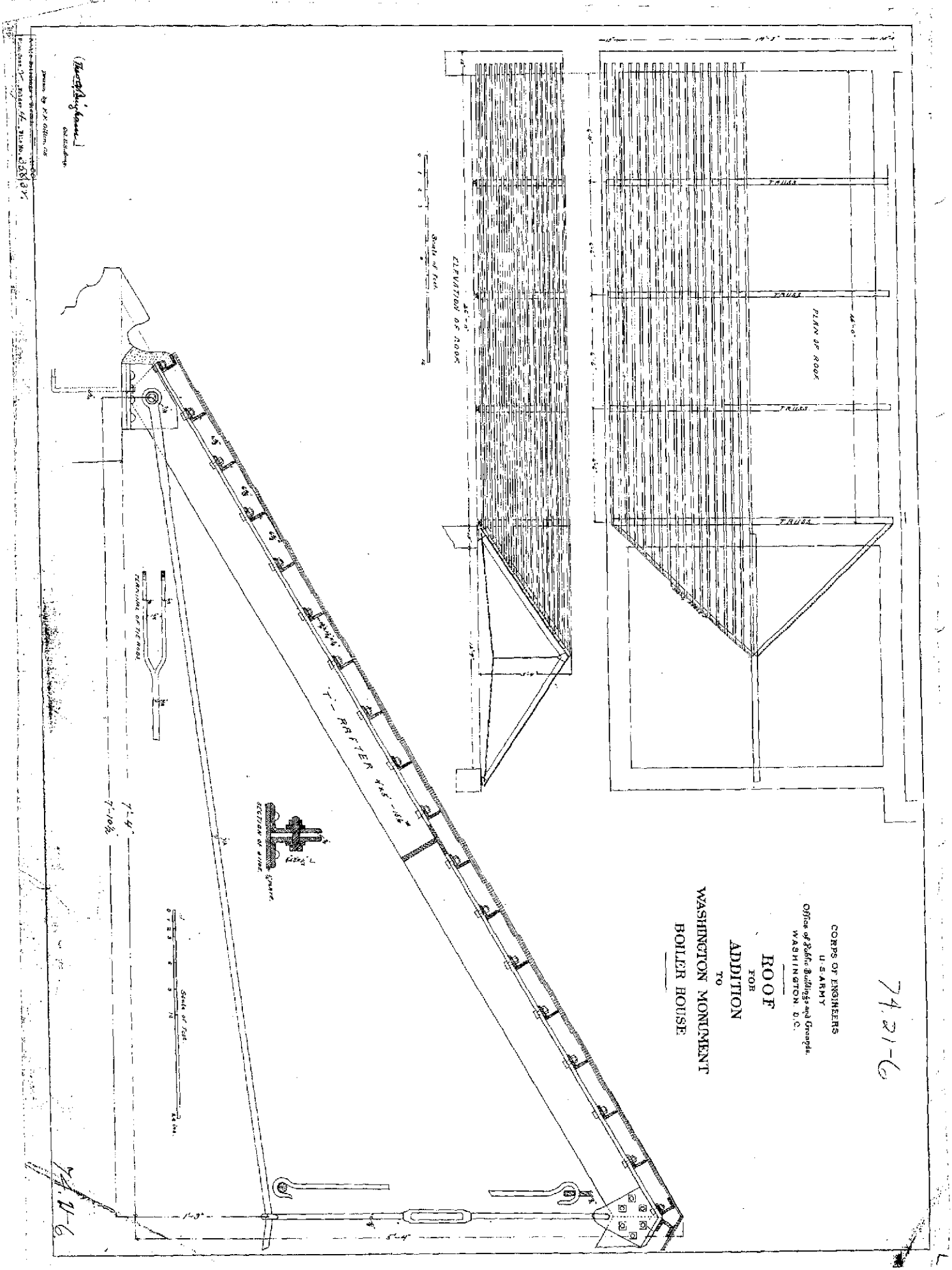
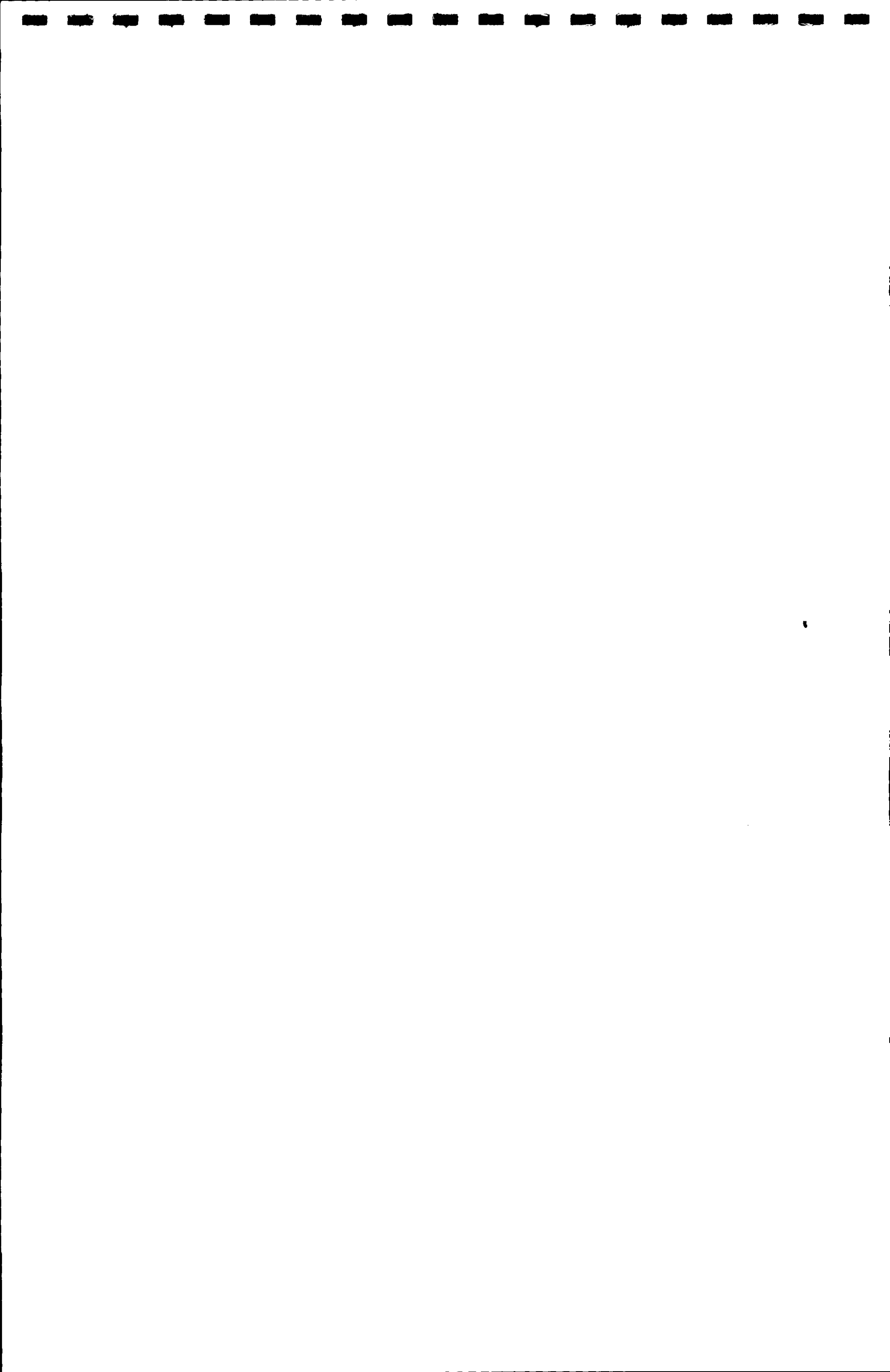

Figure 3.4: Roof for Addition to Washington Monument Boiler House, 1900. ([Architectural Drawing] File 74-21-6; NCP 807; RG 79; Cartographic and Architectural Records LICON; Special Media Archives Division, National Archives at College Park, College Park, Md.)



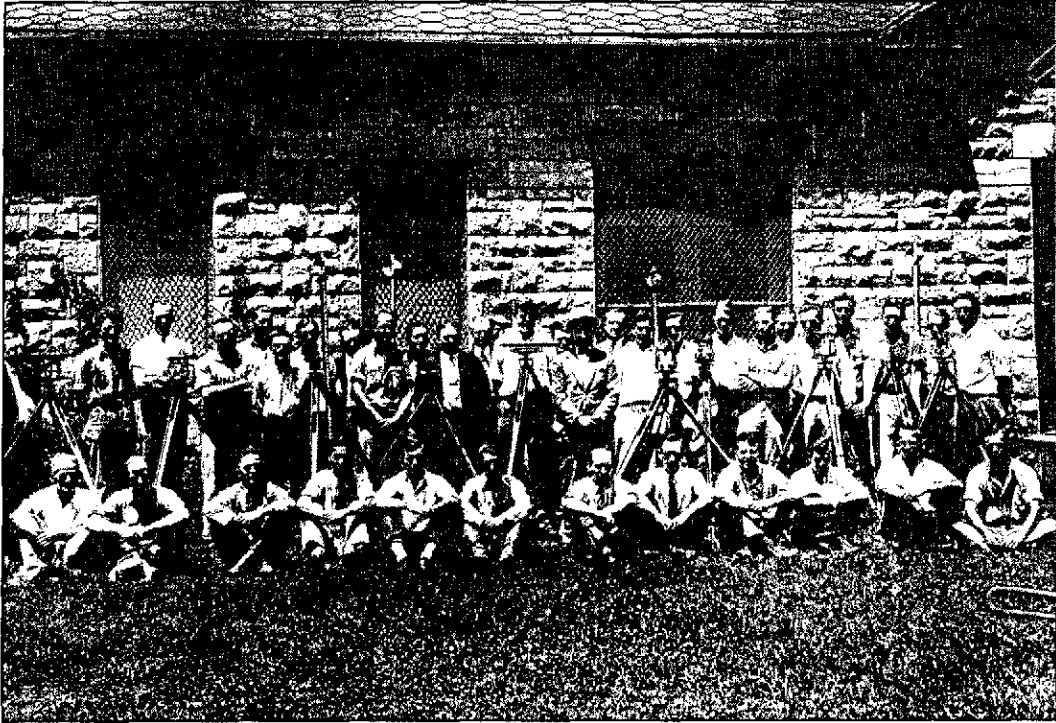

Figure 3.5: July 7, 1932, photograph of a survey crew outside the Survey Lodge. ([Photograph], 7 July 1932; NPS-NCR Collection).



74,21-9

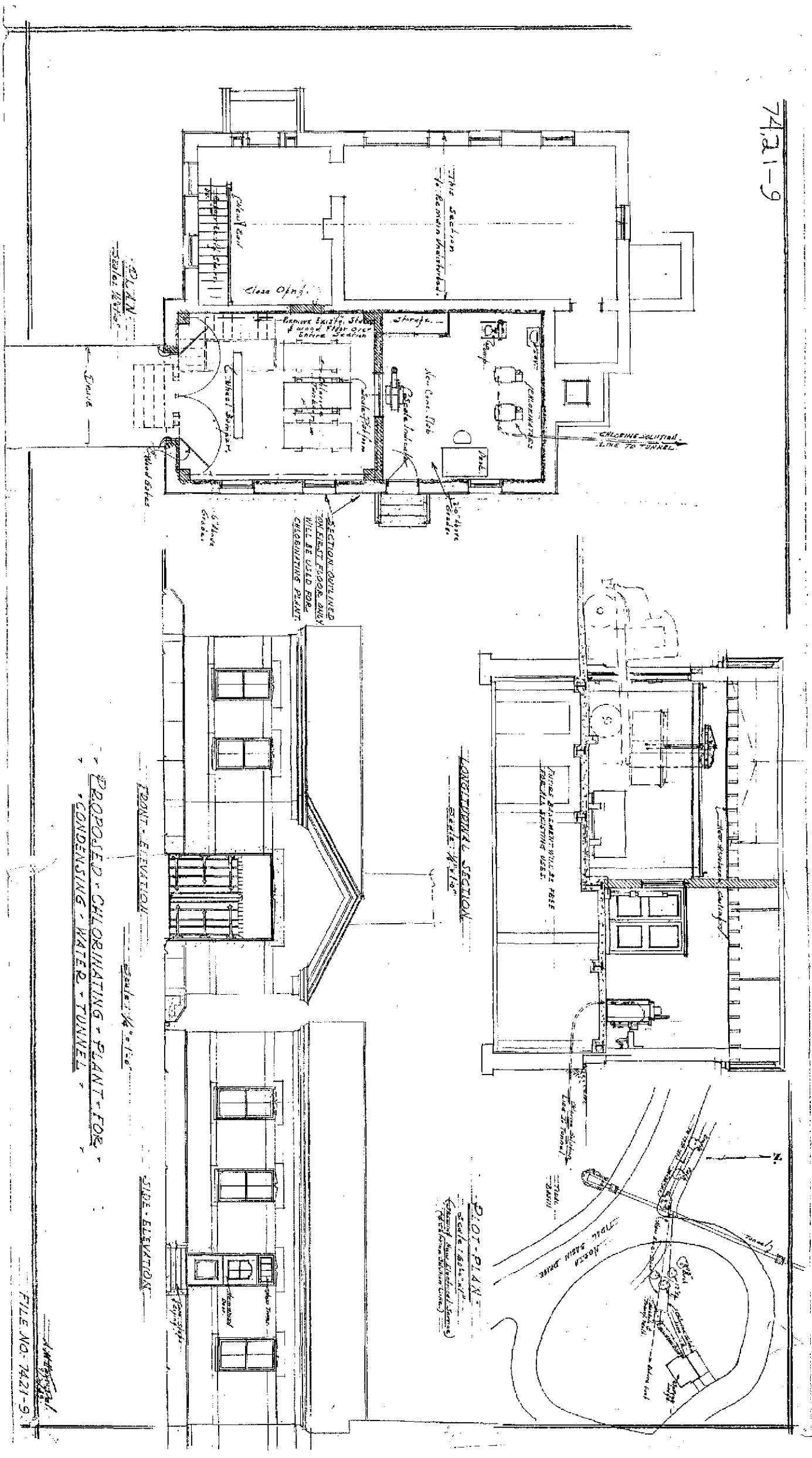

Figure 3.6: Proposed Chlorinating Plan for Condensing Water Tunnel, 2 September 1939, this alternative not built. ([Architectural Drawing] File 74-21-9; NCP 807; RG 79. Cartographic and Architectural Records LICON, Special Media Archives Division, National Archives at College Park, College Park, Md.)



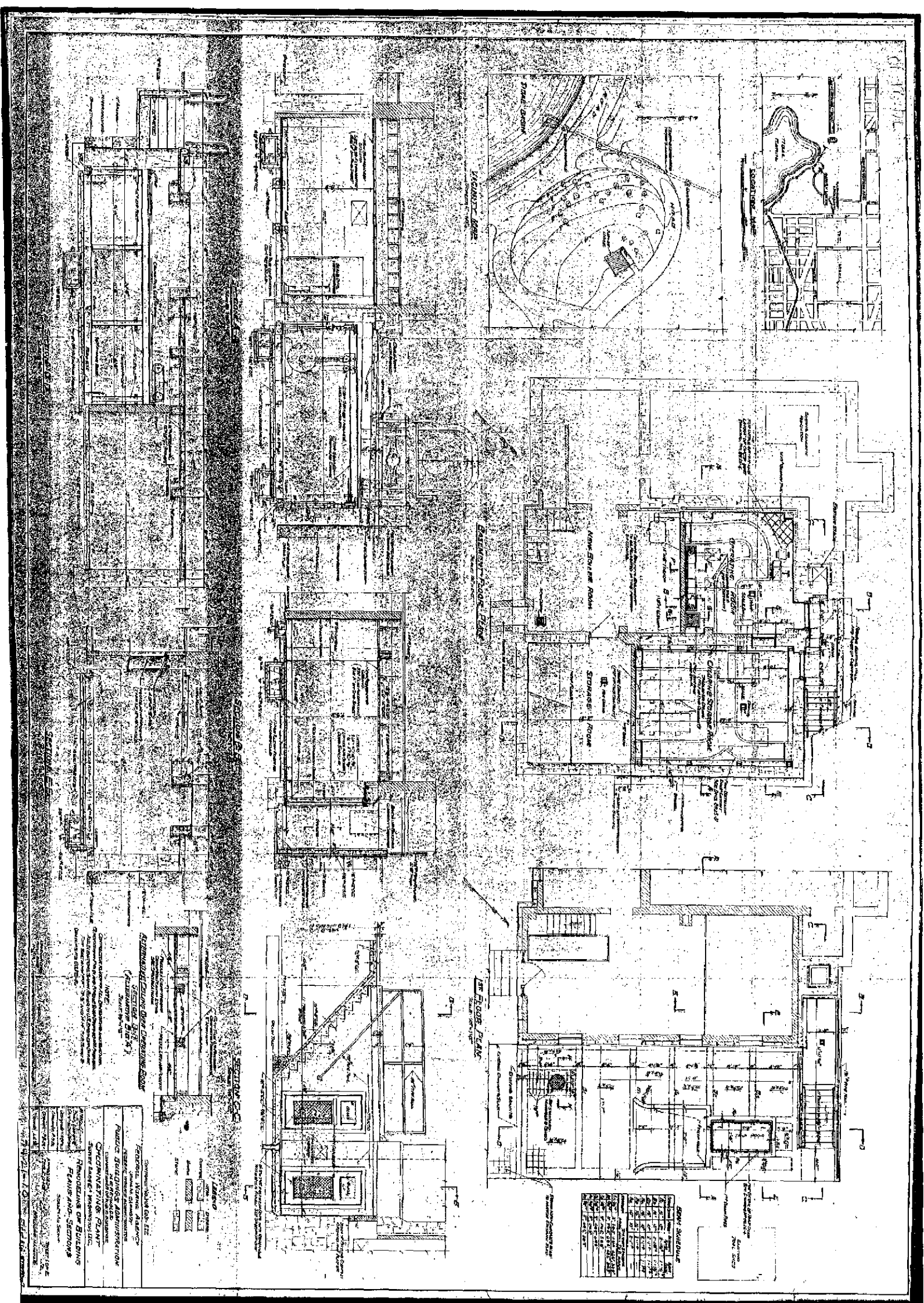

Figure 3.7: Chlorinating Plant Survey Lodge - Washington, D.C., Approved 2 February 1940. (Architectural Drawing] File 74-20-10, NCP 807; RG 79; Cartographic and Architectural Records LICON, Special Media Archives Division, National Archives at College Park, College Park, Md.)



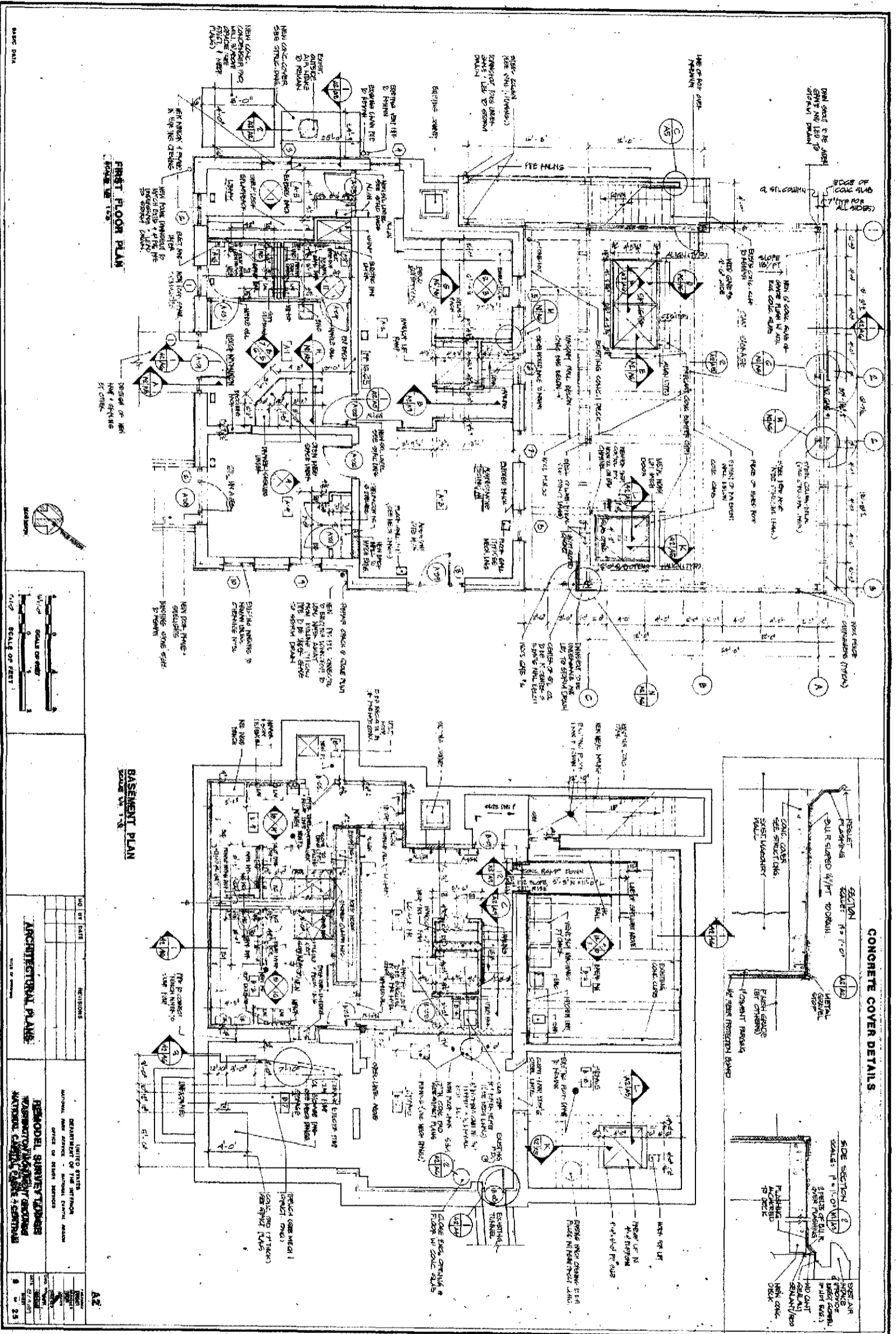
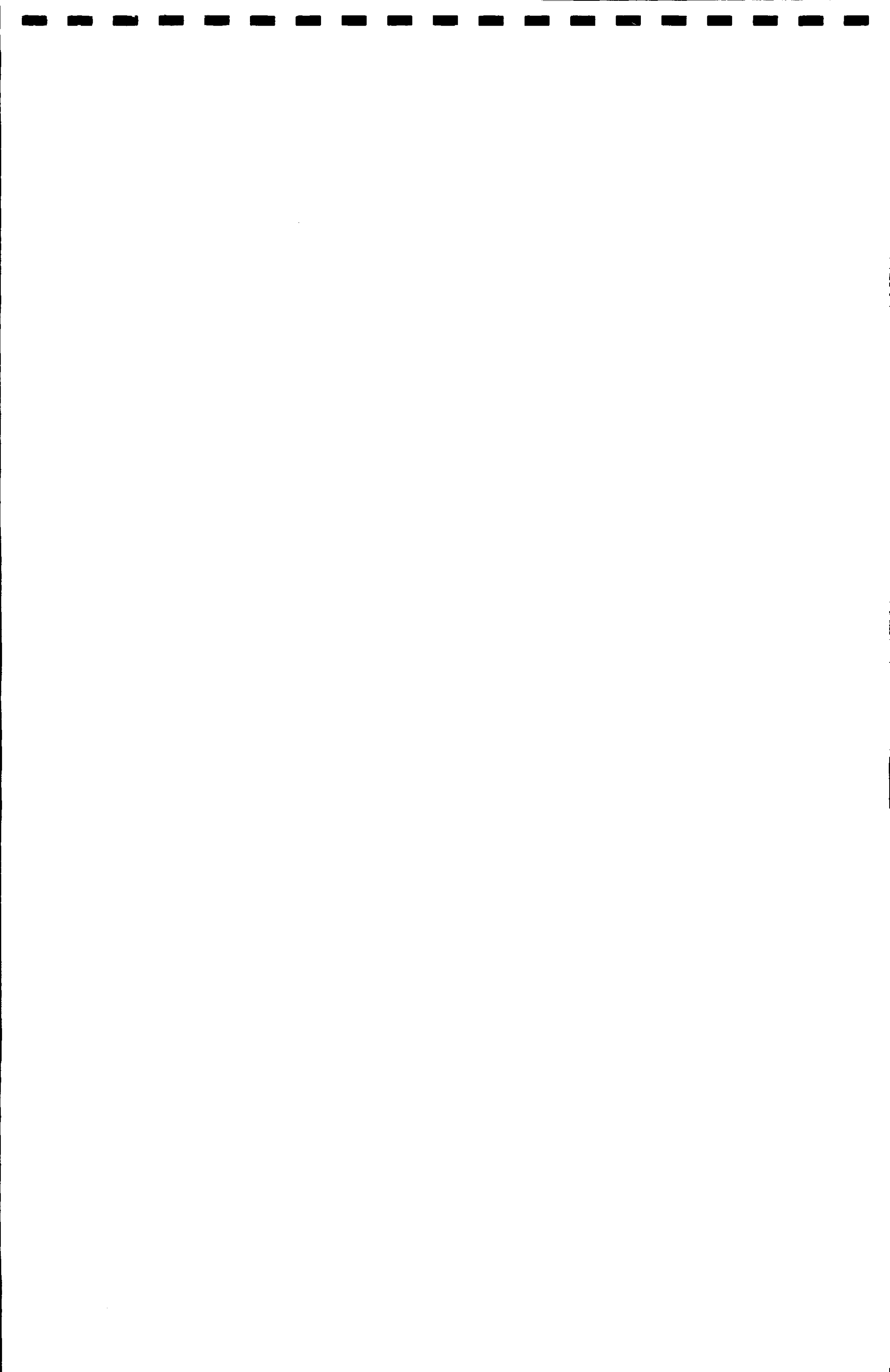

Figure 3.8: Architectural Plans, Remodel Survey Lodge Washington Monument Grounds, 3 August 1989. (Denver Service Center, National Park Service.)



Part I – Developmental History

CHAPTER FOUR
PHYSICAL DESCRIPTION



CHAPTER FOUR

PHYSICAL DESCRIPTION

4.1 GENERAL DESCRIPTION

The Survey Lodge is sited on Reservation 2, approximately 750 feet southwest of the Washington Monument, on Independence Avenue facing southeast. The lodge structure consists of a marble and granite Boiler House, completed in 1886, and a marble and stucco addition to the south, completed in 1901.¹ The 1886 Boiler House is a one-story structure ell-shaped in plan, with the interior crook of the ell facing south. The building has a full basement, a slate gable roof, and an attached chimney approximately 40 feet tall. The 1901 addition fills out the ell, making the current building footprint roughly rectangular in plan. A large metal utility shed sits to the northwest of the lodge, and it is enclosed and tied back to the building with a wood fence. Originally built to supply steam to the Washington Monument elevator and dynamo, the Survey Lodge currently serves as the Headquarters of Mall Operations for the National Park Service. It contains a visitor contact station, handicapped-accessible rest rooms, offices and facilities for Park Service staff, and storage space.

4.2 SITE

The Survey Lodge is situated near the intersection of Independence Avenue and 17th Street, and the lodge site is encircled by an asphalt service drive connected to Independence Avenue at both ends. This drive provides parallel parking for Park Service vehicles and is lined with cobblestone gutters. The ends of the drive are bordered by a series of cast-metal bollards connected by metal chains, all of which are painted black. Planting beds of deciduous shrubs and groundcover surround the building on the northeast, southeast, and southwest sides, giving way to mown turf to the service drive and Independence Avenue. An open stand of canopy trees screens the lodge from view from both Independence Avenue and the Washington Monument plaza (see figure 4.1).

An asphalt path, which connects to Independence Avenue and 17th Street sidewalks, crosses the Survey Lodge site. It is connected to the front entry of the lodge by an exposed aggregate concrete sidewalk 6 feet in width (see figure 4.2). This sidewalk loops around to the east of the building, passing two decorative cast-metal phone booths set on an exposed aggregate concrete pad near the east corner of the building (see figure 4.3). The sidewalk also passes a smooth 18-by 24-inch concrete access cover located approximately 3 feet from the north corner of the building. From there, the sidewalk parallels the service road until reaching a larger pathway intersection northwest of the Survey Lodge. Here the sidewalk branches into two exposed aggregate concrete paths: a 6-foot-wide vehicular access path to the utility shed, and a 4-foot-wide pedestrian path to the lodge basement entry. Approximately halfway past the utility shed, the exposed aggregate pedestrian path merges with a smooth-finish concrete sidewalk that continues to the basement entry stair (see figure 4.4).

To the northwest of the pathway intersection, a tubular-steel bicycle rack is provided for park employees and guests. Nearby, along the north edge of the Survey Lodge site, are two wood picnic tables and wood trash receptacles with metal round-top inserts (see figure 4.5). At the southwest side of the Survey Lodge, close to the base of the original chimney, there is a small concrete pad supporting an electrical generator. A below-grade mechanical vault roof pops up to the right of this generator, and two air-conditioning units follow to the right near the south corner of the building.

4.3 SURVEY LODGE – EXTERIOR

According to the historic specifications for the construction of the Survey Lodge,² this one-story building was erected over a full basement with walls and footings of dressed stone taken from the refuse marble and granite of the Washington Monument. Exterior walls above grade are of marble in a random-coursed ashlar pattern, with a granite base course or water table, two granite belt courses, and a granite cornice. The marble masonry is dressed to a rock faced finish and laid with raised half-round mortar joints $\frac{3}{8}$ inches wide. The granite is dressed smooth. All of the original exterior walls, except for those in the historic coal and ash vaults, were constructed with a brick back-up separated from the stone by a narrow air cavity.

The main southeast façade is four bays wide with the easternmost bay dating to the original 1886 construction period (see figure 4.6).³ This bay historically acted as the building's main entry, and it has a single large opening spanned by a granite lintel carved with a semi-circular pendant design in the bottom center of its face. The opening is filled with a single six-panel wood door, topped by a wood transom panel, and flanked by two three-panel wood sidelights. Dating from a 1989 renovation,⁴ all of these elements are set in a simple wood frame, and the entirety is painted white. The door retains its original knob and dead-bolt hardware, but it is now fixed closed. Immediately in front of this door, below the granite sill, are a granite landing and two granite steps descending to grade. The landing and steps are flanked by miter-topped granite cheekwalls that angle up with the steps to become level with the top of the granite water table. Though original to the 1886 construction period,⁵ only the landing and an upper portion of the cheekwalls are currently visible, as the surrounding planting bed has been re-graded (see figure 4.7). Immediately to the right of the door, and level with the upper granite belt course, is a surface-mounted exterior light fixture, rectangular in shape, with an opaque plastic lens. The eastern bay of the main façade is topped by the cross-gable end of the original roof structure. The roof overhang is supported by a raked cornice of granite with partial cornice returns of granite tying into the building cornice line.

The other three bays of the southeast façade were constructed in 1901 as part of the Survey Lodge expansion.⁶ The easternmost bay of this expansion contains a single large opening identical in size to the historic opening immediately to its right (see figure 4.8). It is topped by a carved granite lintel similar in design to the previously described historic lintel, but the lintel over this opening is of a slightly different color granite than any other granite found on the building. This piece of stone probably dates from the 1901 expansion. The other granite and marble pieces used in the expansion appear to be stones reused from the original building, as no difference in color or texture could be detected between the 1886 building and the 1901 addition.

The opening in this second bay is currently used as the main building entry, and it is filled with a two-light over two-panel wood door, topped by a single-light transom window, and flanked by 3-pane sidelights, all of clear glass. Dating from 1989,⁷ all of these elements are set in a simple wood frame, and the entirety is painted beige. The door has a lever-style knob, dead-bolt, and closer of satin-brass finish, as well as brass kick plates on the interior and exterior bottom rails. There is also a cast-brass threshold at the door opening that is bolted to the granite sill. To either side of the door opening, level with the upper granite belt course, are two surface-mounted exterior light fixtures, rectangular in shape, with opaque plastic lenses. The fixture to the right of the door is identical to that described in the historic entry bay, but the fixture to the left of the door appears to be a much more recent addition and is probably a replacement fixture installed since the 1989 renovation of the Survey Lodge was completed.⁸ The two southern bays of the expansion each contain a single two-over-two, double-hung, wood-sash window with a carved granite lintel and protruding granite sill. The windows are constructed with visible peg joints, set in plain wood frames, and painted white. The upper sash of each window is fixed in place, and one-over-one, double-hung, interior storm windows have been installed with insect screens. At the southern end of this elevation is a 4-inch round, through-cornice metal downspout connected by a PVC boot to a subsurface drain.

The southwest elevation of the Survey Lodge is two bays wide, with a chimney bisecting the western bay. The southern bay and the south half of the west bay are part of the 1901 expansion;⁹ they extend slightly beyond the original attached chimney, and are constructed of brick finished with stucco. Each of these areas contains a single two-over-two, double-hung, wood-sash window with a granite sill and a wood arched-head panel (see figure 4.9). Other than this head panel, the windows are identical to those on the southeast elevation. The southern bay is marked by two marble stones set into the wall to the west of the window, and these form anchor points for a pivoting metal arm (see figure 4.10). Immediately below this arm is a flat-roofed mechanical vault connected to the main building with flashing. The vault has a bituminous roof with gravel ballast and metal trim painted white, and cement parging extends over the sides above grade. Protruding from the top of this vault is a curved vent painted black, which serves as a fresh-air intake for the basement rest rooms. A large metal conductor head, which feeds into a 5-inch round metal downspout, is located at the valley formed by the two gable-end bays of the southwest elevation. This downspout is connected by a PVC boot to a subsurface drain, and it empties a rectangular section of flat-seam metal roof between the two gable ends. The gables of the brick and stucco addition are topped by a band of projecting stucco and capped by a metal fascia.

The west half of the west bay of the southwest elevation dates from the original 1886 construction period, as does the adjacent attached chimney.¹⁰ The west half-bay is of marble and granite construction above grade and poured-in-place concrete below, all backed by brick. It has a raked cornice and partial return cornice of granite as well as a basement entry door. This door, installed in 1989,¹¹ is a six-panel wood door set in a wood frame with satin-finish brass hardware, including a flat-bar exit device. The door is connected to the building security system by magnetic contacts.

The basement entry door opens into an areaway with a finish floor approximately 8 feet below grade (see figure 4.11). The areaway, constructed in 1940,¹² is approximately 5 feet-6 inches wide and is formed of the basement walls of the building and chimney, with a 12-inch-wide, 8-foot-6-inches-tall concrete retaining wall on the third side. A series of poured-in-place concrete steps ascends to grade. To the left of the basement entry door, the areaway contains a large, single-light wood window in a wood frame with an expanded metal grille on the interior, all of which was installed in 1989.¹³ The window is topped by a short length of rectangular metal gutter. There is also a drain covered by a square cast-metal grate in the center of the areaway floor. The areaway and stair are covered by a roof of corrugated light-gauge galvanized steel on steel beams supported by steel columns on concrete pads. This shed roof has a painted K-type hanging gutter leading to a corrugated rectangular metal downspout. The areaway retaining wall is topped by a tubular-steel handrail, and all of the areaway steel is painted a uniform beige (see figure 4.12). Suspended from the areaway roof are three, 2-foot-square fluorescent light fixtures attached to light-gauge steel channels fixed between the roof beams.

In addition to the building's typical coursing, the attached marble and granite chimney has a carved granite molding above the water table, as well as two projecting granite belt courses. The chimney rises approximately 40 feet above grade, tapering slightly as it ascends, and it is topped by a granite cornice and a two-piece cast-iron cap.

The northwest elevation of the Survey Lodge is four bays wide and dates from the original 1886 construction period.¹⁴ Each bay contains a single two-over-two, double-hung, wood-sash window with a carved granite lintel and protruding granite sill. These windows are identical to those found on the main southeast elevation. The granite water table has an additional quarter-round curb of granite at its base approximately 12 inches high, but other stone coursing continues unchanged (see figure 4.13). Exposed electrical conduit is attached to the granite water table for approximately half its length, and a 4-inch round, through-cornice metal downspout at the west end of the elevation carries water to the areaway roof previously described. The entire northwest façade is enclosed with an alternating-board wood fence approximately 8 feet tall, creating an open-air gallery 5 feet-6 inches wide. This gallery is paved with smooth-finish poured-in-place concrete scored on a 15-inch module. The wood fence is attached to the building with wood blocking at two points, and boards are scribed to the stone wall (see figure 4.14). The gallery has a hinged wood gate at its northeast end that is locked, which makes the gallery inaccessible.

The northeast elevation of the Survey Lodge is three bays wide, and also dates from the original 1886 construction period.¹⁵ The north bay projects slightly from the rest of the elevation and is one gable end of the historic roof structure (see figure 4.15). It has a raked cornice and partial cornice returns of granite. This bay originally contained a boiler room overlook, and it has a single large opening with a concrete sill and a carved granite lintel. The opening is filled with a single six-panel wood door, topped by a wood transom panel, and flanked by two three-panel wood sidelights. Dating from 1989,¹⁶ all of these elements are set in a simple wood frame, and the entirety is painted white. The door retains its original knob and dead-bolt hardware, but it is now fixed closed. Flanking the door, and level with the upper granite belt course, are two surface-mounted exterior light fixtures, rectangular in shape, with opaque plastic lenses. The other two bays of the northeast elevation each contain a single two-over-two, double-hung,

wood-sash window with a carved granite lintel and protruding granite sill. These windows are identical to those found on the main southeast elevation. In the corner of the gable return of this elevation is a 4-inch round, through-cornice metal downspout connected by a PVC boot to a subsurface drain.

The structure of the Survey Lodge slate roof is composed of three intersecting gables in the shape of a "U." The middle of the "U" is filled with a flat-seam metal roof that drains to a large conductor head on the southwest elevation. The flat-seam roof is penetrated by a large curved vent (see figure 4.16). The slate roof has built-in metal gutters, through-cornice downspouts, and is composed of 16-inch by 10-inch slate (see figure 4.17). A painted wood and metal cupola adorns the north gable intersection. It is octagonal in shape, with each corner punctuated by a simple half-round pilaster (see figure 4.18). It has decorative base and cornice moldings, and the four primary elevations contain louvered vents with arched heads. The cupola is topped by a lead-coated copper, articulated-bell roof with a metal finial. The cupola was installed in 1993, immediately after the entire roof was replaced, and its design is based on historic construction documents and photographs.¹⁷

4.4 UTILITY SHED

The utility shed located to the northwest of the Survey Lodge is a metal structure erected in 1989¹⁸ over the historic below-grade coal vault. The shed houses Park Service maintenance equipment and vehicles, and it is enclosed by an alternating-board wood fence approximately 8 feet tall (see figure 4.19). Entry is through a double wood gate approximately 6 feet wide on the northwest elevation, with a narrow pedestrian gate on the southwest elevation located at the head of the stair to the basement entry. The shed has a rectangular footprint of approximately 40 feet by 20 feet, a steel column and beam structure, and a low-pitch, corrugated light-gauge galvanized steel gable roof (see figure 4.20). The steel columns of the shed are connected at intermediate points by steel angles, which form a framework for the steel outriggers that support horizontal wood fence members. Exposed electrical conduit running under the roof connects a series of 2-foot square fluorescent light fixtures suspended from the roof structure. Hanging at the edges of the roof structure are two painted K-type metal gutters with rectangular downspouts. The north half of the shed floor is constructed of poured-in-place concrete with a smooth finish. The south half of the shed floor continues beyond the shed enclosure to the northwest elevation of the Survey Lodge. This floor area is composed of poured-in-place concrete scored on a 15-inch module and is finished smooth.

In the east corner of the utility shed, there is a raised concrete platform with a steel double-door cover. This door opens onto a freight lift in the Survey Lodge basement. The south corner of the utility shed contains a raised concrete platform surrounding steel tees and angles, which support a ½-inch-thick Plexiglas skylight. This skylight, installed in 1989¹⁹ to replace a trap door constructed in 1940,²⁰ is located above the staff break room in the Survey Lodge basement.

4.5 SURVEY LODGE – INTERIOR

The interior of the Survey Lodge was completely renovated in 1989 and no historic interior finishes remain.²¹ The original first-floor wood framing was removed during the renovation, and

new concrete floor slabs were installed. The slabs are supported by steel angles attached to the original foundation walls with 1-inch-diameter resin anchors.²²

Original partition walls are generally brick with a plaster finish except for closet walls, which are gypsum wallboard, and some basement walls, which are painted brick or stone. Interior doors are typically four-panel wood doors on the first-floor level and flush wood doors in the basement. All interior doors are set in hollow-metal frames and have satin-finish brass hardware. Most interior spaces occupy the original 1886 Boiler House. Rooms occupying the 1901 addition include the first-floor handicapped-accessible rest rooms, the south office and passage, and the basement-level rest rooms (see figures 4.21 and 4.22).

4.5.1 FIRST-FLOOR LEVEL

4.5.1.1 ENTRY VESTIBULE (VISITOR CONTACT STATION)

The visitor contact station is entered from the southeast. It has walls of gypsum wallboard with wood base molding, 6-inch-square blue-gray ceramic-tile flooring, and a tongue-in-groove wood ceiling with a wood cornice. The room is painted off-white, and a built-in wood reception desk dominates the space. The vestibule is lit by four, 1-foot by 4-foot fluorescent fixtures with parabolic lenses suspended from the ceiling. A security-alarm access panel and a fire-alarm pull station flank the entry door. A wood brochure rack is recessed in the east corner of the northeast wall, and two doors on the southwest wall lead to handicapped-accessible rest rooms (see figures 4.23 and 4.24). A four-panel wood door with a marble threshold is situated in the north corner of the room and leads to Park Service office space.

4.5.1.2 REST ROOMS

Each handicapped-accessible rest room is entered from the visitor contact station through a four-panel wood door. These doors have lever-type knobs, kick plates, and hinges of satin finished brass, and they are set in hollow-metal frames over a marble threshold. The rest rooms are mirror images, and each one contains a single white ceramic toilet, lavatory, and mirror. The rest rooms are finished with ceramic-tile walls and flooring of white with black trim. The ceilings are 2-foot-square suspended acoustic tile with 2-foot-square recessed fluorescent light fixtures.

4.5.1.3 CORRIDOR

The first floor corridor is entered from the southeast. It leads to the first-floor Park Service offices, a small closet containing a handicapped lift, and a stair that descends to the basement. The corridor marks the beginning of Park Service staff space that is closed to the public. It is characterized by plaster walls painted off-white with wood base molding, a tongue-in-groove wood ceiling with a wood cornice, and carpet flooring. A four-panel wood door in the northwest corner of the corridor accesses a small metal lift to the basement level. A marble threshold between the lift enclosure and the north corridor wall marks the beginning of the stair down to the basement. The corridor opens to the northeast into the north office space. A light-gauge metal-framed partition wall on the southwest separates the corridor from the west office. This partition wall has a flush wood door with fabric-covered side panels topped by a metal-framed glass clerestory attached to the ceiling.

4.5.1.4 NORTH OFFICE

The north office has plaster perimeter walls painted off-white with wood base molding, a tongue-in-groove wood ceiling with a wood cornice, and carpet flooring. The room is divided in half by a fabric-covered partition wall running northwest to southeast through the space. The partition wall contains a small flush wood door and is topped by a frameless glass clerestory. Both sides of the north office contain modular office furniture, and in the northeast half of the office, the historic boiler room overlook opening is visible with its wood door and panel infill. The north office is lit by a series of 1-foot by 4-foot fluorescent fixtures with parabolic lenses suspended from the ceiling. The south corner of the office contains a four-panel wood door to the park manager office.

4.5.1.5 PARK MANAGER OFFICE

This office is entered from the northwest and is finished in the same manner as the north office. The north corner of the room contains a gypsum wallboard closet with flush wood double doors. The historic main building entry is visible in the southeast wall with its wood door and panel infill.

4.5.1.6 WEST OFFICE

The west office is entered from the northeast through the partition wall dividing it from the corridor. This room is finished in the same manner as the north office except the furniture consists of built-in wood desktops and shelving. An access hatch in the ceiling above the center of the room leads to the Survey Lodge attic. A doorway in the south corner of the room leads to a passage to the south office.

4.5.1.7 PASSAGE

The passage to the south office is accessed from the northeast through a doorway to the west office. The passage is a transition space between the original 1886 Boiler House and the 1901 addition. It is located southeast of the original chimney, and encloses a portion of the marble and granite exterior walls of the 1886 building (see figure 4.25). The interior finishes of this room are identical to those found in the north office with the exception of stone and brick walls on two sides of the passage. Also, the tongue-in-groove wood ceiling is scribed to the face of the rock walls (see figure 4.26).

4.5.1.8 SOUTH OFFICE

The south office is entered from the northwest through a four-panel wood door. The room is identical in finish to the west office, with the exception of ceiling type. The south office has a 2-foot-square suspended acoustic-tile ceiling with 2-foot square recessed fluorescent light fixtures. The two windows in the space are covered in off-white Venetian blinds, and the northwest end of the office has a dropped acoustic-tile soffit (see figure 4.27).

4.5.1.9 STAIR

The stairway down to the basement is ell-shaped and wraps around the small lift off of the first-floor corridor. The northwest wall of the stairwell is brick painted off-white, and the ceiling is tongue-in-groove wood with a wood cornice. The window in the stairwell has simple interior

wood trim with a decorative wood stool and an arched-top wood head panel (see figure 4.28). The stair itself is of painted steel and has a single painted tubular-steel handrail attached to the south side of the stair (see figure 4.29).

4.5.2 BASEMENT LEVEL

4.5.2.1 CORRIDOR

The basement corridor is entered from the northwest after descending the stair from the first floor, and it connects most of the spaces found on the basement level. The corridor is ell-shaped and extends from the base of the stair, around the lift, to the staff locker room. The south corridor walls are of painted brick and are lined with wooden hatboxes and mailboxes for Park Service staff. The north corridor walls are gypsum wallboard. All walls have a black 6-inch vinyl base and are painted off-white. The floor is painted concrete and the ceiling is 2-foot-square suspended acoustic tile with 1-foot by 4-foot recessed fluorescent light fixtures. Immediately across from the base of the stair, a six-panel wood door leads to an exterior areaway with stairs up to grade. The corridor terminates to the northeast with a concrete masonry unit wall with a flush wood door leading to the Park Service staff locker room (see figure 4.30). It terminates to the northwest with a doorway into the staff break room.

The north walls of the corridor are lined with three flush wood doors. The first door is located next to the stair and opens into a shallow closet. The closet contains wood shelving, but is otherwise finished identically to the corridor. The second door is around the corner from the closet. It opens onto the handicapped lift to the first floor. This door has a brass kick plate, and a painted metal ramp is bolted to the concrete floor directly in front of the opening. This ramp slopes up approximately 2 inches to the floor level of the lift. The third door, located near the northeast end of the corridor, opens into a janitor's closet. This closet occupies the ell-shaped space under the stair and contains a mop sink and shelving for cleaning supplies. The northeast wall of the closet is constructed of concrete masonry units. The northwest wall is of brick, and the south walls are of gypsum wallboard. All are painted uniformly off-white. The floor is of painted concrete, and the ceiling is simply the exposed underside of the steel stair.

4.5.2.2 STAFF BREAK ROOM

The staff break room is accessed from the southeast through a doorway to the basement corridor. A ramp extends from this doorway into the room, sloping down 3 inches to the break-room floor. The ramp is bordered by a painted tubular-steel handrail on either side, which is bolted both to the floor and to the brick wall around the doorway. The room occupies one end of the historic coal vault and is constructed of poured-in-place concrete walls painted off-white, a poured-in-place concrete ceiling with exposed ceiling beams, and a vinyl tile floor over a concrete slab on grade (see figure 4.31). A metal kitchenette occupies the east corner of the space, and a skylight above the west corner of the room has a view of the utility shed interior. Exposed conduit snakes over the walls, connecting outlets as well as 1-foot by 4-foot ceiling-mounted fluorescent light fixtures.

4.5.2.3 REST ROOMS

The basement rest rooms are primarily for the use of Park Service staff and are located to the southeast of the basement corridor in the 1901 building addition. Both contain a shower with adjacent changing area, two toilet stalls, one of which is handicapped accessible, and two sinks, one of which is handicapped accessible. The stalls are separated by partition walls, which do not completely extend to the ceiling. The stalls are enclosed with metal doors and door surrounds painted blue. Wall surfaces in the rest rooms are of 4-inch-square white ceramic tile, and the flooring is 2-inch-square light-yellow ceramic tile. The ceiling is of 2-foot square suspended acoustic tile with 1-foot by 4-foot recessed fluorescent light fixtures.

The women's rest room is entered from the northwest through a flush wood door over a marble threshold. The southwest wall of the rest room contains a short, flush wood door leading to a mechanical vault. The roof of this vault can be seen on the southwest exterior elevation of the Survey Lodge. A narrow metal partition abuts the southwest rest room wall next to the sinks. This partition blocks the south corner of the rest room from view, and this space contains a small wood bench.

The men's rest room is entered through a flush wood door over a marble threshold near the northeast end of the basement corridor. In layout, it is a mirror image of the women's rest room, except the narrow partition blocks two urinals from view. The northeast wall of the men's rest room contains a filled opening, which originally connected to the Boiler House ash vault.

4.5.2.4 STAFF LOCKER ROOM

The Park Service staff locker room is located at the northeast end of the basement corridor. It has a poured-in-place concrete ceiling and floor. Three walls in the locker room are of painted brick while the fourth wall, the southwest, is painted concrete masonry units. The brick walls are lined with double-height metal lockers, and there is a raised concrete pad just west of the entry door, on top of which sits the building's furnace. The room is filled with exposed pipes, duct, and conduit as well as the building's hot-water heater. Lighting is provided by 1-foot by 4-foot fluorescent light fixtures suspended from the ceiling.

The north end of the northeast wall contains a flush metal access door in a metal frame set flush with the brick wall. This door, which is currently welded closed, opens into the original steam-pipe tunnel that connects the Survey Lodge to the Washington Monument. The tunnel is constructed of brick, is 3 feet in width by 4 feet-3 inches in height, and has an arched brick head.²³ The northwest wall of the locker room contains a rectangular opening to the north storage room. This doorway has a painted steel lintel and is barred by an expanded metal gate painted black. The southeast wall contains two openings to the east storage room. The north opening is rectangular with a painted steel lintel. The south opening has an arched brick head (see figure 4.32). Both openings are blocked by expanded metal gates painted black.

4.5.2.5 NORTH STORAGE ROOM

The north storage room occupies one half of the original Boiler House coal vault. It has exposed stone walls on three sides with the fourth wall, the southwest, of painted brick. The floor of this room is poured-in-place concrete finished smooth and painted light gray. There is a drain with a

round cast-metal grate in the center of the floor. The ceiling is of poured-in-place concrete and has exposed concrete beams. Exposed pipes, duct, and conduit line the walls and ceiling around a series of metal shelving and storage units (see figure 4.33). There is a freight lift in the north corner of the room enclosed by expanded metal panels. This lift rises to grade inside the utility shed to the northwest of the Survey Lodge. Lighting in the storage room is provided by 1-foot by 4-foot ceiling-mounted fluorescent light fixtures.

4.5.2.6 EAST STORAGE ROOM

The east storage room occupies the original Boiler House ash vault. It has exposed stone walls on three sides with the fourth wall, the northwest, of painted brick. The floor of this room is poured-in-place concrete finished smooth and painted light gray. The ceiling is also of poured-in-place concrete, and an opening in the southwest wall has been filled with plywood and painted. Electrical service for the Survey Lodge enters along the northeast wall of the storage room, and exposed pipes, duct, and conduit line the walls and ceiling. There is a raised concrete platform in the east corner of the space, which supports a heating-oil tank. A concrete trench runs from the northwest to the southeast of the room, and this trench is covered by cast-metal plates. Metal plates also cover a below-floor sump pump and sewage-ejector basin located in the south corner of the room.

4.5.3 ATTIC

The Survey Lodge attic is accessed through a removable ceiling panel above the center of the west office. Access is by ladder, and provides entry only to the northwest gable of the lodge. Other attic areas are inaccessible from this space or from other offices below.

The lodge attic floor is completely covered in ¾-inch plywood and offers an unobstructed view of the lodge roof structure and roofing (see figure 4.34). Historic cast-iron trusses form the primary roof structure, and they each consist of two 5-inch deck beams connected by ¾-inch tie-rods. The trusses sit in iron shoes fastened to the top of the granite cornice, and the trusses are supplemented by a series of 2-by-4 wood rafters. These rafters are connected to the trusses by 2-by-4 wood purlins, six purlins per roof side. In between each purlin, three 1 ¾-inch by 1 ¾-inch iron angles form the original resting points for the historic slate roof, long since removed. On top of the purlins, a 5¼-inch-wide tongue-in-groove roof deck runs in the direction of the roof slope. This deck forms the nailing surface for the slate roof shingles, which were installed in 1993.²⁴ Though the original iron roof structure is intact and appears in good condition, it no longer structurally supports the roof. The wood members described carry the bulk of the actual weight of both the roofing materials and additional snow loads.

The perimeter of the attic is characterized by brick walls laid in a running bond topped by the granite cornice. Most walls retain a moderate covering of whitewash, which was the finish surface material when the lodge structure was left exposed to the spaces below. The whitewash coating is particularly eroded at the south end of the southeast attic wall where the lodge was expanded in 1901. The granite cornice in this area was removed during the expansion, and the space was filled with red brick. Currently, there is an exhaust vent cut through this wall, and it serves the first-floor handicapped-accessible rest rooms and penetrates the flat-seam metal roof previously described. Brick corbelled out from the brick perimeter wall surrounds the vent.

Attic lighting is provided by four bare-bulb fixtures connected by exposed conduit, and three surface-mounted smoke detectors alert building occupants in case of fire.

ENDNOTES

Abbreviations:

E 484	Letters Received, Entry 484; Records of the Joint Commission for Completion of the Washington Monument, 1876–1892
GPO	Government Printing Office, Washington, D.C.
NAB	National Archives Building, Washington, D.C.
NPS-NCR	National Park Service – National Capital Region
RG 42	Records of the Office of Public Buildings and Public Parks of the National Capital, Record Group 42
RG 79	Records of the National Park Service, Record Group 79

¹ Col. Thomas Lincoln Casey, Engineer in Charge of the Washington Monument, to Brig. Gen. J. C. Duane, Chief of Engineers, "Report of Operations Upon the Washington Monument for the year 1886," 20 December 1886; E 484; RG 42; NAB; Theodore A. Bingham, "Plan Showing Present Boiler House in Dotted Lines and Proposed Addition in Full Lines," 1898; [Architectural Drawing] File 74-21-3; RG 79; Cartographic and Architectural Records LICON, Special Media Archives Division, National Archives at College Park, College Park, Md.

² Lt. Col. Thomas Lincoln Casey, Engineer in Charge of the Washington Monument, "Advertisement and Specifications for Boiler House at the Washington Monument," 3 October 1885; Contracts, Entry 512; Records of the Joint Commission for the Completion of the Washington Monument, 1876–1892; RG 42; NAB.

³ "Washington Monument Boiler House Sections, Elevations, and Details," 1886; [Architectural Drawing] File 74-21-7; NCP 807; RG 79; Cartographic and Architectural Records LICON, Special Media Archives Division, National Archives at College Park, College Park, Md.

⁴ Vincent Chan & Associates, Inc., "Building Elevations," 3 August 1989; [Architectural Drawing] File 807_80116, Sheet 4 of 25; Technical Information Center, Denver Service Center, National Park Service.

⁵ "Washington Monument Boiler House Sections, Elevations and Details," 1886.

⁶ Bingham, "Plan Showing Present Boiler House in Dotted Lines and Proposed Addition in Full Lines," 1898.

⁷ Chan, "Building Elevations," 3 August 1989.

⁸ Oh-Chen & Associates, P.A., "Electrical Plans," 3 August 1989; [Architectural Drawing] File 807_80116, Sheet 24 of 25; Technical Information Center, Denver Service Center, National Park Service.

⁹ Bingham, "Plan Showing Present Boiler House in Dotted Lines and Proposed Addition in Full Lines," 1898.

¹⁰ "Washington Monument Boiler House Plans, Sections and Elevations," 1886; [Architectural Drawing] File 74-21-8; NCP 807; RG 79; Cartographic and Architectural Records LICON, Special Media Archives Division, National Archives at College Park, College Park, Md.

¹¹ Vincent Chan & Associates, Inc., "Architectural Plans," 3 August 1989; [Architectural Drawing] File 807_80116, Sheet 3 of 25; Technical Information Center, Denver Service Center, National Park Service.

¹² Montgomery, "Remodeling of Building Plans and Sections," Approved 2 September 1939; [Architectural Drawing] File 74-21-10, Sheet 1 of 2; NCP 807; RG 79; Cartographic and Architectural Records LICON, Special Media Archives Division, National Archives at College Park, College Park, Md.

¹³ Vincent Chan & Associates, Inc., "Room Elevations, Door/Stair Details," 3 August 1989; [Architectural Drawing] File 807_80116, Sheet 10 of 25; Technical Information Center, Denver Service Center, National Park Service.

¹⁴ "Washington Monument Boiler House Sections, Elevations and Details," 1886.

¹⁵ "Washington Monument Boiler House Sections, Elevations and Details," 1886.

¹⁶ Vincent Chan & Associates, Inc., "Building Elevation & Exterior Details," 3 August 1989; [Architectural Drawing] File 807_80116, Sheet 5 of 25; Technical Information Center, Denver Service Center, National Park Service.

¹⁷ Rebecca Stevens, Regional Historical Architect, NCR, to Superintendent, NACC, Memorandum, 13 February 1992; NPS-NCR Collection.

¹⁸ Chan, "Architectural Plans," 3 August 1989.

¹⁹ Chan, "Architectural Plans," 3 August 1989.

²⁰ Montgomery, "Remodeling of Building Plans and Sections," Approved 2 September 1939.

²¹ Vincent Chan & Associates, Inc., "Demolition Plans," 3 August 1989; [Architectural Drawing] File 807_80116, Sheet 2 of 25; Technical Information Center, Denver Service Center, National Park Service.

²² Carson K. C. Mok, Consulting Engineers, P.A., "Typical Details and Sections," 3 August 1989; [Architectural Drawing] File 807_80116, Sheet 14 of 25; Technical Information Center, Denver Service Center, National Park Service.

²³ Casey, "Report of Operations Upon the Washington Monument for the Year 1886," 20 December 1886.

²⁴ Monika Mayr, Chief, Branch of Construction and A/E Contracts Contracting Officer, NCP-Central, to AEO Construction Co., Inc., "Contract No. 1443CX300092073, Install a Cupola and Replace the Roofing System on the Survey Lodge Building, Washington, DC," 22 October 1992; NPS-NCR Collection.

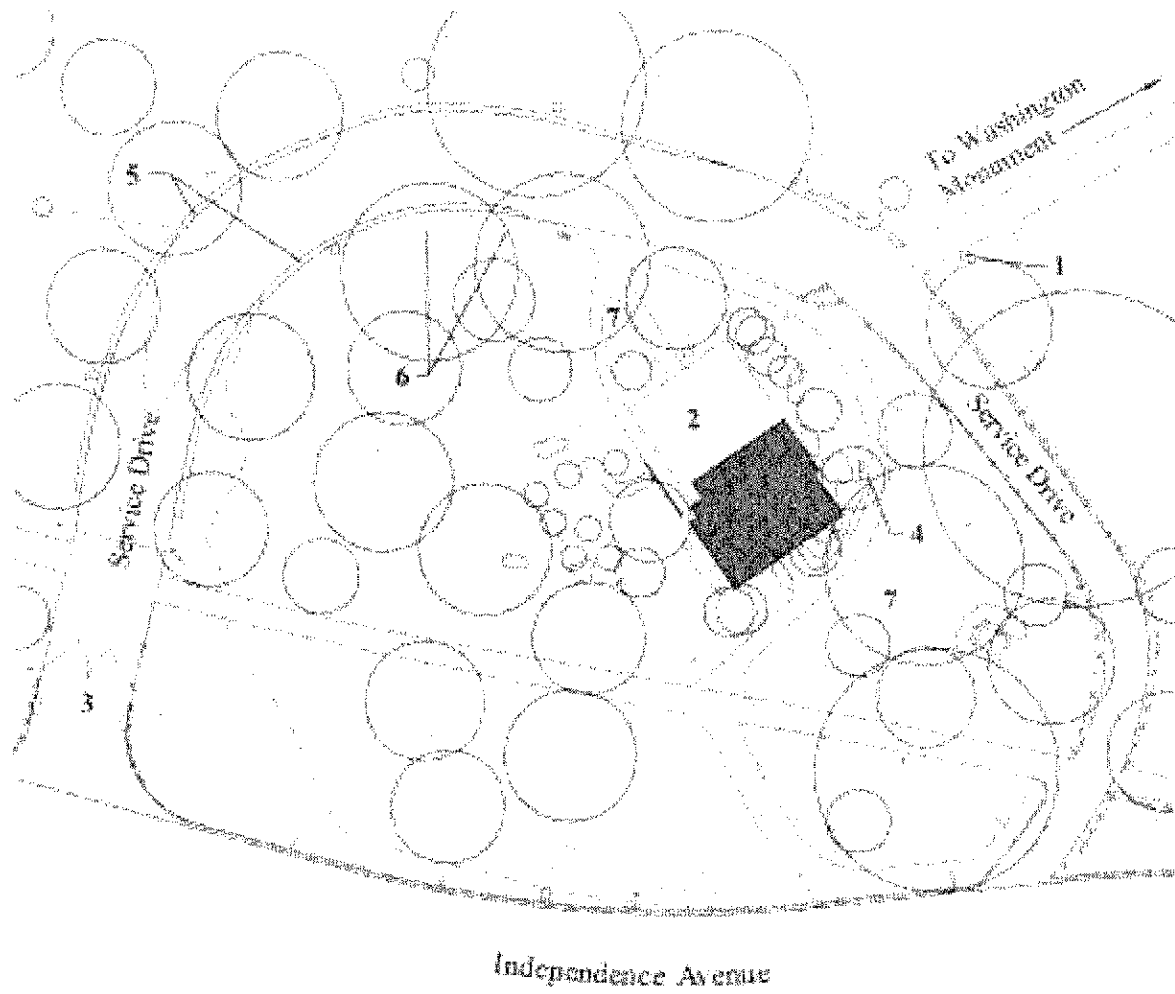

Features Key

- 1 Drinking fountain*
- 2 Utility shed
- 3 Gate
- 4 Pedestal telephone*
- 5 Stone-lined drainage ditch
- 6 Picnic tables
- 7 Bicycle rack

* representative

Legend

- | | |
|--------------------|-----------------|
| Building | Fences |
| Gates | Lamp |
| Drinking fountains | Telephone booth |
| Picnic pavilions | Traffic light |
| Light poles | Tree canopy |
| Signs | Trees |

Scale: 1" = 100'

Figure 4.1: Survey Lodge site plan.

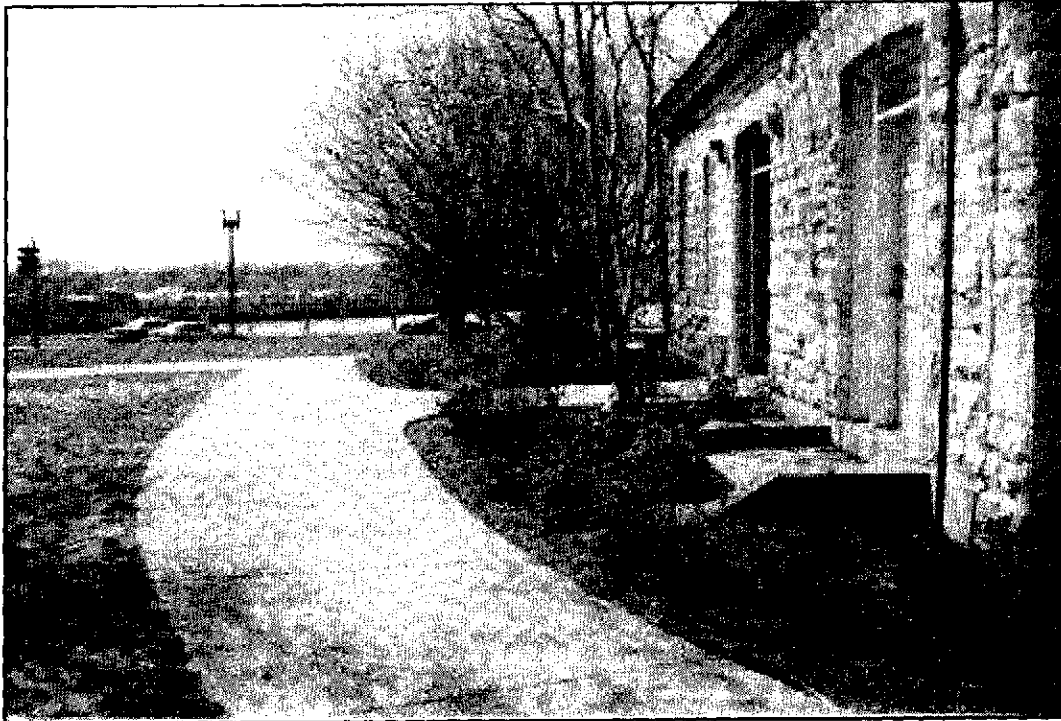

Figure 4.2: Lodge site at southeast façade, view to west.

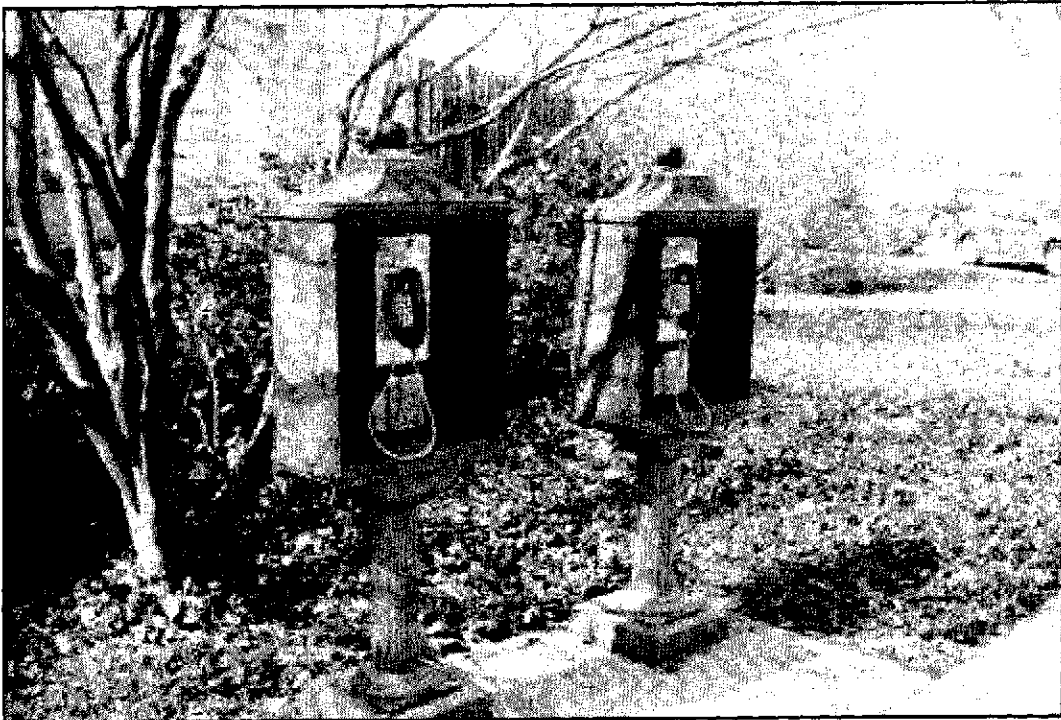

Figure 4.3: Decorative cast-metal phone booths at southeast corner of lodge.



Figure 4.4: Pedestrian path to basement entry, view to southeast.



Figure 4.5: Lodge site north of utility shed, view to west.

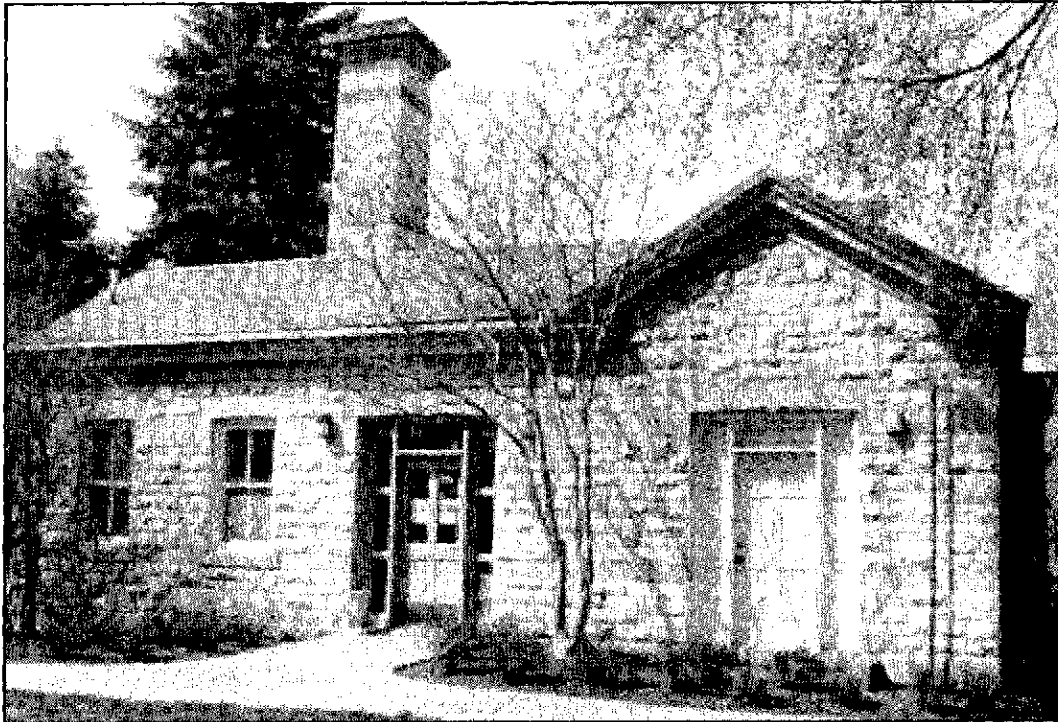

Figure 4.6: Southeast elevation.

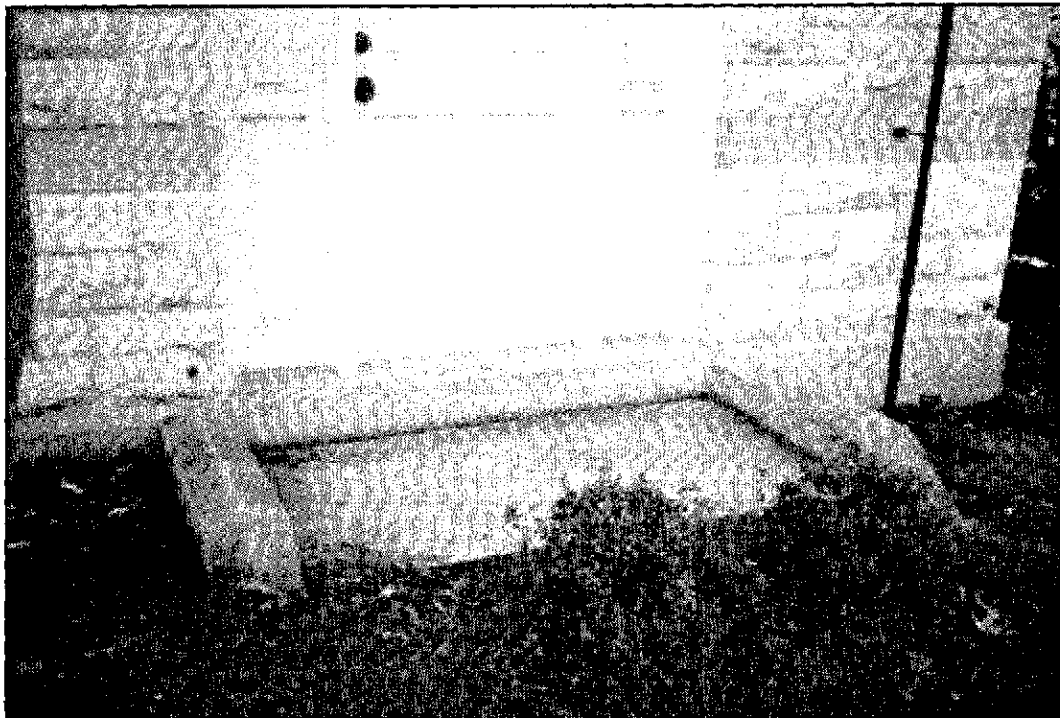

Figure 4.7: Historic granite entry stair has been incorporated in surrounding planting bed.



Figure 4.8: Southeast elevation with current entry on left and historic entry on right.



Figure 4.9: Southwest elevation with 1901 stucco addition.



Figure 4.10: Mechanical vault roof.



Figure 4.11: Basement areaway, view to southeast.

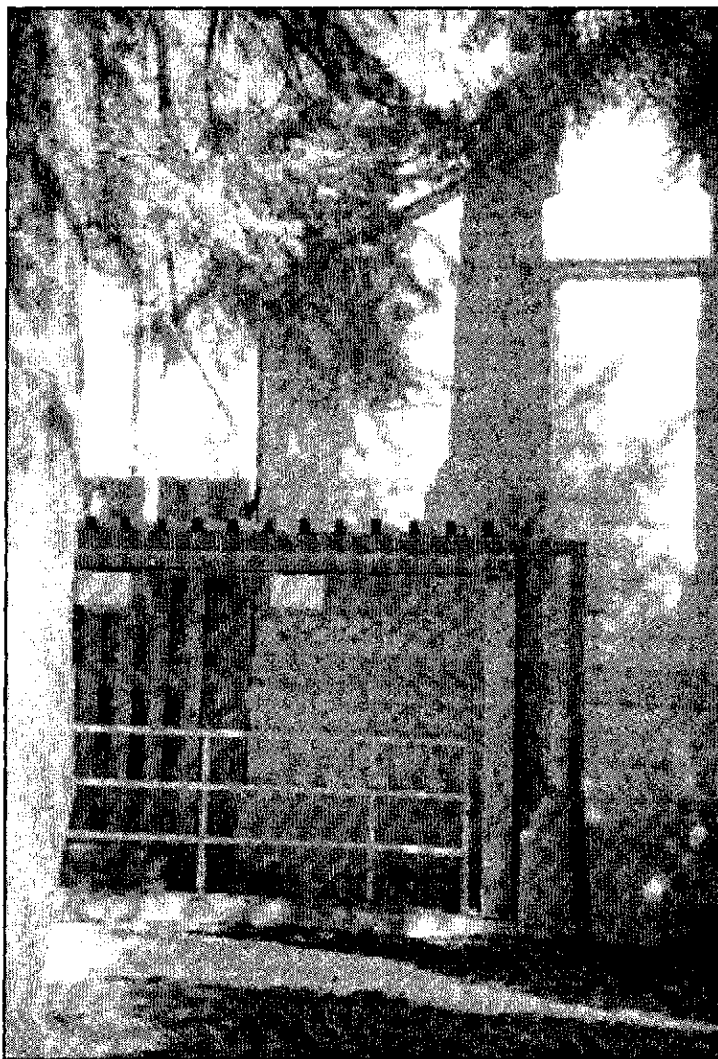

Figure 4.12: Basement areaway roof and handrail with chimney base on right, view to northeast.

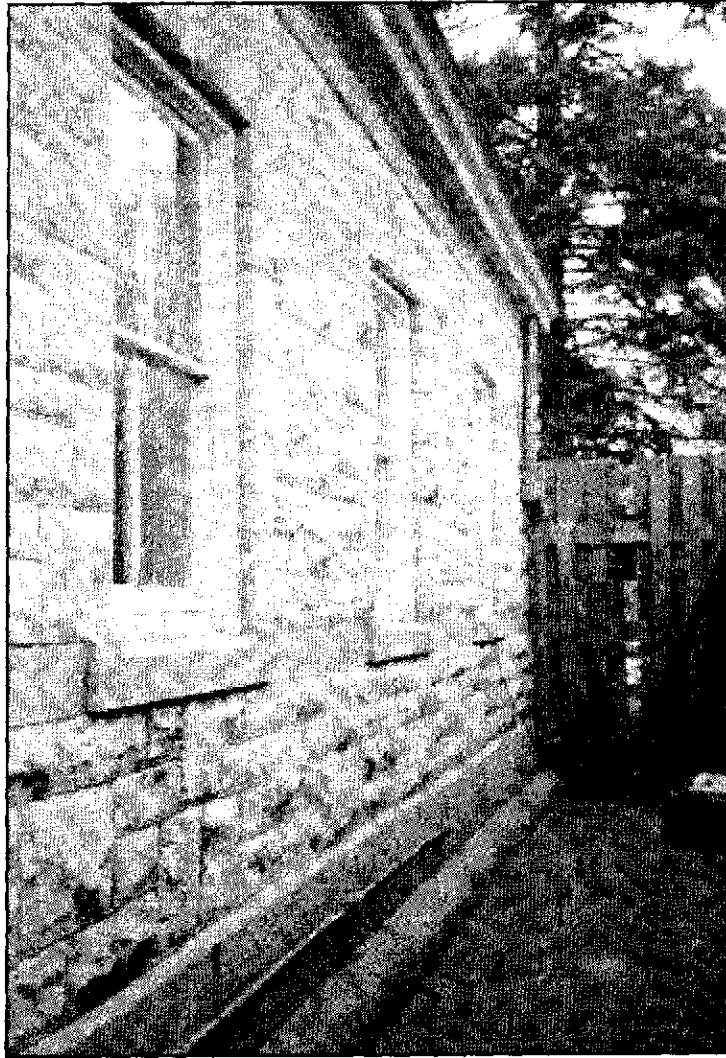

Figure 4.13: Northwest elevation, view to south.

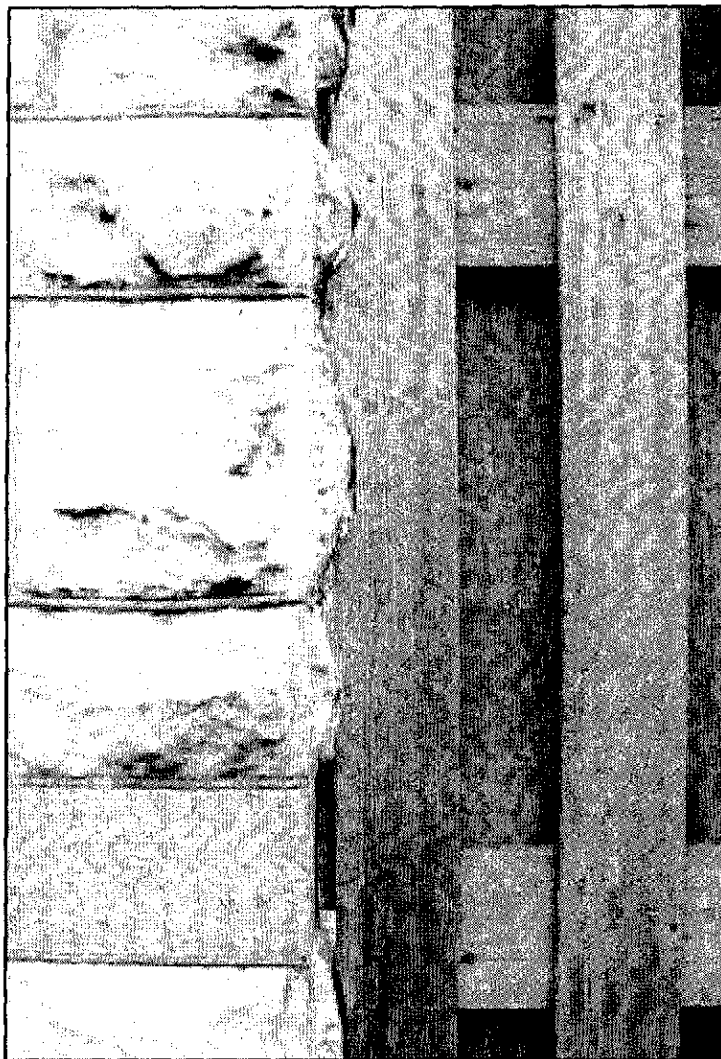

Figure 4.14: Alternating-board wood fence is scribed to stone building wall, view to southwest.

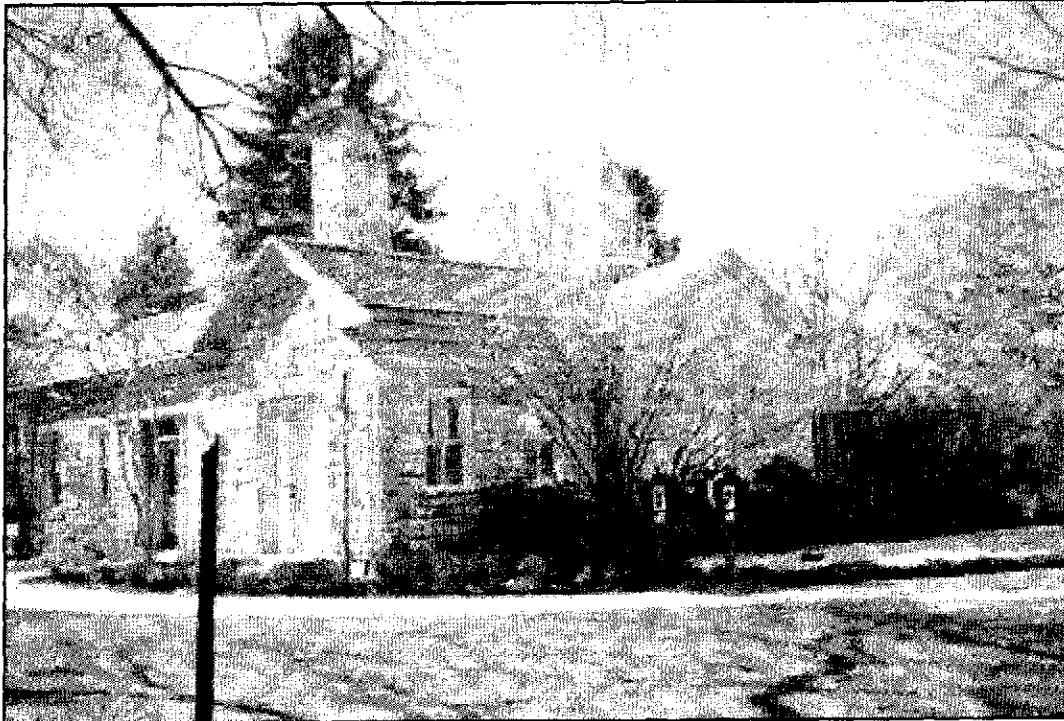

Figure 4.15: Northeast elevation, view to west.

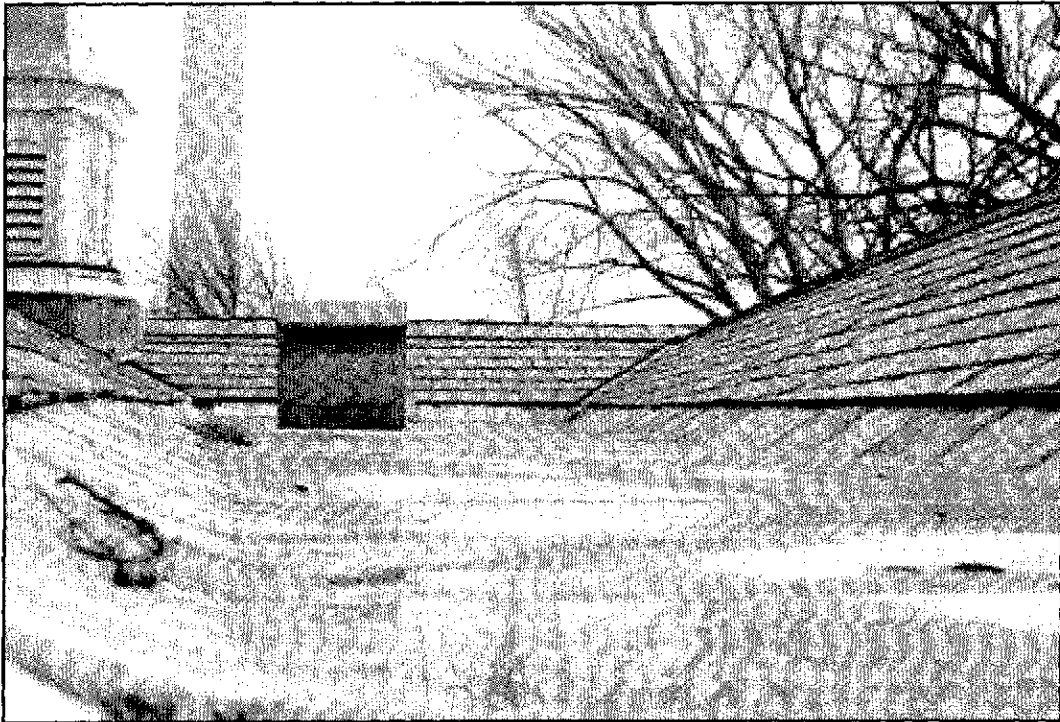

Figure 4.16: Flat-seam metal roof between slate roof gables, view to northeast.

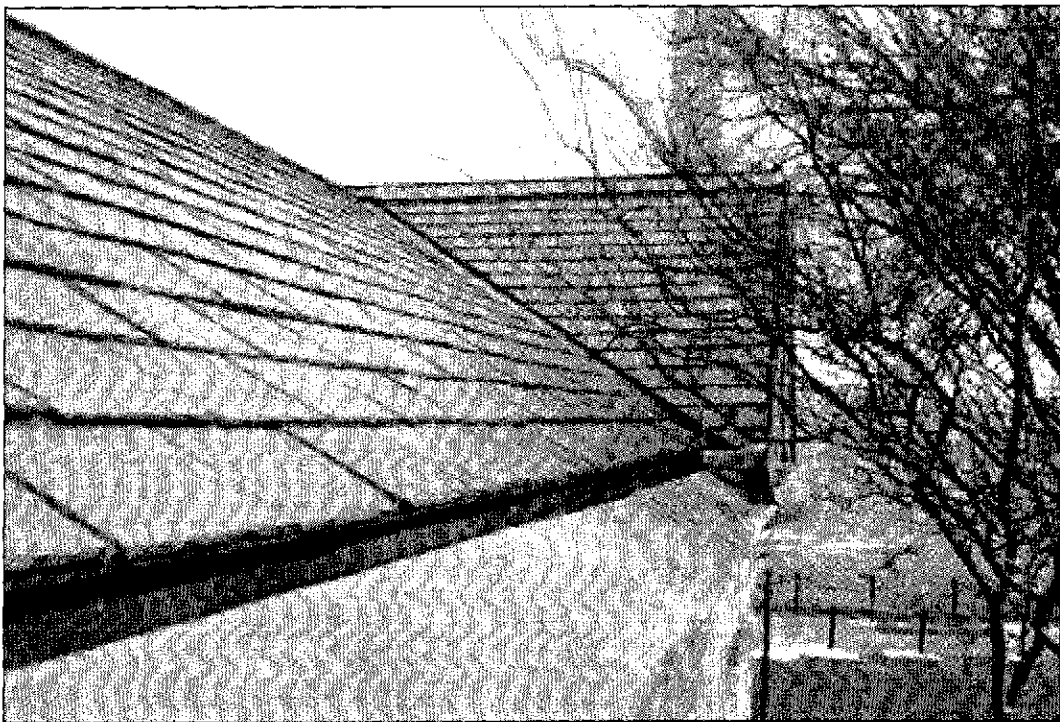

Figure 4.17: Built-in metal roof gutter, view to northeast.

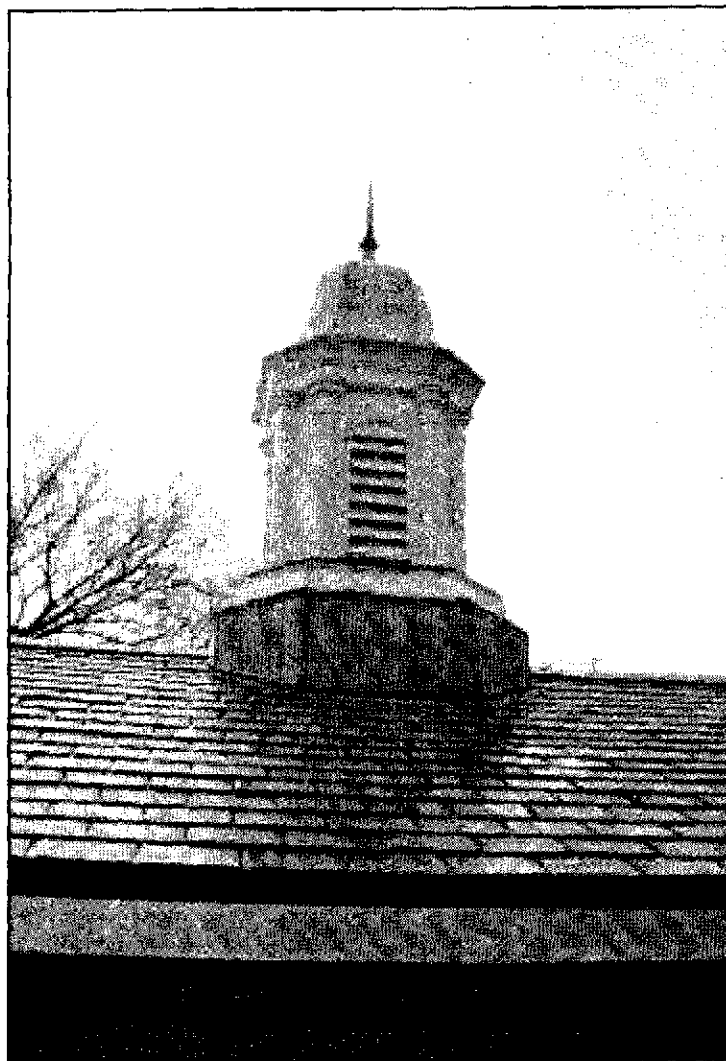

Figure 4.18: Cupola, view to southeast.

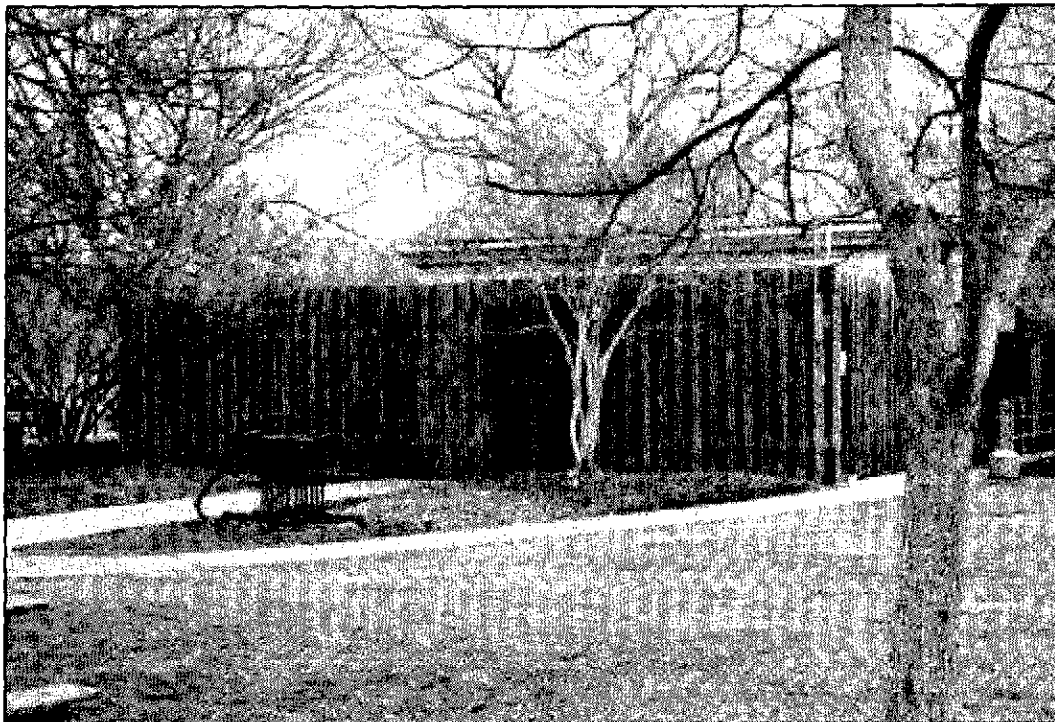

Figure 4.19: Utility shed, view to southeast.

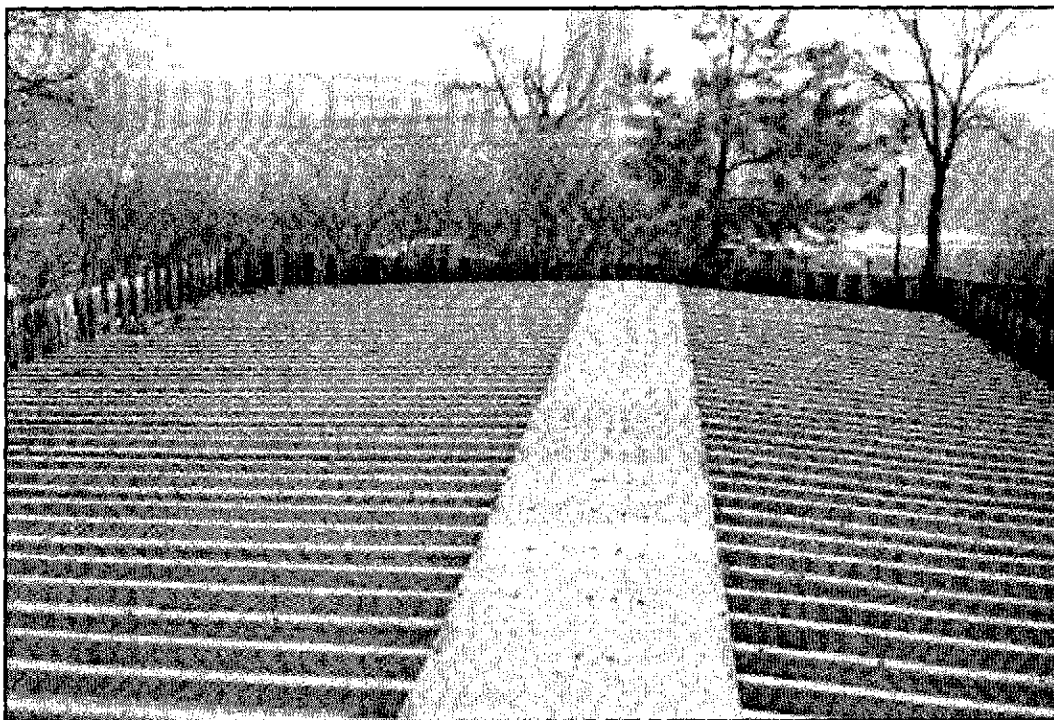

Figure 4.20: Utility shed roof, view to northeast.

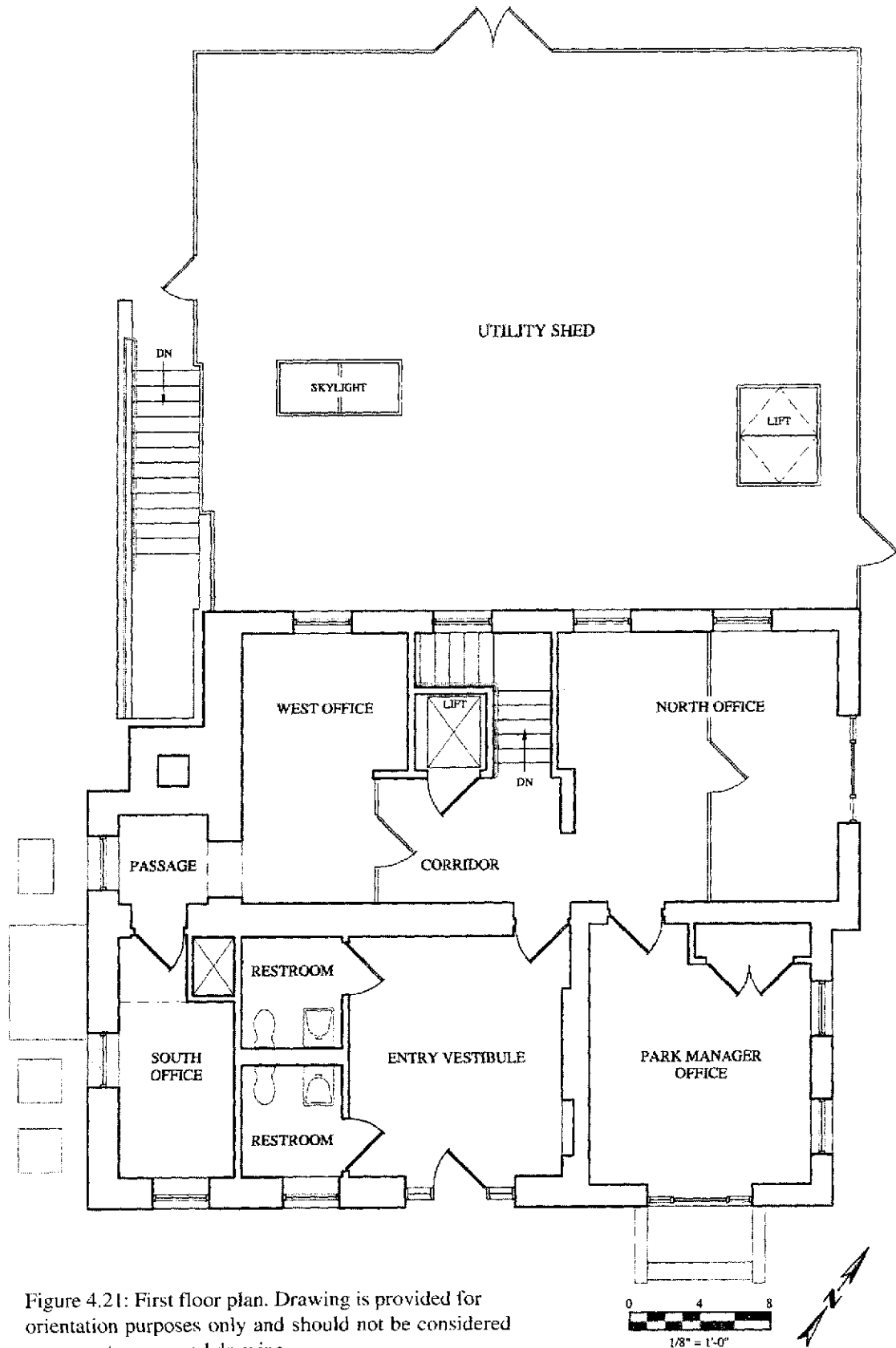

Figure 4.21: First floor plan. Drawing is provided for orientation purposes only and should not be considered an accurate measured drawing.

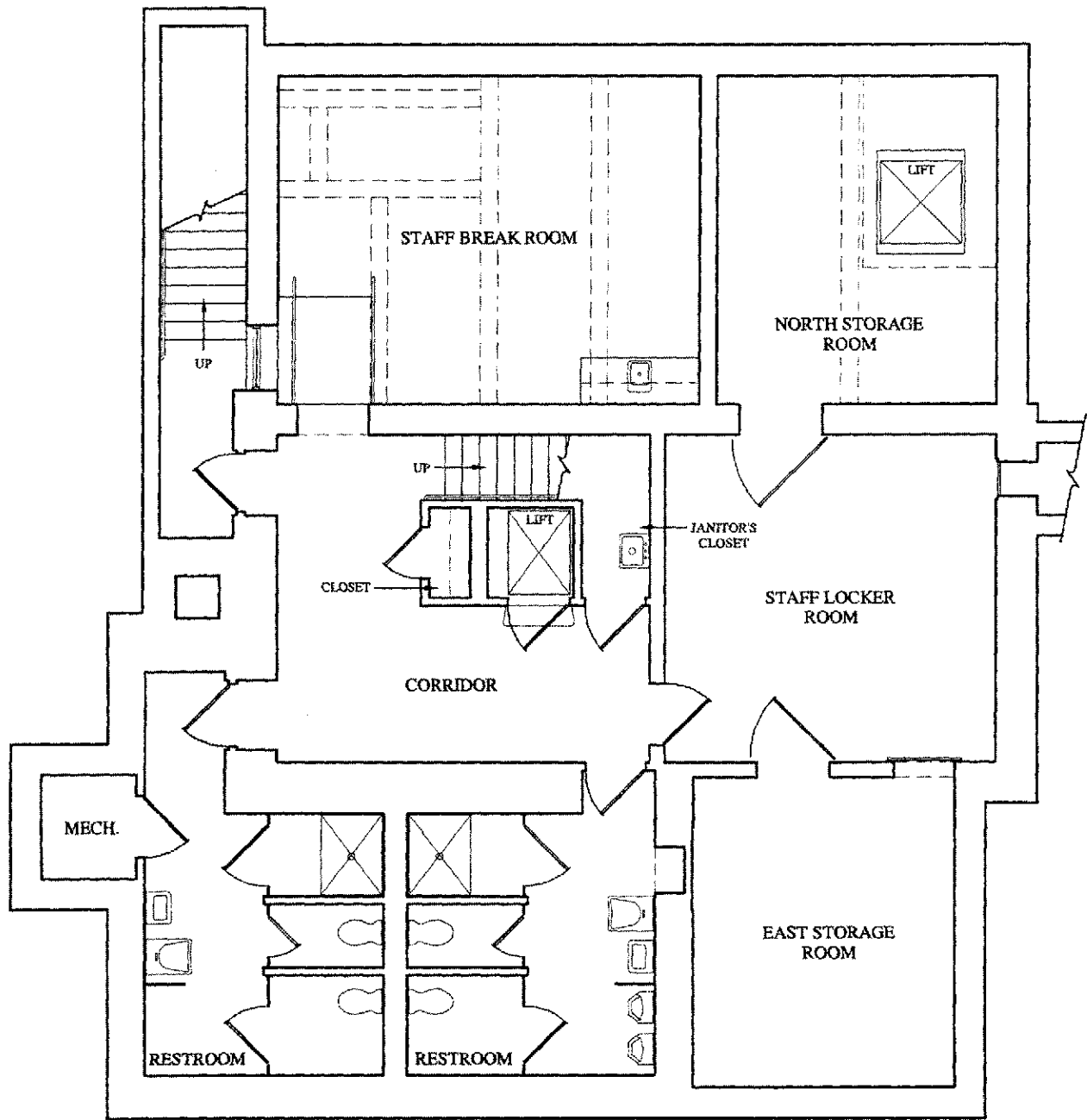

Figure 4.22: Basement floor plan. Drawing is provided for orientation purposes only and should not be considered an accurate measured drawing.

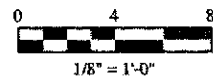



Figure 4.23: Entry vestibule (visitor contact station), view to east.

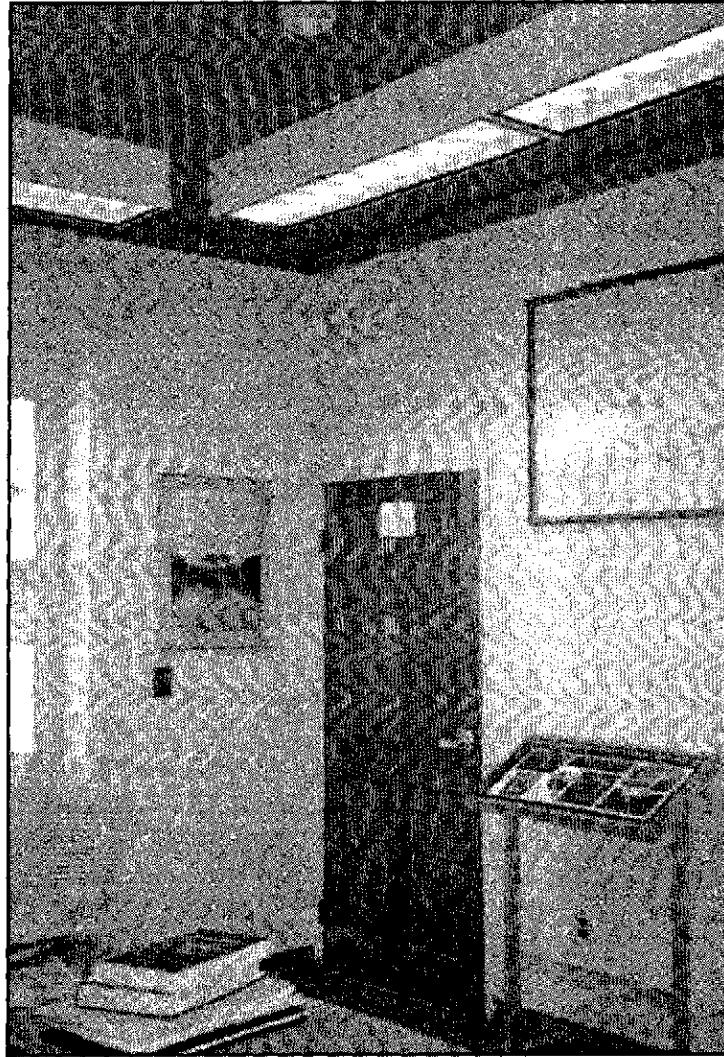

Figure 4.24: Entry vestibule (visitor contact station), view to south.

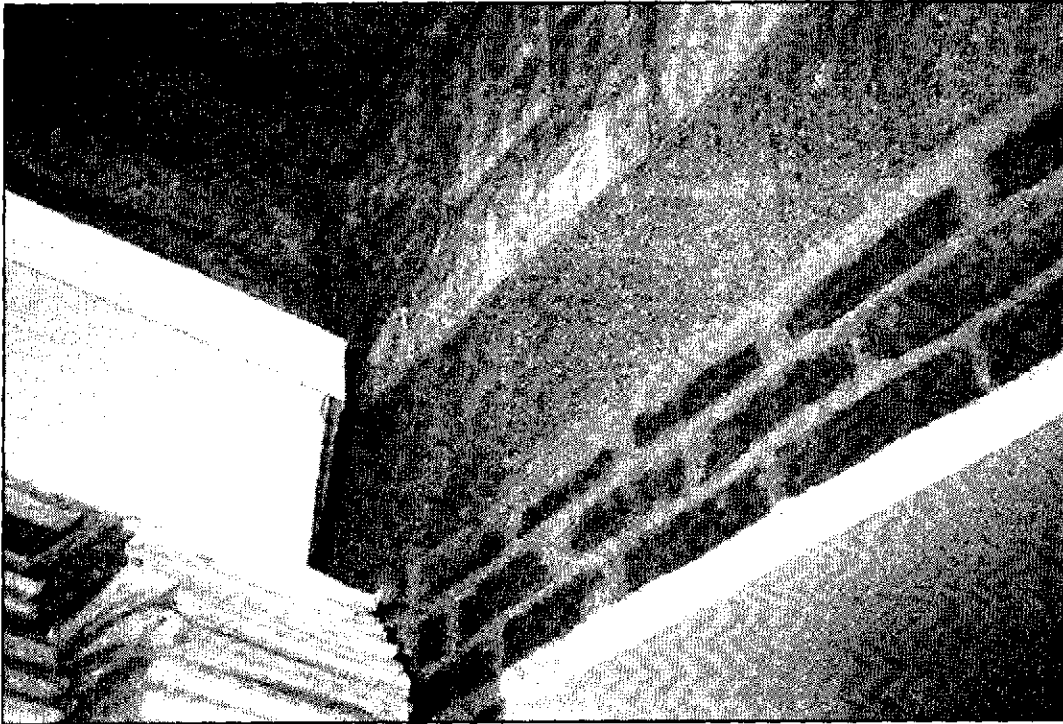

Figure 4.25: Passage, view to north with original marble and granite exterior building walls. This space was enclosed in the 1901 addition, and a new doorway cut. The doorway has been reduced in size with the installation of red brick.



Figure 4.26: Passage, view to northeast with tongue-in-groove wood ceiling scribed to stone building wall.



Figure 4.27: South office, view to southeast.

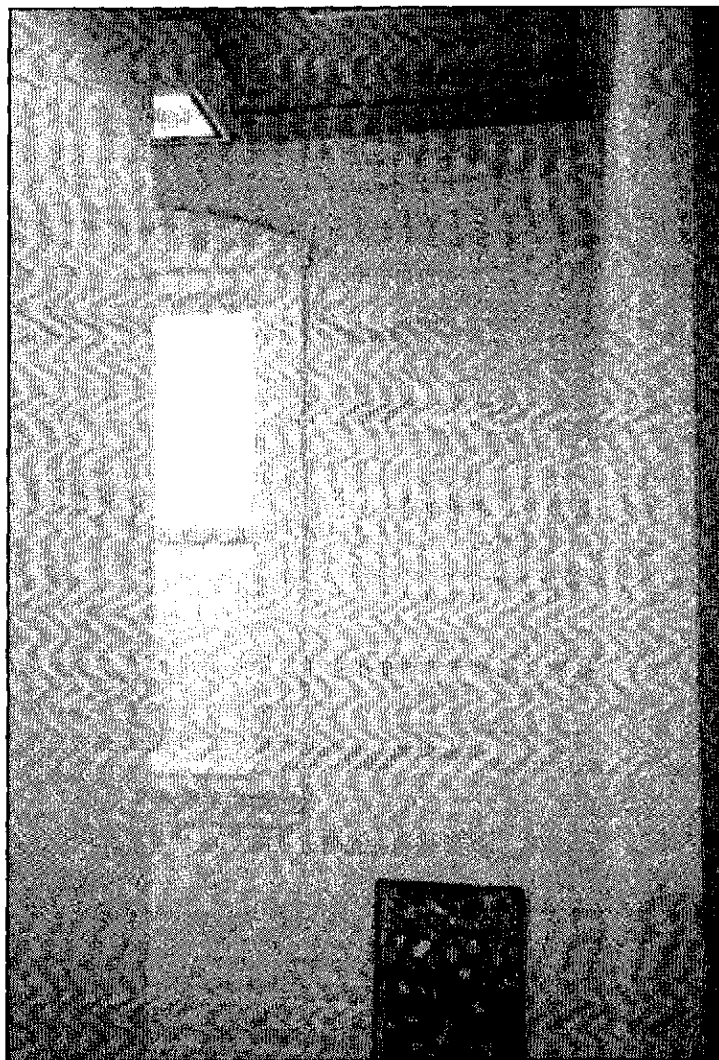

Figure 4.28: Stair, view to northwest from first-floor landing. Note arched-head panel at stair window. This is the only building window with an interior head panel instead of interior trim.



Figure 4.29: Stair, view to northeast from basement floor landing.

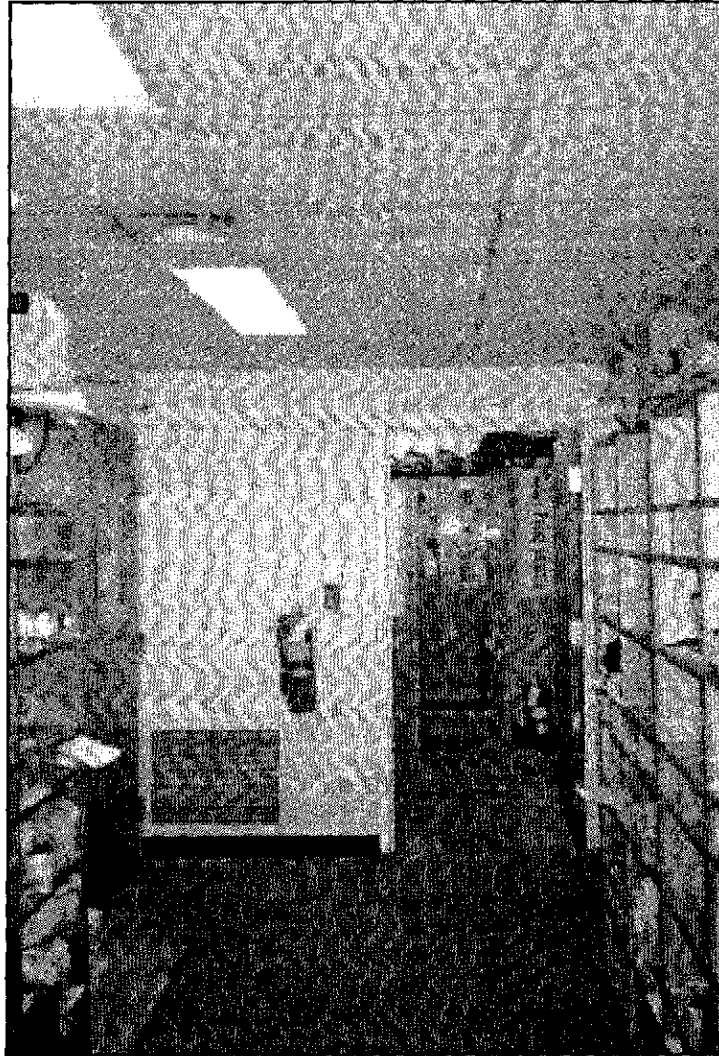

Figure 4.30: Basement corridor, view to northeast into staff locker room.

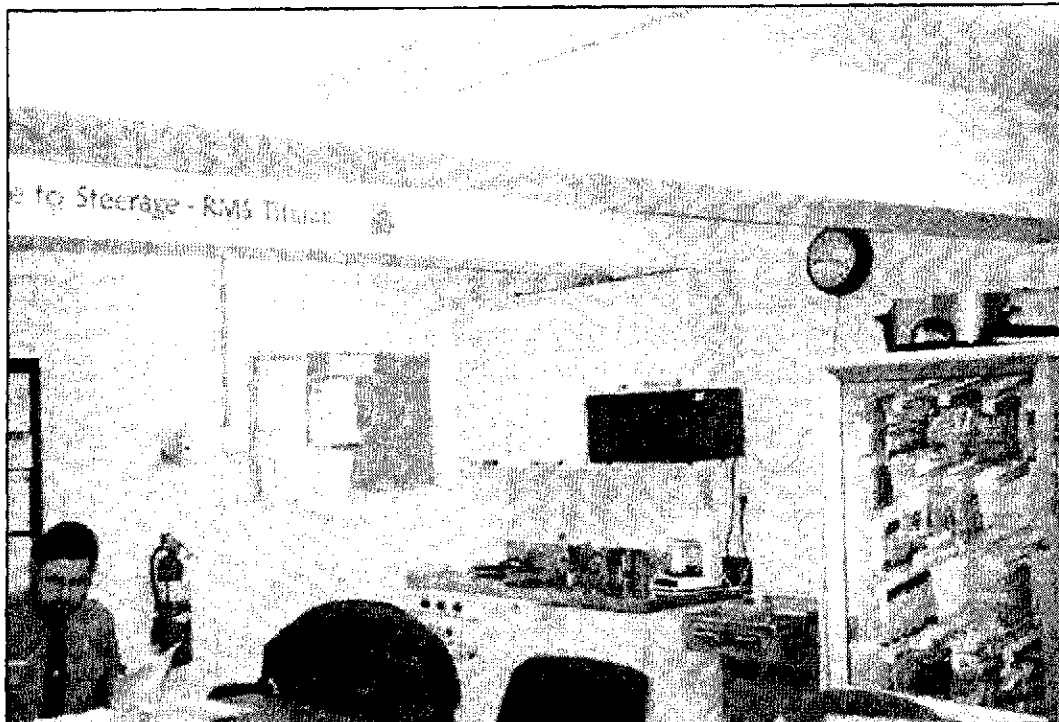

Figure 4.31: Staff break room, view to north.



Figure 4.32: Staff locker room, view to southeast with arched doorway into east storage room.

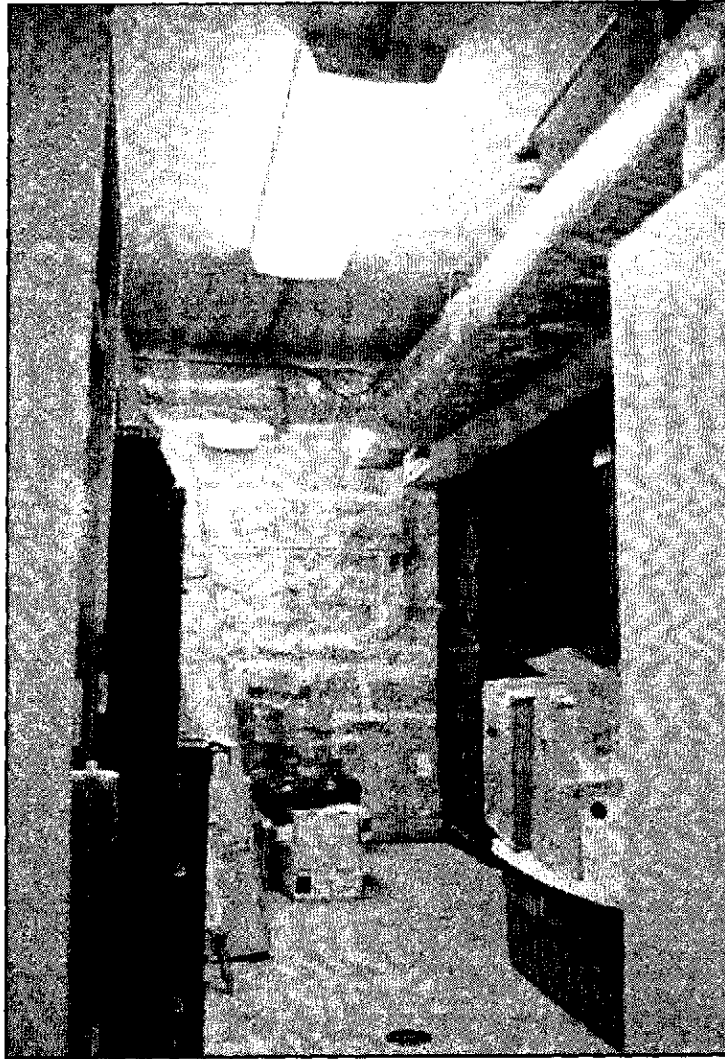

Figure 4.33: North storage room, view to northwest.

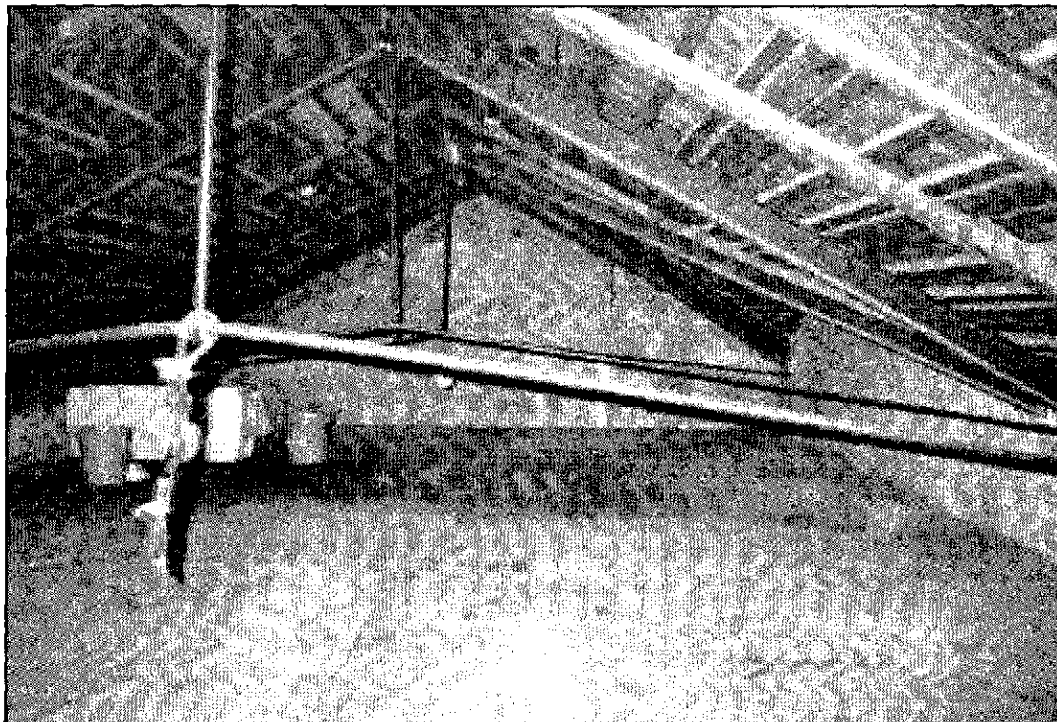

Figure 4.34: Attic, view to northeast.



Part I – Developmental History

CHAPTER FIVE
CONDITION ASSESSMENT

1
2
3
4
5
6
7
8
9
10
11
12
13
14
15
16
17
18
19
20
21
22
23
24
25
26
27
28
29
30
31
32
33
34
35
36
37
38
39
40
41
42
43
44
45
46
47
48
49
50
51
52
53
54
55
56
57
58
59
60
61
62
63
64
65
66
67
68
69
70
71
72
73
74
75
76
77
78
79
80
81
82
83
84
85
86
87
88
89
90
91
92
93
94
95
96
97
98
99
100

CHAPTER FIVE

CONDITION ASSESSMENT

5.1 GENERAL CONDITION

The Survey Lodge is a contributing structure to the Washington Monument Grounds for the period of significance 1886–1901. Building elements dating to this period will be considered significant; all others will be deemed non-contributing. The Survey Lodge, its attached utility shed, and the surrounding hardscape features of the lodge building site are all currently in good condition. The historic exterior masonry of the lodge, its modern interior finishes, and the utility shed only require maintenance-level repairs to ensure their continued preservation. This requirement is also true of the slate roof of the lodge and the galvanized-steel roof of the utility shed. The concrete walkways on the Survey Lodge site, along with site features such as the pedestal-mounted telephones and picnic tables, also require only maintenance-level repairs to guarantee their preservation. Immediate attention, however, is required at the wood windows and cupola to arrest ongoing deterioration. Also, the Survey Lodge heating, ventilating, and air-conditioning system should be thoroughly inspected for mold-spore growth. Large areas of mold growth around interior air-supply vents indicate the presence and propagation of mold spores in lodge ductwork.

5.2 METHODOLOGY

The condition assessment of the Survey Lodge was produced from information gathered during on-site visual inspections of the existing building, including a limited roof inspection. Investigations were carried out in both inclement and fair weather, and included the northwest gable attic and all inhabited interior spaces, as well as each of the storage and mechanical areas in the basement. Destructive testing and material analyses were not included in the scope of work for this report, nor were structural, electrical, and mechanical investigations. Conditions were noted on historical floor plans and elevations and site sketches. Schematic plans documenting existing conditions are included with this report. Color photographs were also taken to document existing conditions.

5.3 SITE

The concrete sidewalks surrounding the Survey Lodge are currently in good condition. They are of uniform color and texture and show no signs of serious deterioration. Maintenance issues that should be addressed, however, include seedling vegetation sprouting in sidewalk control joints and isolated areas of staining due to unusually heavy soiling or paint spatters. These areas of staining can be easily removed by cleaning. In contrast, the asphalt drive that encircles the lodge site is in very poor condition with severe cracking and erosion evident (see figure 5.1). Several previous asphalt patches dot the drive's surface, some of which are already failing. The drive does not date from the period of significance for the Survey Lodge, and it is recommended that

the drive be replaced or resurfaced in its entirety to correct its appearance and to prevent serious areas of erosion from becoming dangerous potholes. The stone-lined gutters flanking the service drive are currently in good condition. A few stones have shifted vertically due to tree-root growth and settlement, and these stones should be readjusted to provide a uniform appearance and ensure adequate drainage. The cast-metal bollards lining portions of the service drive, and their connecting chains, are currently in good condition with touch-up paint required as weathering occurs.

5.3.1 SOUTHEAST (MAIN ENTRY APPROACH)

The planting bed surrounding the historic granite entry stair near the east end of the southeast elevation of the Survey Lodge has been re-graded to the level of the stair landing. Continued burial of the stair will accelerate the deterioration of the stone due to high moisture levels, freeze-thaw cycles, and vegetation-root growth. The stair is a significant site feature, and it is recommended that the soil in this area be removed to completely expose the stair. The stair should then be brushed to dislodge remaining loose soil, and the granite stair, landing, and cheek walls should be thoroughly cleaned. At the south corner of the Survey Lodge, a large deciduous shrub has grown quite close to the building. Its branches overhang both a lodge roof gutter and a gutter outlet. It is recommended that this shrub be pruned to prevent branches and foliage from blocking water flow through the gutter and downspout. This is also true for the deciduous tree located to the east of the lodge main entry.

5.3.2 NORTHWEST

The bicycle rack located near the intersection of the vehicular and pedestrian pathways is beginning to show signs of rust. It should be cleaned of any flaking paint and repainted. The grass in and around this pathway intersection is very thin due to foot and vehicular traffic and erosion. It should be reseeded, possibly with the inclusion of a groundcover similar to that found to the southwest of the lodge. This would considerably reduce both foot and vehicular traffic across this area.

5.3.3 NORTHEAST

The two decorative cast-metal phone booths near the east corner of the Survey Lodge are heavily soiled and should be cleaned and/or painted.

5.4 SURVEY LODGE – EXTERIOR

The general condition of the exterior masonry of the Survey Lodge is very good, only requiring cleaning and isolated pointing and repair. Less than 5% of the mortar joints over all four building elevations appear to be open and in need of pointing. Such joints occur primarily in the granite water table and cornice, as well as corner joints around the attached chimney. These joints should be pointed with mortar mixed and tooled to match the rest of the building. Also, the exterior masonry of the Survey Lodge should be cleaned to remove biological growth and staining. Areas of biological growth should be treated with a non-acidic biocidal cleaner to remove biological growth and prevent it from causing damage to the masonry. Rust stains should be removed after a series of cleaning tests have been performed to determine the most

effective method of removal. All masonry repairs and cleaning should be undertaken very carefully to ensure that the excellent integrity of the exterior masonry is preserved.

The double-hung wood windows of the lodge are currently in fair condition, requiring immediate maintenance-level repairs to ensure their preservation. The windows were last rehabilitated in 1990,¹ but appear to have had little or no maintenance since that time. Paint crazing and flaking is prevalent at all wood windows and frames, particularly along sills and sash bottom rails (see figure 5.2). The windows all have one or more loose or protruding pegs, and at least 25% of the glazing putty has failed overall. Also, the meeting rails of these windows are very thin and prone to deterioration. Even minor deterioration in these rails can cause complete failure of the wood members. The meeting rails should be regularly inspected and repaired to prevent this from occurring. All wood windows should be immediately repaired and painted to avoid further deterioration. The slate roof of the Survey Lodge, installed in 1993,² is in excellent condition, and it will be many more years before it sees the end of its service life. Basic maintenance is all that is required to ensure its longevity.

5.4.1 SOUTHEAST FAÇADE

The marble and granite masonry of the main southeast elevation is in good condition overall. There is heavy soiling along the granite water table due to splashing rain, and there is a series of insect nests along the underside of the granite cornice, which should be removed. The raked cornice over the eastern bay of this elevation is cracked in one location near the roof ridge. The crack is not a sign of imminent masonry loss, however it is recommended that the crack be filled with a cementitious mortar to prevent further water infiltration. Embedded ferrous fasteners near both doorways are rusting, causing staining to appear on the masonry, which could be a precursor to masonry cracking. All of the masonry openings have lines of paint around their perimeters where over-painting has occurred at door and window frames. Paint spatters are also visible on door and window sills and on the masonry under each of the façade's two windows. Each masonry opening is further characterized by a series of ¼-inch- to ½-inch-diameter holes where security screen fasteners have been removed. In some cases these holes have been filled with sealant, but in most instances the fastener anchors are still in place. These anchors should be removed and the holes filled with a cementitious mortar.

The wood door, panels, and surrounding frame in the eastern bay of the southeast elevation are experiencing moderate paint failure, but no wood deterioration can as yet be appreciated. The center rail of the main entry door to the Survey Lodge has a split at the knob approximately 6 inches in length. This split should be filled, and all wood door and frame members should be painted to prevent further deterioration.

5.4.2 SOUTHWEST FAÇADE

The marble and granite masonry of the southwest elevation is currently in good condition. There are heavy soiling and a series of insect nests on the western bay of this elevation under the adjacent areaway roof. Above this roof, biological growth is thriving on the underside of marble projections in the rock-faced finish masonry due to splashing rain. This condition continues across the face of the adjacent attached chimney (see figure 5.3). Directly below, at the base of the granite water table, small areas of tar are visible above the poured concrete and stucco of the

basement areaway. All of these areas should be cleaned and insect nests removed. Biological growth should be treated using a non-acidic biocidal cleaner, and cleaning tests should be performed to determine the most effective method of tar removal.

In the southern bay of the southwest elevation, two pieces of marble masonry act as anchor points for a pivoting metal arm. The lower of these two stones has severe ferrous staining from the metal arm and drips of paint from maintenance on the metal arm (see figure 5.4). Just below this stone, the red brick masonry of the 1901 Survey Lodge addition is visible, and a 1-inch-diameter hole is evidence of a previously removed fastener. The red brick masonry of the 1901 addition is also visible at the southern end of the southwest elevation where the stone masonry of the southeast elevation ends. The masonry joints at this corner and the perimeter of the adjacent stucco have undergone several pointing campaigns, but the pointing is not uniform in color or profile and should be replaced (see figure 5.5). It is recommended that all of the mortar joints at the south end of the southwest elevation be pointed with mortar and tooling to match the rest of the building.

The masonry of the attached chimney is in good overall condition. Its topmost granite belt course and its granite cornice have spalled in small isolated areas, and the metal chimney cap has caused staining on the granite cornice (see figure 5.6). The metal chimney cap was removed in 2001. The granite should be cleaned and patched with a suitable patching material.

The current condition of the stucco finish of the 1901 Survey Lodge addition is poor. It is riddled with hairline cracks, patches, and penetrations. Cracking is particularly severe over both window heads, and rust has bloomed at window lintels, around an array of ferrous fasteners, and under the large galvanized conductor head in the center of the southwest elevation (see figure 5.7). The stucco on the southwest elevation does not date to the period of significance for the building, and it is recommended that the existing stucco be removed and replaced. Obsolete fasteners should be removed, and remaining ferrous fasteners should be replaced with stainless steel. Embedded ferrous elements should be cleaned of rust and painted where replacement is not feasible.

The stucco coating at the basement concrete areaway of the southwest elevation also has several cracks and penetrations. At the base of the westernmost stone corner of the lodge, a large area of stucco is delaminating and is in imminent danger of detachment. The stucco is also beginning to delaminate from large sections of the concrete retaining wall opposite this location. All of the stucco in the areaway is covered with rust staining, heavy soiling, and biological growth. The areaway stucco does not date to the period of significance for the building, and it is recommended that the existing stucco be removed and replaced in its entirety. Obsolete fasteners should be removed, and remaining ferrous fasteners should be replaced with stainless steel. Embedded ferrous elements should be cleaned of rust and painted where replacement is not feasible.

The general condition of the two double-hung wood windows in the southwest elevation is described in the general exterior conditions section above. The western window, however, has additional deterioration that should be noted. The wood arched head panel of this window is

seriously deteriorated at its left end, requiring a dutchman repair of less than 1 square foot. The meeting rail of the upper sash of this window is likewise deteriorated, with a large split forming along its length. It is recommended that this member be replaced in its entirety.

The single-pane wood window in the basement areaway of the southwest elevation is cracked, and its glazing should be replaced. The wood frame and trim reveal the beginnings of paint failure and should be sanded and painted.

The six-panel wood door in the basement areaway exhibits severe paint failure. Both the wood frame of the door and its trim are heavily scratched and gouged, and the hinges are severely rusted. Also, the door is no longer level. The door, frame, and trim should be repaired with wood filler and painted. The hinges should be cleaned of rust and painted or replaced with stainless steel, and the door should be adjusted to hang level.

The steel column and beam structure supporting the basement areaway roof is beginning to show signs of paint failure and rust bloom (see figure 5.8). A 1½-inch-diameter metal-pipe handrail tops the concrete retaining wall that encloses the southwest side of the areaway and continues down the areaway stair to the basement entry. Severe paint failure is evident at this handrail along its entire length as is resulting rust bloom. Each of these elements should be cleaned of rust and flaking paint and should be painted to prevent deterioration and further staining of adjacent building elements. Also, all metal elements, including fasteners, should be replaced with stainless steel wherever possible.

Hanging from the painted steel structure of the areaway roof are three 2-foot square fluorescent light fixtures. The tops of these fixtures have become ideal nesting locations for small birds, and their droppings cover the concrete steps below (see figure 5.9). Screens or bird guards should be installed over the light fixtures to prevent bird nesting, or the fixtures should be replaced with a model that does not provide a nesting surface.

5.4.3 NORTHWEST FAÇADE

The marble and granite masonry of the northwest elevation is currently in good condition. There is heavy soiling along the granite water table due to splashing rain; along the underside of the granite cornice, there is a series of insect nests, which should be removed. The cornice joints appear to be substantially open, causing staining on the masonry below and allowing water to infiltrate the masonry wall. The entire cornice of this elevation should be cleaned and pointed. The joint between the granite water table and curb is completely open along its entire length and should be pointed. Also, pointing is required at approximately 50% of the vertical joints in the water table where hairline cracks have appeared. Biological growth is thriving on the underside of the projecting surfaces of the marble masonry below the lower belt course and on the granite water table and curb. It is particularly severe underneath the northernmost window where an air-conditioning unit was previously removed (see figure 5.10). All areas of biological growth should be treated with a non-acidic biocidal cleaner to prevent masonry deterioration. Exposed electrical conduit is attached to the granite water table for approximately half its length, and the ferrous fasteners have rusted and stained the granite below. The fasteners should be removed and replaced with stainless steel. Several other ferrous fasteners, which appear to be obsolete,

dot the northwest elevation and should be removed to prevent further rust stains and possible masonry cracking. All of the masonry openings have lines of paint around their perimeters where over-painting has occurred at window frames. Paint spatters are also visible on window sills and on the masonry under each of the façade's four windows. Each masonry opening is further characterized by a series of ¼-inch- to ½-inch-diameter holes where security-screen fasteners have been removed. In some cases these holes have been filled with sealant, but in most instances the fastener anchors are still in place (see figure 5.11). These anchors should be removed and the holes filled with a cementitious mortar.

The narrow gallery along the northwest elevation enclosed by the utility shed fence is littered with tree branches and foliage. This vegetation holds moisture and accelerates the deterioration of the concrete paving below. As this paving also serves as a portion of the staff break room and north storage-room roofs, its deterioration can be a major source of water infiltration in these spaces, and it should be maintained free of debris at all times. Also, the paving is heavily soiled and stained in several locations, and a series of large ferrous fasteners protrude from the paving approximately 16 inches from the granite curb of the northwest elevation. These fasteners create a significant tripping hazard and should be removed immediately.

The gallery is accessed through a narrow gate at its northwest end. This gate is secured with a padlock, which at the time of site investigation was unable to be opened due to the inability of the investigative crew or Park Service staff to locate the appropriate key. Access to the gallery was obtained through the window of the west office. This situation should be immediately remedied to allow maintenance personnel to routinely remove debris from the gallery and inspect the area for deterioration and damage.

The general condition of the four double-hung wood windows in the northwest elevation is described in the general exterior conditions section above. Three of the windows, however, have additional deterioration that should be noted. The meeting rail of the upper sash of the northernmost window has severely deteriorated at its left end. A dutchman approximately 3 inches long should be installed in this location. The window immediately to the right of this has several areas of wood deterioration. Both ends of the meeting rail of the upper sash have rotted, requiring the installation of two dutchmen, each 3 inches in length. The bottom 3 inches of the bottom sash's mullion also require a dutchman replacement. The left pane in the bottom sash is cracked and should be replaced as well. In the westernmost window, the meeting rail of the upper sash has deteriorated at both ends. A dutchman approximately 3 inches long should be installed in these two locations.

5.4.4 NORTHEAST FAÇADE

The marble and granite masonry of the northeast elevation is in good overall condition. There is heavy soiling along the granite water table due to splashing rain, and there is a series of insect nests along the underside of the granite cornice, which should be removed. Two ½-inch-diameter holes immediately under the gable raked cornice are evidence of removed fasteners, and a spall approximately 2 square feet in area is apparent in the granite water table of the gable return. This spall appears to have occurred some time ago because the exposed granite surface has weathered long enough to be uniform in color with the adjacent stone. It should be patched, however, if a suitable patching material can be acquired. Biological growth is thriving on the

underside of projecting surfaces of the marble masonry on the lower half of the building wall and on the granite water table along the entire length of the northeast elevation. It is particularly severe under the western window where an air conditioning unit was previously removed (see figure 5.12). All areas of biological growth should be treated with a non-acidic biocidal cleaner to prevent masonry deterioration. The concrete sill below the door opening in the north bay of the northeast elevation is heavily soiled, covered in biological growth, and should be thoroughly cleaned.

The general condition of the two double-hung wood windows in the northeast elevation is described in the general exterior conditions section above. Both of the windows, however, have additional deterioration that should be noted. The meeting rail of the upper sash of the eastern window is severely deteriorated, with a large split forming along its length. It is recommended that this member be replaced in its entirety. The left end of the wood sill of this window is likewise deteriorated, and a dutchman approximately 3 inches long should be installed in this location. In the western window, the left end of the bottom rail of the bottom sash is deteriorated, requiring the installation of a dutchman approximately 6 inches in length.

The door in the northern bay of the northeast elevation is damaged in two locations. The center rail opposite the doorknob has been severely injured, possibly due to impact stress, but the wood does not appear to be rotten (see figure 5.13). Limited probing did not reveal the wood to be soft or the paint to be bubbled, and the damage currently appears to be only cosmetic. The bottom 10 inches of the knob side stile have rotted, and a dutchman should be installed in this location. The bottom 10 inches of the left side of the wood perimeter frame have rotted and should also be replaced with a dutchman. The bottom third of the door, flanking panels, and doorframe are all heavily soiled due to splashing rain, and small areas of paint failure are beginning to appear. All wood elements should be cleaned and painted to prevent impending deterioration. The sealant joint at the junction of the wood frame and its surrounding masonry opening has completely failed and should be replaced.

5.4.5 ROOF

The slate roof of the Survey Lodge is currently in excellent condition, requiring only basic maintenance to ensure its preservation. The built-in gutters of the roof are clogged with branches and foliage, trapping water and causing heavy rain to overflow onto the granite cornice and ground below. Excess water also percolates up under the bottom course of slate shingles, and standing water eventually finds its way through small fissures in the sheet-metal gutter joints to the stone wall below. Through-cornice downspouts are also clogged, which accelerates this problem. The south downspout on the southeast elevation is completely disconnected from its rain leader, and the downspout is clogged with vegetation (see figure 5.14). Because this is the only downspout along the length of this gutter, all water landing on the southeast half of the lodge currently runs over the face of the building. All gutters and downspouts should be routinely cleaned of debris. Pruning overhanging branches of nearby trees and shrubs will significantly diminish the amount of debris washed into them. Rain leaders may also be clogged along their length, and should be investigated and cleaned on a routine basis. The disconnected leader on the southeast elevation should be given particular scrutiny before it is reconnected to its downspout.

The flat-seam metal roof between the lodge roof gables is currently in fair condition. Some debris was observed along with small areas of standing water that were still visible approximately 12 hours after the last rainfall. The roof should be routinely swept of debris, and the underside of areas regularly promoting standing water should be checked for water infiltration. Active leaks apparent on first-floor ceilings may be a direct result of this standing water, but further investigation should be conducted.

The wood and metal cupola located atop the north gable intersection is in poor condition. While the articulated-bell metal roof and finial appear to be weathering well, all of the wood surfaces below exhibit severe paint failure. Problem areas have been coated with tar and sealant, lending the cupola an unsightly appearance (see figure 5.15). Further investigation is required to determine the extent of wood-member deterioration, but at the least, all tar and sealant should be removed and wood members scraped and painted. No water damage was visible in the attic below this location.

5.5 UTILITY SHED

The utility shed to the northwest of the Survey Lodge is in good condition, and only requires maintenance-level repairs to ensure its longevity. The alternating-board wood fence that encloses the shed is supporting biological growth in isolated areas, and there are approximately two vertical boards missing. The interior steel structure of the shed has small areas of paint failure and resulting rust bloom. The concrete paving is heavily soiled and should be cleaned. As this paving also serves as a portion of the staff break-room and north storage-room roofs, its deterioration can be a major source of water infiltration in these spaces, and it should be maintained free of debris at all times. The corrugated galvanized steel roof deck is littered with branches and foliage, which hold standing water long after other roof areas are dry. The K-type hanging gutters of the roof are also clogged with debris and contain standing water (see figure 5.16). All of these surfaces should be routinely cleaned to assure adequate drainage and to lengthen the life of the roof deck. Ferrous fasteners on the roof deck have begun to rust, and the gutters and downspouts reveal the beginnings of paint failure. Any rust staining on the roof deck or gutters should be contained to prevent any impact on Survey Lodge building elements.

5.6 SURVEY LODGE – INTERIOR

The interior of the Survey Lodge is currently in good condition. The building was renovated in 1989 and no historic interior finishes remain.³ All of the modern finishes are showing typical wear from daily office-space use, and maintenance-level repairs are all that will be required to ensure continued service.

Condition assessment drawings for the first floor and basement have been prepared to visually represent areas of more serious damage (see figures 5.17 and 5.18). Damage represented on these drawings includes severe paint failure, biological growth, and water damage on ceiling surfaces, as well as concrete cracking in walls and floors. Water damage shown may be the result of active leaks in the building envelope or condensation on hidden pipes or ducts (see figure 5.19). Severe paint deterioration on ceiling surfaces, such as flaking or bubbling, may also be a direct result of water infiltration (see figure 5.20). All of these areas should be

thoroughly inspected to determine the source of the moisture, and steps should be taken to prevent its intrusion. Water-damaged areas should then be repaired.

Areas of biological growth are typically located at supply air vents and indicate both high humidity in the ventilation system and possible mold spores in the air ducts. The presence of large numbers of mold spores in the air system can be a contributing cause of employee health problems and discomfort. Humidity levels in the supply air ducts should be closely monitored and decreased as needed to prevent the spread and growth of mold spores in the building. The building supply and return air ducts may also have to be cleaned to rid the system of hidden mold sources.

Cracks shown in the concrete walls and floor slabs in the basement typically appear to be areas of building settlement rather than possible material failure. The cracks should be filled with a cementitious mortar to prevent possible water infiltration. Carpeting and other finish material prevented a visual inspection of concrete surfaces on the first floor.

5.6.1 FIRST-FLOOR LEVEL

All of the finishes on the first floor require maintenance-level repairs to freshen their appearance and prolong their service life. Many signs of normal wear can be found in each room including general carpet soiling, paint deterioration, and scuff marks from furniture movement. Minor soiling and paint deterioration can be seen on all wall surfaces approximately 3 feet or less from the finish floor, particularly near workstations. Paint flaking and rust bloom are apparent at the base of all hollow-metal doorframes, and chips and gouges in paint and plaster surfaces occur on every type of corner or protrusion.

5.6.1.1 NORTH OFFICE

A section of carpet in the east corner of the north office is missing and should be replaced.

5.6.1.2 PASSAGE

The center boards of the tongue-in-groove wood ceiling, directly above the door opening to the west office, have settled approximately 1 inch.

5.6.1.3 STAIR

The paint on the metal stair is extremely worn. Small areas of rust are beginning to form, particularly at the base of the bottom riser. The paint on the handrail is chipped in isolated areas. Paint on the northwest brick wall of the stair is severely deteriorated in the lower half of the space. All flaking paint and rust should be removed and these areas repainted.

5.6.2 BASEMENT LEVEL

All of the finishes in the basement require maintenance-level repairs to freshen their appearance and prolong their service life. Many signs of normal wear can be found in each room including paint deterioration and scuff marks from foot traffic and furniture movement. Minor soiling and paint deterioration can be seen on all wall surfaces approximately 3 feet or less from the finish floor, particularly in high-traffic areas. Paint flaking and rust bloom are apparent at the base of

all hollow-metal doorframes, and chips and gouges in paint and plaster surfaces occur on every type of corner or protrusion. The painted finish on some concrete-floor areas is extremely worn and should be repainted (see figure 5.21).

5.6.2.1 CORRIDOR

An irregularly shaped area of gypsum wall board approximately 1 square foot in size is missing at the base of the northeast corridor wall near the bottom of the stair. It appears that this loss is due to a severe impact. It should be patched and painted to match the adjacent wall. The metal ramp bolted to the floor in front of the access door to the handicapped lift is experiencing severe paint failure at its edges as well as general wear (see figure 5.22). The first traces of rust bloom are also apparent.

5.6.2.2 STAFF BREAK ROOM

The concrete walls of the staff break room are dotted with abandoned fasteners, and there is an inappropriate patch approximately 2 square feet in size located on the southeast wall west of the kitchenette. The vinyl-tile flooring in this room is very worn and has been replaced in small areas. The flooring is missing at the edge of the ramp to the corridor, and the entire floor should be replaced to provide a uniform appearance. The metal handrails on either side of the ramp to the corridor display severe paint flaking and rust bloom and should be cleaned of rust and painted. The northwest handrail has caused a crack in the brick wall to which it is attached. The steel angles framing the window opening on the southwest wall have rusted and should be cleaned of rust and painted. This is also true of rusting metal light fixtures mounted in or near areas of ceiling water damage.

5.6.2.3 RESTROOMS

In the women's rest room, there are six loose ceramic tiles on the stall side of the soffit near the shower enclosure. In the men's rest room, the urinal side of the metal partition on the northeast wall is severely rusted, and there are two damaged acoustic ceiling tiles above this area. Both rest rooms exhibit general soiling, particularly on floors, with heavy soiling in corners and hard-to-reach areas.

5.6.2.4 STAFF LOCKER ROOM

The floor of the staff locker room in the immediate vicinity of the building furnace is covered in rust stains. The brick walls display isolated areas of flaking paint, and the welds on the metal access door to the historic steam tunnel are severely rusted. The welding process discolored the brick wall into which the door was set (see figure 5.23).

5.6.2.5 NORTH STORAGE ROOM

The northwest stone wall in the north storage room has been badly pointed in some areas with off-color mortar and inappropriate tooling. These areas should be repointed with mortar to match the rest of the room.

5.6.2.6 EAST STORAGE ROOM

The stone walls at the south corner of the east storage room appear damp and have been badly pointed with off-color mortar and inappropriate tooling. This area is directly below a deciduous tree in the re-graded planting bed immediately northeast of the building main entry. The walls should be closely monitored, and if dampness persists, subsurface investigations should occur to determine the extent of damage resulting from tree-root growth. The exterior of the wall may need to be waterproofed, a subsurface drain installed, or the tree relocated. The stone walls in this area should be repointed with mortar to match the rest of the room, with care taken to not disturb the remains of the historic whitewash finish on the stone surface. A historic opening in the southwest wall of the room has been in-filled and finished with painted plaster, which is in marked contrast to the other finishes in the room. The concrete floor has severe rust stains around cast-metal trench covers and equipment.

5.6.3 ATTIC

The Survey Lodge northwest gable attic is currently in good condition. Only maintenance-level repairs are required to ensure its preservation. Isolated areas of rust on historic iron structural members should be cleaned and painted. The area underneath the south-corner granite roof rake has been filled with mortar, which is now crumbling and falling out (see figure 5.24). Several bricks at the west-corner granite roof rake are loose with large voids between the top of the brick wall and the underside of the roof deck. There are also a few loose bricks at the top of the southeast wall where the 1901 Survey Lodge addition was constructed. The vertical joints in the granite cornice are at least 50% open, and the brick joints in the gable-end walls are approximately 5% open overall. Areas of mortar failure should be pointed to match the surrounding walls and voids should be filled. Special care should be taken to not disturb the remains of historic whitewash finishes wherever possible. One of the cast-iron trusses of the historic roof structure has wood wedges inserted between the deck beams and tie-rod, but it is unclear what purpose these wedges are serving. They appear to be decreasing the deflection of the tie-rod, but further structural investigations should occur to determine the stability and integrity of the iron elements. Finally, approximately halfway down the roof slope on the northwest side of the attic, water stains are visible on wood purlins and sheathing. Plastic containers have been placed below this location to catch dripping water (see figure 5.25). At the time of investigation, this leak did not appear to be active, but close monitoring is required to determine if a roof patch is necessary.

The southeast gable attic is not accessible and was not surveyed for this report. To ensure proper maintenance and regular inspection of roof framing and sheathing, an attic access hatch should be installed in this area.

ENDNOTES

Abbreviations:

NPS-NCR National Park Service – National Capital Region

¹ H. Thomas McGrath, Williamsport Preservation Training Center, HFC, to Superintendent, National Capital Parks – Central, Memorandum, 2 October 1990; NPS-NCR Collection.

² Monika Mayr, Chief, Branch of Construction and A/E Contracts Contracting Officer, NCP-Central, to AEO Construction Co., Inc., "Contract No. 1443CX300092073. Install a Cupola and Replace the Roofing System on the Survey Lodge Building, Washington, DC." 22 October 1992; NPS-NCR Collection.

³ Vincent Chan & Associates, Inc., "Demolition Plans," 3 August 1989; [Architectural Drawing] File 807_80116, Sheet 2 of 25; Technical Information Center, Denver Service Center, National Park Service.



Figure 5.1: Asphalt service drive north of lodge, view to the southeast with serious cracking and previous patches evident.



Figure 5.2: Lower sash of double-hung wood window with granite sill, northwest elevation. Note paint deterioration and loose pegs in the window, and drips of paint on the granite sill.

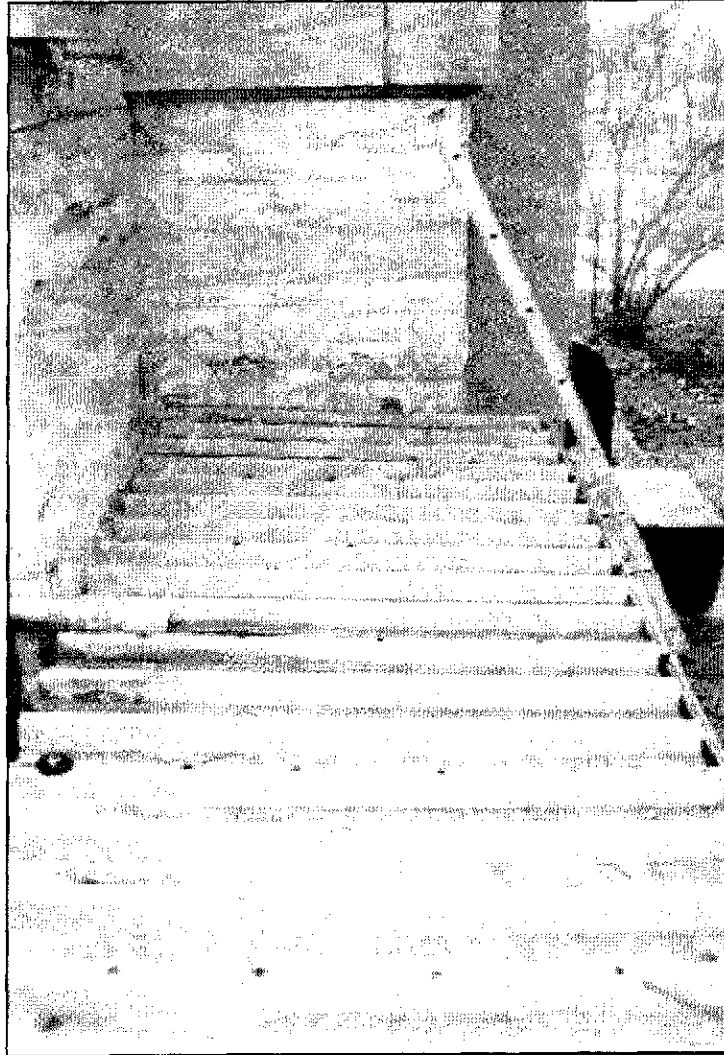

Figure 5.3: Southwest elevation and attached chimney, view to the southeast. Splashing rain is encouraging biological growth above the areaway roof, and ferrous fasteners on the roof deck are beginning to rust.

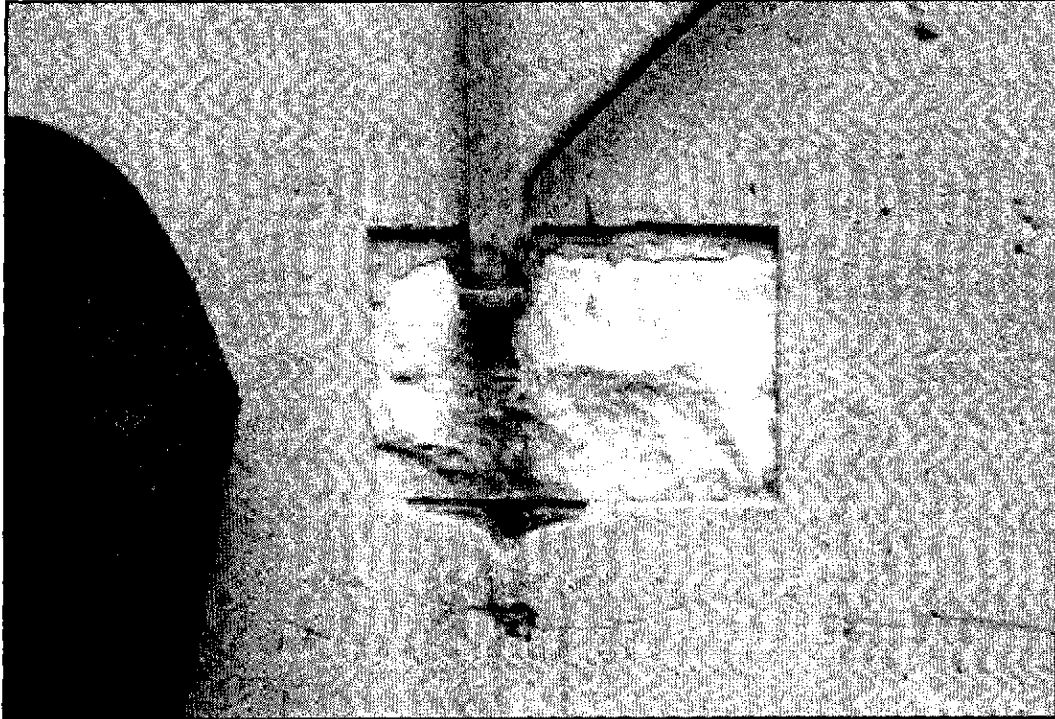

Figure 5.4; Detail of southwest elevation with ferrous staining under attached pivoting metal arm. The stucco has spalled, revealing the red brick back-up of the 1901 addition, and two penetrations are visible.

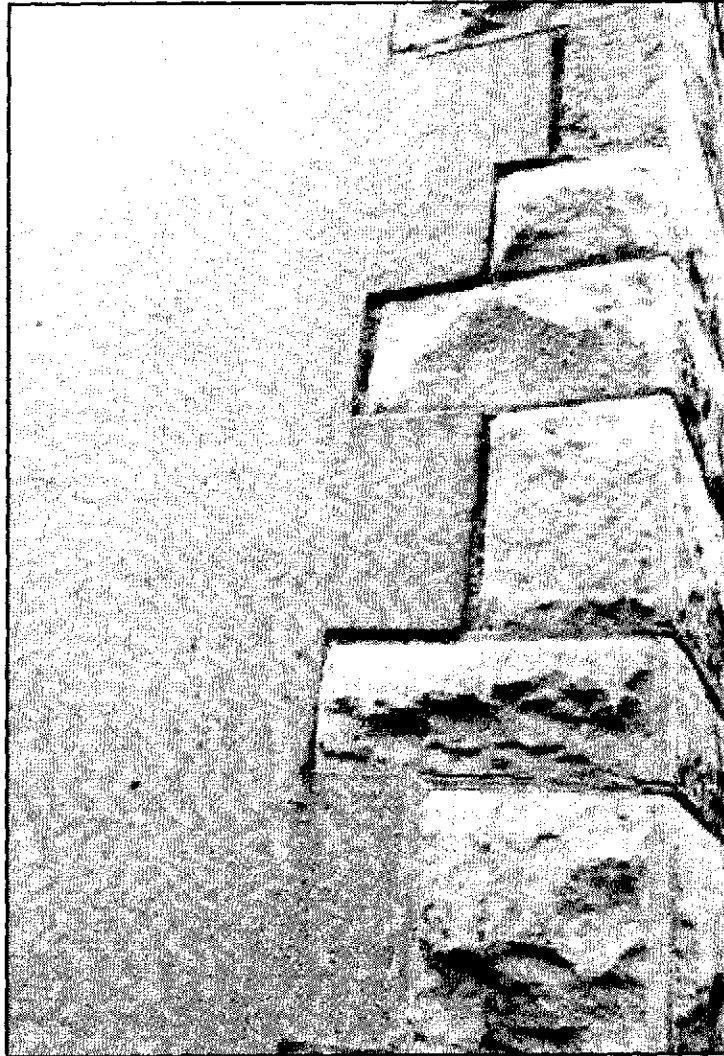

Figure 5.5: Detail of southwest elevation at south corner with open and improperly tooled mortar joints. The red brick back-up of the 1901 addition is visible at the edge of the stucco in some locations.



Figure 5.6: Attached chimney, view to the south. The granite belt course has spalled, and the metal chimney cap has stained the granite cornice.

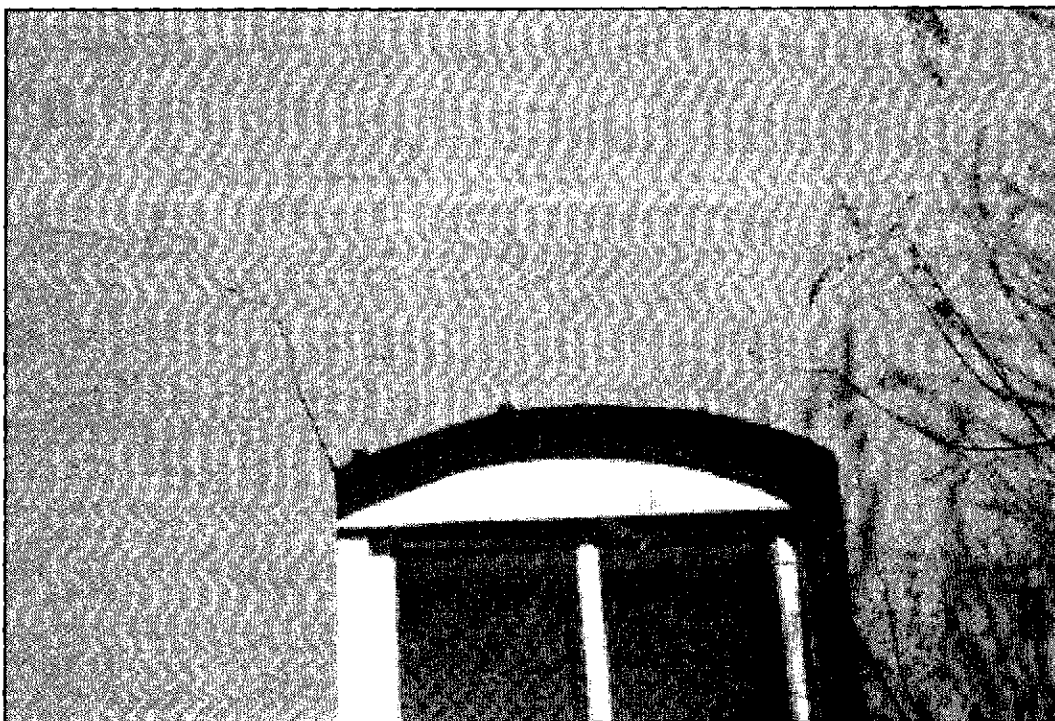

Figure 5.7: Detail of southwest elevation with severe stucco cracking and spots of ferrous staining at window head.



Figure 5.8: Detail of steel structure at northwest areaway roof with failing paint and rust bloom. The K-type hanging gutter and downspout are also experiencing paint failure.

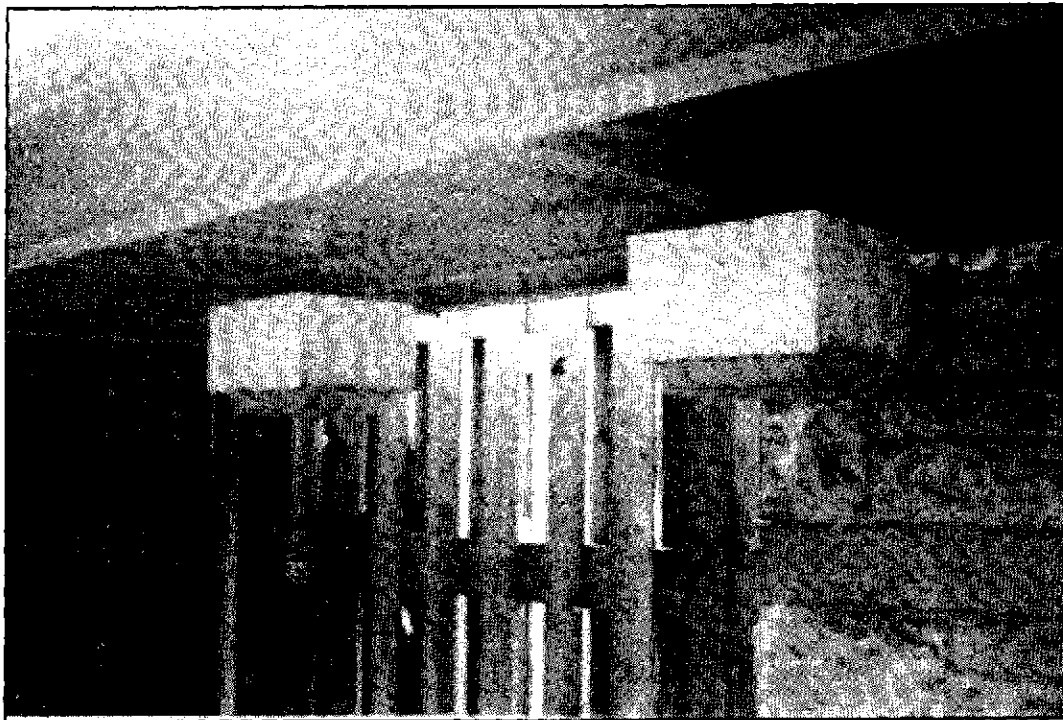

Figure 5.9: Light fixtures under areaway roof supporting bird nests.

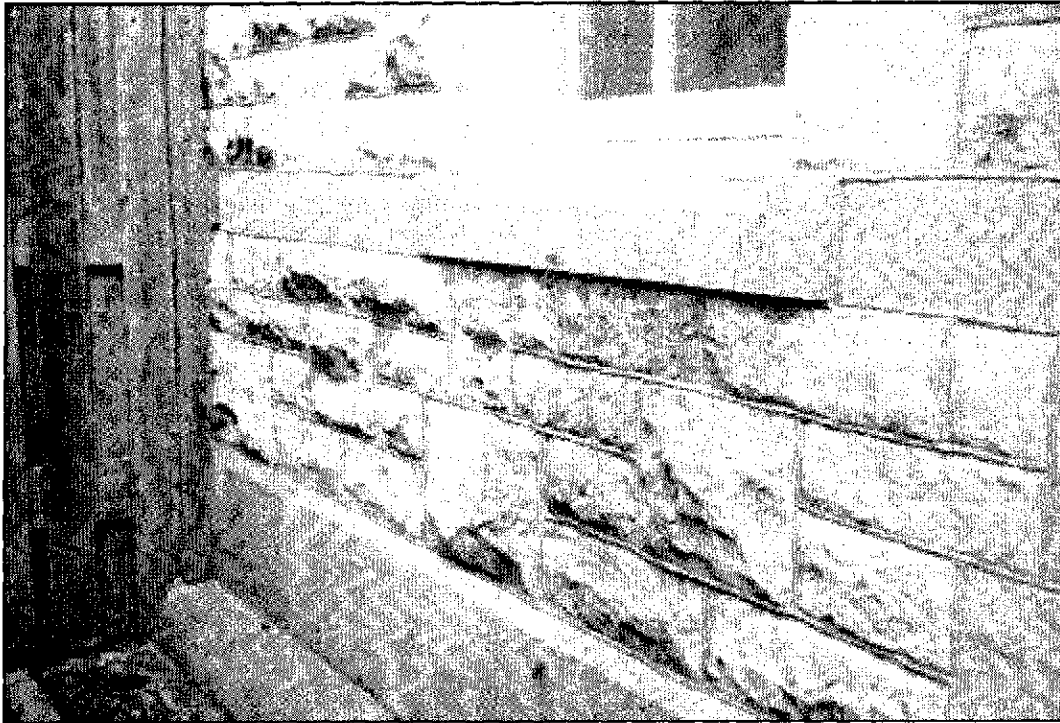

Figure 5.10: Detail of northwest elevation with significant biological growth under previous location of window air-conditioning unit. Ferrous staining and paint spatters are also visible at the granite window sill and water table.

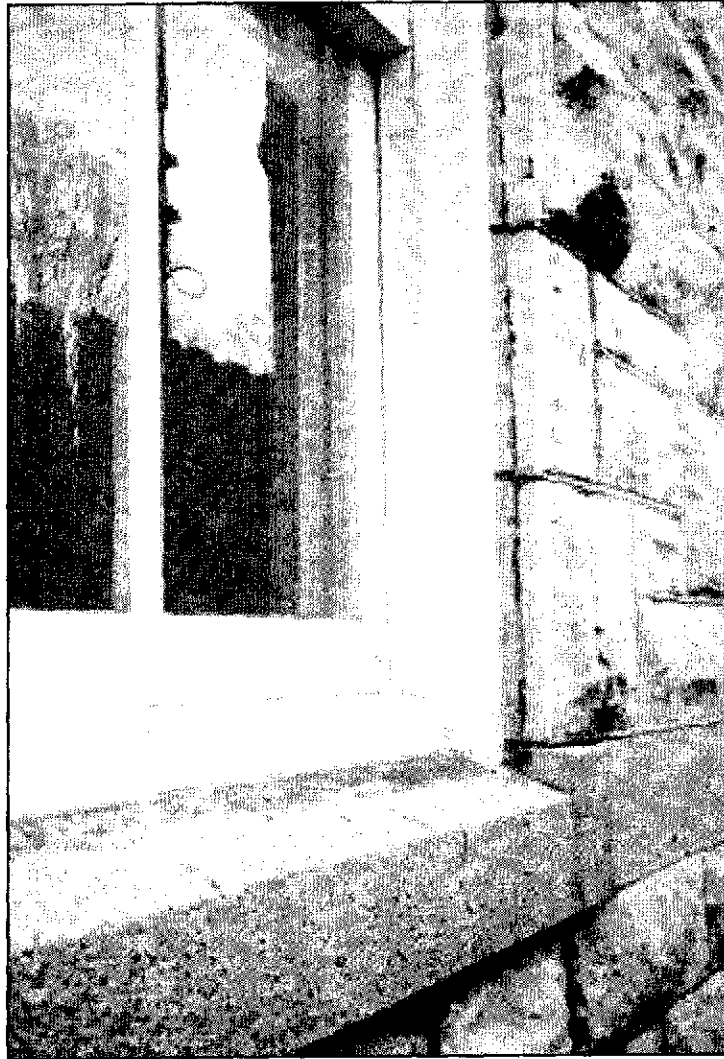

Figure 5.11: Lower sash of double-hung wood window with granite sill, northwest elevation. Note the line of paint at the masonry opening, drips of paint on the granite sill, and the remains of an anchor from a previously removed security screen.



Figure 5.12: Northeast elevation with significant biological growth on underside of rock-faced finish marble and granite water table.



Figure 5.13: Detail of door at northeast elevation with damage to center rail.



Figure 5.14: Detail of through-cornice downspout disconnected from rain leader at south end of southeast elevation. The downspout is clogged with branches and foliage.

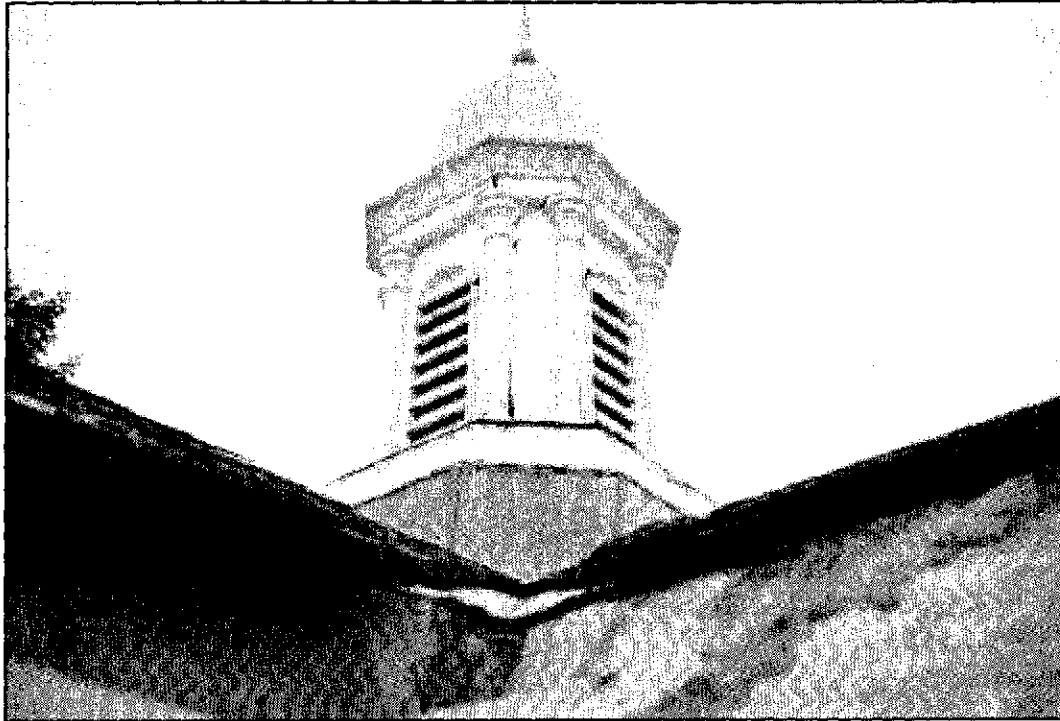

Figure 5.15: Cupola, view to the west with black sealant and failing paint.

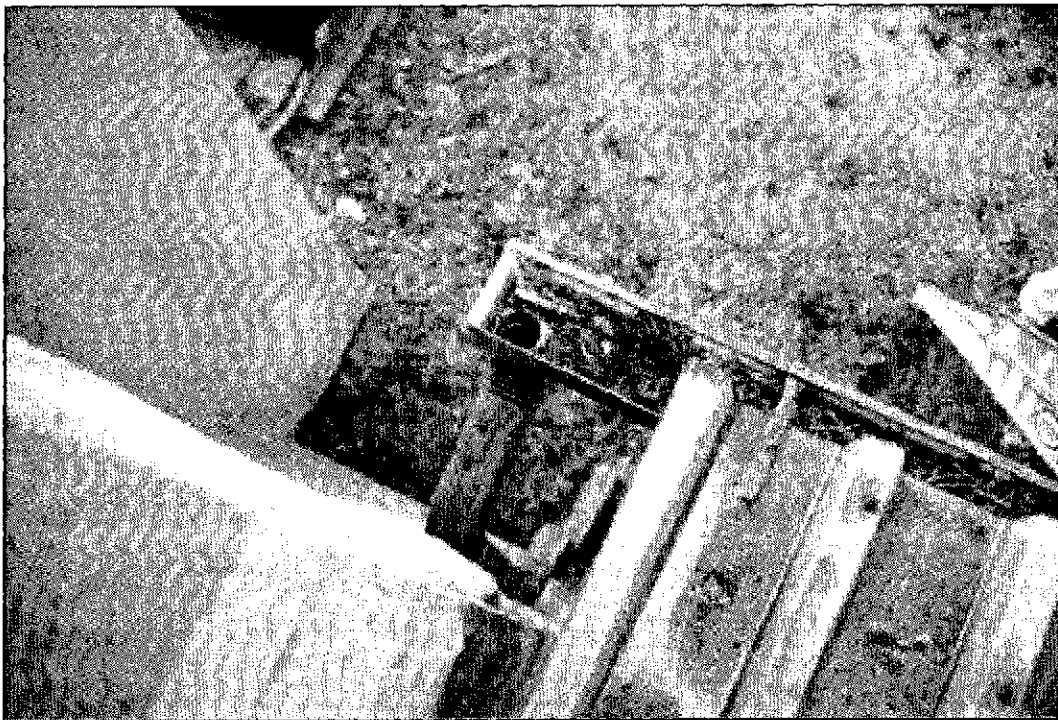
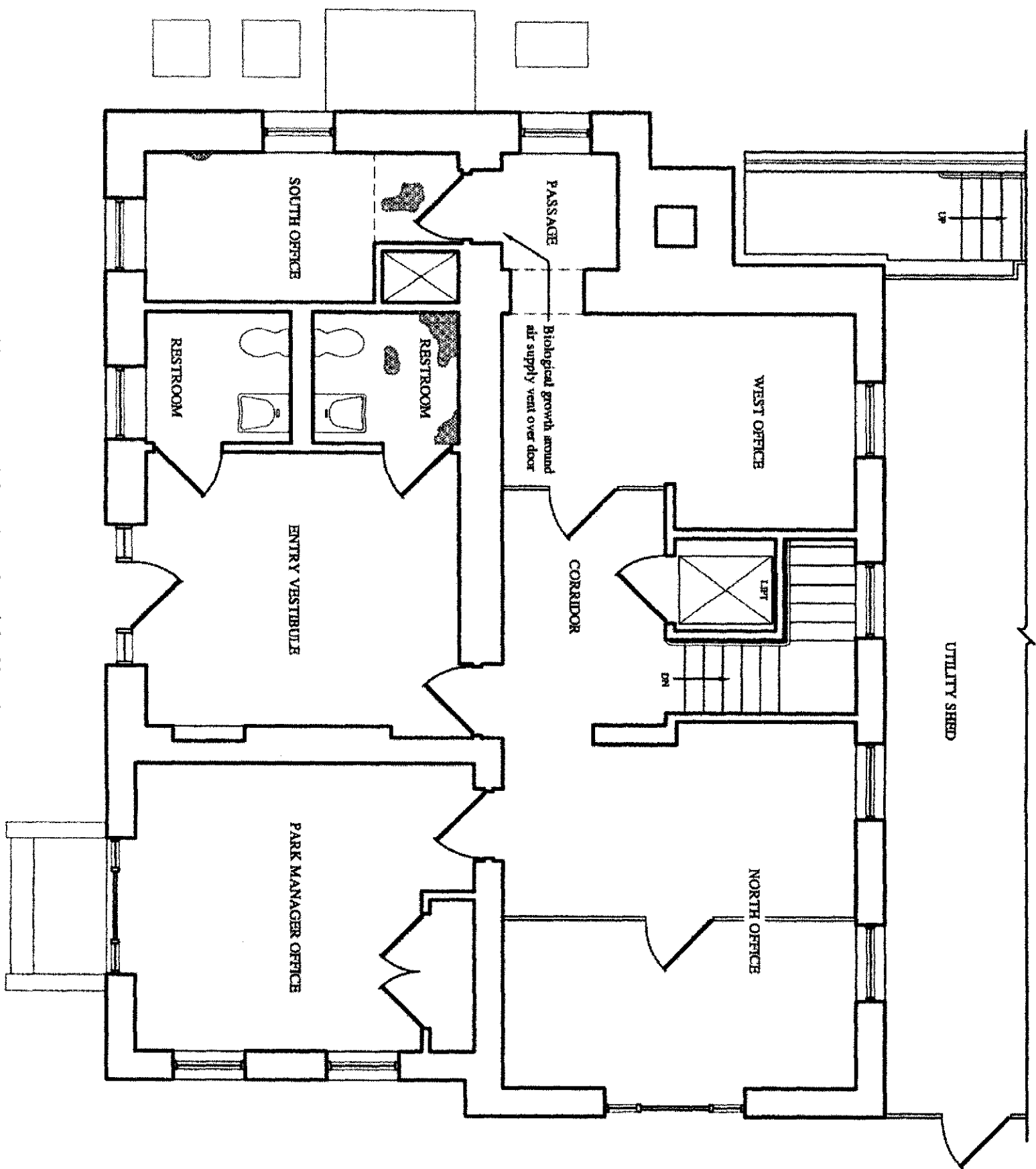





Figure 5.16: Gutter and downspout at southwest corner of areaway roof. Gutter is clogged with branches and foliage and contains standing water. Ferrous fasteners in the roof deck are beginning to rust and stain the galvanized steel. In the background, stucco patches adjacent to the attached chimney are visible.





CONDITIONS KEY:

-  CRACKING IN CONCRETE FLOOR
-  WATER DAMAGE AT CEILING
-  BIOLOGICAL GROWTH AT CEILING
-  SEVERE PAINT FAILURE AT CEILING

0 4 8
3/16" = 1'-0"





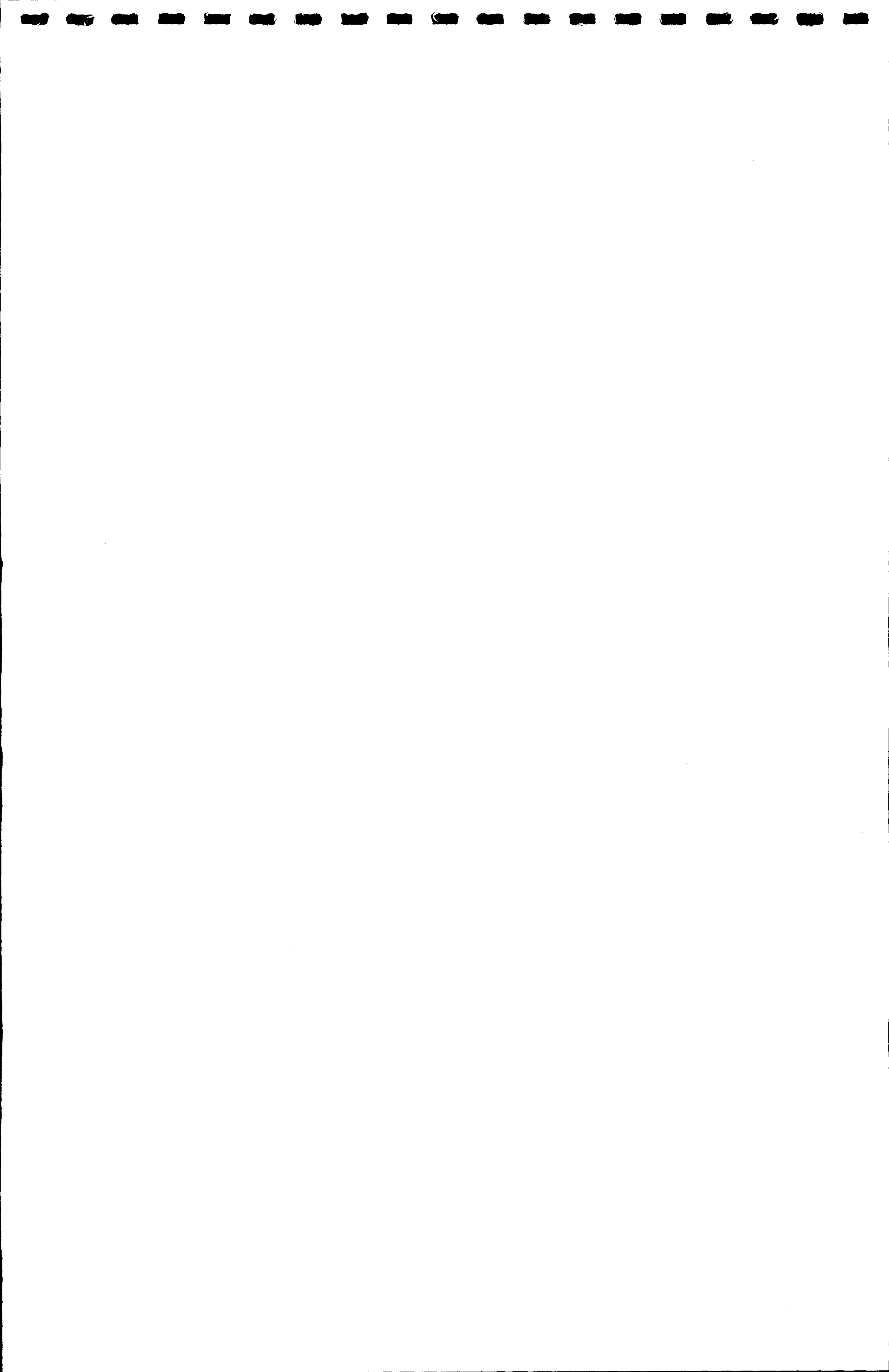

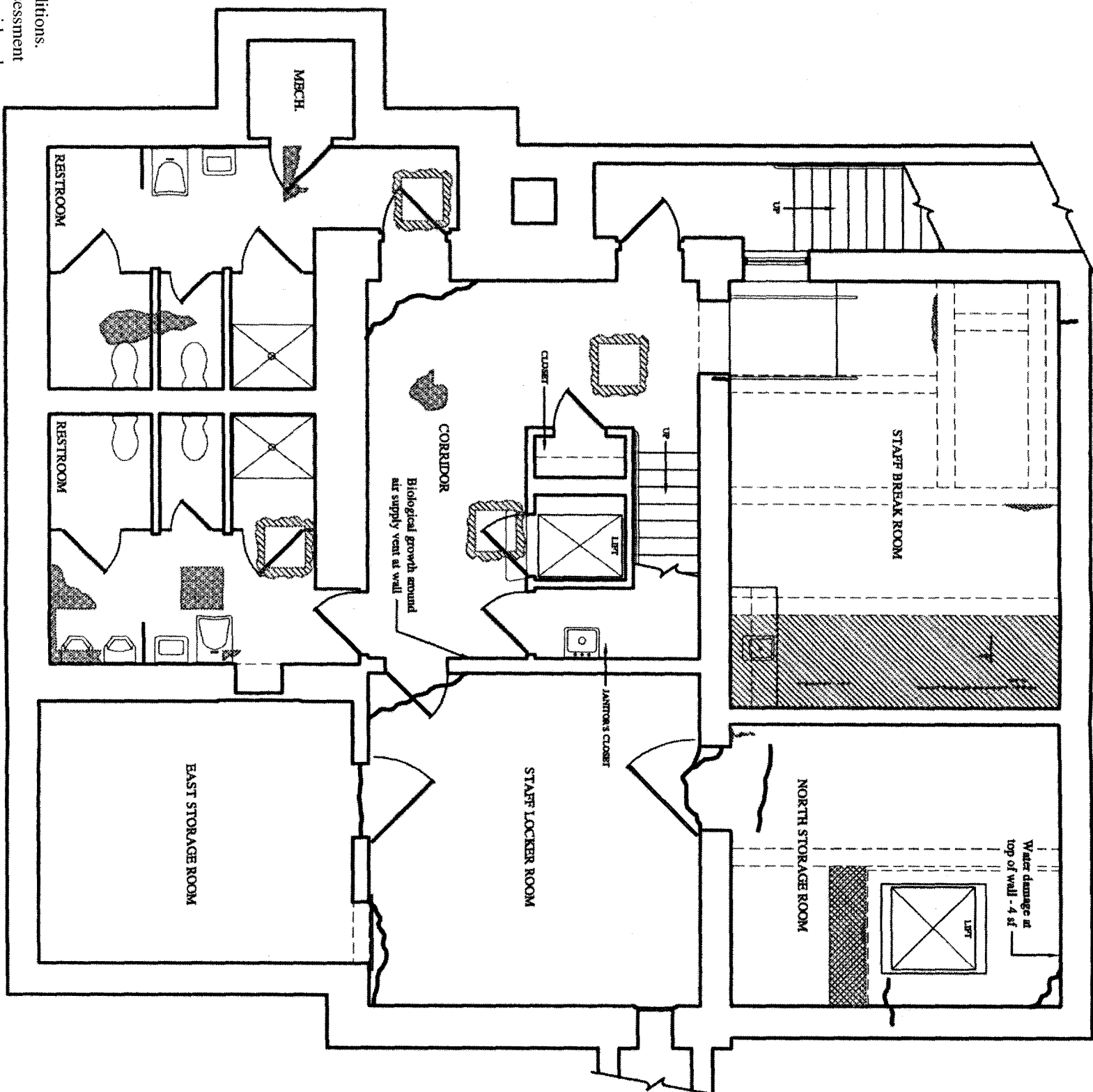
Figure 5.17: First floor plan conditions. Drawing is provided for conditions assessment information only and should not be considered an accurate measured drawing.





CONDITIONS KEY:

-  CRACKING IN CONCRETE FLOOR
-  WATER DAMAGE AT CEILING
-  BIOLOGICAL GROWTH AT CEILING
-  SEVERE PAINT FAILURE AT CEILING

0 4 8
3/16" = 1'-0"



Figure 5.18: Basement floor plan conditions. Drawing is provided for conditions assessment information only and should not be considered an accurate measured drawing.

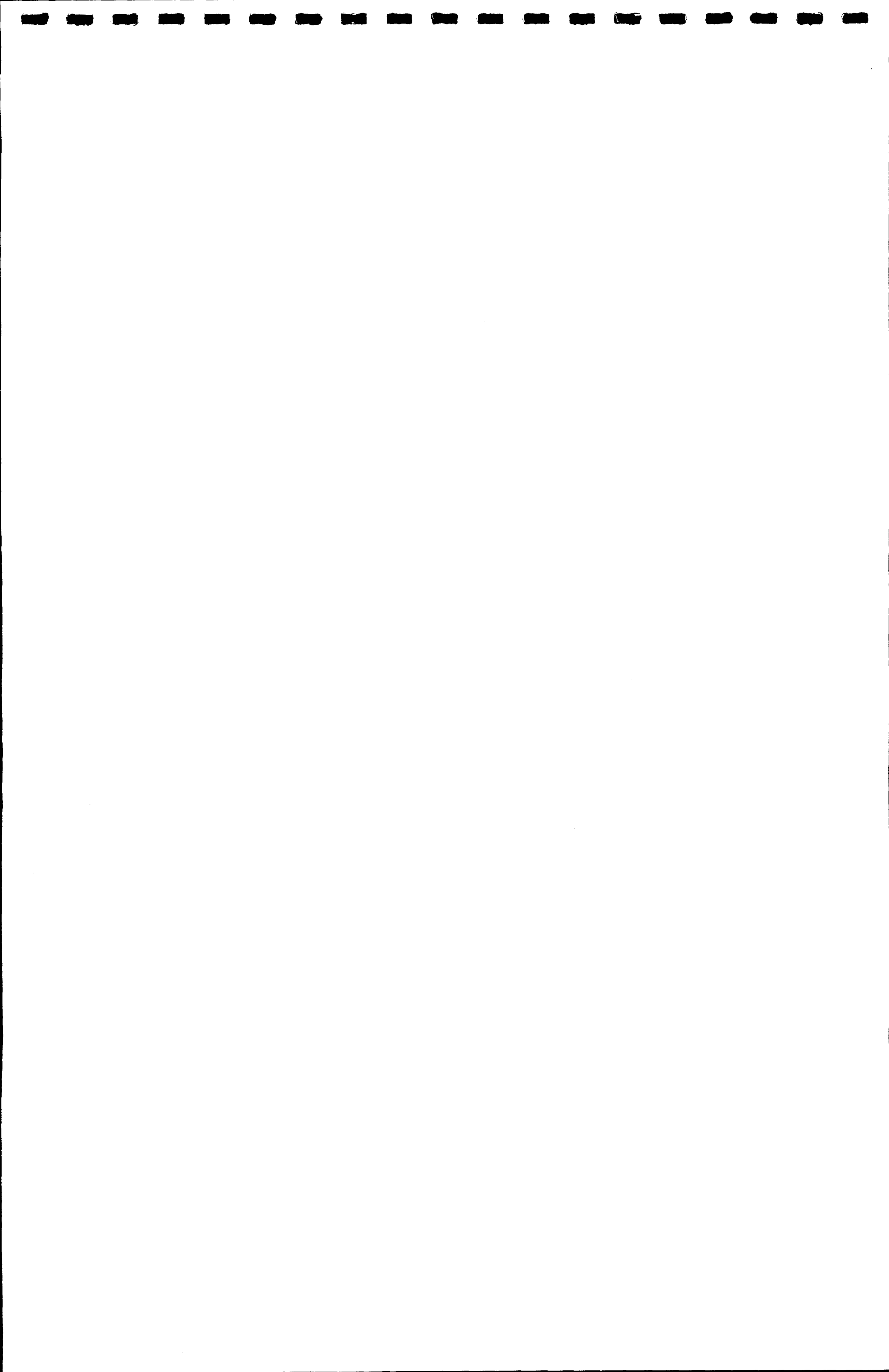



Figure 5.19: Detail of paint failure and water infiltration at concrete ceiling of north storage room. The painted concrete and brick wall at this location has also eroded and is showing signs of rust bloom from embedded ferrous elements.

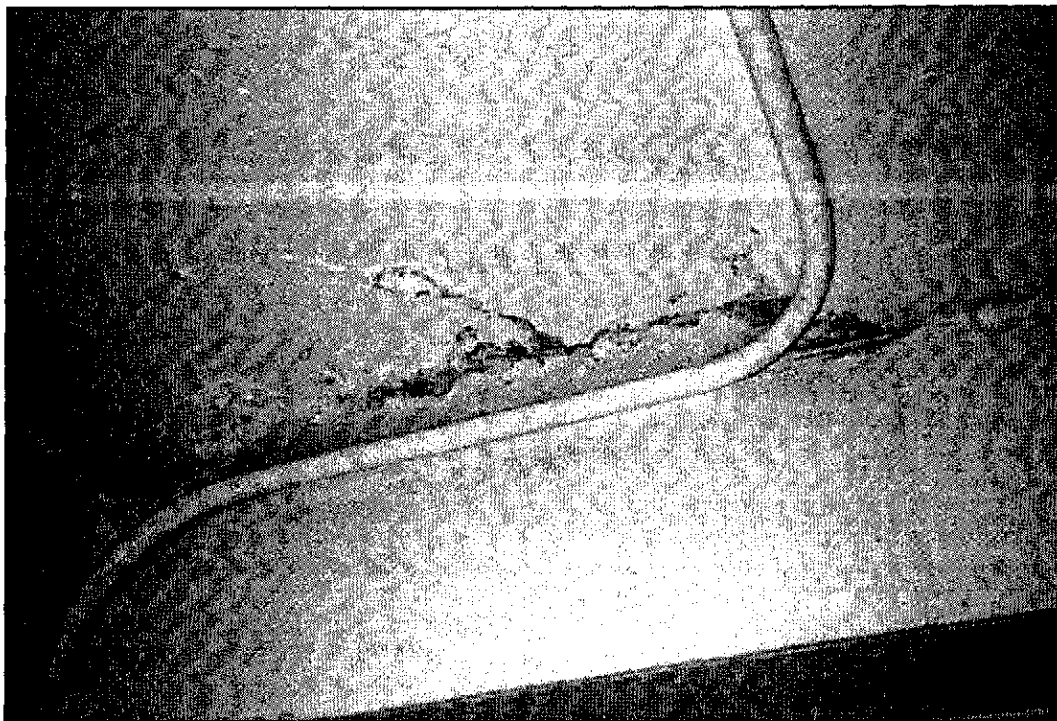

Figure 5.20: Detail of paint failure and water infiltration at concrete ceiling of staff break room.

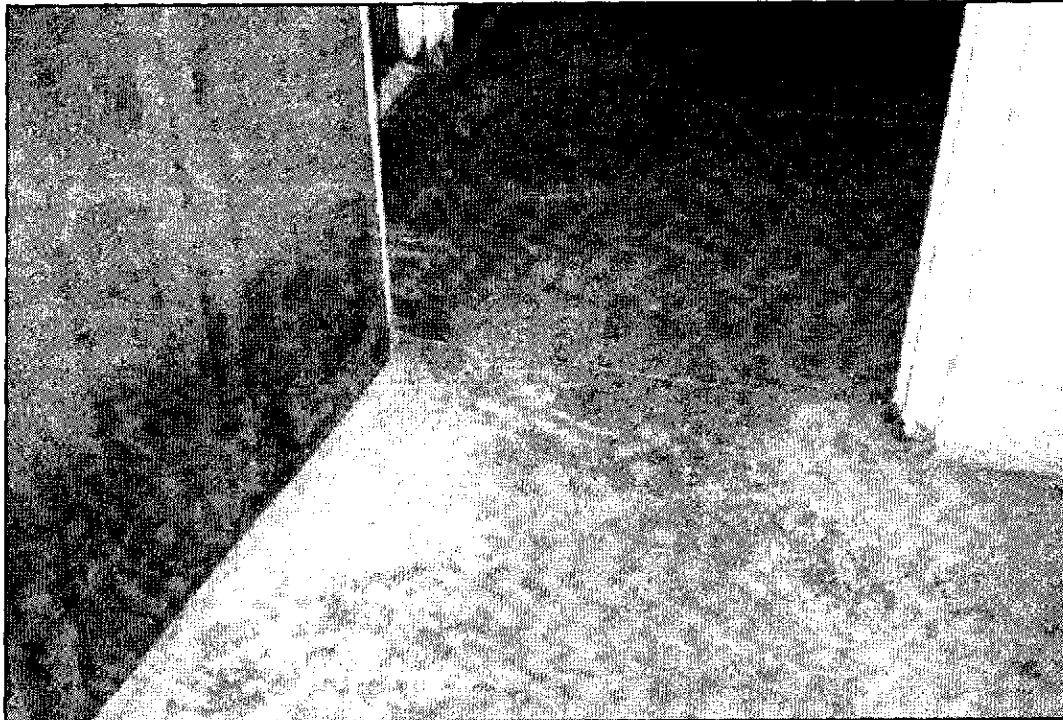

Figure 5.21: Detail of painted concrete floor at door of staff locker room. A large crack beginning at the door frame runs across the opening to an adjacent wall, and the paint has eroded in high-traffic areas.

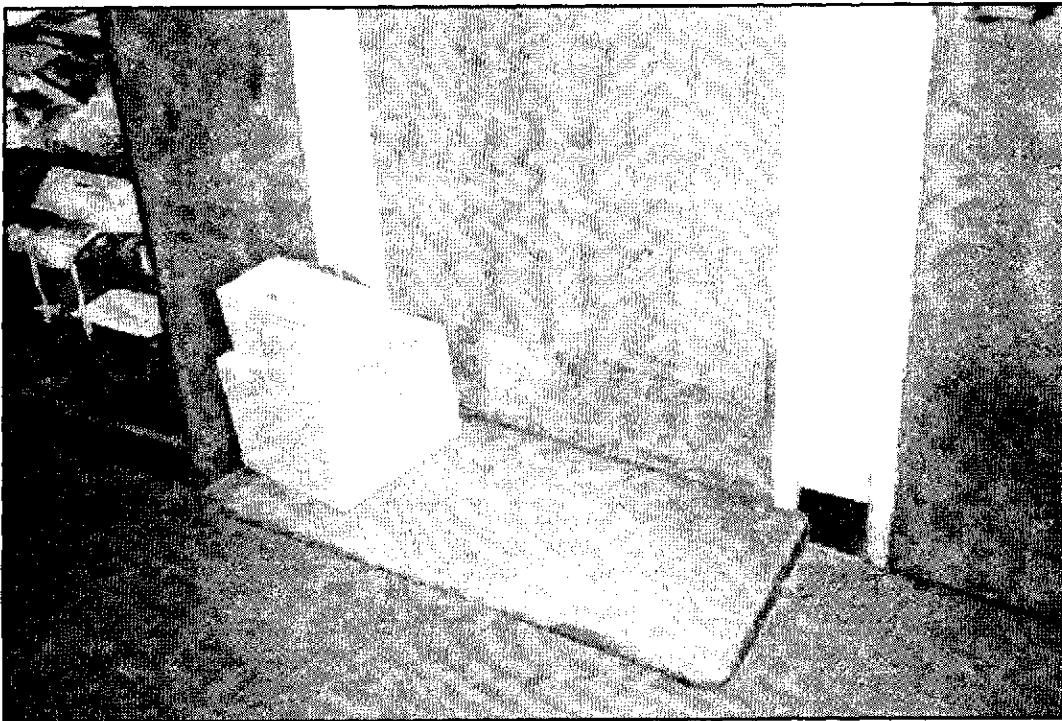

Figure 5.22: Detail of metal ramp at basement entry to handicapped lift with paint failure and rust bloom at perimeter. Also note the soiling and wear at the adjacent wall and door frame.

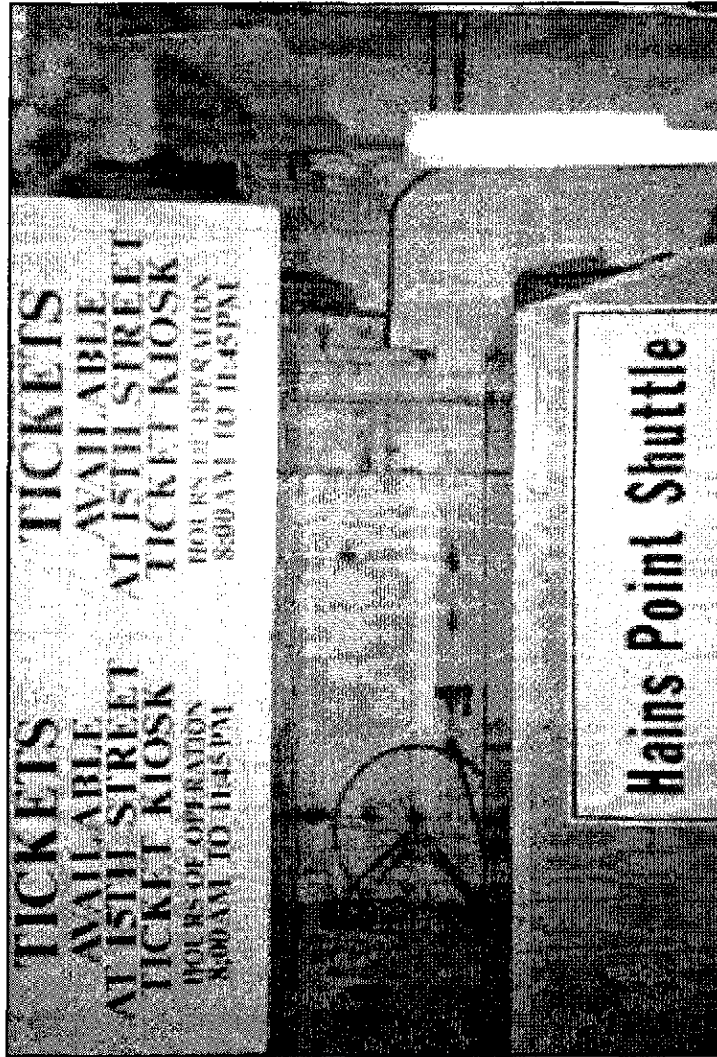

Figure 5.23: Staff locker room, view to the northeast with metal access door to historic steam tunnel. The door is currently welded closed and the welds have severely rusted.

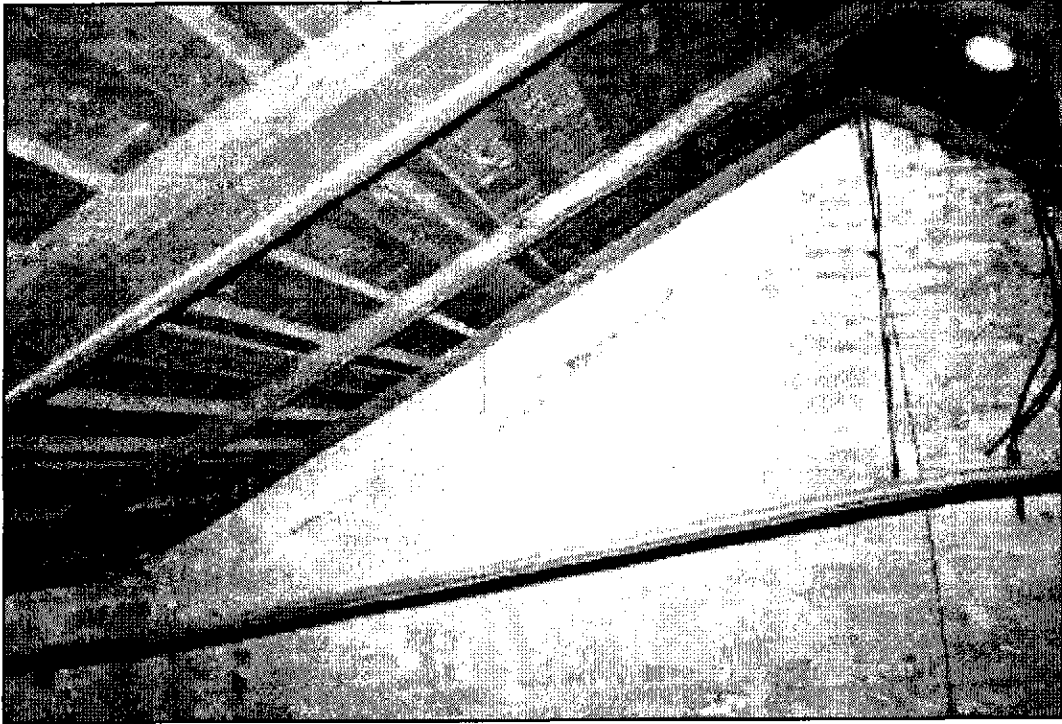

Figure 5.24: Attic, view to the southwest with remains of whitewash and deteriorated mortar under granite cornice.

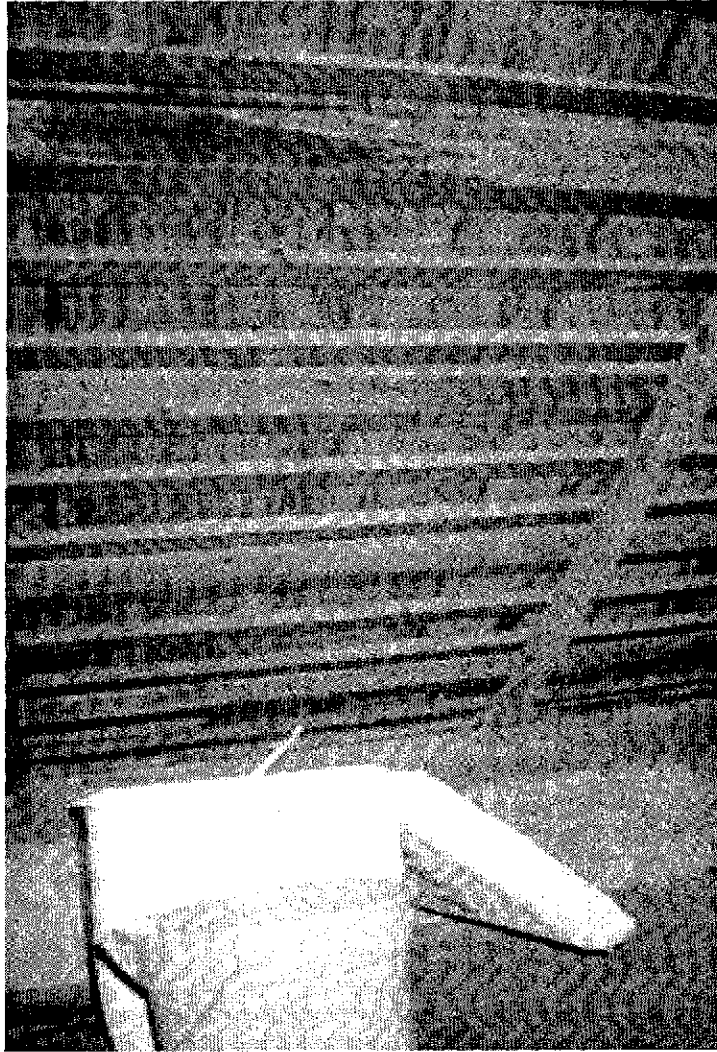

Figure 5.25: Attic, view to the northwest with plastic containers catching water from rain-dampened wood purlins and sheathing.



Part I – Developmental History

CHAPTER SIX
EVALUATION OF INTEGRITY



CHAPTER SIX

EVALUATION OF INTEGRITY

The Survey Lodge is historically significant under National Register Criterion C, Design/Construction, for the period 1886–1901 as an aesthetically designed mechanical/utility structure. It embodies the distinctive characteristics of this period in both design and method of construction. The Survey Lodge is also significant due to its relationship with the Washington Monument, as it was the historic power source for the monument elevator. The utility shed constructed in 1989 to the northwest of the lodge is not deemed historically significant. The ability of the Survey Lodge structure to convey its significance is analyzed in the following sections using the seven aspects of integrity outlined in *National Register Bulletin 15: How to Apply the National Register Criteria for Evaluation*.¹ These aspects include location, design, setting, materials, workmanship, feeling, and association.

6.1 CHARACTER-DEFINING FEATURES

The defining architectural features of the Survey Lodge are identified using *Preservation Brief 17 Architectural Character: Identifying the Visual Aspects of Historic Buildings as an Aid to Preserving Their Character*.² In this document, defining features are distributed into three categories: overall building character, construction details and materials, and interior features and finishes.

The overall building character of the Survey Lodge is defined by its form and massing. The building is a low, one-story building, rectangular in shape, with an attached chimney that conveys its historic function as a power plant. Utilitarian functions, such as mechanical equipment, are placed at a sub-grade level to lessen the building's impact on the surrounding landscape. The building is characterized by a series of three low-rise gable roofs, a cupola over one gable roof intersection, and a three- by four-bay fenestration configuration. The building has very little trim or ornamentation, which signifies its historic utilitarian use. It also stands alone among an open stand of canopy trees far from any other structure on or surrounding the Washington Monument Grounds, making it quite distinctive in form and location. The Survey Lodge is still intimately tied to the Washington Monument in function as a support structure for monument activities. The building houses Park Service staff offices, a visitor contact station, and handicapped-accessible rest rooms, which serve visitors to the Washington Monument as well as other National Mall tourist destinations.

The construction details and materials that define the character of the Survey Lodge include simple two-over-two double-hung windows, slate gable roofs, simple carved granite lintels, and stone masonry construction. In particular, the contrast of off-white, rock-faced marble with dark-gray, smooth-finished granite forms an eye-catching pattern of light and dark, rough and smooth. The random-coursed ashlar pattern and rough finish of the marble also create dramatic

shadow patterns along the face of the building that are accentuated by the half-round mortar joints found in the marble masonry. It is truly in the simple construction details of windows and masonry that the high quality of craftsmanship in the Survey Lodge becomes apparent. Visible peg joints and extremely thin meeting rails in window sash, carved granite lintels and cornice lines, built-in gutters, and through-cornice downspouts all contribute to the elegant, yet utilitarian, nature of the building.

The interior of the Survey Lodge was completely renovated in 1989,³ leaving no original interior finishes or features. Therefore, existing finishes and features are not deemed to contribute to the defining character of the building.

6.2 INTEGRITY

6.2.1 LOCATION AND SETTING

The Survey Lodge currently sits in its original location on Reservation 2, approximately 750 feet southwest of the Washington Monument. The building was historically situated at this distance from the monument to decrease its visual impact on the monument and the open vistas of the monument site. This desire was reinforced early in the building's history by the addition of a grove of trees to the site, which further screened the Survey Lodge from view. Although changed from its current configuration, a drive encircling the site was also an early feature. Pedestrian pathways, fences, and ornamental plantings have been modified many times over since the construction of the Survey Lodge. The overall site character, however, primarily defined by its relationship to the Washington Monument and grounds, remains intact to the building's period of significance.

6.2.2 DESIGN, MATERIALS, AND WORKMANSHIP

The exterior details and overall character of the Survey Lodge closely reflect the building's appearance in 1901,⁴ though not all materials are original. The slate roof and cupola were installed in 1993⁵ and are based on historic documentation of original features. The original wood windows have been rehabilitated and/or replaced, and new doors and sidelights similar to the historic doors were installed in 1989.⁶ The main entry door on the southeast elevation was at one time a large window, with the door to its right serving as the building's main entry. One window has been added on the southwest elevation, and a basement entry and an access stair were added in 1940.⁷ The wood and metal utility shed to the northwest of the Survey Lodge was added in 1989,⁸ and the door on the northeast elevation has been closed and its entry steps removed. With the exception of the utility shed, however, none of these changes has had a large negative impact on the integrity of the building. The original form, shape, and fenestration pattern remain intact from the building's period of significance. The historic masonry color, texture, and pattern have been preserved, as has the chimney, the type, size, and construction detailing of wood windows, and the overall simple character of the building and its ornamentation. The lodge also retains a significant relationship to the Washington Monument through its stone masonry. Constructed of refuse marble and granite from the monument construction site, changes to the Survey Lodge over the life of the building have carefully maintained this masonry in its entirety.

6.2.3 FEELING AND ASSOCIATION

The integrity of feeling and association in the Survey Lodge building and site may be the most important aspect of the property. The building's simple utilitarian design, attached chimney, and use of refuse marble and granite from the Washington Monument construction site all combine to present the building as one quite particular to its time and place. Its siting at a distance from the monument conveys its secondary, support character, and this is reinforced by its lack of ornamentation and subsequent tree plantings. The Survey Lodge retains a very high level of integrity in its feeling and association as a late-nineteenth-century, aesthetically designed mechanical/utility structure on the grounds of the Washington Monument.

ENDNOTES

Abbreviations:

NPS-NCR National Park Service – National Capital Region

RG 79 Records of the National Park Service, Record Group 79

¹ National Park Service, Cultural Resources, *National Register Bulletin 15: How to Apply the National Register Criteria for Evaluation*, Washington, D.C.: U.S. Department of the Interior, National Park Service, 1997.

² Lee H. Nelson, FAIA, *Preservation Brief 17 Architectural Character: Identifying the Visual Aspects of Historic Buildings as an Aid to Preserving Their Character*, Washington, D.C.: U.S. Department of the Interior, National Park Service, 1988.

³ Vincent Chan & Associates, Inc., "Demolition Plans," 3 August 1989; [Architectural Drawing] File 807_80116, Sheet 2 of 25; Technical Information Center, Denver Service Center, National Park Service.

⁴ Theodore A. Bingham, "Plan Showing Present Boiler House in Dotted Lines and Proposed Addition in Full Lines," 1898; [Architectural Drawing] File 74-21-3; NCP 807; RG 79; Cartographic and Architectural Records LICON, Special Media Archives Division, National Archives at College Park, College Park, Md.

⁵ Monika Mayr, Chief, Branch of Construction and A/E Contracts Contracting Officer, NCP-Central, to AEO Construction Co., Inc., "Contract No. 1443CX300092073, Install a Cupola and Replace the Roofing System on the Survey Lodge Building, Washington, DC," 22 October 1992; NPS-NCR Collection.

⁶ Vincent Chan & Associates, Inc., "Building Elevations," 3 August 1989; [Architectural Drawing] File 807_80116, Sheet 4 of 25; Technical Information Center, Denver Service Center, National Park Service.

⁷ Montgomery, "Remodeling of Building Plans and Sections," Approved 2 September 1939; [Architectural Drawing] File 74-21-10, Sheet 1 of 2; NCP 807; RG 79; Cartographic and Architectural Records LICON, Special Media Archives Division, National Archives at College Park, College Park, Md.

⁸ Vincent Chan & Associates, Inc., "Architectural Plans," 3 August 1989; [Architectural Drawing] File 807_80116, Sheet 3 of 25; Technical Information Center, Denver Service Center, National Park Service.



Part II

CHAPTER SEVEN
TREATMENT AND USE



CHAPTER SEVEN

TREATMENT AND USE

7.1 ULTIMATE TREATMENT AND USE

The most recent National Park Service planning document that directly addresses the treatment of the Survey Lodge, the 1973 "Comprehensive Design Program and Engineering Feasibility Report," calls for the retention of the Survey Lodge and the remodeling of its office space to "increase privacy and amenities and to improve appearance."¹ Subsequent documents submitted by the National Park Service (NPS), and approved by the National Capital Planning Commission (NCPC), make no direct recommendations for the treatment of the Survey Lodge other than showing it on plans as retained.² The lodge's surrounding circle drive and nearby pedestrian pathways, though, are shown to be reconfigured in these documents. No indication of how these items would be reconfigured appears in the approved plans, but the purpose of all proposed work is to improve security, visitor flow, and accessibility, while retaining recreational areas and preserving the quality of the cultural landscape. These issues are discussed more fully in the companion report to this document: the Washington Monument Grounds Cultural Landscape Report.

In 1989, the Survey Lodge underwent a massive rehabilitation campaign that restored exterior masonry and windows, reconstructed the historic slate roof and cupola, and renovated the entire interior of the building. It is assumed that prior to the rehabilitation, appropriate assessments of impact were made and approvals processes were followed; however, no documentation of these processes was available from the National Park Service. The structure now serves as the Headquarters of Mall Operations for the Park Service and contains a visitor contact station, handicapped-accessible rest rooms, offices and facilities for Park Service staff, and storage space. The approved ultimate treatment of the lodge is retention of the existing structure.

Based on the findings of this Historic Structure Report, it is recommended that the existing historic elements of the Survey Lodge be preserved in order to maintain the building's excellent exterior integrity. Historic exterior elements include the form, massing, fenestration pattern, and roof truss system of the structure, as well as granite and marble masonry, wood windows, the prominent chimney, and the overall simple character of the building and its ornamentation. To increase the integrity of the building setting, it is recommended that the wood and metal utility shed to the northwest of the lodge be removed and its functions relocated.

On the interior of the Survey Lodge, no historic finishes remain; however, extant historic masonry load-bearing walls should be preserved. It is recommended that the interior finishes be upgraded and repaired as needed to provide adequate and attractive facilities for Park Service staff and visitors. Mechanical and electrical systems should be investigated with the intent of improving energy efficiency, and any new materials or finishes installed should employ

sustainable materials and construction practices. Any future changes contemplated to the Survey Lodge should be included in a Visitor Experience and Resource Protection (VERP) framework implemented for all resources within the Washington Monument Grounds.

7.2 REQUIREMENTS FOR TREATMENT

The purpose of the National Park Service as stated in the NPS Organic Act of 1916,³ and clarified under the NPS General Authorities Act of 1970, as amended in 1978,⁴ is the conservation of park resources and values and the provision for the enjoyment of these resources by current and future generations of Americans. Where use of these resources, either by NPS or the public, conflicts with the goal of resource conservation, the overriding goal is the preservation of the resource.⁵ As a federal agency, NPS must conform to various laws,⁶ executive orders,⁷ and guidelines⁸ aimed at integrating the preservation of cultural resources into ongoing agency programs and policies. Further, Section 110 of the National Historic Preservation Act (NHPA) requires the NPS, as a federal agency, to take into account the effects of their actions on properties listed or eligible for listing in the National Register of Historic Places. Adverse effects to cultural resources must be mitigated according to Section 106 of NHPA. Within the Park Service, "NPS-28: Cultural Resource Management Guideline" elaborates on the laws, policies, and standards applying to cultural resources and offers guidance on their implementation.⁹ Regarding the specific proposed undertaking involved in the implementation of the Washington Monument permanent security improvements, a Programmatic Agreement is in place, which sets forth the process by which the NPS will meet the requirements of Section 106 of NHPA.¹⁰

The Secretary of the Interior's "Standards for Preservation and Guidelines for Preserving Historic Buildings" states that preservation is recommended, "when the property's distinctive materials, features, and spaces are essentially intact and thus convey the historic significance without extensive repair or replacement."¹¹ The eight criteria for the preservation of historic properties emphasize the retention of historic use where possible and retention of distinctive materials, features, spaces, and spatial relationships. The historic structure will be recognized as a physical record; therefore, repairs will be made with compatible but identifiable non-historical materials, and significant historical changes will be retained. Repairs will involve limited replacement in kind, and chemical and physical treatments will use the gentlest means possible. Archeological resources will be protected and preserved in place.¹² The NPS document "Management Policies 2001" clarifies when preservation should be implemented within the NPS: a historic structure will be preserved in its present condition if "that condition allows for satisfactory protection, maintenance, use, and interpretation."¹³ The "Management Policies" also states that "historic properties will be used to the maximum extent practicable, provided that the use will not affect their significance."¹⁴

Within the Washington Monument Grounds administrative unit of NPS, alterations to existing structures and construction of new facilities requires approval of the National Capital Planning Commission (NCPC) and the Commission of Fine Arts (CFA).¹⁵ NCPC planning and design decisions are based on the Federal Element of the "Comprehensive Plan for the National Capital." An important component of the "Comprehensive Plan" concerning the Washington Monument Grounds is the "Parks, Open Space, and Natural Features Element," which states that

“the Mall should be considered complete, and any improvements necessary in this area should be limited in scope and sensitively designed to reinforce the integrity of the Mall complex.”¹⁶ NCPC is a signatory of the “Programmatic Agreement” prepared for the Section 106 review of the proposed work at the Washington Monument Grounds. The CFA has not been involved in recent design submittals for the proposed work.

The design and construction of new facilities, additions, and renovations to historic structures are subject to nationally recognized codes and standards.¹⁷ The *International Building Code* contains standards for the design and installation of building systems. Special considerations for existing structures are detailed in chapter 34.¹⁸ Fire-safety regulations to prevent fires, explosions, and to ensure proper evacuation in case of emergency are standardized under the National Fire Protection Association (NFPA) codes and standards. Fire-safety codes dealing with construction are detailed in NFPA 5000: Building Construction and Safety Code. NFPA 101: Life Safety Code deals specifically with features that will minimize danger from fires, smoke, fumes, or panic during evacuation. NFPA 909: Code for the Protection of Cultural Resources provides guidance on integrating fire-safety codes with cultural properties without impairing their historic integrity. Additional recommendations for identifying and dealing with fire hazards in historic buildings are contained in NFPA 914: Code for Protection of Historic Structures. Specific NPS requirements are outlined in “Director’s Order #58 and Reference Manual 58: Structural Fires.”

The NPS must comply with the Occupational Safety and Hazard Administration (OSHA) standards when dealing with the abatement of hazardous materials while maintaining, altering, or constructing new or existing structures.¹⁹ OSHA Standard 1910 deals with general industry standards, and section 1001 addresses asbestos hazards. OSHA Standard 1960 focuses specifically on occupational safety and health programs for federal employees. General construction standards are contained in OSHA Standard 1926. Further guidance for the application of OSHA standards to NPS facilities is contained in “Director’s Order #50B and Reference Manual 50B: Occupational Safety and Health Program.”

Design considerations regarding accessibility are also standardized. The NPS must provide for the accessibility for persons with disabilities in all buildings and facilities “to the greatest extent possible, in compliance with all applicable laws, regulations, and standards.”²⁰ In accordance with previous legislation,²¹ NPS must comply with both the Uniform Federal Accessibility Standards (UFAS)²² and the Americans with Disabilities Act of 1990 with its implementing ADA Accessibility Guideline (ADAAG).²³ Where the standards of the UFAS and ADAAG differ, the more stringent requirements apply.²⁴ “Director’s Order #42: Accessibility for Visitors with Disabilities” outlines how accessibility standards apply to NPS properties.

NPS is also required to adhere to energy-efficiency standards for new construction or rehabilitation work as stated in the Energy Policy Act of 1992²⁵ and applicable executive orders.²⁶ The NPS “Management Policies 2001” declares that any facility work, “whether it be a new building, a renovation, or an adaptive re-use of an existing facility,” must include improvements in energy efficiency in both the building envelope and mechanical systems using

alternative energy and energy-efficient systems. Where appropriate, construction within the parks must also employ sustainable materials and construction practice.²⁷

7.3 ALTERNATIVES FOR TREATMENT

The approved ultimate treatment of the Survey Lodge is simply retention of the existing structure. In the "Washington Monument Permanent Security Improvements Environmental Assessment," the NPS has reviewed this treatment and analyzed alternatives for the rest of the monument grounds and facilities.²⁸ The National Capital Planning Commission (NCPC) has found the assessment consistent with the "Comprehensive Plan of the Nation's Capital," and has issued a "Finding of No Significant Impact" (FONSI).²⁹ These procedures fulfill the requirements of the National Environmental Protection Act (NEPA), but further approval for the plan is contingent on full compliance with Section 106 of NHPA, including completion of this Historic Structure Report.

The NPS "Environmental Assessment" presented two action alternatives A and B, with a third no-action alternative. The two action alternatives A and B each include an identical recommendation for the Survey Lodge: retain the building for administrative use.³⁰ In addition, alternate A includes the elimination of the existing pedestrian path from the Washington Monument to the Survey Lodge, while alternative B shows a reconfiguration of this path.³¹ No other changes to the Survey Lodge building or site are currently proposed.

Within the approved treatment of retaining the existing structure, three major alternatives can be considered. These consist of restoring the structure to its period of significance, rehabilitating the structure for new uses, or preserving the structure in its current condition.

7.3.1 RESTORATION OF SURVEY LODGE

Restoring the Survey Lodge to its historic appearance during the period of significance 1886–1901 would involve substantial demolition of all post-1901 alterations, repair of historic materials and finishes, and reconstruction of missing features. Selective demolition would include removal of the 1989 utility shed to the northwest of the Survey Lodge and removal of the 1940 stair and basement entry to the southwest of the lodge. Selective demolition would also require removal of 1989 exterior doors, frames, and transom windows and removal of all non-historic partitions and finishes on the interior of the building. The current main entry and the two historic exterior doorways would be returned to their 1901 appearance, and one window on the southwest elevation would be removed and infilled. On the interior, the existing concrete floor slabs would be removed. Wood-framed floors would be reconstructed over part of the first floor, leaving other spaces double height. Brick floors would be installed in the basement. New partition walls would be reconstructed in both the basement and first floor, and existing wood ceilings would be removed at the first floor to expose the iron roof-truss system. The historic stair to the basement would be reconstructed, and all interior spaces would be completely refinished with new materials to match those documented in historic specifications and drawings. The slate roof and cupola have already been reconstructed as part of the rehabilitation project executed in 1989–1993.

Restoration of the Survey Lodge would retain all of the existing character-defining features, preserve the existing historical materials and finishes, and recreate all missing features to return the lodge to its 1901 appearance. However, the current poor integrity of the interior of the Survey Lodge pushes restoration of the interior to outright reconstruction. While restoration would increase the ability of the lodge to convey its period of significance, its integrity would not increase. The interior would lose the physical evidence of its building history, and restored elements could be easily confused for, or with, historic materials. Further, the current interpretation of the Washington Monument and surrounding grounds makes restoration of the Survey Lodge to its 1901 appearance questionable. The grounds do not reflect their appearance in 1901, and the historic function that the Survey Lodge represents has become obsolete. Restoration of the Survey Lodge would place a 1901-era structure within a contemporary landscape and strip it of its usefulness as a resource for park management and development. Finally, restoration of the Survey Lodge would eliminate park management office and storage space and require that these spaces be provided elsewhere. Therefore, restoration of the Survey Lodge is not a recommended treatment option.

7.3.2 REHABILITATION OF SURVEY LODGE

Rehabilitating the Survey Lodge for new uses was contemplated by the National Park Service in the 1973 "Comprehensive Design Program and Engineering Feasibility Report." At that time, it was the intention of NPS to renovate the building's existing office space. However, at least one other option was discussed: remodeling the lodge as a "toilet facility and snack bar."³² The process of rehabilitation allows more aggressive repairs, alterations, and additions to historic structures than restoration, while still preserving significant historic features and materials. Though the exterior of the Survey Lodge has excellent integrity, the interior spaces and finishes have been heavily altered and can be replaced to serve a new function.

The introduction of a new snack bar, or other similar facility, would require extensive interior renovation, as well as significant removal and alteration of historic fabric on the exterior, or construction of a sizeable addition. The use of the Survey Lodge as a purely public structure is simply not compatible with the building's existing form, size, or accessibility. New openings would have to be cut in the historic exterior masonry to allow large numbers of visitors to enter and exit the building, and all service spaces would have to be fully accessible. Facilities that could not be accommodated in the first floor of the building could be located in the basement, requiring an elevator, or within an addition. Both options would drastically change the form and setting of the building. Also, as discussed in the approved "Washington Monument Revised Development Concept Plan," such public facilities are already slated to be included in a new visitor addition in or near the Washington Monument Lodge. This addition is more thoroughly discussed in the Monument Lodge Historic Structure Report.

Rehabilitation of the Survey Lodge for a new public use would compromise the existing character-defining features of the structure, and would therefore decrease the building's overall integrity. An addition to the building could be designed to comply with NPS policy, but that would still not meet the management objectives of improved security, visitor flow, and accessibility to the Washington Monument while preserving the quality of the cultural landscape. Any gained space would be offset by the permanent damage to the historic structure. Also,

rehabilitation of the Survey Lodge for a new use would eliminate park management office and storage space and require that these spaces be provided elsewhere. Therefore, rehabilitation of the Survey Lodge for new uses is not a recommended treatment option.

7.3.3 PRESERVATION OF SURVEY LODGE

Preserving the Survey Lodge in its current form would require maintenance-level activities to ensure the continued good condition of the historic building. The lodge would continue its current use as a center of administration for Park Service Mall Operations and as a visitor contact point for those visiting surrounding monuments and memorials. Preservation of the lodge would include sensitive repair of historic character-defining features, materials, and finishes. The exterior masonry would be maintained with appropriate cleaning, repointing, and repairs. The wood windows, doors, frames, and cupola would be sustained with appropriate repairs and regularly scheduled painting. The existing historic roof-truss system would be preserved during any future roofing work. Mechanical, electrical, and plumbing systems could be upgraded in a sensitive manner in order to meet code and facility requirements. Interior office and rest room spaces would continue to be updated as needed. The current integrity of the Survey Lodge, excellent on the exterior though poor on the interior, would be maintained.

Preservation of the Survey Lodge would retain all of the existing character-defining features of the structure, maintain and repair the existing historic fabric, replace deteriorated non-historic elements, and upgrade systems as required. This treatment would be in compliance with NPS policy and, in conjunction with other projects within the grounds of the Washington Monument, would meet NPS management objectives. Preservation is by far the preferred treatment option for the future of the Survey Lodge.

ENDNOTES

Abbreviations:

CFR	Code of Federal Regulations
FR	Federal Register
NCPC	National Capital Planning Commission
PL	Public Law
USC	United States Code

¹ Hartman-Cox Architects, "Comprehensive Design Program and Engineering Feasibility Report" (20 September 1973), 1.

² National Park Service, U.S. Department of the Interior, "Development Concept Plan and Alternatives, Washington Monument Grounds, Washington, D.C.," September 1981, revised 1989; NPS-NCR Collection; National Park Service, U.S. Department of the Interior, "Phases of Implementation for Grounds Improvement and Accessibility, Washington Monument Grounds," May 1993; National Park Service, U.S. Department of the Interior, "Washington Monument Grounds Revised Development Concept Plan and Preliminary Site and Building Plans for Visitor and Security Improvements," 9 January 2003; NCPC File No. 1303/6152; National Park Service, U.S. Department of the Interior, "Washington Monument Permanent Security Improvements Environmental Assessment," April 2002.

³ 16 USC 1-4; August 25, 1916, ch. 408, 39 Stat. 535.

⁴ 16 USC 1a-1 et seq.; PL 91-383, 94-458, 95-250.

⁵ U.S. Department of the Interior, National Park Service, "Management Policies 2001," December 2000: 60.

⁶ Antiquities Act of 1906 (16 USC 431-433; June 8, 1906, ch. 3060, 34 Stat. 225); Historic Sites, Buildings, and Antiquities Act (16 USC 461-467; August 21, 1935, ch. 593, 49 Stat. 666); National Environmental Policy Act of 1969 (NEPA) (42 USC 4321-4370d; PL 91-190); National Historic Preservation Act (NHPA) (16 USC 470-470x-6; PL 89-665, 96-515).

⁷ Executive Order 11593, 13 May 1971, 36 FR 8921 (Protection and Enhancement of the Cultural of the Cultural Environment); Executive Order 13287, 5 March 2003 (Preserve America).

⁸ Standards and Guidelines for Federal Agency Historic Preservation Programs Pursuant to the National Historic Preservation Act (63 FR 20497-508).

⁹ U.S. Department of the Interior, National Park Service, "NPS-28: Cultural Resource Management Guideline," August 2002.

¹⁰ "Programmatic Agreement Among the National Park Service, National Capital Planning Commission, District of Columbia State Historic Preservation Officer, and the Advisory Council on Historic Preservation Regarding Implementation of Permanent Security Improvements to the Washington Monument and its Grounds," 7 May 2002.

¹¹ *The Secretary of the Interior's Standards for the Treatment of Historic Properties with Guidelines for Preserving, Rehabilitating, Restoring, and Reconstructing Historic Buildings* (36 CFR 68) (Washington D.C.: Government Printing Office, 1995).

¹² *The Secretary of the Interior's Standards for the Treatment of Historic Properties with Guidelines for Preserving, Rehabilitating, Restoring, and Reconstructing Historic Buildings* (36 CFR 68) (Washington D.C.: Government Printing Office, 1995).

¹³ U.S. Department of the Interior, National Park Service, "Management Policies 2001" (December 2000), 59.

¹⁴ 112. U.S. Department of the Interior, National Park Service, "Management Policies 2001" (December 2000), 59.

¹⁵ National Capital Planning Act of 1952 (40 USC 71).

¹⁶ "Parks, Open Space, and Natural Features Element, Comprehensive Plan for the National Capital" (1 February 2001), 19.

¹⁷ Public Buildings, Compliance with Nationally Recognized Codes (40 USC 619).

¹⁸ *International Building Code*, International Code Council, 2000.

¹⁹ Occupational Safety and Hazard Administration Standards (29 CFR 1910).

²⁰ U.S. Department of the Interior, National Park Service, "Management Policies 2001" (December 2000), 102.

²¹ Architectural Barriers Act of 1968 (42 USC 4151-4157; PL 90-480); Section 504 of the Rehabilitation Act of 1973 (29 USC 701-797b; PL 93-112, 105-220).

²² Uniform Federal Accessibility Standards (UFAS) (41 CFR 19.6; 49 FR 31528).

²³ Americans with Disabilities Act of 1990 (ADA) (42 USC 12101-12213; PL 101-336).

²⁴ U.S. Department of the Interior, National Park Service, "NPS-28: Cultural Resource Management Guideline" (August 2002), Chapter 4-A-2.

²⁵ Energy Policy Act of 1992 (42 USC 13201-13556; PL 102-486).

²⁶ Executive Order 13123. 3 June 1999, 64 FR 30851 (Greening the Government Through Effective Energy Management).

²⁷ U.S. Department of the Interior, National Park Service, "Management Policies 2001" (December 2000), 102.

²⁸ National Park Service, U.S. Department of the Interior, "Washington Monument Permanent Security Improvements Environmental Assessment," April 2002.

²⁹ National Capital Planning Commission, "Decision Notice and Finding of No Significant Impact, Washington Monument Permanent Security Improvements Environmental Assessment," July 2002.

³⁰ National Park Service, U.S. Department of the Interior, "Washington Monument Permanent Security Improvements Environmental Assessment" (April 2002), 6-30.

³¹ 3-5 and 3-9. National Park Service, U.S. Department of the Interior, "Washington Monument Permanent Security Improvements Environmental Assessment" (April 2002), 6-30.

³² Hartman-Cox Architects, "Comprehensive Design Program and Engineering Feasibility Report" (20 September 1973), J-19.

APPENDIX A
SCOPE OF WORK

1
2
3
4
5
6
7
8
9
10
11
12
13
14
15
16
17
18
19
20
21
22
23
24
25

APPENDIX A

SCOPE OF WORK

INTRODUCTION

The purpose of the Historic Structure Report (HSR) is to inform the analysis and evaluation of the proposed visitor facility and security design improvements, to document and assess the historic significance and integrity of the buildings, and to help guide future management of the facilities. The HSR was commissioned in conjunction with a companion Cultural Landscape Report (CLR) for the Washington Monument Grounds. Together the HSR and CLR will provide a guide for the treatment and management of the Washington Monument, Monument Lodge, Survey Lodge, and Monument Grounds. The HSR scope of work includes the architectural and historical evaluation of the designated structures. Civil, structural, mechanical, plumbing, and electrical analysis of the Washington Monument, the Monument Lodge, and the Survey Lodge are not included in the scope of work.

HISTORIC STRUCTURE REPORTS

The National Park Service provides guidelines for the preparation of Historic Structure Reports in *Director's Order Number 28: Cultural Resource Management Guidelines* as follows¹:

The Historic Structure Report (HSR) is the primary guide to treatment and use of a historic structure and may also be used in managing a prehistoric structure. A separate HSR should be prepared for every major structure managed as a cultural resource. Groups of similar structures or ensembles of small, simple structures may be addressed in a single report. In no case should restoration, reconstruction, or extensive rehabilitation of any structure be undertaken without an approved HSR, Parts 1 and 2.

An HSR includes the following:

- *Management Summary*: This is a concise account of research done to produce the HSR, major research findings, major issues identified in the task directive, and recommendations for treatment and use. Administrative data on the structure and related studies are included.
- *Part 1, Developmental History*: This is a scholarly report documenting the evolution of a historic structure, its current condition, and the causes of its deterioration. It is based on documentary research and physical examination. The scope of documentary research may extend beyond the physical development of the structure if needed to clarify the significance of the resource or to refine contextual associations; however, major historical investigation of contextual themes or background information should be conducted as part of a historic resource study.

- *Part 2, Treatment and Use:* This presents and evaluates alternative uses and treatments for a historic structure. Emphasis is on preserving extant historic material and resolving conflicts that might result from a structure's "ultimate treatment." Part 2 concludes by recommending a treatment and use responding to objectives identified by park management. In most cases, design work does not go beyond schematics.
- *Part 3, Record of Treatment:* This is a compilation of information documenting actual treatment. It includes accounting data, photographs, sketches, and narratives outlining the course of work, conditions encountered, and materials used.

All aspects of a historic structure and its immediate grounds should be addressed in an HSR. Potential overlaps with other cultural resource types and natural resource issues should be identified, and applicable studies and reports should be called for or referenced. An HSR and analogous reports (e.g., a cultural landscape report) may be combined to address multiple resource types at a single property or area.

SCOPE OF WORK

This report constitutes Parts I, Developmental History, and Part II, Treatment and Use, of a HSR for the Washington Monument and Associated Structures. This HSR has been prepared in accordance with the scope of work presented in the request for proposal provided by the NPS and Grunley Walsh as follows²:

The products will be written Historic Structure Reports on the Washington Monument, Washington Monument Lodge, and the Survey Lodge. The focus of the HSR effort will be to develop historical background, determine the building developmental history and use, update existing conditions documents and in one instance will lead directly to schematic design for adaptive reuse of the Monument Lodge (as opposed to a more academically focused, research-type HSR). The document should also clearly define the elements that give these properties their architectural character, define primary and secondary spaces, and convey their significance. This information should be the basis upon which to carefully evaluate any alterations that are proposed.

Each report shall be professionally produced following the National Park Service's Management of Cultural Resource Director's Order Number 28 (DO-28) and its technical supplements. DO-28 is available at <http://www.nps.gov/refdesk/DOrders/DOrder28.html>. All reports shall consist of sections, parts, narratives, graphics, and appendix as outlined below. The level of research for this report will be "thorough." This is one of three levels of investigation—exhaustive, thorough, and limited, as defined by DO-28. The final reports shall include, but not be limited to:

- A. Cover Page
- B. Table of Contents
- C. Executive Summary:
 - Research done to produce the HSR.

- Major research findings.
 - Major issues identified in the task directive.
 - Recommendations for treatment or use.
- D. Administrative Data:
- Names, numbers (park structure numbers and LCS #3s), and location data used to refer to the historic structure.
 - The proposed treatment of the structure including the source document.
 - Related studies.
 - Cultural resource data including date listed in the National Register and National landmark status data.
 - Recommendations for documentation, cataloging, and storage of materials generated by the HSR.
- E. Part I: Developmental History:
- **Historical Background and Context:** This section briefly describes the people and events associated with the structure. The section should establish a recommended period or periods of significance if this has not been done in the National Register nomination, historic resource study (HRS) or legislation.
 - **Chronology of Development and Use:** Physical construction, modification, and use of the structure is summarized in this section. The text should be based on historical documentation with corroboration from first-hand observation and materials analysis.
 - **Physical Description:** This section contains a description and analysis of all features, materials, and spaces according to age, significance, and condition. Describe and document all alterations to the structure. Discuss character-defining features, and primary and secondary spaces. Copies of inspection reports should be included in the appendix but summarized in the body of the chapter. The text should also discuss causes of deterioration. For the Washington Monument, the interior description will reference prior reports prepared by the NPS for description of the memorial stones.
 - **Condition Assessment:**
 - a) **General:** This is a conclusive narrative stating the overall physical condition and recommendations for work critical to preservation of the existing building.
 - b) **Graphic Data:**
 - 1. **Site Plan:** Scaled plan indicating boundaries of the building and locations of all related hardscape features. Historic American Building Survey (HABS) and current survey drawings may be reproduced and used.

2. Architectural Drawings: Include historic scaled plans for each building including foundation plans, floor plans, roof plans, as available.
 3. Photographic Copies: Organized photographic records showing overalls and details of exterior elevations, interior spaces, and significant elements of the building.
- c) Methodologies: Narrative descriptions of methodologies used for inspections, fabric investigation, material analyses and testing, and recording of existing conditions for the property.
 - d) Condition Assessment Data: This includes information pertaining to deficiencies in physical conditions of features and materials identified through inspections and evaluations. It also includes information pertaining to deficiencies in design, specifically how architectural components interrelate, potentially resulting in building component failure. Special attention is given to issues regarding integrity and stability, accessibility, life safety, fire protection.
 - e) Evaluation of Integrity: This section is a statement of historical and/or architectural significance, which discusses how well the building is still able to convey a sense of its history and/or architectural design. This needs to be evaluated in order to make preservation treatment decisions based on the building's historical and architectural importance.

F. Part II: Treatment and Use

- Ultimate Treatment and Use: This narrative discusses and analyzes the ultimate treatment and use of the structures as defined in park planning documents. If they have not been defined, this section may recommend an ultimate treatment and use. If analysis of the structure suggests that a planned treatment or use would adversely affect it, the text may present an alternative approach. Recommended treatment in general is to preserve the extant historic materials and features, but not to arbitrarily restore missing features unless they are highly characteristic and needing treatment for other reasons such as severe deterioration. Any proposed rehabilitation associated with new uses would have to be carefully considered, so that the existing character-defining features of the site and building are maintained.
- Requirements for Treatment: In concise terms, this text outlines applicable laws, regulations, and functional requirements. Specific attention should be given to issues of life safety, fire protection, energy conservation, abatement of hazardous materials, and handicapped accessibility.
- Alternatives for Treatment: This section presents and evaluates alternative approaches to realization of the ultimate treatment. Alternatives are presented in both text and graphic form. Analysis addresses the adequacy of each solution in terms of impact on historic materials, effect on historic character, compliance with

NPS policy, and other management objectives. The section concludes with elaboration on the recommended course of action and specific recommendations for preservation treatments.

- **Technical Data:** This portion of the report contains copies of field reports, material data sheets, field notes, correspondence, accounting spread sheets, and contract summaries.

G. **Appendices**

The appendices include relevant information that is not included in the text. Appendix shall include, but not be limited to:

- Bibliography
- Drawings
- Photographs

ENDNOTES

¹ NPS *Director's Order Number 28: Cultural Resource Management Guidelines*, June 11, 1998, Chapter 8, 4.

² NPS, Task Order #25, Modification 3, NPS Contract # 1443cx3059980901, *Scope of Services for Historic Structures Report - Washington Monument and Associated Structures*, February 14, 2003, 1-4.

1
2
3
4
5
6
7
8
9
10
11
12
13
14
15
16
17
18
19
20
21
22
23
24
25
26
27
28
29
30
31
32
33
34
35
36
37
38
39
40
41
42
43
44
45
46
47
48
49
50
51
52
53
54
55
56
57
58
59
60
61
62
63
64
65
66
67
68
69
70
71
72
73
74
75
76
77
78
79
80
81
82
83
84
85
86
87
88
89
90
91
92
93
94
95
96
97
98
99
100

APPENDIX B
ANNOTATED CHRONOLOGY

1
2
3
4
5
6
7
8
9
10
11
12
13
14
15
16
17
18
19
20
21
22
23
24
25
26
27
28
29
30
31
32
33
34
35
36
37
38
39
40
41
42
43
44
45
46
47
48
49
50
51
52
53
54
55
56
57
58
59
60
61
62
63
64
65
66
67
68
69
70
71
72
73
74
75
76
77
78
79
80
81
82
83
84
85
86
87
88
89
90
91
92
93
94
95
96
97
98
99
100

APPENDIX B

ANNOTATED CHRONOLOGY

1886-1923: POWER PLANT FOR WASHINGTON MONUMENT

10/22/1885 William Bradley, Washington, D.C., was awarded a \$6,994.58 contract to build a boiler house at the Washington Monument, with the building to be completed by May 15, 1886.¹

The Boiler House, now known as the Survey Lodge, was located 750 feet southwest of the Washington Monument. The building housed two coal-fired boilers, a 90-ton coal vault, an ash vault, and a workroom with toilet. The building was to be built using "White Marble and Granite, to be obtained from the waste of the stock used in building the Monument . . . white marble and granite, to be obtained from the waste of the stock used in building the Monument and now lying on the ground near the base. The building will be lined with brick and covered by an iron and slate roof, and will include the chimneys, which will be of the same material (Marble, Granite and brick) as the building itself . . . The contractor will furnish all materials of every description required to complete the building entire, except the Marble and Granite stock above-mentioned." The marble exterior walls had a quarry-faced finish and the granite trim was bush-hammered.²

11/1885 William Bradley, contractor building the Boiler House, had completed the excavation for the Boiler House and had nearly finished the foundation.³

12/1885 William Bradley had completed the cellar walls, the arched coal-vault roof and the granite base course of the Boiler House.⁴

1/1886 William Bradley continued work on the Boiler House, but since laying masonry during freezing weather was prohibited, work for the month consisted of preparing the granite courses and the marble facing blocks.⁵

2/1886 William Bradley continued cutting stone for the Boiler House.⁶

3/15/1886 Haliday & Wilson, Washington, D.C., was awarded a \$2,929.05 contract to construct a brick tunnel to carry steam pipes between the Boiler House and the Washington Monument. The brick tunnel had a concrete slab foundation and was 3-feet wide and 4-feet 3-inches high with an arched ceiling.⁷

- 3/1886 William Bradley resumed laying stone at the Boiler House on March 15, and by the end of the month the exterior walls were up to two-thirds the height of the window frames.⁸
- 4/1886 The walls of the Boiler House were completed and work on the chimney begun. Haliday & Wilson began excavation for the pipe tunnel. Excavation for the tunnel reached from the Boiler House almost to the terrace around the Washington Monument; the floor of the tunnel was covered with concrete for 630 feet; the side walls of the tunnel were built for nearly the length of the excavation; the arched ceiling of the tunnel had been built over the first 175 feet of the tunnel.⁹
- 5/1886 Except for cleaning, the exterior walls and chimney of the Boiler House were completed. The Boiler House roof was covered with slate and the coal vault with asphaltum. Carpenters began finishing the Boiler House workroom to prepare for plastering. The "pipe tunnel was about completed to the terrace and the vertical well at its extremity in the terrace commenced."¹⁰
- 6/30/1886 The Boiler House was completed.¹¹
- 10/1886 Mr. Lyons, contracted to provide the boilers for the Boiler House and the steam pipe connecting the Boiler House and the Engine House, had completed setting the boilers, which were then ready for testing. The steam pipes were in place and were awaiting anchorage to the floor. A 1-1/2-inch water pipe was installed to the brick tunnel. It entered the tunnel near its midpoint and branched to provide water for the Boiler House and the Engine House.¹²
- 3/6/1889 The Boiler House roof was damaged by fireworks. George B. Clark & Son were hired on March 18, 1889, to repair it.¹³
- 1891-1892 The exterior doors and casings of the Boiler House were painted.¹⁴ The ceilings and walls of the Boiler House were calcimined and the woodwork coated with hard oil.¹⁵
- 1892-1893 The Boiler House roof and spouting were repaired, and the gutters were repainted.¹⁶ The boilers were thoroughly cleaned, tested, and given an exterior coat of asphaltum. The interior of the Boiler House was whitewashed and the floor of the coal vault was re-laid. The steam pipes in the tunnel were repaired.¹⁷
- 1894-1895 The boiler house, engine room, monument, and elevator car were connected by telephone. The steam pipes in the tunnel were coated with a magnesia covering. In December 1894, the boilers were overhauled. The dynamo engine was replaced by a 6-by-6-inch Ideal engine.¹⁸
- 1895-1896 The exterior woodwork was repainted.¹⁹ The boilers were overhauled and repaired, and interior woodwork was repainted.²⁰

- 1896-1897 A storm blew off the ridge pole and broke slate and glass at the Boiler House. All the damage was repaired. A drain pipe was laid to drain the downspouts.²¹ The interior of the Boiler House was whitewashed.²²
- 1897-1898 The Corps of Engineers first proposed replacing the Washington Monument elevator's inefficient steam engine with an electric motor, with the generating unit housed in an addition to the Boiler House.²³ The interior of the Boiler House was whitewashed.²⁴
- 1898-1899 A new water heater was installed. The water closet received a new flush tank. A permanent phone connection was made between the top of the monument, the engine room, the boiler house, and the elevator cage. (With the earlier telephone system, if the elevator was at the bottom of the shaft, the top of the monument had no telephone contact.)²⁵
- 2/1899 Extreme cold weather caused some pipes in the Power House tunnel to break, and this caused the Washington Monument elevator and electric lights to be out of commission February 13-27.²⁶
- 1899-1900 The interior walls of the Power House were whitewashed. The fronts of the boilers and steam pipes were painted with asphaltum. New telephones were installed in the elevator car, Engine Room, Power House, and Lodge House.²⁷
- 6/6/1900 Congress appropriated \$26,500 to replace the Washington Monument's steam elevator with an electric model.²⁸
- 6/22/1900 A call for bids was issued for the installation of an electric elevator and motor at Washington Monument and an electrical generating unit in a new addition to the Boiler House. The bids opened on July 14, 1900, were too high.²⁹
- 9/22/1900 A second call for bids was issued for the installation of an electric elevator and motor at the Washington Monument and an electrical generating unit. These bids were opened on October 22, 1900, and were again too high.³⁰
- 11/12/1900 A satisfactory bid for the generating unit was received from Crocker-Wheeler Co., Ampere, NJ, and a contract was awarded to them on December 18, 1900.³¹
- 10/1900 Construction of an addition to the boiler house began, undertaken by the Corps of Engineers, Office of Public Buildings and Grounds. This addition was completed January 1901. After the installation of the new generating unit, the Boiler House was known as the Power House.³²
- 11/1900 The Power House woodwork was painted.³³
- 7/29/1901 The new Washington Monument electric elevator began public use.³⁴

- 1901 As part of the expansion of the Boiler House to accommodate the new Washington Monument elevator generating unit, a new 1600-foot-long water main was laid from the 14th Street public main through the Washington Monument Grounds to the Boiler House.³⁵
- 1902–1903 The leaking Power House slate roof was repaired and its tin roof and gutters were painted. The boiler room walls were whitewashed. The exterior window frames, sash, doors, waterspout, and cupola were painted. The dynamo engine was maintained and repaired.³⁶ The boiler room walls were whitewashed. The brickwork around the boilers was repointed, repaired, and whitewashed. The steam pipes, water pipes, condenser, air pump, and all pipes were painted. The boiler room floor and steps were given two coats of floor stain. The dynamo engine was maintained and repaired.³⁷
- 1903–1904 The boilers were frequently cleaned and inspected. In the dynamo room, the water closet was painted and both watt meters were repaired.³⁸
- 6/18/1904 A contract was made to replace the two old boilers with two new 80-horsepower horizontal boilers.³⁹
- 7/24/1904 In preparation for the installation of the new boilers, workers began removal of the old boilers and their brickwork in the boiler room of the Power House.⁴⁰
- 8/1904 Two new 80-horsepower horizontal return tubular boilers were installed in the Power House boiler room.⁴¹
- 1905–1906 The woodwork, windows, and engine room floor were painted. The engine was varnished, overhauled, cleaned, and repaired as necessary.⁴²
- 1906–1907 In the lower engine room, the walls were whitewashed and the woodwork and steam pipes painted.⁴³
- 1907–1908 The exterior doors, window sash, ironwork, and tinwork were painted.⁴⁴ The interior brick and stone walls of the Power House were whitewashed. The window, door, and doorframe woodwork, roof ventilator, and floors were cleaned and repainted.⁴⁵ A cement apron for handling ashes from the boiler room was built at the rear of the building.⁴⁶
- 1908–1909 The engine and power-transmitting cables were overhauled and repaired as needed.⁴⁷
- 1910–1911 The Power House woodwork was given two coats of paint.⁴⁸
- 1910–1911 The asphalt roof over the coal vault was replaced with a cement roof.⁴⁹ The flag walk east of the boiler house was replaced with a cement walk.⁵⁰

- 2/20–25/1911 The power plant was shut down for a complete overhaul and repair of machinery.⁵¹
- 3/5–9/1914 The power plant was shut down to repair the engine and steam pipes.⁵²
- 1916–1917 The Power House roof was repaired and painted.⁵³ The engine-room walls, ceiling, and woodwork and the toilet-room walls were scraped and given two coats of paint.⁵⁴
- 1918–1919 A septic tank was installed, and the Power House interior was painted.⁵⁵
- 1922–1923 The use of the power plant to operate the Washington Monument elevator was discontinued after the installation of electric cable and conduit connecting the monument to the local electric power and light utility.⁵⁶

1923–PRESENT: OFFICES AND CHLORINATION PLANT

- 6/17/1926 “The building situated southwest of the Washington Monument and housing the old power plant for the Monument, is hereby assigned to the Design and Construction Division.”⁵⁷
- 1930s The Power House became a Survey Lodge, accommodating the crews who surveyed the boundaries of the National Capital Parks.⁵⁸
- 1930 The former Power House was “altered” with “renovations” by “architect.”⁵⁹
- c. 1932 The Power House slate roof and cupola were removed. A hexagonal-tab asphalt-shingle roof was installed, and the cupola was not replaced.⁶⁰
- 9/2/1939 Plans were made for converting part of the former boiler house to a water chlorinating plant. While the vehicular entry and several other changes shown in the plans do not appear to have been fully implemented, some items were, including the concrete steps, retaining wall, and basement entrance, trap door over the coal vault, and application of quarry tile to the basement floor.⁶¹
- 5/13/1940 Heman S. Ward (Civil Engineer, Contractor and Builder) requested permission from the Superintendent of NPS to cut through a roadway as part of work he was doing in connection with the chlorinating plant at the Survey Lodge.⁶²
- 3/7/1946 A fireproof vault was proposed to be built in the then records room of the Survey Lodge.⁶³
- 8/1954 At this time, the Survey Lodge cupola is not present, the roof is covered with hexagonal asphalt shingles, and a sign above the southeast (main) entrance reads “Survey Lodge.”⁶⁴
- c. 1960–1970 Three-tab asphalt-shingle roof installed at Survey Lodge.⁶⁵

- 5/29/1963 NCP approved repair of the chlorination station at the Survey Lodge but cannot provide the assurance that the chlorination station will remain in this location indefinitely as NCP is planning an extension of South Reflecting Pool Dr. across 17th St. that would entail the removal of the chlorination station and the Survey Lodge.⁶⁶
- early 1970s NPS establishes the Mall Operations Office at the Survey Lodge to oversee and manage the monuments and memorials in the Mall area.⁶⁷
- 9/20/1973 Washington Monument Visitor Facility Comprehensive Design Program and Engineering Feasibility Program: engineering report recommendations for Survey Lodge: "retain as office space but [remodel] to increase privacy, amenities and to improve appearance. Remove chlorination tanks."⁶⁸
- 4/1974 The interim development plan for the Washington Monument Grounds for the Bicentennial proposed no alterations to the Survey Lodge or its immediate surroundings.⁶⁹
- 4/25/1985 A termite infestation inspection of Survey Lodge revealed that "swarmers have been observed here for many years."⁷⁰
- 12/3/1987 Restoration is proposed for Survey Lodge because "forced abandonment of the structure is imminent, brought about by on-going structural deterioration."⁷¹
- 12/7/1987 The National Capital Parks Region requests emergency funding to address visitor safety and historic preservation concerns for the Survey Lodge on the Washington Monument grounds, because the building "has been extensively damaged and weakened by termite infestation. An inspection done in 1987 by National Park Service Engineers indicated severe structural damage and additional hidden damage is suspected. Throughout the entire building, the floors are not level and a section of the flooring gave way. The floor was partially shored up by our maintenance staff to prevent collapse and a temporary floor was installed. Both of these measures are temporary and not expected to provide safe quarters for our staff for any extended time." The building served as headquarters for Mall operations, was open 16 hours/day, seven days/week, and housed staff responsible for the Washington Monument, Lincoln, Jefferson and Vietnam Veterans Memorials, National Mall, and Sylvan Theatre. In order to complete a thorough inspection of the damage to the building, NCP proposed closing the structure to the public and staff and move operations to a temporary trailer. Estimated cost of the restoration / renovation project was \$295,000.⁷²
- 1989-1993 The Survey Lodge was rehabilitated as a "staff support facility with minimal visitor services."⁷³

- 2/13/1992 National Capital Parks proposed restoration of the Survey Lodge cupola. This cupola was an original feature, previously removed. This work was not part of the initial Survey Lodge renovation proposal, but was added later.⁷⁴
- 10/22/1992 Notice to Proceed for AEO Construction Co., Inc. to install a cupola and replace the Survey Lodge roof. Work was to begin November 2, 1992, and the contract would expire in 90 days, on January 31, 1993.⁷⁵
- 1/1993 The Survey Lodge roof sheathing was replaced.⁷⁶
- 5/1993 The amendment/revision of 1981 Development Concept Plan for the portion of the monument grounds north of Independence Avenue includes Phase 5: Ranger Station (Survey Lodge) parking lot reconfiguration, but not alterations to the ranger station itself.⁷⁷
- 8/22/2001 The flange was removed from the Survey Lodge chimney to correct discoloration of the chimney by rusting ferrous plate.⁷⁸
- Fall/2001 The Survey Lodge chimney was cleaned to remove discoloration caused by rusting chimney flange.⁷⁹

ENDNOTES

Abbreviations:

- E 484 Letters Received, Entry 484; Records of the Joint Commission for Completion of the Washington Monument, 1876-1892
- GPO Government Printing Office, Washington, D.C.
- NAB National Archives Building, Washington, D.C.
- RG 42 Records of the Office of Public Buildings and Public Parks of the National Capital, Record Group 42
- RG 79 Records of the National Park Service, Record Group 79

¹ Thomas Lincoln Casey, Engineer in Charge of the Washington Monument, and William Bradley, "Articles of Agreement," 22 October 1886; Contracts, Entry 512; Records of the Engineer in Charge, 1876-1892; Records of the Joint Commission for the Completion of the Washington Monument, 1876-1892; RG 42; NAB.

² Thomas Lincoln Casey, Engineer in Charge of the Washington Monument, "Advertisement and Specifications for Boiler House at the Washington Monument," 3 October 1885; Contracts, Entry 512; Records of the Engineer in Charge, 1876-1892; Records of the Joint Commission for the Completion of the Washington Monument, 1876-1892; RG 42; NAB.

³ Thomas Lincoln Casey, Engineer in Charge of the Washington Monument, to Joint Commission for Completion of the Washington Monument, "Report of Operations Upon Completion of the Washington Monument for the Month of November 1885," 2 December 1885; E 484; RG 42; NAB.

⁴ Thomas Lincoln Casey, Engineer in Charge of the Washington Monument, to Joint Commission for Completion of the Washington Monument, "Report of Operations Upon Completion of the Washington Monument for the Month of December 1885." January 1886; v. 4, p. 250; Letters Sent, Entry 495; Records of the Engineer in Charge, 1876-1892; Records of the Joint Commission for the Completion of the Washington Monument, 1876-1892; RG 42; NAB.

⁵ Thomas Lincoln Casey, Engineer in Charge of the Washington Monument, to Joint Commission for Completion of the Washington Monument, "Report of Operations Upon Completion of the Washington Monument for the Month of January 1886," 4 February 1886; E 484; RG 42; NAB.

⁶ Col. Thomas Lincoln Casey, Engineer in Charge of the Washington Monument, to Joint Commission for Completion of the Washington Monument, "Report of Operations Upon Completion of the Washington Monument for the Month of February 1886," 1 March 1886; v. 4, p. 272; Letters Sent, Entry 495; Records of the Engineer in Charge, 1876-1892; Records of the Joint Commission for the Completion of the Washington Monument, 1876-1892; RG 42; NAB.

⁷ Thomas Lincoln Casey, Engineer in Charge of the Washington Monument, and James B. Haliday and William A. Wilson, "Articles of Agreement," 15 March 1886; Contracts, Entry 512; Records of the Engineer in Charge, 1876-1892; Records of the Joint Commission for the Completion of the Washington Monument, 1876-1892; RG 42; NAB.

⁸ Thomas Lincoln Casey, Engineer in Charge of the Washington Monument, to Joint Commission for Completion of the Washington Monument, "Report of Operations Upon Completion of the Washington Monument for the Month of March 1886," 1 April 1886; E 484; RG 42; NAB.

⁹ Thomas Lincoln Casey, Engineer in Charge of the Washington Monument, to Joint Commission for Completion of the Washington Monument, "Report of Operations Upon Completion of the Washington Monument for the Month of April 1886," 1 May 1886; E 484; RG 42; NAB.

¹⁰ Thomas Lincoln Casey, Engineer in Charge of the Washington Monument, to Joint Commission for Completion of the Washington Monument, "Report of Operations Upon Completion of the Washington Monument for the Month of May 1886," 2 June 1886; E 484; RG 42; NAB.

¹¹ Thomas Lincoln Casey, Engineer in Charge of the Washington Monument, to Joint Commission for Completion of the Washington Monument, "Report of Operations Upon the Washington Monument for the Year 1886," 20 December 1886; E 484; RG 42; NAB.

¹² Thomas Lincoln Casey, Engineer in Charge of the Washington Monument, to Joint Commission for Completion of the Washington Monument, "Report of Operations Upon the Washington Monument for the Month of October 1886," 3 November 1886; E 484; RG 42; NAB.

¹³ Custodian of the Washington Monument, to Engineer in Charge of the Washington Monument, "Report of Operations at the Washington Monument for Month of March 1889," April 1889; Monthly Reports of Operations, Entry 538; Records of the Custodian, 1879-1929; Records of the Engineer in Charge of the Monument, 1879-1929; RG 42; NAB.

¹⁴ Oswald H. Ernst, *Annual Report upon the Improvement and Care of the Public Buildings and Grounds, and Care and Maintenance of the Washington Monument in the District of Columbia, by Oswald H. Ernst, Major, Corps of Engineers, Col., U.S.A., being Appendix BBB of the Annual Report of the Chief of Engineers for 1892* (Washington, D.C.: GPO, 1892).

¹⁵ Ernst, *Annual Report*, 1892.

¹⁶ John M. Wilson and Oswald H. Ernst, *Annual Report upon the Improvement and Care of the Public Buildings and Grounds and Care and Maintenance of the Washington Monument in the District of Columbia*, by John M. Wilson, Lieut. Col., Corps of Engineers, Col., U.S.A., and Oswald H. Ernst, Major, Corps of Engineers, Col., U.S.A., being Appendix CCC of the Annual Report of the Chief of Engineers for 1893 (Washington, D.C.: GPO, 1893).

¹⁷ Wilson and Ernst, *Annual Report*, 1893.

¹⁸ John M. Wilson, *Annual Report upon the Improvement and Care of the Public Buildings and Grounds, and Care and Maintenance of the Washington Monument in the District of Columbia*, by John M. Wilson, Lieut. Col., Corps of Engineers, Col., U.S.A., being Appendix DDD of the Annual Report of the Chief of Engineers for 1895 (Washington, D.C.: GPO, 1895).

¹⁹ John M. Wilson, *Annual Report upon the Improvement and Care of the Public Buildings and Grounds, and Care and Maintenance of the Washington Monument in the District of Columbia*, by John M. Wilson, Lieut. Col., Corps of Engineers, Col., U.S.A., being Appendix DDD of the Annual Report of the Chief of Engineers for 1896 (Washington, D.C.: GPO, 1896).

²⁰ Wilson, *Annual Report*, 1896.

²¹ John M. Wilson, T. A. Bingham, and John S. Sewell, *Annual Report upon the Improvement and Care of the Public Buildings and Grounds, and Care and Maintenance of the Washington Monument in the District of Columbia*, by John M. Wilson, Col. (now Brig. Gen), Corps of Engineers, U.S.A., T. A. Bingham, Capt., Corps of Engineers, Col., U.S.A., and John S. Sewell, First Lieutenant, Corps of Engineers, U.S.A., being Appendix BBB of the Annual Report of the Chief of Engineers for 1897 (Washington, D.C.: GPO, 1897).

²² Wilson, Bingham, and Sewell, *Annual Report*, 1897; Theodore A. Bingham, *Annual Report upon the Improvement and Care of the Public Buildings and Grounds, and Care and Maintenance of the Washington Monument in the District of Columbia*, by Theo. A. Bingham, Capt., Corps of Engineers, Col., U.S.A., being Appendix CCC of the Annual Report of the Chief of Engineers for 1898 (Washington, D.C.: GPO, 1898).

²³ Bingham, *Annual Report*, 1898.

²⁴ Wilson, Bingham, and Sewell, *Annual Report*, 1897; Bingham, *Annual Report*, 1898.

²⁵ Theodore A. Bingham, "Appendix CCC Annual Report upon the Improvement and Care of the Public Buildings and Grounds, and Care and Maintenance of the Washington Monument in the District of Columbia" in *Annual Report of the Chief of Engineers for 1899*, Washington, D.C.: GPO, 1899.

²⁶ Bingham, *Annual Report*, 1899.

²⁷ Theodore A. Bingham, *Annual Report upon the Improvement and Care of the Public Buildings and Grounds, and Care and Maintenance of the Washington Monument in the District of Columbia*, by Theo. A. Bingham, Capt., Corps of Engineers, Col., U.S.A., being Appendix HHH of the Annual Report of the Chief of Engineers for 1900 (Washington, D.C.: GPO, 1900).

²⁸ Theodore A. Bingham, *Annual Report upon the Improvement and Care of the Public Buildings and Grounds, and Care and Maintenance of the Washington Monument in the District of Columbia*, by Theo. A. Bingham, Capt., Corps of Engineers, Col., U.S.A., being Appendix DDD of the Annual Report of the Chief of Engineers for 1901 (Washington, D.C.: GPO, 1901).

²⁹ Bingham, *Annual Report*, 1901.

³⁰ Bingham, *Annual Report*, 1901.

³¹ Bingham, *Annual Report*, 1901.

³² Bingham, *Annual Report*, 1901.

³³ Bingham, *Annual Report*, 1901.

³⁴ Theodore A. Bingham, *Annual Report upon the Improvement and Care of the Public Buildings and Grounds, and Care and Maintenance of the Washington Monument in the District of Columbia*, by Theo. A. Bingham, Capt., Corps of Engineers, Col., U.S.A., being Appendix DDD of the *Annual Report of the Chief of Engineers for 1902*, (Washington, D.C.: GPO, 1902).

³⁵ Bingham, *Annual Report*, 1901.

³⁶ Thomas W. Symons and Theodore A. Bingham, *Annual Report upon the Improvement and Care of the Public Buildings and Grounds, and Care and Maintenance of the Washington Monument in the District of Columbia*, by Thomas W. Symons, Major, Corps of Engineers, U.S.A., and Theo. A. Bingham, Major, Corps of Engineers, Col., U.S.A., being Appendix EEE of the *Annual Report of the Chief of Engineers for 1903* (Washington, D.C.: GPO, 1903).

³⁷ Symons and Bingham, *Annual Report*, 1903.

³⁸ Thomas W. Symons and Charles S. Bromwell, *Annual Report upon the Improvement and Care of the Public Buildings and Grounds, and Care and Maintenance of the Washington Monument in the District of Columbia*, by Thomas W. Symons, Major, Corps of Engineers, U.S.A., and Chas. S. Bromwell, Captain, Corps of Engineers, U.S.A., being Appendix DDD of the *Annual Report of the Chief of Engineers for 1904* (Washington, D.C.: GPO, 1904).

³⁹ Symons and Bromwell, *Annual Report*, 1904.

⁴⁰ William A. Craig, Custodian of the Washington Monument, to Col. Charles S. Bromwell, Engineer in Charge of the Washington Monument, "Report of Operations at the Washington Monument for the Month of July 1904," 1 August 1904; Monthly Reports of Operations, Entry 538; Records of the Engineer in Charge of the Washington Monument, 1879-1929; RG 42; NAB.

⁴¹ William A. Craig, Custodian of the Washington Monument, to Col. Charles S. Bromwell, Engineer in Charge of the Washington Monument, "Report of Operations at the Washington Monument for the Month of August 1904," 1 September 1904; Monthly Reports of Operations, Entry 538; Records of the Engineer in Charge of the Washington Monument, 1879-1929; RG 42; NAB.

⁴² Charles S. Bromwell, *Annual Report upon the Improvement and Care of the Public Buildings and Grounds, and Care and Maintenance of the Washington Monument in the District of Columbia*, by Chas. S. Bromwell, Captain, Corps of Engineers, U.S.A., being Appendix EEE of the *Annual Report of the Chief of Engineers for 1906* (Washington, D.C.: GPO, 1906).

⁴³ Charles S. Bromwell, *Annual Report upon the Improvement and Care of the Public Buildings and Grounds, and Care and Maintenance of the Washington Monument in the District of Columbia*, by Chas. S. Bromwell, Major, Corps of Engineers, U.S.A., being Appendix HHH of the *Annual Report of the Chief of Engineers for 1907* (Washington, D.C.: GPO, 1907).

⁴⁴ Charles S. Bromwell, *Annual Report upon the Improvement and Care of the Public Buildings and Grounds, and Care and Maintenance of the Washington Monument in the District of Columbia*, by Chas. S. Bromwell, Major, Corps of Engineers, U.S.A., being Appendix GGG of the Annual Report of the Chief of Engineers for 1908 (Washington, D.C.: GPO, 1908).

⁴⁵ Bromwell, *Annual Report*, 1908.

⁴⁶ Bromwell, *Annual Report*, 1908.

⁴⁷ Spencer Cosby, *Annual Report upon the Improvement and Care of the Public Buildings and Grounds, and Care and Maintenance of the Washington Monument and the Highway Bridge Across the Potomac River, Washington, District of Columbia*, by Spencer Cosby, Major, Corps of Engineers, U.S.A., being Appendix EEE of the Annual Report of the Chief of Engineers for 1909 (Washington, D.C.: GPO, 1909).

⁴⁸ Spencer Cosby, *Annual Report upon the Improvement and Care of the Public Buildings and Grounds, and Care and Maintenance of the Washington Monument and the Highway Bridge Across the Potomac River, Washington, District of Columbia*, by Spencer Cosby, Major, Corps of Engineers, U.S.A., being Appendix EEE of the Annual Report of the Chief of Engineers for 1911 (Washington, D.C.: GPO, 1911).

⁴⁹ Cosby, *Annual Report*, 1911.

⁵⁰ Cosby, *Annual Report*, 1911.

⁵¹ Cosby, *Annual Report*, 1911.

⁵² William W. Harts, *Annual Report upon the Improvement and Care of the Public Buildings and Grounds, and Care and Maintenance of the Washington Monument and the Highway Bridge Across the Potomac River, and Upon Erection of Monuments, Memorials, Etc., Washington, District of Columbia*, by William W. Harts, Lieut. Col, Corps of Engineers, Col., U.S.A., being Appendix CCC of the Annual Report of the Chief of Engineers for 1914 (Washington, D.C.: GPO, 1914).

⁵³ Office of Public Buildings and Public Parks of the National Capital, *Annual Report of Director of Public Buildings and Public Parks of the National Capital* (Washington, D.C.: GPO, 1917).

⁵⁴ Office of Public Buildings and Public Parks of the National Capital, *Annual Report*, 1917.

⁵⁵ Office of Public Buildings and Public Parks of the National Capital, *Annual Report of Director of Public Buildings and Public Parks of the National Capital* (Washington, D.C.: GPO, 1919).

⁵⁶ War Department. U.S. Army Corps of Engineers, *Annual Report to the Chief of Engineers, U.S. Army* (Washington, D.C.: GPO, 1923).

⁵⁷ Grant, U. S., 3d, Director, "General Order No. 67, Office of Public Buildings and Public Parks," 17 June 1926; U.S. Department of the Interior Library, Washington, D.C.

⁵⁸ "Survey Lodge 'The Boiler-House,'" n.d.; NPS-NCR Collection.

⁵⁹ Richard Quinn, "List of Classified Structures, Survey Lodge - Res. 2, Structure Number 00230000," 29 September 2000; NPS-NCR Collection.

⁶⁰ Assistant to the Regional Architect, to Chief of Maintenance Division, Memorandum, 4 November 1991; NPS-NCR Collection.

⁶¹ "Proposed Chlorinating Plant for Condensing Water Tunnel," 2 September 1939; [Architectural Drawing] File 74-21-9; RG 70, Cartographic and Architectural Records, LICON, Special Media Archive Division, National Archives at College Park, College Park, Md.

⁶² Heman S. Ward, to Superintendent, National Park Service, 13 May 1940; NPS-NCR Collection.

⁶³ U.S. Department of the Interior, National Park Service, National Capital Parks, Engineering Division, "Proposed Fireproof Vault Survey Lodge Washington Monument Grounds," 7 March 1946; [Architectural Drawing] NCP 807_84242; NPS-NCR Collection.

⁶⁴ "Survey Lodge," [photograph] August 1954; NPS-NCR Collection.

⁶⁵ Assistant to the Regional Architect, to Chief of Maintenance Division, Memorandum, 4 November 1991; NPS-NCR Collection.

⁶⁶ Robert C. Horne, Associate Regional Director, National Capital Region, to A. W. [Immorati] Regional Director, Region 3, Public Buildings Service, General Services Administration, 29 May 1963; NPS-NCR Collection.

⁶⁷ "Survey Lodge 'The Boiler-House,'" n.d.; NPS-NCR Collection.

⁶⁸ Hartman-Cox Architects, *Visitor Facility for the Washington Monument, Washington D.C. Comprehensive Design Program and Engineering Feasibility Design Program*, 20 September 1973; p.1; NPS-NCR Collection.

⁶⁹ *Impact Assessment, Interim Development Plan for Washington Monument Grounds*, Washington, D.C.: National Park Service, unpublished report, May 1974.

⁷⁰ IPM Assistant, Center for Urban Ecology, to Superintendent Central, Memorandum, 21 May 1985, NPS-NCR Collection.

⁷¹ U.S. Department of the Interior, National Park Service, "Development/Study Package Proposal, Restoration of Survey Lodge Building on Washington Monument Grounds," 3 December 1987; NPS-NCR Collection.

⁷² Jack Fish, Regional Director, National Capital Region, to Director, National Park Service, 7 December 1988; NPS-NCR Collection.

⁷³ National Capital Parks – Central, "Program Description, PDS Project Number NAC-046, Remodel Survey Lodge," 1988; NPS-NCR Collection.

⁷⁴ Rebecca Stevens, Regional Historical Architect, NCR, to Superintendent, NACC, Memorandum, 13 February 1992; NPS-NCR Collection.

⁷⁵ Monika Mayr, Chief, Branch of Construction and A/E Contracts Contracting Officer, NCP-Central, to AEO Construction Co., Inc., "Contract No. 1443CX300092073, Install a Cupola and Replace the Roofing System on the Survey Lodge Building, Washington, DC," 22 October 1992; NPS-NCR Collection.

⁷⁶ "Survey Lodge sheathing replacement," [photograph] 15 January 1993; NPS-NCR Collection.

⁷⁷ *Process of Implementation for Grounds Improvement and Accessibility, Washington Monument Grounds, Development Concept Plan*. Washington, D.C.: U.S. Department of the Interior, National Park Service, May 1993.

⁷⁸ "Crane removing chimney flange from Survey Lodge," [photograph] 22 August 2001; NPS-NCR Collection.

⁷⁹ "Cleansed Survey Lodge Chimney," [photograph] Fall 2001; NPS-NCR Collection.



BIBLIOGRAPHY

1
2
3
4
5
6
7
8
9
10
11
12
13
14
15
16
17
18
19
20
21
22
23
24
25
26
27
28
29
30
31
32
33
34
35
36
37
38
39
40
41
42
43
44
45
46
47
48
49
50
51
52
53
54
55
56
57
58
59
60
61
62
63
64
65
66
67
68
69
70
71
72
73
74
75
76
77
78
79
80
81
82
83
84
85
86
87
88
89
90
91
92
93
94
95
96
97
98
99
100

BIBLIOGRAPHY

ABBREVIATIONS

- GPO Government Printing Office, Washington, D.C.
NAB National Archives Building, Washington, D.C.
NPS-NCR National Park Service – National Capital Region
RG 42 Records of the Office of Public Buildings and Public Parks of the National
 Capital, Record Group 42
RG 79 Records of the National Park Service, Record Group 79

BOOKS AND ARTICLES

- Cowdrey, Albert E. *A City for the Nation: The Army Engineers and the Building of Washington, D.C., 1790–1967*. Washington, D.C.: Historical Division, Office of Administrative Services, Office of the Chief of Engineers, 1979.
- Dictionary of Building Preservation*, Ward Bucher, ed. New York: John Wiley & Sons, Inc., 1996.
- Museum for the Preservation of Elevating History, "Major Components," <http://www.theelevatormuseum.org/d/d.htm>, accessed July 22, 2003.
- Thurston, Robert H. *A History of the Growth of the Steam-engine*. New York: Appleton and Co., 1878.
- Torres, Louis. "To the Immortal Name and Memory of George Washington" *The United States Corps of Engineers and the Construction of the Washington Monument*. Washington, D.C.: GPO, 1984.
- U.S. Army Corps of Engineers, "Brigadier General Thomas Lincoln Casey," <http://www.hq.usace.army.mil/history/coe2.htm>, accessed 25 June 2003.

NATIONAL ARCHIVES – RECORDS OF THE OFFICE OF PUBLIC BUILDINGS AND PUBLIC PARKS OF THE NATIONAL CAPITAL, RECORD GROUP 42 (RG 42)

LETTERS RECEIVED, ENTRY 484; RECORDS OF THE JOINT COMMISSION FOR COMPLETION OF THE WASHINGTON MONUMENT (E 484)

- Casey, Lt. Col. Thomas Lincoln, Engineer in Charge of the Washington Monument, to Joint Commission for Completion of the Washington Monument, "Report of Operations Upon Completion of the Washington Monument for the Month of June 1880," July 1880; E 484; RG 42; NAB.

- Casey, Col. Thomas Lincoln, Engineer in Charge of the Washington Monument, to Joint Commission for Completion of the Washington Monument, "Report of Operations Upon Completion of the Washington Monument for the Month of November 1885," 2 December 1885; E 484; RG 42; NAB.
- Casey, Col. Thomas Lincoln, Engineer in Charge of the Washington Monument, to Joint Commission for Completion of the Washington Monument, "Report of Operations Upon Completion of the Washington Monument for the Month of January 1886," 4 February 1886; E 484; RG 42; NAB.
- Casey, Col. Thomas Lincoln, Engineer in Charge of the Washington Monument, to Joint Commission for Completion of the Washington Monument, "Report of Operations Upon Completion of the Washington Monument for the Month of March 1886," 1 April 1886; E 484; RG 42; NAB.
- Casey, Col. Thomas Lincoln, Engineer in Charge of the Washington Monument, to Joint Commission for Completion of the Washington Monument, "Report of Operations Upon Completion of the Washington Monument for the Month of April 1886," 1 May 1886; E 484; RG 42; NAB.
- Casey, Col. Thomas Lincoln, Engineer in Charge of the Washington Monument, to Joint Commission for Completion of the Washington Monument, "Report of Operations Upon Completion of the Washington Monument for the Month of May 1886," 2 June 1886; E 484; RG 42; NAB.
- Casey, Col. Thomas Lincoln, Engineer in Charge of the Washington Monument, to Joint Commission for Completion of the Washington Monument, "Report of Operations Upon Completion of the Washington Monument for the Month of October 1886," 3 November 1886; E 484; RG 42; NAB.
- Casey, Col. Thomas Lincoln, Engineer in Charge of the Washington Monument, to Brig. Genl. J. C. Duane, Chief of Engineers, "Report of Operations Upon the Washington Monument for the Year 1886," 20 December 1886; E 484; RG 42; NAB.

LETTERS SENT, ENTRY 495; RECORDS OF THE JOINT COMMISSION FOR THE COMPLETION OF THE WASHINGTON MONUMENT (E 495)

- Casey, Col. Thomas Lincoln, Engineer in Charge of the Washington Monument, to Joint Commission for Completion of the Washington Monument, "Report of Operations Upon Completion of the Washington Monument for the Month of December 1885," January 1886; v. 4, p. 250; E 495; RG 42; NAB.
- Casey, Col. Thomas Lincoln, Engineer in Charge of the Washington Monument, to Joint Commission for Completion of the Washington Monument, "Report of Operations Upon Completion of the Washington Monument for the Month of February 1886," 1 March 1886; v. 4, p. 272; E 495; RG 42; NAB.
- Casey, Col. Thomas Lincoln, Engineer in Charge of the Washington Monument, to Joint Commission for Completion of the Washington Monument, "Report of Operations Upon

Completion of the Washington Monument for the Month of June 1886," 2 July 1886; v. 4, p. 282; E 495; RG 42; NAB.

CONTRACTS, ENTRY 512; RECORDS OF THE JOINT COMMISSION FOR COMPLETION OF THE WASHINGTON MONUMENT (E 512)

Casey, Lt. Col. Thomas Lincoln, Engineer in Charge of the Washington Monument, "Advertisement and Specifications for Boiler House at the Washington Monument," 3 October 1885; E 512; RG 42; NAB.

Casey, Col. Thomas Lincoln, Engineer in Charge of the Washington Monument, and William Bradley, "Articles of Agreement," 22 October 1886; E 512; RG 42; NAB.

Casey, Col. Thomas Lincoln, Engineer in Charge of the Washington Monument, and James B. Haliday and William A. Wilson, "Articles of Agreement," 15 March 1886; E 512; RG 42; NAB.

MONTHLY REPORTS OF OPERATIONS, ENTRY 538; RECORDS OF THE CUSTODIAN, 1879-1929; RECORDS OF THE ENGINEER IN CHARGE OF THE MONUMENT, 1879-1929 (E 538)

Craig, William A., Custodian, to Theodore A. Bingham, Major, Corps of Engineers, "Report of Operations on the Washington Monument for the month ending November 30th, 1902," 1 December 1902; E 538; RG 42; NAB.

Craig, William A., Custodian of the Washington Monument, to Col. Charles S. Bromwell, Engineer in Charge of the Washington Monument, "Report of Operations at the Washington Monument for the Month of July 1904," 1 August 1904; E 538; RG 42; NAB.

Craig, William A., Custodian of the Washington Monument, to Col. Charles S. Bromwell, Engineer in Charge of the Washington Monument, "Report of Operations at the Washington Monument for the Month of August 1904," 1 September 1904; E 538; RG 42; NAB.

Custodian of the Washington Monument, to Engineer in Charge of the Washington Monument, "Report of Operations at the Washington Monument for Month of March 1889," April 1889; E 538; RG 42; NAB.

NATIONAL PARK SERVICE PUBLICATIONS

1987 Development/Study Package Proposal No. 138, 3 December 1987; NPS-NCR Collection.

Hartman-Cox Architects. *Visitor Facility for the Washington Monument, Washington D.C. Comprehensive Design Program and Engineering Feasibility Design Program*, 20 September 1973; NPS-NCR Collection.

Heine, Cornelius W. *A History of National Capital Parks*. Washington, D.C.: U.S. Department of the Interior, National Park Service, National Capital Parks, 1953; http://www.cr.nps.gov/history/online_books/nace/adhi.htm, accessed August 19, 2003.

- Mackintosh, Barry. *The National Parks: Shaping the System*. Washington, D.C.: National Park Service, 2000, web-only edition, http://www.cr.nps.gov/history/online_books/mackintosh1/index.htm, accessed 16 April 2003.
- National Capital Parks – Central. “Development Concept Plan and Alternatives, Washington Monument,” September 1981; NPS-NCR Collection.
- National Capital Parks, National Park Service, U.S. Department of the Interior. *Environmental Impact Assessment, Interim Development Plan for Washington Monument Grounds*. Washington, D.C.: National Park Service, unpublished report, May 1974.
- National Capital Parks, National Park Service, U.S. Department of the Interior. “Survey Lodge ‘The Boiler-House,’” n.d.; NPS-NCR Collection.
- National Park Service, U.S. Department of the Interior. *Development Concept Plan: Washington Monument Grounds (Revisions to the 1981 Development Concept Plan)*. Washington, D.C.: National Park Service, April 1989.
- National Park Service, U.S. Department of the Interior. *Process of Implementation for Grounds Improvement and Accessibility, Washington Monument Grounds*. Washington, D.C.: U.S. Department of the Interior, National Park Service, May 1993.
- National Park Service, Cultural Resources. *National Register Bulletin 15: How to Apply the National Register Criteria for Evaluation*. Washington, D.C.: U.S. Department of the Interior, National Park Service, 1997.
- Nelson, Lee H., FAIA. *Preservation Brief 17 Architectural Character: Identifying the Visual Aspects of Historic Buildings as an Aid to Preserving Their Character*. Washington, D.C.: U.S. Department of the Interior, National Park Service, 1988.
- Quinn, Richard. “List of Classified Structures, Survey Lodge – Res. 2, Structure Number 00230000,” 29 September 2000; NPS-NCR Collection.

HISTORIC AMERICAN BUILDING SURVEY / HISTORIC AMERICAN ENGINEERING RECORD

- Wunsch, Aaron V. *Washington Monument, HABS No. DC-428*. Washington, D.C.: U.S. Department of the Interior, National Park Service, Historic American Buildings Survey, 1994.

NATIONAL REGISTER OF HISTORIC PLACES

- Phanz, Donald C. “Washington Monument.” *National Register – Documentation of Existing National Register Property*. Washington, D.C.: U.S. Department of the Interior, National Park Service, 1980.

U.S. ARMY CORPS OF ENGINEERS, ANNUAL REPORTS

- Bingham, Theodore A. *Annual Report upon the Improvement and Care of the Public Buildings and Grounds, and Care and Maintenance of the Washington Monument in the District of Columbia, by Theo. A. Bingham, Capt., Corps of Engineers, Col., U.S.A., being Appendix*

- CCC of the Annual Report of the Chief of Engineers for 1898.* Washington, D.C.: GPO, 1898.
- Bingham, Theodore A. *Annual Report upon the Improvement and Care of the Public Buildings and Grounds, and Care and Maintenance of the Washington Monument in the District of Columbia, by Theo. A. Bingham, Capt., Corps of Engineers, Col., U.S.A., being Appendix CCC of the Annual Report of the Chief of Engineers for 1899.* Washington, D.C.: GPO, 1899.
- Bingham, Theodore A. *Annual Report upon the Improvement and Care of the Public Buildings and Grounds, and Care and Maintenance of the Washington Monument in the District of Columbia, by Theo. A. Bingham, Capt., Corps of Engineers, Col., U.S.A., being Appendix HHH of the Annual Report of the Chief of Engineers for 1900.* Washington, D.C.: GPO, 1900.
- Bingham, Theodore A. *Annual Report upon the Improvement and Care of the Public Buildings and Grounds, and Care and Maintenance of the Washington Monument in the District of Columbia, by Theo. A. Bingham, Capt., Corps of Engineers, Col., U.S.A., being Appendix DDD of the Annual Report of the Chief of Engineers for 1901.* Washington, D.C.: GPO, 1901.
- Bingham, Theodore A. *Annual Report upon the Improvement and Care of the Public Buildings and Grounds, and Care and Maintenance of the Washington Monument in the District of Columbia, by Theo. A. Bingham, Capt., Corps of Engineers, Col., U.S.A., being Appendix DDD of the Annual Report of the Chief of Engineers for 1902.* Washington, D.C.: GPO, 1902.
- Bromwell, Charles S. *Annual Report upon the Improvement and Care of the Public Buildings and Grounds, and Care and Maintenance of the Washington Monument in the District of Columbia, by Chas. S. Bromwell, Captain, Corps of Engineers, U.S.A., being Appendix EEE of the Annual Report of the Chief of Engineers for 1906.* Washington, D.C.: GPO, 1906.
- Bromwell, Chas. S. *Annual Report upon the Improvement and Care of the Public Buildings and Grounds, and Care and Maintenance of the Washington Monument in the District of Columbia, by Chas. S. Bromwell, Major, Corps of Engineers, U.S.A., being Appendix HHH of the Annual Report of the Chief of Engineers for 1907.* Washington, D.C.: GPO, 1907.
- Bromwell, Chas. S. *Annual Report upon the Improvement and Care of the Public Buildings and Grounds, and Care and Maintenance of the Washington Monument in the District of Columbia, by Chas. S. Bromwell, Major, Corps of Engineers, U.S.A., being Appendix GGG of the Annual Report of the Chief of Engineers for 1908.* Washington, D.C.: GPO, 1908.
- Cosby, Spencer. *Annual Report upon the Improvement and Care of the Public Buildings and Grounds, and Care and Maintenance of the Washington Monument and the Highway Bridge Across the Potomac River, Washington, District of Columbia, by Spencer Cosby, Major, Corps of Engineers, U.S.A., being Appendix EEE of the Annual Report of the Chief of Engineers for 1909.* Washington, D.C.: GPO, 1909.

- Cosby, Spencer. *Annual Report upon the Improvement and Care of the Public Buildings and Grounds, and Care and Maintenance of the Washington Monument and the Highway Bridge Across the Potomac River, Washington, District of Columbia, by Spencer Cosby, Major, Corps of Engineers, U.S.A., being Appendix EEE of the Annual Report of the Chief of Engineers for 1911.* Washington, D.C.: GPO, 1911.
- Ernst, Oswald H. *Annual Report upon the Improvement and Care of the Public Buildings and Grounds, and Care and Maintenance of the Washington Monument in the District of Columbia, by Oswald H. Ernst, Major, Corps of Engineers, Col., U.S.A., being Appendix BBB of the Annual Report of the Chief of Engineers for 1892.* Washington, D.C.: GPO, 1892.
- Harts, William W. *Annual Report upon the Improvement and Care of the Public Buildings and Grounds, and Care and Maintenance of the Washington Monument and the Highway Bridge Across the Potomac River, and Upon Erection of Monuments, Memorials, Etc., Washington, District of Columbia, by William W. Harts, Lieut. Col., Corps of Engineers, Col., U.S.A., being Appendix CCC of the Annual Report of the Chief of Engineers for 1914.* Washington, D.C.: GPO, 1914.
- Symons, Thomas W. and Chas. S. Bromwell. *Annual Report upon the Improvement and Care of the Public Buildings and Grounds, and Care and Maintenance of the Washington Monument in the District of Columbia, by Thomas W. Symons, Major, Corps of Engineers, U.S.A., and Chas. S. Bromwell, Captain, Corps of Engineers, U.S.A., being Appendix DDD of the Annual Report of the Chief of Engineers for 1904.* Washington, D.C.: GPO, 1904.
- Symons, Thomas W. and Theo. A. Bingham. *Annual Report upon the Improvement and Care of the Public Buildings and Grounds, and Care and Maintenance of the Washington Monument in the District of Columbia, by Thomas W. Symons, Major, Corps of Engineers, U.S.A., and Theo. A. Bingham, Major, Corps of Engineers, Col., U.S.A., being Appendix EEE of the Annual Report of the Chief of Engineers for 1903.* Washington, D.C.: GPO, 1903.
- War Department, U.S. Army Corps of Engineers. *Annual Report to the Chief of Engineers, U.S. Army.* Washington, D.C.: GPO, 1923.
- Wilson, John M. *Annual Report upon the Improvement and Care of the Public Buildings and Grounds, and Care and Maintenance of the Washington Monument in the District of Columbia, by John M. Wilson, Lieut. Col., Corps of Engineers, Col., U.S.A., being Appendix DDD of the Annual Report of the Chief of Engineers for 1895.* Washington, D.C.: GPO, 1895.
- Wilson, John M. *Annual Report upon the Improvement and Care of the Public Buildings and Grounds, and Care and Maintenance of the Washington Monument in the District of Columbia, by John M. Wilson, Lieut. Col., Corps of Engineers, Col., U.S.A., being Appendix DDD of the Annual Report of the Chief of Engineers for 1896.* Washington, D.C.: GPO, 1896.
- Wilson, John M. and Oswald H. Ernst. *Annual Report upon the Improvement and Care of the Public Buildings and Grounds and Care and Maintenance of the Washington Monument*

in the District of Columbia, by John M. Wilson, Lieut. Col., Corps of Engineers, Col., U.S.A., and Oswald H. Ernst, Major, Corps of Engineers, Col., U.S.A., being Appendix CCC of the Annual Report of the Chief of Engineers for 1893. Washington, D.C.: GPO, 1893.

Wilson, John M., T. A. Bingham, and John S. Sewell. *Annual Report upon the Improvement and Care of the Public Buildings and Grounds, and Care and Maintenance of the Washington Monument in the District of Columbia, by John M. Wilson, Col. (now Brig. Gen), Corps of Engineers, U.S.A., T. A. Bingham, Capt., Corps of Engineers, Col., U.S.A., and John S. Sewell, First Lieutenant, Corps of Engineers, U.S.A., being Appendix BBB of the Annual Report of the Chief of Engineers for 1897.* Washington, D.C.: GPO, 1897.

OFFICE OF PUBLIC BUILDINGS AND PUBLIC PARKS OF THE NATIONAL CAPITAL (OPB&PP), ANNUAL REPORTS

Office of Public Buildings and Public Parks of the National Capital. *Annual Report of Director of Public Buildings and Public Parks of the National Capital.* Washington, D.C.: GPO, 1917.

Office of Public Buildings and Public Parks of the National Capital. *Annual Report of Director of Public Buildings and Public Parks of the National Capital.* Washington, D.C.: GPO, 1919.

LETTERS AND MEMORANDA

Assistant to the Regional Architect, to Chief of Maintenance Division, Memorandum, 4 November 1991; NPS-NCR Collection.

DiSalvo, Carol, Center for Urban Ecology, to Superintendent Central, National Park Service, 10 May 1985; NPS-NCR Collection.

Fish, Jack, Regional Director, National Capital Region, to Director, National Park Service, 7 December 1988; NPS-NCR Collection.

Grant, U. S., 3d, Director, "General Order No. 67, Office of Public Buildings and Public Parks," 17 June 1926; U.S. Department of the Interior Library, Washington, D.C.

Horne, Robert C., Associate Regional Director, National Capital Region, to A. W. [Immorati], Regional Director Region 3, Public Buildings Service, General Services Administration, 29 May 1963; NPS-NCR Collection.

IPM Assistant, Center for Urban Ecology, to Superintendent Central, Memorandum, 21 May 1985; NPS-NCR Collection.

Mayr, Monika, Chief, Branch of Construction and A/E Contracts Contracting Officer, NCP-Central, to AEO Construction Co., Inc., "Contract No. 1443CX300092073, Install a Cupola and Replace the Roofing System on the Survey Lodge Building, Washington, D.C.," 22 October 1992; NPS-NCR Collection.

McGrath, Thomas H., Williamsport Preservation Training Center, HFC, to Superintendent, National Capital Parks - Central, Memorandum, 2 October 1990; NPS-NCR Collection.

National Capital Parks – Central, “Program Description, PDS Project Number NAC-046, Remodel Survey Lodge,” 1988; NPS-NCR Collection.

Stevens, Rebecca, Regional Historical Architect, NCR, to Superintendent, NACC, Memorandum, 13 February 1992; NPS-NCR Collection.

U.S. Department of the Interior, National Park Service, “Development/Study Package Proposal, Restoration of Survey Lodge Building on Washington Monument Grounds,” 3 December 1987; NPS-NCR Collection.

Ward, Heman S., to Superintendent, National Park Service, 13 May 1940; NPS-NCR Collection.

MAPS, PLANS, AND DRAWINGS

1886

“Washington Monument Boiler House Sections, Elevations and Details,” 1886; [Architectural Drawing] File 74-21-7; NCP 807; RG 79; Cartographic and Architectural Records LICON, Special Media Archives Division, National Archives at College Park, College Park, Md.

“Washington Monument Boiler House Plans, Sections and Elevations,” 1886; [Architectural Drawing] File 74-21-7; NCP 807; RG 79; Cartographic and Architectural Records LICON, Special Media Archives Division, National Archives at College Park, College Park, Md.

1889

“Plan of Washington Monument Ground, showing the surface grade to be formed under the present contract,” 1889; [Architectural Drawing] File 44-49; NCP 807; RG 79; Cartographic and Architectural Records LICON, Special Media Archives Division, National Archives at College Park, College Park, Md.

1898

Bingham, Theodore A., “Power House Washington Monument Showing – Proposed Additions for Electric Motors,” in *Annual Report upon the Improvement and Care of the Public Buildings and Grounds, and Care and Maintenance of the Washington Monument in the District of Columbia, by Theo. A. Bingham, Capt., Corps of Engineers, Col., U.S.A., being Appendix CCC of the Annual Report of the Chief of Engineers for 1898* (Washington, D.C.: GPO, 1898); U.S. Department of the Interior Library, Washington, D.C.

“Plan Showing Present Boiler House in Dotted Lines and Proposed Addition in Full Lines,” 1898; [Architectural Drawing] File 74-21-3; NCP 807; RG 79; Cartographic and Architectural Records LICON, Special Media Archives Division, National Archives at College Park, College Park, Md.

1902

Bingham, Theodore A., "Plan for the Improvement of the West Side of Monument Park," in *Annual Report upon the Improvement and Care of the Public Buildings and Grounds, and Care and Maintenance of the Washington Monument in the District of Columbia, by Theo. A. Bingham, Capt., Corps of Engineers, Col., U.S.A., being Appendix DDD of the Annual Report of the Chief of Engineers for 1902* (Washington, D.C.: GPO, 1902).

1939

"Proposed Chlorination Plant for Condensing Water Tunnel," 2 September 1939; [Architectural Drawing] File 74-21-9; NCP 807; RG 79; Cartographic and Architectural Records LICON, Special Media Archives Division, National Archives at College Park, College Park, Md.

Montgomery, "Remodeling of Building Plans and Sections," Approved 2 September 1939; [Architectural Drawing] File 74-21-10, Sheet 1 of 2; NCP 807; RG 79; Cartographic and Architectural Records LICON, Special Media Archives Division, National Archives at College Park, College Park, Md.

1942

U.S. Department of the Interior, National Capital Parks, Planning and Construction Division, "Washington Monument Grounds, Proposed Walks," 25 June 1942; NCP File 807_84208; NPS-NCR Collection.

1946

U.S. Department of the Interior, National Park Service, National Capital Parks, Engineering Division, "Proposed Fireproof Vault Survey Lodge Washington Monument Grounds," 7 March 1946; [Architectural Drawing] NCP File 807_84242; NPS-NCR Collection.

1989

Vincent Chan & Associates, Inc., "Architectural Plans, Remodel Survey Lodge Washington Monument Grounds," 3 August 1989; [Architectural Drawings] NCP File 807_80116, 25 Sheets; Technical Information Center, Denver Service Center, National Park Service.

PHOTOGRAPHS

1923

National Geographic, June 1923; File 13193; Washingtoniana Collection, Martin Luther King Library, Washington, D.C.

1932

Photograph of survey crew outside Survey Lodge, 7 July 1932; NPS-NCR Collection.

1954

"Survey Lodge," August 1954; NPS-NCR Collection.

1993

"Survey Lodge sheathing replacement," 15 January 1993; NPS-NCR Collection.

2001

"Crane removing chimney flange from Survey Lodge," 22 August 2001; NPS-NCR Collection.

"Cleaned Survey Lodge Chimney," Fall 2001; NPS-NCR Collection.

