

Seacoast Fortifications Preservation Manual

Golden Gate National Recreation Area
San Francisco, California

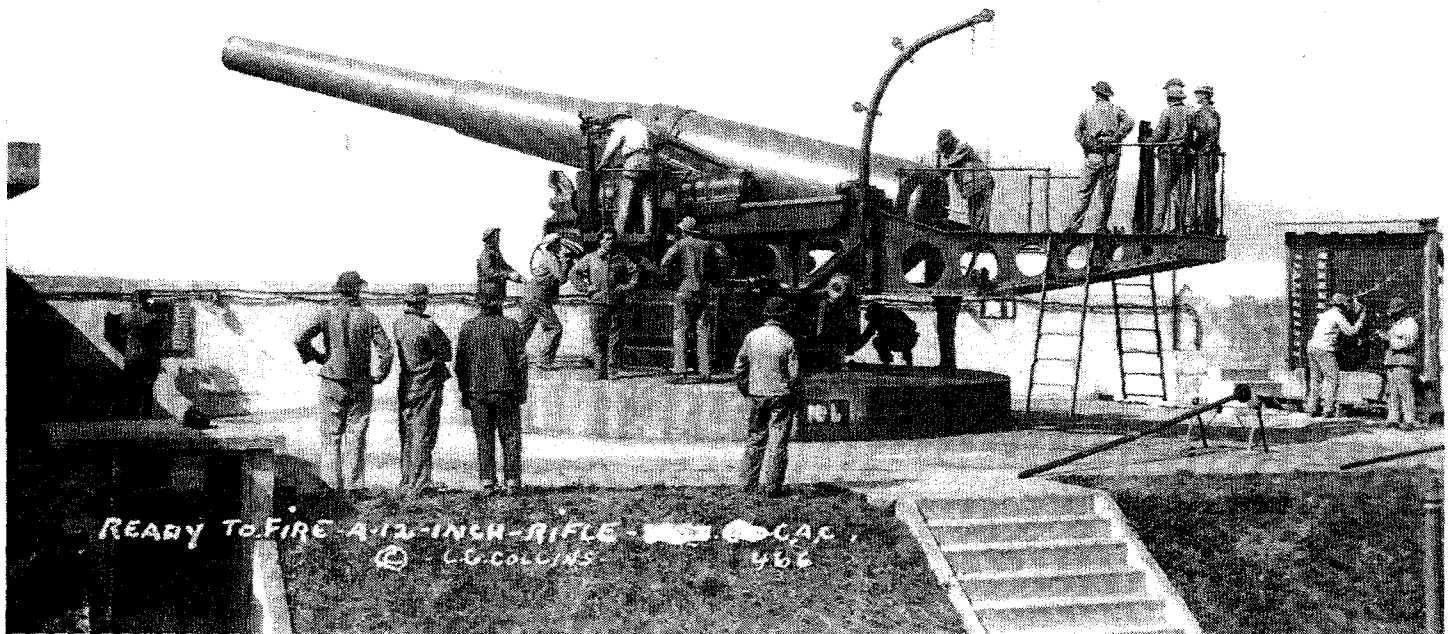

by

Joe C. Freeman, AIA
Stephen A. Haller
David M. Hansen
John A. Martini
Karen J. Weitze

National Park Service and KEA Environmental
Golden Gate National Recreation Area
San Francisco, California

July 1999



Seacoast Fortifications Preservation Manual
Golden Gate National Recreation Area
San Francisco, California

By:
Joe C. Freeman, AIA
Stephen A. Haller
David M. Hansen
John A. Martini
Karen J. Weitze

National Park Service and KEA Environmental
Golden Gate National Recreation Area
San Francisco, California

July 1999

TABLE OF CONTENTS

Acknowledgments	ix
Glossary of Terms	x
List of Acronyms	xxv
Introduction	xxvi

Part I: History and Preservation for Coast Defenses

Chapter 1: Why Preserve Coast Defenses?	1
Significance.....	1
Reasons to Preserve	2
Links Between the Coast Defenses of San Francisco and the Northwest.....	13
Properties Addressed in the Maintenance Manual.....	14
A Preservation Charette	14
Graffiti.....	16
Vegetation and Habitat.....	17
Concrete Design and Site Settlement.....	18
Observations.....	18
Chapter 2: Historical Context for the Seacoast Fortifications of San Francisco Bay	21
Prelude	21
The Significance of the Seacoast Fortifications of San Francisco Bay.....	22
The Spanish Colonial and Mexican Era, 1794-1846.....	23
Third System Fortifications, 1850-1861	25
Civil War and Post-Civil War, 1861-1884.....	28
Endicott Period, 1891-1928 (including the Taft Era and World War I).....	31
World War II Era, 1937-1948	37
Cold War Era Antiaircraft Defenses, 1952-1974	40
Concluding Remarks.....	41
Chapter 3: Character-Defining Features.....	44
Location and Site	44
Principal Character-Defining Features.....	44
Change Over Time	44
Construction Materials.....	46
Principal Character-Defining Features.....	46
Change Over Time	46
Structure	54
Principal Character-Defining Features.....	54
Change Over Time	54
Linking Analysis to the Coast Defense Resource Checklist.....	57
Chapter 4: Standards and Guidelines for the Preservation Process.....	60
The Existing Management Plan	60
Historic Preservation Guidelines	60
Stewardship.....	60
Technical Advice	61
Levels of Treatment	62
Rehabilitation	62
Restoration and Reconstruction	63
Preservation.....	63
Historical Research and Evaluation	63

The Archives and Documentation.....	63
Conducting the Research.....	64
Documentation of Existing Conditions.....	65
Coast Defense Resource Checklist.....	65
Photographs.....	65
Photograph Plan.....	65
Photograph Annotations.....	65
Historic Photographs.....	66
Cartographic Resources.....	66
Feature Mapping.....	66
Action Log.....	66
Recommended and Not Recommended: A Summation.....	66

Part II: Engineering, Design, Construction and Maintenance Issues

Chapter 5: Historic Materials and Maintenance Methods.....	71
Chronology of Structural Events: What was Built When, With What Materials?.....	71
Post-Civil War, 1865-1876.....	71
Endicott and Taft Periods, 1885-1916.....	74
World War I — World War II, 1917-1945.....	85
The Cold War.....	90
Selected Highlights.....	92
Concrete Mixes of the 1890s.....	92
Surfacing Schemes: Damp-Proof Coatings; Camouflage Paint, Washes, and Tints.....	94
Site Preparation and Issues of Settlement: Excavations and Fill.....	96
Landscape: Cultivation of Native Vegetation versus Imported Plants and Trees.....	100
Historic Maintenance Methods and Issues in the Recent Past.....	102
Chapter 6: The Design of Concrete Coastal Fortifications.....	106

Part III: Treatments

Chapter 7: Elements of Deterioration.....	113
Existing Conditions.....	114
Causes of Deterioration.....	114
Identifying Characteristics.....	115
General Conditions Assessment.....	115
Earthworks.....	116
Vegetation.....	116
Brick Masonry.....	116
Concrete.....	116
Metals.....	117
Wood.....	117
Waterproofing.....	117
Roofing.....	117
Doors and Windows.....	117
Coatings.....	117
Ventilation.....	118
Trails.....	118
Maintenance.....	118
Interiors.....	118
Levels of Treatment.....	118
Stabilization.....	119
Preservation.....	119

Repair and Restoration	119
Common Treatment	119
Chapter 8: Safety and Security Issues	120
At the Batteries.....	120
Safety	120
Security	121
Awareness of Ancillary Structures.....	122
Safety	122
Security	124
Standard Operating Procedures for Law Enforcement Actions	124
Chapter 9: Treatment Plans	126
Stabilization	127
Sitework	127
Concrete	127
Masonry	127
Metals.....	127
Carpentry.....	128
Moisture Protection.....	128
Doors and Windows.....	128
Finishes	128
Special Items	128
Preservation.....	128
Sitework	128
Concrete	129
Masonry	129
Metals.....	129
Carpentry.....	129
Moisture Protection.....	129
Doors and Windows.....	130
Finishes	130
Special Items	130
Repair and Restoration.....	130
Sitework	130
Concrete	131
Masonry	131
Metals.....	131
Carpentry.....	131
Moisture Protection.....	131
Doors and Windows.....	131
Finishes	132
Special Items	132
Chapter 10: Treatments and Procedures.....	133
Regulations and Standards.....	133
Objectives	133
Inspection Procedures	133
Documentation and Records Maintenance.....	133
Testing Procedure	134
Procedures and Controls	134
Safety	134
Protection	135

Products and Materials.....	135
Recommended Treatments.....	135
Sitework: General.....	136
Sitework: Excavation.....	137
Sitework: Soil Stabilization.....	138
Sitework: Earthworks.....	139
Sitework: Drainage.....	140
Sitework: Landscaping and Vegetation.....	141
Sitework: Trails and Paving.....	142
Concrete: Causes of Deterioration.....	143
Concrete: Identifying the Problem.....	144
Concrete: Inspection and Testing.....	145
Concrete: Treatment Overview.....	146
Concrete: Cracks.....	147
Concrete: Separation.....	148
Concrete: Spalling.....	149
Concrete: Epoxy Injection.....	150
Brick Construction: General.....	151
Brick Construction: Identifying the Problem.....	152
Brick Construction: Treatment Overview.....	153
Brick Construction: Mortar and Repointing.....	154
Brick Construction: Cleaning and Restoration.....	155
Brick Construction: Graffiti Removal.....	156
Metals: General.....	157
Metals: Structural Iron and Steel.....	158
Metals: Imbedded Hardware.....	159
Metals: Handrails and Guardrails.....	160
Metals: Ferrous, Miscellaneous.....	161
Carpentry: General.....	162
Carpentry: Treatment.....	163
Moisture Protection: Causes of Deterioration.....	164
Moisture Protection: Identification and Testing.....	165
Moisture Protection: Treatment.....	166
Moisture Protection: Built-Up Roofing.....	167
Doors and Windows: General.....	168
Doors and Windows: Treatment for Doors.....	169
Doors and Windows: Treatment for Wood Windows.....	170
Doors and Windows: Treatment for Metal Windows.....	171
Doors and Windows: Hardware.....	172
Finishes: General.....	173
Finishes: Exterior Concrete Coatings.....	174
Finishes: Interior.....	175
Finishes: Wood and Metal Coatings.....	176
Finishes: Graffiti Removal.....	177
Finishes: Signs and Stenciling.....	178
Special Items: General.....	179
Special Items: Treatment.....	180
Annotated Bibliography.....	181
Books.....	181
Government Documents.....	183
Periodicals: History.....	185
Periodicals: Architecture.....	186

Appendix A: Fortifications List, Golden Gate National Recreation Area.....	A-1
Appendix B: U.S. Army, Report of Completed Works, Form 7s.....	B-1
Historical Sketch	
Fort Baker	
Battery Spencer	
Battery Duncan	
Battery Kirby	
Battery Orlando Wagner	
Battery Yates	
Battery Kirby Beach	
Fort Barry	
Battery Mendell	
Battery Alexander	
Battery Smith-Guthrie	
Battery O'Rorke	
Battery Rathbone-McIndoe	
Battery Wallace	
Antiaircraft Battery No. 2	
Battery Construction #129	
Fort Cronkhite	
Battery Townsley	
Antiaircraft Battery No. 1	
Fort Funston	
Antiaircraft Battery No. 3	
Battery Davis	
Fort Miley	
Battery Livingston-Springer	
Battery Chester	
Battery Lobos	
Battery Construction #243	
Fort Winfield Scott	
Battery Marcus Miller	
Battery Godfrey	
Battery Howe-Wagner	
Battery Saffold	
Battery Lancaster	
Battery Cranston	
Battery Stotsenburg-McKinnon	
Battery Boutelle	
Battery Crosby	
Battery Slaughter	
Battery Sherwood	
Battery Baldwin	
Battery Blaney	
Battery Chamberlin	
Antiaircraft Battery	
Milagra Ridge	
Battery Construction #244	
Appendix C: Coast Defense Resource Checklist and Action Log	C-1
Coast Defense Resource Checklist	
Action Log	

Appendix D: Sources for Treatment, Materials, and Techniques	D-1
Sources for Treatment, Materials, and Techniques	
General	
Concrete	
Masonry	
Metals	
Moisture Protection	
Cleaning and Restoration	
Testing	
Protective Coatings	
Appendix E. Manufacturers Materials and Techniques: Cut Sheets	E-1

LIST OF TABLES

Table 1. Coast Defense Fortifications Preservation Needs and Goals	19
Table 2. General Guidance Practices for the Treatment of Coastal Fortifications.....	70
Table 3. Landscaping at the San Francisco Batteries, 1870-1944.....	101

LIST OF MAPS

Map 1. Coast Defense Locations, General	3
Map 2. Coast Defense Batteries, North: Fort Baker, Fort Barry, and Fort Cronkhite.....	4
Map 3. Coast Defense Batteries, North: With general locations of ancillary structures and Nike sites.....	5
Map 4. Coast Defense Batteries, South: Fort Mason, Fort Point, Fort Winfield Scott, and Fort Miley	6
Map 5. Coast Defense Batteries, South: With general locations of ancillary structures and Nike sites.....	7
Map 6. Coast Defense Batteries, Far South: Fort Funston and Milagra Ridge	8
Map 7. Coast Defense Batteries, Far South: With general locations of ancillary structures and Nike sites	9

LIST OF PLATES

Plate 1. Battery Godfrey, Fort Winfield Scott.....	2
Plate 2. Battery Kirby, Fort Baker	10
Plate 3. BC Station, Battery Construction #129, Fort Barry	11
Plate 4. Battery Wallace, Fort Barry	11
Plate 5. Power Plant, Battery Dynamite, Fort Winfield Scott.....	12
Plate 6. Missile Assembly Building, Nike Site SF-88L, Fort Barry	12
Plate 7. Battery Stotsenburg-McKinnon, Fort Winfield Scott	17
Plate 8. CRF Station for Battery Yates, Cavallo Battery, Fort Baker	18
Plate 9. Batteries Boutelle, Marcus Miller, Cranston, and Lancaster, Fort Winfield Scott; and, Batteries Spencer, Duncan, and Cavallo, Fort Baker	23
Plate 10. Battery Godfrey, Fort Winfield Scott.....	33
Plate 11. Cavallo Battery, Fort Baker	47
Plate 12. Battery Godfrey, Fort Winfield Scott.....	48
Plate 13. Mine Casemate, Fort Barry	48
Plate 14. Battery Marcus Miller, Fort Winfield Scott	50
Plate 15. Battery Crosby, Fort Winfield Scott	50

Plate 16. Battery Marcus Miller, Fort Winfield Scott	52
Plate 17. Battery Dynamite, Fort Winfield Scott	52
Plate 18. BC Station, Battery Construction #129, Fort Barry	53
Plate 19. Battery Stotsenburg-McKinnon, Fort Winfield Scott	55
Plate 20. Battery Stotsenburg-McKinnon, Fort Winfield Scott	58
Plate 21. Battery Wallace, Fort Barry	58
Plate 22. East Battery, Fort Winfield Scott	71
Plate 23. Nike Site SF-88L, Fort Barry	72
Plate 24. Cavallo Battery, Fort Baker	73
Plate 25. Battery Duncan, Fort Baker	75
Plate 26. Battery Duncan, Fort Baker	76
Plate 27. Battery Spencer, Fort Baker	77
Plate 28. Battery Chamberlin, Fort Winfield Scott	81
Plate 29. Gilhuly & Ambler, Fabricated Structural Steel, advertisement in <i>Architect and Engineer of California</i>	81
Plate 30. Batteries Cavallo and Yates, Fort Baker	82
Plate 31. Entrance for the Living Wall at the Panama Pacific International Exposition, San Francisco ..	84
Plate 32. The Living Wall at the Panama Pacific International Exposition, San Francisco.....	85
Plate 33. Battery Townsley, Fort Cronkhite.....	87
Plate 34. Landscape Plan, Fort Funston	88
Plate 35. Battery Davis, Fort Funston	89
Plate 36. Battery Davis, Fort Funston	89
Plate 37. Nike Hercules Warhead Building, Nike Site SF-88L, Fort Barry.....	91
Plate 38. Josson Portland Cement, advertisement in <i>Architect and Engineer of California</i>	92
Plate 39. The Paraffine Paint Co., advertisement in <i>Architect and Engineer of California</i>	95
Plate 40. Townsley Reserve Magazine, Fort Cronkhite.....	97
Plate 41. Battery Townsley, Fort Cronkhite.....	99
Plate 42. Battery Townsley, Fort Cronkhite.....	99
Plate 43. Battery Marcus Miller, Fort Winfield Scott.....	107
Plate 44. Cavallo Battery, Fort Baker	107
Plate 45. East Battery, Fort Winfield Scott	108
Plate 46. Battery Godfrey, Fort Winfield Scott.....	110
Plate 47. Battery Crosby, Fort Winfield Scott	113
Plate 48. Battery Mendell, Fort Barry.....	121
Plate 49. Battery Mendell, Fort Barry.....	122
Plate 50. Mine Casemate, Fort Barry	123
Plate 51. B ¹ S ¹ , Battery Construction #129, Fort Cronkhite	124
Plate 52. Battery Kirby, Fort Baker	126

ACKNOWLEDGMENTS

The *Seacoast Fortifications Preservation Manual* for the Golden Gate National Recreation Area is the collaborative outcome of much thought, many people, and numerous ideas—not all remembered here. Working together, the National Park Service and KEA Environmental talked through the present and future maintenance needs challenging park personnel in the management of its historic coast defense installations. Spanning nearly 100 years, from about 1870 into the 1960s, the seacoast fortifications are an intensely complex resource that requires teamwork for its interpretation and preservation. The primary authors of the manual included two historians from the National Park Service, Stephen A. Haller and John A. Martini, and three contributors representing KEA Environmental, Joe C. Freeman, David H. Hansen, and Karen J. Weitze. Mr. Haller conceptualized and managed the project for the National Park Service. He developed the scope of work, secured the funding, and served as the lead reviewer across the five authors. His coordination of all National Park Service involvement was essential to the project's success. Dr. Weitze directed the team on a day-to-day level and provided the perspective of an architectural historian. Mr. Freeman served as the project's preservation architect and Mr. Hansen as the lead military historian. KEA historian Christy Dolan served as a research assistant for the team.

Early in the project, the National Park Service hosted a preservation charette to bring together a larger professional group to discuss the batteries and their ancillaries. On a windy, cold December Saturday, a group of 16 preservationists visited selected installations and exchanged perspectives. The *Manual* owes its gratitude to architects Steade Craigo, Hank Florence, and Ric Borjes; to historic materials conservationist Mary Hardy; to landscape architect Denise Bradley; to preservation photographer Brian Grogan; to historians Gordon Chappell and Christy Dolan; to military site volunteers Milton "Bud" Halsey and Eric Heinz; and to maintenance supervisor Tima Alexandro, for joining the authors in volunteering their time that day. In addition, past and present National Park Service maintenance supervisors Charles Schultheis, Therron Hunter, Al Pond, and John Schuster offered their thoughts to Ms. Dolan by telephone. At the Park Archives of the Golden Gate National Recreation Area, Susan Ewing-Haley, Mary Gentry, and Janette Rojas worked with the project team, opening up research files and making available historic photographs and drawings. During the project also, additional representatives from the National Park Service landscape and maintenance departments offered their perspectives and guidance. Mr. Martini, as historian of San Francisco's coast defenses, deserves a double thanks for his willingness to answer email inquiries covering a myriad of details. And through Mr. Martini, the project team wishes to thank the other historians of fortifications with whom he exchanged ideas and retrieved even more information—especially Matthew L. Adams of Australia who contributed the history of the U.S. Army Report of Completed Works for the Appendix B collation of Form 7s. Finally, the project team owes its gratitude to the word processing and graphics staff at KEA, and is especially appreciative of the efforts of Gina Zanelli, Julie Mentzer, and Monica Clarke, whose keen eyes and steadfast patience made significant contributions and supported the efforts of all involved.

GLOSSARY OF TERMS

Architecture, Fortifications, and Preservation

- active cracking** cracking showing recent movement
- adaptive reuse** contemporary reuse for an existing historic structure, often with an updating of infrastructure and added amenities, and, typically with few sustained ties to the original historic function
- adobe** sun-dried (unburnt), clay-soil brick; the clay was often mixed with chaff, straw, chopped weeds, tule reeds, or sometimes manure for historic adobe bricks in California, with the individual brick sizes approximately eleven by twenty-five inches and of two-to-five inches thickness; each brick weighed about sixty pounds; Spanish word derived from Arabic *atob* (mud)
- aggregate** a constituent in cementitious mixes, usually sand or gravel
- alkalinity** the presence of chemical base material such as hydroxides and carbonates of calcium, sodium, or potassium
- alligatoring** a surface cracking pattern resembling alligator skin
- ammunition hoist** a mechanical device for moving projectiles and powder from the magazine to the level of the gun
- ancillary** a dependent structure, often but not always small in scale; associated hierarchically with a primary structure; often found in clusters with other dependent structures
- angle iron** iron or steel cross section with two legs ninety degrees apart
- architectonic** resembling architecture in manner and organization
- area drain** a surface drainage inlet to convey and disperse water
- artificial stone** varieties of cement-based, man-made imitations of naturally occurring rock, the latter typically quarried for building
- asphalt (asphaltum)** various bituminous substances, both naturally occurring and resultant from petroleum processing; also a bituminous substance mixed with crushed rock for paving
- asphalt emulsion paint** a surface coating containing emulsified asphalt for moisture protection
- automatic cannon** rapid-fire, light-caliber guns in which the force of the recoil is used to load and fire the piece without the crew having to manually insert and fire each round
- backer rod** a foam, tubular-shaped rod placed in a joint that is to receive a sealant to provide a solid base to receive and hold sealant
- backfill** filling a previous excavation

balanced pillar mount	a mount for smaller caliber coast artillery, which raises the gun above the parapet into the firing position and lowers it below the parapet for loading using a telescoping cylinder
barbette carriage	a mount for seacoast artillery in which the gun remains above the parapet for loading and firing
base line	a pre-surveyed horizontal line used for accurate position-finding and fire control, with observation posts called base-end stations at either end
base-end station	observation station at either end of a base line, containing an azimuth instrument or depression position finder, used to supply position data for the indirect aiming of coast artillery weapons
battery	a defensive structure containing all features and appliances necessary to support and serve a number of cannon
battery parade	the area in the rear of a battery where troops take formation
Beaux-Arts	French term [<i>Ecole Nationale et Spéciale des Beaux-Arts</i> , Paris] meaning fine arts; label for an architectural movement and training program, and for its associated architects, 1865-1915; loosely, architecture as fine art, characterized by an emphasis on classical tradition; Beaux-Arts was sometimes used as an alternative term for Classical or Colonial Revival design in the United States during the late nineteenth and early twentieth centuries
benching	installing fill materials in lifts
bentonite panel	an organic clay sheeting (compressed and rolled) to provide a waterproof membrane
berm	a ledge, embankment, or shoulder, often man-made, and typically earthen; also, a narrow path between a fortification parapet and its surrounding ditch
beton agglomeré	a French term for an artificial stone of cementitious materials in a matrix
binder	cementitious materials which chemically bind aggregates in a matrix
bitumen	rock largely consisting of hydrocarbons; naturally occurring asphalt
blackboard rack	a metal frame extending from the side of the data booth in a mortar battery to support a set of blackboards upon which firing data could be written
blast apron	a relatively thin paving of concrete in front of a gun emplacement that protects the ground from erosion, reduces dust, and helps control the possibility of fire
blind drain	a hidden drain
bombproof	a heavily built shelter, either a separate structure or a room within a battery, that can withstand the effects of bombardment

breast wall	a wall of breast height, typically used to provide a defensive position for infantry soldiers
breech-loading weapon	a weapon in which the round is loaded by opening a plug at the base of the gun tube
built environment	buildings, structures, and ancillaries comprising an inter-related man-made area, often architectural in character
bunker	an indistinct term that generally means a heavily built structure, usually a shelter against bombardment, that may or may not have provisions for defense; no specific meaning in coast defense; comes into popular use during WWI
butyl membrane	a rubberized sheet membrane utilizing butyl
caliber	the minimum diameter of the bore of a firearm, and therefore the diameter of the projectile it fires; also used to describe the length of a cannon, expressed as a multiple of its diameter
camouflage	the measures taken, or the material used, to conceal or misrepresent a military position
cantilever	to project horizontally with one end of the structure (beam or slab) anchored into a pier or wall; also, the term for such an extension or for a projecting bracket
caponier	a protrusion from the wall of a fortification, designed to allow grazing fire from within to sweep across the scarp walls adjacent to the parapet
carbonization	<i>formation of carbon from organic matter under heat and compression</i>
casemate	a chamber within a fortification built with overhead cover, and therefore resistant to bombs or high-angled shell fire
casement window	a window opening on hinges, which are generally attached to the sides of the window frame
castillo	the Spanish term for fortification
cast iron	a brittle iron cast from molten iron to a specific shape
ceiling trolley	a wheeled carriage running on, or in, tracks fastened to the ceiling, from which a projectile was suspended for movement
cement paint	a water-based paint containing Portland cement
cement-stabilization	to stay chemical activity in cement; to prevent further deterioration
chalking	<i>paint deterioration caused by loss of paint binder, leaving dried pigments</i>
chamfer	an oblique surface cut on the edge or corner of a board, usually sloping at forty-five degrees

character-defining / distinctive feature

features particular to a historic structure that distinguish and/or typify its character in terms of its original visual and structural design (and engineering), and in terms of its historic function or use

charette

a French term for a small, two-wheeled cart; at the *Ecole Nationale et Spéciale des Beaux-Arts* instructors collected students' drawings for assigned projects in a charette and the term came to be associated with the process of designing, and in particular with a work in progress by a group of architectural professionals

choke point

a constricted geographical area, easy to defend.

cold joint

a break in a construction installation; a stopping point

cold rolled steel

steel pressed and shaped without heat

columbiad

a large caliber, smoothbore, breech-loading cannon, designed to fire both shot and shell

common brick

utilitarian brick used for normal-load-bearing construction

compressive force

the tendency of a mass to bear on a surface by gravity

counter-scarp wall

in field fortification, the wall opposite the scarp; more directly, the side of a defensive ditch closest to the opposing force

crazing

random hairline surface cracking

cross fire

direct fire coming from two opposing directions at once

cultural landscape

the comprehensive (and linked) built and natural landscape defining a distinctive cultural-use area

curing

chemical process of dehydration by which cement and aggregate harden or set

cut and fill

efficient earthwork where cut materials are used to fill low spots adjacent to the cut

dado

the lower, broad part of an interior wall, finished in a painted or textured scheme different from that of the overall wall surface

damp course

a thru-wall membrane to resist rising damp

deflection

deformation of a structural element caused when loading exceeds resistance

deflector

a large stone placed within the mass of early concrete fortifications and intended to deflect a projectile that might strike it, thereby protecting interior spaces

delamination

deterioration in disconnected sheets or plates

dependent structure

ancillary structure

- design parameters** variables of function, need, or usage that directly affect the design of a building, structure, or object
- disappearing carriage** a gun mount designed to raise the gun to firing position above the parapet by means of a counterweight, and use the force of recoil to carry the gun back to its loading position below the parapet
- dog** a metal connector or strap
- dormant cracking** cracking that is not active
- double-hung window** a sash-type window with the lower framework typically moving up and down vertically, and the upper framework fixed; single-paned or multi-paned in type
- drip line** the line where water is shed from a surface
- dynamite battery** an experimental, and impractical, pneumatic gun that fired dynamite, using compressed air rather than gun powder to propel the dynamite to the target
- earthwork** a military construction formed chiefly of earth, used in both defensive and offensive operations
- efflorescence** soluble salts forming on a surface
- elastomeric membrane** a flexible sheet of rubberized material used for moisture protection
- elevation** a scale drawing representing a structure or building as projected geometrically on a vertical plane parallel to the chief dimension
- embrasure** a small opening in a fortification through which the weapon fires
- emplacement** a subdivision of a battery that refers to a single gun and the provision of services necessary to its functioning; compare with *pit*
- escutcheon plate** the door plate to which the handle is attached; or, the door plate protecting the keyhole or locking mechanism
- esplanade** a level area of a fortification
- Endicott** William C. Endicott, Secretary of War under the administration of President Grover Cleveland, associated with the program of modernization of American seacoast fortifications at the end of the nineteenth century
- epoxy** a polymer-based substance where oxygen and carbon atoms bond in a unique way; used in paints and adhesives; usually a two-component paint system where the components are mixed to achieve the chemical reaction that results in a hard and durable finish
- existing condition** the current condition, inclusive of advancing deterioration, of the physical fabric defining a site, structure, building, or object
- expansion joint** a joint used to compensate for or isolate structural movement

fatigue	natural deterioration or loss of strength in a material
feature mapping	the accurate recording of all features in a structure, including the observable imperfections of fabric, as a base for future preservation work or measuring the rate of change in physical condition
field artillery	the light and medium artillery pieces, and their units, whose function is to support the army in mobile battles and campaigns, not emplaced permanently in one area
field density	field-measure density used to determine degree of compaction; expressed as a percentage
field review (inspection / reconnaissance)	the on-site, physical observation and analysis required to ascertain the current conditions present at a historic property; here, when accompanied by maintenance actions, using the Action Log (Appendix C)
fire control station	a structure housing the equipment and personnel necessary to accurately determine the location of targets or to command the fire of several batteries
first system of American seacoast fortification	open fortification works of earthen construction, dating to the 1790s, which represent the first American attempt at a seacoast fortification network
flag	a flat slab of stone, or artificial stone, used for paving
flash rust	immediate corrosion of bare ferrous metals due to exposure to moisture in the air
flashing	a mechanical device used to prevent moisture infiltration
flat trajectory fire	high velocity direct fire, in which the projectile travels in a relatively straight line to the target
fog base	a base line system positioned at low elevation, to act as an alternate base line in case the view from the primary base-end stations was obscured by fog
footing	the perimeter base (or bottom) beam of a structure
formwork	the temporary mold of timber or metal boards, or sheets, that is used to give concrete its desired form, and, to give it support until it has hardened sufficiently
French drain	an underground linear drain designed to intercept and disperse water
gallery	a long room or passage, typically enclosed
garrison	the troops permanently assigned to a military post
general management plan	the official master plan for a park, approved after a period of public comment

- GPF gun** the U.S. 155mm gun, Model 1918 on field carriage, a large mobile artillery piece used to supplement the fixed seacoast defenses; GPF is the acronym for *Grand Puissance, Fillioux* or high-powered gun, named after its French designer
- granolithic finish** a cement-based surface (or floor) finish for concrete resembling granite; often applied when the concrete is fresh (green) and sometimes augmented by a surface hardener based on sodium silicate
- gravity / convection ventilation** ventilation using natural convection or air movement caused by differential pressure and air temperature
- grazing fire** flat trajectory fire placed low along the ground or water
- gritblast** high pressure air cleaning using sand or other grit
- groin vault** a vault formed by the intersection of two or more barrel vaults, with the omission of all of those parts that would lie below each of the uppermost vault forms
- groupment** an organization of firing batteries grouped together, irrespective of their permanent units, to provide the most effective command and control of an area's harbor defenses
- grout** a thin, coarse mortar poured into the joints of masonry and brickwork; to fill such joints
- gun** a cannon that fires a high velocity projectile on a flat trajectory
- gun platform** that portion of a permanent battery upon which the cannon is emplaced
- habitat** the kind of place where a particular animal or plant lives or grows naturally, or, thrives
- harmonic movement** coordinated movement due to the effects of wind loading
- historic architectural inventory** a systematic inventory recording the physical fabric and setting for historic properties; usually accompanied by photography; here, using the Coast Defense Resource Checklist (Appendix C)
- historic structure / resource** generally, with respect to American preservation efforts, a building, structure, or object meeting the requirements of eligibility for the National Register of Historic Places
- historic site** generally, with respect to American preservation efforts, a prehistoric or historic archeology site meeting the requirements of eligibility for the National Register of Historic Places
- hopper window** a window opening outwards at an angle and having a bin-like appearance when open

horizontal crest	a coastal fortification term that refers to the desire of the designers to keep the highest part of a gun battery, particularly those for guns mounted on the disappearing carriage, flat and unmarked by any object that could be used to identify the location of the battery from the sea
hydrostatic pressure	variation in air pressure that causes moisture to rise vertically in a wall
I beam	a metal structural shape designed to withstand deflection and twisting forces; consists of flanges and web
infrastructure	the structural skeleton beneath the outer skin of a building; also, the comprehensive system underlying a cohesive group of buildings and structures
integrity	with respect to American preservation actions, a reference to the seven points of integrity—location, design, setting, materials, workmanship, feeling, and association—defined within the criteria for eligibility to the National Register of Historic Places
interpretive plan	a document that describes the themes and objectives of a park's public education program, and the means for reaching those objectives
jack	a mechanical device to lift
jamb	a vertical piece forming the side of a doorway or window opening
jig	template
joist	a simple timber, steel, or precast-concrete beam supporting floor boards or ceiling lath
laitance	a condition occurring when concrete is mixed too wet, causing cementitious materials to concentrate and leaving portions of the mix cement-poor
lamellar tearing	stress-related metal deterioration
lampblack	a carbon byproduct of burning hydrocarbons; used as a pigment in paint
lime mortar	a mortar of one part lime and three parts sand
lime wash	a thin lime mortar used as a paint
lintel	a horizontal supporting member above an opening such as a window or door
loam	a loose soil composed of clay, sand, and organic matter, often highly fertile
louver	a slanted board or slat in an opening, overlapping with other boards or slats, and arranged to admit air but to exclude rain
magazine	a room within a battery or an emplacement where munitions are kept; often used more narrowly to indicate a room for the storage of powder
maintenance	the ongoing efforts to clean and repair a structure in order to prevent or slow its deterioration

Mandary flue cap a proprietary name for a type of clay flue cap manufactured by the Superior Clay Company in Ohio

maneuvering ring an iron ring set into the interior wall of a gun pit to aid in moving or adjusting the position of the heavy weapons

microclimate the distinctive climate of a restricted geographic area as defined within the more encompassing climate of a region

microcrystalline wax a fine wax with the ability to fill microscopic pores in materials; a sacrificial coating and protection

mine casemate a heavily protected room or building specially fitted out for the firing of submarine mines

moisture / damp-proof membrane
a surface coating that prevents moisture infiltration

monolithic of one material

mortar (architecture) a mixture, as of lime or cement, sand, and water, which hardens in the air and is used for binding together bricks or stones

mortar (fortification) a cannon designed to fire projectiles in a high, arched trajectory to reach over line-of-sight obstacles

mortar joint the area between individual bricks or stones, and between layers of such masonry, filled with binding material to create a compact mass

mortise a rectangular cavity of considerable depth in a piece of wood for receiving a corresponding projection (tenon) of another piece of wood

muntin a slender, vertical or horizontal, wood or metal piece separating individual window panes

muzzle-loading weapon
a weapon in which the projectile is loaded from the front, or muzzle, end of the gun tube

National Historic Landmark
nationally significant properties in American history and archeology; recognition established through the Historic Sites Act of 1935; official list maintained by the National Park Service on behalf of the U.S. Secretary of the Interior

National Historic Site
nationally significant sites in American history and archeology; program established through the Historic Sites Act of 1935; National Historic Sites are formally a part of the U.S. National Park system and are managed as physical property by the National Park Service

National Register of Historic Places

the official list of historically significant national, state, and local districts, sites, buildings, structures, and objects maintained by the National Park Service on behalf of the U.S. Secretary of the Interior; established through the National Historic Preservation Act of 1966

native vegetation	vegetation indigenous to a geographic area
neat cement	a mix of one part cement and one part sand without large aggregate
open space	relatively undeveloped land set aside for its recreational, habitat, or resource values
ordnance	artillery pieces and the equipment used to maintain and fire them
Panama mount	a permanently fixed open gun platform upon which a mobile artillery piece can be quickly placed for accurate fire and ease of traverse
parados	an earthen or concrete barrier that protects a battery from fire from the rear
paraffin paint	a paint containing petroleum-based wax
parapet	in coast defense, a wall of concrete or masonry that protects the cannon and those manning it
paring	coating masonry with a cement-rich wash
percolation	filtration of water through a material
pintle	a pin or bolt, especially one on which something turns, as in a hinge
pit	an emplacement containing two to four mortars and the provisions necessary for their service; compare with <i>emplacement</i>
plan	a drawing made to scale to represent the top view or a horizontal cut of a structure or building
planes of weakness	cold joints or planes susceptible to differential movement
plasticity index	a scale of relative value indicating swelling or the expansive characteristics of soil
plate	a thin, flat sheet of metal or other material of uniform thickness
plotting room	a room containing the men and equipment required to develop the necessary data to accurately aim a gun or a group of mortars
pneumatic gun	a gun that fires a projectile by the sudden release of highly compressed air
point	to apply a final layer of mortar to a joint

point loading	structural loading concentrated on a small cross-sectional area, as in the load of a beam transferred to a column
poultice	a material applied to a surface that absorbs a previous coating and draws it out
Portland cement	a hydraulic cement made by burning limestone and clay
preservation	an effort to sustain the remaining physical fabric of an historic structure, with attention to the seven points of integrity—location, design, setting, materials, workmanship, feeling, and association—as defined by the criteria of the National Register of Historic Places
presidio	the Spanish term for a fortified garrison
primary structure	the key building or structure defining a cluster of buildings and / or structures; or, the key building or structure supported by a group of ancillary (dependent) buildings and / or structures
prime	the first coat of a series of coats, usually paint
projectile	a generic term for the destructive missile thrown from a firearm
protection	to provide an historic site or property with a defensive system intended to inhibit further loss or deterioration of the existing physical fabric
punching shear	a point load acting on a horizontal plane, as in a column resting on a slab
rail	a horizontal timber or piece in a window framework, wainscot, or door paneling; paired with <i>stile</i>
rapid-fire gun	a gun that can be loaded and fired with great rapidity because of a single-motion breech mechanism; such guns also usually employ fixed ammunition, avoiding the need to load the propellant and the projectile separately
rebar	reinforcing steel bars used to provide a tensile component to compressive cement; various shapes: billeted, deformed, smooth, and twisted
redan	a small fortification consisting of two parapets forming a salient angle, with the rear face of the fortification open
rehabilitation	an effort that minimally alters the remaining physical fabric of an historic property, while sometimes adding features to allow efficient contemporary use; executed with an emphasis on the seven points of integrity—location, design, setting, materials, workmanship, feeling, and association—defined by the criteria of the National Register of Historic Places
repoint	replacement of masonry joint mortar
resource management zone	geographical areas defined in a park's general management plan that are managed according to distinct legislative and administrative requirements, resource values, and public preference

restoration	an effort to retain, preserve, or restore the complete physical fabric of an historic property appropriate to a researched temporal period, with close attention to the seven points of integrity—location, design, setting, materials, workmanship, feeling, and association—defined by the criteria of the National Register of Historic Places
retaining wall	a wall built to hold back a mass of earth; a revetment
rifled artillery	a large caliber, long-range weapon, with helical grooves cut in the bore to impart spin, and therefore stability and accuracy, to the projectile
riser	the vertical face of a stair step
rising damp	moisture rising in a wall due to hydrostatic pressure
Rosendale cement	a Portland-type cement found in New York state; naturally occurring
saddle	a structural implement or connector
salients	the portion of a fortification that projects towards the enemy
sally port	the protected entry way of a fortification
sash	a moveable framework in which planes of glass are set, as in a window
scab	a new piece of wood attached to an existing, deteriorated, or weakened member
scarp wall	in field fortification, the wall closest to the defenders in a ditch built as an obstruction
seacoast fortification	the fortification network designed and emplaced to protect naval bases, seaports and other important coastal waters from the intrusion of hostile warships
second system of American seacoast fortification	open batteries and masonry-faced forts constructed by the United States to protect strategic points on the Atlantic seaboard; predominantly prior to the War of 1812
section	a cross-sectional drawing made to scale representing a vertical cut through a building or structure
Sewell building	a frame building clad with cement stucco applied over an expanded metal lath, and referred to by the name of the army engineer officer who developed the technique, John Sewell
sheepsfoot roller	a heavy steel roller with individual protruding cleats in a shape associated with that of the feet of sheep; used for soil compaction
sheet lead	flat sheets of lead used for flashing
sheet metal	flat, thin metal, usually steel or steel alloy

shell	a hollow projectile, filled with explosives, designed to exercise destructive force by explosive energy
shoring	supporting posts, beams, and auxiliary members placed against the side of a building or structure; especially supports placed obliquely
shot	a solid projectile of dense metal, designed to exercise destructive force through penetration and kinetic energy
shot room	a room within a battery or an emplacement for the storage of projectiles
sloughing (soil)	the movement or partial collapse of an earthen slope
shuttering	overlapping or sheet materials to shed water; shingling
sidewalk concrete	concrete with a granolithic finish or with a finish of small stones imbedded in cement
significance	generally in American preservation efforts, defined through the four criteria (A, B, C, and D) of the National Register of Historic Places; summarized as significance associated with key historic events (A), the lives of important persons (B), established architectural or engineering merit (C), and, the potential to yield worthy new information in history or prehistory (D).
sill	a horizontal timber, block, or the like, serving as the foundation for a wall; the horizontal piece beneath a window, door, or other opening
smoothbore artillery	large caliber weapons with smooth, unrifled bores, designed to fire spherical shot or shell ("cannonballs")
soil grouting	injection of lime or cement into soil for stability
sonic meter	a device using sound waves to determine relative density
sounding hammer	a hammer used to strike concrete to determine consistency by the characteristics of the sound
spall	the flaking off of a material caused by expansion and contraction, or by material decomposition
speaking tube	a metal tube, either imbedded in the body of concrete or suspended from the ceiling, through which voice communication could be had between various parts of an emplacement or battery
splinterproof	a heavy concrete roof designed to protect against shell fragments
stabilization	to reestablish the structural equilibrium of an historic building or structure, or, to arrest further deterioration to an historic property or site, generally
stanchion	an upright bar, beam, post, or support, as in a window, stall, or compartment
stewardship	the management of a property, site, or historic resource

- stile** a vertical member in a wainscot, window, paneled door, or other piece of framing; paired with *rail*
- strategic** military art and science applied on the large scale to the employment of nations, their resources, armies and fleets
- stud** a post or upright wood member in the wall of a building
- stirrup** a shaped piece of reinforcing steel designed to tie two (top and bottom) horizontal rows of reinforcing
- substrate** a raw, base material (wood substrate to paint); underlying layer
- suction spotting** inconsistent absorption by a porous substrate caused by inconsistent surface preparation; volatile solvents evaporate at different rates
- surface bonding** chemical or friction connection between a substrate and applied finish surface
- tactical** military art and science applied to the employment of small scale units and capabilities of particular weapons
- tamping** manipulation of concrete in a form to settle concrete and eliminate voids
- Taylor-Raymond hoist**
the most successful of several ammunition hoist designs, developed by Harry Taylor through a series of improvements upon an earlier design by Robert Raymond; Taylor and Raymond were both army engineer officers
- telautograph booth** a free-standing concrete structure (but also a recess) that housed a telautograph, an electro-mechanical distance writing instrument
- tensile force** force which seeks to pull materials apart
- terreplein** a term that dates from much earlier fortification practice and meaning the area of a rampart where guns could be maneuvered; by the 1890s, it was used most often to indicate the ground level of a battery, but it soon fell out of use
- thermal expansion / contraction**
differential movement due to change in size caused by changes in temperature
- third system of American seacoast fortification**
a system of permanent masonry forts and supplementary batteries, designed between the War of 1812 and the Civil War, to improve upon the protection of strategic points along the Atlantic and Gulf coasts of the United States
- tongue-and-groove joint**
a common joint consisting of a projecting strip along the edge of a board and a matching groove on the edge of the next board
- tramway** a light rail line upon which ammunition carts could be pushed or hauled by hand

transfer drawing	a detailed drawing made by U.S. Army engineers when a completed battery was transferred to the artillery service; it provided instructions about the use and care of all the equipment and facilities furnished with the battery
transit	an optical instrument used to set lines, grades, and elevations
traverse	in fortifications, the structure on either side of an emplacement that provides protection from flanking fire; when referring to a cannon and its carriage, it can also mean movement to the left or the right
treatment plan	a plan describing specific operations used in maintaining or preserving architectural properties
trench drain	a linear drain designed to convey, intercept, or trap water
turret mount	a weapon mounted in a rotating, armored enclosure
variable-burning powder	propellant charge consisting of various sized grains of powder, which will therefore burn at different rates; the effect will accelerate the projectile more gradually out the gun tube, providing increased ultimate velocity and less strain on the gun barrel
viewshed	the panoramic, or otherwise fully encompassing, view <i>from</i> an historic site or property
water battery	a gun battery placed to lay grazing fire across the water
whitewash	a mix a hydrated white lime, alum, water used as a surface coating
wythe	the width of a brick

LIST OF ACRONYMS

AASHTO	American Association of State Highway and Transportation Officials
ACI	American Concrete Institute
APA	American Plywood Association
APT	Association for Preservation Technology
ARADCOM	Army Air Defense Command
ARPA	Archeological Resource Protection Act
ASTM	American Society for Testing Materials
AWPBS	American Wood Preservers Bureau Standards
BC	battery commander
CFR (fort.)	coincidence range-finder [station]
CFR (pres.)	Code of Federal Regulations
CRSI	Concrete Reinforcing Steel Institute
EPA	Environmental Protection Agency
FHWA	Federal Highway Administration
GPF	<i>Grand Puissance, Fillioux</i> [a high-powered gun named after its French designer]
GRI	Geosynthetic Research Institute
ICBM	intercontinental ballistic missile
MC	mine casemate
NACE	National Association of Corrosion Engineers
NOMMA	National Ornamental and Miscellaneous Metals Association
OCE	Office of the Chief of Engineers
OSHA	Occupational Safety and Health Administration
psi	pounds per square inch
RCB	Report of Completed Batteries
RCW	Report of Completed Works
SCR	Signal Corps Radio [Army radar classification developed during World War II]
SPIB	Southern Pine Inspection Bureau
SWRI	Sealant, Waterproofing, and Restoration Institute
WCLIB	West Coast Lumber Inspection Bureau
WWPA	Western Wood Products Association

INTRODUCTION

The *Seacoast Fortifications Preservation Manual* for the Golden Gate National Recreation Area is a collaborative effort, drawing upon expertise across several disciplines. Five primary authors contributed to the manual, with other individuals crucial for their roles as discussants, question answerers, and sources of specialized information. The manual is divided into three parts, with appendices supporting the volume.

“Part I: History and Preservation for Coast Defenses” introduces the installations and the preservation process. The four chapters of Part I include an opening conversation with readers of the manual—why preserve coast defenses—and three background introductions to the broader topic of these fortifications and their maintenance. Historian Stephen A. Haller and architectural historian Dr. Karen J. Weitze, leaders for the National Park Service and KEA Environmental team, contributed chapter 1. Mr. Haller, as Park Historian for the Golden Gate National Recreation Area, wrote chapter 2, a look at the national context for the coast defense fortifications of the San Francisco Bay Area. Military historian and preservationist David M. Hansen authored chapter 3, defining the character-defining features of the fortifications and giving readers a basic vocabulary with which to interpret these specialized historic resources. Chapter 4, standards and guidelines for the preservation process, is the joint effort of Mr. Hansen, Mr. Haller, and Dr. Weitze.

“Part II: Engineering, Design, Construction and Maintenance Issues” focuses on historic architectural-engineering practices at the San Francisco batteries. Chapter 5 offers an introductory analysis of the materials used at the San Francisco batteries and at the Nike sites, 1870 to 1970, and is authored by Dr. Weitze. Several complementary paragraphs written by Mr. Freeman, and originally appearing in chapter 7, have been incorporated into chapter 5. Paired with chapter 5 is Mr. Hansen’s chapter 6, a discussion of American battery design, concentrated on the Endicott period.

The four chapters of “Part III: Treatments” develop maintenance treatments and procedures, with the individual pull-out sheets of chapter 10 typically addressing known concerns and challenges. Pull-out sheets are organized by historic materials and subtopics, such as “Brick Construction: Mortar and Repointing” and “Metals: Handrails and Guardrails,” with each sheet independently formatted. Historical architect Joe C. Freeman contributed chapter 10. Chapters 7, 8, and 9 support the treatments and procedures presented by Mr. Freeman. Chapter 8, discussing safety and security issues at the batteries and their ancillaries, is the joint contribution of Dr. Weitze, Mr. Hansen, and John A. Martini, Curator of Military History for the Golden Gate National Recreation Area. Chapters 7 and 9, contributed by architect Freeman, provide analyses of the elements of deterioration across the coast defense installations, as well as overviews of types of suggested treatment plans. The suggested plans are focused on a range of alternatives from stabilization to restoration.

The appendices offer further source material to the reader. Appendix A gives a list of the coast defense fortifications within the jurisdiction of the Golden Gate National Recreation Area, with a representative selection of ancillaries. The list is intended as a basic guideline for the reader, providing him with beginning and completion construction dates; and, with gun emplacement and removal dates. Installations visited during field work for the manual are so noted. Appendix B is a set of U.S. Army Form 7s, simple plans, elevations, and sections for the batteries. Although the Form 7s are not a complete set, they do offer useful information for future maintenance site work. A brief history of the Form 7, derived from the work of military historian Matthew L. Adams, opens the appendix. Appendices A and B are researched and written by military historian Martini. Appendix C provides the Coast Defense Resource Checklist, with an introductory discussion of its intended use in a future historic architectural inventory and in ongoing maintenance work. Mr. Hansen developed the resource form, with additional comments for its best use found in chapter 4. Also in Appendix C is an Action Log for use by the maintenance staff of the National Park Service. The Action Log can be reproduced in multiple.

Completing the concluding sections, Appendix D offers a summary of professional sources for treatment materials and techniques, while Appendix E provides professional cut-sheets discussing manufacturers' standards for items often required in the maintenance of historic structures—such as appropriate soil stabilization products, concrete pigments, coatings, and epoxy injection.

Over 100 illustrations accompany the *Seacoast Fortifications Preservation Manual* for the Golden Gate National Recreation Area, inclusive of historic photographs from the collections of the Park Archives of the Golden Gate National Recreation Area; contemporary photographs at the batteries taken by Mr. Hansen; and, sketches provided by architect Freeman. Together these illustrations offer the reader a close look at the range of challenges present at the coast defense sites of the San Francisco Bay.

Text and illustrations are offered to encourage thoughtful maintenance and preservation at the batteries and ancillaries of the Golden Gate National Recreation Area, and to further encourage such efforts for all coast defense fortification sites—American and international.

PART I

HISTORY AND PRESERVATION FOR COAST DEFENSES

Chapter 1: Why Preserve Coast Defenses?

The Golden Gate National Recreation Area is challenged to protect, preserve, and interpret a grouping of more than fifty coast defense fortifications, ranging in age from fifty-five years to more than a century, inclusive of the remaining earth-and-brick batteries of the early 1870s, to the experimental and sophisticated reinforced concrete structures of the Endicott period through World War II (Maps 1-4). Augmenting the oversized scale of the primary gun emplacements that define the batteries, themselves sometimes eight in number at a mortar site, are approximately 160 ancillary structures and associated features of the coast defense cultural landscape. Ancillaries include casemates that served as the explosive operating units for mines placed under bay waters; fire control stations for modernizing the command required with the expanded range and accuracy of modern guns; and, searchlights at multiple points of land jutting out along the coastline both north and south of the harbor entrance. Mine casemates and fire control stations, the latter also known as base-end stations, first appeared during the 1890s, while systematic searchlights followed after the turn of the century. Extending coast defense through World War II and into the Cold War decades of the 1950s and 1960s are radar stations and Nike anti-aircraft batteries, with Nike emplacements found from the northernmost edges of today's park to the far south (Maps 5-7).

Significance

The seacoast fortifications of San Francisco Bay are significant as well-preserved examples of nearly every important development in military fortification engineering from before the Civil War to the guided missile era; as tangible manifestations of changing periods of the nation's history and of its changing military responses; and as associative links with people important to the history of the nation as a whole from John C. Fremont and "Kit" Carson to Irvin McDowell and Douglas MacArthur. The military reservations that provide a relatively unchanged physical context for these fortifications also provide a spectacular backdrop of largely undeveloped open space at the very verge of a great urban metropolis. This open space is not only a defining factor in the San Francisco Bay Region's world-renowned scenic beauty, but has become the core of land around which is established the first of the nation's urban national park areas.

Public Law 92-589, the enabling legislation which created the Golden Gate National Recreation Area in 1972, stated that the new park's purpose was, "to preserve for public use and enjoyment certain areas on Marin and San Francisco Counties, California, possessing outstanding natural, historic, scenic, and recreational values..."¹ This national park is one of the 375 units (at the time of this writing) of a world-renowned system of natural reserves, scenic areas, and historic sites whose overall mission is to "preserve unimpaired the natural and cultural resources and values of the national park system for the enjoyment, education, and inspiration of this and future generations."²

The *Golden Gate National Recreation Area/Point Reyes National Seashore General Management Plan* (1980) placed all the fortifications within a preservation zone, where the historic resources are "to be managed and used primarily for the purpose of facilitating public enjoyment, understanding, and appreciation of their historic values" and for "protection of structures from influences and uses that could cause deterioration."³

In carrying out its mission of historic preservation, the National Park Service adheres to the provisions of the National Historic Preservation Act of 1966, as amended. This act requires the heads of all federal agencies to establish a preservation program that identifies, evaluates, protects and nominates historic properties to the National Register of Historic Places. The Act stipulates that such historic properties "are managed and maintained in a way that considers the preservation of their historic, archeological, architectural, and cultural values ...and gives special consideration to the preservation of such values in the case of properties designated as having National significance."⁴

In accordance with the above laws, regulations and policies, the seacoast fortifications within Golden Gate National Recreation Area have been determined eligible for, or placed upon, the National Register of Historic Places as: the Fort Mason Historic District; the 6-Inch Disappearing Rifle; the Fort Miley Military Reservation; the Fort Baker, Barry and Cronkhite Historic District; Fort Funston; and the Hill 640 Military Reservation. In addition, the following coast defense properties have been designated National Historic Landmarks because of their national significance: the Presidio of San Francisco; Fort Point; and Alcatraz Island. The entire seacoast fortification network at Golden Gate National Recreation Area is presently in the process of being nominated as a National Historic Landmark, and is being managed as such until an official determination is made.

Therefore, within the framework of the mission of the National Park Service; the legislated purpose of the Golden Gate National Recreation Area; and established legislation and approved park policy; the answer to the question "Why preserve coast defenses?" is clear: "It is policy, firmly based upon law."

Reasons to Preserve

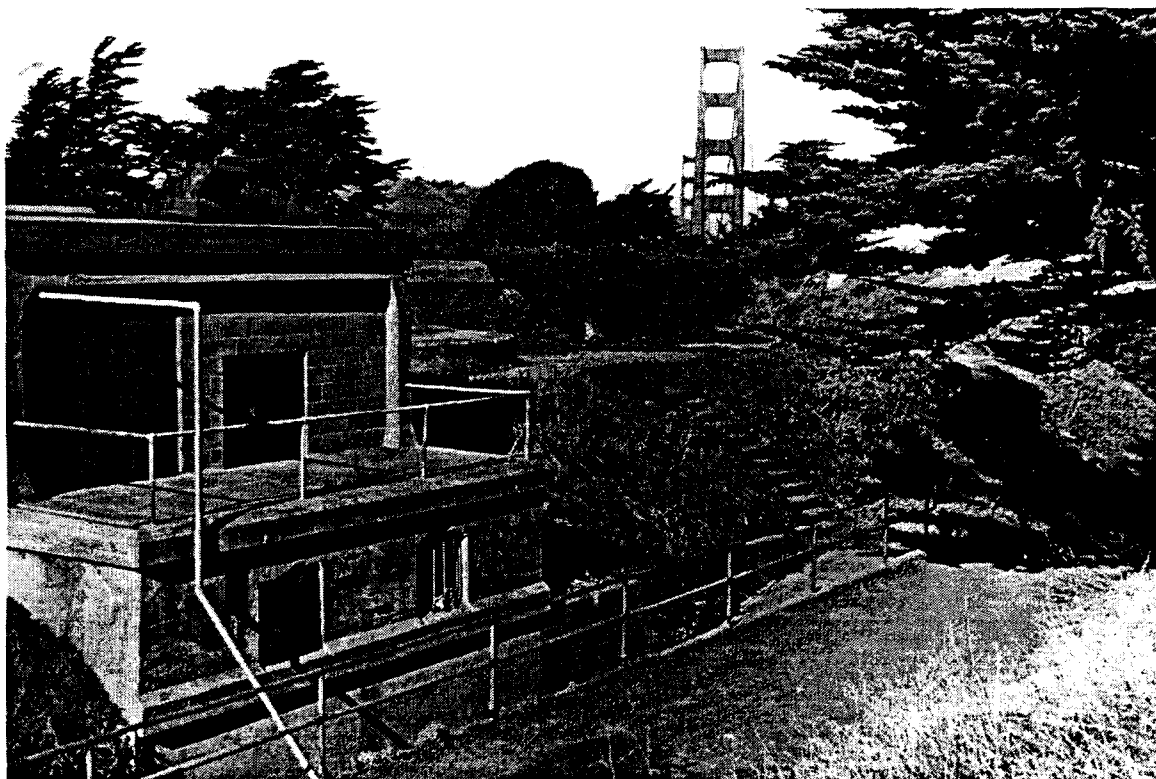
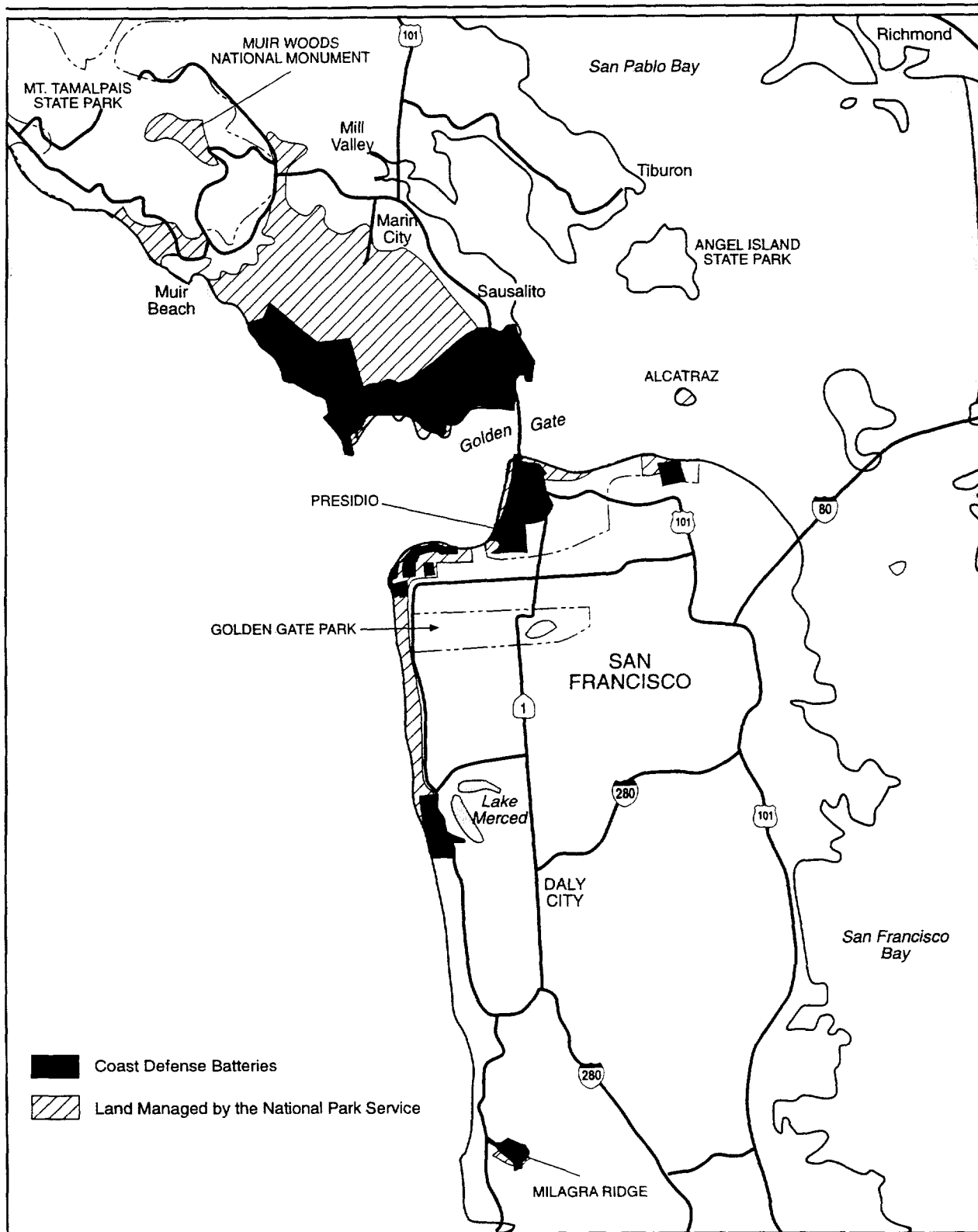
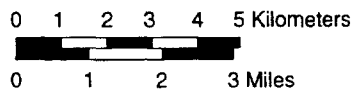

Plate 1. Battery Godfrey, Fort Winfield Scott, constructed 1892-1896. Looking northwest at loading platform.

Today walkers, hikers, and joggers are confronted with many images as they explore trails within the park. A single view can yield a close look at a stolid defense site of the 1890s, such as that of Battery Godfrey, and simultaneously include one of the elegant Moderne towers of the Golden Gate Bridge of the late 1930s—the pair of historic resources framed by the mature landscaping evocative of the complexities of the immediate setting of the Presidio. The man-made beauty inherent in the sculptural forms of many gun pits, such as at Battery Kirby at Fort Baker, offer any park visitor a heightened moment of pause when, after climbing up steep battery steps to the blast apron, he turns back to be rewarded with the sweeping precision of a crisp circular form not quite anticipated (Plates 1 and 2).



Source: Golden Gate National Recreation Area California, 1994



Map 1
Coast Defense Locations, General
Golden Gate National Recreation Area

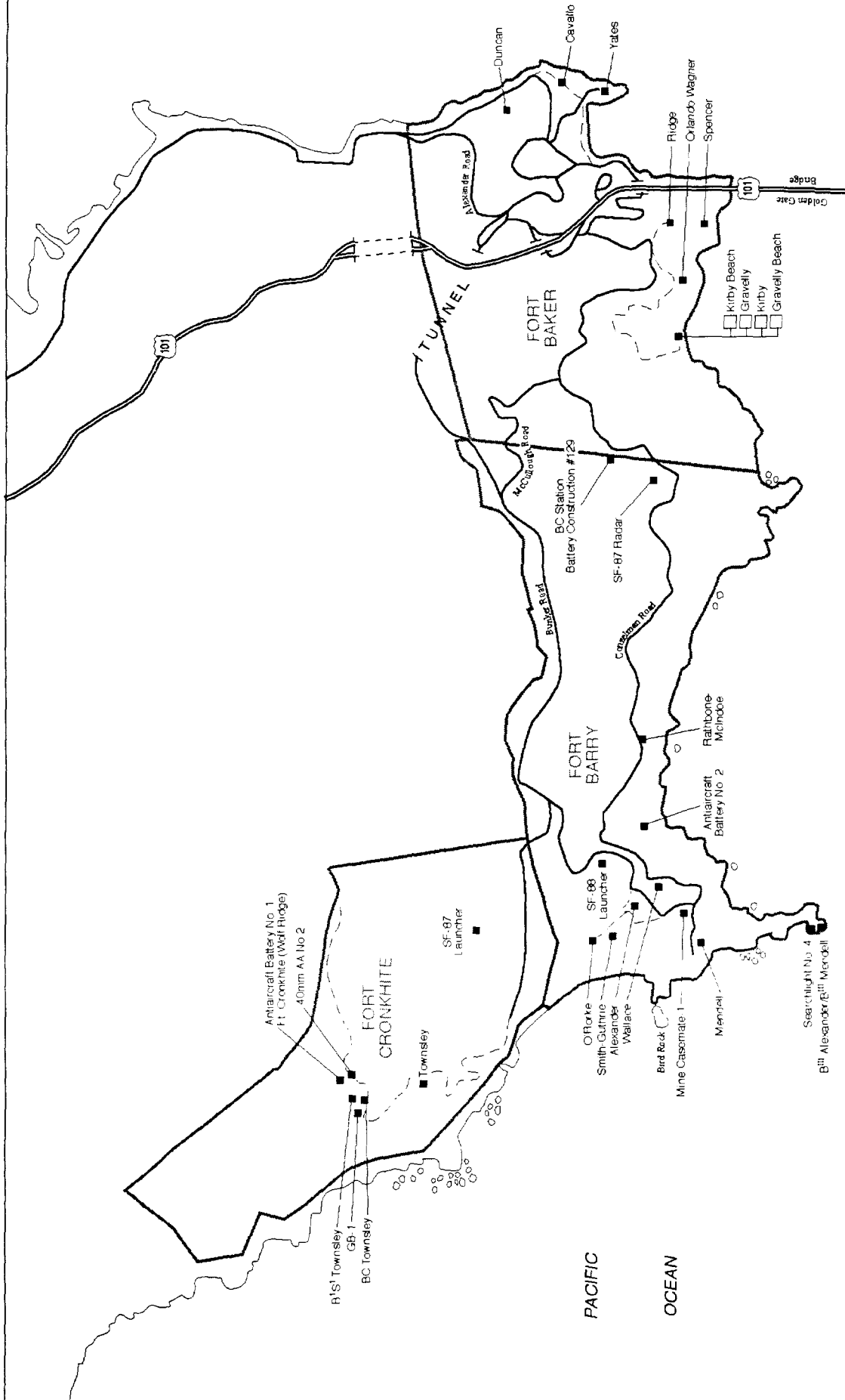

Map 2
**Coast Defense Batteries, North
 Fort Baker, Fort Barry, and Fort Cronkhite
 Golden Gate National Recreation Area**

100 1000
 1986 by the Golden Gate National Parks Association



Not to Scale



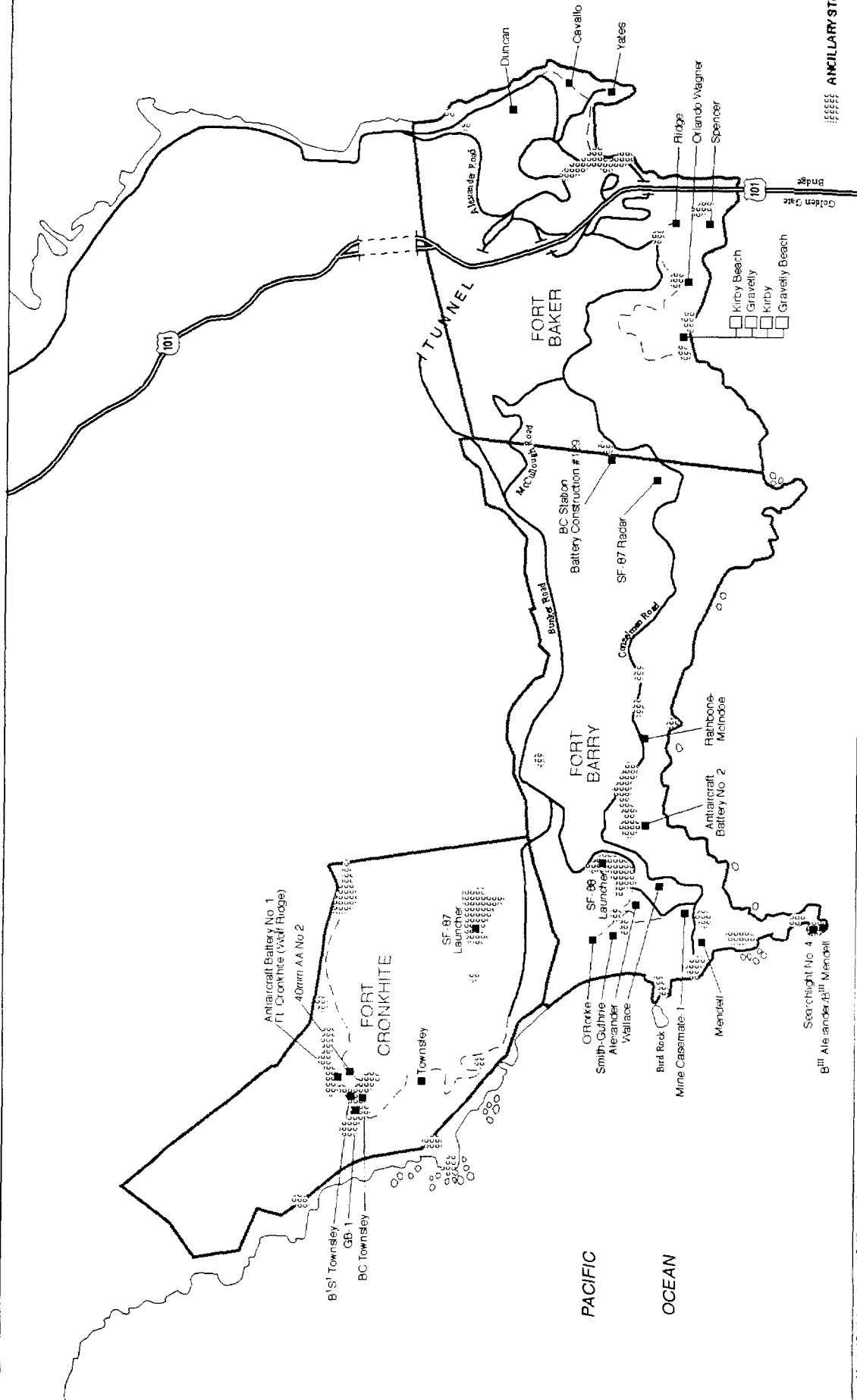

ANCILLARY STRUCTURES/NIKE SITES

Map 3
**Coast Defense Batteries, North
 With general locations of ancillary structures and Nike sites
 Golden Gate National Recreation Area**

Map and Guide to the Seaside Fortifications of the Golden Gate
 1986 by the Golden Gate National Parks Association



Not to Scale



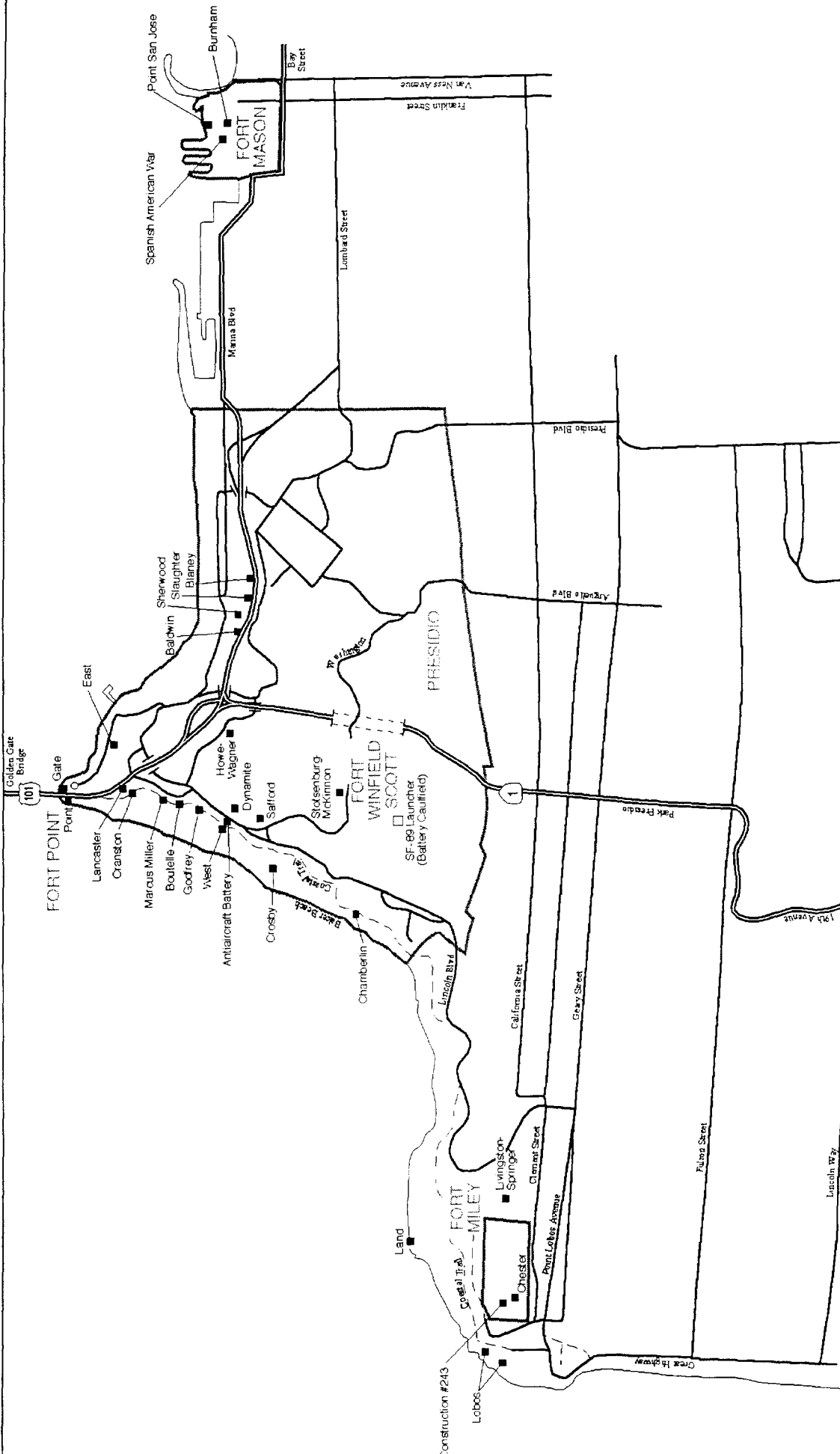

Map 4
 Coast Defense Batteries, South
 Fort Mason, Fort Point, Fort Winfield Scott, and Fort Miley
 Golden Gate National Recreation Area

Map 4
 Coast Defense Batteries, South
 Fort Mason, Fort Point, Fort Winfield Scott, and Fort Miley
 Golden Gate National Recreation Area

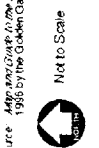

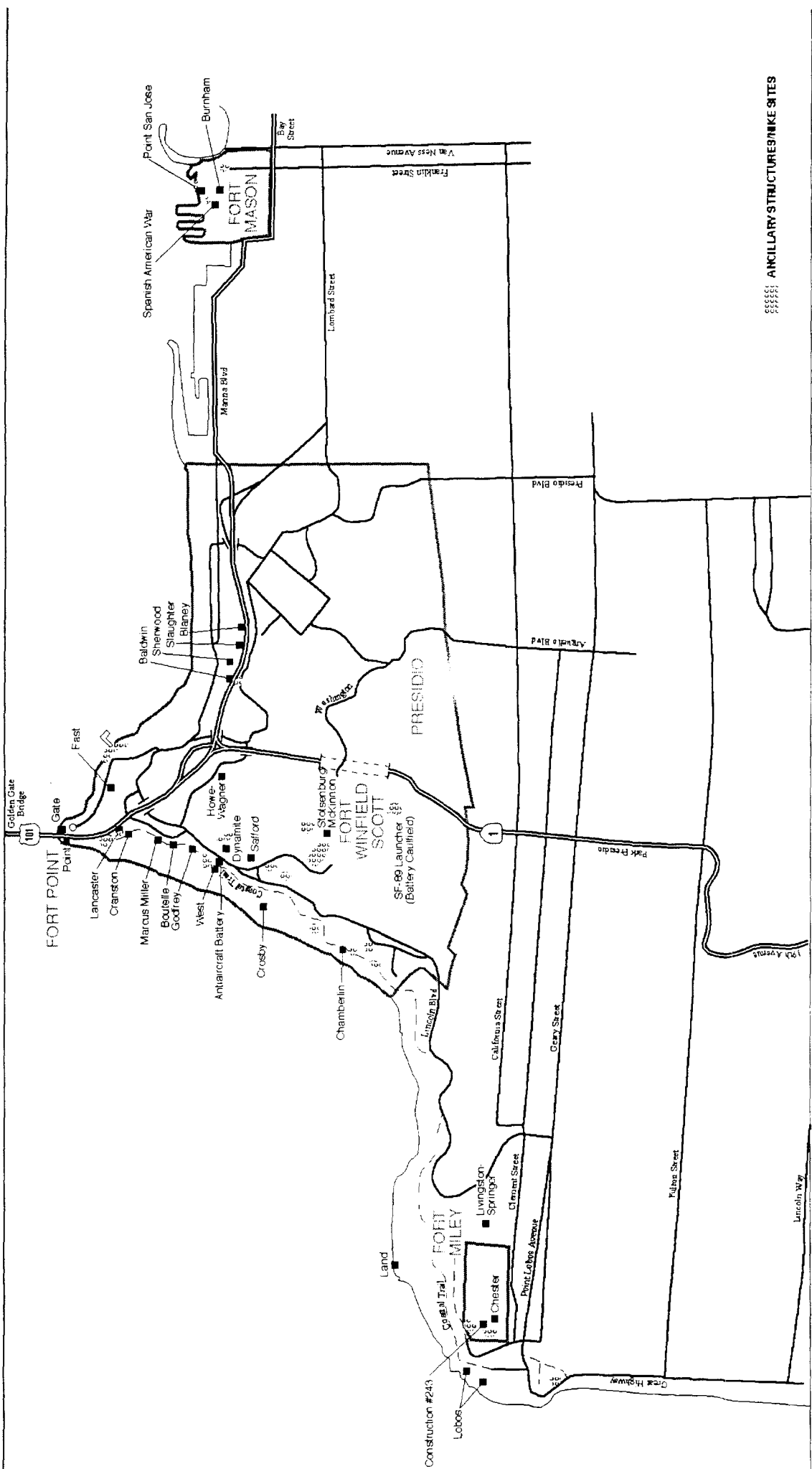

ANCILLARY STRUCTURES/NIKE SITES

Map 5
 Coast Defense Batteries, South
 With general locations of ancillary structures and Nike sites
 Golden Gate National Recreation Area

Source: Maps of the Golden Gate National Recreation Area, prepared by the Golden Gate National Parks Association, 1956 by the Golden Gate National Parks Association.



Not to Scale

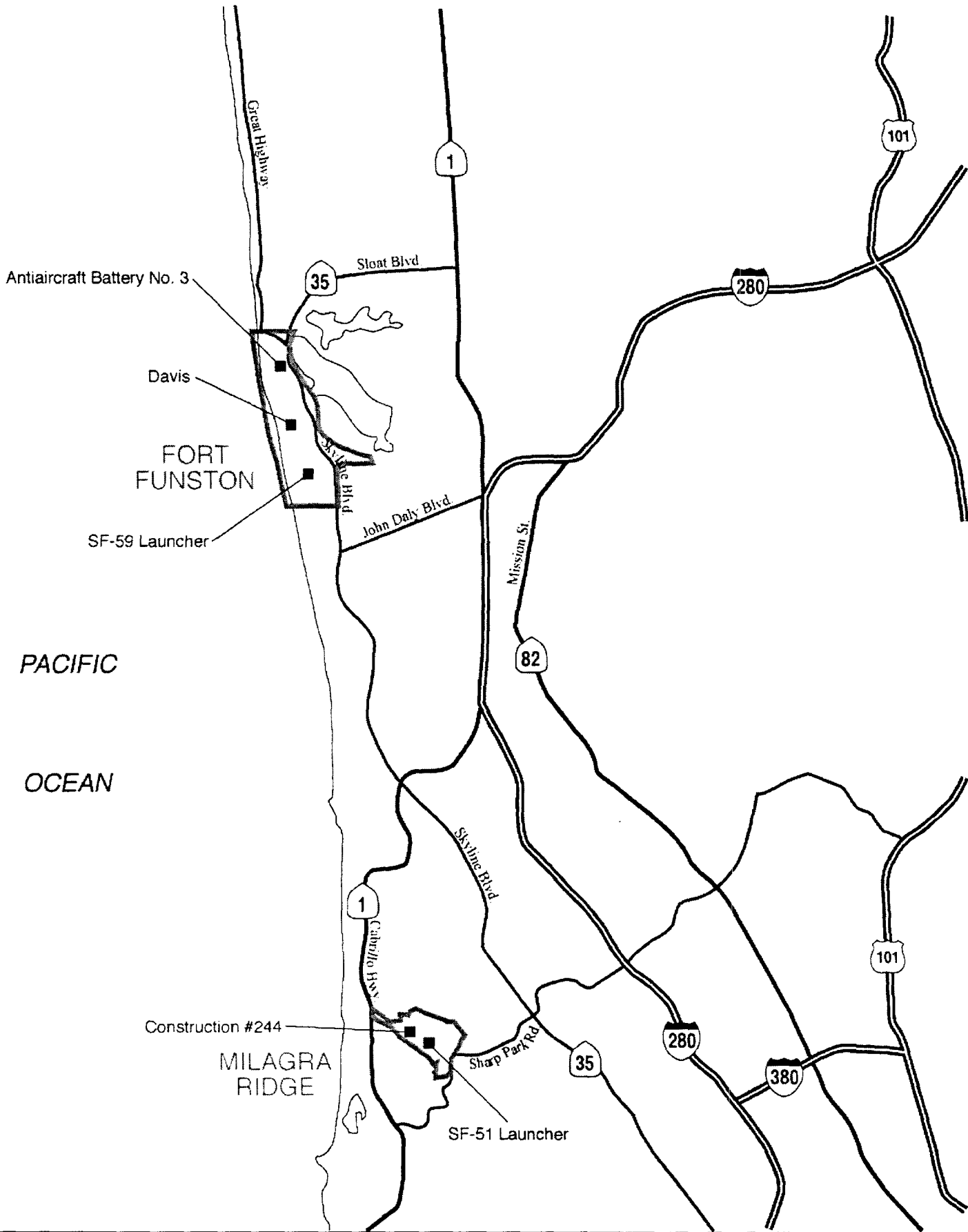

Source: Northern California Atlas & Gazetteer, 1995 DeLorme Mapping

Map 6

**Coast Defense Batteries, Far South
Fort Funston and Milagra Ridge
Golden Gate National Recreation Area**



Not to Scale



ANCILLARY STRUCTURES/NIKE SITES

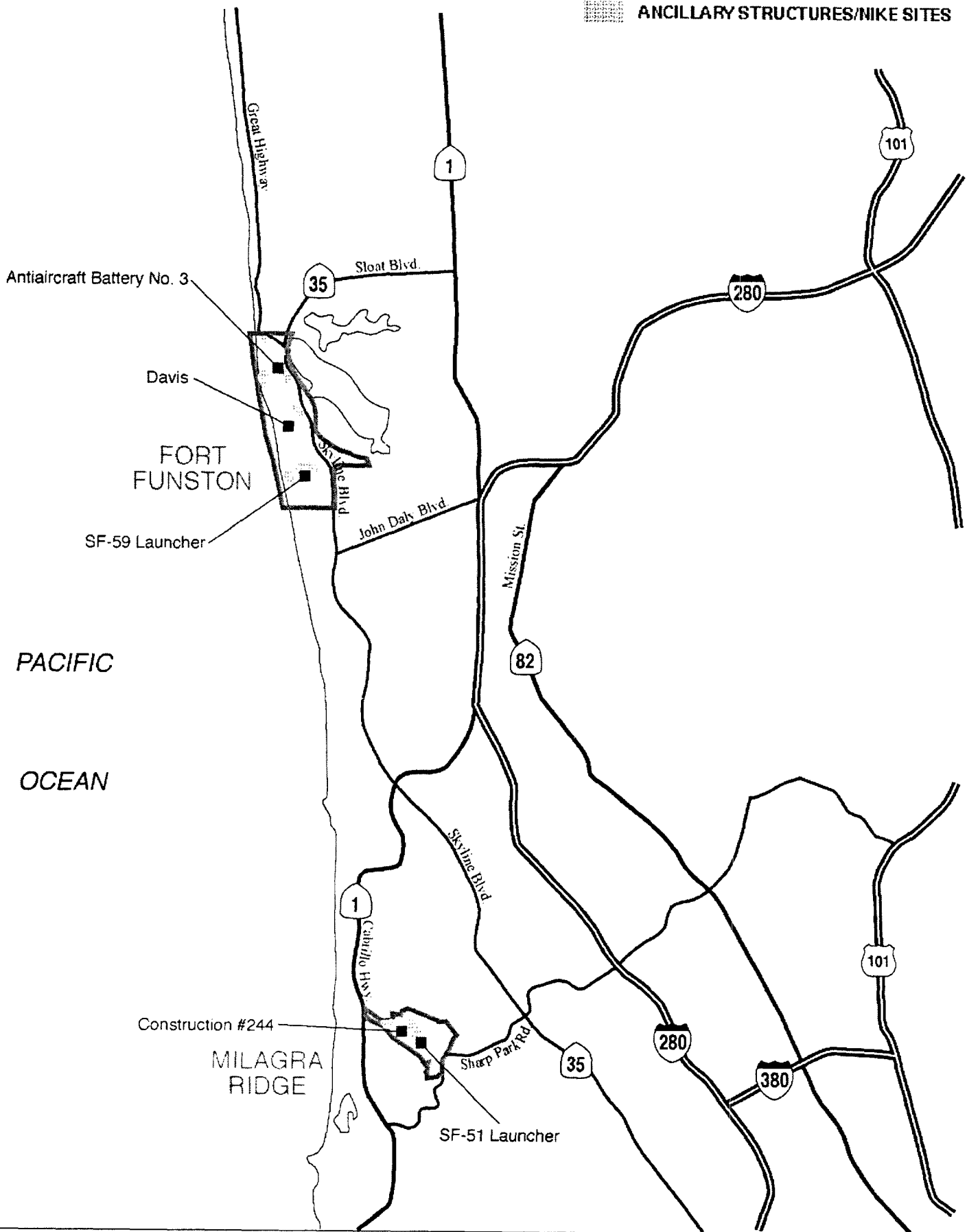

PACIFIC
OCEAN

Source: Northern California Atlas & Gazetteer, 1995 DeLorme Mapping

Map 7



Not to Scale



Coast Defense Batteries, Far South With general locations of ancillary structures and Nike sites Golden Gate National Recreation Area

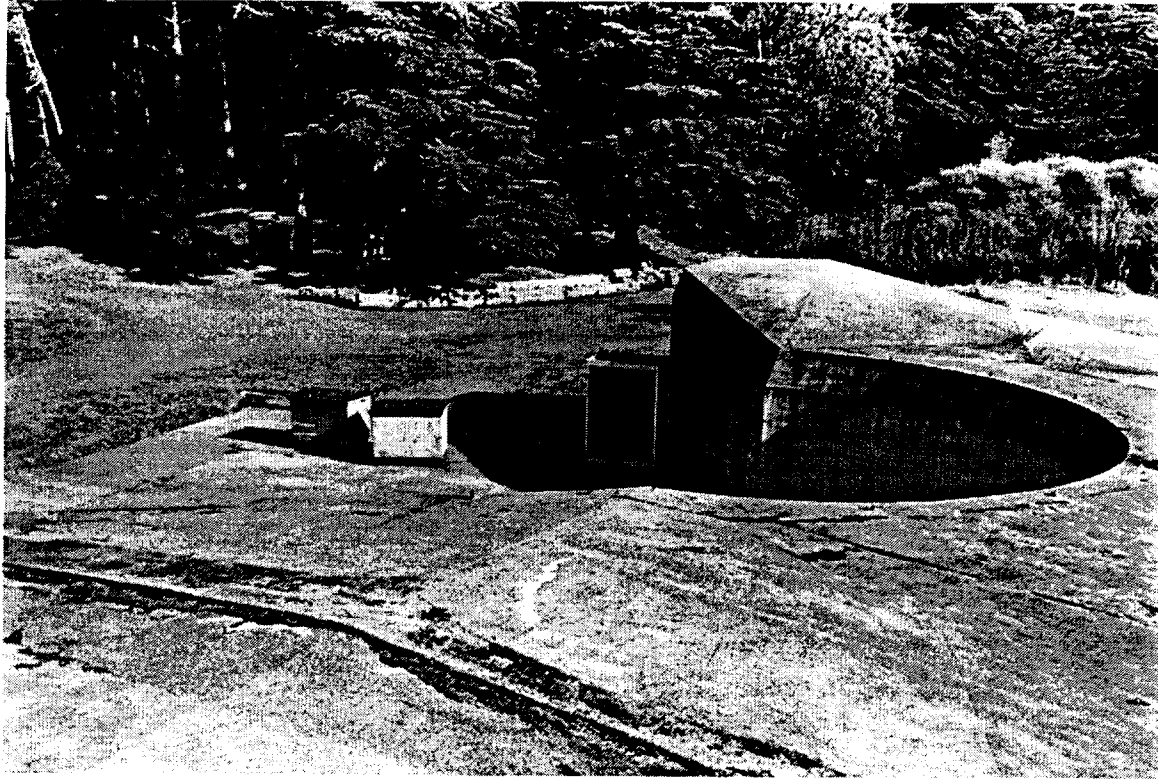

Plate 2. Battery Kirby, Fort Baker, constructed 1899-1900. Looking into emplacement from battery crest.

Explorations in the immediate proximity of a battery can yield not just a better understanding of the primary structure, but also of its important ancillaries. For World War II Battery Construction #129 within Fort Baker, a battery commander's station gives a clear sense of the role of the observation post, half-buried, with its viewshed framed by a bunker-like horizontal, panoramic opening. And when one comes upon Battery Wallace, one is stopped, as one is always stopped, by the graphic announcement of a formal name and date of construction: *Battery Wallace 1942*. As is often true when we confront the painted signage and imagery added to the equipment of war, from aircraft to the command blockhouses controlling missiles, we are pulled back into the past through specificity (Plates 3 and 4). We preserve coast defenses, then, so that we may allow future generations to see and touch the past.

As history moves forward, these many and diverse defense resources remain what they were designed and engineered to be: an intimate part of the land forms on which they are both imbedded and perched. The Army built the coast defense fortifications bracketing the San Francisco Bay, from batteries to ancillaries, with deliberate care in their texturing and coloration, achieved through planted foliage, coated blast aprons, and structural paint schemes. When addressing the larger cultural landscape of coast defense within the Golden Gate National Recreation Area, one is asked to reflect on the original beaches and man-made cuts and fills; the contours of the hills, deliberately altered by emplacements to re-achieve the appearance of a natural vista from the vantage of hostile approaching ships; the roles of native and introduced plantings—from grasses, iceplant, and eucalyptus in the Endicott years to exotic kudzu by the late 1930s; the roadways, paths, and parade areas both at and between the installations; and, the line-of-sight viewsheds from the batteries themselves, engineered seawards. The setting for San Francisco's coast defenses is made even more complex by the long and prominent history of the Presidio, Fort Baker and other posts, each accented through a formal built environment and landscaped grounds.



Plate 3. BC Station, Battery Construction #129, Fort Barry, constructed 1942-1944. Looking east.



Plate 4. Battery Wallace, Fort Barry, constructed 1917-1921. With casemating of its two guns in 1942-1943. Emplacement entry.

Interpretation of such a resource demands repeated looks at the many included sites within the coast defense system of fortifications, coupled with renewed archival siftings through Army reports; through letters between military engineers, as well as between commanders; and through drawings, plans, and historic photographs. We preserve coast defenses, too, so that tomorrow's historians may apply knowledge and interpretations to physical fabric in its more encompassing context, rather than applying what they discover only to changed land forms and mere records of what is no longer there to be seen.

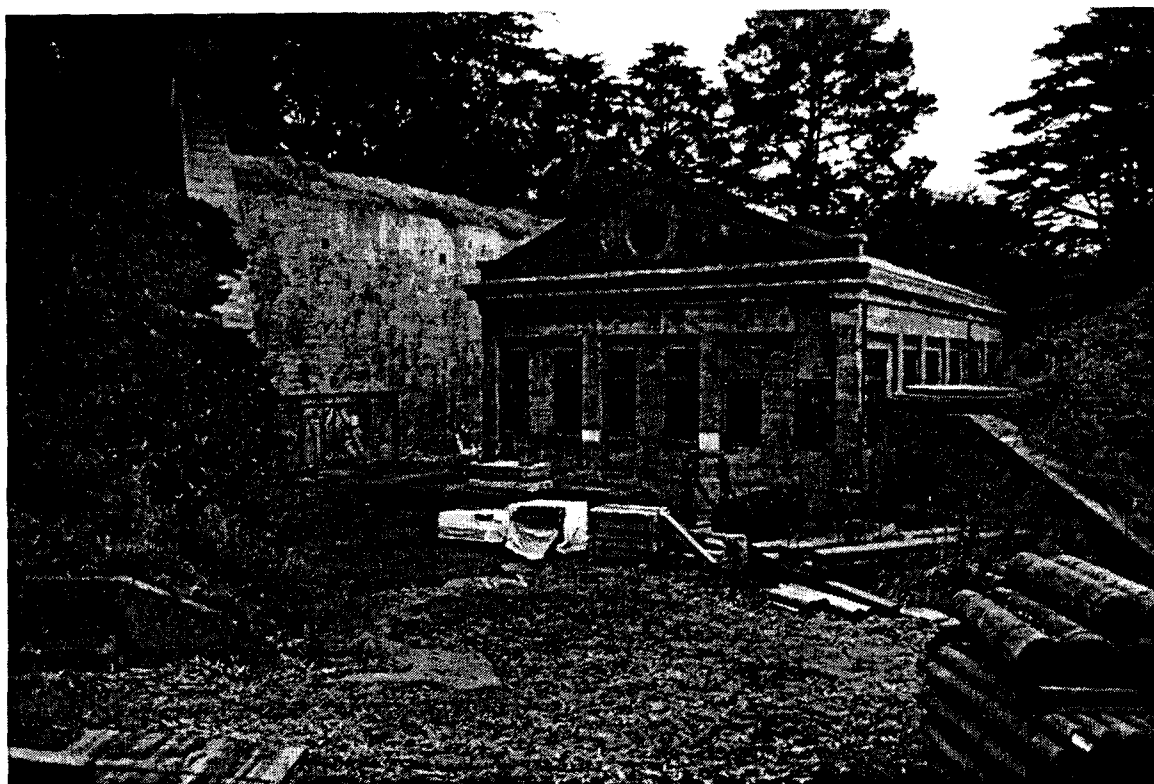
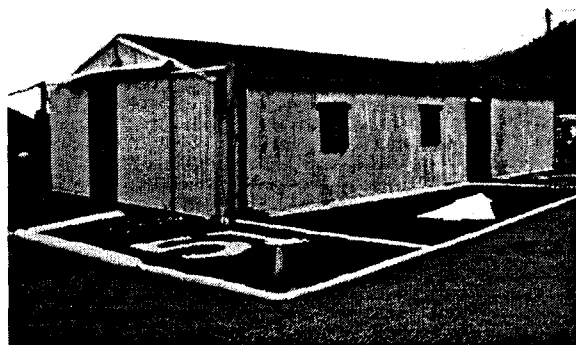

Plate 5. Power plant at Battery Dynamite, Fort Winfield Scott, constructed 1894-1895, with major additions and remodeling, 1899-1900.

Plate 6. Butler Manufacturing Co., Missile Assembly Building, Nike Site SF-88L, Fort Barry, erected 1962. Courtesy of the Park Archives of the Golden Gate National Recreation Area.



The larger cultural landscape of coast defenses within the Golden Gate National Recreation Area offers structures that contrast widely with each other, from the formal Beaux-Arts classicism found in the mid-1890s power plant built to accompany Battery Dynamite, to the simple corrugated, metal-frame Butler building used to house the missile assembly for Nike during the early 1960s. The power plant was exemplary of the high stylistic trends of its time, while the Nike structure harkened straight back to World War II and the opening of the Cold War, with little change (Plates 5 and 6).

Links Between the Coast Defenses of San Francisco and the Northwest

In undertaking a maintenance manual for the coast defense fortifications of the Golden Gate National Recreation Area, the National Park Service at the Presidio, San Francisco, follows in the footsteps of the Washington State Parks and Recreation Commission, for the planned management of its coast defense installations, and, the National Park Service through the National Maritime Initiative, for the similarly thoughtful management of its coastal lighthouses. In the Northwest, military historian David Hansen authored the *Coast Defense Resources Management Plan* for Washington State Parks (1989), following this effort with the context statement titled *Never Finished: The National Coast Defense Program in Washington State* (1997). At the national level, the *Historic Lighthouse Preservation Handbook* (1998) is recently accessible not only in printed format, but also on a National Park Service website. For the coast defenses of the San Francisco Bay, discussed herein, the National Park Service is challenged by an even greater breadth of resources, in type and time period, than in either the Washington management document or the lighthouse handbook.

In particular, the Golden Gate National Recreation Area hopes to continue discussions and research put forth for the Washington coast defense fortifications, encouraging further detailed scholarship focused on engineering history for the Pacific. In 1886 Secretary of War William C. Endicott had convened a board to develop modern coast fortifications effective against the evolving sophistication of naval weapons. Endicott's name later became associated with those coast defenses built during the 1890s and into the first years of the twentieth century. Commonly referenced as the Endicott period, this fifteen-year span was of key importance in the design and engineering experimentation for fortifications along America's seaboards. Yet in the middle 1880s, the West Coast was so sparsely settled and militarily remote, that the Endicott Board had recommended augmentation at only three Pacific harbors among the twenty-seven reviewed nationwide: San Francisco, the Columbia River between Oregon and Washington, and, San Diego. In the Northwest, the Columbia River location ranked eighteenth in urgency for construction, with batteries begun at Fort Stevens, Oregon, in 1896; and, at Chinook Point and Fort Canby, Washington, in 1897 and 1899. The U.S. Army Corps of Engineers added Puget Sound to the national program in 1894, with construction first undertaken at Fort Worden beginning in 1896. Hence, erection of coast defenses in the Northwest was a phenomenon of the turn of the twentieth century. Subsumed under the jurisdiction of San Francisco, the Columbia River and Puget Sound fortifications were perfectly timed and orchestrated to draw directly upon the work that occurred first at the Golden Gate, between 1891 and 1898.

The U.S. Army Corps of Engineers had initiated construction of the Northwest coast defenses under the leadership of Captain Walter L. Fisk. An engineer on his staff, Harry Taylor, actively involved himself in solving some of the design problems that arose in this period. In early 1898 Taylor sent his assistant, M.L. Walker, to study and review the coast defense fortifications then just-finished and under construction in San Francisco. Although unnamed by the War Department until 1902, these batteries included the Fort Winfield Scott installations Marcus Miller (built between 1891 and 1898), Godfrey (1892-1896), Howe-Wagner (1893-1895), Boutelle (begun 1898), Dynamite (1894-1895), Saffold (1896-1897), Cranston (1897-1898), Stotsenburg-McKinnon (1897-1898), and Lancaster (begun 1898) on the south side of the bay, and, the Fort Baker batteries Spencer (1893-1897) and Duncan (begun 1898) on the north. The Endicott Board recommendations of 1886 had ranked San Francisco second in needed new construction, and several of the first Endicott batteries built bracketing the bay were characterized by their unusual, sometimes singular, design and engineering, and were overseen directly by the division engineer Charles Suter. Both Suter and Taylor worked steadfastly as engineering designers of coastal fortifications, collaborating on some of the first work undertaken at Fort Worden in Washington. Suter's contribution, in particular, needs the attention of historians. Another motivation in the preservation of coast defenses is the uncovering of details important in engineering history—so that from our archival discoveries we may interpret the critical physical features of individual batteries. Where such features are

unique, we learn to pause and appreciate, to link specific achievements and failures with the engineering of coast defenses that came before, and followed afterwards—linking San Francisco to the nation's seaboards in a historic continuum.

Properties Addressed in the Maintenance Manual

In undertaking the preparation of a coast defense maintenance manual, the National Park Service limited itself to those batteries, and a representation of their related ancillary structures, currently within the boundaries of the Golden Gate National Recreation Area. Although such a demarcation is necessarily somewhat artificial with respect to Army history, it allows the clearest and most efficient management of the park's historic resources. In his thorough and exemplary 1979 study, *Seacoast Fortifications San Francisco Harbor*, Erwin N. Thompson acknowledges this dilemma, and includes discussion of the related batteries and ancillary structures on Angel, Alcatraz, and Yerba Buena Islands. The Fort McDowell Endicott batteries of 1899 to 1901 on Angel Island—Drew, Ledyard, and Wallace—are especially noteworthy from the vantage of engineering history, and although they presently are managed under the ownership of the State of California, may merit cross-referencing during later research efforts for the National Park Service properties.

In addition, the National Park Service is in the process of preparing a National Historic Landmark nomination for the seacoast fortifications of San Francisco Bay, under a multiple property designation. The landmark nomination, as a historically comprehensive interpretation of the coast defenses surrounding San Francisco Bay, extends outside of the management boundaries of the Golden Gate National Recreation Area. The proposed National Historic Landmark includes numerous properties not discussed in the maintenance manual: these are six batteries, a mine casemate, and a Nike site on Angel Island; selected buildings, magazines, tunnels, and walls on Alcatraz Island; a mine storehouse on Yerba Buena Island; and thirty-three ancillary structures (fire control stations, a mine casemate, searchlights, generator buildings, antiaircraft emplacements, and World War II SCR 296-type radars) at the six additional military reservations of Devil's Slide, Little Devil's Slide, Frank Valley, Hill 640, Pillar Point, and Wildcat Ridge, to the north and south of the Golden Gate National Recreation Area.

Within the jurisdiction of the Golden Gate National Recreation Area, and referenced in this manual, are fifty total batteries: six batteries of the Civil War and post-Civil War eras (Forts Baker, Mason, and Winfield Scott); thirty-one batteries of the early-modern Endicott, Taft, and World War I eras (Forts Baker, Barry, Mason, Miley, and Winfield Scott); and, thirteen batteries of World War II (Forts Baker, Barry, Cronkhite, Funston, Miley, and Point, with one installation at Milagra Ridge).⁵ For the purposes of representative field review, the maintenance manual team looked at twenty of these batteries, and sampled an additional nine ancillary structures. The full list of batteries, with visited batteries and ancillaries marked by asterisks, is given in Appendix A, with many of the Army's Form 7s—simplified elevations, sections, and plans—reprinted in Appendix B. Batteries selected for field review were agreed upon by the National Park Service and the maintenance manual team, and offer a cross section of age and type, as well as presenting the range of maintenance issues found in the Golden Gate National Recreation Area.

A Preservation Charette

At the outset of the field inspections, the maintenance manual team, under the direction of KEA Environmental, gathered together on December 12, 1998 for an informal charette of interested preservation professionals. Our goal was to discuss firsthand the types of challenges raised in the care and interpretation of coast defense fortifications. We can preserve such resources only if we can manage them well over time. Attending the all-day event were members of the National Park Service, the maintenance manual team, and representatives of the preservation community. Four historical architects and an architectural historian were in attendance, including Ric Borjes and Hank Florence from the National Park Service, Golden Gate National Recreation Area and Seattle offices, respectively; Steade

Craig and Joe Freeman, AIA restoration architects from Sacramento, California, and, Austin, Texas; and Dr. Karen Weitze, from KEA Environmental and maintenance manual project manager. Mary Hardy, from the Berkeley firm of Siegel & Strain Architects, represented the specialty of historic materials conservation, while San Francisco landscape architect Denise Bradley represented that discipline. Brian Grogan, of Grogan Photography & Preservation Associates, Yosemite, California, brought the fine arts perspective. Mr. Grogan is the large-format photographer for the National Historic Landmark nomination in progress for the San Francisco coast defense fortifications. Three military historians, with many years experience, brought superlative expertise to the gathering: John Martini, curator of military history for the Golden Gate National Recreation Area; David Hansen, a member of the maintenance manual team and author of earlier studies and published articles on the coast defenses of Washington; and, Milton "Bud" Halsey, Colonel USA, retired, manager of the restored Nike missile site SF-88L, Fort Barry. Mr. Halsey's first-hand experience in the preservation and interpretation of the Nike site complemented all discussions of the battery locations throughout the day. Three historians further augmented the expertise of the military group: National Park historians Steve Haller and Gordon Chappell, and, KEA historian Christy Dolan. Filling out the charette were the Marin Buildings and Utilities Supervisor from Fort Baker, Tima Alexandro, and, a National Park Service volunteer for Battery Chamberlin and site representative for the Coast Defense Study Group, Eric Heinz.

The morning opened with general introductions and a presentation of the larger goals of the National Park Service in its work with coast defense fortification restoration and interpretation, both in the San Francisco Bay Area and in Puget Sound. Ric Borjes stated the desire for a practical tool available to his personnel in the Golden Gate National Recreation Area, one that could aid in prioritizing needed maintenance and stabilization work at the batteries and their associated ancillary structures, and, could serve to effectively organize annual plans and budgets, using a collaborative team of individuals ranging from volunteers and students, to contracted preservation specialists. Hank Florence spoke about the upcoming projects planned for Washington, with work continuing at Fort Worden, and with a management manual similar to that undertaken by the National Park Service in San Francisco planned for the summer of 1999. Efforts in the Northwest are geared toward an international conference on coast defense fortifications tentatively set for 2001. Both Mr. Borjes and Mr. Florence are seeking a united Pacific Coast perspective on coast defenses, and are hopeful that coordination of their projects can serve the National Park Service in other districts, as well as enhancing our understanding of the historic ties between the fortifications of San Francisco, the Columbia River, and Puget Sound.

Before leaving on selected site tours of the batteries, military historians Martini and Hansen opened discussions for the group through two lively and thorough slide presentations, focused on the coast defenses in San Francisco and Puget Sound. Mr. Martini poignantly reminded the group of sixteen professionals that park preservation and interpretation always begins with the public. Growing up in the Bay Area, Mr. Martini happened upon the batteries as a boy, exploring them repeatedly, and never forgetting his first experiences. Similarly, years of military service and participation in organizations like the Coast Defense Study Group bring layers of experience to later efforts focused on the interpretation of defense sites. Charette members Bud Halsey and Eric Heinz both added this kind of irreplaceable perspective, with factual knowledge of the working details within functioning military installations of the recent past, complemented by understandings focused on the usefulness of items like military procedures and technical manuals, themselves now historic resources. Mr. Hansen, not only a military historian, but an architectural-engineering historian as well, gave the group a professionally reflective introduction to the batteries, making correlations between military needs and engineering innovations documented in the infrastructure. He pointed out that we must remember that buildings are designed for the use of specific groups of people, operating under the quite definitive constraints of their own times and places. We must acknowledge the client, here the U.S. Army.

The Army required that its coast defenses achieve some very basic design parameters. The fortifications needed to keep men and equipment—from the ammunition to the loading mechanisms—warm, dry, and safe from premature explosion, while simultaneously guaranteeing that the batteries and their ancillaries

were strong enough to withstand attack. Planning for the coast defense fortifications went slowly, moving through a bureaucracy of cross-checks and approvals. The design and engineering process inside the Army, therefore, was necessarily one overly dependent on the drafting boards: early construction tended to be overdesigned, making the batteries physically more extensive than they might have been if practical observations could have been forthrightly incorporated into the process. Predictably experimentation to strengthen the batteries occurred from the first, with massive poured concrete receiving rock, iron, and steel reinforcing in a variety of treatments that ranged from dismal failures to transitional, qualified successes. There was also the matter of adaptation to evolving weaponry, both from the vantage of defense against advancing naval guns, and from the vantage of effective land retaliation.

Mr. Hansen noted, like civil engineers of the early twentieth century, that batteries were much like ships—they really were never finished, demanding continuous maintenance and improvements. The earthen embankments immediate to the batteries protected the fortifications, deflecting projectiles away from the installations. As cannon adapted to the disappearing carriage, Army engineers developed mechanisms to load the guns behind walls and then raise them to fire. The resulting batteries had two stories, the upper area open behind walls, and the lower fully enclosed as rooms. Such a design also required hoisting heavy and dangerous ammunition from a low point upwards, making clear just how the physical form of the battery would always be subservient to ordnance. In other cases, barbette carriages did not require the crested upper wall design, and thus also affected experimentation with placement of the ammunition magazines on a more nearly equal level to the guns. Over time batteries tended to become larger, with individual emplacements separated within single installations and with batteries increasingly spread out across the coastal terrain. Less dramatic, engineering efforts also attacked problems of water percolation through the porous concrete; varieties of deliberate plantings immediate to the installations; and, methods of blending the batteries into their hosting land forms. And in all cases, Army procedure dictated how the post would be commanded. Such procedure also changed over the decades and is reflected today in the nearly archeological remnants of items like the turn of the century blackboard racks in the data booth at Battery Stotsenburg-McKinnon (Plate 7).

Graffiti

The charette then reconvened at the post-Civil War era Cavallo Battery, north of the Golden Gate Bridge. A massive earth-and-brick battery, Cavallo has sustained major, recent problems with vandalism by graffiti artists, even with regular patrolling by park personnel and within locked fencing. In many places on the battery's brickwork there are layers of graffiti, and in some areas, the art work has been carved into the face of the masonry. A single treatment to remove paint is neither possible, nor practical, as the different paints each are defined by a distinct chemical make-up. Architect Joe Freeman suggested that the most straightforward solution might be to temporarily mask the graffiti with a breathing, benign paint similar in color to the bricks. Such a tack would discourage the graffiti artists; could be repeated; and, at a later date, as conservation techniques become more sophisticated, the interim masking and the hidden graffiti could be removed. Conservationist Mary Hardy carried these thoughts further with the idea of letting the graffiti fade through natural weathering, while architect Steade Craigo reiterated the fragile nature of the masonry itself. In the future, with the graffiti cleaned from the surfaces of the battery, a microcrystalline wax could be used to coat the brickwork, allowing the material a viable protection from wandering artists.



Plate 7. Battery Stotsenburg-McKinnon, Fort Winfield Scott, constructed 1897-1898. Blackboard racks at data booth.

Vegetation and Habitat

The vegetation issues, while not as technically complicated, raise their own sophisticated questions. Gathered at Cavallo Battery overlooking the adjacent Battery Yates, the charette group discussed the challenges of discovering the original plantings at the batteries; the role of native vegetation; differing landscape and camouflage plans in sequential eras; and the maturation of unintended vegetation on site (Plate 8).

At Batteries Cavallo and Yates, grass species, coyote bush, sage, and lupine dominate the current vegetation. The lupine, a low-growing plant, is now home to a protected species of butterfly. Here issues of contemporary habitat will need to be weighed against historical accuracy, and in fact a landscape plan for the batteries might suggest that the lupine stay as a reasonable historic planting. Characteristics such as low plant height, vegetation density, overall coloration, and untended vigorous growth are parallel with original plans for the site, and can perhaps be employed as landscape maintenance plan parameters to achieve the dynamics of sustaining needed habitat. Indeed, at other battery sites with the Golden Gate National Recreation Area, the Army deliberately planted lupine as the selected ground cover. At some installations, such as the grouping Sherwood, Slaughter, and Blaney observed in the late morning and Stotsenburg-McKinnon visited in the afternoon, cypress and eucalyptus trees—typically introduced to augment Presidio landscaping or to hide the installations—are damaging the concrete installations through their root growth, cracking both walls and foundations. And there, a sensitive regional plant species, San Francisco lessingia (*lessingia germanorum*), is currently growing on the bermed earthworks.

Plate 8. Preservation charette group at the CRF station for Battery Yates, located at Cavallo Battery, Fort Baker, 1903. Discussion of vegetation and habitat issues.

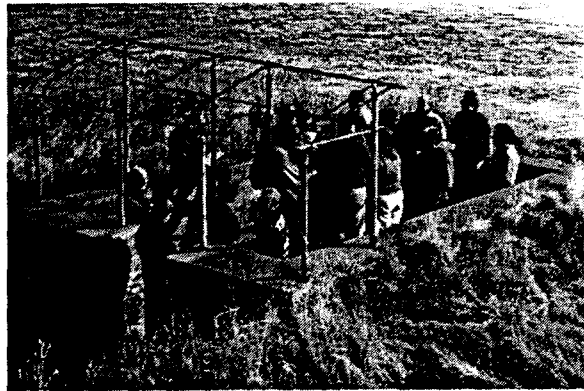

Concrete Design and Site Settlement

At Battery Marcus Miller, inspected next, charette participants discussed the spalling concrete, damage from the region's earthquakes, rusted and fallen cables, removal of valued metals (here bronze hinges) by vandals, interior flooding, clay layered over floorings, remnants of historic paint schemes and tinted surfaces, and scored flagging around the gun pits. Mr. Hansen and Mr. Craig pointed out relatively subtle design details, such as chamfered corners and the use of an incised drip line. The range of aesthetic and structural details supported the need for a careful inventory site by site, with eyes toward identifying the character-defining features common across the San Francisco batteries and those occurring only rarely, or perhaps, unique. Review of available archival records will also help to ascertain how much cut and fill has taken place. Soil stability might be enhanced—and settlement minimized—through soil grouting, injecting concrete into the soil surrounding certain installations in order to tie battery foundations to the host land forms.

Observations

At the close of the charette, the group reconvened at the Presidio to draw together the thoughts of the participants. Given what we had seen firsthand, and with the specialized professional backgrounds brought to this type of historic resource, what did the group feel was generally applicable? What's ahead for the Golden Gate National Recreation Area in the preservation of its coast defense fortifications? The group identified the themes of inventory; management; interpretation; maintenance; public involvement; realistic assessments; variable funding; and appropriate professional advice.

To conclude the charette, and to open the chapters that follow, the group suggested that we most effectively preserve such specialized resources as coast defense fortifications when we understand them as fully as possible. To begin an inventory and track integrity of the historic resource, a checklist is suggested, given in Appendix C. The checklist is intended for use after becoming familiar with the broad character-defining features of the coast defenses within the Golden Gate National Recreation Area, presented in chapter 3. For maintenance, we begin by looking at causes of deterioration. Here the checklist achieves a second life as a tool for recording recurring problems, and for making annual workplans. Both inventory and maintenance site visits can additionally benefit from selected use of the simple plans, elevations, and sections provided through the reprinted Form 7s historically compiled by the Army (Appendix B). Even before we begin our efforts, though, we can secure the sites, and restore minimal insurances of public safety. Simple assessments for replacement of handrails, clearance of inappropriate vegetation, and removal of debris can be a start. Straightforward actions, such as repainting wood and metal detailing where it is intact and in reasonably good condition, can slow down site degradation. And everyone agreed the an understanding of the cultural landscape, looking both seawards and toward the coast defenses, is essential for the resource we have here, one that is so completely integrated with the land.

Table 1
Coast Defense Fortifications
Preservation Needs and Goals at the Golden Gate National Recreation Area

Need	Goal
<i>Identification of Historic Resources</i>	<i>Park Inventory</i>
<ul style="list-style-type: none"> *Establishing character-defining features for the batteries *Listing and mapping ancillary structures *Determining the larger cultural landscape 	<ul style="list-style-type: none"> *Use of National Park Service personnel *Volunteer teams *Specialized contributions in architectural/landscape history
<i>Management of Batteries and Ancillaries</i>	<i>Effective Long-Range Planning</i>
<ul style="list-style-type: none"> *Determination of sites for interpretation *Decisions across the resources for stabilization, preservation, rehabilitation, or restoration *Stewardship plans 	<ul style="list-style-type: none"> *Interdisciplinary meetings within National Park Service *Site reconnaissance *Management decisions and allocation of National Park Service resources
<i>Appropriate Interpretation of Coast Defenses</i>	<i>Enhancement of Role in the Golden Gate National Recreation Area</i>
<ul style="list-style-type: none"> *Continued archival research *Communication with other managed coast defense fortifications / parks *Interim solutions for site security and stabilization 	<ul style="list-style-type: none"> *Attractive resource for visitors *Tourist destination *Integrated resource across National Park Service regionally and nationally
<i>Maintenance</i>	<i>Stabilization of All Resources</i>
<ul style="list-style-type: none"> *Monitoring and testing at selected sites *Selected treatments applicable at multiple sites *Vegetation management *Graffiti removal / treatment prioritized *Address issues of site drainage and settlement 	<ul style="list-style-type: none"> *Easily available, effective products *Practical treatments *Economies of scale through chosen methods *Involvement of varied personnel, including volunteers
<i>Realistic Assessments</i>	<i>Development of the Golden Gate National Recreation Area</i>
<ul style="list-style-type: none"> *Maintenance manual specific to Golden Gate National Recreation Area *Variable funding projections *Variable personnel assigned to tasks *Achievement of public safety 	<ul style="list-style-type: none"> *Maintenance manual broadly useful across National Park Service *Optimal use of limited monies and people *Sustainment of desirable parklands
<i>Leveraging Professional Advice</i>	<i>Well Maintained Resources. Accurately Interpreted</i>
<ul style="list-style-type: none"> *Targeting specialty testing—chemical, physical, and acoustical in type *Developing tiered approaches to problem solving and analysis *Consideration of large-format photography for selected recordation and for wider audience park publications and brochures 	<ul style="list-style-type: none"> *Protection of coast defenses *Balanced allocation of funding *Public advocacy for its historic resources, with sustained involvement

¹ As quoted in *Statement for Management, Golden Gate National Recreation Area* (San Francisco: National Park Service, 1992), 7.

² *The National Parks: Index 1997-1999* (Washington, D.C.: U.S. Department of the Interior, 1999), 2.

³ *Golden Gate National Recreation Area/Point Reyes National Seashore General Management Plan / Environmental Impact Statement* (San Francisco: National Park Service, 1980), 20.

⁴ *National Historic Preservation Act of 1966, as amended* (Washington, D.C.: The Advisory Council on Historic Preservation, 1993), 27.

⁵ There are also were also six Nike missile launch sites within the present boundaries of Golden Gate, including one on Angel Island State Park. Although many of the treatments recommended in this manual may be successfully used to preserve certain historic fabric at the Nike sites, these sites are different enough from the gun batteries to be dealt with separately. They are referenced in, but are not intended to be a part of, this study.

Chapter 2: Historical Context for the Seacoast Fortifications of San Francisco Bay

Prelude

The subject of seacoast fortifications of the United States has been a remarkably consistent and powerful component of the nation's military policy throughout nearly its entire history. Indeed the American interest in the subject "was to grow virtually into an obsession," according to a leading military historian.¹ The enduring emphasis on seacoast fortifications is based in part on geography and in part on fundamental political convictions about America's place in the world and the nature of our government. Throughout American history, investment in generations of coast defense weapon systems has reflected a faith in technological solutions to problems, a consensus that it is better to spend resources and wealth than sacrifice American lives, and a practical solution to the challenge of national defense that did not require a large standing army and could not be diverted for use as an instrument of internal suppression. A noted military officer recognized before the Civil War that:

When once constructed they require but little for their support. In time of peace they withdraw no valuable citizen from the useful occupations of life. Of themselves they can never exert an influence dangerous to public liberty, but as the means of preserving peace, and as obstacles to an invader, their influence and power are immense.²

The influential Board of Engineers for Fortifications put it thus in the nation's first strategic deterrent analysis prepared by American-developed, not foreign-sponsored, military thinkers after the War of 1812:

The means of defense for the seaboard of the United States, constituting a system, may be classed as follows: First, a navy; second, fortifications; third, interior communications by land and water; fourth, a regular army and well-organized militia.

The navy must be provided with suitable establishments for construction and repair, stations, harbors of rendezvous, and ports of refuge, all secured by fortifications, defended by regular troops and militia, and supplied with men and materials by the lines of intercommunication. Being the only species of offensive force compatible with our political institutions, it will then be prepared to act the great part which its early achievements have promised, and to which its high destiny will lead.³

Beginning with the Board of Engineers for Fortifications in 1816 and continuing until the elimination of the Coast Artillery Corps in 1950, a series of high-level boards has examined the nature of the nation's defense strategy, providing national policy and systematic defense programs which resulted in a nationally-significant fortification networks, which reflects the constant evolution of military technology and strategic circumstances. The Board of Engineers quoted above would have found much it could recognize in the basic strategic principles of the nation's Cold War defensive systems: navy carrier groups; Nike missiles and the Strategic Defense Initiative; the interstate highway system for interior communications; and the constant low-level state of mobilization of a professional army and a National Guard and peace-time draft.

The more purely strategic, as opposed to political, considerations upon which this nation's defense policy is based have remained relatively stable due to the nature of geography. This has long been a seafaring nation and our greatest potential enemies have generally been located overseas.

Throughout most of its history, the United States, separated from the other powerful nations of the world by large bodies of water, relied on coast defense to deter enemy invasion. This defensive measure depended on fortifications but also included submarine mines, nets, and booms; ships; and airplanes. Thus, all of the country's armed forces

participated in coast defense, but the U.S. Army Corps of Engineers played a central role.⁴

Consequently the United States was free to choose an isolationist policy as long as coast defense, coordinated with command of the seas, and more recently the skies, allowed us to effectively defend our shores. Classic coastal fortifications have been obsolete since World War II, but the nation's role as a world power has been backed up by continental defenses based on many of the same basic principles. This military policy has been informed by political, strategic and technical factors that have evolved through time yet also retain a remarkable degree of consistency. Indeed, few principles have been as long-lasting as the dominance of naval ships by land-based fortifications. The key role coastline and hemispheric defense strategy has played in that policy, is reflected today in the successive generations of coast defense fortifications that have evolved and that survive as a tangible manifestation of our historic conceptions of military preparedness.

The Significance of the Seacoast Fortifications of San Francisco Bay

In an early study of fortifications entitled *A History of San Francisco Harbor Defense Installations: Forts Baker, Barry, Cronkhite, and Funston*, noted military historian E.R. Lewis said that "the batteries to be described should be understood to constitute an excellent sample not only of the Bay Area defensive system as a whole, but of the entire scope of American fortifications during this era. While similar works were located in varying numbers on the Presidio, and Forts Mason, McDowell and Miley, Forts Baker and Barry represented, by 1905, one of the two or three best collections of modern coast defense batteries to be found on any single military tract in the United States."⁵ The subsequent, broader historic resource study by historian Erwin N. Thompson entitled *Seacoast Fortifications: San Francisco Harbor, Golden Gate National Recreation Area*, expands this concept to all of the San Francisco Bay seacoast defenses. They are nationally significant as an entire system: one that contains many individual elements that are themselves nationally significant.⁶ Their only possible rival as an extensive outdoor military museum are those which protect New York harbor, but those around San Francisco faced a different ocean replete with threats from different potential enemies, often at different times from those faced by the New York harbor defenses. In other words, the entire historic context was different on the Pacific shores (Plate 9).

The significance of the seacoast fortifications of San Francisco Bay structures as a group is of the highest order. Therefore, the seacoast fortifications of San Francisco Bay, as described chronologically in the following historical context, are believed to possess exceptional value in illustrating the heritage of the United States: because of their association with events that have made a significant contribution to, are identified with, and outstandingly represent, broad national patterns of United States history; because of their important associations with lives of persons nationally significant in the history of the United States; because they embody the distinguishing characteristics of military fortification architecture and engineering that are exceptionally valuable for the study of an extraordinary range of periods, styles, and methods of construction, even when some individual components may lack distinction; because they collectively compose an entity of exceptional historical significance and outstandingly illustrate military culture and technique; and because areas within the fortification system are likely to yield information that sheds light upon the military period of occupation of these lands.

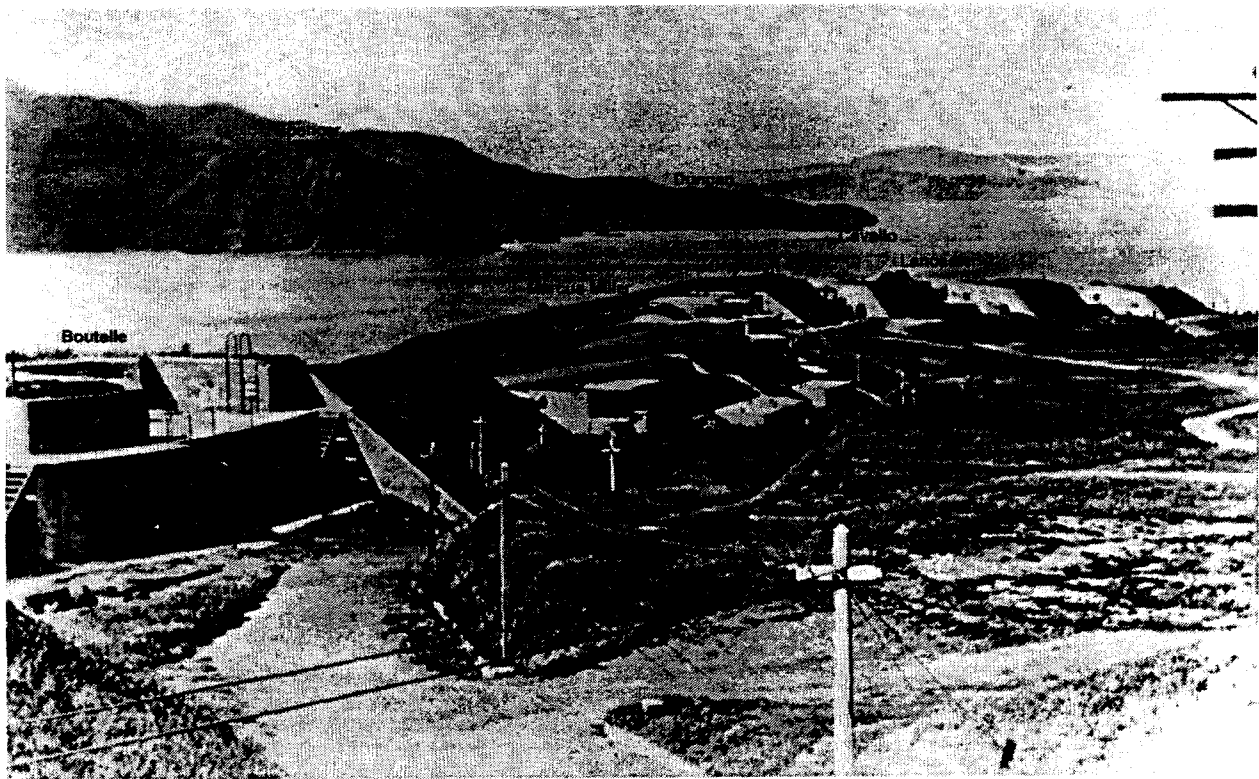

Plate 9. Foreground, from left to right, Batteries Boutelle (constructed 1898-1901), Marcus Miller (constructed 1891-1898), Cranston (constructed 1897-1898), and Lancaster (constructed 1896-1899), Fort Winfield Scott. Background, from left to right, Batteries Spencer (constructed 1893-1897), Duncan (constructed 1898-1899), and Cavallo (constructed 1872-1876), Fort Baker. Looking north, circa 1910. Courtesy of the Park Archives of the Golden Gate National Recreation Area.

The Spanish Colonial and Mexican Era, 1794-1846

The earliest permanent seacoast defense works in the country are associated with the colonial empires in North America. All the major colonial and seafaring powers provided some protection to the most important ports with varying degrees of success and permanence. The *Castillo de San Marcos* was begun in the Spanish colony of Florida in 1672 and Castle William in Boston around 1700. Scattered, less permanent, batteries guarded anchorages from British Rhode Island to Spanish Alta California.

Compared with its ascendancy under the name of San Francisco in the arena of world commerce and trade, the outpost of Yerba Buena, on San Francisco Bay, was a relatively unimportant settlement. Yet within the context of Spanish colonial and Mexican heritage in the United States the fortifications of San Francisco Bay were significant because they protected the claim of the Spanish crown to the northernmost permanent outpost of its empire on the shores of the Pacific Ocean. It was during this era that the potential of the vast harbor of St. Francis was first recognized, and its fortification first begun.

The establishment of a military frontier outpost to physically assert Spanish hegemony over San Francisco Bay dates to the fall of 1776. However, this outpost, or presidio, was a protected garrison that can in no way be regarded as a seacoast fortification. In light of diplomatic agreements reached at the Nookta Convention of 1790, British and Russian influence in the Pacific basin was reluctantly conceded by the Spaniards. Two years later, the British naval officer George Vancouver visited the Presidio of San Francisco, and apprised his government of the total lack of defenses there. In response to this visit, Governor Jose Arrillaga ordered fortifications begun to protect the strategic harbor.

As a result, works were begun in 1793 on a land battery to protect the Bay of San Francisco at its narrow entrance. Located on *La Punta de Cantil Blanco*, or the point of the white bluff overlooking the two-mile wide channel from the south, a brick-faced adobe lozenge with 15 embrasures surrounding a wooden esplanade, was completed in December of 1794 and christened the *Castillo de San Joaquin*. (The site is identical to that of the present fort at Fort Point.) The castillo was only intermittently manned by soldiers from the nearby Presidio, and in spite of subsequent reconstruction attempts (in the shape of a horseshoe), quickly fell victim to rain, a shifting sand substrate, and lack of adequate upkeep. Because of the construction of the fort at Fort Point at the site, nothing remains of castillo today. However, six bronze cannon, once a part of its armament, still remain in various locations about the Presidio of San Francisco and Fort Point National Historic Site. Another cannon from the castillo now resides at the U.S. Naval Academy at Annapolis, where it was brought by Commander Jonathan B. Montgomery along with other trophy guns from California after the Mexican War. Some already more than 160 years old when delivered to the Presidio by the Spanish frigate *Aranzazu* in 1794, these cannon, cast in Peru between 1628 and 1693, are among the oldest dated artillery pieces in the United States.

Not long after the establishment of the castillo at *La Punta de la Cantil Blanco*, Spain's relations further soured with Britain, and Spain and Britain went to war in 1797. When it finally reached this remote border settlement, the news galvanized Governor Diego de Borica to order an additional battery built two miles to the east of the castillo, well inside the bay at a point where a convenient anchorage sheltered the installation under the lee of a commanding bluff (at the site of present-day Fort Mason). Called *La Bateria Yerba Buena* after the name of the cove, or *La Bateria San Jose*, this work was even more of an emergency structure than was the castillo. These earthworks were built with eight embrasures, although only five iron eight-pounders are thought to have been placed at the site. An account written in 1822, about the time Alta (or upper) California passed quietly to Mexican authority, recalled only one rusty cannon at the derelict battery. By 1846 the site was entirely abandoned. No traces of this work are known to exist today.

During the period of Mexican rule, increasing seaborne trade in hide and tallow, and an expanding influx of Anglo-American settlers resulted in the territorial ambitions of the young United States becoming focused upon California. By the mid 1840s unrest, intrigue, invasion, and annexation became the lot of Alta California. Lieutenant John C. Fremont, U.S. Army Corps of Topographical Engineers; mountain man Christopher "Kit" Carson; and others, allied themselves to the group of rebels known as the Bear Flag party, and journeyed from Sonoma Barracks towards Yerba Buena, skirmishing on the way. They crossed the harbor entrance (soon to be christened by Fremont himself the Golden Gate) in a small craft to the site of the old castillo at Fort Point. There, they spiked the cannon lying derelict in the ruined work, to prevent their future use. The remains of one of these historic spikes can still be found in the touchhole of the western cannon, named *La Birgen de Barbaneda*, now flanking the flagstaff at the main parade ground of the Presidio of San Francisco.

The transition of seacoast defense weaponry from the Spanish-Mexican era to the United States may be symbolized by the arrival in San Francisco Bay of the U.S. frigate *Portsmouth*, under the command Commander Montgomery. Her crew landed at the Yerba Buena shoreline, proceeded to the plaza, and raised the American flag on 9 July 1846. Marching overland from the settlement, Montgomery's sailors and Marines, went to the site of the Bear Flagger's adventure, and there retrieved five of the six bronze cannon. They were put to use at Clark's Point, in a temporary battery built to overlook the north part of Yerba Buena Cove, the shallow bay at the foot of the town (not to be confused with the Yerba Buena anchorage, near Fort Mason further to the west, soon to be known by the Americans as Black Point Cove). No traces of the Clark's Point battery are believed to exist, the cliffs having been cut back to allow development at the foot of San Francisco's Telegraph Hill.

Third System Fortifications, 1850-1861

The United States had only an uncoordinated collection of local fortifications and no permanent system of seacoast fortifications until Congress made the first appropriations for the purpose in 1794, in reaction to the increased threat of war with European powers. The fortifications that followed are collectively referred to as the first system of American seacoast fortification, and were constructed in relatively small numbers at sixteen commanding locations guarding the ports, naval shore establishments, and harbor entrances along the eastern seaboard. Although a few substantial works were constructed incorporating stone, such as Fort McHenry at Baltimore and Fort Mifflin near Philadelphia, fortifications consisted largely of barbette gun batteries emplaced for protection behind open works with walls of earth, wood and stone. When the threat of war with France receded, the defensive works began to fall into neglect and disrepair in the absence of ongoing garrison and maintenance.

History repeated itself in 1807 when the Congress again appropriated funds for the upgrading of seacoast fortifications in the wake of impressment of American seamen and the threat of war with Britain. This, second system of seacoast fortification, was most notably characterized by the construction of all-masonry forts mounting guns in multiple tiers of casemates, allowing high concentrations of fire. These brick and stone forts were supplemented by an array of barbette batteries at other locations along the eastern seaboard and Gulf Coast. Their development marks the first major manifestation of a strictly American capability for military engineering that followed from the recent establishment of the Military Academy at West Point. The national defense was sorely tested and found wanting during the War of 1812 as British seapower was able to land substantial invasion forces of regular troops in undefended localities in spite of generally effective resistance from fixed defenses. Indeed, the stand of Fort McHenry inspired Frances Scott Key to write *The Star Spangled Banner*, but British regulars were still able to conquer and burn the nation's capital in 1814.

A thoughtful reassessment of the fundamentals of the nation's defense policy unfolded in the relatively peaceful climate of the years that followed the War of 1812. Fixed coast fortifications more than held their own against direct challenge, yet they were successfully outflanked by landings supported by the dominant seapower of the Royal Navy. Once established ashore, the American field armies had mixed success in coping enemy land forces in battle. Although isolated successes of U.S. warships on the high seas won renown, the role of the U.S. Navy remained tied to the defense of coastal waters for most of the century.

In 1816, the Board on Fortifications was established under the leadership of a French fortification expert of the Napoleonic Wars, Simon Bernard, to advise on defense policy and recommend modern projects in the light of recent wartime lessons. Sometimes called the Bernard Board, the establishment of this body of officers marks the nation's first permanent institution devoted to codifying a strategic doctrine and building the infrastructure of a unified defense network.

The system of fortifications that evolved from the work of the Board of Engineers in the period from 1816 to 1860 was the most comprehensive, most uniform, and most advanced the nation had yet had. The third system rationally assigned priorities for a work program to fortify numerous strategic sites. This program is best represented by large brick or stone forts with multiple tiers of gun batteries, in some cases three and four tiers high, built on promontories and on islands at choke points to important harbor entrances.

It was among the principal forts of the Third System, however, that some of the most spectacular harbor defense structures to come out of any era of military architecture were to be found. Included by virtue of their role in the Civil War were certainly some of the most famous—Sumter, Pulaski, Monroe, Pickens, Morgan and Jackson. From the technical standpoint, this large group of massive, vertical-walled forts represented the general embodiment and the fullest development of features which had previously

appeared in only a few and isolated instances, i.e., structural durability, a high concentration of armament, and enormous overall firepower.⁷

The forts were armed by specialized seacoast artillery of relatively standardized type: it was the beginning of standardized armament systems for U.S. coast defense artillery. They incorporated defensive innovations, such as improved firing embrasures which allowed a great deal of lateral traverse from a smaller, iron-shuttered opening. The sites protected the nation's most vital naval bases, commercial ports and strategic anchorages. When these installations were completed the United States had a true system of coast defense for the first time: it encompassed all three coasts, and it was second to none in the world. Of the more than thirty forts of the third system, begun after 1816, nearly all remain extant, and although a number have been partially altered by the superimposition of later works, the majority in their original form constitute the oldest surviving body of major military structures in the United States.⁸

In March of 1847, U.S. troops occupied the Presidio, based on the temporary ruling of military authorities that the government of the United States assumed the title of all public lands formerly reserved by Mexico—a ruling that encompassed islands in the bay such as Angel, Alcatraz, and Yerba Buena, as well as the former Spanish Presidio. The military governor, Colonel Richard B. Mason, further defined the reserved lands with respect to the boundaries of the Presidio and an area around Point San Jose (now Fort Mason). President Millard Fillmore substantially approved Mason's decisions on 6 November 1850, and added areas at Benicia, Mare Island, and a reservation "from the southern boundary of Sau Salito Bay, a line parallel to the channel of entrance to the Pacific" which became the Lime Point Military Reservation. A further presidential order, on 31 December 1851, refined the boundaries of the Presidio of San Francisco, and established the boundary of the reserve at Point San Jose as an arc 800 yards from its extreme point. With these strokes, the land that encompasses the bulk of today's historic fortifications was acquired. And by this time, the discovery of gold in California gave dramatic new urgency to plans to fortify portions of these reserves.

A Joint Commission for the Defense of the Pacific Coast was established in 1849, and visited the area that same year. Although beset by difficulties in securing reliable manpower and adequate material support, typical of those experienced by many in gold rush California, the Commission eventually completed a survey of the San Francisco Bay Area in 1850 which recommended that it be protected in a manner fitting the most important region on the Pacific Coast.

Among the Joint Commission's specific conclusions were the necessity of "strong works near Fort point on the south side of the channel and also on the north side of the channel nearly opposite to Fort point...batteries at point [San] Jose and on Alcatrazos Island would cooperate with the exterior works and altho' as auxiliaries they may be regarded as of secondary importance, the value of the latter is far greater than that of the former and nearly equal to that of the works at Fort point and opposite to it. A temporary battery on Angel island opposite Alcatrazos would cooperate with the latter..."⁹

The tactical rationale behind this proposal (commonly referred to as the Plan of 1850) was to guard choke points with batteries close to water level in order to bring grazing fire from opposite flanks to bear simultaneously on vessels attempting to run past. Such fire was particularly effective for two reasons. First, vessels could not hug the far shore of a channel in order to increase their distance from the defenses without bringing themselves nearer to fire from the opposite direction. Second, grazing fire was more accurate because flat trajectory fire, skipping along the water surface, had only to be accurate in deflection and not in range. Since attacking vessels obviously benefited by exposing themselves to fire as briefly as possible, local conditions encouraged a full speed dash with both the strong incoming tide and the prevailing northwest winds combining to boost effective speed past the defenses. The proposed works on Alcatraz neutralized such a maneuver, since such vessels would unavoidably head straight at Alcatraz and present a steadily approaching target hardly moving in deflection. The works on Point San Jose and on Angel Island would similarly provide the benefits of cross fire at the locations where channels lead toward the San Francisco waterfront and towards the Benicia Arsenal and Mare Island.

The placement of this first generation of fortifications at San Francisco Bay reflected the limited range (about two miles) and accuracy of the ordnance of the time, which necessitated the close-in defense of key points from within the bay itself and at its immediate entrance. It was prophetically noted by the Joint Commission that these works could be expected to cost four times as much as similar works built on the Gulf and Atlantic coasts, closer to developed sources of material and labor and not subject to the artificially high prices of gold rush California.

In 1851 the War Department established a Board of Engineers for the Pacific Coast. This Board, which included such notable soldiers as J.K.F. Mansfield and Henry Wager Halleck, elaborated on the Joint Commission's proposals, and recommended casemates for the pair of works at the Golden Gate, and barbette batteries on Alcatraz Island. Mansfield emphasized that a state-of-the-art fort at Fort Point was "the key to the entire Pacific Coast in a military point of view."¹⁰ Congress first appropriated funds for the construction of seacoast defenses at San Francisco Bay for fiscal year 1854, in the amount of \$500,000. Work began promptly, supervised at the various sites by several junior officers who went on to distinguished military careers, such as John B. McPherson, G.W.P.C. Lee, Rene de Russy, and Zealous B. Tower.

At Fort Point, in order to begin the leveling of the *Punta de la Cantil Blanco*, Tower reported in late 1853 that "an old Spanish redan of brick which crowned the promontory has been removed."¹¹ At Alcatraz, the bluffs were blasted to a perpendicular face twenty-five feet high all around the island, and a beginning made on the barbette "North" and "South" batteries. Since these construction projects commenced while U.S. commerce and trade on the West Coast was in its formative stages, the difficulties the Board of Engineers had foreseen became immediately apparent. Isolation and uneven development of markets led to immense difficulties in procurement of materials, especially granite and brick. In any event, most of the brick for the projects was made on site at Fort Point, granite came from as near as Point Reyes and as far away as China, while sandstone used at Alcatraz' South Battery scarp was quarried on Angel Island.

In 1855, appropriations were increased due to the threat of war with Spain over Cuba. The barbette works on Alcatraz, being less complex and time-consuming to build than the casemated batteries at Fort Point, were given priority. The 8-inch and 10-inch columbiads at South Battery became the United States' first permanently mounted guns on the Pacific Coast. Continued construction on Alcatraz throughout the decade resulted in 1860 in a fortress "completed in a very perfect manner, to the extent of 75 guns of the heaviest caliber" ringing the island in all directions, mounted in barbette batteries, with a stout brick "defensive barracks" overlooking the island from the hill at its center.¹² Thus, all of Alcatraz Island became a fortification, and all of the works upon it took advantage of the island's hilly topography for tactical advantage. The few contemporary similarly fortified islands, such as Fort Sumter, Fort Warren, Fort Carroll and Fort Jefferson are entirely flat. They are basically merely foundations for a structure, where the topography of the island is not an integral part of the fortification and defensive fire plan, as it is on Alcatraz.¹³

Meanwhile, at Fort Point, construction continued at a slower pace because of the cost and complexity of building multi-storied tiers of arched brick casemates at a site exposed to the force of the open Pacific Ocean. By 1860, the fort had been raised to the barbette (top) tier, and had been made ready to mount ninety guns. Today, Fort Point is an excellently preserved example of a classic multi-tiered, casemated fort, belonging to the third system of American seacoast fortifications. It is the only such structure on the west coast of North America.

Both Alcatraz Island and Fort Point individually merit the status of national significance. And the contrast between the two nearby fortresses enhances their individual significance, since together they clearly demonstrate the culmination of ante-bellum military engineering in the United States. Alcatraz has already been recognized as a National Historic Landmark, while Fort Point is presently a National Historic Site.

After an inspection trip to the West Coast brought about by the Pig War filibustering of 1859 in the San Juan Islands of Washington Territory, Chief Engineer Joseph G. Totten stated of the seacoast fortifications of San

San Francisco Bay that "They will compare favorably with any batteries in the world."¹⁴ By the last day of 1859, Alcatraz had received its permanent garrison; a year later it mounted seventy-five guns. Fort Point was by then ready for as many as ninety guns to be mounted. However no action had been taken on the inner line of defenses at Angel Island and Point San Jose. A crucial omission to the Plan of 1850 was the failure of the government to acquire clear title to the lands north of the Golden Gate around Lime Point. Federal courts upheld the title of early settler William Richardson to that land, and its transfer to subsequent owner William Throckmorton, a notorious land speculator. Throckmorton's asking price was considered exorbitant. The entire Plan of 1850 was jeopardized by this failure, since "The effectiveness of Fort Point without the complimentary works across the channel was far less than even half of what it should have been with the realization of the full plan."¹⁵ As events elsewhere swept the nation towards civil war, the seacoast defenses of San Francisco Bay stood only partially complete.

Civil War and Post-Civil War, 1861-1884

The outbreak of the Civil War and rapid technological advances of the industrial revolution put the third system fortifications to severe test. Their strategic locations placed them in the forefront of numerous crucial battles of the next four years, from the first guns at Fort Sumter, to the siege of Fort Pulaski, the running of the guns at New Orleans and Mobile Bay, and the stand at Fort Fisher. Steam propulsion, ironclad warships, and rifled cannon combined to spell *finis* to the predominance of thick masonry walls and expensive permanent fortifications in lieu of more flexible, repairable and cheaper earthworks, which, paradoxically, better absorbed the shock of repeated hammering from large-caliber smoothbore and rifled siege artillery.

As the Civil War commenced in the east with the bombardment of Fort Sumter, a third-system fort very similar to Fort Point, Lieutenant McPherson was ordered in June of 1861 to prepare a plan for defending the California coast from San Francisco as far south as Monterey. Within this historic context, it is of interest to note that Baker Beach in the Presidio of San Francisco was considered to be a "hazardous" but nonetheless possible landing spot for a hostile force. However, the basic strategy developed for the defense of San Francisco centered around a plan to contest a hostile ground force by holding a line with infantry and field artillery across the San Francisco peninsula south of the city, between Lake Merced (to be developed in the future as Fort Funston) and San Bruno Mountain. Three generations later, in early World War II, the basic approach to holding the area against potential Japanese landings had not changed.

With civil war a reality, budgetary purse-strings were loosened, resulting in increased armament on Alcatraz and the mounting of fifty-nine of the eighty-five cannon on hand at Fort Point by October 1861. These measures were taken as a reaction to Britain's augmenting the strength of their squadron at Vancouver Island and the fear of a British move to seize California while the United States was preoccupied with war in the east, rather than out of immediate fear of any Confederate naval action. George W. Wright, commanding general of the Department of the Pacific wrote in January 1862, "In case of a war with a maritime nation, the immediate attention of the enemy would most certainly be directed to this city, the great entrepot of our possessions on the Pacific coast," and in March that, "[a]lthough there are several points on the Pacific Coast that are exposed to capture by a hostile fleet, yet, in case of a war, San Francisco would first attract the enemy's attention. The loss of San Francisco and harbor involves also the loss of our navy-yard and our military arsenal at Benicia, in fact, it destroys for the time all our commerce on the Pacific. Hence this place should be made impregnable."¹⁶

In February 1863, the U.S. gunboat *Cyane* arrived to aid in protecting the harbor. Throughout the Civil War, the major elements of two regular army regiments, the 9th Infantry and the 3rd Artillery, were stationed at San Francisco, yet another measure of the strategic importance attached to the area.

The inner line of batteries proposed in the Plan of 1850 now began to take form, although as temporary wartime structures, rather than as permanent fortifications. On Angel Island, temporary batteries of wood and earth were constructed at Points Stewart, Knox, and Blunt, and cannon mounted at the first two sites in 1864.

At Point San Jose, the temporary structure completed that same year was of a more substantial nature, with a breast-high wall of brick, mounting six 10-inch Rodmans and six 42-pounder banded James rifles. On Angel Island, only sites presently remain where temporary batteries once stood. However at Point San Jose, now known as Fort Mason, excavation in the early 1980s uncovered the well-preserved remains of the western half of the temporary battery, which has now been restored to its Civil War appearance. This northernmost point of Fort Mason is significant as a site fortified since 1797 with four generations of coast defenses that remained active into the twentieth century.

In July 1864, Major General Irvin McDowell arrived in San Francisco to assume command of the Department of the Pacific. Although outclassed by the Confederacy's best generals on eastern battlefields, McDowell was nonetheless a professional and a veteran, and his tenure in command brought a new seriousness to California's role in the war. McDowell's arrival coincided with an increased awareness of the technical changes that wartime experience mandated, the gradually improving strategic situation east of the Mississippi, increasing domination of Mexico by France, accelerating British development of western Canada, and the perceived threat of Confederate commerce raiders (such as the C.S.S. *Shenandoah*, which had actually approached San Francisco as the war came to an end). These factors combined to cause a flurry of improvements in 1864-1865 to the harbor's defenses that included the mounting of the first 15-inch Rodmans on the West Coast at Alcatraz, a start on a bombproof casemate barracks there, and the burying of the brick scarp walls of the island's Batteries McClellan and Tower behind banks of earth.

With the end of the Civil War there came a time to assimilate the lessons learned on the battlefield and to apply them to future construction of fortifications. As formalized in 1869 by the Board of Engineers for Fortifications, the essence of those lessons was that only large rifles and 15-inch Rodman smoothbores were effective against armored vessels, that masonry works were vulnerable to such weaponry, and that earthwork barbette batteries were not only the most resistant to such fire but also the most cost-effective to build. In consequence, major changes to the seacoast defenses of San Francisco Bay were implemented in the period immediately following the Civil War, under the scheme known as the Plan of 1870. This plan reflected the new reality in seacoast fortification engineering, described thus by E.R. Lewis:

The harbor defense construction begun after the Civil War marked the beginning of an entirely new trend in the positioning of seacoast fortifications. In contrast to the high concentrations of armament sought by designers of Third System forts, the new works were planned to be dispersed at the most tactically favorable locations permitted by terrain and the extent of the available land. In some areas new tracts were acquired for battery sites, and in certain instances these acquisitions had profound long-term effects upon regional land use. A particularly clear example is to be found in the San Francisco area...¹⁷

All around Alcatraz Island, the sandstone or brick scarp walls of barbette batteries disappeared behind earth fill. Remodeling on the island soon turned into full-scale rebuilding, incorporating wider spacing between weapons, concrete earth-covered traverses separating each pair of cannon, thickened parapets, a lowering of the silhouettes of the caponiers, and a wider use of covered magazines in the counter-scarp walls of the batteries. To supplement the seventy-six mounted and eighty-nine unmounted pieces at the now technically obsolete third-system fort at Fort Point, permanent barbette batteries of earth and brick were begun on the open bluffs of the Presidio. They were named East Battery and West Battery for their position relative to the old third system fort.

In a development of major importance (both for the San Francisco fortification system and for the future of regional land use), the Lime Point Military Reservation was finally acquired in 1866, by a purchase that included all of the Marin Headlands from Point Cavallo, south of Sausalito, west to land's end at Point Bonita. At Lime Point itself, directly across the Golden Gate from Fort Point, the largest-yet, non-combat, blasting operation in the United States began, in an attempt to initiate construction for the long-awaited casemate and barbette fort complimenting Fort Point. Between 1868 and 1869, under the supervision of Major George Mendell, up to 24,000 pounds of gunpowder at a time were exploded in an effort to blast out a

level site at the base of the 300-foot cliff.¹⁸ This rubble still exists, in part, under the northern approaches to the Golden Gate Bridge.

Although the location offered considerable tactical advantages, Lime Point was an extraordinarily difficult site for large-scale construction. Indeed, the proposed works were designed but never begun—and would have been astronomically expensive to build. As early as 1869, the New York Board of Fortifications (reviewing the recommendations of the Pacific Board) recognized the practical difficulties of the Lime Point site by declaring that simple, detached barbette batteries be built in supporting positions nearby. Thus the post-Civil War fortifications in the Lime Point area finally evolved into a water-level battery called Gravelly Beach Battery (at today's Kirby Cove) to provide grazing ricochet fire, and two barbette batteries known as Ridge and Cliff Batteries, which were situated high on the bluffs above to avoid exposure yet retain a wide field of fire. The Gravelly Beach Battery boasted the only 15-inch Rodman mounted north of the Golden Gate until 1893, when four 15-inch Rodmans salvaged from West Battery at the Presidio were remounted in Ridge Battery.¹⁹ Ridge and neighboring Cliff Batteries, at an elevation of more than 400 feet above sea level, were the highest such structures yet built in the United States.²⁰

The plan for casemated works at Lime Point was ultimately abandoned in favor of a large water battery of exceptionally handsome design at Point Cavallo, just to the east and across Horseshoe Cove. This work consisted of earthwork barbettes shaped as rough triangles, bisected by a long traverse containing magazines and bombproofs. In each half of the work were the emplacements for the now-typical pairs of 15-inch Rodmans, also separated by brick and concrete earth-covered traverses and magazines. (Three 20-inch Rodmans were proposed for the site, but never mounted; indeed, the three 8-inch converted rifles finally mounted at Cavallo Battery in 1900 were the only cannon ever emplaced there.) Cavallo Battery is the finest example of the style of earthwork fortifications representative of this era in the United States. Its builder was so proud of this completely enclosed earthwork that he even sought permission to build a sally port into it, which was, however, disapproved by his superiors as an extravagance.

The construction of this cluster of fortifications north of the Golden Gate soon led to the establishment of a new post at Horseshoe Cove, which evolved into today's handsome and well-preserved Fort Baker. These Lime Point fortifications typified in microcosm the drastic changes in seacoast fortifications over the preceding decade. "Never again would forts be built in the storybook style as single structures housing large numbers of cannon. From this time on, a fort was a piece of real estate occupied by a number of dispersed individual batteries."²¹

The only exception of any consequence to the general state of neglect of seacoast defense between 1875 and 1890 was the continued development of submarine mine warfare. The great successes the Confederates had with such devices during the Civil War seemed to indicate that here was an effective defensive weapon that was relatively inexpensive and easy to emplace as compared with building permanent fortifications. Mines first arrived in San Francisco in 1884 and were stored in an unused casemate-style powder magazine in the 1866 defensive barracks on Alcatraz. These electrically-fired mines (or torpedoes, as they were called at the time) were intended to be sited in the inner harbor "in front of" and "in the rear of" the island.

In 1889 an appropriation was made for "Torpedoes for Harbor Defense" which allocated funds for a permanent torpedo storehouse of concrete, and for two mine casemates for the control and detonation of the mines. In 1890, as a result of that allocation, the casemate on Alcatraz was remodeled into a mine casemate (from which the mines would be electrically detonated), a storehouse was built on Yerba Buena Island, and Fort Mason became the site of the first purposefully-built mine casemate in the San Francisco Bay defenses. In 1891, a mine casemate was added at the foot of Mortar Hill on Angel Island. Additional casemates were constructed on Yellow Bluff to the north of Cavallo Battery in 1895 and at Quarry Point on Angel Island in 1897.

The harbor's mines were first planted and activated in 1898, upon the outbreak of the Spanish-American War. San Francisco was the major concentration area for the U.S. expeditionary force to the Philippines,

and the only harbor on the west coast of the United States that was protected by minefields during the war. By that time only the Fort Mason and Point Cavallo casemates were used for control of the minefields, which were located to the northeast and southwest of Alcatraz, and contained a total of sixty-three mines. At the present, the Yerba Buena torpedo storehouse, and mine casemates at Alcatraz, Fort Mason, Yellow Bluff, and Mortar Hill on Angel Island still stand, representing the first use of submarine mine warfare on the Pacific Coast.

After 1875, with the exception of underwater mine warfare, modernization came to an abrupt halt due to a number of crucial political and technical considerations. As the initial exuberance at the end of the Civil War turned to a sober realization of the war's great cost, the country's political climate changed more and more to one of isolationism. As the Indian wars raged, the Army's energies became centered on its role as a frontier constabulary, rather than as a force to be pitted against other modern military establishments. Technical developments in the field of artillery began to proceed at such a rapid pace that the building of fortifications could not, or could not afford to, keep up. Briefly summarized, these technical developments consisted of: improved casting techniques which presaged the manufacture of stronger guns in longer calibers; the continued perfection of rifling; breech-loading weapons becoming practical; better recoil systems and disappearing carriages; and higher quality, variable-burning powders becoming available. Now, artillery could theoretically be made safer to operate, easier to protect, and more deadly at ranges four times greater than ever before.

It is ironic that, when these technical advances were combined with the prevailing political climate, the practical result was that the seacoast fortifications of San Francisco Bay entered a fifteen year period of neglect in which they rapidly passed from among the nation's most formidable to being practically non-existent. This decline mirrored the nationwide trend in the state of seacoast fortifications, and indeed in the state of the nation's entire military establishment. With the exception of the battery near the Division of the Pacific headquarters at the post at Point San Jose (officially christened Fort Mason in 1884), earthwork fortifications went into ruin, and "a little rodent called the gopher (became) the worst enemy....He burrows on the parapets and destroys their shape and compactness."²²

The works throughout the area lay in caretaker status—quiet and largely unused, until the next phase of dramatic change.

Early Modern Era, 1891-1928 (including the Endicott Period, Taft Era and World War I)

In the years immediately prior to 1890, the period of neglect for major caliber gun batteries began to draw to a close. The technical advances in artillery previously alluded to began to be synthesized with the establishment of a Gun Foundry Board in 1882. President Grover Cleveland established a special Board on Fortifications or Other Defenses in 1885 to make recommendations as to the future of the nation's seacoast defenses in light of the advances of the past fifteen years. This board soon became known as the Endicott Board, after its chairman, Secretary of War William C. Endicott.

As the frontier began to disappear and industry to increasingly prosper, America turned elsewhere for an outlet for her energies. As noted military historian Russell F. Weigley states, "merely working on the Endicott Program offered the feeling that the country now possessed a kind of military policy looking toward foreign war, and this feeling was so reassuring that in the War Department reports and the military publications of the 1890's interest in the coast defenses became almost obsessive."²³ This feeling soon became something of a self-fulfilling prophecy with the onset of the Spanish-American War, which rapidly propelled the nation into the role of an imperial power. These interrelated influences resulted in a golden age of coast artillery, which manifested itself in many coastal areas of the United States by the rapid construction of great numbers of state-of-the-art fortifications.

The turn-of-the-century revival of seacoast fortification is a reflection of the end of the frontier, the burgeoning industrial capability of the nation, and its conscious policy of engaging the other powers of

the world in new nationalistic competition. The United States launched its new steel navy as its contribution the world-wide naval arms race of the *Dreadnought* era. A new generation of strategic thinkers espoused "a fundamental change in the relationship between the harbor defenses and the Navy, for these were the years during which the fleet was transformed from a force devoted largely to immediate continental protection into an instrument of genuine sea power" following the sea principles espoused by Alfred Thayer Mahan.²⁴

Let the port be protected by the [Army's] fortifications; the fleet must be foot-loose to search out and destroy the enemy's fleet; that is the function of the fleet; that is the only function that can justify the fleet's existence.... For the protection of our coasts we need fortifications; not merely to protect the salient points of our possessions, but we need them so that the navy can be foot-loose.²⁵

In this new unified scheme of national defense, the Army fell sole heir to the mission of protecting vital naval operating bases and repair yards. The increased technical sophistication of seacoast weapon systems was acknowledged by the Army's reorganization of 1901 when separate companies of coast artillery were formed. Six years later the Army established the Coast Artillery Corps as a separate arm of the service in recognition of the importance of the specialized mission of strategic deterrence. The overseas role of the Navy in a modern defense policy was made possible by the ambitious shield of seacoast fortifications projected for the Army under the principles laid down by the Endicott Board in 1883, and now made practical by technological advances as well as by changing the changing political situation.

The Endicott Board made grandiose recommendations for twenty-two seaports on all U.S. coasts, and it gave its name to not only the type of fortifications it recommended, but also to the era in which they flourished. The board also clearly established the national significance of the structures under discussion when it ranked San Francisco second only to New York in the importance of its harbor defense, and the most important on the nation's Pacific shore. "The United States by 1900 came again to possess the most powerful coast defense system in the world."²⁶ In the San Francisco Bay Area, the extensive and well-preserved works of this system remain as tangible evidence of America's industrial growth, the consequent development of military technology, the era of American imperial expansion, and America's coming of age as a world power.

In order to distill the Endicott Board's sweeping plans into a practical scheme, a New York Board of Engineers convened in 1890. This board prepared a project to modernize San Francisco's seacoast defenses which, in general form, would be implemented over the next fifteen years. The most significant feature of this project was the great extension of the outer line of defenses to points well beyond the harbor entrance proper, in a reflection of the ten- to twelve-mile range of the new artillery pieces. These ranges were more or less matched by the powerful armament of modern battleships, therefore the new coast defenses were sited to engage targets as far outside the bay and its vital installations as possible. Activity thus commenced to acquire lands in San Francisco at Point Lobos and Lake Merced, south of the Golden Gate, while plans were made to construct batteries in the Point Bonita area near the outermost headlands to the north.

The general characteristics of the batteries of the Endicott era are concrete construction, partially buried behind wide parapets of earth. The cannon were mounted individually, or occasionally in pairs, and were more widely separated than before. However they had no overhead protection, for military aircraft did not yet exist. Magazines became an integral part of the battery, placed below the level of the surrounding terrain, and enclosed battery commander positions were built into the structures (Plate 10).

New construction first began to the south of the Golden Gate. At the western portion of the Presidio of San Francisco (to be constituted in 1912 as a separate coast artillery post named Fort Winfield Scott), ground was broken in 1891 for Battery Marcus Miller. Designed for three 10-inch breech-loading rifles on disappearing carriages, construction of this battery initiated the process of destruction of old West Battery above Fort Point.

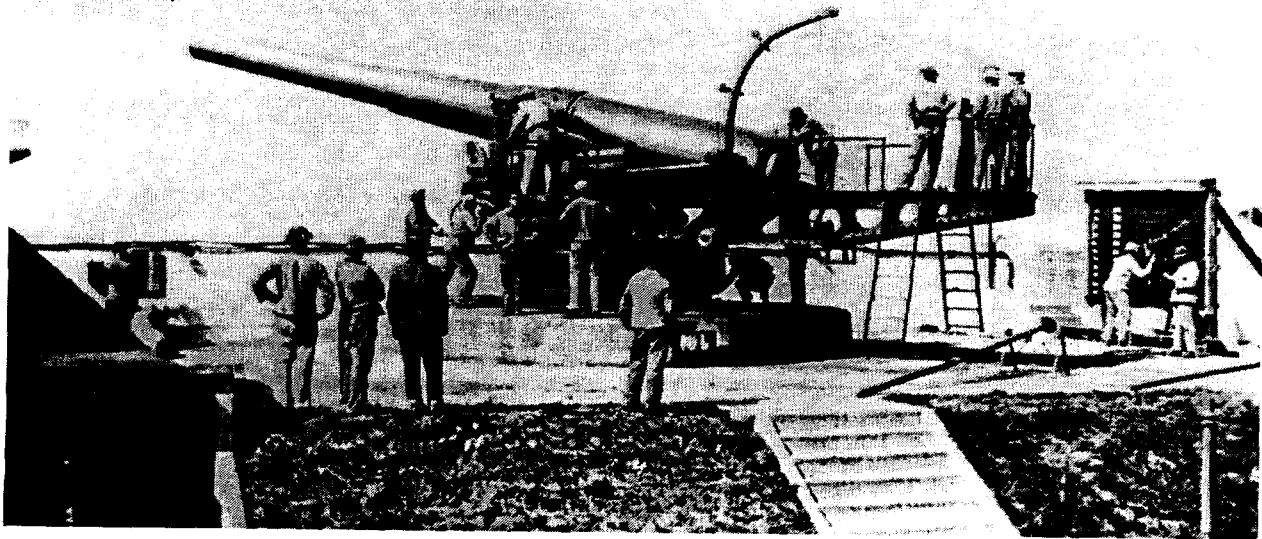

Plate 10. Battery Godfrey, Fort Winfield Scott, constructed 1892-1896. First 12-inch gun platform constructed in the United States, with the first 12-inch breech-loading rifle for the West Coast mounted in 1895. View of circa 1915. Courtesy of the Park Archives of the Golden Gate National Recreation Area.

The first modern mortar battery in the San Francisco defense system was begun in 1893, with the construction of the cross-shaped Battery Howe, designed for sixteen breech-loading mortars (12-inch). At nearby Battery Godfrey, the first 12-inch gun platform in the United States was constructed and the first 12-inch breech-loading rifle on the West Coast was mounted in 1895. Two other batteries for three 12-inch rifles, Battery Saffold and Battery Lancaster, were begun at Fort Winfield Scott during this first phase of the Endicott period.

In 1894, an experimental battery mounting three 15-inch pneumatic guns firing charges of dynamite was built between Batteries Godfrey and Saffold. This extraordinary emplacement, which included a steam plant for producing the compressed air that fires the charge, was built by the developers of the guns. It is one of only two such batteries in the United States. These weapons never proved of practical value, although they killed prodigious numbers of fish when test-fired. They were declared obsolete and sold by 1904. Battery Dynamite continued to play an important role however, even after the guns were removed. Its power house became the power unit for all of Fort Winfield Scott, and in 1919 the battery became the central fire control station for all of that fort. In World War II, Battery Dynamite was used as the harbor defense command post for the entire Bay Area.

In 1893, construction began on the first modern fortifications to the north of the Golden Gate, located on the Lime Point Military Reservation. Battery Spencer, mounting three 12-inch breech-loading rifles, was begun at the lofty site of the old Cliff Battery. Subsequent improvements to similar batteries nationwide followed an inspection of Battery Spencer by Douglas MacArthur in his role as acting chief engineer officer for the Pacific Division. Spencer was soon followed by the construction of Battery Duncan (two 8-inch breech-loading rifles) to the north of Horseshoe Cove, and Battery Kirby (two 12-inch breech-loading rifles) on the

site of old Gravelly Beach Battery. The two latter works were both unusual for their one-story design. Battery Kirby was also distinctive for its very thick parapet, and for the unusual positioning of such large weapons as water batteries.

The onset of the Spanish-American War quickened the pace of construction, and Batteries Stotsenburg (sixteen 12-inch breech-loading mortars), Cranston (two 10-inch breech-loading rifles), and Boutelle (three 5-inch rapid fire guns) were completed in quick order at Fort Winfield Scott. The latter was the first use of rapid fire guns in the area as well as the first use of the balanced pillar mount. Old emplacements at Knox Battery on Angel Island, East Battery at the Presidio, and Cavallo Battery at Lime Point were readied for the mounting of old 8-inch muzzle-loading converted rifles, of which the concrete temporary battery immediately west of the Civil War battery at Fort Mason is best-preserved. These old muzzle-loaders were a very successful reuse of the common but obsolete 10-inch Rodman smoothbore.²⁷ Hasty rearmament during the Spanish-American War led to some unusual contrasts in weaponry, such as at Battery Spencer, where modern rifles on the latest carriages were mounted side by side with 15-inch Rodmans of the Civil War era.

Also quickened at this time, was the pace of action on the inner line of modern heavy batteries. Although not completed until well after the close of hostilities Batteries Drew and Wallace on Angel Island (each with one 8-inch breech-loading rifle), Battery Slaughter at the Presidio east of the Golden Gate (three 8-inch breech-loading rifles), Battery Duncan at newly-constructed Fort Baker (two 8-inch breech-loading rifles), and Burnham at Fort Mason (one 8-inch breech-loading rifle) all date to this period.

In addition, because of the impetus of the war, a unified system of fire control was provided for San Francisco's harbor defenses. Such a system was developed by the Board of Regulations of Seacoast Artillery Fire in 1896, and was later instituted first in San Francisco and at Fort Monroe, Virginia, home of the Army's elite coast artillery school. This system, a considerable technological leap forward in command and control capability, was the first instance of the control of weaponry from well beyond the sights of the individual piece.

One of the results of lessons learned from the rapid rearmament of the area's defenses was the efficiency of minefields and the new rapid fire guns in protecting the inner reaches of the harbor. This realization made the 8-inch batteries of the inner line obsolete almost as soon as they were completed. Thus a series of batteries for rapid-fire guns proliferated on the shores immediately around and just inside the Golden Gate: Battery Ledyard built on Angel Island, Batteries Sherwood, Blaney and Baldwin at Fort Winfield Scott, and Batteries Orlando Wagner, and Yates at Fort Baker. Battery O'Rorke, at newly-minted Fort Barry, was located rather farther out near Point Bonita, but its mission too was to cover minefields as well as to prevent landing parties from coming ashore on nearby Rodeo Beach.

The brief emergency of the Spanish-American war over, the focus of construction turned to Marin's headlands, on the outer line of defenses to the north of the Golden Gate on the Lime Point Military Reservation, in 1897 designated Fort Baker in the east and in 1904 Fort Barry to the west. There, overlooking the northernmost headlands of the Golden Gate and the Pacific coastline stretching north, engineers completed Battery Mendell (two 12-inch breech-loading rifles) and Battery Alexander (eight 12-inch breech-loading mortars) in 1901. Great difficulty was encountered in transporting heavy ordnance and equipment over the rugged hills of the headlands, and so a wharf was built at nearby Bonita Cove. Carriages for Battery Alexander's mortars fell into the sea off the wharf in 1902, but were recovered—an indication that although the engineer's wharf may have been preferable to the trip over the hills, it was not entirely without its challenges.

Meanwhile, on the San Francisco side, post-war construction on the outer line resulted in completion of Battery Chester (three 12-inch breech-loading rifles) and Livingston (sixteen 12-inch breech-loading mortars) at newly-acquired lands at Point Lobos, designated Fort Miley in 1901. Endicott era construction at San Francisco Bay culminated with Battery Chamberlin (four 6-inch breech-loading rifles) at Baker Beach, and the twin batteries (each with four 6-inch breech-loading rifles, Rathbone and Guthrie, located at Fort Barry.

The Endicott batteries of the San Francisco harbor defenses collectively compose a well-preserved and nationally-significant collection of state-of-the-art military fortifications from the turn of the century. Individual elements, and the system as a whole, embody the distinctive, specialized characteristics of military engineering at the limits of ordnance and engineering technology of the time. They are tangible symbols of events that marked the emergence of the United States as a major military power, and they have a great deal of associative significance, since they carry the names of soldiers of distinction and American military heroes in every war from the Revolutionary War onward.

The Endicott period was a great leap forward; the next important phase in the development of coast defense technology was a logical evolution to reach the full potential of the new weapons system. These developments were synthesized by the so-called Taft Board in 1905, named for President Theodore Roosevelt's Secretary of War, William Howard Taft. The mission of this board was to review and update the results of the Endicott program, and although it proposed little new in the way of major construction (at least at continental U.S. locations), the significant contribution was to accelerate the modernization of existing emplacements.

Specific modernizations of the resulting Taft era included the widespread use of searchlights organized in batteries to illuminate targets, the widespread electrification of many aspects of seacoast defense including inside lighting, telephonic communications, electrified hoists for ammunition handling, and most significantly, a modern system of indirect aiming. This method of fire control was the most significant advance in artillery fire control until the advent of radar.²⁸

Indirect fire control became feasible because of simultaneous progress in optical systems, telephone communications, and mechanical devices for rapid mathematical calculation. The result was the completion by June of 1908 of over twenty-five fire control stations around the Bay Area forts. These fire control stations were used to direct groups of two or three batteries called fire commands, and relayed data on target range, bearing, course, and speed to plotting rooms at the batteries themselves. The stations were grouped in carefully surveyed base lines at high elevations with a commanding view, and also in separate low level fog bases in case of poor visibility. These structures are commonly called base-end stations because the coast artillery base lines had one such station at either end. With a complete system of such electrified base-end stations, the nation's harbor defense system would have an efficient system of integrated command and control with a previously unsurpassed accuracy of fire. The harbor defense of San Francisco became an exemplar of just such a system.

Searchlight emplacements were constructed, in locations as accessible as Fort Mason, as far-flung as Bird Rock north of Point Bonita, and at Tennessee Point, where five acres were acquired in 1914. It will be recalled that the inner line of early Endicott batteries was progressively abandoned in favor of underwater mines, with Battery Burnham at Fort Mason leading the way to oblivion in 1909 followed by those on Angel Island, and culminating with the abandonment of mortar Battery Howe-Wagner in 1920.

Mine warfare now received a great deal of attention. Many of the original mine casemates were considered unsatisfactory at the time of the Spanish-American War and more modern casemates were built at Point Bonita in 1908 and Baker Beach in 1912 to control projected off-shore fields. Between 1907 and 1910 a new mine depot was built just to the east of old Fort Point, further reflecting the decision to lay future minefields outside the Golden Gate. The location of the mine depot was not without controversy. Although Fort Point was convenient to the minefields, the storehouse site on Yerba Buena Island remained serviceable, preferable to some because it lay behind all of the harbor's defenses and was protected by them. Nevertheless, the Fort Point depot became the major facility for San Francisco's minefield defenses until just prior to World War II.

During the period of technological upgrading marking the Taft era, the structural soundness of San Francisco's fortifications was severely tested by the great earthquake in April of 1906. Although causing massive damage to buildings in the city, the fortifications required only minor repairs totaling less than

\$5,000. Indeed, the most unfortunate consequence of the earthquake from the perspective of the historian was the loss of the U.S. Army Corps of Engineers' construction records, which burned in their downtown office.

Tension with Japan, a consequence of California's racist treatment of Japanese settlers and American exclusionist legislation, resulted in the construction of Battery Call (two 5-inch rapid-fire guns, no longer extant) at Fort Miley to assist in covering off-shore minefields. In spite of the fact that these two nations were to be official allies in World War I, increasing animosity was to be their mutual lot until resolved by conflict in World War II.

Although World War I had a smaller direct impact on the San Francisco Bay region than conflicts immediately before and after, certain older batteries were stripped of their armament in order to provide pieces for heavy field and railroad artillery on the Western Front, and to protect the nation's other Pacific possessions. Some years later the most significant example of this occurred, when 12-inch rifles from Battery Kirby were sent to Corregidor in 1934, and again in 1941 because of the abrogation of the Washington and London Naval Treaties.²⁹

However lessons learned on European battlefields eventually had a great effect on the course of future planning for the nation's seacoast defenses, and as ever, those plans were soon put into effect at San Francisco. Britain had launched the *Queen Elizabeth* class of battleships, which mounted 15-inch rifles that outranged any of San Francisco's defenses. These powerful weapons were also able to fire at such high trajectories and great range that they could stand outside the range of the coastal batteries and bombard them with impunity, even reaching those mounted on disappearing carriages, although the higher elevation batteries and those with disappearing carriages remained relatively well-protected against short range direct fire. Many batteries, therefore, received attention in terms of extra earth and concrete protection. Although the United States continued to have color-coded plans on file for war against any of the major powers, the motivation for improving the fortifications at this time was more fear of German or Japanese warships that had followed Britain's technical lead, rather than it was of the increasingly unlikely scenario of war with Great Britain.

In reaction, the defenses of the area were extended to include construction at the Lake Merced Military Reservation (named Fort Funston in 1917). First construction on the site consisted of the very temporary Battery Bruff, two 5-inch guns, and the more permanent Battery Walter Howe (four 12-inch breech-loading mortars). The latter battery is significant because of its unusual straight line configuration (a result of the practical difficulties of having four crews working simultaneously in a four mortar pit), and because it was the very last mortar battery in service in the United States.³⁰

Not surprisingly, 1915 was the year first mention was made of the need for 16-inch rifles to keep pace with battleship weaponry. Such massive pieces would obviously need to be placed at the far reaches of the defended area, and the areas at Lake Merced and Tennessee Point received attention as likely sites. As a stopgap measure, until the great rifles could be developed, a battery for two 12-inch long-range guns was built in 1919 at Point Bonita. So rapidly did the arms race continue, that Battery Wallace, with its wide spacing between guns, 360-degree traverse capability, and deep pits for high-angle firing, became for a time the only thoroughly modern emplacement in the area's seacoast defenses. Even so, its guns were not mounted until some years after the completion of the battery, and they were not test fired until 1928.

The final reflection of lessons learned from World War I was the appearance of antiaircraft defenses and the beginnings of aerial spotting of artillery fire. Batteries mounting two 3-inch antiaircraft guns were constructed at Fort Miley, Fort Winfield Scott, Fort Barry, and Fort Funston. The latter three emplacements are still extant. All further designs for seacoast fortifications were destined to take into account defensive measures against aircraft. The consequent need for dispersion resulted in a wider separation between guns, as at Battery Wallace, magazines being built farther from the emplacements, and additional camouflage

measures to avoid aerial observation.³¹ (Battery Wallace was casemated after the outbreak of World War II to provide additional overhead protection.)

Large hangars for observation balloons were built at Forts Funston, Winfield Scott and Barry in 1921: of this group, the structure at Barry still remains. It was used that same year to correct the accuracy of fire from Battery Mendell, "a problem was fired, [the Army conducted a coast defense firing exercise], *for the first time in the history of the world*, in which all data was supplied from the air *by balloons*. (italics added)."³² Use of balloons to adjust fire accurately on vessels far out at sea or hidden from land by haze or fog was soon discontinued because of high winds at the launching sites, and the vulnerability of balloons to defensive fire. It makes a short, but interesting episode: the hangar at Fort Barry is the last survivor of this type with integrity on the west coast of the United States.

Western Department Air Service Officer, and future commander of the U.S. Army Air Forces, Henry H. "Hap" Arnold, oversaw completion of Crissy Field in 1921. It was the only U.S. Army Air Service coast defense air station in the western United States, and the only survivor of this type in the nation. Located in purposeful proximity to the coast artillery command network, the primary mission of the airfield's 91st Observation Squadron and 15th Photographic Section was to locate friendly and enemy forces and to correct the fall of shot from the coast artillery batteries by visual or radio signals.

Chronology makes it fitting to introduce the construction of the Golden Gate Bridge from 1933-1937. This grand structure was the immediate cause of the burial of Batteries Slaughter and Baldwin, and the partial destruction of Battery Lancaster. In exchange, the Golden Gate Bridge District agreed to construct a new Central Reserve magazine for the Army at Fort Winfield Scott. Of greater lasting value was the effort that bridge engineer Joseph Strauss made to save old Fort Point. After extensive design work was accomplished, the northern bridge approaches were constructed in such a way as to allow the structure to vault over the fort in a great arch that emphasizes the dramatic contrast between the old and the new. With the Golden Gate, and its sister bridge across San Francisco Bay to Oakland completed, the Bay Area can be perceived as having approached the end of the Great Depression. War clouds could be dimly seen gathering on both the eastern and western horizons.

World War II Era, 1937-1948

The development of the ultimate generation of classic coast defense guns, immense 16-inch rifles, was a direct outgrowth of the greatly increased range of naval guns during and after World War I. In San Francisco, the most important continental base in any future Pacific war scenario, the need for protection from rapidly-modernizing Japanese shipboard weaponry was exacerbated by the lack of large caliber guns bearing south along Ocean Beach. A thoroughly modern battleship could thus lie off Pedro Point and leisurely shell much of the city from a range of 21,000 yards without receiving any return fire. The solution presented itself in a relatively economical way as a result of the Washington Naval Treaty of 1922.³³

This treaty set certain limits on the size of the navies of the great powers, placed a moratorium on the further fortification of Pacific islands, and caused the abandonment of many projects already underway. The proposed *Lexington* class battlecruisers were converted to two aircraft carriers, and the 16-inch/50 caliber naval rifles already being forged for battlecruisers and battleships became available instead for coast defense. These outstanding naval weapons, with a range of 44,600 yards, became the nucleus around which future Army seacoast defense construction was planned.

As early as 1925, San Francisco was recognized as the site in the continental United States with the highest priority need for the new 16-inch rifles. (Only fortifications at the Panama Canal and in Hawaii received higher priority from the U.S. Army Corps of Engineers). Throughout the 1930s, the Army continued to update planning for harbor defense. "Concern over the developing use of aircraft and aircraft carriers caused the Army to design 16 inch batteries with substantial overhead cover. The older emplacements looked like bullseyes from the air and had no overhead protection at all. The new design enclosed the gun in a reinforced

concrete shell, similar to the old casemates of the early 1800s, but on a larger scale. Plans were also developed for 8 inch and 6 inch batteries. In (fiscal year) 1937 funds were authorized for the construction of two new 16 inch batteries at San Francisco."³⁴

For a number of reasons, history was made when construction began at Fort Funston on Battery Richmond P. Davis (actually commenced in October 1936). San Francisco's harbor defenses were about to be extended to their greatest geographical extent: the huge base lines needed to get the full potential from the new rifles required five base-end stations 15,600 yards apart stretching from Pedro Point in the south to Wildcat Ridge in the north. In a wider context, Battery Davis mounted the first 16-inch guns on the Pacific Coast of the continental United States, as well as the first twentieth century use of a casemated emplacement, built as such from the ground up as a reaction to airpower. (Naturally, great pains were taken to hide the emplacements from aerial observation, even to the extent of building false roads that led away from the site.) It was thus a prototype and model for all subsequent heavy seacoast batteries built by the United States, and in some ways an example for all subsequent casemated batteries. The particular weapons mounted at Battery Davis were cast for use on the U.S.S. *Saratoga*, which went on to a distinguished career in World War II metamorphosed from battlecruiser to aircraft carrier.

To compliment the fire from Battery Davis, the Army purchased a further 800 acres in 1937 around the existing Tennessee Point Military Reservation north of the Golden Gate, and designated it Fort Cronkhite. Battery Townsley, completed there in 1940, incorporated some improvements suggested during the building of Davis. Townsley had its own reserve magazine, and an upper structure separated from its foundations in order to cushion the shock of bombs. Its base line extended 15,300 yards from Hill 640 Military Reservation in Stinson Beach south to Fort Funston. On 1 July 1940 the first 16-inch round ever fired from the West Coast left the barrels of Battery Townsley during its test-firing—and windows broke in San Francisco from the concussion. With the completion of Batteries Davis and Townsley, San Francisco can rightly be said to have had for a time the most strongly fortified harbor in the world.³⁵

The timing could not have been more apt. It was, of course, motivated by increased threats of war, and developed concurrently with the deliberate sinking of the U.S. gunboat *Panay* in a Chinese river by Japanese bombers, the Spanish Civil War, and Hitler's territorial aggrandizement in Europe.

The installation of the big new rifles eventually came to be supported by numerous other technical improvements to the bay's defenses that reflected the nationwide priorities outlined by the Army's Harbor Defense Board. The defenses of San Francisco had the highest priority of any Pacific Coast area, and were systematized in the plan known as the 1937 Project for San Francisco Harbor Defenses. Highlighting the 1937 project was the concurrent development of several integrated systems. Additional batteries were called for. Concrete pads called Panama Mounts were quickly laid at Fort Funston to provide fixed firing platforms for usually mobile 155mm GPF guns sited to protect the blind spots of Battery Davis. Two additional batteries of 16-inch rifles were proposed, but only one was begun, high above the Golden Gate at an elevation over 800 feet—Battery Construction #129 became the highest heavy seacoast battery ever built. Of the 6-inch batteries proposed, Battery Construction #243 (two 6-inch rifles on shielded barbette carriages) and Battery Construction #244 (two 6-inch rifles on shielded barbette carriages) were eventually completed at Fort Miley and Milagra Ridge, respectively, and reflected the further technological advances of the 1940 modernization project.

Improved fire control was a second feature of the 1937 project. Improvements in wide base position finding allowed greater advantage to be taken of the new long range pieces, if longer base lines with more stations were established. Therefore purchases were made at Pedro Point, Mussel Rocks, Point Lobos, and Hill 640 in order to place more base-end stations. Prefabricated steel base-end stations began to replace wooden, brick and concrete structures that dated as far back as 1910. The earliest base lines only needed two base-end stations. The fire control system of the World War II era still required at least two stations for a base line, but increasingly greater ranges led to a profusion of additional stations for guns of all calibers. Coast Artillery theory dictated that the optimum length for a base line was one-third of the estimated distance to the target,

and a 16-inch battery might have as many as a dozen permanent and emergency base-end structures assigned to it. This plethora of base-end stations allowed for a vast variety of possible base lines.

Searchlights were greatly increased in number over the nine that had been emplaced prior to the 1937 project, and antiaircraft defenses were considerably strengthened. The six 3-inch antiaircraft guns mounted in pairs at Forts Funston, Winfield Scott and Barry in 1937 were augmented by additional batteries constructed at Wolf Ridge in Fort Cronkhite, and the Lincoln Park Golf Course near Fort Miley, and numerous earthwork-protected sites for .50 caliber machine guns and 40 mm automatic cannon. (Fort Miley's two antiaircraft guns were removed by the time World War II began. One weapon went to Fort Funston and one to Fort Barry to increase the number of guns at each of those batteries to three.)

A new mine depot and wharf were begun in 1937 at Fort Baker, their mission to service and maintain the north channel minefields from a location better protected than the Fort Point Depot. A supplementary storehouse on Yerba Buena Island and additional depot facilities at Fort Winfield Scott rounded out the prewar improvements to the submarine mine defenses of the Bay Area.

Improvements in tactical control thus became necessary in order to effectively manage the greatly increased flow of information to the guns, improvements that resulted in the organization of the new and old batteries into manageably-sized groupments of mutually supporting weapons with related missions. Groupment command posts were constructed at Fort Barry and Fort Funston while a command post for the entire command, designated Harbor Defenses of San Francisco, was built at the old dynamite battery at Fort Winfield Scott. It was 1940 by the time that most of these improvements had actually been started, although the underwater defenses of the area received attention somewhat earlier.

World War II came with dramatic suddenness to the United States, and it came in the Pacific rather than the Atlantic. The West Coast in particular felt the strongest fear of enemy action off its shores, due to the nature of the surprise attack on Pearl Harbor. By the end of 7 December 1941, the seacoast fortifications of San Francisco Bay were fully manned, mobile field artillery had been placed behind beaches as far north as Drake's Bay, and two battalions of the 7th U.S. Infantry Division set up beach defenses behind barbed wire obstacles at Cronkhite Beach and to the south of the Golden Gate. The tactical plan for the mobile land defense of the area had not changed much since the Civil War. In case of a landing the main line of resistance was still planned to be to the north of Mount Tamalpais and to the south of the city near Crystal Springs Reservoir. On 11 December 1941 the Western Defense Command was designated a theater of operations, with the Harbor Defenses of San Francisco as a major subordinate unit. The war gave the ultimate impetus for improved coast defense, and resulted in the culmination of the defensive system in the conventional sense.

Minefields were immediately thickened outside the harbor, eventually resulting in a 1945 total of 481 mines in thirty-seven distinct groups. A new station for the North Channel minefield was built overlooking the beach at Tennessee Cove, and a double casemate at Baker Beach was constructed to control the main and south channel minefields. Both structures are still extant. Numerous "anti-motor torpedo boat" batteries were built, mounting 90mm or 37mm antiaircraft guns and sometimes aging 3-inch guns, in rapidly traversing mounts sited to fire flat across the water at minesweepers, high-speed gunboats, or submarines attempting to run past the minefields. These temporary emplacements were named Batteries Gravelly Beach, Bonita, Cavallo, Yates, Gate, Point, Winfield Scott, Baker, Land, and Buck, their names alluding to their locations. Numerous field fortifications, often merely dugouts of concrete-filled sandbags, proliferated in tactically advantageous coastal locations, housing an observation post, a searchlight, a machine gun, or a light antiaircraft cannon.

The most important development in fire control systems since the establishment of indirect aiming principles was the perfection of radar early in the war. Soon five SCR-296A surface search radar systems were emplaced at Wildcat Ridge at Point Reyes, Hill 640 overlooking Stinson Beach, Bonita Ridge in the Marin Headlands, Devil's Slide south of Milagra Ridge, and Pillar Point near Half Moon Bay. A typical radar

station had a tower, a concrete transmitter house, and two power plants associated with it. Eventually there were nine such radar emplacements including ones at Wolf Ridge, Baker Beach, Fort Miley, and south of Fort Funston, and two SCR-682 general surveillance radars near the Point Reyes lighthouse and at Wolf Ridge in Fort Cronkhite.

In September 1942, work began at Battery Construction #129 in the Marin Headlands, and continued until November 1943, when it became obvious that such a huge fortification mounting 16-inch guns was no longer needed. The guns were brought up to the top of the hill, but never actually mounted. Even so, Battery Construction #129 made history as the most expensive fortification the United States ever built. Battery Constructions #244 and #243 were brought to completion, although weapons were not actually mounted in either until after the war.

At the start of the war, fifteen of the older Endicott period batteries had already been disarmed. By 1943, a further thirteen followed suit, the pieces salvaged for wartime scrap drives, the coast artillery units increasingly serving antiaircraft guns or being combed out for infantry replacements. By the time rapid wartime developments were assimilated in 1945, it was planned to have only twelve of the most modern 6-inch and 16-inch batteries armed after the war. But reality was to be different from plans.

The tactical and strategic lessons of World War II, especially the wartime capabilities of modern aircraft, spelt the doom of seacoast artillery fortifications in the conventional sense. Seacoast artillery entered a final stage in which it became solely a means of defending against air attack and not against ships. Amphibious warfare had been developed to such an extent during the war that beaches far removed from built-up ports were successfully used to logistically support large field formations. This enabled the fixed defenses at large seaports to be outmaneuvered, and since not all of the coastline could be effectively defended by permanent fortifications, they lost their value. The campaign in Malaya was a classic example of the outflanking of the seaward-located 15-inch guns of Singapore by a thrust against its landward side supported logistically from beaches hundreds of miles away. Airpower had assumed an importance that relegated striking fleets to the role of mobile waterborne airfields that operated well out of range of any artillery piece. It was the atomic bomb that most strikingly necessitated expansion of the concept of the outer line of defense to a distance great enough to intercept and destroy atomic bomb-armed aircraft without harm from either blast or fallout.

In 1947, all guns at the seacoast defenses of San Francisco Bay were declared surplus with the exception of the new 6-inch and 16-inch models. The very next year however, the 16-inch rifles fell to the cutter's torch and were scrapped. Four batteries of 6-inch weapons to protect the minefields were the last conventional artillery of the permanent harbor fortifications. Battery Construction #244 at Milagra Ridge Military Reservation, Pacifica, gave up its weapons last, in 1950. The now disarmed batteries lay abandoned, or were used as dormitories, storage for explosives, or air raid shelters. In 1949 the responsibility for minefield defense passed to the control of the Navy, and the Coast Artillery disappeared as a separate arm of the U.S. Army in 1950. An era had come to a close.

Cold War Era Antiaircraft Defenses, 1952-1974

When the Army Air Defense Artillery assumed the aerial defense mission of the old Coast Artillery branch, it still carried on the mission of defending the continental United States from attack from outside its shores. The threat now came entirely from aircraft, particularly those carrying nuclear weapons. Tangible manifestations of the Cold War era are reflected in the San Francisco Bay Area in terms of the continual high state of readiness maintained by local antiaircraft defenses from the Korean War through the implementation of the Strategic Arms Limitation Treaty of 1972.

Modern conventional air defense artillery up to 120mm in caliber was emplaced around San Francisco beginning in 1950 and during the Korean War, but it was the installation of the famous Nike antiaircraft missile system in sites around San Francisco Bay that marked the transition to the Cold War in a most character-defining way. The Nike-Ajax, and its successor the nuclear-capable Nike-Hercules, were used for

medium range interception of attacking aircraft formations. These radar-guided missiles could reach thirty-seven miles (Ajax) and eighty-seven miles (Hercules) and were the most widespread and longest-lived missile systems of the Cold War era.

The Nike missile system demonstrates exceptional significance due to the large numbers of weapons deployed and the extensive area they covered (300 sites and thirty states); the great expense of such a system (the most expensive missile system to date, by far); the extraordinary longevity of the system nationwide and in the Bay Area (1954-1979 nationwide and 1954-1974 in the Bay Area); and, the unusual proximity of many of these sites to the civilian population (in essence, bringing *Doctor Strangelove* to suburban backyards and to the national consciousness).³⁶

Beginning in 1954, and under the command of the Sixth ARADCOM region (Army Air Defense Command), twelve permanent launch sites and associated control, housing, and command sites were constructed around the Bay Area (on San Pablo Ridge, Rocky Ridge, Lake Chabot and Coyote Hills in the East Bay; Milagra Ridge, Fort Winfield Scott and Fort Funston to the south of the Golden Gate; and Fort Cronkhite, Fort Barry, Angel Island and San Rafael to the north). The individual missile sites received target information in tactical firing situations from an Army air defense command post co-located with the U.S. Air Force at the early-warning radar station at the Mill Valley Air Force Station on Mt. Tamalpais.

After twenty years of constant readiness, the Nike missile system was declared obsolete by 1974. "Changing military technology made the use of long-range bombers unlikely in the event of modern war. The United States and the Soviet Union both developed Inter-Continental Ballistic Missiles (ICBMs) which flew at altitudes and speeds beyond which an AJAX or HERCULES could hope to reach. The NIKES were left without targets."³⁷

Most of these facilities have either been removed or altered to such an extent that they lack integrity, but the launching complex known as SF-88L at Fort Barry has been thoroughly restored and is widely recognized as the finest example of this quintessential Cold War weapon system in the nation.

Although less than fifty years old, the exceptional role of the Nike missile system in the spectrum of Cold War weaponry, and the remarkable level of integrity at Nike site SF-88L, clearly merit its consideration as integral to the proposed National Historic Landmark, especially within the context of a district with clear linkage to previous generations of weapons systems. Those missile stations located among the older fortifications are significant to the story of coast defense in the San Francisco Bay region because they demonstrate the exceptional range of the historic resources represented here. Nike site SF-88L is the last permanent fortification to defend San Francisco. "From Spanish colonial times up through the 1970s, many generations of fixed defenses were built to protect the people of the Bay Area, Site SF88L was the last link in that historic chain that extended backwards two centuries."³⁸

Concluding Remarks

The seacoast fortifications of San Francisco harbor have played a significant role in the military history of the United States from the time of roundshot, black powder, and bronze cannon to the era of radar guided rockets. Throughout history, it has been the best-defended harbor on the West Coast, sometimes in the entire United States, and in some ways, the entire world. Throughout the geographic area associated with San Francisco coastal fortification history, excellently preserved examples of the evolution of military construction, engineering, and technology from 1794 to 1974 provide a veritable outdoor museum. The setting of a large part of this outdoor museum has already been chosen by Congress to be worthy of inclusion in the National Park System because of its exceptional recreational, scenic, and cultural values. The tangible fortification resources must now receive the attention and treatment they need in order to be preserved.

¹ Russell F. Weigley, *History of the United States Army* (New York: The Macmillan Company, 1967), 284.

² Emanuel Raymond Lewis, *Seacoast Fortifications of the United States: An Introductory History* (Missoula, Montana: Pictorial Histories Publishing Company, 1990), 4.

³ As quoted in Colonel Eben Eveleth Winslow, *Notes on Seacoast Fortification Construction*, Occasional Papers, Engineer School, United States Army, No. 61 (Washington, D.C.: Government Printing Office, 1920), 12.

⁴ Dale E. Floyd, *Defending America's Coasts, 1775-1950: A Bibliography* (Alexandria, Virginia: U.S. Army Corps of Engineers, 1997), xi.

⁵ Emanuel Raymond Lewis, *A History of San Francisco Harbor Defense Installations: Forts Baker, Barry, Cronkhite, and Funston* (Corvallis: Oregon State University, 1965), 165.

⁶ Erwin N. Thompson, *Historic Resource Study Seacoast Fortifications of San Francisco Harbor Golden Gate National Recreation Area California* (Denver: U.S. Department of the Interior, National Park Service, 1979), 1.

⁷ Lewis, *Seacoast Fortifications*, 42.

⁸ *Ibid*, 45.

⁹ As quoted in *Ibid*, 21. 1 and 29 August 1849 and 31 March 1850, Letters Received 1838-1866, Office of the Chief of Engineers, RG 77, National Archives Record Center, San Bruno.

¹⁰ *Ibid*, 28.

¹¹ *Ibid*, 31.

¹² *Ibid*, 45.

¹³ *Ibid*, 54, 90.

¹⁴ Thompson, 45. Chief Engineer Joseph G. Totten to Secretary of War Floyd, 9 November 1859, Office of the Chief of Engineers, RG 77, National Archives Record Center, San Bruno.

¹⁵ Lewis, *Forts Baker, Barry, Cronkhite and Funston*, 34.

¹⁶ As quoted in Benjamin Franklin Gilbert, "San Francisco Harbor Defense During the Civil War," *California Historical Society Quarterly*, 33 (September 1954). Original citing, Wright to Governor Leland Stanford and Wright to General Lorenzo Thomas.

¹⁷ Lewis, *Seacoast Fortifications*, 72.

¹⁸ Thompson, 77-80.

¹⁹ *Ibid*, 103.

²⁰ *Ibid*, 93.

²¹ Lewis, *Seacoast Fortifications*, 70.

²² As quoted in Thompson, 118.

²³ Weigley, 284.

²⁴ Lewis, *Seacoast Fortifications*, 98.

²⁵ *Ibid*, 99.

²⁶ *Ibid*, 119.

²⁷ *Ibid*, 124.

²⁸ *Ibid*, 93.

²⁹ *Ibid*, 238.

³⁰ Lewis, *A History of San Francisco Harbor Defense*, 213.

³¹ Lewis, *Seacoast Fortifications*, 221.

³² Thompson, 287, and *Air Service News Letter*, 29 December 1920.

³³ See Edward S. Miller, *War Plan Orange* (Washington: Naval Institute Press, 1991) for an excellent discussion of United States planning for war with Japan at the highest strategic level, beginning in 1904, and San Francisco's role both as a base and as a part of a hemisphere-wide defense network..

³⁴ Mark Berhow, "America's Last Seacoast Defenses: The World War II-Era Construction Program," *Coast Defense Study Group Journal* 8:3 (August 1994), 33.

³⁵ Lewis, *Seacoast Fortifications*, 251.

³⁶ Michael Binder, notes from a presentation entitled "Cultural Resource Management and Cleanup of Nike Missile Sites," presented at the Annual Conference of the National Council on Public History, Sacramento, California, March 1994.

³⁷ John A. Martini, *Nike Missile Site SF88L (Fort Barry): Self-Guided Tour, Golden Gate National Recreation Area* (San Francisco: U.S. Department of the Interior, National Park Service, 1987), 7.

³⁸ *Ibid*, 7.

Chapter 3: Character-Defining Features

It is of the highest importance that the artillery organizations be encouraged to take pride in their guns and emplacements. Everything in and about the emplacements should at all times present a spick and span appearance.¹

Looking at the remnants of the fortifications that once protected the entrance to San Francisco Bay, it is difficult to appreciate what they once were. Slopes that were crisp and groomed a century ago are now muted by erosion, unplanned and untended vegetation, and a web of trails. The massive concrete emplacements are separated from their view of the sea by walls of trees, and their once-trim parapets and traverses are marked with crumbling concrete as well as the free expression of a thousand sentiments from hands that wielded an equal number of spray-paint cans. Wooden doors are shattered, steel doors are shredded with rust and corrosion. Some structures have disappeared altogether.

The atmosphere of neglect disguises one of the nation's most complete and compact representations of coastal fortifications. Pushing aside the effects of contemporary indifference reveals a rich pattern of military architecture. Coastal fortifications were once a keystone of national defense, and both treasure and talent were invested in their construction. The character of the defenses between the 1870s and World War II finds expression in the selection of location and sites, the choice of materials used in their construction, and the manner of their design. The location of the defenses moves from close to the water and harbor entrances, to distant from them. Concrete becomes the preferred building material, wholly displacing the earlier preference for brick and stone. The plan of the batteries shifts from two guns side by side in a single emplacement, to two guns each in its own emplacement—separated from the other by hundreds of feet. The design of individual structures migrates from simple storage to sophisticated specialization.

Most discussions of character-defining features have as their orientation the conventional structures of our community, the commercial buildings and private dwellings that make up our cities and towns. In these structures, the idea of materials, craftsmanship, decorative details, and interiors have a familiar vocabulary because we encounter these buildings every day, and we come to know what to expect in similar buildings. We also know that architects design with such qualities in mind. All of these aspects of character-defining features disappear when we turn to fortifications. Their forms are architectonic rather than architectural, and we need to look carefully at their use and history to determine the unique nature of their distinctive qualities.

Location and Site

Principal Character-Defining Features

Since coastal fortifications were built to mount artillery, the location of the gun batteries was affected by the range of the armament. The ordnance available in the 1870s had a range that was short, and thus the batteries built at the time had to be close to the water. They also had to be close to the narrowest area of the harbor entrance. As the range of cannon increased, there was greater flexibility in where the fortifications could be located.

Change Over Time

The guns mounted in the 1870s had a range between 4,200 and 5,000 yards, and as a result they occupied sites that were close to the shore. The engineers could not afford to sacrifice any of their ability to cover a water area by choosing locations that might be better from the point of view of construction or protection. Typically, the batteries of the 1870s flanked a waterway in a long line, in a fashion reproduced by West Battery and East Battery, or as a defended point such as Ridge and Cavallo Batteries. The locations in

San Francisco were notable in that they were very high; on the north side of the Golden Gate, Ridge Battery and Cliff Battery occupied positions more than 400 feet above the sea.² These were enviable positions from the point of view of the defenders, giving them the ability to fire down on hostile vessels. Batteries at lower elevations (although no site occupied in the 1870s at San Francisco could be considered low) had to do with bombarding the ships from the sides, the above-water hulls being more difficult to penetrate.

The locations selected for the construction of the 1890s (and later) often duplicated—and therefore displaced—the locations chosen for earlier works. Distance from the shore was less of a consideration—the maximum range of heavy guns had increased to about 12,000 yards with an expected “working” range of about 5,000 yards—but the sites occupied by earlier batteries were still desirable because, given the topography, they were the right ones. Height remained the defenders’ best ally in implementing the recommendations of the Endicott Board. Thus Battery Spencer occupied the location of Cliff Battery, Batteries Marcus Miller, Cranston, and Godfrey obliterated most of West Battery, and Battery Yates found its place on top of the Cavallo Battery outwork.

Another aspect of location, as a character-defining feature, had to do with a weapon that was one of the strongest elements of the defense. Submarine mines were powerful deterrents to an attacking fleet, so mine fields were carefully located on both sides of the harbor entrance. Electrical cables connected the mines to the shore, and the mines could be exploded electrically at just the right moment. The mine fields needed protection, and some batteries occupied locations chosen for their view of the mine fields rather than positions from which they could bombard vessels. Batteries Duncan, Yates, Slaughter, Sherwood, Blaney and Baldwin, in conjunction with other batteries at Fort Mason and Fort McDowell, overlooked the interior mine fields, and together they created an internal corridor to the defenses that did not before exist. Their positions east of the Golden Gate reflected the importance assigned to the mine defense. Seaward, batteries of 6-inch guns at Fort Scott and Fort Barry occupied positions where they could defend the minefields west of the harbor entrance.

Locations for the mortar batteries also reflected the particular aspects of this artillery weapon. Batteries Howe-Wagner, Stotsenberg-McKinnon, and Alexander were placed well back from the shore because the mortars had a minimum range; locating them too close to the shore would create a gap in the defended water area. In addition, the engineers preferred to locate a mortar battery behind a large hill or elevation that not only obscured the battery from view, but also provided it with substantial protection from naval bombardment.

The batteries of the 1890s began a trend that continued to World War II: the spread of the defenses to the north and south to locations that could support the defenses in the immediate vicinity of the Golden Gate. Fort Miley, the first of these specialized posts, occupied a position that denied a sheltered location from which vessels could attack the batteries farther north. The spread of the defenses was an indication that geography could hinder as well as help. The same geography that gifted the engineers with high elevations also presented them with a difficult problem in coast defense—defending a port that was essentially a gap in an unbroken coastal scarp.³

By the advent of World War II, the range of the guns had increased to more than twenty-five miles, and the location again reflected the change in technology. Gun batteries pushed further outward, as did the proliferating numbers of fire control stations now required for the long-range cannon. With weapons so powerful, there was no consideration of their position in regard to the shoreline. Instead, location was a matter of selecting the best site to make the most of the guns to be mounted there. Location in this period also reflects an increased desire to take advantage of existing terrain for added protection from the air, a new and more deadly form of assault than that offered by the warships that were the targets of the coast guns.

In addition to the geographic location of the batteries, their character was also defined by changes to the sites themselves. In the 1870s and through the Endicott period, the site improvements were often not much more than a cleared space or road to the rear of the battery. This feature was often identified as the battery parade, a space used to form up the artillery detachment before it took to the guns, but it was also used as a means of point-to-point communication. East Battery retains its parade as a path used by visitors today. Battery Spencer features an approach road that is a covered way, a conventional feature of much older fortifications. Roads and parades were often surfaced with crushed rock or brick, or compacted clay. Gutters and drains trimmed the edges.

The areas in front of Endicott and Taft works were graded flat with a slight angle of depression that continued the concrete slope of the battery. Although distinct angles in earth were discouraged in the 1890s as potentially giving away the location of the guns, Cavallo Battery was a complete exercise in earth shaping. The site and the structure itself were made of the same material, and at its completion, it appeared to emerge from the earth with a symmetry and regularity that made it immediately distinguishable from its surroundings. The sites of batteries built during the period of air power display the great attention that was devoted to duplicating natural land forms. The splayed emplacements of Battery Townsley are an effective demonstration of the care that was taken to work the construction into the landscape when regularity might otherwise reveal its position. Wherever possible, the site was carried over the work through camouflage. Roads in this period did not so much connect the elements of the defense as they led past them.

There were other site features of smaller scale. Stone retaining walls survive at Battery Blaney, and the right wall of Battery Crosby extends as a retaining wall. The lightly-built structures of the Endicott-Taft fire control systems were given a degree of protection by modifying the construction sites with a depression or surround of earth. The early battery commander's stations for Saffold and Godfrey are indications of these practices.

Construction Materials

Principal Character-Defining Features

Construction materials exhibit the adaptation of common materials to the specific requirements of military architecture; the techniques of construction exhibit a high degree of craftsmanship, and in the case of concrete, a growing understanding of how the material can be used.

Change Over Time

The defenses of the 1870s were distinctly different from those that had preceded them as well as from those that followed. They were built largely of earth, and viewed today, they appear to be sculpted from the surrounding terrain. That is a deceptive vision. Earth was the material that was used in the greatest quantity, but it was earth placed over and around armatures of brick, concrete, and stone. The traverse magazines were concrete or brick rooms covered in deep banks of earth; emplacements featured granite blocks to support the heavy muzzle-loading cannon. Brickwork faced the parapets and the entry to the magazines. These other critical building materials were disguised by the mounding of earth around the structural elements, and today they have become further obscured by lush plant growth.

Earth was the natural choice for a number of reasons. As presented in almost every overview of the history of fortifications, the American Civil War demonstrated that the age of the masonry fortress had passed, to be replaced by earthworks that could better absorb the force of the more powerful ordnance then arriving in arsenals throughout the world. They also could be built and repaired more easily. Earth remained the best choice in the 1870s for another reason—military technology was moving forward rapidly, and it was difficult to know what to prepare against. The defenses built by the United States at

that time were intended to be only an interim solution. They would do until the nature of the threat could be better perceived and the capacity of the nation to support a specific type of coast defense was better understood, and the designs of proposed new guns and carriages could be settled upon.

The brickwork in this period formed the round-arched passageways that connected different portions of the defenses. Exposed arch faces were made of common brick that was not sanded to shape; mortar joints were tapered instead. The craftsmanship was at a level equal to other well-built masonry structures, and it has contributed to the generally excellent condition still apparent today (Plate 11). There was little stone. At Cavallo Battery, lintels and sills were of cut granite set into the brick walls. East Battery contains an indicator of things to come. The groin formed by the intersection of two galleries is rendered in concrete, not brick. It is a limited application of the material, and early evidence that concrete was considered simple to fashion into complex shapes, more economical than brick and requiring less skill.



Plate 11. The quality of brickwork in the surviving elements of the 1870s is very high, reflecting both the careful selection of materials as well as the skill of the masons. Cavallo Battery.

Earth remained an essential feature in the 1890s. Each battery was designed to resist the penetration of a projectile, the resistance calculated in so many feet of earth placed in front of so many feet of concrete. In addition to its protective values, earth was graded into the natural contours surrounding each structure (Plates 12 and 13). It remained equally important in later years, as earth cover protected fortifications from attack and observation by both sea and air.

There were some shortcomings. The long side slopes of Batteries Howe and Wagner were made of clay faced with a deep layer of loam, and then planted. Moles and gophers criss-crossed the area with burrows, and in the heavy rains of the 1894-1895 winter, the slopes turned liquid and flowed into the mortar pits. After the exhausting work of removing some 1,000 cubic yards of material by hand and

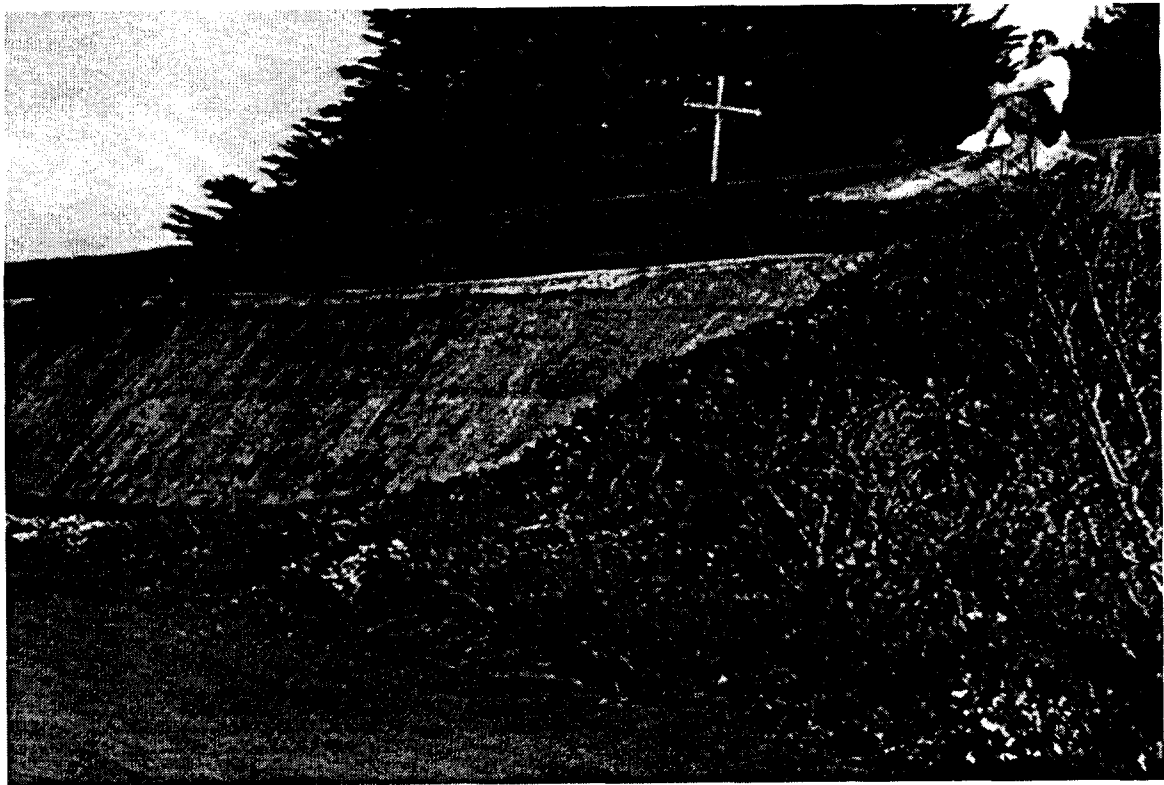

Plate 12. Earth was a critically important component of fortification construction: its loss can distort the intended appearance of a structure. Battery Godfrey.



Plate 13. Earth remained a constant in the fortifications built after the Civil War. Here at the Fort Barry mine casemate, it covered a modern structure of reinforced concrete, rendering that structure invisible to eyes that might view it from the sea or the air.

carried out in pails, the slopes were rebuilt.⁴ Landslides in disturbed slopes were not uncommon, and earth would settle in unanticipated ways or not hold the slopes intended for it. The material continues to act in the same manner in fortifications currently held as historic properties. For example, the state of New Jersey recently went to considerable expense to stabilize the earth slopes surrounding a battery at Fort Mott State Park.⁵

Brick and stone were not part of fortifications built after the 1870s. Some defenses on the East Coast retained masonry as a decorative element in concrete or as an anchor for door hinge-pins, but these practices were not incorporated into the works at San Francisco. Concrete was the material of choice for all modern work. It was rapidly replacing stone as a choice in commercial building and paving, and seemed ideal for the type of defenses contemplated by the Endicott Board.

Concrete was the hallmark of the new fortifications, and it made manifest the break with all previous techniques of fortification. The construction of new works of concrete made it clear that the form of American coast defenses had come of age, and the selection of concrete as the material of the future emphasized how tentative had been the system of the 1870s.

The coast defense weapons of the 1890s were more massive, more strongly built, and more complex than any that had preceded them. Guns and their carriages could weigh hundreds of tons, other mechanical devices required electrical power to operate, and electricity illuminated the interior of the emplacements. These new and sophisticated devices required protection from naval weapons that were equally impressive, and they also required a clean environment. These were qualities that concrete could provide better than anything else available to the designers and builders. Concrete was the material of modernity, and fluid shapes of concrete symbolized what was up to date in both civil and military architecture well into the 1940s.⁶

Portland cement was used in all the concrete placed in the defenses of San Francisco. As a result, the fortifications built in the fifty-year period from the close of the nineteenth century to the close of World War II are notable for the quality of their basic fabric. Moreover, they are also distinctive for the finish given the concrete. More than anything else, it is the visible surface of a concrete structure that best expresses the care with which it was built.

Vertical and horizontal surfaces have differing character-defining features. Vertical surfaces often show indications of the formwork or shuttering that was erected to hold the mixed concrete in place until it hardened. Sometimes these features were disguised or softened by parging the surface or sanding it to remove the shuttering marks. Some batteries show several of these features together, as at Battery Marcus Miller. In that instance, the differences in the finish are also indications of a difference in construction sequence, the center part of the emplacement being completed first to allow mounting the gun at the earliest opportunity (Plate 14). Horizontal surfaces were considered walking surfaces and received a different treatment. Often the aggregate was a coarse sand of ground granite used in many paving applications, and it had a look and feel that was distinct. Horizontal surfaces were also marked in flags, the division of the plain surface into regular shapes by narrow grooves pressed into the wet concrete. The purpose was in part decorative, but it was also an aid in drainage and the control of surface cracking (Plate 15).

The nature of finished surfaces changed in the 1930s and 1940s. The methods of building with concrete had altered over the years, and the structures built during that time contain reflections of those practices.



Plate 14. Concrete often retains evidence of how it was placed and finished. Different methods can still be seen today, and are expressions of building history. Battery Marcus Miller.

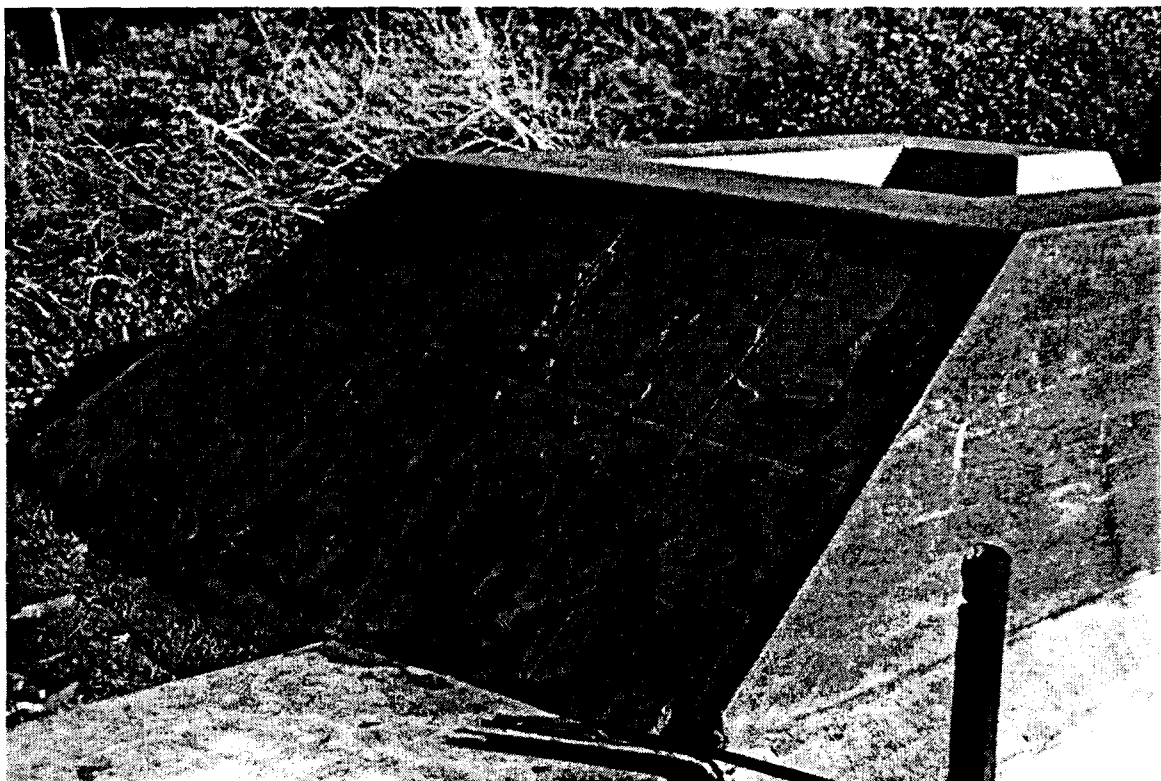

Plate 15. Exposed concrete was often finished very carefully, both for the sake of appearance as well as helping to produce a waterproof surface. Crows nest, emplacement one, Battery Crosby.

Plywood panels replaced the use of individual form boards, and specialized hardware (some of which remains intact at the ceiling level of emplacement two, Battery Construction #129) helped speed the erection of the formwork. Surfaces were not parged because the shuttering itself tended to leave a more handsome and finished appearance. Some horizontal surfaces were rendered with a cement-rich mixture that left a smooth, almost lustrous surface that was unbroken by flags, while other floors were completed in a manner that was similar to earlier practices.

One of the results of early concrete construction was an unusually porous mass, and there were many efforts to control water penetration and to encourage run-off. These efforts could leave visible marks on the defenses, and they are an important aspect of their history as structures. While many surface coatings were tried, the one that is the most evident today is tar, and many horizontal surfaces retain surviving flecks and splotches of the tar layer. The introduction of the Taylor-Raymond ammunition hoists in 1904 brought about significant modifications to many existing batteries, including the addition of layers of new concrete over the old. The event was an opportunity for greater efforts at waterproofing, and sometimes layers of sheet lead or tar were incorporated into the modifications; Battery Godfrey contains exceptionally clear evidence of the practice. The forward slope of Battery Godfrey also depicts an example of an informal response to the need to promote surface drainage as well as to build up the surface of a settled mass. Drains of iron pipe with an in-fill of local clay saturated with oil or asphalt are the distinguishing marks of an expedient repair to a permanent structure.

Painted surfaces are also a character-defining feature, and paint was applied on both the exterior and the interior. In most early batteries, interior painting schemes were simple, often little more than a white ceiling and upper walls, with black lower walls (Plate 16). The result was a more reflective surface that made the most of the limited lighting in place, coupled with one that hid dirt and scuff marks that were inevitable during use. Exterior colors served to dull the surface of new concrete, which could be almost white in bright sunlight. The painting of Battery Duncan was an exception, and the upper walls of the tall traverse were rendered in red to better match the clay of its building site.⁷ Battery Duncan also contains the fading evidence of another feature once common in coast defense practice—the painting of a time-range grid on a traverse wall where it could be seen by the gun crew.

Other less prominent materials also contribute to the character of the defenses. Wood, bronze, ferrous metals, and clay tile all served their own particular purpose and were part of the composite.

Bronze frequently found use in hinge-pins, and was typically cast into a unit that could be incorporated into a structure during its construction. Although the doors are missing in some places, the bronze hinge-pins remain intact, except in those places where they have been robbed out of the structure for their salvage value. Battery Spencer bears ample testimony to the practice. Door closures, where they remain, can also be bronze.

The most readily visible use of wood is in the heavy doors that close most of the entrances. A wooden door built of layers of tongue-and-groove boards, and held together with iron straps and through-bolts was a typical feature of early magazines and gun emplacements from the 1870s through the initial years of the Endicott period. They were not a universal success, and the intent was to replace them with riveted doors of iron and steel.⁸ Newer construction included metal doors, and as a result an addition to an older battery (the power room at Battery Saffold, for example) would carry doors of metal while the balance of the battery retained the original wooden versions. Fewer wooden doors were replaced in the San Francisco defenses than elsewhere, perhaps because the generally benign climate was more favorable to their continued good condition (Plate 17).

Wooden boards set high on the interior walls of concrete emplacements provided a fastening surface for the brackets that held electrical wiring, and wooden wiring chases were a common feature of many Endicott and Taft structures, particularly in fire control buildings. Wood-framed Sewell buildings (a type

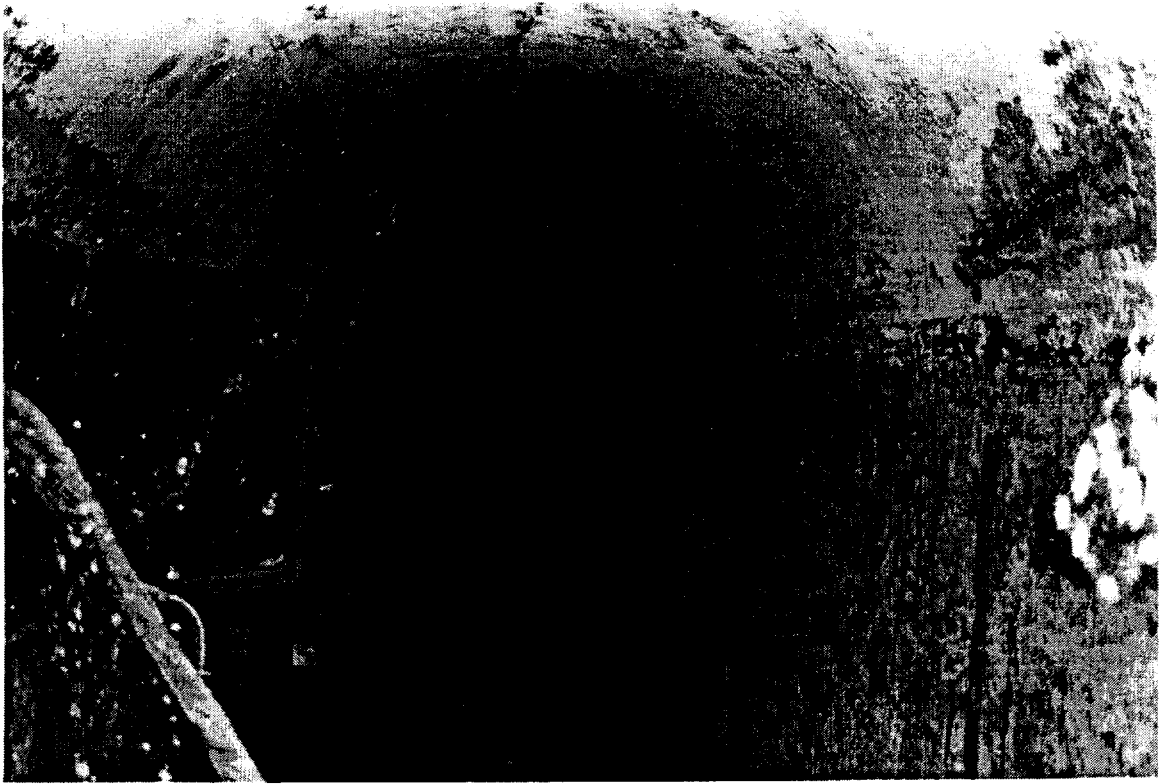

Plate 16. The simple contrasting color scheme of black and white was basic to early concrete fortifications. This interior view of Marcus Miller also shows the round-arched ceilings that were also typical of the first construction work of the 1890s.

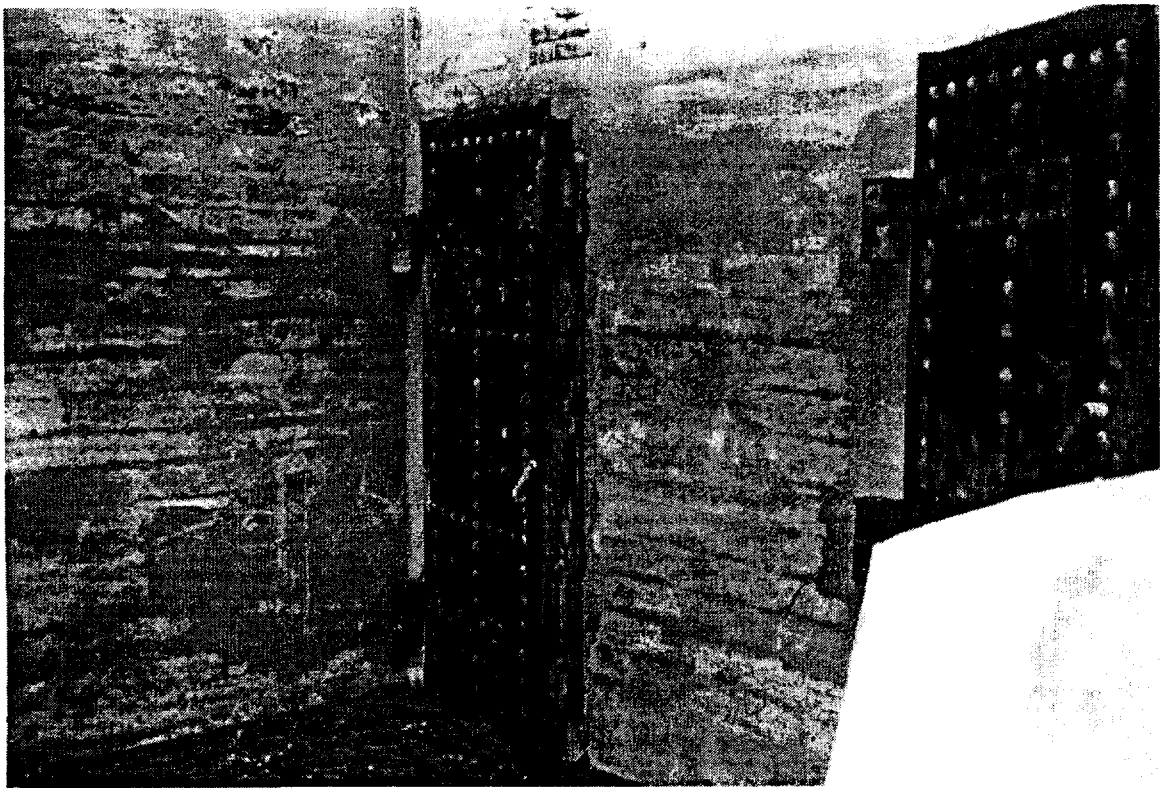

Plate 17. The steel doors and window closures of Battery Dynamite are among the most massive in the defenses, and may indicate the replacement of original closures when this portion of the battery was converted to a telephone switchboard.

of construction that called for cement plaster over expanded metal lath) were used for many auxiliary purposes in coastal fortifications, although none have been identified to date in the San Francisco defenses. The latrines built for Batteries Stotsenburg-McKinnon and Duncan were probably of Sewell construction; the concrete floors and partial walls are all that remain today. Wood plaques also carried identifiers for speaking tubes (Battery Crosby has one such plaque in place, although it is heavily damaged and unreadable) and doors. Wooden window sash is also a common feature of the early San Francisco defenses, although they were less frequently used in other locations of the same time period. During the World War II period, wood found employment for the interior doors and partitions of the Fort Barry mine casemate, the combined mine casemate at Baker Beach, temporary magazine doors at Battery Construction #129, and other locations.

Features of iron and steel are an expected component of fortifications. They are character-defining because of their intended purpose, but also because they help moderate what would otherwise be a plane of concrete; in addition, they often contain a level of detail that is otherwise absent from the structures. Most prominent and already mentioned are the heavy doors, both single- and double-leaf, but also important in their ability to add detail to fortifications are the shutters in observation stations and telautograph booths, ceiling beams and reinforcing bars, trolley I-beams, lighting fixtures, curved pipe railings (Battery Kirby), ladders (Battery Boutelle), stairs (Battery Marcus Miller), gates (Battery Construction #129 and Battery Townsley), stanchion and chain railings (Battery Stotsenburg-McKinnon), window grilles (Batteries Mendell and Duncan, as well as others), ventilator openings (Battery Crosby), and components of ammunition service and supply. Many of the elements are damaged or in some cases missing altogether, and their current state helps promote the sense that the fortifications are of little historical value (Plate 18).

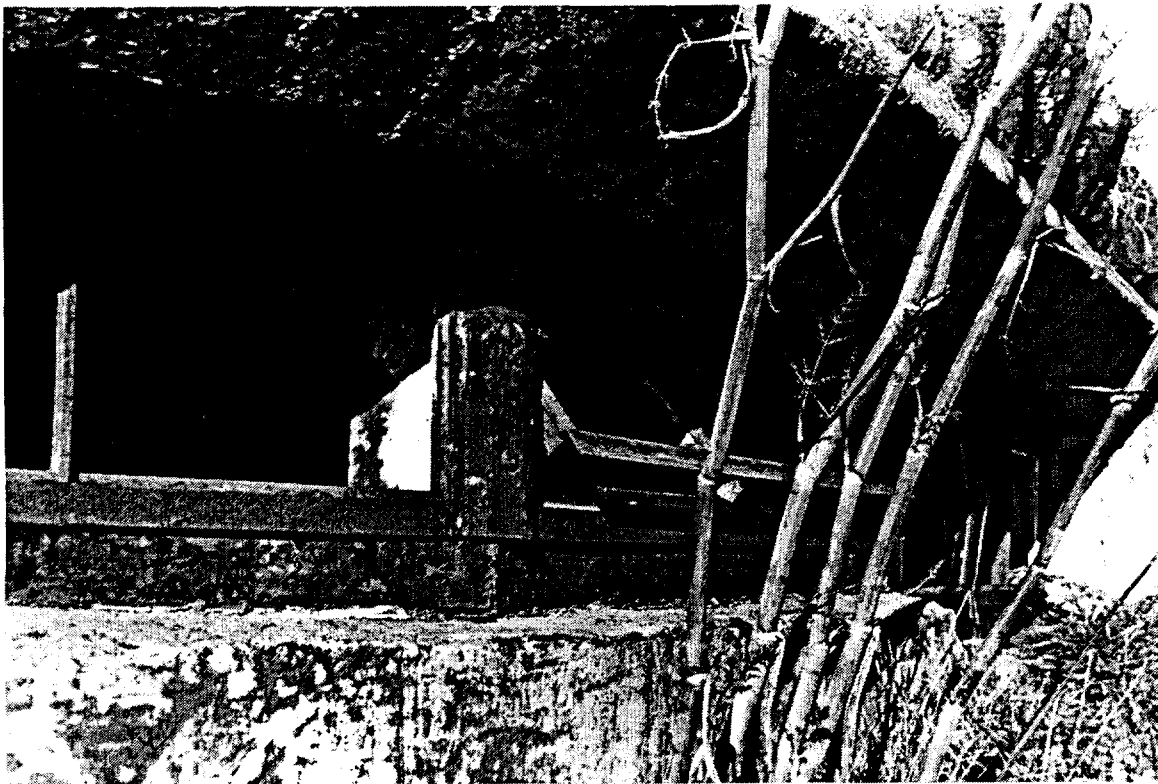

Plate 18. Metals—usually bronze, iron, and steel—served many specialized uses in fortifications, such as this tilting sash at the BC Station, Battery Construction #129.

Clay tile appears as electrical ductwork (an unusual example is in the ramped passage of emplacement three, Battery Godfrey) and as a sub-surface applique to help move water away from concrete walls. That use carried through World War II. Clay tile also appeared in one visually distinctive and widely used form, and it apparently has but one surviving example. Roof ventilators in concrete structures that served auxiliary purposes (power plants, plotting rooms, storage battery rooms, latrines, and so on) were often fitted with a decorative clay cap. These were always fragile, and today all are gone save one, and it is perhaps the most unlikely survivor of all. In the gardens that have been built in the remnants of Battery Lancaster, the single example of a “Mandary” flue cap stands among the plantings, its pagoda-like form making it appear to be a consciously selected element of the landscape.⁹

Structure

Principal Character-Defining Features

Each of the three major periods of construction—1870s, Endicott-Taft, and World War II—produced structures that characterized the style of fortifications then in force. The structures, and the collections of multiple structures, ranged from simple forms in the 1870s, to complex in Endicott-Taft, and to sophisticated in the final years of coast defense.

Change Over Time

The basic character of the fortifications of the 1870s emphasized their impermanence and their place in military architecture as transitional designs. Although West and East Batteries were little more than enhancements on the hastily built works of the Civil War, more regard needs to be given to Cavallo Battery. As mentioned earlier, its character devolves from the material used in its construction, but with its salients and parapet enclosing the entire work, it was also self-defensible. That capacity was unique among the other coastal fortifications of the 1870s, and the battery was arranged in that manner because of its isolated location. Its articulate combination of slopes and angles have been called handsome, and few can fail to be impressed by this singular structure.¹⁰ The architectural quality of Cavallo Battery places it with that small group of fortifications that are recognized and valued by the general public, an aspect that is enhanced by the emergence of its conspicuously artificial form from the surrounding terrain.

The work of the Endicott and Taft boards produced a dizzying variety of structures with an equally diverse catalog of character-defining features. For gun and mortar batteries, the major features are in the plan, the program contained by the plan, and the external form. The time of the design—whether it was done before or after 1900 —also had a particular influence on the appearance of gun batteries.

The large-caliber gun batteries in San Francisco were among the first designs to be put into concrete, and Batteries Marcus Miller and Godfrey are good examples of early floor plan designs. The interior plan was simple, and consists basically of narrow rooms that seem to be little more than spaces hollowed out of the concrete mass for the storage of projectiles and powder. A single passageway, also narrow, led into the shot room, which itself connected to a forebay that linked the powder room to a small hoist shaft leading to the exterior. The passageway was long, in the case of Battery Godfrey some forty feet, but about half that distance in Battery Marcus Miller. The passageways were the principle entry as well as serving as the galleries for ammunition supply. Moving ammunition into Marcus Miller was direct since the entry gallery was at the same elevation as the roadway behind it. That same movement was more difficult at Battery Godfrey because there the entry passageways were at the foot of a long, narrow, and comparatively steep ramp that led below the road elevation. Considering that the projectiles fired by the



Plate 19. Tramways with turntables at intersections carried small rail cars that could be pushed by several men to carry ammunition into the interior of a battery. They were an uncommon feature of fortifications built in the United States. Battery Stotsenburg-McKinnon.

12-inch guns of the battery weighed a half-ton each, moving them down the ramp and into the magazine must have been a tedious and difficult requirement to meet (Plate 19).

The plans of Endicott batteries shifted as engineers began to see more efficient ways to meet the needs of the artillery service, and understanding the evidence of that pattern of change is key in a comparative evaluation of individual batteries. As an example, Battery Saffold is also an early battery, designed in 1896, and it reveals a shift in floor plan that underscores change as an early constant. The entryway at Saffold is a true circulation corridor, and the magazine spaces open onto the corridor, each with its own entry. There was also an additional room in the interior; called a bombproof, intended for shelter during bombardment, and its inclusion demonstrates the desire for more specialized spaces within the battery interior.

While changes in the nature of the interior floor plan may be difficult to perceive in structures whose interiors are not accessible, the exteriors contain a great many examples of improvements made after their initial construction. Almost all major caliber gun batteries show the effect of additions and other improvements. Not long after Batteries Marcus Miller and Godfrey were completed, the artillery officers complained that they did not offer all the space that was necessary, and engineer officers had their own list of changes they wanted to make as well. As a result, small separate structures were tacked onto the new batteries. On the right rear of emplacement three of Battery Marcus Miller, the engineers situated storerooms, a latrine, and a motor-generator room; they also added a plotting room behind emplacement one. Engineers built a similar collection of rooms into a much more constricted space between the right side of Battery Godfrey and a retained 1870s magazine. In much the same vein, the magazine space of the same battery was expanded by the addition of a large room; the windows of the enlarged magazine are visible at the rear of the battery.

There were other conspicuous changes as well. Between 1904 and about 1912, all the big gun batteries underwent further modifications that brought them closer to the appearance they have today. The greatest impact came about as a result of modifications to the method of delivering ammunition from the magazine to the emplacement above. The hoists installed when the batteries were first constructed were limited in many ways, and in 1904, the Army began a nationwide program to upgrade the ammunition delivery service. They installed a new mechanism called a Taylor-Raymond hoist, which required considerable reworking of most existing gun batteries. Old hoist shafts were closed, new shafts were cut through mass concrete, space was created for the new hoist mechanism in the magazine, and a heavy concrete roof called a splinterproof was built over the top of the replacement hoist. At about the same time, special booths (to house a distance writing instrument called a telautograph) were built to the rear of many emplacements, and extensions were added to some loading platforms. Earth was removed from the rear of the traverses of Marcus Miller and Godfrey, permitting movement between the loading platforms of adjacent guns for the first time since the batteries were built. The final conspicuous change came when the battery commander's stations were added to most gun batteries.

Battery Spencer shows best the changes that could be brought about by the collective improvements. Because of the compressed and angular plan, the battery parade is more like a courtyard, and it is easier here than it is at other batteries to see the net effect of the changes from a single position. The tall telautograph booth, the free-standing truck recesses, the small platform extension at emplacement one, the battery commander's station, and the Taylor-Raymond hoist positions with their thick concrete covers, all indicate improvements to the battery to keep it modern and useful. This battery too had its complement of out-buildings to make up for specialized spaces not foreseen when the battery was first designed. There was so little room on the site that these new structures had to be fitted into either side of the approach road, forming a corridor for visitors today.

After the enhancements of the Taft board had been considered and put into place, the construction of fortifications effectively came to a halt until the advent of World War II. There was some modest activity, and Battery Wallace was one of the few projects built in the United States after World War I. While it appears to be wholly unrelated to features common in Endicott works, Battery Wallace and others like it were the natural outgrowth of the designs that took shape at the turn of the century.

The fundamental character-defining feature of the first concrete batteries was a two-story appearance. The magazines were on the first or ground floor, and the gun above was on a higher level with the ammunition hoist connecting the two. That was never a wholly satisfactory design for a number of reasons, and after much experimentation, the engineers were able to do away with the hoist and it became possible to place ammunition storage and the gun on the same level. Battery Wallace, a later version of that idea, was built for a different type of gun, but it contained an equally dramatic element that set it and later batteries aside from what had been built before. They were now to be single-story structures. The guns were widely separated from each other, and the magazines and storage spaces between the guns were covered with a heavy layer of earth (Plates 20 and 21).

Battery Wallace, Battery Davis, Battery Construction #129 and others like them, are the culmination of what had been learned during the construction of the Endicott and Taft periods. Where plotting rooms, power plants, latrines, store rooms, and guard rooms had been added onto the exterior of the gun batteries of the 1890s, later designs of that period (Battery Mendell) had incorporated those features into the floor plan at the outset. It was only natural that all of those elements would be in place when the next generation of coast defenses came to be built. The character-defining feature of these plans was efficiency, and the visual quality was characterized by a subtle appearance that made them seem more a part of the landscape. In some ways, the designs had come full circle, the works of World War II bearing similarities of form to those of the 1870s. Missing from that assessment is the acknowledgment of the

sophistication of these last fortifications, for they represented the conquest of many of the problems of design and construction experienced in the first generation of concrete fortifications.

Linking Analysis to the Coast Defense Resource Checklist

The major divisions of this chapter—Location and Site, Construction Materials, and Structure—also form the core of the Coast Defense Resource Checklist. The checklist is the device by which much of the content of this manual is conveyed to the resources. Those preparing inventories will have to be alert to the variable nature of fortification structures and look beyond the brief and comprehensive categories included on the checklist.

The character-defining features of fortifications are often nuanced, surprising in a resource whose most conspicuous aspect is great size. For example, there are many types of railings and rail fittings, and the checklist should note the varieties—or link to another document that catalogs these differences. Failure to identify and acknowledge the importance of such detail can lead to unfortunate choices, such as the replacement handrail at Battery Chester. These details change from one structure to the next. Iron doors may cover ventilation openings in one battery, but a grill might be used for the same purpose in another. Noting both uses is a part of any inventory.

Vegetation poses its own set of challenges. The control of the landscape was presumed in fortification design, especially during the period when aircraft came into military use for observation. Yet few of the landscape decisions made by the builders are recognizable today. Small trees that may have been planted on the slopes of batteries have grown to a maturity they were never intended to reach. Heavy underbrush has effectively destroyed the visible evidence of any original groundcover. The combined effect can often isolate a coast defense structure from a necessary view of the water area, and that view as well is a character-defining feature. The fundamental purpose of plant materials in fortifications was to disguise and obscure the location of a structure, but not at the cost of reducing their effectiveness.

The lesson to be learned from this chapter is that the successful comprehensive identification of character-defining features moves from the general to the specific. The general is included on the Coast Defense Resource Checklist, but the specific must remain in the hands—and eyes—of those who will complete the forms.

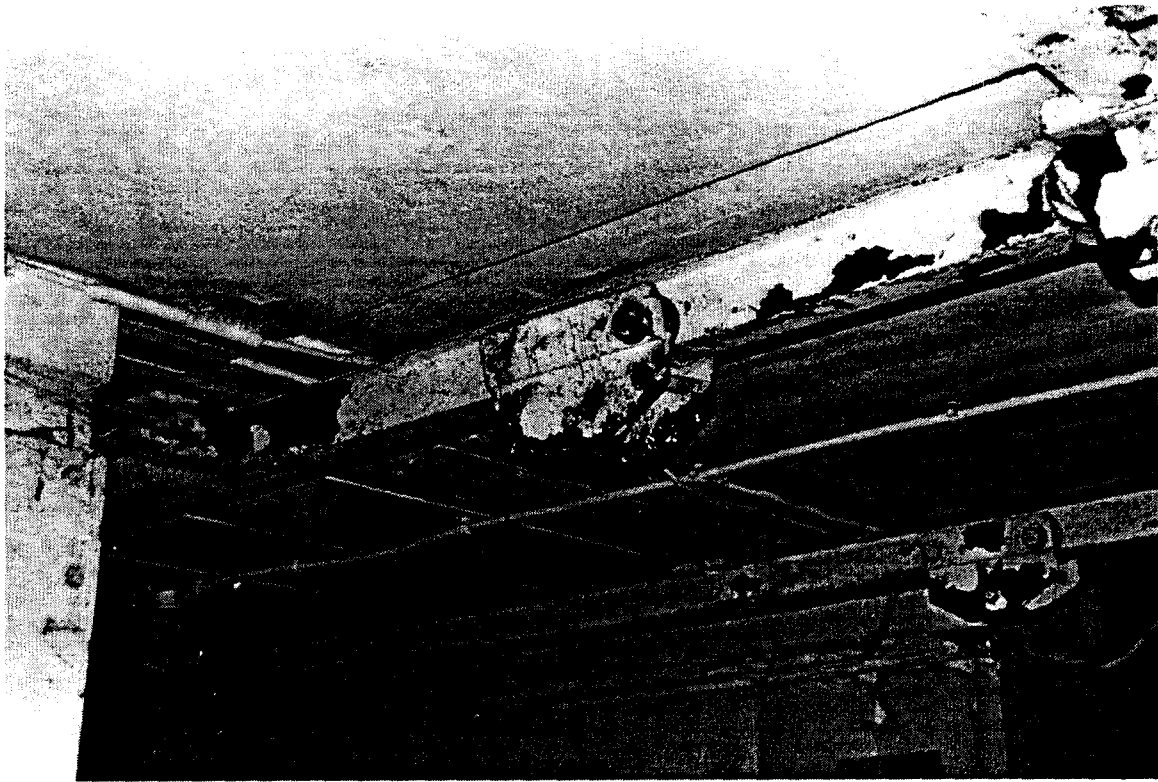

Plate 20. Almost all mortar batteries featured ceiling trolleys for delivering ammunition to the exterior of the emplacement. Trolleys found the same use in batteries for large-caliber guns, but there they led to an ammunition hoist. Battery Stotsenburg-McKinnon.

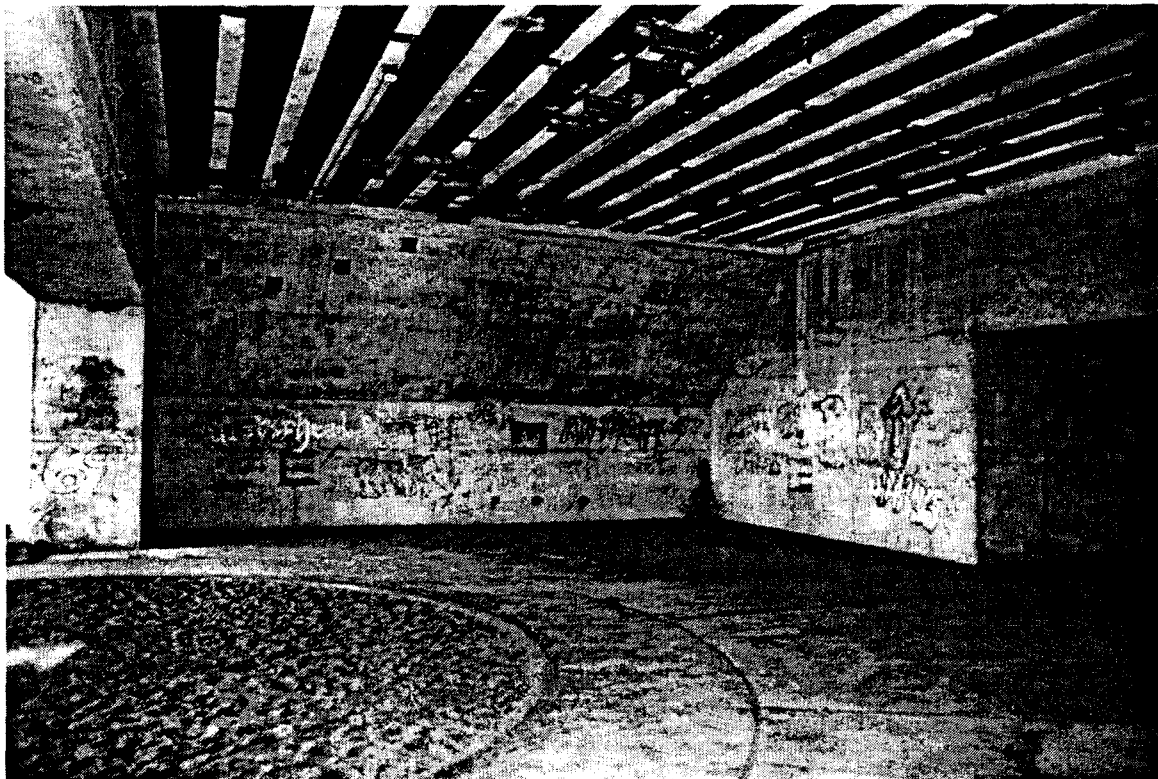

Plate 21. Ceiling trolleys were efficient, and they were also out of the way, leaving ample space in the battery. Fastenings for overhead trolleys dot the ceiling of emplacement one, Battery Wallace.

¹ U.S. Army Corps of Engineers, Board of Engineers, *Mimeograph No. 102*, "Storage of implements, etc., at emplacements," 16 January 1907. Hereafter cited by mimeograph number, title, and date. Erwin N. Thompson, *Historic Resource Study, Seacoast Fortifications, San Francisco Harbor, Golden Gate National Recreation Area* (Denver: U.S. Department of the Interior, National Park Service, 1979), 93.

² *Mimeograph No. 2*, "Memoir of Mortar Battery No. 1, Fort Point, Cal.," 30 September 1895.

³ San Francisco's port, as essentially a gap in an unbroken coastal scarp, made defense in depth more difficult. In the case of San Francisco, defense in depth was accomplished by the creation of mine fields and covering batteries *inside* the harbor entrance, a less than satisfactory solution. At other locations, local geography allowed the use of more numerous headlands and islands *outboard* of the harbor mouth. A well-maintained navigation channel through shallow water at still other locations also helped govern the nature of approach for any attacking fleet. These advantages are not present at San Francisco.

⁴ U.S. House of Representatives, *Annual Report of the Chief of Engineers, United States Army, to the Secretary of War*, 1895, 517.

⁵ Watson and Henry Associates, "Concrete Stabilization, Battery Gregg and Postern Tunnel, Fort Mott State Park," project specifications, 17 February 1995.

⁶ Keith Mallory and Arvid Ottar, *The Architecture of War* (New York: Pantheon Books, 1973), 281.

⁷ U.S. House of Representatives, *Annual Report of the Chief of Engineers, United States Army, to the Secretary of War*, 1899, 987.

⁸ *Mimeograph No. 64*, 16th endorsement, 19 June 1903.

⁹ *Mimeograph No. 48*, 42nd supplement, "Brick switchboard room, type B, at Fort Totten, N.Y.," 16 December 1907, sheet 3.

¹⁰ Thompson, 106.

Chapter 4: Standards and Guidelines for the Preservation Process

The Existing Management Plan

The *Golden Gate National Recreation Area/Point Reyes National Seashore General Management Plan/Environmental Analysis* of 1980 conceptualized a series of natural resource and historic resource management zones. Within the category of historic resource zones, the *General Management Plan* placed all the fortifications in the "preservation zone," along with the historic ships, lighthouses, and the historic buildings on Alcatraz. (Today historic ships are treated as a separate national park.)

The *General Management Plan* describes the preservation zone for the Golden Gate National Recreation Area as follows:

Spaces and objects placed in this category are managed and used primarily for the purpose of facilitating public enjoyment, understanding, and appreciation of their historic values. Management activities will include the protection of structures from influences and uses that could cause deterioration and the presentation of tours, exhibits, or other appropriate interpretive efforts.

Because of the unusually large number of historic structures in the parks, many that are suitable for adaptive use have been placed in this category simply because a use has not yet been specifically identified for them. Undoubtedly some of these will be adapted for management or visitor uses in the future, but in the meantime they will be simply protected from damage and deterioration.

The National Park Service has treated most of the batteries, base-end stations, and other related ancillaries in a preservation mode as funding and personnel resources permitted. The few exceptions have been handled as adaptive reuse, and include a small museum of coast defense at Battery Chamberlin; stables for the Park Police at Battery Livingston-Springer; and, an environmental education camping facility at Battery Alexander. In 1994, the *Final General Management Plan Amendment Environmental Impact Statement, Presidio of San Francisco* essentially reaffirmed the *General Management Plan* of 1980 when it prescribed a continued preservation treatment for the fortifications at the Presidio: "Historic structures along this stretch of the coast will be stabilized and preserved." Intent across the National Park Service management documentation is to encourage preservation.

Historic Preservation Guidelines

Guidelines directly pertinent to the seacoast fortifications under the jurisdiction of the National Park Service management include those listed below, and can be grouped as references for general stewardship and as ones offering technical advice.

Stewardship

1. Kay D. Weeks and Anne E. Grimmer, *Secretary of the Interior's Standards for the Treatment of Historic Properties with Illustrated Guidelines for Preserving, Rehabilitating, Restoring & Reconstructing Historic Buildings*, Washington, D.C.: National Park Service, 1996. (Unillustrated version, 1995.)
2. Charles Birnbaum, with Chris Capella-Peters, editors, *Secretary of the Interior's Standards for the Treatment of Historic Properties with Guidelines for the Treatment of Cultural Landscapes*, Washington, D.C.: National Park Service, 1996.
3. *Guide to Sustainable Earthworks Management [90% Draft]*, Washington, D.C.: National Park Service in association with the Georgia Trust for Historic Preservation, 1998.

4. Robert Page, Cathy A. Gilbert, and Susan A. Dolan, *A Guide to Cultural Landscape Reports: Contents, Process, and Techniques*, Washington, D.C.: National Park Service, 1998.
5. Margaret Coffin, Olmsted Center for Landscape Preservation, *Guide to Developing a Preservation Maintenance Plan for a Historic Landscape*, Washington, D.C.: National Park Service, 1995.
6. *Cultural Resource Management Guideline*, National Park Service Bulletin No.28, Release No. 5, Washington, D.C.: National Park Service, 1997. [NOTE: National Park Service Director's Order No. 28: *Cultural Resource Management* states that Bulletin No. 28, Release No. 5, will provide interim guidance for cultural resource management until issuance of a cultural resource management handbook. The National Park Service anticipates that the handbook will be published by 31 December 1999.]
7. Charles A. Birnbaum, *Protecting Cultural Landscapes: Planning, Treatment and Management of Historic Landscapes*, Preservation Briefs, No. 36, Washington, D.C.: National Park Service, 1994.
8. Andropogon Associates, Ltd., *Earthworks Landscape Management Manual*, Washington, D.C.: National Park Service, 1989.

Technical Advice

1. Thomas C. Jester (ed.), *Twentieth-Century Building Materials: History and Conservation*, New York: National Park Service / McGraw-Hill.
2. Sharon C. Park, *The Use of Substitute Materials on Historic Building Exteriors*, Preservation Briefs, No.16, Washington, D.C.: National Park Service, 1988.
3. Margot Gayle, David W. Look, and John G. Waite, *Metals in America's Historic Buildings*, Washington, D.C.: Government Printing Office, 1982.
4. William B. Coney, *Preservation of Historic Concrete: Problems and General Approaches*, Preservation Briefs, No.15, Washington, D.C.: National Park Service, 1987.
5. Anne E. Grimmer, *A Glossary of Historic Masonry Deterioration Problems and Preservation Treatments*, Washington, D.C.: National Park Service, 1984.
6. Baird M. Smith, *Moisture Problems in Historic Masonry Walls, Diagnosis and Treatment*, Washington, D.C.: National Park Service, 1986.
7. Sharon C. Park, *Holding the Line: Controlling Unwanted Moisture in Historic Buildings*, Preservation Briefs, No.39, Washington, D.C.: National Park Service, 1996.
8. Robert C. Mack, *The Cleaning and Waterproof Coating of Masonry Buildings*, Preservation Briefs, No.1, Washington, D.C.: National Park Service, 1975.
9. Anne E. Grimmer, *Dangers of Abrasive Cleaning to Historic Buildings*, Preservation Briefs, No.6, Washington, D.C.: National Park Service, 1979.
10. Anne E. Grimmer, *Keeping It Clean: Removing Exterior Dirt, Paint, Stains and Graffiti from Historic Masonry Buildings*, Washington, D.C.: National Park Service, 1988.
11. Martin E. Weaver, *Removing Graffiti from Historic Masonry*, Preservation Briefs, No.38, Washington, D.C.: National Park Service, 1995.
12. Kay D. Weeks and David W. Look, *Exterior Paint Problems on Historic Woodwork*, Preservation Briefs, No.10, Washington, D.C.: National Park Service, 1982.
13. Sharon C. Park, *Proper Painting and Surface Preparation*, Preservation Tech Notes, Exterior Woodwork No.1, Washington, D.C.: National Park Service, 1986.
14. Robert C. Mack and John P. Speweik, *Repointing Mortar Joints in Historic Masonry Buildings*, Preservation Briefs, No.2, Washington, D.C.: National Park Service, 1998. [Revision of 1977 Brief.]
15. *Window Rehabilitation Guide for Historic Buildings*, Washington, D.C.: Historic Preservation Education Foundation / National Park Service, 1997.
16. Charles Fisher (ed.), *The Window Handbook: Successful Strategies for Rehabilitating Windows in Historic Buildings*, Washington, D.C.: National Park Service. [Includes

seventeen Preservation Tech Notes from 1984-1991 focused on the treatment of windows; individual authors for the Notes.]

17. John H. Myers, *The Repair Historic Wooden Windows*, Preservation Briefs, No.9, Washington, D.C.: National Park Service, 1981.
18. Sharon C. Park, *The Repair and Thermal Upgrading of Historic Steel Windows*, Preservation Briefs, No.13, Washington, D.C.: National Park Service, 1984.
19. H. Ward Jandl, *Rehabilitating Interiors in Historic Buildings—Identifying Character-Defining Elements*, Preservation Briefs, No.18, Washington, D.C.: National Park Service, 1988.
20. Sara B. Chase, *Painting Historic Interiors*, Preservation Briefs, No.28, Washington, D.C.: National Park Service, 1992.
21. Marylee MacDonald, *Repairing Historic Flat Plaster—Walls and Ceilings*, Preservation Briefs, No.21, Washington, D.C.: National Park Service, 1989.
22. Sharon C. Park, *Mothballing Historic Buildings*, Preservation Briefs, No.31, Washington, D.C.: National Park Service, 1993.

Additional publications exist which discuss management of related types of resources, but are not included here. As specific challenges arise, the Golden Gate National Recreation Area staff are advised to contact the appropriate technical professionals within the National Park Service for updated guidance. Especially useful is the internet web site: www2.cr.nps.gov/tps/tpscat_1.htm.

Levels of Treatment

The *Secretary of the Interior's Standards for the Treatment of Historic Properties* have been alive and well in the preservation community since they were first published in 1979. Revised in 1992 and most recently published in 1995 and 1996 with inclusion of guidelines for the treatment of historic buildings (1995/1996) and for the treatment of cultural landscapes (1996), the *Standards* have become the test most often applied to the work proposed for an historic property to gauge the appropriateness of what is contemplated and to consider the possible impact of individual project elements on character-defining features. The *Standards* of 1995 consider four types of possible treatments for all types of historic properties: preservation, rehabilitation, restoration, and reconstruction. Subsumed within preservation, and pertinent to the coast defense fortifications, is stabilization. (See also, chapter 9—treatment plans—for more detailed discussion of stabilization, preservation, repair, and restoration, focused on the subtopics of sitework; concrete; masonry; metals; carpentry; moisture protection; doors and windows; finishes; and, special items.)

Rehabilitation

Rehabilitation has been the treatment most often used in our communities because its purpose is to give guidance to the active reuse of historic buildings. The return to purposeful function has been a central theme in the national historic preservation movement for more than thirty years. The success of rehabilitation is revealed by the popular use of the term, and it is language that is not restricted to a narrow band of preservation professionals. The *Standards for Rehabilitation* continue to have utility in the management of historic fortifications due to their broad acceptance within the architectural community as appropriate guiding principles, and as evocative of a philosophy of treatment for historic structures. While not candidates for true rehabilitation, fortifications will still benefit from the listed “recommended” / “not recommended” guidance provided by the National Park Service within this section. Yet fortification structures are by their nature specialized, and the particular requirements of their original purpose, as well as difficulties related to some shortcomings of their design and construction, do limit their potential for modern, adaptive reuse. There are individual examples of new uses being found for former defenses, but the examples are unique and indicate a response to local needs rather than a reproducible pattern. For many years, a small public library was located in a battery at Fort Moultrie, South Carolina, and the state of Delaware occupied a portion of the mortar battery at Fort

DuPont for archives. In Washington state, a county sheriff used the capacious interior of BC 131 as a secure impound lot. The most architecturally successful rehabilitation of a coast defense structure is at Fort McKinley, Maine, where a private residence has been built into a mine casemate.

Restoration and Reconstruction

Restoration and reconstruction are also fitting treatments, but they carry severe limitations when applied to fortifications. In any but the most simple defense, restoration is made difficult because it suggests the return of absent equipment, from objects as large as a seacoast gun and carriage to as small as the knurled brass screw terminal on electrical equipment. Much of the specialized inventory that outfitted the defenses no longer exists, and without it, any restoration will ring hollow. The compelling contribution of hardware to a military structure needs no greater demonstration than that present at the Fort Barry Nike installation. The recovered and operating technology is impressive in its own right, but the sights, sounds, and even smells are distinguished elements of the exemplary restoration.

Reconstruction may be called for in those instances where structures have been removed, but whose form and function are important to a complete understanding of the fortifications as an historic resource. At Fort Scott, for example, a complete interpretive plan might call for the reconstruction of the fire control stations that once occupied Rob Hill. The expense of such a reconstruction compared with the expenditures required to address the significant needs of numerous and genuine historic structures will most certainly mean that reconstruction will be a treatment that is seldom used.

Preservation

For the great majority of fortifications of all periods, preservation is the most fitting as well as the most affordable treatment. The public ownership of most former coastal fortifications implies that some kind of interpretive use is in the future, and the protection and stabilization treatments that form a large part of the preservation standard will yield results that are satisfactory for interpretive purposes. Some types of preservation treatments are also within the capabilities of maintenance staff as well as trained volunteers; the careful pairing of projects and workers can be an effective and happy combination.

Historical Research and Evaluation

Determining what is historically important about any fortification can be challenging, and perhaps those built in the years following the Civil War even more so. Earlier works such as Fort Point or Fort Adams or Fort Knox are distinct, well-defined structures, wholly contained by their form. Later works cover extensive amounts of ground, and some related components of the World War II defenses are separated by miles. Any assessment of historical significance has to take into account such dispersal. Under those circumstances, it is too easy to consider the large and close at hand to be more important and thus more valuable than the compact and distant. Ultimately, management decisions will determine which resources receive treatment, and those decisions must consider the historical value of individual as well as collective elements of the defense.

The Archives and Documentation

The primary and secondary sources of research material for the study of fortifications are rich. The basic source is Record Group 77, the records of the Office of the Chief of Engineers maintained by the National Archives and Records Administration. Consisting of years of correspondence between district engineer offices and the Chief of Engineers in Washington, D.C., it is a voluminous record set that details the construction and maintenance of the fortifications of all periods. Much of it is held in the National Archives central collection in the nation's capitol, although locally significant elements have been sent to regional archives near the defended harbors. Few scholars have done justice to this daunting assembly, although working with the materials will reveal not only the techniques but also the reasoning of the designers and builders of the fortifications.

Related to the written record is the cartographic collection. These materials are also maintained by the National Archives, but have not been distributed to regional archives. This too is a complex holding. It contains site plans and topographical maps as well as thousands of drawings of individual structures; the gamut runs from pencil tracings of contemplated but never built features to the exquisite drafting that is part of the ink-on-vellum transfer drawings. Most are associated with written records that are contained in the textual collection, but it is often difficult to place the two elements together. Despite that difficulty, the cartographic materials are exceptionally valuable, and certainly the record most useful for the preservation of fortifications is the transfer drawing. It is the equivalent of an as-built, and depicts in great detail the nature and function of each structure as well as any equipment that had been installed at the time the work was completed by the U.S. Army Corps of Engineers and transferred to the Army's artillery force.

The Golden Gate National Recreation Area is fortunate in that it has its own extensive and professionally administered archive. Since the materials there incorporate the holdings of the post engineer at the time the property was transferred to the National Park Service, the collection contains some elements that are not included in the National Archives.

The most common form of record associated with structures built in the 1890s through the 1940s is a numbered set of forms called *Reports of Completed Works*. Created in 1919 and consolidating information that had been collected since 1896, the *Reports of Completed Works* covered gun batteries, searchlights, electrical plants, plotting rooms, and other important elements of the defenses. Form 7 of this set was a small plan of each structure, and examples of the Forms 7 for the San Francisco defenses are reproduced in Appendix B. Their page-size format and comprehensive nature have given Form 7s a reputation for desirability that exceeds their actual value as a source of information. The details they contain bear little on questions of historical significance, they can carry errors, and the scale of the Form 7 drawings is so small that they cannot be used for off-sets or construction estimates. Despite those limitations, the *Reports of Completed Works* are affirmation that all parts of the defense were considered sufficiently important to be the subject of a comprehensive record-keeping system.¹

A final important primary source is one that is also readily available. The *Annual Reports of the Chief of Engineers* are part of the Congressional serial set, and they often contain details of fortification construction. The reports are condensations or excerpts from the reports of the district engineers, and depict the contemporary interest in construction methods as well as cost control. The reasons behind any single design decision are typically not part of the text.

By far the most useful secondary source, especially for its portrayal of the antique technology and practices of coast defense, is the *Coast Defense Study Group Journal*. The articles tend toward detail and chronology rather than analysis and exposition, but they can be excellent sources of information. The Coast Defense Study Group has also supported the publication of long out of print volumes important in the history of U.S. coast defense.

Conducting the Research

There are several challenges for those undertaking fortification research. The first need, as it is in any research effort, is to pose the right questions, and knowledge of the right questions usually comes from familiarity with what others have done in the same field. In fortifications, this task is more difficult because the literature that considers their historical attributes is very slim, and almost anyone attempting a serious examination of the origin and contributions of the structures is a pioneer. An additional hurdle is the size of the record itself; to thoroughly investigate even the most accessible sources requires considerable time and organization. An additional demand is to consider the significance of what actually remains of the fortifications themselves, and not to become distracted by what is gone. The most common effect of this unbalanced perspective is to interpret and evaluate fortifications on the basis of the

armament they once contained, rather than the attributes that survive today. Seeing fortifications as valid historic structures is often unaccomplished, and there is a temptation to revert to chronology and detail, and trust that the volume of dates and data will somehow intersect with historical significance.

Fortifications and systems of fortifications reveal their significance through historical and architectural themes. Historical themes are associated with unique events in the development of the defenses (Battery Dynamite and the importance of the mine defense) or patterns of change (the shift from individual designs to standard plans). Closely related are architectural themes associated with the contributions of particular engineers (Henry Abbott and the configuration of early mortar batteries such as Howe-Wagner) and influences from other sources (Cavallo Battery and the experiences of the Franco-Prussian War). These themes of significance are not self-revealing, and they must be constructed from the raw material contained in the primary and secondary sources.

Documentation of Existing Conditions

As suggested by the brief reference to the *Reports of Completed Works*, the documentation of resources was a time-honored practice when the defenses were active. Our current need for documentation springs from a different source. To manage historic properties effectively, we need a fixed point to measure our success as well as to evaluate actions that did not go as we had hoped. The documentation of existing conditions fulfills that requirement.

The Coast Defense Resource Checklist included in Appendix C is the first step in documentation. An adequate record of existing conditions would include the elements below and would be compiled by a field team of a photographer and recorder. As park personnel maintain the batteries over time, they can support continuous documentation and future efforts through use of an Action Log (also in Appendix C).

Coast Defense Resource Checklist

The checklist has several uses. It is a general indication of what features are present in an historic resource as well as indicating what deficiencies are apparent. It is a basic component of the record of existing conditions because it can serve as the document preface and summary overview.

Photographs

In either black and white or color print, 35mm views of the interior and exterior provide an image of details large and small. The photographer should take pictures of each elevation of the interior rooms and exterior elevations as well. Special attention should be taken to photograph small character-defining features such as door closures, decorative concrete or masonry, lighting fixtures, and architectural millwork.

Photograph Plan

The photograph plan is a sketch of the resource indicating the camera direction and coverage for each view. Depending on the complexity of the resource, more than one photograph plan may be required for clarity.

Photograph Annotations

Annotations accompany the photographs to identify the view, direct attention to particular elements, and otherwise indicate the presence of character-defining features. These comments can also address colors and markings. The annotations convey the impressions of the recording team as it examines the resource.

While the four measures of the documentation are basic and should not be abbreviated, the record can be enhanced and made more useful by the addition of other steps.

Historic Photographs

Views of the resources when they were in active military use are particularly valuable supplements because they portray the defenses as they were actually maintained at different periods. They can confirm changes as well as identify the origins of paint shadows or equipment fastenings that are observable today.

Cartographic Resources

Reproductions of historic plans should be part of the documentation because of the range of detail they contain. Because many drawings of fortifications are large and may not be suitable for or available as reductions, the identification and provenance of those materials could be included as a substitute.

Feature Mapping

Feature mapping records observable elements on the horizontal and vertical surfaces of an historic resource. These elements include cracks and spalls, exposed reinforcing or other metal work, markings, and craft or construction details. At a gun battery, the feature map treats each area of surface as a separate component of the structure, and begins with the preparation of vertical and horizontal base maps for each emplacement. The vertical base map depicts in true scale each adjacent vertical surface, so that the map appears as a set of contiguous rectangles. Horizontal base maps outline the superior slope, loading platform, and if necessary, the parade. Separate base maps cover the first and second levels of two-story batteries, and encompass interior spaces as well, including the ceiling.

Feature mapping is labor intensive, but it produces documentation that is highly accurate and comprehensive. It is also an undertaking that can be conducted by trained volunteers. No other technique provides such a thorough foundation of information, and the result is invaluable as a resource in preparing scopes of work or estimating the cost of repairs.

Action Log

The action log records continuing maintenance, providing a record of actions taken and products used. It specifically references individual battery locations with visit dates and pertinent additional comments.

Recommended and Not Recommended: A Summation

The *Secretary of the Interior's Standards for the Treatment of Historic Properties with Guidelines for Preserving, Rehabilitating, Restoring & Reconstructing Historic Buildings* (1995) recommend a number of general practices for effective preservation of historic structures. As applied to coast defense fortifications they are broadly summarized in Table 2 following, and draw upon published National Park Service standards for each treatment category.

Standards for each category summarized through Table 2 are drawn from the Secretary of the Interior's standards for preserving, rehabilitating, restoring and reconstructing historic buildings.

Standards for Preservation

A property will be used as it was historically, or be given a new use that maximizes the retention of distinctive materials, features, spaces, and spatial relationships. Where a treatment and use have not been identified, a property will be protected and, if necessary, stabilized until additional work may be undertaken.

The historic character of a property will be retained and preserved. The replacement of intact or repairable historic materials or alteration of features, spaces, and spatial relationships that characterize a property will be avoided.

Each property will be recognized as a physical record of its time, place, and use. Work needed to stabilize, consolidate, and conserve existing historic materials and features will be physically and visually compatible, identifiable upon close inspection, and properly documented for future research.

Changes to a property that have acquired historic significance in their own right will be retained and preserved.

Distinctive materials, features, finishes, and construction techniques or examples of craftsmanship that characterize a property will be preserved.

The existing condition of historic features will be evaluated to determine the appropriate level of intervention needed. Where the severity of deterioration requires repair of limited replacement of a distinctive feature, the new material will match the old in composition, design, color, and texture.

Chemical or physical treatments, if appropriate, will be undertaken using the gentlest means possible. Treatments that cause damage to historic materials will not be used.

Archeological resources will be protected and preserved in place. If such resources must be disturbed, mitigation measures will be undertaken.

Standards for Rehabilitation

A property will be used as it was historically or be given a new use that requires minimal change to its distinctive materials, features, spaces, and spatial relationships.

The historic character of a property will be retained and preserved. The removal of distinctive materials or alteration of features, spaces, and spatial relationships that characterize a property will be avoided.

Each property will be recognized as a physical record of its time, place, and use. Changes that create a false sense of historical development, such as adding conjectural features or elements from other historic properties, will not be undertaken.

Changes to a property that have acquired historic significance in their own right will be retained and preserved.

Distinctive materials, features, finishes, and construction techniques or examples of craftsmanship that characterize a property will be preserved.

Deteriorated historic features will be repaired rather than replaced. Where the severity of deterioration requires replacement of a distinctive feature, the new feature will match the old in design, color, texture, and, where possible, materials. Replacement of missing features will be substantiated by documentary and physical evidence.

Chemical or physical treatments, if appropriate, will be undertaken using the gentlest means possible. Treatments that cause damage to historic materials will not be used.

Archeological resources will be protected and preserved in place. If such resources must be disturbed, mitigation measures will be undertaken.

New additions, exterior alterations, or related new construction will not destroy historic materials, features, and spatial relationships that characterize the property. The new work shall be differentiated from the old and will be compatible with the historic materials, features, size, scale and proportion, and massing to protect the integrity of the property and its environment.

New additions and adjacent or related new construction will be undertaken in such a manner that, if removed in the future, the essential form and integrity of the historic property and its environment would be unimpaired.

Standards for Restoration

A property will be used as it was historically or be given a new use which reflects the property's restoration period.

Materials and features from the restoration period will be retained and preserved. The removal of materials or alteration of features from the restoration period will be retained and preserved. The removal of materials or alteration of features, spaces, and spatial relationships that characterize the period will not be undertaken.

Each property will be recognized as a physical record of its time, place, and use. Work needed to stabilize, consolidate and conserve materials and features from the restoration period will be physically and visually compatible, identifiable upon close inspection, and properly documented for future research.

Materials, features, spaces, and finishes that characterize other historical periods will be documented prior to their alteration or removal.

Distinctive materials, features, finishes, and construction techniques or examples of craftsmanship that characterize the restoration period will be preserved.

Deteriorated features from the restoration period will be repaired rather than replaced. Where the severity of deterioration requires replacement of a distinctive feature, the new feature will match the old in design, color, texture, and, where possible, materials.

Replacement of missing features from the restoration period will be substantiated by documentary and physical evidence. A false sense of history will not be created by adding conjectural features, features from other properties, or by combining features that never existed together historically.

Chemical or physical treatments, if appropriate, will be undertaken using the gentlest means possible. Treatments that cause damage to historic materials will not be used.

Archeological resources affected by a project will be protected and preserved in place. If such resources must be disturbed, mitigation measures will be undertaken.

Designs that were never executed historically will not be constructed.

Standards for Reconstruction

Reconstruction will be used to depict vanished or non-surviving portions of a property when documentary and physical evidence is available to permit accurate reconstruction with minimal conjecture, and such reconstruction is essential to the public understanding of the property.

Reconstruction of a landscape, building, structure, or object in its historic location will be preceded by a thorough archeological investigation to identify and evaluate those features and artifacts which are essential to an accurate reconstruction. If such resources must be disturbed, mitigation measures will be undertaken.

Reconstruction will include measures to preserve any remaining historic material, features, and spatial relationships.

Reconstruction will be based on the accurate duplication of historic features and elements substantiated by documentary or physical evidence rather than on conjectural designs or the availability of different features from other historic properties. A reconstructed property will re-create the appearance of the non-surviving historic property in materials, design, color, and texture.

A reconstruction will be clearly identified as a contemporary re-creation.

Designs that were never executed historically will not be constructed.

With these guidelines, then, we can begin to stabilize, preserve, protect, and, with time perhaps, restore, the coast defense fortifications within the Golden Gate National Recreation Area. The National Park Service may also choose to make the information in this manual available over the internet, inclusive of any subsequent revisions or updates, to facilitate public education and wider preservation use.

Table 2
General Guidance Practices for the Treatment of Coastal Fortifications

Recommended	Not Recommended
Temporarily stabilize when needed to prevent further deterioration.	Stabilization that detracts from historic appearance or promotes continued deterioration.
Correct for unsafe conditions.	Safety corrections that compromise the general historic appearance or alter individual character-defining features.
Begin evaluations at the level of protection and maintenance.	Immediate, extensive work.
Identify the character-defining features for the fortifications and for their sites.	Undertaking preservation, rehabilitation, restoration, or reconstruction without an understanding of those features that define a resource's historicity.
Assess the historic materials and technologies pertinent to individual batteries and their ancillaries in order to analyze causes and processes of deterioration.	Undertaking more than rudimentary protection and maintenance without first carefully assessing historic materials and technologies. Materials may be further damaged or even lost altogether without such an assessment. Opportunities for understanding historic techniques may be foregone.
Test selected sample areas of the feature needing treatment where pertinent. Allow sufficient time for test results to be useful.	Complex repair or restoration without testing and evaluation. Especially not recommended where chemical reactions over time have affected the basic materials of the historic structure.
Repair where possible.	Replacement where unwarranted.
Retain existing materials and features to the greatest extent possible.	Introduction of substantial new materials or replacement of undamaged features.
Replace in kind.	Replacement not in kind.
Limit activities to parts of features, where possible.	Removal of entire features rather than selective removal of the isolated damage.
Clean surfaces of historic structures only as needed.	Overzealous cleaning that introduces chemicals or moisture, or that is physically harsh to building fabrics.
Maintain historic paint and texturing schemes.	Changing paint and/or texturing schemes, inclusive of color, type, and character of the known original materials.
Identify and document all introduced new materials. Site files, with field notes and working photographs, are recommended.	Lack of documentation for the introduction of new materials.

¹ Matthew L. Adams, "A Brief History of Reports of Completed Batteries and Reports of Completed Works," *Coast Defense Study Group Journal* 12 (May 1998), 64.

PART II

**ENGINEERING, DESIGN, CONSTRUCTION AND
MAINTENANCE ISSUES**

Chapter 5: Historic Materials and Maintenance Methods

Modern-era coast defense fortifications currently within the Golden Gate National Recreation Area range from the 1870 earthen barbette East Battery, at Fort Winfield Scott, on the south side of the entrance to the San Francisco Bay, to the recently restored Nike missile installation SF-88L of the late 1950s and early 1960s, at Fort Barry, on the north (Plates 22 and 23). As one might anticipate, the challenges surrounding our understanding of the historic materials used to erect such a wide range of defense structures outpace our current knowledge. Nonetheless, much archival detail does exist. What follows is an introduction to topics of further research, many deserving of future consideration and some, perhaps, of more interest than others in the active preservation and maintenance of the batteries and their ancillary structures.

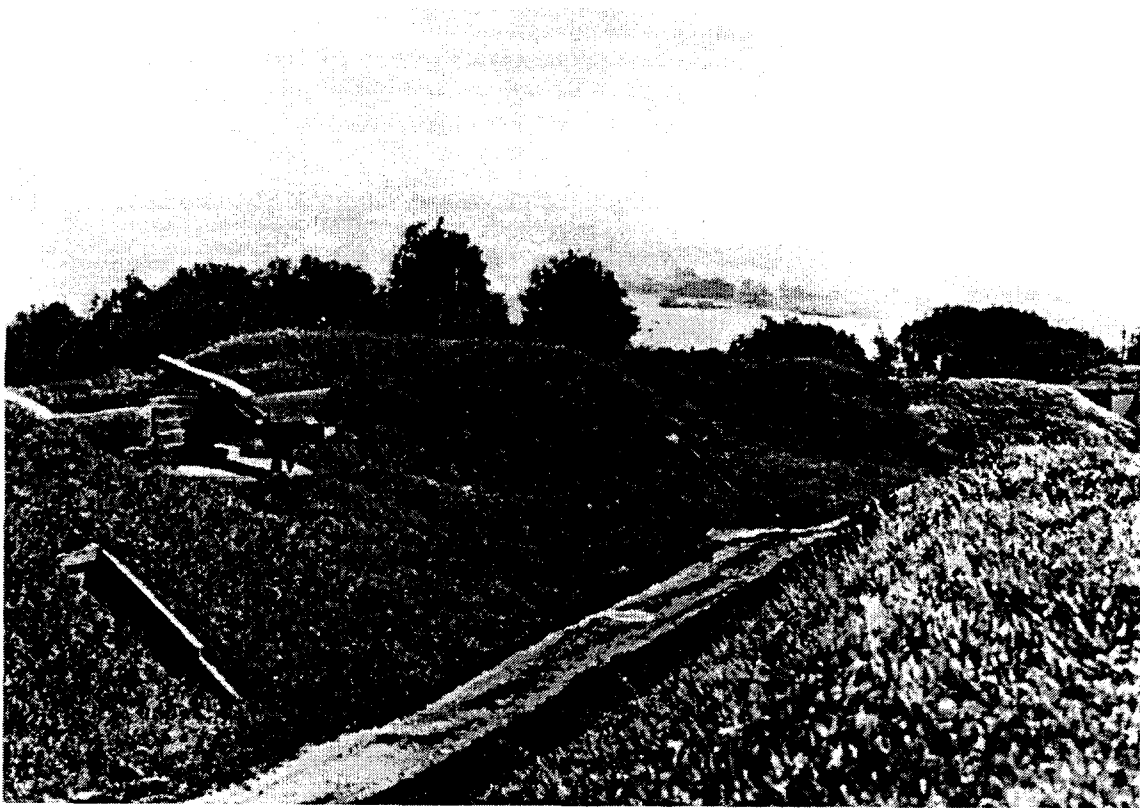

Plate 22. East Battery, Fort Winfield Scott, constructed 1872-1876. Panama Pacific International Exposition in the background to the southeast. View of circa 1914-1915. Courtesy of the Park Archives of the Golden Gate National Recreation Area.

Chronology of Structural Events: What was Built When, With What Materials?

Post-Civil War, 1865-1876

Post-Civil War construction methods and materials were characterized by a dependence on brick and stone masonry combined with enhanced earthworks. Despite the reduction of masonry fortifications such as Fort Pulaski during the Civil War, U.S Army engineers continued to rely on masonry construction through the 1870s. However, the masonry was used in support of earthworks. The brick masonry consisted of multiple wythe brick walls joined by regularly spaced header courses. The brick was set in lime-sand, cement, lime-sand mortars, or cement-sand mortars and the joints were concave or flush.

Spans were accomplished by means of segmental arches and vaulting. Wooden slab doors on metal strap hinges provided closure for bombproofs, magazines, and casemates. The guns were paired and set on terrepleins behind masonry or concrete parapets fronted by earthen berms. Emplacements were separated by masonry bombproofs covered by earth, and powder magazines were placed in central locations and reached by vaulted tunnels. The powder magazines and tunnels were also earth-covered. Earthworks were sodded to combat erosion and to blend the fortification with the adjacent landscape.

Some thought was given to the composition and slopes of the fortification's earthworks. Civil War experience with the bombardment of earthen fortifications indicated that certain slopes, densities, and compositions reacted in specific ways to both explosive ordnance and solid shot.

During the three-year period of 1868-1870, the U.S. Army Corps of Engineers initiated expansion and modernization of the coastal fortifications defending the harbor of San Francisco. Although battery construction for the harbor as a whole had begun in the early 1850s, on Alcatraz Island, the Army soon established a permanent defensive installation at Fort Point and by 1860 had plans for a large fort and permanent batteries at Lime Point to the north, and, batteries on Angel Island and at Point San Jose in the harbor and to the south. Temporary batteries followed with the Civil War, with that at Point San Jose falling into this category. Although the Army had constructed it only six years earlier, the earthen structure, with wooden platforms and magazine, was already in severe decay.



Plate 23. Nike Site SF-88L, Fort Barry. Actual view taken sometime between 1965 and 1970. Courtesy of the Park Archives of the Golden Gate National Recreation Area.

In 1868 engineers had begun the preliminary site work for the new batteries needed both north and south of the entrance to San Francisco Bay. At Fort Point, south of the harbor mouth, the Army completed a 600-foot seawall in late 1868 to protect the proposed "eastern battery" [a never-completed water battery], simultaneously undertaking experiments with the readily available "building sands" immediate to the harbor, and with Pacific Coast cements and limes. At what would be named Fort Baker (in 1897), the Army removed approximately 165,000 cubic yards of site rock through explosive blasting during 1868 and 1869, with plans for three earth-and-brick batteries at the water's edge and on the overlooking bluff. During 1870 to 1876 five batteries were under construction within the geographic parameters of this study, with substantial additional activity on Alcatraz Island: East and West Batteries to the south and Gravelly [historically, Gravelly Beach; now co-located with the Endicott-era Battery Kirby and World War II Battery Gravelly Beach], Ridge [historically two sites, Ridge and Cliff], and Cavallo Batteries, to the north. These were each open, earthen barbette batteries, requiring angled embankments for parapets, terrepleins, and traverses, and incorporating in their construction significant cubic yardage of stone, brick, and unreinforced concrete masonry for ammunition magazines, arched passageways, and gun mount foundations and platforms.¹ The Army engineered Cavallo Battery to an especially high level, considering it nearly a fortification in its own right (Plate 24).

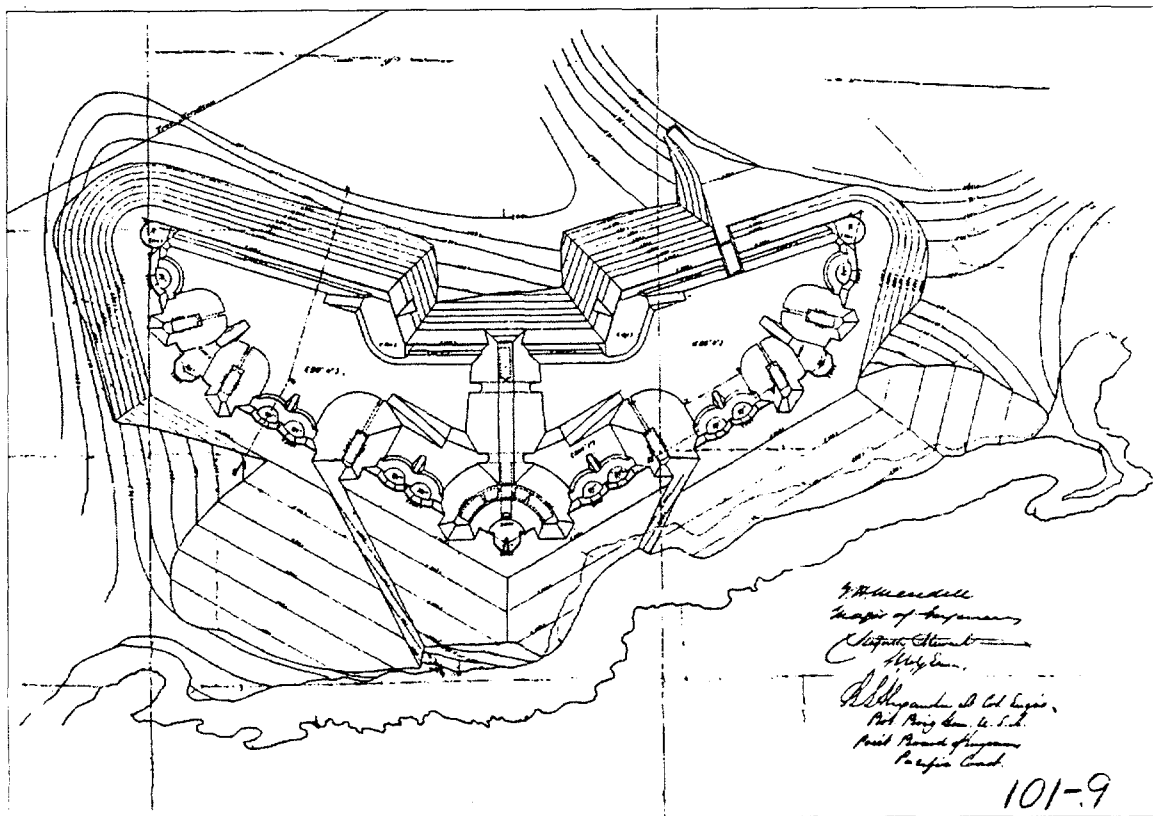

Plate 24. Cavallo Battery, Fort Baker, constructed 1872-1876. Plan of proposed works. Courtesy of the Park Archives of the Golden Gate National Recreation Area.

Foreshadowing technical challenges to come were the details of completing construction. Foundations for the gun platforms represented the heaviest construction, and were poured concrete, without reinforcing. Above the concrete foundations were the actual platforms, either of granite masonry or timber, with the latter set in the concrete. (Granite may have been the choice for mortar platforms, as was the case for the Endicott mortar battery, Howe-Wagner of 1893.)² As the gun platform structures were substantially heavier than the earth-and-brick works that surrounded them, they typically had settlement problems. By 1876, at least at Gravelly Battery, the Army poured additional concrete between the

separating platform timbers. At Battery Cliff, the Army chose not to install the timber platforms at all—due to their known short life—and in early 1893 completely dug up the concrete foundations of the gun platforms to prepare the site for the Endicott battery Spencer.³ Overall, woodwork employed redwood, oak, pine and sugar pine. Early mention is made of “asphaltic” and boiled oil coatings for the platforms, and lead painting of the wood doors, presumably for damp-proofing. Metal work and plate covers were noted as cast iron. And from the start, the batteries at San Francisco had a landscaping element: for the earthen batteries of the early 1870s, exterior and interior slopes were carefully sodded. Grass types mentioned in this period included barley and oats, with sodding described in “square yards” and assumed to be prepared squares (as distinct from sown seed).⁴

Endicott and Taft Periods, 1885-1916

During a long hiatus from the middle 1870s until about 1890, no battery construction went forward for San Francisco’s harbor until Congress appropriated funding for the U.S. Army Corps of Engineers to act upon the recommendations of the Endicott Board. Beginning with two adjacent installations at Fort Winfield Scott, Marcus Miller and Godfrey, in 1891-1892, the years through 1904 saw construction for twenty-nine batteries which are still extant and discussed in this manual: nineteen to the south, and ten to the north. This fourteen-year period witnessed many experiments in strengthening concrete; in more effective damp-proofing through applied coatings; in revisions of site excavations and fill; and in landscaping. Limited reinforcing of the battery concrete occurred from the first.

In its infancy, concrete construction was crude and experimental. Quality was limited by inexperience in storing, mixing, placing, and finishing concrete. Construction details were developed locally based on common practice and a limited number of manuals and trade publications. Despite difficult building sites and a variety of unstable soil conditions, the San Francisco Bay Area had an abundance of beach sand and gravel and suitable stone for concrete aggregates. Water was available from local springs or reservoirs. In order to construct fortifications on selected sites, roads and logistical planning were required to transport workers, tools, materials and equipment.

By 1890, the U.S. Army Corps of Engineers had tested various concrete mixes and had a sense of proper mix proportions. The dry materials were mixed with water to produce a workable mix of a consistency that was neither too dry or too wet. Forms were of horizontal wood planks braced to withstand the weight of the mass of wet concrete. Experiments began with imbedded iron streetcar cables and rails, with aluminum-bronze hold-down bolts. Set in a circular pattern below the gun platform the reinforcing extended downwards fourteen to seventeen feet to bedrock, with alternating layers of radiating rails and coils of cable—the Army placed ten to sixteen flat rails in a spiral pattern, every two feet vertically. First such experimentation was emplacement three, Battery Godfrey, in 1895, with emplacements one and two handled in the same manner in 1896.⁵ (See Plate 10, chapter 2.) Interestingly, even though the Army initiated Marcus Miller before Godfrey, work on the gun platforms was in a reversed order. The foundations for the gun platforms at Marcus Miller, however, are still recorded as more conservative in the Army annual reports, with no notation of cable-and-rail reinforcing.⁶ The other sections of the batteries were not reinforced—although they were thought to be strengthened. At both Marcus Miller and Godfrey, the Army used a combination of machine-mixed and hand-mixed concrete, adding to the latter a nearly equal cubic yardage of broken concrete taken from “old magazines” (presumably from West Battery) and a small cubic yardage of rock boulders.⁷

The matter of proto-reinforcing is uncertain for the other early Endicott batteries in San Francisco, but it appears that the Army used the cable-and-rail experiment a second time at Battery Spencer on the north side of the bay, shortly after finishing the platform foundations at Godfrey.⁸ For the batteries that were either in construction as of 1897, or still not fully completed, Army annual reports reference the use of steel I beams for the roof structures of the magazines—possibly as reinforcement in some cases and for ceiling trolleys. The Army introduced the use of steel I beams for battery roof reinforcement about 1895, overengineering the technique with beams from four to ten inches wide, spaced two feet apart.⁹ The

Plate 25. Battery Duncan, Fort Baker, constructed 1898-1899. Pier base at rear of emplacement near entry road. Illustrates use of streetcar rails as reinforcing.

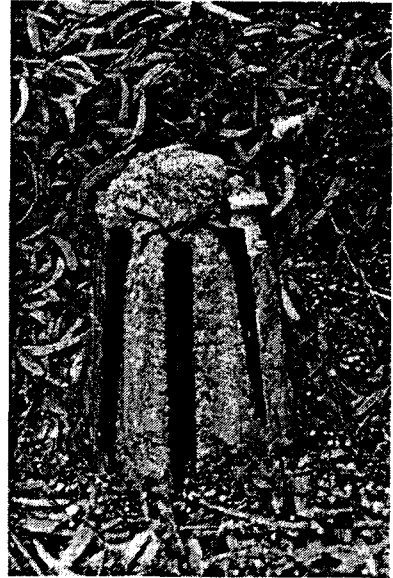

closely spaced beams were tied together with steel rods and corrugated metal pans, fitted and sprung between the bottom flanges of the I-shaped beams. Concrete was then poured over the assembled metal framework. Subsequent variations deleted the metal pans and substituted a flat formed and exposed concrete soffit between the beams. Rusting of the exposed portions of these beams caused the beams to be entirely covered in concrete so that the soffit appeared to be a continuous surface. Spencer may be the only San Francisco battery to use both iron cable-and-rail reinforcement for the foundations of its three gun platforms and steel I beams (for the ceiling trolleys of its magazines).¹⁰ (See Plate 27, below.) Batteries that used I beams for proto-reinforcement during the 1893-1898 period included at least those of Spencer, Howe-Wagner, Saffold, Lancaster, Cranston, Boutelle, and Stotsenburg-McKinnon, and an added guardroom at emplacement one, Godfrey.¹¹ Isolated use of iron cable car rails does appear to have occurred elsewhere among the pre-1900 batteries, with a remnant of a pier (of unknown original purpose) still in place at Battery Duncan today (Plate 25). These first batteries continued to use cast iron for ladders, some stairs, and cranes.¹²

The evolution of concrete from unreinforced to reinforced, during the period, shows a growing understanding of the material and its characteristics. Plain concrete's primary limitation was a lack of tensile strength. This limitation was structural and affected horizontal spans, and therefore the enclosure of space. Prior to the introduction of steel into concrete, constructors had begun to understand and solve expansion and contraction problems. The use of weakened plane joints to isolate different elements in the construction and the use of surface scoring to reduce cracking was understood. Experience gained in mixing and placement of the material produced increased efficiency and better quality control. But plain concrete could not be made to span useful lengths without the benefit of arches or vaulting. For this reason, steel beams were placed so as to span between walls. The introduction of steel elements within the body of the concrete changed the material from a static compressive material to a material useful in resisting both tension and compression. In addition to experimentation with strengthening concrete construction, the Army became more sophisticated in other ways. Batteries routinely included surfacing layers of bituminous rock, three-to-six-inches thick.¹³

As of 1892, Army annual reports discuss temporary construction sites accompanying work on the batteries, with the comparisons between hand-mixing and machine-mixing the concrete. Specific recipes for battery concrete are reported, with further notations as to the physical locations of the regionally-excavated rock, gravel, and sand, and mention of the purchased Portland cement by brand name. Of interest, while work went forward on Batteries Marcus Miller and Godfrey, the Army made a change from asphaltum floors to ones of "sidewalk concrete" (alternately described as "artificial stone" and "granolithic finish."). The floors of the three emplacements at Marcus Miller were originally split: those of emplacements one and two were asphaltum, while emplacement three was sidewalk concrete. All three emplacements of Godfrey went in as sidewalk concrete.¹⁴

The Army plastered concrete, inside and out, with top surfaces further coated with a "bituminous paint," and with the chemical composition of both the asphaltum and bitumen paint changing as the batteries went forward. By 1897, the Army used "paraffin paint" over plastering as a maintenance technique at the batteries.¹⁵ Another finishing technique tried as of 1896 forewent hard exterior plastering, due to the

quick appearance of hairline cracking. Workers created a smooth concrete surface by using tongue-and-groove flooring boards as the final exterior formwork. They then troweled on a two-inch thick layer of concrete mixed with fine gravel and sand. The surface gravel-concrete layer replaced plasterwork, and was finished with a cement wash tinted with lampblack to dull and darken concrete's generic lightness against the landscape.¹⁶ At Battery Duncan, set high on an isolated red-rock knoll at Fort Baker, the Army went to further extremes to blend the installation with the surrounding land form. Here the walls were visible at a distance, and were deliberately tinted red.¹⁷ (Plate 26)

The Army also experimented with blast aprons—those features protecting a battery from its own blast effects—through variations in the extent of the aprons, their respective depths, and the physical composition. Trials with asphaltic concrete for blast aprons occurred as early as emplacement one at Marcus Miller.¹⁸ In 1899 for Battery Kirby, at Fort Baker, the Army built the blast aprons on a composite of natural ground and fill, attempting to stabilize them by distributing “old flat iron traverse circles” throughout the concrete.¹⁹ And, generally, a continued experimentation characterized a repetitive treatment for exposed battery surfaces—what worked best for minimal blast damage; for keeping out moisture; for achieving a reasonable weathering of settlement at the site; and, for accommodating the effects of the microclimate. As early as 1897, the Army removed the macadam from the upper ramparts (terrepleins) at Battery Godfrey, replacing them with concrete pavement. Godfrey had been finished for less than two years. The Army planned the same replacement for Marcus Miller.²⁰

Site excavation for the batteries involved substantial earth moving. Dependent on the underlying soil and rock layers for stability, battery sites also demanded a variety of drains and culverts—particularly when clay was encountered. The Army prepared the site using plows and scrapers, and by blasting. Day labor removed undergrowth and trees.²¹ Excavated material not reused in “strengthening” the concrete was typically placed in an immediately adjacent dump site.²² Often the battery was backcovered with sand, in addition to earth, for greater protection from artillery fire. Planting the battery slopes continued for



Plate 26. Battery Duncan. Rear of traverse showing fenestration, ladder to BC station, and BC station (overgrown at top of elevation).

these first Endicott defenses, sowing oats and barley into a layer of added garden loam, fertilized with manure (Plate 27).

Beginning in 1894, the Army substantially expanded its efforts at the batteries. Personnel began artificially watering battery slopes during the dry months in this year. While the Army did adopt this policy nationwide by circa 1910, using a hose attached to hydrants located at the site, San Francisco may well have been among the first locations to formalize the practice at the batteries—as a byproduct of a higher Army profile achieved due to the Midwinter Fair of January through June 1894. San Francisco's Midwinter Fair, like the Panama-Pacific International Exposition of twenty years later, was a world's fair, intended to showcase the West—with the Midwinter a directed effort by California to promote itself on the heels of the Columbian Exposition in Chicago of 1893. As of 1895, with the mortar batteries at Howe-Wagner, much more complex underlying slope work preceded grass sodding, in order to hold steeper $\frac{3}{4}$ slopes, with benching, blind drains, base retaining walls, and gutters.²³ By 1893 the first major ancillary structures associated with the batteries were in construction, with one mine casemate completed, and two nearly so. Associated roadways were formally designed, with drains and macadam surfacing.²⁴ At Battery Howe-Wagner, the Army built a seven-foot high redwood picket fence 1900 feet in length around the site, treating it with a dull-red lime wash.²⁵ A cultural landscape was unfolding.

At about the turn of the century, Army engineers had reached another set of plateaus in the use and maintenance of materials, and in detailing, for the San Francisco batteries. By 1900, experimentation in a finer quality concrete had occurred. In reorchestrating the mix of sand and gravel for the concrete, engineers developed a much harder substance, which in turn encouraged them to omit broken stone in a first trial at the small battery Orlando Wagner, Fort Baker. Use of large stone in attempts to strengthen the concrete continued, however, with a quarry opened for this purpose at a 100-foot elevation in the cliffside at Batteries Mendell and Alexander in 1901.²⁶ Simultaneously the Army continued active

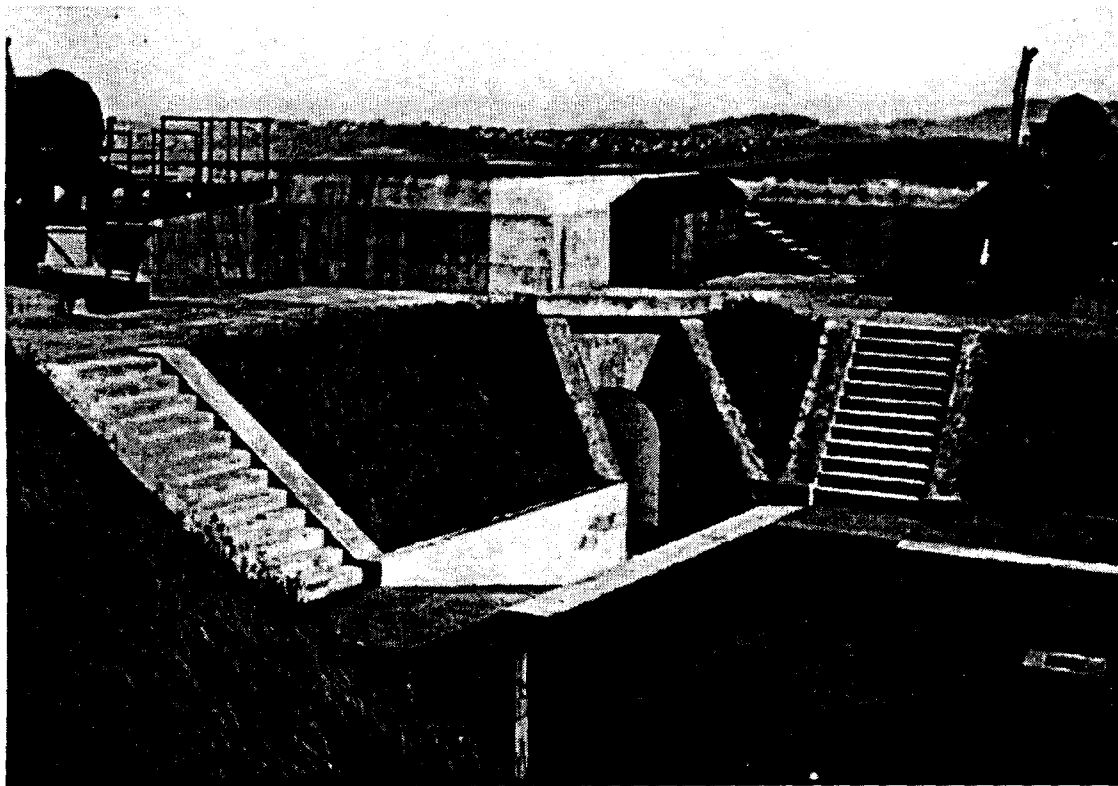

Plate 27. Battery Spencer, Fort Baker, 1893-1897. Courtesy of the Park Archives of the Golden Gate National Recreation Area.

experimentation with concrete mixes, especially with regards to the selected Portland cement. First mention was of the imported Josson & Co.'s Portland cement in 1893, and Josson's and Gillingham's in 1896.²⁷ In 1901, although the Army was still actively relying on two foreign Portland cements (Hemmoor's and Cannon's), it was also testing an American-made product, Red Diamond, manufactured in Utah. Red Diamond came in sacks, unlike the foreign imports which were shipped in barrels, and although of good quality, a percentage hardened in the sacks due to dampness. The Army then used these rock-like bags of cement as boulders in the subfoundation concrete work at Battery Boutelle. Foreign Portland cements were still the preferred choice, but clearly the Army was seeking widened choices through active testing of as many brands as possible. At Battery Livingston-Springer, engineers tried five brands: Scales, Josson, Cannon, Alsen, and a minor amount of Red Diamond. Of these, they used three times as much Cannon as each of the other foreign Portland cements.²⁸

At the same battery, engineers demonstrated an enhanced sophistication in their understanding of, and compensation for, the planes of weakness that would inevitably manifest themselves once the concrete began to settle—due to the inherently heavier concretework of the gun platform foundations. Army *Mimeograph No.8* of 1896 had first described planes of weakness in batteries, with attempted solutions for the settlement problems. Initially efforts were focused to create as monolithic a structure as possible, and the planes of weakness manifested themselves in unwanted locations. By pouring the batteries in fully separate sections, planes of weakness were somewhat predefined.²⁹ In 1901, engineers in San Francisco additionally incorporated lead flashings in the construction at Battery Boutelle—to move the water away from the planes of weakness, and thus keep them from becoming a guaranteed conduit of moisture to rooms within the structure. At Battery Kirby, at this same time, leaks over the winter of 1900-1901 had forced Army engineers to re-excavate emplacement one to assess cracking from uneven settlement of the concrete. Engineers concluded that *after* settlement had fully stopped they would need to *go back* and apply lead flashings there as well.

These issues at Batteries Boutelle and Kirby make a more comprehensive point: learning at the batteries was so fluid, with overlapping and varied progress at sites under construction at the same time, that a battery started at an earlier date (Boutelle, 1898) could showcase an innovation not found in a battery begun later (Kirby, 1899), due to a later completion of the first battery (Boutelle, 1901) than that of the second (Kirby, 1900).³⁰ At the mortar battery Livingston-Springer, under construction simultaneously, the Army tried yet another experiment to circumvent settlement cracking and leaks. Here they weighted the battery walls with foundation offsets proportional to the expected loads, thus attempting to equalize the loads through the battery. At Livingston-Springer, engineers placed sheets of "tarred paper" between the joints of the floors and the walls, to prevent their bonding, and to create planes of weakness where they would be least likely to create unwanted leaks.³¹

At the same time, both at Orlando Wagner, Fort Baker, and just previously at the recently completed batteries on the south side of the bay, a shift occurred from wooden doors to ones made of steel sheet metal riveted to angle-iron frames.³² Stairs at the batteries were primarily wood through 1898, with Marcus Miller somewhat unusually noted as receiving wood, cast iron, and concrete stairs in that same year, the latter for its added guard house. Although concrete stairs did appear as early as 1895 at Battery Godfrey, the Army did not incorporate them as a major design feature until 1899, at Battery Kirby.³³ The Army first mentioned adding iron handrails for the San Francisco batteries in its 1898 annual report, at Batteries Cranston, Lancaster, Marcus Miller, and Stotsenburg-McKinnon, all at Fort Winfield Scott.³⁴ As such, site safety must have become a concern, as handrails were added at existing batteries at about this same time.

Also in 1901, the Army began a radical experiment in its landscaping for battery slopes. Up until this year, no mention occurs of any sodding or seeding other than oats and barley, a consistency that appears to have been unbroken in San Francisco from the batteries of the early 1870s through those of 1900. In the first year of the new century, however, the Army tried alfalfa at Orlando Wagner, and a combination of oats, iceplant (*mesembryanthemum crystallinum*), bunch grass (*arundinario*), lupine, and gum

(eucalyptus) trees at Livingston-Springer.³⁵ Since Livingston-Springer was a mortar battery, it challenged engineers through its very steep surrounding embankments. Land slides had been a significant problem for the mortar batteries from the first winter at Howe-Wagner during 1894-1895.

The experimental solution at Livingston-Springer, like solutions for other continued problems in battery construction, showed an advancing sophistication and, literally, the creation of a larger landscape. The Army planted 500 pounds of oats to cover the outer slopes of the battery, with significant labor expenditure. With this solution, the outer slopes seeded themselves very quickly and blended the grassy land form into its surroundings as observed from the sea. Army personnel made cuttings of iceplant, which was described as already "of very vigorous growth in this locality," establishing it on the inner slopes of the battery. The Army apparently did not purchase the cuttings, as the annual report showed no associated cost, but rather had men make the cuttings themselves from a site not too far distant. As the labor expenditure was only fifteen to twenty percent of that for the oats, it is assumed that the area planted was relatively small. The iceplant, also a quick grower that was drought resistant, held the steep inner slopes even more tightly than the oats, and thus protected the men and the guns from slides. The inner slopes, however, would have been an intense green with closely spaced white or pink flowering—and as such would have called attention to the battery if visible to enemy ships, unless further camouflaged by a more encompassing (and dense) landscape of iceplant, or of iceplant and added low-bush, flowering, shrubs. In its inner placement, this initial planting of iceplant could not be seen. Perhaps most interesting of all, the Army planted bunch grass on all barren sandy dunes in the near vicinity of the battery. The bunch grass did two things: it prevented the sand from blowing into the mortar pits, a danger to the battery, and, it initiated a change in the larger landscape and what would come to be perceived as "the natural landscape." Complementing the bunch grass, the Army planted 100 pounds of lupine, apparently both buying seed and "gathering" it, and 4,000 eucalyptus trees immediate to the battery on the host military reservation.³⁶

Efforts at Livingston-Springer in 1901 pointed to a new way of landscaping the batteries. The Army sought not just site stability, but also camouflage. Army personnel created a landscape based upon the immediate native vegetation, reorchestrating it at the batteries to include not just grasses, but also denser, low- and intermediate-height vegetation, and, trees. On the north side of the bay, during 1902, the Army used lupine and sagebrush stalks as a "brush foundation" for a 1500-foot segment of road set in deep sand between Batteries Mendell and Alexander—indicating that both the lupine and sagebrush, like the iceplant, were already actively established throughout the military reservation. At Battery Chester, also in 1902, the Army controlled the sand at the installation itself by heavily loaming the sand before seeding the slopes, and by planting the barren sand some distance from the battery to bunch grass and lupine.³⁷ The first couple of years of the twentieth century also witnessed heavy road building by the Army, connecting batteries. The Army typically macadamized the roads leading to the batteries, but used rock taken from site excavations for surfacing between closely spaced batteries. At Livingston-Springer red rock paved the immediate roadway at the battery.³⁸ At this same time, the Army also began to landscape the road banks to stabilize the sand, and likely to make them less visibly stark. At Chester, the Army bracketed both sides of the road with bunch grass.³⁹

Although the Army annual report for the defenses of San Francisco harbor contains substantial information on battery construction, the information becomes more generic, with less identification of work at explicit installations, after 1902. Batteries Chester, Livingston-Springer, and Mendell are nearing completion, and Alexander, Baldwin, and Blaney are in active construction. Engineers reached the third plateau for reinforcing experimentation at the rapid-fire batteries of this group, those of Baldwin and Blaney. Heretofore the Army had specified nationwide that steel I beams were to be used for reinforcing the concrete masonry of the battery roofs, with the walls handled variously through differing concrete mixes and inclusion of large rock. Although structurally sound, the placement of steel I-beams was cumbersome, expensive, and, due to the weight of the dead load of the beams, required greater depth and more heavy concrete for coverage. The understanding that steel and concrete expanded and contracted at similar rates and the development of sophisticated mathematical calculations brought about a better

integration of steel and concrete. That integration took the form of critically placed round, reinforcing rods, later modified to include twisted square bars. Placement of reinforcing bars required the construction of a metal armature (or "cage") inside the wooden forms (See Plate 28). By the time reinforcing steel bars became common, it came to be understood that the placement of large pieces of broken rock added little to the strength of the mix and were difficult to place in the confined space inside the forms. Reinforcing bars and the elimination of large rocks allowed more precision in form construction and resulted in carefully formed concrete columns, overhead slabs, and superior concrete construction. Army mimeographs officially recommended the use of twisted steel for the first time in 1902-1903, with published plans showing the size and placements for reinforcement.⁴⁰ San Francisco began employing three-fourths-inch twisted steel set at one foot centers for its rapid-fire batteries as of 1903.⁴¹

Endicott battery construction continued for only a few more years, through 1905 in San Francisco, with all five of the batteries from 1903-1905 likely employing twisted steel reinforcing: Chamberlin, O'Rorke, Smith-Guthrie, Yates, and Rathbone-McIndoe (Plate 28). Beginning in 1905 as well, the Army began to widen the 10-inch and 12-inch gun platforms, including those at Batteries Mendell, Kirby, Lancaster, Cranston, Marcus Miller, and Chester; this work also used the modern reinforced concrete technology.⁴² This type of reinforcing was directly traceable to the patents of San Francisco engineer Ernest L. Ransome. Stanford University had used Ransome's bars in its museum of 1891, one of the earliest such major applications.⁴³ Just as the Endicott period closed, with a long hiatus in the erection of batteries lying ahead, numbers of steel companies and dealers offered the twisted bar as representing the "American system of concrete reinforcing." By this date, steel manufacturers added carbon to the reinforcement steel, increasing its strength (Plate 29).

With increased bearing strength and the flexibility to shape concrete elements it was possible to anchor increasingly complex gun mounts directly to concrete platforms. Precision in the placement of anchor bolts to fit gun mounts that were manufactured elsewhere was a necessity. Jigs, templates, and other mounting devices were devised to hold the anchor bolts during the placement of concrete. The placement of other inset metal items such as maneuvering rings, stair railing, handrails, hinges, and other items required setting and holding these items in place during the concrete pour. Setting inset items in concrete was a skill as new as concrete was a material. Where voids were cast into the concrete in order to receive inserts, such as handrails, molten sulfur was used as a grout.

Between 1905 and 1917, the Army built no batteries for San Francisco, with a general construction stoppage nationwide. During this dozen-year period, Army efforts were largely concentrated on making repairs, further enlarging gun platforms, and landscaping. The latter, treatment of the landscape, is of the most interest. In 1905, Army engineers reduced the steep slopes at the mortar battery Livingston, taking the slope out just over six feet and decreasing its pitch from 3:4 to 2:3. The Army replanted the inner slopes again to iceplant for one of the mortar pits, seeding the sister pit to Australian rye grass. As both pits had held iceplant in 1901, the revegetation marked a change, with a first documented appearance of rye grass.⁴⁴ In 1907 the Army noted, after inspections of batteries on the south side of the harbor, that in some cases installations still appeared as abrupt breaks in the landscape, rather than blending in. For Fort Winfield Scott, in particular, it was stated that in such a heavily forested location, trees should be encouraged to grow up and provide concealment.⁴⁵ On the north side of the bay, Cavallo Battery had become bucolic, looking agrarian in the midst of fenced horse pastures (Plate 30).

As of the spring of 1910, the Office of the Chief of Coast Artillery, in Washington, D.C., issued a memorandum taking the position that San Francisco had been approaching since 1901-1902. "Whenever coast defenses are hereafter [sic] erected, all exterior slopes of these defenses will be made to conform in appearance [sic] as possible [sic] to the surrounding ground, and geometrical contours will be carefully avoided." The memorandum directed coast defenses to plant "such trees and shrubs, as can be obtained in the neighborhood of the defenses, on the slopes of the defenses and around about them in such a way as to make them as effective a concealment of the defenses as possible [sic]... the engineer officer will

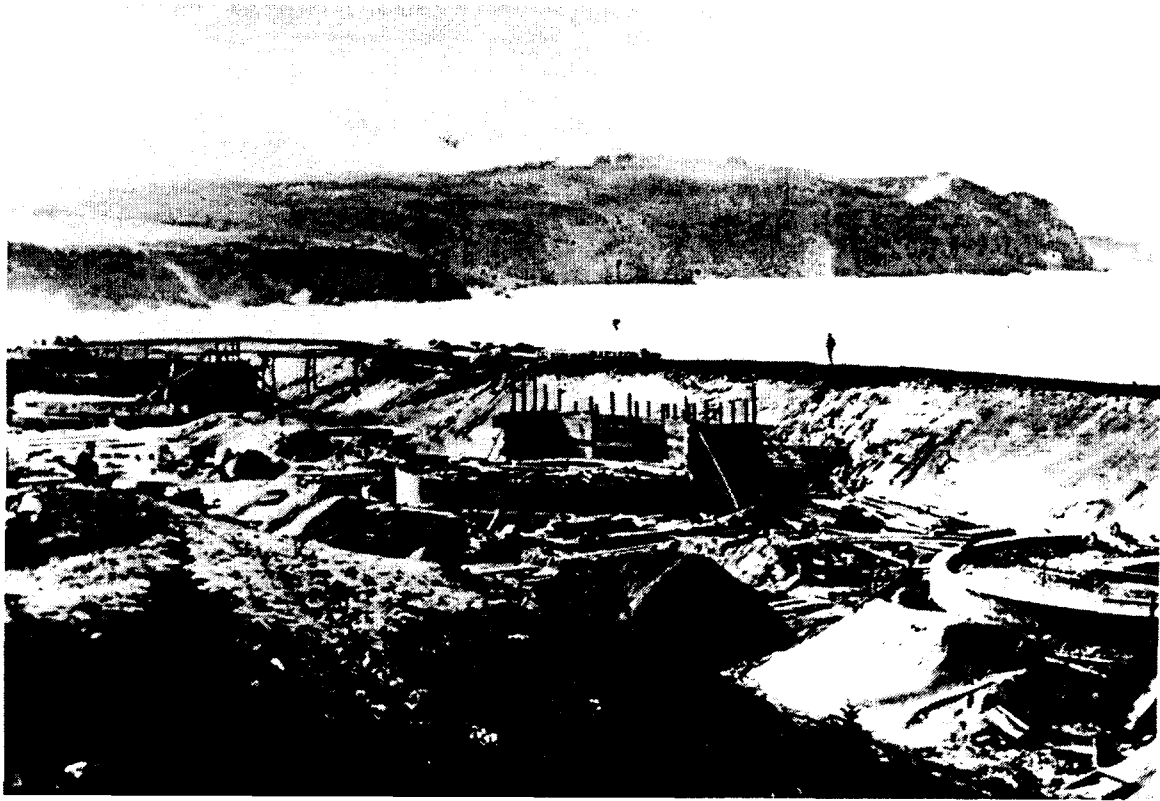

Plate 28. Battery Chamberlin, Fort Winfield Scott, 1903-1904. Under construction. Courtesy of the Park Archives of the Golden Gate National Recreation Area.

FABRICATED
STRUCTURAL
STEEL

Prompt Shipments

High Carbon Bars
Rounds, Squares, Twisted, Spiral.
Immediate Shipment.

GILHULY & AMBLER

Atlas Bldg. 604 Mission St., San Francisco, Cal.

Plate 29. Advertisement for reinforcing steel in *Architect and Engineer of California*, August 1907.

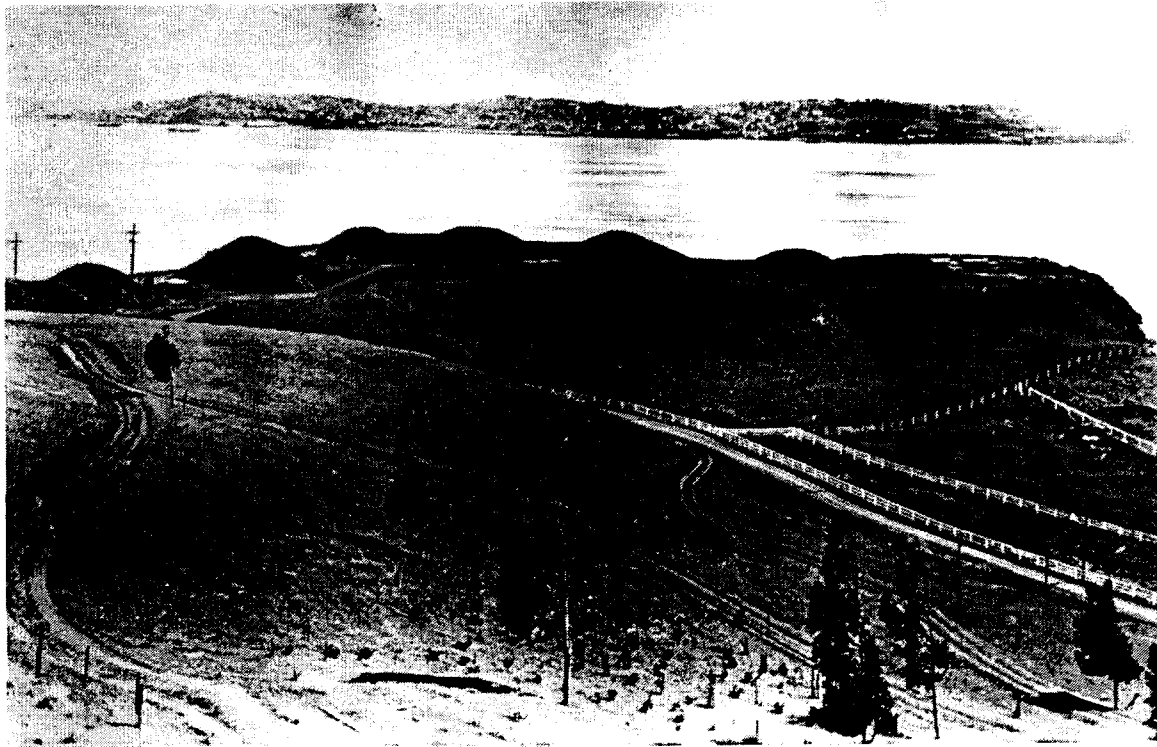

Plate 30. Batteries Cavallo (1872-1876) and Yates (1903), Fort Baker. View of about 1914. Courtesy of the Park Archives of the Golden Gate National Recreation Area.

personally see that they are properly cared for, and that [sic] those that die are replaced when practicable [sic].” The Coast Artillery memorandum went on to describe a hierarchy of landscaping that would be most appropriate for camouflage. “Tall trees...should be planted in rear of and between adjacent batteries and in rear and on the sides of stations; low trees at the foot of batteries, bushes and shrubs on the superior slopes of batteries and low shrubs in irregular splotches between guns.” The memorandum further directed that during seasonal planting, company commanders would be responsible for assigned grounds on the military reservation, where they would remove native trees and shrubs for transplanting at the batteries. A prescribed fallback position was to obtain vegetation from willing local landowners, or to find vegetation suitable to the native landscape and import it. A final point established the new formality of battery landscaping practices. The Coast Artillery asked “post commanders [to] start small nurseries at which bushes, trees, etc., may be produced and cultivated.” Most compelling here, the Coast Artillery’s directives are filed with the Stotsenburg-McKinnon emplacement books. Stotsenburg-McKinnon, like Livingston-Springer and Howe-Wagner before them, were mortar batteries, and demanded more sophisticated landscape and camouflage solutions due to their steeper slopes.⁴⁶

The Army’s efforts at landscaping may well have accelerated in the years immediately before the Panama Pacific International Exposition—the world’s fair planned for San Francisco in 1915. The watershed year for landscape issues was 1912. At that time, after internal debate, the Army decided to “throw open all the batteries” for public visitation during the upcoming fair. It had been standing practice to fence the batteries to protect them from vandals since early in the Endicott period. Making them publicly accessible also implied an active interest in making them attractive—as the Army quite deliberately sought public goodwill and was still existing without Congressional support for new batteries.⁴⁷ The major nursery for the exposition was on the Army’s grounds, established at a location in the southeastern portion of the Presidio described as “Tennessee Hollow.” The directors of the exposition had appointed John McLaren, landscape architect of Golden Gate Park, as the fair’s landscape engineer. Beginning in

early 1912, he organized the collection of specimen plants from throughout the Bay Area, ranging from large trees to cuttings of iceplant, for propagation in an exposition nursery. After using a temporary nursery in Golden Gate Park, McLaren set up the permanent facility in Tennessee Hollow, where six greenhouses, potting sheds, a heating plant, and a lath house for small plants accommodated preparations for the exposition.⁴⁸

The Panama Pacific International Exposition nursery at Tennessee Hollow of 1912-1914, on Army land, also notably supports the April 1910 memorandum of the Coast Artillery—to undertake such small nurseries for the propagation of native vegetation appropriate for camouflaging the batteries. And, as it was McLaren's nursery, that at Tennessee Hollow also indicates a strong likelihood that landscaping efforts on the part of the Army in San Francisco would take on the character of the California Arts and Crafts movement. Not only would native vegetation be a central feature, but chosen plants would be ones already present in the existing beach and cliff landscape near the batteries, with consideration of issues like relative natural textures, and, especially, color. Horticulture had occupied a special place in the California psyche since its shepherding by agronomist Edward James Wickson during the 1890s. Wickson, who had assumed editorship of the *Pacific Rural Press* in San Francisco during 1875, lectured at the University of California in Berkeley. In 1887 he directed all the university's agricultural lands, and in 1905 he became dean of the College of Agriculture. He published prolifically, and was well-read by the small farmer and all those who cultivated their own gardens. Wickson advocated planting flowers, shrubs, vines, and trees, most notably eucalyptus, around the California ranch house. He complemented John McLaren directly.

Wickson's books, from *The California Fruits and How to Grow Them* (1889) to *California Garden* (1915) to *California Garden Flowers* (1926), went through many editions, and he, like the Army and McLaren, talked quite a bit about appropriate landscaping.⁴⁹ Wickson described iceplant in detail, noting that "one is apt to find [it] installed here and there on the California beaches, wherever it can find a nook out of the sand-blow and the brine...and grows easily from long stem-cuttings even carelessly covered with soil, at distances of a couple of feet each way. It grows very flat...and is popular for covering rocks..."⁵⁰ For the fair, as for the batteries beginning with Stotsenburg-McKinnon in 1901, iceplant took on a concerted role. McLaren, working with San Francisco architect Hart Wood (as chief draftsman for Bliss & Faville), designed a 1150-foot iceplant double-hedge running across the grounds, eight feet in diameter and twenty feet high, with a thirty-foot tall formal Beaux-Arts arched entry (Plates 31 and 32). Using *mesembryanthemum spectabilis*, an iceplant that flowered heavily in pink, McLaren and Wood planted 8700 boxes, turning them on their sides for the much-talked about living wall.⁵¹ The Tennessee Hollow nurseries had nurtured the iceplant cuttings, and in all likelihood, the Army's beaches had served as their source.

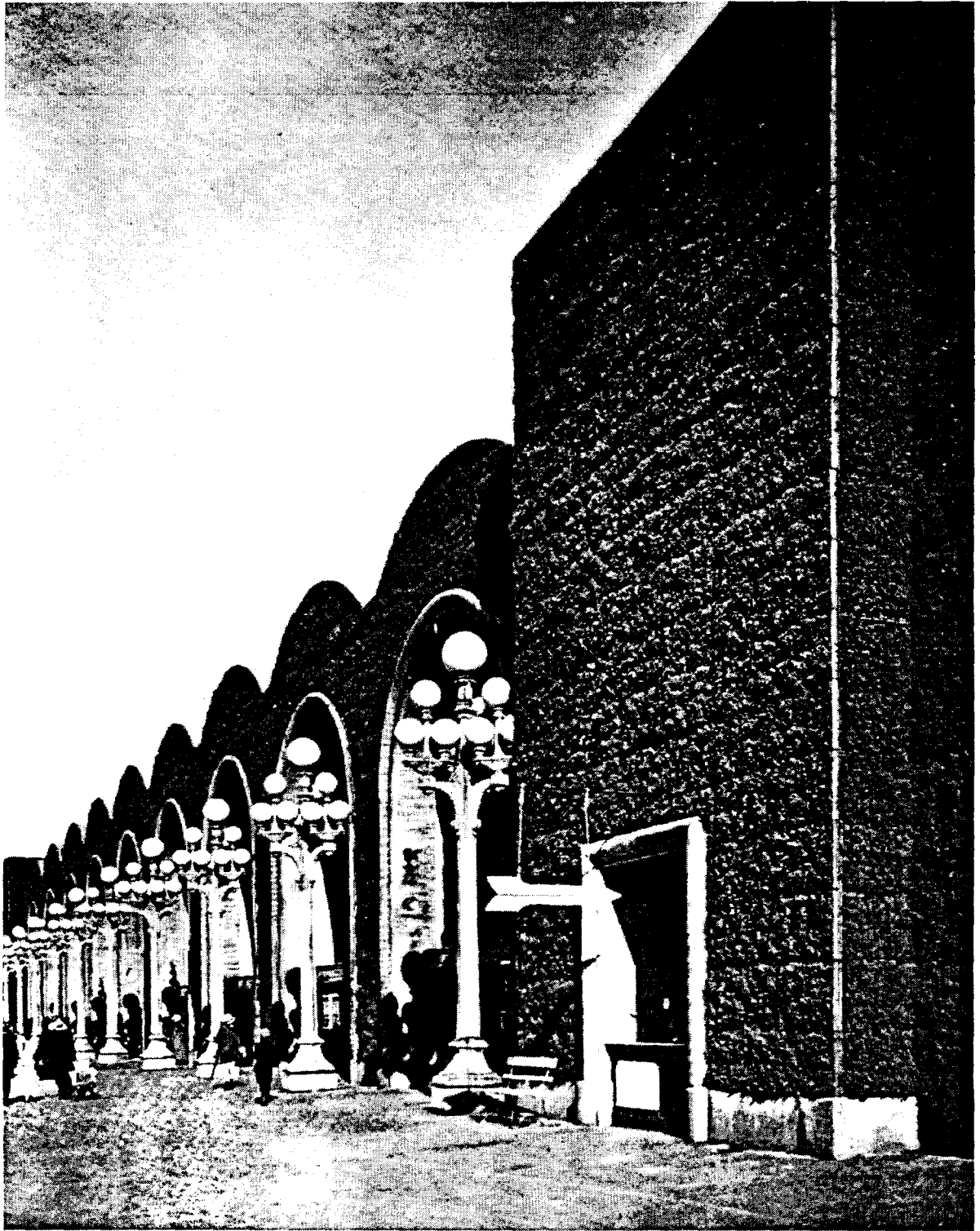

Plate 31. Hart Wood and John McLaren, iceplant wall, Panama Pacific International Exposition, San Francisco, 1915. Center arched entry thirty feet high. From *The Architect*, July 1915. Courtesy of the California State Library, Sacramento.

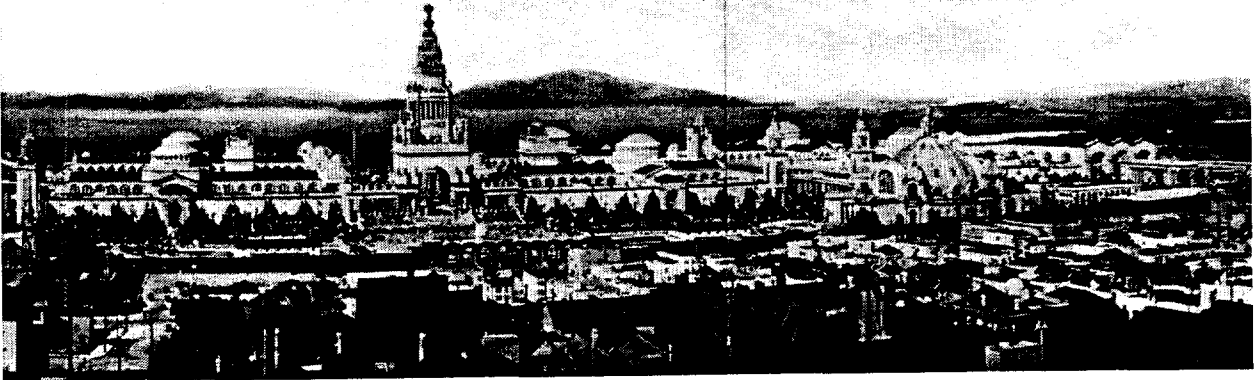

Plate 32. Wood and McLaren, 1150-foot long, living wall of flowering iceplant, Panama Pacific International Exposition, San Francisco, 1915: midground. Frank Morton Todd, *The Story of The Exposition*, 1921. Courtesy of the California State Library, Sacramento.

World War I — World War II, 1917-1945

During the final era of battery construction for San Francisco, that of World War I through World War II, achievements continued to focus on improvements in the technologies of reinforced concrete, and on experiments in landscaped camouflage. In mid-1915, the War Department convened a board to review coast defenses for San Francisco, with several new works projected. Of these, the only sizable project that was built was Battery Wallace, at Fort Barry, begun in 1917 and completed in 1921. The War Department aborted other plans. By late 1917, in fact, the Army dismantled the less-effective guns of the San Francisco coast defenses for use elsewhere during World War I—primarily the 5-inch and 8-inch guns and some of the 12-inch mortars. During this period, steel reinforcement still focused on the twisted bar, with the practice fully accepted following the rebuilding of San Francisco after the earthquake of 1906. In San Francisco, the Pacific Coast Steel Company offered “square corrugated and cold twisted, plain rounds and squares,” while Woods, Huddart & Gunn advertised “twisted squares, plain squares and rounds.” Predictably, as was true at the end of the Endicott period, experimental steel bar forms for reinforced concrete construction were also advocated, including Havemeyer Deformed steel bars promoted by the Southern California Iron & Steel Company.⁵²

Reinforced concrete construction benefited from the development of excavation and grading equipment that made earthwork more efficient. Motorized rollers aided in the compaction of sub-foundation base materials and soil stabilization. Special rebar configurations such as stirrups, saddles, dowels, and other fittings had been standardized. Concrete mixes, free of large ungraded pieces of rock, utilized carefully graded aggregate proportions. Plywood forms were used to form large expanses of concrete surface. Chamfers, which first appeared around the turn of the century, were common devices to ease the sharp edges of the formed concrete. Improved concrete forms reduced the amount of finish work needed after forms were removed. Where weakened plane joints had been used to isolate concrete movement, expansion joints and control joints were “cast in” the larger concrete pour. Real advances, nonetheless, awaited experimentation during the 1920s and 1930s, when a highly vocal group of talented civil engineers took up the topic of reinforced concrete construction for hydroelectric projects.

These men included individuals prominent in both San Francisco-Berkeley and Los Angeles, who published their work for dam construction both in civil engineering journals and as circulating offprints. In the Bay Area, discussions by Carl Ewald Grunsky, J.B. Lippincott, Lars R. Jorgensen, John Debo Galloway, Walter LeRoy Huber, and Charles Derleth were especially noteworthy. Huber, Galloway, and

Jorgensen worked for Pacific, Gas & Electric in San Francisco. Jorgensen, a Danish engineer who had emigrated in 1901, was a particularly active discussant regarding the issues of site stability, water tightness, and appropriate amounts of steel reinforcement.⁵³ Army engineers appended some of Jorgensen's published discussions to their files for Battery Davis, Fort Funston, 1936-1940. The key offprint, *Solidification of Sand, Gravel and Granular Materials by Chemical Means*, addressed stabilization of a site through injecting several chemicals into "the mass to be solidified, where they react with one another to form a mortar which binds the granular material or poor rock together, forming a cemented solid mass in place." The method was intended to petrify loose ground, "rejuvenate" poor rock, and widen planned foundations—applicable not just to dams, but also to batteries.⁵⁴ It was the precursor of today's soil grouting.

With Battery Davis, the issues shifted from reinforcement of the concrete foundations and superstructure, to stabilization of the larger site. In addition to the Jorgensen offprint, the Battery Davis files included further professional engineering debate and methodology for "cement-stabilization." Army engineer Norman W. Haner, in a report of December 1938, argued that the second method, cement-stabilization, was simpler than chemical stabilization, and more reliable, and that both methods were more economical than the heretofore-used concrete spread footings.⁵⁵ Cement-stabilization created a cement-solidified backfill, on which the footings then rested. Load tests supported the hypothesis that cement-stabilized ground allowed less settlement of the heavy concrete structure than did an untreated base surface for the foundations.⁵⁶ (See Chapter 10, *Sitework: Soil Stabilization*.) Appended to the analysis of cement-stabilization were two articles from *Engineering News-Record*, authored by key engineers from the Portland Cement Association, and cost breakouts for its use in the construction of the Spring Street "Soil-Cement Project" in Redwood City of October 1937.⁵⁷ One article, in particular, "How to Process Soil-Cement Roads," set out the process step by step, with illustrations for each layer of the process. The Army photographed construction at Battery Davis very thoroughly, including documentary photographs of the cement-stabilization process nearly identical to those appearing in *Engineering News-Record*—from the machinery pulverizing the base soil, to the spreading of the contents of cement sacks, to the mixing of the soil and dry cement, to the spraying of water and the mechanical mixing of the soil, cement, and water, to the final compacting of the mix with "sheepsfoot rollers."⁵⁸

Generally, with the batteries of the late 1930s and early 1940s, concrete and its reinforcing met detailed Federal specifications, as did treatments for damp-proofing. At Battery Townsley, Fort Cronkhite, for example, the cement was of Class A and Class B types, mixed per cubic yard in proportions of 5.5 bags (517 pounds) to 4.5 bags (423 pounds), with water content also called out precisely at six gallons for the Class A cement and 6.5 gallons for the Class B. Chemical composition for the Portland cement adopted standards of the Portland Cement Association, as did the sizing of the aggregates. Reinforcing steel was of Type B deformed bars, set in size and weight, and of square and round type.⁵⁹ Curing the poured concrete required fourteen continuous days keeping all surfaces wet, with the battery protected from too much sun, heavy rain, or mechanical damage.

The Army accomplished damp-proofing the foundations, and those parts of the structure in contact with replaced fill, by applying an asphalt coating to the concrete and constructing a "drainage course of split furring tile on the roof and sides," allowing water to flow away from the batteries into open-tile drains running transversely near the concrete footings.⁶⁰ Both asphalt and tile met prescribed specifications, with the tile three inches thick for the roof areas and 1.5 inches thick for the vertical walls, laid without mortar and with the split cells paralleling the slope for the roof, and, with a sand-cement mortar, the split cells running vertically for the walls. A one-foot thick layer of one-fourth inch gravel was allowed as substitution for the roof tile (Plate 33). This method of providing a damp-proof membrane for the batteries had been in place nationwide, more or less, since the publication of Colonel Eben Eveleth Winslow's *Notes on Seacoast Fortification Construction*, of 1920, with the porous layer established either as tile or broken stone. The Army had first discussed engineering of its damp-proof membranes for San Francisco coast defenses with one for Battery Mendell in 1903, noting use of "three-inch book tile." Engineers specified that the book tile be laid on a three-ply felt, tar, or asphalt coating, between it and the

concrete, and that the tile be covered by a layer of fine dry sand from the neighboring hillside. For Battery Alexander, engineers used "S-shaped Spanish" tile, set in a heavy mortar on the concrete and covered with a triple layering of straw, six inches of coarse shale from nearby excavations, and sand.⁶¹



Plate 33. Battery Townsley, Fort Cronkhite, 1938-1940. Under construction, showing damp-proof membrane. Courtesy of the Park Archives of the Golden Gate National Recreation Area.

Predictably, experimentation with camouflage vegetation continued with the World War II batteries, with continued positioning on the issue of native plants. In the late 1930s, the Army completely cleared a site before beginning construction, leaving trees and shrubbery outside the immediate area. At Battery Davis—a site previously heavily planted to eucalyptus, the 1938 planting plan for the vicinity included small areas of *leptospermum*, 825 acacia trees, 1,420 pine trees, 1,070 eucalyptus trees, and selected areas of kudzu.⁶² (Plate 34) The maintenance and operations plan from the same time noted that the Army collected and sowed seeds, from what it interpreted as plants typical of ("native to") the surrounding area, at the battery itself—including seeds from sagebrush, wormwood, *baccaris*, and lizard leaf. For erosion control, and to protect the sown—"native"—vegetation, the Army also planted lupine, vetch, *meliolotus indica* (all members of the pea family), and barley mustard. The intentions were to create both a temporary landscape, and a longer-term one. "The foreign plants will prevail for approximately two years and then will be crowded out by the native [typical] growth." Immediate post-construction photographs show a palm-like tree and hanging vines at the face of the battery, in addition. The Army watered landscaping carefully, with an automated sprinkler system in place, and continued planting and seeding any surviving bare spots near the battery.⁶³ (Plates 35 and 36) The Army also employed netting and a camouflage "mottled" paint scheme. Although not acted upon in 1910, Coast Artillery directives of that period had also suggested "the front [of the batteries] will be splashed with different colored paints."⁶⁴ As time went forward, the Army increasingly addressed camouflage not just from the land and sea, but from the air.

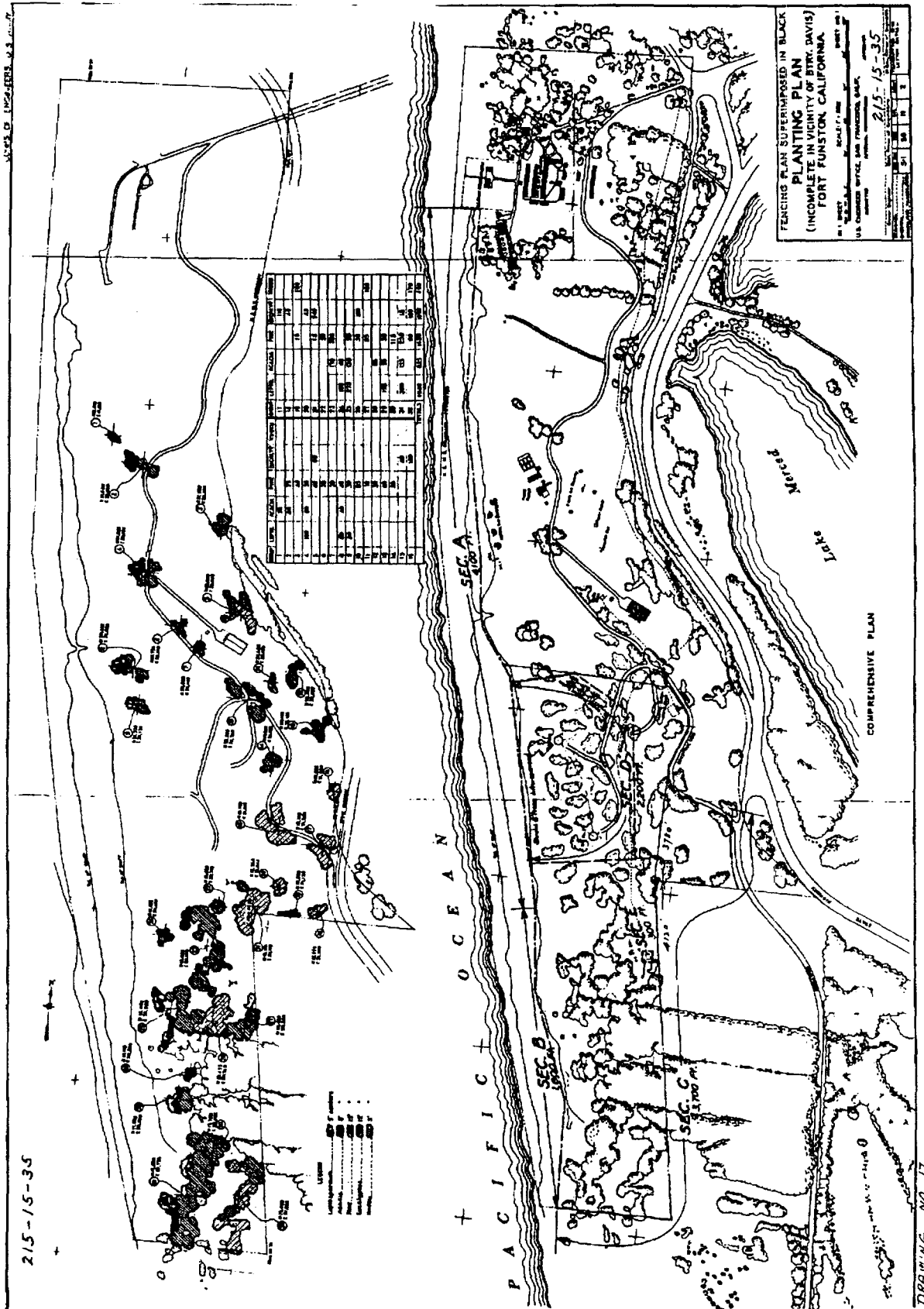

Plate 34. Fort Funston, inclusive of vicinity of Battery Davis, landscape plan, 1938. From Erwin N. Thompson, *Historic Resources Study Seacoast Fortifications San Francisco Harbor*, 1979.

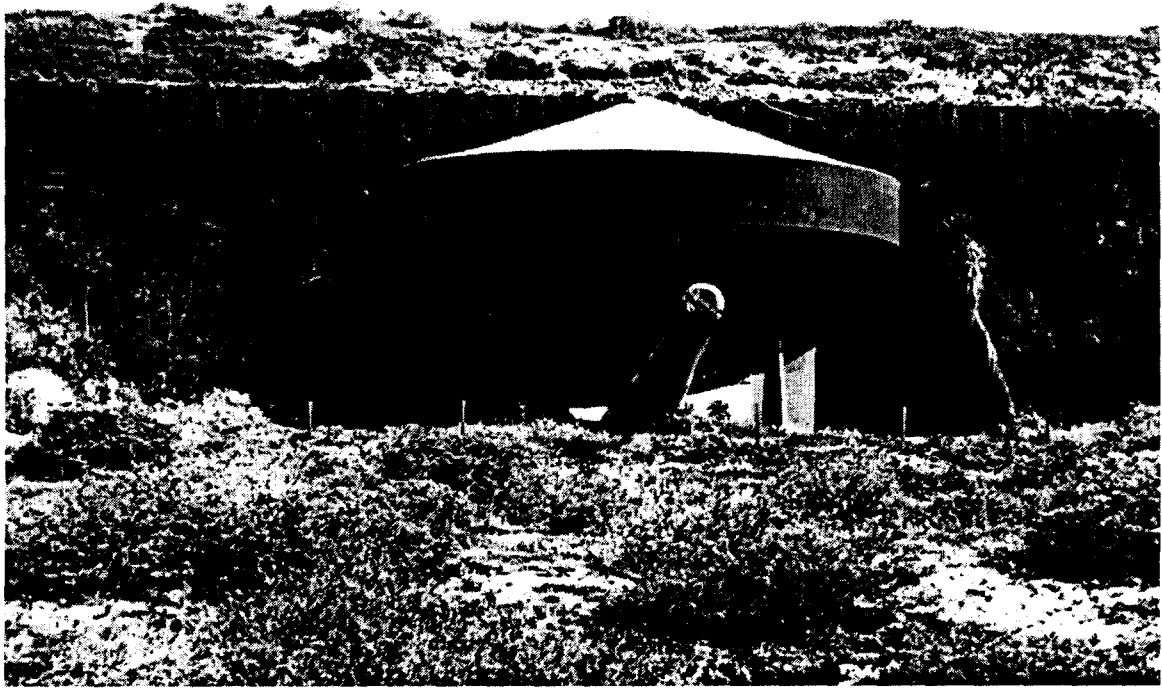

Plate 35. Battery Davis, Fort Funston, 1936-1940. View immediately post construction, September 1940. Courtesy of the Park Archives of the Golden Gate National Recreation Area.



Plate 36. Battery Davis. Landscape camouflage at the power room entrance. View immediately post construction, September 1940. Courtesy of the Park Archives of the Golden Gate National Recreation Area.

The larger issue raised here is that of landscaping with native vegetation. Army officers discussing native vegetation during the first half of the twentieth century used the term native loosely, most often meaning vegetation typical of the immediate area. Lupine and sagebrush were growing wild on the military reservations of San Francisco from at least 1901, and with eucalyptus and acacias introduced from Australia during the 1880s. Wickson described lupine as native, noting its presence on many California beaches.⁶⁵ Although iceplant is considered as originally Northern European, its tenure in California—and likely on the San Francisco coastline—was well established before the Endicott batteries. Certainly, sagebrush and lizard leaf were truly indigenous. Kudzu had been introduced to the U.S. in 1876, native to China and Japan, and initially used as for erosion control and as a forage crop like alfalfa. California's orientation to the Pacific, as well as its easy acceptance of exotic vegetation from both tropical and arid climates, made it an early recipient of non-native plants that then became wild. The last larger issue here is one of color. From the Arts and Crafts years forward into the late 1930s, chosen landscaping for the San Francisco batteries, both at the immediate installation sites and over the larger vicinity, was full of color. Lupine flowered blue-lavender and yellow; iceplant white and pink; sagebrush, violet; kudzu, purple (with large blossoms); lizard leaf, white; and, acacia, yellow. Efforts to intensify the given landscape, and its color, are steady during this thirty-year period.

The Cold War

Although not formally part of the Army's construction of batteries, the Nike installations of the late 1950s and early 1960s represent a thoughtful addendum in the discussion of historic materials for the coast defense of the San Francisco harbor. In response to the realization that the Soviet Union was anticipated to possess an atomic bomb stockpile numbering seventy-five to 200 by 1954, the Air Force pressured the Army in 1950 to develop an anti-aircraft system for placement around strategic sites. After a review of the guided missiles program, the Department of Defense accelerated two Army anti-aircraft programs, Nike Ajax and Nike Hercules. The Nike Hercules guided missile was intended to carry variable-yield nuclear warheads, developed at Sandia Laboratories and Los Alamos, in New Mexico. As of 1952, both were planned to use the same infrastructure, although the upgrading from Nike Ajax to Nike Hercules involved major rebuilding of the missile sites. Nike Ajax emplacement began in April 1954, with Nike Hercules replacements underway as of 1958. The Army incorporated a final set of Nike developments in the antiballistic missile defense program. The U.S. program relied on the Nike Zeus (1956-1963), and thereafter the Nike X (1963-1967), Sentinel (1967-1969), and Safeguard (1969-1976). San Francisco maintained Nike Ajax and Nike Hercules sites, and was slated for a Sentinel site. The deployed Safeguard system used the Sprint and Spartan missiles, with only a single location near Grand Forks Air Force Base in North Dakota. The Army intended Nike emplacements to replace gun batteries, and as such, the Nikes were the final chapter of coast defenses.⁶⁶

By 1958 the Army had deployed almost 200 Nike Ajax batteries around U.S. cities and military installations, with the Nike Ajax total reaching over 300 sites at the program's buildout. The U.S. Army Corps of Engineers had projected that each installation would require 119 acres, a significant problem in real estate acquisition. First installations did, in fact, utilize large acreages, and had aboveground launchers. To accommodate a smaller, forty-acre installation, however, the Corps' architect on the project, Leon Chatelain, Jr., designed an underground magazine, built for twelve missiles with elevators lifting the missiles to the surface in a horizontal position. Three physical areas articulated each Nike battery, with the administrative center coupled with either the integrated fire area or the launching area, and with the integrated fire areas and the launching areas separated by distances no less than 1000 yards and sometimes exceeding a mile, but visible to one another.⁶⁷ Infrastructure followed patterns established for intermediate range and intercontinental ballistic missiles, in development simultaneously: sites used equipment trailers and prefabricated steel structures where possible, and were typically quickly erected, but for critical structures, such as warhead storage and assembly structures, were nominally hardened. In understandings of the early 1950s, hardening was intended to withstand non-direct hit, blast effects. As such, tests in Nevada by the Atomic Energy Commission had shown that thick-walled, reinforced

concrete structures were most suitable, but that even windowless cement cinder block structures did well.⁶⁸

The Nike site SF-88L, now restored at Fort Barry, was under construction as of 1953-1954, with "Type B" underground missile storage structures. Although not researched here, it is likely that the engineering firm responsible for the Type B storage structure was Black & Veatch of Kansas City. Sandia had hired Black & Veatch in 1946 to design the very first atomic weapons storage facilities in New Mexico, and by the early 1950s the firm consistently designed all such structures for the U.S. military. The Type B structure closely followed in name and typology Black & Veatch's Plant B for the nuclear weapons stockpile and operational storage sites, known as Q Areas (due to their restricted Atomic Energy Commission clearance status). Q Areas were associated with thirteen U.S. Air Force and Army installations, with selected additional facilities built in French Morocco for use by Strategic Air Command. Black & Veatch also typically designed missile assembly buildings for the Air Force over generations of nuclear missiles, and often undertook the associated design of heightened security systems. At SF-88L, the Army made early reuse of existing batteries for the aboveground needs in an ad hoc manner, even continuing this approach in its long use of assembly vans and a Butler building as the final missile assembly building in 1962. (See Plate 6, chapter 1.) Yet, such sustained improvised solutions were common during the Cold War, often running in tandem with permanent infrastructure. By the erection of the cinderblock warhead building in 1959 for Nike Hercules, it was understood that all aboveground structures would not survive the increased destructive power of thermonuclear warheads. Nonetheless, the structure remains cinderblock. The Air Force typically built such structures in reinforced concrete, windowless and with identical loading doors, for its missiles at Vandenberg and elsewhere. The choice of a Butler structure for the missile assembly building at SF-88L may also be an alternate use of the Butler Type III launch shelter for Bomarc, designed in 1958-1959 (Plate 37).



Plate 37. Nike Hercules Warhead Building, Nike Site SF-88L, Fort Barry, 1959. Courtesy of the Park Archives of the Golden Gate National Recreation Area.

JOSSON CEMENT

AND OTHER FIRST CLASS BRANDS

Belgian and German Artificial Portland Cements

W. R. GRACE & CO.

614 CALIFORNIA ST San Francisco., Cal.

Plate 38. Advertisement for Jossen Portland cement in Architect and Engineer of California, November 1907.

Selected Highlights

Concrete Mixes of the 1890s

First mention of the details for the composition and mixing of the concrete for the San Francisco batteries occurs in the Army annual reports of 1891 and 1893, with references to the purchase of a 50 horse-power boiler, a 35 horse-power Westinghouse Junior Engine, a Gate No.3 rock-crusher, a Stearn's bucket elevator, and two concrete mixers, a Ransome and a Smith No.3.⁶⁹ The machinery comprised the initial "concrete plant" for the batteries. Of note, the Ransome mixer was undoubtedly a machine patented by San Francisco engineer Ernest L. Ransome, who also patented numerous steel reinforcement bars—most notably that of the twisted square steel bar. Concrete used in Batteries Marcus Miller and Godfrey is described simply as made with one part cement, three parts sand, and eight parts rock, with gravel sometimes substituted for rock. The cement was imported Portland cement, Josson & Company by brand and bought for \$2.21 per barrel. Josson's was still a preferred Belgian Portland cement sold in San Francisco as late as 1907 (Plate 38). The Army excavated the sand for these first batteries from the Fort Point and Presidio beaches, with rock quarried on Angel Island and gravel taken from Gravelly Beach and Horseshoe Cove at Fort Baker (then the Lime Point reservation).⁷⁰

The concrete plant was mobile, set up near the sites under construction, and typically run for weeks or months at one location. Although desirable, it was not always practical to make continuous concrete pours due to the limitations of labor and mixing equipment. Interrupted pours created divisions in the concrete called "cold joints" that proved to be a deficiency that was more pronounced in unreinforced concrete than in the later reinforced material. The Army described the mix and pour procedures thusly: "The materials were dumped into hoppers feeding to the mixer, which automatically combines them in proper proportions, mixes them in a revolving churn, and delivers to boot of elevator, which raises them 32 feet to a hopper over the cars on a tramway above the top of masonry."⁷¹ For Battery Howe-Wagner, the Army mixed some of the concrete by hand, using the concrete plant for only part of the work, spreading the pours over 1893 and 1894. For Howe-Wagner, the Army used rock from a different quarry located at Fort Point Beach, where personnel also excavated the needed sand.⁷² During the second season, the Army altered the machine-mixed concrete in its basic proportions to one part Portland cement, 3.46 parts sand, and 9.16 parts rock and gravel, in effect increasing the proportion of both sand and rock/gravel to that of the Portland cement used in the mix.⁷³

Specific mixing and pouring at the earliest Endicott batteries in San Francisco was somewhat dependent on the reliability of transportation, particularly the shipment and arrival of the imported Portland cement, and on the availability of the mobile concrete plant. For Battery Spencer, at Fort Baker, the portable concrete plant again did the mixing and pouring via tramway, until supplies ran out. At that point, the Army resolved to add the remaining 200 cubic yards by hand mix and pour, once the shipment of Portland cement docked. As of 1896, the Army began actively testing all available Portland cements, adding Gillingham's to its supplies of Josson's. Testing of the Portland cements increased in 1897, with the arrival of division engineer Colonel Charles R. Suter. The Army simultaneously continued its practice of partial hand-mixing and partial use of the concrete plant. For Battery Lancaster, Fort Winfield Scott, concrete mixing and pouring was exclusively by hand from October 1896 into early December 1897, thereafter exclusively by machine. Assistant engineer Captain Charles L. Potter described the two processes, hand and machine, in a letter to Suter in late 1897. He noted that both processes required a gang of thirty-five men, but that the concrete plant could mix as many as fourteen barrels in an hour—at a rate of about four minutes to the barrel. Potter gave concrete mixes as one barrel of Portland cement, to one or one-and-one-third cubic yards of rock, to one-half to five-ninths of a cubic yard of sand. Army personnel “scraped, loaded and hauled” the sand from an immediately accessible beach.⁷⁴ Concrete at Battery Stotsenburg-McKinnon was also handled by the hand and machine processes, with hand mixing and pouring preceding arrival of the concrete plant, and, with completion by hand in very late 1897.⁷⁵

By Spring 1898, the Army annual reports indicate a full, or nearly full, shift to use of the concrete plant, and machine mixing and pouring. Described in detail for construction at Battery Duncan, the process used a steam-driven, “cubical” mixer, an elevated hopper, ten or more revolutions of the mixer per batch, and delivery by cars “running on a track that extended from the mixer to all parts of the work.” Water used was brackish, taken from a lagoon in Horseshoe Cove. Typically, however, mix water was fresh. For all except the gun platform foundations, the concrete mix had not changed much: one part Portland cement, three parts sand, and eight parts broken stone. For the gun platforms the Army altered the mix to one part Portland cement, three parts sand, and six parts rock.⁷⁶ Exclusive machine mixing is also the noted process with Batteries Mendell and Alexander in early 1901. For this site, the Army excavated a new porphyritic sandstone quarry into the face of the site cliff. The Army annual report noted that the particular sandstone was nearly identical to that which had been in use for thirty years, excavated for coast defense construction at the quarry on Angel Island. A tramway connected the mobile concrete plant to both batteries via gravity. At this site, a train transported rock from the new nearby quarry, with a cableway lifting very large stones from the train and positioning them into the unreinforced concrete of the batteries.⁷⁷

For work at the batteries after the turn of the century, the concrete mix definitively changed: one portion Portland cement, to two portions sand, to five portions rock for Batteries Mendell and Alexander, and 1:3:6 at Baldwin and Boutelle.⁷⁸ The Army continued to use the older proportional mix, 1:3:8, only for retaining walls at the rear of the emplacements.⁷⁹ During this hallmark year for concrete mix proportions, the Army also experimented very heavily with multiple brands of imported Portland cement, and, with the American Portland cement manufactured in Utah, all mentioned above. Mixing partially returned to a hand process, notably at Batteries Baldwin and Chester.⁸⁰ Final concrete character for the batteries of the Endicott period, although not definitively either hand- or machine-mixed, also acknowledged what had been learned regarding planes of weakness. Any needed below grade site stabilization, discussed below, was handled at approximately 1:6:12 Portland cement/sand/rock proportions; the gun platforms and their foundations, at 1:3:6; and the remainder of the battery at 1:3:8.⁸¹

The proportions that closed the active experimentation of the Endicott years attempted to compensate for differing settlement and cracking patterns inherent in the batteries respective parts. The 1:6:12 mix foreshadowed the cement-stabilization process adopted during the late 1930s, while the differentiation between the gun platforms and the host battery paid respect to planes of weakness. Engineering the final Endicott batteries as “separate monoliths” at each installation—for example, six at Battery Chester—

further recognized the role that planes of weakness played in coast defense design. At Chester, the gun platform was one monolith (with 1:3:6 concrete mix), while the breast wall in front of the gun platform was a second monolith (with 1:3:8 concrete mix).⁸² Such lessons would become codified when battery construction re-commenced in earnest just prior to World War II.

Surfacing Schemes: Damp-Proof Coatings; Camouflage Paint, Washes, and Tints

Real discussions of surface treatments for the batteries begin with those of the Endicott period. The Army applied coatings to the battery surfaces primarily for two purposes, to try to keep water from seeping into the structure or from causing metalwork to rust, and, to disguise the installation against its setting. Earliest references focus on the issue of dryness. The Army typically treated the top surfaces of the exposed concrete masonry and the outdoor floors with a three-to-six-inch thick layering of bituminous rock, sometimes also called asphaltum, in the first designs. (Such treatment for flooring was present in San Francisco's earth-and-brick batteries of the early 1870s.⁸³) Walls, inside and out, were given a coating of hard plaster.⁸⁴ At both Batteries Marcus Miller and Godfrey, the Army also coated the hard plaster finish of the magazine upper surfaces with a bituminous paint. For Howe-Wagner, the exposed hard plaster exterior wall surfaces and arches of all rooms and passages were "painted with bitumen," as were the exterior surfaces of the structure to be covered by sodded earthen slopes. To drain water away from those parts of the battery in contact with soil, the Army placed a layer of sand between the bitumen paint and the earthworks.⁸⁵ First mention of any kind of color treatment came with the fencework for Battery Howe-Wagner in 1895, where Army personnel applied a "dull-red lime wash," mentioned above.

At mid-decade, experiments with coatings began to accelerate, with the intent broadened from just achieving damp-proofing, to one including steps toward camouflage. Effective water resistance was, however, still uppermost. When the Army began to add the three-inch layer of asphalt to the parapets, blast aprons, and magazines at Battery Godfrey in July 1895, personnel discovered that multiple small cracks appeared in the line of fire for emplacement three. For emplacements one and two, the Army selected a softer bitumen, to create a "more elastic" asphalt covering, noting that blast effects required surfacing distinct from that of street pavements. The mix for battery asphalt at the San Francisco coast defenses at this time was eighty-five percent sand to fifteen percent bitumen, prepared at 300 degrees Fahrenheit. Men spread the asphalt layer with hot shovels and rakes, first treating the concrete surfaces with a coating of hot bitumen paint. The bitumen paint was intended to encourage the bonding between the concrete and the asphalt. Final application steps used rollers, with an initial compacting by a 300-pound machine, and a second compacting by a 1000-pound machine. Further experimentation with asphalt continued with the blast apron at emplacement one, Marcus Miller. Here the Army added asphalt directly to a concrete-like mix, using sixty percent broken stone, thirty percent sand, and ten percent bitumen, and then covering the apron with the traditional three-inch layer of asphalt.⁸⁶ Mixtures soon addressed not just damp-proofing, but also disguise. At Battery Spencer, personnel mixed higher amounts of sand in with the asphalt before application to the exposed top surfaces, creating a somewhat mottled and textured surfacing. At Marcus Miller, also discussed above, personnel applied a "wash of cement colored with lampblack." The tinted wash was intended to dull the reflection of light off the exposed walls, thus helping to hide the battery against the landscape. Use of a lampblack-tinted wash became standard Army treatment for its batteries nationwide.⁸⁷

Beginning in 1897 and significantly increased in 1898, Army annual reports again discussed new surface treatments. First mentioned is "paraffin painting," as an 1897 treatment at Batteries Lancaster and Saffold, both at Fort Winfield Scott.⁸⁸ Application of hot paraffin as moisture-proofing had first been tried with an outdoor monument in Central Park, New York, in 1879, with a variety of "cement and stone waterproofing solutions" available commercially in the early years of the twentieth century—some effective, some less so. For example, in San Francisco during 1907, the Paraffine Paint Company offered the Pabco Damp-Proof Compound for "coating cement and brick walls."⁸⁹ (Plate 39) The Army continued to apply paraffin paint to the walls of Batteries Cranston, Howe-Wagner, Stotsenburg-

McKinnon, and Duncan in 1898 and 1899, listing thirty-three gallons priced at \$33 for the work at Howe-Wagner.⁹⁰ Paraffin paint appears to have been a replacement for bitumen paint, used by the Army to treat all battery surfaces "in contact with the earth"—either direct concrete or plastered surfaces. For the latter, a gallon covered eight square yards of wall in a single coat, or, six square yards of wall in two coats.⁹¹ In 1902 at Battery Chester, the Army moved toward a true moisture membrane, applying the paraffin paint and placing a course of rock between the battery walls and the earthen cover. Archeologists discovered a cobble layer also serving this same damp-proofing purpose at turn-of-the-century Battery Baldwin.⁹²

In this same year, the Army begins to mention "whitewashing" for the San Francisco batteries, specifically for these same three batteries, and at Marcus Miller. Whitewashing was also adopted Army-wide, with published mimeographs and circulars giving suggested chemical formulas. Whitewash was the counterpoint to lampblack—used to lighten interior walls and ceilings just as lampblack was employed to darken exteriors.⁹³ The formula for Army whitewash at Battery Duncan is given as one barrel lime, one pound bluing, one pound potash, and 10 pounds Russian tallow. "The tallow is melted and mixed with the potash and the mixture is added to the lime during the process of slaking. The bluing is dissolved in water and added to the slaked lime, the whole being thoroughly stirred and then screened through a sieve having at least 10 meshes per linear inch to remove lumps."⁹⁴ Painting the metalwork, too, became a concern at the turn of the century, with initial mention the protective painting for the I beams at Battery Cranston. California architectural journals of the period listed iron oxide paints and boiled linseed oil as rust inhibitors, noting that the best effects were had when a final black varnish coating of "pitch or asphaltum" was applied.⁹⁵ As of 1903, the Army had turned to a portable sand-blaster, devised by the Rix Engineering Company of San Francisco, to first clean the metalwork of the Bay Area batteries, then adding a "priming coat of red lead" and leaving it to weather.⁹⁶

MALTHOID ROOFING

is being used extensively in rebuilding San Francisco. It not only covers hundreds of temporary structures but occupies a prominent place in the plans of architects engaged in the erection of the large buildings now under way. Malthoid is impervious to heat, cold, dampness, acids and alkalies. Malthoid lasts longer and gives better results than any other roofing. Send for booklets that will tell you all about Malthoid.

PABCO DAMP-PROOF COMPOUND

is in great demand for coating cement and brick walls. It forms a tough elastic coating that permits the plaster to adhere tenaciously, and prevents moisture in the brick from entering the plaster. Buildings coated with Pabco Damp-Proof Compound are dry and free from musty odors. Send for folder.

THE PARAFFINE PAINT CO.

City Warehouse :: :: Guerrero near 15th Street, San Francisco
General Offices :: :: Merchants' Exchange Building, San Francisco

E. G. JUDAH,

313 North Los Angeles St.,

General Representative Southern California, Arizona, New Mexico and Mexico.

Plate 39. Advertisement for the Paraffine Paint Co. in *Architect and Engineer of California*, November 1907.

The most remarkable innovation in surface treatments at the San Francisco batteries, however, came in 1899 at Battery Duncan. Under the direction of division engineer Suter, the design of Duncan was the first of the San Francisco harbor defenses to demonstrate a more sophisticated camouflage. The battery stood out against the skyline, on an isolated knoll. To blend the man-made form with its site, Army engineers called for the walls to be "tinted to correspond with the color of the spoil bank surrounding the battery." The applied wash was a mix of cement and water, to whitewash consistency, to which was added "Pecora mortar stain, yellow ocher, and lampblack in such proportions as to produce as nearly as possible the dull red color" of the site.⁹⁷ Army engineer Winslow noted that the Army frequently did add "powdered blue stone" or "powdered red stone" to concrete surface treatments as a darkener, akin to the use of lampblack, but does not mention when this practice came into being, and whether it was typically a generic attempt at darkening, or, as at Duncan, a deliberate matching of the landscape.⁹⁸

A final surface treatment adopted by the Army nationwide for its batteries pre-1920 was the use of boiled linseed oil. In San Francisco, the Army applied two coats of boiled linseed oil to battery roofs and the tops of parapet walls, "allowing the cement to absorb all the oil it will take." A third final coating consisted of boiled linseed oil mixed with "Prince's metallic brown." While these treated surfaces were still wet, Army personnel spread screened, dry sand over the oiled and painted surfaces. Slow drying, the sand and oil-paint layer hardened as a single unit, and provided both camouflage and an improved walking surface.⁹⁹ The Army used boiled linseed oil, generally, to darken its coast defenses, and as in San Francisco, sometimes added pigment. The oil was thought to also help waterproof concrete, but was discovered in the early twentieth century to often injure it. Linseed oil was found to be very damaging to any hard plaster layer, dissolving both the plaster and the bond between the plaster and the underlying concrete. The actions of linseed oil were observed as very slow, and even as late as 1920, Winslow advised caution in using oil and recommended strongly against oil-based paints when water-based paints could be had.¹⁰⁰

After the long hiatus between the Endicott batteries and those of World Wars I and II, many of the surfacing treatments attempted early on had become formulaic. Membrane coatings of asphalt were standard for those structural concrete elements to be earth covered, and concrete surfaces were grouted and polished for plaster applications (Plate 40). In maintaining Battery Davis, the Army advised against any interior painting of exposed concrete. If that proved necessary, directions were to wet the walls, and mix white Portland cement with black iron oxide for a gray color scheme, or, with yellow iron oxide for a cream color scheme. When the interior surfaces were to be repainted, the Army indicated that any earlier oil paint or Portland cement plaster be removed with muriatic acid first. The late-1930s interior paint scheme of gray-and-cream was exactly noted for Battery Townsley: a gray, five-foot dado for all rooms, with the remaining wall and ceiling surfaces painted cream.¹⁰¹ Treatment for all exposed iron and steel work began with wire brush cleaning, or other abrasive cleaning, and then, as had been true at the turn of the century, included one or more applications of red lead paint. This technique had also been in steady use for maintenance of highway bridges since at least 1919, with formulas at that time suggesting eighteen pounds of red lead to one gallon of linseed oil.¹⁰² The Army camouflaged outer walls with a mottled paint scheme, with no maintenance painting planned. World War II color schemes found at Batteries Dynamite, Wallace, and Townsley were green, ochre, and brown, respectively.¹⁰³

Site Preparation and Issues of Settlement: Excavations and Fill

From the very first, erecting coast defense fortifications required massive earth movement, with significant excavations and backfills. At the close of 1870, the Army had embanked 29,586 cubic yards of earth for East and West Batteries on the south side of the bay,¹⁰⁴ while during early stages of site work for Cavallo Battery in 1875 the Army removed a nearly equal amount of dirt, rock, and sand: 24,000 cubic yards.¹⁰⁵ Settlement was a continuing problem even before batteries were completed: at Ridge Battery—where initial construction had necessitated heavy earthen fill of 15,000 cubic yards, settlement

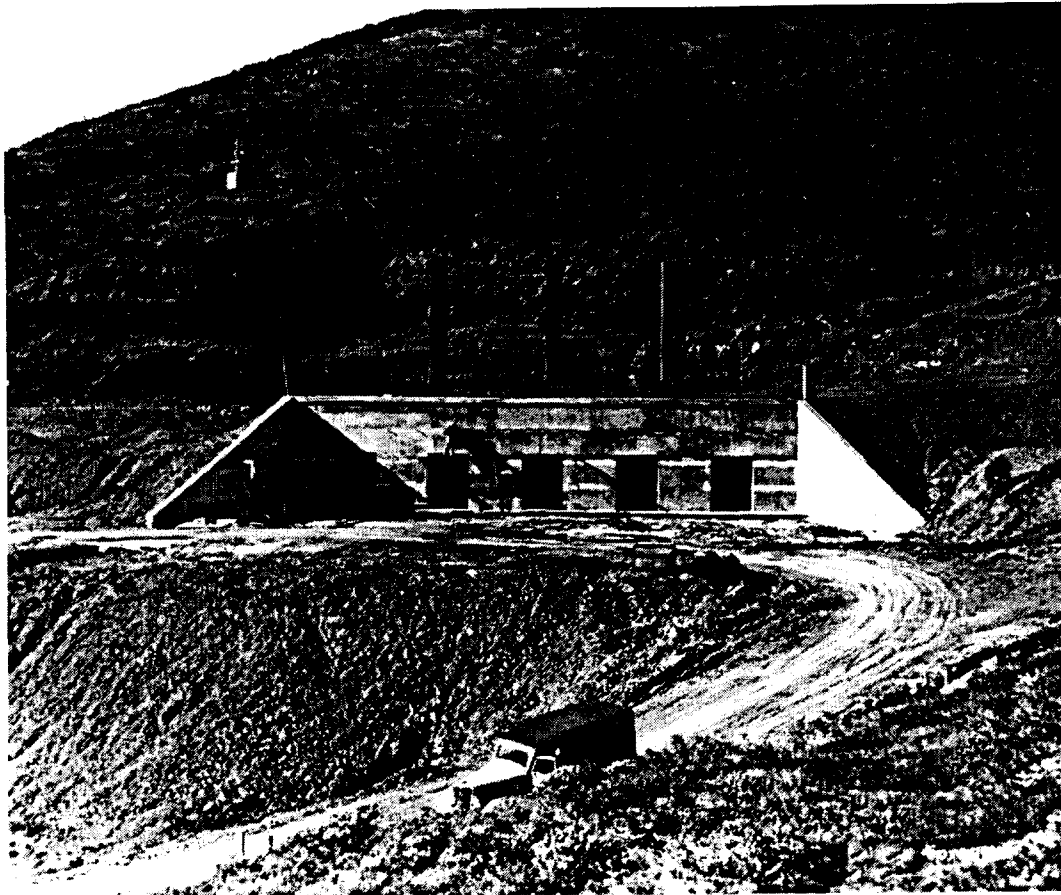

Plate 40. Townsley Reserve Magazine, Fort Cronkhite, 1938-1940. Grouting and polishing of reinforced concrete, before final surfacing. View of January 1939. Courtesy of the Park Archives of the Golden Gate National Recreation Area.

was already compromising the installation in 1875. The situation forced the Army to add 2,100 cubic yards more material to the site.¹⁰⁶ Following the fifteen-year hiatus until construction renewed in the early 1890s, not much changed. Before 1892 ended, Army engineers had poured 20,000 cubic yards of concrete at the excavated sites for Batteries Marcus Miller and Godfrey. The Army report for that year commented: "Much back filling has been executed."¹⁰⁷

Often excavated materials were reused for backfill, at the front and rear of the battery site. Excavation of the roadway and parade area at Batteries Marcus Miller and Godfrey provided fill for front slopes. Battery plans of these Endicott-era installations called for sand as additional fill to protect the seaward-facing emplacements from artillery damage and to shield the bitumen-painted concrete work from direct contact with wet earth and clay. Usually, sand for fill at the battery sites was hauled from nearby. At these two batteries, sand came from the Fort Point Beach and from dunes in the rear of the installation. In order to accommodate sodding and seeding the protective fill of the battery slopes, the Army applied a final layer of loam. Marcus Miller's and Godfrey's loam came from excavations to the rear of its site. In all, the Army excavated 10,004 cubic yards of site materials for the two batteries during 1892 and 1893, with 23,946 cubic yards of fill—19,922 cubic yards earthen and the remainder, sand.¹⁰⁸ For Battery Howe-Wagner, initial site preparation featured "plowing and scraping on the shallow portions" and "blasting on the deeper ones, with 10,781 cubic yards of preliminary excavation."¹⁰⁹ By the end of fiscal year 1894, the Army had excavated a staggering 32,324 cubic yards of site materials at Howe-Wagner, with a large proportion of rock in the yardage. Total fill at the installation, at that time, was 44,124 cubic

yards: 6,714 cubic yards of loam; 4,136 cubic yards of sand; and, the remainder, presumably, a combination of rock and earth from the original excavations on site.¹¹⁰

Foundation work at the base of site excavations, and generally effective drainage, were immediate Army concerns for the coast defenses. For Battery Godfrey, excavations to thirteen feet for the foundations of the gun platforms uncovered a yellow clay that was particularly unsuitable as a stable base when wet. To counteract this condition, Army engineers placed an open concrete drain, layered in gravel, around the base of the concrete gun platform foundations.¹¹¹ Drainage was an even greater issue for the steeply-sloped mortar installation, Battery Howe-Wagner. Following very heavy rainfall during the winter of 1894-1895, the Army experienced its first major recorded landslide at the San Francisco batteries. In January 1895 more than 200 cubic yards of embanked clay and loam slid into mortar pit one, with another 800 cubic yards cascading into pit two—completely burying the platforms under construction with mud and water. Gophers and moles had honeycombed the topmost seeded loam of the battery slopes, allowing water to saturate the embanked earth. To correct the situation, Army engineers installed a new drainage system during the spring and early summer. They benched the underlying clay slopes, laying them with blind drains, and redressing the top with equal parts loam and sand. Engineers then designed a low, 322-foot long, concrete retaining wall and 1,135-foot gutter at the base of the magazine slope, with another blind drain discharging into the weepers of the base gutter.¹¹²

For Battery Duncan, beginning in April 1898, the Army re-engineered the soft red rock ridge site at Fort Baker. Excavating sixteen hours daily into mid-May, personnel altered the natural slope, sinking a water tank into the ridge above and behind the battery. The Army annual report noted that “[m]uch grading was required in trimming off the ridge in front of the battery.”¹¹³ The Army removed the rock by blasting, with the shifts running from 4am to noon, and noon until 8pm, with two crews of men. The blasting teams used large oil lamps to illuminate the site after dark. The substantial grading in front of Battery Duncan, not surprisingly, accommodated the field of fire. To facilitate Battery Duncan’s straddling of the ridge, work crews also built a 2,400-foot long road, connecting the existing lower road to the ridge site. Evocative of its time, the new road to the battery climbed at a 6.67 percent grade.¹¹⁴

Prototypical cement-soil stabilization at San Francisco battery sites is first encountered in 1901, with discussions for Battery Baldwin at Fort Winfield Scott. Engineers excavated the site more deeply in the front than in the rear, using horse-drawn scrapers and plows to loosen and clear the sand and clay. Excavated material was entirely sand at the front of the site (down seven feet), while at the back (down fourteen feet) it included both sand and moderately hard clay. At the northeast corner of the immediate site for the installation, sand extended below the intended foundation. To achieve a firm base at this corner, excavation continued below grade, down to clay. Engineers then backfilled the corner area with a rough concrete mix, in the proportion of one part Portland cement, five parts sand, and twelve parts rock/gravel.¹¹⁵ Army personnel undertook a similar approach to site stabilization at Battery Chester in July the same year. Here the problematic corner was that of the northwest, with the excess excavation up to the main floor grade backfilled with a concrete mix of 1:6:12.¹¹⁶ As of the autumn of 1902, Army engineers carried the subgrade concrete stabilization work further, with enhanced footings for Battery Mendell. The base material was a porous mix of sandy soil and clay at grade. To offset this condition, engineers devised a general concrete foundation over three feet deep, rather than a then-typical feature of one foot depth.¹¹⁷ The “foundation” was completely unreinforced by iron or steel, although mention is made in Army reports that this was by reason “that there were no old rails on hand, nor could any be obtained in the market cheaply at the time.”¹¹⁸

By the time of the World War II batteries, soil-cement stabilization around reinforced concrete foundations was standard, drawing upon lessons learned from both the engineering of concrete dams and soil-cement highways. Nonetheless, virgin battery sites still required massive amounts of excavation and backfilling, with completed installations literally implanted into the land (Plates 41 and 42).



Plate 41. Battery Townsley. Initial construction, January 1938. Courtesy of the Park Archives of the Golden Gate National Recreation Area.

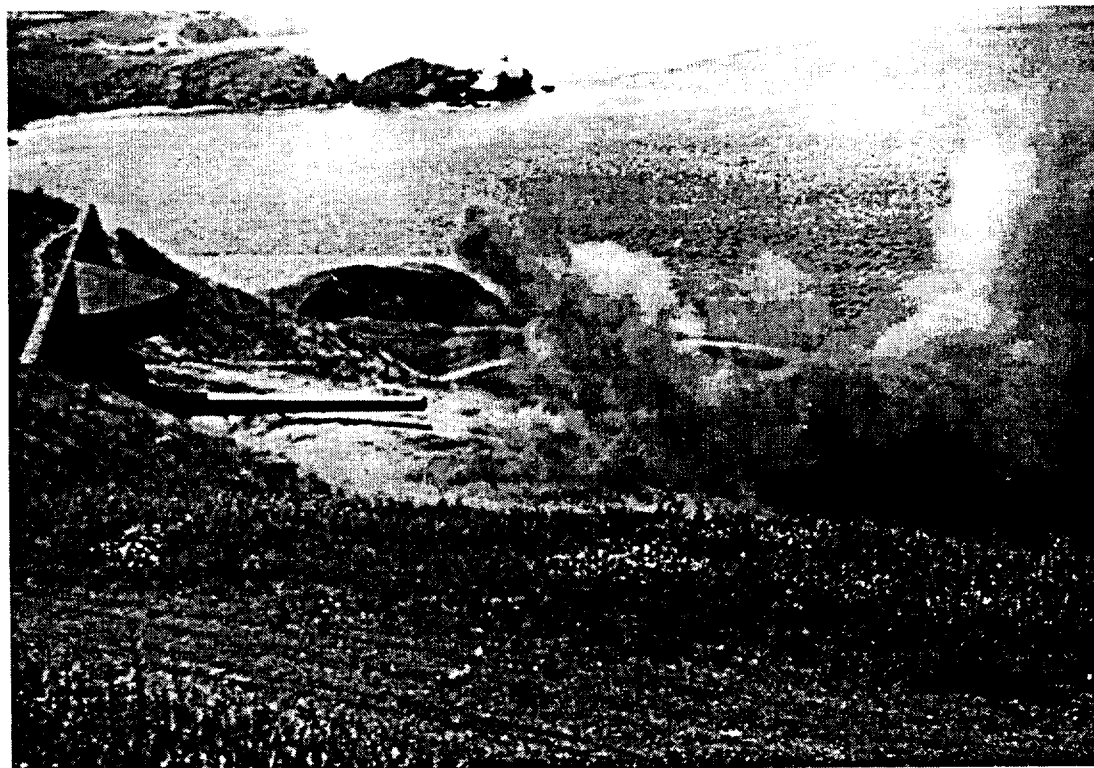

Plate 42. Battery Townsley. Immediately post construction, July 1940. Test firing gun no. 2. Courtesy of the Park Archives of the Golden Gate National Recreation Area.

Landscape: Cultivation of Native Vegetation versus Imported Plants and Trees

The coast defense fortifications for the San Francisco harbor raise a variety of questions focused on landscape. Landscapes exist as constantly changing over time. They vary with sustained microclimatic conditions such as long-term drought or multiple wet-year periods. Man-introduced alterations to waterways; cultivated fields; forest removal; and chemical usage are just a few other factors that can precipitate shifts in landscapes many miles away. Birds, rodents, and animals—as well as the wind—can accentuate change in progress. Landscape layers, as slices of chronological understanding, are important to batteries. In order to interpret the landscape designed—and redesigned—for the batteries, a benchmark landscape might be useful. Deeper analysis of the meaning at a battery landscape to its designers, in its own time, would also offer insights. Terms like “native,” in particular, may range in intent from “typical” to “indigenous.” Larger landscape movements, like that of the Arts and Crafts and the back-to-the-land movements of the 1890s-1920s, too, affected battery landscape design. These issues, and doubtless others, should be addressed in future studies at the Golden Gate National Recreation Area.

Engineer Winslow, in *Notes on Seacoast Fortification Construction*, summarized Army-wide policies on landscaping the batteries before 1920. He noted that the practice of landscaping was a very old one, with respect to grasses. “The custom of sodding the slopes of fortifications originated many, many years ago and at a time when the range of gun was so small as to make an attempt at concealment unnecessary.” Winslow commented, however, that from the first both sodding and seeding grasses tended to call attention to the batteries, as the manicured appearance was overly conspicuous. He stated that Army policy formally had changed in the early twentieth century (“some years ago”) to include planting “trees between the batteries and the shore” and “fine bushes, shrubs, and small trees...along the outer slopes of the batteries.” Winslow distinguished between “sodding” and “seeding” as methods to hold a newly established earthen embankment in place, with sodding common in the northern states, and seeding or transplanting elsewhere. As an example, he noted that the Army planted Bermuda grass tufts, watering them artificially, to create a sod on batteries in the South. Installing hydrants for watering the battery embankments through dry seasons appears to have become Army policy in the early twentieth century.¹¹⁹

Winslow exemplified Army attempts with a multi-tiered landscape at, and in the vicinity of batteries, through a deliberately “experimental” emplacement at Fort Morgan, Mobile, Alabama, in 1915. Before the landscaping, a natural vegetation did exist at the site, inclusive of “irregular splotches of vegetation, bushes, wild grass, small trees, etc.”

In building the emplacement care was taken not to injure any of the bushes or vegetation in the neighborhood. The emplacement itself was given a generally rounded contour not unlike that of most of the sand dunes. The sand used in the parapet was that taken from the vicinity and appeared just like the sand exposed in the dunes. In order not to make the area of bare sand around the parapet too large and thus too conspicuous, a number of bushes were transplanted from neighboring sand dunes and were made to grow on the parapet so that in its general appearance from the sea there was nothing to distinguish the emplacement from the sand dunes in which it was placed.

In addition to the landscaping, the Army added a burlap netting to the parapet of the Fort Morgan battery, coating it with a sand-and-cement grout. Winslow concluded his discussion by praising the combined landscape-and-burlap treatment as effectively hiding the battery in the dunes, from ranges as far away as 5,000 yards. He also noted that the time was coming when the Army would need to conceal batteries from the air, with “modern development of air craft.”¹²⁰ These issues would all surface for the coast defense fortifications in San Francisco as well.

Can a pre-existing pattern of vegetation, a pattern of vegetation characterizing the landscape immediately before construction of a battery, be established? Can, or should, patterns of vegetation be assigned to temporal periods, with change occurring due to both man and to nature? Were some plants introduced

into California so early that by the time of the batteries they were essentially a part of the immediately pre-existing landscape? And, as such, thought of as "native?" Are some plants considered indigenous in one period of time, and "introduced" in another? Such a situation would make the interpretation of period terminology of critical importance. When and where did seed gathering and cutting (for landscaping the batteries) occur on the military reservations associated with coast defenses? When and where were nurseries established for propagating vegetation for the batteries? How frequently did man-made drainage and watering systems accompany landscaping the batteries? In what periods? What were the truly exotic plantings at the batteries, vegetation never considered to be native to the area? When did the Army coordinate landscaping with camouflage painting and/or net schemes?

For reference, landscape treatments known to have been in place at the San Francisco batteries are summarized in Table 3 below. Two plantings appear to have been interpreted as indigenous in one period and introduced in another—thus having conflicting columns of data. The table is intended to reflect the opinions current during the periods when the listed plantings are known to have been in place at the batteries—not to indicate professional assessments of "native" and "introduced" today.

Table 3
Landscaping at the San Francisco Batteries, 1870-1944

	Period in Active Use	Planted on Site	Considered Indigenous	Considered Introduced	Considered Temporary
Barley	1870-circa 1902	Yes	No	Yes	No
Oats	1870-circa 1902	Yes	No	Yes	No
Alfalfa	1901	Yes	No	Yes	No
Iceplant	1901-1905	Yes	Yes	Yes	No
Lupine	1901-1938/44	Yes	Yes	Yes	?
Eucalyptus	1901-1938/44	Yes	No	Yes	No
Bunch grass	1901-1902	Yes	Yes	No	No
Sagebrush	1902[?]/1938	Yes	Yes	No	No
Rye	1905	Yes	No	Yes	Yes
Leptospermum	1938/44	Yes	?	?	No
Acacia	1938/44	Yes	No	Yes	No
Pine	1938/44	Yes	No	Yes	No
Kudzu	1938/44	Yes	No	Yes	No
Wormwood	1938/44	Yes	Yes	No	No
Baccaris	1938/44	Yes	Yes	No	No
Lizard Leaf	1938/44	Yes	Yes	No	No
Vetch	1938/44	Yes	No	Yes	Yes
Mustard	1938/44	Yes	No	Yes	Yes
Meliolotus Indica	1938/44	Yes	No	Yes	Yes

Historic Maintenance Methods and Issues in the Recent Past

Over the past 10 to 20 years maintenance methods used at the San Francisco batteries have focused on practical solutions to problems at hand, with substantial deferred work. Actions taken have included isolated replacement of handrails; painting of handrails to retard rust; adding some new hinges; sealing and welding selected wood and steel doors; attempts at graffiti removal; latex painting-out of graffiti; selected installation of lighting and security doors; selected removal of asbestos and lead paints; spot carpentry; occasional weed cutting; selected experimentation to remove lichen; some erosion and drainage work, and, security fencing of sites attractive to vandals. Such actions are reasonably inferred as probable maintenance practice historically, with specific methods those most common and expeditious at the time. Army maintenance, in particular, may have followed the published directives of the Coast Artillery. Personnel of the Coast Artillery were those men responsible for upkeep at the batteries. Future studies might review Coast Artillery records for San Francisco to glean further information on historic maintenance practices. A final probable source of useful references is likely the *Coast Artillery Journal*, which is understood to have published several articles between World War I and World War II on the caretaking of batteries.

¹ U.S. House of Representatives, *Annual Reports of the Chief of Engineers, United States Army, to the Secretary of War*, 1869, 19, and 1870, 27.

² U.S. House of Representatives, *Annual Report of the Chief of Engineers, United States Army, to the Secretary of War*, 1894, 11.

³ Erwin N. Thompson, *Historic Resource Study Seacoast Fortifications San Francisco Harbor Golden Gate National Recreation Area California* (Denver: U.S. Department of the Interior, National Park Service, 1979), 105, and, U.S. House of Representatives, *Annual Report of the Chief of Engineers, United States Army, to the Secretary of War*, 1893, 10.

⁴ U.S. House of Representatives, *Annual Reports of the Chief of Engineers, United States Army, to the Secretary of War*, 1872, 22-23; 1874, 27-28; 1875, 26-28; and, 1876, 28-29; Thompson, 108-109; Charles L. Potter to Colonel C.R. Suter, 10 December 1896, Operation and Maintenance Files, 1896-1941, RG77, Box 58, National Archives Record Center, San Bruno.

⁵ U.S. House of Representatives, *Annual Reports of the Chief of Engineers, United States Army, to the Secretary of War*, 1895, 11-12, and, 1896, 535.

⁶ *Annual Report*, 1896, 535-538.

⁷ *Annual Report*, 1893, 620.

⁸ *Annual Report*, 1896, 528-530.

⁹ Colonel Eben Eveleth Winslow, *Notes on Seacoast Fortification Construction*, Occasional Papers, Engineer School, United States Army, No. 61 (Washington, D.C.: Government Printing Office, 1920), 60.

¹⁰ *Annual Report*, 1896, 528-530.

¹¹ *Annual Report*, 1896, 528-538, and, U.S. House of Representatives, *Annual Reports of the Chief of Engineers, United States Army, to the Secretary of War*, 1897, 748-755, and 1898, 779-797.

¹² *Annual Report*, 528-538.

¹³ U.S. House of Representatives, *Annual Report of the Chief of Engineers, United States Army, to the Secretary of War*, 1892, 8.

¹⁴ *Ibid.*

¹⁵ *Annual Report*, 1894, 11, 465-466, and, Potter to Suter, 28 February 1897, Operation and Maintenance Files, 1896-1941, RG77, Box 58, National Archives Record Center, San Bruno.

¹⁶ *Annual Report*, 1896, 536.

¹⁷ U.S. House of Representatives, *Annual Reports of the Chief of Engineers, United States Army, to the Secretary of War*, 1898, 781, and, 1899, 987.

¹⁸ *Annual Report*, 1896, 535.

¹⁹ *Annual Report*, 1899, 986.

²⁰ *Annual Report*, 1897, 749.

²¹ Potter to Suter, 20 October 1896, Operation and Maintenance Files, 1896-1941, RG77, Box 58, National Archives Record Center, San Bruno.

- ²² Potter to Suter, 18 October 1897, Operation and Maintenance Files, 1896-1941, RG77, Box 58, National Archives Record Center, San Bruno.
- ²³ *Annual Report*, 1895, 517.
- ²⁴ *Annual Report*, 1893, 619.
- ²⁵ *Annual Report*, 1895, 518.
- ²⁶ U.S. House of Representatives, *Annual Report of the Chief of Engineers, United States Army, to the Secretary of War*, 1901, 864.
- ²⁷ *Annual Reports*, 1893, 620, and, 1896, 538.
- ²⁸ *Annual Report*, 1901, 874, 878.
- ²⁹ Winslow, 60-61.
- ³⁰ *Annual Report*, 1901, 860-894.
- ³¹ *Ibid*, 876.
- ³² *Ibid*, 861.
- ³³ *Annual Reports*, 1895, 516, and 1899, 985.
- ³⁴ *Annual Report*, 1898, 779-797.
- ³⁵ *Annual Report*, 1901, 877, 880.
- ³⁶ *Ibid*.
- ³⁷ U.S. House of Representatives, *Annual Report of the Chief of Engineers, United States Army, to the Secretary of War*, 1902, 764.
- ³⁸ *Ibid*, 763, 769.
- ³⁹ *Ibid*, 764.
- ⁴⁰ Winslow, 61.
- ⁴¹ U.S. House of Representatives, *Annual Report of the Chief of Engineers, United States Army, to the Secretary of War*, 1903, 2419.
- ⁴² Thompson, 213, 235.
- ⁴³ Paul V. Turner, "The Collaborative Design of Stanford University," *The Founders & the Architects* (Stanford: Department of Art), 1976, 53.
- ⁴⁴ Thompson, 213.
- ⁴⁵ Thompson, 237.
- ⁴⁶ Battery Stotsenburg Emplacement Book, Coast Artillery Harbor Defenses of San Francisco, RG392, Entry 335, Box 3, National Archives Record Center, San Bruno.
- ⁴⁷ Thompson, 251.
- ⁴⁸ Donald McLaren, "Landscape Gardening at the Exposition," *The Architect* 10:1 (July 1915), 12-14, with unpaginated plates. [Rare holding of a limited-run periodical, California State Library, Sacramento.]
- ⁴⁹ Kevin Starr, *Inventing the Dream: California Through the Progressive Era* (New York: Oxford University Press, 1985), 137-139.
- ⁵⁰ Edward J. Wickson, *California Garden Flowers, Shrubs, Trees and Vines* (San Francisco: Pacific Rural Press, 1926), 118.
- ⁵¹ McLaren, 12-14, plate immediately following; Karen J. Weitze, unpublished manuscript on the career of architect Hart Wood.
- ⁵² *Architect and Engineer of California*, 1906-1918, advertisements, *passim*.
- ⁵³ Karen J. Weitze, *Historic American Engineering Record Addendum to Little Rock Dam, Palmdale, California*, HAER No. CA-8, August 1994, 80-92.
- ⁵⁴ Lars Jorgensen, "Solidification of Sand, Gravel and Granular Materials by Chemical Means," undated offprint published by Lars Jorgensen, Hydro-Electric Engineer, Berkeley, California. Contained in "Reports of Foundation Development for Casements Battery Davis, Fort Funston, December 6, 1938," Records of the Office of the Chief of Engineers San Francisco District, RG77, Box 19, National Archives Record Center, San Bruno.
- ⁵⁵ Norman W. Haner, "Development of the Casemate Foundations by Cement-Stabilization Method at Battery Richmond P. Davis, Ft. Funston, California," memorandum, 6 December 1938, in "Reports of Foundation Development for Casements Battery Davis."
- ⁵⁶ *Ibid*.
- ⁵⁷ Frank T. Sheets and Miles D. Catton, "Basic Principles of Soil-Cement Mixtures," and, "How to Process Soil-Cement Roads," *Engineering News-Record*, circa 1938, in "Reports of Foundation Development for Casements Battery Davis."
- ⁵⁸ Battery Davis, dated construction photographs, in "Reports of Foundation Development for Casements Battery Davis."

- ⁵⁹ "War Department Seacoast Defenses 1938, 1939, 1940. Specifications for Construction of Battery Elements for a Battery of Two 16-Inch Guns at Fort Cronkhite, California," Records of the Office of the Chief of Engineers San Francisco District, RG77, Box 19, National Archives Record Center, San Bruno.
- ⁶⁰ U.S. Army Corps of Engineers, *Instructions for Maintenance and Operation of Battery Richmond P. Davis, Fort Funston, Calif.*, 3, Records of the Office of the Chief of Engineers San Francisco District, RG77, Box 19, National Archives Record Center, San Bruno.
- ⁶¹ *Annual Report*, 1903, 2419, 2421.
- ⁶² Thompson, included foldout illustration.
- ⁶³ *Instructions for Maintenance and Operation of Battery Richmond P. Davis*, 14.
- ⁶⁴ Office of the Chief of Coast Artillery, memorandum of 30 April 1910, in Battery Stotsenburg Emplacement Book.
- ⁶⁵ Wickson, 169.
- ⁶⁶ John C. Lonnquest and David F. Winkler, *To Defend and Deter: The Legacy of the United States Cold War Missile Program*, USACERL Special Report 97/01 (Rock Island, Illinois: Defense Publishing Service, 1996), 55-64, 107-117, 165-183, 463-473.
- ⁶⁷ *Ibid.*
- ⁶⁸ Karen J. Weitze, engineering context, in *Inventories for U.S. Air Force, Air Mobility Command, Cold War Properties*, Andrews, Charleston, Dover, Grand Forks, McChord, Scott, Travis Air Force Bases, 1996.
- ⁶⁹ *Annual Reports*, 1891, 8, and 1893, 620.
- ⁷⁰ *Annual Report*, 1893, 620, 622.
- ⁷¹ *Annual Report*, 1893, 620.
- ⁷² *Annual Report*, 1893, 622.
- ⁷³ *Annual Report*, 1894, 465.
- ⁷⁴ Potter to Suter, letter of 31 October 1896, and, letter of 18 October 1897, Operation and Maintenance Files, 1896-1941, RG77, Box 58, National Archives Record Center, San Bruno.
- ⁷⁵ *Annual Report*, 1898, 792.
- ⁷⁶ *Annual Report*, 1899, 987.
- ⁷⁷ *Annual Report*, 1901, 864-865.
- ⁷⁸ *Ibid.*, 869, 874.
- ⁷⁹ *Annual Reports*, 1901, 874, and, 1902, 769.
- ⁸⁰ *Annual Report*, 1902, 771.
- ⁸¹ *Annual Report*, 1902, 769.
- ⁸² *Ibid.*, 772.
- ⁸³ *Annual Report*, 1874, 27.
- ⁸⁴ *Annual Reports*, 1892, 8, and, 1893, 624.
- ⁸⁵ *Annual Report*, 1894, 465-466.
- ⁸⁶ *Annual Report*, 1896, 534-535.
- ⁸⁷ Winslow, 57-58.
- ⁸⁸ *Annual Report*, 1897, 754.
- ⁸⁹ Maximilian Toch, "History and Development of Waterproofing," *Architect and Engineer of California* 9:3 (July 1907), 88-90.
- ⁹⁰ *Annual Reports*, 1898, 788-789, 793, and, 1899, 987.
- ⁹¹ *Annual Report*, 1899, 987.
- ⁹² *Annual Report*, 1902, 772; Leo Barker, Park Historical Archeologist, to Stephen A. Haller, 1 May 1999, personal communication.
- ⁹³ Winslow, 58.
- ⁹⁴ *Annual Report*, 1899, 987.
- ⁹⁵ "Painting Ironwork" and "The Protection of Iron from Rust," *California Architect and Building News* 19:8 (August 1898), 91, 92-93.
- ⁹⁶ *Annual Report*, 1903, 2420.
- ⁹⁷ *Annual Report*, 1899, 987.
- ⁹⁸ Winslow, 58.
- ⁹⁹ *Annual Report*, 1903, 2422.
- ¹⁰⁰ Winslow, 59-60.
- ¹⁰¹ "Specifications for Construction of Battery Elements for a Battery of Two 16-Inch Guns at Fort Cronkhite," 42; *Instructions for Maintenance and Operation of Battery Richmond P. Davis*, 2-3.
- ¹⁰² Charles D. Snead, "Maintaining and Painting Highway Bridges," *Architect and Engineer of California* 58:2 (August 1919), 86-89.

¹⁰³ *Instructions for Maintenance and Operation of Battery Richmond P. Davis*, 3. National Park Service personnel offered the World War II camouflage colors for Batteries Dynamite, Wallace and Townsley.

¹⁰⁴ *Annual Report*, 1871, 24.

¹⁰⁵ *Annual Report*, 1875, 27.

¹⁰⁶ *Annual Reports*, 1872, 22, and, 1876, 28.

¹⁰⁷ *Annual Report*, 1892, 8.

¹⁰⁸ *Annual Report*, 1893, 621.

¹⁰⁹ *Ibid*, 622.

¹¹⁰ *Annual Report*, 1894, 466.

¹¹¹ *Annual Report*, 1895, 515-516.

¹¹² *Annual Report*, 1895, 517.

¹¹³ *Annual Report*, 1898, 781.

¹¹⁴ *Annual Report*, 1899, 987.

¹¹⁵ *Annual Reports*, 1901, 874, and, 1902, 769.

¹¹⁶ *Annual Report*, 1902, 771.

¹¹⁷ *Ibid*, 763.

¹¹⁸ *Annual Report*, 1903, 2417-2418.

¹¹⁹ Winslow, 183.

¹²⁰ *Ibid*, 184-185.

Chapter 6: The Design of Concrete Coastal Fortifications

Many authors have described the fortifications that once protected San Francisco and have commented on their richness as historic properties. The comments are in part a response to the quantity and variety of defensive works that have survived to the present. From the landmark qualities of Fort Point, through the simple shapes of the 1870s, to the manifold types of the 1890s, and concluding with the subtle forms of the 1940s, it is a collection of great number. As collections go, it is also disquieting since there is nothing here to indicate the evolutionary nature of fortification design and construction. The structures of each period appear unique unto themselves, claiming no antecedents and leaving no descendants. They create the impression that their designers drew only from within themselves for inspiration, if inspiration was called upon at all, and that their later fellows tore up existing notes and drawings to begin wholly anew. The names of the builders are lost or unrecognized, and to that anonymity we have added our own doubts about the historical merits of these structures, aided by the tendency to sniff with great suspicion around the animal called military architecture.

It is not a new attitude. More than fifty years ago, M. Waterhouse, the Honorary Secretary of the Royal British Institute of British Architects, drew a blank when struggling with language that would define military construction. "It cannot be called Architecture," he declared, "either as we knew it—or as we know it ought to be. I don't know what it really can be called. I am tempted to define it as a combination of Organization and Improvisation."¹

While organization and improvisation are well-traveled approaches to the construction of expedient defenses, the fortifications remaining throughout the Golden Gate National Recreation Area are the products of skillful engineering, deliberate construction, and money. The defenses have their designers, and the designers, after a fashion, have their inspirations. We need not look for a Palladio or a Wright, and we should not try to identify the equivalent in military architecture of a Villa Capra or Fallingwater. As stewards of historic property, however, we should know who designed what we are now charged with caring for, and we should have some sense of why they made the decisions they did.

Previous research, notably the work accomplished beginning in the late 1960s by historians of the National Park Service as well as other scholars, identified some of the principals and the chronology of their work. As a result, we know some about the construction of the 1870s, a great deal more about what took place in the Endicott and Taft years, but almost nothing about the designs of the 1940s. There are several reasons for the gap in the most recent period, however the lack of specific knowledge has little impact on what we know about the building of fortifications out of concrete. The use of concrete for defensive purposes was explored thoroughly in the years before World War I, and it is that period of innovation that is the most instructive. However, to fully comprehend the marks that fortifications have made on the landscape, our vision must extend beyond the material of construction itself. We must look at American military experience, the impressions made or not made by other nations on the American military, and a native engineering contribution to a distinctly American form of coast defense (Plate 43).

The utilitarian and rhythmic emplacement-and-magazine plan of the 1870s batteries at Fort Scott owes its heritage to the Civil War, and there is little to separate them from similar fortifications of that conflict. Yet Cavallo Battery is a distinguished design and it has no surviving counterparts. Its seaward face is well understood, but its general trace and rear parapet suggest some similarities with French fortifications erected in the Franco-Prussian War, especially in regard to the positions for land defense armament at the extremities of the plan. American officers regularly toured the battlefields, arsenals, and fortifications of European nations, and did so even until the late 1930s, and what others were doing became part of the base of ideas that contributed to the defenses² (Plate 44).



Plate 43. Even after the structures of the Endicott and Taft periods were completed, there was a pattern of improvements that also incorporated advances in concrete construction. The telautograph booth, ammunition hoist and splinterproof, and battery commander's station, shown here, were built between 1904 and 1912. These additions at Battery Marcus Miller were among the first attempts to use reinforced concrete in the fortifications.



Plate 44. The design of Cavallo Battery called for the work to be accomplished in earth, and rendered in regular outlines. Those crisp outlines have been obscured by a century of plant growth.

At the same time that Colonel Mendell was reconfiguring the ground at Point Cavallo to look more like a fortification, builders in Europe and especially England, were investing great sums to mount large muzzle-loading cannon in granite fortresses sometimes plated with iron. It was an astounding investment for the time, particularly since it appeared to be an endorsement of a type of ordnance that was born in the age of sailing ships, yet for England there was little choice. Both France and Italy had launched impressive armored vessels, and an immediate response was essential to defend both home and Mediterranean ports. These same kinds of vessels could pose an equally decisive impact on American coastal cities, although the possibility was slight. Both the Atlantic and Pacific Oceans were barriers to many early iron warships, and the insurance they provided allowed American engineers years of grace in which their counterparts of other nations could not share.

The coming of modern fortifications was slow in the United States. There was little need for speed, and in any case, Congress was not likely to provide any funding for a new defensive network with the Civil War so recently passed. There was movement, however. In January, 1873, a board of officers met to decide what sort of weaponry would be best suited for defense against the new naval vessels, and they came to a decision that would govern the appearance of defended harbors for years to come. They opted for guns mounted on depressing or disappearing carriages. They gave special encouragement to the proposals of Captain A. R. Buffington, who some twenty years later, would produce the prototype of all disappearing carriages to be placed in U.S. service.³

The selection of a disappearing carriage, either Buffington's or any other competitor for the design, meant that the batteries mounting it would have to be big—at least as tall as the machinery that would move the cannon above the parapet—and would have to be scaled in two stories. The first or lower story would contain the magazines for the projectiles and powder, and the upper story would provide a platform for the gun. Those requirements meant that earth was gone as a basic building material. Stone was an alternative, but it could only be worked by skilled craftsmen, while another material would be just as good and less expensive as well. It was concrete, and the adaptability of the material propelled it into the forefront of choice (Plate 45).



Plate 45. Although the batteries of the 1870s were built of earth and brick, concrete played an important role as well. Here a groin formed by the intersection of vaults in East Battery is made of concrete, displacing more expensive brickwork.

The engineers had considered other alternatives, most notably the iron-sheathed walls of masonry fortifications being erected in Europe, but they were costly. In any case, that technology would be difficult to adapt to the type of armament suggested by the Endicott Board in its report of 1886. The engineers were confident that concrete would meet all their needs. There was little difficulty adapting the conventional methods of concrete construction to the construction of fortifications, and not much was different in the methods of erecting the plant or placing the material.⁴

The specification for concrete was general, and to get it right a great deal depended on the abilities of individual engineers to translate the broad instructions into more detailed measures to be taken by supervisors and contractors. A sense of just how general the approach was can be gained by this excerpt from the notes accompanying a new standard design for a battery of 6-inch guns:

The proportion of cement, sand and broken stone will depend largely on the quality of the materials. One to three is a common ratio for cement to sand, but the amount of sand can be increased if the results of briquette testing so justify. The run of the crusher should be taken for the stone, and 1-1/2 inches should be the superior limit of the size. Enough water should be used to insure a concrete as wet as can be conveniently handled, and the mortar should be fairly flowing so as to settle into and thoroughly fill all voids in the stone after tamping. The proportion of mortar to stone...should be so adjusted that after tamping, the upper layer of stones should project at least half their thickness above the main mass.⁵

There were, however, a few new ideas that bear mentioning, and they had to do with either increasing resistance or increasing cohesiveness of concrete. In the Endicott and Taft structures, earth was still an important material, and counted upon to slow the penetration of projectiles striking the defenses. As further protection, the engineers dumped large boulders called deflectors into the concrete mass, the idea being that these huge stones would cause the projectiles to bounce away from critical areas. Chunks of the demolished West Battery were added to Battery Godfrey during its construction for apparently the same purpose. There was also concern that the long bolts holding the carriage to the emplacement might rack and twist when the gun was fired, an action that would weaken the concrete and loosen the connection with the carriage. As an aid in resisting fracture, the builders of some early emplacements in San Francisco created a framework of iron interlaced with surplus cables from the street railway, and the concrete was then tamped into the framework. Both of these practices fell away as experience accumulated.⁶

Experience in modern fortification construction was a rare commodity when work initiated at the San Francisco defenses. The earliest construction had begun in 1890 on the East Coast, and engineers who had overseen these efforts then went to other projects already underway or about to start. They took with them what they had learned by doing, and a practice of exchanging plans and information about fortification construction with their peers. It was at first an informal process, and then made more uniform by guidance issued regularly by the Chief of Engineers, although the official guidance did not halt the discussion among what was a very small group of individuals. Prior to 1900, engineers had an open invitation to adapt basic requirements to meet their particular needs. Those that did created batteries notable for their innovations, but a national defense system based on unique structures meant that estimating construction costs would be impossible. As a result, the Chief of Engineers in 1900 directed that unless otherwise required by some remarkable local conditions, engineers designing the fortifications remaining would do so by following the standard designs issued from his office.⁷

All of these aspects of design, experience, and standardization reveal themselves in many ways during the 1890s and early 1900s in the San Francisco defenses. What emerges from that perspective is an interpretation of the fortifications that shows them to be distinctive rather than an indication of what was done elsewhere. The collection of gun batteries at Forts Scott, Baker, and Barry also demonstrates that

the unusual dominates the expected, and this circumstance figures more into the significance of the historic resources than does their large number (Plate 46).



Plate 46. The designs for the earliest batteries did not anticipate the need for latrines, power plants, plotting rooms, and storage spaces. As a result, later building tacked on these components to fortifications completed only a few years before. These additions at Battery Godfrey are an example of the practice; they also portray the preference for steel doors in later construction.

The defenses of San Francisco were a laboratory in which young engineering officers could find practical experience in how to build a modern concrete fortification. It was an occupation of many parts, from requisitioning materials to measuring the monthly progress of the work. It was a practicum much endorsed by Colonel Mendell. "It is considered a fortunate condition," he said, "for a young Officer to get his first introduction to the profession under such circumstances; and the officers who have gone through this practical school at Fort Point, have, so far, justified all reasonable expectations. They have learned from the system which they found in operation, or which they aided to establish, sound means of construction in masonry & earth; the management of men; a reasonable task for a laborer, and the business habits essential for success."⁸

It was not one of the young Turks hailed by Mendell that left the most indelible stamp on the San Francisco defenses, but a senior engineer much like himself. Mendell retired in 1895, moving on to a position with the city's Board of Public Works until his death in 1902. His position as district engineer was filled by Charles Suter, about ten years younger than Mendell, but like Mendell a veteran of much action during the Civil War. Suter had a creative mind, and it was his opinion that the weakest part of fortification design lay in the way that ammunition was moved or lifted from the magazines to the level of the loading platform. There was too much movement and too much reliance on machinery to do the job faultlessly, and his concern was that those faults would only reveal themselves in action when it would be too late to make any changes.⁹

"The abolition of lift is of so much importance as to justify almost anything," he once wrote in support of a design that had been based on one of his batteries in San Francisco. Perhaps the most arresting quality of the batteries for heavy guns built to protect the Golden Gate is the number of them that were constructed without ammunition lifts or any provision for them, and Suter appears to have been associated with most if not all of these designs. Batteries Slaughter, Kirby, Duncan, and two emplacements of three at Battery Lancaster had no lifts at all, and this at a time when the most ordinary form of an American coastal battery for heavy guns was its distinctive two-story appearance and ammunition hoist. Suter's design for Battery Saffold incorporated traditional lifts, but added a new element. As convention dictated, there was a road or battery parade to the rear, and supplementing it was an unconventional paved road to the loading platform. That additional road meant that in case the lifts failed, ammunition trucks could still exit the rear of the battery and reach the guns, courtesy of Suter's thinking.¹⁰

Suter left San Francisco in 1898, and he continued his work while he was assigned to fortification construction in other harbors. In the end he was successful, and an example of Suter's final design is Battery Chamberlin, which was reproduced in great number in all the defended harbors. (See Plate 28, chapter 5.)

Also unusual is the number of designs that ignored the guideline identified as the horizontal crest. To ensure the invisibility of the defenses and to make the most of the qualities of the disappearing carriage that was the backbone of coast defense, no part of the defenses were to be visible from the sea. The battery location would appear as a flat line, or a horizontal crest. Yet Battery Slaughter did not have a horizontal crest, and neither did Kirby, Duncan, Lancaster, or Marcus Miller. Stranger still, two of those batteries—Lancaster and Marcus Miller—did not mount their guns all at the same elevation.

One oddity of many of the San Francisco defenses is an unusually deep traverse, that is, the side walls of the emplacement are carried back further than typical. That feature was shared by Duncan, Lancaster, Rathbone, Slaughter, and to some extent, Cranston. Less odd, but certainly notable are the number of single gun emplacements, usually frowned upon because of their high cost: Batteries Chester, Godfrey, and Marcus Miller all contain third emplacements that functioned as single gun emplacements, and Batteries Burnham, Drew, and Wallace were built as single-gun batteries.

Of all the major caliber gun batteries in San Francisco of this period only Battery Mendell and emplacements one and two of Battery Chester were conventional. The plan of Battery Spencer was so contorted that only two of the three guns were useful (the battery commander's station did not even have a field of view of the water area covered by the third gun); Battery Saffold contained improbable features that allowed its guns to fire well to the rear into San Francisco Bay; and Battery Dynamite was in every respect the two-headed calf of coast defense.

Many of these unusual aspects were adaptations to the terrain just as they were an important indication of the skill and invention of the engineers as they tried to perfect the defense of one of the nation's most important harbors. Still, given that such specialization does not seem to have taken place to an equal degree elsewhere, there may be merit to the thought that the defenses of the 1890s were over-built. It gives some truth to the comments of a foreign observer that "the preposterous proposals . . . for the defense of a comparatively unassailable port such as San Francisco, have created extravagant standards attainable only by a people disposing of superabundant funds, and, if attained, adding nothing to national security."¹¹

¹ As quoted in Keith Mallory and Arvid Ottar, *The Architecture of War* (New York: Pantheon Books, 1973), 9.

² Quentin Hughes, *Military Architecture* (New York: St. Martin's Press, 1974), 225.

³ *Annual Report of the Chief of Ordnance, Ordnance Memoranda No. 16*, Serial 1599, 43rd Congress, 1st Session, 452.

⁴ Colonel Eben Eveleth Winslow, *Notes on Seacoast Fortification Construction*, Occasional Papers, Engineer School, United States Army, No. 61 (Washington, D.C.: Government Printing Office, 1920), 52 and 54.

⁵ Board of Engineers to the Chief of Engineers, 14 October 1902, in *Mimeograph No. 40, 2nd supplement*, 6. An example of concrete meeting the specification that the aggregate should protrude half its thickness above the main mass can be found at Battery Godfrey, emplacement three. At the extremity of the emplacement, the finish layer has broken off, presenting a clear view of the mass layer beneath it.

⁶ Erwin N. Thompson, *Historic Resource Study Seacoast Fortifications San Francisco Harbor Golden Gate National Recreation Area California* (Denver: U.S. Department of the Interior, National Park Service, 1979), 144; *Mimeograph No. 40, 2nd supplement*, 5.

⁷ John Millis to Alexander MacKenzie, 5 January 1904, Defenses of Puget Sound, Records of the Office of the Chief of Engineers, RG 77, National Archives and Record Center, Seattle.

⁸ G. H. Mendell to the Chief of Engineers, 4 October 1895, later published as *Mimeograph No. 1*.

⁹ *Register of Graduates and Former Cadets of the United States Military Academy* (West Point, N.Y.: West Point Alumni Foundation, Inc., 1970), s.v. Mendell, George Henry, and Suter, Charles Russell.

¹⁰ Suter's quote and other information about his design contributions is more fully contained in David M. Hansen, "With Every Problem Solved: The Development of Mechanical Ammunition Hoists in America's Coastal Fortifications," *Coast Defense Study Group Journal* (November 1998).

¹¹ Sir George Sydenham Clarke, *Fortification: Its Past Achievements, Recent Developments, and Future Progress* (Liphook, GB: Beaufort Publishing Ltd.: n.d.), reprint of 1907 edition, 169.

PART III

TREATMENTS

Chapter 7: Elements of Deterioration

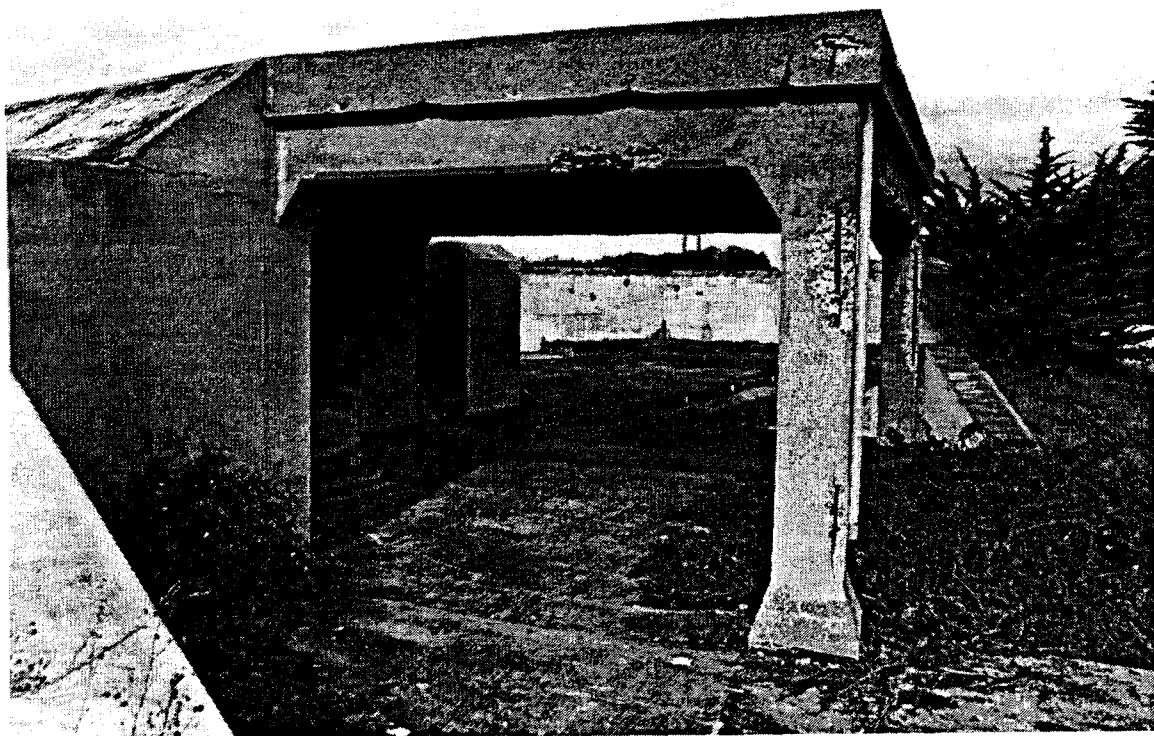

Plate 47. Concrete spalling is evident in the splinterproof at Battery Crosby, Fort Winfield Scott, constructed 1899-1900. Splinterproof added between 1904 and 1912.

Just as the fortifications reflect the evolution of fixed weapons from smooth-bore cannon to large caliber rifled guns and missiles, the fortifications show an evolution of construction methods and materials that parallel technological innovations that occurred from the Civil War to the Cold War (Plate 47). Construction methods and logistics such as roads for access, materials storage and handling, and water and power for construction permanently altered the immediate building sites and the surrounding landscape. Beyond the design influences of terrain, armament, and military doctrine, the fortifications represented mastery of traditional brick masonry construction, experimentation with plain and reinforced concrete construction during its formative period, and ultimately proficiency in advanced reinforced concrete construction.

The U.S. Army Corps of Engineers was well-informed about advances in the technology of limes, mortars, and cements both in the United States and in Europe in the latter half of the nineteenth century. Indeed, the military's interest paralleled early experimentation in the development of Portland cement in England and Europe and the Rosendale cements in the United States. Due to the limitations in the quality, consistency, and quantity of naturally occurring cements, military engineers sustained a keen interest in the manufacture of kilns, rock crushers, testing methods, structural calculations, and in new uses for cementitious materials. The value of cement in military construction was obvious. When combined with sand, gravel, crushed stone, and water in proper

proportions, cement became concrete. Concrete had enormous structural advantages, particularly in resisting compressive forces. But concrete was found to be weak in resisting tensile forces. The U.S. Army Corps of Engineers was aware of concrete's tensile limitations and had been following French experiments that placed tension-resisting metal within the compression-resisting concrete. The French called the reinforced concrete mix *beton agglomeré*.

Concurrent developments in steel manufacture, and an understanding that certain steel configurations could span great distances, led to the replacement of wooden structural elements in situations requiring long spans. The Chicago fire of 8 October 1871 pointed out the benefits of fireproof construction and led to the combination of steel I-beams with either hollow tile or concrete to produce fireproof floor and roof systems. The parallel developments of fireproof construction and the combining of concrete and reinforcing steel to create a material that resisted both tension and compression merged near the end of the nineteenth century to form reinforced concrete, a material that would change the building culture of the twentieth century. That the U.S. military was an early observer, experimenter, and builder in reinforced concrete was not an accident of history; rather, it was the result of fifty years of attention by the U.S. Army Corps of Engineers. That attention would have profound effects that changed the military fortifications from brick masonry construction to one that relied heavily on reinforced concrete at the end of the nineteenth century.

In 1871, as an example of the military's concern with the technological possibilities of both concrete and steel, Quincy Adams Gillmore of the U.S. Army Corps of Engineers issued a report on *beton agglomeré* under *Professional Papers, Corps of Engineers, U.S. Army, No. 19*. In the report Gillmore discusses the raw materials, characteristics, and potential uses of an experimental material that would become known as reinforced concrete. Beyond its general use in construction, Gillmore noted that *beton* could be "used in fortifications, for foundations, generally, both in and out of water; for the piers, arches, and roof surfaces of casemates; for parade and breast-height walls, for counterscarp walls and galleries; for scarp walls, except those that shield guns; for service and storage magazines; for pavements of magazines, casemates, galleries, &c, and generally for all masonry not exposed to direct impact of an enemy's shot and shell." Gillmore's reservations about exposing *beton* to direct fire may reflect both a lack of understanding of reinforcement and ongoing experiments into impact-absorbing earthen fill configurations.

Existing Conditions

Causes of Deterioration

The historic and architecturally significant coast fortifications in the Golden Gate National Recreation Area have been exposed to a harsh environment high in moisture and salt. Built largely on seismically and structurally unstable soils and steep slopes, the fortifications have experienced all of nature's destructive forces except for the damaging effects of regular freeze-thaw cycles. In addition to wind loads, salt-laden moisture, and seismic instability, the fortifications have suffered from intrusive vegetation, vandalism, general neglect, and a lack of regularly scheduled maintenance. Methods used to construct the fortifications were themselves characterized by change, primarily due to steadily advancing experimentation at the batteries. Brick masonry and concrete construction, used in association with earthworks, dominate the construction materials. The relatively small number of materials used in the fortifications, and their consistency of design and construction techniques within distinct periods, however, is a counterpoint to the irregularity of

historic construction methods over multiple periods—and as such offers an advantage in developing a treatment program.

Deterioration may be caused by a single condition or by the combined effect of a number of conditions acting together. Based on the building types, materials, and environment, the following causes of deterioration are present and typical:

1. Erosion by wind and/or water.
2. Seismic movement or soil instability.
3. Moisture infiltration.
4. Salt- and moisture-related corrosion.
5. Thermal expansion and contraction.
6. Intrusive vegetation.
7. Inherent design and structural deficiencies.
8. Removal of building elements.
9. Lack of regular maintenance.
10. Vandalism.
11. Visitor impact.

Identifying Characteristics

Preliminary identification of deteriorated conditions requires review of drawings and associated documents, visual inspection, and analysis. Deterioration may be recognized by the following indicators:

1. Presence of moisture.
2. Discoloration, staining, efflorescence.
3. Cracking within a material.
4. Cracking or separation at joints of different materials.
5. Sagging, deflection, or material failure.
6. Material loss, spalling, surface erosion, or exfoliation.
7. Accumulation of soil or organic matter at or on building elements.
8. Mildew, fungus, or plant growth.

Some signs of deterioration may not be readily apparent due to vegetative cover, soil covering, or the nature of the original construction. While the indicators of deterioration, listed above, may suggest active deterioration of a specific kind, the exact location and extent of deterioration requires more careful analysis. Indications of deterioration may also suggest that testing is required. Indications of deterioration usually do not occur in isolation but in related groups. Recognition of patterns of related elements of deterioration is critical to understanding active and latent deterioration and taking appropriate corrective action.

General Conditions Assessment

The historic and architecturally significant buildings and structures that comprise the coastal fortifications around San Francisco Bay have suffered extensive past deterioration and continue to suffer from the effects of active deterioration. Historic engineering records, in the form of annual reports from the Secretary of War, reported deterioration even as the batteries were under

construction. Original architectural and engineering drawings for a number of the batteries were marked with specific recommendations for maintenance. Despite the effects of nature, historic use, and abandonment, the batteries and supporting facilities retain significant integrity of materials, context, and association.

The consistency of the materials and construction techniques within each period leads to a certain consistency in the elements of deterioration. A general assessment of condition includes the following material-specific items:

Earthworks

Bermed earthworks, built in association with masonry or concrete batteries were placed so as to absorb impact of shells and to blend, or hide, fortifications from view. Earthworks are in generally good condition with isolated erosion and soil instability. Seismic activity and erosion have undermined some smaller concrete structures at Battery Townsley and Battery Crosby. Battery Mendell was placed on an eroding sand hillside and has developed serious structural problems. Other batteries including Battery Boutelle exhibit major cracking. Trails often contribute to erosion. At most batteries, soil migration and washing have affected surface drainage by obstructing positive drainage away from structures and filling surface and subsurface drainage systems.

Vegetation

Fortification sites were greatly disturbed during initial construction. Natural topographic profiles were altered and vegetation was planted to reduce erosion and provide natural camouflage. Existing vegetation is not fully original to the sites. Vegetation has overgrown most of the sites to the extent that it has obscured character-defining features. And while grasses and low vegetation have had some beneficial effect by holding soil materials in place, larger trees have caused structural deterioration. Large tree roots threaten both masonry and concrete structures. In addition, surface vegetation provides a host for insects and the accumulation of moisture.

Brick Masonry

Original brick masonry, typically found in the post-Civil War period, remains in generally sound condition with isolated brick surface deterioration and mortar joint deterioration. Bricks at Cavallo Battery and Ridge Battery show signs of surface spalling in areas of exposure and stress. Mortar joint deterioration of the Portland cement mortar materials is localized to areas that have been exposed to wet-dry cycles. Some mechanical actions such as expansion and contraction have caused loss of mortar in the joints. Vandalism and graffiti have had the most damaging effect on extensive amounts of historic brickwork at Cavallo Battery. Spray paint, applied in multiple layers, will require drastic intervention to remove or mitigate.

Concrete

Plain and reinforced concrete at the fortifications has experienced moderate deterioration due to moisture infiltration, intrusion of vegetation, inherent concrete defects, soil movement, and corrosion. Concrete deterioration, while isolated, requires complex and expensive measures to arrest active deterioration and to preserve and restore surfaces and configurations to original lines. Many

concrete problems may be hidden within masses of concrete and may be detectable only through testing. Concrete deterioration is visible in the forms of cracks, spalls, separations, material loss, rusting reinforcing steel, the presence of moisture, and stains related to moisture.

Metals

Metals, in the form of inset reinforcing steel, metal hardware, window bars, handrails, fittings, ladders, doors, gun mounts, and anchor bolts are in fair condition due to corrosion caused by moisture, the salt-rich environment, and galvanic action caused by contact between dissimilar metals. Many metal elements, including handrails, have been removed.

Wood

Wooden elements in the coastal fortifications are limited to wood doors, windows, frames, and isolated superstructures. Superstructures include framing, roof decking, and trim. Wooden doors, of slab and beaded board construction with metal straps and hardware, are typical through the Endicott and Taft periods. Wood superstructures can be seen at Battery Spencer (latrine), the meteorological station at Fort Baker, and at the observation post below Point Bonita Lighthouse. The wood is in generally poor condition from the effects of vandalism, moisture, and rot.

Waterproofing

Asphalt waterproofing, originally applied to concrete surfaces in contact with earth and protected by hollow clay tile, is in unknown condition. Although waterproofing conditions are hidden by earthworks, it would be reasonable to expect degradation of the asphalt materials due to age. In some cases erosion has exposed edges of waterproofing coatings and tile. The superior slope at Battery Godfrey is an example of this type of erosion.

Roofing

Roofing is limited to isolated, small buildings (such as those at Battery Spencer and some observation posts) and is usually either a built-up "tar and gravel" roof or organic, granular surfaced roll roofing. Roofing materials are in poor condition. A number of unsealed bare concrete roofs are in fair condition.

Doors and Windows

All wood doors and windows, and wood door and window frames, were found to be in poor condition from moisture and vandalism. Metal doors were found to be in fair condition with active deterioration in progress from the effects of moisture and corrosion. In some cases metal doors have been welded shut and in other cases metal plates have been installed for security.

Coatings

Camouflage Coatings: Few examples of camouflage coatings remain. Those that do remain are in very poor condition. Remnants of an early (1890s) camouflage treatment can be seen at Battery Duncan, Battery Dynamite, and Antiaircraft Battery No. 1. Other remnants of camouflage coatings remain in varying states of deterioration.

Other Coatings: Other coatings used on the fortifications include standard military paint coatings, primers, and finish coats, for concrete, wood, and metal.

Ventilation

Ventilation of interior spaces at batteries and associated buildings has been limited due to the closure of doors and windows for reasons of security and the incapacity of original mechanical and gravity ventilation systems. The lack of ventilation has resulted in the accumulation of moisture within interior spaces. The failure to dissipate accumulated moisture has led to increased corrosion of reinforcing steel, imbedded metal items, and fixed and mounted metal equipment. Closure of openings for security reasons has contributed to moisture problems related to lack of vent.

Trails

Existing hiking trails associated with the fortifications are in fair to poor condition. Trails are often not clearly defined or marked, are overgrown with vegetation, and often have steep slopes. Some batteries and associated structures are enclosed by fences for security reasons and lack access. Trails have also contributed to erosion problems.

Maintenance

No active cyclical maintenance program appears to be directed at the fortifications. The fortifications are subject to infrequent condition inspections and irregular maintenance and repair.

Interiors

Interior spaces at Battery Chamberlain and Battery Wallace have been the subject of preservation and interpretive activities. But most spaces have been sealed or are not otherwise accessible. Drawings and limited inspection reveal that interior spaces are generally utilitarian spaces with simple wall coatings of whitewash, unfinished, or painted concrete. In some cases floors are finished in vinyl composition tile. The interiors have suffered primarily from moisture infiltration and lack of ventilation. Interior surface coatings have been damaged by moisture penetration through exterior walls and roof structures.

Levels of Treatment

Architectural treatment is governed by provisions of *The Secretary of the Interior's Standards for the Treatment of Historic Properties with Guidelines for Preserving, Rehabilitating, Restoring & Reconstructing Historic Buildings* (1995). These standards set forth appropriate treatment for historic buildings and structures. As a general guideline for treatment, the standards limit treatment

in order to retain original historic fabric, character-defining features, and integrity. Architectural treatment, whether interim stabilization, preservation, or full repair and restoration, is dependent on what treatment is appropriate for a particular period in order to express original construction and use. Other factors affecting treatment include funding and interpretation. Each period, post-Civil War, Endicott and Taft, World Wars I and II, and Cold War, has distinct character-defining features. And although each period may have distinct characteristics, many fortifications saw use in more than one period.

Three general treatment levels are available and allow flexibility in planning, funding, and interpretation.

Stabilization

Control deterioration in order to retain historic configurations and materials. Stabilization may involve using temporary, intrusive, non-historic means that are reversible.

Preservation

Control and arrest deterioration in order to retain historic configurations and materials using appropriate means. Preservation seeks to maintain existing historic materials with only limited replacement of missing or deteriorated materials.

Repair and Restoration

Control and arrest deterioration while replacing missing or deteriorated materials using historically appropriate materials and means. Although restoration can be specific to a period, it may also include modifications that occurred in later historical periods. Restoration seeks to replace missing elements and to renew or replace severely deteriorated elements. Some modern materials and methods may be required due to the severity of the conditions encountered.

Common Treatment

Certain treatments are common to stabilization, preservation, and restoration. These treatments, however, may vary in scope according to intentions:

1. Site Cleaning: Remove trash and debris from the site.
2. Vegetation Removal: Trim back vegetation from contact with concrete and masonry materials and remove from the site. Remove dead wood and trees with harmful root growth.
3. Limited Earthwork: Remove soil wash from surface drainage paths. Establish adequate surface drainage away from structures.
4. Drains: Clean out cast concrete gutters and downspouts and coordinate with surface drainage.
5. Ventilation: Establish a ventilation program that regularly vents interior spaces by use of mechanical fans and/or natural convection.
6. Security: Increase site monitoring by appropriate means.

Chapter 8: Safety and Security Issues

The coast defense fortifications within the boundaries of the Golden Gate National Recreation Area present challenges for the safety of park users and maintenance staff, while simultaneously suggesting the kinds of associated issues that necessarily arise from the needs of securing isolated government property. Maintained by the National Park Service, the sites of these fortifications primarily pose safety and security situations inherent in their existence as former military installations built to blend into coastal land forms at the entrance to a large and prominent bay. As such, their role as effective, but historically camouflaged, guardians is no different along the Pacific shore at San Francisco than along coastal terrain anywhere. Site peculiarities may vary from battery to battery, and states of sustained physical fabric may pose differing problems due to microclimatic conditions and the intrinsic ability of a structure to weather well or poorly over time. Ready access to a location today, or lack thereof, may also either alleviate or aggravate safety and security concerns, as may general cultural trends in urban and suburban San Francisco. The public may choose to participate in keeping its park attractive and viable, just as it may select locations to conduct activities ranging from picnicking and hiking, to garbage dumping and serious crime. National Park Service staff must balance perceived issues, staying alert to changes, and actively involving park constituents in the care, concern, and appreciation of the batteries—and their host sites—as irreplaceable windows into history.

Current park users seek a rural recreational experience effectively set within, and immediately near, a densely populated city. Visitors typically want to relax, to find respite from the regimen and stress of work schedules, long and sustained commutes, and just being inside too many hours at a time. More often than not, urban visitors are somewhat inattentive to the physical hazards posed by the batteries. They easily can be surprised while exploring a location, can wander away from prescribed trails and fencing, and can leave common sense at home. While accidents at unpopulated sites might be worsened by the lack of interpretive park staff at individual batteries, it is also reasonable to assume that a key need of the late twentieth century park visitor is focused on rural discovery unaccompanied by too many constraints. Again, park staff must balance user needs with staying alert to site conditions, and must themselves be aware of locational hazards while maintaining, preserving, and restoring the batteries.

At the Batteries

Safety

Batteries themselves are oversized and imposing structures. By virtue of what they are, they offer visitors and staff alike a heads up experience with an eye toward safety concerns. One is not likely to wander across a hillside or along a cliff and stumble into a submerged or completely overgrown battery—although precarious footholds and unseen structural features hidden by vegetation can be present at all sites and all trails should be clearly marked, on ground allowing firm footings. Once at a battery, safety issues focus on paying attention to smaller details. Types of safety concerns include deteriorated and missing segments of handrails; protruding metalwork; crumbled concrete; precarious drop-offs; steep and narrow stairs; puddled and slippery surfaces; uneven, sometimes separated, floorings and gun mount areas; sloped battery blast aprons unintended for climbing; splintering doors; peeling paint accumulated to toxicity with standing moisture; obscuring, entangling, or poisonous vegetation; and, general debris (Plate 48).

For example, at Battery Crosby, a large fragment of stairway has spalled away, leaving a far more narrow passage than a visitor might be assumed to expect. Midway up the stair to the crows nest on the right flank of Battery Marcus Miller, emplacement three, a riser has dropped dramatically, and would not be easily noticed by someone descending the stairs. Plant growth substantially hides the stairs at the Stotsenburg-McKinnon site. Tripping hazards due to uneven settlement are exemplified in the subsidence

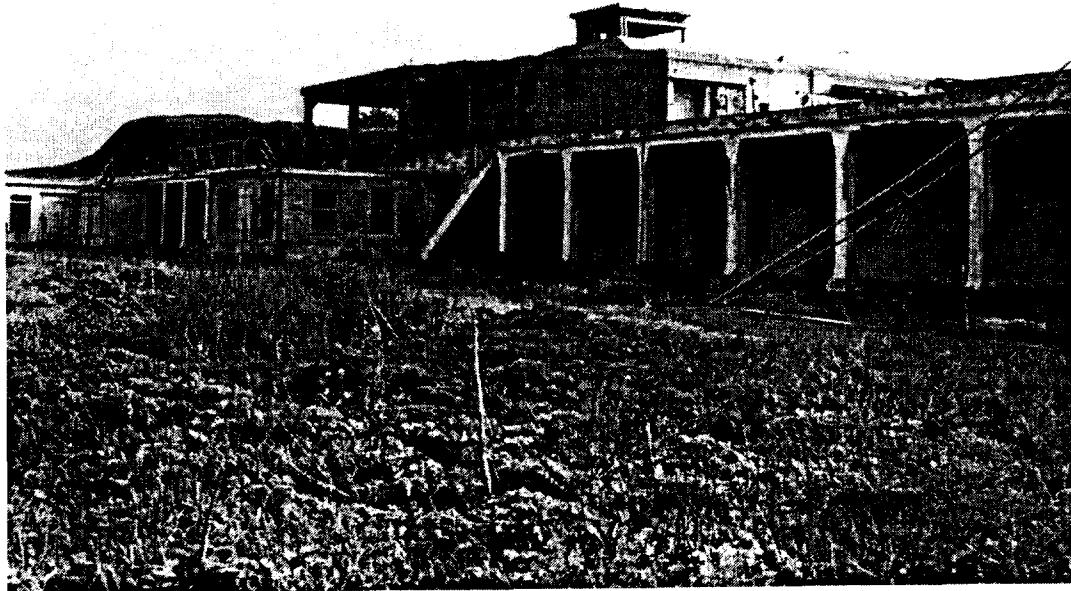

Plate 48. Battery Mendell, Fort Barry, constructed 1900-1902. View of 1973. Courtesy of the Park Archives of the Golden Gate National Recreation Area.

of the blast apron from the main concrete mass at Battery Mendell (Plate 49). And almost every structure contains an unprotected drop, sometimes of great height as at Batteries Dynamite and Duncan. While high parapet walls exist at most gun batteries of the Endicott and Taft periods, these walls and their definitive heights are fundamental to historic structural character, and are an inseparable aspect of the batteries' nature in the same way that precipitous rocky outcroppings are what we expect to see in the mountains. The pervasive concern over handrails effectively weights safety against the compromise of essential resource character, and must be most judiciously reviewed before taking action.

Security

Security issues at the batteries, on the other hand, demand an opposite, more encompassing perspective than one honed pre-emptively to detail. Fencing for sites with major (or multiple) safety concerns; for fragile earthworks locations in an unrestored condition; and, for batteries that have become the focus of undesirable activities (such as gang exchanges, drug sales and use, and competitive graffiti murals), might be warranted, but necessitates maintenance and vigilant site review. Fences at most battery locations, such as at Cavallo Battery, can be penetrated with little effort—due to the isolation of the sites, to the desire to keep the location relatively open for viewing, and to attempts at lessening impacts on the general viewshed. Fencing itself can create secondary safety and liability issues once cut into or pushed over, or if mangled or rusted.

Within a fenced battery site, or at an open-access location, security frequently is often further achieved through temporary (or non-permanent) closure of the structure from the outside in. Closures at the batteries of the Golden Gate National Recreation Area were observed as most effective where they were recent, such as the steel plates welded over the opening at Batteries Spencer and Godfrey, or, where staff has maintained historical closures, such as at Battery Wallace. Welding the hasp bar found on the typical

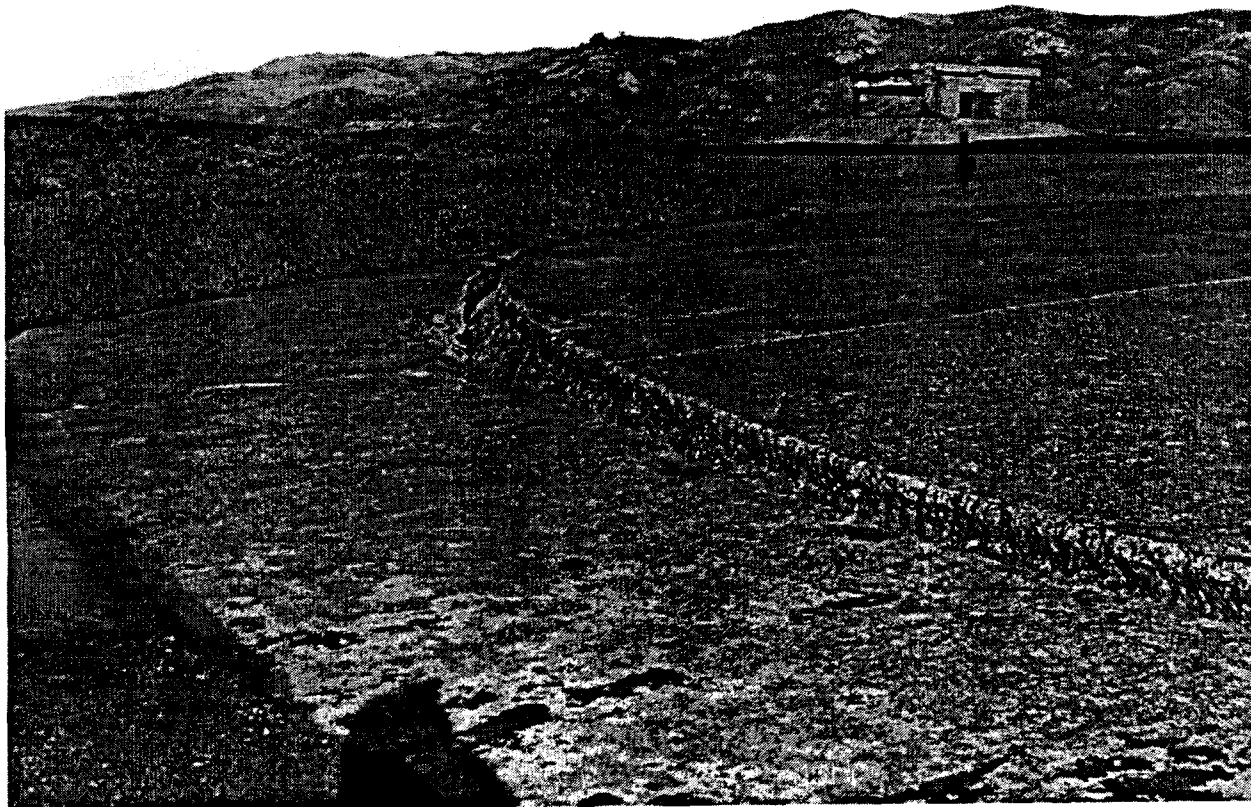

Plate 49. Battery Mendell. Looking North to BC station from front of emplacement two, showing separation and subsidence of blast apron from concrete mass.

wooden single- and double-leaf doors most often has brought about an ineffective closure that has additionally damaged the fabric of the resource itself. Similarly, welding the unique door and window covers at Battery Dynamite in a partially open position has prevented the use or rehabilitation of the mechanical closures built into those features. Sealing of original openings for security purposes should also always be coordinated with ventilation of interior spaces. Although overall ventilation should be considered, each closure panel should have integral top and bottom vents, screened for security. Both site-enclosing fencing and immediate closure for battery apertures are sometimes demanded to achieve security, but both ask for future creative thought to remain as sensitive as is reasonable and to allow an accurate historic site interpretation.

Awareness of Ancillary Structures

Safety

Original design engineering and placement on site, aggravated by ground settlement and growth of vegetation over time, create special safety issues for the myriad of ancillary structures built to accompany coastal defense fortifications. Beginning in the 1890s, the Army constructed both mine casemates and fire command stations to improve the technologies of defense and its controlled accuracy. Men stationed in the bombproof rooms of the casemates operated the switchboards that sent electric signals to explode underwater mines in the bay. Concrete mine casemates were engineered into, and under, ground areas, with steep passageways, poorly lit descending stairs, inclined cable galleries, and thick, pipe-ventilated, earthen overcover. Siting included steep and rocky bluffs, as well as locations re-engineered through

excavation and fill. Today mine casemates are among the most dangerous of all coast defense structures due to their obscured locations and remnants of unprotected original construction features, such as deep cableways remaining in flooring. MC-1 at Fort Barry contains two large and uncovered openings at the end of the entry gallery: it is dark at the end of the passage, and an unwary visitor or staff member without a flashlight could easily fall into the openings. The switchboard room immediately adjacent now has no floor at all, posing a definite hazard to those who try to enter the building (Plate 50).



Plate 50. Absence of flooring, at the entrance to the switchboard room, mine casemate, Fort Barry.

Systems of fire command and control stations pose similar problems to those of mine casemates through their buried design and engineering, often with only roofs and observation slits protruding above the soil line. Their multiplicity, coupled with their abandonment, long periods of disuse, and their more-active deterioration as a byproduct of their direct exposure to ground water retention, add to the challenges the structures will continue to present. Fire control stations, including those for battery commanders (BC stations) as well as observation stations, offer relative unpredictability for visitors who are not knowledgeable about the history of how systems for controlling the fire of modern weapons evolved. Those from the 1930s and 1940s were often elaborately camouflaged to blend into the land forms that hosted them. Steep sites, typically with the surrounding ground uneven or abruptly dropping away, contribute to these features, but sometimes have fared badly through land mass subsidence—quite literally in the case of B¹S¹ for Battery Construction #129 on Wolf Ridge within Fort Cronkhite, a structure beginning to slide into the Pacific Ocean below (Plate 51). A detailed inventory of coast defense ancillary structures is warranted, with maintenance concerns called out as a first step toward a safety plan.

Security

Security issues for ancillary structures are perhaps less problematic than those found at the main batteries. Most of these structures are too small to become major gathering places. They offer little shelter for unwanted activities, although they could become attractive for graffiti artists. For maintaining park resource security, a comprehensive inventory with mapping should allow staff to highlight any structures warranting careful and repeated observation.

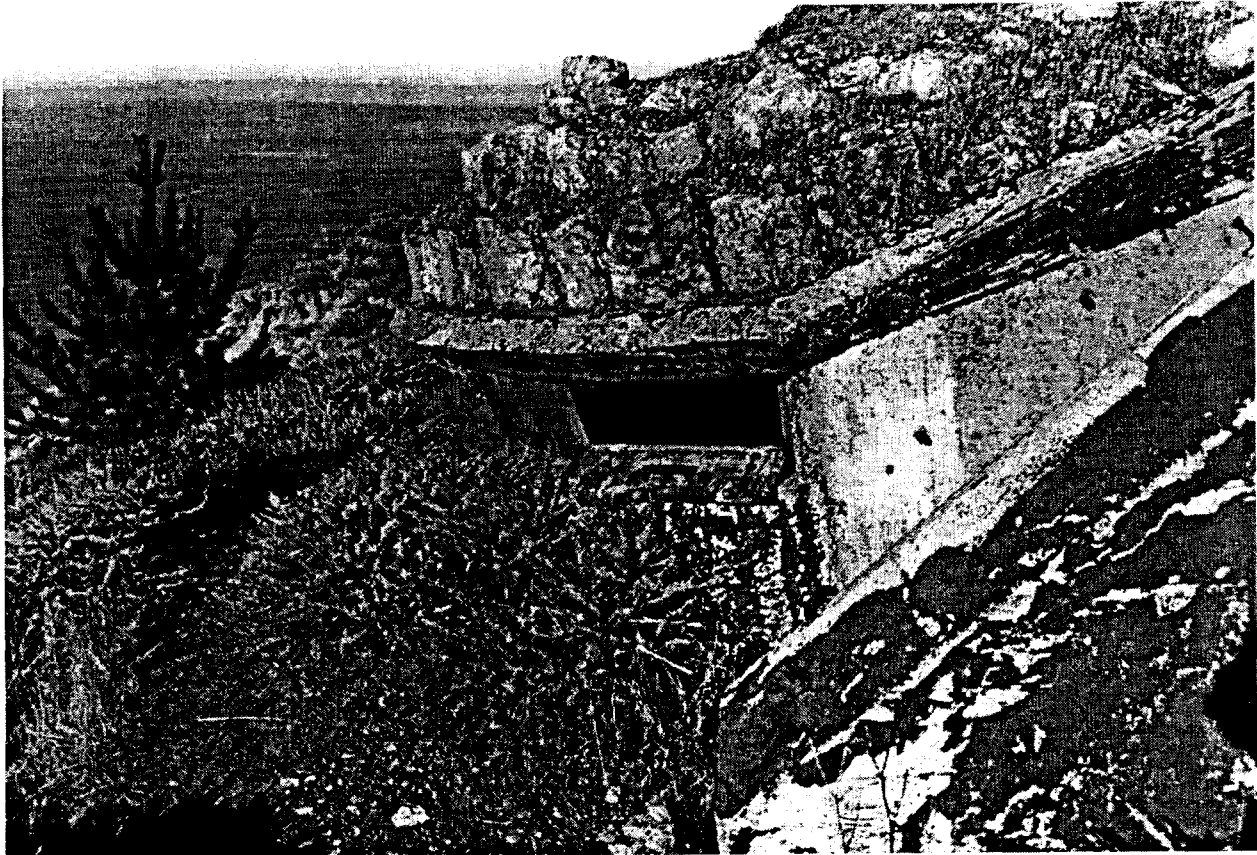

Plate 51. B¹S¹ for Battery Construction #129, Fort Cronkhite. Detail of roof camouflage and observation slit shutters. Subsidence at site.

Standard Operating Procedures for Law Enforcement Actions

Abandoned fortification structures are sometimes the sites of full-fledged law enforcement incidents. These illegal activities may include vandalism, graffiti, destruction or theft of government property, breaking and entering, unauthorized camping by vagrants, and rowdy behavior such as drinking, drug use or gang-related activities. In some locations, fortifications structures have been the scenes of satanic rituals, assaults, suicides, and even murders.

Whenever park staff encounter any type of illegal activity they should immediately notify law enforcement personnel. In the Golden Gate National Recreation Area, the United States Park Police carry out this responsibility. Untrained staff should never enter any building that is discovered unsecured until the area is thoroughly searched by peace officers. Personal safety of the park staff and visitors should always be of primary concern.

Once an area is secure, law enforcement staff should file the appropriate incident reports describing the nature of the event and any resulting damages or costs. These reports and any subsequent criminal investigations should describe the affected fortifications by name and building number, clearly noting that these resources are *historic structures*. Special mention should be made of any impacted resources over 100 years of age since these structures may be covered by the Archeological Resource Resource Protection Act (ARPA). ARPA violations may be prosecuted as felony offenses instead of as misdemeanors.

Concurrent with law enforcement reports, work orders should be submitted to repair or clean up the fortifications. Preparation of these work orders, or the delegation of their preparation, should be the responsibility of the reporting party. Critical elements to include in these work orders are (a) securing any doors or windows that have been forced open; (b) removal of debris such as beverage containers, litter or (in some cases) drug paraphernalia; (c) appropriate treatments for any site hazards known—or assumed—to be toxic or poisonous; and, (d) removal or painting out of graffiti.

Re-securing of the fortifications and graffiti treatment should follow established procedures detailed in chapter 10. The reasons for taking these immediate actions are

- (1) to prevent further damage to the resource that might result from leaving it unsecured;
- (2) to remove safety hazards;
- (3) to deny access to parts of the structures where illegal activities might occur;
- (4) to remove visible signs of criminal activity that, if allowed to remain, might encourage similar behavior; and
- (5) to maintain a cared-for appearance around the fortifications.

All staff actions should strive to achieve safe and secure locations within the boundaries of a large, public park, understanding its immediate access to individuals living in, or visiting, the urban setting of San Francisco.

Chapter 9: Treatment Plans

All specific treatment plans should incorporate, as initial steps, the appropriate common treatments discussed in chapter 7, with individual treatment plans then developed for each site (Plate 52). The treatment plans must be site-specific due to the complexity of each site, the often overlapping periods of construction and occupation, and the lack of a comprehensive interpretive plan. Site-specific treatment plans allow treatment to be phased and coordinated with other related sites.

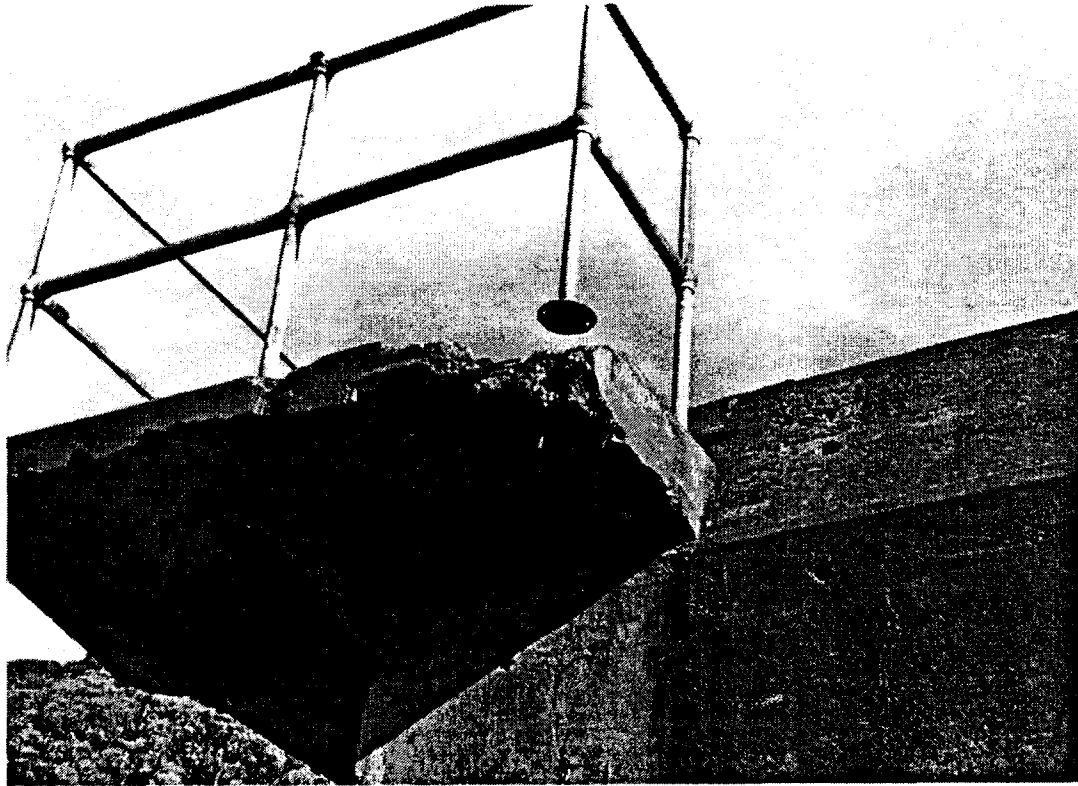

Plate 52. Major spalling and loss of concrete, underside of the battery commander's walk, Battery Kirby, Fort Baker, constructed 1899-1900. Battery commander's walk added after 1904.

From the site-specific treatment plans, similar elements can be identified and efficient treatment managed. For example, items such as concrete construction, wood and metal doors, waterproofing, handrails, and finish treatment issues can be coordinated throughout the system of fortifications insuring consistent and efficient treatment in detail. Specific treatment categories to be coordinated throughout the fortifications system include:

- Trail Development and Vegetation Control
- Concrete and Masonry Treatment
- Metals Treatment
- Waterproofing Treatment
- Paint and Coatings Treatment
- Graffiti Control and Removal
- Stenciled Signage
- Military Equipment and Fittings

Ventilation

Site-specific treatment plans should include three general categories of treatment: stabilization, preservation, and repair and restoration.

Stabilization

Sitework

1. Excavation: Limited excavation to improve surface drainage and to expose materials for investigation and testing.
2. Soil Stabilization: Temporary erosion barriers.
3. Earthwork: Limited earthwork to improve drainage and halt erosion.
4. Drainage: Clean all drainage paths including building gutters and downspouts, French drains, area drains, and surface drainage paths. Modify slopes to improve site drainage.
5. Landscaping and Vegetation Control: Removal of dead wood, selective removal of trees, clearance of brush, tree and brush thinning, and selective planting for soil stabilization.
6. Trails and Paving: Install new trails or pathways by installing compacted crushed stone paving materials. Modify slopes for visitor access and maintenance access.

Concrete

1. Cracks and Spalls: Install temporary fillers to prevent moisture infiltration into cracks and spalls. Install temporary patches to protect exposed rebar.
2. Structural Instability: Install temporary braces and shoring to hold unstable structural elements in place.

Masonry

1. Brickwork: Perform repairs to brickwork including temporary repointing with lime-sand mortar mix to secure bricks and prevent moisture infiltration. This patching mix is easily removed with no damage to the masonry. Install reinforcing in brick joints to bridge cracks and minimize separation. Reinforcing should be with one-fourth inch diameter galvanized threaded steel rods. Brace brick walls with temporary shoring if required.
2. Masonry Cleaning and Restoration: Remove mildew, efflorescence, or mild staining with a mix of water and bleach. Scrub with a soft bristle brush and rinse (one cup of bleach to one gallon of water.)

Metals

1. Structural Iron or Steel: Exposed structural iron and steel in the form of reinforcing steel and structural steel shapes should not be treated if more comprehensive treatment has been scheduled or if exposure threatens loss of material or structural integrity. If structural instability in the form of deflection is noted, bracing and shoring may be added to stabilize loading. Avoid attempting to reposition deflections. Temporary protection for severe exposure to moisture includes light brushing with a wire brush or steel wool, wiping metal with solvent, and the application of a temporary protective coating such as a rust-inhibiting primer.
2. Imbedded Metal Items: Wipe down with solvent.
3. Handrails: No stabilization required.

4. Miscellaneous Metals: For brass items, such as hinges, brush with a soft bristle brush to remove efflorescence and wipe with solvent.
5. Vegetation: Remove vegetation in contact with metal surfaces.

Carpentry

Wooden Materials: Provide temporary protection for exposed wood by cleaning away debris, rot, and any absorbent materials in contact with the wood. Remove any vegetation in contact with wood. With a dry brush, clean away any fungus, mold, or other surface growth. Brace sagging wood structures. Bleach in water may be used to remove mildew from wood surfaces.

Moisture Protection

1. Patch obvious leaks at cracks and joints using silicone sealants or lime-sand mortar mix (1:1 by volume) to minimize moisture infiltration.
2. Institute regular ventilation program.

Doors and Windows

1. Remove conditions that promote standing water adjacent to doors.
2. Install padlocks where existing hardware permits.
3. Brace doors that are warped or distorted.
4. Install painted plywood covers over existing windows to protect remaining historic fabric. Plywood should have holes drilled to allow for ventilation.

Finishes

Remove conditions that promote moisture such as encroaching vegetation or standing water.

Special Items

1. Secure or remove historic materials subject to vandalism or active deterioration to secure storage location.
2. Institute temporary ventilation program.

Preservation

Sitework

1. Excavation: As required for drainage improvement, investigation and testing, and for preservation of historic waterproofing materials.
2. Soil Stabilization: Installation of soil stabilization fabrics and barriers to preserve earthworks.
3. Earthwork: As needed to preserve berms and overhead earthen coverings including cut and fill work.
4. Drainage: Make historic drainage systems operable by cleaning out piping, drains, and drainage paths. Remove metal grates and apply protective coatings and patch inlets and piping. Clean and maintain integral drainage systems of structures.

5. Landscaping and Vegetation Control: Removal of dead wood, selective tree and brush removal, tree and brush thinning, and removal of all trees that have roots causing structural or moisture-related deterioration.
6. Trails and Paving: Install new trail materials, modify slopes for visitor and maintenance access, and coordinate trails between sites where possible. Augment with appropriate signage.

Concrete

1. Cracks and Spalls: Install permanent patches conforming to building lines and finishes to prevent moisture infiltration.
2. Structural Instability: Install permanent braces or shoring to hold concrete in a stable position. Where possible, realign concrete that has separated to original position and brace in place. Install visible permanent anchors or braces.

Masonry

1. Brickwork: Perform repairs to brickwork including permanent repointing with historic mortar mix, reverse deteriorated bricks, and reset bricks around cracks utilizing imbedded reinforcing ties.
2. Masonry Cleaning and Restoration: Remove mildew, efflorescence, and staining with bleach-water mix or approved chemical applications. Remove graffiti by approved means.

Metals

1. Structural Iron and Steel: Gritblast any exposed structural iron or steel, wipe with solvent, prime, and paint. Apply approved and tested migrating rust-inhibitors to concrete for protection of imbedded metal reinforcing. Install braces, shoring, or structural scabs to metals where required for structural integrity.
2. Imbedded Metal Items: Wipe with solvent and coat with microcrystalline wax or rust-conversion coating.
3. Handrails: Reset handrails in sleeves and regROUT. Clean metal by gritblasting, wipe with solvent, prime, and paint. Screw down all escutcheon plates.
4. Miscellaneous Metals: For brass items, brush to remove efflorescence, wipe with solvent, and provide protective wax coating.

Carpentry

Wooden Materials: Remove rotted wood and replace with treated lumber. Install wood bracing or missing elements sufficient for structural stability and moisture protection. Remove sources of moisture such as vegetation or standing water. Secure connections. Prime wood with anti-fungal primer and apply finish coats that contain anti-fungal components.

Moisture Protection

1. Where obvious leaks in waterproofing coatings are found, excavate any fill covering the material and repair using compatible materials. Patch any holes, penetration, or cracks allowing moisture infiltration.
2. Repair exposed roofs of concrete structures by application of appropriate, approved coatings.
3. Repair integral drains and gutters in concrete structures and make operable.

Doors and Windows

1. Wood Doors: Remove wood doors from hinges, provide temporary closure, and move doors to shop. Disassemble doors, replace rotted wood, gritblast metal frame and hardware, prime wood and metal and paint, and reassemble. Reinstall doors.
2. Ferrous Metal Doors: Remove metal doors, provide temporary closure, and move door to shop. Gritblast entire metal door and frame, wipe with solvent, prime, and paint. Reinstall door.
3. Hardware: Remove loose hardware and repair in shop. Repair fixed hardware in place. Clean hardware. If iron or steel, gritblast and apply appropriate finish. If non-ferrous metal, clean and wax. Reinstall.
4. Wood Windows: Remove window sash, repair frame in place, and repair sash in shop. Replace rotted or deteriorated stiles, rails, and muntins; prime; and reglaze. Reinstall window.
5. Ferrous Metal Windows: Clean metal frames and sash free of rust and loose paint. Replace missing elements and hardware. Prime, reglaze, and paint. Install sealants and make windows operable.

Finishes

1. Remove conditions that promote moisture deterioration such as vegetation and standing water.
2. Prepare surfaces, prime, and paint scheduled items including metals and wood. Do not remove remnants of historic concrete camouflage coatings or paint concrete surfaces.

Special Items

1. Preserve fixed items in place where possible. Reinstall items removed for security and shop repair.
2. Clean all fixed items.
3. Provide electrical service to each site and install basic lighting for interior spaces.
4. Institute regular ventilation program at each site utilizing restored or augmented ventilation systems or portable fans as needed to dissipate moisture.

Repair and Restoration

Sitework

1. Excavation: Perform excavation to expose and repair waterproofing surfaces, to repair or install drainage systems and underground utilities, and to restore original earthwork configurations.
2. Soil Stabilization: Perform soil stabilization measures as needed to stabilize soil around earthworks and foundations. Install erosion control fabrics, stable fill materials, and erosion control structures.
3. Earthwork: Restore earthworks by cutting, filling, and reconfiguring to achieve interpretive intentions.
4. Drainage: In addition to the restoration of existing drainage systems, perform drainage construction as needed to achieve site preservation and maintenance requirements.
5. Landscaping and Vegetation Control: In addition to tree removal and vegetation control, plant mixed native grasses for erosion control and to achieve period landscape character.
6. Trails and Paving: Install trails, paved areas, ramps, and steps for visitor access and safety. Restore original bituminous paving as a character-defining feature of the fortifications.

Concrete

Restore concrete by patching all spalls and cracks that admit or trap moisture, closing separations, and realigning shifted concrete. Perform epoxy injection to major structural cracks and separations. Install additional hidden reinforcement, jacks, dogs, and braces to maintain concrete stability. Reconstruct missing concrete elements.

Masonry

Fully restore brickwork by repointing all deteriorated joints, reversing damaged brick, patching brick, inserting reinforcement, and cleaning brick. Restore missing elements with replicated or salvaged matching brick. Remove graffiti in an approved manner.

Metals

1. Structural Iron and Steel: Restore exposed structural iron and steel by preparing surfaces, priming, and painting. Tighten all connections and fill voids. Construct and install replicated structural metal items such as frames, stairs, ladders, and other items.
2. Imbedded Metal Items: Restore imbedded metal items such as maneuvering rings by resetting and regrouting if required. Restore surfaces and apply protective wax coatings.
3. Handrails: Restore existing handrails and fabricate new handrails to match where original rails are missing or cannot be restored. These include, square section bars, chain rails and stanchions, and pipe rails and fittings.
4. Miscellaneous Metals: Clean metals and restore original finishes.

Carpentry

Wooden Materials: Restore all structural wood framing, trim, doors, windows, and other wood items.

Moisture Protection

1. Restore all waterproof coatings on vertical and overhead surfaces. Repair drainage courses, French drains, and replace missing clay drainage tile. Apply protective coatings to roofs and cast concrete drains.
2. Install sealants at cold joints, expansion joints, at window and door frames where moisture is admitted or trapped.
3. Roofing: Install new built-up roofs to replace original deteriorated or damaged roofs and ballast with matching local gravel.

Doors and Windows

1. Wood Doors: Restore all exterior wood slab doors in metal frames to a secure and weatherproof condition. Replace deteriorated wood to match original wood, prepare wood and metal surfaces, and paint.
2. Metal Doors: Restore all exterior metal sheet doors in metal frames to a secure and weatherproof condition. Replace or restore severely deteriorated metal, prepare surfaces and paint.
3. Hardware: Restore all hardware including latches, hasps, eyes, and other fittings, prepare surfaces and paint. Install padlocks.

4. Wood Windows: Restore all wood windows; replace missing or deteriorated parts or entire unit; reglaze, paint, and install sealants.

Finishes

1. Historic Concrete Coatings: Restore original paints and camouflage coatings on concrete matching original finishes. Remnants of original finishes may be damaged/destroyed if full restoration is selected. Document original finishes. Approximate original colors and textures. Where original mixes called for the use of oil on concrete, select a substitute binder and reconfigure mixture to avoid oil which is destructive to concrete.
2. Interior Finishes: Restore interior paintwork and whitewash finishes.
3. Ferrous Metal Coatings: Prepare surfaces by gritblasting, solvent wiping, and rust-conversion coating. Prime with zinc-rich or rust inhibiting primer, and paint with at least two coats of exterior enamel finish paint.
4. Wood Coatings: Prepare surfaces to bare wood or stable paint layer; prime with anti-fungal primer; and apply at least two coats of exterior enamel finish paint.
5. Graffiti Removal: Remove graffiti by approved means designed to cause minimal damage to substrate.
6. Signs and Stenciling: Protect existing historic signage and stencils. Restore by careful repainting or restenciling. Add new stenciling where supported by documentation.

Special Items

1. Mounted Equipment: Where possible and when available, purchase and install period or replicated equipment.
2. Military Hardware and Equipment: Where possible and when available, purchase and install military hardware and equipment including guns, optical instruments, communications equipment, furnishings, and other similar items.
3. Ventilation: Restore and make operational all mechanical and gravity/convection ventilation systems. Install new permanent mechanical or gravity/convection ventilation systems where interior spaces were not vented. Establish a regular ventilation program according to the quantity of air flow needed to dissipate accumulated moisture.
4. Electrical and Communications Equipment: Install underground electrical power to each site. Install disconnects, panels, wiring, conduit, switches, outlets, and fixtures as required for maintenance and approximating original lighting. Restore exposed fittings and fixtures.

Chapter 10: Treatments and Procedures

Regulations and Standards

Treatment and protection regulations and standards are set forth by the *National Historic Preservation Act* of 1966, as amended, and *The Secretary of the Interior's Standards for the Treatment of Historic Properties* (1995 and 1996).

Objectives

The objectives of any treatment program for a large integrated group of historic structures are to maintain integrity, preserve character-defining features, and to retain, to the greatest extent possible, the original materials. These objectives are modified by the limitations of budget, manpower, codes, life-safety regulations, hazardous materials abatement, and requirements for efficient operations and interpretation.

Inspection Procedures

An effective treatment program has as its foundation a regular and comprehensive building inspection procedure. Inspections should be accomplished by trained and experienced staff members on a regular basis and according to standardized procedures. While a comprehensive inspection program can greatly assist in gathering information, the knowledge and experience of the inspector is essential. A standardized inspection procedure is needed to identify and list deleterious conditions. Personnel are advised to use side two of the Coast Defense Resource Checklist to identify and document problems, and to use the Action Log to record site visits, products applied, and actions taken. Both forms are provided in Appendix C. In any procedure the skill of the inspector is called upon to synthesize the various data, to identify patterns of deterioration, and to make critical judgments about treatment requirements. When a condition of deterioration is identified, it may be an isolated problem or it may involve other related conditions. The inspector must be able to determine the involvement of related materials and conditions in setting forth a detailed treatment program.

Documentation and Records Maintenance

Documents that pertain to the treatment of the fortifications may be found at the Park Archives of the Golden Gate National Recreation Area. These documents include:

- Original architectural drawings
- Annual reports of the Chief of Engineers, U.S. Army, to the Secretary of War (selected excerpts)
- Manuals
- Historic maps
- Historic photographs
- Aerial photographs
- Maintenance records

A file should be established for each site and should include updated copies of the Coast Defense Resource Checklist and Action Log, and record-photographs as well as reproductions of historical documentation. The development of working files with reproductions is important to make information readily accessible to those who actively deal with the fortifications and to minimize use of original

records. When completed Coast Defense Resource Checklist and Action Log forms are superceded, the non-current forms should be kept as a part of a site's permanent maintenance file.

Testing Procedure

Materials testing is an essential element in any treatment program, particularly where historic resources are involved. Determining composition, constituent and proportional parts of materials, and characteristics of materials for analysis of the causes of deterioration should be considered early in the treatment process. A base line testing program should include the following materials:

- Concrete (various types)
- Brick
- Mortar
- Paints and Coatings (various types)
- Soils and Geotechnical
- Hazardous Materials

All testing should be as non-destructive as possible. Where testing requires the taking of samples for off site analysis, samples should be taken carefully and from inconspicuous places. Testing should be to standards generally governed by the ASTM (American Society for Testing Materials, latest standard or revision) or other recognized testing standard. Test data should be placed in site files. Specific testing requirements are included in appropriate technical sections that follow.

Procedures and Controls

Procedures and controls refer to the administration of treatment programs. Treatment programs for complex historic preservation projects require careful coordination and consistent administration. Before any treatment program is initiated coordination meetings are required and should include all interested parties. Where culturally and environmentally sensitive resources are involved preliminary scoping meetings are essential. For the treatment of fortifications, these meetings should include:

- Architects
- Historians
- Archeologists
- Botanists
- Landscape Architects
- Interpretive Planners
- Engineers
- Material Testing Engineers
- Wildlife Biologists
- Law Enforcement
- Hazardous Materials Specialists
- Maintenance Specialists

Safety

General safety requirements are covered in OSHA General Industry Safety and Health Standards (29 CFR 1910), Publication V2206, and OSHA Construction Industry Standards (29 CFR 1926) and other related standards. Other health and safety related information is contained in OSHA Publication 2207, National Emission Standards for Hazardous Air Pollutants (40 CFR, Part 6), and Environmental

Protection Agency Final Rule (40 CFR, Part 761, latest edition). Note: OSHA, EPA, and other local and state regulations are subject to regular revision. Always check for revisions, latest editions, and newly promulgated regulations.

Material Safety Data Sheets are governed by Federal Standard 313A. Submission of Material Safety Data Sheets should be required for all products and materials used for treatment. The Data Sheets should be reviewed prior to the initiation of work.

Protection

1. Take all necessary precautions to prevent injury or property damage.
2. Store, position, and use equipment, tools, materials, and other associated items in a safe manner in order to avoid hazards.
3. Maintain unobstructed work paths and exit corridors.
4. Provide and install fences, barricades, scaffolding, bracing, shoring, and other appurtenances as required for safe operations.
5. Institute safety measures specifically designed for excavation, trenching, scaffolding, and bracing as prescribed by applicable laws and regulations.

Products and Materials

All products and materials should be of high quality and appropriate for the work. Products and materials should be carefully evaluated prior to application or installation. General requirements for evaluating, handling, and using products and materials are as follows:

1. Select material based on sound research and evaluation.
2. Require Material Safety Data Sheets for all products and materials.
3. Select materials appropriate for the particular work.
4. Where materials or products are selected to duplicate, replace, or approximate historic building materials greater care must be used in determining product and material appropriateness and compatibility.
5. Assure that products and materials meet required standards and regulations and that labels reflect compliance.
6. Use standard products that are compatible with other materials.
7. Deliver, handle, and store products and materials in accordance with manufacturer's recommendations in order to prevent damage, deterioration, or loss.
8. Maintain and enforce product warranty. Coincidental product warranty is available when manufacturers publish or list a warranty in connection with a product without regard for specific application except as limited by terms of the warranty. Document date of installation, inspection, and expiration of warranties.
9. Install products according to a manufacturer's written instructions.
10. Maintain all product information, inspection reports, warranties, Material Safety Data Sheets, and other records.

Recommended Treatments

Following are forty-five recommended treatments for subcategories of sitework, concrete, brick construction, metals, carpentry, moisture protection, doors and windows, finishes, and special items. Each is presented in a single-page format, and most are illustrated by architect sketches, or, historic and contemporary photographs.

Sitework: General

Due to the mass and weight of masonry and concrete, extensive site preparation was a major component of original construction. Excavation, backfilling, cutting, and grading permanently altered the natural terrain around the fortifications. Steep slopes, unstable soils, seismic activity, and the massive nature of construction activities contributed to site disturbance.

Identification:

Sitework associated with coastal fortifications is limited to the immediate area of disturbed earth around or adjacent to the original construction. Sitework includes excavation, soil stabilization, earthwork, drainage, landscaping, paving, vegetation, walkways and paths, and other related items.

Inspection and Testing:

It is essential that disturbed areas be inspected in order to mark limits of responsibility, to constrain environmental regulation that would otherwise include previously disturbed areas, and to provide accurate quantities for estimating treatment costs. It should be noted that environmental regulations may still apply inside disturbed area boundaries, particularly regulations concerning botanical and biological habitat. Coordination with environmental managers within the Golden Gate National Recreation Area is recommended at the earliest stages of project planning. Locate and protect existing underground utilities.

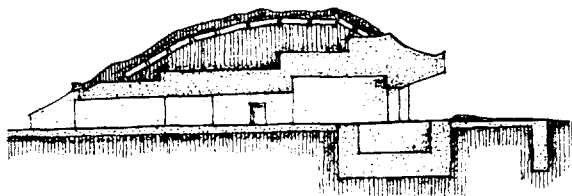

Battery Wallace. Cross section showing gun pit, concrete mass, burst slab, and earthworks.



East Battery. Flooded magazine entry.

Treatment

Site drainage is critical to move both surface water and water collected by fortification drainage systems away from the base of the fortification. Over the years grades adjacent to buildings tend to build up with soil and organic matter. The accumulated soil traps moisture and impedes drainage. Achieving effective drainage at fortifications is often key to all site treatments.

Work Categories:

1. Excavation.
2. Soil stabilization.
3. Earthwork.
4. Drainage.
5. Landscaping and vegetation control.
6. Trails and paving.

Sitework: Excavation

Causes:

Excavation is usually associated with other construction operations. Excavation may provide useful information about original construction by exposing covered items such as waterproofing coatings, protective tile, evidence of soil stabilization methods, and compaction levels or "lifts."

Excavation may also identify the extent to which fill materials were imported from remote sites.

Identification:

Excavation is limited to designated areas and only for the purpose of earth removal to expose structures for investigation and treatment, to repair or install underground utilities, or to remove accumulated earthen fill adjacent to structures. Excavation includes removal of soil fill covering fortification features. Excavation should only be initiated under the direct supervision of the project architect/engineer.

Inspection and Testing:

Take and mark samples during excavation for storage and classification. Field notes and photographs should be made of all excavations.

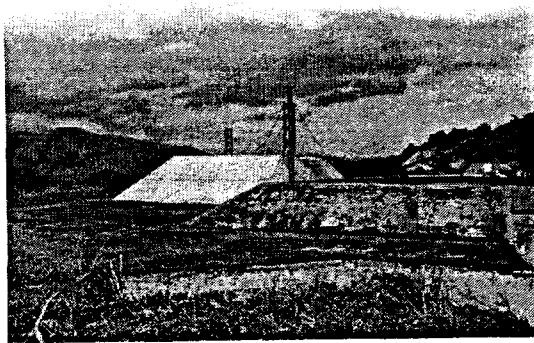

Battery Crosby. Concrete elevations for ammunition hoist (right) and crow's nest (center).

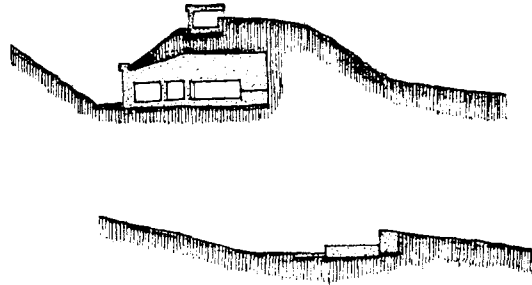

Battery Duncan. Cross sections through battery (top) and gun emplacement (bottom). Note the weakened plane joints and the relationship between earthwork and concrete.

Treatment:

Excavate using hand tools and equipment under controlled conditions. Excavate only to the depth and extent indicated. Excavated materials should be carefully stored on the site and covered to prevent erosion. After excavation backfill using original soil materials. Compact backfill in lifts of not more than six inches to match original density. Monitor any settlement and install additional fill as needed to achieve original grades.

Coordination:

Coordinate any excavation with a park archeologist and with a military historian familiar with coast defense fortifications.

Sitework: Soil Stabilization

Soil stabilization refers to strengthening soil stability by means of the addition of lime and/or Portland cement to soil or by the use of soil base materials that are inherently resistant to expansion or migration—such as crushed limestone or granite. This type of soil stabilization is only appropriate where excavation has exposed original construction or stabilization is to correct erosion. Berm stabilization by means of vegetative ground cover or netting is covered under Sitework: Landscape and Vegetation.

Identification:

Historic soil stabilization, such as that carried out with stable base materials during the Endicott and Taft periods and soil-cement mixing as carried out during the World War II period may be identified by changes in soil color and composition. Base materials will appear in contrast to soils of the local site. Lime or cement stabilizers were surface applied to subsoils and wetted. These stabilizers may appear as thin friable layers with indistinct edges when viewed in section.

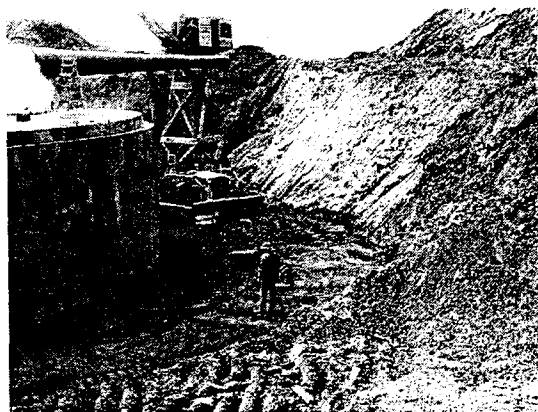

Battery Davis. Cement-soil stabilization, first operation, April 1938.



Battery Davis. Cement-soil stabilization, second operation, April 1938.

Inspection and Testing:

Inspection should be by a civil engineer. Testing is not required except in extreme conditions of erosion, settlement, or soil movement. Testing includes but is not limited to:

Field Density
Plasticity Index

Treatment:

1. Compact soil to at least ninety percent of Standard Proctor (ASTM D 698) maximum dry density.
2. Scarify soil surface to a depth of six inches.
3. Apply cement (or lime) at a rate of not less than sixteen pounds per square yard. And disk in to achieve a soil cement mix.
4. Add water and compact to maximum density.
5. Add additional layers of compacted soil to achieve desired grades.

Note: The installation of geosynthetic fabric soil stabilizing materials or degradable jute mesh may be appropriate in order to provide additional stability.

Coordination:

Coordinate all soil stabilization with recommendations provided in Sitework: Excavation; Earthwork; Drainage; and, Landscape and Vegetation.

Sitework: Earthworks

Earthwork consists of cutting, filling, and grading earth adjacent to fortifications. Earthwork includes existing earthen berms built in association with masonry or concrete fortifications. Original earthen berms have suffered isolated erosion and settlement. Treatment includes cutting, filling, grading, and reshaping existing berms.

Identification:

Earthen berms are integral components of fortifications and are found on or adjacent to related masonry or concrete structures. The berms are usually steep-sloped, flat-topped formations that contrast with natural terrain. However some earthworks appear as extensions of natural topography and, due to overgrown vegetation, may be difficult to distinguish.

Inspection and Testing:

Not required.



East Battery. Erosion of earth cover on magazine roof as a result of informal trail.

Treatment:

Where berms have been damaged by erosion, soil instability, or seismic activity, corrective action is required. Depending on the level of treatment prescribed, earthwork may involve work ranging from interim stabilization to full restoration.

Stabilization:

1. Add selected fill material to eroding areas and compact by hand.
2. Monitor erosion and replace soil wash.

Preservation:

1. Add selected fill to eroding areas and compact by hand.
2. Add approved ground cover to bare areas and maintain.
3. Monitor erosion and plant growth and replace soil wash.
4. Install degradable jute grid fabric to stabilize slopes.

Restoration:

1. Perform excavation and soil stabilization as required.
2. Excavate to stable soil materials and make repairs to structures, foundations, and waterproofing materials. Install new drainage systems or repair existing systems.
3. Install geotextile fabric reinforcement sheets according to manufacturer's written instructions and the Federal Highway Administration (FHWA), American Association of State Highway and Transportation Officials (AASHTO), and Geosynthetic Research Institute (GRI) standards.
4. Backfill with original earthen materials and compact soils in six-inch lifts.
5. Hand grade topsoil to achieve original lines and grades.
6. Install vegetative materials. (See Sitework: Landscaping and Vegetation.)

Coordination:

Coordinate all earthwork with other related sitework sections and with a park archeologist.

Sitework: Drainage

Drainage work includes repair or replacement of existing surface and subsurface drainage systems. These systems include French drains, piping, intercept and trench drains, area drains, rock drainage courses, and tile drainage cavities adjacent to vertical concrete surfaces. These drainage systems were designed and originally installed to remove and disperse surface water from rainfall. Drainage systems were a consideration in the original design of the fortifications and are shown on drawings and described in engineers reports. The critical importance of drainage is illustrated by notations on drawings for regular maintenance of drainage lines and gutters.

Identification:

Existing drainage systems may be identified by reviewing original drawings, by visual inspection in the field, and by investigation. French drains and drainage courses usually occur at the base of vertical wall planes of structures. Subsurface drain lines usually drain from downspout leaders and can be located by digging and following the lines. Metal detectors may locate cast iron piping. Area and trench drains occur in locations where surface water can be intercepted. Surface drainage is across sloped surface planes.

Inspection and Testing:

Individual site inspections coordinated with the use of original drawings should locate visible and suspected drainage lines. Selective excavation may determine actual locations, depths, and slopes. Testing with high pressure water may help to locate lines and leaks.



Battery Godfrey. Surface drainage system on blast apron composed of pipe, earth fill, and asphalt or oil-saturated earth.

Treatment:

Cleaning and repair of existing drainage lines:

1. Flush existing drain lines using high pressure water to remove accumulated debris. Insert hose in drainage inlet and observe outflow or leaks. Excavate where leaks are observed.
2. Repair or replace broken or deteriorated segments of drainage piping with like materials.
3. Retest with high pressure water and observe outflow. Clean excess soil and debris from outflow opening.

Installation of new drainage lines:

1. Where drainage lines have collapsed, replace with like materials or Schedule 40, four-inch diameter PVC piping and connections.
2. Slope drain lines a minimum of one-eighth inch per linear foot.
3. At inflow clean, repair, or replace drain device.
4. At outflow, position splash block to avoid erosion.

Installation of trench and area drains:

1. Install trench drains or area drains to replace deteriorated or missing units or install new drain inlets where required to protect existing fortifications from erosion damage.
2. Install additional piping, fittings and drain lines as required.

Sloped surface drainage:

1. Slope drainage surfaces a minimum of one-eighth inch per linear foot.
2. Remove impediments to drainage and maintain clear drainage paths.
3. **Note:** Repair of drainage systems is associated with waterproofing and clay tile in the Moisture Protection section.

Sitework: Landscaping and Vegetation

Landscaping and vegetation include the control of overgrown, intrusive vegetation and the installation of appropriate vegetative ground cover for earthworks and berms. Changes in vegetative cover since the construction of the various fortifications have altered original appearances. Post-Civil War fortifications used earthworks for protection. Fortifications from the Endicott and Taft periods combined earthworks with concrete construction for protection and camouflage. The advent of aviation changed World War I and World War II-era earthworks by including overhead protection and camouflage.

Identification:

Review of historic photographs, drawings, and military reports should be compared with existing vegetation conditions at each fortification. The extent of vegetative changes should be noted and recorded. Accurate identification of vegetative materials by a botanist experienced in local plants is critical.

Inspection and Testing:

A complete vegetative survey should be completed for each fortification. Trees, shrubs, woody vines, and grasses should be noted as well as any endangered plants or critical habitat.

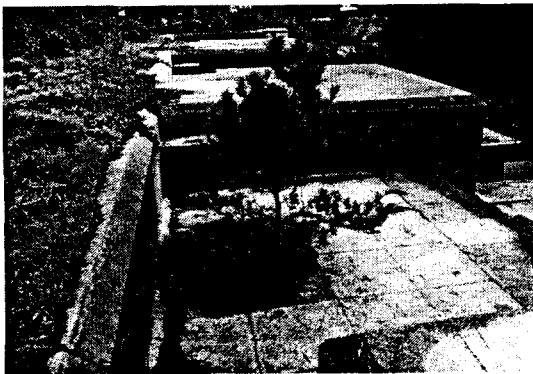

Battery Blaney. Volunteer coniferous tree growing through a gun mounting ring.

Treatment:

1. Preservation of historic earthworks.
2. Retention or restoration of character-defining earthwork features.
3. Restoration, to the greatest extent possible, of the landscaping and vegetative elements as originally planned.
4. Compliance with existing environmental requirements.
5. Ease of maintenance.

General treatment priorities:

1. Remove all dead wood and fallen trees.
2. Selectively remove trees that are causing root damage to existing historic structures.
3. Encourage the establishment of a natural mix of low maintenance native grasses for ground cover.
4. Remove invader species.
5. Thin trees to remain, especially to allow adequate sunlight for the ground cover and to reduce the accumulation of organic matter.

Specific treatment requirements:

1. Cut trees flush with the ground using chain saws. Treat stumps of deciduous trees with an approved herbicide. (Coniferous tree stumps require no treatment.)
2. Tree cutting and pruning should be accomplished by a trained arborist and felling should be carefully planned to avoid damage to historic resources.
3. Install a naturally proportioned mix of low maintenance native grasses.
4. Mowing should be minimized and limited to areas adjacent to trails. String-type powered weed cutters may be used but not adjacent to historic structures. Weed cutters can damage original historic materials if used inappropriately.
5. Due to the danger of fire spread and the dense urban environments nearby, controlled burning is a carefully monitored procedure in the Golden Gate National Recreation Area. It is generally inappropriate as a treatment for controlling vegetation in the immediate vicinity of gun batteries.

Coordination:

Coordinate all landscaping and vegetation control with environmental regulations.

Sitework: Trails and Paving

Trails and paving include work to establish trails and to retain and treat original paved surfaces associated with fortifications. Trails are for use by the visitor while historically paved areas are a part of the fabric of the fortifications. Existing trails require repair and maintenance and, in some cases, improved trails are required to enhance the visitor experience and augment interpretation. Existing historic paving includes compacted soil materials, bituminous surfaces, and concrete walkways.

Identification:

To determine original paved areas and walkways associated with the construction and use of the fortifications refer to original drawings and historic photographs. These areas should be noted and compared to existing trail configurations. The extent of paved areas, walkways, and trails should be recorded and included in each site folder. In addition, informal paths made by visitors should be noted and evaluated for potential damage to earthworks.

Inspection and Testing:

Bituminous and asphalt paving materials should be sampled and the composition noted in site folders.

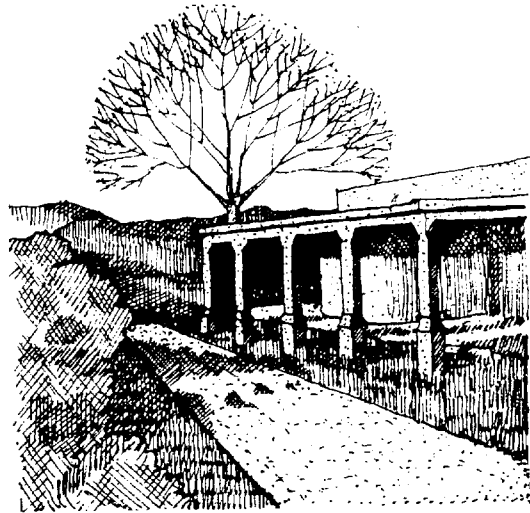

Battery Marcus Miller. General view showing a well-defined trail adjacent to a battery structure.

Treatment:

1. Develop a trail system for each site and, where possible, link trails to adjacent sites.
2. Lay out trails to follow natural terrain and to minimize disturbance to historic earthworks.
3. Select appropriate trail materials that achieve maximum compaction and are low maintenance.
4. Avoid steep slopes and, where possible, comply with *Americans with Disabilities Act* requirements and National Park Service standards.
5. Where existing historic paving, such as bituminous surfacing, has been applied minimize access in order to preserve original fabric. Due to environmental and surface drainage considerations, restoration of bituminous surfaces should be avoided.

Materials:

- Trails: crushed local red rock compacted to maximum density and sloped to drain.
Edging: pressure treated wood, metal, or concrete.
Steps: treated timber or concrete.

Concrete: Causes of Deterioration

Historic concrete work at the Golden Gate National Recreation Area fortifications consists of cast-in-place, plain and reinforced concrete. The late nineteenth and early twentieth century concrete was frequently cast in wooden board forms resulting in a rough surface and finished with a fine cement finish coat. Improved forming techniques and materials resulted in abandonment of the finish coat. By the mid-1930s concrete was cast in plywood forms, and burnished and spot patched with cement grout.

Although concrete is considered to be a durable construction material it is subject to deterioration caused by a number of factors which range from poor workmanship and materials to environmental effects.

Materials and Workmanship:

Concrete may experience deterioration caused by materials used in the mix or by errors that occurred in mixing, forming, or placing. Materials and workmanship problems include:

1. Improper aggregate.
2. Alkali-aggregate reactions.
3. Improper aggregate sizing.
4. Calcium chloride or similar salt additives.
5. Incomplete consolidation in tamping (voids and honeycombs).
6. Placement of reinforcing steel too close to surface.
7. Improper handling of cold or weak plane joints.
8. Inadequate curing.

Environmental Factors:

Concrete is subject to deterioration caused by absorption of moisture and thermal expansion and contraction. Extreme temperature ranges can cause freeze-thaw cycles. Moisture absorbed by the concrete expands and contracts with temperature changes and the resulting mechanical action causes fractures and spalling. Airborne components, such as carbon dioxide, can cause adverse chemical reactions which can cause surface deterioration.

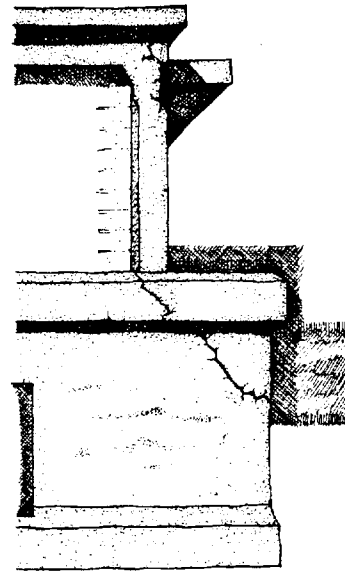

Battery Godfrey. Concrete construction indicating structural cracking, spalling, and surface erosion.

Structural Design Defects:

Defective structural design in historic concrete can cause subsequent deterioration. Typical design defects include:

1. Inadequate concrete coverage over reinforcing steel.
2. Inadequate or improperly placed expansion joints or cold joints.
3. Improper sizing and placement of reinforcing steel.
4. Inadequate cross-sectional area or depth to resist loading forces.
5. Inadequate soil and site preparation.
6. Instability of slopes and seismic movement.

Maintenance Procedures:

Improper or inadequate maintenance procedures can contribute to concrete deterioration. Maintenance related deterioration may be attributed to:

1. Moisture exposure and penetration caused by unrepaired leaks.
2. Improper application of surface sealers and coatings.
3. Failure to clean drains and drainage paths.
4. Inadequate control of vegetation.

Concrete: Identifying the Problem

Concrete deterioration may be observed visually and more precisely determined through testing.

Cracking: The types and severity of cracks in concrete are varied and include dormant and active cracking. Dormant cracking is caused by shrinkage during curing and is not a cause for concern except for potential moisture infiltration. Active cracking is more serious and can indicate severe problems. Active cracks show movement and are related to structural overloading, foundation settling, inherent design flaws, or other deleterious conditions. Active cracking can be temporary or continuous. Active cracking requires monitoring and may require corrective action. Inactive, or dormant, cracking usually requires observation and limited corrective action to prevent moisture infiltration. Random surface cracking, or crazing, may indicate an adverse reaction between cementitious alkalis and aggregates and requires surface corrections.

Spalling: Surface concrete loss in pieces of various sizes is called spalling and is caused when expansive forces inside and near the surface of concrete act along a weak plane or create a weakened plane. The expansive force can be caused by the stress of corrosion of reinforcing steel or imbedded metal items. Corrosive oxidation (rust) causes expansion which in turn creates additional stress. Internal expansion can also be caused by moisture absorbed by porous aggregate that expands and contracts in thermal cycles. Moisture may be trapped inside the matrix of the concrete by paints or sealants that do not allow moisture to migrate and escape at the surface. Spalling can occur due to a condition called laitance where concrete, during placement, was mixed too wet and cement rich paste rises to the surface of the concrete thereby depriving other portions of the mix of cement-related cohesion and consolidation.

Deflection: Concrete footings, foundations, beams, columns, slabs, and walls are subject to deflection that can be seen in bending, bowing, or sagging. Deflection can be caused by overloading, the effects of corrosion, inadequacies in original construction, seismic stress, and by long-term shrinkage. Deflection, by creating internal stress within a concrete mass, may cause spalling at the concrete's extreme surfaces. Most design standards rate structural failure as deflection exceeding $1/360$ or about a one-inch drop over a length of thirty feet.

Stains: Stains on concrete surfaces that are not purposely applied may indicate internal problems such as corrosion or adverse chemical reactions. Corrosion usually involves reinforcing steel and the resulting stains are rust-colored. Alkali-aggregate reactions are usually seen as a white efflorescence. Moisture-related stains may appear as a variety of colors.

Erosion: Weathering of concrete surfaces by wind, rain, snow, or other mechanical action can cause surface loss. Temperature related expansion and contraction of surface moisture exerts a mechanical action and results in the gradual wearing away of the concrete surface. Exposed aggregates are particularly susceptible due to differences in the rates of expansion among the various constituent materials.

Corrosion: Reinforcing steel that has been placed too close to the surface of the concrete or that has been exposed by spalling, erosion, or cracking, can corrode, or rust. Oxidation of the steel in the presence of moisture causes rust. The presence of salt-rich moisture adds to the rate of deterioration. Corrosion is an active chemical process that exerts its own expansive stress. High alkalinity in the concrete promotes corrosion and causes, in addition to expansion, a loss of surface bonding between steel and concrete. This loss of bonding reduces the unified effect of reinforced concrete to resist tensile and compressive forces.

Concrete: Inspection and Testing

Determining the causes of concrete deterioration requires careful analysis by experienced architects and structural engineers. Structural deterioration can have life-safety implications and threaten a structure's existence. In addition to inspection and observation by experienced professionals, materials testing and analysis may be needed. Procedures for testing and inspection involve field analysis and documentation, review of documents, testing, monitoring, and laboratory analysis.

Testing and Inspection Procedures:

Field Analysis: Locate and record nature and extent of concrete deterioration.

Document Review: Refer to original drawings and engineering reports and compare to field data. Check historic records and photographs for further information.

Field Testing: If required, after visual inspection, institute a testing program to determine the nature and extent of deterioration. A testing program involves both on-site testing and laboratory analysis. On-site testing includes:

1. Use of calibrated metal detectors, sonic meters, and other devices to locate imbedded metals.
2. Use of sounding hammers and chains to locate voids.
3. Use of direct application of controlled water spray to determine moisture penetration.
4. Use of a moisture meter to determine presence and extent of moisture in concrete.
5. Use of computer simulation and test models to calculate deflection.
6. Measuring for deflection with a transit.



Typical concrete cold joint showing minor spalling, surface deterioration and original form marks. This cold joint is at Battery Marcus Miller.

Laboratory Analysis:

1. Compressive strength testing.
2. Mix composition analysis by weight and volume.
3. Chemical reaction analysis testing for alkalinity, carbonation, porosity, chloride presence, and other components.

Analysis:

Analysis of field data, inspection reports, documents, and testing data requires careful and thorough analysis by structural and materials testing engineers to determine the exact scope of corrective action. This is particularly important where historic concrete is involved. Since improper repairs can cause additional deterioration, no action may be preferable to improper measures.

Concrete: Treatment Overview

Standards:

Contemporary standards may not be directly applicable to historic concrete mixes. Comparison of historic materials to current standards is a useful basis for evaluation.

Comply with the provisions of the following minimum codes and standards:

1. American Concrete Institute (ACI) 301, *Specification for Structural Concrete for Buildings.*
2. American Concrete Institute (ACI) 318, *Building Code Requirements for Reinforced Concrete.*
3. Concrete Reinforcing Steel Institute (CRSI), *Manual of Practice.*

Materials:

Materials used in concrete repair and maintenance should conform to the following standards:

Portland Cement:	ASTM C-150, Type I or II.
Reinforcing Bars:	ASTM A-615, Grade 40 or 60
Welded Wire Fabric:	ASTM A-185
Wire:	ASTM A-82
Stainless Steel Rods:	one-fourth inch to one-half inch diameter, smooth and threaded
Non-Shrink Grout:	CRD-C-621, factory pre-mixed grout
Bonding Compound:	compatible with patch
Epoxy Bonding Agent:	epoxy resin type, MIL-B-19235
Epoxy Adhesive:	ASTM C-881
Gravel Aggregate:	local crushed stone to match existing
Sand Aggregate:	local beach sand to match existing
Filler:	molten sulfur
Non-Sag Mortar:	one-component, polymer-modified, silica flume enhanced, passing ASTM C-884 (Modified)
Corrosion Inhibitor:	two-component, polymer-modified, cementitious, trowel grade migrating mortar, passing ASTM C-884 (Modified)

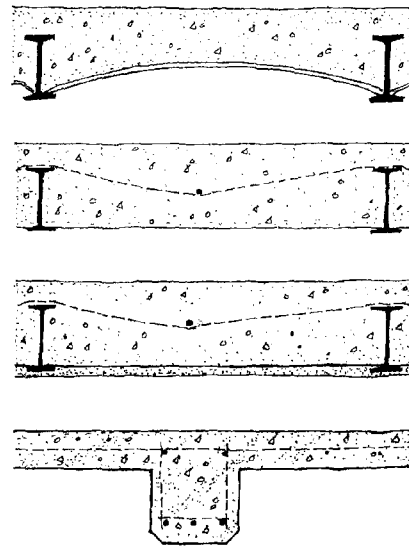

Evolution of reinforced concrete from imbedded I-beams to reinforcing bars.

Concrete Repair System Products:

A wide range of products are available for concrete restoration including grouts, epoxy systems, hardeners, and coatings.

Manufacturers include Sika Corporation, Thoro Products, Dayton Superior Corporation, and Master Builders Technologies.

Procedures:

Examine areas and conditions under which work is to be accomplished. Plan work in a systematic way and follow manufacturer's written instructions. Avoid work during periods of extreme weather.

Concrete: Cracks

Narrow Cracking:

Cracking can be repaired using a variety of methods depending on the size and severity of the crack. Narrow cracks one-fourth inch wide or less that are not structural can be repaired with "neat cement" mortar (a Portland cement and water mix) or by the use of a wide range of non-shrinking grout. Non-shrinking grouts usually contain silica flume or other stable aggregates.

Large to Severe Cracking:

The addition of a small amount of fine sand to the neat cement acts as a shrinkage reducer for slightly larger cracks. In cases where cracks are deeper than one-and-one-half inch, a backer rod is recommended. Where severe cracking has occurred and extends through a structural member, is over one-half inch wide, and shows signs of movement, extensive repair is required. Insertion of dowels and/or epoxy injection may be required. Epoxy injection is a complex repair process addressed in Concrete: Epoxy Injection.

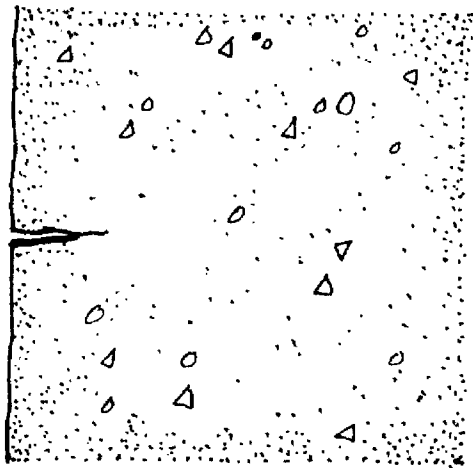

Typical detail. Small surface crack in concrete.

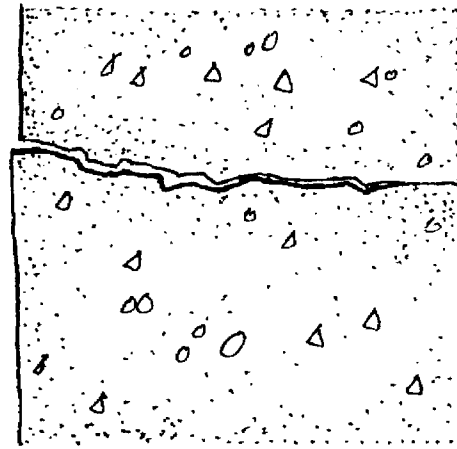

Typical detail. Structural crack through concrete showing displacement.

Repair Procedure:

1. Clean crack free of accumulated debris and roughen surfaces. Remove any loose or soft concrete.
2. Wash out crack and allow to dry. Rake out crack if additional depth is required to achieve bonding and penetration. A bonding agent compatible with the mortar mix may be required, but is not always appropriate.
3. Apply crack-repair mortar or grout according to manufacturer's written instructions. It may be necessary to build the patch up in layers.
4. Finish surface to match existing adjacent surface.

Note: Test repair a crack using the prescribed mortar mix and finishing technique before attempting other repair work. Surface finish color may not match original concrete finish color. Adjustments may be made in the color of the mix or a different product may more closely approximate the original color. Age will help to diminish color differences.

Concrete: Separation

Causes:

Separation occurs when independently cast concrete elements move apart because of settlement or differential movement. Separation may also occur when unreinforced concrete elements cannot withstand lateral forces and are forced apart. Intrusive tree roots are a primary cause of separation. Repair of separations requires more extensive intervention.

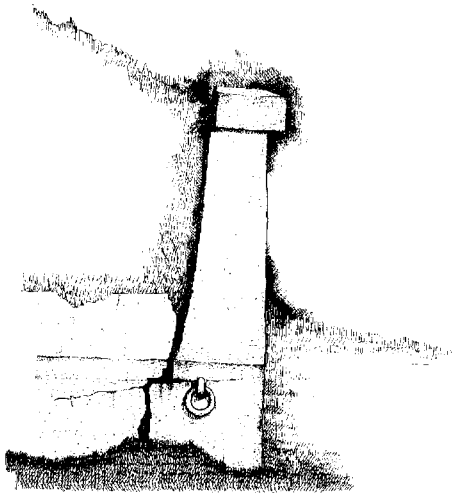

Battery Stotsenburg-McKinnon. Separation of unreinforced concrete. Lateral forces overcome tensile resistance in unreinforced concrete wing wall. A weakened plane crack through the maneuvering ring mounting predates the separation.

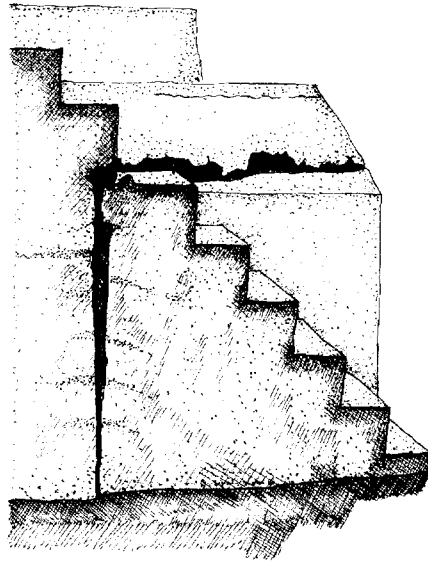

Typical. Concrete separation at unreinforced steps.

Repair Procedure:

1. Clean out separation by removing all debris and loose or soft concrete. Remove trees, roots, and earthen fill that may be causing the separation.
2. Drill concrete to receive threaded stainless steel dowels and grout dowels in place, with epoxy grout mix.
3. Install underpinning and slip braces as needed.
4. Apply pressure to close separation. When repositioning is accomplished, complete dowel installation. Apply final pressure to close opening until excess mortar is compressed out of separation. Brace concrete in final position until epoxy mortar sets.
5. While wet, remove excess mortar and clean surfaces.
6. When cured, reinstall fill materials.

Note: Prior to repairing a separation, decide whether it is better to leave the separation in place and treat it as a crack, or to move the separated portion back into place.

Concrete: Spalling

Identification and Inspection:

Repair of spalled areas involves removal of loose or deteriorated material, surface preparation, removal of exposed, imbedded reinforcing corrosion, application of patching materials, and surface treatment. Where spalling has been caused by corrosion of reinforcing and reinforcing is exposed, removal of non-critical reinforcing elements or sandblasting to remove rust may be required. Exposed reinforcing must be cleaned to bare bright metal before treatment. For vertical and overhead conditions, forming may be required for proper installation of the mortar or grout. Spalling also occurs around imbedded conduit and piping.

Treatment:

Removal of deteriorated or loose materials is easily accomplished with hand tools and small power tools. A hammer and masonry chisel will remove most loose or deteriorated concrete. Surface preparation requires removal of dust, dirt, grime, and mildew from surfaces to receive repairs. While wire brushing, washing, and similar measures may clean most surfaces, light gritblasting, limited to the affected area, may be required. When gritblasting, shield areas adjacent to the treatment area. After blasting wipe surfaces with solvent and immediately apply protective primer.

Spalling that exposes imbedded reinforcing, clips, angles, or metal anchors requires removal of all exposed corrosion. Where surface corrosion is to be removed, either by brushing or sandblasting, the application of a seal coating over the cleaned metal is critical to the repair. Migrating rust inhibitors may be applied to the general area. Coordination of material compatibility is essential.

Replacement of large areas of spalled concrete will require the use of steel dowels to anchor the epoxy, cement mortar or grout. The dowels should be inserted in holes drilled in the concrete in the area to be repaired.

Application of spall repair mortars or grouts should be accomplished by laying up successive layers of material. For vertical and overhead applications, use only those epoxy adhesives recommended by the manufacturer for vertical or overhead applications.



Battery Marcus Miller. Detail view of spalling concrete. Spalling can be caused by expansive corrosion acting on reinforcing steel.

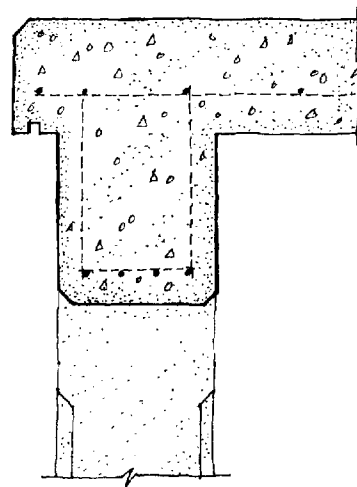

Cross section through concrete showing profile, reinforcing bars, and articulated, chamfered corners and edges.

Materials:

- | | |
|----------------|--|
| Epoxy Putty: | 100 percent solid, two-component, epoxy adhesive. |
| Metal Dowels: | one-fourth inch to one-half inch diameter threaded stainless steel dowels. |
| Metal Sealant: | as recommended by epoxy or grout manufacturer. |

Installation:

1. Install according to manufacturer's written instructions
2. Drill dowel holes allowing at least one-fourth inch between the perimeter of the dowel and the side of the hole. Dip dowel in epoxy putty and insert.
3. Apply epoxy putty with a spatula or putty knife. Fill solid and work out to align with original surface. Work material flush and work surface to match adjacent surface.
4. It may be necessary to construct a form matching the original lines of the structure in order to contain and shape the repair.

Concrete: Epoxy Injection

Identification and Inspection:

Epoxy injection is an extreme measure and should be used in rare circumstances where concrete has lost structural integrity. The concrete must be in failure or eminent failure and must threaten life-safety or the loss of the structure.

Epoxy injection should be accomplished by a certified applicator of the Structural Concrete Bonding Process Association.

Materials:

Epoxy Resin Adhesive for Injection: Two-part, solventless, low viscosity adhesive, or similar approved product.

Surface Seal: Material adequate to hold injection fittings firmly in place and to resist injection pressure.

Equipment:

Automatic pressure control equipment with displacement pumps with interlock to provide positive ratio control of exact proportion at the nozzle. The pumps shall be electric or air powered and shall provide in-line metering and mixing.

Discharge Pressure: Not to exceed 160 psi.

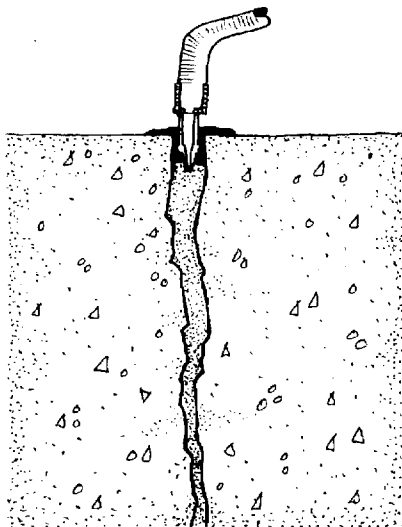

Epoxy injection. Cross section showing concrete crack, dam, and injection port.

Treatment:

Surface Preparation: Clean surfaces adjacent to cracks free of dirt, dust, grease, oil, efflorescence, or other foreign matter. Do not use acids or corrosives for cleaning. Provide entry ports along the crack at intervals of not less than the thickness of the concrete at that location. For through-cracks, surface seal both faces. Allow adequate time for the surface seal to gain adequate strength to withstand injection pressure.

Epoxy Injection: Begin epoxy injection at lower entry port and continue until there is an appearance of epoxy adhesive at the next entry port adjacent to the entry port being pumped. When epoxy adhesive travel is indicated by appearance at the next adjacent entry port, discontinue injection on the entry port being pumped and transfer to next port. Perform epoxy injection until all cracks are filled.

Finishing: When cracks are completely filled, epoxy adhesive should be allowed to cure sufficiently to allow removal of the surface seal. Finish crack flush with adjacent concrete. Where historic architectural finish must be matched, work surface to achieve matching finishes.

Quality Control:

Perform tests required to confirm structural integrity. Cracks must be ninety percent filled to a bond strength of approximately 6,500 psi.

Brick Construction: General

Masonry work includes historic brickwork from the post-Civil War period and the materials and operations associated with its treatment. The brick used in the fortifications is a dense, reddish-brown, common brick laid in a running bond pattern with regularly spaced header joints. Laid in multiple wythe walls and utilizing arches and vaulting to span openings, the brickwork is set in a Portland cement-sand mortar. Little or no lime was used in the mortar.

Causes of Deterioration:

1. Rising damp from subsurface moisture sources.
2. Windblown moisture in the form of rain.
3. Condensation due to lack of ventilation.
4. Moisture infiltration through deteriorated moisture joints.
5. Moisture accumulation from the encroachment of vegetation.
6. Moisture from inadequate surface drainage.
7. Improper maintenance.
8. Improper coatings that trap moisture.
9. Failure of waterproofing, roofing, or protective coatings.

Identification:

Brickwork deterioration can be readily identified by visual inspection. Identifying characteristics include:

1. Mildew, staining, or efflorescence.
2. Soft, loose, or crumbly mortar.
3. Spalling.
4. Cracking.
5. Deflection.
6. Loose bricks.

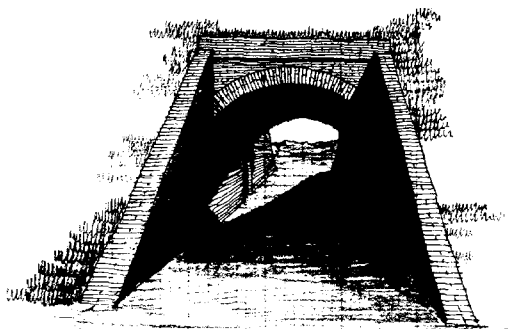

Cavallo Battery. Detail view of brickwork at vaulted passageway through earthworks. Note arched vault facing with brick headers.

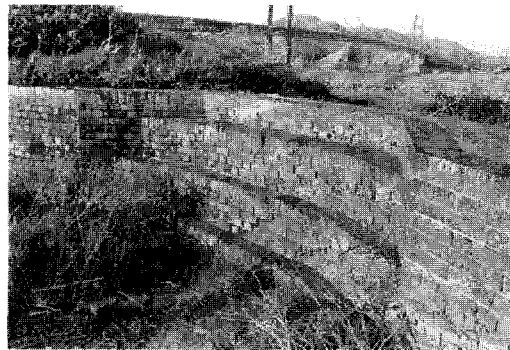

East Battery. Brick parapet at forward edge of gun emplacement.

Inspection and Testing:

Determining the causes and extent of deterioration of historic brick work requires careful field investigation, analysis, and laboratory testing. Review of drawings and other documents can enhance the identification of deterioration. Inspection and testing procedures include:

1. **Field Inspection:** Locate and record the extent of brickwork deterioration.
2. **Document Review:** Refer to original drawings and engineering reports and compare to field data. Check historic records and photographs.
3. **Field Testing:** If required, institute a field testing program including moisture meter readings and sampling of bricks and mortar for laboratory analysis.
4. **Laboratory Analysis:** Laboratory analysis includes:

Brick compression tests
Mortar composition analysis (by volume)
Moisture absorption of brick

Review of field inspection, field testing, and laboratory analysis should give a comprehensive view of the causes of deterioration. Based on the results, a plan for corrective treatment can be developed and tailored to meet treatment objectives.

Brick Construction: Identifying the Problem

Brickwork deterioration can be the result of individual causes or a number of related causes acting in concert.

Spalling:

Spalling is a loss of surface material due to moisture infiltration. It occurs when moisture inside the brick expands and contracts due to thermal action and when moisture evaporates at the surface of the brick. In climates where freeze-thaw cycles are frequent and extreme, spalling is more pronounced.

Expansion and contraction, and evaporation, are mechanical actions that exert force and stress inside the brick. The presence of spalling may indicate that a mortar either too dense or too high in cement content has been used in joints. Dense and brittle mortars obstruct the migration of moisture from the interior of the brick to the point where evaporation occurs. Mortar joints act as sacrificial wicks allowing inevitable deterioration to occur at a location and in a material that is easily repaired. The critical relationship between bricks and mortar relies on the fundamental rule that the mortar should never be harder or more dense than the brick.

Cracking:

Cracking may occur along mortar joints or through bricks. Cracking can be caused by structural movement due to expansive soils, by tree roots too close to a building, by inherent defects in the original construction, by imbedded materials, or by the use of rigid mortars that do not allow normal expansion and contraction. Cracks that follow mortar joints can be addressed through normal treatment procedures while cracks through bricks indicate more severe structural problems. Cracks most often occur at masonry openings.

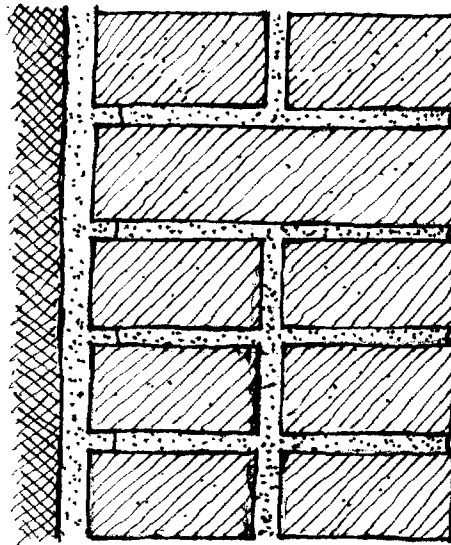

Cross section of brick wall showing header course and cement plaster parging on earthwork side of brick wall.

Efflorescence:

Efflorescence indicates that soluble salts are present within a brick and are migrating to the surface of the brick. An indication of chemical reactions within the brick, efflorescence can signal moisture-related deterioration.

Mortar Deterioration:

Loss of mortar, while an expected masonry condition, can contribute to further deterioration by allowing continued moisture infiltration. Loss of mortar can be caused by normal leaching-out of lime and through cracking of rigid, high-cement mortars.

Structural:

Structural deterioration is caused by excessive loading, differential load distribution, soil instability, and inadequate foundation support.

Brick Construction: Treatment Overview

Eliminate the Retention of Moisture:

Clean drains and clear drainage paths. Clear encroaching vegetation and slope grades to drain away from the structure. Install additional drains and repair existing drains.

Eliminate or Minimize Rising Damp:

Install damp course or mechanical barriers that resist hydrostatic pressure. The barrier may be in the form of thru-wall flashing, chemical injection, or surface-applied moistureproofing. Install the barrier above grade. Thru-wall barriers are best installed in mortar joints by raking out the mortar and inserting flashing material in small sections that do not exceed the width of the wall. Flashing sections may be shingled, or lapped as the work proceeds horizontally along the joint. Injection of chemical consolidant involves the saturation of a portion of the masonry with a material that will render the masonry impermeable. Such a procedure depends on the porosity of the masonry and requires extensive testing and coordination. Surface applied waterproofing involves digging out around the base of a wall and installing a vertical barrier from the base of the wall to a point above grade. The vertical barrier is in the form of a membrane material or trowel-applied asphaltic material. In some cases vertical barriers enhance hydrostatic pressure by creating a wick. Vertical barriers must be used in conjunction with other treatment methods that relieve the hydrostatic pressure before it can rise in the wall.

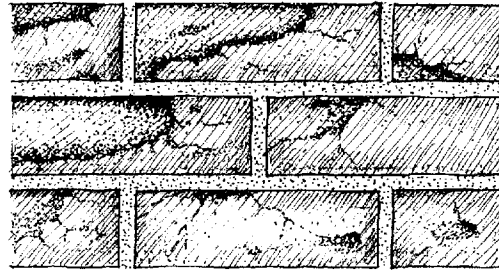

Brick spalling caused by moisture and thermal expansion and contraction and the use of high-cement mortars.

Consider Cracked Brick:

Cracked brick should be replaced only if the cracking goes all the way through the brick and is a part of a larger, more extensive cracking pattern. Replacement will depend on the availability of matching brick. Small hairline cracks that do not extend through the brick should be left alone. Cracks wider than one-sixteenth inch can be repaired with tinted grout that matches the color of the brick.

Brick Spalling is Almost Impossible to Repair:

In some cases, individual bricks may be removed from the wall, cleaned, and reinstalled with the damaged face to the inside of the wall. Where spalling is severe, and reversing the bricks is not possible, remedial efforts may be taken to save the remaining fabric of the material. Remedial measures include application of a water-repellent coating or the application of paint that matches the original brick color. Application of protective coatings is not generally recommended but if used, the coating should be breathable and should not significantly alter the brick finish. If salvaged or replica bricks can be obtained, severely damaged brick may be replaced.

Brick Construction: Mortar and Repointing

Mortar joints deterioration is the most common brick masonry problem. The repointing of deteriorated mortar joints requires the careful removal of deteriorated, inappropriate, or loose mortar; cleaning the joints; and installation of new mortar.

Identification and Inspection:

Original mortar should be tested to determine its original constituent materials by volume. The constituents will include cementitious materials and aggregate. The cementitious materials are composed of Portland cement and/or lime. The aggregate is usually sand. The usual and accepted ration of cementitious materials to aggregate is 1:3. That is: one part cementitious materials to three parts aggregate (by volume). While most nineteenth century mortars before 1880 were lime-sand mortars, the mortar used for fortification construction around San Francisco Bay for brick masonry was high in Portland cement content. The extensive use of Portland cement mortar was successful because of the relatively constant climatic conditions of humidity and temperature, and the rarity of freeze-thaw cycles. The hardness of the brick was also a factor allowing the use of a harder mortar. The character-defining features of the mortar depend on the color of the binders, the aggregate, and the joint treatment or finish. Mortar joints from the post-Civil War period were found to be flush to slightly concave joints about three-eighths to one-half inch wide.

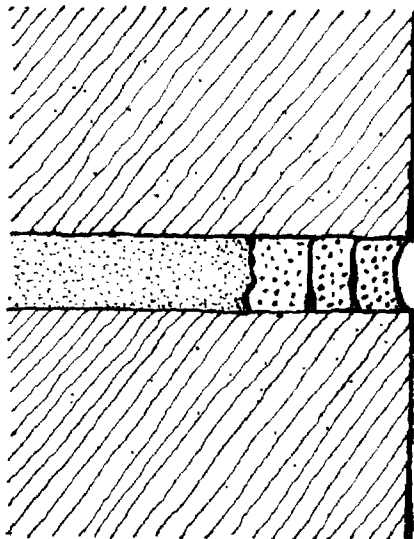

Typical brick joint showing repointing technique where deteriorated mortar is raked out to a depth equal to about twice the joint width and replacement mortar is built up in layers.

Treatment:

Rake out loose mortar from joints using handtools, such as chisels, and remove dust and small debris with a brush of compressed air. Avoid damage to adjacent brick.

Mortar for repointing brickwork should be mixed in the following proportions, subject to adjustments based on laboratory analysis:

White Portland Cement: ASTM C 207, Type S	one part
White Hydrated Masons Lime: ASTM C 150, Types I or III	one part
Screened Local Beach Sand: ASTM C 144	six parts

The mortar should be mixed in a paddle mixer or by hand with clean potable water. Based on laboratory analysis, the proportion of lime to cement may vary but the cementitious to aggregate ratio of 1:3 by volume must be maintained.

Finish joints to match original construction profile; concave or flush. After pointing, mortar may be tooled, brushed, or wiped (with burlap) when mortar has set to "thumbnail" hardness.

Brick Construction: Cleaning and Restoration

Masonry cleaning and restoration involves the removal of stains, mildew, dirt, grime, efflorescence, and paint from the brick surface. Masonry cleaning should be approached in a graduated manner. In arriving at an appropriate cleaning and restoration program, proceed from the least strong cleaning method to stronger methods. Use only enough chemicals and force to clean the material. It is preferable to retain existing imperfections than to permanently damage the structure by improper cleaning. Under no circumstances should brick masonry be abrasively cleaned or blasted.

Inspection and Testing:

Masonry cleaning and restoration should be accomplished only by experienced specialists implementing a comprehensive program. The cleaning and restoration program should be based on the approved results of field testing and sample panels. The cleaning and restoration program must be tailored to specific needs. Most cleaning can be accomplished with low pressure water blasting in association with scrubbing with a soft bristle brush. Isolated areas that retain staining or painted coatings such as graffiti after initial cleaning may require stronger measures.

Treatment:

1. Prior to the start of overall cleaning, clean a sample control panel for approval and reference. Demonstrate materials and methods to be used for cleaning the brick on the sample panel. The panel should be selected to include a range of cleaning and restoration requirements and should be of adequate size. Allow panel to stabilize for seven days before proceeding with other cleaning work. Longer observation may be appropriate.
2. Prepare a written program of procedures to be used including a description of the cleaning methods, working pressures, materials, equipment, and other information for each type of cleaning procedure. Comply with safety and environmental requirements.
3. Clean masonry surfaces only when the air temperature is between forty degrees Fahrenheit and eighty degrees Fahrenheit and will remain so

for at least forty-eight hours after completion of the work.

4. Perform cleaning and restoration work in sequence with other masonry work. Clean masonry surfaces prior to repointing or other restoration work.
5. Proceed with cleaning in an orderly manner; work from the top to the bottom of each segment and from one end of a structure to the other. Clean in a uniform and consistent manner. Rinse off any residue by working upward from the bottom to the top of each treated area of each segment.
6. Apply water or cleaners in compliance with pressure, volume, and temperature requirements. Hold spray nozzle not less than six inches from the masonry surface and spray from side to side in overlapping bands to insure uniform coverage. Use low-pressure spray from 100psi to 300psi at three to six gallons per minute.
7. Pre-wet masonry to soften and loosen surface materials. Wash, scrub, and spray with low-pressure spray. Apply cleaner only in accordance to manufacturer's written instructions. Rinse as required to remove all chemicals and residue. Repeat cleaning process if required.

Materials and Equipment:

Water: clean, potable, non-staining, and free of oils, acids, salts, and organic matter.

Brushes: fiber bristle only

Spray Equipment: low-pressure tank or chemical pump with a fan-shaped spray tip with an angle of not less than fifteen degrees.

Chemical Cleaning Solutions: dilute all cleaning solutions to produce mixes of a concentration not greater than that required to clean the masonry.

Note: Coordinate cleaning and restoration with other applicable sections in chapter 10.

Brick Construction: Graffiti Removal

Graffiti removal should be treated as a separate and distinct cleaning process. Graffiti removal will require specific treatment based on the type of paint used, the number of layers, the condition of the substrate, and the degree to which cleaning may permanently affect the historic materials involved. Where large areas have been painted with many coats of paint treatment may be different than small areas that have a single coat of paint. If graffiti removal, based on tests and sample panels, will permanently harm the historic materials a non-permanent, reversible sacrificial coating may be applied to enhance the visual effect.

Painting Out Graffiti:

Temporary solutions for problem graffiti areas include painting over the graffiti with two coats of any high quality latex paint of commercial grade. No special specifications are required.

Note: Refer to Finishes: General; Exterior Concrete Coatings; and Graffiti Removal, for details and coordination.

See also Martin E. Weaver, *Removing Graffiti from Historic Masonry*, Preservation Briefs, No.38, National Park Service, 1995, and, Anne E. Grimmer, *Keeping It Clean: Removing Exterior Dirt, Paint, Stains and Graffiti from Historic Masonry Buildings*, National Park Service, 1988.

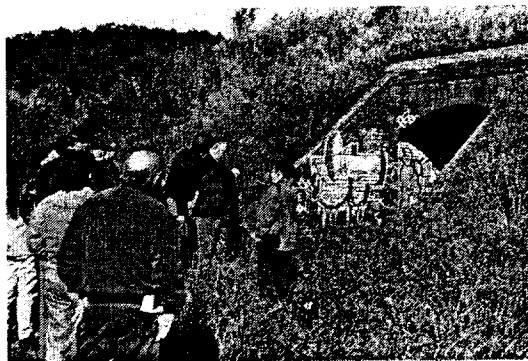

Cavallo Battery. Preservation charette discussing treatments for graffiti cleaning or breathable, non-permanent coating.



Cavallo Battery. Graffiti on brickwork forming angle above vault.

Metals: General

Metal items associated with the coastal fortifications around San Francisco Bay include iron and structural steel in the form of steel beams and other structural shapes, reinforcing steel in the form of twisted, billeted, and deformed bars, imbedded steel items and hardware, metal handrails, metal doors and windows, and anchors and connectors. The use of structural metal items changed with the development of concrete construction, particularly from the late nineteenth century to the beginning of World War I. Imbedded metal items and hardware such as maneuvering rings and anchoring plates changed little. Handrails evolved from small square bar rails and chain rails to pipe rails with threaded connections.

Causes of Deterioration:

1. Corrosion: Iron, steel and other metal may suffer from corrosion due to chemical and electrochemical reactions which cause the metal to oxidize or combine with chemicals such as carbonates or sulfides. The salt- and moisture-rich environment of the coastal fortifications is particularly hard on metals. Contact between dissimilar metals can also cause electrochemical reactions.
2. Fatigue: Structural iron and steel may be subject to metal fatigue due to excessive loading, repetitive movement due to wind loading, or stress from cyclical loading. Harmonic movement from wind loading and seismic movement can also cause fatigue.
3. Impact: Equipment and vehicles impacting structural metals can cause localized damage that can lead to further deterioration and failure.
4. Lamellar Tearing: Tearing at welded joints results from improper welding practices.
5. Loose Connections: Structural steel joints and connections may loosen due to impact, vibration, or stress on connectors and anchors such as bolts and nuts.

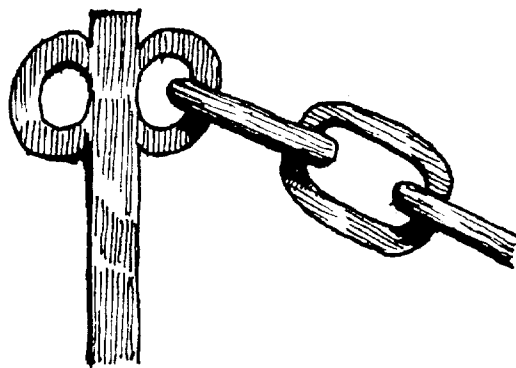

Detail. Iron stanchion and chain rail.

Identification:

The detection of metal deterioration is best accomplished by a structural engineer. However, many problems are visible through careful and systematic inspection. Whatever symptoms are found, professional evaluation is recommended. The signs of metal deterioration include:

1. Wearing away of metal surfaces.
2. Cracks, especially at points of maximum stress.
3. Localized distortion, twisting, or bending.
4. Paint or coating failure (an indication of underlying metal stress).
5. Misalignment.
6. Lack of plumb or level, sagging, or deflection.
7. Rusting or staining.
8. Loose bolts, rivets, or other connectors.
9. Broken welds.
10. Visible movement.

Inspection and Testing:

Inspection can identify deleterious conditions and distinguish among the various materials and conditions but testing and laboratory analysis may be required to identify hidden conditions, particularly those within masses of concrete. Such testing may be required where structural failure has occurred or where failure is eminent. This type of testing is best recommended by a corrosion or structural engineer. Testing methods include the use of ground-penetrating radar, x-ray analysis, and sonic penetration.

Metals: Structural Iron and Steel

Structural iron and steel items include I-beams, angles, channels, rails, bars, and smooth, twisted, deformed, or billeted reinforcing bars. Structural iron and steel, where exposed, should be inspected regularly and treated promptly to prevent further deterioration.

Replacement of Deteriorated or Damaged Members:

Replacement of structural items should be a last resort to prevent structural failure or damage to adjacent historic fabric. Replacement should be with similar materials if hidden and with matching materials if exposed.

Repair of Deteriorated or Damaged Members:

Repair of structural metal, in place, is preferable to removal and replacement. Surface patching and filling should be done with metal fillers such as automobile repair compounds.

Prevention of Corrosion:

Corrosion is prevented by removal to bare metal and the application of appropriate protective coatings. Sandblasting, or gritblasting, is the preferred method of removal of rust and corrosion from steel but may cause damage to wrought and cast iron. Gritblasting should be limited to specific areas of corrosion and adjacent areas protected with plywood. Where metal items such as doors can be removed, it is preferable to remove the item and gritblast and prime coat the item in protected shop conditions. After cleaning to bare metal, the metal surface should be wiped with a solvent and a primer should be immediately applied. Priming should be followed by finish painting with at least two coats of approved paint material applied according to the manufacturer's written instructions. A single manufacturer for the primer and top coats is recommended to insure compatibility. Specific painting and coating treatment is addressed in Finishes: Wood and Metal Coatings.

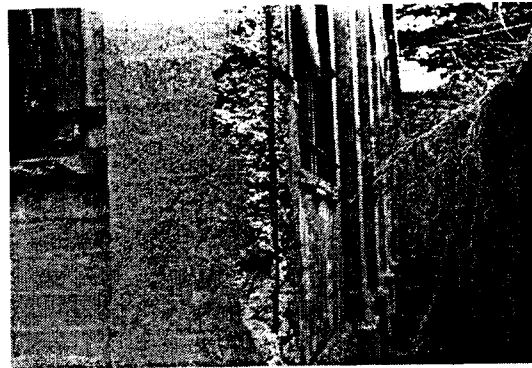

Battery Dynamite power plant. Spalled concrete and exposed rebar.

Relief from Excessive Loading:

Excessive loading of structural beams such as I-beams or reinforcing steel can be reduced by reducing the loading or by adding additional supports to transfer or redistribute the loading. Plant growth, vegetation, and trees, and trapped moisture can contribute to loads in overhead earthworks. Additional supports, in the form of support columns and plates can be useful in transferring loads. Additional supports should be designed by a structural engineer and carefully placed to avoid punching shear or point loading where bearing capacity is inadequate.

Connectors:

Bolts, nuts, rivets, anchoring plates, and other connectors should be inspected. All loose connectors should be tightened and monitored. Replace missing connectors.

Metals: Imbedded Hardware

Imbedded metal items include wrought iron maneuvering rings, brass hinges, window bars, and other miscellaneous fittings. These items are set into concrete or masonry either being cast-in-place or attached to cast-in-place anchors. Imbedded metal items can have corrosion problems that can affect the masonry or concrete into which they are set. Weakened planes can form around the imbedded item and can contribute to cracking and spalling.

Wrought Iron Maneuvering Rings:

Wrought iron maneuvering rings are set in concrete on walls adjacent to fortification gun positions. The rings were designed to be used in the placement and setting of guns on their mounts. The rings are in good condition and require only regular inspection, cleaning, and protective coating.

Hinges:

Brass pivot hinges are set in concrete walls adjacent to masonry openings and support iron strap hinge assemblies attached to wood or metal doors. The brass hinge portion is in direct contact with the iron hinge portion and the electrochemical reaction causes corrosion and efflorescence. Treatment should be directed at isolating the two incompatible metals. For efficiency, treatment of the doors should be coordinated with isolating the metals.

1. Remove metal or wood doors from hinges.
2. Clean brass hinges free of efflorescence using an approved chemical cleaner and brass wool.
3. Install a solid neoprene gasket and sleeve over the brass hinge portion.
4. Rehang door. Treatment and repair of doors is covered in Doors and Windows: General; Treatment for Doors; and Hardware.

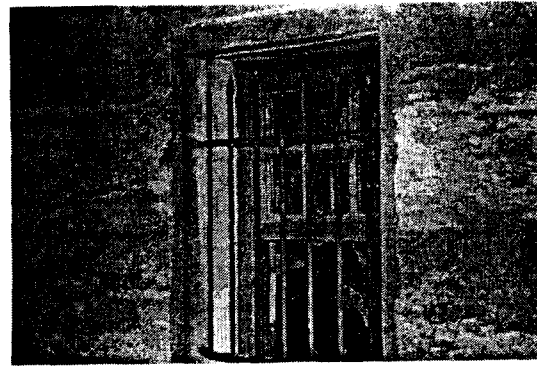

Battery Duncan. Double-hung window at traverse wall showing grill with decorative points.

Window Bars:

Hand-fabricated, wrought iron and steel bars are installed in some window openings. The openings are in masonry or concrete walls. The bars are simple vertical rods set on horizontal bar stock which is anchored into the concrete at the window jambs. The bars are flattened at the top ends to form a decorative "spear point" design. The bars have suffered vandalism in the form of bending and distortion. In some cases bars have been removed. Anchorage of the horizontal bars in jambs has become loose. Treatment involves removal of the bars, reworking in a metal shop, and reinstallation. Repair concrete and masonry jambs if required.

For restoration purposes, removal of window bars and other imbedded items may be required. When bars are loose, the metal may be heated sufficient to bend the metal, or cut for removal. Where inset metal has already caused spalling or masonry deterioration, break out additional material, repair metal, reinstall, and patch masonry.

Metals: Handrails and Guardrails

Handrails at the fortifications are of three types: Solid square wrought iron bars, chain rails, and pipe rails. Few of the early square section bar rails and chain rails from the Endicott and Taft periods are extant, although many examples of pipe rails remain intact. Retention of existing original metal railings and installation of new railings to replace missing elements is important for safety and as character-defining features. The square-section railings are set in sleeved holes cast into the concrete. The risers for the rails are set in cement or molten sulfur grout. Pipe rails are set in escutcheon plates bolted to risers at the concrete. In some cases, piperail uprights are screwed into escutcheon plates bolted to concrete. Rails are connected by four-ways, elbows, and Ts. The joints are threaded. Original pipe rails were primed and painted.

Treatment:

Railings should be repaired or replaced to meet standards that require railings to resist a lateral load of 200 pounds at any point along the rail.

Existing Railings:

1. Tighten all joints at screwed or bolted connections. Replace bent or severely deteriorated components to match original materials. Verify secure anchorage.
2. Gritblast metal railings and wipe down with solvent to remove residue and flash corrosion.
3. Prime immediately and paint.
4. Wrought iron bar rails and chain rails require solvent cleaning and waxing.

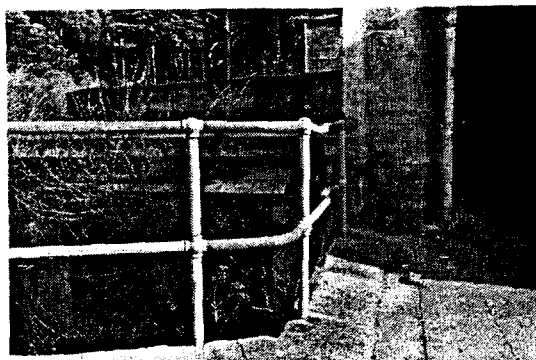

Battery Kirby. Handrails.

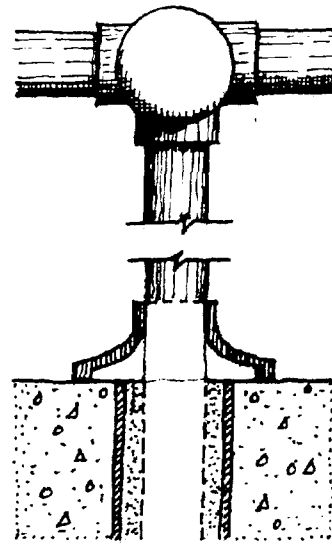

Typical pipe rail detail.

New Railings:

1. Design new railings to match existing original railings. Pipe railings are typically two-inch outer diameter, thick-walled, black iron piping with cast ornamental ball joint connectors. Railings are anchored into pipe sleeves cast or drilled into the concrete and grouted in place. The joint between the pipe and concrete is covered with an escutcheon plate and screwed in place.
2. Fabricate railings as specified from pipe of the proper diameter. Ball joint connectors may require special casting. Rails are to be shop primed.
3. Install new railings. Clean out existing sleeves and set railings plumb and level. Grout in place using a non-shrink metallic grout. Install escutcheons.
4. Fabricate wrought iron bar rails and stanchions for chain rails from mild steel to match original construction.

Metals: Ferrous, Miscellaneous

Miscellaneous metals includes military hardware attached to or set in the fortifications. Items include gun mounts, armored conduits, surface mounted boxes for electrical and communications equipment, ammunition handling equipment and other items.

Treatment:

1. Clean metal item free of dirt, oils, debris, corrosion, and deteriorated paint.
2. Brush or clean to bare metal or to stable paint level and wipe with solvent.
3. Secure anchorage devices.
4. Apply approved coatings.

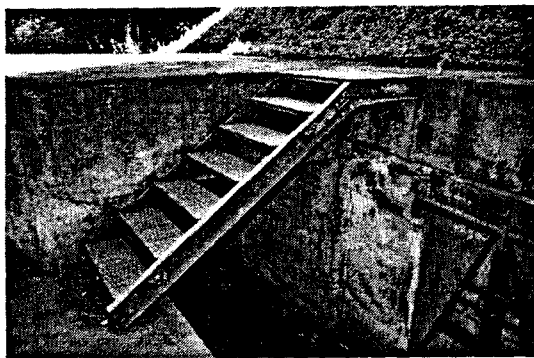

Battery Marcus Miller. Steps leading from loading platform to working platform.

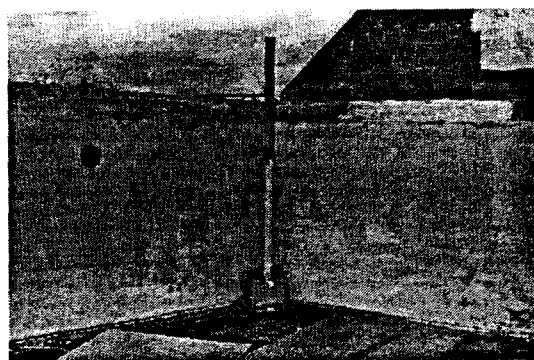

Battery Crosby. Emplacement one, support for camouflage, corner of loading platform. Note also, ventilator opening to left; heavy asphalt coating on floor.



Battery Marcus Miller. Counterweight cable pulley for ammunition hoist doors.



Battery Stotsenburg-McKinnon. Ammunition supply tramway and turntable in central corridor between pits.

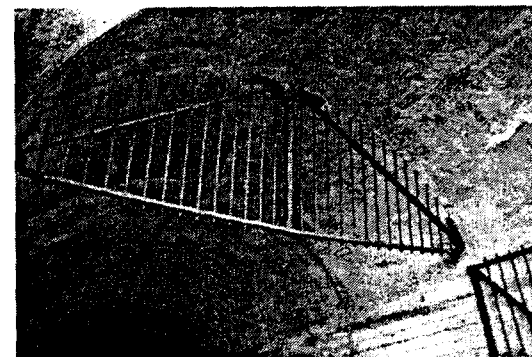

Battery Construction #129. Emplacement two, grill above entry gates.

Carpentry: General

Carpentry includes both rough and finish carpentry associated with wood framing, wood finish surfaces, and trim. Carpentry work is limited at the fortifications to light wood framing, wood doors, windows, and frames, wood roof decking, and wood siding. Some associated structures had wood floors and beaded board ceilings.

Causes of Deterioration:

Sources of wood deterioration are primarily associated with moisture. Secondary sources include excessive loading, wind loading, abrasion, and vandalism.

Moisture: Moisture infiltration can deteriorate wood through the growth of destructive fungi. Fungi induced rot requires a host material (wood), air, a stable temperature, and moisture content above twenty-five percent. Rot is found in two forms: soft rot, a surface decay caused by moisture saturation and alternating wet-dry cycles; and brown rot, or dry rot, a pervasive decay having a crumbly appearance. Fungi can be transmitted by contact and by airborne spores.

Excessive Loading: Excessive loading can cause deflection which can weaken structural wooden elements. Common causes of deflection are the mounting of equipment on structural members that are not designed for the loading and lack of diagonal bracing. Wind loading, especially high, intermittent winds, can loosen connections allowing moisture penetration.

Abrasion: Wind blown sand can abrade wood surfaces and the coatings that protect them.

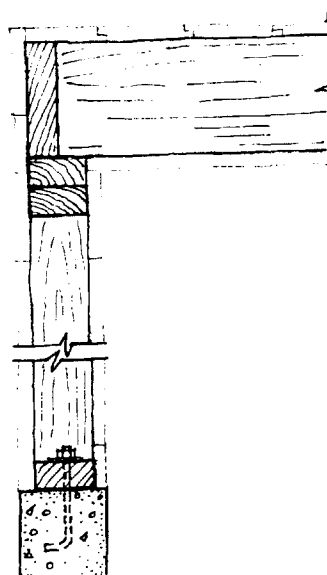

Detail. Typical basic wall and roof framing section showing plates, studs, headers and joists.

Identification:

Deterioration of wood elements may be identified by the following signs:

1. Presence of moisture.
2. Staining or discoloration of wood.
3. Presence of mildew or fungi.
4. Presence of soft rot or brown rot.
5. Soft or spongy wood.
6. Loss of wood material.
7. Sawdust-like debris and insect droppings.
8. Structural deflection of wood members, lack of plumb or level.
9. Paint deterioration on wood members.
10. Deterioration of applied finish materials.
11. Sagging, buckling, cupping, or bowing of wood members.
12. Loose connections.

Inspection and Testing:

Inspection for moisture-related deterioration in wood involves systematic and thorough on-site investigation. Most moisture problems are readily observed. Further investigation requires the use of a sharp probe to penetrate wooden elements in order to detect soft spots that may be hidden by paint or the outer wood surface.

Carpentry: Treatment

Eliminate sources of moisture infiltration

such as roof leaks, failed waterproofing, gutter and downspout leaks, coating failure, standing water, and inadequate surface drainage. Dampness and the accumulation of moisture vapor should be reduced by the installation of adequate ventilation of interior spaces.

Removal and replacement of a deteriorated wood element

may be required in cases of severe damage or where structural integrity has been degraded. Removal and replacement may require removal of covering finish material. Replacement of original historic materials should be considered only if other means have been exhausted. While it is best to replace deteriorated material with materials that match, it may not be possible to obtain exact matching materials. Substitute materials should be carefully evaluated and selected on the basis of closeness of match, durability, and structural requirements. High grade pine and fir are usually safe selections for most replacement conditions. Redwood and cypress are appropriate where moisture resistance is required but structural requirements are minimal. Pressure treated wood is appropriate for high moisture conditions that include contact with the ground.

Repair by attachment of additional structural elements. Scab onto existing deteriorated wood elements, add blocking or additional nailers. In some cases new wood elements can be used to bridge across deteriorated members in order to distribute structural loads. Where visual appearance is important, new wood materials may be pieced in (or let in) by cutting out deteriorated portions and fitting in new wood to match that removed.

Repair of individual deteriorated

members can be accomplished by removal of the deteriorated portion and repair with epoxy filler. A variety of epoxy repair products are available including putties and low viscosity penetrating consolidants. Epoxy resins can be mixed with fillers such as pea-gravel, sand, or sawdust and used to fill voids in original wood. Deteriorated wood should be carefully removed and the area to receive patching materials cleaned and dried. In some applications forms or dams may be required to retain the epoxy mix until it sets up.

The application of protective coatings to deteriorated wood should be carefully considered. While application of such coatings may prevent moisture penetration, some coatings may trap moisture within the wood and cause further deterioration. Select products that are "breathable" and follow manufacturer's written instructions.

Materials and Equipment:

1. While **new materials** should match original materials to the greatest extent possible, standards for new wood materials include:
 - PS 20 "American Softwood Lumber Standard"
 - SPIB (Southern Pine Inspection Bureau)
 - WCLIB (West Coast Lumber Inspection Bureau)
 - WWPA (Western Wood Products Association)
 - APA (American Plywood Association)
 - AWPBS (American Wood Preservers Bureau Standards)
2. Moisture content of **replacement lumber** should not exceed nineteen percent.
3. For **structural uses** lumber should be graded and marked appropriately. Structural grade yellow pine or fir are recommended.
4. **Special molding profiles** may not be commercially available for some wooden elements. When commercial sources have been exhausted, it may be necessary to fabricate router knives to match some wood profiles. Router knives should be retained for future use.

Moisture Protection: Causes of Deterioration

Moisture protection includes the repair or application of new protective coatings and membranes to existing surfaces. Waterproofing is applicable to vertical and horizontal surfaces except for exposed roofs and includes surfaces below grade and under earthworks. On the fortifications asphaltic waterproofing was applied to concrete and masonry surfaces below grade and under earthworks and was protected with hollow clay drainage tile. The tile had the dual role of protecting the waterproofing membrane and providing a drainage conduit for moisture that accumulated around the structure. (In some cases, cobble stones were used as drainage coursing.)

Waterproofing products are in the form of trowel-applied asphaltic or bituminous coatings; expansive sheet goods such as bentonite panels; penetrating chemicals; and membranes such as modified bitumen, butyl, and elastomeric.

Historic methods include trowel-applied asphaltic coatings, and parging with cement paint or a cement plaster wash.



Battery Godfrey. Cold joint displaying sheet lead as waterproof layer. Stained concrete from imbedded metal elements.

Deterioration frequently occurs when one or more of the following changes have occurred on site:

1. Waterproofing deteriorates through degradation of materials. As sacrificial coatings, waterproofing materials normally deteriorate.
2. Waterproof coatings are breached by structural movement, cracking, and penetration by mechanical means.
3. Grade changes adjacent to a protected surface can expose the edges of the waterproofing to the elements and cause subsequent deterioration.
4. Grade changes adjacent to a protected surface can be such that the exterior finish grade at the structure is above the level of the waterproofing and surface water can flow into a wall.
5. Original application of the waterproofing may have been faulty; too thickly applied; too thinly applied; inconsistently applied; incompatible with the substrate; or deficient in workmanship.
6. Asphaltic built-up roofs deteriorate due to direct exposure to moisture and the subsequent degradation of materials. In addition, asphaltic built-up roofs deteriorate due to exposure to wind, rain, and sunlight. Deterioration of the roof deck and deficiencies in the original installation are also contributory to roof deterioration.

Moisture Protection: Identification and Testing

Identification

Moisture problems often occur when the following conditions exist:

1. The presence of moisture on interior walls and floors.
2. Obvious active leaks.
3. High humidity inside a structure.
4. Exposed edges of waterproofing materials.
5. Exposed surfaces of waterproofing that show thinness, drying, cracking, or material loss.
6. Mold, staining, efflorescence, or fungi on wall surfaces.

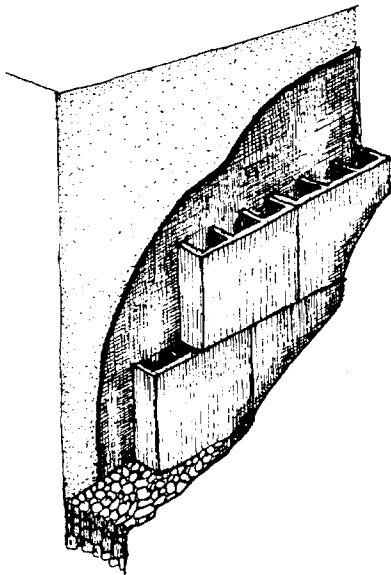

Typical detail, Endicott & Taft periods. Exterior waterproofing: asphaltic troweled-on coating on concrete protected by split clay tile. Tile cavity is for drainage to gravel course below.

Inspection and Testing:

Inspection of waterproofing at the fortifications requires the removal of earthen cover to expose vertical and horizontal surfaces. Selective excavation should start where waterproofing is exposed to view at its edges and corners.

1. Remove enough fill to expose a sample area that includes the top and bottom edges of the waterproofing. Inspection of interior surfaces corresponding to exterior waterproofing locations can be useful in discovering moisture infiltration.
2. Examine cold joints, cracks, and penetrations for dampness or the presence of water, staining, or efflorescence. The use of a calibrated moisture meter is useful when moisture penetration routes are not clear.
3. Grid the interior surface into four-inch squares with a level and chalk line. Take moisture readings at the grid points and graph readings to locate moisture sources.

Note: Infrared remote thermal sensing can also be used to locate moisture penetrations and accumulations. Wet areas appear as thermal anomalies because wet areas retain heat in contrast to drier areas.

Moisture Protection: Treatment

Procedures:

1. Perform testing and on-site investigation to determine the extent of moisture infiltration.
2. After the extent of the moisture infiltration has been identified and located, remove fill from the exterior of the structure adjacent to the problem area and expose the surface of the waterproofing. If the top edge of the waterproofing is below grade, regrade adjacent to the top edge. If trenches adjacent to the structure must be left open for repairs, provide interim drainage or make provisions to pump out any accumulated water.
3. Perform demolition of deteriorated waterproofing materials down to a stable and clean substrate. Repair cracks and seal penetrations.
4. Prepare the surfaces to receive waterproofing according to waterproofing manufacturer's written instructions. Allow substrate and primers to dry thoroughly.
5. Apply waterproofing to the prepared substrate. Application should be according to manufacturer's written instructions. Coordinate the entire installation with adjacent finishes, sealants, and other work.
6. Allow proper curing of the waterproofing before replacement of any protective tile, installation of drainage fill, or backfilling of trenches. Monitor the installation of the waterproofing to insure that moisture penetration has been eliminated.
7. Where historic clay drainage tile is uncovered, store tile properly during waterproofing work and reinstall when work is complete. Carefully backfill to hold tile in place. Where tiles are missing, replace with salvaged tile or substitute material.

Materials:

1. Sheet Membrane Waterproofing:

Mechanically applied or adhered to substrate, these membranes are rubberized sheet stock, elastomeric, or expansive mineral sheets such as bentonite.

2. Fluid-Applied Waterproofing:

Fluid-applied material is directly applied to a substrate which forms an elastic surface membrane.

3. Bituminous Damp-Proofing:

Hot- and cold-applied damp-proofing is surface applied by trowel and minimizes moisture infiltration.

4. Water Repellents:

Clear silicones, acrylics, and other penetrating chemicals are surface applied and consolidate either on the surface or within the material to prevent the passage of moisture.

Moisture Protection: Built-Up Roofing

The use of built-up roofing is limited to isolated structures associated with the fortifications. Existing built-up roofs are multiple-ply, tar and gravel installations that are in very poor condition.

All existing roofs require complete replacement. After repairs to roof substrates (wood decking) new built-up roofing should be installed as follows: Mechanically fastened modified bitumen unsurfaced roll roofing with torched seams over manufacturer approved base sheet. Ballast should match original local gravel. Coordinate installation with wood trim, flashing, and roof penetrations.

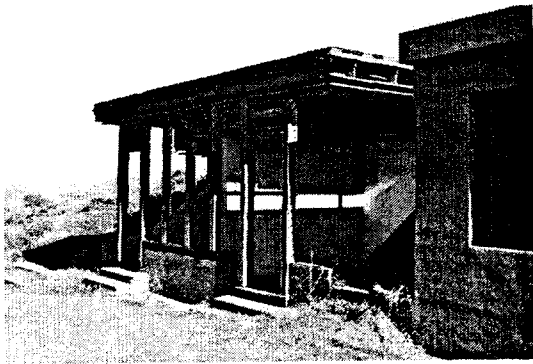

Battery Spencer, emplacement two. Remnant of latrine superstructure showing cross section of built-up roof. Oil room to the right.

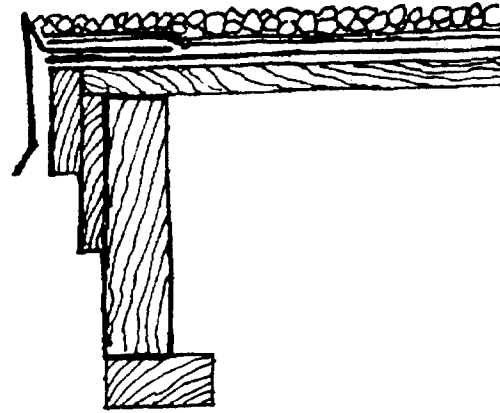

Detail. Cross section showing roof deck, base sheet, roofing membrane, gravel ballast, and gravel guard.

Doors and Windows: General

Doors and windows at the fortifications include slab wood doors with metal bracing, solid plate metal doors with metal bracing, standard wood panel doors in wood frames, wood sash double-hung windows in wood frames, and fabricated metal combination awning, hopper, and casement windows. Wood and metal slab doors are the most common exterior door types. Wood panel doors are limited to interiors and to support structures. Wood windows are very limited. Metal windows, although also limited in number, range from factory manufactured industrial metal units to shop fabricated metal frames and stops used with protective metal shutters. Most doors and windows are in poor condition. Some metal doors have been welded shut for security reasons and some masonry openings have been closed with plywood or metal sheeting.

Hardware includes hinges, strap braces, hasps, eyes, and other shop-built devices. Interior wood doors are fitted with standard butt hinges, mortise locks, and knobs.

Causes of Deterioration:

1. Exposure to moisture.
2. Loose hardware.
3. Lack of interior ventilation.
4. Vandalism.
5. Loss of protective coatings.

Identification:

1. Corrosion, rusting, and staining.
2. Rot.
3. Deterioration of coatings.
4. Loss of materials.
5. Loose hardware.
6. Missing parts.
7. Separation of panels, stiles, rails, and frames.

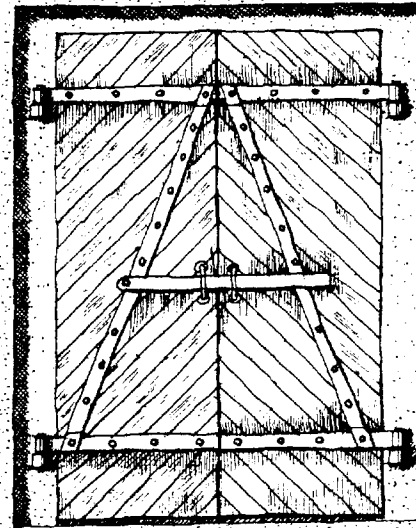

Detail. Exterior wood slab door on metal angle frame. Wood boards are bolted to steel angles and flat bars. Metal strap hinges are attached to bronze pivot hinges.

Inspection and Testing:

Inspection should begin with a survey to document all doors and windows in the fortifications. Each door and window should be measured, photographed, and assessed. From the field data, develop a door schedule, window schedule, and a hardware schedule. Group doors, windows, and hardware by type. From the schedules, develop a work plan that maximizes shop repair procedures, material purchases, and setup time. A systematic approach can save time, money, and can yield valuable information about a significant and highly visible historic building component.

No laboratory testing or analysis required.

Doors and Windows: Treatment for Doors

Slab Wood Doors:

1. Remove door from opening and provide a temporary and secure closure.
2. Remove deteriorated wood elements and replace with matching materials such as ship lap and beaded board. Use redwood or treated pine. Wood joints should be coated before joining. Repair existing salvageable wood elements. Prime wood surfaces.
3. Shield wood surfaces and gritblast metal surfaces to bare metal. Wipe metal with solvent and prime.
4. Repair bolts and rivets and tighten all connections. Spot prime all bare spots.
5. Repair and rework hardware.
6. Apply finish paint coats in shop.
7. Repair opening to receive repaired door. Patch deteriorated concrete edges; remove debris, vegetation, and accumulated fill around door; and insure proper drainage.
8. Repair inset brass pivot hinge section by cleaning, removal of efflorescence, and installation of neoprene washer. Sheathe to pintle to isolate dissimilar metals.
9. Reinstall door, secure, and monitor condition.

Solid Plate Metal Doors:

1. Remove doors to shop.
2. Gritblast to bare metal and wipe with solvent.
3. Repair surface deterioration and prime entire unit.
4. Repair and rework hardware.
5. Apply finish coats in shop.
6. Repair opening to receive reworked door. Remove debris, vegetation, and fill. Insure proper drainage around door.
7. Repair inset brass pivot hinge section and clean free of corrosion and efflorescence. Install neoprene isolation washer and sheath.
8. Reinstall door, secure, and monitor.
9. Where metal elements are deteriorated beyond repair, complete or partial replacement may be required. Replacement materials, techniques, and configuration should match original construction.

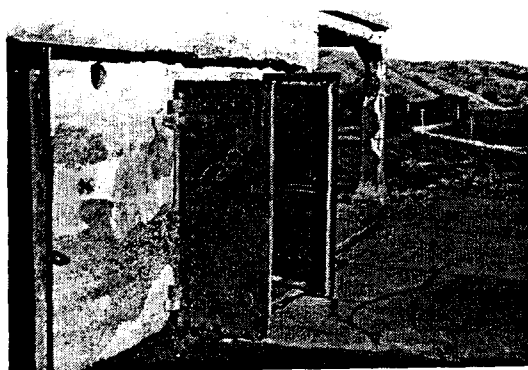

Battery Mendell, emplacement one. Steel doors for truck access. Note deterioration at base of door. Also spalling at drip mold and splinterproof columns.

Wood Panel Doors:

1. Remove wood panel door to shop.
2. Repair door by replacing deteriorated stiles, rails, or panels.
3. Remove deteriorated paint to bare wood or stable paint layer.
4. If severely deteriorated, fabricate new matching door unit.
5. Prime door and coordinate placement of hardware. (Reuse existing hardware or match with replica hardware.)
6. Apply finish paint coats.
7. Reinstall door in repaired opening and frame, secure, and monitor.

Doors and Windows: Treatment for Wood Windows

1. Remove window sash to shop.
2. Repair by replacing deteriorated stiles, rails, and muntins, or replace with a replicated shop-fabricated sash to match. Reglaze windows with new glazing, glazing points, and compound. Shop prime.
3. Apply finish coats in shop.
4. Rework window frames replacing deteriorated materials or missing parts and paint.
5. Reinstall window. (Window repair should be accomplished in association with a secure building that is weather tight. Interim protection requires the installation of a painted plywood covering.

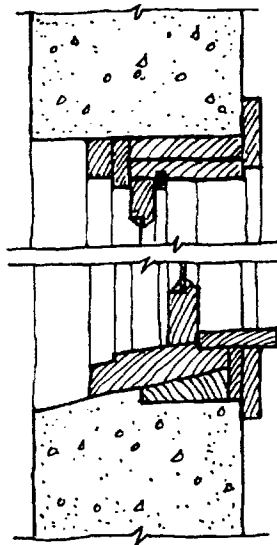

Detail. Typical head and sill section of double-hung wood window.

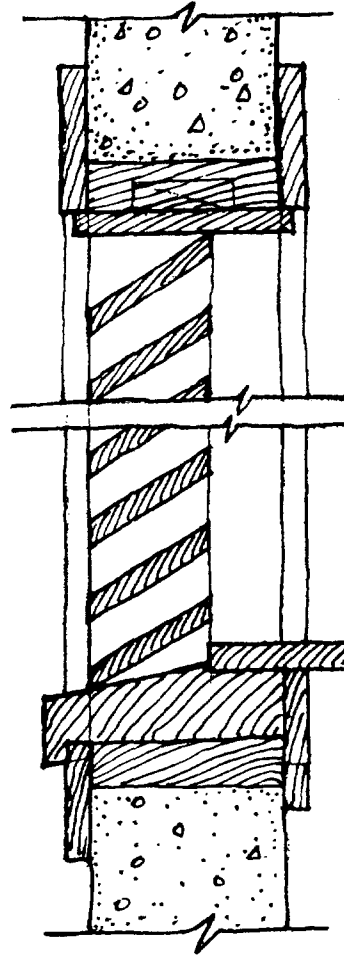

Detail. Typical louvered wood window in concrete opening.

Doors and Windows: Treatment for Metal Windows

Treatment:

1. Determine the condition of the metal window and determine the level of repair required. If rust is found to be only surface corrosion the normal maintenance procedures may be sufficient. If rust is found to be moderate and only penetrates into the metal enough to distort the metal's surface, then repair in place is called for. If rust permeates the metal and causes delamination, extensive repairs in place and/or removal to a shop may be required. Other conditions, including the method of attachment, may determine the extent to which steel windows may be repaired in place.
2. Clean window sash and metal frames. Remove dirt, loose paint, and surface rust.
3. Determine level of repair or if complete replacement is required.
4. After surface rust has been removed by use of sandpaper, wire brush, or gritblasting wipe bare metal with solvent and spot prime with a zinc-rich, rust-inhibitive primer. Coordinate spot priming with overall surface preparation. Metal elements that have lost at least fifty percent of their thickness due to rust will require replacement.
5. If reglazing is required, remove glass and glazing compound. Scrape metal to bare metal. Metal should have one primer coat and one finish coat of paint before reglazing.
6. If metal is bent, bowed, or misaligned reform or realign the metal. Pressure, or heat and pressure, may be required to straighten deformed metal. Severely deteriorated sections of the sash may be removed and newly fabricated elements welded in place. Steel window frames are usually set into adjacent masonry or concrete and are difficult to remove.
7. Replace any missing hardware, screws, bolts, operators, or other fittings.
8. Make window operational so that it opens, closes, and swings freely.
9. Coordinate window repairs with appropriate weather protection materials.

10. Provide temporary security with painted plywood panels.
11. Seal joints between metal frame and adjacent masonry or concrete with an elastomeric sealant.
12. Repair and paint metal shutters and associated fittings.

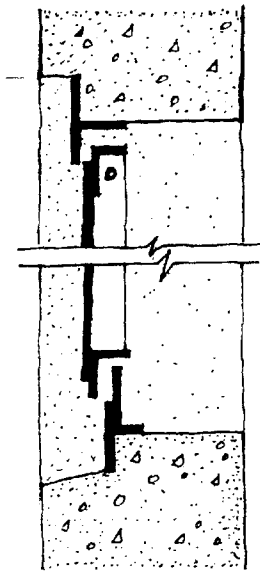

Detail. Metal window shutter showing head and sill condition.

Materials:

- | | |
|---------------|--|
| Steel: | Cold rolled mild steel one-eighth inch thick. |
| Gritblasting: | Small grit (#10-#45) at eighty to 100 psi pressure. |
| Fillers: | Epoxy fillers with high fiber content and auto body patching compound. |
| Primer: | Zinc-rich, rust-inhibiting primer compatible with finish paints. |
| Paint: | High gloss alkyd exterior enamel formulated for metal. |

Doors and Windows: Hardware

Hardware includes hinges, hasps, eyes, mortise locks, knob sets, and associated fittings. The utilitarian nature of most hardware at the fortifications is typical for military architecture. Much of the hardware items for exterior slab and metal plate doors at the fortifications is shop fabricated for use with pad locks. More formal hardware is seen on wood panel doors.

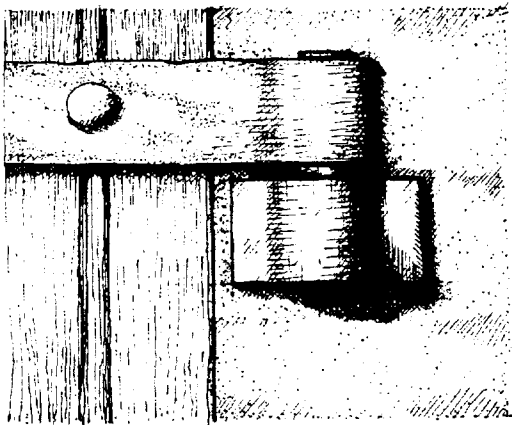

Detail. Typical exterior door hinge. Iron strap attached to brass pivot hinge base set in concrete. Beaded boards are riveted to the strap. Contact between the iron and brass is creating electrochemical corrosion.

Treatment:

1. Tighten hinges and all fasteners attaching hardware to doors. Make sure that all hinge-pins are in place.
2. Clean, prime, and apply rust-conversion coating.
3. Clean and lubricate all locking devices.
4. Fabricate new hardware to match original. Shop fabricate items where original hardware is missing.
5. Install isolation gaskets at hinges.

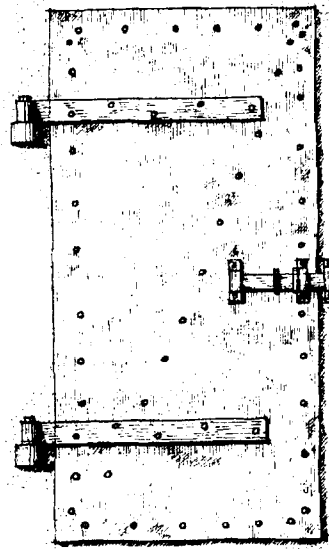

Typical metal exterior door. Sheet iron riveted to angle frame. Note that strap hinges are set on bronze pivots set in concrete. Custom-made slide latch.

Finishes: General

Finishes include both interior and exterior coatings. Interior finishes include paint and whitewash on concrete, masonry, metal, and wood. Exterior finishes include camouflage coatings for concrete; and, paints for concrete, metal, and wood. Also included in this section are graffiti removal, and signs and stenciling. Finish coatings at the fortifications are utilitarian and follow typical military painting patterns. Of special note are the concrete coatings developed for camouflage. These coatings were prototypical and represent early experiments in camouflage techniques. Although in poor condition, many examples of camouflage coatings remain. Some recent attempts to paint out graffiti have altered the appearance of some fortification structures.

Causes of Deterioration:

1. Improper or inadequate surface preparation.
2. Moisture infiltration behind paint layers.
3. Weathering and the hostile marine environment.
4. Incompatibility between primer and finish coats.
5. Improper paint application.
6. Improper paint selection.
7. Use of poor quality paint materials.
8. Uneven paint coverage.
9. Paint application during adverse weather conditions.
10. Overpainting.

Identification:

1. Presence of mildew.
2. Chalking.
3. Crazing.
4. Cracking.
5. Intercoat peeling.
6. Solvent blistering.
7. Wrinkling.
8. Peeling.
9. Alligatoring.
10. Fading.
11. Suction spotting.
12. Flaking.

Inspection and Testing:

Inspection and testing are critical to identify historical paint coatings and colors. Historical mix design is documented in engineering reports and coordination between historical descriptions and formulae with extant finishes is essential to preserve original coating materials. To accomplish the preservation of existing historical coatings and to restore fortifications to their appropriate appearances, it is recommended that a master paint schedule be developed. The extent of the paint work at each fortification should be documented. Samples should be taken and matched to standardized paint chips. Coordinate all paint investigation and removal with applicable regulations concerning hazardous materials, especially lead-containing paints.

Finishes: Exterior Concrete Coatings

The determination of conditions and corrective procedures is complicated by the need to match historic paint colors, the need to preserve historic painted surfaces, and the requirement to do no harm to the substrate. The development of a comprehensive approach to the preservation of historic surface coatings and the installation of new painting is advisable.

Identifying Historic Concrete Coatings:

Historic concrete coatings were designed to camouflage exposed concrete so that it would blend with surrounding terrain. During the Endicott and Taft periods, 1885-1916, camouflage was experimental as both a military concept and as a coating for concrete, an emerging building material. Camouflage was designed to work when viewed from the sea. With the advent of military aviation, camouflage was required to work when viewed from the air. Camouflage coatings for concrete were developed in the late nineteenth century and remnants remain on the concrete at a number of fortifications. Historical concrete camouflage coatings were required to hide the stark new concrete work. Some coatings described in the *Annual Reports of the Chief of Engineers, U.S. Army*, from the period, include:

- 1896: Lampblack/cement wash applied with a whitewash brush.
- 1898: One coat of boiled linseed oil; one coat mineral brown in oil.
- 1899: Cement and water mixed to the consistency of whitewash, with Pecora stain, yellow ochre, and lampblack mixed in to create a color matching adjacent spoil banks.
- 1902: Two coats of brown metallic paint.
- 1903: Two coats of boiled linseed oil was allowed to be absorbed by the concrete; a third coat consisting of oil and Prince's metallic brown was applied and, while still wet, screened, dry sand was swept over the surface.
- 1913-1945: Pigmented cement paints and black asphalt emulsion paints. Colors for World War II camouflage include greens, ochre, and brown and can be seen at Batteries Dynamite, Wallace, and Townsley, respectively.

Treatment:

It is important to preserve remnants of historic surface coatings, particularly those pigmented coatings that represent early efforts at camouflage. It is preferable to retain the historical coatings, even in a deteriorated condition, than to remove historical finishes in the interest of applying new replicated finishes. Oil-based coatings proved, shortly after being installed, to be detrimental to concrete. If any replicated finishes are to be used, they should be oil-free.

To Preserve Historic Concrete Camouflage Coatings:

1. Remove deleterious conditions that contribute to coating deterioration including: vegetation, sources of moisture, and adverse structural conditions.
2. Fully document remaining examples of surface coatings showing location and extent. Review historical photographs. Record existing coatings with large format color photography.
3. Take samples for analysis and determine colors.
4. No further action is required for stabilization or preservation.

Finishes: Interior

Historic interior finishes for the fortifications included both paint and whitewash. Paints included both oil-based enamels and pigmented cement paints. Whitewashed surfaces proved to be very durable in that they allowed for the migration of moisture.



Battery Mendell. Remnants of wall finish and wooden wiring chase.



Battery Spencer. Finishwork for the fireplace in the commanding officer's room. Dependent structure.

Treatment:

1. Remove deleterious conditions that contribute to paint or whitewash deterioration such as vegetation, trapped moisture, and defective moisture proofing.
2. Fully document interior painted surfaces showing the location and extent of paint work. Photograph interior painted surfaces using large format color photography and take samples for color matching.
3. Remove loose paint carefully with a soft paintbrush after documentation.
4. No further action is required for stabilization or preservation.
5. Whitewash: Remove loose whitewash carefully using a soft paintbrush. The historical mix (1899) for whitewash was:

one barrel lime
one pound bluing
one pound potash
ten pounds Russian tallow (animal fat or lard)

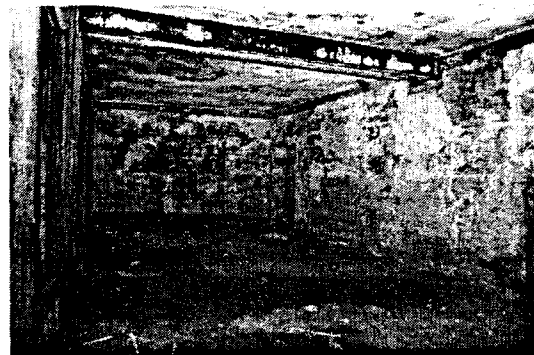

Battery Kirby. Interior of plotting room. Remnants of wall and ceiling finishes. Note accumulation of mud on floor.

Finishes: Wood and Metal Coatings

Wood

Wood materials include windows, slab doors, interior wood doors, and trim. Wood materials are limited at the fortifications. The most common wood elements are the slab wood doors built to metal frames.

Treatment:

1. Remove all loose paint, mildew, and other foreign materials from wood. Use sanding, scrapers, or other hand-held devices to remove paint. Removal to bare wood is preferred. However, removal to a stable paint layer is acceptable.
2. After paint removal, wipe wood down with solvent to remove dust.
3. Paint with an anti-fungal primer.
4. Lightly sand dry primer and wipe down with solvent before applying finish coats.
5. Apply two finish coats of approved anti-fungal paint.

Metals

Metals requiring painting include handrails; ladders; inset metal items; structural steel; metal doors; iron strap hinges and door bracing; metal windows, grilles, vents and gun mountings. Historical metal coatings changed little from 1900 to 1945. Red lead was the preferred primer. Linseed oil-based enamel was the typical top coat. While paint technology has improved greatly since World War II, technological improvements have barely compensated for the removal of lead from paints for environmental reasons. Red lead paint was universally accepted as the standard primer of choice for metals. New, environmentally neutral, paint systems are available and offer satisfactory results when combined with thorough surface preparation.

Treatment:

1. Remove all deteriorated exterior paint on metal by gritblasting, brushing, or other approved means. Where paint is in good condition remove loose paint down to a stable paint layer. When gritblasting, clean down to bare metal surface.
2. After blasting or abrasive cleaning, wipe surfaces down with solvent to remove flash rust and prime immediately.
3. Prime with zinc-rich primer or rust-inhibitive primer according to manufacturer's written instructions.
4. After the primer is dry apply two coats of exterior enamel finish coats.

Notes:

1. Use a paint system from a single manufacturer.
2. Do not paint brass, bronze, wrought iron, or cast iron. Wrought iron door closures and hinges are best treated by wiping with solvent and applying microcrystalline wax. See Doors and Windows: Hardware.
3. Consider the use of high-performance coatings such as urethane or epoxy.

Finishes: Graffiti Removal

Graffiti removal methods should be evaluated according to a thorough investigation of the condition of the substrate, the type of media used in the graffiti, and the requirements of the interpretive program. Graffiti removal should be accomplished by the method least destructive to the substrate. Where graffiti ranges from large areas of multiple layers of painting to small areas with a single coating, removal methods should be tailored to suit the situation. Develop a comprehensive graffiti removal program and utilize technical representatives from product manufacturers.



Battery Dynamite, emplacement three. Graffiti at rear corner, showing entry to cross-gallery. Also note debris accumulation and unique profile of sidewall.



Battery Dynamite. Graffiti in cross-gallery, looking toward entry doors for emplacement one. Also showing significant floor deflection as a result of seismic action.

Methods:

1. Abrasive measures include hand and mechanical sanding, scraping, low pressure waterblasting, and gritblasting. Gritblasting should only be used for metals.
2. Thermal methods include the use of heat guns or irons to soften paint for removal by hand scraping. Thermal methods should be used with care due to the potential for fire.
3. Chemical methods include surface-applied chemical compounds, spray-applied chemicals, poultices, and neutralizing rinses. Chemical methods should only be used by skilled technicians after testing and subsequent to the approval of a sample panel.
4. Low pressure steam cleaning methods may be appropriate in certain cases after testing and sample approval.

Note:

Some graffiti, such as names and dates scratched or written on historic materials, may be historical and worthy of preservation.

Finishes: Signs and Stenciling

The fortifications and associated structures retain the military markings of their periods of use in the form of painted signs and stencils. These markings are important records of how the facilities were used and are character-defining features.

Documentation:

Each stenciled or lettered sign painted on concrete, metal, wood, or masonry should be identified, photographed, and recorded. This work can be accomplished by trained volunteers under proper supervision. Records of signage should be placed in site files and coordinated with periods of military use.

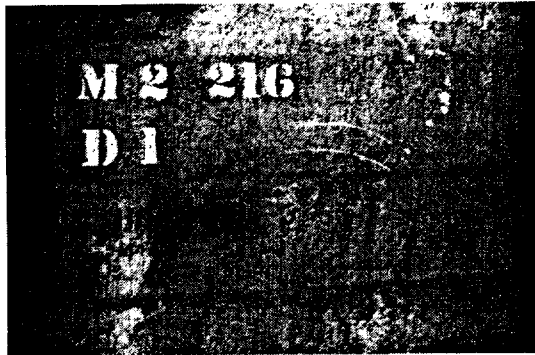

Typical military identification stenciling on concrete wall.

Treatment:

1. Do not attempt paint removal near historic signage.
2. Do not paint over existing historic signage.
3. Develop a comprehensive approach to stabilize, preserve, repair, or restore signage.
4. The best approach to treatment for signage is to reduce the effects of deterioration caused by moisture and vandalism.

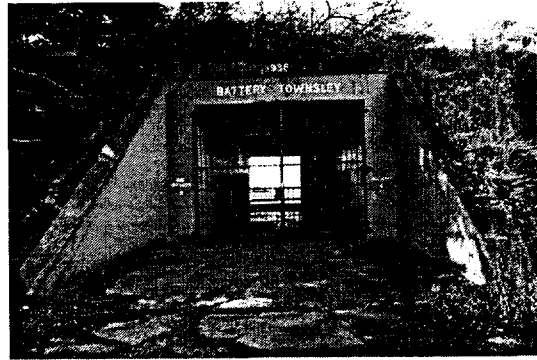

Battery Townsley. Identification signage.

Special Items: General

The following listing of special items associated with the fortifications includes equipment, fitting, fixtures, and mountings that either remain intact, partly intact, or are missing from the fortifications due to salvage or vandalism.

Mounted Equipment:

- Generators
- Pumps
- Compressors
- Engines

Military Hardware and Fittings:

- Guns
- Gun mounts
- Anchor bolts
- Hoists
- Ammunition conveying devices
- Sighting devices, instruments, and mounts

Ventilation:

- Vents
- Grilles
- Fans
- Ducts
- Vent stacks and caps

Mechanical Equipment and Fixtures:

- Plumbing piping
- Plumbing fixtures
- Plumbing fittings

Electrical/Communications Equipment and Fixtures:

- Electrical panels and switches
- Electrical conduits, wiring, and boxes
- Electrical fixtures
- Communications equipment and panels
- Communications conduit and wiring
- Speaking tubes

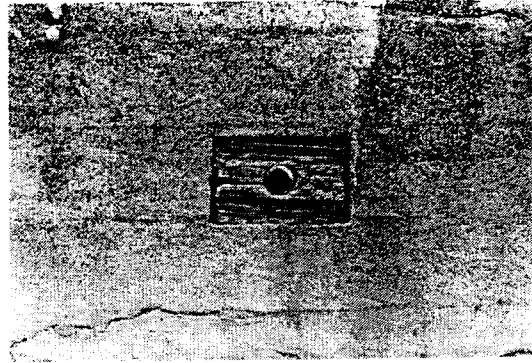

Battery Crosby. Speaking tube face with wooden sign plate.

Causes of Deterioration:

Causes of deterioration are predominantly related to salvage, moisture, and vandalism. See other sections for treatment of specific materials.

Identification:

The presence of special items should be documented for each site and an inventory included in each site folder. The items should be photographed and manufacturer's identification plates and markings recorded.

Inspection and Testing:

Testing is limited to measurement of air flow for interior spaces for ventilation design and implementation.

Special Items: Treatment

All special items require appropriate treatment based on their material. Where historic systems such as electrical lighting or ventilation are to be made operable, it will be necessary to repair existing equipment and install replicated or similar fixtures or fittings.

Ventilation:

A primary cause of deterioration at the fortifications is a lack of adequate ventilation of interior spaces. The accumulation of moisture above the ambient humidity of the marine environment can only be dispersed by cycling moving air through the spaces. Some fortifications had provisions for ventilation, either by gravity/convection or mechanical means. When the fortifications were in use, activity which opened doors helped to vent the spaces. However, closure of interior spaces for security reasons has caused moisture to be trapped inside the spaces. Recognizing the need for interior spaces to be closed for security reasons, it will be necessary to provide alternate means of ventilation.

1. Where existing air intakes and outflow grilles or vents exist at fortifications, they should be cleaned and made operable. Where the ventilation system was based on gravity and convection, make sure air circulation paths are clear. Where mechanical systems were used and grilles for intake and outflow remain (and power is available), install exhaust fans on timers or instruments designed to measure relative humidity to provide regular ventilation. Place fans inconspicuously.
2. Where no provisions for ventilation were a part of original construction, either install inconspicuous gravity vents and/or institute a regular ventilation schedule as part of maintenance operations where doors are opened and portable fans powered by portable generators are placed to provide ventilation.

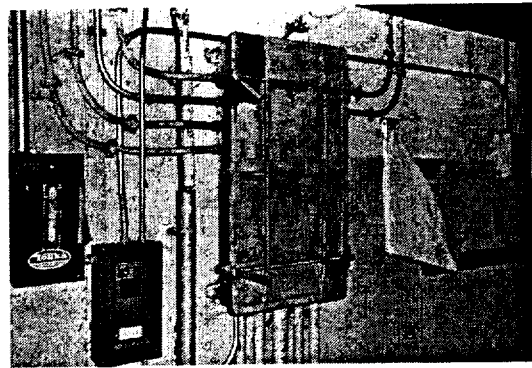

Battery Stotsenburg-McKinnon. Pit A interior, electrical panel.

Electrical Systems:

Where electrical power is required, bring electrical lines to the site underground. Place meters, disconnects, panels, and switches inconspicuously. Where historic lighting is to be reactivated, use existing conduit where possible. Where armored conduit and explosion-proof fixtures were used, provide either matching materials or restored original fixtures.

Annotated Bibliography

The annotated bibliography provided below is not intended to offer a comprehensive list of references used in compiling the *Seacoast Fortifications Preservation Manual*. While the materials do include some references used in the preparation of the text, the fullest citations for these documents is in the endnotes following each chapter. Also not included here are the National Park Service sources and general advised archives mentioned in Chapter 4, "Standards and Guidelines for the Preservation Process." The materials discussed herein are intended to guide future researchers and preservationists of coast defense fortifications, both in San Francisco and generally. Each of the KEA authors contributed to the annotated bibliography, with an emphasis on professional specialty. **Items bolded within the list are those essential to work on the San Francisco coast defenses and their preservation.**

Books

Elliott, Cecil D. *Technics and Architecture*. Cambridge, Massachusetts: The MIT Press, 1992.

A useful reference organized by materials and techniques tracing the origins and development of steel, concrete, glass, plumbing, and other items.

Floyd, Dale E. *Defending America's Coasts, 1775 – 1950: A Bibliography*. Alexandria, Virginia: Office of History, U.S. Army Corps of Engineers, 1997.

A comprehensive and useful aid to any research project dealing with coast fortifications. Floyd's familiarity with the subject and thoroughness of approach makes this work a standard. The bibliography is oriented toward historical sources rather than preservation and maintenance—however, these subjects may be touched upon in some of the references.

Gillmore, Quincy Adams. *Beton Agglomerate*. Professional Papers, No. 10, U.S. Army Corps of Engineers. Washington, D.C.: Government Printing Office, 1871.

An extremely rare analysis of a French construction technique that utilized cement reinforced with iron. Includes diagrams and illustrations of bridges and aqueducts under construction.

Gillmore, Quincy Adams. *Limes, Hydraulic Cements & Mortars*. Practical Treatise No. 9. New York: D. Van Nostrand, 1863.

A very rare publication by the U.S. Army's expert in cement and mortars during the last half of the nineteenth century. Includes early references to American and European cement manufacture and applications to military construction. Includes diagrams of early kilns and cement manufacturing equipment.

Graf, Don. *Basic Building Data, 10,000 Timeless Construction Facts*. New York: Van Nostrand Reinhold Company, 1949.

A compilation of fundamental building information (materials and techniques) current in 1949, with useful illustrations and clear text.

Hughes, Quentin. *Military Architecture*. New York: St. Martin's Press, 1974.

An overview of European examples through the nineteenth century, and useful as an introduction to fortification forms that would have been familiar to the builders of the San Francisco defenses.

Mallory, Keith and Arvid Ottar. *The Architecture of War*. New York: Pantheon Books, 1973.

This older volume remains useful for the breadth of its inquiry into the subject, as well as for its portrayal of the contributions of military design to more conventional building types.

Ramsey, Charles George and Harold Reeve Sleeper. *Architectural Graphic Standards*. New York: John Wiley & Sons, Inc., 1936. Second edition.

A useful desktop reference for the historic architect, with many materials and techniques from the period, such as metal pipe handrails and clay drainage tile shapes and sizes.

Texas Historical Commission. *Handbook of Maintenance Techniques*. Austin: Texas Historical Commission, 1984.

A maintenance manual prepared for the historic buildings in Galveston, Texas, with excellent references on the causes of masonry deterioration and moisture related deterioration.

Turner, C.A.P. *Concrete Steel Construction*. Minneapolis: Farnham Printing & Stationary Company, 1909.

An early, and rare, technical manual for reinforced concrete (called concrete-steel construction at the time). Includes structural calculations, design of reinforcing steel and concrete mix design. Includes examples from the period.

Winslow, Eben Eveleth. *Notes on Seacoast Fortification Construction*. Number 61 in the Occasional Papers of the Engineer School. Washington: Government Printing Office, 1920.

The basic treatise on the design and construction of coastal fortifications in the United States. Winslow's contribution, aside from his own considerable insights into the subject, was in the organization and interpretation of the engineering mimeographs that formed the core of his work. The mimeographs are now difficult to locate, and *Notes* too was considered rare until republished by the Coast Defense Study Group. This reproduced reference consists of two parts, a hardcover volume of text and a softcover volume containing the referenced plates.

Government Documents

Brown, Moraig and Paul Pattison. *Beacon Hill Fort*. Cambridge: RCHM England, 1997.

An example of an attractively produced survey and inventory of a coastal fortification with extant features from the 1890s to World War II. The emphasis on detailed physical descriptions is not always useful, but it is a successful demonstration of how a survey may be presented to the public.

Fort Glanville Conservation Park Management Plan. National Parks and Wildlife Service, Department of Environment and Planning, South Australia, 1988.

A detailed and comprehensive study of Fort Glanville, a small coastal fortification in South Australia. The approach is a familiar one, beginning with an historical overview, presentation of significance, and description of significance; followed by a careful description of existing features, and concluding with recommendations for treatment and implementation.

Lonnquest, John C. and David F. Winkler. *To Defend and Deter: The Legacy of the United States Cold War Missile Program*, USACERL [U.S. Army Construction and Engineering Laboratory] Special Report 97/01. Rock Island, Illinois: Defense Publishing Service, November 1996.

Conducted as a research effort under the Department of Defense Legacy Resource Management Program, the 600-page volume addresses the complete American missile program of the Cold War years, from 1945 through 1989. The Nike program, inclusive of its precursors, is handled in several chapters. Part I of the study offers a history of the U.S. Cold War missile program; Part II, system profiles for the weapons systems; and, Part III, a state-by-state listing of deployment sites.

Look, David, AIA, and Dirk H. R. Spennemann, PhD. *For Future Use: A Management Conservation Plan for the World War II Sites in the Republic of the Marshall Islands*. San Francisco and Albury, NSW: the National Park Service and Charles Sturt University, 1993.

Particularly helpful for its coverage of treatment techniques for ordnance and other military objects of metal, but may be limited in non-tropical areas.

Martini, John A. and Stephen A. Haller. *What We Have We Shall Defend: An Interim History and Preservation Plan for Nike Site SF-88L, Fort Barry, California*. San Francisco: National Park Service, Golden Gate National Recreation Area, 1998.

The Martini and Haller study offers a thorough look at the Nike anti-aircraft program in the San Francisco Bay Area, with a focus on the installation known as Nike Site SF-88L. The continuing preservation interpretations efforts undertaken at SF-88L offer a model for such Cold War sites, nationwide. The Department of Defense Legacy project, *To Defend and Deter*, completed in 1996, offers an excellent companion volume to this study.

Thompson, Erwin N. *Historic Resource Study Seacoast Fortifications San Francisco Harbor Golden Gate National Recreation Area California*. Denver: National Park Service, Historic Preservation Team, May 1979.

Thompson's 650-page study provides the definitive research for the coast defense fortifications of the San Francisco Bay to date. Although Thompson does not discuss historic materials in his work, the research and citations offered here will continue to guide future historians of the fortifications—and indeed, will provide signposts to all those attempting the preservation of the coast defense sites for many years to come. Especially useful are references to archival materials held in Washington, D.C.

U.S. Army, Chief of Engineers, *Annual Report of the Chief of Engineers, U.S. Army, to the Secretary of War*. Washington, D.C.: 1869-1903.

Covering a long range of years, the *Annual Report* offers the starting point for detailed information on historic materials and practices at the San Francisco batteries, as well as at a number of the ancillaries. The Army did not name the batteries until 1902, and hence a researcher using the *Annual Reports* must be familiar with the historic emplacement numbering and gun sizes for the batteries being sought in order to decipher the information. The *Annual Reports* require close and repeated reading to glean facts, often necessitating a back-and-forth approach to understanding the work proceeding at single batteries. Information is typically not given in a linear or strictly chronological way, but is extremely useful.

Periodicals: History

Two currently published English-language periodicals concentrate on fortifications. *FORT* is published annually by the Fortress Study Group of Great Britain, and covers fortifications of all types throughout the world. It is a refereed academic journal and the quality of its articles is high. The *Coast Defense Study Group Journal* is published quarterly by the Coast Defense Study Group, an organization based in the United States. It has as its focus the defense built by the United States; the articles are edited but not refereed, and they tend to concentrate on the technology of the defenses.

FORT and the *Coast Defense Study Group Journal* seldom contain articles discussing the maintenance or preservation of fortifications--however they are excellent sources of historical and interpretive information.

A third journal, *Fortress*, is no longer published, although it is still easily available at the time of this writing. It presented articles of defensive structure from all periods, prehistoric to modern. The emphasis was on historical summary and description of works, and often addressed fortifications that were open to the public. Diversity is the message to be gained from *Fortress*, both in the geography covered and the fortifications presented.

Also of interest are several foreign-language periodicals. They are noted here chiefly as an indication of the growing interest in fortifications as a class of historic properties.

DAWA (Deutsches Atlantik Wall Archiv) Nachrichten – The title is a little misleading. While the central theme is often the defense of the Atlantic Wall, there are many articles about the defenses of other periods and locations. German language articles.

IBA (Interessengemeinschaft für Befestigungsanlagen beider Weltkriege) Informationen – The coverage is of European subjects and emphasizes technical description over matters of preservation or interpretation. German language articles.

Forteca – A glossy quarterly magazine that includes a great many unusual fortifications from eastern Europe, often with indications of present use. Of the periodicals mentioned here, *Forteca* is the only one that devotes regular coverage to the designers and builders of fortifications. The Polish language articles are accompanied by brief summaries in English.

Fortifications & Patrimoine – Similar to *Forteca*, but with more color and better reproduction. The geographic extent of the French-language journal is Europe and Scandinavia, spanning the period from the 1870s to post-World War II; there is little coverage of preservation-related subjects.

Periodicals: Architecture

The researcher of San Francisco coast defense fortifications is also advised to review the historic California architectural journals, most especially *California Architect and Building News* for the late nineteenth century, and, *Architect and Engineer of California* for the twentieth century after 1906. In addition, small, limited-run architectural periodicals will yield substantial information on historic practices and materials pertinent to the batteries. Such journals may be held at the San Francisco Public Library; the Bancroft Library at the University of California, Berkeley; the Environmental Design (Architecture) Library at the University of California, Berkeley; and, in the California Room of the California State Library, Sacramento. Examples include *The Architect and Pacific Coast Architect* (both of San Francisco).

Those seeking information on historic engineering practices are also recommended to review national engineering journals, particularly *Engineering News-Record* and *Civil Engineering*.

A final recommendation, not yet reviewed for its usefulness to coast defense fortifications, are the journals and publications associated with the American Portland Cement Manufacturers Association. This association had a major impact on the concrete industry and is historically, and currently, headquartered in Detroit, with a research library. The key journal series begins with the title *Concrete Engineering*, becoming sequentially *Cement Age*, *Concrete-Cement Age*, and *Concrete*, over a period spanning from the turn of the twentieth century into the 1960s. The journal run, although changing titles over the decades, is very well illustrated, with significant discussions of experimentation with reinforced concrete and associated cement-based surfacing applications. Complete runs of this journal sequence are rare, but partial runs are often found in major university engineering libraries and special collections. Also very useful for excellent discussions of advances in the design and engineering of reinforced concrete structures from the 1920s forward is the *Journal of the American Concrete Institute*.

APPENDICES

APPENDIX A

**FORTIFICATIONS LIST
GOLDEN GATE NATIONAL RECREATION AREA**

Fortifications List

Golden Gate National Recreation Area

Project team members David Hansen and Joe Freeman field-reviewed those fortifications marked by an asterisk. The remaining fortifications complete the group directly within the ownership and real property jurisdiction of the Golden Gate National Recreation Area. The total grouping of fire control stations, gun emplacements, searchlight shelters and mine casements is not listed here. Cold War era properties are not included below, although they are within project parameters for contextual and maintenance discussions.

Prior to the 1890s those individuals responsible for naming the batteries closely associated an installation with its immediate local geography, with the term "battery" following its designation. With the new fortification program of the last decade of the nineteenth century, battery naming formally followed Army orders—with installations named after individuals rather than geographic locations and with the term "battery" preceding its designation.

Batteries within the Golden Gate National Recreation Area are given below, with those of the first era reflecting the historic naming tradition.

Civil War and Post-Civil War Eras:

- Point San Jose Battery*, Fort Mason: restored to an 1864 appearance during the 1980s. [Guns emplaced, 1864, with removal, 1898.]
- * *West Battery*, Fort Winfield Scott: construction begun, 1870, with completion, 1873; guns emplaced, 1873, with removal, 1898. Most of this battery was obliterated during construction of the Endicott-era batteries during the 1890s. Only a few traverse magazines remain.
- Gravelly Battery*, Fort Baker: construction begun, 1870, with work suspended, 1876; single gun emplaced, 1873, with removal, ca.1898.
- Ridge Battery*, Fort Baker: construction begun, 1870, with work suspended, 1876; guns emplaced, 1893, with removal, 1901.
- * *East Battery*, Fort Winfield Scott: construction begun, 1872, with work suspended, 1876; guns emplaced, 1891, with removal, ca.1914. Approximately half of this battery was buried during construction of the Golden Gate Bridge.
 - * *Cavallo Battery*, Fort Baker: construction begun, 1872, with work suspended, 1876; guns emplaced, 1900, with removal, 1905.

Endicott Period (including the Taft Era and World War I):

- * *Battery Marcus Miller*, Fort Winfield Scott: construction begun, 1891, with completion, 1898; guns emplaced, 1899, with removal, 1920.
 - * *Battery Godfrey*, Fort Winfield Scott: construction begun, 1892, with completion, 1896; guns emplaced, 1896, with removal, 1943.
- Battery Howe-Wagner*, Fort Winfield Scott: construction begun, 1893, with completion, 1895; guns emplaced, 1895, with removal, 1920.
- * *Battery Spencer*, Fort Baker: construction begun, 1893, with completion, 1897; guns emplaced, 1897, with removal, 1943.

- * *Battery Dynamite*, Fort Winfield Scott: construction begun, 1894, with completion, 1895; guns emplaced, 1895, with removal, 1904. Extensive additions and remodeling, 1898-1900.
- Battery Saffold*, Fort Winfield Scott: construction begun, 1896, with completion, 1897; guns emplaced, 1898, with removal, 1943.
- Battery Lancaster*, Fort Winfield Scott: construction begun, 1896, with completion, 1899; guns emplaced, 1899 and 1900, with removal, 1918.
- Battery Cranston*, Fort Winfield Scott: construction begun, 1897, with completion, 1898; guns emplaced, 1898, with removal, 1943.
- * *Battery Stotsenburg-McKinnon*, Fort Winfield Scott: construction begun, 1897, with completion, 1898; guns emplaced, 1898, with removal, 1943.
- * *Battery Duncan*, Fort Baker: construction begun, 1898, with completion, 1899; guns emplaced, 1900, with removal, circa 1917.
- Spanish-American War Battery*, Fort Mason: construction begun, 1898, with completion, 1899; guns emplaced, 1900, with removal, circa 1909.
- Battery Boutelle*, Fort Winfield Scott: construction begun, 1898, with completion, 1901; guns emplaced, 1901, with removal, 1919.
- Battery Burnham*, Fort Mason: construction begun, 1899, with completion, 1900; guns emplaced, 1900, with removal, 1909.
- Battery Chester*, Fort Miley: construction begun, 1899, with completion, 1903; guns emplaced, 1902, with removal, 1943.
- * *Battery Crosby*, Fort Winfield Scott: construction begun, 1899, with completion, 1900; guns emplaced, 1900, with removal, 1943.
- * *Battery Kirby*, Fort Baker: construction begun, 1899, with completion, 1900; guns emplaced, 1900, with removal, 1943.
- Battery Livingston-Springer*, Fort Miley: construction begun, 1899, with completion, 1902; guns emplaced, 1902, with removal, 1943.
- Battery Orlando Wagner*, Fort Baker: construction begun, 1899, with completion, 1901; guns emplaced, 1901, with removal, 1917.
- * *Battery Slaughter*, Fort Winfield Scott: construction begun, 1899, with completion, 1900; guns emplaced, 1900, with removal, 1917.
- * *Battery Mendell*, Fort Barry: construction begun, 1900, with completion, 1902; guns emplaced, 1905, with removal, 1943.
- * *Battery Sherwood*, Fort Winfield Scott: construction begun, 1900, with completion, 1900; guns emplaced, 1900, with removal, 1920.
- Battery Alexander*, Fort Barry: construction begun, 1901, with completion, 1903; guns emplaced, 1905, with removal, 1943.
- Battery Baldwin*, Fort Winfield Scott: construction begun, 1901, with completion, 1903; guns emplaced, 1903, with removal, 1920.
- * *Battery Blaney*, Fort Winfield Scott: construction begun, 1902, with completion, 1903; guns emplaced, 1903, with removal, 1920.

- * *Battery Chamberlin*, Fort Winfield Scott: construction begun, 1903, with completion, 1904; guns emplaced, 1904, with removal, 1948.
Battery O'Rorke, Fort Barry: construction begun, 1903, with completion, 1904; guns emplaced, 1909, with removal, circa 1943.
Battery Smith-Guthrie, Fort Barry: construction begun, 1902, with completion, 1904; guns emplaced, 1905, with removal, 1948.
- * *Battery Yates*, Fort Baker: construction begun, 1903, with completion, 1903; guns emplaced, 1905, with removal, circa 1942.
Battery Rathbone-McIndoe, Fort Barry: construction begun, 1904, with completion, 1905; guns emplaced, 1905, with removal, 1948.
- * *Battery Wallace*, Fort Barry: construction begun, 1917, with completion, 1921; guns emplaced, circa 1918, with removal, 1948.
Antiaircraft Battery, Fort Winfield Scott: construction begun, 1920, with completion, 1920; guns emplaced, 1920, with removal, 1925.
Antiaircraft Battery No.2, Fort Barry: construction begun, 1920, with completion, 1925; guns emplaced, 1925, with removal, circa 1945. Expanded 1940.
Antiaircraft Battery No.3, Fort Funston: construction begun, 1920, with completion, 1925; guns emplaced, 1925, with removal, circa 1945.

World War II:

- Battery Davis*, Fort Funston: construction begun, 1936, with completion, 1940; guns emplaced, 1939, with removal, 1948.
- * *Battery Townsley*, Fort Cronkhite: construction begun, 1938, with completion, 1940; guns emplaced, 1939, with removal, circa 1948.
Antiaircraft Battery No.1, Fort Cronkhite: construction begun, 1939, with completion, 1940; guns emplaced, 1940, with removal, 1945.
- * *Battery Construction #129*, Fort Barry: construction begun, 1942, with completion, 1944; never armed.
Battery Point, Fort Point: construction begun, 1942, with completion, 1942; guns emplaced, 1944, with removal, 1945.
Battery Gate, Fort Point: construction begun, 1942, with completion, 1942; guns emplaced, 1942, with removal, circa 1945.
Battery Lobos, Fort Miley: construction begun, 1942, with completion, 1942; guns emplaced, circa 1942, with removal, circa 1945.
Battery Kirby Beach, Fort Baker: construction begun, 1942, with completion, 1942; guns emplaced, 1943, with removal, 1944.
Battery Construction #243, Fort Miley: construction begun, 1943, with completion, 1943; guns emplaced, 1948, with removal, 1949.
Battery Land, Fort Miley: construction begun, 1943, with completion, 1943; guns emplaced, 1943, with removal, post-1945.

Battery Construction #244, Milagra Ridge: construction begun, 1943, with completion, 1944; guns emplaced, 1948, with removal, 1950.

The following ancillary structures represent only a small sampling of the total numbers within the Golden Gate National Recreation Area, selected by the National Park Service to typify maintenance issues across the group.

Fire control stations, antiaircraft emplacements, searchlight shelters, and mine casemates:

- * Searchlight No.14, 1911.
- * B^{III} Mendell, 1917.
- * B^{III} Alexander, 1917.
(Adjacent to one another, tip of Point Bonita.)
- * MC-1, Fort Barry, 1908. Reconstructed, 1920. Concrete and earth added to bombproof, 1940.
- * BC Station, Battery Construction #129, Wolf Ridge, Fort Cronkhite, 1944.
- * Fire Control Station GB-1 [Groupment Barry], circa 1942.
- * Fire Control Station B1S1 Townsley, circa 1942.
- Fire Control Station BC Townsley, 1940.
(Above three, north of Battery Townsley.)
- * 40mm Antiaircraft No.2 Gun Emplacement, circa 1942.
(North of Battery Townsley.)

APPENDIX B

**U.S. ARMY
REPORT OF COMPLETED WORKS – SEACOAST FORTIFICATIONS
(BATTERY PLAN)
FORM 7s**

**Excerpted from the collections held at the Park Archives of the Golden Gate National
Recreation Area, National Park Service, San Francisco**

Historical Sketch of the U.S. Army, Report of Completed Works, Form 7

The following historical sketch of the U.S. Army Corps of Engineers, Report of Completed Work, Form 7, is excerpted from an article written by Matthew L. Adams for the Coast Defense Study Group Journal of May 1998. Wording and content remain here with minor changes, although tables are deleted and the article is condensed. Not included below are selections from Army regulations; references to numbered circulars published by the Office of the Chief of Engineers; guides to information held in the National Archives; and a list of international coastal defense locations.

Reports of completed batteries (hereafter referred to as RCBs) and reports of completed works (hereafter referred to as RCWs) were forms used by the Corps of Engineers to document seacoast fortifications and other buildings related to coast defense in the United States and its territories. RCBs were in use from 1900 until 1919. RCWs were in use from 1919 until the Coast Artillery was disbanded in 1950.

The antecedent of the RCB was the armament report and sketches described in sections v and vi, *Circular No. 2*, Office of the Chief of Engineers (OCE), 1896. The armament report summarized guns and carriages received at the post, and whether the armament was mounted or unmounted. The armament sketches contained a general drawing of the work with each emplacement marked and numbered properly. The sketches also indicated the type of platform, its construction, whether the platform was serviceable or not, and whether the gun was mounted or not. If the gun was mounted, the type of gun and whether it was serviceable or not was also noted. Some of these details can be traced back to Army regulations in force in 1863.

Circular No. 2, 1896, was issued in response to the increased clerical load in the Office of the Chief of Engineers from the increased fortification construction activity. In excess of 30 batteries were either completed or under construction and many more were planned at the time this circular was issued. (The first [document] would not be transferred to the Artillery until a few months after this circular was issued in March.)

When the Spanish American War started in 1898, fortification construction increased markedly over the 1896 levels as Congress appropriated substantial sums for defense. By October 1900, over 125 batteries had been transferred to the Artillery. Trying to distill the operational readiness of each harbor defense from the monthly operations reports, armament reports, and armament sketches, described in *Circular No. 2* (which included statements of financial accounts), must have become increasingly difficult for the staff at the Office of the Chief of Engineers. To make the task of assessing operational readiness easier the RCB was designed. The RCB form was [first] printed in *Circular No. 30*, 1900.

The major strength of the RCB over earlier forms was its tabular format; a concise summary of the operational readiness of the harbor defenses in any engineer district. In filling out this form, engineers were only required to fill out the first two columns for works transferred prior to 1890. The RCB was also to be used for reporting on completed range-finding stations, cable tanks, mine casemates, and torpedo storehouses. For each engineer district, the RCB was to be current to 1 October 1900, and it was intended that new works would be added at the bottom of the list as they were transferred to the Artillery. Most importantly, this was a monthly report.

By the order of *Circular No. 18*, 22 September 1903, annual armament reports were discontinued. In its place a more expanded form of RCB was introduced. In addition to requiring the listing of the official name of each battery, the new form recorded the individual number and name of the manufacturer of each gun or mortar and carriage, and further listed the number of the emplacement for each gun, or, mortar and carriage. A number of other items were to be recorded as well.

In contrast to its predecessors, these RCBs were to be submitted annually rather than monthly. The shift in frequency was undoubtedly intended to reduce unnecessary paperwork. By the time *Circular No. 18* was issued approximately 250 batteries had been transferred to the Artillery. Only minor changes were made to the RCB from 1903 until RCWs were created in 1919.

Reports of completed works (RCWs) were created by the circular letter issued by the Chief of Engineers, Eben E. Winslow, on 30 January 1919. It prescribed that the annual RCBs were no longer required and that all data that the RCBs were intended to provide would be submitted on seven forms referred to as a Report of Completed Works. Furthermore, new forms need only be submitted whenever changes in works made the old forms obsolete.

A brief description of the content of each of those seven forms, which changed remarkably little over the next 30 years, follows:

Form 1: all important data relating to an individual battery.

Form 2: details of fire control and torpedo structures.

Form 3: details of mine wharves and tramways.

Form 4: details of searchlights (with a separate sheet for each light).

Form 5: details of electric [power] plants.

Form 6: existing engineering structures of a permanent or semi-permanent nature.

Form 7: a blueprint of the battery.

Four copies of each RCW were to be made, with one distributed to each of the district, military department, division, and chief of engineers offices.

The main difference between the RCW and the RCB was the separation of data onto distinct forms. For example, the details of different electric plants in a harbor defense area may have been listed under fort subheadings in an RCB, with the information scattered over several pages of a lengthy treatment for an entire harbor defense area. The RCW, on the other hand, consolidated all electrical plants onto a series of Form 5s, permitting easier comparison and assessment of material present in each harbor defense area.

Reports of completed batteries (RCBs) and reports of completed works (RCWs) were the end products of an increasing clerical load at the Office of the Chief of Engineers. In comparison to armament reports and sketches of the 1890s, the RCBs of the early 1900s allowed staff to distill much more easily operational readiness of fortifications at each harbor across the country by listing individual batteries and armament in a table. The RCBs extended this idea by subdividing the information recorded in RCBs into categories (general battery and armament information, fire control structures, searchlights, etcetera). RCWs also allowed for greater detail in documenting different elements of coast defenses than had the earlier RCB. Both are essential documents in the study of modern U.S. coastal defenses, 1890-1950.

FORT BAKER

Battery Spencer, under construction 1893-1897

Battery Duncan, under construction 1898-1899

Battery Kirby, under construction 1899-1900

Battery Orlando Wagner, under construction 1899-1901

Battery Yates, under construction 1903

Battery Kirby Beach, under construction 1942

REPORT OF COMPLETED WORKS - SEACOAST FORTIFICATIONS
(BATTERY PLAN)

COAST DEFENSES OF SAN FRANCISCO,
FORT BAKER
BATTERY SPENCER
NO. OF GUNS 2 : CALIBER 12 IN. : 3 NONDISAPPEARING
CARRIAGES

CORRECTED TO DEC. 1919

FORM-7

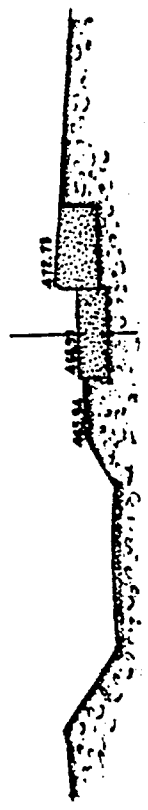
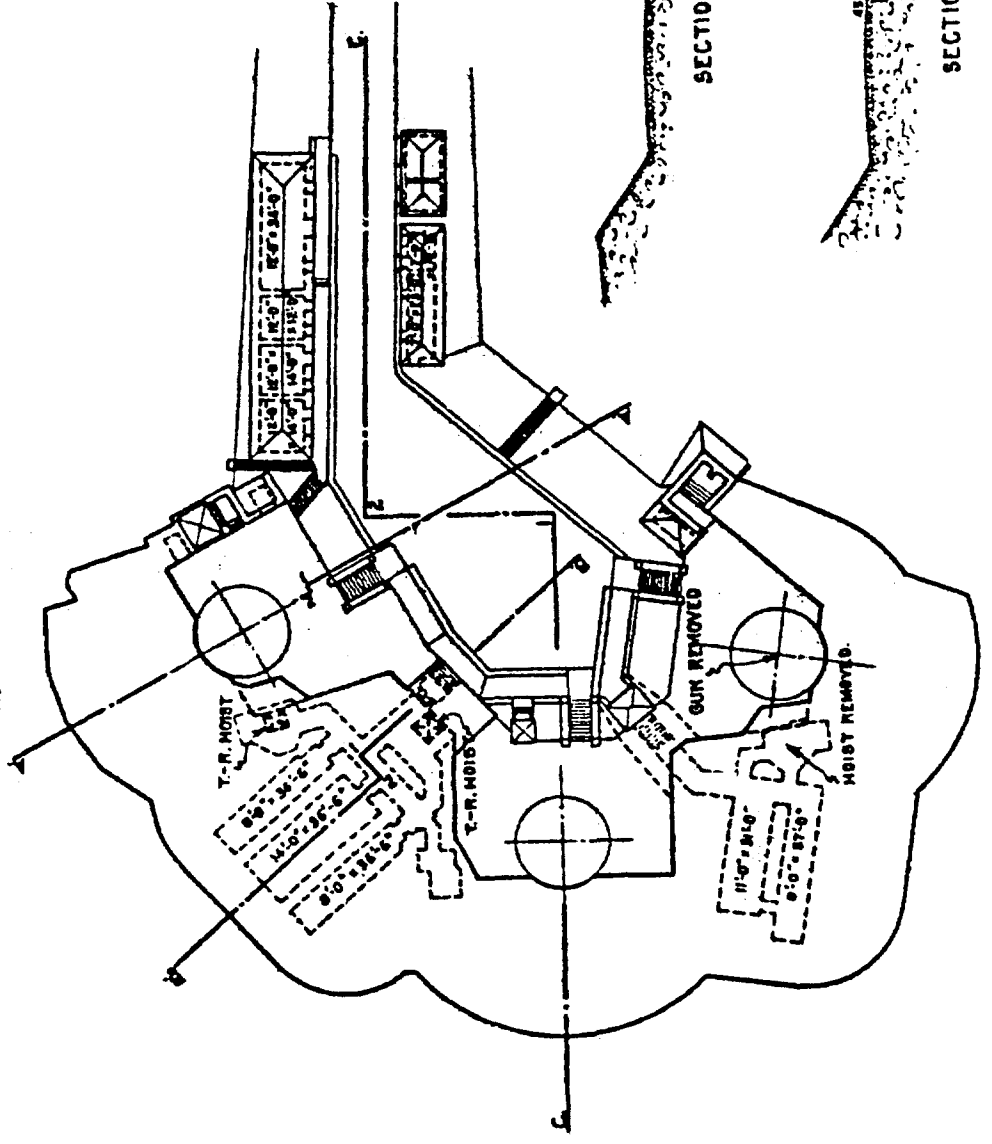
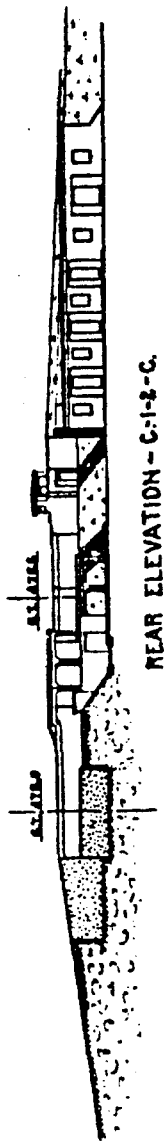

SECTION - A-1-2-A.

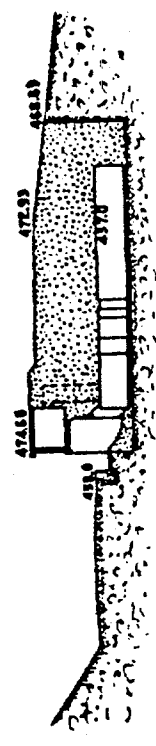

SECTION - B-1-2-B.

COAST DEFENSES OF SAN FRANCISCO, CAL.
FORT BAKER
BATTERY DUNCAN

No. of GUNS 0: CALIBER --- : CARRIAGE 0
EMPTS. FOR 8" GUNS NONDISAPPEARING CARRIAGES

CORRECTED TO DEC. 1919.

REPORT OF COMPLETED WORKS - SEACOAST FORTIFICATIONS
(BATTERY PLAN)

FORM-7

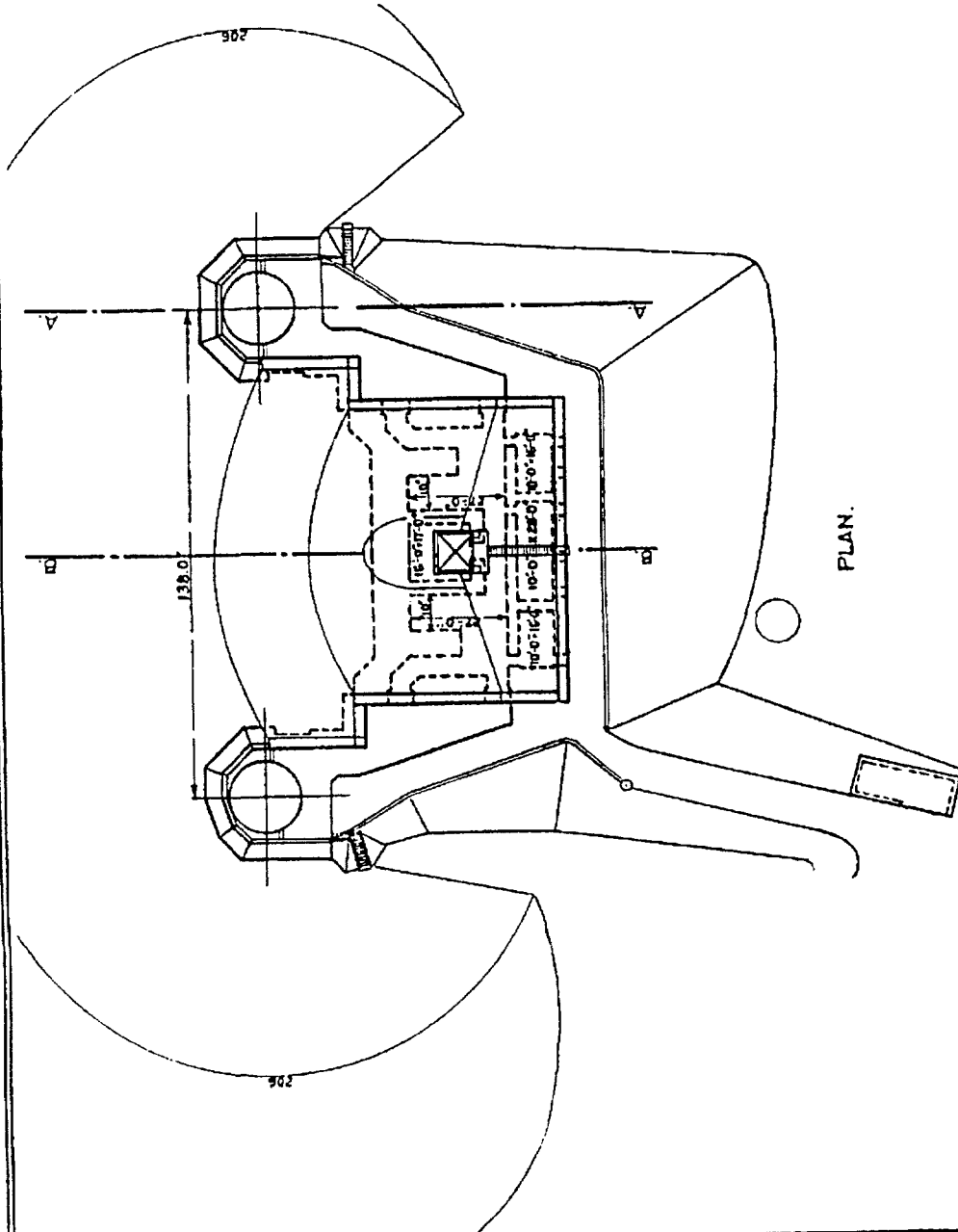

PLAN.

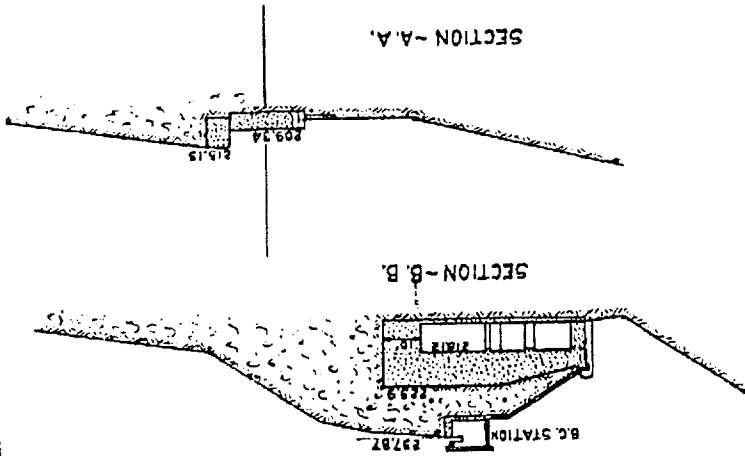

SECTION -A-A.

SECTION -B-B.

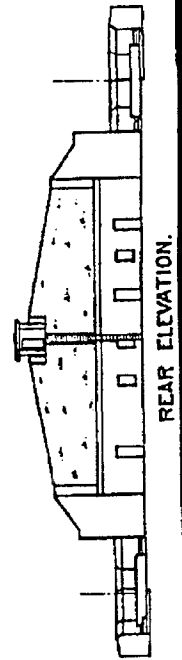

REAR ELEVATION.

COAST DEFENSES OF SAN FRANCISCO, CAL.
FORT BAKER
BATTERY KIRBY
NO. OF GUNS 2: CALIBER 12" DISAPPEARING CARRIAGE

REPORT OF COMPLETED WORKS - SEACOAST FORTIFICATIONS
(BATTERY PLAN)

CORRECTED TO DEC. 1919.

FORM-7

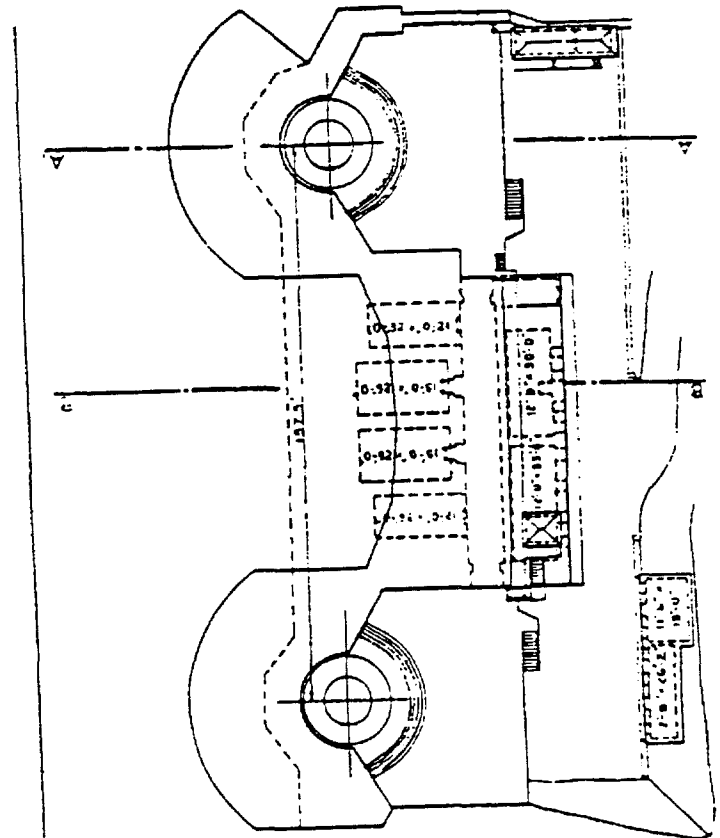
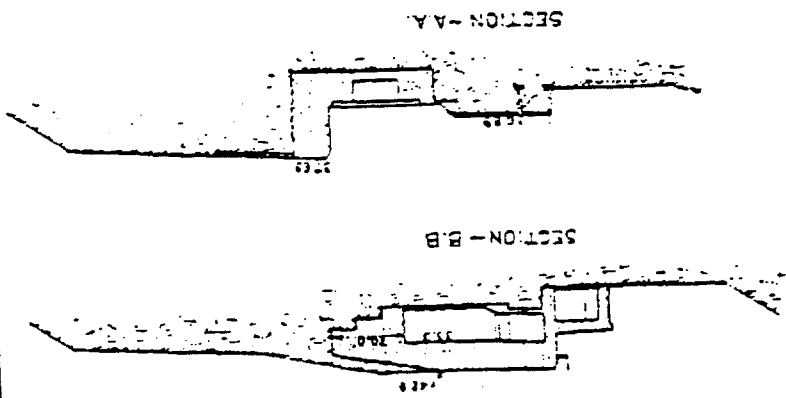
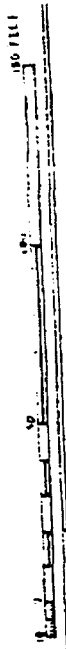

PLAN.

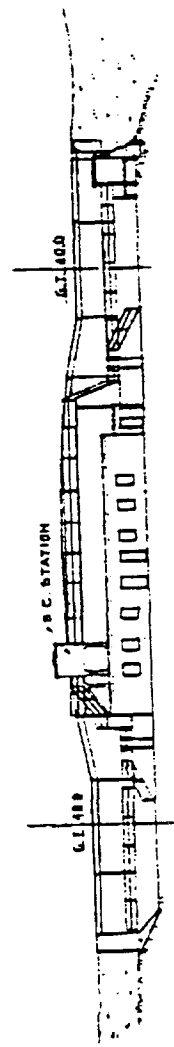

REAR ELEVATION.

REPORT OF COMPLETED WORKS - SEACOAST FORTIFICATIONS
(BATTERY PLAN)

COAST DEFENSES OF SAN FRANCISCO, CAL.
FORT BAKER
BATTERY ORLANDO WAGNER
NO. OF GUNS 0: CALIBER - 2-5" BAL. PILLAR CARRIAGES

CORRECTED TO DEC. 1919.

FORM-7

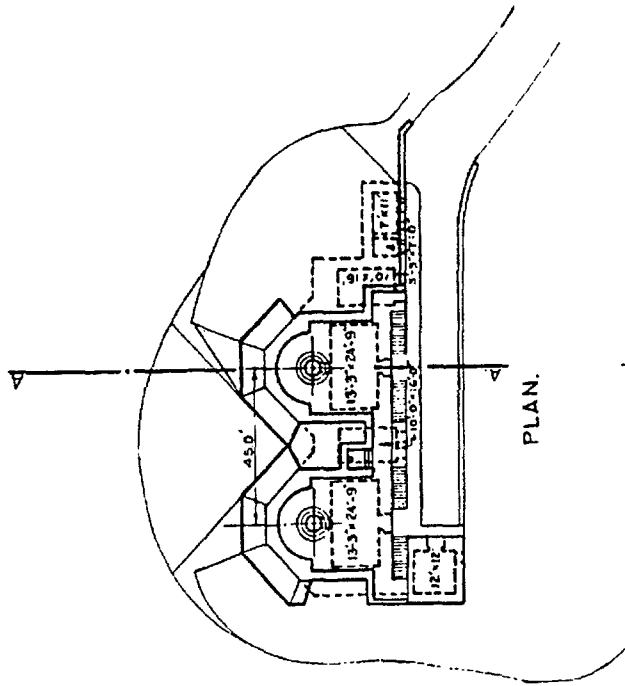

PLAN.

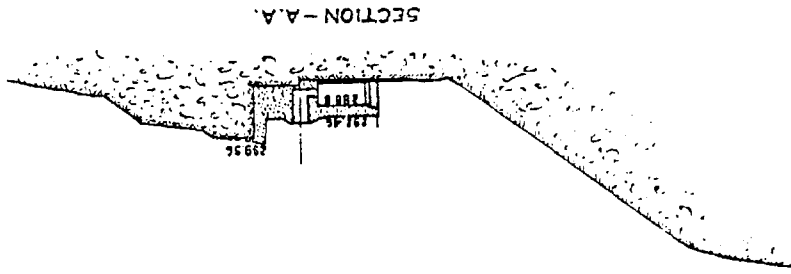

SECTION - A.A.

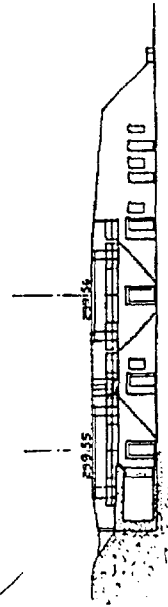

REAR ELEVATION.

COAST DEFENSES OF SAN FRANCISCO, CAL.
FORT BAKER
BATTERY GEORGE YATES
NO. OF GUNS 6 : CALIBER 3 IN. : BARBETTE CARRIAGE



REPORT OF COMPLETED WORKS - SEACOAST FORTIFICATIONS
(BATTERY PLAN)

CORRECTED TO DEC. 1919.

FORM-7

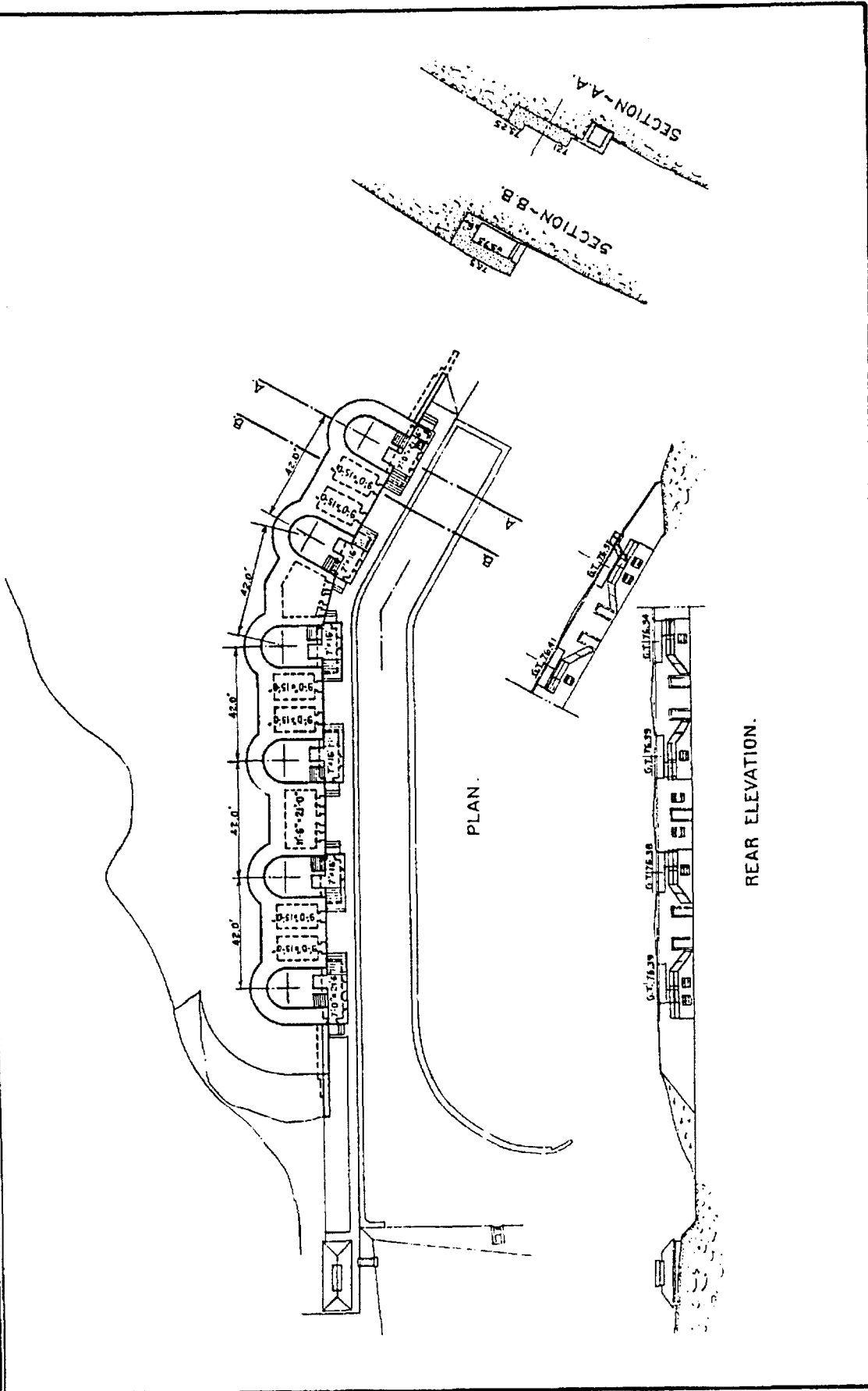

REPORT OF COMPLETED WORKS - SEACOAST FORTIFICATIONS
(Gun Block)

HARBOR DEFENSES OF SAN FRANCISCO
FORT BAKER, CALIFORNIA
90 MM BATTERY

N^o of Guns - 2 Caliber - 90 MM Carriage T3-Fixed

PLAN & ELEVATION
PLAN OF GUN BLOCK & SECTION

Part VII Corrected to November 1943

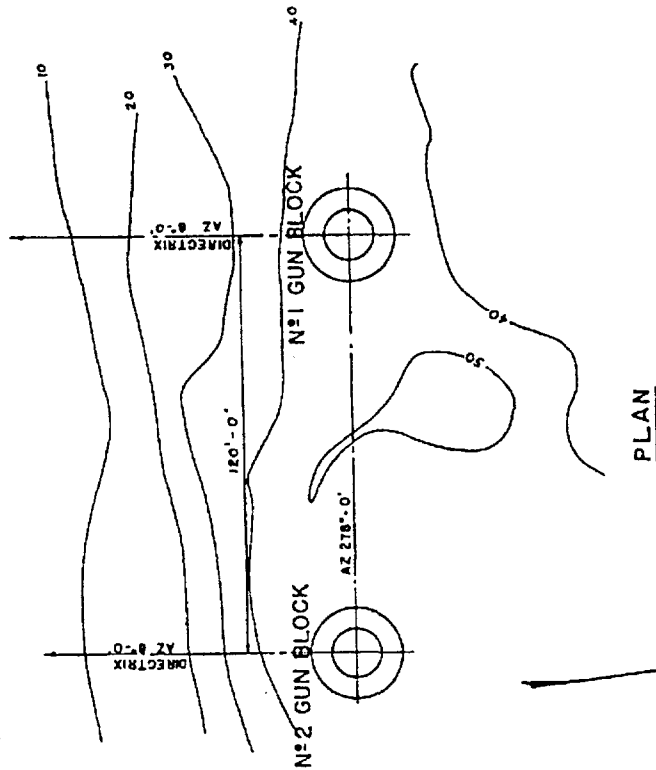

PLAN OF GUN BLOCK

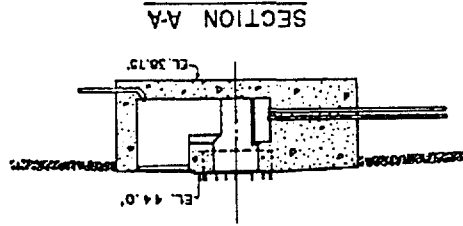

81701

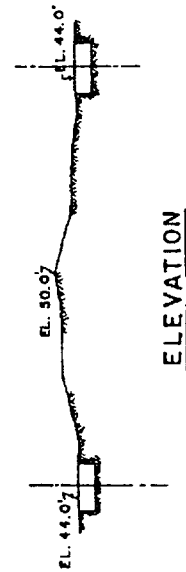

Handwritten signature/initials

FORT BARRY

Battery Mendell, under construction 1900-1902

Battery Alexander, under construction 1901-1903

Battery Smith-Guthrie, under construction 1902-1904

Battery O'Rorke, under construction 1903-1904

Battery Rathbone-McIndoe, under construction 1904-1905

Battery Wallace, under construction 1917-1921

Antiaircraft Battery No. 2, under construction 1920-1925

Battery Construction #129, under construction 1942-1944

REPORT OF COMPLETED WORKS ~ SEACOAST FORTIFICATIONS
(BATTERY PLAN)

COAST DEFENSES OF SAN FRANCISCO, CAL.
FORT BARRY
BATTERY MENDELL
NO. OF GUNS ~ 2 : CALIBER ~ 12 IN. : DISAPPEARING CARRIAGE

CORRECTED TO DEC. 1919.

FORM ~ 7

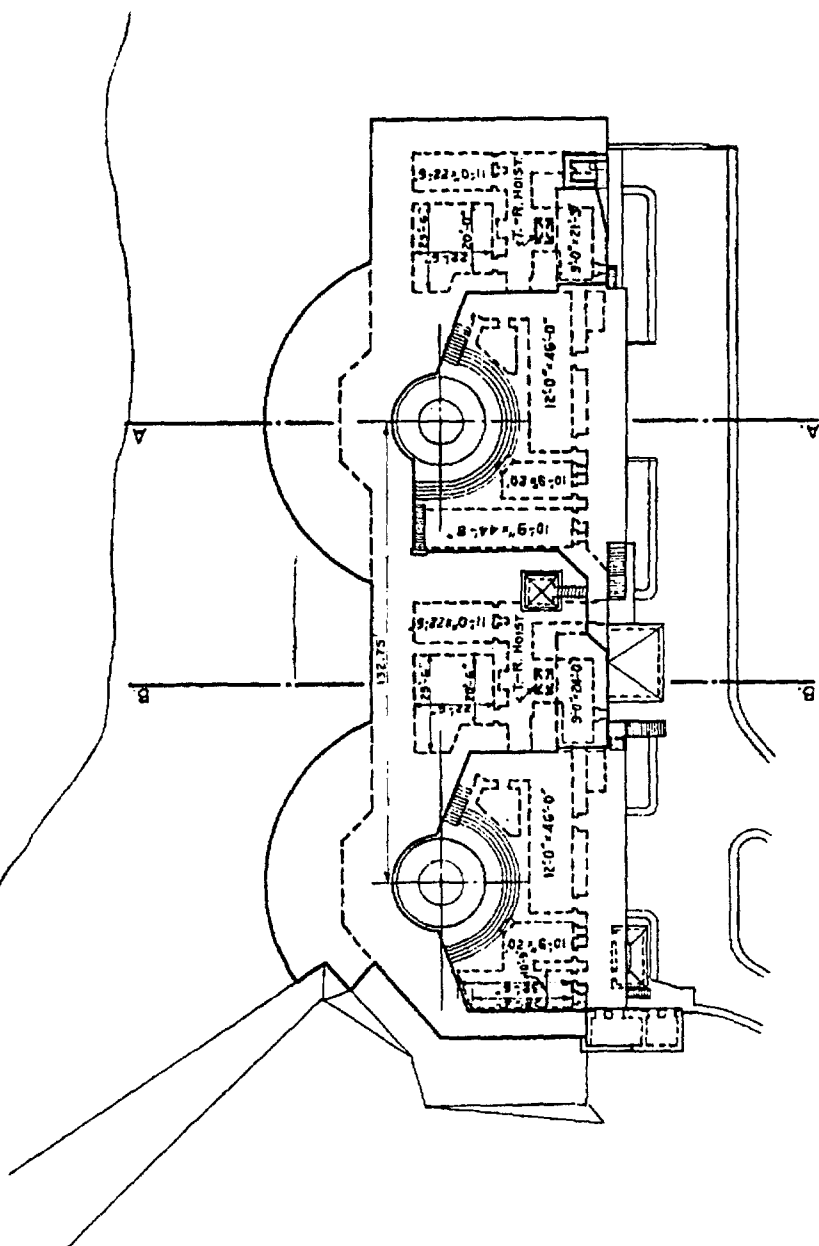

PLAN.

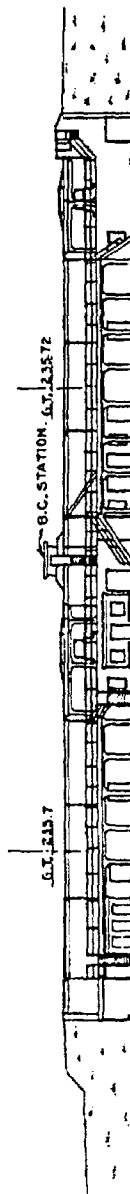
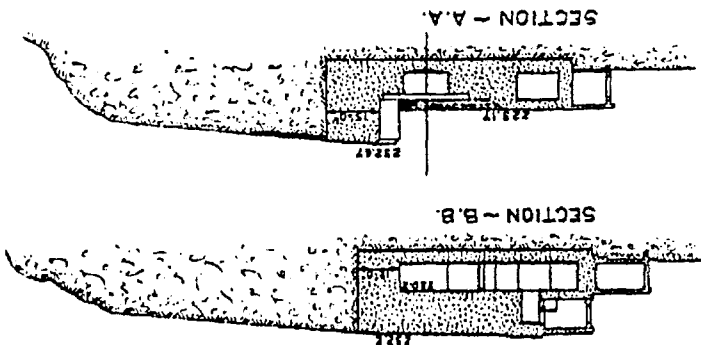

REAR ELEVATION.

COAST DEFENSES OF SAN FRANCISCO, CAL.
FORT BARRY
BATTERY ALEXANDER
NO. OF MORTARS 4: CALIBER 12" : 4 MORTAR CARRIAGES

REPORT OF COMPLETED WORKS - SEACOAST FORTIFICATIONS
(BATTERY PLAN)

CORRECTED TO AUG. 1923

FORM-7

150 FEET

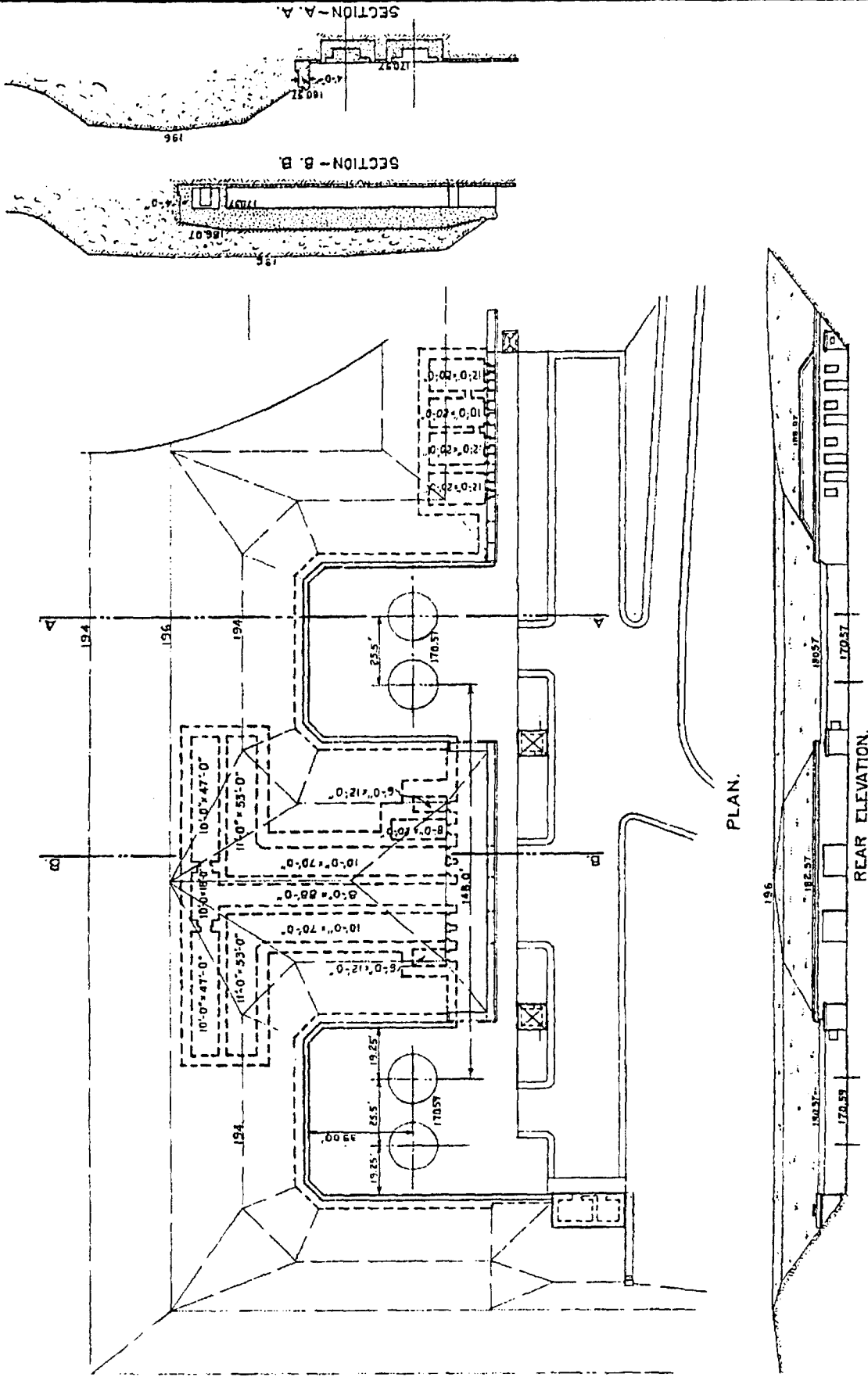

U.S. GEO. SURV. DIST. O ENV. 1-8

REPORT OF COMPLETED WORKS-SEACOAST FORTIFICATIONS HARBOR DEFENSES OF SAN FRANCISCO
(Battery Plan)

FORT BARRY, CALIF.
BATTERIES GUTHRIE & SMITH

No. of Guns- 4 - Caliber-6" - Barbettes Carriage

Corrected to Dec. 1943.

Part VII

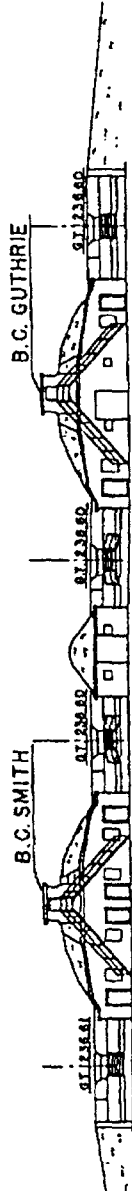
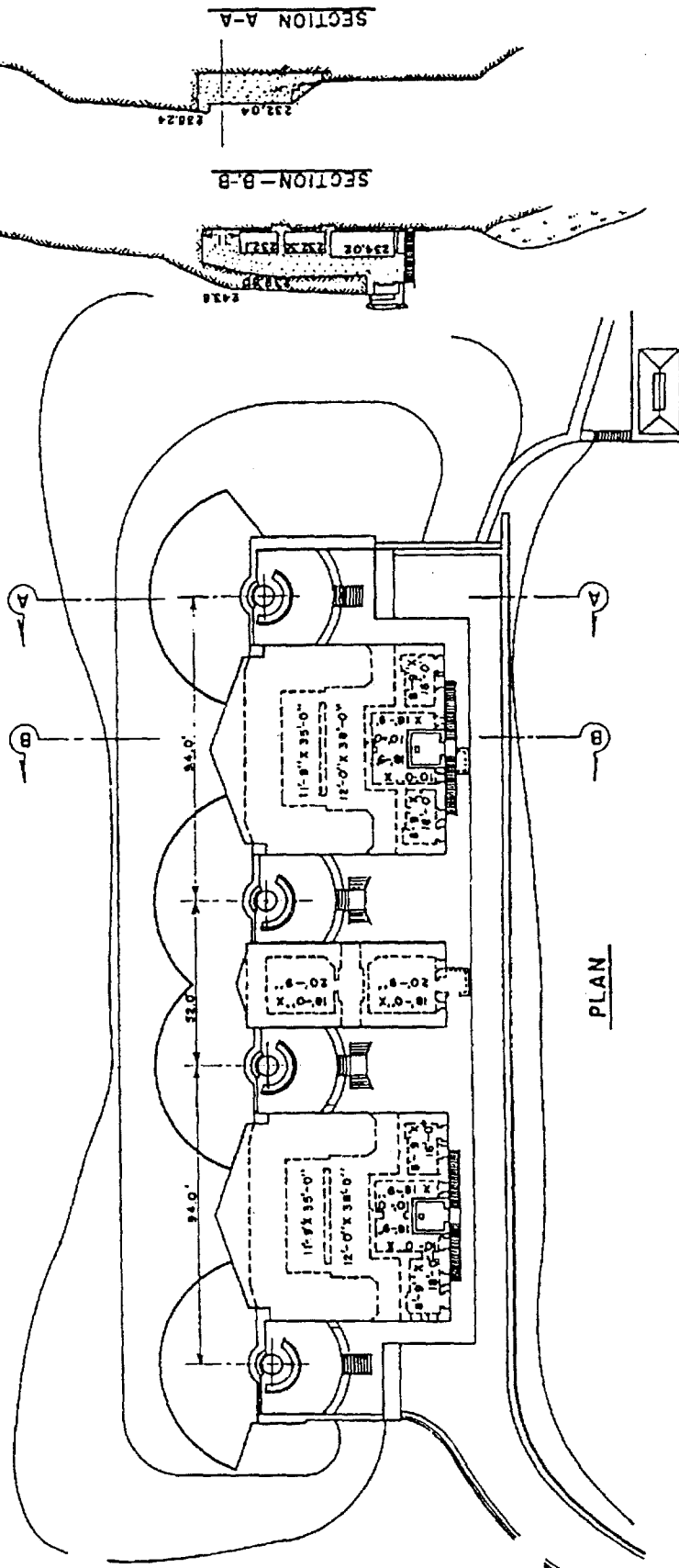

NOTE: See reverse side
this form for modifications
completed in 1942 & 1943.

REAR ELEVATION

BATTERY HAMILTON SMITH BATTERY EDWIN GUTHRIE U.S. Eng. Office 1st S.F. Dist. 22 Env. 1-8

Incl. 35

REPORT OF COMPLETED WORKS - SEACOAST FORTIFICATIONS
(BATTERY PLAN)

CORRECTED TO DEC. 1919.

FORM-7

COAST DEFENSES OF SAN FRANCISCO, CAL.
FORT BARRY
BATTERY PATRICK O'RORKE
NO. OF GUNS 4: CALIBER 3"IN.: BARBETTE CARRIAGE

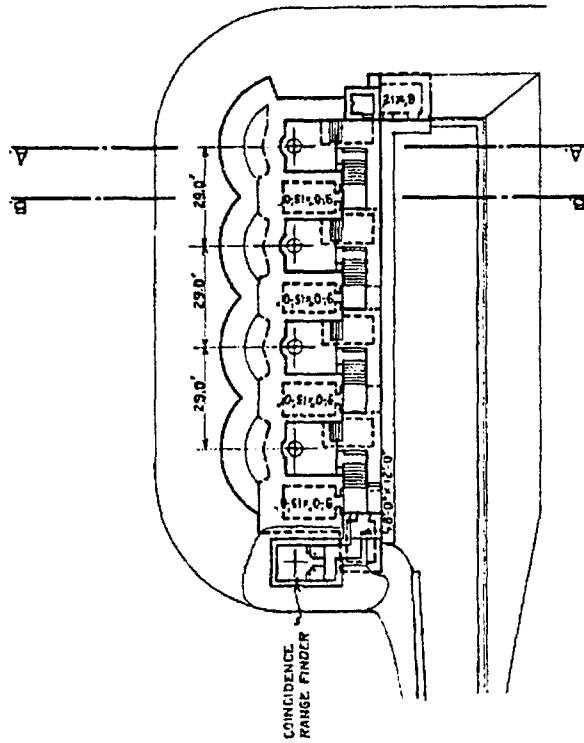

PLAN

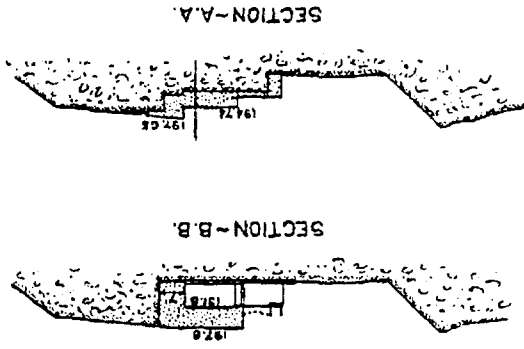

SECTION-A.A.

SECTION-B.B.



REAR ELEVATION

REPORT OF COMPLETED WORKS--SEACOAST FORTIFICATIONS HARBOR DEFENSES OF SAN FRANCISCO
(Battery Plan)
FORT BARRY, CALIF
BATTERIES RATHBONE & M^CINDOE
No. of Guns 4: Caliber 6" : Barbettes Carriage

Corrected to Dec. 1943.

Part VII

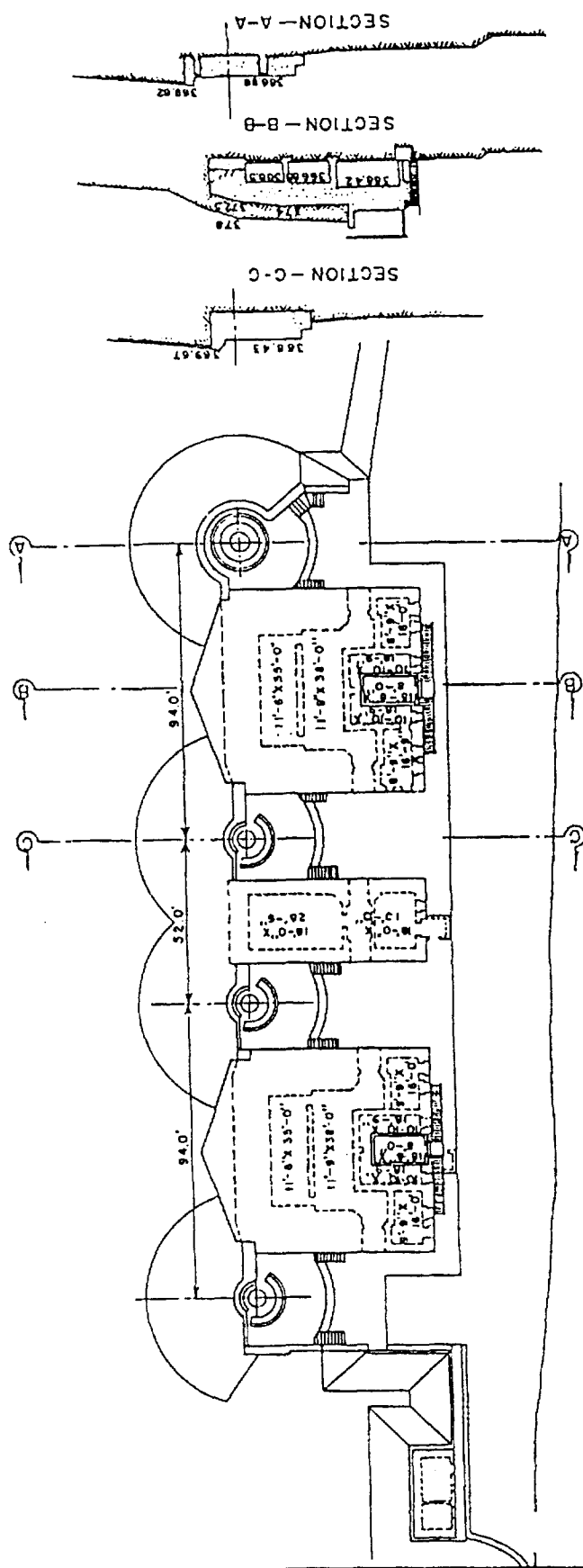

PLAN

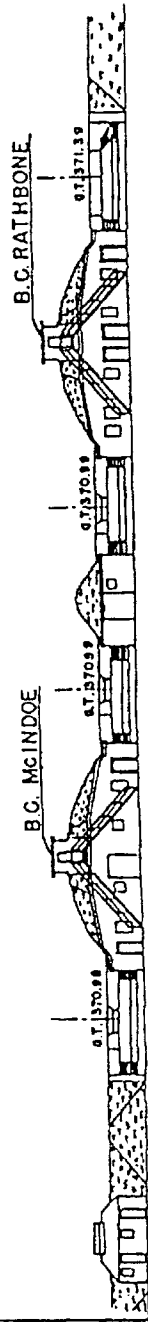

REAR ELEVATION

NOTE: See reverse side for modifications completed in 1942 & 1943.

BATTERY JAMES McINDOE BATTERY SAMUEL RATHBONE U.S. Eng. Office 1st S.F. Dist. 32 Env.-1-7.

REPORT OF COMPLETED WORKS - SEACOAST FORTIFICATIONS
(Battery Plan)

HARBOR DEFENSES OF SAN FRANCISCO, CALIFORNIA
FORT BARRY
BATTERY ELMER J. WALLACE
No. of Guns - 2 : Caliber - 12 inch : Carriage - Barbette

Part VII

Corrected to Oct. 1943

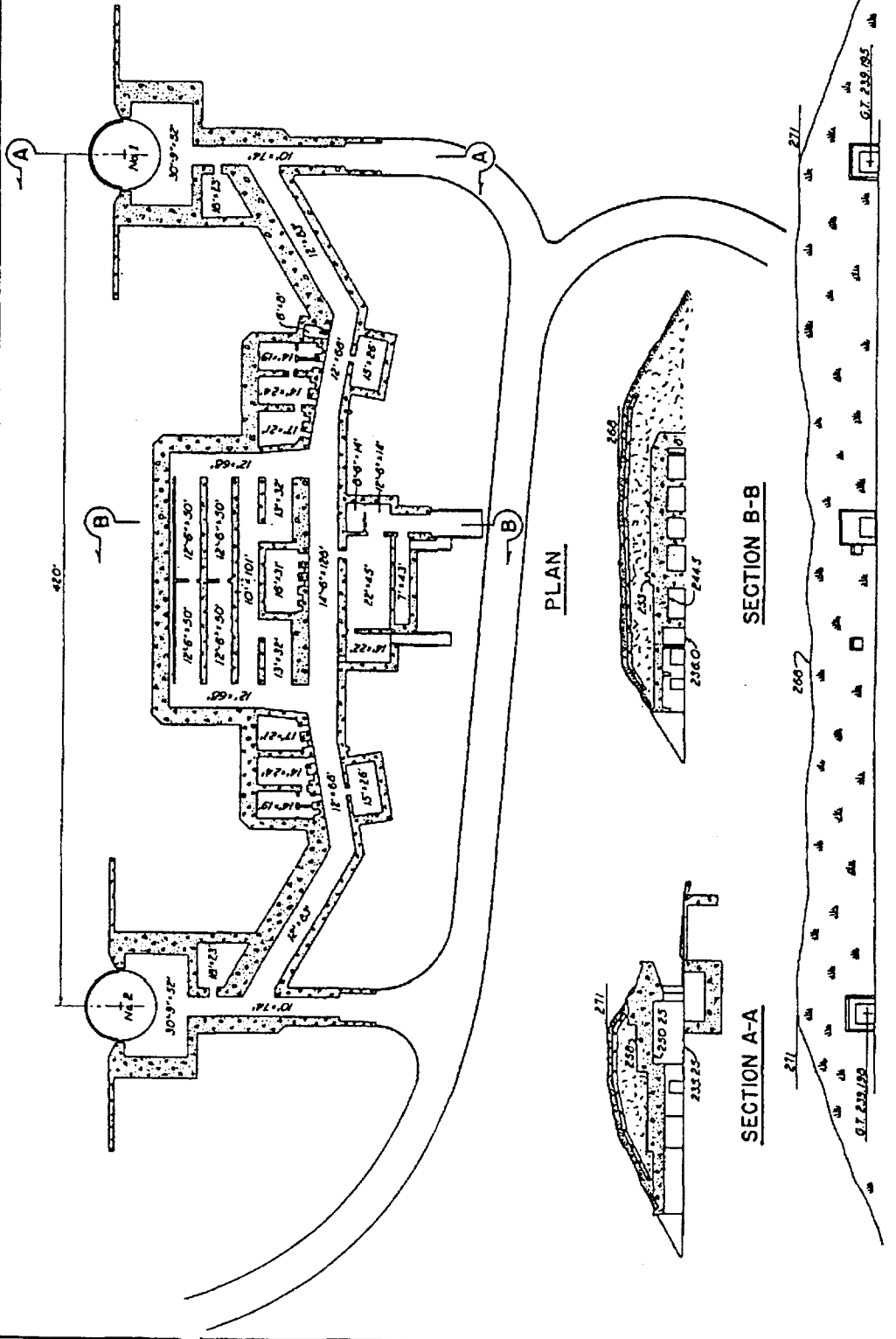

REAR ELEVATION

Incl. 22 55

HARBOR DEFENSES OF SAN FRANCISCO
FORT BARRY CALIFORNIA
ANTI AIRCRAFT BATTERY
NO OF GUNS-3 CALIBER-3 CARRIAGE-19
SCALES AS SHOWN

REPORT OF COMPLETED WORKS - SEACOAST FORTIFICATIONS
(BATTERY PLAN)

FORM 7 CORRECTED TO JANUARY 6, 1943

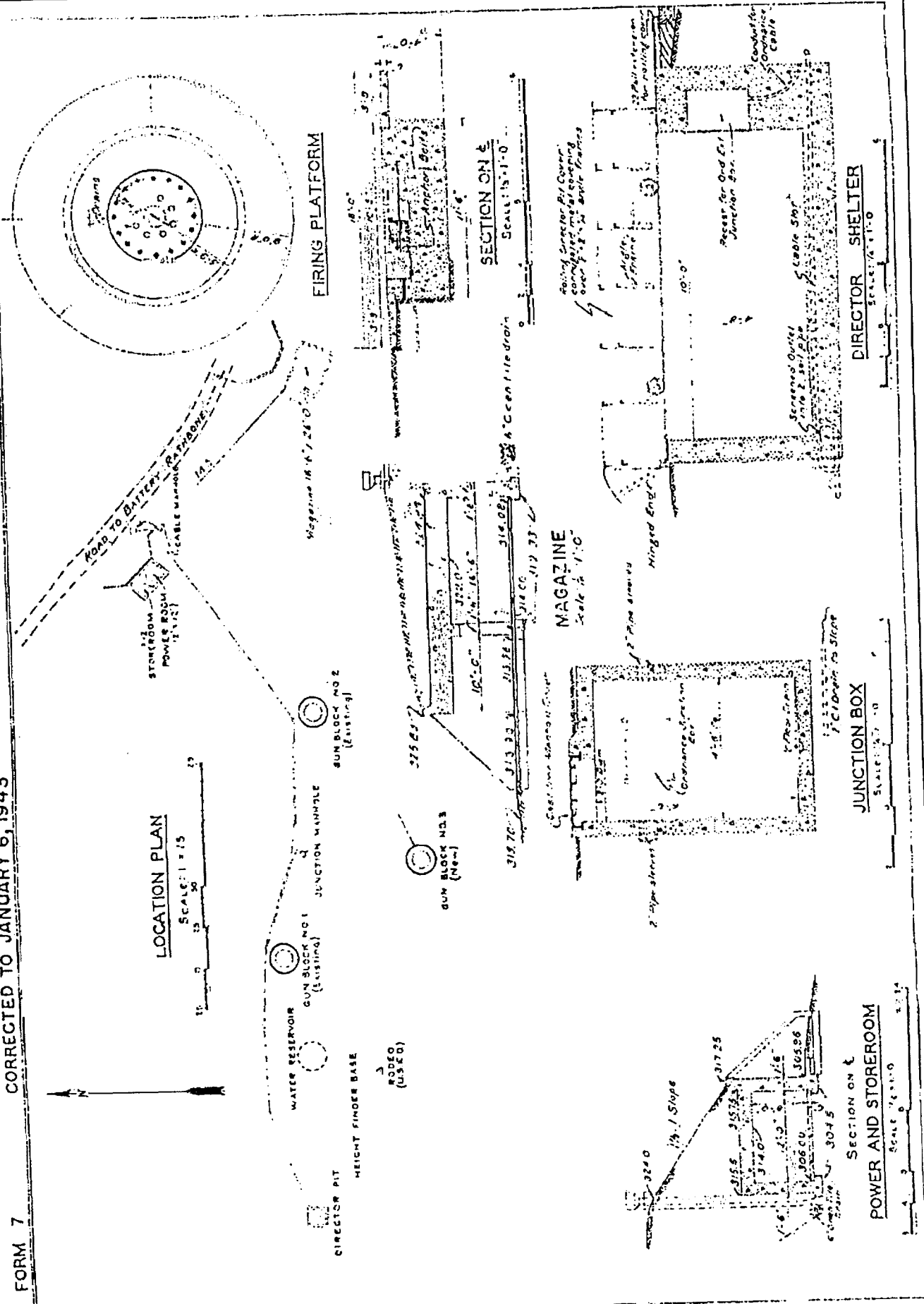

HARBOR DEFENSES OF SAN FRANCISCO, CALIFORNIA
FORT BARRY

BATTERY CONSTRUCTION NO. 129

No. of guns - 2 Caliber - 50 (16 inch) Carriage - Barbette



Corrected to April 1944

Part VII

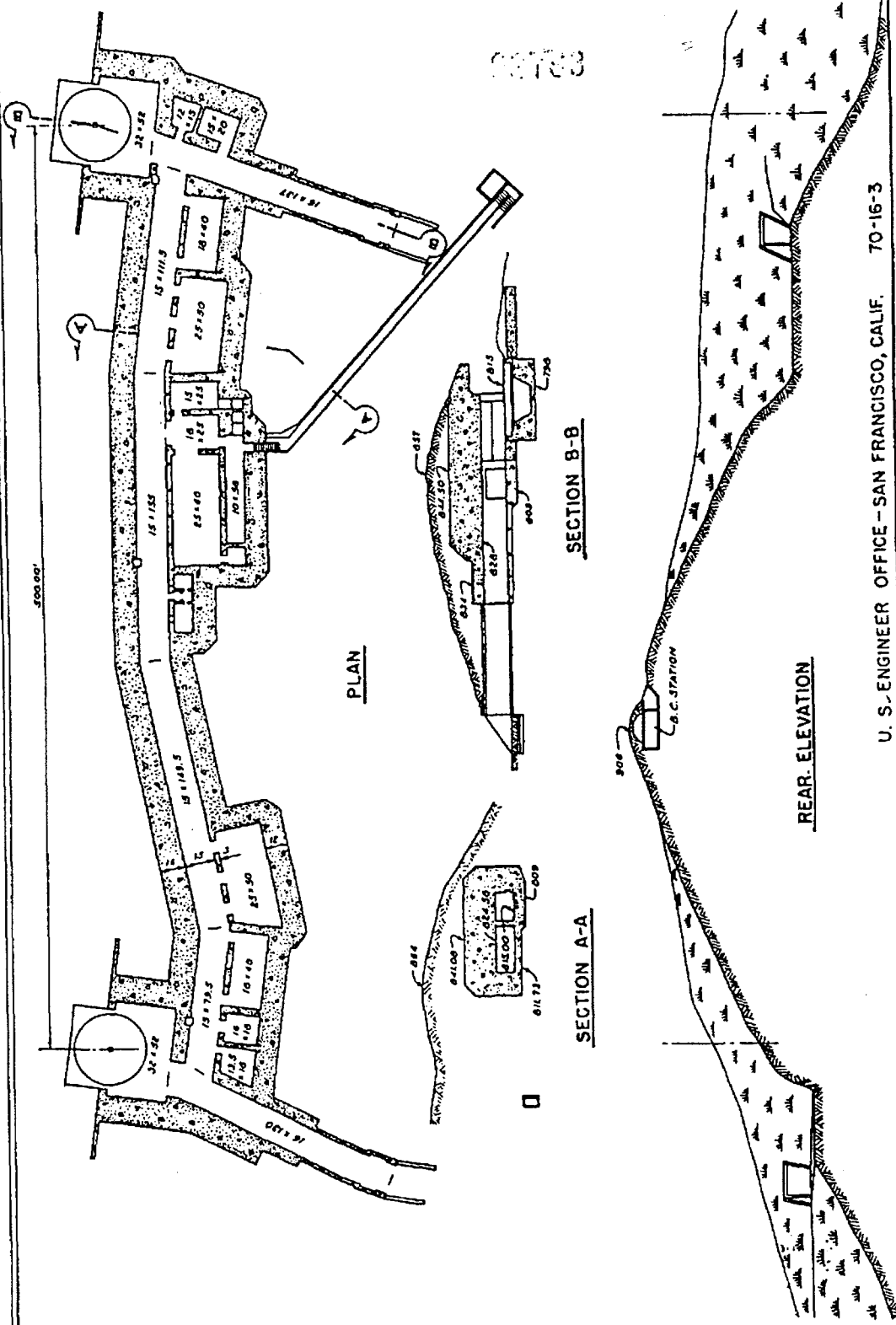

U. S. ENGINEER OFFICE - SAN FRANCISCO, CALIF. 70-16-3

FORT CRONKHITE

Battery Townsley, under construction 1938-1940

Antiaircraft Battery No. 1, under construction 1939-1940

REPORT OF COMPLETED WORKS -- SEACOAST FORTIFICATIONS
(BATTERY PLAN)

FORM 7 CORRECTED TO JULY 24, 1940

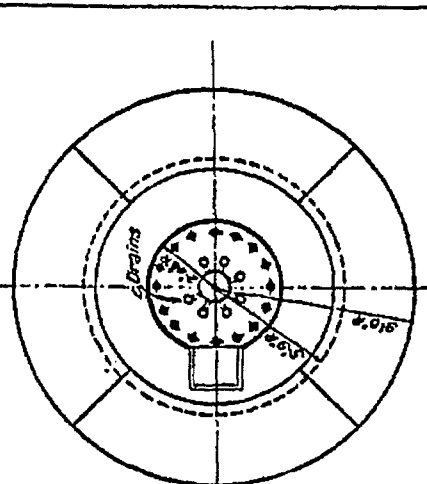
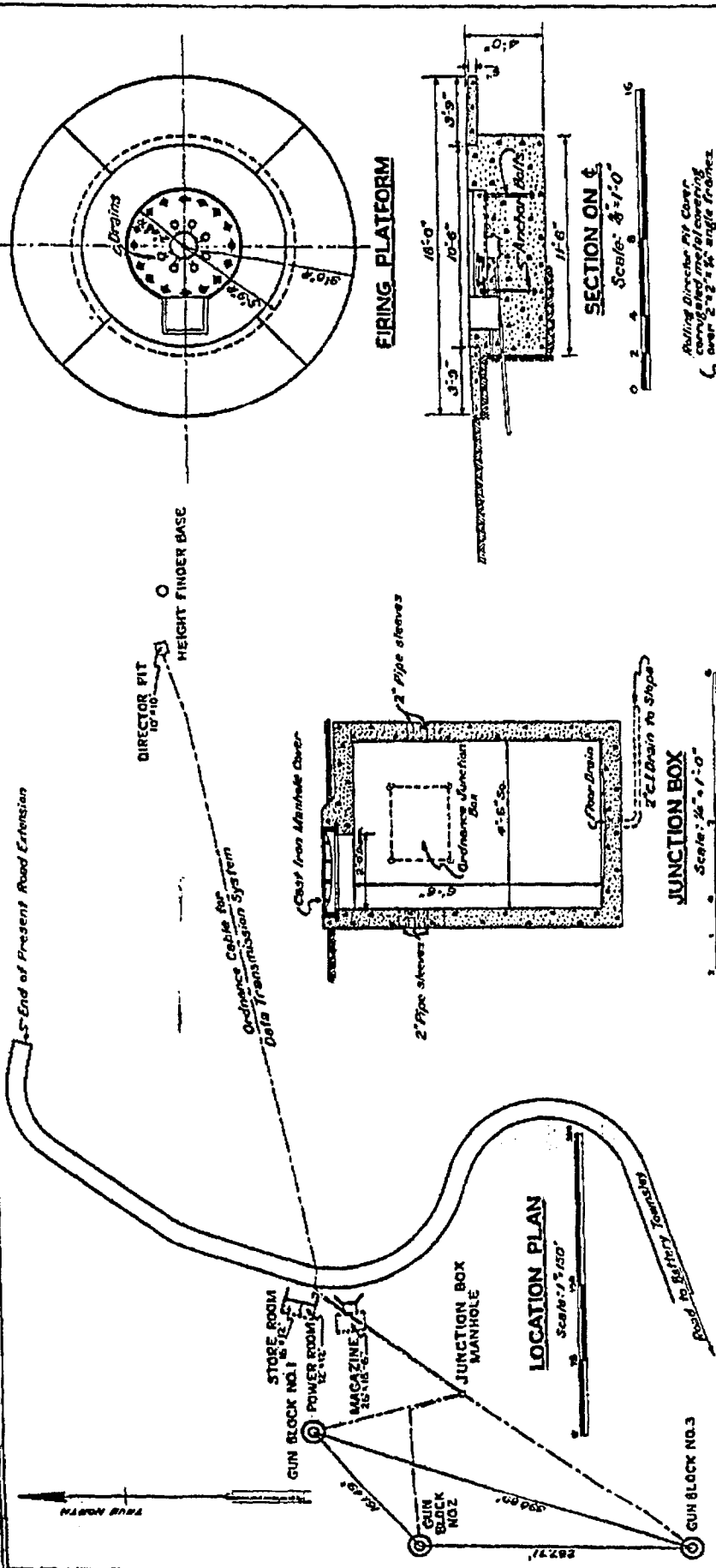

FIRING PLATFORM

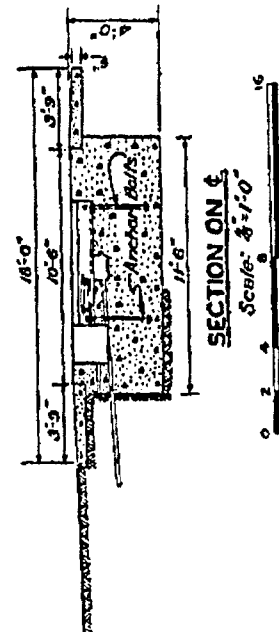

JUNCTION BOX

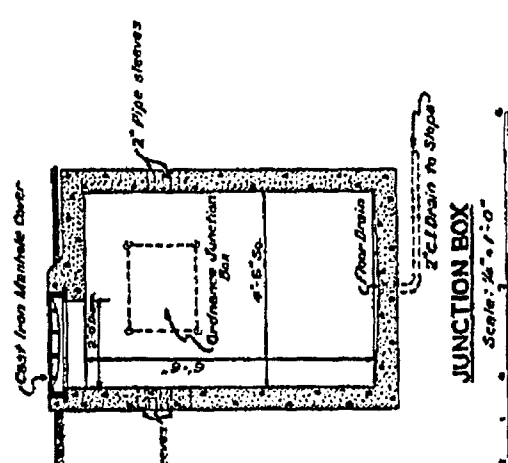

SECTION ON E

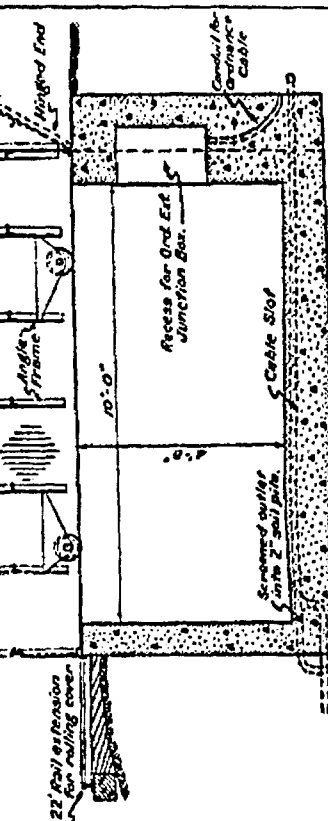

DIRECTOR SHELTER

MAGAZINE

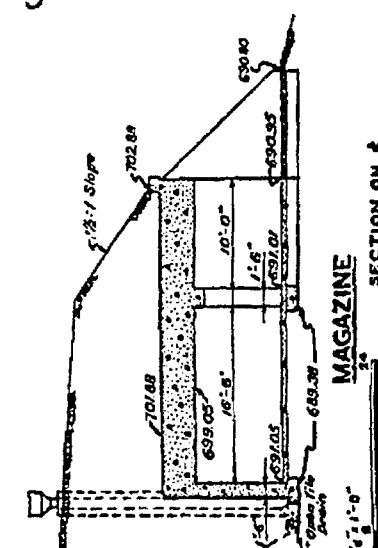

POWER AND STORE ROOM

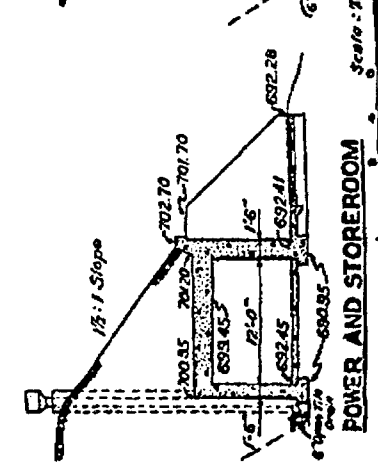

FORT FUNSTON

Antiaircraft Battery No. 3, under construction 1920-1925

Battery Davis, under construction 1936-1940

HARBOR DEFENSES OF SAN FRANCISCO
 FORT FUNSTON, CALIF.
 ANTI AIRCRAFT BATTERY
 No of Guns 3 - GALIBER 3" CARTRIDGE 1917
 SCALES AS SHOWN

REPORT OF COMPLETED WORKS - SEACOAST FORTIFICATIONS
 (BATTERY PLAN)

FORM 7 CORRECTED TO Aug. 27, 1938

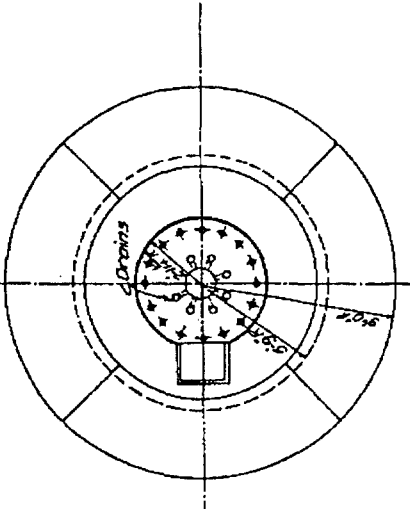
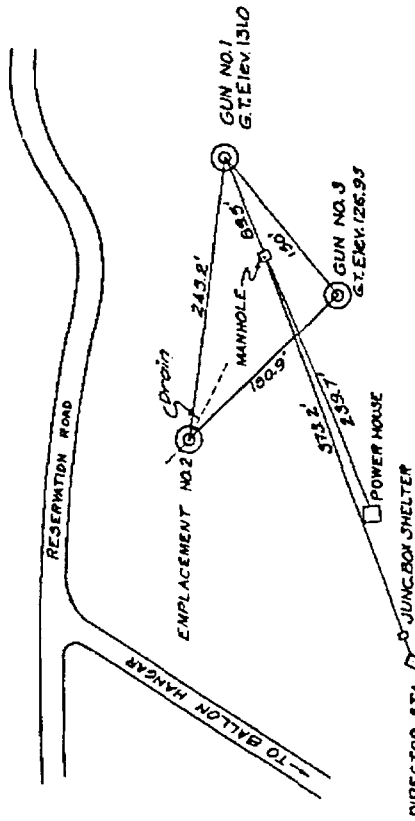

FIRING PLATFORM

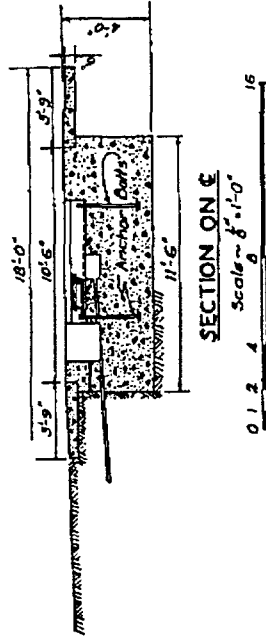

SECTION ON C

Scale - 1/4" = 1'-0"

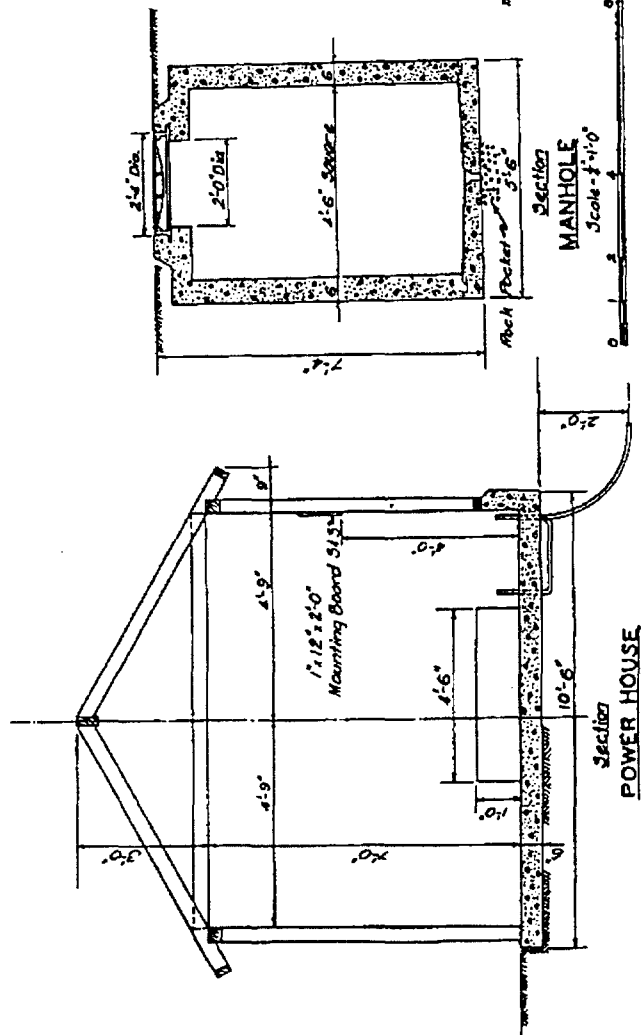

SECTION ON A
POWER HOUSE

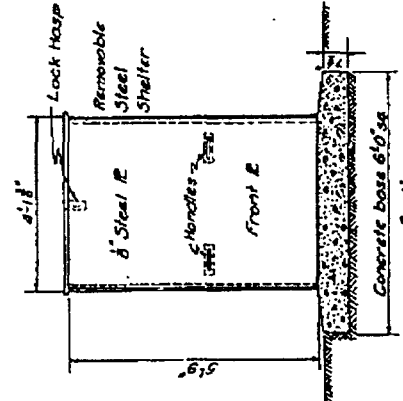

SECTION ON B
DIRECTOR SHELTER

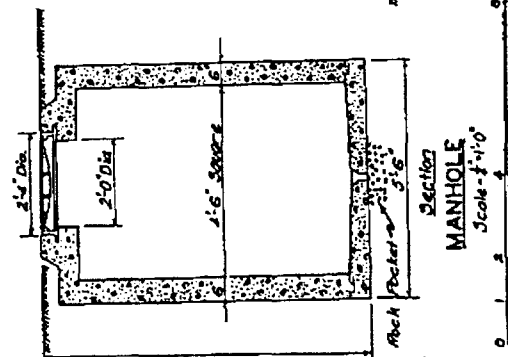

SECTION ON D
MANHOLE

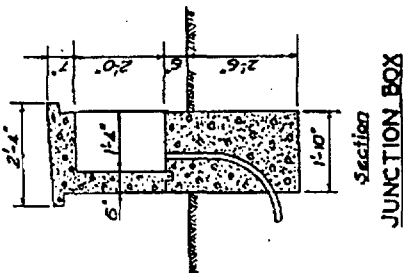

SECTION ON E
JUNCTION BOX

115 ENR MAPS, San Francisco Cal 19-1-40

REPORT OF COMPLETED WORKS -- SEACOAST FORTIFICATIONS
BATTERY PLAN

FORM 7 CORRECTED TO SEPT. 21, 1940

HARBOR DEFENSES OF SAN FRANCISCO
FORT FUNSTON CALIF.
BATTERY - RICHMOND P. DAVIS
NO OF GUNS 2 CALIBER 50 CARRIAGE LF
SCALE AS SHOWN

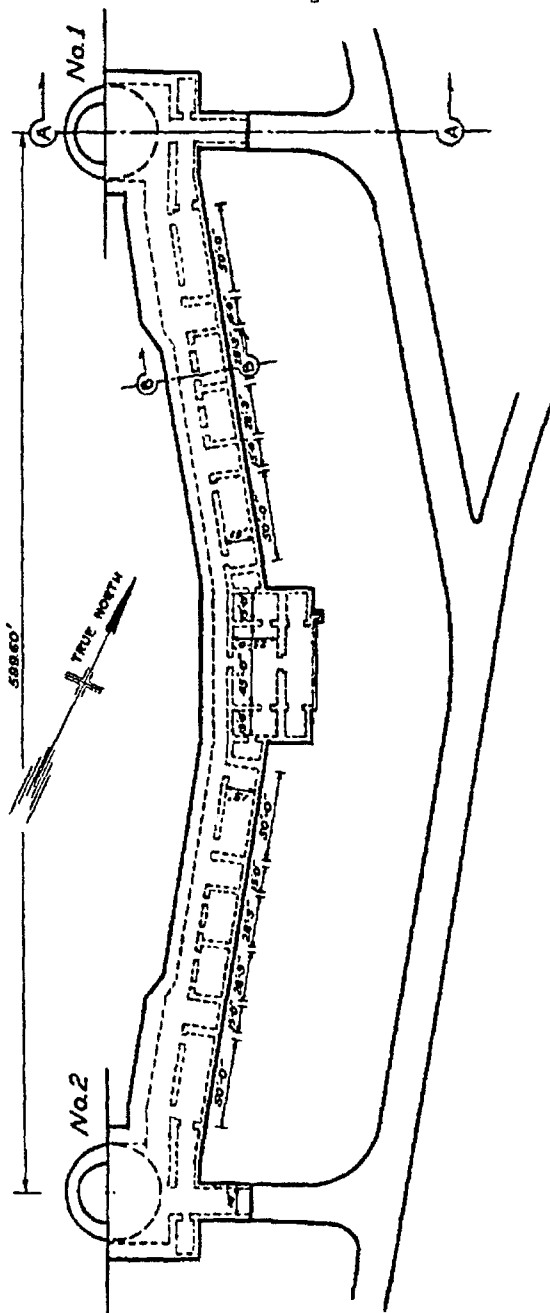

PLAN OF BATTERY

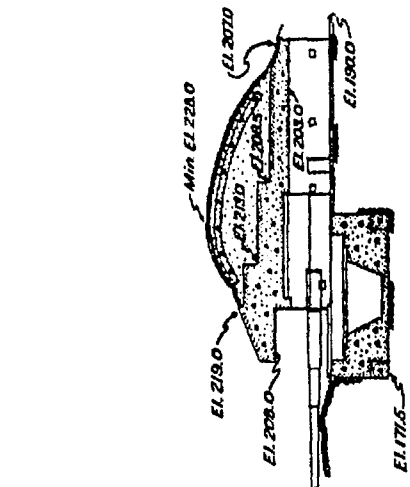

SECTION A-A

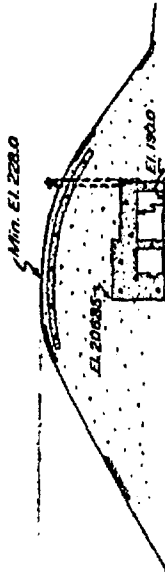

SECTION B-B

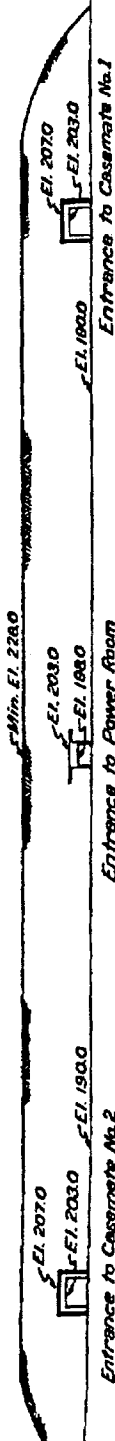
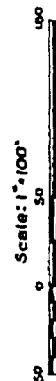

REAR ELEVATION

FORT MILEY

Battery Livingston-Springer, under construction 1899-1902

Battery Chester, under construction 1899-1903

Battery Lobos, under construction 1942

Battery Construction #243, under construction 1943

COAST DEFENSES OF SAN FRANCISCO, CAL.
FORT MILEY
BATTERY LA RHETT LIVINGSTON
No. of MORTARS 4: CALIBER 12": 8 MORTAR CARRIAGES

REPORT OF COMPLETED WORKS - SEACOAST FORTIFICATIONS
(BATTERY PLAN)

CORRECTED TO DEC. 1919.

FORM - 7

10 0 50 100 150 FEET

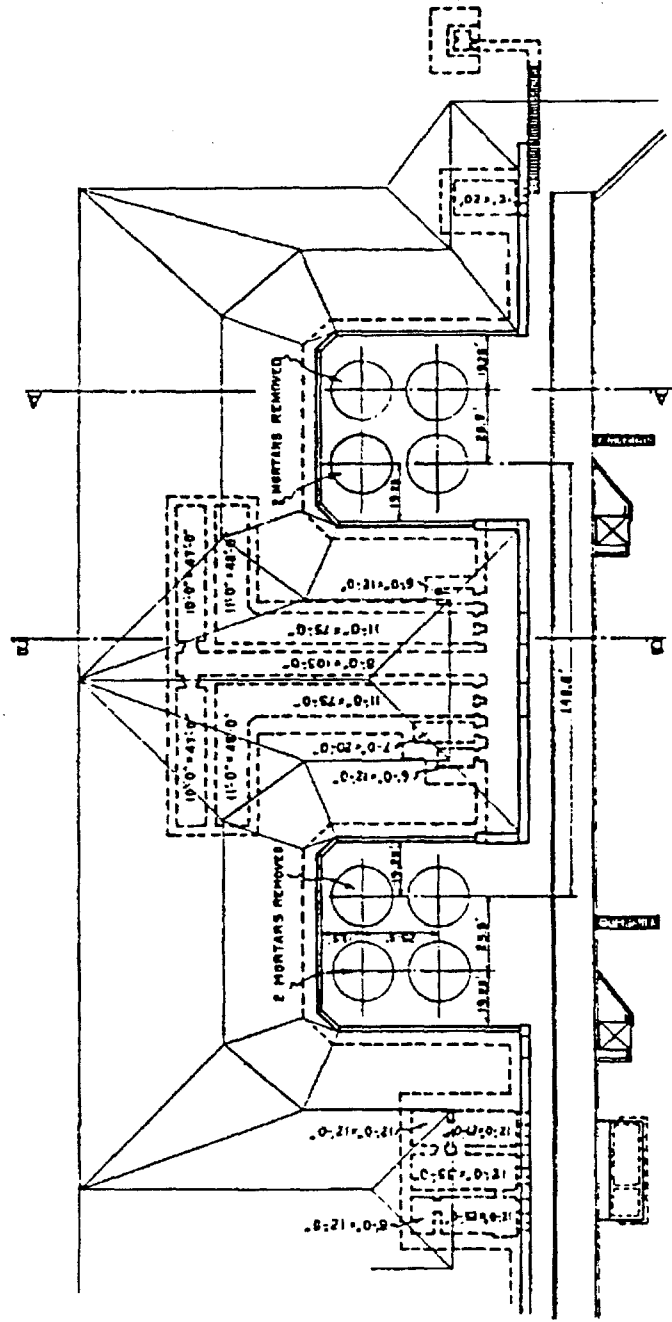
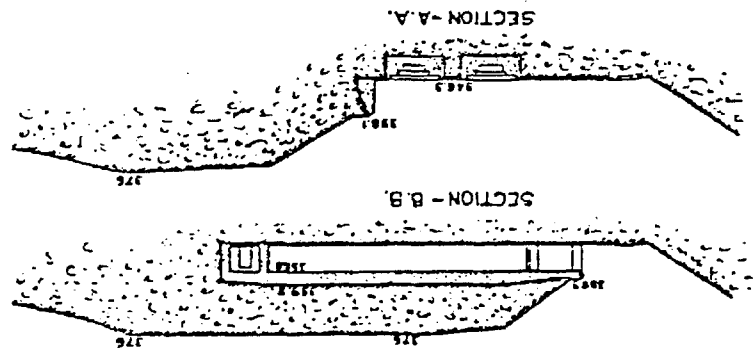

PLAN

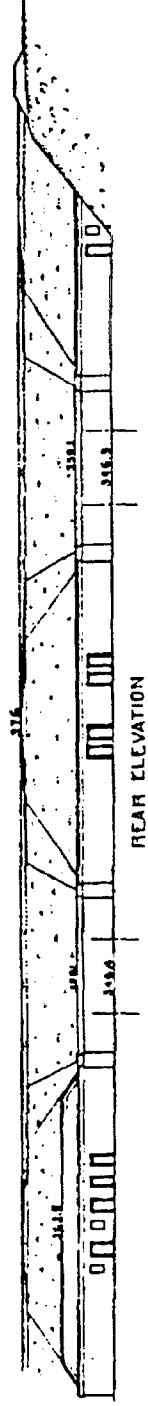

REAR ELEVATION

REPORT OF COMPLETED WORKS - SEACOAST FORTIFICATIONS
(BATTERY PLAN)

COAST DEFENSES OF SAN FRANCISCO, CAL.
FORT MILEY, CAL.
BATTERY JAMES CHESTER

CORRECTED TO DEC. 1919.

NO. OF GUNS 3: CALIBER 12"^{M.}: 2 DISAPPEARING CARRIAGES
1 NONDISAPPEARING CARRIAGE

FORM - 7

100 50 0 50 100 FEET.

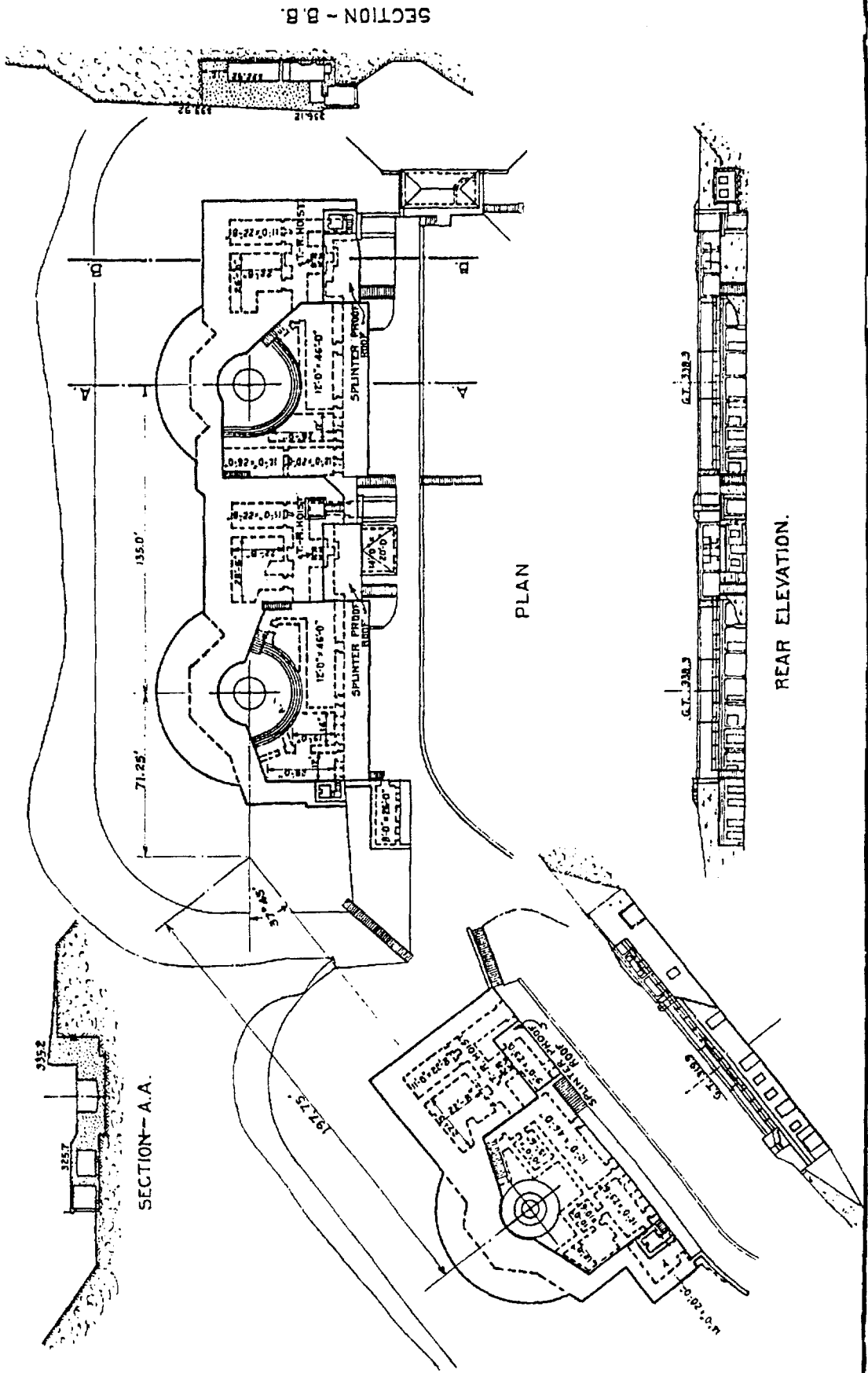

REPORT OF COMPLETED WORKS—SEACOAST FORTIFICATIONS

Corrected to March 13, 1943.

Form 7

HARBOR DEFENSES OF SAN FRANCISCO
 POINT LOBOS, CALIFORNIA
 6" NAVY GUNS
 No. of guns 2 Caliber 6" Gamage

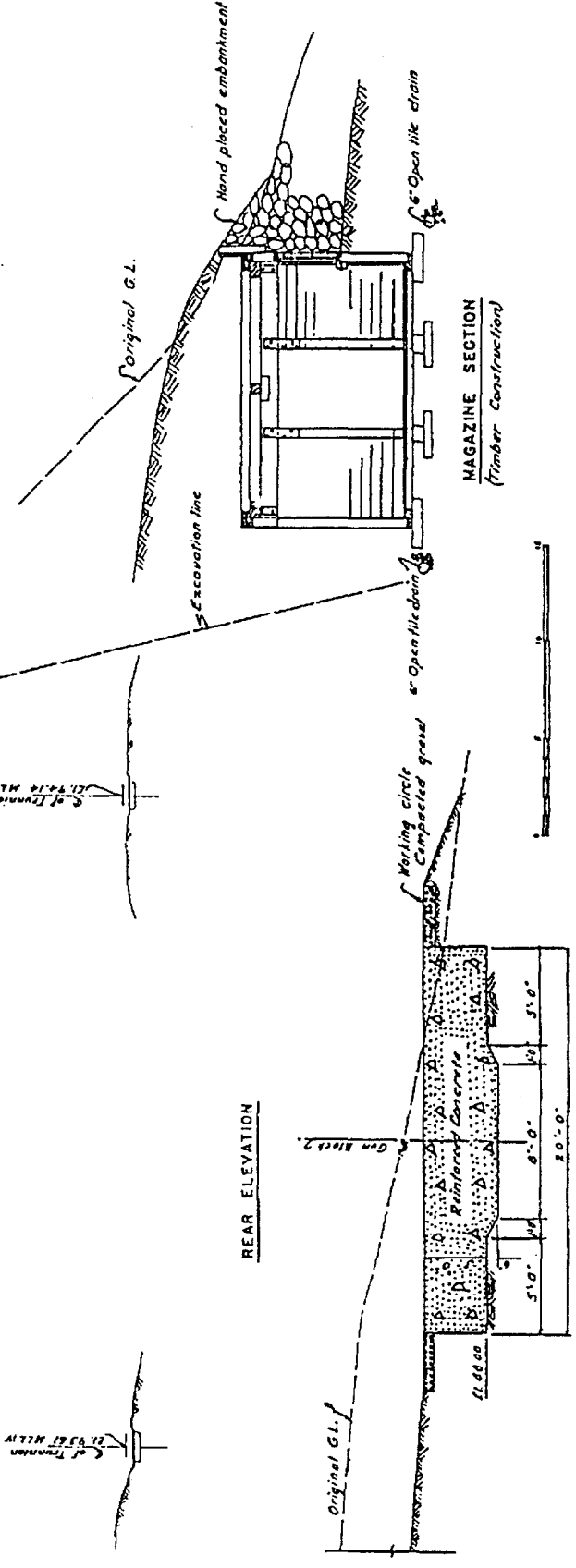
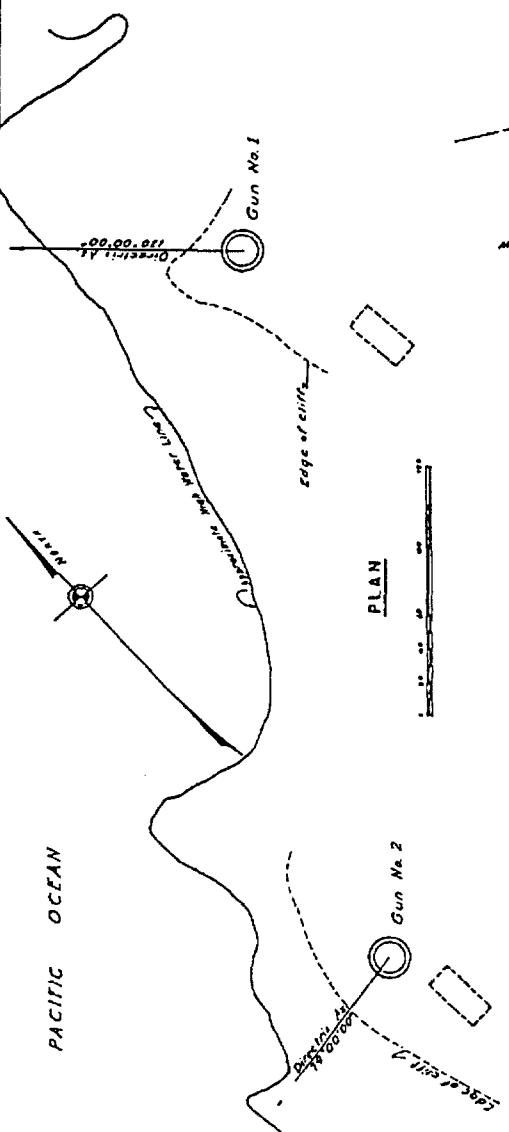
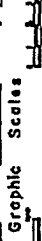

REPORT OF COMPLETED WORKS - SEACOAST FORTIFICATIONS
(Battery Plan)

HARBOR DEFENSES OF SAN FRANCISCO, CALIFORNIA
FORT MILEY
BATTERY N^o 243

N^o of Guns - 2 Caliber - 50; 6 in. Carriage - M 4



Part VII
Corrected to August 1944

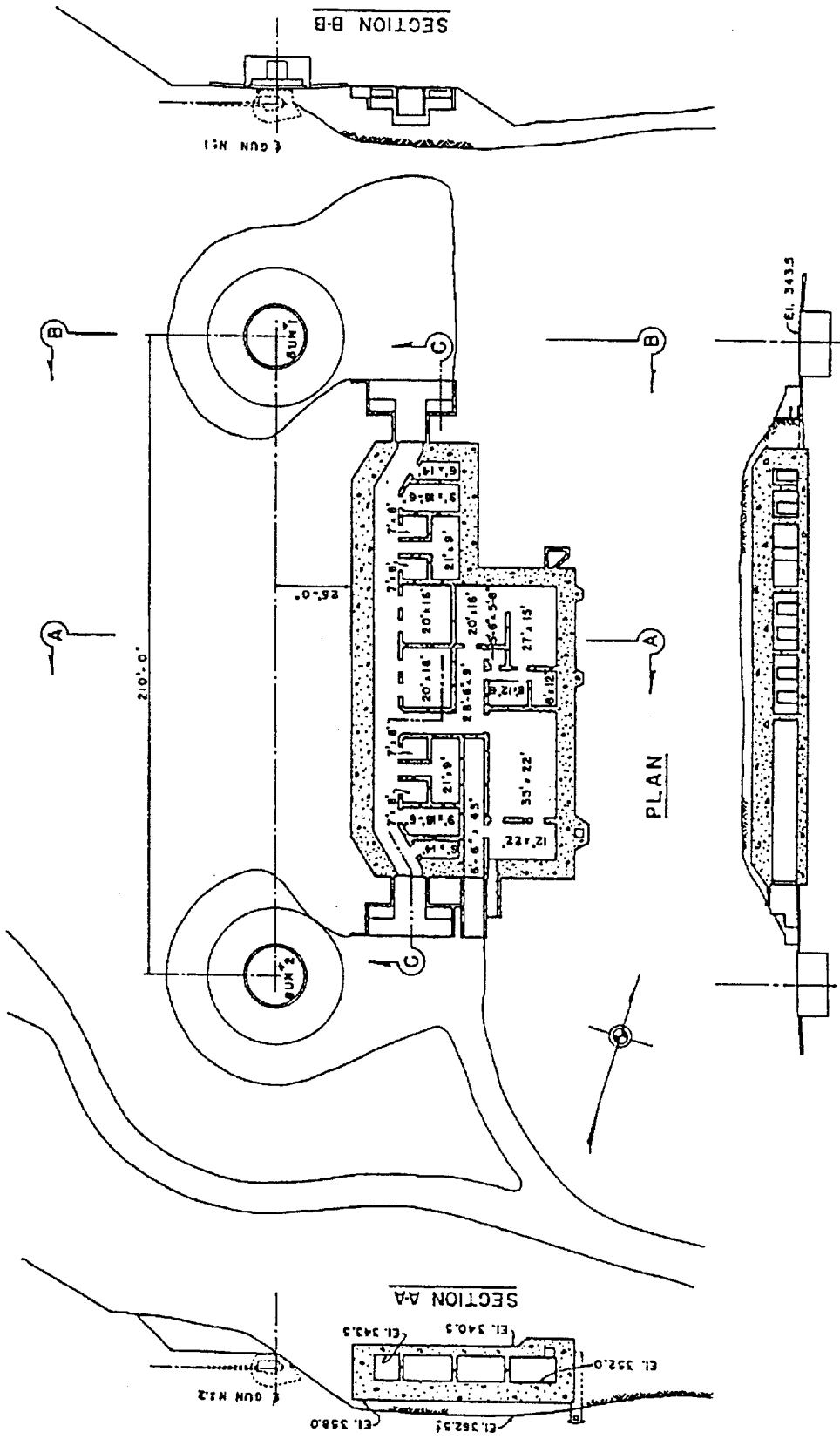

SECTION C-C

FORT WINFIELD SCOTT

Battery Marcus Miller, under construction 1891-1898

Battery Godfrey, under construction 1892-1896

Battery Howe-Wagner, under construction 1893-1895

Battery Saffold, under construction 1896-1897

Battery Lancaster, under construction 1896-1899

Battery Cranston, under construction 1897-1898

Battery Stotsenburg-McKinnon, under construction 1897-1898

Battery Boutelle, under construction 1898-1901

Battery Crosby, under construction 1899-1900

Battery Slaughter, under construction 1899-1900

Battery Sherwood, under construction 1900

Battery Baldwin, under construction 1901-1903

Battery Blaney, under construction 1902-1903

Battery Chamberlin, under construction 1903-1904

Antiaircraft Battery, under construction 1920

REPORT OF COMPLETED WORKS - SEACOAST FORTIFICATIONS
(BATTERY PLAN)

COAST DEFENSES OF SAN FRANCISCO, CAL.
FORT WINFIELD SCOTT
BATTERY MARCUS MILLER

CORRECTED TO AUG. 1923.

NO. OF GUNS: CALIBER - NO. OF CARRIAGES 0.
EMPTS. FOR 10" GUNS ON DISAPPEARING CARRIAGES.

FORM-7

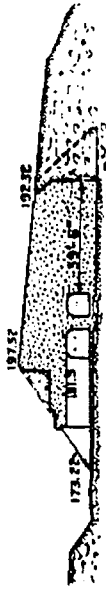

SECTION - B.B.

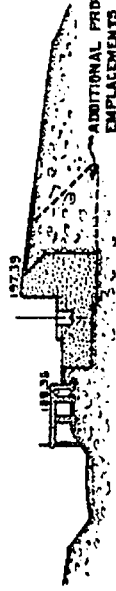

SECTION - A.A.

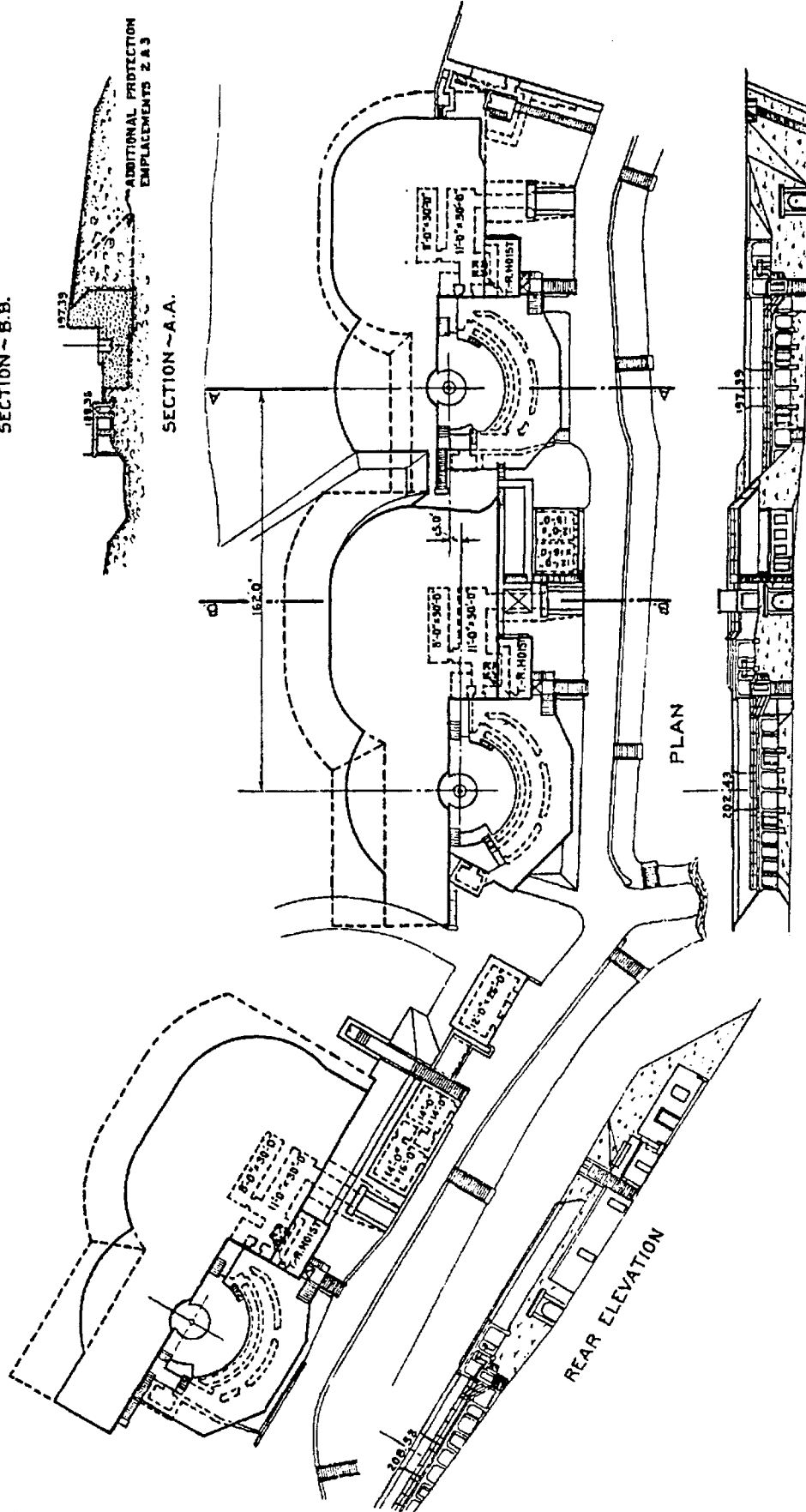

PLAN

REAR ELEVATION

U.S. Eng. Office, 1st Sd. Dist., 30 ENV. 1-17

REPORT OF COMPLETED WORKS - SEACOAST FORTIFICATIONS
(BATTERY PLAN)

COAST DEFENSES OF SAN FRANCISCO, CAL.
FORT WINFIELD SCOTT
BATTERY GODFREY
NO OF GUNS 3: CALIBER 12" : NONDISAPPEARING CARRIAGE

CORRECTED TO DEC. 1919

FORM-7

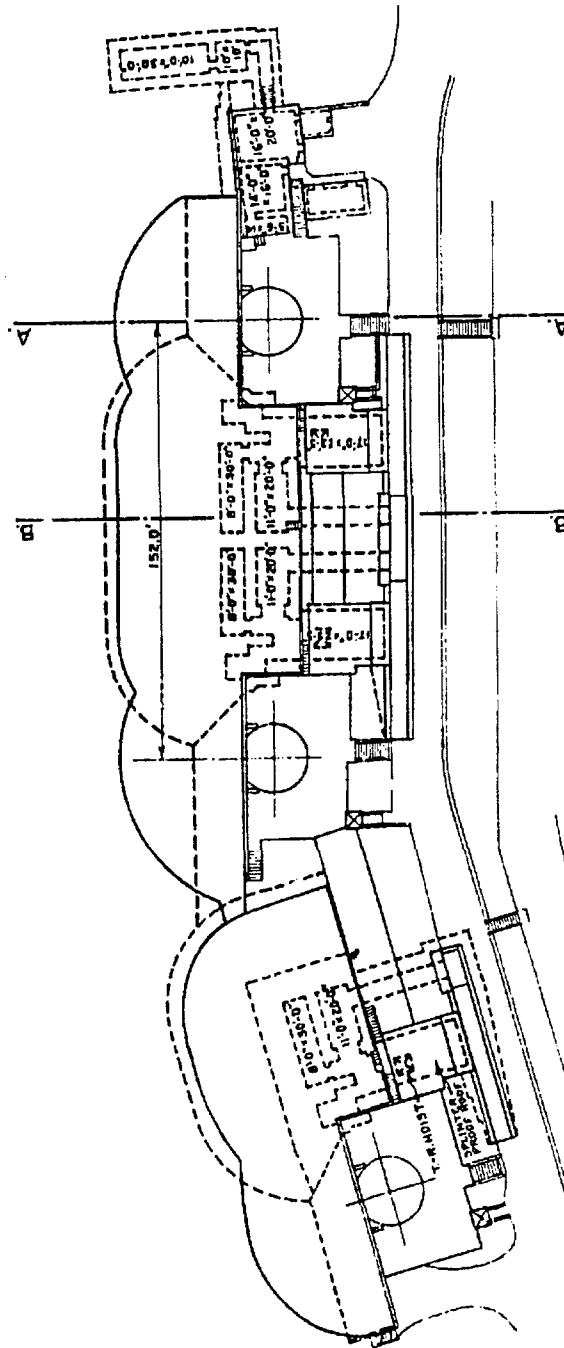

PLAN

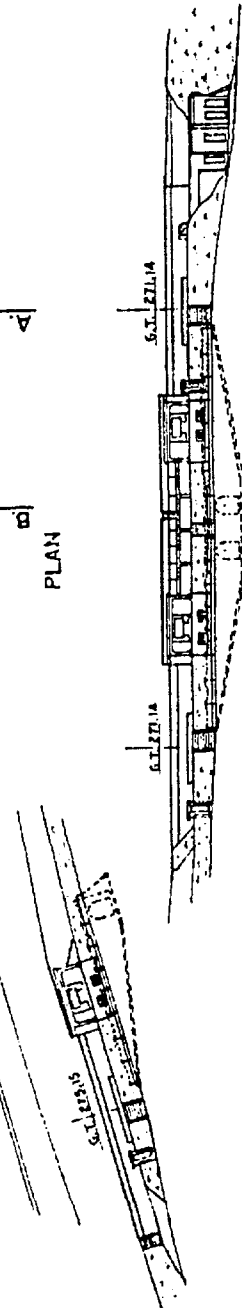
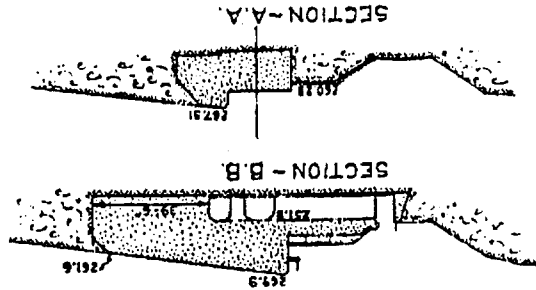

REAR ELEVATION.

REPORT OF COMPLETED WORKS ~ SEACOAST FORTIFICATIONS
(BATTERY PLAN)

COAST DEFENSES OF SAN FRANCISCO, CAL.
FORT WINFIELD SCOTT
BATTERY HOWE

NO. OF MORTARS 0 : CALIBER - : NO. OF CARRIAGES 0
EMP'TS FOR EIGHT 12 IN. MORTARS.

CORRECTED TO AUG. 1923.

FORM-7

150 FEET

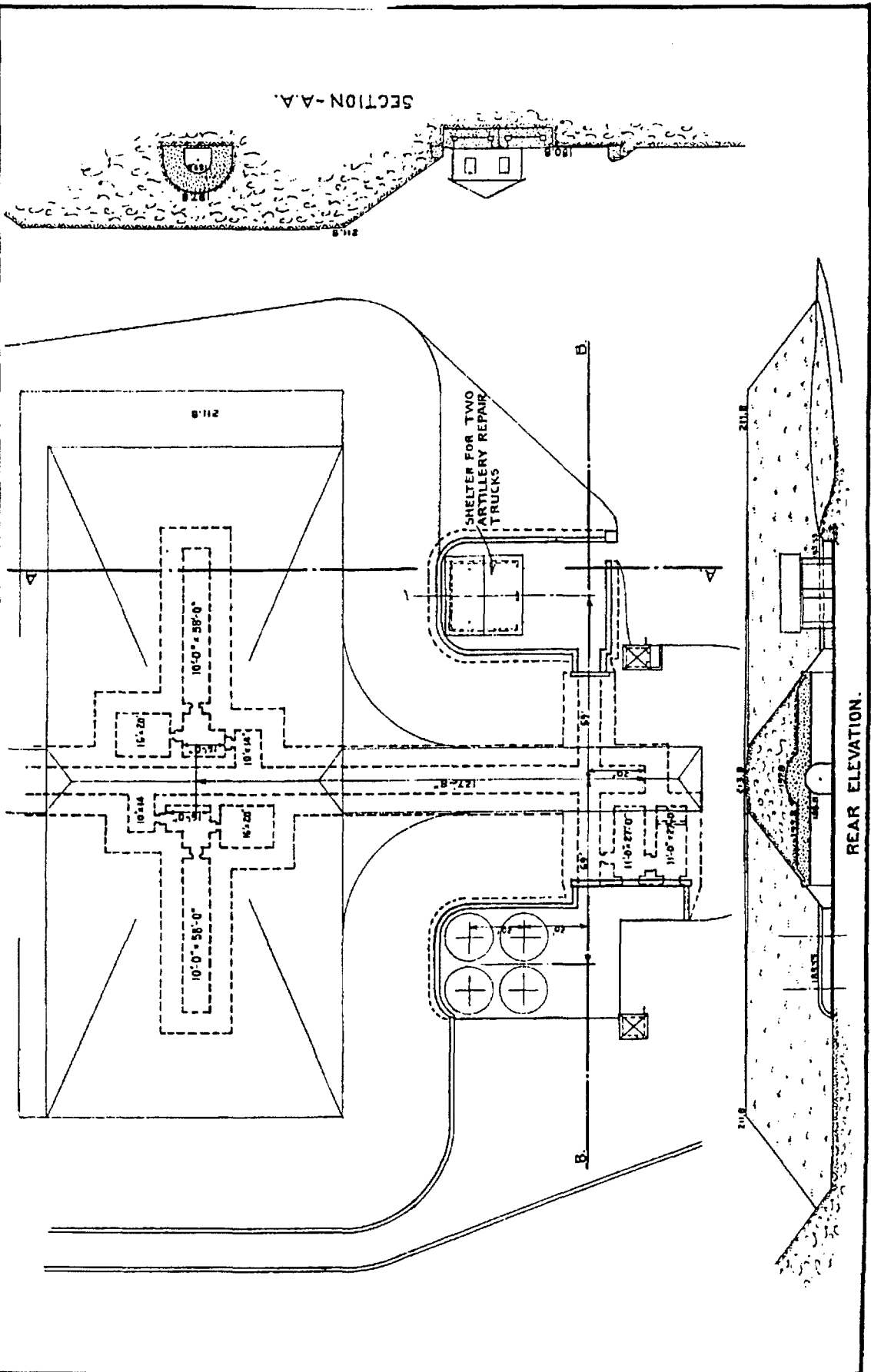

COAST DEFENSES OF SAN FRANCISCO, CAL.
FORT WINFIELD SCOTT
BATTERY SAFFOLD
NO. OF GUNS 2: CALIBER 12 IN.: NONDISAPPEARING CARRIAGE

REPORT OF COMPLETED WORKS ~ SEACOAST FORTIFICATIONS
(BATTERY PLAN)

CORRECTED TO DEC. 1919.

FORM - 7

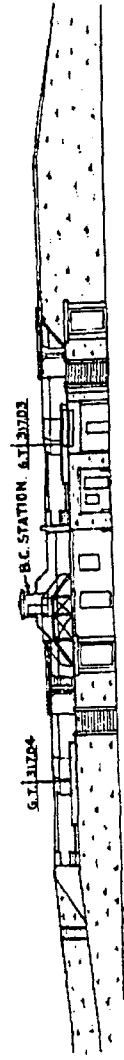
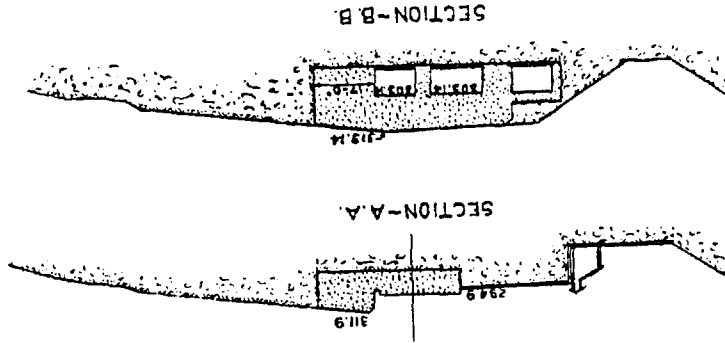
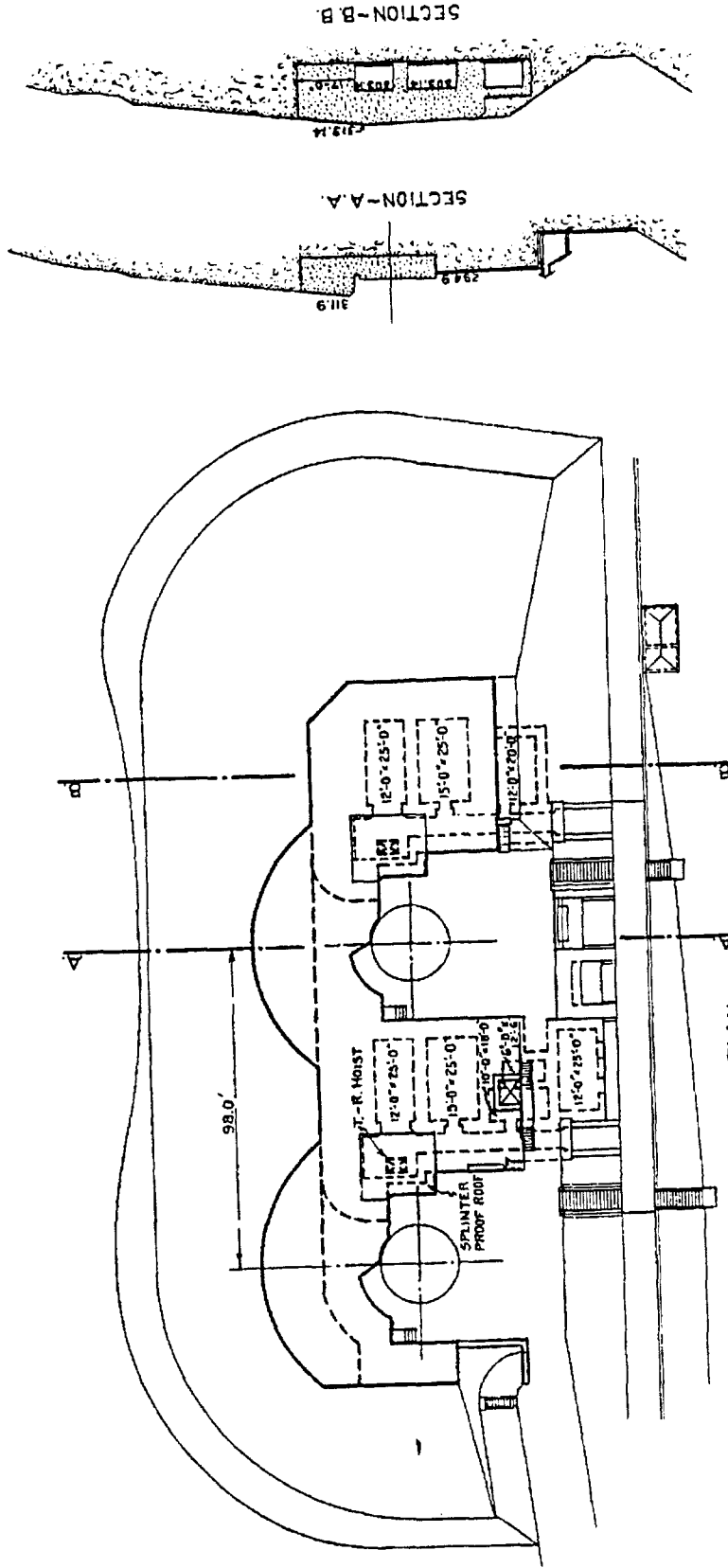

REAR ELEVATION.

REPORT OF COMPLETED WORKS - SEACOAST FORTIFICATIONS
(BATTERY PLAN)

CORRECTED TO DEC. 1919.

FORM-7

COAST DEFENSES OF SAN FRANCISCO, CAL.
FORT WINFIELD SCOTT
BATTERY LANCASTER
NO. OF GUNS 0: CALIBER 3-12" DISAPPEARING CARRIAGES

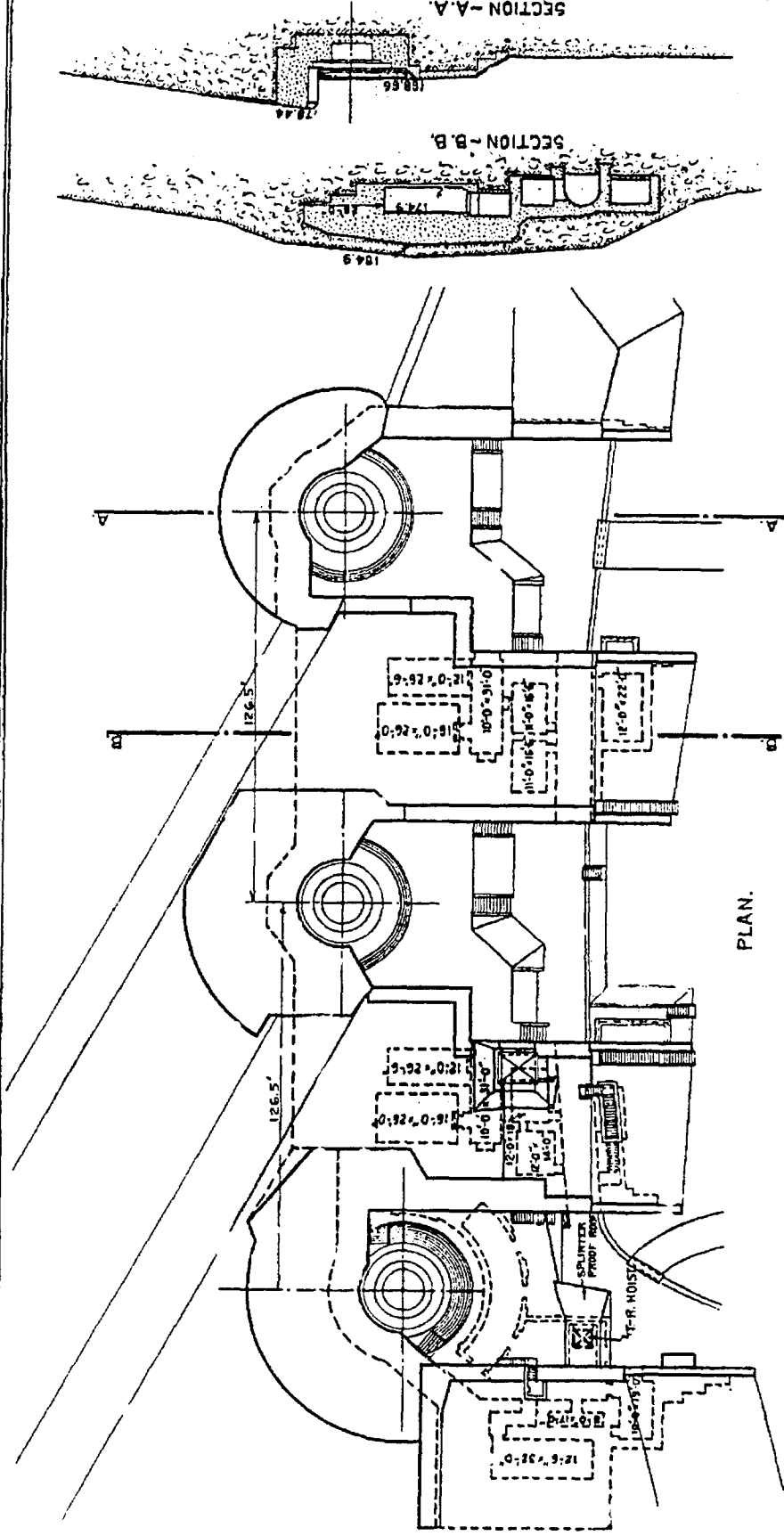

PLAN.

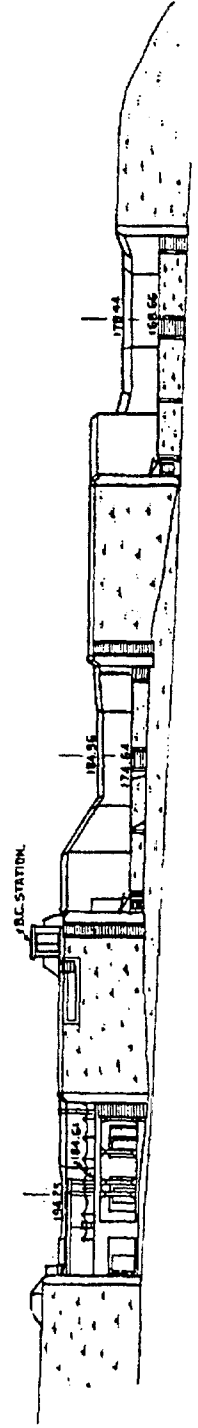
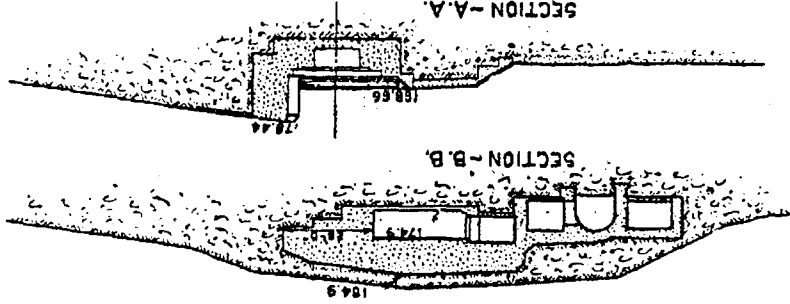

REAR ELEVATION.

REPORT OF COMPLETED WORKS - SEACOAST FORTIFICATIONS
(BATTERY PLAN)

COAST DEFENSES OF SAN FRANCISCO, CAL.
FORT WINFIELD SCOTT
BATTERY BOUTELLE

CORRECTED TO DEC. 1919

NO. OF GUNS 0: CALIBER - 3-5 IN. BAL. PILLAR CARRIAGES

FORM-7

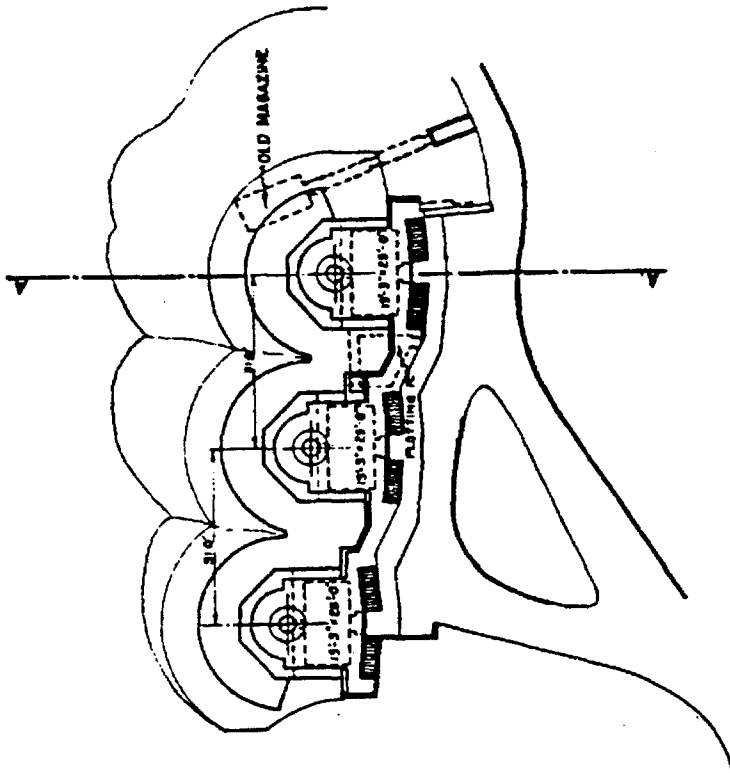

PLAN

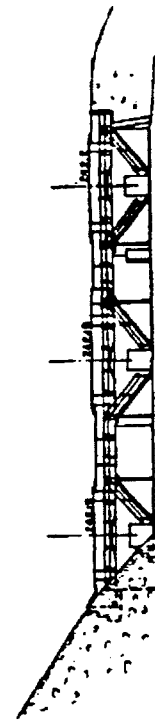
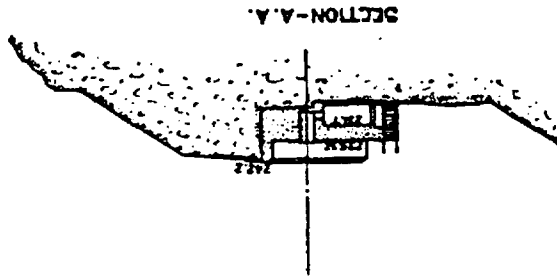

REAR ELEVATION.

REPORT OF COMPLETED WORKS - SEACOAST FORTIFICATIONS
(BATTERY PLAN)

COAST DEFENSES OF SAN FRANCISCO, CAL.
FORT WINFIELD SCOTT
BATTERY CROSBY
NO. OF GUNS 2 : CALIBER 6^{IN.} : DISAPPEARING CARRIAGE

CORRECTED TO DEC. 1919

FORM-7

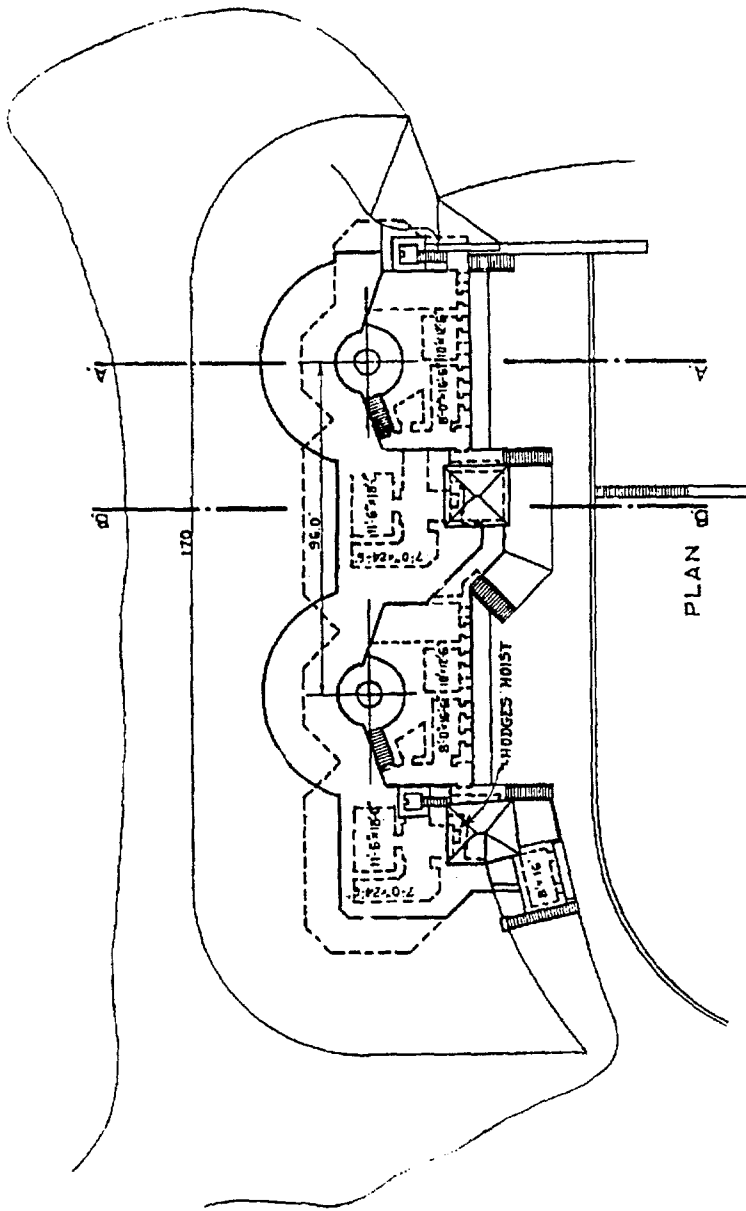

PLAN

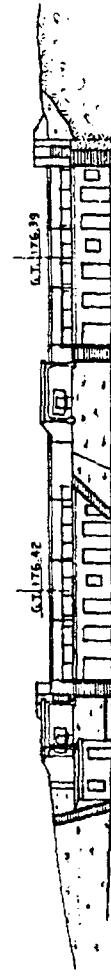
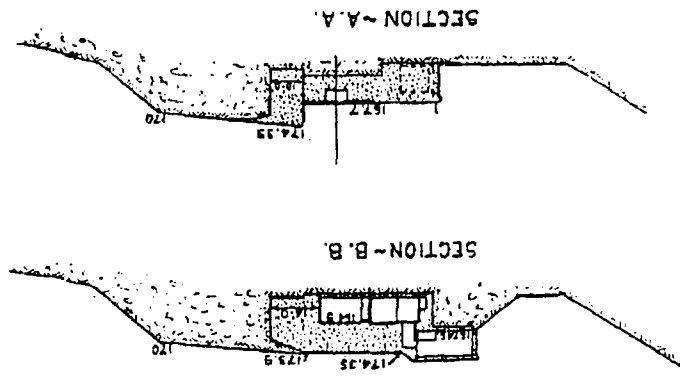

REAR ELEVATION

REPORT OF COMPLETED WORKS - SEACOAST FORTIFICATIONS
(BATTERY PLAN)

COAST DEFENSES OF SAN FRANCISCO, CAL.
FORT WINFIELD SCOTT
BATTERY SLAUGHTER

CORRECTED TO DEC. 1919.

NO. OF GUNS 0: CALIBER ---: CARRIAGE 0
EMPTS. FOR 8" GUNS ON DISAPPEARING CARRIAGES

FORM-7

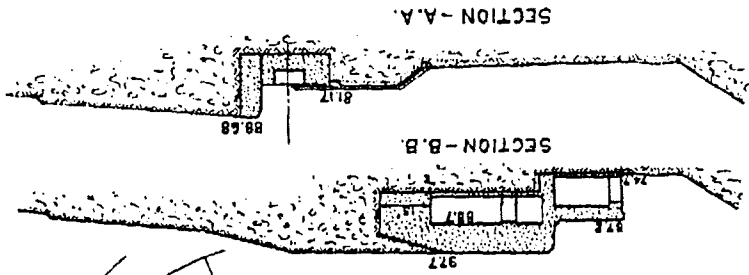
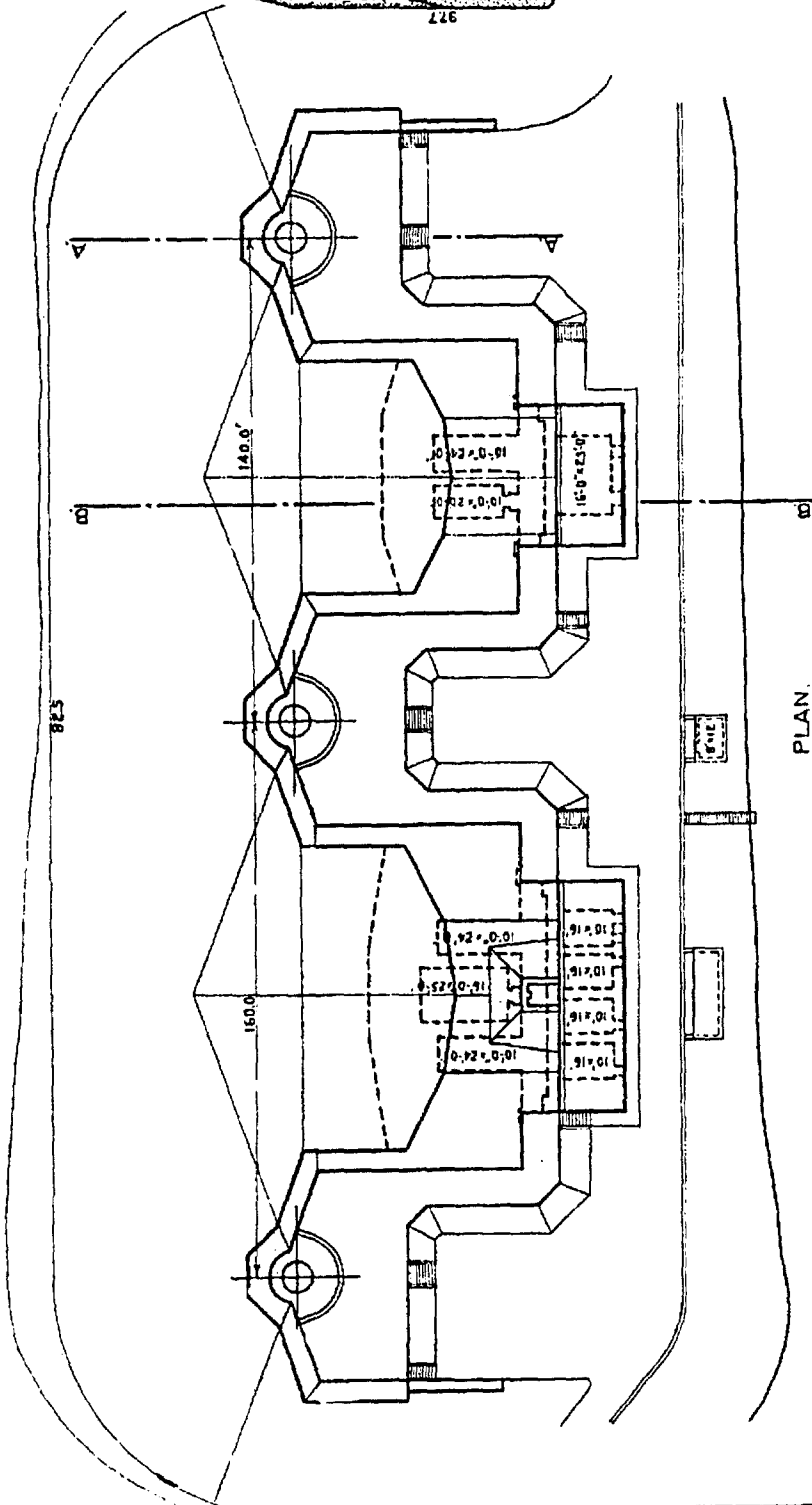

PLAN.



REAR ELEVATION

COAST DEFENSES OF SAN FRANCISCO, CAL.
FORT WINFIELD SCOTT
BATTERY SHERWOOD

NO. OF GUNS 0 : CALIBER — : CARRIAGE 0
EMPTS. FOR 5" GUNS BARBETTE CARRIAGES

REPORT OF COMPLETED WORKS - SEACOAST FORTIFICATIONS
(BATTERY PLAN)

CORRECTED TO DEC. 1919

FORM - 7

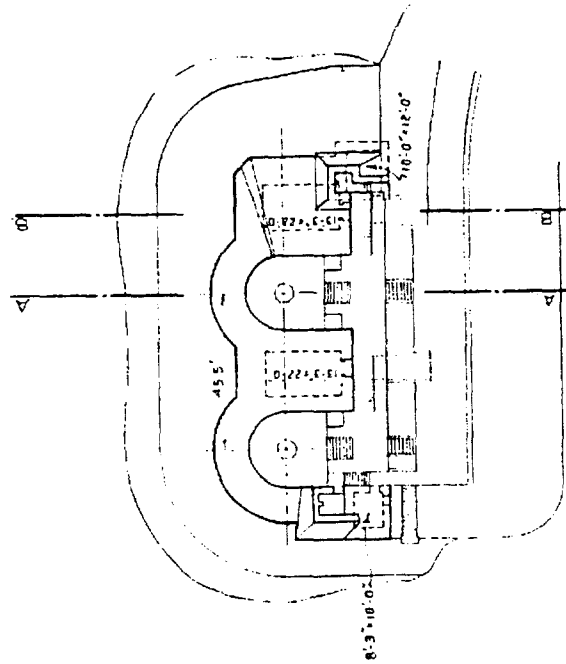
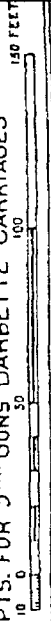

PLAN

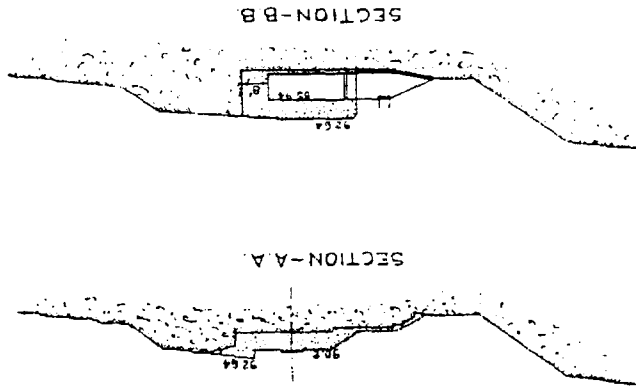

REAR ELEVATION

REPORT OF COMPLETED WORKS - SEACOAST FORTIFICATIONS
(BATTERY PLAN)

CORRECTED TO AUG. 1923.

FORM - 7

COAST DEFENSES OF SAN FRANCISCO, CAL.
FORT WINFIELD SCOTT
BATTERY BALDWIN

NO. OF GUNS 0 : CALIBER 3 IN. : BARBETTE CARRIAGES 2
(BAL. P.L. CONVERTED)

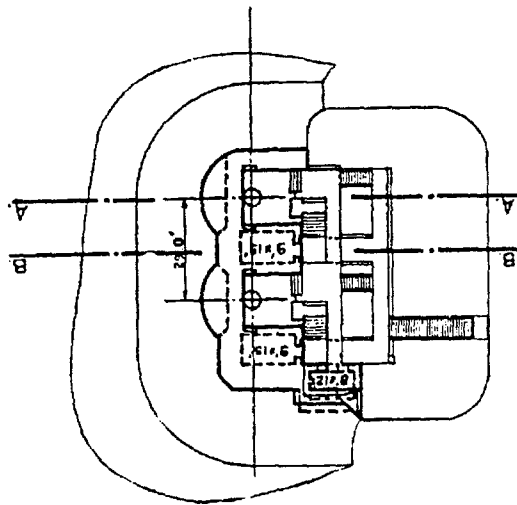

PLAN.



REAR ELEVATION.

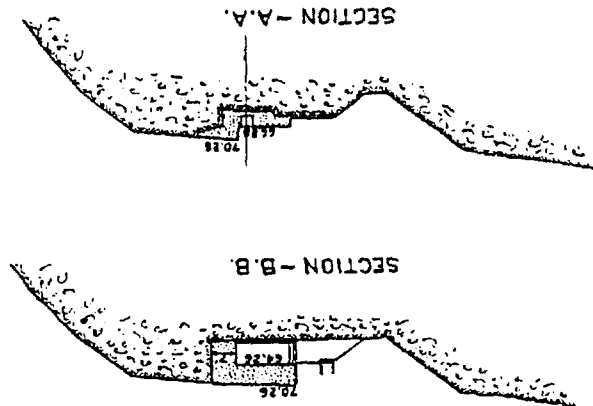

COAST DEFENSES OF SAN FRANCISCO, CAL.
FORT WINFIELD SCOTT
BATTERY BLANEY

REPORT OF COMPLETED WORKS - SEACOAST FORTIFICATIONS
(BATTERY PLAN)

CORRECTED TO AUG. 1923.

NO. OF GUNS 0 : CALIBER --- : NO. OF CARRIAGES 0
EMP'T'S FOR 3" GUNS BARBETTE CARRIAGES (BAL-PIL CONVERTED)

FORM-7

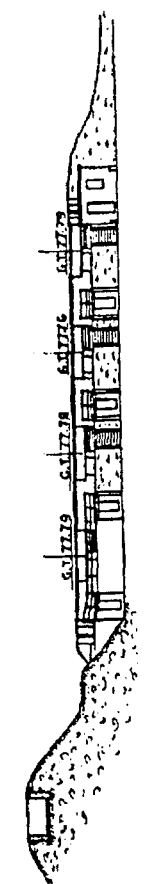
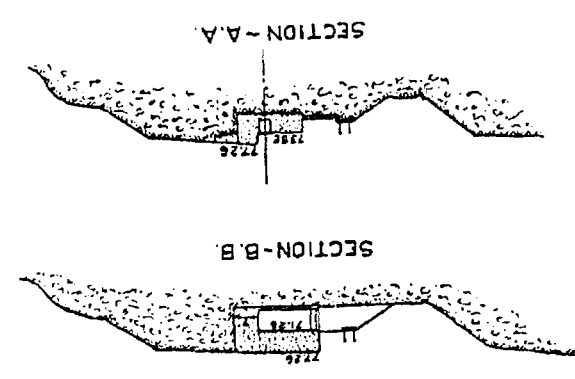
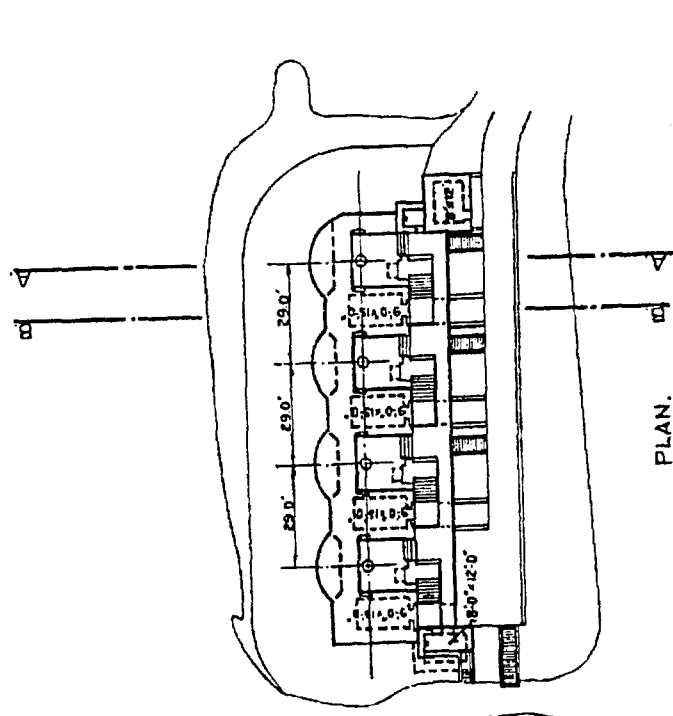

REPORT OF COMPLETED WORKS-SEACOAST FORTIFICATIONS
(Battery Plan)

HARBOR DEFENSES OF SAN FRANCISCO
FORT WINFIELD SCOTT, CALIF.
BATTERY LOWELL CHAMBERLIN
No. of guns 2: Caliber 6^{IN}: Barbette Carriages

Corrected to Dec. 1943.

Part VII

150 FEET
100
50
0

SECTION A-A Empls. Nos. 1 & 4 as originally constructed for Disappearing Mounts.

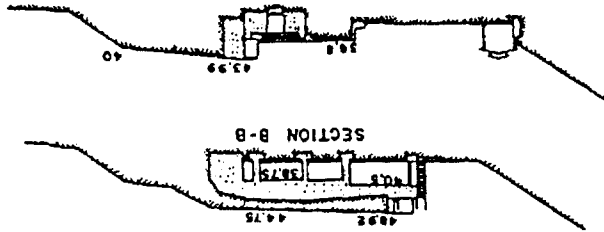

SECTION C-C Empls. Nos. 2 & 3 as altered for Barbette Mounts

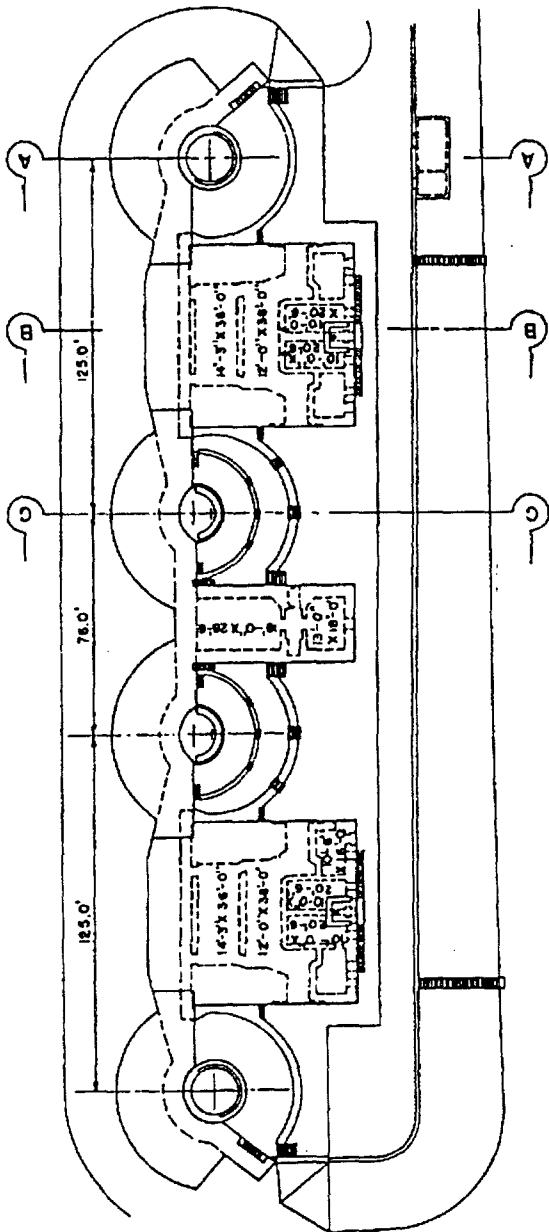

PLAN



REAR ELEVATION

NOTE: See reverse side this form for modifications completed in 1942 & 1943.

U.S. ENGINEER OFFICE 1ST S.F. DIST. 15 ENV. 1-7.

HARBOR DEFENSES OF SAN FRANCISCO
 FORT WINFIELD SCOTT, CALIF.
 ANTI AIRCRAFT BATTERY
 NO. OF GUNS 2 - CALIBER 3" - CARRIAGE 1917
 SCALES AS SHOWN

REPORT OF COMPLETED WORKS - SEACOAST FORTIFICATIONS
 (BATTERY PLAN)

CORRECTED TO AUG. 25, 1938

FORM 7

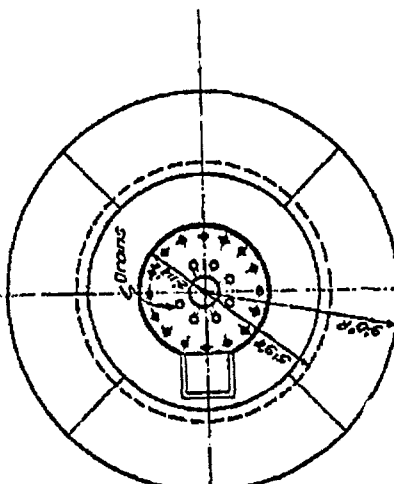

FIRING PLATFORM

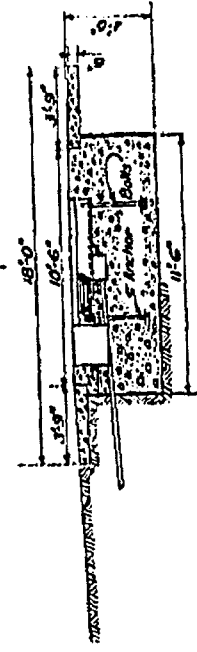

SECTION ON C

Scale - 1/4" = 1'-0"

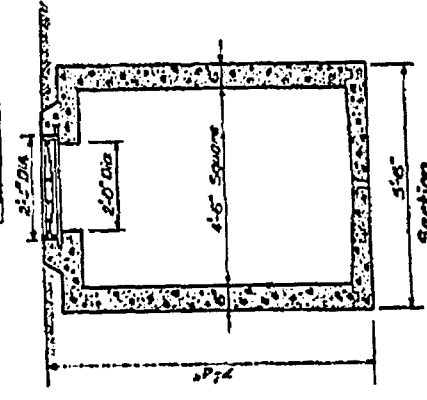

MANHOLE

U.S. Eng. Office San Francisco Cal. 7-1-43

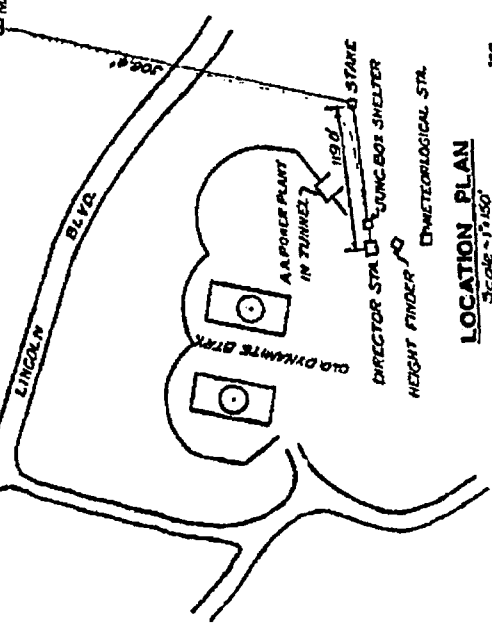
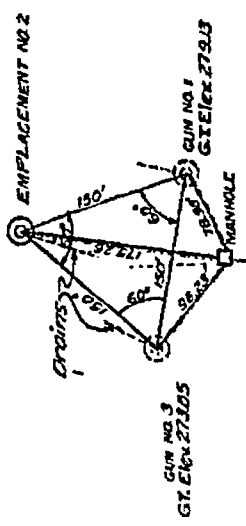

LOCATION PLAN

Scale - 1/4" = 1'-0"

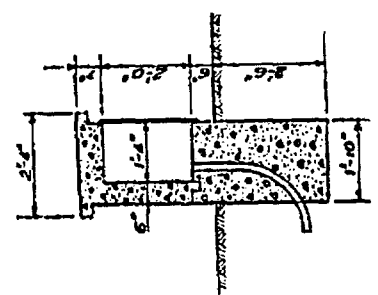

JUNCTION BOX

Scale - 1/4" = 1'-0"

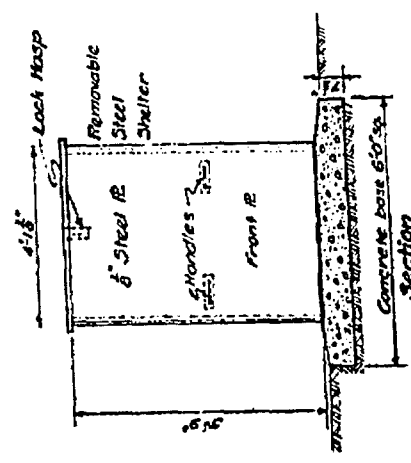

DIRECTOR SHELTER

Scale - 1/4" = 1'-0"

MILAGRA RIDGE

Battery Construction #244, under construction 1943-1944

HARBOR DEFENSES OF SAN FRANCISCO, CALIFORNIA
MILAGRA RIDGE
BATTERY N^o 244
N^o of Guns 2 Caliber-50; 6 in. Carriage - M4

REPORT OF COMPLETED WORKS - SEACOAST FORTIFICATIONS
(Battery Plan)

Part VII Corrected to August 1944

SCALE IN FEET

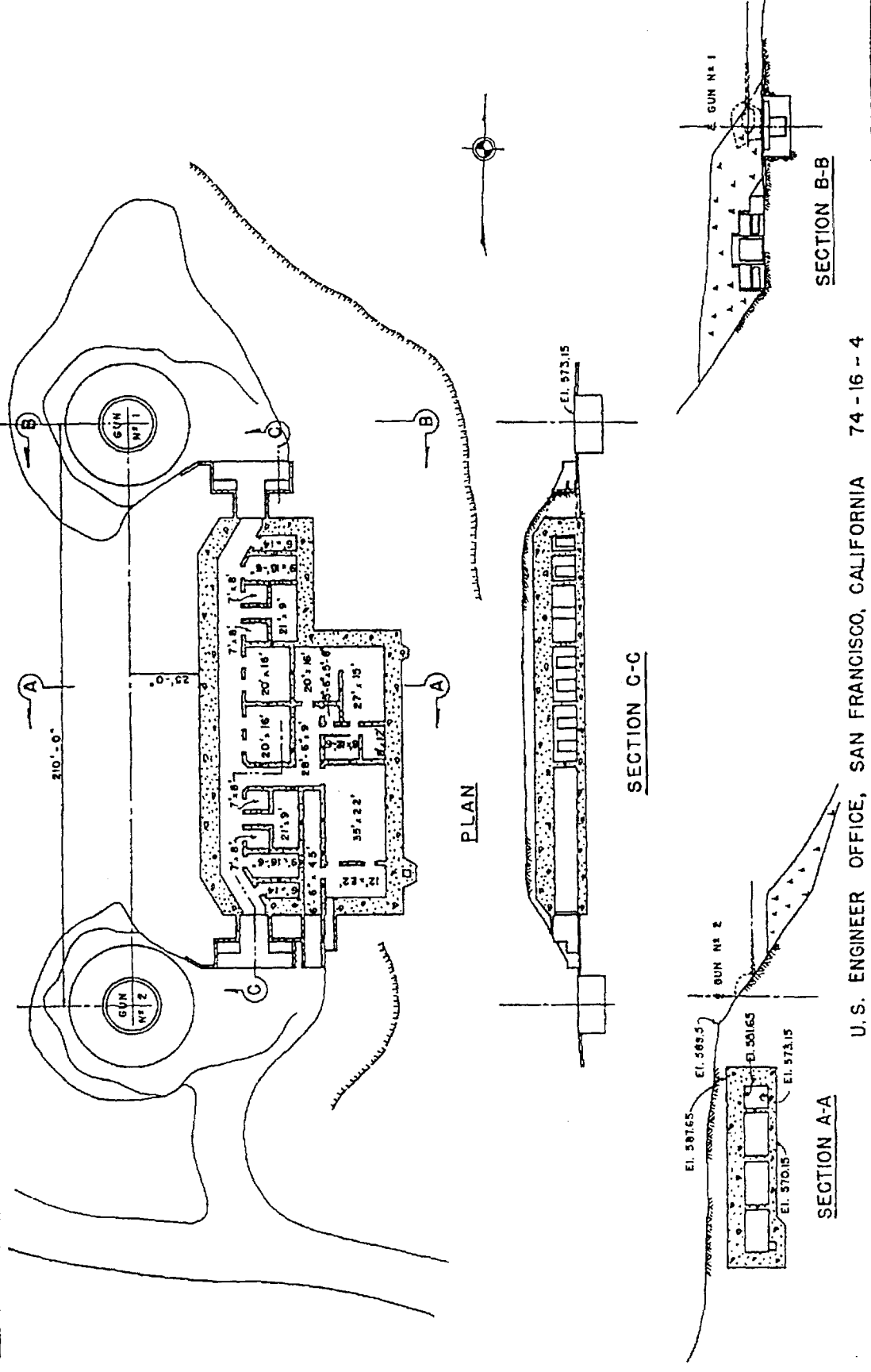

APPENDIX C

COAST DEFENSE RESOURCE CHECKLIST ACTION LOG

Coast Defense Resource Checklist

The Coast Defense Resource Checklist is intended to help structure National Park Service architectural inventories and maintenance efforts, with a range of possible users. For inventories—or surveys—of the batteries and their ancillaries, the checklist is devised to focus on detailed physical description (side one), and on integrity, as defined by the National Register of Historic Places (side two). For maintenance reviews of the installations, the checklist has an alternate application, with side one written to aid in ascertaining the essential character-defining features of the site, and side two written to identify significant deterioration requiring Park Service attention. Users of the checklist will complete the listed items variously, with more detail anticipated from professional architectural and military historians, for example, than would be expected from volunteers. Pre-field and post-field comments will also be widely divergent, dependent on the point of view of the user. All users are advised to take photographs during a field visit, with brief notation of the appropriate film roll and frames, and direction of the camera view (looking north), noted on the checklist. Comments made on the checklist are anticipated to vary from particular professional detailing, to reminders relevant only to the user, to warnings or cautions meant for anyone returning to the site at a subsequent date (poison oak present at this location, for example). Use of the checklist is discussed at greater length in chapter 4, while setting up field files (reflective of events at individual sites) is referenced in chapters 8, 9, and 10. Field files, like the checklist itself, will vary in their composition. At the least, such files will want to include the checklist, photographs, sketch maps, and possibly a xerox of the appropriate Form 7 battery plan, annotated with specific user remarks. Separate site files, of course, will undoubtedly be set up for the process of inventory (survey) and for maintenance.

Action Log

The Action Log is suggested as a device for recording routine maintenance actions at the batteries, as well as for documentation of more unusual, experimental, or encompassing activities undertaken by the National Park Service.

Both forms are for reproduction in multiples as needed.

COAST DEFENSE RESOURCE CHECKLIST

FORT: _____ STRUCTURE: _____ STRUCTURE NO.: _____
 LCS NO.: _____ NAMES: _____ DATES: _____
 PREPARED BY: _____ PURPOSE: _____

- PERIOD: Post-Civil War Endicott-Taft WWII Cold War
- MATERIALS: Concrete Brick/Masonry Iron/Steel Frame Earth
- TYPE: Battery Fire Control Structure Mine Casemate Mine Structure
- Magazine Emplacement Searchlight Shelter Power Plant
- Dependent Structure Other

MISCELLANEOUS: _____
 PRE-FIELD DATA: _____

I. CHARACTER-DEFINING FEATURES	YES	NO	COMMENTS
A. SITE			
1. Earthen Berms/Parados/Parapets	<input type="checkbox"/>	<input type="checkbox"/>	_____
2. Roadways/Walks	<input type="checkbox"/>	<input type="checkbox"/>	_____
3. Stairways/Ramps	<input type="checkbox"/>	<input type="checkbox"/>	_____
4. Retaining Walls	<input type="checkbox"/>	<input type="checkbox"/>	_____
5. Remnants of Historic Vegetation	<input type="checkbox"/>	<input type="checkbox"/>	_____
6. Historic Viewshed	<input type="checkbox"/>	<input type="checkbox"/>	_____
B. MATERIALS			
1. Concrete Surfaces Marked in Flags	<input type="checkbox"/>	<input type="checkbox"/>	_____
2. Concrete Vertical Surfaces Smooth	<input type="checkbox"/>	<input type="checkbox"/>	_____
3. Narrow Mortar Joints in Brickwork	<input type="checkbox"/>	<input type="checkbox"/>	_____
4. Graded Earth Slopes/Earth-Covered	<input type="checkbox"/>	<input type="checkbox"/>	_____
5. Iron or Steel Doors/Shutters/Sash/Ladders	<input type="checkbox"/>	<input type="checkbox"/>	_____
6. Wood Doors/Shutters/Windows	<input type="checkbox"/>	<input type="checkbox"/>	_____
C. STRUCTURE			
1. Additions such as Splinterproofs or Platform Extensions	<input type="checkbox"/>	<input type="checkbox"/>	_____
2. Windows in Rear Walls	<input type="checkbox"/>	<input type="checkbox"/>	_____
3. Technological Features	<input type="checkbox"/>	<input type="checkbox"/>	_____
4. Decorative Details	<input type="checkbox"/>	<input type="checkbox"/>	_____
5. Interior or Finishing Elements	<input type="checkbox"/>	<input type="checkbox"/>	_____
6. Round/Arched Interior Spaces	<input type="checkbox"/>	<input type="checkbox"/>	_____
7. Historic Paint Schemes (In/Out)	<input type="checkbox"/>	<input type="checkbox"/>	_____
8. Camouflage Fixtures, Fittings, or Elements	<input type="checkbox"/>	<input type="checkbox"/>	_____
9. Historic Signage	<input type="checkbox"/>	<input type="checkbox"/>	_____

II. DETERIORATION/CHANGE

YES NO

COMMENTS

A. SITE

1. Gutters Plugged, Surface Drainage Inadequate

2. Soil Eroded

3. Soil Unstable or Sloughing

4. Vegetation Overgrown or Intrusive

5. Native Vegetation Issues

6. Trails Inadequate or Inappropriately Placed

7. Routine Maintenance Inadequate

8. Hazard Issues Present

B. MATERIALS

1. Metal Elements Embedded in Concrete, Rusted or Corroded

2. Rusted or Corroded Reinforcing Steel Forcing Spalls or Cracks in Concrete

3. Reinforcing-Steel Inappropriately Placed, Concrete Inappropriately Mixed/Placed

4. Concrete Surface Deteriorated

5. Concrete Marked by Structural Cracks or by Separation

6. Wood Doors, Windows, Deteriorated

7. Routine Maintenance Inadequate

C. STRUCTURE

1. Drains Plugged, Surface Drainage Inadequate

2. Vegetation Overgrown or Intrusive

3. Interior Spaces Inadequately Vented

4. Handrails Inadequate

5. Graffiti Present

6. Trash and Debris Present

7. Routine Maintenance Inadequate

POST-FIELD COMMENTS/ASSESSMENT:

PHOTOGRAPHIC NOTES

Roll and Frame No.:

Direction of View:

APPENDIX D

SOURCES FOR TREATMENT, MATERIALS, AND TECHNIQUES

Sources for Treatment, Materials, and Techniques

Trade associations, institutes, and councils can provide names of standards, suppliers, technicians, and state-of-the-art research in their particular disciplines. This is not a complete listing of all sources of information. Specifications should be developed to treat conditions of deterioration based on the site-specific analysis of the architects or engineers preparing construction documents. Local suppliers of materials and techniques are known to local trade and material organizations and professional organizations.

General:

Association for Preservation Technology (APT)
(540) 373-1621

Sweet's General Building and Renovation Catalog
Telephone: (800) 892-1165
(800) 814-7703 (Sweet's Buyline)
Web Site: www.sweets.com

Concrete:

American Concrete Institute
Telephone: (248) 848-3800

Concrete Reinforcing Steel Institute
Telephone: (847) 517-1200

International Concrete Repair Institute
Telephone: (703) 450-0116

Portland Cement Association
Telephone: (706) 966-6200

Reinforced Concrete Research Council
Telephone: (217) 333-7384

Masonry:

Brick Institute of America
Telephone: (703) 620-0010

Council for Masonry Research
Telephone: (703) 620-0010

Metals:

American Foundrymens Society, Inc.

Telephone: (800) 537-4237

American Iron and Steel Institute

Telephone: (202) 452-7100

Copper and Brass Fabricators Council

Telephone: (202) 833-8575

Institute of Metal Repair

Telephone: (760) 432-8942

Metal Fabricating Institute

Telephone: (815) 965-4031

Metal Treating Institute

Telephone: (904) 249-0459

National Association of Corrosion Engineers (NACE)

Telephone: (713) 492-0535

National Ornamental and Miscellaneous Metals Association (NOMMA)

Telephone: (404) 363-4009

Moisture Protection:

Sealant, Waterproofing, and Restoration Institute

Telephone: (816) 472-SWRI

Cleaning and Restoration:

Association of Specialists in Cleaning and Restoration

Telephone: (800) 272-7012

Institute of Inspection, Cleaning, and Restoration

Telephone: (360) 693-5675

Testing:

American Society for Nondestructive Testing

Telephone: (614) 274-6003

Protective Coatings:

Federation of Societies for Coatings Technology

Telephone: (215) 940-0777

National Paint and Coatings Association

Telephone: (202) 462-6272

Manufacturers Materials and Techniques: Cut Sheets

The cut sheets provided are for specialized and hard-to-find materials and techniques. They are not intended to list all materials or techniques used in the treatment of the fortifications. The listing herein is not meant to endorse a specific product, or to exclude manufacturers of similar, comparable products, but are offered to set a standard. These materials should be used only after site-specific testing and under professional supervision. Cut sheets include the following:

- Earthwork Stabilization
- Concrete Restoration and Coatings
- Concrete Repair Products
- Concrete Epoxy Injection
- Concrete and Masonry Moisture Proofing
- Concrete Repair Mortars
- Migrating Rust Inhibitors
- Concrete Pigments
- Concrete Coatings
- Concrete Anchorage Devices
- Colored Pigments for Concrete Camouflage Restoration
- Graffiti Removal and Masonry Restoration
- Industrial and Special Paint Coatings



THORO
SYSTEM
PRODUCTS

Technical Bulletin No. 91-J

THOROSHEEN®

A water-based, acrylic coating for concrete, masonry and stucco.

DESCRIPTION

THOROSHEEN® is a water-based, acrylic, film forming coating used on various substrates to provide long term protection from the ingress of wind driven rain, fungus and mildew growth, and degradation caused by acid rain or mild alkalis (bases) when used in an approved system. It forms a tough, durable, smooth film capable of long term adhesion and weathering. It resists staining and dirt accumulation, is aggregate-free and is easily maintained. It adds protection from freeze thaw damage, has excellent resistance to natural sunlight and UV attack, and excellent color retention. It has a high rate of water vapor transmission which permits moisture in the substrate to escape without causing blistering, peeling, or flaking. It dries quickly and without objectionable paint odors. It will perform in cold to hot seasonal temperature cycling without age embrittlement. It is unaffected by the alkalinity of new concrete, plaster, stucco or mortar substrates. In white or other light colors, it provides much more reflectivity than uncoated concrete. THOROSHEEN, when cured, has a flat finish nearly identical to architectural concrete. THOROSHEEN's low gloss disguises and masks planar irregularities and surface imperfections to produce an aesthetically pleasing coated surface. THOROSHEEN has a very low VOC content and very low odor during application.

USES

THOROSHEEN can be applied directly to new or aged concrete, portland cement plaster, stucco, mortar, gunite, shotcrete, tilt-up panels, brick or concrete masonry units, or porous natural stones. It can be used above-grade for interior or exterior surfaces and below-grade, for interior use. It can be applied directly to cured THOROSEAL®, THOROSEAL® PLASTER MIX, THORO® STUCCO, SUPER QUICKSEAL®, and INTERMIX blockfiller base coats (see technical bulletins for details).

THOROSHEEN can be used on fully cured, but chalky, portland cement plaster or stucco which has been cleaned, profiled and primed with PRIMER 1000®. Use THORO PRIMER 1000 on all chalky mineral substrates prior to applying THOROSHEEN. THOROSHEEN can be applied to mineral substrates which have been pretreated with THOROSILOXANE®

8S clear, penetrating water repellent. THOROSHEEN can be used on cleaned and properly prepared, new or aged ThoroWall® exterior insulation and finish systems to change or renew their color, to provide for architectural detailing or accents, or on the inside faces of sealant joints.

Aged THOROSHEEN surfaces can be easily cleaned and recoated to change their color or to restore stained or damaged areas.

A uniform, defect-free, pinhole-free film is required in all applications for best performance. Apply two coats with a minimum 3 to 5 mils total dry film thickness.

TOPCOATS

Cured THOROSHEEN films can be topcoated with low gloss, clear, water-based THOROGLAZE®, or THOROSHIELD® for added protection from staining or abrasion. It can also be topcoated with solvent-based THOROGLAZE® H, a high gloss finish with excellent abrasion resistance and protection from stains and chemical attack. Clear topcoats should be used at street levels to provide extra protection from abrasion and better cleanability of handprints and stains, or in areas of localized dirt buildup and frequent cleaning, such as near kitchen vents.

LIMITATIONS

Do not apply to frozen or frost covered substrates.

Do not apply when temperature (substrate or ambient) is 40°F (4°C) or below or expected to fall below 40°F (4°C) within 24 hours after application.

Do not apply if rain is expected within 24 hours.

Do not apply to horizontal, traffic bearing surfaces.

SURFACE PREPARATION

Remove all dust, dirt, form oils, form release agent residues, curing compounds, efflorescence, biological residues, chemical contaminants, laitance or any other loose, poorly bonded, existing acrylic paint films. A combination of cleaning methods may be used. Pressure water blasting (1,500 or more psi), with or without abrasives in the water stream, can be used. A properly prepared concrete surface will have the appearance and texture of 60-80 grit sandpaper.

Allow substrates to dry out after water cleaning. Surface moisture should not be present when tested per ASTM D4263-83. Some stains and surface contaminants may require chemical removal.

If chemical cleaners are used, be sure to neutralize the compounds and fully rinse the surface with clean water.

THOROSHEEN, when applied to a properly prepared and cleaned substrates, should have a minimum tensile bond strength of 100 psi when measured by ASTM D4241, Pull Off Strength of Coatings Using the Portable Adhesion Testers. An alternative method for measuring adhesion is ASTM D3359, Measuring Adhesion by the Tape Test.

On the 0 to 5 scale, a minimum adhesion rating of 4 is required.

THOROSHEEN is not a crack filling or crack bridging coating. For substrates with cracks refer to the THOROLASTIC Technical Bulletin.

Precast or Cast-in-Place Concrete

Remove all form tie wires and patch holes, small voids and spalls using THORITE®, THORITE® 200, THORITE® 300, or THORITE® 400, all modified with ACRYL 60 diluted with water. Use THORITE 300 or THORITE 400 in a color that best matches the existing concrete to reduce or eliminate the ghost images of the darker patching materials. Allow patches to cure and air dry. New concrete should be cured 28 days prior to coating. Clean and prepare the surface as indicated above. All water ingress into concrete elements should be eliminated before application begins. Check and repair copings, roof flashings, roof leaks or other defects. Refer to proper ASTM references for surface preparation.

Concrete Masonry Units

All new CMU should be laid true and cured to full load bearing capacity. Remove all mortar splatter and excess mortar before coating. After cleaning the surface, repair all broken units with THORITE or THORITE 200 modified with ACRYL 60 diluted with water. Remove all loose, friable mortar from the joints and replace with DRYJOINT® or DJ GROUT® modified with ACRYL 60. Apply SUPER QUICKSEAL or SUPER QUICKSEAL INTERMIX as a blockfiller and allow to cure. Use two coats of THOROSEAL, modified with ACRYL 60 diluted with water, for waterproofing to wind driven rain or for resistance to hydrostatic pressures when using THOROSHEEN on below-grade, interior concrete masonry walls. Refer to ASTM D4261, Practice for Surface Cleaning of Concrete Masonry Units for Coating.

Plaster and Stucco

Remove all disbonded or delaminated plaster or stucco and patch with THOROSEAL PLASTER MIX or THORO STUCCO, both modified with ACRYL 60. Allow to cure and air dry a minimum of 7 days at 70°F (21°C), 50% RH.

Gunite/Shotcrete

New gunite and shotcrete must be fully cured and free of all rebound or poorly bonded aggregates.

Existing Acrylic Coatings

Existing acrylic paint films should be completely cleaned and have all blisters or delaminated areas removed. If, after cleaning the film, it is still chalky, complete removal of the chalk is required. A paint film is considered to be chalky if a black cloth which has been rubbed on the cleaned film has a visible residue on it of greater than a no.8 rating as defined in ASTM D4214, Test Method A. The edges of the existing film should be hand sanded or power tool finished to featheredge the spot. Remove all dust and paint film residues with clean water and allow film to dry.

ThoroWall Exterior Insulation and Finish System

Clean the existing ThoroWall Acrylic Finish to remove all dust, dirt, grease, oils, or any residues which could prevent good adhesion. Refasten or readhere any loose or delaminated expanded polystyrene (EPS) insulation per approved methods. Replace or patch any missing or damaged EPS to restore the lamina and the finish, to be true in plane and matching in texture. Allow all patched areas to fully cure. For additional technical information refer to the ThoroWall technical guides for repair and recoating.

MIXING

THOROSHEEN is packaged ready to use. Stir well in its container. Boxing is recommended to assure color uniformity. If thinning is required for spray application, add up to 12 liquid ounces (0.45 ℓ) of clean, drinkable water per 5 gallon (18.9 ℓ) pail. Over thinning will affect color uniformity.

APPLICATION

Apply by brush, roller or spray. Always work to a wet edge with a 50% overlap. Pretape all fixtures, glass or other items not intended for coating. Protect all foilage from overspray.

Before applying, dampen brushes or rollers with water. Use equipment designed for water-based coatings. Apply at 4 to 5 mils wet film thickness (WFT) per coat.

Cure Time

At 70°F (21°C), 50% RH. To touch, 1 to 2 hours. To recoat, 2 to 4 hours. To topcoat, 2 to 4 hours. Full cure, 5 days. Lower surface or air temperatures and higher relative humidity can extend dry time.

CLEANUP

Clean spray equipment with warm, soapy water then flush with high quality paint thinner to prevent rusting and corrosion. To remove cured THOROSHEEN films use a soft cloth dampened with Xylene, MEK, acetone or use mechanical cleaning methods.

COVERAGE

150 to 200 ft²/gal. (3.7 to 4.9 m²/ ℓ) depending on surface roughness and porosity.

TECHNICAL DATA

For STRUCTURITE® modified with ACRYL 60® diluted with water in a 1:1 ratio. All values are averages for laboratory mixed material tested under controlled conditions. Field results may vary due to transport or storage conditions or site mixing variables.

Physical or Performance Property	Test Method	Result (Averages)
Compressive Strength (using 2" cube specimens)	ASTM C109	1 day = 4620 psi (32.3 N/mm ²) 5 days = 5980 psi (41.5 N/mm ²) 14 days = 7070 psi (49.5 N/mm ²)
Flexural Strength	Technical Research Center of Finland (VTT)	1 day = 5150 psi (36.0 N/mm ²) 7 days = 6240 psi (43.7 N/mm ²)
	ASTM C348-80	3 days = 5920 psi (41.4 N/mm ²) 7 days = 6720 psi (47.0 N/mm ²) 28 days = 7880 psi (55.2 N/mm ²)
Tensile Strength	Technical Research Center of Finland (VTT)	1 day = 885 psi (6.2 N/mm ²) 5 days = 950 psi (6.6 N/mm ²) 14 days = 1530 psi (10.7 N/mm ²)
	ASTM C190-77	3 days = 860 psi (6.0 N/mm ²) 7 days = 1045 psi (7.3 N/mm ²) 28 days = 1440 psi (10.1 N/mm ²)
Drying Shrinkage (Linear)	ASTM C596-89	7 days = 0.07% 21 days = 0.12%
	Technical Research Center of Finland(VTT)	14 days = 0.11% 28 days = 0.13% 56 days = 0.80%
Water Vapor Transmission	ASTM E96	0.15 grains/hr/sq ft, 0.42 Perms
Coefficient of Thermal Expansion	Bureau Veritas (France)	Permeability = 0.0436 g/m ² .h.mm.Hg
Modulus of Elasticity	ASTM C531-85	28 days = 1.125 x 10 ⁶ in/in °F (2.03 x 10 ⁶ m/m °K)
Slant Shear Bond	ASTM C469	2.7 x 10 ⁶ psi (1.86 x 10 ⁴ N/mm ²)
Tensile Bond	ASTM C1042-85 (Modified)	2770 psi (19.4 N/mm ²) No bond shear
Freeze/Thaw Resistance	Lab Value	28 days = 300 psi
Surface Burning Characteristics	ASTM C666 Procedure A	300 cycles, < 0.006% loss
	ASTM C672	Pending
Water Absorption	ASTM E84	Fuel = pending, Flame spread = pending, Smoke propagation = pending
	British Standard 476	Noncombustible at 746°C
Potable Water	Part 4:1970	Flame spread = class 1 = 0
Salt Scaling Resistance to Deicing Chemicals	Part 7:1971	Fire propagation = pending
Water/Cement ratio (w/c)	Part 6:1981	After 24 hours and boiling immersion = 6.2%
Polymer/Cement ratio (p/c)	ASTM C642	Approved for cold water service conditions
Total Liquid Demand	BS920:1988	50 cycles, no scaling
Initial Set	ASTM C672 Section 5.1	0.325
Final Set	Lab Value	0.048 to 0.054
Density	Lab Value	11.0 to 12.5% at 3 qt/50 lb bag (2.71 #/22.7 kg bag) and 3.5 qts per 60 lb pail (3.3 #/27 kg pail)
Chloride Content	ASTM C807-83 (modified)	10 to 15 minutes at 70°F (21°C), 50% RH
	ASTM C114	45 minutes at 70°F (21°C), 50% RH
Sulphate (SO ₄) Content	ASTM C807-83 (modified)	Wet = 2.075 to 2.150 g/cm ³ (130 lbs/ft ³)
Electrical Resistivity	Lab Value	Cured = 2.000 to 2.075 g/cm ³ (125 lbs/ft ³)
Yield	Lab Value	< 0.01% (trace amount)
Pullout Strength	ASTM C114	1.20% (theoretical)
	ASTM C114	1 day = 3150 ohm-cm, 28 day = 119,650 ohm-cm
Pullout Strength	Lab Value	50 lb (22.7 kg) bag = 0.44 ft ³ (0.012 m ³) 60 lb (27 kg) pail = 0.53 ft ³ (0.015 m ³)
	ASTM C900-87	Threaded #4 Rebar, standard grade 60 1/2" (12.7 mm) diameter = 3650 psi (25.5 N/mm ²) Smooth #4 Rebar, standard grade 60 1/2" (12.7 mm) diameter = 1496 psi (10.5 N/mm ²) Smooth, unprimed bar = 48.2 N/cm ²
	Bureau Veritas (France)	

FIGURE 1 - Expose rebar 1" beyond corrosion.

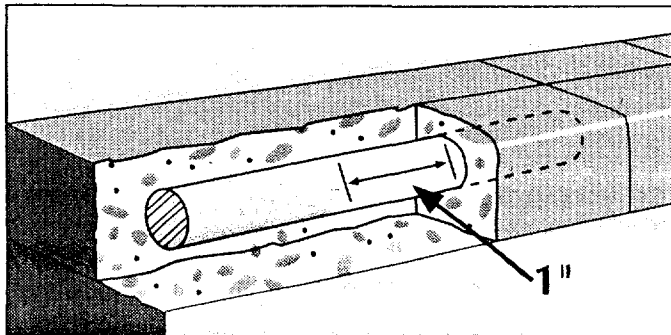

FIGURE 2 - Shape of repair on vertical as seen from front elevation.

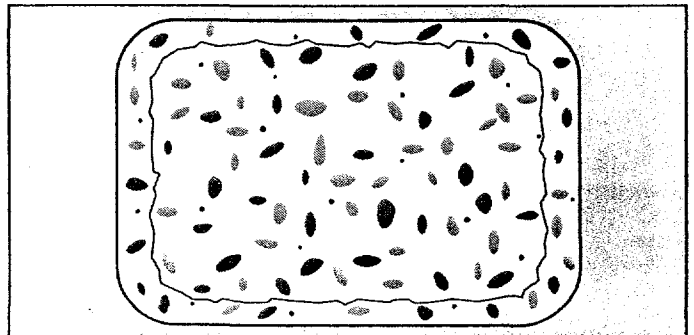

FIGURE 3 - Cross Section.

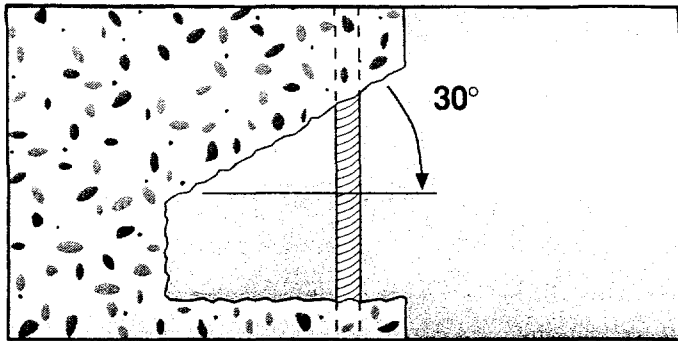
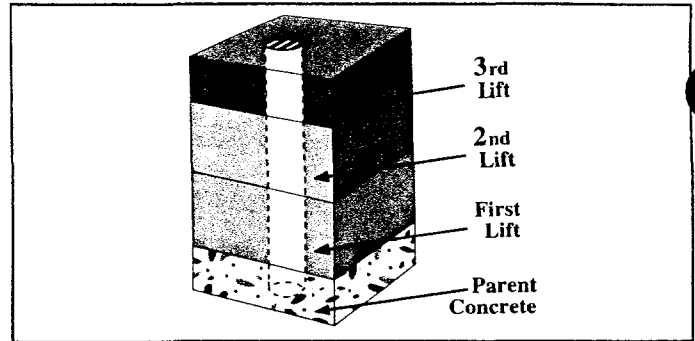

FIGURE 4 - Up to 7 bags can be placed at one time.



STORAGE

Transport and store STRUCTURITE® in original containers and keep in a dry condition. All bags should be stored in a dry place with low 50% relative humidity. Do not stack bags more than two pallets high to avoid compression set of the powder. STRUCTURITE® pails should be protected from impact damage. Use recyclable, metal pails when dry transport or site storage is unavailable or extended shelf life is required. Do not allow ACRYL 60® to freeze.

SHELF LIFE

In polyethylene-lined bags properly transported and stored, up to 6 months from date of manufacture. Up to one year in unopened, undamaged pails.

SILICOSIS STATEMENT

DANGER! Contains: cement and crystalline silica. Dust may irritate nose, throat, and respiratory tract. Causes eye burns. Repeated/prolonged contact may cause skin burns and allergic skin reaction. May cause delayed lung injury (silicosis). IARC reports there is limited evidence that crystalline silica may cause cancer in humans. Do not get in eyes. Wear chemical tight goggles. Avoid direct contact with skin. Avoid breathing dust. Use with adequate ventilation. Wash thoroughly after handling. Keep container closed.

SAFETY, HEALTH AND ENVIRONMENTAL RECOMMENDATIONS

Appropriate eye protection meeting the most current ANSI 287 standard should be worn. For help during transportation emergencies, call CHEMTREC at 1-800-424-9300 day or night. For specific health and safety information consult a STRUCTURITE® Materials Safety Data Sheet available from Thoro System Products.

KEEP OUT OF REACH OF CHILDREN.

COMMITMENT TO QUALITY

Thoro System Products is dedicated to providing quality, value-added products and services which consistently satisfy our customer's needs. As a group and as individuals, we are striving to improve the quality of our activities, and to do them correctly the first time. We welcome input from our customers and suppliers.

WARRANTY

Thoro System Products warrants that this product conforms to its applicable current specifications. Otherwise, Thoro System Products makes NO OTHER WARRANTIES EXPRESS OR IMPLIED WITH RESPECT TO THE PRODUCT COVERED BY THIS WARRANTY AND SPECIFICALLY DISCLAIMS THE WARRANTIES OF MERCHANTABILITY AND FITNESS FOR PARTICULAR PURPOSE. Thoro System Products also disclaims responsibility for claims for incidental or consequential damages, including lost profits, arising from a breach of this warranty.

In certain jurisdictions or countries, products of Thoro System Products may be eligible for extended warranties. Contact Thoro System Products for eligibility details. Approval prior to application is required.

TECHNICAL SERVICES

Thoro sales and technical staff are available worldwide to assist in job-site evaluations, equipment recommendations, specification writing, contractor training, job follow-ups and warranty issuance. Contact any office of Thoro System Products for additional information or assistance.

Eastern: Bristol, PA 800/227-8410
Central: Brooklyn Park, MN 800/443-5090
Western: Freemont, CA 800/445-6182



7800 N.W. 38th STREET • MIAMI, FL 33166-6599
 CENTERVILLE, IN • BRISTOL, PA • NEWARK, CA • MOL, BELGIUM • REDDITCH, U.K.

STRUCTURITE, ACRYL 60, PRIMER 900, THOROSEAL, THOROCCOAT, THOROSHEEN, THOROLASTIC, THOROGLAZE, and THOROSHIELD are registered trademarks.
 ©1992, Thoro System Products. All Rights Reserved.
 Made in U.S.A. / Printed U.S.A. 600450592-Rev0592
 Editor: J. Miller, Technical Marketing, Thoro System Products, 05/92.

A two-component, portland cement-based, polymer-modified structural concrete repair mortar.

DESCRIPTION

STRUCTURITE® is a portland cement-based, powder formulation, structural repair mortar designed to be mixed with ACRYL 60® diluted in a 1:1 ratio with clean, drinkable water. It is a precise formulation and is intended to be used without adding any other additives or aggregates. Its coefficient of thermal expansion and the modulus of elasticity of the cured mortar are virtually identical to standard density concrete. It responds to thermal changes and loads at the same rate as normal concrete assuring its long term durability and performance.

USES

STRUCTURITE® is recommended for use as a structural repair mortar for steel-reinforced concrete and for unreinforced, load bearing structural concrete elements. It can be used on interior or exterior surfaces either above or below grade. It can be used on submerged elements or on elements subjected to hydrostatic pressure or for immersion service. It is a fast-setting, low-slump mortar which can be used with formwork in single placement volumes up to 7 bags per placement for vertical and overhead repairs. When placed in volume in simple formwork, its in-place cost is usually lower than trowel-applied, fast-setting patching mortars. Overhead and vertical placements without formwork are limited to 3/4" (19 mm) per lift.

SURFACE PREPARATION

Remove all damaged, delaminated or unsound concrete. All rusted, actively corroding steel reinforcement should be fully exposed. See figure 1. Clean the full circumference (360°) of all rusted rebar to a Steel Structures Painting Council SSPC-SP10 Near White Metal Specification by abrasive blasting, needle guns or other approved methods. Immediately coat rebar with PRIMER 900®, before rust back, and allow it to cure. Saw cut the perimeter of the repair to a depth of 1/4" to 1/2" (6.4 to 12.7 mm) at a 90° or undercut angle. Avoid cutting or damage to rebars. Roughen the saw cut surfaces before placing mortar for best bonding. Use only hand-held, pointed tools for removing the unsound concrete. Avoid chisel-edged tools. Chisel-edged tools can fracture the aggregates and induce microcracking of the parent concrete. Hydroblasting or hydrodemolition is also acceptable. In seismically active areas the anchor profile should be a

minimum of 1/4" (6.4 mm). For best results remove concrete in a square or rectangular shape of uniform depth with rounded inside corners. See figure 2. Avoid feathered edges. The upper lip of the patch should be slanted at 30° especially when formwork is to be used to avoid creating air voids. See figure 3.

MIXING

Dilute the ACRYL 60® in a 1:1 ratio with clean, potable water. Use this mixing solution to mix STRUCTURITE®, adding the powder to the liquid when mixing mechanically. Mix a 50 pound (22.7 kg) bag of STRUCTURITE® with up to 3 quarts (2.7 liters) of total mixing solution. A 60 pound (27 kg) pail of STRUCTURITE® requires 3.5 quarts (3.3 liters) of mixing solution. Total liquid demand is dependent on the temperatures of the powder, and the mixing liquid. All components should be kept at or below 70°F (21°C). Do not exceed 3 quarts (2.7 liters) of mixing solution per 50 pound (22.7 kg) bag. **DO NOT OVERMIX.** Use slow speed mixers and avoid entrapping air in the mix. Overmixed mortar can have lower density, strengths and will not perform as expected. Do not mix more material than can be placed in 10 minutes at 68°F (20°C). Do not retemper. For overhead placements by trowel, use the least amount of mixing solution needed to provide a cohesive yet relatively dry mortar consistency. In cool temperatures warm the ingredients to maintain set times.

APPLICATION

Bond Coat

Prewet the concrete substrate to reduce wicking the liquid out of the wet STRUCTURITE® mortar. Apply a bond coat by vigorously brushing the mortar into the substrate profile. Immediately apply the STRUCTURITE®. Do not allow the bond coat to dry. If bond coat dries out before mortar placement, brush off dried material and reapply a fresh brush coat.

Placement in Forms

Simple wood or metal forms may be used for vertical and overhead placements. Forms should be erected and secured after all surface preparation has been completed. Prior to mortar placement soak the substrate with water to ensure a saturated surface dry condition. Filling the formwork with water-soaked burlap can be a cost-effective method to ensure full saturation. Remove all burlap and free water from concrete before placing mortar. Place STRUCTURITE®

into the form and compact by rod to ensure full consolidation. Small vibrators can be used on the forms or the steel reinforcement. Do not over vibrate. All forms and substrates must be free of liquid water prior to placing the STRUCTURITE®. Up to 7 bags of fresh mortar can be placed at one time. See figure 4. Allow for final set of material between placements. The relatively fast set times of STRUCTURITE® assures a fast cycle time for the formwork.

Trowel Application

Apply mortar by trowel using firm pressure to fully compact the material especially around reinforcing bars. STRUCTURITE® placed on a vertical surface can be applied up to 3/4" (19.0 mm) before its own weight causes it to slump. It can be built up in successive layers as it achieves its initial set. Up to 7 bags of material can be placed in one volume. When applying in layers, score each layer to increase the mechanical bond between layers. STRUCTURITE® patches should be overbuilt, wait for initial set and shave back with a clean trowel to the desired plane.

Overhead placements by trowel are limited to 3/4" (19.0 mm) per lift.

SET TIMES

Set times will vary depending on temperature. Initial set in 10 to 15 minutes at 70°F (21°C) and 50% relative humidity. At lower temperatures set times can be much slower. At temperatures over 80°F (26°C) use STRUCTURITE® 200.

CURING

As a minimum, fog spray the fresh mortar with water until final set. Under hot and windy conditions place wet burlap on the fresh mortar and keep it soaked with water for up to 24 hours. Evaporation from the burlap can be reduced by covering the burlap with 6 mil polyethylene. In cool conditions, cover fresh mortar with an insulating blanket. Do not allow the fresh mortar to freeze until it is fully cured. If heat is used, only vented heaters are permitted. Do not use salamanders or other open flame type heaters to heat the enclosures. Unburned hydrocarbon residue can condense on the cooler concrete substrates and act as a bond breaker. Exhaust gases can also cause carbonation of the upper layer of the fresh mortar reducing its strength. Curing compounds are not recommended. Allow fresh mortar to air dry for at least 2 to 3 days before topcoating or applying clear water repellents.

Coating Compatibilities

Cured STRUCTURITE® repairs can be coated with THOROSEAL® or THOROSEAL® PLASTER MIX, both modified with ACRYL 60® diluted with water, after mortar has air dried for at least 2 to 3 days. These coatings provide waterproofing protection to the parent concrete. They also provide an additional protective barrier to the deleterious effects of the ingress of carbon dioxide (CO₂) on steel reinforced concrete

elements. Refer to Technical Bulletins #16 and #71, respectively. Cured STRUCTURITE® repairs can be coated with direct applications of THOROCOAT®, THOROSHEEN® or THOROLASTIC® (exterior only) or clear THOROGLAZE®, THOROGLAZE® H, or THOROSHIELD® when added protection from stains, acid rain or mild bases is required. Refer to Technical Bulletins #3, #91, #62, #26, #27, and #28 respectively.

Textures

When topcoating cured mortar, special care is required to achieve a suitable surface texture. Improperly textured repairs will be clearly visible when viewed at certain low angles, especially when direct applications of water-based acrylic emulsions are used. A jobsite sample should be prepared by the applicator and retained throughout the repair project to use as a standard until final acceptance.

LIMITATIONS

Do not use on horizontal, traffic-bearing surfaces such as bridge decks or roadways.

Protect fresh mortar from freezing until it is fully cured.

Do not overwater.

Do not overmix.

Do not add aggregate, sand or any other additives.

Do not retemper.

YIELD

50 lb. (22.7 kg) polyethylene lined bag = 0.44 cu. ft (0.012 m³) of cured mortar.

60 lb. (27 kg) metal pail = 0.53 cu. ft. (0.015 m³) of cured mortar.

COLORS

STRUCTURITE® cures to a light gray concrete color.

SERVICE CONDITIONS

For immersion service.

For exposures above or below grade, interior or exterior.

Service Temperatures

Dry, -50°F (-45°C) to 200°F (93°C).

Wet, up to 180°F (82°C).

APPROVALS

British Board of Agrément, Certificate No. 89/2353.

Approved by the United Kingdom Water Bylaws Scheme - Potable Water Report No. SO 4207/10.

Conforms to DOT BO 27/86 Clause 6.1.

PACKAGING

50 lb. (22.7 kg) polyethylene lined bags.

60 lb. (27 kg) rubber-gasketed, metal pails.

	Units Per Pallet		
Units/Plants	Bristol	Centerville	Newark
Bags	50	50	48
Pails	36	39	39



**THORO
SYSTEM
PRODUCTS**

Technical Bulletin No.13-J

THOROCRETE®

A one-component, cement-based patching mortar for horizontal concrete and masonry.

DESCRIPTION

THOROCRETE® is a one-component, dry polymer-modified, cement-based patching mortar that cures to a light gray concrete color. THOROCRETE® is ready-to-use, when mixed with clean water. Bonding to clean, properly prepared, structurally sound concrete is excellent. THOROCRETE® is self-curing under normal conditions of 70°F (21°C), 50% RH and fast-setting. It does not contain gypsum and it will not soften or delaminate even when submerged or constantly wet.

USES

THOROCRETE® is used for patching interior or exterior concrete floors, residential driveways, sidewalks, steps, and patios. It can also be used to repair spalled horizontal concrete, to level low spots in concrete slabs, and to patch concrete curbs and decks. It can withstand foot traffic and light pneumatic rubber wheeled vehicular traffic operating at low speeds. THOROCRETE® is also suitable for use as a setting bed mortar for patio blocks, flagstones, quarry tile, or slate exposed to exterior conditions.

LIMITATIONS

Do not apply to frozen or frost-covered substrates or when surface and air temperatures are below 40°F (4°C) or expected to fall below 40°F (4°C) within 24 hours after application.

Do not add any chemical accelerators, retarders, or air entraining agents.

Do not use as an overlay or to completely resurface large slabs.

Do not extend with pea gravel, sand or metal aggregates.

SURFACE PREPARATION

If possible sawcut the perimeter of the area to be patched to a depth of 1/8" or 1/4" (3 to 6 mm) for best results. Chip out area to be patched leaving large aggregates exposed and protruding. Chip out all loose materials and disintegrated concrete. Use hand-held tools with pointed, not chisel edges. Remove all oils, grease, dust, dirt, salt deposits, paint, laitance or efflorescence. Flush area with plenty of clean water. All new concrete should be fully cured for at least 28 days.

MIXING

Power mixing is recommended. Add 2.5 qts. (2.35 ℓ) of water to the mixing vessel, then slowly add the powder. Mix at low speed until all the powder is fully wetted out and no dry lumps remain. Add up to 0.5 qts. (0.47 ℓ) more water as needed to achieve a stiff workable

mortar. Use the least amount of water possible. Mix only the quantity of mortar which can be placed in 30 minutes at 70°F (21°C), 50% RH. In high temperatures, set time will be faster. In cooler temperatures, set time will be slower. To maintain set times in cool temperatures, use warm water. In hot temperatures, use cool water.

APPLICATION

Dampen surface with clean water. Wait for puddles to evaporate. Apply a bond coat of neat THOROCRETE® using a stiff tampico fiber brush and work it into the area to be patched. Never dilute the bond coat. Apply up to 1/4" (6 mm) THOROCRETE® by trowel while bond coat is still wet. Force material into area to be patched and finish as desired, but do not over trowel. Keep trowel clean and wash tools immediately after use. Patched areas can be open to foot traffic after 12 hours, and for rubber wheeled traffic in 48 hours at 70°F (21°C), 50% RH.

THOROCRETE® can be built-up in successive layers for deeper patches. Apply first layer, scratch surface with trowel, allow to harden, then place next lift. Do not apply THOROCRETE® in excess of 1/2" (12 mm) total thickness. Place up to 1 bag per patch. For larger placement volumes refer to THOROPATCH® or ROADPATCH® II technical bulletins. THOROCRETE® is self-curing, but in high temperatures above 80°F (27°C), or in windy conditions water misting or wet burlap curing may be needed. Maintain all expansion, control, or construction joints. Do not fill in joints. THOROCRETE® will not bridge dynamic cracks.

When used to patch floors, do not apply floor coverings, paint films, or coatings until the mortar has fully cured for 28 days at 70°F (21°C) 50% RH.

TOPCOATING

Cured patches can be topcoated with THOROSILOXANE® 8S solvent-based, penetrating water repellent; or with THOROGLAZE® or THOROSHIELD®, clear water-based, film forming coatings. For maximum protection from abrasion, staining, and wear use clear, solvent-based, THOROGLAZE® H. Cured THOROCRETE® patches can also be topcoated with THOROCOAT® F-74.

YIELD

40 lbs. (18 kg) will patch 10 sq. ft. (1.0 m²) at 1/2" (12.0 mm) depth.

SERVICE CONDITIONS

Above-, below-, or on-grade, interior or exterior. Can be used for immersion service.

PACKAGING

40 lb. (18 kg) sacks.

TRANSPORT AND STORAGE

Transport and store in original, unopened, undamaged containers protected from moisture and dampness. Keep THOROCRETE³ away from acids and other oxidizers. Store in cool, dry area off-ground.

COLOR

Cures to a light gray concrete color.

MAINTENANCE

Occasional cleaning with detergent and warm water will usually restore the cured patch to its original appearance.

TECHNICAL SERVICES

Thoro sales and technical staff are available worldwide to assist in job-site evaluations, equipment recommendations, specification writing, contractor training, job follow-ups and warranty issuance. Contact the Customer Service Department of Thoro System Products at 1-800-327-1570, for any information or assistance required.

Thoro Headquarters:

World Headquarters 7800 N.W. 38th Street Miami, FL 33166 Phone: (305) 597-8100 Customer Service: (800) 327-1570 FAX: (305) 592-9760	European Headquarters Thoro N.V. Berkenbossenlaan 6 B-2400 Mol, Belgium Phone: 14-81-12-71
--	--

SAFETY, HEALTH AND ENVIRONMENTAL RECOMMENDATIONS

Use appropriate personal protective equipment including eyewear, meeting the most current ANSI Z 87.1

TECHNICAL DATA

For THOROCRETE[®] mixed with water at 3 quarts (2.8 l) per 40 lb. (18 kg) bag.

Physical or Performance Property	Test Method	Results
Compressive Strength	ASTM C109-64	7 day = 3260 psi 28 day = 4030 psi
Flexural Strength	ASTM C348-61T	7 day = 600 psi 28 day = 800 psi
Tensile Strength	ASTM C190-63	7 day = 300 psi 28 day = 420 psi
Adhesion in Shear	Lab Value	7 day = 250 psi 28 day = 300 psi

standard. WARNING: This product contains a chemical suspected by the state of California to cause cancer. For specific health, safety, and environmental information consult the label and Material Safety Data Sheet available from Thoro System Products.

COMMITMENT TO QUALITY

Thoro System Products is dedicated to providing quality, value-added products and services which consistently satisfy our customer's needs. As a group and as individuals, we are striving to improve the quality of our activities and to do them correctly the first time. We welcome input from our customers and suppliers.

WARRANTY

Thoro System Products warrants that this product conforms to its applicable current specifications. OTHERWISE, THORO SYSTEM PRODUCTS MAKES NO OTHER WARRANTIES EXPRESSED OR IMPLIED WITH RESPECT TO THE PRODUCTS COVERED BY THIS WARRANTY AND SPECIFICALLY DISCLAIMS THE WARRANTIES OF MERCHANTABILITY AND FITNESS FOR A PARTICULAR PURPOSE. Thoro System Products also disclaims responsibility for claims for incidental or consequential damages, including lost profits, arising from a breach of this warranty. In certain jurisdictions or countries, products of Thoro System Products may be eligible for extended warranties. Contact Thoro System Products for eligibility details. Approval prior to material application is required.



7800 N.W. 38th STREET • MIAMI, FL 33166-6599
CENTERVILLE, IN • BRISTOL, PA • NEWARK, CA • MOL, BELGIUM • REDDITCH, U.K.

THOROCRETE, THOROSILOXANE, THOROGLAZE, THOROcoat,
THOROPATCH, ROADPATCH, and THOROSHIELD are registered trademarks.
©1993, Thoro System Products. All Rights Reserved.
Made in U.S.A./Printed in U.S.A. 600080587-Rev0793

Tieback Anchor Selection

For retaining projects, Chance screw anchors can be matched to soil and heavy tension loads in the same way Chance HELICAL PIER® Foundation Systems anchors are for compression applications.

Typical applications include building-site preparation, roadways, retaining walls, levees, dams and revetments.

The usual number of helices on the anchor shaft is four or less. These are welded to a round-cornered square-steel shaft available in four cross-sectional sizes. Nominal helix diameters are 6, 8, 10, 12 and 14 inches. These square-shaft anchors are

designated as the "SS" series. Mechanical properties are given on the facing page.

All anchor components are available with a hot-dip galvanized coating that meets the requirements of ASTM A153.

Installing Tools

For attachment to a torque-output source directly or via a torque-indicating device, SS anchor drive tool sizes are of the same basic design.



Catalog No.	Description	Weight	Attachment Flange
639001	SS150 Tool	7 lb.	5 1/4" bolt circle for six 1/2" bolts
C303-0195	SS175 Tool	18 lb.	7 5/8" bolt circle for six 5/8" bolts
C303-0201	SS200 Tool	30 lb.	7 5/8" bolt circle for twelve 5/8" bolts
C303-0202	SS225 Tool	30 lb.	7 5/8" bolt circle for twelve 5/8" bolts

Methods of Anchor-Wall Load Transfer

Screw anchors are compatible with various threadbars that are used in tieback construction. Round-cornered square-shaft extensions are used to install screw anchors to depths required. Then, the threadbar is coupled to the anchor by means of an adapter with an internal thread for the appropriate threadbar design.

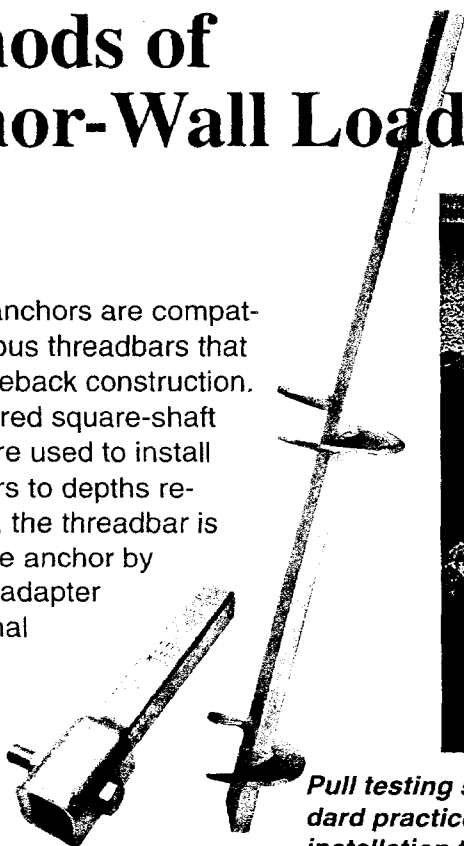

Pull testing serves as a check on analytical design procedures. Standard practice recommends all tieback anchors should be loaded after installation to eliminate deflection at working loads. Chance concurs with this practice when utilizing screw anchors.

Advantages of the Chance tieback anchor

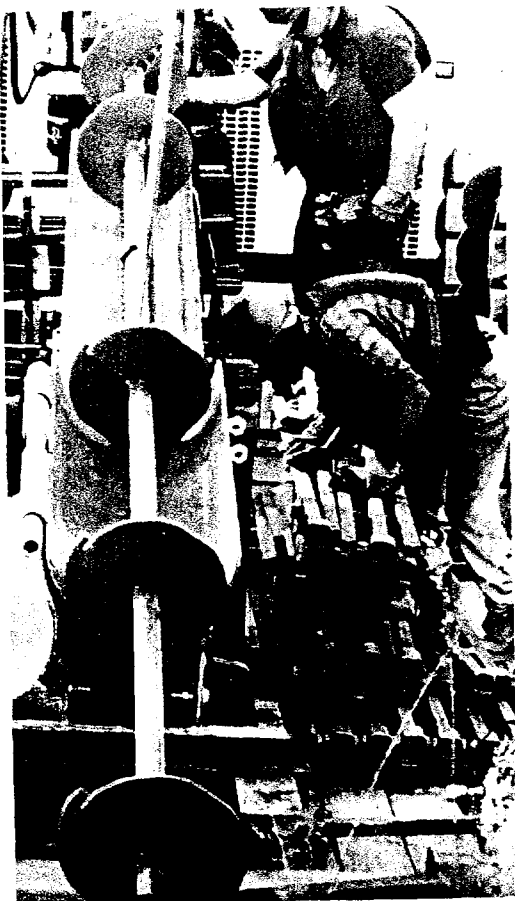

- ✓ Competitive installing costs
- ✓ Immediate proof testing and loading
— no waiting for grout to cure
- ✓ Installs in any weather
- ✓ Speeds excavation and construction
- ✓ Readily-available components
- ✓ Installs with available equipment
- ✓ Predictable results
- ✓ Permanent or temporary installation
- ✓ Removable
- ✓ Less equipment needed — no concrete trucks or grout pumps
- ✓ Labor saving — as few as four on a crew
- ✓ No spoils to remove

Write or call for information on any of these applications:

- Environmental walkways
- Marine mooring
- Foundation underpinning
- Tieback anchoring
- Soil nailing

DISCLAIMER: The material presented in this bulletin is derived from generally accepted engineering practices. Specific application and plans of repair should be prepared by a local structural/geotechnical engineering firm familiar with conditions in that area. The possible effects of soil (such as expansion, liquefaction and frost heave) are beyond the scope of this bulletin and should be evaluated by others. Chance Company assumes no responsibility in the performance of anchors beyond that stated in our SCS policy sheet on terms and conditions of sale.



CHANCE®

Hubbell / Chance
210 N. Allen St.
Centralia, MO 65240-1395 USA



ISO 9001-1994
Cert. No. 001136
A. B. Chance
Centralia, MO

POWER SYSTEMS

Phone: 573-682-8414 Fax: 573-682-8660 Net: www.hubbell.com/abchance

NOTE: Because Chance has a policy of continuous product improvement, we reserve the right to change design and specifications without notice.

Bulletin 31-9601
A&J 20M 4/98

Rev. 4/98

©Copyright 1998

Printed in U.S.A.

SOIL SCREW™ RETENTION WALL SYSTEM



Design Manual

More than

100 pages detail how to take advantage of the SOIL SCREW™ Retention Wall System for your soil nail walls, based on these industry guidelines and recommendations:

- FHWA (Federal Highway Administration) design and build guidelines.
- Recommendations of Clouterre - France.
- Key software for internal and global stability.

Expand your design team — just request your copy

Share in the profitable SOIL SCREW Retention Wall System. This manual can help you put it to work for you. Join other innovative designers who already have.

Contact your Chance representative today.

A practical desktop design reference

By designers for designers, this illustrated guide coordinates with accepted principles and computer tools.

Contents include:

- Comparison to other walls such as tiebacks and mechanically stabilized earth (MSE)
- Suitable applications
- Procedures for Design
- Procedures for Construction.

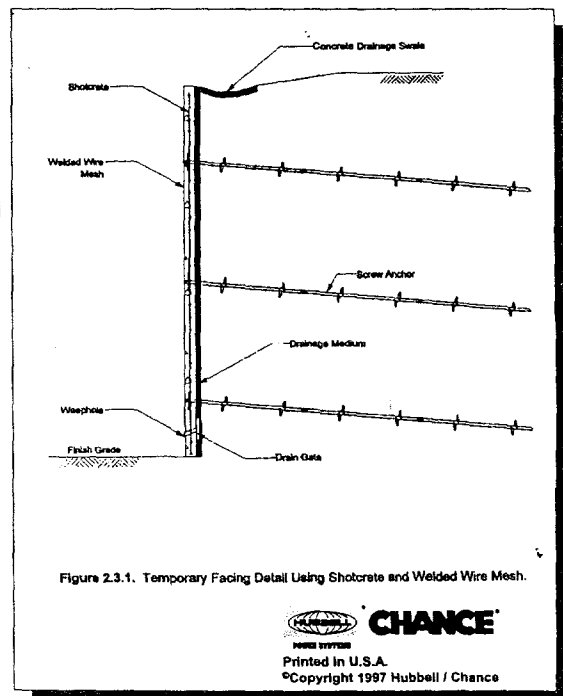

NOTE: Because Chance has a policy of continuous product improvement, we reserve the right to change design and specifications without notice.



POWER SYSTEMS

Bulletin 31-9701

Rev. 3/98 A&J 10M

CHANCE®

Printed in U.S.A.

©Copyright 1998 Hubbell / Chance



ISO 9001-1994
Cert. No. 001136
A. B. Chance Co.
Centralia, MO USA

A.B. Chance Company • 210 North Allen Street • Centralia, MO 65240 USA

Voice: 573-682-8414 • Fax: 573-682-8660 • Net: www.hubbell.com/abchance

SOIL SCREW™ RETENTION WALL SYSTEM

Site-specific, matched to conditions and loads

Simple Procedure

Faster, with fewer steps, the Chance SOIL SCREW™ Retention Wall System gives you economic advantages.

- Install quickly by the same hydraulic rotary equipment commonly used for soil nail wall construction.
- Immediate loading.
- No spoils to remove.
- Installs in any weather.
- Easy to store, reusable.

Compatible with other materials and practices

Terminations fit threadbar or provide a threaded stud to work with prefabricated or site-made lock-off devices. Other termination fittings also are available.

In some cases, the through-hole at the shaft end may be simply crossspinned.

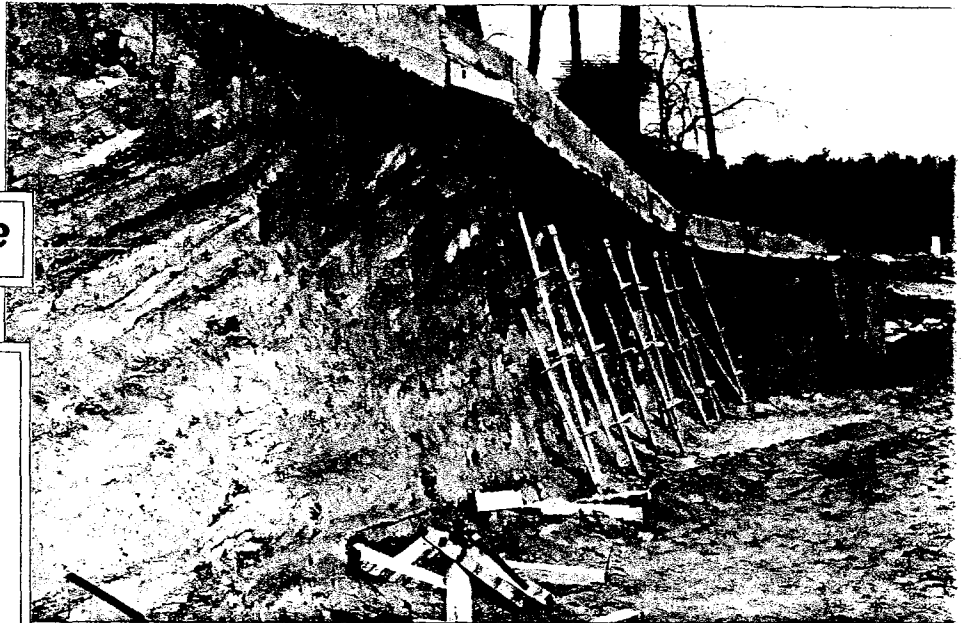

Load-bearing mode superiority of screw anchors

To remove the performance uncertainties and associated costs of grouted soil nails in soils of low shear strength, the Chance SOIL SCREW Retention Wall System employs screw anchors. When placed in the soil, a screw anchor acts as a bearing device. This is its fundamental difference compared to a grouted anchor, which relies on friction between

the soil and the grout.

In a soil nail application, the SOIL SCREW Retention Wall System constructs a gravity wall to reinforce in-situ soil with screw anchors nearly horizontal. Anchor sizes and grid spacing are determined by soil conditions and load requirements.

A reinforced-shotcrete veneer often is applied to the face.

Modular components serve a wide range of jobs

Select from double- and triple-helix leading and extension sections for job-specific combinations. Forged integral coupling sockets bolt-up quickly and efficiently transfer installing torque.

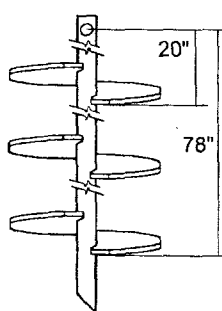

**Three-Helix
SOIL SCREW™
Lead Section
C110-0691**

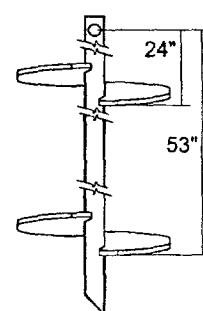

**Two-Helix
SOIL SCREW™
Lead Section
C110-0692**

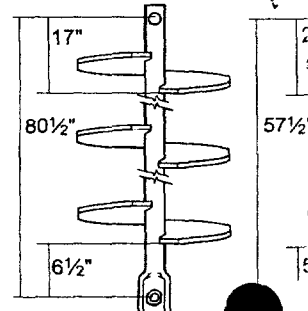

**Three-Helix
SOIL SCREW™
Extension
C110-0689**

Slopetame²

Working on a Slope Made Simple

Quick, complete coverage on any slope is easy with large rolls in standard or custom sizes.

Notice the walls between rings every third row to prevent rill erosion from forming.

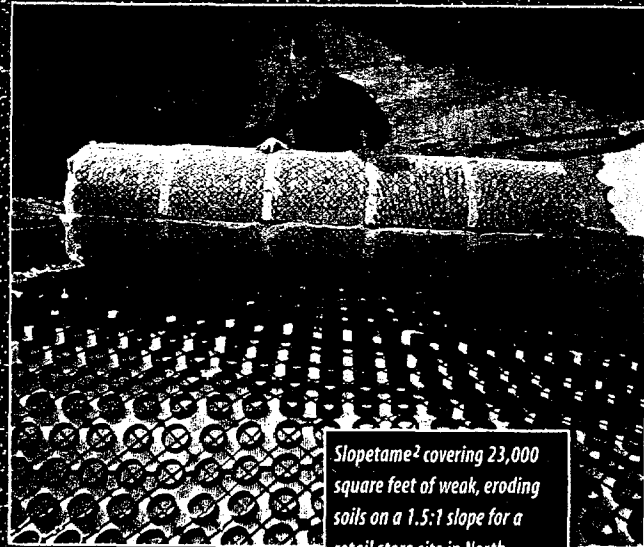
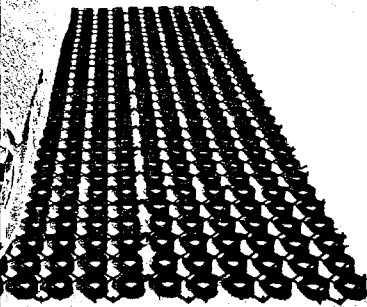

Slopetame² covering 23,000 square feet of weak, eroding soils on a 1.5:1 slope for a retail store site in North Carolina. Trees were planted by cutting out sections in the Slopetame² rolls.

Slopetame² is a three-dimensional erosion control blanket that covers steep slopes of weak and/or eroding soils by easily unrolling lightweight large rolls downhill. The 100% recycled plastic rings and grid are molded onto an open-weave fabric that also serves to cover soils and provide a support structure for vegetation.

Rolls are easily secured at the top of the slope by anchoring rebar between the rings. Custom roll sizes are available and washers are included to fasten pegs and holes together with adjoining rolls.

Trees and shrubs can be easily planted in cutout sections by clipping the grid with pruning shears and then digging holes. Fill the blankets with soil and hydroseed or plant ground covers on the slope for a quick, finished appearance that is structurally sound.

U.S. Patent No. 5,123,778

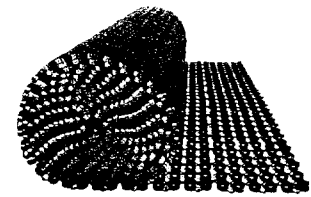

Grasspave²

9 roll sizes
Color: black, 100% recycled HDPE plastic, peg and hole connectors
Weight: 2.0 kg/m² (.42 lbs/sf)
Strength: 400 kg/cm² (5,720 psi) when filled with sand

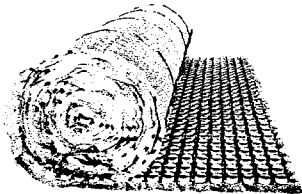

pave

9 roll sizes
Color: black, pewter gray, cashew brown, terra cotta, 100% recycled HDPE plastic, peg and hole connectors
Weight: 2.15 kg/m² (.47 lbs/sf) with polyester non-woven filter fabric
Strength: 400 kg/cm² (5,720 psi) when filled

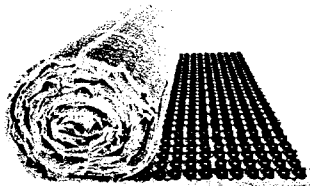

Slopetime²

9 roll sizes
Color: black, 100% recycled HDPE plastic, peg and hole connectors, crossbars every third row of connecting rings
Weight: 2.15 kg/m² (.47 lbs/sf), with open weave polypropylene netting

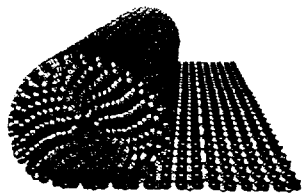

Drain²

9 roll sizes
Color: black, 100% recycled HDPE plastic, peg and hole connectors
Weight: 2.0 kg/m² (.42 lbs/sf), laid over 30 mil PVC impervious liner, covered by polyester non-woven filter fabric, both sold separately

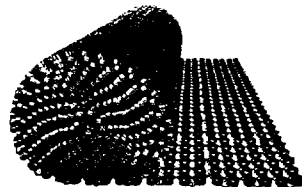

Rain³

Sizes built to project requirements
Color: black, 100% recycled HDPE plastic, peg and hole connectors
Weight: 2.0 kg/m² (.42 lbs/sf), encased in a bladder of 30 mil PVC (or other type) impervious liner. Built on site by a licensed contractor/distributor.

CAD disks with details and specifications are available free on all our products by calling 800-233-1510. Visit our web site — www.invisiblestructures.com — to download complete specifications, installation steps, photos to show clients, and a selection of design details.

100% Recycled

Recycling is at the core of our manufacturing process. We collect plastic in the form of 55-gallon drums, bread trays, shopping carts, milk jugs, road construction markers, and many other items. Our 14-foot-high granulator turns these plastic items into the little colorful pieces you see. Then our injection molding machines heat and form the pieces into our products. We reuse our manufacturing waste as well.

This year we have begun capturing film-grade plastics through the process of pelletizing to make more pieces for molding product. Instead of putting more plastic into landfills, we're encouraging more recycled products be used for improving the environment with porous paving, erosion control, and water collection.



Invisible Structures, Inc.

20100 E. 35th Drive, Aurora, CO 80011-8160
 Toll Free USA and Canada: 800-233-1510
 Fax: 800-233-1522
 Overseas and Locally: Country Code + 303-373-1234
 Fax: 303-373-1223
<http://www.invisiblestructures.com>

© Copyright 1997



Invisible Structures — Standard Product Roll Sizes										
Model	Width		Length		Diameter		Area		Weight	
	m	ft	m	ft	m	ft	m ²	ft ²	kg	lbs
1010	1	3.3	10	32.8	0.5	1.7	10	108	19	41
1020	1	3.3	20	65.6	0.8	2.7	20	215	37	82
1050	1	3.3	50	164	1.2	4	50	538	93	205
1520	1.5	4.9	20	65.6	0.8	2.7	30	323	56	123
1550*	1.5	4.9	50	164	1.2	4	75	807	139	308
2020	2	6.6	20	65.6	0.8	2.7	40	430	75	164
2050*	2	6.6	50	164	1.2	4	100	1,076	186	410
2520	2.5	8.2	20	65.6	0.8	2.7	50	538	93	205
2550*	2.5	8.2	50	164	1.2	4	125	1,346	233	513

*Roll sizes marked with asterisks should be installed by lifting machines only. All other rolls can be installed manually (2 people advised). Rolls apply to Grasspave², Gravelpave², Draincore², and Slopetime². Custom roll sizes available by request.

CONCRETE RESTORATION

CONCRETE RESTORATION

ABOCRETE

Patches, resurfaces and restores concrete permanently. Fills cracks and replaces missing sections of concrete. Bonds broken sections of concrete together, anchors posts and railings. The 5-gallon (18.9 liters) kit contains 1 gallon liquid epoxy resin (ABOCRETE A), 1 quart liquid hardener (ABOCRETE B) and enough sand to blend about 4.5 gallons of ABOCRETE compound, all packaged separately inside the same pail.

ABOCRETE:

- Contains no solvents or volatiles.
- Unaffected by salt water, oils and other chemicals that corrode concrete.
- Ideal for heavy-traffic floors, stairs, loading and parking areas, warehouses, plants, ship docks, pitted, worn or cracked concrete.
- Holds better than bolts to install equipment, machinery, precasts, posts, columns, structural and decorative components.
- Apply in any thickness from a few mils to more than 1 foot thick.
- Shrink-free.
- Makes anti-slip floors and decks.
- Much stronger than concrete.

Typical comparative reference data:

	Concrete	ABOCRETE
Tensile Strength, psi	300	9,000
Flexural Strength, psi	500	10,500
Compressive Strength, psi	3,500	12,000

ABOCRETE hardens in approximately 1 to 6 hours depending on the temperature, thickness, amount of aggregate and other variables. It can be applied with simple hand tools or by brush, paint roller or squeegee.

Coverage: One gallon of ABOCRETE, with or without sand or aggregate, covers 231 cubic inches or exactly the volume of 1 gallon, the maximum coverage any material can offer. For example, 1 gallon covers 320 sq. ft., 5 mils thick.

For cold, even sub-freezing weather, and/or on wet surfaces, ABOCRETE A can be blended with ABOCURE 7912-1 in a ratio of 2 parts by volume ABOCRETE A with 1 part by volume ABOCURE 7912-1 for patching and resurfacing.

ABOWELD 55-1

Build-up vertical surfaces such as broken risers, columns and walls with this no-slump adhesive paste without the help of any forms or molds. Ideal for ceiling repairs, as well. The tenacious adhesion and structural strength of ABOWELD 55-1 make it well-suited for even the most punishing environments. This 2-component epoxy paste is easy to apply with a trowel or spatula. It forms a permanent, stronger-than-concrete bond with concrete, metals, ceramics, masonry bricks and most rigid materials. Color: Gray. Hard in 1-6 hours at room temperature.

For cold weather applications, ABOWELD 55-1 A can be mixed with an equal volume of ABOCURE 55-1 B CLD.

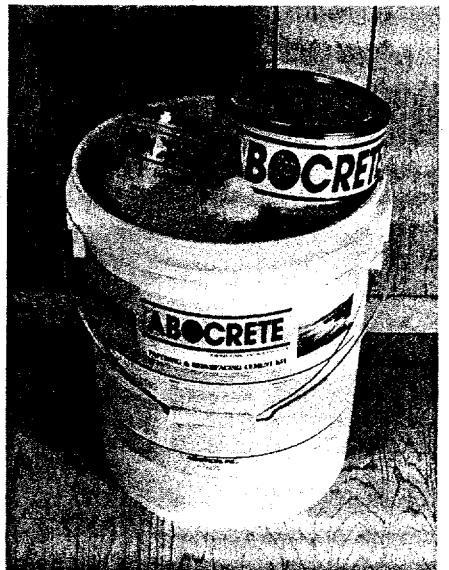
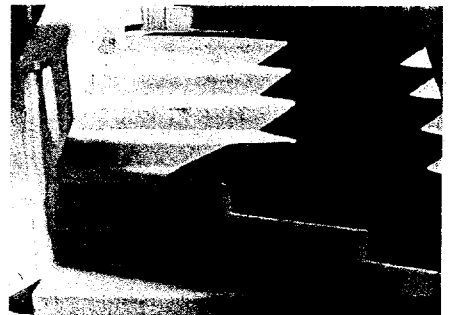
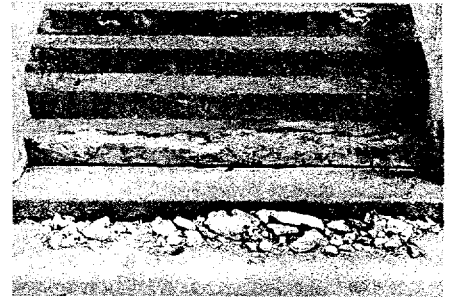

METAL RESTORATION

METAL RESTORATION

Restoring metal, bonding broken sections, building-up missing sections, has never been easier. The **MASTERSHOP** series of metal-filled epoxy compounds offers the latest technological improvements and convenient packaging. Mastershop compounds offer these advantages:

- Superior adhesion.
- Exceptional strength.
- Virtually shrink-free.
- Resistance to water, chemicals and heat.
- Can be applied in any thickness.
- Ample working time.

Please Note:

P = Paste

PH = High Temperature Paste

L = Liquid

LH = High Temperature Liquid

PBW = Parts by Weight

PBV = Parts by Volume

Typical Test Results (Standard Version):

- Hardness: 83-87 Shore D
- Adhesive tensile shear strength: 2,500-3,000 psi
- Compressive strength: 9,000-13,000 psi
- Tensile strength: 5,000-6,000 psi
- Flexural strength: 5,000-7,000 psi

ALUMINUM-FILLED

FERROUS METAL-FILLED

WEAR-RESISTANCE COMPOSITE-FILLED

METALFIX-P

Aluminum-filled structural adhesive putty.

A: 15 lbs/gal; B: 8 lbs/gal. Mixing ratios, A/B: 9/1 pbw (5/1 pbv). Pot life: 1 hr. Gray. Machinable, corrosion resistant, versatile "metal plastics" alloy. Ideal to patch, bond, resurface metal, structural components, patterns, molds, pipes, tanks, sculptures, appliances. It forms permanent bonds with metals, ceramics, glass, fiberglass and most materials.

METALFIX-PH

METALFIX-P for up to 320°F (160°C) under stress.

A: 15 lbs/gal; B: 9.8 lbs/gal. Mixing ratios, A/B: 100/8.3 pbw (100/12.6 pbv). Pot life: 5-8 hrs. Gray. It requires heat cure: 1-12 hrs. at 176-302°F (80-150°C). Used when it must resist up to 320°F in operation. It also offers superior resistance to strong solvents and other chemicals.

METALFIX-L

Fluid-pourable version of METALFIX-P.

A: 14.8 lbs/gal; B: 8 lbs/gal. Mixing ratios, A/B: 9/1 pbw (5/1 pbv). Pot life: 1 hr. approx. For patterns, molds, prototypes, casting and all applications where a castable, fluid METALFIX-P is needed. Excellent for tooling.

METALFIX-LH

METALFIX-L for up to 320°F (160°C) under stress.

A: 14.8 lbs/gal; B: 9.8 lbs/gal. Mixing ratios, A/B: 100/8.85 pbw (100/13.1 pbv). Pot life: 5-8 hrs. Gray. It requires heat cure: 1-12 hrs. at 176-302°F (80-150°C). It also offers superior resistance to strong solvents and other chemicals.

FERROBOND-P

Steel-filled structural adhesive putty.

A: 26 lbs/gal; B: 8 lbs/gal. Mixing ratios, A/B: 9/1 pbw (10/3.6 pbv). Pot life: 1 hr. approx. Dark gray. The latest "steel-plastics" alloy. Ideal to repair or fill metal components, castings, tanks, magnetic fixtures. Heavy, hard, wear resistant, machinable, magnetic. Preferred to METALFIX-P where heavier weight, magnetability or highest heat transfer are the main criteria.

FERROBOND-PH

FERROBOND-P for up to 320°F (160°C) under stress.

A: 26 lbs/gal; B: 9.8 lbs/gal. Mixing ratios, A/B: 100/5.5 pbw (100/14.5 pbv). Pot life: 5-8 hrs. Dark gray. Heat cure: 1-12 hrs. at 176-302°F (80-150°C). Used when it must resist up to 160°C in operation. Superior resistance to strong solvents and other chemicals.

FERROBOND-L

Fluid-pourable FERROBOND-P.

A: 23 lbs/gal; B: 8 lbs/gal. Mixing ratios, A/B: 9/1 pbw (100/32 pbv). Pot life: 1 hr. approx. Casting version of FERROBOND-P. Chosen when flowing consistency is needed for pouring. Excellent for tooling.

FERROBOND-LH

FERROBOND-L for up to 320°F (160°C) under stress.

A: 23 lbs/gal; B: 9.8 lbs/gal. Mixing ratios, A/B: 100/6.9 pbw (100/16.1 pbv). Pot life: 5-8 hrs. Dark gray. It requires heat cure: 1-12 hrs. at 176-302°F (80-150°C). Superior resistance to strong solvents and other chemicals.

WEARSURF-P

Wear-resistant structural adhesive putty.

A: 17 lbs/gal; B: 8 lbs/gal. Mixing ratios, A/B: 9/1 pbw (4/1 pbv). Pot life: 1 hr. approx. Dark gray. Exceptional wear-resistance and hardness. Self-lubricating. Ideal to restore or repair worn surfaces, as in pumps, shafts, bearing or sliding surfaces, metal-forming dies, patterns, tools and machinery.

WEARSURF-PH

WEARSURF-P for up to 320°F (160°C) under stress.

A: 17 lbs/gal; B: 9.8 lbs/gal. Mixing ratios, A/B: 100/8.4 pbw (100/14.5 pbv). Pot life: 5-8 hrs. Dark gray. Heat cure: 1-12 hrs. at 176-302°F (80-150°C). It also offers superior resistance to strong solvents and other chemicals.

WEARSURF-L

Fluid, castable WEARSURF-P.

A: 17 lbs/gal; B: 8 lbs/gal. Mixing ratios, A/B: 9/1 pbw (4/1 pbv). Pot life: 1 hr. approx. Dark gray. Preferred for pouring patterns, dies, molds, engraving and high-precision reproductions.

WEARSURF-LH

WEARSURF-L for up to 248°F (120°C) under stress.

A: 17 lbs/gal; B: 8 lbs/gal. Mixing ratios, A/B: 100/8.4 pbw (100/14.5 pbv). Pot life: 5-8 hrs. Dark gray. Heat cure: 1-12 hrs. at 176-302°F (80-120°C). Superior resistance to strong solvents and other chemicals.

Silicone Microemulsions:

The Solution for Rising Damp



Rising damp in the underlying masonry caused this extensive surface coating damage.

Rising damp is caused by the deterioration of a structure's horizontal damp course. This potential hazard can be eliminated with the injection of silicone masonry water repellents, which halt capillary action and prevent damp from rising.

Due to their outstanding ability to penetrate building surfaces and repel water, silicone microemulsions are ideal injection agents for establishing damp-proof courses in masonry restoration applications. Silicone microemulsion concentrates (SMC) are advanced solvent-free silicone concentrates based on silanes and oligomeric siloxanes. A patented process modifies the formula so that the result, when diluted with water, forms particles small enough to penetrate even the finest capillaries of the building material. Because of the spontaneous miscibility of SMC's, the need for sophisticated mixing devices is eliminated and optimal performance properties are achieved up to 48 hours after dilution.

Wacker's state-of-the-art microemulsion products are designed for effective performance—even on extremely thick masonry—and feature:

- **Environmental compatibility**, since microemulsions are VOC-compliant, water-based and non-corrosive
- **Concentrated form** to minimize waste and eliminate disposal problems
- **Strong penetration capabilities** when applied into dry, dampened or even moisture-saturated building materials
- **No carbon-dioxide activation needed** from the atmosphere, permitting the protection of thicker substrates

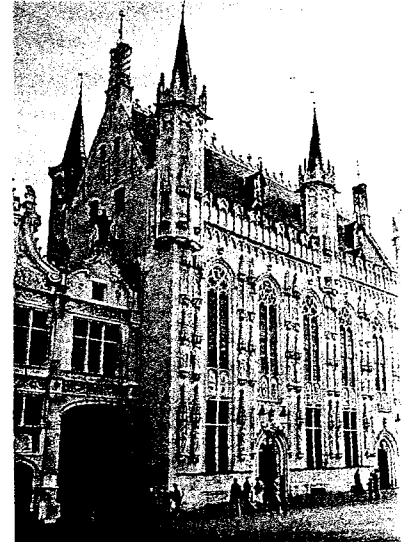

Wacker microemulsions and masonry water repellents protect renovated buildings from rising damp while preserving their aesthetic qualities.

The Problem: Rising Damp

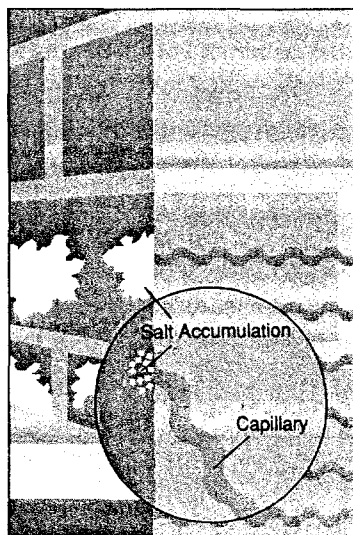

The Solution: Silicone Microemulsion Concentrates

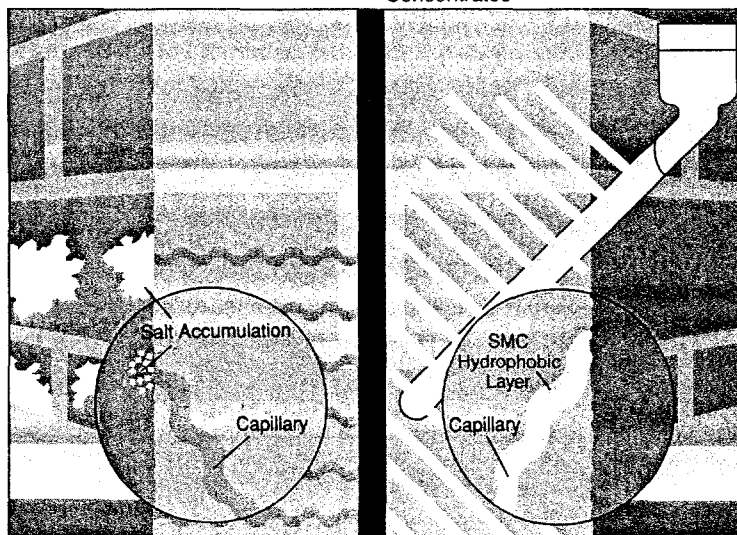

Gravity injection through pre-drilled holes allows Wacker microemulsions to penetrate deep into the substrate's capillaries, halting the spread of damp.

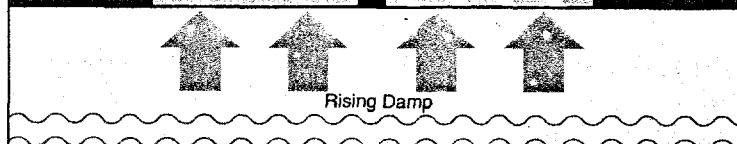

VEOCEAL® 500 Silicone Microemulsion

VEOCEAL® 500 is Wacker's VOC-compliant, water-based microemulsion. It is recommended for imparting water repellency to the surfaces of absorbent building materials such as plaster, brick, sand limestone and concrete.

Other products for damp proofing applications

Wacker microemulsions are just part of our complete line of silicone masonry water repellents. Wacker offers two other effective solutions to the problem of rising damp in masonry surfaces:

- **BS-15**—an aqueous potassium methyl silicate solution which can be diluted with water. The active substance produced upon reaction with atmospheric carbon dioxide or other acidic compounds is a silicone resin.
- **BS-20**—an aqueous potassium propyl silicate solution requiring a mixture of alcohol and water for dilution. The active substance produced upon reaction with atmospheric carbon dioxide or other acidic compounds is a silicone resin which is more stable to alkaline environments such as concrete.

These water-based and VOC-compliant masonry water repellents provide you with two effective alternatives when the superior performance of a microemulsion is not essential for a specific application.

Wacker Silicones Corporation manufactures a broad range of silicone-based products for a wide variety of industrial applications. Wacker's complete line includes silicone fluids, antifoams, release agents, silicone compounds, paint raw materials, sealants, adhesives and silicone rubber products. For more information, please contact your nearest Wacker Silicones Corporation office.

Wacker Silicones Corporation
3301 Sutton Road
Adrian, Michigan 49221-9397
Telephone: 517/264-8500
Toll-free: 800/248-0063
Telex: 510/450-2700
FAX: 517/264-8246

NORTH AMERICAN OFFICES

Regional Sales Offices

EAST:

399 Thornall St.
Edison, NJ 08837
Telephone: 908/549-5911
Toll-free: 800/634-6752
FAX: 908/549-5956

CENTRAL:

Two TransAm Plaza Drive
Suite 300
Oakbrook Terrace, IL 60181
Telephone: 708/691-1313
Toll-free: 800/521-4566
FAX: 708/691-1395
3301 Sutton Road
Adrian, MI 49221
Telephone: 517/423-2199
Toll-free: 800/248-0063
FAX: 517/423-1180

SOUTH:

2709 Water Ridge Pkwy.
Suite 410
Charlotte, NC 28217-4538
Telephone: 704/329-0300
Toll-free: 800/521-3698
FAX: 704/329-0306

WEST:

2 Park Plaza
Suite 610
Irvine, CA 92714
Telephone: 714/553-0111
Toll-free: 800/541-9517
FAX: 714/553-1405

Canada:

Henley Chemicals Ltd.
420 Finchdene Square
Scarborough, Ontario, Canada M1X 1C
Telephone: 416/297-0999
Toll-free: 800/387-5247
Telex: 652-5147
FAX: 416/297-6517

Mexico:

Wacker Mexicana, S.A. de C.V.
Apartado Postal 99-070
Av. Periferico Sur 3343/PH
San Jerónimo
10200 Mexico, DF
Telephone: (52) 5 95 75 99
Telex: 17 72 920 wack me
FAX: (52) 6 83 84 34

INTERNATIONAL HEADQUARTERS

Wacker-Chemie GmbH
Hanns-Seidel-Platz 4
8000 Munich 83
Germany
Telephone: (089) 62 79-01
Telex: 529 121-56
Telefax: (089) 62 79 1033

ISO 9000

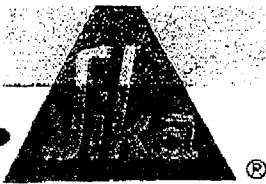

Sika MonoTop® 615

One component, polymer-modified, silica fume enhanced, non-sag mortar

DESCRIPTION

Sika MonoTop 615 is a one-component, polymer-modified, silica fume enhanced, cementitious, non-sag mortar. It is a multi-purpose mortar which can be applied by trowel or low pressure wet spray process.

WHERE TO USE

- ▲ On buildings, facades, and balconies.
- ▲ On grade, above, and below grade on concrete and mortar.
- ▲ On vertical, overhead, and horizontal surfaces.
- ▲ As a general purpose repair mortar for use on concrete structures in a mild or moderate service environment.

ADVANTAGES

- ▲ One component, factory controlled for consistent quality.
- ▲ To be mixed with potable water only.
- ▲ Excellent workability.
- ▲ Adjustable consistency.
- ▲ Excellent thixotropic behavior, especially suitable for overhead and vertical application.
- ▲ Good mechanical strengths.
- ▲ High bond strength ensures excellent adhesion.
- ▲ Increased freeze/thaw durability and resistance to deicing salts.
- ▲ Compatible modulus of elasticity to concrete generally used for building/facade construction.
- ▲ Compatible with coefficient of thermal expansion of concrete - Passes ASTM C-884 (modified).
- ▲ Application by hand or low pressure wet spray method.
- ▲ High coverage rate.
- ▲ Not a vapor barrier.
- ▲ Not flammable, non-toxic.

YIELD

0.55 cu. ft./bag.

PACKAGING

50 lb. multi-wall bag.

HOW TO USE

SUBSTRATE

Concrete, mortar, and masonry products.

SURFACE PREPARATION

Concrete / Mortar: Remove all deteriorated concrete, dirt, oil, grease, and all bond-inhibiting materials from surface. Be sure repair area is not less than 1/8 in. in depth. Preparation work should be

TYPICAL DATA FOR SIKA MONOTOP 615

(Material and curing conditions @ 73F (23° C) and 50% R.H.)

SHELF LIFE:	One year in original, unopened packaging.		
STORAGE CONDITIONS:	Store dry at 40-95F (4-35C). Condition material to 65-75F before using.		
COLOR:	Concrete gray when mixed.		
MIXING RATIO:	3.5 qts. (±0.25 qts.) of water per 50 lb. bag as required for desired consistency, (water:powder ratio = 0.146:1).		
APPLICATION TIME:	Approximately 45 min. after adding water. Application time is dependent on temperature and humidity.		
FINISHING TIME:	Approximately 60 min. after adding water: depends on temperature, relative humidity, and type of finish desired.		
DENSITY (WET MIX):	104 lbs./gal.	(1.65 kg/l)	
FLEXURAL STRENGTH (ASTM C-293):	28 days	1,000 psi	(6.9 MPa)
SPLITTING TENSILE STRENGTH (ASTM C-496):	28 days	400 psi	(2.8 MPa)
BOND STRENGTH* (ASTM C-882 MODIFIED):	28 days	1,000 psi	(6.9 MPa)
COMPRESSIVE STRENGTH (ASTM C-109):	1 day	1,500 psi	(10.3 MPa)
	7 days	3,500 psi	(24.1 MPa)
	28 days	4,300 psi	(29.7 MPa)
CARBON DIOXIDE DIFFUSION COEFFICIENT (μCO₂)	1,300		
WATER VAPOR DIFFUSION COEFFICIENT (μH₂O)	300		

*Mortar scrubbed into substrate.

done by high pressure water blast, scabber, or other appropriate mechanical means to obtain an aggregate-fractured surface with a minimum surface profile of ±1/16 in. Saturate surface with clean water. Substrate should be saturated surface dry (SSD) with no standing water during application.

Reinforcing Steel: Steel reinforcement should be thoroughly prepared by mechanical cleaning to remove all traces of rust. Where corrosion has occurred due to the presence of chlorides, the steel should be high-pressure washed with clean water after mechanical cleaning. For priming of reinforcing steel use Sika Armatec 110 EpoCem (consult Technical Data Sheet).

MIXING

Pour water in the proper proportion (3.5 qts. ±0.25 qts. per bag) into the mixing container. Add powder while mixing continuously. Mix mechanically with a low-speed drill (400-600 rpm) and mixing paddle or mortar mixer. Mix to uniform consistency, minimum 3 minutes. Manual mixing should be avoided.

APPLICATION & FINISH

Sika MonoTop 615 can be applied either by hand or wet spray process equipment. Mortar must be scrubbed into the substrate, filling all pores and voids; or the use of a bonding agent (Sika Armatec® 110) is recommended. Force Sika MonoTop 615 against edge of repair, working toward the center.

After filling repair, consolidate, then screed. Material may be applied in multiple lifts. The thickness of each lift, not to be less than 1/8 in. minimum or more than 2 in. maximum, may vary depending on the conditions of the repair area.

Where multiple lifts are required, score top surface of each lift to produce a roughened surface for next lift. Allow preceding lift to set before applying fresh material. Saturate surface of the lift with clean water. Scrub fresh mortar into preceding lift. Allow mortar to set to desired stiffness, then finish with wood or sponge float for a smooth surface, or texture as required.

CURING:

As per ACI recommendations for portland cement concrete, curing is required. Moist cure with wet burlap and polyethylene, a fine mist of water or a water based* curing compound. Curing compounds adversely affect the adhesion of following layers of mortar, leveling mortar or protective coatings. Moist curing should commence immediately after finishing. Protect newly applied material from direct sunlight, wind, rain and frost.

*Pretesting of curing compound is recommended.

LIMITATIONS:

- ▲ Application thickness:
 - Minimum 1/8 inch
 - Maximum in one lift - 2 inches
- ▲ Minimum ambient and surface temperatures 45 F and rising at time of application.
- ▲ Do not use solvent-based curing compound.

CAUTION

Irritant; Suspect Carcinogen - Contains portland cement and sand (crystalline silica). Skin and eye irritant. Avoid contact. Dust may cause respiratory tract irritation. Avoid breathing dust. Use only with adequate ventilation. May cause delayed lung injury (silicosis). IARC lists crystalline silica as having sufficient evidence of carcinogenicity in laboratory animals and limited evidence of carcinogenicity in humans. NTP also lists crystalline silica as a suspect carcinogen. Use of safety goggles and chemical resistant gloves is recommended. If PELs are exceeded, an appropriate, properly fitted NIOSH/MSHA approved respirator is required. Remove contaminated clothing.

FIRST AID:

In case of skin contact, wash thoroughly with soap and water. For eye contact, flush immediately with plenty of water for at least 15 minutes, and contact a physician. For respiratory problems, remove person to fresh air.

CLEAN UP:

In case of spillage, scoop or vacuum into appropriate container, and dispose of in accordance with current, applicable local, state, and federal regulations. Keep container tightly closed and in an upright position to prevent spillage and leakage.

Mixed components: Uncured material can be removed with water. Cured material can only be removed mechanically.

Product Code MONO615. Sika, Amatec, and MonoTop are registered trademarks. Made in USA. Printed in USA. May, 1996

**KEEP CONTAINER TIGHTLY CLOSED
NOT FOR INTERNAL CONSUMPTION**

**KEEP OUT OF REACH OF CHILDREN
FOR INDUSTRIAL USE ONLY**

CONSULT MATERIAL SAFETY DATA SHEET FOR MORE INFORMATION

SIKA WARRANTS ITS PRODUCTS TO BE FREE OF MANUFACTURING DEFECTS AND THAT THEY WILL MEET SIKA'S CURRENT PUBLISHED PHYSICAL PROPERTIES WHEN APPLIED IN ACCORDANCE WITH SIKA'S DIRECTIVE AND TESTED IN ACCORDANCE WITH ASTM AND SIKA STANDARDS. THERE ARE NO OTHER WARRANTIES BY SIKA OF ANY NATURE WHATSOEVER, EXPRESSED OR IMPLIED, INCLUDING ANY WARRANTY OF MERCHANTABILITY OR FITNESS FOR A PARTICULAR PURPOSE IN CONNECTION WITH THIS PRODUCT. SIKA CORPORATION SHALL NOT BE LIABLE FOR DAMAGES OF ANY SORT, INCLUDING REMOTE CONSEQUENTIAL DAMAGES, RESULTING FROM ANY CLAIMED BREACH OF ANY WARRANTY, WHETHER EXPRESSED OR IMPLIED, INCLUDING ANY WARRANTY OF MERCHANTABILITY OR FITNESS FOR A PARTICULAR PURPOSE OR FROM ANY OTHER CAUSE WHATSOEVER. SIKA SHALL ALSO NOT BE RESPONSIBLE FOR USE OF THIS PRODUCT IN A MANNER TO INFRINGE ON ANY PATENT HELD BY OTHERS.



1-800-933-SIKA NATIONWIDE

Regional Information and Sales Centers

For the location of your nearest Sika sales office, contact your regional center.

Northeast

201 Polito Avenue
Lyndhurst, NJ 07071
Phone: 1-800-933-7452
Fax: 201-804-1020

Midwest

2190 Gladstone Court
Suite A
Glendale Heights, IL 60139
Phone: 708-924-7900
Fax: 708-924-8508

Southern

3778 La Vista Road
Suite 100
Tucker, GA 30084
Phone: 404-315-0337
Fax: 404-315-0117

Western

12767 East Imperial H
Santa Fe Springs, CA
Phone: 310-941-0231
Fax: 310-941-4762

What is **XYPEX** Concrete Waterproofing by Crystallization™

Though applied as a coating, XYPEX is a unique chemical treatment for the waterproofing and protection of concrete. Manufactured in the form of a dry powder compound, XYPEX consists of portland cement, very fine treated silica sand and various active proprietary chemicals.

How does **XYPEX** Waterproof Concrete?

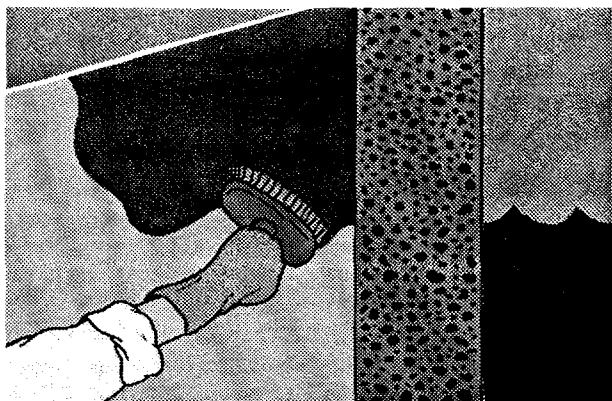

When mixed with water and applied as a cementitious coating, the active chemicals in XYPEX cause a catalytic reaction which generates a non-soluble crystalline formation of dendritic . . .



. . . fibres within the pores and capillary tracts of concrete. Thus the concrete becomes permanently sealed against the penetration of water or liquids from any direction

Advantages of **XYPEX**

Can waterproof underground structures from the inside against hydrostatic pressure.

By the process of osmosis and because the chemicals in XYPEX have an affinity with water, the crystalline formation migrates throughout the pores and capillary tracts of concrete even against strong hydrostatic pressure.

Protects concrete and reinforcing steel

The XYPEX treatment is highly resistant to most aggressive substances. (pH 3-11 constant contact, 2-12 periodic contact). By preventing the intrusion of chemicals, salt water, sewage and other harmful materials, XYPEX protects concrete and reinforcing steel from deterioration and oxidation. The concrete is also protected against spalling, efflorescence, popouts and other damages caused by weathering, bleeding of the salts and internal expansion and contraction during the freeze-thaw cycle.

Permits concrete to 'breathe'

The XYPEX crystalline formation has 'fixed-size' air spaces so small that water cannot pass through. However, it does allow the passage of air and vapor, thus the concrete is able to 'breathe' and become thoroughly dry, preventing moisture vapor buildup.

Is Non-toxic

XYPEX products have been approved by the U.S. Environmental Protection Agency, Agriculture Canada and many other government health agencies throughout the world for use on concrete structures that hold potable water or foodstuffs. The XYPEX treatment contains no solvents and emits no harmful vapors.

Can be applied to moist or 'green' concrete.

XYPEX requires moisture to produce the crystalline formation. Therefore, concrete that is moist or 'green' is ideal for the XYPEX treatment. If the concrete is dry, it must be predampened prior to application.

Some other advantages

- XYPEX is not just a coating. Because the crystalline formation becomes an integral part of the concrete, XYPEX does not rely on its surface coating to waterproof concrete.
- XYPEX will seal hairline cracks up to $\frac{1}{4}$ inch (0.4 mm).
- XYPEX does not require costly surface priming or leveling prior to application.
- XYPEX cannot puncture, tear or come apart at the seams.
- XYPEX does not require protection during backfilling or during placement of steel, wire mesh or other materials.
- XYPEX is less costly to apply than most other methods.

Typical **XYPEX** Projects

- ◆ Reservoirs
- ◆ Sewage and Water Treatment Tanks
- ◆ Tunnels
- ◆ Manholes
- ◆ Underground Vaults
- ◆ Foundations
- ◆ Parking Decks

Independent Test Results

Permeability - U.S. Army Corps of Engineers CRD-C-48-73 "Permeability of Concrete"

Two Inch thick, 2000 PSI (13,790 KPa) XYPEX-treated concrete samples were pressure tested up to a 405 ft. water head (175 PSI-1207 KPa), which was the limit of the testing apparatus. While untreated samples showed marked leakage, the XYPEX treated samples, as a result of the crystallization process, became totally sealed and exhibited no measurable leakage.

Chemical Resistance - A.S.T.M. C267-77 "Chemical Resistance of Mortars"

XYPEX treated cylinders and untreated cylinders were exposed to such chemicals as hydrochloric acid, caustic soda, toluene, mineral oil, ethylene glycol, pool chlorine and brake fluid. Results of these studies indicated that chemical exposure did not have detrimental effects on the XYPEX coating. Tests following chemical exposure

indicated average compressive strength increases of 20% for XYPEX-treated specimens over untreated control samples.

Freeze-Thaw and De-icing Chemical Resistance - A.S.T.M. C672-76 "Standard Test Method for Scaling Resistance of Concrete Surfaces Exposed to De-icing Chemicals"

XYPEX-treated samples restricted chloride ion concentration to below the level necessary to promote electrolytic corrosion of reinforcing steel. Visual examination of untreated panels after 50 cycles showed a marked increase in surface deterioration as compared to treated panels.

Radiation Resistance - U.S.A. Standard No. N69-1967 "Protective Coatings for the Nuclear Industry"

After exposure to 5.76×10^4 rads of gamma radiation, the XYPEX treatment revealed no ill effects or damages.

Products

XYPEX crystalline waterproofing materials are packaged in powder form and are mixed with water for application as a cementitious slurry coating on concrete surfaces, or as a Dry-Pac™ for sealing of construction joints and repair of cracks.

XYPEX Concentrate

Used as a single coating on above or below grade concrete, or as the first of a two coat application where two coats are required (see XYPEX Specification Manual). Also used as a Dry-Pac for sealing strips (fillets) at construction joints, and for repair of cracks, faulty construction joints and honey combing. XYPEX CONCENTRATE is the most chemically potent of the XYPEX crystalline waterproofing materials.

XYPEX Modified

Used as a second coat to reinforce XYPEX CONCENTRATE where two coats are required. Also used as an exterior dampproofing.

Coverage

For normal surface applications coverage per coat is: 1.5 pounds per square yard or 0.8 kilograms per square meter.
For construction joint surfaces coverage is: 2.0 pounds per square yard or 1.0 kilograms per square meter.
See mixing instructions below.

Application Information

Surface Preparation

Concrete surfaces to be treated must be clean and free of laitance, dirt, films, paint, coatings or other foreign matter. The surfaces must also have an open capillary system so as to provide 'tooth and suction' for the XYPEX treatment. If surfaces are too smooth, the concrete should be acid etched or lightly sandblasted (or waterblasted).

Structural defects such as cracks, faulty construction joints and honeycombing should be routed out to sound concrete and repaired in accordance with the XYPEX Specification Manual Repair Procedures. It should be noted, however, that XYPEX is not designed for use in expansion joints or chronic "moving" cracks.

Horizontal surfaces should preferably have a rough wood float or broom finish. All concrete laitance must be removed either by etching with muriatic acid or by light waterblasting or sandblasting.

Wetting Concrete

Prior to the application of XYPEX, concrete surfaces must be

thoroughly wetted with clean water (concrete should be saturated) to control surface suction, aid the proper curing of the treatment and ensure the growth of the crystalline formation deep within the pores of the concrete. Of course, excess surface water should be removed before the application.

Mixing for Slurry Coat

XYPEX powder is mixed with clean water to a creamy consistency in the following proportions by volume:

For brush application

1.5 lbs./sq.yd. - 5 parts powder to 2 parts water

2.0 lbs./sq.yd. - 3 parts powder to 1 part water

For spray application

1.5 lbs./sq.yd. - 5 parts powder to 3 parts water (may vary with equipment type)

Mixing for Dry-Pac

Mix 6 parts XYPEX CONCENTRATE powder with one part clean water by volume. Do not mix too wet (ie. a putty-like consistency), otherwise mix may crack and spall as it dries.

Application

The XYPEX treatment should be applied with a semi-stiff bristle brush, janitor's broom (for large horizontal applications) or with specialized spray equipment. For recommended equipment contact XYPEX Chemical Corporation or your nearest distributor

The XYPEX treatment must be uniformly applied under the conditions and quantities specified. One coat should have a thickness of just under $\frac{1}{16}$ inch (1.2 mm). When a second coat is required, it should be applied after the first coat has reached an initial set but is still 'green' (less than 48 hr.). Light pre-watering between coats may be required due to drying. The XYPEX treatment cannot be applied in rain or during freezing conditions. For best results, application should take place at temperatures above 40°F (4°C).

Curing

A misty fog spray of water must be used for curing the XYPEX treatment. Curing must begin as soon as the XYPEX coating has hardened sufficiently so as not to be damaged by a fine spray. Under most conditions it is sufficient to spray XYPEX treated surfaces three times a day for 2-3 days. In hot climates spraying may be required more frequently. During the curing period the XYPEX treatment must be protected from rain, frost and puddling of water.

For concrete structures that hold liquids (e.g.) reservoirs, tanks, etc.), the XYPEX treatment should be cured for three days and then allowed to set for 12 days before filling with liquid.

Other XYPEX Products

DS1 & DS2

XYPEX Concentrate DS1 and DS2 are special formulations which have been designed specifically for a dry-shake application on horizontal concrete prior to finishing.

Patch 'n Plug

Fast setting, non-shrink, high bond strength hydraulic cement compound for concrete repairs. Stops flowing water in seconds. PATCH 'N PLUG seals cracks, tie holes etc. and is also used for the general repair or patching of concrete. PATCH'NPLUG may be used in conjunction with XYCRYLIC ADMIX to increase the compressive strength and bond strength to existing concrete.

Ultra Plug

Used in conjunction with XYPEX QUICKSET liquid to form a fast setting plug (controlled variable set of 15-45 seconds) for stopping a direct flow of water. ULTRA PLUG also has chemical properties to generate crystalline formation within the surrounding concrete.

Xycrylic Admix

An acrylic polymer formulation specifically designed for use as an admix to fortify portland cement mixes. XYCRYLIC ADMIX increases hardness, durability, bonding capability and chemical resistance.

Technical Services

This presentation has been prepared to provide basic information about XYPEX® Concrete Waterproofing by Crystallization™. For more complete information, assistance in developing specifications or arranging for application supervision, please contact XYPEX Chemical Corporation or the nearest XYPEX distributor.

Packaging and storage

XYPEX powder materials are packaged in the following containers: 20 lb. pail, 50 lb. bag, 60 lb. pail, 500 lb. barrel.

QUICKSET, XYCRYLIC ADMIX, and GAMMA-CURE are packaged in 1 gal., 5 gal. and 55 gal. containers.

XYPEX products must be stored dry at a minimum temperature of 45 degrees F. (7 degrees C.). The shelf life is one year when stored under proper conditions.



Warranty

XYPEX CHEMICAL CORPORATION warrants that the products manufactured by it shall be free from material defects and will be consistent with its normal high quality. Should any of the products be proven defective, the liability to XYPEX shall be limited to replacement of the product ex factory. XYPEX MAKES NO WARRANTY AS TO MERCHANTABILITY OR FITNESS FOR A PARTICULAR PURPOSE AND THIS WARRANTY IS IN LIEU OF ALL OTHER WARRANTIES EXPRESS OR IMPLIED. User shall determine the suitability of the product for his intended use and assume all risks and liability in connection therewith.

XYPEX CHEMICAL CORPORATION

13731 Mayfield Place, Richmond, B.C.
Canada V6V 2G9

Telephone: (604) 273-5265

Fax: (604) 270-0451

Distributed By:



RESTORATION and MAINTENANCE PRODUCTS

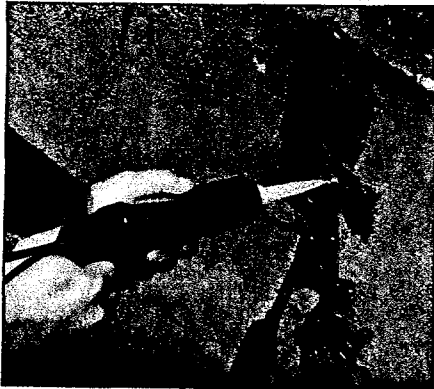

THE PRODUCTS DESCRIBED IN THIS CATALOG ARE SPECIFIED BY RESTORATION PROFESSIONALS FOR THEIR EXCEPTIONAL PERFORMANCE, EASE OF USE AND SAFETY.



WOOD RESTORATION.....	Page 2,3	CASTING COMPOUNDS	Page 11
CONCRETE RESTORATION	4,5	ADHESIVES	12,13
CRACK-INJECTION.....	6,7	COATINGS	14,15
METAL RESTORATION	8,9	PORCELAIN REFINISHING.....	15
MOLDMAKING.....	10	ACCESSORIES	16



ABATRON, INC.

5501 - 95th Ave., Kenosha, WI 53144 USA

800/445-1754

414/653-2000 Fax 414/653-2019

CRACK-INJECTION

CRACK-INJECTION: Restoration Instead of Demolition

The ABATRON **ABOJET** crack-injection system is a proven method to restore monolithic integrity to a cracked structural element by injecting a structural adhesive epoxy resin (ABOJET) into the crack, to fill and "weld" it back together. Since ABOJET bonds permanently and is stronger than concrete, the so "welded" wall can be stronger than it was originally.

The ABOJET series of resins is best known in the restoration of load-bearing walls, but its advantages are also obvious in restoring structural and decorative components, machinery and equipment supports, cable systems, bridges, artifacts, archaeological structures, sculptures.

Concrete is the material repaired in most cases, but most rigid materials can be restored, such as masonry, marble, stone, wood, ceramics, metals, stucco, gypsum.

Normally, an ABOJET resin system consists of 2 solventless (100% solids) liquids packaged separately: Resin (part A) and Hardener (part B). When needed, A and B are mixed and the resulting blend is then injected into the crack or cavity. A reaction starts when A and B are mixed, the blend will harden within minutes or hours (depending on the ABOJET chosen). Before hardening, the ABOJET A/B blend remains sufficiently fluid to be injected. The hardened system is dimensionally stable and virtually shrink-free.

Where structural requirements cannot be compromised, the ABOJET system is often the only dependable and cost-effective alternative to demolition. Crack-injection with the ABOJET resins has also gained prominence in sealing foundations and other under-grade walls against water seepage.

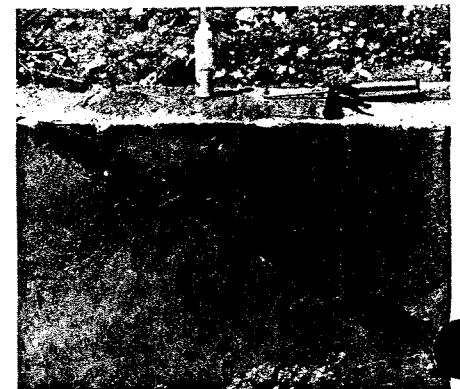

Typical comparative reference data:

	Concrete	ABOJET
Compressive Strength, psi	3,500	8,000-16,000
Tensile Strength, psi	300	5,000-11,000
Flexural Strength, psi	500	5,000-13,000

Restore:

- Load-bearing walls
- Columns
- Tanks
- Retaining walls
- Dams
- Foundations
- Decks
- Garages
- Vaults
- Domes
- Pipes
- Swimming pools

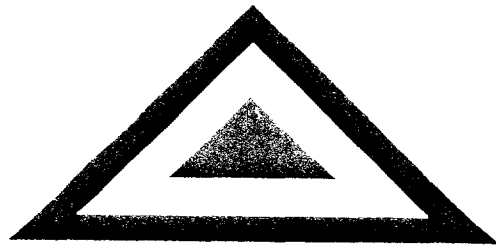
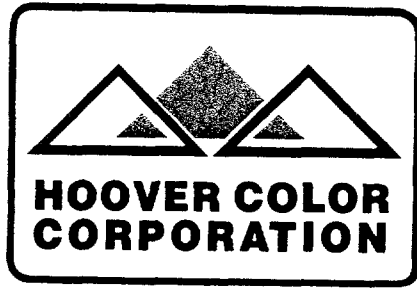

Pigments
For
Coloring Concrete Products

P.O. Box 218, Hiwassee, Virginia 24347 (703) 980-7233 Fax (703) 980-8781

PIGMENTS FOR COLORING CONCRETE PRODUCTS

Founded in 1923, Hoover Color Corporation has been manufacturing quality pigments to serve the needs of many industries, including coatings, building products and plastics. This brochure illustrates our line of pigments recommended for the concrete market.

The pigments exhibited here, formulated in both gray and white cement, are a select group of the more popular colors used in this market segment. Additional pigments are available from our extensive standard line of products or can be custom formulated to suit individual design specifications.

All single or blended pigments meet stringent quality parameters of color uniformity, lot to lot consistency, color strength and dispersibility. In addition, these pigments meet or exceed ASTM C-979 for lightfastness, alkali resistance and water wettability.

Because of the unique pigment performance characteristics, these products are recommended for coloring concrete blocks, pavers, roof tiles, bricks, mortar, grout, dust-on colors, stucco, precast and ready mix concrete.

Using these pigments to color concrete products is relatively simple, but some care must be exercised to achieve optimum performance. It is recommended that pigment be added by weight rather than volume. Typical pigment loadings can normally range from a fraction to about 10 percent, based on the cement content of the mix. For a given project, the cement, sand, aggregate, pigment and additives should be kept the same. The slump of the colored mix should be consistent with an uncolored mix. This can be achieved by the addition of water. Efflorescences is more apparent in colored products, therefore, it is recommended that the mix be allowed to cure slowly.

GRAY CEMENT

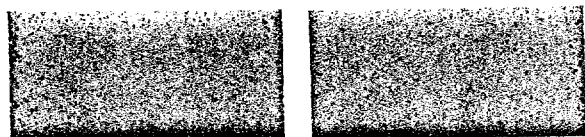

2% Yellow 420 5%

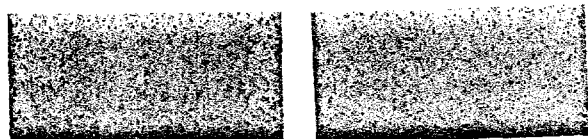

2% 110NO Ochre 5%

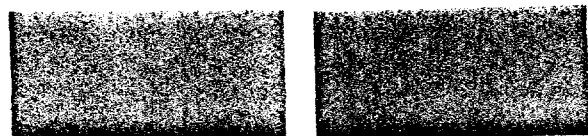

2% 105NO Ochre 5%



2% 775BN Brown 5%



2% 524BU Bt. Umber 5%

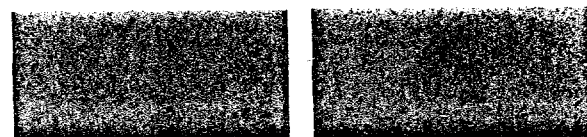

2% 703BG Brown 5%



2% 705BG Brown 5%

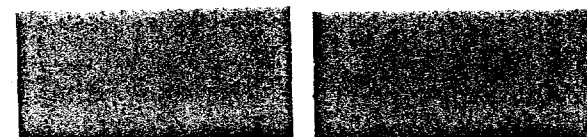

2% 707BG Brown 5%

EQUIPMENT RECOMMENDATIONS

PUMP/MODEL	GUN	HYDRAULIC FLUID LINE PRESSURE	TIP SIZES
Speeflow/Power Twin	Airless Spraygun	Minimum 2000 psi	0.021
Hylflex/MP5	Binks 2001 Spraygun	Minimum 2000 psi	242 Slotted Tip
Graco/480 Hydra Spray	Silver Airless Spraygun	Minimum 2000 psi	0.021

TECHNICAL DATA

THOROSHEEN applied in a two coat system of 5 mils total dry film thickness.

PHYSICAL OR PERFORMANCE PROPERTY	TEST METHOD	RESULTS (AVERAGES)
Water Vapor Transmission	ASTM E96-84, Procedure A	19.4 Perms, (9.323 g/m ² /24 hrs.)
Accelerated Weathering	ASTM G26, Xenon Arc	5,000 hours, no defects.
Mildew Resistance	TT-P-29G, Federal Standard 141B, Method 6271.	No growth at 21 days at 28°C, aspergillus niger.
% Solids by weight	Lab Value	56.5%, ± 1%
% Solids by Volume	Lab Value	38%, ± 1%
VOC Content	EPA Method	40 g/l, (0.33 lbs./gal.)
Viscosity	ASTM D4212-88	Zahn seconds
Flash Point	Lab Value	Noncombustible, >200°F (93°C)

COLORS

THOROSHEEN comes in 10 standard colors and a wide range of custom colors.

PACKAGING

1 gallon (3.8 ℓ), 5 gallon (18.9 ℓ), 30 gallon (113.5 ℓ) and 55 gallon (208 ℓ) containers.

TRANSPORT AND STORAGE

Transport and store in original, unopened, undamaged containers protected from freezing.

If partially frozen, place in a heated area and allow to warm up. Do not apply heat directly to the containers.

SHELF LIFE

Up to 12 months in unopened, undamaged original sealed containers which have been properly transported and stored.

MAINTENANCE

Occasional cleaning with mild soap or detergent and warm water will usually restore the cured THOROSHEEN film to a "like original" appearance. Use soft bristled brushes to clean and low water pressure to rinse. Remove stain causing agents as soon as possible to achieve maximum film life. Repair damaged films and recoat as quickly as possible. Refer to surface preparation directions above.

SERVICE CONDITIONS

Above-grade, interior or exterior. Below-grade, interior only. Not for immersion service.

Service Temperatures

Dry, - 20°F (-29°C) to 140°F (60°C).

Cleaning water, up to 140°F (60°C).

TECHNICAL SERVICES

Thoro sales and technical staff are available to assist in job-site evaluations, equipment recommendations, specification writing, contractor training, job follow-ups and warranty issuance. Contact the Customer Service Department of Thoro System Products at 800-327-1570, 8:00 a.m. to 7:00 p.m. E.S.T., for information and/or assistance.

Thoro Headquarters:

World Headquarters
7800 N.W. 38th Street
Miami, FL 33166

Phone: (305) 597-8100

Customer Service: (800) 327-1570

FAX: (305) 592-9760

European Headquarters
Thoro N.V.

Berkenbossenlaan 6

B-2400 Mol, Belgium

Phone: 14-81-12-71

SAFETY, HEALTH, AND ENVIRONMENTAL RECOMMENDATIONS

Use appropriate personal protective equipment including eyewear meeting the most current ANSI Z 87.1 standard. For specific health, safety, and environmental information consult the label and Material Safety Data Sheet available from Thoro System Products.

COMMITMENT TO QUALITY

Thoro System Products is dedicated to providing quality, value added products and services which consistently satisfy our customer's needs. As a group and as individuals, we are striving to improve the quality of our activities and do them correctly the first time. We welcome input from our customers and suppliers.

WARRANTY

Thoro System Products ("TSP") warrants that this product conforms to its applicable current specifications.



The U.S.E. line of expansion and specialty fasteners require that a hole be pre-drilled in the substrate. Our products are designed to function in holes drilled with bits that conform to ANSI B94.12-1977 standards.

Nominal Drill Diameter	Tolerance Band	Nominal Drill Diameter	Tolerance Band
3/16	.206 - .198	5/8	.660 - .650
1/4	.268 - .260	11/16	.723 - .713
5/16	.335 - .327	3/4	.787 - .775
3/8	.398 - .390	7/8	.917 - .905
7/16	.468 - .458	1	1.041 - 1.030
1/2	.530 - .520	1 1/8	1.175 - 1.160
9/16	.592 - .582	1 1/4	1.300 - 1.285

Incorrect bits and/or holes drilled irregularly may reduce anchor capacities and increase installation time. Anchors function best in clean holes and we suggest:

- Taper Bolts; Sup-R-Studs; Sup-R-Sleeves; Forway -- hole may be drilled 1/2-1" deeper than required embedment to allow debris to fall into bottom of hole.
- All other Expansion Anchors -- blow out debris with compressed air.

SUBSTRATES

Anchors are not tested in concrete less than 2,000 p.s.i. strength and we do not recommend the setting of anchors in "green" concrete. Taper Bolts and Sup-R-Studs are not sold for use in lightweight materials such as block or brick. Recommended for such substrates are Forway, Sup-R-Sleeves or our adhesive anchor line.

LOAD CONDITIONS

With few exceptions most mechanical anchors do not give maximum performance under all loading conditions. Some function well under dynamic but do poorly under vibratory loads, as is the case with stud/wedge anchors. Plastic and lead stretch and compact under heavy impact loads. Manually expanded anchors cannot be retightened, so should not be used under dynamic loads.

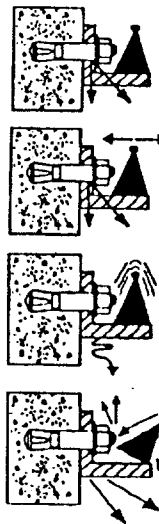

STATIC

No outside force applied.

VARIABLE

Irregular loading such as suspended signs and handrails.

VIBRATORY

High-frequency impact of low intensity such as compressors and motors.

DYNAMIC

Intense or sharply applied impact such as dock bumpers and guard rails.

I. TENSILE

Published values are the ultimate tensile force required to fail the anchor system and are always published in lbs. **A safety factor of 4:1 minimum is recommended** when designing for use. Where vibration is high and of concern safety factors up to 10:1 are usual.

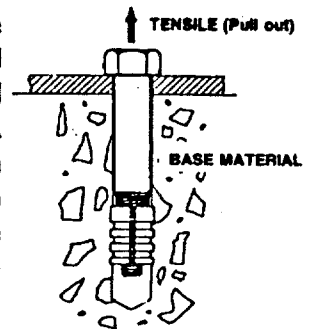

Failure of the anchor system can take different modes:

- Spall, edge failure or coning of the base material will indicate that the base material strength has been exceeded. This mode is usual for shallow embedments or anchors set too close together. To attain the published pull-out values we recommend that anchors be spaced no closer than x6 anchor diameters to the edge and x12 anchor diameters from each other.
- Pull out of the anchor will indicate that the applied force has exceeded the frictional force or keying action between the anchor and the base material. The mode of failure is rarely influenced by a change in the anchor bolt material as the bolt does not create the friction forces. The shield material or the expander mechanism is the critical item.
- Anchor bolt failure indicates that the frictional force of the anchor exceeds the tensile strength of the bolt.

2. SHEAR

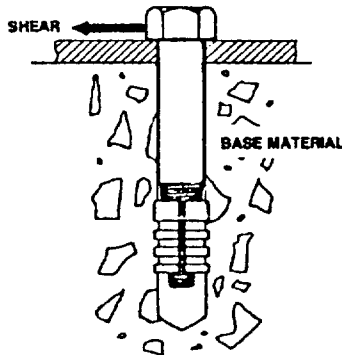

Published shear strength values are for the anchor system and not necessarily that of the bolt material. As all expansion anchors leave a gap between the bolt and the hole (see below) an application of a shear load may deform the mouth of the hole. Repeated loads eventually deform the entire hole and the base material may fail or the anchor

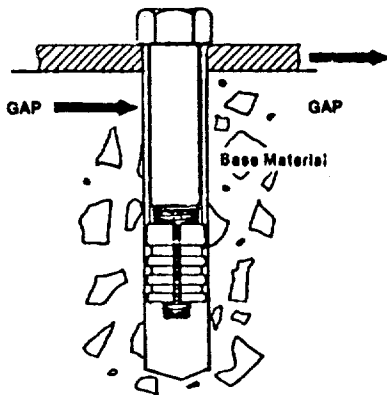

may pull out. It is very rare for the force to exceed the shear strength of the bolt material.

3. COMBINED LOADING

Anchors loaded in tension and shear simultaneously will have ultimate capacities lower than an anchor loaded in tension or shear separately. Combined loads should be calculated in a straight line interaction diagram of pure shear (S) and pure tension (T).

$$\frac{S \text{ Applied}}{S \text{ Allowed}} + \frac{T \text{ Applied}}{T \text{ Allowed}} \leq 1$$

Gunnebo Anchors are tested in York, PA and by Independent Testing Laboratories. All tests are conducted in accordance with ASTM E488.

MATERIAL FINISH

All our carbon steel anchors are supplied zinc plated with a clear dichromate lacquer. The finish meets ASTM-B-633 Type II, Class 3 and ASTM-A-164-SS type RS.

Mechanically galvanized finish can be made available for Sup-R-Studs, Taper Bolts and Threaded Rod/Rebar for adhesive resins. If absolutely necessary we will attempt to obtain a hot dipped galvanized finish provided it is accepted that this finish creates mating problems with any threaded parts.

There are a wide range of stainless steels available and Gunnebo supplies the following:

- Type 303 · an austenitic basic 18:8 stainless with special elements added to improve machinability. This material is used for Sup-R-Studs.
- Type 304 · an austenitic basic 18:8 stainless steel used for bolt blanks, Taper Bolt and threaded rod. Not available in Sup-R-Stud range.
- Type 316 · an austenitic, complex 18:8 stainless with very superior corrosion resistance. This material is used for Sup-R-Studs.

Gunnebo can produce Sup-R-Studs and Taper Bolts in B7, B8, Monel, Inconel, Brass or other corrosion resistant materials.

SETTING TORQUE

For most applications of Sup-R-Studs and Sleeves a simple turn of the nut to hand tight with 3-5 additional turns will provide all that is necessary to set the anchor. Concrete relaxation will occur and anchors will need to be retightened if the torque values are important. If the torque and/or load capacity is critical, specific torque values can be used for setting the anchor. The bolt can be re-torqued as required.

Over-torquing can result in anchor material or base material failure.

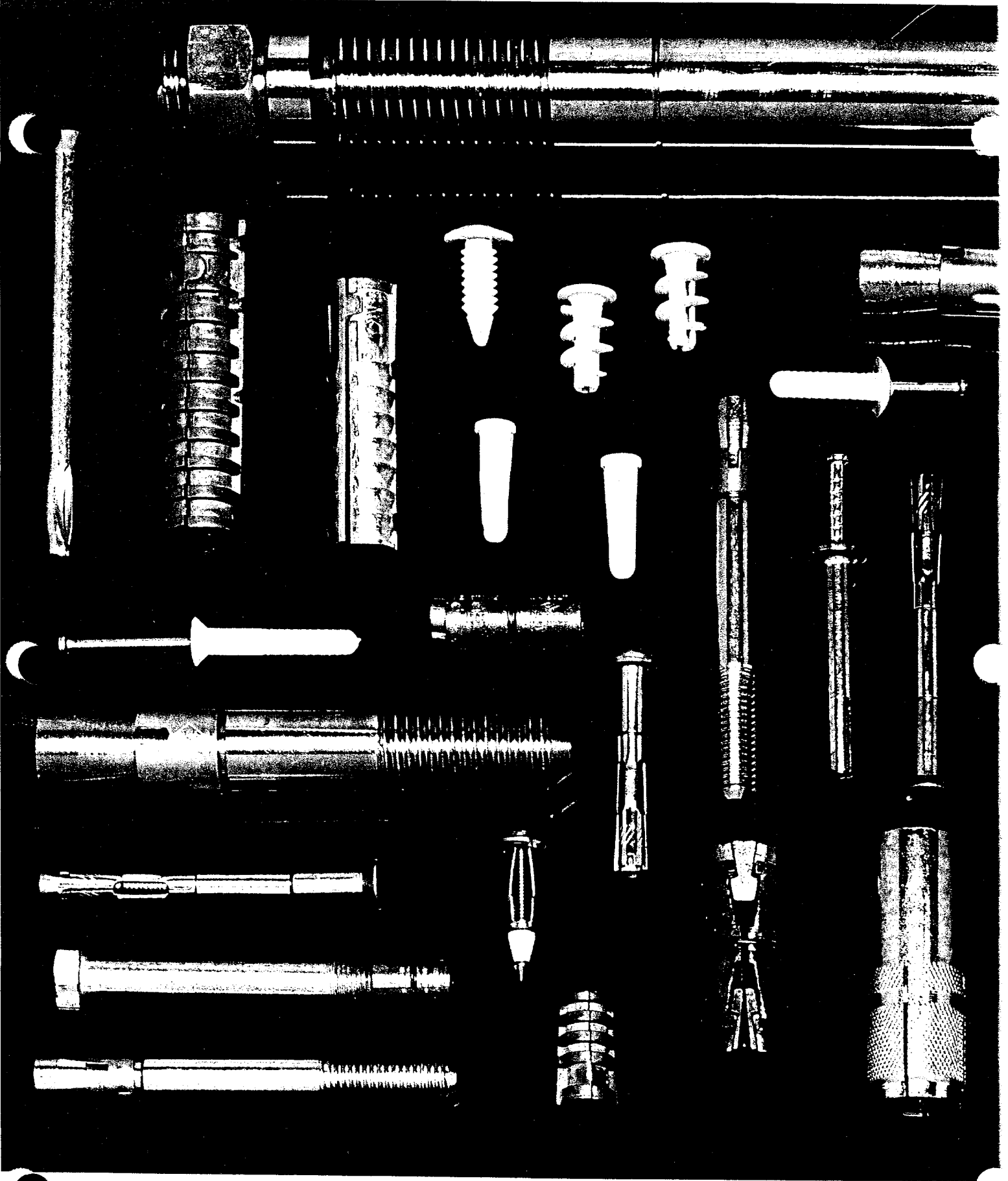

GUNNEBO

FASTENING

P.O. Box 1589 • 180 S. Hartman St., York, PA 17405
717-846-2200 • FAX 717-852-0809





TYPICAL APPLICATIONS

WEDGE ANCHORS AND DROP-INS

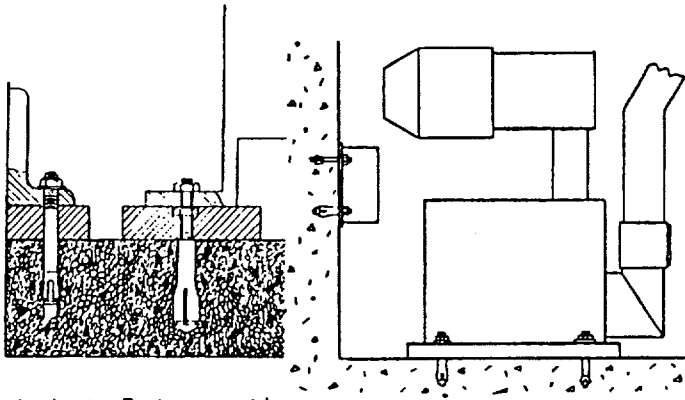

Anchoring Equipment with grout pad

HVAC Equipment anchoring

Medium-duty applications also include: base angles, suspended fixtures, stair units, chair carriers, dock bumpers, access ladders, hand rails, pipe supports, etc. and other applications where the base material is poured structural concrete.

SLEEVE AND M/C SCREW

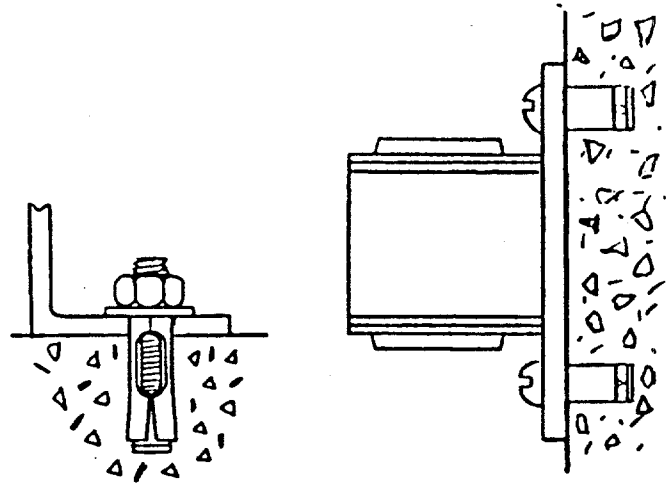

Brackets

Transformers

Light and medium duty applications also include: wall and ceiling fixtures, cable straps, panel boxes, shelving, racks, door tracks, window frames, partitions, panel boxes, etc. in poured concrete as well as base materials that are not suitable for wedge and drop-in expansion anchors (block, brick, stone).

TOGGLE AND HOLLOW WALL

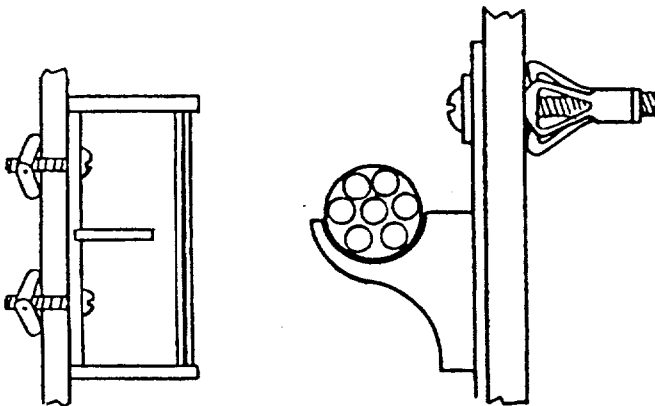

Cabinets

Cable Trays

Light duty applications include: fixtures, flush mounted signs, door stops, picture hangers, curtain tracks, etc. and other applications where the base material includes wall board, drywall, cinder block, plywood paneling, etc.

HAMMER DRIVE, TAP-IT, PLASTIC SCREW ANCHORS

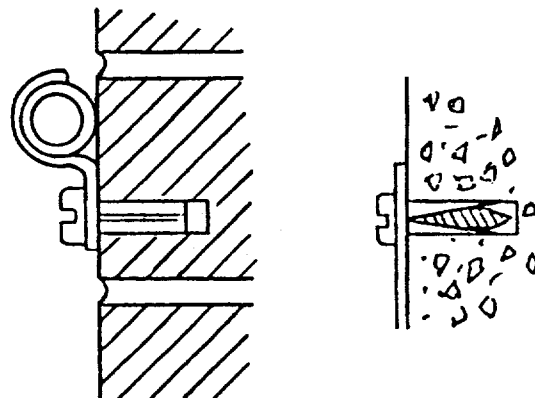

Conduit

Flush-mounted Signs

Applications include a wide variety of light duty applications in concrete, block, brick, mortar, tile, wood, etc.

RESTORATION PRODUCT

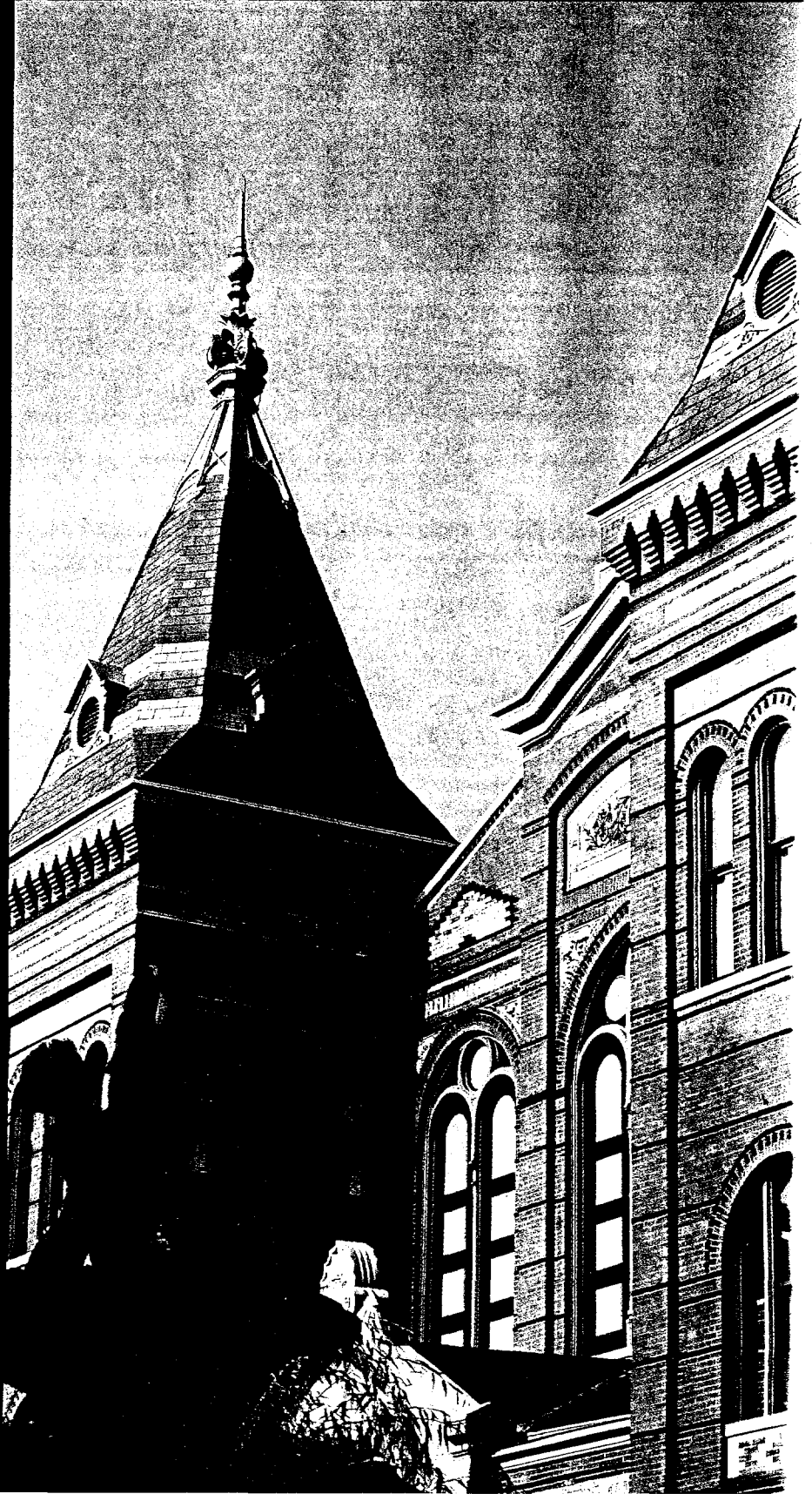

The ProSoCo History in Restoration Cleaning

In 1959, Mountain States Telephone Company was in the process of restoring their building in Denver, Colorado. Turning to ProSoCo, Inc., Mountain States asked for a cleaning agent that would remove the accumulated dirt without harming the delicate terra cotta on their building. Using what became the first cleaning material ever formulated specifically for restoration cleaning, Sure Klean® Restoration Cleaner, the results were dramatic and successful.

From this one building in Denver, ProSoCo has emerged to become the nation's largest manufacturer of proprietary cleaning products for the restoration cleaning of masonry surfaces.

How Our Experience Can Help You

- *Questions and Problems* — Call our Kansas City, New Jersey or Georgia offices. A knowledgeable customer service representative will answer your questions.
- *Job site assistance* — Factory-trained representatives throughout the U.S. are available for assistance with cleaning specifications, applying test panels and trouble shooting.
- *Laboratory testing* — Tough cleaning problems are reviewed and products are tested in the ProSoCo laboratory, located in our company's Kansas City headquarters.
- *Our assurance of quality* — All Sure Klean® products have been field and laboratory tested. Thousands of architects and historians have trusted our products to clean their buildings. We take pride in this reputation. In the future, we will continue to provide superior products and services for your restoration project.



Mtn. States Telephone Building
Denver, Colorado

Smithsonian Arts and Industries Building

(Cover Photograph)

The Smithsonian Arts and Industries Building is one of Washington D.C.'s most notable landmarks. Built in 1897, the colorful old building is constructed of red brick, glazed brick, buff sandstone and granite. Six different Sure Klean® Restoration Products have been used to remove staining and dirt from brick and stone on this prestigious structure.



ProSoCo, Inc.

PO. Box 171677 • Kansas City, KS 66117 •
913/281-2700

111 Snyder Road • South Plainfield, NJ
07080 • 201/754-4410

1601 Rock Mountain Blvd. • Stone
Mountain, GA 30083 • 404/939-9890

2924 West Story Road • Irving, TX 75038 •
214/252-9399

3423 Investment Blvd., Suite 206 •
Hayward, California 94545 • 415/785-3950

Restoration Cleaners

Tragically, sandblasting and waterblasting are often used to clean older buildings. Both processes "clean" by literally scouring away the dirt. In doing so, the protective surface of the masonry is removed, leaving the softer substrate exposed. When this protective layer is gone, weathering and resulting deterioration accelerates up to ten times faster.

To counter such destructiveness, Sure Klean® Restoration Cleaners were developed. These proprietary chemical cleaners are safer. And they clean better. Wetting agents and surfactants hold the materials on the surface, gently dissolving the particles of dirt, carbon, algae and oxidation . . . then pressure water rinses the grime away leaving the masonry surface looking like new.

Sure Klean® products are recognized and specified by leading historic preservation groups, state agencies, the General Services Administration and other federal agencies across the nation as *the* products to use for the cleaning of historic buildings.

Sure Klean® Restoration Cleaner — Our original Restoration Cleaner has been proven effective on thousands of historical structures. Cleans brick, granite, marble, sandstone, terra cotta, exposed aggregate and many other surfaces.



Sure Klean® Heavy Duty Restoration Cleaner — Highly populated urban areas result in extremely heavy accumulations of dirt, carbon and pigeon droppings. Sure Klean® Heavy Duty Restoration Cleaner is a highly concentrated product that removes built-up grime on brick, granite, marble, sandstone, terra cotta, exposed aggregate.

766 Masonry Prewash — 766 Prewash presoaks and softens layers of deep set carbon and mildew prior to application of the suitable Sure Klean®

restorative cleaner. 766 Prewash is normally used for spot cleaning of heavily carboned areas such as window sills, parapet walls, cornices, etc. Use on brick, stone, limestone, concrete, terra cotta and other surfaces in conjunction with an "afterwash" of Sure Klean® Restoration Cleaner, Limestone Afterwash or Limestone Restorer.

Limestone Prewash/Afterwash — A two-part cleaning system for heavily carboned, extremely dirty limestone and concrete surfaces. Limestone Prewash is an alkaline cleaner that penetrates and softens carbon and dirt, allowing water to rinse it away. Limestone Afterwash then neutralizes and brightens the surface, restoring the limestone to its natural color and appearance.

Acid Stop® Strippable Masking — An easily applied liquid masking material that protects non-porous surfaces such as glass, metal, polished marble, etc. from cleaning chemicals and residues. Acid Stop® is applied with brush or rollers and dries to touch within minutes. After the cleaning is complete, Acid Stop® is easily removed by peeling from the surface in one piece. Put-up and take-down require approximately one-third the time of polyethylene protection.

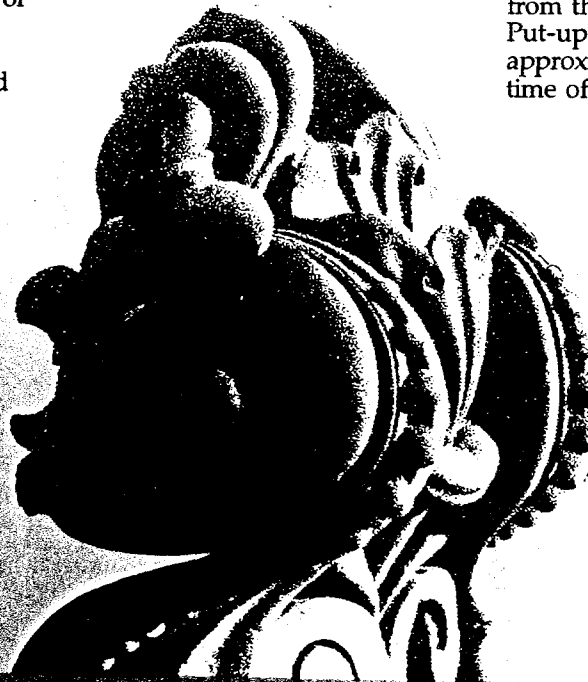

→ SUREKLEAN →

Asphalt and Tar Remover — Removes tar, asphalt, grease and oil stains from brick, stone, concrete and other masonry surfaces. Also removes many clear sealers, caulk residues and light paint splatters from masonry.

Aluminum Cleaner — Cleans aluminum oxidation, atmospheric dirt, carbon and other stains from all types of aluminum surfaces.

Sure Klean® Restoration Cleaners have been used on numerous historic buildings, a few of which include:

Woolworth Building, New York City — N.Y.C. Landmark — glazed terra cotta, (1913)

National Building Museum (Pension Building), Washington, D.C. — National Historic Landmark — brick and terra cotta, (1881)

Wainwright Building, St. Louis, Missouri — Louis Sullivan Landmark — brick and unglazed terra cotta (1890)

Rookery, Chicago, Illinois — Burnham & Root Historic Landmark — sandstone, unglazed terra cotta (1886)

U.S. Treasury Building, Washington, D.C. granite (1839)

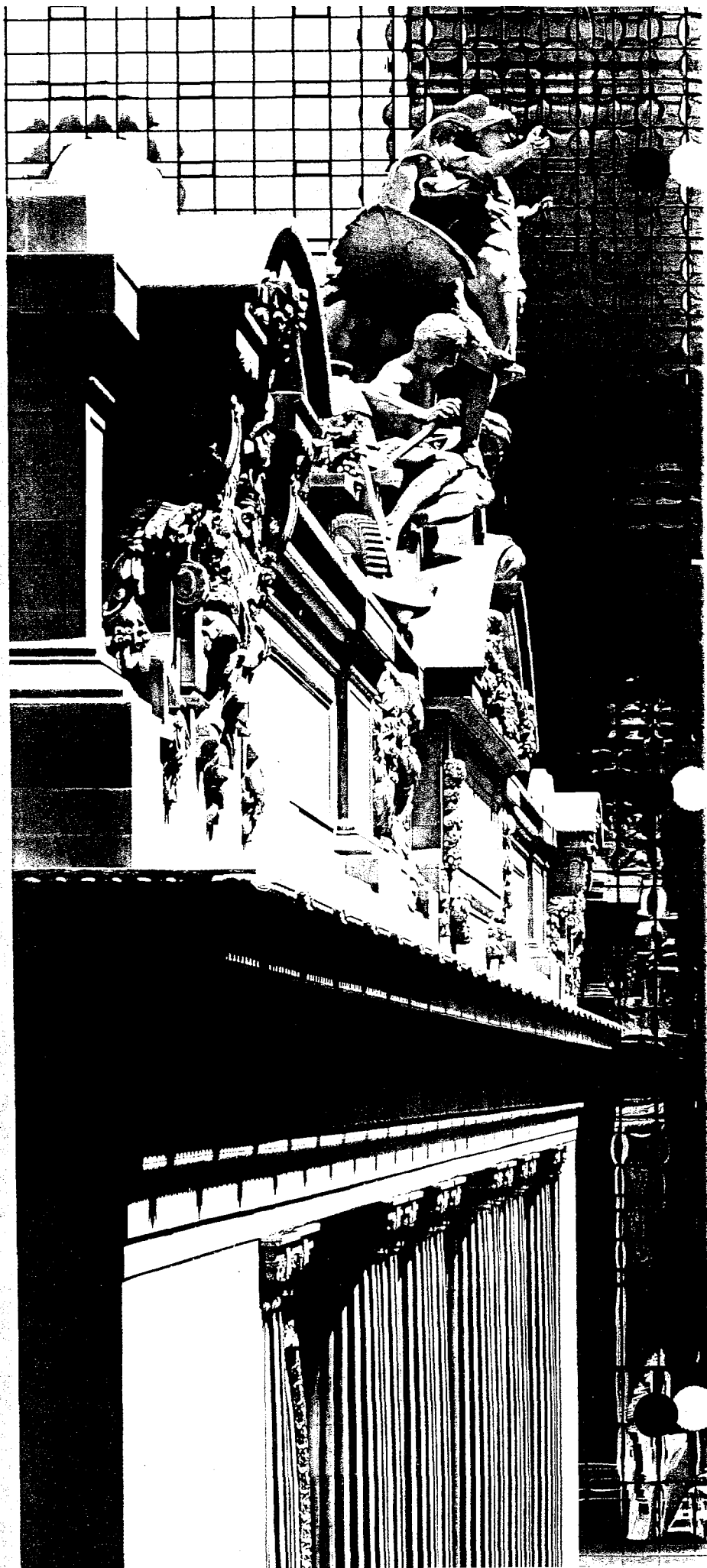

Grand Central Station

In 1978, a landmark decision by the U.S. Supreme Court saved Grand Central Station from the wrecker's ball. During the Station's restoration, carbon encrustation $\frac{3}{4}$ " thick was removed from its limestone exterior using Sure Klean® Limestone Prewash/Afterwash.

Chemical & Water Resistant Epoxy Enamel 182 Epoxy Hardener (Curing Agent) 177 / Epoxy Thinner 178

Product Description

Type: A polyamide epoxy, two-component high gloss enamel.

Use: For interior or exterior galvanized iron, bare or previously coated steel, aluminum, cement, concrete, cinder block, masonry, unglazed brick, wallboard, plaster and wood surfaces subjected to a broad range of solvents, grease, oil, moisture, fumes and chemicals. Ideal for floors, machinery, equipment, partitions, storage tanks and similar surfaces in cement, petroleum, mining, chemical, sewage, pulp and paper plants. Also recommended for schools, recreational and health care facilities.

Finish: Gloss

Colors Available: Safety White, Safety Black, Falls Blue, Vista Green, Dunes Tan, Sierra Sand, Platinum Gray, and Deck Gray.

Safety Colors: Meet ANSI specification Z53.1 and comply with OSHA standards for color coding physical hazards.

Package Sizes: Gallons

Coverage: 225-400 sq. ft. (20.9-37.1 sq. meters) per gallon

Dry Time:

- To Touch— 2 hours
- To Handle— overnight
- To Recoat— overnight
- To Cure— 7 days full cure
- To Service— 2 to 3 days light use

Mil Film Thickness:

- Wet— 5.1 mils @ 312 sq. ft. per gallon after mixing with IronClad Epoxy Hardener (177)
- Dry— 2.5 mils @ 312 sq. ft. per gallon after mixing with IronClad Epoxy Hardener (177)

Solids Content: By Weight— 68% By Volume— 48%

Weight Per Gallon: 11 lbs. 11 oz.

Viscosity: 75 ± 3 KU

Flash Point: Combustible

Thinning/Cleanup:

Apply as received in the container. Do not thin. Clean equipment with IronClad Epoxy Thinner (178).

Mixing Requirements: Prior to painting, ensure having enough paint boxed or mixed in one container to complete an entire section. This practice is important with standard as well as custom blended colors.

Thoroughly mix equal parts by volume of IronClad Chemical & Water Resistant Epoxy Enamel (182) and IronClad Epoxy Hardener (177). Allow to stand 1 hour before use.

DO NOT MIX ON PAINT SHAKER.

DO NOT MIX MORE MATERIAL THAN CAN BE USED IN ONE DAY.

Pot Life: At 70°F (21°C) up to 18 hours.

Performance Characteristics

- Protects against chemicals, oils, grease and detergents.
- Resists abrasion and impact.
- Excellent adhesion.
- Withstands frequent and hard scrubbing, including steam cleaning.
- Excellent hiding and leveling.
- Comes in two specially formulated safety colors.
- Do not add tinting colors.
- Caution: All high-gloss floor enamels may become slippery when wet. Where non-skid characteristics are desired, a small amount of clean sand may be added. Stir often during application.

Federal Specifications

Generic Equivalent

TT-C-535-B (Type II)

Environmental Considerations

Formulated with non-photochemically reactive solvents. Formulated without lead or mercury.

Finishing Systems

Previously Painted Surfaces:

Remove any loose paint. Spot-prime as recommended for substrate. Check a small, isolated area for lifting or wrinkling before topcoating with IronClad Chemical and Water Resistant Epoxy Enamel (182)

Galvanized Iron, New:

Primer: IronClad Galvanized Metal Latex Primer (155)
Finish: 1 or 2 coats IronClad Chemical & Water Resistant Epoxy Enamel (182)

Galvanized Iron, Weathered 6 Or More Months:

Primer: IronClad Epoxy Rust Inhibitive Primer (181)
Finish: 1 or 2 coats IronClad Chemical & Water Resistant Epoxy Enamel (182)

Galvanized Iron, Repaint:

Primer: Spot prime as needed with IronClad Epoxy Rust Inhibitive Primer (181)
Finish: 1 or 2 coats IronClad Chemical & Water Resistant Epoxy Enamel (182)

Ferrous Metal, New:

Primer: IronClad Epoxy Rust Inhibitive Primer (181)
Finish: 1 or 2 coats IronClad Chemical & Water Resistant Epoxy Enamel (182)

Ferrous Metal, Repaint:

Primer: IronClad Epoxy Rust Inhibitive Primer (181)
Finish: 1 or 2 coats IronClad Chemical & Water Resistant Epoxy Enamel (182)

Plaster/Drywall, New:

Primer: Moore's Latex Enamel Underbody (345)
Finish: 1 or 2 coats IronClad Chemical & Water Resistant Epoxy Enamel (182)

Plaster/Drywall, Repaint:

Primer: Spot prime with Moore's Latex Enamel Underbody (345)
Finish: 1 or 2 coats IronClad Chemical & Water Resistant Epoxy Enamel (182)

Wood, New:

Primer: Apply 1 coat IronClad Chemical & Water Resistant Epoxy Enamel (182)

Finish: 1 or 2 coats IronClad Chemical & Water Resistant Epoxy Enamel (182)

Wood, Repaint:

Primer: Apply 1 coat IronClad Chemical & Water Resistant Epoxy Enamel (182)

Finish: 1 or 2 coats IronClad Chemical & Water Resistant Epoxy Enamel (182)

Masonry, New:

Primer: Etch smooth troweled concrete; flush with water. When dry, apply 1 or 2 coats IronClad Chemical & Water Resistant Epoxy Enamel (182). First-coat cinder and cement block with Moorcraft Interior & Exterior Block Filler (173)

Finish: 2 coats IronClad Chemical & Water Resistant Epoxy Enamel (182)

Concrete Floors:

Primer: 1 coat IronClad Chemical & Water Resistant Epoxy Enamel (182)

Finish: 1 or 2 coats IronClad Chemical & Water Resistant Epoxy Enamel (182)

Masonry, Repaint:

Primer: Prime or spot-prime smooth concrete as needed with IronClad Chemical & Water Resistant Epoxy Enamel (182). Priming not normally required on previously painted block.

Finish: IronClad Chemical & Water Resistant Epoxy Enamel (182)

Aluminum, New:

Finish: IronClad Chemical & Water Resistant Epoxy Enamel (182)

Aluminum, Old or Weathered:

Primer: IronClad Epoxy Rust Inhibitive Primer (181)

Finish: IronClad Chemical & Water Resistant Epoxy Enamel (182)

Application

- Do not apply when air and surface temperatures are below 50°F (10°C).
- Brush: Stir thoroughly and apply as received in the container with a good quality, bristle brush.
- Roller: Stir thoroughly and apply as received in the container with a good quality, short nap roller.
- Spray, Airless: See **General Information** for specifications.

Product Description

IronClad Epoxy Hardener (Curing Agent)—177

A chemical curing agent for use with IronClad Epoxy Rust Inhibitive Primer (181) and IronClad Chemical & Water Resistant Epoxy Enamel (182). IronClad Epoxy Hardener (177) is to be mixed with equal volumes of the appropriate IronClad product following the directions on the label. Available in gallon size only.

Product Description

IronClad Epoxy Thinner—178

A solvent blend specifically intended for use with IronClad industrial maintenance products.

IronClad Epoxy Thinner (178) is also useful as a cleanup solvent for painting tools and spray equipment or as a pre-painting solvent for oily or greasy surfaces. It is not compatible with water-thinned paints.

Available in quarts and gallons.

Retardo Rust Inhibitive Paint 163

Retardo Rust Inhibitive Primer (Aerosol) 493

Product Description

Retardo Rust Inhibitive Paint (163)

Type: A high performance rust inhibitive alkyd coating formulated with specially processed chemical ingredients that effectively protect metal against rust and corrosion.

Use: New or previously painted exterior ferrous metal surfaces such as storage tank exteriors, structural steel, weathered factory finished structures, and farm and construction equipment, as well as weathered and/or rusting galvanized metal buildings, guardrails, and similar structures.

Finish: Satin

Colors Available: White, Red, Green, Bronzestone, Deep Bronze, Medium Gray, Aluminum, and Black. White may be tinted with up to 2.0 fl. oz. universal tinting colors per gallon.

Package Sizes: Half-pint, Pint, Quart, Gallon, and Five Gallon containers.

Coverage:

Colors—500–600 sq. ft. (46.4–55.7 sq. meters) per gallon.

Aluminum—700 sq. ft. (65.0 sq. meters) per gallon.

Dry Time:

- To Touch— 2 to 4 hours
- To Handle— 8 hours
- To Recoat— overnight
- To Service—24 hours

Mil Film Thickness:

Colors: Wet—2.9 mils @ 550 sq. ft. per gallon

Dry—1.3 mils @ 550 sq. ft. per gallon

Aluminum: Wet—2.3 mils @ 700 sq. ft. per gallon

Dry—0.7 mils @ 700 sq. ft. per gallon

Solids Content:

Colors: By Weight—66% By Volume—44%

Aluminum: By Weight—40% By Volume—30%

Weight Per Gallon: 10 lbs. 10 oz.

Viscosity: 85 ± 2 KU

Flash Point: Combustible

in Use Temperature Range: Aluminum may be used as a heat-resistant coating on unpainted metal surfaces at temperatures up to 500°F

Thinning/Cleanup: Apply as received in the container. Do not thin. Clean equipment with mineral spirits.

Performance Characteristics

- Resists rust and corrosion when exposed to coastal climates and moderate levels of industrial fumes.
- Seals out harmful moisture.
- Withstands extremes in climate and weather.
- May be used as a primer under conventional solvent-thinned and water-thinned coatings.
- An ideal shop primer when used as a foundation for conventional alkyd or latex coatings.
- Extremely durable; an ideal finishing paint.
- High-hiding.
- Excellent brushing and leveling qualities.
- Aluminum should not be used as a rust-inhibitive primer.

Federal Specifications

Generic Equivalents

TT-P-1757

TT-P-636-D

TT-E-485-F

Environmental Considerations

Formulated with non-photochemically reactive solvents. Formulated without lead or mercury.

Finishing Systems

Ferrous Metal, New:

Primer: 2 coats IronClad Retardo Rust Inhibitive Paint (163)

Ferrous Metal, Repaint:

Primer: 1 or 2 coats IronClad Retardo Rust Inhibitive Paint (163)

Galvanized Iron, New:

Primer: IronClad Galvanized Metal Latex Primer (155)

Galvanized Iron, Weathered 6 Months or More:

Primer: IronClad Retardo Rust Inhibitive Paint (163)

Galvanized Iron, Repaint:

Primer: Prime or spot prime as needed with IronClad Retardo Rust Inhibitive Paint (163)

Aluminum:

Primer: IronClad Retardo Rust Inhibitive Paint (163)

Tinplate:

Primer: IronClad Retardo Rust Inhibitive Paint (163)

Application

Prior to painting, ensure having enough paint boxed or mixed in one container to complete an entire section. This practice is important with standard as well as custom blended colors.

- Do not apply when air and surface temperatures are below 50°F (10°C).
- Stir thoroughly and apply as received in the container with a good quality bristle brush or short-nap roller.
- Spray, Airless: See **General Information** for specifications.

Product Description

IronClad Retardo Rust Inhibitive Primer (493) Aerosol Spray

A fast-drying, aerosol, rust-inhibitive primer designed for spot-priming or touch-up convenience, or for use on objects that are difficult to brush-coat. Recommended for new or previously painted steel and aluminum, as well as chemically-etched galvanized iron—interior or exterior. For proper performance and service, IronClad Retardo Rust Inhibitive Primer (493) aerosol must be topcoated with Utilac Spray Enamel (490) or other selected finish. Available in White, Red, and Medium Gray. Dry Time: 15 minutes.

Chex-Wear Epoxy-Ester Enamel 226

Product Description

Type: A ready-to-use (single component) interior/exterior epoxy-ester enamel, chemically resistant to moderate industrial environment, with excellent resistance to wear and abrasion.

Use: Primed or previously painted plaster, wallboard, wood or metal, and cured concrete surfaces. Recommended for wood, metal, or concrete floors, walls, doors, dados, trim, metal, partitions, machinery, rolling equipment, structural steel, and storage tank exteriors.

Finish: High Gloss

Colors Available: Industrial White, Terra Red, Vista Green, Dunes Tan, Sierra Sand, Brown, Light Gray, Cobblestone, and Platinum Gray. May be tinted with up to 2.0 fl. oz. universal tinting colors per gallon.

Package Sizes: Quarts and Gallons. Five Gallon containers available on special order.

Coverage: 550–650 sq. ft. (51.0–60.3 sq. meters) per gallon over smooth surfaces.

Dry Time:

To Touch— 3 to 6 hours
To Handle— 8 to 12 hours
To Recoat— 24 hours
To Service—24 hours

Mil Film Thickness:

Wet—2.7 mils @ 600 sq. ft. per gallon
Dry—1.1 mils @ 600 sq. ft. per gallon

Solids Content: By Weight—53% By Volume—42%

Weight Per Gallon: 9 lbs. 2 oz.

Viscosity: 73 ± 3 KU

Flash Point: Combustible

Thinning/Cleanup: Apply as received in the container. Do not thin. Clean equipment with IronClad 660 Solvent Thinner (293).

Performance Characteristics

IronClad Chex-Wear Epoxy-Ester Enamel (226) is resistant to alkali, grease, and mild acids and chemicals. Performs favorably as a replacement coating for two-component epoxy enamels. It will not lift previous coats of conventional paint, nor soften when recoated. It provides a tough, durable film which resists hard wear and more than average abuse. It is resistant to sagging, flows easily under the brush, and levels free of brushmarks. When used on exterior surfaces, the coating will exhibit light chalking; however, the inherent qualities are not affected and it offers an excellent repaint surface. IronClad Chex-Wear Epoxy-Ester Enamel (226) is not recommended on concrete surfaces in direct contact with the earth unless laid over a waterproofing membrane.

Caution: All high-gloss floor enamels may become slippery when wet. Where non-skid characteristics are desired, a small amount of clean sand may be added. Stir often during application.

Environmental Considerations

Formulated with non-photochemically reactive solvents. Formulated without lead or mercury.

Finishing Systems

New Surfaces

Unpainted, Cured Concrete Floors:

Surface Preparation: New or smooth troweled concrete floors must first be etched with a muriatic acid mixture. **Caution:** Follow acid manufacturer's label directions: use work goggles, rubber boots, and gloves.

Primer: IronClad Chex-Wear Epoxy-Ester Enamel (226)

Finish: 1 or 2 coats IronClad Chex-Wear Epoxy-Ester Enamel (226)

Unpainted, Cured Poured/Precast Concrete Walls:

Primer: IronClad Chex-Wear Epoxy-Ester Enamel (226)

Finish: 1 or 2 coats IronClad Chex-Wear Epoxy-Ester Enamel (226)

Unpainted, Concrete Block Walls:

Primer: 1 coat Moore's Moorcraft Interior & Exterior Block Filler (173)

Finish: 1 or 2 coats IronClad Chex-Wear Epoxy-Ester Enamel (226)

Metal, Ferrous, New:

Primer: IronClad Retardo Rust Inhibitive Paint (163)

Finish: 1 or 2 coats IronClad Chex-Wear Epoxy-Ester Enamel (226)

Metal, Galvanized, New:

Primer: IronClad Galvanized Metal Latex Primer (155)

Finish: 1 or 2 coats IronClad Chex-Wear Epoxy-Ester Enamel (226)

Drywall Walls & Ceilings, New:

Primer: 1 coat Moore's Latex Quick Dry Prime Seal (201)

Finish: 1 or 2 coats IronClad Chex-Wear Epoxy-Ester Enamel (226)

Wood:

Exterior Trim, Doors, Frames:

Primer: 1 coat Moore's Moorwhite Primer (100)

Finish: 1 or 2 coats IronClad Chex-Wear Epoxy-Ester Enamel (226)

Interior Trim, Doors, Frames:

Primer: 1 coat Moore's Alkyd Enamel Underbody (217)

Finish: 1 or 2 coats IronClad Chex-Wear Epoxy-Ester Enamel (226)

Interior Wood Flooring:

Primer: 1 coat IronClad Chex-Wear Epoxy-Ester Enamel (226)

Finish: 1 or 2 coats IronClad Chex-Wear Epoxy-Ester Enamel (226)

Previously Painted Interior Surfaces:

Interior Walls/Ceilings:

Primer: Prime or spot prime as needed with Moore's Alkyd Enamel Underbody (217) or Moore's Latex Enamel Underbody (345)

Finish: 1 or 2 coats IronClad Chex-Wear Epoxy-Ester Enamel (226)

Machinery, Equipment, Metal Partitions, Railings, Catwalks:

Primer: Prime or spot prime as needed with IronClad Retardo Rust Inhibitive Paint (163)

Finish: 1 or 2 coats IronClad Chex-Wear Epoxy-Ester Enamel (226)

Concrete Floors:

Primer: Prime or spot prime as needed with IronClad Chex-Wear Epoxy-Ester Enamel (226)

Finish: 1 or 2 coats IronClad Chex-Wear Epoxy-Ester Enamel (226)

Metal Surfaces (Storage Tanks, Galvanized Sheet Metal Siding, Structural Steel, Sash, Trim, Doors):

Primer: Prime or spot prime as needed with IronClad Retardo Rust Inhibitive Paint (163)

Finish: 1 or 2 coats IronClad Chex-Wear Epoxy-Ester Enamel (226)

Masonry Surfaces:

Primer: Prime or spot prime as needed with IronClad Chex-Wear Epoxy-Ester Enamel (226)

Finish: 1 or 2 coats IronClad Chex-Wear Epoxy-Ester Enamel (226)

Wood (Trim, Doors, Sash):

Primer: Spot prime as needed with Moore's Moorwhite Primer (100)

Finish: 1 or 2 coats IronClad Chex-Wear Epoxy-Ester Enamel (226)

Application

Prior to painting, ensure having enough paint boxed or mixed in one container to complete an entire section. This practice is important with standard as well as custom blended colors.

- Do not apply when air and surface temperatures are below 50°F (10°C).
- Stir thoroughly and apply as received in the container with a good quality bristle brush or short-nap roller.
- Spray, Airless: See **General Information** for specifications.

Epoxy Rust Inhibitive Primer 181

Epoxy Hardener (Curing Agent) 177 / Epoxy Thinner 178

Product Description

Type: A polyamide epoxy, two-component primer formulated with a rust-inhibitive pigment.

Use: On interior and exterior steel, aluminum, or galvanized surfaces prior to topcoating with IronClad Chemical & Water Resistant Epoxy Enamel (182).

Finish: Semi-Gloss

Colors Available: White and Red

Package Sizes: Gallons

Coverage: 200–225 sq. ft. (18.5–20.9 sq. meters) per gallon

Mixing: Prior to painting, ensure having enough paint boxed or mixed in one container to complete an entire section. Mix equal parts by volume of IronClad Epoxy Rust Inhibitive Primer Base (181) and IronClad Epoxy Hardener (177). Stir thoroughly and permit to stand at least one hour. **DO NOT MIX ON SHAKER. DO NOT MIX MORE MATERIAL THAN CAN BE USED IN ONE DAY.**

Dry Time:

- To Touch— 2 hours
- To Handle— overnight
- To Recoat— overnight

Pot Life: 18 hours @ 70°F (21°C)

Mil Film Thickness:

- Wet—7.6 mils @ 212 sq. ft. per gallon after mixing with IronClad Epoxy Hardener (177)
- Dry—3.8 mils @ 212 sq. ft. per gallon after mixing with IronClad Epoxy Hardener (177)

Solids Content: By Weight—63% By Volume—50%

Weight Per Gallon: 12 lbs. 9 oz.

Viscosity: 100 ± 5 KU

Flash Point: Combustible

Thinning/Cleanup: Apply as received in the container. Do not thin. Clean equipment with IronClad Epoxy Thinner (178).

Performance Characteristics

- Ideally suited for industrial maintenance painting.
- Resistant to most solvents and chemicals.
- Possesses excellent adhesion qualities.
- Outstanding leveling and hiding qualities.

Environmental Considerations

Formulated with non-photochemically reactive solvents. Formulated without lead or mercury.

Finishing Systems

Ferrous Metal, New:

Primer: IronClad Epoxy Rust Inhibitive Primer (181)
Finish: IronClad Chemical & Water Resistant Epoxy Enamel (182)

Ferrous Metal, Repaint:

Primer: IronClad Epoxy Rust Inhibitive Primer (181)
Finish: IronClad Chemical & Water Resistant Epoxy Enamel (182)

Galvanized Iron, New:

Primer: IronClad Galvanizes Metal Latex Primer (155)
Finish: IronClad Chemical & Water Resistant Epoxy Enamel (182)

Galvanized Iron, Repaint:

Primer: Prime or spot prime as needed with IronClad Epoxy Rust Inhibitive Primer (181)
Finish: IronClad Chemical & Water Resistant Epoxy Enamel (182)

Aluminum, Old or Weathered:

Primer: IronClad Epoxy Rust Inhibitive Primer (181)
Finish: IronClad Chemical & Water Resistant Epoxy Enamel (182)

Application

- Do not apply when air and surface temperatures are below 50°F (10°C).
- Brush: Stir thoroughly and apply as received in the container with a good quality, bristle brush or good quality roller.
- Spray, Airless: See **General Information** for specifications.

Product Description

IronClad Epoxy Hardener (Curing Agent)—177

A chemical curing agent for use with IronClad Epoxy Rust Inhibitive Primer (181) and IronClad Chemical & Water Resistant Epoxy Enamel (182). IronClad Epoxy Hardener (177) is to be mixed with equal volumes of the appropriate IronClad product following the directions on the label. Available in gallon size only.

Product Description

IronClad Epoxy Thinner—178

A solvent blend specifically intended for use with IronClad industrial maintenance products.

IronClad Epoxy Thinner (178) is also useful as a cleanup solvent for painting tools and spray equipment or as a pre-painting solvent for oily or greasy surfaces. It is not compatible with water-thinned paints.

Available in quarts and gallons.

Damp Surface High Gloss Enamel 225

Product Description

Type: Alkyd resin enamel

Use: For interior surfaces subjected to continuing dampness and humidity. May be used over properly prepared metal, wood, masonry, plaster, and wallboard. Not recommended for floors.

Finish: High Gloss

Colors Available: White. May be tinted with up to 2.0 fl. oz. universal tinting colors per gallon.

Package Sizes: Gallons. Five Gallon containers available on special order.

Coverage: 350–450 sq. ft. (32.5–41.8 sq. meters) per gallon.

Dry Time:

- To Touch— 4 to 6 hours
- To Handle— 8 hours
- To Recoat— overnight
- To Service—overnight

Mil Film Thickness:

- Wet—4.0 mils @ 400 sq. ft. per gallon
- Dry—1.7 mils @ 400 sq. ft. per gallon

Solids Content: By Weight—62% By Volume—43%

Weight Per Gallon: 9 lbs. 11 oz.

Viscosity: 86 ± 3 KU

Flash Point: Combustible

Thinning/Cleanup: Apply as received in the container. Do not thin. Clean equipment with mineral spirits.

Performance Characteristics

- Washes down quickly and easily.
- Especially suited for use in dairies, food processing plants, textile plants, shower rooms, and other constantly damp areas.
- Heavy-bodied.
- Smooth-flowing.
- Very low odor.

Environmental Considerations

Formulated with non-photochemically reactive solvents. Formulated without lead or mercury.

Finishing Systems

Wood, New:

Primer: IronClad Damp Surface Primer (205)
Finish: 1 or 2 coats IronClad Damp Surface High Gloss Enamel (225)

Wood, Repaint:

Primer: Prime or spot prime as needed with IronClad Damp Surface Primer (205)
Finish: 1 or 2 coats IronClad Damp Surface High Gloss Enamel (225)

Plaster/Drywall, New:

Primer: IronClad Damp Surface Primer (205)
Finish: 1 or 2 coats IronClad Damp Surface High Gloss Enamel (225)

Plaster/Drywall, Repaint:

Primer: Prime or spot prime as needed with IronClad Damp Surface Primer (205)
Finish: 1 or 2 coats IronClad Damp Surface High Gloss Enamel (225)

Masonry, New:

Priming Porous Masonry: Moorcraft Interior & Exterior Block Filler (173)
Intermediate Coat: IronClad Damp Surface Primer (205)
Finish: 1 or 2 coats IronClad Damp Surface High Gloss Enamel (225)

Priming Smooth Poured or Precast Concrete: IronClad Damp Surface Primer (205)

Finish: 1 or 2 coats IronClad Damp Surface High Gloss Enamel (225)

Ferrous Metal, New:

Primer: IronClad Retardo Rust Inhibitive Paint (163)
Finish: 1 or 2 coats IronClad Damp Surface High Gloss Enamel (225)

Ferrous Metal, Repaint:

Primer: Prime or spot prime as needed with IronClad Retardo Rust Inhibitive Paint (163)
Finish: 1 or 2 coats IronClad Damp Surface High Gloss Enamel (225)

Galvanized Iron, New:

Primer: IronClad Galvanized Metal Latex Primer (155)
Finish: 1 or 2 coats IronClad Damp Surface High Gloss Enamel (225)

Galvanized Iron, Repaint:

Primer: Prime or spot prime as needed with IronClad Retardo Rust Inhibitive Paint (163)
Finish: 1 or 2 coats IronClad Damp Surface High Gloss Enamel (225)

Application

Prior to painting, ensure having enough paint boxed or mixed in one container to complete an entire section. This practice is especially important with custom blended colors.

- Do not apply when air and surface temperatures are below 50°F (10°C).
- Stir thoroughly and apply as received in the container with a good quality bristle brush or short-nap roller.
- Spray, Airless: See **General Information** for specifications.

Quick Dry Industrial Rust Inhibitive Primer 168

Product Description

Type: A fast-drying, phenolic-modified, alkyd, rust-inhibitive primer.

Use: Specially formulated for use on new or previously painted interior or exterior metal surfaces.

Finish: Eggshell

Colors Available: White and Red. White may be tinted with up to 2.0 fl. oz. universal tinting colors per gallon to make light pastels.

Package Sizes: Quarts, and Gallons. Five Gallon containers available on special order.

Coverage: Apply at 500–600 sq. ft. (46.0–57.5 sq. meters) per gallon

Dry Time:

- To Touch— 1 hour
- To Handle— 2 hours
- To Recoat— 3 to 4 hours

Mil Film Thickness:

- Wet—2.9 mils @ 550 sq. ft. per gallon
- Dry—1.1 mils @ 550 sq. ft. per gallon

Solids Content: By Weight—65% By Volume—42%

Weight Per Gallon: 10 lbs. 9 oz.

Viscosity: 83 ± 2 KU

Flash Point: Combustible

Thinning/Cleanup: Apply as received in the container. Do not thin. Clean equipment with mineral spirits.

Performance Characteristics

- Permits application of a complete primer/finish coat system within one working day.
- Excellent corrosion resistance.
- Excellent adhesion.
- Excellent foundation metal primer when time is an important factor.
- May be topcoated with latex or alkyd paints or enamels.
- Excellent hiding qualities.
- Excellent leveling properties.

Environmental Considerations

Formulated with non-photochemically reactive solvents. Formulated without lead or mercury.

Finishing Systems

Ferrous Metal, New:

Primer: IronClad Quick Dry Industrial Rust Inhibitive Primer (168)

Finish: IronClad Quick Dry Industrial Enamel (071)

Ferrous Metal, Repaint:

Primer: IronClad Quick Dry Industrial Rust Inhibitive Primer (168)

Finish: IronClad Quick Dry Industrial Enamel (071)

Galvanized Iron, New:

Primer: IronClad Galvanized Metal Latex Primer (155)

Finish: IronClad Quick Dry Industrial Enamel (071)

Galvanized Iron, Weathered 6 Months or More:

Primer: IronClad Quick Dry Industrial Rust Inhibitive Primer (168)

Finish: IronClad Quick Dry Industrial Enamel (071)

Galvanized Iron, Repaint:

Primer: IronClad Quick Dry Industrial Rust Inhibitive Primer (168)

Finish: IronClad Quick Dry Industrial Enamel (071)

Aluminum:

Primer: IronClad Quick Dry Industrial Rust Inhibitive Primer (168)

Finish: IronClad Quick Dry Industrial Enamel (071)

Application

Prior to painting, ensure having enough paint boxed or mixed in one container to complete an entire section. This practice is especially important with custom blended colors.

- Do not apply when air and surface temperatures are below 50°F (10°C).
- Stir thoroughly and apply as received in the container with a good quality bristle brush or short-nap roller.
- Spray, Airless: See **General Information** for specifications.

Retard-X Rust Inhibitive Latex Primer 162

Product Description

Type: An alkyd modified acrylic rust-preventive latex primer.

Use: For new or previously painted interior and exterior metal surfaces such as steel columns, trusses, tanks, and galvanized iron structures, as well as masonry.

Finish: Flat

Colors Available: White and Red. White may be tinted with up to 2.0 fl. oz. universal tinting colors per gallon to make light pastels.

Package Sizes: Pints, Quarts, and Gallons. Five Gallon containers available on special order.

Coverage: 375–425 sq. ft. (34.8–39.4 sq. meters) per gallon

Dry Time:

- To Touch— 1 hour
- To Handle— 2 hours
- To Recoat— 4 hours

Mil Film Thickness:

- Wet—4.0 mils @ 400 sq. ft. per gallon
- Dry—1.6 mils @ 400 sq. ft. per gallon

Solids Content: By Weight—51% By Volume—40%

Weight Per Gallon: 10 lbs. 2 oz.

Viscosity: 85 ± 3 KU

Flash Point: None

Thinning/Cleanup: Thinning not normally required; when necessary use small amounts of clean water. Clean up with warm, soapy water.

Performance Characteristics

- Useful in controlling rust leaching of reinforcing steel in pre-stressed concrete ceilings.
- Provides a firm foundation for topcoating with latex or oil-based finishes
- Fast dry permits two coat work in one working day.
- Alkali resistant.
- No fire hazard during use or in storage.
- Excellent adhesion and may be applied over damp masonry surfaces.
- Easy to apply with brush, roller, or spray.
- Fast cleanup with soapy water.
- Very low in odor.

Environmental Considerations

Formulated without lead or mercury.

Finishing Systems

Ferrous Metal:

One coat of IronClad Retard-X Rust Inhibitive Latex Primer (162) should be applied over extremely rust-prone or rough metal within 48 hours of cleaning. One coat of IronClad Retard-X Rust Inhibitive Latex Primer (162) over a rusty surface may occasionally exhibit rust staining; this condition can be remedied by applying a second coat; allow at least 4 hours drying time between coats.

Galvanized Iron:

Apply one or two coats of IronClad Retard-X Rust Inhibitive Latex Primer (162).

Masonry:

IronClad Retard-X Rust Inhibitive Latex Primer (162) is particularly useful for application on cured poured concrete or pre-stressed concrete ceilings. It will also contain the rust leaching on new or old cinder block construction. Exterior masonry surfaces that have been previously painted with cement paint or are in otherwise poor condition must be sandblasted. Heavy chalk and scaling paint must be removed by power wirebrushing, by high pressure cleaning, or other appropriate means. Apply two coats Retard-X Rust Inhibitive Latex Primer (162) to these surfaces.

Application

Prior to painting, ensure having enough paint boxed or mixed in one container to complete an entire section. This practice is important with standard as well as custom blended colors.

- Do not apply when air and surface temperatures are below 50°F (10°C).
- Best surface wetting and coverage is achieved by brush application. Stir thoroughly and apply as received in the container with a good quality nylon brush or good quality roller.
- Spray, Conventional: Thin as needed with small amounts of clean water.
- Spray, Airless: See **General Information** for specifications.

Damp Surface Primer 205

Product Description

Type: A low odor, alkyd enamel undercoater

Use: For interior use on wood, wallboard and properly cured plaster in dairies, food processing plants, shower rooms, textile plants, and other constantly damp areas. Prepares surface for topcoating with IronClad Damp Surface High Gloss Enamel (225). Not recommended for floors.

Finish: Flat

Colors Available: White. May be tinted with up to 2.0 fl. oz. universal tinting colors per gallon.

Package Sizes: Gallons. Five Gallon containers available on special order.

Coverage: 350–450 sq. ft. (32.5–41.8 sq. meters) per gallon

Dry Time:

- To Touch— 2 hours
- To Handle— 4 hours
- To Recoat or Sand—overnight

Mil Film Thickness:

- Wet—4.0 mils @ 400 sq. ft. per gallon
- Dry—2.0 mils @ 400 sq. ft. per gallon

Solids Content: By Weight—73% By Volume—49%

Weight Per Gallon: 12 lbs. 3 oz.

Viscosity: 110 ± 5 KU

Flash Point: Combustible

Thinning/Cleanup: Apply as received in the container. Do not thin. Clean equipment with mineral spirits.

Performance Characteristics

- Prepares surfaces for topcoating with IronClad Damp Surface High Gloss Enamel (225).
- Heavy-bodied.
- Smooth flowing.
- Provides a moisture resistant system.
- Can be sanded easily without gumming of the paper.
- Very low odor.

Environmental Considerations

Formulated with non-photochemically reactive solvents. Formulated without lead or mercury.

Finishing Systems

Wood, New:

Primer: IronClad Damp Surface Primer (205)

Finish: 1 or 2 coats IronClad Damp Surface High Gloss Enamel (225)

Wood, Repaint:

Primer: Prime or spot prime as needed with IronClad Damp Surface Primer (205)

Finish: 1 or 2 coats IronClad Damp Surface High Gloss Enamel (225)

Plaster/Drywall, New:

Primer: IronClad Damp Surface Primer (205)

Finish: 1 or 2 coats IronClad Damp Surface High Gloss Enamel (225)

Plaster/Drywall, Repaint:

Primer: Prime or spot prime as needed with IronClad Damp Surface Primer (205)

Finish: 1 or 2 coats IronClad Damp Surface High Gloss Enamel (225)

Application

Prior to painting, ensure having enough paint boxed or mixed in one container to complete an entire section. This practice is especially important with custom blended colors.

- Do not apply when air and surface temperatures are below 50°F (10°C).
- Stir thoroughly and apply as received in the container with a good quality bristle brush or short-nap roller.
- Spray, Airless: See General Information for specifications.

Galvanized Metal Latex Primer 155

Product Description

Type: An alkyd-modified vinyl-acrylic latex primer.

Use: For interior or exterior use on new or unpainted galvanized metal gutters, leaders, siding, guardrails, roofs, vents, and ducts that are free of rust.

Finish: Low-Lustre

Colors Available: White. May be tinted with up to 2.0 fl. oz. universal tinting colors per gallon to make light pastels.

Package Sizes: Quarts and Gallons. Five Gallon containers available on special order.

Coverage: 500–600 sq. ft. (46.4–55.7 sq. meters) per gallon.

Dry Time:

To Touch— 1 hour

To Handle—2 hours

To Recoat—4 hours

High humidity may prolong drying time.

Mil Film Thickness:

Wet—2.9 mils @ 550 sq. ft. per gallon

Dry—1.2 mils @ 550 sq. ft. per gallon

Solids Content: By Weight—58% By Volume—40%

Weight Per Gallon: 11 lbs. 14 oz.

Viscosity: 88 ± 3 KU

Flash Point: None

Thinning/Cleanup: Thinning not normally required; when necessary use small amounts of clean water. Wash equipment with warm, soapy water before, after, and occasionally during use. Spray equipment should be given a final rinse with solvent.

Performance Characteristics

- Excellent adhesion properties.
- Permits immediate painting of galvanized metal without weathering or special etching.
- Suitable for use as a primer or as a finishing paint.
- Equally compatible with other latex, alkyd, or epoxy topcoats.
- Quick drying for same day application of finish coat.

Environmental Considerations

Formulated without lead or mercury.

Finishing Systems

Galvanized Iron, New:

Prime with IronClad Galvanized Metal Latex Primer (155)

Galvanized Iron, Repaint:

Primer: IronClad Retardo Rust Inhibitive Paint (163) or IronClad Retard-X Rust Inhibitive Latex Primer (162) in lieu of IronClad Galvanized Metal Latex Primer (155)

Application

Prior to painting, ensure having enough paint boxed or mixed in one container to complete an entire section. This practice is especially important with custom blended colors.

- Do not apply when air and surface temperatures are below 50°F (10°C).
- Stir thoroughly and apply as received in the container with a good quality nylon brush or short nap roller.
- Spray, Conventional: Thin as needed with clean water.
- Spray, Airless: See **General Information** for specifications.