

D-12

February 1997

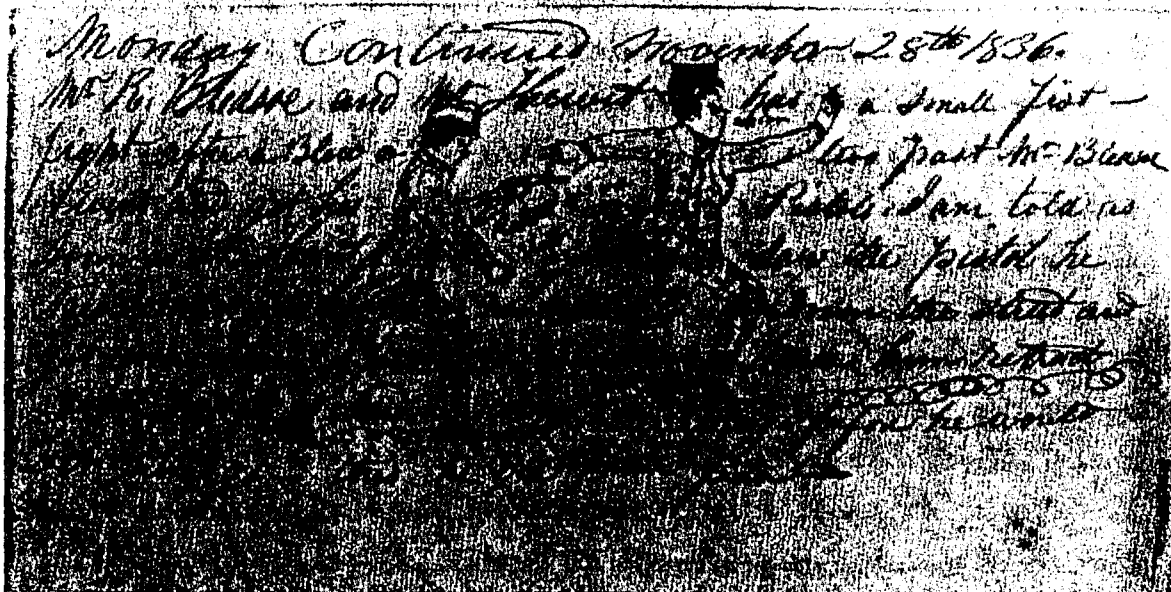

"Mr R. Bledsoe and Mr Hewit has a . . . fight"
From the Johnson Collection

**WILLIAM JOHNSON HOUSE
NATCHEZ NATIONAL HISTORICAL PARK
NATCHEZ, MISSISSIPPI**

HISTORIC STRUCTURE REPORT

PLEASE RETURN TO:

HISTORICAL INFORMATION CENTER
DENVER SERVICE CENTER
NATIONAL PARK SERVICE

ANN BEHA ASSOCIATES

BOSTON, MASSACHUSETTS





United States Department of the Interior

NATIONAL PARK SERVICE

Southeast Region
1924 Building
100 Alabama Street, S.W.
Atlanta, Georgia 30303

February 19, 1997

Memorandum

To: Technical Information Center, Information
and Production Services, Denver Service Center

From: Chief, Design, Planning, Facility Management
and Design, Southeast Region

Subject: Historic Resource Study, Historic Structure
Report, and Cultural Landscape Report, Natchez
National Historical Park

Enclosed is a Historic Resource Study, a Historic Structure Report, a Cultural Landscape Report for the Melrose Estate, and a Historic Structure Report for the William Johnson House in Natchez, Mississippi.

The above-mentioned reports consist of the history, studies, collections, evaluations, assessments, presentation, and primary guidelines for the treatment of our cultural resources in the Natchez National Historical Park.

These reports were prepared by Ann Beha Associates with the coordination of members of our office and the Natchez National Historical Park.

Stuart Johnson

FOR Richard Ramsden

cc:

Superintendent, Natchez National Historical Park

3/17/97 in TIC

339/D-11

D-12

D-13

D-14

B&W Scans

2-4-2004



0.0 TABLE OF CONTENTS

Illustrations	iv
1.0 Introduction	1
1.1 Project Scope and Goals	
1.2 Acknowledgments	
1.3 Project Team	
2.0 Executive Summary	3
2.1 Introduction	
2.2 Historical	
2.3 Architectural	
2.4 Structural	
2.5 Mechanical, Electrical, Plumbing, and Fire Protection	
2.6 Recommended Treatment and Proposed Use	
2.7 Cost Estimate	
3.0 Administrative Data	7
3.1 Names, Numbers, and Management Category	
3.2 Statement of Significance	
3.3 Proposed Treatment	
3.4 Cooperative Agreements	
3.5 Related Planning Documents	
3.6 Recommendations for Documentation and Storage of Materials	
4.0 Developmental History	10
4.1 Introduction	
4.2 Early Life of William Johnson	
4.3 Prior History of State Street Property	
4.4 Early Married Life of William Johnson and Development of State Street Property	
4.5 Later Life of William Johnson and the Construction of the William Johnson House	
4.6 William Johnson's Descendants	
4.7 Preservation of the Johnson House	
5.0 Physical Description	53
5.1 Site	
5.2 Main House	
5.2.1 Exterior	
5.2.2 Interior	

5.2.3	Structural	
5.2.4	Mechanical, Electrical, Plumbing, and Fire Protection	
5.3	Kitchen Dependency	
5.3.1	Exterior	
5.3.2	Interior	
5.3.3	Structural	
5.3.4	Mechanical, Electrical, Plumbing, and Fire Protection	
6.0	Conditions Assessment	.65
6.1	Introduction	
6.2	Sitework	
6.3	Main House	
6.3.1	Roofing and Gutters	
6.3.2	Masonry	
6.3.3	Wood Trim and Porches	
6.3.4	Doors and Windows	
6.3.5	Interior Finishes	
6.3.6	Structural (Robert Silman Associates)	
6.3.7	Mechanical, Electrical, Plumbing, and Fire Protection	
6.4	Kitchen Dependency	
6.4.1	Roofing and Gutters	
6.4.2	Masonry	
6.4.3	Wood Trim and Porches	
6.4.4	Doors and Windows	
6.4.5	Interior Finishes	
6.4.6	Structural (Robert Silman Associates)	
6.4.7	Mechanical, Electrical, Plumbing, and Fire Protection	
7.0	Previous Preservation Treatment	.80
7.1	Completion Report	
7.2	Technical Data	
8.0	Treatment and Proposed Use	84
8.1	Ultimate Use	
8.2	Code Analysis and Regulations	
8.3	Functional Requirements	
8.4	Alternatives for Treatment	
8.4.1	Landscape and Site	
8.4.2	Main House	
8.4.3	Kitchen Dependency	
8.5	Recommendations for Further Research	
8.5.1	Site	
8.5.2	Main House	
8.5.3	Kitchen Dependency	

9.0 Appendices..... 96

- 9.1 Bibliography
- 9.2 Glossary of Terms
- 9.3 List of Repositories
- 9.4 Research Notes
- 9.5 Historical Documents
- 9.6 Drawings
- 9.7 National Park Service Maintenance Task Directives
- 9.8 Data Sheets
- 9.9 Cost Estimates
- 9.10 Building Assessment Documents



ILLUSTRATIONS

Note: All Illustrations are called out in the text numerically with their corresponding division, such as H (Historical), A (Architectural), or S (Structural).

4.0 DEVELOPMENTAL HISTORY

- 1-H Post 1906 photograph of facade and west elevation of Johnson House. (Norman and Gandy Photographic Collection.)
- 2-H ca. 1880 photograph of commercial buildings on Market Street in Natchez. (Norman and Gandy Photographic Collection.)
- 3-H ca. 1880 photograph of eastern gable end of McCallum House and northern facade of Johnson House. (Norman and Gandy Photographic Collection.)
- 4-H ca. 1880 photograph of western gable end and southern rear elevation of Johnson House. (Norman and Gandy Photographic Collection.)
- 5a-H ca. 1976 photograph of northern facade of Johnson House with two-story porch dating from 1910 to 1925. (Collection of the Natchez National Historical Park.)
- 5b-H 1979 photograph of north facade showing porch removed. (Building Conservation Technology.)
- 6-H 1864 Map of the Defenses of Natchez. (Historic Natchez Foundation - HNF.)
- 7-H May 1886 Sanborn Insurance Map showing William Johnson House and McCallum House. (HNF)
- 8-H May 1892 Sanborn Insurance Map showing William Johnson House and McCallum House (Cistern no longer shown). (HNF)
- 9-H January 1897 Sanborn Insurance Map showing William Johnson House and McCallum House. (HNF)
- 10-H September 1901 Sanborn Insurance Map showing William Johnson House and McCallum House. (HNF)
- 11-H December 1904 Sanborn Insurance Map showing William Johnson House and McCallum House. (HNF)
- 12-H January 1910 Sanborn Insurance Map showing William Johnson House and McCallum House. (HNF)
- 13-H June 1925 Sanborn Insurance Map showing William Johnson House and McCallum House. (HNF)
- 14-H 1946 Updated Sanborn Insurance Map showing William Johnson House and McCallum House. (HNF)

5.0 PHYSICAL DESCRIPTION

Architectural

- 15-A Main House - north elevation. (Ann Beha Associates - ABA.)
- 16-A Main House - west elevation. (ABA)
- 17-A Main House - south elevation. (ABA)
- 18-A Masonry pocket for the original handrail on the south porch. (Building Conservation Technology.)
- 19-A Dependency - north and west elevation. (ABA)
- 20-A Dependency - north and east elevation. (ABA)
- 21-A Dependency - south elevation. (ABA)

Drawings

- First Floor Plan, ca. 1840-1870.
- Second Floor Plan, ca. 1840-1870.
- Attic Floor Plan, ca. 1840-1870.
- First Floor Plan, ca. 1870-1900.
- Second Floor Plan, ca. 1870-1900.
- Attic Floor Plan, ca. 1870-1900.
- First Floor Plan, ca. 1900-1979.
- Second Floor Plan, ca. 1900-1979.
- Attic Floor Plan, ca. 1900-1979.
- First Floor Plan, ca. 1979-1995.
- Second Floor Plan, ca. 1979-1995.
- Attic Floor Plan, ca. 1979-1995.

6.0 CONDITIONS ASSESSMENT AND TREATMENT

Architectural - Main House

- 22-A Gap in wall injected with foam at southeast corner of second floor. (ABA)
- 23-A Deteriorated mortar on east wall in attic. (ABA)
- 24-A Mortar cracks on south elevation. (ABA)
- 25-A Gaps between porch floorboards, opened joints at column bases, and mildewed ceiling. (ABA)
- 26-A Detached porch column. (ABA)
- 27-A Peeling paint on porch, and rotted balustrade. (ABA)
- 28-A Peeling paint on north facade window frames. (ABA)
- 29-A Gap between left window frame and wall on west elevation. Right window frame and sash unpainted. (ABA)
- 30-A Second-floor window frames on south elevation need to be caulked and painted. (ABA)
- 31-A Door and frame need to be caulked and painted. (ABA)
- 32-A Missing floor joists and floor from first floor, missing plaster. (ABA)
- 33-A Missing lath and plaster from ceiling of first floor. View of underside of second-floor framing and the top of the columns supporting the second-floor partition wall (above). (ABA)
- 34-A Holes in second-floor flooring. (ABA)
- 35-A Missing plaster from second-floor walls and ceiling. (ABA)
- 36-A Peeling wallpaper on second floor. (ABA)
- 37-A Baseboard pulling from east wall of second floor. (ABA)
- 38-A Missing baseboard in northeast room of second floor. (ABA)
- 39-A Typical second-floor door with missing hardware. (ABA)
- 40-A Missing third-floor plaster. (ABA)
- 41-A Third floor balustrade. (ABA)

Structural - Main House

- 42-S View of rotted wood below south porch ground floor. (Robert Silman Associates - RSA.)
- 43-S View of northwest corner of basement. (RSA)
- 44-S View of bottom of weather column supporting second-floor partition wall above. (RSA)
- 45-S Crack between second-floor east/west partitions and the "party" wall. (RSA)
- 46-S Close-up view of photograph 45-S. (RSA)
- 47-S View, looking south, of attic floor movement "away" from the "party" wall. Close up of right side of photograph 61-S. (RSA)
- 48-S View of underside of attic-floor framing. (RSA)
- 49-S Porch floor on left side of photograph has moved away from the south wall of the building. (RSA)
- 50-S Detail view of photograph 49-S, showing spalled brick. (RSA)
- 51-S View of north end of basement, showing diagonal bracing installed by National Park Service. (RSA)
- 52-S View of first-floor framing in dependency building. (RSA)
- 53-S Area of spalling mortar on south elevation of the dependency building. (RSA)
- 54-S South elevation of the William Johnson House and McCallum House. Note missing wood column on right side of porch. (RSA)
- 55-S View of the south porch roof. (RSA)
- 56-S View of southern half of the coping of the "party" wall between the William Johnson House (top) and the McCallum House (bottom). (RSA)
- 57-S View of cracked floor joist on south side of the attic. (RSA)
- 58-S View of the northern half of the roof of the dependency. (RSA)
- 59-S View of the top of the south porch. Note missing wood column on the right side of the porch. (RSA)
- 60-S Area of probe made into the south elevation of the McCallum House and the William Johnson House. (RSA)
- 61-S View of attic looking toward the "party" wall. (RSA)
- 62-S View looking into probe in the south elevation. (See photograph 60-S for general view). (RSA)
- 63-S View looking west into probe in the south elevation. South porch framing is at left. (RSA)

Architectural - Dependency

- 64-A Poor match of mortar on north facade. (ABA)
- 65-A Broken bricks on southwest corner. (ABA)
- 66-A Caulk gaps at window frames on north facade. (ABA)
- 67-A Plywood covering door and windows on south elevation. (ABA)
- 68-A Second-floor walls replastered, unpainted. (ABA)
- 69-A Original mantel repaired in west room of first floor. (ABA)

Structural - Dependency

- 70-S Deterioration of brick and mortar on south elevation of the dependency. (RSA)
- 71-S Close-up of deterioration of brick on the south elevation of the dependency. (RSA)
- 72-S View of the rising damp damage to the brick and mortar at the southwest corner of the dependency. (RSA)

Drawings

- First Floor Plan showing Conditions Assessment.
- Second Floor Plan showing Conditions Assessment.
- Attic Floor Plan showing Conditions Assessment.

9.0 APPENDICES

Appendix 9.6

Muntin profiles reproduced from Peggy A. Albee's Finishes Analysis The William Robert Johnson House (National Park Service 1993).

Casing profiles reproduced from Peggy A. Albee's Finishes Analysis The William Robert Johnson House (National Park Service 1993).

Casing profiles reproduced from Peggy A. Albee's Finishes Analysis The William Robert Johnson House (National Park Service 1993).

First Floor Plan, William Johnson and John McCallum Houses, Natchez, Adams County, Mississippi (HABS no. MS-270, Sheet 2 of 8). Drawn by: Roderick Fluker - Melrose Recording Project 1992.

Second Floor Plan, William Johnson and John McCallum Houses, Natchez, Adams County, Mississippi (HABS no. MS-270, Sheet 3 of 8). Drawn by: Rachel L. King - Melrose Recording Project 1992.

Attic Floor Plan, William Johnson and John McCallum Houses, Natchez, Adams County, Mississippi (HABS no. MS-270, Sheet 4 of 8). Drawn by: Lawrence A. Weintraub, Roderick Fluker - Melrose Recording Project 1992.

Appendix 9.8

First Floor Plan - Structural Photo Key.

Second Floor Plan - Structural Photo Key.

Attic Floor Plan - Structural Photo Key.

1.0 Introduction



1.0 INTRODUCTION

1.1 Project Scope and Goals

The William Johnson House is located at 210 State Street in Natchez, Mississippi. It is a two-and-one-half-story brick and wood-frame structure built in 1841. The House was owned and constructed by a free African American family during the height of slavery in the southern United States. William Johnson was born a slave and freed at the age of eleven. Trained as a barber, he operated several barber shops in town and invested in land and property in and around Natchez. Equally important, Johnson kept meticulous records of his business and social activities which provide a unique understanding of life in Natchez during this significant period. The William Johnson House is listed on the National Register of Historic Places but is not a National Historic Landmark.

In 1990, the City of Natchez donated the William Johnson House and neighboring McCallum House to the National Park Service to become a key feature in the Natchez National Historical Park. According to the General Management Plan for the Park established in 1994, the William Johnson House is to be restored to its appearance during Johnson's life and contain exhibits interpreting the black history of Natchez.

The William Johnson House has been the subject of many studies over the past twenty years. In 1979, a Historic Structure Report was prepared for the Preservation Society of Ellicott Hill by Building Conservation Technology of Washington, DC. Historical research was expanded by a Historic American Buildings Survey team in 1992, and historic finishes and archeological investigations were undertaken by the National Park Service in 1993 and 1994, respectively.

The National Park Service contracted with Ann Beha Associates to provide a new Historic Structure Report of the William Johnson House in March of 1995. The goal of the HSR was to build on the previous studies, documenting the history of the building and developments over the years, providing a general building assessment, and offering treatment and recommendations for the building with respect to its future use as a historic site.

1.2 Acknowledgments

The project team would like to thank the staff of the Natchez National Historical Park for their assistance in sharing research materials and providing access to the site. These include: Bob Dodson, Superintendent; Thom Rosenblum, Curator; Kathleen Jenkins, Museum Technician; and Kim Fuller, Maintenance Foreman. In addition, we would like to thank Dr. and Mrs. Thomas H. Gandy and the Norman Collection, the Louisiana State University Libraries, and the Mississippi Department of Archives and History for sharing their research materials and allowing us to reproduce some of their illustrations. We would also like to acknowledge the Preservation Society of Ellicott Hill for saving the House from demolition and their efforts in the initial preservation of the site.

1.3 Project Team

Contracting Officer:

Charles Vicari
National Park Service
Southeast Regional Office
Atlanta, GA

*Project Manager, NPS:
Reviewers*

Ali Miri, Historical Architect
Bob Blyth, Historian
Lucy Lawliss, Landscape Architect
National Park Service
Southeast Regional Office
Atlanta, GA

Architect:

Ann Beha Associates, Inc.
Boston, MA
Pamela Hawkes, Principal-in-Charge
Betsy Sandidge, Project Manager
Tobin Tracey, Project Associate

Architectural Historian:

Historic Natchez Foundation
Natchez, MS
Mary W. and Ronald Miller

Structural Engineer:

Robert Silman Associates, P.C.
New York, NY
Ed Meade, P.E.

Mechanical/Electrical Engineer:

Roger Preston and Associates
Atlanta, GA
Bob Ellington, P.E.

Cost Estimating:

Hanscomb Associates
Atlanta, GA
Beatriz Pita
Michael Pritchett

2.0 Executive Summary



2.0 EXECUTIVE SUMMARY

2.1 Introduction

The William Johnson House has been the subject of many studies over the past twenty years. In March 1995, the National Park Service contracted with Ann Beha Associates to provide a new HSR which would build on the previous studies. The goal was to document the history of the building and developments over the years, providing a general building assessment, and offering treatment and recommendations for the building with respect to its future use as a historic site.

To accomplish this work, Ann Beha Associates compiled a team of experts that consisted of architectural historians; structural, mechanical, and electrical engineers; and cost estimators.

2.2 Historical

The William Johnson House, part of the larger Natchez National Historical Park, is located in downtown Natchez at 210 State Street. The House was built in 1841 by and for William Johnson, a free black man. It was built in a simplified version of the Greek Revival style popular in the period, with a commercial space on the ground floor and living quarters on the second and third floors. William Johnson's business acumen and his high standards of conduct placed him in a position at the top of Natchez free black society, a position recognized by both the white and black populations of the city. He died at the age of forty-two in 1851, leaving behind a 2,000-page diary documenting his daily life.

Johnson's wife, children, and descendants continued to live in the House. The most significant alteration made by the family was in 1897 when the original Kitchen Dependency was torn down and the present dependency constructed. The Johnson descendants did preserve Johnson's diary along with a wealth of historically important papers in the attic of their home.

The House remained in the Johnson family until 1976, at which time it was purchased by the Preservation Society of Ellicott Hill. In 1986, the Mississippi Department of Archives and History established a trust fund for the restoration and acquisition of the property. In 1990, the William Johnson House and the McCallum House next door were donated to the National Park Service.

2.3 Architectural

The Johnson House is in fair condition as a result of stabilization and restoration efforts during the past two decades. Prior to this survey, the Preservation Society of Ellicott Hill stabilized the House, removed a twentieth-century porch and interior residential

partitions, and restored the street facade, a rear two-story gallery on the House, and a collapsed wall on the rear dependency. All interior first-floor partitions and finishes, and portions of the first-floor framing, were removed by the Park Service to perform an archeological survey. New roof framing and roofing, as well as repairs to brick chimneys, exterior masonry, and window sash and frame, have been carried out under the Park Service ownership.¹

The second and third floors need extensive work to restore them for interpretation and to provide public access. Wallcoverings are peeling, ceiling and wall plaster is deteriorated, and floorboards are missing or loose. Access to the second floor is by the stair on the rear gallery. The gallery and stair have experienced some significant deterioration since their relatively recent reconstruction.

The rear dependency has been stabilized and rehabilitated for use as an interpretive area and Park administrative facilities. New electrical and HVAC systems have been installed by the Park Service. Nonetheless, brick remains in need of pointing, and windows need repair.

2.4 Structural

The structural fabric of the William Johnson House was reviewed by Robert Silman Associates (RSA) and is in fair condition. The foundations and the walls of the building are in good condition; there are only a few cracks on one small portion of the south facade. However, the opening on the rear facades between the William Johnson House and the McCallum House is of concern. In order to determine whether this crack is active, RSA has recommended that a series of crack gauges be installed to measure the relative movement of these two buildings as soon as possible. Through examination of a structural probe, RSA has discovered that there is no connection between the south and north walls of the William Johnson House and the party wall that is shared with the McCallum House.

The structure does not meet current code requirements for stress levels and the anticipated deflections of floors and the roof. The second- and attic-floor joists and the roof rafters are not capable of supporting the code required minimum live loads and, under such loads, would deflect considerably. RSA therefore has recommended a series of interventions be made, including doubling up framing members and creating a new line of support under the second-floor joists, in order to support the proposed uses. It is also recommended that the connections between the walls and the floor joists of the building be reinforced with new anchors between these elements of the structure. There is rot in the wood members supporting two sections of the exterior walkway; these members should be replaced immediately. The missing porch column on the first-floor level of the south porch should also be replaced immediately.

¹ Based on Task Directives in the Natchez National Historical Park files which were reviewed by Ann Beha Associates.

2.5 Mechanical, Electrical, Plumbing, and Fire Protection

A mechanical engineering investigation was performed by Roger Preston and Associates. Currently there is no mechanical system in the Main House of the William Johnson complex, and recommendations have been made for new systems consistent with future use of the building as a period house. An air-conditioning system has been installed in the attic of the dependency building, which appears adequate for its use as a visitor and administrative area, without collections.

The National Park Service has recently installed a new main electrical service to the William Johnson House, but redistribution for lighting and outlets, as well as fire detection and security, have not been installed. General recommendations for appropriate systems were provided. New electrical service has been installed in the dependency, which has been provided with modest lighting.

Currently neither building has water nor sewer connections. It has been recommended that systems for restrooms and housekeeping be provided in the adjacent McCallum House.

2.6 Recommended Treatment and Proposed Use

According to the *Natchez National Historical Park General Management Plan/Development Concept Plan/Environmental Impact Statement*, the Johnson House is to serve as a center for interpreting the African American history of Natchez.² Based on discussions between the HSR team and the NPS Park and Division staff, the Period of Significance for the Main House has been selected as 1840-1866, from its construction during William Johnson's lifetime to the death of his wife, Ann, in 1866. The House would be restored and furnished to its original appearance. The first floor has been more significantly altered, but the HSR's recommendation is generally to restore it to its ca. 1866 appearance as a single large room, which will readily permit use as an exhibit space.

To present the second and third floors as they appeared during Johnson's lifetime, finishes must be restored to their appearance during that period. A Historic Furnishings Report is currently being prepared by the National Park Service to document furnishings, window treatments, and lighting during the period, and with appropriate collections to be acquired and restored. Once the objects have been confirmed, conservation criteria must be developed and conservation methods implemented. Based on the assumption that the collections will include nineteenth-century furniture, textiles, and paper-based items, it is anticipated that interior storm windows and climate control for the museum rooms will be required. Relative humidity and temperature set points should be carefully considered in order to minimize potential for condensation on or within building fabric, and maximize

² Department of the Interior, National Park Service, *Natchez National Historical Park General Management Plan/Development Concept Plan/Environmental Impact Statement*, Denver Service Center ([Denver, CO], January, 1994), 52.

collections care. Installation and routing of systems must be carefully detailed in order to prevent impact on historic fabric and spaces.

The Period of Significance for the Kitchen has been established as 1897, its date of construction. The first floor is already used for exhibit space, and the second floor could be used as office space.

The 1994 Standard Building Code, the NFPA 101 Life Safety Code, and Americans with Disabilities Act were reviewed for requirements associated with use of the Johnson House. It is assumed that overall visitation will increase substantially when the House is restored fully, but for reasons of security, limited space, and impact on the historic fabric, visitation to the upper levels of the House will be restricted to small groups, and a guide will always be present. While this will enable some code requirements to be waived where they would impact the significant features of the House, recommendations were made for improving fire alarms, extinguishers, and emergency lighting. Handicapped access to the upper levels may be provided from an elevator in the adjacent McCallum House, though this option requires further study to determine its impact on the historic fabric of both the Johnson House and the McCallum House.

2.7 Cost Estimate

A Class "C" cost estimate was prepared by Hanscomb Associates of Atlanta based on the treatment recommendations listed in the Historic Structure Report. The Class "C" estimate is a conceptual cost estimate based on square foot cost of similar construction. It was assumed that restrooms and any other visitor services would be provided in the adjacent McCallum House. A separate Conditions Assessment Report and cost estimate were prepared for the McCallum House in November 1995.

The estimate for restoring the House and dependency is \$291,770.00, or approximately \$72.00 per square foot. This figure includes a contractor's overhead and fee of 25% and a design contingency of 20%. This figure is based on 1996 prices and does not account for inflation. The cost estimate does not include a construction contingency, phasing contingency, professional fees, or owner-supplied items such as furnishings and light fixtures already in the possession of the Park Service. A complete breakdown of the cost estimate can be found in Appendix 9.9.

3.0 Administrative Data



3.0 ADMINISTRATIVE DATA

3.1 Name, Numbers, and Management Category

The William Johnson House, located in downtown Natchez at 210 State Street, is part of the larger Natchez National Historical Park, established by Congress on October 7, 1988. The Johnson family sold the Johnson House to the Preservation Society of Ellicott Hill in 1976. In 1986, the Mississippi Department of Archives and History became involved with the House's preservation, and established a trust fund for the restoration and acquisition of the property. The City of Natchez acquired the William Johnson House and neighboring McCallum House, donating them to the Park Service on September 28, 1990, under Public Law 101-399.

The William Johnson complex consists of two structures and is listed in the National Park Service List of Classified Structures as:

William Johnson House	LCS No. 90307
William Johnson House Dependency (kitchen)	LCS No. 90308

Currently, the Johnson House is not listed as a National Historic Landmark, although it is on the National Register. A copy of that nomination is included in the Historic Resource Study.

3.2 Statement of Significance

The William Johnson House represents the life of a prosperous African American in the antebellum South. Johnson kept a 2,000-page diary describing his personal and business affairs and offering glimpses of Southern life and relationships between whites, free blacks, and slaves.

The Johnson House possesses significance under National Register Criteria "A" and "C." Under Criterion "A," the life of an enterprising free black man in the antebellum South is historically significant at a national level and falls under the area of ethnic heritage. Johnson was an entrepreneur, a land owner, and he led a comfortable middle-class life in antebellum Natchez at a time when slavery was common practice.

Under Criterion "C," the House itself is locally significant as an example of a Greek Revival style urban townhouse. It is a middle-class house with a commercial space below. The original floor plan is intact. The integrity of the residential portion of the House itself is good, and all original millwork remains. Remnants of nineteenth-century wallpaper and paint also survive. Most of the doors have their original hardware.

3.3 Proposed Treatment

According to the *Natchez National Historical Park General Management Plan/Development Concept Plan/Environmental Impact Statement*, the Johnson House is to serve as a center for interpreting the African American history of Natchez: "The first floor of the Main House would be rehabilitated and would contain exhibits interpreting the black history themes of Natchez, with special emphasis on seeing Natchez through the eyes of William Johnson. The exhibits would explore various aspects of black history in Natchez, from slavery to modern times."³ The second floor would be restored and furnished to its appearance during William Johnson's lifetime.

The proposed treatment is consistent with the conclusions of this Historic Structure Report. There is sufficient physical, photographic, and written documentation to enable the upper floors of the Johnson House to be restored to their ca. 1840-1866 appearance with a reasonable degree of accuracy. The first floor has been more significantly altered, but our recommendation is generally to restore it to its ca. 1840-1866 appearance as a single large room, which will readily permit use as an exhibit space. The Kitchen Dependency, which appears to date from 1897, has not been specifically addressed in the *General Management Plan*. It is the recommendation of this report that the dependency be left in place and used for exhibits. While the foundations of the earlier kitchen built by Johnson have been located, there is not sufficient information available at this time to reconstruct the earlier building. Some flexibility must be allowed for interpretation of the House and site based on future findings and on the Historic Furnishings Report.

3.4 Cooperative Agreements

In the enabling legislation for the Natchez National Historical Park, the Secretary of the Interior was authorized to enter into cooperative agreements with the owners of properties of historical or cultural significance within the established historic districts of Natchez.⁴ There are no outstanding cooperative agreements related to the William Johnson House, though the Mississippi Department of Archives and History holds an easement which requires its review of proposed work.

3.5 Related Planning Documents

Natchez National Historical Park General Management Plan/Development Concept Plan/Environmental Impact Statement, approved by the National Park Service, May 5, 1994.

³ Department of the Interior, National Park Service, *Natchez National Historical Park General Management Plan/Development Concept Plan/Environmental Impact Statement*, Denver Service Center ([Denver, CO], January, 1994), 52.

⁴ *Ibid.*, 169.

A stabilization analysis of the McCallum House, which shares a party wall with the Johnson House, was carried out by this team in the Spring of 1995. It provides additional information on the historic context and current conditions of the House.

A Historic Resource Study is being prepared by this team, and will be completed in the Summer of 1996. It provides additional information on the historic resources of Natchez.

A Historic Furnishings Report is being prepared by the National Park Service in conjunction with this report.

3.6 Recommendations for Documentation and Storage of Materials

The Park Service should establish a central archival storage facility for all sites within the Natchez National Historical Park. This facility should be climate controlled and large enough to house all types of documentation from written material to actual objects and building materials.

Whenever work is done at the William Johnson House, it should be documented and catalogued immediately, and then put into the central archival storage facility. The best location for this storage facility would most likely be at Melrose. There is not enough space at the Johnson House or in the adjoining McCallum House.



4.0 Developmental History



4.0 DEVELOPMENTAL HISTORY

4.1 Introduction

William Johnson was born a slave in Natchez in 1809 and was freed in 1820 by his white owner, who was probably his father. He learned from his brother-in-law the profession of barbering, a popular trade among free African Americans in the South. At an early age, he became proprietor of his own barber shop and used his trade to launch himself into other aspects of commercial enterprise. By the 1840s, he had acquired substantial land holdings and established himself as a farmer as well as an urban businessman.

William Johnson's business acumen and his high standards of conduct placed him in a position at the top of Natchez free black society, a position recognized by both the white and black populations of the city. Johnson was murdered in 1851, and the eulogy published in the newspaper testifies to the high regard in which he was held by the local community. Despite public outrage, the legal restrictions of race prevented the conviction of his murderer. Under Mississippi law, a black man, slave or free, could not testify in court against a white man, and the only witnesses to the crime were black. The defense rested solely on proving the murderer to be white. During the course of two trials, the prosecution was unable to prove to the jury that the murderer, Baylor Winn, had African blood because he had voted, married a white woman, and was listed in census records as white. Johnson family papers, however, contain documents from the State of Virginia and local government officials certifying that all of the Winns of King William County were free Negroes.

William Johnson died at the age of forty-two in 1851. In 1951, 100 years after Johnson's death, Louisiana State University Press published his 2,000-page diary. The conduct of his life assured his position at the top of his social class; his personal account of that life secured him an important place in American history. Johnson's diary provides the most complete account of the life of a free black in the antebellum South. The diary documents the extraordinary rise of a black man from slavery to freedom and to an established, although circumscribed, position as a substantial citizen of Natchez, the town that was the symbolic capital of the antebellum cotton kingdom of the Deep South.⁵

In addition to the diary, William Johnson and his descendants preserved a wealth of historically important papers in the attic of their personal home. This collection, which spans the years 1793-1937, includes legal and financial documents, personal and business letters, family papers of various types, sixty volumes of account books, bound and unbound issues of rare antebellum newspapers, and more than 400 pieces of nineteenth-

⁵ William Ransom Hogan and Edwin Adams Davis, eds., *William Johnson's Natchez, The Ante-bellum Diary of a Free Negro* (Baton Rouge: Louisiana State University Press, 1951), 1-64.

century sheet music. Both the diary and the family papers are housed in the Louisiana and Lower Mississippi Valley Collection at Louisiana State University in Baton Rouge.⁶

William Johnson's two-and-a-half-story, Greek Revival brick townhouse has survived to become a local landmark on State Street in Natchez and tangibly reflects his social and economic position in antebellum Natchez. Built to the street in commercial fashion, the House exhibits the three-bay facade typical of Natchez townhouses, but it is distinguished by the all-stretcher bond of the brickwork on the facade, the splayed brick arches above its doorways and windows, the sawtooth cornice that extends across the facade and rear elevation, and the two pilastered dormer windows that light the attic that, for so many years, housed so much of the city's history.

The personal diary of William Johnson provides the best resource for understanding the developmental history of the William Johnson House and its site during its period of greatest significance, from the beginning of its construction in 1840 until the death of William Johnson in 1851. References to diary entries throughout the developmental history of the Johnson House are by date in the text, since portions of the original diary are not paginated or are paginated inconsistently. The diary also does not consist of simply one or two large bound volumes; it is distributed among fourteen bound volumes, some portions of which are now in folders due to deterioration. Referencing the diary by date in the text reinforces the chronology of the developmental history and allows readers to access the reference in either the original manuscript or published diary. The draft version of this report relied heavily on the published diary due to the condition of the original and the ready accessibility of the published version.⁷ The original manuscript, however, is the only source for the illustrations that are referenced in the text, and all quoted diary entries were cross checked with the original for accuracy.⁸

Also valuable to an understanding of the developmental history of the Johnson House are the personal and business papers of the Johnson family, particularly day books, cash books, business receipts, and personal correspondence between family members. The best distillation of this material is found in the introduction by editors William Ransom Hogan and Edwin Adams Davis to the published diary, which is entitled *William Johnson's Natchez, The Ante-bellum Diary of a Free Negro*. The developmental history of the Johnson House includes frequent footnote references to Hogan and Davis, particularly when it is difficult to improve upon the narrative of their introduction. Editorial footnotes by Hogan and Davis are also invaluable because they represent a more comprehensive research effort than is possible in a Historic Structures Report. Even more than forty years after publication of the diary, no scholarship on William Johnson

⁶ William Johnson and Family Memorial Papers [hereafter cited as Johnson Papers], Louisiana and Lower Mississippi Valley Collections [hereafter cited as LLMVC], Louisiana State University [hereafter cited as LSU], Baton Rouge, Louisiana.

⁷ Hogan and Davis, *William Johnson's Natchez*, n.p.

⁸ In references to the diary, spelling has been transcribed verbatim. Where there is the possibility of confusion, [sic] has been inserted.

has surpassed the editorial work of Hogan and Davis with the only major shortcoming being an inadequate index. Hogan and Davis also wrote a biography of William Johnson, *The Barber of Natchez*, which was published in 1955. Although the biography was directed to a less scholarly audience, it contained evidence of additional research into the Johnson family papers.⁹

Several in-depth studies prepared under the direction of the National Park Service provide additional information as well as help rectify information that sometimes seems to be contradictory. These studies include 1992 draft reports on the William Johnson House and the adjacent McCallum Building prepared by Dena Sanford for the Historic American Building Survey, National Park Service.¹⁰ Jim Atkinson's 1994 report, "Archeological Excavations at the William Johnson House Complex, Natchez National Historical Park, Natchez, Mississippi," provides excellent information about the history of the Johnson House site prior to the construction of the present House, as well as information about the existing Johnson House, its original non-extant kitchen, and the grounds of the House during the Johnson family occupancy.¹¹ The Atkinson report expanded and clarified earlier archeological work undertaken by Thomas Padgett in 1978.¹² Particularly helpful in understanding the developmental history of the House and in rectifying conflicting documentary and physical evidence is Peggy A. Albee's "Finishes Analysis, the William Johnson House, Natchez, Mississippi."¹³

The 1979 "Historic Structures Report, William Johnson House, Natchez, Mississippi," prepared by Building Conservation Technology, is the best resource for documenting the physical appearance of the House prior to the first phases of restoration undertaken by the Preservation Society of Ellicott Hill in the 1970s and 1980s. The photographs and descriptions in this report provide the best record of the House at the time it was last occupied by a member of the Johnson family.¹⁴ The Johnson House files maintained by the Preservation Society of Ellicott Hill during their ownership were first donated to the Historic Natchez Foundation, who subsequently transferred them in 1991 to Stuart Johnson, then Superintendent of the Natchez National Historical Park. Portions or all of

⁹ Edwin Adams Davis and William Ransom Hogan, *The Barber of Natchez* (Baton Rouge: Louisiana State University Press, 1955).

¹⁰ Department of the Interior, National Park Service, *Draft HABS Report, William Johnson Complex*, by Dena Sanford, Draft Report, Historic American Building Survey, (n.p. 1992).

¹¹ Department of the Interior, National Park Service, *Archeological Excavations at the William Johnson Complex, Natchez National Historical Park, Natchez, Mississippi*, by Jim Atkinson, Draft Report, Southeast Archeological Center (Tallahassee, FL, July 1994).

¹² Thomas J. Padgett, *Final Report on the Text Excavations at the William Johnson House, Natchez, Mississippi*, a report prepared for Koch and Wilson Architects, New Orleans, Louisiana, and the Preservation Society of Ellicott Hill, Natchez, Mississippi ([Hattiesburg, MS]: University of Southern Mississippi, 1978).

¹³ Department of the Interior, National Park Service, *Finishes Analysis, the William Johnson House, Natchez, Mississippi*, by Peggy A. Albee, Report, Cultural Resources Center, North Atlantic Region (Boston, MA, October 4, 1993).

¹⁴ Pamela Hawkes, Mary Oehrlein, and Mary Jane Wells, *Historic Structures Report, William Johnson House, Natchez, Mississippi*, Report, Building Conservation Technology (Washington, DC, April 1979).

these files are now located in the office of the curator at Melrose and include black-and-white photographs of the facade and an original copy of the 1979 archeological report. The records of the New Orleans architectural firm of Koch and Wilson, who directed the restoration work for the Preservation Society of Ellicott Hill, have recently been donated to Tulane University in New Orleans. Unfortunately, the files maintained by the Mississippi Department of Archives and History that documented the grant-funded restoration work on the Johnson House no longer exist.

Other important resources that provide information about the developmental history of the William Johnson House include the 1864 "Map of the Defences of Natchez," Sanborn Insurance Maps dating to 1886, 1892, 1897, 1901, 1904, 1910, 1925, and 1946, Historic Natchez Foundation site and research files, historic photographs, city directories spanning the years 1858-1976, and nineteenth-century Natchez newspapers.¹⁵

4.2 Early Life of William Johnson

William Johnson's birth in Natchez in 1809 is documented both on his tombstone in the Natchez City Cemetery and in his 1851 obituary.¹⁶ An 1820 petition to the Mississippi Legislature and the subsequent "An Act to Emancipate William, a Person of Color" provide the primary biographical details of the early life of William Johnson. These documents describe William Johnson as a mulatto, who was the son of Amy, a free woman of color, and the slave of William Johnson of Adams County. William Johnson, the elder, freed his slave Amy in 1814 in Vidalia, Louisiana, and Amy's daughter, Adelia, in 1818 in Philadelphia, Pennsylvania.¹⁷ Amy and her two children obtained their freedom in three states as a result, not of changing residence, but of changing Mississippi and Louisiana laws regarding the freedom of slaves.

In his successful petition to the Mississippi legislature, William Johnson, the elder, requested that he be allowed to grant "Liberty to a human being which all are entitled to as a Birth-right, & extend the hand of humanity to a rational Creature, on whom unfortunately Complexion Custom & even Law in This Land of freedom, has conspired to rivet the fetters of slavery."¹⁸ William Johnson's father was undoubtedly the William Johnson who owned him and petitioned for his freedom.

Unlike white landowner William Barland, who clearly specified in his will that his twelve children were born of a former slave named Elizabeth, William Johnson, the elder, did

¹⁵ "Map of the Defences of Natchez and Vicinity," Sanborn Insurance Maps (Natchez City Directories, William Johnson House Site File, record group 77, drawer 138, sheet 39 [National Archives & Records Services, General Services Administration, Washington, DC], Historic Natchez Foundation [hereafter cited as HNF], 1864, photocopy); historic photographs are found in the Norman Collection, Thomas H. Gandy; Natchez and Stewart Collection, William S. Stewart.

¹⁶ *The Natchez Courier*, June 20, 1851.

¹⁷ Hogan and Davis, 15-17.

¹⁸ *Ibid.*, 16.

not officially acknowledge in any legal document his relationship to the William Johnson that he freed.¹⁹ The lack of an official acknowledgment was not unusual. No acknowledgment was made by merchant Christopher Kyle who willed freedom and property to Nancy Kyle and her daughter Caroline.²⁰ No acknowledgment was given by carpenter James McCary, whose will not only bequeathed property to his slaves Kitty and Bob, but provided for their emancipation and education.²¹ Numerous diary references to Bob McCary, often called Mc by Johnson, document McCary as William Johnson's closest friend. Bob McCary, like Johnson, operated a barber shop in Natchez.

The 1820 act that freed eleven-year-old William Johnson specified that his former owner would educate him and maintain him until the age of twenty-one. Where and by what means Johnson received his education remains a mystery. Legal documents indicate that his mother Amy Johnson was illiterate, since she signed with her mark.²² Johnson apparently learned the barbering trade by working in the Natchez barber shop of his brother-in-law James Miller, who married Johnson's sister, Adelia, in 1820, the same year that Johnson obtained his freedom.²³ In 1827, forty-four prominent Natchez-area men petitioned the state legislature in favor of the removal of James Miller's civil disabilities as a free man of color and noted that he had lived in Natchez for nine years.²⁴

Johnson's first foray into business appears to have been in nearby Port Gibson when he was but nineteen years old. In a September 1830 entry in one of his account books, Johnson wrote, "The amount taken in During my Stay in Port Gibson which was twenty two months was one thousand and ninety four Dollars and fifty cents, This was by Hair Cutting and Shaving alone." On October 14, 1830, about a month after his return to Natchez from Port Gibson, Johnson bought his brother-in-law's lease on a Main Street barber shop and his barber shop equipment. James Miller and his wife Adelia decided to relocate to New Orleans the same year.²⁵

From October 1830 until April 1835, when he married, William Johnson meticulously recorded his expenditures in his account books. These expenditures paint a vivid picture of the life of a young, single free man of color who was both educated and well rounded. He gambled, drank, played games like billiards and dominos, attended performances at the circus and theater, and visited prostitutes for "Sensual Pleasure." He courted free African American young women and occasionally bought them presents.²⁶

¹⁹ Adams County, Mississippi, Office of Chancery Clerk, "Last Will and Testament of William Barland, Deceased," 1816, Will Book I, 132-38.

²⁰ *Ibid.*, 419.

²¹ *Ibid.*, 88-90.

²² Adams County, Mississippi, Circuit Court, marriage certificate of Adelia to James Miller, Marriage Record Book II, 54.

²³ *Ibid.*

²⁴ Hogan and Davis, 19-20.

²⁵ *Ibid.*, 20.

²⁶ *Ibid.*, 15-21.

At the same time that Johnson was enjoying the young single life, he was also working hard and prospering in business. By 1833, Johnson had earned enough money to buy the Main Street property that he had been leasing since 1830.²⁷ He also traveled to New York and Philadelphia for two to three months. In 1834, he expanded his barbering business to include bathhouses as well. Johnson catered almost exclusively to whites, and his business was conducted entirely by free or slave African Americans working under his supervision. Johnson also became a money lender to supplement his other sources of income and investment. Johnson's growing prosperity and business expansion in the 1830s paralleled the booming economy of the town.²⁸

In 1835, Johnson acquired his first large tract of land, a parcel of about 160 acres, which he quickly sold for a large profit.²⁹ His interest in land acquisition, however, temporarily diminished as the demands of a growing business, a new wife, and the birth of his first child in 1836 occupied his attention.

On April 21, 1835, at the age of twenty-six, William Johnson married Ann Battles, the daughter of Harriet Battles, a free African American woman.³⁰ Almost exactly nine months later, Johnson recorded in his diary the birth of their first child on January 24, 1836. With his marriage to Ann Battles came the State Street property where Johnson would later build his family's long-time residence.

4.3 Prior History of State Street Property

In 1829, Harriet Battles had acquired a 36'-by-140' lot on First South Street (later State Street) in square 2 of the Spanish plan of the City of Natchez from Gabriel and Elizabeth Tichenor.³¹ Earlier, in 1822, Gabriel Tichenor had filed emancipation papers for "Harriet, a mulatress aged about thirty years and upwards."³² Gabriel Tichenor was the cashier of the Bank of Mississippi, and his wife Elizabeth was the daughter of George Overaker, owner of the White Horse Tavern and the suburban villa Hope Farm in the early nineteenth century.³³

The Spanish government had laid out the grid plan of the City of Natchez about 1790.³⁴ Each square was divided into four lots. The southwestern quarter of each square was

²⁷ Adams County, Mississippi, Office of Chancery Clerk, Deed Book W, 133-35.

²⁸ Hogan and Davis, 21-24.

²⁹ *Ibid.*, 35.

³⁰ Marriage Record Book V, 542.

³¹ Deed Book R, 451.

³² Deed Book O, 36.

³³ D. Clayton James, *Ante-bellum Natchez* (Baton Rouge: Louisiana State University Press, 1968), 198-99; Hawthorne Site File, National Register Nomination and Hope Farm Site File, National Register Nomination, HNF.

³⁴ Mississippi Department of Archives and History [hereafter cited as MDAH], Division of Historic Preservation, *Comprehensive Plan for Historic Preservation for the Period of European Colonization in Mississippi*, by Jackson Elliot, Preservation Planning Study (Jackson, MS, 1989), n.p.

designated lot 1; the northwestern quarter, lot 2; the southeastern quarter, lot 3; and the northeastern quarter, lot 4. The lot acquired by Harriet Battles in 1829 was located on lot 4 in square 2.³⁵ Square 2 of the Spanish plan of the City of Natchez is today the block bordered by State Street on the north, Wall Street on the east, Washington Street on the south, and Canal Street on the west.

When Harriet Battles acquired the property in 1829, the block was then bordered by First South Street on the north, Second Street on the east, Second South Street on the south, and First Street on the west. Until the 1830s, the streets of the city's grid plan were unnamed except for Main Street. The streets that paralleled Main (which ran from west to east) were designated as First Street North or First Street South and extended to Third Street North and Third Street South. Present-day Canal Street was the first street from the edge of the bluff and was designated First Street (sometimes also called Front Street) with the streets parallel to Canal being designated as Second, Third, Fourth, Fifth, Sixth, and Seventh Streets.

The creation of Broadway Street in the 1830s caused the city to consider renaming the streets, since Canal Street would no longer be the first street. Broadway Street was established in the mid-1830s after the 1827 settlement of a lawsuit between Jefferson College and the City of Natchez resulted in the division of the public commons.³⁶ The city streets were subsequently renamed with several honoring a founding father: Washington, Jefferson, Monroe, and Franklin. Canal Street's name derived from the brick aqueduct that extended its length and is still visible where it terminates into a bayou near the railroad tracks that cross the street. In an 1835 publication, travel writer Joseph Holt Ingraham described the brick aqueduct and the bridges that spanned it.³⁷ At the same time that the city was renaming streets, it was also engaged in digging out streets. Minutes of the Selectmen of the City of Natchez record the 1836 digging out of Jefferson Street from Canal to Wall Street.³⁸ Downtown streets had originally followed the hilly topography of the land.

In 1793, only a couple of years after the grid plan of Natchez was laid out, the Spanish government granted lot 4 in square 2 to Dona Maria Gertrudis Solibellas.³⁹ In 1796, Gertrude Solibellas sold lot 4 in square 2 with a house to George Overaker. The \$150 selling price, however, indicates that the house was not a very substantial building.⁴⁰ In 1806, George Overaker received a United States patent to lot 4 in square 2, and the patent noted that he had improved and built on the lot in 1795 [one year before he bought it from

³⁵ Deed Book L, 592, and R, 489-90.

³⁶ William T. Blain, *Education in the Old Southwest: A History of Jefferson College, Washington, Mississippi* (Washington: Friends of Jefferson College, 1976), 14.

³⁷ Joseph Holt Ingraham, *The South-West. By a Yankee* (New York: Harper & Brothers, Cliff-St., 1835), vol. 2, 24.

³⁸ Minutes, Board of Selectmen, March 30, 1836, City Hall, Natchez, Mississippi.

³⁹ Mary McBee, *Natchez Court Records* (1953; reprint, Baltimore: Genealogical Publishing, 1979), 480.

⁴⁰ *Ibid.*, 121.

Gertrude Solibellas].⁴¹ After the death of George Overaker, his widow Margaret and trustee Lewis Evans, in 1820, sold lot 4 in square 2 to George's daughter Elizabeth, wife of Gabriel Tichenor. Although the deed refers to the "tenements and buildings thereon," this was common legal language to include all improvements, in the same way that deeds often refer simply to "improvements," which could be fencing as well as a building.⁴²

In 1824, Gabriel Tichenor rented to Mary White a house that was on his property on the corner of First South and Second Streets.⁴³ In 1826, Tichenor sold to attorneys William Griffith and John Quitman a strip of land along the southern border of lot 4 that measured 22' by 169'. This portion of lot 4 was described as being bordered on the south by the lot "on which stands Mr. Griffith's dwelling house."⁴⁴ This particular "dwelling house" is the house now known as Texada, which was then owned by Griffith's father-in-law Edward Turner.⁴⁵ William Griffith's wife Theodosia was Turner's daughter by his first wife, Mary, the daughter of territorial official Cato West.⁴⁶ In 1829, the Tichenors deeded to Harriet Battles a portion of lot 4 that measured 36' by 140' and fronted First South [State] Street.⁴⁷ Finally, in 1832 the Tichenors sold the remaining part of lot 4 in square 2, located east of the Battles property, to William Lancashire.⁴⁸

What stood on the lot purchased by Harriet Battles in 1829 is unknown. However, a house was located on the lot by 1836, when her son-in-law Johnson noted in his diary on November 22 that "Mrs. Battles commences to move out of Her House to have another put up in the place of the old One,...." Archeological investigations indicate that it was a frame house and that some of its brick piers were reused in the construction of the Battles House built in 1836. Within the remains of the piers is evidence of brick paving associated with a still earlier building that preceded the two houses associated directly with Harriet Battles.⁴⁹

4.4 Early Married Life of William Johnson and Development of State Street Property

Immediately after his marriage in April 1835, William Johnson apparently took charge of his mother-in-law's property. Johnson's business accounts and his diary show that he hired local master builder Thomas Rose to tear down the old house on his mother-in-law's property and to build a new frame house. On March 9, 1837, Johnson paid Rose and

⁴¹ Adams County, Mississippi, Office of Chancery Clerk, Lands Claim Book E, 446.

⁴² Deed Book L, 592.

⁴³ Deed Book O, 36.

⁴⁴ Deed Book P, 451.

⁴⁵ Deed Book I, 381, and II, 630.

⁴⁶ *Biographical and Historical Memoirs of Mississippi* (Chicago: The Goodspeed Publishing Company, 1891), vol. 2, 929; *Mississippi Portraiture*, comp. by Vera Jacobs Speaks (Jackson: National Society of Colonial Dames of the State of Mississippi, 1987), 266.

⁴⁷ Deed Book R, 489-90.

⁴⁸ Deed Book U, 379.

⁴⁹ Atkinson, i and fig. 48.

received a receipt for a total of \$2,675. On April 16, Johnson paid Rose for the plans of the new house, which were drawn by "Deadsmore the Carpenter." J. C. Deadmore advertised in 1836 as an architect and draftsman.⁵⁰ Archeological investigation beneath the existing Johnson House documented a frame house with two rooms per floor that was supported by brick piers and heated by fireplaces in each room that shared a single chimney. At the rear was a one-story kitchen building with a single chimney that was probably wood frame and built at the same time as the 1836-1837 house.⁵¹

Johnson diary entries for March 11 and 16, 1837, record the rental of the new house on Harriet Battles's property to a Mr. A. Green and George W. Blake for one year from the eleventh of March for \$125 per month. Green and Blake operated the Southern Exchange, which was closed on May 3 "for debt due the State."⁵² Johnson continued to refer to his State Street building as the Southern Exchange even after the departure of Green and Blake.

On May 11, 1837, Johnson wrote, "I gave Mr McGetrick the keys to day of the Southern Exchange." McGetrick and family apparently lived upstairs over the business, because Johnson recorded on October 4, 1837, that Mrs. McGetrick died the previous evening at the Southern Exchange. Johnson wrote, "She was the first person that Ever died under that Roof in this world...." On November 10, Johnson noted that McGetrick was elected "Ranger" and, on the twenty-third, that McGetrick paid him \$79 for one month's rent. On November 29, Johnson witnessed McGetrick being taken to jail for stealing. McGetrick must have been soon released because he paid Johnson another month's rent on December 26, after being unable to pay him when Johnson attempted to collect on December 20. McGetrick operated a coffee house in the building.⁵³

On January 23, 1838, McGetrick paid only \$63 for rent, since he paid \$16 "for the setting of 3 grates." During the 1830s, most of the wood-burning fireplaces in downtown Natchez were fitted for coal, which was readily available at Natchez Under-the-Hill. Country houses also often had at least one fireplace fitted for coal, which was hauled from the city to the country. Coal proved to be a much more efficient fuel for heating than wood.

On August 6, 1838, Harriet Battles moved into the house on State Street. McGetrick apparently moved out about the same time because, on August 24 and 31, Johnson wrote about settling with McGetrick for back rent and counters left in the building. On December 1, a Mr. Carroll and Mr. Evans paid \$50 for rent of the State Street property. Johnson recorded his move into the house on December 11, 1838. Johnson's move into the State Street property coincided with his construction of a new barber shop building on Main Street from 1838-1839. On January 16, 1839, he paid "Mr. Weldon [George or

⁵⁰ *Mississippi Free Trader and Natchez Gazette*, March 11, 1836.

⁵¹ Atkinson, 7 and fig. 48.

⁵² This information expands upon the 1994 archeological report and the editorial comment of Hogan and Davis, both of whom failed to connect Green and Blake to the Southern Exchange.

⁵³ Hogan and Davis, n. 20, 177.

Thomas] to Day for the Brick Building that he put up for me.” Earlier, on February 26, 1838, Johnson had expanded his barbering business by renting space for an additional barber shop at Natchez Under-the-Hill.

On September 25, 1839, Johnson described the fire that destroyed the State Street house built by him on his mother-in-law’s property. The State Street building had cost Johnson \$2,952 to build, and he collected \$2,000 in insurance money to compensate for his loss.⁵⁴ At the time of the fire, Johnson was away from town, having sought refuge in the country from a yellow fever epidemic in the city. He noted on September 25 that he was in the country “sound as a Dollar.” Diary entries on September 17 and 25, October 1, and November 15 document that Johnson was renting the “Quigless [sic] Plantation” to escape the yellow fever in town. The “Quigless Plantation” would have been the property of Joseph Quegles or his son John. Joseph Quegles was a Spaniard, who was both a merchant and planter.⁵⁵

When Johnson returned to town, he rented a house that belonged to Mrs. Richards on November 18, 1839. Mrs. Richards was most likely Sarah Buckholts Richards, widow of John Richards who died in 1828.⁵⁶ He remained at the Richards House until August 1840. On July 29, Johnson wrote that he was unhappy that Mrs. Richards wanted two months rent in advance, and, on August 16, he returned Mrs. Richards’s house key. On October 10, Johnson paid “Mrs Neibut [Sarah Neibert, widow of contractor Joseph Neibert]” house rent up to November 10.⁵⁷ He recorded on March 15, 1841, that he moved from Mrs. Neibert’s house, at which time he moved into his new house on State Street. Johnson’s moves in and around the city of Natchez, and out of the city into the country during an outbreak of yellow fever in 1839, indicate that he experienced little or no prejudice in renting from white property owners. Mrs. Richards, Mrs. Neibert, and the Quegles family were all white and relatively prominent local citizens.

According to a Natchez newspaper, the 1839 fire that burned Johnson’s new building destroyed almost an entire city block, bounded by Canal, State, Wall, and Washington streets, sparing only Texada Tavern located on the northwest corner of Wall and Washington.⁵⁸ Texada Tavern dates to just after 1798 when the property was acquired by Manuel Texada and stands today as one of the oldest houses in downtown Natchez.⁵⁹ Texada served as the meeting place for the state legislature during the early years of statehood when Natchez was the state capital.⁶⁰ At the time of the fire, Edward Turner, father of Mary Louisa McMurrin of Melrose, owned Texada, which he acquired in 1817

⁵⁴ *Ibid.*, 33.

⁵⁵ Adams County, Mississippi, Office of Chancery, Probate Box 57.

⁵⁶ Richards’s tombstones, plat 1 and Old Catholic section, Natchez City Cemetery.

⁵⁷ Choctaw Site File, Neibert-Fisk House, National Register Nomination, 1979, HNF.

⁵⁸ *Mississippi Free Trader and Natchez Weekly Gazette*, October 1, 1839.

⁵⁹ Texada Tavern, Site File, Chain of Title, photocopy of 1803 Tax Roll and 1979 National Register Nomination, HNF.

⁶⁰ *Natchez Daily Courier*, March 7, 1856; *Mississippi State Gazette*, January 29, 1825.

and which had been the 1820s home of his daughter Theodosia and her husband William B. Griffith, both of whom died in the late 1820s.⁶¹ Turner later deeded Texada to his daughter, Frances Conner, in 1853.⁶²

Also on the block was the law office of John Quitman and John McMurren, husband to Mary Louisa McMurren. Quitman and his former partner, the late William Griffith, had acquired the property in 1826.⁶³ The fate of the Quitman and McMurren law office in the 1839 fire is unknown, but, if the *Mississippi Free Trader and Natchez Weekly Gazette* was correct in its reporting, all buildings on the block were destroyed but Texada.⁶⁴

4.5 Later Life of William Johnson and the Construction of the William Johnson House

Johnson waited a few months after the fire before beginning construction of a new house. On January 3, 1840, Johnson recorded that he "...Commenced this morning again to Survey the lot in State Street." In February 1840, while Johnson was planning to rebuild on the Battles State Street property, he opened still another barber shop in the new Tremont Hotel on the corner of Main and Wall streets. On February 10, Johnson noted that "Charles takes Charge below [Under-the-Hill barber shop] and Bill in the Tremont House."⁶⁵

Johnson recorded that he surveyed his property on January 3, 1840, and he noted that his neighbor "McCullam [McCallum] Come On my Lot a fraction over four inches on the front on State Street..." The McCallum family, which included Gus Ronald and son John McCallum, began earlier than Johnson to build anew on their State Street lot after the 1839 fire.⁶⁶ The McCallum family soon suffered a setback, however, when one of the most devastating tornadoes in American history struck Natchez on May 7 and caused \$1,000 in damages to their "new" building on State Street.⁶⁷ Nevertheless, the McCallum family continued construction, and, by August, ordered flooring for their new building from Andrew Brown's Sawmill.⁶⁸ The McCallum Building and the Johnson House share a common wall, but the evidence of windows in the western gable-end wall of the McCallum building indicates that the common wall was not initially planned or that Johnson initially intended to build a building of fewer stories than the existing building.

The same tornado that damaged the McCallum building demolished Parker's Hotel located across the street from Johnson's State Street lot.⁶⁹ Parker's Hotel was a three-

⁶¹ Deed Book P, 451; tombstones, plat 1 and Old Catholic section, Natchez City Cemetery.

⁶² Deed Book I, 381; Deed Book II, 630.

⁶³ Deed Book P, 451.

⁶⁴ *Mississippi Free Trader and Natchez Weekly Gazette*, October 1, 1839.

⁶⁵ *The Natchez Courier*, November 27, 1837.

⁶⁶ Deed Book DD, 542 and EE, 481.

⁶⁷ *The Mississippi Free Trader and Natchez Weekly Gazette*, May 11 and 14, 1840.

⁶⁸ Andrew Brown Day Book 1837-1840, August 13, 1840, Andrew Brown Papers, University of Mississippi [hereafter cited as UM], Oxford.

⁶⁹ *Mississippi Free Trader* [Natchez], May 8 and 11, 1840.

story building that slept 200 people and was built in 1818, enlarged in 1820, and “plastered in imitation of stone” in 1836.⁷⁰ The hotel had been severely damaged by fire in September 1839, only to be demolished by the tornado in May 1840.⁷¹ Parker’s Hotel was already a local landmark when it was destroyed in 1840. The hotel hosted numerous well-known travelers to Natchez and served as the site of the reception for the Marquis de Lafayette when he visited Natchez in April 1825.⁷² Parker’s Hotel is one of the most visible buildings in Audubon’s 1822 landscape of Natchez.⁷³ The ruins of Parker’s Hotel provided the bricks for Johnson’s new house, the original Kitchen Dependency, and for walks and paving on the property. Johnson also recorded on September 1, 1840, that he spent the day “taking my Brick from the yard of McMurrin.” The tornado of 1840 leveled the Wall Street law office of John McMurrin and John Quitman, which was located on the same block as the William Johnson House.⁷⁴

On May 21, 1840, Johnson recorded that he was “to day very Buissy in Cleaning Brick in State Street...Mr. Parker is selling of[f] his Brick very fast--number of Carts are hauling from there.” On May 22, he continued work on Parker’s ruin. “I was to Day geting Brick down at Mr parkers. He gave me a Small Lot of them to take them away which I did with Great pleasure.” On June 12, Johnson noted, “I am yet Getting Brick from Mr. parkers Hotell.” On June 23, he wrote, “I was to day down at Mr. Parkers at work as usual, cleaning away the trask [trash].” On June 25, Johnson was busy “...packing up Brick on his lot.”

Besides salvaging brick, Johnson also bought window sashes and doors that had previously been used or were perhaps intended for other buildings. On June 15, 1840, Johnson recorded in his business papers that he bought three doors from Parker.⁷⁵ These three doors are probably the double-leaf doors later installed on the front wall of the Johnson House. The invoice of George Tucker, recorded in the diary on March 24, 1841, includes the information that he charged Johnson \$3 “To repairing Front Doors.” The three doorways on the facade are today filled by double-leaf, bead-and-butt doors installed during restoration work undertaken by the Preservation Society of Ellicott Hill after their purchase of the property in 1976.⁷⁶

No documentation in historic photographs or any other material has been found for a bead-and-butt primary door without a glazed panel in a first story intended for

⁷⁰ *Mississippi Free Trader and Natchez Gazette*, January 29, 1836.

⁷¹ *The Natchez Daily Courier*, March 7, 1856.

⁷² *Mississippi State Gazette* [Natchez], April 23, 1825.

⁷³ *The Natchez Daily Courier*, March 7, 1856; John James Audubon, untitled oil on canvas, private collection, photographs in Audubon Landscape of Natchez Slide File, 1976, HNF.

⁷⁴ John Quitman to Eliza Quitman, Jackson, MS, May 12, 1840, Quitman Family Papers, Subseries 1.1, Folder 18, Southern History and Folklife Collection [hereafter cited as SHFC], University of North Carolina [hereafter cited as UNC], Chapel Hill, typed transcript, Natchez National Historical Park [hereafter cited as NATC].

⁷⁵ Sandford, 33.

⁷⁶ Deed Book 13-J, 431.

commercial use. Architect Henry Krotzer, then with the firm of Koch and Wilson in charge of the restoration work for the Preservation Society of Ellicott Hill, recalls basing the design on photographic documentation, but no photograph illustrating bead-and-butt, double-leaf doors has been located.⁷⁷ The 1979 Historic Structures Report concluded that the historic photograph of the facade was "too dark to discern the original first-floor door configuration."⁷⁸

Most likely, the doorways originally contained double-leaf doors with glazed upper panels and wood lower panels. Photograph 1-H is a blow-up of the same photograph cited in the 1979 Historic Structures Report, and is the only known photograph that documents the Johnson House facade before its early-twentieth-century remodeling. By working with the owner of the photograph, a better copy negative and blow-up was produced than the one available to Building Conservation Technology in 1979. This photograph supports the existence of double-leaf doors with glazed upper panels, which appear to be visible in the easternmost doorway opening.⁷⁹

The date of the photograph of the unaltered Johnson House facade (1-H) is after 1906, based on the corner tower of the Wall Street Baptist Church in the background and on the railroad station roof overhang visible on the right edge. Sanborn Insurance Maps document the corner tower on the Wall Street Baptist Church as having been built between 1901 (10-H) and 1904 (11-H), and the railroad station between 1904 (11-H) and 1910 (12-H). The Johnson family owned the railroad property until 1906 when they sold it to the Natchez & Eastern Railway Company.⁸⁰ This post-1906 photograph (1-H) is one of the more valuable resources in understanding the developmental history of the William Johnson House property.

Illustration (2-H) is a ca. 1880 photograph illustrating two types of commercial door treatments that would typically be found on a pre-Civil War Natchez building that combined residential and commercial use. The buildings in the photograph stood on the northern side of Market Street across from the Adams County Courthouse, less than two blocks from the William Johnson House. The building on the left, which is stylistically similar to the Johnson House, features double-leaf doors with glazed upper panels, one of which shows an incorporated shutter on the upper glazed portion. Original double-leaf doors with evidence of incorporated shutters survive on the storefront of the Riverboat Gift Shop at Natchez Under-the-Hill. The other building on the right shows double-leaf doors with glazed upper panels that are closed by separate hinged and paneled shutters. Either treatment could have existed at the 1840-1841 William Johnson House, but the post-1906 photograph shows no evidence of hinged full-length blinds and appears to support the existence of incorporated shutters.

⁷⁷ Henry Krotzer, interview by Mary W. Miller, telephone, September 15, 1995, HNF.

⁷⁸ Hawkes, Oehrlein, and Wells, 12.

⁷⁹ William Johnson House, photograph in William Johnson House Site File, after 1906, HNF. Original photograph in Conner family photograph album in the collection of Dr. Thomas H. Gandy, Natchez.

⁸⁰ Deed Books HH, 525-27; 4-B, 638 and 821-823; 3G, 546-547.

Mary Louise Miller, an indirect descendant of the Johnson family, recalls doors with diagonal boards that angled from the sides to meet in the center.⁸¹ Mary Louise Miller was the great-niece of Sallie Johnston, wife of Dr. William R. Johnston who was the grandson of diarist William Johnson. Either the main doors or possibly exterior shutters, if any ever existed, may have been reinforced on the back with the diagonal boards described by Mary Louise Miller. The double-leaf doors at Gloucester in Natchez feature flush diagonal boards on the rear for extra strength.

The case against retaining the existing bead-and-butt doors installed ca. 1980 on the first story of the Johnson House is strong. Double-leaf doors with upper glazed panels appear to be visible in the easternmost door opening in the post-1906 photograph (1-H). Bead-and-butt doors without glazed panels across the front of a commercial structure are not documented on any existing Natchez building or in any historic photograph of a first-story commercial facade in Natchez. Most importantly, the first-story commercial space would have been dark and almost unusable when the doors were closed during cold weather because the first-story windows in the western gable end were added later.

In addition to purchasing used doors, Johnson also bought window frames and sashes that were either used or perhaps intended for other jobs. On August 25, 1840, Johnson wrote that he purchased "window frames" and "sash frames" from Mr. Elam and noted, "...[I]f they are good I got them Cheap." Elam was a builder and these sash might have been used or new, possibly left over from another job.

By August 3, 1840, Johnson was working on the site of his new house. He noted in his diary that "he sent down Stephen and Phillip this morning to Commence on the House we had Burned down last year. The[y] Commenced at Breakfast time and worked all Day. Mr. Brown was giving them the Instructions &c." The next day Johnson noted that Mr. Brown "Commenced to measure off the Ground Yesterdy." Mr. Brown was probably the Mr. W. Brown who advertised his services in late 1837 to prepare "designs, plans, specifications, estimates and working drawings for Churches, Court Houses, Banks, Hotels and other public buildings and city and country dwellings, and superintend their construction."⁸²

At least two other Browns were working in the building trades in Natchez in the late 1830s, but they are less likely to have provided instructions at the building site. Mr. Brown could possibly have been Andrew Brown, a builder and owner of the largest sawmill operation in the region, or James Brown, master mason, who was born in England and was fifty years old in 1860.⁸³ Because James Fox submitted a bill for the brickwork, it is unlikely that James Brown is the Brown in question. James Brown did,

⁸¹ Sanford, 33.

⁸² *Natchez Daily Courier*, November 25, 1837.

⁸³ John Hebron Moore, *Andrew Brown and Cypress Lumbering in the Old Southwest* (Baton Rouge: Louisiana State University Press, 1967); Population Schedules, U.S. Census microfilm, Armstrong Library, Adams County, Mississippi, 1860, 17.

however, later plaster for Johnson on the interior of the House. Supporting the supposition that the Mr. Brown who measured off the ground was the Mr. W. Brown who advertised as a designer in a Johnson business ledger that records a William Brown as an occasional customer.⁸⁴

On August 4, 1840, "Stephen and Phill worked all Day down at the Building and I also Hyred 2 hands and gave them 1.75 to work from 12 Oclock untill night--they belonged to the Miss Evanss [the Evans sisters lived at Elms Court]."⁸⁵ By August 15, the bricklayers had reached the point where the first-story joists could be installed. According to Johnson, "Mr Weldon Commenced to put on the Joice for my new House."

The Mr. Weldon was Mr. George Weldon, one of the Weldon Brothers of Natchez, who were described as being at one time "the wealthiest and most extensive contractors and builders in the state of Mississippi."⁸⁶ The Weldon Brothers, George and Thomas, designed and built the National Historic Landmark Warren County Courthouse in Vicksburg in 1858.⁸⁷ They also built the courthouse in Raymond, and Institute Hall in Natchez.⁸⁸ The Weldon Brothers were described in an 1885 publication as having employed more than 100 slave mechanics, including their principal draftsman John Jackson.⁸⁹ Another Weldon brother, William, was a merchant with a dry goods business on Main Street in Natchez.⁹⁰

On August 17, "two Layers" were at work on the brick. On September 3, after some time off, Johnson recorded that the "Brick Layers Commenced to work to Day on my Building Again..." By September 14, Johnson reported that the "Joice of the Second Floor was partley put up this Evening," and by the end of the next day he was able to note that "we finished putting on the Joice on my State St Building." After the laying of the second-story joists, the bricklayers commenced work again on September 16. On September 17, the "Carpenter set two windows and one Door Frame this Evening." By October 9, the building was progressing rapidly. Johnson noted in his diary, "The Rafters was put on yesterday and to day--the Brick Layers this Evening at work and will Finish or nearly do so to morrow--I partly made a Bargain to Day with Mr Weldon to make me a pair of Dormer windows for Sixty Dollars..." Johnson may have decided to install dormer windows after reading advice published in the *Mississippi Free Trader* on May 28, 1840,

⁸⁴ William Johnson Ledger, February 1837-October 1841, Johnson Papers, vol. 36, no.3, LLMVC/LSU.

⁸⁵ Elms Court, Site File, Chain of Title and 1977 National Register Nomination, HNF. The Evans sisters lived at Elms Court.

⁸⁶ *Biographical and Historical Memoirs of Mississippi*, vol. 1, 328.

⁸⁷ Warren County Courthouse, [Vicksburg], Warren County, National Register File, MDAH.

⁸⁸ Hinds County Courthouse, [Raymond], Hinds County, 1986 National Register File, MDAH; Minutes, Board of Selectmen [Natchez], May 5, 1852.

⁸⁹ H. S. Fulkerson, *Random Recollections of Early Days in Mississippi* (Vicksburg: Vicksburg Printing and Publishing Company, 1885), 131-135.

⁹⁰ 315 Main Street Site File, Chain of Title and Sanborn Insurance Maps (photocopies), HNF.

following the May 7 tornado. The writer advocated the installation of dormer windows to equalize interior and exterior air pressure in case of tornado.⁹¹

On October 10, 1840, Johnson paid rent up to November 10 and wrote in his diary, "My new Brick House is very near Finished--that is the Brick work--it will be Finished on Monday if we have Good weather and nothing Happens...." Johnson made arrangements with George Weldon for a wood shingle roof on October 15. He agreed to pay Weldon "four Dollars the square" and to furnish the nails. He records the purchase of a keg of nails for the shingles at a cost of "Eight Dollars."

On October 17, Johnson noted his surprise at the bill presented by James Fox for the brickwork. According to Johnson, "His Bill commenced in this way--Mr. William Johnson Natchez, Miss Oct. 13th 1840

	To James C. Fox Dr [director]	
To Laying 83936 Brick and Furnishing Materials at \$7 p m		558.55
Furnishing 2 Trimmer arches 2 each		4.00
56 ft of Cornice 1 Dol per ft		56.00
Three Doble arches 3 dollars Each		9.00
12 Single dito 1.50 each		18.00
Seting 3 window Frames 50 each		1.50
Plank in Foundation		10.00
7000 Bricks at \$10 per thousand		<u>170.00</u>
		\$856.05

Johnson did not record why he was surprised at James Fox's bill, but he recorded on October 19 that he paid him the amount he owed him "Except fifty five Dollars which I gave Him my Due Bill for...." No other brickwork has been documented to Fox, who died on December 4, 1856.⁹² Joseph Buck Stratton, minister of the First Presbyterian Church, attended the funeral and described James C. Fox as an "old resident, a kind-hearted man, a warm friend of mine, but a profane intemperate, and ungodly man."⁹³ This description of Fox would have been apt for many of the mechanics, or men in the building trades, in nineteenth-century Natchez.

James Fox laid the brickwork of the facade at the William Johnson House in the all-stretcher bond that was most fashionable during the Greek Revival period, and the Johnson House is one of the earliest Natchez houses to exhibit this bond. Some other examples include Elward (1844), the Catholic Rectory (1846), Melrose (1847), Dr. Dubs Townhouse (1852), Dixie (1853), and a ca. 1850 townhouse located on the northeast

⁹¹ Sanford, 34.

⁹² Sexton's Records, trans. by Robert Shumway, Armstrong Library, Natchez, Mississippi, HNF.

⁹³ Joseph Buck Stratton, Diary, December 5, 1856, LLMVC/LSU, typed manuscript, HNF, 174.

corner of State and South Union streets.⁹⁴ The all-stretcher bond appears only on the facade, with the other elevations featuring common bond. Builders commonly used the finest brick bonds only on the facades or the most public elevations. The all-stretcher bond was so fashionable that it was applied as decorative painting atop the common bond brickwork on the facade of the McClure House at 609 Jefferson Street. The bricks of the facade are also finer in quality than the other bricks used in the construction of the House, and their purchase was probably reflected on mason James Fox's bill in the charge for 17,000 bricks at \$10 per thousand.

The bill for brickwork submitted by James Fox also documents three double arches and twelve single arches, which corresponds with the number of splayed arches above the original openings of the House. The three double arches refer to the double-leaf doorways of the first story. The twelve single arches refer to the three original openings on the upper facade, the six openings on the rear elevation, and three openings on the upper two stories of the western gable end. The mason's bill also indicates a charge for the brick sawtooth cornice across the front and rear elevations.

On October 20, 1840, Johnson wrote, "Mr Weldon nearly done putting on the Shingles on my House--State street." Johnson records nothing about work on the State Street property from October 20 to November 16 and 17, when he himself began constructing a fence on his State Street property. Johnson was probably distracted during this period by another visitation from fire. On November 4, he saw his barber shop at Natchez Under-the-Hill "wraped in Flames" and he lost everything. On November 6, he again hired George Weldon, this time "to Bui[l]d me a Small House down at the Landing."

The completion of the interior of the State Street house began in earnest on November 26, when William Johnson "Closed a Bargain with Mr Tucker for the completion of my House in State Street." They agreed on a price of \$270. Johnson later described Mr. Tucker as "my Carpenter" on January 8, 1841. Mr. Tucker was apparently George Tucker, who is documented as the designer and builder of a theater on Main Street in 1841.⁹⁵

On November 30, 1840, Johnson remarked that he had learned that his "New Brick Building" was about to fall down. He expressed hope that it was not true but, if so, he

⁹⁴ The 1844 date for Elward is based on stylistic details and the 1844 acquisition of the property by Richard Elward (Adams County, Mississippi, Deed Book DD, 120); the 1846 date for the Catholic Church Rectory is documented in a building contract with John Crothers (Deed Book FF, 508); the 1847 date for Melrose is based on family correspondence (Eliza Quitman to John Quitman, September 2, 1847, Quitman Family Papers, Series 1.1, Folder 53, SHFC, UNC, Chapel Hill, typed transcript, NATC, computer printout, HNF); the Andrew Brown Papers, UM (Order Book 1844-51, 31 January 1848); the 1852 date for the Dr. Dubs Townhouse is documented in the brick where Dubs or a builder scraped "Built 1852," and "Built by C. H. Dubs/1854" on a rear addition and in a newspaper advertisement that his house and office were located in the building (*The Daily Courier* [Natchez], April 19, 1854); the 1853 date for Dixie is documented in Edward Templeman's probate papers (Probate Box 156).

⁹⁵ *The Natchez Courier*, February 13, 1841.

figured that it “must have been Ocasioned by the Tornado.” Although he does not specify Main Street in the diary entry, Johnson built a new brick building on Main Street in 1838-1839, and construction on his State Street building had not yet begun when the tornado struck Natchez on May 7, 1840. Confirming that the structural damage occurred on Main Street are later references on March 17 and 18, 1841, that document the removal of an old pier and the construction of a new pier on Main Street by a Mr. Brick.

On December 12, 1840, Johnson paid Mr. Tucker ten dollars on his work, and Johnson himself worked nearly all afternoon, “Filling in dirt that was washed out from yesterdays and Last nights Rain.” He also recorded the purchase of a staircase and a stove. A portion of the staircase that Johnson purchased might possibly have been used on the back gallery, because it is doubtful that he would have been able to install an already constructed staircase on the interior between existing walls on the second story. Neither of the two carpenters’ bills includes a charge for a staircase.

Johnson began building a kitchen building on December 18, 1840. He recorded in his diary, “I Commenced to Day to haul Brick down from my yard to State Street to Build a Kitchen with--Brick Layers Commenced the Foundation of the Kitchen this Evening.” The following day, he paid Mr. Tucker another \$25, making a total of \$35 of a \$270 contract for interior work on the House. As Christmas approached, he noted on the twenty-first that he was “Quite Buisy with Building in State Street. The last entries in 1840 about the State Street house are on December 22, when he pays \$27 for lumber for “my Building,” most likely the kitchen. He noted that the “Carpenter Commenced to petition [sic] of[f] the Rooms this Evening--Chimney was commenced in the Kitchen today.”

The original kitchen building that Johnson built was perpendicular to the Main House and is well documented on the 1864 Map of the Defenses of Natchez (6-H) and on the 1886 (7-H) and 1892 (8-H) Sanborn Insurance Maps. The 1994 archeological report recorded the location of all exterior walls but was unable to locate evidence of the kitchen chimney mentioned in the diary.⁹⁶ The kitchen disappeared between 1892 (8-H) and 1897 (9-H), when the Sanborn Insurance Map of that year illustrated the new kitchen and designated it on the map as “BEING BUILT.” The 1994 archeological study concluded that the original kitchen did not burn, based on the absence of a charcoal strata inside the brick walls.⁹⁷

On January 5, 1840, Johnson “partly Engaged” a plasterer for \$80 per month. He also made a bargain, as he described it, with Mr. A. Brown for fifteen thousand lath at \$3 per thousand. Mr. A. Brown is Andrew Brown who owned and operated Brown’s Sawmill below the bluff. Johnson sent for the lath and referred to the lath being “hauled up.” The description of “partly engaged” a plasterer becomes clearer on reading entries dated January 6 and 7, when he also hired a Mr. Barbee at \$80 a month and a Mr. Evans at \$3 a day to plaster the house on State Street. A later diary entry, March 3, 1841, identifies

⁹⁶ Atkinson, 50-52.

⁹⁷ *Ibid.*, 52.

Evans as George M. Evans. Johnson wrote that lime was available at the landing for \$1.25 per barrel. On January 11, Johnson recorded paying plasterer Evans \$6 on his work. On January 15, Johnson wrote, "The Plasterer Commenced this Evening and Plastered the Left Hand Conner Room." The plasterer who continued working must have been Evans, who was paid an additional \$10 on January 16.

Work on the kitchen continued while the House was being finished on the interior. On January 16, 1841, Johnson wrote, "Brick layers Commenced on the Building or [of] the Kitchen and it rained so they had to Leave it." The bad weather delayed any work at State Street until January 21, when the carpenter "Commenced to day to Lay the Gallery Floor--also the floor in the Dormer window." This diary entry confirms the determination of the 1979 Historic Structures Report that the first-story gallery floor was originally wood.⁹⁸ On the following day, January 22, the plasterers resumed work, and the gallery was finished in the evening.

On January 27, 1841, Johnson "Got Mr Tucker to make a Couple of Large Window frames...for the Kitchen--they were made to mach the sash that Mr Weldon made for my store windows--Front windows in the Kitchen was set up this Evening and [if] the weather Continues clear the Brick Layers will Finish this week very Easy." On January 28, Johnson made the "Whitning" for the third coat of plaster and noted that the bricklayers were nearly finished with one end of the kitchen. On January 19, Johnson wrote that the bricklayers came close to finishing the kitchen and should finish it early the morning of January 20, with the roof to be installed the following week. Johnson closed out the January entries relating to his new house by sending his slaves to get more brick from the Parker's Hotel site; he noted that they got very few bricks and he sent them again to Parker's lot on February 1.

On February 2, 1841, Johnson began, with the help of one laborer, to dig a hole for a "Back House in State Street," and he remarked on February 4 that he "Built up a Brick Privey to day--Commenced it yesterday." The term "Brick Privey" more than likely refers to a brick-lined pit rather than an above-ground brick structure. Brick-lined privy pits are common in downtown Natchez, and the 1886 Sanborn Insurance Map indicates that most were topped with frame structures. Neither Sanborn Insurance maps nor archeological evidence indicates that Johnson had a brick above-ground privy.

On February 8, Johnson again had his men "Hauling Brick from Parkers Building," and, on February 9, the plasterers resumed work after an absence of two weeks. On February 10, Johnson noted that he "Commenced this Evening to put on the Sheating on the Kitchen." On February 16, he recorded in his diary that he was having some difficulty with the plastering. Only one of the plasterers showed up for work and he thought that the other one was on a "spree." The following day, both plasterers returned to work and began applying the "white Coting." On the eighteenth, Johnson recorded that the

⁹⁸ Hawkes, Oehrlein, and Wells, 24 and fig. 15.

plasterers had been busy all day “White coting...in the Garret of the Building.”⁹⁹ Beside this diary entry, Johnson also sketched what appears to be the floor plan of the gallery--a rectangle within which is a small rectangle representing the stairwell.¹⁰⁰

On February 19, the plasterers finished the “Large front Room...in the second story and Commenced on the other Back Room.” This notation in the diary about the large front room indicates that the second-story residential portion of Johnson’s House may originally have had only three rooms, which is indicated by construction details evident in the second story. The partition wall that divides the front two rooms of the House was installed after the interior face of the front wall was plastered. The baseboard is also not mitered at the corner. This partition wall, however, was probably added before construction was complete or shortly afterwards, since all wood trim on the wall matches the other trim in the two front rooms, and both the 1979 Historic Structures Report and the 1993 Finishes Analysis cite the trim on the partition wall as having the same finishes as the other trim in the front portion of the building. The wall was definitely in place by March 12, 1844, when Johnson recorded that three interior doors were oak-grained. One of the three oak-grained doors is the connecting door in the partition wall between the two front rooms.

On February 20, 1841, Johnson recorded that he bought “four China trees and Set them Out.” These trees were probably bought for the State Street property, since any earlier trees on the property or along its street front would have been destroyed or badly damaged in the 1839 fire. The chinaberry tree, or Pride of China as it was then called, was the most popular street and yard tree of antebellum Natchez. In describing the “China tree,” writer Joseph Holt Ingraham, who described Natchez in an 1830s travel account, wrote that it “yields in beauty to no other.” He closed a lengthy description of the tree’s desirable properties by noting, “Such is the tree which surrounds the dwellings and borders the streets in the villages of the south-west...”¹⁰¹ Historic photographs of nineteenth-century Natchez document chinaberry trees lining all the downtown streets.¹⁰²

On February 23, 1841, Johnson wrote that he had been busy nearly all day “making mortar &c.” On the twenty-fourth, he was “Buisy Painting up Stairs in the garret of the House, myself and Winston and John did a little too.” A new plasterer, Mr. Brown, began work on the twenty-fifth and finished the upstairs and began to work on the “Large Room below.” This Mr. Brown, who also was cited as laying a hearth in the kitchen building on March 11, is identified in family papers as James Brown, a plasterer and mason who was born in England and who would later unite with Charles Reynolds to form the firm of

⁹⁹ This reference to white coating the garret refutes Sanborn’s “William Johnson House” in its conclusion that the garret did not have finish plaster (p. 35) and supports Albee’s conclusion in her “Finishes Analysis” that the garret had more than one layer of plaster (p. 27).

¹⁰⁰ Johnson Papers, Diary, LLMVC/LSU, vol. 20, no. 3, folder 38, 1 of 3, February 16, 1841-October 14, 1841.

¹⁰¹ Ingraham, no. 2, 110-11.

¹⁰² Stewart Collection, William S. Stewart, Natchez; Norman Collection, Dr. Thomas H. Gandy, Natchez.

Reynolds and Brown.¹⁰³ By the 1850s, the firm of Reynolds and Brown was the preeminent masons of antebellum Natchez. They were the masons for the Institute Hall (1853) and Stanton Hall (1858), as well as a large number of other buildings.¹⁰⁴

The reference on February 25 to the "Large Room below" supports the determination by architect Henry Krotzer and the 1979 Historic Structures Report that the first-story room was originally planned to have no interior partitions.¹⁰⁵ Also supporting the existence of a single large room is the carpenter bill submitted by George Tucker on March 20, 1841, that included an entry for "Bridging Joist & Putting up Pillar." This single "Pillar" is probably the 11"-by-11" or 12"-by-12" central support post described by Mary Louise Miller as having existed in her childhood when the first story was divided into only three rooms.¹⁰⁶ William Johnson's lease on November 3, 1841, to Joseph Barbieri for use of the first floor as a dancing school further supports the existence of a large single room on the first story.

On February 24, 1841, Johnson's man Winston painted all day and finished the garret. On the twenty-sixth, three plasterers were at work in the building, and William Johnson, Winston, and John removed trash from the building and "Painted the garret Stairs." On February 27, 1841, Johnson recorded that the plasterers finished the "roughf Coating [of] the Large room below stairs to day about One Oclock." He also wrote that he had been busy all day removing lime from the base and doors, that John also removed lime, and that Winston painted. He also paid plasterers Evans and Brown and lamented his inability to put the plasterers to work on the kitchen because a floor was not yet installed.

In March 1841, interior work on the Main House and kitchen continued. Johnson himself spent almost all day putting nails on March 1, while Winston was painting and John was cleaning off lime. On the same day, two of the plasterers, probably Brown and Evans, decided that the plaster was too green to give it a white coat, but plasterer Barbee disagreed and put in a full day's work. The carpenter put in the floor in the kitchen building.

On March 3, 1841, Johnson paid off plasterer George M. Evans and hired two workmen from Mr. Ruffner to paint. He also bought "three Keggs of White Lead from Mr Lambdin." Lambdin was merchant Samuel H. Lambdin for whom the mansion Edgewood was built in 1859.¹⁰⁷ The three kegs of white lead are reflected in the 1993 Finishes Analysis. Throughout the following week, plasterers and painters continued working. On March 8, Johnson recorded that he and Winston painted five doors in a short time, and, on the following day, Johnson himself did some plastering on the kitchen building.

¹⁰³ Population Schedules, Mississippi, Adams County, 1860, 17; Institute Hall Site File, Institute Hall, , 1979 National Register Nomination, HNF; Johnson Papers, Diary, LLMVC/LSU, File 39; *Daily Democrat* [Natchez], October 15, 1903, 3; *The Natchez Daily Courier*, July 4, 1855, 3.

¹⁰⁴ Minutes, Board of Selectmen [Natchez], 5 May 1852, *Mississippi Free Trader*, April 5, 1858.

¹⁰⁵ Krotzer, interview; Hawkes, Oehrlein, and Wells, 31-32.

¹⁰⁶ Sanford, 11.

¹⁰⁷ Edgewood Site File, Chain of Title, 1979 National Register Nomination, HNF.

On March 10, 1841, Johnson moved a wooden cistern onto the State Street property, and he sketched a cistern beside the diary entry.¹⁰⁸ On the same day, the plasterer finished the rough coat in the kitchen. Plasterer Brown finished the kitchen on the eleventh and "Layed One Hearth in Kitchen." Also on the eleventh, Johnson noted that the paperhangers had begun to hang the paper in the front room and he began to move "some of the Furniture to the Building &c." He also worked on the wooden cistern, "stoping up the cracks with tar &c."

On March 12, 1841, Johnson made a "Hen House," and the "Paper Hangers got done papering this Evening." Apparently, only the front room, or parlor, of the second story was originally papered, since it was the only room mentioned and the paperhangers completed their work in two days. Johnson moved his family into the house on State Street on March 15, when he wrote that he "Mooved to Day from Mrs. Neibut [Sarah, widow of Joseph Neibert] House."¹⁰⁹ On March 18, Johnson noted that he was building a partition in the kitchen building.

On March 20, 1841, William Johnson recorded the complete bill submitted by George Weldon for "work Done on my Building in State Street." Johnson noted that it was about \$1.30 more than he expected.

March 11th 1841

William Johnson Dr[director]--	
To G. Weldon--For first floor and	
3 Door frames and 3 window frames as per Contract	117.00
To framing second floor, 12 Sqr 4.	48.00
To 1 door frame & transum Light Sash	20.00
To seting 3 window frames	1.50
Framing, Raising Floor 12 Sqr.	48.00
framing 15 Sqr of Rafters	60.00
7 Sqr. Collar Beames	28.00
To 15 Sqr Sheeting and Shingles	90.00
100 ft. reveal Bourd	5.00
2 Dormer Windows	75.00
12 pds nails	1.50
150 ft 2 inch pine 6 ct per	7.50
60 feet wall strip for second floor	1.80
60 feet raising floor do [ditto]	1.80
60 ft. Raising plate	1.80
	506.90

¹⁰⁸ Johnson Papers, Diary, LLMVC/LSU, vol. 10, no. 3, folder 38, 1 of 3, February 16, 1841-October 14, 1841.

¹⁰⁹ Choctaw Site File, Chain of Title, Neibert-Fisk House 1979 National Register Nomination, HNF.

Here He makes a Deduction of \$3 for weather
Bourding that He Kept-- 3.90
503.90

Here He makes a deduction of \$15 for over charge on
singling per square 15.00
488.90

here He adds on \$40 for a Kitchen built on Main Street
40.00
528.90

Here He give me Credit for cash \$150
pd Some time ago-- 150.00
378.90

Here He gives a credit of \$15 that I
paid Him to day--20th March, 1841 15.00
363.90

In addition to receiving a bill from George Weldon, Johnson paid George Tucker "Thirty Doolars on account of Building work," and noted that "Mr. Tucker swung the Front Gate this Evening but did not Quite finish it." George Tucker's gate or a descendant of it might possibly be the same gate that appears in the post-1906 photograph (1-H) of the William Johnson House. On March 20, Johnson recorded in his diary the bill of George Tucker. Unfortunately, unlike Weldon, Tucker does not specify that all the work related solely to the State Street property, but diary entries support this assumption. In his diary, Johnson writes, "Here is the Bill of work done by Mr Tucker for me, the full Amout of which I paid Him for this Day, 24th March, 1841":

To repairing Front Doors-- --	3.00
" do [ditto] window sashes	2.50
To Lumber, Pine Lumber	4.00
" Caseing 3 Windows at \$4 per	12.00
"Making 4 window Frames @ \$4	16.00
do [ditto] 2 Door Frames	70.00
Caseing 2 Doors under Stairway	9.00
Bridging Joist & Putting up Pillar	5.50
2 pine Doors at \$7 per	14.00
Putting up furrowing to Lath on	3.00
Geting out & puting Down Base in Closepress under Stairway	2.00
Making 18 Lights of Sash, 24 cts	4.50

Putting up Studing & Finishing around Dormer windows	8.00
Putting in framing timbers in 2 windows & making 2 window frames	8.00
Strateages & Darbeys for Plasterers	1.50
Framing Roof to Kitchen	8.00
do [ditto] joist for 2 floors	10.00

A comparison of builder George Weldon's bill with George Tucker's bill yields valuable information about the appearance of the William Johnson House in March 1841. The bills indicate, as previously noted and commented upon, that Johnson salvaged some windows and doors, which were repaired by Tucker. Also of particular interest is the reference to the "Closepress" under the stairs, which was obviously intended for clothes storage. The mystery of why only one door and transom light appears in either builder's invoice and today the rear elevation has two mid-nineteenth-century doors with transom lights is solved in a later diary entry on April 29, 1842, when Johnson reports converting a first-story window on the rear elevation to a door. The 1979 Historic Structures Report noted and photographed this alteration.¹¹⁰

Neither of the two carpentry bills references mantelpieces, and Johnson never recorded buying a mantelpiece for the kitchen or Main House. However, all three mantelpieces in the Main House are original. Previous studies which described the first-story mantelpiece as "colonial revival" were obviously influenced by the later colored tiles that had been added to the surround of the fire chamber in the late nineteenth or early twentieth century. The mantelpiece stylistically dates to ca. 1835, was installed with cut nails, and features molding consistent with a ca. 1835 date. No evidence of any different mantelpiece was found to exist on the chimney wall. The evidence of a black-painted finish further confirms the mantel's pre-Civil War date, since black was the most common painted finish on mantelpieces in the Natchez region during the antebellum period. Johnson could have purchased the first-story mantelpiece, which is exceptionally fine, from the ruins of Parker's Hotel, which had been updated in 1836.¹¹¹ The two plainer mantelpieces of the second story are matching, are Greek Revival in style, and were undoubtedly built for the Johnson House. The mantelpiece intended for bedroom use was originally painted black. The mantelpiece in the more formal room, the parlor in the front portion of the house, was originally painted cream like the woodwork.

On March 26, 1841, Johnson hired a man to begin digging out the cellar at the State Street house, hauled a few loads of dirt for the yard from Parker's Hotel yard, and put a box on one of his trees. Tree boxes, which protected trees from being chewed by horses and otherwise attacked, are well documented in a series of 1866 and ca. 1880

¹¹⁰ Hawkes, Oehrlein, and Wells, 22 and fig. 8.

¹¹¹ *Mississippi Free Trader and Natchez Gazette*, January 29, 1836.

photographs of Natchez streetscapes.¹¹² Johnson noted on April 3 that he was still “operating upon my Cellar.” The purpose of Johnson’s cellar was storage, and people in Natchez today still refer to their underground partial cellars as “root cellars.” Substantiating its use as a root cellar is a diary entry on March 22, 1849, where Johnson records hauling a barrel of potatoes from Under-the-Hill and later taking a bad fall after he “Stepd head first into the cellar and Came near breaking my neck as well as cutting my chin very much.” The fall kept Johnson home from work for the following two days. In addition to potatoes and other foodstuffs, canned items and wine were also stored in cellars. Mary Louise Miller remembers the cellar being used by Dr. and Mrs. William R. Johnston for storing wine, preserves, and potatoes.¹¹³

On April 10, 1841, Johnson made an offer of \$100 for “Brick and all the Ruins that was on Mr Parkers primises.” He was cautioned not to “pull down the Houses that the people are Living In.” The offer was accepted, but Johnson must not have removed all the brick since an 1856 Natchez newspaper article mentions the arched ruins of Parker’s Hotel.¹¹⁴

On April 12, with the help of his Stephen and several other workers, Johnson “took Down...4 or five thousand Brick.” The next several days were passed in hauling the brick from the hotel property to Johnson’s property.

On May 13, 1841, Johnson wrote that he put up an “arning [awning]” down at the House. That this awning was erected on the State Street house is documented in a later diary entry on June 9, when Johnson noted that wind had blown an “arning [awning] that I had put up down at my dwelling House.” He provides no clue for whether the awning was put on the front or rear of the House and no mention is made of a replacement. He does include a sketch of what may be the awning beside the diary reference.¹¹⁵ Also on May 13, Johnson bought a keg of “Spanished Brown” paint. References to Spanish brown paint appear frequently in nineteenth-century building invoices and building contracts, and paint analysis documents that Johnson used brown paint at his State Street property. On June 24, Johnson put a pump on the stand above the “Barrell [cistern barrel] to force the water into the Barrells.” He wrote also that a carpenter put up a windlass on the cistern. Johnson illustrated the windlass beside the diary entry.¹¹⁶

On July 1, 1841, Johnson installed a “big gate” that “Mr Raly gave me.” Mr. Raly was James Railey of Oakland Plantation in the Second Creek Community.¹¹⁷ Unfortunately, he gave no information about where or even on which property Johnson installed the gate, although it was probably the State Street property.

¹¹² Stewart Collection and Norman Collection.

¹¹³ Mary Louise Miller, interview by Kathleen Jenkins and Carol Petravage, February 6, 1996, typescript copy, William Johnson House Site File, NATC History Files, 2.

¹¹⁴ *The Natchez Daily Courier*, March 7, 1856.

¹¹⁵ Johnson Papers, Diary, LLMVC/LSU, no. 3, Folder 38, 1 of 3, February 16, 1841-October 14, 1841.

¹¹⁶ *Ibid.*

¹¹⁷ Oakland Plantation Site File, “Last Will and Testament of James Railey,” (photocopy), Chain of Title, HNF.

Also in July, on the twenty-second, Johnson began work “Lathing up the under part of the Gallery for to make a Dining or Eating Room--....” In a travel account published in 1835, Joseph Holt Ingraham remarked on the necessity and uses of galleries in Natchez: “Galleries, as they are termed here, ...are as necessary to every house in this country as fire-places to a northern dwelling. No house...is complete without this gallery...which furnishes a fine promenade and dining-room in the warm season....”¹¹⁸

Johnson’s July 1841 reference about “Lathing up the under part of the Gallery for to make a Dining or Eating Room” had previously been interpreted as plastering the ceiling.¹¹⁹ However, it would not have been necessary to plaster the ceiling to make a dining room on the gallery; a board ceiling would have done just as well. Furthermore, the 1979 Historic Structures Report recorded no evidence of lath and plaster on the first-story gallery ceiling joists.¹²⁰ Johnson was not plastering the second-story gallery ceiling, because it also has no evidence of plaster or lath and did not exist until 1844, when Johnson recorded on May 16 and 20 that he built a “Cover” for his gallery and that it took two carpenters four days.

Most likely, Johnson used lath on July 22 to build lattice to enclose a portion of the first-story gallery to provide a small measure of shade and privacy for dining. The 1970s pre-restoration photographs of the first-story gallery document a partial lattice enclosure that could be either the remnants or a descendant of Johnson’s 1841 enclosure. The rear gallery of the Johnson House faces southwest, and lattice, perhaps vine covered, would have provided welcome relief from the evening sun and privacy from neighbors on both sides. Lattice was a popular way to enclose cistern houses, crawl spaces beneath houses on piers, and galleries in the Natchez region in the mid-nineteenth century. Johnson also noted another use for lath besides plastering. On May 12, 1842, he wrote that he used lath for building a garden fence.

On July 29, 1841, Johnson records that he built the first of what would eventually be three sheds in his yard on State Street.

On October 26, 1841, Johnson recorded that he had “a grate put up today in my 3 story Building.” He mentioned having bought two grates the day before at the Auction Store. These were probably coal grates, since they required installation. Since Johnson moved into the House in March 1841, he did not need to worry about heat until late October when he bought the coal grates. The fire chambers in Johnson’s State Street House probably always burned coal, since it became the primary heating fuel in Natchez in the 1830s. On October 31, Johnson voiced a familiar homeowner’s lament, “Our new House Leeks very much from the rain.”

¹¹⁸ Ingraham, 43-44.

¹¹⁹ Hawkes, Oehrlein, and Wells, 16-17.

¹²⁰ Ibid.

Johnson's diary documents that he rented space to Joseph Barbieri for dancing classes at thirty dollars per month on November 3, 1841. Barbieri was still renting from Johnson on February 23, 1842, but he was behind in his rent. Although references to renting family property appear throughout Johnson's diary and family papers, Barbieri is the only tenant documented specifically as renting the first-story of the State Street property.

In 1842, Johnson began work on the grounds around his State Street house. From February 1 until February 17, he worked to dig a cistern. On the eighteenth, Johnson judged the cistern ready for the plasterer or the cement man. On the nineteenth, Johnson noted that Mr. Oblemis began constructing the arch to the cistern and installed it. By March 8, Johnson and Winston put one course of bricks on the cistern top, put on a top, cut a hole through the top for the pipe, and planted a post for the pipe to rest on. Mr. Walker, the tinner, put up the pipe from the House and kitchen to the cistern. The historic photograph of the facade and western side elevation of the Johnson House (1-H), shows a downspout traveling from the front gutter of the House across the side elevation toward the rear of the House, presumably to supply the cistern. Mary Louise Miller recalls a cistern with pump located between the Main House and the 1897 Kitchen Dependency.¹²¹

On April 29, 1842, Johnson noted that he "had a Door Cut in the Back of the Lower Room in the dwelling House in State Street. Cost to be \$20.00." Since all three first-story openings on the rear wall feature splayed brick arches and the number of openings with splayed arches corresponds to the mason's bill, Johnson obviously had the center window extended for a door. As mentioned earlier in this report, evidence for the alteration of the center-bay window, which became a door, was noted in the 1979 Historic Structures Report.¹²²

On May 6, 1842, Johnson wrote that he erected a small fence on the lot of Mr. S. Davis, an adjoining property owner, in which to keep his calves. On May 12, Johnson sent Under-the-Hill to buy lath to make a garden fence. On May 13, Johnson continued making his fence and noted that Stephen was to "white wash" the fence. On May 14, Johnson described his yard as having "few plants."

Most of the work on Johnson's State Street property recorded in July 1842 involved laying brick pavement in the yard, including brick paving in front of the kitchen, and digging a gutter on July 12. Johnson also noted on July 15 that he had a hole dug on the fourteenth, bricked it up, and built a house on it. This entry records the construction of the second privy on the property. Earlier, on February 2, 1841, Johnson recorded the construction of the first brick-lined privy on the property. One of these two privies is probably the privy remembered by Mary Louise Miller as being located on the back southwest corner of the property. The privy described by Miller was divided into two

¹²¹ Mary Louise Miller, interview, 1.

¹²² Hawkes, Oehrlein, and Wells, 15.

compartments. She remembers the female compartment as being larger and located on the north side.¹²³

On July 15, 1842, Johnson wrote that “Gim had those Big Gates swung at lower End of my yard....” On July 30, Johnson engaged Charles Reynolds to build him a cistern 12 by 20 feet deep. The brickwork on the cistern was not completed until early September. On September 20, Johnson recorded that the cistern was being plastered and noted, on September 22, that the plastering was complete. On October 10, a Mr. Finney delivered the cistern top, which was probably a cast-iron top similar to the many that survive in Natchez.

Initially, Johnson had moved a temporary, above-ground barrel cistern onto his property. In February 1842, he recorded digging and plastering a cistern, and, in September, he hired Charles Reynolds to build a second below-ground cistern. The first cistern may have simply been a plastered hole in the ground with a wide brick neck and could possibly be the cistern in which the family billy goat died in March 1845. By February 1842, Johnson had two privies and two underground cisterns on his State Street property.

Johnson recorded on October 22, 1842, that, among other yard work, he and one of his men dug a gutter at the State Street house. This was the second gutter Johnson mentioned in the diary, the first gutter having been referenced earlier on July 12. The 1994 archeological report describes a brick gutter feature uncovered during investigation that could have been one of these two gutters described by Johnson.¹²⁴ Another feature discovered on the State Street property that could date to Johnson’s occupancy is the remnant of a round, brick-edged flower bed beneath the floor of the present kitchen.¹²⁵ A second similar brick-edged flower bed was uncovered between the Main House and the existing dependency during the 1978 archeological study undertaken by Padgett.¹²⁶ In February 1843, from the seventh until the eleventh, he was engaged in fencing his neighbor Lapiece’s property. Beside the entry for the eighth, he sketched a rail fence. On February 20, he wrote that he and Winston began to make a shed, and he illustrated a shed with a roof of indiscernible shape and a single door.¹²⁷

On July 13, 1843, Johnson noted that “The Man put up the Blinds this morning to the front windows....” No other reference to blinds is found in the diary. The ca. 1880 photograph (4-H) of the western gable end shows no exterior blind on the third-story window, and the western wall is not stuccoed. The post-1906 photograph (1-H) shows louvered blinds on all three stories of the western side elevation with the louvered blinds of the third-story window in deteriorated condition and not matching the other blinds. Although the third-story louvered blinds are closed in the photograph, they must have

¹²³ Mary Louise Miller, interview, 1.

¹²⁴ Atkinson, 37-38 and fig. 77.

¹²⁵ Ibid., 32 and fig. 65.

¹²⁶ Padgett, 5.

¹²⁷ Johnson Papers, Diary, LLMVC/LSU, vol. 20, no. 3, folder 38, 3 of 3, May 31, 1842-May 25, 1843.

stood open for a number of years because their ghost is very visible on the stuccoed wall surface on either side of the third-story window. The second-story blinds appear to match the louvered blinds on the facade. The northernmost window on the first story shows only the top portion of the louvered blinds, which are in a closed position. Unfortunately, no previous study included documentation of the existing blind hardware or the evidence of earlier blind hardware that would have aided in the dating of the blinds on the western elevation. The window frames on the first story of the western side elevation have been recently rebuilt by the National Park Service.

On December 1, 1843, Johnson noted, "I won the Painting of three Doors from Mr Dillon, the painter." Johnson won the painting from betting on a horse race. Dillon showed up to paint the doors on March 12, 1844, and Johnson described him as having painted the doors "Oken," meaning they were grained in imitation of oak. Paint analysis has further documented that the three doors opening into the large front room were oak-grained.¹²⁸ On December 9, Johnson recorded the construction of a second shed.

On February 12, 1844, Johnson recorded that he tore down one shed and put up another. On March 4, he referred to cleaning out his "Corn House to put a Floor in it etc." On March 5, he described installing more fences and a new gate. Also in March, he contracted with a carpenter named St. Clair to build a cistern house. He had the lumber hauled up on March 15 and, on March 29, he paid St. Clair \$10 "for the Building of it." This cistern house was probably a small latticed building similar to the extant cistern houses and gazebos at Melrose, The Elms, Hope Farm, and Myrtle Bank. Other latticed cistern houses and gazebos are documented in historic photographs. Cistern houses are occasionally illustrated on Sanborn Insurance Maps, where they appear as small circular or octagonal structures outlined in dotted lines.

Johnson hired carpenter St. Clair again in May 1844 to build a "Cover" for his gallery. On May 16, Johnson wrote, "A Carpenter is now at work at my Galery Stuff, to make a Cover to the Gallery." St. Clair, assisted by a Mr. Shaw, completed the gallery on May 20 and was paid \$25. These entries indicate that Johnson's rear gallery was originally a one-story gallery with a roof deck that was probably railed, and that the roof structure and upper-level supports, either solid wood posts or box columns, were added in 1844. The existing flooring on the second-story level is now inappropriate narrow tongue-and-groove flooring installed during the restoration undertaken by the Preservation Society of Ellicott Hill in the late 1970s and 1980s. During the 1840s, the typical width of tongue-and-groove porch flooring would have been five inches.

The 1979 Historic Structures Report supports the diary information that indicates that the rear gallery was probably built in two stages. The report notes that the first-story gallery was supported by wood posts resting on a piece of the original wood deck, with one original post remaining, and that the second-story gallery featured box columns, with

¹²⁸ Albee, 16.

three of the originals remaining. The 1979 Historic Structures Report states that the capital moldings on both the lower original post and the original upper box columns is the same, but does not include a drawing of the profiles.¹²⁹ However, switching from wood posts on the first story to box columns on the second story would not in itself be a sure indication that the two-story rear gallery was built in two stages. Solid posts might have been used on the first-story level for added support. Although pilasters echoing the box columns were installed on the second story during the first phases of restoration by the Preservation Society of Ellicott Hill, the 1979 Historic Structures Report includes photographs that indicate that the upper rear wall was not framed at each end by pilasters and that the handrail of the second-story gallery balustrade terminated directly on the face of the brick wall.¹³⁰

The 1979 Historic Structures Report noted that the original gallery roof framing was attached below the sawtooth cornice and that the roof attachment was later raised above the cornice.¹³¹ A ca. 1880 photograph (4-H) of the rear and western gable end indicates that the roof was not raised until after ca. 1880, when the gallery is pictured as still attached below the sawtooth cornice. The photographs also illustrate the gallery roof as being sheathed in boards rather than shingles.

The sawn balusters of the second-story gallery were definitely added after Johnson's death. Sawn balusters have not been documented in Natchez before 1855. Documentary evidence indicates that the sawn balusters were added in 1873, when John S. Kouney billed Miss Ann [Anna L.] Johnson, daughter of William Johnson, for sawing "63 banisters." During the same month that Anna Johnston received a bill for sawing banisters, she also received bills from Dixon's store for white paint for the State Street House.¹³² At present, sixty balusters are used in the balustrade with the spacing of the balusters appearing to duplicate the spacing documented in pre-restoration photographs in the 1979 Historic Structures Report.¹³³ However, the existing balustrade terminates into pilasters that do not appear to have been an original feature of the House, and the carpenter would have made a few more than necessary in case any were split during installation.

The earliest sawn balusters in the Natchez area are found on the William Harris House on Jefferson Street (remodeled after a fire in 1855), The Elms on South Martin Luther King Street (remodeled in 1856), the Shields Town House on North Union Street (built 1859-1860), the Greek Revival townhouse at 615 High Street (ca. 1855), the Tillman House at 506 High Street (remodeled ca. 1858), White Wings on North Wall Street (remodeled ca. 1860), and Edgewood on Airport Road (1859-1860).

¹²⁹ Hawkes, Oehrlein, and Wells, 15-30.

¹³⁰ Ibid., 28 and fig. 25.

¹³¹ Ibid.

¹³² Johnson Papers, Diary, LLMVC/LSU, no.3, folder 23, 1873 .

¹³³ Hawkes, Oehrlein, and Wells, 22 and figs. 9, 28, and 26.

Several early examples of sawn balustrades are heavy, sometimes constructed of multiple parts, and are different in character from the sawn balusters at the William Johnson House. Only the sawn balusters on the townhouse at 615 High Street, The Elms, and White Wings closely relate to the balusters on the rear gallery of the Johnson House. The sawn balusters documented to the mid-nineteenth century on these three houses, however, all have one stylistic feature in common. They all terminate at the handrail in an arrow-like motif that looks like the top of a fir tree. The sawn balusters at 615 High Street are documented to have existed at least as early as 1866, when the House is pictured in a historic photograph.¹³⁴ The sawn balusters at The Elms, which was remodeled in 1856, are documented in an 1859 pencil sketch of the House.¹³⁵ The remodeling of White Wings is documented as having occurred by 1864.¹³⁶

Attempts to date the sawn balusters on the Johnson House stylistically have not been successful, and no other balusters identical to those on the rear gallery of the William Johnson House have been identified. Knowing whether the original balusters were cypress or pine would help support the 1873 date of installation, but no original balusters have been located. Cypress balusters would probably date to before 1880 and pine balusters to after 1880.

On June 12, 1844, Johnson built a shed roof in his yard, but gives no idea of its purpose. On June 7, he harvested ears of corn, greens, squash, and radishes from his State Street garden. On August 12, he turned the horses loose in the remains of the vegetable garden, which he noted he would soon plow for turnips. On November 28, 1844, he had "Glass Frames" moved from Main Street to his residence on State Street. Earlier studies, including the 1979 Historic Structures Report and Sanford's 1992 "William Johnson House" report for the Historic American Building Survey, concluded that these glass frames were probably the windows that were installed at a later date in the first story of the western wall.

The "Glass Frames" mentioned in 1844 were more likely mirrors rather than window sashes and/or frames.¹³⁷ The 1979 Historic Structures Report noted also that the molding

¹³⁴ Collection of William Stewart [Natchez], personal photographs (photocopy), HNF; Collection of Dr. Thomas H. Gandy (Natchez: HNF Slide Files, HNF, photocopy), slides.

¹³⁵ T. K. Wharton, *The Elms*, pencil sketch, 1859, The Elms, Natchez, Mississippi.

¹³⁶ "Map of the Defences of Natchez and Vicinity," Sanborn Insurance Maps (Natchez City Directories, William Johnson House Site File, record group 77, drawer 138, sheet 39 [National Archives & Records Services, General Services Administration, Washington, DC], HNF, 1864, photocopy).

¹³⁷ Throughout his diary, Johnson uses the term "glass" or "looking glass" when describing mirrors. The term *mirror* was not yet in popular use in Natchez. On December 7, 1841, Johnson recorded purchasing a "Looking Glass--cost of which was \$11.50." On May 9, 1843, Johnson wrote that he had a "bench" made for the "large glass" in his shop. The purpose of the bench was undoubtedly to provide support for what was probably a "peer glass [pier mirrors]" as Johnson termed it. Johnson's 1851 household inventory lists "2 Mantle Glass" and "1 Small Looking Glass"(Probate Box 136). Mary Louise Miller owns a pier mirror with marble base [bench?] and an overmantel gilt mirror, both of which she describes as having originally been in the barber shop (Mary Louise Miller, interview,

on the window architrave matched the molding on the rear gallery handrail, which they assumed to date to 1844, based on Johnson's May 1844 diary entries about adding a cover to his rear gallery. No profile for the gallery handrail was included in the report.

Comparing the results of paint analysis from both the 1979 Historic Structures Report and the 1993 "Finishes Analysis" cast doubts on an 1844 date for the installation of the first-story windows in the western gable end. Both reports are unclear and/or uncertain about the paint chronology on the exterior surfaces of these windows. The 1993 "Finishes Analysis" cites weathering as a problem, but notes that the southernmost of the two windows reflects only the last five or more modern paint layers.¹³⁸ However, both reports state that the interior surrounds are missing the first cream paint layer applied to the original millwork. The 1979 report states that the nine-over-six sashes are missing the first three layers of paint.¹³⁹ The 1993 "Finishes Analysis" notes that one of the nine-over-six sashes apparently came from another building and that one sash does display a "complete stratigraphy."¹⁴⁰

The 1993 "Finishes Analysis" concludes that the window surrounds of the first-story western elevation are missing only the first layer of paint and states that if the window had been installed ca. 1844 that "either the trim to these openings was left unpainted, or all of the first floor trim was repainted a white color..."¹⁴¹ It is possible that the trim might have been left unpainted, but it is highly unlikely that all the first-story interior trim was repainted three years after the House was finished. No mention or record of any repainting in the 1840s is found in Johnson's diary or family papers.

One possible date for the windows in the first-story western elevation is found in a July 30, 1858, invoice to Mrs. Ann Johnson for two window frames made by builder N. L. Carpenter.¹⁴² No mention is made of sash or a particular building. Another possibility has arisen from the recognition that the existing mantelpieces in the 1897 kitchen building were pre-Civil War and were recycled from the earlier kitchen building, which the 1994 archeological report proved did not burn. This opened up the possibility that the non-original, mid-nineteenth-century windows in the first-story western wall of the Main

3 and 6). If Johnson had relocated windows, he would surely have used the terms window frames, or sashes, or sash frames, as he did on August 25, 1840, January 26, 1841, and at numerous other times throughout the diary. The existing first-story windows in the western gable end of the William Johnson House were definitely added after the first phase of construction, because they do not match the other windows of the house in size and installation, are not set beneath the splayed arches that define all other openings, and do not have the characteristic beaded frames associated with window openings of the ante-bellum period. The 1844 date for the window installation was strengthened by the stylistic date of the window architraves. Although the architraves of the western gable-end windows do not match the architraves of the original windows, they are similar.

¹³⁸ Albee, 9.

¹³⁹ Hawkes, Oehrlein, and Wells, 40-42,

¹⁴⁰ Albee, 12.

¹⁴¹ Ibid.

¹⁴² Johnson Papers, Diary, LLMVC/LSU, no. 2, folder 20, July 30, 1858.

House could also have been recycled from the original kitchen building when it was demolished between 1892 and 1897.¹⁴³ This possibility receives additional confirmation by the very close match of the ogee and angle molding of the mantelpieces to the molding of the window architraves in the first-story western elevation. The relocation of windows from the original kitchen in 1897 is not in conflict with the results of paint analysis in the 1979 Historic Structures Report and the 1993 "Finishes Analysis."

On March 7, 1845, Johnson wrote that the billy goat fell into his cistern the day before and was not found until the following day. He recorded that the cistern was then drained of water and cleaned. In addition to the death of the billy goat, the Johnson family's dog, Pollo [short for Apollo?], died on May 8 at the age of thirteen.

On May 8, 1845, Johnson wrote that "The Boys [are] Papering Some Little to day & Painting also." Although documentation for paper in rooms other than the parlor, which Johnson earlier recorded in the diary, is found in the 1993 "Finishes Analysis," no fragments of wallpaper have been found that are thought to predate 1850.¹⁴⁴

With his new residence on State Street completed and a new store built on Main Street, Johnson turned his attention to land acquisition. In August 1845, he bought 120 acres of swamp land south of Natchez for \$600. This tract he called Hard Scrabble. A little over a year later, he bought 242.14 acres adjacent to Hard Scrabble. A later survey indicated that Johnson acquired 345.5 acres in these two purchases. In 1846, he leased for 99 years 403.1 acres of school-section land that was near, but not adjacent to, his other properties. In 1851, shortly before his death, Johnson bought nearly 800 acres of additional swamp land in scattered tracts near his farm.¹⁴⁵ He also bought property on the southeast corner of Canal and State Streets adjacent to his family residence.¹⁴⁶

Occupied by his farming pursuits south of Natchez, Johnson did little work on his State Street residence after he began to acquire farm land in 1845. On September 2 and 3, 1847, Johnson again wrote of building fencing and swinging a gate. On October 21, Johnson wrote that he had been busy "Fixing a closet under the steps...." Since a clothespress was an original feature under the stairs between the second and third stories in his State Street House, he may have been building a closet beneath the rear gallery stairs. Johnson may also have been working on the existing clothespress to make it function as a closet.

In March 1850, Johnson undertook the construction of a new frame building on the State Street property. This building was probably the frame building attached to the southern wall of the original 1841 kitchen building and illustrated on the 1886 and 1892 Sanborn Insurance Maps. On March 28, Johnson wrote that "Mr Waller Commences to day at a

¹⁴³ Sanborn Insurance Maps, 1892 and 1897, HNF.

¹⁴⁴ Albee, 29-30.

¹⁴⁵ Hogan and Davis, 36.

¹⁴⁶ Deed Book HH, 525-527.

Late hour to put up the Little Frame house in the yard....” By April 2, Waller had finished weatherboarding and was putting on the roof shingles. Mr. Waller completed his work on the frame building on April 4 and was paid \$75 by Johnson on the following day. Johnson noted that he had spent \$130 on materials. On April 10 and 11, after the carpenter had finished his work, Johnson instructed his workers to pave the yard and whitewash the inside of the new building. On April 16, Johnson erected a fence between his property and the Turner property [Texada]. On April 19, Johnson wrote that his workers began to build a “wash House.”

On May 12, 1850, Johnson recorded that “Mr Waller Puts up The Gallery Post This Evening or to day....” The 1886 (7-H) and 1892 (8-H) Sanborn Insurance Maps do not illustrate a porch or gallery on the frame addition to the original kitchen, so the reference probably applies to the Main House, or the 1841 Kitchen Dependency. This gallery post could also have been gallery *posts*, since Johnson’s diary entries indicate that he also would have used the singular *post* for more than one post. On May 15, Johnson noted that Winston and Gim “Built me a Little Carriage House yesterday,” and that more gates were built for the House.

In early 1851, Johnson engaged surveyors to determine the boundary of property he acquired south of Natchez. His neighbor Baylor Winn was displeased about the survey and threatened Johnson on several occasions. Johnson filed suit against Winn but, on May 2, 1851, offered a settlement before the case went to trial. Winn agreed to the settlement. On June 16, 1851, Baylor Winn shot William Johnson in the back; he died the following morning at 2:00. Johnson had identified his murderer before his death. Under Mississippi law, a black man, slave or free, could not testify in court against a white man, and the only witnesses to the crime were black. The defense rested solely on proving the murderer to be white, and Johnson’s murderer was eventually freed two years after the crime.

William Johnson died intestate. Inventories taken at his death show that he owned fifteen slaves, property on Main and State Streets in Natchez, and his recently acquired acreage south of town.¹⁴⁷ The inventory of his household furnishings is an invaluable resource for documenting the historic interior furnishings.¹⁴⁸ Johnson’s diary also documents numerous purchases of household furnishings. Johnson made most of his purchases at auction houses near his barber shop on Main Street.

¹⁴⁷ Adams County, Mississippi, Office of Chancery Clerk, Probate Real Estate Record Book 2, 232-239.

¹⁴⁸ Probate Box 36.

4.6 William Johnson's Descendants¹⁴⁹

William Johnson was survived by his wife and nine children. Johnson's tenth child, a son Phillip, died in infancy. After Johnson's death, his widow, Ann Johnson, headed the Johnson family. In 1854, she built a new brick building on Main Street.¹⁵⁰ She also bought new furnishings for the House which are documented in invoices from the local furniture establishment of Robert Stewart (1854-1856).¹⁵¹ In an 1858 city directory, son William R. is listed as a barber whose place of business is on the corner of Main and Wall Streets.¹⁵² The northwest second-story room was probably the bedroom of William Johnson during his life, since Anna Johnson recorded in her diary in 1864 that her mother's room was off the parlor and this room had access to the clothespress beneath the stairs.

During the Civil War, the family's prosperity began to dissipate. Daughter Katherine Johnson noted the family's diminishing resources in 1865, and commented that brother William and his family were a "heavy weight on [family] income."¹⁵³ Ann Johnson died in 1866, the same year her son William R. Johnson Jr. was committed to an insane asylum in New Orleans.¹⁵⁴ Letters dating 1868 from Natchez planter Adam L. Bingamon, then living in New Orleans, to Byron Johnson indicate that Bingamon was trying to look after William, who escaped from the asylum at least three times in 1866. By 1867, the Johnson children were renting out the kitchen.¹⁵⁵ Son Byron apparently assumed the role of head of household after his mother's death and brother's commitment. Byron Johnson, like his father and brother William, was also a barber. In 1872, Byron Johnson, like his father, was murdered. Byron's murderer was a member of the Fitzhugh family, another prominent free African American family living in Natchez during the antebellum period. Anna L. Johnson, the oldest daughter, assumed the role of family leadership after her brother's death.

With Byron dead and William Jr. in a New Orleans mental institution, Richard and Clarence Johnson continued living in the State Street house with their sisters. Mary Louise Miller cites the northeastern corner room of the first story as Richard's room prior to his death. Clarence Johnson became a blacksmith and married Catherine Lynch, the sister of prominent African American Congressman and politician John R. Lynch, who was formerly a Natchez slave.¹⁵⁶ His blacksmith shop was apparently located at the corner of State and Canal Streets, the property that had been acquired by Johnson shortly before his death. When the Johnson family sold this property to the Eastern Railway

¹⁴⁹ Additional information on William Johnson's descendants can be found in Appendix 9.4.

¹⁵⁰ Hogan and Davis, 63.

¹⁵¹ Johnson Papers, Diary, LLMVC/LSU, no. 2, folder 20, 1854-1856.

¹⁵² *A. Mygatt & Co's Business Directory* ([Natchez, MS], 1858, photocopy), HNF, n.p.

¹⁵³ Johnson Papers, Diary, LLMVC/LSU, vol. 31, 1865.

¹⁵⁴ Sexton Records [Natchez], June 4, 1866, Armstrong Library.

¹⁵⁵ Anna Johnson's Day Book, Johnson Papers, Diary, LLMVC/LSU, vol. 45.

¹⁵⁶ John R. Lynch to William R. Johnston, September 9, 1934, Johnson Papers, Diary, LLMVC/LSU, no.1, folder 4.

Company in 1906, Clarence received payment for business damages.¹⁵⁷ In 1911, Clarence died in Natchez at the age of sixty, and his son Dr. William R. Johnston and his wife, Sallie, eventually became the last Johnson family members to reside in the house.¹⁵⁸ Most likely, very few physical changes occurred at the State Street property during the 1860s and 1870s, although the number of boarders increased. Family tradition as recalled by Mary Louise Miller maintains that the first-story commercial space was used only for storage during the Civil War years.¹⁵⁹ In the 1870 census, two barbers, Juanito and Carlito Garrus, were residing in the House, along with a tinner named William York. Juanito Garrus later married Eugenia, one of the Johnson daughters.¹⁶⁰ Juanito died in Natchez in 1906 at the age of sixty-nine.¹⁶¹ The date of Eugenia's death is unknown, although she was still living in Natchez in 1896.¹⁶² The Garrus family residence still stands at 17 Reynolds Street.¹⁶³

In 1873, Katherine Johnson lamented, "I believe that to all our other ills and troubles is to be added that of poverty, for every year we grow poorer and poorer..."¹⁶⁴ In a letter to her sister [unnamed but probably Anna], written from a teaching position at Ravenswood Plantation on March 12 in an unspecified year [probably 1871], Katherine expressed feminist sentiments in describing the condition of her sister and herself as "chained to the rock of adversity--bound there, by masculine mismanagement & indolence, not a little mixed with meanness."¹⁶⁵

The financial situation of the Johnson family would seem to have precluded any major changes to the State Street house during the 1870s. In 1873, Harriet Battles, mother-in-law of William Johnson, died and subsequently willed the Johnson family residence, which was built on her property, to her five granddaughters.¹⁶⁶ Invoices dating to February 1873 record that sixty-three banisters were sawn for Miss Ann [sic] Johnson by John S. Kouny, and that a large amount of white lead paint was purchased from the paint and wallpaper store of R. S. Dixon.¹⁶⁷ The sixty-three banisters are probably the deteriorated jigsaw balusters that still railed the rear gallery of the Johnson House in the 1970s and early 1980s, and were restored by the Preservation Society of Ellicott Hill. The white lead paint was probably used to paint the back gallery of the William Johnson House.

¹⁵⁷ Johnson Papers, Diary, LLMVC/LSU, no. 1, folder 5, 1906.

¹⁵⁸ "Miscellaneous Individual City of Natchez Copies of Signed Death Certificates and Hospital Death Records from the Collection of the Natchez Historical Society," ed. Robert Shumway, photocopy, HNF. Sanford, 23.

¹⁵⁹ Ibid., 29.

¹⁶⁰ Sexton Records, August 10, 1873 [Natchez], Armstrong Library.

¹⁶¹ Deed Book 3-G, 546-547.

¹⁶² Duncan Morgan, interview by Mary W. Miller, February 2, 1996, William Johnson Site File, HNF, n.p. Sanford, 28.

¹⁶³ Johnson Papers, Letter, LLMVC/LSU, no. 2, folder 23.

¹⁶⁴ Sexton Records, January 2, 1906 [Natchez], Armstrong Library; Will Book 4, 63-64.

¹⁶⁵ Johnson Papers, Diary, LLMVC/LSU, no. 2, folder 23, 1873.

In the 1880 census, six people are listed as occupying the Johnson State Street residence, including two teachers in addition to family members.¹⁶⁸ In 1892, daughter Eugenia Johnston Garrus deeded her one-fifth interest in the property to her four sisters.¹⁶⁹ In the late nineteenth century, William Johnson's children began spelling their surname on public records as Johnston. When William Johnson died in 1851, the sexton listed him in the city death records as William Johnston, which indicates that the Johnson or Johnston spelling differences had occurred as early as 1851.¹⁷⁰

In 1897, the Johnson family built a new brick kitchen. The Sanborn Insurance Map of that year illustrates the new kitchen and labels it as "BEING BUILT." The 1897 kitchen replaced an 1841 kitchen. The 1994 archeological study, which located all the walls of the 1841 kitchen and noted no burned strata on the inside of the kitchen walls, states, "It is therefore definite that the earlier kitchen did not burn."¹⁷¹ The Johnson family apparently tore down the old kitchen to build a new one. The demolition of the old building is supported by the antebellum period mantelpieces in the new kitchen that were probably recycled from the old kitchen. These mantelpieces have the simple molded architrave surrounds common to plainer mantelpieces installed in dependency buildings and in lesser rooms of Main Houses. The mantelpieces feature the ogee and angle molding that is prevalent in Natchez during the 1840s and 1850s. Further documenting the antebellum origin of the mantelpieces is that they were originally painted black and exhibit an overcoat of the gray paint that was determined to be the original finish on the woodwork in the 1897 building.¹⁷²

As previously noted in the report, the first-story windows in the western end wall of the Main House exhibit the same ogee and angle moldings found on the mantelpieces. The installation of these windows may date to 1897, when the new kitchen was built. Further supporting a late-nineteenth-century date for the window installation is the photographic documentation that the upper portion of the western wall was not stuccoed until after ca. 1880. Earlier studies had surmised that the stucco was original. The stucco and the windows may have been added at the same time, about 1897. In the post-1906 photograph (1-H), the western wall is stuccoed and the windows are in place.

The first-story windows appear to have been installed by 1910, when that year's Sanborn Insurance Map (12-H) illustrates the Johnson House with symbols indicating windows on all three stories. The symbols appear as lines terminating in dots and relate to a key on the index page of the Sanborn Map. Window symbols on the 1886 Sanborn Insurance Map (7-H) indicate windows on only two floors, but no window symbols appear on the 1892 (8-H), 1897 (9-H), 1901 (10-H), and 1904 (11-H) Sanborn Map illustrations of the

¹⁶⁸ Sanford, 29.

¹⁶⁹ Deed Book 3-G, 546-47.

¹⁷⁰ Sexton Records, June 17, 1851 [Natchez], Armstrong Library.

¹⁷¹ Atkinson, 52.

¹⁷² Hawkes, Oerhleim, and Wells, 95.

Johnson House. The Sanborn Insurance Maps seem to narrow the time frame for the window installation to 1886 to 1910 but the evidence is not conclusive.

The installation of the windows in the western gable end of the House probably relates to the first partitioning of the first-story interior into three rooms. Mary Louise Miller recalled three first-story rooms: one large rear room with an 11"-by-11" or 12"-by-12" wood pier, and two front rooms. When this first partitioning occurred is unknown. The picture molding in the upper story and the fireplace tiles may have been installed at the same time that the first story was partitioned.

The 1994 archeological study uncovered, in the side yard, two rows of inverted stoneware ginger bottles manufactured between 1869 and 1899.¹⁷³ Although the archeological report did not know what to make of the bottle rows, they are obviously the remnants of edging for flower beds. Bottle gardens were sometimes a feature of nineteenth-century landscape, but few survive today. Such gardens adorned the grounds of middle-class townhouses as well as upper-class plantation houses. In downtown Natchez, the John Smith House at the southwest corner of North Pearl and Jefferson Streets once had a bottle-edged parterre in front of the House, and the bottles appeared to date to the mid-nineteenth century. The bottles at the John Smith House have since been removed and replaced with brick because tourists were stealing the bottles.¹⁷⁴ In Natchitoches Parish on the Cane River, Oakland still retains its bottle-edged garden.

By 1900, occupancy at the Johnson family residence on State Street reached an all-time high. Fourteen people with two heads of household are listed. In addition to four Johnson daughters, son Clarence and wife Catherine Lynch Johnston were living there with their four children. Also residing in the household were two teachers, a paymaster, and a barber. The large number of residents coincides with the earlier 1897 construction of the new kitchen building, and the possible 1897 installation of windows in the western side wall of the Main House and partitioning of the first-story interior space.

All four of William Johnson's single daughters, Anna, Alice, Katherine (Kate), and Josephine, worked as school teachers.¹⁷⁵ In 1901, Katherine Johnston bequeathed her interest in the property to her three surviving sisters.¹⁷⁶ Between 1904 (11-H) and 1910 (12-H), the gallery of the 1897 kitchen building was altered from a one-story porch with railed roof deck to a two-story porch with upper roof.

In 1910, Dr. William R. Johnston, the grandson of William Johnson, returned to Natchez to practice medicine.¹⁷⁷ In the 1912 Natchez City Directory, two heads of household are

¹⁷³ Atkinson, 36-38 and figs. 75 & 76.

¹⁷⁴ Gladys Smith, interview by Mary W. Miller, 1970s, William Johnson House Site File, HNF, n.p.

¹⁷⁵ "Teacher Pay Register and Teacher Pay Certificates, 1873-1915," Adams County, Mississippi, Circuit Court Records, HNF.

¹⁷⁶ Will Book 5, 305.

¹⁷⁷ "Index to Physicians, Pharmacists & Dentists, Starting 1808," ed. Robert Shumway, computer print-

listed at 210 State Street--Dr. W. R. Johnston and A.[Anna] L. Johnston.¹⁷⁸ Mary Louise Miller recalled the House as being divided into two separate apartments.¹⁷⁹ In 1912, Anna L. Johnston moved to the family's Peachland Plantation, an area known today as "Anna's Bottom" (a reference to the area's rich bottom land.)¹⁸⁰ In 1921, Dr. Johnston married Sallie Welch.¹⁸¹

Anna Johnston died in 1922, and, in 1924, the surviving two daughters of William Johnson, Alice and Josephine, deeded their interest in the State Street residence to their nephew, Dr. William R. Johnston, and his wife, Sallie, with the stipulation that the sisters could reside there until their deaths. The 1924 deed also gives the information that the two surviving Johnston sisters had spent \$2,000 on improvements for the House.¹⁸²

The \$2,000 sum probably reflects the remodeling of the exterior and interior of the House. Photographs and Sanborn Insurance Maps document the addition to the facade of a two-story porch between 1910 (5a-H and 12-H) and 1925 (13-H). Mary Louise Miller dates the exterior remodeling to about 1920.¹⁸³ When the gallery was added to the front, the center-bay window of the second-story facade was converted to a doorway opening onto the second-story of the gallery. Also, between 1910 and 1925, Sanborn maps document that all wood-shingled roofs were replaced by metal and that an elevated walkway was built to connect the second-story galleries of the rear of the Main House and the 1897 kitchen building (9-H). Mary Louise Miller states that the overhead walk, or bridge, from the Main House to the kitchen had been built before she arrived in Natchez ca. 1917, but that the partitioning of the first story, and the introduction of electricity, gas, and city water, all date to the 1920s remodeling.¹⁸⁴ She does not recall stairs ever leading to the second floor of the dependency; however, stairs appear alongside the bridge in photographs taken in 1979.¹⁸⁵

The ca. 1920 remodeling partitioned the large rear first-floor room into four rooms with a center hallway, and installed a screen of battered box columns and leaded-glass bookcases between the two front rooms. Still evident in 1995, beneath the paired joists of the second-story floor, is the frame arch with supports that was created for the hallway in this last subdivision of the first-story interior. Miller also recalled being told that the attic

out, HNF Library, HNF, 69.

¹⁷⁸ *Polk's Natchez City Directory 1912* (Memphis: R. L. Polk & Co., 1917), 74.

¹⁷⁹ Mary Louise Miller, interview, 4 and 8.

¹⁸⁰ Sanford, 30.

¹⁸¹ Marriage Record, Colored, KK-42, 181.

¹⁸² Hogan and Davis, 63; Deed Book J, 456.

¹⁸³ Mary Louise Miller, interview, 3.

¹⁸⁴ There is some speculation that the bridge was built in 1897 when the dependency was completed. The Sanborn Maps were not always accurate and it is possible that the bridge was not drawn on until 1925. The maps do not show any stairs leading to the second floor of the dependency either, yet the access to the second floor was from the exterior.

¹⁸⁵ Mary Louise Miller, interview, 3 and 10.

garret room was originally the bedroom of the Johnson sons.¹⁸⁶ During the time of Miller's occupation, the second story of the House was occupied by Alice Johnston, surviving daughter of William Johnson, who used the Kitchen Dependency for cooking, and the attic garret for storage.¹⁸⁷

Dr. William R. Johnston built a garage at the rear of the property before his 1921 marriage to Sallie Welch. The garage extended across the rear of the property and was accessed from its southern end.¹⁸⁸

In 1939, Dr. William R. Johnston willed the House to his widow, Sallie Johnston. Sallie Johnston made few improvements or repairs to the House after the death of her husband. After 1946, she enclosed the western end of the second-story gallery for a bathroom (14-H).¹⁸⁹ This construction of the bathroom enclosure caused the columns to be shifted from their original locations.¹⁹⁰ The first-story gallery was also altered by the replacement of the original gallery framing and decking with concrete.¹⁹¹ Mary Louise Miller has stated that Sallie Johnston continued the tradition established by her husband's aunts of taking in boarders as late as the 1940s or 1950s.

4.7 Preservation of the Johnson House

In 1975, Sallie Johnston willed the House to her great-nephew, Spencer Griggs, and great-niece, Mary Louise Miller.¹⁹² She and her husband had no children, and her closest relatives were her two heirs: a great-nephew and great-niece that she had reared in the Johnston household. According to Margaret Moss, neighbor of Sallie Johnston, president of the Natchez Garden Club, and chairman of the Johnson House Committee for the Preservation Society of Ellicott Hill, Sallie Johnston was highly esteemed in the Natchez community and was one of the city's finest seamstresses.¹⁹³

In 1976, the Johnston heirs sold the House to the Preservation Society of Ellicott Hill for \$35,148.53, with the Mississippi Department of Archives and History administering a federal grant of \$17,500 to aid in acquisition.¹⁹⁴ The Preservation Society of Ellicott Hill had no long-term plans for the William Johnson House when it was acquired. Their goal was to ensure its preservation, which was uncertain at the time, and to transfer the building to an organization in the local African American community with the financial stability to restore and operate it as a site important to African American history.

¹⁸⁶ Ibid., 9.

¹⁸⁷ Ibid.

¹⁸⁸ Ibid., 1.

¹⁸⁹ No portion of the gallery is enclosed on the 1946 Sanborn Insurance Map.

¹⁹⁰ Hawkes, Oehrlein, and Wells, 11.

¹⁹¹ Ibid., 16.

¹⁹² Will Book 8, 344; Will Book 34, 199.

¹⁹³ Margaret Moss, interview by Mary W. Miller, September 1 and 5, 1995, HNF.

¹⁹⁴ Deed Book 13-J, 431.

However, the society was immediately confronted with the need for preservation and stabilization work. The roof needed repair, the front gallery added to the building between in 1910 and 1925 was not in sound structural condition (5a-H), and the rear gallery was also in deteriorated, unsafe condition. Photographs included in the 1979 Historic Structures Report document the condition of the House, as did a structural assessment made by structural engineer Neil Jeffrey of New Orleans. Local contractor, Dix Fowler, supervised initial repairs to the building, which included work on the metal roof.¹⁹⁵

Following completion of the HSR, major work on the Johnson House was undertaken by the Preservation Society of Ellicott Hill, partially funded by federal historic preservation grant money administered by the Mississippi Department of Archives and History. Gregory B. Free, architectural historian with the Mississippi Department of Archives and History, administered the grant. The Preservation Society of Ellicott Hill hired the firm of Koch and Wilson of New Orleans to plan and supervise the restoration work on the William Johnson House. The supervising architect was Henry Krotzer.¹⁹⁶

Koch and Wilson hired Building Conservation Technology, Inc., of Washington, DC, to prepare the Historic Structures Report, which was completed in April 1979. Koch and Wilson also hired Thomas J. Padgett of the University of Southern Mississippi to do an archeological study, the purpose of which was to gain "additional information on the original appearance of the William Johnson House and its associated buildings and grounds." Excavations under Padgett's supervision were conducted from September 11 to September 20, 1978.

The non-original front gallery was removed early in the restoration process for reasons that related as much to public safety as to restoration. Its removal showed that the stucco on the facade had been added after its construction, since the brick had no stucco behind the places where the gallery attached to the House (5b-H). The stucco was sampled to determine the ease of removal and the condition of the bricks underneath, and was subsequently removed. The second-story window that had been converted into a doorway for access to the upper level of the porch was restored to a window to match the existing original windows. The first-story openings, which had been altered to become a center-bay doorway with sidelights and flanking windows, were restored to their original size based on the surviving physical evidence. The brickwork of the facade was repaired, rebuilt, and re-pointed only where necessary. The architect designed double-leaf, bead-and-butt doors for the original openings, as noted earlier in this chapter.¹⁹⁷

The double-tiered rear gallery was restored to what was believed to be the original appearance with wood posts below and box columns above. The 1979 Historic Structures Report ascertained that the gallery roof had originally been attached below the sawtooth

¹⁹⁵ Moss, interview; William Johnson House File, Preservation Society of Ellicott Hill, NATC.

¹⁹⁶ Ibid.

¹⁹⁷ Ibid.; Gregory B. Free, interview by Mary W. Miller, November 26, 1995, HNF.

cornice across the rear but had later been raised. The gallery roof was reattached beneath the cornice as part of the restoration. The concrete decking on the first-story level was replaced by plank. New narrow tongue-and-groove decking was installed on the upper level. New sawn balusters and molded handrail were made to match the deteriorated balustrade that existed at project initiation. Pilasters were installed at either end of the rear wall on the second-story level, although the photographs in the 1979 Historic Structures Report appear to indicate that pilasters were not an original feature. Deteriorated lattice was a feature of the first-story rear gallery; however, it was not included in the restoration. New stairs were installed within the rear gallery based on the surviving physical evidence.¹⁹⁸

The western gable-end wall was unaltered by the Preservation Society of Ellicott Hill during the period of their ownership other than to make minor repairs to windows to keep the building watertight.¹⁹⁹ On the interior of the House, all partition walls were removed on the first story after being determined to be later installations. Most of the first-story flooring, which was deteriorated, was also removed. The upper two stories of the Johnson House were not altered by the Society during their ownership.²⁰⁰

During the first decade of the Preservation Society of Ellicott Hill's ownership, the 1897 kitchen was unaltered except for the rebuilding of the eastern gable end by Natchez mason, Duncan Morgan.²⁰¹

In 1989, anticipating the likelihood of the property's transfer to the National Park Service, the Preservation Society received a \$7,600 grant from the Seagram's Whiskey Company. Ronald Miller, with the Historic Natchez Foundation, and Mimi Miller, then with the Mississippi Department of Archives and History, worked with Margaret Moss, chairman of the Johnson House committee, to target the money in the direction where it was most needed for preservation work. Local African American historian and master mason Duncan Morgan re-pointed very deteriorated areas on the first story of the rear wall, and contractor James Moore stabilized what remained of the first-story section of the double-tiered gallery on the Johnson dependency.²⁰²

In 1990, the Preservation Society of Ellicott Hill sold the Johnson House to the City of Natchez, which immediately donated the Johnson House and the adjacent McCallum House to the National Park Service. Between 1990 and 1994, the National Park Service also undertook work on the House. The Park Service re-pointed and partially rebuilt the deteriorated west wall of the House and reframed the first-story windows. The 1994 archeological investigation of the property by the Park Service resulted in the removal of

¹⁹⁸ Moss, interview; Free, interview; Hawkes, Oehrlein, and Wells, 103-104.

¹⁹⁹ Moss, interview.

²⁰⁰ Moss, interview; Free, interview; Hawkes, Oehrlein, and Wells, 11.

²⁰¹ Duncan Morgan, interview by Mary W. Miller, October 1, 1995, HNF.

²⁰² Moss, interview.

more of the fabric on the interior of the first story. The National Park Service also replaced the existing standing-seam metal roof with a wood-shingle roof.

The National Park Service did major work on the 1897 kitchen building between 1990 and 1994. The double-tiered porch was reconstructed, although the upper portion was not an original feature. New floors, new hearths, and new finishes, including new plaster, were installed. The design of the hearths is questionable, since they rise above the floor and feature bricks laid with mortar. Nineteenth and early-twentieth-century brick hearths were traditionally not laid with mortar. They were butt-jointed on a bed of sand and did not rise above the level of the floor. Wood-decked service walks that also provide accessibility for the disabled were built to extend from the State Street sidewalk back along the western side of the Johnson House to terminate in a porch-like deck attached to the northern facade of the 1897 kitchen building.²⁰³ Climate control was added to the Kitchen Dependency because the building was to be used as office and exhibit space by the National Park Service.

²⁰³ Ibid.



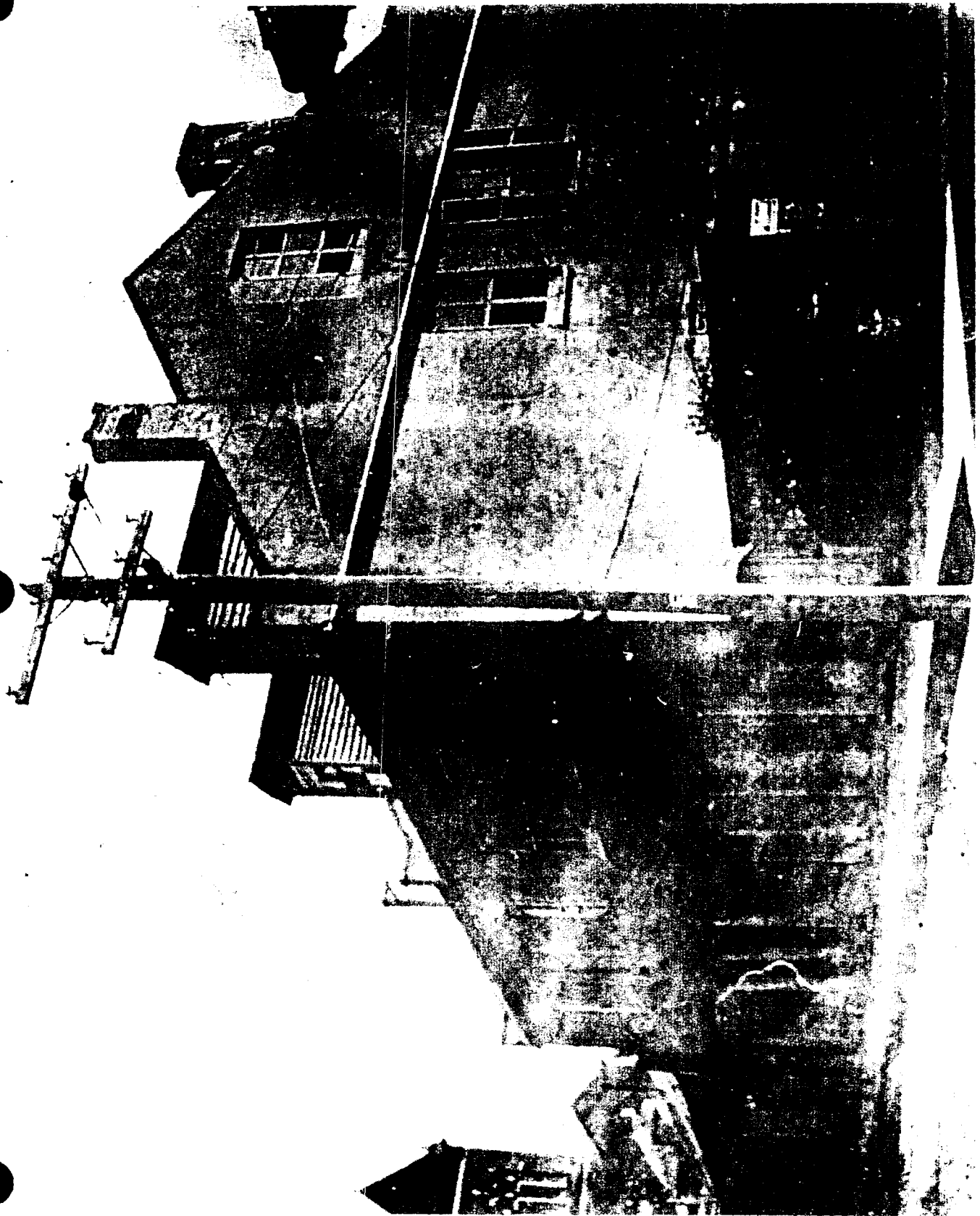

1-H Post-1906 photograph of the facade and west elevation of William Johnson House.

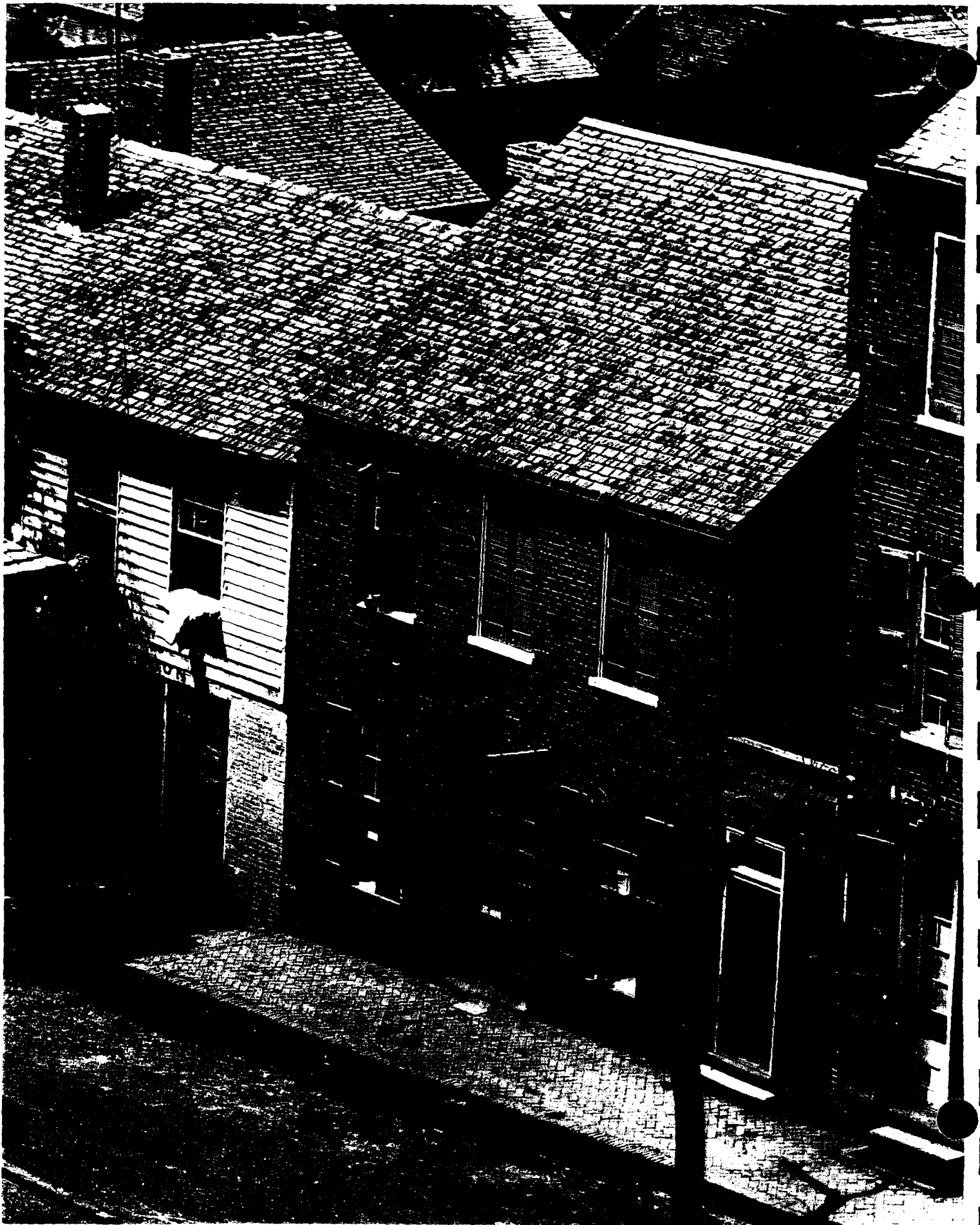

2-H ca. 1880 photograph of commercial buildings on Market Street in Natchez.



3-H ca. 1880 photograph of the eastern gable end of the McCallum House and north facade of the William Johnson House.

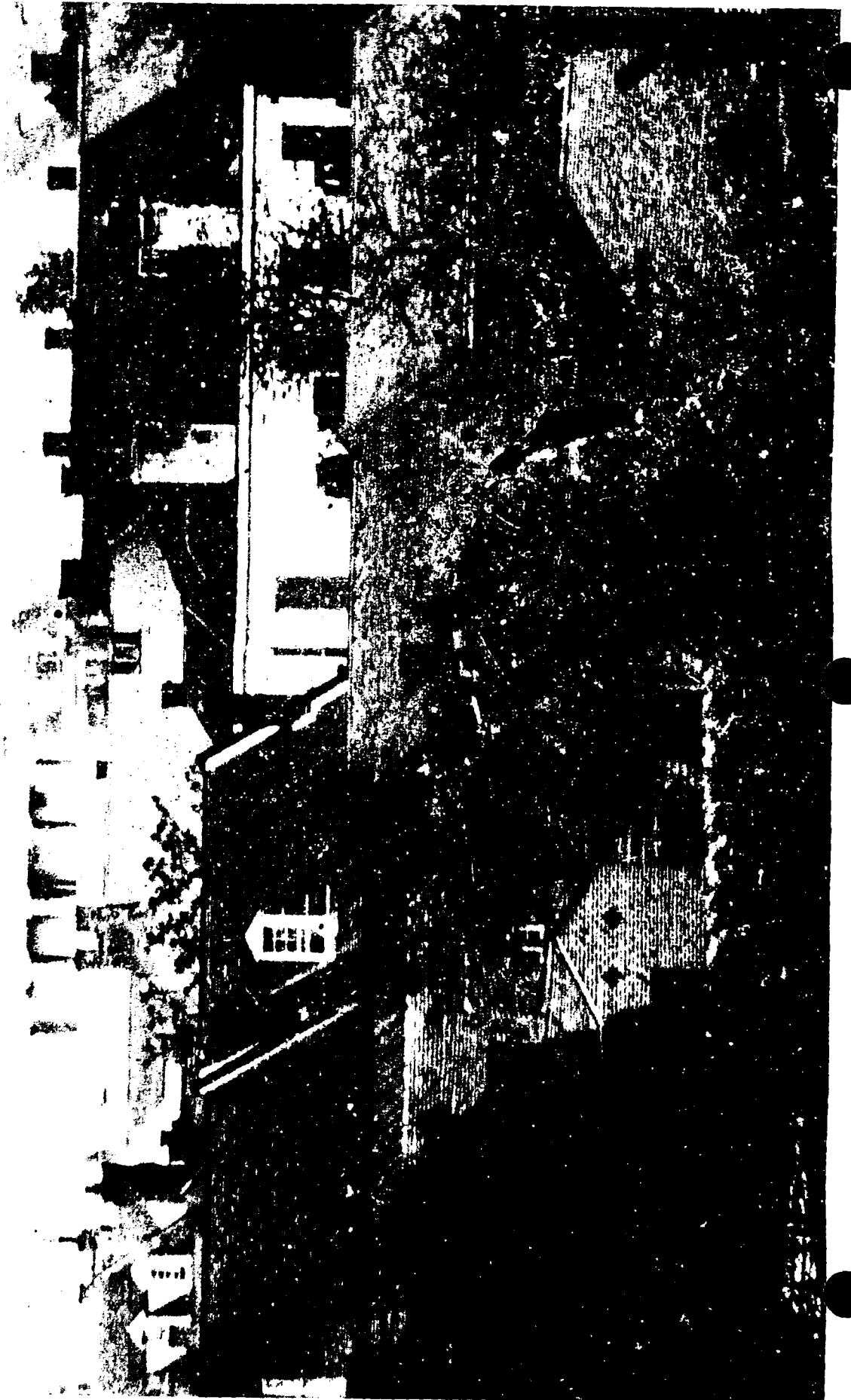

4-H ca. 1880 photograph of the western gable end and the southern rear elevation of the William Johnson House.



5a-H ca. 1976 photograph of the north facade of the William Johnson House with two-story porch dating from 1910 to 1925.



5b-H 1979 photograph of the north facade showing porch removed.

↑
N

William Johnson House

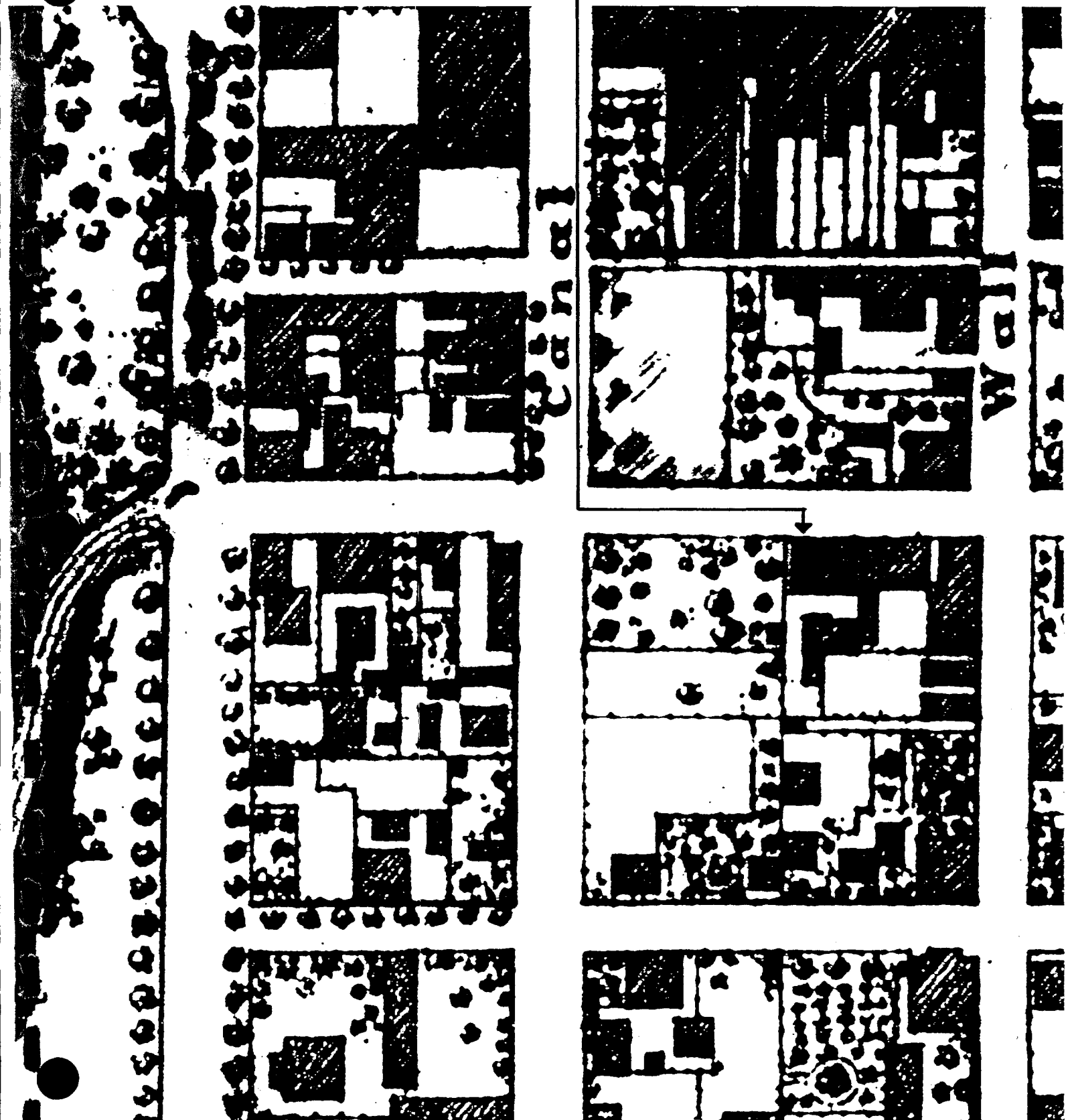

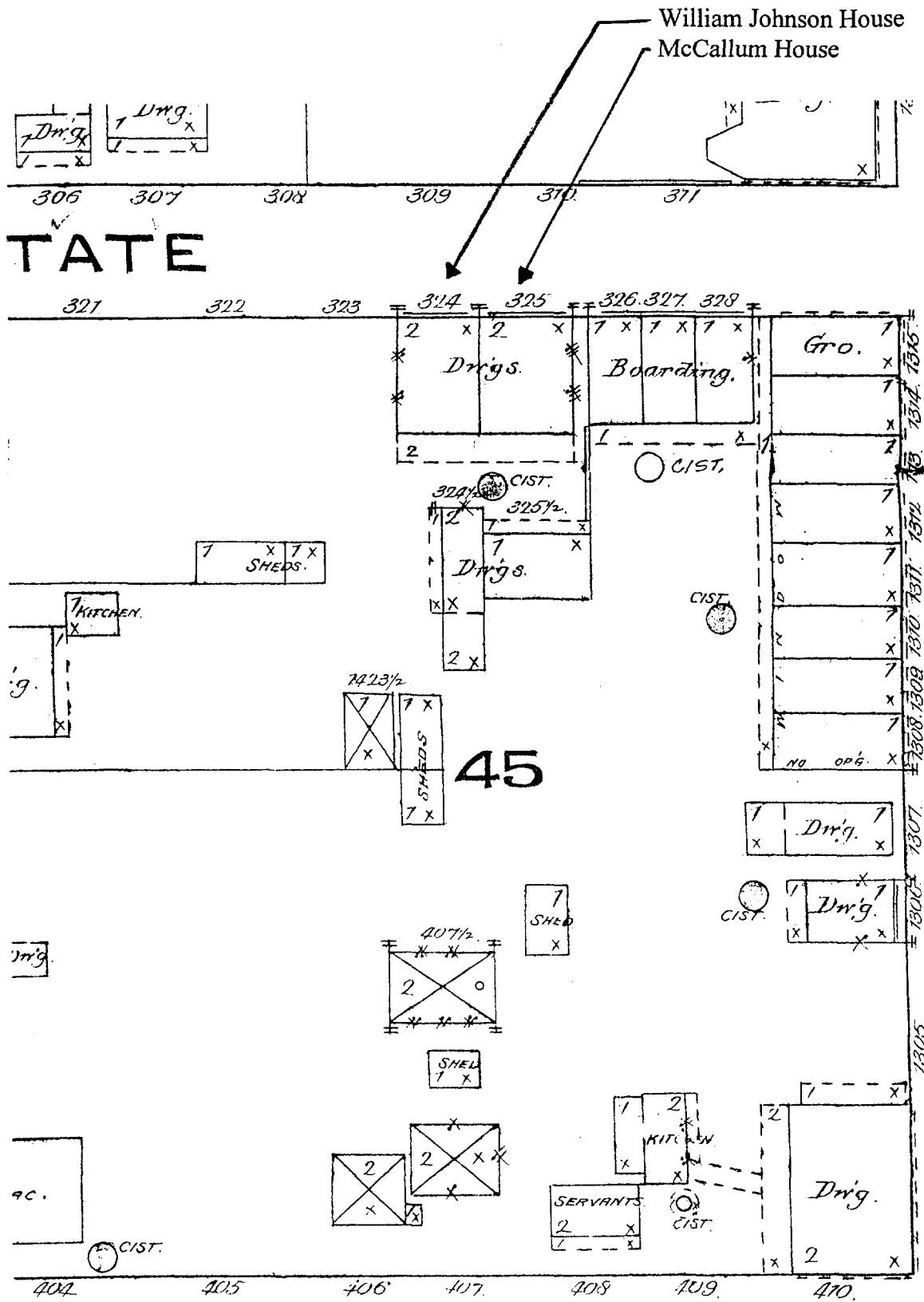

31

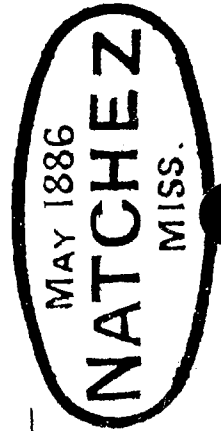

7-H May 1886 Sanborn Insurance Map showing the William Johnson House and the McCallum House. Note the rear gallery, dependency, and cistern locations.

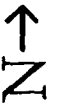

William Johnson House
McCallum House

BAYNARD HO.
STATE

G.W.
D.H.

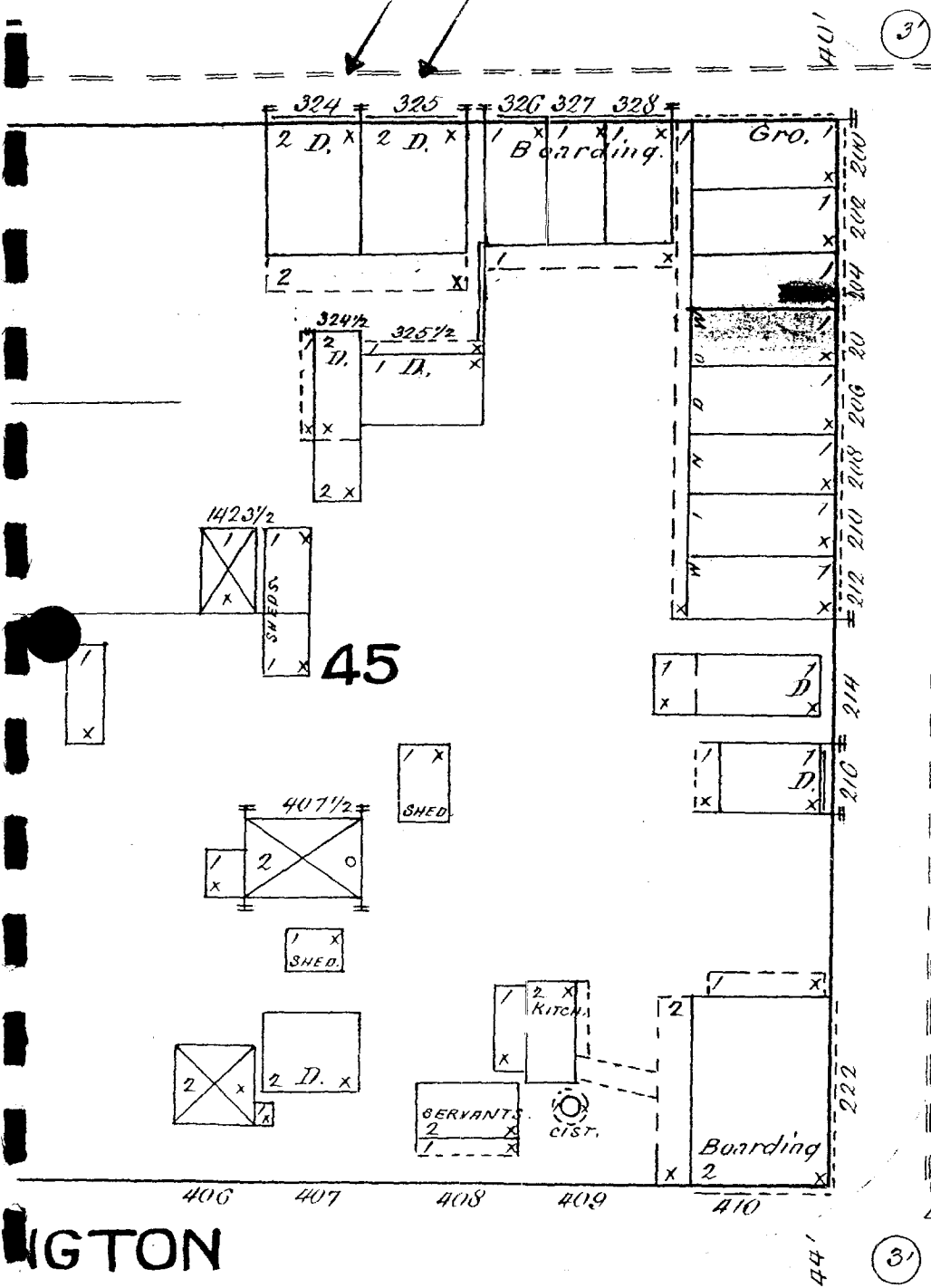

SHEET

MAY 1892
NATCHEZ
 MISS.

WIGTON

8-H May 1892 Sanborn Insurance Map showing the William Johnson House and the McCallum House. Note the rear gallery and dependencies. The cistern is no longer shown.

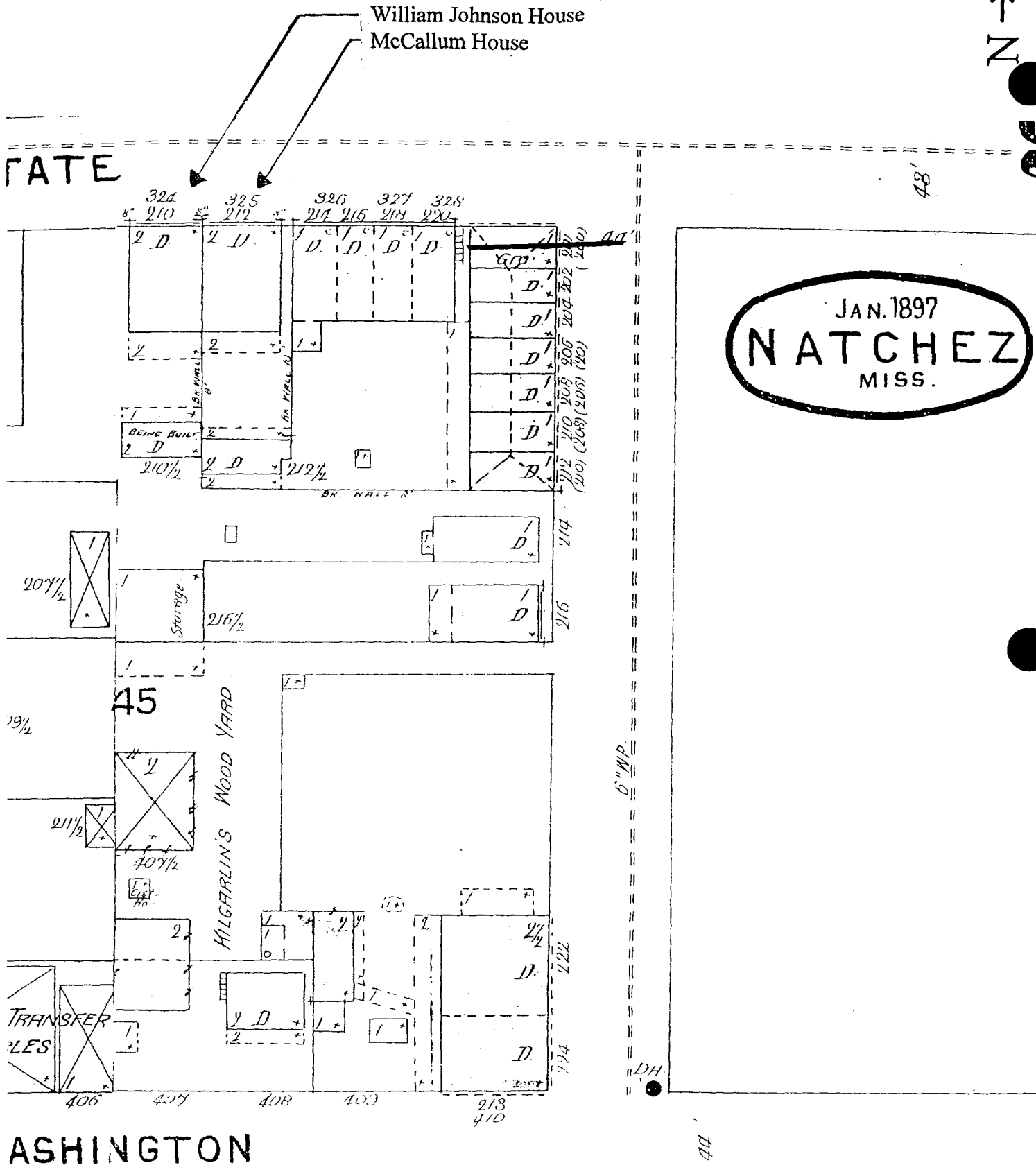

9-H January 1897 Sanborn Insurance Map showing the William Johnson House and the McCallum House. Note the new configuration of dependencies and galleries. The cisterns are not recorded or have been eliminated. Also, note the addition of an 8' high brick wall between the Johnson property and the McCallum property. The street address designations are changing.

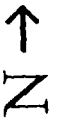

William Johnson House
McCallum House

ATE

ADAMS HO.

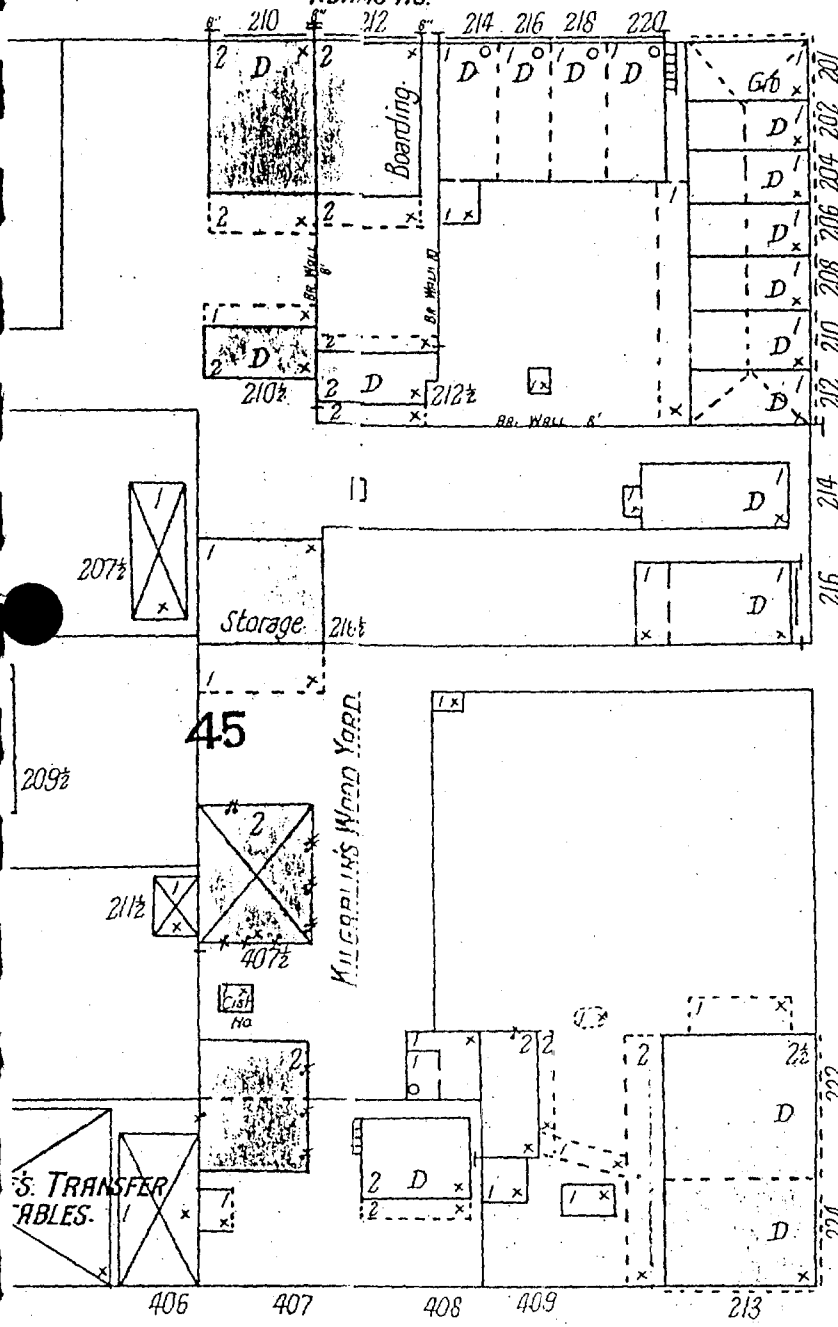

10-H September 1901 Sanborn Insurance Map showing the William Johnson House and the McCallum House. The McCallum House has "Boarding" added to its designation, and is labeled as "Adams House."



William Johnson House
McCallum House

16

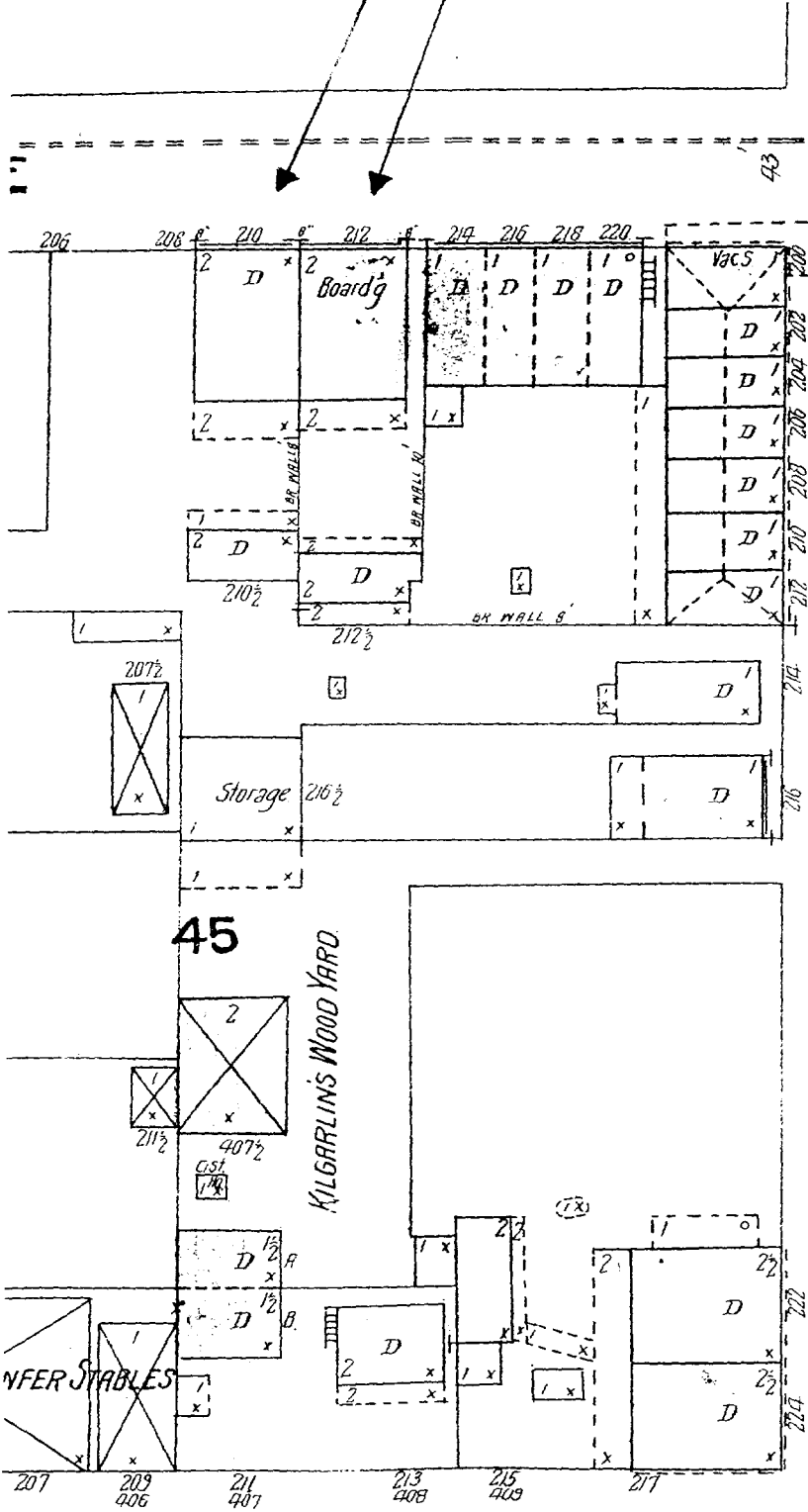

DEC. 1904
NATCHEZ
MISS.

11-H December 1904 Sanborn Insurance Map showing the William Johnson House and the McCallum House. No changes noted between 1901 and 1904.



24

William Johnson House
McCallum House

ATE

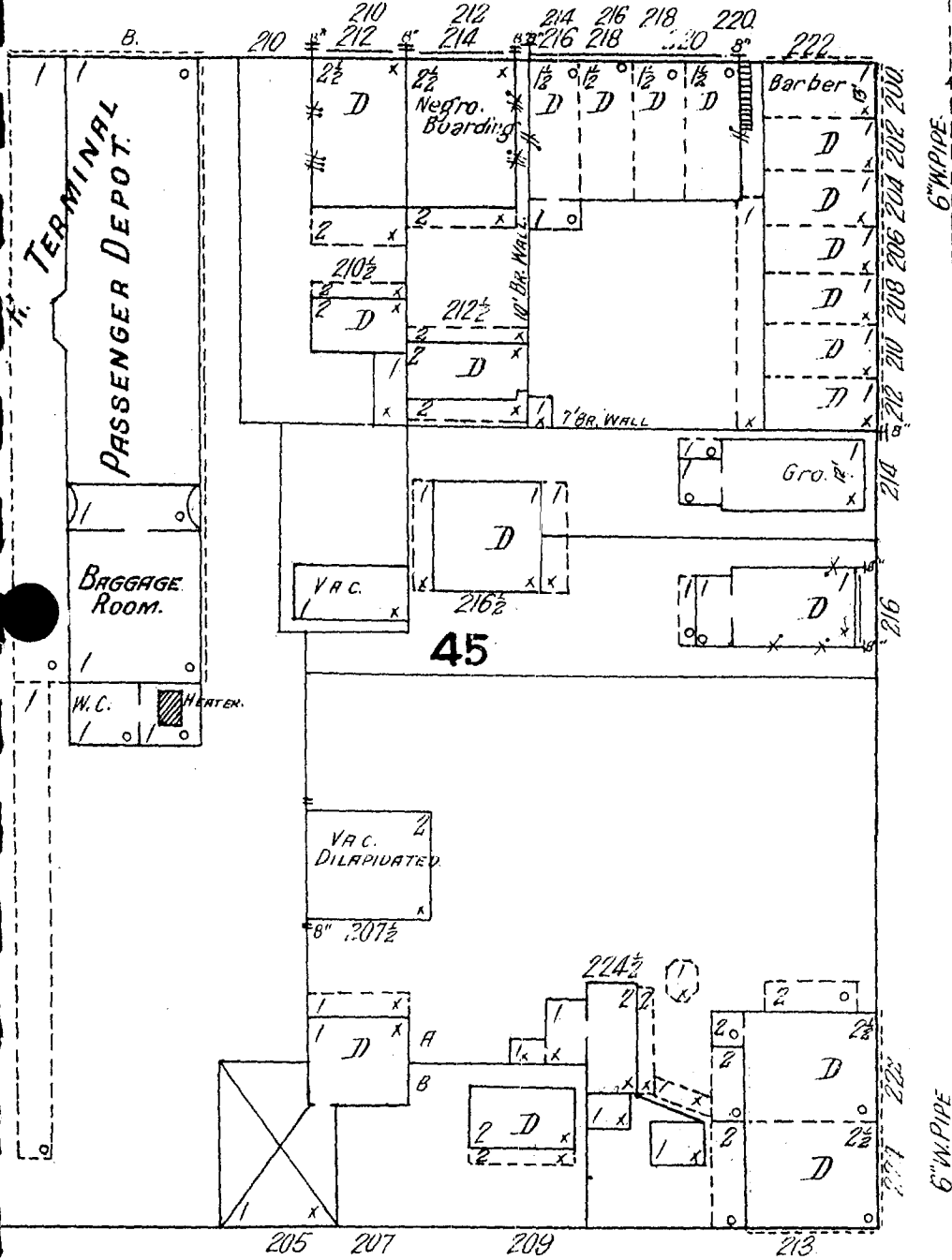

JAN. 1910
NATCHEZ
MISS.

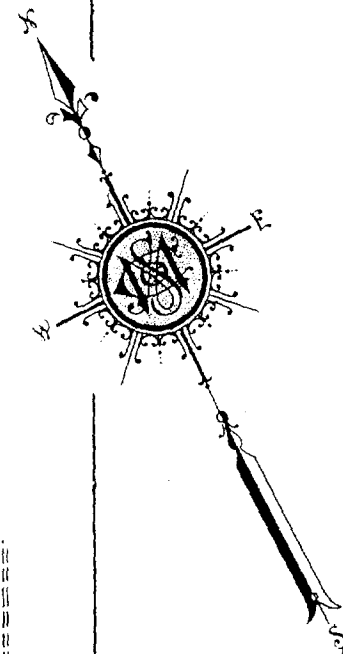

WASHINGTON

Q-H January 1910 Sanborn Insurance Map showing the William Johnson House and the McCallum House. Note the changes in the galleries and the Johnson dependency. The McCallum House is now labeled as "Negro Boarding." The street address designations are changing.

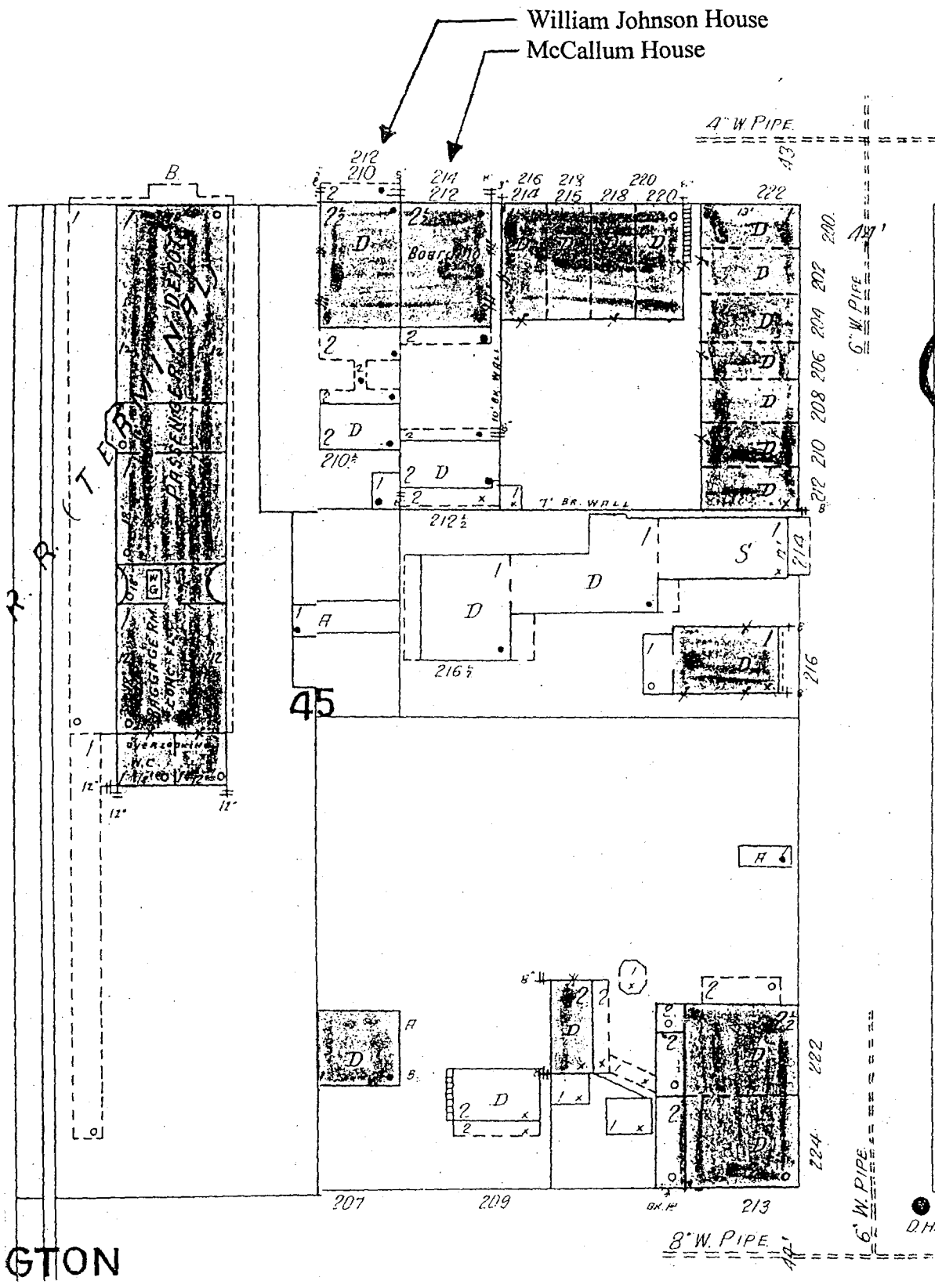

13

JUNE 1925
NATCHEZ
MISS.

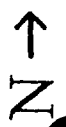

William Johnson House
McCallum House

GTON

13-H June 1925 Sanborn Insurance Map showing the William Johnson House and the McCallum House. Note the addition of the front gallery and changes to the rear galleries at the William Johnson House. There are more changes to the Johnson dependencies. No changes occurred at the McCallum House.

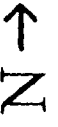

William Johnson House
McCallum House

13

JUNE 1925
NATCHEZ
MISS.

Updated to 1946

KEY

	FIRE WALL 6 IN. A.B.V. ROOF
	METAL CORNICE
	FIRE WALL 12 IN. A.B.V. ROOF
	WOOD CORNICE
	FIRE WALL 18 IN. A.B.V. ROOF
	FRAME PARTITION
	OPENING WITH IRON DOOR
	" " "STANDARD" IRON DOOR
	WINDOWS & IRON SHUTTERS
	WINDOW - 1ST STORY
	WINDOWS 1ST & 3RD STORIES
	" " 2ND & 4TH "
	TABLE
	BUILDINGS COLORED YELLOW ARE FRAME
	" " RED BRICK
	" " BLUE STONE
	" " GRAY IRON
	" " BROWN ADOBE
	" " GREEN SPECIALS

(5) (2) INDICATE RELATIVE HEIGHTS.
+ FIRE STATION, AS SHOWN ON KEY MAP.
ALTERNATE STREET NUMBERS ARE ACTUAL
CONSECUTIVE STREET NOS ARE ARBITRARY.

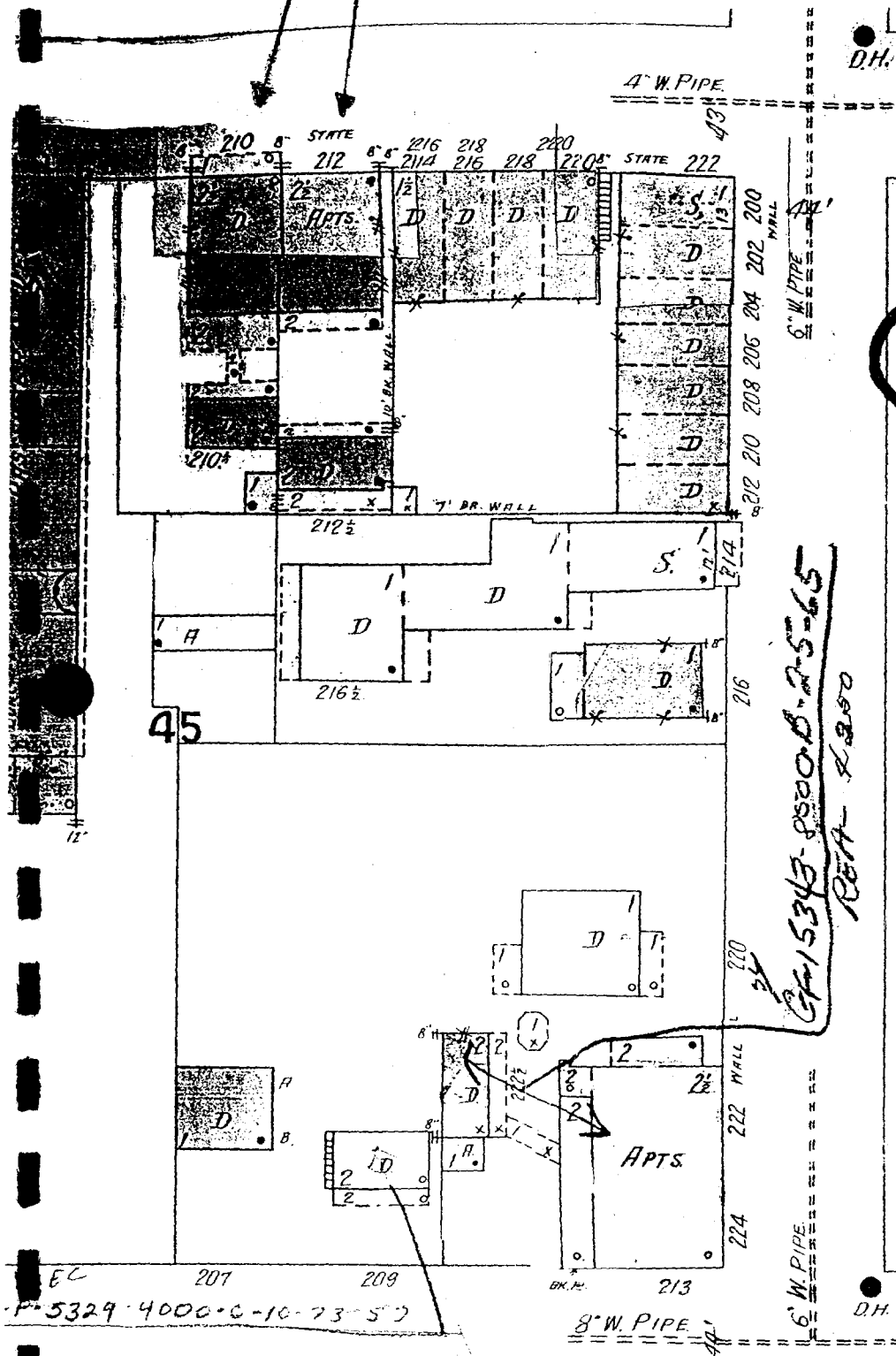

14-H 1946 Updated Sanborn Insurance Map showing the William Johnson House and the McCallum House. No changes noted to either house other than the final address designation.





5.0 Physical Description



5.0 PHYSICAL DESCRIPTION

5.1 Site

Appearance 1840-1866. The Main House sat on a relatively flat site, 32' by 140', and is 27'-9" wide by 42'-5" deep with a porch extending an additional 9'-2" off the back.²⁰⁴ The front facade faced northeast (called north) and sat right on the property line. It was separated from the street by a 6'-0" wide poured concrete sidewalk. According to the 1829 *Ordinances of the City of Natchez...* this walk was originally a 6'-9" brick paved walk and gutter. The House was of brick construction with the east wall being a shared party wall with the neighboring McCallum House. A Kitchen Dependency, approximately 30'-8" wide by 15'-7" deep with a 4'-6" porch on the front (or west), sat approximately 12'-0" back from the house, along the east property line, and was perpendicular to it.

Significant changes have occurred to the site since Johnson's lifetime, and documentation on the appearance of the yard during his life is more sketchy than for the House and Dependency. Several archeological investigations have yielded important information on the site and its features, but the investigations have not covered the entire site.

Johnson's diary records that a fence was erected on the lot by the end of 1840, about the time that the House was occupied and work on the earlier Kitchen Dependency started.²⁰⁵ A series of cisterns was constructed (see Section 4.2.2), and a "cistern house" built over one in 1844, as well as a hen house and pen for Johnson's cow. A shed, a privy, and a "little Frame house," possibly an extension to the Kitchen building, were also constructed.²⁰⁶

Four chinaberry trees were purchased for the site in 1841, and rose bushes a year later.²⁰⁷ A vegetable garden was enclosed with lath in the spring of 1842, and that summer, the yard was "leveled, paved, and fenced."

Alterations. In 1892-1897, the brick wall separating the rear yards of the Johnson House and the McCallum House at 212 State Street was constructed.²⁰⁸ The archeological study in 1994 uncovered two rows of bottles, which may have been edging for flower beds.²⁰⁹ The current Dependency was built in 1897. It is 30'-8" wide by 15'-7" deep with a 4'-6" porch on the front (or north), sits approximately 12'-0" back from the house, and is parallel to it.

The post-1906 photograph of the west elevation (1-H) shows a tall board-and-batten fence on two sides of the front corner of the lot, with a gate at the House. This fence is

²⁰⁴ Sanford, 4.

²⁰⁵ Hogan and Davis, 307.

²⁰⁶ *Ibid.*, 317, 392, 478, and 709.

²⁰⁷ *Ibid.*, 50.

²⁰⁸ Sanford, 15.

²⁰⁹ Atkinson, 36-38; figs. 75 and 76.

contemporary with the construction of the Mississippi Central Railroad station immediately to the west of the House, and must have provided much-needed privacy. A privy, which Thomas Padgett believes to have been constructed in the 1930s, is noted as being in place during his 1978 excavations and as being "preceded by a series of privies located in the same general area around the corner and south side of the brick foundation wall."²¹⁰

Mary Louise Miller's description of the property in ca. 1920 tells of a garage, workshop, chicken coops, and privy all south of the Dependency. A pecan tree was located to the south of the Dependency, and white and red camellias, red japonicas, altheas, fig trees, and sweet olive were planted in other parts of the yard. Vegetables were grown at Peachland, a plantation that the Johnson family owned.

An existing vertical board fence was replaced by NPS along the front of the property in 1992. There is a lawn covering most of the west yard, with plantings beside the fence and a fig tree near the Kitchen Dependency. A frame storage building is located southwest of the Kitchen.

5.2 Main House

5.2.1 Exterior

Appearance 1840-1866. The William Johnson House has always been two-and-one-half stories high, with a gable roof running parallel to State Street. The principal or State Street facade faced north and was divided into three equal bays, with three double-wide door openings on the first floor and windows above them. Two dormers at the attic level were unequally spaced, with one above the east window and the other roughly centered between the center and west windows.

The north facade of the House (15-A) was brick in running bond with flush mortar joints. A row of brick soldiers formed jack arches over all window and door openings. There was a brick sawtoothed cornice running along the top of the wall. It was three rows high with the center row of bricks turned at a forty-five degree angle creating the sawtooth. The bottom of the cornice projected about one inch from the face of the wall, and the top approximately three inches. The roof was originally covered with wood shingles, which had been preserved under the rear porch.²¹¹

Based on historic photographs and existing commercial buildings from the same period, it appears likely that the first-floor doors originally had glazed sections above a single panel, with deep, paneled jambs and louvered folding shutters on the exterior.²¹² All

²¹⁰ Padgett, 9.

²¹¹ Hawkes, Oehrlein, and Wells, 13.

²¹² Mary W. Miller, Director of Preservation at HNF, pointed out extant buildings from the same era in Natchez Under-the Hill that have doors matching this description. HNF has historic photographs on file showing other buildings with doors that match this description.

original windows had double-hung, six-over-six sash, simple wood frames with a beaded inner edge, and louvered shutters. The dormers had gable roofs, clapboarded sides, and simple pilasters framing the sash. Doors, sash, and frames were painted cream color, and the shutters dark green.

The west elevation (16-A) was laid in common bond brick, with headers every sixth course, and flush mortar joints. The lower ends of the gable straightened out for a length of 2'-6" on each end, creating a parapet. There appear to have been no windows on the first floor of the west wall during Johnson's lifetime. Two openings on the second floor were located between the chimney stacks, slightly off center, and a single opening, shifted slightly off center, on the third floor. Historic photographs show a rain leader running from the gutter on the north side of the house to the south side of the house and a downspout. This most likely fed the cistern.

The south elevation (17-A) was, like the west, constructed of brick laid in common bond. Like the north elevation opposite, it was divided into three equal bays. The first floor appears to have originally had three window openings when first constructed. In 1842, Johnson replaced the center window with a six-panel door, set deep into the wall, with a three-light transom above.²¹³ The second floor had two window openings which aligned with the windows below and a door in the center. This door was original to the construction of the House and provided the sole entry to the second-floor rooms.

Access to the second level has historically been from an exterior porch along the south elevation. It appears to have been supported by five square wood posts on raised brick piers. The posts had simple capitals formed of applied ogee and half-round moldings. The first floor was formed of thick planks running parallel to the House. At least one original post and a small section of floor remained in place until 1979.²¹⁴ A stair at the east end of the porch began near the rear door and ran up to a landing along the east property line, then to the center of the second floor. Masonry pockets for the original handrail were found in the brick of the south elevation, and the railings appear to have been constructed of simple square balusters, rather than the current cut-outs (18-A).

When the House was finished and occupied in 1841, the second floor of the porch does not appear to have had a roof, but simply an awning. During the first year, Johnson appears to have added lattice to provide privacy along the east side of the first floor, above the brick wall shared with the McCallum House.²¹⁵ In 1844, Johnson paid

²¹³ Sanford, 14; Hawkes, Oehrlein, and Wells, 15; Albee, 9.

²¹⁴ Hawkes, Oehrlein, and Wells, 16.

²¹⁵ On July 22, 1841, Johnson recorded "I commenced this evening late to do some work down at the house, lathing up under part of the gallery to make a dining or eating room." (Edwin Adams Davis and William Ransom Hogan, *The Barber of Natchez* [Baton Rouge: Louisiana State University Press, 1955]; Hawkes, Oehrlein, and Wells, 16). The BCT HSR had assumed this indicated a plaster ceiling to the porch, though it also noted that there were no plaster stains. Mary W. Miller noted that Johnson also recorded using lath for a garden fence. (Mary Louise Miller, interview by Kathleen Jenkins and Carol

carpenter St. Clair to build a "cover," or roof for the porch. The roof was supported by five wood columns which aligned with those below and had matching capitals. Five joist pockets for the roof framing were noted in 1979, as well as a line of paint which indicated that the porch ceiling originally ended below the brick cornice.²¹⁶

Alterations. The first series of alterations to the House appear to have occurred ca. 1873 when the sawn balusters were added to the back porch. These were probably added around the same time that the porch roof framing was changed, so joists ran parallel to the House and the roof extended above the brick cornice. Construction of interior partitions on the first floor appear to date from ca. 1892-1897, and it now seems likely that the original Kitchen Dependency was demolished, rather than burned.²¹⁷ In the House, two window openings were added on the first floor of the west elevation. These openings are smaller than the original windows, measuring 3'-4" by 5'-11", rather than 3'-9 3/4" by 7'-1 1/2". The frames lack the beaded edge, and they have nine-over-six light sash, more common in buildings from the eighteenth century and early nineteenth century. Thus it is possible that the sash were re-used from the old Dependency. To mask the alterations, the walls appear to have been covered in stucco, which is visible in a photograph taken ca. 1906 (1-H), and remained in place until 1992. During this same time the easternmost pair of doors on the north facade may have been changed to a single door.²¹⁸

Alterations were made to the north facade ca. 1924-1930. The central door opening was changed to a single door with sidelights, and the two openings on either side were filled to create windows.²¹⁹ At this time, the facade was also covered with stucco, scored to imitate ashlar, and it appears likely that a two-story covered porch was added at the same time, documented in a 1976 photograph in the *Yazoo Herald*. To provide access to the porch, the center window on the second floor was lengthened into a doorway. Sometime prior to 1979, the north porch was removed. The roofing was replaced with standing-seam painted tin and, at the same time, the porch roof pitch may have been revised so that it was continuous with the main roof.

In ca. 1950, a bathroom was also created on the rear porch.²²⁰ This may have been when the original south porch stair was removed. Access was accomplished via the existing bridge from the Dependency.

Petravage, February 6, 1996, typescript, HNF, 2.) The lattice remained in place in 1979, but it is assumed that the lattice was removed during the porch repairs/restoration in 1979-81.

²¹⁶ Hawkes, Oehrlein, and Wells, 17; it is not clear whether the earlier porch railing would have been removed, or somehow incorporated into the new arrangement of columns.

²¹⁷ Sanford, 6.

²¹⁸ Mary Louise Miller, interview. Mrs. Miller described the yard and room layouts of the house while she lived there. She described the easternmost door on the north facade as a single door prior to 1920.

²¹⁹ The ca. 1910 photo documenting the addition of the west windows shows that the original doors still remained (Natchez: The Norman Collection, Thomas H. Gandy).

²²⁰ Albee, 7; Hawkes, Oehrlein, and Wells, 11.

In 1982, restoration work was carried out by the New Orleans architectural firm of Koch and Wilson for the Preservation Society of Ellicott Hill. On the north elevation, stucco was removed, the second-floor door changed back to a window, and the original first-floor doorways re-opened. The new doors, currently in place, are tongue-and-groove with six panels, based on what architect Henry Krotzer interpreted from the historic photos. On the south elevation, the bridge to the Dependency was removed, along with the bathroom, and lattice. A new stair was installed in the rear porch, following what was believed to be the original configuration. The sawn balusters were retained, but simple square spindles provided on the stair railing. The present first floor of unfinished wide plank boards and a board-and-batten ceiling were added at this time.

After NPS acquired the House in 1992, the stucco was removed from the west elevation and a new wood-shingle roof was installed. At this time the window sash were repaired.

5.2.2 Interior

Appearance 1840-1866. The first floor was originally one large room with a post in the middle. It was entered through the three sets of double doors on the north facade. The door on the south elevation provided access to the rear porch after it was installed in 1842. The flooring was wood with the boards running north and south.²²¹ The walls and ceiling were plaster on wood lath. The plaster was composed mostly of fine-sized granules, and the overall color was tan with black and orange particles. A large percentage of hair was also found in the plaster; this could have been hair from Johnson's barber shop, as he discusses selling hair to a plasterer in his diary. Wallpaper originally covered the walls, although no traces of it remain.²²² The original ceiling finish was whitewash as determined by Building Conservation Technology in 1979.

A fireplace was located along the west wall near the south end. It had a wood mantel which was painted black. This has been removed, but is stored in the house. It was incorrectly identified as Colonial Revival in the Building Conservation Technology report. There was a wood baseboard running around the room. The baseboard and all window and door casings were painted a cream color.

The second floor was entered from a door on the south elevation. It was divided into four rooms with a central hall. The door from the rear porch opened into the Hall 201, which was 19'-7" long. The original use of the Southwest 202 and Southeast 207 rooms on either side is unclear; the Southeast Room 207 may have been where Johnson's daughters slept and, on the southwest, Room 202, where his mother-in-law lived. The large room at the north end of the corridor was most likely the living room. A stair to the third floor was entered from the east side of the hall at the northernmost end. The fourth room,

²²¹ Sanford, 17.

²²² Albee, 11; Hawkes, Oehrlein, and Wells, 31.

Room 204, which appears to have been Johnson's bedchamber, was entered from the Northwest Room 203.²²³

The flooring was typically wood with the boards running north and south. Walls and ceilings were plastered. Running trim included baseboards, and door and window casings, the latter installed before plastering. The baseboards had a flat lower section with an ovolo profile molding on top.²²⁴ The walls and ceiling were plaster and had similar composition to the first floor, indicating that they were applied at approximately the same time.²²⁵

It is unclear whether the hallway walls were originally painted or wallpapered. The majority of time that the House has been standing, they have been wallpapered, but there are traces of a pink lime-based paint that was applied early on, and no documentation of wallpaper for this room appears in Johnson's diary. The ceiling was painted with a pink calcimine paint. The woodwork was originally painted a cream color, and the door to the northwest room was grained within a few years after the House was completed.

The Southwest Room 202 was entered directly from the Hall 201. There was a fireplace on the west wall which originally had an iron coal grate with a semi-circular opening, rectangular frame trimmed with cable molding, and a simple scrollwork in the spandrel.²²⁶ The fireplace mantel was a simple Greek Revival style, painted black. The rest of the woodwork was initially painted a cream color except for the door to the Northwest Room 203 which was grained when it was installed in 1844.²²⁷ The finish analysis confirmed that all woodwork in this room is original except for the picture railing which was a later addition. The walls and ceiling were initially covered with a white calcimine paint.

The Northwest Room 203 was entered directly from the end of the hall. There were doors into the Southwest Room 202 and the Northeast Room 204. A fireplace on the west wall originally contained an iron coal grate matching that in the Southwest Room 202. The fireplace mantel and all woodwork were initially painted the cream color found in the rest of the house. The exception would be the three doors which were grained in 1844. The original cream color was used as a base coat for the graining.²²⁸ As in the Southwest Room 202, all woodwork is original except for the picture molding and the north wall, right window, which has been restored. The walls and ceiling were initially unpainted or covered with wallpaper.

The Northeast Room 204 was entered from a door on the west wall. This door had a plate latch with bolt. There was a door to a closet located at the east end of the south

²²³ Mary Louise Miller, interview, 7, 8, and 9.

²²⁴ Hawkes, Oehrlein, and Wells, 62.

²²⁵ Albee, 27-28.

²²⁶ Noted in Building Conservation Technology 1979 report, 69.

²²⁷ Albee, 14; Hawkes, Oehrlein, and Wells, 71.

²²⁸ Albee, 15-16; Hawkes, Oehrlein, and Wells, 72.

wall, under the attic stairs. All woodwork in the room, except for the doors, was initially painted cream. The door to the Northwest Room 203 was grained, and the door to the closet was painted white. In his diary, Johnson mentions on May 8, 1845, that some wallpaper was being put up in the "front room." Paint analysis indicates that the walls have indeed always been wallpapered. The original wallpaper does not survive.²²⁹ The ceiling was covered with a lime-based paint. A hole for a stove pipe is located on the east wall. This connects to the McCallum chimney, but it is unknown when the stove was installed. It was gone by the 1920s.

The Closet 205 under the stairs was entered from both the Northeast 204 and Southeast 207 Rooms. It was referred to as the clothespress by Johnson, but no evidence has been found, such as hooks, shelves, or drawers, that suggests it was actually used as such. All woodwork and plaster is original. The woodwork was painted the cream color found everywhere else in the house, and the walls and ceiling were covered with a whitewash.

The Southeast Room 207 was entered from the Hall 201. The door had a plate latch lock on the room side. The woodwork in this room is original and was painted cream. The exception would be the picture molding, which was a later addition. The walls and ceiling were initially painted with a white, lime-based calcimine paint.²³⁰

The Attic 301 was reached by a set of stairs from the second-floor hallway. The stairs were wood and were initially painted the cream color found in the rest of the house, then covered with a protective varnish. The walls to the stairway were painted with the same pink lime-based paint used in the hall.²³¹

The Attic 301 was always one large room, with two dormers on the north side and a window in the west gable. It is believed to be where Johnson's sons slept. The flooring was wood with the boards running east and west. There was a wood baseboard running around the perimeter of the room. All walls and ceilings were plastered. The stairway was open and had a simple wood banister supported by square balusters. The woodwork was initially painted cream, and the stair rail and surround baluster were covered with a protective varnish just like the steps. The walls and ceiling were covered with a whitewash.²³²

Alterations. The first alterations to occur in the house, other than the addition of the three doors in the Northwest Room 203 already mentioned, were paint changes. Several layers of paint and wallpaper were found throughout the house. Some of these changes occurred during the 1840-1851 period. The most significant would be the wood trim. On the first floor, the baseboards had a second layer of white and then the third layer was rose/brown. This color was also detected on the south door. The baseboards throughout

²²⁹ Albee, 17; Hawkes, Oehrlein, and Wells, 76.

²³⁰ Albee, 18-19; Hawkes, Oehrlein, and Wells, 63.

²³¹ Albee, 19.

²³² Albee, 20; Hawkes, Oehrlein, and Wells, 82.

the second floor had a second layer of black. The baseboards on the third floor had a second layer of gray/green.²³³

In 1897, the first floor was divided into three rooms, and the preponderance of evidence suggests that the first-floor west windows were installed. The front half had two rooms, each with a door to one large sitting room in the back.

This floor was divided again into six rooms in the 1920s. There was a center hall entered from the south door with one 24'-0"-by-12'-0" room to the east and west at the back of the house. Each of these rooms had a smaller 9'-0"-by-12'-0" room next to it, and then the front of the house (or north) was one large room. The flooring on the first-floor and the second-floor halls was replaced during this construction. Around the time this work was done, the three doors on the north facade were altered. The two outer doors were changed to six-over-six double-hung sash windows, and the center double door was changed to a door with sidelights.

During the 1920s changes on the first floor, a porch was added to the north facade. The center window on the second floor was changed to a door. The porch was then accessible from the northwest room which served as the parlor. All of these interior alterations were removed after 1980 as archeological work and restoration began on the House.

5.2.3 Structural

The exterior brick walls of the building were load-bearing; interior floors and the roof were framed in wood. At present, there are no wood floor joists on the first-floor level. The western half of the building had a full basement, and the eastern half of the building had a crawlspace below the first-floor level. The first-floor wood joists spanned in an east-west direction. This is evident from the joist pockets and masonry ledger on the west wall and the masonry support wall in the middle of the space.²³⁴ The second-floor wood joists spanned in the east-west direction and were supported by the brick masonry walls. The attic or third floor was supported on wood joists that spanned in the north-south direction. These attic joists were supported on the north and south sides of the House by brick masonry walls; near the center of their spans, they were also supported by a bearing partition on the second-floor level. This second-floor partition rested on floor joists in the second floor; at present there are two wood columns underneath this partition in the first floor. The roof rafters run in the north-south direction, from the roof ridge down to the

²³³ Albee, 20; Hawkes, Oehrlein, and Wells, 82.

²³⁴ The joist pockets which are exposed change in size, with those at the north and south ends being smaller than those in the middle. The smallest joist pocket will hold a 2-by-12. The pockets at the south end do not rest on the ledger like those on the north end do. Visually, the ledger does not appear to be level, sloping down toward the south. The internal support wall has two steps in it which coincide with the change in size of the joist pockets. The floor of the building would most certainly have been constructed level, so what this might indicate is that when the masonry work began the soil was not quite level. By the time they reached the first-floor joists, the south end of the building was lower than the north and the builders had to compensate for it while building the joist pockets.

tops of the north and south elevation brick walls. The south elevation of the William Johnson House had a two-story wood-framed porch supported by wood posts and the south elevation brick wall.

5.2.4 Mechanical, Electrical, Plumbing, and Fire Protection

Appearance 1840-1866. Relatively little is known about the original systems during Johnson's lifetime. Lighting was probably provided by oil lamps placed on furniture. There are no lighting fixtures listed in the estate inventory made after Johnson's death and, while gas was available in Natchez by 1857-1858, there was no physical evidence of ceiling fixtures or sconces. The HFR should further research appropriate lighting fixtures and locations.

Fireplaces were provided in the southwest corner of the first floor and in the two west rooms on the second floor. By 1837, most townhouses in Natchez were heated by coal, and so all fireplaces were probably fitted with coal grates when originally constructed. Greek Revival-style grates, with arched tops and cabled moldings, were located in each of the fireplaces, though some have been relocated during chimney repairs. Stove holes are located in the attic adjacent to the northwest chimney and in the Northeast Room 204, probably for heating stoves rather than cooking stoves. The hole in the Northeast Room 204 connects into the chimney of the McCallum House. A terra cotta flue spans between the opening and the flue of the McCallum chimney. Cross-ventilation was provided by opening doors and windows and closing the louvered blinds.

There was no running water inside the House. Johnson mentions constructing several cisterns, and it is likely that, as at Melrose and other buildings in Natchez, the gutters and downspouts were connected to the cistern in the back yard that was fitted with a pump. It is interesting to note that Johnson operated commercial baths, yet, in contrast to Melrose, he was unable to afford space for interior bathrooms.

Alterations. Electricity was installed in the building during the 1920s, at the same time that the final alterations were made in the first floor. The lighting fixtures observed on the first floor in 1978 and remaining on the second floor are in the Colonial Revival style.

City gas and water were installed throughout the House at the same time that electricity was installed. The middle room on the west side of the first floor was a bathroom.²³⁵ The rear porch was enclosed for a second bathroom in ca. 1950. There are currently no bathrooms in the Main House or Kitchen Dependency.

²³⁵ The HABS report indicated that plumbing was not installed until the 1950s, but Mary Louise Miller confirmed that the middle room, on the west side of the first floor, was a bathroom in the 1920s.





15-A Main House - north elevation.



16-A Main House - west elevation.

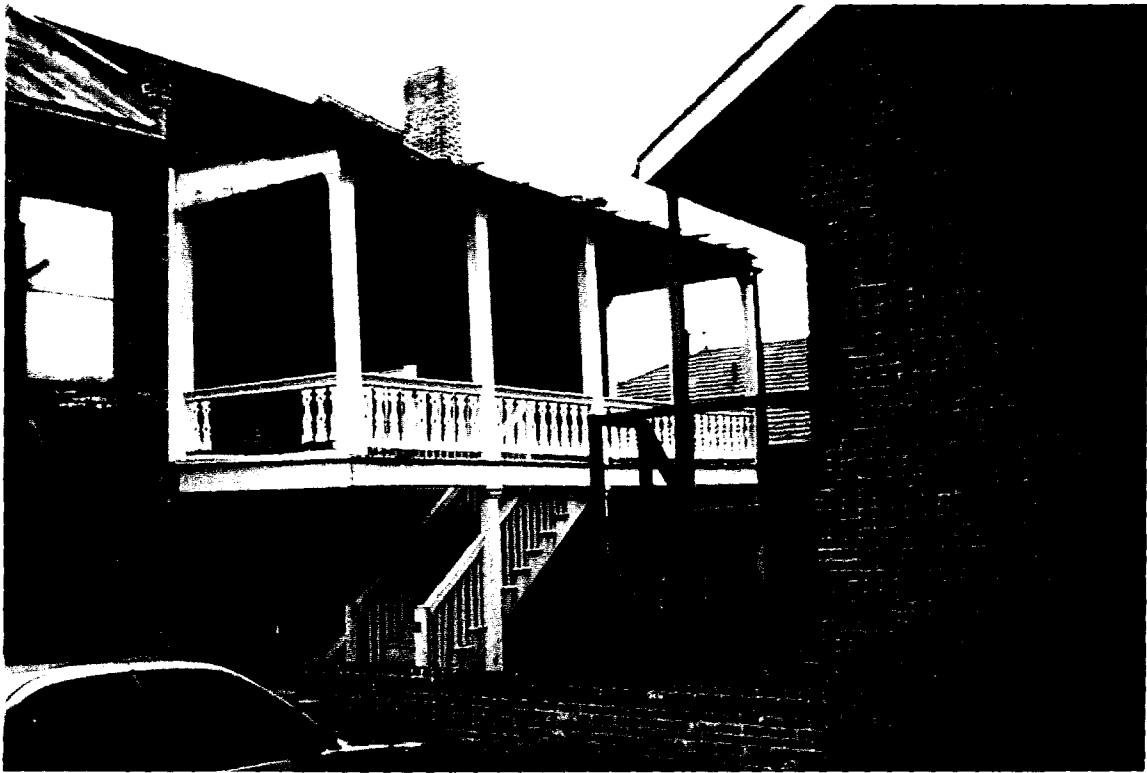

17-A Main House - south elevation.



18-A Main House - Masonry pocket for the original handrail on the south porch.

5.3 Kitchen Dependency

5.3.1 Exterior

Appearance 1840-1866. The original Kitchen Dependency was two stories high, of brick, and approximately the same dimensions as the existing Dependency.²³⁶ It was perpendicular to the Main House, with the principal facade facing west. There was a one-story gallery running along the west elevation.²³⁷ The only other information available indicates there were two windows on the west elevation and a chimney.²³⁸

Alterations. A two-story addition, approximately 15'-0" long and the width of the Dependency, appears on the 1886 Sanborn Maps. Johnson discusses the construction of a wood-frame building in his yard in March of 1850, and it is possible that he is referring to this addition.²³⁹

The current Dependency was built in 1897 and has always been two stories high with a low-pitched gable roof running parallel to the Main House. The principal facade faces north and is divided into two bays, as is the south elevation. The building is of brick with all elevations common bond, with a header course every seventh course, and flush mortar joints. Windows have six-over-six, double-hung sash. The roof, originally cedar shingles, was changed to metal between 1910 and 1925, and changed back to red cedar shingles by the Park Service in 1994.

The north facade (19-A & 20-A) is brick with flush mortar joints. There is a rowlock course supported by a wood lintel above all four doors and the first floor, west window. The other three windows have only wood lintels. The doors have four panels with a glazed transom. There are two windows and two doors per floor. The windows are closest to the end walls, and the doors toward the middle. Two 4"-by-4" (approximately) vent holes are centered beneath each first-floor window. They appear as openings between the bricks in the header course, eight courses below the window sill. The windows and doors on the second floor align with those on the first.

Access to the second story has been from a porch running the length of the front facade. It was originally supported by five square posts which rested on a brick patio.²⁴⁰ The brick was replaced by the Park Service around 1992 with tongue-and-groove pressure-treated wood decking which sits approximately eight inches above grade. The decking runs north and south. The posts are unfinished and without a base or capital. The framing for the second-floor porch is left exposed. Access to the second floor is by a set of stairs, the location of which is unknown. Between 1910 and 1925, a connecting bridge

²³⁶ Comparison of Sanborn Maps from 1886, 1892, and 1897, HNF; Sanford, 6.

²³⁷ Comparison of Sanborn Maps from 1886 and 1892, HNF.

²³⁸ Hogan and Davis, 316.

²³⁹ Ibid., 710. (See discussion in Chapter 4.0.)

²⁴⁰ Hawkes, Oehrlein, and Wells, 86.

was built between the second floor of the Dependency and the House. Photographs from 1979 show a set of stairs running alongside the bridge providing access to the second floor; however, it is not clear when these stairs were constructed.

When the Dependency was first built, the second-floor porch did not have a roof. In 1910, a roof was added, which is basically a shed extension of the gable roof.²⁴¹ It was supported by five square posts, thinner than those below. The railing around the second floor consisted of three horizontal rails.²⁴² In 1987, the entire gallery was rebuilt by the Preservation Society of Ellicott Hill.

The west elevation (19-A) is brick with flush mortar joints. There is a wood lintel above both windows. One window is centered on the wall of the first floor with an identical window above it on the second floor. A wood rake board runs along the gable edge.

The south elevation (21-A) is brick with flush mortar joints. There is a rowlock course supported by a wood lintel above both doors. The two windows only have wood lintels. On the first floor there are two four-panel doors. The western door is currently covered with a sheet of plywood. Two windows on the second floor align with the doors below and are currently covered over with sheets of plywood. There is a wood fascia running just under the eave and a galvanized gutter with no downspout, which was installed by Park Service in 1992.²⁴³

The east elevation (20-A) is brick with flush mortar joints. There are no penetrations in this wall. At one time, it was a party wall with the neighboring Dependency. The current wall was reconstructed in 1978.²⁴⁴

5.3.2 Interior

Appearance 1840-1866. There is no information available on the interior of the original Dependency structure, which was used as a kitchen and for slave quarters.²⁴⁵ Since it was similar in size to the existing Dependency, we can speculate that it had two rooms on the first floor and two rooms on the second. There was probably a center chimney with a fireplace in the Kitchen and possibly one or more of the other rooms.

Alterations. The 1897 building has always had two rooms on the first floor. Each room is entered by a door off the north gallery. Each room also has a door on the south wall to the exterior, and a door connected the two rooms. The flooring is wood with the boards running east and west. The walls and ceiling are plaster, and there is a simple wood baseboard around the room.

²⁴¹ Sanford, 5.

²⁴² Hawkes, Oehrlein, and Wells, 86.

²⁴³ Park Service Maintenance Files for William Johnson House, NATC, August 1992.

²⁴⁴ Sanford, 17.

²⁴⁵ *Ibid.*, 6.

The East Room 102 has a fireplace on the west wall. A small closet is to the left of the fireplace and the connecting door to the right. The mantel is painted a medium gray, as are the baseboards and doors. The walls and ceiling are covered with a whitewash finish.²⁴⁶

The West Room 101 has the same fireplace on the east wall, but no closet. The finishes are the same as the east room except that the fireplace mantel is painted black.²⁴⁷

The second-floor interior is laid out identically to the first, but has no closet. All of the woodwork is painted a light red brown and the walls and ceiling whitewashed.²⁴⁸

In 1979, the east wall of the building was no longer standing and was rebuilt. In 1993, the entire interior was rehabilitated. New tongue-and-groove flooring was installed, new wiring put in, the walls and ceiling re-plastered, and an HVAC system was installed. This required the addition of a closet on the second floor, directly above the first-floor closet.

5.3.3 Structural

The present structure has no basement; its first-floor joists are less than two feet above grade. The exterior brick walls of the building are load bearing. The floors and roof are framed out in wood. The northern elevation of the building has a two-story wood framed porch supported on wood posts and the north elevation brick wall of the Dependency. The east end wall was re-pointed by the Ellicott Hill Society in 1978-1979. The first floor was rebuilt by the National Park Service in 1992-1993 (52-S). The entire building was re-pointed by the National Park Service over the period of 1991 to 1994. See Photographs 19-A, 20-A, 21-A, and 58-S for general views of the exterior of the building.

5.3.4 Mechanical, Electrical, Plumbing, and Fire Protection

The Dependency was constructed in 1897. Recent renovations have removed all evidence of previous systems, and they were not noted in the 1979 HSR. A new air-conditioning system and electrical wiring were installed by NPS in 1993.

²⁴⁶ Hawkes, Oehrlein, and Wells, 94.

²⁴⁷ Ibid.

²⁴⁸ Ibid., 96.



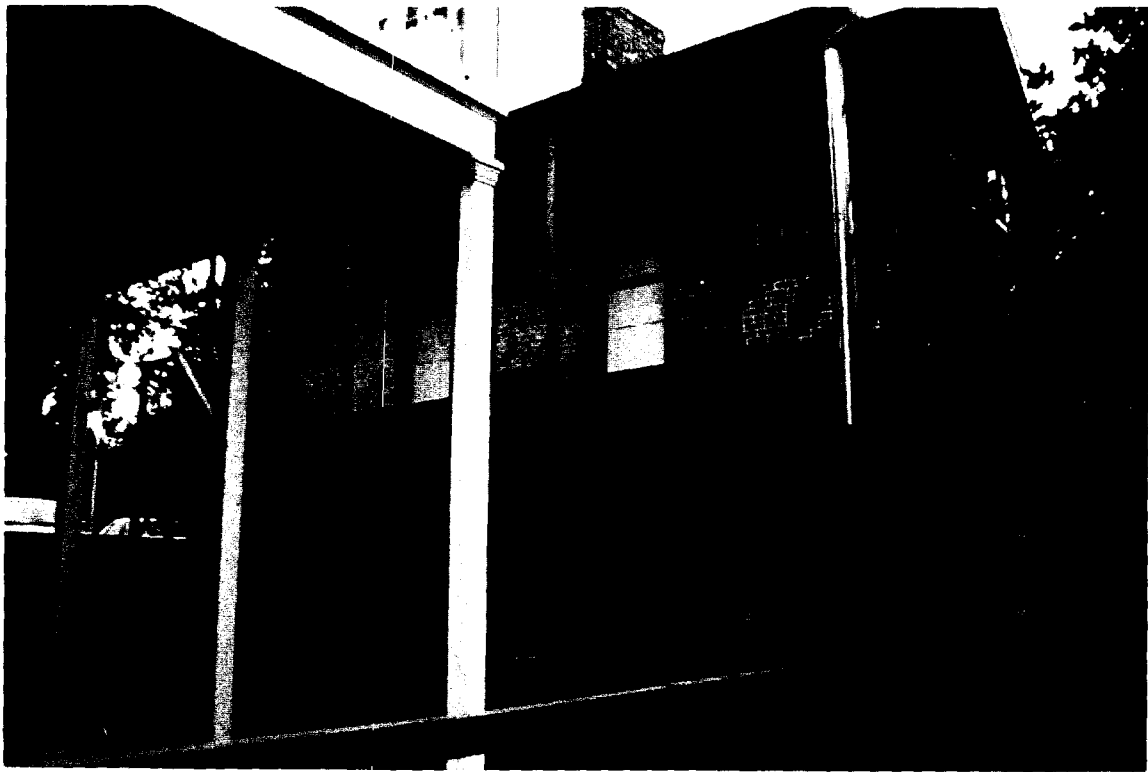

19-A Dependency - north and west elevation.



20-A Dependency - north and east elevation.



21-A Dependency - south elevation.



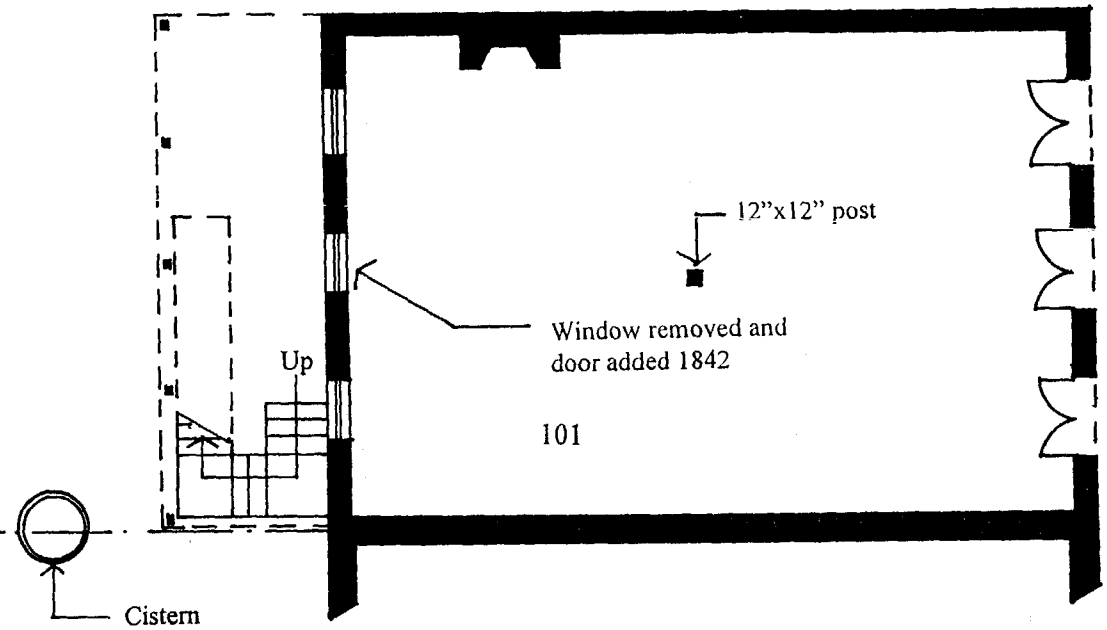
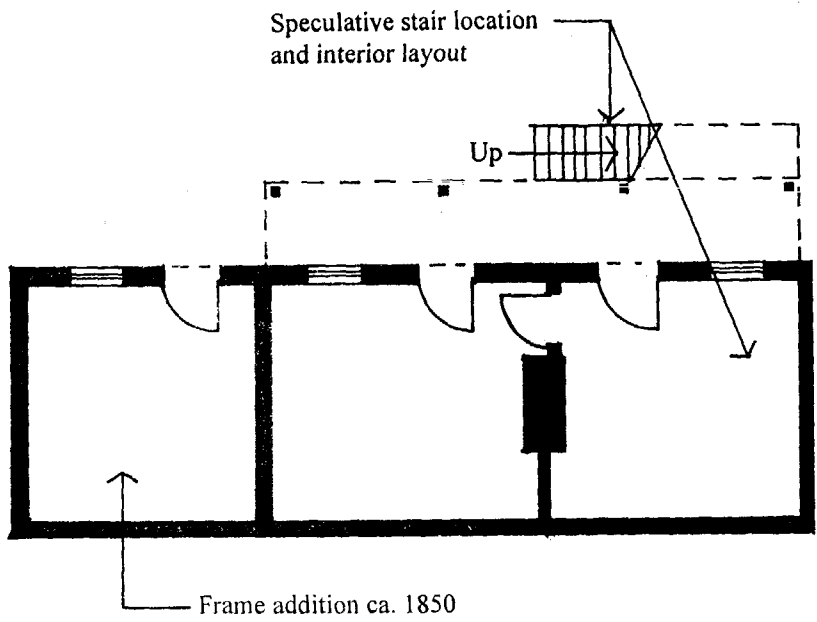
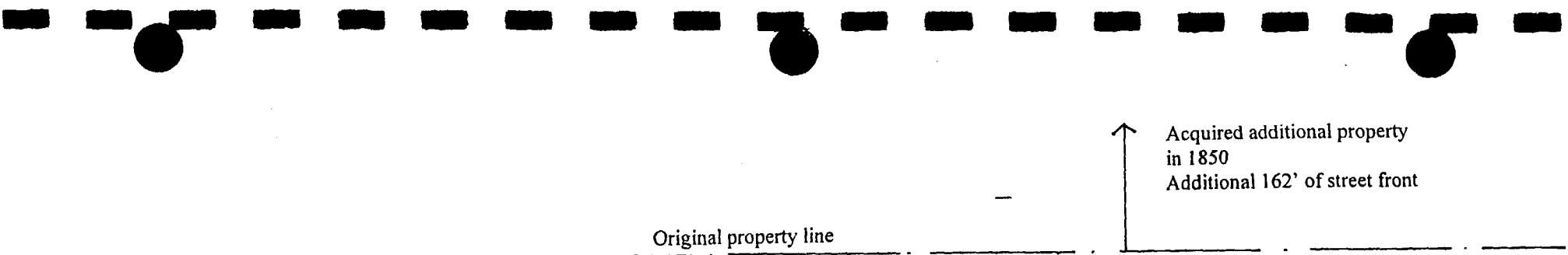

N →

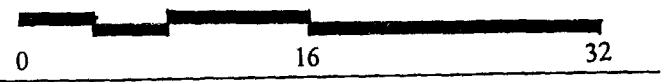

FIRST FLOOR PLAN
ca. 1840-1870

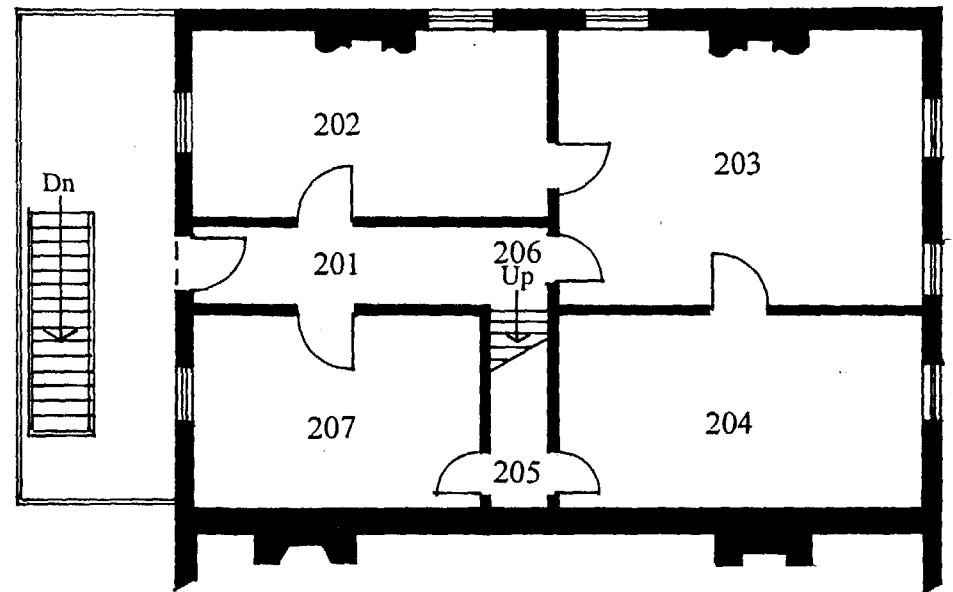
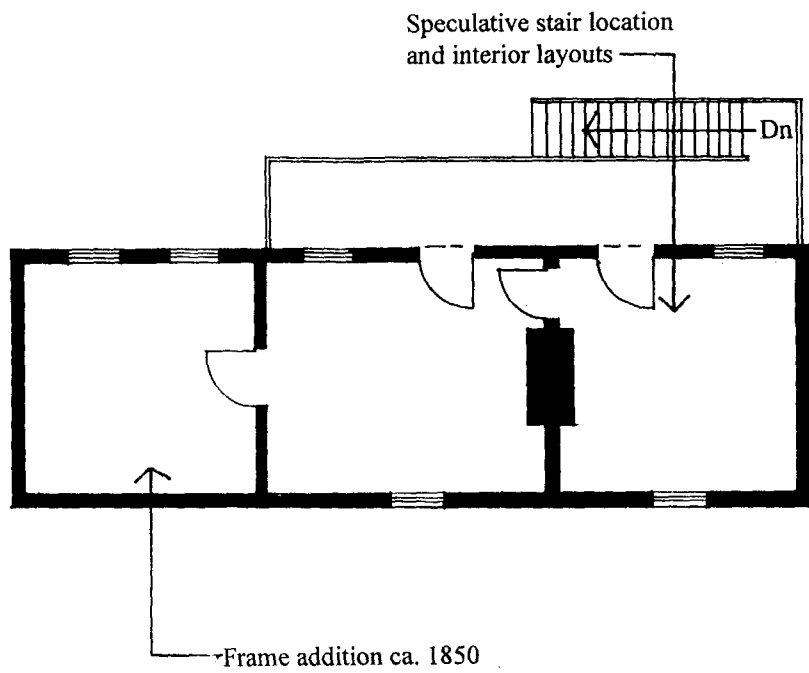

N →

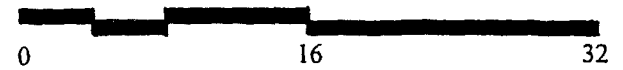

SECOND FLOOR PLAN

ca. 1840-1870

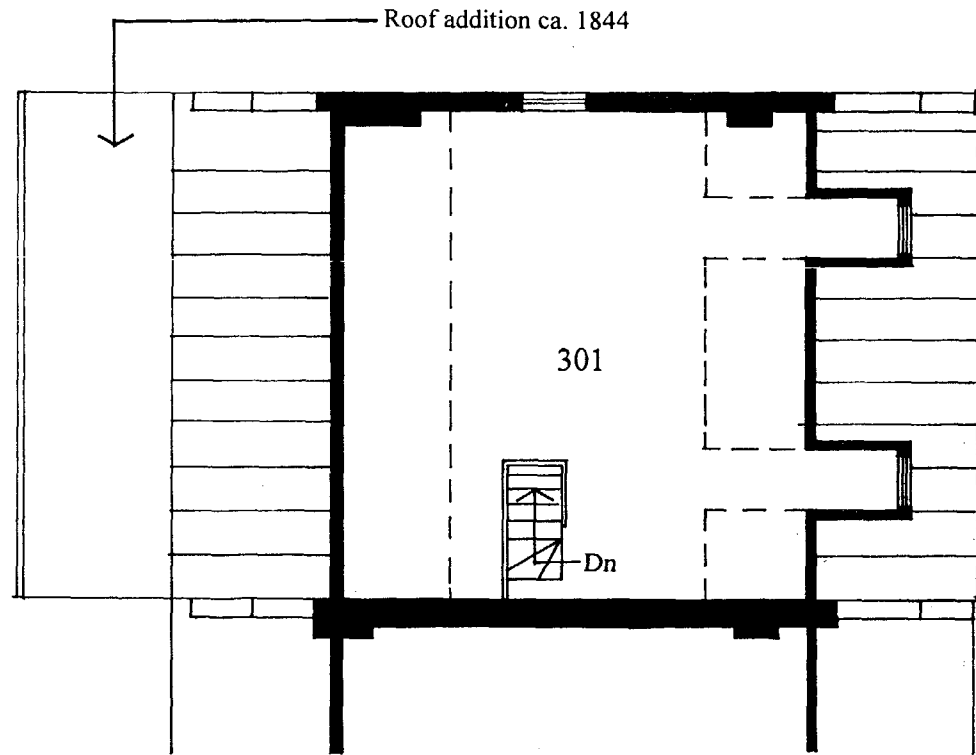
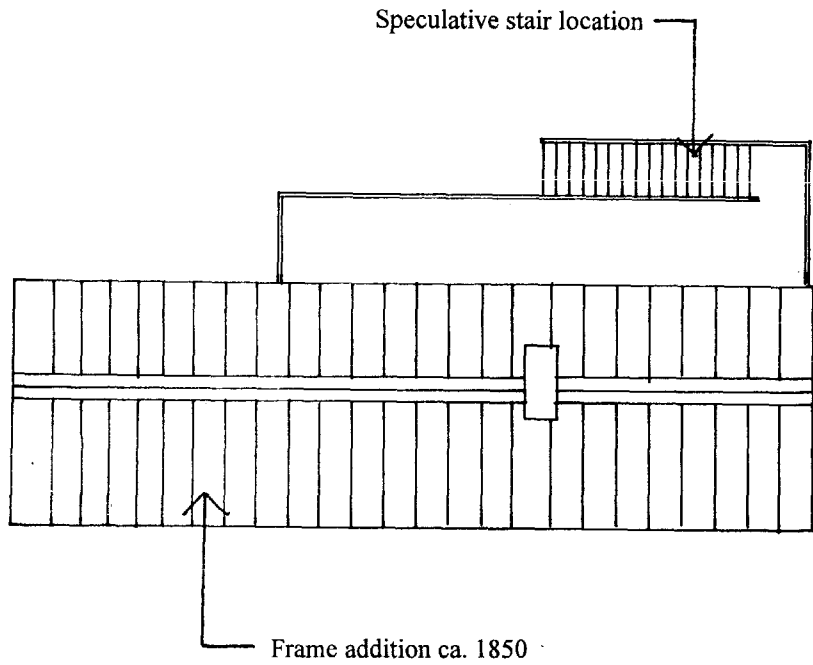

N →

ATTIC FLOOR PLAN
ca. 1840-1870

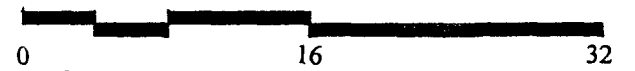

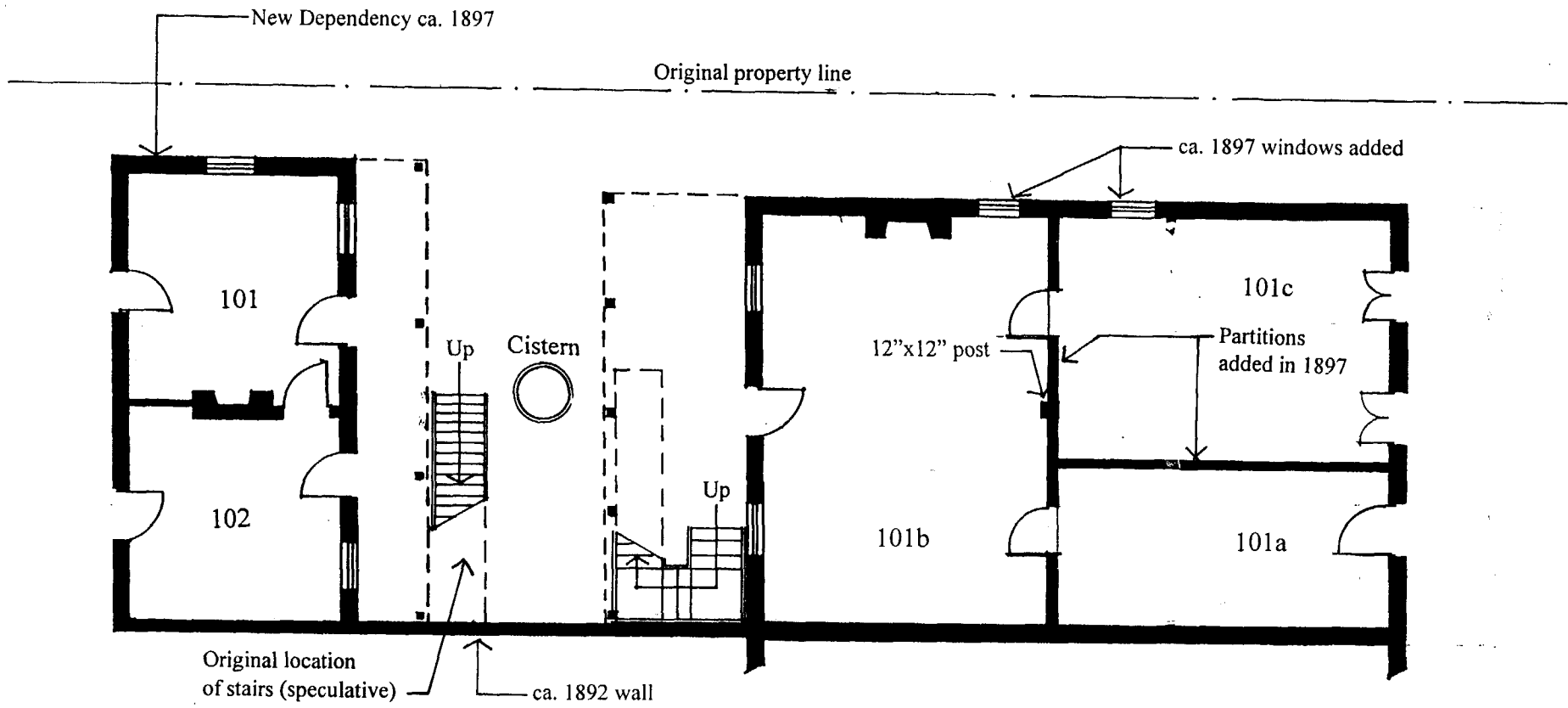

N →

FIRST FLOOR PLAN

ca. 1870-1900

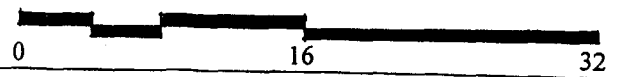

New Dependency ca. 1897

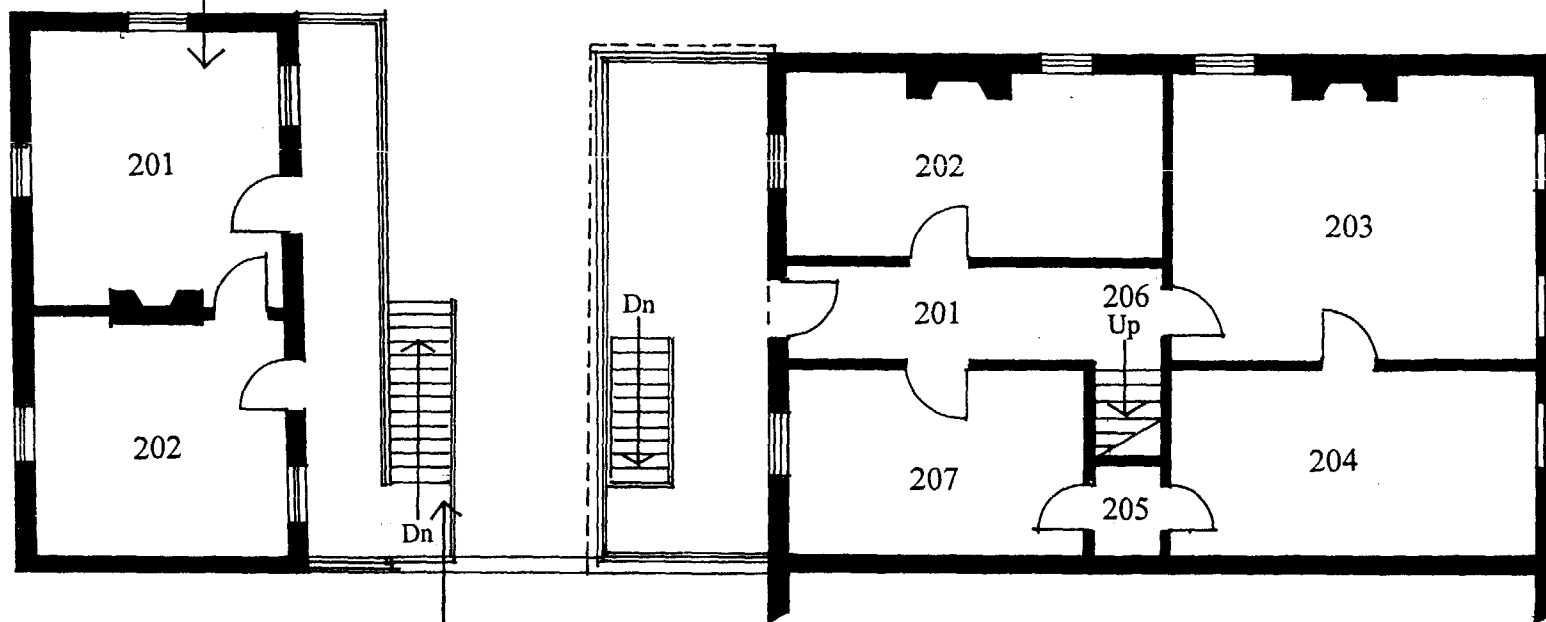

Original location of stairs (speculative)

N →

SECOND FLOOR PLAN
ca. 1870-1900

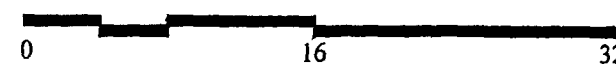

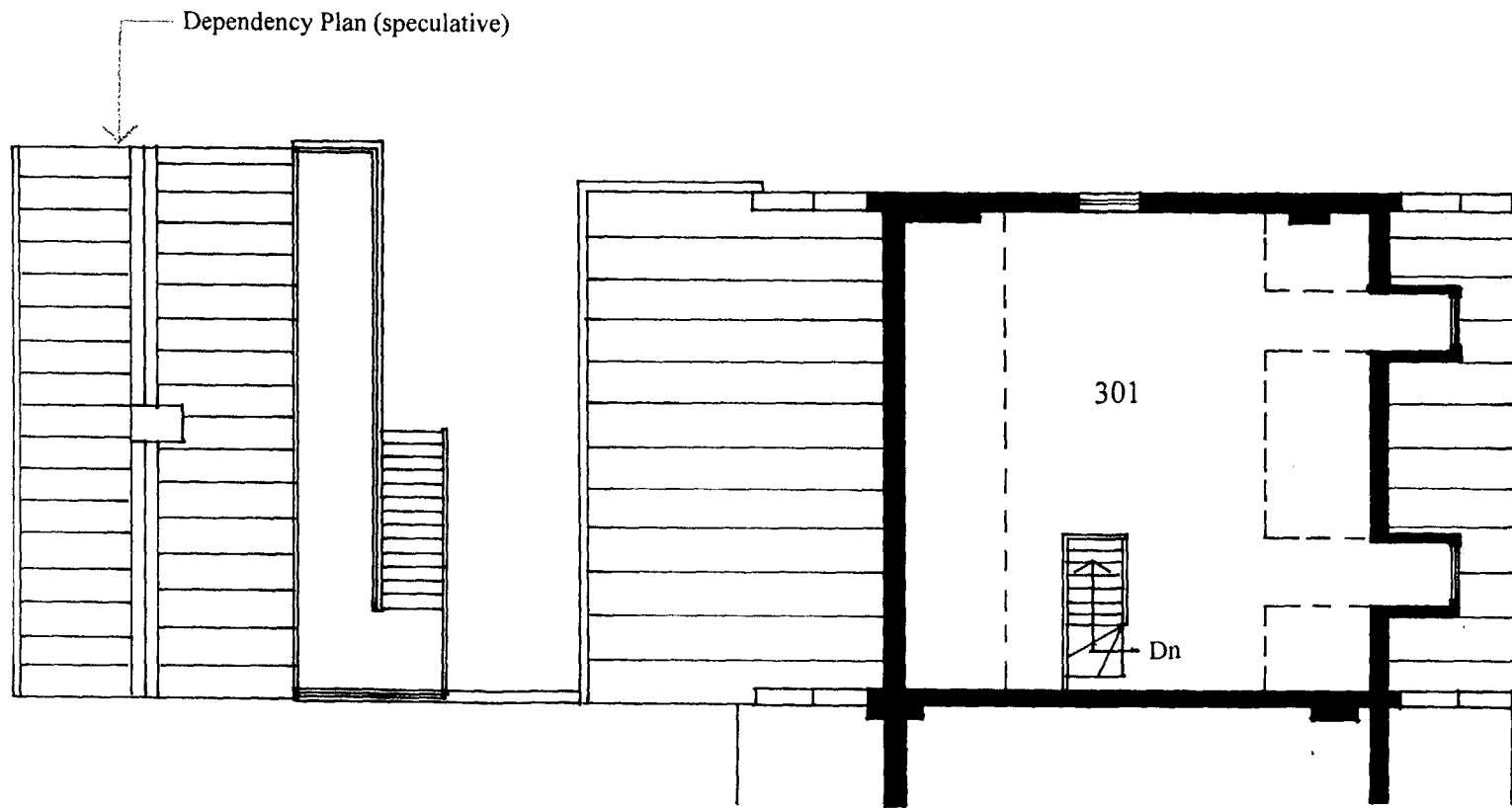

N →

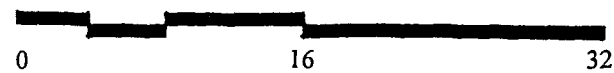

ATTIC FLOOR PLAN
ca. 1870-1900

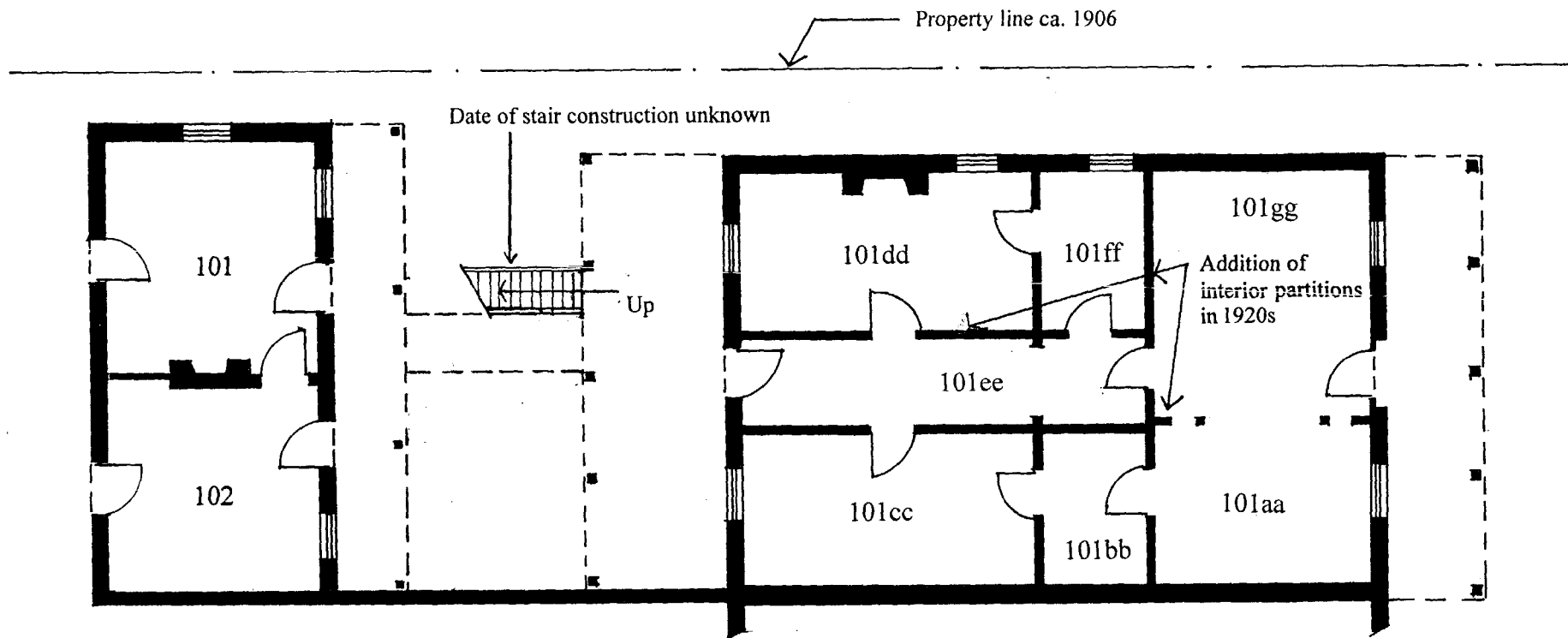

N →

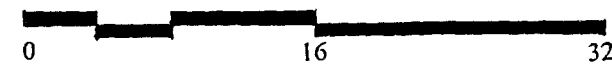

FIRST FLOOR PLAN
ca. 1900-1979

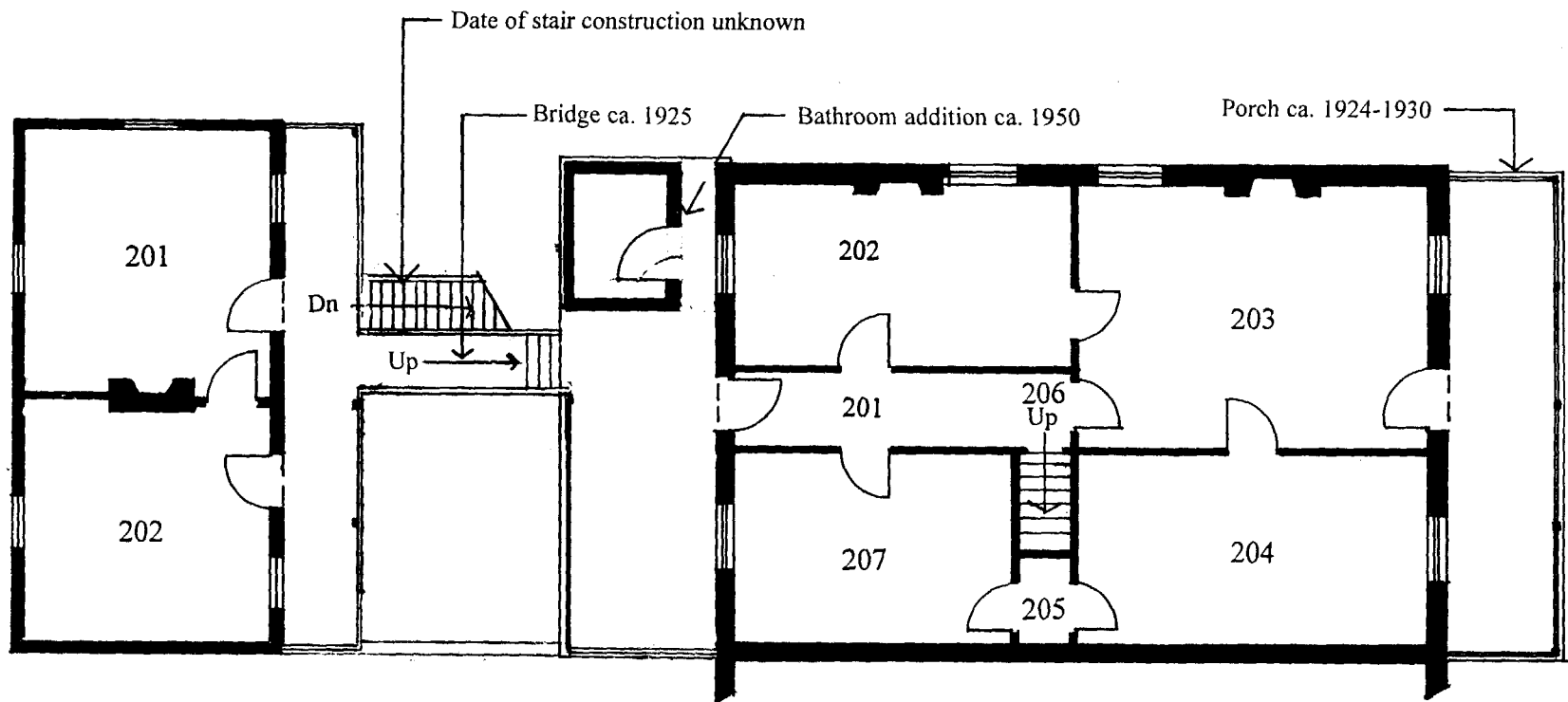

N →

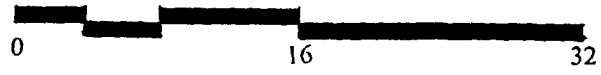

SECOND FLOOR PLAN

ca. 1900-1979



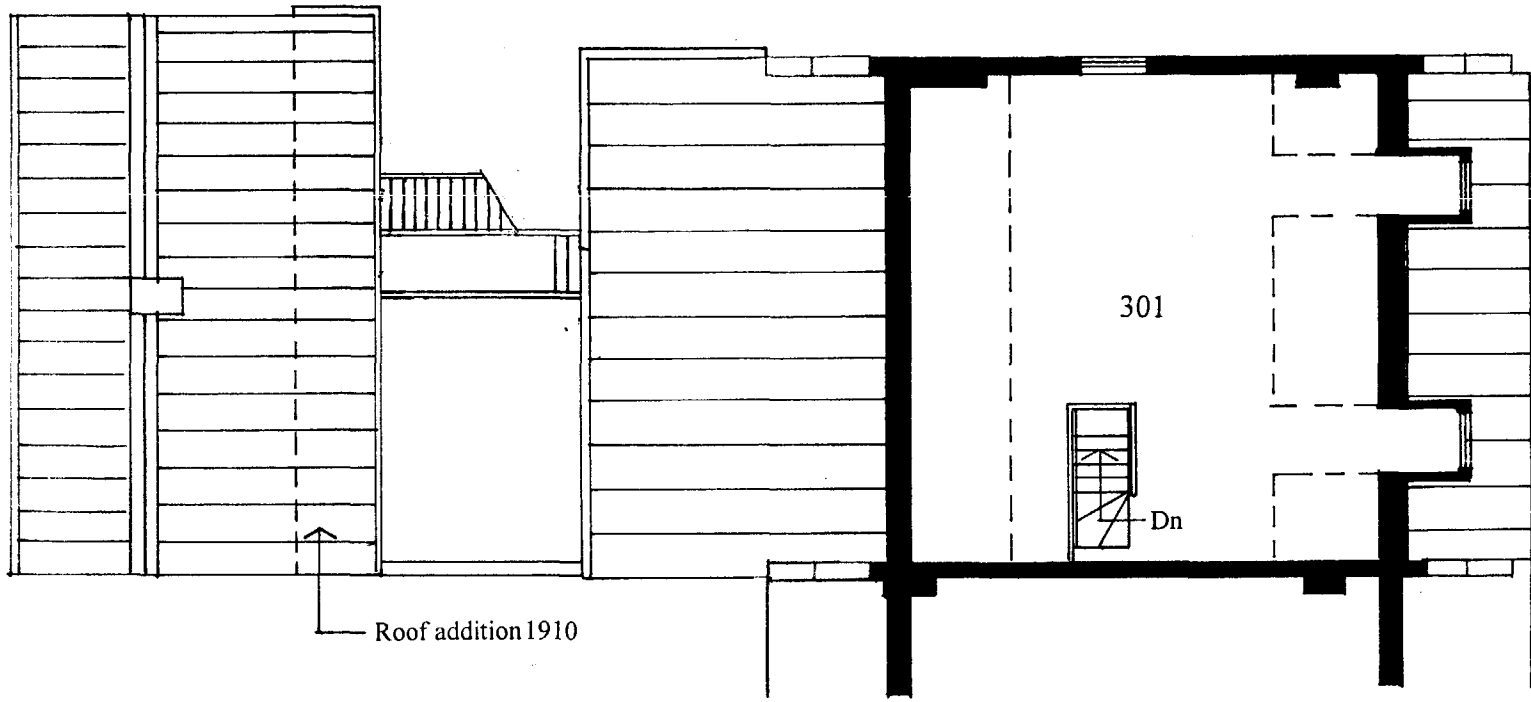

N →

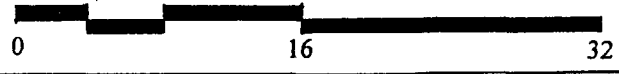

ATTIC FLOOR PLAN
ca. 1900-1979

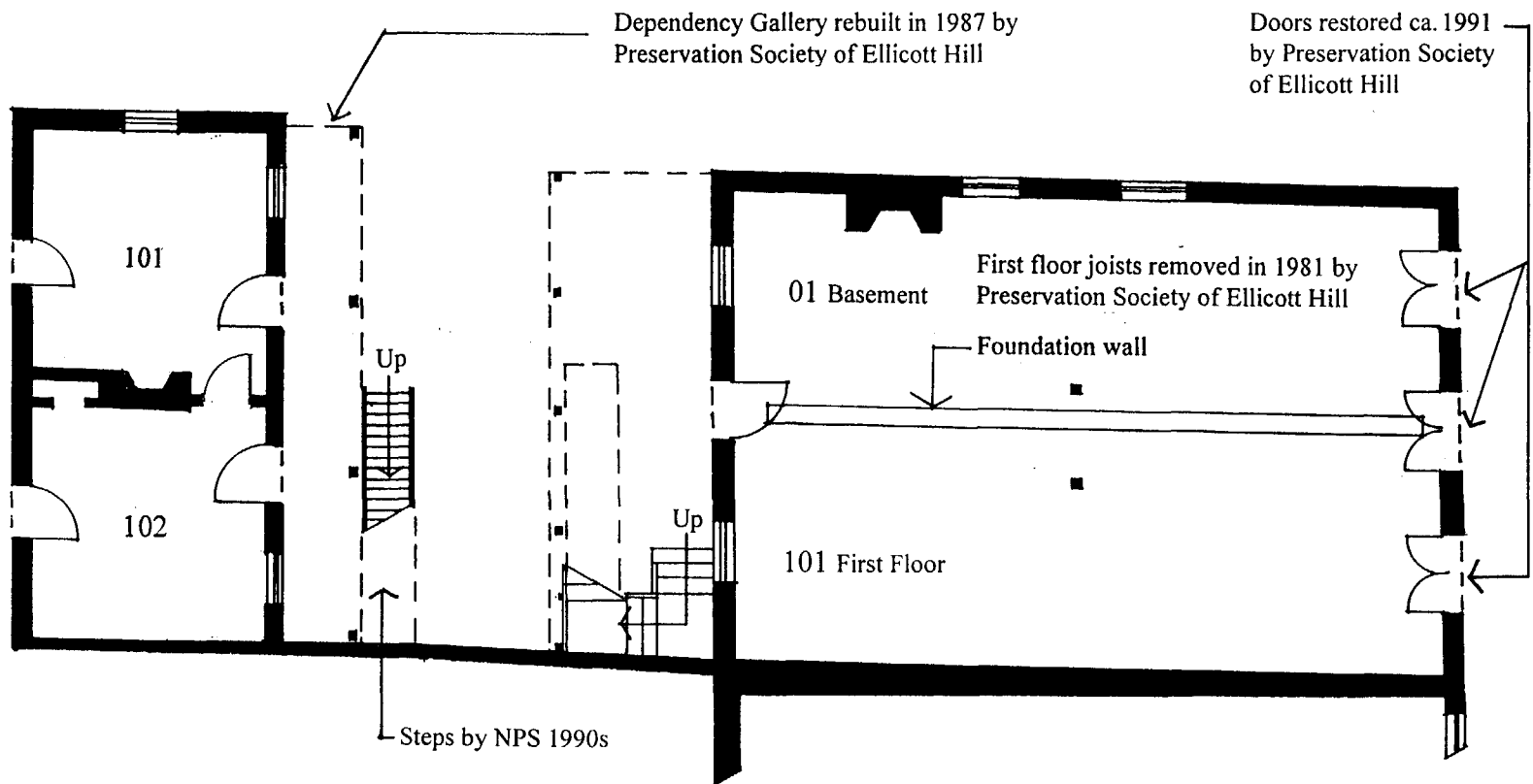

N →

FIRST FLOOR PLAN
ca. 1979-1995

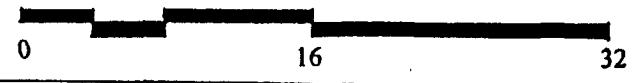

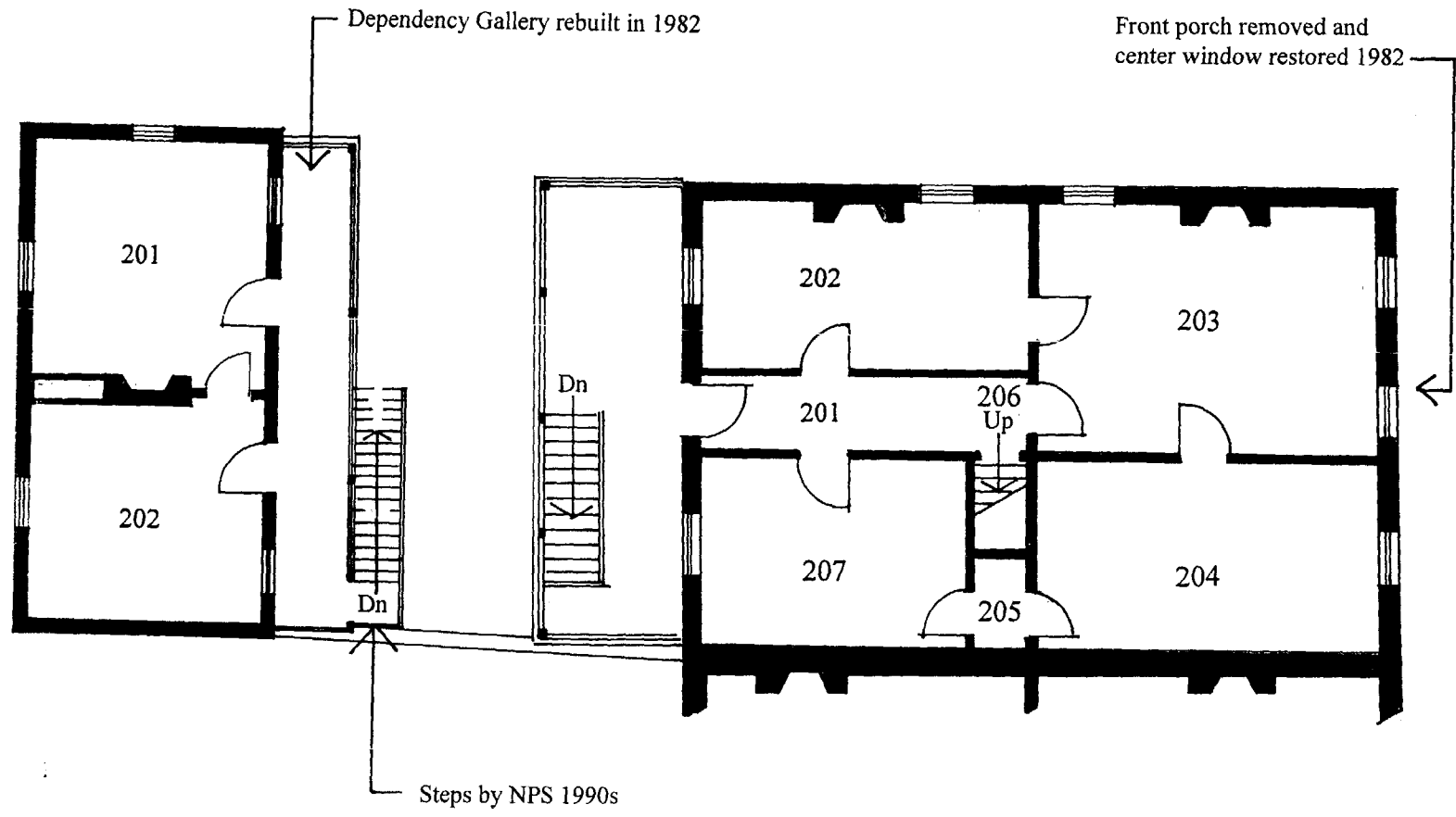

SECOND FLOOR PLAN
ca. 1979-1995

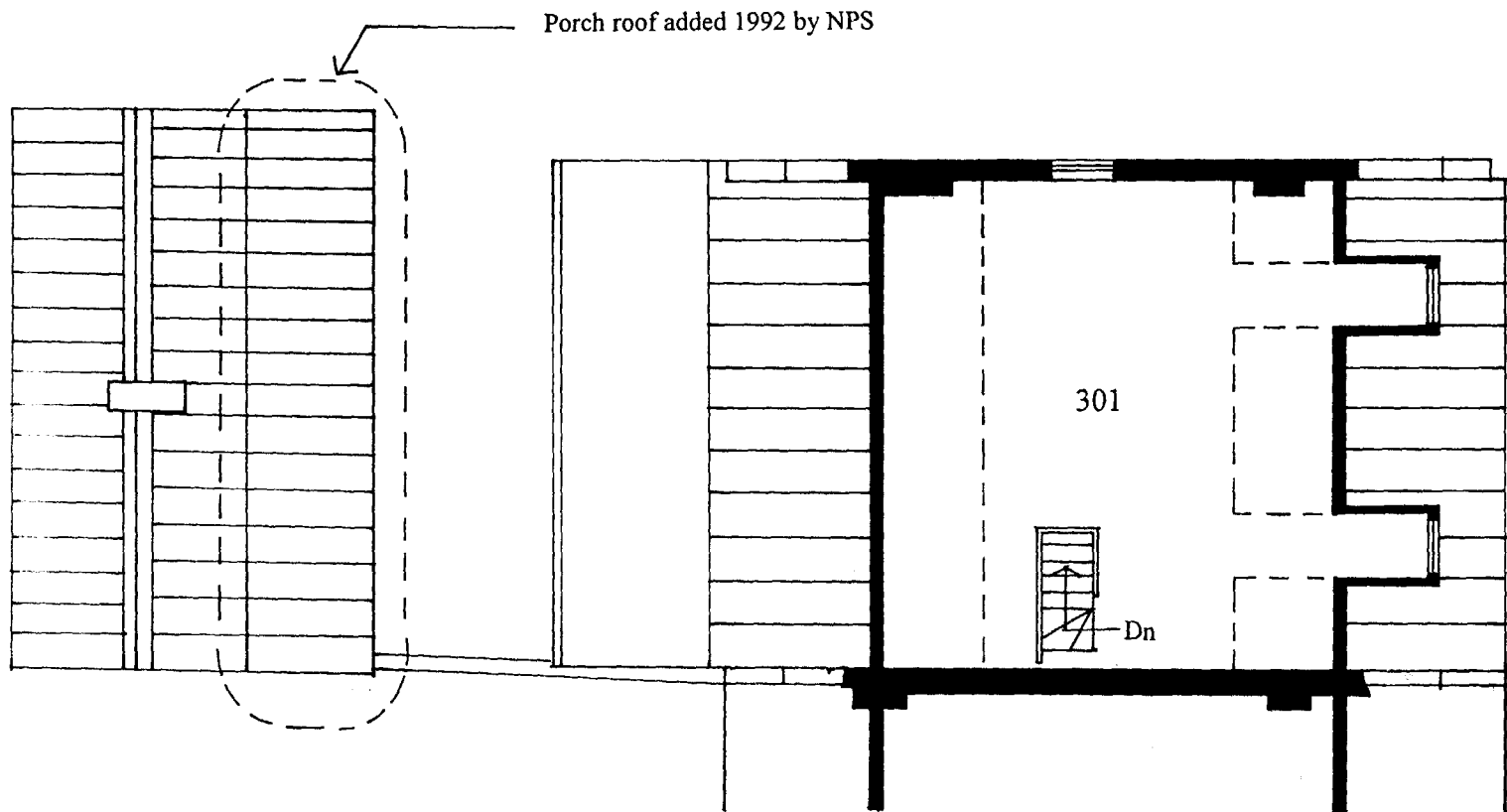

Porch roof added 1992 by NPS

301

Dn

N →

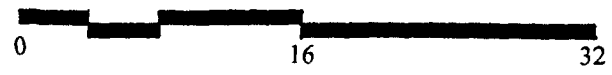

ATTIC FLOOR PLAN

ca. 1979-1995





6.0 Conditions Assessment



6.0 CONDITIONS ASSESSMENT

6.1 Introduction

Conditions at the Johnson House and Dependency were reviewed on May 18, 1995, and July 18, 1995, by Pamela Hawkes, Betsy Sandidge, and Tobin Tracey. The examination was visual only and focused on the condition of the existing fabric and current needs for repair. Findings are summarized in this chapter, and detailed assessments are included on condition assessment forms in Appendix 9.10. The condition of the structural systems was made by Robert Silman Associates, and the condition of mechanical systems was assessed by Roger Preston and Partners. A summary of previous repair and preservation treatments on the structures, which identifies ongoing maintenance problems and areas of weakness, is provided in Chapter 7.0. Recommendations related to the re-use of the building as a museum and restoration of original features are included in Chapter 8.0.

6.2 Sitework

Existing Conditions. There are approximately five trees scattered along the western side of the property and a shrub, west of the house, against the wooden fence. None of the plantings are believed to be original to the time of Johnson's occupancy of the house.

A board walk has been provided leading from the front gate to the porches of the House and the Dependency. This walk is not level with the rear porch of the House, and sections of the walk are rotted.

6.3 Main House

6.3.1 Roofing and Gutters

Existing Conditions. The roof is in excellent condition, as are the gutter and downspout on the north and south elevations. The downspout on the north elevation currently discharges onto the sidewalk below. The roof over the porch is currently covered with plywood sheets which are on sleepers. This is a protective cover from when the roofing was replaced.

6.3.2 Masonry

Existing Conditions. The existing masonry is in fair condition. The entire house appears to have pulled away from the shared wall with the McCallum House. The gap increases with height and is approximately 2"-3" at the second-floor level. Foam has been injected into this crack on the south side to fill it (22-A). The mortar on the shared wall is deteriorating and turning to powder in the attic (23-A). (See Structural Report.)

The north facade has been completely re-pointed, but there are a few small areas that need to be touched-up (approximately 5% of wall) (15-A). The west elevation has been re-pointed and appears in good condition. There appears to be some efflorescence near the roof peak. The mortar on the south elevation is in the worse condition with approximately 30% of the wall needing re-pointing. Most of this work is on the second floor. Some rather large cracks are occurring under the windows, and the mortar is completely gone in spots (24-A).

6.3.3 Wood Trim and Porches

Existing Conditions. The dormers on the north side are in good condition. The windows and clapboards appear to have been recently restored. Some nail holes were not properly filled, and the eaves need to be scraped and painted.

The south porch is currently in poor condition. The floorboards on the first floor were replaced. They are unpainted, gaps have opened up (1/4"-1/2") between some of the boards, and a few of the boards have split and checked (24-A). There is a hatch to the cellar that opens up, and a board has been nailed to the decking next to this hatch. This board can easily be tripped over. The bases of the columns supporting the second floor have opened up at their joints (25-A). The southeast corner column has come completely detached from the second-floor joists (26-A). Eighty to ninety percent of the board-and-batten ceiling for the first floor shows signs of mildew, as does the second-floor ceiling (25-A).

The paint on the stairs and second-floor decking is peeling, leaving 50%-75% of the bare wood exposed. Several of the boards are cupping. The bottom of the balustrade has rotted on the east end of the porch and become detached from the corner post (26-A). Approximately ten balusters are missing from the east balustrade.

6.3.4 Doors and Windows

Existing Conditions. In general, the windows are in good condition. On the north facade, the window frames on the second floor need to be scraped and painted (28-A). The doors should be replaced with units which are historically appropriate. (See discussion in Chapter 5.0.) On the west elevation, the second-floor left window needs to be caulked around one-third of the frame. The upper half of the frame on the other second-floor window is unpainted (29-A).

All door and window frames on the south elevation need to be caulked. The sash and frames of the first-floor windows were recently restored by the Park Service. They appear to have been primed only. The window frames and sash on the second floor are bare wood and are in the process of being restored by the Park Service (30-A), as are both doors on this elevation. These frames, sashes, and doors need to be scraped and painted (31-A).

6.3.5 Interior Finishes

Existing Conditions.

a. First Floor: The interior finishes are in poor condition. On the first floor, the joists and flooring have been removed to repair the half-basement masonry walls and for archeology. Some of the original joists are in storage, but the floor boards were badly deteriorated and could not be salvaged.²⁴⁹ Approximately 75% of the plaster is missing from the brick walls. The plaster that remains is covered with peeling paint (32-A). The plaster and lath have been completely removed from the ceiling (33-A). The only trim that remains are the casings around the north doors, south windows, and door. This needs to be scraped and painted.

b. Second Floor: The second-floor flooring is six-inch plank everywhere except the hallway, which is four-inch tongue-and-groove. The Southeast Room 207 and Northwest Room 203 have linoleum covering the wood floor. Holes can be found in the Southwest Room 202 near the fireplace, below the northwest window in the Northwest Room 203, and in the center of the Northeast Room 204. Also, there is a board missing in the Hall 201 (34-A). In the Southeast Room 202, the floor has pulled away from the south wall approximately two inches, and the floor is deflecting in the Northeast Room 204 along the north wall.

Plaster remains on 80%-90% of the second-floor walls and ceiling, but it has several large cracks and areas that are not tight to the lath or partition (35-A). In the Southwest Room 202, the plaster was removed from a portion of the west wall to rebuild the chimney. There are also areas of plaster missing in the Northwest Room 203 on both the west and north walls. The Southwest 202, Southeast 207, and Northwest 203 Rooms have sections of lath and plaster missing. The rest of the walls and ceilings have several large cracks with 10%-20% of the plaster not tight to the walls. In general, paint and wallpaper are peeling from all walls and ceilings (36-A).

Most of the baseboard has been removed from the Southwest Room 202; it is pulling away from the south and west walls in the Southeast Room 207 (37-A); it has been patched along the north and east walls of the Northeast Room 204; and a small section is missing below the east window on the north wall of the Northwest Room 203 (36-A). All doors on the second floor are four-panel doors, five of them flush on one side. The majority of the hardware is missing (39-A). In general the frames and casings are in good condition.

c. Attic: The flooring in the Attic 301 is 6"-8" plank, and several of the boards in the middle of the room have come loose. There is a 4"-5" gap along the east wall (shared wall with McCallum House). Approximately 50% of the plaster is missing from the walls (40-A). The lath and plaster are completely gone from both the flat and sloped

²⁴⁹ Conversation with Kim Fuller during a site visit September 21, 1995.

portions of the ceiling. The original baseboard remains in good condition, but it is pulling away from both the east and west walls. The original finish has worn off. There are no window casings. There is a wood balustrade around the top of the stairs which has pulled out of the east wall. The balusters are let into the floor and are loose (41-A).

6.3.6 Structural (Robert Silman Associates)

Stability and Condition of the Foundation. Because a test pit was done next door on the McCallum House, no test pit was excavated for an examination of the subgrade condition of the foundations of the William Johnson House. We did, however, have an opportunity to view the interior, basement face of the foundations on the west side of the building and to view the western half of the interior, basement face of the foundations on the north and the south sides of the building (43-S & 51-S). Only the east wall foundations were not visible from within the basement. In all cases where the basement elevations of the foundations were visible, we saw no signs of unusual deterioration. In general, the walls appeared to have been rebuilt and/or extensively re-pointed with new mortar. The foundation walls on the north side of the house have been braced with wood frames. It is our understanding that most of the rebuilding of the interior and exterior faces of the north, west, and south walls was done at the request of, and under the supervision of, the National Park Service.

The brick on the north, west, and south walls was in good condition, and the re-pointed mortar appears adequate for its required structural performance (15-A & 16-A). There was no footing projection observed below the basement-floor level; we did note that the north, west, and south walls were approximately four inches thicker from the level of the first floor on down. We were unable to directly observe the condition of the foundation of the east wall of the house (i.e., the wall that the William Johnson House shares with the McCallum House). There were no indications of differential settlement that might be associated with this wall's foundations.

The stability of the foundation walls appears to be adequate to support the existing loads and the loads resulting from the proposed future use of the building. There are no signs of distress that would indicate that the foundation is inadequate to support the walls above.

Stability and Safety of the Walls. The east wall of the William Johnson House is a party wall shared with the McCallum House to the east. The other three walls are independent brick walls. From one of the structural probes completed for this investigation, we determined that the party wall on the east side of the William Johnson House was built so that it is "toothed," or structurally engaged, with the south walls of the McCallum House. Our probe revealed no evidence of any such "toothing," or structural bonding, of the party wall with the south wall of the William Johnson House (60-S, 62-S, & 63-S). Thus, on the south elevation, it appears that the south wall of the William Johnson House was just built up against the west wall of the McCallum House. In addition, there is exterior

and interior evidence to suggest that these conditions also exist on the north wall of the McCallum House/William Johnson House complex.

There was some noticeable separation of the north wall of the William Johnson House from the west wall of the McCallum House (i.e., the party wall). There was also some separation of the south wall of the William Johnson House from the west wall of the McCallum House. This separation appears to be most severe at the top half of these north and south elevation walls (45-S, 46-S, 47-S, & 48-S). The separation is at least two inches in width on the north elevation and is nearly that much on the south elevation. We do not know whether the movement that caused this separation is still active.

Stability and Safety of Floors, Ceilings, Roof, Beams, and Connections. Most of the timber joists and rafters appeared to be in good condition. As noted in later sections of this report, most joists and rafters were overstressed and would deflect too much if they experience the minimum code-required live loads. This lack of live-load capacity is the major deficiency in these members.

For the sizes and spacing of members, see the drawings that accompany this report. The specific analysis of the floor and roof framing members is contained in Section 5.2.1. Live Load Capacity. One may also refer to the Structural Calculations that follow this report.

Our primary concern with the wood-floor framing is that it be adequately anchored into the bearing brick masonry walls. Such attachments often take the form of iron straps embedded into the masonry. Because of the high ambient moisture levels in the air much of the year, it would be advisable to use stainless steel anchors that could be attached to the joists and embedded in the brick walls. If this is systematically completed around the full perimeter of the building, there will be much more solid lateral connections between the walls and each of the floors. This should help to minimize the movement that has been observed between the walls and the floors.

Most of the interior joists were in good condition. Only those of the attic floor, which span in the north-south direction, had significant visible cracks. (This condition is discussed in more detail in a subsequent section of this report.)

The major areas where we observed rotted wood were underneath the two sections of the exterior wood walkways that span over those sections of the basement extending beyond the exterior walls of the building (42-S). These two "wells," which provide entry into the basement, appear to have been framed with relatively new wood. As such, they are suffering severely from exposure to the water, insects, and fungi that are prevalent in this portion of the United States.

The roof rafters were almost all in good condition, including their bearing ends at the eaves. These eaves were open to the outside; thus, water vapor was free to move through this location. There is, however, little evidence of damage to rafters from water

infiltration. What damage that has occurred appears to have halted since the new roof was put on the William Johnson House. In addition, we should note that the National Park Service added a number of structural members to the roof framing in the last five years. These members appear to help stiffen the roof; they do not, however, strengthen the roof sufficiently to bring it up to code requirements.

The stair that connects the second floor to the attic is wood-framed. It has several damaged wood treads and appears to have lost its plumbness and levelness. This is most likely related to the deflection of the second-floor joists that support this stair. When the structural repairs and restoration work are being designed, we recommend that a small probe be made to reveal the framing members under this stair. Measurements of these members will then permit an analysis of the stairs to determine their load capacity and the required repairs.

Besides the deterioration noted above, there is also some deterioration of the wood framing of the rear (south) porch (49-S, 54-S, & 59-S). This deterioration includes a missing wood column on the east end of the porch, some horizontal movement of the porch second-floor framing (away from the main south elevation brick wall), and several deteriorated wood balusters and handrails on the second-floor level.

Stability, Safety, and Condition of the Fireplaces. Structurally the fireplaces were basically stable. As most of the interior and exterior surfaces of the west wall were rebuilt or re-pointed with new mortar, there is very little evident deterioration of the brick walls themselves. Since it is the west wall that has several fireplaces in it, this would be the wall to have distress in it associated with the fireplaces. We see no such distress. We should note that the National Park Service has repaired sections of the north, south, and west walls of the William Johnson House during the last five years. These walls should be monitored by the National Park Service for any signs of deterioration.

Our only note of concern is that associated with the fireplace hearths themselves. As is often the case with structures from the nineteenth century, we noted that the fireplace hearths on the second floor are supported by wood headers and the wood floor joists. If any rotational movement of the headers occurs, it is possible that the brick of the hearth can move and fail to be properly supported by the wood. We recommend that when the house is undergoing its full interior structural repairs and restoration, a point be made by the architects and engineers undertaking this work to look closely at these hearths. We see no signs of severe distress in these locations at this time.

Location, Magnitude, and Extent of Cracking. There is very little cracking of the exterior brick masonry walls. The primary location of such cracks is on the south elevation, between the first-floor and second-floor windows. These cracks, some of which are diagonal cracks, appear to be associated entirely with the window sills and window heads in these locations (24-A). It is possible that these cracks developed over time as ways to distribute and relieve any temperature-induced stresses that may develop

in the walls. It is also possible that some of this cracking occurred as a result of a gradual deflection of the window heads. These cracks do not, however, appear to be active; they do look like they have been present for some time (it does not appear that extensive repairs were made recently to the exterior brick of the second-floor portion of the south elevation). It is our recommendation to re-point them with a relatively soft mortar (no stronger than a type "N"), thus allowing some future movement to occur. The National Park Service should monitor these cracks after they have been re-pointed.

The principal additional points of separation between bricks on the exterior of the building are the junctures between the north elevation and the McCallum House and the south elevation and the McCallum House. As noted above, these separations appear to be the result of a lack of tothing or connection between the various brick walls. This lack of brick bonding can allow the two buildings to move relative to each other. A similar lack of tying together of the wood joists and the walls that support them causes the brick walls of the building to move from their original positions.

The interior plaster walls are also cracked throughout the interior of the building. The most obvious cracks are those associated with the separation between the exterior bricks on the north and south elevations and the adjacent bricks of the McCallum House. There are also numerous other cracks in the plaster walls of the building. These cracks appear to have been caused by several things, including water damage from the elements, gradual deterioration of the plaster and its keying into the lath, and vandalism or improper interventions over the years. (See Photograph 61-S for an illustration of typical damage in the attic.)

Durability of the Building Materials. The brick of the four walls of the William Johnson House is in generally good condition. Normally it should be perfectly durable, and can be reused when any repairs are made. In a few locations (31-A & 50-S), there are spalls of the exterior of the brick. These spalls have exposed the interior heart of the bricks. Some of these spalls are associated with improper mortar re-pointing; others of these spalls are probably associated with a lower quality of brick.

The portion of the masonry walls that requires relatively frequent attention is the mortar between the bricks. Buildings from this era that are pointed with historically appropriate mortar often have mortars with a high lime content; they usually contain little or no hydraulic cement (such as Portland cement). Over time, this high-lime-content mortar tends to wash out with exposure to moisture.

With respect to the wood elements in the building, there was little rot evident during this investigation. It appears that much of the wood that was so damaged must have been removed during the earlier repairs completed by the National Park Service several years ago. The primary wood deterioration left in the building was associated with the walkway framing and the porch framing (discussed above). There was little evidence of insect infestation at this time. Prior to the start of any reconstruction, we recommend that the architects and engineers at work on those designs examine the wood members for any

signs of infestation. If such an infestation is discovered, it can be arrested by proper application of approved pesticides.

Soil Pressure and Ground Movement. While no test pit was excavated adjacent to the exterior walls of the William Johnson House, it should be noted that a test pit was completed on the immediately adjacent McCallum House. This test pit revealed that up to a depth of 3'-8" below the top of the first floor, no footing projection was observed, and no ground water was encountered.

At the Johnson House, we saw no evidence of footing projections. While we do not know the actual foundation widths, we can figure out what would be the worst-case scenario for soil-bearing pressures. In the William Johnson House, the north, west, and south walls of the building are twelve inches thick from the first-floor level on up and approximately sixteen inches thick from the first-floor level on down. From the first-floor elevation on up, we know that the east wall of the William Johnson House is twelve inches thick (this is the party wall shared with the McCallum House). We do not know what the thickness of this wall is below the level of the first floor.

Based upon the above information, the approximate soil-bearing pressures can be estimated to be the following (sixteen-inch width used for the north, south, and west walls; twelve-inch width used for the east wall) (see the Structural Calculations which follow this report for details of the calculation of these bearing pressures):

<u>Wall Location</u>	<u>Soil Pressure (psf)</u>	
	<u>Dead Load Only</u>	<u>Dead Load & Live Load</u>
North Wall	2700	3200
South Wall	2800	3500
West Wall	3600	4000
East Wall	4100	6200

If the footings are wider than the known widths of the walls, then these soil pressures will be decreased substantially. Much of the live load will be transient and will therefore not greatly influence settlement of the soil.

There was no observed evidence of settlement or ground movement in the structure. Any distress noted in the walls, such as the crack separation between the north and south walls of the William Johnson House and the party wall they share with the McCallum House, is due to a materials or anchorage failure, not to soil settlement. The test pit performed on the McCallum House showed that its walls appear to rest on a stratum of firm clay. This is likely to be the case with the William Johnson House as well.

The party wall that the two houses share appears to be stable. We are most concerned about the north and south elevation walls of the William Johnson House. The monitoring

of the existing cracks and the measurement of the position of the adjacent walls (described above) should help us to determine if movement of any of the walls is still active. Very likely, the repair of the building will require the placement of new anchorages between the floor joists and each of the bearing masonry walls. Such a series of connections between the floors and the walls would help restrain and brace the brick walls, and thus make it much less likely that the walls would continue to move.

Traffic Vibration. In general, we do not think that traffic vibrations have any significant effect on the structure.

Live-Load Capacity. As noted above, there are no first-floor joists in place. Some existing first-floor joists exist in National Park Service storage; their condition will need to be evaluated by the construction-phase design engineers when it comes time for restoration efforts at the William Johnson House. It is our understanding that there are not enough existing joists to rebuild the first floor fully; therefore new joists will be required to replace those removed during earlier investigations of the house. In all likelihood the existing joist pockets in the brick walls can be reused. To keep the stresses and deflections of the new joists within acceptable limits, it will also likely be necessary to use the north/south brick wall (that forms the boundary between the full basement and the crawlspace) as a line of support for these first-floor joists.

The second-floor joists are 2 3/4" by 12" at sixteen inches on center. They span in the east-west direction. Now, the joists span twenty-six feet from wall to wall. With this span and a minimum live load of 40 psf (building code minimum for residential occupancy), the joists would be overstressed and would deflect almost two inches. These conditions are not acceptable if occupancy and installation of architectural finishes are anticipated. This floor performs poorly in its present condition. It is likely that, during earlier occupancy of the building, this condition was mitigated by the presence of some sort of stiffening partition on the first floor. This stiffening partition, whether an actual wall or a series of posts and beams, would have helped transfer loads from the second floor down to the first floor and from there into the foundations. The existing posts below the second floor are shown in Photographs 33-A and 44-S.

Since there is therefore negligible live-load capacity for the second floor, we recommend that a stiffening partition or a series of beams and posts be constructed to support the second-floor joists. The options include:

1. Laminated Veneer Lumber (LVL): (4) 1 3/4"-by-16" beams.
2. Structural Steel: W6 by 16s.

Any of these options will require the installation of new columns, either 8"-by-8" timber or five-inch-diameter steel pipe columns. The beams below the second-floor joists, whether the LVLs or the W6s, would run north-south through the building and could probably be supported, via their columns, by the brick wall in the basement/crawlspace.

Once this reinforcement is added to the underside of the second-floor joists, the second floor will have ample live-load capacity to serve as exhibition and display space. The attic-floor joists are 3" by 8" at twenty-four inches on center. They span approximately twenty feet from the exterior bearing walls to the east-west running stiffening partition on the second floor that is underneath these joists. With a code minimum live load of 40 psf these joists are overstressed and deflect in excess of two inches. These joists therefore perform poorly both structurally and architecturally (especially if it is desired to add plaster finishes to the ceiling under these joists).

Two options regarding the attic floor exist. The first would require that no regular use be made of the attic. If absolutely no occupancy or use of the attic were made, then it would not be necessary to reinforce the attic-floor joists. If any use of the attic floor is anticipated or needed, then it would be necessary to place additional structural elements in the floor (parallel to the existing floor joists). For control of the stresses in the attic-floor joists, it would be necessary to add a new 3"-by-8" joist to each of the existing joists. To control deflection it would be necessary to introduce at least two new 3"-by-8" joists next to each of the existing joists. Evidence of the degree to which the attic-floor joists are overstressed can be seen in the several sections of joists that are split (57-S). Exact details of the repair scheme should be worked out during a subsequent contract for construction documents because it may be desirable to incorporate some reinforcement of these joists, with the reinforcement of the roof (see below).

The roof rafters are 2 3/4" by 5" at twenty-four inches on center. They span approximately twenty feet (in horizontal plan dimensions) from ridge to sill, or approximately thirteen feet (in horizontal plan dimensions) from ridge to the half-height attic walls. The roof rafters run in the north-south direction. The roof rafters are overstressed and deflect over one-and-one-half inches when the code minimum required live load of 20 psf is applied. When this load is applied to the roof, load is transferred to the half-height attic walls that are at the north and south ends of the attic. These walls in turn transfer their loads to the attic-floor joists that are already overstressed.

Because excessive deflection of the roof rafters can be deleterious to the longevity and effectiveness of the roof membrane, one option is to introduce new 3"-by-6" rafters between each of the existing roof rafters. Depending upon the extent of repairs to the second-floor ceilings and the attic floor itself, it may be desirable to introduce new connections between the existing and new structural elements of the repaired roof and the repaired attic floor. If these connections are designed and placed properly, it should be possible to help stiffen and strengthen the attic floor and the roof. These connections would include the placement of through bolts between each of the attic joists and the roof rafters and between the studs in the half-height attic walls (and the joists and the rafters that they frame into).

As an alternate to reinforcing the existing roof by placing new 3"-by-6" rafters adjacent to each roof rafter, it should be possible to reinforce the roof one other way. This

reinforcement would require the construction of a new wood-ridge beam below the existing ridge of the building. The present ridge beam does not support the loads from the roof; it does not transfer the rafter loads into the east-and-west bearing walls of the building. If a new ridge beam were installed, it would be possible to take some of the loads that now go into the knee walls and to the attic floor and transfer them to the east-and west-brick-bearing walls.

The new ridge beam could be created out of two 1 3/4"-by-7 1/4" LVLs. These LVLs would span, in the east-west direction, a maximum of approximately twelve feet between supports (with three lengths to make up the full twenty-six foot distance). They would therefore be delivered in relatively small lengths. On the east and west sides of the attic they could be supported by the existing east- and west-bearing walls. Near the center of the attic, we would propose that they be supported by two new wood posts (approximately 5-1/2" square). Each post would be placed so that it aligns with the east-west running second-floor wall that is beneath the attic floor (called a stiffening partition in other sections of this text). The framing underneath this second-floor partition could be reinforced when the other proposed framing underneath the second floor is installed (described above).

There may be several advantages to this second option in that there would be less intervention to the actual roof rafters (no potentially invasive and damaging sistering of rafters would be required). This would also permit the repair to be potentially reversible - if required or desired at some future date. This option, while still requiring the reinforcement of the attic-floor joists (described above), would put less load into the attic floor directly. This would reduce the expected dead and live deflection of the roof and the attic structure. This installation of new wood beams below the ridge would require the temporary removal of several of the wood cross-bracing elements that tie together the roof rafters; these could be re-installed as soon as the new ridge beams were installed.

The brick-bearing walls, which support each floor and the roof, are very lightly stressed, with the maximum load in the east wall (i.e., the party wall) being about 43 psi. All other walls of the William Johnson House are more lightly stressed.

General Discussion of the Extent of Deterioration. Throughout the text of this report, we have noted areas of deterioration. Specific areas of deterioration are associated with the areas of wood rot underneath the exterior walkway paths, the missing post underneath the south porch, the movement crack between the William Johnson House and the McCallum House, and the generally poor structural performance of the floor and roof framing members.

Less than 10% of the bearing brick masonry walls should require rebuilding. Between 10%-25% of the walls will require re-pointing of their exterior and interior surfaces. Because of the removal of most of the deteriorated wood during earlier work on the building, it should be necessary to replace less than 10% of the wood elements due to rot

or insect damage. The structural reinforcement of these wood elements, however, does require significant additions to the framing of the building.

6.3.7 Mechanical, Electrical, Plumbing, and Fire Protection

The Main House has no installed mechanical, plumbing, or fire protection systems. There is a new 150-amp distribution panel located in the cellar area below where the air floor has been removed. When reviewed, there was only one circuit breaker installed in the panel. All other spaces in the panel were empty. That circuit breaker served the alarm system for the Main House. The panel front was off and lying alongside the panel. The wiring for the alarm consisted of motion detectors, local control panel, alarm horn, and transmitter to the local police department. The alarm worked properly, giving a short delay after entry, sounding the local horn when the proper code was not entered, and the local police responded.

For protection of the interior, any items of furniture installed, and human comfort for the tours expected to be conducted, a new HVAC system will be required. The cooling system needs to address the varying loads the building will experience and periods of high humidity typical in the area in the summer season. Heating for the spaces with some minor humidification should provide satisfactory conditions in the winter season.

The current plans discussed indicate that plumbing will not be installed in this building but likely will be installed in the adjacent building along with the elevator.

The electrical panel and service installed are new and have space for most anything reasonable that might be installed for this building. When the interior restoration is done, proper access and clearance to the panel must be provided.



22-A Main House - Gap in wall injected with foam at southeast corner of second floor.



23-A Main House - Deteriorated mortar on east wall in attic.

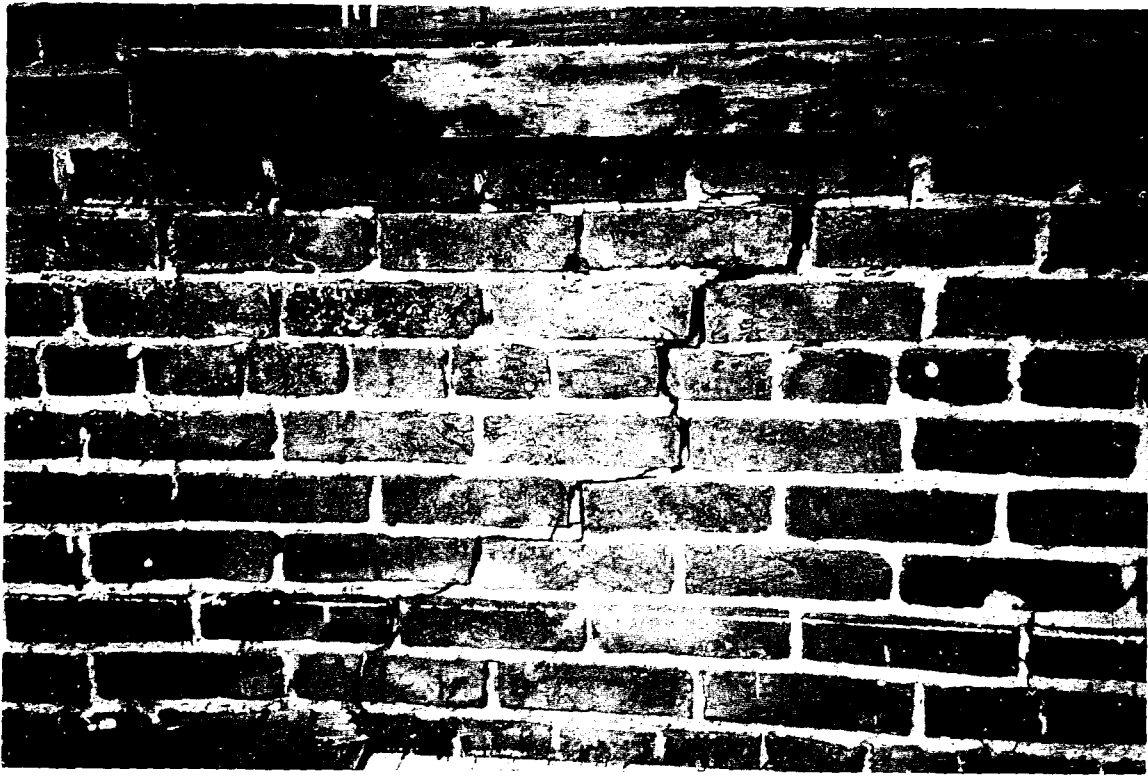

24-A Main House - Mortar cracks on south elevation.



25-A Main House - Gaps between porch floorboards, opened joints at column bases, and mildewed ceiling.

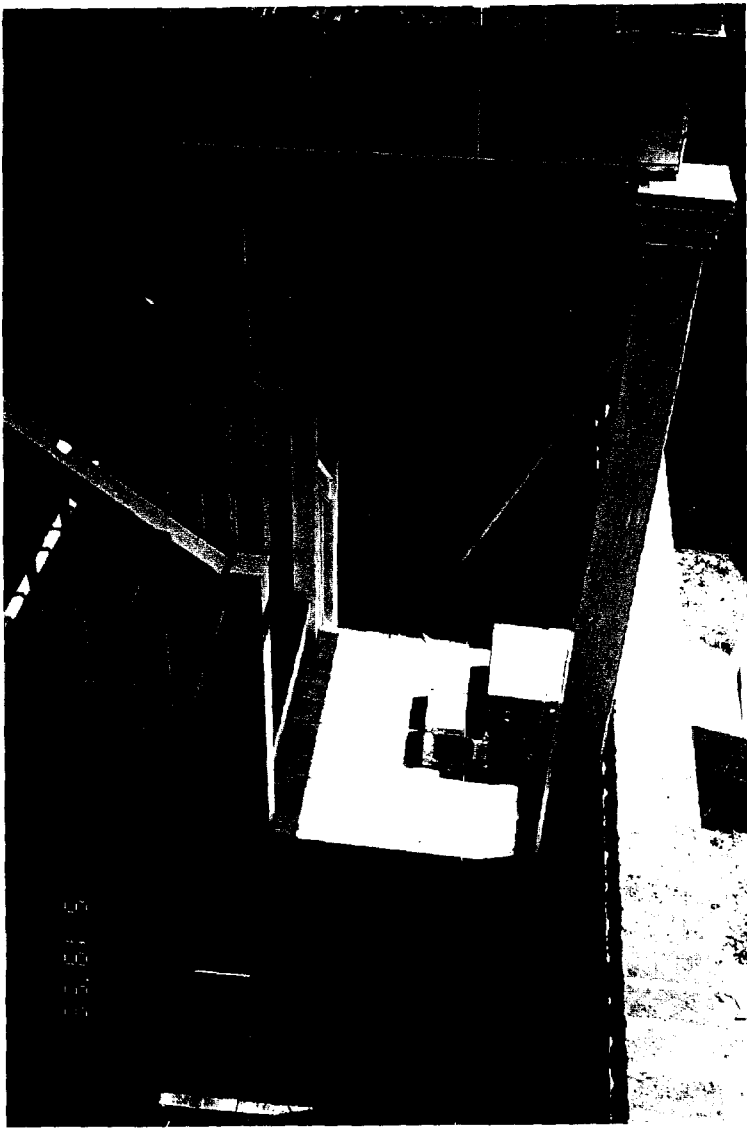

26-A Main House - Detached porch column.



27-A Main House -
Peeling
paint on
porch,
and rotted
balustrade.



28-A Main House - Peeling paint on north facade window frames.



29-A Main House - Gap between left window frame and wall on west elevation. Right window frame and sash unpainted.



30-A Main House - Second-floor window frames on south elevation need to be caulked and painted.

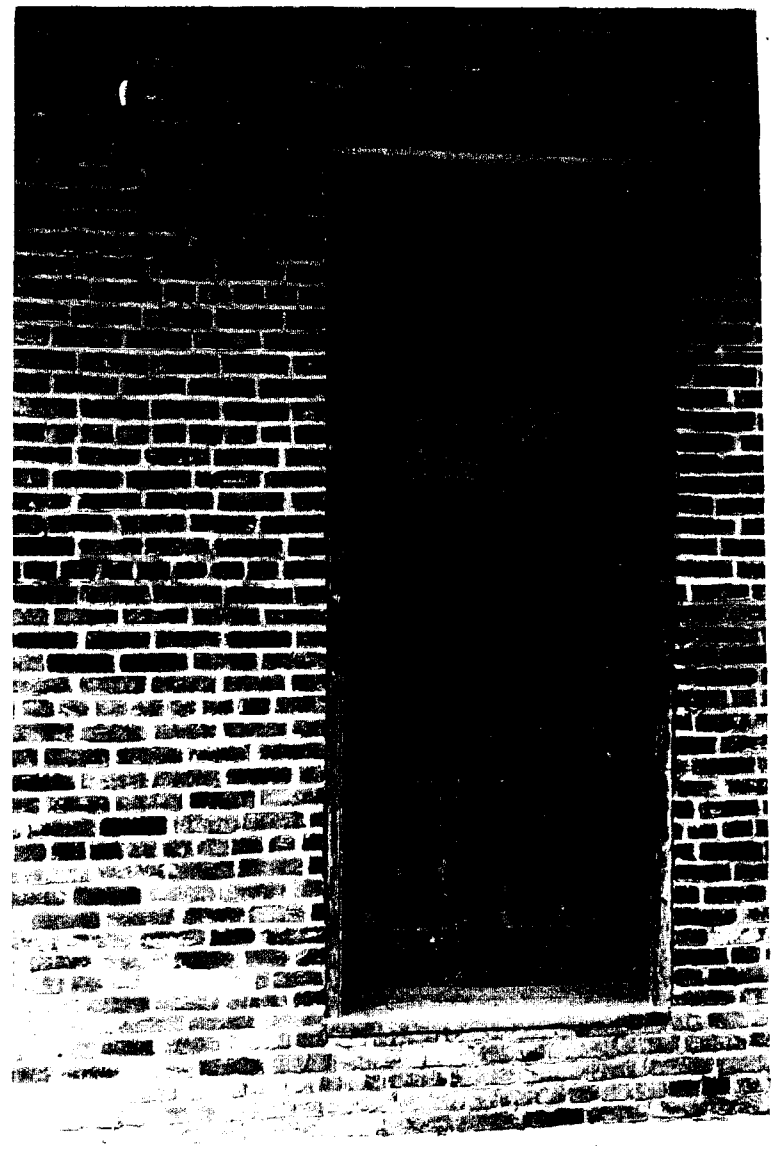

31-A Main House - Door and frame need to be caulked and painted.



32-A Main House - Missing floor joists and floor from first floor. Missing plaster from walls.

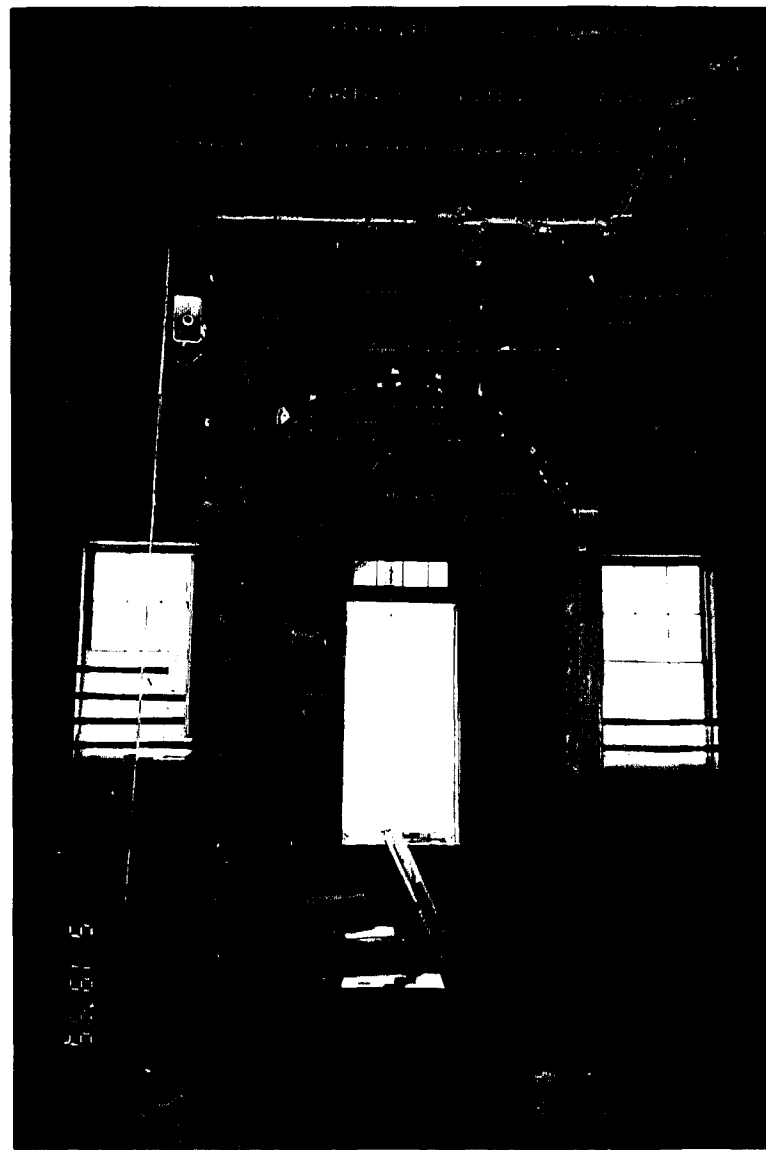

33-A Main House - Missing lath and plaster from ceiling of first floor. View of underside of second-floor framing and the top of the columns supporting the second-floor partition wall (above).

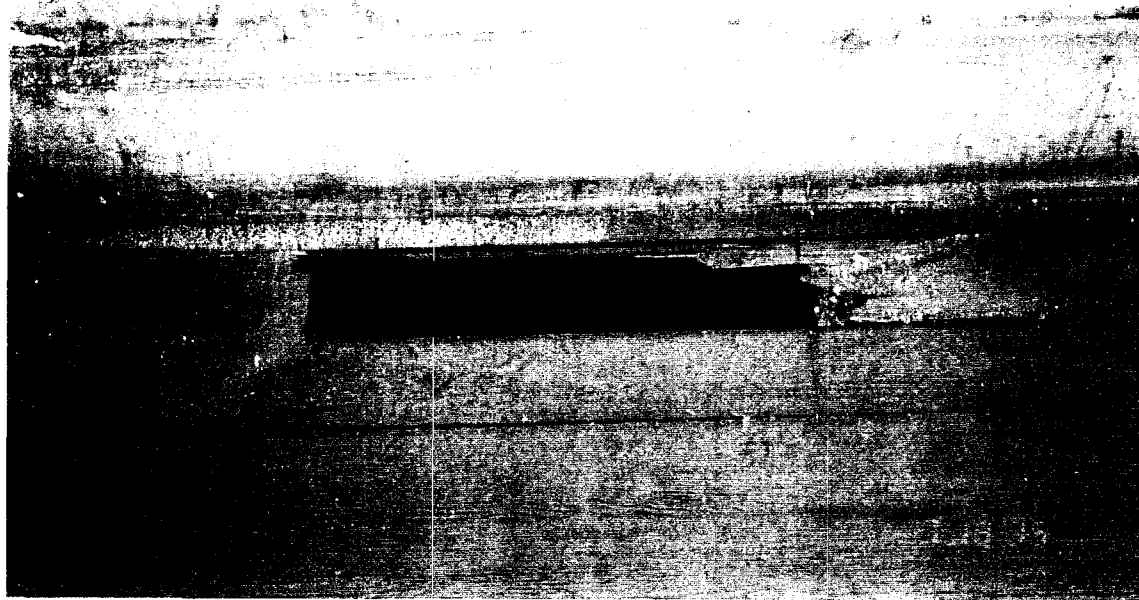

34-A Main House - Holes in second-floor flooring.



35-A Main House - Missing plaster from second-floor walls and ceiling.



36-A Main House - Peeling wallpaper on second floor.



37-A Main House - Baseboard pulling from east wall of second floor.

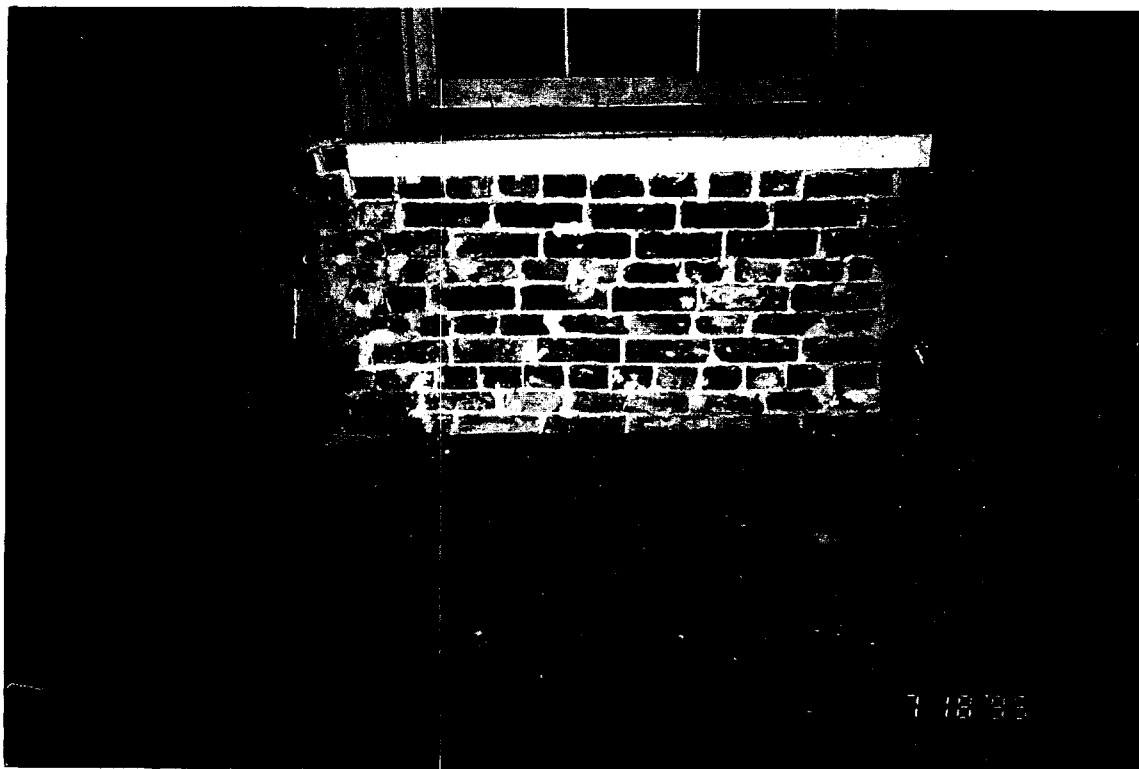

38-A Main House - Missing baseboard in northeast room of second floor.

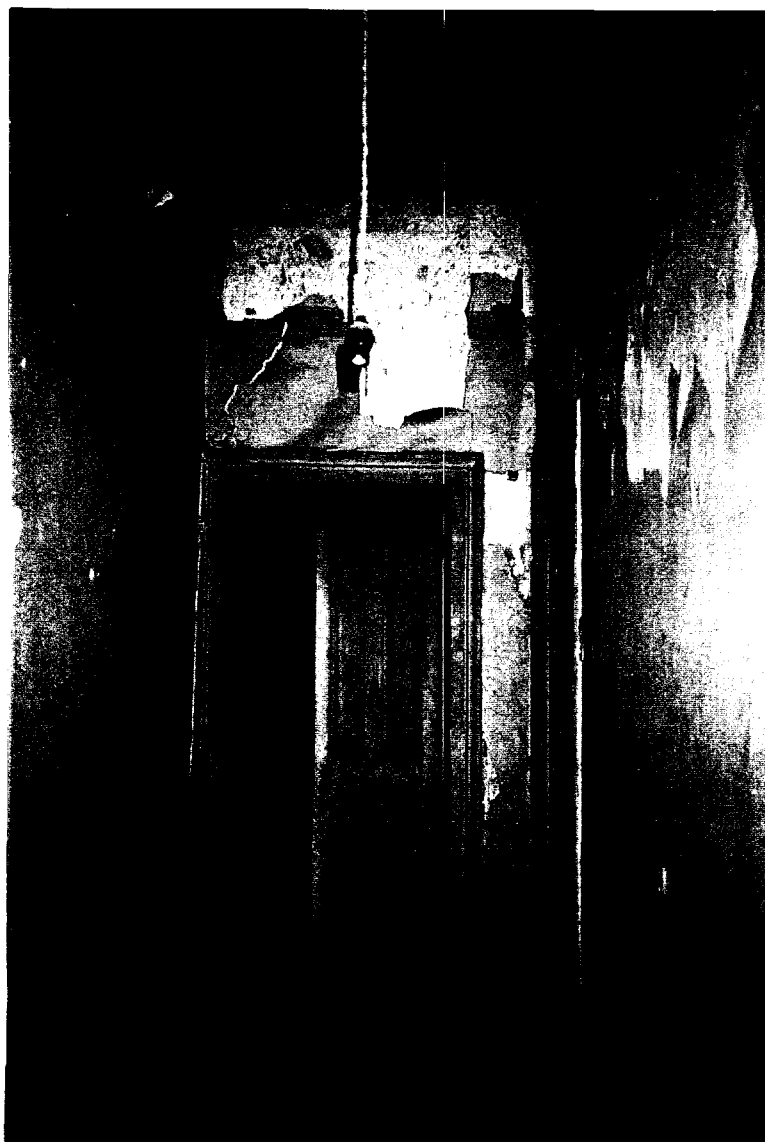

39-A Main House - Typical second-floor door with missing hardware. (ABA)

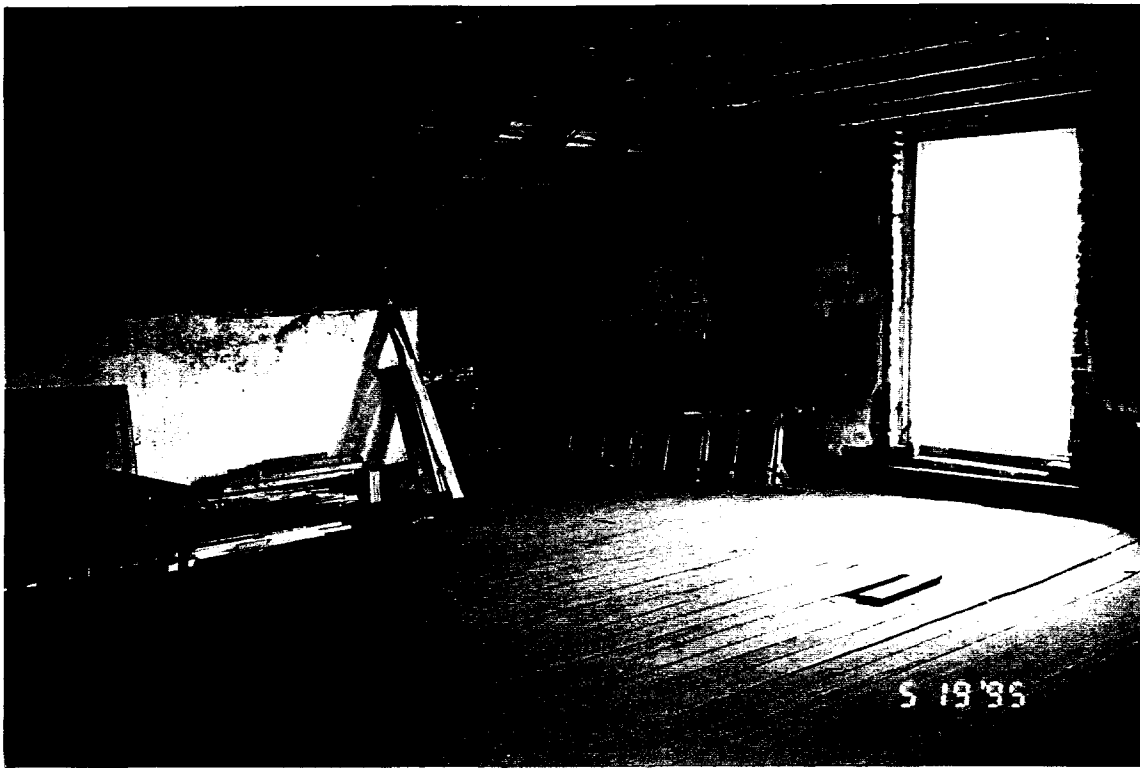

40-A Main House - Missing third-floor plaster.



41-A Main House - Third floor balustrade.



42-S Main House - View of rotted wood below south porch ground floor.



43-S Main House - View of northwest corner of basement.



44-S Main House - View of bottom of weather column supporting second-floor partition wall above.

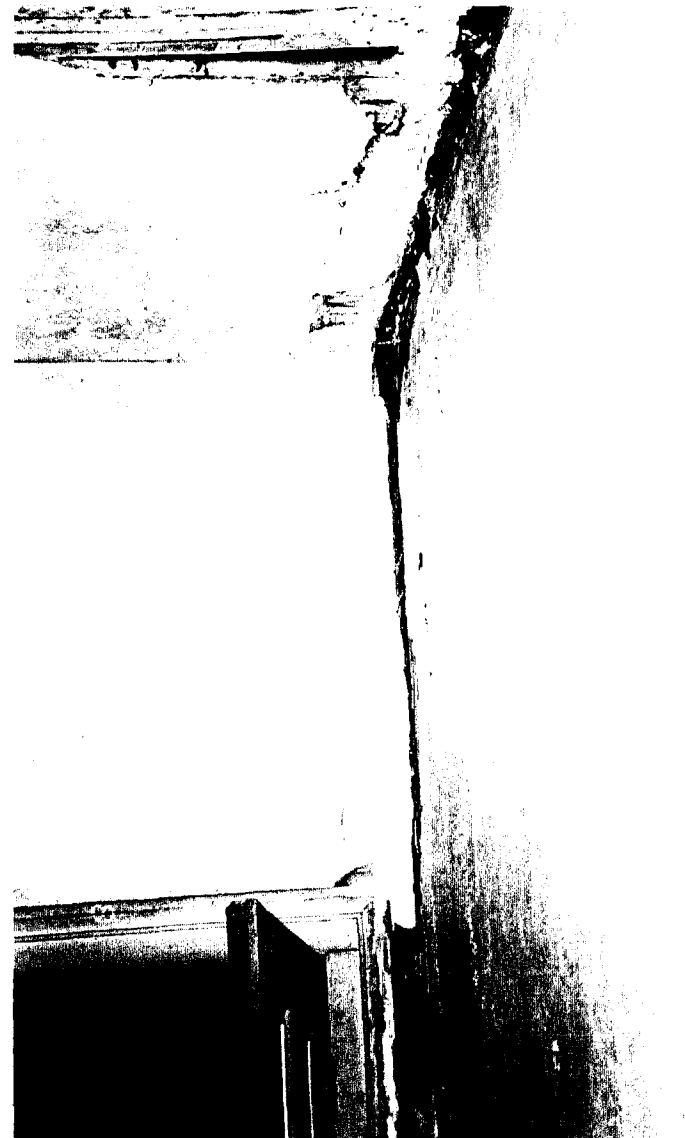

45-S Main House - Crack between second-floor east/west partitions and the "party" wall.

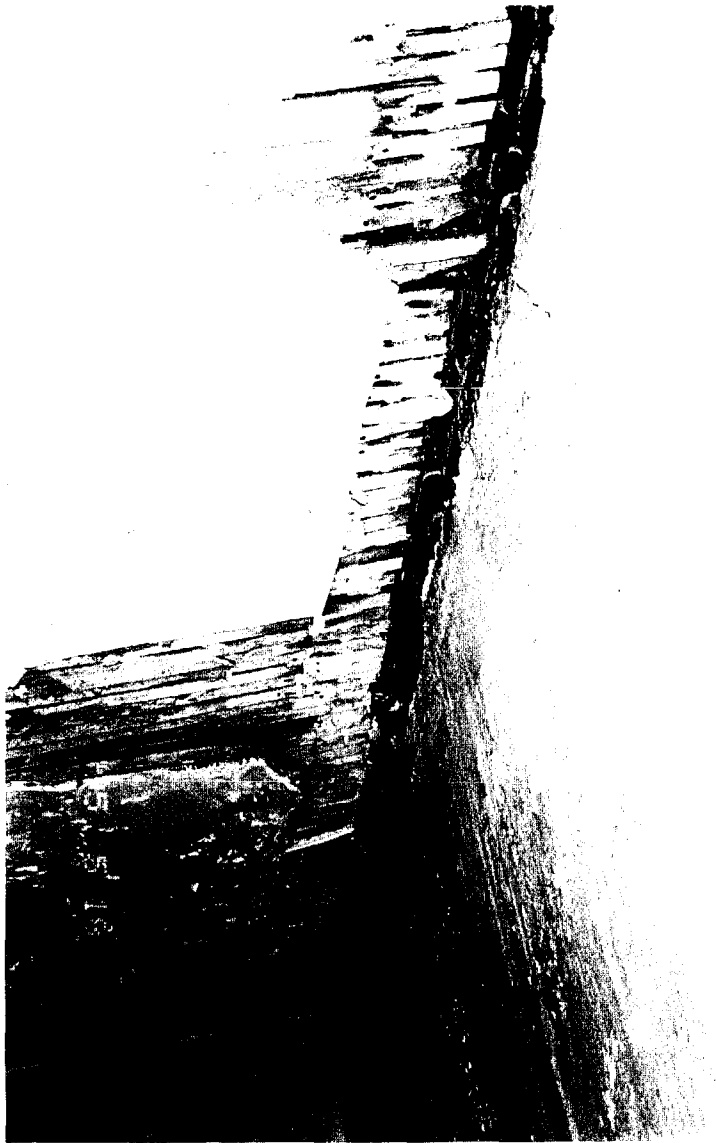

46-S Close-up view of photograph 45-S.



47-S Main House - View, looking south, of attic floor movement "away" from the "party" wall. Close up of right side of photograph 61-S.

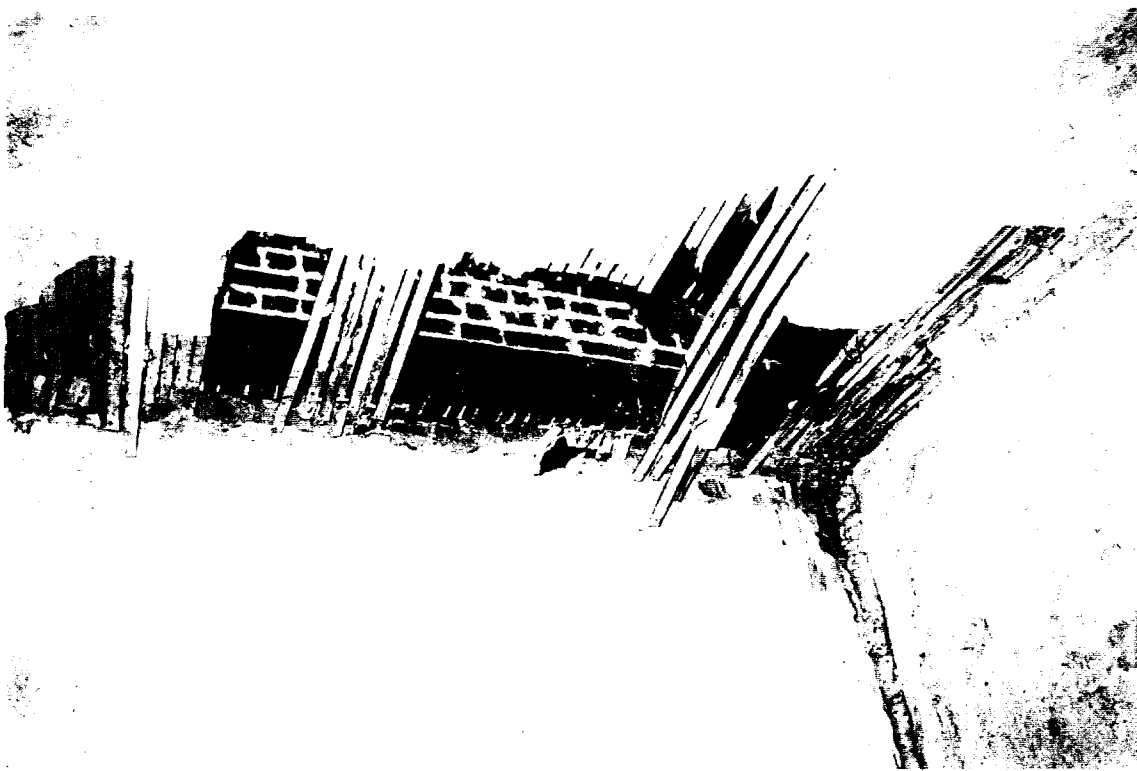

48-S Main House - View of underside of attic-floor framing.



49-S Main House - Porch floor on left side of photograph has moved away from the south wall of the building.



50-S Main House - Detail view of south wall showing spalled brick.



51-S Main House - View of north end of basement, showing diagonal bracing installed by National Park Service.

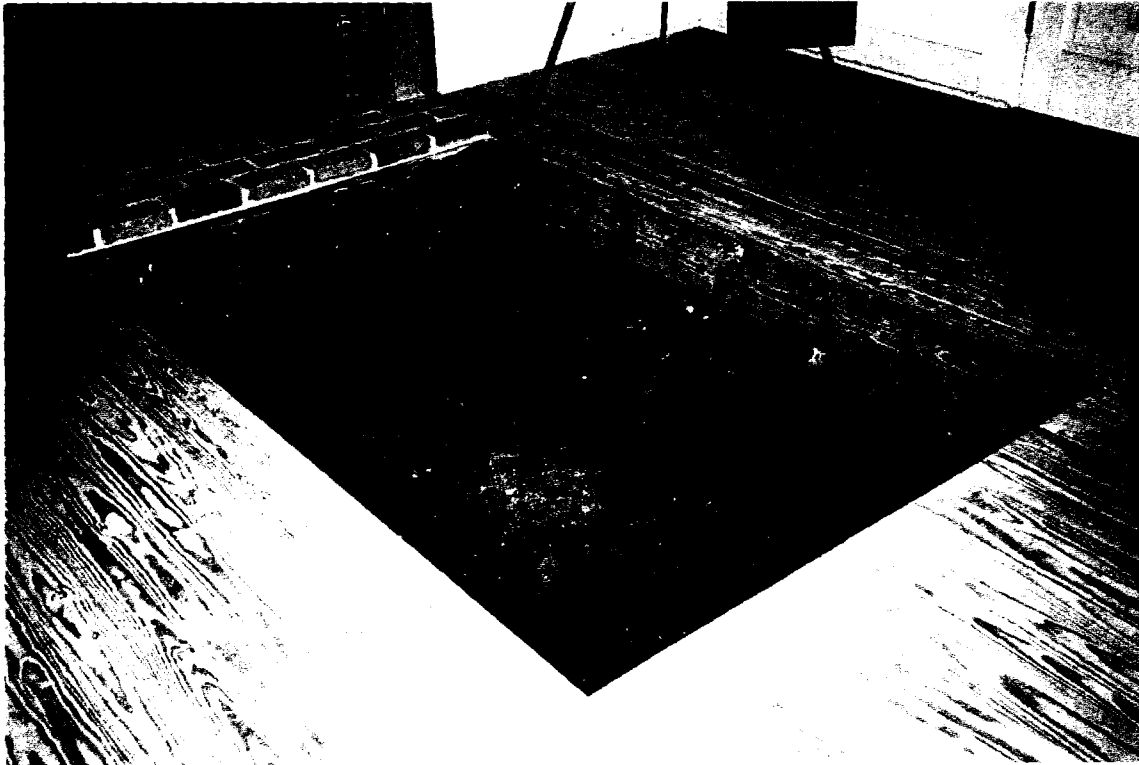

52-S Dependency - View of first-floor framing.



53-S Dependency - Area of spalling mortar on south elevation.



54-S Main House - South elevation of the William Johnson House and McCallum House. Note missing wood column on right side of porch.

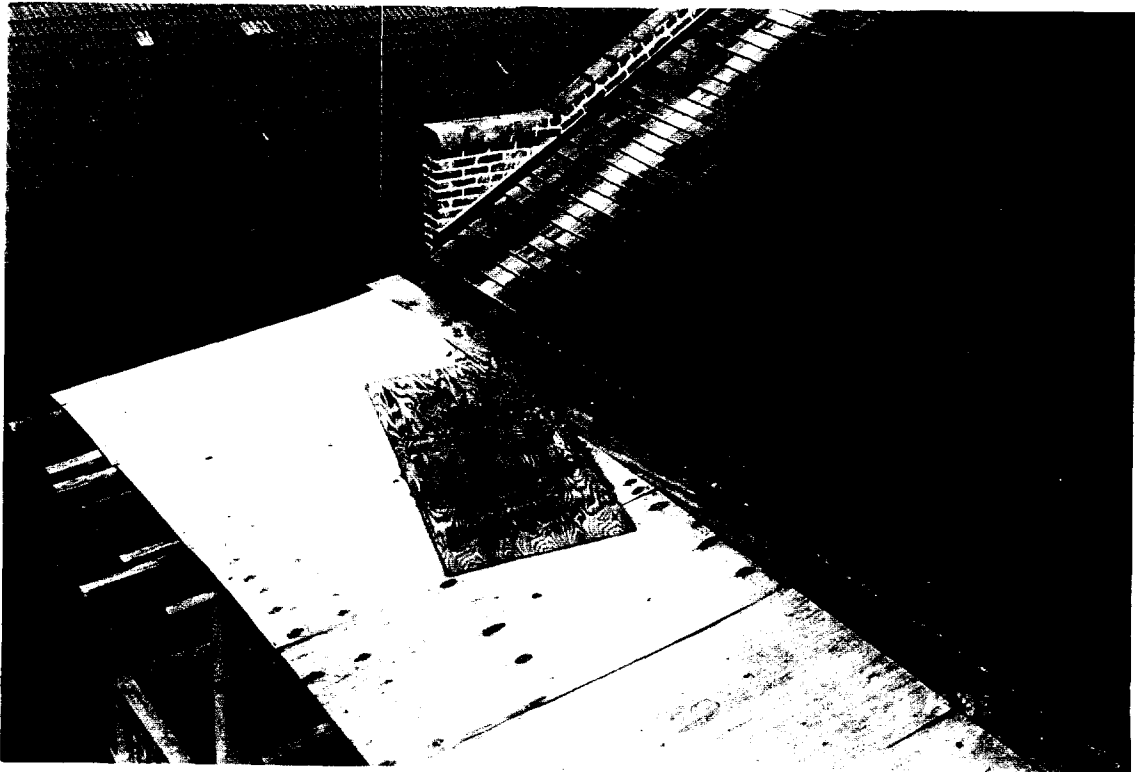

55-S Main House - View of the south porch roof.



56-S Main House - View of southern half of the coping of the "party" wall between the William Johnson House (top) and the McCallum House (bottom).

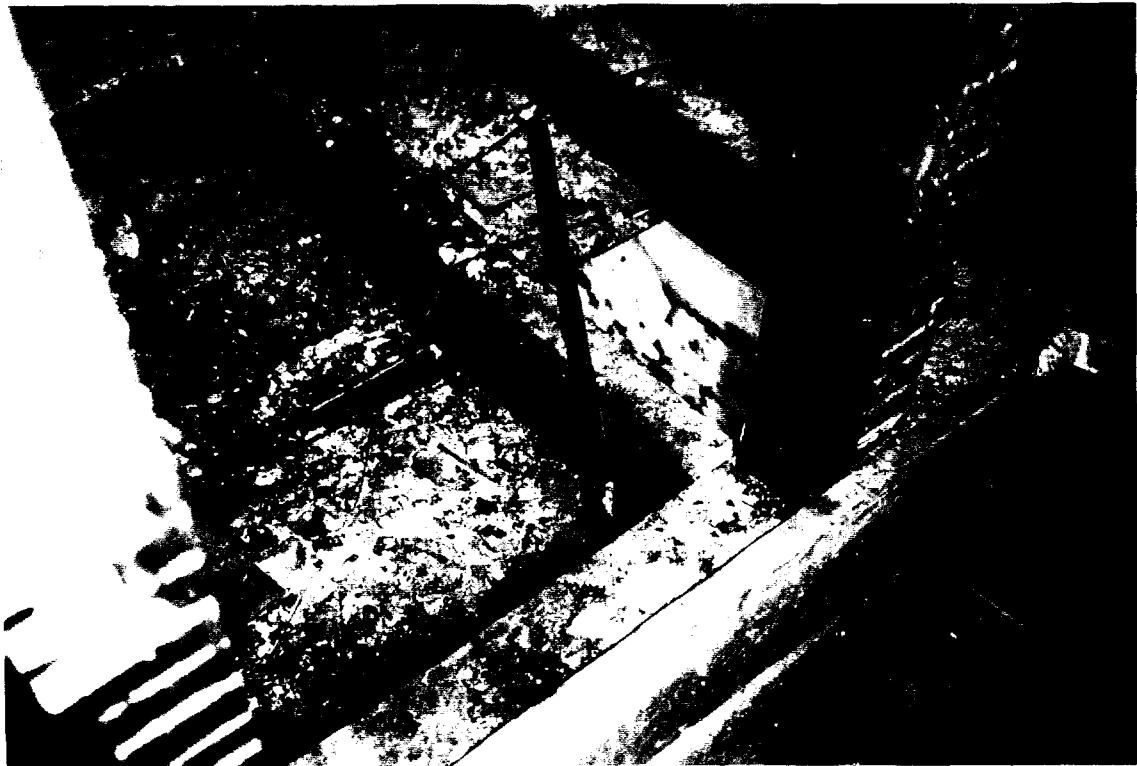

57-S Main House - View of cracked floor joist on south side of the attic.



58-S Dependency - View of the northern half of the roof of the dependency.



59-S Main House - View of the top of the south porch. Note missing wood column on the right side of the porch.



60-S Area of probe made into the south elevation of the McCallum House and William Johnson House.



61-S Main House - View of attic looking toward the "party" wall.



62-S Main House - View looking into probe in the south elevation.
(See photograph 60-S for general view).



63-S Main House - View looking west into probe in the south elevation.
South porch framing is at left.



6.4 Kitchen Dependency

6.4.1 Roofing and Gutters

Existing Conditions. The roof is recent and appears to be in excellent condition. There appears not to have been a roof over the porch when the Dependency was originally constructed. On the north facade, the galvanized gutter dips at both ends and there is only a downspout at the west end (19-A). There is a new galvanized gutter on the south elevation, but there are no downspouts.

6.4.2 Masonry

Existing Conditions. The existing masonry is in good condition. On the north facade, the pointing that was done on the second floor, under the west window, was not a good match. It appears as though Portland cement may have been used instead of a lime mixture (64-A). There is also some minor cracking occurring around the door and window lintels. This exterior wall was whitewashed at one time, and it is now fading. It is not certain when this was done, but it is the only wall with any signs of whitewash remaining.

There is some spalling occurring on the west wall, but this does not appear to be a problem. Several bricks on the lower portion of the south corner have been broken on the corner edge (65-A). This also does not appear to be a problem. Both the south and east walls appear to be in good condition. There is some minor soil erosion occurring at the east wall, leaving the waterproofing exposed.

6.4.3 Wood Trim and Porches

Existing Conditions. The porch is in poor condition. It was reconstructed using pressure-treated wood; it was not painted. Some of the posts have started to check and split. There is no railing on the second floor; 2"-by-4" guards have been installed at railing height (19-A). The temporary stairs installed by the Park Service are still in place.

The rest of the trim on the building appears to be in good condition.

6.4.4 Doors and Windows

Existing Conditions. On the north facade there are four four-panel doors, with transoms above and four six-over-six double-hung sash windows. The doors and windows appear solid, however there are some gaps between the masonry and wood frames, sills, and lintels that need to be caulked (66-A). The frames and lintels are bare wood and need some minor consolidation. The doors only have a primer coat of paint applied to them. The shutter hardware remains, but the shutters have been removed.

There are two windows on the west elevation, one on each floor, stacked above each other. The sash and sills have been replaced, as has the frame of the second-floor window. The frame on the first-floor window needs to be consolidated and painted.

The south elevation has two doors on the first floor and two windows on the second floor. The door opening to the west has been covered over with plywood. From the interior you can see that a new four-panel door has been installed. The opening to the east has a four-panel door which appears to be in good condition; the frame needs minor repairs and consolidation. Both window openings have been covered over with plywood, but new wood sills can be seen (67-A). From inside new sash and frames are visible. The lintel over the west window appears to be a replacement and its condition should be further examined. No signs of a problem were noted. The lintel over the east window is bare wood and appears to have had a piece of flashing added over the top.

6.4.5 Interior Finishes

Existing Conditions. The interior is in good condition. The walls are newly re-plastered and all need to be painted except the first floor, West Room 101 (68-A). The flooring has been replaced throughout.

The fireplace mantel in the West Room 101 of the first floor appears original. The right side has been repaired and the board is unpainted (69-A). All other mantels have been primed, but not painted. In the second-floor West Room 201, there is an approximate 1/4" gap between the fireplace mantel and the floor.

The baseboards, casings, and doors have all been primed and need to be painted in all rooms except the West Room 101 of the first floor.

6.4.6 Structural (Robert Silman Associates)

Introduction. No structural probes were made to reveal the size of the framing of the dependency wood framing. The spans involved were short enough, and there were no signs of deterioration or distress that warranted such an invasive removal of architectural fabric.

Stability and Condition of the Foundations & Walls. Most portions of the exterior were in satisfactory-to-good condition. We noticed that on the south elevation of the Dependency that there was fairly extensive loss of brick re-pointing mortar (especially on the eastern half of the first story of the elevation) (53-S, 21-A, 70-S, & 71-S). It is possible that some of this deterioration of the mortar was caused by water moving through the brick from the higher elevation of ground that is immediately to the east of the Dependency. There also was some very limited spalling of brick associated with this loss of mortar.

On the southwest corner of the building, within approximately one foot of the ground level, we noticed some green algal growth on the brick and some deterioration of the brick mortar. This damage is probably associated with rising damp. (See Photograph 72-S for an illustration of this damage.)

Stability and Condition of the Floors and the Roof. We observed no deterioration of the floors or of the roof of the Dependency.

6.4.7 Mechanical, Electrical, Plumbing, and Fire Protection

The Dependency has an HVAC system consisting of natural gas heater and air-cooled DX split system installed in the attic. Recently, the electrical service and lighting have been upgraded. There was not any plumbing or fire protection noted in the Dependency. The air-conditioning and heating systems in the Dependency are new and seem to be in proper working order.





64-A Dependency - Poor match of mortar on north facade.



65-A Dependency - Broken bricks on southwest corner.



66-A Dependency - Caulk gaps at window frames on north facade.



67-A Dependen
- Plywood
cover
door and
windows
on south
elevation.



68-A Dependency - Second-floor walls replastered, unpainted.



69-A Dependency - Original mantel repaired in west room of first floor.



70-S Dependency - Deterioration of brick and mortar on south elevation.



71-S Dependency - Close-up of deterioration of brick on the south elevation.



72-S Dependency - View of the rising damp damage to the brick and mortar at the southwest corner.



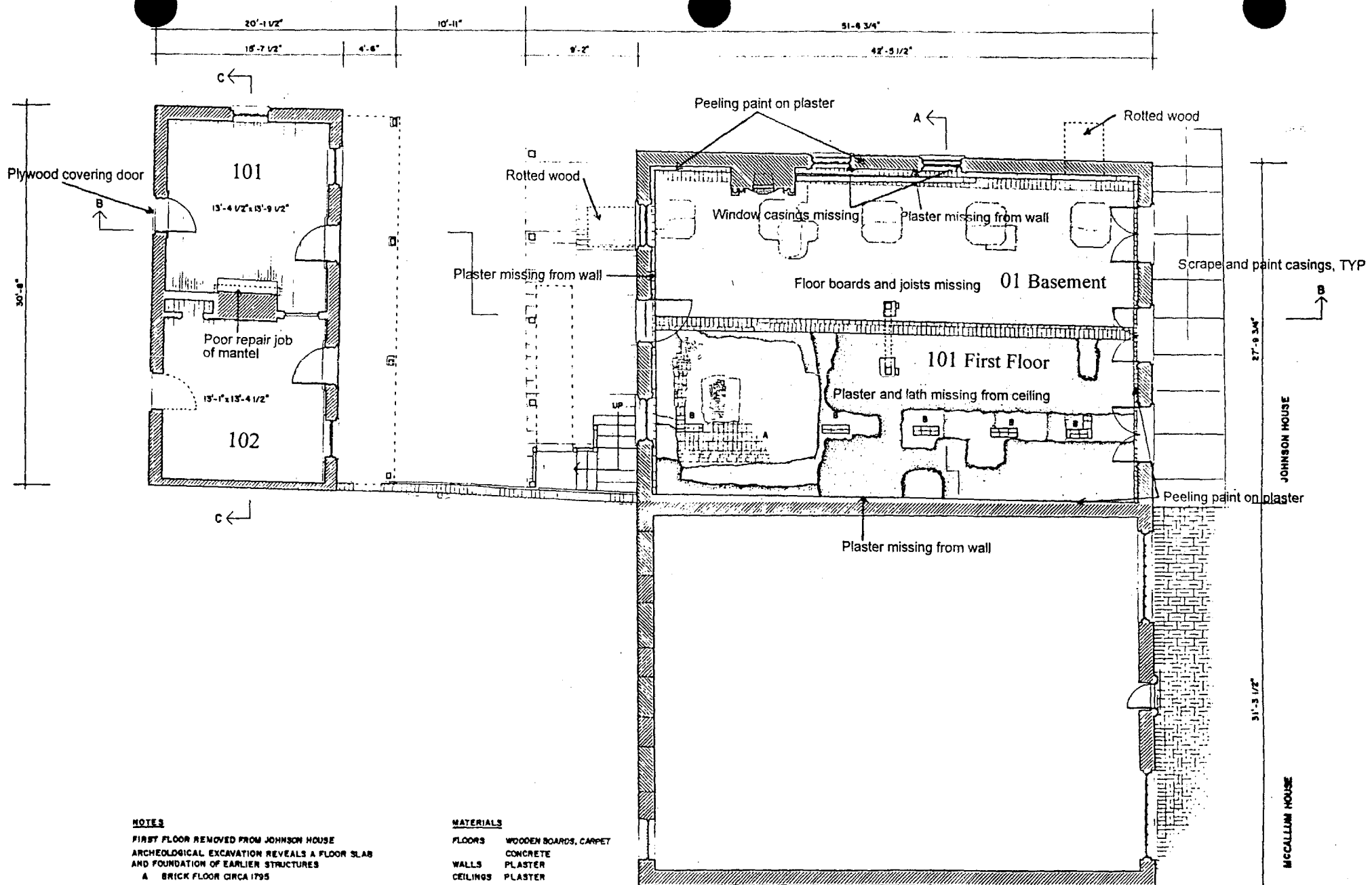

NOTES

FIRST FLOOR REMOVED FROM JOHNSON HOUSE
 ARCHEOLOGICAL EXCAVATION REVEALS A FLOOR SLAB
 AND FOUNDATION OF EARLIER STRUCTURES
 A BRICK FLOOR CIRCA 1795
 B BRICK FOUNDATION CIRCA 1820

MID TWENTIETH-CENTURY PARTIONS IN McCALLUM HOUSE
 BEING DEMOLISHED AT TIME OF DOCUMENTATION

MATERIALS

FLOORS WOODEN BOARDS, CARPET
 CONCRETE
 WALLS PLASTER
 CEILINGS PLASTER

FIRST FLOOR PLAN

Existing Conditions

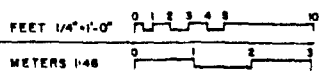

HABS drawings 1992
 Prepared by National Park Service

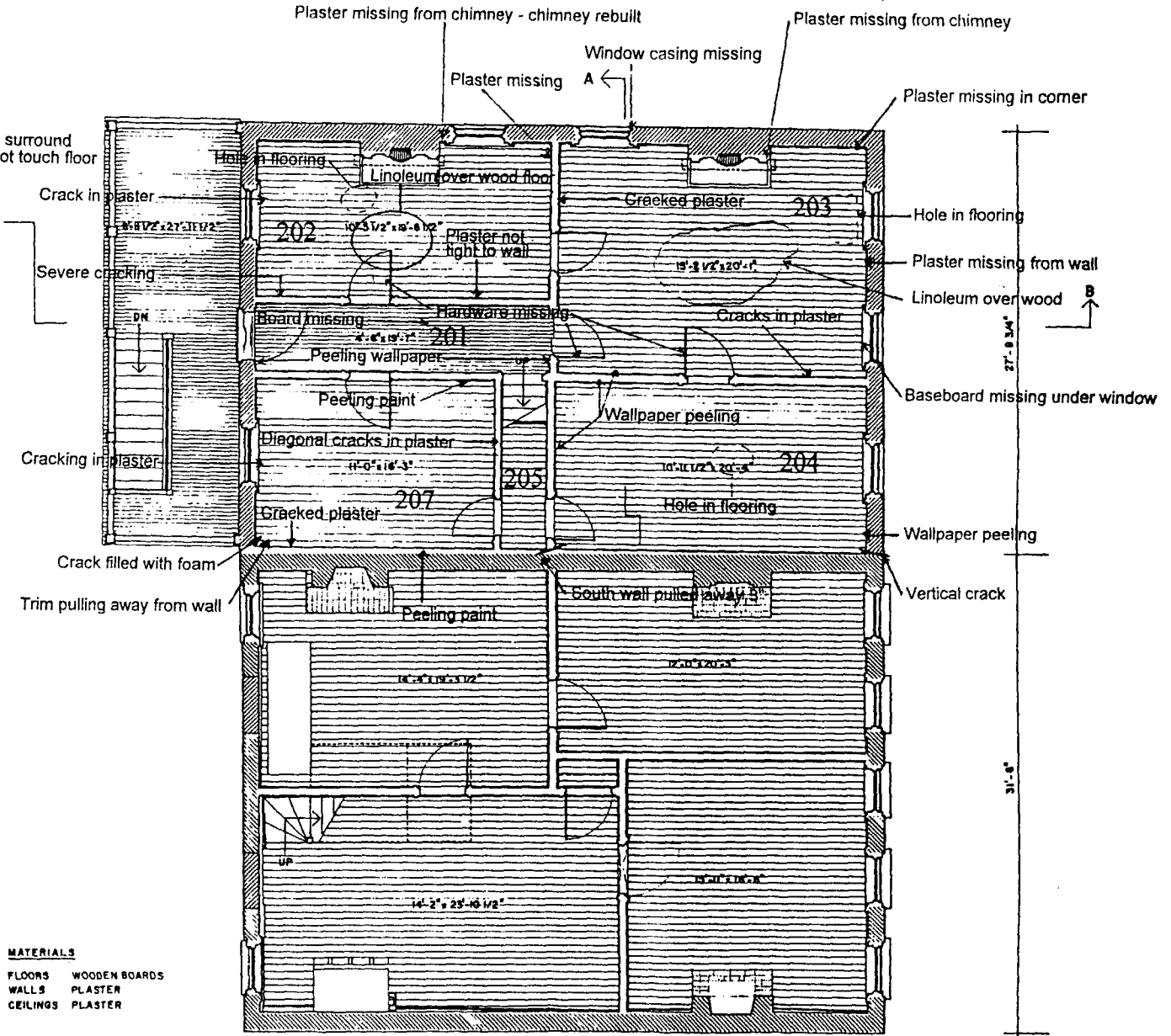
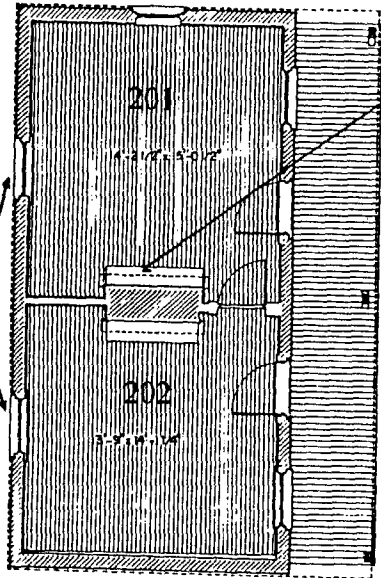
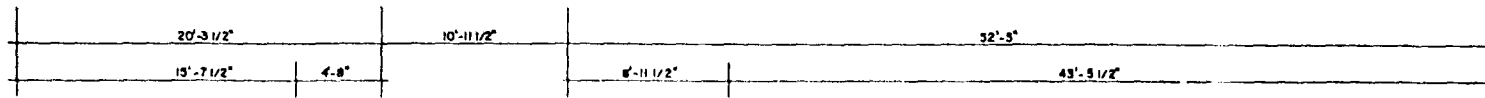

- MATERIALS**
- | | |
|----------|---------------|
| FLOORS | WOODEN BOARDS |
| WALLS | PLASTER |
| CEILINGS | PLASTER |

SECOND FLOOR PLAN

Living Conditions

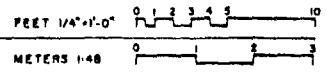

HABS drawings 1992
Prepared by National Park Service

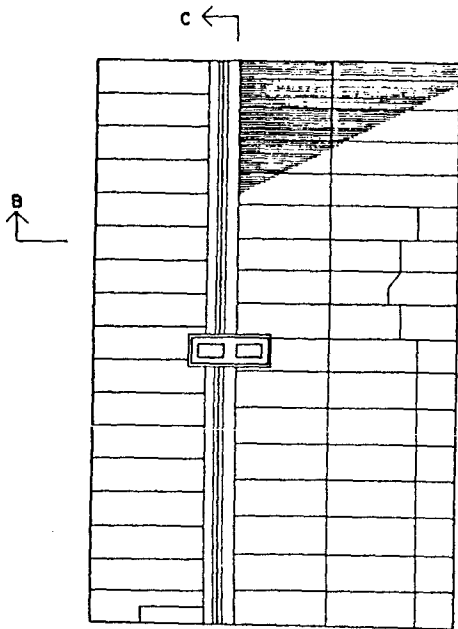

ROOF PLAN

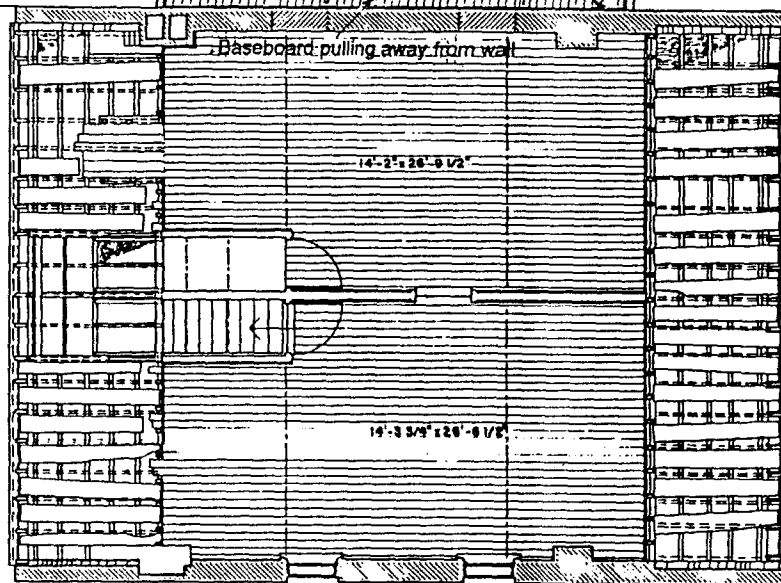
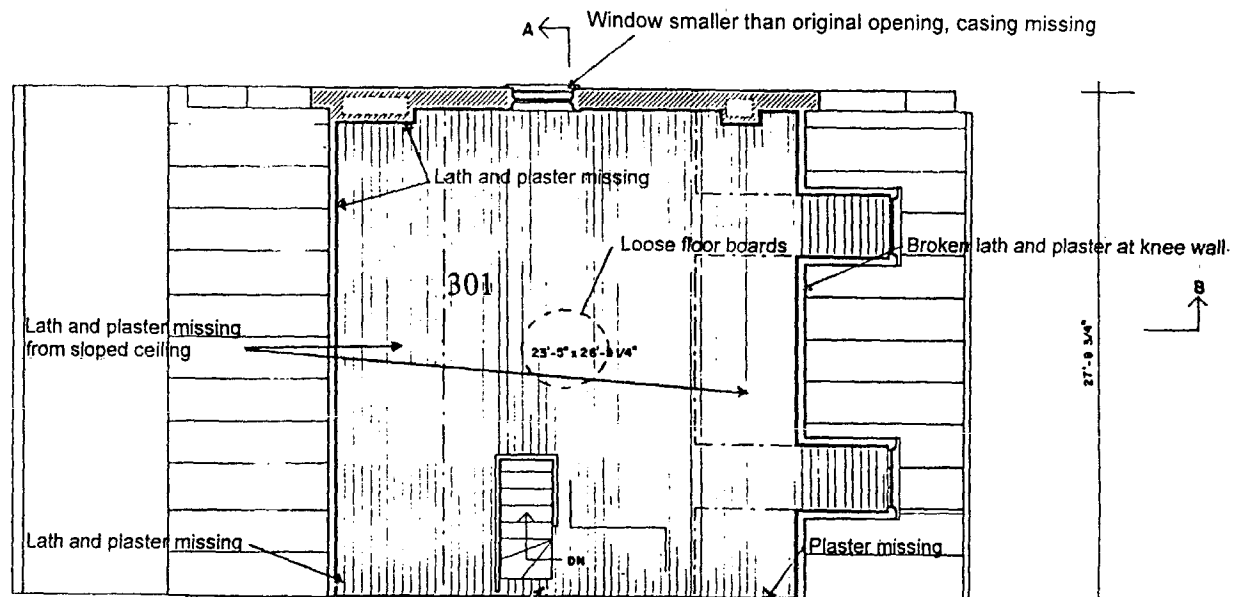

- MATERIALS**
- | | |
|----------|---------------|
| FLOORS | WOODEN BOARDS |
| WALLS | PLASTER |
| CEILINGS | PLASTER |

ATTIC FLOOR PLAN
Existing Conditions

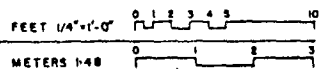





7.0 Previous Preservation Treatments



7.0 PREVIOUS PRESERVATION TREATMENTS

7.1 Completion Report

The following is a summary of known treatments to date. Most information was obtained from the 1992 HABS Report by Dena Sanford and NPS maintenance files in Natchez.

DATE	INTENT OF WORK	COST	CONTRACTOR
1840-1841	<i>Main House constructed.</i>		<i>Carpenters-George Weldon and George Tucker; Mason-James Fox; Plasterers-Mr. Barbee, George Evans, and James Brown</i>
1844	<i>Roof built over second floor of porch.</i>	\$25.00	<i>St. Clair, assisted by Mr. Shaw.</i>
1865-1880	<i>Roof framing for second-floor porch of Main House changed.</i>		
1873	<i>Sawn balusters replace original blusters on second floor of porch.</i>		<i>John S. Kouny sawed the balusters.</i>
1897	<i>Dependency constructed.</i>		
1897-1906	<i>West elevation of Main House stuccoed.</i>		
1910	<i>Roof added to second floor of Dependency porch.</i>		
1910-1925	<i>Addition of second-floor porch to north facade of Main House. All wood-shingled roofs replaced with metal. An elevated walkway was built to connect second-story galleries of the Main House and Dependency.</i>		

1920s	<i>Entire first-floor and second-floor hall flooring replaced.</i>		
1924-1930	<i>North facade stuccoed.</i>		
1950	<i>Second-floor porch balusters replaced, original stairs removed, and floorboards replaced.</i>		
1978-1979	<i>East wall of Dependency reconstructed.</i>		<i>Contractor-Dix Fowler; Mason-Duncan Morgan</i>
1979	<i>New metal-seam roof and gutters installed on Main House.</i>		<i>Contractor-Dix Fowler</i>
1979-1981	<i>Porch on south side of house restored. Board-and-batten ceiling on first floor of porch discovered and restored.</i>		<i>Architects-Koch and Wilson of New Orleans</i>
1981	<i>Stucco removed from north facade. First-floor joists and floorboards removed.</i>		
1982	<i>Center window on second floor of north facade restored.</i>		
1987	<i>Dependency gallery rebuilt.</i>		
1991	<i>Metal roof on Main House patched. Porch balustrade and handrail restored. North elevation and first floor of south elevation tuck pointed.</i>		<i>Contractor-NPS Crew</i>
1991	<i>In the Main House: repaired exposed interior masonry in the half-basement, repaired deteriorated window frames and sash, repaired deteriorated rear porch balustrade and handrail, temporarily patched roof leaks.</i>	\$22,900	<i>Contractor-NPS Crew</i>
1991-1994	<i>Waterproofed east foundation wall of Dependency.</i>		

1992	<p><i>Replaced vertical board fence and gate along State Street and west property line. Pressure-treated-wood walk added from State Street gate to Dependency.</i></p> <p><i>Cedar shingle roof, new flashing, gutters, and downspouts installed on Dependency.</i></p>		Contractor-NPS Crew
1992	<p><i>Repaired/replaced two deteriorated second-level floor joists, replaced all first-floor joists with pressure treated pine, installed new tongue-and-groove pine flooring, re-pointed joist pockets, removed dirt to six inches below joists and installed vapor barrier in crawlspace, removed loose wall plaster, built temporary stairs and guard rails at second-story porch, replace second-story-porch posts with pressure treated 4"-by-4" posts, removed metal roof and made repairs to ceiling joists and roof rafters, temporarily replaced sheathing and cover with rolled roofing and batten strips on Dependency.</i></p>	\$17,212	Contractor-NPS Crew
1993	<p><i>HVAC added in Dependency.</i></p>		
1993	<p><i>On Main House removed stucco from west wall and re-pointed, rebuilt coping at top of west parapet wall, completely rebuilt chimney on west elevation, repaired jambs and headers of five west windows, repaired south basement opening, installed bracing at north wall of basement, and re-pointed all basement walls.</i></p> <p><i>On Dependency, repaired all joist pockets, removed plaster from Room 101, installed electrical conduit chase for all rooms, removed any unstable</i></p>	\$156,318	Contractor-NPS Crew

plaster, re-pointed all interior walls to stabilize, plastered all rooms and ceilings, relayed fireboxes on three chimneys and sealed throats and cap, selectively re-pointed south elevation, and repaired retaining wall at rear of Dependency.

- | | | | |
|------|---|----------|----------------------------|
| 1993 | <i>On Dependency replaced fascia at south elevation and hung gutter and downspout, replaced two door headers and rebuilt one door and repaired one door on south elevation, repaired four north doors, rebuilt two interior doors, repaired eight windows and rebuilt two windows, repaired/replaced interior trim, provided access hole to attic, constructed platform in attic for HVAC and cut openings for supply and return air, replaced attic-ceiling joists as needed, constructed closet at second floor to accommodate HVAC, removed, repaired, and reinstalled four mantles.</i> | \$29,059 | <i>Contractor-NPS Crew</i> |
| 1994 | <i>Cedar shingle roof, new flashing, gutters, and downspouts installed on Main House. Portions of parapet walls re-pointed.</i> | | |

7.2 Technical Data

Copies of the National Park Service's Task Directives for Preservation Maintenance and Stabilization of Historic Structures can be found in Appendix 9.7.



8.0 Treatment and Proposed Use



8.0 TREATMENT AND PROPOSED USE

8.1 Ultimate Use

According to the *Natchez National Historical Park General Management Plan/Development Concept Plan/Environmental Impact Statement*, the Johnson House is to serve as a center for interpreting the African American history of Natchez.²⁵⁰ On December 14, 1995, a meeting of Park Service staff and HSR consultants was held in Natchez to determine the Period of Significance for the Johnson site. It was agreed that the site should be interpreted to 1840-1866, to reflect William Johnson's occupation of the house from 1840 until the time of his death in 1851, and that of his wife, Ann, who continued to live in the house until her death in 1866. This enables exhibits to tell the full story of the Johnson family--and the free black community in Natchez--through the Civil War and the start of Reconstruction.

The proposed treatment is consistent with the conclusions of this Historic Structure Report. There is sufficient physical, photographic, and written documentation to enable the upper floors of the Johnson House to be restored to their appearance ca. 1866 with a reasonable degree of accuracy. The first floor has been more significantly altered, but our recommendation is generally to restore it to its ca. 1866 appearance as a single large room, which will readily permit use as an exhibit space.

The current Kitchen Dependency was constructed in 1897, and its Period of Significance was established as that year. The first floor of the Kitchen Dependency is proposed for use as exhibit space, with the second floor used for office space.²⁵¹ The adjacent McCallum House would also be used for office space on the upper level and visitor services on the ground floor.

8.2 Code Analysis and Regulations

The National Historic Preservation Act of 1966 established the Section 106 Review, which requires that "every Federal agency 'take into account' how each of its undertakings could affect historic properties."²⁵² The Mississippi Antiquities Act empowers the Mississippi Department of Archives and History to review all work proposed on buildings of historic significance within the State of Mississippi. Any work proposed for the Johnson House or Dependency would be subject to review because it is listed on the National Register, and to make sure the work is consistent with the *Secretary of the Interior's Standards for Rehabilitation*.

²⁵⁰ Department of the Interior, National Park Service, *Natchez National Historical Park General Management Plan/Development Concept Plan/Environmental Impact Statement*, Denver Service Center ([Denver, CO], January 1994), 52.

²⁵¹ Ibid.

²⁵² Advisory Council on Historic Preservation, *A Five-Minute Look at Section 106 Review* (Washington, DC, 1986).

A brief review of code and functional requirements was made based on the uses recommended in Alternative #2 of the General Management Plan. These recommendations included use of the first and second floors of the Main House and the first floor of the Dependency as exhibit space, and the second floor of the Dependency as office space.²⁵³ A more detailed assessment will need to be made once the actual plans for use are determined. The City of Natchez has adopted the 1994 Standard Building Code. That is the code used for this review, along with the NFPA 101 Life Safety Code and Americans with Disabilities Act (ADA).

Reviewing the attendance records for the past twelve months, it appears that there are never more than 100 people visiting the site at one time. It is assumed that overall visitation will increase substantially when the House is restored fully, but for reasons of security, limited space, and impact on the historic fabric, visitation to the upper levels of the House will be restricted to small groups and a guide will always be present. Because of this, the House and Dependency could both be classified as "Business Occupancy." Both buildings fall under the provisions of 3401.5 Special Historic Buildings (SBC) because they are listed on the National Register. Section 3401.5 states:

"The provisions of the technical codes relating to the construction, alteration, repair, enlargement, restoration, relocation or moving of buildings or structures shall not be mandatory for existing buildings or structures identified and classified by the state or local jurisdiction as historic buildings when such buildings or structures are judged by the building official to be safe and in the public interest of health, safety and welfare regarding any proposed constructions, alteration, repair, enlargement, restoration, relocation or moving of buildings within fire districts."²⁵⁴

The extent of noncompliance allowed will depend on the judgment of the governing official. At a minimum the following requirements will have to be considered:

Means of Egress: The Main House currently meets egress requirements for the first floor with two exits. Only one exit exists from the second floor. This building, classified as a business occupancy because its occupancy load is less than 100 people, meets all of the requirements for only needing one exit. The third floor has only one set of stairs, but a second means of egress could be provided via the adjacent McCallum House (which would, in turn, provide an alternate egress for the McCallum House).

The Dependency meets egress requirements on both floors. The first-floor rooms each have doors leading to the outside, and both second-floor rooms have doors leading to the porch.

²⁵³ *General Management Plan*, 52.

²⁵⁴ *1994 Standard Building Code* (Birmingham: Southern Building Code Congress International, Inc., 1994), section 3401.5, 676.

None of the doors which would be used for exits swings in the direction of travel or has panic hardware. Local building officials do not require this on historic properties used as house museums.

Exit Signs and Emergency Lights: NFPA 101 requires that emergency lighting be provided for all means of egress during the hours the building is occupied and exit signage be installed to indicate all means of egress. However, exit signage may be omitted for main exterior exit doors, according to Section 5, where such doors are "obviously and clearly identifiable as exits." The level of illumination must be determined by the local fire official. A separate source of power is not required for this illumination because of its size and occupancy load, but we would recommend that historic light fixtures in egress paths be put onto emergency circuits.

Fire Alarm System: Smoke detectors should be installed on all levels of each building, with an alarm audible throughout the building as well as to a remote monitoring station for periods when the building is unoccupied. Manual pull stations are not required due to the low occupancy level. Fire extinguishers should be located throughout the building and as directed by the local fire official.

Accessibility: The ADA requires that "persons with disabilities are to be provided accommodations and access equal to, or similar to, that available to the general public." With regard to existing buildings, the law requires only that "reasonable accommodation" must be made without "undue burden" and provides consideration for instances in which the owner of a building has made a "good faith effort" to comply with the law.²⁵⁵ However, these and all other provisions of the law must be tested in the courts.

In the case of a building which is eligible for listing on the National Register of Historic Places, or is listed, such as the William Johnson House, if the owner believes that compliance with the ADA would threaten or destroy its historic significance, then the State Historic Preservation Office can be consulted and an alternative solution provided.

The first floor of both the Main House and Dependency enters directly to the ground level and appears to be accessible or could easily be made accessible. The accessible entrance for the Main House would have to come through one of the north doors because the door on the south side has a very high step. If the Dependency porch is restored to its original appearance, a small ramp may also be required to accommodate a step.

The second floor of the Main House currently is not accessible from the ground level, but could be made accessible by an elevator in the adjacent McCallum House, proposed for use as a visitors center. However, this option requires further study to determine its impact on the historic fabric of both the Johnson House and the McCallum House. Another option would be to prepare a video tour of the upper floors which could be

²⁵⁵ Ibid., section 3403.

shown on the first floor. Installing an elevator in the Johnson House itself would destroy the historical and architectural character of the House.

8.3 Functional Requirements

The Main House would be well suited for exhibit space on both the first and second floors to tell the story of William Johnson. Flexible and clearly modern lighting could be added to help light exhibit spaces if necessary. Based on the *General Management Plan*, restrooms and more intrusive audio-visual presentations could be provided in the adjacent McCallum House.

To present the second and third floors as they appeared during Johnson's lifetime, finishes must be restored to their appearance during that period. A Historic Furnishings Report is currently being prepared by the National Park Service to document furnishings, window treatments, and lighting during the period, and appropriate collections acquired and restored. The layout of furnishings must be reviewed in light of anticipated visitation levels and traffic patterns; the center hall is extremely narrow and will make it difficult to accommodate more than ten to twelve visitors inside at one time.

Once the objects have been confirmed, conservation criteria must be developed and conservation methods implemented. Based on the assumption that the collections will include nineteenth-century furniture, textiles, and paper-based items, the following additional features are anticipated:

- Provide ultraviolet filters on narrow-profile, interior storm sash. Custom color sash to match historic finishes.
- Provide climate control for museum rooms, for exhibit space on first floor, and for any curatorial storage or workspaces. Relative humidity and temperature set points should be carefully considered in order to minimize potential for condensation on or within building fabric, and maximize collections care. Installation and routing of systems must be carefully detailed in order to prevent impact on historic fabric and spaces. It is anticipated that exposed, carefully finished ductwork could be used to supply the first and second floors, and that additional supply could be provided in the eaves of the attic.

The first floor of the Dependency is already configured as exhibit space and can easily continue as this. The second floor of the Dependency is already suitable to be used as office space.

8.4 Alternatives for Treatment

The following detailed recommendations are for the repair of materials and systems. All recommendations are based on the period of significance. Any repair work should follow the *Secretary of the Interior's Standards for Rehabilitation*:

- Deteriorated architectural features should be repaired rather than replaced wherever possible.
- When replacement of original building material is necessary, new materials should match the material being replaced in composition, design, color, texture, and other visual qualities.
- Replacement of missing architectural features should be accurately duplicated based on historical or physical evidence rather than conjecture.
- Repair methods, such as surface cleaning of the buildings, should be undertaken using the gentlest methods possible.²⁵⁶

These principles recognize that historic materials and details have proven records for durability and compatibility, and that a small amount of maintenance at regular intervals avoids large investments in repairs.

Any work that is done, or original fabric that is removed, should be carefully documented for future reference. It is also extremely important that any work done be coordinated with the Historic Furnishings Report. The placement of any historical furnishings needs to be considered before new wiring and HVAC work is completed.

8.4.1 Landscape and Site

- Further review and discussion with NPS will be required to develop an appropriate landscape treatment which will be historically accurate, contribute to the interpretation of the site, and meet contemporary standards for visitation. Further archeological research should be undertaken to determine the locations and appearance of outbuildings and gardens at the time of Johnson's death and during the period when the existing Dependency was built. Because the current Kitchen Dependency will remain in place, it would be inappropriate to reconstruct the outbuildings to their appearance at the time of Johnson's death. However, ways to indicate the use of the site for animals, vegetable gardens, and household systems, such as the privy and cisterns, should be suggested.
- Rebuild boardwalk to provide level access from street to rear porch and to repair rotted portions over basement wells. Sections over basement wells should be operable to provide access to the basement. Assume a path approximately 20'-0" by-5'-0" wide. Use a rot-resistant wood, such as cypress.

²⁵⁶ "The least degree of intervention possible such as patching, piecing-in, splicing, consolidating, or otherwise reinforcing or upgrading them according to recognized preservation methods. Repairing also includes the replacement in kind-or with compatible substitute material-of extensively deteriorated or missing parts of features when there are surviving prototypes."; Department of the Interior, National Park Service, *Standards for Rehabilitation and Guidelines for Rehabilitating Historic Buildings (Revised 1983)*, by Gary L. Hume and Kay D. Weeks, Report, Technical Preservation Services (Washington, DC: Preservation Assistance Division, 1983), 5, 6, and 9.

8.4.2 Main House

Roofing and Gutters

- A leader should be provided along the west side of the House to carry water from the north-elevation gutter to the back of the House. This is shown in historic photographs and is most likely the way the cisterns were fed. This will also prevent water from being discharged onto the sidewalk, in front of the gate to the yard.
- Reconstruct the south-porch roof to its 1866 appearance. The roof ended below the brick cornice with joists being supported by pockets in the brick. Five columns with capitals matching those on the first floor support the carrying beam on the south side.

Masonry

- Install crack-monitoring gauges between the east-west walls (interior and exterior) of the William Johnson House and the party wall it shares with the McCallum House. Regular measurements should be taken and recorded by the Park Service to determine whether it is the William Johnson House that is moving “away” from the McCallum House or vice versa. Dial gauges that can span each crack would be most effective at measuring any changes in the dimensions of the cracks. Once the cause of the crack has been determined and corrected, close the gap with masonry.
- Once the attic is sealed weather tight, re-point the entire east masonry wall in the attic, approximately ninety-four square feet (shared wall with McCallum). Use a mortar that matches the original in strength, composition, color, and texture.
- Re-point 5% of north elevation. Re-point south elevation where mortar is missing or deteriorated (approximately 30% of wall). Use a relatively soft mortar (no stronger than type “N”) to allow for future movement. The mortar should match the original in color and texture.
- Clean efflorescence from brick on west elevation. Use low pressure water, a mild detergent (if necessary), and a natural bristle brush. Do a test spot first before cleaning all areas.
- Remove two first-floor windows on west elevation. Windows should be documented, labeled, and put into storage. Infill openings with brick to match original.
- Install stainless steel anchors from all interior wood joists into the exterior-bearing brick masonry walls. Installation of these anchors will increase effectiveness of the bracing connection between the walls and the floors of the structure. Repair coping stones of the party wall shared by the William Johnson House and the McCallum House, approximately forty-four lineal feet (See Photographs S-21 and S-22 in Chapter 6.0 for a depiction of the condition of the coping). Rebuild brick below these coping stones as required.

Rough Carpentry

- Reconstruct first-floor framing. Use original joists which are currently in storage (assume enough original joists in storage for half of the required framing).
- Install structural reinforcements to the roof rafters, including doubling up roof rafters (approximately thirty-four rafters, seventeen per side) with new 3"-by-6" rafters. Place temporary shoring to support existing structure, as required, to execute these repairs.
- Install structural reinforcements to the attic-floor joists, including tripling up of joists (there are approximately fifteen existing joists) with new 3"-by-8" joists. Install structural reinforcements to the second-floor joists, including doubling up of joists (there are approximately twenty-one existing joists) with new 2"-by-12" joists. Place temporary shoring to support existing structure, as required, to execute these repairs.
- Install new wood or steel girders and columns or stiffening partition below the second-floor joists to provide permanent structural support of the second floor and upper portions of the building. For pricing purposes assume either four 1 3/4"-by-16" LVL with three 8"-by-8" timber posts or one W6 by 16 with three five-inch-diameter steel pipe columns.
- Repair rear (south) porch, especially lateral attachments to building's brick walls and replacement of the missing porch column. Repair of lateral attachment can take the form of new stainless steel straps between the wood joists of the porch and the brick wall of the south facade.
- Stick a probe into the stairs going from the second floor to the attic to determine framing. If the framing is undersized, a method for stiffening will need to be determined.

Finish Carpentry

- Fill nail holes at dormers. Scrape and repaint eaves.
- Tighten up joints of five column bases on first floor, fill cracks and splits with epoxy. This will be an ongoing maintenance issue.
- Replace first-floor porch floorboards with a more durable wood (such as cypress, cedar, or redwood). New boards should match existing in dimension and orientation (2" by 8" running north and south).
- Confirm details of lattice enclosure at the end of porch, installed by Johnson, based on 1979 photographs, and reconstruct. The lath was placed at an angle creating a diamond-shaped opening with a vertical orientation (assume 9'-0" by 10'-0").
- Reattach southeast-corner-porch post immediately (currently removed and in storage).
- Clean both porch ceilings and treat with anti-mildew solvent. Repaint.
- Scrape and repaint stairs and second-floor decking.
- Replace second floor porch decking with five-inch wide tongue-and-groove which is more appropriate to the 1840s.
- Restore balustrade on second floor of porch to 1841-1866 appearance. Sawn balusters should be documented, removed, and put into storage. Square balusters should be installed in their place (approximately forty-eight lineal feet of balustrade).

- Provide a single pier in center of first-floor space, to accommodate structural requirements and recreate historic appearance of the space. Develop details based on existing details in extant commercial buildings.
- Mill new baseboard for first floor (approximately 130 lineal feet). Profile should be representative of similar buildings from the time period.
- Mill new baseboard to match original in southwest room, second floor (approximately thirty-eight lineal feet).
- Reattach baseboard to south and west walls in the southeast room, second floor.
- Reattach baseboard to east and west walls in attic.
- Reattach stair balustrade to wall in attic. Tighten all balusters and stabilize balustrade.

Door and Windows

- Replace the three front doors with new units which match their 1866 appearance, based on historic photographs and examination of existing extant doors in contemporary commercial buildings. Doors had glazed sections above a single panel, with louvered folding shutters on the exterior.
- On the north facade, scrape and repaint three window frames on second floor.
- Caulk around second-floor north window frame on west elevation.
- Scrape and repaint (cream color) all windows and frames on west elevation.
- Caulk around all door and window frames on the south elevation.
- Touch-up first-floor window frames (two windows) on south elevation. Paint the second-floor window frames and sashes (two windows).
- Scrape and paint both doors on the south elevation.
- Provide ultraviolet filters on narrow-profile, interior storm sash for all windows (twelve windows). Custom color sash to match historic finishes.
- Install original or reproduction door hardware (on six doors) based on HABS report, BCT Report, and further research on period hardware. Reproduction hardware should match the original as close as possible or be of the same time period and appropriate to the House.

Interior Finishes

- Remove the linoleum from the second-floor Southeast 207 and Northwest 203 Rooms. Document and save it for record.
- Patch the holes (3) on the second floor in the Southwest 202, Northwest 203, and Northeast 204 Room floors. Replace missing board in hallway.
- Reattach floorboards in attic that have come loose (approximately 10%).
- Replaster portions of wall where plaster is missing on first floor (75% of walls).
- Add lath and plaster over the two first-floor windows on west wall to be removed and filled in.
- Reconstruct the lath-and-plaster ceiling on the first floor (100% of ceiling).

- Replaster portions of second-floor walls and ceiling where plaster is missing (10%-20% of walls and ceiling). Patch and repair cracks in remaining plaster (10%-20% of plaster).
- Reattach areas of plaster that have pulled loose from the wall on the second floor, if economically feasible (10%-20% of walls). If the plaster has to be removed and the area replastered, retain as much original plaster as possible.
- Replaster portions of attic walls where plaster is missing (50% of walls). Patch and repair cracks in remaining plaster (10% of plaster).
- Reconstruct the lath-and-plaster ceiling in the attic.
- Remove peeling paint and wallpaper from all walls and ceilings. Restore to original whitewash or wallpaper finish. The NPS finish analysis identifies wallpapers for the second-floor hallway and stairs as being from 1850-1860. No other papers were found that date from before 1866. The finish analysis also indicates that the Northeast Room on the second floor has never been painted.
- Restore original painted finish to all woodwork, including baseboards, doors, and door and window casings and frames.

Mechanical

- Re-install original coal grates or reproductions based on 1978 photographs. The coal grates may not appear on any of the 1978 photographs. The Park Service has none in storage.
- Provide fire extinguishers throughout the building (one per floor).
- Provide climate control (heating, cooling, humidification, and de-humidification) for museum rooms, for exhibit space on first floor, and for any curatorial storage or workspace that may be provided. Installation and routing of systems must be carefully detailed in order to prevent impact on historic fabric and spaces. Concealed ductwork could be provided in the eaves of the attic.

Electrical

- Install wiring to serve new lighting, exit signs, egress lighting, etc. Wire decorative fixtures in public areas on emergency circuits.
- Provide reproduction or historic lighting fixtures for all spaces, based on HFR.
- Install exhibit lighting in first floor.
- Install smoke detectors on all levels, with an alarm audible throughout the building as well as to a remote monitoring station for periods when the building is unoccupied.

8.4.3 Kitchen Dependency

Roofing and Gutters

- Install a downspout at the low end of the gutter on the south elevation. The water should be drained away from the foundation. A perimeter drain should be installed around the full exterior of the Dependency.

Masonry

- Re-point the area under the second floor, west window, of the north facade with a mortar that matches the original in strength, composition, color, and texture.
- Tuck point the cracks that have appeared at the door and window lintels on the north facade.
- Test the whitewash on the north facade to determine if it is lime-based or a distemper paint and if it is original to the building or a later addition. Until that determination is made, let the whitewash on the north facade fade off naturally. If it is original, re-whitewash the face of the building.
- Fill where the soil has eroded at the east wall.

Finish Carpentry

- Reconstruct the porch to its 1897 appearance. Remove roof and provide stair, based on further research of location. For cost-estimating purposes, the stair is assumed to be a straight run on the north side of the porch. Provide railing with square balusters.
- Caulk under the west room second-floor fireplace mantel.

Doors and Windows

- Caulk the gaps around all door and window frames.
- Consolidate the window frames (10% of frames) on the north elevation with an epoxy and paint frames and sash.
- Paint the doors to match original color.
- Replace the shutters on the north windows (four windows).
- Consolidate the first-floor window on the west elevation with an epoxy (10% of frame and sash). Paint the frame and sash of both windows to match the original color.
- Remove the plywood covering the door and window openings on the south elevation.
- Paint all doors, windows, frames, sills, and lintels to match the original color.
- Consolidate the east door frame with epoxy (10% of frame).
- Further research the reason for adding the flashing over the east window. Remove the excess flashing and repair the problem.

Interior Finishes

- Restore original paint finish to all woodwork, including baseboards, mantels, doors, and door and window casings and frames.
- Paint walls an appropriate color if original finish cannot be determined.

8.5 Recommendations for Further Research

The recommendations discussed in this chapter have been based on the historical documentation currently available and careful visual inspection of the site and structures. Some historical information has emerged late in the research process, and other information remains in the possession of family members. William Johnson's diary has

9.0 Appendices



9.1 Bibliography



BIBLIOGRAPHYCity, County, and State Records:

- Adams County, Mississippi. Office of Chancery Clerk. Lands Claim Books.
- Adams County, Mississippi, Office of Chancery Clerk. Deed Books.
- Adams County, Mississippi. Office of Chancery Clerk. Probate Boxes.
- Adams County, Mississippi. Office of Chancery Clerk. Probate Real Estate Record Book.
- Adams County, Mississippi. Office of Chancery Court. Will Books.
- Adams County, Mississippi. Office of Circuit Court. Marriage Records.
- Board of Selectmen, City of Natchez. Minutes. 1836 and 1852. City Hall. Natchez, Mississippi,
- Neibert-Fisk House [Choctaw]. Adams County. National Register Files. Mississippi Department of Archives and History, Jackson.
- Bureau of the Census. Population Schedules. Armstrong Library, Adams County, Mississippi, 1860. Microfilm.
- Sexton's Records, City of Natchez. Originals and typescript copy, translated by Robert Shumway. Armstrong Library. Historic Natchez Foundation, Natchez, Mississippi.
- "Teacher Pay Register and Teacher Pay Certificates, 1873-1915." Adams County Circuit Court Records. Historic Natchez Foundation, Natchez, Mississippi.
- Warren County Courthouse. Warren County. National Register file. Mississippi Department of Archives and History, Jackson.

Government Documents:

- Albee, Peggy A. *Finishes Analysis, the William Johnson House, Natchez, Mississippi*. Report, U.S. Department of the Interior. National Park Service. Cultural Resources Center, North Atlantic Region. Boston, October 1993.

-
- Atkinson, James R. *Archeological Excavations at the William Johnson House Complex, Natchez National Historical Park, Natchez, Mississippi*. Draft Report, U.S. Department of the Interior. National Park Service. Southeast Archeological Center. Tallahassee, July 1994.
- Elliot, Jackson. *Comprehensive Plan for Historic Preservation for the Period of European Colonization in Mississippi*. Preservation Planning Study, Mississippi Department of Archives and History. Division of Historic Preservation. Jackson, 1989.
- Hawkes, Pamela, Mary Oehrlein and Mary Jane Wells. *Historic Structures Report, William Johnson House, Natchez, Mississippi*. Report, U.S. Department of the Interior. National Park Service. Building Conservation Technology, Washington, DC, April 1979.
- Sanford, Dena. U.S. Department of the Interior. National Park Service. *Draft HABS Report, William Johnson Complex*. Draft Report, Historic American Building Survey. 1992.
- U.S. Department of the Interior. Advisory Council on Historic Preservation. *A Five Minute Look at Section 106 Review*. Washington, DC, 1986.
- U.S. Department of the Interior. National Park Service. Maintenance Records. Natchez National Historical Park, Natchez, Mississippi.
- U.S. Department of the Interior. National Park Service. *Natchez National Historical Park General Management Plan/Development Concept Plan/Environmental Impact Statement*. Denver Service Center, Denver, January 1994.

Manuscript, Photography, and Art Collections:

- A. Mygatt & Co's *Business Directory*. Historic Natchez Foundation, Natchez, Mississippi, 1858. Photocopy.
- Audubon, John James. Untitled oil on canvas. Painting. 1822-1823. Private Collection. Audubon Landscape of Natchez Slide File, Historic Natchez Foundation. Natchez, Mississippi. Slides of original.
- Brown, Andrew. Day Books and Order Books. Andrew Brown Papers. University of Mississippi, Oxford.
- Historic Natchez Foundation, Natchez, Mississippi: 315 Main Street Site File; Choctaw Site File; Edgewood Site File; Elms Court Site File; Hawthorne Site File; Hope

Farm Site File; Institute Hall Site File; Oakland Plantation Site File; Texada Tavern Site File; William Johnson House Site File.

William Johnson and Family Memorial Papers. Louisiana and Lower Mississippi Valley Collections. Louisiana State University, Baton Rouge.

Norman Collection. Dr. and Mrs. Thomas H. Gandy. Historic Photographs. Historical Natchez Foundation, Natchez, Mississippi.

Padgett, Thomas J. *Final Report on the Text Excavations at the William Johnson House, Natchez, Mississippi*. A report prepared for Koch and Wilson Architects, New Orleans, Louisiana, and the Preservation Society of Ellicott Hill, Natchez, Mississippi. Hattiesburg: University of Southern Mississippi, 1978.

Quitman Family Papers. Southern History and Folklife Collection. University of North Carolina, Chapel Hill, NC. Natchez National Historical Park, History Files, transcribed copy.

Sanborn Insurance Maps. Historic Natchez Foundation, Natchez, Mississippi. Photocopies and originals.

Shumway, Robert, ed. "Miscellaneous Individual City of Natchez Copies of Signed Death Certificates and Hospital Death Records from the Collection of the Natchez Historical Society," and "Index to Physicians, Pharmacists & Dentists, Starting 1808." Robert Shumway: Vidalia, Louisiana, n.d.

Stewart Collection. William S. Stewart, Natchez, Mississippi, and Historic Natchez, Mississippi. Historic Photographs.

Wharton, T. K. *The Elms*. 1859. Pencil Sketch. Alma K. Carpenter. The Elms, Natchez, Mississippi.

Personal Interviews:

Free, Gregory B. Interview by Mary W. Miller. November 26, 1995. Historic Natchez Foundation, Natchez, Mississippi.

Fuller, Kim. Interview by Pamela Hawkes. September 21, 1995. William Johnson House, Natchez, Mississippi.

Krotzer, Henry. Interview by Mary W. Miller. Telephone. September 15, 1995. Historic Natchez Foundation, Natchez, Mississippi.

Miller, Mary Louise. Interview by Kathleen Jenkins and Carol Petravage. Typescript copy. February 6, 1996. Yazoo City, Mississippi. Natchez National Historical Park, Hisory Files, Natchez, Mississippi.

Morgan, Duncan. Interview by Mary W. Miller. February 2, 1996. William Johnson Site File. Historic Natchez Foundation, Natchez, Mississippi.

Moss, Margaret. Interview by Mary W. Miller. September 1 and 5, 1995. Historic Natchez Foundation, Natchez, Mississippi.

Smith, Gladys. Interview by Mary W. Miller. 1970s. William Johnson Site File. Historic Natchez Foundation, Natchez, Mississippi.

Other:

Richards's Family Tombstones: plat 1 and Old Catholic section. Natchez City Cemetery, Natchez, Mississippi.

Books:

Blain, William T. *Education in the Old Southwest: A History of Jefferson College, Washington, Mississippi*. Washington, MS: Friends of Jefferson College, 1976.

Biographical and Historical Memoirs of Mississippi. Vols. 1 and 2. Chicago: The Goodspeed Publishing Company, 1891.

James, D. Clayton. *Ante-bellum Natchez*. Baton Rouge: Louisiana State University Press, 1968.

Davis, Edwin Adams, and William Ransom Hogan. *The Barber of Natchez*. Baton Rouge: Louisiana State University Press, 1955.

Fulkerson, H. S. *Random Recollections of Early Days in Mississippi*. Vicksburg: Vicksburg Printing and Publishing Company, 1885.

Hogan, William Ransom, and Edwin Adams Davis, eds. *William Johnson's Natchez, The Ante-bellum Diary of a Free Negro*. Baton Rouge: Louisiana State University Press, 1951.

Ingraham, Joseph Holt. *The South-West. By a Yankee*. Vol. 2. New York: Harper & Brothers, Cliff-St., 1835.

McBee, Mary. *Natchez Court Records*. 1953. Reprint, Baltimore: Genealogical Publishing, 1979.

Moore, John Hebron. *Andrew Brown and Cypress Lumbering in the Old Southwest*. Baton Rouge: Louisiana State University Press, 1967.

Polk's Natchez City Directory 1912. Memphis: R. L. Polk & Co., 1917.

Speaks, Vera Jacobs, compiler. *Mississippi Portraiture*. Jackson: National Society of Colonial Dames of the State of Mississippi, 1987.

Newspapers:

The Mississippi Free Trader and Natchez Weekly Gazette, January 29, 1836-April 5, 1858.

Mississippi State Gazette, January 29, 1825-April 23, 1825.

The Natchez Daily Courier, November 25, 1837- March 7, 1856.





9.2 Glossary of Terms



GLOSSARY

Sources used for defining the following words were: A Visual Dictionary of Architecture by Francis Ching; The Penguin Dictionary of Architecture, 3rd edition, by John Fleming, Hugh Honour, and Nikolaus Pevsner; and Webster's New Collegiate Dictionary, 2nd edition.

architrave - the lowest of the three main parts of an entablature; also, more loosely, the molded frame surrounding a door or window.

awning - a rooflike cover of canvas or other material extending in front of a doorway or window, or over a deck, to provide protection from the sun or rain.

baluster - an upright support of a rail.

balustrade - a row of balusters topped by a rail.

bead - a small convex molding usually having a continuous cylindrical surface.

bead-and-butt - boards placed so the edges are flush against each other, with one of the edges having a continuous bead running along it.

board-and-batten - siding consisting of wide boards or plywood sheets set vertically with butt joints covered by battens.

cable molding - a Romanesque molding, imitating a twisted cord.

calcimine - a white or colored wash for a ceiling or other interior plastering; usually made with whiting or powdered chalk.

cistern - an artificial reservoir for storing water.

clapboard - a narrow board, thicker at one edge, for weatherboarding frame buildings.

common bond - a brickwork bond having a course of headers between every five or six courses of stretchers.

cornice - the top, projecting section of an entablature; also any projecting ornamental molding along the top of a building, wall, arch, etc, finishing or crowning it.

double-leaf - typically a shutter or door made up of two panels, one of which folds back on top of the other, which then folds back against the wall.

eave - the projecting lower edge of a roof, overhanging a wall.

efflorescence - a white powdery deposit that forms on an exposed masonry or concrete surface, caused by the leaching and crystallization of soluble salts from within the material.

entablature - the upper portion of a wall or story, generally supported on columns or pilasters. In classical orders it consists of architrave, frieze, and cornice.

extant - in existence; not destroyed.

facade - the front or face of a building, emphasized architecturally.

fascia - any broad, flat, horizontal surface, as the outer edge of a cornice or roof.

flanking - to either side of something.

gable - the triangular upper portion of a wall at the end of a pitched roof corresponding to a pediment in classical architecture. It normally has straight lines, but there are variants.

garrett - the part of a house just under or within the roof.

header - a brick or other masonry unit laid horizontally in a wall with the shorter end exposed or parallel to the surface.

HVAC - abbreviation for Heating, Ventilating, and Air Conditioning.

intrados - the inner curve or surface of an arch forming the concave underside.

intestate - without having made a will.

jack arch - an arch having a horizontal intrados with voussoirs radiating from a center below, often built with a slight camber to allow for settling. Also called a *flat arch*.

jamb - the vertical surface of an archway, doorway, or window.

joist - horizontal timber laid between the walls or the beams of a building to carry the floorboards.

lath - any of a number of thin narrow strips of wood, often nailed to rafters, ceiling joists, and studs, to make a groundwork for plaster.

lattice - a framework or structure of crossed wood or metal strips.

lintel - a horizontal member spanning an opening to carry a superstructure.

louver - sloping boards set to shed rain water outward in openings which are to be left otherwise unfilled.

munтин - the vertical part in the framing of a door, screen, paneling, window, etc., butting into, or stopped by, the horizontal rails.

ogee - a double-curved line made up of a convex and concave part.

ovolo - a convex molding, usually a quarter of a circle. Sometimes called a *quarter round*.

pilaster - a shallow pier or rectangular column projecting only slightly from a wall and, in classical architecture, conforming with one of the orders.

rake - inclination from a perpendicular direction; slope.

running bond - a brickwork or masonry bond composed of overlapping stretchers. Also called *stretcher bond*.

sash - sliding glazed frames running in vertical grooves, as in a window.

sconce - a bracket light fixture secured to a wall.

soldier - a brick laid vertically with the longer face edge exposed.

spandrel - the triangular space between the side of an arch, the horizontal drawn from the level of its apex, and the vertical of its springing; also applied to the surface between two arches in an arcade, and the surface of a vault between adjacent ribs. A panel-like area in a multistory frame building, between the sill of a window on one level and the head of a window immediately below.

splay - a sloping, chamfered surface cut into the walls. The term usually refers to the widening of doorways, windows, or other wall-openings by slanting the sides.

stretcher bond - a method of laying bricks so that only the side of the bricks appears on the face of the wall.

tongue-and-groove - when the rib on one edge of a board fits into the groove in an edge of another board to make a flush joint.

transom - a window above a door or other window, built on, and commonly hinged to, a transom; a horizontal crossbar in a window, over a door, or between a door and a window or fanlight above it.

vousoir - any of the wedge-shaped units in a masonry arch or vault, having side cuts converging at one of the arch centers.

weatherboarding - overlapping horizontal boards covering a timber wood-framed wall; the boards are wedge-shaped in section, the upper edge being the thinner.



9.3 List of Repositories



REPOSITORIES

Adams County Courthouse
Office of the Chancery Clerk
Adams County Courthouse
115 South Wall Street
Natchez, Mississippi 39120
(601) 446-6684

Contact: Thomas O'Beirne, Chancery Court Clerk

Adams County Courthouse
Office of the Circuit Clerk
Adams County Courthouse
115 South Wall Street
Natchez, Mississippi 39120
(601) 446-8862

Contact: Fred Ferguson, Circuit Court Clerk

Judge George Armstrong Library
214 South Commerce Street
Natchez, Mississippi 39120
(601) 445-8862

Contact: Donna Jancke, Director

Historic Natchez Foundation
PO Box 1761
Natchez, Mississippi 39205-0571
(601) 442-2500

Contact: Ronald W. Miller, Executive Director

Louisiana State University Libraries
Louisiana State University
Baton Rouge, Louisiana 70803-3300
(504) 388-6551

Contact: Faye Phillips, Director

Mississippi Department of Archives and History
Archives Division
PO Box 571
Jackson, Mississippi 39205-0571
(601) 359-6850

Contact: Hank Holmes, Director

Natchez National Historical Park
National Park Service
Department of the Interior
504 South Canal Street
Natchez, Mississippi 39120
(601) 441-7047

Contact: Robert Dodson, Superintendent

The Norman and Gandy Photographic Collections
c/o Dr. and Mrs. Thomas H. Gandy
408 North Pearl Street
Natchez, Mississippi 39120
(601) 446-6563

Contact: Dr. Thomas H. Gandy



9.4 Research Notes



Research notes on the William Johnson House and Family

Office of the Chancery Clerk--Adams County Courthouse

Will Book 5:305 Katherine Johnston

Will Book 7:306 Anna Johnston

Will Book 8:135 Josephine Johnston

Will Book 8:341 Alice Johnson
mentions her nephew Clement Garrus

Deed Book TT:193 James F. and Martha McCaleb to Anna L. Johnston
March 1, 1874
450 acres more or less, being that part of Peachland Plantation known
as the Swamp Tract

Information about Peachland Plantation and Anna Johnston

Martha McCaleb, who sold Peachland to Anna Johnston, was originally a member of the prominent Bisland family of Pine Ridge. The late Glen McNeely, first wife of Natchez attorney Thomas M. McNeely, was a direct descendant of James and Martha McCaleb. Glen grew up at Peachland and Thomas McNeely has a photograph of the McCaleb house that stood on Peachland. The house was demolished in the 1960s. Natchez architect Charles Moroney bought the house site and built a new house.

Members of the McCaleb family associated with Peachland probably were familiar with members of the Johnston family. The only surviving older member of the family is the widow of Duval Henderson, whose son Robert Henderson lives in Houston, Texas. Robert Henderson is going to interview his mother about any knowledge or memories she may have about the Johnston family.

The area where Anna Johnston's Peachland Plantation was located is known today as Anna's Bottom [a reference to the bottom land]. The USGS map depicting the Peachland portion of Adams County designates a community, or perhaps just a post office, as Anna. This reference to the name Anna is almost certainly the Anna Johnston that was William Johnson's daughter. Anna Johnston's name is also identified with a National Historic Landmark archaeological mound site known as the Anna Site. The mounds of the Anna Site are actually on land owned today and historically by the Stowers family, but the site was called Anna probably due to its proximity to the community designated as Anna on the USGS map.

Information about Byron Johnson, son of William Johnson

Natchez Weekly Democrat, Wednesday, 17 January 1872, p. 3

Byron Johnson murdered on Saturday, 13 January 1872, at 10 o'clock Saturday night
at rear of his barber shop

suspected murderers included David Singleton, former body servant of Alfred V.

Davis and a Louisiana planter and storekeeper

Singleton and Johnson had met on the ferry boat returning from their Louisiana
plantations--Singleton accused Johnson of enticing one of his hands to
leave employ of Singleton

suspected murderers also included Charles Cotesworth, a drayman,

suspected murderers also included William Fitzhugh, who was in the planting business
with Singleton

William T. Martin [former Confederate General who also represented Johnson family
as a special prosecutor in trying Baylor Winn for the murder of William
Johnson] was to represent the prosecution at a hearing

Natchez Weekly Democrat, 24 January 1872

article #1

describes the funeral of Byron Johnson
held in the Chapel of the First Presbyterian Church

large crowd

services conducted by Joseph B. Stratton

article #2

published testimony of witnesses to the murder

Juanito and Carlito Garrus are mentioned as witnesses; stated that they worked
in the barber shop of Byron Johnson--[Juanita Garrus married Byron
Johnson's sister

Nelson Fitzhugh

Will Book 3:337

made will 2/05/1868

will probated August 1868

beloved wife Agnes

sons Charles, Samuel, Lewis, Edward, Robert (doesn't mention son William Fitzhugh
who was arrested as one of Byron Johnson's murderers)

daughter Elizabeth (married first to John B. Johnson, second to Bingamon)

daughter Catherine married Robert McCary, son of William Johnson's best friend

1850 census, p. 2

Nelson Fitzhugh was born in Virginia

free man of color

age 43

wife Agnes, 30, also born in Virginia

1,000 in real estate

no occupation given

The Natchez Weekly Courier, 12 November 1866, p. 3

Nelson Fitzhugh chastised in local paper for writing letter that was published in the North
Article mentions that he clerked in a mercantile house

The Natchez Weekly Courier, supplement, 10 November 1866

Catherine A. McCary, daughter of Nelson Fitzhugh, apologizes in the newspaper for the letter her father wrote about the South

Other Fitzhugh information:

Natchez Weekly Democrat, 24 January, 1872

obituary of Agnes Fitzhugh, who apparently dropped dead after learning her son had murdered Byron Johnson

obituary states "result of grief and distress arising from the fact of her son William having been engaged in the recent Johnson tragedy"
described as estimable and charitable woman

The Daily Democrat, 8 January 1882

A Fitzhugh with no first name is mentioned as being the postmaster

Fitzhugh House stood on the northwest corner of the intersection of Martin Luther King [formerly Pine Street] and Orleans Street. A photograph of the house that is labeled Fitzhugh can be found in the Conner family album that is owned by Dr. Thomas H. Gandy of Natchez.

Robert Fitzhugh lived at the intersection of Williams and Minor Street
Deed Book TT:481, 10 April 1874.

Edward Fitzhugh, son of Nelson Fitzhugh, appears in a labeled photograph in the Norman Collection, owned by Dr. and Mrs. Thomas H. Gandy



HISTORIC NATCHEZ FOUNDATION

April 3, 1996

To: Tobin Tracey
Ann Beha & Associates

From: Mimi Miller
Historic Natchez Foundation

Re: William Johnson House joist pockets

On Wednesday, April 2, Tom Rosenblum opened the William Johnson House for me to inspect the joist pockets at the William Johnson House. A projecting brick ledge extends the length of the interior of the western wall, and the bottoms of the joist pockets coincide with the ledge except on the portion of the wall that extends between the fire chamber and the southwest corner of the house. On this portion of the wall the bottoms of the joist pockets are a brick course above the ledge and the joist pockets are only 4 brick courses tall. To the north of the fire chamber, the joists pockets are 5 brick courses tall as they extend northerly from the fire chamber and decrease to 4 brick courses in height at the northwest corner. However, the bottoms of the joist pockets all coincide with the ledge north of the fire chamber. The ledge itself does not appear to be level.

The differences in the joist pockets (their heights and some joist bottoms raised above the supporting ledge) are reflected on the brick wall that extends the length of the building and originally supported the other ends of the joists. The wall increases two brick courses in height from the front wall to the rear wall and makes the two adjustments at the point where the joists change. The floor itself would originally have been level as long as the joists were the same width.

Attached is a rough sketch of the joist pockets and corresponding brick supporting wall. I hope this explains the irregular joist situation.

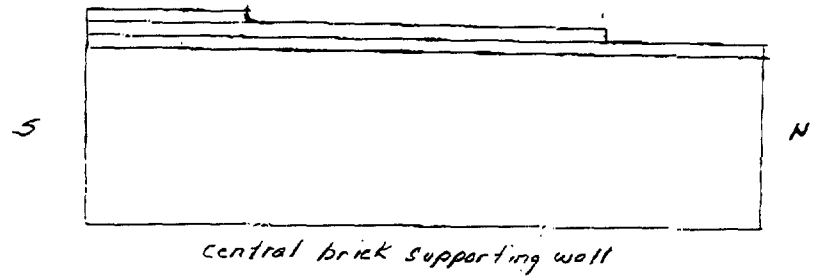
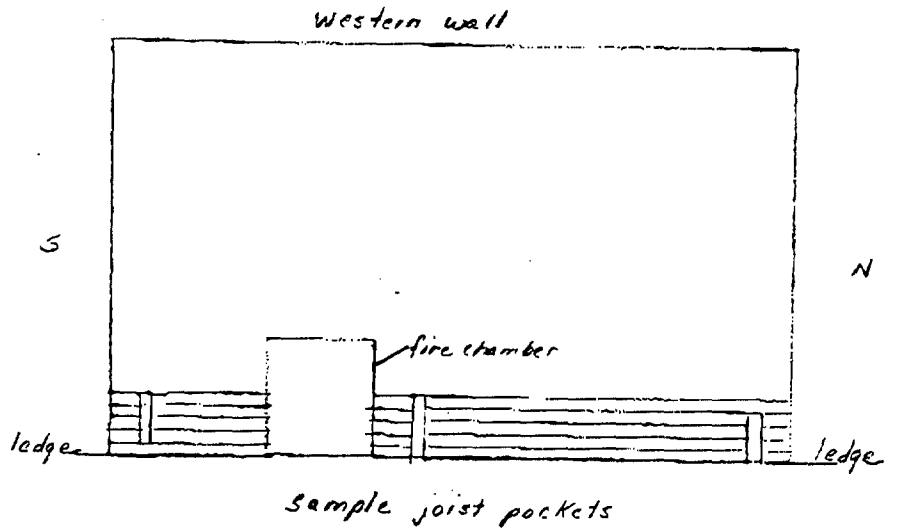





9.5 Historical Documents
Estate Inventory of Robert Smith
Estate Inventory of William Johnson



THE STATE OF MISSISSIPPI,

To *William Cannon, John C. Brown* and
John J. Butler

Greeting:

This is to authorize you, jointly, to appraise the goods, chattels and personal estate of *Robert D. Smith* late of Adams county, deceased, as far as the same shall come to your sight and knowledge, each of you having first taken the oath or affirmation hereto annexed; a certificate whereof you are to return, annexed to an inventory of the said goods, chattels and personal estate, by you appraised, in dollars and cents—and in the said inventory you are to set down, in a column or columns, opposite to each article, the value thereof; having first set apart to *Ann Smith* the widow of said deceased, all of the personal estate of her said husband, to which she is entitled by law, and the year's provision for herself and children, to which you may deem her entitled; to be allotted upon oath, reduced to writing, and returned to this Court with the appraisement aforesaid.

Witness

Ruben Bullock Esquire,

Judge of Probate of the county of Adams, this *thirtieth* day of *June*

in the year of our Lord one thousand eight hundred and *fifty eight*.

Wm. A. Brown
Chas

We do solemnly *swear*

that we will well and truly, without partiality or prejudice, value and appraise the goods, chattels and personal estate of *Robert D. Smith* deceased, so far as the same shall come to our sight and knowledge, and will, in all respects, perform our duty as appraisers, to the best of our skill and judgement, so help us God.

SWORN TO and subscribed before me, this *1st* day of *July* 1858 }

Wm. A. Brown
Chas

Wm. Cannon

John C. Brown

John J. Butler

Appraisement.

A true and perfect "Inventory" & Appraise-
ment of the goods, chattels and personal
Estate of Robert D. Smith, deceased.

Curtains & Mantel Ornaments,	7 50
One small Rocking Chair,	5 "
Three Carpets at \$10. each,	30 "
One Piano, and Stool,	200 "
One Marble Top Centre Table,	20 "
One Mahogany Table,	15 "
One Plush Rocking Chair,	7 50
One Arm Chair,	10 "
Two Mohair Settees at \$5. each,	10 "
One Sofa,	10 "
Six Mohair chairs,	15 "
Six cane bottom chairs,	4 50
One Parlor Clock \$25. 2 parlor lamps \$3.	28 "
One Sideboard \$12. Six straw bottom chairs \$6.	18 "
One Book Case and Contents	20 "
One Dining Room Safe	8 "
One Dining table \$4. One Yankee Clock \$1. ⁵⁰	5 50
Two large writers, one small writer	2 "
Lot of Glassware & Table Ware	10 "
Three large Bedsteads, with Bedding	60 "
One small do do	20 "
Three small Lounges do	15 "
One sewing table \$2. ⁵⁰ Three wash stands \$3.	5 50
One Bureau \$7. ⁵⁰ One Marble top toilet stand \$10.	17 50
Four cane bottom Bedroom Chairs	4 "
Three Hickory, bottom Chairs	1 50
Two Wardrobes \$20. One small writing stand \$1. ⁵⁰	21 50
Four small Looking Glasses	6 "
One Jewel Rack \$5. One Clothes Chest \$3.	3 50
Amount carried forward	580. 50

Amount Brought Forward	\$ 580.50
Three Oil Paintings & 16 Engravings	2.
Three Kitchen Tables \$2.50. Four kitchen chairs \$2	4.50
One Cooking Range & Appertenance	25.
Lamps and Lanterns	2.50
Four Public Stacks	5.00
Six old Stacks	150.
one Barouche	50.
one Baggage Wagon	100.
one Stable Wagon	25.
nine Horses	900.
Five Sets of Double Harness	75.
one Riding Saddle & Bridle	5.
Sixteen Floor Blankets	16.
7500 Shingles @ \$2.50 per thousand	18.75
Six cords of wood	20.
one Wheelbarrow, 2 Shovels & 1 Rake	5.
Lot of Hay \$50. Lot of Corn \$37.50	87.50
One Gold Watch	75.
Lot of old Silver	18.
1/2 dozen German Silver Forks.	3.
1/2 " " Silver Forks.	2.40
1/2 " " Spoons	2.10
One Hall Lamp	5.
	\$ 2,715.75





William Johnson
1851

Amount Paid forward

65.056.40

Woods Hold Furniture

2 Sofas		15.00
9 Mahogany Chairs (damaged)		5.00
1 Centre Table		2.50
1 Pair Side Tables		10.00
1 Rocking Chair		1.25
4 Pictures and frames		20.00
1 Old Parlor and Stool		20.00
1 Work Stand		3.00
2 Mantle Glass		10.00
4 Spittons		1.50
2 Book Cases and Books		50.00
1 Sawsaw		3.50
1 Writing desk		5.00
1 Clock		5.00
2 Bed Steads & Bedding	\$20.00	40.00
2 Lamp		10.00
3 Small Stands		5.00
1 Mahogany Armchair		25.00
2 Small Cherry do		10.00
1 Trundle Bed		2.50
24 Common Chairs	27.00	6.00
1 Small Side Board		3.50
4 Safes	12.00	6.00
3 Dining Tables		10.00
1 Small Looking Glass		1.50
Kitchen utensils		5.00

\$5.333.65

Amount Carried over

~ Negroes ~
 Amount Paid forward

\$5,333.65

Jim
 Old Philip
 Sarah
 Lucinda
 John
 Celia
 Mary Jane
 Old Rose

1000 00
 250 00
 700 00
 600 00
 200 00
 300 00
 250 00
 25 00

Barber Shop -

2 Dophis
 6 Barber Chairs & 4 Stools (Lot)
 4 Mirrors
 31 Pictures in frames @ \$1.00
 1 Show Case and perfume
 2 Wash Stands @ \$1.00
 1 Coats Rack
 1 Hat do
 1 Small writing desk
 1 Table @ \$1.00 1 Ironing Stand 4/
 Razors Scissors & C. (Lot)

6 00
 18 00
 40 00
 31 00
 5 00
 2 00
 50
 50
 1 50
 1 50
 5 00

Total \$8,769.65



9.6 Drawings



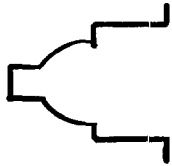

- Muntin Profile ca. 1840-1841

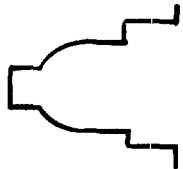

- Muntin Profile ca. 1980

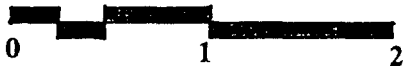

DRAWING TITLE

Muntin Profiles Reproduced from NPS 1993 Finish Analysis

Ann Beha Associates, Inc.

33 KINGSTON STREET ■ BOSTON ■ MASSACHUSETTS 02111
TEL. (617) 338-3000 ■ FAX (617) 482-9097

PROJECT

William Johnson House

DATE

SCALE

JOB #

DRAWN BY

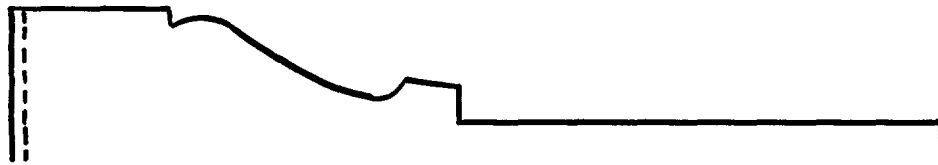

• Window Casing ca. 1840-1841

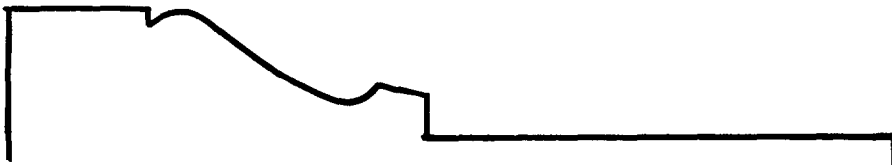

• Second-Floor Door Casing ca. 1840-1841

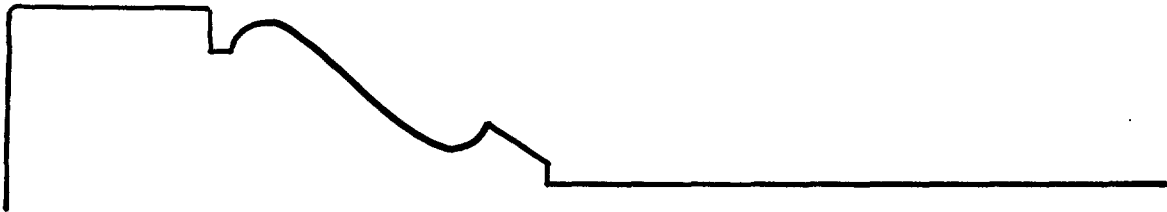

• First-Floor West Wall Window Casing ca. 1897



• First-Floor North Door Casing ca. 1980



DRAWING TITLE

Casing Profiles Reproduced from NPS 1993 Finish Analysis

Ann Beha Associates, Inc.

33 KINGSTON STREET ■ BOSTON ■ MASSACHUSETTS 02111
TEL. (617) 338-3000 ■ FAX (617) 482-9097

PROJECT

William Johnson House

DATE

SCALE

JOB #

DRAWN BY



- First-Floor South Door Casing ca. 1842

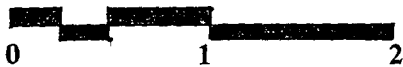

DRAWING TITLE

Casing Profiles Reproduced from NPS 1993 Finish Analysis

Ann Beha Associates, Inc.

33 KINGSTON STREET ■ BOSTON ■ MASSACHUSETTS 02111
TEL. (617) 338-3000 ■ FAX (617) 482-9097

PROJECT

William Johnson House

DATE

SCALE

JOB #

DRAWN BY



NORTH ELEVATION

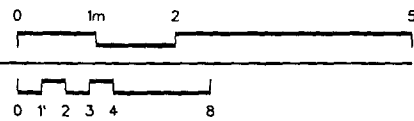



WEST ELEVATION

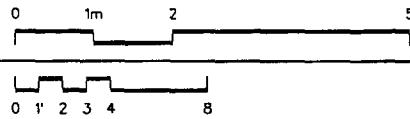

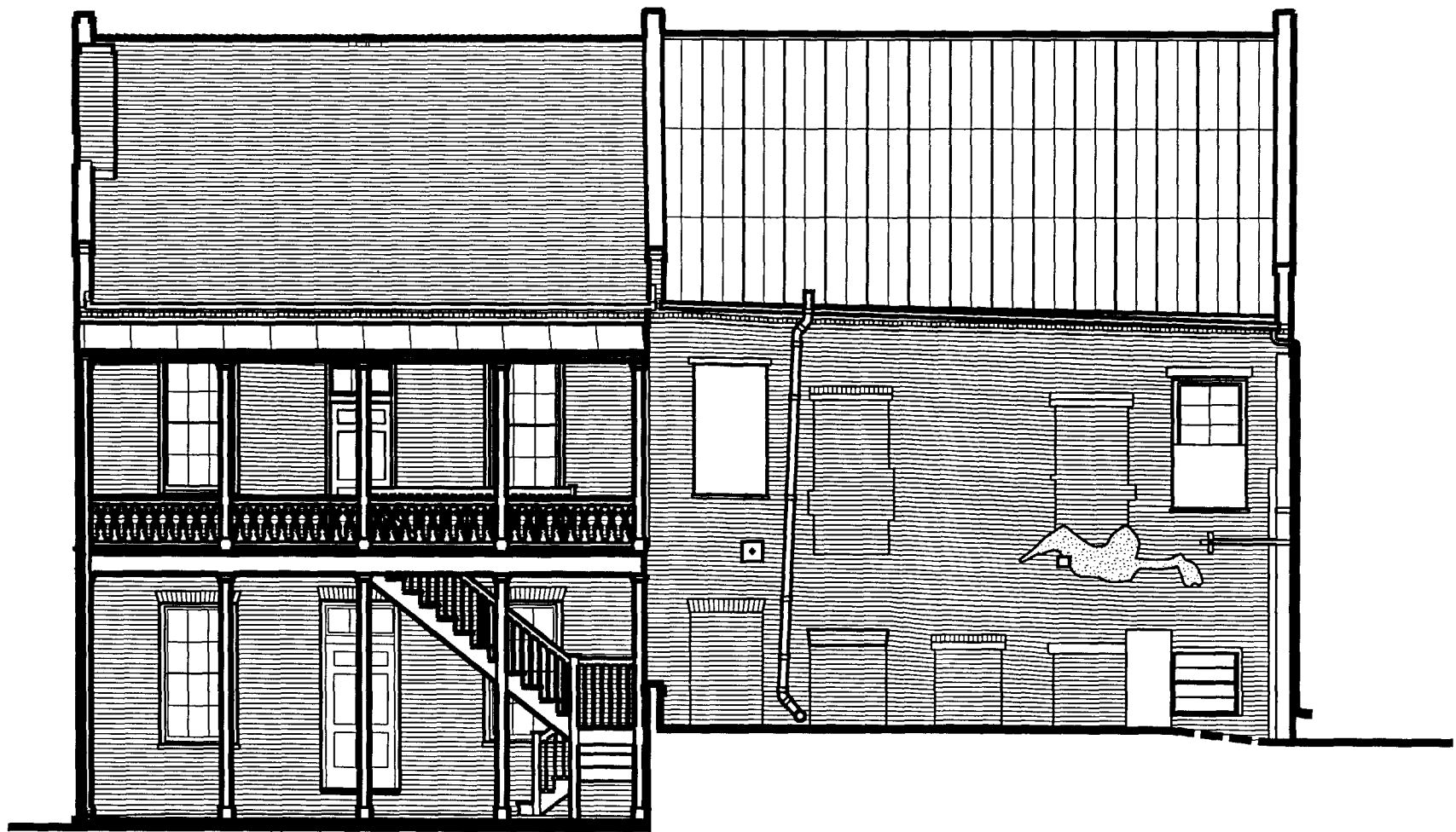

SOUTH ELEVATION

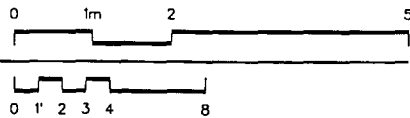



SOUTH ELEVATION

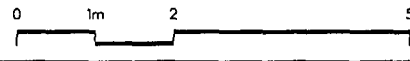

SECTION THRO' WM. JOHNSON PORCH

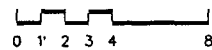

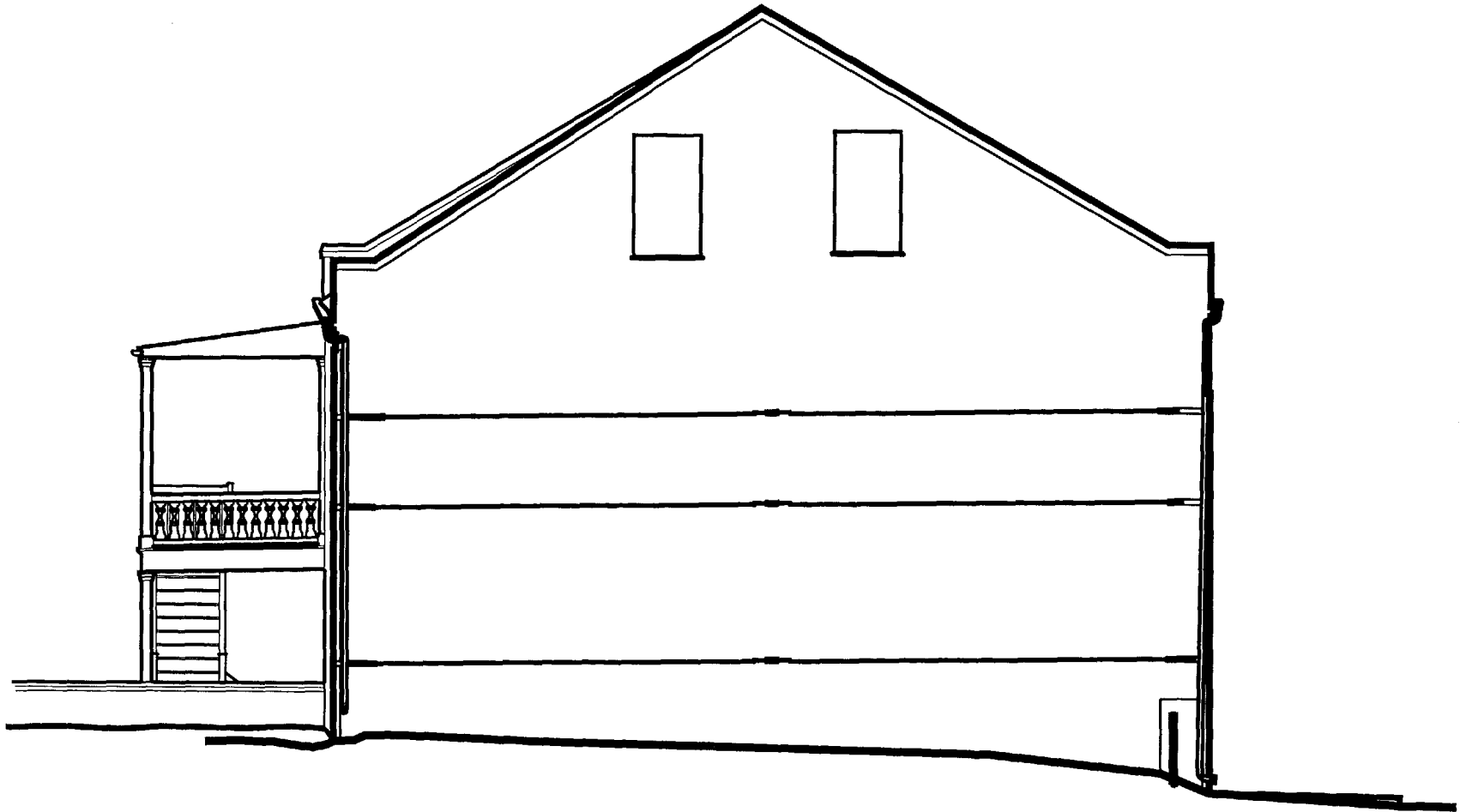

EAST ELEVATION



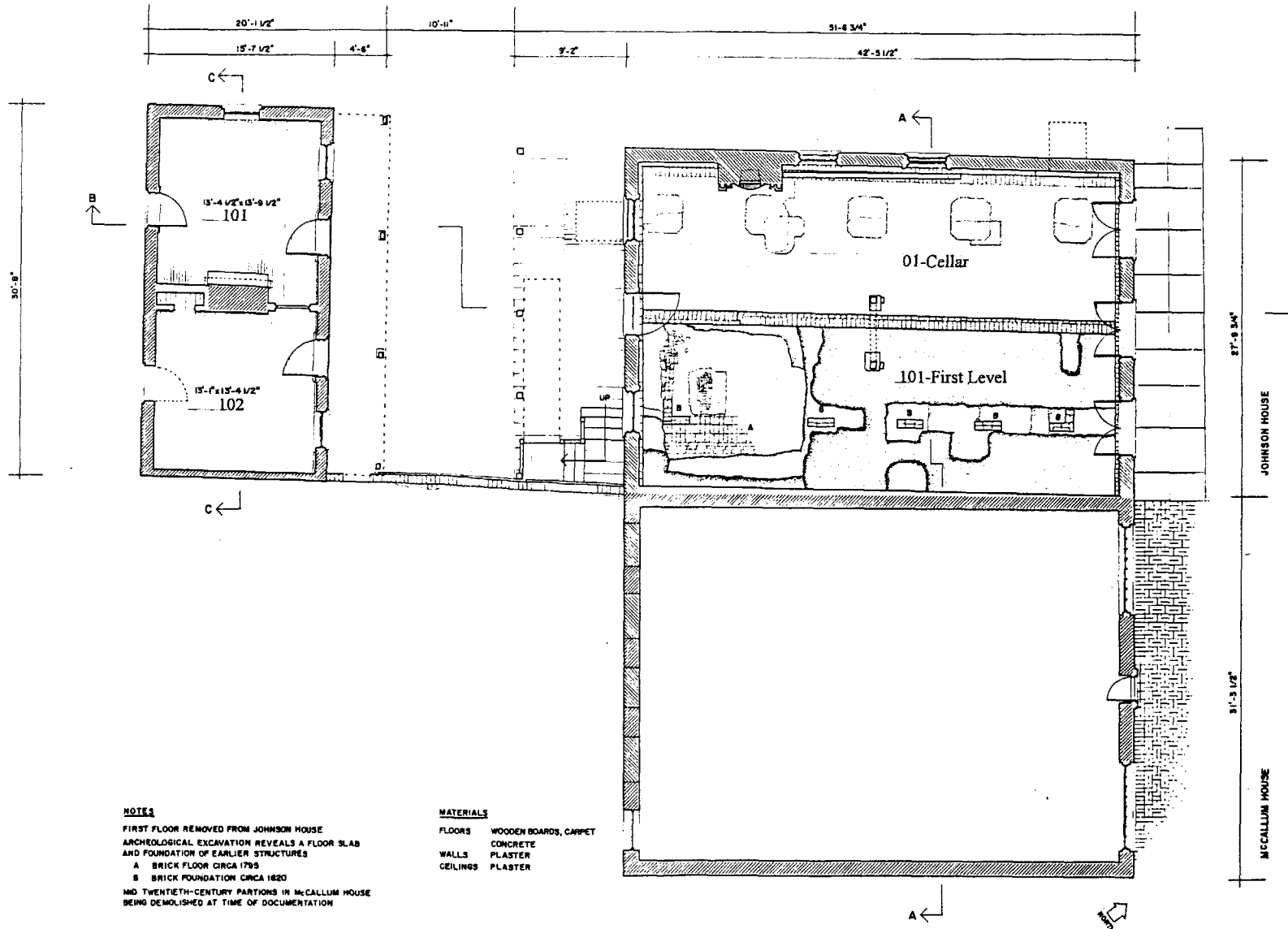

NOTES

FIRST FLOOR REMOVED FROM JOHNSON HOUSE
 ARCHEOLOGICAL EXCAVATION REVEALS A FLOOR SLAB
 AND FOUNDATION OF EARLIER STRUCTURES
 A BRICK FLOOR CIRCA 1795
 B BRICK FOUNDATION CIRCA 1820
 MID TWENTIETH-CENTURY PARTIONS IN MCCALLUM HOUSE
 BEING DEMOLISHED AT TIME OF DOCUMENTATION

MATERIALS

FLOORS WOODEN BOARDS, CARPET
 CONCRETE
 WALLS PLASTER
 CEILINGS PLASTER

FIRST FLOOR PLAN

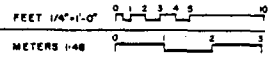

RODERICK FLIKER
 MICRORÉCORDING PROJECT 1992
 NATIONAL HISTORICAL PARK
 NATIONAL ARCHIVES
 WILLIAM JOHNSON AND JOHN MCCALLUM HOUSES
 210-212 STATE STREET
 NATCHEZ, ADAMS COUNTY, MISSISSIPPI
 MS - 270
 HISTORIC AMERICAN BUILDINGS SURVEY
 Sheet 2 of 8 sheets
 REPRODUCED FROM GREAT HISTORICAL AMERICAN BUILDINGS SURVEY, NATIONAL ARCHIVES RECORDS DIVISION, DATE OF THE ORIGINAL

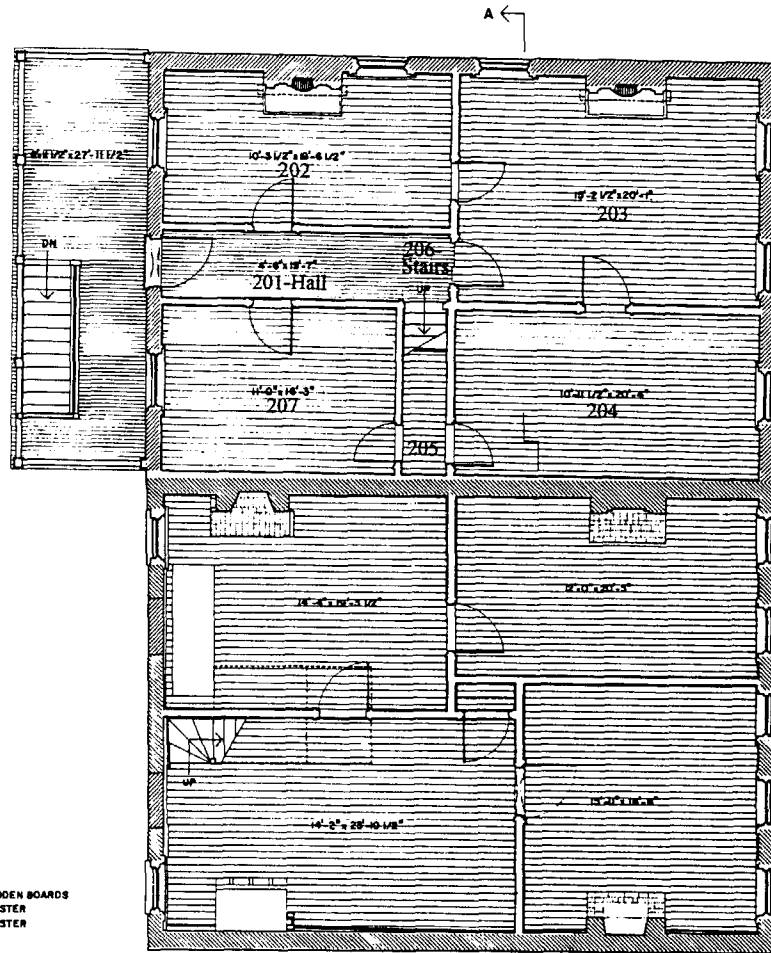
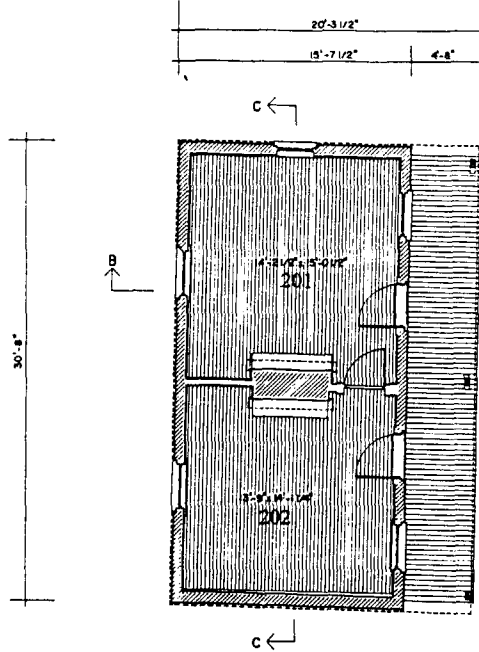

MATERIALS
 FLOORS WOODEN BOARDS
 WALLS PLASTER
 CEILINGS PLASTER

SECOND FLOOR PLAN

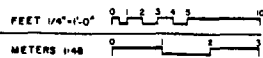

DRAWN BY MICHELLE L. ZING
 ROSE RECORDING PROJECT 1982
 MATCH WITH ARCHITECTURAL PLAN
 LOCATED AT THE ARCHIVES OF THE UNIVERSITY OF MISSISSIPPI
 WILLIAM JOHNSON AND JOHN MCCALLUM HOUSES
 ADAMS COUNTY MISSISSIPPI
 HISTORIC AMERICAN BUILDINGS SURVEY
 MS - 270
 SHEET 3 OF 8 SHEETS
 HISTORIC AMERICAN BUILDINGS SURVEY, NATIONAL PARK SERVICE, MADE BY MEASUREMENT, DATE OF THE DRAWING

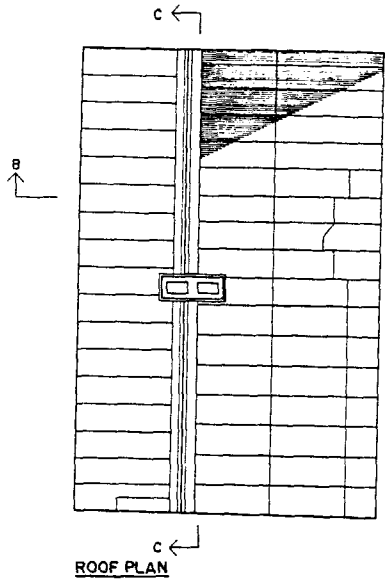

7'-11 1/2" PORCH ROOF EDGE ROOF EDGE 34'-11" 5'-5" EXTERIOR WALL 5'-2" DORMER EDGE ROOF EDGE

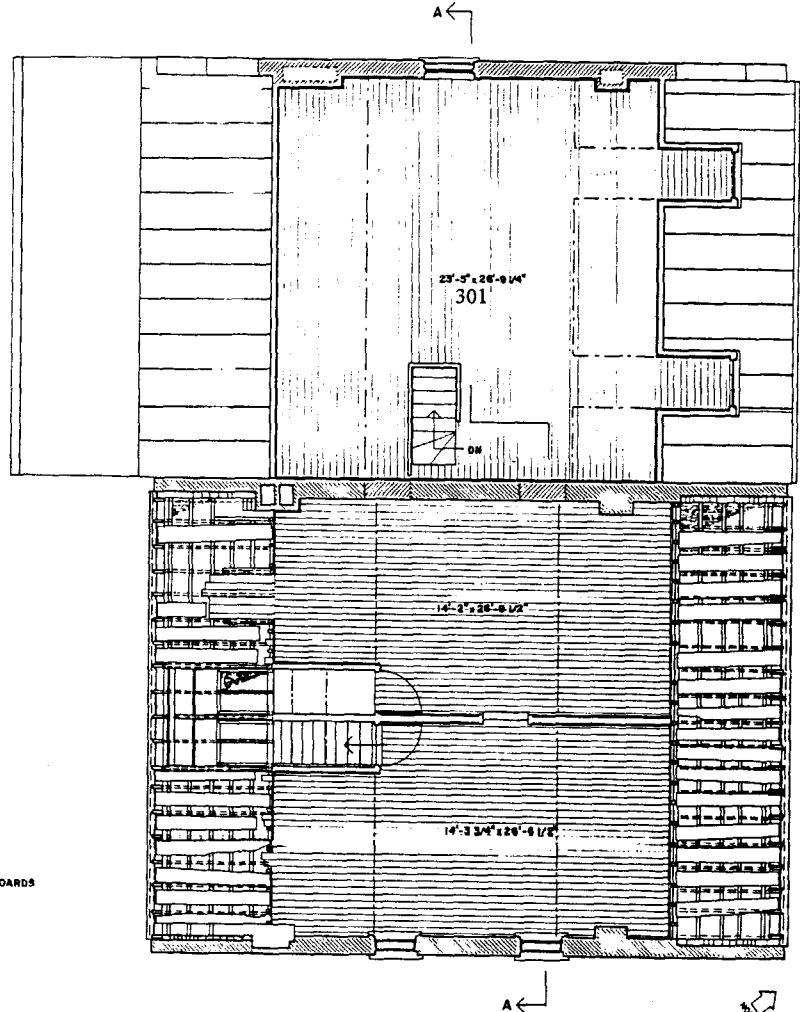

27'-9 3/4" B

31'-3 1/2" B

MATERIALS
 FLOORS WOODEN BOARDS
 WALLS PLASTER
 CEILINGS PLASTER

ATTIC FLOOR PLAN

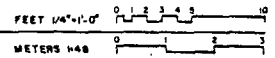

DESIGNED BY LAWRENCE A. WENTWORTH, RODERICK FLUHER
 MELROSE RECORDING PROJECT 1982
 MATCHES NATIONAL HISTORICAL PARK
 COURTESY OF THE NATIONAL ARCHIVES

NAME AND LOCATION OF STRUCTURE
WILLIAM JOHNSON AND JOHN MCCALLUM HOUSES
 ADAMS COUNTY
 MISSISSIPPI
 210-212 STATE STREET
 NATCHEZ, MISSISSIPPI

SURVEY NO.
 MS - 270

HISTORIC AMERICAN
 BUILDINGS SURVEY
 SERIES 4 OF 8 SHEETS

© COPYRIGHT 1982 BY LAWRENCE A. WENTWORTH, RODERICK FLUHER, MELROSE RECORDING PROJECT. ALL RIGHTS RESERVED. MADE OF RECYCLED PAPER. DATE OF THIS DRAWING





**9.7 National Park Service
Maintenance Task Directives**

Capps 8/30/91
K. Coble 8/30
PTL 8/30

NATC-91-06

AUG 30 1991

Memorandum

To: Superintendent, Natchez National Historical Park
From: Deputy Associate Regional Director, Cultural Resources,
Southeast Region
Subject: Section 106 Clearance for repair and rehab work on
Johnson House, Lawyers Building, and Johnson Dependency

We are pleased to inform you that Section 106 compliance procedures have been completed for the above project under the Programmatic Agreement (PA). A copy of the completed XXX Form is enclosed.

You are free to proceed with the project if funds are available and all other requirements have been met.

Paul B Hartwig

Enclosure

bcc:

SER-PC
Chief, OHA
Chief, OSC

MACapps: mbm 8/29/91: natc9106



United States Department of the Interior

NATIONAL PARK SERVICE
SOUTHEAST REGIONAL OFFICE

75 Spring Street, S.W.
Atlanta, Georgia 30303



IN REPLY REFER TO:

0 3 SEP 1991

H30 (SER-OHA)

Memorandum

To: Superintendent, Natchez National Historic Site

Through: Deputy Associate Regional Director, Cultural Resources,
Southeast Region *pmj*

From: Chief, Historic Architecture Division, Cultural
Resources, Southeast Region

Subject: Preservation maintenance and stabilization of the Johnson
House, (FY 91)

We are pleased to make the following proposal for preservation and stabilization of the Johnson House. The intent of the project is to improve the structural integrity and weather resistance of the building.

Listed below is work which will be completed by the regional preservation crew:

- A. Repair exposed interior masonry in the half-basement, including joists pockets and chimney foundation. Deteriorated floor joists will be set aside as required to allow for the masonry work.
- B. Repair deteriorated window frames and sashes, install new glazing, replace broken and missing window panes, and ensure double hung windows are made operable.
- C. Repair deteriorated rear porch balustrade and handrail.
- D. Temporarily patch roof leaks.

The preservation crew will prime all new wood installed as part of
woodwork repairs. It is understood that the park will complete
finish painting on the interior.

Total estimated cost for this project is \$22,900.00. Major cost
categories are outlined below:

Labor.....	\$10,941
Materials.....	1,750
Equipment Rental.....	1,500
Overhead.....	2,769
Per diem.....	5,940
 Total.....	 \$22,900

We propose to start the masonry part of the project on August 28,
1991. Carpentry work is scheduled to commence on September 11,
1991.

Earl Gillespie Head of OHA Field Services, will coordinate this
project with you. Every effort will be made to ensure that the
specified work is done to preservation standards within proposed
budget and project schedule. Unforeseen conditions which may
result in changes of scope, cost, or project duration will be
brought to your attention as soon as we are aware of them. Any
changes you may wish to make should be brought to Mr. Gillespie's
attention. All substantial changes are to be agreed to in writing
by you, and the OHA Division Chief.

We look forward to working with you on this project.

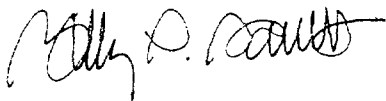

I concur with this task directive.

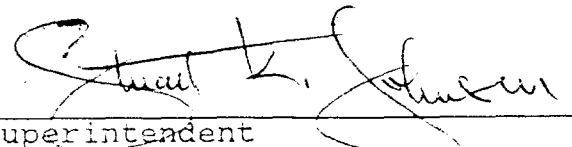

Superintendent

09-03-91
Date



United States Department of the Interior

NATIONAL PARK SERVICE
SOUTHEAST REGIONAL OFFICE

75 Spring Street, S.W.
Atlanta, Georgia 30303



IN REPLY REFER TO:

H30 (SER-OHA)

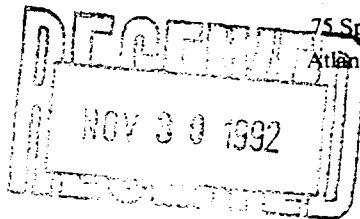

NOV 25 1992

Memorandum

To: Superintendent, Natchez National Historical Park

Through: Deputy Associate Regional Director, Cultural Resources,
Southeast Region *M. Hart*

From: Chief, Historic Architecture Division, Cultural
Resources, Southeast Region

Subject: Task Directive for Preservation Maintenance Masonry
Work at William Johnson House and Dependency

We are pleased to make the following proposal for preservation maintenance masonry work at the William Johnson House and Dependency. The intent of this project is the stabilization of masonry in both structures.

Activities have been divided into the following work elements:

Johnson House:

West Elevation (1450SF)

1. Erect scaffold
2. Remove stucco
3. Deep rake joints
4. Repoint
5. Rebuild coping at top of parapet wall

Chimney, (West elevation, South corner)

1. Interior firewall demolition
2. Excavate/pour footer
3. Rebuild brick foundation
4. Rebuild 1st floor firebox
5. Rebuild 2nd floor firebox
6. Rebuild attic stack
7. Rebuild chimney cap

Basement

1. Repair south wall, west corner access opening
2. Install bracing at north wall, west corner per specifications of Richard Ohmstede, Denver Service Center, structural engineer
3. Repoint 100% to bottom of floor joists

Dependency:

1. Repair joist pockets at all three levels
2. Portland plaster removal west room 1st floor
3. Provide electrical conduit chase for four rooms
4. Demo unstable plaster
5. Repair structural fractures
6. Repoint selectively to stabilize
- ✓ 7. Plaster 4 rooms and ceilings
8. On three fireplaces remove loose material, relay fireboxes, seal throat and cap chimney
9. Selective repointing at south elevation
- ✓ 10. Wingwall repairs at rear of Dependency

Total estimated cost for this project is \$122,818. Major cost categories are outlined below:

Labor.....	\$76,448
Materials & Equipment.....	8,000
Travel & Per diem.....	37,970
 Total.....	 \$122,818

We propose to start the project in January, 1993. Estimated completion date is May, 1993. Because of the heavy masonry workload of the preservation crew in FY 93, we anticipate hiring local craftsmen or detailing personnel from other parks to assist us during this project in order to finish all work elements.

Mike Doelger, Head of OHA Field Services, will coordinate this project with you. Every effort will be made to ensure that the specified work is done to preservation standards within proposed budget and project schedule. Unforeseen conditions which may result in changes of scope, cost or project duration will be brought to your attention as soon as we are aware of them. Any changes you may wish to make should be brought to Mr. Doelger's attention. All substantial changes are to be agreed to in writing by you, and the OHA Division Chief.

We look forward to working with you on this project. As this project is funded through construction money, all expenditures will be charged directly to the park project account. We will maintain our service of tracking all project expenditures.



I concur with this task directive.

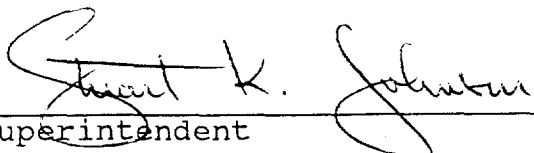

 Superintendent

12-01-92
 Date

memorandum

DATE: December 11, 1992

REPLY TO
ATTN OF: Steve Sherwood, Mechanical Engineer, SER-OM

SUBJECT: Preliminary Design, HVAC for Johnson House Dependency

TO: Rene Cote, Historic Architect, SER-OHA

Per our discussion enclosed are the sketches on the subject system. Please note the following points:

1. Supply duct is insulated, return need not be. Thus a supply duct that is an indicated size of 20 x 14 is 20" on the inside horizontal direction and 14" on the inside vertical direction. This is for a plan view, of course and is drawn 22" by 16" in order to add the insulation.
2. The duct going down the chase appears to meet your requested maximum size but we may need to "shift" the ducts upstairs toward the top of the page (to the Northwest) and that should not be any problem.
3. Also enclosed are the load calculations on the structure which Stuart may need if a contractor has a question. There were some assumptions made that need to be documented:

Occupant heat gain is based on a total of 8 persons. Appliances include 2 computers but no coffee makers, microwaves, fax machines, copiers, or any other significant heat generators. The lighting load was assumed to be one direct 75 watt incandescent and one indirect 75 watt incandescent bulb. Transmission and convection gains through glass were based on "standard" $\frac{1}{4}$ " glass with no storm or low 'e' panes. R-38 (12" fiberglass insulation) in the attic and R-19 (6" fiberglass insulation) in the crawlspace. Walls have no insulation and consist only of 12" brick and plaster. Standard infiltration rates were used with a summer design condition of 95⁰F and winter condition of 25⁰F.

A high efficiency gas furnace was used in the design but a heat pump would work just as well and would not require an outside exhaust and intake vent. Please call if any questions.



Steve Sherwood

cc: Superintendent, NATC
Acting Chief, SER-OM

15'-7 1/2"

4'-8"

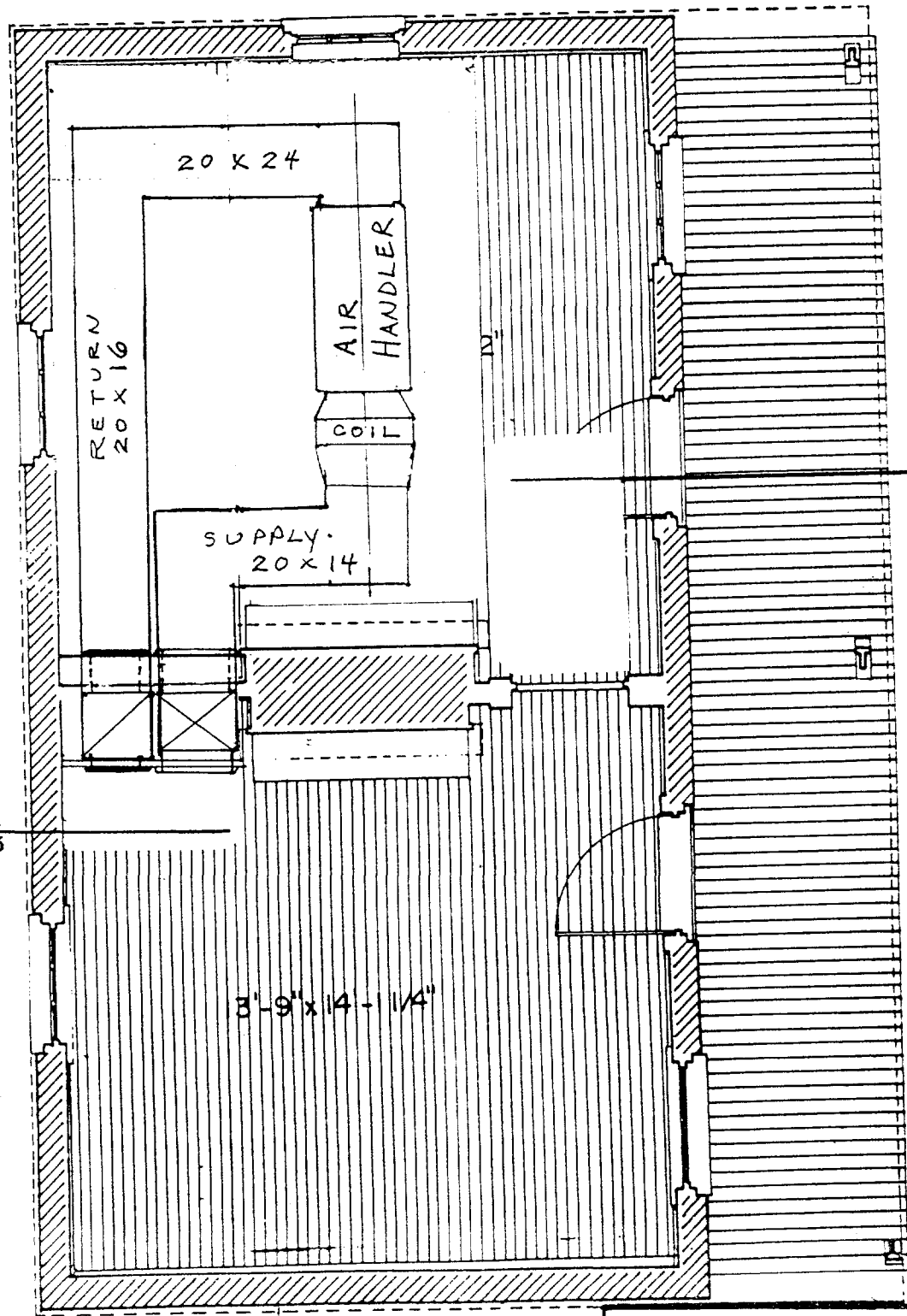
C ←



S ↑
REF.
HVAC-3

S ↑

C ←

Natchez NHP
 Johnson Dependency
 Second Floor HVAC
 12/10/92 N. P. S. Atlas

HVAC - 1

15'-7 1/2"

4'-6"

C ←

13'-4 1/2" x 13'-9 1/2"

CHASE FOR
CONDUIT, REFR
LINES, & GAS
PIPING

S ↑

REF.
HVAC-3

RUN REFR LINES
& ELEC CONDUIT
UNDERGROUND, INTO
THE CRAWLSPACE
AND UP TO THE
ATTIC IN CHASE

13'-1" x 13'-4 1/2"

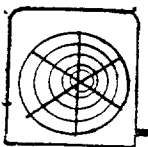

SUGGESTED LOCATION
OF OUTDOOR CONDENSER

C ←

Natchez NHP
Johnson Dependency
First Floor HVAC
12/10/92

N. P. S. Atlan

HVAC 12

20 X 6 TYPE VHD
DOUBLE DEFLECTION
SUPPLY REGISTER
APPROX. 300 CFM
@ 550 FPM & 15 FT
THROW. TYP 4

14 X 6 TYPE RH45
RETURN GRILLE
HART & COOLEY
TYP. 8

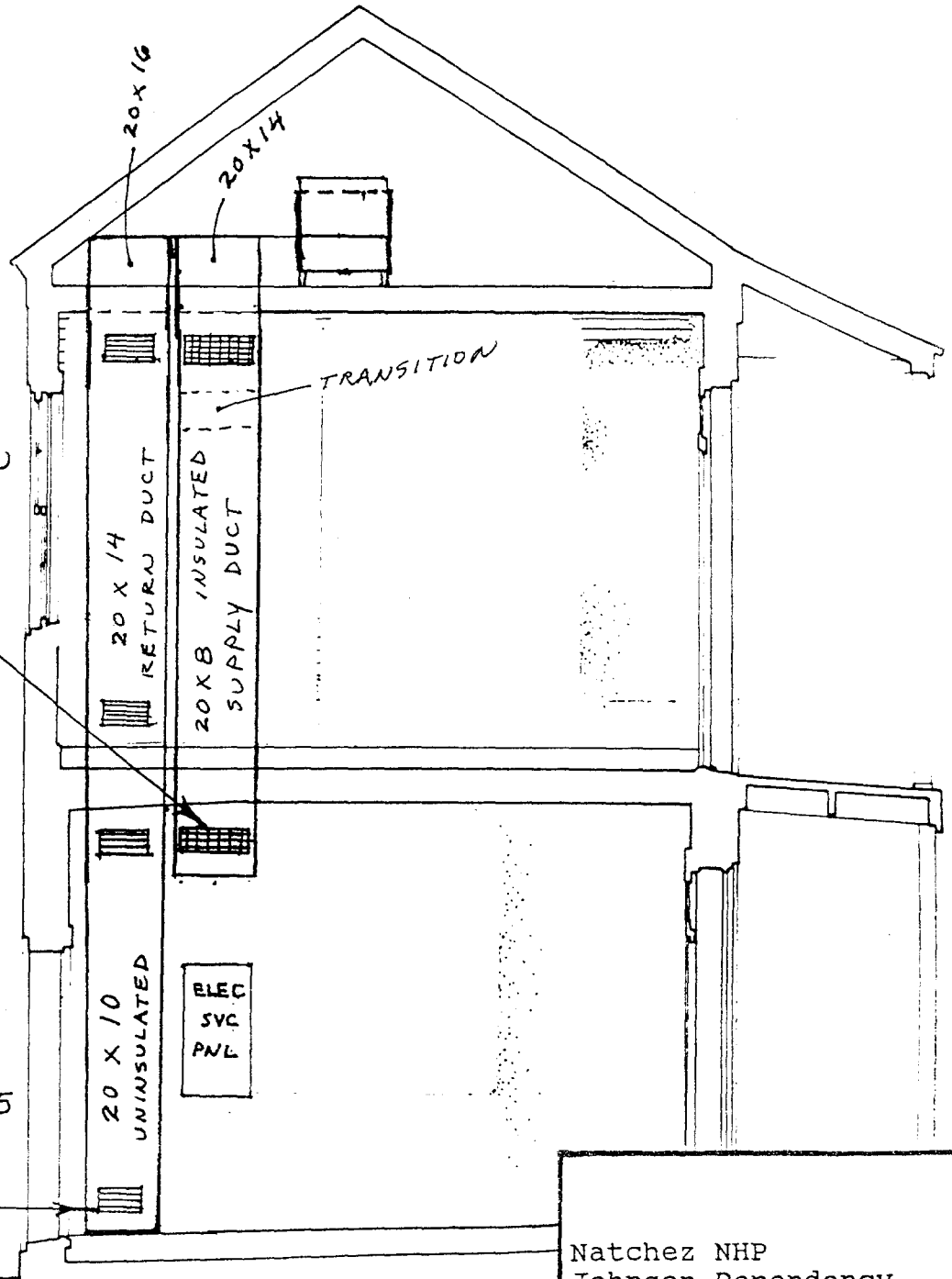

DEPENDENCY

Natchez NHP
Johnson Dependency
Section "S-S" HVAC
12/10/92 N. P. S.

HVAC -

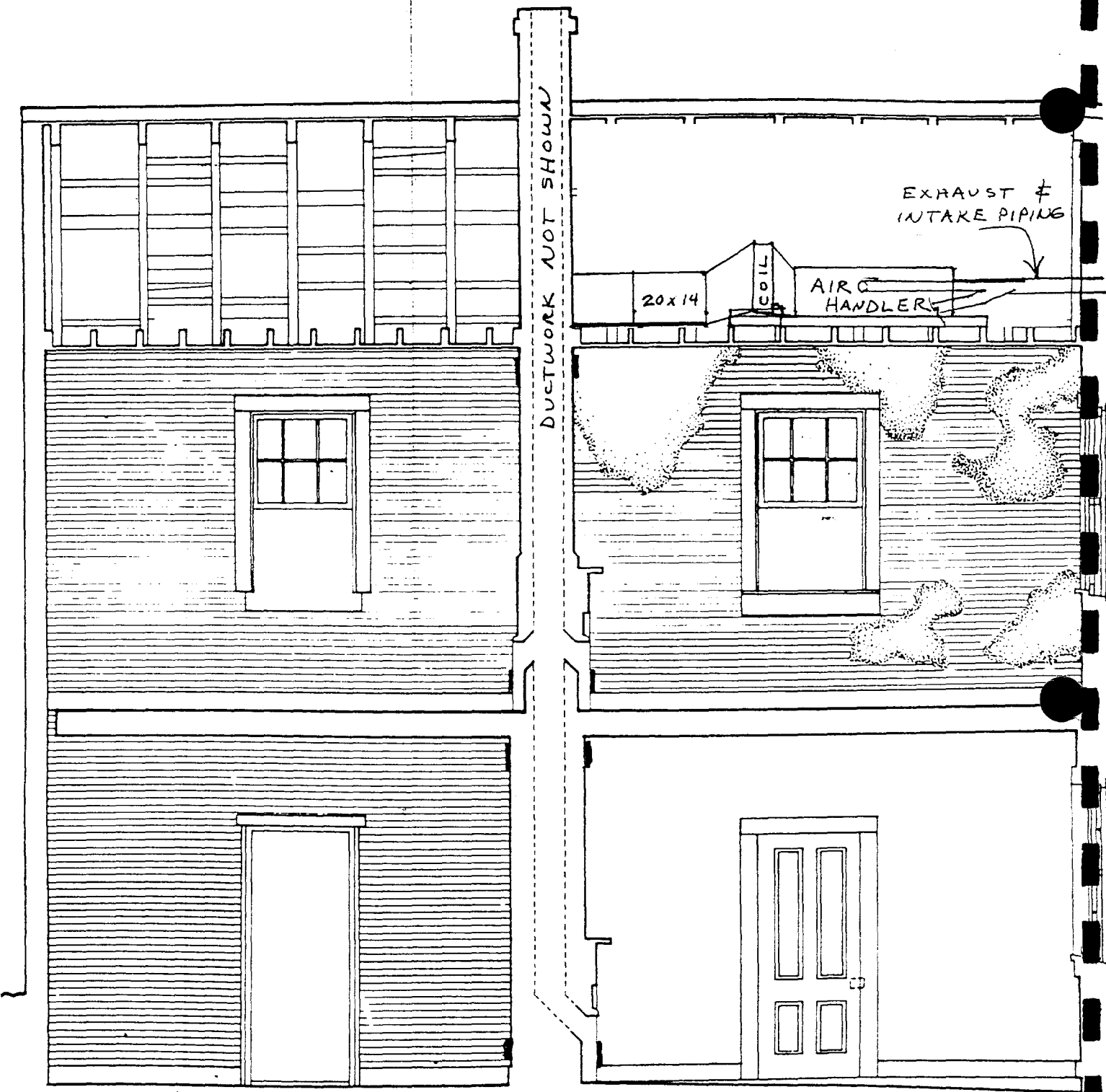

Natchez NHP
 Johnson Dependency
 Section "C-C" HVAC
 12/10/92 N. P. S. Atlanta

HVAC-4

NATC JOHNSON HOUSE DEPENDENCY AIR CONDITIONING SUMMARY

A/C ZONE	LOCATION/ DESCRIPTION	FLOOR AREA	DESIGN CFM	CFM/ S.F.	COOLING BTU/HR	COOLING TONS	S.F./ TON
	BOTH FLOORS	783	1,275	1.63	34,809	2.9	270

NATC JOHNSON HOUSE DEPENDENCY HEATING SUMMARY

A/C ZONE	LOCATION/ DESCRIPTION	FLOOR AREA	DESIGN CFM	CFM/ S.F.	HEATING BTU/HR	HEATING KW	BTU/ S. F.
	BOTH FLOORS	783			33,468	9.8	42.7

NATCHEZ- DEPENDENCY EQUIPMENT DESIGNATION

A/C ZONE	LENNOX OUTDOOR	INDOOR	S.E.E.R	NOMINAL CFM	EQUIPMENT COOLING BTU/HR	NOMINAL COOLING TONS	ELEC LOAD AMPS
ALL	HS22-411	GSR21Q3-50	12.0	1200	35,400	2.95	18.0
	W/CH16-41FF EVAPORATOR						
					HEATING INPUT	50,000	BTU/HR
					HEATING OUTOUT	47,000	BTU/HR
					A. F. U. E.	94%	



DEPENDENCY

HVAC LOAD CALCULATIONS

PAGE 1

NATC

FOR: JOHNSON HSE- DEPENDENCY

BY: STEVE SHERWOOD

DATE: 12/08/92

1. DESIGN CONDITIONS (COOLING).

LATITUDE: 31

REV

TIME OF DAY: 3:00 PM DAILY RANGE: 21 C. F.: -0.5
 INSIDE D. B. 75 OUT D. B.: 95 T. D.: 20
 INSIDE R. H.: 50% OUT W. B.: 78 GRAINS: 56

2. SOLAR RADIATION HEAT GAIN THROUGH GLASS.

EXPOSURE- GLASS	SQ. FT.	SOLAR FACT.	SHADING FACTOR	COOLING SENSIBLE	LOAD NOTES
NORTHEAST	68	39	0.94	2,475	
SOUTHEAST	0	65	0.94	0	PEAK TO BE AT 3:00P
SOUTHWEST	30	96	0.94	2,707	
NORTHWEST	25	42	0.94	987	
SUB-TOTAL				6,169	

3. TRANSMISSION GAINS

EXPOSURE	SQ. FT.	COLOR	U-FACTOR	EQUIV OR T. D.	SENSIBLE	NOTES
GLASS ALL EXPOSURES	123		1.04	20	2,548	
WALLS NORTHEAST	459	0.83	0.21	20.5	1,630	
NET SOUTHEAST	287	0.83	0.21	23.5	1,170	GROUP
AREA SOUTHWEST	537	0.83	0.21	16.5	1,537	D
NORTHWEST	262	0.83	0.21	14.5	659	CORR -0.5
DOOR NORTHEAST	84		0.46	20	773	
DOOR SOUTHWEST	42		0.46	20	386	
FLOOR R-19	392		0.05	20	412	
CEILING/ROOF R-38	534	1	0.03	68	948	
SUB-TOTAL					10,064	

4. INTERNAL HEAT GAIN

COOLING LOAD

a. OCCUPANTS

NUMBER	SENSIBLE	LATENT	SENSIBLE	LATENT
8	255	255	2,040	2,040
0	315	325	0	0

b. LIGHTS, MOTORS, AND APPLIANCES

INCANDESCENT-	600 WATTS	1	3.4	2,040	
FLUORESCENT-	0 WATTS	1	4.1	0	
COMPUTERS- CPU & CRT	2 EACH	600	3.4	4,097	
COMPUTERS- PRINTERS	2 EACH	912	3.4	623	10%

SUB-TOTAL 8,800 2,040

NATC

JOHNSON DEPENDENCY

TOTAL- PAGE 1

25,032

2,040

NATC	DEPENDENCY	HVAC LOAD CALCULATIONS;				NATC	PAGE 2
		TOTAL- FROM PAGE 1				25,032	2,040
5.	INFILTRATION	VOLUME =	3,132 CU.FT.				
	21 CFM X T D	20 X 1.1 FACTOR=			459		
	21 CFM X	56 GRAINS X .68 FACTOR=				795	
6.	SUBTOTAL COOLING LOAD FOR SPACE					25,492	2,835
7.	SUPPLY DUCT HEAT GAIN						
	GAIN FACTOR	0.1 X LINE 6 SENSIBLE=			2,549		
8.	ROOM, ZONE OR BLOCK DESIGN LOAD					28,041	2,835
	COOLING CFM = LINE 8 /1.1/20=	1,275 CFM					
9.	VENTILATION						
	40 CFM X	20 D. B. X 1.1 FACTOR=			880		
	40 CFM X	56 GRAINS X .68 FACTOR=				1,523	
10.	RETURN AIR LOAD FROM LIGHTING AND ROOF						
11.	RETURN DUCT HEAT GAIN						
	GAIN FACTOR	0.06 X LINE 6 SENSIBLE=			1,529		
12.	TOTAL LOADS ON EQUIPMENT (BTU/HR):					30,450	4,358
					BTU/HR	TONS	
	S/T RATIO: 0.87	TOTAL COOLING LOAD			34,809	2.90	
13.	DESIGN CONDITIONS HEATING	70 INDOOR	25 OUTDOOR	45			
				T. D.			
14.	TRANSMISSION LOSSES						
	EXPOSURE	SQ. FT.	U-FACTOR	T. D.	HEATING LOAD		
GLASS	ALL EXPOSURES	123	1.10	45	6,064		
WALLS	NORTH	459	0.21	45	4,312		
	EAST	287	0.21	45	2,699		
	SOUTH	537	0.21	45	5,050		
	WEST	262	0.21	45	2,464		
CEILING	534	SQ. FT	0.03	45	632		
FLOOR	392	SQ. FT	0.05	45	927		
DOORS	84		0.46	45	1,739		
DOORS	42		0.46	45	869		
			SUB-TOTAL		23,888		
15.	INFILTRATION CFM-	31 X TD-	45 X 1.1 FAC	1,550			
16.	SUBTOTAL HEATING LOAD FOR SPACE					25,438	
17.	SUPPLY DUCT HEAT LOSS						
	LOSS FACTOR	0.10 X LINE 16 LOSS=			2,544		
18.	VENTILATION CFM-	80 X T D	45 X 1.1 FAC	3,960			
19.	HUMIDIFICATION LOAD						
20.	RETURN DUCT HEAT LOSS	LF 0.06 X LINE 16 LOSS =			1,526		
					BTU/HR	KW	
21.	TOTAL HEATING LOAD ON EQUIPMENT JOHNSON DEPENDENCY					33,468	9.81

CH16-21FF, CH16-31FF & CH16-41FF HORIZONTAL EVAPORATOR UNITS

*12,800 to 40,500 Btuh Cooling Capacity

* ARI Standard 210/240 Certified Ratings With Matching Condensing Unit

CH16

Bulletin #480061

February 1992

Supersedes October 1991

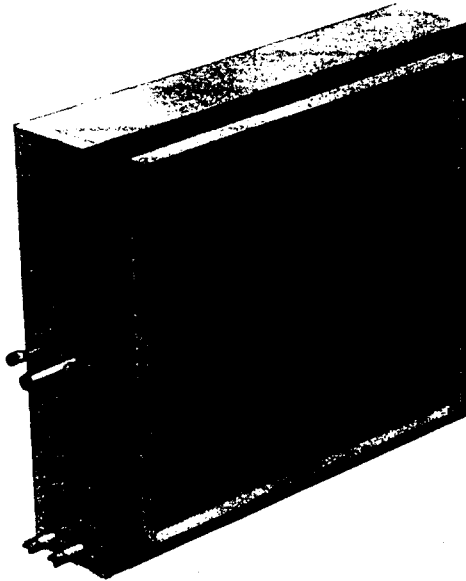

Lennox Evaporator Coil Units Provide High Efficiency Add-On Cooling For Horizontal Furnaces

Lennox CH16 series horizontal evaporator coil units are applicable to additive cooling installations with Lennox horizontal furnaces. See Heating Units tab section for furnace data. For cooling capacities see condensing unit bulletins indexed in section Cooling Units — Condensing Units. See FUELMAS-TER+™ bulletin in Heat Pumps — Matched Remote Systems tab section for heat pump application ratings.

Heavy gauge galvanized steel coil cabinets are completely lined with thick fiberglass insulation. Flanges on air openings of cabinet allow ease of duct connection. Removable panels provide access to interior of cabinet. Deep corrosion resistant drain pan is constructed of heavy gauge galvalume-u steel and has dual drain connections for protection from overflow. Refrigerant lines are extended outside of the cabinet for ease of connection. See dimension drawings. Refrigerant lines are equipped with flare fittings. A field installed expansion valve kit is required for coils and must be ordered extra. See condensing units bulletins.

Lennox designed and fabricated coil is constructed of precisely spaced ripple-edged aluminum fins machine fitted to sturdy copper tubes. Slab coil provides extra large surface and contact area for highest efficiency. Precise circuiting gives uniform refrigerant distribution. Copper tubing provides long service life and ease of service. Fins are strengthened to resist bending and are equipped with collars that grip the tubing for maximum contact area resulting in excellent heat transfer. Flared shoulder tubing joints and silver soldering provide leakproof joints. Coil is thoroughly tested under high pressure to insure leakproof construction.

Coil units have been thoroughly tested with matching condensing units in the Lennox Research and Development Laboratory environmental test room and rated in accordance with ARI Standard 210/240 conditions and DOE test procedures. Air resistance data is from tests conducted in the Lennox Laboratory air test chamber. Coil units are shipped factory assembled.

Typical Applications

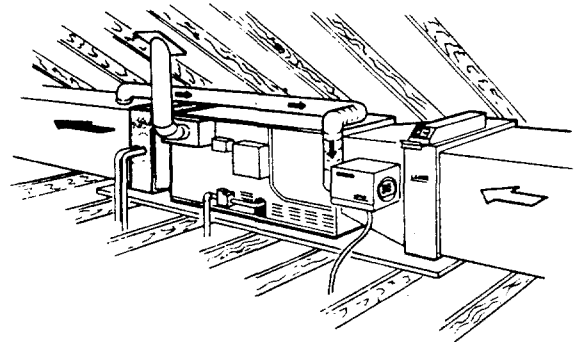

Attic Installation
With Cooling Coil, Electronic Air Cleaner
and Automatic Humidifier

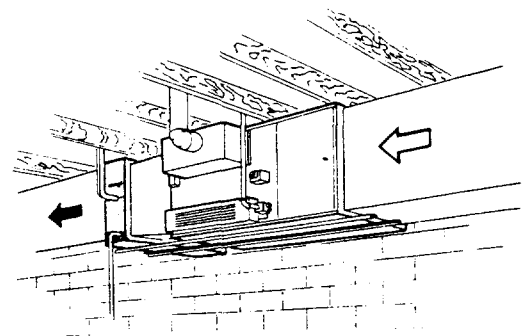

Basement Installation
With Cooling Coil

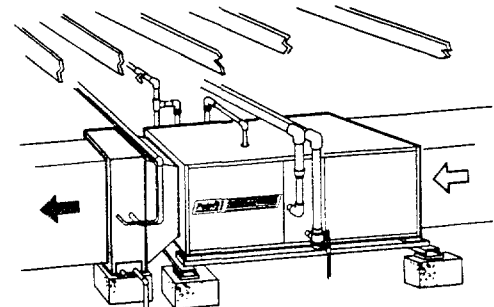

Crawl Space Installation
With Cooling Coil

SPECIFICATIONS

Model No.		CH16-21FF	CH16-31FF	CH16-41FF
Evaporator Coil	Net face area (sq. ft.)	2.48	2.48	3.35
	Tube diameter (in.)	3/8	3/8	3/8
	No. of rows	3	4	4
	Fins per inch	15	13	14
Suction line connection (in.) — flare		*5/8	**3/4	3/4
Liquid line connection (in.) — flare		3/8	1/2	1/2
Condensate drain (mpt) (in.)		3/4	3/4	3/4
Refrigerant		R-22	R-22	R-22
Coil shipping weight (lbs.) 1 package		36	41	52

* 3/4 MF x 5/8 FF adaptor required with HS19-261V & HS22-261V condensing units.
 **5/8 MF x 3/4 FF adaptor required with HS22-211V condensing units.

AIR RESISTANCE

Model No.	Air Volume (cfm)	Total Resistance (in. wg.)
CH16-21FF	500	.05
	600	.06
	800	.11
	1000	.15
CH16-21FF CH16-31FF	600	.09
	800	.13
	1000	.19
	1200	.26
CH16-41FF	800	.08
	1000	.10
	1200	.12
	1400	.14
	1600	.18

FURNACE SELECTOR

Evaporator Model No.	Field Fabricated Adaptor Required For Installation With The Lennox Furnaces Listed Below
CH16-21FF	GSR21Q3-50, GSR21V3-50, GH19Q3-50, GH19Q3-75, OSR20Q3-105, OSR20Q3-120
CH16-31FF	GSR21Q3-50, GSR21Q3-80, GSR21V3-50, GH19Q3-50, GH19Q3-75, OSR20Q3-105, OSR20Q3-120
CH16-41FF	GSR21Q3-50, GSR21Q3-80, GSR21V3-50, GH19Q3-50, GH19Q3-75, GH19Q3/4-100, GH19Q4/5-125, OSR20Q3-105, OSR20Q3-120, OSR20Q4/5-140, OSR20Q4/5-154, OS20-175

DIMENSIONS (inches)

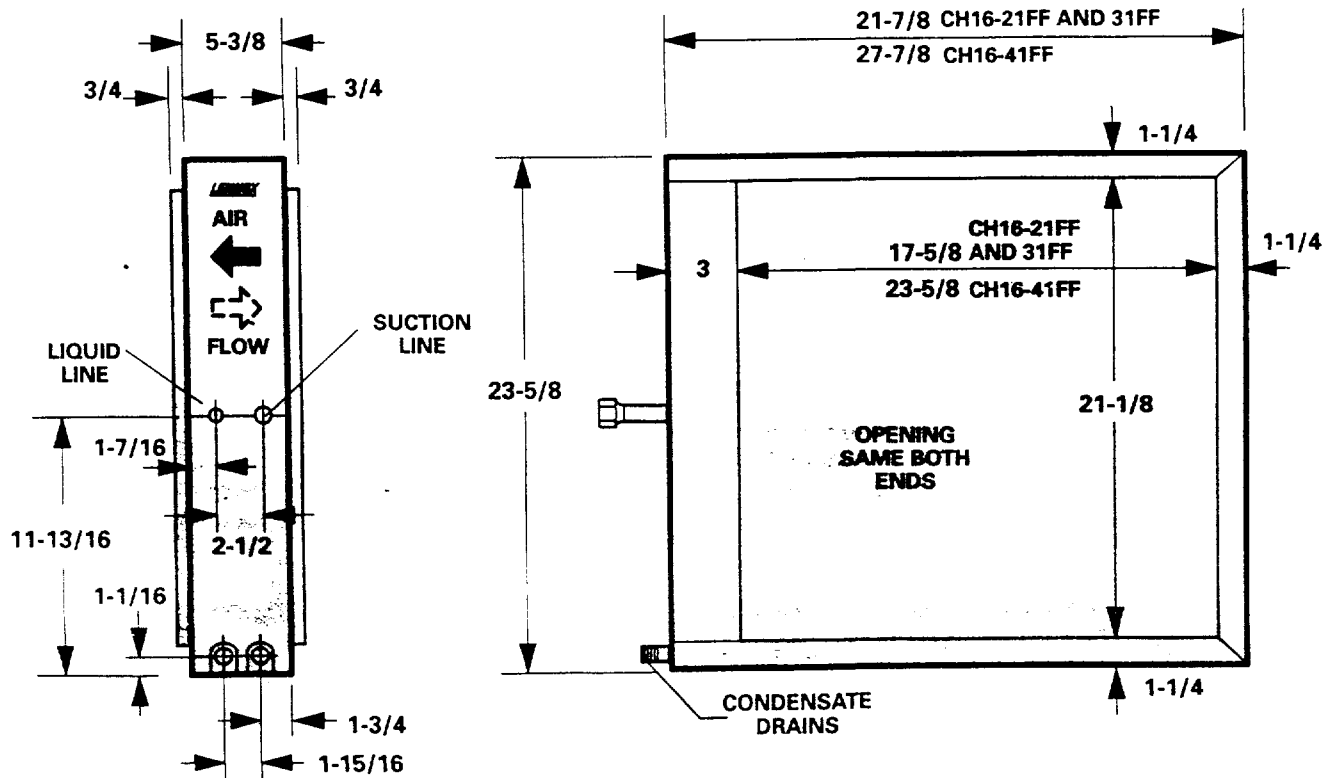



One Stage Heat and One Stage Cool — Thermostat DSP-200 (18H15) features manual changeover, built-in time delays, LCD readout with set point temperature and actual temperature in °F or °C, plus system status and operational mode. Individual 'Heating' and 'Cooling' buttons raise or lower temperature set points. 'Mode' button selects heat, cool or system off setting. 'Fan' button allows continuous (On) or intermittent (Auto) blower setting. Solid-state electronic technology eliminates battery back-up and maintains thermostat settings during power failure.

One Stage Heat and One Stage Cool — Thermostat DSP-300 (18H14) features automatic changeover, built-in time delays, LCD readout with set point temperature and actual temperature in °F or °C, plus system status and operational mode. Individual 'Heating' and 'Cooling' buttons raise or lower temperature set points. 'Mode' button selects heat, cool, heat/cool (auto changeover) and system off setting. 'Fan' button gives a choice of continuous (On) or intermittent (Auto) blower setting. Solid-state electronic technology eliminates battery back-up and maintains thermostat settings during power failure.

PROGRAMMABLE THERMOSTATS Heating/Cooling Systems

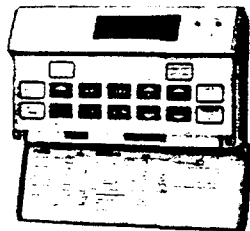

One Stage Heat and One Stage Cool — Thermostat T8600D (27H31) with wiring wallplate features automatic changeover, built-in time delays, system switch (Heat-Off-Cool-Auto), fan switch (On-Auto) for continuous or intermittent blower operation, touch sensitive keyboard and LCD display with time, day, status and temperature readout in °F or °C. Thermostat has 5-1-1 day programming for weekdays and Saturday/Sunday schedules with four different time and temperature settings (Wake-Leave-Return-Sleep) per day. Two LEDs indicate Energy Savings (Setback) and System 'On'. Has instant override capabilities for skipping current program, running previous program, temporarily raising or lowering temperature for current program or overriding program indefinitely. Three 'AAA' alkaline batteries protect programs in case of power failure.

Two Stage Heat and Two Stage Cool — Thermostat T8621D (27H29) with switching subbase features automatic changeover, built-in time delays, system switch (Heat-Auto-Cool-Off), fan switch (On-Auto) for continuous or intermittent blower operation, touch sensitive keyboard and LCD display with time, day, status and temperature readout in °F or °C. Thermostat has full independent 7 day programming with four different time and temperature settings (Morning-Midday-Evening-Night) per day. Three LEDs indicate Cooling Stage 1, Cooling Stage 2 and System 'On' status. Has instant override capabilities for skipping current program, running previous program, temporarily raising or lowering temperature for current program or overriding program indefinitely. Three 'AAA' alkaline batteries protect programs in case of power failure.

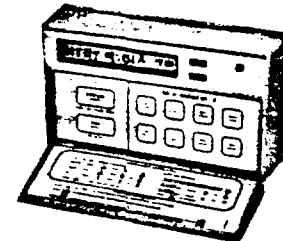

One Stage Heat and One Stage Cool — Thermostat 1F90 (18H10) with wiring wallplate features automatic or manual changeover, built-in time delays, system switch (Heat-Off-Auto-Cool), fan switch (On-Auto) for continuous or intermittent blower operation, touch sensitive keyboard with audible indicator, and backlit LCD readout with time and temperature in °F or °C, plus operational mode and system status. Thermostat has 5-2 day programming for Monday thru Friday and Saturday/Sunday scheduling with up to four separate time and temperature settings (Morning-Day-Evening-Night) per day. Red LED indicates system operation. Has instant override capabilities for temporary 2 hour override of current program, overriding program indefinitely, or advancing to next program. Temperature 'Up' and 'Down' buttons adjust temperature settings during programming and override functions. Keyboard lockout prevents program tampering. Three 'AA' alkaline batteries protect programs in case of power failure.

One Stage Heat and One Stage Cool — Thermostat 1F97 (18H11) with wiring wallplate features automatic or manual changeover, built-in time delays, system switch (Heat-Off-Auto-Cool), fan switch (On-Auto) for continuous or intermittent blower operation, touch sensitive keyboard with audible indicator and backlit LCD readout with day, time and temperature in °F or °C, plus operational mode and system status. Thermostat has full independent 7 day programming with up to four separate time and temperature settings per day. Red LED indicates system operation. Has instant override capabilities for temporary 2 hour override of current program or overriding program indefinitely. Temperature 'Up' and 'Down' buttons adjust temperature setting during programming and override functions. 'Copy' button allows duplication of one day's programming to another day. Keyboard lockout prevents program tampering. Three 'AA' alkaline batteries protect programs in case of power failure.

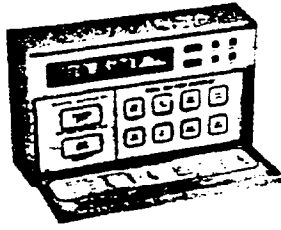

Three Stage Heat and Two Stage Cool — Thermostat 1F92 (18H12) with wiring wallplate features automatic or manual changeover, built-in time delays, system switch (Heat-Emergency Heat-Off-Cool-Auto), fan switch (On-Auto) for continuous or intermittent blower operation, touch sensitive keyboard with audible indicator and backlit LCD readout with time and temperature in °F or °C, plus operational mode and system status. Thermostat has 5-2 day programming for Monday thru Friday and Saturday/Sunday scheduling with up to four separate time and temperature settings (Morning-Day-Evening-Night) per day. Four LEDs indicate Emergency Heat (Red), Auxiliary Heat (Yellow), Heat Pump Malfunction (Red), and Heat Pump Operation (Green). Has instant override capabilities for temporary two hour override of current program, overriding program indefinitely or advancing to next program. Temperature 'Up' and 'Down' buttons adjust temperature settings during programming and override functions. A 9 volt alkaline battery protects programs in case of power failure.

Three Stage Heat and Two Stage Cool — Thermostat 1F94 (18H13) with wiring wallplate features automatic or manual changeover, built-in time delays, system switch (Heat-Emergency Heat-Off-Cool-Auto), fan switch (On-Auto) for continuous or intermittent blower operation, touch sensitive keyboard with audible indicator and backlit LCD readout with day, time and temperature in °F or °C, plus operational mode and system status. Thermostat has full independent 7 day programming with up to four separate time and temperature settings per day. Four LEDs indicate Emergency Heat (Red), Auxiliary Heat (Yellow), Heat Pump Malfunction (Red) and Heat Pump Operation (Green). Has temporary override capabilities for temporary two hour override of current program or overriding program indefinitely. Temperature 'Up' and 'Down' buttons adjust temperature settings during programming and override functions. 'Copy' button allows duplication of one day's programming to another day. Keyboard lockout prevents program tampering. A 9 volt alkaline battery protects programs in case of power failure.

PROGRAMMABLE THERMOSTATS Heat Pump Systems Only

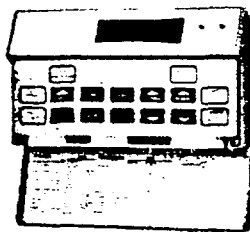

Two Stage Heat and One Stage Cool — Thermostat T8611G (27H30) with switching subbase features automatic changeover, built-in time delays, system switch (Emergency Heat-Heat-Off-Auto-Cool), fan switch (On-Auto) for continuous or intermittent blower operation, touch sensitive keyboard and LCD display with time, day, status and temperature readout in °F or °C. Thermostat has 5-1-1 day programming for weekdays and Saturday/Sunday schedules with four different time and temperature settings (Wake-Leave-Return-Sleep) per day. Five LEDs indicate System 'on', Energy Savings (Setback), Emergency Heat, Auxiliary Heat and Check System status. Has instant override capabilities for skipping current program, running previous program, temporarily raising or lowering temperature for current program or overriding program indefinitely. Three 'AAA' alkaline batteries protect programs in case of power failure.

GSR21Q "PULSE21™" SERIES HORIZONTAL/DOWN-FLO GAS FURNACES HORIZONTAL UNIT HEATERS AND DOWN-FLO MOBILE HOME UNITS

GSR21Q

Bulletin #480177
March 1992
Supersedes
February 1992
November 1991



*91.7% to 95.3% A.F.U.E.
50,000 to 100,000 Btuh Input
Add-On Cooling — 1-1/2 thru 5 Nominal Tons

*Isolated Combustion System Rating for Non-Weatherized Furnaces

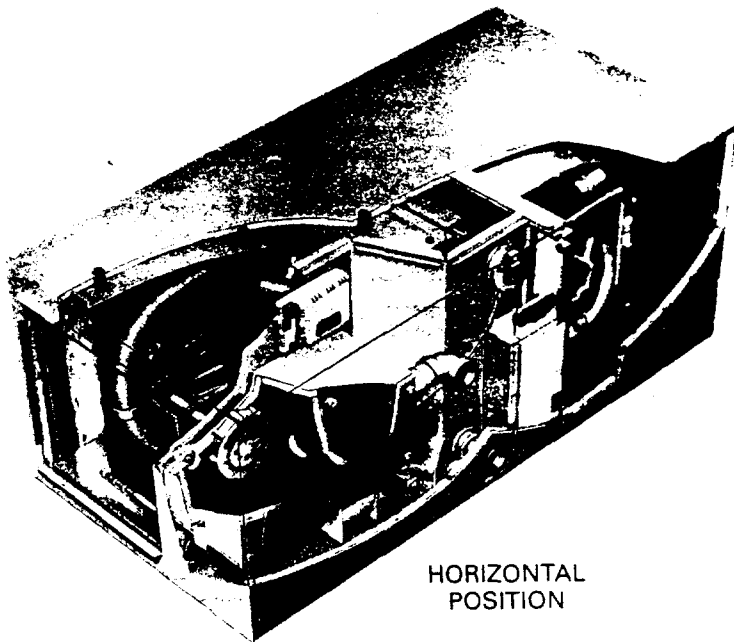

HORIZONTAL POSITION



DOWN-FLO POSITION

Typical Applications

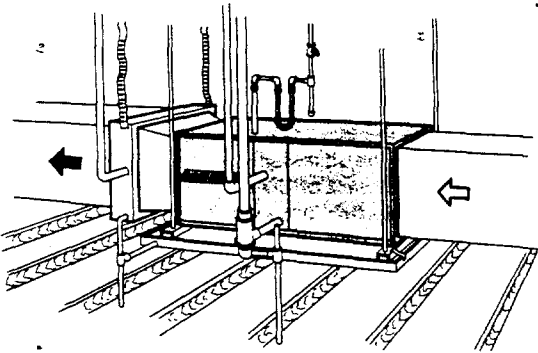

Horizontal Attic Installation

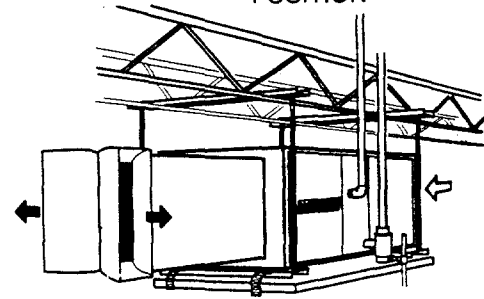

Suspended Horizontal Unit Heater Installation

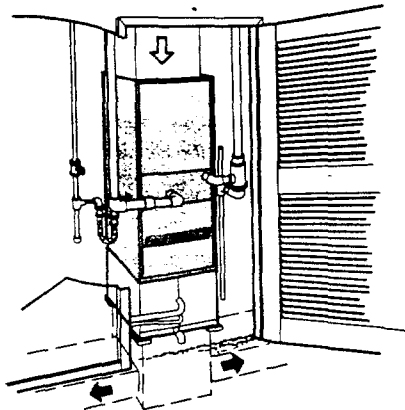

Down-Flo Mobile Home Closet Installation

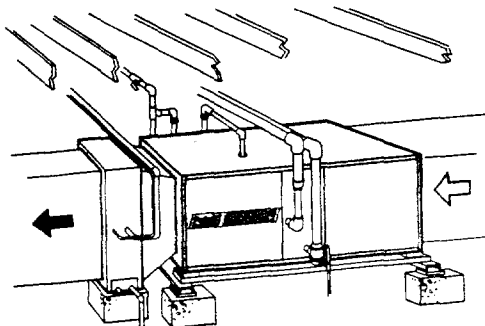

Horizontal Crawlspace Installation

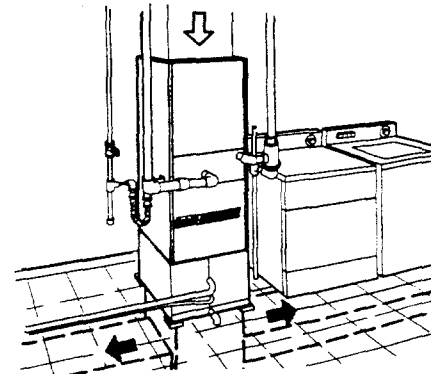

Down-Flo Utility Room Installation

NOTE — Specifications, Ratings and Dimensions subject to change without notice.

©1992 Lennox Industries Inc.

PROCESS OF COMBUSTION

The process of combustion begins as gas and air are introduced into the sealed combustion chamber with the spark plug igniter. Spark from the plug ignites the gas/air mixture, which in turn causes a positive pressure buildup that closes the gas and air inlets. This pressure relieves itself by forcing the products of combustion out of the combustion chamber through the tailpipe into the heat exchanger exhaust decoupler and on into the heat exchanger coil. As the combustion chamber empties, its pressure becomes negative, drawing in air and gas for the next pulse of combustion. At the same instant, part of the pressure pulse is reflected back from the tailpipe at the top of the combustion chamber. The flame remnants of the previous pulse of combustion ignites the new gas/air mixture in the chamber, continuing the cycle. Once combustion is started, it feeds upon itself allowing the purge blower and spark plug igniter to be turned off. Each pulse of gas/air mixture is ignited at a rate of 60 to 70 times per second, producing from one-fourth to one-half of a Btu per pulse of combustion. Almost complete combustion occurs with each pulse. The force of these series of ignitions creates great turbulence which forces the products of combustion through the entire heat exchanger assembly resulting in maximum heat transfer.

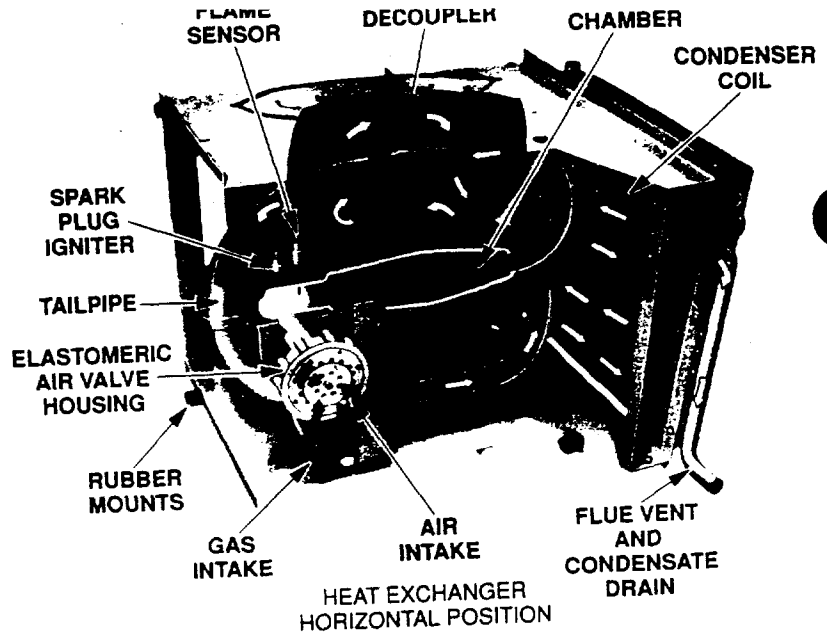

FEATURES

Application — GSR21 series pulse furnaces are designed to be installed in either horizontal or down-flo positions. Horizontal air flow is left hand air flow only. Units provide heating efficiencies (AFUE) of up to 95%. Five models (natural gas or LPG) are available with input capacities at 50,000, 80,000 and 100,000 Btu/h. Units operate on the pulse combustion principle and do not require a pilot burner, main burners, conventional flue or chimney. Units can be installed in a utility room, alcove, closet, crawlspace or attic. Also, units are applicable as horizontal unit heaters in non-ducted systems and 50,000 and 80,000 Btu/h input down-flo models in mobile home applications. GSR21Q3-80, GSR21Q4/5-80 and GSR21Q4/5-100 models are applicable to the GSR21 Commercial Heat-Vent-Cool-Modular Indoor System. See page 39 in this tab section for specifications. Lennox add-on evaporator coils, electronic air cleaners and power humidifiers can easily be added for a total comfort all-season system. *

High efficiency of the GSR21 series is achieved with a unique heat exchanger design which features: finned cast iron combustion chamber, temperature resistant steel tailpipe, aluminized steel exhaust decoupler section and a finned stainless steel tube condenser coil. Moisture, during the process of combustion, is condensed in the coil, extracting almost every usable Btu out of the gas. Most of the combustion heat is utilized in the heat transfer from the coil, producing flue vent temperatures as low as 100F to 130F which allows the use of PVC (polyvinyl chloride) pipe for venting. Furnace can be vented through a side wall, roof or to the top of an existing chimney with up to 35 ft. of PVC pipe and up to four 90 degree elbows. Condensate created in the coil (PH ranges from 4.0 to 6.0) is not harmful to standard household plumbing and can be drained into city sewers and septic tanks without damage.

The GSR21 furnace has no pilot light or burners. An automotive type spark plug is used for ignition on the initial cycle only, saving gas and electrical energy. In the pulse combustion process, the use of atmospheric burners is eliminated, with combustion confined to heat exchanger combustion chamber. Sealed combustion system virtually eliminates the loss of conditioned air due to combustion and stack dilution. Combustion air is piped to the furnace with same type PVC pipe as used for exhaust gases.

Furnace is equipped with a standard type redundant gas valve in series with a gas expansion tank and gas intake flapper valve. Also factory installed are an air intake flapper valve, purge blower, spark plug igniter, flame sensor with solid-state control, solid-state blower control, dual limit controls, high and low voltage terminal strip, 30VA transformer

and cleanable air filter. Furnished for field installation are a flexible gas line connector, (4) isolation mounting pads, base insulation pad and condensate drip leg.

Optional equipment available are: flue vent/air intake line roof or wall termination installation kits, down-flo additive base, horizontal support frame kit, mufflers, heat cable kit and thermostat.

GSR21 units are shipped completely factory assembled with all controls installed and wired. Units are test fired at the factory to insure proper operation.

Approvals — GSR21 series furnaces are certified by A.G.A. Laboratories as central furnaces and horizontal unit heaters. 50,000 and 80,000 Btu/h input down-flo models have mobile home approval. Ratings are certified by GAMA. Units meet the California Nitrogen Oxides (NO_x) standards and California Seasonal Efficiency requirements. In addition, units have been rated and tested in the Lennox Research Laboratory according to Department of Energy (DOE) test procedures and Federal Trade Commission (FTC) labeling regulations. Blower data is from unit tests conducted in the Lennox Laboratory air test chamber.

Equipment Warranty — GSR21 "Pulse" heat exchangers have a limited lifetime warranty. Solid-state ignition modules have a limited warranty for three years. All other components have a limited warranty for one year. Refer to Lennox Limited Equipment Warranty certificate included with the equipment for details.

Sequence of Operation — Room thermostat, on a demand for heat, will initiate purge blower operation for a pre-purge cycle (30 seconds) followed by energizing and opening of the gas valve. As ignition occurs, the flame sensor reacts to proof of ignition and de-energizes the spark plug igniter and purge blower. Furnace blower operation is initiated 45 seconds after combustion ignition. When thermostat is satisfied, gas valve is closed and purge blower is re-energized for a post-purge cycle (34 seconds). Furnace blower will remain in operation until the "fan off" factory setting of 180 seconds (adjustable from 120 to 240 seconds) is reached. Should loss of flame occur before thermostat is satisfied, flame sensor controls will initiate 5 attempts at re-ignition before locking out unit operation. Additionally, loss of either combustion intake air or flue exhaust will automatically terminate system operation. If unit becomes locked out, Watchguard circuit on GC3 ignition control will automatically reset ignition control after one hour of continuous thermostat demand.

FEATURES

Heat Exchanger Assembly — Lennox developed heat exchanger assembly consists of combustion chamber, tailpipe, exhaust decoupler section and condenser coil. Combustion chamber contains the spark plug igniter, flame sensor and combustion air and gas intake manifolds. Cast iron construction provides excellent radiation of heat over entire surface area. Finned "teardrop" shape design permits total air coverage of all surfaces with low resistance. Tailpipe connects the combustion chamber to the exhaust decoupler section. Precisely sized and shaped tailpipe is constructed of combination stainless and aluminized steel for superior resistance to high temperatures. Aluminized steel resonator on tailpipe minimizes combustion sound. Heavy gauge aluminized steel exhaust decoupler section has large surface area for maximum heat transfer. Air foil shape design results in complete air coverage with minimum air resistance. Condenser coil intake header connects to bottom of exhaust decoupler section. Large face area and circuiting of coil provides high heat transfer, minimum air resistance and proper moisture drainage. Coil is constructed of exactly spaced ripple-edged aluminum fins fitted to stainless steel tubes. Flared collars on fins grip tubes for maximum contact area. Flared tubing connections and high temperature brazing provide tight, leakproof joints. Combined flue vent and condensate drain outlet is located on the coil. Coil is factory tested for leaks. All components are mounted in a heavy gauge steel frame and installed in the furnace cabinet on resilient rubber mounts assuring quiet, vibration free operation. Heat exchanger has been laboratory life cycle tested.

Rugged Cabinet — Constructed of heavy gauge cold rolled steel. Cabinet is subject to a five station metal wash process resulting in a perfect bonding surface for a paint finish of baked-on enamel. The paint solution and metal are given opposite electrical charges resulting in positive adhesion and even coverage of the paint to the metal surfaces. Heat exchanger section is completely lined with thick (1-1/2 lb./ft.³ density) foil faced fiberglass insulation. Blower compartment is completely lined with thick (1-1/2 lb./ft.³ density) black mat faced fiberglass insulation. This results in quiet and efficient operation due to the excellent acoustical and insulating properties of fiberglass. Complete service access is accomplished by removing heating section and blower access panels. Removable panel is provided in vestibule panel for access to the spark plug and flame sensor. Safety interlock switch automatically shuts power off to unit when blower access panel is removed. Electrical inlets, gas line inlets, air intake and exhaust air outlets are provided in the cabinet.

Powerful Blowers — Units are equipped with quiet multi-speed direct drive blowers. Each blower assembly is statically and dynamically balanced. Slide-out blower assembly is equipped with jack-plug connection for easy removal for servicing. Multiple-speed leadless motor is resiliently mounted. A choice of blower speeds is available on each blower. See blower performance tables. Change in blower speed is easily accomplished by simple wiring change.

Cleanable Air Filters — Washable or vacuum cleanable frame type filter is furnished as standard. Polyurethane media is coated with oil for maximum efficiency. Filter is readily accessible in unit for quick and easy removal for servicing.

Combustion Air Intake Box — Contains the purge blower and air intake flapper valve. Box is located on vestibule panel. Purge blower is equipped with a permanently lubricated motor. Blower operates only during pre-purge and post-purge cycles. Air is drawn through the blower during the combustion cycle by negative pressure in the combustion chamber. Pressure switches terminate unit operation in case of air intake or flue exhaust blockage. Flapper valve air housing is constructed of an elastomeric non-metallic polymer which reduces operating sound levels. Flapper valve section of the box is completely lined with 1 inch thick (6 lb./ft.³ density) duct liner board, black neoprene coated fiberglass. Valve opening and closing is actuated by back pressure and negative pressure in combustion chamber during the heating cycle. Differential pressure switch, mounted on the vestibule panel, terminates unit operation in case of air intake or flue exhaust blockage.

GC3 Ignition Control — Solid-state control provides power for spark plug igniter. Also controls pre-purge and post-purge cycles and re-ignition sequence if loss of flame occurs. Also features Watchguard circuit. Solid-state control provides automatic reset of ignition controls after 1 hour of continuous thermostat demand after unit lockout. Ignition control is factory installed on the vestibule panel.

Automatic Gas Valve, Expansion Tank and Gas Intake Flapper Valve — 24 volt redundant dual gas control valve combines gas pressure regulation and manual main shutoff valve into one compact combination control. Dual valve design provides double assurance of 100% close off of gas on each heating cycle. Expansion tank is located downstream from the gas valve and absorbs any pressure pulsations. Gas intake flapper valve is installed in the combustion chamber intake manifold between the orifice and expansion tank. Valve is opened by entering gas pressure and closed by back pressure from combustion pulse during the heating cycle.

Wiring Junction Box — Power supply and thermostat connections are made at the wiring junction box located on the vestibule panel. Box contains 30 VA transformer, high and low voltage terminal strips and blower cooling relay. Terminal strip permits easy connections for optional power humidifiers and electronic air cleaners. Blower cooling relay activates blower operation for add-on air conditioning cooling.

Solid-State Blower Control — Circuit board located in wiring junction box contains all necessary controls to automatically operate the blower. Contains blower timed-on control (45 seconds fixed) and adjustable blower timed-off control (120 to 240 seconds). Factory setting is 180 seconds.

Dual Limit Controls — Factory installed and accurately located upstream and downstream of the heat exchanger. Primary and secondary limit controls provide protection from abnormal operating conditions. Primary control is automatic reset, secondary is manual reset.

Installation Recommendations — Lennox recommends the following installation procedures to minimize any vibration transmitted from furnace during operation. Place (4) neoprene rubber isolation mounting pads (furnished) and/or base insulation pad (furnished), 1 inch thick (1-1/2 lb./ft.³ density) fiberglass, under the unit. Install flexible duct connectors in the supply air plenum and return air plenum or duct connection. Insulate (1 inch thick, 1-1/2 to 3 lb./ft.³ density, mat faced fiberglass) supply and return air plenums through take-off or duct elbow. Use flexible gas connector (furnished) in gas supply piping where allowed by local codes. Insulate (refrigerant piping insulation or equivalent) all straps and hangers used in suspending ducts, electrical conduit, gas piping, combustion air intake piping and flue exhaust piping. In addition, use plastic pipe or tubing for drain line from the condensate coil drip leg (furnished) to the drain, do not use copper tubing.

OPTIONAL ACCESSORIES (Must Be Ordered Extra)

In-Line Mufflers (Optional) — Two mufflers LB-52057CA (67F81) are optional and must be ordered extra. Mufflers field install, vertical or horizontal, one in the intake line and one in the exhaust line. See dimension drawings. Two mufflers are required on -80 & -100 units.

LPG Conversion Kits (Optional) — 100,000 Btuh input model requires a LPG conversion kit LB-83176CM (73H60) for field changeover to natural gas. Kit is not furnished and must be ordered extra. 50,000 and 80,000 Btuh input models are shipped with the LPG orifice furnished as standard for field conversion. See specifications table.

Thermostat (Optional) — Heating thermostat is not furnished and must be ordered extra. See Thermostats bulletin in Accessories Section. For all-season applications, heating-cooling thermostat is available with the condensing unit.

Continuous Low Speed Blower Kit (Optional) — Field installed kit LB-83611B (89H88) is available to provide continuous low speed blower operation. Kit includes switch and all necessary wiring. Kit is not furnished and must be ordered extra.

GSR21-50 Low Ambient Thermostat Kit (Optional) — Kit LB-58659C- (70G49) prevents GSR21-50 unit from short cycling (run times of less than 4 or 5 minutes) when system thermostat is set at 55 degrees F or less. Kit contains low temperature thermostat and relay with mounting bracket, mounting screws and necessary wires. Thermostat field installs in return air stream on blower housing. Must be ordered extra.

Down-Flo Additive Base (Optional) — Additive base is required for heating only models installed on combustible floors. Base is not furnished and must be ordered extra for field installation. See specifications table. Not required in add-on cooling coil applications.

Horizontal Support Frame Kit (Optional) — Kit provides support of the unit in horizontal applications. Kit consists of (2) 1" x 1-1/2" x 32-5/8" and (2) 1" x 3" x 53-7/8" painted, heavy gauge cold rolled steel support channels with assembly and suspending holes. Bolts and nuts are furnished for field assembly of channels. Suspending rods must be furnished by installer. Kit is not furnished and must be ordered extra. See specifications table.

Condensate Drain Heat Cable Kits (Optional) — Self-limiting wattage heat cable prevents condensate drain from freezing when unit is installed in unconditioned space. Kit LB-56539DA (39G80) has 100 ft. of heat cable. Kit LB-56496DA (39G01) contains 25 ft. of heat cable. Splicing Kit LB-56530DA (39G02), available for connecting cable, makes two splices. Installation Kit LB-56497CA (38G81) contains necessary installing hardware.

Concentric Vent/Intake Air Roof/Wall Termination Kit (Optional) — Facilitates installation of combustion air intake pipe and flue exhaust pipe. Kit LB-49107CE (60G77) contains concentric termination assembly, mounting clamp, roof flashing, reducer bushing and 45 degree elbow. Kit requires single hole penetration of roof or wall for installation. Kit is A.G.A. certified and must be ordered extra for field installation. See dimension drawings.

Vent/Intake Air Wall Termination Kit (Optional) — Facilitates installation of combustion air intake pipe and flue exhaust pipe. Kit must be ordered extra. Select one of the following:

- 1 — Kit LB-49107CB (15F74) contains 2 stainless steel outside seal caps, 2 galvanized steel inside seal caps, 4 seal rings for the caps and 18 inch insulation sleeve for sealing and isolating intake and exhaust piping penetration of wall. Maintain a maximum of 8 inches between the inlet and outlet openings in the installation of the pipes. See dimension drawings.
- 2 — Kit LB-49107CD (22G44) consists of close-couple side-by-side PVC piping with galvanized steel wall cover plate for sealing and isolating piping penetration of the wall. Piping spacing and length is sized for proper wall installations. A.G.A. certified. See dimension drawings.

Vent/Intake Air Roof Termination Kit (Optional) — Facilitates installation of combustion air intake pipe and flue exhaust pipe. Kit contains two neoprene rubber roof flashings and 18 inch insulation sleeve for sealing and isolating intake and exhaust piping penetration in roof. Kit LB-49107CC (15F75) must be ordered extra for field installation. See dimension drawings.

SPECIFICATIONS

Model No.		GSR21Q3-50	GSR21Q4-50	GSR21Q3-80	GSR21Q4/5-80	GSR21Q4/5-100
Input Btuh		50,000	50,000	80,000	80,000	100,000
Output Btuh		47,000	47,000	71,000	72,000	92,000
*A.F.U.E.		94.8%	95.3%	91.7%	94.1%	92.0%
California Seasonal Efficiency		89.7%	90.1%	87.6%	88.6%	87.3%
Temperature rise range (°F)		30 — 60	25 — 55	40 — 70	30 — 60	45 — 75
High static certified by A.G.A. (in wg.)		.50	.50	.50	.50	.50
Gas Piping Size I.P.S. (in.)	Natural	1/2	1/2	1/2	1/2	1/2
	*LPG	1/2	1/2	1/2	1/2	1/2
Vent/Intake air pipe size connection (in.)		2	2	2	2	2
Condensate drain connection (in.) SDR11		1/2	1/2	1/2	1/2	1/2
Blower wheel nominal diameter x width (in.)		10 x 8	10 x 10	10 x 10	12 x 12	12 x 12
Blower motor hp		1/3	1/2	1/3	3/4	3/4
Number and size of filters (in.)		(1) 20 x 25 x 1				
Tons of cooling that can be added		1-1/2 — 3	3-1/2 — 4	2 — 3	3-1/2 — 5	3-1/2 — 5
Shipping weight (lbs.)		311	316	317	329	335
Number of packages in shipment		1	1	1	1	1
Electrical characteristics		120 volts — 60 hertz — 1 phase (less than 12 amps) All models				
LPG kit (optional)		**Furnished				*LB-83176CM (73H60)
Optional Horizontal Support Frame Kit — Ship. Weight		LB-56495CA (39G05) (All Models) — 18 lbs.				
Optional Down-Flo Additive Base — Shipping Weight		LB-80639BB (68387) (All Models) — 6 lbs.				

*LPG kit must be ordered extra for field changeover.

*Annual Fuel Utilization Efficiency based on D.O.E. test procedures and according to F.T.C. labeling regulations. Isolated combustion system rating for non-weatherized furnaces.

**LPG orifice furnished as standard with unit for field changeover. Convertible gas valve requires simple adjustment without adding any parts. See installation instructions.

A.G.A. INSTALLATION CLEARANCES

DOWN-FLO

Sides	1 inch
Rear	1 inch
Top	1 inch
Front	6 inches
*Floor	*Combustible
Flue Pipe	0 inches

* Clearance for installation on combustible floor if optional additive base is installed between furnace and combustible floor. Not required in add-on cooling coil applications if installed in accordance with local codes or National Fuel Gas Code ANSI-Z223.1.

HORIZONTAL

Ends	3 inches
Rear	3 inches
*Top	*3 inches
Front	6 inches
Floor	Combustible
Flue Pipe	0 inches

* Line contact installation permissible between jacket top or sides and building joists.

GSR21Q3-50 BLOWER PERFORMANCE

External Static Pressure (in. wg)	Air Volume (cfm) @ Various Speeds			
	High	Med-High	Med-Low	Low
0	1640	1405	1070	875
.05	1620	1390	1065	870
.10	1595	1375	1060	865
.15	1570	1360	1055	860
.20	1545	1345	1045	855
.25	1520	1325	1035	850
.30	1490	1305	1025	840
.40	1430	1260	995	810
.50	1365	1200	960	775
.60	1285	1135	910	735
.70	1195	1055	840	-----
.80	1085	955	755	-----

NOTE — All cfm data is measured external to unit with the air filter in place.

GSR21Q4-50 BLOWER PERFORMANCE

External Static Pressure (in. wg)	Air Volume (cfm) @ Various Speeds			
	High	Med-High	Med-Low	Low
0	1935	1725	1530	1225
.05	1900	1695	1515	1220
.10	1865	1665	1490	1210
.15	1825	1630	1465	1195
.20	1790	1595	1435	1175
.25	1745	1560	1400	1140
.30	1700	1520	1365	1105
.40	1585	1420	1285	1030
.50	1470	1320	1200	975
.60	1360	1215	1115	920
.70	1235	1115	1030	-----
.80	1105	1000	930	-----

NOTE — All cfm data is measured external to unit with the air filter in place.

GSR21Q3-80 BLOWER PERFORMANCE

External Static Pressure (in. wg)	Air Volume @ Various Speeds		
	High	Medium	Low
0	1735	1455	1095
.05	1720	1445	1090
.10	1700	1435	1085
.15	1675	1420	1080
.20	1640	1405	1070
.25	1615	1385	1060
.30	1585	1355	1045
.40	1520	1290	995
.50	1440	1210	930
.60	1330	1120	870
.70	1180	1015	-----
.80	1035	900	-----

NOTE — All cfm data is measured external to unit with the air filter in place.

GSR21Q4/5-80 BLOWER PERFORMANCE

External Static Pressure (in. wg)	Air Volume (cfm) @ Various Speeds				
	High	Med-High	Medium	Med-Low	Low
0	2355	2205	1965	1740	1520
.05	2325	2175	1940	1715	1495
.10	2290	2150	1920	1695	1475
.15	2255	2115	1890	1670	1450
.20	2220	2085	1860	1645	1425
.25	2185	2050	1830	1620	1400
.30	2150	2020	1800	1595	1375
.40	2080	1950	1745	1540	1320
.50	2000	1880	1680	1475	1260
.60	1915	1805	1615	1410	1195
.70	1825	1720	1540	1330	-----
.80	1730	1635	1460	1240	-----

NOTE — All cfm data is measured external to unit with the air filter in place.

GSR21Q4/5-100 BLOWER PERFORMANCE

External Static Pressure (in. wg)	Air Volume (cfm) @ Various Speeds				
	High	Med-High	Medium	Med-Low	Low
0	2275	2140	1940	1725	1520
.05	2245	2110	1915	1700	1490
.10	2215	2075	1885	1675	1465
.15	2185	2040	1860	1645	1435
.20	2150	2005	1830	1620	1410
.25	2115	1970	1805	1590	1380
.30	2075	1935	1775	1560	1350
.40	1990	1870	1710	1500	1290
.50	1925	1800	1645	1435	1235
.60	1835	1730	1570	1370	1175
.70	1760	1650	1490	1300	-----
.80	1675	1570	1400	1225	-----

NOTE — All cfm data is measured external to unit with the air filter in place.

DOWN-FLO POSITION

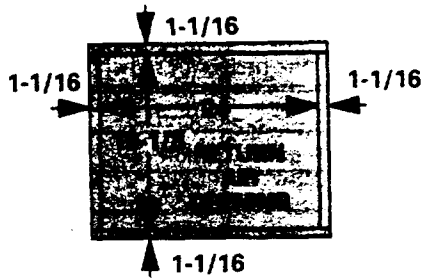

NOTE — When heating only unit is installed on a combustible floor, an additive base is required. This is optional equipment and must be ordered extra. When using additive base, make opening in floor 2-5/8 inches larger (front to rear and side to side) than furnace supply air opening.

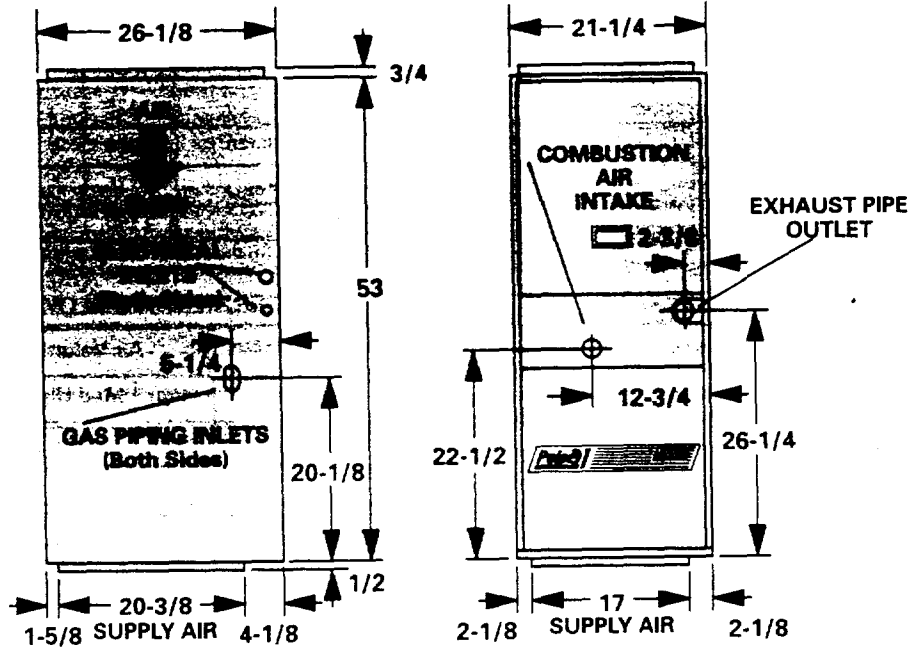

HORIZONTAL POSITION

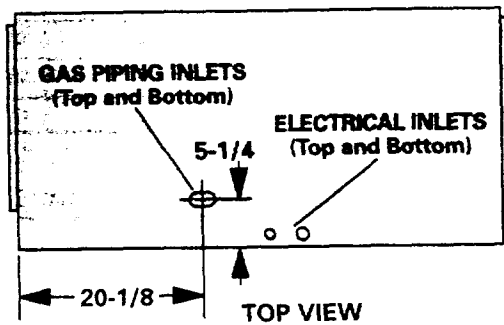

TOP VIEW

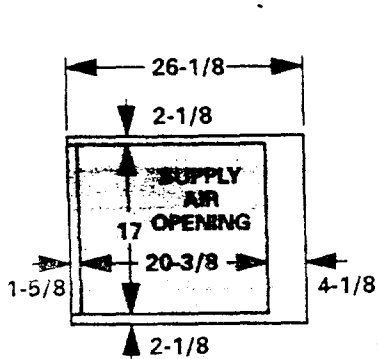

DISCHARGE END

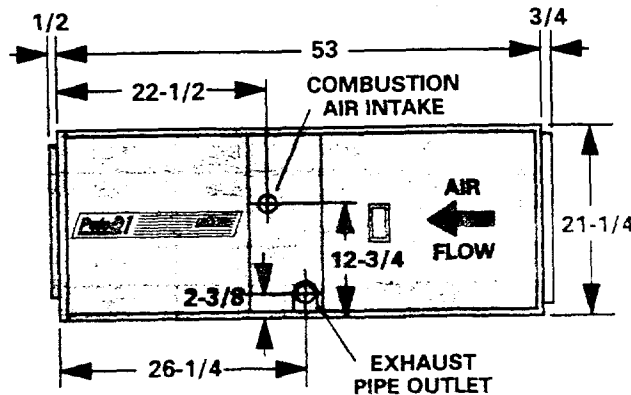

FRONT VIEW

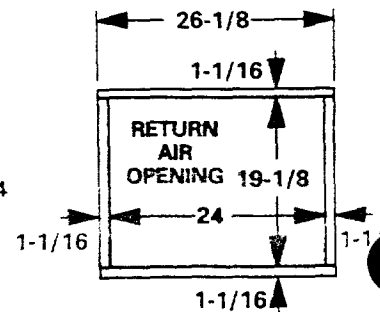

INLET END

**IN-LINE MUFFLERS
(LB-52057CA)**

NOTE — Two mufflers are furnished per order no.

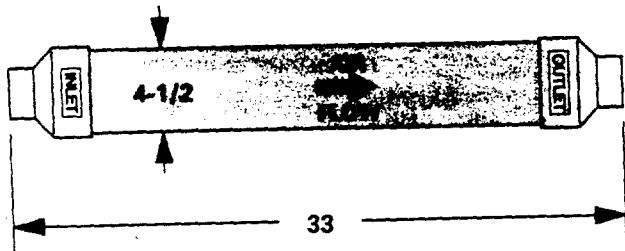

**CONCENTRIC ROOF/WALL
TERMINATION KIT
(LB-49107CE)**

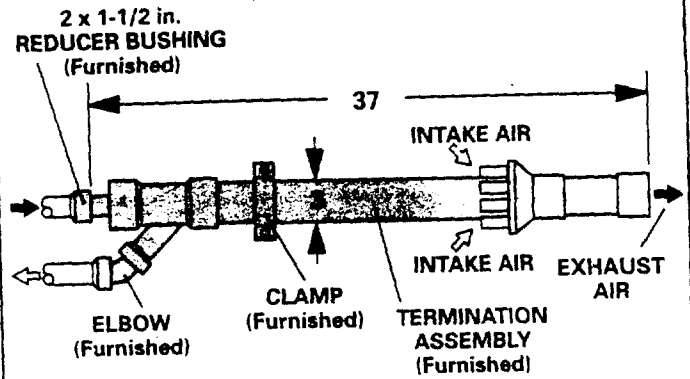

**CONCENTRIC WALL
TERMINATION APPLICATIONS**

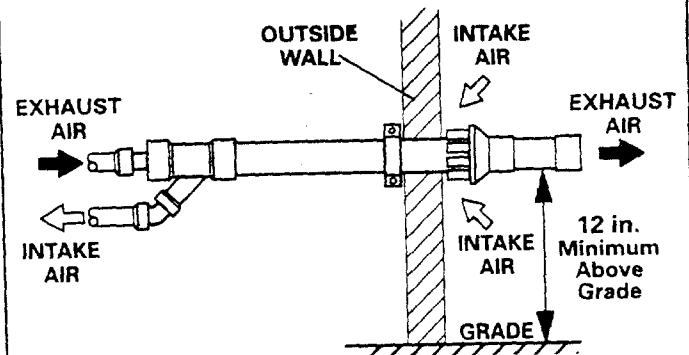

**ROOF TERMINATION KIT
(LB-49107CC)**

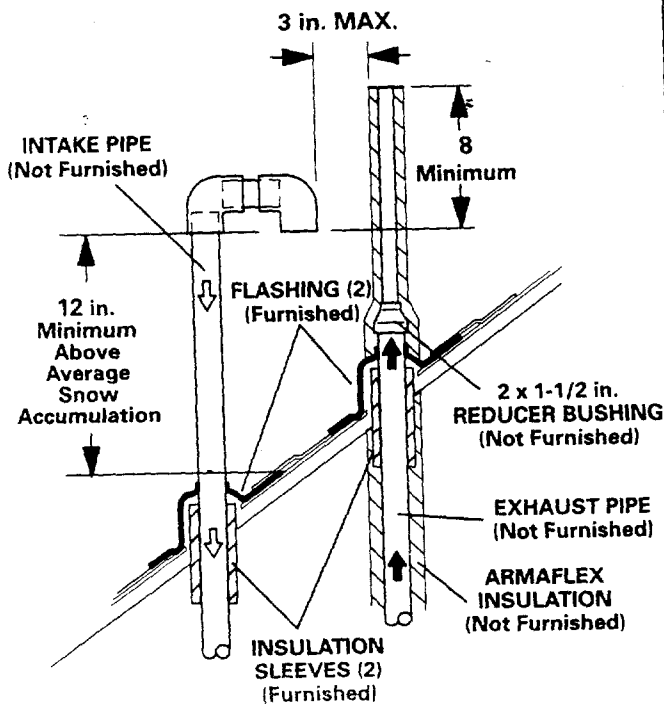

**CONCENTRIC ROOF
TERMINATION APPLICATIONS**

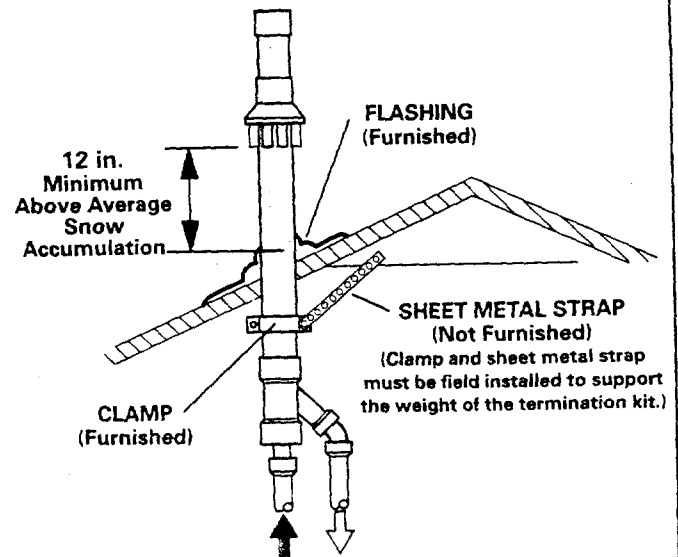

CLOSE-COUPLE WALL TERMINATION KIT (LB-49107CD)

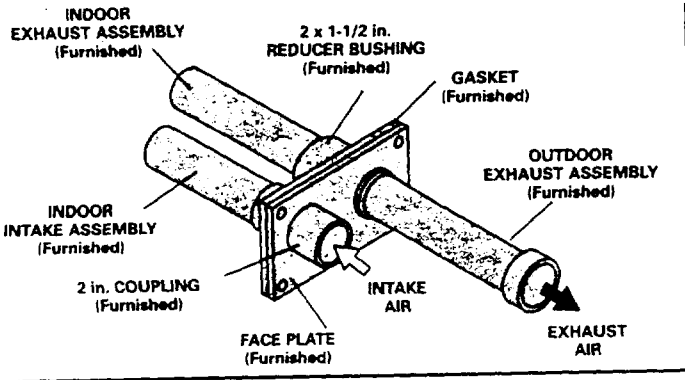

If Intake and Exhaust Pipe is less than 12 in. above snow accumulation or other obstructions, field fabricated piping must be installed.

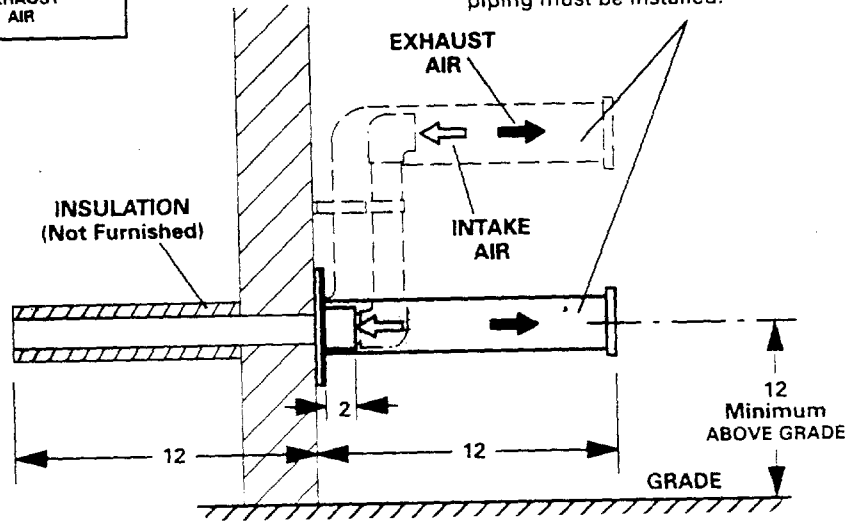
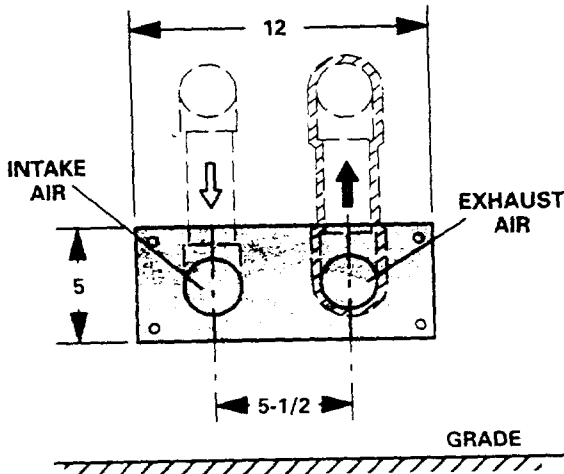

WALL TERMINATION KIT (LB-49107CB)

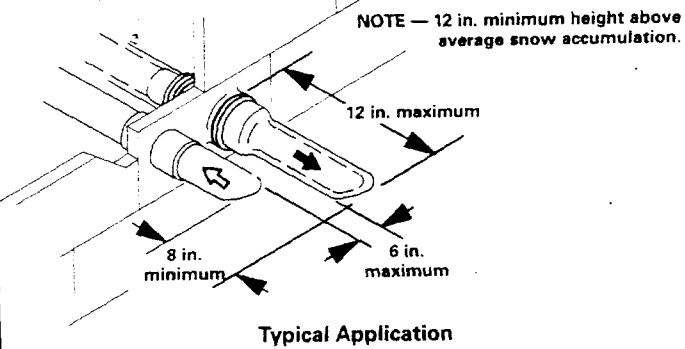

NOTE — EXHAUST PIPE SHOWN

INSULATION SLEEVE
(2 Furnished 1 for intake and 1 for exhaust)

GALVANIZED STEEL INSIDE SEAL CAP
(2 Furnished 1 for intake and 1 for exhaust)

STAINLESS STEEL OUTSIDE SEAL CAP
(2 Furnished 1 for intake and 1 for exhaust)

ARMAFLEX INSULATION
(Not Furnished)

SEAL RINGS (4 Furnished
2 for intake and 2 for exhaust)

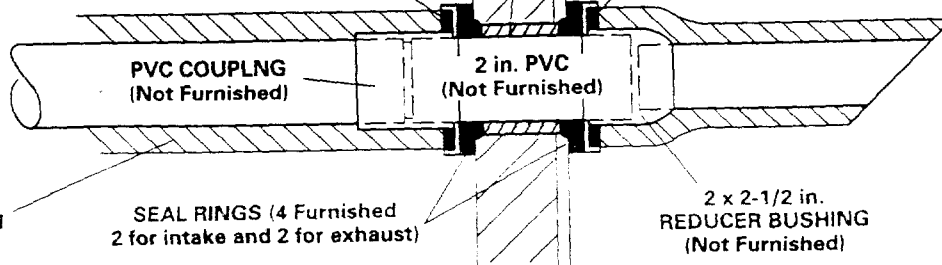

LENNOX®

HS22 DIMENSION™ SERIES CONDENSING UNITS

(1-1/2 thru 3-1/2 Nominal Tons)

*19,000 to 44,500 Btuh Cooling Capacity

*DOE and ARI Certified Ratings

ENGINEERING DATA
COOLING UNITS
CONDENSING UNITS

Page 35

November 1990

Supersedes December 1989



CERTIFICATION APPLIES ONLY
WHEN USED WITH PROPER
COMPONENTS AS LISTED
WITH ARI



CERTIFICATION APPLIES ONLY
WHEN USED WITH PROPER
COMPONENTS AS LISTED
WITH ARI

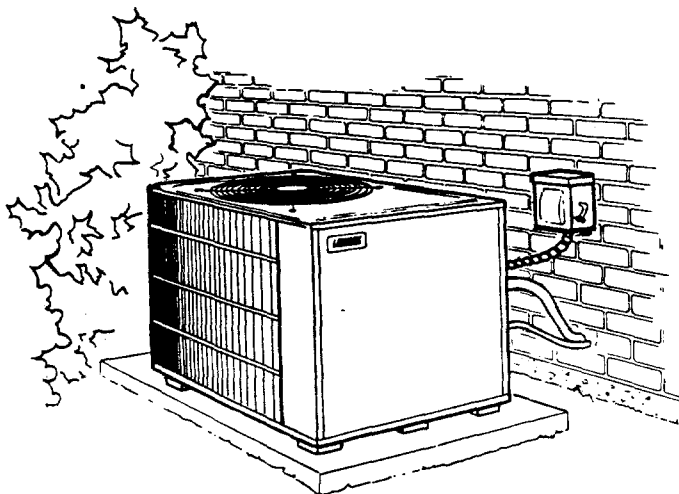
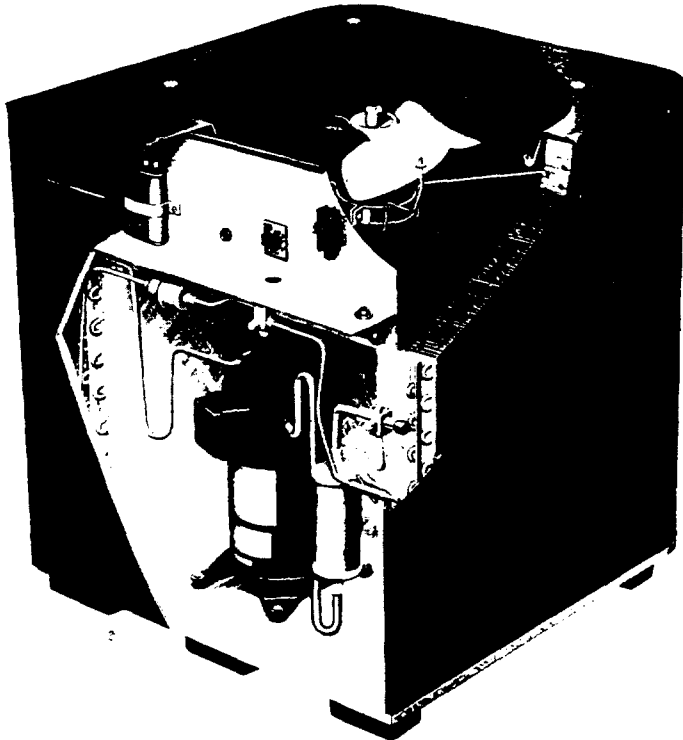

Unit on slab at ground level

Application — The HS22 series condensing units feature extra high efficiency with minimum operating sound levels. Units have seasonal energy efficiency ratings of up to 13.50 with cooling capacities of 19,000 to 44,500 Btuh and are applicable to expansion valve systems only. Units may be installed at ground level or on a roof. Units are adaptable to several blower powered and add-on evaporators providing a wide range of cooling capacities for selective sizing and application versatility. For evaporator unit data see tab Coils — Blower Coil Units in this section. Units are shipped completely factory assembled, piped and wired. In addition, each unit is test operated at the factory insuring proper operation. Installer has only to place condensing unit in desired location, connect refrigerant lines and make electrical connections to complete the job.

Approvals — Condensing units have been tested in the Lennox Research Laboratory environmental test room and rated according to U.S. Department of Energy (DOE) test procedures and in accordance with ARI Standard 210/240-89. In addition, units have been sound rated in the Lennox reverberant sound test room in accordance with ARI Standard 270-84. Condensing units and components within are bonded for grounding to meet safety standards for servicing required by U.L. and N.E.C. Units are also U.L. listed.

Copeland® Compliant Scroll™ Compressor — High efficiency compressor features durability, steady uniform suction flow, constant discharge flow, high volumetric efficiency, quiet operation and the ability to start under any system load. Use of the scroll compressor eliminates the need for accumulator, crankcase heater, start capacitor and start relay. The compliant scroll type compressor is a simple compression concept design consisting of two involute spiral scrolls matched together to generate a series of crescent-shaped gas pockets between them. During compression, one scroll is stationary while the other is allowed to orbit, not rotate, around the fixed one. As this motion occurs, gas is drawn into the outer pocket sealing off the open passage. As the spiral movement continues, the pockets between the scrolls are slowly pushed to the center of the scrolls while simultaneously being reduced in volume. When the pocket reaches the center, the gas is now at high pressure and is forced out of a port located in the center of the fixed scroll. During compression, several pockets are being compressed simultaneously resulting in a smooth, nearly continuous compression cycle. Continuous flank contact, maintained by centrifugal force, minimizes gas leakage and maximizes efficiency. The scroll compressor is tolerant to the effects of liquid slugging and contaminants. Should this occur, the scrolls separate and allow the liquid or contaminants to be worked to the center and discharged. Low gas pulses during compression minimize operational sound level. Factory installed muffler in discharge line, external to the compressor, provides additional sound reduction. Motor is internally protected from excessive current and temperature. Discharge temperature thermostat protects compressor from high discharge temperature. Compressor is installed in the unit on resilient rubber mounts, assuring vibration free operation.

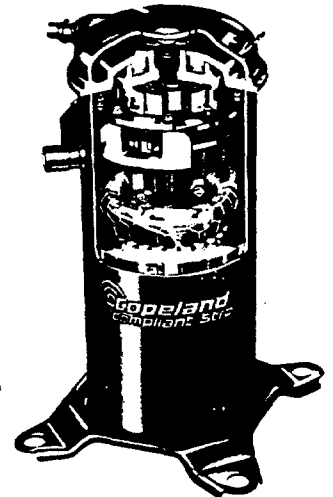

Equipment Warranty — The compressor has a limited warranty for ten years in residential installations and 5 years in non-residential installations. All other components have a limited warranty for one year. Refer to Lennox Equipment Limited Warranty included with the unit for details.

FEATURES

Durable Steel Cabinet — Heavy gauge galvanized steel cabinet is subject to a five station metal wash process. This preparation results in a perfect bonding surface for the finish coat of baked-on outdoor enamel. The attractive enamel finish gives the cabinet long lasting protection from rust and corrosion. Compressor and control box are located in a separate compartment insulated with thick fiberglass insulation. Compartment provides protection from the weather and keeps sound transmission at a minimum. Control box is conveniently located with all controls factory wired. Large removable panel provides service access. Drainage holes are provided in the base section for moisture removal. High density polyethylene base channels raise the unit off of the mounting surface away from damaging moisture. Non-corrosive PVC (polyvinyl chloride) coated steel wire condenser coil guard is furnished.

Copper Tube/Enhanced Fin Coil — Lennox designed and fabricated coil is constructed of precisely spaced ripple-edged aluminum fins machine fitted to seamless copper tubes in a wrap around "U" shaped configuration providing extra large surface area with low air resistance. Lanced fins provide maximum exposure of fin surface to air stream resulting in excellent heat transfer. In addition, fins are equipped with collars that grip the tubing for maximum contact area. Precise circuiting provides uniform refrigerant distribution. Flared shoulder tubing connections and silver soldering provide tight, leakproof joints. Long life copper tubing is corrosion-resistant and easy to field service. Coil is thoroughly factory tested under high pressure to insure leakproof construction. Entire coil is accessible for cleaning.

Powerful Condenser Fan — Efficient direct drive fan moves large volumes of air uniformly through the entire condenser coil resulting in high refrigerant cooling capacity. Vertical discharge of air minimizes operating sounds and eliminates hot air damage to lawn and shrubs. Fan motor is inherently protected and totally enclosed for maximum protection from weather, dust and corrosion. A rain shield on the motor provides additional protection from moisture. Fan service access is accomplished by removal of fan guard. Corrosion resistant PVC (polyvinyl chloride) coated steel wire fan guard is furnished as standard.

Hi-Capacity Drier — Furnished as standard and factory installed. Drier traps any moisture or dirt that could contaminate the refrigerant system.

Timed-Off Control — Furnished and factory installed. Prevents compressor short-cycling. Automatic reset control provides a time delay between compressor shutoff and start-up.

Refrigerant Line Connections, Electrical Inlets and Service Valves — Suction and liquid lines are located inside of the cabinet and are made with sweat connections. Brass service valves prevent corrosion and provide access to refrigerant system. Suction and liquid line service valves and gauge ports are located inside the cabinet. A thermometer well is located in the liquid line to check the refrigerant charge. Refrigerant line connections and field wiring inlets are all located in one central area of the cabinet. See dimension drawing.

Thermostat (Optional) — Thermostat is not furnished with the unit and must be ordered extra. See Accessories tab section, Page 13 and Lennox Price Book.

Refrigerant Line Kits (Optional) — Lines are available in several lengths and must be ordered extra. See Refrigerant Line Kit table. The refrigerant lines (suction and liquid) are shipped refrigeration clean. Lines are cleaned, dried and pressurized at the factory and sealed. Suction line is fully insulated. Lines are furnished with a flare fitting (evaporator unit connection) on one end and less any fitting (stubbed) on the opposite end for connection to the condensing unit.

Expansion Valve Kits (Optional) — Must be ordered extra and field installed on matching evaporator units. See ARI Ratings table.

Low Ambient Kit (Optional) — Condensing units will operate satisfactorily down to 50°F outdoor air temperature without any additional controls. For cases where operation of the unit is required at low ambients a Low Ambient Control Kit (LB-57113BC) can be added in the field, enabling it to operate properly down to 0°F.

Mounting base (Optional) — Rugged mounting base provides permanent foundation for condensing units. High density polyethylene structural material is lightweight, sturdy, sound absorbing and will withstand the rigors of the sun, heat, cold, moisture, oil and refrigerant. Will not mildew or rot. Can be shipped singly or in packages of 6 to a carton. Use MB1-32 (83C83) 32" x 34" x 3" shipping weight 15 lbs. each.

SPECIFICATIONS

Model No.			HS22-211V	HS22-281V	HS22-311V	HS22-411V	HS22-461V
Condenser Coil	Net face area (sq. ft.)	Outer coil	11.8	11.8	15.9	15.9	15.9
		Inner coil	----	5.4	5.5	5.5	8.8
	Tube diameter (in.) & No. of rows		3/8 - 1	3/8 - 1.48	3/8 - 1.36	3/8 - 1.36	3/8 - 1.57
	Fins per inch		20	20	20	20	20
Condenser Fan	Diameter (in.) & No. of blades		20 - 4	20 - 4	24 - 3	24 - 3	24 - 3
	Motor hp		1/6	1/6	1/6	1/6	1/6
	Cfm		2600	2450	3150	3150	3100
	Rpm		820	820	820	820	820
	Watts		200	210	215	210	205
**Refrigerant — 22 charge furnished			6 lbs. 2 oz.	6 lbs. 8 oz.	8 lbs. 1 oz.	8 lbs. 1 oz.	8 lbs. 5 oz.
Liquid line (o.d. in.) connection — sweat			3/8	3/8	3/8	3/8	3/8
Suction line (o.d. in.) connection — sweat			5/8	3/4	3/4	3/4	7/8
Shipping weight (lbs.) 1 package			157	169	204	216	227

**Refrigerant charge is sufficient for 25 ft. length line set.

ARI RATINGS

Condensing Unit Model No. ★ ARI Standard 270 SRN (bels)	*ARI Standard 210/240 Ratings			Evaporator Unit			★ Expansion Valve Kit
	SEER (Btuh/ Watt)	Cooling Capacity (Btuh)	Total Unit Watts	Up-Flo	Down-Flo	Horizontal	
HS22-211V (7.2)	11.00	19,000	1885	C16-21FF	CR16-21FF	----	LB-53081CF
	11.15	19,400	1875	----	----	CH16-21FF	
	11.85	19,400	1815	**CB18-21	----	**CBS18-21	
	11.75	19,800	1880	C16-31FF, C16-31WFF	CR16-31FF	CH16-31FF	
	11.95	20,400	1885	C16-28FF, C16-28WFF	----	----	
	12.00	20,400	1885	C14-26FF	----	----	
	12.30	20,400	1835	**CB18-26	----	**CBS18-26	
	12.85	20,800	1790	**CB19-21	**CB19-21	**CBH19-21	
HS22-261V (7.4)	11.35	22,400	2232	C16-21FF	CR16-21FF	----	LB-53081CD
	11.60	22,600	2191	**CB18-21	----	**CBS18-21	
	11.50	22,800	2236	----	----	CH16-21FF	
	12.70	23,000	2068	**CB19-21	**CB19-21	**CBH19-21	
	11.95	23,800	2248	C16-28FF, C16-28WFF C16-31FF, C16-31WFF	CR16-31FF	CH16-31FF	
	12.00	23,800	2303	**CB18-26	----	**CBS18-26	
	12.90	24,000	2126	**CB19-26	**CB19-26	**CBH19-26	
	12.20	24,400	2255	C16-41FF, C16-41WFF	CR16-41FF	----	
	12.30	24,600	2257	----	----	CH16-41FF	
	12.65	25,400	2252	C14-26FF	----	----	
HS22-311V (7.4)	12.20	29,400	2686	**CB18-26	----	**CBS18-26	LB-53081CD
	12.85	29,800	2593	**CB19-26	**CB19-26	**CBH19-26	
	12.35	29,800	2709	C16-28FF, C16-28WFF C16-31FF, C16-31WFF	CR16-31FF	CH16-31FF	
	12.45	30,200	2716	**CB18-31	----	**CBS18-31	
	12.65	30,200	2673	C14-26FF	----	----	
	12.55	30,600	2715	C16-41FF, C16-41WFF	CR16-41FF	CH16-41FF	
	12.65	30,600	2741	**CB18-41	----	**CBS18-41	
	12.90	31,200	2683	**CB19-31	**CB19-31	**CBH19-31	
	13.25	32,000	2683	C14-41FF	----	----	
	HS22-411V (7.6)	11.55	33,000	3194	C16-28FF, C16-28WFF C16-31FF, C16-31WFF	CR16-31FF	
12.30		35,200	3218	**CB18-31	----	**CBS18-31	
11.90		35,400	3282	----	CR16-51FF	----	
12.00		35,400	3284	C16-41FF, C16-41WFF	CR16-41FF	CH16-41FF	
12.35		35,600	3233	**CB18-41	----	**CBS18-41	
12.15		36,000	3292	C16-46FF, C16-46WFF	----	----	
13.00		36,000	3105	**CB19-31	**CB19-31	**CBH19-31	
12.15		36,200	3307	C16-51FF	----	CH16-51FF	
12.20		36,600	3327	**CB18-51	----	**CBS18-51	
13.20		36,600	3158	**CB19-41	**CB19-41	**CBH19-41	
12.75		36,800	3272	C14-41FF	----	----	
13.05		37,000	3130	**CB21-41	**CB21-41	**CBH21-41	
13.00		37,600	3238	**CB19-51	**CB19-51	**CBH19-51	
13.50	38,000	3155	**CB21-51	**CB21-51	**CBH21-51		
HS22-461V (7.6)	11.75	38,500	3711	**CB18-41	----	**CBS18-41	LB-53081CB
	12.00	39,000	3698	C16-41FF, C16-41WFF	CR16-41FF	CH16-41FF	
	12.10	40,000	3761	C16-46FF, C16-46WFF	CR16-51FF	----	
	12.60	40,500	3664	**CB19-41	**CB19-41	**CBH19-41	
	12.20	41,000	3817	C16-51FF	----	----	
	11.85	41,000	3884	**CB18-51	----	**CBS18-51	
	12.50	41,000	3540	**CB21-41	**CB21-41	**CBH21-41	
	12.55	41,500	3748	C14-41FF	----	----	
	12.45	41,500	3790	----	----	CH16-51FF	
	12.45	42,500	3830	**CB19-51	**CB19-51	**CBH19-51	
12.75	44,500	3775	**CB21-51	**CB21-51	**CBH21-51		

NOTE - Shaded area denotes most popular evaporator coil.

★ Sound Rating Number in accordance with ARI Standard 270.

*Rated in accordance with ARI Standard 210/240 and DOE; 95°F outdoor air temperature, 80°F db/67°F wb entering evaporator air with 25 ft. of connecting refrigerant lines.

**Denotes blower powered evaporator.

★ Kit must be ordered extra for field installation.

ELECTRICAL DATA

Model No.		HS22-211V	HS22-261V	HS22-311V	HS22-411V	HS22-461V
Line voltage data		208/230V 60hz/1ph.	208/230V 60hz/1ph.	208/230V 60hz/1ph.	208/230V 60hz/1ph.	208/230V 60hz/1ph.
Compressor	Rated load amps	9.7	11.6	13.5	18.0	20.0
	Power factor	.96	.96	.96	.96	.97
	Locked rotor amps	50.0	62.5	76.0	90.5	107.0
Condenser Coil Fan Motor	Full load amps	1.1	1.1	1.1	1.1	1.1
	Locked rotor amps	2.0	2.0	2.0	2.0	2.0
Recommended maximum fuse size or circuit breaker size (amps)		20	25	30	35	40
Minimum circuit ampacity		13.3	15.6	18.0	23.6	26.1

Refer to National Electrical Code manual to determine wire, fuse and disconnect size requirements.
 NOTE — Extremes of operating range are plus 10% and minus 5% of line voltage.

FIELD WIRING

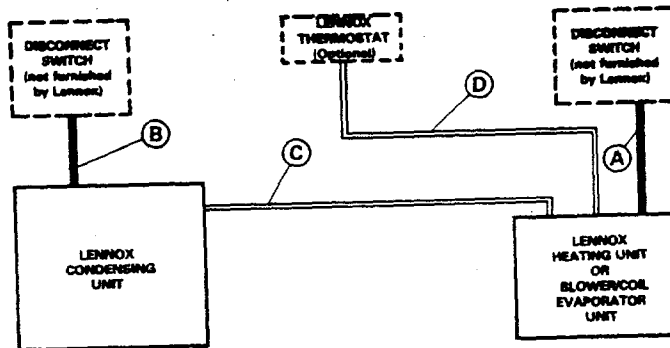

- A — Two wire power (not furnished)
 - B — Two wire power (not furnished) — See electrical data
 - C — Two wire low voltage (not furnished) — 18 ga. minimum
 - D — Four wire low voltage (not furnished) — 18 ga. minimum
- All wiring must conform to NEC and local electrical codes.

REFRIGERANT LINE KITS

Condensing Unit Model No.	Line Set Model No.	Length of Suction & Liquid Lines (ft.)	Liquid Line (o.d. in.)	Suction Line (o.d. in.)
HS22-211V	L10-26-20	20	3/8	5/8
	L10-26-25	25		
	L10-26-35	35		
	L10-26-50	50		
HS22-261V HS22-311V HS22-411V	L10-41-20	20	3/8	3/4
	L10-41-30	30		
	L10-41-40	40		
	L10-41-50	50		
HS22-461V	L10-65-30	30	3/8	7/8
	L10-65-40	40		
	L10-65-50	50		

HS22-411V WITH CB18-31 OR CBS18-31 EVAPORATOR UNIT

Enter. Wet Bulb (°F)	Total Air Vol. (cfm)	Outdoor Air Temperature Entering Condenser Coil (°F)																			
		85					95					105					115				
		Total Cool Cap. (Btuh)	Comp. Motor Watts Input	Sensible To Total Ratio (S/T)			Total Cool Cap. (Btuh)	Comp. Motor Watts Input	Sensible To Total Ratio (S/T)			Total Cool Cap. (Btuh)	Comp. Motor Watts Input	Sensible To Total Ratio (S/T)			Total Cool Cap. (Btuh)	Comp. Motor Watts Input	Sensible To Total Ratio (S/T)		
				Dry Bulb (°F)					Dry Bulb (°F)					Dry Bulb (°F)					Dry Bulb (°F)		
75	80	85	75	80	85	75	80	85	75	80	85	75	80	85	75	80	85				
63	950	34,200	2330	.71	.84	.96	33,000	2580	.72	.85	.98	31,800	2880	.73	.87	.99	30,500	3260	.74	.89	1.00
	1200	35,800	2350	.76	.91	1.00	34,600	2600	.77	.92	1.00	33,400	2910	.78	.94	1.00	32,100	3290	.80	.96	1.00
	1450	37,200	2370	.80	.96	1.00	36,100	2620	.81	.97	1.00	34,600	2930	.83	.99	1.00	33,200	3320	.85	1.00	1.00
67	950	36,200	2360	.57	.69	.81	35,000	2610	.57	.70	.82	33,700	2910	.58	.71	.83	32,500	3300	.58	.72	.85
	1200	37,900	2380	.59	.73	.87	36,700	2630	.60	.74	.89	35,400	2950	.61	.76	.90	34,000	3330	.62	.77	.92
	1450	39,200	2400	.62	.77	.93	37,900	2660	.63	.79	.94	36,500	2970	.64	.80	.96	35,100	3360	.65	.82	.98
71	950	38,100	2390	.43	.55	.66	36,900	2640	.43	.55	.67	35,700	2950	.44	.56	.68	34,400	3340	.44	.57	.69
	1200	40,000	2410	.44	.58	.71	38,700	2670	.45	.58	.72	37,400	2990	.45	.59	.73	36,100	3390	.45	.60	.74
	1450	41,400	2430	.45	.60	.75	40,100	2690	.46	.61	.76	38,700	3020	.46	.62	.78	37,200	3420	.47	.63	.80

NOTE - All values are gross capacities and do not include evaporator coil blower motor heat deduction.

HS22-411V WITH CR16-51FF EVAPORATOR UNIT

Enter. Wet Bulb (°F)	Total Air Vol. (cfm)	Outdoor Air Temperature Entering Condenser Coil (°F)																			
		85					95					105					115				
		Total Cool Cap. (Btuh)	Comp. Motor Watts Input	Sensible To Total Ratio (S/T)			Total Cool Cap. (Btuh)	Comp. Motor Watts Input	Sensible To Total Ratio (S/T)			Total Cool Cap. (Btuh)	Comp. Motor Watts Input	Sensible To Total Ratio (S/T)			Total Cool Cap. (Btuh)	Comp. Motor Watts Input	Sensible To Total Ratio (S/T)		
				Dry Bulb (°F)					Dry Bulb (°F)					Dry Bulb (°F)					Dry Bulb (°F)		
75	80	85	75	80	85	75	80	85	75	80	85	75	80	85	75	80	85				
63	950	34,100	2330	.72	.84	.96	33,000	2580	.73	.85	.97	31,800	2880	.74	.87	.99	30,600	3260	.75	.89	1.00
	1200	35,800	2350	.76	.90	1.00	34,700	2600	.77	.91	1.00	33,400	2910	.78	.93	1.00	31,900	3290	.80	.95	1.00
	1450	36,900	2370	.80	.95	1.00	35,700	2620	.81	.97	1.00	34,400	2930	.83	.99	1.00	33,200	3320	.84	1.00	1.00
67	950	36,100	2360	.57	.69	.81	35,000	2610	.58	.70	.82	33,800	2920	.58	.71	.83	32,600	3300	.59	.72	.85
	1200	38,000	2380	.60	.73	.86	36,700	2630	.60	.74	.88	35,500	2950	.61	.76	.90	34,200	3340	.62	.77	.92
	1450	39,200	2400	.62	.77	.92	38,000	2660	.63	.79	.94	36,700	2970	.64	.80	.96	35,300	3370	.65	.82	.97
71	950	38,200	2390	.43	.56	.67	37,000	2640	.43	.56	.68	35,800	2960	.43	.57	.69	34,600	3350	.44	.57	.70
	1200	40,100	2410	.44	.58	.71	38,900	2670	.45	.59	.72	37,600	2990	.45	.60	.73	36,300	3400	.45	.61	.74
	1450	41,500	2430	.46	.61	.75	40,200	2690	.46	.62	.76	38,900	3020	.46	.63	.78	37,500	3430	.47	.64	.79

NOTE - All values are gross capacities and do not include evaporator coil blower motor heat deduction.

HS22-411V WITH C16-41FF, C16-41WFF, CR16-41FF OR CH16-41FF EVAPORATOR UNIT

Enter. Wet Bulb (°F)	Total Air Vol. (cfm)	Outdoor Air Temperature Entering Condenser Coil (°F)																			
		85					95					105					115				
		Total Cool Cap. (Btuh)	Comp. Motor Watts Input	Sensible To Total Ratio (S/T)			Total Cool Cap. (Btuh)	Comp. Motor Watts Input	Sensible To Total Ratio (S/T)			Total Cool Cap. (Btuh)	Comp. Motor Watts Input	Sensible To Total Ratio (S/T)			Total Cool Cap. (Btuh)	Comp. Motor Watts Input	Sensible To Total Ratio (S/T)		
				Dry Bulb (°F)					Dry Bulb (°F)					Dry Bulb (°F)					Dry Bulb (°F)		
75	80	85	75	80	85	75	80	85	75	80	85	75	80	85	75	80	85				
63	950	34,400	2340	.72	.85	.97	33,300	2580	.73	.86	.98	32,000	2890	.74	.88	.99	30,700	3260	.75	.90	1.00
	1200	36,000	2360	.77	.91	1.00	34,900	2610	.78	.93	1.00	33,600	2910	.79	.95	1.00	32,300	3290	.81	.96	1.00
	1450	37,400	2380	.81	.97	1.00	36,100	2630	.82	.98	1.00	34,900	2940	.84	.99	1.00	33,600	3320	.86	1.00	1.00
67	950	36,400	2360	.57	.70	.81	35,300	2610	.58	.70	.83	34,000	2920	.58	.72	.84	32,700	3310	.59	.73	.86
	1200	38,200	2390	.60	.74	.88	36,900	2640	.61	.75	.90	35,600	2950	.61	.77	.91	34,300	3340	.62	.78	.93
	1450	39,500	2410	.63	.79	.94	38,200	2660	.63	.80	.95	36,800	2980	.64	.82	.97	35,300	3370	.65	.83	.98
71	950	38,400	2390	.44	.56	.67	37,200	2640	.44	.56	.68	36,000	2960	.44	.57	.69	34,700	3350	.44	.57	.70
	1200	40,300	2420	.45	.58	.72	39,000	2670	.45	.59	.73	37,700	3000	.45	.60	.74	36,300	3400	.46	.61	.75
	1450	41,700	2430	.46	.61	.76	40,400	2700	.46	.62	.78	39,000	3030	.47	.63	.79	37,500	3430	.47	.64	.81

NOTE - All values are gross capacities and do not include evaporator coil blower motor heat deduction.

HS22-411V WITH CB18-41 OR CBS18-41 EVAPORATOR UNIT

Enter. Wet Bulb (°F)	Total Air Vol. (cfm)	Outdoor Air Temperature Entering Condenser Coil (°F)																			
		85					95					105					115				
		Total Cool Cap. (Btuh)	Comp. Motor Watts Input	Sensible To Total Ratio (S/T)			Total Cool Cap. (Btuh)	Comp. Motor Watts Input	Sensible To Total Ratio (S/T)			Total Cool Cap. (Btuh)	Comp. Motor Watts Input	Sensible To Total Ratio (S/T)			Total Cool Cap. (Btuh)	Comp. Motor Watts Input	Sensible To Total Ratio (S/T)		
				Dry Bulb (°F)					Dry Bulb (°F)					Dry Bulb (°F)					Dry Bulb (°F)		
75	80	85	75	80	85	75	80	85	75	80	85	75	80	85	75	80	85				
63	950	34,500	2330	.71	.84	.97	33,300	2580	.72	.86	.98	32,000	2880	.73	.88	.99	30,700	3260	.75	.89	1.00
	1200	36,200	2360	.76	.91	1.00	35,000	2610	.77	.92	1.00	33,700	2910	.78	.94	1.00	32,400	3290	.80	.96	1.00
	1450	37,600	2380	.80	.97	1.00	36,100	2630	.82	.98	1.00	34,900	2940	.84	.99	1.00	33,700	3320	.86	1.00	1.00
67	950	36,500	2360	.57	.69	.81	35,300	2610	.57	.70	.82	34,000	2920	.58	.71	.84	32,800	3300	.59	.72	.86
	1200	38,300	2390	.59	.73	.88	37,000	2640	.60	.75	.89	35,700	2950	.61	.76	.91	34,300	3340	.62	.77	.93
	1450	39,600	2410	.62	.78	.93	38,200	2660	.63	.79	.95	36,800	2980	.64	.81	.97	35,300	3370	.65	.83	.99
71	950	38,500	2390	.43	.55	.66	37,300	2640	.43	.56	.67	36,000	2960	.44	.56	.68	34,700	3350	.44	.57	.69
	1200	40,400	2420	.44	.58	.71	39,100	2670	.45	.59	.72	37,700	3000	.45	.59	.73	36,300	3400	.45	.60	.75
	1450	41,800	2440	.46	.61	.76	40,400	2700	.46	.62	.77	39,000	3030	.46	.63	.78	37,500	3430	.47	.64	.80

NOTE - All values are gross capacities and do not include evaporator coil blower motor heat deduction.

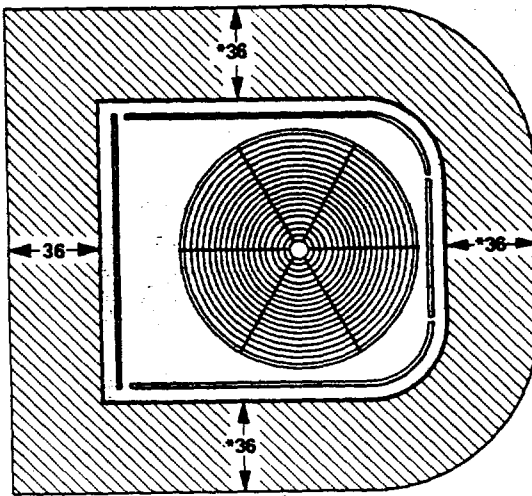

NOTE — 48" clearance required on top of unit.
 *NOTE - One side of coil may be 12"

DIMENSIONS (inches)

Model No.	A	B	C	D	E	F	G	H
HS22-211V, HS22-261V	27-7/8	25-7/8	29-7/8	12-7/8	22-7/16	14-7/16	22-1/8	1-7/8
HS22-311V, HS22-411V	30-7/8	32-1/8	34-1/16	15	26-5/8	18-5/8	28-1/8	2
HS22-461V	34-7/8	32-1/8	34-1/16	16	26-5/8	18-5/8	28-1/8	2

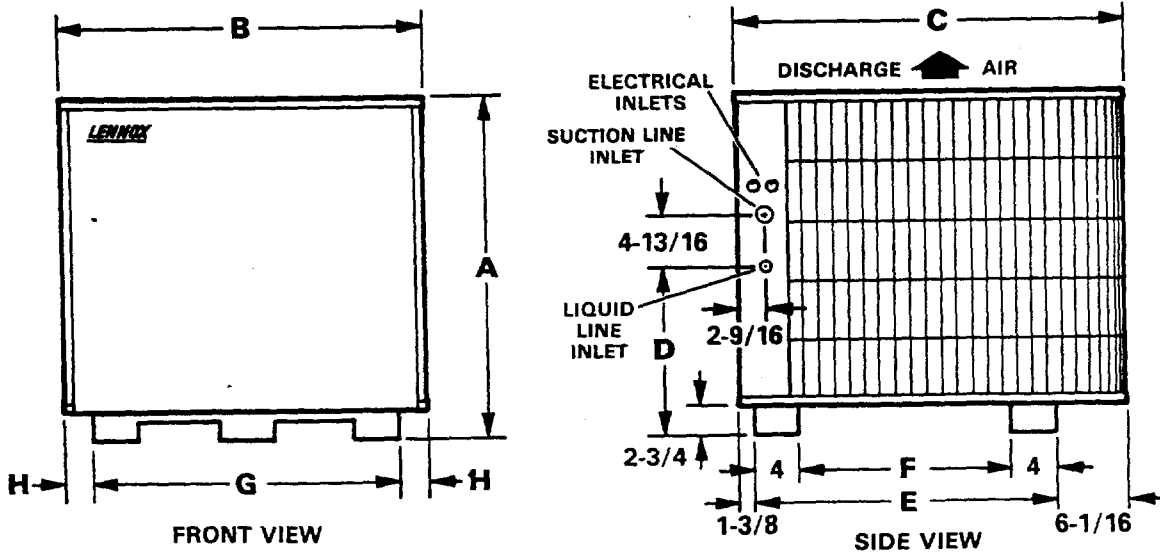
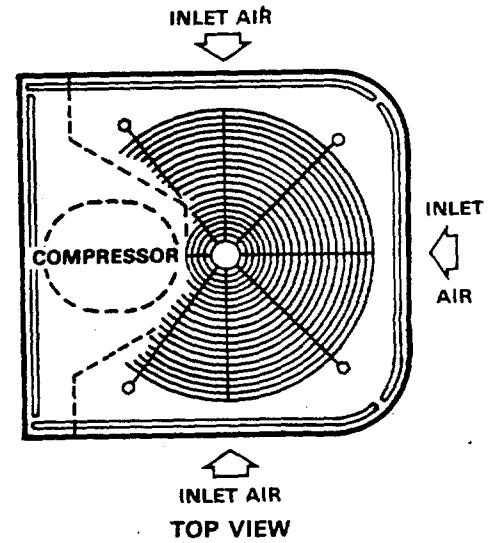

Single & Double Deflection Registers & Grilles—Aluminum

VM Vertical front bars, horizontal valve blades, multi-shutter valve
HM Horizontal front bars, vertical valve blades, multi-shutter valve

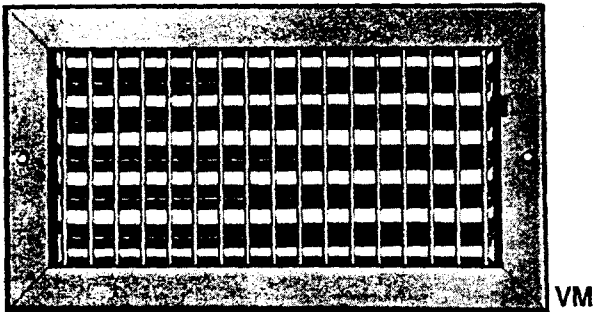

- Extruded aluminum face
 - Single row of individually adjustable face bars
 - Pivoted bars for easy positive setting
 - Lever-operated multi-shutter valve
 - Equipped with gasket
 - Dover White or Satin Anodized finish
 - Aluminized steel valve blades
- See price list for available sizes

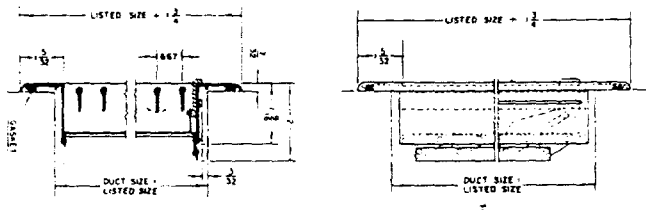

VM Side View

VM End View

V Grille, vertical front bars
VD Register, as above, with opposed blade damper
H Grille, horizontal front bars
HD Register, as above, with opposed blade damper

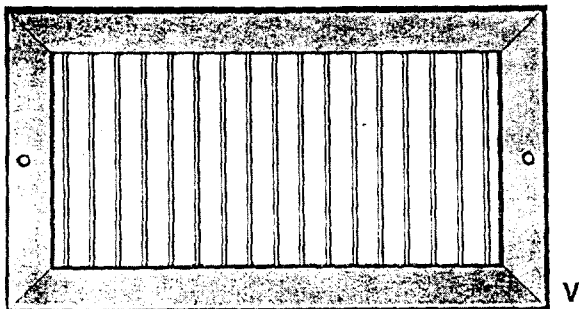

- Extruded aluminum registers and grilles
- Single row of individually adjustable face bars

- Pivoted bars for easy positive setting
 - Opposed blade damper on VD and HD
 - Equipped with gasket
 - Dover White or Satin Anodized finish
- See price list for available sizes

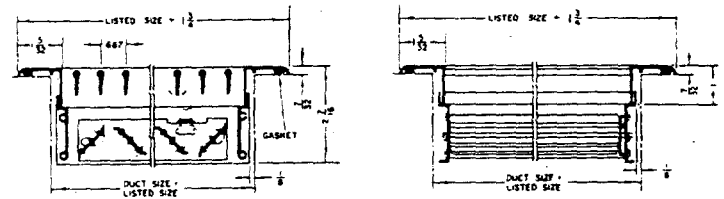

VD Side View

VD End View

VH Grille, vertical front bars, horizontal second bars
VHD Register, as above, with opposed blade damper
HV Grille, horizontal front bars, vertical second bars
HVD Register, as above, with opposed blade damper

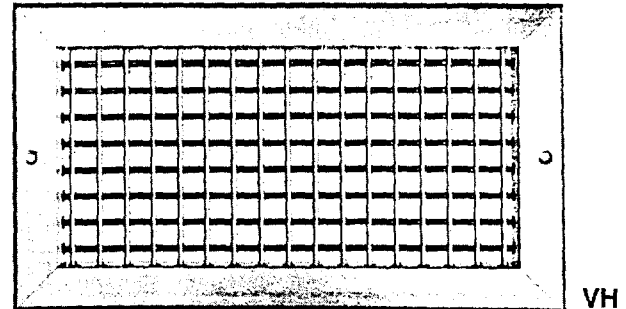

- Extruded aluminum registers and grilles
 - Two rows of individually adjusted face bars for horizontal and vertical deflection
 - Pivoted bars for easy positive setting
 - Opposed blade damper on VHD and HVD
 - Equipped with gasket
 - Dover White or Satin Anodized finish
- See price list for available sizes

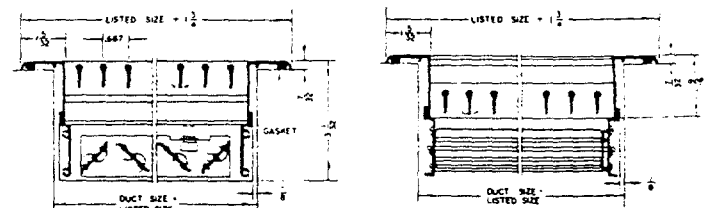

VHD Side View

VHD End View

Return Registers & Grilles—Aluminum

- RH45 Grille, horizontal bars at 45 degrees
- RHD45 Register, as above, with opposed blade damper
- RH90 Grille, horizontal bars at 90 degrees
- RHD90 Register, as above, with opposed blade damper

- RE5 Grille, grid core $\frac{1}{2} \times \frac{1}{2} \times \frac{1}{2}$ "
- RED5 Register, as above, with opposed blade damper

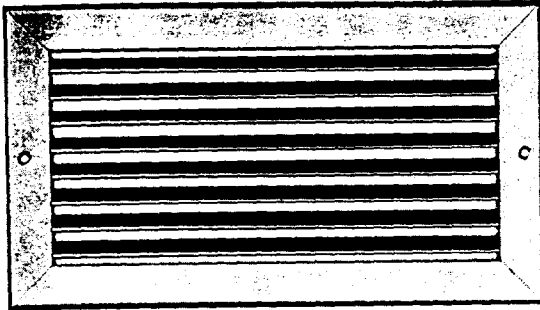

RH45

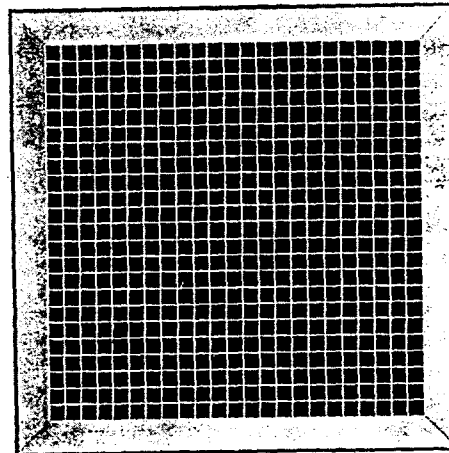

RE5

- Extruded aluminum construction
- Face bars permanently fixed into heavy aluminum frames at a 45 or 90 degree angle
- Opposed blade damper on RHD45 and RHD90
- Dover White or Satin Anodized finish

See price list for available sizes

- All-aluminum construction
- Square mesh design with extruded aluminum frame
- Opposed blade damper on RED5
- Dover White or Satin Anodized finish

See price list for available sizes

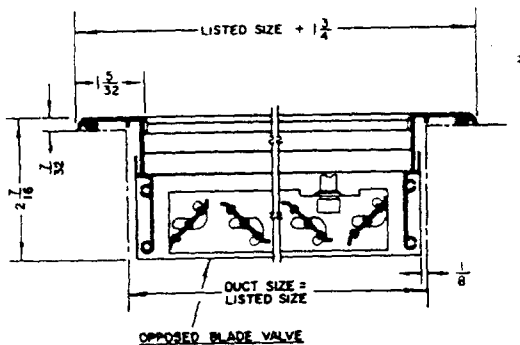

RH45/RHD45 Side View

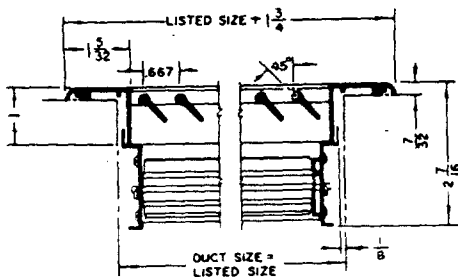

RH45/RHD45 End View



United States Department of the Interior

NATIONAL PARK SERVICE
SOUTHEAST REGIONAL OFFICE

75 Spring Street, S.W.
Atlanta, Georgia 30303



IN REPLY REFER TO:

H30 (SER-OHA) JUL 8 1992

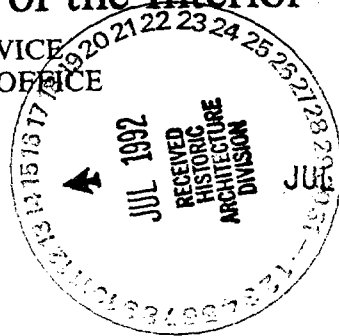
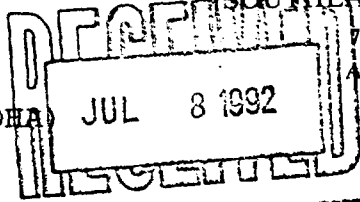

1992

Memorandum

To: Superintendent, Natchez National Historical Park

Through: *ASW* Deputy Associate Regional Director, Cultural Resources,
Southeast Region *L. Adell 7-2-92*

From: Acting Chief, Historic Architecture Division, Cultural
Resources, Southeast Region

Subject: Task Directive for Preservation Maintenance Work
at Johnson House Dependency

We are pleased to make the following proposal for preservation maintenance work on the Johnson House Dependency. The intent of this project is make structural repairs and provide a watertight envelope.

To better organize and track the work of this project, activities have been divided into the following work elements.

1. Remove flooring and ceiling lath as needed to repair/replace two deteriorated second level floor joists at the southeast corner. Pressure treated southern yellow pine will be used for replacement lumber.
2. Remove first level floor boards and replace all floor joists with pressure treated pine.
3. Remove ground floor dirt to 6 inches below joists. The park will arrange for an archeologist to be present during this work. Cover soil with a vapor barrier.
4. Repoint joist pockets.
5. Replace all first level flooring with 1 inch by 4 inch tongue and groove pine flooring. Use approximately 40SF of salvageable floor boards on second level.
6. Remove loose interior wall plaster. Retain good plaster.

- 7. Build temporary stairs and install guard rails at second story porch. Replace second story porch posts with pressure treated 4 by 4 inches at locations consistent with first floor posts.
- 8. Remove metal roof. Remove sheathing boards as needed to work on rafters. Make repairs to three ceiling joists and three roof rafters. Make minor repairs to top plate and rafter tails as needed matching-in-kind materials and using half-lapped joinery. Temporarily replace sheathing and cover with rolled roofing and batten strips pending roof work by contractor.
- 9. Remove demolition debris from job site.

The preservation crew will prime all exterior woodwork repairs. The finish paint will be applied by park personnel or by contract.

Total estimated cost for this project is \$17,212. Major cost categories are outlined below:

Labor.....	\$9640
Materials.....	1700
Per diem.....	5872
 Total.....	 \$17,212

Per diem rate includes site visits by regional architect.

We propose to start the project on or about July 7. Once on site, we anticipate being able to use the shop equipment at the carriage house coordinating our work closely with the park maintenance staff. Estimated completion date is July 30, 1992.

Mike Doelger, Head of OHA Field Services, will coordinate this project with you. Every effort will be made to ensure that the specified work is done to preservation standards within proposed budget and project schedule. Unforeseen conditions which may result in changes of scope, cost or project duration will be brought to your attention as soon as we are aware of them. Any changes you may wish to make should be brought to Mr. Doelger's attention. All substantial changes are to be agreed to in writing by you, and the OHA Division Chief.

We look forward to working with you on this project. As this project is funded through construction money, all expenditures will be charged directly to the park project account. We will maintain our service of tracking all project expenditures.



I concur with this task directive.

Stuart L. Johnson
Superintendent

7/10/92
Date

cc: SERO-Hartwig
SERO-Cote

Note:

If we are unable to arrange for archeological investigation of the dependency ground floor, it will not be possible to remove 6 inches of dirt (#3) or replace the floor joists and flooring (#3 and #5). I will expect the project costs to be adjusted accordingly in this event. I discussed this with Rene Cote on 07-10-92.

SKJ 7/10/92

Capps 8/5/92

NATC-92-05

Memorandum

To: Superintendent, Natchez National Historical Park

From: ~~for~~ Deputy Associate Regional Director, Cultural Resources,
Southeast Region

Subject: Section 106 Clearance, Stabilization of Johnson House
Dependency

We are pleased to inform you that Section 106 compliance procedures have been completed for the above project under the Programmatic Agreement (PA). This project has been cleared under exclusion Cla. A copy of the completed XXX Form is enclosed. You are free to proceed with the project if funds are available and all other requirements have been met.

Enclosure

bcc:

SER-PC
Chief, OHA

MACapps:mc:8/5/92

Capps 2/8/93
Rehm 2/8/93

NATC-93-03

FEB 9 1993

Memorandum

To: Superintendent, Natchez National Historical Park

From: ~~ASAC~~ Deputy Associate Regional Director, Cultural Resources,
Southeast Region

Subject: Section 106 Clearance, Placement of utility lines at
the William Johnson House complex

We are pleased to inform you that Section 106 compliance procedures have been completed for the above project under the Programmatic Agreement (PA). This project has been cleared under exclusion Clh. A copy of the completed XXX form is enclosed. You are free to proceed with the project if funds are available and all other requirements have been met.

/S/ JOHN E. EHRENHARD

Enclosure

bcc:

Chief, SEAC

MACapps:mc:2/8/93



United States Department of the Interior



NATIONAL PARK SERVICE

Southeast Regional Office

24 Spring Street, S.W.

Atlanta, Georgia 30303

IN REPLY REFER TO:

H30 (SER-OHA)

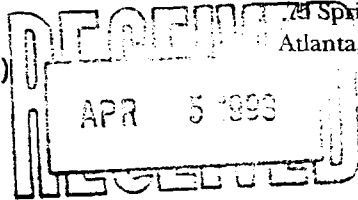

APR 02 1993

Memorandum

To: Superintendent, Natchez National Historic Site

Through: Deputy Associate Regional Director, Cultural Resources,
Southeast Region *PH*

From: Chief, Historic Architecture Division, Cultural
Resources, Southeast Region

Subject: Task Directive Modification for Preservation Maintenance
Masonry Work at William Johnson House and Dependency

We are submitting this modification to the original Task Directive for preservation maintenance masonry work at the William Johnson House and Dependency dated November 30, 1992. The intent of this project is the stabilization of masonry in both structures.

Johnson House

Removal of exterior stucco from the west wall of the Johnson House revealed extensive deterioration of the brick masonry. The bottom 4 feet of wall was in very bad shape as a result of rising damp problems that had been exacerbated by a portland stucco patch. Most of the jambs and headers at 5 windows need to be repaired.

Also, revealed were serious failures of the structural connection between the two interior fireplaces and the external brick envelope. Large areas of the wall surface on either side of each fireplace stack have numerous vertical fractures that run through the wall from the exterior to the interior.

It is necessary to repair these structural fractures as well as reconstruct the connection between the fireplace stacks and the west wall. Wall areas between fireplace stacks and nearby windows are extremely unstable. At certain locations of the stacks, bricks have collapsed into the flues leaving only the stucco itself remaining as part of the exterior structural wall. Chimneys are very unstable once stucco is removed.

NATCHEZ NHP

- Supt. _____ Curat. _____
- Ad. Off _____ Maint. _____
- Chf. I&VG _____ _____
- FILE

ACTION BY _____

Approximately 500 square feet of brickwork is currently being replaced to reestablish structural integrity and eliminate an unsafe condition. Additionally, the chimney at the northwest corner of the west wall is being dismantled down to the roof line and will be rebuilt using salvageable brick where possible.

William Johnson Dependency

After beginning the removal of deteriorated lime plaster and making repairs to the brickwork on the second floor interior of the Johnson House Dependency, it has been noted that the existing brick mortar needs repointing. On the first floor, walls are presently covered by a hard portland plaster and we can now project that once this material is removed, conditions similar to that on the second floor will be found. Instead of selective repointing as previously planned, we are recommending that the entire interior walls of the dependency be repointed to provide a sound surface on which to apply new plaster.

Total estimated costs for these changes is \$33,500. Costs are outlined below:

Repairs to Johnson House West Wall.....	\$20,000
Repairs to Dependency.....	13,000
Materials for both.....	<u>500</u>
Total	\$33,500

Above costs include labor, lodging, per diem, and supervision. Estimated completion date is May, 1993.

Mike Doelger, Head of OHA Field Services, will coordinate this project with you. Every effort will be made to ensure that the specified work is done to preservation standards within proposed budget and project schedule. Unforeseen conditions which may result in changes of scope, cost or project duration will be brought to your attention as soon as we are aware of them. Any changes you may wish to make should be brought to Mr. Doelger's attention. All substantial changes are to be agreed to in writing by you, and the OHA Division Chief.

We look forward to working with you on this project. As this project is funded through construction money, all expenditures will be charged directly to the park project account. We will maintain our service of tracking all project expenditures.

ACTING

I concur with this task directive.

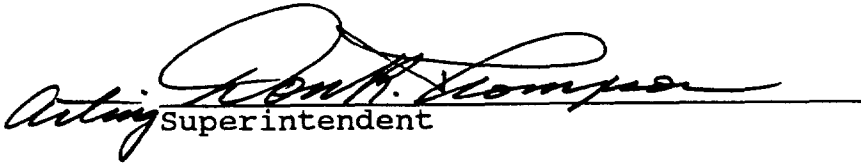
Acting Superintendent

4/7/93
Date

cc: Hartwig-ODC
Cote-OHA
Hester-OHA



IN REPLY REFER TO:

United States Department of the Interior



NATIONAL PARK SERVICE

Southeast Regional Office

75 Spring Street, S.W.

Atlanta, Georgia 30303

H30 (SER-OHA)

AUG 11 1993

Memorandum

To: Superintendent, Natchez National Historical Park

Through: Deputy Associate Regional Director, Cultural Resources,
Southeast Region *P. Hart*

From: Chief, Historic Architecture Division, Southeast Region

Subject: Site Inspection, Johnson House and Dependency

On July 14, 1993, Mike Doelger and Rene Cote inspected ongoing preservation crew work at the site. Stephen Siggins, Historic Architecture Division, Mason and a park hired laborer, were currently working on the chimney at the west elevation south corner. The entire chimney system including foundation, fireboxes at first and second floors, flue system and stack are complete and match original configuration. Stephen Siggins was nearing completion of the chimney cap at the end of the day. All items within the task directive dated November 25, 1992, and titled "Preservation Maintenance Masonry Work at the Johnson House and Dependency" have been completed with the exception of the following items:

Dependency

7. Plaster four rooms and ceilings.
8. Repair brick within three fireboxes, seal throats and cap chimney.
10. Repair wing wall at rear of structure.

Before work can be completed on items 7 and 8, other elements of work must be completed first, specifically, installation of HVAC, electrical system, and interior wood work repairs. The HVAC and electrical system design are currently being reviewed by the Advisory Council in Washington, D.C., as part of the 106 compliance review process. We are hopeful that by mid August we will receive approval to proceed with installation of HVAC and electrical systems. We are recommending that item 10 be put on hold until a comprehensive landscape plan can be developed for the site.

2

All completed masonry work associated with this task directive is of high quality and the masonry crew should be commended for their work. Because the funding for this project will carry over to FY 94, it is recommended that the masonry crew plan to be back at the site in November to complete items 7 and 8, this will allow ample time to complete utilities installation and wood work repairs.

Work completed under task directive dated November 13, 1992, titled "Preservation Maintenance Carpentry Work at Johnson House Dependency" was also reviewed. The following items have not been completed:

2. Rebuild one door and repair one door at rear elevation.
3. Repair four doors at front elevation.
4. Rebuild two interior doors.
5. Repair eight windows and rebuild two windows. Reglaze all windows.
12. Repair and reinstall three mantles.
13. Fabricate and install second story 4 inches x 4 inches porch posts, rail and stair.
14. Prime all millwork.
15. Repair and replace wood lath for plaster as needed.

Punchlist items exist on portions of the carpentry work that have been completed, specifically :

- A. Baseboard trim is not properly anchored into masonry walls.
- B. Baseboard trim does not fit properly to floor, gaps exist between baseboard trim and floor.
- C. Door and window trim finish could be better executed, connections between trim pieces are not flush.

Punchlist items A, B, and C identified above will be repaired as specified in existing task directive. Because of other commitments throughout the region the carpentry crew will not be able to return to the site until October. They will complete all task directive items at that time.

Discussions took place between Acting Superintendent, Kim Fuller, Thom Rosenblum, Mike Doelger and Rene Cote, and was specifically directed toward the Johnson House Complex. Kim indicated the park's interest in moving into the Johnson House Dependency the first quarter of 1994. We also discussed the need to determine the location and configuration of the proposed stair at second level of the Dependency. There was a consensus that more information was needed to determine this and that archeological work be completed adjacent to the front elevation of the dependency and this might provide evidence of stair base location. Another possible approach to the stair issue would be to install a good quality compatible stair in a location which suits the parks needs.

Future research through historic documentation may reveal original location of the stair. A discussion also took place regarding the need for the development of Historic Structures Reports (HSR) for both the Johnson House Complex and Melrose. Work to date at the Johnson House Complex has been mainly limited to stabilization/preservation. It is our understanding that the park has requested funding for an HSR. Upon completion of the two task directives that are currently underway it will be important to develop an HSR before much more work is completed at the site. There is a wide variety of historic documentation that currently exist, the Johnson Diary, HABS historic documentation and drawings, and state archival records. Peggy Albee, NARO Architectural Conservator is completing a materials analysis of the Johnson House. This information will provide excellent documentation of existing historic fabric within the house and will provide the author of the HSR a scientific basis for historic finishes.

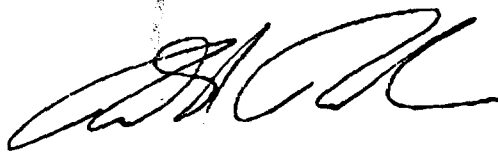

cc: Fuller, NATC
Rosenblum, NATC



United States Department of the Interior

NATIONAL PARK SERVICE
SOUTHEAST REGIONAL OFFICE

75 Spring Street, S.W.
Atlanta, Georgia 30303



DE 10/1/1995 70

H30 (SKR-OHA)

Memorandum

X
To: Superintendent, Natchez National Historic Site
Through: Deputy Associate Regional Director, Cultural Resources,
 Southeast Region *Marking*
From: Chief, Historic Architecture Division, Cultural
 Resources, Southeast Region
Subject: Task Directive for Preservation Maintenance Carpentry
 Work at Johnson House Dependency

We are pleased to make the following proposal for preservation maintenance carpentry work at the Johnson House Dependency. The intent of this project is to rehabilitate the structure for adaptive use by the park.

Activities have been divided into the following work elements:

1. Replace fascia at rear elevation and hang gutter and downspout.
2. Replace two door headers, rebuild one door and repair one door at the rear elevation.
3. Repair four front doors.
4. Rebuild two interior doors.
5. Repair eight windows and rebuild two windows. Repair/replace window trim as needed. Reglaze all windows.
6. Repair/replace interior trim as needed. Modify baseboards for electrical receptacles.
7. Cut and frame access hole to attic and install platform for HVAC. Cut and frame openings for supply and return air.
8. Replace attic ceiling joists as needed.
9. Replace first level floor. Install 2 x 10 to center support. Install vapor barrier, deck with new 1 x 3, T&G, pine, to be finished by park/contract.
10. Replace four floor joists on second floor. Repair deteriorated flooring using salvageable first level floor boards.
11. Construct false closet at second floor to accommodate HVAC chaseway.
12. Remove, repair and reinstall four mantles.
13. Fabricate and install second story 4 x 4 porch posts, rail and stair.

- 14. Prime all millwork.
- 15. Repair/replace plaster lath as needed.

The finish paint cost on all woodwork will be applied by park personnel or by contract. Millwork will be completed using the supply of poplar at the park.

Total estimated cost for this project is \$46,271. Major cost categories are outlined below:

LABOR.....	\$28,151
Materials.....	6,240
Travel & Per diem.....	11,880
Total.....	\$46,271

We propose to start the project on November 18 in anticipation of archaeological investigations at the dependency being completed by that time. Once on site, we anticipate being able to use the shop equipment at the carriage house, coordinating our work closely with the park maintenance staff. Estimated completion date March 30, 1993.

Mike Doelger, Head of OHA Field Services, will coordinate this project with you. Every effort will be made to ensure that the specified work is done to preservation standards within proposed budget and project schedule. Unforeseen conditions which may result in changes of scope, cost or project duration will be brought to your attention as soon as we are aware of them. Any changes you may wish to make should be brought to Mr. Doelger's attention. All substantial changes are to be agreed to in writing by you, and the OHA Division Chief.

We look forward to working with you on this project. As this project is funded through construction money, all expenditures will be charged directly to the park project account. We will maintain our service of tracking all project expenditures.

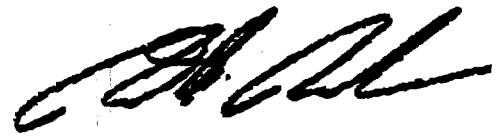

I concur with this task directive.

Stuart K. Jensen
Superintendent

11-16-92
Date

cc: SERO-Hartwig
SERO-Cote



IN REPLY REFER TO:

United States Department of the Interior



NATIONAL PARK SERVICE

Southeast Regional Office
75 Spring Street, S.W.
Atlanta, Georgia 30303

H26 (SER-OHA)

NOV 30 1993

Memorandum

To: Superintendent, Natchez National Historic Park

From: Chief, Field Services, Historic Architecture Division,
Southeast Region

Subject: Bi-Weekly Progress Report

During pay period 25 the OHA Field Services crew worked on the Johnson House Dependency Building.

Interior wood trim was replaced or repaired as needed, shoe molding installed, a window opening rebuilt, one rear door replaced, safety rails installed on top porch, attic door opening installed, new door locks installed, and new thresholds installed. All trim was primed to protect it from plaster repairs.

Window sash and one door were removed as samples. Three sets of windows and two door units will be made and later installed.



9.8 Data Sheets



ROBERT SILMAN ASSOCIATES, P.C.

CONSULTING ENGINEERS
88 UNIVERSITY PLACE, NEW YORK, N.Y. 10009

PROJECT Wm. Johnson House
SUBJECT _____

JOB NO. 5060.02
BY EPM

PAGE 1/8
DATE 6/15/95

2nd floor joists - check of f_b & Δ_{max}

\rightarrow size = $2\frac{3}{4}'' \times 12'' @ 16'' \text{ o.c.}$ $\rightarrow S_{xx} = \frac{1}{6}(2.75)(12)^2 = 66 \text{ in}^3$
 $\rightarrow I_{xx} = \frac{1}{12}(2.75)(12)^3 = 396 \text{ in}^4$

\rightarrow SPAN = $21' \pm$

$w = \frac{16}{12}(78) = 104 \text{ plf}$
 $M = \frac{1}{8} \frac{(104)}{\text{plf}} (21')^2$
 $= 8,788 \text{ lbf}$

LOADS	JOISTS	5 PSF
(w/ finishes)	FLOORING	5
	PLASTER & LATH	8
	PARTITIONS	20
	LIVE	40
	Σ	78 PSF

$\therefore f_b = \frac{8,788(12)}{66.0} = 1600 \text{ psi}$

$\Delta_{max} = \frac{5(104/12)(21 \times 12)^4}{384(1,440,000)(396)} = 1.87'' \equiv \frac{L}{106} \leftarrow \text{too high!}$

$f_v = \frac{3(12)(104)(21')}{2(2.75)(12'')} = 62 \text{ psi}$

PROJECT Wm. Johnson Home
 SUBJECT _____

JOB NO. 5060.02
 BY EPM

PAGE 2
 DATE 6/15/96

Attic Floor Joists & Other Attic Framing

size = 3" x 8" @ 24" o/c
 ↳ span N/S, span = 20' → to 2nd floor interior partition (stud bearing wall); this wall is, in turn, supported by 2nd floor joists & these are supported by 2 stud columns on the 1st floor (to be checked, see below).



ATTIC FLOOR PLAN

N.T.S.

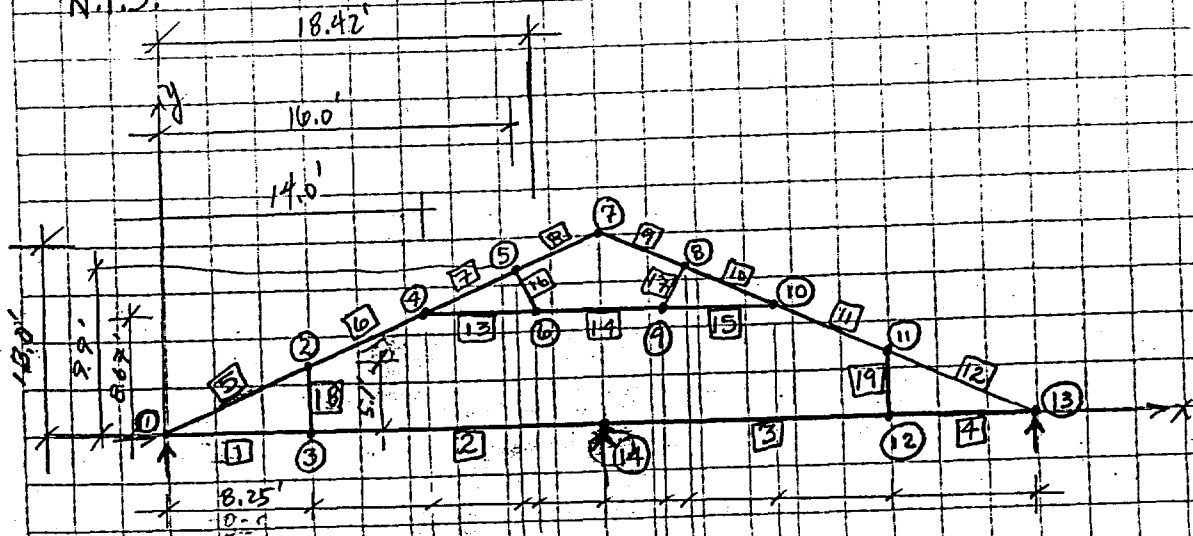

SECTION 'A' WITH JOINTS & MEMBERS LABELLED

N.T.S.

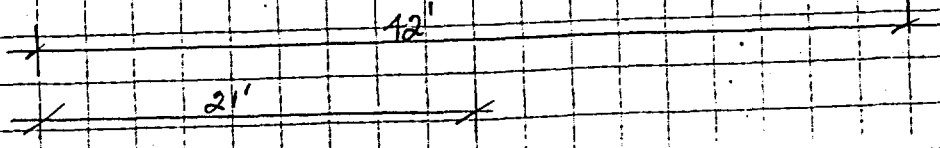

PROJECT Wm. Johnson House
SUBJECT _____

JOB NO. 5060.02 PAGE 3/18
BY EPM DATE 6/16/9E

Attic Framing (Cont.)

Roof LOADS:

DEAD	SHINGLES ON ROOF	2 PSF
	SUBROOFING	5 PSF
	RAFTERS	4 PSF
	(CYPOLA)	5 PSF
	SNOW (or other) → min. (see below)	20 PSF
		Σ = 30 PSF

WIND ← Basic Wind Speed = 85 MPH → $P_v = 18.5 \text{ lb/ft}^2$

per BOCA/1993:
mean roof height = $h = 30'$ above the street
Exposure B
Importance factor = 1.0 = I

Windward wall Pressure = $P = P_v I / [K_z G_h C_p - K_h (G C_{pi})]$

$P_v = 18.5 \text{ lb/ft}^2$
 $I = 1.0$
 $h/L = 30'/40' = 0.75$

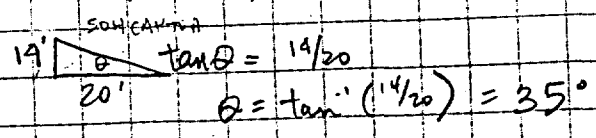

$C_p = 0.05$ for windward } per BOCA
 $C_p = -0.7$ for leeward } Table 1611.7(2)

$Z_z = K_h = 0.50$; $G_h = G_z = 1.51$

$G C_{pi} = \pm 0.25$
∴ Windward $P = (18.5 \text{ PSF})(1.0) [(0.5)(1.51)(0.05) - 0.5(+0.25)]$
 $= -1.6 \text{ PSF} \rightarrow \text{min. per code} = 10 \text{ PSF} \Rightarrow W_3 = 10 \text{ PSF} \times 2 = 20 \text{ PSF}$

Leeward $P = P_v I [K_h G_h C_p - K_h (G C_{pi})]$
 $= (18.5 \text{ PSF})(1.0) [(0.5)(1.51)(-0.7) - 0.5(+0.25)]$
 $= -7.40 \text{ PSF} \rightarrow \text{min. per code} = 10 \text{ PSF}$
 $W_4 = 10 \text{ PSF} \times 2 = 20 \text{ PSF}$

ROBERT SILMAN ASSOCIATES, P.C.

CONSULTING ENGINEERS

88 UNIVERSITY PLACE, NEW YORK, N.Y. 10003

PROJECT Wm. Johnson House
SUBJECT _____

JOB NO. 5060.02
BY EPM

PAGE 4
DATE 6/16/95

Attic Framing (Cont.)

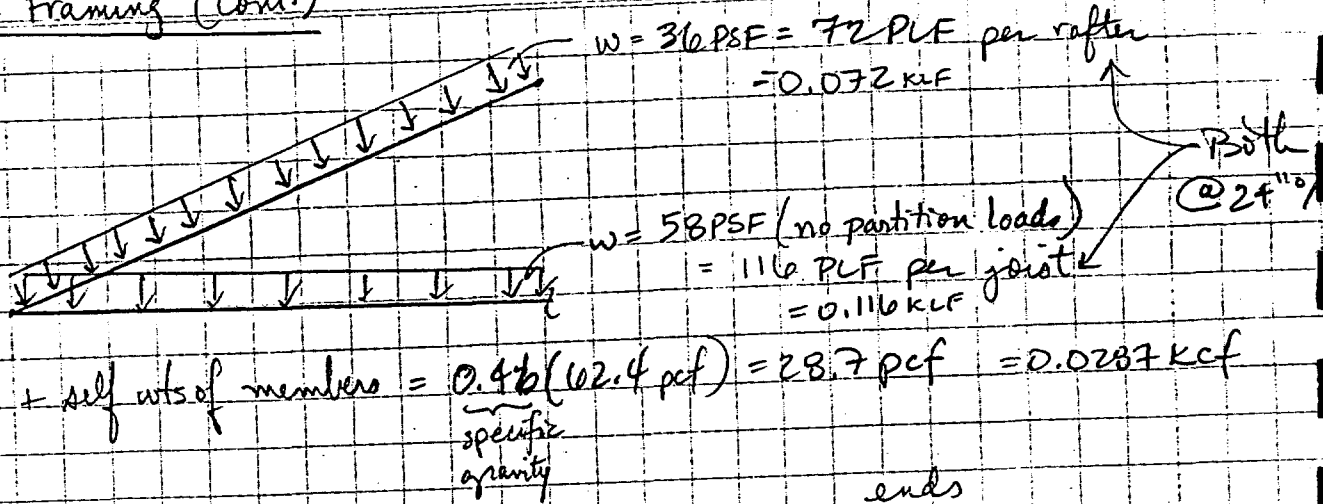

JOINT #	LOCATIONS of JOINTS		members	ends	
	X	Y		i	j
1	0	0	1	3	
2	8.25	5.1	3	14	
3	8.25	0	14	12	
4	14.0	8.67	12	13	
5	16.0	9.9	1	2	
6	18.42	8.67	2	4	
7	21.0	13.0	4	5	
8	26.0	9.9	5	7	
9	23.58	8.67	7	8	
10	28.0	8.67	8	10	
11	33.75	5.1	10	11	
12	33.75	0	11	13	
13	42.0	0	4	6	
14	21.0	0	6	9	

mat'l label

- 1
- 2
- 3
- 4
- 5

	A	I_{xx}
1 RAFTERS: $2\frac{3}{4} \times 5 \text{ @ } 24 \text{ o/c}$	13.75	28.65
2 JOISTS: $3 \times 8 \text{ @ } 24 \text{ o/c}$	24	128
3 STUDS: $3 \times 4\frac{1}{2} \text{ @ } 24 \text{ o/c}$	1.5	22.78
4 HORIZ. TIE BMS: $3 \times 3\frac{3}{4} \text{ @ } 24 \text{ o/c}$	11.25	13.18
5 DIAG. TIE BMS: $1\frac{1}{2} \times 3\frac{1}{2} \text{ @ } 24 \text{ o/c}$	5.25	5.35

$3 \times 10^6 = 0.3 \times 10^9$

ROBERT SILMAN ASSOCIATES, P.C.

CONSULTING ENGINEERS
UNIVERSITY PLACE, NEW YORK, N.Y. 10003

PROJECT Wm. Johnson House
SUBJECT _____

JOB NO. 5060.02
BY EPM

PAGE 5/18
DATE 6/16/95

2 load cases: ① DL + 20 PSF LL - uniform



② DL + Wind 20 PSF - uniform
(windward pressure & leeward suction)

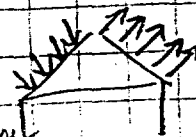

N.B. RISA model already takes into account the DL of the rafters & joists;

Therefore: Roof shingles 2 PSF
 subroofing 5
 cupola 5
 12 PSF (excl. rafter wt.)

DL: $w_1 = 12 \text{ PSF} \times 2' = 24 \text{ PLF}$

$w_2 = 20 \text{ PSF} \times 2' = 40 \text{ PLF}$ (really min LL ↓) snow

$w_3 = 20 \text{ PLF}$ wind
 $w_4 = 20 \text{ PLF}$

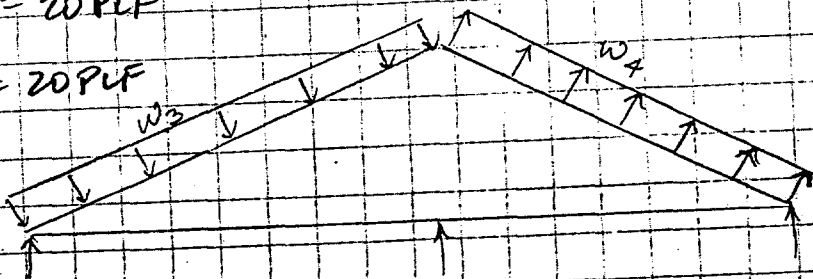

Case ① $\sum w_1 + w_2 = 64 \text{ PLF}$ windward leeward

Case ② $\sum w_1 + w_3/w_4 = 44 \text{ PLF} \downarrow$ & $4 \text{ PLF} \downarrow$

Plus, Revise Floor Loads: DL: JOISTS 0' BF (incl. in RISA DL self wts.)
 Flooring 5
 plaster/floor 8

UL: 40
 $\sum = 53 \text{ PLF} \rightarrow w_5 = 53 \text{ psf} \times 2' = 106 \text{ PLF}$ (joists 2' on cent)

**ROBERT SILMAN
ASSOCIATES, P.C.**

CONSULTING ENGINEERS

88 UNIVERSITY PLACE, NEW YORK, N.Y. 10003

PROJECT Wm. Johnson House
SUBJECT _____

JOB NO. 5060.01
BY EPM

PAGE 9/10
DATE 6/16

Attic Framing (Cont.)

JOISTS → Case 2 Worst

$$M = 4.23 \text{ k}$$

$$S = \frac{1}{6} (3) (8)^2 = 32 \text{ in}^3$$

$$f_b = \frac{4.23 (12)}{32} = 1.58 \text{ ksi}$$

$$f_t = \frac{1.61 \text{ k}}{(3) (8)} = 0.067 \text{ ksi}$$

Check:

$$\frac{f_t}{F_t} + \frac{f_b}{F_b} = \frac{0.067}{\quad} + \frac{1.58}{\quad}$$

Rafters → Case 1 Worst

$$M = 2.46 \text{ k}$$

$$S = \frac{1}{6} (2.75) (5)^2 = 11.46 \text{ in}^3$$

$$f_b = \frac{2.46 (12)}{11.46} = 2.46 \text{ ksi} \leftarrow \text{too high}$$

RAFTERS ARE OVERSTRESSED, even w/out axial stresses added in.

PROJECT Wm. Johnson House
 SUBJECT _____

JOB NO. 5060.02 PAGE 6/18
 BY EPM DATE 6/17/77

Rafters = 15' long

$w = 64 \text{ PLF } (= 32 \text{ PSF} \times 2')$ ← DL+LL

$I = \frac{1}{18} (2.75") (5")^3 = 28.6 \text{ in}^4$

$\therefore M = \frac{1}{8} (64) (15')^2 = 1800 \text{ '}\#$

$\therefore f_b = \frac{1800 (12')}{11.46 \text{ in}^3} = 1885 \text{ psi} \leftarrow \text{too high}$

$\Delta_{\text{max}} = \frac{5 (64/12) (15 \times 12)^4}{384 (1,180,000) (28.6)} = 2.1" \approx \frac{L}{83} \leftarrow \text{too high}$
 ↑ (w/out other bracing in the attic).

w/ bracing in the attic, RISA model shows deflection "controlled" to be $\approx 1.8" \approx \frac{L}{100}$, still too high.

N.B. Attic Floor Rafters Also Deflect Too Much.

Attic floor joists, simple span, no roof loads:

$l = 20'$ $w = 116 \text{ plf}$ $M = \frac{1}{8} (116) (20')^2 = 5800 \text{ '}\#$

$S = \frac{1}{6} (3) (8)^2 = 32 \text{ in}^3$ $I = \frac{1}{12} (3) (8)^3 = 128 \text{ in}^4$

$f_b = \frac{5800 (12)}{32} = 2175 \text{ psi} \leftarrow \text{too high}$

$\Delta_{\text{max}} = \frac{5 (116/12) (20 \times 12)^4}{384 (1,180,000) (128)} = 2.1" \leftarrow \text{too high}$

Robert Silman Associates, P.C.
 88 University Place
 New York, NY 10003

Job _____
 Page _____
 Date _____

Wm. Johnson House, Natchez, Miss.; Anal.
 of Roof and Attic Framing--Case 1

Units Option : US Standard
 AISC Code Checks : No
 Shear Deformation: No
 P-Delta Effects : No
 Redesign : No
 Edge Forces : No
 A.S.I.F. : 1.000

Node No	X-Coord (ft)	Y-Coord (ft)	Boundary Conditions			Temp. (F)
			X-dof (in, K/in)	Y-dof (in, K/in)	Rotation (r, K-ft/r)	
1	0.00	0.00	R	R		0.00
2	8.25	5.10				0.00
3	8.25	0.00				0.00
4	14.00	8.67				0.00
5	16.00	9.90				0.00
6	17.00	8.67				0.00
7	21.00	13.00				0.00
8	26.00	9.90				0.00
9	25.00	8.67				0.00
10	28.00	8.67				0.00
11	33.75	5.10				0.00
12	33.75	0.00			R	0.00
13	42.00	0.00			R	0.00
14	21.00	0.00				0.00

Material Label	Elastic Modulus (Ksi)	Poisson's Ratio	Thermal Coefficient (F)	Weight Density (K/ft ³)	Yield Stress (Fy) (Ksi)
wood	1440.00	0.30000	0.30000	0.029	1.900

Section Label	Database Shape	Matl. Set	Area (in ²)	Moment of Inertia (in ⁴)	As Coef	y/y
rafter		wood	13.75	28.650	1.20	
joist		wood	24.00	128.000	1.20	
stud		wood	1.50	22.780	1.20	
horiz tie		wood	11.25	13.180	1.20	
diag tie		wood	5.25	5.360	1.20	

Robert Silman Associates, P.C.
 88 University Place
 New York, NY 10003

Job _____
 Page _____
 Date _____

Johnson House, Natchez, Miss.; Anal.
 of Roof and Attic Framing--Case 1

I No	I Node	J Node	Section	I Releases			J			Sec	Sway	End Offsets		Length (ft)
				x	y	z	x	y	z			I (in)	J (in)	
1	1	3	joist										8.25	
2	3	14	joist										12.75	
3	14	12	joist			1							12.75	
4	12	13	joist										8.25	
5	1	2	rafter			1							9.70	
6	2	4	rafter										6.77	
7	4	5	rafter										2.35	
8	5	7	rafter										5.88	
9	7	8	rafter			1							5.88	
10	8	10	rafter										2.35	
11	10	11	rafter										6.77	
12	11	13	rafter						1				9.70	
13	4	6	horiz tie			1							3.00	
14	6	9	horiz tie							1			8.00	
15	9	10	horiz tie							1			3.00	
16	5	6	diag tie			1				1			1.59	
17	9	8	diag tie			1				1			1.59	
18	2	3	stud			1				1			5.10	
19	11	12	stud			1				1			5.10	

I No	I Node	J Node	Unbraced Lengths			K Factors		Bending Coefs	
			Lb-in (ft)	Lb-out (ft)	Lc (ft)	In	Out	Cm	Cb
1	1	3							
2	3	14							
3	14	12							
4	12	13							
5	1	2							
6	2	4							
7	4	5							
8	5	7							
9	7	8							
10	8	10							
11	10	11							
12	11	13							
13	4	6							
14	6	9							
15	9	10							
16	5	6							
17	9	8							
18	2	3							
19	11	12							

Robert Silman Associates, P.C.
 88 University Place
 New York, NY 10003

Job _____
 Page _____
 Date _____

Wm. Johnson House, Natchez, Miss.; Anal.
 of Roof and Attic Framing--Case 1

BLC No.	Basic Load Case Description	Load Totals		
		Nodal	Point	Dist.
1				12

Member Distributed Loads, BLC 1:

Membr No	I Node	J Node	Dir	Start Magnitude (K/ft, F)	End Magnitude (K/ft, F)	Start Location (ft)	End Location (ft)
1	1	3	Y	-0.106	-0.106	0.000	8.250
2	3	14	Y	-0.106	-0.106	0.000	12.750
3	14	12	Y	-0.106	-0.106	0.000	12.750
4	12	13	Y	-0.106	-0.106	0.000	8.250
5	1	2	Y	-0.064	-0.064	0.000	9.699
6	2	4	Y	-0.064	-0.064	0.000	6.768
7	4	5	Y	-0.064	-0.064	0.000	2.347
8	5	7	Y	-0.064	-0.064	0.000	5.883
9	7	8	Y	-0.064	-0.064	0.000	5.883
10	8	10	Y	-0.064	-0.064	0.000	2.347
11	10	11	Y	-0.064	-0.064	0.000	6.768
12	11	13	Y	-0.064	-0.064	0.000	9.699

Load Combination No.	Description	Self Wt Dir	Wt Fac	BLC Fac	BLC Fac	BLC Fac	BLC Fac	BLC Fac	DYNA	W S	E V
1	DL + snow/min LL	Y	-1	1	1					n	n

Dynamic Analysis Data

Number of modes (frequencies) : 3
 Basic Load Case for masses : None
 BLC mass direction of action : X only
 Acceleration of Gravity : 32.20 ft/sec**2

Load Combination is 1 : DL + snow/min LL
 Nodal Displacements

Node	Global X (in)	Global Y (in)	Rotation (rad)
1	-0.00000	-0.00000	-0.02447
2	1.09891	-1.80684	0.01469
3	0.00557	-1.81838	-0.00819
4	0.02864	-0.10157	0.01682
5	-0.10016	0.10785	0.00249
6	0.02234	0.20706	0.00680

Robert Silman Associates, P.C.
 88 University Place
 New York, NY 10003

Job _____
 Page _____
 Date _____

Wm. Johnson House, Natchez, Miss.; Anal.
 of Roof and Attic Framing--Case 1

Node	Global X (in)	Global Y (in)	Rotation (rad)
7	0.01417	-0.07667	-0.00487
8	0.12850	0.10785	-0.00249
9	0.00599	0.20706	-0.00680
10	-0.00031	-0.10157	-0.01682
11	-1.07057	-1.80684	-0.01469
12	0.02277	-1.81838	0.00819
13	0.02833	-0.00000	0.02447
14	0.01417	-0.00000	0.02566

Load Combination is 1 : DL + snow/min LL
 Reactions

Node	Global X (K)	Global Y (K)	Moment (K-ft)
1	0.00000	2.75484	0.00000
13	0.00000	2.75484	0.00000
14	0.00000	2.00826	0.00000
Totals	0.00000	7.51794	0.00000

Final M @ other pts is max or less?

Load Combination is 1 : DL + snow/min LL
 Member End Forces

No	Nodes		I-End			J-End		
	I	J	Axial (K)	Shear (K)	Moment (K-ft)	Axial (K)	Shear (K)	Moment (K-ft)
1	1-	3	-1.94	0.92	0.00	1.94	-0.00	3.79
2	3-	14	-1.94	0.41	-3.79	1.94	1.00	0.00
3	14-	12	-1.94	1.00	0.00	1.94	0.41	3.79
4	12-	13	-1.94	-0.00	-3.79	1.94	0.92	-0.00
5	1-	2	2.62	0.54	0.00	-2.60	0.10	2.13
6	2-	4	2.39	-0.45	-2.13	-2.38	0.90	-2.46
7	4-	5	0.01	0.66	2.46	-0.01	-0.50	-1.10
8	5-	7	0.02	0.38	1.10	-0.01	0.01	-0.00
9	7-	8	0.01	0.01	0.00	-0.02	0.38	-1.10
10	8-	10	0.01	-0.50	1.10	-0.01	0.66	-2.46
11	10-	11	2.38	0.90	2.46	-2.39	-0.45	2.13
12	11-	13	2.60	0.10	-2.13	-2.62	0.54	0.00
13	4-	6	2.83	-0.08	0.00	-2.83	0.08	-0.24
14	6-	9	2.76	0.01	0.24	-2.76	0.01	-0.24
15	9-	10	2.83	0.08	0.24	-2.83	-0.08	0.00
16	5-	6	-0.12	0.00	0.00	0.12	0.00	0.00
17	9-	8	-0.12	0.00	0.00	0.12	0.00	0.00
18	2-	3	-0.41	0.00	0.00	0.41	0.00	0.00
19	11-	12	-0.41	0.00	0.00	0.41	0.00	0.00

T T C C C C

Robert Silman Associates, P.C.
 88 University Place
 New York, NY 10003

Job _____
 Page _____
 Date _____

Wm. Johnson House, Natchez, Miss.; Anal.
 of Roof and Attic Framing--Case 2

Units Option : US Standard
 AISC Code Checks : No
 Shear Deformation: No
 P-Delta Effects : No
 Redesign : No
 Edge Forces : No
 A.S.I.F. : 1.000

Node No	X-Coord (ft)	Y-Coord (ft)	Boundary Conditions			Temp. (F)
			X-dof (in,K/in)	Y-dof (in,K/in)	Rotation (r,K-ft/r)	
1	0.00	0.00	R	R		0.00
2	8.25	5.10				0.00
3	8.25	0.00				0.00
4	14.00	8.67				0.00
5	16.00	9.90				0.00
6	17.00	8.67				0.00
7	21.00	13.00				0.00
8	26.00	9.90				0.00
9	25.00	8.67				0.00
10	28.00	8.67				0.00
11	33.75	5.10				0.00
12	33.75	0.00			R	0.00
13	42.00	0.00			R	0.00
14	21.00	0.00				0.00

Material Label	Elastic Modulus (Ksi)	Poisson's Ratio	Thermal Coefficient (F)	Weight Density (K/ft3)	Yield Stress (Fy) (Ksi)
wood	1440.00	0.30000	0.30000	0.029	1.900

Section Label	Database Shape	Matl. Set	Area (in^2)	Moment of Inertia (in^4)	As Coef	y/y
rafter		wood	13.75	28.650	1.20	
joist		wood	24.00	128.000	1.20	
stud		wood	1.50	22.780	1.20	
horiz tie		wood	11.25	13.180	1.20	
diag tie		wood	5.25	5.360	1.20	

Robert Silman Associates, P.C.
 88 University Place
 New York, NY 10003

Job _____
 Page _____
 Date _____

Wm. Johnson House, Natchez, Miss.; Anal.
 of Roof and Attic Framing--Case 2

No	I Node	J Node	Section	I Releases			J			End Offsets		Length (ft)
				x	y	z	x	y	z	Sec	Sway	
1	1	3	joist									8.25
2	3	14	joist									12.75
3	14	12	joist			1						12.75
4	12	13	joist									8.25
5	1	2	rafter			1						9.70
6	2	4	rafter									6.77
7	4	5	rafter									2.35
8	5	7	rafter									5.88
9	7	8	rafter			1						5.88
10	8	10	rafter									2.35
11	10	11	rafter									6.77
12	11	13	rafter						1			9.70
13	4	6	horiz tie			1						3.00
14	6	9	horiz tie									8.00
15	9	10	horiz tie						1			3.00
16	5	6	diag tie			1			1			1.59
17	9	8	diag tie			1			1			1.59
18	2	3	stud			1			1			5.10
19	11	12	stud			1			1			5.10

No	I Node	J Node	Unbraced Lengths			K Factors		Bending Coefs	
			Lb-in (ft)	Lb-out (ft)	Lc (ft)	In	Out	Cm	Cb
1	1	3							
2	3	14							
3	14	12							
4	12	13							
5	1	2							
6	2	4							
7	4	5							
8	5	7							
9	7	8							
10	8	10							
11	10	11							
12	11	13							
13	4	6							
14	6	9							
15	9	10							
16	5	6							
17	9	8							
18	2	3							
19	11	12							

13/18

Robert Silman Associates, P.C.
 88 University Place
 New York, NY 10003

Job _____
 Page _____
 Date _____

Wm. Johnson House, Natchez, Miss.; Anal.
 of Roof and Attic Framing--Case 2

BLC No.	Basic Load Case Description	Load Totals		
		Nodal	Point	Dist.
1				12

Member Distributed Loads, BLC 1:

Memb No	I Node	J Node	Dir	Start Magnitude (K/ft, F)	End Magnitude (K/ft, F)	Start Location (ft)	End Location (ft)
1	1	3	Y	-0.106	-0.106	0.000	8.250
2	3	14	Y	-0.106	-0.106	0.000	12.750
3	14	12	Y	-0.106	-0.106	0.000	12.750
4	12	13	Y	-0.106	-0.106	0.000	8.250
5	1	2	Y	-0.044	-0.044	0.000	9.699
6	2	4	Y	-0.044	-0.044	0.000	6.768
7	4	5	Y	-0.044	-0.044	0.000	2.347
8	5	7	Y	-0.044	-0.044	0.000	5.883
9	7	8	Y	-0.004	-0.004	0.000	5.883
10	8	10	Y	-0.004	-0.004	0.000	2.3
11	10	11	Y	-0.004	-0.004	0.000	6.768
12	11	13	Y	-0.004	-0.004	0.000	9.699

Load Combination No.	Description	Self Wt Dir	Wt Fac	BLC Fac	BLC Fac	BLC Fac	BLC Fac	BLC Fac	DYNA	W S	E V
1	DL + snow/min LL	Y	-1	1	1					n	n

Dynamic Analysis Data

Number of modes (frequencies) : 3
 Basic Load Case for masses : None
 BLC mass direction of action : X only
 Acceleration of Gravity : 32.20 ft/sec**2

Load Combination is 1 : DL + snow/min LL
 Nodal Displacements

Node	Global X (in)	Global Y (in)	Rotation (rad)
1	0.00000	-0.00000	-0.02640
2	1.19743	-1.95412	0.00716
3	0.00461	-1.96317	-0.00871
4	0.40134	-0.68240	0.01733
5	0.21287	-0.37546	0.00904
6	0.39739	-0.22523	0.01285

14/18

Robert Silman Associates, P.C.
 University Place
 New York, NY 10003

Job _____
 Page _____
 Date _____

Wm. Johnson House, Natchez, Miss.; Anal.
 of Roof and Attic Framing--Case 2

=====

Node	Global X (in)	Global Y (in)	Rotation (rad)
7	0.01394	-0.05334	0.00421
8	0.42634	0.61134	0.00335
9	0.38660	0.64272	0.00051
10	0.38216	0.53921	-0.01098
11	-0.53247	-0.92206	-0.01432
12	0.01887	-0.94856	0.00509
13	0.02348	-0.00000	0.01284
14	0.01174	-0.00000	0.02734

Load Combination is 1 : DL + snow/min LL
 Reactions

Node	Global X (K)	Global Y (K)	Moment (K-ft)
1	-0.52000	2.13086	0.00000
13	0.00000	1.87181	0.00000
14	0.00000	1.83527	0.00000
Totals	-0.52000	5.83794	0.00000

Load Combination is 1 : DL + snow/min LL
 Member End Forces

No	Nodes		I-End			J-End		
	I	J	Axial (K)	Shear (K)	Moment (K-ft)	Axial (K)	Shear (K)	Moment (K-ft)
1	1-	3	-1.61	0.97	-0.00	1.61	-0.06	4.23
2	3-	14	-1.61	0.37	-4.23	1.61	1.04	-0.00
3	14-	12	-1.61	0.80	0.00	1.61	0.62	1.15
4	12-	13	-1.61	0.32	-1.15	1.61	0.60	-0.00
5	1-	2	1.54	0.41	0.00	-1.52	0.04	1.83
6	2-	4	1.35	-0.31	-1.83	-1.34	0.62	-1.33
7	4-	5	-0.17	0.31	1.33	0.18	-0.20	-0.74
8	5-	7	-0.18	0.26	0.74	0.19	0.01	-0.00
9	7-	8	-0.08	-0.18	0.00	0.07	0.22	-1.10
10	8-	10	-0.11	-0.50	1.16	0.10	0.51	-2.34
11	10-	11	1.52	0.67	2.34	-1.53	-0.62	2.00
12	11-	13	2.03	-0.18	-2.01	-2.04	0.24	0.00
13	4-	6	1.78	0.01	0.00	-1.78	-0.00	0.00
14	6-	9	1.82	-0.05	-0.02	-1.82	0.07	-0.40
15	9-	10	2.00	0.15	0.45	-2.00	-0.15	0.00
16	5-	6	0.07	0.00	0.00	-0.07	0.00	0.00
17	9-	8	-0.28	0.00	0.00	0.29	0.00	0.00
18	2-	3	-0.32	0.00	0.00	0.32	0.00	0.00
19	11-	12	-0.94	0.00	0.00	0.93	0.00	0.00

2nd floor joists → spans cut in 1/2

span = 14' (max)

take LL = 50 PSF
 DL = 38 PSF
 $\Sigma = 88$ PSF

$w = \frac{14}{12} (88) = 118$ plf

$M = \frac{1}{8} (118) (14')^2$
 $= 2891$ ft-lb

$\therefore f_b = \frac{2891 (12)}{66.0} = 526$ psi ... ok ✓

$\Delta_{max} = \frac{5 (118/12) (14 \times 12)^4}{384 (1,440,000) (396)} = 0.17'' \approx \frac{L}{900}$ ✓

$f_v = \frac{3 (1/2) (118) (14')}{2 (2.75) (12)} = 38$ psi ... ok ✓

Put in stiffening partition or some sort of beam below the 2nd floor joists.

Design schematic of Beam Below 2nd floor joists

$w = 88$ PSF $(1/2) (26') = 1144$ plf

→ say Beam w/ 5 points of support: $l = 40/2 = 20'$
 $M_{max} = \frac{1}{8} (1144) (10')^2 = 14290$ ft-lb

↑ ↑ ↑ ↑ ↑ try W6x16 A36 beam

↑ ↑ w/ 3 pts of support: $l = 20'$, $M_{max} = \frac{1}{8} (1144) (20')^2 = 57.2$ k-ft
 try W12x26.

PROJECT Wm. Johnson House
SUBJECT _____

JOB NO. 5060.02 PAGE _____
BY EPM DATE 9/22/95

Bearing Pressures on Foundations

max. loads anticipated

FIRST FLOOR: LL 50 PSF
DL 40 PSF
 $\Sigma = 90$ PSF
→ JOISTS RUN E/W

SECOND FLOOR: LL 50 PSF
DL 40 PSF
 $\Sigma = 90$ PSF
→ JOISTS RUN E/W

THIRD (ATTIC) FLOOR: LL 50 PSF
DL 20 PSF
 $\Sigma = 70$ PSF
→ JOISTS RUN N/S

ROOF: LL 20 PSF
DL 25 PSF
 $\Sigma = 40$ PSF
→ RAFTERS RUN N/S

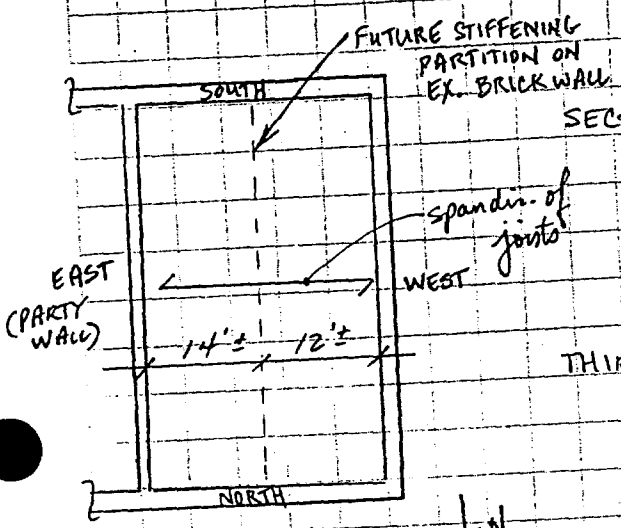

WM. JOHNSON
N.T.S.

(FIRST & SECOND FLOORS)

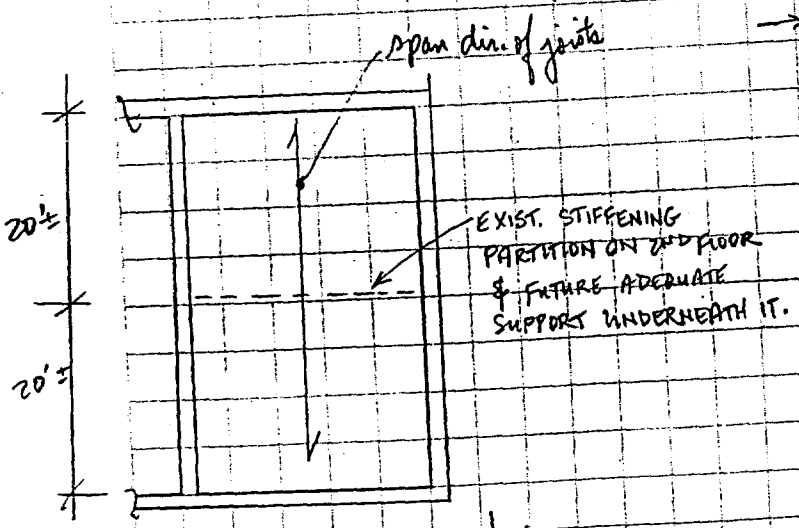

WM. JOHNSON
N.T.S.

(ATTIC & ROOF)

PROJECT Wm. Johnson House JOB NO. 50600.02 PAGE _____
 SUBJECT _____ BY EPM DATE 9/22/45

Bearing Pressures on Foundations (cont.)

NORTH WALL

1ST FLOOR	-	WALL	DL only	
2ND FLOOR	-	"	" "	
ATTIC	$\frac{1}{2}(20')(50 \text{ PSF}) = 500 \text{ plf LL}$			} $\Sigma = 700 \text{ plf DL+LL}$
	$\frac{1}{2}(20')(20 \text{ PSF}) = 200 \text{ plf DL}$			
ROOF	$\frac{1}{2}(20')(20 \text{ PSF}) = 200 \text{ plf LL}$			} $\Sigma = 450 \text{ plf DL+LL}$
	$\frac{1}{2}(20')(25 \text{ PSF}) = 250 \text{ plf DL}$			

WALL DL = $\left(\frac{24'}{\text{high}} \right) \times 1' \times 120 \text{ plf} = 2880 \text{ plf DL (above grade)}$
 $\times 0.75 \text{ (25% windows)} = 2160 \text{ plf}$
 $6' \times \frac{16'}{12} \times 120 \text{ plf} = 960 \text{ plf DL (below grade)}$

$\Sigma \text{ DL} = 3570 \text{ PLF} \div 16" \text{ wall} = \frac{223125}{16} \text{ PSF DL only}$
 $\Sigma (\text{DL+LL}) = 4270 \text{ PLF} \div 16" \text{ wall} = \frac{266875}{16} \text{ PSF}$

WEST WALL

1ST FLOOR	-	$\frac{1}{2}(12')(50) = 300 \text{ plf LL}$	
		$\frac{1}{2}(12')(40) = 240 \text{ plf DL} \leftarrow$	
2ND FLOOR	-	$\frac{1}{2}(12')(50) = 300 \text{ plf LL}$	
		$\frac{1}{2}(12')(40) = 240 \text{ plf DL} \leftarrow$	
ATTIC	-	$\frac{1}{2}(12')(50) = 300 \text{ plf LL}$	
		$\frac{1}{2}(12')(30) = 180 \text{ plf DL} \leftarrow$	
ROOF	-	$\frac{1}{2}(12')(20) = 120 \text{ plf LL}$	
		$\frac{1}{2}(12')(25) = 150 \text{ plf DL} \leftarrow$	

WALL DL = $\uparrow 37' \text{ high (max)} \times 1' \times 120 = 4440 \text{ plf} \times 0.75 = 3330 \text{ plf} \leftarrow$
 $(25\% \text{ wind.})$
 $\downarrow 6' \times \frac{16'}{12} \times 120 = 960 \text{ plf}$

$\Sigma \text{ DL} = 4770 \text{ PLF} \div 16" \text{ wall} = 3000 \text{ PSF}$
 $\Sigma (\text{DL+LL}) = 5370 \text{ PLF} \div 16" \text{ wall} = 4000 \text{ PSF}$

PROJECT Wm. Johnson House JOB NO. 5060.02 PAGE 9/22/95
SUBJECT BY EPM DATE

Bearing Pressures on Foundations (cont.)

SOUTH WALL

1ST FLOOR - WALL DL only
2nd Floor - " " + Porch = 1/2(9')(40) = 180 pcf LL
1/2(9')(20) = 90 pcf DL
ATTIC - 1/2(20')(50 psf) = 500 pcf LL
1/2(20')(20 psf) = 200 pcf DL
porch roof - 1/2(9')(20) = 90 pcf LL
1/2(9')(20) = 90 pcf DL
ROOF 1/2(20')(20 psf) = 200 pcf LL
1/2(20')(25 psf) = 250 pcf DL
WALL = 2100 pcf + 960 pcf = 3120 pcf DL
(see prev. page of calcs)

Σ DL = 3750 pcf ÷ 16" wall = 2800 psf DL only
Σ DL+LL = 4720 " ÷ 16" wall = 3540 psf DL+LL
3500 psf

EAST WALL
(PARTY WALL)

JOHNSON { 1ST FLOOR - 1/2(14') 50 = 350 pcf LL
2ND FLOOR - 1/2(14') 50 = 350 pcf LL
McCALCUM { 1ST FLOOR - 1/2(16') 50 = 400 pcf LL
2ND FLOOR - 1/2(16') 50 = 400 pcf LL
JOHNSON { 1ST FLOOR - 1/2(14')(40) = 280 pcf DL
2ND FLOOR - 1/2(14')(40) = 280 pcf DL
McCALCUM { 1ST FLOOR - 1/2(16')(40) = 320 pcf DL
2ND FLOOR - 1/2(16')(40) = 320 pcf DL
WALL DL =

Σ DL = 4280 pcf = 4100 psf for 12" wall } max.
= 3100 psf for 16" wall

Σ(DL+LL) = 5800 ≈ 6200 psf (in Bob's Report)

for 12" wall
≈ 4600 psf for 16" wall

∇ = different assumptions for foundation depth.

avg. ht. wall = 32122 / 2 = 27"
∇ voids.
(0.9) [27' (120) + 1.5(120)] = 3090

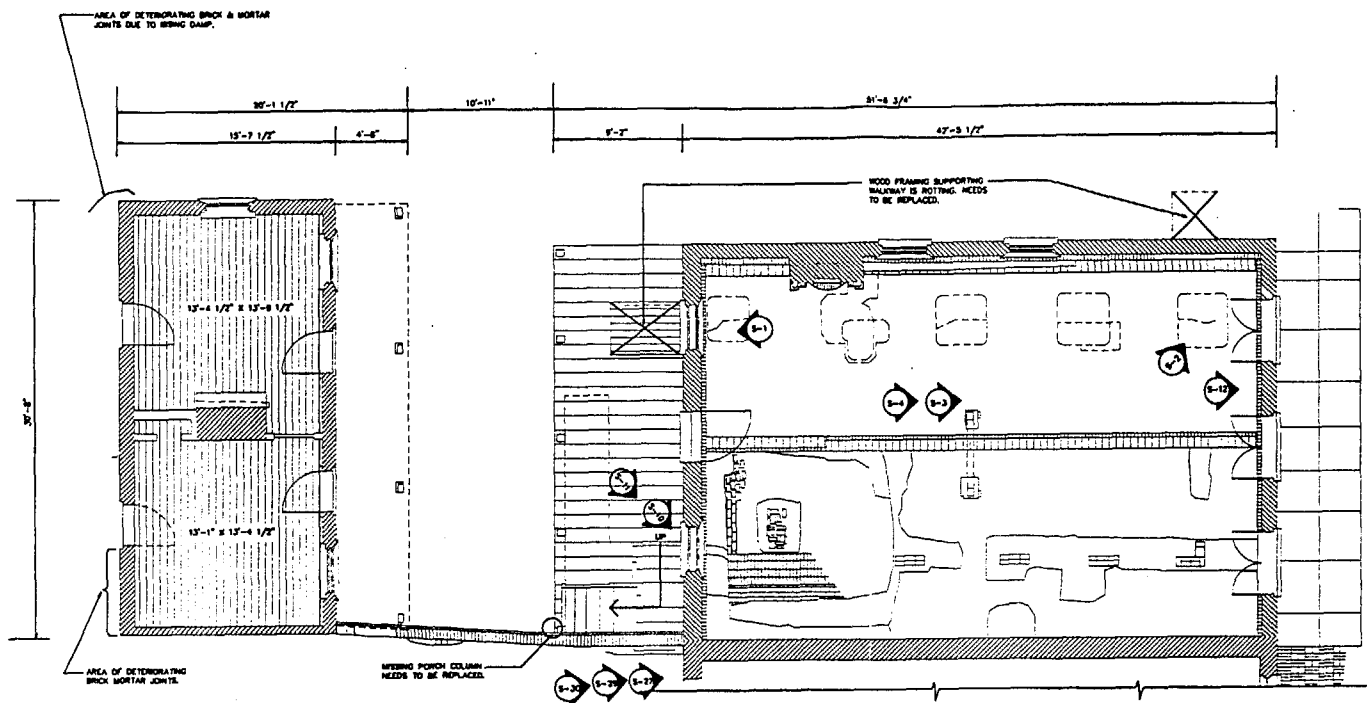

AREA OF DETERIORATING BRICK & MORTAR JOINTS DUE TO BEING DAMP.

WOOD FRAMING SUPPORTING WALKWAY IS ROTTING. NEEDS TO BE REPLACED.

AREA OF DETERIORATING BRICK MORTAR JOINTS.

SPRING PORCH COLUMN NEEDS TO BE REPLACED.

NOTE:
NO FIRST FLOOR FRAMING IS EXTANT IN THE MAIN HOUSE.

MCCALLUM HOUSE
JOHNSON HOUSE

FIRST FLOOR PLAN

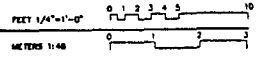

NOTE: DRAWINGS TAKEN FROM 1992 HABS DRAWINGS.
XX REFERS TO PHOTOGRAPH LOCATION—SEE REPORT.

DESIGNED: EM	SUB SHEET NO. S1.1	TITLE OF SHEET FIRST FLOOR PLAN	DRAWING NO. WS 27D
DRAWN: MAM/XB		HATCHEZ NATIONAL HISTORICAL PARK WILLIAM JOHNSON HOUSE HATCHEZ, MISSISSIPPI	PKG. NO. SHEET
FIELD NUMBER RS			OF

RS4/2002.01 DATE: 09-28-95

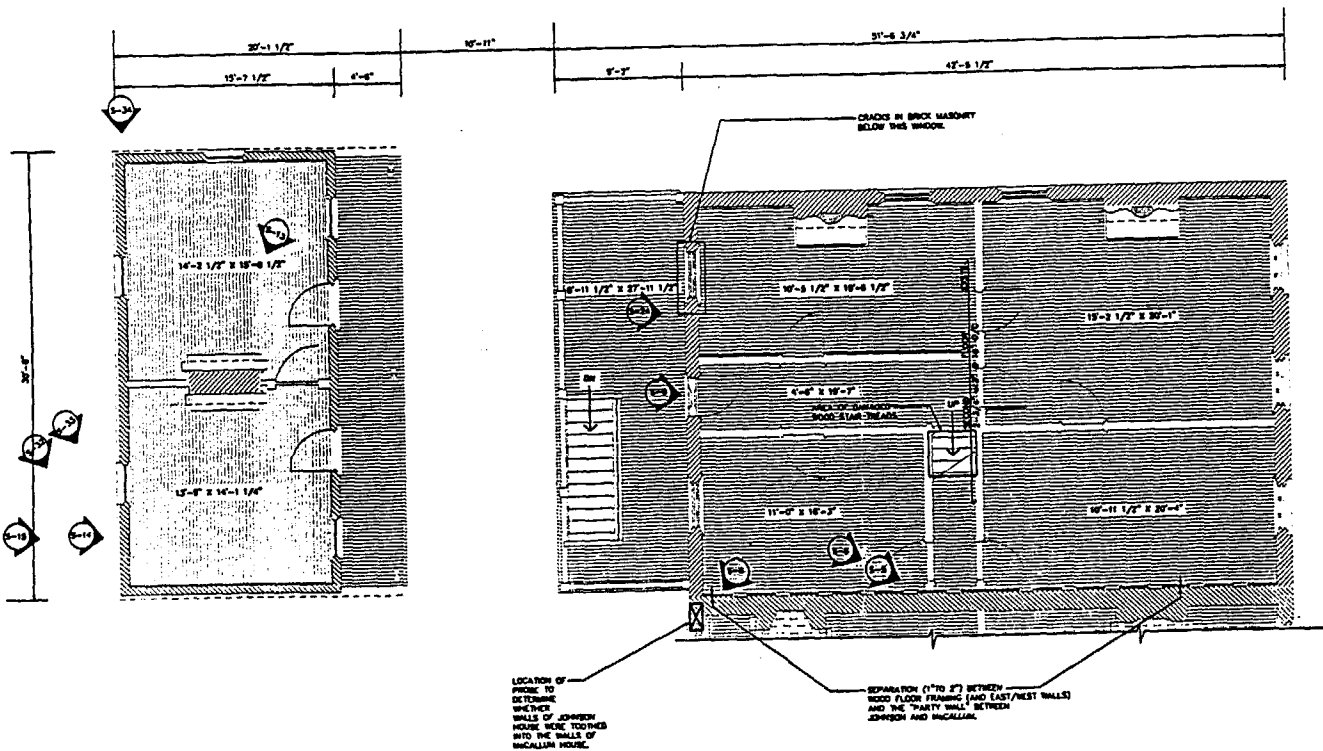

SECOND FLOOR PLAN

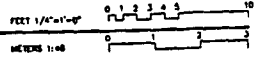

NOTE: DRAWINGS TAKEN FROM 1992 HABS DRAWINGS.
 XX REFERS TO PHOTOGRAPH LOCATION—SEE REPORT.

DRAWER: EM DRAWN: MJM/KB TECH. REVIEW: RS	SHEET NO. S1.2	TITLE OF SHEET SECOND FLOOR PLAN NATCHEZ NATIONAL HISTORICAL PARK WILLIAM JOHNSON HOUSE NATCHEZ, MISSISSIPPI	DRAWING NO. MS 270 SHEET OF
--	-------------------	---	---

PSA/P060.01 DATE 09-28-93

9.9 Cost Estimates





THE JOHNSON HOUSE
NATCHEZ, MISSISSIPPI

TYPE 'C' ESTIMATE
E79-115.3

Client

Ann Beha Associates
33 Kingston Street
Boston, Massachusetts 02111

Construction Consultants

Hanscomb Associates, Inc.
1175 Peachtree Street, NE
Suite 1650
Atlanta, Georgia 30309

14 March 1996

BASIS OF ESTIMATE

This estimate for the proposed restoration of the historic Johnson House was produced from the following documents: 1) An Architectural report produced on January 16, 1996, by Anne Beha Associates and 2) Drawings of this site produced by the National Park Service, U.S. Dept of the Interior.

Please note that any design and engineering changes and/or additions produced subsequent to these documents are not included in this estimate.

This estimate is based upon the measurement of quantities where possible. For the remainder, parametric measurements were used in conjunction with references from similar projects recently estimated by Hanscomb Associates Inc.

BASIS FOR PRICING

Pricing shown reflects probable construction costs obtainable in the Natchez area of Mississippi, on the date of this statement of probable costs. This estimate is a determination of fair market value for the construction of this project. It is not a prediction of low bid. Pricing assumes competitive bidding for every portion of the construction work for all subcontractors, as well as the general contractor; that is to mean 6 to 7 bids. If less bids are received, bid results can be expected to be higher.

Please note that no allowance for escalation has been incorporated into this estimate.

Subcontractor's markups have been included in each line item unit price. These markups cover the cost of field overhead, home office overhead and profit. These markups can range from 15% to 25% of the cost for that particular item of work.

General Contractor's Overhead and Profit used is 25%. This is a compound rate to cover jobsite general condition's, home office overhead, profit and bond.

A 20% Design and Pricing Contingency has been added to the summary sheet to cover a reasonable number of unknown requirements or design elements not anticipated or detailed at this stage of development. As the design develops further, this contingency will be reduced on subsequent estimates. At the final Construction Document phase estimate, it will be eliminated.

No construction contingency has been added to the summary sheet to try to anticipate change orders which normally occur after the project is under construction.

No Phasing Contingency has been added to the summary sheet to cover the costs associated with temporary partitions, multiple mobilizations and demobilizations, additional cost of labor for work done other than during normal working hours, as well as other costs incurred during a phased renovation project.

PROJECT DESCRIPTION

This construction project for the restoration of the historic Johnson House in Natchez, Mississippi to its original condition incorporates an area of approximately 4080 SF.

ITEMS EXCLUDED FROM THIS ESTIMATE

Items which are not in this estimate include, but are not limited to:

- Land acquisition and real estate fees
- Professional fees and Testing
- Owner Furnished Items
- Escalation
- Asbestos and lead paint removal

ITEMS AFFECTING THE COST ESTIMATE

Items which may change the estimated construction cost include, but are not limited to:

- Modifications to the scope of work included in this estimate
- Unforeseen subsurface conditions
- Special Phasing requirements
- Restrictive technical specifications
- Non-competitive bid conditions
- Sole source specifications of materials or products
- Bids delayed beyond the projected schedule

STATEMENT OF PROBABLE COST

Hanscomb Associates has no control over the cost of labor and materials, the general contractor's or any subcontractor's method of determining prices, or competitive bidding and market conditions. This opinion of probable cost of construction is made on the basis of experience, qualifications, and best judgement of a professional construction consultant familiar with the construction industry. Hanscomb Associates cannot and does not guarantee that proposals, bids or actual construction costs will not vary from this or subsequent cost estimates.

Hanscomb's staff of professional cost consultants has prepared this estimate in accordance with generally accepted principles and practices. This staff is available to discuss its contents with any interested party.

RECOMMENDATIONS FOR COST CONTROL

Hanscomb Associates recommends that the owner, architect and engineers carefully review this document, including line item descriptions, unit prices, clarifications, exclusions, inclusions and assumptions, contingencies, escalation, and markups. If the project is over budget, or if there are unresolved budgeting issues, alternative systems/schemes should be evaluated before proceeding into the final design phase.

Requests for modifications of any apparent errors or omissions to this document must be made to Hanscomb within ten (10) days of receipt of this

Thu 14 Mar 1996

Hanscomb Associates, Inc.

TIME 09:09:17

Eff. Date 03/14/96

PROJECT 791153: THE JOHNSON HOUSE - NATCHEZ, MISSISSIPPI

PROJECT NOTES

TYPE 'C' ESTIMATE

TITLE PAGE 4

estimate. Otherwise, it will be understood that the contents have been concurred with and accepted.

It is recommended that a final update estimate be produced by Hanscomb Associates, using bid documents as well as all addenda, to determine overall cost changes which may have occurred since the preparation of this estimate. The final update estimate will address changes and additions to the documents as well as addenda issued during the bidding process. Hanscomb cannot reconcile bid results to any estimate not produced from bid documents including all addenda.

INCLUSIONS AND ASSUMPTIONS

Please refer to the reports attached hereto.

SUMMARY REPORTS	SUMMARY PAGE
PROJECT DIRECT SUMMARY - BIDITEM.....	1
PROJECT DIRECT SUMMARY - UN1.....	2

DETAILED ESTIMATE	DETAIL PAGE
01. THE JOHNSON HOUSE REPAIR	
01. SELECTIVE BUILDING DEMOLITION.....	1
02. SHORING WORK.....	1
03. EXTERIOR REPAIR.....	1
04. ROOF AND ATTIC REPAIR.....	2
05. INTERIOR REPAIR.....	2
06. MECHANICAL.....	3
07. ELECTRICAL.....	3
02. THE KITCHEN DEPENDENCY	
01. SELECTIVE BUILDING DEMOLITION.....	5
02. SITE WORK.....	5
03. EXTERIOR WALL REPAIR.....	5
05. INTERIOR REPAIR.....	6
06. MECHANICAL.....	6
07. ELECTRICAL.....	6

* * * END TABLE OF CONTENTS * * *

** PROJECT DIRECT SUMMARY - BIDITEM **

	QUANTITY UOM	UNIT COST	TOTAL CO

THE JOHNSON HOUSE			
01 THE JOHNSON HOUSE REPAIR	3136.00 SF	55.85	175,132
02 THE KITCHEN DEPENDENCY	944.00 SF	20.53	19,381

SUBTOTAL	4080.00 SF	47.67	194,513
CONTRACTOR'S OVERHEAD & FEE @ 25%		11.92	48,628

SUBTOTAL		59.59	243,142
DESIGN CONTINGENCY @ 20%		11.92	48,628

TOTAL THE JOHNSON HOUSE		71.51	291,770

** PROJECT DIRECT SUMMARY - UNIL **

	QUANTITY UOM	UNIT COST	TOTAL COST
THE JOHNSON HOUSE			
01 THE JOHNSON HOUSE REPAIR			
01 01	SELECTIVE BUILDING DEMOLITION	3136.00 SF	2.41 7,561
01 02	SHORING WORK	3136.00 SF	2.65 8,326
01 03	EXTERIOR REPAIR	3136.00 SF	11.30 35,432
01 04	ROOF AND ATTIC REPAIR	3136.00 SF	3.17 9,933
01 05	INTERIOR REPAIR	3136.00 SF	23.05 72,288
01 06	MECHANICAL	3136.00 SF	8.22 25,793
01 07	ELECTRICAL	3136.00 SF	5.04 15,800
SUBTOTAL			55.85 175,132
CONTRACTOR'S OVERHEAD & FEE @ 25%			13.96 43,783
SUBTOTAL			69.81 218,915
DESIGN CONTINGENCY @ 20%			13.96 43,783
TOTAL THE JOHNSON HOUSE REPAIR			83.77 262,698
02 THE KITCHEN DEPENDENCY			
02 01	SELECTIVE BUILDING DEMOLITION	944.00 SF	1.60 1,509
02 02	SITE WORK	944.00 SF	1.22 1,153
02 03	EXTERIOR WALL REPAIR	944.00 SF	9.90 9,350
02 05	INTERIOR REPAIR	944.00 SF	4.95 4,674
02 06	MECHANICAL	944.00 SF	0.21 195
02 07	ELECTRICAL	944.00 SF	2.65 2,500
SUBTOTAL			20.53 19,381
CONTRACTOR'S OVERHEAD & FEE @ 25%			5.13 4,845
SUBTOTAL			25.66 24,226
DESIGN CONTINGENCY @ 20%			5.13 4,845
TOTAL THE KITCHEN DEPENDENCY			30.80 29,071

 SELECTIVE BUILDING DEMOLITION QUANTITY UOM UNIT COST TOTAL COST

THE JOHNSON HOUSE REPAIR

SELECTIVE BUILDING DEMOLITION

REMOVE S. PORCH ROOFING / JOISTS	280.00 SF	1.75	490
REMOVE WINDOWS-DOCUMENT-STORE	2.00 EA	69.21	138
REMOVE 1ST LEVEL PORCH FLOORING	280.00 SF	1.00	280
REMOVE BALUSTRADE-PORCH-DOCUMENT	48.00 LF	4.00	192
REMOVE ENTRY DOOR	6.00 EA	29.39	176
REMOVE LINOLEUM - DOCUMENT	509.00 SF	0.44	224
REMOVE WALLPAPER	766.00 SF	1.00	766
PREPARE/PATCH PLASTER AT WALLS	3790.00 SF	0.65	2,464
PREPARE/PATCH PLASTER @ CEILINGS	1801.00 SF	0.80	1,441
RAKE OUT MORTAR JOINTS	312.00 SF	1.25	390
MISCELLANEOUS DEMOLITION	1.00 LS	1000.00	1,000

TOTAL SELECTIVE BUILDING DEMOLITION	3136.00 SF	2.41	7,561

SHORING WORK

TEMPORARY SHORING TO 2ND FLOOR	1110.00 SF	3.50	3,885
TEMPORARY SHORING TO ATTIC	626.00 SF	2.80	1,753
TEMPORARY SHORING TO ROOF	1344.00 SF	2.00	2,688

TOTAL SHORING WORK	3136.00 SF	2.65	8,326

EXTERIOR REPAIR

EXTERIOR WALLS AND PORCHES

BRICK VENEER IN HIGH LIME MORTAR	36.00 SF	9.50	342
POINTING TO RAKED OUT JOINTS	312.00 SF	2.40	749
CLEAN BRICK	1250.00 SF	0.75	938
CRACK MONITORING GAUGES	1.00 LS	3500.00	3,500
MASONRY REPAIR AT CRACKS - ALLOW	1.00 LS	2500.00	2,500
REPAIR COPING STONE	44.00 LF	15.00	660
BRICK REPAIR AT COPING STONE	1.00 LS	300.00	300
S. S. ANCHORS TO MASONRY	177.00 EA	16.00	2,832
DORMER REPAIR AND PAINT	2.00 EA	300.00	600
REATTACH PORCH POST	1.00 EA	25.00	25
REPAIR TO WOOD COLUMNS	5.00 EA	75.00	375
NEW WOOD COLUMN	1.00 EA	400.00	400
NEW BALUSTRADE @ 2ND FLOOR PORCH	48.00 LF	40.00	1,920
LATTICE ENCLOSURE	1.00 LS	2500.00	2,500
FIRST LEVEL PORCH FLOORING	694.00 BF	2.50	1,735
REBUILD BOARDWALK PATH	1.00 LS	1500.00	1,500
MISCELLANEOUS REPAIR AND PAINT	1.00 LS	1000.00	1,000

TOTAL EXTERIOR WALLS AND PORCHES	3136.00 SF	6.98	21,877

EXTERIOR REPAIR		QUANTITY UOM	UNIT COST	TOTAL COST
EXTERIOR DOORS				
	HISTORIC REPLICA DOOR & FRAME	3.00 PR	2000.00	6,000
	HISTORIC REPLICA HARDWARE-ALLOW	3.00 PR	1000.00	3,000
	SCRAPE & PAINT DOORS AND FRAMES	2.00 EA	71.35	143
	PAINT NEW DOORS AND FRAMES	6.00 EA	45.58	273
TOTAL EXTERIOR DOORS				9,416
EXTERIOR WINDOWS				
	MINOR REPAIRS TO FRAMES & SASHES	12.00 EA	120.00	1,440
	SCRAPE & PAINT WINDOWS & FRAMES	12.00 EA	125.00	1,500
	UV FILTERS TO WINDOWS	12.00 EA	100.00	1,200
TOTAL EXTERIOR WINDOWS				4,140
TOTAL EXTERIOR REPAIR				35,432
ROOF AND ATTIC REPAIR				
	WOOD JOISTS	498.00 BF	1.75	872
	ROOF DECKING	746.00 BF	2.50	1,865
	PLYWOOD SHEATHING	280.00 SF	2.60	728
	FELT UNDERLAYMENT	280.00 SF	0.09	26
	NEW ROOF MATERIAL	280.00 SF	6.00	1,680
	COPPER FLASHING	56.00 SF	9.00	504
	COPPER GUTTERS	28.00 LF	10.00	280
	COPPER DOWNSPOUTS	104.00 LF	12.00	1,248
	ATTIC SEALED WEATHERTIGHT	910.00 SF	3.00	2,730
TOTAL ROOF AND ATTIC REPAIR				9,933
INTERIOR REPAIR				
STRUCTURE				
	MISCELLANEOUS STEEL BEAMS/PIPE	1.00 TON	2600.00	2,600
	NEW PIER	1.00 EA	600.00	600
	INSTALL EXIST WD JOISTS 1ST FLR	14.00 EA	20.00	280
	WOOD STRUCTURAL REINFORCEMENTS	5594.00 BF	1.75	9,790
	OTHER STRUCTURAL REPAIR	1.00 LS	2000.00	2,000
TOTAL STRUCTURE				15,270
FLOORS				
	RESTORE CUT OUT WOOD SECTIONS	1.00 LS	500.00	500
	REATTACH FLOORBOARDS IN ATTIC	70.00 SF	0.68	48
	NEW FLOOR DECKING	2986.00 BF	2.50	7,465
	CLEAN AND RESEAL WOOD FLOORS	3136.00 SF	0.50	1,568
	REATTACH WOOD BASEBOARDS	77.00 LF	1.00	77

INTERIOR REPAIR	QUANTITY UOM	UNIT COST	TOTAL COST
NEW WOOD BASEBOARDS	168.00 LF	12.00	2,016
MISCELLANEOUS FLOOR REPAIR	1.00 LS	1000.00	1,000
TOTAL FLOORS	3136.00 SF	4.04	12,674
WALLS			
NEW PLASTER TO WALLS	2563.00 SF	3.50	8,971
PATCH EXISTING PLASTER	2217.00 SF	2.50	5,543
PAIN T / SEALER TO PLASTER WALLS	4780.00 SF	0.40	1,912
PERIOD WALLPAPER	1870.00 SF	3.75	7,013
SCRAPE & PAINT DOORS AND FRAMES	7.00 EA	71.29	499
FIREPLACE REPAIR - ALLOW	3.00 EA	500.00	1,500
MISCELLANEOUS WALL REPAIR	1.00 LS	2000.00	2,000
TOTAL WALLS	3136.00 SF	8.75	27,437
STAIRS			
REPAIR TO EXISTING ATTIC STAIRS	1.00 LS	1500.00	1,500
TOTAL STAIRS	1.00 FLT	1500.00	1,500
CEILINGS			
SCRAPE - CLEAN - REPAINT CEILING	1840.00 SF	0.85	1,564
NEW PLASTER CEILINGS	1992.00 SF	4.20	8,366
PATCH EXISTING PLASTER	852.00 SF	3.00	2,556
PAINT TO PLASTER CEILINGS	2844.00 SF	0.50	1,422
MISCELLANEOUS CEILING REPAIR	1.00 LS	1500.00	1,500
TOTAL CEILINGS	3136.00 SF	4.91	15,408
TOTAL INTERIOR REPAIR	3136.00 SF	23.05	72,288
MECHANICAL			
HVAC WITH DE-HUMIDIFICATION	1.00 LS	25000.00	25,000
RE-INSTALL COAL GRATES	1.00 LS	500.00	500
FIRE EXTINGUISHER	3.00 EA	97.50	293
TOTAL MECHANICAL	3136.00 SF	8.22	25,793
ELECTRICAL			
EXIT SIGNS, EMERGENCY LIGHTS	1.00 LS	2000.00	2,000
SMOKE DETECTORS, REMOTE STATIONS	1.00 LS	3000.00	3,000
REPRODUCTION LIGHTING	1.00 LS	2500.00	2,500
EXHIBIT LIGHTING	1.00 LS	3500.00	3,500
SERVICE UPGRADE	1.00 LS	4000.00	4,000
ADD POWER OUTLETS	1.00 LS	800.00	800

Thu 14 Mar 1996
Eff. Date 03/14/96
DETAILED ESTIMATE

Hanscomb Associates, Inc.
PROJECT 791153: THE JOHNSON HOUSE - NATCHEZ, MISSISSIPPI
TYPE 'C' ESTIMATE
01. THE JOHNSON HOUSE REPAIR

TIME 09:09:17
DETAIL PAGE 4

ELECTRICAL

QUANTY UOM

UNIT COST

TOTAL COST

TOTAL ELECTRICAL

3136.00 SF

5.04

15,806

TOTAL THE JOHNSON HOUSE REPAIR

3136.00 SF

55.85

175,132

 SELECTIVE BUILDING DEMOLITION QUANTITY UOM UNIT COST TOTAL COST

THE KITCHEN DEPENDENCY

SELECTIVE BUILDING DEMOLITION

REMOVE PORCH ROOFING / JOISTS	153.00 SF	1.75	268
REMOVE PORCH COLUMNS	3.00 EA	25.00	75
MODIFICATIONS TO PORCH FOR STAIR	1.00 LS	300.00	300
RAKE OUT MORTAR JOINTS	257.00 SF	1.25	321
REMOVE PLYWOOD AT DOOR & WINDOWS	3.00 EA	14.89	45
MISCELLANEOUS DEMOLITION	1.00 LS	500.00	500

TOTAL SELECTIVE BUILDING DEMOLITION	944.00 SF	1.60	1,509

SITE WORK

PERIMETER DRAIN EXCAVATION	24.00 CY	5.72	137
6" PVC PERFORATED PIPE	110.00 LF	3.72	409
FILTER FABRIC	220.00 SF	1.54	340
GRAVEL PIPE BEDDING	24.00 CY	9.14	219
DIRT FILL AT EAST WALL	24.00 CY	2.00	48

TOTAL SITE WORK	944.00 SF	1.22	1,153

EXTERIOR WALL REPAIR

EXTERIOR WALLS AND PORCH

POINTING TO RAKED OUT JOINTS	257.00 SF	2.40	617
NEW PORCH STAIR	1.00 FLT	2500.00	2,500
NEW WOOD COLUMNS	3.00 EA	400.00	1,200
NEW BALUSTRADE @ 2ND FLOOR PORCH	37.00 LF	40.00	1,480
MISCELLANEOUS REPAIR AND PAINT	1.00 LS	500.00	500

TOTAL EXTERIOR WALLS AND PORCH	944.00 SF	6.67	6,297

EXTERIOR DOORS

MINOR REPAIRS TO DOOR FRAMES	1.00 EA	75.00	75
SCRAPE & PAINT DOORS AND FRAMES	6.00 EA	71.35	428

TOTAL EXTERIOR DOORS	6.00 EA	83.85	503

EXTERIOR WINDOWS

MINOR REPAIRS TO FRAMES & SASHES	5.00 EA	120.00	600
SCRAPE & PAINT WINDOWS & FRAMES	8.00 EA	125.00	1,000
RESTORE & REPAIR SHUTTERS	8.00 EA	100.00	800
FLASHING REPAIR TO WINDOW	1.00 EA	150.00	150

TOTAL EXTERIOR WINDOWS	8.00 EA	318.75	2,550

Thu 14 Mar 1996

Eff. Date 03/14/96

DETAILED ESTIMATE

Hanscomb Associates, Inc.

PROJECT 791153: THE JOHNSON HOUSE - NATCHEZ, MISSISSIPPI

TYPE 'C' ESTIMATE

02. THE KITCHEN DEPENDENCY

TIME 09:09:17

DETAIL PAGE 6

EXTERIOR WALL REPAIR		QUANTITY UOM	UNIT COST	TOTAL COST
TOTAL EXTERIOR WALL REPAIR		944.00 SF	9.90	9,350
INTERIOR REPAIR				
FLOORS				
CLEAN AND RESEAL WOOD FLOORS		944.00 SF	0.50	472
MISCELLANEOUS FLOOR REPAIR		1.00 LS	250.00	250
TOTAL FLOORS		944.00 SF	0.76	722
WALLS				
PAINT TO PLASTER WALLS		2200.00 SF	0.35	770
STRIP & PAINT DOORS AND FRAMES		2.00 EA	71.29	143
FIREPLACE REPAIR - ALLOW		3.00 EA	500.00	1,500
MISCELLANEOUS WALL REPAIR		1.00 LS	500.00	500
TOTAL WALLS		944.00 SF	3.09	2,913
CEILINGS				
SCRAPE - CLEAN - REPAINT CEILING		782.00 SF	0.85	665
MISCELLANEOUS CEILING REPAIR		1.00 LS	375.00	375
TOTAL CEILINGS		944.00 SF	1.10	1,040
TOTAL INTERIOR REPAIR		944.00 SF	4.95	4,674
MECHANICAL				
FIRE EXTINGUISHER		2.00 EA	97.50	195
TOTAL MECHANICAL		944.00 SF	0.21	195
ELECTRICAL				
EXIT SIGNS, EMERGENCY LIGHTS		1.00 LS	700.00	700
SMOKE DETECTORS, REMOTE STATIONS		1.00 LS	1000.00	1,000
REPRODUCTION LIGHTING		1.00 LS	800.00	800
TOTAL ELECTRICAL		944.00 SF	2.65	2,500
TOTAL THE KITCHEN DEPENDENCY		944.00 SF	20.53	19,381
TOTAL THE JOHNSON HOUSE		4080.00 SF	47.67	194,513





9.10 Building Assessment Documents



BUILDINGS ASSESSMENT SURVEY

A. Main House Exterior

LOCATION/ELEMENT	MATERIAL	CONDITIONS/RECOMMENDATIONS
EXTERIOR		
Roof: Main Building Cornice	Wood Shingle Brick	New - installed by NPS 1 1/2 years ago. <i>Clean old roof material from cornice; expose brick cornice line.</i>
Chimney	Brick	<i>Repointing required.</i>
Gutters/Drainage	Galvanized Metal (painted) - Main House	Downspout on north facade discharges onto sidewalk next to gate.
Dormers	Wood Clapboard with Windows	New windows and rebuilt by NPS. <i>Scrape and repaint at eaves; fill nail holes northeast.</i>
Walls: North	Brick	Some pointing areas were missed. <i>Repoint and infill.</i>
South	Brick	Mortar very fragile. <i>Repointing needs to occur to 30%.</i>
East	Brick	Common wall with McCallum House.
West	Brick	Appears to be repointed; some leaching near roof peak.
Foundation	Brick	Repointing done where accessible.
Structure	Wood and Brick	Brick bearing walls. Wood floor and roof framing.
Doors: North	Wood	Double doors (not original) <i>Replace with more historically accurate doors.</i>
South	Wood	<i>Caulk around frame, scrape and repaint door and frame on first and second floors.</i>
Windows: North	Wood	Center frame on second floor is new; <i>Scrape and repaint.</i>
South	Wood	Original; <i>Scrape and repaint.</i>
West	Wood	First floor are from 1897; second floor on right side appears to be original; left maybe new; attic is of unknown age. <i>Remove two windows on west side of first floor.</i>

LOCATION/ELEMENT	MATERIAL	CONDITIONS/RECOMMENDATIONS
Storms	None	
Shutters - North	Wood	Good Condition: <i>Scrape and repaint</i>
Lighting	N/A	
Porches - South	Wood	Second - floor boards chipping and rot at bottom rail of balustrade; ground - floor boards and framing rotting out. <i>Replace second floor balustrade with one typical of 1866; replace ground floor boards and treat with termite infestation; replace missing porch column supports and repair underside of deck; clean and kill mildew on same side.</i>

BUILDINGS ASSESSMENT SURVEY

B. Main House Interior

LOCATION/ELEMENT	MATERIAL	CONDITIONS/RECOMMENDATIONS
INTERIOR/ATTIC		
Ceiling	Exposed Collar Ties	Was lath and plaster; nailers indicate attic was finished. See Structural Notes. <i>Restore lath and plaster.</i>
Walls:		
North	Lath and Plaster	Knee walls - broken lath and plaster; slope ceiling missing.
South	Lath and Plaster on Knee Wall	Broken and cracked lath removed; open wall where eave meets party wall (brick to McCallum).
East	Lath and Plaster on Brick	Large cracks in brick; infilled openings to McCallum House; floor boards pulled away from brick wall (5" gap); joist pockets evident - joists now span NS
West	Lath and Plaster on Brick	Deterioration of brick at rafter against wall; plaster broken off; mortar gone left of chimney; stove pipe hole in chimney; mortar gone in knee wall area. <i>Restore plaster finish on all walls.</i>
Floor	6-8" Wood Plank	Some rising boards, loose boards in center; 4-5" gap along east wall; baseboard pulling away from wall.
Trim	8" Baseboard, Painted	Painted wood baseboard - plain; pulling away at east and west wall; good at north and south.
Windows:		
North	Two 6-over-6 Wood Single Glazed, No Finish Trim	Replaced by NPS within last 5 years.
South	N/A	
East	N/A	
West	6-over-6 Wood, Painted No Finish Trim at Frame	Does not match original sill; smaller than original opening; installed by NPS within the last 5 years
UV Protection	None	
Blinds	None	

LOCATION/ELEMENT	MATERIAL	CONDITIONS/RECOMMENDATIONS
Stair	Wood Paint Wood Rail and Balustrade Cradle/Simple	Spindles let into floor - not sturdy; main posts in shaker style; treads are worn; plaster from 2nd floor walls cracked and flaking; wallpaper remnants; <i>Reinforce spindles; Tie balustrade back to wall; Protect treads from further damage.</i>
Chimney	Brick	Hole for stove pipe (rough cut); mortar gone; <i>Needs repointing. Further research date of stove pipe hole.</i>
INTERIOR/BEDROOM • NORTHEAST		
Ceiling	Lath and Plaster	Peeling wallpaper on painted ceiling; lath broken towards north wall; <i>Patch and repair, restore to 1866 appearance.</i>
Walls: North	Lath and Plaster on Brick Wallpaper	Wallpaper peeling; NE corner has vertical cracking 1" + crack with daylight showing through - previously patched with plaster; cracking at NW corner - open at base; 1/2" + crack to parlor; can see room beyond.
South	Lath and Plaster on Brick Partition Wall Wallpaper	Wall pulled away from east wall; 3" crack; wallpaper peeling; plaster good except at corner.
East	Lath and Plaster on Brick	Vertical crack above 6" steel pipe. Holes in plaster to brick; large crack at NE corner; plaster appears free of brick.
West	Lath and Plaster Partition Wall	Wallpaper peeling; crack NW corner; wall generally good.
Floor	6" Wood Plank	Holes in boards at center of room; floor deflecting along north wall.
Trim	Wood Base, Paint	West wall is good; north and east walls have filler piece added at the base.
Windows: North	6-over-6 Wood Paint	Wood frame/sill intact - sash is good but loose; top center pane and lower sash are discolored and dirty.
South	N/A	
East	N/A	
West	N/A	
UV Protection	None	

LOCATION/ELEMENT	MATERIAL	CONDITIONS/RECOMMENDATIONS
Blinds Frames	Wood Shutters Wood - <i>See Windows</i>	Closed all day
Doors: North South	N/A Wood One Four Panel, Paint	Flush to closet side; decorative on bedroom side; latch type hardware; no hardware on closet side
East West	N/A Wood One Four Panel, Paint	Flush on bedroom side; no hardware; frame is good Repaint
Closet Below Stairs - Between Bedrooms	Wood	Cracks at all wall intersections and ceiling; east wall pulling away from partition walls; 3" + gap all around; plaster missing on south wall past door frame; wood floor is good; hole in baseboard at NW corner
INTERIOR/BEDROOM • SOUTHEAST		
Ceiling	Lath and Plaster	Cracking and peeling paint; lath pulled away from wall; lath and plaster missing against east wall; <i>Electrical in center to be removed.</i>
Walls: North	Lath and Plaster Partition Wall Adajcent to Stair	Diagonal cracks in plaster; paint is alligating/peeling; wall patched with plaster at east wall; 3" return from doorframe/jamb - patched; patch pulled away 1"+.
South	Lath and Plaster on Brick	Vertical crack in SW corner; 1"+ diagonal crack below window sill; vertical crack in SE corner - filled with foam 3"+.
East	Lath and Plaster on Brick	Vertical cracks in plaster start at center and move south; wall pulled away from baseboard 1" + towards south end; paint peeling; <i>Large holes to be filled.</i>
West	Lath and Plaster Partition Wall	Paint peeling; hairline cracks; large crack SW corner; walls pulling away from each other at corner; relatively good; <i>Holes near wood frame door to be filled.</i>

LOCATION/ELEMENT	MATERIAL	CONDITIONS/RECOMMENDATIONS
Floor	6" Wood Planks With Linoleum Over	Good Conditon; south wall pulled away from floor 2"+.
Trim	Wood Base Painted	Intact all around; solid against north and west walls; pulling away from south and west; open joint in corner of SW.
Windows:		
North	N/A	
South	One 6-Over-6 Wood	New sash by NPS (lower sash only); wood frame is good.
East	N/A	
West	N/A	
UV Protection	None	
Blinds	None	
Doors:		
North	Two Wood Four Panel Flush on Closet Side Decorative To Bedroom	Corner - bottom left is notched; hardware is different from others; side latch; knob missing on closet side.
South	N/A	
East	N/A	
West	One Wood Four Panel, Painted Flush to Bedroom Side Decorative to Hall	Good Condition; no hardware.
Frames	Wood, Painted	Minor holes; <i>Patch and Repaint.</i>
INTERIOR/CENTER HALL • SECOND FLOOR		
Ceiling	Lath and Plaster Wallpaper	Cracking in ceiling; wallpaper peeling; joints in corners are fair; <i>Electrical in center to be removed.</i>
Walls:		
North	Lath and Plaster Wallpaper	Wallpaper peeling; open joints at door frame all around.
South	Lath and Plaster on Brick	Wallpaper peeling; plaster has major cracks left of door frame & some loose spots; vertical cracks above door; electrical on wall through transom.
East	Lath and Plaster Partition Wall	Sturdy; patched in places; some cracking north end - diagonally up from door frame; crack in NE corner; vertical joint - open 1/2"+; some at south end; <i>Electrical panel mounted on wall (fuses) to be removed.</i>

LOCATION/ELEMENT	MATERIAL	CONDITIONS/RECOMMENDATIONS
West	Lath and Plaster Partition Wall	Cracks in plaster; wall feels firm; cracks in doorframe corner; wall pulling away at south wall.
Wood	4" Tongue and Groove	Board missing; hole drilled in floor; separated.
Trim	Wood, Paint	Intact
Windows	N/A	
Doors: North	Wood Four Panel, Raised on Hall Side and Trimmed on Parlor Side	No hardware; slight crack at joint at top rail; frame is good.
South	Six Panel Wood Transom Above Panel	No detail; raised rails and stile at interior; flush exterior - minor scoring; hardware intact - loose; broken window pane; <i>transom - repair holes for electrical</i> , otherwise good.
East	<i>See Bedroom SE</i>	
West	<i>See Parlor SW</i>	
Frames	Wood Paint	Good Condition; <i>Repaint</i>
INTERIOR/FRONT ROOM • NORTHWEST • SECOND FLOOR		
Ceiling	Lath and Plaster Wallcovering	Wallcovering is almost gone; plaster is cracking, lath exposed and missing; some mildew at south end; hole in NW corner - lath is gone.
Walls: North	Lath and Plaster on Brick	Some interior repointing has been done; plaster gone, brown, and cracking - was wallpapered; picture mould removed at new window; base cut at new window-removed; <i>Some repointing still needed at window frame.</i>
South	Lath and Plaster on Brick	Some interior repointing has been done; plaster gone, brown, and cracking - was wallpapered; cracking - was wallpapered; picture mould removed at new window; base cut at new window-removed; <i>Some repointing still needed at window frame.</i>
East	Lath and Plaster on Brick	Plaster intact; cracks in plaster; wallpaper peeling; picture molding in place; wood base intact.

LOCATION/ELEMENT	MATERIAL	CONDITIONS/RECOMMENDATIONS
West	Lath and Plaster on Brick	Plaster missing in NW corner; cracks along chimney/fireplace; fireplace intact; plastered up to metal insert and bricked in; plaster gone on chimney; cracks in brick missing; window frame gone; <i>Need repointing below window.</i>
Floor	6" Wood Plank Linoleum Center Piece	Gap at north wall which may have been covered by base - feels sturdy; hole below NW window; hole in wood base at NW corner.
Trim	Wood Base Painted	Good Condition; missing below NE window; front wall pulling away from framing - gap at base; wall appears to run into base (<i>See Plan</i>)
Windows:		
North	6-Over-6 Wood Paint	New by NPS; NW window is original trim at frame; bottom sash original with possibly new mullions; NE new sash frame.
South	N/A	
East	N/A	
West	6-Over-6 Wood Paint	Frame is gone; new window by NPS.
UV Protection	Shutters on North Side	
	Painted Wood	
Blinds	None	
Doors:		
North	N/A	
South	Wood Four Panel, Paint Two Raised Panels Detailing at Panel	Good Condition; Minor holes, scratches; hinges are good; knob gone on SW door; hardware gone on SE door.
East	Wood Four Panel, Paint Flush on bedroom side (east)	
	Detail on Parlor Side	
West	N/A	
Frames	Wood Paint	Good Condition; minor holes; <i>Scrape, fill, repaint per paint analysis missing latch.</i>
Fireplace	N/A	Good Condition; Simple wood mantel - no detail; metal insert with plaster surround; bricked in fireplace.

LOCATION/ELEMENT	MATERIAL	CONDITIONS/RECOMMENDATIONS
INTERIOR/PARLOR • SOUTHWEST		
Ceiling	Lath and Plaster Wallpaper	Cracked plaster; lath is gone in areas; holes in lath near chimney; electrical added in center; <i>Replaster; Remove and replace lath; Remove electrical.</i>
Walls:		
North	Lath and Plaster Wallpaper	Cracks in plaster; plaster missing at NW corner; wall loose in center; hole in center wall; lots of hair - finer than horse hair; picture mould gone; <i>Reattach loose plaster.</i>
South	Lath and Plaster on Brick	Large crack below window; upper right corner of wall looks uneven - cracking in brick; picture mould gone; <i>Remove, repoint brick and replaster.</i>
East	Lath and Plaster Partition Wall	Diagonal cracks; wall is flexible - moves when it is pushed on; plaster is soft in places; severe vertical cracking in SE corner.
West	Lath and Plaster on Brick Brick Chimney/Fireplace	Lath and plaster removed to rebuild chimney; SW corner is missing plaster; brick uneven; mortar gone - same at NW corner near ceiling; plaster crumbling below picture mould; cracks in brick below window; plaster gone; picture mould missing; <i>Repoint brick; Patch and repair plaster.</i>
Floor	6" Wood Plank	Holes in floor - covered by NPS; uneven near fireplace; linoleum over floor is mostly gone; gas heater is located on floor at north wall.
Trim	Wood Base Painted	
Windows:		
North	N/A	
South	6-Over-6 Wood	Wood frame - painted in good shape.
East	N/A	
West	Six-Over-Six Wood Painted	Original wood frame and trim Fill wood sill (consolidate) and paint
UV Protection	None	
Blinds	None	
Frames	<i>See Windows</i>	

LOCATION/ELEMENT	MATERIAL	CONDITIONS/RECOMMENDATIONS
Doors:		
North	<i>See NW Parlor Notes</i>	
South	N/A	
East	One Four Panel	Good Condition; flush to SW Parlor; trim on Hall side; hardware missing; new lock added; wood frame in good shape; <i>Scrape, repaint, remove new and replace with original.</i>
West	N/A	
Fireplace	Brick	Rebuilt chimney and opening (check with NPS); mantel is possibly in storage; hearth gone, boarded over.

BUILDINGS ASSESSMENT SURVEY**C. Dependency**

CONSTRUCTION DATE:

LOCATION/ELEMENT	MATERIAL	CONDITIONS/RECOMMENDATIONS
EXTERIOR		
Roof	Wood Shingle	Good Condition. Redone by NPS 1 1/2 years ago.
Chimney	Brick	Good Condition.
Gutters/Drainage	Galvanized Metal	Good Condition. Gutter dips at both ends on north side trapping water at east end. No downspout on south gutter. <i>Raise east end of north gutter to create positive flow to downspout at west end. Install downspout to south gutter.</i>
Walls: North	Brick, Whitewashed	Fair Condition. Repointing under second floor west window is not a good match. Some minor cracking around door and window lintels. <i>Repoint cracks with mortar that matches original.</i>
South	Brick	Good Condition.
East	Brick	Good Condition. Some minor erosion at base.
West	Brick	Good Condition. Minor spalling some broken bricks on south corner.
Doors: North	Wood, Four-Panel Door with Transom	Fair Condition. Gap between frame and lintel, frames need minor repair and paint. <i>Caulk gaps around frame. Repair frame, scrape and repaint.</i>
South	Wood, Four-Panel Door	Good Condition. Frame needs some repair.
Windows: North	Wood, Double-Hung Sash	Fair Condition. Opening up at joints and needs paint. Consolidate with epoxy. Paint.
South	Wood, Double-Hung Sash	Good Condition. New sash and frame covered over with plywood. <i>Remove plywood covering.</i>

LOCATION/ELEMENT	MATERIAL	CONDITIONS/RECOMMENDATIONS
West	Wood, Double-Hung Sash	Good Condition. Sash and sills have been replaced. Frame on first floor needs paint. <i>Paint.</i>
Shutters	Metal Hardware Only	Poor Condition. Shutters completely gone, some hardware remains. Hardware is rusted. <i>Further research shutter appearance and when they were originally installed.</i>
Porches	Pressure Treated Wood	Fair Condition. Recently rebuilt, no balustrade on second floor. Some checks and splits have opened-up in posts. <i>Reconstruct porch to 1897 appearance.</i>
INTERIOR - EAST ROOM - FIRST FLOOR		
Ceiling	Plaster	Good Condition. Newly replastered.
Walls:		
North	Plaster	Good Condition. Newly replastered.
South	Plaster	Good Condition. Newly replastered.
East	Plaster	Good Condition. Newly replastered.
West	Plaster	Good Condition. Newly replastered.
Floor	Wood, 3" Plank	Good Condition.
Trim	Wood	Good Condition.
Windows:		
North	Wood, Double-Hung Sash	Fair Condition.
Doors	Wood, Four-Panel	
Chimney	Wood Mantle	
INTERIOR - WEST ROOM - FIRST FLOOR		
Ceiling	Plaster	Good Condition. Newly replastered.
Walls:		
North	Plaster	Good Condition. Newly replastered.
South	Plaster	Good Condition. Newly replastered.
East	Plaster	Good Condition. Newly replastered.
West	Plaster	Good Condition. Newly replastered.
Floor	Wood, 3" Plank	Good Condition.
Trim	Wood	Good Condition.
Windows:		
North	Wood, Double-Hung Sash	

LOCATION/ELEMENT	MATERIAL	CONDITIONS/RECOMMENDATIONS
West	Wood, Double-Hung Sash	
Door	Wood, Four-Panel	
Chimney	Wood Mantle	Fair Condition. Poor repair to surround, needs paint.
INTERIOR - EAST ROOM - SECOND FLOOR		
Ceiling	Plaster	Good Condition. Newly replastered.
Walls:		
North	Plaster	Good Condition. Newly replastered. <i>Paint or wash to match period.</i>
South	Plaster	Good Condition. Newly replastered. <i>Paint or wash to match period.</i>
East	Plaster	Good Condition. Newly replastered. <i>Paint or wash to match period.</i>
West	Plaster	Good Condition. Newly replastered. <i>Paint or wash to match period.</i>
Floor	Wood, 3" Plank	Good Condition.
Trim	Wood	Good Condition.
Windows:		
North	Wood, Double-Hung Sash	Fair Condition.
South	Wood, Double-Hung Sash	Fair Condition.
Doors	Wood, Four-Panel	Good Condition.
Chimney	Wood Mantle	
INTERIOR - WEST ROOM - SECOND FLOOR		
Ceiling	Plaster	Good Condition. Newly replastered.
Walls:		
North	Plaster	Good Condition. Newly replastered <i>Paint or wash to match period.</i>
South	Plaster	Good Condition. Newly replastered <i>Paint or wash to match period.</i>
East	Plaster	Good Condition. Newly replastered <i>Paint or wash to match period.</i>
West	Plaster	Good Condition. Newly replastered <i>Paint or wash to match period.</i>

LOCATION/ELEMENT	MATERIAL	CONDITIONS/RECOMMENDATIONS
Floor	Wood, 3" Plank	Good Condition.
Trim	Wood	Good Condition.
Windows: North	Wood, Double-Hung Sash	Fair Condition.
South	Wood, Double-Hung Sash	Good Condition.
West	Wood, Double-Hung Sash	Good Condition.
Doors	Wood, Four-Panel	Good Condition. Hardware missing.
Chimney	Wood Mantle with Coal Grate	Good Condition. Mantle surround does not touch the floor.

