

979/D-378A

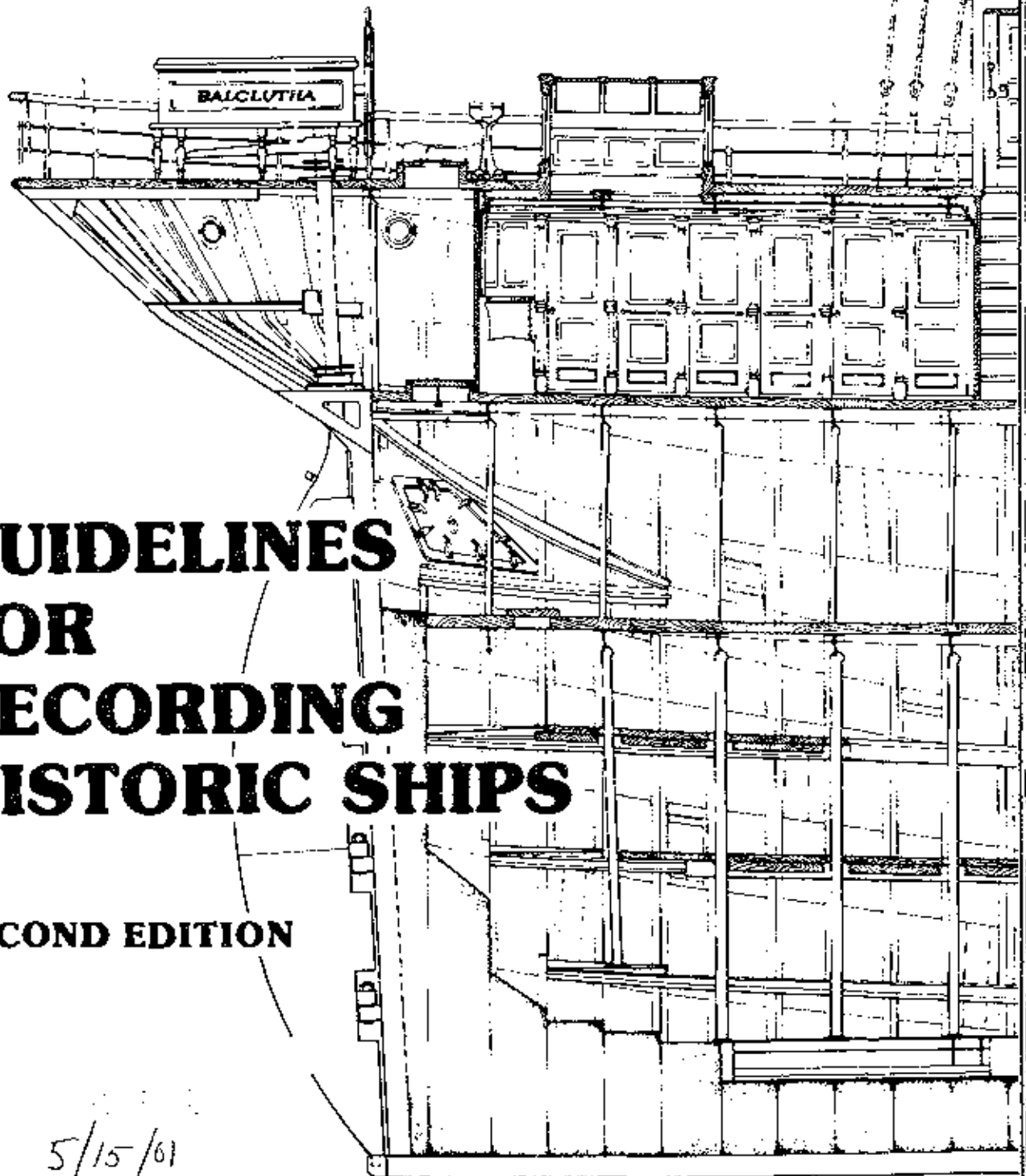

GUIDELINES FOR RECORDING HISTORIC SHIPS

SECOND EDITION

5/15/61

COUNCIL OF AMERICAN MARITIME MUSEUMS

HISTORIC AMERICAN BUILDINGS SURVEY

HISTORIC AMERICAN ENGINEERING RECORD

National Park Service • U.S. Department of the Interior

GUIDELINES FOR RECORDING HISTORIC SHIPS

RICHARD K. ANDERSON, JR.

SECOND EDITION
1995

REPRINTED BY
COUNCIL OF AMERICAN MARITIME MUSEUMS

FOR

HISTORIC AMERICAN BUILDINGS SURVEY
HISTORIC AMERICAN ENGINEERING RECORD
ROBERT J. KAPSCH, CHIEF

NATIONAL PARK SERVICE • U.S. DEPARTMENT OF THE INTERIOR
WASHINGTON, D.C.

LEGISLATIVE AUTHORITY FOR HABS/HAER AND THE USE OF OTHER GUIDELINES

The legislative authority of HABS/HAER is the 1935 Historic Sites Act (Public Law 74-292) and the 1966 National Historical Preservation Act (Public Law 89-665), as amended in 1980 (Public Law 96-515).

The guidelines should be used in conjunction with:

- Secretary of the Interior's Standards and Guidelines for Architectural and Engineering Documentation as published in the *Federal Register*, Vol. 48, No. 190 (Thursday, September 29, 1983), Notices, pp. 44730-44734, generally known as HABS/HAER Standards.
- *Recording Historic Structures*. John A. Burns, editor. Washington, D.C.: The AIA Press, 1989
- *HABS/HAER Guidelines*:
 - *HABS Historical Reports*
 - *HABS/HAER Guidelines: Recording Structures with HABS Measured Drawings (1995)*
 - *Historic American Engineering Record Field Instructions (1981/1995)*
 - *Transmitting HABS/HAER Documentation*

Historic American Buildings Survey/Historic American Engineering Record National Park Service
U.S. Department of the Interior
P.O. Box 37127
Washington, DC 20013-7127
(202) 343-9630

First edition, September 1988.
Second edition, September 1994.

Cover:
Inboard Profile
Ship BALCLUTHA, San Francisco, California
HAER No. CA-54

Reduced from portion of original 3/8" scale drawing
delineated by Robbyn L. Jackson and Deborah J. Cooper, 1987.

CONTENTS

Section 1: INTRODUCTION

- 1.1 Preface
- 1.2 Acknowledgements

Section 2: HISTORY

- 2.1 Historical Report Guidelines
- 2.2 Historical Reports
- 2.3 General Bibliography
- 2.4 Case Study

Section 3: PHOTOGRAPHY

- 3.1 Photography Guidelines
- 3.2 Large-format Photography for Historic Ships
- 3.3 Preparation of Photographs for
Transmittal to the Library of Congress

Section 4: MEASURED DRAWINGS

- 4.1 Measured Drawings Guidelines
- 4.2 What's Involved
- 4.3 Field Methods
- 4.4 Field Notes
- 4.5 Field Photographs
- 4.6 Measured Drawings
- 4.7 Drawing Examples
- 4.8 References and Resources
- 4.9 Appendices

Section 5: FIELD REPORTS

- 5.1 What to Consider

Section 6: CASE STUDIES

Section 1
INTRODUCTION

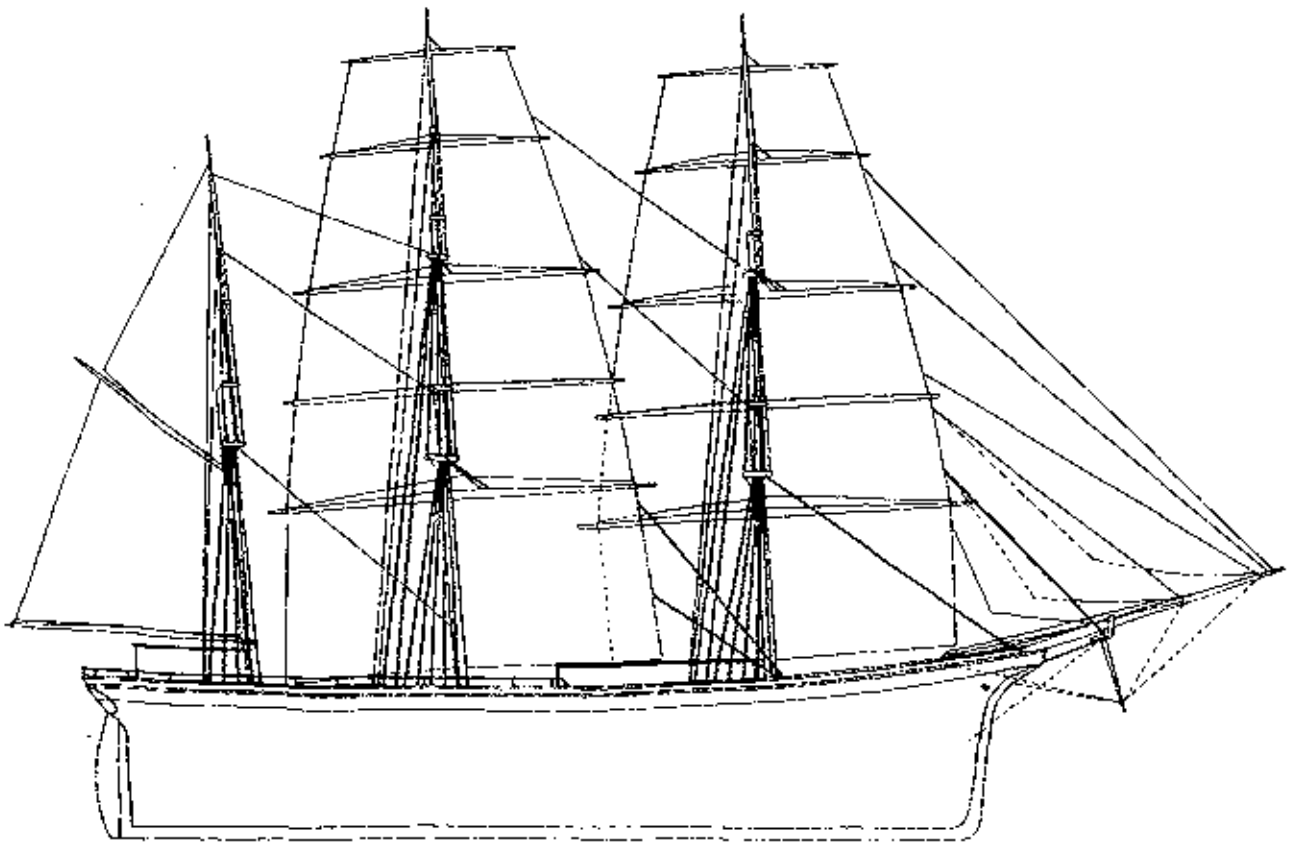

PREFACE

Publication and Revisions. The national guidelines presented here for use in recording large historic ships will eventually be used and tested by a wide variety of institutions and individuals as well as the National Park Service. Since they are one of many new steps in maritime preservation, users no doubt will want to know the background for their development and what responsibilities they do or do not incur. Though this volume is in bound form, these guidelines will continue to evolve and improve as they are used; revisions will be made from time to time without notice. Future editions may be issued in loose leaf form for easier use in the field. Contact the office of the Historic American Engineering Record (HAER) for information on updates to the guidelines.

Background. Nation-wide interest in maritime history and the preservation or replication of large historic ships has grown substantially in recent years. It has become apparent that physical preservation of vessels will not be feasible in a large number of cases, and that documentation--preservation "on paper"--will prove to be the most reasonable preservation method available. Where physical preservation of a ship is undertaken, in most cases detailed documentation must be made before stabilization, repairs, or other preservation measures can be safely undertaken. Such documentation is also a form of insurance against partial or total loss of a significant vessel to posterity should some catastrophe occur to the vessel itself.

Americans have always held an interest in their maritime history; however, efforts to preserve its largest *physical* expression--the ships--have lagged behind preservation of small craft, artifacts, written historical documents, and folklore, with only a few important exceptions. Led by the private and public sectors since the 1960s, the national movement to preserve historic buildings has encouraged a similar movement in maritime history on local and national levels. The impetus for the following HAER guidelines lies with the Standards Committee of the National Maritime Heritage Task Force which met between September 1982 and December 1983 under the auspices of the National Trust for Historic Preservation. The HAER guidelines were one of several related documents prepared in response to a 1985 congressional mandate to "inventory maritime resources, recommend standards for their preservation, and recommend private and public sector roles for that preservation." Vigorous discussion among American maritime museums, professionals, interest groups, and the National Park Service ensued in meeting the goals of this mandate. A national inventory of preserved historic vessels over 40 feet long was completed by the National Park Service, with the cooperation of numerous agencies and museums. In 1987, the National Register of Historic Places published specific instructions for nominating vessels to the National Register (*Bulletin #20: Nominating Historic Vessels and Shipwrecks to the National Register of Historic Places*). The Historic American

Engineering Record produced the *Guidelines for Recording Historic Ships* in 1988 in accordance with the established *Secretary of the Interior's Standards for Architectural and Engineering Documentation*. The Museum Small Craft Association began development of guidelines for documentation of historic small craft in 1988; *Boats: A Manual for Their Documentation* was published in 1994 by the American Association for State and Local History. In 1990 the Maritime Preservation Program within the National Park Service published the *Secretary of the Interior's Standards for Historic Vessel Preservation Projects* and *1990 Inventory of Large Preserved Historic Vessels*. Many of these publications were to form a part of the National Trust's planned Manual for the Documentation of Historic Maritime Resources, which was to have included guidelines for documenting all types of maritime-related tangible and intangible resources. The Department of Maritime Preservation in the National Trust was disbanded in 1993, and this publication was not issued.

The Historic American Engineering Record (HAER). The documentation of historic ships has a long history reflecting the influence of numerous motives, traditions, and important individual authorities. The Historic American Engineering Record was established in the National Park Service in 1969 to create a public record of the United States' engineering and industrial patrimony. It is the companion program to the widely known Historic American Buildings Survey (HABS), founded in 1933 to record historic architecture in the United States. At its fullest, HAER documentation consists of three components--fully

footnoted investigative histories, large-format photography, and detailed measured drawings. Each component has inherent strengths the others lack, so that an integrated "package" focused on a specific site or ship becomes a powerful documentary tool; the ship itself is examined and treated as a document every bit as important as historical records. Since all documentary efforts are necessarily selective and interpretive, the HAER guidelines help to elicit and capture the significant aspects of each vessel and present them as clearly as possible. The final records are produced on archival materials having a 500-year lifespan and are deposited in the HAER collection at the Prints and Photographs Division of the Library of Congress.

Access to HAER Records. HAER records are in the public domain and are open for public access. They may be copied for a fee and used for any purpose, with proper credit given to HAER and the National Park Service, as well as the delineator, photographer, or historian. Microfilm copies of the HAER collection are available at more than 110 libraries and institutions throughout the United States. For further information, write to the HAER Reference Librarian, Prints and Photographs Division, Library of Congress, Washington, DC 20540.

Standards and Guidelines. In order to insure a uniform quality of content and presentation, the *Secretary of the Interior's Standards for Architectural and Engineering Documentation* govern preparation of documents for inclusion in the HABS and HAER collections; they are reproduced for reference in Section 4.9. In order to make the kind and quantity of

documentation appropriate to the significance of a vessel, four levels of effort are outlined in the standards. The maritime guidelines presented here interpret the first three levels of the standards (Levels I - III) for use in producing documentation acceptable to the HAER collection. The fourth level, an inventory or survey, is addressed by present guidelines for the HAER Inventory Card available from the HAER Washington office.

HAER has attempted to base these guidelines on the best of widely accepted, established professional practices in historical research, vessel documentation and measurement, industrial archeology, documentary photography, and measured drawings. The guidelines are not meant to be the final authority, which all recorders must accept regardless of affiliation or before which all previous methods and products are to be seen as inferior. HAER has attempted to draw on the tremendous wealth of previous examples and to make the guidelines as flexible and broadly applicable as possible. HAER anticipates their acceptance by a wide range of authorities and users, and trusts that they will prove useful for non-HAER documentation projects.

Emphases. HAER documentation is vessel-specific, and records should reflect what is significant about the vessel. Where design is important--as it is expected to be in the majority of cases--hull shape and/or vessel construction and propulsion should be highlighted as significance dictates. Measured drawings may not be required in some cases, since significance may inhere in some nondesign facts, such as historical events or associations with important

persons. Existing drawings and records may also be sufficient to document historic conditions. The HAER collection at the Library of Congress does not accept pre-existing or original materials (except as photocopies), but recognizes their great value and strongly encourages their preservation by responsible repositories.

In documenting ships, HAER intends to build on the work of the Historic American Merchant Marine Survey (HAMMS), a 14-month program administered from 1936 to 1937 by the Smithsonian Institution as part of the Works Progress Administration. HAMMS put naval architects and others idled by the Great Depression to work making records of vanishing historic vessels with the intention of providing future naval architects a useful base-line record of American ship design evolution. For its time, it was a monumental effort, and deserves great credit. Of the 426 vessels included in the survey, only one survives in 1988. (The HAMMS Collection is located in the Division of Transportation, National Museum of American History, Smithsonian Institution, Washington, DC 20560. Selected HAMMS drawings were reproduced full-size and published in seven volumes by the Ayer Company of Salem, New Hampshire in 1983; see Section 4.7 for a complete citation.) HAMMS surveys worked from half-models and old drawings as well as extant vessels, and the records vary widely in quality due to the varied skills of HAMMS recorders and the frequent lack of convenient, adequate project verification data in the Survey drawings. Some of the Survey's weaknesses are undoubtedly due to its very short lifespan and consequent lack of time to refine and stabilize its

methodology. The HAER program benefits from a much longer track record and from further developments in general professional standards of documentation and material culture studies. The user should be able to evaluate HAER records more easily and use them with greater confidence since the methods, bases, and limitations of each project will be more clearly stated. A significant review and evaluation of HAMMS was made in 1986 by James P. Warren (cited in Section 4.7, References and Resources).

Since the close of HAMMS, hundreds of historic vessels have disappeared without adequate documentation. It is hoped that the HAER program will help prevent similar losses, and in many cases be a prelude to the physical preservation of many worthy vessels for posterity.

Scope of HAER Maritime

Documentation. HAER documentation should focus on large vessels of national significance as determined by national inventories, other suitable research, or designation by the Secretary of the Interior as National Historic Landmarks. This scope includes significant survivors of regional and local vessel design. *Bulletin #20* from the National Register of Historic Places provides guidance in determining a vessel's significance.

Vessel Size. In general, HAER documentation is currently restricted to vessels more than 30 feet in length that are floating, or in some manner laid up out of water (e.g. in a dry dock, on a marine railway, as hulks on a beach, etc.). Half-models may also be considered. While documentation of small craft is encouraged and is not excluded from the

HAER collection, HAER concentrates on the documentation of larger vessels, principally because they are more susceptible to loss. Small craft--vessels less than 30 feet long--tend to find their way into museums or other protective care much more easily than larger vessels.

Archeology. The scope of these guidelines does not include archeological sites, whether underwater or underground. Exceptions to this are substantially intact hulks, whether sunk, buried or beached, and for which contemporary documentary sources (records, photographs, etc.) can be found. Prehistoric vessels by their very nature have no contemporary written, photographic, or other graphic records to aid in understanding them, hence the approach to recording and interpreting them is considerably different. Professional standards and guidelines already exist for archeological work of this type. Contrary to the expectations of HAER in 1988, the *Guidelines for Recording Historic Ships* have been sought by nautical archeologists for use in underwater documentation of historic vessels. While not originally intended for this purpose, the guidelines have helped fill an apparent gap in archeological guidelines as the field of nautical archeology continues to develop.

Military Vessels. Though documentation of military vessels is in no way excluded from the HAER collection, documentation of 20th-century warships is not specifically addressed in the HAER guidelines. This is largely due to warships' enormous complexity and the survival of voluminous materials (drawings, records, histories, photographs) in the National Archives, U.S. Navy archives and other repositories.

Numerous historical and technical publications for both professionals and laymen are available on this subject. *Recording Structures and Sites for the Historic American Engineering Record* (formerly the HAER *Field Instructions* manual) for recording land-based industrial sites will be of aid in documenting propulsion plants, armament, and other machinery. HAER should be contacted for guidance, as well as other authorities, if a warship is to be recorded for HAER.

Marine Industrial Complexes.

Land-based, maritime-related sites can be documented for HAER using *Recording Structures and Sites for the Historic American Engineering Record* mentioned above.

HAER Project Parameters. HAER usually records a site or vessel as it exists at a specific time, not as an ongoing process. Preserved vessels undergo maintenance, repairs, restorations, and other changes which themselves should be documented, but this kind of ongoing effort is not in HAER's purview. The guidelines are useful, however, for helping establish ongoing documentation programs where they do not now exist by providing a baseline set of records for directing and documenting maintenance, repairs, and restorations.

Project Duration. The average documentation project conducted by HAER runs for 12 weeks during the summer. Some vessels may require two or more successive summers to document, most often due to funding limitations or the need to keep the number of recording team personnel down to a manageable size. Documentation projects conducted for

HAER under other auspices are not necessarily subject to this schedule.

Reconstructions, Reproductions and Replicas of Vessels. Level I HAER documentation can be used as *baseline* information for building reconstructions or reproductions of historic vessels, however, it should not be construed thereby that HAER documentation, such as a set of measured drawings, is intended to be *sufficient* for such projects. The *Secretary of the Interior's Standards for Historic Vessel Preservation Projects* define "reconstruction", "reproduction" and replication as follows:

Reconstruction: (1) the act or process of creating by new construction accurate form and detail of a particular vessel as it appeared at a specific period of time; (2) a vessel, or part thereof, that is the product of such a process.

Reproduction: (1) the construction or fabrication of an approximate copy of an object; (2) an object that is the result of such a process.

[When applied to a vessel, the term "reproduction" or "replica," denotes: (1) the act or process of recreating by new construction the general form and appearance of a particular vessel or type of vessel; or (2) a vessel that is the product of such a process.]

Replication: the act or process of recreating by new construction the general form and appearance of a particular vessel or type of vessel, maritime object, or part thereof.

The *Secretary of the Interior's Standards for Architectural and Engineering Documentation* require HAER records to

"adequately explicate and illustrate what is significant or valuable" about a historic vessel, but this does not necessarily mean the drawings, photographs, and written data will allow a shipbuilder to build a replica without supplementary material. HAER records show a user "what was there" *in relation to its historically significant features*. Recording the *historically significant* aspects of a vessel rarely requires that every piece of equipment be recorded down to the smallest detail. Most historic vessels include relatively insignificant details which do not receive coverage. HAER measured drawings should be accurately scaled views, but they are not intended to be "working" or "shop drawings." Old shop drawings of historic vessel construction are invaluable as records, but production of new ones is in most cases not justifiable unless an actual replication project is imminent.

The distinction between a HAER measured drawing and a shop drawing is slight for small wooden sailing vessels of straightforward construction, such as a catboat; several measured drawings and a set of informative photographs may be all a wooden shipbuilder working in a craft tradition will need to construct a replica. HAER's focus is, however, primarily on *large* vessels, many with complex mechanical systems. Construction of a steam-propelled tug boat replica in a modern yard may require several hundred sheets of shop drawings to permit manufacture of hull, structural systems and details, all parts and assemblies for propulsion equipment, auxiliaries, piping, electrical equipment, etc. In documenting a historic tug boat, HAER will not, for example, produce a new drawing of a

marine engine crankshaft—complete with dimensions, tolerances, finishes, and specifications for metal alloys—suitable for handing to a machine shop for production of a new part. However, an existing historic shop drawing should be photocopied by HAER if that crankshaft represented a significant advance in the history of marine engine technology. Though the HAER collection does not accept original historic records, existing shop drawings for historic vessels are invaluable and ought to be properly conserved and protected by their owners, or turned over to a responsible archive. Old drawings, photos, and records offer significant insights into history, construction, technology, design, and other factors, and they can be significant time savers in producing HAER drawings. They will also be vital to any restoration or replication efforts. HAER data should indicate where such historic materials can be located. Otherwise, HAER drawings and field notes should form an information base from which a team of qualified naval architects, marine engineers, shipwrights, and others can generate shop drawings for manufacturing purposes; production and curation of shop drawings themselves is beyond HAER's mission.

Users of the Guidelines. The HAER guidelines are written primarily for use under HAER supervision by HAER summer employees, most of whom are college students majoring in various aspects of history, photography, architecture, or engineering. They are also intended for use by other agencies, institutions, contractors, and donors doing documentation to HAER standards for submission to the HAER collection or for their own purposes.

Because the guidelines will be used by inexperienced personnel as well as by professionals, portions of the text are devoted to introductory material. An elementary glossary is included in Section 4.1. However, professionals and experienced recorders will find what they need to produce drawings for inclusion in the HAER collection. With these guidelines, proper guidance from a trained field supervisor, and a review team, HAER employees and other interested (if less experienced) recorders should be able to turn out reliable work.

Review and Consultation. HAER recommends strongly that recording projects retain a secondary review team consisting of maritime specialists appropriate to their project. Vessel owners, crewmembers, shipbuilders, naval architects, marine surveyors, engineers, mechanics, riggers, and maritime historians are some examples of types of consultants who may prove useful. Experts who know the contents and whereabouts of various records collections, histories of vessel types, regions, trades, ship construction and technology, etc., can be of incalculable value in producing excellent documentation, saving time, and avoiding mistakes or serious information gaps. Review teams should go over the vessel being recorded with the documentation team and be permitted periodically to go over a documentation team's work. Ships have significant differences from buildings and there are often several issues and agendas to sort out on a documentation project. Funding, time, expertise, significance of the vessel, extant prior documentation, accessibility of ship structure, present condition and future disposition of the vessel, secondary uses of

the documentation, and many other questions can all affect how a project is planned and what records are produced. The guidelines are not intended to substitute for other references or expert advice, and no written instructions are ultimate substitutes for experience. Professionals may be located through major maritime museums or by contacting the Council of American Maritime Museums, the National Park Service, or the National Trust for Historic Preservation. HAER has a list of some potential consultants, but maintains it only as a courtesy--inclusion on the list should not be construed necessarily as endorsement, nor omission as disapproval.

HAER makes final review of all documentation submitted for conformity to the *Secretary's Standards for Architectural and Engineering Documentation* and to HAER guidelines. The HAER program will gladly review "in progress" phases of a project for direction, content, and quality so that potential problems can be caught before they become serious. Failure to conform to specifications for archival materials and sizes may mean rejection of documentation regardless of its merits. Significant departure from the guidelines is necessary in some instances, but must be properly justified. Inappropriate or poorly produced records will be returned for improvement.

Funding of Documentation Projects.

These guidelines do not give guidance for funding projects. Documentation projects operated by HAER are rarely funded by the National Park Service, and the HAER program offers no grants. HAER projects are typically funded on a project-by-project basis from a variety of public and private

sources, depending on vessel ownership, location, and the parties interested in (or legally required to perform) documentation to HAER standards. HAER has relied on other Federal, state, and local government agencies and programs, as well as donations, matching grants, and in-kind services from private individuals, interest groups, historical societies, foundations, corporations, and other institutions.

Other HABS/HAER Guidelines. The *Guidelines for Recording Historic Ships* are part of the following series of guidelines developed by HABS/HAER for recording various types of historic resources to the

Secretary's Standards:

- 1) *Historian's Procedures Manual (HABS)*
- 2) *HABS/HAER Guidelines: Recording Structures and Sites with HABS Measured Drawings*
- 3) *HABS/HAER Guidelines: Recording Structures and Sites for the Historic American Engineering Record: Historical Reports, Large Format Photography and Measured Drawings*
- 4) *HABS/HAER Guidelines: Transmitting HABS/HAER Documentation*

ACKNOWLEDGEMENTS

The *Guidelines for Recording Historic Ships* were first produced in 1988 by the Historic American Buildings Survey/Historic American Engineering Record (HABS/HAER), National Park Service, United States Department of the Interior. Richard K. Anderson, Jr., HAER Staff Architect, was responsible for the overall outline and contents of the guidelines, including delineation of illustrations. Sally K. Tompkins, Deputy Chief of HABS/HAER, initiated and served as Chief Administrator of the HABS/HAER Maritime Program. Melanie Dzwonchyk edited the final text for publication in 1988. The second edition was revised and typeset by Richard K. Anderson, Jr. in 1994. New drawing examples and comments in Section 4.7 are based extensively on work by Robbyn L. Jackson, HAER Staff Architect.

The development and publication of the first edition of the guidelines was funded by congressional appropriation. The effort was supported by Jerry Rogers, National Park Service Associate Director, Cultural Resources; Rowland Bowers, Deputy Associate Director; and Robert J. Kapsch, Chief, HABS/HAER Division; and James P. Delgado, Historian, Maritime Initiative, under Edwin C. Bearss, Chief, History Division.

The first printing of the *Guidelines for Recording Historic Ships* was exhausted within 24 months of its appearance in early 1989. In response to demand, the HABS/HAER division under Dr. Robert J. Kapsch, Chief, and the Council of American Maritime Museums (CAMM),

Burt Logan, President, jointly funded the revision and printing of this second edition. Significant improvements in the new edition are (1) incorporation of more drawings from HAER projects in Section 4.7; (2) inclusion of a section on measuring transoms; (3) inclusion of directions for measuring deck plans; and (4) data on the introduction of a 33"x44" drawing sheet size.

HAER's program for documenting historic ships grew out of the National Trust for Historic Preservation's Maritime Heritage Task Force which met from 1982 to 1983, and from the draft Guidelines for Documentation produced by the task force's Standards Committee, chaired by Maynard Bray. In 1985, Lynn Hickerson, then Acting Director of the National Trust's Maritime Program, provided the first opportunity for HAER's involvement in recording historic vessels by initiating and funding HAER participation in the lines-lifting of the lumber schooner *Wawona* in Seattle. In 1986, the Trust's new Department of Maritime Preservation under Marcia Myers, Vice President, provided seed money for recording the pilot schooner *Alabama*, HAER's first attempt to fully document a historic vessel. Mystic Seaport Museum, Inc., served as cosponsor of this second project, and its director, J. Revell Carr, has been supportive of the HAER effort from the beginning. Two other recording projects have been run on historic vessels to develop and test portions of the guidelines, especially Section 4 (Measured Drawings); vessels involved were the bugeye *Louise Travers* (1986), and the ship *Balclutha*

(1987-88). The Calvert Marine Museum (Solomons, Maryland) under Dr. Ralph Eshelman, Director, sponsored the field work aboard the *Louise Travers*. Documentation of the *Balclutha* was funded by the Maritime Initiative under James P. Delgado in the National Park Service and was aided by the cooperation of the National Maritime Museum in San Francisco, California (now the San Francisco Maritime National Historic Park). Thanks are due to numerous people associated with these vessels, with project cosponsors, and with maritime preservation in general whose expertise and enthusiasm have contributed immeasurably to HAER's growing abilities in the realm of recording historic ships.

As with any such effort, many people and sources were involved in the contents and production of this work. Lynn Hickerson from the Department of Maritime Preservation of the National Trust for Historic Preservation, and Richard Anderson worked closely together during the early developmental stages of the National Trust's Maritime Guidelines and HAER's Guidelines for Recording Historic Ships in order to coordinate the scopes of these manuals. Contents of Section 2 (History) were prepared by staff of the Mystic Seaport Museum under Dana Hewson, Shipyard Director. Portions of Section 3 (Photography) were adapted from existing HABS/HAER "Specifications for the Production of Photographs" by Jack E. Boncher, HABS Staff Photographer.

Portions of Sections 4 (Measured Drawings) were adapted in 1988 from existing HAER *Field Instructions*, whose principal authors were Larry D. Lankton and Richard Anderson. The summary chart

of the *Secretary's Standards for Architectural and Engineering Documentation* reproduced in the Appendix was prepared by Robert J. Kapsch, Chief, HABS/HAER. The balance of the 1988 historic ships guidelines were written by Richard Anderson. HAER architect Robbyn L. Jackson aided with the layout of numerous illustrations in Section 4.7. Sally K. Tompkins, Deputy Chief, HABS/HAER, reviewed and edited drafts of the written text and supervised the project's progress.

Special thanks are due to Maynard Bray and David W. Dillion, who kindly reviewed early drafts of Section 4 and made substantive comments for the 1988 edition. Mr. Dillion also provided a checklist of measurements to be made for sails included in Section 4.3. Welcome contributions by Don Birkholtz, Jr., regarding scantlings for metal vessels and distinguishing between old and new work aboard ships have been included in Sections 1, 4.3 and 4.4. Kevin Foster contributed numerous titles on steam-powered vessels and the history of steam navigation to Section 2.3, and along with William M. P. Dnnne, he contributed to the Introduction to Admeasurement in Section 4.9. HAER also wishes to thank the Museum of American History of the Smithsonian Institution for permission to reproduce drawings from the Historic American Merchant Marine Survey (HAMMS) and from the collections of Howard I. Chapelle. These drawings are used extensively in the Measured Drawings section of the 1988 edition of the guidelines.

HAER also deeply appreciates the time and thought given by numerous members of the maritime community who were

ACKNOWLEDGEMENTS

The *Guidelines for Recording Historic Ships* were first produced in 1988 by the Historic American Buildings Survey/Historic American Engineering Record (HABS/HAER), National Park Service, United States Department of the Interior. Richard K. Anderson, Jr., HAER Staff Architect, was responsible for the overall outline and contents of the guidelines, including delineation of illustrations. Sally K. Tompkins, Deputy Chief of HABS/HAER, initiated and served as Chief Administrator of the HABS/HAER Maritime Program. Melanie Dzwonchyk edited the final text for publication in 1988. The second edition was revised and typeset by Richard K. Anderson, Jr. in 1994. New drawing examples and comments in Section 4.7 are based extensively on work by Robbyn L. Jackson, HAER Staff Architect.

The development and publication of the first edition of the guidelines was funded by congressional appropriation. The effort was supported by Jerry Rogers, National Park Service Associate Director, Cultural Resources; Rowland Bowers, Deputy Associate Director; Robert J. Kapsch, Chief, HABS/HAER Division; and James P. Delgado, Historian, Maritime Initiative, under Edwin C. Bearss, Chief, History Division.

The first printing of the *Guidelines for Recording Historic Ships* was exhausted within 24 months of its appearance in early 1989. In response to demand, the HABS/HAER division under Dr. Robert J. Kapsch, Chief, and the Council of

American Maritime Museums (CAMM), Burt Logan, President, jointly funded the revision and printing of this second edition. Significant improvements in the new edition are (1) incorporation of more drawings from HAER projects in Section 4.7; (2) inclusion of a section on measuring transoms; (3) inclusion of directions for measuring deck plans; and (4) data on the introduction of a 33"x44" drawing sheet size.

HAER's program for documenting historic ships grew out of the National Trust for Historic Preservation's Maritime Heritage Task Force which met from 1982 to 1983, and from the draft *Guidelines for Documentation* produced by the task force's Standards Committee, chaired by Maynard Bray. In 1985, Lynn Hickerson, then Acting Director of the National Trust's Maritime Program, provided the first opportunity for HAER's involvement in recording historic vessels by initiating and funding HAER participation in the lines-lifting of the lumber schooner *Wawona* in Seattle. In 1986, the Trust's new Department of Maritime Preservation under Marcia Myers, Vice President, provided seed money for recording the pilot schooner *Alabama*, HAER's first attempt to fully document a historic vessel. Mystic Seaport Museum, Inc., served as cosponsor of this second project, and its director, J. Revell Carr, has been supportive of the HAER effort from the beginning. Two other recording projects have been run on historic vessels to develop and test portions of the guidelines, especially Section 4 (Measured Drawings);

vessels involved were the bugeye *Louise Travers* (1986), and the ship *Balclutha* (1987-88). The Calvert Marine Museum (Solomons, Maryland) under Dr. Ralph Eshelman, Director, sponsored the field work aboard the *Louise Travers*.

Documentation of the *Balclutha* was funded by the Maritime Initiative under James P. Delgado in the National Park Service and was aided by the cooperation of the National Maritime Museum in San Francisco, California (now the San Francisco Maritime National Historic Park). Thanks are due to numerous people associated with these vessels, with project cosponsors, and with maritime preservation in general whose expertise and enthusiasm have contributed immeasurably to HAER's growing abilities in the realm of recording historic ships.

As with any such effort, many people and sources were involved in the contents and production of the 1988 edition. Lynn Hickerson from the Department of Maritime Preservation of the National Trust for Historic Preservation, and Richard Anderson worked closely together during the early developmental stages of the National Trust's *Maritime Guidelines* and HAER's *Guidelines for Recording Historic Ships* in order to coordinate the scopes of these manuals. Contents of Section 2 (History) were prepared by staff of the Mystic Seaport Museum under Dana Hewson, Shipyard Director. Portions of Section 3 (Photography) were adapted from existing HABS/HAER "Specifications for the Production of Photographs" by Jack E. Boucher, HABS Staff Photographer.

Portions of Sections 4 (Measured Drawings) were adapted in 1988 from

existing HAER *Field Instructions*, whose principal authors were Larry D. Lankton and Richard Anderson. The summary chart of the *Secretary's Standards for Architectural and Engineering Documentation* reproduced in the Appendix was prepared by Robert J. Kapsch, Chief, HABS/HAER. The balance of the 1988 historic ships guidelines were written by Richard Anderson. HAER architect Robbyn L. Jackson aided with the layout of numerous illustrations in Section 4.7 in 1988. Sally K. Tompkins, Deputy Chief, HABS/HAER, reviewed and edited drafts of the written text and supervised the project's progress.

Special thanks are due to Maynard Bray and David W. Dillion, who kindly reviewed early drafts of Section 4 and made substantive comments for the 1988 edition. Mr. Dillion also provided a checklist of measurements to be made for sails included in Section 4.3. Welcome contributions by Don Birkholtz, Jr., regarding scantlings for metal vessels and distinguishing between old and new work aboard ships have been included in Sections 1, 4.3 and 4.4. Kevin Foster contributed numerous titles on steam-powered vessels and the history of steam navigation to Section 2.3, and along with William M. P. Dunne, he contributed to the Introduction to Admeasurement in Section 4.9. HAER also wishes to thank the Museum of American History of the Smithsonian Institution for permission to reproduce drawings from the Historic American Merchant Marine Survey (HAMMS) and from the collections of Howard I. Chapelle. These drawings are used extensively in the Measured Drawings section of the 1988 edition of the guidelines.

HAER also deeply appreciates the time and thought given by numerous members of the maritime community who were asked to review the final draft and who

suggested improvements before these guidelines were published. Many of their comments have been addressed or incorporated into the text.



Section 2

HISTORY

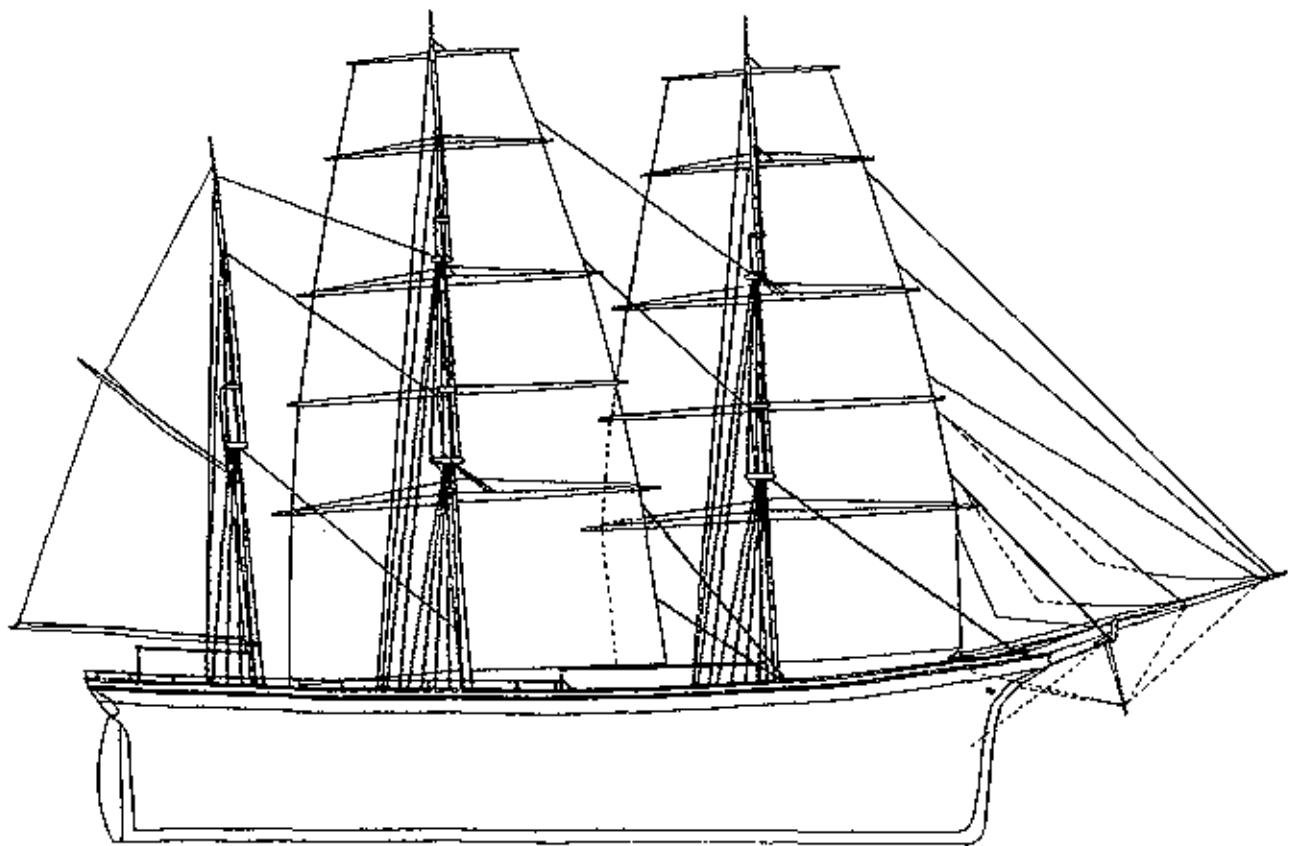

STANDARDS and GUIDELINES

Introduction: The outline format on the following pages provides a quick overview of general applications of the *Secretary's Standards* to the production of HAER historical reports. The text that follows in Sections 2.2-2.4 tells you in more detail how to produce reports that meet the *Secretary's Standards*.

There are four parts to the outline, corresponding to each of the four standards *as they apply to HAER historical reports*:

- I. Guidelines for explicating and illustrating what is significant or valuable about a historic vessel via written reports.
- II. Guidelines for preparing reports accurately from reliable sources.
- III. Guidelines for materials on which reports are to be made.
- IV. Guidelines for producing clear and concise reports.

These standards, as they apply to historical reports, follow well-established scholarly practices and ethical standards.

2.1.2 Historical Report Guidelines

I. Explicating and illustrating what is significant or valuable about a vessel:

Recommended

Determining historically significant data through adequate research into relevant primary and secondary sources, in addition to examination of the physical fabric of the vessel itself.

Determining what significant data are best explicated and illustrated by a written report, as opposed to photographs or measured drawings alone.

Determining what contents are best suited to explicating and illustrating the significant and valuable aspects of the resource.

Not Recommended

II. Guidelines for preparing historical reports accurately from reliable sources.

Recommended

Using endnotes and bibliography for complete and accurate citation of primary and secondary sources, whether written, oral, or graphic.

Reporting gaps in information accurately.

Reporting on the reliability of sources used where they may be undefined or in question.

Distinguishing supported facts from educated guesses and speculation when drawing conclusions and inferences.

Using sources and the written medium within their capabilities and limitations.

Turning to photography, illustrations, and measured drawings where they can more accurately and succinctly provide evidence, explicate or illustrate a significant point.

Not Recommended

Quoting copyrighted information (including graphics) in a HAER report without citation or appropriate written permission from the copyright owner(s).

III. Guidelines for materials on which historical reports are to be prepared.

Recommended

Preparing final copy of report on 8½"x11" archival bond paper (acid-free, 100% cotton, buffered)

Not Recommended

IV. Guidelines for producing clear and concise reports.

Recommended

Organizing a report according to a chronological outline derived from significant aspects of the recorded vessel's history and context.

Including proper pagination and headings on each page.

Using a properly completed cover page.

Using **Courier** typeface at 10 or 12 characters per inch (cpi)

Turning to photography, illustrations, and measured drawings where they can more accurately and succinctly provide evidence, explicate or illustrate a significant point.

Following established rules of clear professional writing practice in grammar and spelling.

Not Recommended

Producing a report in which type is gray, streaked or smudged

2.1.4 Historical Report Guidelines

HISTORICAL REPORTS

Introduction. The goals, content, and format of a HAER historical report are addressed below. For the most part, they follow long-recognized approaches, but in addition to customary documentary sources, a thorough understanding of the physical structure of a particular vessel is necessary for a complete understanding of that vessel's history and her place in history. Documenting the history of a ship or boat can be similar to an archeological excavation, because some of the information necessary for a written report will be gathered from physical evidence on the vessel itself. The guidelines that follow presume the user has some experience in historical research and writing, and in interpreting physical evidence. While the guidelines are intended for use by researchers from a variety of backgrounds, they will not cover fundamentals of research and writing techniques.

While you may rely primarily on the written word as a historian, you should work closely with those who are making graphic documentation of the vessel. You will both be uncovering evidence that will help each other in your work. If you are a HAER summer employee, keep in mind that most HAER recording projects operate on a 12-week schedule, and plan your efforts accordingly. Contracted work, or work sponsored by other organizations, is not necessarily subject to these time constraints.

Watercraft present interesting problems to the researcher, not the least of which is their mobility. Evidence of the vessel's

history may be scattered worldwide and local information about construction techniques may not have much relationship to the vessel at hand.

Levels of Documentation. These guidelines give directions primarily for completing historical reports for ships whose significance requires Level I or Level II documentation as set forth in the *Secretary of the Interior's Standards for Architectural and Engineering Documentation* (see Appendices). Historical reports for Level I or II are substantially the same in content and format; the differences will have more to do with the vessel's significance and available sources than matters of report length or research effort. Guidance given here will also enable the user to complete research for Level III documentation (completion of a one-page "Data Form for Historic Ships") or Level IV (completion of a HAER Inventory Card). The data form is self-explanatory, and Fig. 2.2.1 shows a blank copy. Copies of the inventory card and instructions for completing it are available separately from HAER. A Case Study is included (beginning on p. 2.4.1) as an illustration for Level I/II reports following these guidelines.

Integration of Various Types of Documentation. The author is responsible for more than merely researching and writing a report. He should be conscious that HAER documentation is a package developed from several disciplines. This package contains not only a report, but

NATIONAL PARK SERVICE
HISTORIC LARGE VESSEL INVENTORY

Current name: _____; Official #: _____;	
Previous names: (1) _____	(4) _____
(2) _____	(5) _____
(3) _____	(6) _____
City and State location: _____;	
Builder: _____; Year built: _____;	
Builder location: _____;	
Built for: _____;	
Vessel type: _____;	
Original use: _____;	
Present use: _____;	
Owner: _____;	
Owner's address: _____;	
City/State/Zip: _____;	
# of masts: _____; Rig: _____;	
Length: _____; Beam: _____; Hold Depth: _____; Draft: _____;	
Gross tons: _____; Net tons: _____; Displacement: _____;	
Hull material: _____; Deck material: _____;	
Superstructure material: _____;	
Type of engines: _____; Horsepower: _____;	
Propulsion: _____;	
Armament: _____;	
Condition (circle one):	
POOR	FAIR
GOOD	EXCELLENT
Preservation Objective: _____;	
Data recorded: _____.	

Fig. 2.2.1

formal photographs and may also include measured drawings (in Level I documentation). As part of a team, the researcher should help decide what formal photographic views should be scheduled and write captions for them (see pp. 3.2.1 - 3.2.3 for format of "Index to Photographs").

Due to time constraints, he should be especially sensitive to views that can save him pages of lengthy written work; historic views and graphics should be selected for photographic copying when appropriate. When measured drawings are done, he should be active in focusing the delineators' efforts on those physical aspects of the ship shown to be significant by his research. He should also supply the delineators with notes and that historical information which may be better presented on drawings than in the report. All written data on drawings should be proofread for content, spelling, etc. In turn, some of the data needed for the report may better be obtained by the delineators. The field report author (and all team members) should take care to decide which medium is best for communicating various types of information. References to photos, measured drawings, and other graphic media should be made where appropriate and efficient rather than relying solely on the written word.

Format. HAER reports are generally single-spaced and typewritten in Courier typeface on only one side of 8-1/2" x 11" sheets of archival bond paper with one-inch margins (minimum) on all sides.

Cover Sheet. The first page of all reports is a cover sheet containing the headings and following the format shown on p. 2.3.3.

Pagination. The upper-right-hand corner of every page should contain a three-line single-spaced block with the vessel name, HAER number, and page number as illustrated in the format below.

Schooner ALABAMA
HAER No. MA-64
Page 5

Illustrations. Relevant HAER photos, measured drawings, and photocopies should be referenced directly in your report whenever possible. Selected maps, drawings and other materials not significant enough to be included in the project photographic record may be included in the body of the report with sources properly cited.

Footnotes and Endnotes. Reports should be fully documented, with endnotes appearing at the ends of chapters or the end of the report. Aside from proper citations, endnotes are useful for explanations or digressions which do not blend well into the flow of your paper.

Bibliography. A full bibliography listing all sources consulted (primary, secondary, graphic, oral, etc.) must appear at the end of your report. You should refer to *The Chicago Manual of Style* (Chicago, 1988) or *A Manual for Writers of Term Papers, Theses, and Dissertations* by Kate L. Tnabian (Chicago, 1987) for proper punctuation and forms.

Word Processors. The use of a word processor is strongly encouraged and floppy discs should be submitted to the HAER office along with printouts in order to facilitate the editing process. It is recommended that the HAER office be contacted at the time of the project to

determine compatibility of software (WordPerfect® is the National Park Service standard).

Assessment. Ships are highly specialized vessels which differ widely among themselves. What makes a vessel significant enough to be documented can vary widely, also: associations with important people or events, embodiment of technological advances, unique construction, or representation of a once-common class of vessel, type of trade or craft, etc.

In some cases, effective documentation is best carried out by focusing intensely on a few historically important elements rather than on complete documentation of the entire ship. It is often of far more value to document the unique and important areas of certain time periods in great detail than to document the entire ship in a more superficial way. And if some documentation already exists in the form of construction plans, lines, photographs, drawings, etc., and if these clearly illustrate how portions of this or similar vessels were built, there is no point in covering the same ground again.

The vessel may have required occasional repair. It is probably unusual to find any watercraft that is old enough to be important historically and has survived without some repair and alteration. Sometimes the newer work is as important as the original; sometimes it's not--a lot depends on factors such as age, extent, quality, technology, etc. But it is always valuable to sort out the original fabric from the pieces that came later and to record all changes that occurred up until the boat was taken out of service.

Before any documentation begins on a vessel, the vessel should in all cases be inspected by an experienced review team whose members can, with their knowledge of maritime history, traditional construction techniques, and existing documentation, determine whether the documentation project should be complete or partial and what areas should receive the most attention.

The review team should be made up of individuals familiar with the trades the vessel was engaged in and the type of construction being reviewed. They should also be familiar with existing documentation (historic, photographic, drawn, etc.) so that information recorded is not a duplication of information recorded elsewhere.

In establishing priorities, questions such as the following should be considered:

1. What documentation is already available for similar vessels?
2. What portions of the vessel appear to be original and what is repair work, and how much attention, if any, should the latter receive?
3. Where has the original configuration been altered?
4. What is unique about the vessel's construction?
5. If the vessel is to be restored, are there affected areas that should receive special attention early?
6. Are there unique construction details not found in other vessels or

ones that have never been documented that are worthy of more than the usual focus?

While much of the above information will be recorded photographically or in the form of measured drawings, it is essential that the field report author be involved at this time because many of the clues to the vessel's history may be uncovered during this assessment.

After surveying the vessel, the review team will write up the results of its inspection in a prioritized list of areas to be documented, keeping within the documentation team's limitations and offering rationale for its recommendation. This will include specific recommendations as to which portions of the vessel's history need in-depth documentation and which only need refer to other historical research recorded elsewhere. In a case where the ship or boat is to be destroyed after documentation, the review team should make recommendations on which structural elements, if any, should be preserved, based on their importance to the overall construction as well as the practical limitations of warehousing unusually large pieces.

Content. Who? What? Where? When? How? Why? These basic questions apply to ships as well as to any historic subjects, though for ships each question has a slightly different slant. HAER documentation is planned to have a 500-year lifespan. It is, therefore, instructive to ask yourself what might someone in 2308 A.D. wish to know. Also HAER reports are vessel-specific and should concentrate on highlighting what is significant about the particular vessel being recorded without neglecting context.

What follows is an outline that covers the basic information which a history should record. A history need not be limited to these topics but each of the listed topics should be addressed even if the research leads to a dead end. The history may be written in a strictly narrative form using this outline as a check list and developing chapters on specific significant aspects as appropriate, or the outline may be more closely followed, filling in available information under each heading and adding new headings or subheadings as applicable.

When pertinent and helpful, tables, diagrams, maps, charts, sketches, fragments of engineering drawings, or illustrations may be included in the body of the report; though these may not be suitable for formal photocopies or inclusion in the measured drawings, they assist the user in understanding the resource. As has been noted earlier, care must be exercised in the use of copyrighted materials since HAER reports are in the public domain.

A. IDENTIFICATION

1. Name of the Vessel and Official Number

When assigning the primary name to a vessel, the proper name to use is the historic name, which will not change with each new owner or use. The historic name of a vessel often requires careful research to ascertain. It generally should be the name of the vessel when launched. If this information is not available, the present name should be used as the primary name. Always note the origin or source of the historic name in the text of the data pages. And, whenever using the primary name,

use all capital letters (e.g., TICONDEROGA).

Occasionally the historic name is not well known, and the persons using the HAER records may not be able to identify a vessel by that designation. Secondary names, which are current or past names, are also included to aid in the use of the HAER records. Any secondary names (in capital letters) are placed in parentheses after the primary name, beginning with the present name and including as many past names as are known.

If the original and present name cannot be determined, a brief description should be used. The vessel is then filed alphabetically by type, as S for schooner.

The official number is assigned by the United States Coast Guard and is on the ship's document. This number is also generally carved into a deck beam or other major structural beam. Documentation numbers can also be received from the U.S.C.G. Documentation Office.

2. HAER Number

Each vessel recorded is given a survey number which consists of an assigned number preceded by the appropriate two-letter state abbreviation, such as HAER No. PA-146. HAER will assign these numbers at the request of the person responsible for completing the documentation. Be sure to precede the numbers with "HAER No." to differentiate it from the HABS collection.

3. Report Prepared By

Use the name of the field report author.

4. Present Location

This includes the number and street, the city or town, county, and state. Because vessels are mobile, or were meant to be, exact locations are helpful, but not nearly as much as in the case of buildings.

Often narrative addresses are needed, such as aground at the foot of Isham Street, at a pier behind 5 Main Street, etc.

If a vessel is located within a commercial establishment such as a shipyard, give the shipyard address and describe where within the yard the boat is located. If the vessel is not located within a village, town, or city, locate it in relationship to the nearest town with a zip code or village name in common usage.

5. Present Owner (including address)

If the vessel is in use, this is a relatively easy bit of information to obtain as the owner's permission will have been required to begin the documentation on the vessel. If the vessel is abandoned or appears to be so, the information can be obtained from the state, by using state registration numbers or from the United States Coast Guard by using the vessel's documentation number, usually carved into a deck beam. The latter approach involves boarding the vessel. Often ownership can most easily be determined by inquiries to local people.

6. Present User Including Address

Give a brief description, and also note here whether a vessel is abandoned or not or afloat or not.

B. HISTORICAL INFORMATION

1. Historical Significance

Explain why the vessel was selected for documentation. Be brief. The historical context will contain the details.

Examples: last representative of a once-common type, good example of _____ designs, representative of the work done by _____ shipyard.

2. Principal Dimensions

The official or register dimensions of a vessel (such as length, beam, depth, draft, gross and net tonnage) can be very different from actual physical measurements. It is important that you indicate whether you are giving the vessel's admeasured register dimensions, actual physical measurements made by the recording team, or dimensions based on some other definitions or standards. You must clearly distinguish between each system if you use more than one. Registered dimensions should be those found in Merchant Vessels of the United States or U.S. Coast Guard records. You would be wise to include the information on the Coast Guard registration form *in full* as an appendix to your report. If registered admeasurements are undetermined, list actual length, breadth, and draft as noted by the delineators. This section is not meant to give exact dimensions but only to give an indication of the size of the boat being dealt with.

3. Physical History

a. **Designer.** If not determined, state undetermined. A brief biographic entry is

appropriate here if the vessel has a special place in the designer's development. List source.

b. **Builder/Location.** Include the builder's name if an individual and the name of the shipyard where the vessel was built and its location. If not known, state "undetermined."

c. **Date of Construction.** Include the dates the vessel was under construction and launch date. If unknown, state "undetermined." If estimating the date, indicate by using "circa" and substantiate the estimate. List source(s).

d. **Original Price.**

e. **Original Construction.** Give a brief overview. Differentiate between original material and later material. Mention the physical data which will determine what is original as well as contemporary photographs, newspaper clippings, letters, etc. Take particular note of the review team's survey. List all sources used. Include photocopies of historic photographs or clippings when appropriate.

f. **Alterations and Additions.** Taking note of the review team's survey, which will outline the alterations and additions, include a description of each alteration. Deal with major alterations and changes first. Use your judgment whether to proceed to finer levels of detail (is it a requirement of project cosponsors, or necessary for the project's end use?). Excruciating and exhaustive documentation of all minor changes is unnecessary for HAER purposes, and perhaps even impossible to do in 12 weeks time. A

guideline might be to ask which minor alterations contribute to understanding the major alterations or significant aspects for which the vessel is being recorded.

List all indicators such as photographs, paint lines, wear marks, remnants, fastening holes, etc. Refer to specific HAER drawings or photographs if useful. Also include a chronological list of the changes and, if available, the geographic location of the changes including the persons and shipyard involved with work. List all sources.

4. Historical Context

a. Sources of the Original Name and any others

b. Original and Subsequent Owners.

Research chain of ownership and list sources. If not known state "undetermined." National Archives and Record Service, General Services Administration, Washington, DC, can provide locations for storage of Customs House Records.

c. History of Vessel Type (if appropriate)

Be brief in cases where much material already exists, and give references for further background reading. Where history of vessel type is more obscure or untreated, more elaboration should be attempted.

d. Relationship to History

It will not be possible to answer all the questions that could be addressed. You should be guided by an informed understanding of what is significant about

your vessel. The following remarks are not fool-proof; your work should reflect a thoughtful and creative approach to your vessel.

1. Include information on the vessel's relationship to surroundings and local and maritime events.

2. Relationship to codes, maritime law, Lloyd's, etc. How did these affect ship's design, operation, repair, modification?

3. Relationship to economics of a local, national, or international trade or industry--shipbuilding trade, fishing trade, etc. (How much did vessel originally cost? Cost of repairs, modifications, operation? How did this affect ship's design, operation?)

4. Suppliers of materials used in construction and how they relate to the economics of the time and place, repair, modification, obsolescence? Also relationship to general national/international economic conditions, if relevant.

5. How did new technologies, products, or competitors affect the picture? How was ship adapted to these developments?

6. Relationship to ethnic origins of crew, labor, labor unions, practices, laws, housing aboard ship, working conditions, skills, hours, health, pay, etc. How many crew members were there? Did new machines or methods replace men?

7. Relationship to history of technology (may overlap with, but not be same as history of vessel type). Topics might include marine engineering, hull shape,

construction and maintenance practices, materials, propulsion systems, navigational instruments, cargo handling, defense/ weaponry, etc. How was the vessel sailed? How were the crew organized and how did they handle the vessel? How did they run the machinery or control the sails? What principles or developments made operation possible?

8. Relationship to local communities, politics, international treaties, wars, corporate politics (local/national/international), etc.

9. Intangibles--the human element of cultural values and personal quirks--things like pride of workmanship, sense of tradition, sense of esthetics, greed, ambition, etc.

10. Relationship to literature, folklore, arts, crafts, music, etc.

Sources of Information. Below is a list of sources which can aid in the documentation process of ships and boats. Such things as the original design, construction, arrangement, rig, equipment, and color scheme as well as information on the general history and the historical significance of the vessel can be determined through the study of good source material. Knowledge of the vessel and its history is essential in order to evaluate the sources and judge their credibility.

Oftentimes contradictory information can be gathered from several different sources. As a general rule, the validity of sources which are based on an individual's interpretation or point of view (paintings, models), should be determined by

assessing their credibility. Rely on the most substantial source material but note conflicting sources.

When recording sources, refer to all pertinent sources and evaluate them as to reliability, bias, and errors. Include complete information on every source located and annotate the sources with useful information such as "includes reproduction of original drawings."

Sources will be dependent upon priorities, time available, etc. Note that some sources will be investigated at a later date and will be added to the date pages, so leave clear "foot prints" which can be followed. This is important even if a search turns up nothing so that any subsequent research will not have to go down the same dead end road.

Repositories or owners of the following should be noted, if any:

Plans (Lines, Construction, Deck and Interior Layout, Sail Rigging, etc.) List all plans and give the date and location of the material. Include a brief description and evaluation.

Old Photographs. List the date of the photograph, identifying numbers, and the location of the original photograph. Include the photographer's name if available.

Models and Half Models. List the date, builder, and location of model. Include a brief description and evaluation.

Paintings, Engravings, etc. List the artist's name, date, identifying numbers, and the location of the artwork. Include a brief description and evaluation.

Books, Periodicals, Newspapers, and any Other Published Material. List title, author, date, location, identifying numbers, and publisher. Include a brief description and evaluation.

Logbooks, Account Books, Invoices, and Other Unpublished Material. List title, author (if available), date, location, and identifying numbers. Include a brief description and evaluation.

Oral History (Taped Interviews). List date, name of interviewee with brief background, name of person conducting the interview with brief background, identifying numbers, and location. Include a brief description of the contents of the interview and evaluate the source as to its reliability, biases, knowledge of the subject, etc.

Maritime Equipment and Artifacts. Include maritime artifacts which are pertinent to vessel use. Note equipment such as buckets, lanterns, compasses, windlasses, engines, working gear, etc. Be brief when catalogs can be used for complete description of use and dimensions. List date, artifact with a brief description of its usage, identifying numbers, name of manufacturer, location, and source of data.

Videos and Movies. List subject, date, location, relevance, and a brief description of contents. Include an evaluation of the source.

Surveys. List date, name of person(s) conducting the survey, and a brief description of the contents. Include an evaluation of the source.

Local Sources. Include boat builders, users, historians, merchants, collectors, historical societies, libraries, museums, newspapers, census documents, etc. Collections may be found in basements, cafes, shipyards, marinas, etc. Note that local sources include those local to the vessel's location when built, when rebuilt, and when in use.

State, Regional, National, and International Sources. Include libraries, museums, historical societies, custom houses, expositions, professional researchers, etc. List date, location, description, and identifying numbers. Include the source and evaluate the source.

Location of Sources. Think creatively when deciding where to look for sources. The General Bibliography given on pp. 2.2.1 - 2.1.16 is very broad. Developing a network of contacts can be critical to finding valuable tips specific to your vessel.

Then there is always the "serendipity factor": the book or periodical most appropriate to your vessel may have been published in Seaville, Kansas, only eight copies were made, and they are now available only in Ed Hodge's basement, 9 Blake Avenue, Seaville. It was written by his grandfather, who happens to be the father-in-law of the local librarian you contacted.

Customs House records, local "Merchant Vessels" newspapers, builders' lists, and merchants catalogs are good sources for the bare facts.

Contact naval architects, historians, and collectors for more information, plans,

memorabilia, photographs, and journals. These people will be local, regional, national, and often international.

The library, museum gallery, and historical society, local as well as those nationally known, are essential. They contain newspapers, books, plans, paintings, manuscripts, letters, tapes, periodicals, photographs, indexes, artifacts, and experts.

Search for the old boat yard; the repository of historic material which disappeared when the boatyard gave way to Tim's Cafe. Track down the old rigger who left his home in Seattle for Sun City and find the Key West captain's grandson who has the photo albums in Chicago.

Consult both well-known and obscure photographers and artists who covered the waterfront.

A foreign maritime museum or library may be the only source for models and textual material on the vessel. The only Seaville skiff model may be in Bergen, Norway, for example.

Talk with people who used the vessel. Have them sketch the location of the bait box, for example; find out in detail how the boat and the equipment were used. Recording the conversations may be the most efficient method. Know in advance if other oral histories are available and how to obtain them.

Try to trace changes which were made during the useful life of the vessel and its various uses by studying the tradition, new inventions, characteristic of locale, and economics.

Newspaper archives may yield unpublished photographs. Check the newspaper appropriate to each locale where the vessel was built, worked, was repaired, and was owned.

Asking a lot of questions and following leads you are given will yield results.

Beware of the self-designated authority and of artistic license. Constantly evaluate the credibility of each location and list all locations searched. Indicate ones you did not follow up on, and the reasons.



GENERAL BIBLIOGRAPHY

The bibliography below is intended as a starting point for research. More extensive bibliographies (such as Albion's) are listed below. Merchant vessels are concentrated upon, though some naval references are also included. Many references are old, but they are included because they may prove useful in describing technologies and developments contemporary to now-historic vessels. See Section 4.8 for further technical works. Many authors may have written other works--check card catalogs under names you are interested in to see what else may be available.

I. Field Library

I. Guidelines

Ives, Edward D. *The Tape-Recorded Interview: A Manual for the Field Workers in Folklore and Oral History*. Knoxville, Tenn.: University of Tennessee Press, 1980.

Lipke, Paul, Peter Spectre, and Benjamin A.G. Fuller, eds. *Boats: A Manual for Their Documentation*. Nashville, Tenn.: American Association for State and Local History for the Museum Small Craft Association, 1993.

Strunk, William Jr., and E.B. White. *The Elements of Style*. 3rd ed. New York, N.Y.: The MacMillan Company, 1979.

United States Department of the Interior, National Park Service. *Guidelines for Recording Historic Ships*. Washington, D.C.: U.S. Department of the Interior, National Park Service, Historic American Buildings Survey/Historic American Engineering Record Division, 1988 and 1994.

_____. *National Register Bulletin*. Washington, D.C.: U.S. Department of the Interior, National Park Service, Interagency Resources Division, 1985.

2. Dictionaries

Baker, William A. *The Lore of Sail*. New York, N.Y.: Facts on File Publications, 1983.

de Kerchove, Rene. *International Maritime Dictionary*. 2nd ed. 1961.

Department of Foreign and Domestic Trade, United States Merchant Marine Cadet Corps, War Shipping Administration. *A Glossary of Legal, Insurance and Shipping Terms*. Kings Point, N.Y.: United States Merchant Marine Cadet Corps, 1945. (mimeograph)

Eddington, Walter J. *Glossary of Shipbuilding and Outfitting Terms*. New York, N.Y.: Cornell Maritime Press, 1943.

Kemp, Peter, ed. *The Oxford Companion to Ships and the Sea*. London, Melbourne, New York: Oxford University Press.

Middendorf, Friedrich Ludwig. *Bemastung und Takelung der Schiffe*. Berlin: Verlag von Julius Springer, 1903. Reprinted in 1977 by Horst Hamecher Kassel; untranslated.

Paasch, H. *From Keel to Truck: A Marine Dictionary, English French and German*. Antwerp, Holland: Ratinckx Freres, 1885.

Paasch, Capt. H. *Illustrated Marine Encyclopedia, 1890*. Watford, Herts, England: Argus Books, Ltd., 1977.

Pease, F. Forrest. *Modern Shipbuilding Terms: Defined and Illustrated*. Philadelphia, Pa.: J.B. Lippincott Company, 1918.

Rogers, John G. *Origins of Sea Terms*. Mystic, Ct.: Mystic Seaport Museum, Inc., 1984.

Tryckare, Tre. *The Lore of Ships*. New York, N.Y.: Crescent Books, 1963.

The Visual Encyclopedia of Sea Terms Undersail.
1st ed. 1978.

Webster, F.B., et al., eds. *Shipbuilding
Cyclopedia.* New York, N.Y.:
Simmous-Boardman Publishing Co., 1920.

3. Bibliographies and References

Albion, Robert G. *Naval and Maritime History: An
Annotated Bibliography.* 4th ed. Mystic, Ct.:
The Marine Historical Association, Inc., 1972.

Brouwer, Norman J. "Maritime Preservation
Bibliography." Washington, D.C.: National
Trust for Historic Preservation, 1983.
(unpublished manuscript)

Feltner, Dr. Charles E., and Jeri Baron Feltner.
*Great Lakes Maritime History: Bibliography
and Sources of Information.* Dearborn, Mich.:
Seajay Publications, 1982.

Historical Periodicals Directory. Santa Barbara,
Ca.; Oxford, Eng.: ABC-CLIO, Inc.

Kinnell, Susan K., and Suzanne R. Ontiveros, ed.
American Maritime History: A Bibliography.
Santa Barbara, Ca.; Oxford, Eng.: ABC-CLIO,
Inc.

Labaree, Benjamin W. *A Supplement (1971-1986)
to Robert G. Albion's Naval and Maritime
History: An Annotated Bibliography.* 4th ed.
Mystic, Ct.: Mystic Seaport Museum, Inc.,
1988.

Mooney, James L., ed. *Dictionary of American
Naval Fighting Ships.* Washington, D.C.:
Department of the Navy, Naval Historical
Center, 1981. 8 vols.

*Untapped Resources and Research Opportunities in
the Field of American Maritime History.*
Mystic, Ct.: The Marine Historical
Association, Inc., Mystic Seaport, 1967.

II. Research Guidelines

Barzun, Jaques, and Henry F. Graff. *The Modern
Researcher.* New York, N.Y.: Harcourt, Brace
and World, 1970.

Cantor, Norman F., and Richard I. Schneider. *How
to Study History.* New York, N.Y.: Thomas Y.
Crowell, 1967.

Felt, Thomas. *Researching, Writing, and
Publishing Local History.* Nashville, Tenn.:
American Association for State and Local
History, 1976.

Gottschalk, Louis. *Understanding History.* New
York, N.Y.: Alfred Knopf, reprinted 1960.

Gray, Wood, et al. *Historian's Handbook.* 1964.

Shafer, R.A., ed. *A Guide to Historical Method.*
Homewood, Ill.: The Dorsey Press, 1969.

Stevenson, Noel C. *Search and Research.* Salt Lake
City, Utah: Desert Book Co., 1979.

Tilden, Freeman. *Interpreting Our Heritage:
Principles for Visitor Services in Parks,
Museums, and Historic Places.* Chapel Hill,
N.C.: University of North Carolina Press,
1957.

III. Vessel Types

A. Wooden Boats over 40 Feet

I. Construction and Materials

Abell, Sir Westcott Stilt. *The Shipwright's Trade.*
Cambridge, Eng.: University Press, 1948.

American Bureau of Shipping. *Rules for the
Construction and Classification of Wooden
Ships.* New York, N.Y.: American Bureau of
Shipping.

Curtis, W.H. *The Elements of Wooden Ship
Construction.* New York, N.Y.: McGraw-Hill
Book Company, 1919.

Desmond, Charles. *Wooden Shipbuilding*. Vestal, N.Y.: The Vestal Press Ltd., 1984.

Dodds, James, and James Moore. *Building the Wooden Fighting Ship*. New York: Facts on File Publications, 1985.

Estep, H. Cole. *How Wooden Ships Are Built*. New York, N.Y.: W.W. Norton Co., 1918.

Eyres, D.J. *Ship Construction*. 2nd ed. London, Eng.: Weinmann, 1978.

Frost, Ted. *From Tree to Sea*. Lavenham, Suffolk, Eng.: Terence Dalton Limited, 1985.

Garyantes, Hugo F. *Handbook for Shipwrights*. New York, N.Y.; London, Eng.: McGraw-Hill Book Co., Inc., 1944.

Hegarty, Reginald B. *Birth of a Whaleship*. New Bedford, Ma.: New Bedford Free Public Library, 1964.

MacGregor, David R. *Fast Sailing Ships: Their Design and Construction 1775-1875*. Lymington, Hampshire, England: Nautical Publishing Company, Ltd., 1973.

Mackrow, Clement. *The Naval Architect's and Shipbuilder's Pocket Book*. London, Eng.: Crosby, Lockwood and Son, 1902.

Putz, George, and Marc Halevi. *The Spirit of Massachusetts: Building a Tall Ship*. Thorndike, Me.: Thorndike Press, 1984.

Simmons, Walter J. *Finishing*. Lincolnville, Me.: Duck Trap Woodworking, 1984.

Story, Dana A. *Frame-Up*. Barre, Ma.: Barre Publishing Co., 1964.

—. *The Building of A Wooden Ship: "Sawn Frames and Trunnel Fastened"*. Barre, Ma.: Barre Publications, 1971.

United States Shipping Board, Emergency Fleet Corp. *The Elements of Wooden Ship Construction*. Part 1. Philadelphia, Pa.: United States Shipping Board, Emergency Fleet Corp., 1918.

Wood, Virginia Steele. *Live Oaking: Southern Timber for Tall Ships*. Boston, Ma.: Northeastern University Press, 1981.

2. Rigging

Biddlecombe, Capt. George. *The Art of Rigging: Containing an Explanation of Terms and Phrases, and the Progressive Method of Rigging Expressly Adapted for Sailing Ships*. Salem, Ma.: Marine Research Society, 1925.

Bolger, Philip C. *100 Small Boat Rigs*. Camden, Me.: International Marine Publishing Co., 1984.

Jensen, Jens Kusk. *Haandbog I Praktisk Somandsskab; Handbook of Practical Seamanship*. Copenhagen, Denmark: Host and Sons Forlag, 1982.

Leather, John. *Spritsails and Lugsails*. London, Eng.: New York, N.Y.: Adlard Coles Ltd., 1979.

Luce, S.B., Rear Admiral U.S. Navy. *Textbook of Seamanship*. New York, N.Y.: Van Nostrand, 1898.

Morris, Edward P. *The Fore and Aft Rig in America*. New Haven, Ct.: Yale University Press; London, Eng.: Oxford University Press, 1927.

Riessenberg, Felix C.E. *Standard Seamanship for the Merchant Service*. New York, N.Y.: Van Nostrand, 1922.

Totten, B.J., Commander U.S. Navy. *Naval Textbook and Dictionary*. New York, N.Y.: Van Nostrand, 1862.

Underhill, Harold J. *Masting and Rigging the Clipper Ship and Ocean Carrier*. Glasgow, Scotland: Brown, Son and Ferguson, Ltd., 1958.

3. History

Baker, William A. *Sloops and Shallops*. Barre, Ma.: Barre Publishing Co., 1966.

- The Canal Museum. *A Canal Boat Primer on the Canals of New York State*. Syracuse, N.Y.: The Canal Museum, 1981.
- Chapelle, Howard I. *The American Fishing Schooners 1825-1935*. New York, N.Y.: W.W. Norton Co., 1973.
- _____. *The History of American Sailing Ships*. New York, N.Y.: W.W. Norton Co., 1935.
- _____. *The National Watercraft Collection*. Washington, D.C.: Smithsonian Institution, 1960.
- Church, Albert Cook. *American Fishermen*. New York, N.Y.: W.W. Norton Co., 1940.
- Garland, Joseph E. *Down to the Sea: The Fishing Schooners of Gloucester*. Boston, Ma.: David R. Godine, 1983.
- German, Andrew V. *Down on T Wharf*. Mystic, Ct.: Mystic Seaport Museum, Inc., 1982.
- Goode, George B. *The Fisheries and Fishing Industry of the United States*. Washington, D.C.: Government Printing Office, 1887.
- Greenhill, Basil. *Archeology of the Boat: New Introductory Study*. Middletown, Ct.: Wesleyan University Press, 1976.
- Haley, Nelson Cole. *Whale Hunt: The Narrative of a Voyage by Nelson Cole Haley, Harpooner in the Ship CHARLES W. MORGAN, 1849-1853*. New York, N.Y.: I. Washburn, 1948.
- Hall, Elton W. *Sperm Whaling from New Bedford: Clifford W. Ashley's Photographs of Bark SUNBEAM, in 1904*. New Bedford, Ma.: Old Dartmouth Historical Society.
- Hardy, A.C. *American Ship Types: A Review of the Work, Characteristics, and Construction of Ship Types Peculiar to the Waters of the North American Continent*. (New York, N.Y.: D. Van Nostrand Company, 1927).
- Harland, John. *Seamanship in the Age of Sail*. Annapolis, Md.: The Naval Institute Press, 1984.
- Hornell, James. *Water Transport*. Cambridge, Eng.: Cambridge University Press, 1946.
- Institution of Naval Architects. *Transactions of the Institution of Naval Architects*. London, England.
- International Marine Archives, Nantucket, Ma.* Nantucket, Ma.: International Marine Archives, 1976.
- Johnstone, Paul. *The Sea-Craft of Prehistory*. Cambridge, Ma.: Harvard University Press, 1980.
- Kochiss, John M. *Oystering from New York to Boston*. Middletown, Ct.: Wesleyan University Press, 1974.
- Laughton, L.G. Carr. *Old Ship Figure-heads and Sterns*. New York: N.Y.: Burt Franklin, 1973.
- McFarland, Raymond. *A History of the New England Fisheries*. Philadelphia, Pa.: University of Pennsylvania; New York, N.Y.: D. Appleton and Co., 1911.
- _____. *The Masts of Gloucester: Recollections of a Fisherman*. New York, N.Y.: W.W. Norton Co., Inc., 1937.
- M'Kay, Lauchlan. *The Practical Shipbuilder*. New York, N.Y.: Collins, Keese and Company, 1839.
- Morris, James. *Our Maritime Heritage: Maritime Developments and Their Impact on American Life*. Washington, D.C.: University Press of America, 1979.
- Pierce, Wesley George. *Goin' Fishin': The Story of Deep Sea Fishermen of New England*. Salem, Ma.: Marine Research Society, 1934.
- Society of Naval Architects and Marine Engineers. *Historical Transactions*. New York, N.Y.: The Society of Naval Architects and Marine Engineers.
- Worcester, G.R.G. *The Junks and Sampons of the Yangtze*. Annapolis, Md.: Naval Institute Press, 1971.

B. Wooden Vessels Under 40 Feet

- Ansel, Willits D. *The Whaleboat: A Study of Design, Construction and Use, 1850-1870*. Mystic, Ct.: Mystic Seaport Museum, Inc., 1978.
- Atkin, William, and John Atkin. *The Book of Boats*. Camden, Me.: International Marine Publishing Co., 1976.
- Blanchard, Fessenden S. *The Sailboat Classes of North America*. New York, N.Y.: Doubleday and Co., 1973.
- Bolger, Phillip C. *Small Boats*. Camden, Me.: International Marine Publishing Co., 1973.
- Brewington, M.V. *Chesapeake Bay Log Canoes and Bugeyes*. Cambridge, Md.: Cornell Maritime Press, Inc., 1963.
- Burke, John. *Pete Culler's Boats: The Complete Design Catalog*. Camden, Me.: International Marine Publishing Co., 1984.
- Cannell, David, and John Leather. *Modern Developments in Yacht Design*. New York, N.Y.: Dodd, Meade, 1976.
- Carrick, Robert, and Richard Henderson. *John G. Alden and His Yacht Design*. Camden, Me.: International Marine Publishing Co., 1983.
- Catalog of Boat Building Plans and Books*. New York, N.Y.: The MacMillan Co., Inc., 1942.
- Chapelle, Howard I. *American Sailing Craft*. New York, N.Y.: Kennedy Brothers, Inc., 1936.
- _____. *Boatbuilding: A Complete Handbook of Wooden Boat Construction*. New York, N.Y.: W.W. Norton and Co., 1936.
- Connecticut, State of. *Shell Fish Commission Report, 1901*.
- Culler, R.D. *Skiffs and Schooners*. Camden, Me.: International Marine Publishing Co., 1974.
- Darvin, Tom. *The Rudder Treasury*. New York, N.Y.: The Rudder Publishing Co., 1953.
- Durant, Kenneth, and Helen Durant. *The Adirondack Guide-Boat*. Camden, Me.: International Marine Publishing Co., 1980.
- Gardner, John. *Basic Boatbuilding*. Mystic, Ct.: Mystic Seaport Museum, Inc., 1972.
- _____. *Building Classic Small Craft*. Camden, Me.: International Marine Publishing Co., 1977.
- _____. *Classic Small Boats*. New York, N.Y.: American Sportsman, 1969.
- _____. *The Dory Book*. Camden, Me.: International Marine Publishing Co., 1978.
- Guthorn, Peter J. *The Sea Bright Skiff and Other Jersey Shore Boats*. New Brunswick, N.J.: Rutgers University Press, 1971.
- Herreshoff, Lewis Francis. *The Complete Cruiser*. New York, N.Y.: Sheridan House, 1963.
- _____. *Sensible Cruising Designs*. Camden, Me.: International Marine Publishing Co., 1973.
- Ingersol, Ernest. "The Oyster Industry." *Tenth Census of the United States*. Washington, D.C.: Government Printing Office, 1884.
- Jones, Herald A., ed. *It's a Friendship*. Rockland, Me.: The Friendship Sloop Society, 1962.
- Leather, John. *Clinker Boatbuilding*. Camden, Me.: International Marine Publishing Co., 1973.
- _____. *The Big Class Racing Yachts*. 1st British ed. London, Eng.: Stanford Maritime, 1982.
- Leavens, John M., ed. *The Catboat Book*. Camden, Me.: International Marine Publishing Co., 1973.
- Lipke, Paul. *Plank On Frame*. Camden, Me.: International Marine Publications, 1981.
- Manley, Atwood. *Rushton and His Times in American Canoeing*. Syracuse University Press, 1968.

- McKee, Eric. *Clenched Lap or Clinker*. Greenwich, London, Eng.: National Maritime Museum, 1973.
- . *Working Boats of Britain; Their Shape and Purpose*. 1st British Edition. London, Eng.: Conway Maritime Press in association with the National Maritime Museum, 1983.
- North American Yacht Racing Union. *Scantling Rules for Yachts Built to the Universal Rule in Classes of 46 Foot Racing and Below*. New York, N.Y.: American Yacht Racing Union, 1929.
- Patterson, Harold W. *Small Boat Building*. New York, N.Y.: The MacMillian Co., 1972.
- Rabl, Samuel S. *Boat Building in Your Own Back Yard*. Cambridge, Md.: Cornell Maritime Press, 1958.
- Roberts, Al, ed. *Enduring Friendships*. Camden, Me.: International Marine Publishing Co., 1970.
- Schoettle, Edwin J., ed. *Sailing Craft*. New York, N.Y.: The MacMillian Co., Inc., 1927.
- Simmons, Walter. *Lapstrake Boatbuilding*. 2 vols., revised and updated. Lincolnville Beach, Me.: Duck Trap Woodworking, 1983.
- Smith, Harvey G. *Boat Carpentry*. 1st ed. Princeton, N.J.: Van Nostrand, 1955.
- Stephens, W.P. *Canoe and Boatbuilding*. New York, N.Y.: Forest and Stream Publishing Co., 1889.
- Steward, Robert M. *Boatbuilding Manual*. Camden, Me.: International Marine Publishing Co., 1970.
- Thomas, Barry Gifford. *Building of the Herreshoff Dinghy; Manufacturer's Method*. Mystic, Ct.: Mystic Seaport Museum, Inc., 1977.
- Webb, Frank Rush. *Manual of the Canvas Canoe; Its Construction*. New York, N.Y.: Forest and Stream, 1898.
- ### C. Iron Hulled Vessels
- Grantham, John. *Iron Ship-Building*. 5th ed. London, Eng.: Virtue and Co., 1886.
- Reed, E.J. *Shipbuilding in Iron and Steel*. London, Eng.: John Murray, 1869.
- Thearle, Samuel James Pope. *The Modern Practice of Shipbuilding in Iron and Steel*. 2nd ed. London, Eng.: William Collins, 1891.
- Wilson, Theodore D. *An Outline of Ship Building Theoretical and Practical*. New York, N.Y.: John Wiley and Son, 1873.
- ### D. Steel Hulled Vessels
- American Bureau of Shipping. *Rules for the Classification and Construction of Steel Ships*. New York, N.Y.
- Arnott, David, ed. *Design and Construction of Steel Merchant Ships*. New York, N.Y.: Society of Naval Architects and Marine Engineers, 1955.
- Baker, Elijah III. *Introduction to Steel Shipbuilding*. New York, N.Y.: McGraw Hill, 1953.
- Holmes, A. Campbell. *Practical Shipbuilding: A Treatise on the Structural Design and Building of Modern Steel Vessels*. London, Eng.: Longmans, Green and Company, 1918. 2 vols.
- Talbot-Booth, E.C. *Merchant Ships*. England: MacMillan, 1943.
- Walton, Thomas. *Steel Ships: Their Construction and Maintenance*. London, Eng.: Griffin and Co. Ltd., 1902.
- ### E. Steam Powered Vessels
- #### I. History
- Ambler, Charles Henry. *A History of Transportation in the Ohio Valley*. Westport, Ct.: Greenwood Press Publishers, 1970.

Fletcher, R.A. *Steam-ships: The Story of Their Development to the Present Day*. Philadelphia, Pa.: J.B. Lippincott Company, 1910.

Institution of Naval Architects. *Transactions of the Institution of Naval Architects*. London, England.

Jacobus, Melancthon W. *The Connecticut River Steamboat Story*. Hartford, Ct.: The Connecticut Historical Society, 1956.

Morrison, John H. *History of American Steam Navigation*. New York, N.Y.: Stephen Daye Press, 1958.

Petersen, William J. *Steamboating on the Upper Mississippi*. Iowa City: The State Historical Society of Iowa, 1968.

Preble, George Henry. *A Chronological History of the Origin and Development of Steam Navigation 1543-1882*. Philadelphia, Pa.: L.R. Hamersly and Company, 1883.

Ridgely-Nevin, Cedric. *American Steamships on the Atlantic*. Newark, Del.: University of Delaware Press, 1981.

Rowland, K.T. *Steam at Sea: A History of Steam Navigation*. New York, N.Y.: Praeger Publishers, 1970.

Smith, Edgar C. *A Short History of Naval and Marine Engineering*. Cambridge, Eng.: The University Press, 1937.

Society of Naval Architects and Marine Engineers. *Historical Transactions*. New York, N.Y.: The Society of Naval Architects and Marine Engineers. (Numerous years)

Sprat, H. Philip. *The Birth of the Steamboat*. London, Eng.: Charles Griffin and Company, Ltd., 1958.

Tyler, David Budlong. *Steam Conquers the Atlantic*. New York, N.Y.: D. Appleton-Century Company, 1939.

2. Vessel Types

Bates, Alan L. *The Western Rivers Steamboat Cyclopedium or American Riverboat: Structure and Detail*. Leonia, N.J.: Hustle Press, 1968.

Baxter, Raymond J., and Arthur G. Adams. *Railroad Ferries of the Hudson and Stories of a Deckhand*. Woodcliff Lake, N.J.: Lind Publications, 1987.

Hilton, George W. *The Great Lakes Car Ferries*. Berkeley, Calif.: Howell-North Books, 1962.

Mitchell, Richard M. *The Steam Launch*. Camden, Me.: International Marine Publishing Company, 1982.

Newell, Gordon, and Joe Williamson. *Pacific Coastal Liners*. Seattle, Wash.: Superior Publishing Company, 1959.

3. Technical (Naval Architecture and Marine Engineering)

Babcock & Wilcox Company. *Marine Steam*. New York, N.Y.: The Babcock & Wilcox Company, 1918.

Babcock & Wilcox Company. *Steam*. New York, N.Y.: The Babcock & Wilcox Company (numerous years).

Barton, John K. *Naval Reciprocating Engines and Auxiliary Machinery: A Textbook for the Instruction of Midshipmen at the U.S. Naval Academy*. Annapolis, Md.: The United States Naval Institute, 1914.

Bourne, John. *A Treatise on the Steam Engine and Its Application to Mines, Mills, Steam Navigation and Railways*. London, Eng.: Longman, Brown, Green, and Longmans, 1851.

Bridger, Capt. H.H., and Oswald M. Watts. *The Stowage of Cargo: A Practical Treatise on the Description, Handling, and Stowage of Cargo*. London, England: Imray, Laurie, Norie and Wilson, Ltd., 1927.

- Carmichael, A.W. *Practical Ship Production*. New York, N.Y.: McGraw-Hill Book Company, Inc., 1919.
- Edwards, Emory. *Modern American Marine Engines, Boilers, and Screw Propellers: Their Design and Construction*. Philadelphia, Pa.: Henry Carey Baird and Company, 1886.
- Hillcoat, Charles H. *Notes on the Stowage of Ships: A Handy Book upon the Stowage of Cargoes, with Weights and Measures*. New York, N.Y.: Colonial Publishing Company, 1919.
- Holmes, A. Campbell. *Practical Shipbuilding: A Treatise on the Structural Design and Building of Modern Steel Vessels*. London, Eng.: Lonnans, Green and Company, 1918. 2 vols.
- International Correspondence Schools Reference Library*. Vol. 170 "Marine Engines, Marine Pumps." Scranton, Pa: International Textbook Company, 1907.
- International Library of Technology*. Vol. 9B "Marine Boilers, Refrigeration." Scranton, Pa: International Textbook Company, 1907.
- Lyon, Frank, Lieut. Commander U.S. Navy, and Lieut. Commander A.W. Hinds, U.S. Navy. *Marine and Naval Boilers*. Annapolis, Md.: The United States Naval Institute, 1915.
- Seaton, A.E. *A Manual of Marine Engineering Comprising the Design, Construction, and Working of Marine Machinery*. London, Eng.: Charles Griffin and Company, Ltd., 1928.
- Seward, Herbert Lee. *Marine Engineering*. Vol. I. New York: The Society of Naval Architects and Marine Engineers, 1942. Eleventh printing 1968.
- _____. *Marine Engineering*. Vol. II. New York: The Society of Naval Architects and Marine Engineers, 1944. Eleventh printing 1968.
- Sothern, J.W.M. "Verbal" *Notes and Sketches for Marine Engineers: A Manual of Marine Engineering Practice*. Glasgow, Scotland: James Monroe and Company, Ltd., 1915.
- Sterling, Frank Ward, ed. *Marine Engineers' Handbook*. New York: McGraw-Hill Book Company, Inc., 1920.
- ### F. Yachts
- Chapelle, Howard I. *Yacht Designing and Planning for Yachtsmen, Students and Amateurs*. New York, N.Y.: W.W. Norton Co., 1936.
- Fox, Uffa. *Sailing, Seamanship, and Small Yacht Construction*. New York, N.Y.: Charles Scribner's Sons, 1934.
- Herreshoff, L. Francis. *The Common Sense of Yacht Design*. Jamaica, N.Y.: Caravan-Maritime Publishing Co., 1966.
- Kemp, Dixon. *Yacht Architecture: A Treatise on the Laws Which Govern Resistance of Bodies Moving in Water*. London, Eng: H. Cox, 1885.
- Kinney, Francis S. *Skene's Elements of Yacht Design*. 8th edition. New York, N.Y.: Dodd, Meade and Co., 1981.
- Kunhardt, C.P. *Small Yachts*. New York, N.Y.: Forest and Stream Publishing Co., 1887.
- Rousmaniere, John. *The Golden Pastime; A New History of Yachting*. New York, N.Y.: W.W. Norton, c. 1986.
- Stephens, William D. *Traditions and Memories of American Yachting*. Reprinted from Motor Boating. New York, N.Y.: Hearst Magazines, Inc., 1941.
- Vaughan, T.J. *International Fourteen Foot Dinghy 1928-1964; Handbook and History*. London, Eng.: International Fourteen Foot Dinghy Class Association of Great Britain, 1964.
- ### G. Ship Models
- Ronnberg, Erik A. *To Build a Whaleboat: Historical Notes and a Model Maker's Guide*. New Bedford, Ma.: Old Dartmouth Historical Society, 1985.
- Waite, A. H. *Catalogue of Ship Models, Part 1: Ships of the Western Tradition to 1815*. Greenwich, Eng.: National Maritime Museum, 1981.

IV. Vessel Registration

- Annual List of Merchant Vessels of the United States.* Washington, D.C.: Government Printing Office.
- Brouwer, Norman J. *International Register of Historic Ships.* Annapolis, Md.: Naval Institute Press, 1985.
- Jackson, Melvin H., ed. *Historic American Merchant Marine Survey.* Salem, N.H.: Ayer Co., 1983.
- Lloyd's Register of British and Foreign Shipping.* London, Eng: Lloyd's Register of British and Foreign Shipping.

V. Directories

A. Maritime Museum Directory

- American Association of Museums. *The Official Museum Directory.* Skokie, Ill.: National Register Publishing Company, 1980.
- Howe, Edward Hartley. *North America's Maritime Museums: An Annotated Guide.* New York, N.Y.: Facts on File, 1987.
- Landauer, Lyndall B., and Donald A. Landauer. *Pacific Marine Museums: And Data Research Centers.* Pasadena, Ca.: Flying Cloud Publishers, 1985.
- Nautical Museum Directory.* 4th ed. New York, N.Y.: Quadrant Press, Inc., 1976.

VI. Published Documentation on Individual Historic Vessels

- Braynard, Frank O. *S.S. Savannah: The Elegant Steam Ship.* New York, N.Y.: Dover Publications, Inc., 1963.
- DeLong, Harriet Tracy. *Pacific Schooner WAWONA.* Bellevue, Wash.: Documentary Book Publishers Corporation, 1985.
- Jackson, Melvin H., ed. *The Historic American Merchant Marine Survey, Works Progress Administration, Federal Project No. 6.* Salem, N.H.: The Ayer Company, 1983. 7 vols.

- Kline, M.S. *Steamboat Virginia V. Bellevue.* Wash.: Documentary Book Publishers Corporation, 1985.
- Lambert, Andrew. *Warrior: The World's First Ironclad, Then and Now.* Annapolis, Md.: Naval Institute Press, 1987.
- Owsley, Frank Lawrence, Jr. *The C.S.S. FLORIDA: Her Building and Operations.* The University of Alabama Press, 1987
- Summersell, Charles Grayson. *C.S.S. ALABAMA: Builder, Captain and Plans.* The University of Alabama Press, 1985.

VII. Photography

- Borchers, Perry E. *Photogrammetric Recording of Cultural Resources.* Washington, D.C.: Technical Preservation Services, 1977.
- Chambers, J. Henry. *Rectified Photography and Photo Drawings For Historic Preservation.* Washington, D.C.: Technical Preservation Services, 1975.
- Time-Life Books. "The Camera" (1970); "Documentary Photography" (1972); "Photography as a Tool" (1970). *Library of Life Photography.* New York, N.Y.: Time-Life Books.
- United States Department of the Interior, National Park Service. *Guidelines for Recording Historic Ships.* Washington, D.C.: U.S. Department of the Interior, National Park Service, Historic American Buildings Survey/Historic American Engineering Record Division, 1988.

VIII. Wood Identification and Conservation

- Amburgey, Terry L. *Annotated Bibliography on Preservation and Control of Decay in Wooden Structures.* Gulfport, Miss.: United States Department of Agriculture, 1971.
- Anon. *Nomenclature of Commercial Timbers, Including Sources and Supply.* London, Eng.: British Standards Inst., 1974.

Department of the Navy. *Wood: A Manual for its use as Shipbuilding Material*. Kingston, Ma.: Teaparty Books, 1983.

Hoadley, R. Bruce. *Understanding Wood: A Craftsman's Guide to Wood Technology*. Newton, Ct.: Taunton Press, 1980.

Little, Elbert L., Jr. *1980 Checklist of United States Trees (Native and Naturalized)*. Washington, D.C.: Government Printing Office, 1980.

Oddy, W.A., ed. *Problems of the Conservation of Waterlogged Wood*. Greenwich, Eng.: National Maritime Museum, 1975.

United States Forest Products Laboratory, Madison Wisconsin. *Wood Handbook: Basic Information on Wood as a Material of Construction With Data for its Use in Design and Specification*. Washington, D.C.: Government Printing Office, 1955.

United States Forest Service. *Wood Decay in Houses: How to Prevent and Control It*. Washington, D.C.: Government Printing Office, 1969.

IX. Oral History

Bartis, Peter. *Folklife and Fieldwork: A Layman's Introduction to Field Techniques*. Washington, D.C.: Library of Congress, American Folklife Center, 1979.

Baun, Willa K. *Transcribing and Editing Oral History*. Nashville, Tenn.: American Association for State and Local History, 1977.

Goldstein, Kenneth. *A Guide for Field Workers in Folklore*. Hatboro, Pa.: Folklore Associates, 1964.

Hoopes, James. *Oral History: An Introduction for Students*. Chapel Hill, N.C.: University of North Carolina Press, 1979.

Ives, Edward D. *The Tape-Recorded Interview: A Manual for Field Workers in Folklore and Oral History*. Knoxville, Tenn.: University of Tennessee Press, 1980.

Jolly, Brad. *Videotaping Local History*. Nashville, Tenn.: American Association for State and Local History, 1982.

X. Periodicals (Current and past)

American Canals. York, Pa.: American Canal Society.

American History and Life. Santa Barbara, Ca.; Denver, Co.; Oxford, Eng.: ABC-CLIO Information Services.

American Neptune. Salem, Ma.: The Peabody Museum of Sharron.

Book Review Digest. New York, N.Y.: The H. W. Wilson Co.

Inland Seas. Vermillion, Ohio: The Great Lakes Historical Society.

Mariner's Mirror. London, Eng.: Society for National Research.

Merchant Fleet News. Washington, D.C.: United States Shipping Board, Merchant Fleet Corporation.

Motor Boat. New York, N.Y.: Motor Boat Publications, Inc.

Motor Boating. New York, N.Y.: International Magazine Co.

National Fisherman. Camden, Me.: Journal Publications.

Nautical Gazette. New York, N.Y.

Nautical Research Journal. Washington, D.C.: Nautical Research Guild.

One Design Yachtsman. Chicago, Ill.: One Design Yachtsman, Inc.

Power Boating. Cleveland, Oh.: The Penton Publishing Co.

Rudder. New York, N.Y.: The Rudder Publishing Co.

Sea History. Croton-on-Hudson, N.Y.: National Maritime Historical Society.

Shipmodeler. New York, N.Y.: A.C. and H.W. Dickens.

Steamboat Hill. Providence, R.I.: The Steamship Historical Society.

United States Naval Institute Proceedings. Annapolis, Md.: United States Naval Institute.

Woodenboat. Brooklin, Me.: Woodenboat Publications.

Yachting. New York, N.Y.: Yachting Publishing Corporation.



CASE STUDY

The following case study was written for illustrative purposes and is intentionally brief in order to save space and the user's time. An actual HAER study would be more in-depth, although time, money, and opportunity for research will govern report depth and length more than available research materials under some project conditions. This possibility, however, should not become an excuse for giving important vessels shallower treatment than their significance calls for. While this case study is reproduced in a two-sided format to save space, reports submitted to HAER must be produced on only one side of a page.



Noank Well-Smack EMMA C. BERRY
HAER No. CT-000
Page 1

HISTORIC AMERICAN ENGINEERING RECORD

Noank Well-Smack EMMA C. BERRY
HAER No. CT-000

Rig/Type of Craft: sloop

Trade: fishing

Official Number: 7971

Principal Dimensions: Length: 39.2' Gross tonnage: 15.76
Beam: 14.6' Net tonnage: 14.96
Depth: 5.7'

Location: Mystic Seaport Museum
Mystic, Connecticut

Date of Construction: 1866

Designer: Robert Palmer
(also known as Deacon Palmer)

Builder: R. & J. Palmer Yard
Noank, Connecticut

Present Owner: Mystic Seaport Museum
Mystic, Connecticut

Present Use: historic ship exhibit

Significance: This vessel is the last known representative of the Noank well-smack, a well-known fishing vessel type on the east coast of the United States from New England to Florida.

Researcher: Kevin G. Dwyer
Mystic Seaport Museum, 1988

Noank Well-Smack EMMA C. BERRY
HAER No. CT-000
Page 2

Significance

The EMMA C. BERRY is the last known representative of her type. Noank well-smacks were sloop rigged fishing vessels with a live or wet well.¹ Noank, Connecticut, shipbuilders developed a reputation for building fine smacks. They were known along the coast of North America as far south as Key West, Florida, where they were introduced by Connecticut fishermen.

Principal Dimensions²

The 1885 Merchant Vessels of the United States gives the following dimensions.

Length	39.2'	Gross tons	15.76
Breadth	14.6'	Net tons	14.96
Depth	5.7'		

Designer

The BERRY was designed by Robert Palmer.³ Robert Palmer (1825-1913) was usually referred to as Deacon Palmer. He and his brother John succeeded their father in his partnership with James A. Latham in 1845. The company then being known as Palmer & Latham. Shortly thereafter, Latham withdrew from the partnership. The firm of R. & J. Palmer continued until the death of John Palmer in 1879. The BERRY was built during these years. The yard prospered under Deacon Palmer's management and by 1896 was said to be the largest shipbuilding facility in the country. The early part of the 20th century, however, brought difficult economic times and by 1914 the yard was essentially closed.⁴

Where Built/Builder

The BERRY was built at the R. & J. Palmer Yard. At some point during the construction process, James A. Latham was hired by Robert Palmer to work on the BERRY. James Latham was a builder in his own right. After he withdrew from his partnership with Deacon Palmer, Latham formed James A. Latham & Company.⁵

Date of Construction

Robert Palmer agreed to build a boat for John Berry on February 20, 1866. The exact date construction began is unknown. The BERRY was launched on June 5, 1866.⁶

Noank Well-Smack EMMA C. BERRY
HAER No. CT-000
Page 3

Original Price

Robert Palmer agreed to build the BERRY for \$1,275.⁷ This price is for the hull only. In the 1860s it cost between \$700-\$1,000 more to outfit a vessel of the BERRY'S type.⁸

Original Construction

In terms of original construction, the only thing we can say with confidence about the BERRY is that she was a sloop, had a wet well, and a clipper bow.

The Van Horn Collection is a set of photographs taken of the BERRY prior to and during her 1934-35 rebuild. They are now located at Mystic Seaport Museum. The photographs taken before the BERRY was rebuilt should prove helpful in determining her original outboard configuration.⁹

In a broader perspective, there are several sources of information which might be helpful in distinguishing between original construction and later additions. A model of a schooner well-smack was discovered in Bergen, Norway. The model was exhibited by the United States in the 1880 Berlin Fisheries Exhibition.¹⁰ The scantlings of some of the model's timbers seem heavy for a vessel her size (62'1/2" LOA) but the construction style makes sense in terms of good shipbuilding practices.

A set of plans and construction drawings for the schooner GRAMPUS can be found in the 1887 edition of the Commissioner's Report to the United States Commission of Fish & Fisheries. The GRAMPUS was built as a research vessel for the Fish Commission in 1886. She was built at the R. & J. Palmer Yard, the same yard that built the BERRY. The GRAMPUS was built to government specifications and she is substantially larger than the BERRY.¹¹ Thus, inferences concerning construction methods which are based on the GRAMPUS must be tempered with caution. However, the Bergen model and the GRAMPUS are quite similar in their construction styles. Because of these similarities, I think they reflect at least in a general way, building practices common to the Noank area.

The following is a list of photographs that might also be helpful in making these determinations. The comparisons are based on Custom House measurements. They are all located at Mystic Seaport Museum. The MARY E. HOKIE (Photo identification numbers 72-10-15, 72.882.3 and 72.882.14) was built for John Berry at the Palmer Yard in 1868. The HOKIE is a schooner and about twice the size of the BERRY. WHISTLER (87-5-22) is a sloop rigged well-smack built

Noank Well-Smack EMMA C. BERRY
HAER No. CT-000
Page 4

in Mystic in 1868. She is smaller than the BERRY. JENNIE (87-4-13), a schooner rigged well-smack was built in Noank by John Latham in 1872. She is about the same size as the HOXIE. ELLA MAY (86-2-3, 86-2-20, 86-2-45) is a sloop rigged well-smack about the same size as the BERRY. ELLA MAY was built either in 1871 or 1877.

Alterations and Additions

The BERRY was converted to a schooner some time between November of 1886 and February 1887.¹² The rig change isn't noted in Merchant Vessels of the United States until 1895. In the 1916 edition of MVUS, she first appears as a motor vessel, i.e., an auxiliary engine was installed. Her wet well was removed in 1929.¹³ The 1926 MVUS lists a change of horsepower from the original 8 to 12. This probably represents the addition of an engine because in 1931 she had two engines.¹⁴ The engines were removed in 1931.

The BERRY was rebuilt in the winter of 1934-35 at the Morton Johnson Yard in Bay Head, New Jersey.¹⁵

In 1945 the rudder box was removed and replaced by a rudder tube. The transom was also rebuilt.¹⁶

Original and Subsequent Owners and Masters

The BERRY's first license (#20) was issued at Stonington, Connecticut, on June 18, 1866. John H. Berry is her master and one-half owner. The BERRY'S other owners were: Moses Wilber 1/8, William Latham 1/8, Charles Spencer 1/8, and Amos Lamphear 1/8.¹⁷

By September 27, 1866, the BERRY was sold. Her license (#30) of that date lists Amos E. Lamphear of Waterford, Connecticut, as master and 1/8 owner. The remainder of the ownership was divided between James Fitch, Jr., of New London, Connecticut, 1/4, 1/4 each to Henry Rogers and Thomas Rogers of New York City, and 1/8 to Amos Lamphear of Noank, Connecticut.

Her next license (#35, September 25, 1867) was issued at New London, Connecticut. Her master and ownership remain the same except that Amos Lamphear sold his 1/8 share to Anderson Crandell 1/16 and Albert R. Parrow 1/16, both of New London.

By March 4, 1868 (License #4), the previous owners had sold out to Henry A. Brown Jr., 3/8, and Martha E. Comstock 5/8, both of New London. George W. Comstock (New London) was listed as her

Noank Well-Smack EMMA C. BERRY
HAER No. CT-000
Page 5

master. License #4 (February 6, 1869) issued at New London, shows Henry Chapel of New London owns 5/8 of the BERRY and Henry Brown of New London 3/8. Her master is Robert Westcote also of New London.

The BERRY'S licenses for 1870, issued on March 3 (#12), and 1871 (#23), issued on April 30, list Anderson L. Crandell as master. The owners remain the same.

From 1872-1886 the BERRY was solely owned by Henry Chapel, although she sailed under numerous masters. Robert Westcote was listed as master from April 22, 1872 (License #34) to August 11, 1876 (License #9) when Colby C. Holmes (New London) became her master.¹⁸

Holmes remained her master until October 15, 1878 (License #14), when Truman Crocker (New London) was listed as master.

There is no license for 1879. The license (#18) for 1880 lists William E. Gross (New London) as master. While Henry Chapel remains the owner, he is designated as managing owner on this license. This designation remains the same until 1886. Her masters continue to change yearly: James W. Potter (Noank, April 9, 1881 #20), Edgar M. State (no town given, May 9, 1882 #26), R.S. Watrous (Mystic River, May 11, 1883), Samuel O. Crocker (New London, June 13, 1884 #28), Alvin Rathburn (Noank, June 8, 1885 #25), and Calvin Rathburn (Noank, June 11, 1886 #41).

The preceding list of owners and masters was compiled from Custom House records which were copied under the auspices of the Works Progress Administration. These records have been published for some Custom Districts but not for New London, Connecticut. The New London records are stored at the G. W. Blunt White Library, Mystic Seaport Museum. For some reason the records stop in 1886.

However, an advertisement by Henry Chapel in the February 18, 1887, issue of the New London Morning Telegraph lists the BERRY for sale as does another on February 4, 1892.¹⁹ I think it is safe to assume that Chapel remained the BERRY'S owner until at least 1892. The BERRY'S home port in Merchant Vessels of the United States remains New London until 1895 when it changes to St. George, Maine. It is quite possible that Chapel owned the BERRY until 1894-95. The ownership gap continues until 1919 when we again have licenses for the BERRY. These licenses are on microfilm (N.A. 334 Roll 1) located at the G.W. Blunt White Library.

Noank Well-Smack EMMA C. BERRY
HAER No. CT-000
Page 6

While the licenses themselves are probably available at the Federal Archives and Records Center in Waltham, Mass., time constraints have made it impossible to check there.

License (#6) issued at Machias, Maine, on March 19, 1919, shows F.W. Beal of Jonesport, Maine, as owner and Anson Kelly master. F.W. Beal owned the BERRY until 1924.²⁰

The next license on the microfilm (#5) issued on March 19, 1924, in Machias, Maine, shows George O. Beal owns 1/3 of the BERRY and Milton L. Beal 2/3. Both are from Jonesport. Their joint ownership continued until July 1929 when George Beal bought out Milton. Most of this time either George or Milton sailed as master²¹ except between June 10, 1926, and October 18, 1926, when Charles E. Beal is shown as master and between May 16, 1927, and June 4, 1927, when Corliss J. Crowley is listed as master.

Slade Dale purchased the BERRY in 1931,²² although this doesn't show up in the licenses until 1935. He continued as her owner until November 18, 1969, when he donated the BERRY to Mystic Seaport Museum.

Source of Original Name

The EMMA C. BERRY was named after John Berry's oldest daughter.²³

History of Type

A complete history of Noank smacks has yet to be written. Howard Chapelle, whose work provides the basis for the following history, has presented the most complete work to date.

Boats have been built in Noank since colonial times. Noank builders developed a reputation for building fast, able, seagoing sloops, smacks for fishing as well as large sloops used in the coasting, whaling, and sealing trades. These vessels were heavily sparred setting a large-gaff-mainaail and large jib. In light air, a gaff-topsail and jib topsail could be added.²⁴

Little is known about the early Noank smacks but they were certainly fuller bowed, more burdensome and slower under sail than later models like the BERRY. Chapelle feels they were modeled after mid-19th century New York sloop-yachts.²⁵

Noank Well-Smack EMMA C. BERRY
HAER No. CT-000
Page 7

Relationship to History

Around the middle of the 19th century, the schooner rig began to replace the sloop in popularity. A divided rig with its smaller sails was easier to handle than the single large mainsail of a sloop. Many sloops were converted to schooners. As was noted earlier, the BERRY was converted to a schooner.

The BERRY's working life began one year after the end of the Civil War and continued until 1931. In those years the United States changed from an essentially agrarian society to one of the great industrial nations of the world, fought the First World War, and experienced the beginning of the Great Depression.

The growth of the United States experienced after the Civil War was a continuation of the economic expansion which began after the War of 1812. While there were periodic panics, the general trend was upward. Improvements in the country's transportation system were the basis for this expansion. Roads, canals, and particularly railroads helped to people the West and connected them to the larger marketplace. Road, canal, and railroad construction also created a demand for cheap labor and immigration increased dramatically. The expanded domestic market quickened the pace of industrialization.

New York State and especially New York City were the first to feel the effects of this expansion. The completion of the Erie Canal in 1825, and railroads later, made New York City a leader in that arena.²⁶

In Connecticut, industrial output doubled between 1860 and 1870. In the years between 1850 and 1900 the state's population more than doubled and factory employment more than quadrupled.²⁷

New England fisheries participated in this economic growth. The growing population created an increased demand for fresh fish in coastal cities. The improved transportation system opened up new markets. Better refrigeration techniques expanded these markets even further.²⁸

The exact date when the first smackman sailed the hundred or so miles down Long Island Sound to sell his catch to New York is undetermined, but by 1819 at least some of the fishermen in New London County were engaged in this trade, in addition to their older one of supplying local markets.²⁹ These fishermen and those that followed them intercepted the mackerel on their way north in the spring and fished the near shore grounds of Southern New

Noank Well-Smack EMMA C. BERRY
HAER No. CT-000
Page 8

England for other fish. Some ventured out to George's Bank. Some sailed south in the winter supplying markets there. Connecticut fishermen started the red snapper trade between Key West and Havana Cuba. They also fished out of Pensacola, Florida, and as far west as Galveston, Texas, returning to Connecticut in the spring.³¹

John Berry (1822-1889) was one of those fishermen. According to his daughter, he captained seven vessels during his life. The BERRY was one of the two which were built for him.³¹

The following are entries from Deacon Palmer's journal:

February 10, 1866 - worked some on a model of R. Sawyer smack and drafted it.

February 20, 1866, agree to build boat for John Berry for \$1275.

February 26, 1866 agree with Mr. John Berry to make his smack - we are to build 2 feet longer and one foot wider making her dimensions 34 feet keel, 14 foot beam and 5.9 feet depth.³²

The model Deacon Palmer is referring to is a half-model. A half-model is a scaled representation of one-half of a vessel's hull. The model is constructed in lifts which divide the hull horizontally. "The half-model was shaped by eye to suit the judgement and artistic skill of its maker... (the model maker)... had to satisfy the skipper of the new vessel of the requisite qualities of seaworthiness, capacity and speed." After the model was completed and argued upon, it was taken apart and drafted. Offsets were picked up from these lines and a full-size drawing of the hull was made. The boat was built from the full-size drawings.³³

When Deacon Palmer gives the dimensions for the boat which was to become the BERRY he speaks of building her 2 feet longer, etc. It is likely that he is referring to Roswell Sawyer's smack ALMEDA. Her Custom House measurements were 12.34 tons, 37.0' x 13.5' x 5.1'. The BERRY's were 14.96 tons, 39.2' x 14.6' x 5.7'. It was a common practice among New England builders to increase the length of a boat by adding frames in amidships to assure a fair hull.³⁴ One can almost hear John Berry saying that he liked the Sawyer model but that he would like it about two feet longer and a little wider and deeper.

Noank Well-Smack EMMA C. BERRY
HAER No. CT-000
Page 9

Deacon Palmer's journal:

June 5, 1866...found John Palmer was at lower yard launching smack of John Berry's and he got his arm struck by a stick in his hands - some hurt...³⁵

The BERRY must have been ready to fish soon thereafter because her first license was issued on June 18, 1866, for the mackerel fishery. Licenses aren't exclusionary but it is probable that she was engaged in this fishery for a portion of her first season.

The years after the Civil War were prosperous ones for the New England mackerel fishery. In the years between 1867 and 1885 the average catch was 215,000 barrels per year. The low year was 1877, 117,096 barrels were landed, the high year was 1884 when 478,076 barrels of mackerel were marketed.³⁶

Mackerel are a migratory school fish which move north along the North American coast in the spring going as far north as Nova Scotia and Labrador and south again in the fall. Fishermen intercepted them all along this route.

In the years between 1820 and 1870 mackerel were caught almost entirely by hook and line fishing. The purse-seine didn't come in to common usage until about 1880.

Mackerel were caught on mackerel jigs. Mackerel jigs are hooks with tear drop shaped pieces of lead cast to the shank of the hook. The jig was fastened to a 15"-18" long heavy blue linen line called a "snapper-line." This was in turn fastened to the end of the hand line.

Vessels fitted out as mackerel hookers kept the deck clear for the fishermen. Along the starboard side of the vessel, below the rail, were cleats to which the fisherman attached his line. On the rail was a bait board with grooves cut into it. These held bait, either pieces of pork rind or strips cut from freshly caught mackerel. On the board or on the rail were "snapper cleats," short pieces of metal or wood which kept the lines in place. A bait mill was located on the port side of the vessel. It was used to grind menhadens for chum or toll bait. Near each bait board was a barrel to flip the mackerel into after they were caught.

When mackerel hookers reached a spot where they thought the mackerel were, they would hove-to and drift to leeward. Then a

Noank Well-Smack EMMA C. BERRY
HAER No. CT-000
Page 10

man, usually the skipper, began to spread menhaden chum to attract the mackerel to the boat. While he was doing that, he would put out two lines. If no mackerel were caught after an hour or so they would move on and try again. When one or two were caught, the crew would run to their stations and begin to fish.

"The excitement among the crew when the mackerel are biting fast can hardly be described. When the fishing begins, the drumming of the mackerel in the empty barrels is inexpressibly cheering to the fisherman...Every man is striving to the top of his bent to catch as many mackerel as possible while the "spurt" continues."

After the spurt was over, the catch was cleaned and salted in barrels. The vessels ran to market when the hold was full or when the captain decided it was time.

The occasions when the mackerel were biting fast were separated by long hours under sail looking for signs of the migrating schools. Not every mackerel cruise was a success.³⁷

The BERRY might have salted her catch, but southeastern Connecticut vessels engaged in the spring Block Island fisheries often ran their catch to New York alive in the well in the years before the Civil War. In later years the catch was iced.³⁸

John Berry kept his vessel for only four months. On September 27, 1866, the BERRY was issued a new license under new ownership. On a license issued the next day, John Berry is listed as 1/4 owner and master of the sloop CHAMPION. The CHAMPION was six years old, and measured 30.31 tons, 51.6' x 17.5' x 6.8'. He kept CHAMPION until at least 1867. The licenses for the CHAMPION stop here with no mention of ownership change.

The next vessel we can connect to John Berry is the MARY E. HOXIE which was built for him.³⁹ Her first license was issued in June 1868. Her Custom House measurements were 30.97 tons, 53.9' x 17.8'. He remained with the HOXIE for seven years. The vessel he was part owner and master of before he had the BERRY built was the CONNECTICUT.

Her custom House measurements were 29 1/100 tons, 47.4' x 16' x 7.2'. All three of these vessels are about twice the tonnage of the BERRY. One wonders what prompted him to have the BERRY built.

Noank Well-Smack EMMA C. BERRY
HAER No. CT-000
Page 11

The last vessel Berry commanded was the JOHN FEENEY. Coming home from a winter spent fishing in the south, the FEENEY was caught in a gale off Cape Hatteras. She was thrown on her beam ends but righted herself, however, John Berry was lost.

In 1869 Henry Chapel (1824-1900) began his long association with the BERRY. Henry Chapel was born in Montville, Connecticut. He began fishing in smacks at an early age. He eventually became captain and part owner of a coasting vessel. He continued in that trade until he opened a fish market in New London in the early 1860s. By 1870 he moved his business. His advertisement in the 1870-71 New London City directory states that he is in both the wholesale and retail fish and lobster business. In 1873 his brother joined him in the business, which then became Chapel Brother's Fish Market. His brother ceased to be a partner in 1882 and the business was renamed Henry Chapel and Son. The company placed a one-half page advertisement in that year's City Directory which states that they wholesale and retail all kinds of fresh fish as well as oysters and scallops, have a telephone to receive orders, and also rent first class pleasure boats for parties.

As Chapel's business prospered, he bought smacks and shares in smacks. While there may have been others, the following are the only ones for which Custom House records were found. In 1867 he is one 1/2 owner in the sloop JOHN DEXTER; in 1869 he is 5/8 owner of the BERRY, and sole owner in 1872; in 1878 he and his brother had the CHAPEL BROTHER'S built.

His business interests weren't confined to fishing. In 1873 Chapel had a steam tug built and named after himself. His were the first boats to begin selling fresh water to vessels in New London harbor, initially with the ANNIE SHERWOOD (2,000 gal. capacity) and later with UNDINE (5,200 gal.).

In 1883 Chapel contracted an illness from which he suffered for the rest of his life. In 1886 he sold his business to G.M. Long & Co., another New London fish dealer, for \$12,000.⁴¹

The years between 1860 and 1886 must have been busy ones for New London fishermen and the town as a whole. In 1860 there is one fish market in New London, in 1863 there are four, by 1870 six and in 1880 ten according to City Directories for those years. Wholesale dealers like Chapel bought fish from other fishermen and shipped the fish to New York and other markets by rail and steamer. All fish weren't shipped immediately, some were kept in

Noank Well-Smack EMMA C. BERRY
HAER No. CT-000
Page 12

floating cages called cars. The fish could be kept in the cars for months before they were sold.⁴²

In fact, after the advent of rail service between New London and New York, smacks didn't run to New York so often. They found they could sell their catch in New London just as profitably as in New York, all things considered.⁴³

Frank Slate fished from the BERRY for five years during the 1870s. He was born in July 1847. When he was two years old his father, Captain Jeremiah Slate of the whale ship CORINTHIAN, took Frank, his mother, and older brother with him on a whaling voyage. His youngest brother was born on board the CORINTHIAN off the coast of St. Helena. Slate began his fishing career at age eight.

During a school vacation, he went with Captain Richard Squire in the smack MARY ELLEN. Boys were often taken on smacks and taught how to cook, set table, and wash dishes. To get this experience they had to stand by and watch an experienced man prepare food. If he was good at it the boy qualified as cook in a season and began to fish in addition to his duties as cook. Slate made six dollars a month for his first season and worked on Captain Squire's farm after the season was over. It isn't clear from the account whether he continued with his schooling, but he fished with Captain Squire for a long time and later fished from other smacks besides the BERRY. He eventually became the captain of the yacht VENTURE.⁴⁴

When boys became full-time fishermen, they became "sharesmen." A sharesman's pay was based upon the proceeds received from the sale of the catch. The money was divided between the vessel and the crew. The split varied but a common division was 2/5 for the vessel and 3/5 for the crew.⁴⁵

One of the captains Slate fished with on the BERRY was Anderson Crandall. Coming home from an April fishing trip off Montauk Point, Long Island, they picked up eight men in a boat from the schooner DRINGO. The DRINGO sprang a leak and headed for Block Island. All hands were ordered to the pumps, but 24 hours of pumping were to no avail. The DRINGO filled and the men took to the boat. Soon after the DRINGO sank head first in a heavy sea. Eighteen hours later they were picked up by the BERRY and taken to New London.

In 1880 New London vessels landed 1,230,000 pounds of cod, 490,000 pounds of halibut, 467,500 pounds of bluefish, 73, 500

Noank Well-Smack EMMA C. BERRY
HAER No. CT-000
Page 13

pounds of swordfish, 159,800 pounds of bass, 4,223 barrels of mackerel, and 170,000 pounds of lobster.⁴⁷

The northern fishing grounds for southeastern Connecticut fishermen ranged along the coast of New Jersey north to George's Bank. Smaller vessels like the BERRY didn't go to George's Bank very often. They fished the New Jersey coast along both sides of Long Island and as far north as Nantucket.

The principal season was April through October, although a few vessels fished the year round. Others headed south in the winter to fish. In the early spring, the fishermen fished for mackerel and cod, later in the spring they might switch to blackfish or seabass. They would fish for seabass all summer. In July and August some vessels would pursue swordfish. In the fall they fished the bluefish runs and for blackfish and cod. Some vessels concentrated on one or two species all year long, especially the larger boats that fished George's Bank. Others fished for lobsters.⁴⁸

The March 31, 1881, edition of the Mystic Press notes that "Mr. Walton Potter has chartered the smack EMMA BERRY to go east in the lobster business."⁴⁹ Smacks from New London started going the Maine in the 1830's. They would buy lobsters there and transport them to Boston or New York.⁵⁰ The well-smack helped to change the Maine lobster fishery from a local part-time activity pursued by children and older men, to a regional industry.⁵¹

Sometimes smacks combined trapping lobsters on their own and trips to Maine. William Roy of New London went lobstering on the JOSEPH WOOLEY, John Quinn master and William Clark mate. They fished off No Man's Land for a week but were only getting about 25 lobsters a day. Captain Quinn decided to head for Maine. There they bought 1,600 lobsters and sailed to New York where they sold them.⁵²

The May 9, 1888, issue of the New London Day notes that the "Smack Emma C. Berry arrived today with a good fare of cod and haddock." The July 9, 1888, issue of the same paper states, "Schooners, E. C. Berry, with 27 swordfish, Sis Church with 22, Stephen Woolsey with 27 and Chapel Brothers with 16 arrived today..." The July 19th Day notes that "the smack E. C. Berry (arrived) with 19 swordfish."

According to Captain Benjamin Ashby of Noank, Connecticut, Noank and New London vessels started the swordfish season about the 6th

Noank Well-Smack EMMA C. BERRY
HAER No. CT-000
Page 14

of July. During July they found the most fish between No Man's Land and Block Island.

Swordfish were harpooned from the bowsprit of a vessel. The harpoons consisted of a 15 to 18-foot-long wooden pole 1-1/2 to 2 inches in diameter with one end fashioned to a point. The conical end of a 2-foot long 5/8-inch diameter metal shank was permanently fastened to the pointed end of the pole. A detachable four-inch long swordfish iron was fitted over the end of the shank. One end of this iron came to a triangular point while the other was shaped like a fish's tail. These ends were connected by a short shaft with a hole in the center, through which a harpoon line was attached. The other end of the 300 to 600-foot-long harpoon line was fastened to a buoy of some kind, often a mackerel keg. When the swordfish iron was driven into the fish, the rest of the harpoon was withdrawn. The iron then turned at a right angle to the direction the harpoon line pulled, making it impossible for the iron to be pulled out.

There was a bow pulpit attached to the end of the bowsprit. The bow pulpit consisted of a platform a little larger than is necessary to stand on. To this was fixed a metal upright with a metal circle at its top. The metal circle surrounded the harpooner's waist.

Swordfish were spotted from the masthead. When one was found the vessel was sailed to it. The harpooner, usually the captain, then went to the pulpit. He gave directions from there as to how he wanted the boat positioned so he could make the strike. The fish was harpooned when it was 6 to 10 feet in front of the vessel. The harpoon line was played out and the line was passed to men in a small boat. The fish was played from it. When the fish was finally brought alongside the small boat, the men killed it with a whale lance by striking it through the gills.⁵³

On November 12, 1888, there was a notice in the New London Day that the BERRY was leaving on a codfish cruise. The next mention of the BERRY is in the March 25, 1889, issue of the Day, "Schooner E. C. Berry arrived today with 300 codfish to G. M. Long & Co."

These scattered references almost cover a year. In May, the BERRY is fishing for cod, in July for swordfish. She left on a codfish cruise in November and returns from one in March. It certainly looks as if she is fishing year round, at least in 1888 and 1889; most of the year for cod but changing to swordfishing in season.

Noank Well-Smack EMMA C. BERRY
HAER No. CT-000
Page 15

It is also interesting to note she is landing fish to G. M. Long and Co., the company which bought out Henry Chapel.

As was noted previously, the BERRY was listed for sale in 1887 and again in 1892. By 1895 her homeport is listed as St. George, Maine in Merchant Vessels of the United States. We have been unable to research her history between 1895 and 1919.

In 1918 or 1919 the BERRY was purchased by I. W. (Will) Beal at an auction. By this time she had an auxiliary to help her get through the calms. He used her as a smack to transport lobsters and bait until about 1924. She sat on the Beals Island shore for awhile until Milton Beal decided she had some life left in her, and that he "liked the looks of her." Milton Beal bought her for \$100. He floated her across to Jonesport and hauled her out. There he, his father and another man completed a number of repairs. They also removed the wet well. He sold 1/3 of the BERRY to his brother George and the BERRY was relicensed in March of 1924. Milton Beal used her to transport salt, dried fish and coal and other goods between Rockland, Bangor and Jonesport, Maine. George Beal was in the fish buying business and also used the BERRY. This accounts for license switches between coasting trade and freight. A freight license was used to carry other people's goods; a coasting trade license to carry your own. Between June of 1926 and October of 1926 she was once again used as a fishing vessel with a crew of five. At about this time another engine was installed in the BERRY. She now had engines port and starboard. In 1929 George Beal became the BERRY's sole owner.⁵³

By 1931 the BERRY was 65 hard years old. But in that same year two young men came to Maine looking for a boat; Peter Jenness and Slade Dale. They ran into George Beal and asked him if he knew of any boats for sale. Beal suggested the BERRY. It was midnight before they found the BERRY.

As they came alongside she emerged from the darkness like a beautiful apparition or an angel, or whatever it is that registers a sweet vision on two fevered brains. She was lovely and that was all there was to it we fell in love with her at sight and have stayed so ever since.⁵⁵

They bought the BERRY and sailed her to New Jersey where they had the engines removed and had some repair work done. She was rebuilt in the winter of 1934-35. Dale used her as a yacht although sometimes he carried cargo with her. Dayton Newton sailed the BERRY to Noank in 1966 for her one hundredth birthday.

Noank Well-Smack EMMA C. BERRY
HAER No. CT-000
Page 16

At that time she was thought to be the oldest continuous registered vessel in the United States. Mystic Seaport Museum acquired the BERRY in 1969.

The BERRY is the last of all the smacks built in Noank. She is certainly a handsome vessel but many of her sisters must have been equally handsome. She survived a long time in a dangerous profession; a credit to her builders and the men who sailed her. She survived the transition from sail to power and the Great Depression which claimed so many vessels operating on the edge of profitability. She survived...a lucky vessel.

NOTES

¹A wet well is a water-tight box inside the vessel. They are usually located near the middle of a vessel. The wet wells in Noank smacks of the Berry's time were shaped like truncated pyramids. The top of the well is at deck level. The bottom of the boat forms the base of the pyramid. Many holes were drilled through the bottom of the boat inside the well, water could circulate through it. This allowed the catch to be transported alive. A description of the way wells were constructed in Noank in later years can be found in WoodenBoat 69 (March/April 1986), 47.

²The Custom House Measurements (CHM) cited here are from the 1885 edition of Merchant Vessels of the United States, the first year they appear in this publication. Except for gross tonnage they also appear on a vessel's license, enrollment, or register.

Net tonnage is a measure of a vessel's cargo carrying capacity. It is used to determine the amount of port duties and other charges assessed to a vessel. A history of CHN rules and the way they are calculated can be found in the American Neptune V (1945) 223-234.

Net tonnage for a particular vessel can change over time. The changes can reflect changes in measurement rules or changes to the vessel itself. In 1898 the BERRY'S CHM Changes to 15 gross tons and 14 net tons. All fractions of tons were dropped that year. In 1919 net tonnage changes to 12. This is probably due to the addition of auxiliary power. In 1936 the gross tonnage is changed to 16 and the net tonnage to 10. These changes reflect a

Noank Well-Smack EMMA C. BERRY
HAER No. CT-000
Page 17

reduction in cargo carrying capacity brought about by Dale's rebuilding of the BERRY.

³Robert S. Palmer, unpublished paper, 1971, File 69.231, Registrar's Office, Mystic Seaport Museum, 4. Mr. Palmer lives in Noank, Connecticut, and is a direct descendant of Deacon Palmer. His mother was the former Emma C. Berry.

⁴Richard G. Arms, "The Palmer Shipyards, Early 1800 to 1915," Noank Historical Society. Mr. Arms wrote this pamphlet based upon information supplied to him by Robert S. Palmer.

⁵Palmer, 1971, 4.

⁶Ibid., 2-4

⁷Ibid., 2

⁸ Personal communication with Robert S. Palmer. Figures are from Deacon Palmer's Journal.

⁹These photographs were discovered by Ms. Nancy d'Estang in Bay Head, New Jersey, during the course of her research on the BERRY.

¹⁰One of the people Ms. d'Estang contacted during her research was Eric Ronnberg. Mr. Ronnberg is a well-known model builder. He told her that he had seen a model in the Stiftelsen Fiskerimuseet in Bergen, Norway, which resembled a Noank schooner smack although it was listed as a Gloucester fishing smack. Through Nancy's persistence, it was discovered that the model was mislabeled and that in fact the model represented a Noank schooner smack. Mystic Seaport borrowed the model and a set of lines and construction drawing was lifted from it.

¹¹United States Commission of Fish & Fisheries, Report of the Commissioner (Washington: Government Printing Office, 1889), 438-41. Hereafter cited as Fish Commission Report with appropriate year.

¹²Palmer, 1971, 6.

¹³Maynard Bray, "Memo to Edmund E. Lynch," November 11, 1969, File 69.231, Registrar's Office, Mystic Seaport Museum.

Noank Well-Smack EMMA C. BERRY
HAER No. CT-000
Page 18

¹⁴F. Slade Dale, "Old Emma Comes to Barnegat," Yachting (June 1933) 45.

¹⁵Letter from Slade Dale to Dayton Newton, January 17, 1964, File 69.231., Registrar's Office, Mystic Seaport Museum.

¹⁶Letter from Lachlan Beaton to Maynard Bray, July 1, 1978, File 69.231, Registrar's Office, Mystic Seaport Museum.

¹⁷It was a common practice for individuals to own shares in a vessel. The shares were apportioned in fractions of 1/2, 1/4, 1/8...1/64, etc. The owners divided the vessel's profits in proportion to their ownership. Licenses were issued to vessels between 5-20 tons by the Collector of Customs after proof of measurement, ownership, and place of building were provided.

¹⁸The intervening licenses were: No. 29, April 25, 1873; No. 55, May 30, 1875; and No. 55., June 11, 1875.

¹⁹Palmer, 1971, 6-7.

²⁰Bray, "Memo to Edmund Lynch."

²¹Ibid.

²²Dale, "Old Emma Comes to Barnegat," 34.

²³Palmer, 1971, 5.

²⁴Howard I. Chapelle, The National Watercraft Collection (Washington: Government Printing Office, 1960), 267.

²⁵Howard I. Chapelle, The History of American Sailing Ships (New York: W.W. Norton and Co., 1935), 299-300.

²⁶Samuel Eliot Morison, The Oxford History of the American People (New York: Oxford Press, 1965), 478-85.

²⁷George L. Clark, A History of Connecticut: Its People and Institutions (New York and London: G. P. Putnam's and Sons, 1914), 354.

²⁸James M. Morris, Our Maritime Heritage and Their Impact on American Life (Washington D.C.: University Press of America, 1979), 153-54.

Noank Well-Smack EMMA C. BERRY
HAER No. CT-000
Page 19

²⁹John C. Pease and John M. Niles, A Gazetteer of the States of Connecticut and Rhode Island (Hartford: William S. March, 1819), 154.

³⁰George Brown Goode, The Fisheries and Fisheries Industries of the United States: History and Methods of the Fisheries (Washington: Government Printing Office, 1887), volume 1, section V, 592-94.

³¹Palmer, 1971, 5.

³²Ibid., 7.

³³Chappelle, The National Watercraft Collection, 8-11.

³⁴Ibid., 7.

³⁵Palmer, 1971, 3.

³⁶Raymond McFarland, A History of the New England Fisheries (New York: D. Appleton and Company, 1911), 267.

³⁷Fish Commission Report, 1881, 171-193.

³⁸Goode, History and Methods of the Fisheries, 274.

³⁹Palmer, 1971, 5.

⁴⁰Ibid, 5.

⁴¹Richard B. Wall, The Wall Scrapbook (New London, Ct: New London Historical Society), 582. A microfilm copy of articles written by Mr. Wall in the New London between 1907 and 1927.

⁴²Good, History and Methods of the Fisheries, 315.

⁴³Wall, 11.

⁴⁴Ibid., 578.

⁴⁵Ibid., 585.

⁴⁶Ibid., 440.

⁴⁷Goodes, History and Methods of the Fisheries, 817.

Noank Well-Smack EMMA C. BERRY
HAER No. CT-000
Page 20

⁴⁸Wall, 585.

⁴⁹Palmer, 1971, 6.

⁵⁰McFarland, History of New England Fisheries, 234.

⁵¹Kenneth R. Martin and Nathan Lipfert, Lobstering and the Maine Coast (Bath, Maine: Maine Maritime Museum, 1985), 11.

⁵²Wall, 585.

⁵³Goode, History and Methods of the Fisheries, 317-323.

⁵⁴Bray, 1969.

⁵⁵Dale, "Old Emma Goes to Barnegat," 34.

Noank Well-Smack EMMA C. BERRY
HAER No. CT-000
Page 21

BIBLIOGRAPHY

References

Albion, Robert G., et al. New England and the Sea. Middletown, Ct.: Wesleyan University Press, 1972.

Ansel, Willits D. Restoration of the Smack Emma C. Berry at Mystic Seaport 1969-1971. Mystic, Ct.: The Marine Historical Association, Inc., 1973.

Arms, Richard G., and Robert S. Palmer. The Palmer Shipyards, Early 1800 to 1915. Noank, Ct.: Noank Historical Society.

Baker, William A. Sloops and Shallops. Barre, Mass.: Barre Publishing Company, 1966.

Bray, Maynard. Unpublished Memorandum, File Number 69.231. Mystic, Ct.: Mystic Seaport Museum, Inc., Registrar's Office, 1969.

Chapelle, Howard I. The History of American Sailing Ships. New York, N.Y.: W. W. Norton & Co., Inc., 1935.

_____. The National Watercraft Collection. Washington, D.C.: Smithsonian Institution, 1969.

Clark, George L. A History of Connecticut: Its People and Institutions. New York, N.Y.; London, Eng.: G.P. Putnam's and Sons, 1914.

Goode, George B. The Fisheries and Fishing Industry of the United States. Washington, D.C.: Government Printing Office, 1884-1887.

Hall, Henry. Ship-Building Industry in the United States. Washington, D.C.: Government Printing Office, 1884.

Knapp, Edward E. The Smacks of Noank. Mystic, Ct.: Mystic Seaport Museum, Inc., Manuscript Collection 171, Blunt Library.

Leavitt, John F. Cradle of Ships: Chronological List of Vessels Built in the Stonington - Groton Area 1680 - 1919. Mystic, Ct.: Mystic Seaport Museum, Inc., unpublished manuscript, Blunt Library.

Noank Well-Smack EMMA C. BERRY
HAER No. CT-000
Page 22

Martin, Kenneth R., and Nathan R. Lipfert. Lobstering and the Maine Coast. Bath, Me.: Maine Maritime Museum, 1985.

McFarland, Raymond. A History of the New England Fisheries. New York, N.Y.: D. Appleton and Company, 1911. Facsimile. Ann Arbor, Mich.; London, Eng.: University Microfilms International, 1979.

Merchant Vessels of the United States. Washington, D.C.: Government Printing Office.

Morison, Samuel E. The Oxford History of the American People. New York, N.Y.: Oxford University Press, 1965.

Morris, James M. Our Maritime Heritage and Its Impact on American Life. Washington, D.C.: University Press of America, 1979.

New London City Directories. New London, Ct.: New London Historical Society, 1855-1860, 1863-66, 1872-77, 1887-88.

Palmer, Robert S. Unpublished Manuscript, File Number 69.231. Mystic, Ct.: Mystic Seaport Museum, Inc., Registrar's Office, 1971.

Pease, John C., and John M. Niles. A Gazetteer of the States of Connecticut and Rhode Island. Hartford, Ct.: William S. Marsh, 1819.

Stark, Charles R. Groton, Conn. 1705-1905. Stonington, Ct.: The Palmer Press, 1922.

United States Commission of Fish and Fisheries. Report of the Commissioner. Washington, D.C.: Government Printing Office, 1881-1903.

Wall, Richard B. The Wall Scrapbook. New London, Ct.: New London Historical Society. Microfilm of articles written for New London Day.

Works Progress Administration. Copys of New London Custom House Records. Mystic, Ct.: Mystic Seaport Museum, Inc., Blunt Library.

Periodicals

American Neptune. Salem, Ma.: The Peabody Museum of Sharron.

Noank Well-Smack EMMA C. BERRY
HAER No. CT-000
Page 23

WoodenBoat. Brooklin, Me.: WoodenBoat Publications.

Yachting. New York, N.Y.: Yachting Publishing Corporation.



Section 3
PHOTOGRAPHY

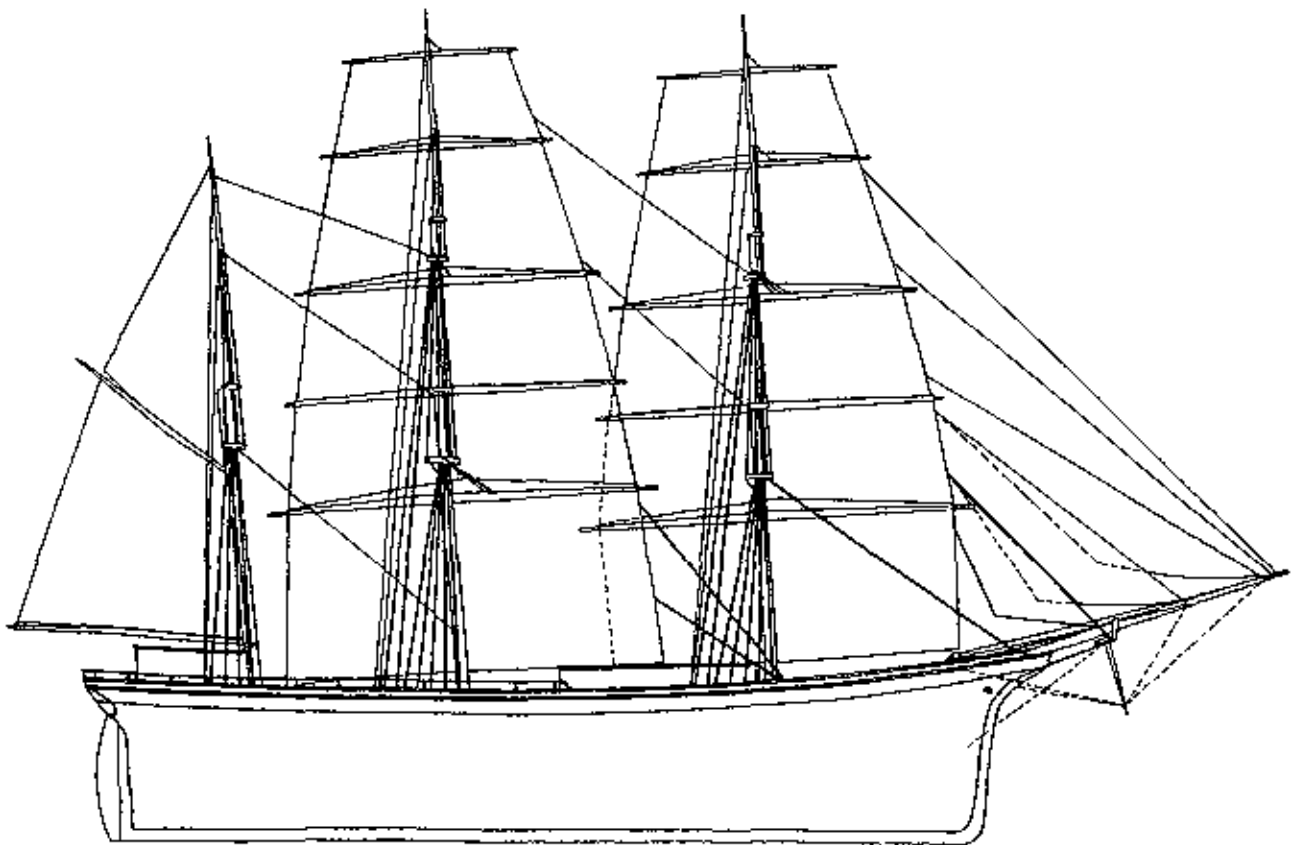

STANDARDS and GUIDELINES

Introduction: The outline format on the following pages provides a quick overview of general applications of the *Secretary's Standards* to the production of HAER large format photographs. The text that follows in Sections 3.2-3.3 tells you in more detail how to produce photos that meet the *Secretary's Standards*.

There are four parts to the outline, corresponding to each of the four standards *as they apply to large format photography*:

- I. Guidelines for explicating and illustrating what is significant or valuable about a historic vessel via photography.
- II. Guidelines for preparing photographs accurately from reliable sources.
- III. Guidelines for materials on which photographs are to be made.
- IV. Guidelines for producing clear and concise photographs.

The standards, as they apply to large format photography, follow well-established professional photographic practices. The distinguishing characteristic of HAER photography is that it is primarily a medium for capturing and storing facts and evidence about a resource, rather than medium for artistic expression.

3.1.2 Photography Guidelines

I. Explicating and illustrating what is significant or valuable about a vessel:

Recommended

Taking photographs of historically significant features, as determined by adequate research into relevant historical documents, publications, photographs, drawings and other sources.

Determining what significant features are best explicated and illustrated by photography, as opposed to measured drawings or written documentation alone.

Determining what views are best suited to explicating and illustrating the significant and valuable aspects of a vessel.

Not Recommended

II. Guidelines for preparing photographs accurately from reliable sources.

Recommended

Verifying identity and location of vessel to be photographed.

Composing photographs from stations that offer the maximum coverage of historically significant features.

Adjusting large format camera lens and film planes so that vertical features are parallel in the photograph to within 1 degree, eliminating distortions from "keystoning".

Including a scale stick in overall views to provide a scale reference for judging dimensions of resources in the photograph.

Selecting film and exposure settings appropriate to the vessel being recorded.

Using film and equipment within their capabilities and limitations.

Identifying resources and views accurately in photographs.

Identifying accurately original photographers, artists, engineers, architects, draftsmen and other authors of pre-existing materials which are photocopied for HAER

Recording accurately original titles, views, captions, identifications of pre-existing materials which are photocopied for HAER

Not Recommended

Photocopying copyrighted information for inclusion in the HAER record without written permission from the copyright owner(s).

III. Guidelines for materials on which large format negatives and prints are to be prepared.

Recommended

Using black and white films and papers with stable base materials and emulsions; placing prints on fiber-based print papers for longevity.

Using negative sizes 4"x5", 5"x7", or 8"x10" and associated contact prints

Processing negatives and prints in fresh or properly replenished chemistry, for proper temperature and processing times, including use of a hypo-eliminator bath or equivalent running water wash time.

Not Recommended

Use of film packs.

Use of color photography.

IV. Guidelines for producing clear and concise photographs.

Recommended

Shooting photographs with significant features in razor-sharp focus

Shooting photographs with lighting and exposures set so that significant features and details are registered on the negatives and easily visible in contact prints.

Organizing a set of photographs into a logical progression of views: general context of vessel, principal elevations, significant exterior details and features, principal interior spaces, machinery, processes, etc.

Identifying views with proper vessel name, view, date, photographer's name.

Preparing an Index to Photographs with proper vessel name, location and HAER number; assigning unique image numbers containing project HAER number to each negative and corresponding print; describing contents of each view in direct language, pointing out historic features or other significant information not readily presentable or discernable in a photograph without accompanying verbal data. (For example, names of spaces, parts, functions, materials, relationships)

Not Recommended

Using soft focus lenses.

3.1.4 Photography Guidelines



LARGE FORMAT PHOTOGRAPHY for HISTORIC SHIPS

Introduction. Ships have made major contributions to America's expansion, trade, defense, and lore throughout this country's history. These accomplishments were made possible in part by technological progress, skilled designers and craftsmen, able seamen, and the vision of many individuals, businesses, industries, and government. Photography of surviving, historically significant vessels is employed by the Historic American Engineering Record to document and interpret such ships for future study, and occasionally for preservation. While the specifications and guidelines to follow are tailored to HAER's requirements, they are based on professional practice and most of them will apply equally well to archival photography made for other clients. The photographs you make of a vessel for HAER will form part of a documentary package which includes a written history and often measured drawings. This documentation is transmitted by HAER to the Library of Congress where it is made available to the public by the Prints and Photographs Division. Photographs made for HAER are in the public domain and cannot be copyrighted.

Large format photography is defined in Section III of the *Secretary of the Interior's Standards for Architectural and Engineering Documentation* as photographs having negatives 4"x5" or larger (see Section 4.9 for the complete text of these

standards). Popular smaller formats such as 2-1/4" x 2-1/4" or 35mm are not acceptable for documentation submitted to HAER, whether archivally processed or not. Negatives smaller than 4" x 5" should not be said to "meet HAER standards" even if retained at another repository. There are three reasons for these specifications: resolution, perspective correction, and handling. The ability of large formats to record and resolve detail is considerably superior to formats such as 35mm. This is primarily a matter of unalterable optical laws, and only secondarily one of equipment or film. Film for film, an 8" x 10" or 11" x 17" enlargement from a good 5" x 7" negative is many times sharper than one made from a 35mm negative, and is thus of much greater potential use to historians, restorationists, exhibit designers, etc. Though perspective correction (or PC) lenses are manufactured for small format equipment, large format view cameras are still more versatile in controlling composition and correcting distortions. Large format negatives are also more easily stored and reproduced at the Library of Congress, where negatives must be individually cataloged and filed. Smaller formats are commonly filed as strips of multiple images, individual images being too difficult to handle. Obviously, small formats cannot be proscribed by HAER for use by organizations doing documentary work for their own purposes.

3.2.2 Photography for Historic Ships

Photography is required for Levels I, II, and III of HAER documentation as defined in the *Secretary's Standards*. The following specifications include information about equipment, films, processing, subjects and composition, photograph identification, and submission of your work to HAER. There are also instructions for use by HAER teams for completing an Index to Photographs and for numbering prints and negatives with HAER numbers for transmittal to the Library of Congress.

Ships documented by HAER are professionally photographed as they exist today, and occasionally historic photographs and drawings are photocopied as well. HAER documentary photography is not intended to cover such things as progressive steps of current restoration work, since this is not within HAER's documentary purpose. Beyond general overall views, there is no cut-and-dried formula to follow when deciding how many photographs are needed to document a specific ship or just what needs to be covered in every instance. The focus and extent of HAER photography is governed by the significance of the particular vessel being recorded and of the features aboard her. Level I coverage--reserved for vessels of the highest significance--is much more thorough than Level III.

Where a predetermined list of photographs is not specified, photographers are expected to consult recording team historians, delineators, and review team consultants for guidance on subject matter so that coverage will not contain serious gaps. Documentation of a vessel is a team effort, hence photographers should feel free to discuss views and suggest changes

when such things as lighting, coverage, or other factors can be improved. Formal photography aids in the preparation of measured drawings, historical reports, technical descriptions, and analyses in addition to providing a photographic survey of a ship. These records are intended to preserve the most significant information about a ship for 500 years, therefore, we urge you to meet the obligations of your responsibilities for photographic documentation.

Photographs to record historic ships *must* be produced according to the following criteria for acceptance to the HAER collection. Contract photographers are urged to read the following specifications before submitting an estimate or bid to HAER or to a third party performing documentation to HAER standards.

EQUIPMENT

Camera. The camera used must be a large-format view camera, no less than 4" x 5", no larger than 8" x 10", having all features necessary for perspective and focus correction, including bubble levels; *5"x7" is the preferred format.*

Note: These requirements will be waived only in cases of most extreme urgency (such as a vessel's imminent destruction) for which the timely procurement of large format photographers or equipment is not practical.

Lenses. No soft focus lenses should be used. The complement of lenses will include at least one of normal focal length, wide angle, and telephoto. View camera lenses must have adequate covering power to accommodate both front and rear

camera movements without vignetting. Aerial camera lenses should not be less than normal focal length.

Filters. Photographer's choice. Use of a pola screen is encouraged when doing photocopy work.

FILM

All documentary photography produced for HAER is black and white. Despite technological advances, no color negative or print process (short of black and white color separations) meets the 500 year lifetime requirements for photographs under Standard III. Digital formats (electronically produced and stored images) are not acceptable due to their rapid technological obsolescence and consequent inaccessibility.

Continuous Tone Photos. Any fine grain cut (sheet) film may be used which has a minimum resolving power no less than 80 lines/mm high-contrast range and 32 lines/mm low-contrast range, such as Tri-X, Royal Pan, Panatomic-X, etc. *No film packs.*

Continuous Tone Photocopies. Kodak Professional Copy Film 4125 or equivalent must be used for making continuous tone copy photographs. This applies to copies of photographs and graphics with colors and/or grey tones. It may be used for line drawings, but is not preferred unless contrast is poor.

High-Contrast or Line Copies. Line copies must be made using Kodalith film or equivalent. This film should only be used to copy line drawings or other graphics where colors and grey tones are

absent. 8" x 10" negatives are preferred. Opaquing and other forms of touch-up are not permitted since they themselves may not be archivally stable and may cause the negative to deteriorate.

PLEASE NOTE: Where preservation of scale and minimal distortion are important, a view camera should not be used to copy line drawings. Scale drawings should be submitted to a reprographics firm with a lithographic copy camera designed for such copy work.

PRINTS

Papers. All prints shall be glossy on single-weight, fiber-based paper in order to meet Standard III; "RC" (resin coated) paper or other bases will not be accepted.

Format. Contact prints. Multiple copies may be required. *See also "submitting photographs" on page 3.1.5.*

PROCESSING

Film and prints are intended to last 500 years. All film and prints shall be processed according to manufacturer's specifications, using fresh chemistry. Each step in the developing process must be thoroughly completed with recommended agitation. (Developer should be replenished according to manufacturers' specifications including limitations.)

Archival Processing. All film and prints must be thoroughly washed or treated in a hypo clearing bath (such as Permawash, Heico, Inc., Delaware Water Gap, Pennsylvania, or equivalent) in order to remove all traces of processing chemicals. This is essential to meeting Standard III.

3.2.4 Photography for Historic Ships

Film and prints must be washed before and after the hypo clearing treatment.

Tests. After processing, film and prints should be tested periodically for significant traces of residual hypo (sodium thiosulfate). Visible levels above comparison patch #1 of the standard Kodak Hypo Estimator Scale (Kodak publication J-11) used with test kit (Cat. No. 196-5847) is cause for rejection of film and/or prints. *Film and prints developed by automatic processors have repeatedly failed the above test and are not considered archivally permanent.* Tests are only accurate if performed within 24 hours of processing, so it is highly recommended that photographers test their film and prints before submitting them to HAER.

Stains and defects. Negatives and prints with visible hypo stains, poor focus, scratches or other defects will be rejected.

TECHNICAL INFORMATION

Composition. All photographs must be composed to give primary consideration to the architectural/structural features of the vessel with aesthetic consideration necessary but secondary. No features vital to the vessel shall be cropped out or hidden by vegetation, dockside machinery, or buildings unless this is absolutely unavoidable. Undesirable intrusions such as trash barrels, litter, bicycles, etc., shall be removed or concealed. Vehicles or other vessels, *when possible*, should be moved from view. Period furnishings, tools, and equipment should not be removed, but care should be taken that they do not block essential details of the vessel. Artistic judgment is necessary and must be exercised by the photographer.

Portions of mechanical or structural elements, such as an anchor capstan or hanging knees, must not be cropped from the picture when they are the primary subject of the photograph.

Lighting. Sunlight is preferred for exteriors, however, light overcast days may provide more satisfactory lighting at times. Flash units or reflectors may be needed to cast light into shadowed areas. Interiors should be illuminated to reveal detail in shadow areas. Be sure to check holds, engine rooms, and machinery spaces for flammable fluids and vapors before using a flash.

Focus. All areas of the picture must be in razor-sharp focus to meet Standards II and IV, regardless of the level of documentation being conducted. The use of a magnifying device is strongly recommended for focusing the camera.

Perspective Distortion. Since ships do not offer readily plumb or level lines and surfaces as do buildings, it is harder to adjust the camera to minimize distortion. However, views should *appear* to be plumb and level, i.e., having one- or two-point perspective. There must be no obvious perspective distortion unless deliberately introduced in a very limited number of cases for reasons of aesthetic effect or coverage in cramped quarters. Some oblique views (three-point perspectives) may be unavoidable in some cases, or even necessary for proper coverage (some parts of rigging, for example).

Exposures. Negatives must be correctly exposed. Thin or dense negatives may be rejected.

Transportation. A photographer working under contract to HAER or to a third party for HAER documentation is responsible for providing his transportation, including that from his base of operation to the location of the assignment and while on assignment.

Photocopies. See *FILM* above. Every effort should be made to make photocopies in a studio under controlled conditions using polarized light. The copying of scaled drawings where preservation of scale and proportion are important should only be made by a reprographics firm having a lithographic copy camera. *All HAER photographs must be in the public domain.* Photocopying of copyrighted material is prohibited unless written waivers to all rights are obtained from copyright owners and put on record at HAER.

VIEWS

General exterior and interior survey views required for Levels I, II, and III coverage are listed below; the checklists below are not exhaustive. Specific directions may be given as needed, usually on a Photographic Services Request form (see Fig. 3.2.1) if on-site direction is not available. Further views required for Level I or II coverage (including any materials to be photocopied) will be listed on the above form, especially where on-site consultation and direction on subject matter is not available. If a number of ships and/or documents are to be photographed, a list complete with their locations and the names, addresses, and telephone numbers of owners and/or critical contacts will be provided on the Photographic Services Request form.

EXTERIOR

Outboard. (required for Levels I, II, and III coverage of intact vessels and hulks)

- Profile (port or starboard)
- 3/4 view at bow
- end-on view of bow
- 3/4 view at stern (port or starboard quarter)
- end-on view of stern

(if possible, obtain views while vessel is out of the water. Include views of rudder/propellers.) wreckage, debris field (in cases of deterioration)

Weather Decks. (required for Levels I, II, and III coverage of intact vessels and hulks)

- Main deck, showing general arrangement of deckhouses, rails, superstructure, equipment, etc.

- Forecastle head, poop deck, other exterior deck areas

Details. (primarily for Level I coverage)

- bowsprit
- capstans, winches
- bulwarks and rails
- carvings, ornaments
- hatches and covers
- companionways
- skylights
- pumps
- donkey engines
- steering gear
- binnacle
- five rails
- masts, rigging
- davits, derricks

3.2.6 Photography for Historic Ships

boats
equipment peculiar to vessel's
trade or type

INTERIOR

Appropriate views selected from the checklist below are required as part of Level I, II, or III coverage, depending on the subject's significance.

accessible framing and structure of
hull
structural details
machinery spaces (engine rooms,
boiler rooms, auxiliaries,
tanks, shaft alleys)
wheelhouse
navigation, communications
equipment
captain's quarters
crew's quarters
passenger's quarters
public spaces (saloons, dining
rooms, staircases)
work spaces (holds, storage)
architectural details (joinery,
carvings, glass lighting
fixtures, metalwork,
brightwork)

OPERATIONS

vessel under way
vessel performing typical duties
(e.g., ore unloading,
fishing, dredging, towing
barges, etc.)
work performed aboard vessel,
showing uses of significant
features, machinery, etc.

Scale Sticks. For Level I coverage,
duplicate views of primary significant

features (as opposed to overall views) must be taken with a scale in the field of view. A minimum of one view with a scale stick is required for Level II or III coverage. For general views, the stick should be 8 or 10 feet in length and at least 1.5 inches wide, painted in alternate black and white areas of one foot each; the last 12 inches should be similarly divided into one-inch black and white stripes (see Fig. 4.5.3 on p. 4.5.6). There is no requirement or prohibition for additional use of a metric scale.

A stick whose section is flat or square is less likely to roll in the horizontal position than one which is round.

The stick should be positioned vertically or horizontally against the structure in a position easily visible and legible to the camera. A small 6" or 12" scale may be especially valuable in detail views where no easy reference for scale exists. In any case, the scale should not conceal or confuse the details being recorded by the camera, and should be clearly in focus.

Aerial Views. Aerial views may be requested to further record site conditions, especially in the cases of hulks or "graveyards." These may include both oblique and plan (direct overhead) views.

Aerial photographs *must* be made by helicopter or other suitable aircraft. Costs of aircraft charter are the responsibility of the photographer and should be included in the bid estimate as a separate item if submitting the bid to HAER. (Other agencies or clients may have different bid requirements.) HAER can provide a close approximation of flying time required. Recommended flying altitude ranges from

a low of 150 feet to a maximum of 500 feet. HAER suggests that the photographer require the door to be removed from the aircraft and that he position himself with appropriate restraints at the opening.

Minimum format for aerial photographs is 4" x 5". Standard aerial film, *archivally processed*, is acceptable. Views should be black and white. A yellow or orange (G) filter should be used to reduce haze effect.

SUBMITTING PHOTOGRAPHS

(see also "Preparations for Transmittal to the Library of Congress" p. 3.3.1)

Identification. The photographer *must* provide full written identification of each photograph taken and submitted. *Do not put identifications on the backs of prints.* (Use of a drawing, such as a deck plan, to further pinpoint location and direction of view may be helpful; drawing and verbal identification must be cross-referenced by match numbers.) Written identification must include, in the following order:

1. **Vessel name** (including rig/propulsion, e.g., Schooner EXAMPLE; vessel's name should be all in capital letters)
2. **Location** (river/harbor, pier/street, city, county, state)
3. **Brief Description of view**, including orientation of camera to vessel (e.g. looking forward, looking toward port quarter, etc.); compass orientation should be included for hulks or permanently exhibited vessels
4. **Day, Month, and Year of view**
5. **Photographer's Name**
6. **Photographer's Firm** (if any)

Data such as shutter speeds and f-stops are not required.

The photographer should *not* prepare an Index to Photographs (HAER format) unless specifically told to do so. Photos must be reviewed by the recording team, review team, (and HAER staff) and put in order, inferior views culled, and historic views and photocopies included in a logical sequence. Captions must be prepared and reviewed by historians before the Index can be prepared. (Proper photo identification provided by the photographer is essential to this process.)

Required Submissions. One original black and white negative and one good quality contact print of each photograph (unless more are specified) will be submitted. All contact prints shall be glossy finish on single-weight, fiber-based photographic paper. Contact prints must be made with black (bleed) margins of the entire sheet of film to reveal all details in the picture area plus the clear film margin (no washed-white margins). *Do not write on the margins of film or prints (numbers, dates, etc.).* Most inks are acidic and non-archival. They do not meet Standard III will adversely affect the life of photographic materials. Again, *do not write identifications on the backs of prints.*

Each negative should be placed in a transparent sleeve, and each sleeved negative, with contact print(s), should be placed in a standard brown kraft paper filing envelope for temporary film storage. Such sleeves and envelopes are not usually archival, so negatives and prints will be inserted into archival containers upon receipt by the National Park Service. Number all negatives on the sleeves only (crayon, marker) and put match numbers *in No. 1 pencil* on the *back edge* of each print and on brown storage envelopes.

3.2.8 Photography for Historic Ships

Write the complete identification (as directed under **Identification**) of an enclosed view on its envelope *before* inserting the negative and prints so you don't crease them.

CONTRACT PROCEDURES

This section is intended only for photographers under contract to the HAER office or to other National Park Service offices administering HAER documentation.

Purchase Order. *No work shall be undertaken until a purchase order is received from the national park service by the photographer.* However, in the case of emergency projects, a purchase order number may be provided by telephone or fax.

Identification. The purchase order will serve to identify the photographer to property owners and authorities. In some instances, a special letter of introduction may be provided by the National Park Service. Often a local organization or person has cooperated with the National Park Service in the administration of a recording project and will be available to provide guidance to the photographer. In such cases, necessary contact names and addresses will be provided. *These people are usually donating their time and services, so every effort should be made to respond to them.*

Pricing Your Bid/Estimate. A single "bottom line" figure is required. This is your estimate or bid. If you are the successful bidder, a purchase order will be issued to you for the submitted amount, and your final billing to the Government

cannot exceed this figure except under extraordinary circumstances and with prior approval by the National Park Service. The figure you provide must include all costs (labor, materials, transportation, subsistence, insurance, etc.). Your invoice must reflect the wording of the purchase order. Payment of invoices can be expected within six weeks of acceptance of your photographs.

Amendments to the Purchase Order. Purchase orders can be amended in certain circumstances, but these amendments must be justified. Should the National Park Service require additional photography while the photographer is on location, an amendment of the purchase order will be issued, the value of which will be based on the prorated unit price per photograph of the original order. *The number of photographs required by the purchase order divided in to the "bottom line" total value of the initial order determines unit cost.*

Partial Payments. Partial payments can be made if necessary when the nature of an assignment is such that work must be spread over a period of months. In any event, partial payment will not total more than 60% of the value of the purchase order, the final payment to be made upon full completion of the assignment and acceptance of the photographs.

Insurance. The National Park Service recommends that the successful bidder be fully protected through insurance against loss, liability, personal injury, and other contingencies. The United States Government is not, and cannot be, responsible for the loss of equipment,

injury, loss of life, damage to property, or other such casualties that may occur.

Performance Time Span. Unless specified, photography is to be completed within four weeks of receipt of the purchase order or purchase order number. Laboratory work and submission of the completed product will be not more than six weeks thereafter.

Weather Problems. It is possible that extraordinary weather conditions or other circumstances will delay a photographer on assignment. If this should occur, the photographer *must* notify the National Park Service of the circumstances without delay, and confirm the situation in writing. No consideration of financial relief will be given to the photographer for the extra time on location unless this instruction is followed.

Transmittal to HAER/National Park Service. Completed work should be hand delivered if possible. If hand delivery is not possible, then all photographs and negatives must be sent by an express mail service. In areas not covered by these services, *Registered* or *Certified* mail (U.S. Postal Service) must be used. Never send negatives and photographs through the mail without enclosing a statement of transmittal showing the complete address

and telephone number of the party to whom the package is being sent. If the package is damaged or delivered to an incorrect address, the enclosed transmittal statement will show the intended destination of the package.

Exclusive Use. All photographs and photocopies submitted to HAER become public domain property. Photographers may make duplicate original or copy negatives and prints for the use of others or themselves, provided that a credit line (e.g., John Doe, Historic American Engineering Record [or HAER]) is used. Address questions concerning photography or photographic contracts to your contracting officer or to:

Jet Lowe, Photographer
Jack E. Boucher, Photographer

HABS/HAER (429)
National Park Service
P.O. Box 37127
Washington, DC 20013-7127

Express mail delivery:

HABS/HAER
National Park Service
800 North Capitol Street, NW
Suite 300
Washington, DC 20001

3.2.10 Photography for Historic Ships



NO-910
(Rev. 4-82)

READ REVERSE SIDE FOR INSTRUCTIONS

STATE	COUNTY	MUNICIPALITY	STRUCTURE	NUMBER
<input type="checkbox"/> HABS <input checked="" type="checkbox"/> HAER <input type="checkbox"/> _____		DEPARTMENT OF THE INTERIOR NATIONAL PARK SERVICE HISTORIC AMERICAN BUILDINGS SURVEY/HISTORIC AMERICAN ENGINEERING RECORD PHOTOGRAPHIC SERVICES REQUEST (INSTRUCTIONS—PLEASE TYPE. Use a separate sheet for each structure except dependencies.)		COMP
STRUCTURE AND EXACT LOCATION:			HABS/HAER Number	DEADLINE
			USGS or City Map attached	PRIORITY <input type="checkbox"/> High <input type="checkbox"/> Medium <input type="checkbox"/> Low
DIRECTION PRINCIPAL ELEVATION FACES:		Number on location map	DATE OF REQUEST:	
FOR ENTRY CONTACT			PHONE NO.: (Include Area Code)	
ADDRESS			Is this structure being measured? <input type="checkbox"/> YES <input type="checkbox"/> NO	
EXTERIOR VIEWS REQUESTED: (Be specific, see instructions, reverse side)				
				TOTAL:
USE EXTRA SHEETS, IF NECESSARY				
INTERIOR VIEWS REQUESTED: (Be specific)				
				TOTAL:
USE EXTRA SHEETS, IF NECESSARY				
PROJECT	ORDERED BY:		(phone)	
	TITLE:			
ACCOUNT NUMBER	OFFICE and/or FIELD PROJECT TITLE			
SPECIAL INSTRUCTIONS: (if any)			DIVISION APPROVAL: DATE:	
SCHEDULE AND DISPOSITION:				(date)
PHOTOGRAPHER'S REMARKS:			(initials)	(date)
			(code)	

COMPLETE THIS INFORMATION AREA ONLY

COMPLETE THIS INFORMATION AREA ONLY++DO NOT WRITE ABOVE OR BELOW HEAVY LINES

Fig. 3.2.1

3.2.12 Photography for Historic Ships

This Photo Request cannot be accepted and photographs cannot be made unless and until this form is completed as outlined below. Please read and follow instructions fully.

1. **Form Usage:**
Use a separate form for each structure, but include minor dependencies on the same form as their parent structure. Please type.
2. **Completing the Form:**
Every statement in the area on the reverse side between the two heavy lines absolutely must be completed in detail.
 - a. It is necessary to list both exterior and interior details required. Use general terms for obvious detail (e.g., front elevation; perspective view of front elevation; detail, oriel, west side; fireplace, 1st floor, NW room). Be sure to describe exact location of hidden details (e.g., original chairrail fragment, closet, 3rd floor, SE room).
 - b. Do not recommend camera location, but specify details to be included in a given photograph, especially if the details have been measured and drawn.
3. **Deadlines:**
Specify, but be realistic. Do not give a date a month early to be on the safe side.
4. **Priority:**
Use *high* if structure is endangered, or of immense importance from an architectural, engineering or historical viewpoint, or if the structure is being measured and drawn.

Use *medium* for all buildings that are significant to the project in which you are involved, such as those for photodata book coverage.

Use *low* for all structures which, if they are not covered, little or no harm will result, or which will be available for photo coverage for a long period of time according to present knowledge.
5. **Direction Principal Elevation Faces:**
This is VERY important. Use a compass. Identify the direction using one of the sixteen points of the compass or by degrees. DO NOT substitute time of day and the sun's presence for the compass reading.
6. **Entry Contact:**
Obtain permission to photograph every structure, whether privately or publicly owned. Positively do not assume that because a structure is a post office, city hall, railroad tunnel, railroad station, bridge, etc., that permission to photograph is automatic. *IT IS NOT!* And record not only the name of the principal person to contact, but the name of a subordinate in charge during his absence. Get phone numbers and addresses.
7. **Location Map:**
Provide a good map of the area, if possible, and indicate on the map the exact location of each structure for which documentation is requested. Key the map sites to the photo request forms using numbers and the space provided on the reverse side. USGS maps are ideal.
8. **Signing the Form:**
Sign your name in the block *ordered by* and give your phone number. It would be very helpful if you would include your address and phone number away from the job (e.g., Team supervisor's winter address & phone). Division or regional approval required.
9. **Heavy Lines:**
Remember, DO NOT write above or below the two heavy lines.
10. **Routing of Request:**
Transmit yellow and pink copies to: Chief, HABS/HAER. You will be personally notified if your request cannot be handled for any reason prior to the noted deadline, in which case arrangements will be made on your behalf if you wish to have the assignment contracted to qualified non-government photographers. Retain blue copy for your record.
11. **Please staple a snapshot of the structure to the front of form, and the requested map.**

MAILING ADDRESS: Historic American Buildings Survey/
Historic American Engineering Record
National Park Service
U.S. Department of the Interior
Washington, DC 20240

PREPARATION OF PHOTOGRAPHS FOR TRANSMITTAL TO THE LIBRARY OF CONGRESS

Introduction. The instructions below are intended for HAER teams who are expected to submit completed photographic documentation at the close of their projects. These instructions may also apply under certain circumstances to agencies, contract photographers, or donors submitting documentation to HAER.

Organization. After the photographic coverage of a vessel has been processed and reviewed, all photographs--whether modern images, photocopied historic views, or line drawings--should be selected and put in a logical progression prior to numbering and captioning. Progressions might be chronological (by date), exterior to interior, or even category of image (line drawings might be grouped together, for example). In general, aerial and exterior views should come first, followed by interiors, and then details.

The "HAER Number". The HAER number for your vessel is the primary identifier for all negatives, prints, captions and other materials from a project. It consists of a two-letter state code abbreviation (same as that used by the U.S. Postal Service), followed by a hyphen and a project number: CA-54, for example, is the number assigned to HAER records of the ship *Balclutha* located in San Francisco, California. The project number should *always* be preceded by "HAER No." in order to distinguish it from a HABS project with the same number. These numbers are assigned only by HAER in order to avoid accidental

duplication and consequent confusion with records of another site. Corresponding negatives, prints and captions are identified in succession by adding a suffix to the HAER number: HAER No. CA-54-1, HAER No. CA-54-2, etc.

Negatives. Negatives should be labeled *only on the glossy side, only on one of the clear margins, never in the image area* (see Fig. 3.2.1). Only a carbon particle based drafting ink rated for plastics (such as "Pelikan FT" or equivalent) is to be used. The only exception to this placement of the HAER number is in cases of lithographic negatives ("line" or "litho negs") of historical drawings. Such negatives frequently have no margins, so a portion of the darkened emulsion outside the image area should be erased and the HAER number inked on the glossy side over this cleared area.

Negative Sleeves. Negative sleeves for transmittal to the Library of Congress are made of archivally stable buffered paper, and come in two sizes, 5"x7" or 8"x10". If your project is not supplied with these, leave labeled negatives in their temporary plastic sleeves for transmittal to HAER--the HAER office will transfer them to archival sleeves. Clear plastic sleeves need no labeling, *but they must be removed if you put negatives into archival sleeves.* Paper sleeves should be labeled only with the HAER photo number (e.g. CA-54-1) in No. 1 pencil (no ballpoint ink, no drafting ink), or else typed (impact printed, not laser printed). Small (5"x7")

3.3.2 Transmittal of Photographs

sleeves should be labeled to the right with the opening at the top, large (8"x10") sleeves in the upper right corners with the sleeve opening at the right side (see Fig. 3.3.1) *Sleeves should never be labeled with the negatives inside, since creasing will result!*

Contact Prints. Contact prints should be labeled with corresponding HAER numbers on *the back side, on one edge only*, using only No. 1 pencil (no ballpoint ink, no drafting ink).

Stamping and Mounting of Contact Prints. In most cases, this will be done by the National Park Service. If the task is yours, however, the backs of all prints should be stamped by a rubber stamp and archival manuscript ink with a rubber stamp identifying the image as part of the HAER collection in the Library of Congress. (Do *not* fill in the blanks in the rubber stamp impression.) When the stamped information is dry, prints are mounted in archivally stable 8½"x11" cards with slits cut in to receive print corners (glue is prohibited). The HAER number is lettered with No. 1 pencil or impact printed (typed) in the upper right corner of the cards, underneath the preprinted heading (see Fig. 3.3.2). (Laser printed numbers are not archivally stable.) Large prints are dry-mounted on the backs of the cards by the Library of Congress.

Index to Photographs. This is the caption listing for all a project's photographic images, including photocopies. The standard format for the first page of the Index appears in Fig. 3.3.3. Successive pages need only a heading in the upper

right corner in the standard format shown below:

Name of Vessel
HAER No. XX-1 (Page X)
INDEX TO PHOTOGRAPHS

Captions. Captions should be descriptive, giving orientation aboard the vessel, names of significant spaces, details, machinery or parts. Comments on the significance of photographed features is encouraged, as are cross-references to other photographs and photocopies, measured drawings, or the historical report. Please identify any intrusions as such.

Photocopies. Photocopied photographs and other graphics should always be identified as such in captions. Pertinent information such as the *original* photographer's name, date, subject, location, size of original photograph, sources, etc. should be provided. For drawings, information such as sheet title, delineator's or designer's name, date, sheet number, location of original, etc. should be provided. The photocopying photographer's name is unnecessary.

Multiple Photographers and/or Sources. Some projects will have a photographic record drawn from the work of a modern photographer, photocopies of photographs by two or more previous photographers, and photocopies of drawings or other graphics. In such cases, wasteful repetition can be alleviated by identifying all photographers and sources on the first page of the Index to Photographs and then assigning them initials to be used in appropriate photo captions (see Fig. 3.3.4).

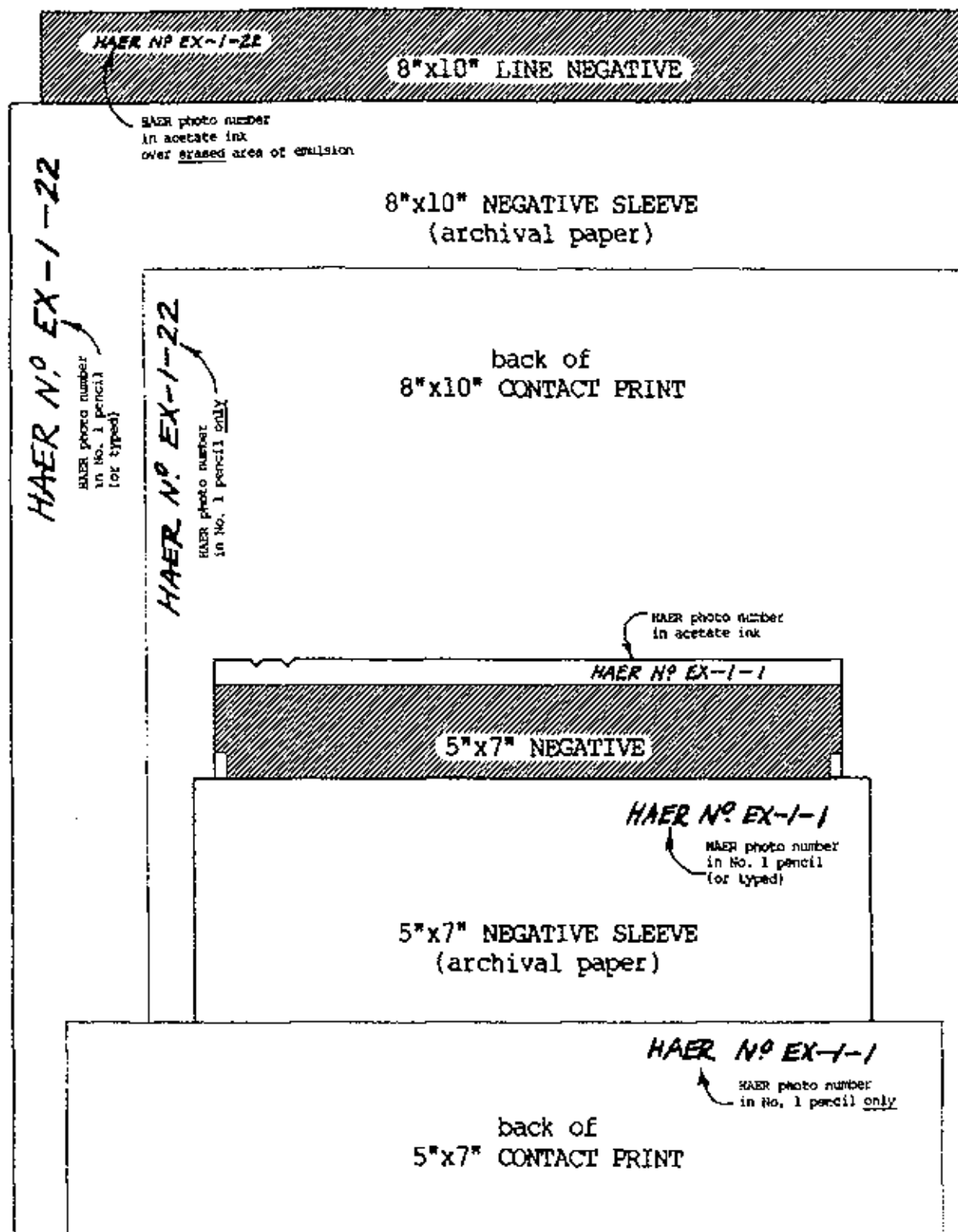

Fig. 3.3.1

3.3.4 Transmittal of Photographs

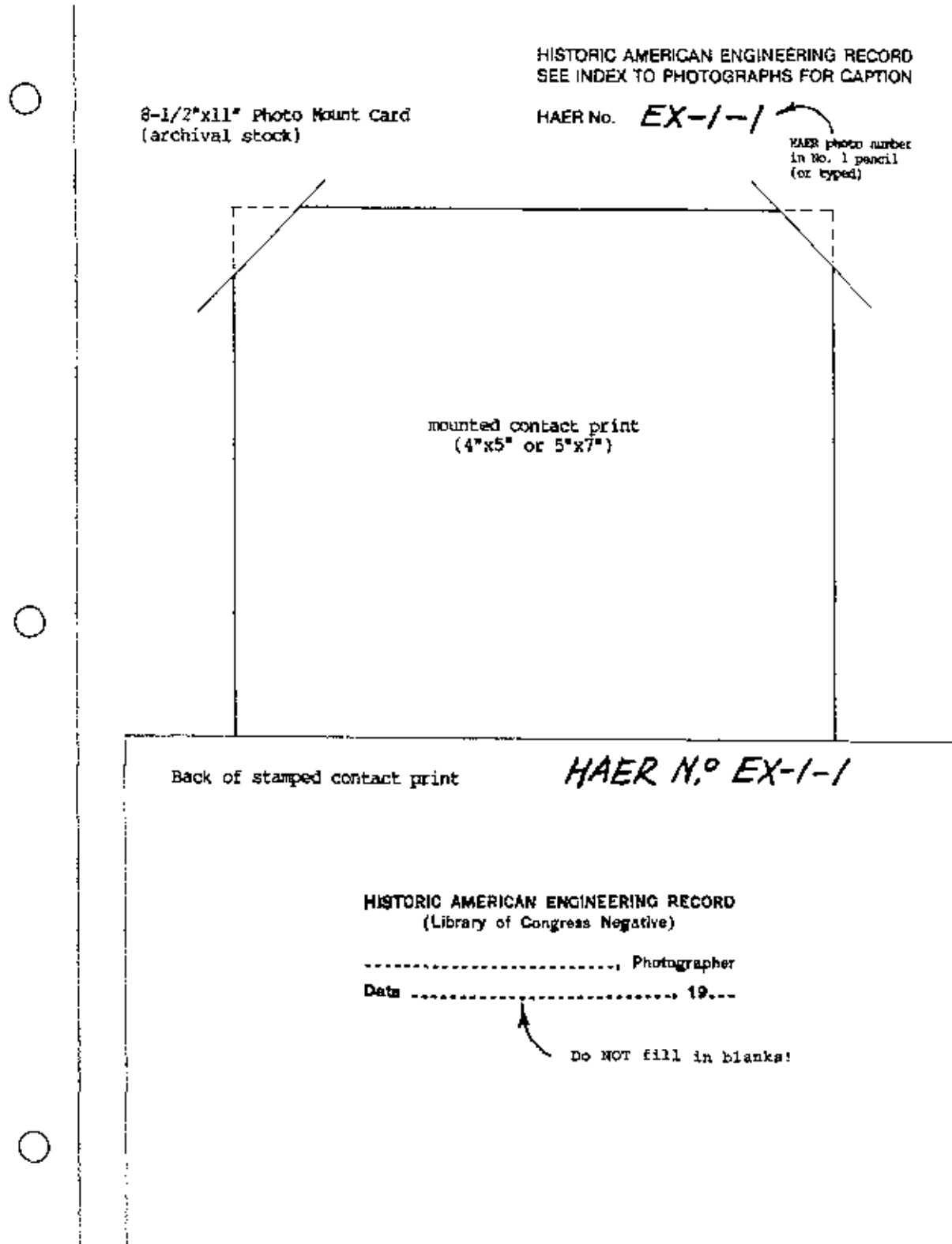

Fig. 3.3.2

HISTORIC AMERICAN ENGINEERING RECORD

INDEX TO PHOTOGRAPHS

Name of Vessel (e.g., Schooner EXAMPLE) HAER No. EX-1
Location (river, harbor, institution, etc.)
Street Address (or best approximation)
City
County [abbreviations such as "St." (Street), "Co." (County),
State or "CA" (California) are not permitted]

All photographs by [name of photographer], [month], [year].

EX-1-1: [Caption] [on the caption sheet, the words "HAER No." may be omitted from each photo number listed, but each negative, negative sleeve, print, and photo mount card MUST have the format "HAER No. XX-00-1"]

EX-1-2: [Caption]

EX-1-3: etc.

Fig. 3.3.3

3.3.6 Transmittal of Photographs

HISTORIC AMERICAN ENGINEERING RECORD

INDEX TO PHOTOGRAPHS

Schooner EXAMPLE
American Maritime Museum
No. 20 Fishermans' Harbor
Lake City
Somename County
Somestate

HAER No. EX-1

Credit JJD: Photographs taken of Schooner EXAMPLE in New York Harbor, July 15, 1921 by John J. Doe. Original photos in possession of Mrs. John J. Doe of Hackensack, New Jersey.

Credit STJ: Photographs taken of Schooner EXAMPLE on marine railway at Smith's Shipyard, 123 Front Street, Philadelphia, Pennsylvania, by S.T. Jones, April 1930. Original photos in possession S.T. Jones of Philadelphia.

Credit AMS: Photocopies of drawings dated August 4, 1953; prepared by A.M. Smith, Naval Architect of Flotsam & Jetsam, Inc., Philadelphia, Pennsylvania, for installation of engines and staterooms in Schooner EXAMPLE. Drawings in files of Smith's Yacht Repair (successor to Smith's Shipyard), Philadelphia.

- EX-1-1 Credit JJD: Starboard profile of EXAMPLE at anchor. Exact location undetermined; Statue of Liberty in distant background.
...
- EX-1-9 Credit STJ: Rebuilding of port bow and rail at Smith's Shipyard, Philadelphia, Pennsylvania, after collision with barge on April 1, 1930. New anchor winch (Smith & Jones, Philadelphia, Pennsylvania, No. 3) in crate to right of photo. This winch still in place during 1987 recording project.
...
- EX-1-22 Credit AMS: Photocopy of "EXAMPLE, Sheet No. 2" (original drawing 21" x 35", 3/8" scale) showing 'tween deck plan for engineroom and staterooms. Compare with HAER measured drawing sheet 5; forward engineroom bulkhead moved in December 1964 to accomodate new head. (Work performed in Guatemala; no further information was available to HAER.)

Fig. 3.3.4

Section 4
MEASURED DRAWINGS

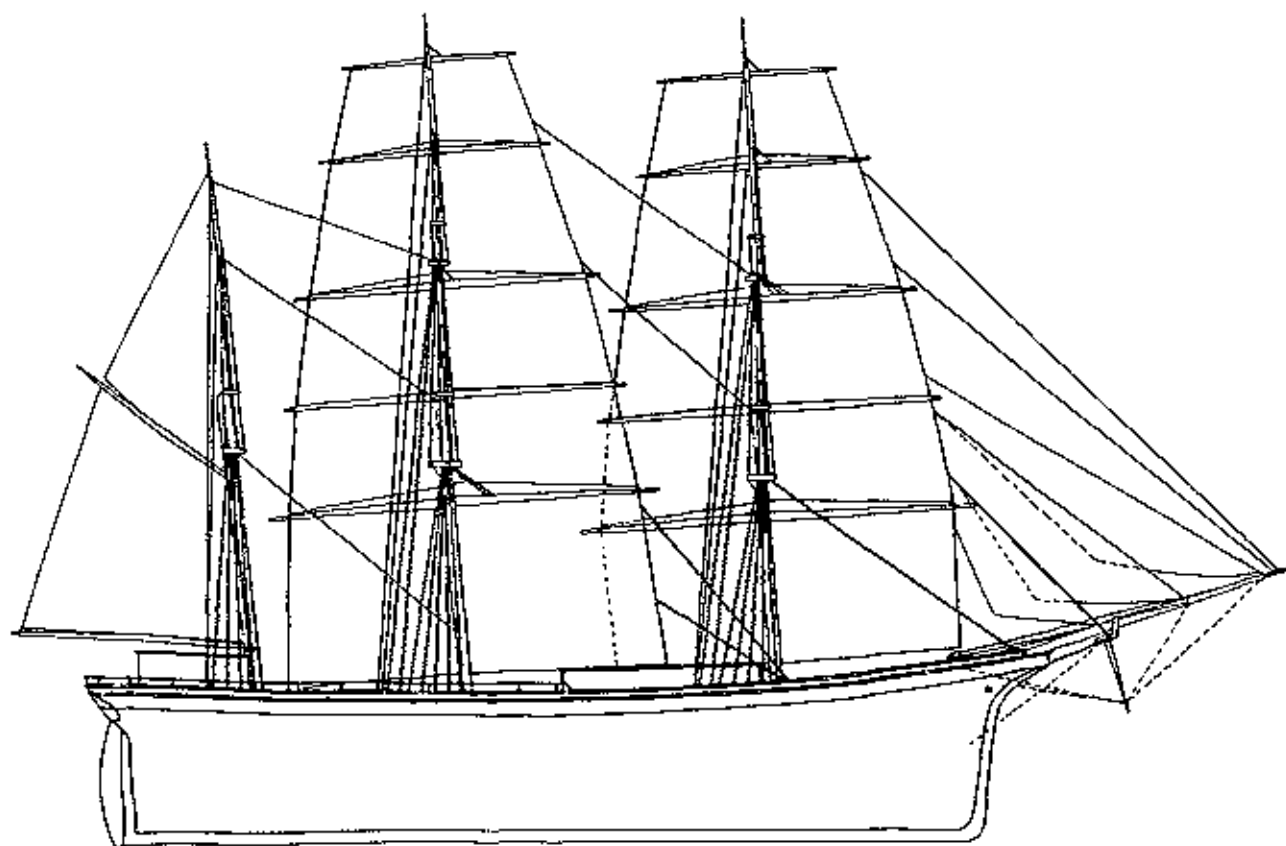

STANDARDS and GUIDELINES

Introduction. The outline format on the following pages provides a quick overview of general applications of the *Secretary's Standards* to the production of HAER measured drawings. The text that follows in Sections 4.2-4.6 tells you in more detail how to accomplish work that meets the *Secretary's Standards*.

There are four parts to the outline, corresponding to each of the four standards *as they apply to measured drawings*:

- I. Guidelines for explicating and illustrating what is significant or valuable about a historic vessel.
- II. Guidelines for preparing drawings accurately from reliable sources.
- III. Guidelines for materials on which drawings are to be made.
- IV. Guidelines for producing clear and concise drawings.

The standards, as they apply to drawings, follow well-established intellectual and ethical rules for good research and presentation. However, there are limitations imposed by the nature of archival records, the need for their longevity, accessibility, and their reproduction that must be addressed. Many commonly accepted architectural drafting "styles" or drawing "tastes" do *not* meet the *Secretary's Standards*, so please read these sections carefully.

4.1.2 Measured Drawing Guidelines

I. Explicating and illustrating what is significant or valuable about a vessel:

Recommended

Determining what aspects of the vessel are historically significant, based on adequate research into relevant historical documents, publications, photographs, drawings and other sources.

Determining what significant features are best explicated and illustrated by measured drawings, as opposed to photography or written documentation alone.

Determining what sorts of graphic views (e.g. maps, plans, elevations, sections, topographic maps, isometrics, perspectives, exploded views) or combinations of them are best suited to explicating and illustrating the significant and valuable factors.

Determining if any pre-existing drawings clearly explicate and illustrate significant factors; photocopying such drawings, or using them as bases for new drawings.

Using verbal annotations in drawings to label significant conditions, features and parts, or to describe process, or explicate the impact of historic events, such as modifications, additions, damage by fire, etc.

Not Recommended

II. Guidelines for preparing drawings accurately from reliable sources.

Recommended

Not Recommended

Preparing measured drawings from clear, thorough field notes, in which are recorded representative sketches and accurate measurements actually taken from the vessel being documented.

Preparing measured drawings from thorough dimensions obtained from a correctly operated photographic or digital measuring system.

Selecting field measurement methods and equipment appropriate to the resource being recorded, and using the methods and instruments within their capabilities and limitations.

Stating in field notes and measured drawings the field methods and instruments used, and the accuracy of their results.

Measuring the resource within a reference frame aligned with the principal planes of the vessel (if it is floating or hauled) or using an independent reference frame if the vessel is a hulk or wreck.

Stating in field notes and measured drawings any parts of a vessel that were inaccessible for sketching, measurement or photography.

Depicting actual existing conditions of the vessel, or depicting pre-existing conditions based on adequate historical documentary or on-site evidence.

Checking any pre-existing architectural or engineering drawings against the vessel itself for discrepancies in dimensions, features, conditions, etc.

Properly citing verbally in measured drawings any drawings, photographs, or other sources used in addition to or in place of actual measurements of the vessel.

Stating in field notes and measured drawings the names of vessel, deck levels, materials, profiles, lines, and machinery parts, etc.

Making numerous field photographs for use as general survey, checks for context, checks for field notes at the drawing board, for use by future users and researchers.

Including graphic scales and written significant dimensions on measured drawings to indicate actual dimensions of recorded resource.

Failing to provide documented hard-copy printouts of instrument-gathered field data and including them with field records for final project transmittal.

Damaging or destroying without permission any significant or valuable historic fabric or finishes in attempts to obtain measurements.

4.1.4 Measured Drawing Guidelines

III. Guidelines for materials on which measured drawings are to be prepared.

Recommended

Preparing measured drawings in waterproof, permanent (fadeproof) black ink (or equivalent) which is properly formulated to adhere permanently to the base material, and does not cause the base material of the drawing to deteriorate.

Preparing measured drawings on durable (tear resistant, acid-free) translucent, inert base materials (such as polyester drafting films or buffered vellums) with a projected 500 year life span.

Preparing photographically reproduced drawings on durable materials and processing them archivally for a 500 year life span.

Using either 19"x24", 24"x36", or 33"x44" drawing sheets with preprinted HAER borders

Using 17"x22" sheets of 8x8 gridded bond paper for field notes

Not Recommended

Preparing final drawings in pencil, which smudges easily, and does not reproduce clearly.

Preparing final drawings in any medium that smudges in ordinary handling, or does not reproduce clearly

Preparing drawing in colored inks or other media, since they may not be archivally stable, or readily reproducible with proper color fidelity.

Using adhesive drafting media such as dry transfer lettering or rendering materials, since their adhesives have short life spans.

Collecting and submitting original architectural and engineering drawings for submission to the HAER collection at the Library of Congress.

IV. Guidelines for producing clear and concise drawings.

Recommended

Organizing a drawing set into a progression of similar views: lines plans, deck plans, profiles, sections, details, exploded views, process diagrams and schematics.

Laying out drawings with distinguishable zones for linework, scales, labels, and verbal annotations.

Using proper line widths to emphasize major components of the vessel and delineate fine details.

Using appropriate rendering symbols and techniques to indicate and distinguish different materials in the vessel in plan, profile, and section

Using drawing scales appropriate to the size and significance of vessel being recorded.

Using lettering sizes and styles that are easily legible in the full size drawing or in reduction to 25% of full size.

Using lettering sizes, styles/typefaces, and weights appropriate to the functions of verbal material in a drawing.

Using verbal annotations to provide information not readily presentable or discernable in a drawing, e.g. names of spaces, parts; historical data important to interpreting a drawing; significant field or documentary data affecting a drawing's content or accuracy; labels for match lines, base lines, datum lines, etc.

Using number keys (or tags) with arrows to annotate features which are too close together or in spaces too confined by significant linework to annotate directly with labels.

Citing and explaining anything in drawings which differs from as-is conditions.

Including graphic scales and written significant dimensions on measured drawings to indicate actual dimensions of recorded vessel.

Not Recommended

Using only a single line width or such a narrow range of line widths that confusing figure-ground effects result.

Using non-industry standard material symbols without explanatory labels.

Using excessively stylized lettering/typefaces that are difficult to read.

Using lettering where upper case letter height or lower case body height is smaller than 3/32" on 19"x24" drawings, smaller than 1/8" on 24"x36" drawings, or smaller than 5/32" on 33"x44" drawings.

Using a single lettering size and/or weight for all lettering on a drawing sheet.

Omitting arrows, or placing labels and number keys in positions where their indications are ambiguous.

Failing to cite sources for drawings based on anything other than field measurements, whether these sources are other drawings, historic photographs, written or oral accounts.

4.1.6 Measured Drawing Guidelines



LEVEL I DOCUMENTATION: WHAT'S INVOLVED IN THE MEASURED DRAWINGS OF YOUR SHIP?

Before you lies a voyage, a journey of discovery. Whether you are a HAER summer employee or someone making records to HAER standards, you are part of a crew charged with the task of bringing a historic vessel home for posterity in words, photographs, and measured drawings. The cargo you bear is information, documentation of a sort which becomes increasingly rare and more valuable with time. As on any vessel, each crew member has different but vital duties. Some set the sails or tend the engines, some chart the course, another takes the helm, while still others cook the grub, and fix the leaks. As a delineator, your duties are to measure the vessel and finish accurate, detailed drawings of her as part of Level I documentation for the captain's inspection by the end of the voyage. Crews new to ships will need the guidance of more experienced, expert hands. If you are a crewmember who has never been aboard ship, this may seem an impossible challenge, but fear not! Others have gone before, and this section of the guidelines is designed to give you the benefit of their wisdom, that your job bringing this project into port may be one well done.

First of all, you must acknowledge that a "voyage" of this type only comes to a successful conclusion through genuine *teamwork*. Crewmembers not working together, combining their strengths and contributing from their diverse backgrounds and interests, can end up beached. You cannot work alone, not only because the vessel's size requires

additional hands for the field work, but also because thorough Level I documentation must draw upon several disciplines. Some team members may be researching the vessel's past, others may be studying her fabric, making large-format photographs, or performing other tasks necessary to document her properly. (Do not overlook or fail to build on any previous documentary work on your vessel.) Each discipline's contribution to the effort is essential to the others' success, and to the quality of the documentation as a whole. The field records and final drawings you produce will complement the written and photographic records, presenting facts about the vessel that monographs or photos cannot do as effectively. You will need the team historian's input to decipher some of the peculiarities you come across in your field work, or you may need to find the shipwright on your review team whose trained eye can fill in the gaping holes in the hull. An old, faded photo may point to the type of engine or wheelhouse instruments she once had. And you will find your work as a team eased by covering some parts of the ship photographically. By the same token, the paint outlines you notice, or changes in the ship's structure, will be clues for historians to consider, confirming or challenging what they may distill from their research.

The need for cooperation and a lively exchange of knowledge, observations, and ideas will become clear when you first

board the vessel and begin work. You will find yourself confronted with a number of "dimensions"--clues to her work, care, design, and construction philosophy, and many other things. Some of these will be easy to spot. Others lie hidden, and require the combined detective work of the team and a qualified review team of ship specialists. Ask questions. Be adventurous. Don't be discouraged if you don't "get it all" the first time out--nobody does. If you are not familiar with ships, there will be some new jargon to learn. If the sight of all those compound curves and oddly angled parts is intimidating, there are many tried-and-true methods for recording and delineating them. You are taking part in a process with a long history of tradition and practice, much of which HAER has tried to condense for your use in these guidelines.

The ship around you, aside from her hull, compartments, means of propulsion, and innumerable pieces of nautical hardware, is for our purposes akin to a mammoth museum artifact. Everything about her is a product of somebody's decision at some time or other. She is a silent record of her designer's tradition and ability, shipwrights' skills, her owner's business decisions, her crew's living standards, maintenance habits, and ways of earning a living. Her present condition may even be a sign of an era, or of changes in an industry, regional economy, labor relations, or developments in technology. You and your fellow crew members will learn to "read" these things by picking up on the scores of clues aboard, but your skills will only develop as you depend on each other's form of research and share your knowledge of the ship's history, structure, materials, service, and the

people who owned, designed, built, and sailed her.

Since you are responsible for lifting and drawing the vessel's lines and making construction drawings, of all your coworkers you may have the most intimate knowledge of your vessel's structure, materials, and dimensions. Do the dimensions tell a story only you would be the first to know? Do irregularities mean anything--construction efficiency? age and use? cheap, sloppy repair jobs? What signs of modification or repair are there? Where are things crafted with precision or given a high finish? Why? What may this unusual piece of joinery mean, or that patch in the deck? How about the wear in the rail at the bow, or the rusty holes in the deck beams? What you find in the bilges can even be clues to the vessel's service or her crew's attitude to their work. Keep in mind that it is important not to shrink from the unknowns--they too may hold interesting surprises, or even critical considerations. You will find yourself going over the ship with combs of finer and finer teeth as you gain new insights during field work and as your drawings take shape at the drafting board. Some of your observations may eventually take the form of notes or even separate, specialized drawings. As always, the team should consult its review team on questions, methods, and conclusions.

As more and more information comes together about your vessel, the new kinds of twists and questions to pursue can grow to seem endless. No team or its HAER records could hope to cover all the relevant threads of thought. The limitations of time, funds, available records, and access to parts of the ship will eventually

make themselves felt as your project proceeds, and the team will have to decide which courses to pursue, and which to cut short. The team will also have to decide what aspects are to be written, or photographed, or drawn. In order to make such judgments soundly, it is imperative that all team members share whatever technical and historical information they acquire and that they actively seek the advice of the project's review team on important questions and problems. A thorough understanding of your vessel is essential to these decisions. The HAER office and staff are available to help as much as possible, but the job of pinpointing and treating significant features may eventually fall to the team itself.

You may also have to take into account the agendas of vessel owners or project cosponsors in your work. In general, any such additional agendas will have been agreed upon between HAER and the other parties before your project begins. HAER documentation is public material (it cannot be copyrighted), and hence may see all sorts of uses: educational materials, model-building, museum exhibits, poster graphics, scholarly studies, vessel repair, restoration, or replication (particularly in conjunction with detailed field records)--the list is long and varied. While HAER drawings should be accurately scaled and thoroughly annotated, they are not intended to be "working" or "shop drawings" complete enough for building full-size vessel replicas or reconstructions. Documentary drawings show a user "what was there" in accurate scaled views and notes, but except for the simplest of small vessels, they will not contain all the dimensional and structural information needed by shipbuilders, machinists,

foundries, pipefitters, and other trades to proceed directly to work. Supplementary material and numerous detailed drawings will be essential in such cases, especially for large steel vessels with complex mechanical systems. Properly executed HAER drawings can provide excellent baseline information for such work. A full set of shop drawings sufficient for building a replica of a large steamer might result in several hundred sheets covering structural details, all parts of propulsion equipment, piping, electrical, etc. HAER drawings and field notes form an information base from which such drawings can be generated for construction purposes, but production and curation of shop drawings themselves is beyond HAER's mission. Existing shop drawings of vessels can be extremely valuable to a recording project (as well as for restoration or replication), since they can provide significant historical and technological information as well as dimensions. HAER data should note the existence and location of any such drawings, and those used in production of HAER drawings should be noted thereon. The HAER team or its review team should recommend repositories for shop drawings, old photographs, or other historical records whose survival is threatened. Selected items may be photocopied for HAER, but HAER cannot accept the original items themselves.

As the team refines its documentation and drawings, you should get used to playing the role of someone looking at your work several hundred years from now. The old adage "familiarity breeds contempt" bears repeating: familiarity may unnecessarily limit your thoroughness and the usefulness of your work. How clear are your field notes and how well did you explain the

parameters of your work? Did you note any specialized terms or technologies that may otherwise be swept into relative obscurity? Did you leave any unintentional or unexplained ambiguities? Did you drop important questions or details because you couldn't answer them? Why not discuss these things? Cultivating such a viewpoint is important, because large vessels, as artifacts, are often doomed by their size. Unlike smaller boats or other more portable artifacts which find their way more easily into museums, the preservation of a large vessel for future generations is a complicated and very expensive undertaking. Few that will be recorded for HAER will receive any further preservation efforts than that which you are giving them--preservation "on paper." It is vital, therefore, that you consider the probable perspectives of someone looking at your work without the benefit of contexts that have become second nature to you. They will not have the opportunity to go back to the vessel itself for further work.

In many ways, the records you will produce have significant advantages over the real vessel. Their accessibility, reproducibility, portability, and care present far fewer problems and expenses than outright preservation of the vessel itself, especially over the 500-year lifespan accorded to HAER materials. Drawings, particularly lines, plans, sectional views or "exploded" assemblies, present information in ways no one would ever see in photographs or real life. However, all drawings--whether based completely on measurements or to some extent on accumulations of other evidence--are

necessarily *selective* about what facts are presented. To this extent, they all are *interpretive*, and will always be more limited than the vessel itself in terms of information content. Therefore, you need to be as well informed as possible in order to capture the most important things worth preserving, and present them as clearly as you can.

The following chapters of Section 4 cover field methods and drawing presentation in much greater detail, along with refined points of HAER's documentary philosophy and examples of previous work. You should become particularly familiar with these sections, but do not neglect the historians' and photographers' guidelines, since the success of your efforts depends to a considerable extent on your understanding of your teammates' roles in this recording project.

Glossaries. A brief glossary of general nautical terms used in this section is included in the following illustrations for easy reference in using these guidelines and in getting around the vessel you are recording. Be prepared to encounter local variations, and be sure to keep a more extensive glossary handy for further details. Local terms *must* be shown on final drawings, and where they vary from more generally used terms, the general terms must also be given in parentheses. A European glossary may be needed for European-built vessels. Several titles are listed in Section 4.8, References and Resources.

Anchors aweigh!

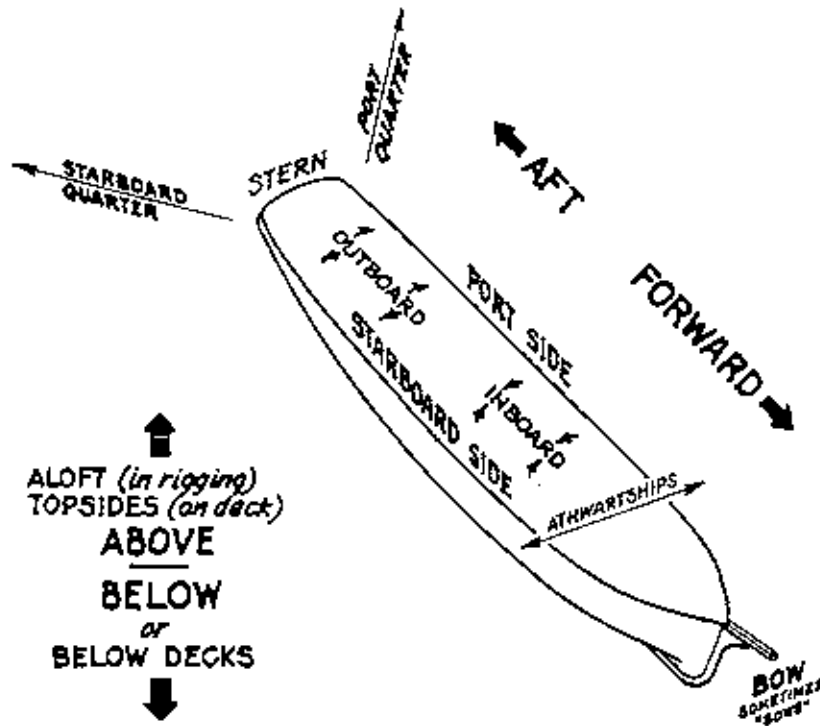

Fig. 4.2.1 Directional Orientation Aboard Ship

Taken from Schummet 184204A HARR No. MA-14, Sheets 5, 6, and 7 of 7

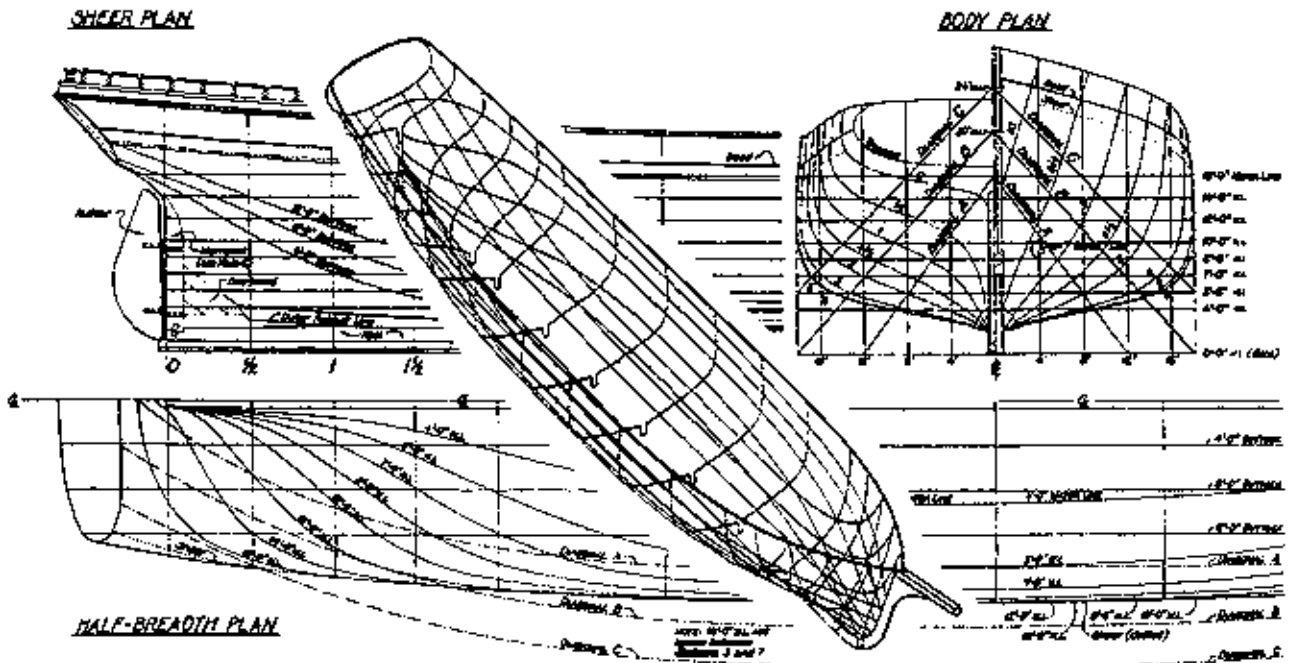
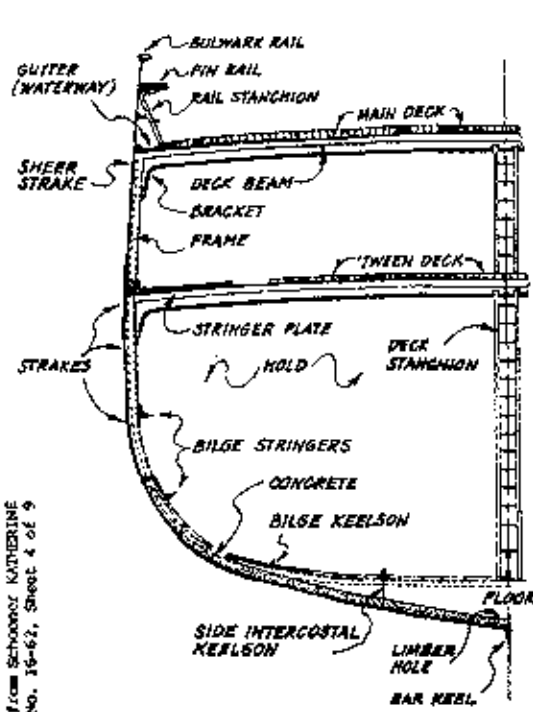
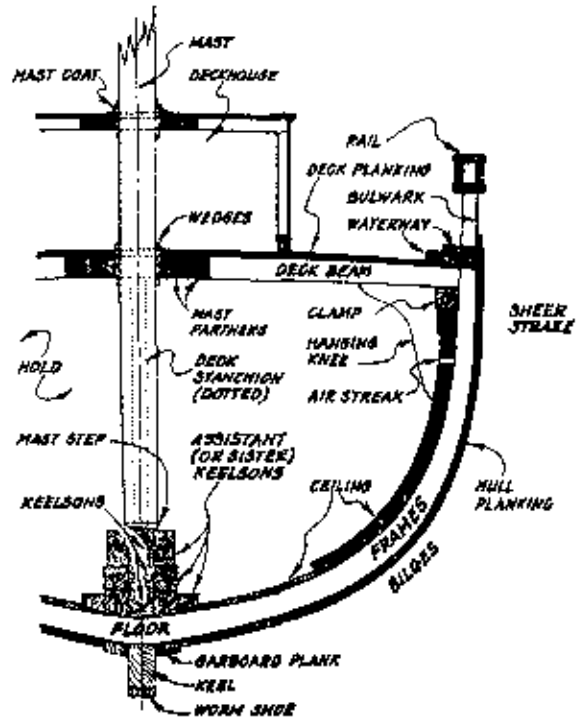

Fig. 4.2.2 The "Lines" or Contours of a Hull



Section through Metal Vessel



Section through Wooden Vessel

Taken From Schooner KATHERINE
Plans No. 16-62, Sheet 4 of 9

Taken From Schooner KATHALA
Plans No. 16-37, Sheet 10 of 12

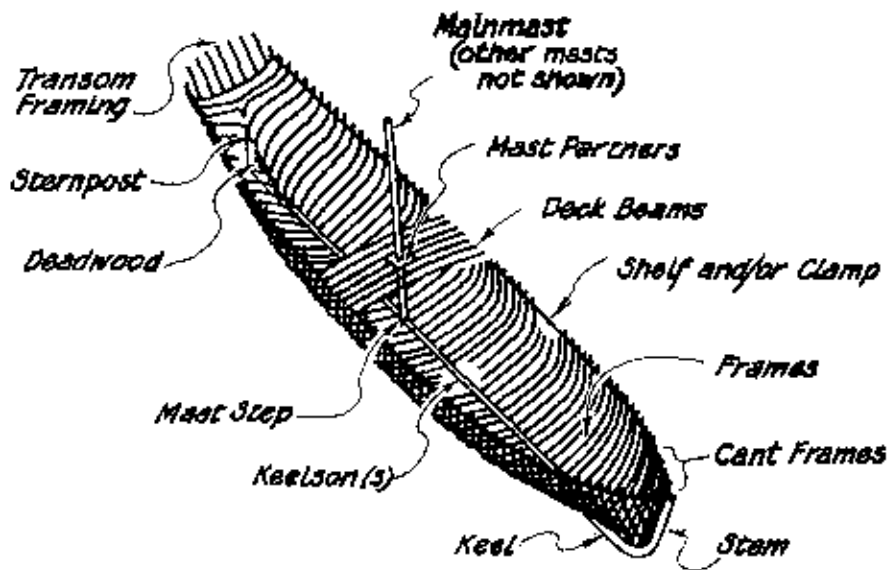

Sketch of Generic Wooden Ship Construction

Fig. 4.2.3
Basic Ship Hull Construction

Based on Bark JOHN WUNSTON
BAMS No. 2-43, Sheets 2 and 3 of 3

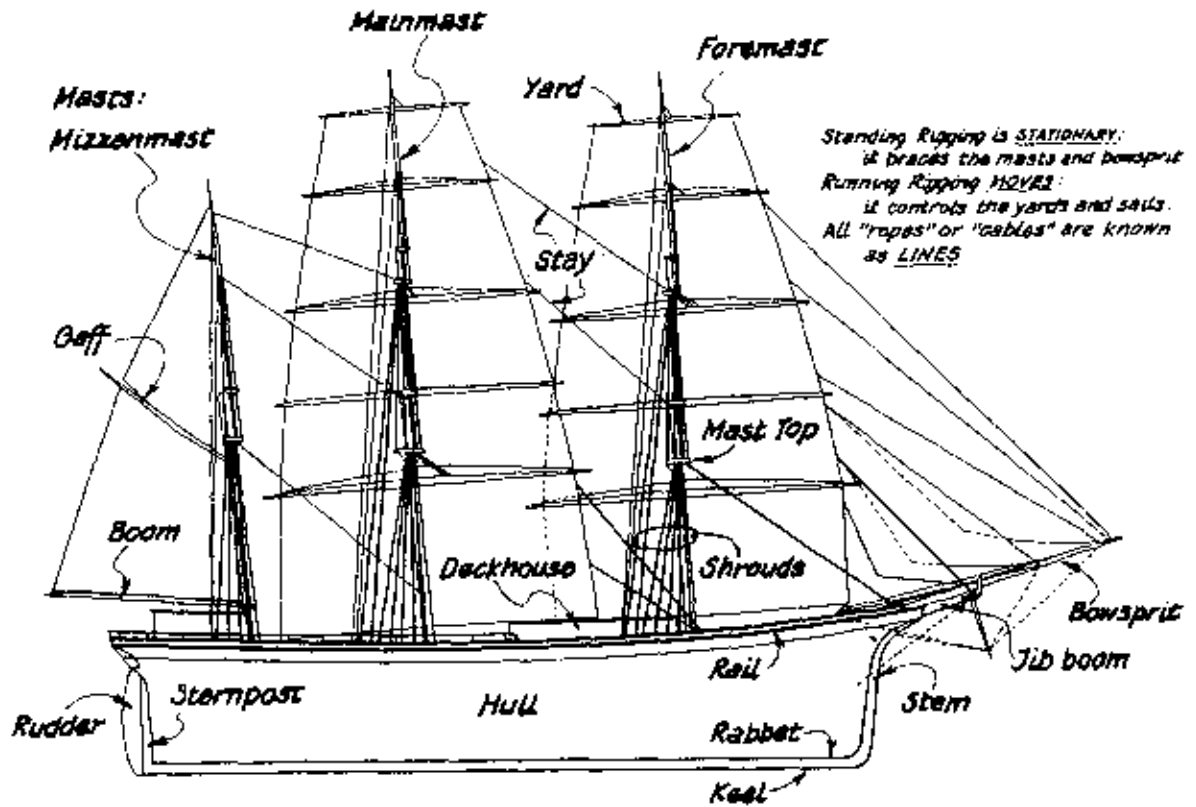

NOTE: The diagram above is elementary. Many parts named above are composed of pieces and subassemblies which have their own proper terms. Consult a guide such as The Lore of Sail for more comprehensive treatment.

Fig. 4.2.4
Some Basic Parts of a Sailing Ship

(For further names of sails and various rigs, see Section 4.9, "Some Basic Sailing Ship Rigs".)

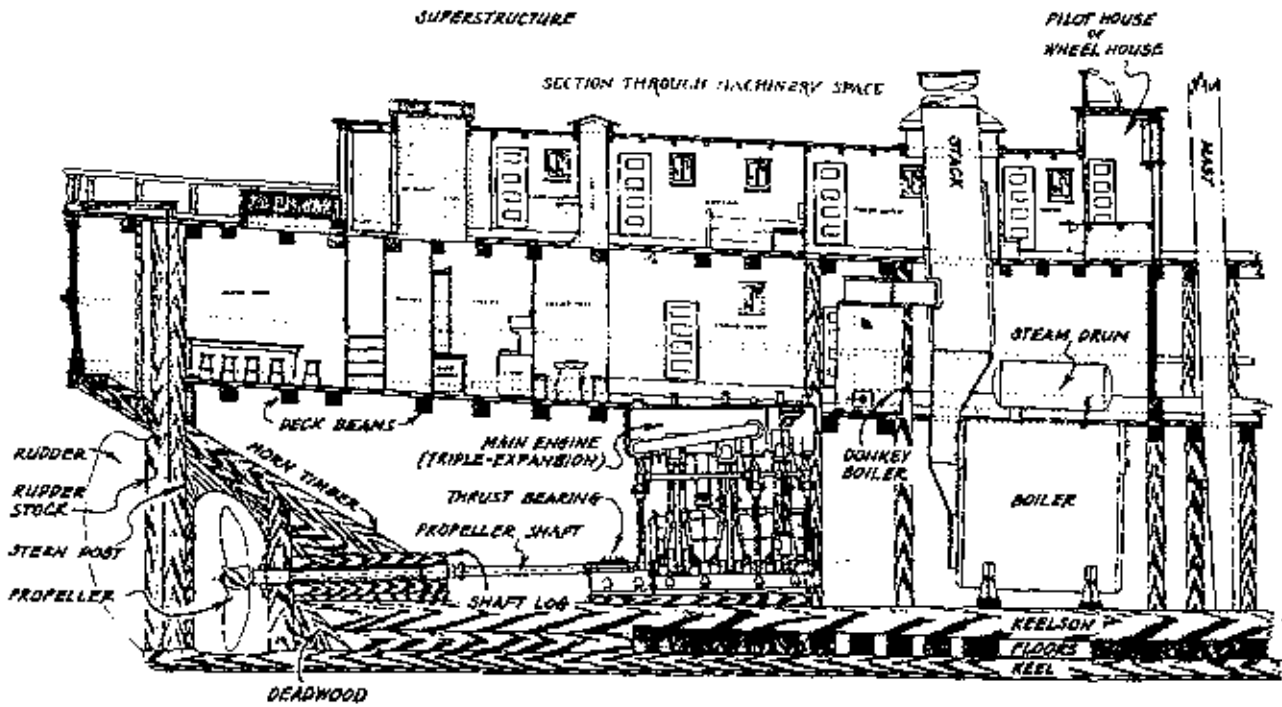

Taken from Steam Schooner WILLAPA
 NAMS No. 16-33, Sheet 9 of 17

Taken from Steam Schooner WILLAPA
 NAMS No. 16-33, Sheet 10 of 17

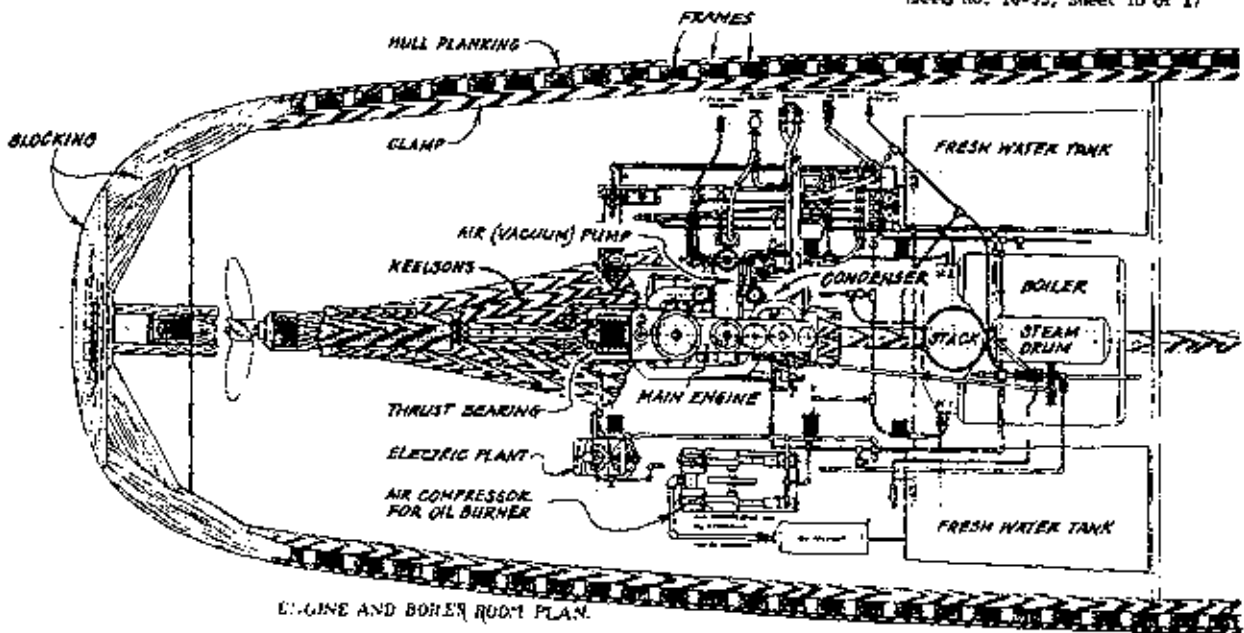

ENGINE AND BOILER ROOM PLAN.

Fig. 4.2.5
 Some Basic Parts of a Steam-propelled Vessel

FIELD METHODS

SIZING UP THE JOB

Any discussion of field methods for recording a vessel's structure and lifting her lines must begin with consideration of her attitude, size, and condition. These factors more than any others will control what general approaches to take in most circumstances, after matters of the vessel's significance and the project's purpose and scope have been settled.

Attitude. A ship heeled over in a mud flat obviously presents more problems to access and measurement than one blocked up level in a dry dock. Then there are situations in between, such as a vessel floating at a pier or sitting in a floating dry dock (where true level and vertical are always changing with respect to the vessel due to wind and waves), or a vessel blocked up on an inclined marine railway. Techniques for tackling each of these situations will be outlined shortly.

Size. The size of the vessel (and its internal complications) have obvious implications for the amount of work your team may need to do, and where your effort is directed. Time or money remaining constant, a larger vessel may receive less attention to some aspects and details (or none at all) in favor of others deemed more significant from the perspective of your project's goals.

Condition. Lastly, the vessel's condition may provide unusual opportunities or impose a number of limits on where, when, and how much data you can collect. A vessel in first-class order presents no

glaring problems of safety (falling through rotten decks), attitude, or missing elements (large portions of the hull, decks, or propulsion systems gone). However, many kinds of structural details may be inaccessible unless the team can discover some other source of information for these things--in builder's drawings, or specifications, for example. A deteriorating hulk may require a lot of educated guesswork, comparison with similar vessels, and reliance on other sources to create useful drawings. On the other hand, if conservation and preservation of the vessel are not intended, a planned program of dismantling the remains (subject to approval and guidance of proper authorities) may yield many valuable insights that would otherwise be impossible to get. Field work for archeological (submerged) sites will not be discussed, since methodologies have long been established in that discipline (see references under Nautical Archeology in Section 4.7).

Other Considerations. In planning your field work, keep in mind that time, budget, and team members' skills will significantly influence your choice of methods since they will govern the degree of expertise you can pay for and the sorts of tools and instruments the project can afford to buy, rent, build, or use with available manpower. Weather and even tides may dictate times of access. You may have to weigh the time and costs required to make specialized measuring equipment (such as large frames) against the rental of things like a transit and your team's skills and ability to use one to advantage.

Different methods may save time without sacrificing accuracy. These are only some of the possible questions to consider when evaluating field methods and planning your approach. If your project has an advisory team, be sure to consult it for advice.

You should have your project's goals firmly in mind, and a preliminary schedule of final drawings in hand before you go out to do field work. These will have obvious implications for how you spend your time; the level of detail to which a drawing set may go is heavily dependent on what is significant about a vessel and the goals of your project. HAER has found it advantageous to make "thumbnail" sketches of the layout and content of each prospective drawing sheet in advance of field work. It is also helpful to keep a checklist of specific features to cover as a hedge against overlooking important details. This may seem a bit premature if a significant amount of simultaneous historical research is planned, the results of which might affect the drawing schedule. However, certain basic views have been required traditionally for all vessels whose significance warrants the time and expense of measured drawings. In most cases, the time you spend in the field gathering information needed for basic views will give the historians time to pinpoint important details for notes or changes in the drawing schedule.

It is strongly recommended that the team's field office be set up aboard the vessel if at all possible, or in an office space close by. There are a number of reasons for this, not the least of which is reduction of commuting time from office to vessel for investigation and measurement. On large vessels, a set of "walkie-talkies" may be great time-savers when conducting procedures (such as lines-lifting) which

involve long distances or require part of the team to be in a space out of convenient earshot.

Terminology. Ship terminology may seem to be a world unto itself, especially when you begin to encounter the details of construction, rigging, etc. If you don't know what something is called, or if you don't understand what a new term refers to, ask. Review team members, shipwrights, and owners are usually quite willing to teach you these things. In addition, HAER strongly advises that you always keep a comprehensive pocket glossary such as *The Lore of Sail* at hand for ready reference--knowledgeable people are not always around when you need them. Be prepared for local variations in meaning, pronunciation, spelling, etc., and be diligent about recording these terms in your field notes. Eventually, sea terms will come easily, and you will need to know them in order to make sense of records, drawings, shipwrights' explanations, and the like without wasting time. Elementary orientation is given in Figs. 4.2.1 - 4.2.5.

BASIC VIEWS

Measured drawings of vessels fall into two groups: lines and construction drawings. Though some of the remarks below preview Section 4.6 (Measured Drawings), you should be familiar with standard views and types of drawings discussed below in order to make the best of your field work. Basic views include:

Lines

Construction Drawings

Outboard Profile (starboard side conventionally, port side if it is the only good one)

Inboard Profile (showing internal

- arrangement of structure, spaces, and equipment)
- Main Deck Plan (often showing framing on one side of centerline, deck arrangement on the other)
- Other deck plans
- Sections (showing internal arrangement of structure and equipment)
- Propulsion (sail and rigging plans and/or mechanical propulsion)
- Details (structural joints, fasteners, fittings, joinery, machinery, carvings, etc.)

Scantlings, a list of structural member sizes and materials, should appear on one of these views. Drawings may also include tables, diagrams, or other means of systematizing information.

Lines Drawings. Lines describe the shape of a vessel's hull. They are topographic views or "contour maps" of the hull's compound curves. They may indicate the outer surface of the hull or the outer edges of the frames. They are abstract in the sense that they sometimes give no indication of materials, fittings, or construction; however, lines drawings have often been combined with similar projections, such as an onboard profile or deck plan in which deck breaks, masts, rails, superstructure, rudder, keel, etc., are shown. Because they describe the shape of the vessel, lines must be drawn (or obtained from other documentary sources) before proceeding to some kinds of construction drawings, such as sections.

Great numbers of lines drawings exist for a variety of vessel types, thanks to the efforts of previous maritime documentarians. It may be that a suitable set exists of your vessel. However, HAER documentation is *vessel-specific*, and for

this reason lines plans should not be overlooked. The use of lines from a half-model or another vessel is permissible but should be accompanied with notes on the HAER drawings explaining what the basis of similarity is. Field measurement of your vessel to verify claims of similarity may be a necessity, even if the team can show by documentary evidence that the vessel being recorded was built, for example, from the same half-model or plans as the similar one for which lines drawings have been discovered. Half-models and older drawings may have changed dimensions, or be mislabeled, and ships are not always built strictly to half-models or lines drawings.

Reconstructed or "As Is" Lines?

Ordinarily, HAER draws an industrial or architectural structure "as is"--warts and all. However, it is traditional to draw lines for a vessel as they would have appeared originally. No depiction is made of hogging, twists, or deterioration. A glance through the Historic American Merchant Marine Survey or the work of Howard I. Chapelle reveals numerous cases where hulls and remains were reconstructed in drawings. How one can produce a set of reconstructed lines from measurements of a distorted hull is discussed in Section 4.6 (Measured Drawings); however, it is usually necessary to draw the lines of a vessel "as is" before making corrections. If your project requires a detailed hull survey and the recording of "as is" conditions for study or repairs, then a set of "as is" lines will probably become part of the measured drawing set. Drawings done for HAER in such cases should include sets of both "as is" and reconstructed lines. In any case, it is important to explain how you derived the

reconstruction from your field measurements in notes on your lines drawings. A more detailed description can be provided in your field report.

Construction Drawings. Construction drawings depict the physical structure and features of a vessel. In the past, this aspect of ship documentation frequently took a distant second place to lines drawings, or was ignored altogether. Historic ship construction cannot be so casually dismissed. Construction drawings range from overall views such as deck plans and inboard profiles to details such as structural joints of the hull and superstructure, carvings, fittings, propulsion, and deck machinery. They may or may not reflect existing conditions. What you concentrate on will be governed by your project's goals, the significant features of your vessel, and the kind and quality of pre-existing documentation. In requiring construction drawings of significant features, HAER is not seeking working drawings in the modern sense of a completely dimensioned, detailed description of every ship component suitable for construction purposes. In most cases the complete disassembly of a vessel for measurement is logistically impractical or philosophically objectionable, making a set of verified working drawings impossible. Many areas of a vessel may be inaccessible or simply missing. Available dimensional information on structure must be included either as scantlings (see Fig. 4.7.12) or as notes on details, sections, or inboard profiles (see Fig. 4.7.13). Other notes and data should be included as described in Section 4.6. Old blueprints or shop drawings may be used to prepare HAER drawings, or photocopied for the HAER record. HAER drawings should be

adaptable for facilitating repairs, reconstructions, or reproductions where owners and contractors must have drawings for cost estimates and construction work.

MEASUREMENT ACCURACY

Precision in Field Work and Measured Drawings. Before describing methods of lifting lines or recording structure, there are some preliminary remarks about measurement methods and accuracy in field work that apply to all aspects of recording a vessel.

Precision and Error Tolerance. Precision can be a slippery word when measuring vessels—in some places it matters a lot, in others, little. It is possible to have a false sense of precision, like measuring barn doors with watchmaker's tools. Theoretically, the maximum precision of a measuring instrument such as a tape is limited to $\pm 1/2$ the smallest graduation on its scale. In the case of a tape graduated in $1/8$ ths of an inch, the maximum precision it is capable of is $\pm 1/16$ ". However, in the real world objects like ships can rarely be measured to the precision a tape theoretically permits. The error tolerance (" \pm ") is usually larger (sometimes a lot) due to various circumstances. The appropriate tolerances depend on what vessel you are recording, her condition, which parts you are measuring, the tools you are using, and how you are using the information. To claim you have measured the 10' x 15' cabin of a yacht in first-class condition to $\pm 1/8$ inch is believable; to claim the same tolerances on a 100-foot long beached hulk is neither believable nor necessary. A tolerance of ± 1 inch on

the length of a 150-foot vessel is understandable, but an error that size on a 6-inch frame in good condition is not.

Recording Your Accuracy. Appropriate precision in your measurements is important, and so is stating your tolerances, or reasonable estimates of error. Remarks on this subject apply to field work for both construction drawings and lines-lifting. Tolerances will become useful when you "fair in" lines or draw structure at the drawing board, but they are especially needed by those who later use your work—they need to know your work's limits as well as its content. Your field notes may also be consulted by future researchers interested in modelling or replicating your vessel. All measurements contain errors, some slight, some gross, and it is simply a matter of professional responsibility as well as accuracy for you to note in your field records what your error estimate is, and what factors contributed to it. Errors are reduced by using running measurements (a series made from a single starting point) as

opposed to additive measurements (the next beginning where the previous one ended). The error tolerance remains substantially the same for each measurement in a running series (all other conditions being the same), whereas the error in an additive series is cumulative (see Fig. 4.3.1). In the field tolerances can be enlarged by tape sag, irregular or decayed features, skill, etc. For hand measurement, it is better to use the "ideal case" as the *minimum*, then think of error as *relative to the total length measured*, and factor in circumstances (such as condition of fabric) accordingly. An error of $1/8$ " in 1 inch is 1 part in 8 (12.5%), whereas an error of $1/4$ " in 100 feet is 1 part in 57,600 (about 0.002%). Now an error of $\pm 1/8$ " measuring a badly pitted steel rod is not too sloppy, but to claim an error of only $\pm 1/4$ " in 100 feet on anything but a vessel in first-class condition begins to exceed credibility. Error should always be shown in your notes as " $\pm X$ " (not "1 part in XXX"). Error for critical distances can be reduced by making the same measurement three or

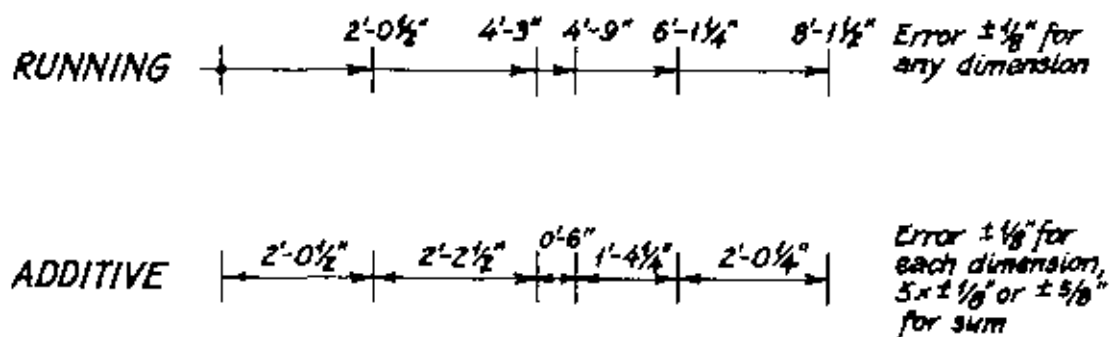

Fig. 4.3.1
Running vs. Additive Measurements

four times and averaging the results. Having said this, it should be pointed out that errors are present in final measured drawings due to several factors such as scale, fairing or averaging of curved features, thicknesses of ink lines, and delineators' skills. This is why finished measured drawings *must* show written dimensions, preferably ones derived from the field notes, not scaled from the final drawing itself.

The following suggestions have proven invaluable in reducing hand measurement errors, both in lines-lifting and structural field work:

1) When a series of measurements is to be taken in a given direction (positions of vessel frames, locations of deck plank seams, for example), always make running measurements rather than measure element-to-element (see Fig. 4.3.1). For example, the position of each

deck plank seam should be measured from the *same starting point* (edge of a covering board, for example), rather than measuring the width of each plank, plank-by-plank. This way, a $\pm 1/8"$ error allowance in each measurement will still apply at the 20th plank, just as at the first. Error would be cumulative for additive measurements, so that the sum of 20 plank widths could be as much as $20 \times 1/8" = 2-1/2"$ in error-- unacceptable over such a relatively short distance on a deck in good condition. This same principle applies to any series of measurements you may make in a given direction from a single starting point.

2) Make overlapping measurements and check measurements of large features which contain many small measurements (see Fig. 4.3.2). Such extra measurements serve to confirm the others, and may help you catch errors and quickly solve problems when you are at the drawing board.

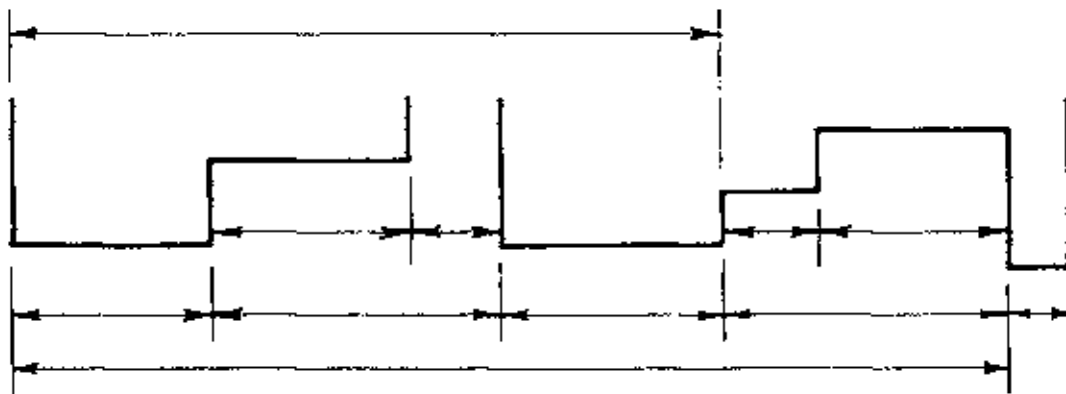

Fig. 4.3.2
Overlapping and Check Measurements

3) Take care in how you read a tape or rule, especially if the scale is upside-down, or you are reading it right-to-left instead of left-to-right. It is very easy to inadvertently add or subtract an inch or even a foot from a dimension by reading the scale in the wrong direction. The numerals "6" and "9" can also be confused when the scale is upside-down. It may be very helpful to keep the rules or tapes you used to make measurements on hand at the drawing board. Being able to retrace the "look" of the scale at the point you took a dimension can solve problems when a recorded dimension appears to be in error. Keeping a log on your field notes of the brand and catalog number of measuring tools used may also help a future researcher solve a perplexing measurement problem.

4) Take care in how you record your dimensions or call them out to others. It is wise to insert a "0" whenever a foot or an inch dimension is less than "1" and to be rigorous in designating foot and inch dimensions. Often, common sense or "fit" to the drawing is not enough when trying to judge the applicability of something like 6'-1/2" at the drawing board. Aside from the confusion stray marks might introduce, should this be read "6 feet and one-half inch," better written 6'-0 1/2", or "6 and one-half feet"? Could it be the recorder got distracted when writing his dimension down and left the inch figure out? Using 0 1/2" would remove all doubt.

5) Dimensions should be recorded as they appear on the rule or tape you are using, whether it is in feet-and-inches or simply inches. It is suggested that you use equipment whose dimensions are given in feet-and-inches rather than inches alone.

The architectural scales used at the drawing board are always in feet-and-inches, and you risk less error in drawing if you eliminate the step converting, say 59-1/4" to 4' - 11 1/4".

As a point of interest, shipbuilders have long been used to writing dimensions in a special format: all dimensions are written in feet, inches, and eighths of an inch, each figure devoid of tic marks (' and ") and separated by a hyphen--6'-0 1/2" would be written 6-0-4 in this case. If you are experienced with this system, use it. However, if you are not used to it, you may be wise to avoid learning it on HAER projects. You should record the numbers your tape or rule shows, rather than risk errors performing conversions. It is easy to fail to convert fractional inches, such as quarters and halves of an inch, to eighths of an inch before writing the fractional dimensions down.

LINES and LINES-LIFTING

Lines-lifting, for those unfamiliar with documenting vessels, is gathering the dimensional data needed to produce lines drawings. Lines are usually lifted from a hull's exterior, though they can be taken from inside in certain cases, or even from half-models used for construction (assuming that the model hasn't shrunk or been mislabeled). Any number of methods and tools will serve the purpose, depending on the accuracy desired, and on other situations discussed above. The "lines" themselves describe the hull's shape as a series of intersections between the exterior hull surface and four sets of imaginary planes passed through it. (Some lines drawings describe the *inside* surface of the hull, even though measurements are

SECTIONS

Fig. 4.3.3

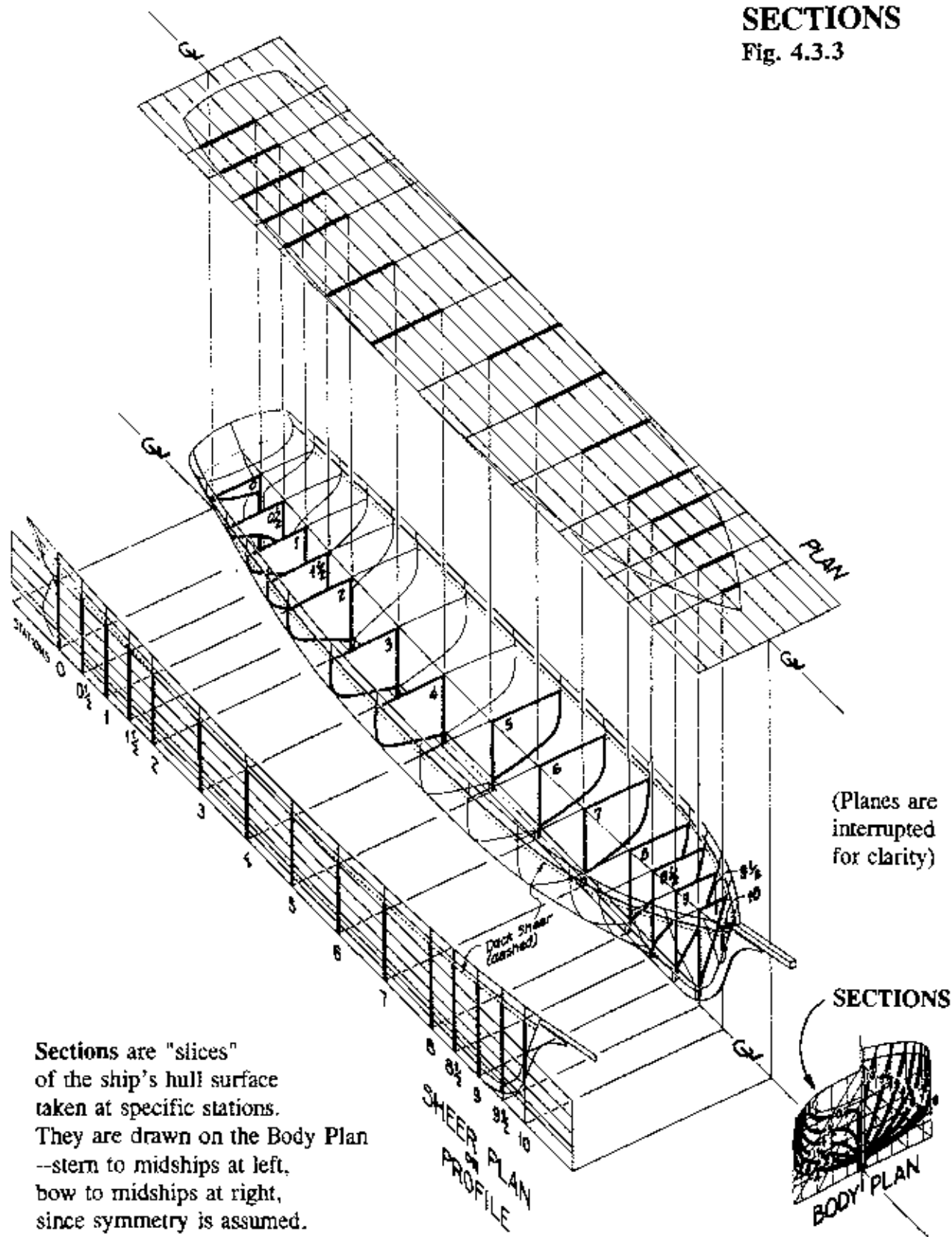

Sections are "slices" of the ship's hull surface taken at specific stations. They are drawn on the Body Plan —stern to midships at left, bow to midships at right, since symmetry is assumed.

taken from the exterior.) Three of these sets of planes are perpendicular to each other; the fourth is set at various angles. Each of these is described briefly below, accompanied by illustrations to help you understand what they are. Instructions for drawing lines are found in Section 4.6 (Measured Drawings), and examples of lines drawings are given in Section 4.7 (Drawing Examples).

Sections or Body Planes (see Fig. 4.3.3) are vertical planes that pass from side to side ("athwartships") through the vessel, perpendicular to the vessel's vertical centerline plane. The sections are probably the most easily understood, since they are to a vessel what slices are to a loaf of bread. Section planes are almost always set parallel to the planes in which the vessel's frames lie. The section lines are the intersections between the section planes and the ship's hull surface. They are always represented in drawings by a view called a *Body Plan*, seen from the ends of the vessel. Since symmetry is usually assumed, half-sections from the bow to midship (forebody plan) are traditionally shown to the right and half-sections (afterbody plan) from the stern to midship to the left of a common centerline.

Water Line Planes (see Fig. 4.3.4) are horizontal and run fore and aft through the vessel, perpendicular to the vertical centerline plane and to the section planes. Water line planes are parallel to each other, but may or may not be parallel to the vessel's keel or floating water line, depending on the vessel's trim. In many cases, water lines are chosen so they lie perpendicular to the vessel's frames. *Water lines* are the intersections between the water line planes and the vessel's hull

surface. In drawings they are always represented from above, usually for the starboard (or right-hand) half of the hull only rather than the full hull, since symmetry is assumed. This drawing view is called a *Half-Breadth Plan*.

Buttock Planes (see Fig. 4.3.5) are vertical and run fore and aft through the vessel. They are parallel to the central vertical plane passing through the vessel's keel and main deck centerline. The intersections between these planes and the hull surface are lines called *Buttock Lines*. In drawings they are usually represented from the starboard side ("dead abeam") in a view called a *Sheer Plan*.

Diagonal Planes (see Fig. 4.3.6) are planes passed fore and aft through the vessel. The intersections between the diagonal planes and the vessel's hull surface are lines called *Diagonals* and are used to help present curves in the hull surface which are not as easily or accurately understood from water lines or buttock lines. The diagonal planes are not necessarily parallel to each other. However, the intersections between them and the central buttock plane are always parallel to each other and to the water line planes.

Because the concepts, traditional techniques, and procedures for lifting lines are pretty much the same no matter what a vessel's size or construction, they can be treated more easily and specifically than recording varieties of construction types. The following detailed treatment of lines-lifting techniques should not be misunderstood as emphasizing shape over construction.

WATER LINES

Fig. 4.3.4

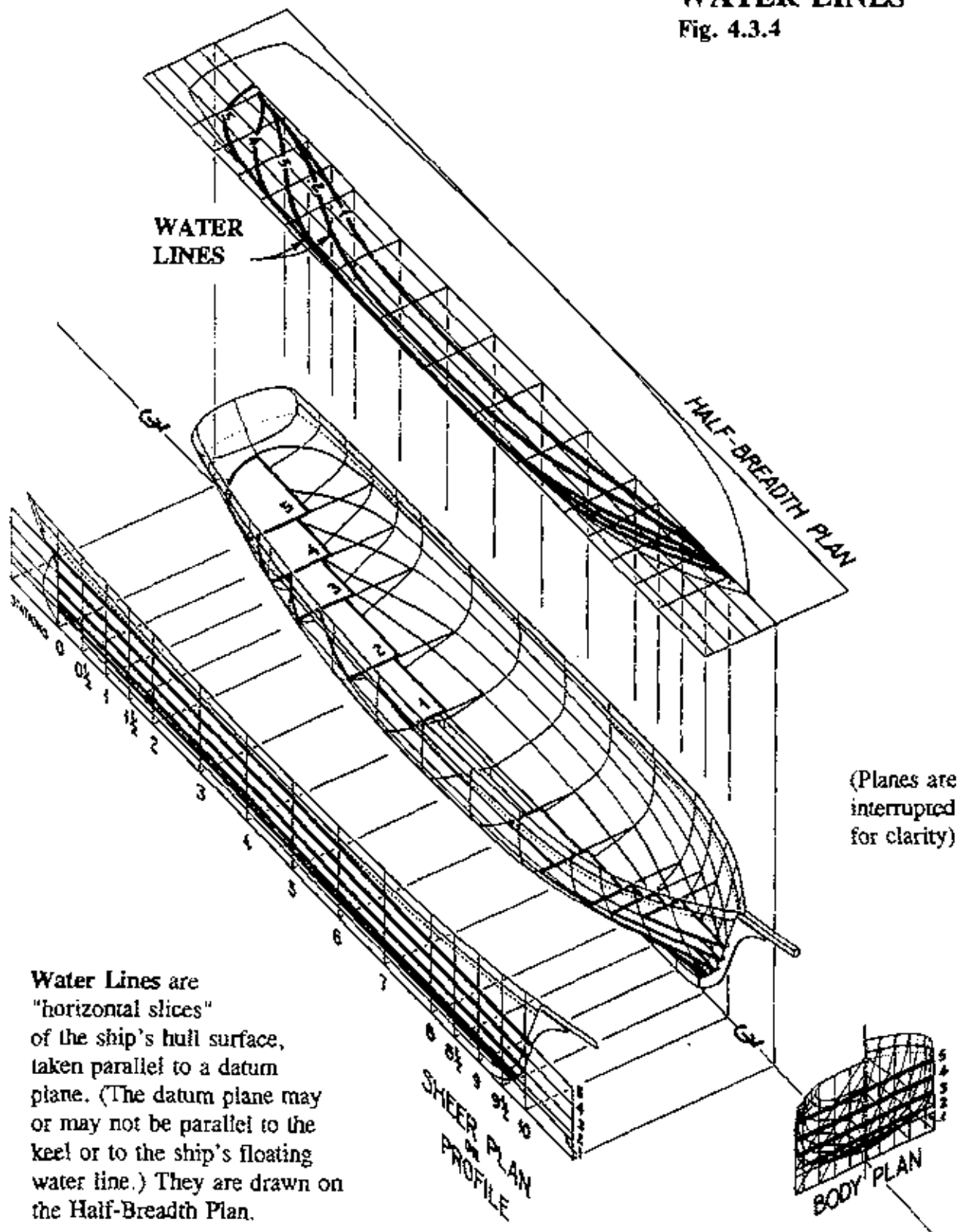

Water Lines are "horizontal slices" of the ship's hull surface, taken parallel to a datum plane. (The datum plane may or may not be parallel to the keel or to the ship's floating water line.) They are drawn on the Half-Breadth Plan.

(Planes are interrupted for clarity)

BUTTOCK LINES

Fig. 4.3.5

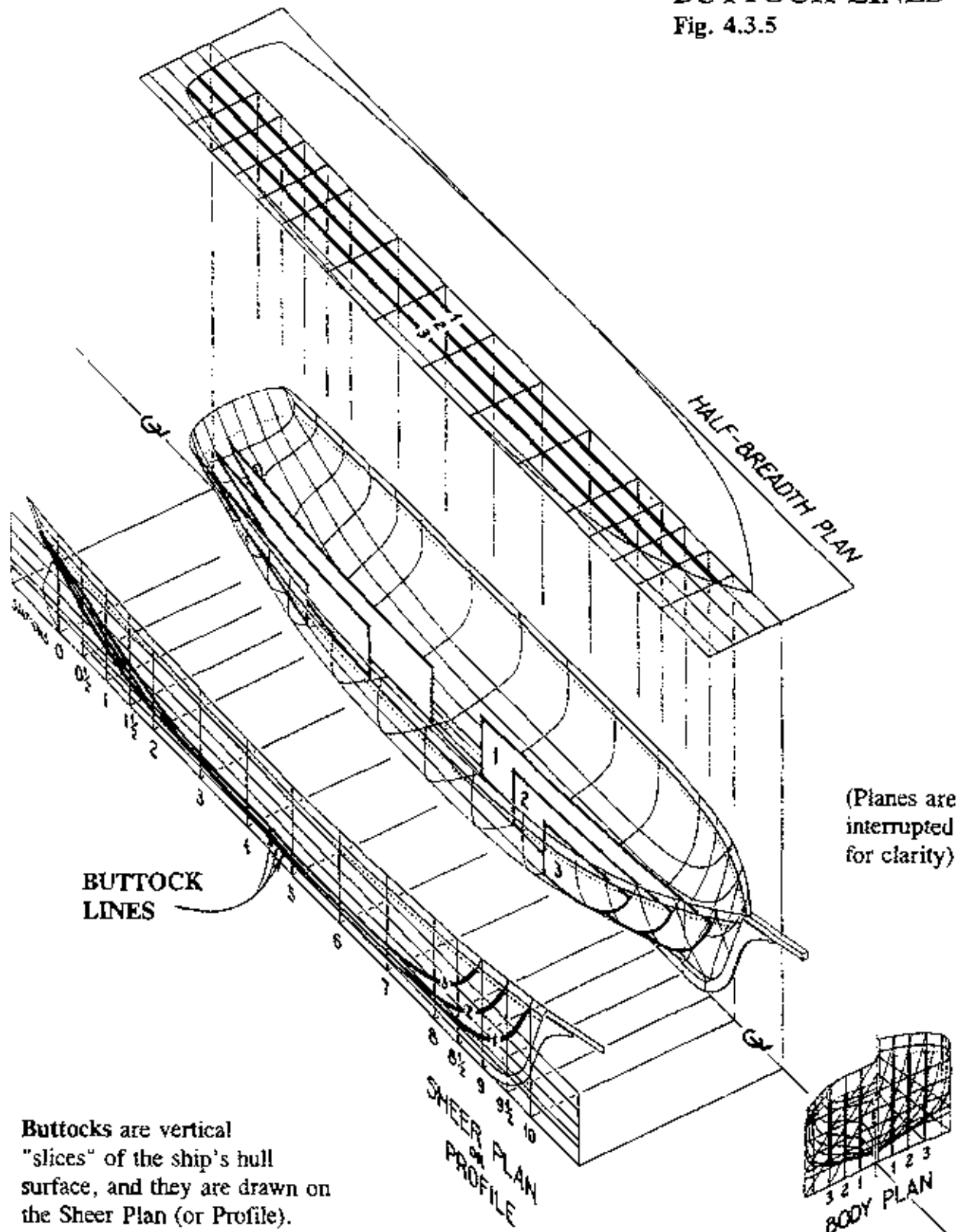

Buttocks are vertical "slices" of the ship's hull surface, and they are drawn on the Sheer Plan (or Profile).

DIAGONALS

Fig. 4.3.6

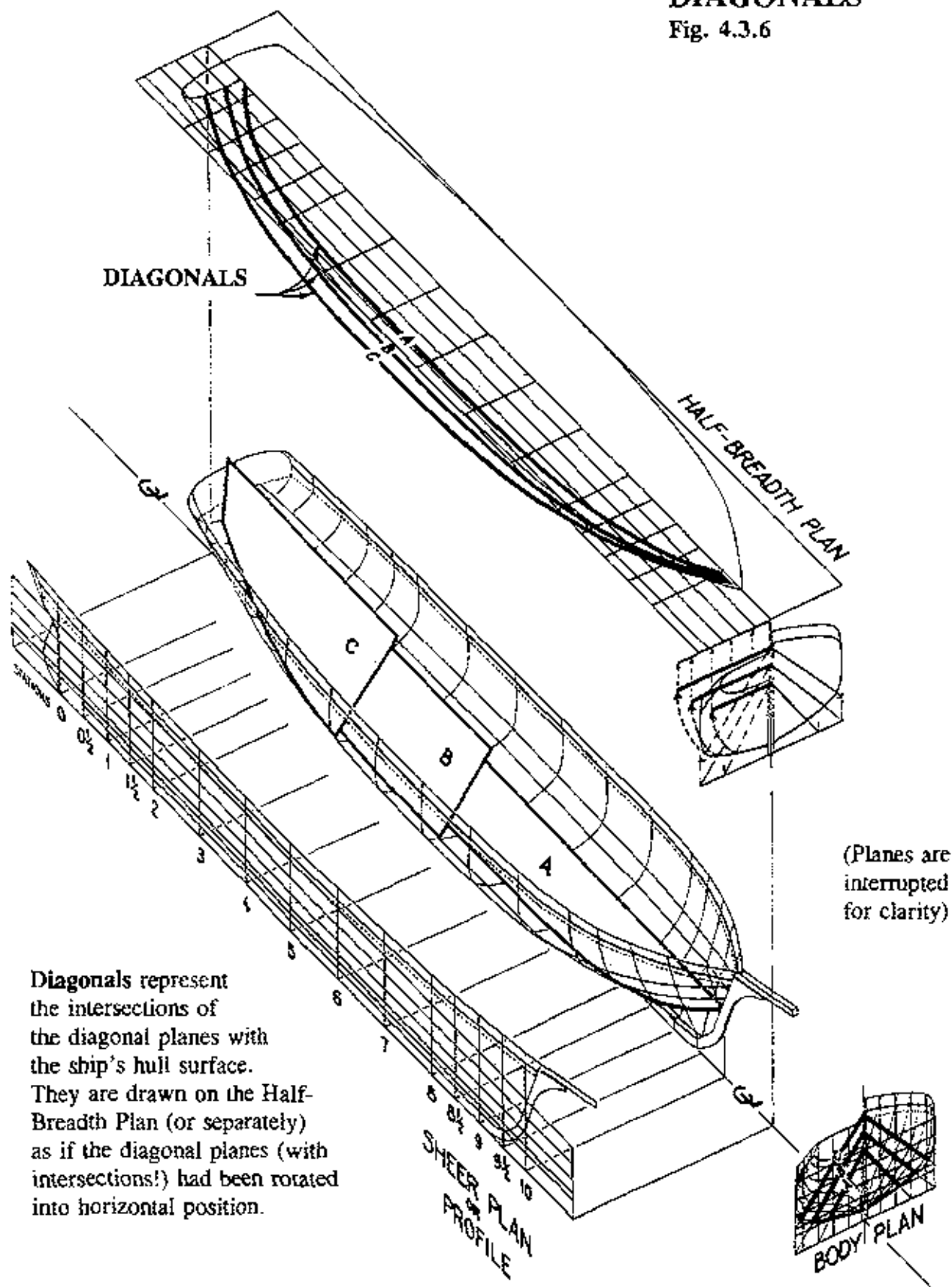

(Planes are interrupted for clarity)

Diagonals represent the intersections of the diagonal planes with the ship's hull surface. They are drawn on the Half-Breadth Plan (or separately) as if the diagonal planes (with intersections!) had been rotated into horizontal position.

In most cases, lifting lines involves measuring the vessel's bow and stern profile and taking sections at specific, recorded stations along the length of the vessel between the forward and aft perpendiculars (see Fig. 4.3.7).

(Perpendiculars, as used here, are set at the extremes of the bow and stern along the vessel's centerline; they can be set at other locations—be sure your field notes indicate where.) In taking a vessel's lines, you are going after hull shape. Several approaches to locating stations are possible: dividing the distance between perpendiculars into closely spaced equal intervals, setting stations at frames, or just where hull shape alone dictates. In going

by shape, sections should be taken at smaller intervals where the hull changes shape most rapidly (at the bow and stern); more widely spaced sections can be taken amidships (see Fig. 4.3.8). Sections and their locations along with bow and stern profiles (covered below) will give the important three-dimensional data needed to plot lines. Once these curves have been plotted from field data, water lines, buttock lines, and diagonals are derived from them, so you do not face the prospect of actually measuring these things from the vessel itself.

Profiles of the sheer, stem, keel, stern, and rabbet line are necessary to finish out

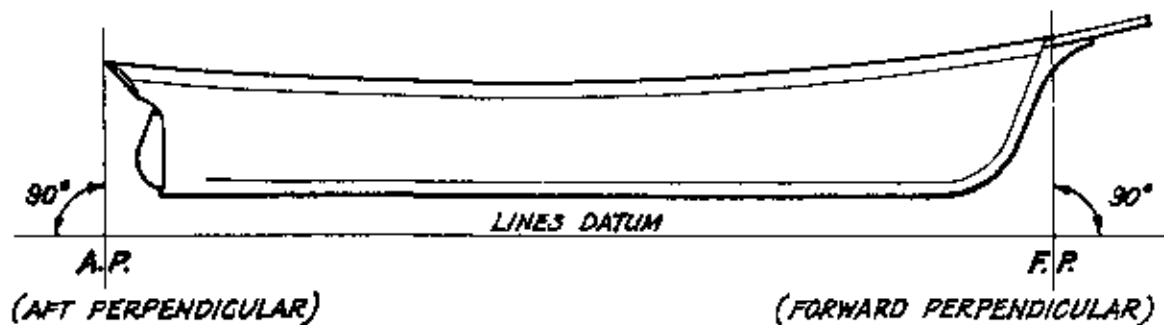

Fig. 4.3.7
Perpendiculars

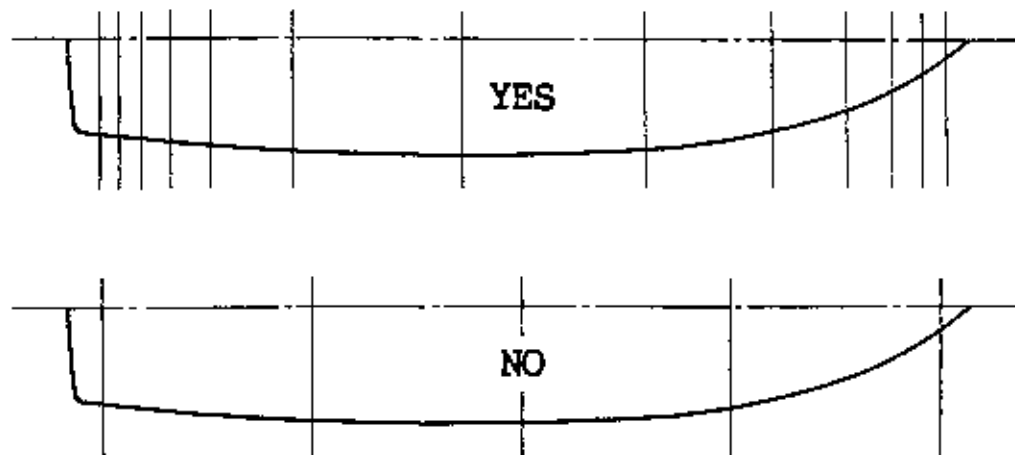

Fig. 4.3.8
Location of Stations

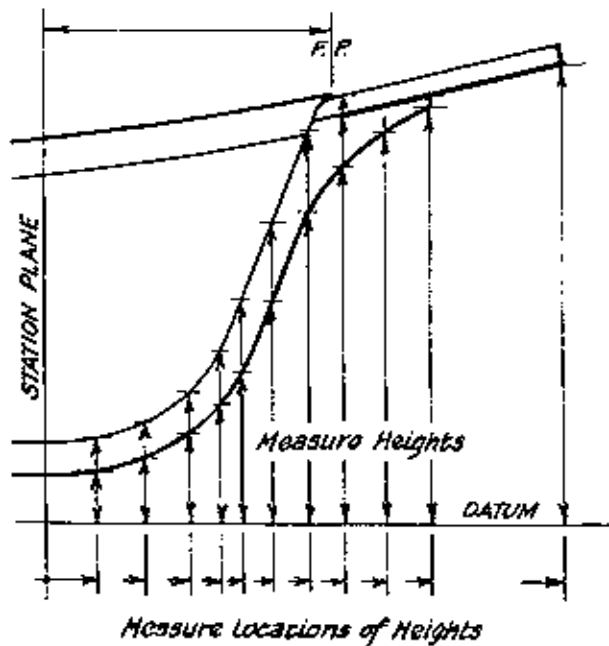

Fig. 4.3.9
Taking Profile of Stem
(Triangulations or quadrangulations
also useful; see Figs. 4.3.19-20)

the lines drawings, because they provide termination points for water lines and sections. (Sheer is generally defined as the line where the outer surfaces of the hull and main deck meet; if you encounter variations, be sure to define the usage in your documentation.) Profiles of hull features are fairly easy to obtain. For the stem and stern (including the rabbets there), all you need to do is pick specific points along these features, then find out how high the points are above the datum plane you are using, and how far forward or aft they are from given horizontal reference points (see Fig. 4.3.9). The horizontal reference points can be either lines-lifting stations or physical features on the hull. The keel profile can be recorded as you lift lines, simply by including a column in your table for the dimension

between the keel (or worm shoe) bottom and the datum plane. If the keel is straight, unworn, and has no drag, the datum plane could be defined as the worm shoe bottom, making this dimension zero (see Fig. 4.3.10).

In addition to locating sections along the length of the vessel, sections taken in the field must be located vertically and horizontally with respect to each other (or to your reference system) in order for you to be able to make accurate drawings of the existing hull shape. Of the two, the vertical positions or "heights" are probably the more important to obtain, since designers and builders intend their hulls to be symmetrical. This does not mean symmetry shouldn't be checked for in the field, at least by eye (for gross variances), if not by some check measurements. Port and starboard sections only need to be made if an especially detailed hull survey is planned, or if obvious distortions require both to be recorded in order to arrive at a reasonable approximation of the lines through averaging or other comparison. The discussions that follow do not assume that a hull is necessarily level and plumb.

There are two basic methods for finding heights:

- 1) The best method is to take all the sections (including the keel profile and sheer heights) with reference to a straight datum line laid below or alongside of the keel (see Fig. 4.3.10). This method kills two birds with one stone: You get a keel profile as well as the sections all in correct relative vertical positions. If the vessel is in a dry dock or on a marine railway with a seemingly flat surface or smooth tracks,

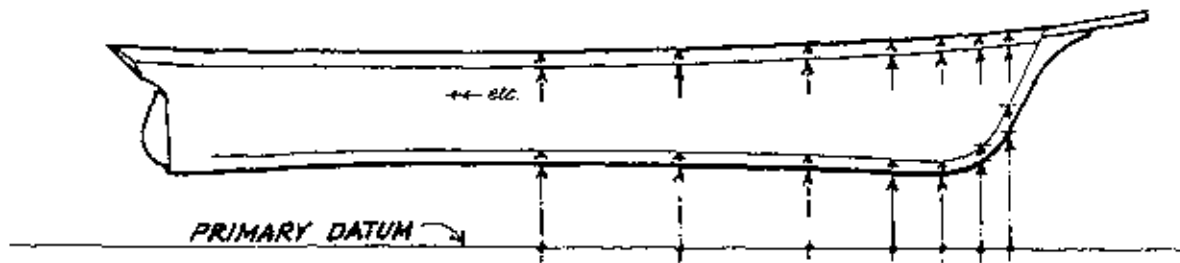

Fig. 4.2.10
Using an Independent Datum Line

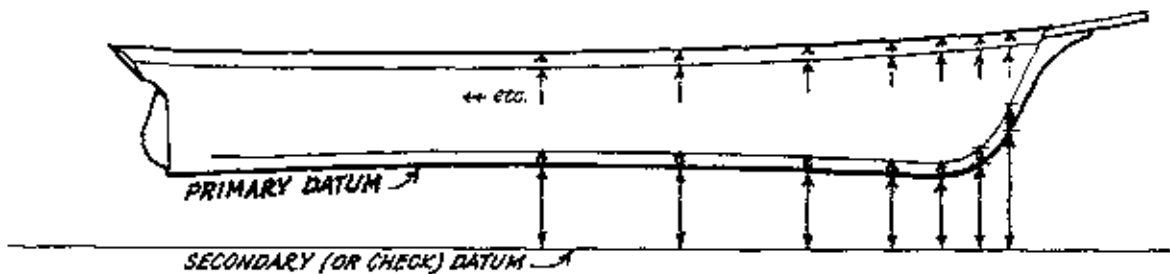

Fig. 4.2.11
Using Keel as Datum Line

these could be adapted as datums for this work, but their suitability for this purpose should be thoroughly checked out. You may save time using the sightline of a transit scope, a string, wire, or some other substitute, if blocks and scaffolding do not interfere.

2) The second method is the opposite of the first, in some ways (see Fig. 4.3.11), and is more prone to errors. Here sections are taken from the keel bottom or rabbet line as datum lines, whether these features are curved or not (see Fig. 4.3.11). (This could be done with a horizontal scale lodged up against the keel or rabbet.) A vertical profile of the keel bottom and/or the rabbet line must then be made with

reference to a separate but *straight* datum line in order to properly line up the sections. (A vessel whose keel droops at each end is "hogged"—this is a condition brought on by age or neglect; few vessels are built this way. Some vessels are built with "rockered" keels, so-called because they curve up at the ends. Many vessels will still retain the straight keels they were built with.)

The sheer heights can be double-checked by plotting a section from rabbet to sheer, and locating the sheer at the half-breadth (horizontal component) of the sheer at that section. This closes a triangle, automatically establishing the height of the sheer (see Fig. 4.3.12). The height can

also be double-checked by a transit survey of the main deck; this procedure is described later.

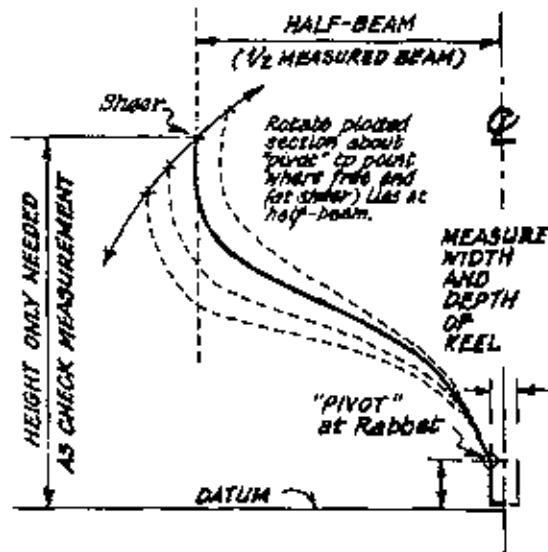

Fig. 4.3.12
Locating Section with
Rabbit and Half-breadth

Horizontal placement of sections is established by the half-breadths of the sheer and rabbet lines. The sheer line can be established horizontally by simply halving the breadth of the vessel at each

programmatic reason to measure for asymmetry. The half-breadth of the rabbet relative to the vessel's centerline should be checked, since some keels vary in width along their lengths. If asymmetry is present in the vessel and is important enough to be checked, there are at least two approaches one can take:

1) Stretch a string or wire fore and aft along the vessel, parallel with the keel, then make measurements at each station to the port and starboard sheer lines from this datum (see Fig. 4.3.13). While this datum should be set parallel to the vessel's centerline, there is no reason for it to be at the centerline, other than for convenience. Indeed, masts and deckhouses may make a center location impossible.

2) Set up benchmarks and a datum line off the vessel, to which measurements are made and included in each section take-off for port and starboard sheer lines and rabbets. If the reference system you establish is consistently referenced at each station, any asymmetry or twists will be picked up and will be comparatively easy to plot.

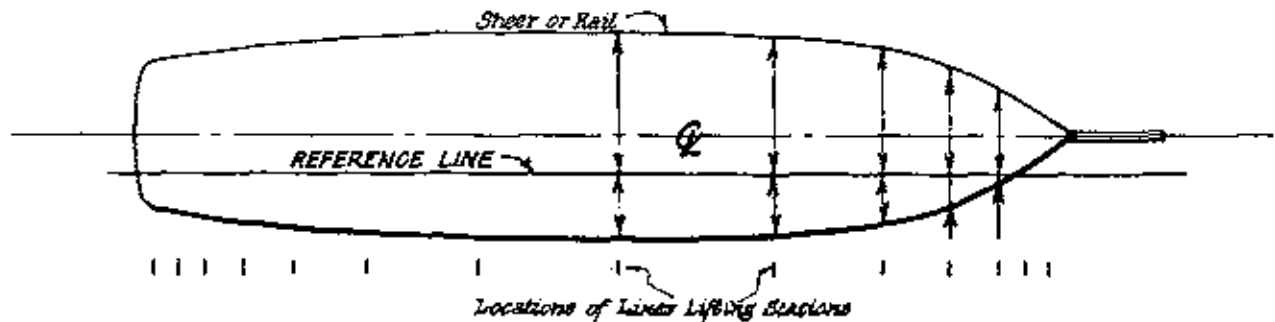

Fig. 4.3.13
Reference Line for Taking Beam Measurements

These methods assume that the keel is straight in plan. A hulk heeled over on a beach may have undergone a lot of bending as its hull deteriorated; the keel and hull may be twisted in both horizontal and vertical planes. Recording lines from such a vessel can be a nightmare, but a systematic approach in setting up a reference system and taking stations can go a long way to reduce the headaches at the drawing board.

BASIC LINES-LIFTING METHODS

Some basic lines-lifting methods will be outlined, intended for use primarily on large vessels (over 30 tons). These are hardly exhaustive in terms of the kinds of situations you may encounter or the sorts of tools and procedures you might use. You should be prepared to be creative in adapting these methods to your particular vessel, budget, team size, etc. Each of these methods is more fully described and illustrated as separate booklets under Section 7 (Case Studies). Projects conducted by HAER will in most cases have the field methods selected by the HAER office before the project begins, or methods worked out in cooperation with the field and review teams.

Before describing the methods themselves, however, there are a number of preliminary remarks to consider:

Hand Methods vs. "Black Box" or "High-Tech" Methods. The computer revolution has produced a number of electronic and photographic measurement devices whose potential for convenience, speed, and accuracy far exceed anything achievable by hand. These instruments can be quite expensive to lease or purchase,

but what advantageous application might they have to lines-lifting (or construction drawings), and when should they be used? The answers to these questions depend on what you want to gain by their capabilities. Prior to the electronic age, hand methods were the only ones available to record vessels, and noted authorities have made very good use of them. Their relative simplicity and cheapness ensures their continued use, and these guidelines are written primarily with hand methods in mind. However, "Black Box" devices and hand methods should be compared to gain an idea of their relative strengths and weaknesses. There can be projects where the trade-offs between costs of equipment and manpower, time, accuracy, safety, and other factors will dictate the use of such equipment. In many cases the trade-offs are complex, and no quick decision can be made. Some comparisons are made below, others in the descriptions of field methods given later. New developments should be studied, since they may offer simpler, cheaper methods for documentation.

Convenience. Convenience and safety may weigh in favor of the "Black Box" at large vessels where hand methods become cumbersome and time-consuming. If your organization owns "Black Box" equipment, there may be strong incentive to use it, since it is at hand. But don't be overly lured by gadgetry. Setting up a "Black Box" so it can function properly or yield its full potential can require a lot of time, expertise, and patience. These can translate into inconvenience, especially if hand methods would be faster for the degree of precision you need. Failure to set a "Black Box" up properly can lead to less precision than hand methods would. Often the time you save in the field may

be spent later in your office reducing "Black Box" data and other field notes to drawings. If you don't need "Black Box" precision or speed, the time spent using hand methods may be more than made up by what you save in money and annoyance.

Speed. A variety of factors should be considered here when comparing hand and "Black Box" methods. Is your crew paid or volunteer? Are you paying for expensive dry dock time? Is the vessel endangered? Would it take you the same amount of time to use hand methods as it would to train your crew to use "Black Box" methods competently and complete the job? Are hand methods more dangerous, thus slower, since you might have to climb carefully on hulls of uncertain strength? Is your field time limited by outside factors (dry dock schedule, money, impending demolition, etc.)? The speed "Black Box" devices offer may be a greater consideration than their cost, especially if loss of the vessel is imminent. Their capabilities may be critical, regardless of your vessel's size and the time it takes to record it, if your project's goals require a sort of archeological accuracy for a highly sophisticated program of studies, repairs, or reconstruction.

Precision. In general, marine workmanship places structural integrity and finish ahead of things like symmetry. For the speeds at which most historic commercial vessels sailed, minor variations in shape (two or three inches) would have had little effect on hull performance (though it is said some vessels were known to tack better on one side than the other!). The hull for an

America's Cup racing yacht has a much more finely tuned shape than a fishing schooner's, for example, so in one sense you should be a lot more careful lifting the lines of a racing yacht when it comes to designed shape. It would be meaningless to precisely document asymmetry on an old schooner, whether by hand or "Black Box" methods, unless you had something more important than mere shape to demonstrate by it. Differences in hull symmetry might tell you something about workmanship, however. They may also reveal the effects of age or show the hull structure's ability to withstand stresses. These can be clues to its condition, or to the quality of the vessel's design, modifications, maintenance, or materials. If you are lifting lines with this sort of research in mind, you may need to measure to $\pm 1/8"$, depending on the vessel. Careful hand methods may do well, but "Black Box" equipment might also be justified by its accuracy and speed.

While "precise" hull shape may not be critical in a lot of vessels, some frames or other major structural members might be prone to failure if variations like $\pm 3/4"$ were permitted in their cross sections, especially in metal members. This argues that you take care in measuring cross sectional dimensions ($\pm 1/8"$) and that precision here is stricter than in lines lifting.

On a clean hull, most hand measurements can be made to $\pm 1/8"$ or $1/4"$ when lifting lines, taking into account tape sag and other factors. Tapes are usually graduated in eighths or sixteenths of an inch. Digital surveying equipment can measure to the nearest 0.01 foot (slightly less than $1/8"$), and stereophotogrammetry

is capable of the same level of precision. By the time the lines are plotted and faired from hand measurements, the difference between the shapes shown in the lines and the actual hull shape could well be $\pm 3/4"$ in some places. This is perfectly fine for recording the shapes of most hulls. Users of your work will ask themselves questions, however: Was the hull clean of barnacles and other growths? Is the vessel in good or poor condition? Did you work quickly or slowly (storm coming? dry dock time short?) or assume certain things for convenience that you couldn't double-check? An error in a section of $\pm 1/8"$ to $\pm 1/4"$ inch measuring in the field is considered good for a clean hull and careful field work. Barnacles can throw you off to $\pm 1/2"$. Deterioration and distortion can throw you off even more. Error tolerances apply to everything: datum lines, squareness of scales, etc. Notes should appear on your final drawings and a thorough account and analysis of these things should be written up as part of your field report. (Guidelines for writing a Field Report are found in Section 5, Field Reports.)

Location of Stations. Most of the methods described below assume that stations along the vessel's keel are chosen and recorded carefully with reference to some easily recoverable benchmarks on the vessel (e.g., the sternpost). Remember that in recording shape, you will need more stations where the hull shape is "quicker" (see Fig. 4.3.8). In some instances, it is useful to take sections at the frames of the vessel. You might be able to locate these from the exterior by looking for telltale patterns of bungs (wooden plugs covering spikes), rivets, or other fastenings that secure the shell to the frames, if paint

doesn't cover the fastenings up. Be prepared to look for a way to check the frames for plumbness or squareness to your *final lines drawing reference planes*. Be aware that the extreme ends of vessels may contain cant frames, which do not lie in a plane square across the ship. You should make a complete sketch of your vessel and its set-up (including benchmarks), and record exactly where your stations are taken. Photographs for the record are also useful. Field notes for your lines-lifting work are treated in the next chapter of these guidelines. Don't forget to record the width of the keel at each station—it varies on some vessels.

How Many Points at Each Station? This depends partly on the vessel's size, partly on her shape. On a large vessel it is usually sufficient to pick points about every 12 to 24 inches along the section line for measurement, but if in doubt, it is better to take more points than to have too few. More frequent points should be set where the hull surface makes a relatively abrupt change, such as the turn of the bilge. If there is a sharp "corner" in the surface (a knuckle or chine), measurements should be made directly to it (see Fig. 4.3.14).

Lines from Inside a Hull. Some vessels may permit lines-lifting from inside the hull. This would be a boon if the vessel is afloat, since there would be little need to take the vessel out of the water. Such an effort would be easiest in a vessel where nearly all frames are exposed on the interior, and little interior structure interferes (see Fig. 4.3.15). In a large intact vessel with sawn frames, the frames can very likely be counted on to lie in

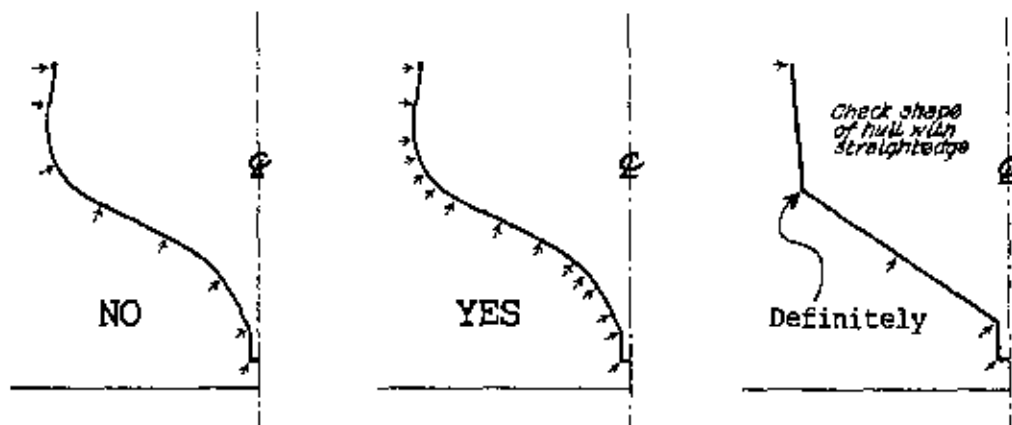

Fig. 4.3.14
Points on a Section

section planes square to the keel or the vessel's floating water line, obviously reducing the labor needed to establish lines-lifting stations. Be sure to check out whether this possibility is so before proceeding, however. The presence of bilge ceilings, decks, compartments, and finish surfaces can significantly impair

such an effort, however, if not render it impossible. Cant frames are not suitable as guides in lifting sections because they lie in vertical planes set at angles to the ship's central buttock plane. It is also difficult to derive an accurate picture of the keel width and keel bottom profile in this procedure. Lines taken from internal

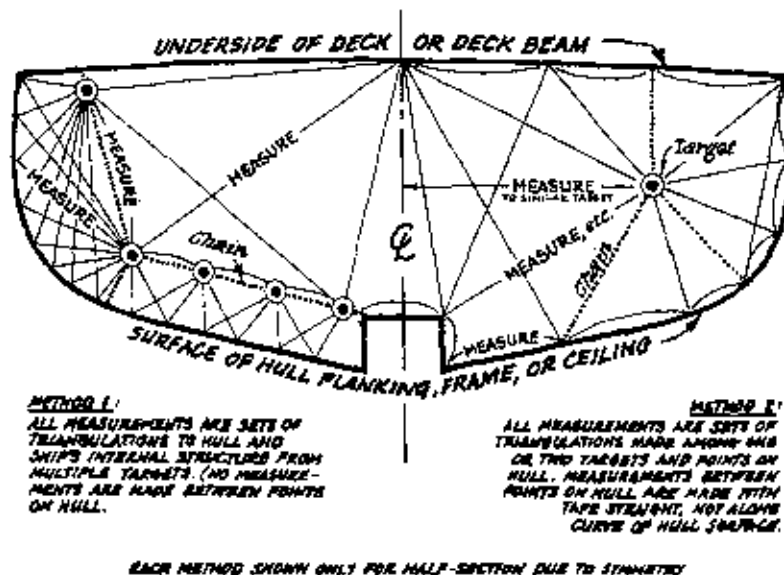

Fig. 4.2.15
Lines (Sections) from Inside a Hull

measurements should most likely be drawn this way (to the inside of the hull), unless you have a way to check the hull thickness for variations.

Lines from a Floating Vessel. All the procedures described in these guidelines assume that a vessel is out of water when her lines are lifted. Technically, it is quite possible to lift lines from a vessel that is afloat, using divers and some of the equipment and procedures described below. Such an effort seems unusual, but HAER resorted to it in 1989 when taking the lines of the *Lettie G. Howard* at South Street Seaport Museum in New York City. A frame 16 feet high and 22 feet wide was designed to fit around the vessel's hull. Welded together from pieces of steel electrical conduit, the frame was hung around the hull from a wooden beam resting on the bulwarks. Trusses at the bow and stern strung two taught wires parallel to the ship's centerline to align the measuring frame consistently at each station. A diver then assisted in obtaining coordinates for each point in the hull section described by the measuring frame. Further description may be found in the Case Studies.

There may be sonar devices available soon that can record the submerged portion of a ship, but this still leaves the remainder to be measured by another method.

GENERAL METHODS

1) **External Measuring Frames.** This method is appropriate for use in a dry dock, marine railway, or other stable, relatively level location, though it can be adapted for use in the proverbial mud flat. A horizontal and vertical scale are braced

and clamped square to each other, and from them measurements are made to points on the hull (see Fig. 4.3.16). This frame can be made from available (straight!) lumber, and the scales marked off on the parts, usually at one-foot intervals. (Some people may elect to clamp a brace at an angle on the inboard side of the frame and mark a scale on that, too.) The horizontal scale must be set level (a 48-inch mason's level will do) and square to the keel in plan. (Be sure to check and see if the vessel is level athwartships. If she cannot be set level, or is twisted, the variations in sheer heights must be handled at the drawing board later--see the section on Measured Drawings.) The top of the horizontal scale should be set consistently at a datum line (string, chalkline on the keel, keel bottom if it is straight, etc.). The frame can be supported on sawhorses, blocks, or whatever is

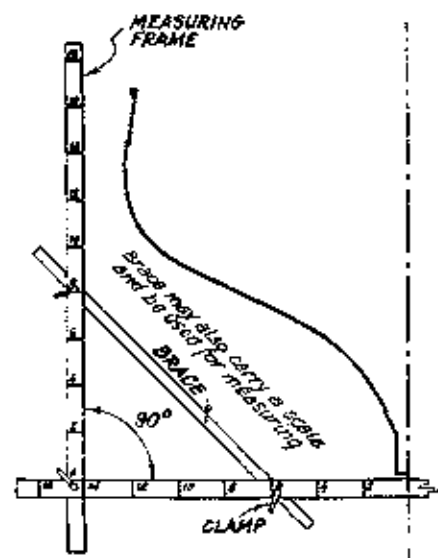

Fig. 4.3.16
Taking Sections with
External Measuring Frames

available. The vertical scale can be plumbed with a mason's level, or you might elect to line it up by eye at frames where rows of fastenings are evident, just to save time. Use of a plumb bob and string can be problematical on windy days--suspending the plumb bob into a bucket of water can dampen the swing and shield the bob against the wind. On inclined marine railways, the vertical scale may have to be inclined in order to keep it square to the plane of the keel bottom or chosen datum line. Fitting a compensating wedge to your level will allow you to keep this inclination consistent station to station, or it may be expedient to erect a second, fixed frame from whose top and bottom the moveable frame is positioned by taping.

Measuring the Hull. Measurements from the frame to the hull can be taken numerous ways. Your team might find it faster to use more than one of these methods at the same time. In any of them, however, measurements must be made from the frame to the hull *in the plane of the section*. (Do note that these measurements are not necessarily square to the hull surface, especially at the bow and stern. The measurements *must* be taken in the plane of the measuring frame.) Since the vertical and horizontal scales of the frame lie in this plane, it is a simple matter for a team member to stand to the side of the frame and "eyeball" the end of a tape (or stick rule) to its proper contact point on the hull in this plane. Subject to the vessel owner's permission, a chalk line could be made on the hull, guided by the team's "eyeballer," to show where the section lies, but this can be an unnecessary waste of time, especially on large vessels. If a hull expansion is to be drawn,

however, such chalk lines are indispensable. (Hull expansions are described later.)

Points with a Stick Rule. The simplest measurement is made with a stick rule projected square from the scales at their buttock or water line marks (see Fig. 4.3.17). It is recorded in a table that shows both the measurement and the number of the buttock or water line mark from which it is made (see Field Notes, Fig. 4.4.5). This method is good when distances to the hull from the scale are less than two feet. Beyond this, it becomes cumbersome, especially from ladders. In principle, it could work for any distance from the scale, but in practice, extra helping hands are required for a long tape or rod. Also, it can become difficult to insure squareness to the scale in the field, and measurements can become inaccurate when the angle between the tape and the hull is less than 30 degrees.

Points with a Plumb Bob. For measurements from the buttock (horizontal) scale, a plumb bob might be suspended from the hull to the scale in cases where the section plane is truly vertical (this method is of no use if the section is inclined, for example, on a marine railway). Alignment of the suspension point on the section line is automatic when the plumb bob is set over a buttock mark on the scale (see Fig. 4.3.18). The dimension from the suspension point to the mark is then recorded in a table along with the buttock number. This method has its limits if it is windy, and when you approach the turn of the bilge. Like the horizontal measurement with a stick rule, it loses its accuracy when the angle between the hull surface

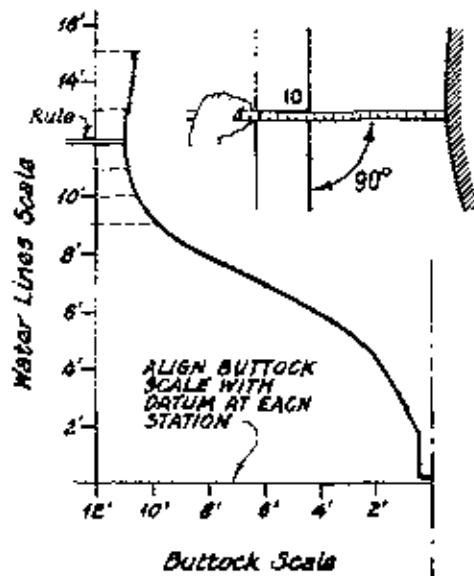

Fig. 4.3.17
Points with a Stick Rule

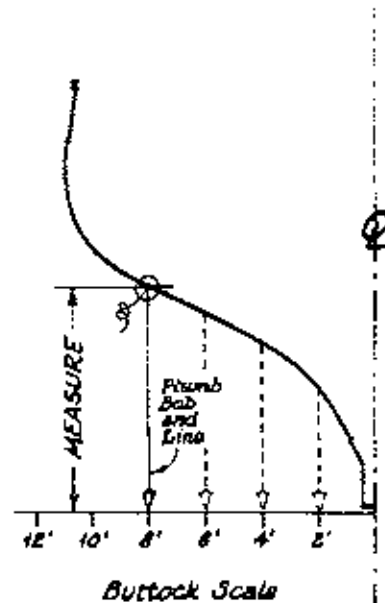

Fig. 4.3.18
Points with a Plumb Bob

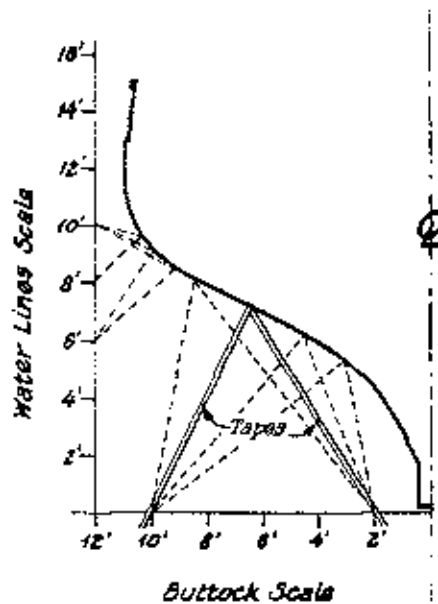

Fig. 4.3.19
Points by Triangulation

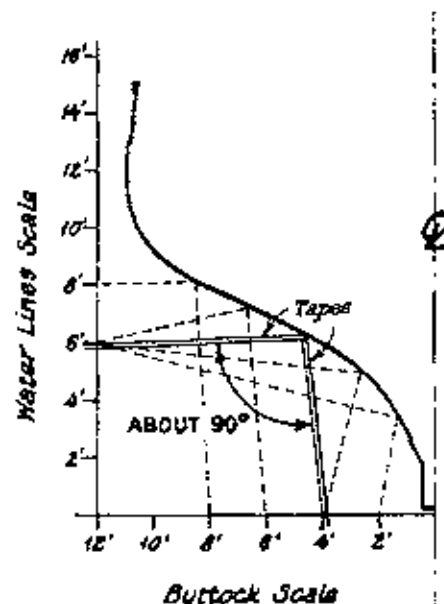

Fig. 4.3.20
Points by Quadrangulation

and the plumb line is small: a slight error horizontally leads to a much larger error vertically.

Points by Triangulation. Triangulation, or even quadrangulation from the frame eliminates many of the limitations encountered with plumb bobs and simple offsets (see Fig. 4.3.19). A point on the section line along the bottom of the vessel may be triangulated to the buttock scale by pulling a tape from the point to each of two widely spaced buttock marks and recording the respective distances and buttock numbers in a table (again see Field Notes, Fig. 4.4.5). This applies similarly to points on the side of the vessel measured from the water line scale. The effort can be speeded up by using two tapes secured at their ends to a long pole; the pairs of measurements can then be made more or less simultaneously. Take care to keep the angles between the tapes greater than 45 degrees, however. At acute angles, small errors in reading or plotting one of the dimensions can mislocate a point by several times the error. Try it and see!

Points by Quadrangulation.

Quadrangulation is simply a modification of triangulation (see Fig. 4.3.20). When recording a point, one tape is pulled to a water line mark, and the other to a buttock mark, with dimensions and positions suitably recorded (a pair of binoculars can be handy for reading tapes at high water line marks). There is no need to keep the tapes square to the scales, though an angle of 90 degrees between the tapes themselves is best. This technique is especially useful at the bow and stern of a vessel, where the hull surface is at some distance from the measuring frame and triangulation may give you too acute an angle between tapes. Aside from reading the tapes properly, the accuracy of quadrangulation depends on the vertical and horizontal scales being kept dead square to each other from station to station.

Sheer and Rabbet Lines. In addition to offsets, both the rabbet and sheer line must be recorded, since these are the endpoints of the section lines (see Fig. 4.3.21). The rabbet line is the intersection between the

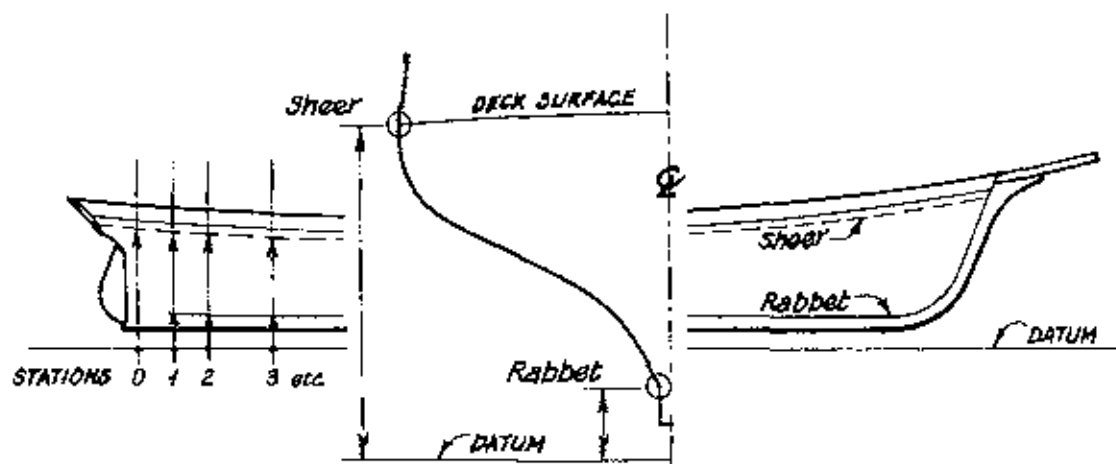

Fig. 4.3.21
Measuring Sheer and Rabbet Lines

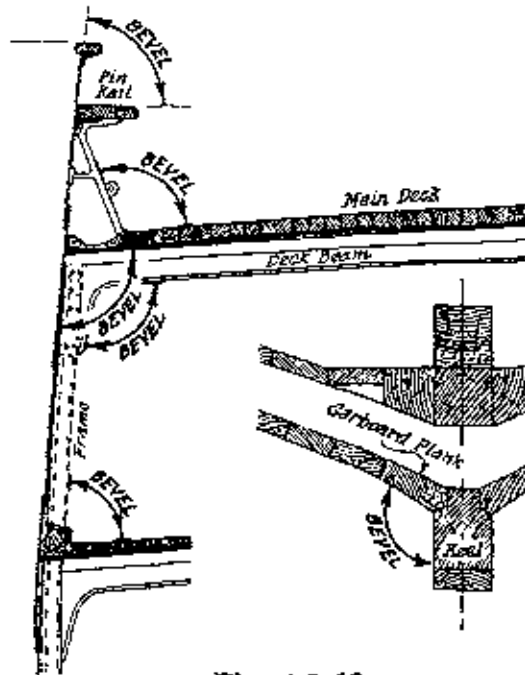

Fig. 4.3.22
Examples of Bevels

exterior surfaces of the garboard plank and the keel (see Figs. 4.3.21-22). The sheer line is generally understood to mean the intersection of the exterior surfaces of the hull and main deck. It does not necessarily have to coincide with an exterior feature of the hull. In looser usage, a sheer line is a somewhat flexible term which refers to the fore-and-aft sweep of the deck (and parallel features such as wales, cap rails, etc.). For convenience, "the" sheer line in your notes and preliminary measured drawings can be the underside of the cap rail, a bead, the sheer plank, the intersection between the main deck surface and the exterior hull surface, or even the underside of the deck planking at the ship's side (plank sheer). Ease of definition should be your guide, but whatever you choose to call the sheer line should be used consistently throughout all parts of your preliminary work to avoid confusion. (In final drawings, the sheer

line as generally defined first above should be shown.) It is important to measure the beam (port sheer line to starboard sheer line) of the vessel at each station, as well. This is later used as one kind of check against mispositioned sections due to the vessel's not lying level athwartships, or being twisted. If asymmetry in the hull is not a problem, the beam dimension is simply halved at the drawing board, and used to locate the offset of the sheer from the central buttock plane.

Bevels. As a check against errors, it is wise to take bevels at every station. A bevel is any angle between two features. On a wooden vessel, you might take the bevel between the garboard plank and the keel (see Fig. 4.3.22), or between the hull and main deck at the sheer, or between a frame and deck beam inboard. A bevel need not be actually measured with a protractor, though if one is available, use it. A carpenter's bevel gauge (which consists of two hinged arms with a lockable hinge pin) can be adjusted to the angle of the bevel and the angle transferred directly onto a field note sheet for measurement at the drawing board.

On-site Verification. Every section should be plotted on site to verify the data before the frame (or any set-up) is moved to the next station. At the drawing board, each section is plotted by first drawing the measuring frame to scale. Simple offsets are drawn square to the frames. To plot a triangulated point, a compass is set and an arc drawn for each of the two recorded legs of the triangle (or quadrangle). The intersection of the arcs is the point location. This is repeated for every point before the section line is faired in through as many points as will fit along a smooth

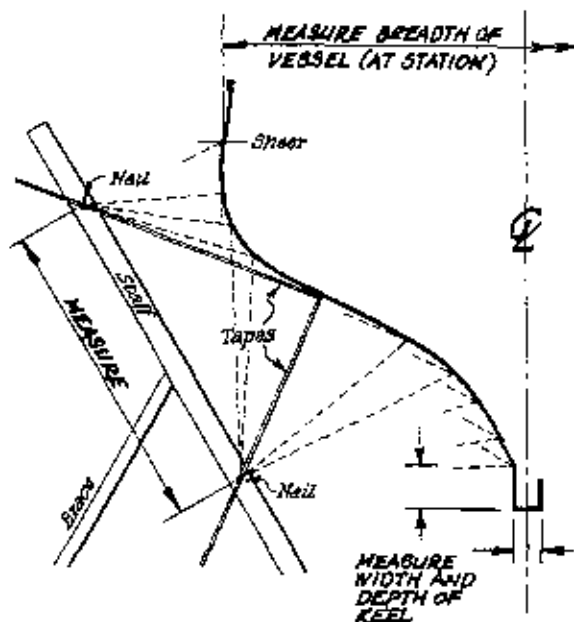

Fig. 4.3.23
Taking Sections with
Staff and Tapes

curve. Any points or series of points showing considerable misalignment from the curve should be checked and, if necessary, remeasured. Plotting lines is more fully discussed in the section on Measured Drawings.

There is no reason why the sort of measuring frame discussed above could not be adapted for use under other conditions, however, the set-up time required will increase where vessels are skewed (e.g., lying in the old mud flat), or where it is less practical to carry large pieces of equipment such as squares and sawhorses. (See Section 6 [Case Studies].)

Many of the above remarks apply equally well to the other methods discussed below.

2) **Staff and Tapes.** Ideal for mud flats and out-of-level vessels. Equipment is simple, easily portable (compared to a large measuring frame), and it can be adapted for use anywhere, though it does present some set-up problems. The staff is simply a piece of sturdy lumber long enough to brace securely and set two nails on 8 to 10 feet apart (see Fig. 4.3.23). This dimension may be greater for large vessels, less for smaller ones; it must be accurately recorded in all cases. The guidelines discussed earlier for choosing station locations at which to set the staff apply here as well. The staff can be driven into the ground, nailed or clamped to haul blocks, or attached to the vessel somehow by outriggered braces clamped or nailed to the cap rail and keel. Each point in a section is located by triangulation from the two nails. Plotting the points is the same procedure as discussed for triangulations above. The relative angle of the staff to the vessel in the section plane is not critical, though an angle of about 45 degrees from the central buttock plane may be best. Ideally, the shape of each section can be properly plotted even though the position of the staff varies from section plane to section plane. However, once the staff is set up for a given section, the entire section must be recorded from this position, or you will not be able to plot it without a lot of extra trouble. Recording the beam at each section and the rabbet and keel profiles is essential to this method. Sections plotted only from the staff merely float in space until endpoints at the sheer and rabbet lines are established with this crucial data.

A weakness of this method lies in the triangles created at the extremes of the section. The acute angle between the tapes

can magnify measurement and plotting errors. This problem can be mitigated by making the distance between the nails larger relative to the distance of the staff from the hull (or even by adding more nails to the staff). It is also much more difficult to eyeball the tape ends in toward the hull in the section plane with this method than with external measuring frames.

Set-up problems stem primarily from difficulties in aligning the staff with the section planes. If the vessel you are measuring is skewed (heeled over with one end higher than the other), it may take some extensive geometric thinking and planning to even set the section planes up square to the ship. If the vessel is greatly deteriorated, the prudent thing to do may be to simply eyeball it, but any lines drawings based on such "guesstimates" must carry notes to that effect. It is possible to plot lines from section planes set at angles to a datum line or to the central buttock plane or the keel, but these angles must be measured in order to draw these skewed sections accurately for later transformation into proper projections. In such cases, it will involve considerable effort and skill at the drawing board to avoid confusing the numerous lines and projections with each other. Under some field conditions you may have no other choice than to take skewed sections, but it will prove more accurate and less frustrating to simply take the time to set up and record "true" sections in the first place.

3) Range and Bearing. This method is useful anywhere, but has some serious weaknesses that make it best used on small vessels unless a surveyor's transit is

handy. As a hand-measuring technique (with protractor), it is the poorest of the three methods covered so far. It is reviewed here in part because it has been used in the past, and others may decide to use the method without knowing its weaknesses. Critical equipment consists of a protractor (or some angle-measuring device) fixed to a staff or frame, and a tape (or other distance measuring device) secured to the radial center of the protractor. Points in a section plane are located by recording their distances from the protractor center and the corresponding angles read from the protractor where the tape crosses the protractor scale (see Fig. 4.3.24). As with the staff-and-tapes method, an entire section must be plotted from a single set-up, and recording the sheer and rabbet lines is crucial to locating the curve relative to the ship's center plane and base plane. The accuracy of the

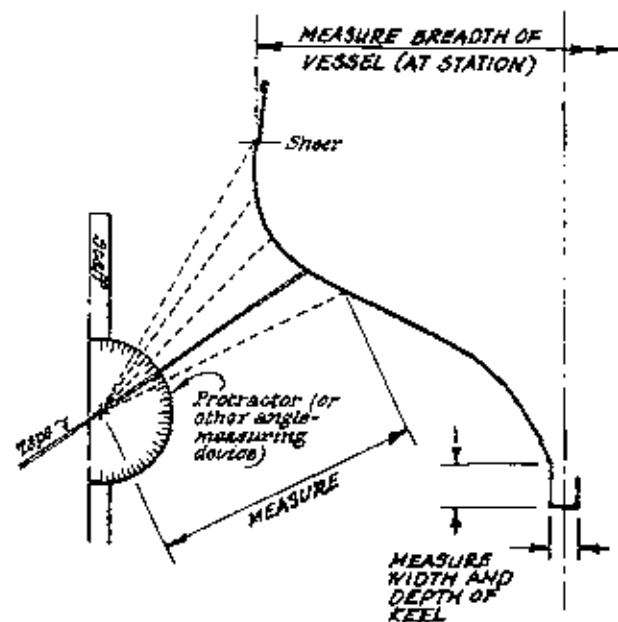

Fig. 4.3.24
Taking Sections with
Range and Bearing

protractor (in part a function of its size) is essential to the method's success.

Depending on the size of the vessel, a small error in angular measurement can produce a serious error in point location. This is why this method is perhaps best used on small vessels if you do not have access to a transit. A transit is capable of much finer angular measurement than you can perform by eye with a protractor.

Larger projects will benefit from substituting a surveyor's transit for the protractor, using the scope sightline to sight in points and recording the angles from the instrument's precise vertical circle. A tape (or electronic distance measuring device) must be used to record distances from points to the scope pivots. You will encounter set-up problems similar to those of the staff-and-tapes method, chiefly ones of aligning the equipment with the section plane at each station. Use of a transit will be most productive in cases where the ship's keel or a wisely chosen water level plane is level, since the instrument is not designed to be easily adjusted to non-horizontal planes.

4) Digital Transit and Electronic Distance Measurement (EDM). This "Black Box" or high-tech process, has great data-gathering potential and flexibility. A digital transit (or theodolite) measures angles electronically and gives a readout in digits instead of requiring the operator to interpolate a vernier scale. This can save time and reduce errors considerably, especially if you are not accustomed to using vernier scales. An EDM unit measures distances by timing how long it takes a series of low-power laser pulses sent from the unit to return from a reflector set up at the point whose

distance is sought. The EDM unit is a separate piece of equipment for many older transit models, since such equipment is usually designed for long-range land surveys. More modern transits incorporate the EDM function in the telescope; such units are known as "total stations". For the relatively short-range distances encountered at a vessel, it is preferable to use a total station. This way, you can avoid the calculations for triangulation errors introduced by an EDM with a line-of-sight different from the transit scope. The EDM and transit functions are interconnected so that distance and angle measurements can be converted by an onboard computer into coordinates or into distance measurements projected into horizontal or vertical planes. Some units provide both a digital file for computer display and a hard copy printout of coordinates. Hard copy printouts should be obtained for all data and stored with project field notes.

In principle, a total station could be set up near a vessel, an arbitrary coordinate system keyed into the system, and measurements made from the vessel by merely spotting a prism on the hull in numerous section planes. A station point from which an entire half of the hull is visible would have to be chosen, unless there are two or three benchmarks that can be used to coordinate several station points. Most total stations store the coordinates of each point in terms of cartesian coordinates or range with horizontal and vertical angles. If downloaded into a computer or plotter, lines could be generated directly from the field data. Some sophisticated programs can plot compound surfaces from a series of points, which could potentially eliminate

the need to set up precise section planes in the field. Instead, section planes could be chosen at will at the computer, and derived from the machine's internal three-dimensional plot of the hull surface. However, this involves expensive equipment and trained personnel. It is also difficult to check the accuracy or suitability of your data in the field, since most such computers and plotters must be located in an office. It may be easier and less expensive in terms of time and money to simply set your instrument up at each station, adjust it to a true section plane, then record the section line with range and bearing coordinates. The EDM eliminates climbing on ladders, and the electronic readouts reduce errors from misread tapes and vernier scales. The readouts could be retained in the instrument's memory, printed out, or recorded by hand and plotted in the field as a rough check to see if you have set the system up properly. A word of caution, though: the EDM device really measures to the position of the prism or reflector, not the actual hull surface, so the sizes of these things introduces an error factor which must be taken into consideration when drawing the lines. Some reflector materials are now available that are fairly thin.

5) **Stereo-photogrammetry.** This is in many respects the ideal recording process, since it is speedy, and far more comprehensive and exacting in its coverage of a hull than any other method discussed so far. In addition to providing information for plotting lines, the photographic images used by the method also provide a detailed photographic survey of a hull's condition and exterior construction features. In principle, two photographs (a "stereopair") are taken of the side of a hull, each from a pair of cameras set at known, recorded

distances from the hull and from each other. After development, the images are placed in a plotting machine whose operator sees them combined as a three-dimensional image or "model." The plotter contains a pointer which can be controlled to measure the model as seen by the operator, causing the machine to draw the contours on a plotting board.

Advanced, computer-controlled analytical plotters can be adjusted for many kinds of error in camera position, focal length, mismatched image size, and so forth. Buttocks, water lines, and sections can all be plotted from stereopairs. In practice, however, field work to place and adjust the cameras must be fairly precise, and targets need to be set on the subject at known intervals to provide scale. Often many stereopairs must be taken to complete a survey that will yield an adequate and accurate plot of the lines. Keel blocks and shoring can also interfere with a complete view of a hull, and the confines of a dry dock may result in taking many more stereopairs than necessary due to the unavoidable closeness of the cameras to the vessel. A problem with stereo-photogrammetry is that most stereopairs are glass plates whose size is less than 4"x5" specified by Standard III.

Combinations of computers and metric cameras have appeared which allow one to use a single camera (not a stereo camera) and images taken from a dozen different vantage points. (Metric cameras are available with a 4"x5" format meeting Standard III.) The camera does not need to be set up or located with a transit. By digitizing a number of the same points or coordinates in each photograph, the computer program calculates the camera locations and lens axis angles for each image. From this point, the operator only

needs to digitize a single point in three different views for the computer to plot its location in three dimensional space. Skill in accurate digitization is vital to the accuracy of the plotted results. Time that would otherwise have been required in the field to measure a vessel by hand can be consumed in the office plotting points, but access to the vessel itself is less necessary. Use of photogrammetry assumes that there are sufficient distinct points on a hull (existing, as in planking seams) or applied points (targets) to plot!

It should be noted that photogrammetric systems can only "measure" what their cameras can "see". Line of sight is critical. Features hidden to cameras must be covered by other photos or by hand-measurement. Photogrammetry probably will not lend itself well to the cramped interiors of most ships.

Major drawbacks to the use of photogrammetric equipment, however, are the very high cost to rent or purchase it and the extensive technical expertise required to operate it. Those who know how to use such equipment need no further introduction to the process, however, photogrammetrists who have not recorded a vessel should read these guidelines carefully in order to achieve proper results from their work. See Section 4.8 (References and Resources), for readings in photogrammetry.

Transoms. When taking lines, a vessel's transom (or round stern) must also be measured. Usually only buttock lines for a transom are drawn, in addition to the transom shape as projected into profile, half-breadth and body plans. A separate transom expansion may also be necessary (see Fig. 4.6.29 for examples of various transom expansions).

Transoms (not round sterns) are usually flat vertical or inclined planes or planes bent to a radius along a vertical or inclined axis. Age and repairs may alter these simple geometries, however.

The set ups for measuring a transom are analogous to those for taking hull sections--the transom is sliced in planes like a loaf of bread, only these planes are *parallel* to the ship's vertical centerline plane rather than perpendicular to it as with hull sections. The intersection between these planes and the transom can be measured with the same methods used for hull sections. The buttock planes are usually evenly spaced from the centerline plane. If you know what buttock planes you will be drawing in your lines drawings, lay these planes out full scale under your vessel. Otherwise, lay out at least three parallel lines (strings) to each side of the vessel's centerline; pick an even spacing like 18" or 24" for convenience.

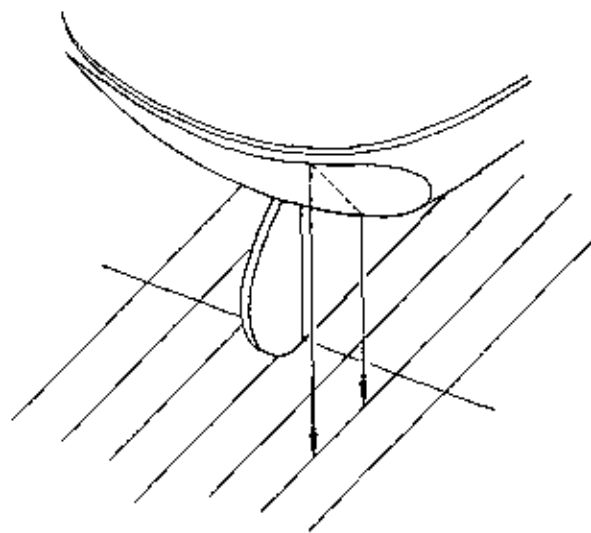

Fig. 4.3.25

Measuring Transoms with a Plumb Line. After laying out buttock lines, a plumb bob can be suspended from the end

of a pole, and the pole end positioned along the top and bottom of the transom at points that align the plumb bob with the buttock lines below (see Fig. 4.3.25). When the plumb bob lies over a buttock line, mark the transom edge at the point from which the plumb line is suspended. This procedure projects the buttock lines vertically through the transom. If you wish, each plumb bob position can be marked on the buttock lines at the same time as the transom is marked. The marks on the strings can then be measured from some transverse line marked at 90 degrees across the buttock lines. This will yield port-to-starboard and fore-and-aft coordinates for each point on the transom edge. The vertical coordinate must be measured from a known datum plane (such as may be described with a transit) or measured between each transom mark and the corresponding mark on the buttock line plumbed beneath it. Later, the vertical elevation of each buttock line mark must be measured relative to a datum plane, or the vertical coordinates cannot be properly plotted.

Measuring Transoms with Triangulations. If using a plumb line is inadvisable or cumbersome (due to obstructions or wind, for example), triangulation from points on the buttock lines to the transom edges may be a viable alternative (see Fig. 4.3.26). The triangulation points on the buttock lines can be established as the intersections between the buttock lines and two lines laid at 90 degrees across the buttock lines fore and aft of the after perpendicular. As with the plumb line points, the elevation of the triangulation points must be measured relative to a datum plane. If obstructions

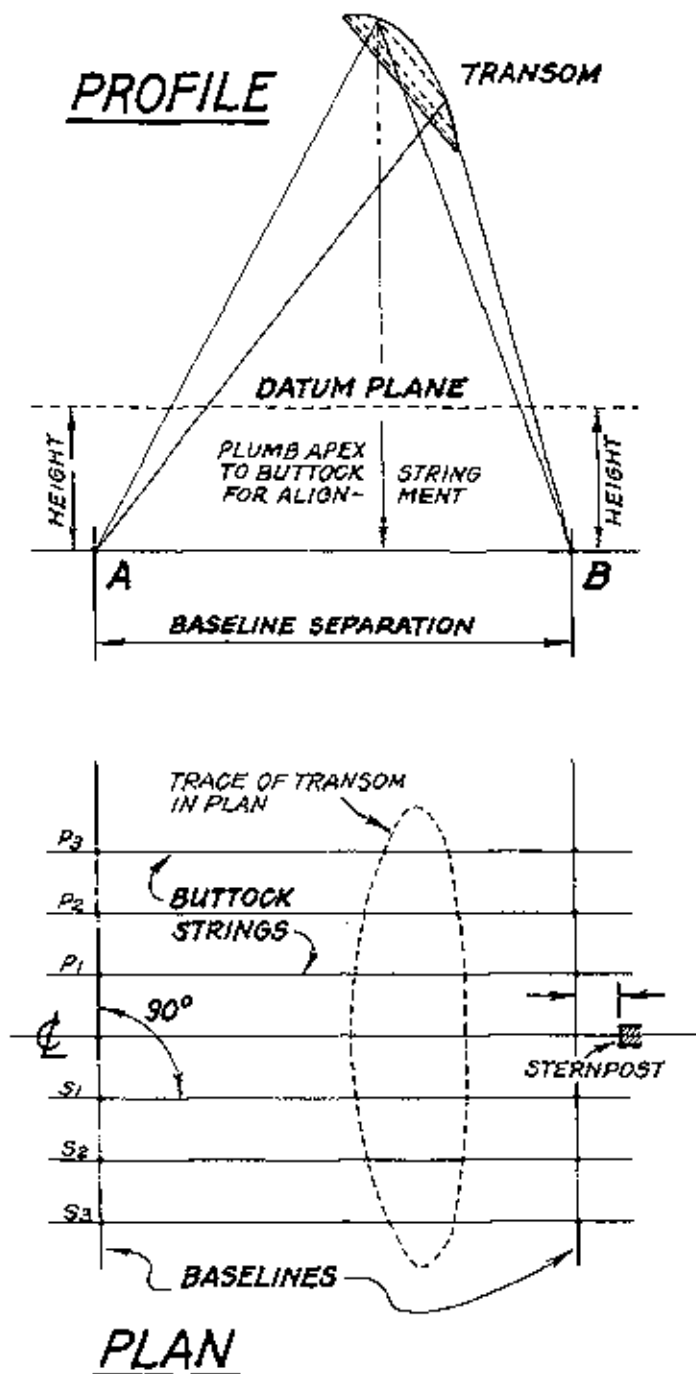

Fig. 4.3.26
Triangulating a Transom

make a layout like Fig. 4.3.26 impossible, each buttock section plane could be measured with a set of triangles different from every other plane. You will have to measure the fore-and-aft position of each triangulation point on each buttock line as well as their elevations in order to plot the transom points later.

The apex of each triangle at the transom edges must be established athwartships by using a plumb line from the transom edge to the buttock lines. If a plumb line cannot be used, you will have to establish the centerline of the transom, and lay out the buttock lines by measuring to each side from it. If the transom is curved (whether along a vertical or inclined axis), a slight error (+0, -1/2") will be introduced in the athwartship positions of the outermost planes. Laying out the apexes with a tape in this manner will be necessary if the vessel is listed to one side.

At the drawing board, once the triangulation points are laid out in profile, the transom edges can be found by swinging arcs from the points with a compass adjusted to the scale lengths of the recorded triangulations. If the field work was accurately performed, the plot of your compass arc intersections should yield the profile projection of the transom as well as the buttock plane locations.

MEASURING STRUCTURE for CONSTRUCTION DRAWINGS

Construction drawings, because of their detail, are in many ways more complex to produce than lines drawings. Because of this, many of the remarks to follow are

general in nature and cannot possibly anticipate all special cases or warn of every pitfall. It is hoped that you will be able to infer many of these things after reading this section and spending a few hours in the field. Review team guidance and reading through case studies applicable to your project will also help you to be better prepared for your field work. The remarks to follow assume hand methods will be used rather than "Black Box" methods or photogrammetry. (Interior sections and plans are extremely cumbersome to produce photogrammetrically, since cameras cannot see through bulkheads and decks.)

In some respects, the field work and notes for producing construction drawings are similar to recording a building for HAER. As you will quickly discover aboard your vessel, however, nothing seems to be straight, square, level, or plumb! Some elements of your vessel may seem to fall easily into a square framework, *but you are better off assuming nothing does, and performing all your fieldwork from this point of view.* This then becomes a very interesting challenge, a test of your ability to imagine objects in three dimensions. Vessels almost sit there and dare you to accurately capture their elusive curves and subtle shapes.

The Golden Key to gathering useful data is to *triangulate the locations of all features in plan and section* from major features or established benchmarks as needed for your final drawings. *There are no shortcuts.* Failure to follow this will mean a return to the ship to obtain measurements to locate otherwise unlocatable or mislocated features.

Team members should actively check each others' work and assumptions as measurements are taken, so critical data are not overlooked or improperly taken.

Simplicity First. Be prepared to find that plans, sections, and profiles are much more intricately interconnected for drawing a ship than for a building. It is best to begin with general overall sketches and measurements, covering ship structure, deck plans, inboard profile (longitudinal section at the vessel's centerline), outboard profile (exterior elevation), and various end views and sections. Details of masts and rigging, joinery, and machinery should be pursued later. Without the plans and profiles, the locations of these latter items will be impossible to plot, anyway. Don't get distracted into sketching and measuring small deck features and other details on overall views. Details should be covered in separate field notes where they can be drawn at a much larger size. The time lost deciphering notes made illegible by tons of crowded details is better spent making clearer notes on separate sheets, especially in the eyes of a future researcher--or your team member at the next board, who will pester you with questions every time he can't figure out your overly cramped notes. Paper is cheap compared to the costs of false economy in frustration and lost effort. See Section 4.4 on Field Notes.

Vessel's Scantlings and Structure. The first feature to record is a vessel's internal structure. You must obtain cross-sectional dimensions, or "scantlings," of the deck beams, deck planking, frames, keel, keelsons, clamps, stringers, hull planking or shell thickness, fasteners, etc., and record their materials. Such data can be recorded in separate tables, or in tables or

notes labeled on sketches (sections, plans, etc.). Thorough scantlings checklists for both wooden and metal vessels appear in Section 4.4 (Field Notes). In general, scantlings may best be recorded in a table, and sketches used to show overall configurations and interrelationships of parts; important dimensions and major notes can be added to these. Inaccessible structure for which data are speculative, unrecorded, or derived from other sources must be noted as such.

Hull Sections. Hull sections should be sketched on which structural configuration and dimensions between major structural members and assemblies can be shown. A midship section is a necessity. Details of mast steps, stanchions, engine mounts, transverse bulkheads, joints, splices, etc., should also be sketched, but on separate sheets. Separate enlarged sections of built-up wooden or metal members may be needed if simple verbal descriptions (such as 2"x3"x1/2" angle) do not suffice. It may prove convenient later to draw and measure these sections at lines-lifting stations in order to more easily relate shape and structure at the drawing board.

Plans. A structural plan for each deck is in order, on which you should sketch all deck beams and record the longitudinal placement of all accessible beams with running measurements. (Inaccessible ones should be positively noted as such, not just left blank.) Mast partners, carlins, clamps, lodging knees, margin plates, longitudinal and diagonal ties (in metal vessels), and other structural members should appear. You might also include frame ends and deck stanchions at the main deck. If you can establish that frames were erected at fairly consistent intervals (such as 2'-0" ±

1/2"), you may save time by measuring only to every 10th frame or so, and drawing the frames between at 2'-0" intervals at the drawing board (with a note explaining how much they vary in actuality). Check with your review team and team historians to see if variations in spacing are significant enough to warrant closer attention. Cross sectional dimensions of some beams may need to be included on the sketch, along with notes of any repairs, replacements, types of materials, or irregular and unusual features. (How to identify some materials and old and new work will be discussed shortly.) Keep your camera handy to photograph *both* typical and unusual conditions. A table of scantlings specific to the view in the sketch might be put on the drawing for convenience at the drawing board. To keep the notes legible, it may be necessary to do a plan several times (you can photocopy it), and separate running measurements of beams from frame locations, etc. Details of joinery, fastener patterns (treenails, drifts, bolts, rivets), and other structural details should be separate sheets, again in order to avoid overlapping too much information.

Once internal structure has been documented, you should move on to profiles, plans, and sections on which to record dimensions to finished surfaces (e.g., compartment bulkheads in crew's quarters) and major components (e.g., engines, capstans). Masts and rigging are discussed beginning at page 4.3.43.

Types of Sketches and Measurements. In a sense, you will be taking two series of measurements: one directly off the features you are recording, and the other as projected into plan or section planes (see

Fig. 4.3.27). These may require different sketches for the same feature in order to keep information clearly organized. Keep in mind that the views you will ultimately draw in finished drawings are *projections*: cambered decks, skewed partitions, tilted rails and other angled features cannot appear "edge-on" or in direct elevation or plane as flat floors and walls might in buildings. A lot of your measurements should be taken in planes parallel to those used in your final drawings (water lines, buttocks, and sections), just to simplify work at the drawing board. Check to see if features aboard your vessel--such as deck plank seams, partitions, deck beams, etc.--fall in or near such planes. If so, you can use them to line up dimensions and triangulations. A good feel for geometry and trigonometry will be invaluable in judging what dimensions to take, and where, thus simplifying your work while maintaining accuracy. Imagining how a

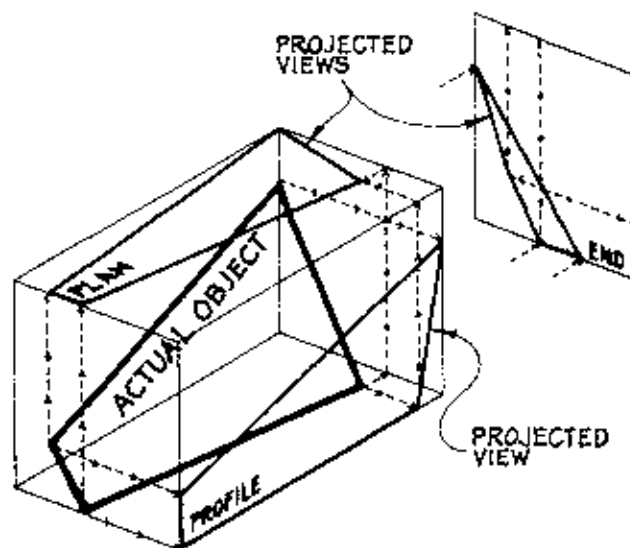

Fig. 4.3.27
Projected vs. Actual Dimensions

feature will look in your final drawing will help you check your judgments. By all means make notes on your field sketches to indicate which dimensions are direct and which are projected, or use different colors for the different types of measurements. Most direct measurements will be foreshortened when you plot them in projection at the drawing board (see Figs. 4.2.27 and 4.5.44).

Checklist. It is wise to develop a checklist at the beginning of a project and keep it handy to guide you in covering the numerous details for which you are responsible. When you think of something additional that bears noting, stop and add it to the list for future action before you forget it.

Field Photography. Field photographs can be of great help here, but bear in mind that they record a perspective, not projected, view of a subject. See Section 4.5. It may occur to some recorders that enlarged photographic prints of features could be used as field notes by drawing dimensions directly onto them. However, the time lost while useful views are selected, photographed, and processed probably makes this method economical only for the most complex subjects or small details whose execution can be left till later in a project.

Old and New Work. Be on the lookout for clues to modifications and repairs. There are many ways to identify them. Some are obvious, like unusually short pieces of wood let into decks or bulkheads. Changes in condition of materials may be indicative--solid clear wood or smooth metal surfaces adjacent to partially weathered, corroded, or worn materials. Changes in wood species--a pine

deck beam amidst oak ones. Changes in the quality of workmanship, such as crudely cut holes or joints, poorly formed rivets, or replacement of elaborate moldings and carvings with simpler ones. Features that don't line up when they probably would have if built at the same time. Look for welded instead of rivetted work in metal vessels built primarily by rivetting, or rivets different from those used in similar work elsewhere in the vessel. Rolled structural shapes (Z-bars, channels, etc.) installed where built-up shapes are predominant very likely indicate later work, as might also changes in manufacturer's names rolled into such shapes. Patterns of corrosion with noticeable edges or boundaries may indicate that something was removed, as may ridges in paint finishes, or changes in the number and colors of paint layers from one area to another on a continuous feature. Look for outlines or joints showing through finishes; changes in fastenings or fastening materials, screws used instead of bolts or nails for similar features, etc. Interpreting these things adequately may depend greatly upon the availability of reliable historical data, such as old drawings, records, photographs, or recollections by owners. Your project's review team may be of considerable help in evaluating these things as well.

Deck Plans. The main deck is most likely a compound curve. It not only curves vertically ("sheer")--higher at the ends than the middle--it also curves horizontally--higher at the centerline than at the sides. The curvature athwartships ("camber") is intended to shed water, since the main deck must also act as a roof for the spaces below. The deck structure is also a major structural member: it keeps the sides of the vessel from collapsing

inward and provides longitudinal strength, just like the top flange of an I-beam.

Lower decks may not have a camber to them, but they more than likely will have a sheer.

General Approach. Overall recording of deck plans should be done *at the deck surface*. Do not attempt to cover things above, such as roof lines of deckhouses, since these very likely may not lie directly above connected features at the deck in strict plan projection. Rely on notes taken for the inboard profile and the sections to locate these things in plan at the drawing board. Treat each deck as if it were flat, and take measurements fore-and-aft, and athwartships. The error introduced by the deck camber is negligible where the camber-to-beam ratio is around 1:50 or less. (For example, a camber of 6" in a deck 25'-0" wide would give a taped reading of 25'-0 5/16".) Again, running measurements are preferred to additive measurements, because errors are not cumulative--an error in one measurement will not throw off all succeeding ones. Take advantage of symmetry, but double-check it occasionally against a grid line or reference line.

Laying Out and Using a Grid. For recording the curves at the edges of the deck, locations of lugs, ventilators, masts, deckhouses, and other features on deck, few things are better than a grid (see Fig. 4.3.28). Swing offsets can be made from features to grid lines, or triangulations made from the grid line intersections (see Fig. 4.3.29). This system is also independent of level or plumb lines, though it can be used with them aboard stationary vessels; grids have been used successfully by HAER aboard floating vessels where there is no constant level or

plumb to refer to. A grid system can be laid out on deck using chalklines, tacks (copper, not steel), and measuring tapes. You might assume for starters that deck plank seams at the deck centerline run true fore-and-aft, but don't leave this unverified. Begin by measuring and halving the beam of the vessel in at least two places where the deck is clear from one bulwark to the other (more places will be necessary on a large vessel, or on one where the deck has a pronounced sheer). Use the bungs in the deck planks to line the tape up squarely athwartships (assuming for starters that the bungs lie in an approximate line and that deck beams beneath lie square to the ship's centerline). Once you have the two centerline points, set up points port and starboard equidistant from the centerline points. These four points should be outboard enough that a string stretched through the two port or starboard points will clear most or all deckhouses and other obstructions. These lines should lie parallel to the ship's centerline, and should be marked on the deck with a chalkline. Next, set a line athwartships, square to the last lines, using a 3:4:5 triangle set with tapes. (If it seems likely that the deck camber may distort this triangle, lay two of them out, back to back with the base lines touching, and split the difference between them, if any.) It may be worthwhile to set this line at a row of bungs (over deck beam), frame, or lines-lifting station depending on the program for your project. From this line, tacks can be measured and set fore and aft along the two earlier parallel lines, and chalklines snapped athwartships between these tacks, being careful that the deck camber doesn't skew the chalkline. Try to set tacks at integer multiples of feet for simplicity's sake, and record the entire

Taken from Ship BALUTINA, HAER No. CA-54

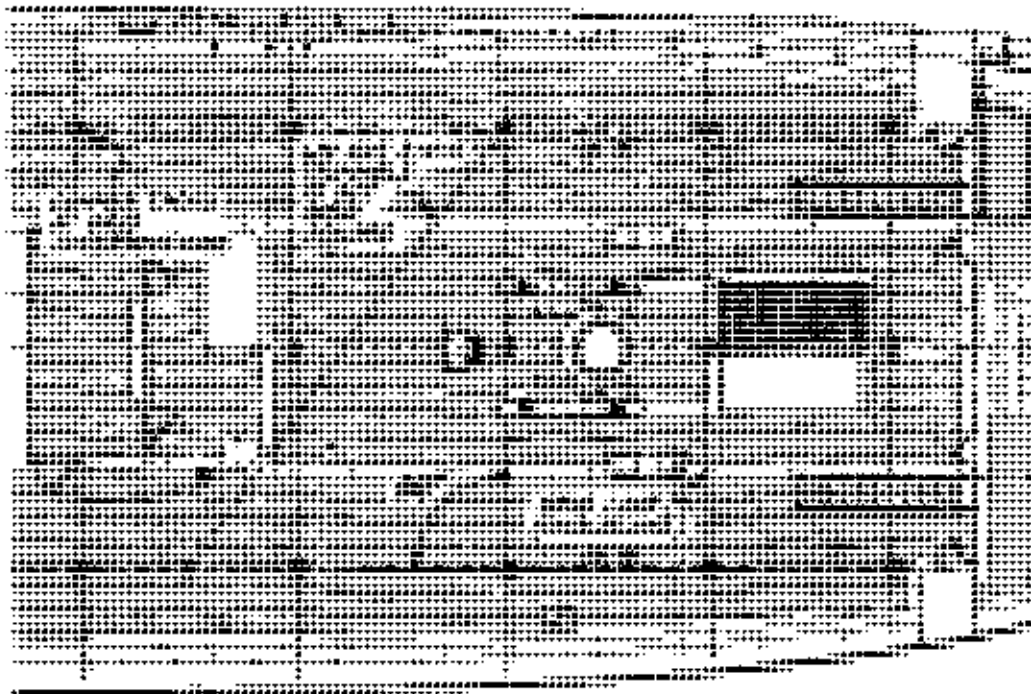

Fig. 4.3.28

Laying out a Grid System on Deck

grid system, with dimensions, for later reference. Extra offset lines from the centerline or athwartships lines can be set to avoid obstructions or for special circumstances. Each tack should be given a reference name which need be no more than an alphanumeric code like "2P" for second station, port side.

The grid system should be drawn to scale after it is laid out in order to verify its suitability. If mylar drawing sheets are used for preliminary plots, the grid system can be plotted on the backs of the sheets, and plotting work done on the fronts. This way, errors can be erased without damage to the underlying reference system. You may choose to plot the grid system on one

sheet, and do all plotting work on separate sheets laid over the grid plot. This way several layers of information can be generated and verified for later combination into final drawings.

Diagonals and Triangulations. Diagonals and triangulations among features and grid tacks should be taken on deck, but they should be treated with caution over long distances, because they may not necessarily be used directly in drawing a plan. On a compound surface, such measurements are actually made along skewed lines, which do not project easily into any orthogonal plane. The error introduced by the curve for short distances and a slight camber or sheer is in most

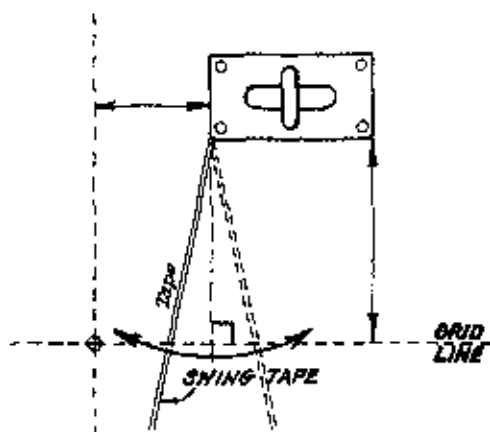

Fig. 4.3.29
Offsets from Grid Lines

cases negligible, but as the deck curve becomes more extreme or the distances longer, the error can grow to several inches on a large vessel. In long measurements, taped measurements made on deck should be supplemented with ones made with the tape lying in a horizontal plane with respect to the deck, just as a check. It may be difficult to do more than approximate level if you are working aboard a floating vessel. The minimum dimension you read from directly above (plumb) to a point is the true dimension.

Arbitrary Triangulation Points. Instead of relying solely on physical features or lines stations as benchmarks, you may find it useful to establish arbitrary triangulation points on a deck for coordinating or double-checking other measurements and triangulations (see Fig. 4.3.30). Such points can be very useful where the layout of physical features produces a lot of triangles with very acute angles. Slight errors in the legs of acute triangles tend to magnify the error in the placement of points. If you set an extra point in the

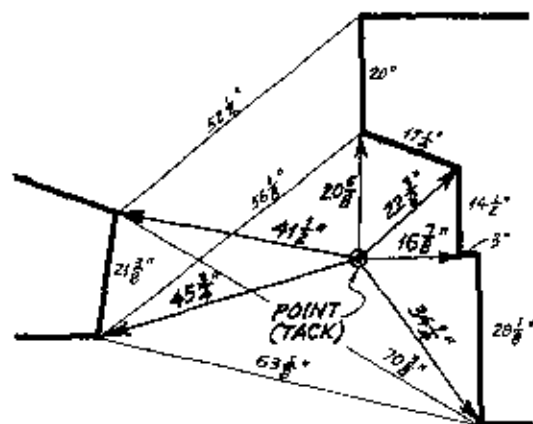

Fig. 4.3.30
Using Arbitrary Triangulation Points

middle of such an area and triangulate to it (as well as other features), the interior angles of the measurement triangles can be made much less acute, and they can then be much more accurately plotted at the drawing board.

Beam Measurements. At the main deck, the beam of the vessel (port sheer to starboard sheer) should be taken at every lines-lifting station or section. (Similar overall widths should be taken on other decks as well, but not necessarily at the lines-lifting section planes.) You should try to measure the beam both with the tape lying along the camber of the deck and with the tape taught (in a straight line), and note what the difference is, especially if it is appreciable enough to affect scaled dimensions at the drawing board. If the bulwarks interfere, measure to the inboard surfaces of them, and add their thickness and any outboard dimensions for a total. If deckhouses or other obstructions interfere, you can either measure them separately (as additive dimensions), or take the beam before and behind such features.

Deck Camber. This may be as good a time as any to take the deck camber of the main deck at each station (see Fig. 4.3.31). This may be done by stretching a string or wire across the deck equidistant above the sheer at the sides (or at points symmetrical about the deck centerline) and measuring the change in deck height at recorded intervals. This may also be done from below deck. Such data will be essential for the inboard profile and sections. Cambers can also be done with a

transit, using a procedure to be covered later. You may find it worthwhile to take and plot the camber at three widely spaced stations. If the curve (not necessarily the depth) remains the same, it is likely the beams were all cut from a single pattern, and no more cambers need be taken unless distortion or other special conditions are present. On some vessels, however, the curve in the deck beam camber may be different for each beam. Recording deck elevations will resolve any questions.

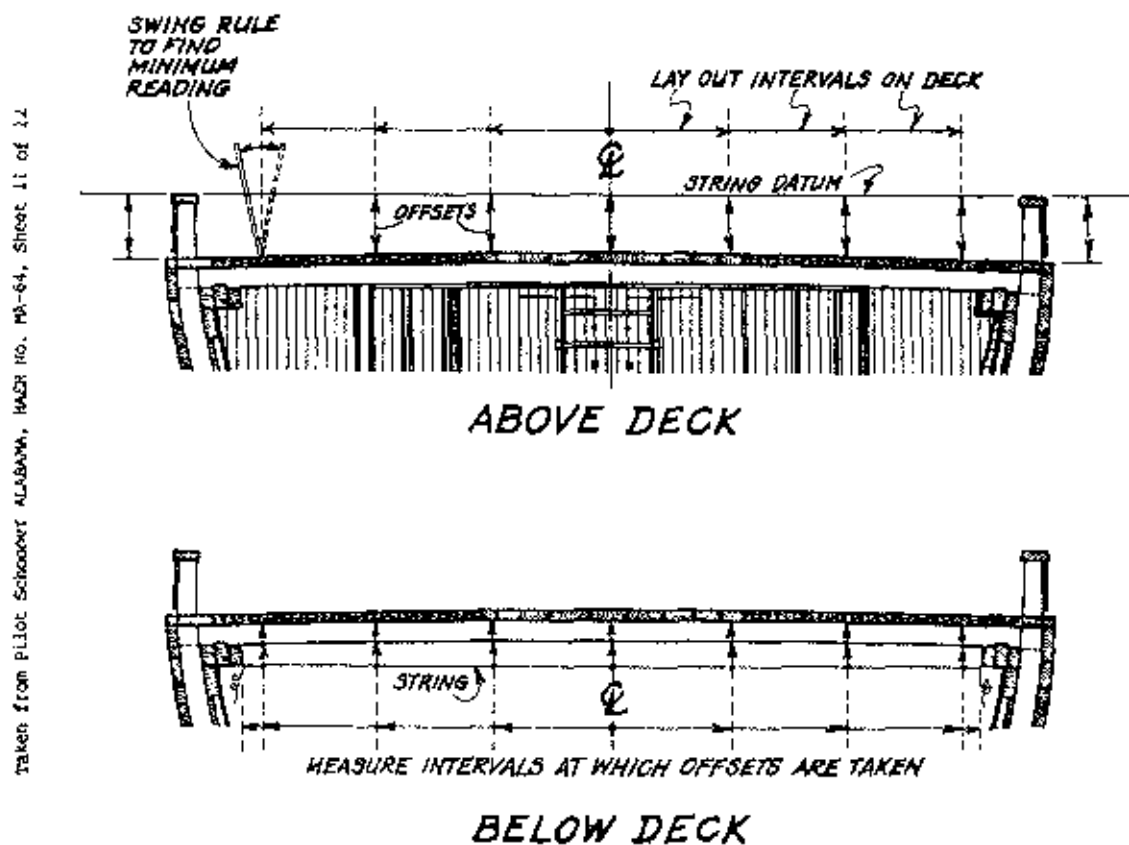

Fig. 4.3.31
Measuring Deck Camber

Features Curved in Plan. Some deckhouse sides or bulkheads may curve in plan. To record these, you can either record the curve as a series of offsets from

the vessel centerline (or from a line parallel to it), or as offsets from some other line whose endpoints are established by other features (see Fig. 4.3.32).

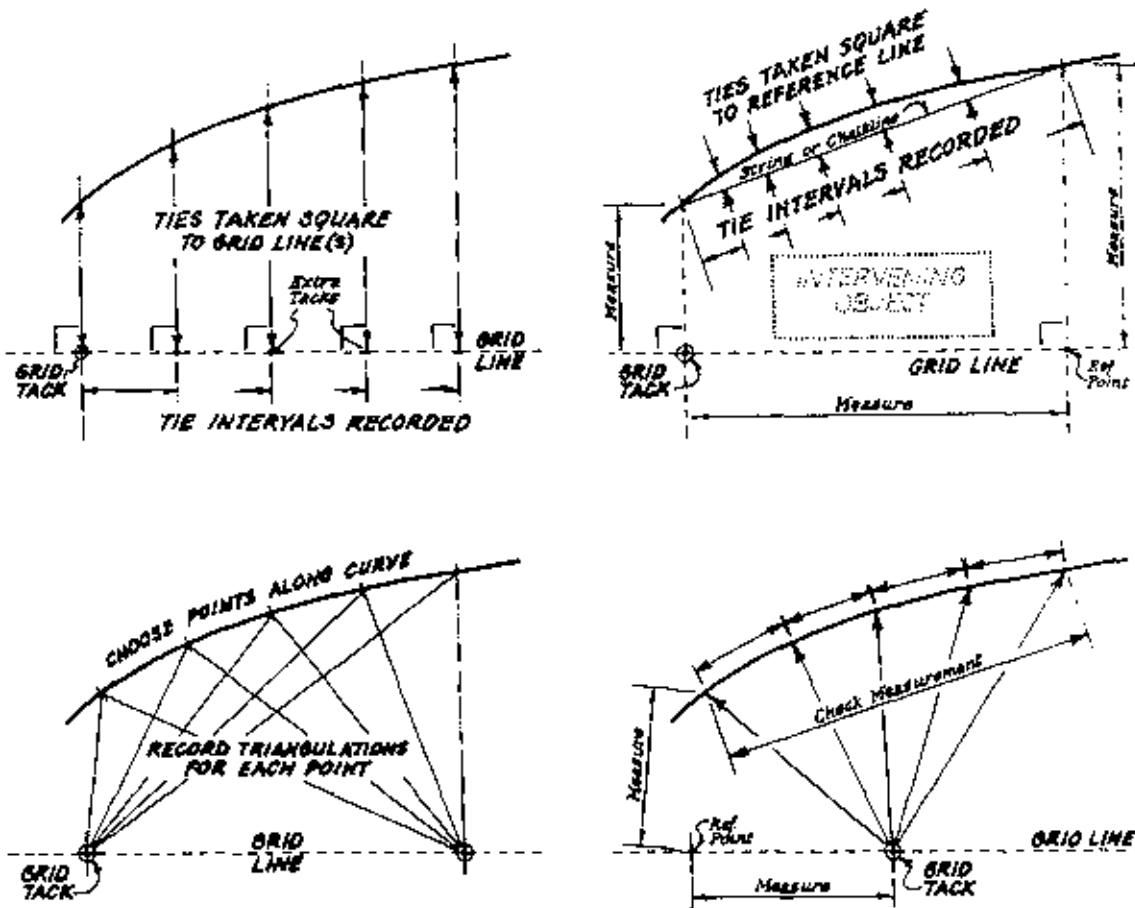

Fig. 4.3.32
Measuring Curved Features in Plan

Hull or Shell Expansions. A hull or shell expansion amounts to a map of a hull's surface akin to a Mercator map of the earth. Just as a Mercator map flattens the curved surface of the globe onto a rectilinear coordinate system, a shell expansion flattens out the surface of a vessel's hull, usually to show surface features such as planking patterns, plate joints, fastener patterns, or other features.

It is developed by taking measurements from the rabbet or sheer lines to planks and other hull features *along the hull surface* where section planes intersect the hull. These measurements are then laid out from a centerline (rabbet or keel) along corresponding section lines in a drawing, and points for planks, etc., are then faired in (see Fig. 4.3.33). This type of drawing sees a lot of use in hull surveys or repairs.

Adapted from Doc. No. 219-1,
 BALZORRA Shell Expansion Plan,
 Survey Report August 1912, App. No. 1
 San Francisco Maritime Museum (now
 National Maritime Museum)

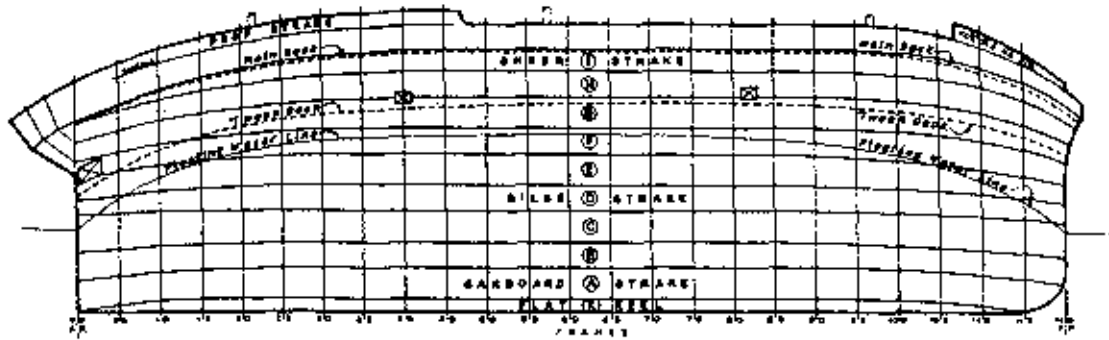

Fig. 4.3.33
 Shell Expansion Plan

Such drawings are not usually required for HAER work, however, and because of the time they consume, they are discouraged unless the features in your vessel's hull surface are of such a significance that they cannot be adequately documented in any other way.

Profiles and Sections. Success in drawing profiles and sections up later will depend very heavily on having accurate deck plans and on having accurate measurements of the sheers (from the lines-lifting), deck cambers, and breadths. Recording the relative heights of all features is also essential to pegging their vertical locations in any profile or sectional drawing--the use of a water level or transit is invaluable for these purposes. Relative horizontal positions are also required so that features can be correctly positioned horizontally in the drawings. Here plumb lines or vertical-plane triangulations to features above (or below) deck surfaces must be used.

Radius and Beam Method for Recording Deck Plans. This procedure works best

for vessels less than 100 feet in length with few deckhouses. To begin, a copper or bronze nail is set securely in the centerline of the stem (or you can begin at the stern or transom centerline). Pull a tape from this nail, labeled A, to points port and starboard along the inboard edge of the vessel's covering board (see Fig. 4.3.34). You may also set marks at the centerlines (or edges) of cap rails and other features that the tape can reach along the vessel edges. The fact that the tape is more inclined for some points than others is of no consequence; calculations will take this into account. Make each pair of points (P_1 for Port 1, S_1 for Starboard 1, P_2 and S_2 , etc.) equidistant from A (that is $AP_1 = AS_1$, etc.) and use integer foot dimensions for simplicity. Make a diagram of the deck and *record all distances from A* in a table, allowing extra columns for some future calculations needed to plot each point. (See the field note illustrated in Fig. 4.4.1 for an example of such a diagram.) Be sure you set pairs of P and S tacks so that a tape pulled athwartships between them is not blocked by a deckhouse or other feature.

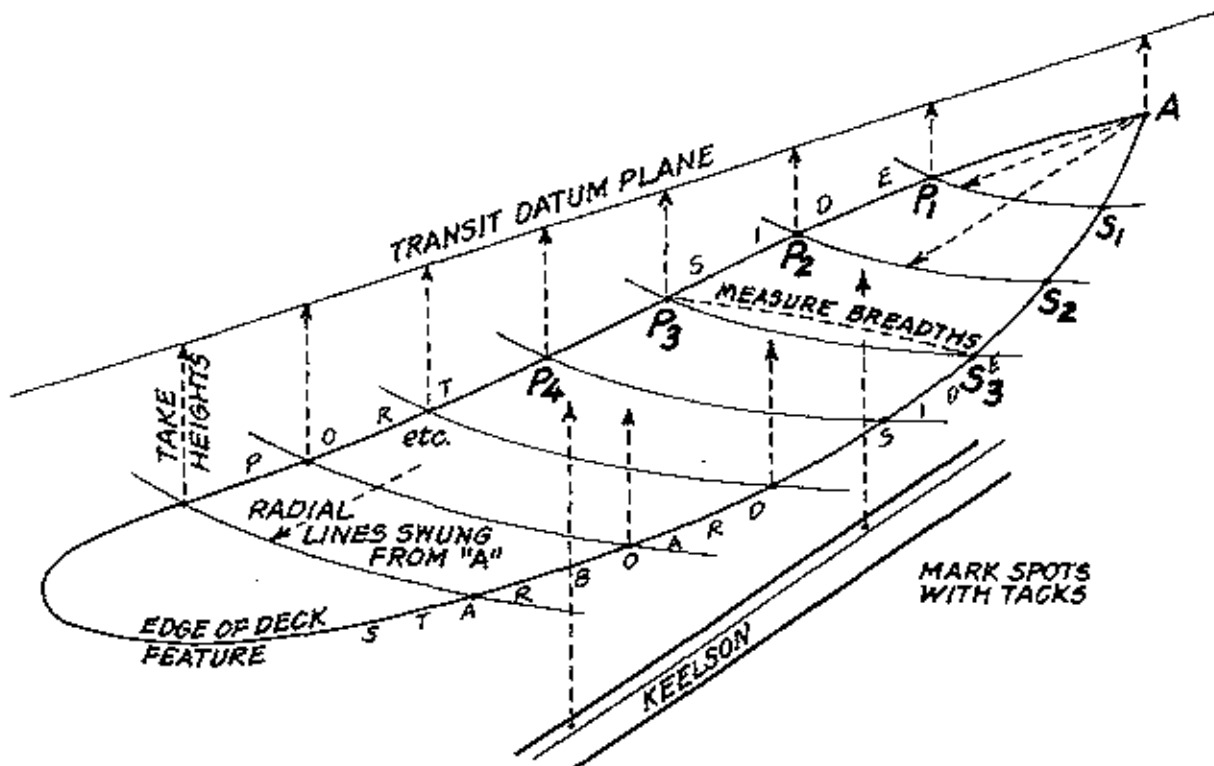

Fig. 4.3.34

Layout of Radius and Beam Method

(longitudinal reference string and placement of transit plane for elevations also shown)

Once the P and S tacks have been laid out and their radial distances from A recorded, you need to establish some bow-to-stern reference line from which the athwarships positions of the tacks can be measured. Otherwise each A-P-S triangle has only point A in common, and no other measured interrelationship established. You could assume each A-P-S triangle was symmetric about the ship's centerline, but in reality, such assumptions become your undoing. The actual centerline of a vessel on deck is usually blocked by masts, deckhouses and the like, so a different reference line must be established. This

can be done in several ways: (1) Pull a string from tack A to a point on the transom, so the string clears all deck features. Then, when you measure and record the distances between each pair of P and S points, you can also pick up the position of the reference line where the tape crosses it. (You may have to use a plumb bob or torpedo level to transfer the reference string location to the tape--this becomes less accurate as distance increases between the reference string and the P and S tape, especially on a floating vessel.) The reference string does not have to begin at A, though this is a most

convenient point for plotting. It can be located at any place and at any angle to the deck centerline (in plan), just so long as it is a continuous straight line. After plotting, this field reference line "disappears". (2) A transit could be used to set such a reference line and read the tapes pulled athwartships after the instrument has been set up to record deck point elevations (more beginning on page 4.3.45).

Once you have recorded the A-P-S triangles, you must set up a transit datum plane amidships, following instructions on pages 4.3.45-48, and record the depths of all tacks beneath the transit datum plane (be *certain* not to forget A!). Before you begin recording elevations, make a field note for recording the centers of forward and aft edges and all corners of all deckhouses, companionways, skylights, etc. (As long as the instrument is set up, you will save time by obtaining the elevations of these features also, and you will have a more accurate job.) If you must record a plan below the main deck later, be sure to set at least two tacks belowdecks at spots beneath deck openings through which you can pull a tape from the tacks up to this main transit plane. This will be essential to setting a datum plane belowdecks which is parallel to the main plane (see Fig. 4.3.34).

Once deck elevations have been taken, you can unlock the vertical circle of the transit and use the instrument to establish and record a longitudinal reference or "centerline" if a string is too cumbersome or inaccurate for the purpose. Center the telescope on tack A and lock the horizontal circle. If A is not visible, simply lock the horizontal circle of the instrument in a

position where the telescope is roughly parallel to the vessel's centerline (exact parallelism is unnecessary). When you pull a tape between a pair of P and S tacks to record a breadth, you can simply rotate the telescope vertically until the crosshairs intersect the tape, then read the tape at the crosshairs and record the dimension. The vertical circle of the telescope describes a plane that is square to the datum plane, so no distortions are introduced by parallax while reading a tape beneath a reference string. Use of a transit for this procedure is highly recommended aboard floating vessels since both the transit datum plane and the vertical circle plane *move with the ship*, unlike plumb bobs and torpedo levels where even short-range use may be too inaccurate on a shifting deck. When you begin measuring P and S tacks astern of the transit, merely "plunge" the scope (rotate it through vertical position) and continue reading the tape as you go astern. There is no need to unlock the instrument's horizontal circle and try to turn it 180 degrees; not only does this take time, you might set the scope at the wrong point.

Reducing Field Measurements for Drawings. This is where the dimension table discussed earlier comes in handy. The radial measurements set out on your vessel with tapes from point A *cannot* simply be laid out with a compass on a drawing sheet. If you do so, your plan will be artificially long (incorrect dimensionally), and the steeper the tape from level (your deck plan plane), the greater the distortion. Instead, you must calculate where each point will project into your deck plan. To do so, you *must* perform the following calculations *for each*

point using the elevation of each point and its distance from A to calculate d (see Fig. 4.3.35):

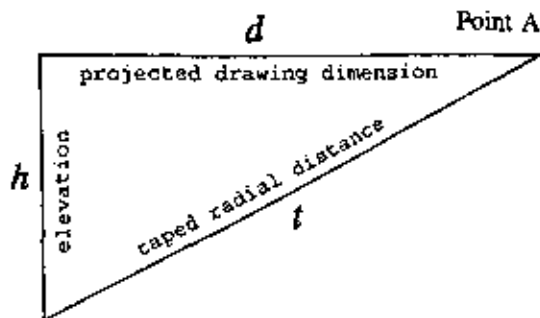

Fig. 4.3.35

$$\theta = \sin^{-1} \times \frac{h}{t}$$

then:

$$d = \frac{h}{\tan \theta}$$

If trigonometry intimidates you, you can resort to the Pythagorean Theorem:

$$d = \sqrt{t^2 - h^2}$$

Whichever procedure you choose, convert *all* your dimensions to decimal inches (e.g. $54 \frac{3}{4}'' = 54.75''$ and $3'-7 \frac{1}{2}'' = 43.5''$) or to decimal feet (e.g. $54 \frac{3}{4}'' = 4.564'$ and $3'-7 \frac{1}{2}'' = 3.625'$). Do not mix the two, or your results will be erroneous. A table will allow you to keep all conversions and operations in a systematic order and reduce mistakes.

Vertical Reference Planes for Heights

The Water Level. For use only aboard *stationary* vessels, this tool relies on the principle that water always seeks its own level (see Fig. 4.3.36). This "low-tech" but extremely effective tool consists simply of a hose (any convenient length) filled

with colored water and having two transparent tubes fixed at either end, left open to the atmosphere. (Corks or stop-cocks can be used at either end to keep the water from running out when the level is being moved or stored.) Using this level, you can "transfer" a reference plane from a single reference point anywhere around the vessel, even around multiple corners where transit sightlines cannot conveniently go. Its use can take some time over long distances--you must wait for the water level oscillations to settle down, then adjust the height of the free end until the water level at the fixed end matches the reference mark. This tool does nothing to locate features horizontally above each other--for this, a plumb line or vertical-plane triangulations must be used.

Advantages of the Transit. Transits may be used aboard stationary vessels, with or without water levels. Aboard floating vessels, however, water levels are useless since true gravity level is always changing with respect to the ship. In these cases a transit is *essential* for providing horizontal reference planes on every deck from which the vertical positions of features in profile or section can be measured. Like the water level, this instrument does nothing to locate features horizontally above each other. Since all you will be doing with a transit is measuring elevations from a reference plane, there is no need for an electronic transit--a mechanical instrument with vernier scales ("Category 1") is less trouble to set up and use. (It may be wise to coat scales, threads, and other exposed metal parts with Vaseline or other preservative to protect them from corrosion by salt.) Obtaining the relative heights of numerous features to reference planes can be of considerable help in tying together a profile or section, especially

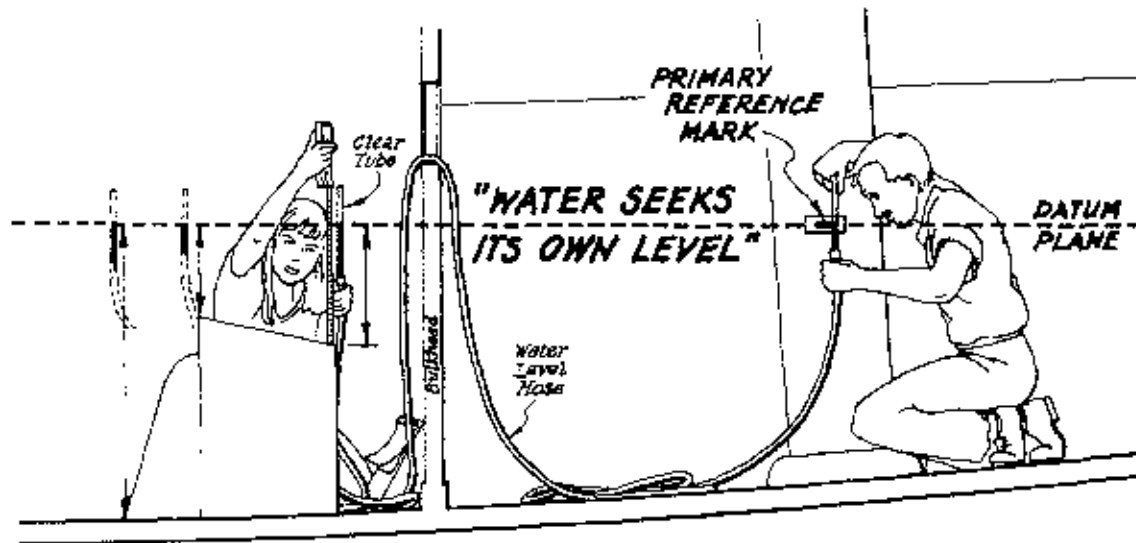

Fig. 4.3.36
Using a Water Level

over the length of the vessel. Spot elevations can be used to double-check not only your triangulation work in locating deck features vertically, but also the vertical coordinates of sheer and deck centerline curves. Making spot elevations is fairly easy. Because the shortest distance from a point to a plane is always a line normal (i.e., perpendicular) to the plane, you can readily determine the distance from a vessel feature to the reference plane by setting a stick rule on the point to be measured, and moving the rule top around while the transit operator records the *lowest* reading seen at the scope crosshairs. No devices of any kind are necessary to try to square the rule to the transit plane (see Fig. 4.3.39).

Using Reference Planes. The locations of these reference planes are in a sense

arbitrary, since all they provide are relative dimensions. However, you will make life a lot easier for yourself if you attempt to establish these planes level athwartships with respect to the vessel's sheer lines (never mind the true horizon), and level fore and aft with respect to the vessel's floating water line. These planes will then closely parallel the ones you will work in at the drawing board or CAD station. Depending on the size and complexity of your vessel, you may have to set up more than one transit station per deck in order to capture all the references you need. If you must set up several planes, it is wise to try to keep them all parallel to each other for ease in laying out your measured drawings. Maintaining parallelism can be done a number of ways, but one of the easiest methods is to mark at least three places on the vessel where

the first plane intersects vessel features. In some situations it may be better to set marks on tall stanchions which have been erected on board and firmly fastened to the ship for the project's duration. A minimum of three points is necessary (the more widely spaced the better), because it takes at least three points to lock in the orientation of a plane; two points will allow a plane to pivot on the line connecting the two points. Four or more points (and stanchions) are advisable for the initial plane, positioned so you can always see at least three points from any location on deck. If you intend to use a transit on other decks, make readings through deck openings to at least three features on each of the other decks (or set at least three marks in each deck space, equidistant from the first reference plane) while your first station is set up. Then whenever new planes are needed on other decks, simply make sure you adjust the instrument's leveling screws at the new station until the plane rests at the same height from the relevant reference marks. Always record the differences in elevation between various levels of reference marks and your actual transit reference planes. Failure to do so will make it impossible to align the planes directly at the drawing board.

Setting Up the Instrument. When beginning, try to choose a station on the main deck from which a major portion of the deck can be seen, and from which you can see both port and starboard rails directly abeam from the instrument station. Actual set-up and adjustment of the instrument is a little tricky, because you will be using the instrument in a manner which is harmless to its mechanism, but one for which it was not designed. Aboard

a vessel, the bubble levels ordinarily used to level the instrument are useless, except in a stable dry dock where the vessel itself has been leveled. When using the instrument aboard a floating or inclined vessel, first be sure the leveling screws are lined up port-to-starboard/fore-and-aft, and that you can sight points at the sides of the vessel directly abeam (see Fig. 4.3.37). This will greatly facilitate the leveling operation. Next, adjust the telescope's vertical swing until the vertical circle reads zero ($0^{\circ}0'0''$), then lock the vertical circle. (Leave the horizontal circle free to rotate.) Following this, the port-to-starboard leveling screws of the instrument are adjusted (*never* the vertical circle of the scope) until you can read the same heights through the scope on rods set up at the port and starboard sheer lines in a plane perpendicular to the vessel's centerline (see Fig. 4.3.38 and 4.2.39). This sets the scope plane level port-to-starboard with respect to the vessel.

Where you level the scope plane fore and aft is a matter of choice. If the vessel is afloat, it is best to set the scope at *approximately* true level by using the "horizon" if it's visible. If the vessel is inclined or skewed, try to set the fore-and-aft orientation so that the plane is as nearly parallel as possible to the vessel's floating water line or the water lines to be used in your lines drawings. The trouble taken to make these arrangements will be more than repaid by the time and headaches saved laying out points at the drawing board.

Relative Horizontal Positioning

Plumb Lines and Levels. Aboard a stationary vessel, a plumb line or mason's

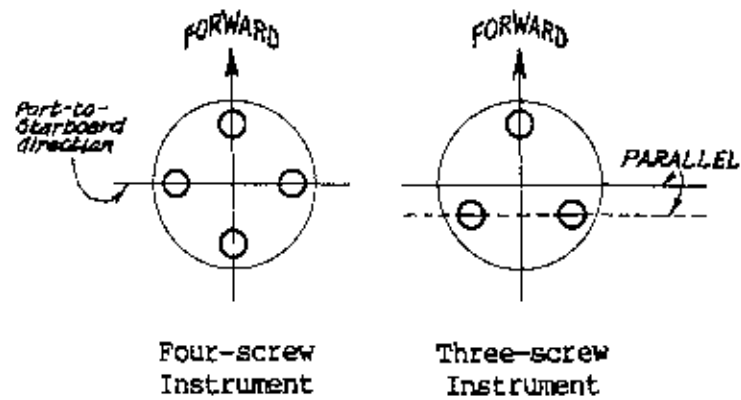

Fig. 4.3.37
Lining up Transit Leveling Screws
with Ship Coordinates

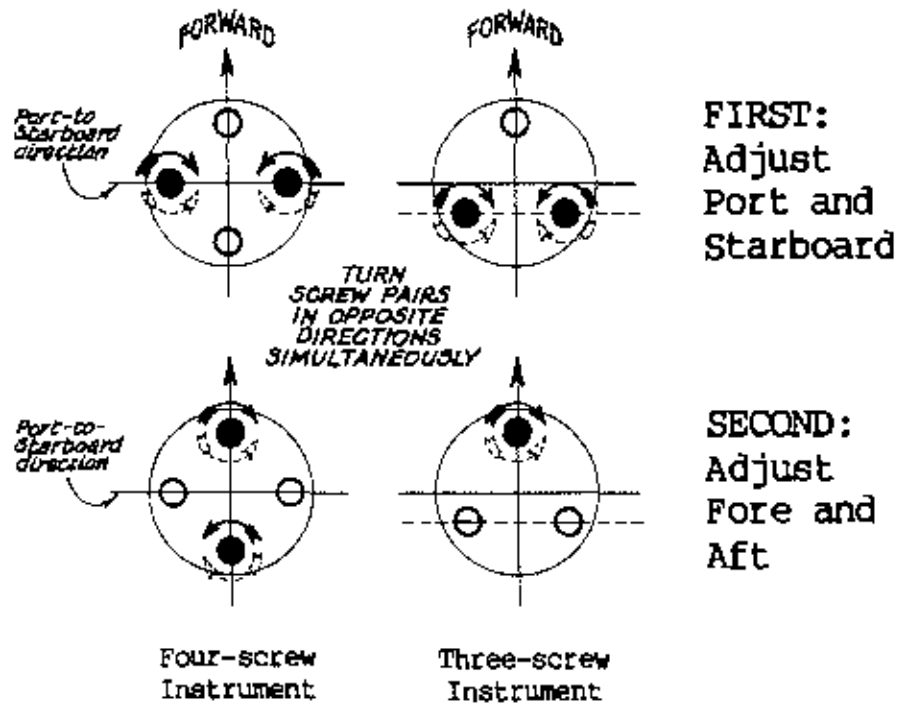

Fig. 4.3.38
Adjusting Leveling Screws

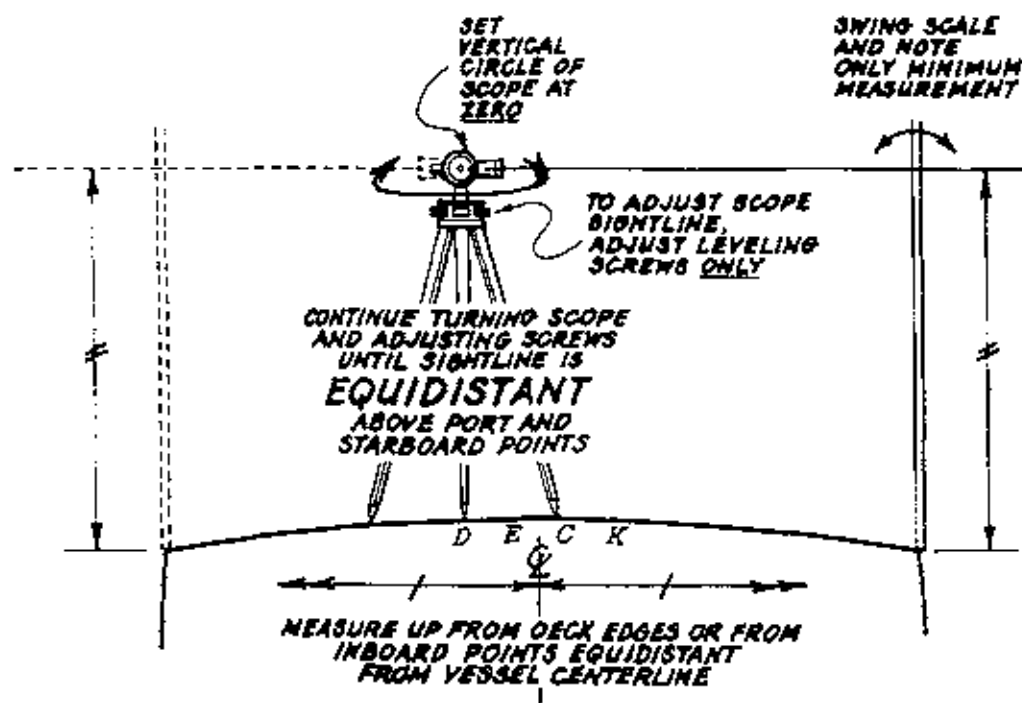

Fig. 4.3.39

"Leveling" a Transit Port and Starboard

level can be used to record the relative horizontal position of one level surface to another, such as a forecastle deck to the main deck. Wind can raise havoc with a plumb bob, however, though immersing the bob in a bucket of water can damp the wind's effect. Inside the vessel and over long vertical distances, a plumb bob will serve much better than a 4' or 6' mason's level. There are many situations where the use of vertical-plane triangulations aboard a stationary vessel will save time and effort, however, so this technique should not be overlooked.

Vertical Triangulations for Horizontal References and Inclined Features.

Vertical-plane triangulations are essential

when recording the relative horizontal relationships of decks, platforms, and other level surfaces aboard floating vessels where plumb lines are useless. In profiles, the angles between bulkheads and decks can be recorded by triangulating the surfaces in vertical planes parallel to buttock or section planes (see Fig. 4.3.40). The same applies to masts, engine mounts, etc. Longer diagonals covering several features will prove useful as check-measurements. When recording things like the side of a deckhouse, or other trapezoidal shapes, measure all edges and both diagonals (see Fig. 4.3.41). If one or more edges of such surfaces are curved, you may have to set up a string or chalkline for an arbitrary reference and

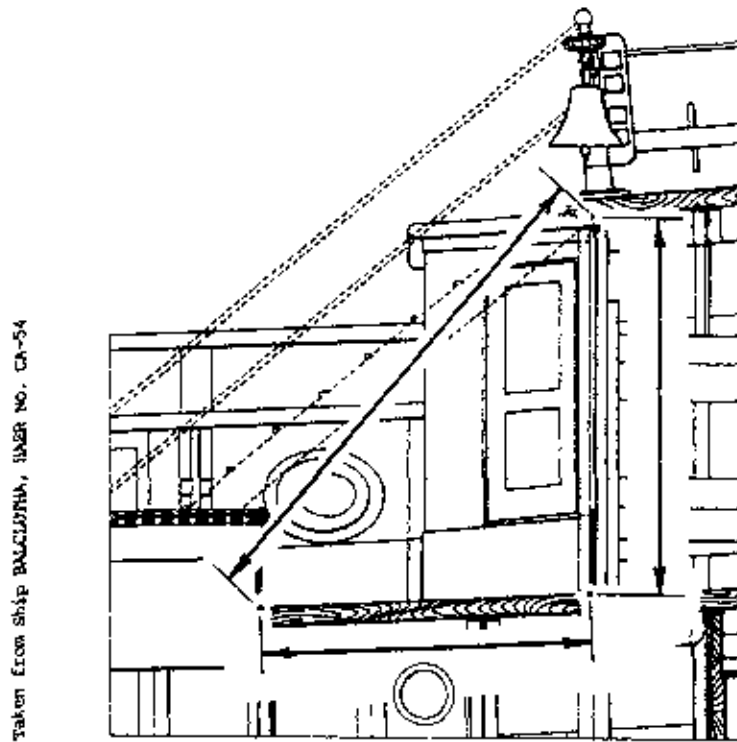

Fig. 4.3.40
Measuring Inclined Features

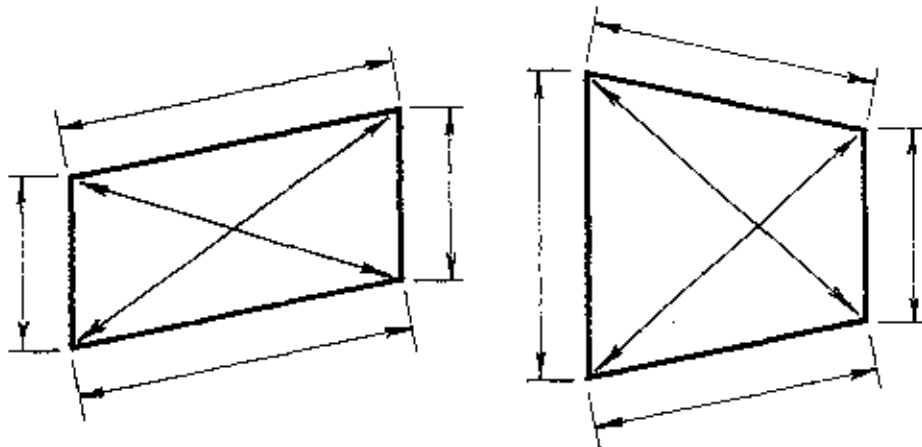

Fig. 4.3.41
Recording Non-rectangular Shapes

record the curve by a series of offsets. (Don't forget to note the dimensional locations of such reference lines.) This shouldn't be necessary where the curved edge meets a deck or hull surface, since the deck curve and other surfaces should have been established already. Again, don't forget to shoot photographs.

Deck-to-deck Locations in Profile.

Distances from the underside of one deck to the top of the next one lower down can be established by recording the minimum distance between them at the vessel's centerline (other locations may be dictated by circumstances). This is easily done at various points by holding the end of a tape to one surface, and swinging the tape near the other surface until you find the minimum. At the drawing board, this can be translated into a series of compass arcs, against which a ship's curve or spline can be fitted to draw the deck profile. Naturally, you should record where you take such measurements, and any special circumstances surrounding them.

Rigging and Sails. Unlike construction details, so much is known about rigging and sails that detailed documentation may not be strictly necessary from the point of view of new or significant information. However, since HAER documentation is vessel-specific, it would be incomplete without some coverage by photography and drawings of a vessel's rig when drawings of the vessel are warranted. Your project goals (which may include training, maintenance, replacement, replication, etc.) may argue for more extensive detail in this area than significance alone might. Your review team, vessel owners, and project cosponsors should be consulted in setting a scope of work in this area.

Rigging. Vessels are usually classified by their "rig"--the shape and location of their sails and the ways they are supported. Rigs can range from the fairly simple to the very complex. "Rigging" refers most commonly to lines (ropes or cables) that seem to festoon the vessel for support and control of the masts, yards, booms, and sails. You should be aware that rigs are often adapted to specific trades or regions, so be on the lookout for peculiarities and the reasons behind them. Ask your review team if there are any unusual features about the rig on your particular vessel. Some vessels have undergone two or more changes of rig in their lifetimes. Unlike spars and standing rigging, running rigging was often changed when owners or captains preferred certain sorts of operational arrangements. Because of this, running rigging is on the average the least important to draw compared to standing rigging and spars; photography will probably cover the subject adequately.

If rigging is unfamiliar to you, it is probably best to start thinking of it as a series of systems designed to hold up and control the masts and sails. The masts are braced to each other and to the vessel by the standing rigging, which needs only occasional adjustment. The sails, with attendant yards or booms, are controlled by running rigging, specifically designed and built for constant adjustment. Running rigging can be broken down into several sub-systems: one raises and supports the yards or booms, another raises the sails, still another controls the angle of the sails to the wind and to the vessel. Looking at rigging this way will go far to reduce confusion for those recording a vessel for the first time, and may help you more

easily learn the names of the various spars, sails, lines, and line systems.

Sails. As with running rigging, recording sails can be problematical, since sails for most older vessels have been repeatedly replaced in service. Details of sail construction were a matter of the sailmaker's craft, rather than something done to sets of engineering drawings. Unless you have specific evidence as to the type and construction of sails used on your vessel for a specific period, it is not prudent to show more than their schematic character in measured drawings. Measurements aren't necessary under these conditions. Evidence gleaned from historic photographs and other sources may be used if specific sources are cited in the final drawings.

In cases where sails deserve recording, there are several things you should be aware of. First, sails may not necessarily lie flat (i.e., without wrinkles or folds) if spread out on a floor. Secondly, they can stretch in service from the time of their manufacture, so that what you measure and draw is not their original shape. In any case, dimensioned sketches and photographs should be taken, and attention paid to significant construction details. A checklist is given below:

- 1) Dimensions of sides and diagonals, with the sail laid flat or stretched
- 2) How panels are laid (whether they are mitered, or parallel to the leech, luff, or foot)
- 3) Panel widths, seam to seam
- 4) Amount of roach (curve in either foot or leech; positive roach is convex, negative roach is concave)
- 5) Dimensions of leech panels, since this is where roach will show up
- 6) Width of seams
- 7) Width of tabling (perimeter seams)
- 8) Size of stitches (number per inch)
- 9) Location and size of reinforcing patches
- 10) Distance between reef bands, and number of reefing points
- 11) Materials and weight
- 12) Maker's name, and approximate date
- 13) How the sail is bent (attached) to spars or stays

Figure 4.2.42 shows the names and locations of some sail parts; further assistance can be had from a book such as Underhill's *Masting and Rigging the Clipper Ship and Ocean Carrier* (see Section 4.8 for full citation).

Recording Hints. Diameters of masts and yards should be taken as shape requires—some have straight tapers, others do not. Remember that the diameters of spars can be measured by taking their circumferences with a tape and dividing them by π (3.1416). To simplify and expedite the recording of masts and spars, record them with typical diagrams accompanied by tables in which the varying sizes and diameters can be put down. A similar approach can be used for details of fittings and construction.

Missing Rigging. On the other hand, it may be that the vessel you are recording has lost some or all of its rig. Telltale things such as holes in spars, blocks with no lines, iron fittings, and wear points, may all be clues to what once used to be there. Your project's goals and its review team should be consulted over whether to restore these things in the drawings, and

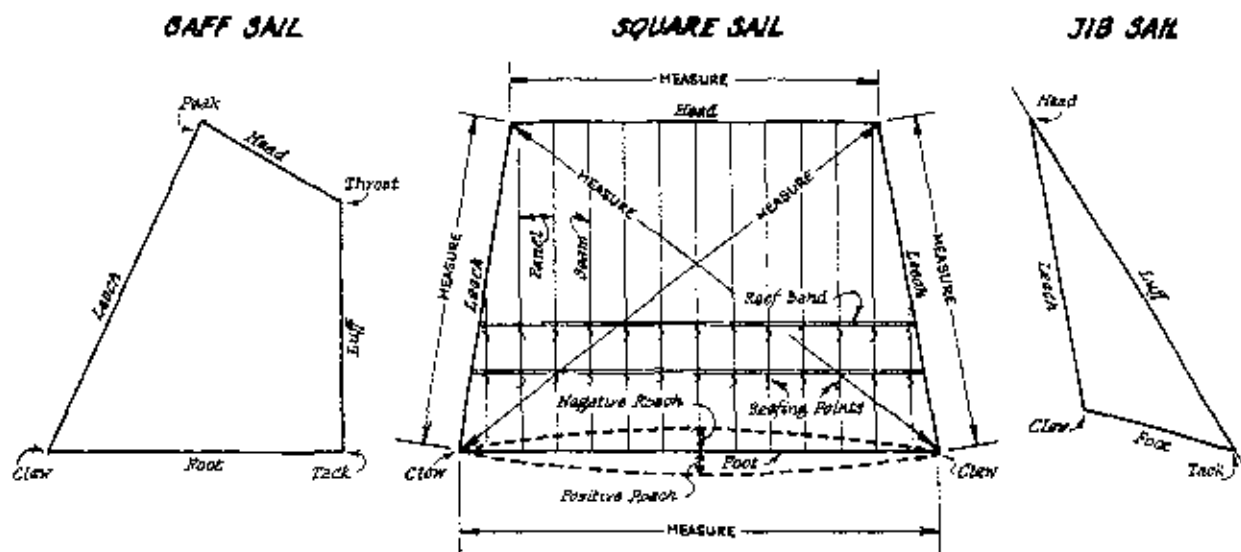

Measurements of panels, seams, reinforcements, reef bands, roach of leeches, etc. should also be made when sails are recorded. Measurements analogous to those shown for square sails above

should be made when recording other sail types. Many types of sail are not shown above, nor are all details indicated. Use of a reference book is recommended for detailed work.

Fig. 4.3.42
Measuring a Sail

on what basis. Other matters besides sheer historical significance may be determining factors. Historical photographs or the recollections of a crew member can be of great importance in cases where graphic restoration is attempted. Speculation not based on physical evidence aboard the vessel, historical photographs, or other reliable evidence, is discouraged. In the late 19th century, sizes and proportions of lines, masts, yards, and other spars were set by specific formulas and published in tabular form by insurance companies (such as Lloyds of London). These tables can be of considerable help in the absence of other information. In some cases, speculation based on less reliable sources may be all you can present; if so, the speculative nature of your reconstruction

and your sources should all be clearly noted.

Machinery. Nearly all vessels have some manner of machinery aboard them, even if it is no more than the steering gear or an anchor capstan. Decisions on how to record them (photos only? photocopies of existing blueprints? detailed measured drawings?) should reflect your project's goals and be made in consultation with the review team.

Old Blueprints or Shop Drawings.

Unlike sailing vessels—which were mostly built from half-models, not sets of blueprints—full sets of engineering drawings had to have been made to produce any machinery you record. You

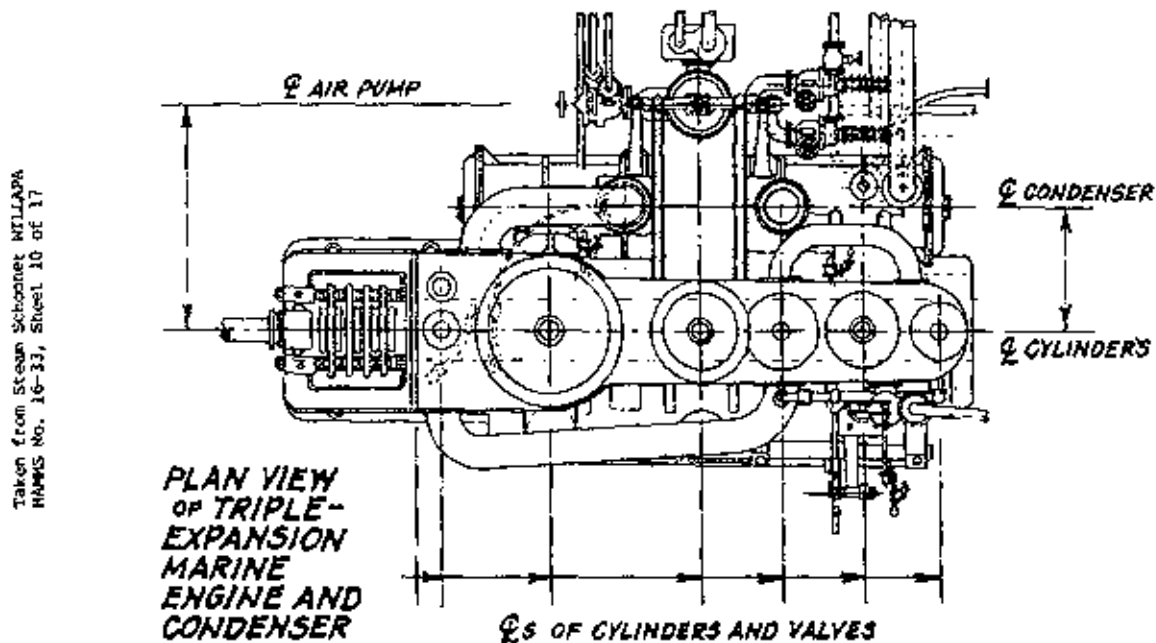

Fig. 4.3.43

Measuring to Centerlines of Objects

may save much field and drawing time by locating surviving drawings and obtaining copies from manufacturers, trade catalogs, museums, archives, owners, and other sources. In some cases it may be wise to obtain permission to photographically copy drawings of significant machinery for formal inclusion in the HAER record photographs. Inclusion in the HAER record can only be allowed if copyrights to such material are waived (in writing) by their owner. (Even if HAER is not permitted to include such materials, copies of any drawings or other graphic materials used to prepare HAER drawings can be included in the field records, along with references from which further copies may be obtained by users. In such cases,

locations of the original drawings should be noted. Copies in the field records may also be simply referenced in the HAER drawings, even if they are not used to prepare the drawings.)

Drawings should always be checked against the machinery itself, so that modifications and variations are not overlooked (these changes may be historically important). Do not try to scale engineering drawings without thoroughly checking them; written dimensions rule in engineering drawings, not scaled ones. In any case, information cast into the machinery's frames or embossed on builder's plates, etc., should be recorded for later inclusion in the final drawings.

Such things as cylinder diameter and stroke, boiler pressures and tube sizes, pump bores, scale range of pressure gauges, capacities of pumps, horsepower of motors, diameter of propellers and propeller shafts, etc., should not go unnoted.

Field Measurement of Machinery. In the absence of pre-existing drawings, some field work on machinery will be necessary. Though some machinery may look extremely complex, boilers and engines, winches, donkey engines, steering gears, and other machinery fall into a fairly easy class of objects to record since they are designed around the centerlines of drums, shafts, frames, bases, or other major components. Recording work can be simplified and made more accurate by laying out your sketches and measurements around such centerlines (see Fig. 4.3.43). A triple-expansion marine steam engine, for example, has three (in some cases four) cylinders along with valve chests in line along a centerline over the main crankshaft (another centerline). Each of these cylinders with its main rods, crosshead guides, and so forth, are located around vertical centerlines lying square to and in the plane of these first two centerlines. Intelligent use of a dimensioned, schematic diagram of all these centerlines will eliminate a lot of unnecessary measurements (such as the gaps between cylinder heads) and permit you to lay out measured drawings more quickly later. Machinery is largely composed of circles, cylinders, rectangles, and boxes, and awareness of this can help you further streamline your recording effort. As with masts and spars, the diameters of large cylindrical objects such as fuel tanks or boiler steam drums can be

gotten most often by taking their circumference with a tape and dividing the dimension by π (3.1416).

Details, Hardware, moldings, and fittings should also be covered. These are the nitty-gritty features: anchors, blocks, fasteners, galley stoves, door hinges, pumps, cabin panelling, wheelhouse instrumentation...and on and on. You should set up a priority system for recording these (in consultation with the project historian and the review team), depending on the size and budget of the project. Some may be covered very well by photographs in which a measuring stick appears. You may, because of time, have to drop things of lesser significance which won't appear in the final drawings. Notes on materials (bronze? wood? glass?), colors, significant wear patterns, maker's names and model numbers, etc. should be jotted down. (Important colors should be recorded using the codes from a *Munsell Book of Color*.) Carvings and relief work can be recorded by making rubbings. Be on the lookout for telltale holes, incomplete fittings, patches, stains, wear marks, and other clues to pre-existing structure or uses. Even graffiti may tell you something.

Some vessels carry more recent equipment or even auxiliary boats--life boats, dories, etc. Determination of their significance should be carefully made before focusing too much time and attention on them. Remember, however, that equipment you may describe as being recent may be seen as historic equipment by someone several generations from now. Give this thought due consideration before you give a "recent" feature cursory documentation, or pass it up altogether.

Artifacts. While the recording of artifacts such as crockery, moveable furniture, tools, clothing, and the like is an important feature of maritime preservation, measured drawings of them are not undertaken by HAER except in cases of extreme significance. It is usually sufficient for HAER documentation to record such objects as part of the general survey photography, or list significant artifacts in a written inventory. Images might appear in a HAER historical report.

Nautical Archeology. Many of the hand techniques covered to this point apply to recording vessels underwater. Numerous "high-tech" methods and instruments have also been developed for recording vessels at depths beyond the range of scuba gear. There are obvious limitations and advantages to working underwater which won't be addressed here.

Field notes are usually taken on plastic materials (polyester drafting films, acrylic panels, etc.) with pencils or wax markers. These notes are transcribed to paper at the end of each day's work; here HAER field note paper would be used if the project were being completed for submission to HAER. Underwater field photography is a vital supplement, though turbid conditions can restrict clarity. Hand drawn preliminary and final drawings proceed much as for floating vessels, using field notes and photographs to depict the resource as accurately as possible. It is standard procedure to draw the vessel and site "as-is" and seek to understand as much as possible about the vessel's history, construction and type before attempting any reconstructed views. See Section 4.7 at Figs. 4.7.65 to 4.7.71 for further discussion of archeological projects submitted to HAER.



FIELD NOTES

Planning Your Work. Field sketches, measurements, annotations, and field photographs should be made of your vessel with the finished drawings in mind, unless your project is designed to produce careful field notes of features for which finished drawings will not be made. A preliminary drawing schedule accompanied by a sketch layout of the drawing series will be invaluable in planning your field work. The recording team members can use the layout to divide various parts of the task up among themselves, coordinate work, and begin to develop an orderly series of notes. Careful thought at this point will prevent team members from rushing off to measure everything in sight without regard to significance or project priorities.

Sharing Expertise. Historians and delineators should make it a point to work together actively, comparing written records and physical clues aboard the vessel. Each will find things the other needs to know about in order to do his work more effectively and contribute to the overall quality and success of the project. If your project has retained a review team, be sure to take its observations of the vessel into account.

Field Notes are Primary Records. Reasonable care should be taken in producing all field notes. They are primary resource material and the basis for verifying the accuracy of your drawings under Standard II. Clarity and legibility are also paramount under Standard IV. Field notes are not only for production of your measured drawings, but for use by

HAER staff in checking your work, and for use by future researchers seeking first-hand dimensional information about your vessel. Never treat field notes merely as personal scribbles whose only user will be yourself. Teamwork being the joint effort that it is, your notes will be used by other team members at their drawing boards or CAD stations. Hence notes must be intelligible to anyone. On HAER projects, finished drawings are carefully compared with field notes in the HAER office to check for errors and perform any needed editing. When the measured drawings, photographs, and written data from your project are transmitted to the Library of Congress for accession in the HAER collection, *the field records must be included as verification for your work.* (Projects lacking field data--or documentation for other sources used as a basis for measured drawings--will be stamped with a disclaimer, and may possibly be excluded from the collection.) Researchers seeking a thorough understanding of a recorded vessel will often call for the field notes. Finally, if the vessel you record should ever need major repairs or become the subject of a reproduction project, the field records will be essential, since measured drawings do not contain the extensive written dimensional information needed for such work.

Simplicity and Neatness. It should be clear from Standard IV and from the many roles field notes play that legibility is a paramount concern. This does not mean that field notes must be finished works of

art, but there are some general rules and hints that result in consistent legibility if you make such guides habits of mind.

1) Sketches made for dimensioning need only be freehand line sketches. Do not make sketches to scale--this is a waste of time except for full-size details (molding profiles of joinery work and the like). While attractive, techniques for illustrative rendering and shadowing are time-consuming and unnecessary in the vast majority of cases--such efforts should be saved for appropriate final drawings. A field photograph, properly lit, will suffice for pictorial data in the field. On your sketches, include dotted lines and make perspective "cutaways" or "exploded" views of details where orthographic views or photographs are not clear enough in presenting hidden internal structures (see Fig. 4.4.4). Notes should be included when exploded views contain unconfirmed speculation about an assembly of parts, etc.

2) Break your subject down into appropriate levels of detail. The overall deck plan of a vessel in many cases need be no more than an outline of the rail or deck edge, with boxes or other simplified shapes for major features. This will leave plenty of room for you to fill in principal dimensions without crowding, and you will be able to retrieve information a lot more easily when you need it (see Figs. 4.4.1 - 4.4.3 for examples). A deckhouse might have several plans: the first plan might dimension only major openings, the second show internal structural features, the third any built-in furniture or machinery, the fourth deck plank seams, etc. A similar practice would apply to profiles or elevations of the deckhouse. Repeated

elements of the same size (porthole frames, molding details, etc.) need only be measured in detail once, and simple outlines used on profiles which locate groups of features. Doors, for example, should be sketched and drawn in detail separately, knobs and special details separately again. Small details should be drawn full-size or larger, as needed for clarity's sake.

3) Analyze your sketches before making measurements, and insert dimension strings where you know you will need to make measurements. This way, it will be easy to check to see if you have obtained all your data--just look to see if every string has a dimension on it. Tables for scantlings serve a similar housekeeping purpose--see if all boxes are filled.

4) Dimensions and written notes should be in clear lettering, not hastily scribbled longhand. Field notes should be cross-indexed as appropriate. All field records should be clearly labeled with the feature recorded, vessel name, recorder's names, current date, and if available, the HAER project record number. Field notes should be organized around specific views (e.g., lines, deck plan, inboard profile) and major features (mainmast, steering gear box, etc.). Each view or feature should receive its own properly labeled folder.

5) At the minimum, sketches should be done in black, with dimension strings and figures in red to aid clarity under Standard IV. (Blue should be avoided because it does not photocopy well.) The use of a single color for all linework and dimensions is strongly discouraged. The multi-color system will allow a user to

easily distinguish reference lines and dimension strings from sketches of recorded objects. Systems of measurements (diagonals, overalls, horizontals vs. verticals, dimensions taken along curves or in projected planes) can be distinguished by the use of a different color for each system. The effort expended in the conscious use of separate colors will be more than rewarded at the drawing board.

6) Try to make sketches and notes on only one side of each sheet of paper, and never put two different, unrelated objects on both sides of the same sheet. This will prevent situations where two team members both need the same field note sheet, but one person's work must be held up to permit the other to use the notes. If copies are made of two-sided field notes, sometimes notes made on the backs will show through.

7) The copying of field notes by hand is discouraged, not only because it takes extra time, but also because information can be *miscopied* in the process. If a field note must be redone due to damage or enormous error, the old should be included with the new (rather than discarded), and notes should be included explaining why the copy was made.

8) If you anticipate that the same sketch or view may need to be drawn several times in order to legibly record all necessary dimensional information, consider making electrostatic copies (on a Xerox® copier, for instance) of the first sketch as a time-saver before dimensioning begins, convenience permitting.

Error Tolerances. Be sure error tolerances and any special conditions affecting the accuracy of your

measurements accompany the affected figures, e.g., "pipe railing severely rusted, 2" dia. \pm 1/4".

Annotations. Important observations, local terminology, measurement procedures, conditions, cautions, speculations, nameplate data, etc., should be put down in your field notes. It is unwise to rely on memory, and future users on or off your project may miss important data if you fail to write it down.

Field Note Papers. HAER strongly advises the use of 17" x 22" sheets of good-quality white bond paper for field notes, printed with a blue grid of 8 lines to the inch. These sheets can be folded to 8-1/2" x 11" for inclusion in a standard folder, and the gridded lines facilitate sketching. The sheets can be taped or sparingly glued together as needed for greater length (a waterproof white glue such as "Elmer's®" is recommended over tape or rubber cement for longevity and least discoloration with age). The use of odd scraps of paper, snatched from memo pads and other places, is strongly discouraged because they are easily lost. An exception to this rule is the use of electrostatically copied sketches or copies of partially completed measured drawings; they frequently make an excellent base for refined measurements or corrections.

There is no requirement that field note papers or folders be archivally stable (acid-free), in spite of the fact that they should be included as part of the project's archival records. This is largely because field notes are frequently soiled with dirt, grease, perspiration, and other contaminants in the field. Every effort should be made to keep notes clean for legibility's sake, but many vessels simply won't lend themselves to "library"

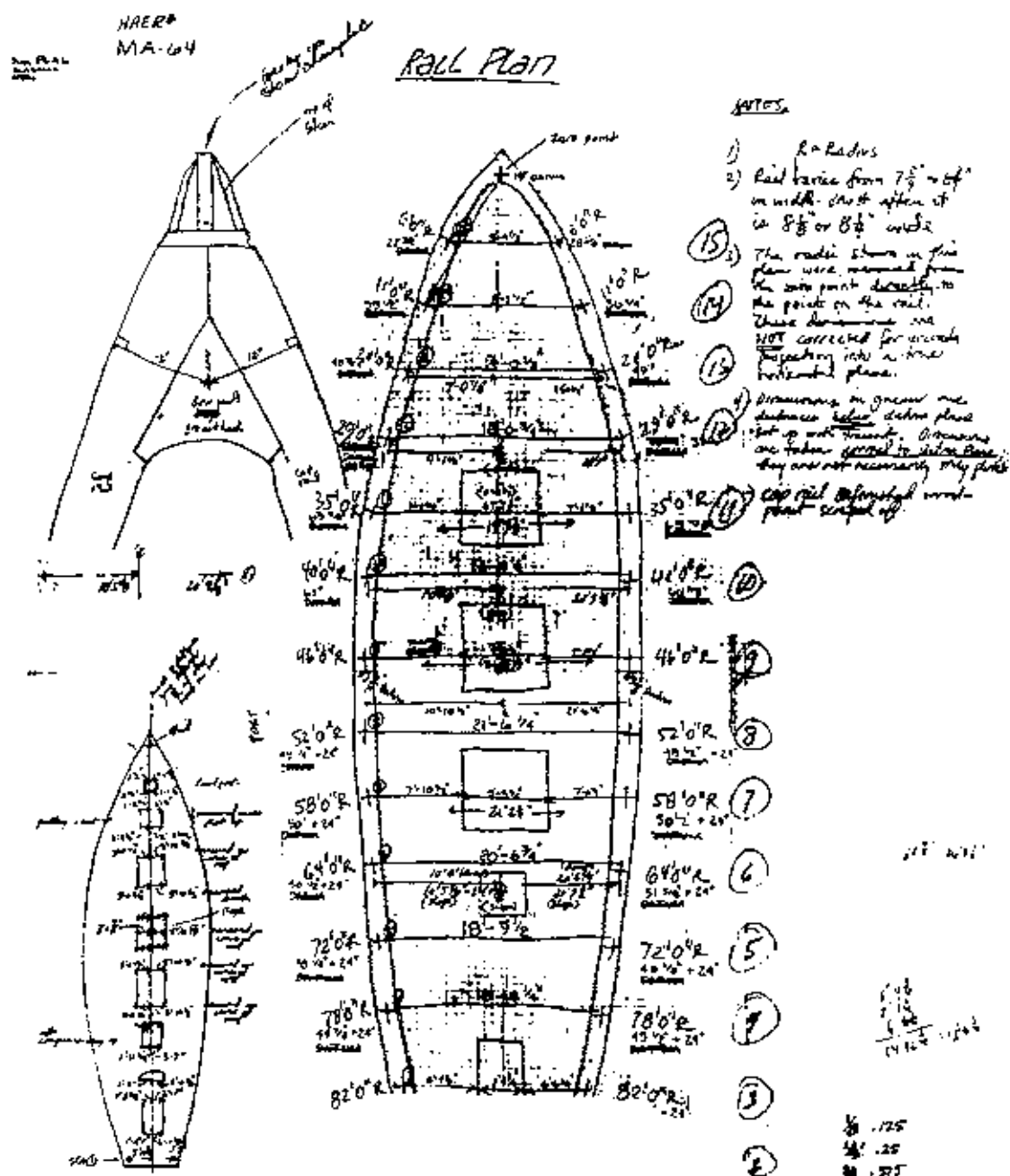

Fig. 4.4.1
Excellent Field Note
(reduced to 35% full size)

This field note is well executed for several reasons: each sketch performs only one function. A diagram of the vessel's rail at the bow shows where the field "zero" is for the purposes of recording the rail. The largest sketch gives only those vertical and horizontal data needed to draw the rail, nothing else. A smaller diagram records how the deckhouses relate to the vessel's centerline as set out by a transit, nothing else. Notes to the side present essential cautions to remember later at the drawing board. While this reproduction cannot show it, horizontal dimensions were recorded in red, vertical in green, to aid in distinguishing the two.

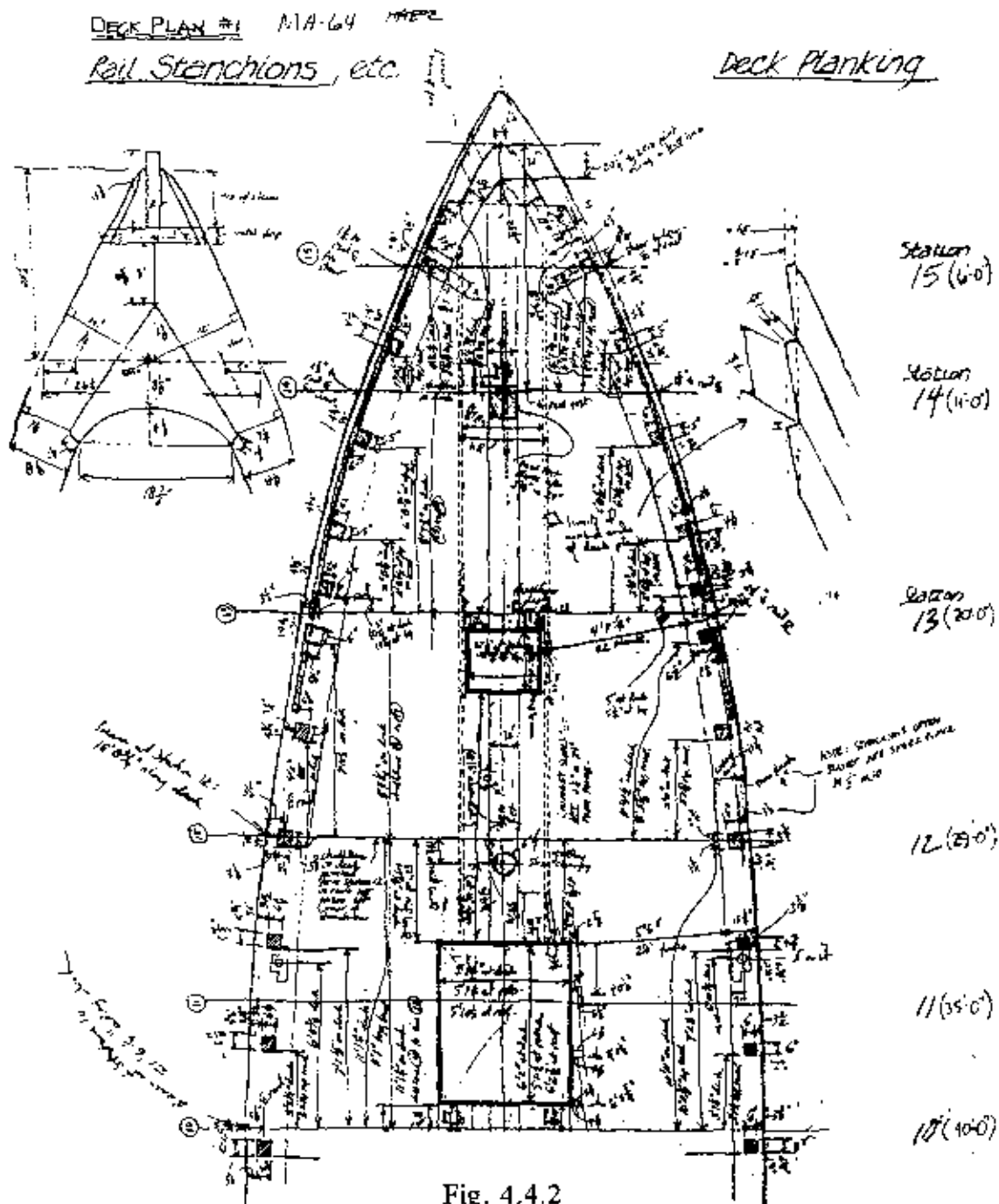

Fig. 4.4.2
Acceptable Field Note
(reduced to 35% full size)

Though complex, this field note is interpretable with a little study (while not shown, the use of three colors diminished potential confusion). However, the main portion of the note would have been better recorded as two separate notes for greater clarity—the systems of dimensions locating the rail stanchions should have been on a different sketch from one showing the deckhouses. Notice that the detail of the rail at the bow is drawn separately at a larger scale than the deck plan for extra space to record measurements.

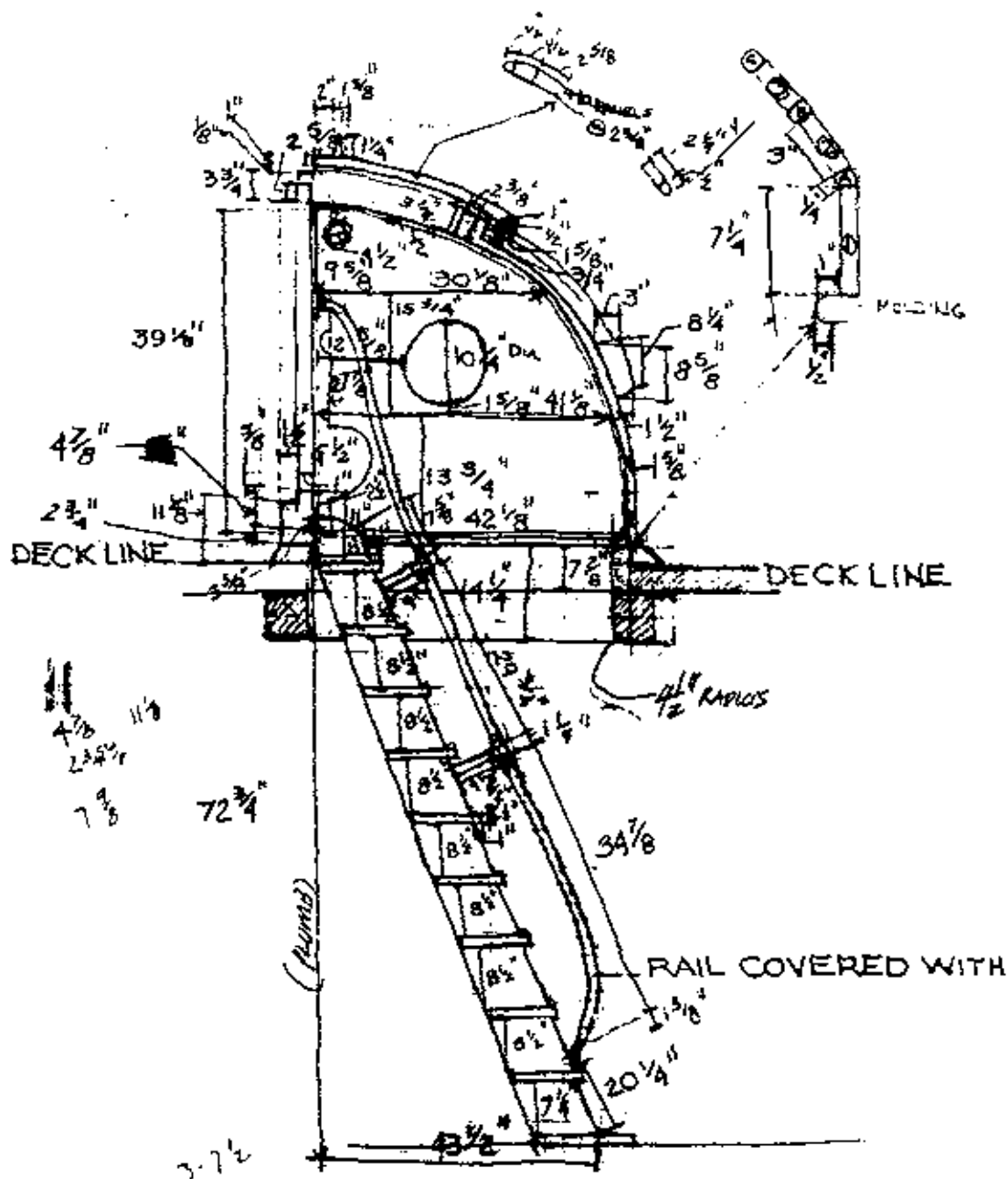

Fig. 4.4.3
 Poor Field Note
 (reduced to only 85% full size)

Even though done in *four* colors, many details in this note are so crowded that they are virtually uninterpretable. Always draw larger, separate sketches of small details (especially when you have measurements to record) and treat overall views of a large feature with schematic simplicity. Also be sure to label every sketch you draw so that others will know what it is without question.

15-a

HAER# MA-64

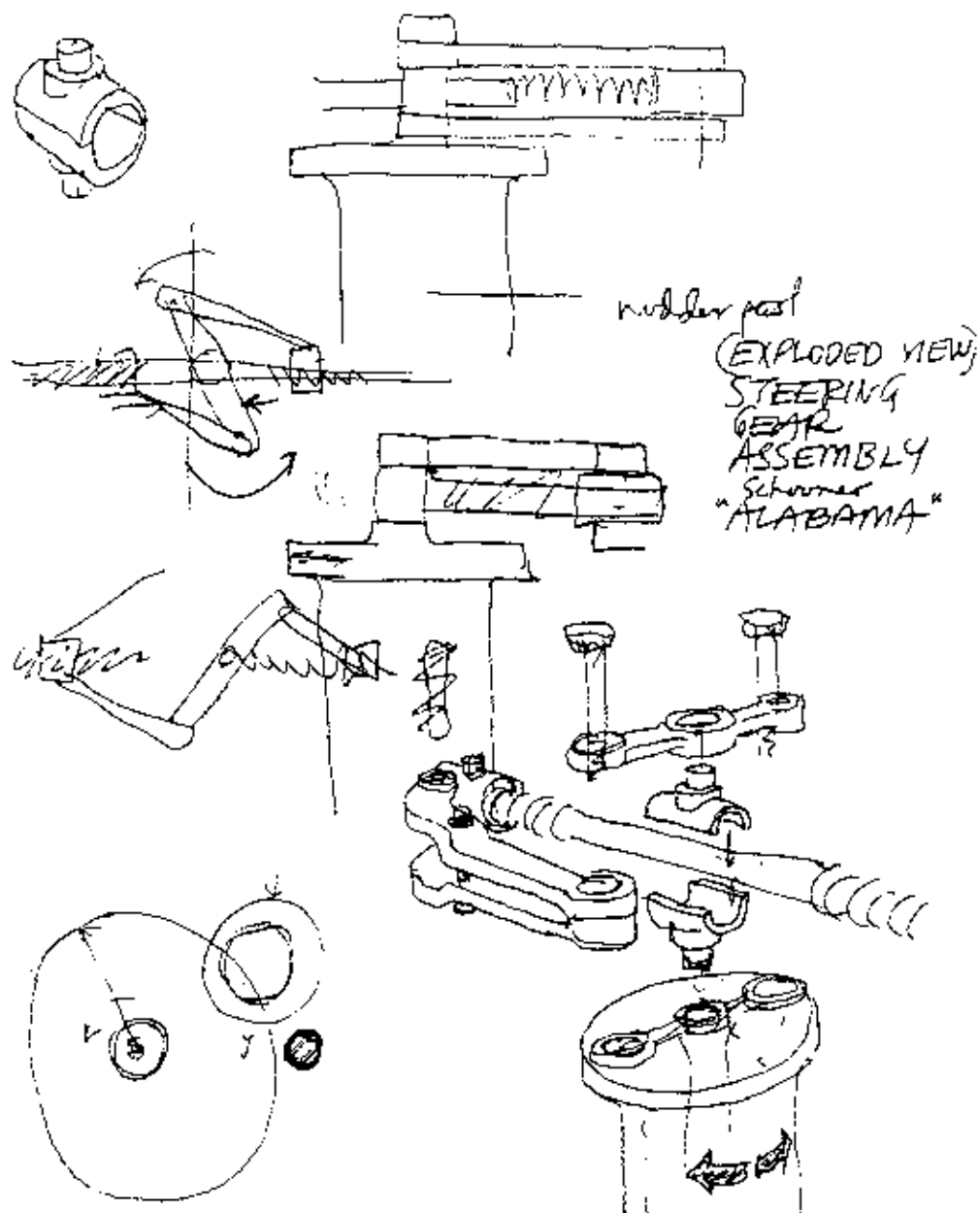

Fig. 4.4.4
 Interpretive Sketches

Don't neglect to make an exploded view of a joint, mechanism, or assembly where it cannot be disassembled for photography and mere dimensioned sketches don't help explain how it is made or operates. Frequently proper understanding of a feature's operation and internal design is important to delineating it correctly.

conditions without undue effort. This does not mean that archival papers should not be used if conditions or sponsoring organizations require it. If desired, records can be treated for archival stability at the project's close (depending on their condition), or electrostatic made onto archivally stable materials.

Media. No. 1 or No. 2 pencil is recommended as the best medium for field sketching. Pencil leads make good, dark lines, easily read or photocopied. Unlike inks, they can be easily erased and corrected if necessary. Smudging can be prevented by separating details from general dimensions, thus avoiding excessive labor on any one sheet. Harder leads are discouraged; they make very light lines which are difficult to see, do not photocopy well, and are easily obliterated. Mechanical pencils are recommended over the familiar wooden office pencil or a drafting lead holder because they do not require constant sharpening, and produce a constant line width. They are sold in a variety of sizes. Color leads are also available for dimensions and notes. Inexpensive makes are suggested, since pencils sometimes end up misplaced or lodged in inaccessible places aboard vessels.

If inks are used, try a good quality drawing ink, or one that is not water soluble. Perspiration, mist, and dampness can make water-soluble inks bleed or run; sometimes they even transfer to other field note sheets when stacked or folded. While field note papers are not necessarily archivally stable, most inks contain oils, acids, or other chemicals which bleed across the paper, attack the paper itself, or cause the ink to fade over time. This may

happen in as short a period as five to ten years, long before the paper itself deteriorates. The use of pencil exclusively will help your notes to last at least as long as the paper.

Forms for Lines-Lifting Data. Between pages 4.4.16 and 4.5.1 is a blank two-sided form suggested for recording lines-lifting data. It may be removed and copied. One sheet per section should be used, and one sheet for each side (port and starboard) if both sides of a vessel are recorded. A sketch (or even a scaled plot) of the hull section should be made in the upper half of the sheet, including any diagrams and critical dimensions of lines-lifting equipment used. Points on a section should be given letter names ("A", "B") so they cannot be confused with dimensions. Measurements for an individual point are recorded in a row across the form. In Fig. 4.4.5, the quadrangulations for point G on the hull, for example, were recorded on the line to the right of G (G being in the column for POINTS). The first box (with a diagonal slash) was used for the measurement of the first leg, and the second box for the second leg. The location on the buttock scale to which the first leg of the quadrangulation was measured is recorded to the left of the slash in the first box--the two-foot buttock is recorded simply as "2B"; to the right of the slash is the dimension between point G and the two-foot buttock mark on the buttock scale, 12'-9 3/4". In the second box, the location on the water line scale to which the second tape from Point G was taken is noted to the left of the slash--the 12-foot water line being recorded as "12W". The dimension from point G to the 12W mark is recorded to the right of the slash,

12'-7". The third column is provided as a back-up in case a third measurement should be desired, or to provide extra space in case a mistake is made in recording one of the earlier measurements. The REMARKS column can be used for notes, such as the physical feature at which the point was set ("bottom of worm shoe"), the condition of the hull at the point, or other information that will be significant in plotting and fairing the section properly.

Scantlings. Checklists for scantlings and important features on wooden and metal

vessels are included on pages 4.4.5 to 4.4.12. These should be adapted as appropriate for your vessel. Consult your review team or a glossary for terminology or special-case structural members. Scantlings may be tabulated separately or included on field sketches in table or annotative form.

Tables. Recording data in tabular form can be a significant time saver when similar elements (yards, blocks, frames, panelling, etc.) are found in a variety of sizes. All tables should be accompanied by annotated field sketches.

VESSEL: "EXAMPLE" STATION: 1 - STARBOARD
 HAER No: EX-1

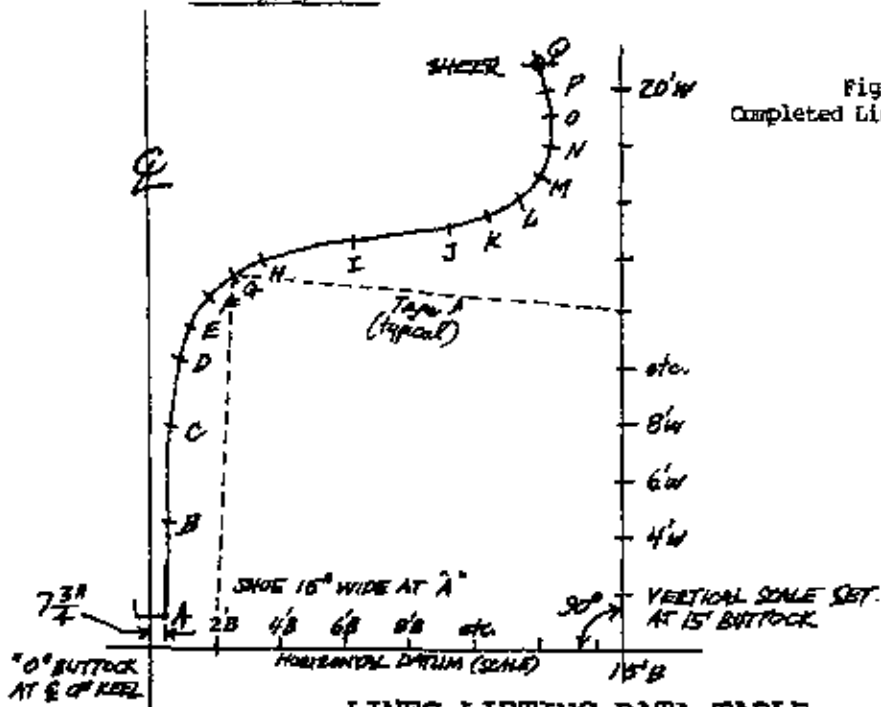

Fig. 4.3.5
Completed Lines Lifting Form

LINES-LIFTING DATA TABLE

Tie	Tie	Tie	Remarks	Tie	Tie	Tie	Remarks
A 0" 4 1/2"			BOTTOM OF NORM SHOE	K 12B 5' 1/4"	16W 3' 0"	16W 3' 0"	SHAD'S
B 1B 5' 0"	4W 14 1/2"		1B = 1 FOOT BUTTOK, ETC.	L 12B 16 1/2"	16W 2' 5 1/2"		↓ ↓ ↓
C 1B 7 1/2"	8W 14 1/2"		4W = 4 FOOT WATER LINE ETC.	M 17W 1' 5 1/2"			MEASUREMENTS TAKEN 90°
D 1B 10 5/8"	10W 13 10/8"		B+W ON SCALES AS SHOWN ABOVE	N 18W 0' 7 1/2"			TO VERTICAL SCALE AT
E 2B 11 5/8"	12W 13' 8"		ROADWAY - 14' BELOW	O 19W 0' 7 1/4"			WATER LINES INDICATED
F 2B 12' 3 1/4"	12W 13' 2 1/4"			P 20W 0' 7 1/4"			↓ ↓ ↓
G 2B 12' 9 1/4"	12W 12' 7"			Q 18B 2' 1' 1/4"	CHUCK		SHOER
H 4B 13' 4 1/4"	12W 11' 6 1/4"			Q 21' 1/4"	ABOVE HORIZ.		
I 6B 14' 1 1/2"	14W 9' 0 1/2"				0' - 7 1/2" OFF SET FROM VERT.		
J 8B 14' 0 1/4"	14W 6' 2 1/4"						

Continued on reverse

ALL MEASUREMENTS +/- 1/4" UNLESS OTHERWISE NOTED

Fig. 4.4.5
Completed Lines Lifting Form

SCANTLINGS
for
WOODEN VESSELS

Include cross-sectional dimensions, wood species, remarks about condition, repairs, replacement, etc.

A. BACKBONE

1. Keel (timber)
2. Keel (ballast)
3. Keelson or keel batten--also sisters and riders
4. Forward deadwood
5. Stem assembly
 - a) inner stem or apron
 - b) outer stem
 - c) gammon knee
 - d) gripe
 - e) stem knee
6. Sternpost and rudderpost
7. Horn timber, centerline transom timbers, fillers and cheeks
8. Stern knee and aft deadwood
9. False keel and worm shoe
10. Mast steps
11. Centerboard bedlogs and trunk
12. Shaft log
13. Rudder trunk

B. HULL

1. Floor timbers
2. Transverse framing, including knightheads, hawse timbers, and cant frames
3. Transom framing
4. Ceiling
5. Planking
6. Bilge Stringers
7. Sheerclamps and shelves

8. Grown knees (hanging, standing, and lodging)
9. Transom timber or beam
10. Pointers
11. Butt blocks
12. Garboards and broadstrakes (if different from other planks)
13. Sheerstrakes and walestrakes (if different from other planks)
14. Rail stanchions
15. Waist planking
16. Toe rails and cap rails
17. Guard rails and spray rails
18. Gunwales
19. Sheathing
20. Strapping
21. Limber (drainage) provision

C. DECKS

1. Transverse beams, main and intermediate
2. Carlins
3. Breasthooks and quarterknees
4. Fillers and blocking
5. Covering boards
6. Sills and grub beams
7. Waterways
8. Decking, including kingplanks and nibbing strakes
9. Lockstrakes and apron pieces
10. Mast partners
11. Sheathing

D. APPENDAGES

1. Rndder
2. Centerboard
3. Cargo hatches
4. Coamings
5. Companionways
6. Cabins and deckhouses

E. INTERIOR--BUILT-IN

1. Bulkheads--structural
2. Stanchions
3. Floor beams
4. Platforms, soles, and floorboards
5. Joiner bulkheads and partitions
6. Sheathing--hull and overhead

7. Seats and thwarts
8. Cabinets, lockers, berths, and shelves

F. FASTENINGS

1. Backbone joints
2. Hull joints
3. Deck joints

See page 4.4.15 for **Machinery and Equipment** checklist.

**SCANTLINGS
for
IRON OR STEEL VESSELS**

Include cross-sectional dimensions (and sketches if necessary), metal type, remarks about condition, repairs, replacement, etc.

A. HULL

1. Longitudinals

- a) Keel (bar, plate, or formed section)
- b) Keelson (include any intercostal plating or swash plates)
- c) Bilge keelsons and bilge stringers (include any intercostal plating or swash plates)
- d) Hold stringers

2. Transverse members

- a) Frames (include frame reverses and note direction of reverses)
- b) Floors (note limber holes)
- c) Bulkheads and web frames (include any stiffening angles)
- d) Transom and cant frames
- e) Knighthead plates

3. Stern assembly

- a) Stem bar
- b) Stem framing (web frames and brackets)
- c) Forefoot casting

- 4. Stern assembly
 - a) Stern post or stern frame
 - b) Rudder post and trunk
 - c) Skeg
 - d) Boss plate
 - e) Oxter or ruck plate

5. Shell
(see notes on page 4.3.15)

- a) Shell plating
- b) Bilge keels
- c) Rub strakes
- d) Ceiling or sparring (include any ceiling clips)

- 6. Inner or double bottom
- 7. Mast steps and bowsprit heel stop
- 8. Machinery foundations
- 9. Centerboard trunk
- 10. Shaft log and alley way
- 11. Hawse pipes and spill pipes
- 12. Chainlocker bulkheading
- 13. Integral tankage

B. DECKS

- 1. Deck beams (include forged knees or riveted brackets)
- 2. Deck plating (vessels with all-steel deck)
- 3. Deck planking (include margin planks, kingplanks and nibbing strakes)
- 4. Stringer plate
- 5. Longitudinal and diagonal tie plates
- 6. Mast reinforcing plates (include partner angles and mast rings)
- 7. Machinery and superstructure foundation plates or angles

8. Waterways (if cement or wooden additions to stringer plates)
9. Hold pillars or girders
10. Engine room flats or platforms

C. APPENDAGES

1. Bulwarks
 - a) Plating and butts
 - b) Stanchions
 - c) Main rail and cap rails
 - d) Freeing ports
 - e) Scuppers
2. Cargo hatches
 - a) Hatch coamings (include brackets, batten clips, and securing rings)
 - b) Hatch girders
 - c) Hatch beams or strongbacks
3. Cabin trunks and deckhouses
4. Fidleys and engine room trunks
5. Coamings
6. Companionways
7. Access ladders
8. Skylights
9. Ventilators and stacks
10. Taff rails and fife rails
11. Guard rails and spray rails
12. Deck lights and port lights
13. Mooring bitts, cleats, and chocks
14. Rudder
 - a) Rudder frame
 - b) Rudder plating
 - c) Rudder stock (include coupling and steady bearing)

- d) Pintles, gudgeons, and carrier bearings

D. INTERIOR

1. Soles and floorboards
2. Collision bulkheads and water-tight bulkheads
3. Joiner bulkheads and partitions
4. Built-in furnishings: benches, seats, thwarts, cabinets, settees, lockers, berths, and shelving

E. FASTENING and ATTACHMENT DETAILS (see notes on page 4.3.10)

1. Rivet type (diameter and type of heads)
2. Rivet pattern (gauge and pitch of rivets)
3. Seam arrangement of hull and deck plating (include any liners, shims, or joggled plates);
 - a) Types of seams:
 - Lapped or "clinker"
 - Flush plated with internal seam straps
 - Flush plated with external seam straps
 - In-out strake construction
 - Joggled plate
4. Butt arrangement of hull and deck plating (include any liners, shims, or joggled plates);
 - a) Types of butts:
 - Lapped

- | | | |
|--|-----|---|
| <ul style="list-style-type: none"> -Flush butted with internal butt straps -Flush butted with external butt straps | (2) | Turbines and reduction gears |
| 5. Hull to deck attachment (sheer strake to stringer plate and deck beam to frame) | (b) | Condensers |
| 6. Details of built-up members: keelson, stringers, floors, and frames | (c) | Shaft diameter |
| | (d) | Propellers (diameter, pitch, number of blades, direction of rotation) |

**MACHINERY and EQUIPMENT
for
WOODEN OR METAL VESSELS**

- | | |
|--|--|
| <ul style="list-style-type: none"> 1. Masts 2. Spars (yards, booms, gaffs, bowsprits, jib booms, etc.) 3. Blocks 4. Lines 5. Main propulsion system (or auxiliary power for sailing vessels) <ul style="list-style-type: none"> a) Engines <ul style="list-style-type: none"> (1) Reciprocating (steam or internal combustion) <ul style="list-style-type: none"> (a) Bore, stroke, and number of cylinders (b) Shaft horsepower (c) Maximum r.p.m. | <ul style="list-style-type: none"> 6. Boilers (include stacks and breeching) 7. Tankage or bunkers 8. Auxiliary equipment (pumps, generators, compressors, lubricators, donkey engines, etc.) 9. Deck gear (windlass, capstans, bitts, lugs, cargo handling gear, davits, hand pumps, stacks, and ventilators) 10. Steering system (include linkages and emergency steering systems) 11. Navigational equipment (including running lights, bells, horns, binnacles, standard compass, etc.) 12. Armament (military vessels) |
|--|--|

NOTES ON HULL CONSTRUCTION DETAILS

The hull construction details of a particular riveted or early welded vessels can provide much information on engineering standards, shipbuilding methods, and available materials and technology of the era in which the vessel was built. For this reason, the following details are worth documenting:

Shell Plate Thickness. Getting shell plate thicknesses can be a real chore. In riveted construction, the thickness of shell plates will often vary from strake to strake. Plate thicknesses should be measured not only at the mid-half-length, but also at the ends, where scantlings were generally reduced. In some cases the scantlings will be lighter at the stern than at the bow.

Original plate thicknesses may have been gauged in various increments. Vessels built in the British Isles were often constructed of plate in 1/20" or 1/16" increments. Plate in U.S.-built vessels was measured in pounds per square foot or standard fractions of an inch (10-pound plate is 1/4" thick). European builders used metric measurements, or in some cases, nonstandard measurement systems peculiar to the building nation.

Getting measurements of original shell plate thicknesses is made difficult when extensive corrosion has occurred. With "in-out" strake construction, in-strakes can be measured at the inside plate laps. The out-strakes can be more difficult as exterior corrosion affects the thickness of the entire plate. The same problem is encountered in flush butted riveted and

welded shell plating. In these cases, documentation of original plate thickness (absent builders' or insurers' records) may not be possible to any high degree of accuracy.

Butts and Seams. A combination of two or more seam or butt arrangements may be found in a vessel. A common example is the use of "clinker" or lapped seams below the waterline and flush seams for topsides.

Rivet Type and Riveting Patterns. Rivets can reveal as much about an iron or steel vessel as fastenings do of wooden construction. Their type and pattern are indicative of available technology and quality of construction. Rivet type is mostly restricted to diameter and type of head. Rivet patterns are numerous, but usually involve staggering or multiple rows. Rivet patterns are measured in "gauge" and "pitch."

Classification societies, such as Lloyds, often required more rivets in shell plate butts in the mid-half-length of a vessel than at the ends. Documentation of hull rivet patterns should therefore be made in the bow and stern sections as well as near midships.

Other aspects of riveted construction which should be documented are use of felt in seams, and caulking of seams. These methods of achieving water tightness can indicate the quality of repair work or original construction.

(Material on pages 4.4.11 - 16 is based on work supplied to HAER via Mystic Seaport Museum by Don Birkholz, Jr., of Santa Cruz, California.)

NOTES:

Continued from reverse

FOUR	Tie	Tie	Tie	Remarks	FOUR	Tie	Tie	Tie	Remarks

FIELD PHOTOGRAPHS

Field photographs, usually 35mm black-and-white, are taken by recording team members to supplement their field notes. As with other HAER field records, these are primary sources of information which are ultimately transmitted to the HAER collection along with field notes and finished drawings. They are not only for your use at the drawing board and for other team members' use in their research, they also serve future researchers, and the HAER office in reviewing your work after the completion of the project. On rare occasions, a field photo may be used as a formal record photograph in cases where spaces are too confined or too precarious to set up a view camera.

It is wise to shoot field photos as early as possible so that processing time doesn't interfere with their use in the drafting room.

EQUIPMENT

Camera equipment must be supplied by HAER team members. Each HAER summer team usually has at least one team member who possesses basic 35mm camera equipment. HAER supplies film and processing for HAER administered teams. Basic equipment is listed below:

- 35mm camera
- assorted lenses (35mm wide angle, 55mm normal, and 135mm telephoto or zoom lens, at minimum)
- flash
- tripod

In 35mm format, an SLR (single lens reflex) camera is by far the best to use, since most models permit lens changes, exposure adjustments, and direct focus control; automatic focus and exposure cameras may not perform well in situations with great variations in depth or lighting. A flash (or photoflood lamp) will obviously serve in dimly lit areas, and can be used to fill in shadowy details on bright days. (Be careful and avoid hot spots in photos from the flash bouncing off shiny surfaces or from being too close to the subject. Also, be sure to check bilges and other areas for explosive fumes that might be ignited by an electrical discharge.) A wide range of lenses or focal lengths gives great flexibility. Wide angle lenses can be used for general surveys or cramped spaces where longer focal length lenses don't "pull in" the desired view. Be careful in using them for shots that you intend to use at the drawing board as an aid to field measurements, since these lenses characteristically distort dimensions at the edges of the photo. A 55mm (normal) lens introduces the least distortion in these cases. Telephoto or zoom lenses permit you to catch exterior or interior details that are at inconvenient heights or distances, and can be used to supplement field notes of elevations which have moderate projections or recessions from the elevation plane. Photographing an elevation from a distance with a long lens compresses the nearby foreground and background, a distortion which places them in nearly the same scale as the main elevation plane. The longer the lens, the better the effect, though stepping back far

enough on a vessel may be a problem, and higher shutter speeds or a tripod may be necessary to prevent blurred images.

FILM

Black-and-white: HAER teams are usually supplied with 36-exposure rolls of Kodak Plus-X (ISO 125) and Tri-X (ISO 400) film, or equivalent. The higher speed film permits shots in dim areas without a flash, but with some sacrifice in definition if enlarged. The slower speed is better for brighter light, and negatives can be enlarged with better preservation of detail.

Color: On some occasions, color slide film will be provided to teams by the HAER office. This is almost always for capturing the recording process with team members at work for later use in lectures or publicity. It is practically never used for field photography. Color films and prints do not have the archival stability of black-and-white, and cost more to process and turn into prints.

Store all film in a cool place. Don't leave film or cameras in vehicles or tool boxes in the hot sun. Excess heat shortens film shelf-life and alters its exposure characteristics. It may also damage sensitive camera and flash electronics.

PROCESSING

Black-and-white film should be processed locally, as soon as is practical for use in the drafting room. Team members are discouraged from doing their own processing, even if someone should own or have access to proper development and printing facilities. (It costs the project more to pay team members to do this than

a commercial processor, and it is time away from more important pursuits to boot.)

Always order a contact print first; prints and enlargements should only be ordered as necessary. If available, obtain archival processing for contact prints. Basically this only involves an extra processing step in which negatives and prints are put through a hypo-eliminator bath to neutralize excess fixer chemicals.

Payment for Photo Services. Processing should be paid for by a government third party draft unless other arrangements have been made by HAER.

Color slide film, if used, should also be processed locally and paid for as described above.

EXTRA FILM SUPPLIES

HAER attempts to send an adequate film supply to all teams at the outset of a project. If you think you will need more film, contact the HAER office before using the last rolls and more will be mailed to you. HAER can obtain film more cheaply in bulk than you can in the field. Purchase film in the field only in cases of urgency. Plan ahead!

Any unused film must be returned to the HAER office at the project's close.

Digital Photography. Cameras are now on the market which record photographs electronically on small optical disks or internal memory banks for playback on a computer. These systems dispense with film and processing altogether. While electronic formats are easily analyzed and

manipulated by computers for use in CAD systems or electronic imaging, they leave behind no easily reproducible archival hard copies, and thus fail Standard III. At this time the cost of electronic systems is not justified for use at numerous field teams. Electronic technologies grow obsolete quickly, rendering electronically formatted images inaccessible to future users at the Library of Congress long before film negatives deteriorate. Film images can always be input into contemporary technologies at the convenience of future researchers.

CAPTION SHEETS

A Field Photo Identification Sheet must be filled out in the field for each contact sheet by the photographer who took the photos (see Fig. 4.5.2). The Field Photo Identification Sheet is completed by giving the name and location of the vessel, the name of the photographer, the date the photos were taken, and a description of each frame, one frame per line. (Unidentified photos fail to meet Standards II and IV.) If the HAER record number has been assigned, fill this in, too; otherwise leave it blank for the HAER office to fill in later. Each view should be numbered according to the frame numbers appearing on the edges of the negative strips; if certain exposures did not turn out for any reason, this should be noted (i.e., "blank," "underexposed").

At the end of the project, all contact sheets, negatives, and enlargements must be returned to the HAER office. Please be sure *all* photo materials are properly labeled and filed. Staff members in the HAER office have neither the time nor the familiarity with your vessel to do this for you.

Transmittal Preparations. After processing, each contact sheet and its corresponding film strips should be identified by a film roll number (see Fig. 4.5.1). If a HAER record number has been assigned your vessel, this also must appear on each contact sheet and film strip (label the film strips between the sprocket holes with drafting ink and a #0 [.35mm] pen). Each film strip should be placed in a separate, acid-free archival envelope (supplied by HAER) and the envelope labeled in No. 1 pencil with the roll number (and HAER number, if known).

These considerations do not preclude the scanning and electronic analysis of film images, however, for projects or contractors equipped with proper systems and software. Film negatives and contact prints still must be submitted for transmittal to the Library of Congress in order to meet the *Secretary's Standards*.

WHAT TO SHOOT

The applications for field photographs are numerous. General survey views of a vessel are the first order of business, covering such things as side profiles, the bow and stern (end-on and quartering views), main deck layout, masts and rigging, major compartments and machinery spaces, etc. These sorts of photographs can be very useful in all phases of the project. However, field photographs should especially cover assemblies (framing and rigging connections, steering gear, etc.), details (carvings, hardware, rivet patterns, machinery, etc.), and special conditions (wear patterns, repairs, places where items are obviously missing, construction details exposed by deteriorated fabric, etc.). Photographs also capture data about

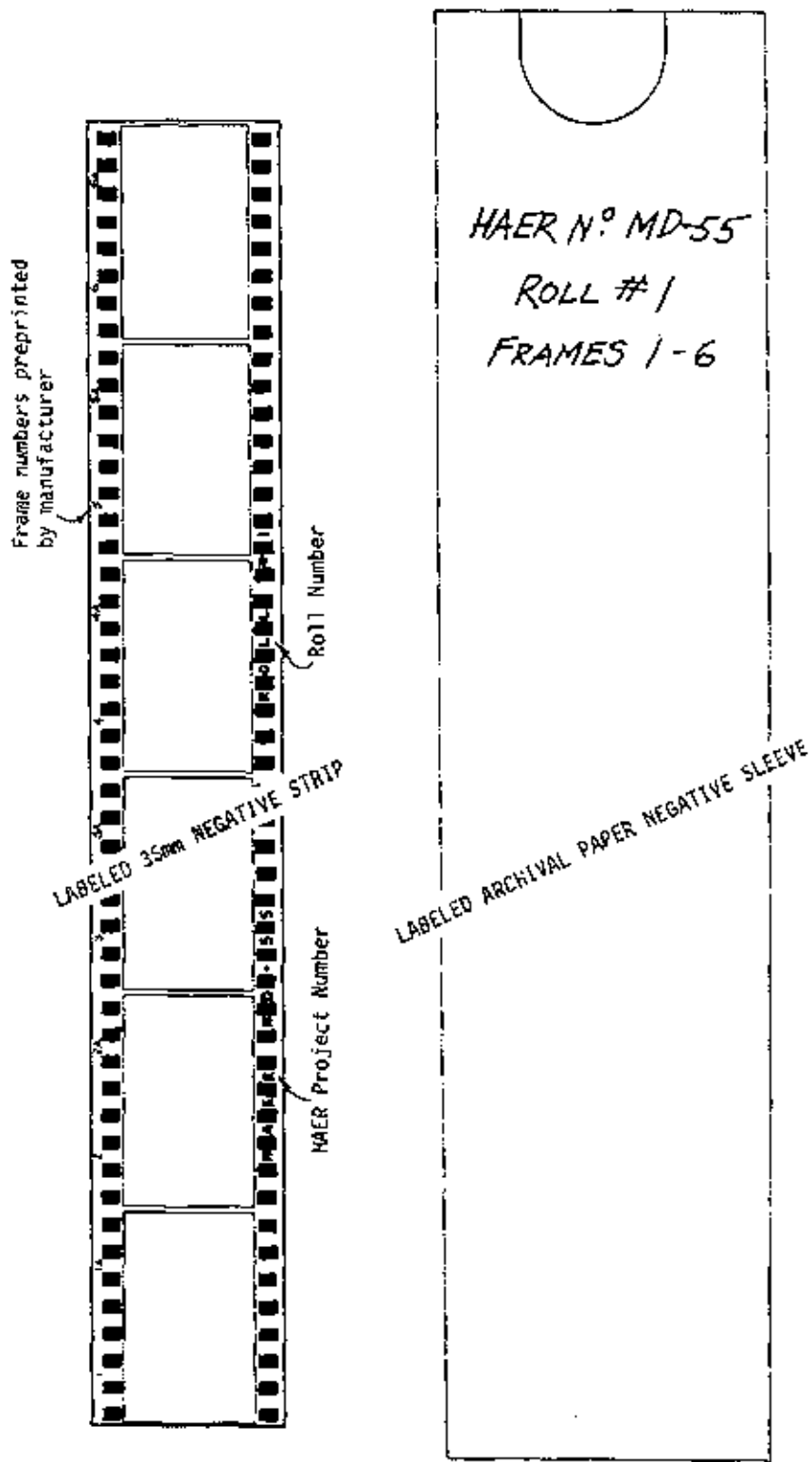

Fig. 4.5.1

materials, textures, finish, relative placement, numbers of planks and rivets (and so on) far more quickly and concisely than could ever be done by sketching and measuring. Some photos can save considerable time over laborious field sketches, though they are no substitute for copious measurements with suitable written annotations in most cases. At the drawing board or computer, photos can be used to double-check and straighten out confusion in field notes without going back to the vessel in many cases. Minor errors and omitted details in field notes can be corrected or filled in from 35mm photos.

In some circumstances you may find more information in negatives than in your prints. If you have problems seeing important details in an unexpected shadow of your contact print or enlargement, examine the negative under an 8x eye loupe. Be sure to protect the negative strip from fingerprints and scratches by using a temporary plastic negative file.

Time is usually at a premium on a field team, so you should reserve dimensioned sketches for more significant aspects, and fill in minor details from field photos. Aside from backing up measurements, photographs can be used to document and count things like steps, bungs, rivets, portholes, and the like. Set up as "rectified" photographs, field photos can be shot of certain kinds of features, then enlarged and traced for inclusion in a

measured drawing, thus saving a lot of hand sketching and dimensioning. These features should be limited to things that lie in fairly flat planes (like deckhouse sides or the ship's wheel), since parallax errors unavoidably introduced by perspective effects can cause scaling problems or unacceptable distortions in objects that project or recede from the subject. The longer the lens you use, however, the more compressed a photo's foreground and background will appear and the less the parallax error. Projections and recessions will gradually approximate the scale of the subject as focal length increases. Aboard ship you may be limited by deck area from using a long lens effectively for rectified shots.

Scaling the diameters of round objects like masts from photographs should be avoided--parallax effects almost inevitably lead to errors.

Scale Sticks. Even though you may have recorded the dimensions of photographed subjects in your field notes, the presence of a scale stick in each view enhances the photograph's verifiability (Standard II).

One of the best kinds of scale stick for legibility purposes is one painted in alternating black and white stripes, each one foot long. For small details, a stick painted in inches or fractions of an inch will be useful (see Fig. 4.5.3). Folding rules and tapes can be used, but it is



Fig. 4.5.3
Effective Photo Scale Stick Format

difficult to read their graduations when the camera is more than ten feet away.

The inclusion of one or more legible scale sticks in the plane(s) of the object you wish to record is advantageous and highly recommended, but not essential. If a horizontal or vertical datum plane passes through the photo field, you would do well to mark it (tight string or chalk line) so the camera can pick that up also.

Rectified Photographs. A fast and accurate way to set up a rectified photograph only requires the use of a mirror fixed in the plane of the subject whose image you wish to record. Your camera should be an SLR (single lens reflex) mounted on a tripod. As you look through the viewfinder, center the *reflected image of the camera lens in the mirror* in the center of the split-image (or microprism) focussing zone in your camera's viewfinder (see Fig. 4.5.4). This will position the lens axis normal to the mirror plane and to the surface to which it is attached. The larger the mirror, the better its parallelism to the subject's surface can be assured. This method results in an undistorted image for the plane in which the mirror lies. (The mirror can be removed once the camera set-up is complete.) Don't forget to include a scale stick.

SCALING FROM FIELD PHOTOGRAPHS

Below, six methods are described for deriving dimensional data from field photos for measured drawings:

1) Count standardized or regularly spaced objects whose dimensions or spacing are

known (e.g. strakes, planks, frames). The dimensions of nearby features can be estimated by using these things as "measuring sticks". Keep in mind that your error tolerance is higher than for direct field measurements, and annotate your final drawings accordingly. This technique is especially useful for inaccessible heights or features whose significance does not justify the time to physically measure them.

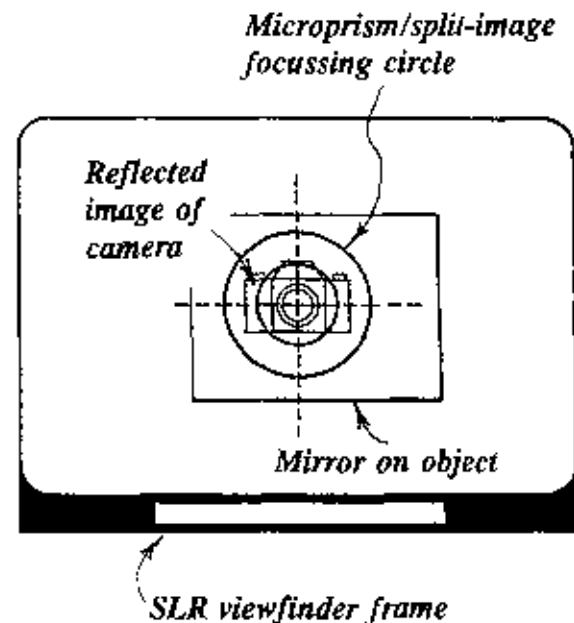

Fig. 4.5.4
"Camera's Eye" View of Rectified Photo Setup with Mirror

2) Measure the photographic image and transfer dimensions to a drawing. This works best with a rectified photograph, but it can be cautiously used with oblique views to fill in minor details. Sometimes oblique views can be rectified with proper

darkroom equipment, but this is not usually feasible with the commercial photo services available to field teams. You should record the object's principal dimensions in field notes as a way to limit and double-check against dimensional errors, even for photos in which scale sticks are included. Once you have the photos and principal dimensions, you can derive the dimensions of details from simple proportional calculations (see Section 4.5).

3) Trace enlargements of rectified photographs, then photographically enlarge or reduce the tracing to the scale of final drawings. Do not go to the trouble of trying to order an enlargement of the field photograph to a specific scale (something most photo labs will not do, or won't do accurately, cheaply or quickly!).

4) Combine overlapping rectified photographs into a collage for tracing things like plate patterns on a hull, carving work on interior joinery, etc.

5) Digitize and rectify film images. There are computer programs on the market which can scan and analyze photographic images, rectify oblique photos and correct distortions, thus producing an image from which a drawing (or portions thereof) can be traced digitally. The tracing can be plotted for use as an underlayment for a hand-inked drawing, or transferred to a CAD drawing file. It is a good idea to have overall hand measurements of the shape and scale of the object you photographed handy to check the output for accuracy rather than rely solely on software to "automatically" produce a correctly scaled image. There is no requirement for submitting digitally processed images for transmittal to the Library of Congress.

6) Use reverse perspective analysis (by hand or computer-aided) to derive dimensions of more or less accuracy from historic or modern photographs of adequate quality. This method is based on the geometric laws of perspective.

MEASURED DRAWINGS

HAER's goals for drawings are derived from the *Secretary's Standards*:

FIRST, that drawings address historically significant aspects of a vessel, whether those be related to hull model, construction technology, rigging and propulsion technology, workmanship and finish, historical events, or any combination of these and other factors.

SECOND, that drawings be accurate and verifiable--that is, that they be accurately scaled and delineated from accurate field notes; that they be dimensioned; and that an adequate accounting be given *on the drawings* for measurement procedures, errors, separate sources, speculation, incompleteness, etc. Drawings should be backed up by adequate field notes and other data. (A more detailed accounting should be given in a Field Report.)

THIRD, that the drawings be made on archivally stable HAER sheets which are easily reproducible.

FOURTH, that drawings be clearly and crisply delineated, graphically "readable," strong, and attractive both in their linework and lettering so that their data are unambiguous and will withstand the effects of reproduction and size reduction.

Measured drawings of a vessel are more than a direct translation of field measurements into line drawings. To meet the *Secretary's Standards*, they must not only be accurate as to content, but employ effective graphic techniques. A drawing's ability to store and present information

depends on a combination of intellectual and aesthetic principles. The guidelines that follow are derived from thousands of man-hours of HAER experience. The reasons behind the guidelines are varied--some reflect archival concerns, others documentary, legibility, reproducibility, and presentation concerns. There are also a series of measured drawings reproduced with comments in Section 4.7 to illustrate many of the principles discussed in this section.

HAER strongly encourages high-quality delineation and graphic techniques, and insists that verbal verification be provided on drawings, both to provide further information and to check misleading assumptions or implications that users may possibly draw. There may be some who believe they cannot meet the drafting standards HAER sets. HAER is in part a training program, and the guidelines provide delineation help "by precept and example" to those who may need it. There is in some circles a prejudice against excellent drafting--the suspicion being that "pretty drawings" are used to hide inaccuracies, fabrications, and other intellectual deficiencies. While no drawing is completely free of mistakes or omissions, there is no defense, in HAER's opinion, for such prejudices. Good drawings, based on proper documentary and drafting procedures, inspire a just confidence in users; poor ones carry their own inaccuracies and lead users to question one's qualifications. You should do the best job you can. If documentation of important historic resources is worth doing and is worth making last to the 20th

generation of one's descendants (500 years), then it's worth doing well. For those who sponsor documentation projects, it is well to note that aside from purely documentary purposes, attractive drawings are also publishable and saleable items for museums, preservation groups, fund raising efforts, etc.

HAER has attempted to write drawing guidelines with the needs of both HAER and users from the general public in mind. They reflect HAER's viewpoints and hence may differ from those of other authorities. However, they are intended primarily to govern work done for the HAER collection, in the expectation that they are sound enough to be approved by other interested parties and professionals. If studied carefully, these guidelines should enable even amateur delineators to produce creditable work. However, success will depend to a large extent on the delineator's previous experience, on his ingenuity, diligence, and sensitivity to the complex tasks of documentation.

Hand Drawing and Computer Aided Drafting (CAD). The guidelines to follow are based on years of hand drawing experience and are addressed primarily to hand-drafted drawings. CAD machinery is replacing hand drawing in many fields because of time (and money) savings it offers. By whatever means HAER drawings may be produced, the *Secretary's Standards* still apply, and the rules for content and graphics will still apply, notwithstanding the change in drawing tools and methods. At present, HAER project schedules and budgets do not make CAD systems economic for numerous small teams on 12 week project schedules. Contractors and others working to HAER standards who are thoroughly familiar with

CAD practice may find CAD the preferable production tool. Since CAD programs vary and are subject to upgrades, these guidelines make no attempt to give CAD instructions other than as performance or results-oriented directions.

BASIC VIEWS

The drawing set for a vessel should be organized generally as follows:

Lines

Construction Drawings

Outboard Profile (starboard side conventionally, port side if it is the only good one)

Inboard Profile (showing internal arrangement of structure, spaces, and equipment)

Main Deck Plan (often showing framing on one side of centerline, deck arrangement on the other)

Other deck plans

Sections (showing internal arrangement of structure and equipment)

Propulsion (sail and rigging plans and/or mechanical propulsion)

Details (structural joints, fasteners, fittings, joinery machinery, carvings, etc.)

Scantlings, a list of structural member sizes and materials, should appear on one of these views. Drawings may also include tables, diagrams, or other means of systematizing information.

Number of Drawings. Not all vessels will receive this complete a coverage, nor is it necessary to devote a minimum of a single sheet to each view or subject listed above

(the main and 'tween deck plans might appear on the same sheet for some vessels, for example). The extent of documentation should depend first on the vessel's significance and the importance and number of specific features aboard it, though other planning factors involved in your project's goals will unavoidably affect the content of the drawing set.

Further instructions on sheet content, layout, and execution will appear under other topics in the remainder of this section.

DRAWING SHEETS

For archival stability, only acid-free polyester materials or "buffered" vellums are recommended for finished measured drawings. Each of these materials has pros and cons in terms of characteristics. Vellums are usually cheapest, but are difficult to erase ink lines from without disturbing the drawing surface; they also can tear easily, and changes in humidity cause them to expand and contract. Linens are very durable, but appear to be unavailable, having given way to plastic-based drafting media.

Polyester-based materials (often called Mylar®, a trade name) are available in rolls and cut sheets, usually in thicknesses varying from three- to five-thousandths of an inch, and with a drafting surface on one or both sides of the sheet. While considerably more expensive than vellum, drafting film is much more translucent, durable, easily erased, and is unaffected by humidity changes. Archival materials should be used whether your drawings go into the HAER collection or not, simply as a means of preserving your effort.

Drawing sheets should never be folded; the creases become areas of structural weakness, collect dirt, and spoil the image. Sheets should be stored flat, or at worst, in a roll.

PRELIMINARY DRAWING SHEETS

Before final drawings can be inked onto HAER drawing sheets, preliminary drawings must be produced to plot field measurements, work out conflicting data, and develop views and sheet layouts. Preliminary drawings are not made a part of the HAER collection at the Library of Congress. However, electrostatic copies may be included with field records in those cases where considerable reconstruction was done or other procedures used which cannot be conveniently shown in the final drawings. If HAER office staff cannot make a field visit, "in progress" diazo copies of your preliminary drawings should be sent to the HAER office periodically for review, especially before final ink drawings are begun.

Either vellums or sheets of mylar cut from a roll may be used for preliminary drawings, though mylar is the better material for reasons discussed above. It is strongly recommended that preliminary drawings of deck plans and profiles be drawn as single views, regardless of length, rather than drawing them in several pieces (as if to put them individually on HAER drawing sheets or other similar size media). This ensures that curves will be fair and that any future sheet divisions will match at cut lines. Long centerlines can be generated by stretching a piece of strong, fine thread as a guide for parallel bars or stainless steel straightedges. (It is best to put such reference lines as well as grids on

the backs of sheets where they cannot be affected by erasures to linework on the fronts.) Preliminary linework is better done with a 4x0 ink pen (on mylar) rather than pencil—it is easier on the eye since the contrast is much better, and ink won't smudge as badly under sliding triangles and other instruments. Plastic leads for use on drafting films do not hold a fine point well. Write down notes on the sheets as you think of them for possible inclusion in final drawings. Principal dimensions from field notes should also be copied onto your preliminary sheets so you don't have to search for or recalculate them again later.

You may find it advantageous on large vessels to set up one or two long drawing boards having 4'x8' or 4'x10' tops for the production of long views. Two delineators can work at such a board without hindering each other. Aboard large vessels with complex machinery spaces, a team may find it beneficial, as a temporary expedient, to trace the general compartment layout from the full-length view, then set up a small drawing board in an individual compartment to work on that particular space.

HAER DRAWING SHEETS

If your drawings are being produced for HAER, your choices of drawing sheet size, material, and graphic media are rigidly specified, due to the limits of the storage facilities and archival requirements at the Library of Congress where the HAER collection is maintained. (See the Secretary of the Interior's Standards for Architectural and Engineering Documentation in Section 4.8.) These specifications are non-negotiable, and failure to follow them will mean return of your work, regardless of its merits.

The HAER Drawing Sheet. HAER provides three sizes of polyester sheets with a standard HAER preprinted border and title block. The sheet size and actual drawing area are given below:

19"x24" (15 3/4" x 20 1/8")
 24"x36" (21-3/4" x 31-3/4")
 33"x44" (31 3/4" x 39 7/8")

The smallest size is rarely used. Mixing sheet sizes in a drawing set for a single vessel is not permitted; all sheets must be of one size.

The HAER polyester sheet is double-matted (i.e. has a frosted drawing surface on each side) so that inking may be done on either as the need arises. Reserve the front side for all linework and labeling, and use the back for lines grids, pochés, and rendering (e.g. deck planks). This way, if mistakes are made in drawing lines or rendering cross sections of materials, they may be easily erased without disturbing prior linework. Most erasures can be made very easily by using a slightly moistened drafting film eraser. Oily fingerprints and smudges, which cause freshly inked lines to bead, can be quickly removed with naphtha (lighter fluid) or a chamois cloth without removing previously inked lines. (Never use acetone or aromatic solvents like toluene--these destroy the drawing surface.) Solvents leave no residual grit to accumulate on or clog pen points as some powdered drawing cleaning products do. Ordinary rubbing alcohol (70% isopropyl alcohol) will remove dried ink lines from drafting films very quickly. The drawing surface of HAER drafting film is not ordinarily impaired by rubbing alcohol, but the surfaces of some brands of drafting film are whitened or removed by

this solvent. Test a corner of your material before applying any solvents to any make of drafting film.

HAER sheets should be used only for final *ink* drawings. Preliminary pencil work, whether in non-photo blue or other media should be done on separate materials, never on the HAER sheet. Aside from smudging, pencil work can leave ghosts on reproductions, and erasure of it wastes time and damages inkwork.

Sheet Orientation. Only two orientations of the HAER drawing sheet are permissible:

- 1) HORIZONTAL with title block to the RIGHT
- 2) VERTICAL with title block at the BOTTOM

Integrity of Borders. The borders of the sheets may be broken when the orientation, scale, or presentation of a subject particularly requires it, but this should not be an excuse for contrived effects or for cramming a view onto a single sheet that would fit better at a smaller scale, or onto two sheets.

Trim Lines. Do not trim the mylar sheets at the "Trim Line" marks. The edges of the sheets are never to be trimmed. HAER sheets are a standard size, and the Trim Line is merely a guide for trimming reproductions for presentation, not the original sheets. Do not "start" pens on the edges of the mylar beyond the Trim Line with the idea that the edges will later be trimmed off. Since the edges will remain, any such marks would have to be removed before a drawing will be accepted for transmittal.

Oversized Sheets. There will be cases where oversized drawing sheets of specific vessels should be made and preserved due to considerations of scale, the needs of a cosponsor, etc. Oversize drawings will not be accepted to the HAER collection, but may be filed at the Library of Congress as part of a separate supplementary collection and cross-indexed to the HAER material. Reduced or "cut up" versions of oversize drawings inserted into standard HAER sheets are all that the HAER collection will accept.

INKS AND DRAWING MEDIA

Inks. On final drawings, only permanent, waterproof, black acetate inks (carbon particle based ones especially for drawing on drafting film) should be used, such as Pelikan-T™ or Pentel® "Ceran-O-Matic" inks. They should never be diluted for use, because diluted ink lines do not reproduce photographically. Color is never used because of the costs of reproduction and assurance of accuracy. Pencil is discouraged because it smudges during drafting and handling. Also pencil drawings tend not to reproduce photographically or electrostatically as well as ink drawings do, primarily because a consistent width and density of pencil line is much harder to maintain.

Adhesive-backed Products. Adhesive-backed ("dry transfer") lettering and rendering materials such as Letratone® and Kroy® are *prohibited* on original drawings submitted to HAER because their adhesives are not archivally stable. There were numerous cases at HAER in the 1970s where dry-transfer lettering and other media flaked or peeled off mylar sheets before the drawings could even be

processed for transmittal to the collection. Drawings may be made using such materials under compelling circumstances, *but only a reproducible mylar copy may be submitted as an original drawing.* Such reproducibles must be made by a photographic, not a diazo (blueprint), process for image permanence and quality. Good electrostatic or laser-printed copies on mylar are acceptable if line quality is clear and image does not flake off. Poor reproducibles will not be accepted.

DRAFTING EQUIPMENT

Projects operated by the HAER office usually require the drafting equipment listed below. Most of this equipment is widely available and would be needed by anyone producing measured drawings of a vessel by hand (rather than by CAD).

Drafting table (at least 36" x 60"--longer for very large vessels)

Parallel bar or drafting machine

12" architects' and engineers' scales

Calculator (with trigonometric functions)

Triangles, ranging from 3" to 12" sizes, in both 30°/60° and 45°/45°

Adjustable Triangles, in 8" and 12" sizes

Protractors

Ames lettering guides

Templates with graduated sizes of circles, ellipses, or specialized shapes

French curves

Ship curves

Adjustable curves or splines (36" or longer recommended)

Bow compasses

Beam compasses

Universal compass adapter (for using pencils and pens with various compasses)

Drafting lead holders and graphite leads (2H to 9H hardness) for preliminary drawings only

Lead pointers

Technical pens (for ink) in the following sizes (These pen sizes vary slightly among manufacturers):

6x0	(0.13mm, 0.005 in)*	—
4x0	(0.18mm, 0.007 in)	—
3x0	(0.25mm, 0.010 in)	—
2x0	(0.30mm, 0.012 in)	—
0	(0.35mm, 0.014 in)	—
1	(0.50mm, 0.020 in)	—
2	(0.60mm, 0.024 in)	—
2-1/2	(0.70mm, 0.028 in)	—
3	(0.80mm, 0.031 in)	—
4	(1.20mm, 0.047 in)	—

**rarely used*

Acetate ink (black)

Erasers (vinyl or plastic for both vellum and mylar)

Erasing shields

Drafting tape

Table brushes

"X-Acto" knife and blades (or equivalent)

Mechanical lettering set (K&E "Leroy" or equivalent)

Roll of polyester film or drafting vellum

HAER polyester drawing sheets

Checking Out Equipment. It is good practice to check architects' (and engineers') scales against one another--it occasionally happens that one or two scales are inaccurate and do not match the others. Failure to find these nonconformists can lead to problems when an inaccurate scale is used with accurate ones on the same drawing. Parallel bars should be checked for straightness and triangles for squareness. To check a

parallel bar, draw a line the length of the bar using one edge; then turn the bar end-for-end (same side up) and draw another line close to the first using the same edge employed earlier. Any bowing between the lines is an indication that the bar is bent. To check a triangle for squareness, set it on a straight parallel bar and draw a line at right angles to the bar; then flip the triangle to the other side of the line and draw a second line close to the first. If the lines diverge, the triangle isn't square and should be discarded.

Use of Splines and Ship Curves. The variety of sweeping curves characteristic of vessels are usually drawn by plotting a series of points from field measurements and then connecting them--or fairing them in--with a ship curve or spline. Ship curves are rigid templates which come in a variety of curvatures and may be used in many combinations to fair in a series of points. A spline can be bent to adjust to an infinite variety of curves. Older splines were held in place by a series of weights or "ducks"; some more recent products are made of a series of interlocking strips or a malleable material that will hold a shape when bent. (Some products hold shape better than others.) When fairing in points, you will often find that not all the points can be intersected without interrupting a smooth curve. In such cases, you will have to decide if a point is to be ignored because its misplacement is obvious, or whether a more average course needs to be steered through the points to be connected.

Equipment Clean-up and Return. HAER equipment is government property, and all nonconsumables must be returned to the HAER office at the project's end. At the close of your project, you must clean all

technical pens thoroughly. Remove all caked ink and ink flakes and dry out all points and reservoirs completely (rubbing alcohol is an excellent cleaner). Set aside any points or other parts that are worn, clogged, or broken and return them separately with a note explaining their specific problems.

Also, all drafting tape must be removed from triangles, curves, templates, and other drafting aids. Tape cement is impossible to remove effectively after a few months without severe damage to the equipment; the gum collects dirt and makes these tools useless. Wash these items with soap and water to remove graphite residues and ink smudges.

Empty the graphite from all pencil pointers and tape all openings. Be sure all bottles are tightly capped and sealed with tape. Properly dispose of any solvents--flammables are not allowed in U.S. mails.

Equipment should be packed firmly in cardboard boxes and taped securely with nylon filament strapping tape. Always mail equipment via registered mail or an express mail service, and send the receipts to the HAER office so the boxes can be traced if lost. Postal regulations require registered mail to be completely wrapped in brown kraft paper and sealed at every seam with gummed brown paper tape.

Shipment of Drawings. Drawings should always be rolled for shipment, NEVER folded. If inked drawings and pencil sketches cannot be returned personally to the HAER office by one of the office staff or a field team member, they should be mailed via registered mail in a sealed

cardboard tube with walls at least 3/16" thick to avoid being crushed in handling.

FIELD OFFICE

It is strongly suggested that a team's drawing boards and other equipment be set up aboard the vessel if at all possible, or in an office space very nearby. This reduces time required to verify measurements or obtain new ones when omissions or errors in field notes are discovered at the drawing board.

The rolling motion of a floating vessel hasn't interfered with drafting in HAER's experience. Electric power should be made available for drafting lamps, along with a convenient telephone and toilet facilities.

LINEWORK ON FINAL DRAWINGS

General Remarks. High-quality drafting is essential. HAER drawings should be free of defects such as overrun or incomplete corners, mismatched meetings of curves and tangents, unfair curves, blobby or sloppy lines, irregularly spaced crosshatching, inconsistencies in repeated or concentric features, and poorly executed lettering. An extremely wide variety of templates and drafting aids are available and help considerably in doing good work. HAER suggests that you make your own templates for specialized features that are frequently repeated (an "X-acto" knife or needle files are usually all you need, in addition to the template plastic).

Specific requirements and recommendations for line weights will follow as drawing content and compositional elements are covered. In general, a wide variety of line weights

should be used to create a rich, bold appearance. This not only results in good quality graphics, it can be essential to the reproducibility and usefulness of a drawing. HAER drawings are rarely reproduced full size; they are often reduced to 8" x 10" or smaller for publication purposes. At this size, drawings that are too delicate or timid will lose detail. Drawings should never be made with only a single line weight; such drawings not only look dull, they can be very difficult for a user to read, because they have very little sense of visual organization; figure-ground effects can create frustrating confusion. Varying line weights are a method of pointing out relative significance of features (Standard I). By using a range of line widths a hierarchy of information is created--overall structure and form can be easily distinguished from substructures and details. Foreground and background can be emphasized by appropriate graduations of line weights.

Delineators should aim to produce drawings that are strong enough and complete enough to stand independently from a drawing set. Full sets of HAER drawings are rarely published, but individual sheets or views often are.

Minimum Line Width. Line widths or pen sizes smaller than 4x0 (0.18mm) are discouraged because they tend not to reduce or reproduce well. Occasionally HAER uses 6x0 (0.13mm) lines in areas of extremely fine detail--closely spaced fine lines tend to read as a heavier line, but they also tend to bleed together in reductions.

Lines Drawings. HAER suggests that a vessel's lines be drawn with a 3x0 (0.25mm) or 2x0 (0.30mm) pen, while other reference lines are drawn with a 4x0 (0.18mm) pen. This way the lines will stand out clearly against their background.

Construction Drawings. The most commonly used line weights range from 4x0 (0.18mm) to 2 (0.60mm). The finest lines are used for small details, joints, patterns, and pochés, including dimension strings and arrows. Pens such as a 2x0 (0.30mm) may be used for outlines and edges of small areas and objects, while heavier lines are used principally for major portions of structure. Sectioned members should always be outlined with a heavy line--2 (0.60mm) or 3 (0.80mm)--depending on the drawing's scale. The 3 (0.80mm) or 4 (1.20mm) pens are used primarily for lettering. Larger pen sizes are available but are very rarely used by HAER. Examples of drawings showing a wide range of line weights appear in Section 4.7 (Drawing Examples).

Pochés and Rendering. Pochés and rendering techniques are recommended, especially for distinguishing materials in section. Stippling can also be used to create a sense of depth. The use of airbrush techniques is acceptable, though not much used by HAER. "Stick on" rendering materials are prohibited from drawings submitted to the HAER collection because of their archivally unstable adhesives. Standard pochés for materials in plan and section appear in Figs. 4.6.1 to 4.6.3 for use in HAER drawings. Techniques for shadowing, shading, and outlining are presented in Figs. 4.6.4 to 4.6.6. Conventional

methods of illustrating breaks in structure and materials are shown in Fig. 4.6.7.

LETTERING and DIMENSIONING

General Remarks. Just as a hierarchy in line weights can be used to make a drawing more intelligible and informative, a system of lettering sizes and line weights can be used to distinguish various types of verbal information and their functions in a drawing. In general, large lettering and heavy line weights should be used for titling views ("Deck Plan," "Section"), small lettering should be reserved for short labels and notes appearing in the view itself. Medium-sized lettering should be used for important notes or explanatory texts. HAER standards for lettering functions, sizes, and line weights are illustrated in Fig. 4.6.8. More sophisticated lettering systems can be developed through using different styles of lettering for different functions (see drawing samples, Section 4.6).

Hand or Mechanical Lettering? HAER accepts either hand or mechanical lettering, but prefers hand lettering as a matter of training for the student employees the program hires for most of its projects. Most hand lettering on HAER drawings is less than 1/2" high. HAER usually produces larger letters mechanically or traces them from samples. Due to its archivally unstable adhesives, transfer lettering is prohibited on drawings submitted for the HAER collection at the Library of Congress.

Lettering can often make or break a drawing visually. Poor lettering is distracting and may unfairly reflect on the quality of your documentation. If you

cannot letter well by hand, HAER strongly recommends that you improve your technique or use a mechanical lettering system.

Mechanical lettering must be used in HAER sheet title blocks. See Fig. 4.6.11 for further instructions.

Lettering Styles. Sans-serif block lettering, whether vertical or inclined, is preferred for all purposes where lettering is smaller than 1/2". Italic forms and typeface styles are usually reserved for larger lettering on title pages or in sheet headings, though a careful mixture of styles can be used in the notes and labels on a drawing to aid legibility and esthetics. CAD systems can apply a wide variety of typefaces to drawings; serif and sans serif letters such as Univers or Times Roman, or similar block letters are most readable. Ornamented or advertising faces are discouraged except for title page titles.

While HAER encourages the use of hand lettering, this does not mean all hand lettering styles are acceptable for use. Legibility and uniformity in lettering are paramount, especially on reduced copies of drawings, and for this reason an unembellished block lettering style is much preferred. Individualized styles characterized by exaggerated forms and stylistic aberrations are excluded, generally because they are difficult to read and do not reduce well. Some examples of unacceptable and acceptable styles are given in Figs. 4.6.9 and 4.6.10. All upper-case lettering or mixed upper-and-lower-case lettering is acceptable, provided that one or the other format is used consistently throughout a drawing set. All lettering in a drawing set

should be done by a single person, or by team members whose lettering styles are very similar in order to maintain a uniform appearance. Where a lot of lettering must be done, there may be good reason to use a mechanical lettering system, since this allows all team members to letter in a uniform style and avoids burdening one or two individuals with the job.

Before doing any lettering (whether by hand or mechanically) it is extremely helpful to make up sheetfuls of lettering guide lines for the various letter sizes and line spacings you will be using. All you have to do after planning your layout is slide a guide sheet under the draft sheet or final mylar and letter away. These sheets will save a lot of time over repeatedly constructing and erasing individual sets of guide lines for every label and blurb. If an up-to-date copy machine is available, you may only have to draw one set of lines: the various other sizes and copies can be made by the machine. If guide lines are pencilled onto the mylar, they must be erased before reproducing the drawings, and frequently erasure thins out ink lines in some places. This danger can be avoided by pencilling on the back of the mylar, but guide sheets will still save you the time and trouble.

Dimensioning. Sizes and weights of numerals follow the same rules as lettering, though in most cases dimensions need not use numerals higher than the minimum 5/32 inch height for HAER work. The format for laying out dimension strings and dimensions for HAER is illustrated in Figs. 4.6.12 to 4.6.14. HAER drawings are not working drawings, hence there is no need to dimension everything down to the smallest

Materials in Plan or Profile (Standard Symbols)



Wood



*Metal
or Any
Material*



Glass

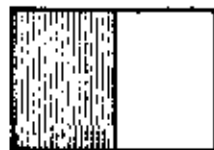

corrugated siding or roofing
plain (show joints or seams)
Sheet Metal

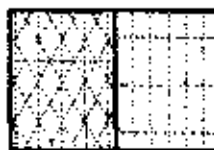

*Open-web
Grating*

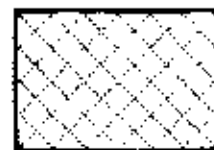

*Non-skid
Cover Plates*



Concrete

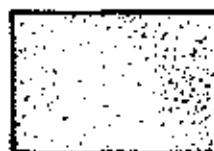

*Sand or
Earth*



Rock

Fig. 4.6.1

Materials in Section

(Standard Symbols)

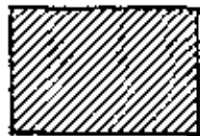

Cast Iron



Wrought Iron

Steel (cast
or rolled)

Forged Steel

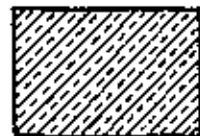
Brass, Bronze,
Copper, or
Compositions

Aluminum

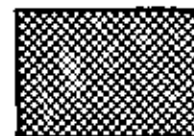
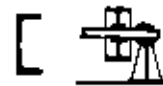
Zinc, Lead,
White Metal,
Babbitt, etc.sections of
metal members
and parts at
small scales
are shown solid

Concrete

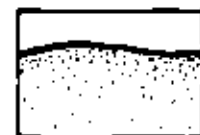
Reinforced
Concreterough cut
Stonecoursed uncoursed
Rubble

Sand



Earth

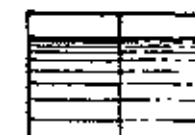

Rock

Water
(and other
Liquids)

(Continued)

Fig. 4.6.2

Materials in Section (Standard Symbols)

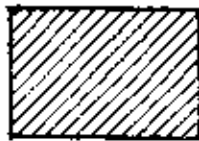

Common
Brick

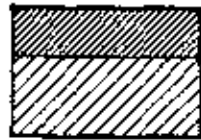

Common Brick
with Facing
Brick

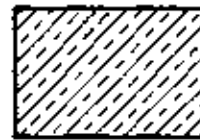

Fire Brick or
Refractory
Materials

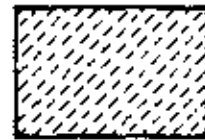

Glass,
Porcelain,
Marble



Wood (along grain)



Wood
(crossgrain)

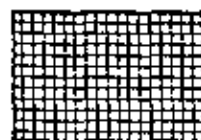

Electric
Windings.
(Generator
Coils, etc.)

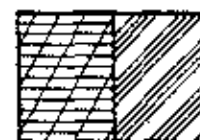

Electric
Insulation



Thermal
Insulation

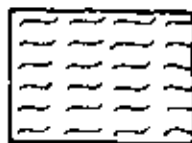

Flexible
Materials
(Rubber,
Leather, etc.)



Any
Material



Any
Material
(used where graphics
or clarity would benefit,
e.g. walls in plan or
section, building or
machinery structure,
etc.)

Fig. 4.6.3

Shadowing

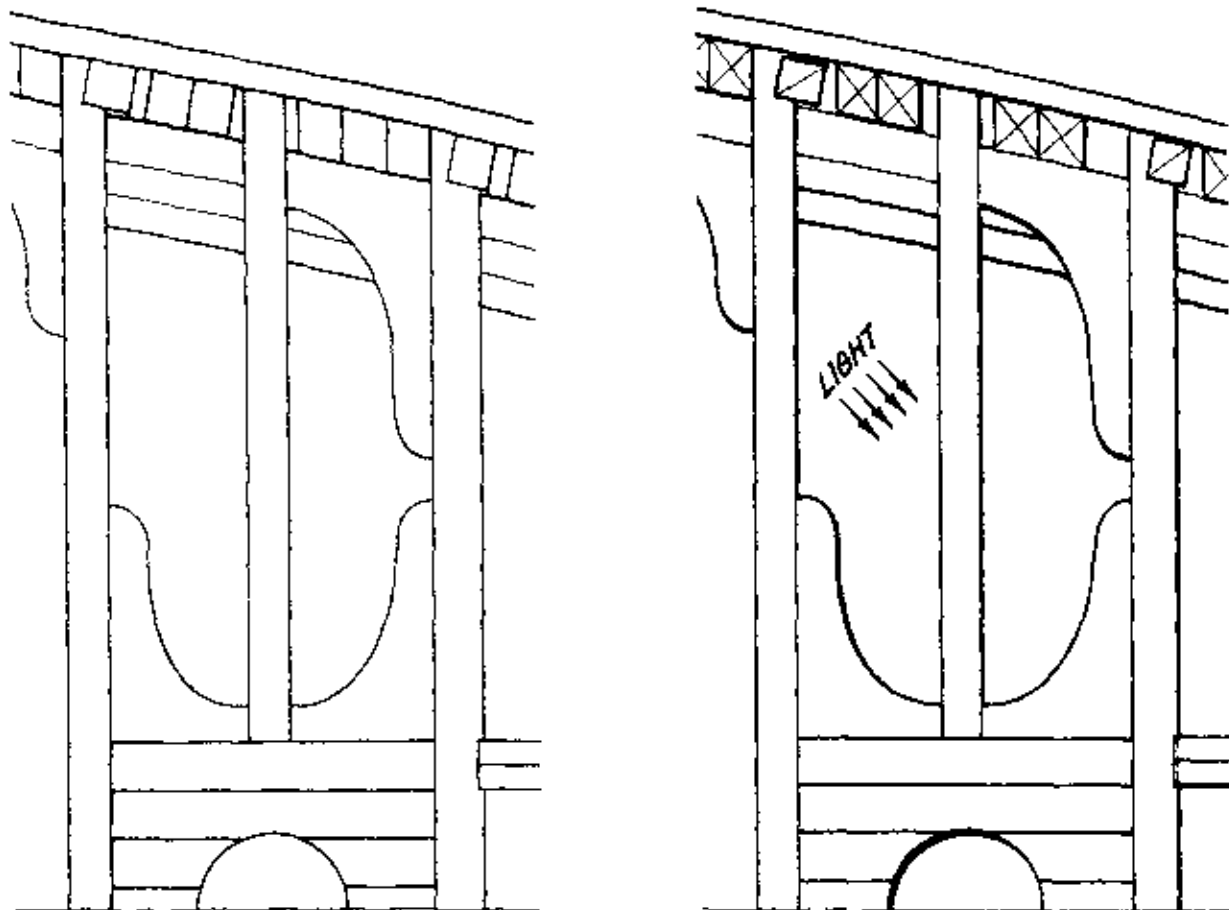

Taken from Pilot Schooner ALBANY, NARR. No. NA-44, Sheet 5 of 12

Fig. 4.6.4

Line shadowing is an old engineering drawing convention which gives drawings a very readable three-dimensional quality. Compare "with" and "without" views shown here of a foredeck construction plan. The line-shadowed convention *always* assumes light is shining from the *upper left* of the drawing (held so the labels are "right-reading"). Edges which

would cast shadows are inked in heavier lines (#2 pen or larger) than those which are directly illuminated. Shadows must be "feathered" on rounded features. The somewhat antique flavor of this technique seems appropriate for historical structures and invites attention. Use of shadowing is not required, it is strongly recommended if outlining techniques are not used.

Outlining

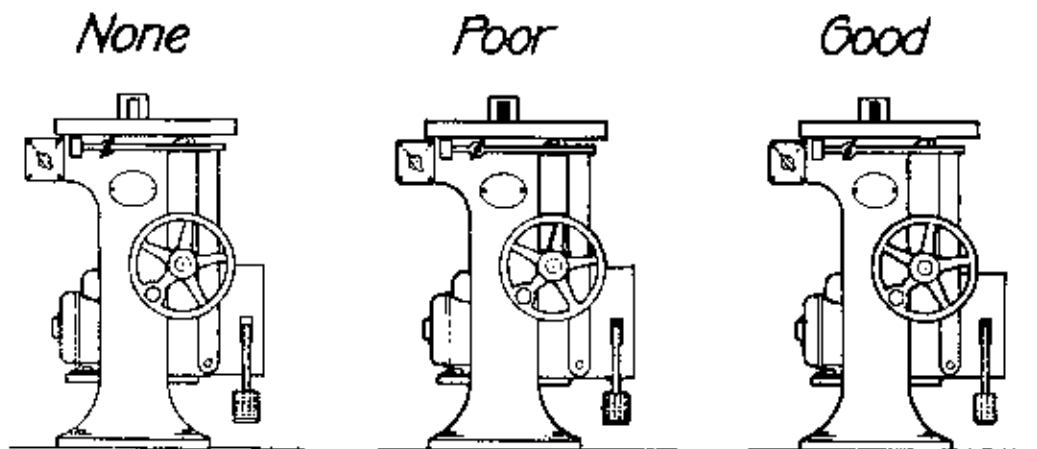

Fig. 4.6.5

Outlining is a more contemporary technique than line shadowing for giving a three-dimensional aspect to a drawing. It creates a "depth effect" by surrounding features with heavier (or lighter) lines in order to make features stand out from (or fall back into) the drawing plane.

Though the above object is not a vessel, the use and misuse of outlining are easily illustrated by it. Views without outlining tend to look "flat" and may introduce confusing figure-ground effects (above left). Outlining is commonly understood to mean emphasizing only the extreme edges and open spaces of an object (above center), a half-baked approach that leads to confusing effects as well. The handwheel in the center example looks awkward because only those parts which have "nothing" behind them have been outlined. The inconsistent emphasis make the wheel

appear to be in different planes at the same time. The foot pedal is also much too heavily emphasized for its relative size.

It is better to outline individually the separate components of an object or those parts of it which lie in different planes. As a rule, the most emphasis should be given to the largest, most important or defining parts or to those parts which lie in the foreground. In the case of the machine on the above right, the handwheel, table top, motor, and pedestal are all outlined as discrete components. Less dominating parts receive less emphasis, while details such as the switch and motor parts receive none at all. The overall drawing is much more readable and consistent in its graphic logic.

Similar rules apply to isometric and perspective drawings.

Shading

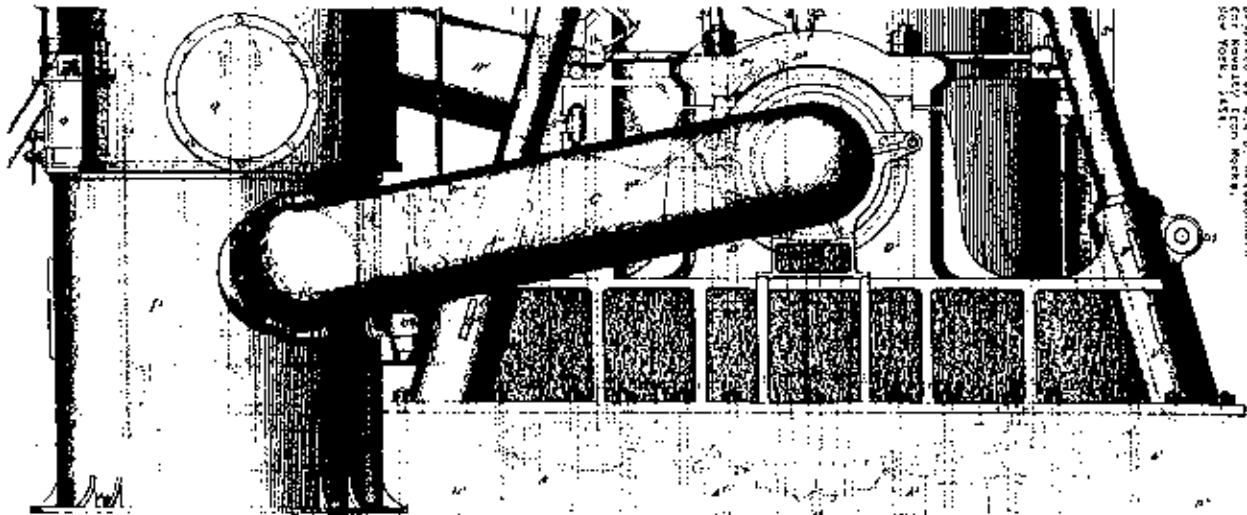

FROM "ENGINE DRAUGHTING" BY R. S. WILSON, ALBANY, N. Y., 1911.
 REVISED BY R. S. WILSON, ALBANY, N. Y., 1921.
 FOR NEWARK, ILL. (REVISED)
 NEW YORK, 1931.

Fig. 4.6.6

Like line shadowing, shading is an old engineering drawing convention, but one used to express the "roundness" of mechanical parts such as pipes, tanks, shafts, castings, etc. Care should be taken

not to use it on features where it might be confused for structure, such as barrels composed of staves. It lends an antique look that works very well graphically, but it is chiefly used for machinery.

Conventional Breaks

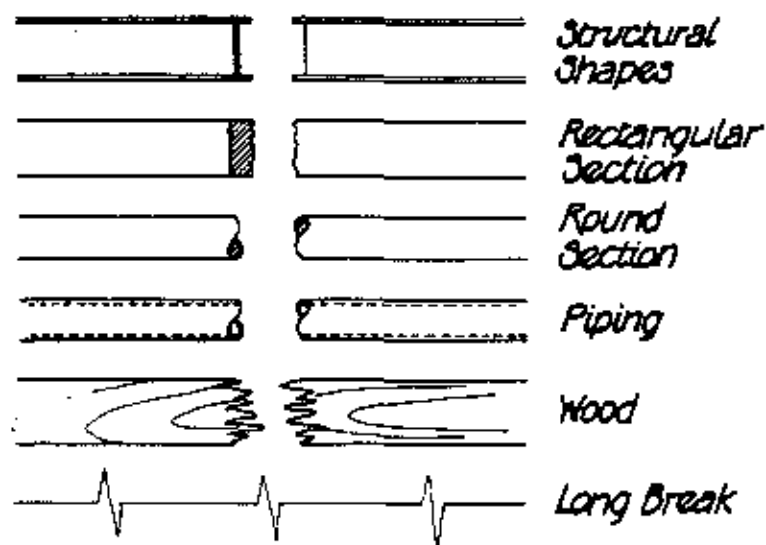

Fig. 4.6.7

Lettering Sizes and Pen Weights

All drawing titles (e.g. "PLAN," "SECTION," etc.) to be a

MAXIMUM $\frac{3}{8}$ " HEIGHT,

#4 PEN

MINIMUM $\frac{1}{4}$ " HEIGHT, #3 PEN

All blurbs and texts to be a

MAXIMUM $\frac{1}{4}$ " HEIGHT, #3 PEN

MINIMUM $\frac{3}{16}$ " HEIGHT, #2 PEN

All notes and labels to be a

MAXIMUM $\frac{3}{16}$ " HEIGHT, #2 1/2 PEN

MINIMUM $\frac{1}{8}$ " HEIGHT, #0 PEN

All dimensions

NO SMALLER THAN $\frac{5}{32}$ " HEIGHT, #1 PEN

EXCEPT FOR NUMERALS IN FRACTIONS

WHICH SHOULD BE NO SMALLER THAN

THAN $\frac{1}{8}$ " HEIGHT, #1 PEN

ABSOLUTELY NOTHING LESS THAN $\frac{1}{8}$ "

HIGH OR LIGHTER THAN #0 IS

ACCEPTABLE BECAUSE IT IS

EXTREMELY DIFFICULT TO READ

WHEN REDUCED TO LESS THAN

$\frac{1}{4}$ FULL SIZE!

Below is this
page reduced
to approximately
 $\frac{1}{4}$ full size ↓

Lettering Sizes and Pen Weights:

All drawing titles (e.g. "PLAN," "SECTION," etc.) to be a

MAXIMUM $\frac{3}{8}$ " HEIGHT,

#4 PEN

MINIMUM $\frac{1}{4}$ " HEIGHT, #3 PEN

All blurbs and texts to be a

MAXIMUM $\frac{1}{4}$ " HEIGHT, #3 PEN

MINIMUM $\frac{3}{16}$ " HEIGHT, #2 PEN

All notes and labels to be a

MAXIMUM $\frac{3}{16}$ " HEIGHT, #2 1/2 PEN

MINIMUM $\frac{1}{8}$ " HEIGHT, #0 PEN

All dimensions

NO SMALLER THAN $\frac{5}{32}$ " HEIGHT, #1 PEN

EXCEPT FOR NUMERALS IN FRACTIONS

WHICH SHOULD BE NO SMALLER THAN

THAN $\frac{1}{8}$ " HEIGHT, #1 PEN

ABSOLUTELY NOTHING LESS THAN $\frac{1}{8}$ "

HIGH OR LIGHTER THAN #0 IS

ACCEPTABLE BECAUSE IT IS

EXTREMELY DIFFICULT TO READ

WHEN REDUCED TO LESS THAN

$\frac{1}{4}$ FULL SIZE!

Fig. 4.6.8

Hand Lettering

Unacceptable Styles

Lettering that is too stylized, elongated, or badly formed falls into the "unacceptable" category. Such lettering does not reduce well and is not very legible to the general public:

THE LAND THAT FORMED THE HACIENDA
HE WAS A SPANISH EMIGRE FROM VENEZUELA,
HIS VENEZUELAN-BORN SON, DON
1845, AND SUBSEQUENTLY FOUNDED THE

Too vertically elongated; middle horizontals too high.

THIS RECORDING PROJECT
WAS PART OF THE HISTORIC
RECORD (HAER) TO DOCUMENT
INDUSTRIAL SITES THROUGHOUT
THE COUNTRY BY HAER FIELD

S, O, R, P, and Ns too compressed; blur when reduced.

1 FREIGHT SHOP
2 TRUCK SHOP
3 MATCHING ROOM
4 RAMMER SHOP
5 WATER TOWER
6 GEN'L STORE Bldg
7 INT AIR DRY
8 HOUSES (KILNS)
9 BIL HOUSE
10 LEAD WAREHOUSE
11 REAR ERECTING
SHOP
12 REAR ERECTING
SHOP

Very eccentric; hard to read; much too elongated vertically. U, O, A, R, P, H, N, and W will all fill in and become blobs when reduced.

FIRST FLOOR PLAN *Just plain sloppy!*

Fig. 4.6.9

Hand Lettering

Acceptable Styles

Acceptable styles have well-rounded letters free of stylistic exaggerations. They read easily, are adequately spaced, and reduce to 1/4 size without blurring. Block, inclined, and lower case lettering are acceptable subject to these conditions.

ESTABLISHED IN 1854, THE EM
CHASED THE MILLS IN 1862
1875 TO 1890 THIS WAS THE

RECENT OWNERS HAVE
ENGINE ORDERED FROM
SUGAR FACTORY AND IS

THE FIELD WORK, MEAS
DIRECTION OF DOUGLAS
DIRECTOR THE SURVEY

THE SURVEY WAS COSP
CITY OF LOWELL THROU
ON MERRIMACK RIVER.

THE FIELD WORK, ME
1974 AND 1975 BY TH
HISTORIAN. FIELD PE

*This Recording and
range program to d
historically significa*

AT THE SMALL VILLAGE
WORKS AFTER THE
SMALL BLAST FURN

—+— } minimum:
 } 1/2 letter height
 } maximum:
 } 1 letter height

Labels and blurbs should be laid out in pencil before inking to check letter spacing, spelling, hyphenation, and visual effect on drawing composition.

Fig. 4.6.10

Title Blocks

All lettering in title blocks must be done with Leroy or Unitech equipment. No hand lettering or presstype!

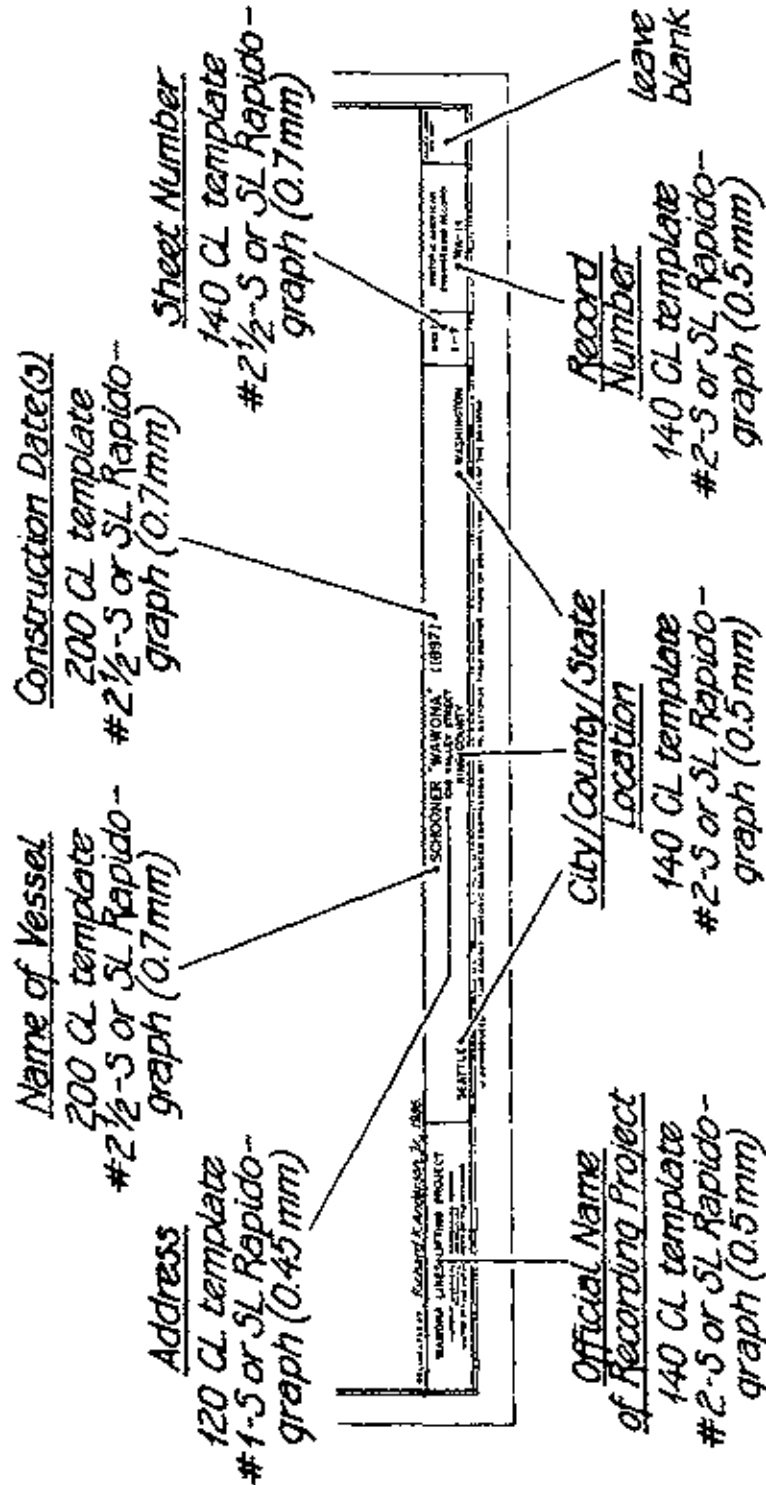

(Continued)

Fig. 4.6.11

Title Blocks

LEFT CORNER BLOCK: The official name of the recording project, such as SHIP BALCLUTHA RECORDING PROJECT is to be lettered here in capital letters.

NAME OF VESSEL: The original name is required here. In some cases, this name will not be readily evident, and careful research will be needed to determine it. Later or more common name(s) may be added in parentheses, e.g. SHIP "BALCLUTHA" (STAR OF AJASKA). If the original name cannot be determined, then a later or current name should be substituted.

DATE: The year of the vessel's construction should follow the name on the same line, set off by two spaces. No additional dates are needed.

ADDRESS: Though some vessels can and will often move from the place they are recorded, the location where a vessel is recorded should be determined as sensibly as possible. Vessels owned by museums of other organizations may be located simply by the organization's street address. The address of a privately owned vessel should be where the vessel is located, *not* that of the owner, unless these places are the same. Otherwise, names of water bodies, prominent geographic landmarks, towns, or major roads should be used.

LOCATION: The geographic location where a vessel is recorded should be established by city (village, town, etc.), county, and state from reliable map sources, even if the vessel is destroyed after documentation. Townships or other local governmental designations should be included where applicable. Vessels in rural areas (abandoned on a beach, for example) should be located as in the vicinity of the nearest settlement having a post office, e.g. "Solomons vicinity, Calvert County, Maryland". No county name is given for independent cities, e.g. "Richmond, Independent City, Virginia".

ALL OF THE ABOVE INFORMATION MUST APPEAR ON THE COVERS OF ALL FIELD NOTEBOOKS.

RECORD NUMBER: This number is assigned by the HAER Washington office or National Park Service regional office. If you do not receive it, leave this space blank. It will be filled in later by the National Park Service.

LIBRARY OF CONGRESS NUMBER: Leave this space blank. It will be filled in by the Library of Congress.

TITLE BLOCKS MUST BE THE SAME ON ALL SHEETS WITH THE SAME HAER NUMBER

(no subtitles, such as "Plan" or "Section" are permitted)

Dimensioning

1. Use either a 3x0 (0.25mm) or 4x0 (0.18mm) pen for dimension strings:

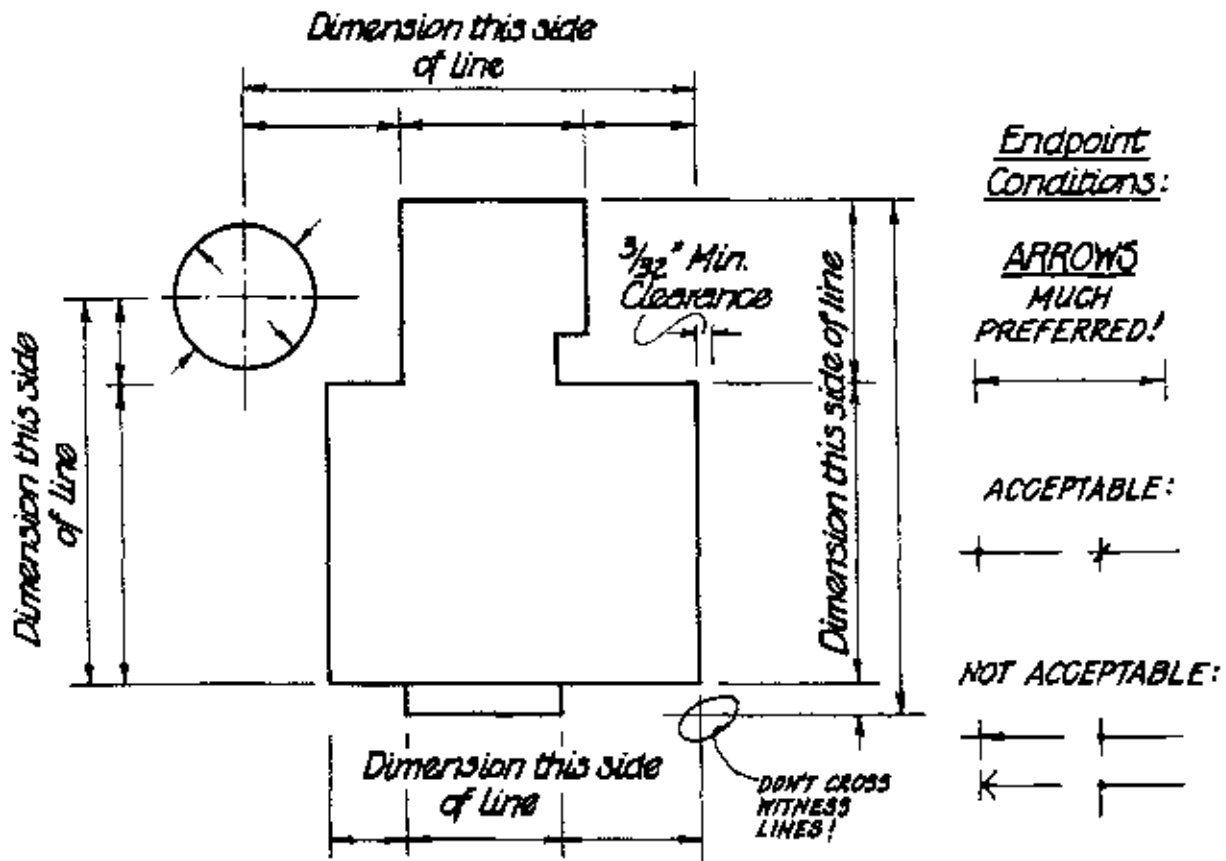

2. Numerals should be a *minimum* of 5/32" in height, except for fractions, whose numerals may be no smaller than 1/8" high.
3. When putting metric measurements alongside English ones, place parentheses around the metric figures, e.g. 12'-0" (3.66M). Always round metric figures to the nearest 0.01 meter!

Fig. 4.6.12

4. Don't dimension across linework! It impairs legibility.

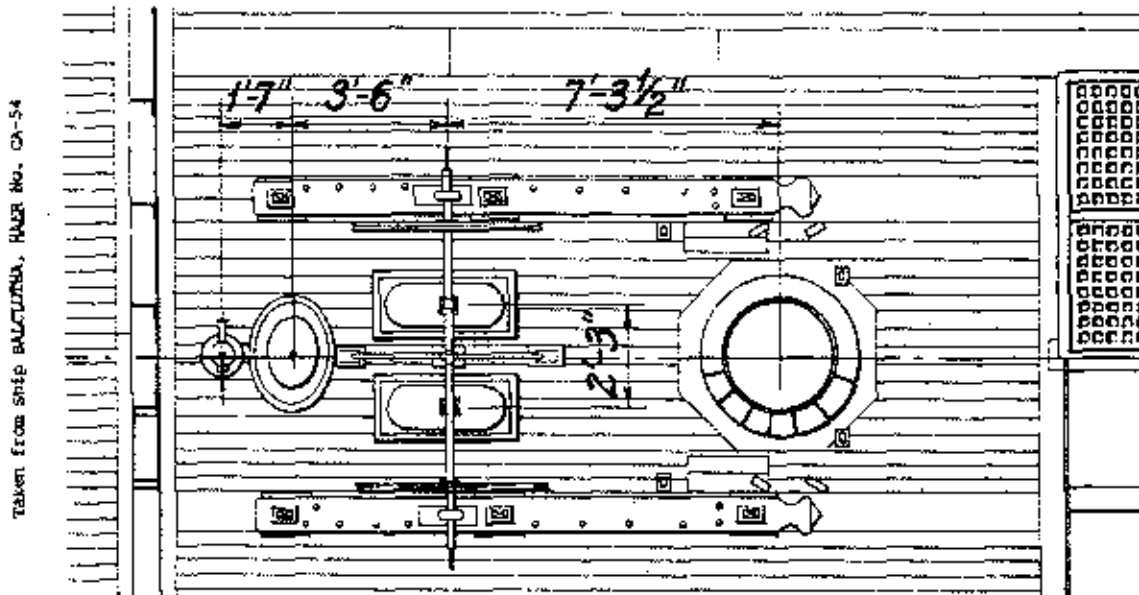

Fig. 4.5.13

5. Put dimensions outside of linework, or where there is no alternative, erase linework for clarity.

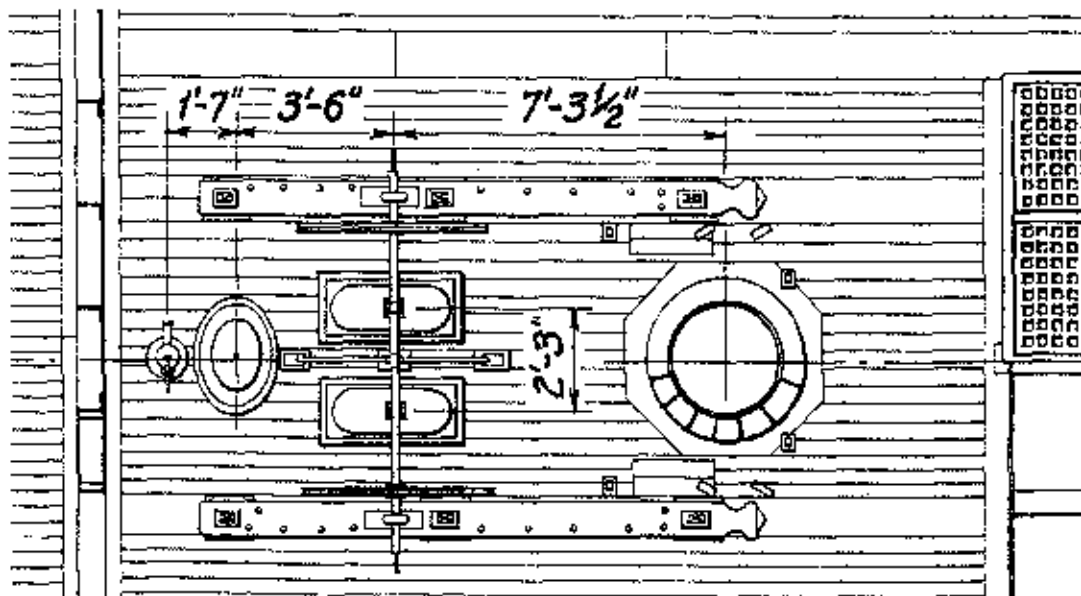

Fig. 4.6.14

detail. Principal overall dimensions and those of major features are all that are usually called for (see drawing samples in Section 4.6).

English and Metric Systems. Though the English system of linear measure is more widely used than the metric system in the United States, metric figures are required along with English figures for principal overall dimensions. Metric figures should be enclosed in parentheses, and rounded to the nearest 0.01 meter. There is no requirement to show metric equivalents of English figures for tonnage, volumes, sail areas, etc., but their inclusion may be helpful to future researchers, assuming that the metric system becomes more widely established.

Graphic Scales. In addition to dimensions, all drawings should contain a graphic scale in the format illustrated in Fig. 4.6.15. This format is based on traditional maritime scales, which have been used by numerous authorities. Such a scale permits the scaling of reduced copies of drawings, and it should be as long as is practical on the drawing sheet. A less prominent metric scale is included to permit use of the metric system by those more accustomed to it.

DRAWING ELEMENTS and COMPOSITION

General Remarks. Laying out and composing a drawing is more than merely stuffing a subject between the borders somehow, and sandwiching in notes, labels, or scales as fancy strikes. Careful planning of a set of drawings is also much more than an exercise in "frilly" esthetics. A drawing is intended to store and

communicate information, and the better it does this, the more useful and successful it is. Drawings are necessarily selective and interpretive about the facts they present, and where organizational and esthetic considerations have been used to further communication, the results are highly useful as well as elegant in appearance. Planning a drawing set involves numerous elements, of which major ones will be discussed in this section and illustrated by example in Section 4.6. Elements are such things as linework, titles, blocks of notes, dimensioning, etc., all of which must be considered and harmoniously combined. (Even empty space needs to be considered as a sheet design element.) Organization, clarity, and consistency are your guiding principles. The idea is to help a user see relationships, not only among the vessel's parts, but also between the vessel and any important historical, technical, or archeological information your project brings together.

Organization. You need to document important information about your vessel. How can your drawing set accomplish this? Is the set designed to take a reader through the vessel in an orderly progression? You may elect to use more than one HAER sheet to record a deck plan or inboard profile; are the drawings laid out in such a way that a future user can combine them with a minimum of effort? Is each sheet organized in such a way that a user can grasp the major elements right away—linework, notes, dimension, a scale, a drawing label, etc.? Are historical notes easy to find?

Clarity. Clarity results not only from good organization, it also involves good delineation, and a thoughtful sheet layout

quickly and clearly communicates its information to the user. Will the user's eye be drawn to the important facts you are documenting by appropriate positioning, delineation, or labeling, or will he have to "dig" for help? Are important notes made in teeny cramped lettering and hidden in a corner, or are they prominent and positioned near the features they discuss? Did you use arrows to clearly and unambiguously point to parts you labeled? Does the drawing of the vessel "read" (strong graphics), or is it uninteresting because it is drawn entirely with a 3x0 pen? Did you provide a visual key on each sheet to show a user what part of the vessel he is looking at? Is the key in the same relative place on every sheet? Is the scale of the drawing appropriate to what is significant to show? Did you title the views boldly and clearly, or use a tiny letter size and a timid pen weight? Did you provide principal dimensions and label important parts? Is vital historical information present? Can the user easily find this sort of information without hunting among other sorts of verbal communication, or did you just letter everything in the same letter size and weight? Did you key in parts of the historical report or selected photographs for the user to consult when this would be helpful? Did you remember not to label across linework so the labels can be clearly read?

Consistency. Treating the same type of information the same way sheet to sheet allows a user to more easily see what is *different* from sheet to sheet. It permits him to study the vessel without being distracted by important, but secondary, background information. Repeated elements, such as titles, graphic scales,

blocks of notes, should be located in the same relative positions on every sheet--in other words, you should always be able to find the sheet title in the lower right hand corner. (The lower left corner, or the bottom center are also acceptable places, but it's the consistency, not the position, that's important here.) Graphic scales should use a consistent format. Notes should be made in a consistent letter size and pen weight from sheet to sheet, as distinguished from sheet titles, which should have their own consistent size and weight.

Review. On HAER projects, ongoing review of drawings in the field is carried out by the field team supervisor. Review of drawings is also performed by the project manager during periodic visits, as well as by a review team of specialists. Where a timely visit by a project manager is not feasible, copies of preliminary drawing sheets should always be sent to the HAER office for review and comment, especially before final drawings are inked.

The following pages constitute a sort of checklist for you to use as you plan and complete your drawings. Basic elements will be considered first, and the composition of title pages, lines, and construction drawings later.

ELEMENTS

Scale. Choice of scale to which a vessel will be drawn depends on the overall size of the vessel and the amount of detail and precision warranted by her significance or required by your project's goals. A scale of 1/4" to the foot has been traditionally used for overall views (deck plans, profiles) as long as a view could be made

to fit on a manageable sheet size. Scales such as 1/8", 3/8" and 1/2" to the foot have been used, and drawings 12 feet long are not unknown. However, HAER sheets are limited to standard sizes, hence the longest overall view (such as an outboard profile) that can be drawn within the borders is about 120 feet at 1/4" scale. Beyond this, either a smaller scale must be used or multiple sheets. There is no requirement to maintain a single scale throughout a drawing set, but disorientation can be kept to a minimum by at least drawing deck plans and profiles at the same scale. Midship sections are generally drawn at a scale two or three times larger than plans and profiles. Certain views for a very large vessel may have to be drawn twice: once at a small enough scale to give the reader the overall appearance on a single HAER sheet, then the same view at a larger scale broken up over several sheets to present more detailed coverage. Details should be drawn at larger scales, e.g. 1/2", 1", or 2" to the foot for 1/4" scale profiles, and 3/4", 1 1/2", or 3" to the foot for 3/8" profiles. Some types of detail, such as molding profiles of joinery, may need to be drawn full size.

Multi-sheet Views. Deck plans and other views which have to be broken up over two or more sheets can be handled a number of ways. Since vessels consist of a number of important continuous curves, there is considerable advantage to drawing a single view (such as a lines plan, deck plan, or inboard profile) in preliminary form as a single oversized drawing on a sheet cut from a roll of drawing material. A photographically reduced copy should then be made to a scale small enough to fit a single HAER sheet before cutting the

larger drawing up for tracing onto HAER sheets. (The same method would apply if you are using sheets intended for other depositories.) The reduced copy is then used as a base for inking the overall view onto a HAER sheet. In some cases, an oversized final ink drawing done on roll material should be made. It may then be preserved (see Oversized Sheets on p. 4.6.5), and a same-size photocopy cut up and spliced into smaller sheets, or the original itself may be cut and spliced. If smaller sheets are to be submitted to HAER, spliced sheets will have to be photographically copied same-size (including HAER borders) onto a new sheet of mylar, since neither tape nor other splicing materials have archivally stable adhesives. Before cutting up a final drawing, however, consideration should be given to making a same-size photographic copy for use by the vessel owner, and a copy reduced enough to fit into a single HAER sheet for the overall view. The photographically reduced view can be well worth the money in terms of the time it would take your team to redraw it at a smaller scale, unless the reduction is so extreme that small details bleed together. In the latter case, the view should be redrawn and simplified at the smaller scale for increased clarity.

All reduced and same-size copies should be checked for scale distortion. Photographic copies made on drafting film with a negative and lithographic copy camera (found primarily in reprographic firms) are the most reliable. Other types of camera may distort unevenly (e.g., stretching at the ends or in corners). Electrostatic copies usually show scale distortion in the direction the drawing travels through the copying machine, information. They may make a historical

Graphic Scale

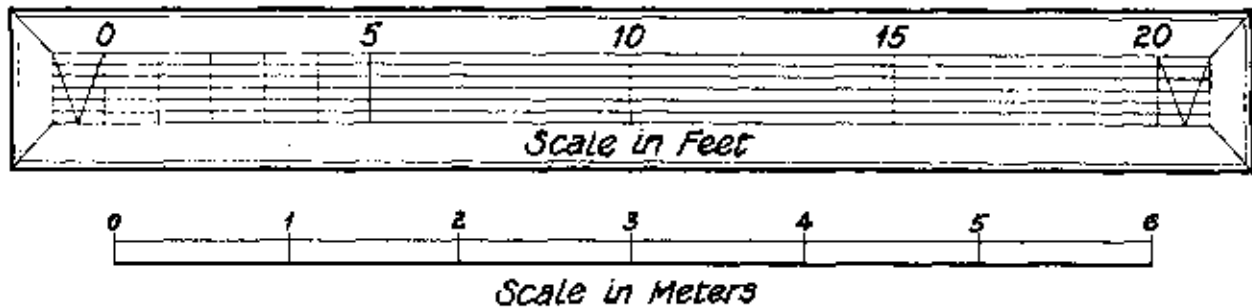

Fig. 4.6.15

The type of graphic scale shown above (reduced) is adapted from a style widely used by marine draftsmen and recorders until the early 20th century. Since it seems to have acquired the status of a standard

and is very useful for scaling enlarged or reduced copies, HAER sees no need to introduce any new standard. The only addition made is a metric scale below the English one.



Fig. 4.6.16

To produce this type of scale, seven evenly spaced parallel lines are drawn for the English scale, and then marked off in 1-, 5-, or 10-scale-foot intervals. When a scale foot is divided by the "V" figure seen above, the diagonal lines intersect the horizontal lines at twelfths of a foot (inches). The metric scale need only be a marked off in 1- or 5-meter intervals.

HAER strongly recommends that scales be drawn the full width of the view the scale accompanies (profile, plan or section) for greater ease and accuracy in marking and using reproductions of drawings (see Drawing Examples, Section 4.7). Short scales introduce larger scaling errors than long ones. Note that the subdivided foot interval is to the *left* of the zero point.

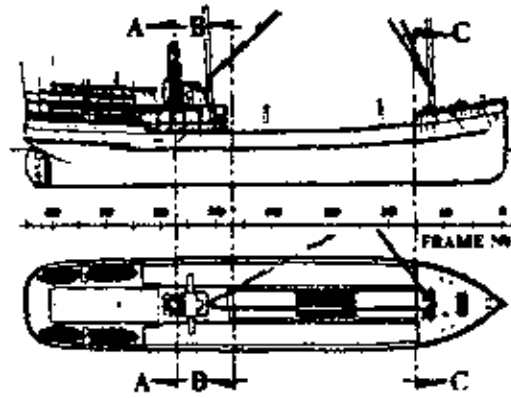

Taken from Steam Schooner WADAWA Historic
Structure Report, Sheet 12 of 13,
by Tri-Coastal Marine, Inc.
for National Park Service

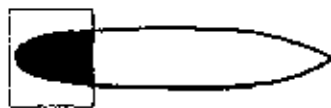

1st Sheet



2nd Sheet



3rd Sheet

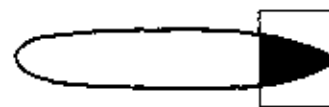

4th Sheet

Fig. 4.6.17
Location Diagrams

though some newer machines have precision adjustments for distortionless copies.

Graphic Scale. The format for the graphic scale is covered in Figs. 4.6.15 and 4.6.16, however, the scale should be located near the bottom of each sheet, and should be approximately the same length as the view it accompanies.

Sheet Titles. Every view must have a title: "Outboard Profile," "Main Deck Plan," "Section - Station 3," etc. This title should be clear and thorough, so that there is no ambiguity as to what is meant. Lettering should follow the sizes and weights given in Fig. 4.6.8. Titles may be underlined to add visual emphasis, and they should be in a prominent place on the sheet.

Diagrams. In views requiring multiple sheets, it is very convenient to include a small diagram near the sheet title showing what is being portrayed about the vessel and where (see Fig. 4.6.17). The entire vessel should be drawn schematically at a very small scale, and the portion appearing on the particular sheet emphasized by heavy lines or shading. A similar approach should be taken when drawing parts of structural or mechanical systems, so the place of each part can be shown in terms of the whole.

Blurbs, Notes, Labels, and Keys. Blurbs, notes, labels, and keys used in drawings should be composed with the assistance of the team historian. This will ensure that important information is conveyed and proper terminology used. HAER delineators are not expected to be writers who know all the ins and outs of vessel construction and terminology, but between

themselves and other team members, all are responsible for seeing that verbal information in the drawings has a professional, scholarly content and is graphically integrated into the sheet design. Specified lettering sizes and weights are given in Fig. 4.6.8.

Blurbs. In general, blurbs should be limited in length and contain only the most important facts and observations. They aren't intended to be a substitute for the historian's report in their depth. They should aid the drawing in documenting and interpreting the vessel. The longest blurb in a drawing set is likely to appear on the title sheet as a brief history of the vessel with a statement of her significance. Connected with this should be a project credit statement listing sponsoring organizations, team members, volunteers, and special acknowledgements. Operations of equipment might also be described in a blurb when such equipment is drawn.

Notes. These are generally condensed remarks consisting of a phrase or brief statement used to supplement graphic information. They may make a historical statement, describe a material or function, give pertinent information on a piece of mechanical equipment, call attention to important qualifications or field conditions, record bibliographical data, make observations, point out important speculations, or account for the accuracy of questionable-looking features in a drawing.

Label and Keys. These are essentially two different methods of citing or describing different parts of a vessel or feature of your drawing. They may be used separately or together as the graphic

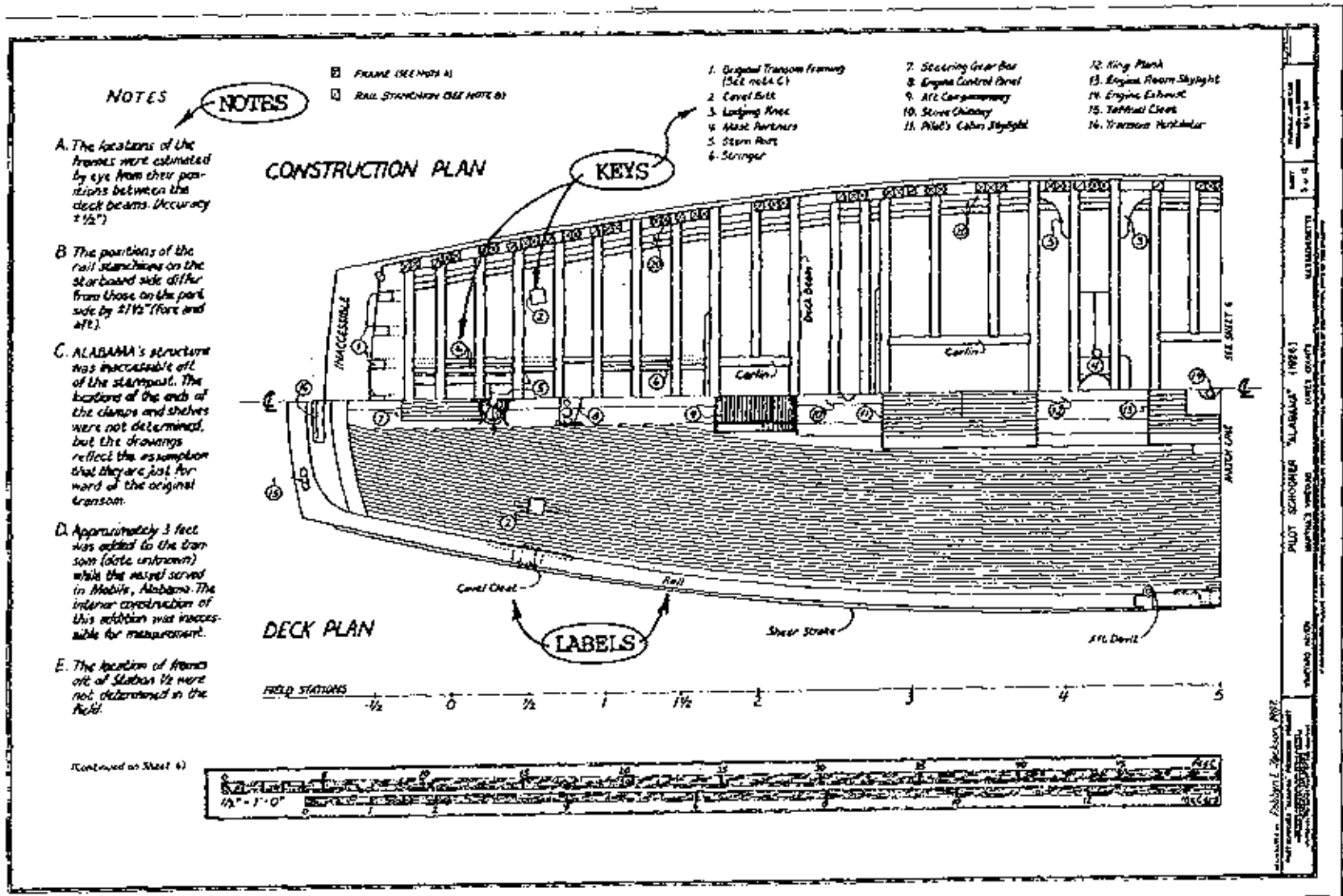

Fig. 4.6.18
Notes, Labels, and Keys

design or available space on a drawing require. Keys with number "tags" are most often used when the number of parts or elements to be cited within a given space is too numerous to label outright without obscuring large portions of the linework or crowding the space with verbiage. Labels are used where the number of things to be described is few and there is ample space to accommodate verbiage. Often drawings will permit labels for some things, but numerous other important elements will be too highly concentrated to label without using keys; hence, both systems are used (see Fig. 4.6.18). Generally a label or key citation is no longer than a word or a phrase. Names and descriptions should be as concise as possible; be sure to include both local and general terminology where variant terms for shipboard features are used. Avoid lettering within the linework of a drawing whenever feasible. If it is inescapable, care should be taken never to letter across linework without first erasing enough linework to provide adequate space. In all cases, lettering and numeral sizes should be large enough to be clear and legible when reduced for publication. Be sure to follow the requirements in Figs. 4.6.8 to 4.6.10.

Arrows. Arrows should be used for clarity's sake when simple location of a label or tag near a feature does not resolve ambiguities.

Below is a checklist of subjects to keep in mind for notes. Some items and questions may require the assistance of your review team or a specialist.

MATERIALS

The woods and metals used in your vessel should be properly labeled. In many cases, an exact determination may not be able to be made without expert examination, or

members may be hidden or painted. Guidebooks exist for distinguishing the more common species of wood (see References and Resources, Section 4.7), but some kinds of metals may be difficult to tell apart without chemical tests, or knowledge of their function. If a material is unknown to you, do not forego labeling it altogether. You may say "wood, species undetermined," or "non-ferrous metal" if a metal is clearly not iron-based, but its composition has not been established. "Brass or bronze" is an acceptable label if you cannot determine between the two.

WOODS

The woods used in building a vessel may come from almost anywhere. Sometimes they are a function of the region in which the vessel was built; in other cases, woods may have been ordered from other areas, or have been on hand when the vessel was repaired at a point far from where she was launched. In general, however, Douglas Fir (*Pseudotsuga menziesii*) is a common shipbuilding wood on the west coast, white oak (*Quercus alba*) in the east, yellow pine (*Pinus palustris* or *Pinus echinata*) in the south. Because of the variances in regional English terminology for woods, it is best to pin down the Latin botanical name for the species in your vessel. Even if you can only identify the species (e.g. "Pine") but not the variety without professional assistance, the Latin species designation should be given (e.g. *Pinus spp.* for "pine species").

METALS

Some common metals and alloys are very easy to distinguish by the color of the bare metal (iron, copper, aluminum, yellow brass, red brass, bronze, etc.), but it can be very hard for a layman to distinguish between some brasses and bronzes, or

wrought iron and steel. (Yellow brass and bronze are distinct copper alloys, but both have a yellow color). A magnet can be a handy thing for testing painted features for ferrous or nonferrous metal content, but it won't distinguish between cast iron, wrought iron, and steel. (Most stainless steels are nonmagnetic.) Wrought iron, grey cast iron, and steels are distinguished from each other by their structure. Grey cast iron (as opposed to some cast malleable irons) is crystalline and brittle. Wrought iron has a fibrous structure due to inclusions of slag in the forging process. Steels are iron alloys, which are not usually brittle and contain no slag. When corroded, the fibrous structure of wrought iron stands out immediately; cast iron and steels tend to pit--cast iron to a much lesser extent than steel. At present, the term "wrought iron" is often used incorrectly for forged or hot-rolled mild steels. Wrought iron was used extensively in the 19th century, and was gradually replaced by steels between the 1860s and 1900s. The function of an object may be a clue to its composition: castings of zinc are often fastened to steel hulls to retard electrolytic corrosion of the steel; cast iron is used for old galley stoves, cylinder blocks, and machinery frames; wrought iron for forged fittings like mast rings, trestles, and other parts of rigging; brasses and bronzes are used extensively for small fittings exposed to the weather. Lead may be used in sheets or castings for various purposes; its relative softness and grey color identify it readily.

Scantlings. A list of the dimensions of structural members is called "the scantlings"--it can also be used to indicate materials. Scantlings should appear on inboard profiles or sections of vessels.

Even if documentation is being carried no further than lines or deck plans, scantlings should appear on the drawings somewhere.

Paint Colors. HAER documentation is all black and white, so some verbal means of recording color is essential. It is best to borrow or purchase a *Munsell Book of Color* and cite colors by their Munsell Color Number. Color descriptions (bright red, dark green, sky blue, yellow ocher) can be fairly subjective, but in a pinch they are better than nothing. Contemporary market terms (Charleston Green, South Bay Yellow) are virtually useless, especially to future researchers.

Alterations. New features, major repairs, or significant alterations should be pointed out with notes. Dates should be included if they can be determined. If a precise date or year is not available, it may be possible to "bracket" a feature's age. Suppose you have two photos, one dated 1890, the other 1905, and no data for the years between. A feature such as a new deck house appearing in the 1905 photo could be labeled as "Added between 1890 and 1905, based on available historical photographs." In some cases, new materials may be graphically distinguished from old by poché.

Prior Documentation. Are you presenting older documentation (drawings, written data, lines from half-models) which you are only adding to or modifying? This should be clearly indicated, with references and locations given for the earlier documentation.

On-paper Reconstructions. Sources used in reconstructing a vessel or its features to original conditions or a specific point in its history should be cited as fully as possible

in a convenient area of the drawing. This applies to old photographs (source? date? owner? photographer?), written materials (diaries? log books? published sources?), oral sources, and drawings of all kinds.

Archeological Evidence. Clues to earlier features or patterns of use should be cited when significant. Sockets, holes, paint ridges, splices or patches, notches, and so forth may all be indicative of earlier uses, structure, fittings, or machinery.

Field Procedures. Important goals or methods of your field procedures should be included where they explain how you derived certain information or omitted particular features or parts of a view. "Inaccessible" should be labeled in areas where structure cannot be drawn; if something has been inferred, the inference must be stated. "Omitted for clarity" should appear when some extant feature is unexpectedly dropped from a view in order to show something else. (Is there some other portion of the documentation, such as a photograph, where the omitted features may be seen?) Standard details should not be summarily omitted, at least not without mentioning where they may be found--standards change, become obsolete, and may be obscure in future centuries. Error tolerances (" \pm ...") should appear in overall dimensions, and estimates of errors in notes.

Machinery. Note the manufacturers, dates of construction (or patent dates), capacities (horsepower, watts, gallons, tons, etc.), model numbers, serial numbers, cylinder bores and strokes, and other vital statistics of existing machinery. Such information may be cast into frames or be found on builder's plates. Dates the machinery was

in service might also be provided, if available. Directions of motion (e.g., rotation of propeller) should be noted where appropriate.

Bits and Pieces. Things like the following should be noted as necessary: accommodations and spaces, structural elements, machinery, fittings, details of construction, rigging, etc.

TITLE PAGES

Each set of drawings for a vessel will have an introductory title sheet, which usually contains four or five things (see Fig. 4.6.19):

Heading. The name of the vessel should appear at the top of the sheet in letters $3/4$ " to $1-1/2$ " high (see Figs. 4.6.21 and 4.6.22). You might consider adapting the lettering from the bow or transom if the style is sufficiently distinctive or attractive (see Fig. 4.6.23). (Remember to note on the drawing that the vessel is the source of the lettering style in such cases; or, if you have indulged in a bit of fanciful graphics work which might be mistaken for something aboard the vessel, be sure you state that it is *not* drawn from anything aboard.) The vessel's rig type should appear above the name in smaller lettering (e.g., pilot schooner, or bug-eye, etc.). The year the vessel's keel was laid (not her launching) should also appear in numerals smaller than the name.

HAER ordinarily supplies its teams with a series of cartographic lettering style templates for title lettering, such as Kenffel & Esser Co.'s (K&E Leroy) No. 61-1250. Scribes are available which can expand or condense the letters (change

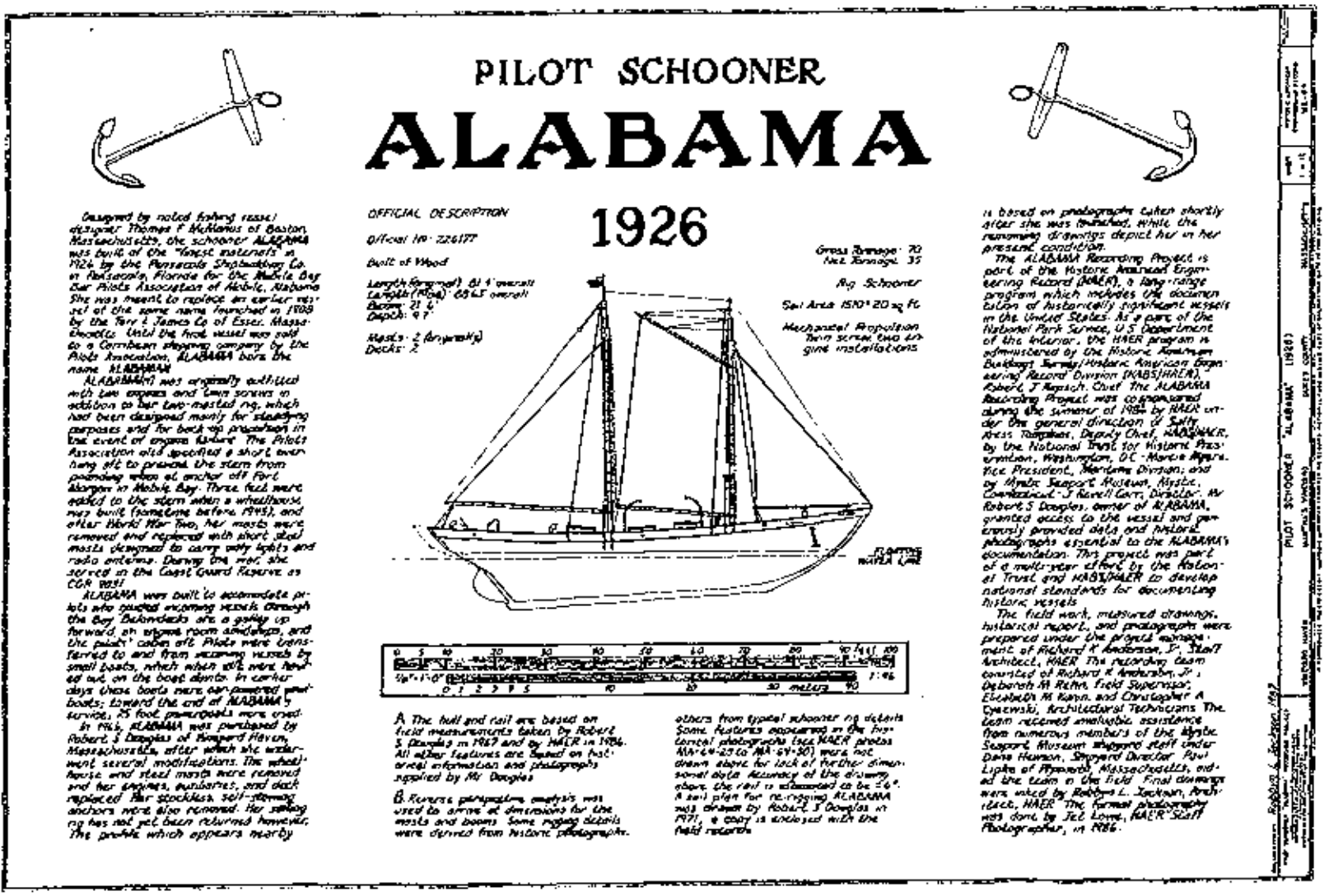

their height-to-width ratios) for various effects. Helpful hints for spacing letters properly are given in Fig. 4.6.24.

Outboard Profile. A starboard profile (right side elevation) is the standard profile to show of a vessel, and for title page purposes, a small scale is suitable. In some cases, advantage might be taken of this small scale profile to show the vessel in its original configuration, assuming that its

present condition is different and that you can document the original conditions through photos or other sources. A note covering such sources should accompany the profile, along with a graphic scale.

General Description. The data listed below should be included on the drawing. Dimensions and other information from official descriptions should be clearly labeled as such, and a complete copy of

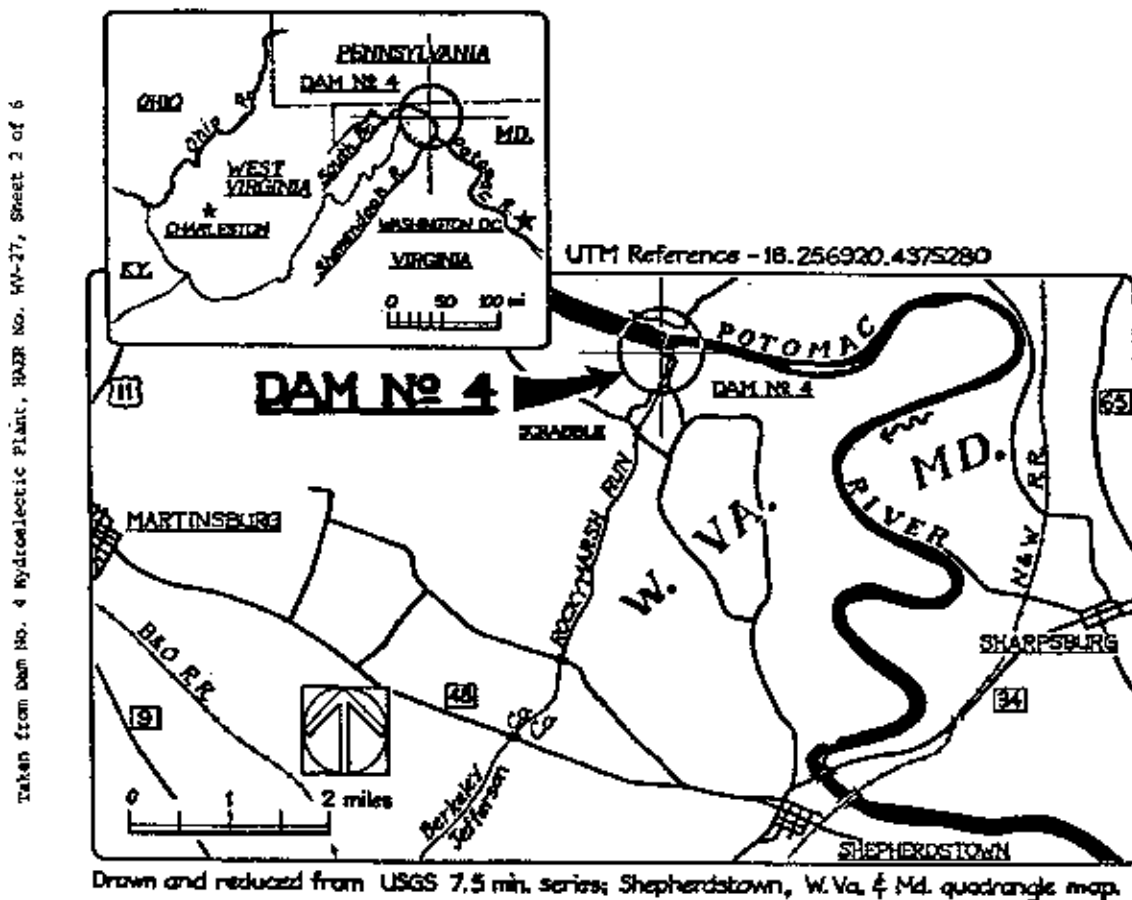

Fig. 4.6.20
Location Map

Title Page Headings

PILOT SCHOONER
ALABAMA
 1926

Taken from title sheet for
 PILOT SCHOONER ALABAMA,
 IRER No. PA-64, Sheet 1 of 12

Heading Content and Lettering Sizes.

Title sheet heading should contain at least the first three and possibly as many as all five elements listed below. Recommended lettering sizes are included. All lettering must be in ink; transfer lettering is prohibited because of its unstable adhesives.

- 1. NAME OF VESSEL** in letters 1" to 1 3/4" high, ALL CAPITALS (in most cases this should be the most prominent historical name of the vessel; no secondary names should appear here).
- 2. VESSEL'S RIG** (e.g. schooner, barkentine, etc.) in letters 5/8" to 1" high, either all capitals or upper and lower case.
- 3. CONSTRUCTION YEAR** in numerals 3/4" to 1 1/4" high, always smaller than the vessel's name, larger than the rig designation.
- 4. VESSEL'S LOCATION** (city and state, no county) in letters 5/8" to 1" high, all capitals or upper and lower case. The location should only be added to the title heading if the vessel is permanently located as part of a museum collection, abandoned on shore, etc.)
- 5. CORPORATE OWNER** (e.g. White Star Lines, New Jersey Central, etc.) in letter 3/4" to 1 1/4" high, all capitals or upper and lower case. (This should be added only if the vessel was built for or spent most of her career with this owner under her name as given in the title sheet heading; it may be omitted if space on the sheet is too tight. Corporate logos or letterhead styles may be used here, but you may have to check with the company or its successors for permission to use them. An unobtrusive note should always appear on the sheet acknowledging sources for such graphics.)

Fig. 4.6.21

Adapted from title sheet for
Schooner WAWONA,
HAER No. WA-14, Sheet 1 of 7

SCHOONER
WAWONA
Seattle, Washington
1897

Fig. 4.6.22

Lettering Styles. Block Roman (serif) lettering is strongly recommended, and there are numerous variations to choose from. You may trace enlargements of existing styles (transfer lettering, letterheads, photographs, etc.) or base the style on nameboard rubbings. Failing these, large lettering templates such as Keuffel

and Esser (K&E) Leroy No. 61-1250 (Cartographic) are used by HAER (see *Wawona* heading above). Non-Roman lettering is acceptable only if it is adapted from something closely associated with the vessel (see *Reporter* below). A note should appear stating the source for the lettering.



Fig. 4.6.23

Nameboard enlarged as example for title lettering from profile of Ship REPORTER, HAER No. 2-57, Sheet 2 of 2

Esthetics. An amateurish appearance should be avoided; if you cannot construct letters well, you are urged to trace existing styles or use templates. Pay attention to letter spacing. Consistent spacing is achieved by keeping the

areas between letters fairly constant. Sometimes the minimum for this area is dictated by adjacent letters with a lot of space between them, such as a K or an L preceding an A.

these spaces govern spacing
of other letters

WILLIAM BISBEE
too crowded

Fig. 4.6.24

WILLIAM BISBEE

better spacing

Taken as example from title block of
Schooner WILLIAM BISBEE,
HAER No. B-62, Sheet 3 of 3

the description included with the historical report. The official length and other dimensions frequently bear little resemblance to a layman's idea of length, since the official figures are the products of rule book formulas. See the section on admeasurement in Section 4.9 (Appendices) for a further discussion and resources on this subject.

Official number (if applicable)

Designer/builder

Place built

Dimensions:

Length (if able, specify whether on deck, at water line, etc.)

Beam (maximum width of main deck)

Breadth (maximum width of hull)

Depth (define)

Draft

Tonnage (note whether registered, net, gross, displacement)

Rig:

Number of masts

Sail area

and/or

Number of Engines (include horsepower, shaft revolutions, cylinder sizes)

Boilers

Statement of Significance. A brief historical account of the vessel should be given, noting the significance of the vessel, and highlighting important aspects of her history up to the present (including place of recording). It should contain the essence of the formal historical report and

not run more than 200 to 400 words, depending on space.

Project Credit Statement. A project credit statement must be included, listing the names of all organizations cosponsoring the project, team members' names and affiliations, and any special contributors or acknowledgements. A model for use by HAER teams on their documentation appears below:

THIS RECORDING PROJECT IS PART OF THE HISTORIC AMERICAN ENGINEERING RECORD (HAER), A LONG-RANGE PROGRAM TO DOCUMENT HISTORICALLY SIGNIFICANT ENGINEERING, INDUSTRIAL, AND MARITIME WORKS IN THE UNITED STATES. THE HAER PROGRAM IS ADMINISTERED BY THE NATIONAL PARK SERVICE, U.S. DEPARTMENT OF THE INTERIOR. THE (name of project) RECORDING PROJECT WAS COSPONSORED DURING (THE SUMMER(S) OF (years)) BY HAER UNDER THE GENERAL DIRECTION OF [ROBERT J. KAPSCH], CHIEF, AND BY (list of all cosponsors).

THE FIELD WORK, MEASURED DRAWINGS, HISTORICAL REPORTS AND PHOTOGRAPHS WERE PREPARED UNDER THE GENERAL DIRECTION OF [ROBERT J. KAPSCH], CHIEF, HAER, AND BY (name), HAER PROJECT LEADER. THE RECORDING TEAM CONSISTED OF (name), PRINCIPAL HISTORIAN [AND/OR TEAM SUPERVISOR]; (name), AND (name), ASSISTANT HISTORIANS; (name), AND (name), DELINEATORS. FORMAL PHOTOGRAPHY WAS DONE BY (name).

The affiliations and professional status of the historians and delineators should be included as appropriate (e.g., name of university, museum, or other organization from which the person came, and whether the person is a historian, naval architect, engineer, shipwright, architect, student, volunteer, etc.). Obviously the credit statement will be different for non-HAER sponsored projects.

When laying out and lettering long blurbs, it will be in the interest of time to letter the entire text on vellum as a single column whose width is the same as the columns on the title sheet, using the spaces between paragraphs as "breathing" spaces when the number of text lines do not divide up evenly among the columns. When everything is in place, the text can then be traced onto the mylar title sheet.

Location Map. Inclusion of a location map for the recorded vessel is a matter of judgment. Is the vessel a museum ship or a hulk? In this case she is probably permanently located, and a map would be appropriate. Is she in private hands and/or in active service? In this case, a map may be misleading, since the vessel may be in several places, or may even be sold to new owners. A textual citation about where she was recorded is probably sufficient for the title sheet. More detailed information concerning the project's circumstances, addresses of owners, etc., belongs in the field report or the written history.

In any case, a location map should be clearly and boldly delineated, showing major geographical and political features, with the vessel's location clearly indicated (see Fig. 4.6.20). Major roads, cities, state and county boundaries, water bodies, etc., should be shown. Additional smaller maps or diagrams showing the vessel's location with respect to a state or region are useful for obscure locations. The UTM (Universal Transverse Mercator) coordinates should also be given for the vessel. These can be easily derived from a recent U.S. Geological Survey topographic map. See Section 4.9 (Appendices) for further information about UTM coordinates.

Index to Drawing Set. This should only be necessary for sets of 10 or more sheets. An index on the title sheet does a lot to help a user locate a particular view--he doesn't have to fumble through countless drawings trying to find what he wants. Sets with 10 sheets or less are not a burden to search through, so a sheet index here is more of a kindly convenience than a necessity. If for some reason an index cannot be included on the title sheet due to priority of other information, you still need to indicate on the title sheet where it can be found (e.g., "Index: see Sheet 2").

LINES DRAWINGS

The following guidelines assume that your ship lines will be lifted and drawn by hand. HAER will accept computer-generated lines drawings, subject to the specifications for line-weights, notes, and other items previously covered, as well as those that follow. Computer-generated plots should carry notes as to the software and hardware used, as well as notes on field methodology. In some cases, you may have opportunity to trace or otherwise reproduce existing lines drawings. If so, the reproductions should carry complete source information, as well as noting whether you field-checked the lines drawings against the vessel or not. Check the drawings you have for scale and distortions before attempting to trace or copy them--there can be hidden problems. The vessel may not have been accurately built to the drawings, and there may have been dimensional changes to the base material of the drawings.

Format. The format of lines drawings has a long-standing tradition. Archeological investigations have shown that some

ancient Greek boat builders used something similar to full-sized lines drawings scribed into the floors of their shops for lofting and erecting their boats. In the past hundred years, it has become standard to show three views when drawing lines: sheer plan (buttock lines) and half-breadth plan (water lines), both usually for the starboard half of the hull, and a body plan where a common centerline is used to show half-sections from midships forward on the right (forebody plan) and from midships aft on the left (afterbody plan). A fourth view, diagonals, may be superimposed on the half-breadth plan or shown separately. Each of these views takes advantage of symmetry to economize on space and drawing time. This same standard is followed by HAER.

For some, it has also become standard practice to make a single drawing by superimposing these views, probably to save space or permit easier cross-checking of points on a hull between various views. This is perfectly acceptable as a preliminary drawing, if you are used to the procedure and can avoid errors using it. However, it is HAER's opinion, as a program whose records are used by a broad section of the public, that such superimposition creates confusion for all but those trained to unscramble it (see Fig. 4.6.25). In some cases, layout and sheet space requirements may suggest that the body plan be superimposed on the sheer plan as a space-saving device (see Fig. 4.6.26). This is acceptable to HAER when clarity doesn't suffer. Clarity and space-saving probably cooperate best on long vessels or vessels whose midbody shape changes little where the body plan would be drawn. These cases permit you to omit the sheer plan where the body plan

is inserted without losing much information on the sheer plan (see Fig. 4.6.27). In cases of diagonals superimposed on half-breadth plans, some have found it helpful to draw the diagonals counter to the water lines, that is, with the diagonal plane centerline outboard of the plan (see Fig. 4.6.27). In most cases, it is best to simply keep the views separated (see Fig. 4.6.28).

Lines to Inside or Outside of Hull? Since lines drawings may be done to either the inside or outside of a hull, a prominent note on your drawings must indicate which condition you are showing. Lines to the inside of a hull give a shipwright an easier time lofting frames for a vessel; lines to the outside are in some cases better for hull performance calculations, but they are certainly much easier to record in the field from intact vessels.

Some lines drawings, especially for wooden vessels, show lines drawn only to the rabbet and deck sheer lines, leaving out the keel and rudder. Some include not only the keel and rudder, but the bulwark as well. HAER requests that the keel, rudder, and bulwarks be shown, especially if the keel bottom (or worm shoe) is used as a base plane. These features must be recorded somewhere in the drawing set, and it seems just as well to cover their outlines in the lines plan.

Scale. A scale of 1/4" to the foot is a traditional departure point in choosing a scale for lines drawings. In general, the lines of vessels shorter than 60 feet should be drawn on one HAER sheet (3/8" or 1/2" scale). Unless it is important to your project to draw on an oversized sheet (see "Oversized Sheets," p. 4.6.5), longer vessels are perhaps better split up and

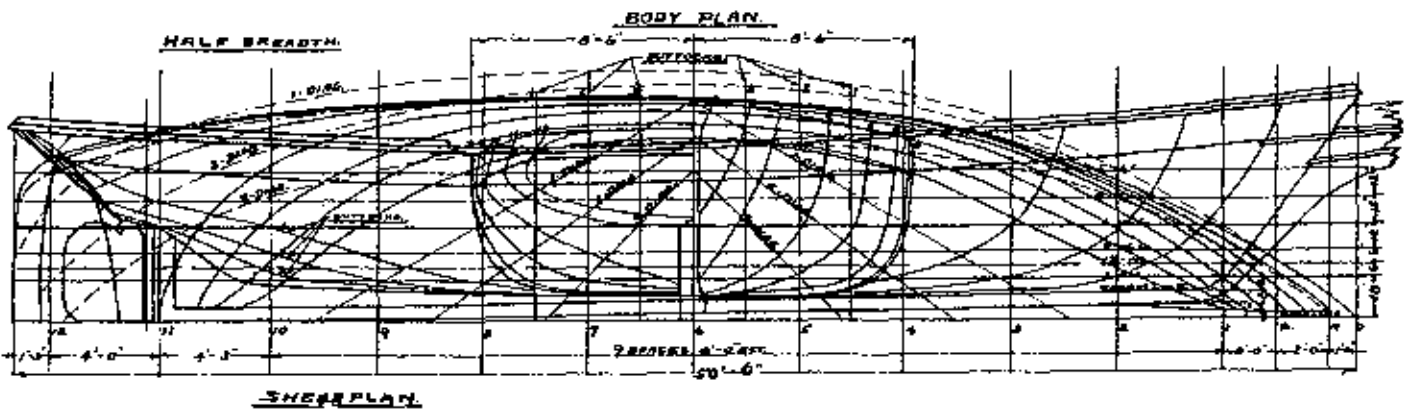

Adapted for illustrative purposes from ANNIE HOLMES, BAMS No. 4-2, Sheet 3 of 4

Fig. 4.6.25
Completely Superimposed Lines
(unacceptable)

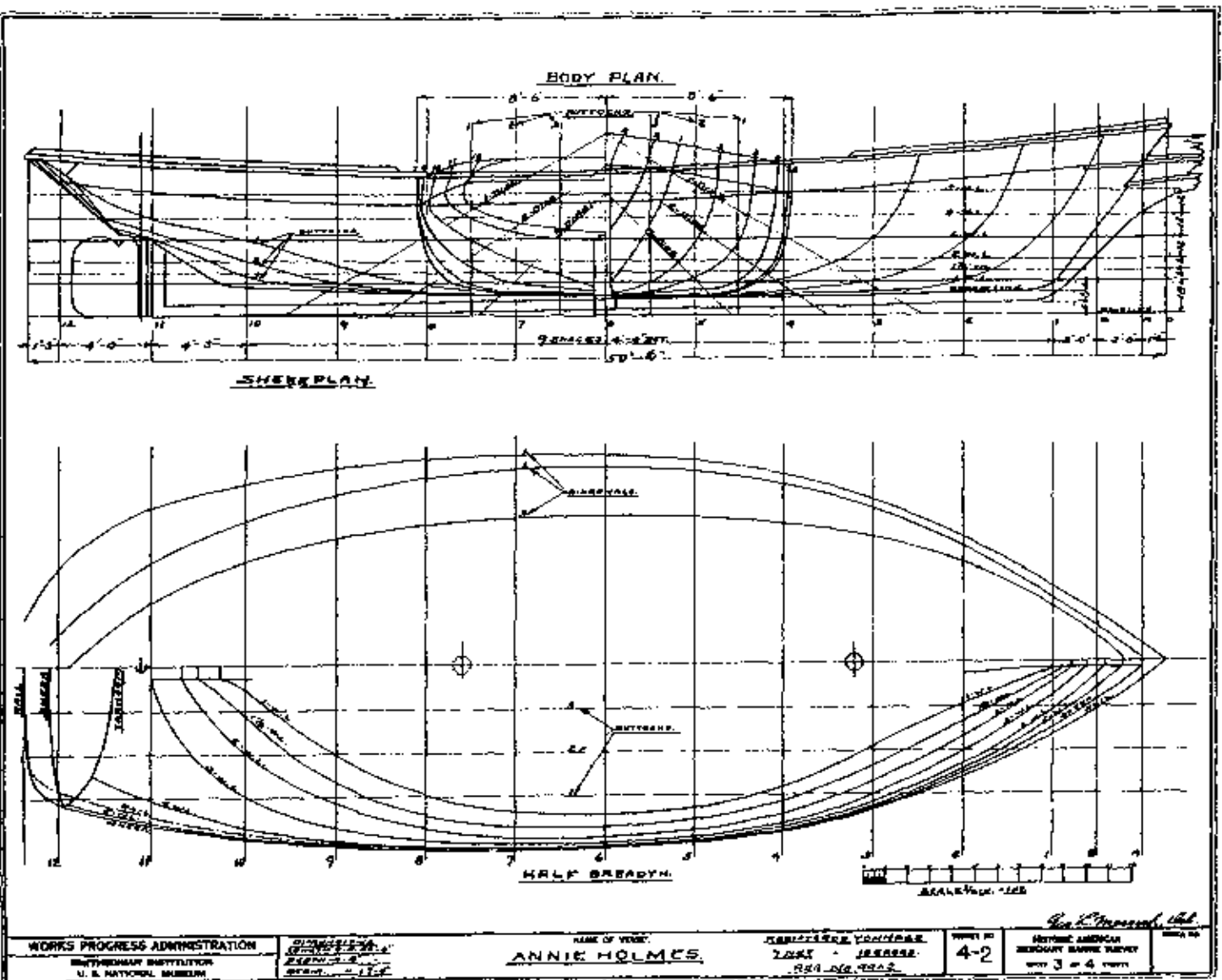
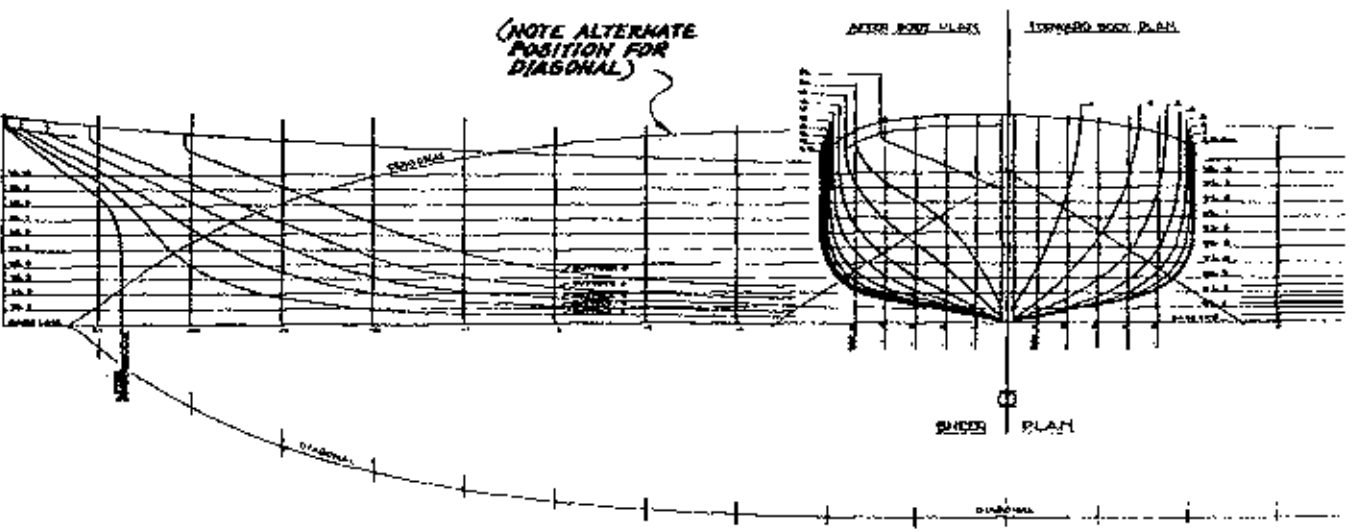

Fig. 4.6.26

Partially Superimposed Lines
(acceptable, but not preferred)



Adapted for illustrative purposes from PRANK WOODS, HAMPS No. 14-18, Sheet 1 of 4

Fig. 4.6.27
Body Plan Inserted into Sheer Plan
(preferred to superimposition)

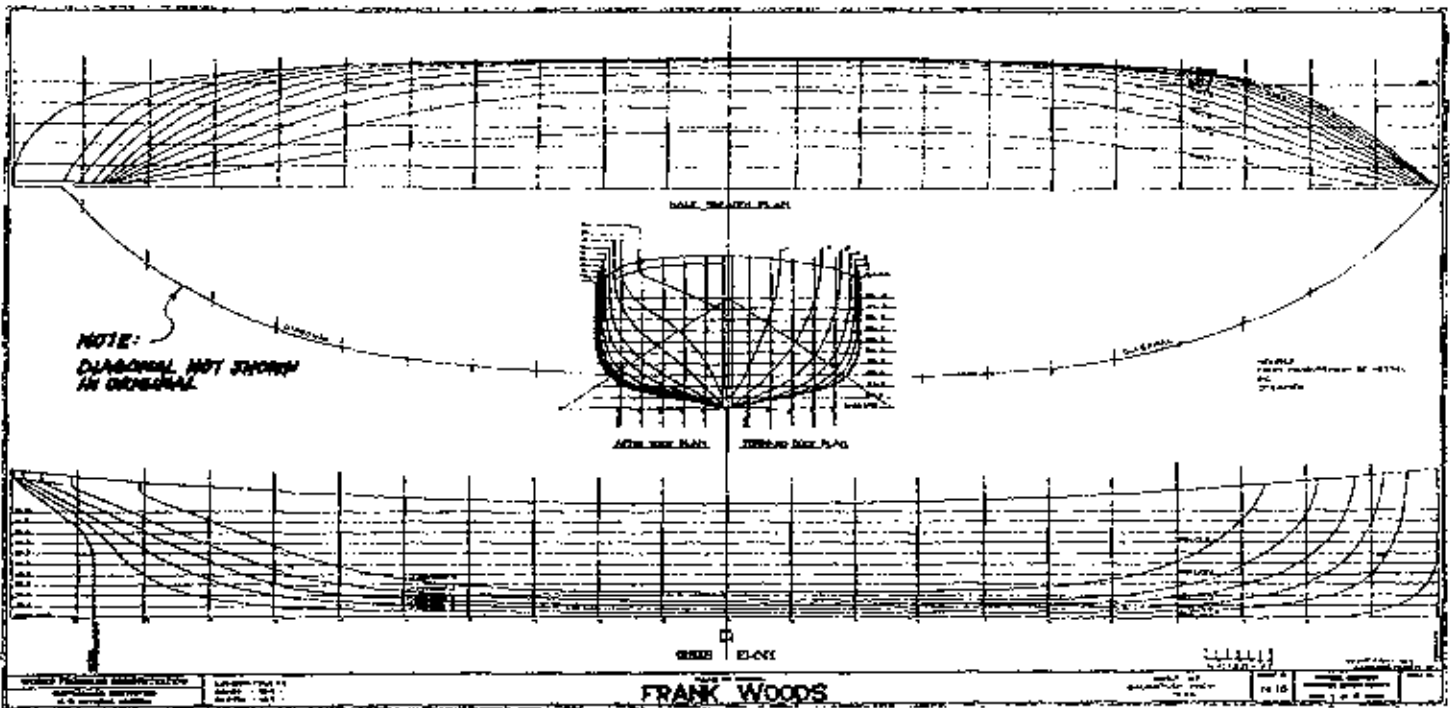

Fig. 4.6.28
Separate Lines Views
(best)

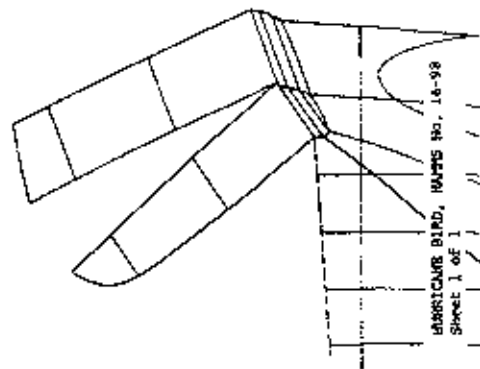
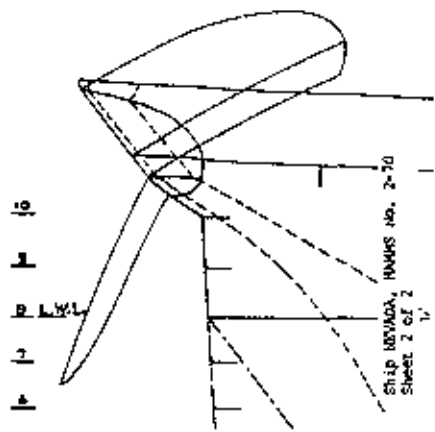
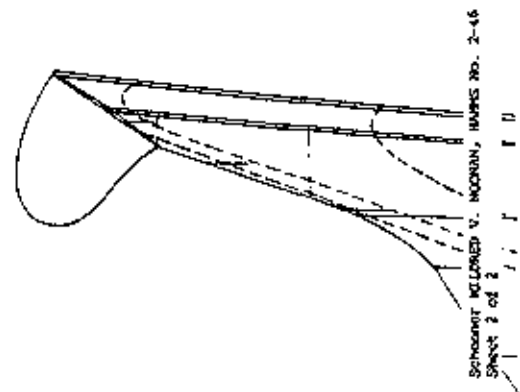
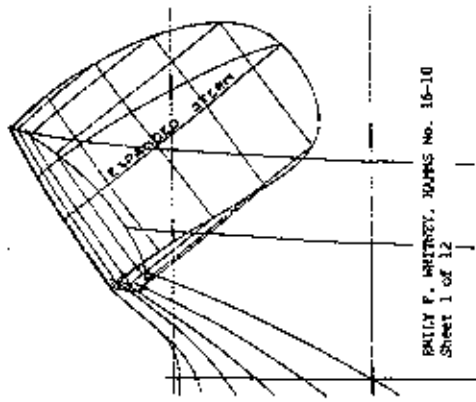
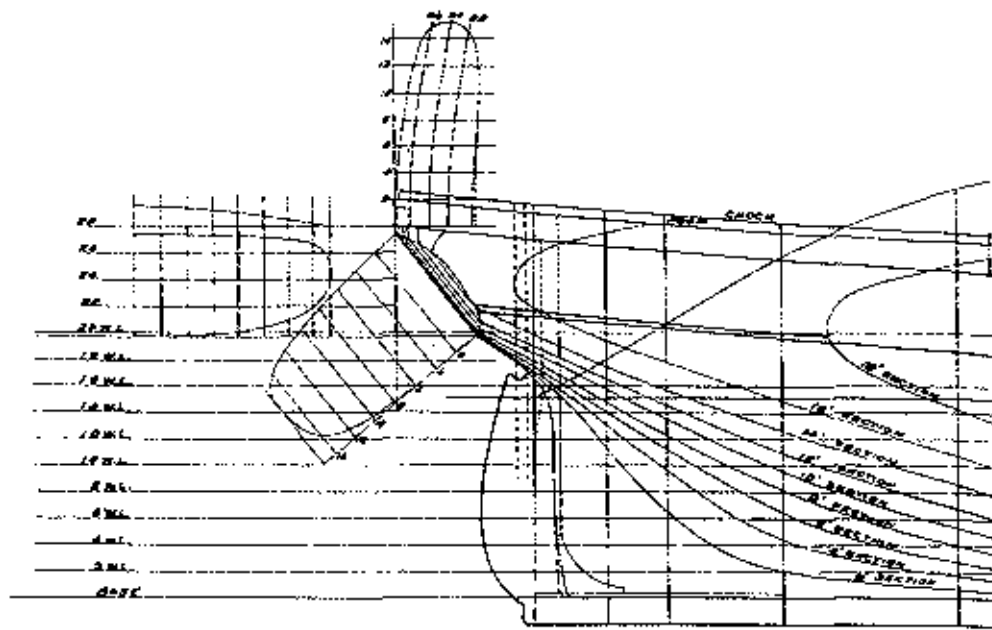

Fig. 4.6.29
Transom Expansions

drawn on two or more sheets. This is not a hard and fast rule. The first concern is to draw lines at a scale large enough for a user to scale from with some reasonable accuracy, but there are some important factors associated with this concern. If a team has gone to the trouble to lift a vessel's lines to $\pm 1/2"$ in the field, it seems reasonable to draw the lines at a scale commensurate with the level of precision to which the job was done, especially if you are creating archival records. A 300-foot vessel drawn at $3/32"$ scale would give a user a general idea of the hull shape, but the accuracy with which the lines could be reasonably well drawn or scaled at that size is probably no better than $\pm 3"$ (scale) at best, even if the field work was done to $\pm 1/2"$. A larger drawing scale would permit a higher degree of precision. On the other hand if you are recording a dilapidated hulk whose lines are really the result of considerable conjecture, it is silly to draw the lines at a large scale and claim a highly accurate representation of that particular vessel's hull. The concern for precision is not so much that the vessel could be reconstructed from the lines--sections and frames are lofted full-size when building a vessel, and any irregularities in lines drawings are taken care of at that time. Recovery of data from drawings with a precision that is representative of the field work (and vessel significance) is the primary concern.

Layout. It makes little difference whether the half-breadth plan lies above the sheer plan or vice versa, just so they are not superimposed. Diagonals may be drawn on the half-breadth plan, or separately if desired. Other data curves, such as curves of area, curves of buoyancy, etc., are not

required, since they can be derived from the lines data. However, they should be drawn if they are needed to bear out some point of significance discussed in the historical report.

Body Plan Measurements. The body plan of a vessel must be accompanied by a table of body plan measurements (see Fig. 4.6.30). This type of table is sometimes referred to as a table of offsets, which is ordinarily used in lofting and shows measurements to the inside of the hull surface. A table of hull measurements describes the curve of each section or station by means of a series of rectangular coordinates. Measurements are scaled for the table from the body plan and are taken along the water lines and buttocks shown in the lines plans. Horizontal measurements, or half-breadths, are taken from the central buttock plane, while vertical measurements, or heights, are taken from a base plane. All dimensions should be shown in feet, inches, and eighths of an inch; that is, $8'-7\ 1/2"$ should be represented as $8-7-4$ ($1/2" = 4/8"$). Blank spaces where no figures apply should be struck through with a diagonal line or an "X" so users will know that no figure was inadvertently omitted. The table should always be accompanied by an estimate of the figures' accuracy, and notes for both common and any unusual conditions (for example, you should note whether the measurements are to the inside or outside of planking, and whether your lines are direct from the vessel, or have been corrected or reconstructed). See Fig. 4.7.4 for an example.

How Many Stations Should Be Drawn? Technically, a vessel's hull shape could be recorded by lifting and drawing her lines

at any number of stations, the more the better. (The number of stations drawn is not necessarily the same as the number of stations lifted.) However, beyond a certain point, you don't gain that much more for all the added effort. Some lines drawings made for construction purposes may show a hull section at every frame (resulting in as many stations as the vessel has frames) so that the drawings can be used for lofting. Others will show hull sections placed as hull shape and economy of time indicate (see Fig. 4.6.31). Those who wish to draw lines for calculating a vessel's displacement (or making other

hydrodynamic studies) will choose stations according to "Simpson's Rules," a method used worldwide for hydrodynamic calculations. Which approach you take--shape or hydrodynamic--may be dependent on your cosponsor's needs, significance of the vessel's hull, or other issues best discussed with your review team. However, both methods record hull shape, and all other things being equal, HAER strongly suggests that your choice of stations be governed by "Simpson's Rules." Space does not permit a complete discussion of Simpson's Rules here (see Section 4.8 [References and Resources].)

ALL DIMENSIONS BELOW ARE GIVEN IN FEET, INCHES AND EIGHTHS OF AN INCH (See note A).

		STATIONS																	
		1/2	0	1/2	1	1 1/2	2	3	4	5	6	7	8	8 1/2	9	9 1/2	10	10 1/2	
HEIGHTS ABOVE BASE	RAIL CAP	16-2-6	15-11-4	15-9-2	15-7-2	15-5-2	15-4-0	15-4-2	15-4-0	15-4-2	16-1-6	16-0-0	17-3-6	17-9-0	18-3-0	18-9-0	19-3-4	19-10-0	
	DECK TOP AT 6	14-10-6	14-7-6	14-5-0	14-2-4	14-0-0	13-11-6	13-11-4	14-1-2	14-4-0	14-8-4	15-3-0	15-11-0	16-4-2	16-10-0	17-4-0	17-10-6		
	SHEER	14-6-2	14-4-2	14-2-0	14-0-0	13-10-0	13-8-6	13-8-2	13-10-2	14-1-2	14-4-4	15-0-2	15-8-6	16-2-0	16-8-0	17-2-6	17-10-2	18-6-0	
	10' BUTT.						13-7-2	11-4-4	9-6-0	8-11-2	9-5-6	11-10-4							
	8' BUTT.			13-9-6	11-7-2	10-5-0	9-4-6	8-6-4	7-5-6	6-11-0	7-1-6	8-7-2	11-1-0						
	6' BUTT.	12-5-6	11-3-6	10-2-0	9-2-2	8-2-0	7-4-4	6-4-2	5-10-0	5-10-4	6-0-0	8-6-6	11-5-2	14-0-0					
	4' BUTT.	12-2-6	10-10-2	9-8-0	8-5-6	7-3-6	6-5-4	5-5-6	5-1-2	4-11-6	5-5-6	6-8-0	8-8-2	10-3-2	12-7-0	14-2-6			
	2' BUTT.	12-2-0	10-7-6	9-1-2	7-8-2	6-5-6	5-6-2	4-5-6	4-1-4	4-1-4	4-4-6	5-1-4	6-7-2	7-9-4	9-5-0	11-8-0	15-2-6		
RABBIT	12-7-6	10-6-4	8-11-2	6-10-2	2-9-4	1-9-6	2-3-6	2-8-0	3-0-6	3-5-6	4-0-0	4-10-6	5-9-2	7-0-6	8-10-6	11-4-4	15-0-2		
HALF-BREADTHS	SHEER	7-2-0	8-0-6	8-9-2	9-5-0	9-11-4	10-5-4	11-0-4	11-2-9	11-1-0	10-6-4	9-5-6	7-10-0	6-9-0	5-6-6	4-3-0	2-9-6	1-3-2	
	13'7" W/L	7-1-4	8-0-0	8-8-4	9-3-2	9-10-2	10-4-4	10-11-6	11-2-0	10-11-2	10-4-2	9-2-2	7-2-6	5-11-0	4-6-2	3-0-0	1-4-2		
	12'1" W/L		7-1-4	8-2-2	9-0-2	9-8-0	10-2-2	10-10-6	11-1-0	10-10-2	10-1-0	8-6-2	6-4-6	5-1-2	3-9-0	2-3-2	0-7-6		
	10'7" W/L			7-7-2	6-9-6	8-2-0	9-7-0	9-8-6	10-6-2	10-9-4	10-5-6	9-4-6	7-8-0	5-5-6	4-2-4	2-10-0	1-3-4		
	9'1" W/L				7-7-2	6-0-2	7-7-2	8-8-0	9-9-2	10-1-0	9-8-2	8-3-0	6-6-2	4-3-4	3-1-0	1-9-2	0-4-2		
	7'7" W/L					1-7-6	4-7-0	6-4-6	8-3-0	8-11-2	8-6-2	6-11-6	5-1-0	2-11-4	1-9-6	0-7-2			
	6'1" W/L						7-5-4	3-2-0	5-6-0	6-5-6	6-4-0	5-1-2	3-4-2	1-8-6	0-6-2				
	4'7" W/L							0-7-6	1-2-0	2-2-2	2-9-6	2-10-6	2-3-2	1-0-6					
3'1" W/L								0-5-4	0-7-2	0-9-4	0-9-6	0-5-6							
HALF-SIDING						0-5-0	0-5-0	0-5-2	0-6-0	0-6-2	0-5-4	0-4-4	0-3-6	0-2-6	0-2-6	0-2-6	0-2-6	0-2-6	
DAGONALS	A		2-1-6	4-0-6	5-5-6	6-6-6	7-4-4	8-3-6	8-10-0	8-9-0	8-0-2	6-9-4	5-3-2	4-9-0	3-2-4	1-11-0	0-6-2		
	B	4-5-0	6-5-0	7-10-0	8-10-4	9-8-4	10-4-4	11-3-4	11-8-4	11-5-2	10-4-4	8-10-6	7-1-0	5-11-6	4-8-6	3-3-2	1-9-6	0-2-6	
	C	7-8-6	8-7-4	9-4-6	10-1-2	10-9-2	11-4-0	12-0-4	12-3-4	11-11-6	11-1-0	9-7-2	7-8-6	6-6-6	5-3-2	3-4-4	2-3-4	0-8-0	

Fig. 4.6.30
Table of Hull Measurements

For drawing lines, it is sufficient to know that a vessel must be divided at her floating water line (between her fore and aft perpendiculars) into any number of even equal spaces that will give an *odd* number of stations--see Fig. 4.6.32. (Remember, if you label your first station "0", station "10" is the *eleventh* station.) The perpendiculars are set where the bow (at the rabbet line) and stern emerge from the water at the floating water line. Ten equal spaces and 11 stations is the most common choice, however smaller vessels may be drawn with fewer stations, and very large ones (over 250 or 300 feet) may

well require more. For shape, fractional stations (0-1/2, 1-1/2, etc.) should be included at the bow and stern to better define the hull there. You may need to set up some additional stations beyond the perpendiculars, in order to record the shape of an overhanging stern, for example.

Labeling Stations. Many schemes have been used for labeling stations. Some methods used letters, others numbers. Some started amidships and used letters going aft and numbers going forward. HAER prefers the use of modern practice,

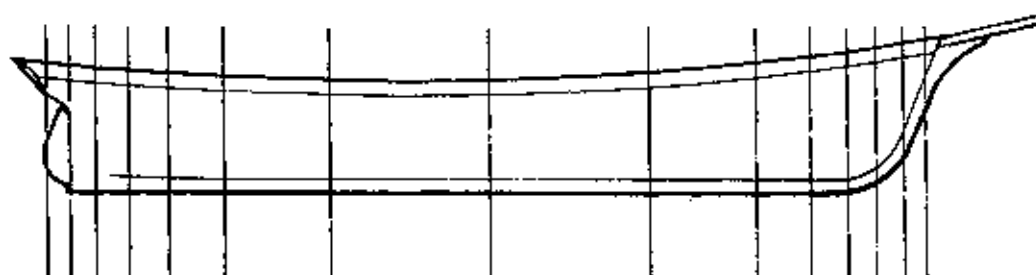

CHOOSE STATIONS FOR SECTIONS AT INTERVALS THAT BEST SHOW HULL SHAPE

Fig. 4.6.31
Sections Chosen to Show Shape



DIVIDE LENGTH OF HULL AT FLOATING WATER LINE INTO EVEN NUMBER OF EQUALLY SPACED INTERVALS (10 IS COMMON)

Fig. 4.6.32
Sections Chosen for Displacement Calculations

which seems to favor the use of numbers alone and to start with "0" at either the forward or aft perpendicular (most likely to permit easy application of Simpson's Rules). It seems easier for some to start with "0" in the stern so that stations read left-to-right in the drawing; others prefer to start with the bow, perhaps because it is the forward end of the vessel.

How Should Buttocks, Water Lines, and Diagonals Be Chosen? The intervals used for buttock and water lines follow no set rules, though the first concern is to place these lines where they are the most effective in describing a hull's shape (see Fig. 4.6.33). A water line plane or buttock plane offers the best control of shape when it intersects the hull surface at a near 90° angle. Due to the changes a hull's surface goes through, the angle of intersection can change dramatically along a given plane of reference. You must choose those planes that offer the best control of shape on the average, and be aware that the lines you draw will be more useful some places than others.

There is no requirement that water lines be set at equidistant intervals; many precedents show water lines at a variety of intervals, often closer together at the bilges of a vessel than up the sides. One water line is almost always set to coincide with the vessel's floating water line. (You may need to consult the project review team about how or where to establish your vessel's trim, especially if she is out of the water.) In most cases, at least one or two water lines are shown above the floating water line to describe the hull higher up at the bow and stern. Water lines have been designated by numbers (e.g., "No. 3"), by

heights above a base plane beneath the vessel (e.g., 6'-0" or 10'-6"), or even by depth beneath the floating water line. If water lines are numbered, your sheer plan should indicate their heights somewhere so a user will not have to try to scale them from the drawing. All things considered, HAER prefers that water lines be designated by their heights above a datum plane set beneath the vessel. Some floating vessels may be listing or hogged, so the current floating water line may need to be merely noted and not indicated as a water line if corrected lines are produced.

A minimum of three buttocks is commonly used, almost always set at equidistant intervals. More buttocks should be used on beamier vessels (see Fig. 4.6.34). Buttocks are usually designated by their offsets from the vessel's centerline (e.g., 4'-0"), though other number and letter designations that give less information about the dimensions have been used.

At least one diagonal should be shown. As many as three to five have been used for large vessels. There is no predetermined mechanical formula for setting diagonals. They are usually set at a vessel's bilges or at other places where the hull shape changes in a way not easily represented by buttocks or water lines. A diagonal plane should be set so it is nearly perpendicular to the surface of the hull along the line of its intersection with the hull. In keeping with this, diagonals are best set between points at *intersections* of water line planes and buttock planes as seen in a body plan (see Fig. 4.6.35). Diagonals are usually drawn superimposed on the half-breadth plan, or as separate plots with their own centerline. Sometimes they are

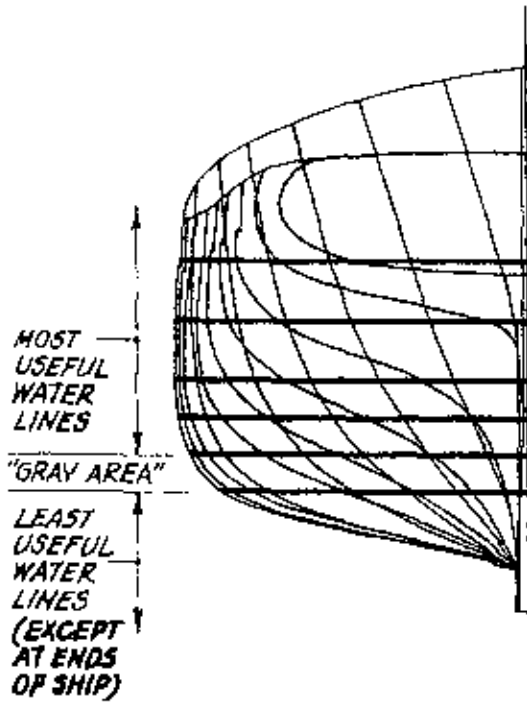

Fig. 4.6.33
Choosing Water Lines Intervals

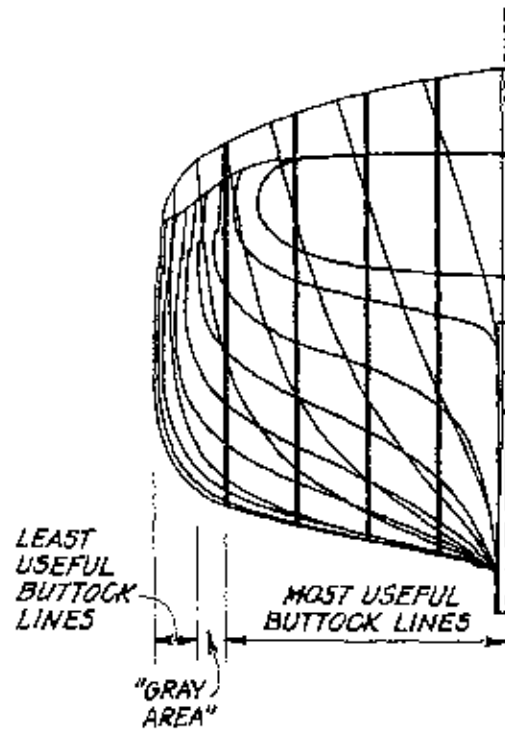

Fig. 4.6.34
Choosing Buttock Line Intervals

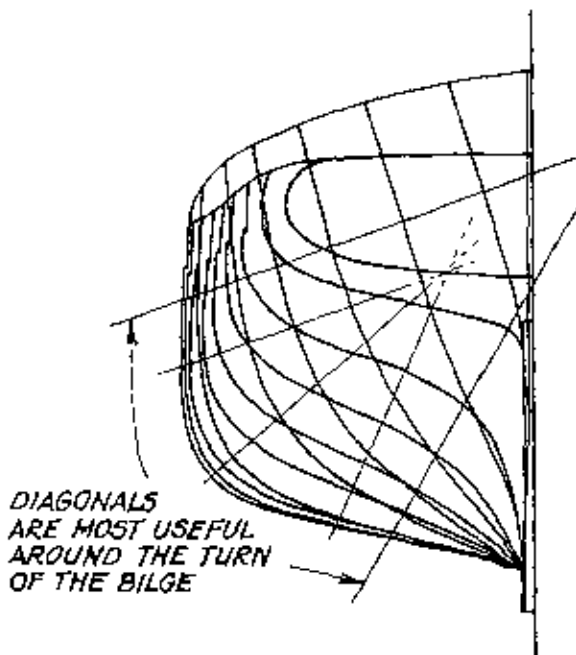

Fig. 4.6.35
Choosing Diagonals

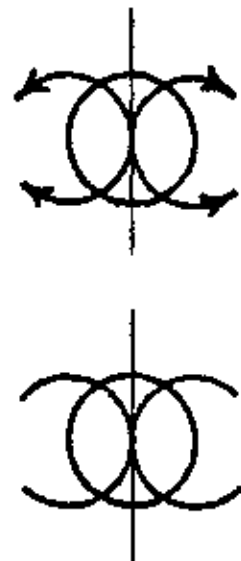

Fig. 4.6.36
Midship Symbol

superimposed on the half-breadth plan with the curves counter to the water lines.

Diagonals are not projected into the half-breadth plan. They are treated as if the diagonal planes had been rotated to lie parallel to the water lines planes (see Fig. 4.2.6). Because diagonals do not coincide with the three perpendicular systems of planes in a lines plan, they are usually given number or letter names in the body plan and diagonal plots.

Rabbit and sheer lines should also be labeled, in addition to water lines, buttocks, stations, and diagonals. If your lines plan takes up two or more sheets, these features should be labeled on every sheet. Other features such as the rail top, keel (or bug shoe) bottom, etc., should also be labeled for clarity.

Midship Symbol. The midship station in the lines should be marked with a midship symbol, as shown in Fig. 4.6.36. (This is somewhat analogous to marking a centerline with "C".)

Fairing in Lines. Fair lines are drawn to approximate the true shape of a vessel. This is done by averaging a line among numerous points, recognizing that some slight errors and irregularities will occur. In general, the larger the scale used to plot and fair lines, the more accurate the final job is. However, there comes a point of diminishing returns on your time and trouble for whatever increase in precision is secured. "Fairing the lines" not only involves drawing a smooth curve through a series of measured points (see Figs. 4.6.37 and 4.6.38), it also requires you to coordinate the intersections among the lines in the three views (see Figs. 4.6.39 to 4.6.41). For example, if the No. 1/2

section crosses the 16-foot water line in the body plan at a point 14'-4" from the vessel's centerline, the half-breadth plan should show the 16-foot water line crossing the No. 1/2 section 14'-4" from the centerline (see Fig. 4.6.40). Similarly, if your sheer plan shows a 4-foot buttock intersecting your No. 0 section plane 15'-0" above the base plane, the No. 0 section in the body plan should cross the 4-foot buttock line at the same 15'-0" height (see Fig. 4.6.41). Sometimes it will take some effort working back and forth between the various views to bring the lines into agreement, especially in areas where the hull shape changes rapidly. Use a pair of dividers to compare and transfer dimensions rather than a scale—it is much more accurate. You should do all you can to bring about agreement without sacrificing large numbers of points obtained in the field (or changing the sections faired from those points) before beginning to alter the sections themselves. This priority is less important if lines are lifted with some degree of imprecision or the hull you are recording is dilapidated. If you have to significantly alter data plotted from careful field work of an intact hull, it may mean you misunderstand how to fair lines, or that something was missed in the field work itself. (Plotting and checking stations in the field can reduce the uncertainties in such cases.)

How to Transform Lines of a Deformed Hull into "Original" Lines. As explained before, it is customary to draw a vessel's lines without the effects of age. You may record a hull which has a 12" hog in it and a twist to boot. Should you draw it this way? Initially, you will have to do a preliminary set of lines showing the vessel "as is" before you can proceed to correct

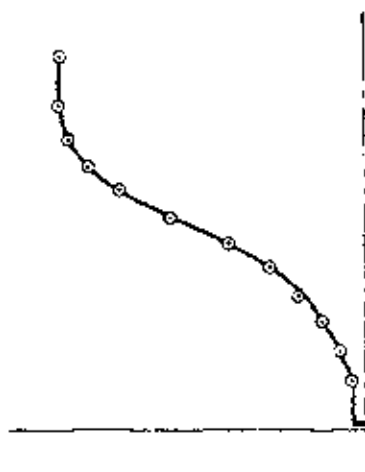

A good set of measurements and a properly faired line may appear like this. (Points measured in field are shown here for illustrative purposes only.)

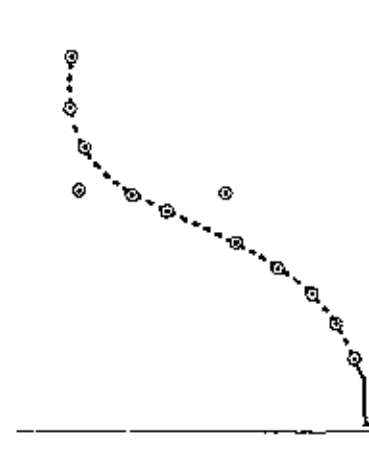

A properly faired line steers an "average" course among recorded points, ignoring (or remeasuring) an obvious errors.

Fig. 4.6.37
Properly Faired Line



Don't try to fair a curve through every field point. Points which do not lie along a smooth "fair" curve may be erroneous. Remeasure such points if possible, or inspect hull for irregularities your drawing seems to show.

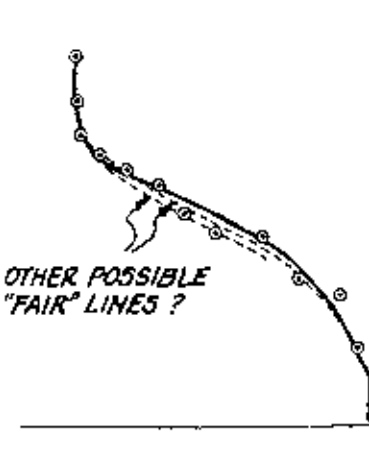

Numerous points that vary significantly from each other and from a fair curve are a sign of poor field technique, unless the hull condition is so poor that such results are unavoidable.

Fig. 4.6.38
Poorly Faired Line

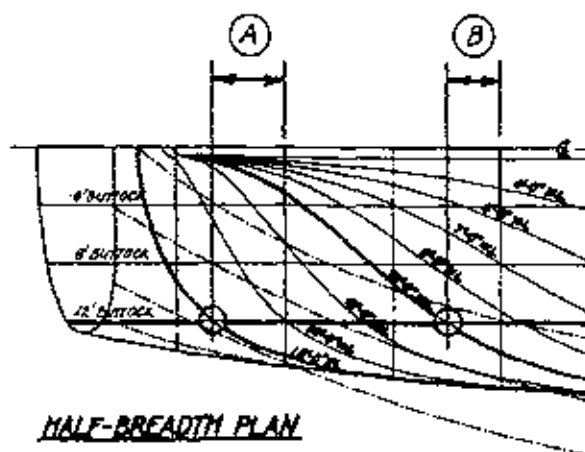

HALF-BREADTH PLAN

DIMENSIONS "A" SHOULD BE EQUIVALENT, AS SHOULD "B" FOR ACCURACY, COMPARISON SHOULD BE MADE WITH DIVIDERS, NOT A SCALE.

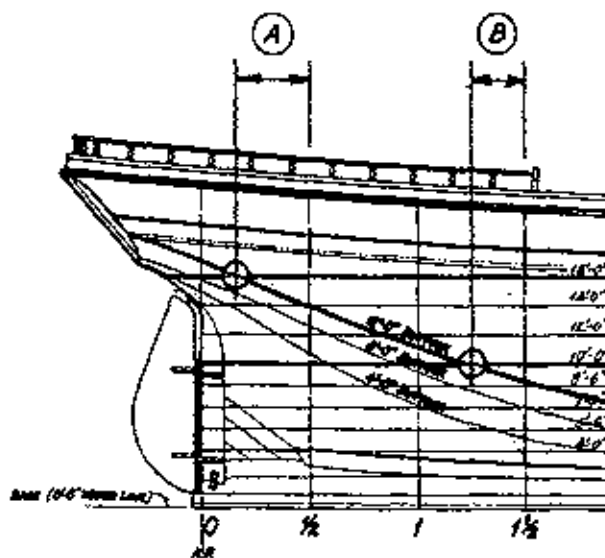

SHEER PLAN

Adapted from Schooner BRONIA, HAER No. 10-14
Sheet 5 of 7

Fig. 4.6.39
Agreement Between Half-Breadth Plan and Sheer Plan
(water line and buttock line intersections)

DIMENSIONS "C" SHOULD BE EQUIVALENT, AS SHOULD "D," "E" AND "F." FOR ACCURACY, COMPARISON SHOULD BE MADE WITH DIVIDERS, NOT A SCALE.

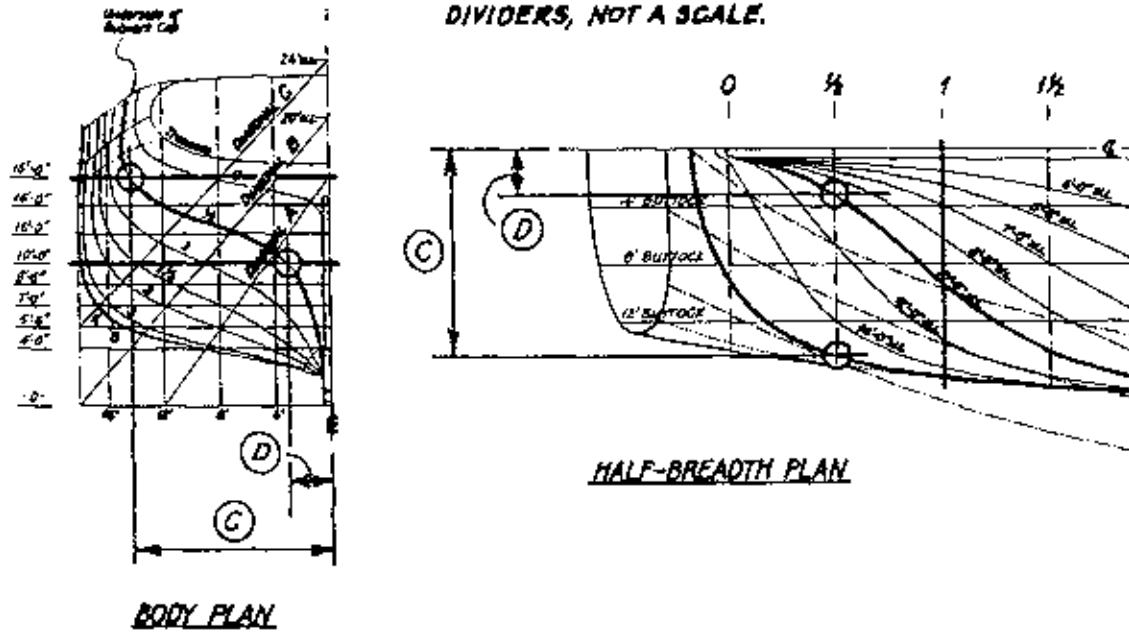

Adapted from Schooner MAMONA, B&S No. 14-14
Sheets 6 and 7 of 7

Fig. 4.6.40
Agreement Between Half-Breadth Plan and Body Plan
(section and water line intersections)

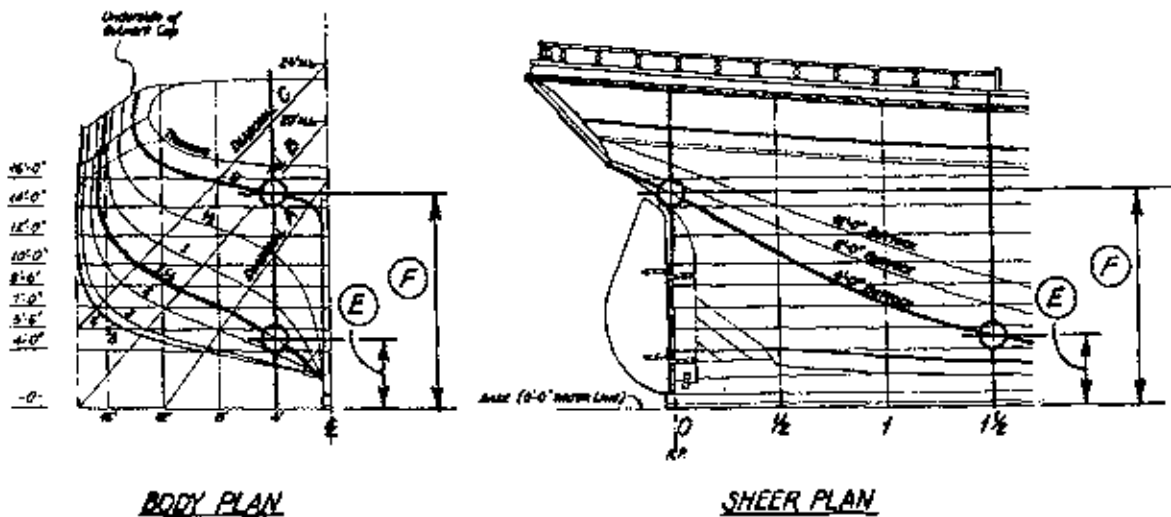

Adapted from Schooner MAMONA, B&S No. 14-14
Sheets 6 and 7 of 7

Fig. 4.6.41
Agreement Between Sheer Plan and Body Plan
(section and buttock line intersections)

them. Whether the "as is" lines become part of your drawing set depends on the goals of your project: a careful survey performed for repairs, structural evaluation, or archeological study may well require "as is" lines to be drawn. Correcting a set of lines can only be adequately done when you have taken into account how the deformation in your vessel's hull came about. (This is an excellent problem to put before your review team.) While this is not a good place to digress into hull engineering, you should be aware that many parts of a hull's structure can "give" when it changes shape over time. The deck in a wooden vessel might stretch fore and aft while the keel, though bent, maintains its original length. This can occur if the deck is more deteriorated than the keel, or if the deck was replaced with the hull hogged. The bilges might bulge if the keel hogs but no deck stanchions exist to keep the keel and decks fixed in relative position (where stanchions exist, you should check for abnormal camber in the deck beams). Severe local deformation can result from deterioration, misplaced loads, collisions, etc. Understanding which parts shifted (and which didn't) takes some careful analysis. Sometimes it is a matter of taking sections of the vessel's hull and redrawing them along a trued-up keel plus rotating the sections until all their centerlines coincide with a common central buttock plane. Comparison with the lines of similar vessels can provide an excellent point of departure, but ultimately you must come to grips with what's going on with *your* vessel. In many cases this may require the services of a naval architect, marine surveyor, or shipyard worker.

In all HAER projects, copies of the "as is" lines of your vessel should be enclosed with your field notes for transmittal to the Library of Congress, especially if such plots are not part of the final drawing set. By enclosing these things, future researchers can follow your steps more easily in retracing your procedures. Discussion of your corrections to a vessel's lines should be included in your field report.

CONSTRUCTION DRAWINGS

General Remarks. Construction drawings get you into the "nuts and bolts" of a vessel. To record the large numbers of details lying in a vessel you must rank them in order of importance by significance (historical, structural, etc.) and plan an orderly set of views that will present and interpret them most clearly to someone who has never seen your vessel before. General arrangement views (plans, profiles, sections) will give the overall relationship of parts. Details focus on specific things of interest. In some cases, specialized drawings such as shell expansions, isometric views, assembly or exploded views, diagrams, or forms of technical illustration may be necessary to fully document the significant aspects of a vessel. Even when money or time is very limited, significant details should be drawn (at the very least as field notes with measurements), and general arrangement drawings, which give the details their context, should not be omitted in favor of details. Significant details should always be covered by photography. Because construction drawings are by nature far more detailed and varied than lines drawings, it is much harder to give specific guidance in this or that case. In

many instances, the vessel itself will settle options because of what you have to do to draw it. The drawing examples (Section 4.7) should prove helpful also. As with lines drawings, you may in some cases discover existing construction drawings of a vessel which could be used as base drawings for further recording work, or which may be traced or photocopied. As with any older documents, such drawings should be scaled and checked against the vessel itself and against the scale indicated on the sheets. Distortions arising from changes in the drawing sheets, or from reproduction processes, should be carefully looked for. Use of such drawings in any way should be fully cited on the new drawings, and any variations made by the team documented in notes.

Scale. As with lines plans, a scale of 1/4" to the foot is a common choice for construction drawings--it is large enough to show some detail, small enough to keep a drawing reasonably compact. Larger vessels may take two or more sheets to show an inboard profile or deck plan at this scale, but in terms of the information content of the drawing it is better to use multiple sheets instead of reducing the scale in an attempt to keep the entire vessel on one sheet. However, if you are drawing a steel vessel, steel structural members have a much finer cross section than wooden members. Since steel structural members won't show up well unless drawn at a very large scale (3/8" or 1/2"), this may allow you to draw plans and profiles at a fairly small scale (3/32" or 1/8"), saving typical structural details for drawing at large scales (1", 1-1/2", etc.) on other sheets. In many cases, if a vessel is drawn at small scale, other drawings will have to be made to show

significant portions of the vessel at larger scales where the significant features can be studied. You may find it an even trade-off (or better) in terms of labor to draw the entire vessel at a larger scale, thereby reducing the need for extra detail sheets even though you will produce more sheets for the general arrangement drawings.

Deck Plans and Inboard Profiles.

Probably the first construction drawings to be done on your project will be overall deck plans and profiles. In any case, you will discover that the deck plans and inboard profile need to be worked out *together*, sometimes even in conjunction with sections. Many features in a deck plan cannot be drawn without projecting them from an inboard profile, because they are inclined to the drawing plane (see Fig. 4.6.42). Measurements fore and aft on deck are required to construct the inboard profile, as well as triangulations taken in vertical planes parallel to the plane of the profile. Heights taken with a transit can be invaluable for quickly laying out the curves of the main deck and lower decks; they can also be used to double-check features located by triangulation. In some cases, you may need to make a profile of the starboard (or even port) sides of deckhouses, or the profile of the inboard sides of the hulwarks. Be sure to remember that features beyond the section plane of the inboard profile may not project squarely into the section plane. Cambered deck beams are a case in point. Though an inboard profile is taken at the center plane of a vessel, some features (such as masts, ladders, anchor winches, etc.) which lie in the center plane are not sectioned in order to preserve clarity. Features that lie beyond the section plane (such as the port side bulwark) should be

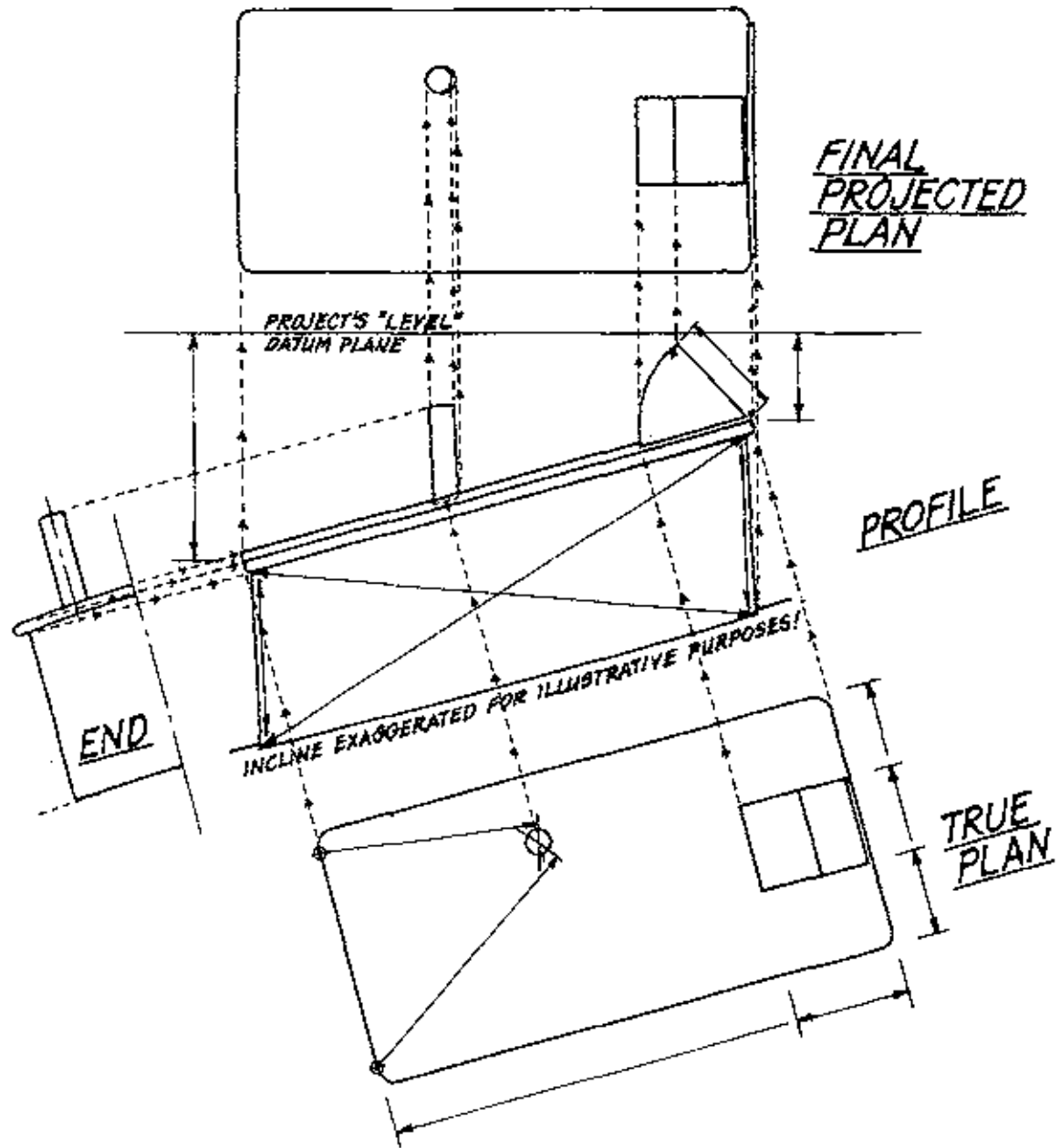
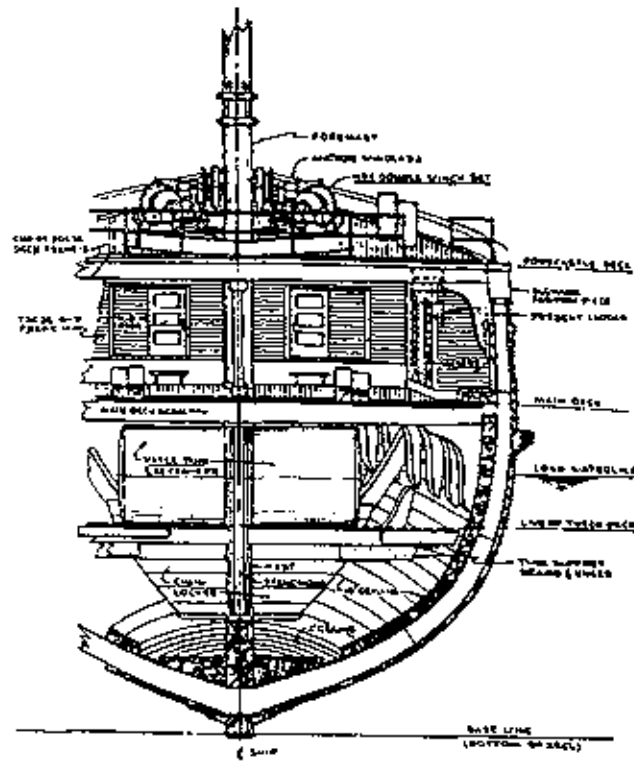
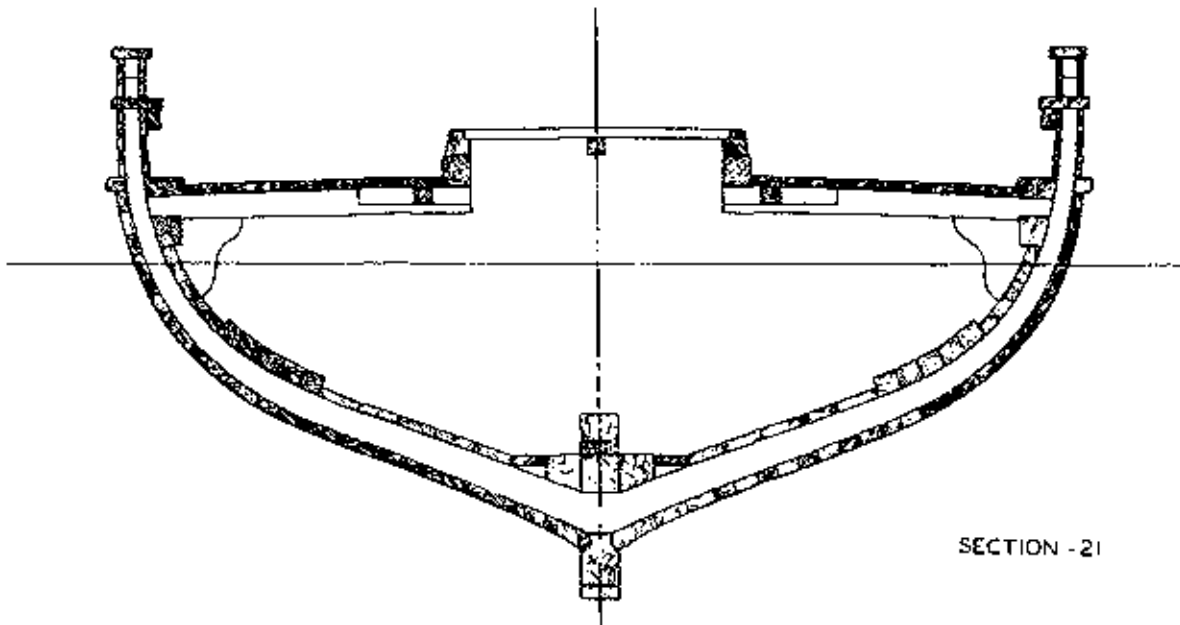

Fig. 4.6.42
Plans and Profiles Working Together



Taken from Steam Schooner WAPAWA Historic Structure Report, Sheet 12 of 13, by TRI-COASTAL Marine, Inc. for National Park Service

Fig. 4.6.43
Section with Projected Background



Taken from LOUISA MORRISON, SHIPS NO. 16-42, Sheet 5 of 9

Fig. 4.6.44
Section without Projected Background

shown in the inboard profile.

Deck plans and inboard profiles are most often drawn with the vessel's bow to the right on the drawing sheet. An additional inboard profile showing the opposite side is warranted in only the most compelling circumstances. For views requiring multiple HAER sheets, you may find it very advantageous to layout deck plans and profiles as single, continuous sheets before dividing them up.

Sections. Generally, a midship section is always drawn as a means of showing internal hull structure in cross section (see Figs. 4.6.43 and 4.6.44). A scale two to four times larger than the overall views is used to better show detail of structural members, and sometimes only a half-section is shown to take advantage of symmetry and save space and drawing time. It may be necessary to draw other sections to show highly finished internal partitions, machinery, special structures, etc. Because of the upward curve of the decks away from the midship section, sometimes the immediate features of the section plane are all that is drawn (see Fig. 4.6.44). The distant bow (or stern) and other deck features beyond the plane are not shown because they may look confusing in strict projection (objects beyond the plane appear to float in the air). The decision whether or not to draw projected features is a judgment call best left to team members and a review team on a specific project (see Fig. 4.6.43). Be sure to list scantlings (structural dimensions and materials), and show the vessel's floating water line (scantlings may be shown alternatively on the inboard profile). All materials drawn in section should be outlined heavily, and where

scale permits, they should be pochéd with the proper materials symbol (wood cross grain for wood, etc.).

Outboard Profiles. It will probably save the most time to do the outboard profile after the inboard profile is completed. Much of what appears in an inboard profile above the main deck also shows up in outline or location in an outboard profile, and there is no point in plotting the same things twice. As with the inboard profile, the outboard is almost always drawn with the bow to the right. HAER prefers that a full profile be shown, rather than one drawn only above the floating water line. Paint colors should be recorded with their Munsell color numbers, though some investigation may be required aboard a weathered or dilapidated vessel to find unweathered paint samples from which to work. The catenary curves of running rigging can be approximated by mounting the drawing on a wall, suspending a ball chain (the type holding rubber stoppers in sinks) between appropriate end points, and plotting points along the chain between the balls. The points can then be faired in with a spline or ship curve.

The amount of detail shown in an outboard profile is partly a matter of scale as well as significance. It may not be strictly necessary to show planking seams, or the joints of steel hull plates. However, chain plates, davits, portholes, hawsepipes, and other features appearing on the hull's exterior surface should be drawn.

Sail Plans. Outboard profiles usually show all sails of a vessel fully set. In the case of square-rigged vessels (or vessels combining square-rigged and fore-and-aft rigged features), the yard arms are drawn

"braced up sharp"—that is, until the yards lie parallel to the vessel's centerline (see Fig. 4.6.45). In most cases, it may not be possible to show more than a dashed outline of the sails, details of their construction either being too small to draw, or unavailable for recording. Most sailing vessels likely to be recorded for HAER have long since disposed of their original sails; what you may have before you could be the 10th or 20th set, and reflect recent sailmaking materials and practices as opposed to ones used when your vessel was originally launched. Before recording the details of sail construction, the team (in consultation with the review team) should determine the relative significance of these features. You may end up drawing them, or recording them photographically, or treating them in detail in the historian's report.

Mast Elevation. Detailed sets of measured drawings of sailing vessels may include mast elevations to show the general arrangement of rigging and hardware on each mast. The masts are usually drawn in profile, with yards braced up sharp, though views drawn looking forward or aft are also possible. On square-rigged vessels, you can take advantage of symmetry and omit the yards, sails, and rigging to one side of each mast. In fore-and-aft views, you might take advantage of symmetry and draw standing rigging alone on one side, running rigging on the other. Same scale or larger sections of each mast may be needed at various levels to show details (trestle trees, trusses, etc.). Fore-and-aft mast elevations of square-riggers may be combined with hull sections to economize on drawing sheets. All parts should be labeled.

Rigging Diagrams. Many people find rigging a mystery, and a nicely executed profile, accurate to the last brace, does nothing to relieve their confusion. On vessels of great significance, it may be worth developing a drawing sheet which explains in simplified terms the various rigging systems used aboard your vessel, especially if the drawings are likely to be used for exhibit or sold as posters to visitors. (These are arrangements to be worked out with project cosponsors, the review team, and vessel owner.) Pin rail diagrams and other sorts of illustrations can do a lot to unscramble for others what may be second nature to you, as well as provide invaluable information to present and future generations about how your vessel was actually rigged and operated.

Mechanical Propulsion. Engines, boilers, and auxiliaries should most certainly appear in deck plans and inboard profiles of vessels carrying such equipment. It is not necessary to section this machinery in an inboard profile, nor is it likely that you will need to do large-scale, detailed drawings of it, unless it is extremely unusual in nature. It may be possible to locate existing engineering drawings of engines and other machinery in published sources, trade catalogs, museum collections, and the like. What should appear in your drawings are notes covering the mechanical specifications of such equipment—builders, patent numbers and dates, model numbers, serial numbers, sizes, pressures, horsepower, capacities, RPMs (revolutions per minute), etc. Much of this can be treated in detail in the historian's report (the drawings should carry notes to this effect). Formal photographic coverage should be thorough.

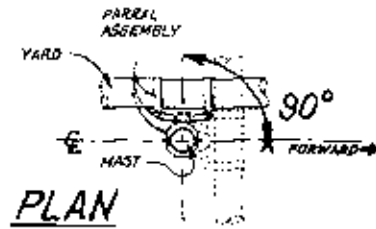

Yards with Parrels are drawn with yards braced parallel to ship's centerline, pivot point centered at mast. Mast is drawn in starboard profile.

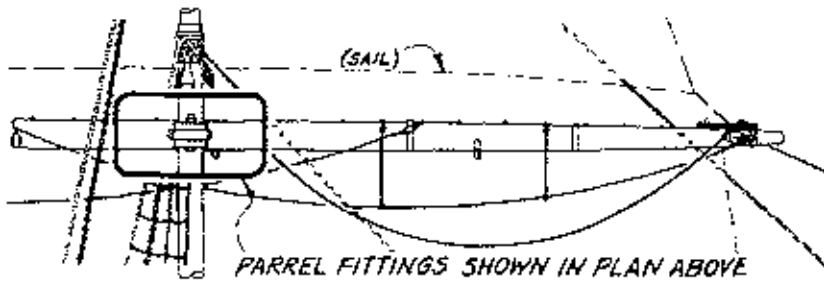

PROFILE

Adapted from Ship BALUCHITA, BARK No. CH-54

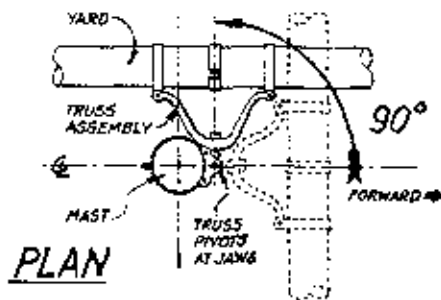

Yards with Cranes or Trusses are drawn with yards braced parallel to ship's centerline, pivot point forward of mast at the hinge. Mast is drawn in starboard profile.

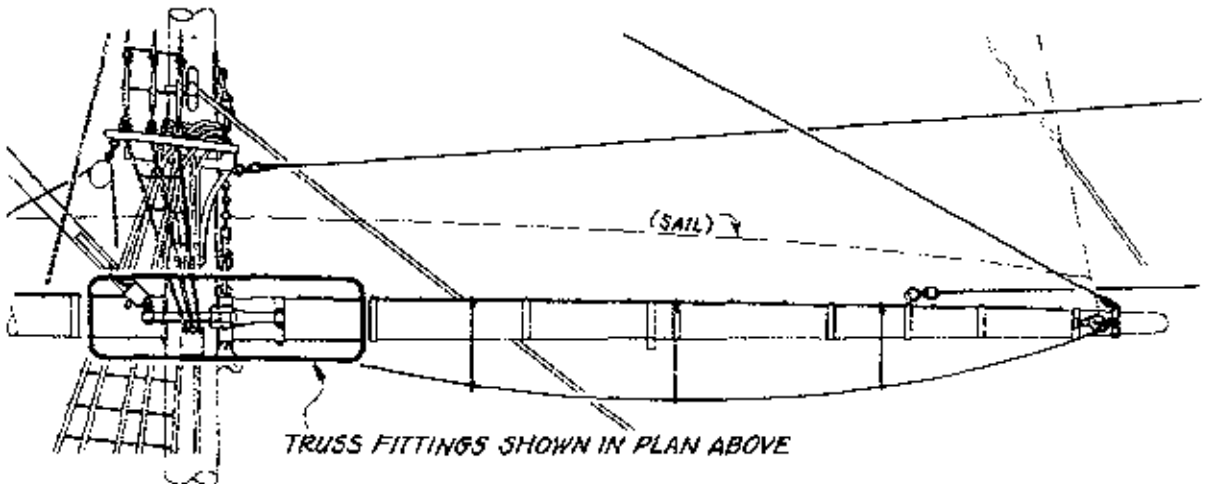

PROFILE

Fig. 4.6.45
How to Draw Braced Yards in an Outboard Profile

If major components are missing, HAER suggests they be restored in the drawings when adequate information is available to do so. Photography can record the existing incomplete conditions.

Equipment. Production of detailed drawings of equipment will depend largely on the equipment's significance. Particular views will depend on the nature of the equipment (is it a small boat? an anchor windlass? a bilge pump? a piping system? an industrial process?). Remember to include any available particulars or specifications (see Notes, p. 4.6.29 and Machinery, p. 4.6.33).

Shell Expansions. A shell expansion amounts to a Mercator map of a hull surface. It is produced by plotting measurements taken in section planes along the hull surface to planking seams, plate joints, and other features. Measurements and plots are usually started at the rabbet line. Once points have been plotted, lines are faired in which correspond to the plank seams, etc. This is not a drawing one can use to scale dimensions for plates or planks, since distortion has been introduced by flattening out a compound surface. Such drawings may be necessary to record specialized

features and fastening patterns, or for use in planning repairs.

Details. If drawn separately, specialized construction details, hardware, fittings, turnings, decorative features, etc., should be grouped carefully on sheets by type, location on board the vessel, and scales of the views. Avoid crowding views together, but try to take advantage of symmetry if you need to save space or avoid an awkward-looking composition. Notes on significance, materials, etc., should be included as necessary.

Isometrics and Perspectives. Occasionally it will save space and confusion to draw certain features or details as isometrics or perspectives instead of relying on two or three orthogonal views. Some features which have a complex internal structures can be usefully interpreted by drawing them in an exploded view, or as an assembly with certain parts cut away in an instructive manner (see Fig. 4.6.46). Views such as this are more technical illustrations than measured drawings, but they should be carefully constructed projections based on measurements or traced over photographs rather than refined freehand drawings. Naturally, labeling and notes are needed to describe what is being shown.

Taken from Elliot Schooner ALABAMA, INDR No. 19-64, Sheet 12 of 12

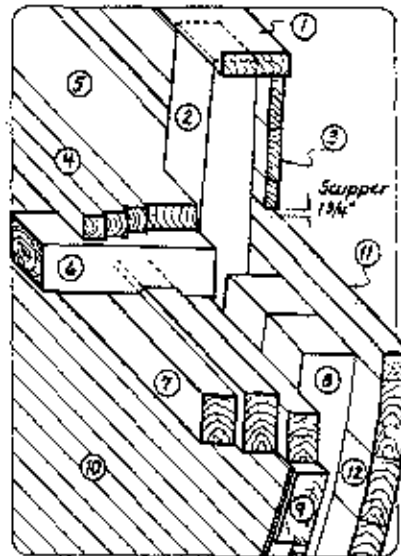

TYPICAL CONSTRUCTION DETAIL

The wood species and fasteners were indicated by Robert S. Douglas.

1. Cap Rail: varies from $7\frac{3}{4}'' \times 2\frac{3}{4}''$ to $8\frac{3}{4}'' \times 2\frac{3}{4}''$. Most often it is $8\frac{1}{4}'' \times 2\frac{3}{4}''$.
2. Rail Stanchions: $6'' \times 6''$ at deck (coped above). The locations of the bases of the rail stanchions were not determined in the field.
3. Bulwark Planking: $1\frac{1}{2}''$ varies.
4. Deck Planking: $3'' \times 3''$, y. pine.
5. Covering Board: $12'' \times 3''$.
6. Deck Beams: $6'' \times 6''$ (average) at approx. $24''$ o.c., notched to fit onto shelf.
7. Shelf: $4'' \times 7''$ secured down two $4'' \times 5\frac{1}{4}''$ y. pine.
8. Frames: double sawn $12''$ juniper (see sheets 6 & 7 for locations).
9. Clamp: $4\frac{1}{4}'' \times 8\frac{1}{2}''$, yellow pine.
10. Interior Finish Sheathing: $3\frac{1}{4}'' \times 2\frac{3}{4}''$ T & G, bevelled edges.
11. Shear Strake: $3\frac{1}{2}'' \times 3''$ yellow pine.
12. Hull Planking: $3\frac{1}{2}''$ y. pine, fastened with $1\frac{1}{2}''$ trenails.

Fasteners: All butts and hood ends below the water line are fastened with $6'' \times \frac{5}{16}''$ copper spikes; above the water line by $6'' \times \frac{1}{8}''$ galv. steel spikes.

Fig. 4.6.46
Axonometric View of Construction



DRAWING EXAMPLES

Introduction. The selection of drawings and drawing fragments in this section has been collected from a number of sources. Each drawing is accompanied by comments to assist the recorder in applying HAER guidelines for laying out and inking HAER drawings. These comments address both what to do and what *not* to do.

At the time these guidelines were first prepared in 1988, HAER had only a small number of completed vessel recording projects in its collection that could be used for illustration. As a result, examples were selected from the Historic American Merchant Marine Survey (HAMMS) and from the works of Howard I. Chapelle, both collections preserved at the Smithsonian Institution. An informative history and evaluation of the HAMMS program, its goals, methods, and results, appears in a master's thesis by James Peter Warren (see Section 4.7 for a complete citation). Many of these examples have been replaced by completed HAER documentation, including some archeological projects.

Many comments have been made on others' efforts, either recommending certain methods or suggesting ways these models may have to be adapted or improved to meet HAER's criteria. HAER's suggestions and comments are not intended as adverse criticism of its predecessors. Much of this early work should be held in great regard, especially

considering some of the constraints in time and money the recorders were working under. HAER's remarks on graphics, layout, and documentary discipline come from thousands of man-years of recording experience (albeit in nonmaritime resources) and from continuing attempts to improve its methods. HAER's goal is not only to make precise drawings and records, but to produce these in such a way that they are as informative, thorough, and attractive as possible. HAER is a public agency producing public records, and hence must go beyond what may seem to be sufficient in some cases. Aside from strict documentary concerns, HAER drawings should be able to do double and triple duty as publishable graphics (from posters to scholarly articles), exhibit and educational materials, base drawings for maintenance and restoration, fund-raising materials, and the like. HAER anticipates that its records will be a significant force in spreading and cultivating the public's interest in America's historic vessels, a goal that we believe the maritime community shares.

The following section is broken down into several groups of drawings, roughly in the order of views in a drawing set (see p. 4.6.2): lines, profiles, inboard profiles, deck plans, sections, and details. HAER will be glad to receive any comments and suggestions for improving this (or any other) section of the guidelines; improvements will be incorporated in succeeding editions.

LINES DRAWINGS

Fig. 4.7.1

Market Schooner *SYLPH*

This drawing was originally made as a book illustration, not intended as documentation in the HAER sense. Pretending that it was for HAER (for the sake of example), we offer the following observations:

Layout

Combination of outboard profile and sheer plan works well in this case.

Drawing is compact, and relationships of views are easily understood.

Scale is a very useful length for checking reductions, scaling with dividers, etc.

Deck plan should be drawn separately from half-breadth plan, not dotted over it.

Notes on vessel's description, history, colors, and lines plans would have been better collected into one area of the sheet (e.g., lower left) rather than scattered about the drawing.

Linework is elegant, but too light; structure of the vessel (e.g. rails, masts, deckhouses) should receive heavier line weights. The scale is the strongest graphic element.

Lettering for notes is clean and legible, but title lettering is much too small and light

Documentation

Note that sections are spaced for sake of shape, not hydrodynamic calculations.

There is no clear indication what this drawing is based on. Seeing that the drawing was made 55 years after the ship sank, was it based on older drawings, a model, a half-model, photographs, or someone's field notes? Are any parts educated guesswork? The reader has no clue.

On what basis are the color identifications made?

How accurate are the drawings? One could assume $\pm 1/2"$ since the molded beam is given as 17'-1", but on what is such precise dimensional information based?

Table of Hull Measurements (sometimes called a "Table of Offsets" or "Table of Ordinates") is missing.

Plate 38, Market Schooner or Beam Trawler *SYLPH*, American Fishing Schooner
 Collection. Delineated by Howard I. Chapelle. Reproduced courtesy of the
 Smithsonian Institution.

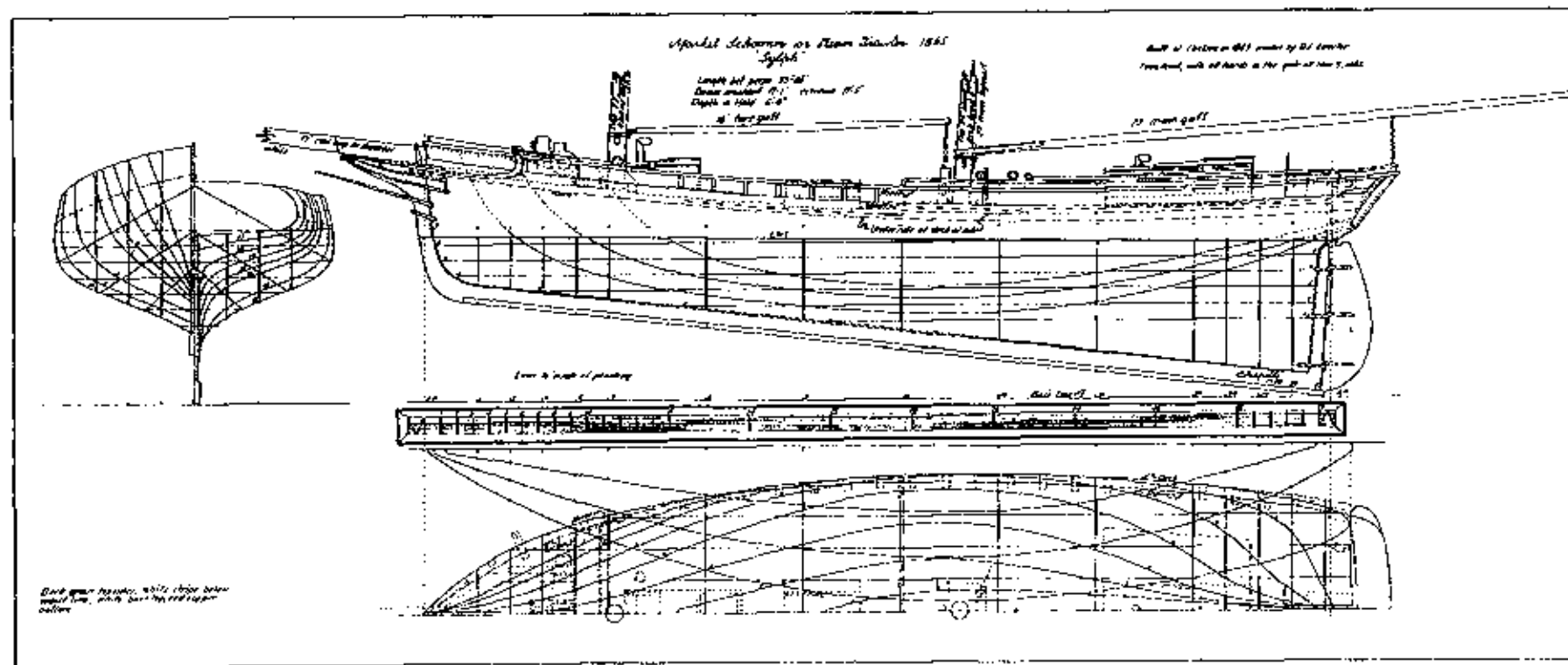

Fig. 4.7.1

LINES DRAWINGS

Figs. 4.7.2 through 4.7.4

Schooner *WAWONA*

These drawings were part of a 1985 HAER documentation project.

Layout

Lines plans were spread out over three sheets to accommodate documentary notes and show lines at a scale (1/4" = 1'-0") somewhat commensurate with accuracy of field work.

Symmetry used to show half-breadth plan and deck plan together on same centerline.

Sheer/half-breadth plans have been laid out so that reproductions of the two sheets may be easily spliced together with extremely little loss or repetition of information.

Delineation

Lines and structure read strongly, though they tend to be overridden graphically by the notes column and the scale.

Lettering is clear and bold; lettering for view titles is heavier and larger than that for labels, and labels stand out against linework.

Notes are organized into columns; labels on linework for buttocks and water lines are grouped visually; arrows are used for clarity.

Diagonals are drawn on half-breadth plan, but with interrupted lines so that confusion with waterlines is prevented.

Documentation

Extensive notes record intent of the drawing, assumptions, relevant field and drafting room procedures, definition of sheer line, and sources for reconstructed bilgehead and scrollwork; omitted features are noted. Estimated dimensional errors in field work and in the drawing are also noted.

It should have been plainly noted whether lines are to inside or outside of planking, though this might be inferred from notes on field methods.

"Deck Plan" would have been better labeled "Rail Plan" for all we see.

Blank boxes in Table of Offsets should have a diagonal line drawn through them to show that omission is intentional, not an oversight (even though user can check body plan or scale from it).

1897 NOTES

- This line drawing depicts MAWONA after an "on paper" removal of all hull distortions evident in 1985 mapping and drawing (whether due to age or construction error) were corrected in the belief that MAWONA'S builder intended her to be constructed with a straight keel and symmetrical frames. It is believed that the lines of rig closely represent the 1897 originals.
- In "straightening out" the hull, it was assumed that the shape of the body plan sections had remained nearly unchanged since MAWONA'S construction due to the exceptionally good condition of the hull below the water line and the intact "S" cutting from the turn of the bilge to the clamp surrings. Any very slight changes in the section shapes due to hogging frames (as transmitted through the cabin sole) were indicated by an average 4" deflection of the deck beams. The 1897 water line thus has about 1" more saring than the 1985 sheer line.
- In plotting the "original" buttocks and water lines, tangents were drawn to the mapped keel on the existing condition drawings at points where the 1985 field section planes intersected the keel. The angle between the tangent and section plane at each station was maintained when the ship's lines were redrawn with this keel straightened out. Tangents were assumed to be true, not passed (mechanically). Copies of these station plots are contained in the project field records for reference.
- Buttocks and water lines between field stations 3 and 10 were replotted with field sections tilted to port 1 inch in 10 feet. The usually produced symmetrical sections and the most correlation (port and starboard) between lines. Lines at other stations were plotted with the sections tilted only as far as necessary to achieve these same results. Only the starboard lines are shown since symmetry is assumed.
- The base line (shown) used in this drawing is set at the bottom of the main shoe and corresponds with existing draft marks on the hull. Water lines shown are relative to this base line, not the field base line or water lines used in the existing condition drawings (1985) on sheets 2 to 4.

(continued on sheet 6)

Stations → 0 1/4 1 1 1/2 2 3 4 5
 (5.20 ft. station spacing)
 See Note 10 on Sheet 6
 see Sheet 7 for Body Plan

DECK PLAN

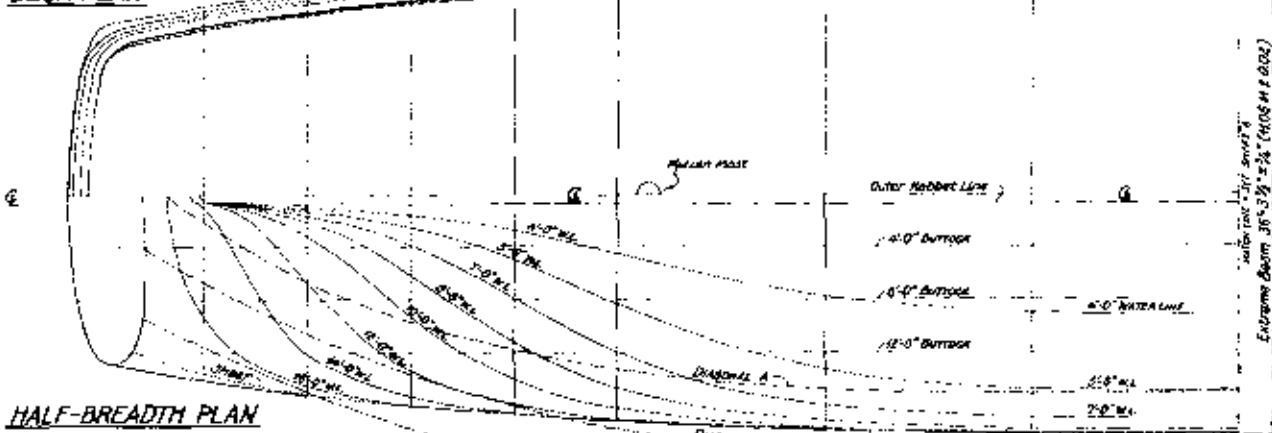

HALF-BREADTH PLAN

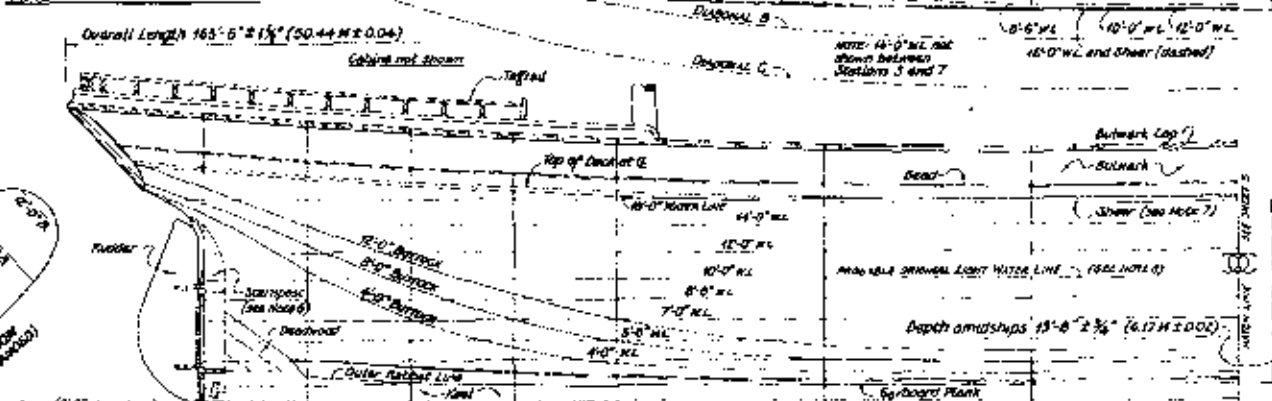

SHEER PLAN

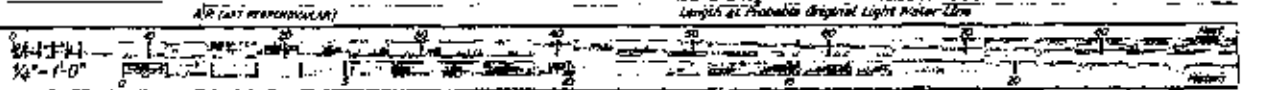
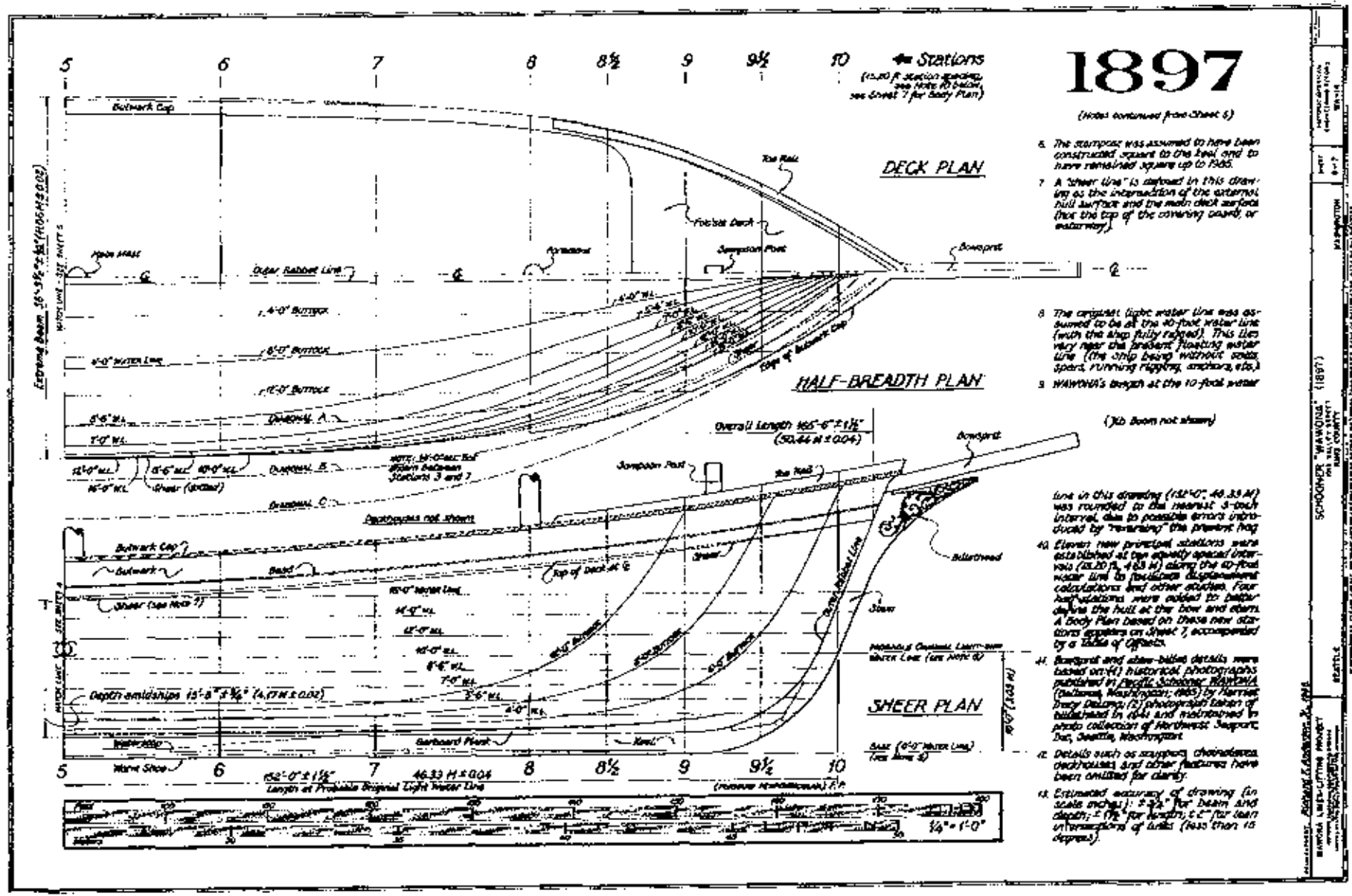

Fig. 4.7.2

PROJECT: MAWONA (1897)
 DRAWING NO.: 1897-1
 SHEET: 1 OF 1
 SCALE: AS SHOWN
 DATE: 1985

Fig. 4.7.3



PROJECT: USS MONITOR (1862)
 SHEET: 1897
 DRAWN BY: [illegible]
 CHECKED BY: [illegible]
 DATE: [illegible]

1897

TABLE OF OFFSETS

ALL DIMENSIONS BELOW ARE GIVEN IN FEET, INCHES, AND EIGHTHS OF AN INCH
(See Notes 1 and 2)

		STATIONS														
		0	1/2	1	1 1/2	2	3	4	5	6	7	8	8 1/2	9	9 1/2	10
HEIGHTS TO E.L.C.	ORIGIN E.L.C.	20-0-0	21-4-6	22-10-6	23-5-6	24-0-0	19-7-0	18-5-0	19-7-2	20-2-4	21-2-0	22-3-0	23-3-4	24-2-6	23-4-2	28-0-6
	SWEEP	18-2-4	17-0-2	16-11-0	16-4-6	16-2-2	15-8-2	15-4-6	15-0-4	15-5-2	17-3-6	18-7-4	19-5-2	20-4-0	21-5-4	22-0-0
	18" BUTT.				12-5-0	11-10-6	7-2-4	6-3-2	10-1-0	8-6-0	8-4-2					
	12" BUTT.	17-0-0	16-0-0	11-3-2	18-10-0	7-0-2	5-0-4	4-6-6	4-4-4	4-0-4	5-3-6	8-3-2	13-2-0	24-7-6		
	8" BUTT.	15-9-0	12-6-0	8-5-2	7-0-6	5-6-4	4-0-2	3-9-0	3-2-0	3-10-2	4-1-0	5-4-6	7-4-4	12-0-4	23-4-0	
	4" BUTT.	14-11-0	10-8-0	7-1-4	4-10-0	3-8-6	3-1-2	2-11-0	2-11-0	2-11-4	3-1-0	3-6-2	4-4-6	16-5-0	11-11-0	25-9-0
	MAST		2-11-0	2-2-4	2-2-0	2-1-6						2-1-6	2-2-0	2-2-2	3-1-6	14-9-4
	DECK CAP	13-6-4	14-7-4	15-4-2	15-10-0	16-5-0	17-1-0	17-5-4	17-7-4	17-5-2	17-0-0	15-9-2	14-4-6	12-0-6	8-7-2	4-3-4
	SWEEP	13-5-4	14-11-4	15-10-0	16-5-0	16-10-6	17-6-4	17-10-6	18-0-4	17-6-6	17-3-0	16-6-0	15-0-2	11-0-6	7-5-2	3-0-4
	HALF-BREADTHS	26" WL												11-11-4	8-2-4	5-5-2
24" WL													11-4-6	7-7-4	2-9-6	
22" WL		11-7-2										15-9-6	14-1-4	11-4-6	7-7-4	2-9-6
20" WL		13-11-0	14-9-0	15-9-6	15-11-6	16-5-4			17-5-4	17-0-4	15-7-2	13-9-4	10-11-4	6-11-4	2-8-0	
18" WL		15-5-0	15-0-0	13-9-0	16-3-4	16-7-4	17-2-6	17-7-2	17-9-2	17-7-6	17-2-6	15-5-0	13-4-6	10-4-6	6-4-0	1-6-6
16" WL		9-1-0	14-4-4	13-8-2	16-9-4	16-10-6	17-0-0	17-9-6	18-0-0	17-10-2	17-3-4	15-2-4	12-11-2	9-8-6	5-7-6	1-0-4
14" WL		1-0-2	12-0-2	13-2-4	15-10-0	15-10-0	17-0-0	17-11-4	18-1-0	17-11-0	17-3-4	14-8-6	12-3-2	9-11-0	6-0-4	
12" WL		0-6-4	5-7-0	13-2-4	15-10-2	16-10-4	17-0-6	18-0-0	18-7-6	17-11-0	17-4-0	14-2-4	11-5-4	7-11-4	4-0-2	
10" WL		0-6-4	3-2-0	9-1-6	13-11-6	16-0-6	17-0-0	17-10-6	18-0-0	17-9-0	16-8-0	13-3-0	10-3-6	6-9-4	3-0-6	
8" WL		0-6-4	2-0-2	6-0-4	11-3-0	14-7-4	16-11-0	17-4-4	17-0-0	17-4-4	16-0-6	12-2-2	9-1-4	5-9-6	2-4-6	
6" WL	0-6-4	1-5-0	5-9-4	7-11-0	12-0-0	15-2-0	16-5-4	16-10-6	16-6-0	14-0-2	10-7-0	7-4-4	4-0-4	1-4-2		
4" WL	0-6-4	0-4-4	2-5-4	5-0-2	8-3-0	13-3-4	14-8-6	14-10-6	14-6-2	12-1-0	8-2-0	5-7-0	3-2-4	1-1-6		
2" WL	0-6-4	0-3-4	1-6-4	2-9-0	4-3-0	7-3-2	9-3-4	9-3-4	9-2-6	8-9-4	7-8-2	5-1-6	3-0-0	1-1-2		
MAST HEIGHT	0-6-4	0-8-0													0-0-0	
STERN	A	2-2-2	6-4-0	9-2-0	11-9-0	15-8-0	14-9-0	15-0-4	15-0-4	14-11-2	14-7-4	13-3-2	11-4-0	9-5-6	6-0-6	1-3-0
	B	6-0-2	10-0-6	13-6-4	15-10-4	17-7-6	19-7-4	20-7-4	20-7-0	20-0-6	19-3-2	16-9-4	14-6-4	11-5-6	7-6-4	2-5-4
	C	11-6-4	14-11-4	17-7-0	19-9-0	21-4-2	23-1-6	23-10-0	23-11-6	23-8-2	22-5-6	19-2-0	16-8-2	13-1-4	10-10-4	7-6-6

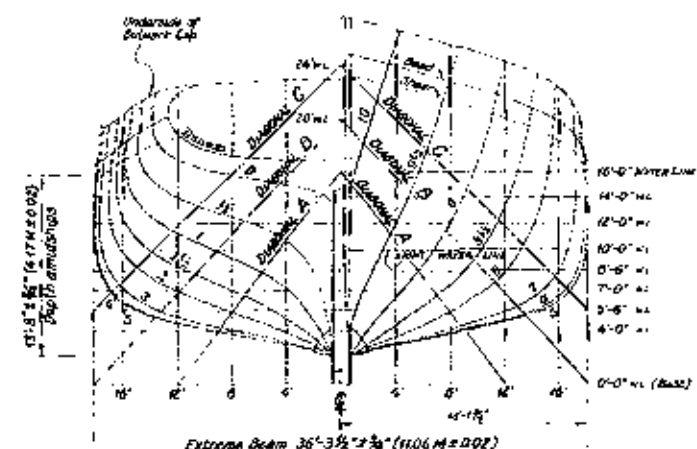

BODY PLAN

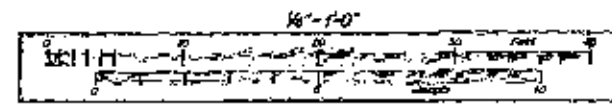

FIG. 4.7.4

- Example: 12-7-7 = 12'-7 7/8"
- Dimensions scaled from Body Plan to 1/4" scale inch, Body Plan accurate to 1/32 scale inch
- All offsets are to outside of side plating and top of deck plating
- The 10-foot water line was assumed to have been the original light water line.
- Section spacing of 15.20' was produced by dividing 1616.0000' length at the 10-foot water line (152'-0" ± 1 1/2") by 10. Four half-stations were added to better define the hull at the bow and stern.
- In addition to the "1897" Half-breadth Plan (see Sheets 5 and 6), see intermediate sheer plan with buttocks at 4-foot intervals was used to plot this Body Plan, thus enabling greater accuracy than might have been achieved using buttocks on 4-foot intervals (This intermediate sheer plan was also the base for the "1897" Shear Plan on Sheets 5 and 6, and a copy is contained for reference in the project field records)
- The base line (plane) is set of the bottom of the stern shoe.
- A "shear line" is defined in this drawing as the intersection of the external hull surface and the main deck surface (not the top of the covering board, or waterway).
- Minimum camber of the main deck was probably about 3/8" originally, (between Stations 4 and 5), after taking into account the current (1997) 1" upward deformation of the deck beams amidships. (Maximum camber in 1985 was about 4 1/2" ± 1/2").
- Bow extension is 4-5-6 forward of Station R3 at the intersection of the outer rabbet line and stem-head (undecked) of bowhead.
- Stern extension is 10-0-4 aft of Station C, at the aftmost extremity of the transom plating (at centerline of the ship).
- Bow and stern extensions of buttocks and water lines were not tabulated, since they may be scaled from the half-breadth and Shear Plans, Sheets 5 and 6

PROJECT: 1897
 DRAWING NO.: 1897-1
 SHEET NO.: 1897-1-1
 DATE: 11/11/97
 DRAWN BY: J. J. JENSEN
 CHECKED BY: J. J. JENSEN
 APPROVED BY: J. J. JENSEN
 PROJECT LOCATION: SEATTLE
 PROJECT OWNER: SEATTLE
 PROJECT NO.: 1897

OUTBOARD PROFILE

Fig. 4.7.5

Martha's Vineyard Cat

This sheet by Howard I. Chapelle contains a lot of detail and is attractive graphically. Pretending that it had been submitted as HAER documentation, however, it falls short in ways outlined below from HAER's perspective. A photographic survey and written report would mitigate this somewhat.

Layout

Sheet is neatly organized, though tables, body plan, and midship section appear somewhat crowded. In lieu of attempting to put everything on a single sheet, HAER would have suggested using two sheets. (Intrusion of gaff into table border at top of sheet is a nice touch, however.)

Delineation

While lettering is clear and legible, lettering for drawing views (e.g., "Construction" on midship section) are not large enough or strong enough to stand out. Title "Martha's Vineyard Cat" does not stand out above all other lettering--hard to find.

Delineation of profile is elegant, but too light relative to lettering and tables.

Documentation

Note is made that the boat's lines were lifted (presumably by Chapelle) rather than taken from a model or someone else's work. However, no record appears regarding overall condition of vessel, recording methods used, accuracy, problems encountered (if any), other personnel involved, etc. No note is made as to boat's builder or place she was built. No note indicates whether even an unsuccessful attempt was made to discover these things.

Scantlings are given on midship section, but no notes as to materials. Dimensions of spars and sails are given, but not size of lines. Some construction information is given verbally here and there, but no attempt is made to be more comprehensive graphically (details of rudder post trunk or mast step). Some of these things could be covered photographically, but much is left for the user to assume or look up without helpful references in the drawing. If some details are generic, this should be clearly stated, as well as where these details may be found. (Remember "User Smith" in the year 2335 A.D. How many 20th century catboats or books on their construction will survive for him to study?)

A separate, detailed deck plan would be preferred over the dotted version superimposed on the half-breadth plan.

Fig. 96. Martha's Vineyard Cut, American Small Sailing Craft Collection. Delineated by Howard I. Chapelle. Reproduced courtesy of the Smithsonian Institution.

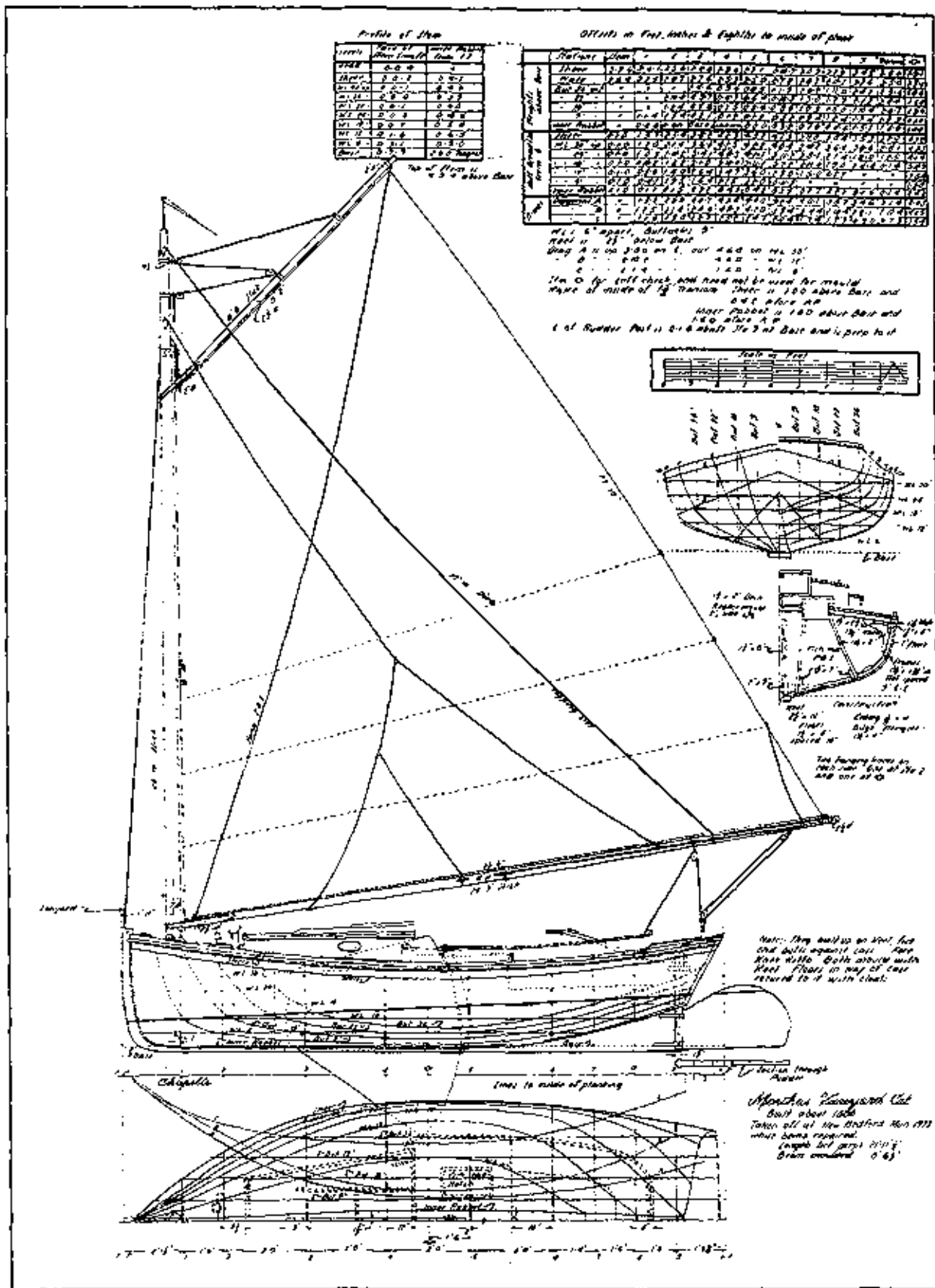

Fig. 4.7.5

OUTBOARD PROFILE

Fig. 4.7.6

Ship *BALCLUTHA*Layout

The sheet is laid out well. The ship fills the sheet, with the scale providing a visual anchor. Notes are contoured to the shape of the drawing.

Delineation

This profile is well delineated. Line weights are appropriate and well balanced. Note that spars and hull were delineated with heavier lines than details, running rigging, etc.

Note the use of shadowing to help distinguish spars from lines.

Some deck features with fine details bleed together in reduction.

The graphic scale runs the length of the ship, making scaling with dividers an easy matter.

Documentation

The information source for features which are no longer extant (sails and rigging) has been verbally documented on the drawing.

It is also noted that most of this drawing was produced by tracing reductions of other drawings without stating clearly that they are HAER drawings. No accounting is given as to the accuracy of the reductions or the final view presented.

The national ensign should be four times larger than shown. Since the sails were reconstructed, perhaps ship's flags should have been displayed as well (house flag at the main peak, courtesy flag at the fore peak, and call letter flags from the mizzen royal mast).

The present color scheme is noted, but not pinned down with Munsell numbers for the grey and red colors cited. There is a reference in the drawing for historical colors.

Overall length and height should have been shown.

The masts and spars, hull outline and main deck features were traced from reproductions of the 3/4" x 1'-0" drawings.

BALCLUTHA's poop deck was extended forward 65' in 1911.

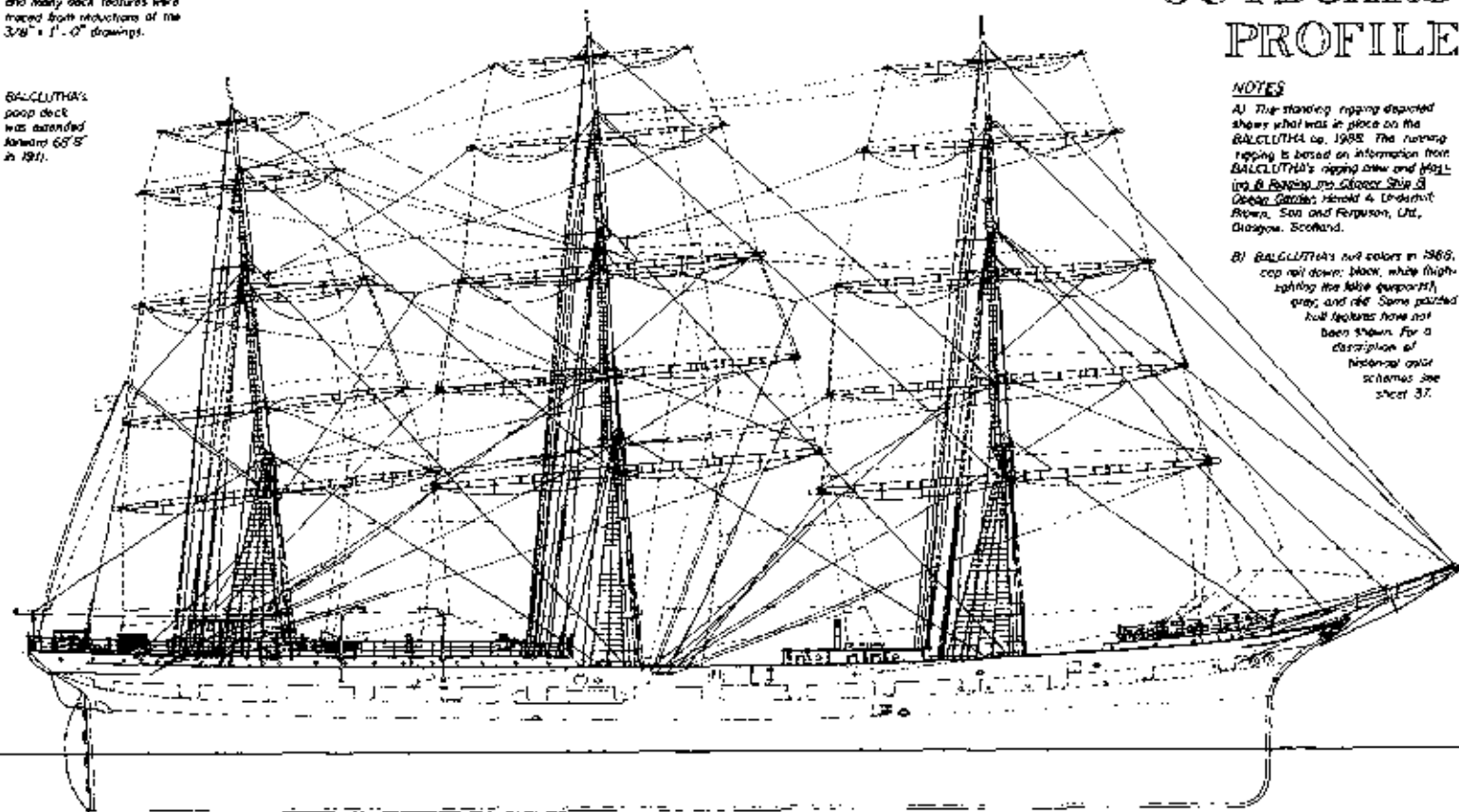

OUTBOARD PROFILE

NOTES

A) The standing rigging depicted shows what was in place on the BALCLUTHA in 1988. The running rigging is based on information from BALCLUTHA's rigging crew and Mast Log & Rigging Log. Owner Ship of Great Britain: Herold & Underhill, Brown, Son and Ferguson, Ltd., Glasgow, Scotland.

B) BALCLUTHA's hull colors in 1988: top rail down: black, white (high-lighting the hull gunports), grey, and red. Some painted hull features have not been shown for a description of historical color schemes see sheet 37.

Scale: 3/4" = 1'-0"

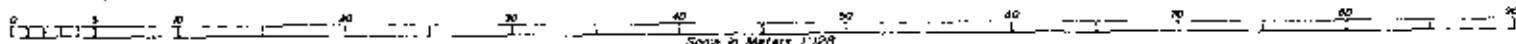
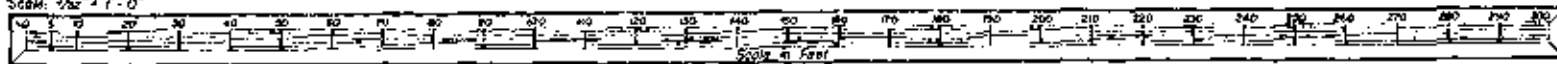

Fig. 4.7.6

SHIP BALCLUTHA (1866)
 NATIONAL MARITIME MUSEUM
 1000 EAST 17TH AVENUE
 DENVER, CO 80202
 TEL: 303-733-1414
 FAX: 303-733-1415
 WWW: WWW.NMMN.MUSEUMS.GOV

OUTBOARD PROFILE

Figs. 4.7.7 and 4.7.8

Bugeye *LOUISE TRAVERS***Layout**

Two sheets were used for this view in order to present the vessel at a reasonable scale and leave space for documentary notes. The two sheets are designed so that reproductions may be spliced together with little loss, repetition, or rearrangement of information.

Note that the radio mast and antenna break the drawing sheet border. This is an acceptable way to show small elements that would otherwise not quite fit inside the borders. (Linework should never extend beyond the trim line or into the title block, however.)

Delineation

The drawing reads well due to use of a variety of line weights and shadowed lines.

Sizes and weights of lettering permit easy reading. Notes are organized into columns. Labels are almost never made over linework, and arrows are used to make positive identification of labeled features.

Documentation

Notes clearly state that the view does not show the existing conditions at the time of field work (1986), but that decayed and missing features have been reconstructed and refers to the HAER record photographs for actual conditions. The decision to show "corrected" views depends on the scope of the project. In this case, the vessel was deemed unrestorable, and the HAER documentation would become the only detailed record of the vessel. In such a case, "corrected" views make sense, especially when field photography and HAER record photographs show the vessel's actual condition. On restoration projects, "as-is" or existing condition (uncorrected) drawings may be necessary in order to guide planning and restoration efforts.

Some notes are keyed to tags in drawings.

The notes on sheet 6 continue on sheet 7, but sheet 6 does not indicate this.

Error tolerances in overall dimensions are indicated as well as a note describing a discrepancy between the drawing and field measurements.

Other sheets are noted where further information can be found.

Fig. 4.7.7

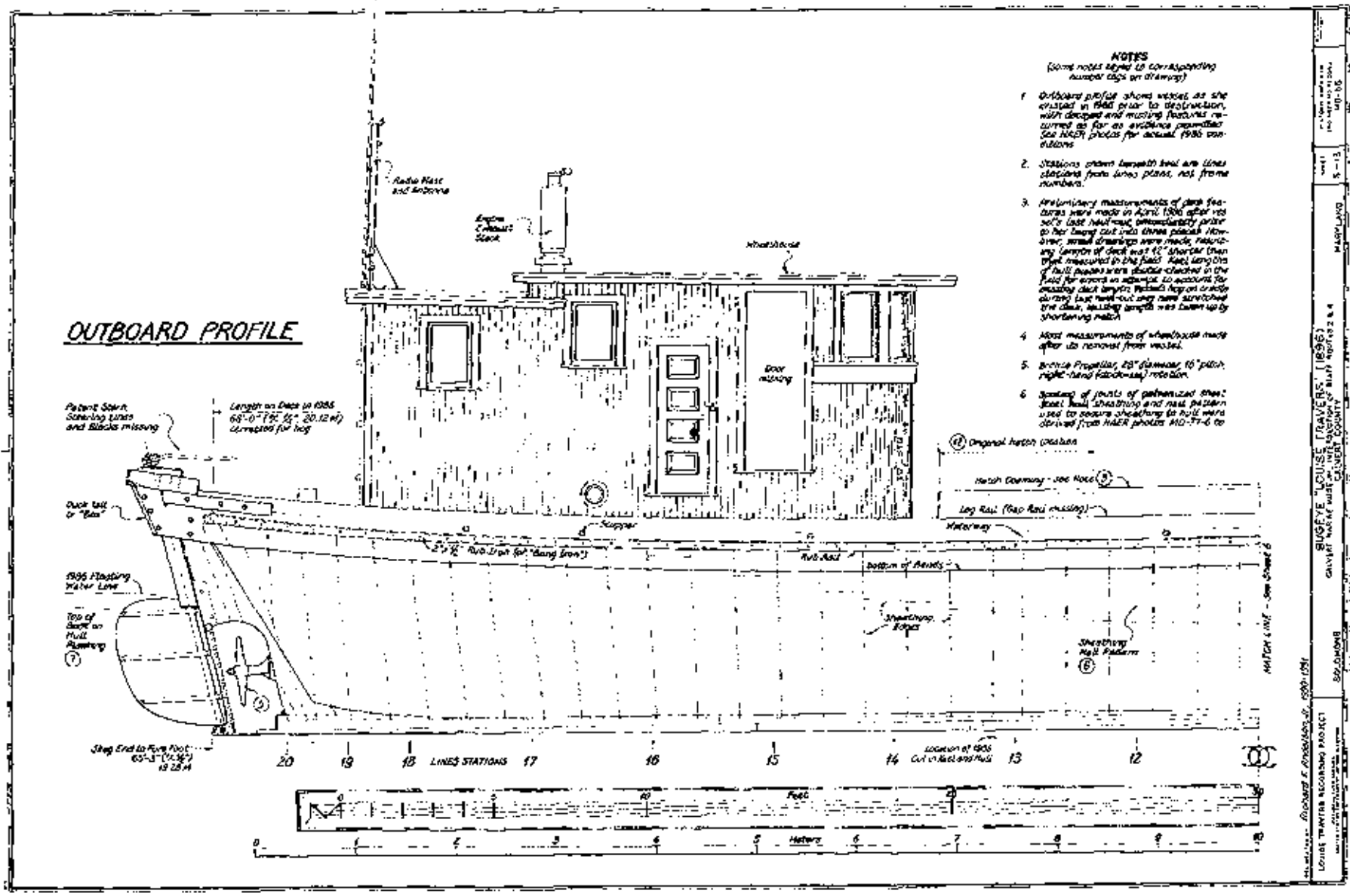

OUTBOARD PROFILE

Fig. 4.7.8

Bugeye *LOUISE TRAVERS*

(see comments on p. 4.7.12)

NOTES
(Some notes refer to corresponding number figs on drawing)

NO-77-B. Sheathing was in 20" wide sheets lapped with 2" to 4" laps, sealed with tar over a layer of asphalt impregnated felt roofing paper. Nails were driven on 3" grid pattern 45° to edges of sheathing. Seal was not checked.

7. Where sheathing was removed, painted back on hull plating and 8" below rail line (1985 fastening rail line) on sheathing.
8. Sheathing observed bands (wales), but bands are drawn as if no sheathing existed, based on photographs and field measurements at ends and at midships.
9. Real values in height, construction shown in place conditions measured by BREIT. BREIT was unable to determine if there were any wood shal joints in ceiling.
10. The rail timbers topped with one 2"x4" in 1986; these members not shown in drawing. Log rail topped with one 2"x4", also omitted in drawing.
11. Rail rail required based on surviving segments, drift holes, and top edges of metal sheathing.
12. Stuyves usually built with two hatches, or three (locations on Traverses determined by examining hatch carlings and cut deck beams where hatches were later joined).

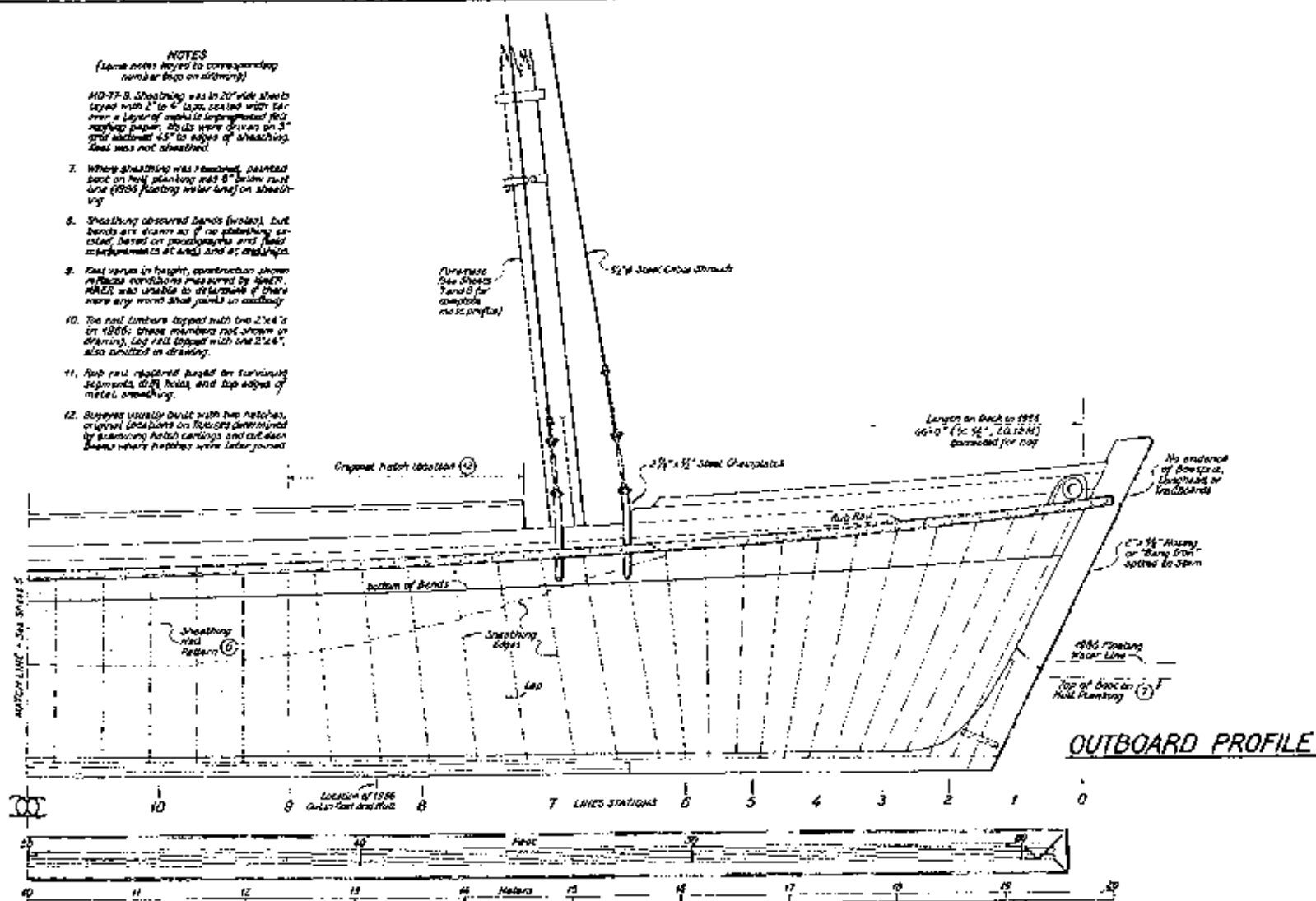

Fig. 4.7.8

NATIONAL ARCHIVES
 RG 226
 BUOYER, LOUIS TRAVERS (1896)
 LOUISIANA ARCHIVES PROJECT
 500 00000
 1980-1981

OUTBOARD PROFILE

Fig. 4.7.9

Sidewheel Ferry *JAMES M. DONAHUE***Layout**

Acceptable. There is plenty of space for notes.

Delineation

Linework is clean and precise, which implies accuracy, but line weights are unacceptably light in full size drawing. Negative for this reproduction was overexposed to make lines register, resulting in blurring. The dark areas are where concentrations of fine lines have bled together.

Glass is indicated with light hatchwork, intended to read as reflections in the windows. A stronger effect would be achieved by blackening in all windows, especially when there are so many. This, in addition to stronger linework, would make a much stronger presentation.

Wood graining on the legs of the walking beam frame reads more as a mechanical feature of the engine than a material rendering because the line weights are the same. In this case, no wood graining should have been used.

View title ("Outboard Profile") is a very suitable size and style. It might have helped to have used bolder line weights in the lettering.

Documentation

Though part of a 15-sheet drawing set, this sheet gives a user nothing verbal for documentation or verification. It draws some credibility as part of the HAMMS survey, but by itself it becomes simply a pretty drawing, approached in blind faith as accurate documentation. The drawing may indeed be accurate, but how is a user to know?

Lack of written dimensions and a graphic scale of adequate length leave the user without back-ups for checking against drafting errors or reproduction distortions. Users also will have a hard time using the miniscule graphic scale to accurately scale the drawing in reproductions other than full-size.

Fig. 479

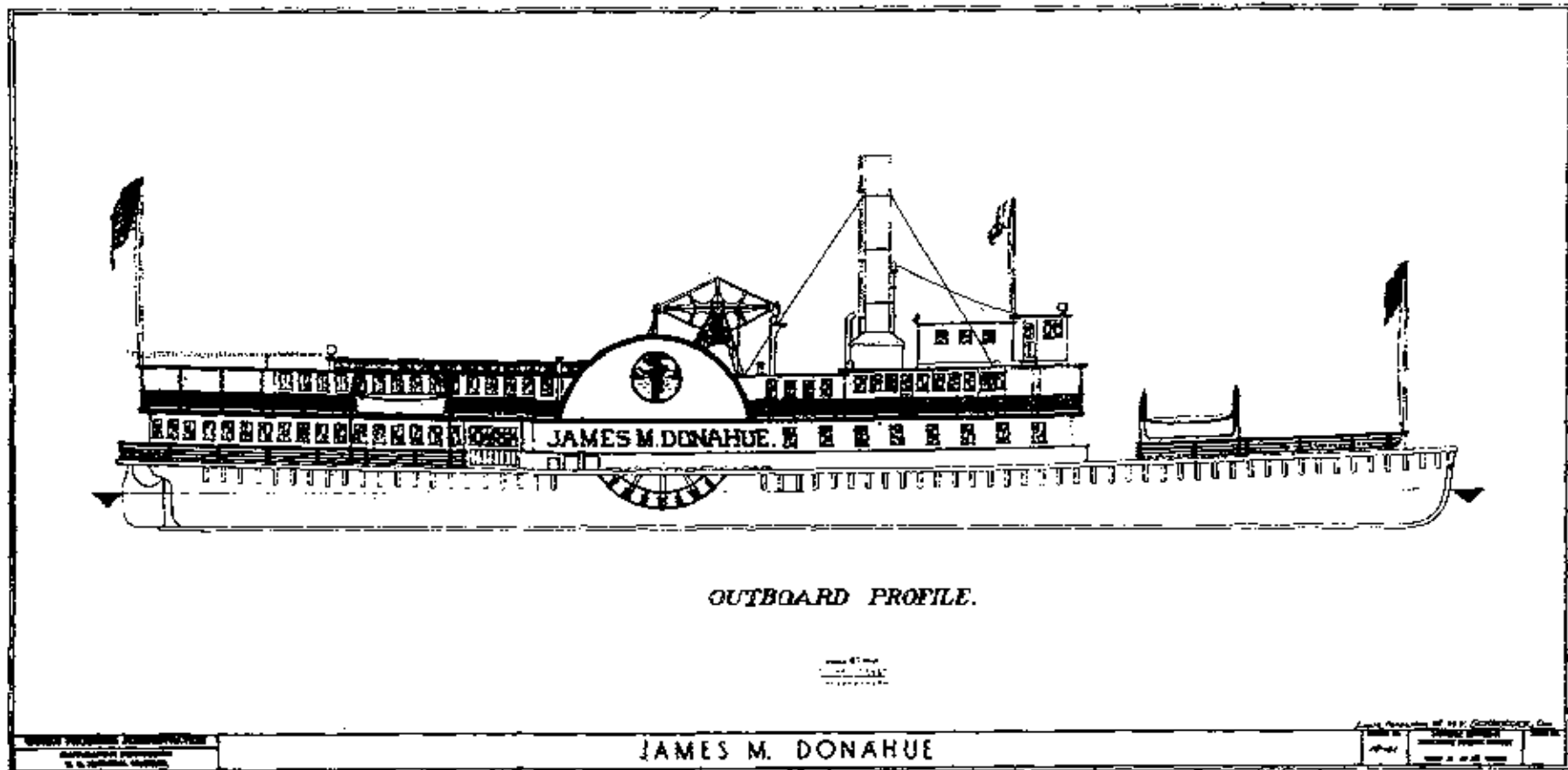

OUTBOARD PROFILE**Fig. 4.7.10**Tug *LOU CHANDLER***Layout**

This profile is a tight fit on the sheet, but the layout is acceptable. A smaller scale for the drawing would have been necessary if the graphic scale had been longer and larger.

Delineation

This is a good example of a drawing made perfectly flat by the use of a single fine line weight. In all other respects the delineation is flawless--no mismatched curves and tangents, no blobby lines, no overrun or unclosed corners. Even closely spaced parallel lines maintain uniform spacing. This drawing creates an impression of razor-sharp precision.

What would improve this sheet? Heavier lines for edges of major features, or the use of shadowed lines. Blackening in windows, portholes, and lamp lenses might also help make the drawing more three-dimensional, if shadowed lines don't do the complete job.

Documentation

As with previous drawings, this sheet gives a user no means to verify or evaluate what he is looking at, either dimensionally or factually. No verbal dimensions are presented. The graphic scale is too small to use reliably for scaling long dimensions, and the user has no clue whether or not the drawing represents the vessel as she was at the time of recording. The presumption is that the drawing is accurate, but all hand-measured and drawn records are a complex combination of measured features, reasonable assumptions, and selective representation, long before such questions as restoring damaged parts, unfair lines, etc., come into play.

Fig. 4.7.10

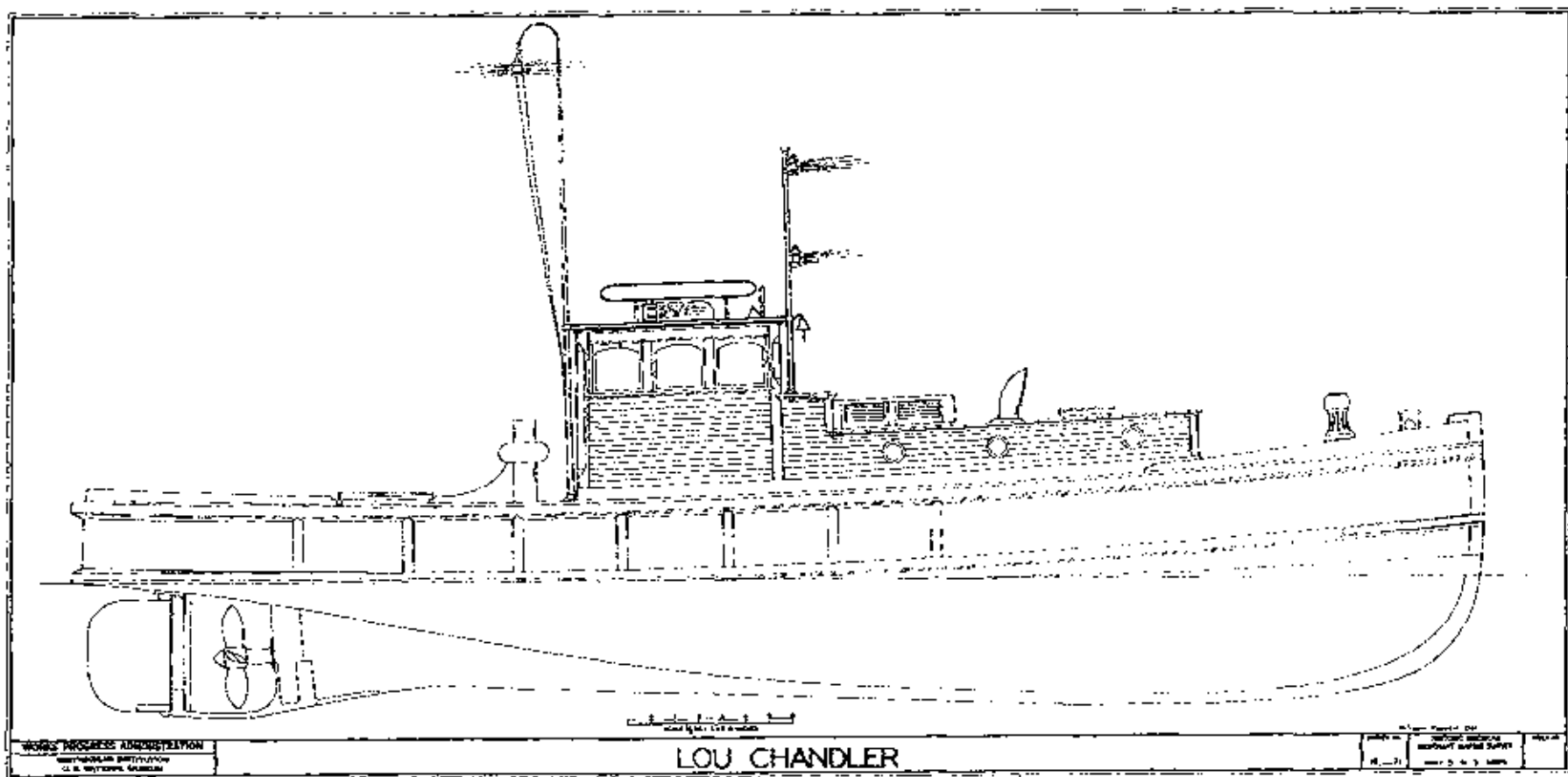

INBOARD PROFILE

Figs. 4.6.11 and 4.6.12

Pilot Schooner *ALABAMA*

Layout

Two sheets were used to accommodate this view in order to present the vessel at a reasonable scale and leave space for documentary notes. The two sheets may be easily spliced together with little loss, repetition, or rearrangement of information.

Note that the view consists of three profiles, one above the other; each presents information partially obscured or missing in the others.

Delineation

Drawing reads well due to use of a variety of line weights and shadowed lines.

Wood graining is limited strictly to sectioned members.

Sizes and weights of lettering permit easy reading. View titles are easy to find, notes and scantlings are organized into columns. Labels are almost never made over linework, and arrows are used to make positive identification of labeled features.

Documentation

This view shows a careful attempt to separate existing and historical conditions, accessible from inaccessible features, and information derived first-hand by the field team from that obtained from other sources. Notes point out modification to transom and lack of original rigging. Inaccessible areas are labeled and no speculation made as to their contents. Information derived from other sources (such as hull below the floating water line) is noted.

There are some ambiguities and confusions in the notes and drawings however. For example, Note A doesn't clarify the species of pine used in the deck; it says other wood species weren't determined (in the field? by research?), thus appearing to contradict scantling note 10 where juniper frames are noted. The wood species and fastener sizes were obtained from the vessel owner, but this is not indicated on these sheets.

Even though the vessel has no masts at present (Note B), it would have been useful to dot-in their approximate location using existing historical photographs and surviving structure aboard the vessel (a note referring user to title sheet for a restored profile might have been useful too).

(continued on p. 4.6.22)

NOTES

- A. No determination was made of the wood species used in construction of the vessel except for the deck (pine)
- B. ALABAMA had no masts or rigging in 1986
- C. The position of the rail stanchions on the starboard side differ slightly from those on the port side (±1 1/2")
- D. Approximately 3 feet was added to the transom (date unknown) while the vessel served in Mobile, Alabama. This area was inaccessible for measurement.
- E. No observations or measurements were made by HAER below the waterline. Data for the lines, keel and rudder were based on work done by Robert C. Douglas in 1987.
- F. The bulges were filled with ballast and were inaccessible for measurement.
- G. ALABAMA'S two engines are Gray Marine Diesel, Model Number 64 FHLS, manufactured by the Detroit Diesel Engine Division, General Motors Corp., Detroit, Michigan

PORT RAIL PROFILE

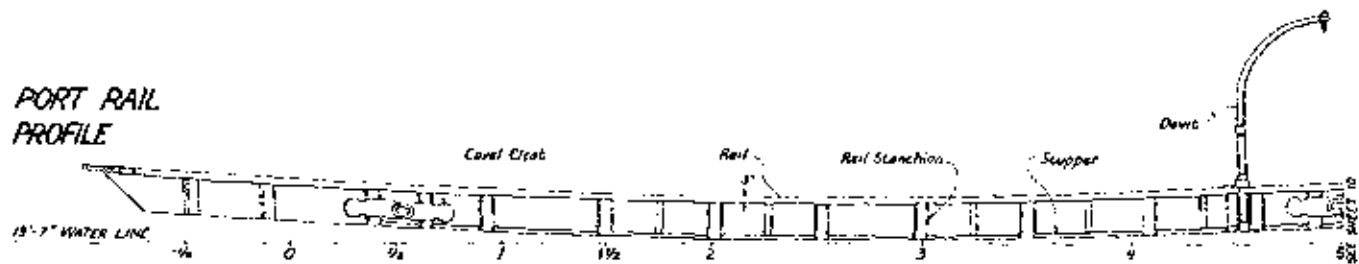

DECKHOUSE PROFILE

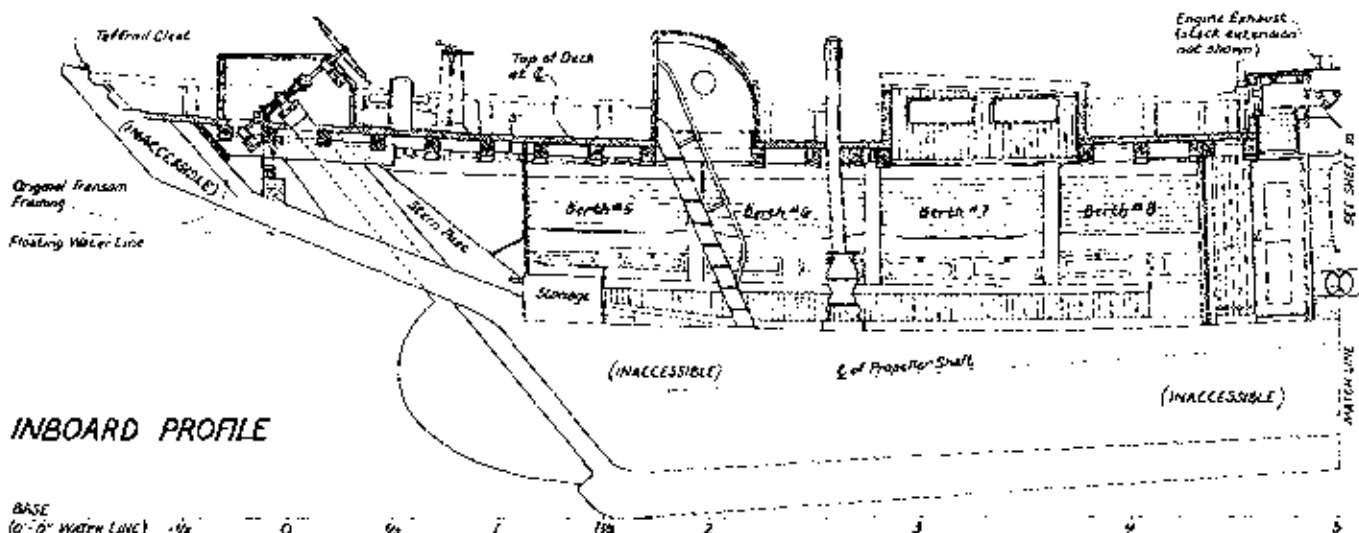
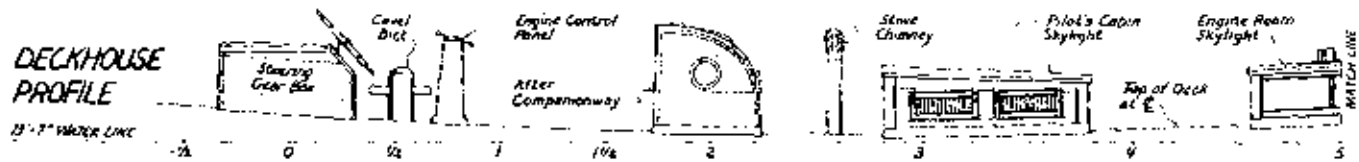

INBOARD PROFILE

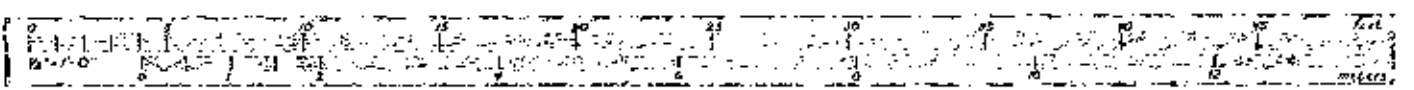

Fig. 4.7.11

Alabama Historical Foundation, 2007
 Project Number: 2007-001
 Project Name: Alabama Historical Foundation
 Project Location: Mobile, Alabama
 Project Dates: 2007-2008
 Project Status: Completed
 Project Manager: [Name]
 Project Engineer: [Name]
 Project Designer: [Name]
 Project Architect: [Name]
 Project Photographer: [Name]
 Project Surveyor: [Name]
 Project Drafter: [Name]
 Project Printer: [Name]
 Project Distributor: [Name]
 Project Copyright: [Name]
 Project License: [Name]
 Project Version: 1.0
 Project Date: 2007-10-15
 Project Sheet: 1 of 1
 Project Title: PORT RAIL PROFILE, DECKHOUSE PROFILE, INBOARD PROFILE
 Project Number: 2007-001
 Project Name: Alabama Historical Foundation
 Project Location: Mobile, Alabama
 Project Dates: 2007-2008
 Project Status: Completed
 Project Manager: [Name]
 Project Engineer: [Name]
 Project Designer: [Name]
 Project Architect: [Name]
 Project Photographer: [Name]
 Project Surveyor: [Name]
 Project Drafter: [Name]
 Project Printer: [Name]
 Project Distributor: [Name]
 Project Copyright: [Name]
 Project License: [Name]
 Project Version: 1.0
 Project Date: 2007-10-15
 Project Sheet: 1 of 1
 Project Title: PORT RAIL PROFILE, DECKHOUSE PROFILE, INBOARD PROFILE

(Figs. 4.7.11 and 4.7.12 continued)

Note C is ambiguous about positioning--is it fore-and-aft or athwartships? Extra space for such clarifications in notes could be had by turning Note G into a label and lettering it near the engine on the second sheet.

Major features and equipment are identified, largely with the general public in mind. Those familiar with ships will know a "boat davit" from an "aft companionway" without being told, but part of HAER's mission is educational as well as documentary.

Rabbit line above keel should be identified so that it isn't confused for the top of the keel in the inboard profile. Do the stations shown above the scale correspond to lines drawings? A user new to this documentation wouldn't know if this were the only drawing he had in hand.

Were the berths numbered by the recording team, or were the numbers

assigned based on evidence aboard the vessel?

Are the engines original or not?

Many notes and clarifications might be had from seeing other sheets in this drawing set. Obviously it is impractical and unnecessary to put every possible note on each sheet, but it might be helpful to indicate that other sheets should or must be seen for other data. Error estimations and overall dimensions appear elsewhere, but aren't indicated on these sheets, for example. It is falsely assumed that the user will obtain or see all the sheets if he sees one, although it is conceivable that the inboard profile could be exhibited or published apart from the other sheets.

Graphic scale runs the full length of the vessel permitting scaling from reproductions and reductions. It also provides a check for distortions which may be introduced in reproductions.

Fig. 4.7.12

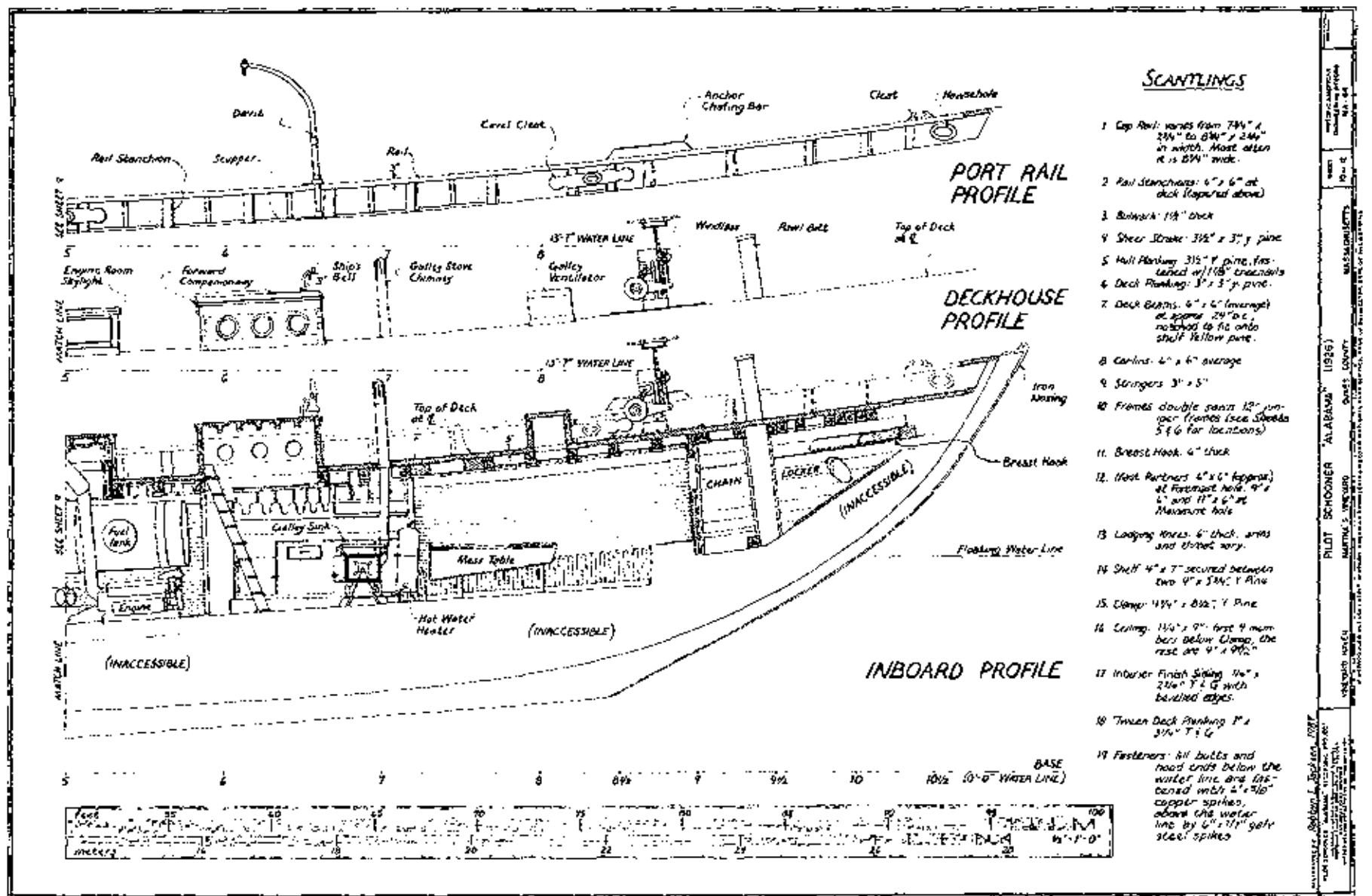

INBOARD PROFILE SECTION

Fig. 4.7.13

Ship *BALCLUTHA***Layout**

Sheet is well organized with distinct zones for drawing, notes, graphic scale and location key.

It might have been more useful to place the graphic scale directly beneath the drawing rather than at the bottom of the sheet.

Delineation

Labels were keyed in most places to avoid obscuring linework with lettering.

The variety of line weights distinguishes major structural elements from details. When choosing line weights, consider whether the drawing will be reproduced at a reduced size and copied as this one was-- fine lines sometimes fade away.

Documentation

The notes list assumptions made by HAER, other sources of information, and methods used to obtain measurements.

The location diagram clearly shows where the drawn portion of the vessel fits into the whole.

References to detail sheets and photographs show where to find more information in the HAER documentation package.

Portions of the drawings based on sources other than field measurement have been noted.

The height of the poop deck above the base of the keel has been given, but not that of the 'tween or main decks.

INBOARD PROFILE

Fig. 4.7.14

Tug *LOU CHANDLER*

Layout

Very good. Lots of room for notes. There is also room for an extended graphic scale beneath the profile.

Delineation

This is a good example of a very finely rendered profile, though the carefully controlled wood graining obscures the joint lines between adjacent members. While attractive, HAER would not ordinarily sanction the time expenditure for such extensive graining during a field project. Cross-sectioned members must be rendered; rendering of longitudinally sectioned members is optional.

The tug's wooden structure reads well, and line weights employed are satisfactory; however, the engine is too weakly delineated. Stronger line weights and section rendering are needed to make it read as boldly as the hull structure.

Documentation

As with the companion outboard profile of this vessel (Fig. 4.7.10) no parameters are given for approaching this drawing. The size of the graphic scale is inadequate for scaling long dimensions from the drawing, and no dimensions are given as a check against misdrawn features or reproduction distortions. The user doesn't even know if it was recorded to the nearest inch or eighth of an inch.

How did the recorder of this vessel get access to construction details of the stem, deadwood, and floor construction? Is it "standard hull construction"? Whose "standard"? Did he measure her while her hull was being replanked, or just make an educated guess? Did he base the engine section on engineering drawings in the vessel owner's possession, or take the engine apart and measure the pieces? Notes anticipating such questions are critical components in a drawing. As it is, we don't know how much is fact or fiction here, short of an exhaustive analysis of original field records.

No spaces or objects are labeled. Unless a user is well acquainted with vessels, he may not even be able to guess where the chain locker or bunk room are, or even what they were called. There is something under the wheelhouse that *could* be a fuel tank, but the user isn't specifically informed. If the manufacturer of the engine were given (along with other pertinent data), a user might be able to do extra research to obtain further details.

Fig. 4.7.14

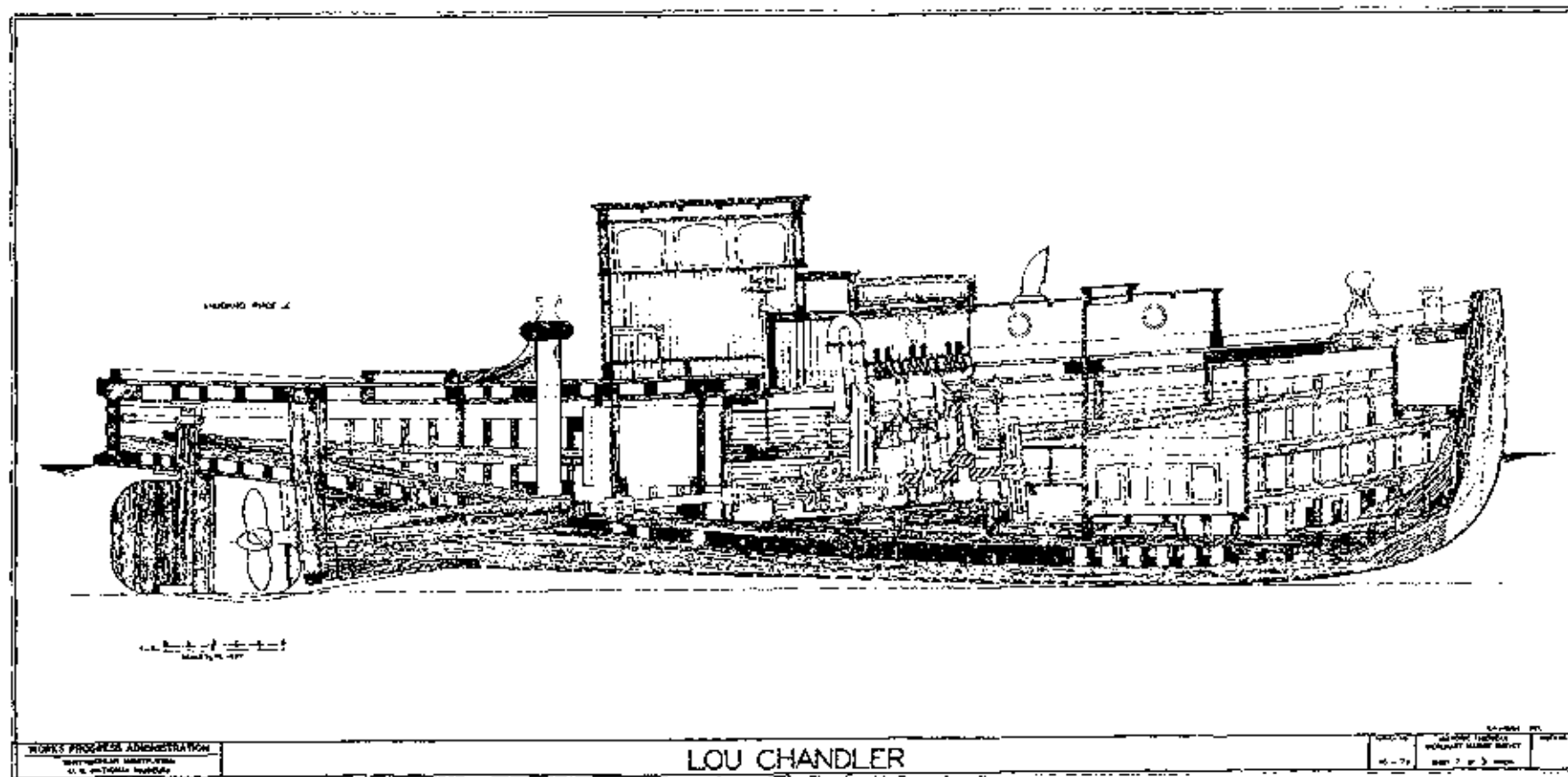

INBOARD PROFILE and PLAN**Fig. 4.7.15**Two Sail Batean (Skipjack) *E.C. COLLIER***Layout**

Conceptually, the layout is practical and interesting with the graphic scale located between the profile and plan. However, the top of the page seems cramped, while empty space lies below the deck plan. The scale should have been redrawn lower down or placed at the sheet bottom.

Delineation

Good use of line weights. Note heavier line weight along lower edges of profiles.

Hand lettering is neat, and labels do not obscure linework.

Arrows indicate location of labeled features.

Documentation

Notes describe conditions under which the vessel was recorded and verify that in fact, deckhouses are not "square" in plan.

Most principal parts and materials are identified. Notes indicate where to look for more detailed information.

Overall length is given, but not extreme breadth.

Main deck planking was omitted for clarity, but a note describes its construction and indicates where to find more information.

The centerboard lift chain or rod is not shown or noted in this drawing. The user doesn't know if it was omitted on purpose, or was missing at time of documentation.

The figurehead, and eagle, is not mentioned.

INBOARD PROFILE

Fig. 4.7.16

Schooner *NEWARK*Layout

Acceptable.

Delineation

A single strong line weight is used, which relieves the flatness slightly, but heavier lines would have helped this drawing read. Lighter lines would have been appropriate for small details such as door panels.

Rendering of sectioned wooden members, surface of engine flywheel, and water is nicely done and unobtrusive.

Documentation

Aside from problems of verification, this drawing is overwhelmingly simplistic. Without knowing why the drawing is simplistic, one cannot say if it is good or bad documentation in that respect. It may be that the vessel was deemed significant enough to record, but interior details were left to a photographer to cover--but the user isn't told this. If photographs were a perfectly legitimate way to handle the details on this vessel, they should be referenced on the drawing.

A single overall dimension is given for the vessel, which is helpful (and required by HAER), but the graphic scale's length is inadequate.

Principal spaces and a few features are labeled (as they should be), but no manufacturer is given for the engine. Notation as to the engine's horsepower and number of cylinders is useful, but not sufficient for HAER's purposes.

The historical note "fish reduction plant removed in 1916" in the lower left corner is the sort of thing HAER requires in drawings, but the note doesn't go far enough. Where was it on board the vessel? Did the delineator know when it was put in? How many tons of fish could it handle in an hour? What sort of fish? This sort of note isn't meant to replace a detailed description in a historical report or rival it in length, but further information, presented succinctly, is needed.

Fig. 4.7.16

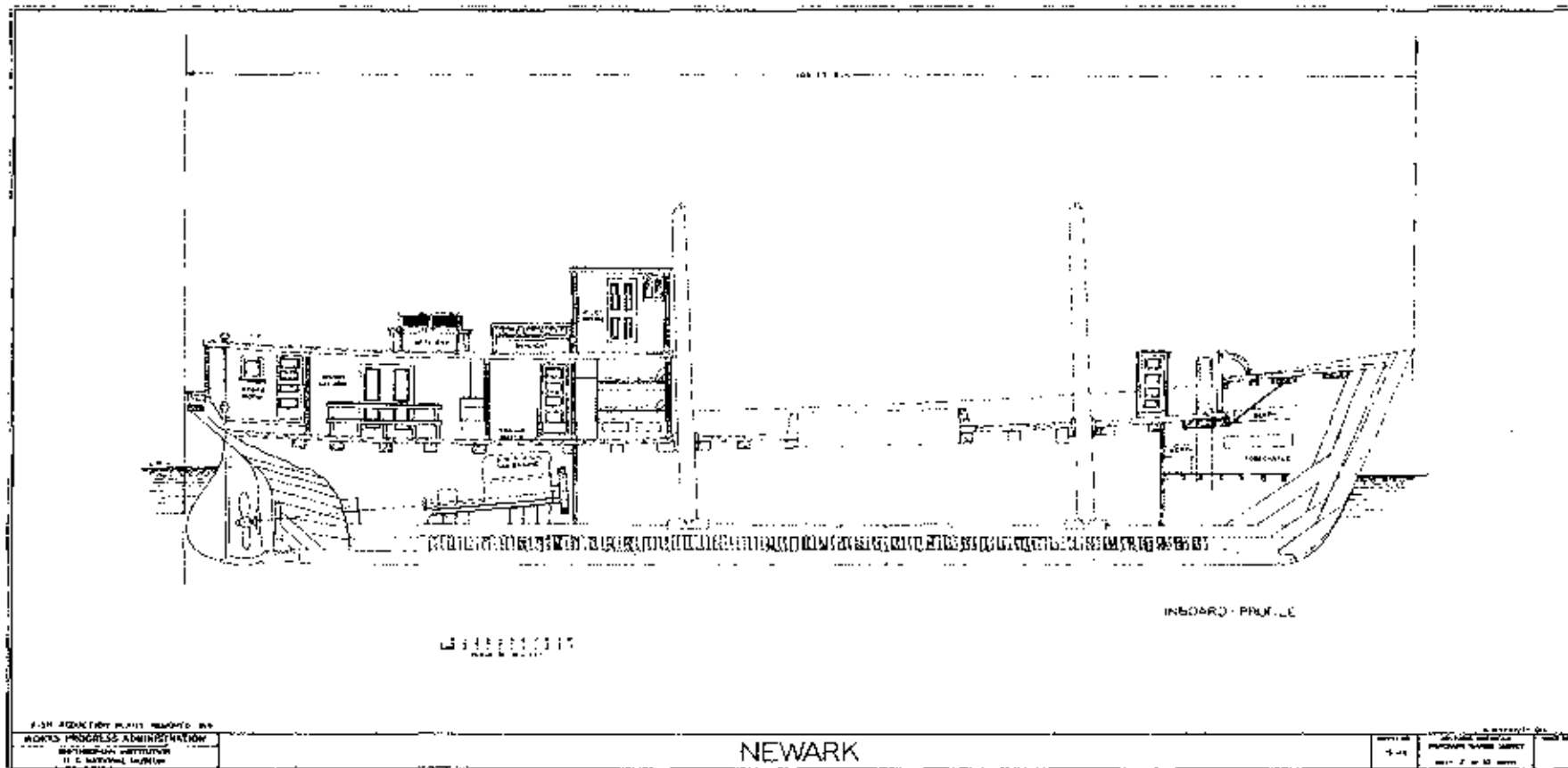

INBOARD PROFILE**Fig. 4.7.17**Steam Schooner *EDNA CHRISTENSON***Delineation**

A single line weight seems to have been used, leaving major features (such as boiler, engine, stack) underemphasized.

Rendering of sectioned wooden members appears haphazard. Some longitudinally sectioned members are rendered (deadwood, horn timber) but not others (keel and keelsons, decks, etc.). The scale of the herringbone wood pattern on the deck stanchions is too large for the purpose (relative to drawing features) and ends up being distracting.

Title for the view is prominent and legible, but should be bolder.

Documentation

This sheet has verification problems like those of previous HAMMS drawings in accuracy and reporting what the drawing shows and is based on. For example, no evidence or explanation is offered as to how inaccessible details were arrived at (deadwood in forefoot and stern).

Major spaces are labeled, but equipment is ignored. Notes should record the engine's manufacturer and year of construction, serial number, cylinder sizes, operating pressure, and rpm, etc. Likewise, the boiler's manufacturer, type, and construction year should be noted, along with operating pressure, fuel, heating surface area, and so forth. Similar information is needed for the donkey boiler, and steam-powered anchor winch and cargo winch engines.

With few exceptions, the delineator seems to have chosen to show nothing behind or before the strict centerline plane of the vessel. Lack of background (sides of compartments, hull ceiling, etc.) may be a good idea if its inclusion makes a confusing view, or if it is covered by other means (photography, other drawings) or structural data is recorded in sections. It can also save drawing time. However, the result is a simplistic view that can fail to capture the look of a vessel's internal appearance.

No overall dimensions are given. The graphic scale does not permit reliable scaling of long dimensions. No error tolerances for field work or drafting are given.

Fig. 4.7.17

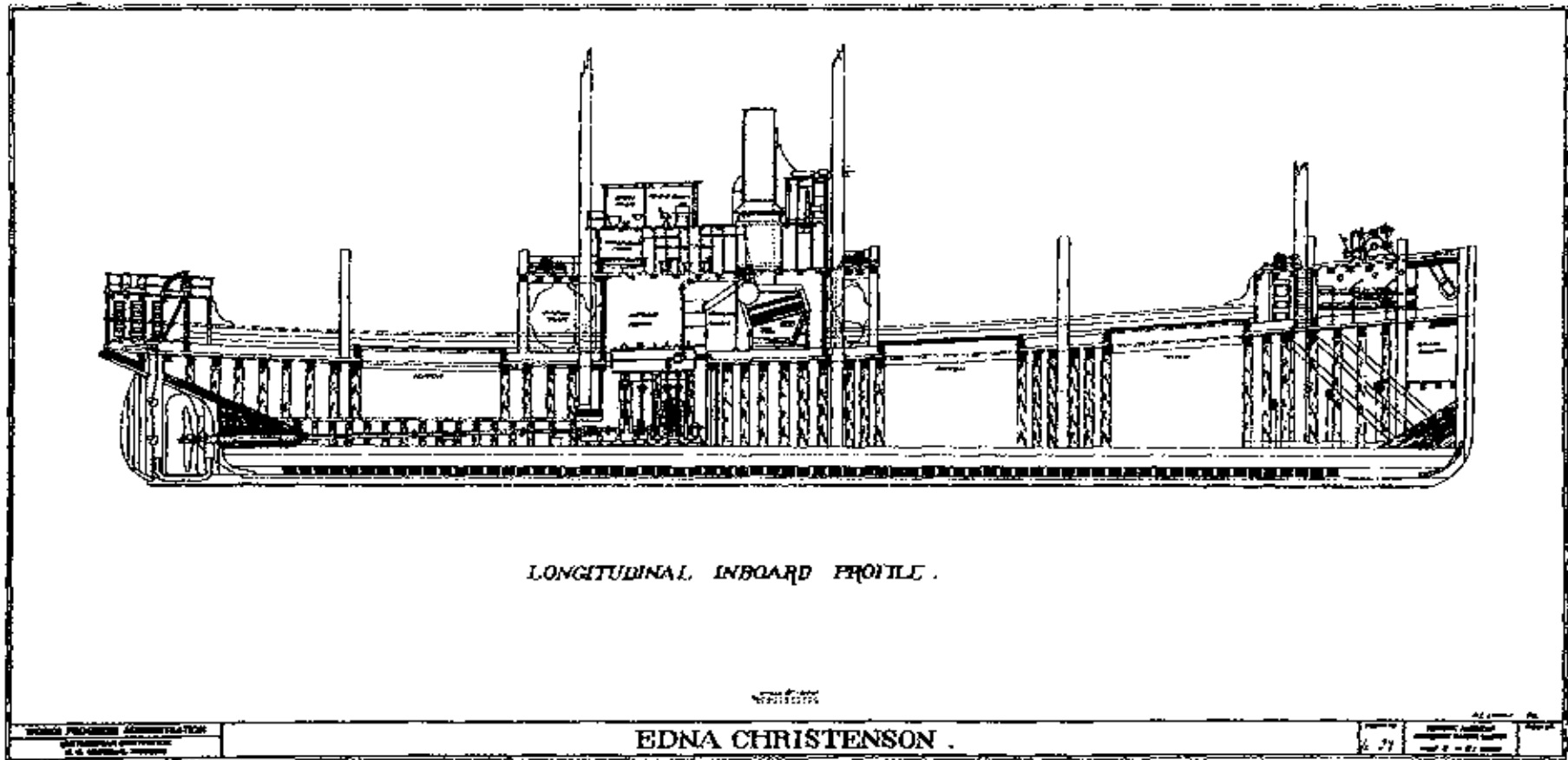

DECK BEAM PLAN

Fig. 4.7.18

Schooner *NEWARK*Delineation

Use of a light line weight is offset by extensive wood graining of structure. However, the overall impression is one of great delicacy.

Wood graining technique used in this drawing is less obtrusive and distracting than the herringbone pattern used on previous examples, but it takes a considerable amount of time to execute.

Documentation

The user is not verbally informed about what is or isn't being shown in the drawing. The presumption is that all parts were measured and located correctly, but the user has no way of verifying this. He does not know which if any parts of the drawing are inferred from other evidence, based on other records, or simply inserted because the delineator feels they must be there.

Although the wood graining is finely executed in this drawing, there is an element in it which is more than simply pictorial. The lodging knees show a curved grain typical of grown knees, i.e., knees cut from tree roots or other parts of trees whose curved grain was ideal for the strongest knees.

One overall dimension is given, but its witness lines did not reproduce, so it cannot be used to scale the drawing. The graphic scale is too small for accurate scaling or checking for distortion in reductions and reproductions.

This drawing is ideal for labeling parts, giving scantlings, and making material notes, but no use was made of the opportunity.

Fig. 4.7.18

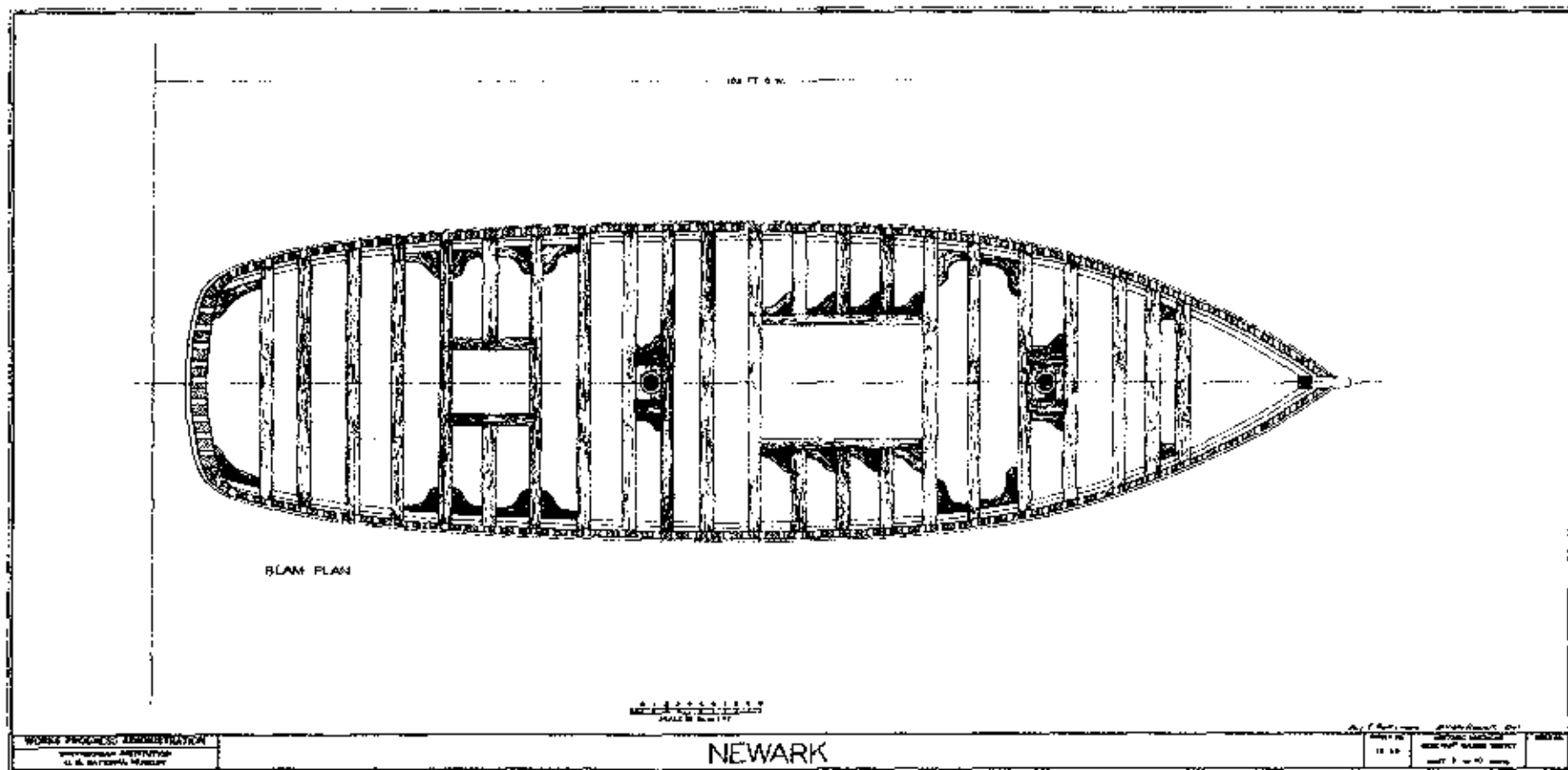

DECK PLAN

Figs. 4.7.19 and 4.7.20

Pilot Schooner *ALABAMA*Layout

Two sheets were used to present the vessel at a reasonable scale and leave space for documentary notes. The sheets may be easily spliced together with little loss, repetition, or rearrangement of information.

Symmetry is used to show a half-deck plan and a half construction (or beam) plan.

A number key system is used in conjunction with labels to keep labels to a minimum in the area of linework.

Delineation

Drawing reads due to use of a variety of line weights and shadowed lines.

Wood graining of sectioned frames and rail stanchions is avoided by using a simple graphic code to distinguish the frames from the stanchions.

Sizes and weights of lettering permit easy reading. View titles are easy to find, notes and scantlings are organized into columns. Labels are almost never made over linework, and arrows are used to make positive identification of labeled features.

A special template drilled with a series of small holes corresponding to the plank edges was pulled along a spline to draw the sprung deck.

Documentation

This view shows a careful attempt to separate existing and historical conditions, accessible from inaccessible features, and information derived first-hand by the field team from that obtained from other sources. Notes point out modification to transom and areas where locations of frames were inferred, not field checked.

Parts are copiously labeled, and the long graphic scale permits its use for scaling parts of the drawing and making accurate reproductions.

No indication is made of field or drafting tolerances, or where they may be found for this drawing set.

NOTES

A. The locations of the frames were estimated by eye from their positions between the deck beams. Accuracy $\pm 1/2"$

B. The positions of the rail stanchions on the starboard side differ from those on the port side by $1 1/2"$ (fore and aft).

C. ALABAMA's structure was inaccessible aft of the sternpost. The locations of the ends of the clamps and shelves were not determined, but the drawings reflect the assumption that they are just forward of the original transom.

D. Approximately 3 feet was added to the transom (date unknown) while the vessel served in Mobile, Alabama. The interior construction of this addition was inaccessible for measurement.

E. The location of frames aft of Station 1/2 were not determined in the field.

(Continued on Sheet 4)

- FRAME (SEE NOTE A)
- ▭ RAIL STANCHION (SEE NOTE B)

- | | | |
|--|----------------------------|--------------------------|
| 1. Original Transom Framing (See note C) | 7. Steering Gear Box | 12. King Plank |
| 2. Covei Bolt | 8. Engine Control Panel | 13. Engine Room Skylight |
| 3. Lodging Knee | 9. Aft Companionway | 14. Engine Exhaust |
| 4. Aftst. Rafter | 10. Scave Chimney | 15. Taffrail Cleat |
| 5. Stern Post | 11. Pilot's Cabin Skylight | 16. Transom Ventilator |
| 6. Stringer | | |

CONSTRUCTION PLAN

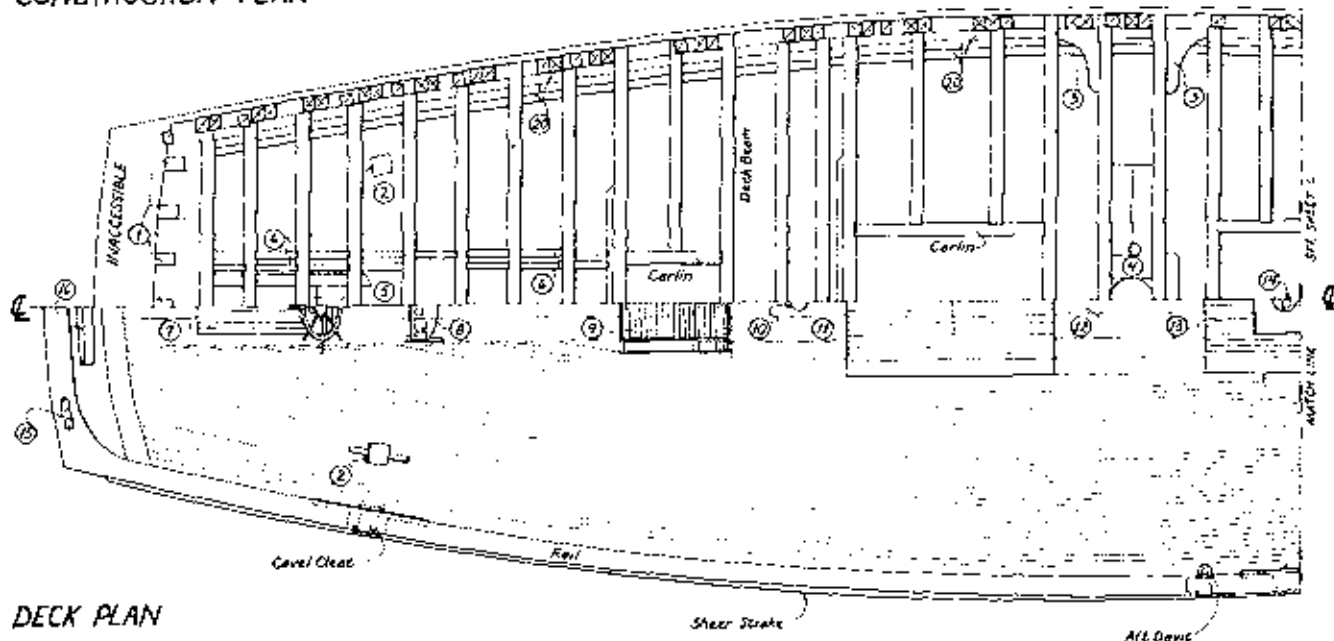

DECK PLAN

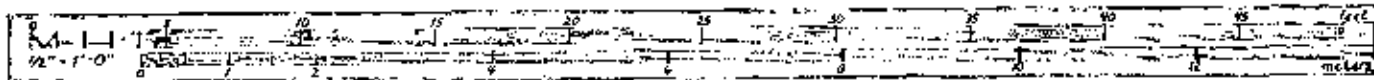
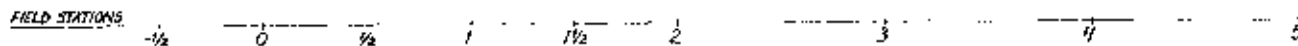

FIG. 4.7.19

PROJECT: ALABAMA
 DRAWING NO.: 4.7.19
 SHEET NO.: 1 OF 2
 DATE: 1968
 DRAWN BY: J. L. MOORE
 CHECKED BY: J. L. MOORE
 PROJECT: PILOT SCHOONER "ALABAMA" 1928
 LOCATION: MOBILE, ALABAMA
 DRAWING NO.: 4.7.19
 SHEET NO.: 1 OF 2
 DATE: 1968
 DRAWN BY: J. L. MOORE
 CHECKED BY: J. L. MOORE

DECK PLAN

Fig. 4.7.20

Pilot Schooner *ALABAMA*

(see p. 4.7.36 for comments)

Fig. 4.7.20

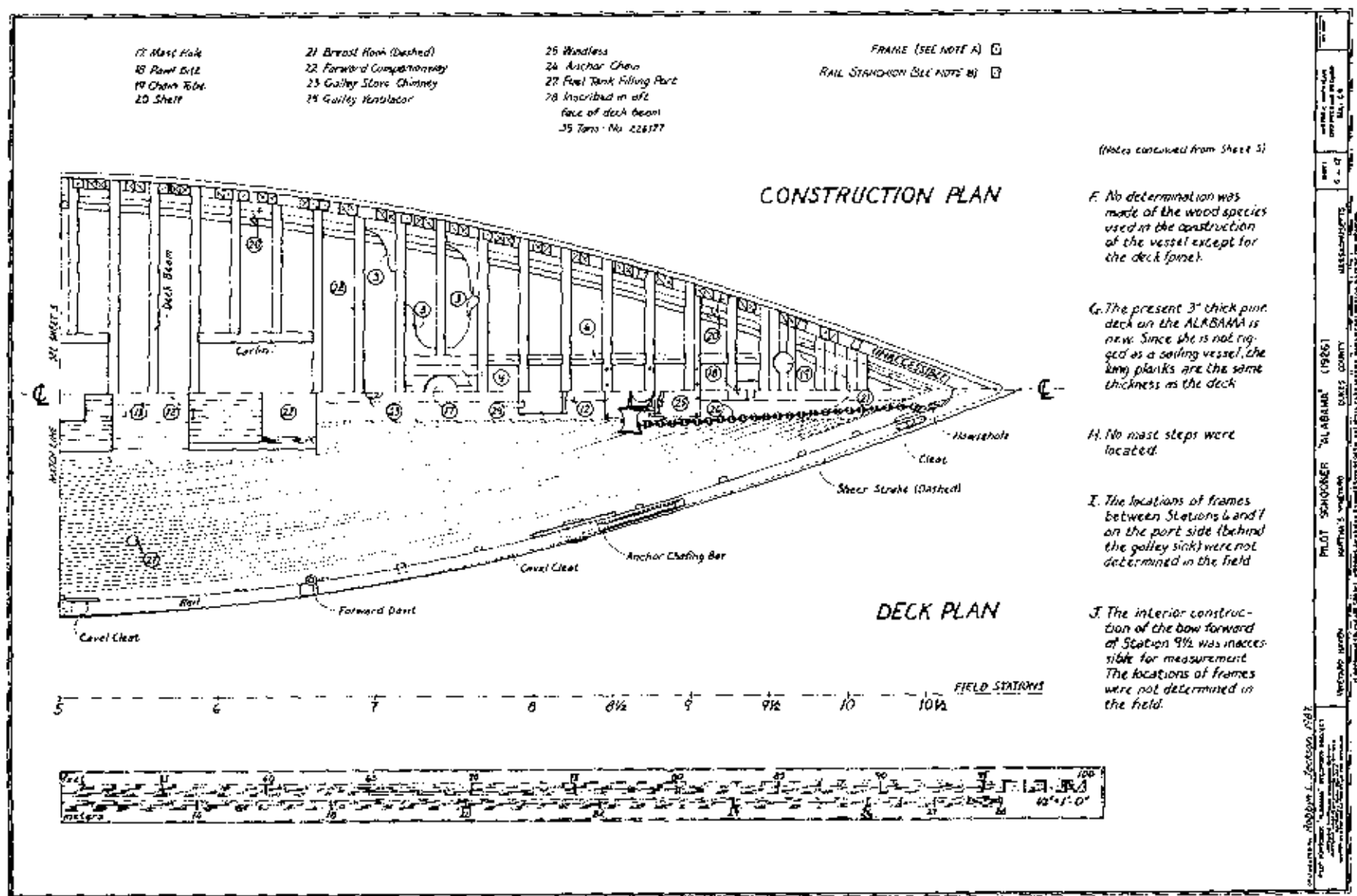

(Notes continued from Sheet 5)

F. No determination was made of the wood species used in the construction of the vessel except for the deck frame.

G. The present 3" thick pine deck on the ALABAMA is new. Since she is not rigged as a sailing vessel, the long planks are the same thickness as the deck.

H. No mast steps were located.

I. The locations of frames between Stations 6 and 7 on the port side (behind the galley sink) were not determined in the field.

J. The interior construction of the bow forward of Station 9 1/2 was inaccessible for measurement. The locations of frames were not determined in the field.

ALABAMA
 PILOT: SCAGNER, ALABAMA (1926)
 COUNTY: GIBBS COUNTY
 STATE: ALABAMA
 DATE: 1926
 DRAWN BY: [illegible]
 SCALE: 1" = 10'

DECK PLANS

Fig. 4.7.21

Steam Schooner *WILLAPA*Layout

Plans are crowded, and there is no room for an adequate graphic scale.

Labels for views are large and clear.

Delineation

Thin partitions and walls would have been rendered better by blackening them in instead of using wood graining. Materials could be simply labeled.

Documentation

Unlike so many of the HAMMS drawings discussed so far, this drawing is loaded with dimensions, too many for HAER's purposes. HAER requires dimension strings and arrows for principal overall dimensions primarily, not for repetitive or small elements. If scaling the spacing of windows and doors from a measured drawing is not sufficient for a user, HAER would ordinarily suggest he see the field notes for further data. The amount of dimensioning shown here would only be done in cases of extreme significance or if the drawings were to be put to an immediate, known use in restoration or replication.

Fig. 4.7.21

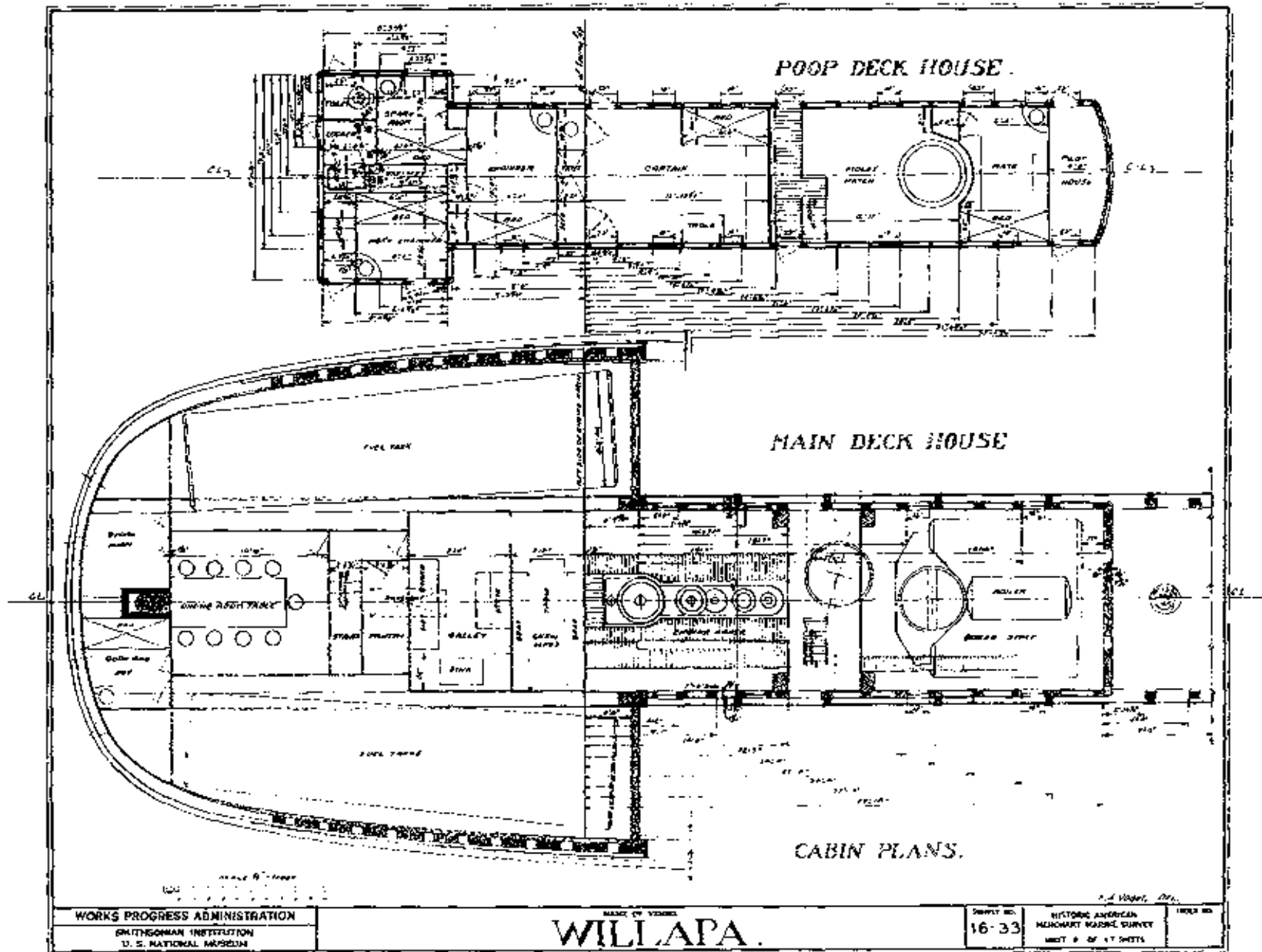

DECK PLANS

Fig. 4.7.22

Schooner *NEWARK*Delineation

Drawing appears to have been done with a single line weight. Use of shadow lines or a variety of line weights would relieve some of the stark flatness.

Documentation

This drawing is one of the few in HAMMS to record an industrial process and its components aboard a vessel. Most of the fish reduction equipment is shown, but no interconnecting piping or structure. The plan verges on the schematic. This may be a legitimate approach if the missing information is supplied by photographs and/or written accounts and diagrams. As it is, the drawing gives no clue how this reduction plant operated, and no other records or project materials are cited for further reference. HAER would not accept such a schematic plan without extensive photography and written description. A schematic plan should be copiously annotated, and probably should include a schematic flow diagram explaining the fish reduction process.

Equipment is only partially documented verbally. All the user will learn about the boiler (other than where it is) is that it contains 727 square feet of heating area. Who made it? Does it have a return flue? What operating pressure did it have? Continuing on, what is the "driver"? There is an unlabeled piece of equipment next to the "driver" that looks suspiciously like a stationary steam engine, but the user is not told what it is. How much fish oil could this plant turn out per day on average? What were the capacities of the various tanks? These are only a few questions that this drawing should answer.

Fig. 4.7.22

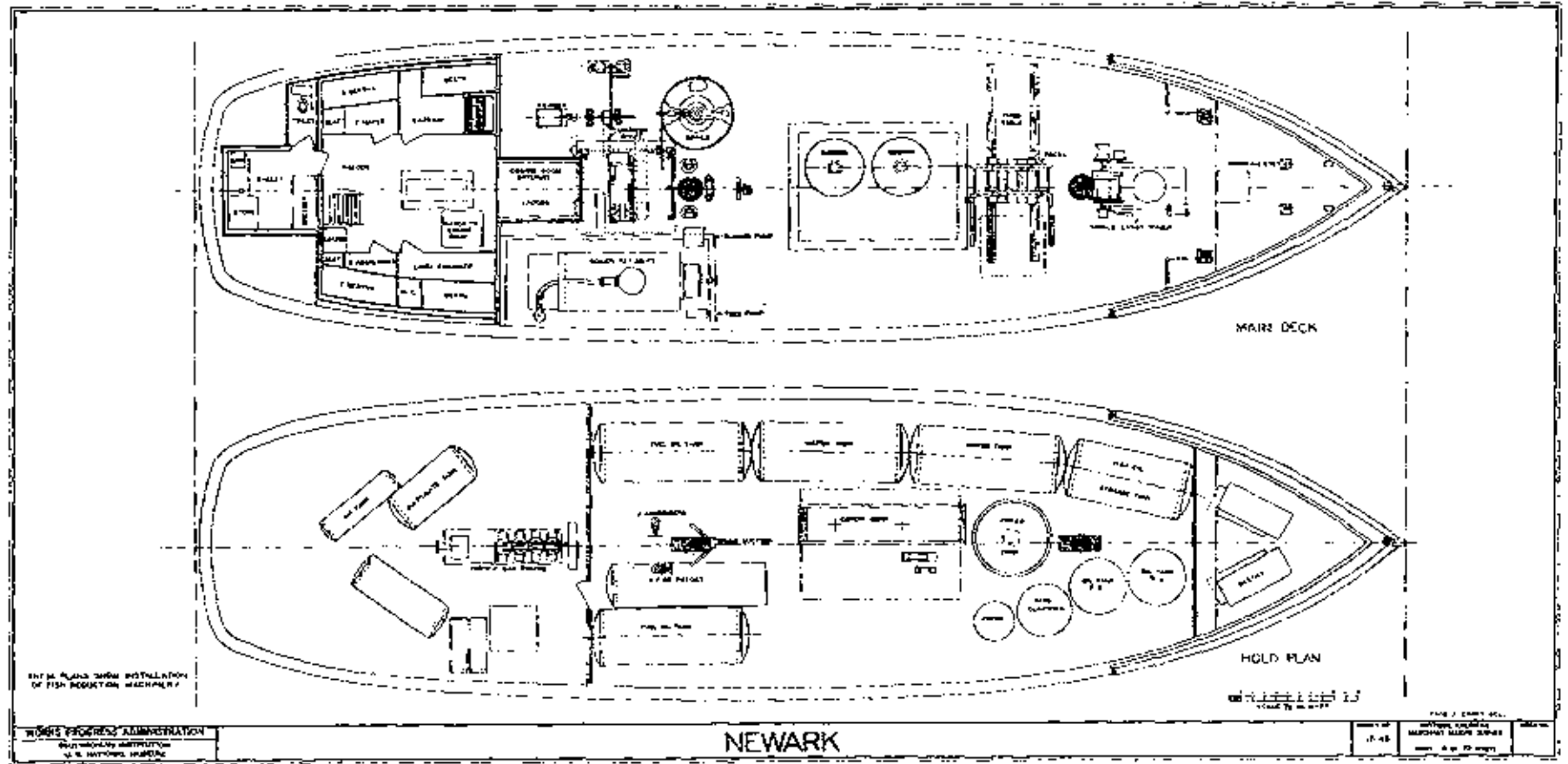

DECK PLAN and MIDSHIP SECTION

Fig. 4.7.23

Schooner *WILLIAM BISBEE*Layout

Two disparate views are juxtaposed, probably to save drawing materials. Not recommended as a rule.

Delineation

The midship section reads far more boldly than the schematic deck plan, but both views could be helped significantly by the use of shadowed lines or heavier lines on principal features.

Labels and other lettering have little graphic impact and are hard to read due to their small size and light lines.

Documentation

The midship section is generously annotated with dimensions. HAER would probably have used dimension strings only for the extreme breadth, depth of hold, and height from keel bottom to cap rail. Timbers such as the clamp would have been labeled as 13" x 14" CLAMP or listed as scantlings. (Dimension strings drawn by the deck stanchion and keelsons are too close and can be confused with structure.) Notes on wood species would have been good here as well.

It is hard to imagine HAER producing or accepting a deck plan as schematic as this one except for a low-budget project on a vessel of marginal Level I or Level II significance whose deck features were extensively photographed. It might be produced to show an early historical plan for a vessel which has since been extensively modified, and whose present deck plan is receiving much more detailed treatment in measured drawings. It might be produced from a series of historical photographs of a once-intact ship combined with measurements from its deteriorated hulk to show basic historical features with their approximate locations and dimensions. All such approaches would need extensive verbal annotation so that a user knows what he is looking at and why it is presented the way it is. Schematics can be better delineated by using contrasting line weights, outlining, and shadowed lines.

Fig. 4.7.23

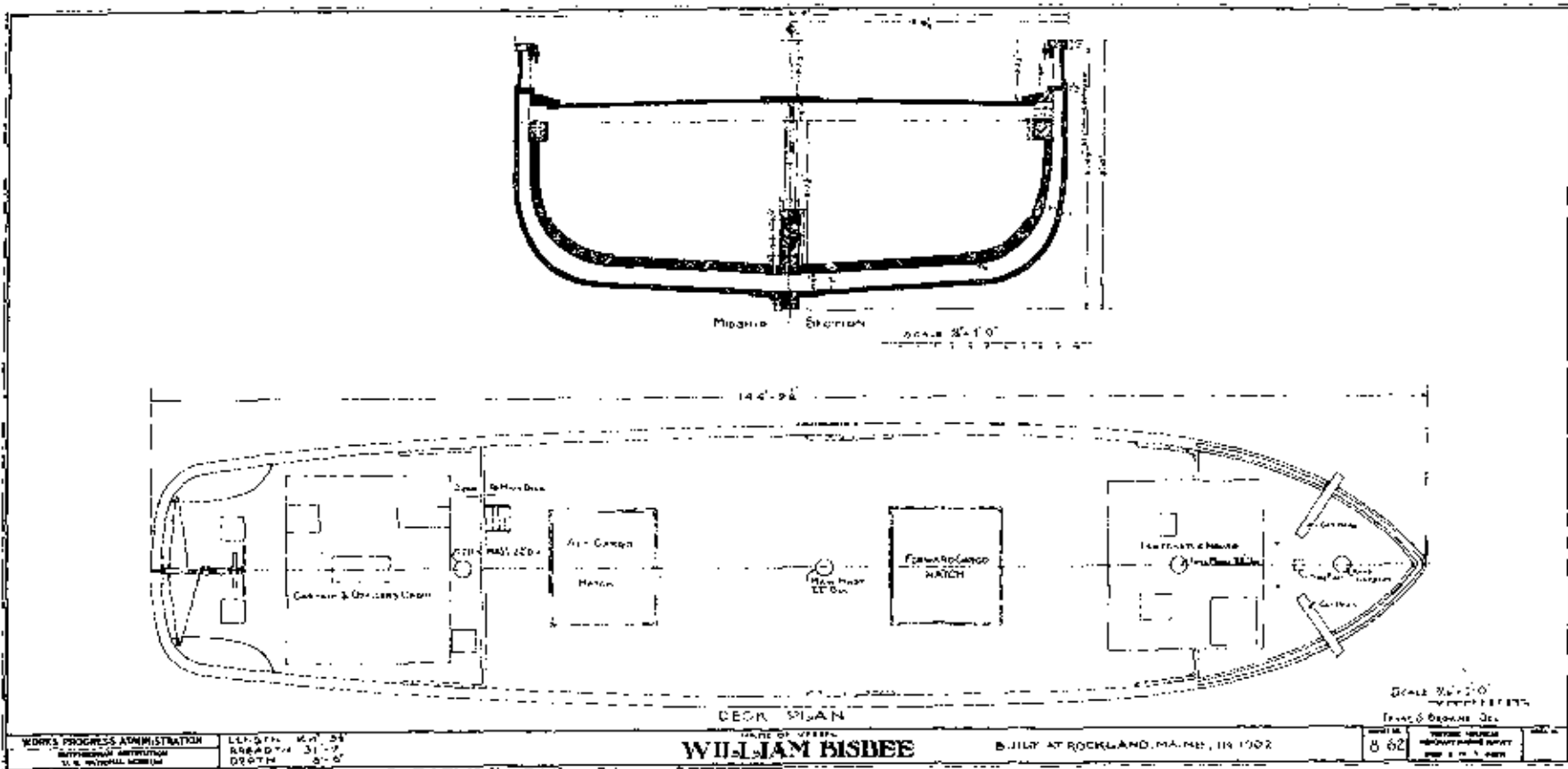

DECK PLANS

Fig. 4.7.24

Schooner *KOHALA*Delineation

The extreme amount of effort in rendering wood grain in this drawing would never be required by HAER. There are other ways to indicate materials (labels, notes, scantlings) that take much less time to execute. Rendering should be used to clarify construction. In many places here, it defeats this purpose by obscuring details, joints, and other linework. It would be difficult to scale many members from this drawing, even if an adequate graphic scale were available.

Documentation

It appears that the delineator may have been trying to indicate different species of wood (white oak, yellow pine, Douglas fir?) by different graining patterns. Since nothing is labeled, however, a user is not sure what woods are indicated, or whether the variations serve only pictorial purposes.

As is the case with many previous drawings, this one does not tell the user if he is looking at an "as is" representation of the vessel, or a partial reconstruction of some kind. Nor does it permit accurate scaling or dimensional verification, since the graphic scale is too small and no overall dimensions are given.



DECK PLAN

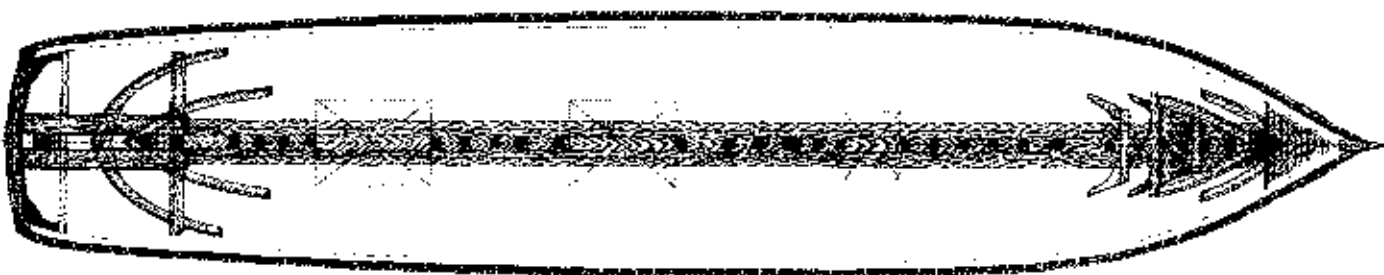

HOLD PLAN

WATERLOO
1911-1912

KOHALA

WATERLOO, ONT.

WORLD'S PROGRESS ADMINISTRATION
NATIONAL LIBRARY
U. S. NATIONAL MUSEUM

FIG. 37
PLATE 10
MAY 1912

FIG. 4.7.24

MIDSHIP SECTION

Fig. 4.7.25

Bark *EMILY F. WHITNEY*Layout

Image is upside down on sheet.

This image fills the sheet well, but is too tight against top border. It would be acceptable to HAER to erase a short segment of border at the companionway door to relieve the pinch.

Delineation

A single line weight appears to have been used to execute the drawing. The bulkhead and cabin sides are noticeably flatter than those parts which have been rendered, however, sectioned members should receive a heavy outline *in addition* to any rendering in order to emphasize their cross-section. As rendered here, there is potential confusion over which members are sectioned and which aren't--are the deck beams and frames sectioned as well as the planking?

Lettering is a bit too small and too light.

Documentation

Notice the good job of sizing and labeling all structural members; no wood species are given, however.

The graphic scale should be the width of the image, and some overall dimensions given (extreme breadth, depth of hold).

The user is not told whether this section is an "as is" or original structural representation.

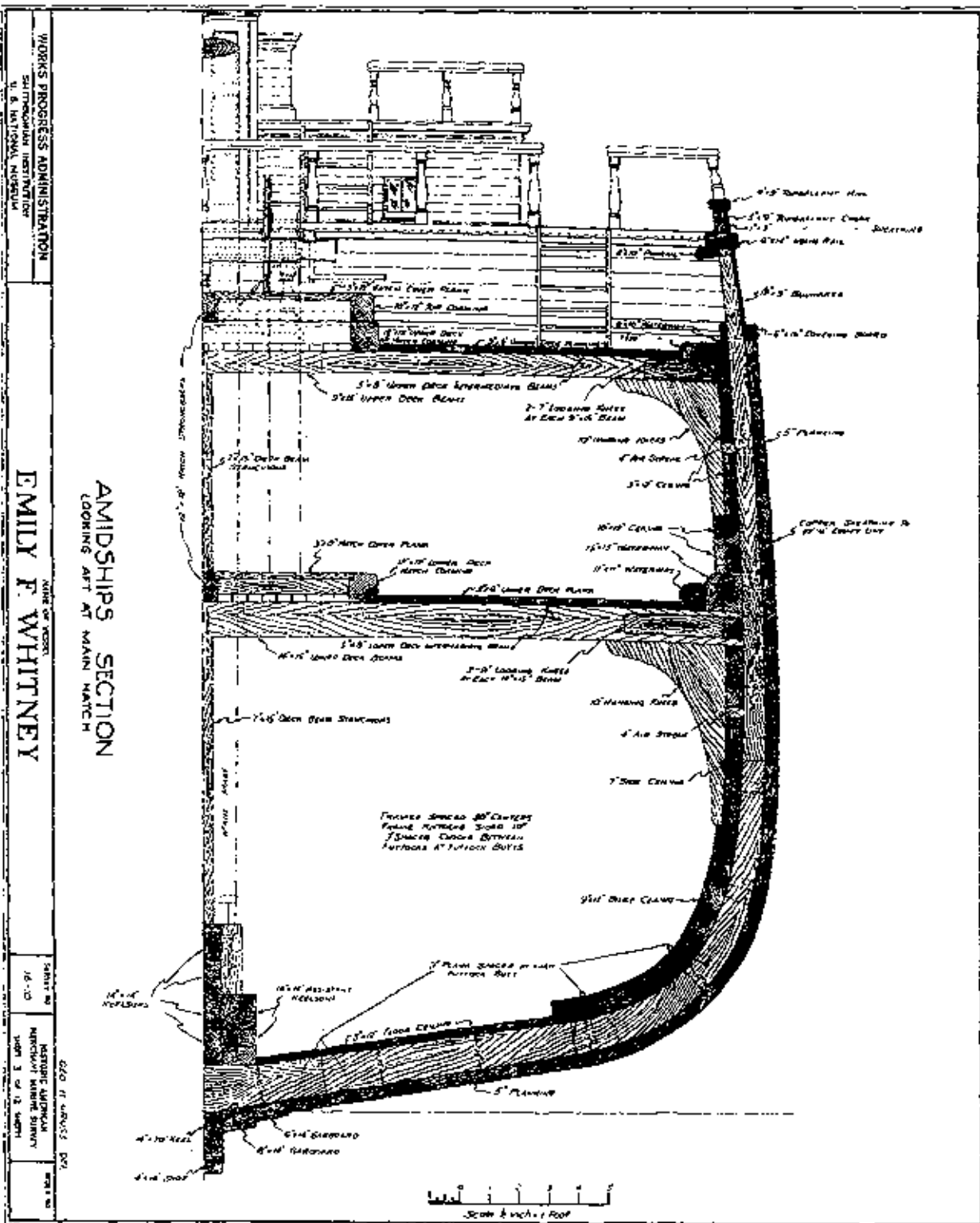

Fig. 4.7.25

MIDSHIP SECTION**Fig. 4.7.26**Ship *BALCLUTHA***Layout**

This sheet tries to do too much. Because there was not enough room for all of the notes to appear at the side of the drawing, they have been spread out over the sheet in a way that detracts from the overall appearance and legibility. Perhaps this information should have been spread out over two sheets, or a smaller scale used for the midship section.

The positioning of the midship section, labels and graphic scale is good.

Delineation

Good use of line weights and poché.

The large lettering used for the view title clearly identifies this drawing.

There is some confusion with dashed lines: sometimes they are used to denote a hidden feature, sometimes to denote modern additions.

The labels do not obscure the linework and arrows positively identify labeled features.

Documentation

Notes indicate that this drawing was based on an original drawing, and the location of the original is given.

Notes clearly identify features that aren't original.

Where possible, labels with scantlings are located near the feature, although those at the top of the sheet seem a little out of place.

The maximum beam is given, but no dimensions are supplied for deck heights and depth of hold.

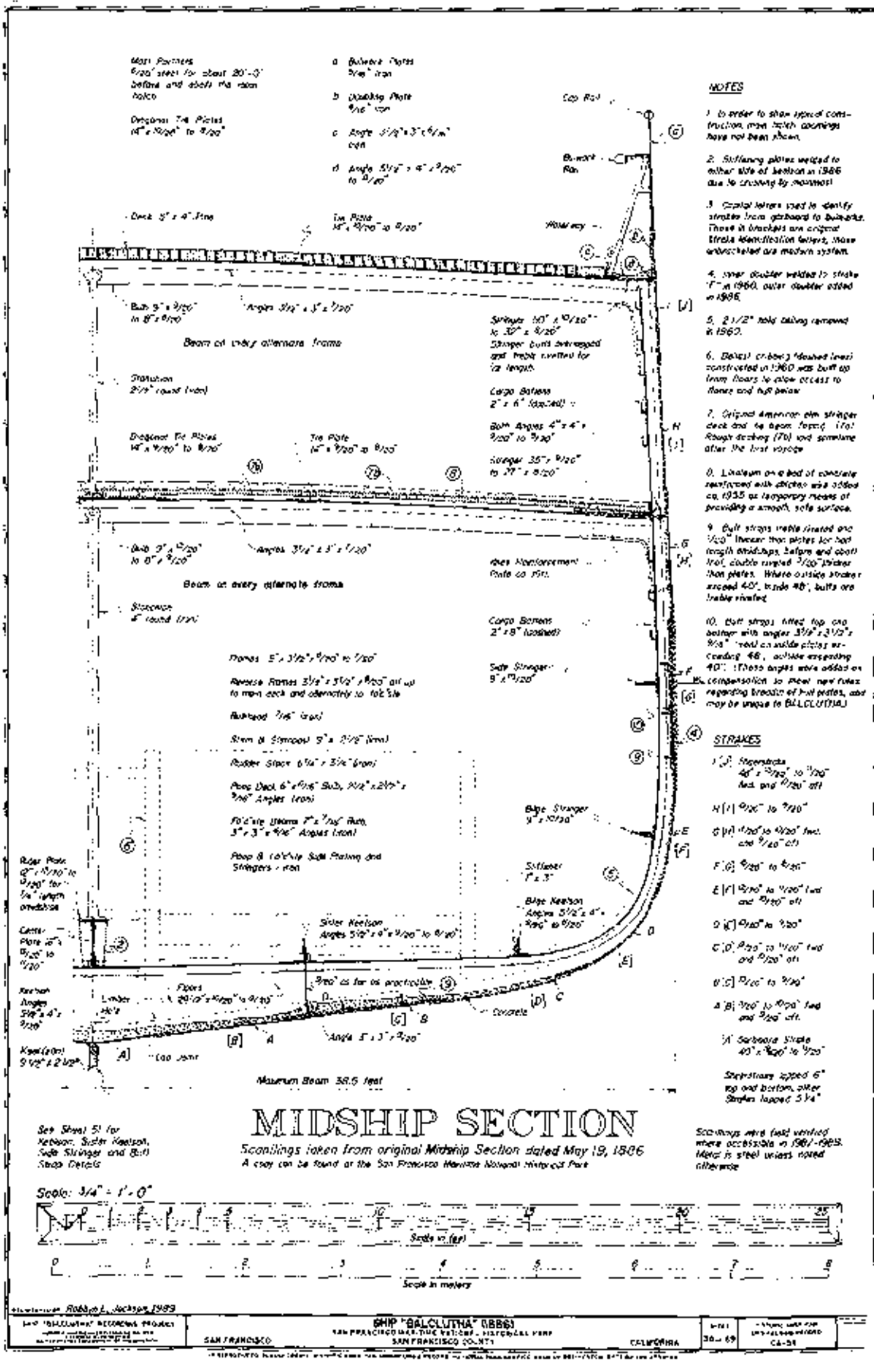

Fig. 4.7.26

SECTIONS

Fig. 4.7.27

Motor Vessel *ROLFE*Delineation

Very cleanly and precisely delineated, but a trifle light. Only sectioned members are rendered, and the rendering job is just right, not so overdone that joints and details are obscured.

Documentation

This section is commendable because it shows the drifts that hold the vessel together, but where did the delineator get his information? Is it accurate or does it show just what should be there?

Scantlings should have been given, either by labeling and sizing individual parts, or by making up a table.

The joint symbols along the buttock joints should be defined, lest it be confused for a fastener of some kind.

Fig. 4.7.28

Auxiliary Schooner *KATHERINE*Delineation

Delineation is excellent for a steel vessel, where structural members have much smaller sections than those for wooden vessels. Note that sectioned members are simply blackened in, not hatched.

Rivets are omitted for clarity.

Documentation

Scantlings should have been given, either by labeling and sizing individual parts, or by making up a table.

Rivets are omitted for clarity, but this is not stated. Could someone confuse it, however briefly, for welded construction? Where should the user go in the drawing set if he wants details of rivet patterns?

Rotated sections might have been shown (as well as labeled and sized) for built-up frames, deck beams and stanchions.

Dimensional and structural verification needed (longer graphic scale, principal dimensions, condition of vessel, sources of information, etc.).

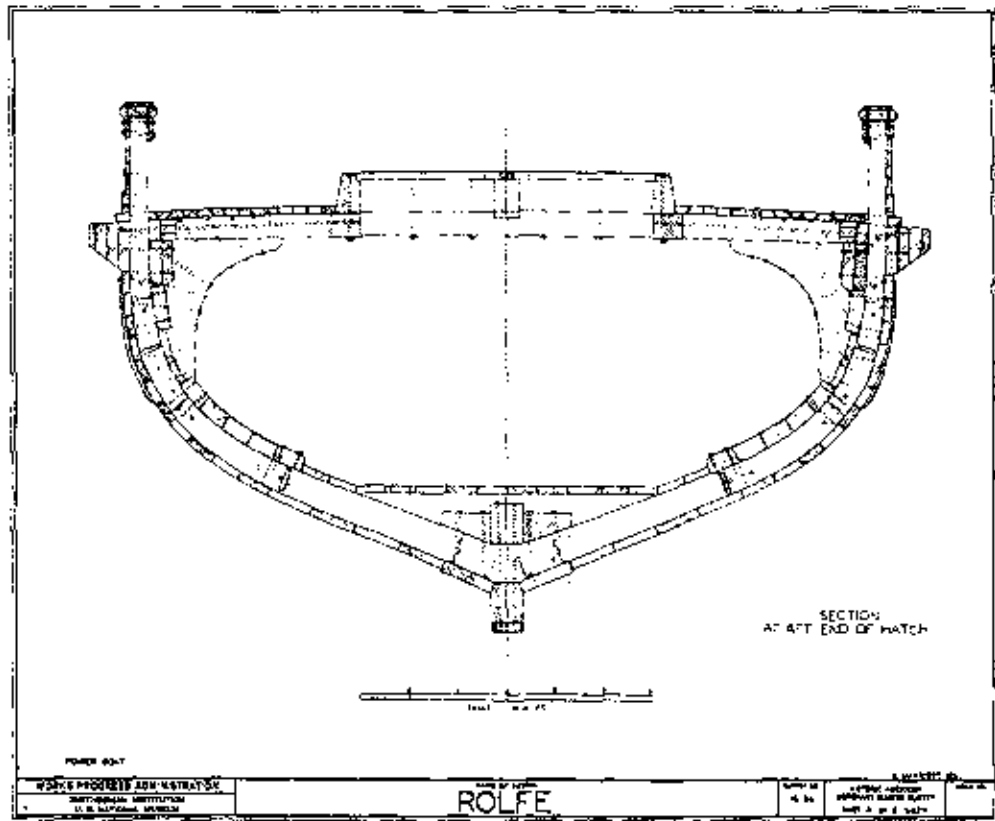

Fig. 4.7.27

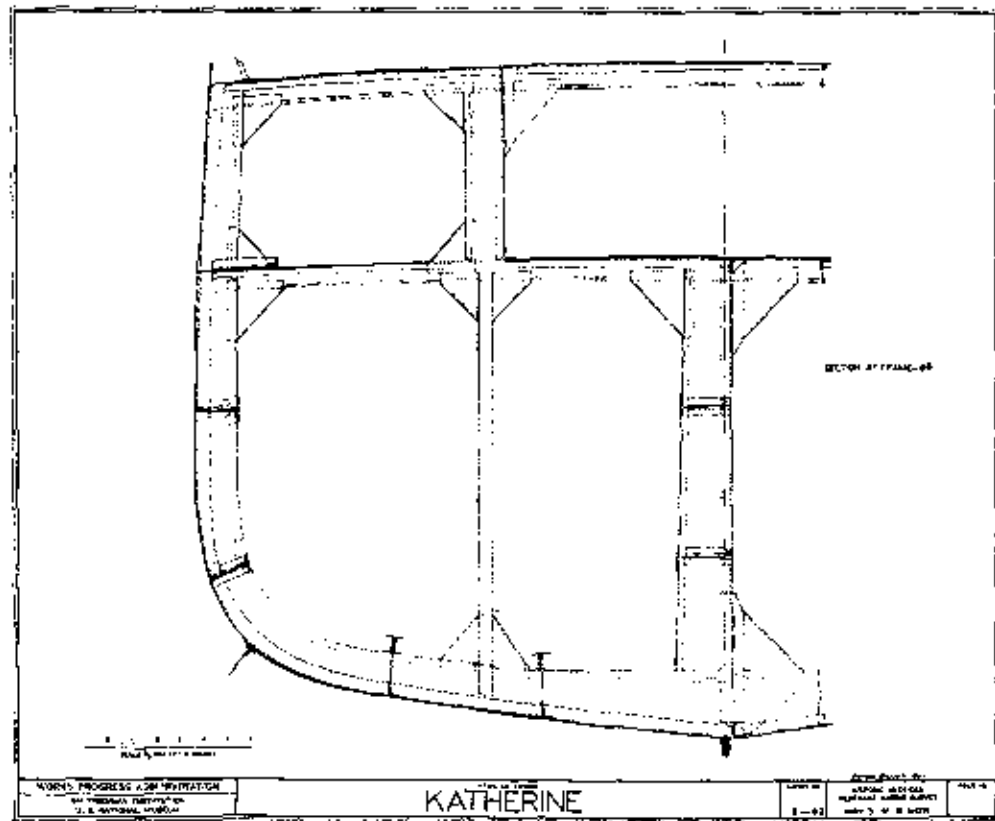

Fig. 4.7.28

SECTIONS

Fig. 4.7.29

Schooner *VIRGINIA*

Layout

A very rational layout for this progression of ship sections.

Delineation

Excellent linework; lettering could have been stronger.

Documentation

While this series of sections is very instructive and delightful, how much of the information presented could have been shown equally as well or better with lines plans and an annotated midship section (with scantlings)? This type of documentary drawing would only be done by HAER if it were the only way some unusual and significant structural variations in a vessel's hull could be presented. Otherwise, there would have to be some major programmatic reason for it (such as a cosponsor's need of it for exhibit purposes), and that reason should be stated on the drawing as part of the documentation.

The instructive character of this drawing could have been improved with labeling and sizing of members.

Unlike most HAMMS drawings, the graphic scale here is a good size for the views given, though it is not very strongly delineated.

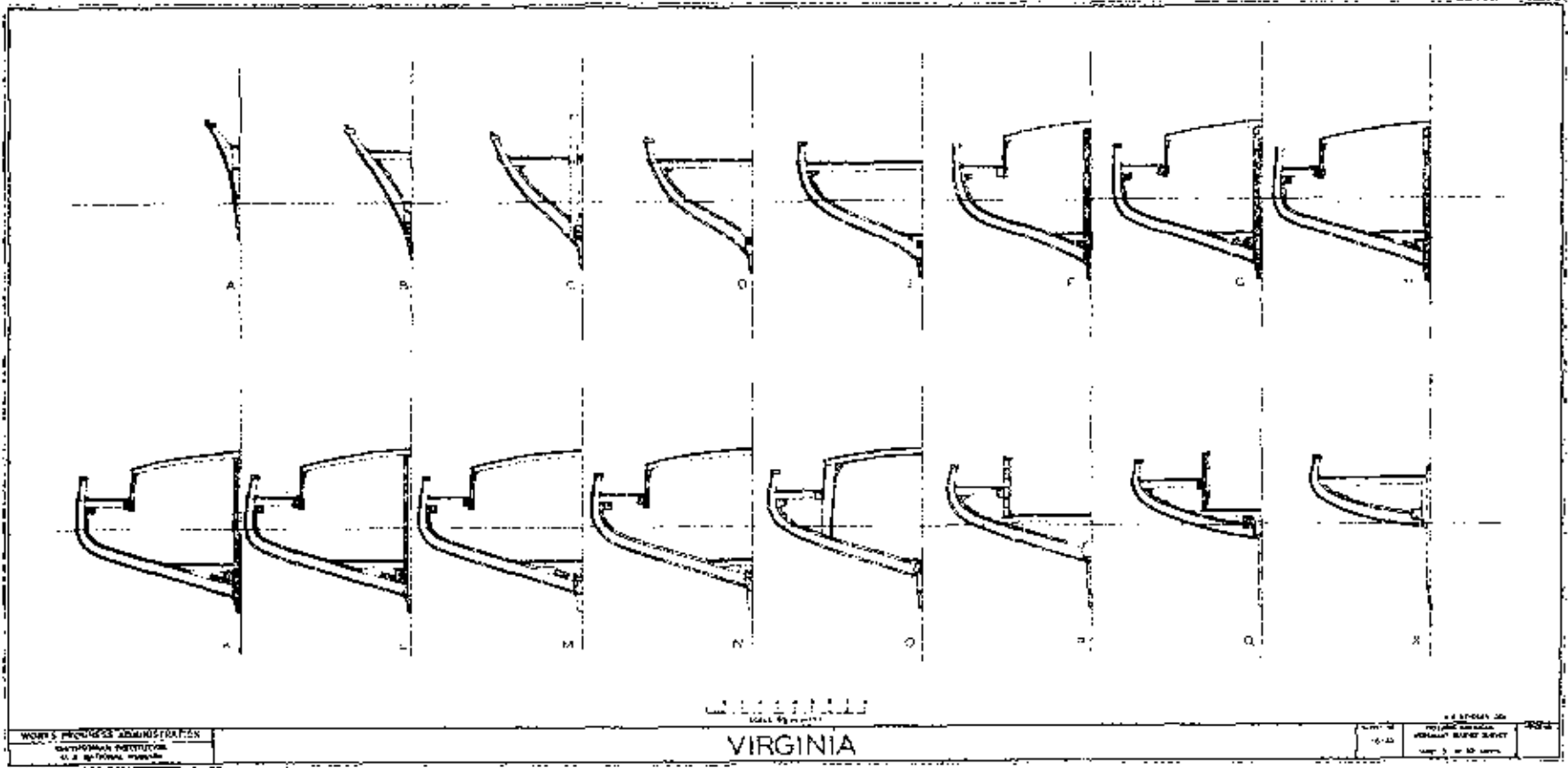

Fig. 4.7.29

SECTIONS

Fig. 4.7.30

Steam Schooner *WILLAPA*Delineation

Overall impression from drawing is one of boldness, but details tend to become lost in rendering. The engine is also lost in the hull structure in terms of graphic emphasis. The engine could have been helped to read better by the use of much stronger line weights to balance it graphically against the heavy wood sections. If shading is going to be used on machinery (see Fig. 4.5.6), interrupted, sketchy shading lines that produce a busy look should be avoided.

The buttons in the captain's seat cushion are a nice touch.

View title lettering is large and bold, as it should be. However, labeling for spaces and machinery parts is undersized and doesn't catch the eye.

Documentation

Dimensional and structural verification is difficult or impossible on this section.

Scantlings and machinery specifications should have been verbally given, or the user told where he can find such information.

The graphic scale should have been the width of the hull to be fully useful for scaling and/or checking reductions.

Fig. 4.7.30

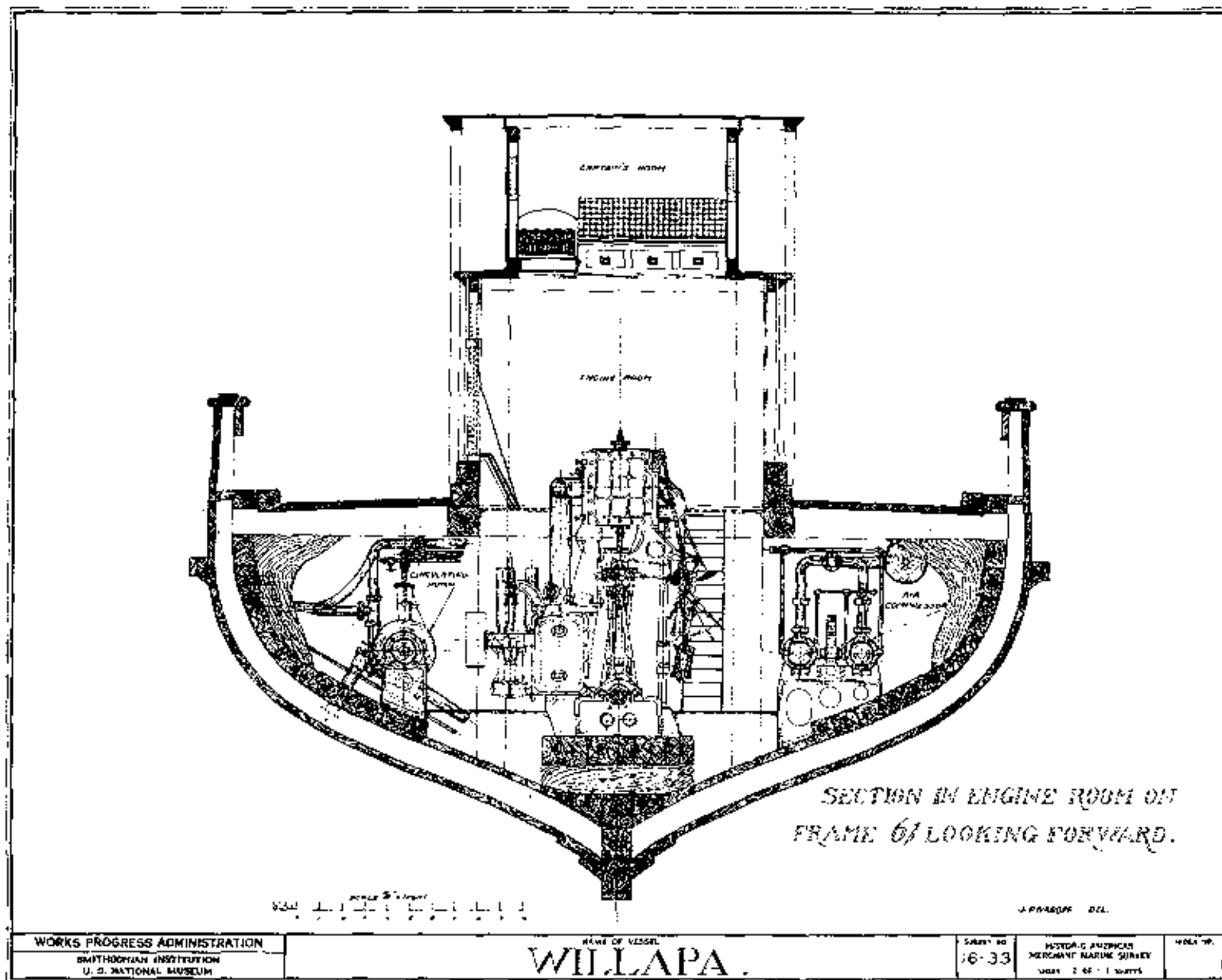

SECTIONS

Fig. 4.7.31

Steam Schooner *WILLAPA*Delineation

Compared to Fig. 4.7.29, this rendition of *WILLAPA* is weaker in some ways, but clearer. Machinery details stand out since they are not sketchily rendered. The hull construction reads better since the cross-sectional rendering doesn't overpower other linework. However, the machinery, for its improved clarity, still doesn't read as well as it might. Stronger line weights would help, and line shading would especially help to bring out the mass of the water tanks and boilers--as they are now, they only look like big circles. The stack and ventilators could also be strengthened by heavier line weights.

Documentation

Dimensional and structural verification is not provided.

Graphic scale is too short to be of use.

Stack and ventilators have been interrupted--what is their true height? A dimension string would help here, and it isn't time consuming to provide it.

View title is very complete as to location of section, and which direction the image is looking.

Auxiliary equipment and pipelines should have been identified with a number tag and separate list of labels. Specifications for auxiliaries and the boiler should have been given; pipeline diameters are optional in most cases.

Scantlings should be given, or the user told what sheet to find them on.

Fig. 4.7.31

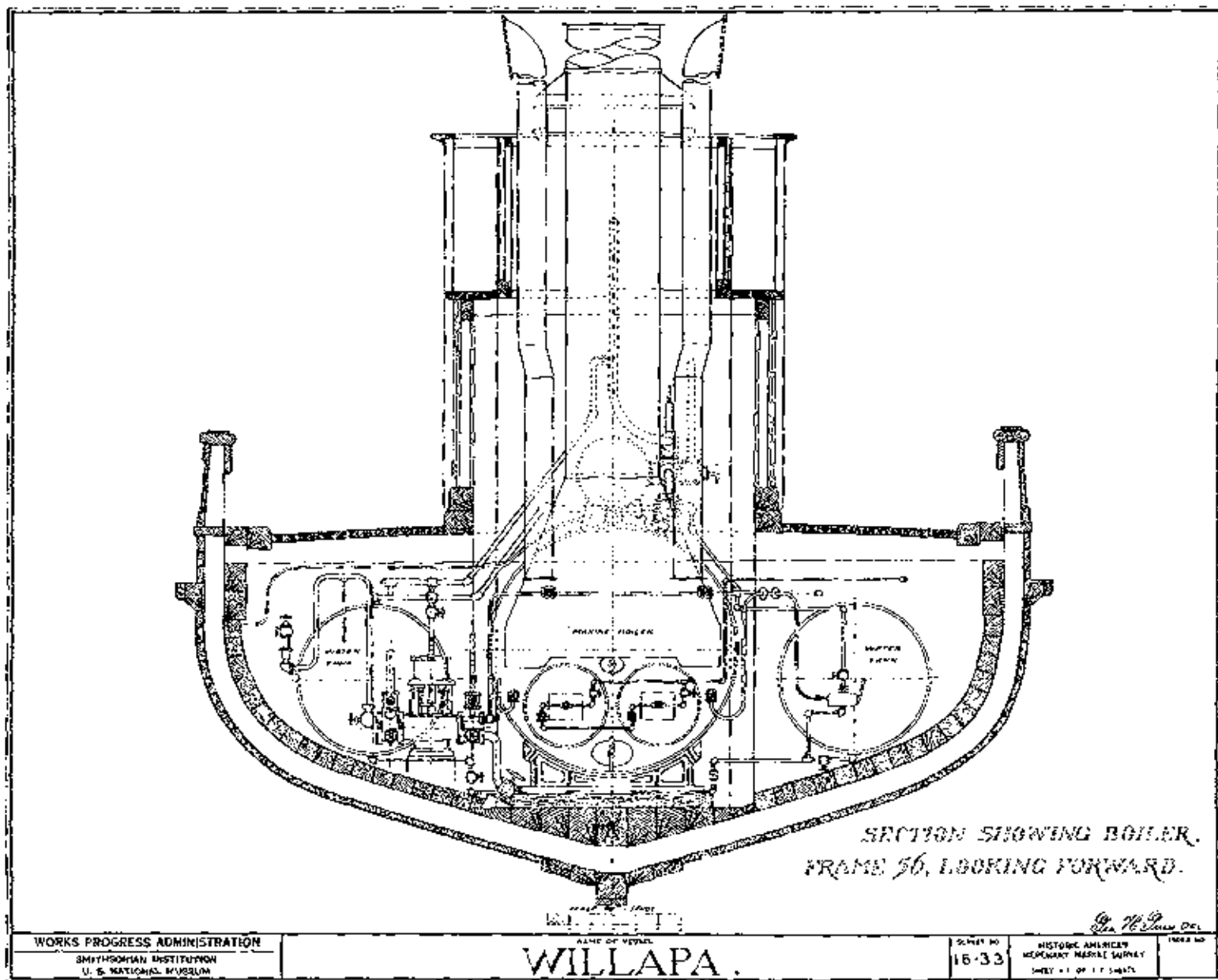

SECTIONS

Fig. 4.7.32

Schooner *NEWARK***Delineation**

Linework is light but legible. A judicious use of heavier line weights would have helped such a schematic drawing read more strongly.

Documentation

As a schematic representation of a fish reduction plant aboard this vessel, this documentation is better than no representation at all, but why is it only schematic? Is it a reconstruction from memory? Is it just the components and layout that are significant, not the details of construction? The omissions are puzzling, and leave a user wondering what he is missing and why when there are no explanatory notes.

Machinery is very poorly labeled. Is that a conveyor belt we are looking at? which way does it run? What does it convey? how much per hour? What are the capacities of the Water Tank and Cooker? Did the Cooker cook fish at any particularly special temperature? Where did the goods on the conveyor go when they got to the top? Many of these questions could be answered by appropriate labels, easily added in the space on this drawing.

"Section 36" is a bit vague. Is that 'Section at Frame 36' or are there 35 (or 48?) other sections for us to look at?

The label "As Fish Reduction Plant" is hidden away in a corner. It's the only descriptive label on the sheet, and should be more prominently sized and placed.

Fig. 4.7.33

Schooner *VIRGINIA***Delineation**

Very cleanly drawn, though the wheel doesn't stand out very well. The rendered sections of the hull read far more strongly than anything else.

Documentation

This is an unusual projected section, more of an illustration of the shape of the boat

than the sections shown previously. While fun to look at, this sort of view requires a lot more work if it is to be drawn accurately, especially if you are going to show planking. The user isn't told here if the planking shown was drawn on measurements or just put in by eye, though this may matter little since measurements on this kind of view of a hull bottom are of little use without a body plan superimposed on it.

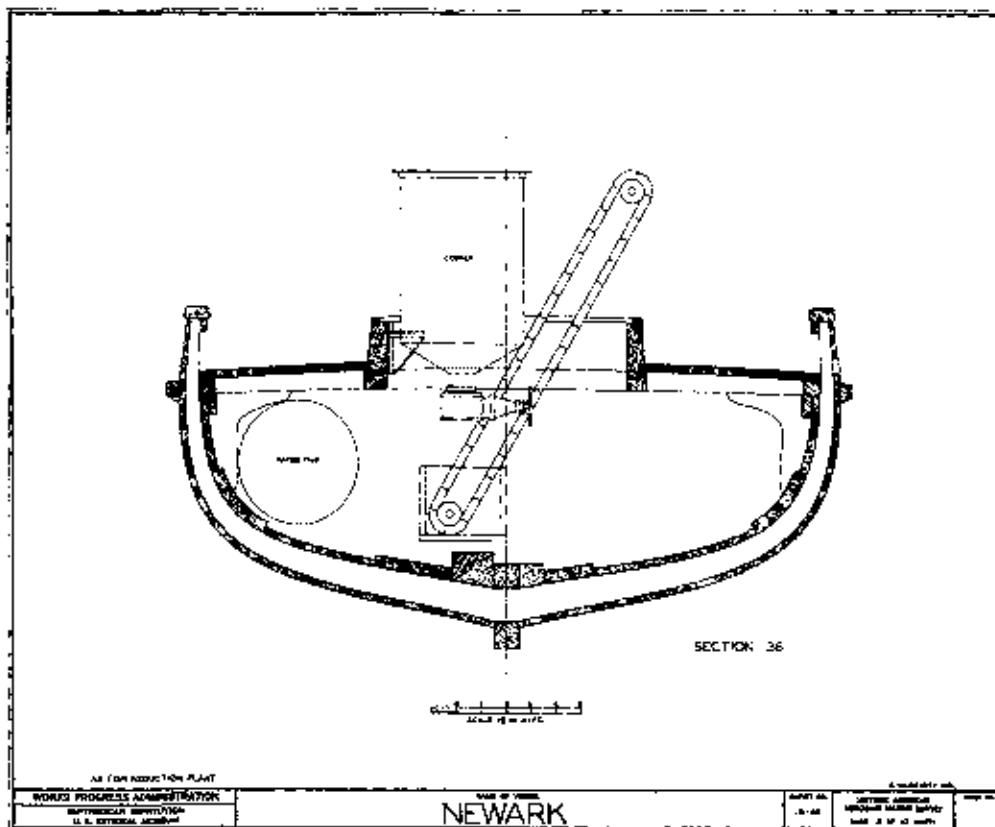

Fig. 4.7.32

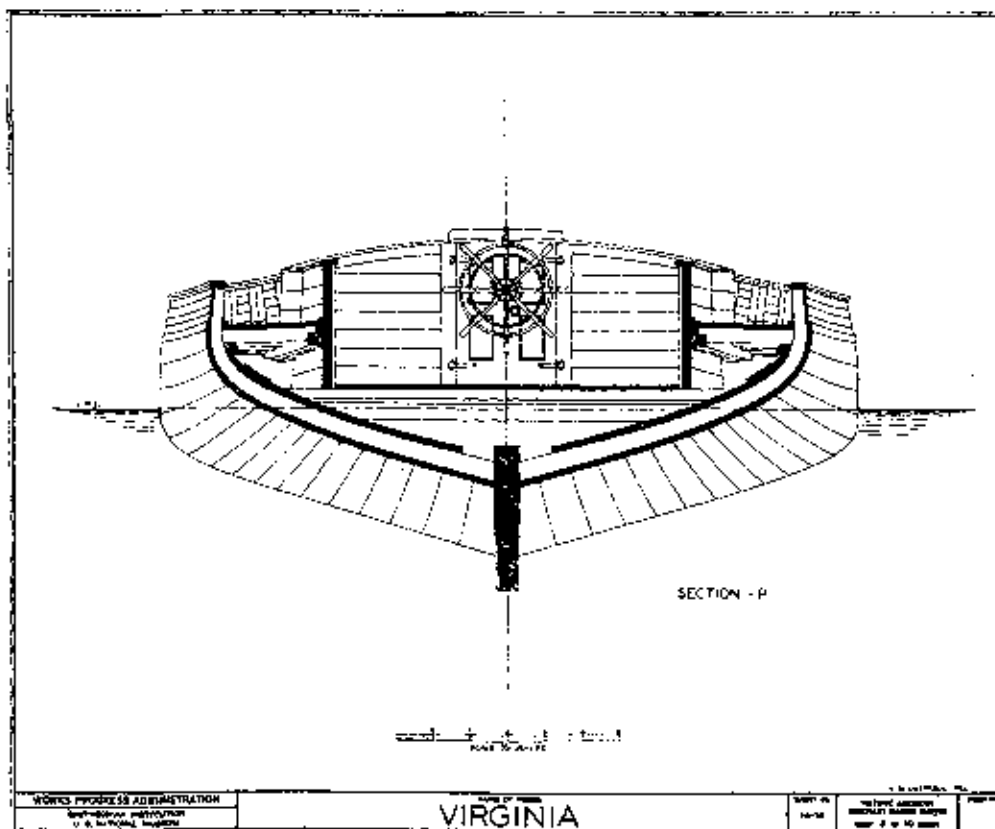

Fig. 4.7.33

SAIL PLANS

Fig. 4.7.34

Sharpie (unnamed)

This sort of documentation is unlikely to come up very often, since sails are pretty ephemeral when compared to hulls and machinery. However, if documentation of a vessel's sails is important to do, this drawing has some good and bad points:

Documentation

Dimensions of all sides of each sail are given, including a diagonal measurement.

Some construction features are noted, such as the reef.

Most construction details of these particular sails are omitted without

explanation. Materials are not given either. It would be wise to cite some reference where similar details could be investigated, if a user wished to do so.

Spar sizes and some line diameters (but not materials) are given. Note that no graphic scale is given.

Plan No. HIC-128, 44'-6" Sharpie Schooner (sheet 4), Howard I. Chapelle
 Collection of yachts and small craft. Delineated by Howard I. Chapelle.
 Reproduced courtesy of the Smithsonian Institution.

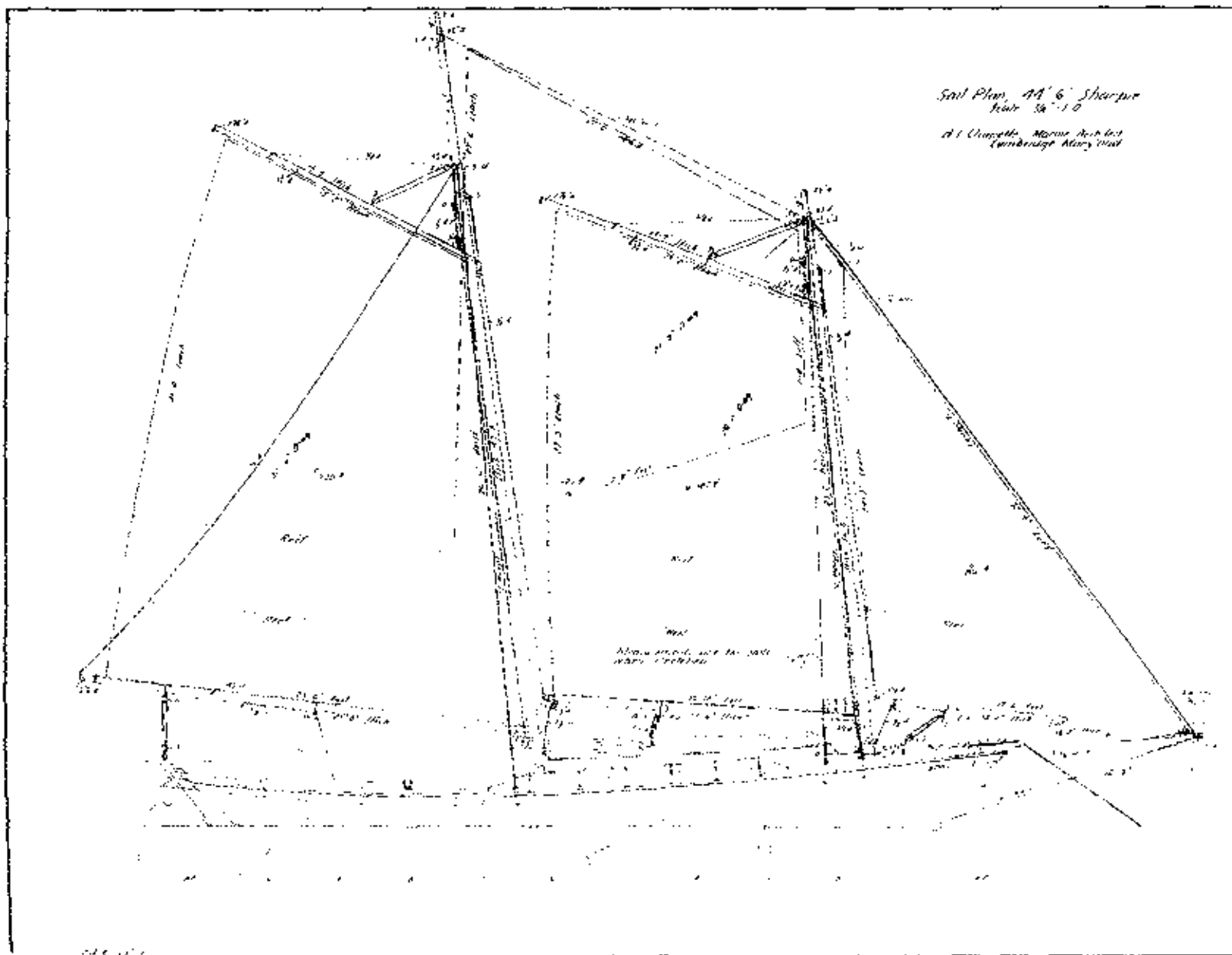

Fig. 4.7.34

SAIL PLANS

Fig. 4.7.35

Schooner *EFFIE A. CHASE*

Documentation

There is not much this plan shows that couldn't be shown on an outboard profile. Notes on sail area take up no great space.

No dimensions are given verbally, and graphic scale is too small to use reliably on size features shown. Lack of dimensions should have been explained.

Source for the drawing is cited, but a more complete citation would have been useful (did the "old book" have a date or not?). The information presented on this sheet could have been more economically preserved by photocopying the page in the old book, unless the notations were difficult to read or photograph.

Fig. 4.7.35

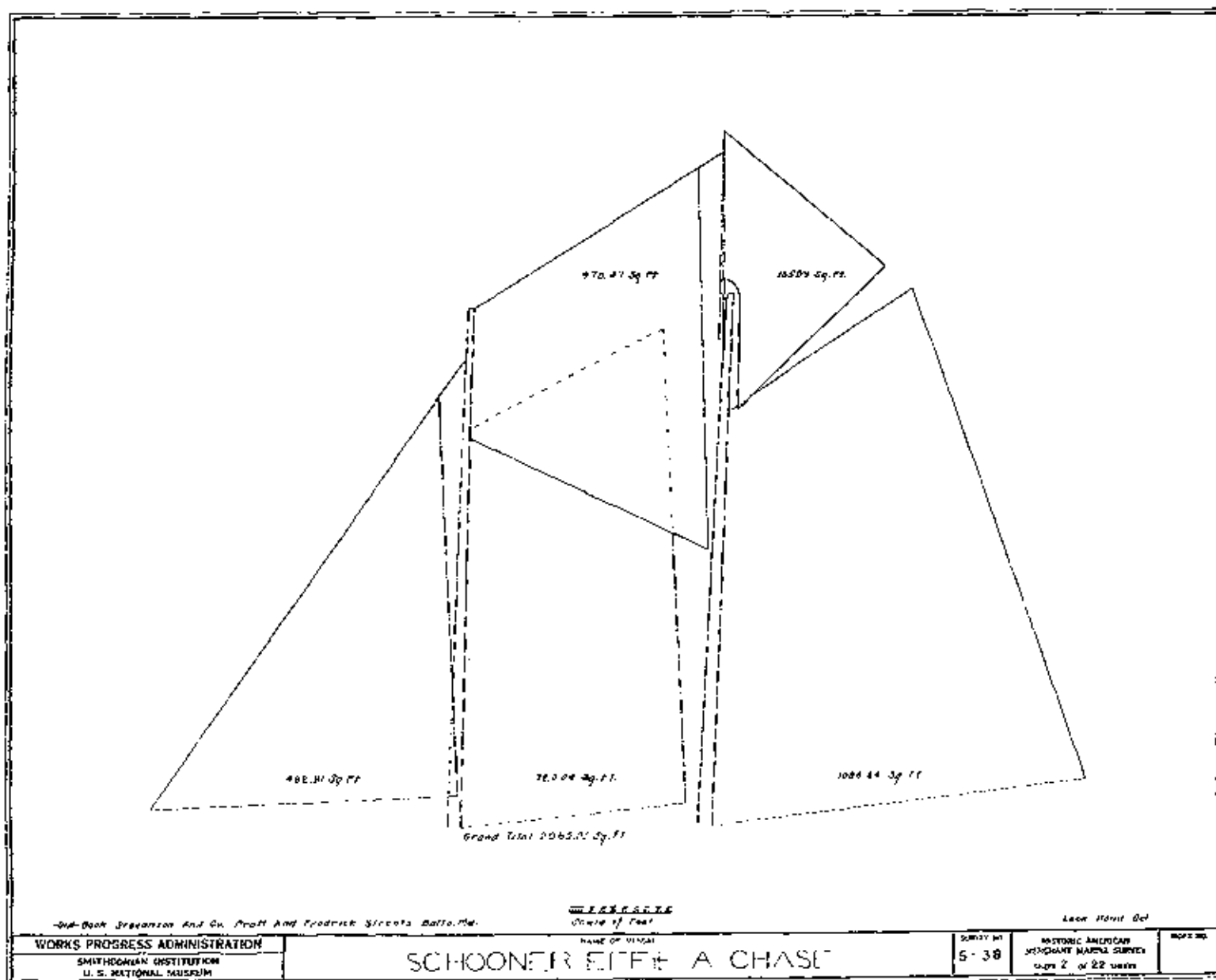

SPAR AND RIGGING TABLE

Fig. 4.7.36

Bark *NEWSBOY*

When significance or recording project purposes dictate the recording of rigging, the tabulation of spar and line dimensions can be a very efficient form of documentation. The information presented here could also be labeled onto a profile view of the vessel, but a table makes for quicker comparisons. If project documentation is to be used for maintenance of a vessel, tabulated data such as this would be very useful for planning work, ordering materials, and other maintenance tasks.

Fig. 4.7.36

SPAR LIST										WIRE RIGGING		CHAIN RIGGING	
NAME	MOULING	DIA AT HEAD	SPANT	EXTREME LENGTH	DIA AT HEAD	DIA AT TACK	DIA AT MIDDLE	DIA AT END	DIA AT TACK	SPANT	WIRE	CHAIN	WIRE
PORT MAST	47'0"	2 1/2"	38'0"	38'0"	2 1/2"	2 1/2"	2 1/2"	2 1/2"	2 1/2"	2 1/2"	100 LBS. GALVANIZED WIRE	100 LBS. GALVANIZED WIRE	100 LBS. GALVANIZED WIRE
MAIN MAST	47'0"	3 1/2"	38'0"	38'0"	3 1/2"	3 1/2"	3 1/2"	3 1/2"	3 1/2"	3 1/2"	100 LBS. GALVANIZED WIRE	100 LBS. GALVANIZED WIRE	100 LBS. GALVANIZED WIRE
MIZEN MAST	47'0"	2 1/2"	38'0"	38'0"	2 1/2"	2 1/2"	2 1/2"	2 1/2"	2 1/2"	2 1/2"	100 LBS. GALVANIZED WIRE	100 LBS. GALVANIZED WIRE	100 LBS. GALVANIZED WIRE
NAME	MOULING	DIA AT HEAD	SPANT	EXTREME LENGTH	DIA AT HEAD	DIA AT TACK	DIA AT MIDDLE	DIA AT END	DIA AT TACK	SPANT	WIRE <td>CHAIN</td> <td>WIRE</td>	CHAIN	WIRE
FORECASTLE MAST	47'0"	3 1/2"	38'0"	38'0"	3 1/2"	3 1/2"	3 1/2"	3 1/2"	3 1/2"	3 1/2"	100 LBS. GALVANIZED WIRE	100 LBS. GALVANIZED WIRE	100 LBS. GALVANIZED WIRE
NAME	MOULING	DIA AT HEAD	SPANT	EXTREME LENGTH	DIA AT HEAD	DIA AT TACK	DIA AT MIDDLE	DIA AT END	DIA AT TACK	SPANT	WIRE <td>CHAIN</td> <td>WIRE</td>	CHAIN	WIRE
MIZEN BOOM	47'0"	2 1/2"	38'0"	38'0"	2 1/2"	2 1/2"	2 1/2"	2 1/2"	2 1/2"	2 1/2"	100 LBS. GALVANIZED WIRE	100 LBS. GALVANIZED WIRE	100 LBS. GALVANIZED WIRE

NOTE: DIMENSIONS FROM PLAN SHEET FIG. 24, 25D

WORKS PROGRESS ADMINISTRATION
SMITHSONIAN INSTITUTION
U. S. NATIONAL MUSEUM

STAFF OF U.S. NAVY
BARK
NEWSBOY

SHEET NO.
40-20

HISTORIC AMERICAN
MARINE SURVEY
SHEET 4 OF 4 SHEETS

NO. 10

STANDING AND RUNNING RIGGING TABLES

Fig. 4.7.37

Barkentine *KOKO HEAD*

This table is far more detailed and complete than Fig. 4.7.36 so far as rigging goes. It gives no spar dimensions. Such a table would be a boon for maintenance of a vessel, and useful also to ship modellers, and for studies of rigging. Some of the abbreviations used in the table need explanation (e.g., "pat" and "com" under "type"). Depending on the significance of the vessel being recorded, the nature of her rig, and what is to be done with the documentation (project agenda), such a table could be a very low or a very high priority. Legibility is paramount in a table with this much information.

PIN RAIL DIAGRAM**Fig. 4.7.38**Bark *EMILY F. WHITNEY*

This is a schematic diagram whose sole intention is to show where various lines are tied down at the rail. No scale is stated, and such a drawing needn't be strictly to scale.

Delineation

The schematic nature of the drawing is borne out well by its delineation.

Lettering is large and clear, but notes and headings should have been more distinguished graphically from labels. Heavier, bolder lettering for headings in addition to underlining would have helped a user find his way around the verbiage.

The arrows are essential, but a different method of drawing them would have made them less like the schematic linework and less likely to be confused with it. Why not draw such arrows with lighter line weights, or use a dashed or slightly curved line? This would make the arrows subordinate to the schematic linework and less competitive with it graphically.

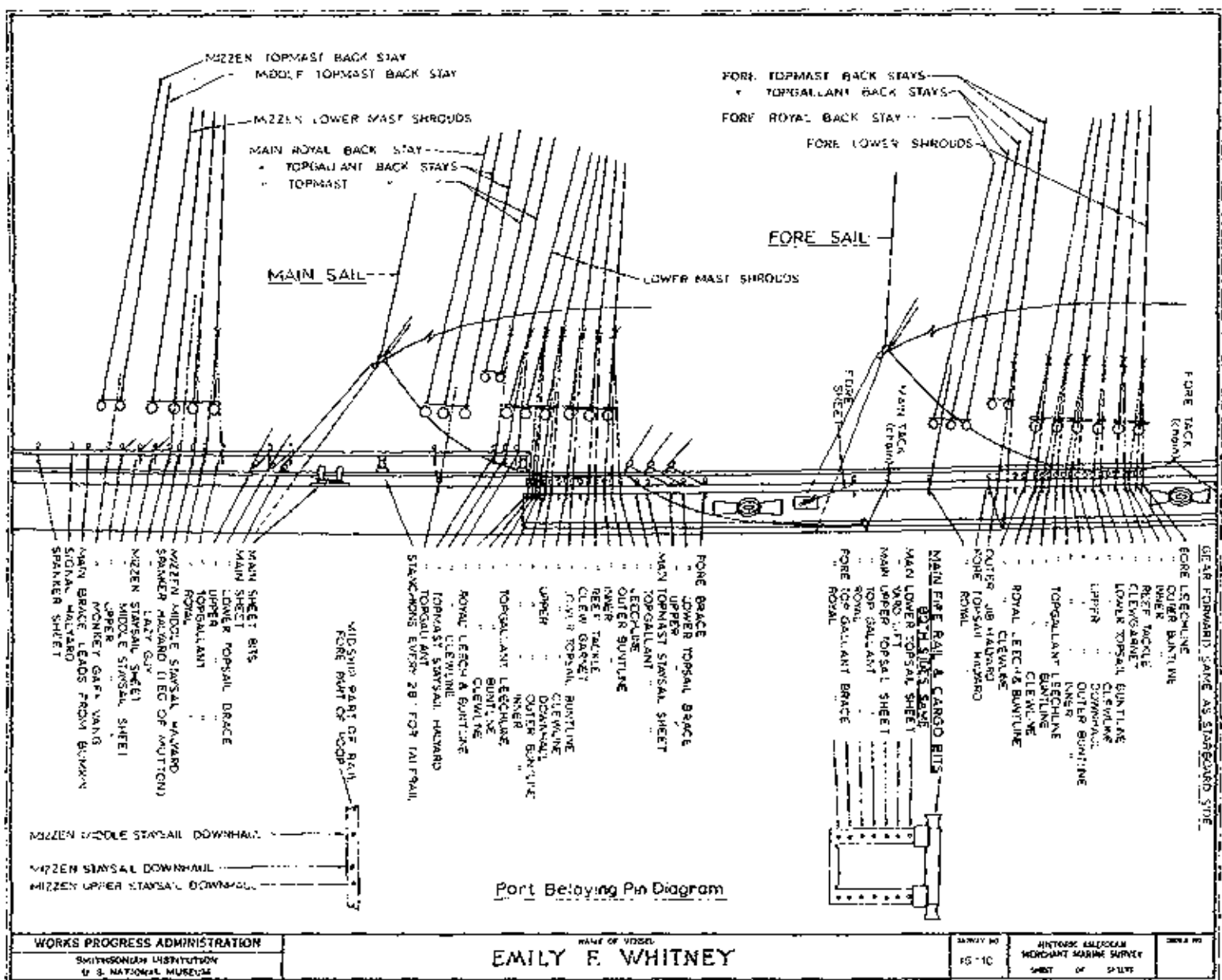

Fig. 4.7.38

MIZZENMAST**Figs. 4.7.39 - 4.7.41**Ship *BALCLUTHA*

Mast and rigging drawings such as these are used to show not only the mast and spars, but also standing rigging and details.

Layout

Three sheets were used in order to present the mast and rigging at a reasonable scale and give room for documentary notes.

The mast is shown with its true rake on the first sheet, but no rake on the second and third sheets. This makes splicing difficult.

Although the upper-topsail lift on the third sheet extends below the bottom match line, it has been shown in one piece for clarity.

Note the use of location diagrams to orient the user to the place of the drawing aboard the ship.

Delineation

Drawing reads well due to use of shadowed lines and a variety of line weights.

These drawings are reproductions made by photographically duplicating the original oversized drawing and splicing each portion into a HAER sheet. After lettering was added, each sheet was photographically recopied as a whole to eliminate non-archival splicing. Some fine lines have not reproduced clearly; choose line weights carefully.

Documentation

Rotated sections of each spar were included, but none for the mast, as should have been.

Most notes and the key appear on the first sheet. Though this is noted on the other sheets, the drawings would be easier to use if the key appeared on each sheet.

Recent repairs and changes are noted.

Notes indicate other sheets where further information may be found.

Mast height dimensions are presented in a table on the third sheet; overall heights have been dimensioned.

Error tolerances in field measurement have been noted.

MIZZENMAST

SHEET 1 OF 3

Scale 3/8" = 1'-0"

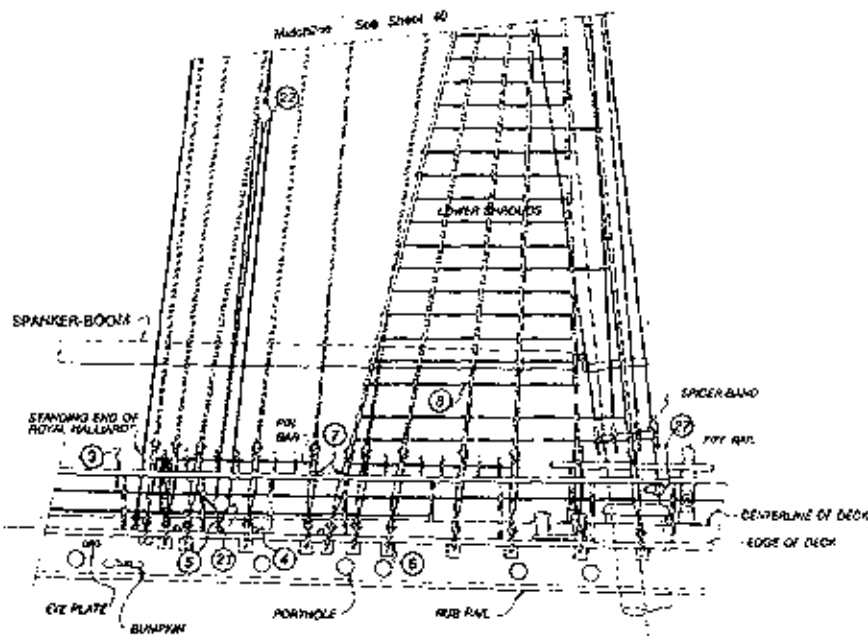
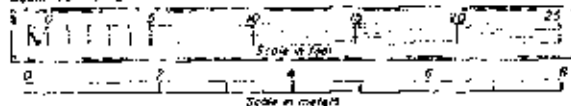

KEY

- | | |
|---------------------------------|-----------------------|
| 1. PAD EYE | 20. TRIPLE BLOCK |
| 2. FARLEAD | 21. DOUBLE BLOCK |
| 3. BELAYING PIN | 22. SINGLE BLOCK |
| 4. EYEBOLT | 23. SHEET BLOCK |
| 5. SHACKLE | 24. GUY BLOCK |
| 6. CHAIN-PLATE | 25. CHECK BLOCK |
| 7. TURNBUCKLE | 26. FARLEAD BAND |
| 8. RIFLE | 27. SADDLE FARLEAD |
| 9. CATCH RATTLE (Topkey) | 28. TARDARRE BAND |
| 10. RING ON END RATTLE | 29. BAND |
| 11. THIMBLE CLEAT | 30. FARLEAD ARM |
| 12. RIGGING CLEAT | 31. JACK-ROD |
| 13. FUTLOCK SHROUDS | 32. JACK-STAY |
| 14. CHECK | 33. JACK-STAY EYEBOLT |
| 15. TWISTLE-FREE | 34. TALEOON |
| 16. CROSS-TREES | 35. STURUP |
| 17. BOLSTER | 36. FOOT-ROPE |
| 18. TOP-CALLANT FUTLOCK SHROUDS | 37. LIFT |
| 19. UPPER-TOPSALE PARREL | 38. MAST-STROP |
| 20. TOP-CALLANT PARREL | 39. SHEAVE (DASHED) |
| | 40. FUNNEL |

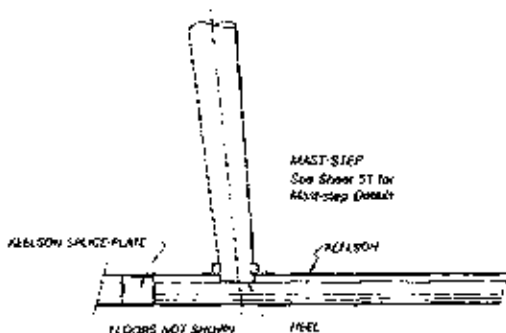

NOTES

- A. The mizzenmast is raised 8 degrees.
- B. The cross-tree (crosby) has not been shown. This was generally not carried although historic photographs indicate that BALLETTEA carried one around the turn of the century.
- C. Doubling plates were added to the lower mast in 1935.
- D. Lower shroud blocks (not shown) are not in place (1980). See footnote, sheet 45 for typical location.
- E. See sheet 51 for mast collar and mast step details.
- F. Approximately 60 feet of the topmast was replaced in 1979.
- G. The mizzen-top is a semi-circular platform of wood and iron built on cross-trees at the hounds of the lower mast, spreading the topmast rigging and forming a work space for men aloft. It is supported by the cleets, cross-trees and cross-tree.
- H. In 1905, 8 to 9 feet were burned off each steel yard arm, and the original fittings removed. New tapered yards were added, welded into place and the rig strings re-attached.
- I. Embley Field FR-9 was sprayed on the interior of the steel yards ca. 1975 to prevent oxidation.
- J. Foremast cross-trees, the combination of brode-trees, bolster, cross-trees and spreaders.
- K. The topmast and royal masts were replaced in 1978.
- L. The upper-topmast, and royal yards, and the spanker-gaff were replaced in 1955. All wooden yards were replaced in the 1970's.
- M. The portside fits and foot ropes are not shown.
- N. The lifts, foot-ropes, braces, and the eyes of the shrouds, stays, backstays, and halliards are parrelled and served as weather protection.



Fig. 4.7.39

Fig. 4.7.41

YARDS	MATERIAL	OVERALL DIMENSIONS
CROSS-JACK	STEEL	60' - 30" + 4'
LOWER TOPSAIL	WOOD	59' - 2" + 16"
UPPER TOPSAIL	WOOD	52' - 8" + 16"
TOPGALLANT	WOOD	42' - 0" + 50"
ROYAL	WOOD	37' - 2" + 50"

MIZZENMAST

SHEET 3 OF 3

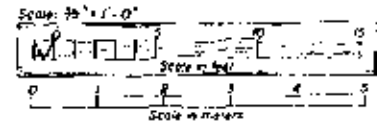

See sheet 29 for NOTES and KEY

N. 1/2" ROYAL & 5/16" TOPGALLANT
 1/4" TOPSAIL & 1/2" CROSS-JACK
 1/4" & 1/2" STAYS & 1/4" STAY
 1/4" STAY TO TRUCK

MAST CAP

BASE OF TOPGALLANT MAST

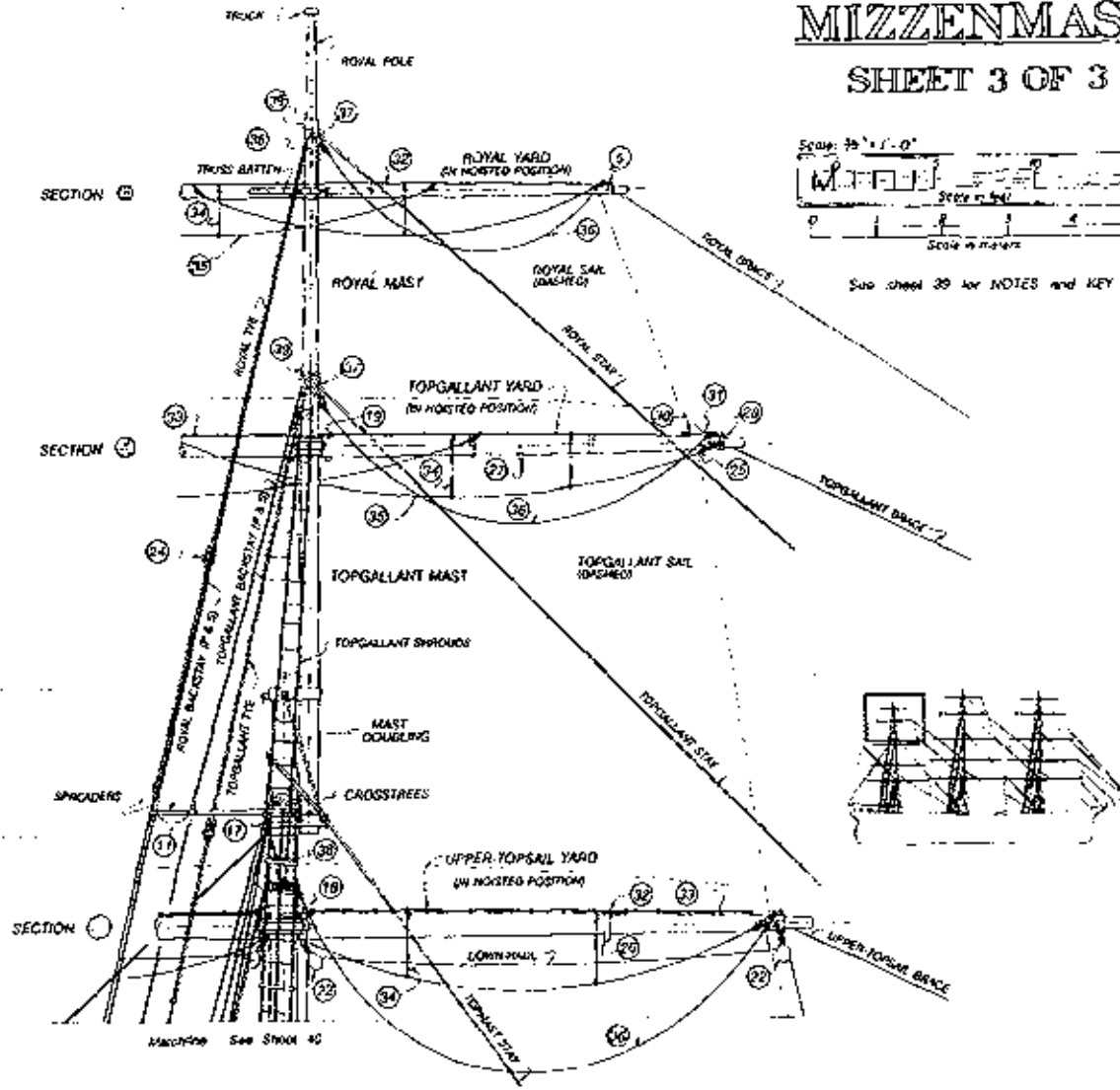

SHEET 3 OF 3 (1988)
 SAN FRANCISCO
 1988

MAIN MAST AND SPARS

Fig. 4.7.42

Schooner *LETTIE G. HOWARD*

The mast and spars of this vessel were already unshipped at the time of documentation. Since the project agreement required "as-is" documentation, rigging has been shown, though the whereabouts of pre-existing photographic documentation is noted.

Layout

The sheet is balanced, though the notes appear slightly off-center.

Enlarged details are placed close to their actual locations on the mast.

A portion of the lower mast has been omitted so that the topmast can be included in this view.

Delineation

Line weights are varied, and shadowing has been used.

Hand lettering is neat, but should have been larger.

Documentation

This drawing is a partial reconstruction, which has been noted. It could have been extended, however, based on known schooner rig details and earlier documentation of the vessel's rigging.

Some assumptions about the indications of paint and rust marks are noted.

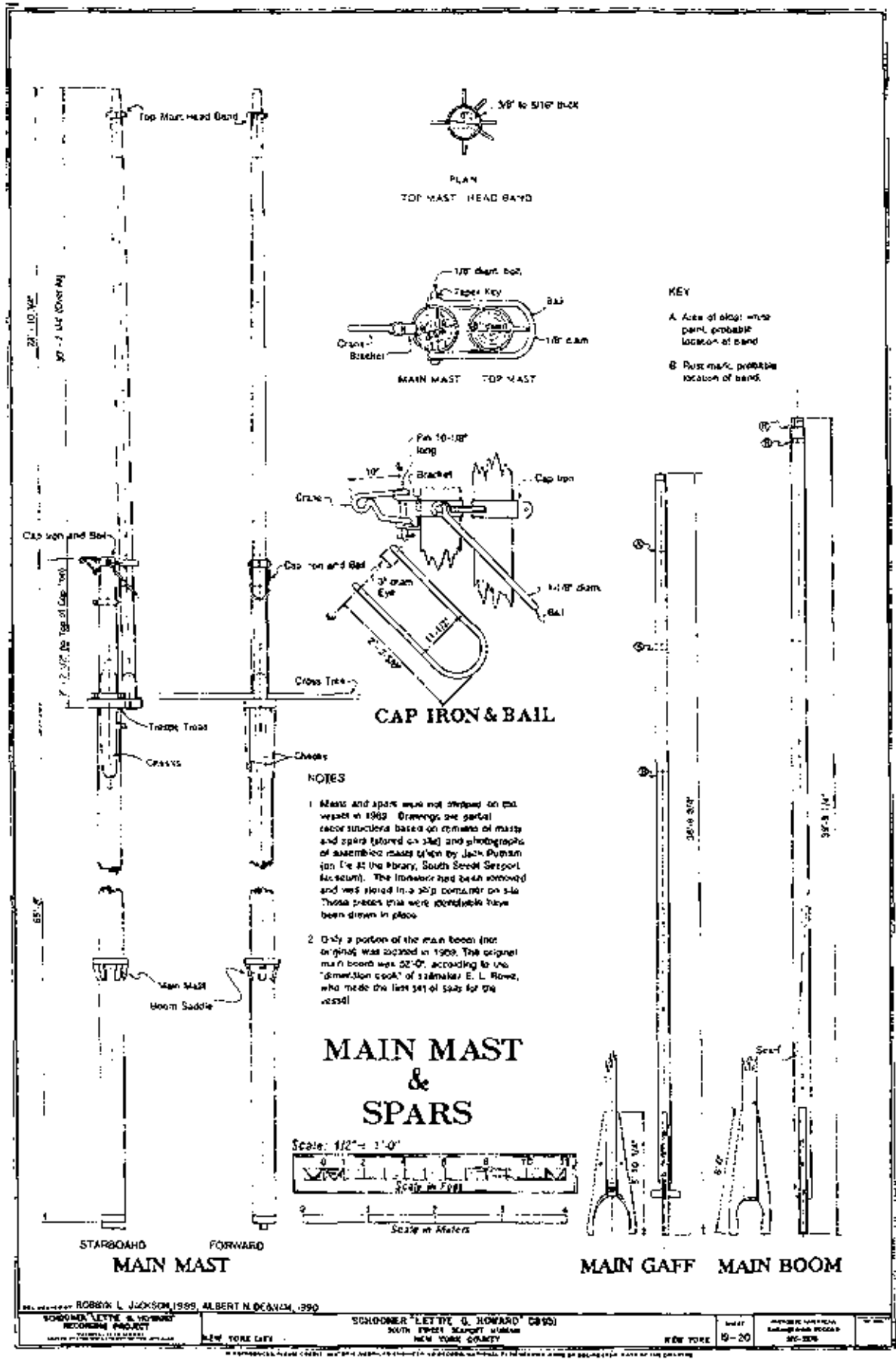

Fig. 4.7.42

MAST DETAILS

Fig. 4.7.43

Schooner *COMMERCE*Layout

This sheet is overcrowded. The close juxtaposition of pin rail plans with elevations of different pin rails is poor layout. This should have been rearranged. Even though each view is labeled, it's a trial to separate it all out.

Small details such as the fairlead, belaying pin, and cavil should be drawn at a larger scale, e.g., 1-1/2" = 1'-0".

Masts are poorly labeled with tiny lettering--user has to dig to find out what he is looking at.

Documentation

Sheet attempts to be comprehensive, but leaves out important information such as dimensions, materials, etc.

Fig. 4.7.44

Skipjack *CARRIE PRICE*Layout

Sheet has room for views, labels, and dimensions; some details are not labeled at all. Heavier lettering is needed.

Notes are needed when an unusual layout is used. Detail of the boom with the midsection broken out and set below is a little strange--without a note, it is confusing. Also, has the mast step been "hiked up" the mast on the mast view, away from the keelson? The fixture around the mast base looks like the mast step, but it's in an odd place. What is going on here precisely?

Documentation

Addition of dimensions is a great help, but notes are needed on materials.

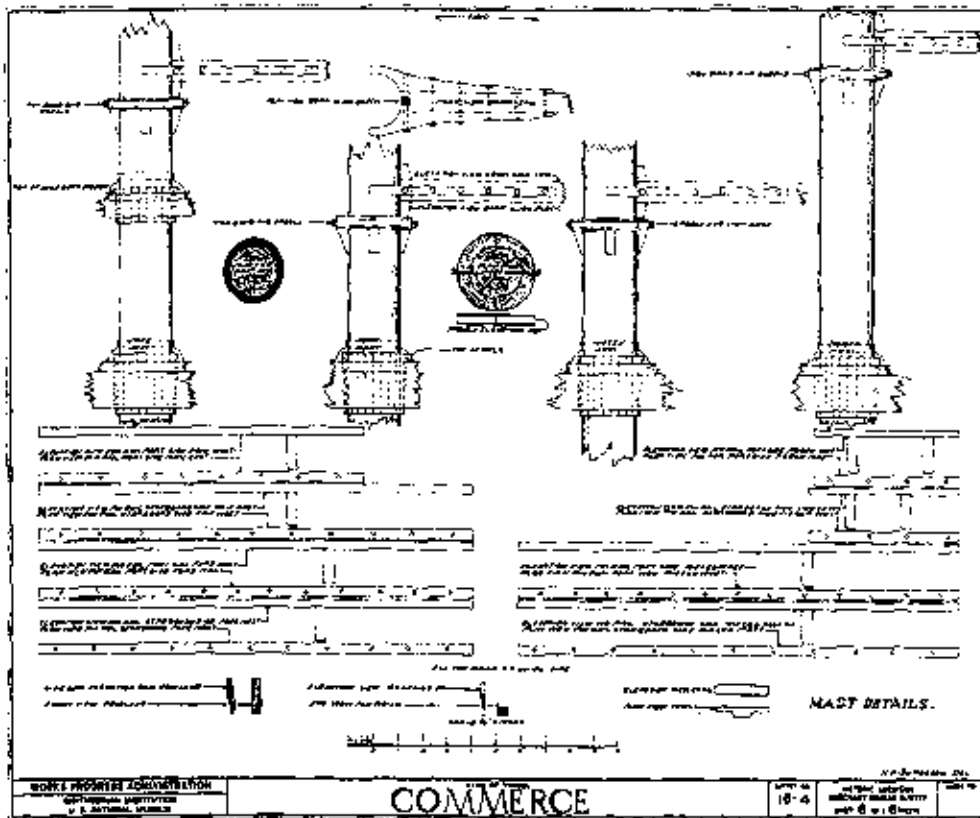

Fig. 4.7.43

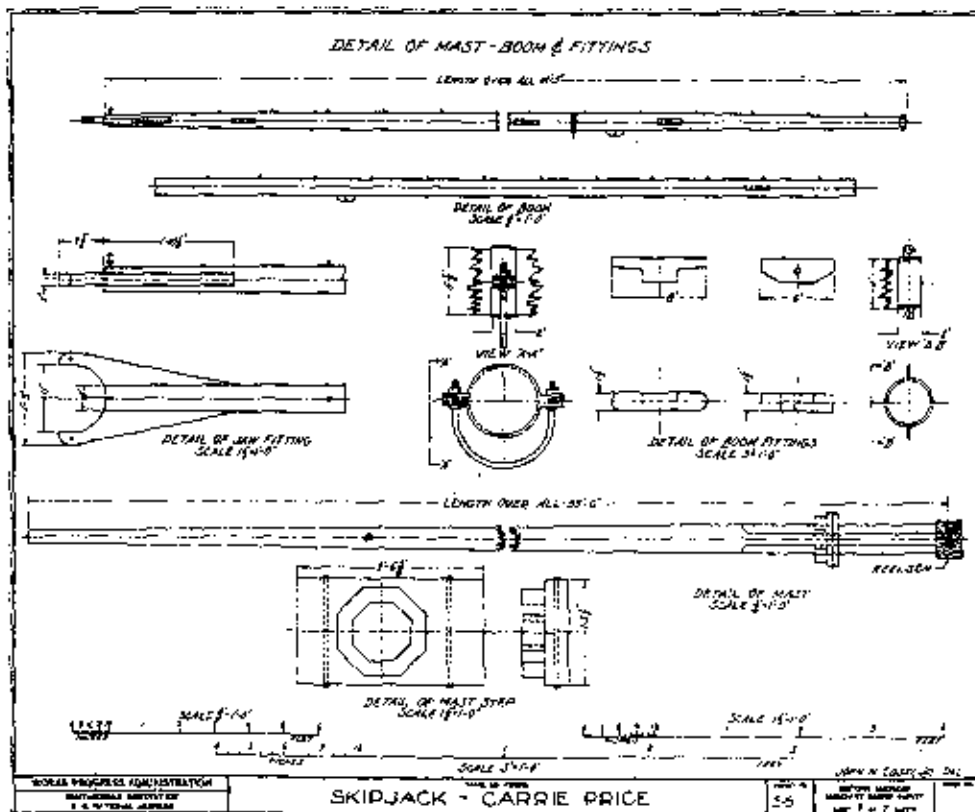

Fig. 4.7.44

MAST FITTING DETAILS

Figs. 4.7.45 and 4.7.46

Yacht *NIXIE***Layout**

Layout is clean and uncluttered.

Delineation

Linework is very cleanly executed and adequate in weight.

Shading used on portions of rings to highlight curves is very well done. It does not overpower other linework, and runs no risk of being mistaken for some sort of physical feature (grooves or flats) on the rings.

Lettering is clear, but labels for rings are too small and too unspecific. There are few indications as to where the fittings were used. If a user were looking for the "Spinnaker Boom Ends," the labels are not prominent enough to permit easy reading. Next to the elliptical ring (Sheet 1) is what appears to be a side view of this same ring or a different piece of hardware altogether--complete labels would eliminate the ambiguity.

Documentation

Several questions are left unanswered due to the lack of annotations on these drawings. Why was the ironwork given so much attention? Was this all there was left of the yacht? Was it typical of a particular builder, or an unusually good example of craftsmanship?

The user is only given the very slightest hint that these drawings are not to scale--tiny notes in the lower right hand corners. Important information should be more prominent than this.

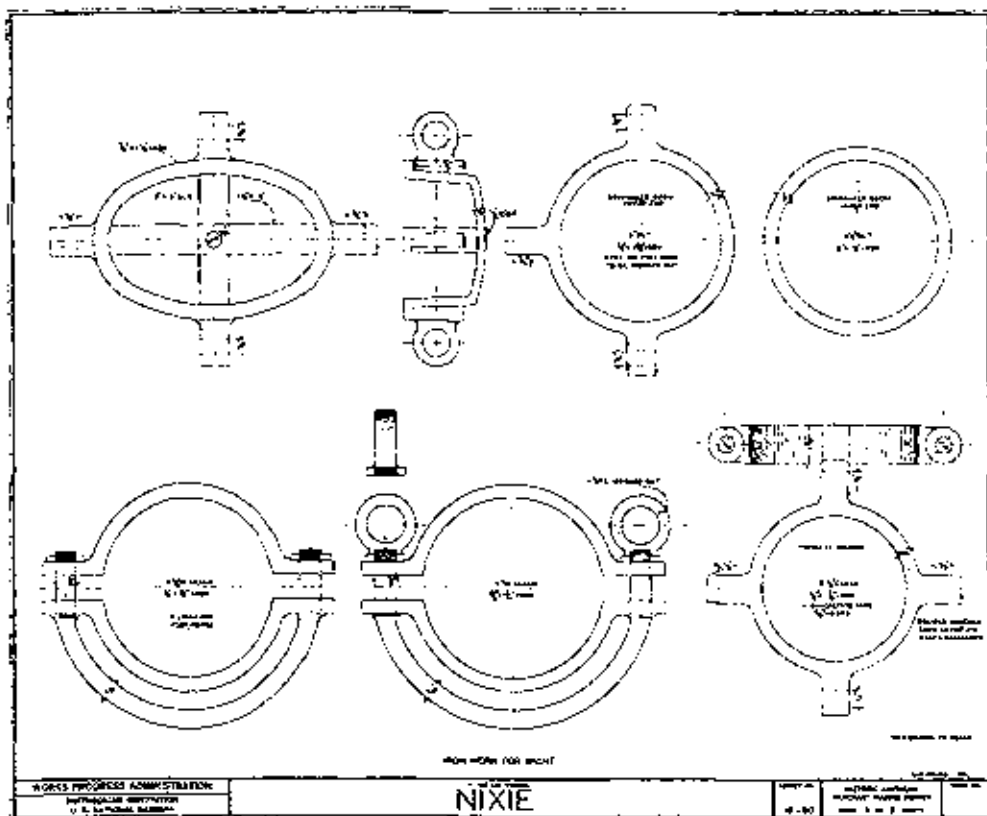

Fig. 4.7.45

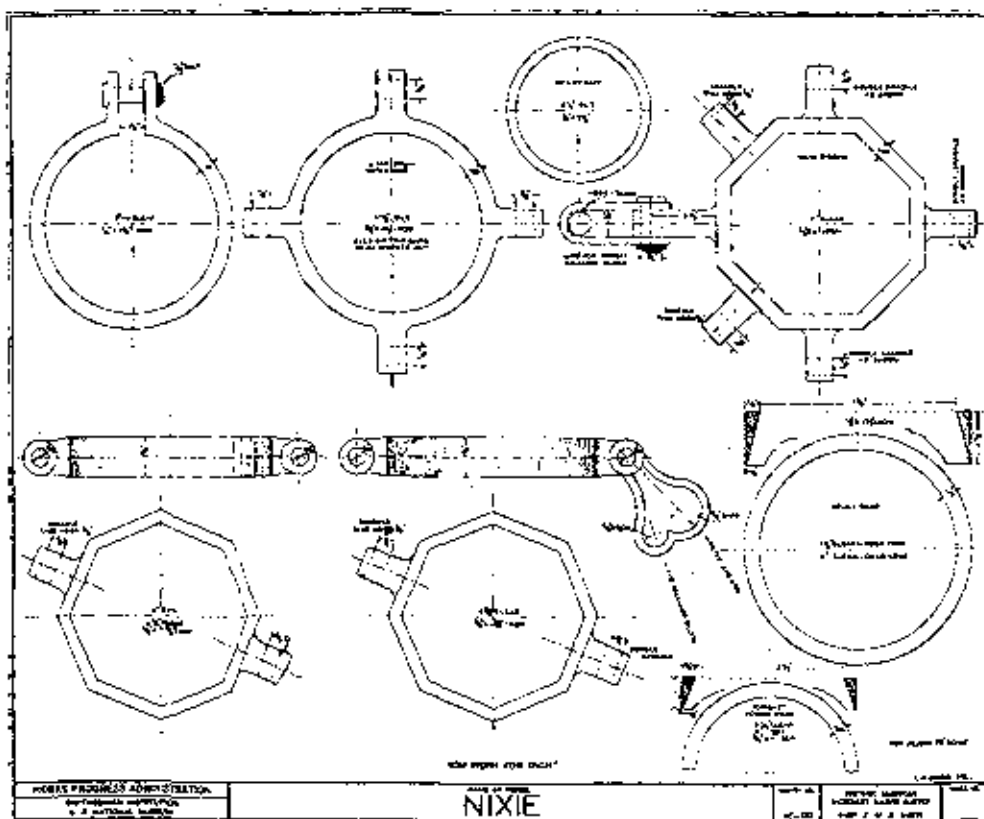

Fig. 4.7.46

MAST FITTING DETAILS

Fig. 4.7.47

Steam Schooner *EDNA CHRISTENSON*Layout

Note the use of foreshortened masts and boom to show how and where rings and fittings are placed. This type of layout permits a logical presentation and progression of views--note particularly the arrangement of side and sectional views of rings for the inclined boom.

Delineation

Good illustration of rendering run amok. Extensive wood graining dominates the graphics of this drawing, almost losing the bands (the chief subject) in the process. If anything, the bands should have been rendered, not the masts, though shading wouldn't be necessary if bolder line weights had been used. Sections of the masts could be rendered with a far less dense and fussy technique. The detail suggests that the actual graining pattern was documented--could this have been done without sawing the spars up?

Title for the sheet is prominent in size, but not weight. Bolder lines would improve its impact (it is now lighter than most of the wood graining).

Locations and names of masts and booms are not given. Labels and notes for rings and fittings are inappropriately sized. Labels such as "Cargo Band" and "Rigging Band" should be much larger. Dimensions should be larger also, but smaller than the labels.

Graphic scale is too small and lacks prominence. It should be longer and bolder, and it would be better placed under the sheet title where it would be "noticed."

FIG. 4.7.47

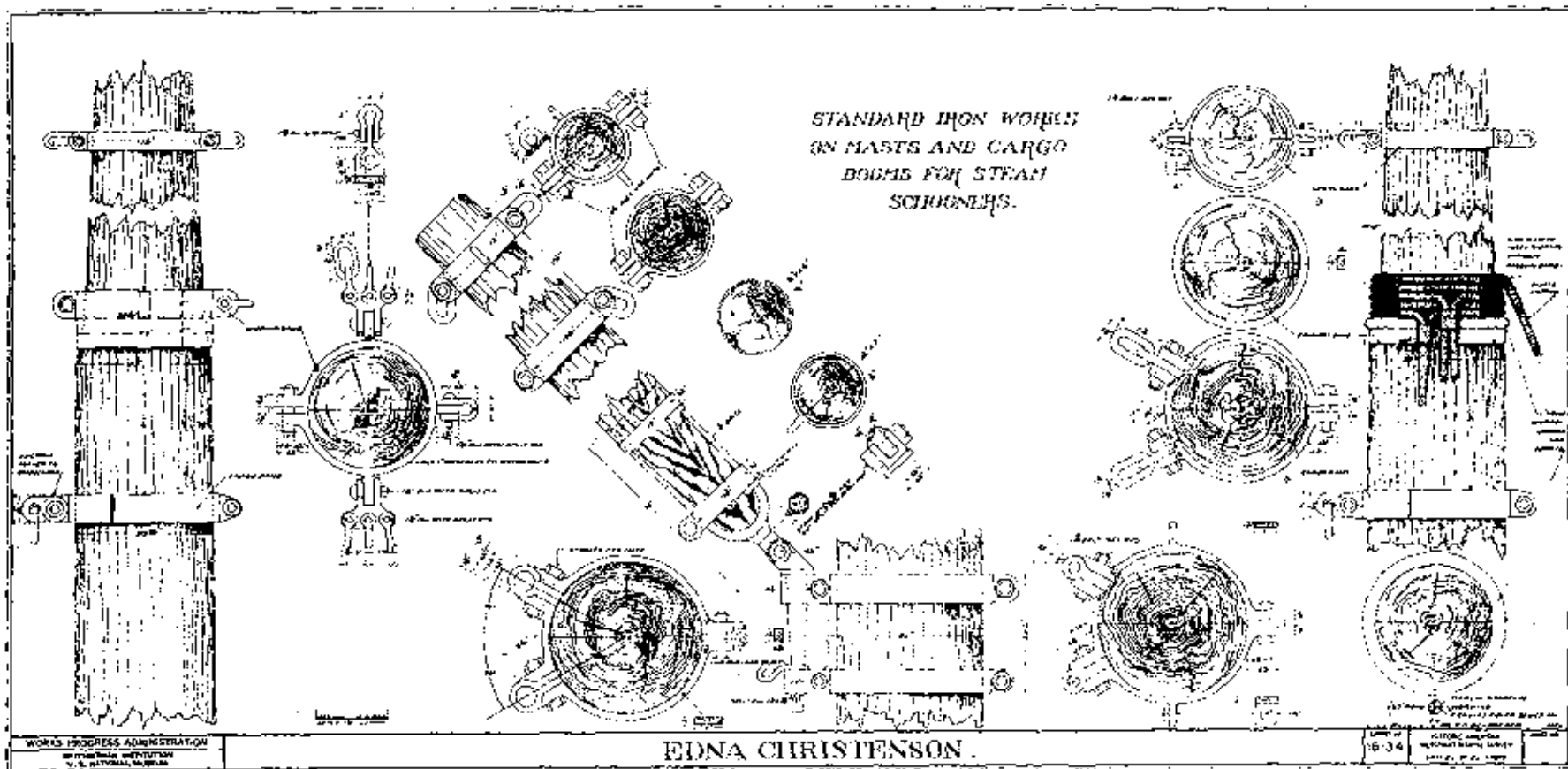

STRUCTURAL FEATURES

Fig. 4.7.48

Sternwheeler *ANTELOPE*

Significant structural features of a vessel should receive individual attention, such as the engine bed and stern hull framing for this wooden sternwheeler.

Delineation

Delineation of this view is fairly weak, though helped by the wood rendering.

In view of the time spent rendering wood, notes on wood material would have been more economic, and the drawing could have been made to read well by using stronger line weights.

The title of this drawing, "Detail of Stern," is lost. It should be much larger and more prominently placed.

Documentation

Dimensional and structural verification for this drawing is not given. No members or parts are sized or labeled, and the graphic scale is too small to rely on for scaling the drawing.

The place where the engine was mounted should have been shown in dotted outline (like the sternwheel), if it was known.

Fig. 4.7.49

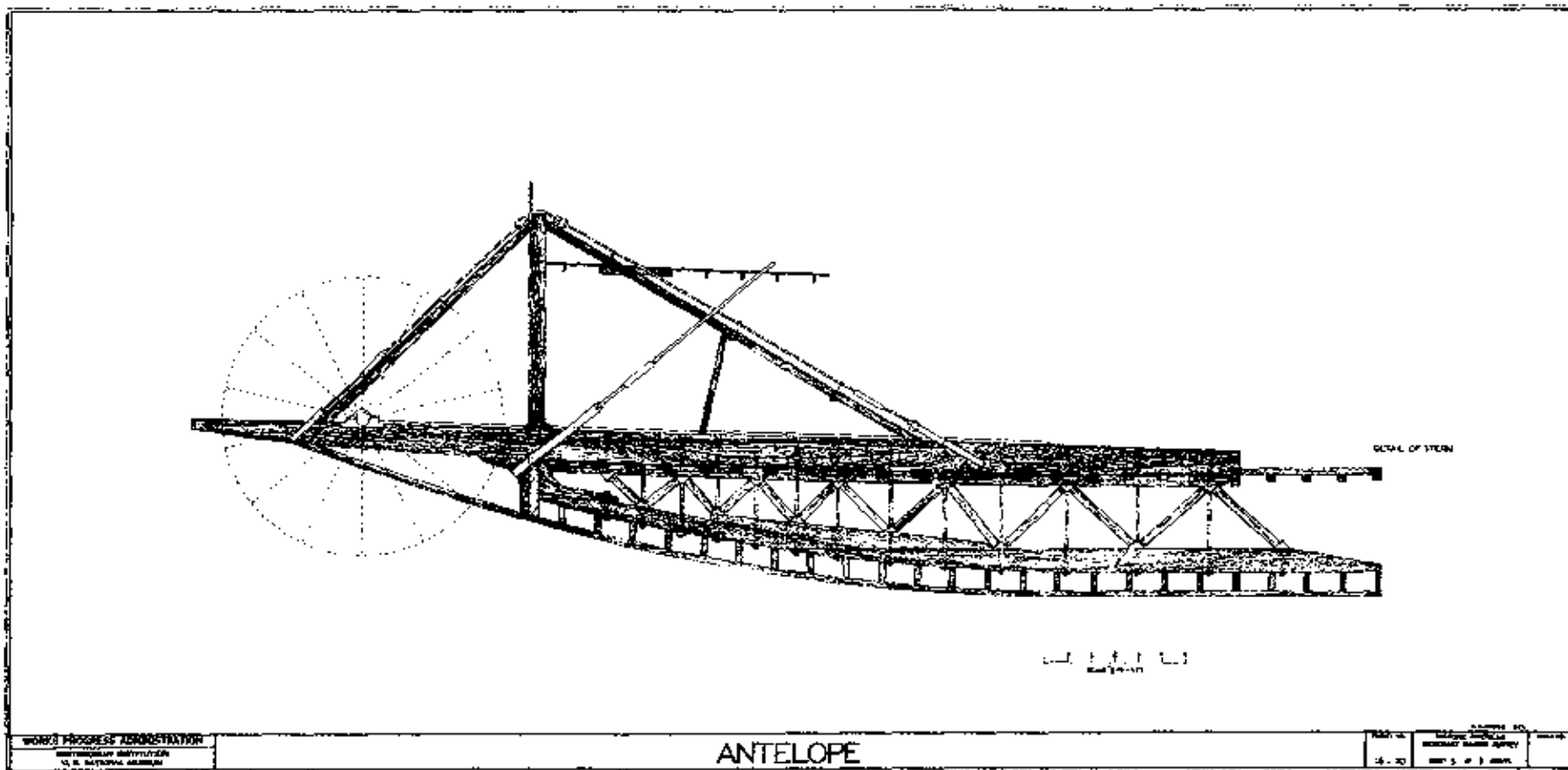

DETAILS

Fig. 4.7.49

Schooner *COMMERCE*

Occasionally a large-scale detail of a portion of a vessel may be necessary to show significant features or internal structural arrangements.

Layout

Juxtaposed side view and section very helpful in relating parts between one view and the other.

Delineation

Single light line weight does not properly emphasize various parts such as rails, beads, etc., against their backgrounds, especially in side view.

The scale of the wood graining in the section competes with details being shown. This could be counteracted by using heavier lines for the structure (especially for sectioned members) and/or using wood graining only on cross-sectioned members (such as deck beams).

View titles are well sized and well delineated.

Documentation

No makers were cited for the capstan or the steering mechanism. If these are not evident on the machinery itself or by other documentation, features should be labeled "maker undetermined."

Why weren't the bolts on the rudder trunk sized?

Where might the user find more information about the interior appointments of the crew's quarters, such as photographs? Why weren't the interior port sides of these compartments drawn?

Fig. 4.7.49

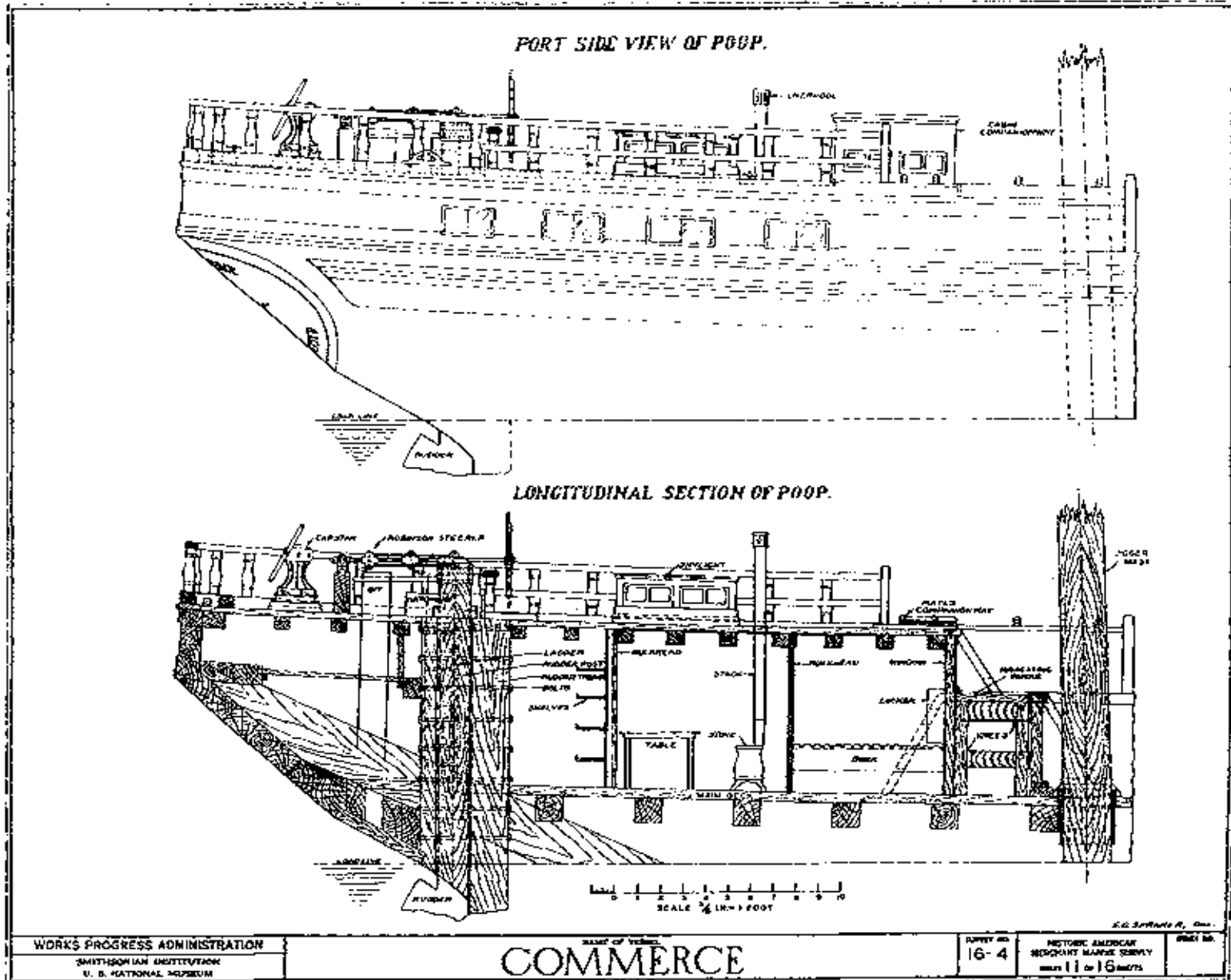

STRUCTURAL DETAILS

Fig. 4.7.50

Ship *BALCLUTHA*Layout

This sheet is very full and shows very different parts of the vessel's structure. It would have been better to use three sheets: first, a sheet of rivetted joint details showing regular butt straps, jogged plating and rivet patterns; second, a sheet of structural details showing a stringer, sister keelson, and keelson/floor/keel; third, a sheet of mast collar details. Each sheet would have had enough space for more descriptive notes and location keys.

Although this sheet is of various structural details, a user might well mistake them all for mizzen mast details since it is the only large title on the sheet.

A drawing showing the relationship among the stringer, keelson and sister keelson would have been helpful.

Delineation

Line weights, shadowing and pochés of cut materials have been incorporated, giving clarity to the drawings.

Isometric views tell more than orthographic plans and sections.

Documentation

The general structural details have not been prominently labeled as such, and may be easily confused with mizzenmast details.

Notes state where scantlings were taken, and what materials were identified.

Later additions to the vessel are noted.

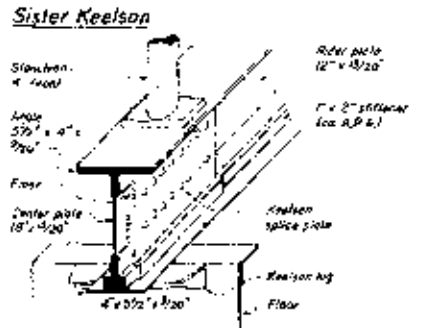
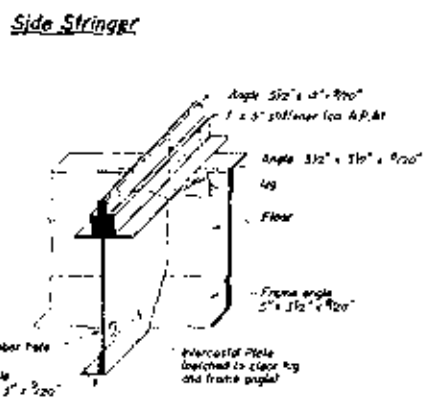
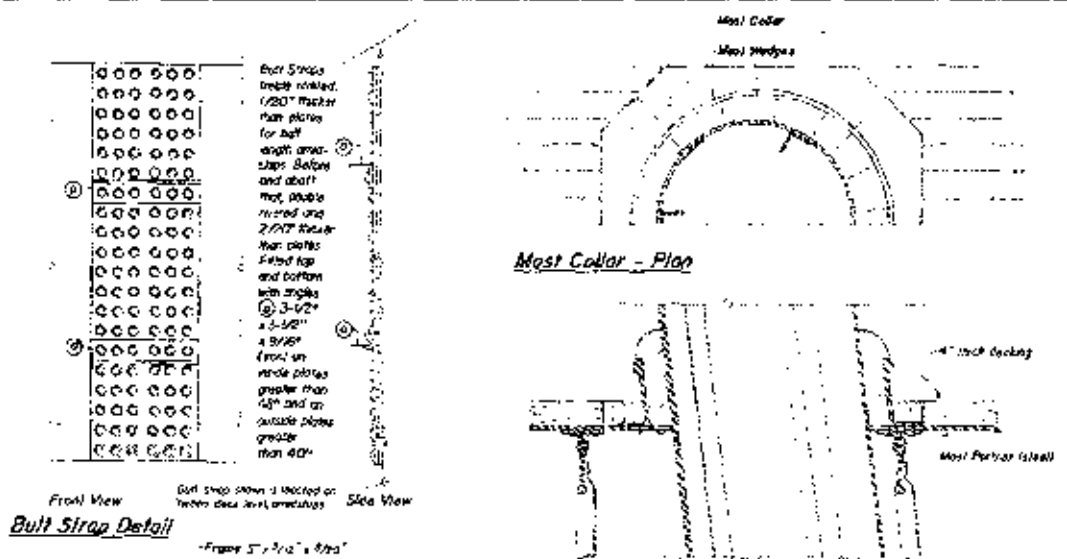

Keelson

NOTE
Scanlings taken from Lloyd's Register of Shipping Survey dated January 1887, and field verified where accessible. All metal is steel unless noted otherwise.

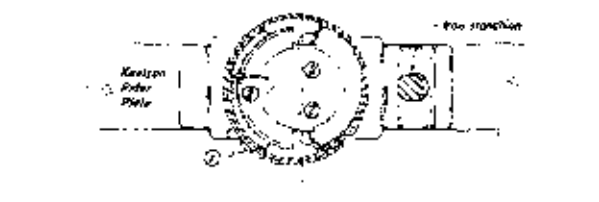
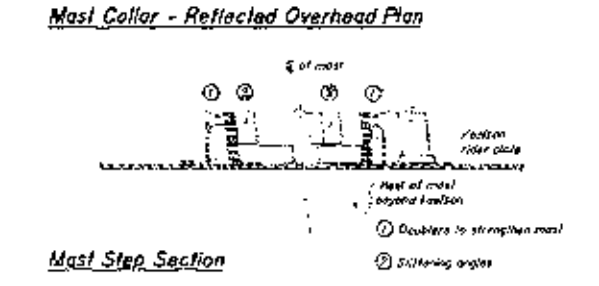
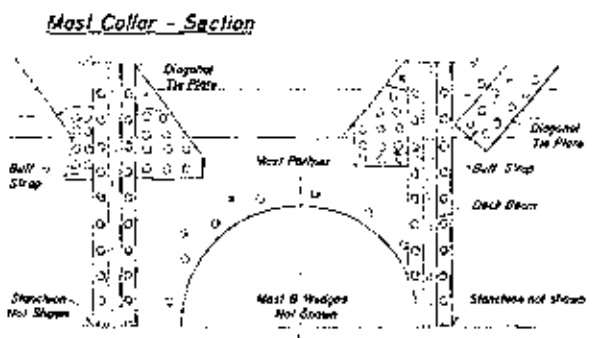

MIZZEN-MAST DETAILS
(Fore Mast Similar)
(See Masting Section, Sheet 36 for Scanlings)

Scale in meters

PROJECT: SHIP "BALCLUTHA" 6866J	SCALE: 1" = 15'
SAN FRANCISCO MARITIME NATIONAL HISTORICAL PARK	DATE: 1-80
5655 BALBUENA BLVD	PROJECT NO: 100003
SAN FRANCISCO, CA 94121	SCALE: 1" = 15'
DATE: 1-80	SCALE: 1" = 15'

Fig. 4.7.50

STRUCTURAL DETAILS**Fig. 4.7.51**Bugeye *LOUISE TRAVERS*

This vessel was in such bad repair at the time of her documentation that she was deemed unrestorable. Consequently, the HAER team was able to disassemble portions of the vessel for detailed structural documentation. Further field work was done on the vessel's remains after she was burned. This rather archeological approach is unusual on HAER projects.

Layout

This sheet is well laid out, with a good balance between the drawings and the text.

The exploded isometric drawings are spaced well, separated enough to be distinct, but aligned with each other for clarity.

Blocks of text follow the curve of the futtocks in the upper drawings and the angle of the keel in the lower drawings.

Delineation

Line weights are used to differentiate a hierarchy of elements.

The wood has been poché to show the actual grain direction, and this has been annotated so that a user cannot mistake it for generic rendering techniques.

The stern and duck tail drawing leaves the user uncertain as to whether some structural elements (knee, shaft log) are inside or outside of the hull. The ghost lines don't do their job well enough.

Documentation

Everything has been extensively documented as to what was and wasn't observed in the field.

Sizes and materials of hardware and fastenings have been noted wherever it was possible to obtain them.

All pieces are identified; labels are close where possible, keyed where they would obscure detail. Arrows are used to make positive identification between labels (or number tags) and indicated parts.

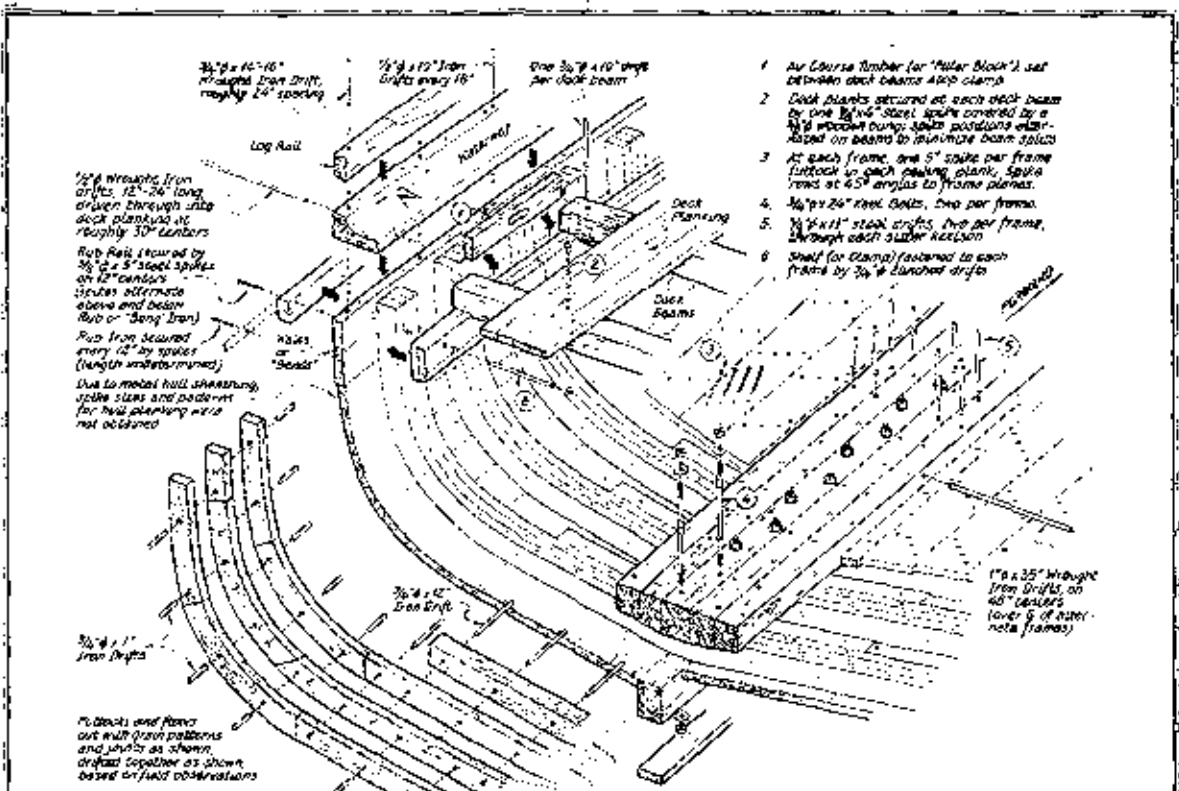

FRAME CONSTRUCTION

Fastening materials (through iron or steel) identified by their characteristic corrosion patterns where enough of fastening remains could be extracted.

The presence or absence of cambium cuts results in these three fibers was not fully checked due to time and access limitations.

TYPICAL HULL CONSTRUCTION and FASTENING DETAILS

(NO SCALE)

Construction details shown above observed in field during disassembly of vessel remains.

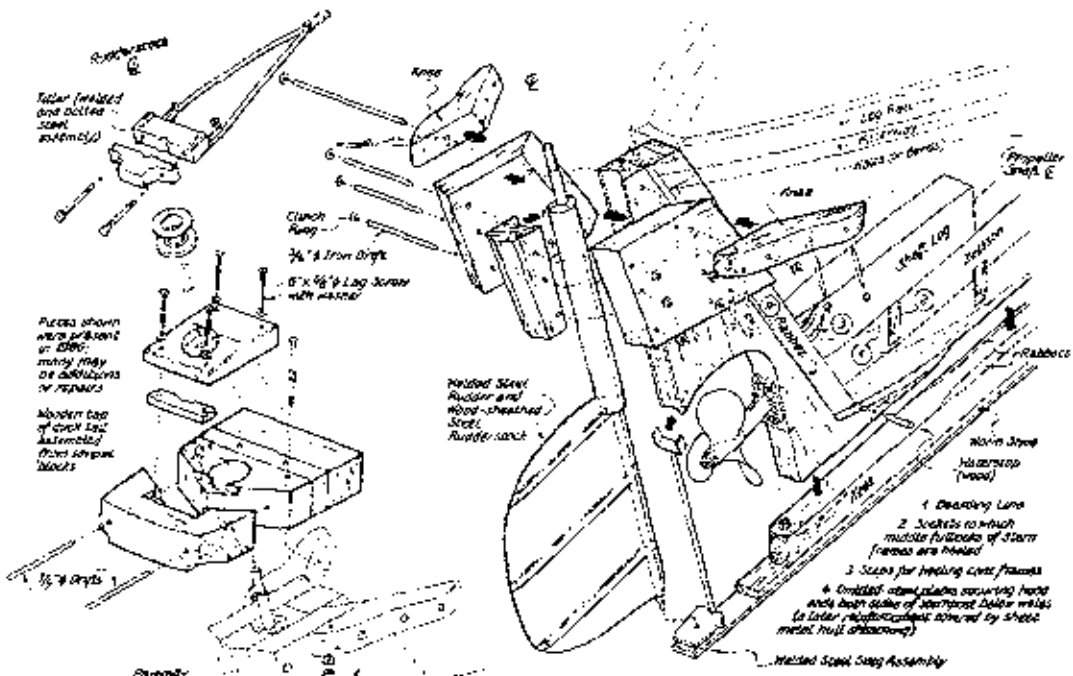

STERN and DUCK TAIL (or "BOX") ASSEMBLY

(NO SCALE)

Construction details shown above observed in field during disassembly of vessel remains.

Fig. 4.7.51

MACHINERY AND JOINERY DETAILS

Fig. 4.7.52

Ship *BALCLUTHA***Layout**

The various views have been placed to correspond to each other as much as possible.

Delineation

A variety of line weights makes this drawing read; note the heavier lines at the edges of cut materials. Details have been delineated with finer lines. Pochés denote cut materials and shadowing creates a sense of depth, especially in the lattice seat of the bench.

Different lettering sizes differentiate "parts" labels, "view" labels, and the "title" label.

Documentation

Although labels denote various parts, not much explains how the steering gear worked, obviously because there was no space for the text. Although the gear is patented, detailed information may be hard to find in the future. A single sheet devoted to just the mechanism may have been a more thorough treatment.

Basic dimensions are given, but not all the details are drawn at the same scale, and the differing scales are not clearly noted.

Some, but not all, materials are noted.

Fig. 4.7.52

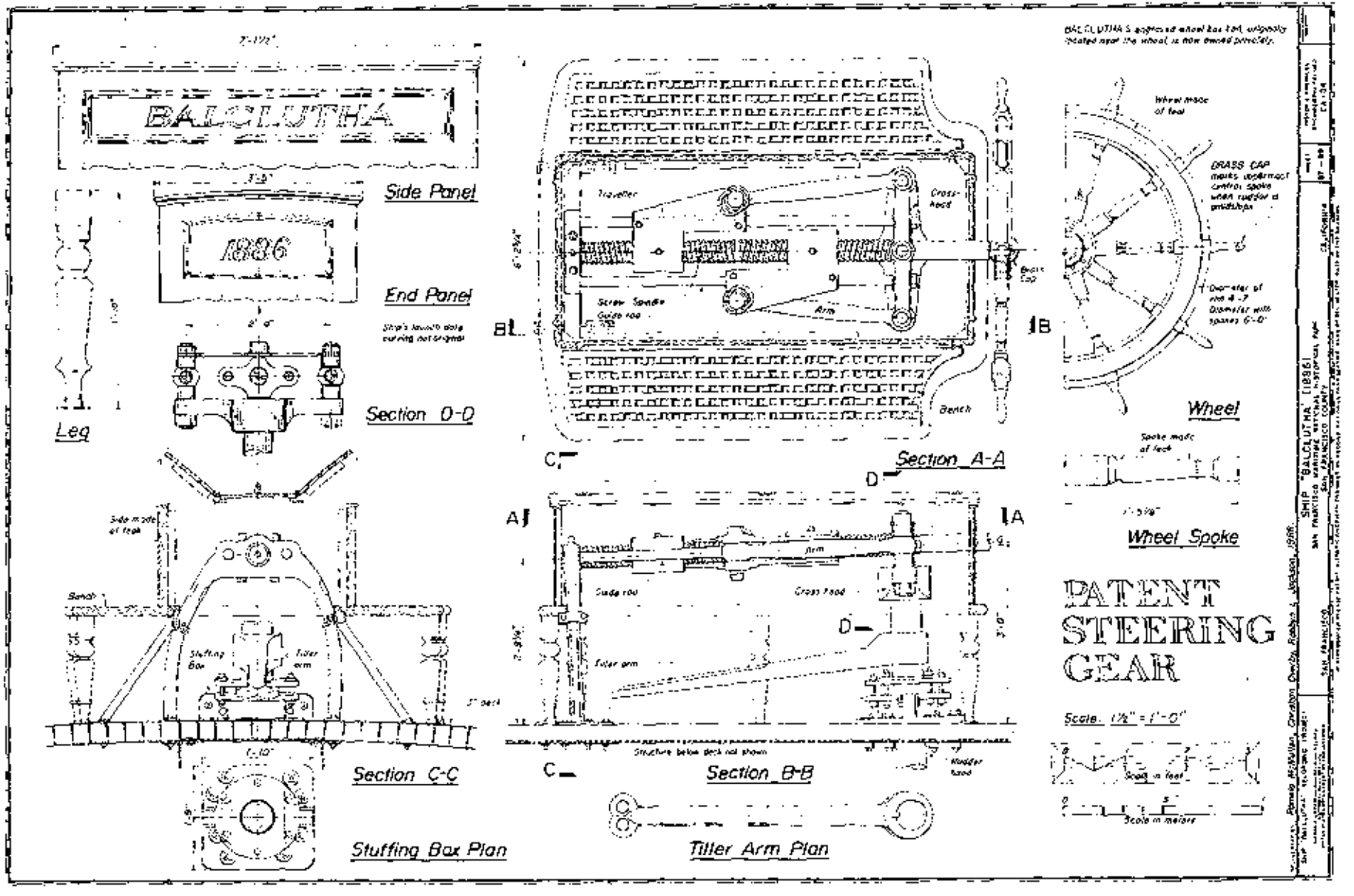

MACHINERY DETAILS

Fig. 4.7.53

Bark *EMILY F. WHITNEY*Layout

Sheet design is orderly for the most part, though some details appear to be spaced by whim (details E, F, and G) when they might have been grouped together.

Delineation

Stronger line weights would have helped this drawing. As it is, the rendered wood cross sections and the steering screw threads read far more strongly than anything else on the sheet. Are these the most important things to see?

Wood graining of the taffrail spindle and section in the steering gear side elevation completely overwhelms all other linework and details in the part. Why is this rail detail located on a sheet about steering gear.?

Documentation

This is a fairly complete mechanical drawing of a steering gear, but who manufactured it? Was that undetermined?

While many views and pieces can be tied together by their letter labels, the labels are frequently insufficient to explain the relationships of parts. Keep in mind that many users of HAER drawings will not be familiar with ship mechanisms or construction. We can tell where "G" fits in in the plan of the steering gear, but where does it "go"? Is it screwed to the top of the rudder post or to another metal part? Where on earth is the "Kick Chock" located in the elevation of the gear, and what does it do? Are the chocks in the sectioned rudder post (showing parts "A" and "B") cut there for a purpose, or are they merely pictorial? Detail in lower right corner of the sheet is a mystery--where does it go in the assembly?

Some dimensional information is always useful, despite a graphic scale (the graphic scale shown here is insufficient in length anyway).

The rotated section of the steering wheel rim is a cryptic appendage, bound to puzzle quite a few users. (Can you find it?) Such details should be drawn at larger scales, fully labeled, and cross-referenced.

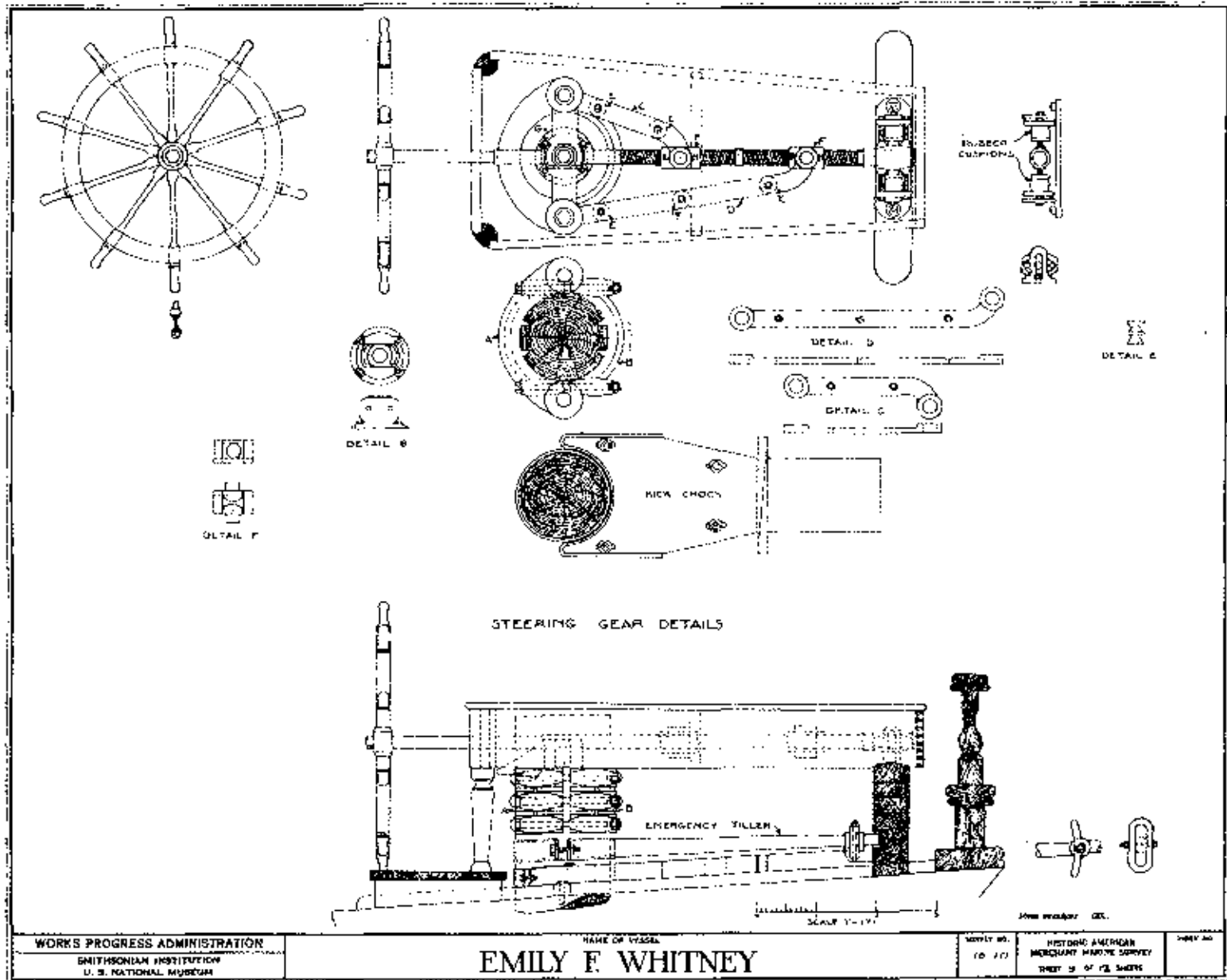

MACHINERY DETAILS

Fig. 4.7.54

Engine, Cutter *GJOA***Layout**

Standard three-view mechanical drawing.

Delineation

Delineation is very clean and precise--no overruns, mismatched curves and tangents, awkward or sloppy details--however, overall effect is flat and lifeless. Some judicious outlining with a heavier line, or use of line shading would improve the character (without much extra labor, had it been done at first).

Lettering is too small and too faint for view titles, sheet title, and graphic scale.

Documentation

This drawing shows in great detail what a "13-horsepower 'Dan' type petroleum engine" looks like, but a lot of important information is *not* addressed:

- Which way was the engine mounted?
- What RPM range did it run at?
- What was cylinder bore and stroke?
- What direction did the flywheel rotate (or was it reversible)?
- Who built the engine? when? where?
- When was it installed in the vessel?
- What are the names of some of the principal parts?
- Where are the connections for fuel, air, and exhaust?
- Are any parts missing that would ordinarily be installed on an operating engine of this type?

Recorders should annotate drawings with this sort of information, giving users references for further levels of detail. Omissions should be accounted for in some manner, even if the reason is lack of resources.

The drawing does not state if it is based on any pre-existing engineering drawings of this type of engine.

It appears that the connecting rods, cranks, and counterweights are missing in the drawing--a not inconsiderable oversight.

Principal dimensions should be shown.

12 HORSE POWER "DAN" TYPE
PETROLEUM ENGINE

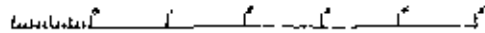

Scale 1-1/2"

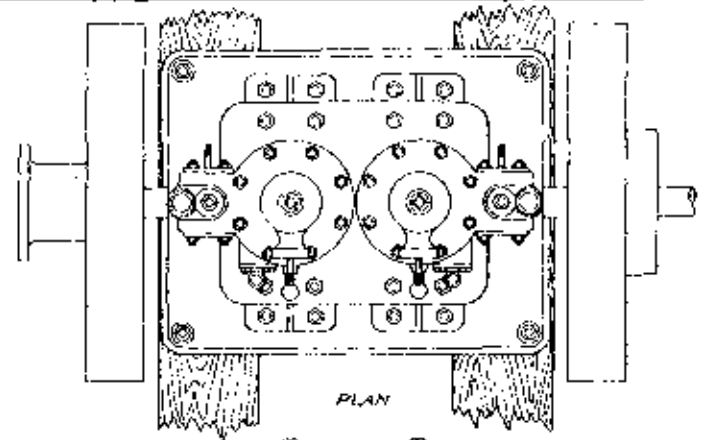

PLAN

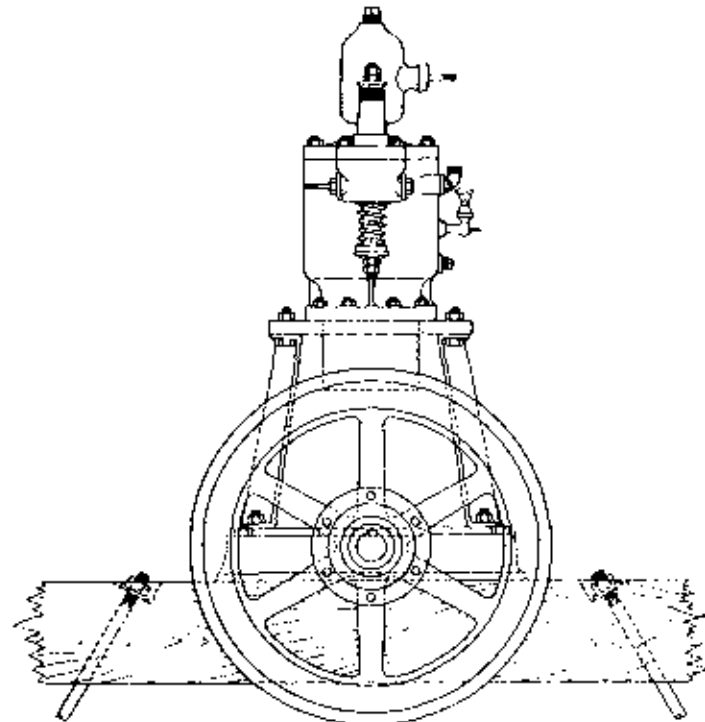

END ELEVATION

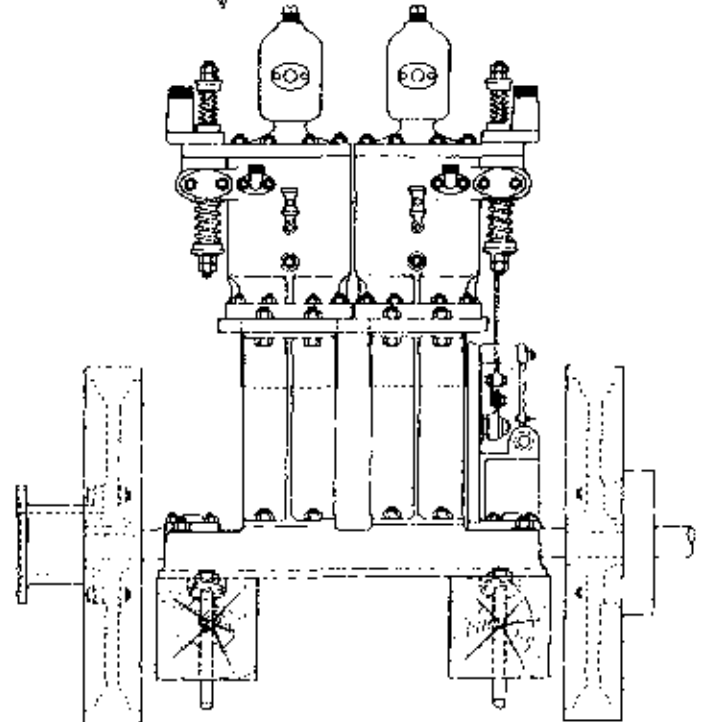

SIDE ELEVATION

Fig. 4.7.54

<p>WORKS PROGRESS ADMINISTRATION SMITHSONIAN INSTITUTION U. S. NATIONAL MUSEUM</p>	<p>NAME OF VESSEL G JOA</p>	<p>SHEET NO. 75 79</p>	<p>SHEET 6 OF 6 SHEETS</p>
--	--	----------------------------	----------------------------

MACHINERY DETAILS

Fig. 4.7.55

Anchor Windlass, Schooner *LOUISA MORRISON***Layout**

Standard mechanical drafting views, laid out with adequate space.

Delineation

Delineation is clean and precise.

Rendering of wooden and metal components is balanced with linework, and doesn't overpower the drawing. However, HAER would only render sectioned materials, and would label other materials. Also, the ratchet teeth on the windlass drum are delineated with the same line weight as the shadowing, permitting easy confusion. Shadow lines should always be lighter in weight than lines used for actual physical features.

Title of sheet should be more prominent.

Documentation

The delineator should have recorded who manufactured this piece of equipment, what its principal dimensions were, and a brief description of how it operates.

Fig. 4.7.55

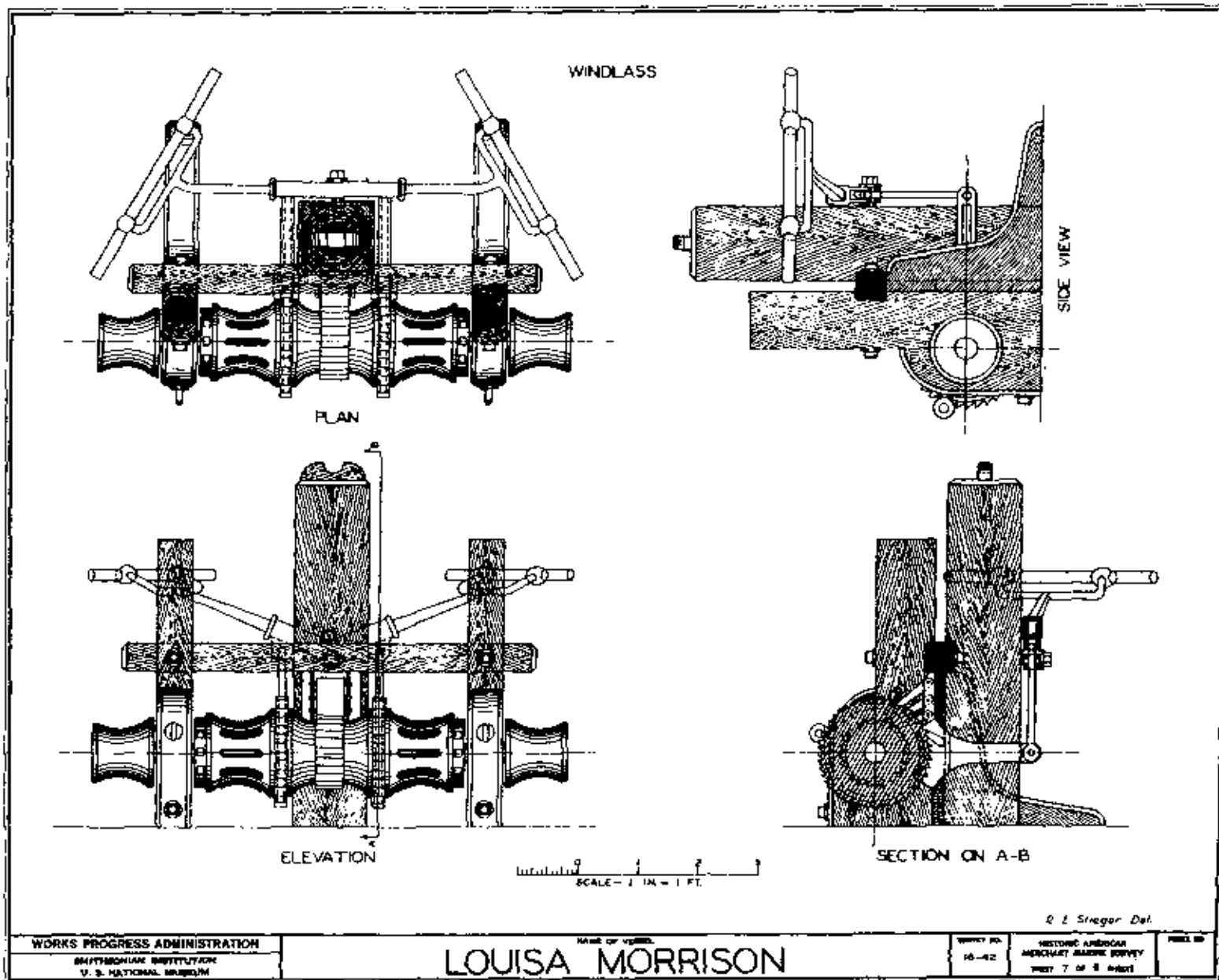

MACHINERY DETAILS

Fig. 4.7.56

Anchor and pump, Scow Schooner *JAMES F. McKENNA*Layout

Slightly awkward juxtaposition of pump and anchor views. This could have been prevented with some thoughtful rearrangement--there is plenty of space.

Delineation

The contrast in treatment between the anchor and pump head is enormous. The anchor is strongly delineated and rendered, but lacks any principal dimensions. The pump head is flatly delineated and accompanied by a large (but unobjectionable) number of dimensions.

Documentation

If a user didn't know that the "non-anchor" object was a pump, this drawing gives no help. Most people have seen an anchor, but does this one serve any special purpose that explains its size, details, and configuration?

Was there any known manufacturer for the pump? What was it used for? How many men did it take to operate it? How much could it pump in an hour? Were there more than one aboard the *MORRISON*?

Fig. 4.7.56

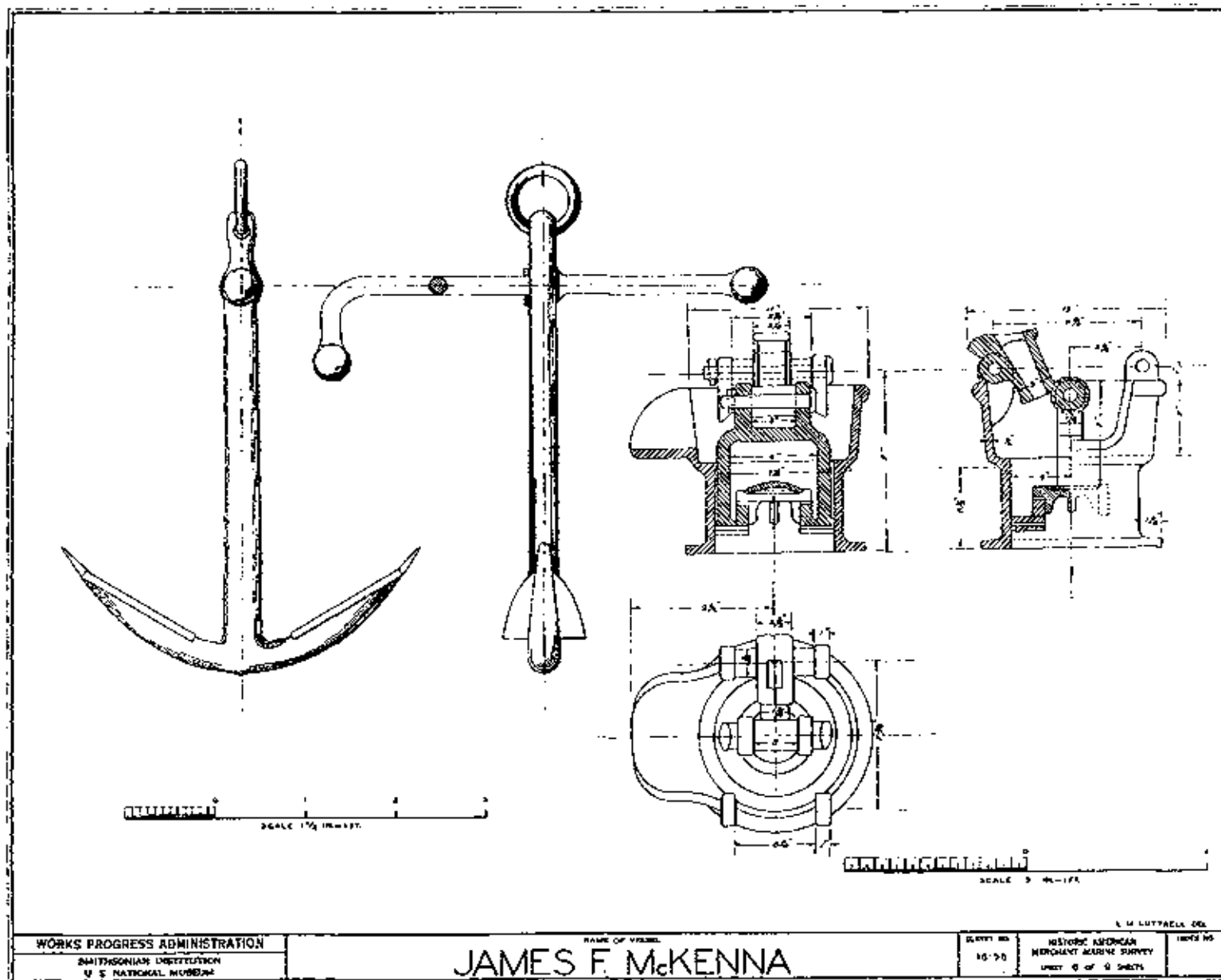

ENGINE DRAWINGS

Fig. 4.7.57

Engine, Sidewheeler *JAMES M. DONAHUE*Delineation

This drawing suffers from several figure/ground effects caused by a poor choice of line weights. In some places it is hard to tell the difference between a dimension string and structure, or between a solid feature and a void. The A-frame and walking beam read very poorly compared to the staircase and boiler, and because of their weak delineation, dimension strings and dashed lines clutter them up far more than they otherwise would. The staircase draws the eye because it is the most strongly and clearly rendered feature on the drawing, but why should it stand out the most on a drawing devoted to propulsion machinery? The A-frame, walking beam, connecting rod, and cylinder should all be much more boldly delineated in outline. Thin features in this drawing (such as tie rods) should be left as is, since two closely spaced thin lines tend to read as a thicker line.

The line shading on the engine cylinder, piping and boiler is sketchy, making these features indefinite and fuzzy looking.

Documentation

Who built this engine? What are its specifications? The same questions could be asked about the boiler.

A great deal of dimensional data pervades the drawing, much of it extraneous, or better left to a more schematic view. After all of that, nowhere are the bore and stroke of the piston noted or dimensioned. The graphic scale is also woefully undersized and weakly delineated.

Despite the dimensioning, not one major part is identified. It is assumed that the user knows what is being shown.

Important mechanical data on the eccentrics is hidden in a cryptic diagram hobbled by teeny lettering, and parts of the valve gear appear to be missing without any accounting for the omission.

Why does a staircase appear here? If an extraneous feature is needed to help orient one aboard the vessel, it should be schematically drawn or dotted in so as not to compete for attention with the chief subject matter.

Fig. 4.7.57

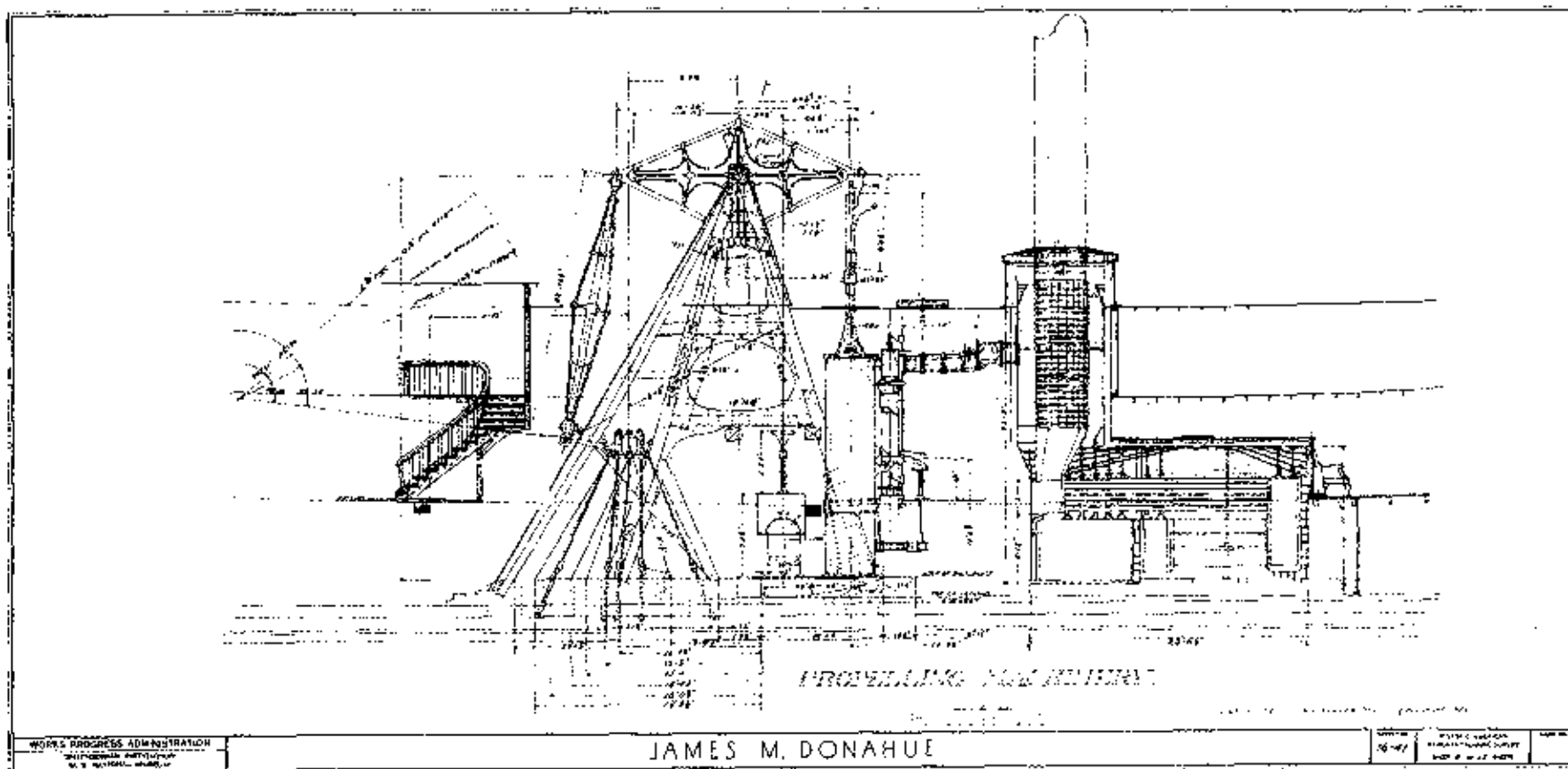

MACHINERY DETAILS

Fig. 4.7.58

Donkey Engine, Schooner *COMMERCE*Layout

The two views shown are a bit cramped.
No plan view is shown.

Delineation

This drawing reads boldly, but the effect is achieved at the expense of time-consuming rendering which often obscures details (plank joints, phantom views of gears, etc.). An unintentional result of this treatment is that the flat-sided metal feedwater tank (extreme left) reads completely as a void, not a feature. (Flat metal surfaces can be stippled to denote a solid plane.) Some rendering shown here is useful, such as that for the boiler barrel and other rounded features (avoid it on small piping).

Some delineation is crude (in part due to the characteristics of vellums).

Documentation

Lack of principal dimensions and annotations reduces this drawing to showing a user how something looks but not much else. So much more can be added by appropriate notes and labels:

- Who built the engine and boiler? when? where?
- When was it installed in the vessel?
- What are the principal specifications on the boiler (operating pressure, heating area, fuel, etc.)?
- What were the bore and stroke of the cylinders?
- What are the names of some of the principal parts?
- What uses was the donkey engine put to aboard the *COMMERCE*?

Plan view of assembly is missing.

Fig. 4.7.58

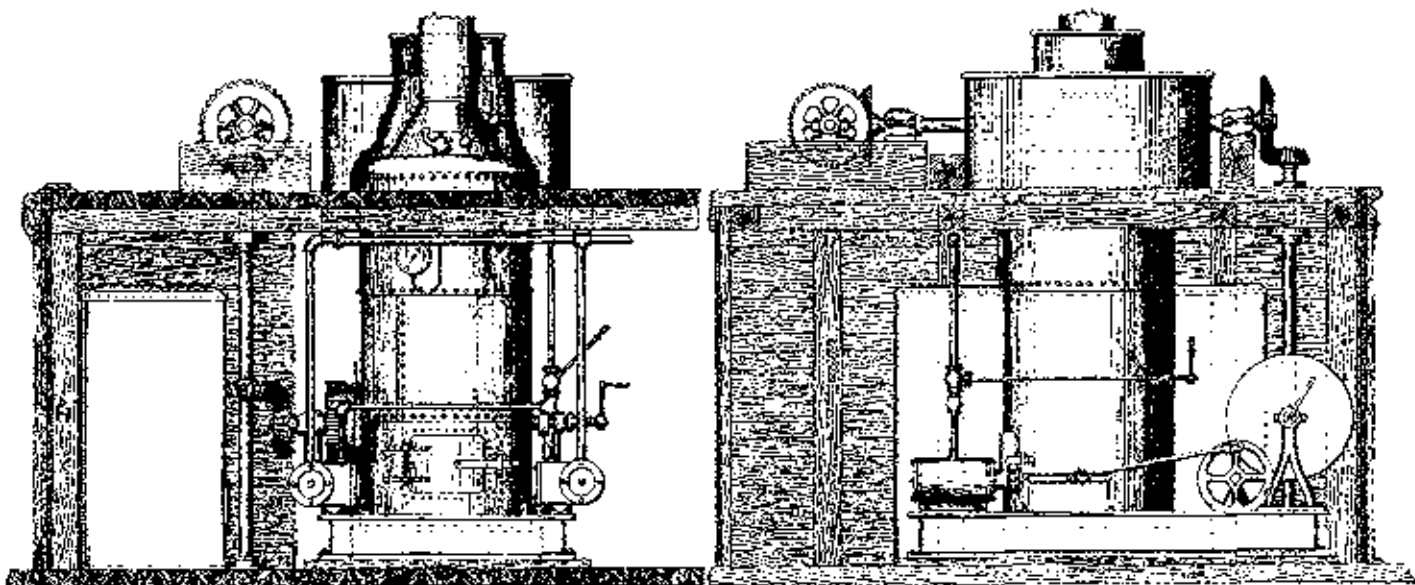

DONKEY ENGINE AND BOILER.

SCALE 1/4" = 1'-0"
ENGINE [unclear] [unclear]

Geo. H. Chase

MACHINERY DETAILS

Fig. 4.7.59

Ship *FALLS OF CLYDE*

This is an interpretive drawing, done to illustrate the cargo and ballast pumping system in a manner much more readable than plans or sections. In drawings such as this, distracting elements such as framing members can be omitted for clarity, and other elements can be elongated or foreshortened to avoid obscuring important features. Accurate plan and section drawings should be completed also.

Layout

The drawing uses the available space well. The detail in the upper right balances the title in the lower left.

Delineation

Some indication of the shape of the ship's hull would add to this drawing.

The use of shadow lines enhances the third dimension of this drawing.

The lettering is large enough to read well when reduced.

Labels located on pipes would look better if their letters followed the curves of the pipes.

The directions of flow in the ballast and cargo pipes should be indicated.

Documentation

The pumps have been identified as to their size, capacity and manufacturer. Only enough details has been shown on the pumps and valves to adequately express their function.

Dashed lines in the shape of a box denote a missing pump. No documentation was available on the pump's size or appearance.

Historic photographs helped in recreating some of the missing portions of the system; notes report their location and identity.

Labels lie close to the parts they identify, but do not obscure line work.

A location key diagram shows the location of the drawn area within the vessel.

KEY

- | | |
|-----------------------|--------------------------------|
| 1. FIREWATER TANK | 11. STEAM DISCHARGE LINE |
| 2. SCOTCH MASH PUMP | 12. FRESHWATER DISCHARGE LINE |
| 3. FUEL OIL TANK | 13. BILGE WATER DISCHARGE LINE |
| 4. GENERATOR ROOM | 14. STEAM SUPPLY LINE TO HULL |
| 5. FUEL OIL FEED PUMP | 15. STRAINER |
| 6. FRESHWATER TANK | 16. SEA COCK |
| 7. REGENERATOR | 17. VALVE |
| 8. CARGO PUMP | |
| 9. BALLAST PUMP | |
| 10. STEAM SUPPLY LINE | |

The Ship *FALLS OF CLYDE* was converted from a passenger and freight carrying vessel to a Sailing Oil Tanker in 1907, when 10 riveted steel bulk headed Cargo Tanks were built into the Ship. A 10-inch steam powered horizontal duplex reciprocating Cargo Pump discharged the Ship's cargo of petroleum or molasses. A similar 60-inch Duplex Pump supplied and discharged seawater ballast to maintain the Ship's stability. A Five 8 Bilge Pump supplied seawater to fight fires throughout the Ship, and removed bilge water from the Lower Pump Room. A second pump, now missing, was assumed by H.A.E.R. to be a Cargo Tank Bilge Pump, based on remaining suction and discharge pipes.

SHIP FALLS OF CLYDE (1878)
HULL
UNUSUALLY QUALITY
MORNING STAR
NOVEMBER 1937
RECORDED PRODUCT
FALLS OF CLYDE

FIG. 4.7.59

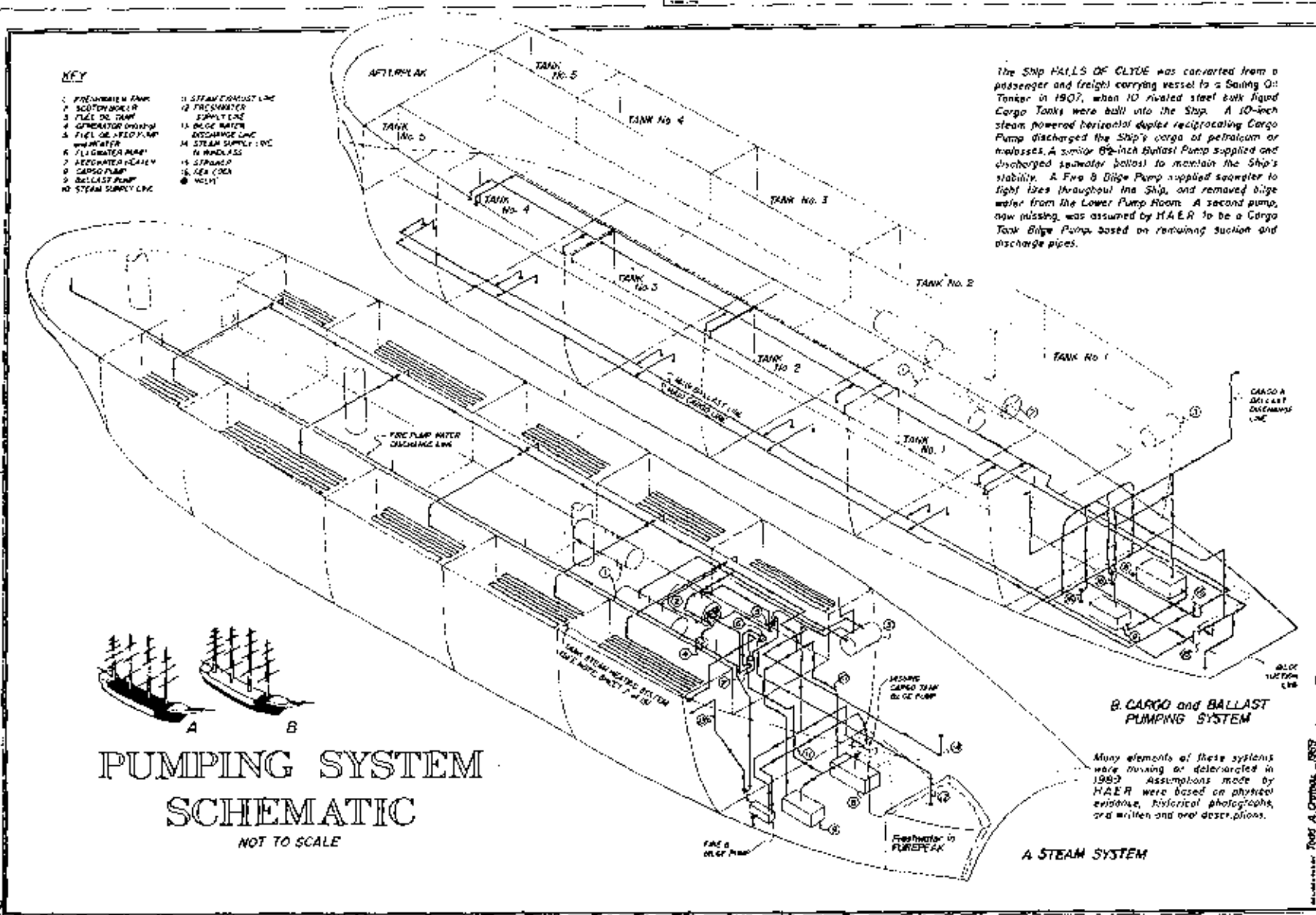

PUMPING SYSTEM SCHEMATIC
NOT TO SCALE

MACHINERY DETAILS - SYSTEM SCHEMATICS

Fig. 4.7.60

Ship *FALLS OF CLYDE*

This 1989 HAER project documented only a portion of the *Falls of Clyde*: the boiler room, port and starboard tanks, and upper and lower pump rooms. An understanding of these areas would not be easy without information on the whole system. A schematic drawing is all that is needed in this case.

Layout

The cargo and ballast pumping system has been separated from the steam system in order to prevent confusion.

Rather than reduce the size of the drawings or crowd them together, the afterpeak of the upper isometric breaks the sheet border to give room for notes.

The key, notes and title rest in the corners of the drawing, balancing the sheet. The note in the upper right hand corner would work better if it had taken a triangular form to follow the angle of the isometric.

Delineation

Heavy lines bring out the most significant parts of the system while light lines indicate the context of the ship's hull.

Size and weight of lettering varies according to its function. Labels are keyed to the drawing so as not to obscure linework.

Documentation

The purpose of the steam system--to heat oil and molasses cargoes for easier pumping--has not been stated.

Locations keys have been included to show which are of the vessel is being shown.

Assumptions made by HAER have been noted, as well as sources on which they are based.

This schematic is not to scale, and that has been noted.

INTERPRETIVE DRAWINGS**Fig. 4.7.61**Two Sail Bateau (Skipjack) *E.C. COLLIER***Layout**

The layout takes advantage of the image shape to place title lettering, graphic scale and labels.

"Sheet 1 of 2" should have been reduced in size.

Delineation

A variety of line weights makes a clear and definite image. Cut materials have been rendered.

Water was rendered along one side of the drawing to reinforce the impression of the marine environment in which the oyster dredging equipment operated.

Hand lettering is clear, but larger letters would have been more legible, especially in the rendered area on the right.

Choice of axes and scales for this axonometric drawing creates a distorted view of the winder and rollers.

Documentation

Space did not permit a detailed description of dredging on this sheet, so readers are referred to the second sheet.

No description is offered or referred to concerning winder operation. Controls and other parts of the winder are not identified.

Although advantage is taken in this view to show some aspects of the vessel's construction, timbers are not sized or labeled in this drawing. The view is focused on the winder and its part in oyster dredging. Scantlings are covered elsewhere.

OYSTER DREDGING

SHEET 1 OF 2

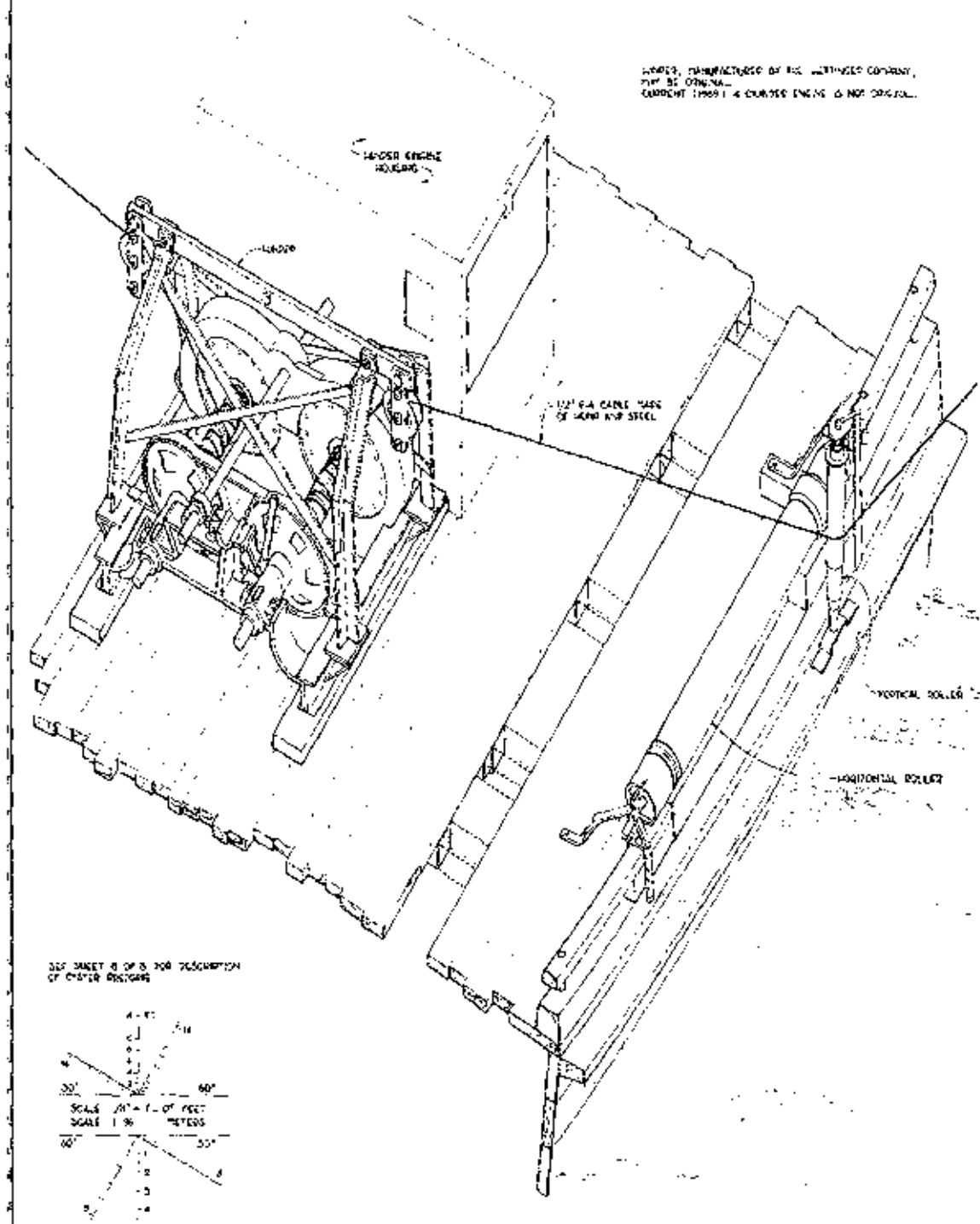

ENGINE, MANUFACTURED BY THE WESTINGHOUSE COMPANY, PITTSBURGH, PENN.
CURRENT (1909) IS A COPIED ENGINE & NOT ORIGINAL.

SEE SHEET 2 OF 2 FOR DESCRIPTION OF OTHER DETAILS



POLYGRAPHIC PLANS TABLE - 12/20/11 (REVISED) - 100 E. C. COLLIER RECORDING PROJECT 1000 W. BROADWAY, NEW YORK 1000 W. BROADWAY, NEW YORK	ST. M. CHABLES	TWO SAIL BATEAU (SHIPYACK) E. C. COLLIER (1910) 1000 W. BROADWAY, NEW YORK 1000 W. BROADWAY, NEW YORK	MARLAND P. M. 4	1000 W. BROADWAY 1000 W. BROADWAY, NEW YORK 1000 W. BROADWAY, NEW YORK
---	----------------	---	--------------------	--

Fig. 4.7.61

INTERPRETIVE DRAWINGS

Fig. 4.7.62

Two Sail Bateau (Skipjack) *E. C. COLLIER*Layout

This long, thin image lies diagonally across the sheet; explanatory paragraphs fill in opposite corners and balance the composition.

Text in the upper left is wrapped around the drawing. (It would have helped to do the same on the lower right.)

As with the first sheet "Sheet 2 of 2" is too large.

Delineation

Hand lettering is clear, but labels placed in the "water" are on the verge of losing their definition. Perhaps it is good that the verbiage blends nicely with the water rendering, but it does make labels harder to find.

Lettering style should have been modified to remain legible in reduction. The letter "E" is especially vulnerable to degradation, and many letters are bleeding together because they are too close together.

Documentation

The oyster dredging process is described in detail in conjunction with a drawing of a dredge basket. Rollers are repeated to provide continuity with the winder on the first sheet.

Sources for information on dredging are cited at the end of the text.

Though an isometric scale is included, the axes on which the dredge basket is drawn are different from the scale. Scaling from the basket image is problematic.

OYSTER DREDGING

SHEET 2 OF 2

OYSTERS ARE HARVESTED EACH YEAR FROM NOVEMBER 15 TO MARCH 15, AND OTHER WINTER EXTREMELY COLD AND LATE CONDITIONS. THE OYSTERS ARE HARVESTED BY DREDGING, OR "DREDGING" AS IT IS REFERRED TO LOCALLY, DRAGGING A DREDGE BASKET ACROSS THE TOP OF SUBMERGED OYSTER BEDS ON AVERAGE. THE DREDGES CAN SWEEP ONE TO FOUR DUES PER WEEK. BEING STOPPED FOR DUES IS A TYPE OF "SQUALLS," COOP FRONTS AND/OR TACKLE.

THE DREDGE BASKET CONSISTS OF A PYRAMIDAL STEEL FRAME WITH A DOWN AND BOW NET ATTACHED TO ITS BASE. A STEEL BAR WITH TINES SPACED APPROXIMATELY 5" ON CENTER IS ATTACHED TO THE FRONT AT THE MOUTH OF THE NET. THE SPACING AND LENGTH OF THE TINES VARY FROM BASKET TO BASKET, DEPENDING ON THE DIFFERENT DREDGING CONDITIONS. AS THE DREDGE BASKET IS PULLED ALONG THE TOP OF THE SUBMERGED OYSTER BEDS, THE TINES LOOSEN THE OYSTERS, AND THE CATCH IS ACCUMULATED IN THE NET. THE VOLUME OF THE CATCH VARIES FROM 50% TO 90% UP TO 20% OF THE BASKET'S CONTENTS BEING EMPTY BAGS, TUBS, AND BOTTLES, AS WELL AS OYSTERS WHICH ARE BELOW THE 5" TINE LIMIT. THE TYPICAL BASKET WEIGHS APPROXIMATELY 200 LBS., SO THAT IT CAN SWAMP BASKET TO THE BOTTOM AND "TACKLE" 750 POUNDS TO TYPICAL OYSTER BEDS AND LAKE BEDS ON EACH DUE. EACH DUE CARRIES TWO DREDGE BASKETS TO HELP THE BOAT BALANCE. BOTH BASKETS ARE DROPPED OVERBOARD AT THE SAME TIME, ONE FROM EACH SIDE, PORT AND STARBOARD, BOTH ARE PULLED UP AT THE SAME TIME EXCEPT WHEN THE DUE NEEDS TURNING. IN THIS CASE, ONLY ONE IS RAISED DEPENDING ON THE DIRECTION OF THE TURN, WITH THE SECOND BASKET BEING DROPPED AFTER THE TURN IS COMPLETE. AFTER THE BASKETS ARE Hauled ON BOCK, EVERYONE HELPS TO "TACKLE" THE CATCH. THE LEGAL OYSTERS ARE THROWN ON ICE, OTHERS ARE PUT AWAY AND THE DUES ARE SET AGAIN AND LAID OFF. THIS PROCESS IS REPEATED CONTINUALLY FROM EARLY MORNING UNTIL LATE AFTERNOON OR UNTIL THE 50-BUSHEL DUE LIMIT IS REACHED.

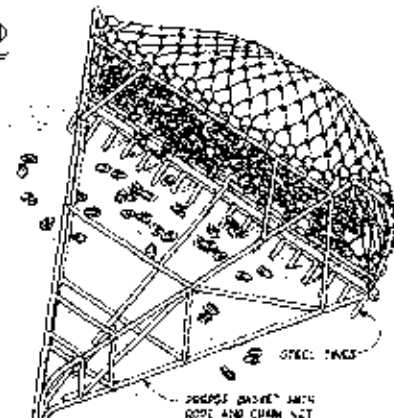

BASKET IS DROPPED IN TYPICAL POSITION ON OYSTER BEDS, DRAGGED SLIGHT BOAT

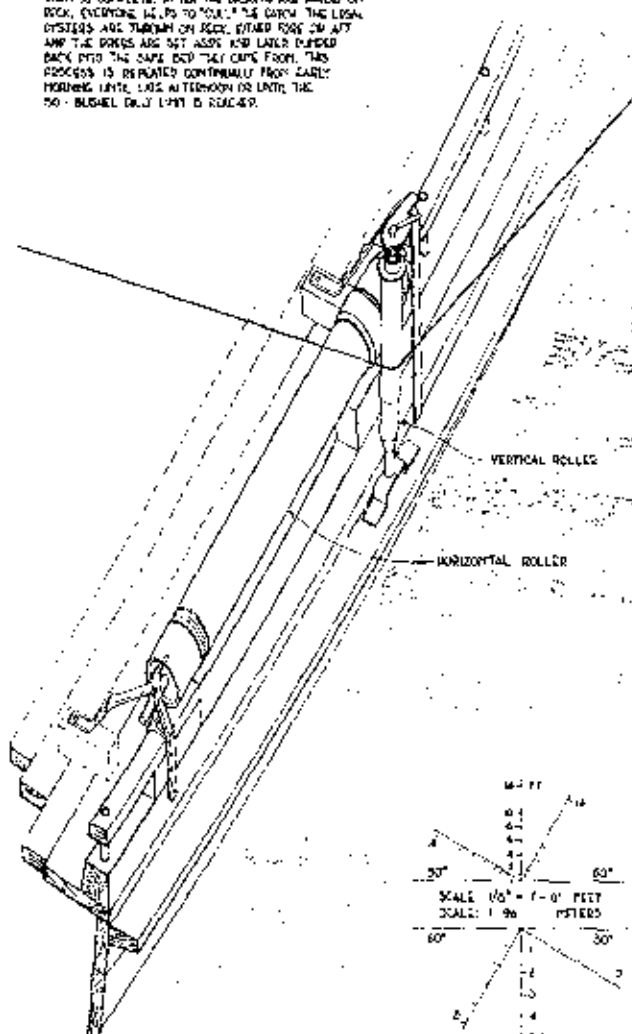

1/2" DIAMETER CABLE MADE OF WIRE AND STEEL

VERTICAL ROLLER
HORIZONTAL ROLLER

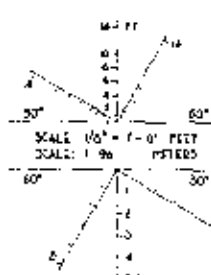

THE DREDGE BASKETS ARE GUIDED AND LOWERED BY A CABLE WHICH IS EXTENDED AS FAR AS 800 FEET TO THE WATER'S SURFACE. THE CABLE IS ATTACHED TO THE "MOUTH" OF A PYRAMIDAL STEEL FRAME (SEE SHEET 1 OF THIS ENGINE, USUALLY A DIESEL AUTOMATIC ENGINE) WHICH HAS A SET OF WHEELS ON THE LANDING AND UNLOADING THE CABLE TO BASE AND LOWER THE BASKETS. THE LOWER COMPONENT IS LOCATED ROUGHLY AHEADWARD, LEAVING ENOUGH SPACE TOWARD THE BOAT AND FOR SORTING THE CATCH ON "ICE" IN ORDER TO FACILITATE THE LANDING PROCESS, AND TO PREVENT DAMAGE TO THE BASKETS FROM THE FRONT AND PULL OF THE BASKETS. A SET OF METAL ROLLERS, ONE HORIZONTAL AND ONE VERTICAL, IS LOCATED ON EACH SIDE, AHEADWARD, ON AVERAGE, IN ADDITION TO THE CAPTAIN'S TACKLE SYSTEM TO EFFECTIVELY RUN A SWAGING OPERATION TWO FEET FROM EACH OF THE BASKETS, ONE TO RUN THE WHEELS AND THE OTHER TO RELIEVE THE OTHERS FROM TIME TO TIME.

TO PREVENT OVER HaulING OF THE OYSTER BEDS, THE DREDGES, AND OTHER WORK IS IN THE DREDGING PROCESS. ONLY DRAIVE FOR DUES IS LOWERED EARLY. THIS CONSIDERATION "SQUALLS" OCCURS BY "TACKLE" IN THE BOAT AND HAS LED TO THE USE OF AN "ENGINE-POWERED" DREDGE, USING OFF-ROAD TIRE AT THE STEER. DREDGES CAN LEGALLY BE USED TO ASSIST PROCEEDING IN AND OUT OF HARBOR AND IN MAKING THE TRIP TO AND FROM THE DREDGING GROUNDS. THE E.C. COLLIER'S DREDGE IS STILL IN PRIVATE HANDS IN 1960. IT WAS BUILT BY DAN AND WAS PROPERTY OF LUTHER, HAZELAND AROUND 1910. NOTHING IS KNOWN ABOUT THE ORIGINAL DREDGEBOAT.

SOURCE: HARRY COMPTON, THE OFFICER-IN-CHARGE, INTERNATIONAL MARINE ENGINEERING, DUNSMITH, CHICAGO, ILL.
MORAN, ROBERT E., THE OYSTER FISHING AND USE OF THE OYSTER BEDS, PUBLISHED BY THE UNIVERSITY OF MARYLAND, COLLEGE PARK, MARYLAND, 1960.
PETER, HENRI, D., MARITIME AND MARINE ENGINEERING, BOSTON, MASSACHUSETTS, 1910.

Fig. 4.7.62

JOINERY DETAILS

Fig. 4.7.63

Ship *BALCLUTHA*Layout

The details on this sheet have been placed to correspond as closely as possible to their locations on the elevation of the saloon door. The plan is below, the jamb and profile to the sides, the lintel above. The capital of the engaged column is next to the smaller profile, and its face is just below.

Delineation

A variety of line weights and pochés express the elegance of the joinery.

Documentation

Some elements are labeled, some are not. Why?

For further visual detail, notes refer the user to HAER large format photographs.

Notes say that the door lintel is drawn 3/4 full size and that the capital is drawn full size. In reduction, these statements are incorrect. Dimension lines would have permitted users to scale these drawings without guesswork or round-about comparison with other drawings.

DETAILS FOR THE ACCOMMODATION OF MASTER

Detail of Door Lintel - Scale is 3/4 Actual Size

Gilded carved leaf, there

Wood carved legend, probably post 1865

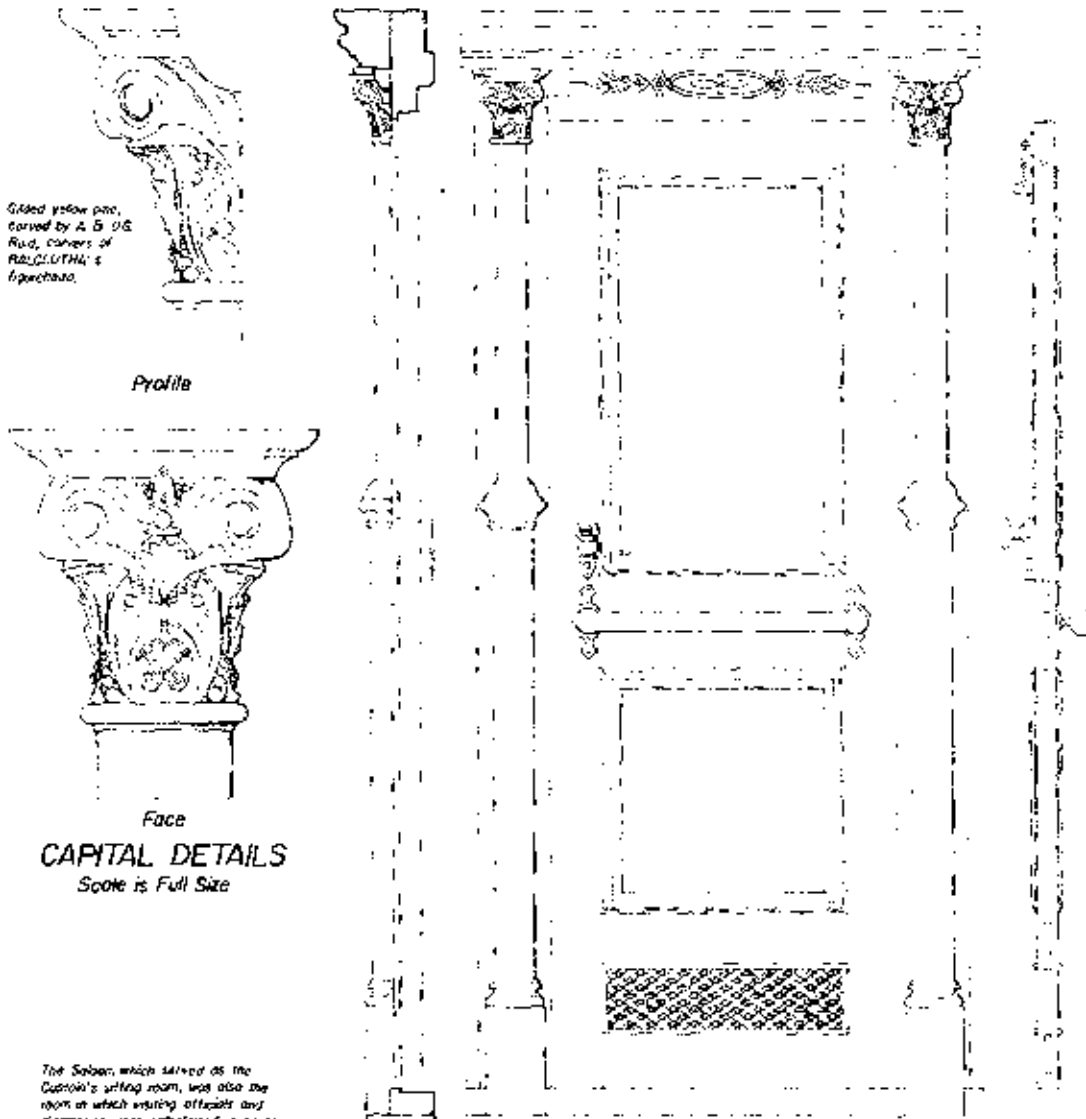

Gilded yellow pine, carved by A. B. U.S. Road, corners of BALCLUTHA's figurehead.

Profile

Face

CAPITAL DETAILS
Scale is Full Size

The Saloon, which served as the Captain's sitting room, was also the room in which visiting officials and dignitaries were entertained in ports visited, and served as a reflection on the shipowner and his pride in his vessel. BALCLUTHA's saloon was framed out in yellow pine and finished in teak, oak, mahogany and bird's eye maple. (See HREB photographs CA-54-65 through CA-54-71.)

Jamb Elevation Profile

Plan

Scale: 3" = 1'-0"

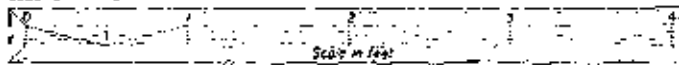

SALOON DOOR DETAILS

LEMO E. SALOMO, 1950	SHIP "BALCLUTHA" (1866)	62	76-54
SHIP "BALCLUTHA" REDWOOD PROJECT	SAN FRANCISCO MARITIME NATIONAL HISTORICAL SOCIETY	67-97	
	SAN FRANCISCO COUNTY		
	CALIFORNIA		

Fig. 4.7.63

CARVINGS and DECORATION**Fig. 4.7.64**Schooner *JOHN W. ATKINS***Documentation**

While delineation of these carving features is bold and legible, the appearance is schematic or simplified. Whether the drawing is schematic or not, there are no notes to inform the user.

Nothing on the drawing indicates whether this decoration is carved into the cutwater, merely painted on it, or both carved and painted.

Do the black, gray, and white tones represent any specific colors? Were the original colors actually black, white and gray? Or are the tones merely artist's interpretation liberally exercised? There is no verbal indication.

Some of these questions may well be answered by a photograph or a description in the written data, but there is little effort involved in adding verbal notes of this sort to a drawing in order to make it more immediately useful.

From Auxiliary Schooner *JOHN W. ATKINS*, HAMMS No. 8-43 (no sheet number)

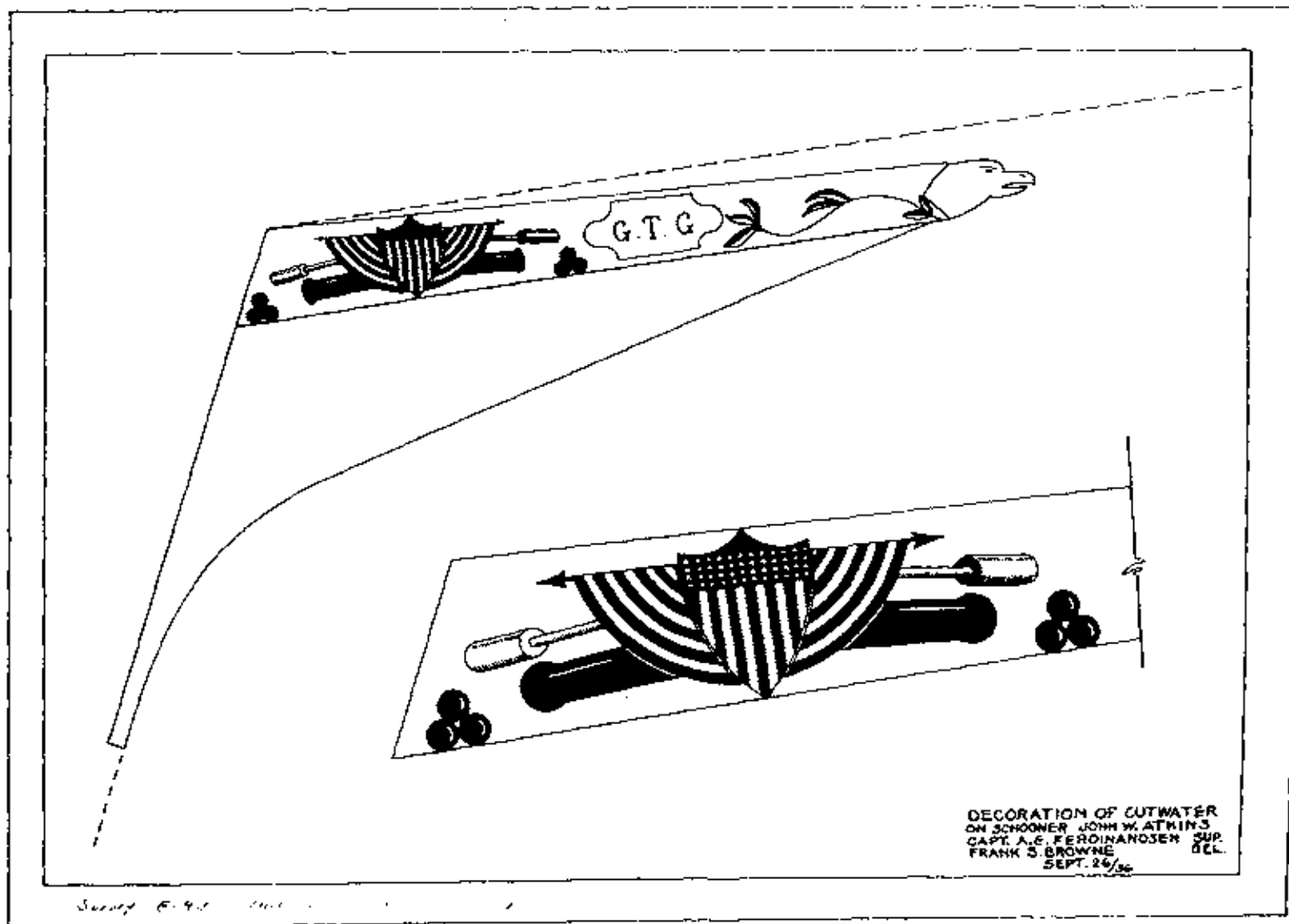

Fig. 4.7.64

MAPS**Figs. 4.7.65 and 4.7.66*****U.S.S. ARIZONA***

Ships were designed to travel, and unlike land-based structures, they were not intended to have permanent berths. In cases of preserved or sunken vessels associated with museums or historic sites, location maps are recommended on title sheets. Other maps to consider include vessel voyages and ports, whether in a regional area (bay or river system), an ocean, or around the world.

Layout

These two sheets were designed to present basic verbal, locational, and pictorial information about this vessel. Titles, text, maps and views are neatly distributed in a symmetrical pattern. A series of maps takes the reader from a view of the Pacific Ocean down to her immediate vicinity.

Delineation

Line weights for lettering, maps and perspective views complement each other. The rendering for water in the maps appears to have "dropped out" in reproduction.

The lettering reads well, however, the styles on the two sheets are different.

Documentation

The text addresses the vessel's history, the purpose of the documentary project, and field techniques used to measure the ship in water of limited visibility. This account of the field procedures, tools, and instruments used, as well as time and team size, allows the viewer to appreciate the accuracy of the work given the field conditions. However, no " \pm " tolerances are given.

Notice that the perspective views provide an overview that could not have been photographically produced.

Labels are prominent and very clear.

U S S A R I Z O N A

PEARL HARBOR HAWAII

The USS ARIZONA, a steel-hulled battleship built in 1915, was the third warship to bear the name. Displacing 31,400 tons standard and accommodating a crew of 53 officers and 860 men, she was the second and last of the Pennsylvania-class battleships. An improvement over the previous Nevada-class battleship, her firepower included four turrets, each mounting three 14-inch naval guns; twenty-two 5-inch, 51-caliber guns; four 3-inch 50-caliber anti-aircraft guns; and two 21-inch torpedo tubes. The vessel was able to achieve a speed of 21 knots with four shafts driven by four paired Parsons turbines and twelve Babcock and Wilcox boilers with 33,375 horse-power capacity. ARIZONA was refitted and modernized several times; her propulsion and engineering systems remained unaltered.

The battleship was destroyed during the Japanese attack on Pearl Harbor, December 7, 1941. A 1,750 pound bomb struck the vessel near turret No 2, and penetrated deep inside before exploding near the forward magazine, causing her to blow up and sink within minutes. Survivors and witnesses of the attack vessel claimed she was by eight additional bombs and one or possibly two torpedoes as she sank. Of the ships attacked at Pearl Harbor, ARIZONA received the most serious battle damage, and 1,177 members of her crew were killed. The Navy salvaged much of the ship's superstructure and what equipment could be reached by divers. The hundreds of crew members entombed with the wreck were declared "buried at sea" by the U.S. Navy and the vessel became a war grave.

The USS ARIZONA currently lies in approximately forty feet of water off Ford Island in Pearl Harbor on the island of Oahu, Hawaii. She remains at her berth (F-7) where she was moored with her repair ship USS VESTAL on the morning of December 7, 1941. In 1983 the Submerged Cultural Resources Unit (SCRU) of the National Park Service, was assigned the task of mapping and photo-documenting the vessel to assess the condition of the remains of the battleship. The project was unique in the fact that no one had ever attempted the detailed mapping of a 608-foot battleship in water of only 6-foot visibility. SCRU assessed the cover and rate of deterioration of the ship's components as a basis for its preservation and site management. The SCRU survey and documentation revealed the

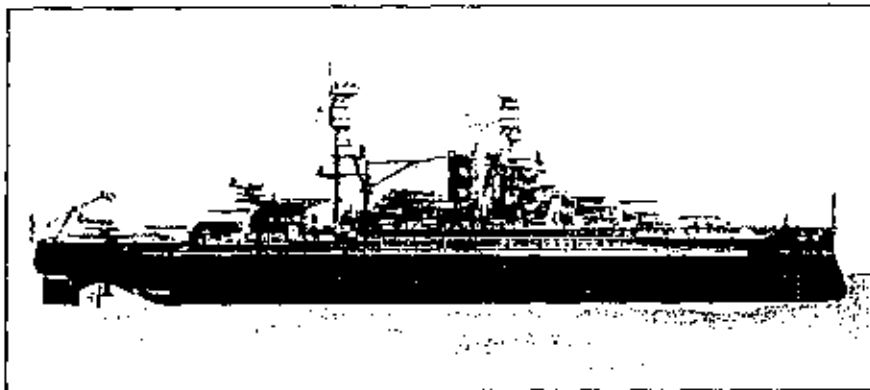

The USS ARIZONA after modernization in 1929 - 1931. The bid-cage masts were replaced by fore and aft tripod types; the 3-inch anti-aircraft guns were replaced by 5-inch mounts; torpedoes "baskets" were added to the outer hull to increase the ship's protection against torpedo attack; additional steel armor was added; and modern boilers and turbines were installed. (Photograph is in the NPS, USAR collection.)

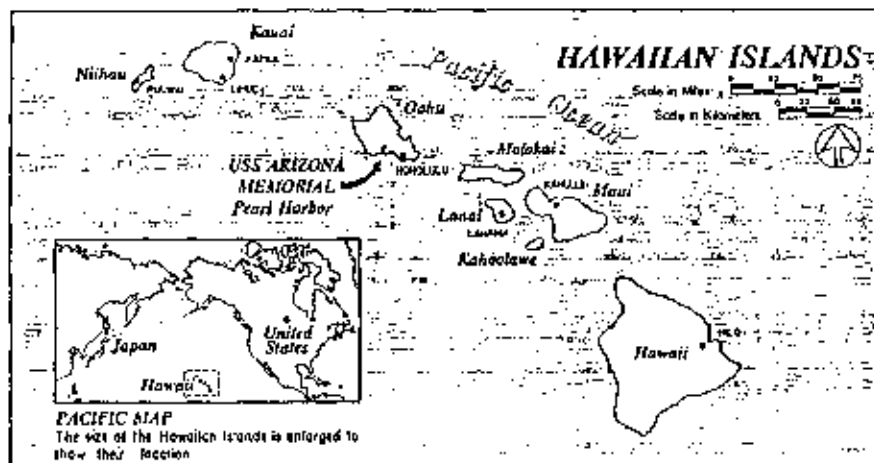

battleship to be substantially intact at her current resting place. As a property of exceptional national significance, she received National Historic Landmark designation on May 5, 1969. The ARIZONA, with the ARIZONA Memorial has become a major shrine and point of remembrance, not only for the lost battleship and her crew, but also for the entire clock.

The Submerged Cultural Resources Recording Project is part of the Historic American Engineering Record (HAER), a long-range program to document historically significant engineering, industrial and maritime works in the United States. The HAER Program is administered by the National Park Service, United States Department of the Interior. The Submerged Cultural Resources Recording Project was sponsored during the summer of 1991 by the Historic American Buildings Survey/Historic American Engineering Record (HABS/HAER) under the general direction of Robert J. Kapsch, Chief of HABS/HAER, Eric M. Delony, Chief of HAER; and the Submerged Cultural Resources Unit (SCRU) of the National Park Service under the direction of Daniel J. Lenihan, Chief.

This project was undertaken for the joint purpose of incorporating existing SCRU documentation drawings into the HAER collection at the Library of Congress and to promote the recording and understanding of this nation's underwater cultural resources. Final inked drawings of the USS ARIZONA wreck were produced in 1985 and 1986 by Jerry L. Livingston, Scientific Illustrator and Larry V. Nordby, Chief of the Branch of Cultural Research, National Park Service, Southwest Regional Office. For more information on the SCRU documentation project see Submerged Cultural Resources Study, USS ARIZONA MEMORIAL and PEARL HARBOR NATIONAL HISTORIC LANDMARK Daniel J. Lenihan, Editor, Submerged Cultural Resources Unit, National Park Service, Southwest Cultural Resources Center, Professional Papers No. 23, Santa Fe, New Mexico 1989. The work of reproducing the original drawings into HAER major sheets, annotating and creating a title page was carried out in 1991 by J. Shannon Barres, and Craig N. Strong, Architects, under the direction of Robbyn L. Jackson, HAER Staff Architect.

MAPS

Fig. 4.7.66

U.S.S. ARIZONA

(see comments on p. 4.7.118)



OFF SOURCE: SURVIVAL DIVISION'S MAP OF OAHU, HAWAII, 1985, WITH 1:50,000 SCALE PHOTOGRAPHY.

USS ARIZONA MEMORIAL (1961-63, Building 4601) (Location 342110)

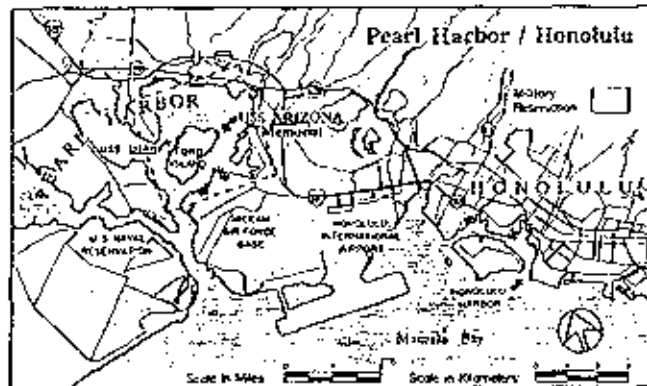

DOCUMENTING THE USS ARIZONA

The submerged battleship USS ARIZONA was documented in 1986 using basic, low cost and labor intensive techniques. The use of photogrammetry was not possible due to the six foot visibility, the shallow water and the high tide relief. The basic measuring tools were string, clothespins, and measuring tape.

No. 10 nylon string was laid over the ship to establish straight lines which were marked every ten feet with numbered plastic clips to form a kind of "cat's paw" over the site. The grid with its measurable lines was then plotted on paper and served as the basis for taking measurements by interpolation - relating known points on the marked lines to target features on the wreck. Thousands of separate measurements were taken during the four weeks spent in the field. Each evening, data collected during the day were copied onto a master set of drawings. Each morning mylar overlays were made of small sections of the drawings and affixed to the diver's plates, along with a list of required measurements. On some dives over sixty measurements were taken by a two-person team.

To confirm accuracy of critical points along the gunnel and other features of the badly deformed deck, a local survey crew shot targets with an inboard theodolite, or electronic distance-measuring (EDM) instrument. Divers held the reflective mirrors of the EDM motionless on top of a PVC (polyvinyl chloride) pole, as the bottom of the pole was held in place on the texture to be mapped. Because of the poor visibility, it was necessary to hand-measure over curves as if they were on a two-dimensional plane. The ship was divided into ten sections of sixty feet by the vertical strings from the grid's, creating twenty individual "frames" to be drawn in two dimensions. The illustrators later detected each frame to compensate for the two-dimensional depiction of the ship's curved hull.

Fig. 4.7.66

VIEW FROM OFF PORT BOW

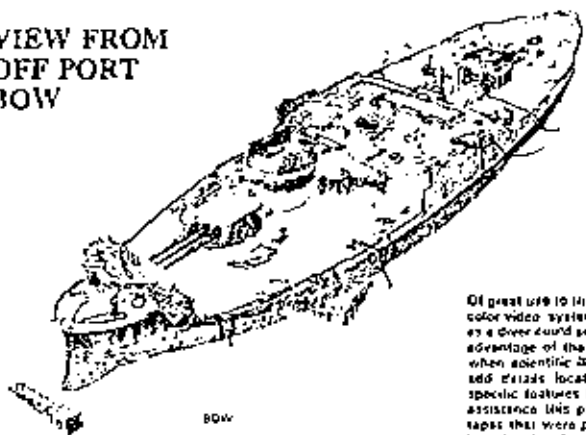

VIEW FROM OFF STARBOARD STERN

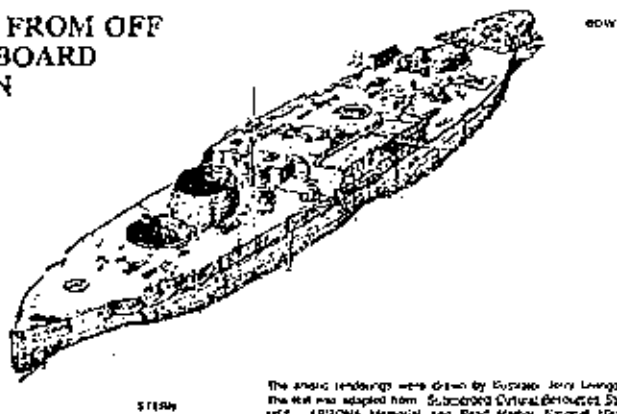

Of great use to the team was a low-cost, self-contained color video system which could record as much as a diver could see in the limited visibility. The greatest advantage of the video became apparent in the office when scientist-illustrator Jerry Livingston was able to add details located between known map points on specific features by consulting the tapes. Besides the assistance this provided in the mapping process, the tapes that were produced during the survey proved to be valuable educational tools.

The basic drawings were drawn by Eugene Jerry Livingston. The map was adapted from "Submerged Cultural Resources: Ship, USS ARIZONA Memorial and Pearl Harbor National Historic Landmark, Daniel J. Jaccard, Edsel, BDR, 1985

UNDERWATER NAUTICAL ARCHEOLOGY

Figs. 4.7.67 and 4.6.68

U.S.S. ARIZONA

The following two sheets (in addition to Figs. 4.7.65 and 4.7.66) are included to show how an underwater resource might be recorded for HAER. The immense size of this ship compared to other vessels shown in this section is notable, as is the limited visibility under which it was recorded.

Layout

The views are laid out without crowding.

Associated blurbs and keys are legibly lettered and placed next to the views they address.

The long graphic scale permits easy scaling of any dimension from the drawings.

Delineation

Note how darkened barbettes and other deck openings read in the 1984 plan as opposed to the 1986 plan. The darkened portions visually indicate the ship's condition a little better

Documentation

These views illustrate in detail the "as is" condition of the ship at the time of documentation. Very small details such as rivets were omitted as too small to show, and much larger remains were measured and depicted.

The different dates for the plans in Fig. 4.7.67 should be more prominently lettered in order to make the distinction more immediately clear to the reader. The 1984 date should be prominently displayed in labels for both views in Fig. 4.7.68 so that no date parallelism between the plans and profiles is assumed on account of the similar sheet layout.

PLAN
Drawn in 1984

USS ARIZONA was documented during three weeks of intensive diving in 1984. Drawings were produced of a planimetric or "bird's eye" view of the ship (shown here) and of its port and starboard profiles (see sheet 4).

The final rendering was done by scribbling illustrator Jerry Livingston, who also created two artist's perspectives of the vessel (see sheet 2). The drawings were finalized during the winter of 1984 and released by SCRU in 1985.

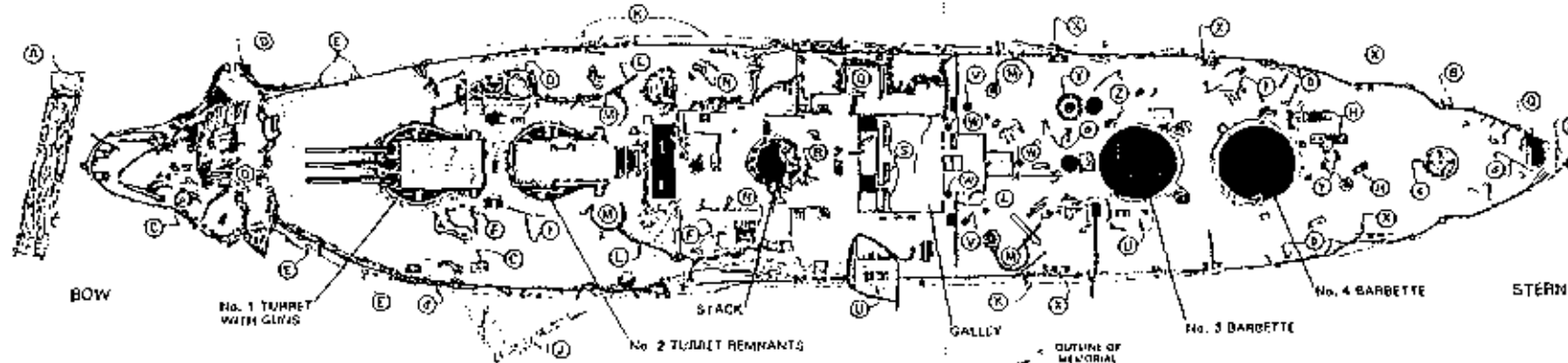

KEY

- | | | | | | | | | | | | |
|---|-------------------|---|-----------------------|---|-------------------|---|--------------|---|--|---|------------------------------|
| A | CABLE | G | MATCH | K | TORPEDO LUSHER | P | PORT | U | OLD MOORING BIRTS FOR VISITING VESSELS | V | VENTILATION |
| B | CABLE RUN | H | OPEN MATCH WITH COVER | L | BULKHEAD REMNANTS | Q | HOLE IN DECK | V | BOAT CRANE BASE | Z | HATCH LENS OR LIGHT CRACKLES |
| C | STEEL PLATE | I | WIND PIPE | M | GUN TUB | R | WINCH DRUM | W | WAST TUNDRU LEG | 1 | RAIL STATION |
| D | MISC. SHEET METAL | J | FRAME | N | ENGINE CABINET | S | OVER BASE | X | BITTS | 2 | CATAPIRT BASE |
| E | INSPECTION PORTS | | | O | HATCH COVER | T | TAIL LEGS | Y | CHAIR | | |

Fig. 4.7.67

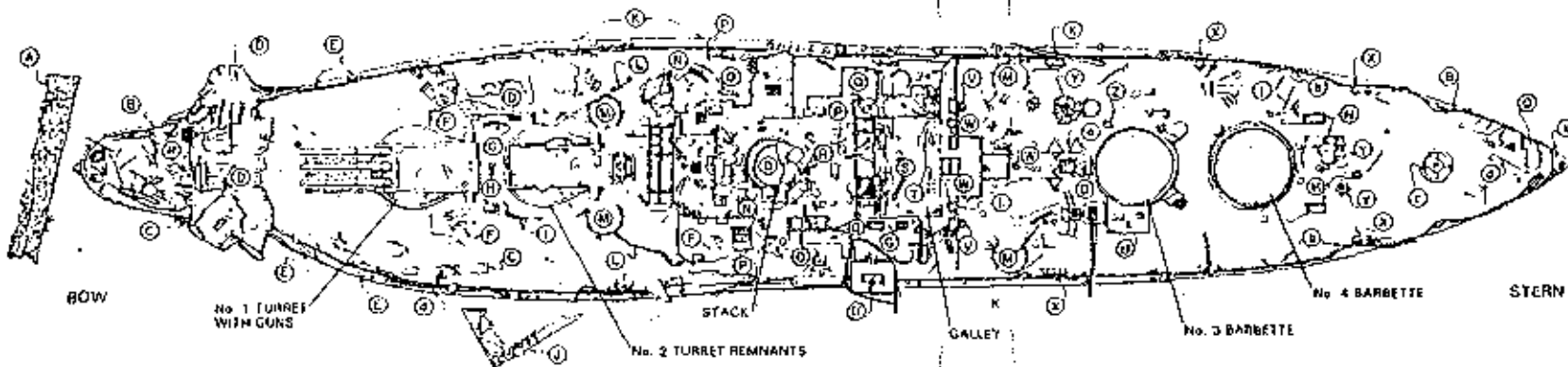

PLAN
Drawn in 1986

In 1986, Robert Samuel, a ship modeler from Annapolis, Maryland, was contacted to use the SCRU drawings to build a model of the ARIZONA as she sits at the bottom of the harbor. He found that the planimetric view did not have enough information, and it was decided to recover the top of the wrecked vessel and add objects on the deck that were overlooked in the earlier survey.

The 1986 plan view (shown above) was drawn by Larry Nordby, Chief of the Branch of Cultural Research, National Park Service, Southwest Regional Office. As the home of the recovery, a bioherpetological study was conducted on the ARIZONA. The purpose of this was to develop a baseline inventory of biological communities and the amount of rock material on the ship and to measure the state of decomposition of the ship's metal structural elements.

Scale: 1:25" = 20'

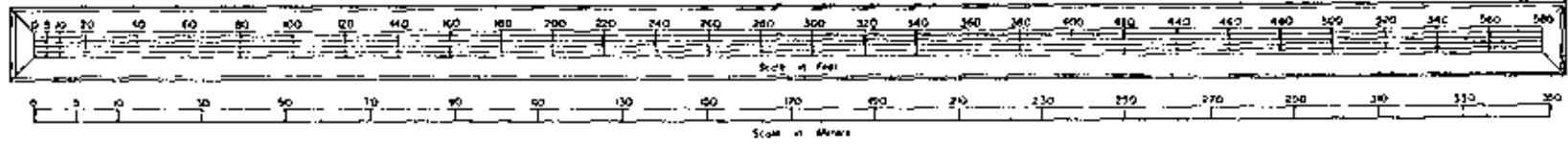

Drawing was photographed, reproduced and published by SCRU in 1985. Drawings were photographed, reproduced and published by SCRU in 1985. Drawings were photographed, reproduced and published by SCRU in 1985.

UNDERWATER NAUTICAL ARCHEOLOGY

Fig. 4.6.68

U.S.S. ARIZONA

(see comments on p. 4.7.122)

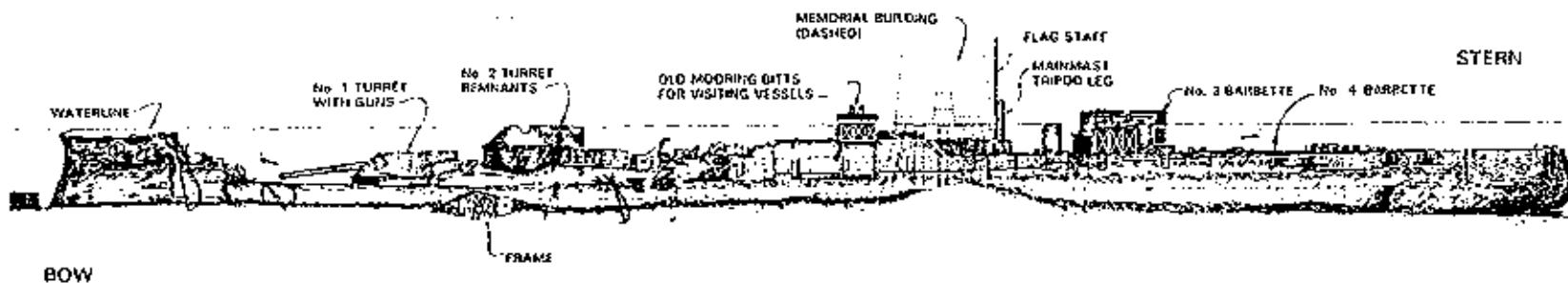

PORT PROFILE

Because visibility in the water was only 8 feet, a diver one body length away from the ship could not see it. For this reason, the curves in the hull had to be hand measured as though they were on a two-dimensional plane. The ship was divided into ten 60 foot long sections using the vertical string of the crane. This created twenty individual "frames" to be drawn in two-dimensions. When the drawings of these frames were connected, they created a scaled drawing longer than the actual ship. To remedy this, it was necessary for the illustrators to correct each frame to compensate for the two-dimensional depiction of the ship's curved hull.

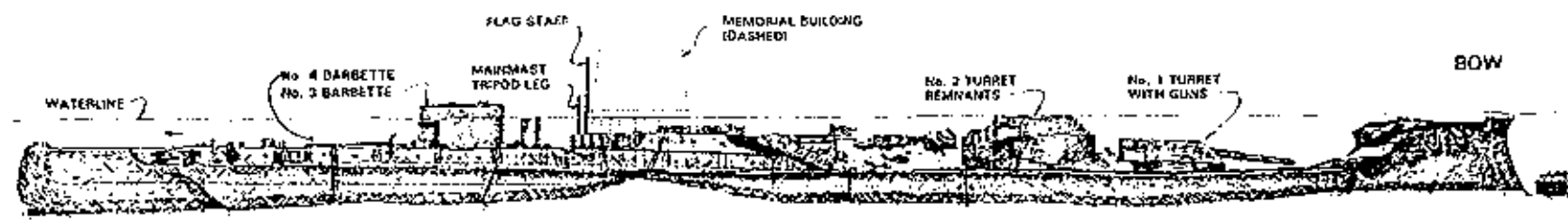

STARBOARD PROFILE

Scale: 1.25" = 20'



Fig. 4.7.68

Jerry L. Umberger, Eric S. Long, and Larry Harbo, 1984. Drawing was photographically reproduced and placed onto the SLER sheet by Robert Jackson, 1992.

SURFACE NAUTICAL ARCHEOLOGY

Fig. 4.7.69

Clipper Ship *SNOW SQUALL*

While "nautical archeology" usually connotes work on an underwater resource, there are potential archeological projects for vessels on land or buried in the earth. The remains of the *Snow Squall* are the only surviving remnants of an American clipper ship. This documentation was prepared as a basis for the conservation and interpretation of the ship.

Layout

The arrangement of views, graphic scale and notes is tight but legible

Delineation

Linework is clear and strong; no lines "dropped out" in reproduction because they were too light.

Lettering is neat and legible.

Documentation

The notes cover the conditions under which the vessel's lines were lifted, the method used, and important qualifications for the lines drawings.

Stations, frames, water lines and buttock lines are almost all labeled. No "zero" water line is indicated, nor is any account given as to how specific water line heights were derived. Water lines above 8'-6" are not dimensioned, nor is the abbreviation "WL" ever spelled out as "water line"

Labels for the rabbet and garboard require arrows so those unfamiliar with ship construction are not confused about which lines denote these features.

Fig. 4.7.69

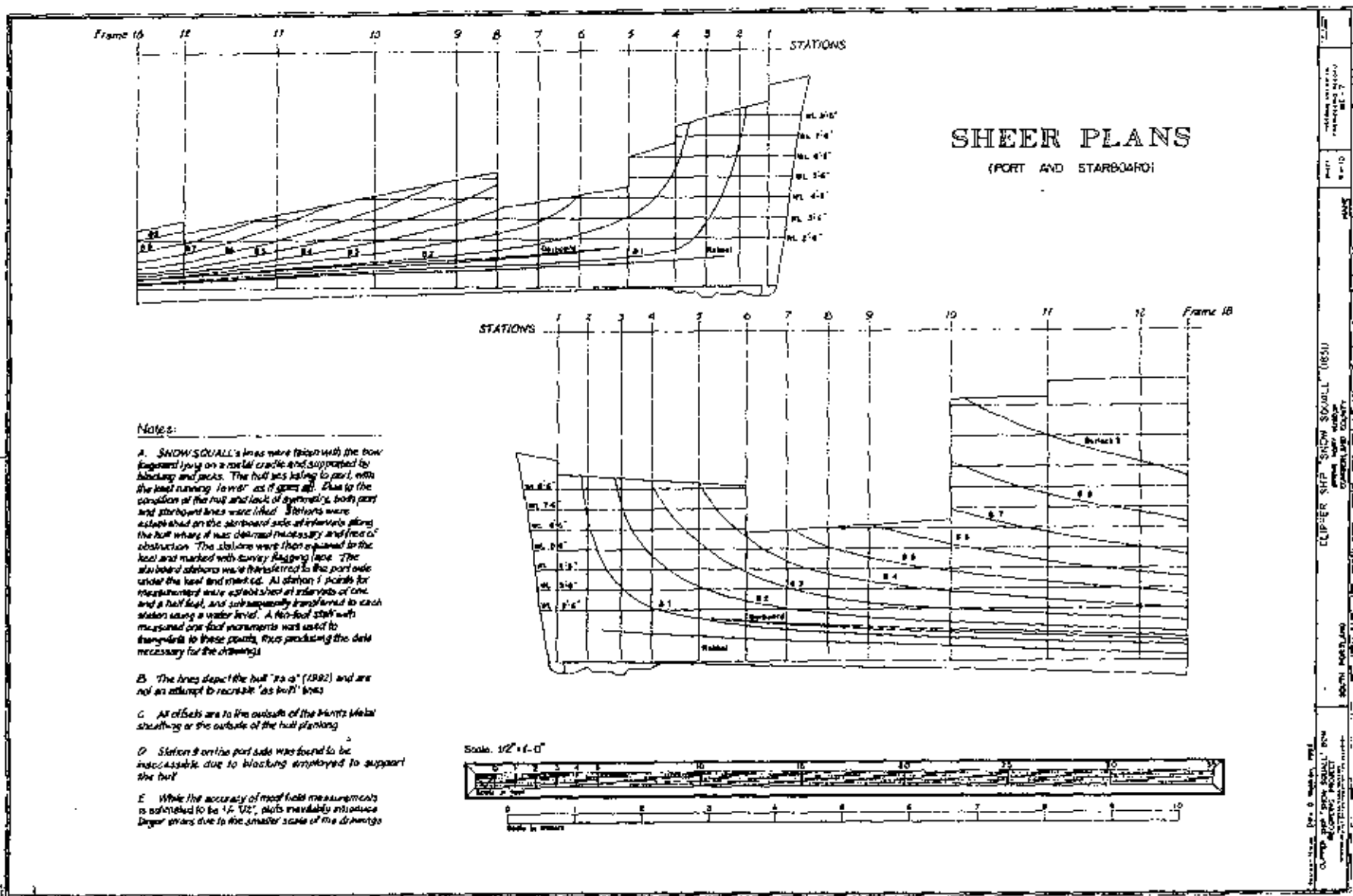

U.S. NAVAL ARCHITECTURE CENTER
 400 NAVAL AVENUE
 WASHINGTON, D.C. 20374
 DRAWING NO. 4.7.69
 SHEER PLANS
 USS-1085
 SNOW-SQUALL (1982)

SURFACE NAUTICAL ARCHEOLOGY

Fig. 4.7.70

Clipper Ship *SNOW SQUALL*Layout

This sheet is very well composed. Note how the block of notes and the number key are positioned to relate to both views of the bow. The placement of the letter key implies it is an afterthought, however.

Delineation

Line work for the remains is very well executed. Pieces are outlined and rendering is done in lighter lines. The rendering is restrained and used to indicate significant evidence rather than "pretty up" the views. However, the reader is not told if the cross-graining in the section represents actual conditions or is merely pictorial in nature.

Notice how notes are placed and lettered in lettering smaller than that used for the key or drawing view. This hierarchy of sizes is very well developed and lends a sense of scale to the drawing.

Number tags are large and legible but unobtrusive.

Documentation

Views of the bow are carefully annotated with an extensive key.

The bases for the drawings are clearly described in the notes, as are tolerances for the drawings.

Scantlings are not provided; they would be very interesting historically. However, it may be argued that the reader could measure them from a drawing like this.

BELOW DECKS PLAN & SECTION

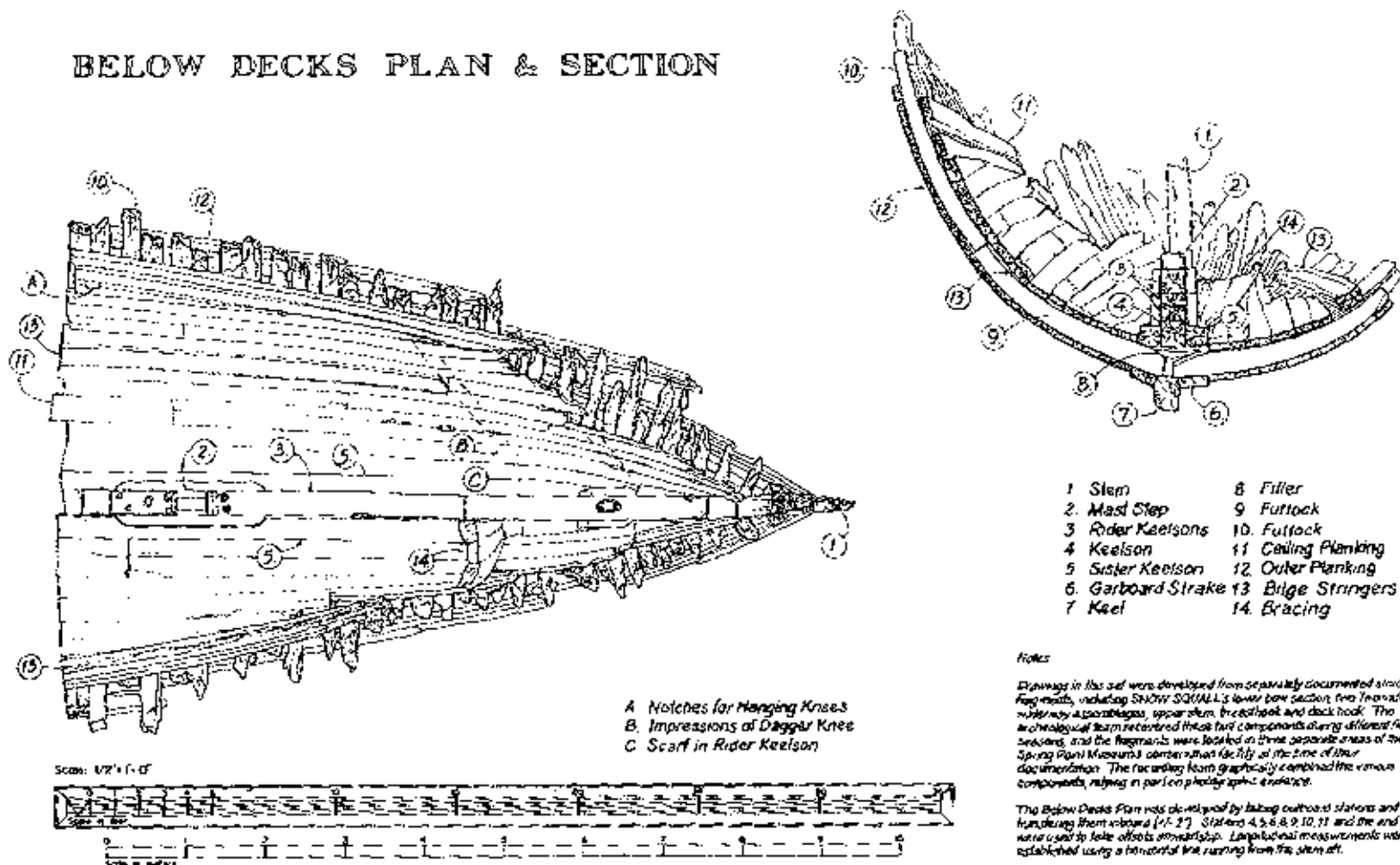

Fig. 4.7.70

Notes

Drawings in this set were developed from separately documented structural fragments, including SNOW SQUALL's lower bow section, two Trepanick midships spartrikes, spartrike, breasthook and deck hook. The archaeological team recovered these four components during different field seasons, and the fragments were located in three separate areas of the Spring Plant Museum's conservation facility at the time of their documentation. The facsimile team graphically combined the various components, relying in part on photographic evidence.

The Below Decks Plan was developed by taking outboard stations and transferring them aboard (1-17). Stations 4, 5, 8, 9, 10, 11 and the end cut were used to take offset measurements. Longitudinal measurements were established using a horizontal line running from the stem aft.

USNHC
 CLIPPER SHIP SNOW SQUALL 1853
 DRAWING NO. 4.7.70
 DATE 11/11/03
 BY J. B. HARRIS
 CHECKED BY J. B. HARRIS
 SCALE 1/2" = 1'-0"
 SHEET NO. 1 OF 1

SURFACE NAUTICAL ARCHEOLOGY

Fig. 4.7.71

Clipper Ship *SNOW SQUALL*Layout

There are only three major components for this drawing. For the most part they are comfortably composed on the sheet, however, the view label ("axonometric") seems a little crowded toward the drawing border.

Delineation

This drawing is very carefully and finely delineated. Foreground assemblies are carefully outlined to make them read forward of background details.

Rendering is admirably restrained so as not to compete with or obscure the shapes of structural components.

Documentation

The note makes very clear how this drawing was derived.

This view is very useful since it assembles pieces that are stored in different locations. Even if the pieces were assembled so that photography were possible, the view excludes extraneous information that would be captured in a photograph.

As an axonometric drawing, an axonometric scale should be given by which a reader may know how the axes were oriented, and what scales were used on each axis. As it is, no scale at all is provided.

A key identifying parts would be instructive.

Was any attempt made to document fastening patterns? The drawing shows none, and the note does not address the issue one way or another.

Fig. 4.7.71

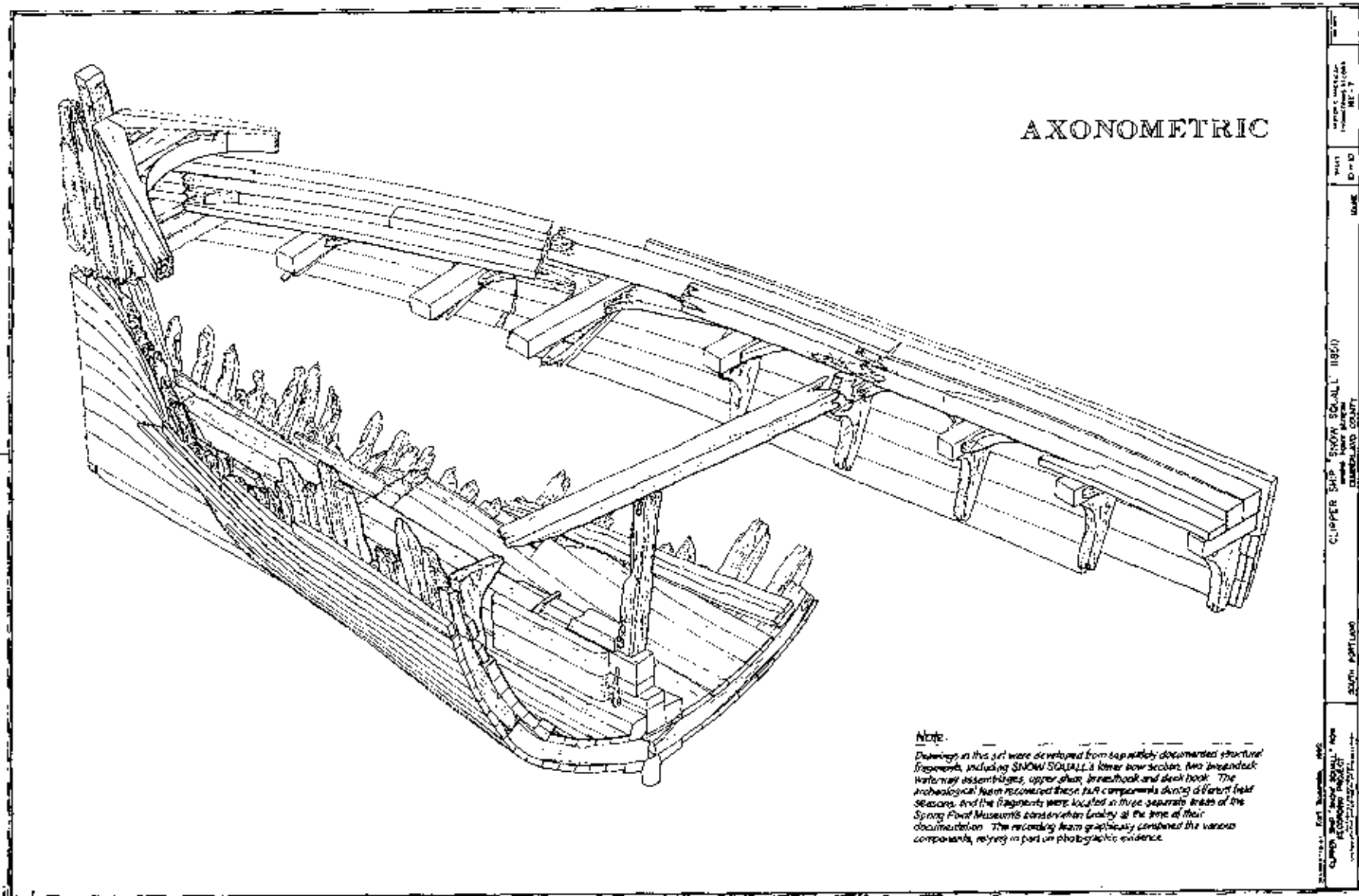



REFERENCES and RESOURCES

The following reference books are cited primarily for technical use in terminology and drawing rather than historical research, although they may certainly augment historical studies. (The HAER history guidelines should be consulted for standard historical references.) Though many of these books are long out of print, there are none like them currently in print for understanding what are now historic vessels. Many of these volumes turn up in the technical sections of used book stores. Annotations are provided to most books' contents.

This list is not exhaustive. Suggestions for further inclusions are welcomed.

GENERAL GLOSSARIES AND DICTIONARIES

Baker, William A. *The Lore of Sail*. New York: 1983. ISBN 0-87196-221-7 This is a very thorough index to the technical terminology of sailing vessels, ideal for use by both amateurs and professionals. Unlike a dictionary, here you find it by the picture; you do not need to know a term before looking it up. Detailed line drawings of all parts of vessels are given, and parts are numbered and labeled for identification. This book is widely available, but may be ordered from:

Facts on File Publications
460 Park Avenue South
New York, NY 10016

Kerchove, Rene de. *International Maritime Dictionary: An Encyclopedic Dictionary of Useful Terms and Phrases, Together with Equivalents in French and German*. New York: Van Nostrand Reinhold Company, 1961. Standard work.

McEwen, W.A., and A.H. Lewis. *Encyclopedia of Nautical Knowledge*. Cambridge, Maryland: Cornell Maritime Press, 1953.

Tryckare, Trc. *The Lore of the Ship*. New York: Crescent Books, 1972. Similar in approach to *The Lore of Sail*; includes mechanical propulsion and warships.

WOODEN SHIPBUILDING

Adkins, Jan. *Wooden Ship: The Building of a Wooden Sailing Vessel in 1870*. Boston: Houghton Mifflin Company, 1978.

Desmond, Charles. *Wooden Shipbuilding*. New York: Vestal Press, 1984.

Estep, H. Cole. *How Wooden Ships Are Built: A practical Treatise on Modern American Wooden Ship Construction with a Supplement on Laying Off Wooden Vessels*. New York: W.W. Norton and Company, Inc., 1983. Reprint of 1918 edition.

IRON AND STEEL SHIPBUILDING

Baker, Elijah III, B.S. *Introduction to Steel Shipbuilding*. New York: McGraw-Hill Book Company, 1943. Long out of print, but useful because it includes both rivetted and welded construction for merchant vessels. A very detailed glossary is included. Lines and offsets are covered, as well as weight and displacement calculations, stability, trim, tonnage, and other subjects.

Lloyd's Register of British and Foreign Shipping. London: Wyman & Sons, 1869. Contains detailed descriptions, tables, and engravings setting out the rules and regulations for design, construction, maintenance, and surveying of wooden and metal vessels.

Swanson, W.E. *Modern Shipfitter's Handbook*. New York: Cornell Maritime Press, 1941. Instructions in layout, molding, assembly, and erection of welded ships. Some riveting.

Thearle, Samuel J.P. *The Modern Practice of Shipbuilding in Iron and Steel*. London: William Collins, Sons, & Co., Ltd., 1891. Vol. I, Text. Vol. II, Plates. Second edition, revised and enlarged. Authoritative guide to late 19th-century practice, includes detailed engravings and descriptions. Out of print, but may be available in some maritime museum libraries or large public libraries.

RIGGING

Biddlecombe, Capt. George, R.N. *The Art of Rigging, Containing an Explanation of Terms and Phrases and the Progressive Method of Rigging Expressly Adapted for Sailing Ships*. Salem, Massachusetts: Marine Research Society, 1925. Extensive tables, diagrams, glossary.

Kipping, Robert. *Sails and Sailmaking*. London, England: The Technical Press, 1936. 196 pp. illustrated.

Lever, Darcy. *The Young Sea Officer's Sheet Anchor, or a Key to the Leading of Rigging and to Practical Seamanship*. London: 1819. 2nd ed. Reflects British practice in the early 19th century, but covers rigging and sails in detail, including various ship handling instructions, and a brief glossary. Reproduced in 1963 by the photolithographic process from the second edition by:

Edward W. Sweetman Co.
Publisher
One Broadway
New York, NY

Underhill, Harold J. *Masting and Rigging the Clipper Ship and Ocean Carrier: with Authentic Plans, Working Drawings and Details of the Nineteenth and Twentieth Century Sailing Ship*. Glasgow: Brown, Son, & Ferguson, Ltd., 1979. ISBN 0-85174-173-8 This is an extremely complete guide to the principles and engineering behind rigging, as well as a key to terminology. A British work, so some terms may be different from American usage. Very thoroughly illustrated. If not available locally, it can be ordered from:

Brown, Son & Ferguson, Ltd.
Nautical Publishers
52 to 58 Darnley Street
Glasgow, G41 2SG
Scotland

WOOD IDENTIFICATION

Constantine, Albert J., Jr. *Know Your Woods: A Complete Guide to Trees, Woods, and Veneers*. New York: Charles Scribner's Sons, 1987. Compiled for the use of cabinetmakers, this volume covers the subject of woods from a number of angles. It contains photos of wood samples from several dozen species worldwide. The photos are all black and white, which may hinder its usefulness for the less experienced.

Edlin, Herbert L. *What Wood is That? A Manual of Wood Identification*. London: Thames and Hudson Limited, 1969. This work discusses and contains actual wood samples for 40 different species worldwide. Pine, oak, Douglas fir, birch, beech, ash, walnut, cedar, elm, and maple are included. Numerous characteristics for each species are discussed and compared. Fifth printing in June 1981 by:

The Viking Press
625 Madison Avenue
New York, NY 10022

MACHINERY AND EQUIPMENT

International Library of Technology. Vol. 9B, *Marine Boilers, Refrigeration*. Scranton, Pennsylvania: International Textbook Company, 1907. Extensive illustrated chapters on marine boilers, details, boiler accessories, and propulsion as well as other topics.

International Correspondence Schools Reference Library. Vol. 170, *Marine Engines, Marine Pumps*. Scranton, Pennsylvania: International Textbook Company, 1907. Extensive treatment of steam reciprocating engines for screw-propulsion and paddlewheel vessels. Also treats valve gears, auxiliaries, and steam turbines. Excellent illustrations.

Seward, Herbert Lee. *Marine Engineering*. Vol. I. New York: The Society of Naval Architects and Marine Engineers, 1942. Eleventh printing 1968. Chapters on steam turbines, boilers, reduction gears, propellers and shafting.

_____. *Marine Engineering*. Vol. II. New York: The Society of Naval Architects and Marine Engineers, 1944. Eleventh printing 1968. Chapters on auxiliaries: condensers, pumps, blowers, generators, piping.

Sterling, Frank Ward, ed. *Marine Engineers' Handbook*. New York: McGraw-Hill Book Company, Inc., 1920. Highly technical, but very useful for understanding construction, terminology, and materials for boilers and machinery aboard ship.

NAVAL ARCHITECTURE

Gillmer, Thomas C., and Bruce Johnson. *Introduction to Naval Architecture*. Annapolis, Maryland: Naval Institute Press, 1982. A textbook for Naval Systems Engineering Department at the United States Naval Academy, it covers contemporary hydrostatics, hull and propulsion systems engineering.

NAUTICAL ARCHEOLOGY

Mucketroy, Keith. *Handbooks in Nautical Archeology*. No. 1, *Discovering a Historic Wreck*. Greenwich, England: National Maritime Museum, 1981.

Robinson, Wendy S. *Handbooks in Nautical Archeology*. No. 2, *First Aid for Marine Finds*. Greenwich, England: National Maritime Museum, 1981.

PHOTOGRAMMETRY

Borchers, Perry E. *Photogrammetric Recording of Cultural Resources*. Washington, DC: Technical Preservation Services, Office of Archeology and Historic Preservation, National Park Service, U.S. Department of the Interior, 1977. Treats subject of terrestrial (as opposed to aerial) photogrammetry of archeological remains and buildings.

Karara, H.M., ed. *Handbook of Non-topographic Photogrammetry*. Falls Church, Virginia: American Society of Photogrammetry, 1979. Extensive presentation on photogrammetric cameras, equipment, and their non-aerial mapping applications. It even includes X-ray photogrammetry.

DRAFTING AND DOCUMENTATION

Baynes, Ken, and Francis Pugh. *The Art of the Engineer*. Woodstock, New York: The Overlook Press, 1981. Engineering drawings at their best. A beautiful graphic record of the evolution of engineering drawing and presentation of ships, railway equipment, automobiles, and airplanes.

International Library of Technology. Vol. 154, *Drawing, Ship Drafting, Projection, Developments*. Scranton, Pennsylvania: International Textbook Company, 1918. Contains a section on mechanical drawing and an extensive section on ship drafting directed toward production of working drawings of steel ships.

Jackson, Melvin H., ed. *The Historic American Merchant Marine Survey, Works Progress Administration, Federal Project No. 6*. Salem, New Hampshire: The Ayer Company, 1983. Seven bound volumes of selected full-size (19" x 24" and 19" x 34") reproductions of drawings and photographs from the HAMMS recording effort of the 1930s. Very expensive to acquire, but might be available at a maritime museum or major library.

Lipke, Paul, Peter Spectre, and Benjamin A.G. Fuller, eds. *Boats: A Manual for Their Documentation*. Nashville, Tenn.: American Association for State and Local History and the Museum Small Craft Association, 1993. Though not written for application to HAER documentation, this comprehensive and extremely useful text on the documentation of small craft contains much that is useful for large vessel documentation. Chapters covering field measurement techniques and drafting instructions are highly detailed and comprehensively illustrated. This volume is strongly recommended as a complement to *Guidelines for Recording Historic Ships*, especially for those who have never documented vessels before.

National Museum of American History. *Ship Plan List, Maritime Collection*. Washington, DC: Smithsonian Institution, 1984. Complete catalog of all drawings by Howard I. Chapelle, the Historic American Merchant Marine Survey, and several other collections. No illustrations however, except on covers. For a copy, send \$6.00 to the Division of Transportation, National Museum of American History, Smithsonian Institution, Washington, DC 20560.

Standards Committee, Maritime Heritage Task Force, National Trust for Historic Preservation. "Guidelines for Documentation". 1983. These draft guidelines (190 pages) include three case studies that may be of great use to documentation teams: Case Study II "The Mooscabec Lobster Boat," Case Study III "Taking Lines from a Vessel Too Large to be Leveled or Moved," and Case Study IV "Lines from a Model." Each case study is profusely illustrated and very "user-friendly." Copies may be obtained by writing the Maritime Division, National Trust for Historic Preservation, 1785 Massachusetts Avenue, N.W., Washington, DC 20036.

Trask, Edgar P. and John P. Comstock. *Ship Drafting*. (Scranton, Pennsylvania: International Textbook Company, 1939). Basic textbook instruction for drawing merchant ships of the mid-20th century. It contains sections titled "Introduction to Ship Drafting," "Ship Drafting Parts 1-2," and "Drawings for Welded Ship Parts."

Warren, James Peter. "The Historic American Merchant Marine Survey." M.A. thesis, Cornell University, 1986. Developed from HAMMS official correspondence, records, and interviews with surviving principals of the Survey, this paper provides an excellent background for evaluating the work of HAMMS. The background history of the program is covered, and a critical examination is made of the program's organization, documentary approach, field methods, and records. For those interested in the development of guidelines for

4.8.4 References and Resources

recording historic vessels, this work cites numerous pre-1930 published sources on which HAMMS workers relied, and HAMMS' "Specifications for the Measurement of Ships and Vessels" is included as an appendix.

APPENDICES

The following items cover material that HAER believes will see a lot of use in the field and at the drawing board in recording historic vessels.

Page

- | | |
|--------|--|
| 4.9.3 | <i>The Secretary of the Interior's Standards for Architectural and Engineering Documentation</i> |
| 4.9.9 | Introduction to Admeasurement |
| 4.9.15 | Basic Geometric and Trigonometric Formulas |
| 4.9.17 | Chart of American Ship Types |
| 4.9.19 | Some Basic Sailing Ship Rigs |
| 4.9.25 | Common Knots |
| 4.9.27 | How to Compute UTM Coordinates |



SECRETARY OF THE INTERIOR'S STANDARDS FOR ARCHITECTURAL AND ENGINEERING DOCUMENTATION

Reproduced from the *Federal Register*, Vol. 48, No. 190
(Thursday, September 29, 1983), pp. 44370-44374.

A summary chart of the Standards is on p. 4.9.7.

Secretary of the Interior's Standards for Architectural and Engineering Documentation

These standards concern the development of documentation for historic buildings, sites, structures and objects. This documentation, which usually consists of measured drawings, photographs and written data, provides important information on a property's significance for use by scholars, researchers, preservationists, architects, engineers and others interested in preserving and understanding historic properties. Documentation permits accurate repair or reconstruction of parts of a property, records existing conditions for easements, or may preserve information about a property that is to be demolished.

These Standards are intended for use in developing documentation to be included in the Historic American Buildings Survey (HABS) and the Historic American Engineering Record (HAER) Collections in the Library of Congress. HABS/HAER, in the National Park Service, have defined specific requirements for meeting these Standards for their collections. The HABS/HAER requirements include information important to development of documentation for other purposes such as State or local archives.

Standard I. Documentation Shall Adequately Explicate and Illustrate What is Significant or Valuable About the Historic Building, Site, Structure or Object Being Documented.

The historic significance of the building, site, structure or object identified in the evaluation process should be conveyed by the drawings, photographs and other materials that comprise documentation. The historical, architectural, engineering or cultural values of the property together with the purpose of the documentation activity

determine the level and methods of documentation. Documentation prepared for submission to the Library of Congress must meet the HABS/HAER Guidelines.

Standard II. Documentation Shall be Prepared Accurately From Reliable Sources With Limitations Clearly Stated to Permit Independent Verification of the Information.

The purpose of documentation is to preserve an accurate record of historic properties that can be used in research and other preservation activities. To serve these purposes, the documentation must include information that permits assessment of its reliability.

Standard III. Documentation Shall be Prepared on Materials That are Readily Reproducible, Durable and in Standard Sizes.

The size and quality of documentation materials are important factors in the preservation of information for future use. Selection of materials should be based on the length of time expected for storage, the anticipated frequency of use and a size convenient for storage.

Standard IV. Documentation Shall be Clearly and Concisely Produced.

In order for documentation to be useful for future research, written materials must be legible and understandable, and graphic materials must contain scale information and location references.

Secretary of the Interior's Guidelines for Architectural and Engineering Documentation

Introduction

These Guidelines link the Standards for Architectural and Engineering Documentation with more specific guidance and technical information. They describe one approach to meeting the Standards for Architectural Engineering Documentation. Agencies, organizations or individuals proposing to approach documentation differently

may wish to review their approaches with the National Park Service.

The Guidelines are organized as follows:

- Definitions
- Goal of Documentation
- The HABS/HAER Collections
- Standard I: Content
- Standard II: Quality
- Standard III: Materials
- Standard IV: Presentation
- Architectural and Engineering Documentation Prepared for Other Purposes
- Recommended Sources of Technical Information

Definitions

These definitions are used in conjunction with these Guidelines:

Architectural Data Form—a one page HABS form intended to provide identifying information for accompanying HABS documentation.

Documentation—measured drawings, photographs, histories, inventory cards or other media that depict historic buildings, sites, structures or objects.

Field Photography—photography, other than large-format photography, intended for the purpose of producing documentation, usually 35mm.

Field Records—notes of measurements taken, field photographs and other recorded information intended for the purpose of producing documentation.

Inventory Card—a one page form which includes written data, a sketched site plan and a 35mm contact print dry-mounted on the form. The negative, with a separate contact sheet and index should be included with the inventory card.

Large Format Photographs—photographs taken of historic buildings, sites, structures or objects where the negative is a 4 X 5", 6 X 7" or 8 X 10" size and where the photograph is taken with appropriate means to correct perspective distortion.

Measured Drawings—drawings produced on HABS or HAER formats depicting existing conditions or other relevant features of historic buildings.

sites, structures or objects. Measured drawings are usually produced in ink on archivally stable material, such as mylar.

Photocopy—A photograph, with large-format negative, of a photograph or drawing.

Select Existing Drawings—drawings of historic buildings, sites, structures or objects, whether original construction or later alteration drawings that portray or depict the historic value or significance.

Sketch Plan—a floor plan, generally not to exact scale although often drawn from measurements, where the features are shown in proper relation and proportion to one another.

Goal of Documentation

The Historic American Buildings Survey (HABS) and Historic American Engineering Record (HAER) are the national historical architectural and engineering documentation programs of the National Park Service that promote documentation incorporated into the HABS/HAER collections in the Library of Congress. The goal of the collections is to provide architects, engineers, scholars, and interested members of the public with comprehensive documentation of buildings, sites, structures and objects significant in American history and the growth and development of the built environment.

The HABS/HAER Collections: HABS/HAER documentation usually consists of measured drawings, photographs and written data that provide a detailed record which reflects a property's significance. Measured drawings and properly executed photographs act as a form of insurance against fires and natural disasters by permitting the repair and, if necessary, reconstruction of historic structures damaged by such disasters. Documentation is used to provide the basis for enforcing preservation easements. In addition, documentation is often the last means of preservation of a property; when a property is to be demolished, its documentation provides future researchers access to valuable information that otherwise would be lost.

HABS/HAER documentation is developed in a number of ways. First and most usually, the National Park Service employs summer teams of student architects, engineers, historians and architectural historians to develop HABS/HAER documentation under the supervision of National Park Service professionals. Second, the National Park Service produces HABS/HAER documentation, in conjunction with restoration or other preservation treatment, of historic buildings managed by the National Park Service. Third,

Federal agencies, pursuant to Section 110(b) of the National Historic Preservation Act, as amended, record those historic properties to be demolished or substantially altered as a result of agency action or assisted action (referred to as mitigation projects). Fourth, individuals and organizations prepare documentation to HABS/HAER standards and donate that documentation to the HABS/HAER collections. For each of these programs, different Documentation Levels will be set.

The Standards describe the fundamental principles of HABS/HAER documentation. They are supplemented by other material describing more specific guidelines, such as line weights for drawings, preferred techniques for architectural photography, and formats for written data. This technical information is found in the HABS/HAER Procedures Manual.

These Guidelines include important information about developing documentation for State or local archives. The State Historic Preservation Officer or the State library should be consulted regarding archival requirements if the documentation will become part of their collections. In establishing archives, the important questions of durability and reproducibility should be considered in relation to the purposes of the collection.

Documentation prepared for the purpose of inclusion in the HABS/HAER collections must meet the requirements below. The HABS/HAER office of the National Park Service retains the right to refuse to accept documentation for inclusion in the HABS/HAER collections when that documentation does not meet HABS/HAER requirements, as specified below.

Standard E: Content

1. **Requirement:** Documentation shall adequately explicate and illustrate what is significant or valuable about the historic building, site, structure or object being documented.

2. **Criteria:** Documentation shall meet one of the following documentation levels to be considered adequate for inclusion in the HABS/HAER collections.

a. Documentation Level I;

(1) Drawings: a full set of measured drawings depicting existing or historic conditions.

(2) Photographs: photographs with large-format negatives of exterior and interior views; photocopies with large format negatives of select existing drawings or historic views where available.

(3) Written data: history and description.

b. Documentation Level II:

(1) Drawings: select existing drawings, where available, should be photographed with large-format negatives or photographically reproduced on mylar.

(2) Photographs: photographs with large-format negatives of exterior and interior views, or historic views, where available.

(3) Written data: history and description.

c. Documentation Level III:

(1) Drawings: sketch plan.

(2) Photographs: photographs with large-format negatives of exterior and interior views.

(3) Written data: architectural data form.

d. Documentation Level IV: HABS/HAER inventory card.

3. **Test:** Inspection of the documentation by HABS/HAER staff.

4. **Commentary:** The HABS/HAER office retains the right to refuse to accept any documentation on buildings, site, structures or objects lacking historical significance. Generally, buildings, sites, structures or objects must be listed in, or eligible for listing in the National Register of Historic Places to be considered for inclusion in the HABS/HAER collections.

The kind and amount of documentation should be appropriate to the nature and significance of the buildings, site, structure or object being documented. For example, Documentation Level I would be inappropriate for a building that is a minor element of a historic district, notable only for streetcape context and scale. A full set of measured drawings for such a minor building would be expensive and would add little, if any, information to the HABS/HAER collections. Large format photography (Documentation Level III) would usually be adequate to record the significance of this type of building.

Similarly, the aspect of the property that is being documented should reflect the nature and significance of the building, site, structure or object being documented. For example, measured drawings of Dankmar Adler and Louis Sullivan's Auditorium Building in Chicago should indicate not only facades, floor plans and sections, but also the innovative structural and mechanical systems that were incorporated in that building. Large format photography of Gunston Hall in Fairfax County, Virginia, to take another example, should clearly show William Buckland's hand-carved moldings in the Palladian Room, as well as other views.

HABS/HAER documentation is usually in the form of measured drawings, photographs, and written data. While the criteria in this section

have addressed only these media, documentation need not be limited to them. Other media, such as films of industrial processes, can and have been used to document historic buildings, sites, structures or objects. If other media are to be used, the HABS/HAER office should be contacted before recording.

The actual selection of the appropriate documentation level will vary, as discussed above. For mitigation documentation projects, this level will be selected by the National Park Service Regional Office and communicated to the agency responsible for completing the documentation. Generally, Level I documentation is required for nationally significant buildings and structures, defined as National Historic Landmarks and the primary historic units of the National Park Service.

On occasion, factors other than significance will dictate the selection of another level of documentation. For example, if a rehabilitation of a property is planned, the owner may wish to have a full set of as-built drawings, even though the significance may indicate Level II documentation.

HABS Level I measured drawings usually depict existing conditions through the use of a site plan, floor plans, elevations, sections and construction details. HAER Level I measured drawings will frequently depict original conditions where adequate historical material exists, so as to illustrate manufacturing or engineering processes.

Level II documentation differs from Level I by substituting copies of existing drawings, either original or alteration drawings, for recently executed measured drawings. If this is done, the drawings must meet HABS/HAER requirements outlined below. While existing drawings are rarely as suitable as as-built drawings, they are adequate in many cases for documentation purposes. Only when the desirability of having as-built drawings is clear are Level I measured drawings required in addition to existing drawings. If existing drawings are housed in an accessible collection and cared for archivally, their reproduction for HABS/HAER may not be necessary. In other cases, Level I measured drawings are required in the absence of existing drawings.

Level III documentation requires a sketch plan if it helps to explain the structure. The architectural data form should supplement the photographs by explaining what is not readily visible.

Level IV documentation consists of completed HABS/HAER inventory cards. This level of documentation, unlike the other three levels, is rarely

considered adequate documentation for the HABS/HAER collections but is undertaken to identify historic resources in a given area prior to additional, more comprehensive documentation.

Standard II: Quality

1. *Requirement:* HABS and HAER documentation shall be prepared accurately from reliable sources with limitations clearly stated to permit independent verification of information.

2. *Criteria:* For all levels of documentation, the following quality standards shall be met:

a. *Measured drawings:* Measured drawings shall be produced from recorded, accurate measurements. Portions of the building that were not accessible for measurement should not be drawn on the measured drawings, but clearly labeled as not accessible or drawn from available construction drawings and other sources and so identified. No part of the measured drawings shall be produced from hypothesis or non-measurement related activities. Documentation Level I measured drawings shall be accompanied by a set of field notebooks in which the measurements were first recorded. Other drawings, prepared for Documentation Levels II and III, shall include a statement describing where the original drawings are located.

b. *Large format photographs:* Large format photographs shall clearly depict the appearance of the property and areas of significance of the recorded building, site, structure or object. Each view shall be perspective-corrected and fully captioned.

c. *Written history:* Written history and description for Documentation Levels I and II shall be based on primary sources to the greatest extent possible. For Levels III and IV, secondary sources may provide adequate information; if not, primary research will be necessary. A frank assessment of the reliability and limitations of sources shall be included. Within the written history, statements shall be footnoted as to their sources, where appropriate. The written data shall include a methodology section specifying name of researcher, date of research, sources searched, and limitations of the project.

3. *Test:* Inspection of the documentation by HABS/HAER staff.

4. *Commentary:* The reliability of the HABS/HAER collections depends on documentation of high quality. Quality is not something that can be easily prescribed or quantified, but it derives from a process in which thoroughness and accuracy play a large part. The principle of independent verification HABS/HAER documentation is critical to the HABS/HAER collections.

Standard III: Materials

1. *Requirement:* HABS and HAER documentation shall be prepared on materials that are readily reproducible for ease of access; durable for long storage; and in standard sizes for ease of handling.

2. *Criteria:* For all levels of documentation, the following material standards shall be met:

a. *Measured Drawings:*
Readily Reproducible: Ink on translucent material.

Durable: Ink on archivally stable materials.

Standard Sizes: Two sizes: 18" x 24" or 24" x 36".

b. *Large Format Photographs:*
Readily Reproducible: Prints shall accompany all negatives.

Durable: Photography must be archivally processed and stored. Negatives are required on safety film only. Resin-coated paper is not accepted. Color photography is not acceptable.

Standard Sizes: Three sizes: 4" x 5", 5" x 7", 8" x 10".

c. *Written History and Description:*
Readily Reproducible: Clean copy for xeroxing.

Durable: Archival bond required.
Standard Sizes: 8½" x 11".

d. *Field Records:*
Readily Reproducible: Field notebooks may be xeroxed. Photo identification sheet will accompany 35 mm negatives and contact sheets.
Durable: No requirement.

Standard Sizes: Only requirement is that they can be made to fit into a 9½" x 12" archival folding file.

3. *Test:* Inspection of the documentation by HABS/HAER staff.

4. *Commentary:* All HABS/HAER records are intended for reproduction; some 20,000 HABS/HAER records are reproduced each year by the Library of Congress. Although field records are not intended for quality reproduction, it is intended that they be used to supplement the formal documentation. The basic durability performance standard for HABS/HAER records is 500 years. Ink on mylar is believed to meet this standard, while color photography, for example, does not. Field records do not meet this archival standard, but are maintained in the HABS/HAER collections as a courtesy to the collection user.

Standard IV: Presentation

1. *Requirement:* HABS and HAER documentation shall be clearly and concisely produced.

2. *Criteria:* For levels of documentation as indicated below, the following standards for presentation will be used:

a. *Measured Drawings:* Level I

measured drawings will be lettered mechanically (i.e., Leroy or similar) or in a handprinted equivalent style. Adequate dimensions shall be included on all sheets. Level III sketch plans should be neat and orderly.

b. Large format photographs: Level I photographs shall include duplicate photographs that include a scale. Level II and III photographs shall include, at a minimum, at least one photograph with a scale, usually of the principal facade.

c. Written history and description: Data shall be typewritten on bond, following accepted rules of grammar.

3. Test: Inspection of the documentation by HABS/HAER staff.

Architectural and Engineering Documentation Prepared for Other Purposes

Where a preservation planning process is in use, architectural and engineering documentation, like other treatment activities, are undertaken to achieve the goals identified by the preservation planning process. Documentation is deliberately selected as a treatment for properties evaluated as significant, and the development of the documentation program for a property follows from the planning objectives. Documentation efforts focus on the significant characteristics of the

property, as defined in the previously completed evaluation. The selection of a level of documentation and the documentation techniques (measured drawings, photography, etc.) is based on the significance of the property and the management needs for which the documentation is being performed. For example, the kind and level of documentation required to record a historic property for easement purposes may be less detailed than that required as mitigation prior to destruction of the property. In the former case, essential documentation might be limited to the portions of the property controlled by the easement, for example, exterior facades; while in the latter case, significant interior architectural features and non-visible structural details would also be documented.

The principles and content of the HABS/HAER criteria may be used for guidance in creating documentation requirements for other archives. Levels of documentation and the durability and sizes of documentation may vary depending on the intended use and the repository. Accuracy of documentation should be controlled by assessing the reliability of all sources and making that assessment available in the archival record; by describing the limitations of the information available from research

and physical examination of the property; and by retaining the primary data (field measurements and notebooks) from which the archival record was produced. Usefulness of the documentation products depends on preparing the documentation on durable materials that are able to withstand handling and reproduction, and in sizes that can be stored and reproduced without damage.

Recommended Sources of Technical Information

Recording Historic Buildings. Harley J. McKee. Government Printing Office, 1970. Washington, D.C. Available through the Superintendent of Documents, U.S. Government Printing Office, Washington, D.C. 20402. GPO number 024-005-0235-9.

HABS/HAER Procedures Manual. Historic American Buildings Survey/Historic American Engineering Record, National Park Service, 1980. Washington, D.C.

Photogrammetric Recording of Cultural Resources. Perry E. Borchers. Technical Preservation Services, U.S. Department of the Interior, 1977. Washington, D.C.

Rectified Photography and Photo Drawings for Historic Preservation. J. Henry Chambers. Technical Preservation Services, U.S. Department of the Interior, 1975. Washington, D.C.

SUMMARY

PERFORMANCE STANDARDS OF THE HISTORIC AMERICAN BUILDINGS SURVEY/HISTORIC AMERICAN ENGINEERING RECORD (HABS/HAER)
 (SECRETARY OF THE INTERIOR'S STANDARDS FOR ARCHITECTURAL AND ENGINEERING DOCUMENTATION, FEDERAL REGISTER, SEPTEMBER 29, 1963, PP. 44730-44734)

STANDARDS	I. CONTENT				II. QUALITY				III. MATERIALS				IV. PRESENTATION							
REQUIREMENTS	"DOCUMENTATION SHALL ADEQUATELY DUPLICATE AND ILLUSTRATE WHAT IS SIGNIFICANT OR VALUABLE ABOUT THE HISTORIC BUILDING, SITE STRUCTURE OR OBJECT BEING DOCUMENTED."				"HABS AND HAER DOCUMENTATION SHALL BE PREPARED ACCURATELY, FROM RELIABLE SOURCES WITH LIMITATIONS CLEARLY STATED TO PERMIT INDEPENDENT VERIFICATION OF INFORMATION."				"HABS AND HAER DOCUMENTATION SHALL BE PREPARED ON MATERIALS THAT ARE READILY REPRODUCIBLE FOR EASE OF ACCESS, DURABLE FOR LONG STORAGE, AND IN STANDARD SIZES FOR EASE OF HANDLING."				"HABS AND HAER DOCUMENTATION SHALL BE CLEARLY AND CONCISELY PRODUCED."							
CRITERIA	LEVEL				I				II				III				IV			
A. MEASURED DRAWING	I	II	III	IV	I	II	III	IV	I	II	III	IV	I	II	III	IV	I	II	III	IV
	FULL SET OF MEAS. DWGS.	SEE PHOTOS BELOW	SKETCH PLAN	INVENTORY CARD	MEASURED DRAWINGS ARE TO BE PRODUCED FROM RECORDED, ACCURATE MEASUREMENTS. THOSE PORTIONS DRAWN FROM EXISTING DRAWINGS OR OTHER SOURCES SHOULD BE SO IDENTIFIED AND SOURCES LISTED				INK OR TRAC; LIGHT MATERIAL	8x10" PHOTO-COPY	INK ON BOND PAPER	INK ON INVENTORY CARD	ADEQUATE DIMENSIONS ON ALL SHEETS				MECH. LETTERING OR EQUIVALENT	SKETCH PLANS SHALL BE NEAT AND ORDERLY		
B. PHOTOGRAPHS	LARGE FORMAT PHOTOGRAPHS EXTERIOR & INTERIOR		25mm B&W		PHOTOGRAPHS SHALL CLEARLY DEPICT THE APPEARANCE OF THE PROPERTY AND AREAS OF SIGNIFICANCE. ALL VIEWS ARE TO BE PERSPECTIVE-CORRECTED AND FULLY CAPTIONED.				PRINTS SHALL ACCOMPANY ALL NEGATIVES MUST BE ARCHIVALLY PROCESSED, NO RUC PAPER 4x5" OR 5x7" OR 8x10"				DUPLICATE PHOTOS WITH A SCALE STICK				MIN. OF ONE PHOTO WITH A SCALE (PRINCIPAL FACADE)			
C. WRITTEN DATA	HISTORY AND DESCRIPTION IN NARRATIVE OR OUTLINE FORMAT	ONE PAGE SUMMARY	INVENTORY CARD	BASED ON PRIMARY SOURCES	SECONDARY SOURCES MAY PROVIDE ADEQUATE INFORMATION	CLEAN COPY FOR XEROXING				ARCHIVAL BOND REQUIRED				TYPEWRITER ON BOND				TYPED ON INVENTORY CARD		
D. OTHER	OTHER MEDIA CAN AND HAVE BEEN USED. CONTACT HABS/HAER OFFICE BEFORE EMPLOYING A MEDIA OTHER THAN THOSE SPECIFIED ABOVE																			
TESTS	INSPECTION BY HABS/HAER OFFICE STAFF. DOCUMENTATION NOT MEETING HABS/HAER STANDARDS WILL BE REFUSED.																			
COMMENTARIES	KIND AND AMOUNT OF DOCUMENTATION SHOULD BE APPROPRIATE TO THE NATURE AND SIGNIFICANCE OF THE BUILDING, SITE STRUCTURE OR OBJECT BEING DOCUMENTED				THE PRINCIPLE OF INDEPENDENT VERIFICATION IS CRITICAL IN ASSURING HIGH QUALITY OF HABS/HAER MATERIALS				BASIC DURABILITY PERFORMANCE STANDARD IS 500 YEARS.				HABS/HAER ARE MOST WIDELY USED OF SPECIAL COLLECTIONS AT THE LIBRARY OF CONGRESS							

Appendices

4.9.7



INTRODUCTION TO ADMEASUREMENT

Admeasurement of a vessel is defined as the process of measuring a vessel's hull (and selected superstructure spaces) for purposes of official record and calculation of displacement and/or cargo carrying capacity. Because hulls are non-rectilinear shapes, rules have been established which specify what measurements should be made and where they are to be taken on a hull. These rules also establish measurements and formulas for approximating the volume of a hull and its cargo capacity. These rules have changed from time to time, so it is important to know what rules were in force at what times in order to interpret "register dimensions" found in official records. It is also important to realize that "register dimensions" bear *no* relationship to what is commonly meant by length, breadth, depth or tonnage. Laymen usually misunderstand such terms to mean overall length, width, height, and total weight of the vessel (as opposed to weight of cargo carried). Register dimensions also are not the same as "lofting dimensions" used for construction.

This section is not intended to be a comprehensive treatment of the subject of admeasurement, the history of its rules, or the rules currently in force. However, some insights will be given in these areas which should help vessel recorders understand what may be meant by terms such as "length" of a vessel, and point users to resources for further exploration of the topic if more information is desired.

In the late 18th century, rules for measuring vessels and calculating displacement and tonnage in the United States varied widely, as they also did worldwide. Tonnage is always independent of displacement. The tonnage of a given vessel doesn't change whether a vessel is loaded or not (unless the rules for calculating tonnage change), however, a loaded vessel will always have a higher displacement than the same vessel unloaded. Displacement is a direct function of a vessel's actual total weight. It is now usually a term employed only for naval vessels.

Determination of tonnage was important, because the cost of building a ship was usually based on it, as were port fees, or what a shipbreaker would pay an owner to scrap a vessel. Vessel owners are interested in lower tonnage to displacement ratios when shipbuilding costs, taxes, and port fees are keyed to tonnage figures. However, a high cargo capacity to displacement ratio is attractive, since this means more cargo can be transported for a given weight of vessel purchased and propelled through the water. In 1694, an act of Parliament in London, England, formalized the first simple tonnage rules which treated a vessel as if it were a box. The formula was modified in 1720 and in 1774 to take into account ships' very un-boxlike shape. The formula applied to both naval and civilian vessels. In 1800, British Tonnage still differed from American Custom House Tonnage, which differed further from Carpenter's Tonnage

(a builder's formula also known as Builder's Old Measurement). In 1799, American Customs House tonnage was set down by Joshua Humphrey as follows:

Customs House Measurements of Ships & Other Vessels

To ascertain the tonnage of any Ship or Vessel the Surveyor or such other person as shall be appointed by the Collector of the District to measure the same, shall if the said Ship or Vessel be double decked take the length thereof from the fore part of the main stem to the after part of the stempost, above the upper deck [a straight line measurement, not made along the deck sweep], the breadth thereof at the broadest part above the main wales, half of which breadth shall be accounted the depth of such Vessel, & shall then deduct from the length three fifths of the breadth--Multiply the remainder by the breadth & the product by the depth, & shall divide this last product by 95 [a deadrise factor added to allow for the angle of the bottom as opposed to a flat bottom]. [T]he quotient whereof shall be deemed the true contents or tonnage of such Ship or Vessel--and if such Ship or Vessel be single decked the said Surveyor or other person shall take the length & breadth as above directed in respect to a double decked Ship or Vessel. Shall deduct from the said length three fifths of the breadth, and taking the depth from the underside of the deck plank to the ceilings in the hold, shall multiply & divide as aforesaid, and the quotient shall be deemed the tonnage of such Ship or Vessel. March 2nd, 1799.¹

Put mathematically,

$$\text{tonnage} = \frac{(L - 3/5B) \times (B \times 1/2B)}{95}$$

and $D = 1/2B$, where L = length, B = breadth, and D = depth as Humphrey specifies above.

British tonnage at one point was calculated by the formula

$$\text{tonnage} = \frac{L \times (B \times 1/2B)}{94}$$

where L = payable length of a vessel's keel (not length of deck), and B = vessel's extreme breadth. American Carpenter's tonnage differed from the British tonnage formula only in using a denominator of 95 instead of 94. The denominator of the tonnage fraction is a quick way to distinguish between American and British tonnage figures.

Humphrey's formula held sway until British tonnage rules underwent major changes in 1836. At this point, American rules adopted some of the British changes. Builder's Old Measure saw use into the 1860s. Prior to 1864 in the United States, register tonnage was an estimate of a vessel's internal volume from which cargo capacity was deduced. Following changes to British rules in 1863, an act of Congress passed May 2, 1864, revised the tonnage formula to more closely determine a ship's cargo capacity. Under the new rules, a given ship might have as little as one-half the tonnage calculated under the old formula. The definition of a ton itself underwent many changes. Seawater weighs approximately one ton for every 35 cubic feet. However, a cargo ton was a unit of volume as opposed to weight. Originally it was equivalent to 60 cubic feet, derived from the volume of a "tunne" or cask of Bordeaux wine. Later, a ton of 100 cubic feet was adopted.

Dimensions themselves were recorded differently at various times. Prior to the latter half of the 19th century, if a vessel's official length were given as "92.5", it

may have meant she was 92'-5" long, not 92 and 5/10 feet. Later, vessels were measured in decimal feet, so that a figure reading "110.4" meant just that, 110 and 4/10 feet.

Recorders will encounter the terms "gross tonnage" and "net tonnage" in records and histories. Gross tonnage usually is the sum of a vessel's cargo space and the space devoted to living quarters and stowage for the crew. Net tonnage is the cargo capacity of the vessel alone. A vessel's draft is also different from her depth. Draft refers to the maximum dimension a vessel extends below the water line (usually at the keel), which can change depending on how laden she is. Draft too has been subject to manipulation by formula. Depth, like tonnage, doesn't change whether a vessel is loaded or not. As a point of departure, "depth" (i.e., depth of hold) may be best thought of as the dimension between the underside of a vessel's main deck beams and the top of the ceilings at the point of the vessel's greatest breadth (which is not necessarily amidships). The official depth of hold may not correspond to this dimension if it is determined by a formula. (In other words, a vessel's actual depth of hold may not necessarily be 1/2 her breadth, as per Humphrey's formula above.) The rules for admeasuring a vessel for registration should never be confused with rules established by Lloyd's or other authorities for building or classing vessels. Builder's rules--using their own definitions of length, breadth, and depth--were established for engineering and insurance purposes and specified minimum allowable dimensions for structural members of a vessel.

The illustrations which follow should help clarify some of the interrelationships between various measurement terms for length, breadth, depth, and tonnage for historic vessels.

NOTES

¹ Joshua Humphrey, "Custom House Measurements of Ships & Other Vessels, March 2, 1799" AMs notebook by Humphrey, Drear Collection, Historical Society of Pennsylvania, Philadelphia.

SUGGESTED READING

Bureau of Navigation, Department of Commerce. *Measurement of Vessels: Regulations Interpreting Laws Relating to Admeasurement of Vessels, Together with the Laws of the United States and the Suez Canal Regulations.* Washington, D.C.: Government Printing Office, 1915.

The Mariner's Mirror (quarterly British publication). Articles on aspects of tonnage may be found in issues listed below:
 American rules: Vol. 53, 260
 Divisor of 94: Vol. 43, 343-343
 Vol. 44, 161-164, 257-258
 Vol. 45, 83-84
 New and old rules: Vol. 47, 9-10
 Shipbuilders' tonnage: Vol. 52, 336 ff.

Read, Samuel. "Investigations and Observations With Reference to the Laws for the Measurement of the Tonnage of Shipping." *Transactions of the Institution of Naval Architects*, Vol. 1, 1860: 121-127.

Richie, Joseph H. "Introduction to Lloyd's Revised Rules," *Transactions of the Institution of Naval Architects*, Vol. 4, 1863: 289-302.

The Transactions of the Institution of Naval Architects is a British publication. See also the *Society of Naval Architects and Marine Engineers: Transactions* (New York, N.Y.) for articles on

American admeasurement and tonnage. For current regulations covering vessel registration and admeasurement, see Title 46 of the Code of Federal Regulations, Subchapter G, Documentation and Measurement of Vessels. Copies of these regulations may be purchased from the Superintendent of Documents, Government Printing Office, Washington, DC 20402. Ask for the Code

of Federal Regulations, Title 46, parts 41-69 (which is a single volume). Part 69 covers admeasurement while parts 67-68 cover documentation (for registration). Questions regarding present admeasurement practices should be addressed to a local Marine Safety Office or Marine Inspection Office of the United States Coast Guard.

Adapted for illustrative purposes from GERTIE, HANNS No. 8-26, Sheets 2 and 3 of 3

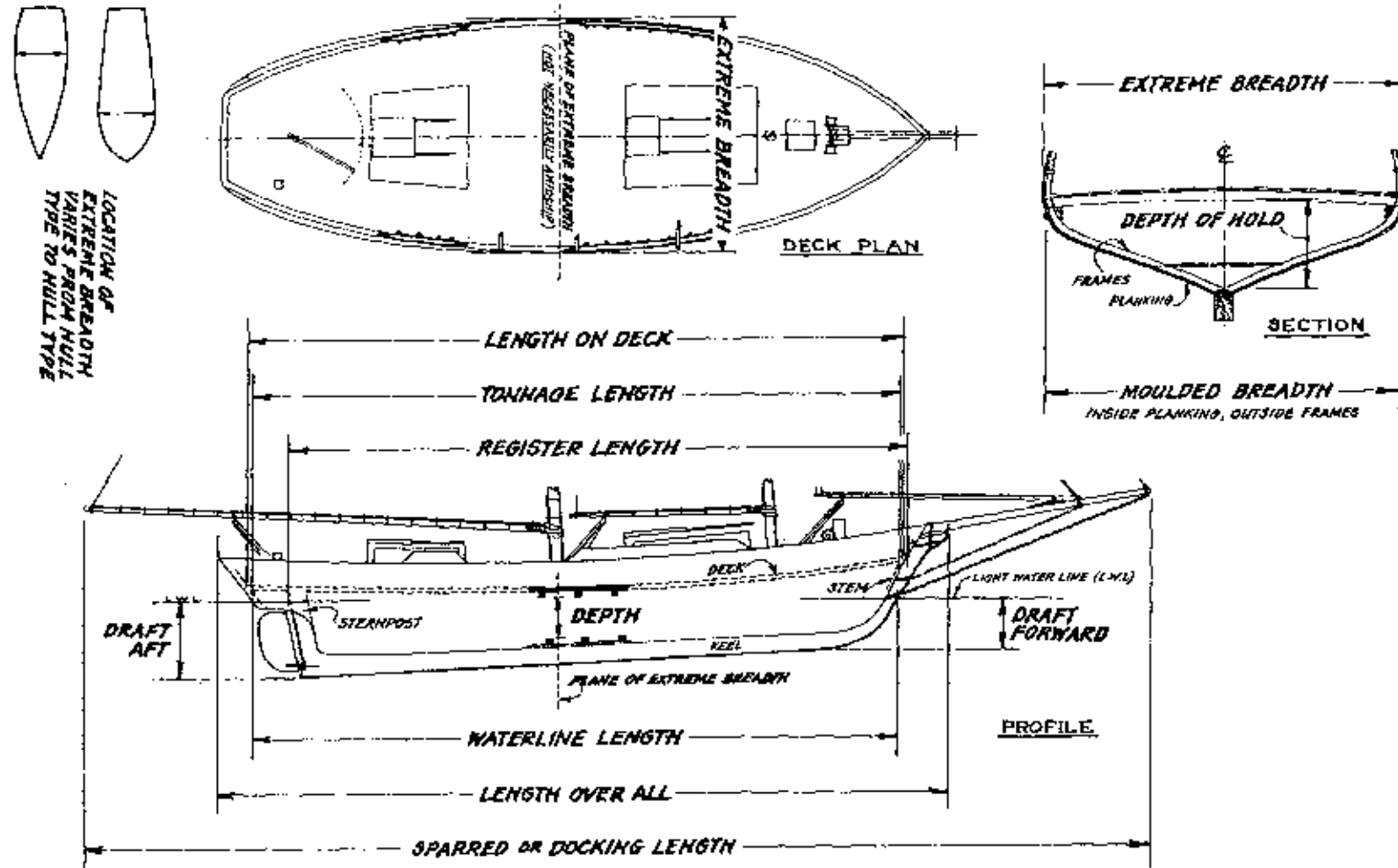

LOCATION OF
EXTREME BREADTH
VARIES FROM HULL
TYPE TO HULL TYPE

PRIMARY VESSEL MEASUREMENTS

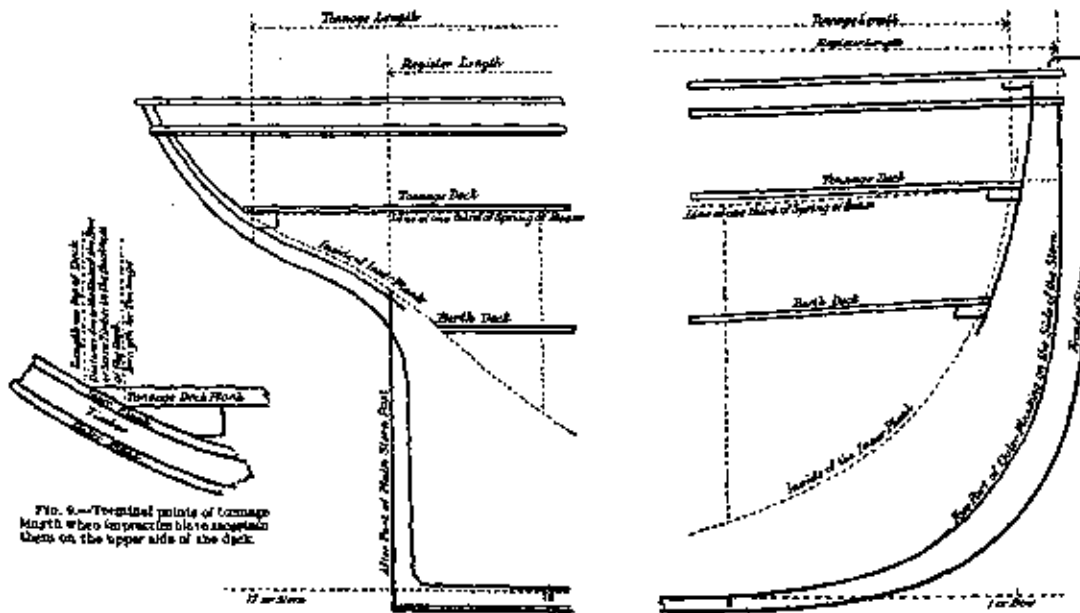

FIG. 1.—Register and tonnage lengths and tonnage deck of ordinary round-stem vessels.

Diagrams reproduced from Bureau of Navigation, Department of Commerce, *Measurement of Vessels; Regulations Interpreting Laws Relating to Admeasurement of Vessels, Together with the Laws of the United States and the Suez Canal Regulations*. Washington, D.C.: Government Printing Office, 1915; pp. 8-9.

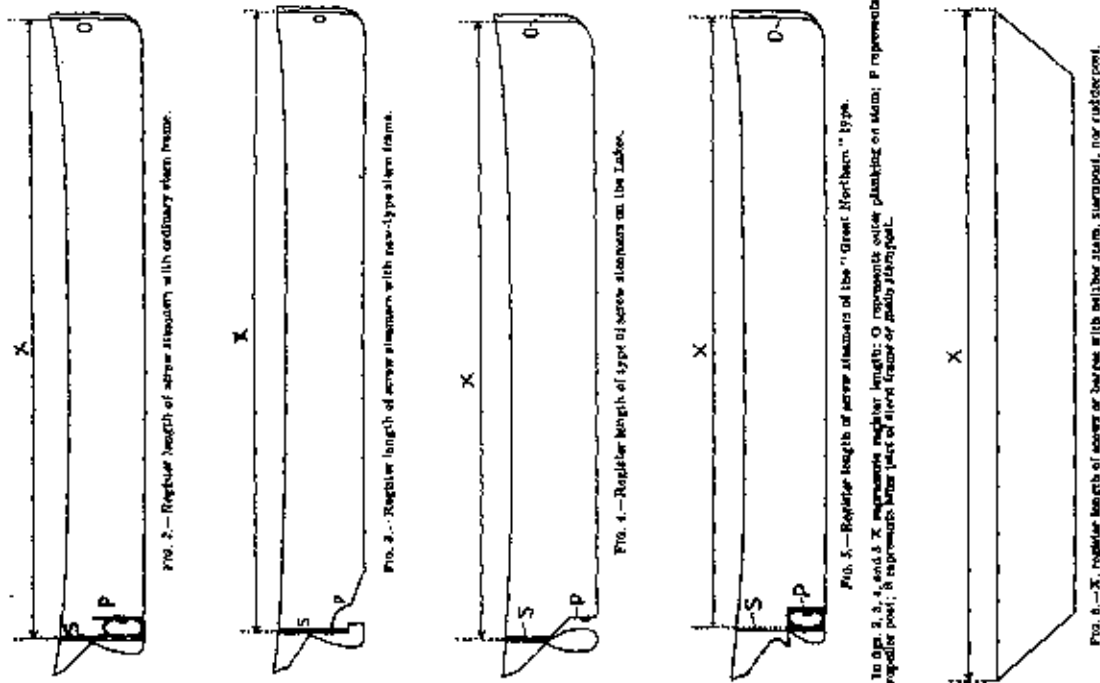

FIG. 5.—Register length of screw steamers of the "great Northern" type. In Figs. 2, 3, 4, and 5, X represents register length; O represents outer planking on stem; P represents propeller post; S represents lower part of stem frame or gully plating.

FIG. 6.—X, register length of screw or barge with bell-holm, stump, or rubberpont.

BASIC TRIGONOMETRIC and GEOMETRIC FORMULAS

RIGHT TRIANGLES

FIND	GIVEN	SOLUTION	FIND	GIVEN	SOLUTION
A	ac	$\sin A = \frac{a}{c}$	a	Ab	$b (\tan A)$
	bc	$\cos A = \frac{b}{c}$		Ac	$c (\sin A)$
	ab	$\tan A = \frac{a}{b}$		bc	$\sqrt{c^2 - b^2}$
B	bc	$\sin B = \frac{b}{c}$	b	Ab	$\frac{a}{\tan A}$
	ac	$\cos B = \frac{a}{c}$		Ac	$c (\cos A)$
	ab	$\tan B = \frac{b}{a}$		bc	$\sqrt{c^2 - a^2}$
C			c	Ab	$\frac{a}{\sin A}$
				Ab	$\frac{b}{\cos A}$
				ab	$\sqrt{a^2 + b^2}$

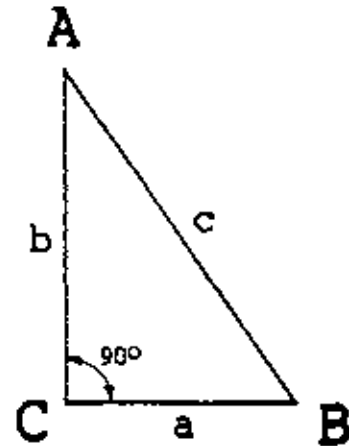

FUNCTIONS of a CIRCLE

A = area α = angle in degrees
 C = circumference l = length of arc
 $C = 2\pi r = 6.2832r = 3.1416d$
 $A_{\text{circle}} = \pi r^2 = 3.1416r^2 = 0.7854d^2$
 $A_{\text{sector}} = r^2/2 = 0.008727 r^2$
 $A_{\text{segment}} = 1/2 (rl - cr - h)$

$$l = \frac{r\alpha}{180} = 0.01745r = \frac{\alpha r}{r}$$

$$c = 2\sqrt{h(2r-h)} \quad r = \frac{c^2 + 4h^2}{8h}$$

$$h = r(1 - \cos(\alpha/2)) \quad \alpha = \frac{57.296 l}{r}$$

$$h = r - 1/2 \sqrt{4r^2 - c^2} \quad \alpha = 2(\sin^{-1} \frac{c}{2r})$$



sector



segment

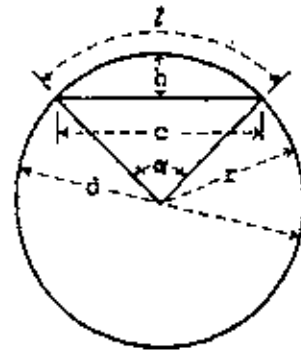

REGULAR POLYGON

A = area n = number of sides
 $\alpha = \frac{360}{n} \quad \beta = 180^\circ - \alpha$
 $A = \frac{nbt}{2} = \frac{nb}{2} \sqrt{R^2 - \frac{b^2}{4}}$
 $R = \sqrt{r^2 + \frac{b^2}{4}}$
 $r = \sqrt{R^2 - \frac{b^2}{4}}$
 $a = 2\sqrt{R^2 - r^2}$

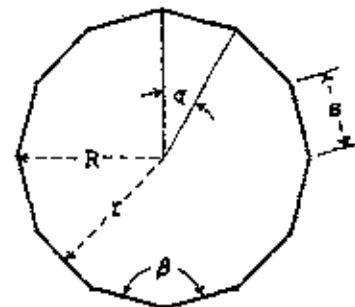

OBLIQUE TRIANGLES

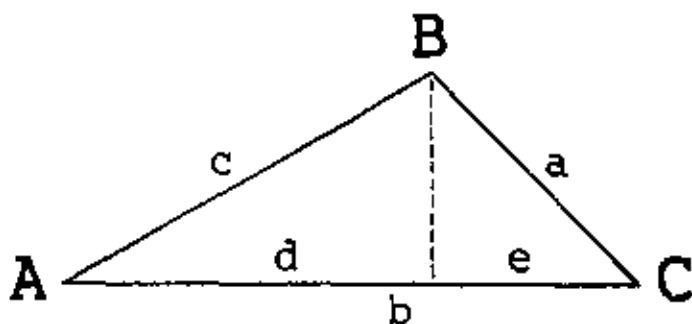

FIND	GIVEN	SOLUTION
AREA	abc	$\sqrt{s(s-a)(s-b)(s-c)}$
	cab	$\frac{ab \sin C}{2}$
s	abc	$\frac{a+b+c}{2}$
d	abcs	$\frac{(b^2+c^2-a^2)}{2c}$
e	abcs	$\frac{(a^2+b^2-c^2)}{2c}$
$\frac{(B+C)}{2}$	Abc	$90^\circ - \frac{A}{2}$
$\frac{(B-C)}{2}$		$\tan = \frac{(b-c)\tan(90-A/2)}{(b+c)}$
$\frac{(A+C)}{2}$	Bac	$90^\circ - \frac{B}{2}$
$\frac{(A-C)}{2}$		$\tan = \frac{(a-c)\tan(90-B/2)}{(a+c)}$
$\frac{(A+B)}{2}$	Cab	$90^\circ - \frac{C}{2}$
$\frac{(A-B)}{2}$		$\tan = \frac{(a-b)\tan(90-C/2)}{(a+b)}$

FIND	GIVEN	SOLUTION
A	abcs	$\sin(A/2) = \sqrt{\frac{(s-b)(s-c)}{bc}}$
		$\cos(A/2) = \sqrt{\frac{s(s-a)}{bc}}$
		$\tan(A/2) = \sqrt{\frac{(s-b)(s-c)}{s(s-a)}}$
	Dab	$\sin A = \frac{a \sin B}{b}$
Bac	$\frac{(A+C)}{2} + \frac{(A-C)}{2}$	
Cab	$\frac{(A+B)}{2} + \frac{(A-B)}{2}$	
Cac	$\sin A = \frac{a \sin C}{c}$	
a	ABb	$\frac{b \sin A}{\sin B}$
	ABc	$\frac{c \sin A}{\sin(A+B)}$
	ACb	$\frac{b \sin A}{\sin(A+C)}$
	ACc	$\frac{c \sin A}{\sin C}$
	BCb	$\frac{b \sin(B+C)}{\sin B}$
	BCc	$\frac{c \sin(B+C)}{\sin C}$
	Abc	$\sqrt{b^2+c^2-2bc(\cos A)}$

FIND	GIVEN	SOLUTION
B	abcs	$\sin(B/2) = \sqrt{\frac{(s-a)(s-c)}{s(s-b)}}$
		$\cos(B/2) = \sqrt{\frac{s(s-b)}{ac}}$
		$\tan(B/2) = \sqrt{\frac{(s-a)(s-c)}{s(s-b)}}$
	Abb	$\sin B = \frac{b \sin A}{a}$
Abc	$\frac{(B+C)}{2} + \frac{(B-C)}{2}$	
Cab	$\frac{(A+B)}{2} + \frac{(A-B)}{2}$	
Cbc	$\sin B = \frac{b \sin C}{c}$	
b	ABa	$\frac{a \sin B}{\sin A}$
	ABc	$\frac{c \sin B}{\sin(A+B)}$
	ACa	$\frac{a \sin(A+C)}{\sin A}$
	ACc	$\frac{c \sin(A+C)}{\sin C}$
	BCa	$\frac{a \sin B}{\sin(B+C)}$
	BCc	$\frac{c \sin B}{\sin C}$
	Bac	$\sqrt{a^2+c^2-2ac(\cos B)}$

FIND	GIVEN	SOLUTION
C	abcs	$\sin(C/2) = \sqrt{\frac{(s-a)(s-b)}{s(s-c)}}$
		$\cos(C/2) = \sqrt{\frac{s(s-c)}{ab}}$
		$\tan(C/2) = \sqrt{\frac{(s-a)(s-b)}{s(s-c)}}$
	ACc	$\sin C = \frac{c \sin A}{a}$
Abc	$\frac{(B+C)}{2} + \frac{(B-C)}{2}$	
Bac	$\frac{(A+C)}{2} + \frac{(A-C)}{2}$	
Bbc	$\sin C = \frac{c \sin B}{b}$	
c	ABa	$\frac{a \sin(A+B)}{\sin A}$
	AAb	$\frac{b \sin(A+B)}{\sin B}$
	ACa	$\frac{a \sin C}{\sin A}$
	ACb	$\frac{b \sin C}{\sin(A+C)}$
	BCa	$\frac{a \sin C}{\sin(B+C)}$
	BCb	$\frac{b \sin C}{\sin B}$
	Cab	$\sqrt{a^2+b^2-2ab(\cos C)}$

CHART OF AMERICAN SHIP TYPES

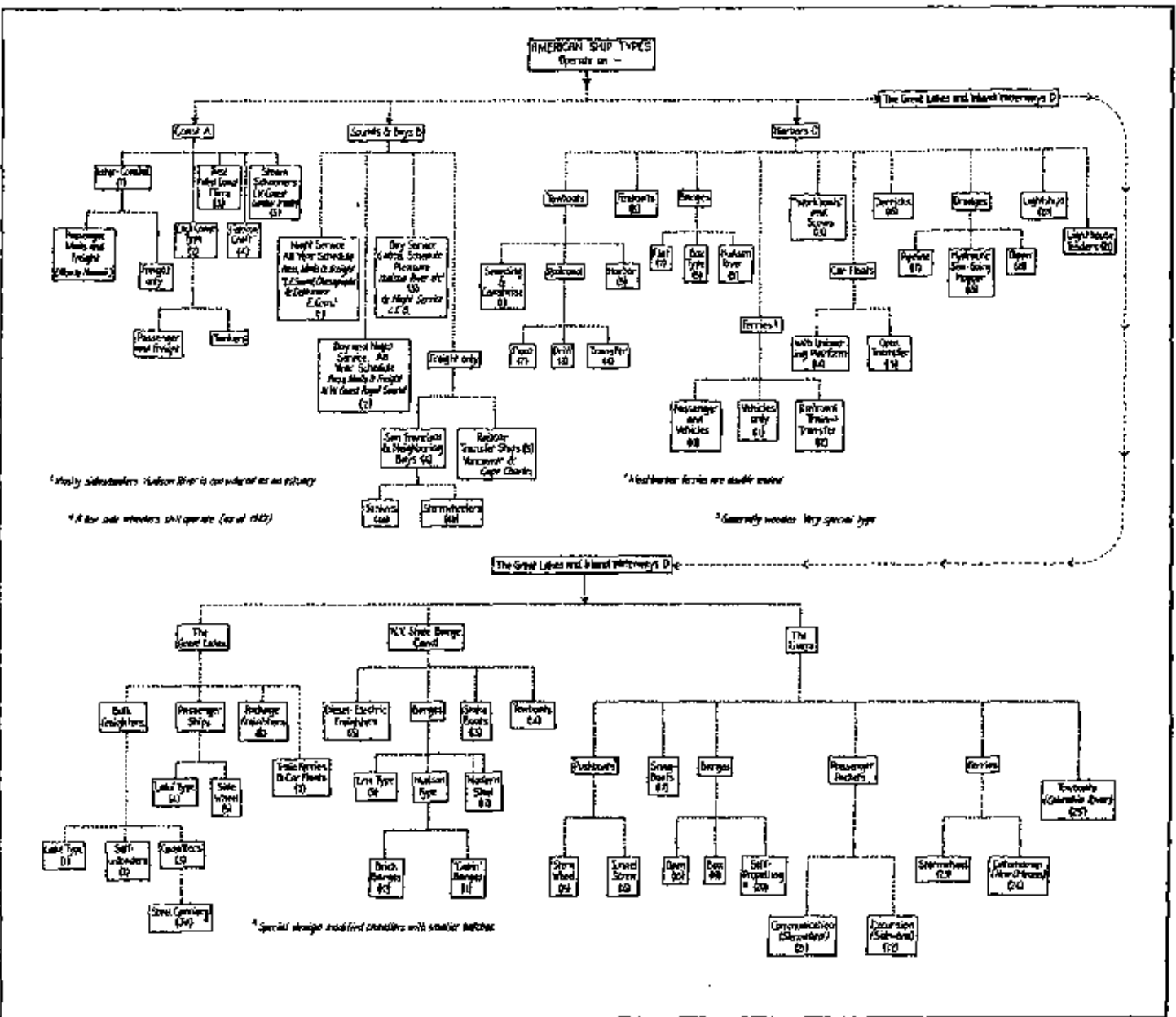

Adapted from "Comparative Analysis Table of 'Family Tree' of American Ship Types" in A. C. Hardy, *American Ship Types: A Review of the Work, Characteristics, and Construction of Ship Types Peculiar to the Waters of the North American Continent*. New York, N.Y.: D. Van Nostrand Company, 1927. Frontispiece.



SOME BASIC SAILING SHIP RIGS

KEY to SAILS

- | | |
|-----------------------------|--------------------------------|
| 1. Flying Jib | 18. Lower mizzen-topsail |
| 2. Jib | 19. Upper fore-topsail |
| 3. Foretopmast-staysail | 20. Upper main-topsail |
| 4. Foresail | 21. Upper mizzen-topsail |
| 5. Mainsail | 22. Fore topgallant sail |
| 6. Cross-jacksail | 23. Main topgallant sail |
| 7. Spanker | 24. Mizzen topgallant sail |
| 8. Lugsail | 25. Fore royal |
| 9. Fore-topsail | 26. Main royal |
| 10. Main-topsail | 27. Mizzen royal |
| 11. Mizzen-topsail | 28. Main skysail |
| 12. Fore gaff-topsail | 29. Main topgallant staysail |
| 13. Main gaff-topsail | 30. Mizzen topgallant staysail |
| 14. Main topmast staysail | 31. Jib topsail |
| 15. Mizzen topmast staysail | 32. Fore-trysail |
| 16. Lower fore-topsail | 33. Staysail |
| 17. Lower main-topsail | 34. Gaff-topsail |
| | 35. Main royal staysail |

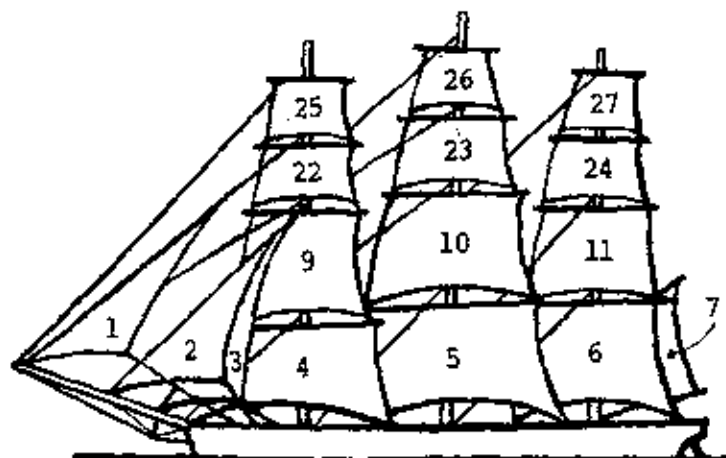

FULL-RIGGED SHIP

Nomenclature and illustrations of rigs based on Gardner D. Hiscox, M.E., *Mechanical Movements, Powers, and Devices*. New York: The Norman W. Hentley Publishing Co., 1915; Sec. 10, Navigation and Roads, pp. 205-210.

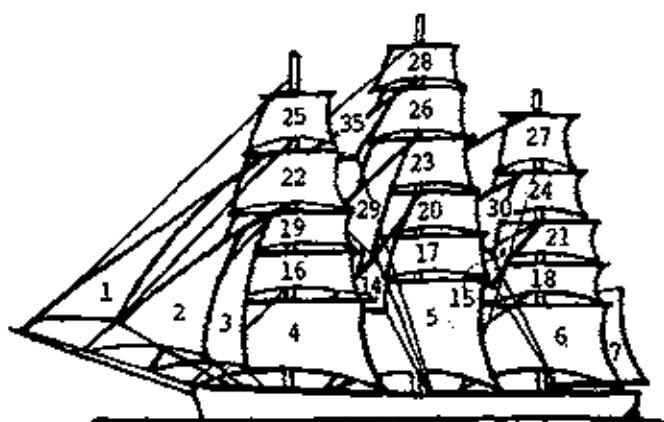

FULL-RIGGED SHIP

(Shows modifications adopted for full-rigged ships in the 1850s; some examples had 4 and 5 masts.)

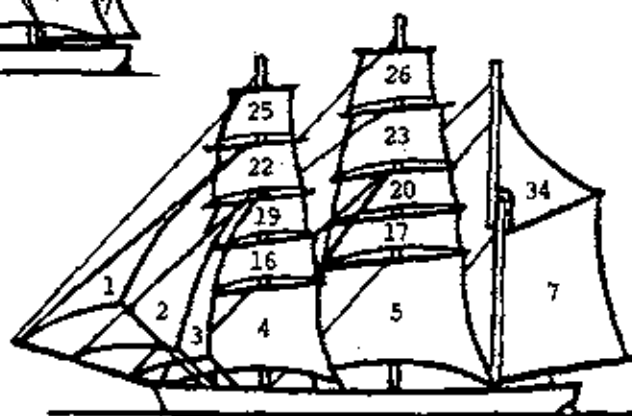

BARK

(Some examples had 4 and 5 masts)

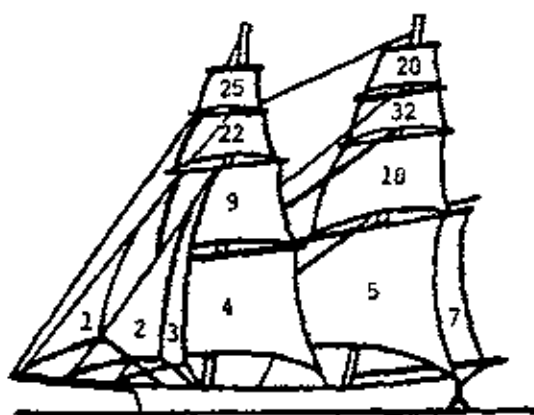

BRIG

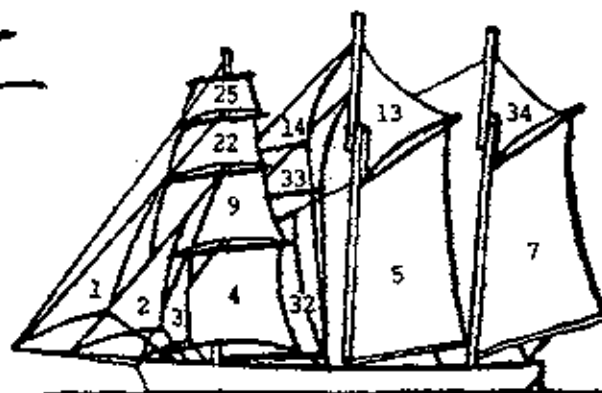

BARKENTINE

(Some examples had 4, 5 and 6 masts)

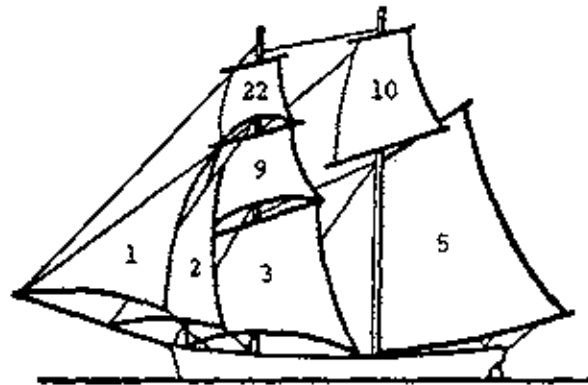

BRIGANTINE
(archaic)

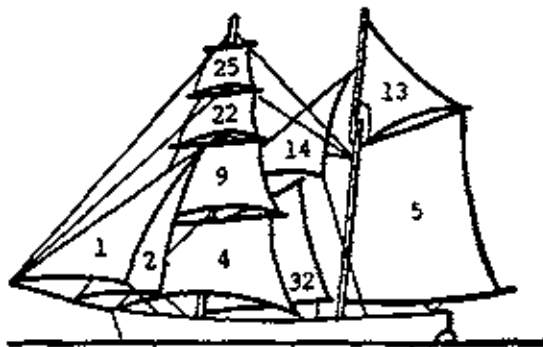

HERMAPHRODITE BRIG or HALF BRIG
(now known as BRIGANTINE)

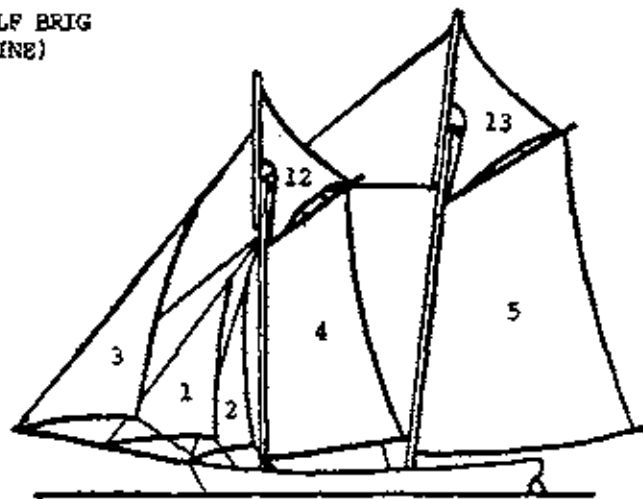

SCHOONER
(Some examples had 3, 4, 5, 6 and 7 masts)

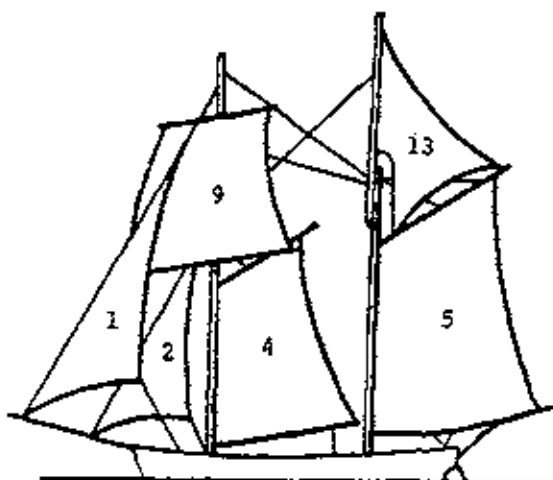

TOPSAIL SCHOONER

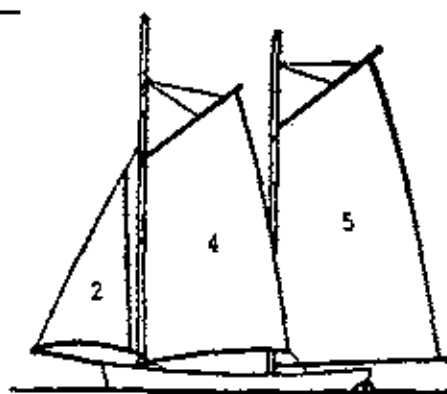

BALDHEADED SCHOONER

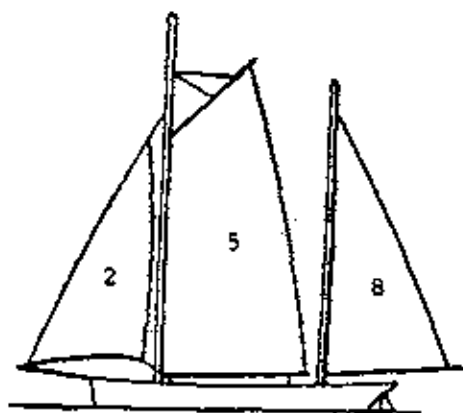

KETCH

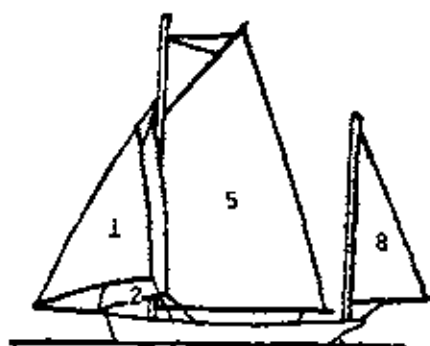

YAWL

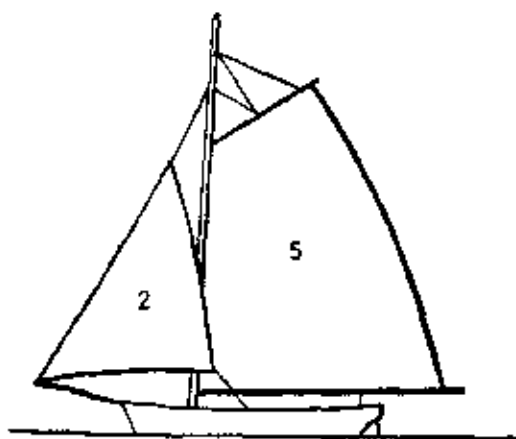

SLOOP

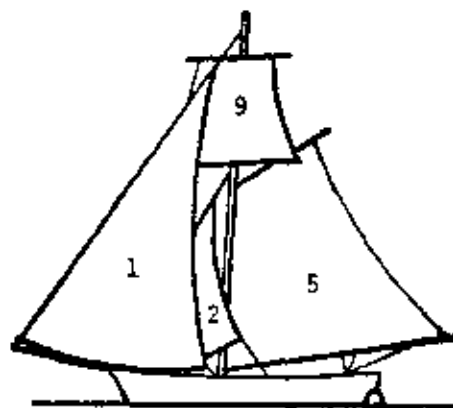

CUTTER

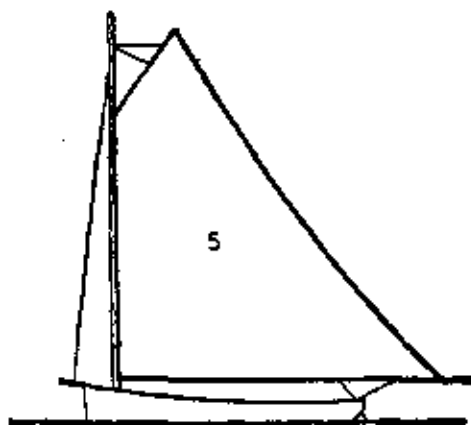

CAT-BOAT



COMMON KNOTS



Clove Hitch



Half-hitch



Timber Hitch



Square or Reef Knot



Stevedore Knot



Slip Knot



Flemish Loo



Bowline Knot



Carrick Bend

Nomenclature and illustrations of knots based on Gardner D. Hiscox, M.E., *Mechanical Movements, Powers, and Devices*. New York: The Norman W. Henley Publishing Co., 1915; Sec. 10, Navigation and Roads, pp. 205-210.



Overhand Knot



Figure Eight Knot



Boat Knot



Sheet Bend and Toggle



Sheet Bend (Weaver's Knot)



Double Knot



Blackwall Tackle Hitch



Fisherman's Bend Hitch



Round Turn and Half Hitch

How to Compute

UTM GRID REFERENCE NUMBERS

The UTM (Universal Transverse Mercator) Grid System provides a simple and accurate method for recording the geographic location of historic sites. The UTM Grid System has a number of advantages over the Geographic Coordinate System (latitude/longitude), particularly in terms of speed and precision, and in the use of linear, metric units of measure, as opposed to the convoluted degrees, minutes and seconds of the geographic system. UTM involves no complex geometric constructions, and in its simplest application, requires only a straightedge, a "coordinate counter" (see p. 4.9.29), and a sharp hard-lead pencil as working tools. (The coordinate counter is a square frosted overlay with the appropriate scales to match the various United States Geological Survey, or USGS, map series.)

The UTM grid "reference" of a point may be found if the point to be located is on a USGS map that has blue UTM tick marks along its edges. Most USGS quadrangle maps published since 1950, and all published since 1959, have these ticks. If no USGS map with UTM ticks exists for your location, or the map has not been updated since 1950, this fact should be noted and extra attention given to the location map for your particular site or structure.

In the UTM system, the earth is divided into 60 "zones" running north and south, each 6 degrees wide, resembling the lines

in a beach ball. Each zone is numbered (most of the United States is in zones 10 through 19), beginning at the 180 degree meridian near the International Date Line. On a map, each zone is flattened, and a square grid is superimposed upon it. The grid is marked off in meters, and any point in the zone may be referenced by citing its zone number, its distance from the central meridian of the zone ("easting"), and its distance north from the equator ("northing"). These three figures in the format below

zone number.easting.northing

make up a complete "UTM grid reference" for any point, and distinguishes it from any other point on the earth.

The simplest method for determining a UTM reference is based on drawing part of the UTM grid on the USGS quadrangle map by connecting corresponding blue tick marks, and measuring from the grid lines to the point. This requires the following:

- A. A flat work surface on which the map may be spread out in full.
- B. A straightedge (ordinary rulers may not be quite straight) long enough to reach completely across the map—generally 30 to 36 inches.
- C. A sharp, hard lead pencil. A 4x0 (0.18mm) drafting pen may also be used.

D. A UTM coordinate counter.

Structures need only be identified by one reference; for linear routes, such as canals or railroads, references for the end points should be given. For each point to be measured, follow these steps:

- A. Identify the point in question on the map.
- B. Draw a line from the top of the map to the bottom, connecting the UTM ticks directly west of the point, i.e. with the highest easting value less than that of the point. (Be sure the tick marks are marked with the same metric easting coordinate number.)
- C. Draw a line from the left to the right side of the map, connecting the grid ticks directly south of the point. (As with B, check that the two tick marks are marked with the same northing coordinate number.) This line will intersect the previous line somewhat to the southwest of the point to be located.
- D. Copy the zone number onto a worksheet; the number is in fine print in the lower left hand corner notes of the quadrangle map.
- E. Copy onto your worksheet the portions of the easting and northing values given at the map ticks through which the lines have been drawn.
- F. Locate the L-shaped scale on the coordinate counter which matches that of the map (usually 1:24,000

for 7.5 minute USGS quads). Align the counter so that

1. The side of the scale that reads from right-to-left lies along the east-west line.
2. The side of the scale that reads from the left-to-right passes directly up through the point.

Check the alignment to be sure it is precise.

- G. Read the coordinate counter scales, right-to-left for easting to the point where the vertical line you drew crosses the scale, and upward for northing to where the point to be located intersects the scale. Enter the measured values
- H. Check the readings for plausibility--are all figures in the correct decimal place?
- I. Check the figures for accuracy by remeasuring.
- J. Be sure that the correct format is observed:

zone number.easting.northing
(2 digits).(6 digits).(7 digits)

On measured drawings, the UTM grid reference of a structure should be noted under the scale bars on the regional or local location map of the title sheet. On small scale maps, a pair of cross hairs with a circle centered on the referenced point should be shown to focus readers on the precise location.

UTM COORDINATE COUNTER

(mylar copy included in field kit)

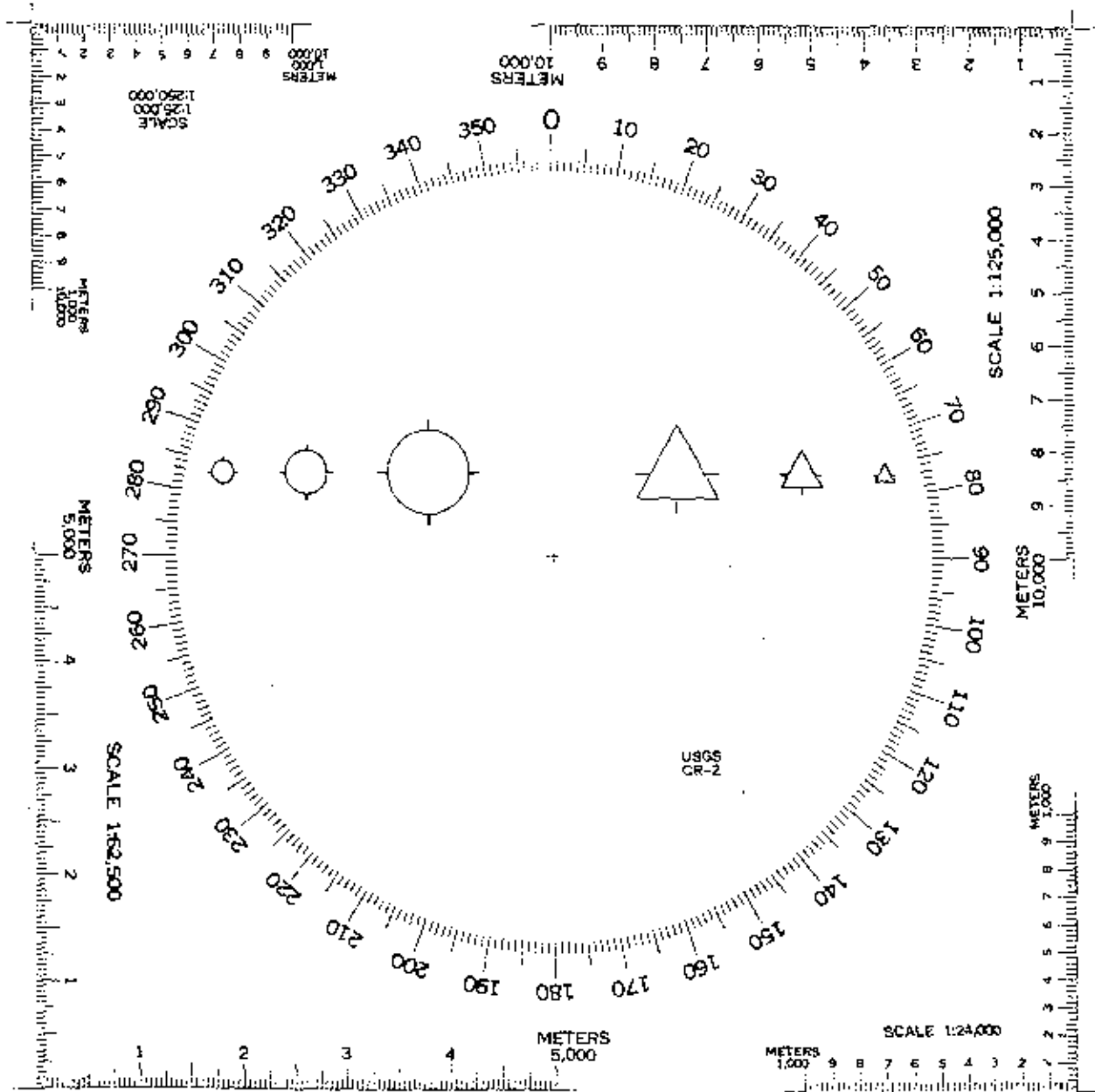



Section 5
FIELD REPORTS

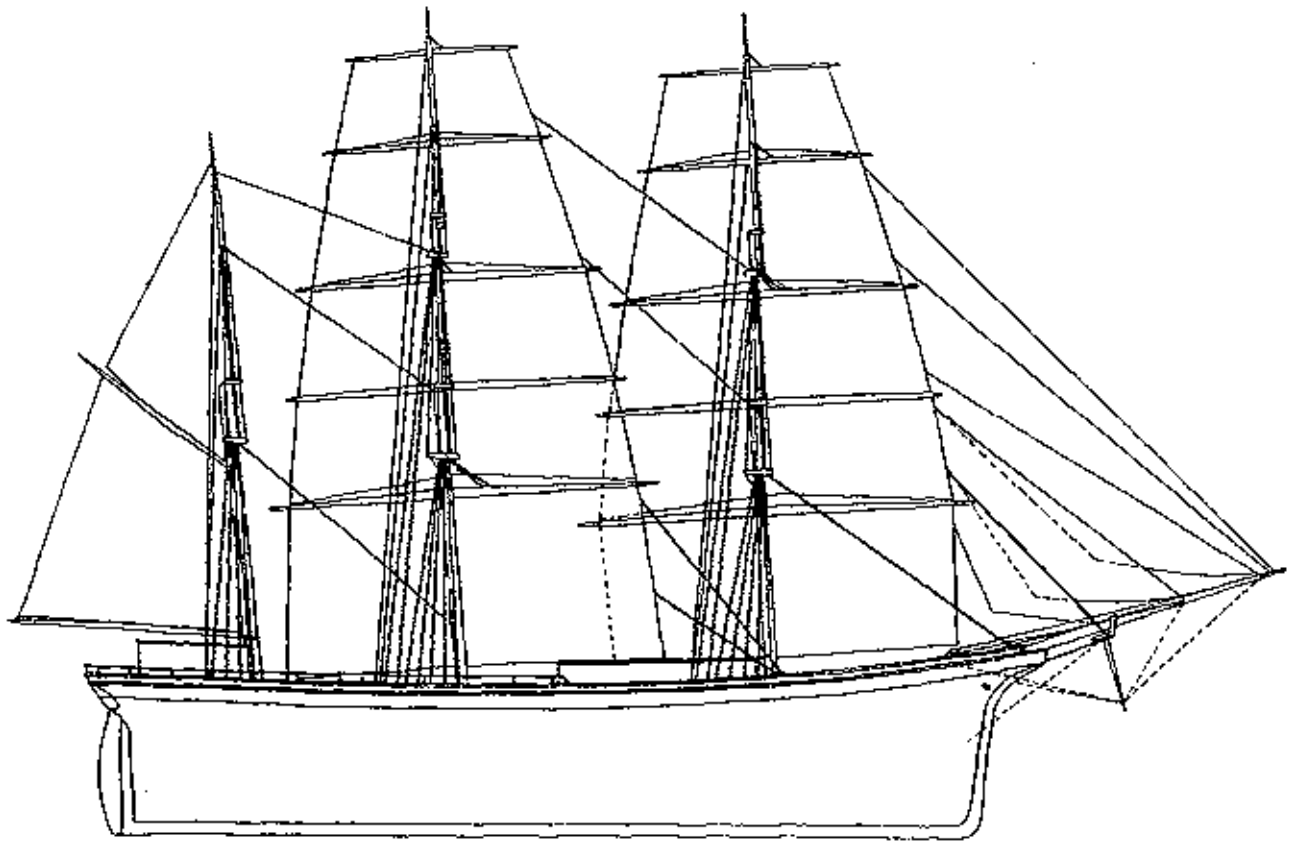

WHAT TO CONSIDER

General Remarks. The field report is intended to be an account and analysis of the recording team's methodologies and their execution during the project. It should cover the production of the historical report, formal photographs, and the measured drawings. The purpose of such a report is to give future users of your documentation an account of the context and parameters within which your work was performed, so they will know how much weight to give the various efforts expended in the project. The chief concept in preparing such a report is to document not only what you did, but also what you *didn't* do, especially when the actual course of your project took a direction different from what might normally or ideally have been expected, or when changes occurred in your planned goals, methods, and products. The field report may have more than one author, especially when different disciplines are involved, and it may have to be finally pulled together by the project manager after the project has been completed. Such reports done for HAER projects should be included with the field records for transmittal to the Library of Congress.

Some recorders may feel that an "open confession" of what they did and didn't do threatens to undermine the acceptance and appreciation of their work. They suspect it means raising issues or answering questions they may wish had not been asked. Nothing could be further from the truth. Researchers and users of your work benefit from knowing the scope of your documentation and sponsors or employers who have paid for your work, as well as users who have paid for copies, really

should know what material has been covered and what has been omitted. When honest project information is provided, it has the effect of making even amateur work valuable. Some documentation of a vessel, even amateur, is better than none. However, if you do not provide a user something with which to evaluate the merits of your work, the user may simply hold the whole effort in doubt, or take it with many more grains of salt than your work deserves. Many situations and conditions occur on even professionally run projects that make the documentation produced less than ideal, and users can sympathize with and make due allowance for problems when they are informed what the problems are. This applies from giving " \pm " estimates on your major dimensions, to giving the backgrounds and qualifications of your team, to accounting for the amount and kind of documentary research performed, etc.

There is no required minimum or maximum length for the field report. It should be to the point, but thoroughness should not be sacrificed for brevity. It is not necessary to go into the smallest details about everything, though detail should be supplied for any conditions requiring description or explanation.

Below is a suggested checklist to use when thinking through the writing of a field report.

Project Plan and Goals. How did your project come about? What were the goals of your project? Documentation for posterity? for use in building a replica? for personal interest? for training in

documentation? for a museum? for HAER? How much time and money did you have to do the work? Who is paying for it (if anyone) and what is their interest in the project? What field conditions did you work under? Did you have supervision or access to consulting services from professionals if the recording team is not staffed by professionals? What other resources or books did you use? Did you model your project on a previous similar, successful project?

Team Member Backgrounds. It is very helpful to know something about the background of each team member, advisor, consultant, etc. involved in the project. What knowledge, expertise, or usefulness did each bring to the project? While a project run by shipwrights and naval architects will have a high level of credibility automatically ascribed to it, this does not mean that a team staffed by astute amateurs cannot turn out excellent work. If a team's accomplishments are within its expertise, there is no reason not to trust its work, as far as it goes. The point is to define that expertise.

History. Did your project or project historian develop a research plan? What was it and how did it work out (or not)? What resources were available to you? Did some resources turn out to be unavailable, inconclusive, or too voluminous to handle? Why? Was something beyond your expertise? Was your work unduly limited by time or money? If so, what further work do you think should be done? What further records and resources might be consulted? (include locations, names). What "dead ends" did you find? Were any sources (owners, oral sources) uncooperative or exceptionally helpful and knowledgeable? What reasonable lines of

inquiry were you unable to follow up on? Why? (Time, travel, expertise, or outside of project goals?)

Formal Photography. Who selected the views to be taken by the photographer(s)? What criteria were being used? Were there any problems encountered, or conditions that prevented the making of certain photos? Were any special or unusual approaches tried? Why? How successful were they?

Measured Drawings. What methodologies and equipment had your project planned to use in its field work, and why? How were they applied? Did any aspects of your plan have to be modified? Did you discover useful shortcuts? How much time did your field work take, and was it within your estimates? What assumptions did you make, and what were the bases of your decisions to use them? How well did your field work plot out at the drawing board? Did you run into any significant problems (such as inability to get a space to "close"), and what did you do to resolve them? What tolerances did you work to in your dimensions? What views or types of information did you add or leave out of the drawing set, and why? Was the drawing set done with a certain slant, such as use for repairs or exhibits? How might the drawing set be different if it had been done only for straight documentation purposes? What things do the drawings omit, and why? Can a future researcher find information about the omissions in the field notes and photos or not? What technical expertise did the team have or call on for guidance? What models or reference books were used? Did you rely on pre-existing drawings or field information, and how reliable was it? (Did you include copies in the field notes?)

Section 6
CASE STUDIES

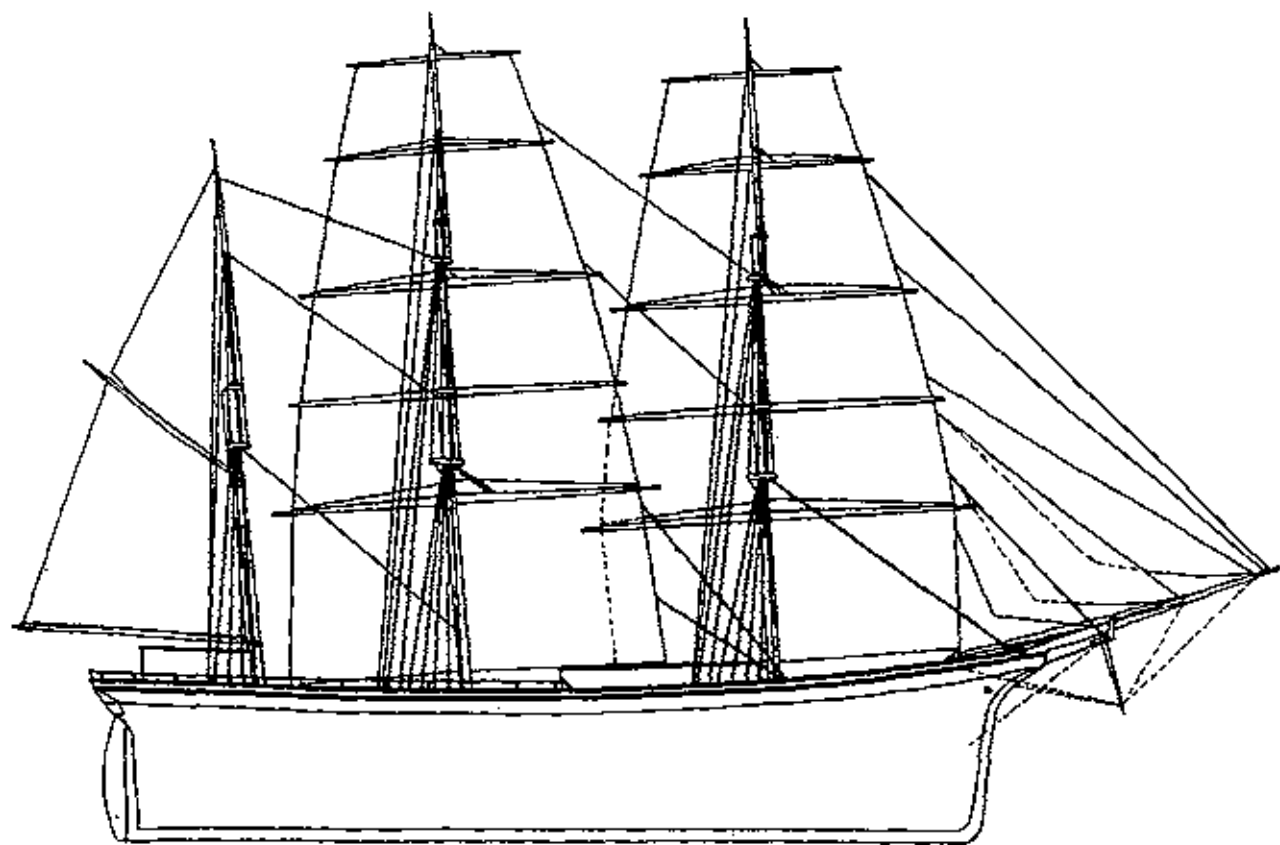

CASE STUDIES

This section of the guidelines is intended to be a separate, ongoing accumulation of pamphlets developed from HAER project field reports or included from other sources. Certain case studies may not be available from the HAER office or published as part of these guidelines due to their authors' desire to retain copyright ownership. In these cases, references will be given to which one may write for copies. The list of available or contemplated case studies listed below concentrates heavily on lines-lifting, but it is not intended that this should be the only subject treated. Case studies will cover historical research, photographic techniques, and measurement methods and illustrate how these were combined to document a historic vessel under conditions which may be repeated on other projects. HAER will appreciate being notified of useful case studies from other sources; this will benefit other users of the guidelines.

- 1) Case Study III "Lines Taken from a Vessel Too Large to be Leveled or Moved," by Samuel F. Manning
- 2) Case Study IV "Lines from a Model," by Samuel F. Manning

The above studies are part of the draft Guidelines for Documentation produced by the Standards Committee of the Maritime Heritage Task Force, National Trust for Historic Preservation, 1785 Massachusetts Avenue, N.W., Washington, DC 20036.

- 3) *Lifting Lines in a Floating Dry Dock* (Field report from HAER-Wawona

Recording Project, HAER No. WA-14)

- 4) *Documenting a Vessel Which is to be Destroyed* (pending field report from HAER-Louise Travers Recording Project, HAER No. MA-55)
- 5) *Lifting Lines from Inside a Floating, Single-Hulled Vessel* (pending field report from HAER-Balclutha Recording Project, HAER No. CA-54)
- 6) *Lifting Lines from Outside a Floating Wooden Vessel* (pending field report from HAER-Lettie G. Howard Recording Project, HAER No. NY-206)

For studies 3 through 6 above, write to HABS/HAER, National Park Service, P.O. Box 37127, Washington, DC 20013-7127.

As of 1994, HAER has produced Level I documentation of the following vessels:

Schooner *Wawona*, HAER No. WA-12
 Ship *Balclutha*, HAER No. CA-54
 Ferry *Eureka*, HAER No. CA-59
 Two-sail Bateau *E.C. Collier*,
 HAER No. MD-77
 Ship *Falls of Clyde*, HAER No. HI-7
 Pilot Schooner *Alabama*,
 HAER No. MA-64
 Schooner *Lettie G. Howard*,
 HAER No. NY-206
 Paddle-wheel Steamer *Ticonderoga*,
 HAER No. VT-14
 Bow of the *Snow Squall*,
 HAER No. ME-7

