Guilford Courthouse National Military Park

Superintendent's Residence

Historic Structure Report

2007

By

Joseph K. Oppermann - Architect, P.A.

P.O. Box 10417, Salem Station Winston- Salem, NC 27108

336/721-1711 FAX 336/721-1712

joskopp@mindspring.com

for

Historic Architecture, Cultural Resources Division

Southeast Regional Office

National Park Service



The historic structure report presented here exists in two formats. A traditional, printed version is available for study at the park, the Southeastern Regional Office of the NPS (SERO), and at a variety of other repositories. For more widespread access, the historic structure report also exists in a web-based format through ParkNet, the website of the National Park Service. Please visit www.nps.gov for more information.

**Cultural Resources
Southeast Region
National Park Service
100 Alabama St. SW
Atlanta, GA 30303
(404) 562-3117**

2007
Historic Structure Report
Superintendent's Residence
Guilford Courthouse National Military Park
Greensboro, NC
LCS#: 91444

Cover image: Undated view of residence, c.
1935 (GUCO NMP files, Box 1)

**Guilford Courthouse National Military Park
Superintendent's Residence
Historic Structure Report**

Approved by: Charles E. Crawford 1/24/07
Superintendent, Guilford Courthouse N. M. P. Date

Not
Recommended by: Alma S. Babo 2/7/07
Chief, Cultural Resource Division Date
Southeast Region

Acting
Recommended by: M. J. Hett 2/7/07
Associate Regional Director, Cultural Resource Date
Stewardship and Partnership, Southeast Region

Folk
Approved by: Art Frederick - Acting RD 2/7/07
Regional Director, Southeast Region Date

TABLE OF CONTENTS

MANAGEMENT SUMMARY

Executive Summary.....	1
Administrative Data.....	4

PART I – DEVELOPMENTAL HISTORY

A. Historical Background and Context.....	I.A.1
Early North Carolina.....	I.A.1
Backcountry Settlers.....	I.A.1
The Revolution.....	I.A.2
The Battle of Guilford Court House.....	I.A.2
Continuing Town Development.....	I.A.4
The Growth of Greensboro.....	I.A.4
The Battle Site.....	I.A.5
Early Preservation Efforts.....	I.A.5
Efforts to Create a Federal Park.....	I.A.7
The New Deal.....	I.A.8
National Park Service Administration.....	I.A.8
Mission 66 and the 1968 Master Plan.....	I.A.9
B. Chronology of Development and Use.....	I.B.1
Design Concept and Pre-Construction.....	I.B.1
Initial Construction.....	I.B.2
Maintenance.....	I.B.4
Timeline.....	I.B.6
C. Physical Description.....	I.C.1
General Description.....	I.C.1
Construction Characteristics.....	I.C.3
Utility Systems.....	I.C.37
Summary of Conditions.....	I.C.39

PART II – TREATMENT & USE

A. Introduction.....	II.A.1
B. Ultimate Treatment & Use.....	II.B.1

C. Requirements for TreatmentII.C.1
D. Alternatives for Treatment II.D.1
E. Recommendations..... II.E.1

REFERENCES

APPENDICES

- A. 1934: Original Drawings
- B. 1934: Original Specifications
- C. 2006: As-found Measured Drawings
- D. Recommended Ultimate Treatment – First Floor Plan
- E. Structural Assessment

PROJECT TEAM

*Building Investigation/
Building Condition Assessment*

Joseph K. Oppermann, FAIA
Joseph K. Oppermann – Architect, P.A.
Winston-Salem, NC

Research

Joseph K. Oppermann, FAIA, Historical Architect
Joseph K. Oppermann – Architect, P.A.
Winston-Salem, NC

Building Recordation

Jennifer Plocher Wilkins, Associate AIA
Joseph K. Oppermann – Architect, P.A.
Winston-Salem, NC

Document Layout

Jennifer Plocher Wilkins, Associate AIA
Joseph K. Oppermann – Architect, P.A.
Winston-Salem, NC

Report Editor

Jane Kelly
Message Makers
Winston-Salem, NC

Project Manager

Tommy H. Jones, Architectural Historian
National Park Service
Southeast Regional Office
Atlanta, GA

Program Review Coordination

Charles E. Cranfield, Superintendent
Guilford Courthouse NMP
Greensboro, NC

Tommy H. Jones, Architectural Historian
Southeast Regional Office

EXECUTIVE SUMMARY

On the morning of March 15, 1781, the experienced British army under British General Lord Charles, Earl Cornwallis met the ragged Continental soldiers and militia under Major General Nathanael Greene near the small backcountry hamlet of Guilford Court House. The resulting battle, technically won by the British but not without insurmountable losses, would prove pivotal in turning the tide of the Revolutionary War to the Americans.

As the years passed, Guilford Court House (later renamed Martinville) became deserted as the newly formed county seat Greensboro, named after the Major General, developed into a bustling city just six miles away. The site of the battle became largely forgotten until Judge David Schenck, an amateur historian, sought it out and began to study the battle. In 1886 Schenck purchased two tracts of battlefield land and established the Guilford Battle Ground Company, a non-profit association to continue the preservation effort.

The charter of the Guilford Battle Ground Company stated that its purpose was “preserving and adorning the grounds on and over which the battle of Guilford Court House was fought.” In practice, the emphasis was on adornment, with changes to the landscape made to create a park-like setting. Monuments were erected honoring not only the heroes of the Battle of Guilford Court House, but other Revolutionary War battles.

The Guilford Battle Ground Park began to have a presence on the national stage in 1910 when a bill was passed allocating federal funds for construction of a monument to Major General Nathanael Greene at the park. This success came after thirteen prior failed attempts at a federally-funded Greene

monument, and three failures at having the park named a National Military Park in the early 1900's. After the Greene Monument was dedicated on July 3, 1915, the next attempt at bringing the park into the national system was successful, with the bill creating Guilford Courthouse National Military Park signed into law on March 2, 1917.

Guilford became the first Revolutionary War battlefield named a national park, and then contained one hundred twenty-five acres of battlefield with twenty-eight gravesites and monuments. Paul W. Schenck, son of Judge David Schenck, became the first commissioner of the park under the administration of the War Department. The administration of military parks was later transferred to the National Park Service in 1933.

A 1933 Public Works Administration appropriation for National Military Parks and National Battlefields earmarked \$97,000 for improvements at the Guilford Courthouse National Military Park site. Four buildings were constructed: an Administration Building, Superintendent's Residence, Utility Building, and Inflammable Storage Building. The Administration Building and residence were modeled after Colonial-era Moravian structures from the town of Salem, approximately thirty miles west. The Superintendent's Residence, the subject of this report, was designed as a handsome story-and-one-half, side-gabled structure with dormer windows and Flemish bond brick walls. A wing on the east side of the building was sheathed in weatherboard siding. Construction was completed on all buildings in May 1935. The first tenant in the residence was Resident Commissioner James H. Roane. The building served successive superintendents until 2002, at which time it

became used for storage and temporary housing.

It has been proposed to use the now-vacant Superintendent's Residence as a library and meeting place, in conjunction with the City of Greensboro's nearby Tannenbaum Historic Park. To study the significance of the residence, its current condition, and the alternatives for treatment, the National Park Service contracted with Joseph K. Oppermann – Architect, P.A. (JKOA) in June 2006, to prepare an historic structure report. The study team included Joseph K. Oppermann, FAIA, historical architect, and Jennifer Plocher Wilkins, intern architect, of JKOA and David C. Fischetti, P.E., structural engineer of DCF Engineering, Inc.

In the preparation of these historic structure reports, Charles E. Cranfield, Superintendent at Guilford Courthouse NMP, provided from that office's files copies of earlier reports and other relevant documents. Tommy Jones, architectural historian of the National Park Service's Southeast Regional Office (SERO), provided technical data and additional sources of information. Angela Fitzgerald, administrative technician at Guilford Courthouse NMP, provided recollections from the course of her long tenure at the park where documentation was lacking. The park's maintenance chief Mike Baxter provided information on recent work at the residence.

Wilkins reviewed the historic documents, located other secondary sources, retrieved maps and other iconographic images. She also took measurements and produced measured drawings of floor plans and architectural details. Oppermann and Wilkins prepared the digital photo-documentation of the building and site. Oppermann prepared the architectural description of the building. Oppermann and Fischetti investigated the building fabric and building equipment to determine the building's evolutionary his-

tory and assess condition. All inspections of the physical building fabric were limited largely to visual observations. There was neither extensive dismantling of building materials nor testing of building systems. Examples of existing conditions were recorded with Canon digital cameras.

The investigating team found that the residence retains a substantial percent of its original building fabric, with the majority of changes affecting fixtures and finishes. Many changes, such as the carpet laid over original wood floors, or ceiling tile applied over original plaster ceilings, are additive and can be reversed. The residence largely retains its original floor plan, with generous sized rooms and handsome detailing. The residence is in good condition, thanks to its high quality original materials and regular maintenance. The most notable exception is the shutters, which suffer from rot and peeling paint. Mechanical, electrical, and plumbing systems are in good working condition, though several elements should be monitored due to age.

The recommended treatment includes the rehabilitation of the interior and exterior of the residence, retaining as much as practical the many original 1934-era design characteristics. This approach would retain character-defining interior and exterior features while providing some flexibility in less significant spaces of the residence. The large, public spaces of the first floor lend themselves well to reading rooms and bookshelves, while the private spaces are appropriately scaled for services. The second floor rooms could easily be used as staff office space, meeting space, and storage for the friends' organization. Modifications to provide a handicapped accessible entry and restroom on the first floor are recommended. In addition, the recommended treatment does not preclude the future return of the building to a residence, should the need arise.

ADMINISTRATIVE DATA

Locational Data

Building Name: Superintendent's Residence

Building Address: 2332 New Garden Road,
Greensboro, NC

Location: Guilford Courthouse National
Military Park

County: Guilford

State: North Carolina

FMSS Number: 68280

Size Information

Total Floor Area: 2893 square feet

First Floor Area: 1398 square feet

Second Floor Area: 1087 square feet

Additional Floor Area: 0 square feet

Crawl Space Area: 752 square feet

Finished Basement Area: 0 square feet

Unfinished Basement Area: 408 square feet

Roof Area: 1530 square feet

Perimeter Length: 165 feet

Number of Stories: 1.5

Number of Rooms: 18

Number of Bathrooms: 1.5

Related Studies

Hiatt, John. *Guilford Courthouse National
Military Park Cultural Landscape
Report*. National Park Service, 2003.

_____. *Guilford Court House Battlefield
National Historic Landmark Nomination*.
National Park Service, 1999.

Baker, Thomas E. *Redeemed From
Oblivion: An Administrative History of
Guilford Courthouse National Military
Park*. National Park Service, 1995.

Cultural Resource Data

National Register Status: Listed

National Register Date: February 1979

Period of Significance: 1935-

Real Property Information

Acquisition Date: November 1935

Numbering Information

LCS #: GUCO 91444

Proposed Treatment

Rehabilitation of the interior and exterior,
retaining as much as practical the many
original 1934 era design characteristics.

PART I. DEVELOPMENTAL HISTORY

A. HISTORICAL BACKGROUND AND CONTEXT

Early North Carolina

The charter for a territory called “Carolina” was granted by Charles II in 1663 to eight ruling Lords Proprietors. At that time, English settlement was concentrated in the coastal Albemarle area. With the development of Charleston as a port in the southern part of the territory, the proprietors divided the province into two administrative units, north and south. The governor was located in Charleston, and a deputy governor appointed for the northern part of Carolina. North Carolina became a separate colony in 1712, with its own governor and administration.

North Carolina became a Royal Colony in 1729, when seven of the eight Lords Proprietors sold their rights to the British crown. The northern part of North Carolina became known as the Granville District, the claim of Lord Carteret, Earl of Granville, who, as the abstaining proprietor, had retained his rights to sell the land. The area was located in Albemarle County which, along with Bath County, was one of the original counties in North Carolina.

Backcountry Settlers

In the 1730s, settlers along the North Carolina coast began to move westward, into what was called the backcountry. As noted in the travel accounts of William Byrd II, the backcountry towns once occupied by the Saura (Cheraw) Indians near the North Carolina-Virginia border (near present-day Danbury) were already abandoned. The Saura had moved southward roughly fifty miles to join the Keyauwee (near present-

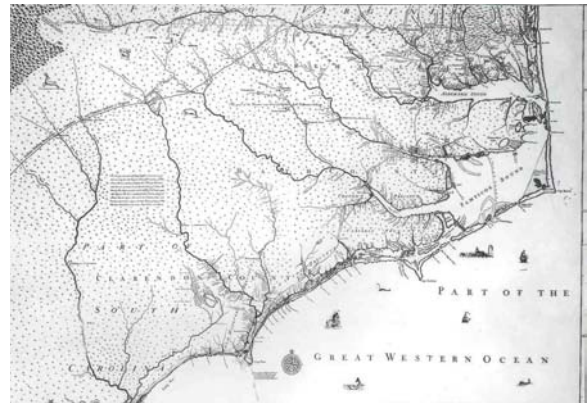

Figure A-1 “A New and Correct Map of the Province of North Carolina”, 1733, Edward Moseley (Colonial Records Project, NC Archives & History)

day Asheboro) in the first decade of the eighteenth century; both tribes later moved into South Carolina.

The majority of new settlers in the backcountry came from the north, down the Great Wagon Road from Pennsylvania through Virginia’s Shenandoah Valley. Among these groups were Pennsylvania Quakers, who established the settlement of New Garden in the mid-eighteenth century, and Moravians, who purchased a 100,000-acre tract from Granville’s agents in 1753. Scots-Irish and English ancestry predominated, although German settlers came in substantial numbers.

In 1771 Guilford County, named for Francis North, the Earl of Guilford, was formed from parts of Orange and Rowan counties. It was one of several new counties in the backcountry, the creation of which was regarded as a political move to decentralize the Regulators. That group of protestors

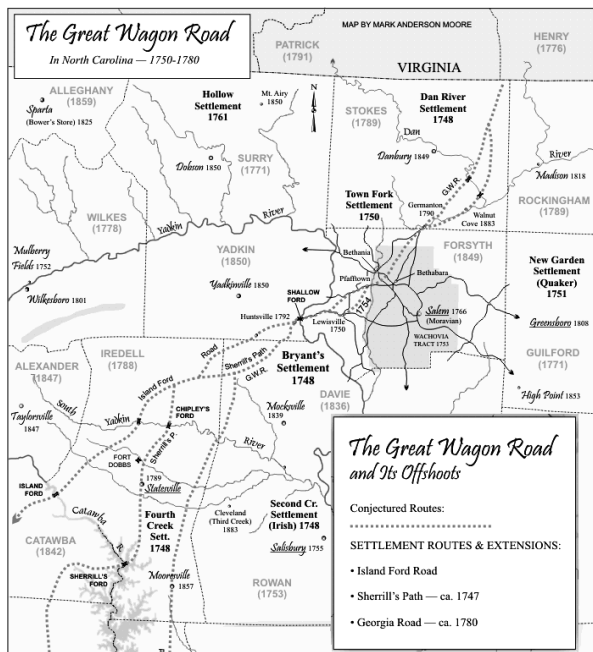

Figure A-2 The Great Wagon Road in North Carolina, 1750-1780 (NC Department of Archives & History)

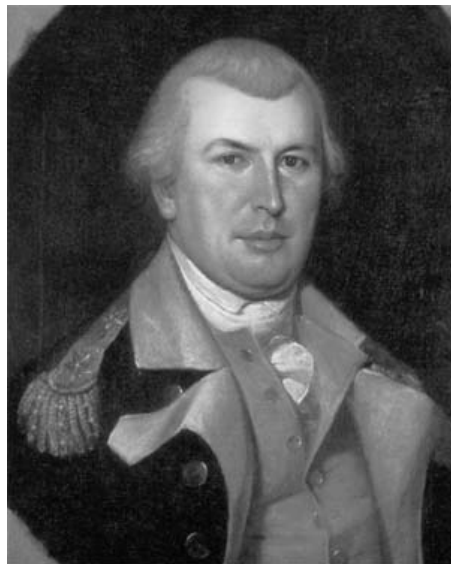

Figure A-3 Major General Nathanael Greene (Soldier-Statesmen of the Constitution, Robert K. Wright Jr., 1987)

against corrupt county officials had caused a riot in the Orange County seat, Hillsborough, in 1770. Seven commissioners for

the new Guilford County were chosen, along with a location for a court house, prison, and stocks. The location of Guilford Court House, approved by the legislature in March 1774, was about thirty miles east of the Great Wagon Road and the Moravian town of Salem.

It is not known exactly when the court house was built, nor its precise design or location. Primary sources note that in 1777, the building was still not completed. Court records from the 1780s suggest that the building was earthfast, with embedded wooden posts or groundills supporting the structure. By 1781, a small town had grown up around Guilford Court House and a store had been opened nearby by Thomas Henderson and Thomas Searcy. Fewer than fifty persons likely resided there, and most were of Scots-Irish descent.

The Revolution

Initially battles of the American Revolution, which unofficially began in Concord, Massachusetts, in 1775, were concentrated primarily in the northern colonies. After several years, the British began to shift their focus to the southern colonies, where it was thought that the Loyalist population was large. British General Lord Charles, Earl Cornwallis led his troops through the south, capturing Savannah in December 1778 and Charleston in May 1780. As Cornwallis moved into North Carolina, Major General Nathanael Greene led his continental soldiers and militia south to eventually meet the British at the Battle of Guilford Court House.

The Battle of Guilford Court House

On the morning of March 15, 1781, Major General Greene marched 4,400 American troops and militia into battle against General Cornwallis and 1,900 soldiers of the British

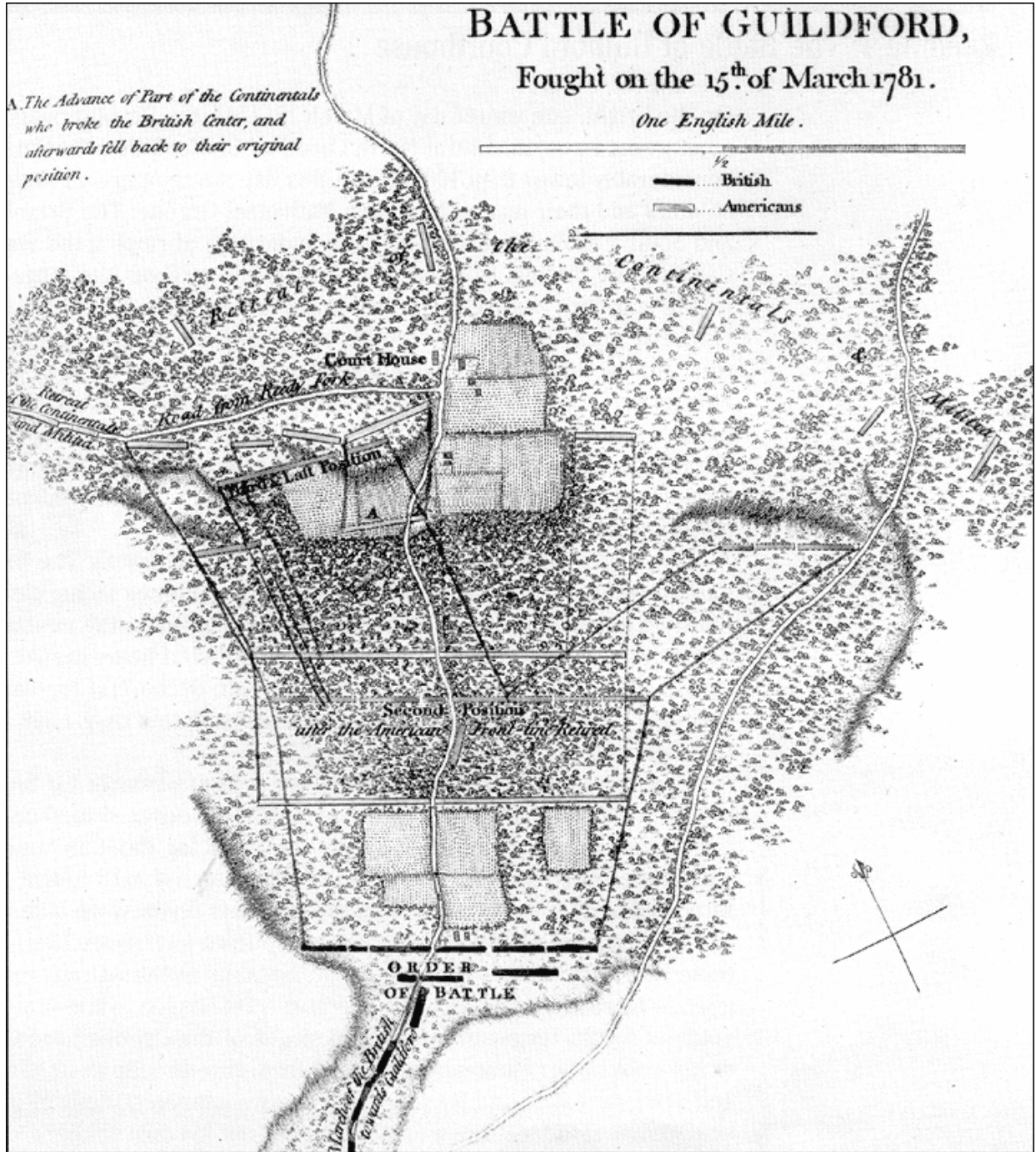

Figure A-4 Map of the Battle of Guilford Court House, by Lt. Col. Banastre Tarleton, 1787
(Guilford Courthouse NMP)

army. The first line of the American side consisted mainly of North Carolina militia. The second line was mostly Virginia militiamen, and the Continental cavalry held the flanks. The remainder of the American force was on the third line. The Americans were first to open fire. The British fought back

with force through both forest and open fields and eventually made it to the third line, where hand-to-hand combat commenced. Soon after, American forces retreated, resulting in a pyrrhic victory for the British, who counted 550 dead and

wounded, while the Americans suffered only 250 casualties.

Afterwards, Lord Cornwallis marched his troops to the coastal city of Wilmington, North Carolina, to recuperate and gather supplies. They then headed into Virginia where they were ultimately defeated in October 1781 at the Battle of Yorktown. The United States army then headed south and liberated South Carolina and Georgia from British control.

Although the British won the Battle of Guilford Court House, it was one of the pivotal points of the Revolution. The victory came at such high cost that Cornwallis and his army were never able to regain full strength for the final battles in Virginia.

Continuing Town Development

At the time of the Battle of Guilford Court House, the State of North Carolina owned the 350-acre tract on which the county seat was located. The land had been seized in 1778 from its owner, Edmund Fanning, an original Guilford County commissioner, because of his continued allegiance to Great Britain. When the state put the land up for public auction in 1781, Alexander Martin and his brother-in-law Thomas Henderson purchased the tract.

Martin was a merchant and politician who had moved to Salisbury from New Jersey in the 1760s. In 1773, he settled northwest of Guilford Court House, following his appointment as one of the original seven commissioners of the county. He was elected to represent Guilford County in the Provincial Assembly that year, and in 1779 first presented a bill to the legislature to establish a town around the court house. Though his bill was unsuccessful, his purchase of the land two years later denoted his confidence in the idea.

Martin was elected governor of North Carolina in 1782, a position which he held until 1785, and again from 1789 to 1792. While still awaiting an official town charter from the Assembly, Martin laid out a town around the courthouse and started selling off lots in the fall of 1785. The charter was granted in December of that year, and the town was named Martinville.

The town contained two principal streets. Battle Street ran north-south along the path of the old Reedy Fork Road, the route of the American retreat during the battle. Green Street ran east-west along the path of the Old Salisbury Road, by which the British had approached to do battle.

Each lot consisted of one acre, though it is not known how many lots the original plat contained. Several lots were subdivided after their purchase. Deed records indicate that by 1792, there were five taverns in the town. The store that had opened in the 1770s was still in operation at least until 1788. Quarter sessions of county court were held in February, May, August, and November, certainly the busiest months for merchants and tavern keepers.

A new courthouse was completed in 1792. The building measured thirty-six feet long and twenty-six feet wide, and was constructed of brick. Despite the early successes of Martinville, only twelve lots were sold between 1785 and 1802. By the mid-1790s, many of the original buyers had sold their land. The final blow came in 1809 when the county seat was relocated to the newly chartered town of Greensboro, more centrally located in the county. Commerce brought to Martinville by the court disappeared, and the town was gradually deserted.

The Growth of Greensboro

Greensboro was established in 1808 and named to honor the great Major General. It

was located about six miles south of Martinville. By the 1820s, industry began to make its way into the new county seat. The first steam-powered cotton mill in the state was started in Greensboro and was soon exporting textiles to other counties and states. This marked the beginning of a major industry in the Piedmont.

In the 1830s, higher education began to play a large role in the progress of the town. Guilford College was founded by the Quakers as New Garden Boarding School in 1837; Greensboro College was chartered the following year. Later in the nineteenth century, development would be further influenced by the establishment of Bennett College in 1873, and institutions that would become the University of North Carolina at Greensboro (1892) and North Carolina A&T State University (1894).

In the 1850s railroads began streaming through the city, aiding commerce and travel to the area. The Civil War caused a temporary pause in the growth of Greensboro, but the city was important in the success of the Underground Railroad.

The Reconstruction era brought new industries into Greensboro and the surrounding areas. The production of tobacco products boomed, as did the lumber and furniture industries. Textile production remained a major presence. Commerce brought with it a need for mass transportation. More than sixty trains a day arrived and departed from the city of Greensboro, giving it the nickname of the "Gate City." Its prosperity continued well into the twentieth century.

The Battle Site

As Greensboro grew, the former site of Martinville crumbled. By the mid-nineteenth century, parcels of land in the old town had been consolidated until they were

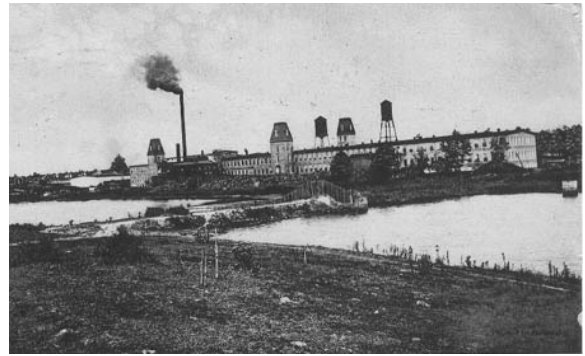

Figure A-5 Postcard of Proximity Mills, Greensboro (Penny Postcards from North Carolina, USGenWeb Archives)

held by just two persons. Author William Henry Foote reported in 1846 that the courthouse was gone and only one house remained occupied. Three years later, historian Benson J. Lossing wrote that "only a few dilapidated and deserted buildings" were left, describing one of them as a "log house, partially clap-boarded."

Artist and travel writer David Hunter Strother visited the site in 1857 and included his observations in an article for the July 1857 issue of *Harper's New Monthly Magazine*. Strother witnessed "ruined chimneys and decayed wooden houses," accompanying his description with an illustration. Stone chimneys were noted by an anonymous author in 1859.

Early Preservation Efforts

The first efforts to commemorate the Battlefield of Guilford Court House came in 1857. The Greene Monument Association was formed that year to raise funds for construction of a memorial to Major General Greene at the battlefield. Its efforts were interrupted by the Civil War and the Reconstruction.

The centennial year of 1876 witnessed a surge in American patriotism focused on the Declaration of Independence. The United States Congress gave appropriations of



Figure A-6 David Schenck, undated
(*A Memorial Volume of the Guilford Battle
Ground Company, 1893*)

\$244,000 to build monuments at Revolutionary War sites; although Guilford Court House was a suggested location, it was not included. A similar measure in 1884 also failed to secure funds for a battlefield monument.

The first act of battlefield preservation was not accomplished by the federal government, but by a private citizen, Judge David Schenck. Schenck had been a Superior Court Judge in Lincolnton, and resigned his post after accepting a job as general counsel for the Richmond and Danville Railroad, headquartered in Greensboro.

Schenck began to study the battlefield. His notes record that the “ancient roads” were abandoned and the town of Martinville was fully barren of structures. The Cape Fear and Yadkin Valley Railroad crossed the park north-south. In 1886, the same year that the railroad’s tracks were completed, Schenck purchased two parcels of land, the first containing thirty acres and the second twenty.

After investing \$700 of his own funds into acquiring battlefield land, Schenck founded the Guilford Battle Ground Company in 1887 as a non-profit association to continue the effort. Though the company’s charter stated its purpose as “preserving and adorning the grounds on and over which the battle of Guilford Court House was fought,” its work focused on making the land a “pleasuring ground” with monuments to war heroes, rather than on restoring the battlefield to its 1781 appearance.

Between 1887 and 1904, the Guilford Battle Ground Company acquired more battlefield land, bringing the total amount to 112 acres. It operated as Guilford Battle Ground Park and continued to “beautify” the battlefield and create a park-like setting.

The first monument constructed was a granite memorial to Captain Arthur Forbis, a local casualty of the battle. Additional monuments, such as one dedicated to Major Joseph Winston in 1895, were placed as part of planned vistas in the designed landscape of the park. Monumental arches installed in 1905 commemorated the service of Brigadier Generals Francis Nash and William Lee Davidson, neither of whom had participated in the Battle of Guilford Court House. The park had become “the state’s general-purpose Revolutionary War memorial.”

The Guilford Battle Ground Company built a “keeper’s lodge” in 1887 for the resident caretaker, which contained a museum and reception room. In 1888, another cottage was constructed for Schenck, along with a speaker’s stand. Two spring houses were built in 1890. By June 1891, the artifact collection had grown enough to warrant a separate museum building. A restaurant was constructed the following year. Historic photos indicate that these structures were of typical Victorian-era design that had little reference to the historic nature of the battlefield.

The creation of a park-like memorial setting occurred at other battlefields as well, driven by Centennial patriotism of private backers. These efforts, although some are now seen through modern eyes as misguided, were successful in generating interest in and preserving the land of early battlefields.

Efforts to Create a Federal Park

In 1904 the Guilford Battle Ground Company launched an effort to make Guilford Courthouse a National Military Park. The initial bill failed, as did similar bills in 1905 and 1907.

A bill proposing a monument to Major General Nathanael Greene at the Guilford Battle Ground Park was introduced in 1910, the fourteenth attempt in a series going back to 1888. The bill passed, and the subsequent law provided funds for the monument if the Battle Ground Company agreed to deed sufficient land to the government. The Nathanael Greene Monument was dedicated on July 3, 1915. The event is now regarded as an important step towards creating a federal presence at the battlefield.

Representative Charles M. Steadman's introduction of a bill to establish Guilford Courthouse National Military Park in 1917 met with favorable response. The bill was signed into law on March 2, 1917, and the park became the first Revolutionary War battlefield to become a national park. The park then contained one hundred twenty-five acres of battlefield with twenty-eight gravesites and monuments. The stated goal of the National Military Park Commission was to restore battle sites to their Revolutionary War appearance, but accurate restoration did not occur at the Guilford site.

Paul W. Schenck, son of the founder of Guilford Battle Ground Company, became



Figure A-7 Guilford Battle Ground Park, undated, showing museum at left, battle monument just left of center, and entrance at right (A Memorial Volume of the Guilford Battle Ground Company, 1893)



Figure A-8 Greene Monument, undated (National Park Service)

the first commissioner of the park under the administration of the War Department. He was replaced by Edward E. Mendenhall in During the tenures of Schenck and Mendenhall, work at the park was mainly cosmetic. The small annual budget allowed too little to prevent deterioration of roads and buildings.

In 1933, administration of the national military parks was transferred from the War Department to the National Park Service. Resident Commissioner James H. Roane replaced Mendenhall in the fall of that year.



Figure A-9 Administration Building, undated but assumed c. 1950 (National Park Service) 1922.

The New Deal

The election of President Franklin Delano Roosevelt in 1932 marked the beginning of relief from the Great Depression, as the new administration instituted a variety of work programs designed to create jobs and stimulate the economy. Collectively called the New Deal, these programs included the Public Works Administration (PWA), which budgeted billions of dollars for the construction of public works.

The total 1933 appropriation to the PWA for improvements at many National Military Parks and National Battlefields was \$4,392,500. From that, the PWA allocated \$97,000 for improvements at the Guilford Courthouse National Military Park site. The work began in the summer of 1934. Improvements were made to the park's roads, trails, and sewer system. Four buildings were constructed, including an Administration Building, Superintendent's Residence (also known as Quarters No. 1), a Utility Building, and an Inflammable Storage Building.

The buildings, designed by the National Park Service's Eastern Division Branch of Plans & Design, were Colonial Revival style structures with Moravian architectural details as seen in the colonial-era town of Salem, located thirty miles west of the park.

The Administration Building was sited on the north side of New Garden (Old Salisbury) Road, across from the Greene Monument. The center block of the building was brick laid in Flemish bond, with three dormer windows into the upper half-story of the side-gabled structure. Weatherboarded wings flanked the center block. The building contained the park's museum, library, and administrative offices. The Superintendent's Residence was similarly designed, but had only one end wing. The Utility Building was an L-shaped frame structure, with painted weatherboard siding. The Inflammable Storage Building, constructed of solid brick walls and a concrete floor, was located adjacent to the utility building, forming one corner of a fenced service court for the utility group.

Construction was supervised by Greensboro architect Joseph J. Sawyer. Sawyer had been hired by the Park Service as an "associate architect" under public works appointment. In a letter from Charles Peterson to Sawyer on May 17 of that year, the position was offered at a salary of \$3,200.

The final construction report written by Sawyer indicates that labor was paid in accordance with PWA requirements, with skilled labor at \$1.10 per hour and unskilled at \$.45 per hour. The highest number of men employed was in March 1935, when sixty-six men labored a total of 3,262.25 hours. The work was officially completed on May 24, 1935. The contractor was George W. Kane, with offices in Greensboro, Roxboro, and Durham. The final cost of the buildings was \$56,002.90.

National Park Service Administration

Resident Commissioner James H. Roane occupied the Superintendent's Residence

after its construction. The first full-time permanent appointment by the National Park Service was William P. Brandon in May 1937, who carried the official title of Junior Historian, but functioned as Acting Superintendent.

The first master plan for the park was completed in 1936 and addressed restoration of the grounds as much as possible. The buildings constructed by the Guilford Battle Ground Company were demolished, along with roads, an artificial lake, inappropriate plantings, and other elements of the earlier designed landscape. An additional 23.5 acres of land, including a parcel thought to be the site of the 1780s Guilford Court House, were acquired between 1934 and 1937 through donations by local citizens.

As the land within the park was gradually coming closer to its original battle site appearance, land outside the park was becoming more urban with the continuing growth of Greensboro. Much of the development occurred on the battleground, since the park included only a fraction of the thousand acres thought to have been fought over in 1781. Forest Lawn Cemetery had been established by the city south of the park in 1930, while a city park was completed to the southeast by the Civil Works Administration in 1934.

Intent on preserving remaining parcels adjacent to the park, Superintendent Brandon developed a land-acquisition program in 1940. The Second World War intervened, requiring a more conservative approach to park management. In the interim, a large entertainment complex was built adjacent to the park in the early 1950s, complete with restaurant, drive-in movie theater, and go-cart track. Its construction potentially damaged archaeological remains from the early town of Martinville.

Population in Greensboro exploded from 19,861 in 1920 to 123,334 in 1960, causing the city to creep even closer to the park. Coupled with its own expansion, the park came to border the city limits of Greensboro on the south and east sides in 1964.

Mission 66 and the 1968 Master Plan

The fiftieth anniversary of the National Park Service occurred in 1966; the milestone was marked by Mission 66, a ten-year program begun in 1956 intended to upgrade outdated park facilities. The Mission 66 plan at Guilford included the purchase of an additional residence in 1956, known as Quarters No. 2, as well as the proposed creation of a tour road through the park. Also included were plans to close New Garden Road, which brought ever-increasing suburban traffic through the park. Additional parcels of land were purchased bringing the park to its current size of 220.25 acres in the 1970s.

A new master plan was completed in 1968 and revised the following year. The plan developed the unrealized Mission 66 goals, including construction of the tour road and expansion of the inadequate Administration Building. It was ultimately decided to demolish the 1934 structure and build a new, modern Visitor's Center, which was completed in 1975. The tour road, forming a loop through the park, was also constructed in 1975.

The railroad tracks through the park were abandoned in 1981 and removed in 1985, eliminating another modern intrusion into the heart of the battlefield.

Tannenbaum Historic Park was created by the city of Greensboro west of Guilford Courthouse in 1988. Although the park does not interpret the battle, it is sited on battlefield land. Structures at the park recall the

backcountry houses that would have stood in the area at the time of the battle. A new master plan was created for the park in 1997.

The majority of future goals outlined in the plan are landscape related, including the planned closure of Old Battleground Road through the park. The plan reportedly did not address the Superintendent's Residence. The park was included in the Guilford Courthouse Battlefield National Landmark district in November 2000, along with Tannenbaum Historic Park, Greensboro County Park, and other private holdings. The landmark nomination did not consider the Superintendent's Residence to be a contributing

structure. However, the National Register nomination, as amended in 1996, recognized a historic district with the Superintendent's Residence, Utility Building, and Inflammable Storage Building listed as contributing structures.

Park superintendents ceased to live in the residence in 2002, at which time the building was used for storage and temporary housing when needed. In recent years, park Superintendent Charles Cranfield began lobbying to use the Superintendent's Residence as a library and meeting place in conjunction with Tannenbaum Historic Park.

B. CHRONOLOGY OF DEVELOPMENT AND USE

Design Concept and Pre-Construction

The drawings for the buildings at Guilford Courthouse National Military Park were produced by the Eastern Division Branch of Plans & Design, a unit of the National Park Service under the direction of Thomas Vint. The individual responsible for the design is not known. Initials on the drawings indicate that the sheets were drawn by L.S.W. and G.H.R., traced by R.E.S., L.S.W., R.F.G., and C.C.P, and checked by J.R.T and C.W.A. The drawings are dated April 28, 1934.

Although the goals of the National Park Service included restoration of the park to its appearance at the time of the battle, the 1934 building designs were not evocative of the structures near the site in 1781. By all accounts, the courthouse itself and the houses later constructed in Martinville were unremarkable, wooden structures. Probably most were log, and some had weatherboard siding. Stone for chimneys would have been taken from local escarpments. This type of construction would have been in keeping with traditional vernacular buildings of the Scots-Irish settlers in the area.

The structures in the park built by the Guilford Battle Ground Company, beginning in the late nineteenth century, also had scant stylistic connection to the time of the battle. Instead, the early park buildings were typical Victorian structures.

Thus, when the National Park Service sought a design concept for the group of new buildings in the 1930s, it chose a concept which both reflected the colonial time period and which was then popular in American architectural design. The Colonial Revival style was consistent with the



Figure B-1 Brick buildings at Old Salem

NPS philosophy of harmonizing buildings with their cultural settings. The brick construction would also present a more substantial appearance than vernacular log structures.

Colonial Revival structures first appeared in the late nineteenth century and remained fashionable, especially for large residences, through the 1930s. Most employed architectural elements and characteristics of early American buildings in the design of the larger-scale structures appropriate for contemporary culture. The buildings at Guilford Courthouse, however, were more accurately scaled representations of the Colonial-era buildings extant thirty miles to the west in Salem, founded in 1766. The Moravians who established the town had arrived in backcountry North Carolina thirteen years earlier seeking to create a religious community. In the Germanic tradition, the buildings of Salem were predominantly brick, with gabled roofs covered with flat tile. Preservation efforts at Salem began in the 1950s, resulting today in a museum town operated as Old Salem.

The most important buildings of the NPS plan at Guilford Courthouse, the Admini-

stration Building and the Superintendent's Residence, were designed as one-and-one-half-story structures of brick laid in Flemish bond, with at least one frame and weatherboard wing. They were side-gabled and had a group of three dormers into the upper half-story; the roofs were covered in flat tile. The Utility Building, as its name suggests, was a more utilitarian wood-framed building with weatherboard siding, fronting a courtyard with the brick Inflammable Storage Building at one corner.

Bids for the construction of all buildings were opened on June 29, 1934. The low bidder of six proposals submitted was George W. Kane, with offices in Greensboro, Roxboro, and Durham. The contract for all four buildings was \$53,943.

Construction was supervised by architect Joseph J. Sawyer of Greensboro, who was hired in May 1924 by the National Park Service as an associate architect under public works appointment.

Initial Construction

Sawyer produced weekly reports that give detailed information of the construction sequence and minor design decisions made during construction. His report for the week ending August 23, 1934, indicated that the job had begun in the afternoon of August 21.¹ By the week of September 6, the footings were in, and the brickwork was started the following week. Window frames were rejected for a second time the week of October 4, because they were not primed before assembling. The roof was felted in by October 25. Plumbing and steam pipes were laid the week of November 22. By January 17, 1935, the plasterwork was complete and was drying out, a process which had begun

with the brown coat the week of December 13. Linoleum floors were installed the week of March 21. All work was deemed complete the week of May 16, 1935, except for screens and the "rubbing" of paint work on doors. Rubbing was done to produce a leveled, smooth finish on painted or varnished surfaces, by rubbing with an abrasive, often pumice, in oil or water.²

Correspondence from John L. Nagle dated August 23 states that face bricks by the Yadkin Brick Works in New London, North Carolina, were approved. It was noted in this letter that the bricks in question were not handmade as requested in the specifications, but the "desired effect" was provided. A letter from Nagle on the following day indicates that common brick by the Borden Brick & Tile Co. was approved for the project. Bond between the face brick and common brick was noted as being at every sixth course, since the vertical dimension of six courses of face brick corresponded to five courses of common brick.

The first official change during construction was recorded in a letter dated November 7, 1934, from contractor George Kane. He proposed building an 8" brick wall from the top of the already-built concrete cross walls in the basement to the bottom of the 6" x 10" floor girders. Tin-clad doors would be installed in the brick walls to provide access to the unexcavated spaces of the basement. The work was intended to make the basement fire proof, and the letter of proposal was accepted as change number one.

Changes two through four are recorded on Sawyer's final construction report, dated June 27, 1935. Change two entailed changing the height of the window in the gable of the residence at a cost of \$39.50. Change three included changing two hinge types for

¹ All construction correspondence and superintendent's reports referenced in this section from Guilford Courthouse NMP files.

² According to Frank Welsh of Welsh Color and Conservation, Inc., a historic finishes specialist.

\$50.60. Change four was for outside electric service wires to buildings, except the Utility Building, at a cost of \$914.25.

The contractor sent a letter on March 4, 1935, giving the price to add a door between the hall and the dining room as \$36. This change was accepted as change number five. Changes six through eight, noted on the final construction report, do not involve the residence. Change number nine installed laundry trays in the basement of the residence at a cost of \$85. The total cost of extra work at all buildings was \$2,059.90, for a final contract price of \$56,002.90.

J.R. Thrower sent a memo to Sawyer on March 25, 1935, regarding the color scheme:

It appears that the interior colors selected seem too brilliant and glaring. Perhaps this is due to the absence of furnishings and household goods, but as Mr. Simmons states, you concur in this opinion and we recommend that you have the painter tone down the colors of the last coat, provided it is not too late to make such a change from the approved color samples.

It is not necessary that additional samples be submitted to this office; just follow your own judgment and tone-sense.

The public works administrator approved an increase in allotment for the project to \$72,005 from \$66,225 on July 16, 1935.

Sawyer's final report indicates that the work was carried out strictly in accordance with the plans and praises the workmanship on the buildings.

The Superintendent's Residence was a handsome, story-and-one-half brick building with a weatherboarded wing to the east. Measuring almost thirty-eight feet by thirty feet, the central brick block of the structure rested on a moulded brick watertable, while the frame wing, thirteen feet six inches by eighteen feet six inches, was supported by a



Figure B-2 Southeast oblique of residence, undated but assumed c. 1935 (Guilford Courthouse NMP files, Box 1)

brick foundation. The side-gabled roofs were clad in red Ludowici-Celadon shingle tiles. Stairs to the three house entrances – the front door, the back door, and the porch wing – were composed of local granite. The front door also featured wrought-iron railings and an arched, copper-covered hood, further recalling Moravian design features. Double-hung wood windows were located on each elevation. The south-facing porch columns of the wing repeated the shallow brick arches above the windows.

Inside, the residence contained a central stair hall which extended almost the full depth of the building with a coat closet in the rear, along with enclosed stairs to the basement. To the left of the hall was the living room with a corner fireplace; behind this room was a small sewing room. To the right of the hall was a dining room with a kitchen beyond. The kitchen had built-in cabinets, a broom closet, and access to the enclosed porch and pantry in the rear of the frame wing. The enclosed porch contained the back door of the house, while the dining room had an exterior door to the porch fronting the frame wing.

According to the plans, the floors of the first level were of oak, with linoleum used in the

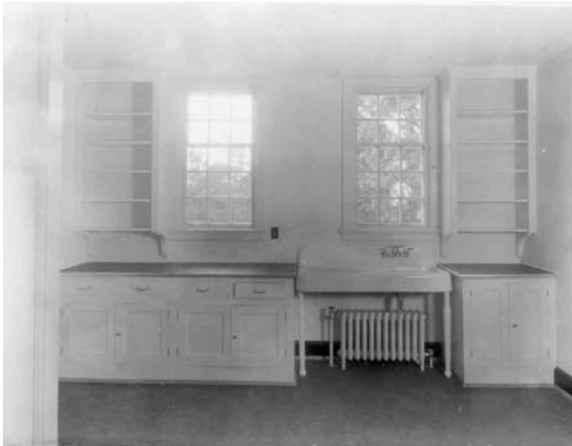

Figure B-3 Kitchen in residence, June 8, 1935
(Guilford Courthouse NMP files, Box 1)



Figure B-4 Stair hall and living room, June 8, 1935
(Guilford Courthouse NMP files, Box 1)

kitchen, enclosed porch, and pantry. Wood picture mouldings were used in all rooms except the kitchen.

Upstairs, the residence contained three bedrooms, a bath, and a generous attic above the wing. Two of the three bedrooms had built-in closets. The flooring was oak in the bedrooms and hall, pine in the attic, and tile in the bath. The newel and railing at the stair was specified as birch.

The basement of the residence contained an L-shaped room with crawl spaces on each side. A coal-fired hot water heater, oil burner, and boiler were located in the basement, while an oil storage tank was buried outside to the west of the house. Exterior stairs provided access from the basement to grade at the rear of the house.

Resident Commissioner Roane moved into the Superintendent's Residence in 1937 and reportedly lived in the house until 1941.

Maintenance

Superintendent's reports indicate areas of maintenance and other work on the residence. Damaged shingles were reportedly replaced on all buildings in May 1947. The report dated July 5, 1947, states that crushed stone was placed on the walks. The following year, a report dated September 11 and written by custodian Raleigh C. Taylor states:

...an attack by termites on the custodian's residence was halted, and further measures are being taken as directed by the Coordinating Superintendent and Architect Higgins.

Details of damage and repair are not reported. Taylor served as park superintendent from November 1945 until August 1955 and, presumably, lived in the residence.

Painting on the exterior was reported underway in a report dated October 6, 1949 and completed on November 11. A report dated May 2, 1951, indicates that mesh overhangs were added to the gutters.

The kitchen was remodeled in 1957 and again in 1988. The coat closet was converted to a half-bath in 1988.

Some light fixtures were replaced at an unknown date. In addition, plastic-coated ceil-

ing tile was placed on all the ceilings of the first floor rooms at an unknown date. The HVAC systems were upgraded in 1983 and 1993. It is not known when air conditioning was originally added to the building. Some electric rewiring was also completed in 1993.

Some doors were removed between first floor rooms at an unknown date. Carpet was installed in the bedrooms and dining room, and modern tile was installed in the second floor bathroom, likely during the other 1980s work. Additional closets were built in two of the second-floor bedrooms at an unknown date, also likely 1980s.

Although there is no documentation of when the side porch was enclosed, that enclosure was remodeled in 1994. At that time, the plywood which formed the existing enclosure, its storm doors and windows, and flooring were removed and replaced with new doors, flooring, and insulated windows. Also that year, new 6" copper gutters and downspouts were installed to replace the original 4" gutters, in an attempt to correct water problems.

Angela Fitzgerald, long-time administrative technician at Guilford Courthouse NMP, recalls several details about remodeling campaigns that are not included in park documentation. Fitzgerald said that the first carpet was installed in the house when Mark Woods became superintendent in March 1991, and was replaced when Robert Vogel began his tenure as superintendent in March 1996. Fitzgerald said that the wood floors had been sanded and varnished at one time prior to the carpet installation.

Fitzgerald recalled that the modern ceiling tiles were installed prior to the most recent kitchen remodeling of 1988, and prior to any wallpaper being installed. She also said that the bathroom upstairs was remodeled near

the end of the tenure of Superintendent Willard Danielson in 1990.

Fitzgerald said that large window air conditioning units were once used in the residence, and that the 1983 HVAC upgrade was likely the first time the building had central cooling. She recalled that additional insulation was added to the building at the same time.³

In early 2005, the original clay roof tiles were removed and cleaned. Missing gutter hangers were replaced. New ice guard at the eaves, felt underlayment, and copper flashing was installed and the tiles were reinstalled. Broken tiles, previously repaired with roofing cement, were replaced with around 700-800 salvage tiles matching the originals. The tile was procured at \$3.45 each, with the total cost of the project reaching \$53,301. The contractor was Carolina Roofing, Inc., in Winston-Salem.⁴

A minor plumbing leak originating at the second floor bathroom occurred in November 2006, during the production of this report. The leak caused several modern ceiling tiles in the entry hall below to become soaked, and fall away. Wood nailers measuring 3 5/8" by 3/4" and attached to the original plaster ceiling were exposed.

The residence ceased to be used in 2002 and has since served as a storage building, occasional meeting place, and temporary housing for park officials. The building is wired for satellite-based NPS training sessions, which are conducted in the east bedroom upstairs.

³ Angela W. Fitzgerald, Administrative Technician, 13 November 2006

⁴ Mike Baxter, Park Maintenance Chief, 13 November 2006

Timeline

- | | | | |
|------|--|-----------|--|
| 1729 | North Carolina became a Royal Colony.

Immigration begins to rise in the colony; the Great Wagon Road (from Pennsylvania to Georgia) is 30 miles west of Guilford Courthouse site. | 1882 | Judge David Schenck moves to Greensboro. |
| 1771 | Bill for establishment of Guilford County is signed into law. Guilford County is named for Francis North, Earl of Guilford. | 1886 | Schenck buys thirty acres of battlefield land for \$10 an acre, and twenty acres of battlefield land for \$20 an acre.

Cape Fear and Yadkin Valley Railroad is built to pass through the park. |
| 1773 | Boston Tea Party occurs as a protest against taxation by the British without representation in Parliament. | 1887 | The non-profit Guilford Battle Ground Company is chartered by the North Carolina General Assembly. Judge David Schenck is named president. |
| 1774 | Construction for a courthouse, prison, and stocks in Guilford County is approved. | 1887-1888 | The Guilford Battle Ground Company spends \$3,000 to acquire sixty-two acres of battlefield land. They build a caretaker's cottage with reception room and museum and erect a granite monument to Captain Arthur Forbis. |
| 1776 | The United States Congress declares independence from Great Britain.

Earliest known reference to "standing" courthouse in Guilford County is made. | 1904 | The Guilford Battle Ground Company launches an effort to make Guilford Courthouse a National Military Park; the bill fails along with similar proposals in 1905 and 1907. |
| 1781 | The Battle of Guilford Court House occurs on March 15.

Cornwallis surrenders the Royal Army at Yorktown on October 19. | 1915 | The Nathanael Greene Monument, constructed with federal funds, is dedicated on July 3. |
| 1783 | Warfare officially ceases and the Articles of Peace are ratified by Congress. | 1917 | Guilford Courthouse National Military Park is established, with 125 acres of land and twenty-eight monuments/graves. It is the first Revolutionary War battlefield established as a national park. The Secretary of War was responsible for preserving the battlefield "for historical and professional military study". |
| 1857 | First local effort to commemorate the battlefield is made by the Greene Monument Association. | 1932 | The Public Works Administration creates Country Park adjacent to |
| 1876 | Congressional appropriations of \$244,000 are made to build monuments at Revolutionary War sites; Guilford Court House is suggested to be included, but is not approved. | | |

	Guilford Courthouse National Military Park.	1956	The National Park Service's Mission 66 initiative for improvements begins.
1933	Administration of the national military parks is transferred from the War Department to the National Park Service. The Public Works Administration allocates \$4,392,500 for improvements in National Military Parks and national battlefields, of which \$ 97,000 was designated for Guilford Courthouse.	1957	The kitchen of the Superintendent's Residence is remodeled.
		1958	The master plan is revised.
		1968	A new master plan is developed to address unrealized Mission 66 goals.
1934	Construction begins on an administration building, superintendent's residence, and utility buildings. Improvements to the park's roads and trails are made.	1975	The new visitor's center is completed, and the 1934 Administration Building demolished.
1934-1939	Just over twenty-three acres of land are acquired through donations of local citizens, including the supposed original site of the 1800s courthouse.	1983	The HVAC system is upgraded in the Superintendent's Residence, likely adding central cooling to the building for the first time. Building insulation is upgraded.
1936	A new master plan is developed.	1988	Tannenbaum Park opens adjacent to Guilford Courthouse National Military Park. The kitchen is remodeled at the Superintendent's Residence. The first-floor coat closet is remodeled into a half bath. The second floor bathroom is remodeled.
1940	Highway 220/Battleground Avenue is relocated half a mile beyond the western boundary of the park; Old Battleground Road still runs through the park. The park superintendent submits "A Land Acquisition Program for Guilford Courthouse National Military Park."	1991	Carpet is installed in some rooms of the residence.
1947	Damaged shingles are replaced at the Superintendent's Residence.	1993	The HVAC system is again upgraded in the Superintendent's Residence, and two electric heat pumps are installed.
1951	Mesh coverings are added to gutters at the Superintendent's Residence.		At least a portion of the electrical system is upgraded.

- | | | | |
|------|--|------|--|
| 1994 | A new master plan is developed.

Gutters are replaced at the Superintendent's Residence, and the porch enclosure is remodeled. | 2005 | The original roof tiles are removed, new underlayment and copper flashing installed, and tiles reinstalled with 700-800 salvage tiles replacing broken originals. |
| 2002 | The Superintendent's Residence ceases to serve as park housing; Robert Vogel is the last superintendent to live in the residence. | 2006 | A minor leak in the second floor bathroom causes several ceiling tiles in the entry hall to become waterlogged and fall, exposing wood nailers and the original plaster ceiling. |

C. PHYSICAL DESCRIPTION

General Description

From the western approach to Guilford Courthouse National Military Park along New Garden Road, an unobtrusive driveway leads north away from the battlefield to service buildings and park equipment. In a clearing to the east is the modestly scaled but handsome Superintendent's Residence. It was designed by National Park Service architects and constructed in 1934-35 as part of a Public Works Administration effort. The style of architecture is Colonial Revival style with frequent references to the eighteenth-century Germanic architecture of the Moravians in nearby Salem.

The Superintendent's Residence is a story-and-one-half brick house with a smaller and lower, story-and-a-half wing of frame and board. The main block is constructed of brownish-red bricks finished to resemble handmade and laid in Flemish bond on all elevations. Gable end wall chimneys frame the long elevations. The wing has weatherboard on its north and east elevations and flush boards on its south elevation, which originally included an inset porch, now enclosed in glass with wood framing.

The main block measures almost thirty-eight feet long by thirty feet deep, with the main façade facing south. This elevation is a three-part, symmetrical composition with a central doorway flanked by large, eight-over-twelve light, double-hung windows. At the second floor level, three roof dormers repeat this pattern of fenestration. The doorway, the main public entrance, is emphasized by broad, granite steps and landing with handsome wrought iron railing, and shaded overhead by a striking, half-round bonnet.

The rear exterior wall, the north elevation, is



Figure C-1 South elevation of Superintendent's Residence



Figure C-2 North elevation of Superintendent's Residence

the service side of the building. Three roof dormers provide second-floor light as on the front elevation, but the windows at first-floor level are smaller, and there is no direct entrance into the main block. A sash door provides entrance to the first floor of the wing, while concrete steps lead to a below-grade entrance at basement level, a service staff access point that avoids travel through the family's living quarters.



Figure C-3 Concrete and brick foundation wall



Figure C-4 Flemish bond brick wall and watertable

Like the front of the house, the west gable end wall is symmetrical in design. Two large eight-over-twelve windows at the first floor flank the center chimney. At the second floor the two flanking windows are smaller and offset to accommodate the steeply pitched roof.

The composition of the opposite east elevation is interrupted by the low, story-and-a-half, wing of frame and weatherboard siding. Placed off center with a massing distinctly lower and smaller than the main block, it is clearly designed for ancillary activities. Its principal exterior feature is the porch stretching across its south (front) elevation. With columns and arches, the porch was originally open, but now is enclosed with glass and light framing. It provides a modest yet attractive feature that blends well with the arched openings of the main block.

Inside, the main block of the residence is organized on a center hall plan, two rooms deep on either side of a center stair hall. The front door enters into the central hall with its handsome, varnished wood staircase leading to the private second floor. The more public rooms are aligned across the south wall on the first floor. To the west, the living room contains the house's one fireplace with a large wood mantel. To the east is the dining room with a chandelier and two corner cupboards. The rooms behind, along the north wall, were designed for service activities such as a kitchen and sewing room. Accordingly, they have neither the major features nor the fine detailing found in the front rooms.

Upstairs, the bedrooms are arranged around the central stair hall. Visible from the first floor, this second-floor hall repeats the handsome detailing found in the first-floor hall's balustrade, baseboards, picture molding, doors and windows and their casings. The bedrooms, as private spaces, have less abundant fine detailing.

The east wing provides ancillary spaces, a service entrance connecting to the north rear of the house, the original pantry (now laundry), and a somewhat exclusive porch accessed from the dining room, a place where visitors might be invited to linger. The overhead attic, originally floored but not finished, was a storage room off an upstairs bedroom. It is now finished and used most recently as a child's playroom.

Construction Characteristics

Structural Systems

Foundations & Cross Walls: The below-grade perimeter walls of the main block and east wing are 9" thick, composed of imitation-handmade brick laid in common bond.

The cross walls below grade are poured in place, reinforced concrete, 9" thick. On top of these cross walls originally sat brick piers. During construction, the open spaces between the brick piers were filled with brickwork laid in common bond.

The footings of the perimeter brick walls and concrete cross walls are indicated on the construction drawings as poured in place reinforced concrete, 21" wide by 9" deep.

Exterior Walls: The above-grade perimeter walls of the main block are 9" thick at both the first and second floors. The bricks are imitation handmade and laid in Flemish bond on all four elevations.

The base of the wing is a perimeter masonry wall of imitation-handmade bricks laid in Flemish bond. On top of the masonry base is a frame structure with weatherboard on the north and east elevations. The original south exterior porch wall is sheathed in flush, tongue-and-groove boards of varying widths. The new south exterior wall, installed in 1994, is primarily thermal glass



Figure C-5 Southeast oblique of frame wing



Figure C-6 Roof framing

supported by a grid of small dimension framing.

Flooring Systems: The floor framing consists of 2" x 10' floor joists spaced at 16" on center. The interior supports for the first floor consist of masonry walls and a 6" x



Figure C-7 Roof shingles, stepped flashing, and gutter



Figure C-8 East chimney

10" timber girder. The interior support for the second floor consists of masonry perimeter walls and 2" x 4" stud framing spaced at 16" on center.

Roof Framing: The roof rafters and collar ties are 2" x 8" at 16" on center with a 2" x 10" ridge. The rafters and collar form a gable roof with a pitch equal to a rise of 11 to a run of 12.

Exterior Features

Roof and Rainwater Collection/Dispersal: The roofing material is a flat, unglazed, pan tile the color of terra cotta. A favorite of the Moravians, it was installed on both the main block and the wing during construction, and was removed and reinstalled in 2005, with salvage tiles replacing those that were broken or damaged.

The flashing at the chimneys and dormers is copper. At the chimneys it is installed as stepped flashing, the method also preferred by the Moravians.

The original, machine-formed, 4" half-round copper gutters were replaced with the 6" version in 1994 to improve rainwater dispersal. The 2" x 3" copper downspouts were replaced in-kind at the same time. At grade, the downspouts connect to cast iron drains that carry the rainwater to buried storm drains running parallel to the front and rear house elevations.

Chimneys: The house has two matching chimneys, one at the center of each gable end of the main block. Each is engaged to the gable end wall so that the roof is offset around the chimney stack. They are built of the same imitation-handmade brick as the main block, and are minimally decorated with stucco banding and a corbelled brick cap.

The west chimney serves the first floor, living room fireplace. The east chimney pro-

vides venting for the mechanical equipment located in the basement.

Rake Board & Cornice: Set flush against the brick gable end walls of the main block are the 8" wide rake boards with a crown molding along the top. These flare as they meet the cornice end board to reflect the kick of the roof, propelling rainwater up and away from the house walls. The wood cornice is richly detailed with a deep soffit offset with modestly scaled crown molding, corona and bed molding. The east wing has a simpler rake board and cornice.

Walls: The perimeter walls of the main block are made of brick. Above grade the bricks are finished to resemble handmade and laid in Flemish bond on all four elevations. The brick size is 7 3/4" x 2 3/4" x 3 1/2". The range of colors, from most common to least common, is brown, reddish-brown, and red. The horizontal joints have a weather joint; the vertical joints are flush.

Below grade and in the interior cross walls of the basement, pressed bricks are used. The size is 7 3/4" x 2 1/4" x 3 1/2". The range of colors, from most common to least common, is red and brown. The mortar joints are pointed flush.

The original south exterior wall of the frame wing, onto the now-enclosed porch, was sheathed in flush, tongue-and-groove boards of varying widths. The new south exterior wall of the porch enclosed in 1994 is primarily thermal glass supported by a grid of small dimension framing. The north and east elevations of the frame wing are sheathed in wood weatherboard siding. At the dormers, flush board siding following the angle of the roofline is installed at the exposed sides.

Doorways: The main front-entrance doorway at the center of the south elevation is the most architecturally sophisticated and, at



Figure C-9 Rake board and cornice at main block



Figure C-10 Front entrance doorway

3'-2", is the widest. The six-panel door is the most complex of the building's door designs, with raised panels on both sides and bold moldings. It is the only door with strap handles and the only doorway with a fanlight transom of complex tracery. The electric lights flanking the door appear to be modern replacements.



Figure C-11 North doorway to east wing



Figure C-12 Eight-over-twelve window on west elevation

Of secondary importance is the doorway from the side porch that opens into the dining room. The door is of the same design as the front door but smaller at 2'-8" wide. There is no transom, and the hardware is the same as found elsewhere in the house.

Of tertiary importance are the rear service doorways, one into the wing and the other at the basement. The sash door into the wing is for use primarily by the resident family. Opening into the room originally called the "enclosed porch" which adjoins the kitchen, it is 2'-8" wide with six lights over a single raised panel. Eight-light casement windows flank the door, with a row of multi-light transoms above. The electric light to the east of the door is a modern replacement.

At basement level of the main block is a sash door for use primarily by service personnel. It is a nine-light door over two raised panels, 2'-8" wide, and opens into the stair hall that adjoins the mechanical room.

Modern storm doors have replaced early screen doors at both the front entrance doorway and the north doorway to the wing.

Windows: On the first floor in the south, east and west elevations of the main block are eight-over-twelve light, double-hung wood sash windows. The sash units measure 3'-4" x 5'-8". On the first floor in the north rear elevation of the main block is a single window unit that measures 2'-8" x 5'-8"; it is a six-over-nine light, double-hung wood sash window located at the far westernmost location. The other windows on the first floor in the rear elevation are six-over-nine light, double-hung, wood sash windows measuring 2'-6" x 4'-8".

On the second floor in the west gable end of the main block are six-over-nine light, double-hung, wood sash windows. The sash units measure 2'-8" x 4'-6".

On the second floor of the east gable end of the main block is a six-over-six light, double-hung, wood sash window. The sash unit measures 2'-8" x 3'-10".

The roof dormers of the main block, both front and back, have six-over-nine light, double-hung, wood sash windows. The sash units measure 2'-4" x 4'-9".

On the first floor of the wing are two six-over-nine light, double-hung, wood sash windows. They each measure 2'-6" x 4'-8". One is in the east elevation and the other is in the south wall, and now opens onto the enclosed porch.

On the second floor of the east gable end of the wing is a single, six-over-six light, double-hung, wood sash window that measures 2'-4" x 3'-8".

The large windows of the first floor of the main block have three-panel wood shutters as originally designed. The smaller windows of the north elevation have two-panel shutters.

The second-floor, gable-end windows of the main block have two-part, louvered shutters, as originally designed.

The double-hung windows of the wing exposed to the weather (i.e. east elevation) on both the first and second floors have two-part, louvered shutters.

All shutters have metal hardware (shutter dogs, strap hinges, slide bolts, and pintle hinges) cast to appear as wrought iron. The dormer windows have never had shutters.

Porches & Stoop: The front entrance is at the center of the south elevation. It is covered with a hood commonly referred to as a "Moravian bonnet," discussed further below. The landing and steps are Mount Airy gray granite. The landing is 3'-0" deep x 6'-0" wide. The steps have a 12" tread and a 6 1/2"



Figure C-13 Dormer window



Figure C-14 Shutter hardware

riser. The top of the landing and steps have a thermal finish. The step risers and sides of the landing are rusticated. The metal hand rail has a 3/4" diameter. The distance between the top of the landing and the top of the threshold is 2 1/2".

The steps leading to the now-enclosed side



Figure C-15 Front entrance stairs and railing



Figure C-16 South porch stairs and railing

porch off the dining room are the same granite and finishes as found at the front entrance. Two steps have a 12" tread and the third or top step has a 14" tread. All the steps have a 6 1/2" riser. The distance between the top of the last step and top of porch deck is 6". The steps leading to the back stoop of the east wing, opening into the room initially labeled "enclosed porch," are made of modern pressed brick. There are three steps with a 6 1/2" riser and 12" tread. The stoop is made of concrete measuring 5 1/2" high by 2'-8" deep by 8'-0" long. The distance from top of stoop to top of threshold is 6".

Other Features: A distinctive element of the front entrance is the hood, so closely associated with the Moravians. Set on a pair of sawn wood brackets, it typically is a half-round roof that cantilevers over the entrance without vertical support. In this case, the bonnet is sheathed in painted galvanized metal roofing. The underside is sheathed in painted flush wood boards.

Interior Features

The Basement

About sixty percent of the area below the main block and all of the area beneath the wing is unexcavated crawl space. The



Figure C-17 Hood at front entrance

height from ground level to underside of the floor framing varies from about 24" to 48", enough to allow the running and maintenance of service lines and mechanical ductwork.

The remaining forty percent beneath the main block is occupied by two finished rooms. This un-climatized, utilitarian space has always been used for the placement of service equipment and some storage. In addition to a staircase to a doorway leading to the first floor interior, there is an exterior doorway on the north wall.

Room 001: The stair hall is the larger of the two finished rooms in the basement. It is centrally located and extends the full depth of the house. Rectangular in plan, it is 7'-7 1/2" wide by 27'-11" long and has a 7'-4" floor-to-ceiling height.

- **Flooring:** The floor system is the original poured-in-place concrete slab.

- **Walls:** The north and south walls, which are also the exterior walls of the house, are made of brick.

The east and west cross walls are a combination of two wythes of brick laid atop a 9"-thick, poured-in-place concrete wall. Originally designed as brick piers atop the concrete base, the brick infill between piers was a change during construction, intended as a fire-proofing measure by closing off the crawl spaces.

- **Doors:** At the center of the north rear wall is an original doorway, opening to the original exterior concrete stairway that rises to grade. This doorway has its original, wood 2'-8" x 6'-8" x 1 3/4" nine-light over two-panel sash door. The original brass door hardware consists of three 4" hinges, a mortise lock with round doorknobs, and a dead-bolt.



Figure C-18 View into basement crawl space



Figure C-19 Room 001 looking northeast

The original door casing also remains; it is the same as that found on the first-floor doors and windows of ancillary rooms: 7/8" x 3 3/4" plank boards with rounded edges and constructed with mitered joints at the corners.

- **Windows:** No windows are present.



Figure C-20 Exterior sash door at north wall of Room 001

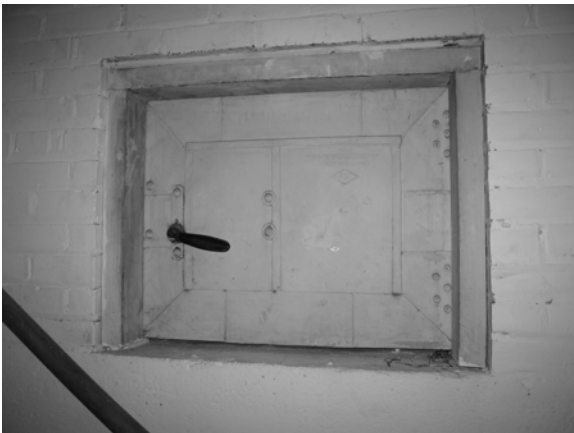

Figure C-21 Metal-clad door to crawl space

- *Ceiling:* The ceiling, which is original, is cement plaster on metal lath as specified in the original architectural plans.

- *Baseboards:* None are present.

- *Finishes:* The walls, door, door casing, and stairs are painted.

- *Mechanical Systems:* Sections of the house's rigid metal ductwork are suspended from the ceiling. Condensation lines are made of PVC and connect to the cast-iron wastewater line in the northwest corner of the room.

The space above the plaster ceiling probably lacks insulation, as is evident in the adjoining boiler room (Room 002).

- *Electrical Systems:* The electrical service is contained in surface-mounted metal conduit. Switches are contained in surface-mounted metal boxes.

- *Plumbing Systems:* Copper water supply and cast-iron wastewater lines are present for servicing the first and second floors. The wastewater line exits the house just west of the exterior door.

- *Other Features:* The original wood staircase to the first floor is located along the east wall. It is 2'-9" wide with 7" risers and 11" treads. It has an unadorned 4" square newel post and square balusters.

A metal-clad door in the added brickwork of the west crosswall leads to the unexcavated crawl space below the living room (Room 101) and the sewing room (Room 110).

A second metal-clad door in the east cross-wall leads to the crawl space below the dining room (Room 103). Both crawl spaces have a dirt floor with the floor joists of the rooms above serving as the ceiling; modern fiberglass-batt insulation has been added between the joists in both spaces. The two windows in the west crawl space and one in the east are single sash with four lights arranged horizontally. The size of the sash is 1'-0" by 3'-2".

Two handheld fire extinguishers sit on the floor in this room. One is at the base of the stairs and the other is at the stair's midsection; both fire extinguishers sit on the floor and reportedly have been serviced recently by the park. There is a battery-operated smoke detector at the top of the stairway to the first floor.

Room 002: The boiler room is the smaller of the two finished rooms in the basement. Rectangular in plan, it measures 13'-9" by about 13'-3" and has a 7'-4" floor-to-ceiling height. It is located in the northeast quadrant of the building below the kitchen. Lacking a west wall, it opens directly into the stair hall (Room 001).

- **Flooring:** The floor system is the original poured-in-place concrete slab.
- **Walls:** The north and east walls, which are also the perimeter walls of the main block of the house, are made of brick.

The south wall is composed of a 9" deep, poured-in-place concrete retaining wall, with two wythes of brick laid atop during construction to close off the crawl spaces.

The west boundary of the room is formed by the brick piers and girder of the original east cross wall structural system.

- **Doors:** High on the east wall is the original 2'-3" x 2'-0" wood batten door that provides access to the crawl space below the east wing.

This crawl space has a dirt floor with the floor joists of the rooms above serving as the ceiling; modern fiberglass-batt insulation has been added between the joists in both sections.

- **Windows:** Two windows hinged to swing

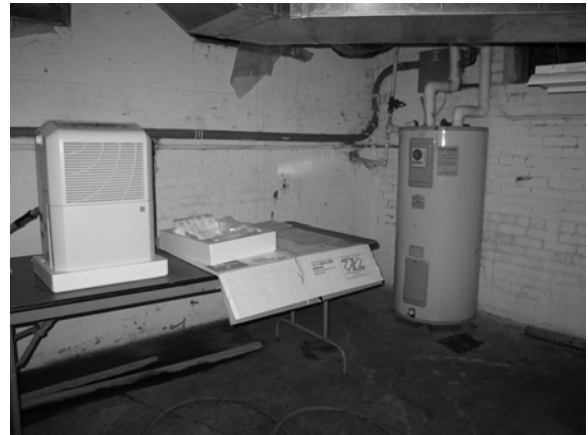

Figure C-22 Room 002 facing northeast

inward are present on the north wall. Both are a single sash with four lights arranged horizontally. The size of the sash is 1'-0" by 3'-2".

- **Ceiling:** The ceiling, which is original, is cement plaster on metal lath.
- **Baseboards:** None are present.
- **Finishes:** The window units and walls are painted.
- **Mechanical Systems:** Sections of the house's rigid metal ductwork are suspended from the ceiling.

Sections of the condensation lines are present and are made of PVC.

The space above the plaster ceiling lacks insulation, as can be seen through a missing section of ceiling plaster.

A fully operational, 45-pint capacity, mobile dehumidifier is located near the northwest corner of the room. The manufacturer is Maytag.

- **Electrical Systems:** Electrical service enters the building at the north wall. A modern, 200 amp capacity electrical panel is at



Figure C-23 Room 101 facing northwest

that location, near the adjoining stair hall (Room 001). The electrical service is contained in surface-mounted metal conduit. Switches are contained in surface-mounted metal boxes. Lighting is provided by a two-light, four-foot long, fluorescent reflector lighting fixture.

- *Plumbing Systems:* Copper water supply and cast-iron wastewater lines are present for servicing the first and second floors.

In the northeast corner of the room is a 52-gallon, fully functional electric water heater. It is a Model PV 52, 2RS2 NC, serial number 888584706, made by State Water Heater.

- *Other:* A cast-iron vent connection clean-out is at the east wall in the southeast corner of the room at the base of the east chimney stack.

The First Floor

This level contains the rooms designed to receive the public. Accordingly, the architectural elements of the living room, hall and dining room have a more pronounced architectural sophistication than other rooms. The hall has the somewhat restrained, but impressive, varnished wood staircase, and

wide cased openings to the adjoining rooms. The living room has the lone fireplace with a large, finely articulated wood mantel. The dining room has two added corner cupboards, and a side porch, now enclosed. The baseboards, door and window casings, and picture moldings of these rooms are the most developed of any rooms in the house. Their flooring is varnished golden oak.

The other rooms on the first floor were clearly intended for ancillary functions and, being less public spaces, received less decorative emphasis. While any of these rooms may have one or more of the details found in the public rooms, none has the combination of finer details found in the public front rooms.

Room 101: The living room is located in the southwest corner of the main house block. It measures 13'-8" x 18'-2" and has a floor-to-ceiling height of 8'-10 1/2".

- *Flooring:* The original flooring, still in place, is 2 1/4" wide, tongue-and-groove, varnished golden oak and is laid north-south.

A sub-floor, visible from the basement, is made up of tongue-and-groove boards, 5 1/2" wide, laid diagonally.

- *Walls:* The original plaster appears to remain on the walls.

The wood picture molding appears to be original and was specified in the original architectural plans.

- *Doors:* The original, 4'-0" wide, cased opening connects this room with the hall (Room 102).

The doorway on the north wall is framed for a 2'-8" x 6'-8" x 1 3/8" hinged door. The

door and its hardware are missing.

The casing of both doorways is the original, composite design: 4 5/8" in width with edge bead, raised field, and backband resting on a plinth.

- *Windows:* One original window opening is on the south wall and one is on the west wall. Both retain their original, six-over-nine light, double-hung sash units measuring 3'-4" x 5'-8".

The casing of both windows is the same original, composite design: 4 5/8" in width, with edge bead, raised field, and backband set on composite apron.

Both windows retain their original brass latching mechanisms. Both windows retain their cotton sash cords and wheels, and are fully operational.

- *Ceiling:* A modern, plastic-coated ceiling tile is now present. The date of installation is unknown, but assumed to be 1980s. It measures 12" x 12" and has an embossed geometric pattern.

Presumably, the original plaster ceiling remains, as suggested by the reduced clearance between the new ceiling tile and the original picture molding on the walls. The picture molding was originally installed approximately 1 1/2" from the plaster ceiling.

- *Baseboards:* The original baseboards remain and are a composite design 7" in height. The original shoe molding also remains; it measures 1/2" in depth by 7/8" in height.

- *Finishes:* The flooring and baseboard shoe moldings are varnished.

The baseboards, window sash and casings, door casings, crown molding and mantel are painted.

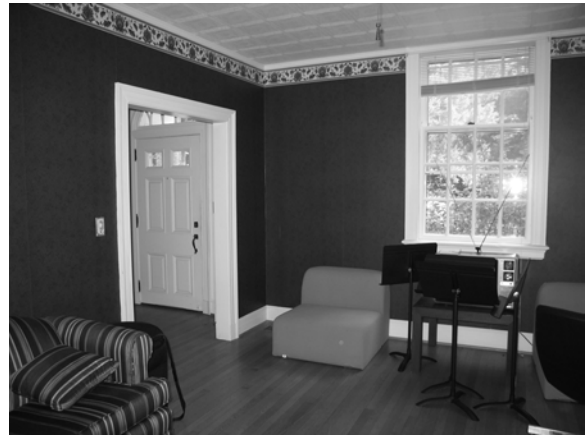

Figure C-24 Room 101 facing southeast

The walls have a modern wallpaper with a paper strip at the cornice. The exact date of its installation is unknown, but it likely dates to the late 1980s.

- *Mechanical Systems:* Two modern, 6" x 12" metal floor-supply registers are present. One is located along the east wall in the southeast corner of the room. The second is located along the west wall near the fireplace in the northwest corner of the room.

- *Electrical Systems:* Wiring is concealed in the walls and baseboards.

The switch plate and outlet covers are modern, brass-plated designs of unknown installation dates.

The ceiling fixture at the center of the room is a modern, light/fan combination of unknown installation date.

- *Plumbing Systems:* No plumbing system elements are present.

- *Other Features:* The original fireplace is located in the northwest corner of the room on a wall set on the diagonal. The exposed brick used in its construction appear to be the original: those of the firebox are fire brick; the surround is constructed of a dark-



Figure C-25 Room 102 facing north



Figure C-26 Exterior door on south wall of Room 102

red, pressed brick; and the brownish-red bricks of the hearth are imitation-handmade and laid in running bond. The outer edges of the hearth are trimmed with oak boards, mitered at the corners. The wood mantel stylistically resembles the Federal Period with its delicate detailing and multiple panels. It measures 4'-7" in both overall width and height. Its shelf is 8" deep and extends 5'-9" in width. The opening for the firebox is 2'-6" tall by 2'-10" wide.

Room 102: The hall is centrally located in the main house block. It is rectilinear in plan, measures 7'-7" wide and extends 18'-2" from the front entrance. The floor-to-ceiling height is 8'-10".

- **Flooring:** The original flooring is 2 1/4" wide, tongue-and-groove, varnished golden oak and is laid north-south.

A sub-floor, although not visible from the basement, presumably consists of tongue-and-groove boards, 5 1/2" wide, laid diagonally as can be seen elsewhere at the first floor.

- **Walls:** The original plaster appears to remain on the walls.

The wood picture molding appears to be the original called for in the architectural plans.

Two original 10"-wide wall offsets, one on either side of the front door and extending from floor to ceiling, contain chases for the plumbing lines of the second-floor bathroom.

- **Doors:** The original front doorway, centered on the south wall, retains its original door, multi-lighted transom, transom bar, and door casing. The door's six-panel configuration comprises four raised panels on the bottom and two smaller top panels, which were removed at an unknown time

and replaced with window glass. The door measures 3'-2" x 6'-8" x 1 3/4". It retains its original brass hardware of mortise lock, key escutcheons, two strap handles, and three, 4 1/2" x 4 1/2", five-knuckle hinges. Although the architectural plans called for a stone sill, it is made of wood.

The original, 4'-0"-wide cased opening along the west wall connects this room with the living room (Room 101).

The original, 3'-4"-wide cased opening of the north wall connects with the back hall.

The original, 3'-0"-wide doorway on the east wall is identified as a cased opening on the architectural plans. During construction, the design was modified to include a door in this opening into the dining room (Room 103). No door is now present.

The casing of all four doorways is the same original composite design: 4 5/8" in width, with edge bead, raised field, and backband resting on plinths.

- *Windows:* There are no windows in this room.

- *Ceiling:* A modern, plastic-coated ceiling tile is now present. The date of installation is unknown. It measures 12" x 12" and has an embossed geometric pattern. A minor plumbing leak originating at the second floor bathroom above occurred in November 2006, during the production of this report. The leak caused several modern ceiling tiles in the entry hall below to become soaked, and fall away. Wood nailers measuring 3 5/8" by 3/4" and attached to the original plaster ceiling were exposed.

- *Baseboards:* The original baseboards remain and are a composite design 7" in height. The original shoe molding also remains; it measures 1/2" in depth by 7/8" in height.



Figure C-27 Damaged modern ceiling tile

- *Finishes:* The flooring and baseboard shoe molding are varnished.

The stair treads, newel post, balusters, handrails, and pendant are varnished. The stair risers, stringer, and trim are painted.

The walls are painted.

The front door, door casing, transom and trim are painted.

- *Mechanical Systems:* A modern, metal 6" x 12" floor supply register is located alongside the staircase.

- *Electrical Systems:* Wiring is concealed in the walls and ceiling.

The switch plates are modern, brass plated.

A ceiling fixture near the front doorway is a modern brass and glass design.

- *Plumbing Systems:* No plumbing system elements are present.

- *Other Features:* The original staircase connecting the first floor with the second is located along the east wall of this room. It measures 3'-2" in width. A painted wood stringer and risers offset the varnished, 9" deep, oak treads. The balustrade is stained and varnished. A simple turned newel post



Figure C-28 Room 103 facing northeast

sits on a $3 \frac{7}{8}$ " square base for a total height of $3'-1 \frac{5}{8}$ "; the unadorned, rectangular balusters measuring $\frac{5}{8}$ " x $\frac{7}{8}$ " in section, are 2'-10" tall and placed $4 \frac{1}{4}$ " on center; and the handrail is a camelback design. There is a sizeable crack near the nosing of one tread, the twelfth from the bottom.

A modern handrail of similar design, stained and varnished, is attached with metal brackets to the east wall.

Room 103: The dining room is located in the southeast corner of the main house block. It measures 13'-8" x 15'-2" and has a floor-to-ceiling height of 8'-10".

- **Flooring:** The original wood flooring is presumed to be in place beneath the modern sculptured, residential-grade wall-to-wall carpet. The original flooring is $2 \frac{1}{4}$ " wide, tongue-and-groove, varnished golden oak and laid north-south.

The carpet is a modern addition of unknown installation date.

A sub-floor, visible from the basement crawl space, is made up of tongue-and-groove boards, $5 \frac{1}{2}$ " wide, laid diagonally.

- **Walls:** The original plaster appears to remain on the walls.

The wood picture molding appears to be that called for in the original architectural plans.

- **Doors:** The doorway on the west wall connects this room with the hall (Room 102). No door is now present, but there are Dutchman patches on the south jamb for two hinges to hang a door swinging into this room.

The doorway on the north wall retains its original swing door and swing mechanism. This door measures 2'-8" x 6'-8" x $1 \frac{3}{8}$ " in a six-panel design. The panels are flush on both sides of the door. There is a wood threshold which also appears to be original.

The doorway on the east wall is the original exterior door onto the porch, now enclosed. There is a wood stoop and brass threshold both of which appear to be original. The original six-panel door remains. The door panels on both sides of the door are raised. The door measures 2'-8" x 6'-8" x $1 \frac{3}{4}$ " and retains its original brass hardware of two 4" five-knuckle hinges, and mortise lock with circular door knobs. There is also a modern deadbolt.

The casing of the three doorways is the same original composite design: $4 \frac{5}{8}$ " in width, with edge bead, raised field, and backband on plinths.

- **Windows:** One original window opening is on the south wall and one is on the east wall. Both retain their original, double-hung sash units measuring 3'-4" x 5'-8".

The casing of both windows is the same original composite design: $4 \frac{5}{8}$ " in width, with edge bead, raised field, and backband set on composite apron.

Both windows retain their original brass latching mechanisms.

Both windows retain their cotton sash cords and wheels and are fully operational.

- *Ceiling:* A modern, plastic-coated ceiling tile is now present. The date of installation is unknown. It measures 12" x 12" and has an embossed geometric pattern.

The plaster ceiling appears to be original, as suggested by the reduced clearance between the new ceiling tile and the original picture molding of the walls.

- *Baseboards:* The original baseboards remain and are a composite design 7" in height. The original shoe molding is missing, presumably removed when the carpet was installed.

- *Finishes:* The baseboards, window sash and casings, doors and door casings, crown molding, and corner cabinets are painted.

The walls have a modern wallpaper installed. The exact date of its installation is unknown, but it likely dates to the late 1980s.

- *Mechanical Systems:* One modern, 6" x 12" metal floor supply register is present. It is located along the south wall below the window.

- *Electrical Systems:* Wiring is concealed in the walls and ceiling.

The switch plates are modern, brass plated.

The ceiling fixture at the center of the room is a modern, brass-plated, colonial style chandelier.

- *Plumbing Systems:* No plumbing system elements are present.



Figure C-29 Corner cabinet in Room 103



Figure C-30 Room 104 facing northeast

- *Other Features:* There are built-in corner cupboards in the northeast and northwest corners of the room. Each cupboard measures 8'-4 1/2" in height with a 2'-6" wide front set on the diagonal. The lower portion is an enclosed cabinet while the upper portion contains open shelves. Though they are not on the original architectural plans and



Figure C-31 Room 104 facing northwest

have been coped to fit around baseboards and light switches, the level of wear suggests that they are early additions.

Room 104: The porch is located on the south side of the east wing. Originally open, it was enclosed at an unknown date and later remodeled in 1994. The room measures 12'-5" x 8'-1".

- **Flooring:** The floor level is 2 ½" below that of the first floor of the house.

The wood flooring is 2 ¼" wide, tongue-and-groove wood boards laid north-south. According to park records, the flooring was reportedly replaced in 1994.

- **Walls:** Cement plaster, apparently original, remains on the west wall.

Flush, tongue-and-groove board siding of random widths of 5 ½", 7 ½", and 9 ½" is on the north wall. It appears to be original.

Wood columns, measuring 5 ½" x 5 ½" square, apparently original, remain on the east and south walls. The modern wood framing, one-over-one double-hung sash windows, French doors and glass transoms

probably date to the 1994 remodeling of this room.

A wood cornice, 3 ⅞" in height, composed primarily of a cyma recta curve, is present on the north, east and south walls. This element is not identified on the original architectural drawings and date of installation is unknown.

- **Doors:** The doorway on the west wall is an original house entrance. There is a wood stoop and brass threshold which appear to be original. The original six-panel door remains. The panels on both sides of the door are raised. The door measures 2'-8" x 6'-8" x 1 ¾" and retains its original brass hardware of three, 4" x 4" five-knuckle, butt hinges, and "Yale" brand mortise lock with round door knobs. The door also has a modern brass, "Best" brand deadbolt.

A modern French door of wood and glass, measuring 3'-0" x 6'-8", was framed at the center of the east wall and made inoperable, presumably in 1994. Apparently during the same remodeling, two similar French doors of 2'-8" widths were installed on the south wall. The easternmost of these is inoperable. The other is operable, set in a new framed doorway opposite the original stone steps.

- **Windows:** There is one original window opening. Located on the north wall, it retains its original, six-over-nine light, double-hung sash measuring 2'-6" x 4'-8." The casing is 3 ½" wide, with a ½" bead on its interior edge and a boldly molded backband on the outer edge.

On the east wall is a pair of modern, double-hung sash windows, one on either side of the inoperable, modern French door.

On the south wall there are four more of these modern, double-hung sash windows.

Two window units flank an inoperable, modern French door in the east bay and two flank the operable, modern French door in the west bay.

- *Ceiling:* There is a cement plaster ceiling, presumably original.
- *Baseboards:* No baseboards are present.
- *Finishes:* The flooring, walls, window sash and casing, door and casing, cornice, and ceiling are painted.
- *Mechanical Systems:* One modern 6" x 12" metal floor supply register is present. It is located near the middle of the east wall.
- *Electrical Systems:* Wiring is concealed in the walls and ceiling.

There is a duplex outlet on the north wall. It has a modern, composite plastic cover.

The ceiling fixture at the center of the room is a modern light/fan combination, hard-wired and operated by a pull cord.

- *Plumbing Systems:* No plumbing system elements are present.
- *Other Features:* No other significant features are present.

Room 105: The small room in the northeast corner of the wing, next to the original enclosed porch, was the pantry. For some time this room has operated as the laundry room. This room measures 4'-1" x 9'-6" and has a floor-to-ceiling height of 8'-7 1/2".

- *Flooring:* The flooring material is modern sheet vinyl which continues through the original enclosed porch and kitchen. The date of installation was probably 1988 when the kitchen was last remodeled. A sub-floor, visible from the basement, is made up of



Figure C-32 View into pantry

tongue-and-groove boards, 5 1/2" wide, laid diagonally.

- *Walls:* The original plaster appears to remain on the walls.

This utilitarian room has neither a cornice nor picture molding.

- *Doors:* The doorway on the west wall is original. The architectural plans specify framing of the opening for a hinged door measuring 2'-6" x 6'-8" x 1 3/8". No door is present. There are no visible marks for earlier hinges, nor is the doorway framed with stops. There is a modern overhead track for bi-fold doors which also are not present.

The original door casing remains. It is made of plank boards measuring 7/8" x 3 3/4" with rounded edges. The casing is assembled using mitered joints at the corners. There are no plinths.



Figure C-33 Room 106 facing southeast

- **Windows:** There is one original window opening. Located on the east wall, it retains its original six-over-nine light, double-hung sash measuring 2'-6" x 4'-8".

The original window casing also remains. It is made of plank boards measuring $\frac{7}{8}$ " x $3\frac{3}{4}$ " with rounded edges. The casing is assembled using mitered joints at the corners. The window retains its original brass latching mechanism.

The window retains its cotton sash cords and wheels which are fully operational.

- **Ceiling:** The room has a plaster ceiling, apparently original.
- **Baseboards:** The original baseboards remain and are a composite design 7" in height. The original shoe molding also re-

mains, measuring $\frac{1}{2}$ " in depth by $\frac{7}{8}$ " in height.

- **Finishes:** The baseboard, shoe molding, window sash, window casing, door casing and shelving are painted.

The walls have modern wallpaper. The date of installation is not known. The ceiling is painted.

- **Mechanical Systems:** No elements of the mechanical system are present.
- **Electrical Systems:** Wiring is concealed in the walls and ceiling.

There are 110v outlets and a 220v outlet for a clothes dryer.

- **Plumbing Systems:** Along the east wall are copper supply lines and a drain for a washing machine.

- **Other Features:** Wood shelves were initially constructed across the north and south walls. The lowest two shelves of the north shelving have been removed, apparently to provide room for a washing machine.

Room 106: The original enclosed porch is located in the northwest corner of the wing, and is now used as a breakfast room. The room measures 8'-6" x 9'-6" and has a floor-to-ceiling height of 8'-6".

- **Flooring:** The flooring material is modern sheet vinyl which continues from pantry to enclosed porch to kitchen. The date of installation is probably 1988 when the kitchen was remodeled.

A sub-floor, visible from the basement, is made up of tongue-and-groove boards, 5 $\frac{1}{2}$ " wide, laid diagonally.

- *Walls:* The original plaster appears to remain.

The original plans call for a wood picture molding in this room. The one that is present appears to be original, as it is found in the kitchen and back hall as well.

- *Doors:* The doorway on the east wall is original, and was discussed in the previous room section.

The doorway on the west wall is original. The architectural plans specify the framing of the opening for a door measuring 2'-6" x 6'-8" x 1 3/8", hinged on the south jamb. The door was to have opened into this enclosed porch. No door is present, but one leaf of both of the original, chrome-plated, 4" x 4", five-knuckle, butt hinges remain on the south jamb as specified.

The doorway on the north wall is original and it retains its original sash door. The door has six lights and a single panel raised on both interior and exterior sides. The door measures 2'-8" x 6'-8" x 1 3/4" and retains its original hardware of round door knobs, chrome-plated on the interior and brass on the exterior, and three chrome-plated, 4" x 4", five-knuckle, butt hinges. It also has a modern brass, "Best" brand deadbolt.

The casing for all three doorways is original, and is the same as that found on the doors and windows of other ancillary rooms of the first floor. These rooms are the enclosed porch, kitchen, and back hall. The casing is made up of plank boards with rounded edges measuring 7/8" x 3 3/4" and constructed using mitered joints at the corners. Doorway casings of these rooms rest on plinths.

- *Windows:* There are three original window openings and three transoms.

One original window opening on the south wall retains its original six-over-nine light,



Figure C-34 Room 106 facing northwest

double-hung wood sash unit measuring 2'-6" x 4'-8". This window retains its original brass latch hardware and its cotton sash cords and wheels, which are fully operational.

On the north wall is an original, composite arrangement of windows, doorway, and transoms. Two eight-light casement windows flank the doorway. Each window opening measures 1'-8" x 6'-8" and has its original eight light casement window with panel base. These two casement window sash retain their original chrome-plated hardware of latch, closer, and hinges.

The three original fixed transoms are intact: one above the door and one above each of the two casement windows. The center transom has three lights arranged horizontally; the other two have two lights each in a horizontal grouping.

The casing for the windows and transoms is original. It is the same as that found on the doors and windows of some ancillary rooms



Figure C-35 Room 107 facing east

of the first floor: the enclosed porch, kitchen, and back hall. The casing is made up of plank boards with rounded edges measuring $\frac{7}{8}$ " x $3\frac{3}{4}$ " and constructed using mitered joints at the corners.

- *Ceiling:* The room has a modern, acoustical ceiling tile, measuring 12" x 12" square, with a textured "wormwood" surface. It matches the tile ceiling of the kitchen.

- *Baseboards:* The original baseboards remain and are a composite design 7" in height. The original shoe molding also remains; it measures $\frac{1}{2}$ " in depth by $\frac{7}{8}$ " in height.

- *Finishes:* The baseboards, shoe molding, windows, window casings, door, door casings, and picture molding are painted.

The walls have modern wallpaper.

- *Mechanical Systems:* One modern, metal floor supply register measuring 6" x 12" is present. It is located along the south wall below the window.

- *Electrical Systems:* Wiring is concealed in the walls and ceiling.

The switch plates and outlets have modern composite plastic covers.

The ceiling fixture at the center of the room is a modern light/fan combination. An original panel box remains on the east wall.

- *Plumbing Systems:* No plumbing system elements are present.

- *Other Features:* There is a section of modern, laminated countertop with wood cabinet base in the northwest corner of the room. The cabinet has two doors and no drawer. The date of installation is not known.

A single, handheld fire extinguisher in this room sits atop the modern cabinet and does not have a mounting harness.

Room 107: The kitchen is located in the northeast corner of the main house block. It was remodeled in 1957 and again in 1988, when many of the current built-in cabinets and appliances were installed. This room measures 13'-8" x 12'-5" with 8'-10" floor-to-ceiling height.

- *Flooring:* The flooring material is modern sheet vinyl, probably installed in 1988 during the last kitchen remodeling. The flooring continues from pantry to original enclosed porch to kitchen.

A sub-floor, visible from the basement, is made up of tongue-and-groove boards, $5\frac{1}{2}$ " wide, laid diagonally.

- *Walls:* The original architectural plans specify "Keene's Cement" (plaster) for the walls and ceiling. Presumably the wall plaster remains, although now covered with modern wallpaper.

The original plans call for a wood picture molding for this room. The molding present appears to be the original and matches that in the enclosed porch and back hall as well.

- *Doors:* The doorway on the east wall, connecting to the enclosed porch (Room 106), is original. The architectural plans specify the framing of the opening for a door measuring 2'-6" x 6'-8" x 1 3/8", hinged on the south jamb, opening into the enclosed porch. No door is present, but one leaf of both of the original, chrome-plated, 4" x 4," five-knuckle, butt hinges remains on the south jamb as specified.

The doorway on the south wall opening into the dining room (Room 103) is original and retains the original swing door and chrome-plated hardware. This door measures 2'-8" x 6'-8" x 1 3/8" in a six-panel design. The panels are flush on both sides of the door. The wood threshold appears to be original.

The original architectural plans also specify that the west wall doorway opening into the back hall be constructed for a door measuring 2'-8" x 6'-8" x 1 3/8" hinged on the south jamb. The original doorway remains intact but the door is missing.

The plans also specify on the west wall a doorway with a narrow 2'-0" x 6'-8" x 1 3/8" door, hinged on the south jamb, connecting to the small broom closet. The doorway remains intact but the door is missing. Currently, there is a modern, two-leaf bi-fold door hinged to the south jamb.

The casing for all four doorways is original and matches that found on the doors and windows of some ancillary rooms of the first floor: the enclosed porch, kitchen, and back hall. The casing is made up of plank boards with rounded edges measuring 7/8" x 3 3/4" and constructed using mitered joints at the corners. Doorway casings of these rooms rest on plinths.



Figure C-36 Room 107 facing northwest

- *Windows:* There are two original window openings, both on the north wall.

Both retain their original six-over-nine light, double-hung wood sash units measuring 2'-6" x 4'-8". These are the same as those found on the doors and windows of other ancillary rooms of the first floor: the enclosed porch, kitchen, and back hall. The casing is made up of plank boards with rounded edges measuring 7/8" x 3 3/4" and constructed using mitered joints at the corners.

Both windows retain their original brass latches.

Both windows retain their cotton sash cords and wheels which are fully operational.

- *Ceiling:* The original architectural plans specify "Keene's Cement" (plaster) for the walls and ceiling. Presumably the plaster remains, although the ceiling is now covered with a modern acoustical tile, measuring 12"

x 12" square, with a textured, "wormwood" surface.

- *Baseboards:* The original baseboards remain and are a composite design 7" in height. The original shoe molding also remains, measuring 1/2" in depth by 1/8" in height.

- *Finishes:* The baseboards, shoe molding, windows, window casings, door, door casings, and picture molding are painted.

The shoe molding is varnished.

The walls of the kitchen have modern wallpaper.

The 1988-vintage cabinets are varnished.

The walls, ceilings, baseboards, shoe molding, and shelving of the broom closet are painted.

- *Mechanical Systems:* Two modern metal 6" x 12" floor supply registers are present. One is located along the south wall, in front of a cabinet near the southwest corner. The other is located along the north wall cabinets near the northeast corner of the room.

- *Electrical Systems:* Wiring is concealed in the walls and ceiling.

The switch plate and outlet covers are modern, made of a composite plastic.

The ceiling fixture at the center of the room is a modern light/fan combination installed at an unknown date.

A 1988-vintage, countertop electric range with hood is fully operational and is located at the west end of the north counter.

Paired 1988-vintage electric convection microwave ovens, fully operational, occupy built-in cabinets in the southeast corner of the room.

A residential-style refrigerator, fully operational, is located in the southwest corner of the room.

- *Plumbing Systems:* Copper supply pipes provide water to the 1988-vintage, stainless steel double sink located in the north wall countertop.

- *Other Features:* There is a small broom closet measuring 2'-2" x 4'-8", just beyond the row of north wall cabinets. It retains its original baseboards, shoe molding, trim and shelving, and all five shelves along its north wall.

Residential, 1988-vintage wood kitchen cabinets with laminate countertops run along the north, south, and east walls and form the island in the center of the kitchen.

The modern doorbell chime is located above the doorway to the dining room (Room 103).

Room 108: The back hall measures 7'-7" x 9'-5" and has a floor-to-ceiling height of 9'-0".

- *Flooring:* The original flooring in place is 2 1/4" wide, tongue-and-groove, varnished golden oak and is laid north-south.

A sub-floor, though not visible from the basement, presumably consists of tongue-and-groove boards, 5 1/2" wide, laid diagonally as is found elsewhere on the first floor.

- *Walls:* The original plaster appears to remain on the walls.

This utilitarian room has neither a cornice nor picture molding.

- *Doors:* The original, 3'-4" wide cased opening of the south wall connects to the hall.

A second original doorway on the south wall leads to a stair to the basement. This doorway is framed for a 2'-8" x 6'-8" x 1 3/8" hinged door. An original six-panel door, with flush panels on both sides, is hung on the east jamb as designed. The doorway retains its original brass hardware of 4" x 4" five-knuckle butt hinges, mortise lock, and oval doorknobs. It also has a modern brass, "Best" brand deadbolt.

The doorway on the west wall connecting to the sewing room (Room 110) is framed for a 2'-8" x 6'-8" x 1 3/8" hinged door, now missing. The original architectural plans specify that the door was to have been hung on hinges on the south jamb, opening into the sewing room. Dutchman repairs confirm the door once hung as designed.

The doorway on the east wall connecting to the kitchen (Room 107) is framed for a 2'-8" x 6'-8" x 1 3/8" door, now missing. The original architectural plans specify that the door was to have been hung on hinges on the south jamb and opens into the back hall. Two leafs of two original, brass 4" five-knuckle butt hinges remain to confirm that the door once hung as designed.

The doorway on the north wall connects to the original coat closet, which was converted in 1988 to a half-bath (Room 110). The doorway is framed for a 2'-8" x 6'-8" x 1 3/8" door. An original, six-panel door, with flush panels on both sides, is hinged on the east jamb and opens into the back hall. However, the original architectural plans specify that the door was to have been hung on hinges on the west jamb, opening into the coat closet. Dutchman repairs confirm that the door was once hung as designed. The door retains its two original brass, 4," five-knuckle, butt hinges and mortise lock with oval doorknobs.

The casing of all five doorways is the same original composite design: 4 5/8" in width,



Figure C-37 Room 108 facing east

with edge bead, raised field and backband, resting on plinths.

- *Windows:* There are no windows in this small, interior room.
- *Ceiling:* The original plaster appears to remain.
- *Baseboards:* The original baseboards remain and are a composite design 7" in height. The original shoe molding also remains, measuring 1/2" in depth by 7/8" in height.
- *Finishes:* The flooring and baseboard shoe molding are varnished.

The baseboards, doors, and door casings are painted.

The walls and ceilings are painted.

- *Mechanical Systems:* A modern metal floor return register is located at the door to the basement. The register measures 20" x 20".



Figure C-38 Room 109 facing northeast

The first-floor thermostat is located on the north wall.

- *Electrical Systems:* Wiring is concealed in the walls and ceiling. The brass-plated switch plates are modern.

The incandescent ceiling light fixture is probably original.

- *Plumbing Systems:* No plumbing system elements are present.

- *Other Features:* There are no other significant features in this room.

Room 109: The original coat closet was converted to a half-bath in 1988. The room measures 4'-8" x 5'-2" with a floor-to-ceiling height of 8'-11 1/2".

- *Flooring:* The flooring material is modern

sheet vinyl probably installed in 1988. It is the same flooring that is found in the pantry, original enclosed porch, and kitchen.

A sub-floor, though not visible from the basement, presumably consists of tongue-and-groove boards, 5 1/2" wide, laid diagonally as is found elsewhere on the first floor.

- *Walls:* The original plaster appears to remain.

- *Doors:* The doorway on the south wall connects to the back hall (Room 108). The doorway is framed for a 2'-8" x 6'-8" x 1 3/8" door. An original, six-panel door with flush panels on both sides is hinged on the east jamb and opens into the back hall. However, the architectural plans specify that the door was to have been hung on hinges on the west jamb and opens into this room, then the coat closet. Dutchman repairs confirm that the door was hung as designed at one time. The door retains two original brass, 4" x 4", five-knuckle, butt hinges and its mortise lock with brass, oval doorknobs.

The casing for the doorway is original and, in design and construction, matches those found on the basement door and first-floor doors and windows of ancillary rooms: 7/8" x 3 3/4" plank boards with rounded edges, and assembled using mitered joints at the corners.

- *Windows:* There is one original window opening, located on the north wall. It retains its original, six-over-nine light double-hung wood sash unit measuring 2'-6" x 4'-8".

The window has its original casing. Its design and construction matches those found on the basement door and first-floor doors and windows of ancillary rooms: 7/8" x 3 3/4" plank boards with rounded edges, and assembled using mitered joints at the corners. The window retains its original brass latches. The window retains its cotton sash

cords and wheels which are fully operational.

- *Ceiling:* The original plaster appears to remain.
- *Baseboards:* The original baseboards remain and are a composite design 7" in height. The original shoe molding also remains; it measures ½" in depth by ⅞" in height.
- *Finishes:* The baseboards and shoe molding, window sash and window casing, and door and door casing are painted.

The walls have modern wallpaper.

The ceiling is painted.

The 1988-vintage lavatory cabinet is painted.

- *Mechanical Systems:* One modern metal 4" x 12" floor supply register is located near the west wall.
- *Electrical Systems:* Wiring is concealed in the walls and ceiling.

The plain brass-plated switch plate is modern, presumably installed during the remodeling of 1988.

The ceiling light fixture at the center of the room is modern, presumably installed in 1988.

- *Plumbing Systems:* Copper supply pipes provide water to the toilet and the 1988-vintage, synthetic-stone lavatory.
- *Other Features:* There is a small residential lavatory cabinet, installed in 1988.

Room 110: Originally the sewing room, this space is now used as the map file room. It is



Figure C-39 Room 110 facing west

located in the northwest corner of the main house block, and measures 13'-8" x 9'-5" with a floor-to-ceiling height of 8'-10 ¾".

- *Flooring:* The original flooring is 2 ¼" wide, tongue-and-groove, varnished golden oak and is laid north-south.

A sub-floor, visible from the basement, is made up of tongue-and-groove boards, 5 ½" wide, laid diagonally.

- *Walls:* The original plaster presumably remains on the walls beneath the modern wallpaper and paper cornice.

The original architectural plans call for a wood picture molding in this room. The one present appears to be a modern modification.

- *Doors:* The doorway on the south wall connecting to the living room (Room 101) is

framed for a 2'-8" x 6'-8" x 1 3/8" door, now missing. The original architectural plans specify that the door was to have been hung on hinges on the east jamb, and opens into the sewing room. Scars from missing hinges confirm the door was once hung as designed. The doorway on the east wall connecting to the back hall (Room 108) is framed for a 2'-8" x 6'-8" x 1 3/8" door, now missing. The original architectural plans specify that the door was to have been hung on hinges on the south jamb, opening into the sewing room. Scars from missing hinges confirm the door was once hung as designed.

The original casing of both doorways is the same composite design: 4 5/8" in width, with edge bead, raised field, and backband, resting on plinths.

- *Windows:* Two original window openings are in this room, one on the west wall and one on the north wall. Both retain their original, double-hung, wood sash units and original brass latches.

The west wall window is an eight-over-twelve light unit measuring 3'-4" x 5'-8". The north wall window is a six-over-nine light unit measuring 2'-8" x 5'-8".

The original casing of both window units is the same composite design: 4 5/8" in width, with edge bead, raised field and backband, set on composite apron.

- *Ceiling:* A modern, acoustical ceiling tile matching that of the kitchen and enclosed porch is now present. It measures 12" x 12" and has a textured "wormwood" pattern.

- *Baseboards:* The baseboards in this room appear to be original. Although 7" in height like others in the house, their design is more simplified. The original shoe molding also remains; it measures 1/2" in depth by 7/8" in height.

- *Finishes:* The flooring and baseboard shoe moldings are varnished.

The baseboard, windows, window casings, door casings, and picture molding are painted.

The walls have a modern wallpaper and paper strip at the cornice.

- *Mechanical Systems:* One modern metal 6" x 12" floor supply register is present. It is located along the west wall slightly north of the window.

- *Electrical Systems:* Wiring is concealed in the walls and ceiling.

The modern switch plate is brass. The modern outlet covers are molded plastic.

The ceiling fixture at the center of the room is a modern light/fan combination. The date of installation is not known.

- *Plumbing Systems:* No plumbing system elements are present.

- *Other Features:* There are no other significant features in this room.

The Second Floor

The rooms of this level are primarily located in the top half-story of the main block.

There is also a single narrow, low-ceilinged room of the wing, originally unfinished attic space.

Many of the more sophisticated original architectural elements employed in the first-floor public spaces are repeated in the second-floor private bedrooms, but none have all of the better details as found in the first-floor public rooms. The abundance of natural lighting on the first floor is much reduced on the second floor by the smaller windows.

Room 201: Bedroom #2 is located in the southwest corner of the main house block. The room measures 13'-8" x 12'-0" and has a floor-to-ceiling height of 8'-11 1/2". There are two built-in closets along the south wall.

- **Flooring:** The original wood flooring is presumed to be in place beneath the modern, residential-grade, sculptured wall-to-wall carpet. The original flooring is 2 1/4" wide, tongue-and-groove, varnished golden oak and laid north-south.

The modern carpet is an addition of unknown date, likely 1980s.

- **Walls:** The original plaster may remain on the walls, which are now covered with modern wallpaper.

The wood picture molding appears to be original and was called for in the architectural plans.

- **Doors:** The original doorway on the east wall is framed for a 2'-8" x 6'-8" x 1 3/8" door; its original six-panel door is in place, hinged on the north jamb to open into this room, as indicated on the architectural plans. The panels on both sides of the door are flush.

Along the south wall are two doorways, each framed for a 2'-4" x 6'-0" door, opening into the room from a closet. The original doors are in place as designed, the west door hinged on west jamb and the east door hinged on the east jamb. Both retain their original brass hardware of two 4" x 4," five-knuckle, butt hinges and a mortise lock with oval doorknobs.

The original casing of both doorways is the same composite design: 4 5/8" in width, with edge bead, raised field, and backband resting on a plinth.



Figure C-40 Room 201 facing southwest

- **Windows:** There are two original windows in this room, one of which is in the gable-end wall, and the other, a dormer window. The dormer window is on the south wall and retains the original, six-over-nine light, double-hung sash unit measuring 2'-4" x 4'-8".

The original casing of the dormer window is mostly covered by the framing for the flanking closets, leaving little more than an edge bead. The apron is a single board with a 1/2" cove trim below.

The second original window on the west wall retains its six-over-six light, double-hung, sash measuring 2'-8" x 4'-6".

The casing for the west, gable-end window is the original. It is the composite design found on the primary rooms of the first floor: 4 5/8" in width, with edge bead, raised field and backband, set on composite apron.



Figure C-41 Room 202 facing south

Both windows retain their original brass latching mechanism.

Both windows retain their cotton sash cords and wheels and are fully operational.

- *Ceiling:* A modern, textured ceiling plaster is now present.

- *Baseboards:* The original baseboards remain and are a composite design 7" in height. The original shoe molding is missing.

- *Finishes:* The baseboards, windows, window casings, doors, door casings, and picture molding are painted.

The walls are covered with a modern wallpaper.

The interiors of the closets have painted walls, ceiling and trim.

- *Mechanical Systems:* A modern metal 12" x 12" ceiling supply register is located over the west window.

- *Electrical Systems:* Wiring is concealed in the walls and ceiling. The brass-plated switch plate is modern, as are the outlet covers, which are made of molded plastic.

The ceiling fixture at the center of the room is a modern light/fan combination.

- *Plumbing Systems:* No plumbing system elements are present.

- *Other Features:* Two original built-in closets are along the south wall, one on either side of the roof dormer.

Room 202: The second floor hall is centrally located in the main house block. It measures 7' -7" x 16'-1" and has a floor-to-ceiling height of 9'-0".

- *Flooring:* The original flooring is 2 1/4" wide, tongue-and-groove, varnished golden oak and is laid north-south.

- *Walls:* The original plaster appears to remain.

The wood picture molding appears to be original as called for in the architectural plans.

- *Doors:* The four original doorways in this room remain intact. A door on the west wall near the head of the stairs connects this room with bedroom #3 (Room 206).

A second door on the west wall near the center of the hall connects to bedroom #1 (Room 201).

The doorway on the south wall connects with the bath (Room 203).

The doorway on the east wall, at the head of the stairs, connects to bedroom #1 (Room 204).

All four doorways were framed for a 2'-8" x 6'-8" x 1 3/8" door and retain their original six-panel doors, flush paneled on both sides, with original, brass hardware of two 4" five-knuckle hinges and a mortise lock with oval doorknobs.

The original casing of all four doorways is the same as found elsewhere in the primary rooms of the house, a composite design 4 5/8" in width, with edge bead, raised field, and backband on plinths.

- *Windows:* There is one window in this room on the north wall, a dormer window, which retains its original six-over-nine light, double-hung sash unit measuring 2'-4" x 4'-8". It also retains its original brass sash latch.

The casing of the dormer window is original, but mostly covered by the framing for the flanking closets, leaving little more than an edge bead. The apron is a single board with a 1/2" cove trim below.

The window retains its original brass latching mechanism. The window also retains its cotton sash cords and wheels and is fully operational.

- *Ceiling:* The original plaster appears to remain.

The original plans call for a wood picture molding in this room. The one present appears to be the original.

- *Baseboards:* The original baseboards remain and are a composite design 7" in height. The original shoe molding also remains; it measures 1/2" in depth by 1" in height.

- *Finishes:* The flooring and baseboard shoe molding are varnished. The stair treads, newel post, balusters handrails, and pendant are varnished.



Figure C-42 Dormer window on north wall of Room 202

The stair risers and stringer are painted.

The baseboards, windows, window casings, doors, door casings, and picture molding are painted.

The walls and ceiling are painted.

- *Mechanical Systems:* A modern metal 26" x 30" ceiling return register is located above the head of the stairs. The second-floor thermostat is located on the west wall near the head of the stairs.

A modern chase north of the door to Room 204 contains mechanical wiring and piping leading to the attic.

- *Electrical Systems:* Wiring is concealed in the walls and baseboards. The switch plate and outlet covers are modern, and made of molded plastic.



Figure C-43 Room 203 facing southwest

A ceiling fixture near the center of the room is a brass lantern that appears to be of an early design.

A battery-operated smoke detector is near the center of the room.

- *Plumbing Systems:* No plumbing system elements are present.

- *Other Features:* The staircase that connects the second floor with the first is located along the east wall of this room. The stairs measures 3'-2" in width. Painted wood stringer and risers offset the varnished, 9" deep, oak treads, and the stained and varnished balustrade: a simple turned newel post sits on a 3 7/8" square base for a total height of 3'-1 5/8"; the unadorned, rectangular balusters measuring 5/8" x 7/8" in section, are 2'-10" tall and placed 4 1/4" on center; and the handrail is a camelback design.

A modern handrail of similar design, stained and varnished, is attached with metal brack-

ets to the east wall. A pull-down attic stair is centrally located along the west wall. The hatch cover measures 1'-8" x 4'-4".

A modern closet is located in the southwest corner of the room, attached to the west wall. The closet is constructed of 3/4" plywood. It is 7'-0" tall by 4'-0" wide by 1'-1" deep.

There is a single, handheld fire extinguisher in this room. It sits on the floor at the base of the dormer window. It does not have a mounting harness or an inspection tag.

Room 203: The bathroom is located at the front of the house, at the south end of the hall and between bedroom #2 and bedroom #1. The room measures 7'-7" x 5'-0" and has a floor-to-ceiling height of 8'-10 3/4".

Flooring: The original architectural plans call for a tile floor. The current floor, reportedly dating from the late 1980s, is a modern ceramic tile of 2 1/4" x 2 1/4" intersected by a 3/4" x 3/4" tile at the corners. This floor is slightly raised suggesting that the original tile may remain below. A marble threshold is used at the door to the hall.

- *Walls:* The 4'-0" tall wainscoting of 4 1/4" x 4 1/4" ceramic tiles indicated in the original architectural plans appears to remain.

The original wall plaster above the wainscoting also appears to remain. The plaster was specified in the original drawings to have been "Keene's Cement."

- *Doors:* The one doorway, on the north wall, connects to the hall (Room 202). An original doorway, it is framed for a 2'-8" x 6'-8" x 1 3/8" door. An original, six-panel door, with flush panels on both sides, is hinged on the east jamb, opening into this room, as indicated on the original architectural plans. The door retains its original

brass hardware including two original 4", five-knuckle brass butt hinges and a mortise lock with oval doorknobs.

The door casing is original, a composite design 4 5/8" in width, with edge bead, raised field, and backband on plinths, as is found elsewhere in the primary rooms of the house.

- *Windows:* One original dormer window located on the north wall, retains its original, six-over-nine light, double-hung wood sash unit measuring 2'-4" x 4'-8".

The casing of this dormer window is the original, mostly covered by the framing of the dormer, leaving little more than an edge bead. The apron is a single board with a 1/2" cove trim below.

The window retains its original brass latching mechanism. The window retains its cotton sash cords and wheels, and is fully operational.

- *Ceiling:* The original plaster appears to remain.

- *Baseboards:* The original ceramic tile base remains.

- *Finishes:* The room's door, door casing, window, sash and window casing are painted.

The wall surfaces above the tile wainscoting are painted plaster.

The modern lavatory cabinet is painted.

- *Mechanical Systems:* One modern metal, 6" x 14," ceiling supply register is located above the door.

- *Electrical Systems:* Wiring is concealed in the walls and ceiling. The switch plates and



Figure C-44 Room 204 facing north

outlet covers are modern and made of molded plastic.

- *Plumbing Systems:* Copper supply pipes provide water to the original toilet and bathtub and a modern, synthetic-stone lavatory. The dates of installation of the modern lavatory is not known

- *Other Features:* There is a small, modern residential lavatory cabinet, apparently installed with the modern lavatory.

Room 204: The entire portion of the main house block east of the hall makes up bedroom #1. The room measures 13'-8" x 20'-4" and has a floor-to-ceiling height of 8'-11 1/2".

- *Flooring:* The original wood flooring is presumed to be in place beneath the modern sculptured, residential-grade, wall-to-wall carpet. The original flooring is 2 1/4" wide, tongue-and-groove, varnished golden oak and laid north-south. The carpet is a modern addition of unknown date.

- *Walls:* The original plaster may remain on the walls, which are now covered with modern wallpaper. The wood picture molding appears to be original as called for in the architectural plans.



Figure C-45 Room 204 facing south

- **Doors:** The doorway on the west wall is original, framed for a 2'-8" x 6'-8" x 1 3/8" door. Its original six-panel door is in place, hinged on the north jamb to open into this room, as indicated on the original architectural plans. The panels on both sides of the door are flush. The original brass hardware remains: two 4" x 4," five-knuckle, butt hinges and a mortise lock with oval door-knobs.

Along the north wall are two doorways, each framed for a 2'-4" x 6'-0" door. The original doors are missing, but replaced with a pair of modern 3/4" thick, wood bi-fold doors. Dutchman repairs on the jambs confirm that the original doors were installed as designed, the west door hinged on west jamb and the east door hinged on the east jamb.

The original doorway on the east wall is framed for a 2'-8" x 6'-4" x 1 3/8" door. Its original six-panel door is in place, hinged on the north jamb to open into this room, as indicated on the architectural plans. The panels on both sides of the door are flush. The original brass hardware remains: two brass, 4," five-knuckle butt hinges and a mortise lock with oval doorknobs.

The casing of all four doorways is the same original composite design: 4 5/8" in width,

with edge bead, raised field and backband, resting on a plinth.

- **Windows:** There are three original windows in this room, two of which are dormer windows.

One dormer window is on the north wall and retains the original, six-over-nine light, double-hung sash unit measuring 2'-4" x 4'-8".

The second dormer window is on the south wall and retains the original six-over-nine light, double-hung sash unit measuring 2'-4" x 4'-8".

The casing of the dormer window is the original, mostly covered by the framing for the flanking closets, leaving little more than an edge bead. The apron is a single board with a 1/2" cove trim below.

The third original window is on the east, gable-end wall, and retains its original six-over-six light, double-hung sash measuring 2'-8" x 3'-8".

The casing for the east, gable-end window is also original. It is the composite design found in the primary rooms of the first floor: 4 5/8" in width, with edge bead, raised field and backband, set on composite apron.

All three windows retain their original brass latching mechanism.

All three windows retain their cotton sash cords and wheels, and are fully operational.

- **Ceiling:** The original plaster appears to remain.

- **Baseboards:** The original baseboards remain and are a composite design 7" in height. The original shoe molding is missing.

- *Finishes:* The baseboards, windows, window casings, doors, door casings, and picture molding are painted. The walls are wallpapered.

The ceiling is painted.

The closet walls are wallpapered, and their ceilings are painted.

The modern, attached cabinet is painted.

- *Mechanical Systems:* There are three modern metal ceiling supply registers.

One measuring 6" x 14" is located above the east doorway.

Two, each measuring 12" x 12", are located above the dormer windows of the north wall.

- *Electrical Systems:* Wiring is concealed in the walls and ceiling.

The switch plate and outlet covers are modern, and made of molded plastic.

The ceiling fixture at the center of the room is a modern light/fan combination. The date of installation is not known.

- *Plumbing Systems:* No plumbing system elements are present.

- *Other Features:* There is a modern wood cabinet in the southeast corner of the room, attached to the west wall. The cabinet measures 6'-0" wide x 7'-0" tall by 2'-5" deep.

A single, handheld fire extinguisher in this room sits on the floor of the west closet and does not have a mounting harness or an inspection tag.

A small door in the side wall of the south dormer provides access to a small floored



Figure C-46 Attic access door in south dormer

attic space between the dormer and the bathroom.

Room 205: The attic above the wing is now finished space. The room measures 9'-0" x 13'-0" and has a floor-to-ceiling height of 7'-7." The date of conversion is not known.

- *Flooring:* The original architectural plans identify the flooring as pine. Presumably, this original wood flooring is in place be-

neath the modern, residential grade, wall-to-wall carpet.

The carpet is a modern addition of unknown date.

- *Walls:* The original architectural plans call for the stud knee walls to be "sheathed up 3'-6" above fl. unfinished above." Whatever the sheathing might have been, the



Figure C-47 Room 205 facing east

knee-wall studs and rafters are now sheathed with gypsum board; the original wall sheathing may remain in place on the knee walls.

- *Doors:* The original doorway on the east wall framed for a 2'-8" x 6'-4" x 1 3/8" door. Its original six-panel door is in place, hinged on the north jamb to open into bedroom #1, as indicated on the architectural plans. The panels on both sides of the door are flush. The original brass hardware remains: two 4"x 4", five-knuckle butt hinges and a mortise lock with oval doorknobs.

- *Windows:* There is one original window in this room, on the east, gable-end wall. It retains its original six-over-six light, double-hung sash measuring 2'-4" x 3'-8". The casing for the east gable-end window is the original. The window retains its original brass latching mechanism.

The window retains its cotton sash cords and wheels, and is fully operational.

- *Ceiling:* The open underside of the sloping roof rafters originally defined the ceiling. Those rafters are now sheathed in gypsum board.

- *Baseboards:* There are no baseboards in this room.

- *Finishes:* The room's door, door casing, window, and window casing are painted.

The gypsum board on the knee walls and undersides of the rafters is painted.

- *Mechanical Systems:* No elements of the mechanical system are in this room.

- *Electrical Systems:* Wiring is partially concealed in the walls and ceiling. Along the west wall is exposed metal conduit and switchbox.

The switch plate and outlet covers are modern and made of molded plastic.

The ceiling fixture at the center of the room is modern.

- *Plumbing Systems:* No plumbing system elements are present.

- *Other Features:* There are no other significant features in this room.

Room 206: Bedroom #3 is located in the northwest corner of the main house block. This room measures 13'-8" x 7'-11" and has a floor-to-ceiling height of 9'-0".

- *Flooring:* The original wood flooring is presumed to be in place beneath the modern sculptured, residential-grade, wall-to-wall carpet. The original flooring is 2 1/4" wide, tongue-and-groove, varnished golden oak and laid north-south.

The carpet is a modern addition of unknown date.

- *Walls:* The original plaster apparently remains.

The wood picture molding appears to be original as called for in the architectural plans.

- *Doors:* The original doorway on the east wall is framed for a 2'-8" x 6'-8" x 1 3/8" door. Its original six-panel door is in place, hinged on the south jamb to open into this room, as indicated on the architectural plans. The panels on both sides of the door are flush. The original brass hardware remains: two brass, 4", five-knuckle butt hinges and a mortise lock with oval doorknobs.

The casing of the doorways is the original, composite design: 4 5/8" in width, with edge bead, raised field, and backband resting on a plinth.

- *Windows:* There are two original windows in this room.

One is a dormer window on the north wall and retains its original six-over-nine light, double-hung sash unit measuring 2'-4" x 4'-8".

The casing of the dormer window is the original, mostly covered by the framing for the flanking closets, leaving little more than an edge bead. The apron is a single board with a 1/2" cove trim below.

The second original window is on the west, gable-end wall and retains its original, six-over-six light, double-hung sash measuring 2'-8" x 4'-6".

The casing for the west, gable-end window is the original. It is the composite design found on the primary rooms of the first floor, 4 5/8" in width, with edge bead, raised



Figure C-48 Room 206 facing east

field and backband, set on composite apron and no chair rail.

Both windows retain their original brass latching mechanism.

Both windows retain their cotton sash cords and wheels and are fully operational.

- *Ceiling:* The original plaster appears to remain.

• *Baseboards:* The original baseboards remain, apparently in their original locations. They are the composite design, 7" in height, found throughout the house in the primary rooms. The original shoe molding is missing.

• *Finishes:* The baseboards, door, door casing, windows, window casings, and picture molding are painted.

The walls are painted.

The ceiling has a modern textured ceiling plaster.

The modern attached cabinet is painted.

- *Mechanical Systems:* One modern metal 12" x 12" ceiling supply register is located

above the window in the west wall.

- *Electrical Systems:* Wiring is concealed in the walls and ceiling. The switch plates and outlet covers are modern and made of molded plastic.

The ceiling fixture at the center of the room is a modern light/fan combination. The date of installation is not known.

- *Plumbing Systems:* No plumbing system elements are present.

- *Other Features:* There is a modern wood cabinet in the northeast corner of the room, attached to the east wall. The cabinet measures 5'-0" wide x 7'-0" tall by 2'-1" deep. It has a modern flush door, also called a slab door, which measures 2'-6" x 6'-8".

There is a small ceiling hatch just inside the doorway. The hatch is not on the original architectural plans, and the date of its installation is not known.

Utility Systems

According to the original architectural plans, the house has had electrical service since its initial construction. Electrical power entered the northwest corner of the basement by metal conduit to a pull box. The distribution board was attached to the north wall of Room 002, where the current panel box is located. At an unknown date, 220v power was added for a clothes dryer in the laundry room, formerly the pantry. Electrical power now enters the building underground on the north side, and the meter indicates 240v service. The electrical panel is rated for 200 amps, suitable for residential or small library usage. The panel itself appears to be relatively new, and was likely installed during the 1993 HVAC upgrade. The panel and

wiring appear to be in good condition and there were no reports of problems.

The architectural plans also indicate that heating was provided by steam radiators placed throughout the first and second floor levels of the main house block. An oil burner along the east wall of Room 002 of the basement provided the heat. The oil storage tank was located to the west of the house.

It is not known when this heating system was removed; it may have been in 1983 during the first recorded HVAC upgrade. The current heating and air conditioning is supplied by two electric heat pumps. The house is divided into two zones; one is the first floor of the main block and the other is the second floor. Both heat pumps are Lennox model HP26-311-1P, and each has approximately 2 ½" tons of capacity and single phase power. According to the serial numbers, both units were manufactured in September of 1993.

Then as now, the house utilized city services for its water supply and waste disposal. Both connections are along the north wall of the house near the northwest corner of Room 001.

A coal-fired water heater initially serviced the house. This water heater was located just north of the oil burner. When this system was removed is not known. Today, a 52-gallon, 240v electric water heater, located in the same area of the basement, provides the hot water. The unit was manufactured by State Water Heater Industries, Inc. in 1988, and is model number PV522RS2NC.

The plumbing for the half-bath is visible in the kitchen's broom closet; it exhibits copper supply lines and galvanized waste lines. The kitchen sink has copper supply lines and PVC waste lines. Galvanized supply lines are visible in the attic adjacent to the second

floor bath. Other than occasional leaks, both supply and waste lines appear to be in sound condition.

Summary of Conditions

Thoughtful design, high quality building materials, and careful construction are apparent in the original building. In addition, maintenance appears to have been regularly performed. As a result, the house is in very good condition, with minor exceptions.

Although park personnel report the heating/cooling system continues to function well, the heat pumps are close to the end of their projected life expectancy. Replacement in the next five years is likely. Similarly, the hot water supply is reportedly without problem. However, given its advanced age, operation of the hot water heater should be monitored closely.

The most obvious deterioration is on the exterior. A number of the window shutters are in poor condition, with rot allowed to go unchecked for some time.

PART II: TREATMENT & USE

A. INTRODUCTION

The Battle of Guilford Court House occurred on March 15, 1781, pitting Major General Nathanael Greene's continental troops and militia against General Lord Charles, Earl Cornwallis and the British army. Though Cornwallis won the battle, the heavy losses incurred by the royals caused them ultimately to lose the war and surrender at Yorktown that October.

The backcountry hamlet of Guilford Court House was soon after renamed Martinville, for land speculator and North Carolina governor, Alexander Martin. After the relocation of the county seat to Greensboro in 1808, Martinville became deserted and the battlefield location largely forgotten.

Through the efforts of amateur historian Judge David Schenck of Greensboro, interest in the battlefield began to rise. Schenck purchased fifty acres of battlefield land and founded the Guilford Battle Ground Company in 1887 as a non-profit association to continue the effort. By 1904, 112 acres of land had been acquired and were operated as Guilford Battle Ground Park. Monuments to local Revolutionary War heroes were constructed, and the landscape "beautified" into a park-like setting. A keeper's lodge, cottage, speaker's stand, two spring-houses, a museum building, and restaurant were constructed by the Guilford Battle Ground Company for the enjoyment of visitors.

Efforts to establish the park as a National Military Park came to fruition in 1917, and the re-christened Guilford Courthouse National Military Park became the first Revolutionary War site to be named a national park. Administered under the National Mili-

tary Park Commission of the War Department and limited by a small annual budget, the park's buildings and roads began to deteriorate.

The National Park Service assumed administration of all national military parks in 1933. That same year, as part of Roosevelt's New Deal, Public Works Administration appropriations funneled \$97,000 for improvements at Guilford Courthouse National Military Park.

Handsome Colonial Revival style buildings were designed for the park by the National Park Service's Eastern Division Branch of Plans and Design. The largest of these, the one-and-one-half-story Flemish-bond brick Administration Building, contained the park's museum, library, and administrative offices. The Superintendent's Residence was smaller in scale though with a similar appearance, having dormer windows in the upper story and a weatherboarded side wing. A Utility Building and Inflammable Storage Building were also constructed. Greensboro contractor George W. Kane built all four structures for \$56,002.90, paying local laborers in accordance with PWA requirements. Work was completed in May 1935.

Park Superintendents occupied the residence until 2002. Over the years, the kitchen was remodeled, the first-floor coat closet converted to a half bath, light fixtures changed, carpet added in several rooms, and HVAC systems upgraded, all to keep up with the changing requirements of a modern residence. Despite these changes, the character of the charming Superintendent's Residence remains largely intact, along with much of its original building fabric.

Because the park is a National Historic Landmark whose importance derives from the 1781 Revolutionary War battle, planning at Guilford Courthouse National Military Park focuses on restoring the battlefield landscape. The 1934 Superintendent's Residence is listed in the amended National Register nomination (1996) as a contributing structure, along with the Utility Building and Inflammable Storage Building. The inclusion of the residence in long-range park planning can preserve a well-built artifact from the earliest era of the National Park Service administration as well as a fine example of the successful programs of the New Deal.

As the park ceases to provide on-site residential housing, park management is seeking a new use for the Superintendent's Residence. It has been proposed that the building be adapted to provide much-needed space for the park library, map collection, and meeting rooms for the park's friends organization. This proposed new use helps further the mission stated in the park's enabling legislation, namely to "preserve for historical and professional military study one of the most memorable battles of the Revolutionary War." Such activities are envisioned to be conducted in conjunction with nearby Tannenbaum Historic Park.

B. ULTIMATE TREATMENT AND USE

The construction of the Superintendent's Residence at Guilford Courthouse National Military Park in 1934, along with the similar Administration Building and associated service buildings, was the result of a New Deal appropriation coinciding with the beginning of National Park Service administration at the park.



*Figure B-1 Southeast oblique of residence, undated but assumed c. 1935
(Guilford Courthouse NMP files, Box 1)*

The style chosen for the buildings, the Colonial Revival style, was both popular in the early twentieth century and thought to reflect the time period of the battle, though the buildings more closely mirrored the structures found in the nearby historic Moravian town of Salem than the log buildings likely standing near the battle site.

The Superintendent's Residence is a tangible artifact demonstrating the design aesthetic and administrative approach of the National Park Service during the 1930s.

The residence retains a large amount of building material from the initial 1930s construction. The scale of the spaces inside corresponds well to the functions desired by the

park. Considering these circumstances, the following recommendation is made.

The Recommended Ultimate Treatment includes the rehabilitation of the interior and exterior of the residence, retaining as much as practical the many original 1934-era design characteristics.

This approach would have the following advantages:

- Preserves character-defining interior and exterior elements of the building's period of greatest significance;
- Preserves character-defining elements of the most important public interior spaces of the building's period of greatest significance;
- Avoids impacting the more significant character-defining elements by concentrating the physical modifications of rehabilitation in the secondary spaces of the interior to house management and support activities (offices, handicapped-accessible public restrooms, storage);
- By preserving the more significant elements and limiting rehabilitation modifications in the areas of less significant elements, this approach allows the opportunity to provide a degree of public interpretation of the earliest era of National Park Service administration at Guilford Courthouse NMP, while satisfying the current space needs of the park.
- Proposed modifications do not preclude a later return to its original use as a residence.

There would be disadvantages to this approach as well:

- Precludes the use of the building as a park guest or staff residence.

C. REQUIREMENTS FOR TREATMENT

The Superintendent's Residence is not discussed in the park's General Management Plan of 1997, which focuses instead on restoring the landscape of the battlefield.

The National Park Service Cultural Resources Management Guideline (DO – 28) requires planning for the protection of cultural resources on park property.

In addition, Section 106 of the National Historic Preservation Act (NHPA) mandates that federal agencies, including the National Park Service, take into account the effects of their actions on properties listed or eligible for listing in the National Register of His-

toric Places and give the Advisory Council on Historic Preservation a reasonable opportunity to comment.

Treatment of the building and site are to be guided by *The Secretary of Interior's Standards for Historic Preservation Projects*, the Americans with Disability Act, and the International Building Code. Threats to public life, safety and welfare are to be addressed; however, because this is an historic building, alternatives to full legislative and code compliance are recommended where compliance would needlessly compromise the integrity of the historic building.

D. ALTERNATIVES FOR TREATMENT

In addition to the Ultimate Treatment discussed in Section II.B above, two other alternatives are discussed below.

Alternative #1: Restore the exterior and interior of the building to its 1930s appearance, for continued use as a residence, either for park personnel or for guests.

This approach would have the following advantages:

- Preserves and restores character-defining exterior elements of the period of greatest significance;
- Readily presents to the public an exterior preserved and restored to the period of greatest significance for constant viewing by the public;
- Preserves and restores character-defining interior elements of the period of greatest significance;
- Provides options for at least occasional public viewing of the interior preserved and restored to the period of greatest significance.
- Provides housing for use by the park as a guest residence or staff residence.

This approach would have the following disadvantages as well:

- By remaining a private building, minimizes the opportunity to interpret the earliest era of National Park Service ad-

ministration at Guilford Courthouse National Military Park;

- Does not respond to the current needs of the park;
- Requires another approach to obtain needed space for a library and staff offices, such as a new, separate modern building or an addition to the existing visitor's center.

Alternative #2: Rehabilitate the exterior and interior of the building, for continued use as a residence, either for park personnel or for guests.

This approach would have the following advantages:

- Allows retention or modernization of features added later, such as the side porch enclosure and kitchen. Retention means cost savings in both unneeded demolition cost and less construction/maintenance;
- Provides housing suited to modern needs for use by the park as a guest residence or staff residence.

This approach would have the following disadvantages as well:

- Does not respond to the current needs of the park;
- Requires another approach to obtain needed space for a library and staff offices, such as a new, separate modern building or an addition to the existing visitor's center.

E. RECOMMENDATIONS

The recommended treatment for the Superintendent's Residence is a rehabilitation of the interior and exterior that preserves the original 1934-era materials and features as much as is practical, especially the more significant characteristics. By focusing physical modifications in the secondary spaces where the less significant characteristics are located, this approach preserves the more significant parts of the building, which are also the most visible, ensuring that the era of earliest Park Service administration represented by the residence can be appreciated by the public. The rehabilitation of the more private interior spaces provides important ancillary spaces for the administration of the park.

Conversion of the residence to a public research library with reading and meeting rooms may require structural modification, depending on the amount and location of the added library material and equipment. However, as indicated by the attached structural analysis, a strengthening of the loading capacity is not difficult or expensive to achieve.

The greater challenge in such a conversion is providing for access by the handicapped. A wheelchair lift set below-grade on the exterior of the house could unobtrusively provide access to the first floor, possibly through the re-opened porch on the side wing. Minor modifications to some doorways, such as the removal of door stops to increase the width of the opening and the addition of a shallow ramp to traverse a small change in elevation, could allow a wheelchair to travel to most first-floor rooms.

The creation of a first floor unisex restroom that fully meets the recommended standards

of wheelchair accessibility could be accomplished by increasing the width of the existing half bath to accommodate a 5' wheelchair turning radius. Incorporating the space of the broom closet into the accessible restroom could provide additional space in the restroom. If a larger restroom or separate restrooms for men and women are desired, the kitchen or sewing room could be subdivided.

The existing restroom on the second floor could be retained as is to serve the needs of staff and other non-public users on that level, and provide the option for future return to the building's original use as a residence.

Addition of a wheelchair lift to provide access to the second floor is not required by current standards. The ADA accessibility guidelines state the following in section Part 4.1.6.1.k.i :

These guidelines do not require the installation of an elevator in an altered facility that is less than three stories or has less than 3,000 square feet per story unless the building is a shopping center, a shopping mall, the professional office of a health care provider, or another type of facility as determined by the Attorney General.

If access to the second floor is desired, an inexpensive, reversible system such as a chair lift along the stair would be appropriate.

Operation of the mechanical, electrical, and plumbing systems should be monitored.

Installation of a fire suppression system should be considered. Station 6 of the Greensboro Fire Department is 1.1 miles northeast of the residence, at 4504 Lake Brandt Road. Hydrant number 124-005 is approximately 300 feet away, just south of

the Old Battleground Road and New Garden Road intersection. The Greensboro Fire Department has a Class 1 fire insurance rating, indicating exemplary public protection.⁵ However, use as a library would include valuable papers and publications, so installation of a fire suppression system may be desirable.

Specific Recommendations

To achieve the recommended Ultimate Treatment the following actions should be taken:

- When performing maintenance or making repairs, employ techniques that preserve the evidence of earlier paint, wallpaper and other finishes.
- Repair, repaint, and reinstall exterior shutters;
- Consider the potential impact to the cultural landscape of installing a wheelchair lift adjoining the side porch. Such modifications might include enlarged or additional parking, and additional walkways. If the impact is acceptable, remove modern porch enclosure at wing. Reopen original 1930s porch to accommodate new wheelchair lift;
- Install below-grade wheelchair lift at reopened porch;
- Modify trim of door from porch to dining room to provide 32" minimum clear width for wheelchair accessibility;
- Remove modern ceiling tiles in first floor rooms. Re-expose and repair original plaster ceiling;
- Reinstall missing doors with originals if located, or install new matching doors;
- Retain early lighting fixtures. Install more stylistically compatible reproduction lighting fixtures where poorly matching reproductions now exist. If supplemental lighting is needed in reading rooms, consider stylistically compatible task lighting fixtures or modern fixtures;
- Remove carpet in dining room. Re-expose original wood floor to facilitate wheelchair accessibility;
- Assess loading of final library design. Install structural modifications in crawl space if required.

As stated in the attached structural report by engineer David C. Fischetti, P.E., if library shelving is supported primarily by the floor framing at the perimeter, no structural reinforcing is required where the joists run perpendicular to the wall with the shelves. Where the floor joists are parallel to the wall with the shelves, then the first two joists will have to be reinforced.

If shelving is to be used near the center of rooms, assess final design to determine if additional reinforcement is necessary;

⁵ Leslie Lippa, Executive Assistant to the Fire Chief, Greensboro Fire Department

tend to be the most reliable and least expensive to install. They are relatively safe for the occupants. Both types of systems can leak. Although only activated sprinkler heads produce water in a fire and do cut off as the fire is extinguished, over-wetting can occur. Given the relatively small total area for protection, the cost for the more expensive water mist and dry chemical systems, such as Ener-

gen and FM 200, may be negligible; both systems are potentially less damaging to valuable manuscripts though the dry chemical systems may have health implications for the occupants. Because of the likely diverse capabilities and physical conditions of the occupants, the water mist system may be the most desirable though the most expensive.

REFERENCES

- “\$97,000 Fund Set Aside to Improve the Battleground.” *Greensboro News Record*, 13 October 1933.
- “Preliminary Work is Begun on Battleground Buildings.” *Greensboro News-Record*, 1934.
- “Program at Battleground is to Start in Next Few Days.” *Greensboro News Record*, 15 March 1934.
- “Guilford Battleground now has Three New Structures.” *Greensboro News Record*, 5 May 1935.
- Arnett, Ethel Stephens. *Greensboro, North Carolina: The County Seat of Guilford*. Chapel Hill: University of North Carolina Press, 1955.
- Baker, Thomas E. *Redeemed From Oblivion: An Administrative History of Guilford Courthouse National Military Park*. National Park Service, 1995.
- _____. *Guilford Courthouse National Military Park: Superintendent's Residence, Utility Building, and Inflammable Storage Building*. Unpublished manuscript.
- Caruther, Rev. Eli. *Interesting Revolutionary Incidents: And Sketches of Character, Chiefly in the Old North State*. Philadelphia: 1856.
- Construction reports and correspondence in the files of Guilford Courthouse NMP.
- Guilford Battle Ground Company. *A Memorial Volume of the Guilford Battle Ground Company, Organized May 6, 1887, at Greensboro, N.C.* Reece & Elam, Printers, 1893.
- Hiatt, John. *Guilford Courthouse National Military Park Cultural Landscape Report*. National Park Service, 2003.
- _____. *Guilford Court House Battlefield National Historic Landmark Nomination*. National Park Service, 1999.
- Tolson, Hilary A. *Historic Listing of National Park Service Officials*. National Park Service, 1964; updated by Harold P. Danz in 1991.
- Records on file at Guilford Courthouse NMP:**
- Box 1, Construction Report
 - Box 5, Superintendent's Reports
 - Box 7, Fixed Property Record Data
 - Box 8, Weekly Construction Reports and Project Correspondence
 - Map Files, Original Blueprints

APPENDIX A

1934: Original Drawings

1. Site Plan
2. Floor Plans and Fireplace Details
3. Elevations and Transverse Section
4. Entrance and Exterior Wall Details
5. Mechanical Details and Plan
6. Full Size Details
7. Full Size Details of Kitchen Porch Door
8. Full Size Details of Windows
9. Full Size Details of Arches over Windows
10. Full Size Details of Cornices
11. Mantel, Door, Cabinet, and Shutter Details

DOORMER GABLE MOULD
 MATCH MOULD TO MITRE WITH SHANK

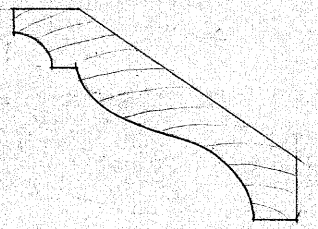

F.S. SECTION OF HOOD

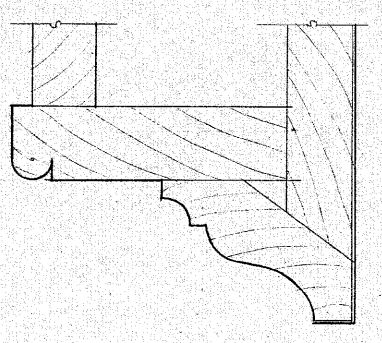

F.S. BRACKET FOR FRONT ENT. HOOD

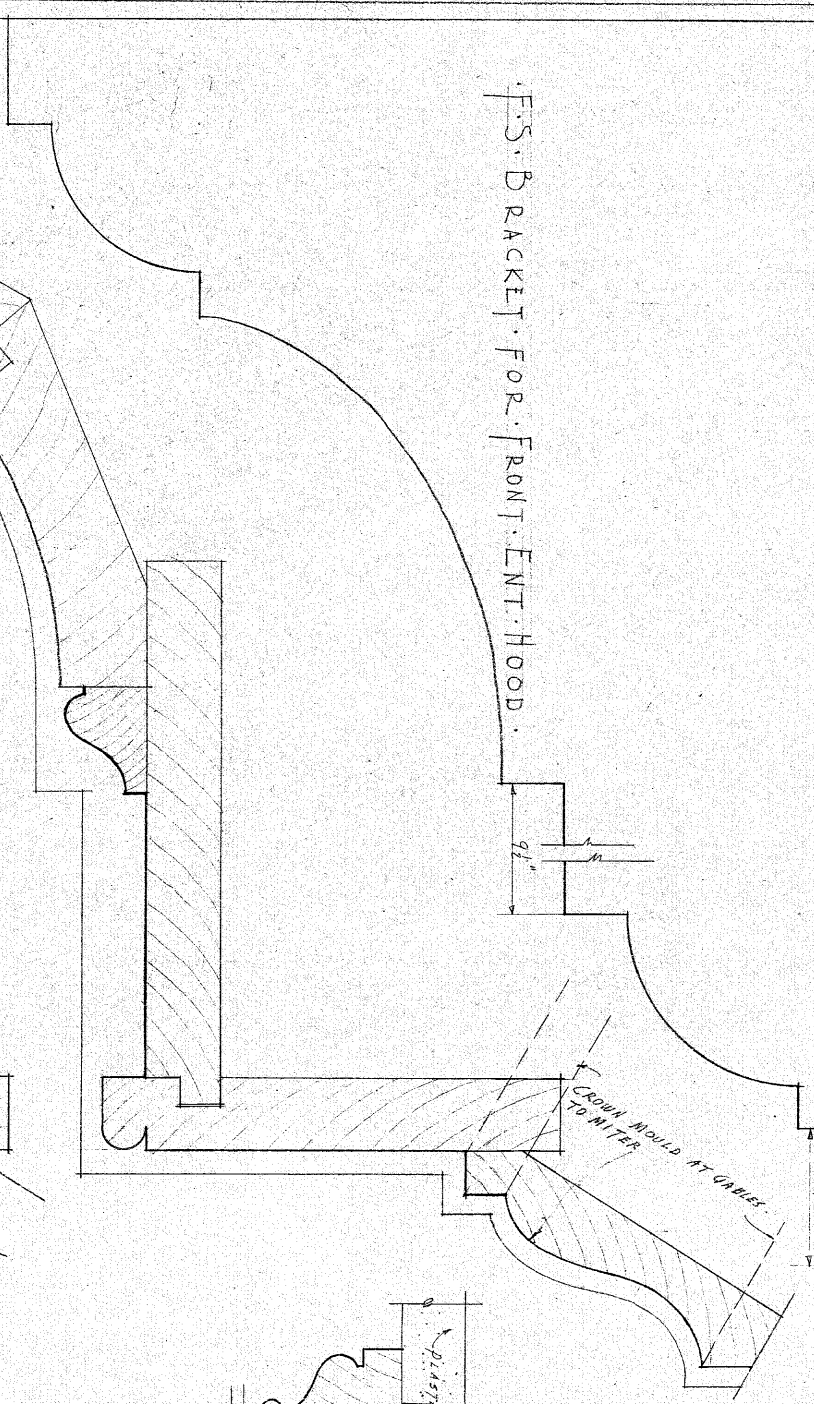

F.S. SECTION OF MAIN CORNICE

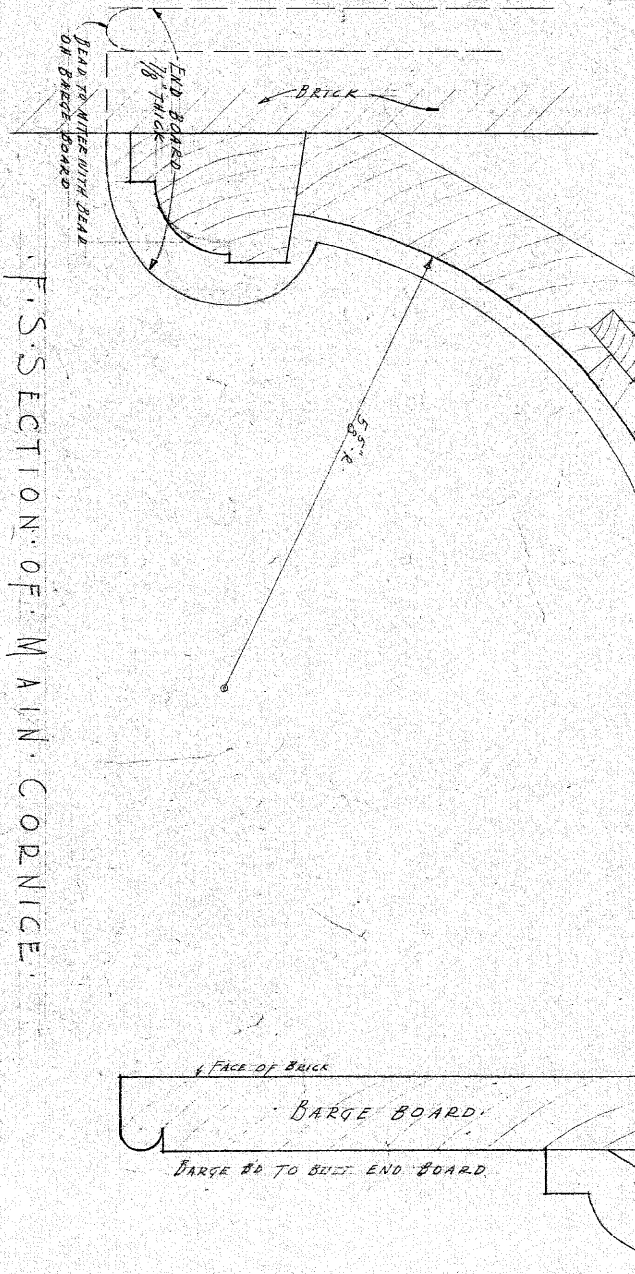

ELEVATION AT CORNER OF CORNICE

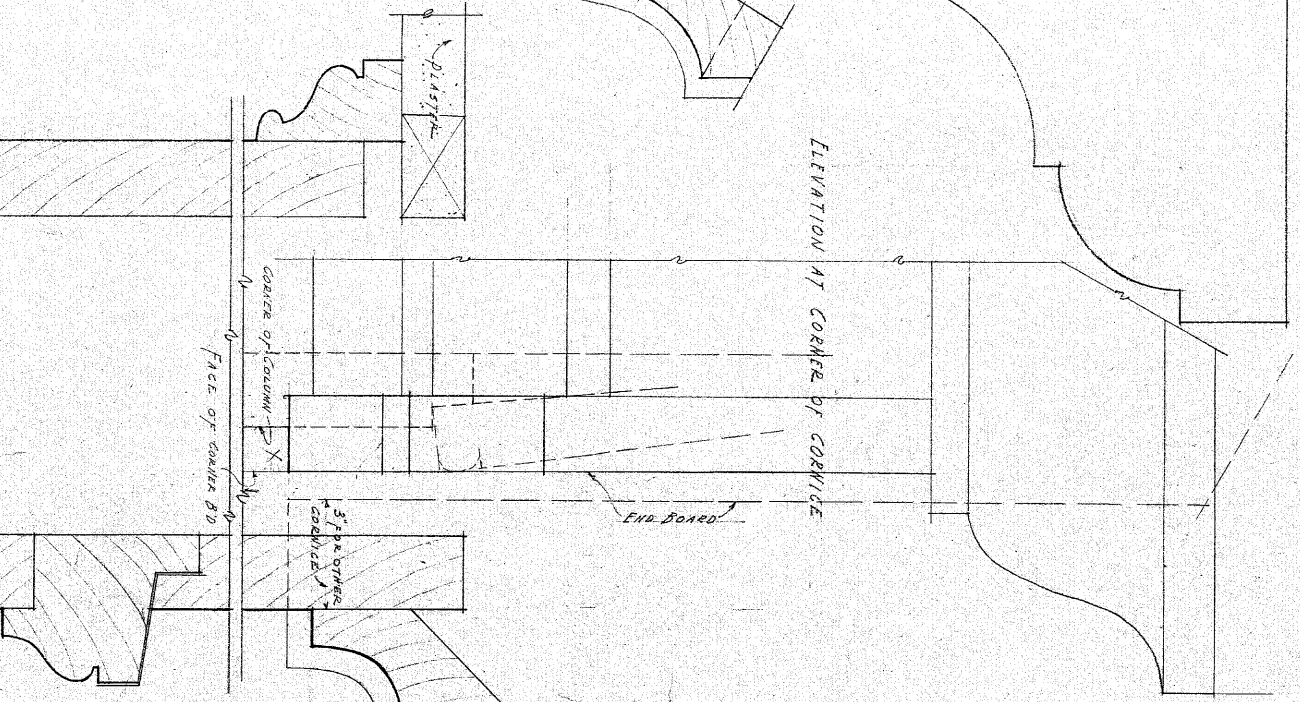

F.S. SECTION OF PORCH CORNICE

NOTE: OTHER CORNICE OF WING SIMILAR - SEE ORIG. DWGS

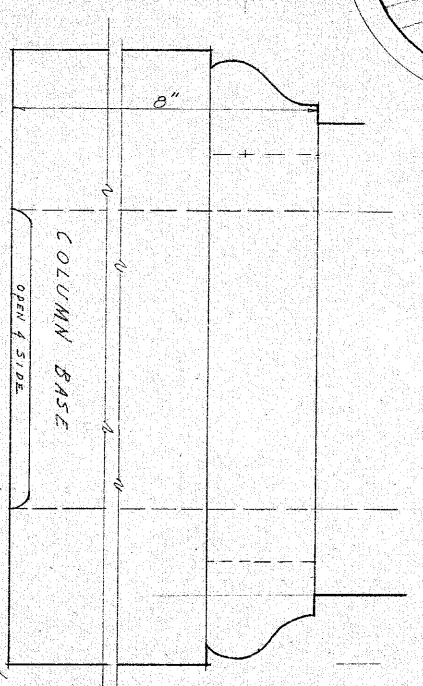

DETAIL OF COLUMN

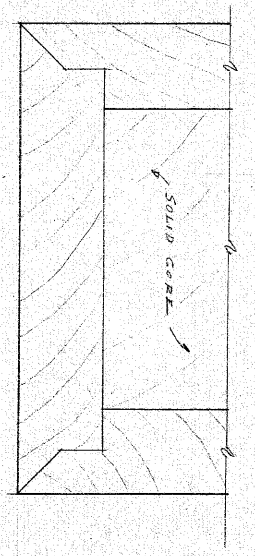

DR. BY RES. TR. BY RES. C.A. BY RES. REVISED	U.S. DEPARTMENT OF THE INTERIOR NATIONAL PARK SERVICE GUILFORD COURTHOUSE NATIONAL MILITARY PARK SUPERINTENDENT'S RESIDENCE DRAWN BY EASTMAN DIVISION BRANCH OF PARK SERVICE	DATE SEP. 29, 1934 SHEET 5 OF 5 Dwg. No. 1001-A
---	--	--

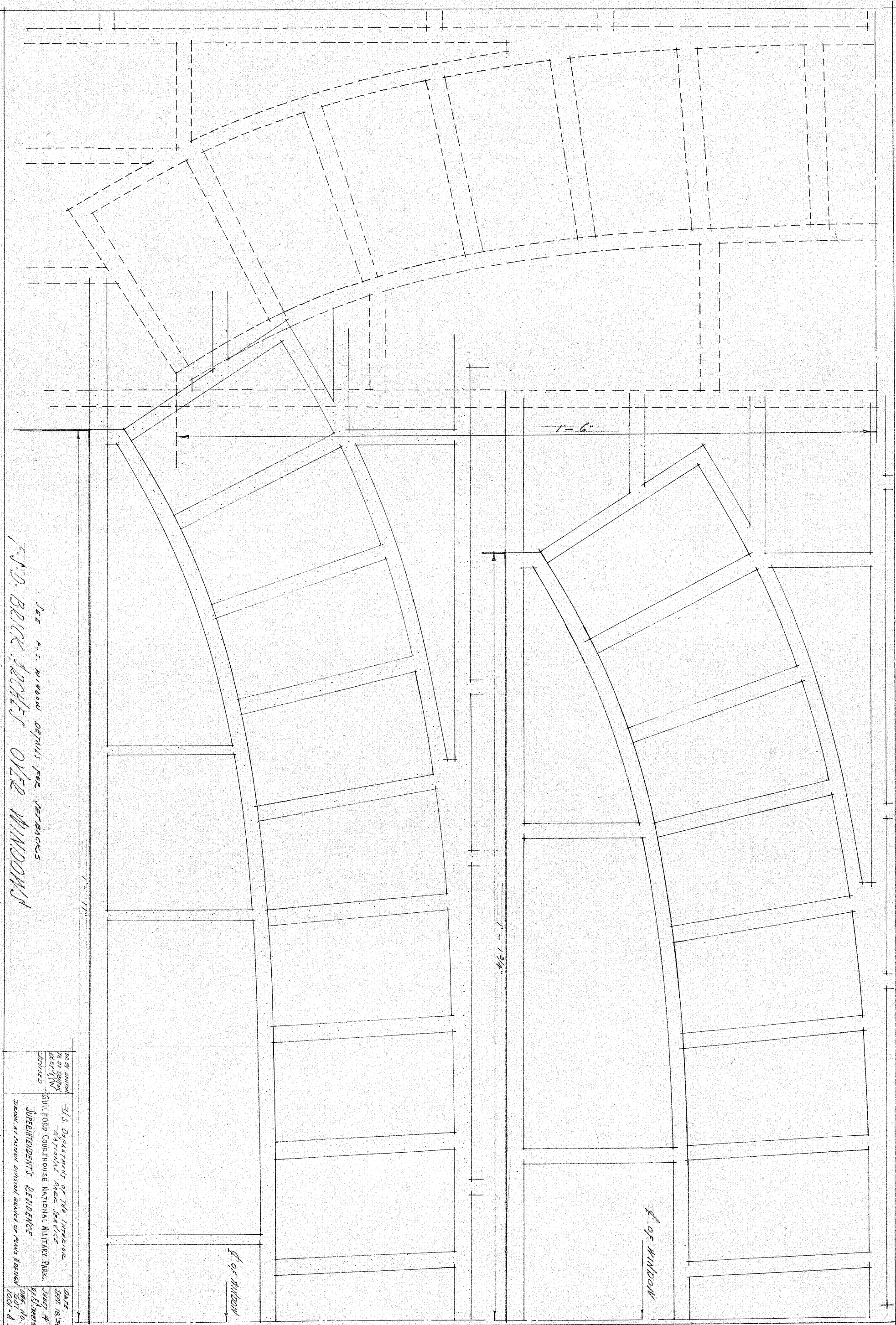

J.E.F. P.S. WINDOW DETAILS FOR VERANDAS
 F.S.D. BRICK FACIES OVER WINDOWS

DATE	1924
BY	J.E.F.
FOR	U.S. DEPARTMENT OF THE INTERIOR GULF FORD COMBHOUSE NATIONAL MILITARY PARK
PROJECT	JOPELHENDENT'S RESIDENCE
NO.	1001-A
SCALE	AS SHOWN
KEY	AS SHOWN
REVISIONS	

FACE OF WINDOW

FACE OF WINDOW

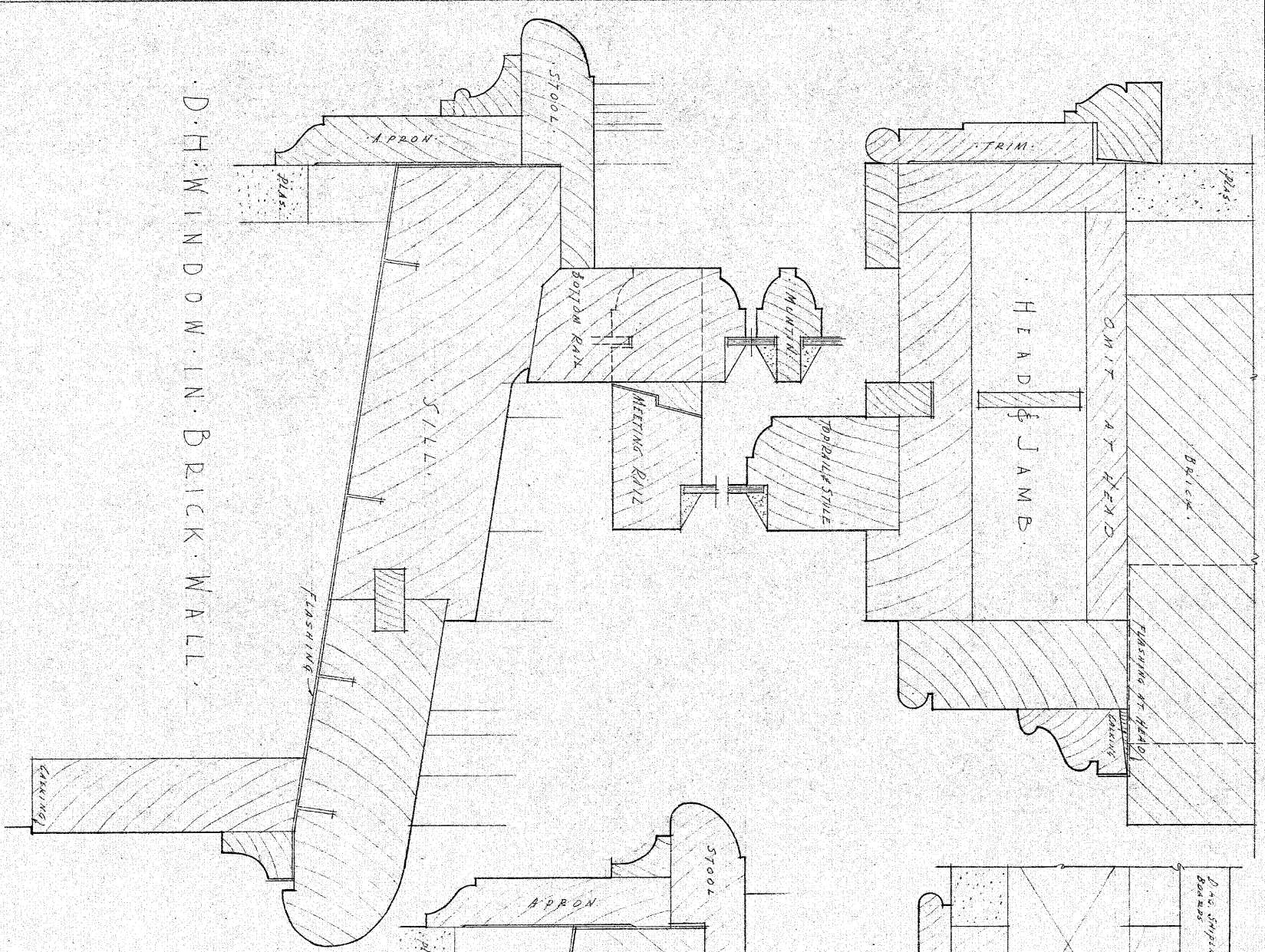

D.H. WINDOW IN BRICK WALL.

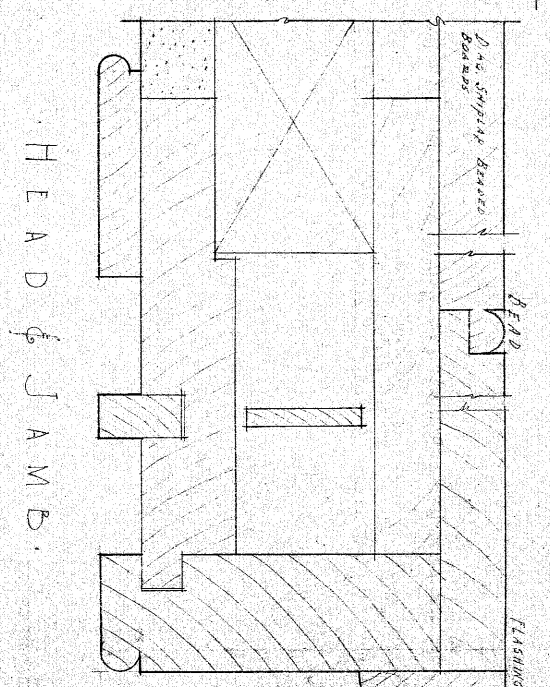

HEAD & JAMB.

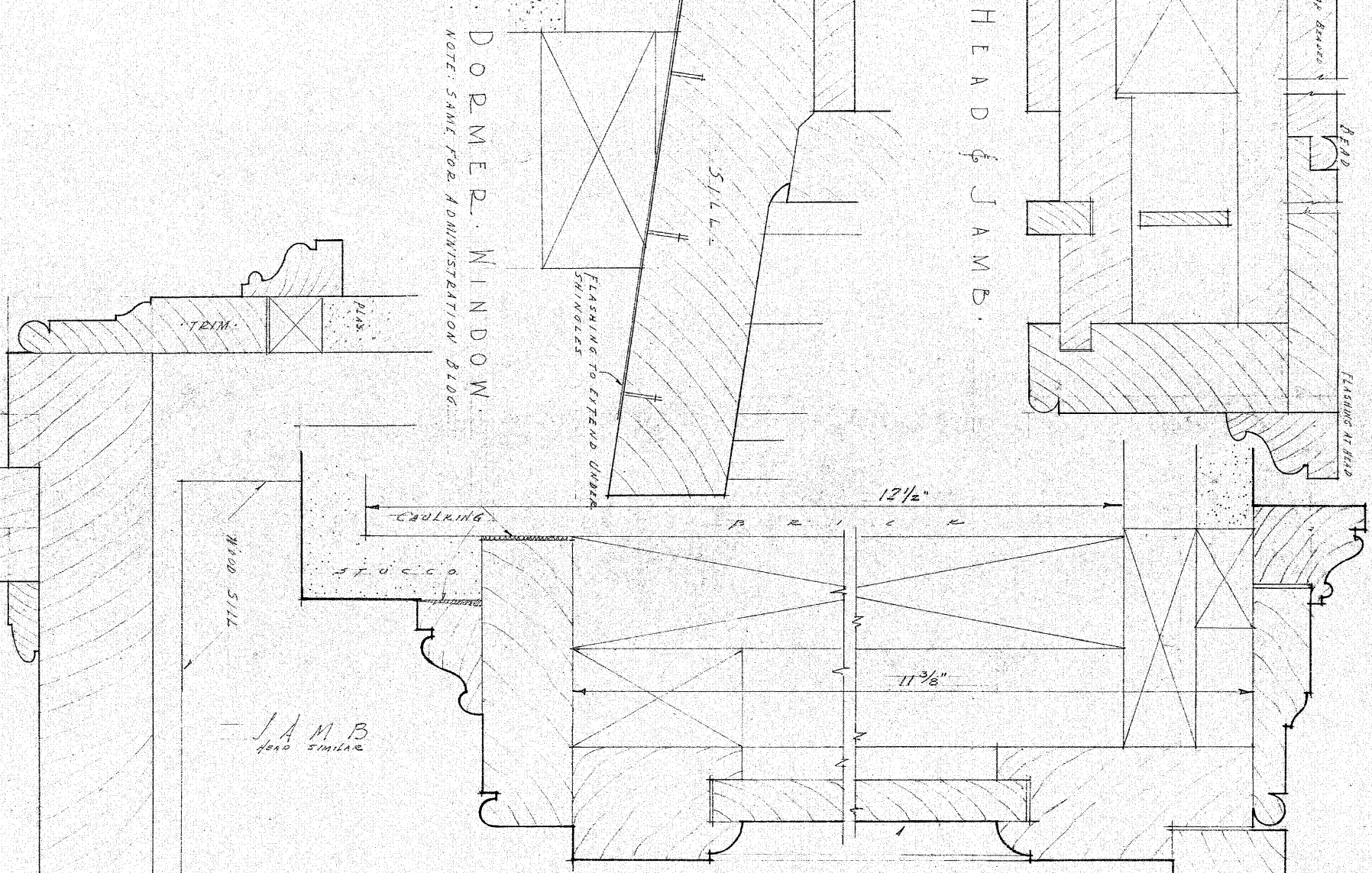

DORMER WINDOW.
NOTE: SAME FOR ADMINISTRATION BLDG.

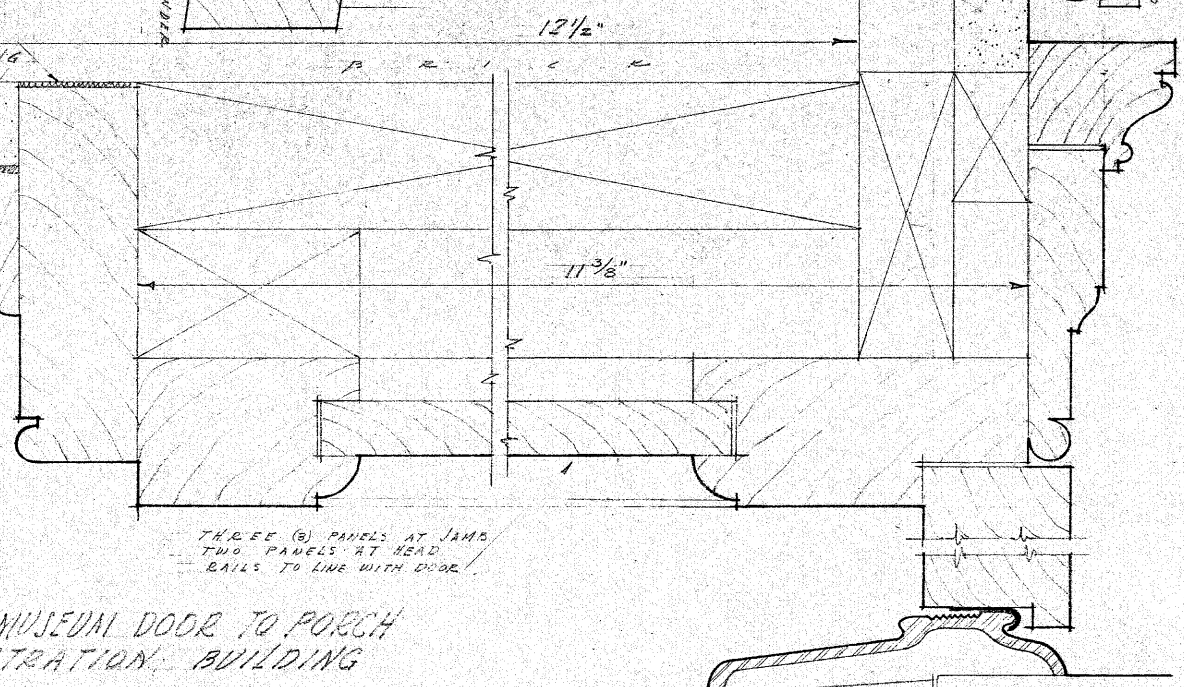

F.S. DETAIL OF MUSEUM DOOR TO PORCH
ADMINISTRATION BUILDING

F.S. DETAILS.

SEC. WINDOW (H) ADMIN. BLDG.

Dr. Ingers To Address C. B. 11/11/11	U.S. Department of the Interior National Park Service Supintendent's Residence National Park Service	Date Submitted Sheet 3 9/15/11 1001-A
Revised 1/22/11	U.S. Department of the Interior National Park Service Supintendent's Residence National Park Service	Drawn by 1001-A

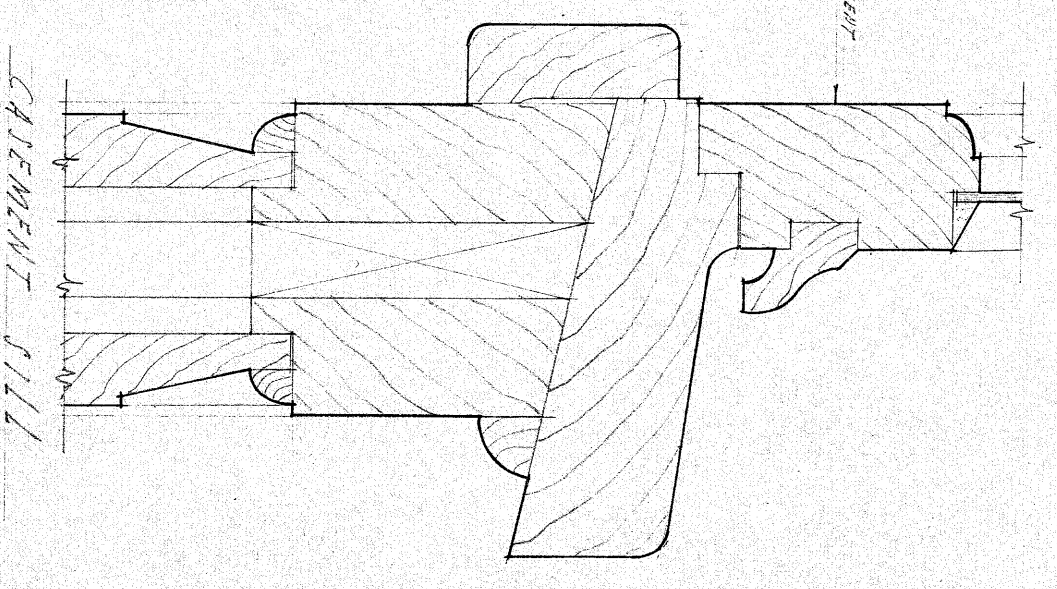
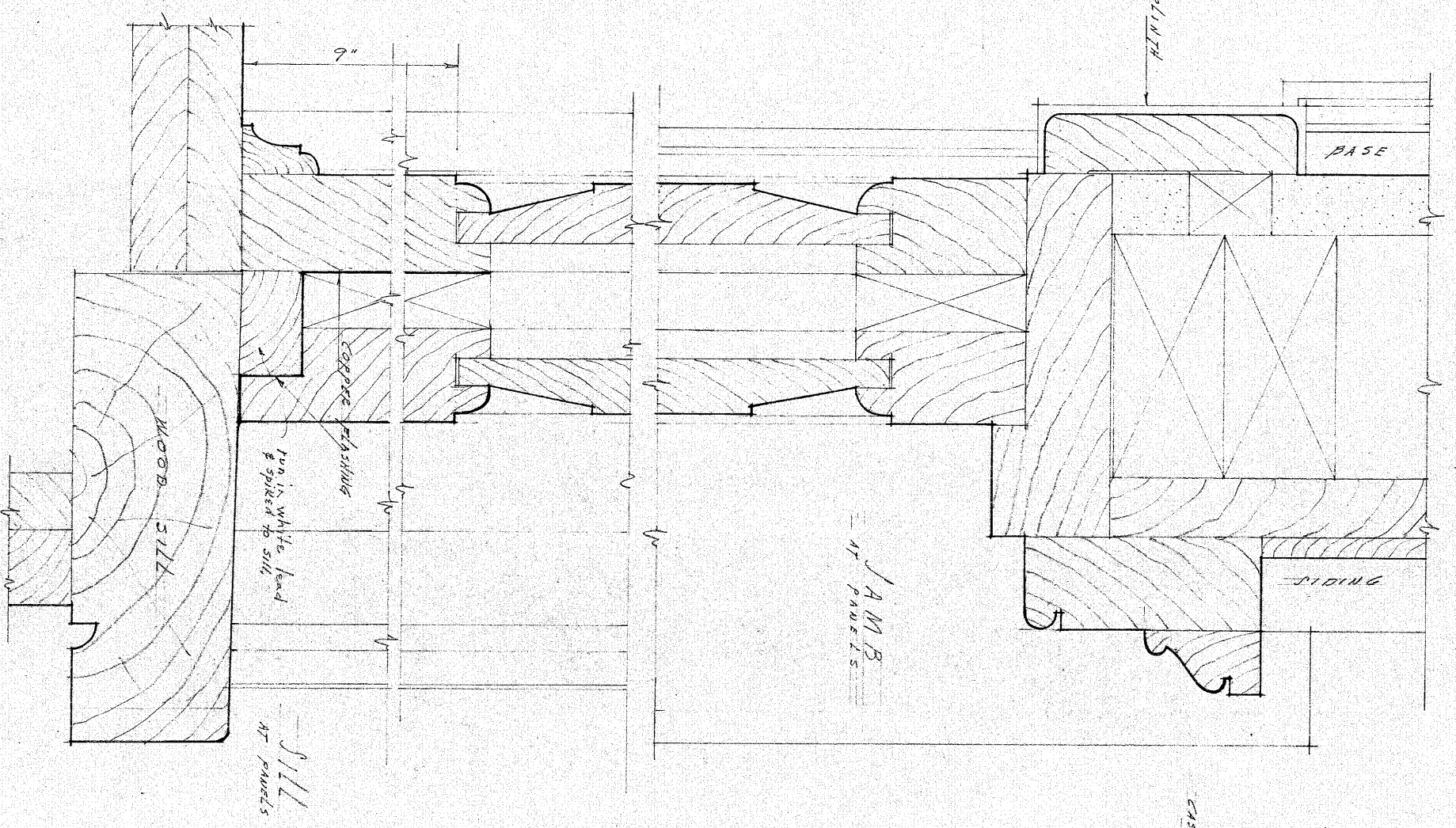
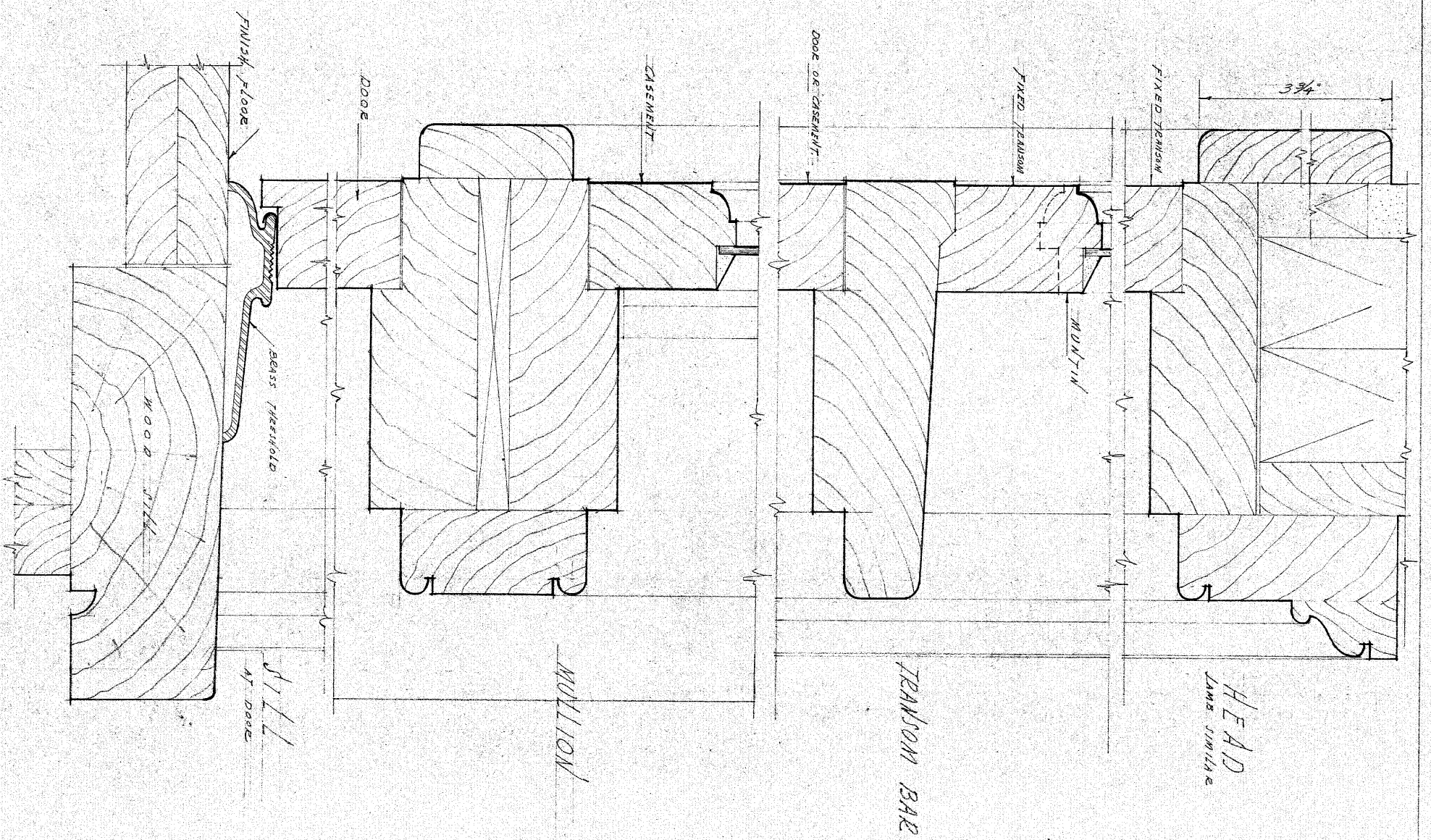

FULL SIZE DETAILS
OF
KITCHEN PORCH DOOR

DESIGNED BY G. W. BROWN	DATE 1937/11/24
DRAWN BY G. W. BROWN	SHEET 2 OF 3
PROJECT U.S. DEPARTMENT OF THE INTERIOR NATIONAL PARK SERVICE GUILDFORD COUNTRY HOUSE NATIONAL MILITARY PARK SUDBRIDGE, VERMONT RESIDENCE	APP. BY G. W. BROWN
224444 BY EXHIBIT DIVISION BUREAU OF PUBLIC WORKS 1937 - A	

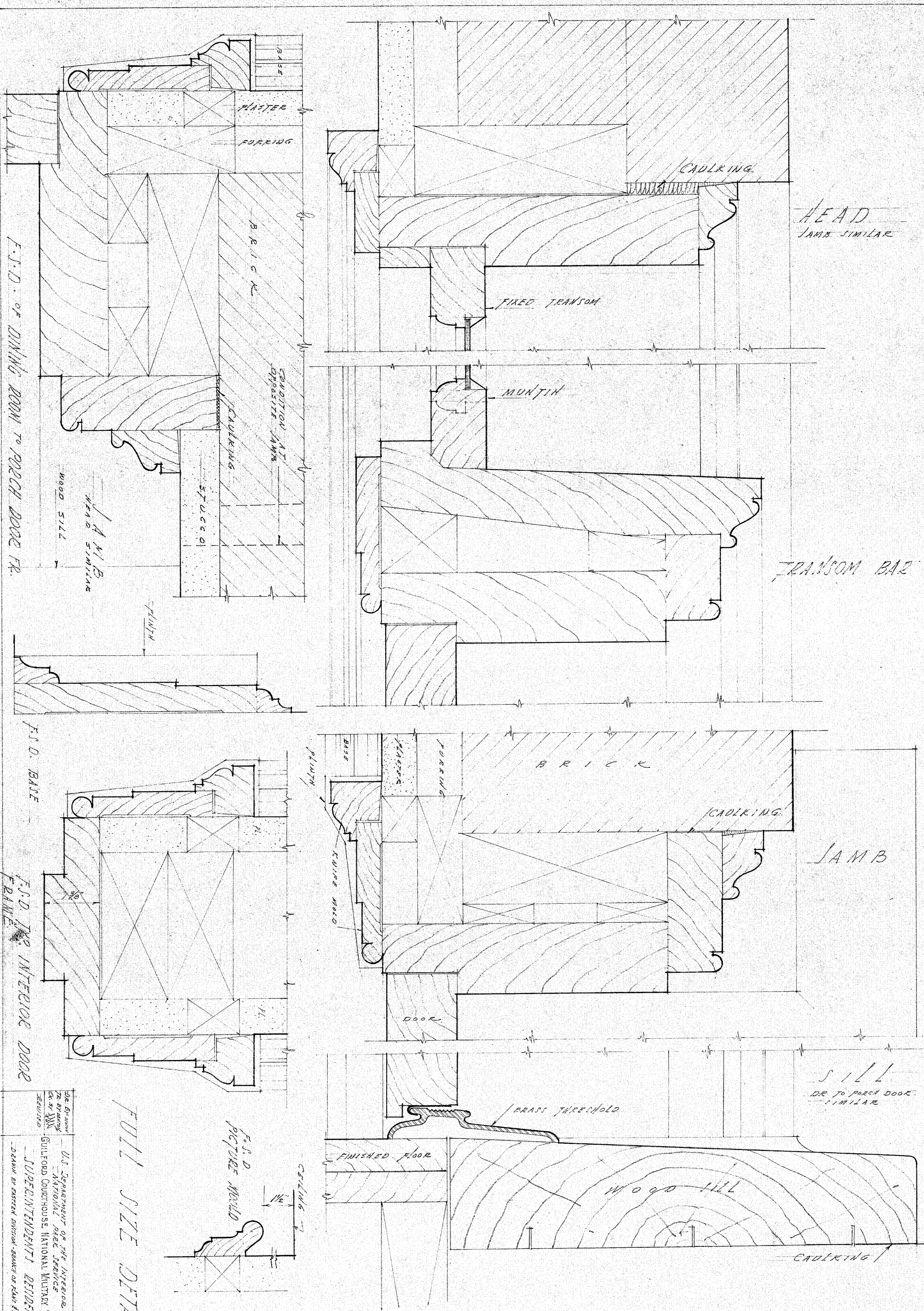

F.S.D. of DINING ROOM TO PORCH DOOR FR.

F.I.D. BASE

F.S.D. TR. INTERIOR DOOR FRAME

FULL SIZE DETAILS

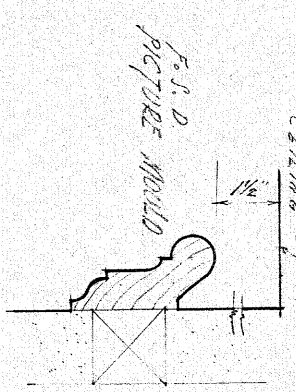

U.S. Department of the Interior NATIONAL PARK SERVICE GULFORD COURTHOUSE NATIONAL MILITARY PARK SUPERINTENDENT'S RESIDENCE DRAWN BY ESTERL DIVISION - BUREAU OF PLANS & SPECIFICATIONS 1001-A	DATE 1917/11/1917 SHEET 1
--	------------------------------------

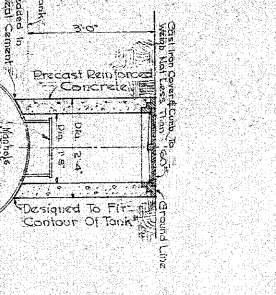
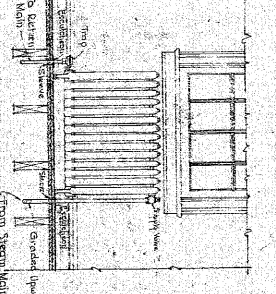
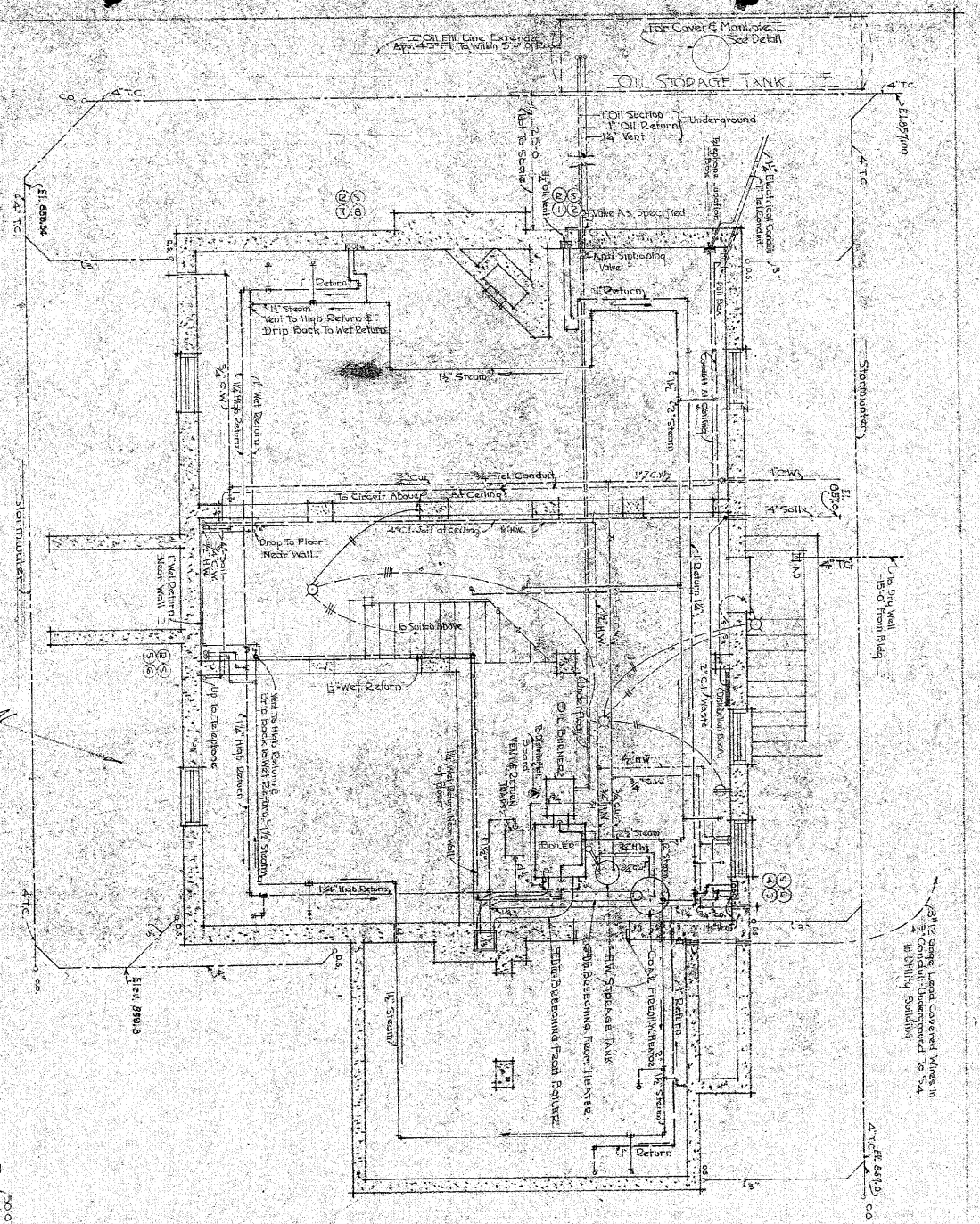

MECHANICAL SYMBOLS

Piping & Fittings	
Soil	—
Steam	—
Water	—
Gas	—
Hot Water	—
Chilled Water	—
Electrical	—
Lighting	
Track	—
Panel	—
Switch	—
Recessed	—
Surface	—
Emergency	—
Interior	—
Exterior	—

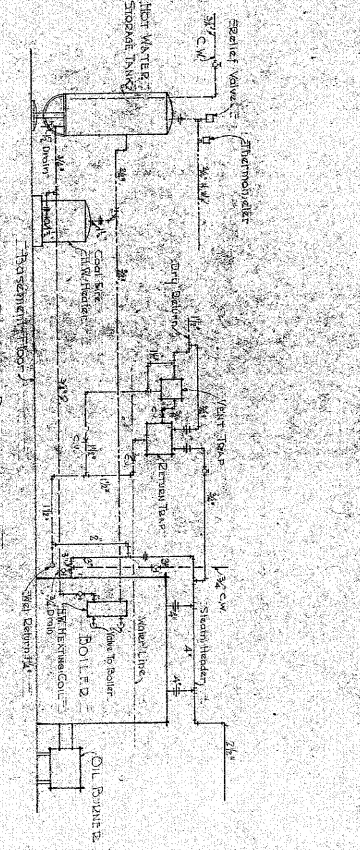

WINDOW CONNECTIONS

Window Size	Connection	Notes
1-20	Standard	
2-30	Standard	
3-00	Standard	
4-00	Standard	
5-00	Standard	
6-00	Standard	
7-00	Standard	
8-00	Standard	
9-00	Standard	
10-00	Standard	
12-00	Standard	
14-00	Standard	
16-00	Standard	
18-00	Standard	
20-00	Standard	
24-00	Standard	
30-00	Standard	
36-00	Standard	
42-00	Standard	
48-00	Standard	
54-00	Standard	
60-00	Standard	
72-00	Standard	
84-00	Standard	
96-00	Standard	
108-00	Standard	
120-00	Standard	

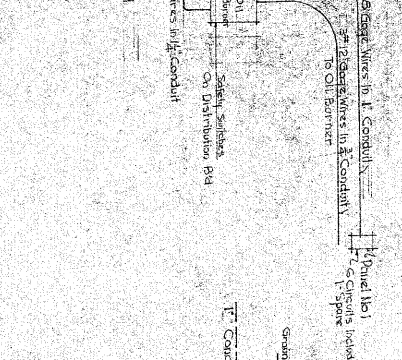
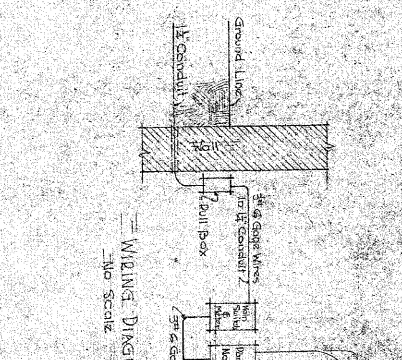
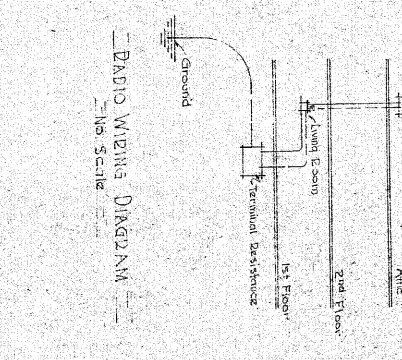
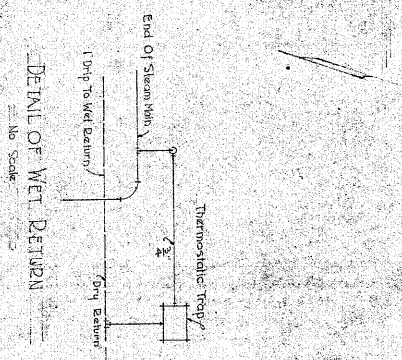
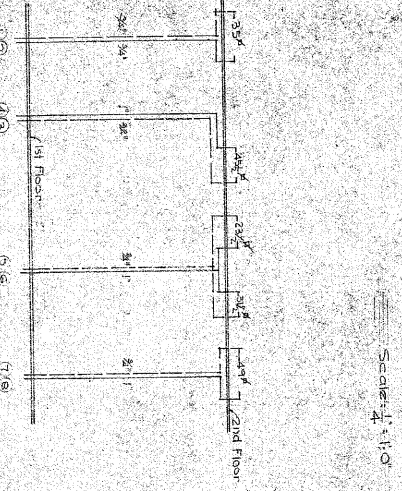

MECHANICAL DETAILS & PLAN

U.S. Department of the Interior
BUREAU OF MINES
GEOLOGICAL SURVEY
SUPPLEMENTARY DESIGN
DRAWN BY EASTERN DIVISION, BUREAU OF LANSING DESIGN

DATE: APRIL 2, 1934
DRAWN BY: [Name]
CHECKED BY: [Name]

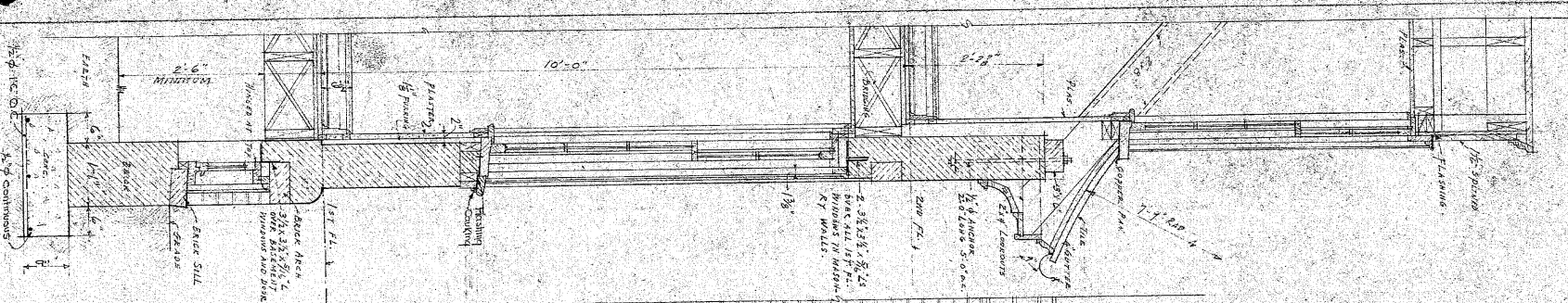

SECTION

DETAILS OF EXTERIOR WALL

ELEVATION

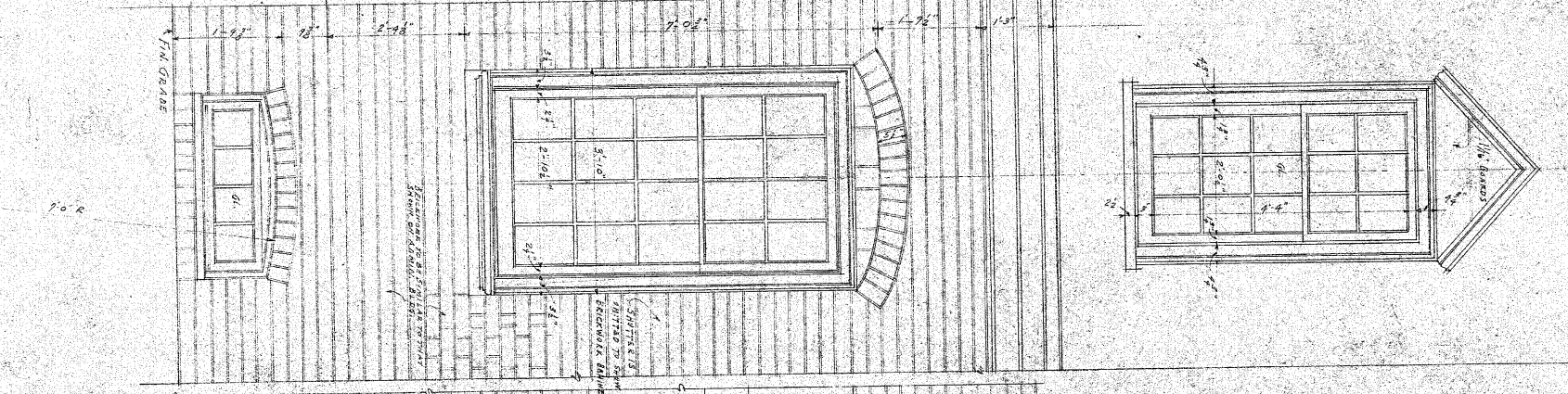

SECTION

DETAILS OF PORCH

ELEVATION

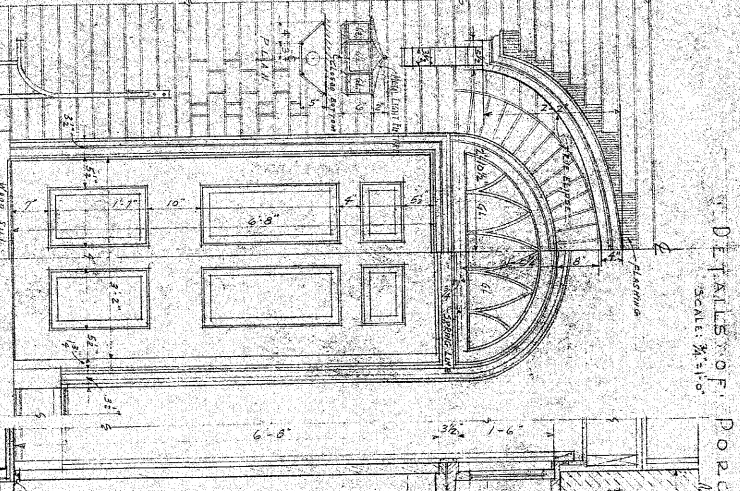

SECTION

DETAILS OF FRONT ENTRANCE

ELEVATION

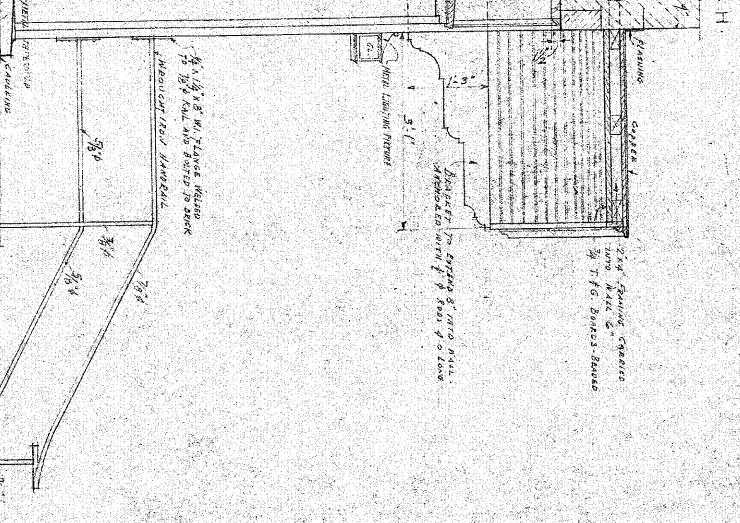

SECTION

DETAILS OF STAIRS

ELEVATION

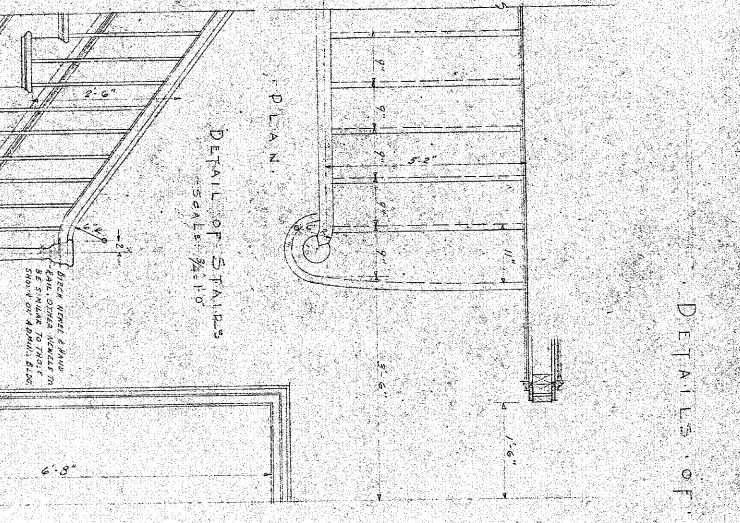

SECTION

DETAILS OF ENTRANCE TO ENCLOSED PORCH

ELEVATION

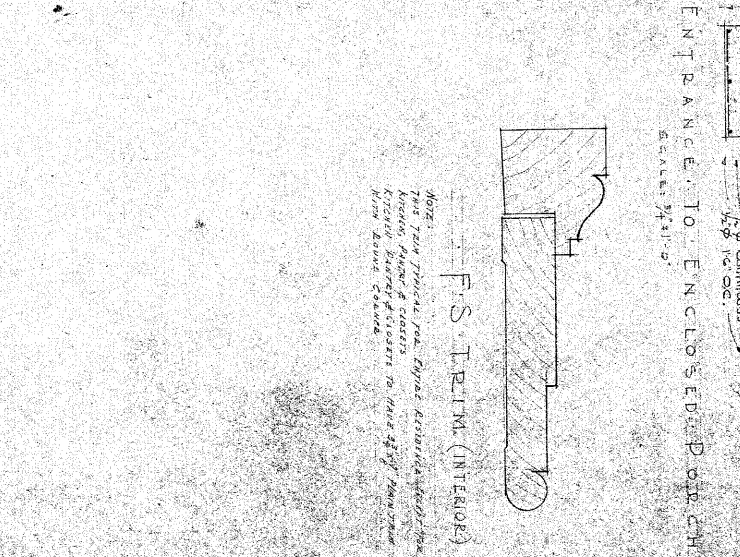

F.S. TRIM (INTERIOR)

Note: This trim profile was drawn according to the kitchen picture & is subject to the 3/4\"/>

U.S. DEPARTMENT OF THE INTERIOR
 NATIONAL PARK SERVICE
 GULFPORT COURTHOUSE NATIONAL HISTORIC PARK
 SUPERINTENDENT'S RESIDENCE
 DRAWN BY: [Name]
 DATE: [Date]

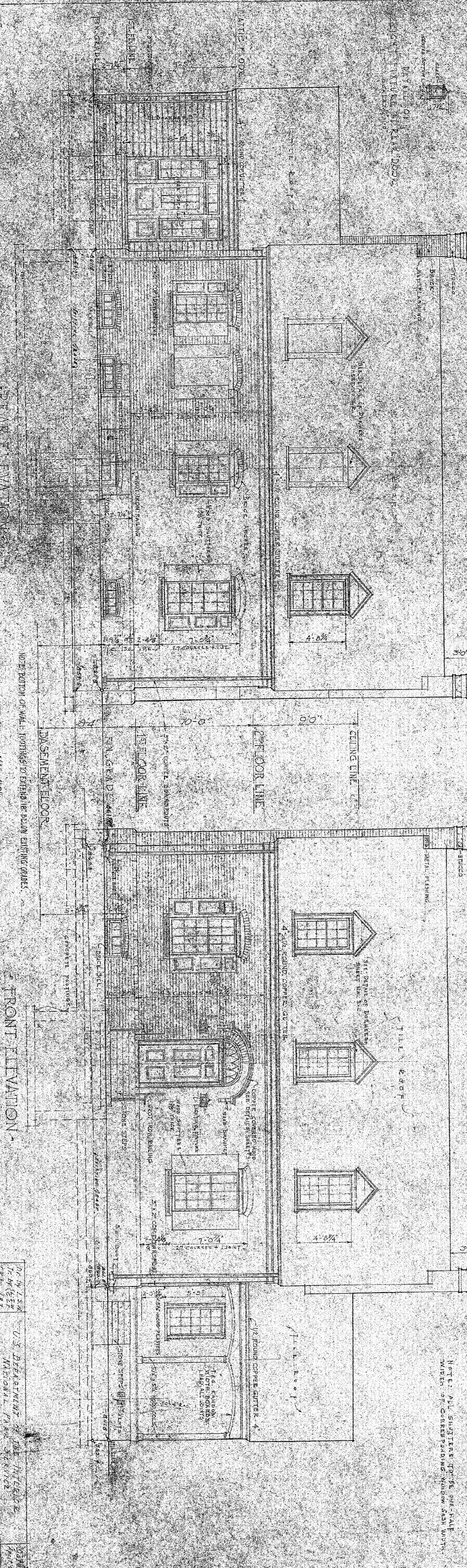
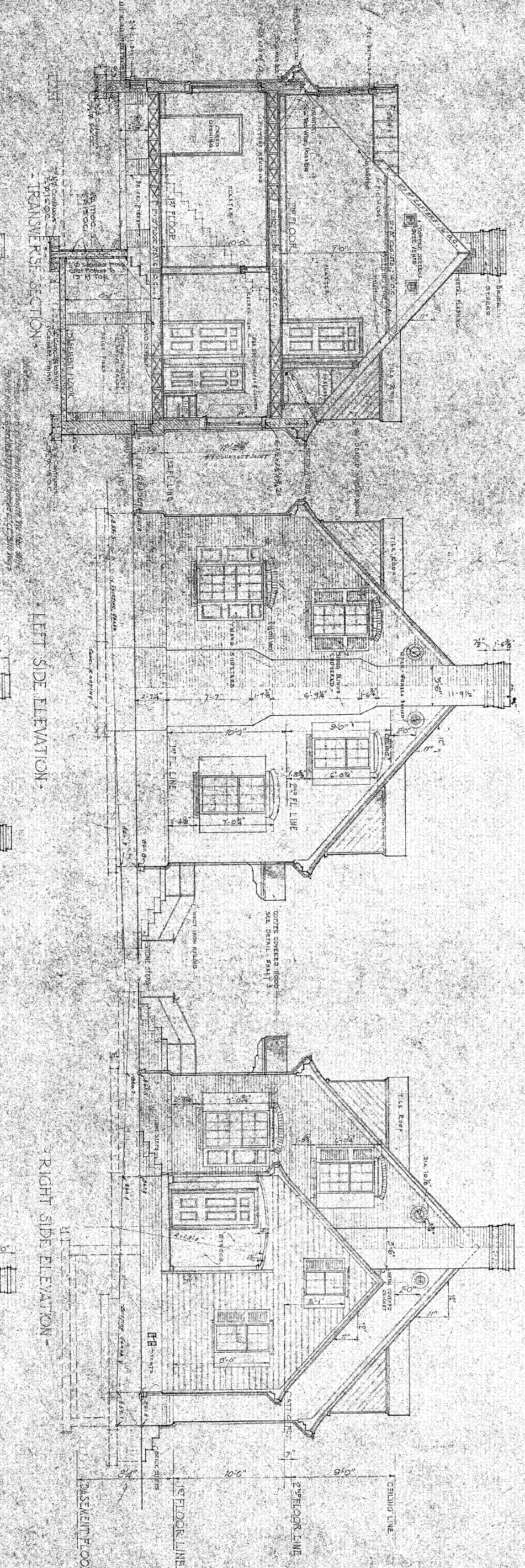

DATE OF
 1911

NOTE: PORTION OF WALL PORTIONS TO EXTEND TO BEAR ON EXISTING GRADE.

SCALE 1/4" = 1'-0"

DR. BY J. S. M.	U.S. DEPARTMENT OF THE INTERIOR
DESIGNED BY J. S. M.	NATIONAL PARK SERVICE
CONSTRUCTED BY J. S. M.	GUARD HOUSE NATIONAL MONUMENT, BALZ
NO. 3334	SUPERINTENDENT'S RESIDENCE
	NO. 3334

NOTE: ALL SHUTTERS TO BE ONE HALF WIDTH OF CORRESPONDING WINDOW WITH WHICH THEY ARE TO BE USED.

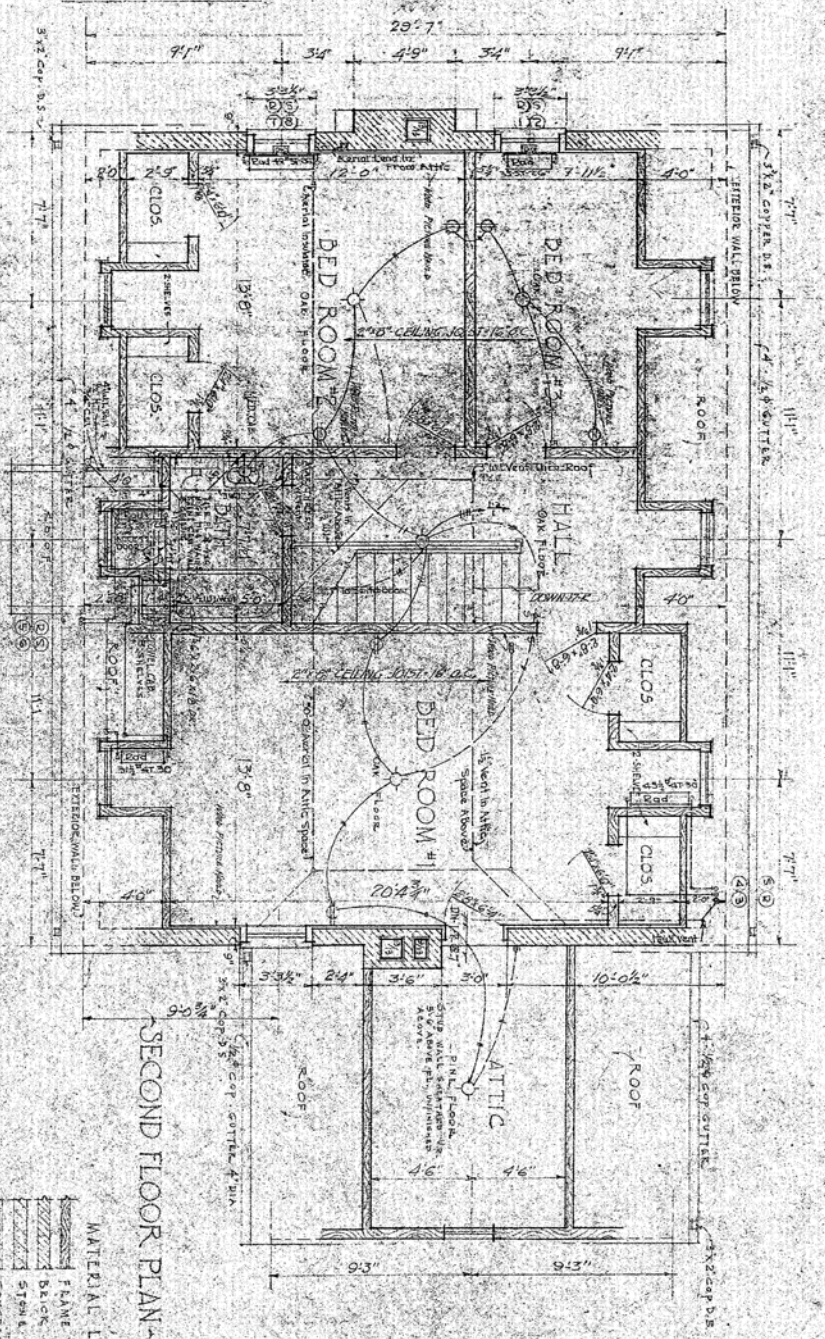
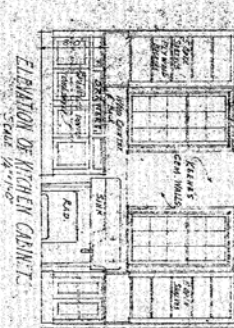
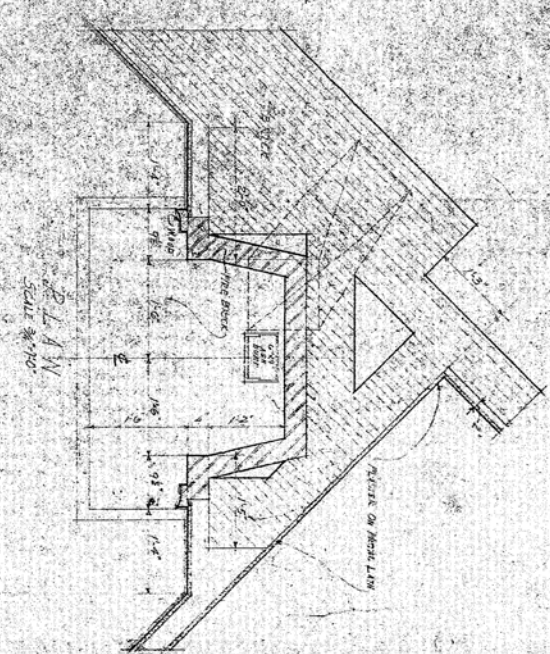
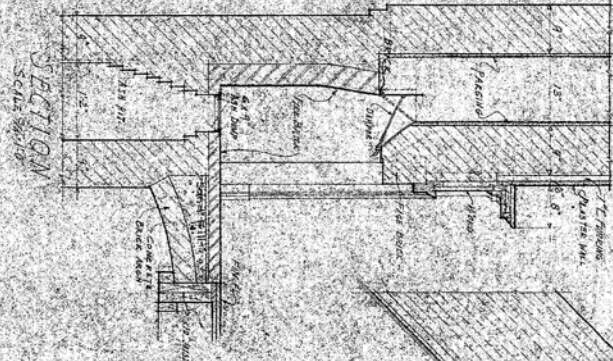
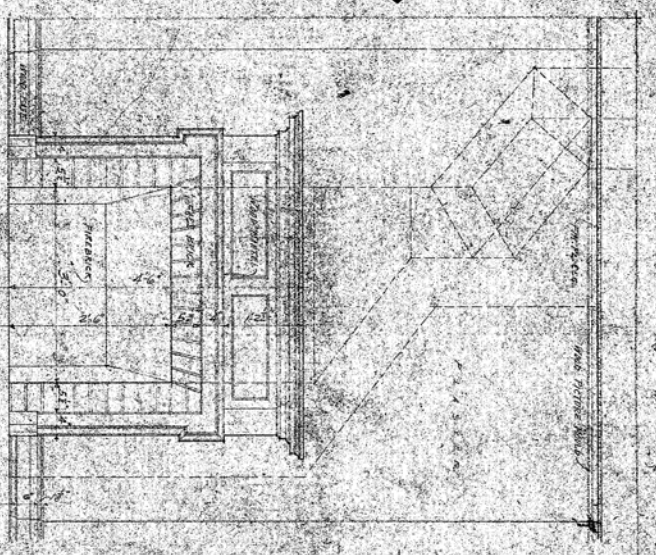

SECOND FLOOR PLAN

MATERIAL LEGEND
 FLAME WALLS
 BRICK
 STONE
 CONCRETE

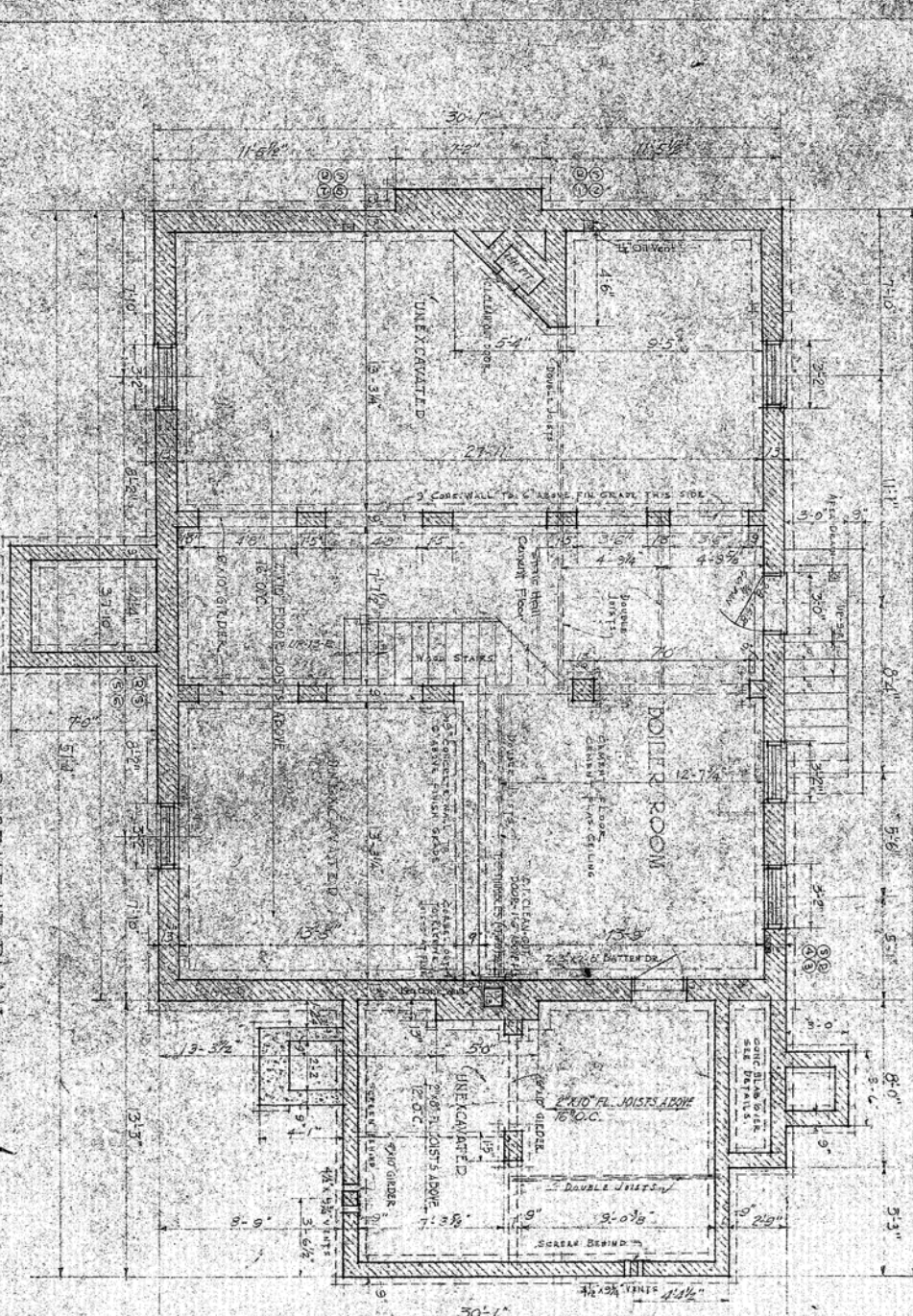

BASEMENT PLAN

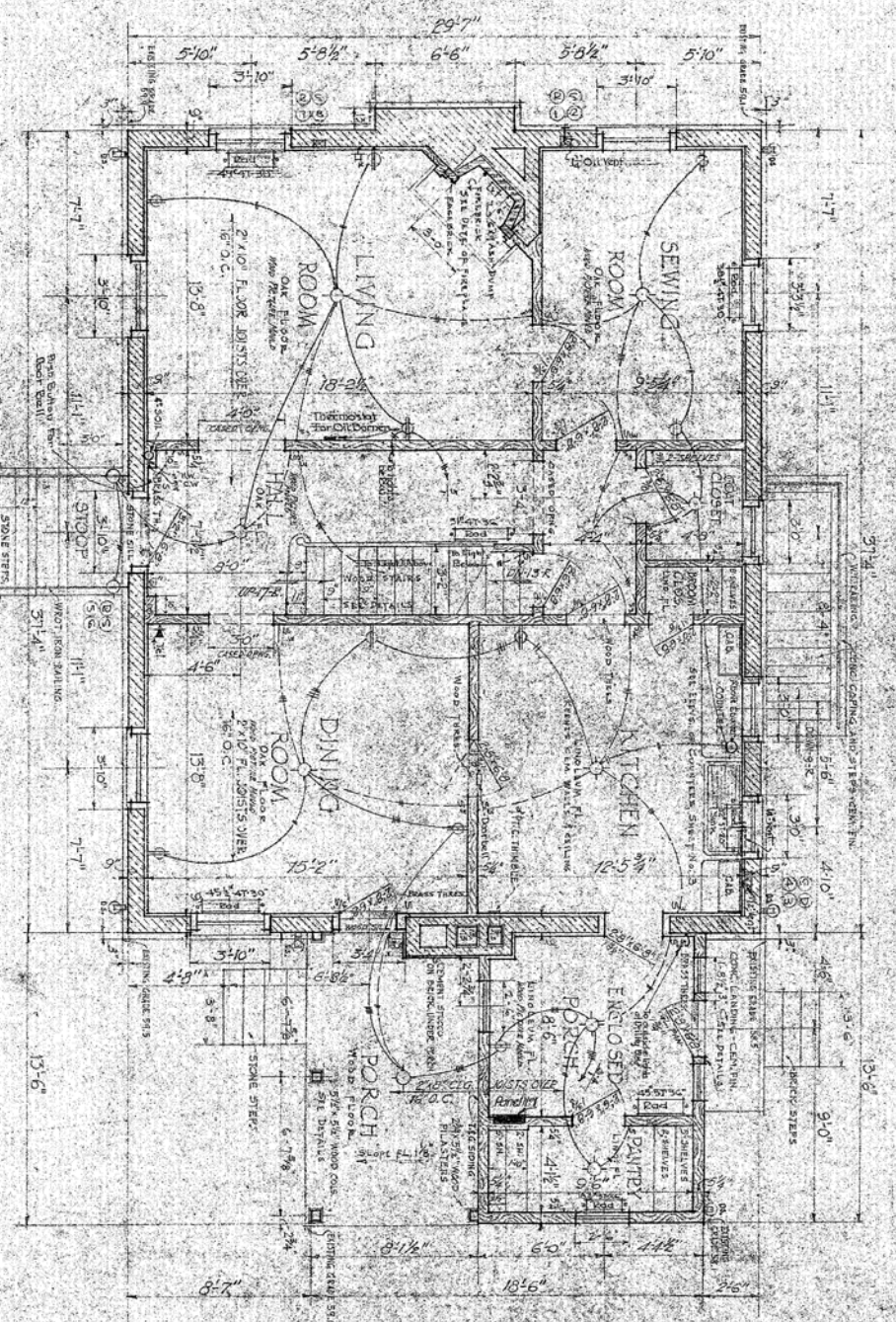

FIRST FLOOR PLAN

U.S. DEPARTMENT OF THE INTERIOR
 NATIONAL PARK SERVICE
 GULFPORT COBBLEHOUSE NATIONAL MONUMENT PARK
 SUPERINTENDENT'S RESIDENCE
 DRAWN BY EASTERN DIVISION OFFICE OF PLANS & DESIGN

DATE: 5/11/54
 DRAWN BY: [Signature]
 CHECKED BY: [Signature]
 APPROVED BY: [Signature]

U.S. DEPARTMENT OF THE INTERIOR
 NATIONAL PARK SERVICE
 BRANCH OF PLANS AND DESIGN

PLANIMETRIC PLAN - SUPERINTENDENT'S RESIDENCE AREA
 GUNFORD COURTHOUSE NATIONAL MILITARY PARK

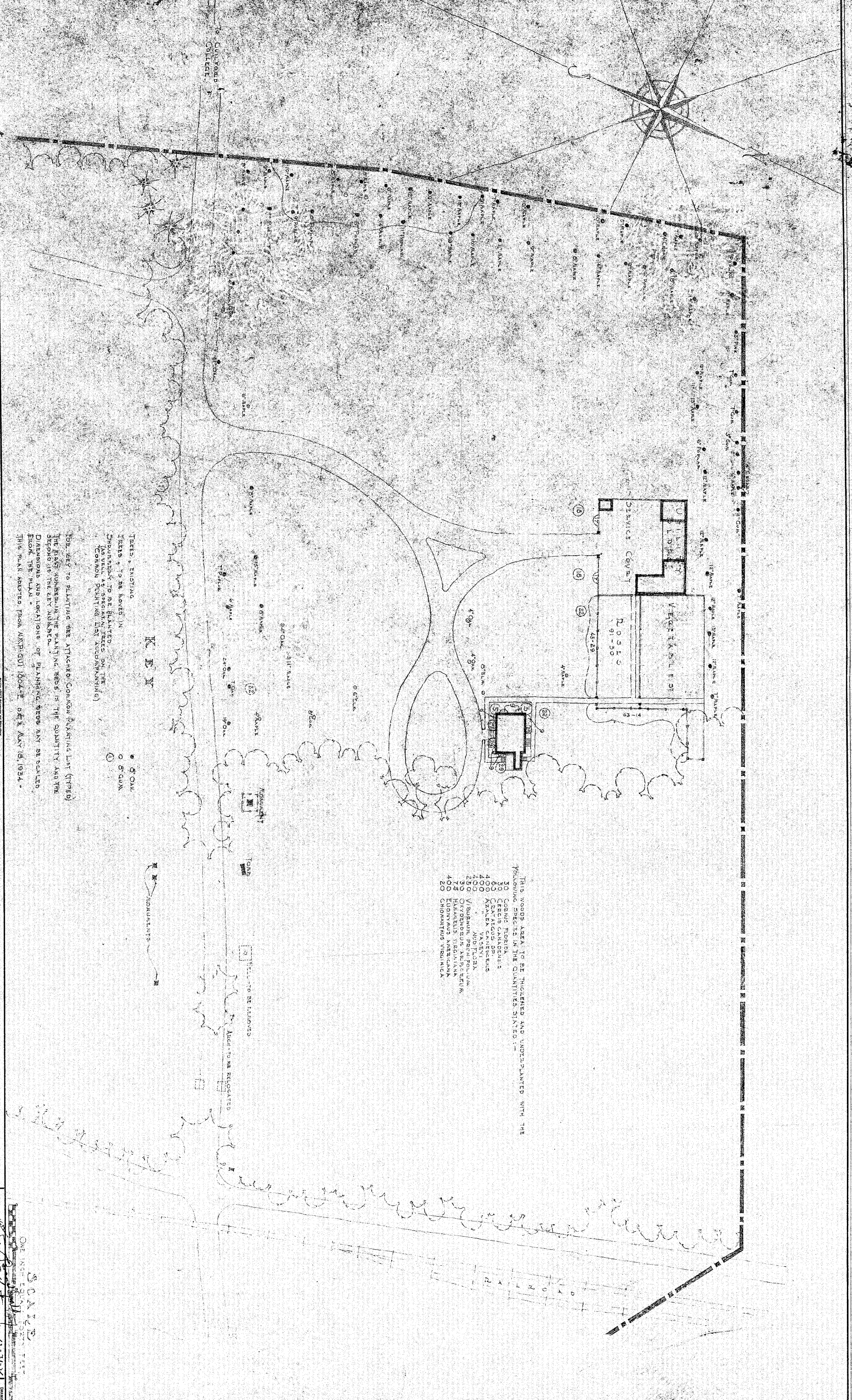

THIS WOODS AREA TO BE THINNED AND UNDERPLANTED WITH THE FOLLOWING SPECIES IN THE QUANTITIES LISTED:

- 30 COENUS FLORIDA
- 30 CERCIS CANADENSIS
- 400 AZALEA CANADENSIS
- 400 VASEYI
- 250 YUCCA
- 250 LIRIODENDRON SPECIOSUM
- 75 HAMAMELIS VIRGINIANA
- 400 EUCONYMUS AMERICANUS
- 20 CORYMPHOS VIRGINICA

TAKES, EXISTING
 TAKES TO BE MOVED IN
 SHADINGS TO BE PLANTED
 SPECIES AS SET FORTH ON THE
 COMMON PLANTING LIST ACCOMPANYING

FOR KEY TO PLANTING SEE ATTACHED COMMON PLANTING LIST (SEE PAGE 2)
 THE FIRST NUMBER IN THE PLANTING KEY IS THE QUANTITY AND THE
 SECOND IS THE KEY NUMBER.

DIMENSIONS AND LOCATIONS OF PLANTING REEFS MAY BE LOCATED
 FROM THE PLAN.

THIS PLAN ADAPTED FROM NADPCWD 1604-E OF 12 MAY 1954.

ONE INCH EQUAL TO 10 FEET

SCALE

DATE: 12-31-54
 DRAWN BY: J. H. [Signature]
 CHECKED BY: [Signature]
 APPROVED BY: [Signature]
 SUPERVISOR: [Signature]

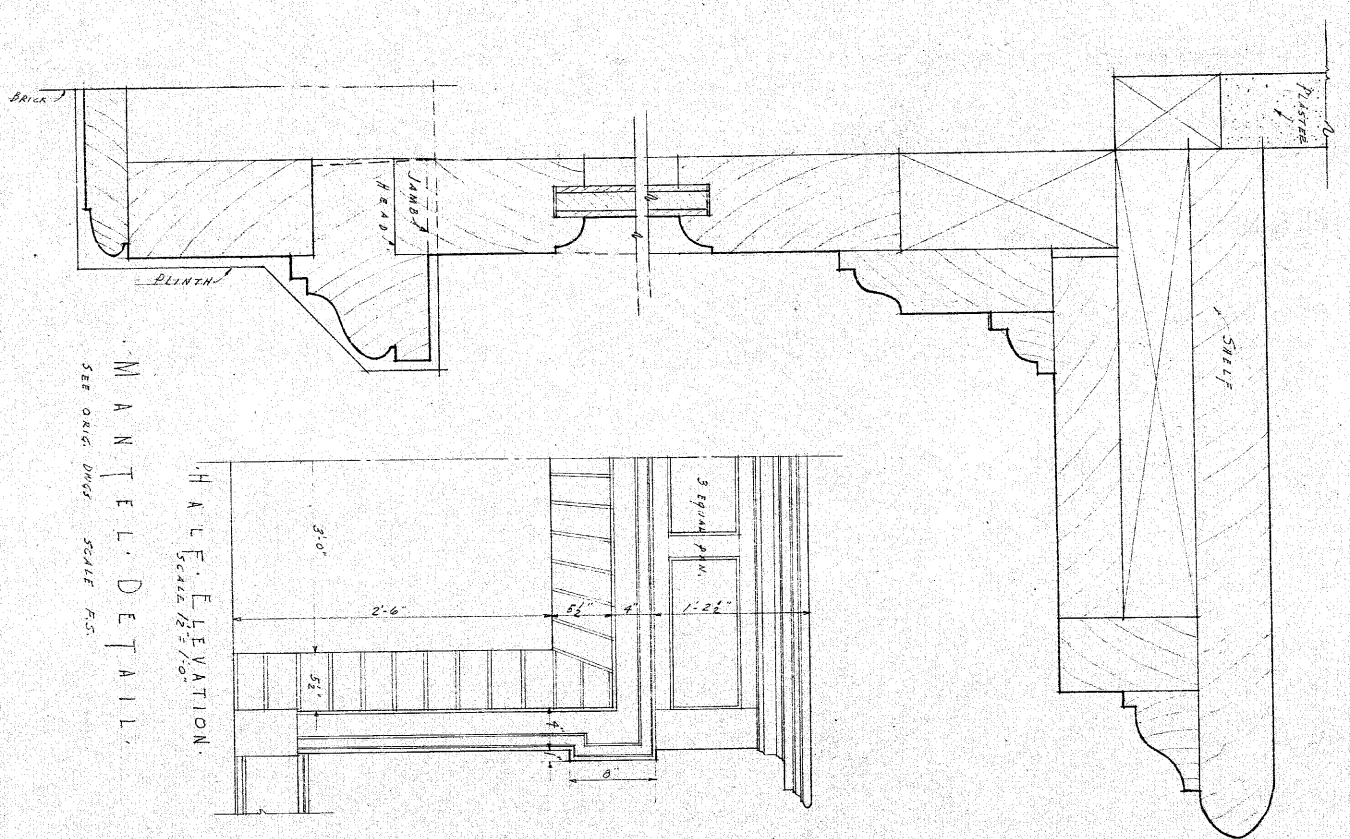

MANTLE DETAIL.
SEE ORIG. DWGS. SCALE F.S.

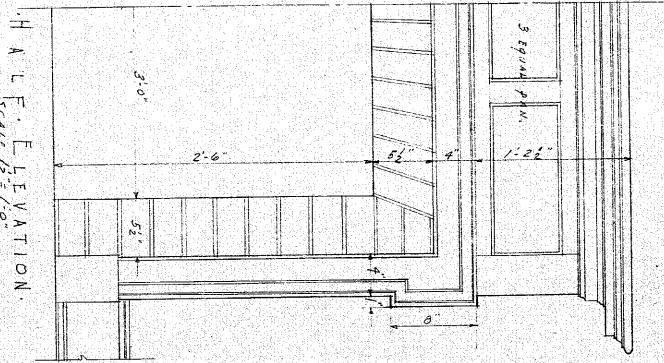

HALF ELEVATION.
SCALE 1/2" = 1'-0"

SECTION THRU CABINET IN KITCHEN.
SEE ORIG. DRAWINGS. SCALE 1/2" = 1'-0"

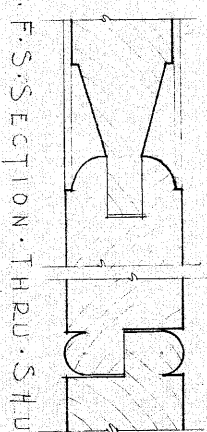
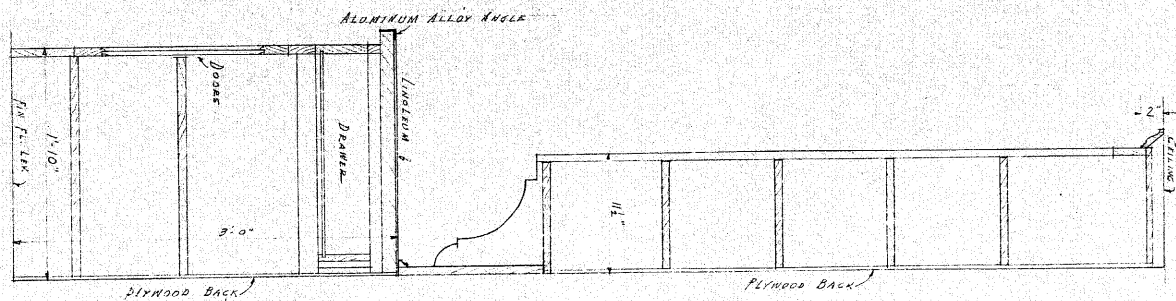

F.S. SECTION THRU SHUTTER.

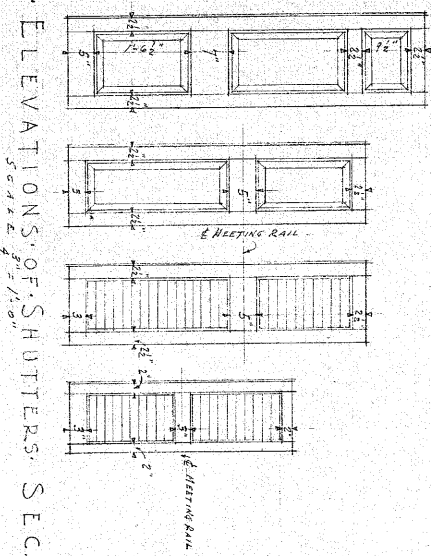

ELEVATIONS OF SHUTTERS. SEC. THRU STAIR TREAD
SCALE F.S.

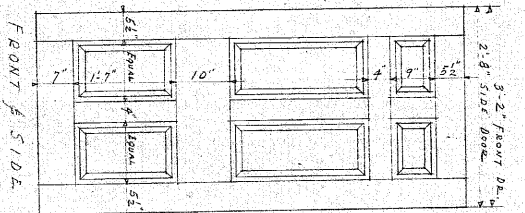
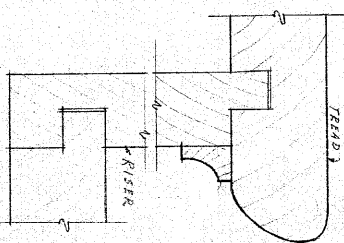

FRONT SIDE

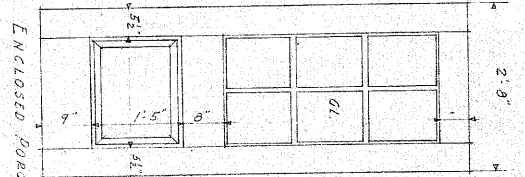

ENCLOSED PORCH

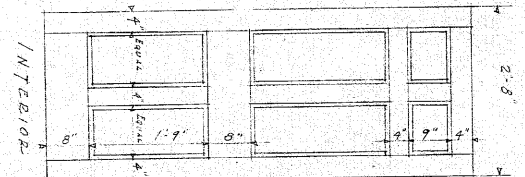

INTERIOR

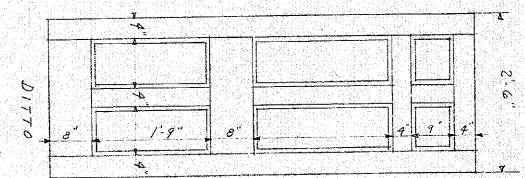

DITTO

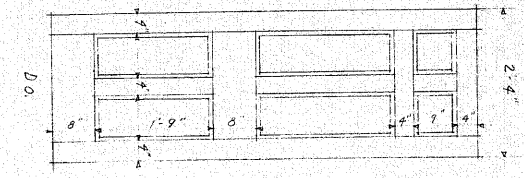

DO.

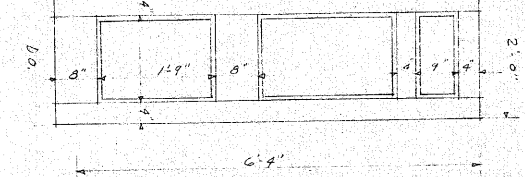

DO.

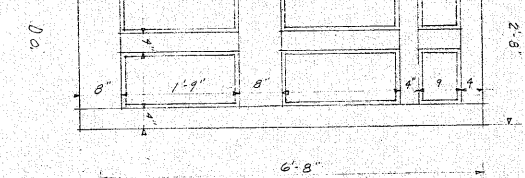

DO.

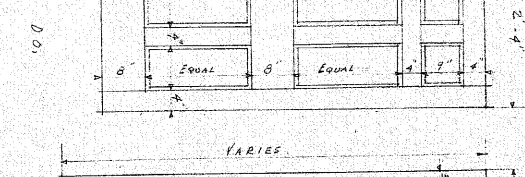

DO.

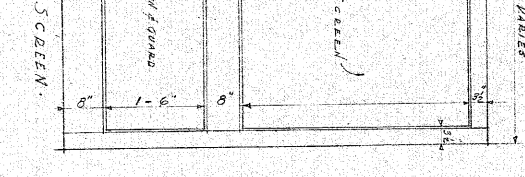

SCREEN.

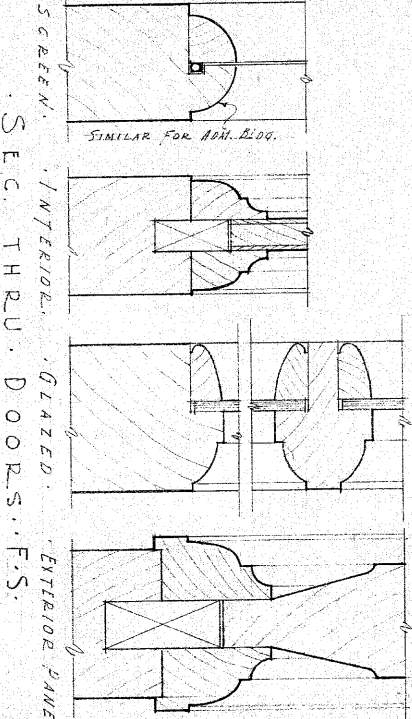

SEC. THRU DOORS. F.S.

U.S. DEPARTMENT OF THE INTERIOR
NATIONAL PARK SERVICE
GULFORD COURTHOUSE NATIONAL MILITARY PARK
SUPERINTENDENT'S RESIDENCE.
DRAWN BY EASTMAN DIVISION, BRANCH OF PLANNING DESIGN

Dr by DEE
Tr by DEE
R by DEE
Revised

Date
Sept 28, 34
Sheet 8
1095 sheets
1091-4

APPENDIX B

1934: Original Specifications

1-23
(by 1929)
6-7410

UNITED STATES
DEPARTMENT OF THE INTERIOR
NATIONAL PARK SERVICE
Guilford NATIONAL PARK

FILE NO. 403

Contracts

Contract I-LP-1858

George W.
Kane

Contractor

IMPORTANT

This file constitutes a part of the official records of the National Park Service and should not be separated or papers withdrawn without express authority of the official in charge.
All Files should be returned promptly to the File Room.
Officials and employees will be held responsible for failure to observe these rules, which are necessary to protect the integrity of the official records.

ARNO B. CAMMERER,
Director.

Guilford 1734b

INDEX

SECTION I. GENERAL PROVISIONS.

1. Public Works Project.
2. Bids and Bid Bonds.
3. Contract and Bonds.
4. Definition of Terms.
5. Bidders to Visit Site.
6. Reputation of Bidders.
7. Subcontractors.
8. Supervision and Inspection.
9. Spirit and Intent of Specifications.
10. Minor Modifications.
11. Errors and Omissions.
12. Extra Work.
13. Materials and Workmanship.
14. Use of Non-Domestic Materials.
15. Ownership.
16. Contractor to be Present or Represented.
17. Responsibility for Employees, and Plant.
18. Traffic Provisions.
19. Report of Men and Materials.
20. Protests.
21. Patents.
22. Approval of Contract.

SECTION II. WORK, CHANGES, DRAWINGS, ETC.

23. Work to be Done.
24. Photographs.
25. Temporary Buildings at Site.
26. Use of Space
27. Federal Specifications.
28. Contract Drawings.
29. Detailed Working Drawings.
30. Final Drawings.
31. Materials and Samples.
32. Samples to be Furnished.
33. Restoration.
34. Watchmen.

35. Lines, Grades and Positions.
36. Protection of Workmen.
37. Light, Heat and Water.
38. Guaranty of Work and Materials.

SECTION III. TIME AND PAYMENTS.

39. Commencement, Prosecution and Completion.
40. Liquidated Damages.
41. Payments.
42. Program of Construction Work.

SECTION IV. EXCAVATION AND DRAINAGE.

43. Scope of Work.
44. Excavation for Building.
45. Omitted.
46. Disposal of Excavated Materials.
47. Protection of Trees.
48. Trenches for Footings.
49. Excavating for Oil Storage Tanks and Pipe Work.
50. Pipe Trenches.
51. Dry Well.
52. Pumping.
53. Backfilling and Grading.

SECTION V. CONCRETE WORK.

54. Scope of Work.
55. Cement.
56. Sand.
57. Coarse Aggregate.
58. Water.
59. Forms.
60. Pointing and Patching.
61. Preparing and Placing Reinforcement.
62. Proportions of Concrete.
63. Measurements of Concrete Ingredients.

Co.
D

SECTION XXIV. ELECTRICAL WORK.

- 264. Scope of Work.
- 265. Workmanship.
- 266. Tests and Guaranty.
- 267. Type of Current.
- 268. Entrance of Services.
- 269. Excavation and Backfilling.
- 270. Distribution Boards.
- 271. Safety Switches.
- 272. Meters.
- 273. Radio Distribution System.
- 274. Door Bell, Transformer, Etc.
- 275. Conduit.
- 276. Pull Boxes.
- 277. Outlet and Junction Boxes.
- 278. Lighting Panels and Boxes
- 279. Wires.
- 280. Telephone Outlets.
- 281. Radio Outlets.
- 282. Local Switches.
- 283. Flush Receptacles.
- 284. Fan Outlets and Receptacles.
- 285. Finish Plates.
- 286. Lighting Fixtures.

SECTION XXV. ALTERNATIVE BIDS.

- 287. Alternative Bid "A"
- 288. Alternative Bid "B"
- 289. Alternative Bid "C"
- 290. Alternative Bid "D"
- 291. Alternative Bid "E"

Desk

3/1/34

DEPARTMENT OF THE INTERIOR
NATIONAL PARK SERVICE
Washington, D. C.

June 2, 1934.

Specifications for
The Construction of the Administration Building
Superintendent's Residence
Utility Building
Inflammable Storage Building
The fence enclosing the yard at the Utility Building
at
Guilford Court House National Military Park,
Greensboro, North Carolina

Public Works Administration Federal Projects Nos. 442, 443, and 444.

Contract No. I-1P-1858.

61401734b

UNITED STATES GOVERNMENT COMBINED FORM
(Federal Emergency Administration of Public Works Project)

DEPARTMENT OF THE INTERIOR

NATIONAL PARK SERVICE

(Department or Establishment)
Guilford Courthouse Nat'l Military Park,
P.O. Box 30, Greensboro, North Carolina

(Office)

June 2, 1934.

(Address)

(Date)

INVITATION

Sealed bids, in duplicate, on the attached schedule of supplies, services, buildings, or work, subject to the applicable conditions of Government Form No. P.W.A. 51 and the specifications covering the project, will be received at this office until 3 o'clock P. M., June 29, 1934 and then publicly opened in the Museum Bldg., at Guilford Courthouse Nat'l Military Park.

Bid security in the sum of 20% of amount bid will be required.

Oliver G. Taylor, Chief,

Eastern Division, Branch of Engineering.
(Title)

BID

(Date)

In compliance with the above invitation for bids, and subject to all the conditions thereof, the undersigned offers and agrees, if this bid be accepted within 60 days (if a different period be not specified) from the date of the opening, to furnish the supplies, services, buildings, or work, as the case may be, upon which prices are quoted, at the price set opposite each item, within the time stipulated on the attached schedule.

Discount will be allowed as follows:

George W. Loue

(Bidder)

Greensboro N.C.

(Address)

By _____ (Title)

(Member of firm or person authorized to sign bids for corporation.)

ACCEPTANCE

(Not required to be executed when U.S. Government Form No. P.W.A. 51 is to be executed)

(Date)

The above bid is accepted as to items numbered _____

In the event execution of U. S. Government Form No. P.W.A. 51 is waived, the applicable provisions thereof shall nevertheless apply to this project.

(Name)

(Title)

SCHEDULE FORM A

Sheet 1 of 3.

(Federal Emergency Administration of Public Works Project)
(Construction or Repair Project)

The Contractor shall furnish all labor, equipment and materials and perform all work required for the erection and completion of the Administration Building, Superintendent's Residence, Utility Building and Inflammable Storage Building, at Guilford Court House National Military Park, Greensboro, North Carolina, for the consideration of the following lump sum (See Paragraph 23) and Alternative Bids:

LUMP SUM BID:

Fifty three thousand nine hundred forty three DOLLARS(\$ 53,943⁰⁰)
(Amount in Words) (Figures)

ALTERNATIVE BID "A" (SUBSTITUTION OF METAL LATH AND PLASTER, PICTURE MOULDING, AND WOOD CASED SQUARE HEAD OPENINGS FOR SPECIAL TRIM, ARCHES, CORNICES, AND WOOD PANELS). - If the work is executed in accordance with the provisions of Paragraph 287, ADD to or DEDUCT from the Main (lump sum) bid:

DEDUCT DOLLARS(\$ 609⁰⁰)
(State which)

ALTERNATIVE BID "B" (SUBSTITUTION OF SLATE FOR TILE ON THE ROOF OF THE SUPERINTENDENT'S RESIDENCE). - If the work is executed in accordance with the provisions of Paragraph 288, DEDUCT from the Main (lump sum) bid:

DEDUCT DOLLARS(\$ 110⁰⁰)

ALTERNATIVE BID "C" (SUBSTITUTION OF SLATE FOR TILE ON THE ROOFS OF THE UTILITY BUILDING AND THE INFLAMMABLE STORAGE BUILDING). - If the work is executed in accordance with the provisions of Paragraph 289, DEDUCT from the Main (lump sum) bid:

DEDUCT DOLLARS(\$ 185⁰⁰)

SCHEDULE FORM A

Sheet 2 of 3.

ALTERNATIVE BID "D" (SUBSTITUTION OF COAL FIRED BOILERS FOR OIL BURNING BOILERS AND OIL BURNING EQUIPMENT). - If the work is executed in accordance with the provisions of Paragraph 290, DEDUCT from the main (lump sum) bid:

DEDUCT DOLLARS(\$ 1700⁰⁰)

ALTERNATIVE BID "E" (OMISSION OF UTILITY BUILDING, IN-FLAMMABLE STORAGE BUILDING AND FENCE ENCLOSING YARD AT UTILITY BUILDING). - If the work is executed in accordance with the provisions of Paragraph 291, DEDUCT from the main (lump sum) bid:

DEDUCT DOLLARS(\$ 9568⁰⁰)

in strict accordance with the specifications, drawings, and schedules, all of which are made a part hereof.

The work shall be commenced and completed in accordance with Paragraph 39.

Performance bond shall be furnished as per Paragraph 3 of the specifications.

Liquidated damages will be assessed as per Paragraph 40 of the specifications.

Partial payments will be made as per Paragraph 41 of the specifications.

SCHEDULE FORM A
(Last Sheet)

In conformity with the provisions of Section 54 of Federal Emergency Administration of Public Works Bulletin No. 51, the following minimum wage rates are applicable to the work of this contract:

Skilled Labor	<i>One and</i> $\frac{10}{100}$	Dollars (\$ <i>1</i> $\frac{10}{100}$)	per hour.
Unskilled Labor	<i>No and</i> $\frac{45}{100}$	Dollars (\$ <i>0</i> $\frac{45}{100}$)	per hour.
	(Amount in Words)	(Figures)	

Also, in conformity with the provisions of Paragraph 6 of the specifications, the following list of works which the bidder has executed similar in character and magnitude to that covered by this contract is submitted:

LIST OF WORKS

Structure	City	Total Cost
-----------	------	------------

The bidder is:
a corporation organized and existing under the laws of
the State of ;
a partnership consisting of ;
or an individual trading as *George W. Kave* ;
of the city of *Durham N.C.* ;
(Cross out wording which does not apply)

CERTIFICATE OF COMPLIANCE WITH NRA IN CONNECTION WITH P.W.A. PROJECTS

To be signed and submitted by all contractors and sub-
contractors in lieu of U. S. Government
Form No. P.W.A. 61

The following certificate form shall be signed and submitted by all bidders with all bids involving expenditure of Government funds (whether Federal or non-Federal), in accordance with Executive Order No. 6646, dated March 14, 1934. Only bids accompanied by such certificate shall be considered or accepted. Bidders shall also require subcontractors (including suppliers) to sign similar certificates before making awards to or purchases from such subcontractors. Such certificates may be accepted as evidence that the contractor is complying with the applicable approved code or codes of fair competition adopted under Title I of the National Industrial Recovery Act for the trade or industry or subdivision thereof involved, or, if there be no such approved code of fair competition, with the President's Reemployment Agreement.

CERTIFICATE OF COMPLIANCE

It is hereby certified that the undersigned is complying with and will continue to comply with each approved code of fair competition to which he is subject, and/or if engaged in any trade or industry for which there is no approved code of fair competition, then as to such trade or industry that he has become a party to and is complying with and will continue to comply with an agreement with the President under Section 4 (a) of the National Industrial Recovery Act (President's Reemployment Agreement) and that all other conditions and requirements of Executive Order No. 6646, dated March 14, 1934, are being and will be complied with.

Provided, that where supplies are purchased that are not mined, produced, or manufactured in the United States (see sec. 2, title III, of the act approved March 3, 1933, Public No. 428, 72d Cong.), the special or general code of fair practice shall apply to that portion of the contract executed within the United States,

June 29th 1934
.....
(Date)

George W. Koe
.....
(Individual or firm name)

.....
.....

THE FOLLOWING REQUIREMENT IS INCLUDED WITH THESE
BIDDING PAPERS IN CONFORMITY WITH THE P.W.A. ORDER DATED
APRIL 9, 1934.

Each bidder shall submit with his bid a list of the names of all subcontractors and their respective bids upon which his bid is based; and the submission of this list shall be deemed to constitute an acceptance by the bidder, if he is awarded the contract, of the bid of each of the subcontractors; provided, however, that nothing in this paragraph shall be construed as limiting the action of the Contracting Officer as provided for under the provisions of Paragraph 7. Any alteration in the list, after the award of the contract, shall be subject to the approval of the Contracting Officer.

In the event the bidder proposes to carry out the work of the contract without subletting any portion of it, a statement to that effect shall be submitted in lieu of the list described above.

This list shall be submitted in a separate sealed envelope clearly identified with the name of the bidder and plainly marked " Bids of Subcontractors".

SECTION I

GENERAL PROVISIONS

1. PUBLIC WORKS PROJECT. - All work to be done under the provisions of this contract is to be financed from funds appropriated by the Administrator of Public Works under the authority of the National Industrial Recovery Act.

All bids shall be prepared in conformity with, and submitted subject to all of the requirements and conditions of the United States Government Combined Form No. P.W.A. 50, attached hereto, and the Federal Emergency Administration of Public Works Bulletin No. 51, a copy of which will be furnished upon request.

2. BIDS AND BID BONDS. - All bids and bid bonds shall be submitted in duplicate, in the blank spaces provided therefor on the respective forms attached hereto (U. S. Government Combined Form No. P.W.A. 50 and Standard Form No. 24). The amount of the bid bond shall be twenty (20) per cent of the total amount of the bid. The right is reserved to consider as informal any bid on which any alteration of or departure from the Form of Bid has been made. Unless otherwise specifically provided for in these specifications, it is expected that all of the work covered by these specifications will be let as a whole to one bidder.

The Bid Form has an entry for all items on which estimates will be given or payments made, and no allowance of any kind will be made unless specifically provided for in these specifications, in the contract, or in written orders for extra work.

3. CONTRACT AND BOND. - The successful bidder will be required to execute a written contract with the United States, with good and approved bond, in an amount approximately equal to and not less than 50 per cent of the amount of the contract within ten (10) days after being notified of the acceptance of his bid.

The Contract and Performance Bond which the successful bidder and his surety promise to execute are the United States Government Form of Contract (U. S. Government Form No. P.W.A. 51) and the Standard Government Form of Performance Bond (Standard Form No. 25) copies of which are attached hereto.

At the time of the opening of the bids, each bidder will be presumed to have read and to be thoroughly familiar with all of the requirements and conditions of Bulletin No. 51.

previously referred to in Paragraph 1, and of the Form of Contract and the Form of Performance Bond just mentioned.

4. DEFINITION OF TERMS. - Whenever the term "Contracting Officer" is used in these specifications, it is understood to refer to the Chief, Eastern Division, Branch of Engineering, National Park Service, Department of the Interior, under whose supervision the work will be done. He will be represented on the work by as many assistants as may be necessary. Whenever the term "Contractor" is used, it is understood to refer to the second party of the contract. Subcontractors, as such, will not be recognized.

Whenever, "as directed", "as required", "as permitted", "approval", "acceptance", or words of similar import are used, it shall be understood that the direction, requirements, permission, approval, or acceptance of the Contracting Officer is intended, unless stated otherwise.

5. BIDDERS TO VISIT SITE. - All bidders are expected to visit the site of the work and to inform themselves as to all existing conditions. Failure to do so will in no way relieve the successful bidder from the necessity of furnishing all equipment and materials and performing all work required for the completion of the contract in conformity with the specifications.

No allowance will be made for the failure of a bidder correctly to estimate the difficulties attending the execution of the work.

6. REPUTATION OF BIDDERS. - The reputation of bidders as being skillful and successful in carrying out work of the type and magnitude required by these specifications, and the adequacy of their resources and facilities for accomplishing the work satisfactorily and within the specified time, will be considered in making the award. Each bidder shall cite, in the appropriate space provided therefor on the bid schedule, the items of plant and equipment which he owns, or otherwise has immediately available for use on the work of this contract, and also a list of works similar in character and magnitude to that covered by these specifications which have been successfully accomplished by him and which may be examined by the Contracting Officer.

If, in the opinion of the Contracting Officer, information as furnished with the bid is not complete or conclusive, the Contracting Officer shall have the right to submit questionnaires to the bidder concerning the latter's financial

resources, experience, and equipment, and to reject the bid if the bidder fails to return the questionnaires properly executed or if the information contained therein is not satisfactory and conclusive.

The information contained in the replies to the questionnaires will be considered confidential.

7. SUBCONTRACTORS. - Each bidder shall submit a list of all subcontractors to whom he proposes to sublet the various parts of the work. The Contracting Officer shall have the right to take such steps as he deems necessary to determine the ability of the subcontractors to handle their respective portions of the work successfully; and the bidder shall furnish to the Contracting Officer such information as may be requested concerning the reputation and experience of the subcontractors, and shall otherwise assist the Contracting Officer in ascertaining the fitness of the subcontractors for their respective parts of the work.

The Contracting Officer shall have the right to reject any bid if any of the subcontractors named on the list furnished are found to be inexperienced or if their reputation for doing only first-class work is not demonstrated to the satisfaction of the Contracting Officer; but the bidder may, with the prior permission of the Contracting Officer, revise the list by selecting other subcontractors until it becomes satisfactory to the Contracting Officer.

After the list of subcontractors has been approved no changes shall be made in it without the permission and approval of the Contracting Officer. The Contracting Officer will, however, permit the Contractor to take the work out of the hands of any or all of the subcontractors and complete it himself, if for any reason it becomes necessary or desirable for him to do so.

8. SUPERVISION AND INSPECTION. - All work done under this contract will be under the immediate supervision of duly qualified representatives appointed by the Contracting Officer, whose salaries will be paid by the United States.

The Contractor shall remove, reconstruct, replace and make good, as directed, all defective materials and workmanship without additional charge and regardless of any previous approval or acceptance of such defective materials and workmanship.

In all questions relating to the interpretation of any part of these specifications, the decision of the Contracting Officer shall be final.

When the completed work is ready for final inspection, the Contractor shall so notify the Contracting Officer in writing, and any defects or omissions the Contracting Officer may find during such final inspection shall be made good prior to final acceptance.

9. SPIRIT AND INTENT OF SPECIFICATIONS. - It is the spirit and intent of these specifications, and of the drawings forming part of them, to provide that the work and all parts thereof shall be fully completed, and suitable in every way for the purposes for which designed. The Contractor shall supply all materials and do all work which is described, or which may be reasonably implied, as being incidental to the work of this contract.

10. MINOR MODIFICATIONS. - The Contractor shall make such minor changes in the execution of the work to be done under these specifications as, in the judgment of the Contracting Officer, may be necessary or expedient to carry out the intent of the contract. No increase over the contract price will be paid to the Contractor on account of such minor modifications, provided that at the time the change is to be made the work involved has not already been executed; but work which materially increases the cost to the Contractor will not be ordered under the provisions of this paragraph.

11. ERRORS AND OMISSIONS. - The Contractor will not be allowed to take advantage of any errors or omissions in these specifications or in the accompanying contract drawings, as full instructions will always be given if such errors or omissions are discovered.

The Contractor shall, immediately upon his discovery of any statement or detail which is discrepant or which otherwise appears to be in error, bring the same to the attention of the Contracting Officer for decision or correction.

12. EXTRA WORK. - The Contractor shall perform all extra work not otherwise covered by these specifications which, in the judgment of the Contracting Officer may be necessary or expedient to carry out the intent of the contract or is incidental in any way to the work of the contract, and which is ordered in writing by the Contracting Officer.

The cost of the respective items of extra work carried out under the provisions of this paragraph will be paid for by one or the other of the following methods, at the election of the Contracting Officer:

(a) On the basis of a stated lump sum price, or other consideration, fixed and agreed upon by negotiation between the Contracting Officer and the Contractor in advance; or

(b) On the basis of the actual cost of the extra work to the Contractor (including the hire or rental of such plant as may be used exclusively for such extra work and including also workmen's compensation insurance, but excluding overhead), plus fifteen (15) per cent of that cost to cover profit and all indirect charges against such extra work except those specifically mentioned herein to be included.

In either case, an appropriate extension of the working time, if such be necessary, will also be fixed and agreed upon, and stated in the written order in which the extra work is requested.

13. MATERIALS AND WORKMANSHIP. - Whenever not explicitly described in these specifications or on the contract drawings, all materials and workmanship used or employed in carrying out the work under this contract shall be of the best of their respective grades and qualities used in modern construction practice; and in all such cases, the Contractor shall first submit to the Contracting Officer for approval the methods which he proposes to follow, and the names or brands of the materials which he proposes to use, and he shall not proceed with the work involved until the approval for such methods and materials has been obtained.

All mechanics, tradesmen, workmen and other employees shall be trained and skilled in their various trades and occupations. Upon request from the Contracting Officer to do so, the Contractor shall immediately discharge any employee who, in the opinion of the Contracting Officer, is either incompetent or objectionable. This requirement shall not be made the basis of any claims for compensation or damages against the United States or any of its officers or agents.

14. USE OF NON-DOMESTIC MATERIALS. - The following materials of non-domestic origin which, investigation has disclosed, are not mined or produced in the United States in sufficient quantities for general commercial use, may be used in the manufacture of materials or equipment required under this contract:

Chromium	Rubber
Platinum	Silk
Cork	Tin
Jute	Sisal
Nickel	Asbestos
Kaurigum	China Wood Oil (Tung Oil)
Lac	Balsa Wood.

15. OWNERSHIP. - All parts and materials paid for under the system of partial payments hereinafter described shall become thereby the sole property of the United States, but this provision shall not be interpreted as relieving the Contractor from the sole responsibility for the proper care and protection of said parts and materials prior to the completion of the work and its final acceptance by the United States, or from any other of the provisions of this Contract; nor shall this provision be interpreted as preventing the Contracting Officer from requiring the Contractor to store and handle the parts and materials so as to preserve them from danger.

If any materials or parts of the work be lost, damaged, or destroyed by any cause or means whatsoever, the Contractor shall satisfactorily repair or replace the same at his own cost and shall be responsible for delays or incidental expenses that may result therefrom.

16. CONTRACTOR TO BE PRESENT OR REPRESENTED. - The Contractor shall at all times be personally present upon the work or be represented thereon by a responsible agent, to be designated in writing by the Contractor, who shall be clothed with full authority to act for him in all cases, and to carry out any instructions relative to the work which may be given by the Contracting Officer, either personally or through an authorized representative.

17. RESPONSIBILITY FOR EMPLOYEES AND PLANT. - The Contractor shall be responsible for the safety of his employees, plant and material, and for any injury or damage done to or by them from any source or cause. He shall save and hold the United States free from all claims for damages to any and all persons and (or) property arising from the execution of the work covered by these specifications.

The Contractor shall make good, at his own expense, all damage to any property of the United States arising from his operations under these specifications or from the fault or neglect of any of his employees.

18. TRAFFIC PROVISIONS. - The Contractor shall so conduct his operations as to interfere as little as possible with the use ordinarily made of any roads, streets, driveways, sidewalks, facilities, etc., near enough to his work to be affected thereby; and he shall not close or obstruct any such roads, streets, driveways, sidewalks, facilities, etc., without prior written approval from the Contracting Officer.

The Contractor shall provide, erect and maintain, at his own expense, all lights, barriers, etc., that may be required by traffic regulations or by the Contracting Officer for the safety of the public.

19. REPORTS OF MEN AND MATERIALS. - The Contractor shall upon request of the Contracting Officer to do so, furnish to the latter copies of bills of all materials intended for use either in the permanent structure or in the plant or false-work; the Contractor shall also make daily reports to the Contracting Officer covering the amounts of materials received or en route and the number and classification of all men engaged upon the work for the preceding day.

20. PROTESTS. - If the Contractor considers any work demanded of him to be outside the requirements of the contract, or considers any record or ruling of the Contracting Officer or of the inspectors to be unfair, he shall immediately ask for written instructions or decision, and, within ten days after the receipt of the same, he shall file a written protest with the Contracting Officer, stating clearly the basis of his objections. Unless the Contractor files protest as thus provided, he will be considered to have accepted the record or ruling.

21. PATENTS. - The Contractor shall hold and save the Government, its officers, agents, servants and employees, harmless from liability of any nature or kind, including costs and expenses, for or on account of any patented or unpatented invention, article or appliance manufactured or used in the performance of this contract, including their use by the Government, unless otherwise specifically stipulated in this contract.

22. APPROVAL OF CONTRACT. - This contract shall be subject to the written approval of the Assistant Secretary, Department of the Interior, and shall not be binding until so approved.

SECTION II

WORK, CHANGES, DRAWINGS, ETC.

23. WORK TO BE DONE. - The work to be done under this contract consists in the furnishing of all labor, machinery, equipment, and materials, and constructing therewith, in accordance with these specifications and the accompanying plans for the Administration Building, the Superintendent's Residence, the Utility Building, the Inflammable Storage Building, the fence enclosing the yard at the Utility Building, located according to the Flot Plan, at Guilford Courthouse National Military Park, Guilford Courthouse, North Carolina.

The work shall include all necessary excavation and grading; the construction of reinforced concrete footings and foundation walls, piers, stairs, counterceiling, and floor slabs; the construction of stone and brick walls, stone key-blocks, door sills, stone steps and floors, brick fireplaces and chimneys; and the furnishing and erecting of steel lintels, iron cleanout doors, manholes, cast iron column bases, and iron railings and guards, the waterproofing of all basement walls. The roof construction shall be covered with tile roofing laid over felt, and metal roofing over entrance hood and cupola. Metal flashings shall be installed in connection with the roof and woodwork. The finished floors shall be of cement, tile, wood, and linoleum as indicated. The walls and ceilings of all rooms, shall be plastered, except the walls in basement and where tile is called for, and stucco shall be applied on all porch ceilings, cornices, chimneys and brickwork where indicated. Dampproofing shall be installed over all interior masonry walls to be plastered. The necessary wood furring and metal lathing shall be installed as indicated.

The work shall include metal partitions for toilets. All necessary construction woodwork, including all rough woodwork, and the interior and exterior wood finish shall be installed.

The work shall include fly screens for all windows and doors, all rough and finishing hardware, and the glazing of windows and doors. All woodwork, metal work, and plastered surfaces, shall be painted as specified.

The work shall include plumbing, electrical, and heating, as specified.

Alternative bids shall be submitted as called for by the specifications and the bid form.

24. PHOTOGRAPHS. - After the work has been started, suitable photographs shall be taken on approximately the first and fifteenth of each month to show clearly the rate of progress of the work. The photographs shall be contact prints, 8 by 10 inches in size, mounted on linen, with a 1-inch folding margin on the left for bindings; and they shall be accurately trimmed to the same size so they can be neatly bound in albums. Three copies of each view shall be furnished the Contracting Officer as soon as possible after being taken. Views shall be sufficient in number and comprehensive enough in scope to provide a thorough pictorial history of the construction work. For the information of bidders it is estimated that an average of 5 views per month will meet the requirements.

On the back of each photograph shall be typed the titles of the photograph, the date on which it was taken, and the direction toward which the camera was facing.

The cost for all photographs shall be included in the contract price for the work.

25. TEMPORARY BUILDINGS AT SITE. - The Contractor will be permitted to erect such temporary shacks as he will require for the storage of materials and for other purposes.

The Contractor shall construct and maintain adequate temporary toilet facilities for the use of his employees.

The location of temporary sheds shall be subject to the approval of the Contracting Officer.

26. USE OF SPACE. - The Contractor will be permitted to use such space adjacent to the site as the Contracting Officer deems necessary. However, nothing in this paragraph shall be construed as restricting the Contracting Officer from requiring the Contractor to vacate such space as, in the opinion of the former, may have been occupied unnecessarily or without authority.

The Contractor shall be responsible for all damages caused by his operations to all parts of the property and to the adjacent grounds, and shall repair, replace or otherwise make good any damage caused by him as directed by the Contracting Officer.

The time required to repair damage caused by the Contractor shall be included in the time named in the contract for the completion of the work.

27. FEDERAL SPECIFICATIONS. - Reference will be made throughout these specifications to certain United States Government Specifications. Where so designated these Standard Specifications shall form a part of this contract and will be considered as incorporated in these specifications. Bidders who are furnished plans and specifications will also be furnished copies of these specifications upon request. The list of specifications referred to is as follows:

FEDERAL SPECIFICATIONS BOARD SPECIFICATIONS.

- SS-B-656 - Brick; building, clay.
- SS-C-181 - Cement, Masonry.
- SS-C-191 - Cement, Portland.
- SS-S- 51 - Sand for cement mortar bed.
- SS-L-351 - Lime, hydrated for structural purposes.
- QQ-S-721 - Steel, structural for buildings.
- QQ-I-666 - Iron, gray; castings.
- QQ-I-686 - Iron, wrought bars.
- QQ-B-101 - Metal Lath.
- QQ-S-571 - Solder; tin lead.
- QQ-B- 71 - Bars, concrete reinforcement.
- SS-C-571 - Stone, for concrete.
- LLL-F-321 - Fiber Board, insulating.
- SS-S-451 - Slate
- SS-C-153 - Plastic Cement.
- SS-P-401 - Plaster, gypsum.
- TT-W-566 - Creosote.
- R-P-381 - Pitch; Coal-tar.
- CCC-B-811 - Burlap; jute.
- MM-L-751 - Lumber.
- C-G-451 - Glue; animal for wood-working.
- HH-F-191 - Felt, asphalt saturated.
- FF-B-571 - Bolts, Nuts, etc.
- FF-N-101 - Hardware (nails, spikes)
- FF-P-101a- Hardware (nontemplate)
- FF-H-106 - Hardware (nontemplate)
- FF-H-111 - Hardware (nontemplate)
- FF-H-116 - Hardware (nontemplate)
- TT-W-251 - Basic carbonate white lead.
- TT-R-191 - Red lead, dry and paste.
- TT-V- 71 - Varnish; interior.
- TT-V- 51 - Asphalt varnish.

TT-V- 81 - Varnish; mixing for aluminum paint.
 TT-V-121 - Varnish; spar.
 TT-F- 36 - Lead, zinc base.
 TT-A-476 - Aluminum Powder; for paints.
 TT-D-651 - Drier, paint liquid.
 TT-Z-301 - Zinc oxide.
 JJJ-O-336 - Oil Linseed, raw.
 LLL-T-791a- Turpentine.
 TT-F- 61 - Faint, black.
 DD-G-451 - Glass; for glazing.
 TT-P-791 - Fatty.
 WW-P-351 - Pipe, brass.
 WW-P-401 - Pipe and fittings soil, cast-iron,
 coated and uncoated.
 WW-F-448 - Pipe fittings, brass.
 WW-F-441 - Pipe, wrought iron.
 WW-P-521 - Pipe fittings, malleable iron.
 WW-P-501 - Pipe fittings, cast iron.
 HH-M- 71 - Magnesia pipe covering.
 WW-P-541 - Plumbing fixtures.
 WW-C-581 - Conduit, rigid steel.
 HH-I-531 - Insulations, wire and cable.
 J-C-101 - Wire, copper.
 W-F-791 - Fuses.
 SS-P-361 - Clay, Sewer pipe.
 WW-C-571 - Enameled conduit.
 WW-P-431 - Steel Pipe.
 Navy Specification - No. 9yd., Electric Apparatus.

The latest available revised edition of each of the above Federal Specifications will apply to this work.

28. CONTRACT DRAWINGS. - The following drawings signed and approved by the Contracting Officer form a part of, and are supplementary to these specifications:

<u>CONTENTS</u>	<u>Drawing Number</u>
Guilford	1000-A
Flot Plan (all buildings)	Sheet 1-
ADMINISTRATION BUILDING	
Basement Plan	Sheet 2-
First Floor Plan	Sheet 3-
Second Floor Plan	Sheet 4-

CONTENTSDrawing
Number

Front and Rear Elevations	Sheet 5-
End Elevations and Sections	Sheet 6-
Details of Wings	Sheet 7-
Details of Center Portion	Sheet 8-
Interior Details	Sheet 9-
Stair Details	Sheet 10-
Mechanical Layout	Sheet 11-

SUPERINTENDENT'S RESIDENCE

Guilford 1001-A

Floor Plans	Sheet 1-
Elevations and Sections	Sheet 2-
Details	Sheet 3-
Mechanical Layout	Sheet 4-

UTILITY BUILDING & INFLAMMABLE STORAGE

BUILDING

Guilford 1002-A

Floor Plans	Sheet 1-
Front and Rear Elevations	Sheet 2-
Side Elevations and Sections	Sheet 3-

The drawings and these specifications are intended to be mutually explanatory and complete. In case of any disagreement between drawings, details or specifications, the specifications will take precedence over the drawings, figures over scaled measurements, and details over general drawings, but all work called for by one, even if not by the other shall be fully executed.

29. DETAILED WORKING DRAWING. - The contract drawings are expected to serve as working drawings. The Contracting Officer will furnish such additional full size details as may be necessary. Any other working or shop drawings or sketches which may be necessary in the execution of the work shall be prepared by the Contractor and shall be submitted to the Contracting Officer in triplicate; one set will be returned to the Contractor approved, or showing the changes or corrections required; triplicate copies shall be resubmitted after such corrections until they are approved. The Contractor shall report any errors found in these drawings to the Contracting Officer who will make or approve the necessary corrections. The United States will not be responsible for errors in the Contractor's drawings, even though approved. Payment for Contractor's drawings, revisions thereof, and for copies furnished, shall

be included in the amounts paid for material or work. The Contractor shall furnish as many sets of paper blueprints of working drawings as the Contracting Officer may need for the work.

The shop drawings shall include complete details of reinforcing steel, masonry work, stone work, exterior and interior woodwork, fly screens, ornamental and miscellaneous ironwork, copper, mechanical work, plumbing work, wiring diagrams, etc.

30. FINAL DRAWINGS. - After the entire work has been completed and before final payment therefor is made, the Contractor shall prepare and deliver to the Contracting Officer a complete set of blue-line prints, the originals of which will be furnished free to the Contractor by the Contracting Officer, upon which are indicated in a neat and accurate manner all changes in the original design and all extras affecting the permanent structure which exist in the completed work. These corrections shall be made with colored ink or a fine-pointed colored pencil, and they shall be sufficiently clear and complete to enable the Contracting Officer to reproduce the changes on the original tracings. The cost of making the corrections shall be borne by the Contractor and shall be included in the amounts bid for the entire work.

31. MATERIALS AND SAMPLES. - Immediately after the signing of the contract, the Contractor shall furnish the Contracting Officer with a list of the manufacturers who will supply materials for the work, together with the names of the materials which each will furnish. Before actual operations at the site are begun this list shall be amplified to show the trade name, catalogue number or other means of identification of the various materials. All of each kind of material shall be secured from the same manufacturer unless special permission is granted to deviate from this requirement.

All materials shall be secured from the manufacturers having a reputation for producing high-grade materials. The Contracting Officer reserves the right to require the Contractor to alter or revise his list of manufacturers until it includes only those who, in the opinion of the Contracting Officer, will furnish material of the best quality.

All samples shall be delivered sufficiently in advance of the actual need of the material represented thereby to permit of thorough examination and test by the Contracting Officer, and further to permit the Contracting Officer to require additional samples and to make additional tests if he so desires,

without causing any delay in the execution of the work. The Contracting Officer will not be responsible for any loss of time due to delays caused by rejection of unsatisfactory samples. All samples submitted will be promptly considered and those which obviously conform to the requirements of the specifications will be approved within a reasonable time.

The approval of samples shall in no way nullify or alter the requirements of these specifications, and such approval shall only apply in so far as the samples meet the specification requirements.

Actual material shall not be delivered on the premises until satisfactory samples have been submitted and approved. All materials delivered shall equal the approved samples in all respects. Approved samples may be used in the work when they are not destroyed in making tests.

32. SAMPLES TO BE FURNISHED. - The Contractor shall furnish the following samples:

- Stone - one sample of each kind showing finish.
 - Slate, roofing shingles - three samples showing finish, color and size.
 - Copper nails - four samples.
 - Face brick - two samples, showing quality, size and color.
 - Terra cotta flue lining - one sample.
 - Common brick - two samples showing quality & size.
 - Building paper - one sample of each kind.
 - Insulation - one sample.
 - Metal reinforcement - one sample showing type and quality.
 - Interior mill work - one sample piece of trim & handrail.
 - Exterior woodwork - one sample piece.
 - Plaster caulking - one sample.
 - Corner bead - one piece 12 inches long.
 - Metal lath - one sample.
 - Plaster bond - one sample.
 - Hair or fiber for plaster - one sample.
 - Metal flashing - one sample.
 - Marble - one sample piece of each kind showing finish and color.
- Hardware:
- Lockset, - one complete set with trim of each type required.
 - Loose-pin butt - one sample of each kind.
 - H- and -L hinges - one sample of each kind.

Checking floor hinges	- one sample.
Door stops and holders	- one sample.
Painting	- sample panels, colors and finishes.
Glass	- one sample of each kind, about 6 inches by 6 inches.
Weatherstripping	- one sample piece for windows, one for door, one piece of door threshold.
Fly screens	- one sample with each kind of hardware.
Pipe	- one sample of each kind.
Escutcheon plate	- one sample of each type required.
Pipe covering	- one sample of each type required.
Wire	- one sample of each type required.
Switch	- one sample of each type required.
Plug receptacle	- one sample of each kind.
Brass cover plates	- one sample of each kind.
Conduit	- one sample.
Bath room accessories	- one sample of each type.
Plumbing fixtures	- pictorial cuts of each fixture.

The samples will be returned to the Contractor when practically all of material and equipment they represent have been delivered on the site and approved as equal to the samples.

33. RESTORATION. - The Contractor will be required to repair at his own expense any damage done to Government or private property, by or because of the Contractor's work under this contract. Upon the completion of his contract, the Contractor shall remove all apparatus, plant, tools, surplus materials, rubbish, etc., and shall leave the premises clean, neat, and orderly, and otherwise in as good condition as they were before the beginning of the work.

The time necessary for the restoration of the work is understood to be included in the time named in Paragraph 39 for the completion of the entire work.

34. WATCHMEN. - The Contractor shall employ from the beginning to the end of the work, including Sundays, legal holidays, and when the work may not be in progress, a sufficient force of watchmen who shall be employed exclusively on this work and whose duties it shall be to guard and protect the property and to keep the building free from trespassers and intruders at all times.

35. LINES, GRADES AND POSITIONS. - All work to be done under this contract, and every part thereof, shall be accurately

SECTION III

TIME AND PAYMENTS.

39. COMMENCEMENT, PROSECUTION AND COMPLETION. - The Contractor shall commence the work under this contract within five (5) calendar days after the date of receipt of notification to proceed. He shall prosecute the work with faithfulness and energy, in a neat and orderly manner, and shall complete it within two hundred (200) calendar days after the above-mentioned date of receipt of notification to proceed. This interval of two hundred (200) calendar days is hereby agreed upon as the time necessary for the completion of the entire work.

40. LIQUIDATED DAMAGES. - The time of completion as stated in the foregoing paragraph will be made a part of the contract which will provide for liquidated damages in the amount of ten dollars (\$10.00) per calendar day for the entire delay in completing the work beyond the time thus fixed and agreed upon for its completion.

41. PAYMENTS. - Payments to the Contractor for the work done under this contract will be made in accordance with a well balanced schedule to be prepared by the successful bidder, and submitted to and approved by the Contracting Officer before the commencement of the work, apportioning the amount of the contract among the various major items of the work that go to form the completed contract. The total amount shown by said schedule shall equal the total amount of the contract price.

On or about the first day of each month, the Contracting Officer will estimate the value of the work done and approved materials delivered at the site to that date, and ninety (90) per cent of the value so estimated, less all payments previously made will be paid to the Contractor.

Upon completion of the entire work by the Contractor, and the acceptance thereof by the Contracting Officer, the balance due to the Contractor for the entire work will be paid.

42. PROGRAM OF CONSTRUCTION WORK. - Except as otherwise specified the Contractor's procedure and methods of construction may in general be of his own choosing, provided they are calculated to secure results which will satisfy the requirements of the plans, specifications and supervision.

Before beginning any work, the Contractor shall outline in writing his program of construction and shall submit written

revisions of the same as modifications may become necessary, or as may be required, both sufficient in detail to enable the Contracting Officer to judge of the adequacy of the Contractor's operations and to anticipate the progress and completion of the work; and the Contractor shall not proceed with the work until this program has been approved in writing by the Contracting Officer.

The Contractor shall supply all plant, tools, and equipment of every kind, ample in quantity and capacity, in good working order and suitable in character to carry on the work of his contract according to the approved program.

SECTION IV

EXCAVATION AND DRAINAGE.

43. SCOPE OF WORK. - This work shall include the excavation and removal of all earth, rock, boulders, debris, etc., from all areas to permit the construction of:

Administration Building and the Superintendent's Residence, - all trenches for pier and wall footings, heating lines, electrical conduits, sewer lines, water lines, drainage lines; the entire basement and other portions to the required elevations;

Utilities Building, - all trenches for pier and wall footings, holes for fence and gate posts, electrical conduits, sewer lines, water lines, and other portions to the required elevations;

Inflammable Storage Building, - All trenches for wall footings and grading the floor to the required elevations.

All trees and stumps located in the line of the work, or located on the ground hereinafter specified to be graded, shall be removed by the Contractor as directed by the Contracting Officer, and all other trees within the area of 25 feet extending out from each of the building walls shall be protected with suitable guards to prevent damage.

The ground around the buildings extending ten feet out from each of the building walls and steps at every point, and the yard adjacent to the Utilities Building shall be graded to the new established grades shown on the drawings.

This work shall further include the backfilling of trenches and the filling in around footings and against walls.

If sheet piling or bracing is necessary to facilitate any of this work, it shall be included. Any necessary pumping to keep excavation dry during the work, is also included. Wherever existing paving is cut or disturbed, it shall be properly repaired as called for under Concrete Work.

The surplus excavated earth shall be removed from the building site and deposited at the direction of the Contracting Officer.

44. EXCAVATION FOR BUILDING. - The Contractor shall excavate areas to the depths indicated. All top soil shall be

kept separate from sub-soil, and shall be piled for future use, as will be directed by the Contracting Officer.

All excavation work shall be inspected and approved by the Contracting Officer before any footings are placed.

46. DISPOSAL OF EXCAVATED MATERIALS. - The top soil shall be left in a pile near the site of the building, and the surplus excavated material shall be placed and spread out where directed by the Contracting Officer, at a location within a mile of the site of the building.

47. PROTECTION OF TREES. - Wood guards shall be constructed, 5 feet high, encircling the tree. The guards shall be constructed of 1 inch rough lumber substantially put up and maintained in good condition until completion of all work.

48. TRENCHES FOR FOOTINGS. - Trenches for concrete footings shall be cut to the exact size of the footings or wooden forms of the proper size shall be used. In case the excavation is carried below the bottom of the footings, no backfilling will be permitted, but the concrete work shall be extended to the undisturbed natural earth without expense to the United States.

49. EXCAVATING FOR OIL STORAGE TANKS, AND PIPE WORK. - The Contractor shall excavate for the Oil Storage Tank and piping at points shown on drawing. The excavation shall be of such size to permit the lowering of tank into permanent position and shall be of such depth to provide 36 inches covering from top of tank to finished grade.

50. PIPE TRENCHES. - All trenches for water, sewer, land drainage lines, electric conduits, oil pipes and manholes, shall be excavated by the Contractor. All trenches shall be excavated along straight lines and of such dimensions as will leave ample room for bracing and for handling pipe materials.

Trenches shall be of the necessary depths for the proper grading of the pipe lines, and in no case shall they be less than:

Water pipe	30 inches below finished grade.
Sanitary sewer	30 inches below finished grade.
Storm water sewer	to elevations noted.
Electric conduit,	24 inches below finished grade.
Oil pipe lines	30 inches below finished grade.

Excavation for pipe bells and joints shall be sufficient to permit pipe to have a full bearing along its length. Where a trench has been dug too deep, it shall be filled to proper grade with clean sand, which shall be thoroughly compacted. Refilling under the pipes with clay or loam will not be permitted. Whenever necessary, excavations shall be shored and protected from injurious caving or erosion by temporary timbers or in such other manner as may be required.

51. DRY WELL. - The Contractor shall excavate for and construct a dry well at location shown on the drawings. The well shall be 36 inches in diameter and 48 inches below the drain pipe discharging into the well. After the drain pipe is in place and inspected by the Contracting Officer, the well shall be filled 12 inches above the drain pipe, with clean, broken stone that will pass a 1 inch diameter ring. The well shall then be filled with good earth to the finished grade level.

52. PUMPING. - Should water occur in any of the excavations or trenches, from any cause, the Contractor shall provide adequate pumps and keep the excavations pumped free from water.

53. BACKFILLING AND GRADING. - All necessary backfilling, around the foundations and in all other locations where excavation has been done under this contract, shall be done with excavated material. All backfill shall be deposited in approximately 6-inch layers and thoroughly tamped. Fuddling of trenches will be permitted only with the permission of the Contracting Officer.

The grading shall be confined to the area around the entire building and extending ten feet out from every point of wall and steps.

Grading shall consist in the removal of sufficient earth and backfilling to establish the grades as shown on drawings.

SECTION V

CONCRETE WORK

54. SCOPE OF WORK. - This work includes the furnishing of all materials and constructing the concrete work in the four buildings under this contract, consisting of concrete footings for walls, piers, and columns, and the concrete walls, piers, floor slabs, curbs, steps and platforms. The work also includes the concrete floor finish, coves and bases, the concrete for electric and telephone conduits, nogging, counter-ceiling, and for the oil tank manholes, and wherever concrete is indicated on the drawings. The cinder fill shall also be included.

All steel reinforcement shown on the drawings and all necessary specialties are also included.

All necessary working drawings and shop drawings shall be furnished as called for in Paragraph 29 and such samples as are required by Paragraph 32.

The Contractor shall arrange the work for the entrance of the heating boiler into the basement, to the satisfaction and approval of the Contracting Officer. Should the boiler not be at the building site when the walls and floors are being constructed, ample provision shall be made for future delivery into the basement.

55. CEMENT. - The cement shall be an American Portland brand, and shall conform to the requirements of Federal Specification No. SS-C-191.

Cement that is caked or otherwise damaged by storing or exposure to the elements will be rejected.

56. SAND. - Sand for concrete shall consist of clean, hard, durable, uncoated grains of siliceous materials, free from injurious amounts of lumps, soft or flaky particles, salt, alkali, organic matter, clay, loam or other deleterious substances. Sand shall be well graded from coarse to fine, it shall pass a 1/4-inch (No. 4) sieve, not more than thirty (30) per cent shall pass a 50-mesh "Standard" sieve. Not more than three (3) per cent by weight shall be removed by the elutriation test. Briquets made of the cement and sand used in the concrete, mixed in the proportions 1 to 3 by volume, shall withstand a tensile test of at least one hundred (100) per cent to that withstood by similar briquets made with standard Ottawa sand.

In all cases the methods and apparatus for measuring the ingredients shall be subject to the approval of the Contracting Officer.

64. MIXING CONCRETE. - All concrete shall be mixed in mechanical mixers of types and capacities approved by the Contracting Officer.

The mixing of the ingredients shall be continued for one and one-half minutes after the last of the ingredients is deposited in the mixer, or for such longer intervals as the Contracting Officer may consider necessary for the thorough mixing and incorporating of all ingredients. The time of mixing shall not be left to guess, but shall be determined by a sand glass or other timing device of approved type, which shall be constantly at the mixer and placed handy for reference by the mixer foreman and inspectors. The concrete for walls enclosing basements and for all concrete floors shall have 10 per cent lime added to the mix.

The amount of water used in the concrete, including that contained in the sand, shall not be left to the judgment of the mixer foreman, but shall be measured and controlled by an apparatus approved by the Contracting Officer. The consistency of the concrete, especially as regards the amount of water used, shall be at all times subject to the control and approval of the Contracting Officer. In general, such a quantity of water will be allowed as to produce concrete which is plastic enough to flow sluggishly in the forms and around the reinforcing bars after being well spaded or otherwise agitated with suitable tools.

65. CINDER FILL. - All concrete floors laid on the ground shall have a sub-bed of cinders 6 inches deep raked out and tamped well, covering the entire area to receive concrete.

The cinders shall conform to the requirements of cinders for cinder concrete as specified under Paragraph 68.

66. PLACING CONCRETE AND FINISH. - Immediately after being mixed, the concrete shall be conveyed in place in such a manner that it shall suffer no separation of the ingredients. The concrete shall be rammed, spaded, and agitated by suitable methods so as to produce a thoroughly compacted mass of maximum density in intimate contact with all reinforcing steel, and so that the concrete will present a smooth, finished, unbroken surface without honeycomb or exposed coarse aggregate when the forms are removed.

No concrete shall be placed in the work after having attained its initial set, and no retempering of the concrete will be permitted. Any concrete which has attained its initial set before being placed in the work will be rejected and shall immediately be removed from the site of the work.

Cement topping composed of 2 parts cement and 3 parts sand by volume shall be placed over all concrete floors, 1 inch thick, and shall be constructed integrally with the base concrete, and the bond between the two shall be as strong as either the base concrete or the cement topping. The surface shall be floated and troweled to a smooth even finish. The treads and risers on cement finished steps shall be finished like floors.

67. CONCRETING IN COLD WEATHER. - All concreting in cold weather shall be done at the sole risk of the Contractor, but this requirement shall not be construed as preventing the Contracting Officer from requiring the Contractor to take such measures for protecting the work against cold as he may consider necessary. All concrete damaged by weather conditions shall be removed and replaced by the Contractor at his own expense. In all cases the Contractor shall submit to the Contracting Officer a complete description of all measures which he proposes to take for protecting the concrete before beginning to place it.

The following precautions shall be observed in addition to any other which the Contractor may desire to take:

If the concreting is done when the atmospheric temperature is below 40 degrees F., the water and the aggregate shall be heated so that the temperature of the concrete shall not fall below 60 degrees F., until 15 minutes after it is placed in the forms. The coarse aggregate shall not be heated to a temperature higher than 150 degrees F. Special care shall be taken to place the concrete as quickly as possible after mixing and it shall be properly covered and artificially heated to prevent it from freezing until, in the judgment of the Contracting Officer, it will not be detrimentally affected by cold weather. Newly placed concrete shall be covered and heated when a falling temperature is anticipated.

68. CONCRETE FOR CONDUITS, NOGGING, AND COUNTER-CEILING. - All electric conduits underground shall be encased in three inches of concrete, and concrete nogging shall be placed between joists over foundation walls supporting frame walls as

noted on drawings. This concrete shall be composed of cement, sand, and 3/4 inch gravel in the approximate proportions of 1:2:6, but shall contain not less than four bags of cement per cubic yard of concrete in place.

The concrete for counter-ceiling under tile floors and fireplaces and as noted on drawings shall be of cinder concrete mixed in the same proportions as concrete for conduits, specified above. The cinders shall be used in lieu of the coarse aggregate and shall be clean, steam boiler cinders obtained by the quick combustion of bituminous coal and free from injurious percentage of ash, alkali or unburned coal.

69. CONCRETE FOR OIL TANK MANHOLES. - The manholes specified under Paragraph 99 shall conform to the requirements of the details shown on drawings.

The manhole for oil tank shall be built-up precast stock, reinforced concrete pipe 20 inches inside diameter and 36 inches from top of tank to grade. This concrete pipe shall be shaped to suit curvature of tank and bedded in neat cement.

SECTION VI

BRICKWORK

70. SCOPE OF WORK. - This work includes the furnishing and constructing of all exterior brick walls and brick steps. All brick chimneys, flue linings and fireplaces are also included.

Samples of brick shall be furnished in accordance with Paragraph 32.

71. MORTAR. - The mortar used in connection with all brickwork shall be composed of 1 part Portland cement and 3 parts sand with enough lime added to obtain workability. The lime added shall not exceed 25 per cent of the cement by volume. The sand shall be a deep yellow in color subject to the approval of the Contracting Officer.

The cement, lime and sand shall conform to Federal Specifications SS-C-191, SS-L-351, and SS-S-51, respectively.

The Contractor will be permitted to use masonry cement for setting and pointing mortar in lieu of Portland Cement specified above. The masonry cement shall be waterproof, non-staining and shall comply with the following requirements:

The methods of testing shall be in accordance with Federal Specification SS-C-191, except that tests for soundness shall be in accordance with Federal Specification SS-C-181;

The residue on a standard No. 200 sieve shall not exceed 12 per cent by weight;

The initial set shall not take place in less than 45 minutes and the final set in not more than 20 hours as determined by the Gillmore Needle Test;

The compressive strength of 2-inch cubes made in the proportion of one part cement to three parts Standard Ottawa sand, cured 24 hours in moist air and the remainder of the time in water, shall test on an average not less than 350 pounds per square inch at 7 days, and the average strength attained at 28 days shall be not less than that attained at 7 days.

A | 72. FACE BRICK. - The face brick shall be shale, sand mold, soft mud, brick; moulded in a red burned sand with slightly warped faces and ends and somewhat blunted edges and

corners. The color shall vary from a light red to a very deep brown, and with very slight variations in the size of 8-1/8 inch by 2-3/4 inch by 3-3/4 inch. All headers shall be dark, fireflashed, except in the arches over openings. The face brick shall be well burned, good sound hard brick, free of imperfections on the face and ends. ~~Special shapes of face brick for the watertable as shown on the drawings shall be made to conform to the details.~~

73. BRICK ARCHES. - The brick arches over exterior openings shall be constructed of radial ground or moulded face brick. These brick shall be shaped to radiate from a common center, except on elliptical arches as shown on drawings, with an allowance of 3/8 inch for joints.

Brick for elliptical arches shall be made to radiate from several centers and according to approved detail drawings.

74. BACKING-UP BRICK. - Backing-up brick shall be hard-burned, red common brick, of approximately the same size as face brick, conforming to Federal Specification SS-B-656, medium or hard grade.

75. BUILDING IN ANCHORS. - The Contractor shall build into the masonry walls, all joist, sill and plate anchors as specified under Paragraph 102.

76. CHASES. - Chases shall be neatly built in the walls wherever required for the passage of pipes. All chases shall be plumb and true without offsets at the back and shall have steel lintels over them, where necessary.

77. DAMPPROOFING COURSE. - A dampproofing course of slate shall be laid down on the foundation walls two courses below finished grade before starting the brickwork. The slate shall conform to Federal Specification SS-S-451, Grade A, and shall be nearly the width or thickness of the brick wall and bedded in cement mortar. Care shall be taken to prevent the slate from showing on the face of the wall.

78. REGLETS. - The Contractor shall cut all of the necessary reglets in the brickwork to receive flashings, etc., as shown on the drawings, and where not shown, as directed. These reglets shall be of sufficient width and depth to meet the requirements of "Roofing", and "Sheet Metal Work".

79. **FLUE LINING AND THIMBLE.** - The flue in the chimneys for heating boilers and fireplaces shall be lined with terra cotta fire-clay, flue lining of stock size indicated on the drawing, and shall extend the full height of the flue. The flue lining shall be hard, well burned, straight and square, sound and free from cracks or other imperfections, with not less than $3/4$ inch walls. The lining shall be set with close joints, filled with mortar composed of one part cement and three parts of sand.

A standard stock terra cotta thimble shall be built-in to the chimneys, of the required size to receive the breeching to heating boilers.

80. **LAYING BRICK.** - All brick shall be drenched with water immediately before being used, except in freezing weather, and shall be laid straight, plumb, and true. Joints shall be not more than $3/8$ inch thick. The brick shall be shoved into full beds of mortar completely filling every joint. The face brickwork shall be laid flemish bond and thoroughly bonded with the backing-up brick, and all joints pointed as directed by the Contracting Officer. Where the temperature is below 40 degrees F., or when a falling temperature which may reach freezing is anticipated, the Contractor shall take such precautions as may be necessary to prevent the work from freezing. The precautions shall in all cases be satisfactory to the Contracting Officer.

Wherever flemish bond is called for, closers instead of three-quarter stretchers shall be used at all corners and about openings. If the bond does not work out properly for each individual space it shall be lost in the middle as gracefully as possible. Drawings and instructions shall be faithfully followed in order to achieve the spirit intended for the completed work.

81. **FIREPLACES.** - The fireplaces shall be lined on the back and sides, with fire clay brick conforming to Federal Specification HH-B-571a, laid in Portland cement mortar as specified under Paragraph 71 "Mortar", with joints of width and finish as directed.

Except where facias are specified to receive soapstone, all other fireplace facias shall receive face brick as specified under Paragraph 72.

82. WOOD NAILING BLOCKS AND GROUNDS. - Wood nailing blocks and grounds shall be substantially built in all masonry walls to provide nailing for all interior and exterior finish, as specified under Paragraph 108. All blocks and grounds shall be set plumb and true to line and in the proper plane to receive finish as shown on drawings.

SECTION VII

STONEWORK

83. SCOPE OF WORK. - This work includes the furnishing and constructing of all exterior stone walls, platforms and steps, door sills and key blocks. A sample panel of wall shall be included in the work.

Samples shall be furnished in accordance with Paragraph 32.

84. MATERIALS AND FINISH. - The stone shall be sound, hard, durable, "Granitic" rock, "gneiss", or "schist", properly quarried, and shall be equal to the best quality of any of those types of rock obtainable from quarries located in the vicinity of the project. The stone shall be free from rifts, seams, laminations, and minerals which by weathering for a long period of time, would cause any appreciable spalling, deterioration or disintegration. The stones need not be the product of any one quarry, however, they shall show sufficient variation in harmonizing colors to give interest and warmth to the masonry.

The Contractor shall submit samples of the stone which he proposes to use for the masonry; the name and location of the quarry or quarries from which it will be obtained, and a list of installations constructed with similar stone from the same quarry or quarries, which has been exposed to the weather for a period of not less than ten years, and which may be inspected by the Contracting Officer.

If "gneiss" or "schist" cannot be quarried in sufficient quantities in the vicinity to warrant being used for the project,

a true granite of quality, color and texture subject to the approval of the Contracting Officer may be used.

The exposed face shall have a pitched finish of fairly even texture, with not more than 1/2 inch projections, and shall be free from spalls, chips, stains or other defects marring its appearance.

All stones shall be cut with square corners to the sizes and arrangement indicated on the drawings.

The key stones and door sills shall have a finish equivalent to a 6-cut finish. The stones of the platforms and steps shall have exposed faces of natural seam face with a relatively even surface. The stones shall have the vertical face pitched with a tool to a relatively even surface and seam face on the upper face.

85. MORTAR AND POINTING. - The mortar used for setting all stonework shall be the same mortar used for brickwork as specified under Paragraph 71.

The pointing of all stone work shall be done with similar mortar as used for brickwork and made to produce the color and effect as approved. Before being pointed all joints shall be raked to depth of not less than 3/4 inch and thoroughly cleaned by brushing and washing with water.

The pointing mortar shall completely fill the joint and be finished with a tool, to meet the approval of the Contracting Officer.

86. KEYSTONES AND DOOR SILLS. - All keystones shall be 3-3/4 inches thick and of the size and shape shown on the drawings. All door sills shall carry back of the frame and be full and square to the dimensions. All sills and steps shall be set in full beds of mortar at the ends, with no mortar in the middle of the sill.

87. PLATFORMS AND STEPS. - The stone for the platforms and steps shall be cut to the size and laid in the design as shown on the drawing. Stones generally shall be seam face cut with a flat bed.

88. STONE WALLS. - The exterior face of the stone walls of the Administration Building will be coursed ashlar with heights varying as shown on the drawings. Random wall lengths

shall be used as shown on the drawings, care being taken to secure a pleasing distribution of sizes.

All stones shall be so cut that they will be set in the work on their natural bed with the stratification level.

The bond of the various portions with the stone backing shall be generally alternating courses of 4 inches and 8 inches in thickness, but the stone ashlar shall, in all cases, be adapted to meet every condition of construction. The wood sill anchors shall be built-in as specified under Paragraph 75.

Joints shall run close to 1/2 inch, but shall not exceed 3/4 inch.

All joint surfaces forming beds or other joints shall be cleaned of all dust, dirt and other foreign substances, and each stone shall be wetted thoroughly immediately before setting.

A sample panel of stone wall, 4 feet high x 8 feet long, shall be constructed in advance of starting the stonework to establish the size of stones, face finish, jointing, pointing, etc., and shall meet the approval of the Contracting Officer. This sample panel may be used, if and when approved, as part of the permanent wall of the building.

89. PROTECTION AND CLEANING. - All stonework which is liable to be damaged after being set shall be carefully protected. All door sills and steps shall be securely boxed with 7/8 inch lumber on the tops and faces and the stone porch floor shall be covered with 7/8 inch lumber. The protection shall be maintained until the completion of the exterior of the building, or until permission has been secured for its removal.

At completion of the building, all stonework shall be carefully cleaned with stiff fiber or bristle brushes and clean water, and all dirt, stains and foreign matter shall be removed. No acids or steel brushes will be allowed in cleaning down the stonework.

SECTION VIII

STEEL AND IRON WORK.

90. SCOPE OF WORK. - This work includes the structural lintels and reinforcing steel, steel joint hangers, iron anchors, cast iron column bases, cleanout doors to chimneys, ash dumps, iron manholes, iron railings, iron guards, and all incidental and necessary steel work required to complete the four structures.

91. QUALITY OF THE MATERIAL. - All structural steel shall be of uniform quality, conforming to the requirements of Federal Specification QQ-S-721, for structural steel for buildings.

All wrought iron shall conform to the requirements of Federal Specification QQ-I-686. All cast iron shall be of tough, gray metal of the very best foundry mixture and free from blow or sand holes and cold shuts. It shall meet the requirements of Federal Specification QQ-I-666.

All material shall be furnished straight and smooth, free from defects, and of the full size and weight called for on the drawings. All steel and iron shall be free from rust when placed in the work. Workmanship shall be equal to the best practices in modern structural and hand wrought work. All of the steel and iron shall be accurately set and substantially secured in place.

92. IRON GUARDS. - The iron guards on the horse stalls in the Utility Building shall be constructed of steel bars and pipe with all bars let into the pipe and all connecting points welded. Iron flanged holders shall be provided for fastening in position with screw bolts.

93. IRON GRAIN BOX. - The manger in each stall in the stable of the Utility Building shall receive a standard stock grain box. These boxes shall be approximately 17 inches by 17 inches, quarter round, of galvanized iron heavy pattern, and lag screwed in the left corner of the manger.

94. JOIST HANGERS. - In the wood framing at the stairwells and where necessary in framing the floor construction and framing for the passage of pipes, etc., the joists shall be hung in standard stock pressed steel joist hangers, of standard adequate size and weight.

95. STEEL LINTELS. - The angle iron lintels over the fireplace openings, and in all masonry openings as shown on the drawings, shall be standard steel angles of the sizes indicated on the drawings, and shall be of such length as to permit 6 inch bearing at each end.

96. REINFORCING STEEL. - All reinforcing steel for concrete placed under this contract shall be rolled from new steel billets and comply with Federal Specification QQ-B-71 for intermediate steel. The exact type of bars to be used shall have the written approval of the Contracting Officer before orders therefor are placed.

All fabric reinforcement shall consist of longitudinal and transverse members at right angles to each other. The members shall be rigidly welded at all intersections in such a manner as to develop the full tensile strength across the welds. The steel fabric shall meet the requirements of the latest specifications of the American Society of Testing Materials specifications for Cold Drawn Steel Wire for Concrete Reinforcement. All steel fabric reinforcement shall be shipped from the factory and delivered on the site of the work in flat pieces. A sample and complete description of the chemical and physical qualities of the fabric shall be submitted to and approved by the Contracting Officer before the orders for it are placed. Fabric reinforcement shall weigh not less than 42 pounds per 100 square feet, exclusive of welds and laps.

97. FIREPLACE IRON WORK. - The fireplaces on the first floor of the Administration Building and the Superintendent's Residence shall receive stock iron ash dump doors of an approved make and size, set in the floor of the fireplaces. These doors shall be of the butterfly type pivoted in the center and frames shall be provided with lugs to prevent door from revolving.

All fireplaces shall be provided with cast iron dampers of a standard make, and as approved by the Contracting Officer.

98. CLEANOUT DOORS. - At base of chimneys and at ash pits in all basements, cast iron cleanout doors with frames, shall be constructed in the masonry walls. The doors shall be hung on substantial cast hinges and a fastening device provided to hold doors closed. The frames shall have approved anchors for securing to the masonry. Shop drawings shall be submitted for approval.

99. IRON MANHOLES. - The manholes for the oil storage tank shall be of stock pattern cast iron curb and solid cover. They shall conform to sizes, location, and detail given on drawings, and as specified under Paragraph 69 "Concrete for Oil Tank Manholes".

100. PAINTING STEEL AND IRON WORK. - All steel and iron work provided for under this section of the specification, except galvanized iron anchors, shall be thoroughly cleaned of all rust, scale, grease, dirt, etc., and painted one coat of red

lead and oil paint before leaving the shop. Where members are in contact they shall be painted before being assembled. All paint shall be thoroughly brushed out and allowed to dry before being handled.

102. ANCHORS. - The anchors for wood joists as specified under Paragraph 106 shall be 1/4 inch by 2 inch of wrought iron, bent up 1 1/2 inch on one end and punched with holes for spikes spaced 4 inches on centers.

For ends of joists the anchors shall be 24 inches long and for joists parallel with the wall they shall be 42 inches long.

The sill and plate anchors as specified under Paragraph 106, in the Administration Building and Superintendent's Residence and the plate anchors for the Inflammable Storage Building, shall be 1/2 inch by 24 inches long with screw nuts at both ends, and 3 inches by 3 inches by 1/4 inch steel plate, shall be built into the walls with a spacing of 5 feet centers around the buildings. The sill anchors for the exterior walls in the Utility Building shall be 1/2 inch by 18 inch with screw nuts at both ends, and for the interior partitions 1/2 inch by 12 inches. Both ends of the bolts shall be provided with 2 1/2 inch by 2 1/2 inch by 1/2 inch plates. These anchors shall be so placed as to anchor the wood sill and plate to the masonry walls.

The dowels required under the wood columns in the Utility Building shall be iron dowels, galvanized all over, and of the size indicated on the drawings.

The Contractor shall provide iron anchors, 3/16 inch thick bent up 1 inch at both ends, for anchoring all window frames, door frames in masonry walls and any and all miscellaneous anchoring required. Anchors shall be drilled for nailing where required and the length of anchors shall meet the individual conditions and as approved by the Contracting Officer.

103. IRON RAILINGS. - The railings at entrance steps shall be of wrought iron made to conform to the details on the drawings. The connecting points shall be hand wrought and made rigid. The ends of vertical bars shall be bent at right angles and set into the stone steps with bolts and expansion sleeves, as shown on the drawings. Bracket braces shall be installed at each vertical bar in accordance with the detail shown.

SECTION IX.

LUMBER AND CARPENTRY WORK.

104. SCOPE OF WORK. - This work includes the furnishing and installation of the construction lumber in the four buildings for all frame walls, partitions, floors and roofs, the exterior finishing woodwork for the wood columns, beams and cornices on porches; the outside wood stairway and the wood cornices and dormers. Also the shutters and blinds, and the window and door frames, transoms, the underflooring, sheathing building paper, and weatherboarding shall be included.

The window and door frames, and the places so indicated shall be tightly caulked.

Samples shall be furnished as specified in Paragraph 32.

105. LUMBER. - All lumber for structural framing, partition studs, sheathing, underflooring, in all buildings and the interior woodwork in the Utility Building, etc. unless otherwise specified, shall be of A-grade long leaf Southern pine structural timber, grade-marked in accordance with the latest rules of the Southern Pine Association. All lumber for grounds, blocking and nailing strips shall be of No. 1 common cypress, and for all window sills, clear heart A finish cypress grade - marked in accordance with the latest rules of the Southern Cypress Manufacturers Association.

All wood embedded in concrete or masonry and the wall sills shall be impregnated with creosote under pressure. The creosoting shall be done with creosote oil by the full cell pressure process, and in accordance with the latest specifications of the American Wood Preservers Association For Yellow Pine. The retention of oil by the impregnated wood shall be not less than 15 pounds per cubic foot of wood. All surfaces of creosoted timber exposed by sawing or framing of any kind after the creosoting has been done shall be given two coats of creosote oil before erection.

All window and exterior door frames, weatherboarding, and all other exterior wood work not otherwise specified shall be of Grade A western white pine.

The boards for the fence enclosing the yard adjacent to the Utility Building shall be of No. 1 common heart red cedar, rough sawed, and grade marked according to the rules of the West Coast Lumbermen's Association. The post shall be Robinia Pseudacacia (black locust) stripped of all bark, and

they shall be of their natural round shape and of the sizes indicated.

106. FRAME CONSTRUCTION WORK. - The wood frame portions of the work shall have the wall sill laid on the masonry foundation wall, which shall be in long lengths, treated with a creosote under pressure and set in a $\frac{3}{4}$ inch bed of cement mortar and thoroughly bolted down on the masonry foundation, with anchors as specified under Paragraph 102. Upon this sill shall be erected the corner posts, built-up of 1-2 inch by 6 inch placed between 2-2 inch by 4 inch pieces and all three pieces nailed thoroughly together with 16d. square cut nails. The corners of the frame work shall be braced at right angles in two directions at the corner post, with diagonal braces of 4 inch by 4 inch pieces, 8 feet long, nailed well with 16d square cut nails into the wall sills and the corner posts. The outside frame walls shall be formed of 2 inch by 4 inch studs, placed 16 inches on centers, extending the full height from wall sill to roof rafter plate. This plate shall be formed of 2-2 inch by 4 inch long length pieces thoroughly nailed with square cut 10d. nails to each wall stud. Openings shall be framed in the wall studs for windows and doors. Double studs shall be used for the full height each side of the openings, and the contractor shall also cut in between double studs with double pieces of the same material to form the heads and sills of the openings.

All roof rafters shall be in one length, extending from ridge to eaves and notched over the wall plate and each rafter shall be thoroughly spiked down to the plate and into the ridge. Where rafters rest on brick walls, a wood plate shall be provided and anchored down similar to the wall sill with anchors as specified under Paragraph 102. Rafters shall be doubled on each side of dormers. The collar beams shall be cut between each roof rafter and securely nailed at both ends to rafters with 10d. nails. Dormers shall be framed in the roof with 2 inch by 4 inch material conforming to the details as shown on the drawing. Fire stops shall be placed as shown throughout the length of the building.

Where joists rest on masonry walls, every fifth joist shall be anchored to the wall with anchors securely spiked to the side of the joists near the bottom. Where joists run parallel with the walls, the joists shall be anchored to the wall with anchors spaced 3 feet on centers and run over and notched into three joists. These anchors shall be as specified under Paragraph 102 and spiked into the joists.

All floor joists shall be sized, top and bottom, cut to proper length, with ends to conform to the details of the cornice forming the eaves of the roof, or providing wood look-out of 2 inch material to suit conditions. The joists in the Administration Building and the Residence shall be framed between the girders and set in joists hangers as specified under Paragraph 94. They shall be framed to permit the free passage of pipes running in opposite direction to the run of the joists. Notching of joists will only be permitted for pipe of 1-inch diameter and smaller within 36 inches of the bearing points. The under-flooring shall be laid on the joists to provide proper working conditions, and no finished flooring shall be laid until after the plastering is completed.

All floor joists shall receive double cross-bridging, providing one row in spans between 6 feet and 10 feet in length and two rows in spans not over 16 feet in length. Bridging shall be x-bridging, cut on the rake at both ends and spiked with two 8d. nails for each end of the piece. Bottom nailing shall be driven home only after the under-flooring is in place.

Double joists and standard steel joist hangers of adequate size, as specified under Paragraph 94 shall be used in the frame around stairwells. The stairways shall be framed in accordance with details on the drawing, with three 2-inch by 12-inch carriages, cut to the rise and tread as shown on the drawings, and the stair platforms with 2 inch by 8 inch joists.

The interior partitions shall be built-up of 2-inch by 4-inch studs, spaced 16 inches on centers, sized for lathing both sides; thoroughly spiked at bottom to a 2-inch by 4-inch sill, and at top to a 2-inch by 4-inch plate, braced half way with 2-inch and 3-inch pieces, cut between studs and thoroughly spiked. The partitions in the Utility Building shall have the sill bolted down as specified under Paragraph 102 and as shown on the drawings.

107. NOGGING. - The space between the first floor joists over masonry foundation walls in all frame portions of the work shall receive concrete nogging as specified under Paragraph 68.

This concrete shall be held in place by cutting and nailing 1 inch boards between the joists, as shown on the drawings.

108. WOOD NAILING BLOCKS AND GROUNDS. - Grounds shall be provided for all stair work, chair rails; wall base, trim and finish around all openings and wherever wood finish of any kind occurs. All grounds shall be set plumb, level, straight and true. Grounds shall be of proper thickness to set flush with the finished plaster and $\frac{1}{4}$ inch back from the edge of the finish as designated. All grounds shall be S4S.

Temporary grounds at the top of the tile wainscoting shall be provided and shall be removed after the plaster is completed and before the wainscote is set.

Blocking shall be provided for all exterior wood finish, built into the stone and brickwork during erection and set plumb, level, straight and true. Blocking generally shall be of 3 inch by 4 inch material. Lookouts shall be provided for all cornices, etc., cut out of 2-inch thick material and built into the masonry.

All exterior blocking and lookouts, shall be impregnated with creosote under pressure.

109. SHEATHING. - All vertical frame walls shall receive $\frac{7}{8}$ inch by 8 inch tongue and grooved sheathing laid diagonally at 45 degrees with the sill. All roof surfaces shall be covered with similar sheathing laid parallel with the eaves. All sheathing shall be double nailed at each bearing with 8d. nails, one in the blind nailing and one in the face nailing.

110. BUILDING PAPER. - All building paper required to insulate and waterproof the buildings shall be asphalt saturated felt, conforming to Federal Specification HH-F-191, Type I and II.

Over the entire area of all outside vertical walls, lay one thickness of Type I - 15 pound asphalt saturated felt, lapping the joints at least 4 inches and running parallel to the ground. The fastening shall be with flat head wire nails and tin caps, spaced approximately 10 inches apart. Around all window and door openings, fasten on an additional 12-inch wide strip of felt, fitting tightly around the openings, as required and specified under Paragraph 112.

Over the entire area of all roofs, lay one thickness of Type II 30-pound asphalt saturated felt as specified under Paragraphs 189 and 188, extending 6 inches up the vertical walls of dormers and lapping all joints at least 3 inches horizontally and 6 inches vertically, running parallel to the eaves. An extra piece of felt, 18 inches wide, shall be laid along the ridge.

Under all finish flooring on underflooring, lay one thickness of 15 pound asphalt saturated felt conforming to Federal Specification HH-F-191, and as specified under Paragraph 134.

111. UNDERFLOORING. - All wood finished floors shall receive 13/16 inch by 5 $\frac{3}{4}$ inch tongue and groove underflooring, laid diagonally at 45 degrees to the joists. The boards shall be driven close, but not tight and shall be securely face nailed with two 8d. nails and blind nailed at every bearing, except that nailing shall be double where double bearings occur. The joints shall be properly staggered and made over bearings only. Nailing strips shall be cut between joists to receive the ends of diagonal boards. The attic rooms in the two wings of the Administration Building and the Residence shall receive underflooring only, which will act as finish flooring.

Finish flooring shall be installed as specified under Paragraphs 131 and 134.

112. WEATHERBOARDING. - Over all vertical frame walls, except the walls on porches and dormers, cover with $\frac{3}{4}$ inch by 7 $\frac{1}{2}$ inch S4S, weatherboarding beaded edge and tapered across the width, conforming to the details shown on the drawings. The weatherboarding on sides of dormers will be of similar detail of random widths from 6 inch to 9 inches, laid flush and parallel with the slope of the roof with ship lap joint, and the walls on porches shall have flush tongue and grooved boards 7/8 inch thick of random width from 6 inches to 9 inches laid with ship-lap joints run in white lead. A minimum of splicing shall be done; no splicing shall be allowed under the 16-foot length. All weatherboarding shall be accordingly cut with joint, and seated and matched and securely nailed with 8d nails. Weatherboarding shall butt corner boards at the corners of the building. Corner boards shall be 1 $\frac{1}{4}$ inch by 3 inches, beaded edge, conforming to details on the drawing.

Under all weatherboarding lay one thickness of building paper as specified under Paragraph 110.

113. WALL FURRING. - All masonry walls to be plastered shall be lined with 1 $\frac{1}{4}$ inch dressed 4S, 16 inches on centers extending from floor to ceiling thoroughly nailed to the wood grounds, and made plumb and true to line.

114. COLUMNS. - The wood columns on the porches shall be built-up of a wood core and 1 1/8 inch facing with beveled edges and the caps and bases to these columns shall be built-up of mouldings with mitred corners as shown on the drawings.

The columns in Implement Shed shall be of 8 inch by 8 inch S4S solid wood with beveled edges and the columns in the Stable shall be built-up of three 2 inch by 6 inch S4S edges beveled and thoroughly nailed together with 10d. square cut nails and $\frac{1}{4}$ inch through bolts, 24 inches on centers. All columns shall be straight and true and set up plumb and true to line, securely fastened in place, and set on dowels as specified under Paragraph 102.

The columns on the porch of the Administration Building shall be fastened at the base with 2-inch x 3 inch steel angles bolted down on the cast iron base.

The ends of all columns shall be heavily coated with thick white lead before placing in position.

115. HOOD OVER ENTRANCE. - The hood over the entrance to the Superintendent's residence shall be of the design, shape and construction as shown on the drawings, securely fastened into the masonry wall.

The ceiling lining under the hood shall be done with $\frac{3}{4}$ inch by 2 inch bead joint tongue and groove boards.

116. WOOD CORNICES. - All cornice work shall be constructed on wood lookouts, cut out of 2 inch material, unless otherwise shown, to conform to profiles and provide solid nailing for all members of the cornice and as shown on drawings. Long length material shall be used and where vertical joints must occur, they shall be run in pure white lead and jointed with a tight butt joint, with perfect matching of all members of mouldings, and edges of plain surfaces.

All work shall be thoroughly nailed to solid bearing, and nails countersunk.

117. WINDOW FRAMES. - Box frames shall be constructed as indicated with pulley stiles and parting strips of edge-grain yellow pine. Pulley stiles and outside casings shall be 1 1/8 inches thick. Box frames shall be of such size as will give not less than 1/8 inch clearance on all sides of the weight. The pockets in pulley stiles shall be weatherproof and shall be as long as possible with pocket pieces secured in place with countersunk heavy brass screws. Pendulum strips made of 3/16 inch thick straight grained wood shall be placed in the boxes to separate the weights, and the weight box shall be fully enclosed. Parting strips shall be tightly fitted in grooves, but not fastened. Inside stops shall have countersunk stop adjusters with screws to match, one at each end and at intermediate points about 18 inches apart.

The sills for all window frames shall be of wood plowed and shaped in accordance with details. Frames resting on the masonry shall be bedded in mortar and shall be anchored to the masonry with anchors placed at the top, bottom and at the midpoint on either side. All window frames shall be tightly calked with oakum from both sides before the heads are permanently secured in place.

All dormer windows shall be constructed without weight boxes. The casement and hinged sash frames shall be solid rabbeted, $1\frac{3}{4}$ inch thick.

118. DOOR FRAMES. - All exterior frames shall be rabbeted, the rabbet being worked from the solid wood. Nailing or gluing on of wood strips to form the rabbets will not be permitted. The Contractor shall also construct the transoms, transom bars, and side lights all as shown on the drawings.

The frames from Museum to Porch and from basement stairs to outside in the Administration Building shall have built up paneled jambs as shown and in accordance with the details.

The sliding doors in the garage and work shop shall receive wood jambs $1\frac{3}{8}$ inch thick and in accordance with details.

119. OUTSIDE STAIRWAY. - The outside wood stairway at the Utility Building shall be constructed of all dressed material of the sizes indicated on the drawings, thoroughly nailed with 8 d. cut nails and all nails countersunk. The treads with rounded nosings shall be $1\frac{3}{8}$ inch thick, and the rail with newels built-up as shown on the drawings.

120. SHUTTERS AND BLINDS. - All shutters and blinds shall conform to details and have all joints mortised and tenoned, and louvres or panels mortised into side rails.

The meeting rails shall be solid rabbeted.

121. WOOD FENCE AND GATES. - The wood fence and gates shall be constructed in accordance with the details on the drawings. All posts shall be braced with large stones at the bottom before backfilling the holes and they shall be set and maintained plumb in all directions. All boards shall be substantially nailed at each post and set level in a continuous line throughout the entire length. The ends of boards on the gates shall be through bolted and the end threads upset to permanently set the nuts. All nails shall be 10d. zinc coated iron cut fence nails, and the bolts $\frac{1}{4}$ inch diameter round head with washers and standard square nuts, entirely zinc coated.

122. STABLE MANGERS. - Each stall in the stable of the Utility Building shall have mangers constructed of 1 1/8 inch lumber in accordance with the drawings. The front shall be fastened and securely held in place with 1 1/2 inch by 1 1/2 inch galvanized steel angles and the top board along the front shall be covered with 16 gauge galvanized iron.

123. STABLE STALLS. - The stalls in the stable of the Utility Building shall be constructed as shown on the drawings. The partitions forming the stalls and the wall along one side of stall No. 3 shall be constructed of 2 inch by 10 inch lumber dressed four sides with beveled edges. The floor in each stall shall be of 2 inch by 8 inch solid dimension stock, Select Grade White Oak, dressed one side, and laid on 3 inch by 4 inch yellow pine beveled sleepers 12 inches on centers creosoted under pressure. The creosoting shall be done as specified in Paragraph 105.

The floor boards shall be laid with 3/4 inch open joints, which shall be filled with pitch as specified under Paragraph 184. This work shall be solidly and substantially constructed, thoroughly nailed with 20d, zinc coated wrought iron nails.

124. CAULKING. - All joints between frames and masonry in all exterior window and door frames and all places indicated on the drawings shall be caulked with plastic caulking. The plastic caulking material shall be of a standard make, that is impervious to moisture and unaffected by heat or cold. This material shall not cause staining of any work with which it comes in contact and shall be cream white in color, subject to the approval of the Contracting Officer.

The staff beads on frames shall be removed and the space between wood frame and masonry caulked solid with oakum to within half inch of surface and this half-inch filled with plastic caulking, and the staff beads fastened permanently, after the approval of the Contracting Officer. Where casings and wood finish lay flat on the masonry, the space behind this woodwork shall be filled at least 3/4 inch into the exposed edge with plastic caulking, finished neat and smooth.

125. ANCHORS. - All window and door frames shall be anchored into the masonry with iron anchors, conforming to the requirement of Paragraph 102. Anchors shall be placed 2 feet on centers. The joists shall receive anchors, as specified under Paragraph 102, and the wall sills and plates shall receive anchors as specified under Paragraph 102.

126. LADDERS. - The Contractor shall provide substantial ladders as may be required for easy access to all sections of the work at all times. Ladders shall be securely roped in position at the top and bottom, or securely nailed without damage to finished work.

One ladder of dressed material and substantially constructed shall be installed in the Stable as shown on the plans.

127. MISCELLANEOUS ROUGH WOODWORK. - All blocks, nailing strips, centers for brick arches and all other miscellaneous rough woodwork shall be provided as shown and specified or as may be required to complete the work.

128. ROUGH HARDWARE. - Nails, screws, bolts, expansion bolts, toggle bolts and other necessary rough hardware to secure the wood-work in place shall be provided by the Contractor, conforming to the requirements of Federal Specifications FF-N-101, FF-S-111, and FF-B-571.

The louvres in the cupola on the Utility Building shall be entirely covered on the inside with 16 mesh bronze fly wire, securely fastened with copper nails.

129. PRIMING. - All exterior finishing woodwork, including cornices, trim, columns, column capitals, column bases, beams, weatherboarding, planks, newels, railings, window and door frames, shall be painted one coat of paint, all over, before assembling, and all surfaces accessible after assembling shall receive a second coat of paint. The exposed joints in all columns, column capitals, and column bases, newels and railings and the end wood in columns shall be run in pure white lead before fitting together.

SECTION X.

INTERIOR WOODWORK.

130. SCOPE OF WORK. - This work shall include the furnishing and installing of all interior window trim, sash, stools and aprons, base boards, wood paneling, mantels, cabinets, wood partitions, shelving, and exterior doors, door jambs (plain and paneled).

The work also includes all interior doors, jambs, (plain and paneled), plinths, and trim, stair rails, newels, balusters, string, stair treads, risers, flooring (exterior and interior) wood cornices, arches and picture moulding.

All work necessary in properly finishing the woodwork is also included.

This work shall include the fitting and installation of all hardware.

Shop drawings of the mill work as called for in Paragraph 29 shall be furnished. Samples shall also be furnished as specified under Paragraph 32.

131. KIND, QUALITY AND FINISH OF WOOD. - The newels, balusters and handrails to stairways shall be of Grade A Birch in accordance with the rules of the Hardwood Interior Trim Manufacturers Association.

All other interior finishing woodwork shall be of Grade A, Western white pine, in accordance with American Lumber Standards Basic Grade Classifications, or equivalent grading rules promulgated by manufacturing associations, clear and thoroughly seasoned, air dried and kiln dried stock. All wood throughout shall be assembled in the best cabinet style, and all woodwork shall be so placed that all nailing, so far as possible, will be concealed.

All surfaces of the interior finishing woodwork shall be thoroughly and carefully hand smoothed, sandpapered with the grain of the wood, and cleaned of all mill dust. All moulding, etc., shall conform exactly to the details furnished. All joints shall be tongued or rabbeted together so as to conceal any shrinkage and shall be closely fitted. Mouldings and other continuous members not exceeding commercial lengths shall be installed without splices.

All joints made at the building in installing the interior finish shall be of the same quality of workmanship as required for work done at the mill. All nail heads shall be sunk, and the finished work shall be free from stains, tool marks and open joints.

Mitres in connection with interior finish shall be feathered, glued, and clamped together. Framework, such as doors and panels shall be made up and put together, without glue, and left standing in a warm, dry room for a least two weeks before being clamped and glued together.

All flooring shall be thoroughly seasoned and kiln-dried.

The wood flooring throughout the Administration Building, except in the attic and as otherwise specified, shall be Second Grade Maple flooring, grade marked according to the rules of the Maple Flooring Manufacturers Association. The maple flooring shall be tongue and grooved, dressed and matched, 25/32 inch thickness, and shall be of random face widths of 50% - 1 1/2 inch wide, 25% - 2 1/4 inch wide, and 25% - 3 1/4 inch wide. The wood flooring throughout the Superintendent's Residence, except in the attic and where linoleum floors are shown and unless otherwise specified, shall be clear, plain sawed, white oak flooring, grade marked according to the Oak Flooring Manufacturers Association of the United States. The oak flooring shall be 25/32 inch thick and a face width of 2 1/4 inches.

The finish flooring over all areas covered by linoleum in the Superintendent's Residence and throughout the second floor of the Utility Building shall be Southern Pine "B" Flat flooring, grade marked according to the rules of the Southern Pine Association, having a face width of 3 1/4 inches. The flooring on the second floor of the Utility Building shall be 1 1/16 inch thick and in the Residence 25/32 inch thick.

The flooring for all exterior porches, and outside step platform shall be Grade A, vertical grain, Southern Pine flooring, grade marked according to the rules of the Southern Pine Association, having a face width of 3 1/4 inches and 1-1/16 inch thick.

132. INSTALLING HARDWARE. - All necessary hardware in connection with the woodwork as specified under "Hardware" shall be installed in a workmanlike manner. Hardware shall be fitted and removed before the painting and finishing are executed. It shall be permanently installed after all painting and finishing are completed.

133. SASH FOR WINDOWS AND TRANSOMS. - All wood sash for windows, transoms and sidelights shall be $1\frac{3}{4}$ inches in thickness and shall be rabbeted on the outside to permit the securing of the glass with glazier's points and putty.

All sash shall be mortised and tenoned together and pinned. Vertical sash muntins shall be continuous their full height, tenoned and pinned into the top and bottom rails of the sash, and mortised to receive the tenons of the horizontal muntins. Horizontal muntins shall be tenoned into vertical muntins and into sash stiles.

All top hung in-opening sash shall receive drip moulding set into the bottom rail.

134. FLOORING. - The several kinds of wood for flooring shall be installed in accordance with the requirements of Paragraph 131.

Finish flooring shall be delivered to the building in dry weather and in original bundles, and only after the plastering is completed and dried out, and shall be immediately put under dry cover inside. The flooring shall be laid the longest way of each room, unless otherwise directed, and shall run through doorways continuous, making a flush floor without open joints or thresholds. The flooring material shall be so distributed that the shorter lengths will not be utilized in front of doors but be distributed generally throughout the floors, using as many of the shorter lengths as possible in closets and similar places. The floor work shall be laid out so that it will not be necessary to lay a ripped strip of flooring at an entrance or doorway. Where ripping is necessary, the difference shall be taken off of not less than three adjacent strips instead of taking the whole difference off of one strip.

The Contractor shall underlay all Finish flooring over under-flooring with 15 pound asphalt-saturated felt as specified under Paragraph 110. The felt shall be laid smoothly and lapping all joints at least four inches.

All exterior flooring shall have all joints run in thick white lead. Each piece of flooring shall be securely blind nailed to every bearing with 8d. steel wire flooring nails. Each fourth row of flooring shall be driven tight, driving against its neighbors with a wooden block, and then well nailed. All flooring shall be laid straight, even and true.

Upon completion of all work including the pointing, but before the enamel is applied on the baseboards and plinths,

all oak and maple wood shall be lightly hand scraped, taking off the unevenness in the joints, etc. This wood shall then be scraped with an electric floor finishing machine using the proper grade of sand paper to produce a true, even, and smooth surface over all areas.

Around all walls that cannot be reached by machine, and the treads and platforms of stairs the wood shall be hand scraped.

The Contractor will be required to furnish all materials and equipment as well as the necessary electric connections and current.

Upon completion and after inspection and approval of the floor scraping work by the Contracting Officer, the floors and stairs shall be entirely covered with common rag felt building paper.

135. STAIRS. - The Contractor shall provide all finish wood on the interior stairs. The stairs shall be built according to the details on drawings and shall be completely assembled at the building and erected in place.

All work shall be of the highest grade of stair work, Exposed outside strings, wall skirting, and risers, shall be of white pine with mouldings as indicated, cut and mitred according to the details. The finish of treads and platforms shall be of Grade A Maple in the Administration Building, and plain sawed, clear white oak in the Residence, moulded as shown and $\frac{1}{8}$ inch thick.

Provide all framing for newels, which shall be rigidly secured in place and all railings neatly fitted into them. Treads and risers shall be tongued and grooved together with front and back housed into the stringers and thoroughly wedged, blocked and glued together.

All balusters shall be as detailed, and shall follow the run of the stair, enclosing the stair well at all points, returning to the wall. Balusters shall be housed into rail and dovetailed to treads as detailed.

The hand rail shall be carefully fitted at the building approved by the Contracting Officer and returned to the shop for final finishing. The rail shall be in long lengths with ramps and easements continuous from newel to newel. Joints in the rail shall be secured with concealed rail bolts in an approved manner.

A half section of the hand rail shall be placed and securely fastened on the plaster wall enclosing stairway in the Administration Building following the line of the stair, and at the same height as the stair rail, and extend around walls of stair hall on first and second floors, as shown on the drawings.

Stairs to basements shall be of similar construction with 1-1/8 inch treads and 7/8 inch risers of short leaf Grade A Southern Pine.

136. WOOD MANTELS. - The Contractor shall furnish and install the white pine wood mantels shown on the drawings. This shall be done in cabinet style and in close conformity to the details and shall be installed with secret fastenings in an approved manner.

137. DOORS. - All exterior and interior wood doors shall be of the type, size and thickness indicated on the drawings. The doors in Utility Building shall be of Grade A, short leaf Southern Pine, all other doors shall be of Grade A, Western White Pine.

The stiles and rails shall be blind tenoned, thoroughly glued, primed and wedged up. The doors shall be provided with glazed upper panels, where indicated. All wood panels shall be loosely fitted and finished behind moldings to avoid a marginal line should shrinkage occur. The batten doors shall have the battens fastened with flat head screws, the screw heads to be flush with the surface.

All interior glazed doors shall have wood glass stops.

138. TRIM, PLINTHS, JAMBS AND CORNICES. - The trim for doors, and windows in the Administration Building and the Residence shall be 7/8 inch thick moulded of various sizes to suit conditions and as shown on the drawings. Special moulded trim with caps, arches and key blocks shall be made to conform to full size details. The fluted trim shall be cut from 1 3/8 inch lumber, and the soffits of arches built up solid and the face veneered with 1/4 inch finishing lumber. All door trim shall receive plinths conforming to the trim and the height of base.

The wood cornices in the Administration Building shall be built up as shown on the drawings, with the ornament cut-out from 1/2 inch lumber and glued on. The top pieces of the cornice forming the crown mould shall be cut from 1 1/8 inch lumber and all other parts from 7/8 inch lumber. All corners and angles shall have perfect mitres and securely nailed to blocking every 16 inches with finishing nails, countersunk.

All cornice work shall be in long lengths and set straight and true.

All interior doors shall receive 1 3/8 inch thick solid rabbeted jambs forming a complete frame to the opening.

The Utility Building shall receive door trim and jambs. The trim shall be of 7/8 inch plain lumber with round edges and mitred at corners. The jambs shall be solid rabbeted. There will be no wood plinths required.

139. STOOLS AND APRONS. - All windows shall receive stools and aprons, as shown and detailed on the drawings. The stools shall be 1 1/8 inch thick with rounded edge.

The aprons shall be 7/8 inch by 4 3/4 inches moulded one edge and a 3/4 inch by 1 1/4 inch mould to form finish under stool.

The ends of stools and aprons shall be worked in the solid to conform to the profile of the face.

140. WOOD PARTITIONS AND CABINETS. - The wood partitions and walls in the Utility Building shall receive 7/8 inch thick V-joint tongue and grooved, the "V" filled at top, extending from floor to ceiling. The width of boards shall vary from 4 inches to 10 inches, sized four sides, and an even distribution of widths in the wall, blind nailed, and surface nailed with 8d. finishing nails, countersunk. Blocking for the nailing shall be cut-in between the studs. Around the walls of each room a 3 inch stock crown mould shall be run at the ceiling, mitred at corners and substantially fastened to wood blocking out between studs, forming a finish to the wood finish specified above.

The kitchen cabinets in the Superintendent's Residence shall be constructed of 3/4 inch dressed lumber arranged in two sections, and in accordance with full size details. The bottom section shall contain drawers and paneled doors enclosing shelving, and the top with open shelves and plate strips. The 1 1/8 inch top of the bottom section shall be covered with linoleum as specified under Paragraph 164.

The towel cabinet in bath room in the Superintendent's Residence shall be entirely of 3/4 inch dressed lumber with paneled door.

The cabinet shall have inside measurements of 19 inches wide, 30 inches high, and 16 inches deep and have two fixed shelves.

141. BASEBOARDS AND SHOE MOULDING. - The Contractor shall provide and set baseboards in all rooms with plastered walls. The base shall be in long lengths butted against the back edge of plinths and shall be tongued or dovetailed together at internal angles. Baseboards shall be molded in accordance with the detail drawings and shall be secured to wood grounds at ends and at intermediate points not over 18 inches apart. All nails shall be sunk below the surface.

All rooms with baseboards shall receive shoe moulding of $7/8$ inch by $1\ 3/8$ inch white oak in the Residence and Grade A maple in the Administration Building, fitted and mitred at corners and securely nailed.

The attic storage rooms and closets shall receive plain base of $7/8$ inch by $4\ 3/4$ inch with shoe mould.

142. PICTURE MOULDING. - All rooms in the Administration Building and the Residence shall receive picture moulding as indicated on the drawings. The moulding shall be $1\ 1/8$ inch by $1\ 3/4$ inches conforming to the details and shall be in long lengths and nailed substantially in position to wood grounds.

143. WOOD PANELING. - The wood paneled wainscot shown on the drawings and wood panels over mantel in the Museum in Stair Hall of the Administration Building shall be built-up and fastened to the wood grounds. The panel rails shall be of $7/8$ inch material and the panels of $3/4$ inch material. All joints shall be mortised and tenoned, and the panels fastened secretly and securely to the back.

The wood paneling over radiators in the Museum and Entrance Hall of the Administration Building shall be made removable in an approved manner.

144. SHELVING. - Shelving shall be provided in all closets and the pantry of the Residence, with $7/8$ inch white pine hook strips and shelves. The height of the shelves in closets shall be approximately 5 feet above the finished floor.

The shelving in the Inflammable Storage Building shall be of $1\ 1/2$ inch dressed lumber, arranged as shown on the drawings, work benches in the work shop and garage of the Utility Building shall be of $1\ 3/4$ inch dressed pine, substantially constructed and installed in an approved manner.

The shelving forming the bookcase in the Superintendent's Office in the Administration Building shall be of $1\ 1/8$ inch

material with moulded edge and constructed in accordance with details on the drawings.

145. PRIMING. - The back of all white pine interior woodwork shall be prime painted two coats of paint, and the exposed surfaces which are to be painted, shall be prime painted one coat, before being placed in position, all as required under "Painting", Paragraph 207.

SECTION Xa

INSULATION.

145a. SCOPE OF WORK. - This work shall consist of the furnishing and installing of the insulation in the ceilings under the roof areas to reduce thermal conductivity in the Administration Building and the Superintendent's Residence, except in the Wings of these buildings.

Samples of the material shall be submitted as specified in Paragraph 32.

145b. MATERIAL. - The insulation material shall be the best quality of rock wool, or its equivalent in thermal conductivity. It shall be furnished 3 inches in thickness and in bats of convenient size to meet the requirements of this installation.

145c. INSTALLATION. - The insulating material shall be installed in the attic spaces between joists and studs, extending from the exterior walls to the knee walls, up knee walls to intersection with rafters or follow the line of the roof, and between rafters up to and across the attic ceilings as shown on the drawings. It shall also be installed in the walls and ceilings and under the sills of all dormers, providing a continuous blanket of insulation under the entire roof areas. The bats shall be placed in position and pressed tightly together.

On the unfinished face of knee walls and rafters an approved heavy tough building paper shall be placed and fastened to close and protect the insulating material.

SECTION XI

LATHING.

146. SCOPE OF WORK. - This work shall consist in furnishing and installing all metal lath for all ceilings, walls, partitions and stair soffits to be plastered and stuccoed.

Sample of lath shall be furnished in accordance with Paragraph 32.

147. MATERIALS. - The metal lath shall be No. 18 gage having not less than $2\frac{1}{2}$ meshes to the inch and stiffened with $\frac{3}{8}$ inch V ribs not over 8 inches on centers. Metal lath shall be galvanized after manufacture. The lath shall conform to the requirements of Federal Specification QQ-B-101, Class E3/8 $\frac{1}{2}$.

Corner beads shall be manufactured from sheet metal not less than #26 gage, and shall be galvanized and as approved by the Contracting Officer.

Nails for lathing shall be thin, flat, hook head, diamond point, $1\frac{1}{8}$ inches long and zinc coated.

148. METAL LATH. - The metal lath shall be erected with the rib across the supports and placed so that the lower sheet laps over the upper sheet and sides shall be lapped not less than $\frac{1}{2}$ inch and ends not less than 1 inch. End laps shall occur only over supports.

Where wood beams or lintels are to receive plaster they shall be wrapped with metal lath before the adjacent construction is placed.

Surfaces of lathing shall be constructed level, plumb, true and rigid, in perfect condition to receive the plaster.

The lath shall not be applied until all pipes, ducts, conduits, etc., have been installed and tested and all electrical outlets correctly established.

149. CORNER BEADS. - Corner beads shall extend from the top of the base to the line of the cornice or ceiling in one piece. They shall be erected in a substantial manner, plumb, true, and out of wind, and secured not less than 12 inches apart.

Corner beads shall be set for all external angles in the plaster work throughout all rooms.

SECTION XII

PLASTERING.

150. SCOPE OF WORK. - This work comprises the plastering of all partitions, walls and ceilings inside the Administration Building and the Superintendent's Residence, except the walls of the basements, and the attic storage rooms as shown on the drawings. The work also includes the exterior stucco plaster on all porch ceilings, the cornices, the brickwork on ends of porches and on the chimneys indicated, and cement plaster ceiling in the Inflammable Storage Building, and all necessary pointing after all mechanics and workmen.

All metal lath surfaces shall be plastered with gypsum hardwall plaster applied in three coats; the last coat shall be a troweled white coat finish.

In rooms where tile walls occur, the finish coat shall not be applied until after the completion of the tile work.

151. GYPSUM PLASTER. - The plaster for the first two coats shall be a specially prepared gypsum plaster and shall conform to the requirements of Federal Specification SS-P-401, Type S and Type B.

Calcined gypsum or plaster of Paris shall conform to the requirements of Federal Specification SS-G-901, Class F, for finishing.

The plaster shall be of a make approved by the Contracting Officer and shall be delivered on the work in original containers bearing the maker's name and brand.

152. LIME. - The lime required for the finishing coat shall be finely ground, mill hydrated lime. It shall conform to the requirements of Federal Specification SS-L-351, for finishing lime, Type F. It shall be soaked in water for 24 hours before being used in the work. The use of lump lime will not be permitted.

The lime shall be of a make approved by the Contracting Officer and shall be delivered to the site in the original packages bearing the maker's name and brand.

153. SAND AND HAIR OR FIBER. - Sand for plastering shall be clean sand and of suitable size and gradation for use in plastering mortar.

The sand used for the final coat of cement plaster shall be a clean, white sand, suitable for the finish coat.

Hair or fiber used in plaster shall be clean, free from dust and between $\frac{1}{2}$ inch and 2 inches in length.

154. MIXING PLASTER. - Plaster shall be mixed in a mechanical mixer or in clean, water-tight boxes. The boxes and tools shall be cleaned thoroughly before mixing each new batch. Ingredients shall be mixed dry and again wet, and the mortar shall be worked evenly and thoroughly until it is uniformly of the proper consistency. Batches shall be of such size that an entire batch shall be used within one hour.

155. PROTECTION. - The plastering shall not be started until the exterior openings have been closed to permit the proper regulating of the drying of the work.

All plaster work shall be protected from damage during and after construction.

156. CONDITION OF SURFACES TO BE PLASTERED. - All surfaces to be plastered shall be cleaned thoroughly before the plaster is applied. A plaster bond coat as approved by the Contracting Officer shall be applied on all concrete surfaces to be plastered.

157. SCRATCH COAT. - All surfaces to be plastered shall receive a first or scratch coat. The scratch coat shall be applied to lath with sufficient force to form good keys, and to masonry with sufficient force to form a firm bond.

When the mortar of the first coat has become firm but not fully set, the surface shall be scratched diagonally in both directions with a special tool designed for the purpose and making scratches not over $1\frac{1}{2}$ inches apart. The scratching shall not be deep enough to destroy the keys but shall be deep enough to furnish a proper surface for receiving the second coat.

158. BROWN COAT. - A brown or second coat shall be applied over the scratch coat on all surfaces to be plastered. The brown coat shall be applied after the scratch coat has set but before the scratch coat has dried out fully. If necessary to secure proper bond, the scratch coat shall be wetted with a brush before the brown coat is applied. The brown coat shall be applied in such manner as will form a perfect bond with the scratch coat.

159. FINISH COAT. - The finish coat on all bath rooms and toilets, stairways to basements and kitchens shall be of Keene's Cement as hereinafter specified, everywhere else the finish or white coat shall be approximately 1/8 inch thick and at no place less than 1/16 inch thick and shall be applied over the brown coat on all surfaces to be plastered, except on surfaces where the plaster is covered by wood finish. The finish coat shall be applied in 2 layers, the second following immediately after the first. Both layers shall be applied with a trowel and the second layer must be thoroughly and evenly scoured with water by going over the entire surface at least three times. Sufficient time must be allowed between each scouring to permit the plaster to shrink. The final scouring shall be continued until a dense, even, close-grained surface is secured. The entire surface shall then be brushed and troweled until a hard, uniform smooth surface with a high polish is obtained.

Grounds shall be set accurately and in uniform planes before plastering is commenced. The finished surface shall be run true to the grounds and guide lines and be straight, level, and plumb, with all lines and arrises true and sharp. The finished surfaces shall be free from visible joints, cracks, crazes, tool marks, waves, stains, or other defects.

When possible, the finish coat on any wall or ceiling shall be applied in one continuous operation, but where the size of the wall or ceiling or the special character of the work makes it impossible to complete the finishing of any such surface in one continuous operation, the work shall be stopped on lines as designated by the Contracting Officer.

160. KEENE'S CEMENT WORK. - The bath room and kitchen walls and ceiling, the stairway to basements and the walls and ceilings of all toilets except where tile occurs shall be plastered over the brown coat with Keene's Cement gauged with lime putty and shall be applied in accordance with manufacturer's directions. The finish coat shall be made with the best grade of material, applied after the tile work is completed, and the finish obtained shall be a hard, smooth surface, suitable for receiving enamel.

161. STUCCO WORK. - The exterior surfaces to receive stucco and the ceiling in the Inflammable Storage Building shall be plastered on the metal lath or brick with two coats of Portland cement plaster composed of one part Portland cement, three parts sand with not over 10 percent by volume of hydrated lime added for easier working.

Cement	shall conform to the requirements of Paragraph 55.	
Lime	" " " " " " " "	152.
Sand	" " " " " " " "	71.

The cement and lime after being thoroughly mixed dry to a uniform color, shall be added to the dry sand and the whole manipulated until evenly mixed. Water shall be added to secure proper working consistency. The mortar shall be applied within thirty minutes from time of mixing. No retempered mortar will be allowed.

The scratch coat shall be scratched and cross scratched to receive the second or brown coat, and be kept moist for two days and then allowed to dry out before the application of brown coat.

Immediately preceding the application of the brown coat the wall shall be evenly dampened. The brown coat shall be brought to a true and even surface and then given a rough finish with a wood float to provide bond for the finish coat. The brown coat shall be kept moist for two days and then be allowed to dry out before the application of the finish coat. There will be no finish coat on the ceiling of the Inflammable Storage Building.

The finish coat of stucco plaster shall be of a standard make and as approved by sample by the Contracting Officer. The finish shall be mixed and applied in accordance with manufacturer's directions.

The texture of the finish shall be an even sand finish of a light buff color, and as approved by sample.

SECTION XIII

LINOLEUM FLOORS.

162. SCOPE OF WORK. - This work shall include the furnishing and installing of linoleum flooring in all locations shown on the drawings.

Samples of the material shall be submitted, as specified under Paragraph 32.

163. MATERIAL. - Over all surfaces indicated as linoleum including closets adjoining, Government Standard battleship brown linoleum, 6 millimeters thick, heavy weight, shall be laid over a felt underlining. The linoleum shall be in accordance with Federal Specification LLL-L-351, and as approved by the Contracting Officer. The felt underlining shall consist of an approved material as recommended by the manufacturer of the approved linoleum.

164. LAYING LINOLEUM. - All linoleum and felt shall be laid with a waterproof cement of a manufacture as approved by the Contracting Officer. The linoleum and felt shall in all cases extend into closets and be laid parallel with the length of the rooms and all seams and cutting around pipes, corners, projections, etc., shall be done in a neat and workmanlike manner, and the material shall extend under the shoe moulding. All linoleum shall be thoroughly rolled and weighted down in an approved manner and the weights shall not be removed until the cement has thoroughly set. Approved brass angle binders shall be placed at all openings where linoleum floor finish stops.

The linoleum on the top of the bottom section of the cabinets in the kitchen of the Residence, shall be laid similar to floors and the exposed edge shall be covered with an aluminum alloy angle fastened substantially with aluminum screws.

lath shall be of the type required under Paragraph 148.

169. **SETTING WALL TILE.** - Immediately after the second coat of backing is in place for any section of wall, the tile shall be set. The method of setting shall be approved by the Contracting Officer.

All tile shall be thoroughly soaked in clean water before being placed on the wall. Each tile shall be placed in position and tamped until firmly united to the backing. Where necessary to cut tile, the edges shall be ground or rubbed smooth and the surface of the tile shall not be marred. Tile shall fit closely around outlet boxes and edges shall be well covered when the cover plates are placed in position. All irregularities in shapes, intersections, and returns shall be perfectly formed, using specially shaped tile where necessary.

All wall tile shall be laid with a bond so that the joints shall be in the center of adjacent tile.

All joints between the tiles shall be of uniform width. All lines shall be straight and true and the surfaces shall be brought to true and even planes, free from waves, projections, or other irregularities.

After setting of the tile has commenced, the cutting or pounding of walls adjacent to the tile work will not be permitted, and such work shall be delayed until the tile has thoroughly set.

Attention is invited to the fact that the last coat of plaster on the walls above the tile will be applied after the tile has been set. The tile walls shall be thoroughly protected before the finish coat of plaster is applied.

170. **Finishing Walls.** - The joints between the tiles shall be carefully washed out and filled with neat, white Portland cement. All broken, loose or cracked tile shall be removed and properly replaced. The walls shall be thoroughly cleaned of all mortar or stains and left in perfect condition.

171. **REVEALS, OFFSETS, JAMBS, ETC.** - The Contractor shall tile all reveals, offsets, splays, etc., occurring in tile walls or wainscots with the same tile specified for walls, and set in the same manner.

172. ACCESSORIES. - Toilet accessories shall be furnished and installed in connection with the tile work. The accessories shall be similar in quality, color and finish to wall tile. All accessories shall be clincher back, vitreous, built-in type.

Superintendent's Residence

- 2 - 24 inch towel holder with covered wood bar.
- 1 - Recess type combination soap holder and grab bar at the tub.
- 1 - recess type soap holder at the lavatory.
- 1 - Tumbler holder.

SECTION XV

METAL PARTITIONS FOR TOILETS

173. SCOPE OF WORK. - This work shall include the furnishing and installing of metal partitions for the toilets in the Administration Building, and as approved by the Contracting Officer.

The partitions shall be complete with doors, hardware fastenings and painted finish. Shop drawings shall be submitted in accordance with Paragraph 29.

174. MATERIALS. - Steel sheets and strips shall be cold rolled, furniture stock steel that has been properly annealed and process leveled and has smooth, clean surfaces.

Face plates of doors shall be 22 gauge. Face plates of partition panels shall be 20 gauge. Strips for edges of doors and partitions panels shall be 20 gauge.

Posts shall be square in cross section; either plain or of "paneled" design. Plain posts shall be 16 gauge. Paneled posts shall be 18 gauge.

Top rails shall be either square or rectangular in cross section and of 18 gauge.

Fittings shall be of plain, heavy pattern and shall be either wrought steel or malleable iron, unless otherwise specified. Bolts and rivets shall have finished heads. Through bolts shall have cap nuts.

Shoe fittings at bottom of posts shall be of cast white metal (Aluminum or nickel-bronze) with fastenings to match in white metal or stainless steel. Shoe fittings shall be adjustable to compensate for inequalities in the floor. They shall be provided with expansion bolts for fastening to the floor.

Cores of doors and partition panels shall consist of not less than two layers of double wall and two layers of single wall pads glued into boards approximately 1-inch thick. The two outer single wall pads shall be made with two .016 cylinder Kraft Liners and one .009 straw B flute corrugations. The two inner pads shall be made with three .009 chip liners and two .009 straw A flute corrugations.

175. WORKMANSHIP. - Doors and partition panels shall be made up of two flush sheets with U-formed edges cemented over the core and assembled by interlocking the edges with slip locking strips which shall be mitered and welded at the corners. Locking strips shall be die drawn and shall have the outer face uniformly rounded and designed to lock the plates with a tension grip. The contact edge between post and partition panel shall be flat.

The doors and partition panels shall finish not less than $7/8$ nor more than $1\ 1/16$ inch thick, but each door or panel shall be of uniform thickness throughout and there shall be no variation in thickness of all doors and panels of more than $1/16$ inch.

Partition panels shall be anchored to the posts by not less than three hooks. The hooks shall be inserted into the posts through suitable openings, then forced downward; the hooks being designed to draw the post and panel together with a tension grip. The panel shall be permanently secured by welding the corners at top and bottom to the post.

In setting the enclosures, the wall ends of partition panels shall be kept away from the face of the wainscot or wall finish from $\frac{3}{4}$ inch to 1 inch. The wall ends of partition panels shall be fastened by not less than two stirrup brackets, at points near the top and bottom.

The finished work shall be strong and rigid and free from defects. Surfaces shall be smooth and free from wave, warp, or buckle. Mitres shall be well formed and in true alignment. Welds shall be neatly dressed. Finish shall be free from scratches and abrasions.

A protective paper covering shall be applied to the doors and partitions during erection and maintained until final inspection of the work.

Finish on steel and iron shall consist of prime finish followed with plain enamel finish. All surfaces shall be clean and dry when paint or enamel is applied.

Prime finish shall consist of one dip or spray coat of rust-resisting paint on all exposed and interior surfaces, and one prime coat of paint on exposed surface; each coat to be baked on and exposed surfaces rubbed smooth.

Plain enamel finish shall consist of two coats of enamel on all exposed surfaces, in addition to the prime finish above specified; the final coat to be rubbed to an egg shell gloss. Enamel finish shall be in one solid color as selected.

176. **HARDWARE.** - Doors shall be hung on gravity type double-acting hinges with concealed stainless steel ball-bearing rollers on hardened stainless steel cams, adjustable to permit doors to be made self-opening, self-closing or ajar at time of installation, and on an upper pivot guide pin of stainless steel operating in a graphite impregnated bushing. Each door shall be fitted with a combination keeper and bumper, throw latch and combination coat and hat hook with rubber tipped bumper, and a cylinder lock on one door of Type 153, conforming to Federal Specification FF-H-106.

All hardware shall be of plain, heavy pattern and exposed surfaces shall have a polished finish. Hardware shall be applied with screws, bolts and cap nuts matching the hardware. Hardware shall be of brass or bronze, chromium plated, except parts specified to be of stainless steel.

Hinges of in-swinging doors shall be adjusted to hold the doors open about 30 degrees when doors are at rest.

177. **SETTING.** - The partitions shall be erected in true alignment with the room and in accordance with the specifications of the manufacturer.

SECTION XVI

SHEET METAL WORK, WATERPROOFING AND DAMPROOFING.

178. SCOPE OF WORK. - This work shall include the furnishing and installing of all metal flashings, gutters, downspouts of copper and miscellaneous metal work in connection with the roofing, and the copper roofs over the entrance to the Superintendent's Residence and the cupola on the Utility Buildings. The work shall also include the copper cap flashing over openings in the frame wall construction and dormers, and copper flashing under the two-piece sills of all windows and the sills of dormers.

The galvanized iron vent ducts and metal covering for door and jamb in the Inflammable Storage Building and basement of the Administration Building is also included.

The work shall also include the waterproofing of the exterior face of all walls below grade including the footings that enclose the basements, and the floors of stalls in the stable of the Utility Building.

179. COPPER. * The copper used for flashings, gutters, downspouts and metal roofing work shall generally be of either hot or cold rolled manufacture as best suits the purpose for which it is to be used. Copper shall weigh 16 ounces per square foot, except where otherwise specified.

Samples of copper as called for in Paragraph 32 shall be submitted for approval.

180. FLASHING AND COUNTERFLASHING. - The Contractor shall furnish and set all flashing and counterflashing for all intersections of roof surfaces with chimneys, pipes, etc. The flashings shall be stepped up the sloping roof as indicated on drawings, extending on the roof under shingles at least 6 inches and a minimum of 4 inches up on chimney, forming a saddle or cricket behind chimney. Counterflashing shall extend $1\frac{1}{2}$ inches into brick joints, securely wedged in place and caulked, the lower edge of counterflashing kept 2 inches above roof. All seams and joints shall be flat locked and soldered.

The heads of all openings in frame walls and the dormers, shall receive cap flashing formed neatly over the edge and tacked with copper nails every 2 inches, and extend up 4 inches on the vertical walls. The flashing under dormer sills shall extend under wood sill and turn up 1 inch against back and at ends of sill, and project 6 inches under top course of roof shingles. Flashing shall also be provided under all two piece wood window sills.

181. METAL ROOFING. - One layer of rosin-sized building paper, with 2-inch laps at joints, shall be laid over all roof surfaces to receive metal roofing.

The roofing shall be laid with flat seams. All seams shall be made by turning the edges of the sheets $\frac{1}{2}$ inch and locking and soldering them together. Cleats $1\frac{1}{2}$ inches wide, hooked carefully over the $\frac{1}{2}$ inch upturned edges of sheets and nailed to the roof shall be used, with not less than three cleats to each sheet. The roof or bottom end of each cleat shall be turned back over the nail heads before the next sheet is applied. The edges of all sheets to be soldered shall be tinned at least $\frac{3}{4}$ inch before the sheets are locked.

182. GUTTERS AND DOWNSPOUTS. - The hanging gutters shall be semi-circular (half round) in cross section. They shall be beaded and provided with mitred corners, outlets, etc. as required and on long runs between outlets, the high point shall be placed midway between the outlets and all cross joints shall be lock joints arranged to allow for expansion and contraction. The hanging gutters shall be supported on adjustable approved brass hangers spaced not over 30 inches on centers and secured with heavy brass screws. At each outlet to the downspout, the Contractor shall provide a 10 gauge copper wire, basket pattern, guard, extending into the downspout without soldering.

The exposed downspouts shall be fitted over the outlets in the gutters and secured to the building with approved brass fasteners. The downspouts shall be rectangular and fitted into the drain pipe at the ground. They shall be located as shown on the drawings and erected plumb and true to line.

183. SOLDER AND CAULKING. - All solder shall be composed of pig lead and block tin in accordance with Federal Specification QQ-S-571. The material used in caulking and wedging copper work into reglets shall be an approved lead wool.

184. WATERPROOFING. - The surface to receive waterproofing shall be thoroughly cleaned before waterproofing is applied. This waterproofing shall consist of 2 heavy moppings of hot coal-tar pitch.

All open joints in the stall floor boards in the stable of the Utility Building shall be filled with hot pitch.

185. DAMPROOFING. - Before the application of this material the Contractor shall prepare the surfaces to receive the plaster bond. The interior surface of all masonry walls to be plastered shall be cleaned and made free of all dirt, oil and other foreign matter, and all projections removed. The walls shall be thoroughly dry, before the asphalt plaster bond is applied.

The plaster bond for dampproofing shall be pure asphalt, of a standard make, especially prepared for use as a bond for plaster when combined with grit. This material shall be of such a nature and consistency as to be applied with an air gun.

This material shall be applied in accordance with the specification of the manufacturer. All surfaces shall be thoroughly covered and upon completion the work shall meet the approval of the Contracting Officer before the application of any furring, lath, and plaster.

185a. METAL COVERED DOOR AND FRAME AND VENT DUCTS. - The door in the Inflammable Storage Building shall have the inside face of the door and the inside exposed face of the wood jamb covered with 22 gage galvanized iron. The metal shall be cut neat to fit the door and jambs in one piece and nailed around the edges with 2d. zinc coated or cement coated flat head nails, 3 inches on centers.

The vent ducts in the Inflammable Storage Building shall be constructed of 24 gage galvanized iron, the openings covered with 16 mesh sheradized fly screen wire. The vent openings through the brick walls shall be provided with standard stock cast iron wall vents, built solidly into the masonry, and as approved by the Contracting Officer.

The metal covered door and frame in the basement of the Administration Building shall have the core of the door of white pine, except small mouldings which may be of cypress. The wood shall be well seasoned, free from large or unsound knots, checks or bark, and all connections shall be mortised and tenoned. The covering shall be #26-gauge galvanized copper bearing iron for stiles, and nails, #28 gauge for small mouldings, and #22-gauge for panels.

The covering work shall all be done by machine, except on panels, where metal shall be glued on. All metal shall fit closely to wood cores, the surfaces straight and true, without blisters or rough edges. All edges shall be sharp, with

edge radius of approximately 1/64 inch straight and true.
All panels shall be finished with mouldings that are sharp
and clean.

All necessary provisions and reinforcements necessary
for finish hardware shall be made.

SECTION XVII

ROOFING.

186. SCOPE OF WORK. - This work shall include the roofing of all sloping surfaces of all roofs, not otherwise specified, with shingle tile over felt.

Samples of material shall be furnished as called for under Paragraph 32.

187. MATERIALS. - The felt used under the tile shall be asphalt-saturated rag felt conforming to the requirements of Federal Specification HH-F-191, Type II, and as specified under Paragraph 110.

The tile shall be 7 inch by 15 inch clay or shale shingle tile, granular texture, hand treated, $\frac{1}{2}$ inch thick butts, in a full range of natural colors. Shingles shall have two holes for nails.

All nails used in connection with the roof work shall be flat head hard copper, $1\frac{1}{2}$ inch long, standard cut nails.

188. INSTALLING ROOFING. - One layer of roofing felt shall be laid over all portions of the roof to be covered with tile. All felt shall be securely nailed to the sheathing with small nails driven through flat tin discs. All joints in felt shall be lapped not less than 3 inches, as specified under Paragraph 110.

The tile shall be laid shingle fashion over all portions of the roofs. The tile in the sloping surfaces shall be laid so that the tile in one course will lap 3 inches over those of the second course below.

Each row of tile shall break joints with those of the adjoining rows above and below. All tile shall be laid with the dark colors starting at the eaves and grading to the light colors at the ridge. Each tile shall be properly nailed with 2 copper nails. Where nail holes in the tile come over sheet metal work additional holes shall be punched outside of the metal lines as each tile shall be secured by not less than 2 nails. Exposed nail heads shall be pointed with elastic cement.

Unless otherwise noted the tile at the hips shall be so formed as to form "saddle hips". Butt joints at the hips shall be close fitted, and all tiles at the hips and ridges shall be firmly bedded in slaters plastic cement, conforming to Federal Specification SS-C-153, Type I. At points where tiles abutt vertical surfaces extending above the roof, copper flashing shall be provided as specified under Paragraph 180.

All tile shall be clean and dry when laid and the completed roof shall be smooth and regular. Any cracked, broken or otherwise damaged tiles which appear in the completed roof shall be removed and replaced with new tile.

SECTION XVIII

HARDWARE.

189. SCOPE OF WORK. - This work includes the furnishing and installing of all finishing hardware throughout the four buildings, except the hardware for the doors on metal toilet partitions. All necessary hardware to complete the buildings shall be included, whether specifically mentioned herein or not, together with all necessary brass or bronze screws, expansion and tap bolts, to match the hardware and other appurtenances.

Samples of all hardware shall be furnished as called for under Paragraph 32.

190. QUALITY AND FINISH. - The hardware for each building shall be as follows:

ADMINISTRATION BUILDING. - All doors in the toilet rooms and basement, and all windows throughout shall be standard stock hardware of cast bronze, except the hinges in basement which shall be wrought steel. All other hardware including all outside doors shall be genuine wrought iron hardware, with brass knobs, of similar design in accordance with details shown on the drawings. The wrought iron shall be hand-worked resembling the work of the early American blacksmith of which these designs are reproductions. Designs from stock will be acceptable if they are similar in size and detail and meet the approval of the Contracting Officer.

SUPERINTENDENT'S RESIDENCE. - All hardware throughout shall be standard stock cast bronze hardware, except the hinges in basement which shall be wrought steel.

UTILITY BUILDING, INFLAMMABLE STORAGE BUILDING AND GATES. All hardware shall be standard stock hardware of wrought steel, except locks which shall be brass.

All standard stock hardware shall conform to the requirements of Federal Specifications FF-P-101a, FF-H-106, FF-H-111, FF-H-116. Where type or table numbers appear in this subdivision of the specification, such numbers refer to the above mentioned Federal Specifications. The hardware for metal toilet stall doors will be furnished with the doors as specified under Paragraph 176. In the Administration Building and the Residence the finish in all toilet rooms, bath room,

kitchen, enclosed porch and pantry shall be US26, all wrought iron hardware US19, brass knobs US3, all bronze hardware US9, wrought steel hinges US2S.

In the Utility Building, Inflammable Storage Building and Gates, the finish on all wrought steel hardware shall be US2S, and the brass shall be US3.

191. INSTALLATION. - All hardware shall be installed in a neat and workmanlike manner. The hardware shall be fitted and applied after the second coat of paint is done. All hardware shall be fastened with screws of suitable size and finish, unless otherwise specified.

192. PROTECTION OF HARDWARE. - The Contractor shall be responsible for the care, preservation, and protection of the hardware until the final acceptance of the work by the Contracting Officer. All knobs shall be covered with flannel, securely tied in place. All protection on the hardware shall be maintained until its removal is ordered.

193. SHUTTER AND BLIND HARDWARE. - The shutters and blinds shall receive two pairs of hinges, one throw bolt on the meeting rail, one throw bolt on the bottom rail, and two dog holders, all on each pair and as shown on the drawings.

194. DOOR HARDWARE. - The Administration Building shall receive wrought iron hardware with 2 brass keys to each lock, in accordance with the details and the Hardware Schedule shown on the drawings. The outside rear door to the basement shall receive $1\frac{1}{2}$ pairs of $4\frac{1}{2}$ inch by $4\frac{1}{2}$ inch hinges of Type 2010; a lock of Type 88, and knobs of Type 210. All toilet rooms shall receive on each door, 1 pair of 4 inch by 4 inch hinges of Type 2001; a lock of Type 7; knobs of Type 210 and 211A and a key plate of Type 351. The access door to the roof space shall receive one pair of 2 inch by $1\frac{5}{8}$ inch hinges of Type 2021; 2 friction catches of Type A1081 and a knob of Type A 1283. All other doors shall receive 1 pair of hinges of Type 2001; a lock of Type 7 and knobs of Type 211A. All doors shall receive door stops of Type 1336 or Type 1341 to suit conditions.

The Superintendent's Residence shall receive on each interior door 1 pair of 4 inch by 4 inch hinges of Type 2001, except on the door from the kitchen to the dining room which shall be of Type 2334, a lock of Type 7, knobs of Type 211A and a key plate of Type 351. The exterior main entrance door shall receive $1\frac{1}{2}$ pairs of $4\frac{1}{2}$ inch by $4\frac{1}{2}$ inch hinges of Type 2001, a lock of Type 126 and handles, both sides, of Type 420. All other exterior doors, except in the basement, shall receive $1\frac{1}{2}$ pairs of 4 inch by 4 inch hinges of Type 2001, a lock of Type 22 A, a knob of Type 210, and a key plate of Type 351. The bath room cabinet, plumbing access doors, and the kitchen cabinets shall receive on each door 1 pair of 2 inch by $1\frac{5}{8}$ inch hinges of Type 2021, a friction catch of Type A1081, a knob of Type A 1283, and drawer pulls of Type 1305. All doors shall receive door stops of Type 1336 or Type 1341 to suit conditions. The basement door shall receive $1\frac{1}{2}$ pairs of $4\frac{1}{2}$ inch by $4\frac{1}{2}$ inch hinges of Type 2010, a lock of Type 88 and knobs of Type 210.

The Utility Building shall receive on each door in the office, Storage, Supply Room, Toilet, the hinged door in the garage, and the Inflammable Storage Building, $1\frac{1}{2}$ pairs of 4 inch by 4 inch hinges of Type 2015, thumb latches of Type 1189 and a cylinder rim lock of Type 136. The exterior dutch door in the Stable shall receive plain wrought iron strap hinges. The top hinge on the top and bottom doors shall be 44 inches long by 2 inches wide by $\frac{1}{4}$ inch thick and the bottom hinge on the top and bottom door shall be 24 inches long by 2 inches wide by $\frac{1}{4}$ inch thick. These hinges shall be through-bolted in each plank of the door. The bottom door shall receive a 6-inch barrel bolt of Type 1019 A, and the top door shall receive one door pull of Type 1276, a cylinder rim lock of Type 136, and one 6-inch hook and eye of Type 1601. The sliding door in the Stable shall receive 1 barrel bolt of Type 1019 A, 3 inches long. The garage door shall receive an approved heavy type wrought steel overhead "U" track with bent section and supporting brackets, and roller hangers; 3 pairs of 8 inch by $2\frac{7}{8}$ inch hinges, 4 cane bolts of Type 1051. The sliding doors in the work shop shall receive an approved heavy type wrought steel overhead "U" track with supporting brackets and roller hangers; and on each door, one cane bolt of Type 1051, one 6-inch hasp of Type 1401 with through bolts and a padlock of Type IVa and one hand pull of Type 1276.

The gates in the fence enclosing the yard of the Utility Building shall receive for each gate one pair of heavy wrought iron hook type hinges, zinc coated and two heavy

wrought-iron staples with bolt on a chain for fastening the gate when closed. The hardware for the gates shall be made to suit conditions, zinc coated, and approved by details.

195. WINDOW HARDWARE. - All hardware for double verticle sliding windows shall include sash cord, sash weights, pulleys, and sash fasteners.

All double verticle sliding windows throughout the Administration Building and the Superintendent's Residence shall receive bronze face pulleys, Type 1250 B and sash fasteners, Type 1139; all other double verticle sliding windows shall receive pulleys of Type 1249 A and all sliding windows not fixed shall receive fasteners of Type 1139 A.

All sash cord shall be of best quality obtainable and of suitable size and strength for the size of sash. The brand and weight of the cord shall be approved before the cord is used in the work. Sash weights shall be of Type 1701. They shall be in each case, the weight required to properly counterbalance the sash.

The hinged casement sash in Storage rooms No. 1 and No. 3 of the Administration Building shall receive on each sash one pair of 3 inch by 3 inch hinges of Type 2005; 1 fastener of Type 1134 A; and adjuster of Type 1002. All other hinged sash throughout the Administration Building, Residence and the Utility Building shall receive on each sash, one pair 3 inch by 3 inch hinges of Type 2015 $\frac{1}{2}$, and for all top hung sash the fastener shall be Type A1137 and holder of Type 1601, 4 inches long; all other fasteners on hung sash shall be of Type 1134, 1134A, or 1134B to suit conditions and adjusters of Type 1000.

196. CLOSET HARDWARE. - The closets in the Superintendent's Residence shall be provided with coat and hat hooks of Type 1162 placed 8 inches on centers, and in each closet one clothes-pole secured in position in an approved manner of Type A 1010.

SECTION XIX

FLY SCREENS

197. SCOPE OF WORK. - This work includes the furnishing and installing of wood frame screens and brass thresholds for all exterior doors, and hollow metal frame screens for all exterior windows that open, throughout the Administration Building and the Residence. Screens for doors shall be hung on the outside and for windows shall be placed on the inside of windows and shall be double sliding, the height of sash opening, except basement windows which shall be single screens on the outside of sash.

The vent openings in unexcavated portions in the Administration Building and the Residence, also the circular openings in the east and west wings of the Administration Buildings shall receive screens as part of the work.

Samples shall be submitted as required under Paragraph 32.

198. CONSTRUCTION AND MATERIALS. - The screens shall be double sliding, except as noted on drawings, constructed of hollow, tubular copper content steel of .032 inch thickness with a groove formed on one side to receive the wire cloth. All edges of the frame shall be rounded and have a cross section of not less than 7/16 inch by 1 inch for stiles and rails. All angle corners shall be mitered and spot welded with concealed reinforcement and the entire frame galvanized and finished in baked-on enamel, inside and outside. The finish to match color of adjoining woodwork.

The screen cloth shall be held securely in place, and made removable, with copper bronze spring splines in the groove on the frame. The meeting rails of the metal screens shall line with the wood meeting rails of the window sash.

All frames for screen doors shall be of the same wood as specified for exterior doors in Paragraph 137 and have stiles and rails mortised and tenoned, and as shown on the drawings.

The screen cloth for window and door screens shall be of aluminum alloy 16 meshes to the inch wire cloth, stretched taut within the frame and secured with splines or lock strip without the use of tacks. All door screens shall have aluminum alloy woven wire guards, not lighter than 14-gauge and $\frac{1}{2}$ inch square mesh, over the area of the bottom panels.

All operating hardware and other accessories for a complete installation of screens shall be provided and installed by the Contractor. All hardware shall be cast bronze finished in chromium on nickel. Doors shall have three loose pin butts to each leaf, with mortised cylinder latch complete with knob or lever handles, and liquid door checks. Samples of hardware shall be submitted in accordance with Paragraph 32.

Each screen frame shall have a number permanently stamped on the lower rail and the Contractor shall provide and install on each window and door frame, where directed, a bronze tack with a corresponding number stamped on each head.

The screens for the vent openings in unexcavated portions and the circular openings shall be constructed of 16 mesh bronze fly wire securely in $\frac{1}{2}$ inch brass angle frames, fitted tightly and fastened in the masonry openings, calking between the frames and masonry with plastic cement.

The sills of all exterior doors as noted on the drawings shall receive stock interlocking heavy cast brass threshold, not less than 3 inches wide and on the bottom of doors a spring type weatherstripping of cold rolled bronze, .028 thick.

199. INSTALLATION AND PAINTING. - All screens shall be installed without damage to finished work. The screens shall be installed on the inside of the windows, to slide in channel guide rails screwed to the wood sash bead and made easy in operation. Each screen shall be marked for location with corresponding mark on the window frame.

The sliding screens shall be made easy in operation and easy to remove. The basement window screens shall be held in place with spring catches.

The doors shall fit the openings perfectly and operate with ease, and lock when closed.

The painting of all wood screens shall be done in accordance with Paragraph 210, "Painting Fly Screens".

SECTION XX

PAINTING

200. SCOPE OF WORK. - This work shall include the cleaning, priming and painting of all exterior woodwork, iron work and the metal cap flashing over woodwork on all four buildings. Also, all interior woodwork, including fly-screen doors; iron work and metal work, except all birch and maple wood. The birch and maple shall be filled, stained and waxed.

The work shall also include the staining of interior woodwork in Utility Building, the painting of all plaster surfaces throughout the Administration Building and the Residence; all radiators, enclosures, grilles, oil storage tank, and manhole cover and curb, exposed pipe and radiator connections; plumbing lines and unfinished parts of plumbing fixtures; electric panelboards, receptacles, boxes, conduits, finish plates. The work shall include the retouching and cleaning upon completion.

Such samples of material and workmanship as are specified under Paragraph 32 shall be furnished, and as many additional samples as may be required by the Contracting Officer, until approval is given each color and finish.

201. MATERIALS. - All materials used on the work shall be of the best of their respective grades and classes, and of brands approved by the Contracting Officer. The materials shall conform to the requirements of Federal Specifications as listed in Paragraph 27.

The enamel for the interior wood finish shall consist of a base of white lead or zinc or a mixture thereof ground in a vehicle of pale interior varnish. It shall be colored to match the approved sample.

The radiator enamel shall consist of zinc oxide ground in a damar varnish, thinned with turpentine and colored to match the approved samples. The enamel shall have sufficient pigment to cover in two coats and must dry with a good gloss.

The stain for wood work shall be an approved brand of commercial wood dye or stain.

The aluminum paint shall consist of $1\frac{1}{4}$ to $1\frac{1}{2}$ pounds of aluminum powder per gallon of a mixing varnish vehicle..

202. WORKMANSHIP. - All work shall be finished without polish or floss, except as specially noted herein.

All woodwork shall be cleaned thoroughly of mill dust and hand smoothed before any finish is applied. Wherever necessary to conceal nail holes, putty, colored to match the natural wood, and white lead to match the painted work, shall be used. No puttying shall be done until the first coat has been applied.

All plastered surfaces to be painted shall be carefully inspected and all imperfections made good and any cracks or pit holes shall be pointed with plaster of Paris before any painting is commenced. Any unevenness of the plaster shall be sandpapered, leaving the plaster work absolutely smooth and in first-class condition to receive the paint.

Each coat of paint shall be thoroughly dry and shall be rubbed or sandpapered before any subsequent paint is applied.

Upon completion of the work all surfaces shall be left clean and free from defects. All work shall equal in every respect the approved samples, and any defective work shall be replaced or otherwise made good as directed by the Contracting Officer, without additional cost to the United States.

203. SAMPLES. - The Contractor shall submit samples of all painting work, exterior and interior, after obtaining the proper information for color, for approval of the Contracting Officer. Samples shall be on the same wood that the finish will be applied on in the building, and shall be made up of the same number of coats specified in each case. Samples shall be on panels 4 inches by 10 inches, and as many repeat samples furnished as may be demanded, until approval is given.

204. DELIVERY AND STORAGE OF MATERIALS. - All materials for painting shall be delivered to the building in unbroken packages bearing the brand and name of the manufacturer and shall not be opened until after they have been inspected by the Contracting Officer. Oily rags and waste must be removed from the building every night, as under no circumstances will they be allowed to accumulate.

205. SCHEDULE FOR MIXING PAINT ON THE JOB. -

EXTERIOR WOOD:

<u>Coats</u>	<u>White Lead</u>	<u>Raw Linseed Oil</u>	<u>Turpentine</u>	<u>Drier</u>	<u>Varnish</u>
Prime	100 lbs.	4-Gal.	2-Gal.	1-Pt.	
Body	100 lbs.	1½ -Gal.	1½-Gal.	1-Pt.	
Finish	100 lbs.	3-Gal.	1-Gal.	1-Pt.	

INTERIOR WOOD:

Prime	100 lbs.	3-Gal.	3-Gal.	1-Pt.	-----
Body	100 lbs.	---	2-Gal.	½-Pt.	---
Finish	100 lbs.	-----	2-Gal.	½-Pt.	1-Pt.

INTERIOR PLASTER:

Prime	100 lbs.	5-Gal.	1-Gal.	1-Qt.	---
2nd Coat	100 lbs.	1-Gal.	2-Gal.	1-Pt.	---
3rd Coat	100 lbs.	1-Gal.	2-Gal.	1-Pt.	---
Finish(flat)	100 lbs.	-----	2-Gal.	½-Pt.	1-Pt.

206. EXTERIOR WOOD WORK. - The exterior entrance doors and frames, all window frames, trim, and sash, columns, cornices, beams, and all other exterior wood work, including all metal down spouts, gutters and cap flashing on exposed surfaces and the top and bottom of doors and sash, shall be painted three coats of white paint in addition to the priming coat. There will be no paint required on the copper down spouts on the brick portions of the buildings. The paint shall have a vehicle of linseed oil with a pigment of white lead.

207. INTERIOR WOOD WORK. - All interior wood work of pine in the Administration Building and Residence, which includes window sash and frames, doors and frames, trim, base, etc., shall receive not less than two undercoats of flat white lead and oil paint in addition to the priming coat and such additional coats as may be necessary to produce a suitable foundation for the enamel finish. The undercoats shall be sandpapered to an absolutely smooth surface before enameling.

On this foundation one even coat of enamel shall be flowed. The color of the enamel shall match the approved sample. When thoroughly dry, the enamel shall be rubbed down with pumice and water to a smooth egg-shell gloss.

All concealed surfaces shall be given one coat of white lead and oil before erection as specified in Paragraph 145.

The enamel finish on the baseboards shall not be applied until after the floors are scraped, as specified under Paragraph 134, and finished.

All interior dressed wood in the Utility and Inflammable Storage Buildings shall be given a coat of liquid filler and one coat of light oak stain, brushed out to an even color.

All maple floors, shoe moulding, stair treads and platforms, shall be filled with an approved oil base paste filler with stain incorporated therein, well rubbed in, across and with the grain. When the filler is dry, the surface shall be rubber smooth with No. 00 steel wool, and wiped clean, and finished thoroughly with wax, and polished. All oak floors, shoe moulding, stair treads, and platforms, shall be given ~~two~~ flowing coats with a brush, of an approved penetrating oil with stain to give a light oak finish. Each coat shall be wiped off thoroughly and at least 12 hours shall be allowed between coats. After 6 days the surface shall be polished with a weighted brush or electric polisher, and all surplus oil must be removed.

The oak and maple floors and stair treads shall be scraped as specified under Paragraph 134, before applying the finish.

208. WALNUT FINISH. - All birch wood shall be first sponged with clear water and sanded with No. 00 sand paper and filled with oil base paste filler of approved quality, and with stain incorporated therein, well rubbed in, across and with the grain. When this filler is dry, the surfaces shall be rubbed smooth with No. 00 sandpaper, wiped clean of sand particles and shall be given three coats of approved clear lacquer, and each coat lightly sanded with 00 steel wool. All of this work shall be finished to the entire satisfaction of the Contracting Officer.

208a. LETTERING. - The Contractor shall letter the interior doors to toilet rooms with 1½ inch XX gold leaf letters outlined in black, and the exterior doors to toilet rooms with 2 inch black letters, placed on the respective doors as directed by the Contracting Officer. The style of lettering shall be submitted for approval.

The arrangement of letters shall be as follows:

Interior Doors of Toilets: "White Men".
 "White Women".

Exterior Doors of Toilets: "Colored Men"
 "Colored Women".

209. PAINTING FIREPLACES. - The firebrick on the interior of fireplaces shall be scrubbed thoroughly with clear water and all foreign matter removed. After the firebrick are thoroughly dry, they shall be given two coats of asphalt varnish conforming to Federal Specification TT-V-51.

210. PAINTING FLY SCREENS. - All wood fly screens doors as specified under Paragraph 197 shall be primed and painted with the same material and in the same manner as specified for all exterior woodwork. The finish coat shall match the color of adjoining wood work.

211. PAINTING PLASTER SURFACES. - All plastered surfaces throughout the Administration Building and the Superintendent's Residence shall be given four coats of paint of the following approximate compositions, except on the basement ceilings;

First Coat:

Pigment (percent) - - - - -	65
Carbonate of lead (per cent)--	60
Zinc oxide (percent)- - - - -	40
Vehicle (percent) - - - - -	35
Linseed oil (percent)- - - - -	90
Turpentine and drier(percent)-	10

Second Coat:

Pigment(percent) - - - - -	65
Carbonate of lead(percent)----	50
Zinc Oxide (percent)- - - - -	50
Vehicle (percent)- - - - -	35
Linseed oil (percent)- - - - -	65
Turpentine and drier(percent)-	35

Third and Fourth Coats:

Pigment (Percent) - - - - -	65
Carbonate of lead (percent) - - - - -	40
Zinc Oxide (percent) - - - - -	60
Vehicle (percent) - - - - -	35
Linseed oil (percent) - - - - -	25
Turpentine and drier (percent) - - - - -	75

The paint shall be tinted as directed by the Contracting Officer. A quantity of white enamel varnish, as directed by the Contracting Officer, shall be added to the third and fourth coats.

The third and fourth coats of paint on plaster surfaces in the Administration Building stippled and in the Superintendent's Residence finished absolutely flat.

Where picture mouldings occur, they shall be painted in with the walls.

212. PAINTING IRON WORK. - After erection, exposed surfaces of ornamental and miscellaneous iron work including the iron railings to steps, the guards on horse stalls and the manhole covers and curbs shall be painted two coats of paint in addition to shop coat of the following composition of color as directed by the Contracting Officer:

Pigment(percent) - - - - -	65
Carbonate of lead (percent)- - - - -	50
Zinc Oxide (percent)- - - - -	50
Vehicle (percent) - - - - -	35
Linseed oil (percent) - - - - -	60
Turpentine and drier (percent)-----	40

All of this work shall be thoroughly gone over and cleaned before any finished painting is done, and each coat of paint shall be thoroughly brushed out.

The oil storage tank shall receive two coats of asphalt varnish on the outside only, before lowering into the ground. The asphalt varnish shall conform to Federal Specification TT-V-51.

213. PAINTING PIPE AND BREECHING COVERINGS. - The exposed pipe and breeching covering in the basements shall be painted two coats of cold water paint with a mixture of glue.

214. PAINTING PLUMBING LINES AND FIXTURES. - All exposed cast iron soil lines shall be painted two coats of black paint conforming to Federal Specification TT-P-61.

The exposed unfinished parts of plumbing fixtures shall be thoroughly cleaned and given two coats lead and oil and one coat of enamel, similar to interior wood finish.

215. PAINTING RADIATORS, CABINETS, AND GRILLES. - All exposed radiators and exposed pipe and radiator connections, shall be given two coats of enamel in addition to the priming coat. The enamel for this work shall consist of zinc oxide ground in damar-varnish, thinned with turpentine, and colored to the approval of the Contracting Officer. The enamel shall have sufficient pigment to cover in two coats, colored to match adjoining work, and must dry with a good gloss.

Grilles and radiator cabinets shall be painted two coats of lead and oil paint to match adjacent finish.

216. PAINTING ELECTRIC PANEL BOARDS, ETC. - All panel-boards including doors to same, all fan and base receptacles, junction boxes, exposed conduit, finish plates, etc., shall be painted to match surrounding work.

The electrical distribution board in each building shall receive two coats of shellac and one coat of varnish.

217. RETOUCHING AND CLEANING. - The Contractor shall retouch and refinish all damage to finished painting. Upon completion of the work, he shall clear all glass, plumbing and electrical fixtures, etc. of paint, putty, oil or other foreign substance.

SECTION XXI.

GLAZING.

218. SCOPE OF WORK. - This work shall include the furnishing and installing of all glass in the four buildings in all exterior sash, in door panels, and in transoms and sidelights.

The sash of all exterior windows and doors, except those specified to have obscure glass and in the transoms and sidelights of the main entrance to the Administration Building and the Residence, shall be glazed with flat drawn double strength AA window glass.

Sash in windows of toilet rooms of the Administration Building shall be glazed with 1/8 inch thick Type C., processed glass, acid-ground, obscure.

The sidelights and transoms to entrance doors in the Administration Building and the Residence shall be glazed with 1/8 inch thick silvering quality polished plate glass.

This work shall include the furnishing of samples of the various kinds of glass as called for under Paragraph 32.

219. QUALITY OF GLASS AND PUTTY. - All glass shall conform to the requirements of Federal Specification DD-G-451.

The putty shall conform to the requirements of Federal Specification TT-P-791, Grade A.

220. SETTING GLASS. - Glass in the exterior wood doors in the wing of the Residence shall be bedded in putty and held in place by removable wood stops. All other glass in wood sash, wood transoms and sidelights shall be bedded in putty, back puttied, and secured with glaziers points.

221. CLEANING. - Any glass which may have become broken during the progress of the work or any glass which is not in accordance with this specification shall be removed and replaced by the Contractor without additional cost, leaving all glass whole and perfect. The Contractor shall also clean all glass and remove all excess putty to the entire satisfaction of the Contracting Officer.

SECTION XXII

PLUMBING.

222. SCOPE OF WORK. - This work shall include the furnishing and installing of all hot, cold, standpipe and circulating water piping; down-spout boots, area drains, stormwater sewers, sanitary waste lines and sewers; vent lines, fixtures, toilet room accessories, pipe, fittings, valves, and covering in the Superintendent's Residence, Administration and Utility Buildings.

The coal fired hot water heater, breeching, piping to storage tank, covering, etc., in the Superintendent's Residence shall be included. There will be no domestic hot water supply or stormwater sewers required for the Utility Building.

The water supply lines shall start at a point 5 feet from building walls and run underground to the buildings, as shown on the drawings.

The cold water lines shall extent to and connect to the heating boilers, in the Administration Building and Superintendent's Residence.

The sanitary sewers shall terminate as shown on the outside of buildings with capped ends for extension under separate contract.

The stormwater sewers shall be run as indicated on the drawings, terminating with capped ends for extension under separate contract.

Area drain in the Superintendent's Residence shall be extended to the dry well, located as noted on the drawings.

The standpipe with capped cutlets shall be run as shown in the Administration Building.

Cast iron boots shall be furnished and installed at the base of each down spout.

Valves shall be installed for the complete control of the water piping and as shown on the drawings.

All cold, hot and circulating water lines shall be connected to the hot water storage tanks as shown on the drawings.

Urinals, closet tanks, lavatories, etc., shall be secured to the tile walls by means of concealed brackets and toggle bolts.

Toilet room accessories shall be secured to the walls by means of toggle bolts or screws.

The locations of the various pipes are shown on the drawings, but these locations are intended to be general only. The Contractor shall conform to the conditions in the buildings, and any necessary changes in the run of piping from that shown on the drawings shall be made without extra cost.

The Contractor shall furnish the Contracting Officer with a complete list of materials to be used in the work, together with the names of manufacturers, catalogue numbers and pictorial cuts of each fixture, samples shall be submitted as called for in Paragraph 32.

All work shall be installed in accordance with the local and state regulations governing such work, except where modified herein.

All tests shall be made in the presence of a representative of the Contracting Officer, and at such times as may be convenient to the Contracting Officer.

223. QUALITY OF MATERIAL AND WORKMANSHIP. - All materials, appliances, fixtures and workmanship shall conform to the requirements of Federal Specification WW-F-541, unless specified otherwise in this section.

All fixtures shall be the product of one manufacturer. Any material not explicitly specified shall be of the highest quality used in commercial practice.

All plumbing piping above the basements in the Administration Building and Superintendent's Residence, except connections at fixtures, shall be run concealed; piping in the basements and excavated spaces shall be run exposed.

In general the piping for the Utility Building shall be run underground, and where run above grade, the piping shall be concealed.

Sanitary and stormwater lines underground shall be of cast iron with cast iron fittings to a point 5 feet from the building walls and of terra cotta from this point to their termination.

Water piping underground shall be of galvanized genuine wrought iron wrapped with burlap, and shall have two coats of approved asphalt varnish.

Sanitary and waste piping inside the buildings shall be of cast iron on lines 2 inches in size and above, on lines $1\frac{1}{2}$ inches in size and under, shall be galvanized wrought iron, unless specifically noted otherwise on the plans.

Cold, hot, standpipe and circulating water piping shall be of galvanized genuine wrought iron with galvanized malleable iron fittings, except exposed connections at fixtures which shall be of brass, chromium plated.

The water piping from the coal fired hot water heater to the storage tank shall be of brass with brass fittings.

All fittings, metal strainers, faucets, traps, connections between tanks and closets, tanks and urinals, where specified herein to conform to Federal Specification WW-P-541 shall be of brass, heavily chromium plated.

224. EXCAVATION AND BACKFILLING. - Excavation and backfilling for sewer lines, water lines, etc., shall be as specified under Paragraphs 50 and 53.

225. HOT WATER HEATER. - The Contractor shall furnish and install in the Superintendent's Residence where shown on the plans, one cast iron, coal fired, hot water heater; complete with all necessary attachments and appurtenances. The heater shall be constructed of first quality grey iron, and shall be tested to 150 pounds per square inch hydrostatic pressure.

The heater shall be capable of raising the temperature of 44 gallons of water from 40 degrees to 140 degrees F. per hour, when operating on a 5-hour firing period.

The grate of the heater shall be not less than 12 inches in diameter. The supply and return outlets shall be $1\frac{1}{2}$ inches in size.

The heater shall be complete with ash pit and shall set on the floor of the basement.

The heater shall be connected up complete to the hot water storage tank.

226. BREECHING. - The Contractor shall furnish and erect from the smoke outlet of the heater, and to end into the stack as shown on the plans, a breeching constructed of $1/16$ inch tank steel. The breeching shall be constructed and arranged to suit the heater installed, and shall enter the stack at a point not over 4 feet above the basement floor. An approved damper shall

be installed in the breeching near the heater. The entire breeching and joint at the stack shall be air tight.

227. PIPE AND FITTINGS. - Cast iron piping and fittings shall conform to Federal Specification WW-F-401, and shall be coated.

Galvanized wrought iron pipe shall conform to Federal Specification WW-F-441, Class A.

Galvanized malleable iron fittings shall conform to Federal Specification WW-F-521, Class B.

Exposed brass pipe shall conform to Federal Specification WW-F-351, Grade A; and shall be chromium plated. Fittings on brass piping shall conform to Federal Specification WW-F-448 and shall be plated similar to the brass pipe.

Brass pipe and fittings, used to connect up the hot water heater and the hot water storage tank, in the Superintendent's Residence will not require plating.

Terra cotta pipe and fittings shall conform to Federal Specification WW-F-361.

Piping passing through cinder concrete counterceiment shall have protective casings, as noted under "Pipe Sleeves and Escutcheons".

All joints in piping shall be made up in an approved manner, using the methods and materials, standard with good trade practice.

All screw pipe shall be accurately cut to measurements established from the work, with tapered threads properly cut, burrs removed and ends reamed before installation. Piping shall be worked in place without springing or forcing, and fittings shall be used wherever changes in the direction of pipe are required. Pipe connections to the fixtures shall have ends capped until the fixtures are installed.

228. VALVES, THERMOMETER, ETC. - Valves on water lines shall be of brass or bronze gate type, good for 125 pounds per square inch working pressure.

Check valves shall be 45-degree type of brass or bronze, good for 125 pounds working pressure.

The relief valves in the hot water lines at storage tanks shall be brass of approved manufacture, set to relieve at 25 pounds greater pressure than normal cold water service.

The thermometers in the hot water lines shall be of approved dial type, indicating the temperature range from 50 degrees to 250 degrees F. The insertion elements of the thermometers shall be set in the hot water flow lines from the storage tanks.

229. PIPE SUPPORTS AND HANGERS. - The entire drainage and water supply systems, including soil, waste, vent and hot and cold water lines shall be supported at intervals of not over 8 feet apart; and shall be hung by means of heavy, adjustable, wrought iron hangers of approved form, firmly secured to the building construction. Pipe hooks or chains will not be permitted for supporting pipe.

230. PIPE SLEEVES AND ESCUTCHEONS. - Exposed pipes passing through walls, floors, etc., shall have galvanized iron pipe sleeves, firmly secured to the building construction.

Galvanized iron sleeves with 2 inches of sand over the sleeves shall be used on covered water piping, where the same passes through cinder concrete counterceement.

Exposed pipes shall have escutcheons to match the pipe and fittings where they pass through walls, floors, etc.

Vent lines passing through the roofs shall have flashing and counterflashing made watertight with 5 pound sheet lead.

231. FIXTURES. - The fixtures shall be in accordance with the requirements of Federal Specification WW-P-541, for materials and finish, except as otherwise modified herein, and shall be of types indicated, and as shown and described by the outfit and figure number referred to in the following schedule:

Superintendent's Residence:

- Water Closet - Outfit No. R46L, Figure 2, with seat outfit CRT, Figure 44; white in color; water supply Figure 47.
- Lavatory - Outfit No. VB20, Figure 8; with Pattern L3, Figure 51 compression faucets and pop-up waste; trap Figure 61; water supply Figure 47.
- Bath Tub - Outfit No. A60, Figure 31; with double type compression faucets Pattern T1, Figure 52.
- Kitchen Sink - Outfit No. A52L, Figure 20; with double type compression faucets Pattern K, Figure 54, trap Figure 61; water supply Figure 47. Sink shall be set 36 inches from the floor.
- Lawn Faucets - Figure 69.

Administration Building:

- Water Closets - Outfit No. E46L; with Seat Outfit CE; Figure 43, white in color; water supply Figure 47.
- Lavatories - The same as specified for the Superintendent's Residence.
- Slop Sink - Outfit No. V22G, Figure 27, with double type compression faucets Pattern S, Figure 55.
- Urinals - shall be one piece vitreous china, wall type with integral extended shields. Urinals shall be rectangular in shape 14 inches deep, 18 inches wide and 30 inches high; top of urinals shall be set 50 inches from the floor. Outfits shall be complete with flush tank, flush piping, etc., similar to Federal Specification WW-P-541 for Outfit No. V18H, Figure 4.
- Drinking Fountains - shall be heavy vitreous china wall type, with integral trap housing and concealed wall hanger. Each fountain shall be complete with brass strainer, self-closing stop with cross handle, loose key regulator, 2-stream mound building projector, and automatic stream control. Dimensions of the fountains shall be as follows: width 11 inches, projection from wall $11\frac{1}{2}$ inches, depth of receptor $3\frac{1}{2}$ inches.
- Lawn Faucets - Figure 69.

Utility Building:

- Water Closet - Outfit No. R34L, with Seat Outfit CR, Figure 44; water supply Figure 46.
- Sink - Outfit No. R30; with compression faucet Figure 57; trap Figure 63; water supply Figure 46. Cap the hot water outlet with approved metal cover.
- Hose Bibbs - Figure 56, with $\frac{3}{4}$ inch hose thread.
- Lawn Faucets - Figure 70.

All exposed metal parts on the fixture outfits shall be chromium plated.

232. TOILET ROOM ACCESSORIES. - The following accessories shall be furnished and installed in the lavatories, toilet rooms, and bath room:

Superintendent's Residence

Bath Room:

- 1 - Steel white enameled medicine cabinet, with 2 plate glass shelves, and mirror door in chromium plated steel frame. Cabinet shall be 18 inches by 23 inches, recessed 3-3/8 inches in the wall.
- 1 - Toilet paper holder.
- 2 - Clothes hooks.

Administration Building

White Women's Toilet:

- 3 - Toilet paper holders.
- 2 - Liquid soap dispensers.
- 2 - Mirrors, each 24 inches by 24 inches.
- 2 - Coat hooks.

White Men's Toilet:

- 3 - Toilet paper holders.
- 2 - Liquid soap dispensers.
- 1 - Mirror, 24 inches by 48 inches.
- 2 - Coat hooks.

Colored Men's Toilet:

- 1 - Toilet paper holder.
- 1 - Liquid soap dispenser.
- 2 - Coat hooks.

Colored Women's Toilet:

- 1 - Toilet paper holder.
- 1 - Liquid soap dispenser.
- 2 - Coat Hooks.

Superintendent's Toilet:

- 1 - Toilet paper holder.
- 1 - Liquid soap dispenser.
- 1 - Mirror, 24 inches by 24 inches.
- 2 - Coat hooks.

UTILITY BUILDING

Toilet :

- 1 - Toilet paper holder.
- 1 - Liquid soap dispenser.
- 2 - Coat hooks.

Soap dispensers shall be wall bracket type with glass container, fillable through metal cap on top, and plunger type, with spring action soap valve.

Mirrors shall be plate glass 1/4 inch thick of silvering, Grade A quality, free from defects. The mirrors shall be set in chromium plated white metal frames, and shall be supported by concealed fasteners. Mirrors shall have dampproof backs.

The following accessories shall be in accordance with the requirements of Federal Specification WW-F-541, for materials, type, except as otherwise modified herein:

- Toilet paper holders - Figure 93.
- Clothes hooks - Figure 92.

All exposed parts of the accessories shall be heavily chromium plated.

233. DRILLING OF TILE. - Any drilling of the tile walls and floors, required for the installation of closet tanks, lavatory supports, lavatory connections, urinal supports, toilet room accessories, etc., shall be done by the Contractor to the approval of the Contracting Officer.

234. SIZE OF SUPPLY AND WASTE LINES. - The individual branch supply, waste, and vent pipes to fixtures shall be of the following sizes, except as otherwise noted on the drawings:

<u>Fixture</u>	<u>Hot Water</u>	<u>Cold Water</u>	<u>Waste</u>
Water Closets	-----	1/2 inch	4 inches
Lavatories	1/2 inch	1/2 inch	1 1/2 inches
Bath Tub	1/2 inch	1/2 inch	1 1/2 inches
Slop Sinks	3/4 inch	3/4 inch	3 inches
Kitchen Sink	1/2 inch	1/2 inch	1 1/2 inches
Sink (Utility Bldg.)	-----	1/2 inch	1 1/2 inches
Urinals	-----	1/2 inch	2 inches
Hose Bibbs	-----	3/4 inch	-----
Lawn Faucets	-----	3/4 inch	-----
Drinking Fountains	-----	1/2 inch	1 1/2 inches.

235. GRADING OF LINES. - Horizontal drain, waste and soil lines where run inside the buildings shall have a uniform grade of not less than 1/4 inch to the foot.

Vent lines shall be graded so as to discharge all water of condensation into the soil or waste risers.

Horizontal water supply lines shall be graded so as to drain the lines, into drip or drain points, which shall be valved.

Soil and stormwater lines in trenches outside of the buildings shall have a uniform grade in the direction of the flow, of not less than one per cent.

The Contractor shall establish all grades, elevations, etc., required for the piping outside the buildings and shall furnish this data for the digging of such trenches, etc., as shall be required.

236. WATER SUPPLY LINES. - The underground cold water supply lines shall start at a point 5 feet outside of each building, as shown on the drawings. The ends shall be capped for future extension.

The underground water piping outside of the buildings shall be not less than 24 inches below the finished grade; and where inside of the buildings shall be 12 inches below the finished floors.

237. AREA DRAIN AND DOWNSPOUT BOOTS. - The area drain shall be 3 inches in size and shall have heavy cast iron body, with cast iron non-clog, sediment arresting container. The container shall be easily removable for cleaning.

The Contractor shall furnish and install an approved cast-iron boot at the base of each downspout. The boots shall extend 6 inches above the finished grade and shall have rectangular top to receive the downspouts shown on the plans; the under-grade end shall be 3 inches in size and shall connect to the stormwater sewer as shown on the drawings.

The connections between downspouts and the cast iron boots shall be lightly caulked with oakum and the joints finished with an approved elastic cement, conforming to Federal Specification SS-C-153, Type I.

238. CLEANOUTS. - The Contractor shall provide and install cleanouts in the drainage systems at all traps, bends, changes in the direction, on long runs of pipe and where marked C.O. on the drawings. Plugs in cleanouts shall be countersunk for a

square end wrench.

Cleanouts on outside lines shall be extended to finished grade.

239. PIPE COVERING. - All hot, cold, and circulating water piping, including all branches shall be covered.

The water piping underground, and the exposed plated piping in the buildings will not be covered.

Covering for water lines shall be solid wool felt $3/4$ inch thick, with asbestos paper lining for the hot and circulating water piping and tar paper lining for the cold water piping.

Soil lines in the chases in outside walls shall be covered with $3/4$ inch thick wool felt.

The fittings on all water lines shall be covered with plastic covering containing not less than 50 per cent magnesia, finished with a hard smooth surface flush with the pipe covering.

All covering shall have canvas jacket and pipe bands similar to the requirements of Paragraph E-8 and E-9, Federal Specification HH-M-71.

The covering on soil lines shall be held in place with copper wire.

The coal fired hot water heater, shall be covered with a minimum thickness of 1 inch-85% magnesia blocks. The covering shall be wired in place over metal lath, the final coat of cement and asbestos plaster shall be troweled to a smooth finish, and shall be $1/2$ inch in thickness.

The breeching from the hot water heater shall be covered to a minimum thickness of 1 inch, with 85% magnesia blocks wired in place over metal lath. The metal lath shall have spacers to allow 1 inch air space between the breeching and covering. The finish coat shall be similar to that specified for the hot water heater.

The magnesia blocks shall conform to Federal Specification HH-M-71, Type III.

240. CUTTING AND REPAIRING. - Cutting of walls, floors, partitions, etc., required for the work shall be done in a workmanlike manner and as approved by the Contracting Officer.

Damage to walls, floors, ceilings, etc. caused by the installation of this work, shall be repaired equal to the exist-

ing work and as approved by the Contracting Officer.

All fixtures shall be protected from damage or injury, and any fixture which becomes damaged before final acceptance of the work shall be replaced by the Contractor as approved by the Contracting Officer.

241. PAINTING AND CLEANING. -- Exposed pipe covering and breeching covering shall be painted as required by Paragraph 213.

The exposed parts of plumbing fixtures not finished shall be painted as required by Paragraph 214.

Upon completion of the work, the Contractor shall clean all exposed plated piping, plumbing fixtures, remove all labels, and replace all washers of any faucets where necessary or required.

242. TESTS AND GUARANTY. -- When soil and waste system branches are run, all open ends of pipe shall be securely closed and the entire system tested by filling with water.

All piping in trenches shall be tested and approved before back filling.

The entire water supply systems shall be tested by a hydraulic pressure pump, and an approved test gauge, to a pressure of 100 pounds per square inch.

Any defects in material and workmanship which may appear or be discovered during the tests, shall be repaired and the tests continued until the systems are free from defects. No fixtures shall be connected until the entire system has been tested and approved.

The quality and workmanship of the plumbing shall be guaranteed as provided for by Paragraph 38.

SECTION XXIII

HEATING.

243. SCOPE OF WORK. - This work shall include the furnishing and installing of a complete low pressure steam heating system, of the return trap type, in the Superintendent's Residence, as shown on the drawings and as specified.

The heating system in the Administration Building shall be similar to that specified for the Superintendent's Residence.

There will be no heating system required for the Utility Building.

The furnishing and installing in each building of a low-pressure steam boiler, domestic hot water heating coil; fuel oil burning equipment, hot water storage tank, return trap, vent trap smoke breeching, radiators, thermostat, piping, valves, thermostatic traps, pipe and boiler insulation, and all necessary miscellaneous equipment to complete both of the heating systems, shall also be included.

The oil suction and return lines from storage tanks to the burners, the oil filling lines, and the vents from the oil storage tanks shall also be included.

A 1-inch valved drain shall be installed in the low point of each return main at each boiler.

A 3/4-inch valved water supply and a 1-inch valved drain shall be provided and connected to each boiler.

All necessary samples of material called for under Paragraph 32 shall also be furnished. The Contractor shall furnish the Contracting Officer with a complete list of materials to be used in the work, together with the names of manufacturers, brands, catalogue numbers, etc.

All necessary shop plans and diagrams for the installation work shall be submitted for approval before starting the work.

Testing of the complete heating systems shall be carried out as specified and required.

A guarantee of both entire installations shall also be included.

244. MATERIALS AND WORKMANSHIP. - The plans accompanying these specifications indicate generally the size and location of

pipng. Any necessary changes and modifications of the pipe work shall be subject to the approval of the Contracting Officer.

All pipe for the heating systems shall be of black steel, standard weight, and conform to the requirements of Federal Specification WW-P-431, Class A. Fittings on the heating systems shall be of best quality cast iron, and conform to Federal Specification WW-P-501, Type A.

All fuel oil piping shall be of genuine wrought iron galvanized and conform to Federal Specification WW-P-441, Class A. Fittings shall be galvanized malleable iron and conform to Federal Specification WW-F-521, Type B.

All water piping from the hot water coils at the boilers, to the hot water storage tanks shall be of brass, standard weight and conform to Federal Specification WW-P-351, Grade A; fittings shall be cast brass, and conform to Federal Specification WW-P-448.

All nipples shall be extra heavy type of same material as pipe used on the systems.

All ends of pipe shall be reamed or filed out before erection to secure free and smooth surface in the pipes. All piping shall be put up in an approved manner with proper grades.

A sufficient number of ground joint or flange unions shall be installed in the various lines to permit their easy removal, without disturbance to the various pieces of equipment.

245. BOILERS. - The Contractor shall furnish and install in both the Administration Building and the Superintendent's Residence, where shown on the plans, a cast iron, section, steam boiler; complete with all necessary attachments and appurtenances. Boilers shall be constructed of first quality, grey iron, with sections connected by means of wrought iron push nipples.

The boilers shall each be complete with: a vacuum-pressure gage 30-0-30 type, with 1/4 pound graduations; a water column with trycocks; a 2 1/2 inch brass safety valve set to blow at 10 pounds pressure; and a burner plate to suit the type of oil burner installed.

The boilers shall be of a type designed for oil burning and shall be capable of evaporating not less than the number of pounds of water per hour noted below, from and at 212 degrees Fahrenheit, when operating at 2 pounds pressure.

Superintendent's Residence --- 220 pounds of water.
Administration Building --- 300 pounds of water.

The heating surfaces of each boiler shall be not less than:

Superintendent's Residence --- 70.0 square feet.
Administration Building --- 96.1 square feet.

The heat output at the supply openings of the boilers shall be not less than:

Superintendent's Residence --- 210,000 B.T.U. per hour.
Administration Building --- 288,000 B.T.U. per hour.

*Find
draws*

The steam outlets on the boilers shall be 2-4 inch, and the return inlets 2-4 inch; all outlets shall be connected full size to headers as shown on the drawings.

The boiler water lines shall not exceed $4\frac{1}{2}$ inches.
The firebox of each boiler shall be:

Superintendent's Residence $28\frac{1}{2}$ inches by 23 inches.
Administration Building $40\frac{1}{2}$ inches by 23 inches.

A "Hartford" loop shall be installed in the return line to each boiler.

Each boiler shall have a $1\frac{1}{4}$ inch asbestocel insulation, protected by a sheet steel jacket, with baked enamel finish.

246. HOT WATER COILS. - An approved copper coil, in cast iron shell for heating domestic hot water, shall be furnished for each boiler, and shall be connected to special outlets in each boiler below the water line. The capacity of each coil shall be not less than 30 gallons of water per hour heated 100 degrees rise. Hot and cold water lines from the hot water storage tanks shall be connected to these coils.

247. HOT WATER STORAGE TANKS. - The Contractor shall furnish and install one 30-gallon hot water storage tank in the Superintendent's Residence for domestic hot water.

A similar tank shall also be furnished and installed in the Administration Building.

The tanks shall conform to Outfit S30, Figure 38, Federal Specification WW-P-541; the tanks shall be galvanized inside and outside.

248. BREECHINGS. - The Contractor shall furnish and erect from the smoke outlet of each boiler, and to end into the stacks as shown on the plans, breechings constructed of $\frac{3}{32}$ inch tank steel. Breechings shall be constructed and arranged to suit the

boilers installed, and shall enter the stacks at a point not more than 5 feet above the basement floor. The entire breechings and joints at the stacks shall be air-tight.

249. OIL BURNERS. -- The oil burners shall be of the mechanical oil pressure atomizing type, using electric ignition, as approved by the National Board of Fire Underwriters and the Contracting Officer. The burners shall be of the standard gun type, of sizes and capacities to amply take care of the designed loads of the heating plants.

The oil burners shall be designed for operation with No. 2 standard distillate fuel oil. The pumps shall be capable of handling a uniform maximum of 4 gallons of oil per hour for the Superintendent's Residence; and 6 gallons of oil per hour for the Administration Building from the storage tanks through the burners to the boilers. A filter and a strainer shall be installed in each suction line to each burner.

All firebrick or clay tile lining required to form the proper combustion space in each boiler, shall be furnished and installed.

Motors on the burners shall be not less than 1/4 horsepower each, and they shall operate on the current available, 110-volt, 60-cycle, single phase. The Contractor shall check this data before ordering the equipment. Each burner shall have a pressure control, a low water cut-off, a domestic hot water control, a combustion safety control, electric ignition, a transformer, a radio interference trap, and an approved thermostat for automatic day and night control, with an electric clock for each thermostat. The thermostats shall be located on the first floor of each building where shown on the drawings.

The operation and synchronization of the controls system of each burner shall be in a circuit that only permits the burner to function as long as the secondary controls are calling for heat and the combustion control is in the hot position due to proper combustion. The electric ignition of each burner shall be so designed as to permit either continuous or intermittent operation.

The various control units shall all be electrically operated and so arranged as to operate the unit in full accordance with the manufacturer's approved standard and as specified herein. The burner shall be arranged to keep a constant supply of domestic hot water available in each building when the heating systems are in operation. All wiring between the thermostats and the oil burners shall be run in rigid steel sheradized conduit. Power

for the units will be run as noted in Section XXIV entitled "Electrical Work". Wiring required for the units shall be installed as a part of the oil burners.

250. RETURN AND VENT TRAPS. - The Contractor shall furnish and install on the end of the dry return line, in each building, a float operated vent trap of large storage capacity.

The vent trap for the Superintendent's Residence shall be capable of caring for not less than 1500 square feet of radiation.

The vent trap for the Administration Building shall have a capacity of not less than 2000 square feet.

Each trap shall operate to permit free discharge of air from the system but prevent the overflow of water and the inleakage of air. The apparatus shall operate under a minimum return pressure of 1 ounce per square inch.

The discharge of each vent trap shall be connected through a suitable 45-degree check valve to the boiler return trap.

Each boiler return trap shall be of similar capacity as the vent traps, and shall include in each trap a float operated mechanism that will operate when the trap becomes filled to a predetermined level, to close off the air vent and open a direct connection from the boiler to the return trap. This operation shall permit the accumulated condensate to flow out of the boiler return trap through a second 45-degree check valve into the boiler. This operation shall be repeated as long as the static head of the condensate in the return piping is insufficient to cause free flow to the boiler against the boiler pressure.

251. OIL STORAGE TANKS. - The Contractor shall furnish and install where shown on the drawings, one 1500 gallon Underwriters approved oil storage tank for the Superintendent's Residence and a similar tank for the Administration Building.

Each storage tank shall be buried underground with not less than 3 feet of earth cover.

Each tank shall be 48 inches in diameter by 16 feet long, constructed of 1/4 inch steel plate, with 1/4 inch thick steel heads and shall be welded throughout. All connections to each tank shall be provided with reinforced flanges welded on. Each tank shall have an approved 11-inch by 15-inch manhole in the top of shell.

A concrete collar from the tank manhole to a manhole at the grade shall be furnished and installed for each tank as provided in Paragraph 69.

The Contractor shall furnish and install a 2-inch measuring pipe in each tank from grade level to near the bottom of the tank, with threaded end and cap at grade.

252. EXCAVATION AND BACKFILLING. - Excavation and backfilling for the oil storage tanks and fuel oil lines shall be as specified in Paragraphs 49 and 53.

253. RADIATORS. - The location of the radiators are shown on the drawings, and also the duty to be performed by each radiator is indicated. These duties are noted in square feet of radiation, and are based on an output of 240 B.T.U. per square foot. Radiators not delivering this output under the installed conditions shall have sufficient surface added to perform their duty noted.

If required, the Contractor shall submit satisfactory evidence to the Contracting Officer that the surface proposed or installed fulfills the specified requirements. The specification, of, or the acceptance of, any radiation shall further cover type and manufacture only, and shall not relieve the Contractor from the responsibility of installing the surface required.

All radiation except that in enclosures, shall be cast iron, tube type, $2\frac{1}{2}$ inches wide per section, with top and bottom of sections connected. Piping connections shall be at the top and bottom opposite ends.

Radiation in the enclosures shall be cast iron convection type, with cast iron finned sections and headers, connected by means of malleable iron nipples. The fins shall be cast integral with the cored sections, and so spaced, as to permit a steady and continuous flow of heated air throughout the entire surface.

The height of sills, recesses for enclosures, etc., as well as the length shall be checked by the Contractor prior to ordering, to insure that the space conditions are sufficient.

Radiators shall be moved, disconnected, reconnected if required to suit the floor finishing, painting, etc., without extra cost to the United States.

All radiators shall have approved priming coat of paint applied by dipping at the factory and shall be delivered with all outlets temporarily plugged.

254. RADIATOR CONNECTIONS. - All connections from mains and risers to radiators shall be properly run to allow for expansion and contraction, without causing movement of the radiators, or strain on the pipe and fittings. Radiator connections to risers, mains, etc., shall have a grade of at least $1/2$ inch in 10 feet, grading back to the main or riser.

Tappings and short vertical connections to radiators shall be of the sizes noted on the drawings for supply and return valves.

255. RADIATOR ENCLOSURES. - The Contractor shall furnish and install the radiator enclosures in the Museum and Entrance Hall of the Administration Building.

The enclosures shall be of a standard stock pattern, similar to the detail on the drawings, and shall be of the sizes noted.

The enclosures shall have removable fronts, with grilles at the top front. The grilles shall be furnished and installed as a part of the enclosures.

The enclosures shall be of sufficient size to receive the convection type radiators, and shall also fit the space conditions and panelling as shown on the drawings.

The enclosures shall be constructed of not less than No. 18 U. S. Gage sheet steel, thoroughly braced and supported. The enclosures and grilles shall have a priming coat of paint applied at the factory by dipping.

256. PIPING. - The Contractor shall furnish and erect the steam and return piping, including all valves, fittings, instruments, drips, traps, etc., connecting all radiators, hot water coils, hot water storage tanks, etc., with the boiler.

All drips, vents, etc., shown or found necessary in running the steam mains shall be connected with the traps to the high returns and dripped to the low or wet returns.

The Contractor shall take care in running the branches, and if, after the plants are in operation, any radiators do not circulate freely due to trapped connections, he shall without additional cost, make proper alterations in the defective connections.

All return mains shall have a continuous grade from radiators and risers to the boilers.

All steam mains shall be similarly graded in the direction of the flow of the steam.

The reduction in the pipe sizes to the radiator valve sizes shall be made in the elbows looking up to the steam and return valves.

Piping in the basements shall be run exposed, except oil piping which shall be run under the floors. All piping above the basements shall be run concealed, except vertical connections to the radiators.

Tees shall be installed in the water lines between the storage tank and the hot water heating coil, for connections from the coal fired hot water heater specified under "Plumbing".

Oil lines between oil storage tanks and the burners shall be run underground and under the basement floors, rising at the burners proper.

Vents from the oil storage tanks shall extend as shown on the plans, and terminate with inverted vent fittings, covered with 20-mesh copper gauze.

Approved anti-syphoning devices shall be installed in oil suction line.

The oil filling lines with approved locking fill caps shall be run as shown on the plans.

The oil suction lines in storage tanks shall have approved brass foot valves.

The Contractor shall furnish and install a gate valve with an extended brass stem in brass sleeve to grade in each oil suction line near the building as directed by the Contracting Officer.

257. VALVES, TRAPS, ETC. - Gate valves shall be designed for a steam working pressure of 125 pounds per square inch, and shall have brass bodies and gates, with the name of the manufacturer and working pressure cast or stamped on the body.

Check valves shall be of the swing pattern, working pressure and material similar to that specified for gate valves.

An approved packless radiator valve shall be furnished and installed on each radiator. The radiator valve bodies shall be constructed of bronze, with diaphragms of phosphor bronze and shall have mushroom composition wheels.

Each radiator valve shall have an approved orifice or regulating plate of the proper size to suit the particular unit of radiation on which it is installed.

All exposed parts of the radiator valves, except the wheels, shall be heavily chromium plated.

The radiator valves on the radiators in the enclosures shall be so arranged, as to permit the easy operation of the valve wheel through the opening in the base of the enclosure.

Thermostatic traps of an approved manufacture shall be furnished and installed on each unit of radiation, and on all points of the piping where required for venting the steam mains to the dry returns. Installation of the traps shall be in accordance with the standards of the manufacturer.

Traps shall be of the size as shown or specified, and of angle, corner offset or straightway offset pattern as required.

Trap bodies shall be of brass with caps of forged brass. Union nuts and nipples shall be of forged or bar brass, the nipples having broached lugs. The entire trap shall be heavily chromium plated. The thermostatic element shall be of the bellows or diaphragm type, made of corrosion resisting material, the entire element shall be renewable without requiring further adjustment.

The valve pieces shall be of corrosion resisting material, of conical form and factory-adjusted in the thermostatic element. Seats shall be sharp edged and renewable.

Thermostatic traps shall be capable of withstanding occasional steam pressure of 10 pounds per square inch without permanent damage. Normal operation shall not exceed 5 pounds per square inch.

258. HANGERS, BRACKETS, ETC. - Horizontal piping shall be supported by adjustable wrought iron or steel hangers, of type to allow for expansion of the piping, and spaced not over 10 feet apart. Hangers shall be made of solid stock not less than 1/4 inch thick. Adjustment shall be made by drop forged long nut, with right and left threads. Hangers on basement ceiling shall be fastened, in approved manner to the building construction. Return piping along the wall at the floor shall be supported on approved brackets secured to walls with expansion bolts.

259. SLEEVES AND ESCUTCHEONS. - Pipes passing through wood floors, plaster ceilings, walls, partitions, etc., shall be provided with galvanized iron pipe sleeves. Pipes passing through concrete, brick or tile walls, floors, partitions, etc., shall be provided with wrought iron pipe sleeves. All sleeves in toilet rooms shall extend 1/2 inch above the finished floor and shall be grouted in place; and the piping passing through the same, shall be packed water tight with oakum and red lead.

All exposed piping shall have approved floor and ceiling escutcheons at floors, walls, ceilings, etc., finished to correspond to the piping.

260. NON-CONDUCTIVE COVERING. - The boilers shall be insulated as hereinbefore noted.

The Contractor will not be required to cover the oil piping.

All steam and return piping in the basements, excavated spaces, concealed risers, radiator runouts, excepting exposed verticals, shall be covered with standard thickness, 85 per cent molded magnesia, covering conforming to Federal Specification HH-M-71, Type I. Lacquered brass bands shall be applied after covering has been painted.

All fittings, valves, etc., on the above covering shall be covered with plastic covering containing not less than 50 per cent magnesia.

The hot water storage tanks, shall be covered with a minimum thickness of 1 inch-85% magnesia blocks. Covering shall be wired in place, over metal lath, final coat of cement and asbestos plaster shall be troweled to a smooth finish and shall be 1/2 inch in thickness.

The breechings shall be covered to a minimum thickness of 1 1/2 inches with 85 per cent magnesia blocks wired in place over metal lath. The metal lath shall have spacers to allow 1 1/2 inch air space between the breeching and covering. The finish coat shall be similar to that specified for the hot water storage tank.

The magnesia blocks shall conform to Federal Specification HH-M-71, Type III.

261. CUTTING AND REPAIRING. - Cutting of walls, floors, partitions, etc., required for this work shall be done in a workmanlike manner and as approved by the Contracting Officer.

Damage to walls, floors, ceilings, etc., caused by installation of this work shall be repaired equal to the existing work as approved by the Contracting Officer. Upon completion of the work the Contractor shall remove all debris, dirt, etc., caused by his work and leave the premises broom clean.

262. PAINTING. - Exposed pipe covering and breeching covering shall be painted as required by Paragraph 213.

Radiators, piping, radiator enclosures, grilles, etc., shall be painted as required by Paragraph 215.

The oil storage tanks shall be painted as required by Paragraph 212.

263. TESTS AND GUARANTY. - After the systems have been completed and before any insulation has been applied, the systems shall be thoroughly cleaned of all iron cuttings, sediment, scale, rust, etc., from all pipes, radiators, boilers, etc., by maintaining a pressure of not less than 3 pounds on each system, and blowing same down three times. Each time the boilers shall be refilled with fresh water and sufficient quantity of soda ash used. The interior of traps shall be removed during this cleaning process. Each system shall then be run for a period of not less than eight hours to demonstrate the tightness of same, free circulation of steam or vapor, and the positive and automatic removal of water of condensation and air from the radiators, piping, etc.,. This shall be accomplished in a noiseless manner, any defects or deficiencies which may develop, shall be corrected by the Contractor in an approved manner.

All electricity, fuel, and water required for these tests will be furnished by the U. S. Government.

All tests shall be made under the direction of, and to the satisfaction of the Contracting Officer.

The quality and workmanship of the heating work shall be guaranteed as provided for by Paragraph 38.

SECTION XXIV

ELECTRICAL WORK.

264. - SCOPE OF WORK. - This work shall include the furnishing, installing and connecting in every detail, all materials, apparatus, and devices for complete electrical installation in the Superintendent's Residence, the Administration Building and the Utility Building. This work shall include the incoming service conduit, underground from a point 5 feet outside of each building.

Feeders from the main switch and meter to the various safety switches, panelboards, power outlets, etc., in each of the three buildings shall also be included.

This work shall include in each of the three buildings the distribution boards, safety switches, lighting panels for lighting circuits and all wiring, conduit, fittings, outlet boxes, junction boxes, etc., for the complete electrical systems and the connecting of all outlets, lighting fixtures, switches, etc., to the panels for correct operation.

This work shall include in each of the three buildings, the underground telephone conduit from a point 5 feet outside of each building, into the buildings and the complete systems inside the buildings as indicated.

This work shall further include all wiring to the oil-burning apparatus in the Superintendent's Residence and the Administration Building.

The lighting fixtures shall also be included in this work. All exterior lighting outlets shall be waterproof, and shall have waterproof lighting fixtures.

This work shall include all equipment parts, wiring, conduit, aerial, ground, receptacles, jacks, etc., for the complete radio frequency distribution systems, in the Superintendent's Residence and the Administration Building.

The door bell, push button, bell ringing transformer, fused cutout, conduit, and wiring between the button, transformer and bell for the Superintendent's Residence shall also be included.

The location of the various conduits, switches, outlets panelboards, etc., are shown on the drawings, but these locations are intended to be general only. The Contractor shall conform to the conditions in the buildings, and any necessary changes in the run of the conduits from those shown shall be made without extra cost.

The Contractor shall furnish the Contracting Officer with a complete list of materials to be used in the work, together with the names of the manufacturers, brands, catalogue numbers, etc., for approval.

All necessary samples of material called for under Paragraph 32 shall be furnished.

Certificates of Tests shall be furnished as required.

All necessary shop drawings and wiring diagrams, for panelboards, distribution boards, etc., shall be submitted for approval.

265. **WORKMANSHIP.** - The work herein specified and shown on the accompanying drawings, shall be furnished and installed in complete working order and of the best workmanship, known to the trade. Certain established standards shall be followed the same as if they were fully specified herein. These are as follows:

- (a) The National Electric Code of the National Board of Fire Underwriters.
- (b) The rules and regulations of the local Electrical Code.
- (c) The rules and regulations of the local electric company supplying the current.
- (d) The standardization rules of the American Institute of Electrical Engineers.

The foregoing rules and requirements shall be followed by the Contractor as minimum requirements, but they shall not relieve the Contractor from furnishing and installing higher grade materials and workmanship where herein specified.

266. **TESTS AND GUARANTY.** - All tests required by the Contracting Officer, to show that the requirements of the specifications and laws and regulations have been fulfilled, shall be made by and at the expense of the Contractor. All instruments, bulbs and materials necessary for the complete tests shall be furnished and delivered to the building by and at the expense of the Contractor at a time convenient for the Contracting Officer.

The quality and workmanship of the electrical work shall be guaranteed as provided for by Paragraph 38.

267. **TYPE OF CURRENT.** - The wiring shall be based on the power being alternating current, 110/220-volts, single-phase, 3-wire, 60-cycles.

268. **ENTRANCE OF SERVICES.** - The incoming electric services shall be underground, consisting of empty conduit starting at a point 5 feet outside of each building as shown on the plans.

Incoming underground conduit for the Superintendent's Residence and the Administration Building, shall rise and terminate in pull boxes located on the inside wall of the excavated spaces. Conduit and feeders from these pull boxes shall run exposed on the ceiling to the distribution boards.

Incoming underground conduit for the Utility Building shall rise and terminate at the meter and service switch located on the inside wall of the shop. Conduit underground shall be buried not less than 24 inches below grade.

The incoming underground telephone conduits shall be run similar to the above electric services, except the conduits shall rise and terminate at the telephone pull boxes.

269. EXCAVATION AND BACKFILLING. - Excavation and backfilling for the underground conduits shall be as specified in Paragraphs 50 and 53.

270. DISTRIBUTION BOARDS. - The Contractor shall furnish and install in each building approximately where shown, distribution boards of adequate size to accommodate the safety switches and meters noted herein. Boards shall be constructed of 1-1/8 inch thick Grade A, long leaf Southern Pine S4S, with two 1-inch by 4-inch battens. The boards shall be securely mounted on the wall with expansion bolts in an approved manner to receive the safety switches.

271. SAFETY SWITCHES. - Safety switches shall be of the quick make and quick break, receding blade type, capable of breaking full rated load under continuous operation. The path of current shall not pass through any hinged, soldered or riveted connection, contact surfaces shall be self-burnishing and retain a perfect contact area. Switches shall be front operated and have an interlocking cover.

The Contractor shall furnish and connect up the following safety switches on the various distribution boards.

SUPERINTENDENT'S RESIDENCE.

- One (1) 60-Amp. triple pole fused main switch and meter trim.
- One (1) 60-Amp. triple pole fused switch for Panel No. 1.
- One (1) 30-Amp. double pole fused switch for Oil Burner.

ADMINISTRATION BUILDING.

- One (1) 100-Amp. triple pole fused main switch and meter trim.
- One (1) 100-Amp. triple pole fused switch for Panel No. 1.
- One (1) 30 -Amp. double pole fused switch for Oil Burner.

UTILITY BUILDING.

- One (1) 100-Amp. triple pole fused main switch and meter trim.
- One (1) 60-Amp. triple pole fused switch for Panel No. 1.
- One (1) 60-Amp. triple pole fused switch for future water pump.

Fuses for the above switches shall be cartridge type, conforming to Federal Specification W-F-791.

272. METERS. - The Contractor shall furnish and install in each building where noted on the plans, one detachable watt hour meter. Each meter shall be capable of operating at 300 per cent of rating and shall register within 2 percent when operating at any load from zero to 300 per cent of rating; without injury.

The meters shall be of the following rated capacity:

- Superintendent's Residence - 15 Amp.
- Administration Building - 25 Amp.
- Utility Building - 50 Amp.

Each meter shall be complete with a glass cover, meter socket, terminal blocks and one-piece clamping ring for sealing the meter to the socket.

Each meter shall be connected to the main switch and distribution switches with rigid conduit and wired up complete, ready for outside electric service.

The meters shall be so arranged as to permit dead front testing.

273. RADIO DISTRIBUTION SYSTEMS. - The Contractor shall furnish and install a radio frequency distribution system in the Superintendent's Residence and also in the Administration Building. Each system shall consist of a single indoor aerial not less than 50 feet in length, run in the attic space with all necessary aerial terminal equipment, load coil, insulators, etc. The transmission lines from the aerials to each outlet shall be shielded and shall have a device at each outlet to prevent receiver interaction.

The ground wiring shall be complete from the load coils to each outlet and to approved terminal resistance and ground connections with ground clamps sweated on water mains near the entrance to the building.

All radio wiring except the aerials shall be run in rigid conduit.

274. DOOR BELL, TRANSFORMER, ETC. - The door bell shall be of the self-contained type, 3 inches in diameter and shall be mounted on the wall above the door where noted on the plans. The bell hammer shall strike against the inside of the gong. The springs shall be of phosphor bronze with silver contacts. The gong shall be nickel finish and shall be mounted on an iron base finished with black enamel. The bell shall operate on 8 volts.

The transformer shall be of the bell ringing type, 110 volt primary and 8 volt secondary. The transformer shall be mounted with a plug fused cutout in a steel box. The box shall have a hinged cover and be located so as to be easily accessible. The transformer shall be connected up to the nearest 110 volt circuit.

The push button for ringing the bell shall be of a vaporproof type with threaded end for connection to the conduit. The surface flange shall be of cast bronze and shall fit neatly to the woodwork. The button shall be black composition, and shall actuate the contact member within the shell. The springs and contacts shall be phosphor bronze.

275. CONDUIT. - For electrical, radio, bell wiring and telephone systems, the Contractor shall furnish and install a rigid steel conduit system connecting all outlets as shown on the plans. All ends shall be carefully reamed and all joints made up with white lead.

Couplings shall be used wherever it becomes necessary to join conduits between outlets. Running threads will not be approved in any case.

Conduit underground and in the Utility Building shall be galvanized or sheradized inside and outside and shall conform to Federal Specification WW-C-581.

Conduit in the Superintendent's Residence and the Administration Building shall be black enameled inside and outside and shall conform to Federal Specification WW-C-571.

The conduit systems shall be free from impediments and shall be swabbed out where necessary so as to be dry before installing wires.

All abrasions of coating shall be painted with approved moisture proof paint.

No conduit, except for bell wiring, shall be smaller than 3/4 inch in diameter.

Conduit for telephone systems shall be 3/4 inch, unless otherwise noted.

Conduit for radio systems shall be 3/4 inch.

Conduit for bell wiring shall be 1/2 inch.

Except where it is absolutely unavoidable, conduits shall not cross nor run within one foot of any steam pipe. Where conditions make close runs unavoidable, such conduits shall be hermetically sealed at each end after wires are installed, and shall be provided with drip boxes where practical, to prevent accumulation of condensation moisture.

Conduits shall be fastened to building construction with approved hangers, on approximately 8 foot centers.

Conduit ends at outlet boxes, panelboards, pull boxes, etc., shall have approved insulating bushings and metal caps.

Conduit where run underground shall be encased in three inches of concrete. Concrete shall conform to the requirements specified under "Concrete Work", Section V.

Conduit above the basement in the Superintendent's Residence and the Administration Building shall be run concealed in floors, walls, ceilings, attic spaces, and furred spaces.

Conduit in the boiler rooms and excavated spaces in the Superintendent's Residence and the Administration Building shall be run exposed, and shall be made up with approved conduit fittings, at all breaks, turns, changes in direction, etc.

Conduit in the Utility Building shall be run exposed on the roof trusses, joists, etc., and where a room has siding, the drops or verticals shall be run in the stud spaces. All exposed conduit in the Utility Building shall be made up with approved conduit fittings at all breaks, turns, drops connections, changes in direction, etc.

Each conduit system shall be thoroughly grounded to the water piping of the building by No. 0 gage wire, sweated to the clean surface of the conduit and piping, and shall be held in place with approved clamps.

The conduit systems for radio wiring shall be grounded separately in similar manner to above.

276. PULLBOXES. - The Contractor shall furnish and install any pullboxes required for the installation of wires. Pullboxes

shall be No. 12 U. S. gage steel, galvanized, sheradized, or black enameled, with removable cover plates screwed on.

The pullboxes in the Utility Building shall be galvanized or sheradized.

The pullboxes in the Superintendent's Residence and the Administration Building shall be black enameled.

277. OUTLET AND JUNCTION BOXES. - All outlet boxes shall be of the galvanized, sheradized, or black enameled stamped steel type, of approved size to meet the various requirements. Fittings shall be set tight so as to form good connections, both electrical and mechanical.

All outlets are located in their approximate positions only, and the Contractor shall, without additional compensation, shift them as may be required to meet the job conditions.

Telephone junction boxes shall be No. 10 U. S. gage galvanized sheradized, or black enameled steel, thoroughly braced, and shall have steel trim with hinged doors, lock and keys.

The boxes for the Superintendent's Residence and Administration Building shall be black enameled.

The boxes for the Utility Building shall be galvanized or sheradized. All outlets on the exposed work shall be of the conduit type to receive the receptacles, switches, etc., designated at the outlets.

278. LIGHTING PANELS AND BOXES. - Panels for lighting circuits shall be of the safety, automatic, circuit breaker type. Breakers in the branch lighting circuits shall be 25-ampere type, calibrated to trip at 15 amperes. Panelboards shall be of the circuit capacity noted on the drawings.

Panelboards shall be enclosed in a metal box constructed of No. 12 U. S. gage galvanized sheet steel, and provided with 4-inch wiring gutter on all sides. Each panel shall be provided with steel door fastened to steel trim with concealed hinges. The door shall be provided with latch, cylinder lock and keys.

Panels in the Superintendent's Residence and the Administration Building shall be of the flush type. Panel in the Utility Building shall be of the surface mounted type.

The Contractor shall number all circuits and furnish approved schedule, showing the various rooms, etc., controlled by each circuit and shall mount each schedule, in brass frame with glass

cover on the door of the proper panel. Face of panelboard doors and trims shall be painted as required in Paragraph 216.

All 2-wire branch circuits shall be connected to the panels in such a manner that the two sides of the 3-wire system shall be balanced within 5 per cent.

Drawings of the panelboards shall be submitted for approval.

279. WIRES. - Wires shall connect all outlets in such manner as to obtain the results indicated, and shall be continuous from outlet to outlet.

All wire, except underground shall be in accordance with Federal Specifications J-C-101, except that insulation for wires shall be 30 per cent rubber in accordance with Federal Specification HH-I-531.

All wire underground shall be lead-covered in accordance with Federal Specification J-C-101.

All branch circuits, except for bell wiring, shall be 2-No. 12 gage wires.

Conductors larger than No. 6 gage shall be stranded.

All bell wiring on the low voltage side of the transformer shall be No. 18 gage wires.

Single conductors shall be used throughout.

No wires will be required for the telephone systems.

Radio aeriels in attic spaces shall be 7 strand of No. 22 gage enameled copper wire twisted, aeriels shall be not less than 50 feet in length and shall have approved glass insulators 5 inches long, secured to the building construction.

Radio transmission wire from aeriels to the various outlets shall be No. 14 stranded rubber-covered wire. Ground wiring shall also be of No. 14 stranded rubber-covered wire.

After the wires are installed, they shall be tested out and properly connected and soldered ready to receive the fixture connections, switches, etc.

All loop splices to which fixtures do not connect shall be left insulated as specified by local requirements.

A loop of wire 4 feet long shall be left at each oil burner unit outlet.

Wires shall not be stripped of their covering closer than 6 inches from the bushing out of which they issue. If any should be stripped closer, taping will not be accepted, as sufficient insulation, but new wires shall be furnished in such places by and at the expense of the Contractor.

280. TELEPHONE OUTLETS. - Telephone outlet boxes shall conform to boxes specified under "Outlet Boxes". Outlets shall be set in the baseboards, where approved.

Finish plates shall have a 3/8 inch composition bushing in face, and shall conform to plates specified under "Finish Plates".

281. RADIO OUTLETS. - Radio outlets shall be of the flush type receptacle to receive standard radio jacks. The receptacles shall be top wired to aerial and ground connections, with approved coupler to prevent receiver interaction, and shall be set in steel outlet boxes.

The radio receptacles shall be set in the walls 18 inches above the floor, and shall have finish plates of gang type to cover the flush electric receptacle and radio outlets.

The Contractor shall furnish and deliver to the Contracting Officer, 5 radio jacks for the above type receptacle.

282. LOCAL SWITCHES. - The Contractor shall furnish and connect, where indicated, single pole, compound box, totally enclosed, top wired, flush, tumbler switches; 10-ampere, 125-volt type to control outlets indicated as being controlled by wall switches.

Three and four-way switches shall be similar to above construction and rating.

The exterior switch for the Inflammable Storage shall be of a weatherproof type, with pilot light. The combined switch and pilot light shall be mounted on the exterior wall and shall be complete with all necessary gaskets, ruby bulls-eye, water-proof outlet box, etc.

283. FLUSH RECEPTACLES. - Receptacles, except as noted shall be duplex, flush type, composition base, totally enclosed, top connected, 10-amperes, 125-volt capacity.

The receptacles shall be set in walls 18 inches above the floor unless otherwise noted.

The receptacles shall have two moulded plugs, with handy grip, for use with the above receptacles.

The receptacles at radio outlets shall be single type set in gang formation with radio outlet to receive a single finish plate for both outlets.

The Contractor shall furnish to the Contracting Officer 20 additional plugs similar to the above.

284. FAN OUTLETS AND RECEPTACLES. - Fan outlets shall have a single receptacle, fan hanger, metal hanger receptacle and stud stirrup, all in accordance with the National Electric Code Standards.

The fan outlets shall be set approximately 6 feet, 9 inches above the floor.

Each fan outlet shall be controlled by a local switch located in the wall below the fan.

285. FINISH PLATES. - Receptacle, telephone, radio, and switch plates shall be moulded, black, composition type with standard beveled edges. The plates shall be secured in place with moulded head, attaching screws.

Finish plates for the fan outlets shall be of brass finished for painting.

Where more than one outlet occurs at the same location they shall have one piece, gang finish plates.

Finish plates on outlets in conduit fittings shall be approved metal covers to match the conduits.

286. LIGHTING FIXTURES. - The Contractor shall furnish and install the following lighting fixtures and lamps. The fixtures shall be complete with fixture studs, open female type hickeyes, attachment devices, Edison base sockets, canopies, chains, stems, fibre imitation candles, glassware, bulbs and leads of No. 16 slow burning stranded wire.

Outside fixtures shall be of waterproof type and have approved waterproof, insulated wire.

The metal parts of the fixtures shall be as specified and noted on the drawings.

SUPERINTENDENT'S RESIDENCE

All lighting fixtures in this building shall conform to Navy Specification No. 9 Yd; except as noted otherwise. The finish on all metal parts of the interior fixtures shall be Colonial brass.

SECOND FLOOR:

- Bed Room No. 3. 1 - fixture similar to No. 10; lamp 40 W.
- Hall 1 - fixture similar to No. 12; lamp 40 W.
- Bed Room No. 1. 1 - fixture similar to No. 10; lamp 60 W.
- Attic. 1 - Keyless porcelain sockets on the outlet box; lamp 25 W.
- Bath. 1 - fixture similar to No. 21, without pull cord and receptacle; lamp 40 W.
- Bed Room No. 2. 1 - fixture similar to No. 10; lamp 60 W.

FIRST FLOOR:

- Sewing Room 1 - fixture similar to No. 4; lamp 60 W.
- Coat Closet 1 - fixture similar to No. 26; lamp 25 W.
- Kitchen 1 - fixture similar to No. 15; lamp 150 W.
- Enclosed Porch 1 - fixture similar to No. 12; lamp 60 W.
- Pantry 1 - fixture similar to No. 12; lamp 40 W.
- Dining Room 1 - fixture similar to No. 33; lamps 25 W.
- Hall (Front) 1 - fixture similar to No. 24; lamp 40 W. tinted.
- Hall (Rear) 1 - fixture similar to No. 26; lamp 25 W. tinted.
- Living Room 1 - fixture similar to No. 30; lamps 25 W. tinted.
- Outside Front Entrance 2 - fixtures similar to detail on the plans. The fixtures shall be constructed of wrought iron with rough amber glass panels, and shall have dull black enameled finish; lamps 25 W.
- Porch 1 - lantern fixture similar to detail on the plans. The construction, glass, and finish shall be similar to Entrance Fixtures; lamp 25 W.

BASEMENT:

- Rear Entrance 1 - Fixture similar to detail on the plans. The construction, glass and finish shall be similar to first floor Entrance Fixtures; lamp 25 W.

Boiler Room and base
of stairs

- 2 - keyless porcelain sockets set
on the outlet boxes; lamps
40 W.

ADMINISTRATION BUILDING.

SECOND FLOOR:

Superintendent's Office: 1 - fixture similar to No. 11,
Navy Specification No. 9 Yd; lamp
200 W.

Alcove Superintendent's
Office: 1 - fixture similar to No. 20,
Navy Specification No. 9 Yd; lamp
40 W.

Superintendent's
Lavatory: 1 - fixture similar to No. 20,
Navy Specification No. 9 Yd; without
pull cord and receptacle, lamp 40 W.

Stair Hall: 1 - two candle fixture as per Detail
No. 5 on the plans; lamp 25 W. flame
type, tinted.

Stair Hall Landing: 1 - Single candle fixture as per
Detail No. 8 on the plans; lamp
25 W. flame type, tinted.

Clerical Office: 2- fixtures similar to the Superin-
tendent's Office fixture.

Storage No. 3: 2 - fixtures similar to No. 12,
Navy Specifications No. 9 Yd; lamp
60 W.

Storage No. 1 and No. 2 2- keyless, porcelain sockets set
on the outlet boxes; lamps 25 W.

FIRST FLOOR:

White Men's Toilet: 1 - fixture similar to No. 12,
Navy Specification 9 Yd; lamp 75 W.

Colored Men's Toilet: 1 - fixture similar to No. 14,
Navy Specification No. 9 Yd, lamp
40 W.

Library: 1 - three candle fixture as per
Detail No. 3 on the plans; lamps
40 W. flame type, tinted.

Stair Hall: 1 - fixture similar to second floor Stair Hall, fixture.

Museum: 2-6 candle fixtures as per detail No. 2 on the plans; lamps 40 W. flame type, tinted.

Colored Women's Toilet: 1 - fixture similar to colored Men's toilet fixture.

Women's Toilet (White): 1 - fixture similar to No. 1, Navy Specification No. 9 Yd; lamp 100 W.

Porch: 1 - lantern fixture as per detail No. 6, on the plans. The lantern shall be constructed of wrought iron with rough amber glass panels, and shall have dull, black, enameled finish; lamp 40 W.

Entrance Hall: 1 - four candle fixture as per detail No. 4, on the plans; lamps 25 W. flame, type tinted.

Guides: 1 - fixture similar to Library fixture.

Passage: 1 - single candle fixture as per detail No. 1 on the plans, lamp 25 W. flame type tinted.

Hall: 1 - fixture similar to Passage fixture.

Front Entrance (Exterior): 2 - lantern fixtures, as per detail No. 7, on the plans. The lanterns shall be constructed and finished similar to the lantern for the Porch; lamps 25 W.

Entrance (Hall): 1 - lantern fixture similar to the Front Entrance fixture.

Slop Sink Room: 1 - fixture similar to No. 21, Navy Specification No. 9 Yd; lamp 25 W.

Maintenance: 1 - fixture similar to No. 1, Navy Specification No. 9 Yd; lamp 100 W.

Basement Stair Landing: 1 - fixture similar to No. 12, Navy Specification No. 9 Yd; lamp 25 W.

BASEMENT:

Boiler Room, Hall & Excavated Spaces: 5 - key type porcelain sockets, set on the outlet boxes; lamps 40 W.

UTILITY BUILDING

All lighting fixtures in the building shall conform to Navy Specification No. 9 Yd; except as noted otherwise:

Inflammable Storage: 1 - fixture similar to No. 17; lamp 75 W.

Stable: 2 - fixtures similar to No. 6; lamps 75 W.

Storage over Stable: 1 - fixture similar to No. 17; lamp 75 W.

Implement Shed: 2 - fixtures similar to No. 6; lamps 75 W.

The coal fired boilers shall be of the cast iron, sectional, water tube, low-pressure, steam type. The boilers shall be constructed of first quality, grey iron, with sections connected by means of wrought iron push nipples; the boilers shall be complete with all necessary attachments and appurtenances.

The boilers shall be of the commercially smokeless type, designed for burning bituminous coal.

The boilers shall be capable of evaporating not less than the number of pounds of water per hour noted below, from and at 212 degrees F., when operating at 2 pounds pressure.

Superintendent's Residence - 210 pounds of water.
Administration Building - 300 pounds of water.

The grate area of the boilers shall be not less than:

Superintendent's Residence - 5.28 square feet.
Administration Building - 7.20 square feet.

The heat output at the supply openings of the boilers shall be not less than:

Superintendent's Residence - 200,000 B.T.U. per hour.
Administration Building - 280,000 B.T.U. per hour.

The boilers shall operate at an efficiency of not less than 72 per cent, when fired at 8 hour intervals.

The steam outlets on each boiler shall be 2-4 inch, and the return inlets 2-4 inch; all outlets shall be connected full size to headers as shown on the drawings.

The boiler water lines shall not exceed $4\frac{1}{2}$ inches.

The boilers shall each be complete with an approved damper regulator, smoke hood with damper, shaking grates, firing tools, wire flue brush, poker, hoe, shovel, pressure-vacuum gage 30-0-30 type, with $\frac{1}{4}$ pound graduations, water column, $2\frac{1}{2}$ inch safety valve and an approved ash pit 12 inches deep, formed to suit the base of each boiler.

A "Hartford" loop shall be installed in the return line to each boiler.

Each boiler shall have $\frac{1}{4}$ inch asbestos insulation, protected by a sheet steel jacket, with baked enamel finish.

291. ALTERNATIVE BID "E" (OMISSION OF UTILITY BUILDING, INFLAMMABLE STORAGE BUILDING AND FENCE ENCLOSING YARD AT UTILITY BUILDING). - An alternative bid shall be submitted stating the amount to be deducted from the main (lump sum) bid if all the work to be done for the construction of the Utility Building, the Inflammable Storage Building, and the fence enclosing the yard at the Utility Building as specified under Paragraph 23 and shown on the drawings is not required.

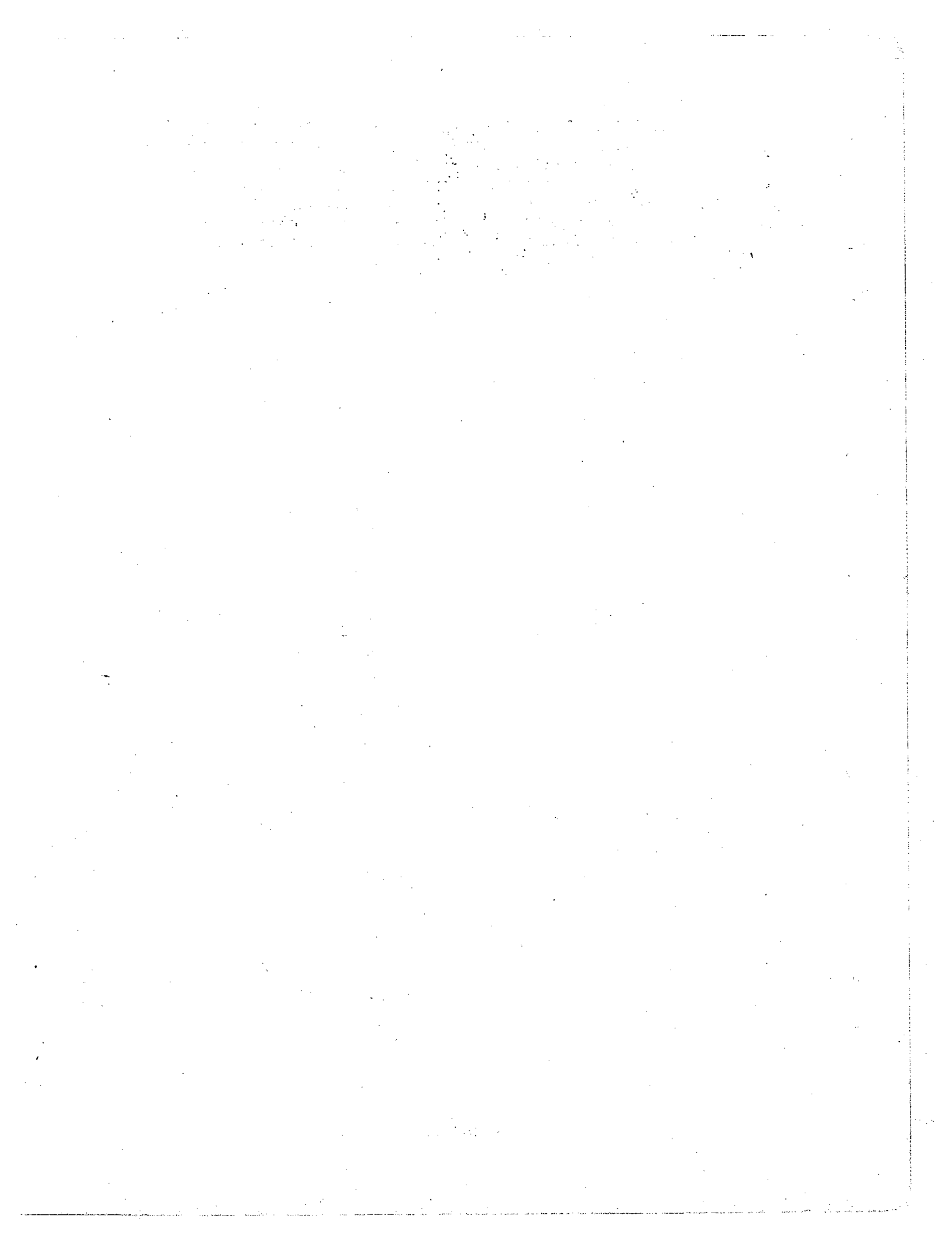

APPENDIX C

2006: As-found Drawings

1. Basement Floor Plan
2. First Floor Plan
3. Second Floor Plan
4. Baseboard Profiles
5. Door and Window Casing Details
6. Secondary Door and Window Casings
7. Window Stool/Apron Elevations
8. Window Stool/Apron Elevations
9. Picture/Crown Molding Profiles
10. Door Panel Profiles
11. Window Muntin Profile

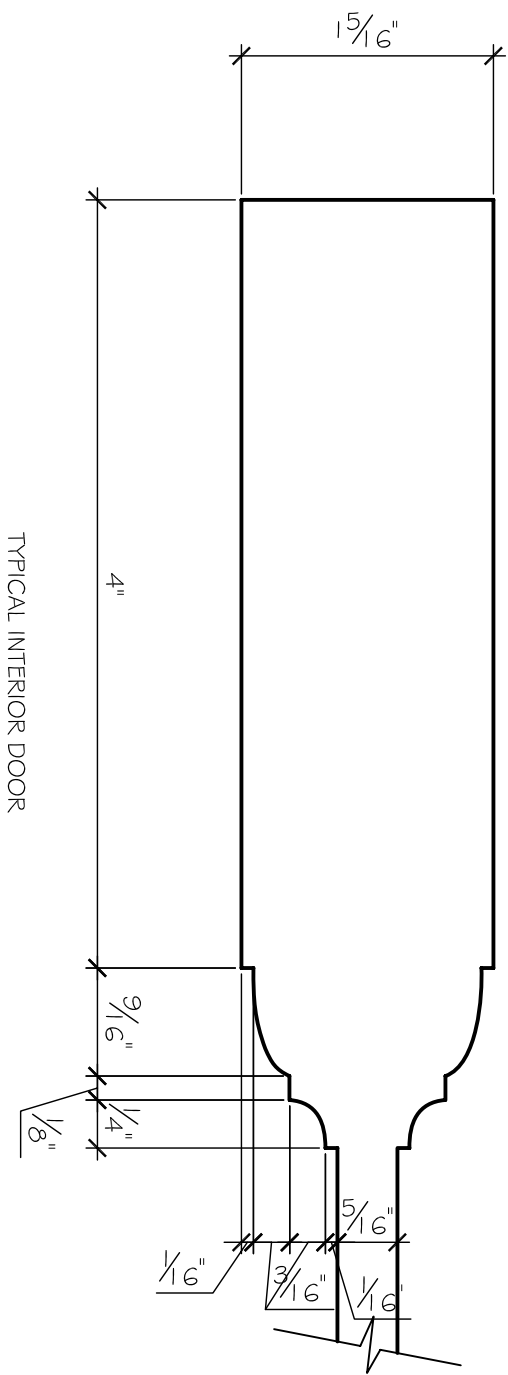

TYPICAL INTERIOR DOOR

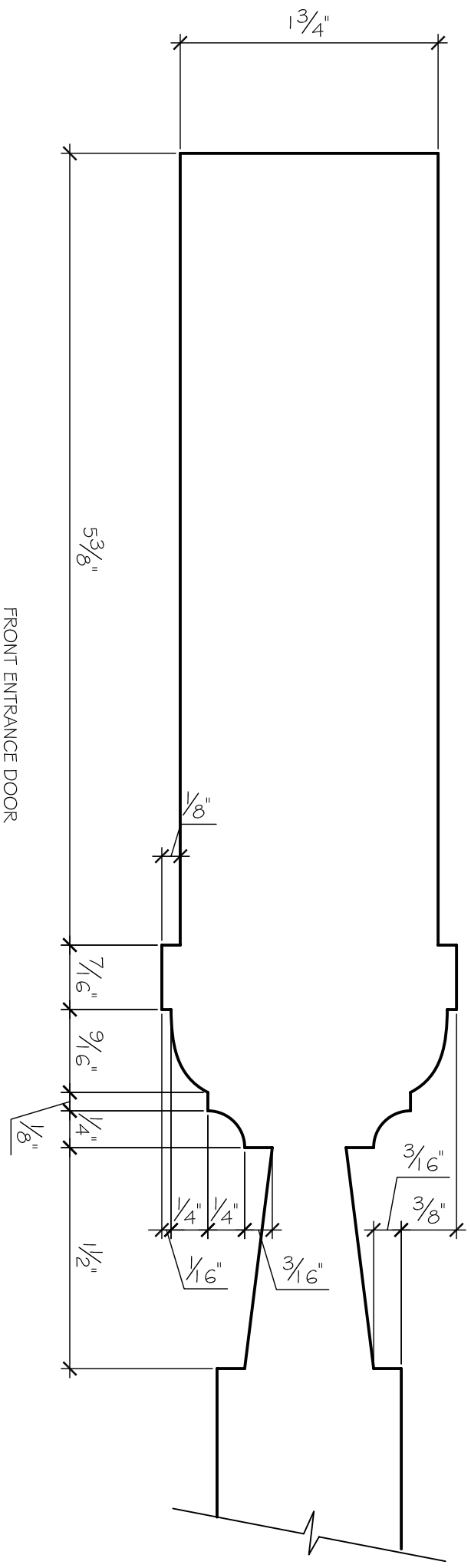

FRONT ENTRANCE DOOR

DOOR PANEL PROFILES
2006

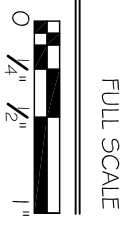

FULL SCALE

JOSEPH K. OPPERMANN-ARCHITECT, P.A.
WINSTON-SALEM, NORTH CAROLINA

SUPERINTENDENT'S RESIDENCE
GUILFORD COURTHOUSE NMP
GREENSBORO, NORTH CAROLINA

JOB #:	0616
DATE:	08-30-2006
DRAWN BY:	JPW
REVISIONS:	
SHEET #:	10

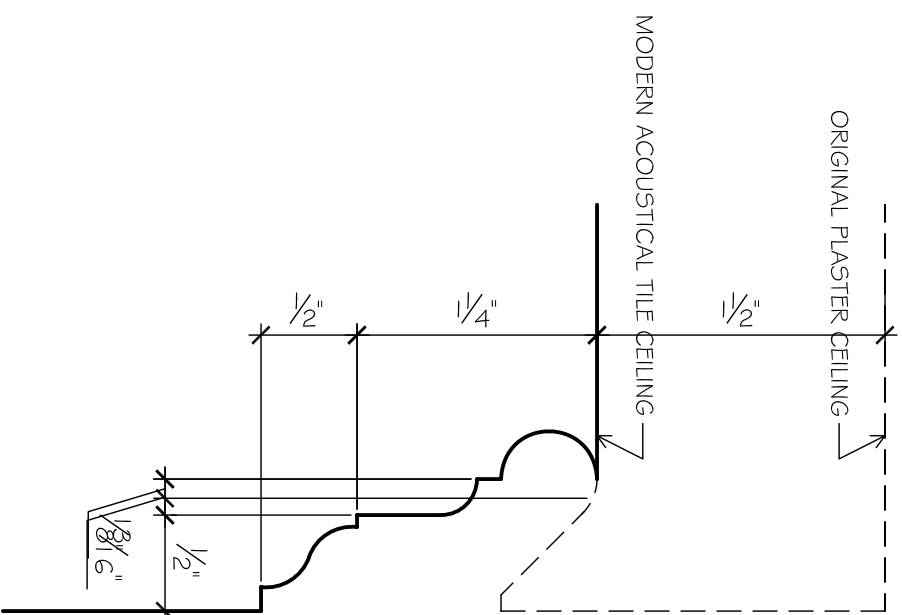

PICTURE MOLDING - ROOMS 101, 102, 103,
201, 202, 204, 206

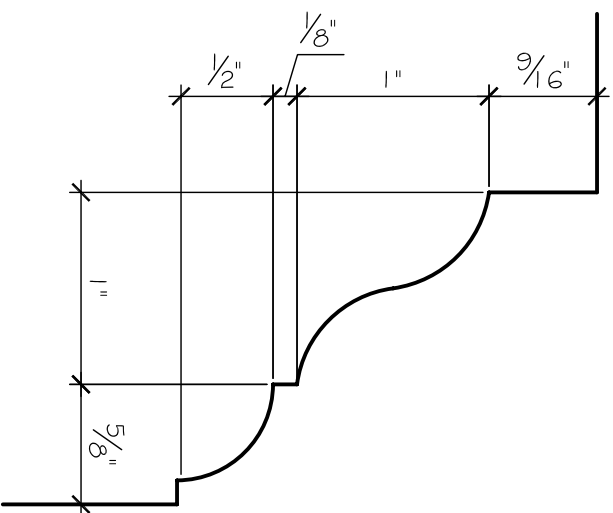

CROWN MOLDING - ROOMS 106, 107

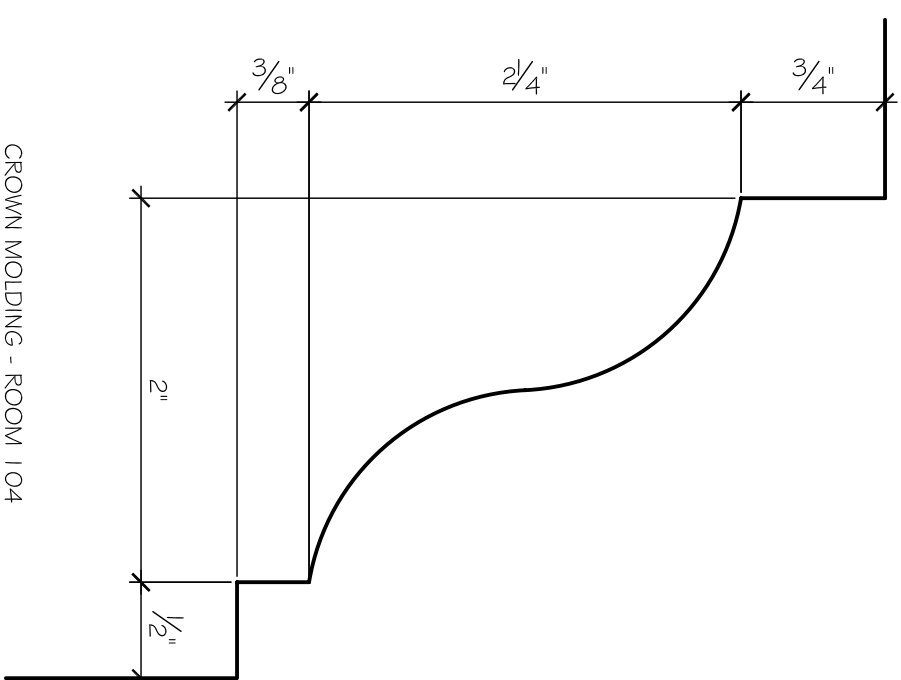

CROWN MOLDING - ROOM 104

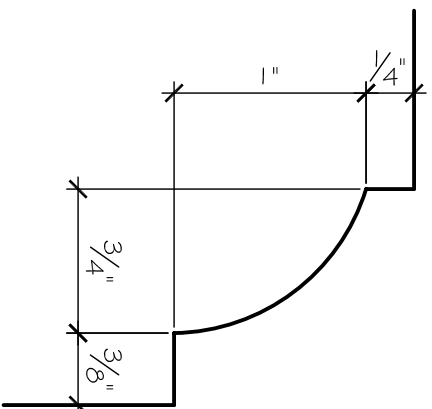

CROWN MOLDING - ROOM 110

PICTURE/CROWN MOLDING PROFILES

2006

FULL SCALE



JOSEPH K. OPPERMANN-ARCHITECT, P.A.
WINSTON-SALEM, NORTH CAROLINA

SUPERINTENDENT'S RESIDENCE
GUILFORD COURTHOUSE NMP
GREENSBORO, NORTH CAROLINA

JOB #:	0616
DATE:	08-30-2006
DRAWN BY:	JPW
REVISIONS:	
SHEET #:	

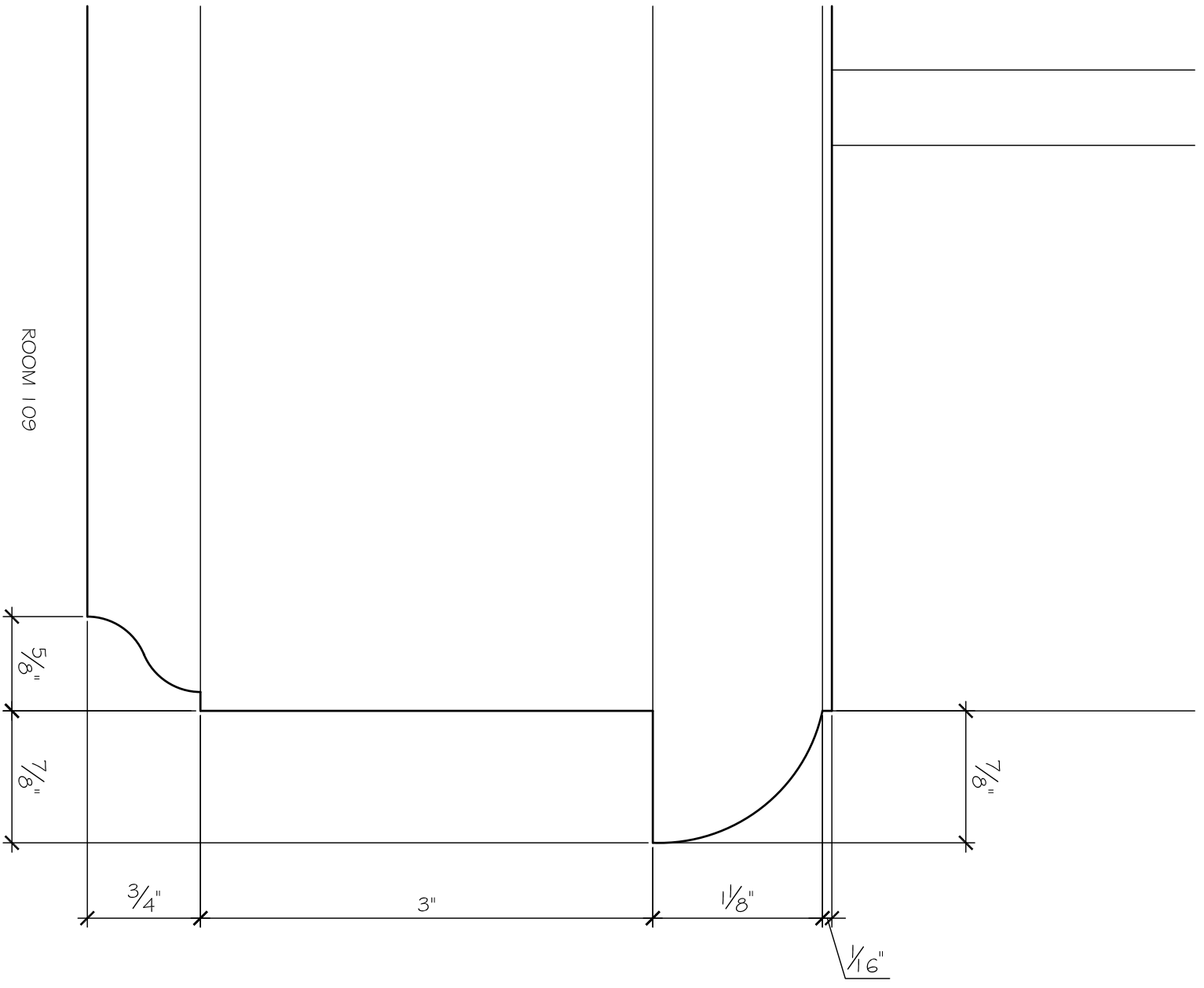

ROOM 109

SECOND FLOOR DORMER WINDOWS

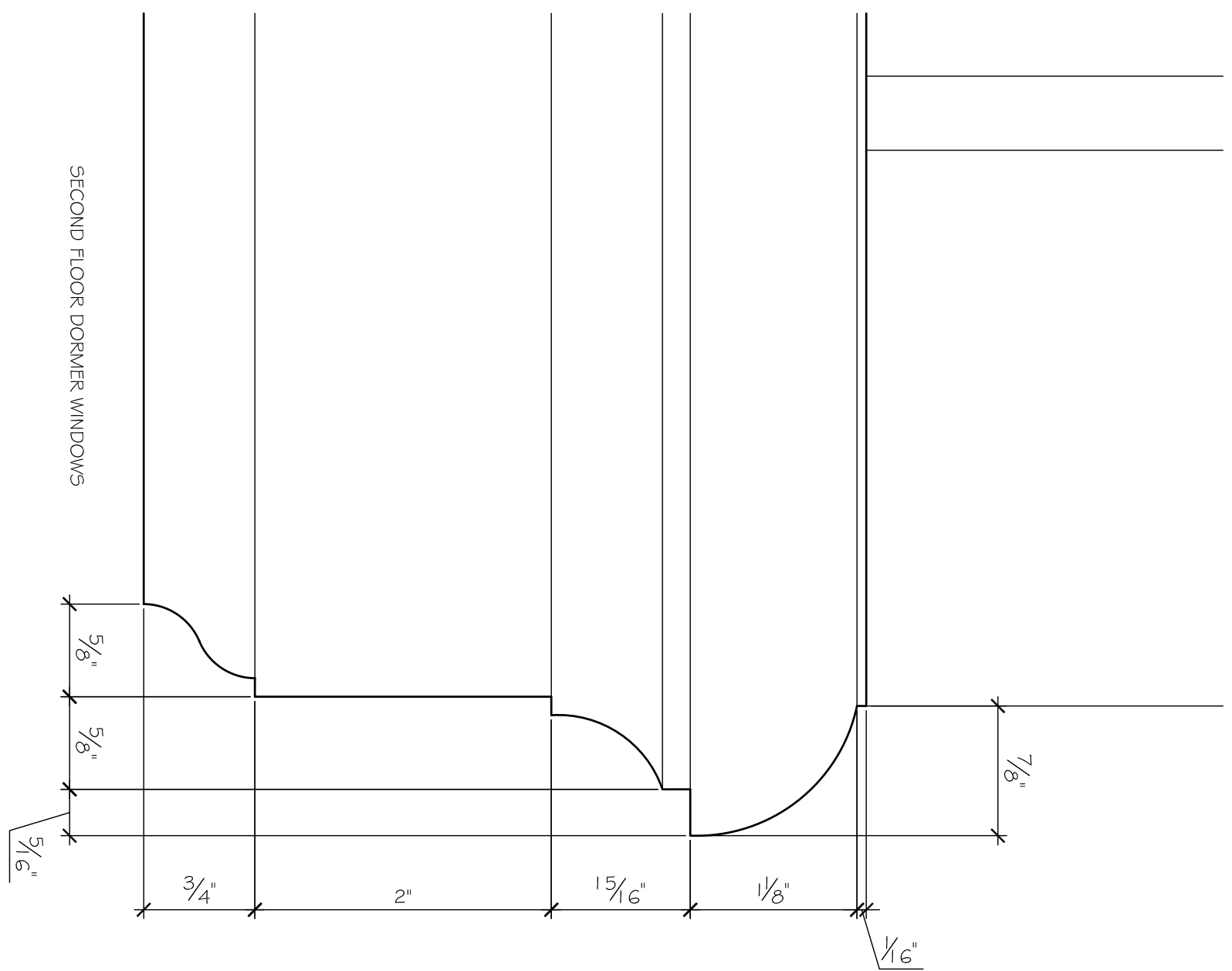

WINDOW STOOL/APRON ELEVATIONS

FULL SCALE

2006

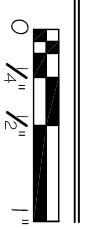

SUPERINTENDENT'S RESIDENCE
 GUILFORD COURTHOUSE NMP
 GREENSBORO, NORTH CAROLINA

JOSEPH K. OPPERMAN-ARCHITECT, P.A.
 WINSTON-SALEM, NORTH CAROLINA

JOB #:	0616
DATE:	08-30-2006
DRAWN BY:	JPW
REVISIONS:	
SHEET #:	

ROOMS 101, 103, 105, 106, 110
AND EASTWEST ELEVATION WINDOWS
ON SECOND FLOOR

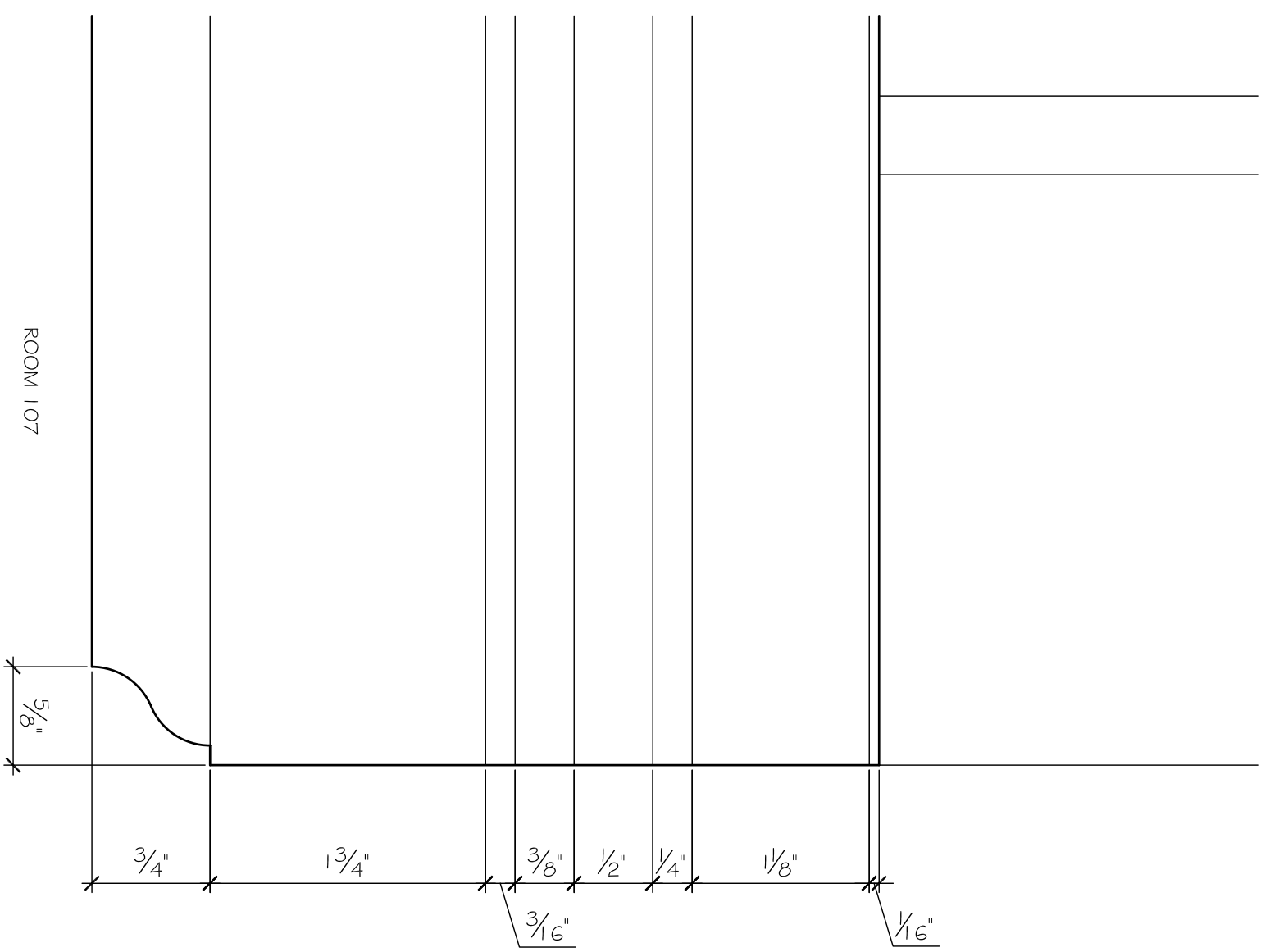
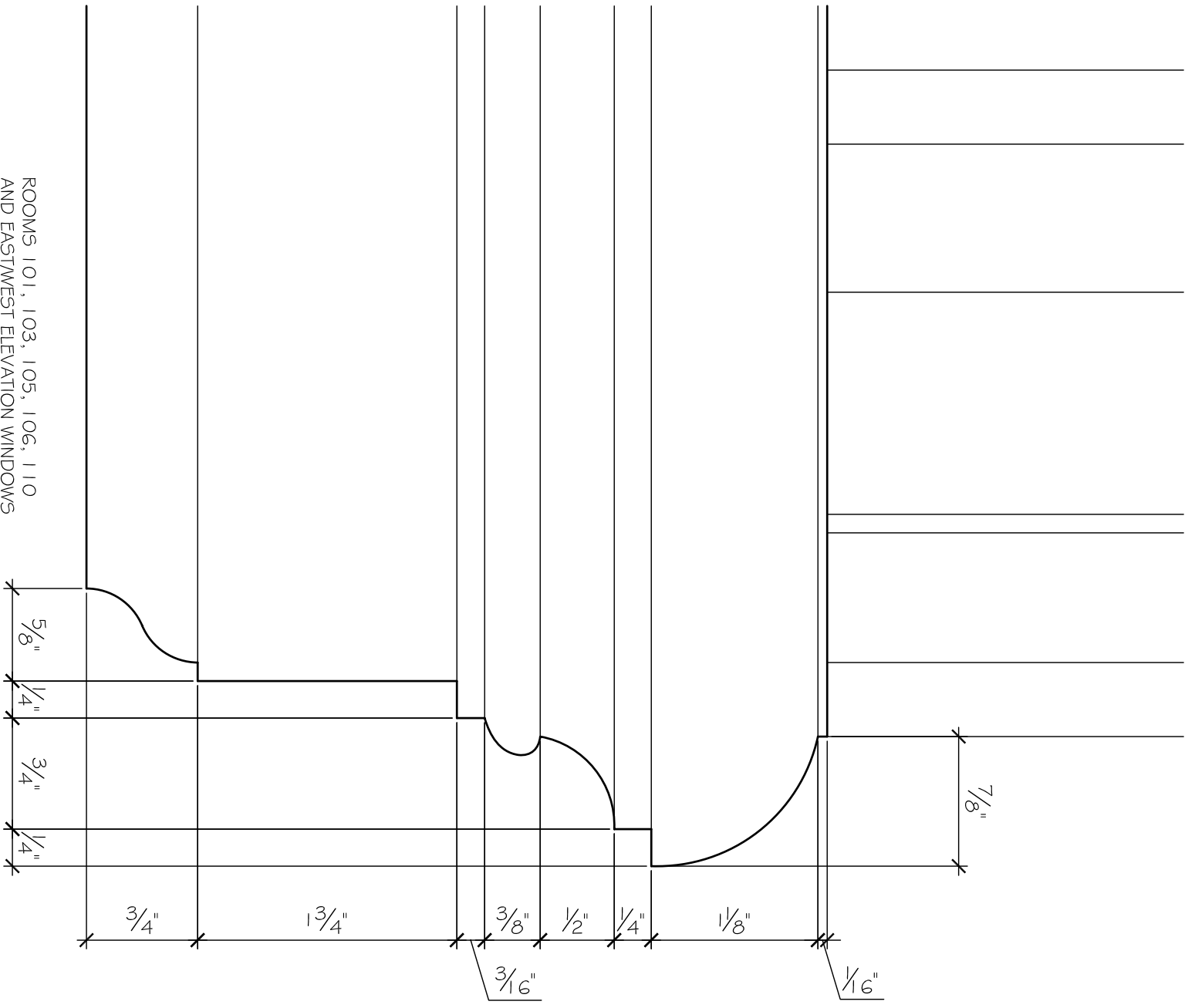

ROOM 107

WINDOW STOOL/APRON ELEVATIONS

FULL SCALE



2006

SUPERINTENDENT'S RESIDENCE
GUILFORD COURTHOUSE NMP
GREENSBORO, NORTH CAROLINA

JOSEPH K. OPPERMAN-ARCHITECT, P.A.
WINSTON-SALEM, NORTH CAROLINA

JOB #:	0616
DATE:	08-30-2006
DRAWN BY:	JPW
REVISIONS:	
SHEET #:	2

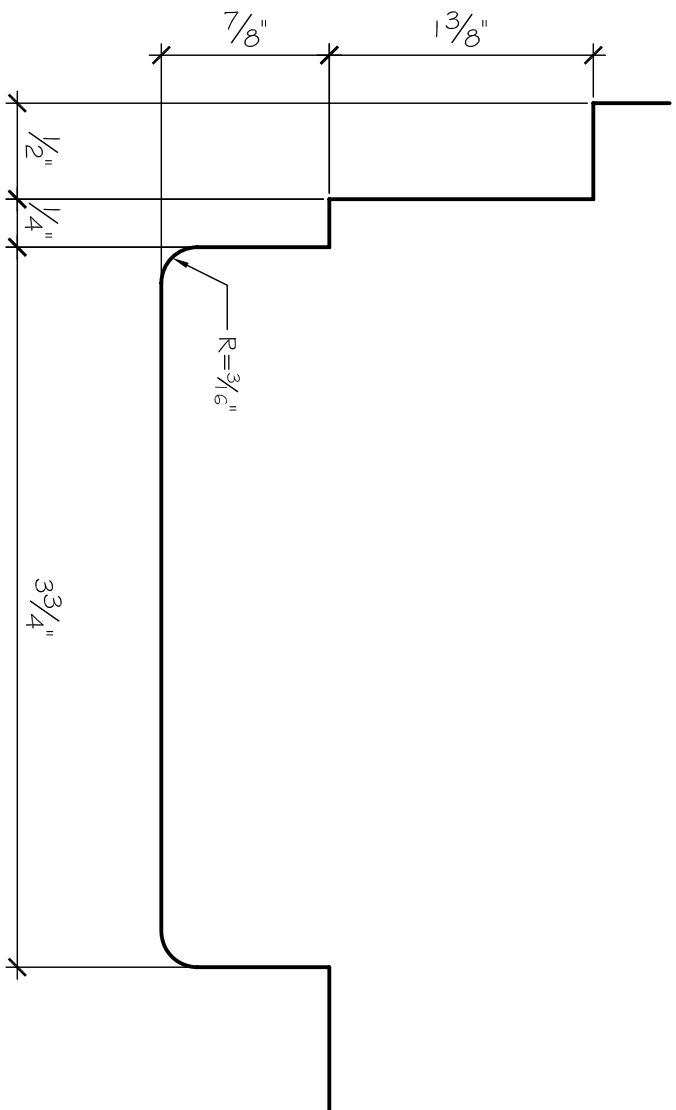

DOOR CASING IN ROOMS 106, 107

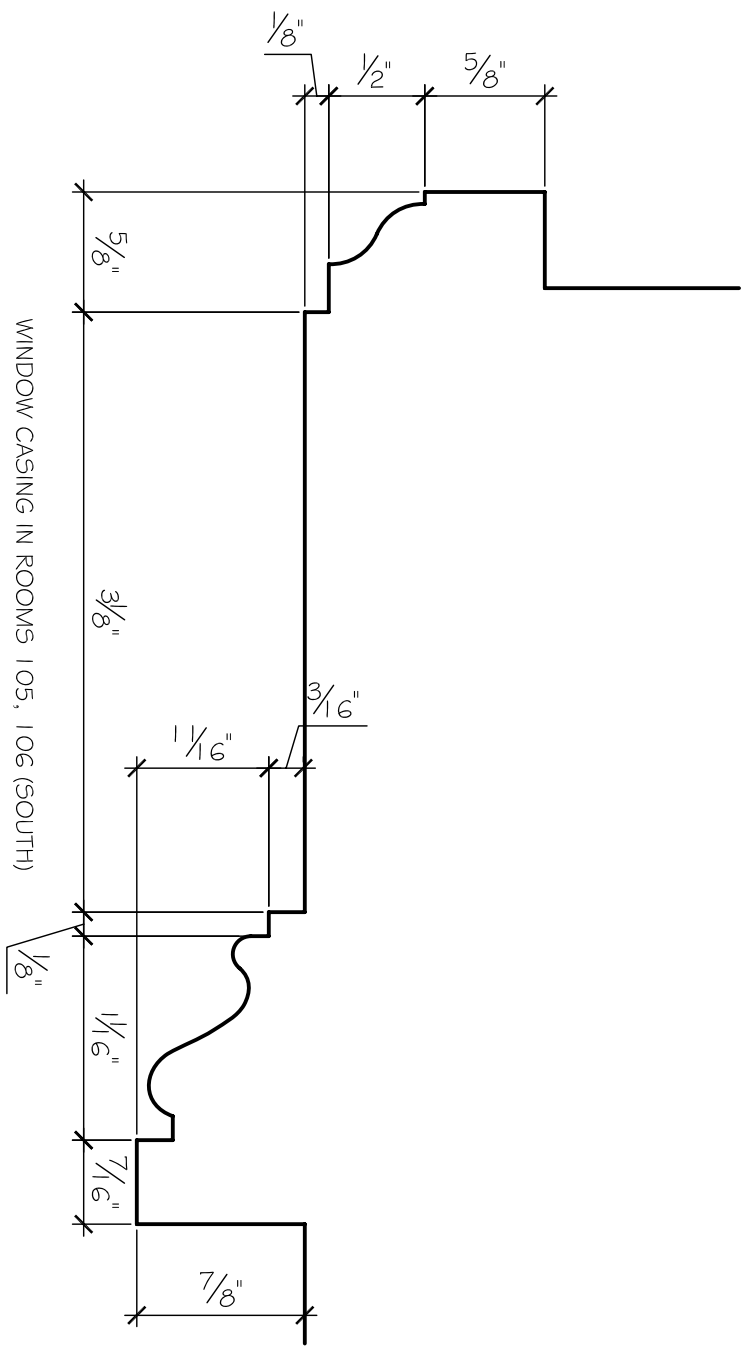

WINDOW CASING IN ROOMS 105, 106 (SOUTH)

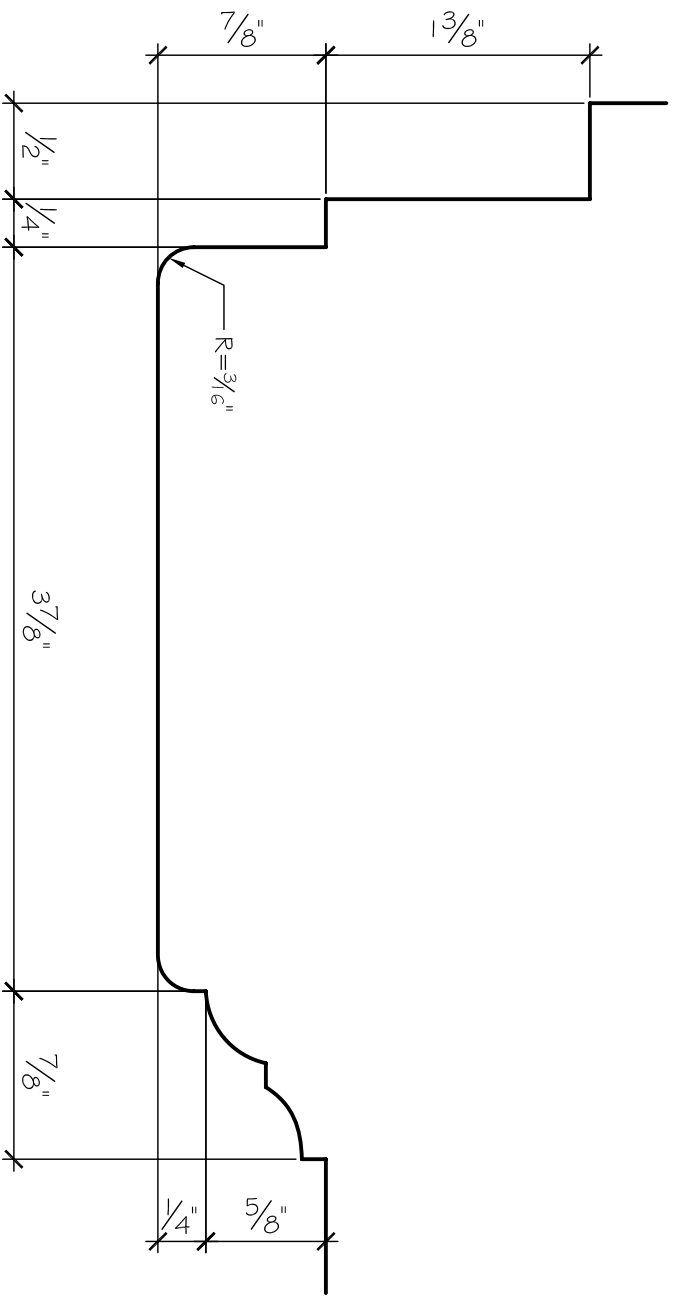

DOOR CASING IN ROOM 109

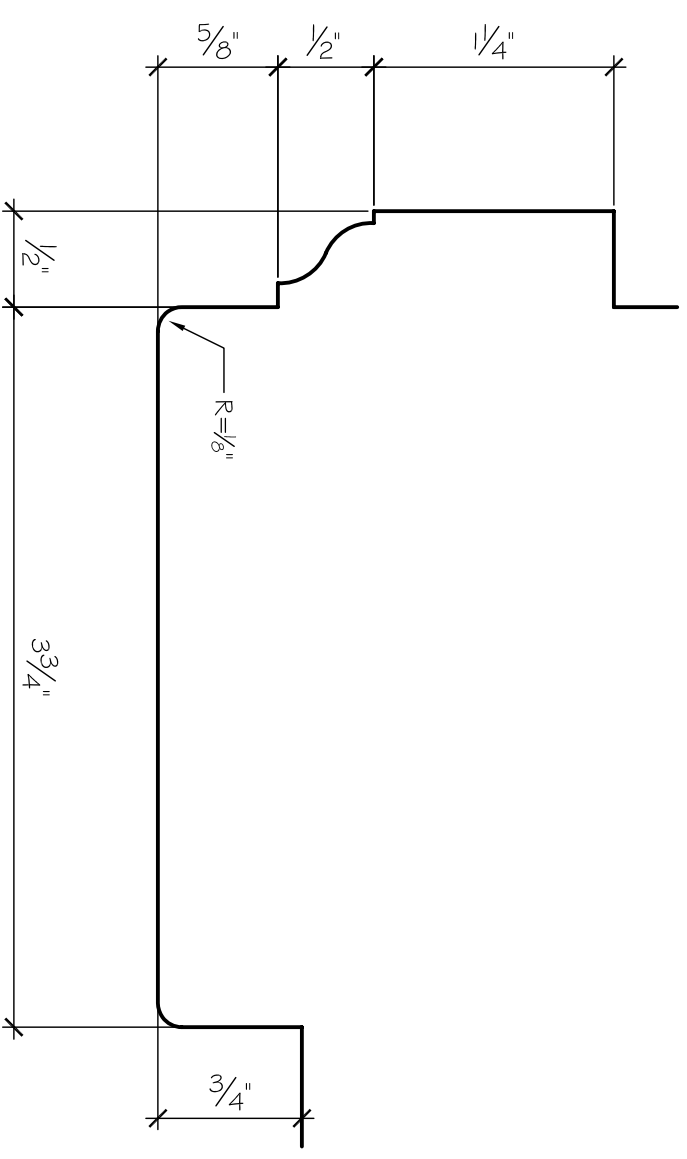

WINDOW CASING IN ROOMS 107, 109

SECONDARY DOOR AND WINDOW CASINGS

2006

FULL SCALE

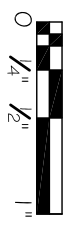

JOSEPH K. OPPERMANN-ARCHITECT, P.A.
WINSTON-SALEM, NORTH CAROLINA

SUPERINTENDENT'S RESIDENCE
GUILFORD COURTHOUSE NMP
GREENSBORO, NORTH CAROLINA

JOB #:	0616
DATE:	08-30-2006
DRAWN BY:	JPW
REVISIONS:	

SHEET #:

6

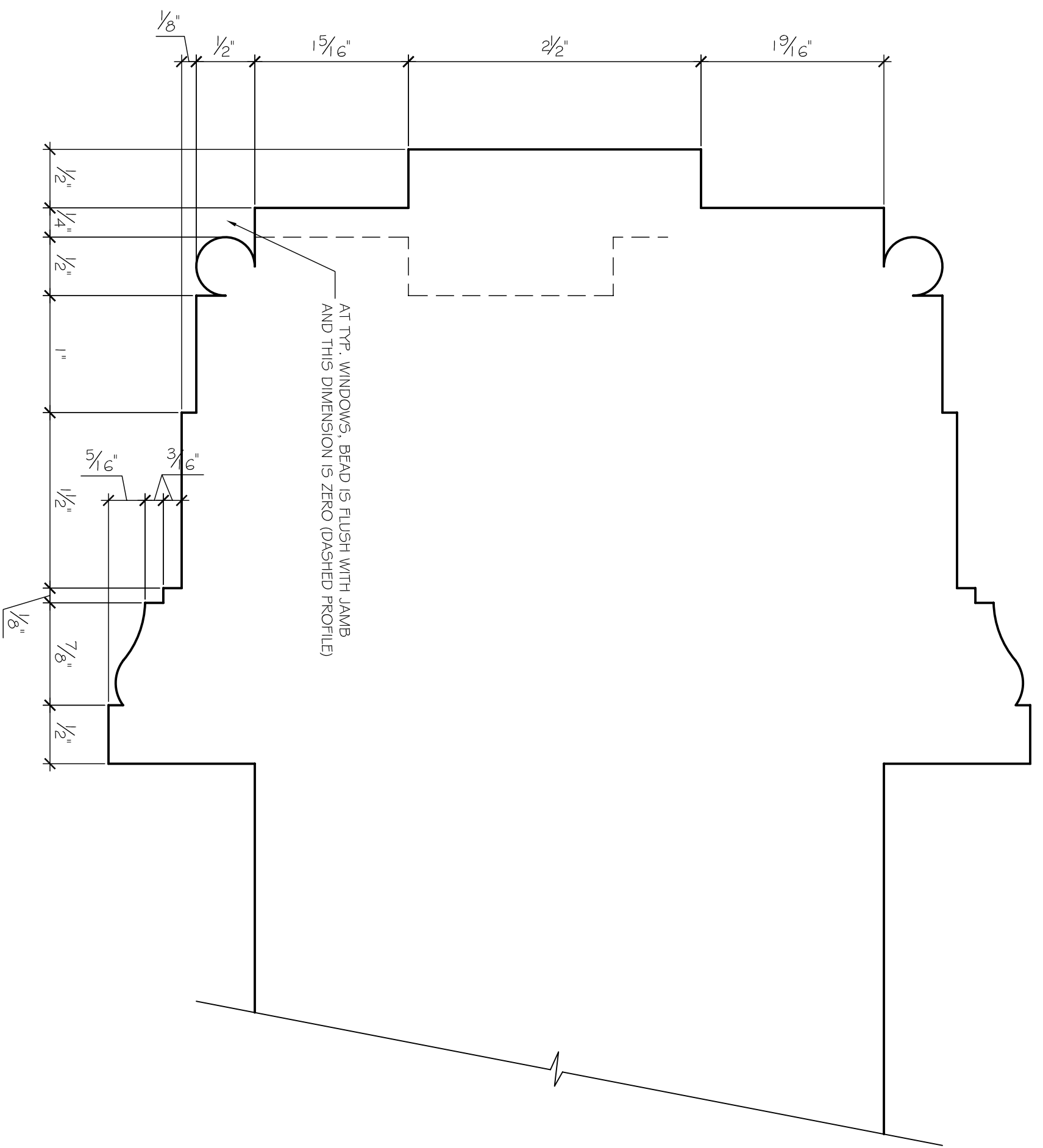

DOOR AND WINDOW CASING - TYP. EXCEPT AS NOTED
2006

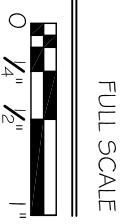

FULL SCALE

SUPERINTENDENT'S RESIDENCE
GUILFORD COURTHOUSE NMP
GREENSBORO, NORTH CAROLINA

JOSEPH K. OPPERMAN-ARCHITECT, P.A.
WINSTON-SALEM, NORTH CAROLINA

JOB #:	0616
DATE:	08-30-2006
DRAWN BY:	JPW
REVISIONS:	
SHEET #:	

ROOMS 101, 102, 105, 106, 107, 202
 ROOMS 103, 201, 204, 206 SIMILAR,
 BUT WITHOUT SHOE MOLDING

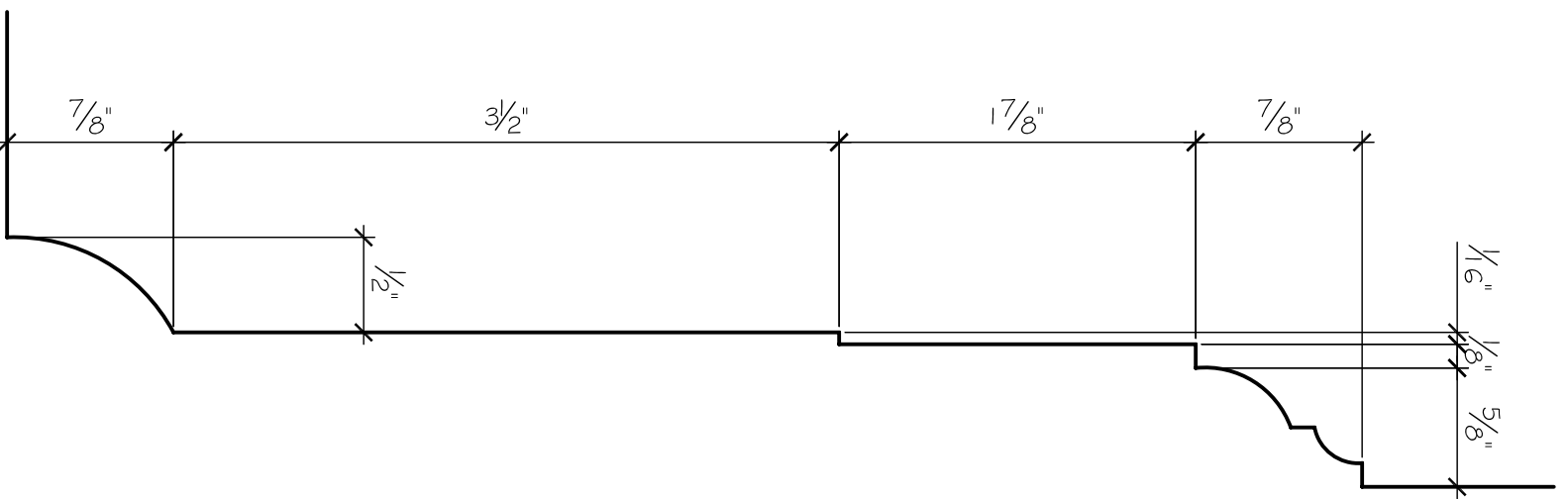

ROOM 110

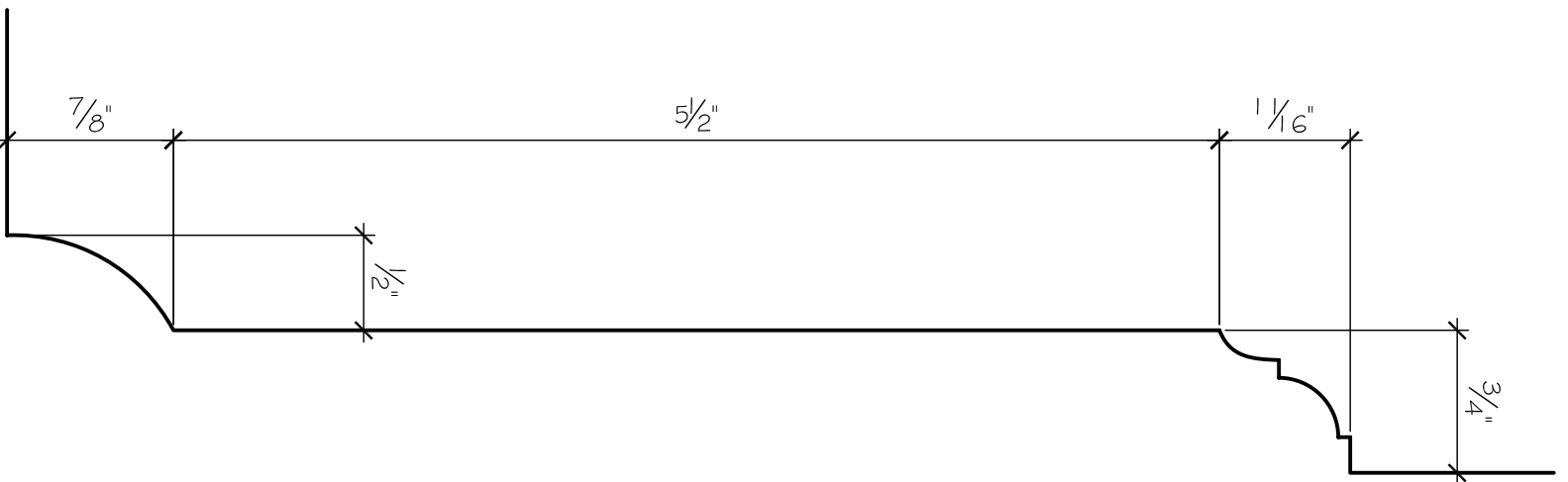

ROOM 109

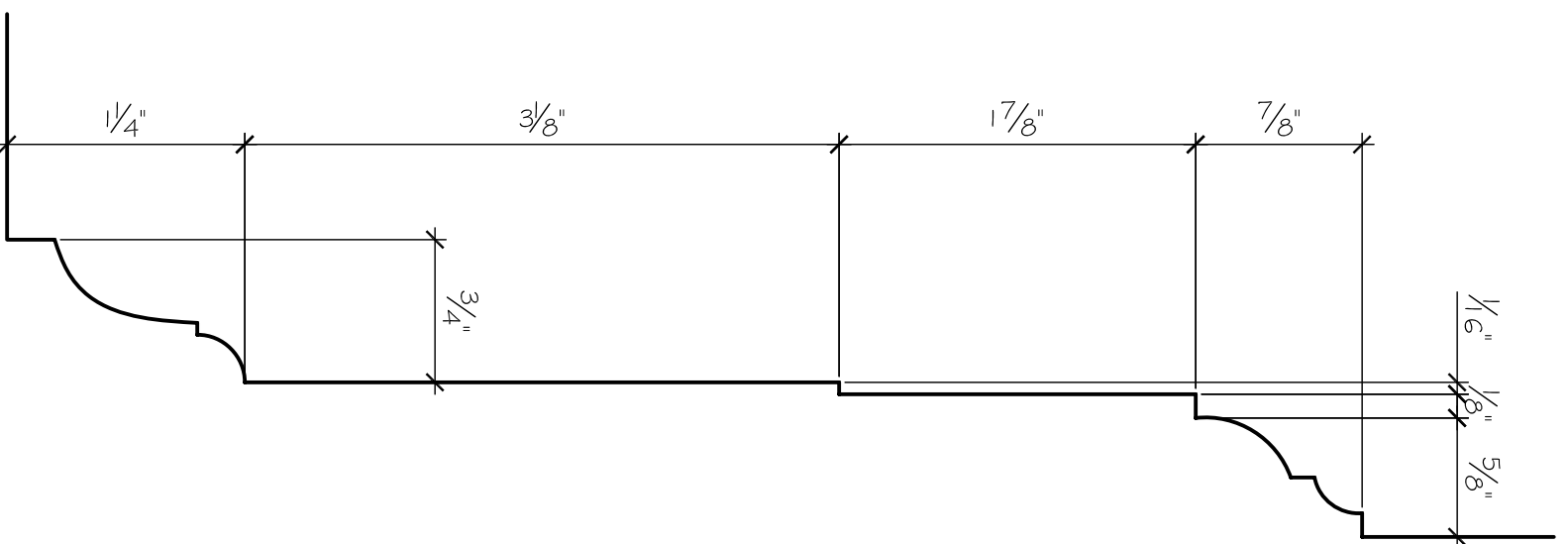

BASEBOARD PROFILES

2006

FULL SCALE



JOSEPH K. OPPERMANN-ARCHITECT, P.A.
 WINSTON-SALEM, NORTH CAROLINA

SUPERINTENDENT'S RESIDENCE
 GUILFORD COURTHOUSE NMP
 GREENSBORO, NORTH CAROLINA

JOB #:	0616
DATE:	08-30-2006
DRAWN BY:	JPW
REVISIONS:	
SHEET #:	

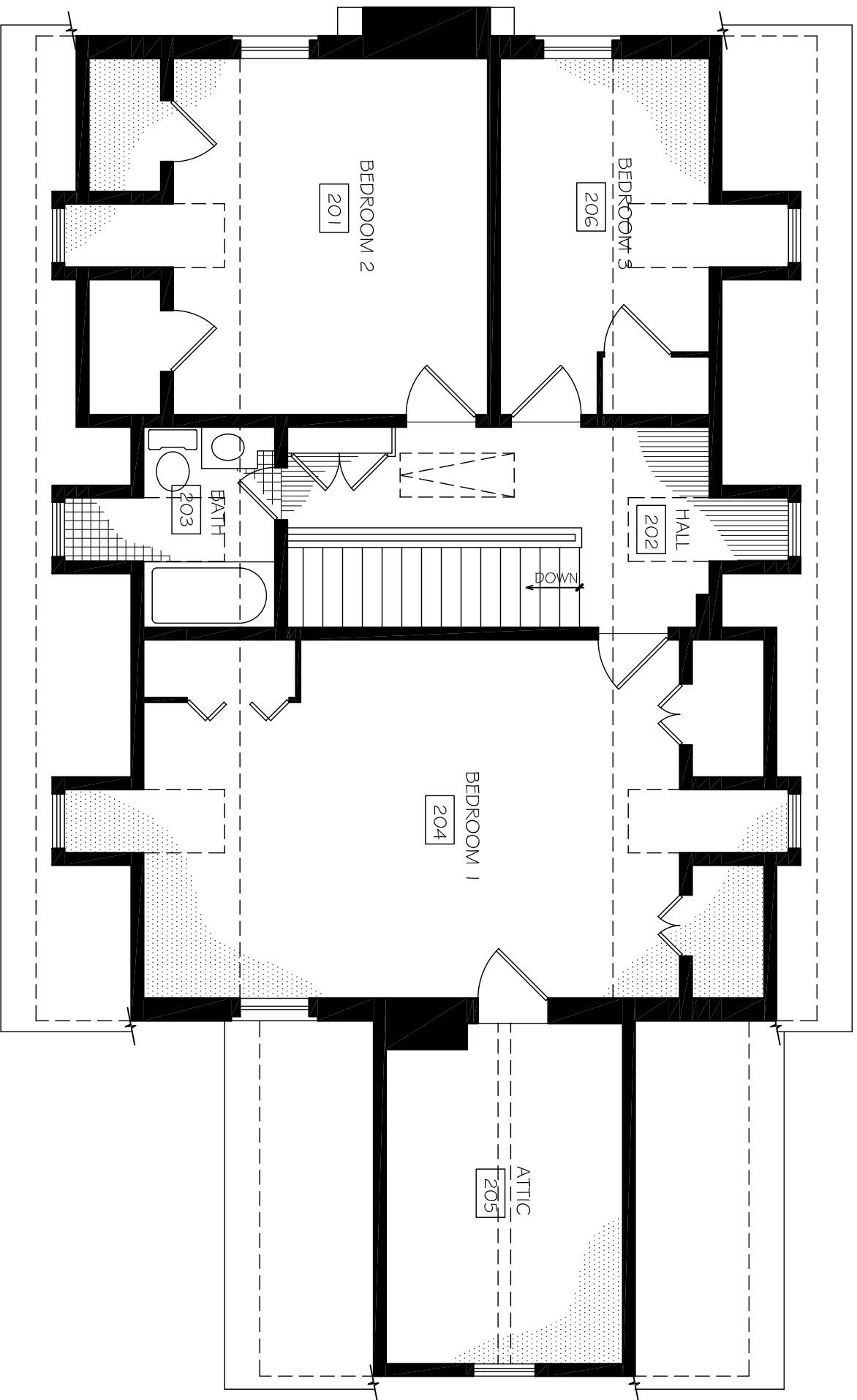

SECOND FLOOR PLAN

2006

SCALE: 3/8" = 1'-0"

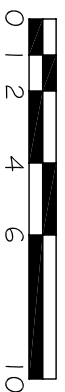

KEY

	WOOD FLOORING
	CARPET
	SHEET VINYL
	CERAMIC TILE

SUPERINTENDENT'S RESIDENCE
 GUILFORD COURTHOUSE NMP
 GREENSBORO, NORTH CAROLINA

JOSEPH K. OPPERMANN-ARCHITECT, P.A.
 WINSTON-SALEM, NORTH CAROLINA

JOB #:	0616
DATE:	08-30-2006
DRAWN BY:	JPW
REVISIONS:	
SHEET #:	

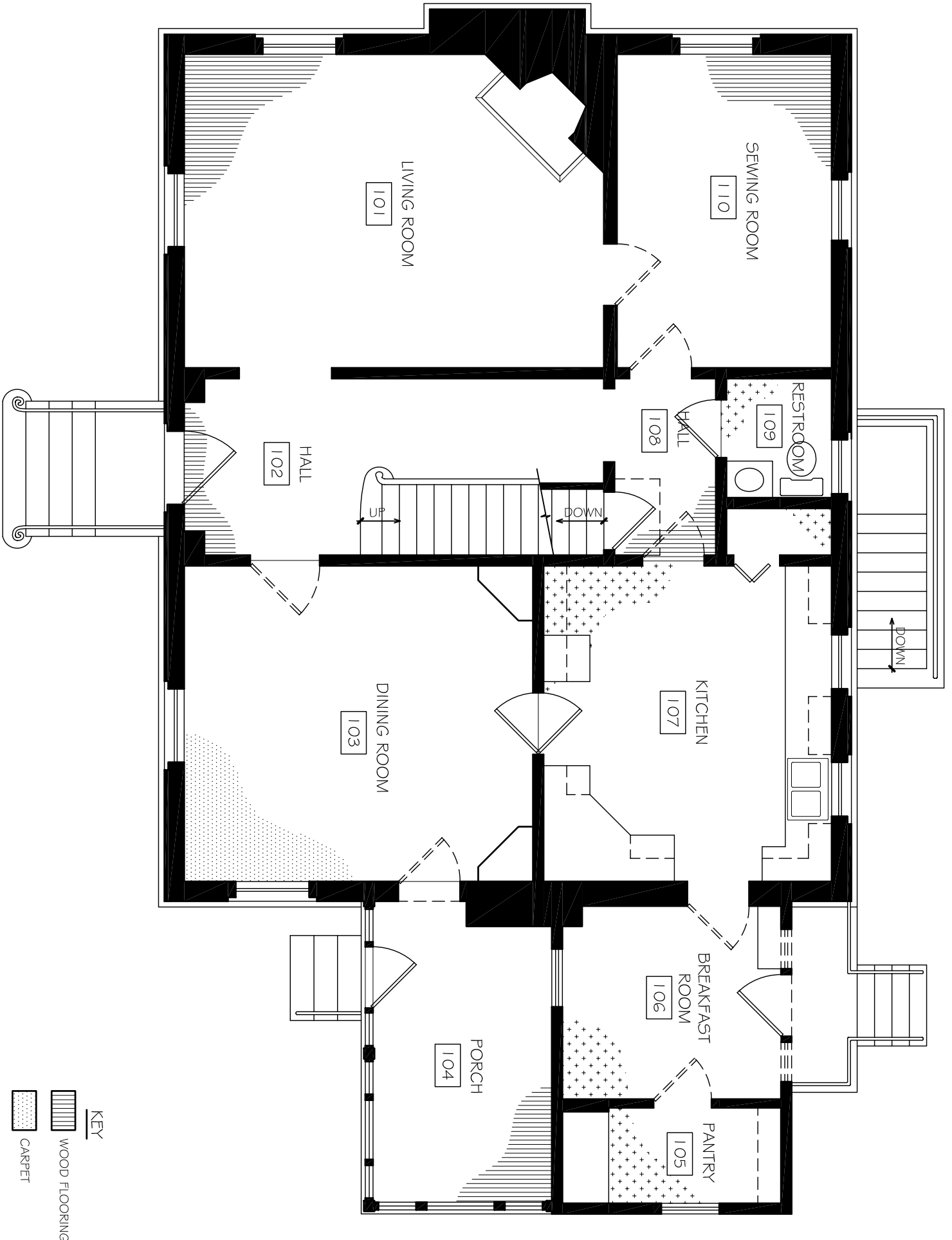

FIRST FLOOR PLAN

2006

SCALE: 3/8" = 1'-0"

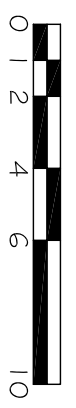

- KEY**
- WOOD FLOORING
 - CARPET
 - SHEET VINYL
 - CERAMIC TILE

SUPERINTENDENT'S RESIDENCE
 GUILFORD COURTHOUSE NMP
 GREENSBORO, NORTH CAROLINA

JOSEPH K. OPPERMANN-ARCHITECT, P.A.
 WINSTON-SALEM, NORTH CAROLINA

JOB #:	0616
DATE:	08-30-2006
DRAWN BY:	JPW
REVISIONS:	
SHEET #:	

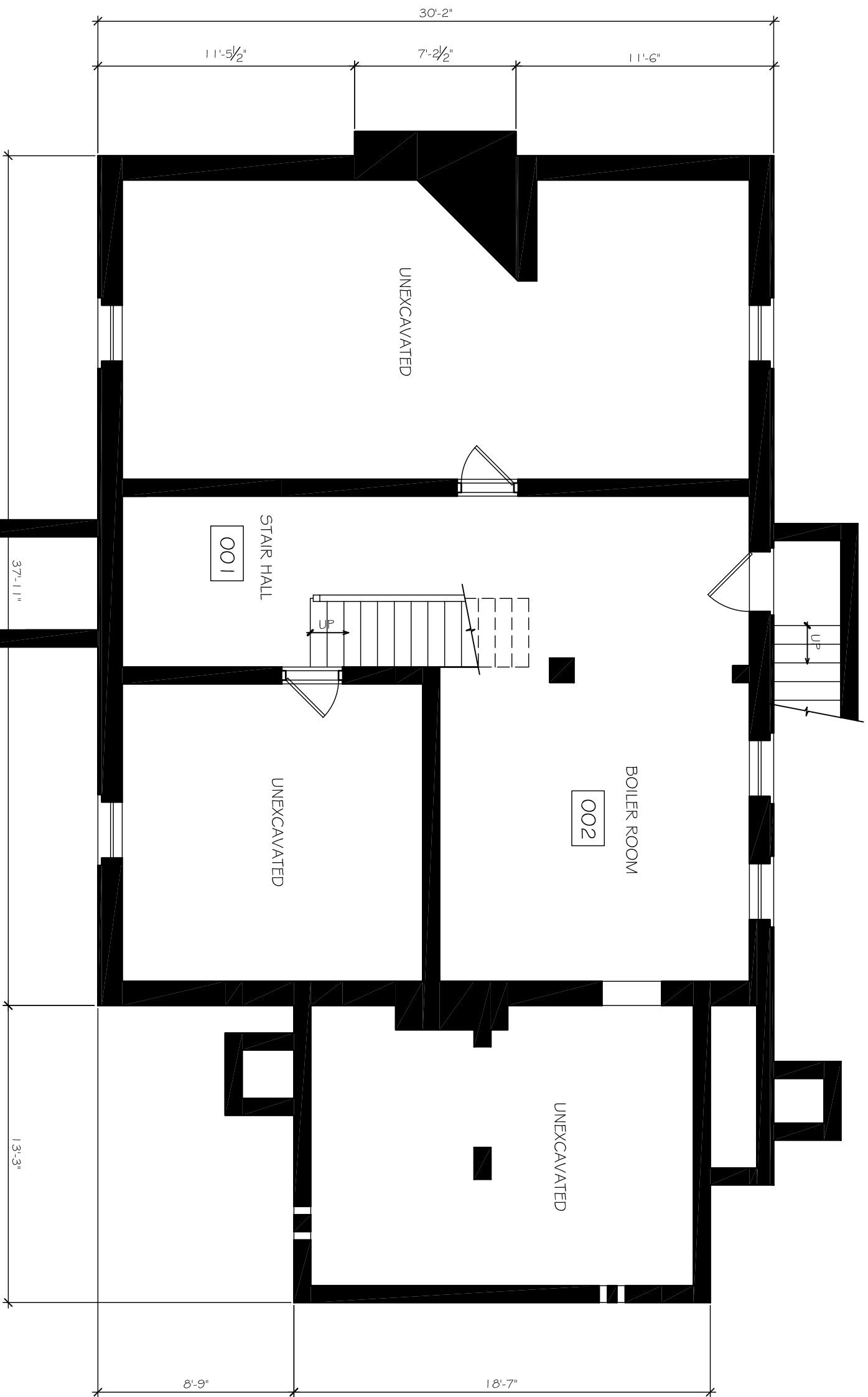

BASEMENT FLOOR PLAN

2006

SCALE: 3/8" = 1'-0"

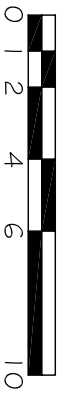

ALL FLOORING CONCRETE
THIS LEVEL

SUPERINTENDENT'S RESIDENCE
GUILFORD COURTHOUSE NMP
GREENSBORO, NORTH CAROLINA

JOSEPH K. OPPERMANN-ARCHITECT, P.A.
WINSTON-SALEM, NORTH CAROLINA

JOB #:	0616
DATE:	08-30-2006
DRAWN BY:	JPW
REVISIONS:	
SHEET #:	

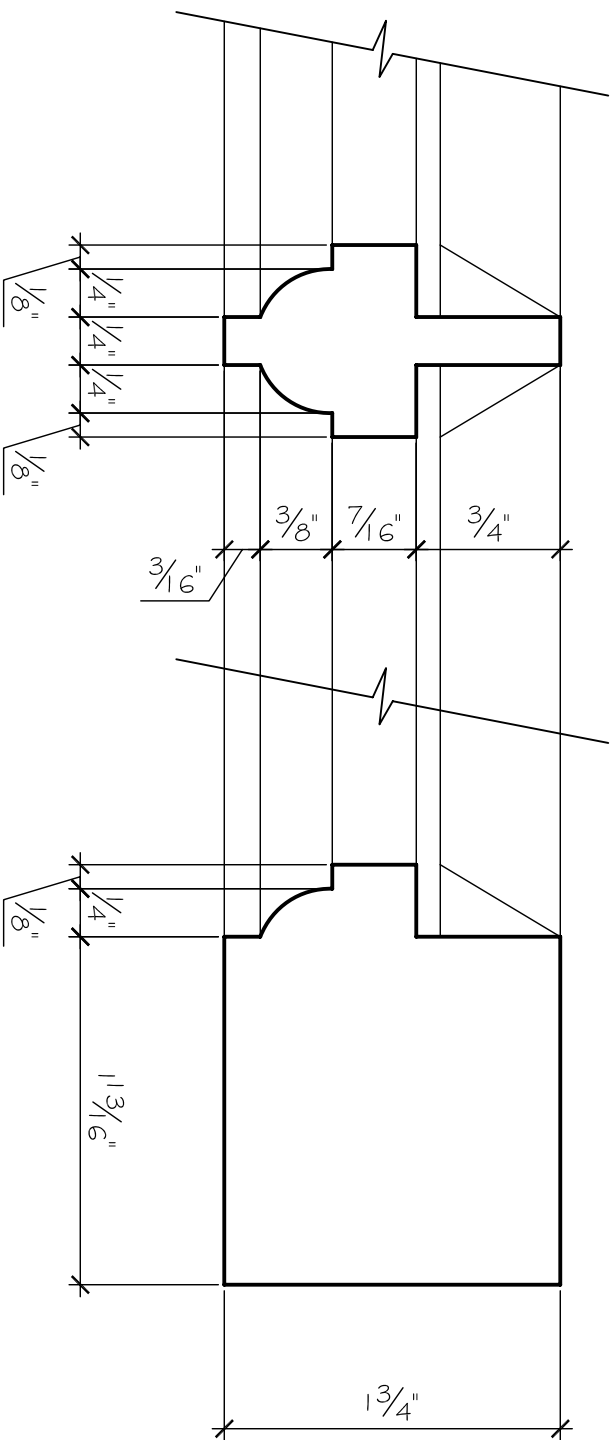

WINDOW MUNTIN PROFILE

2006

FULL SCALE



JOSEPH K. OPPERMANN-ARCHITECT, P.A.
WINSTON-SALEM, NORTH CAROLINA

SUPERINTENDENT'S RESIDENCE
GUILFORD COURTHOUSE NMP
GREENSBORO, NORTH CAROLINA

JOB #:	0616
DATE:	08-30-2006
DRAWN BY:	JPW
REVISIONS:	
SHEET #:	

APPENDIX D

Recommended Ultimate Treatment

1. First Floor Plan

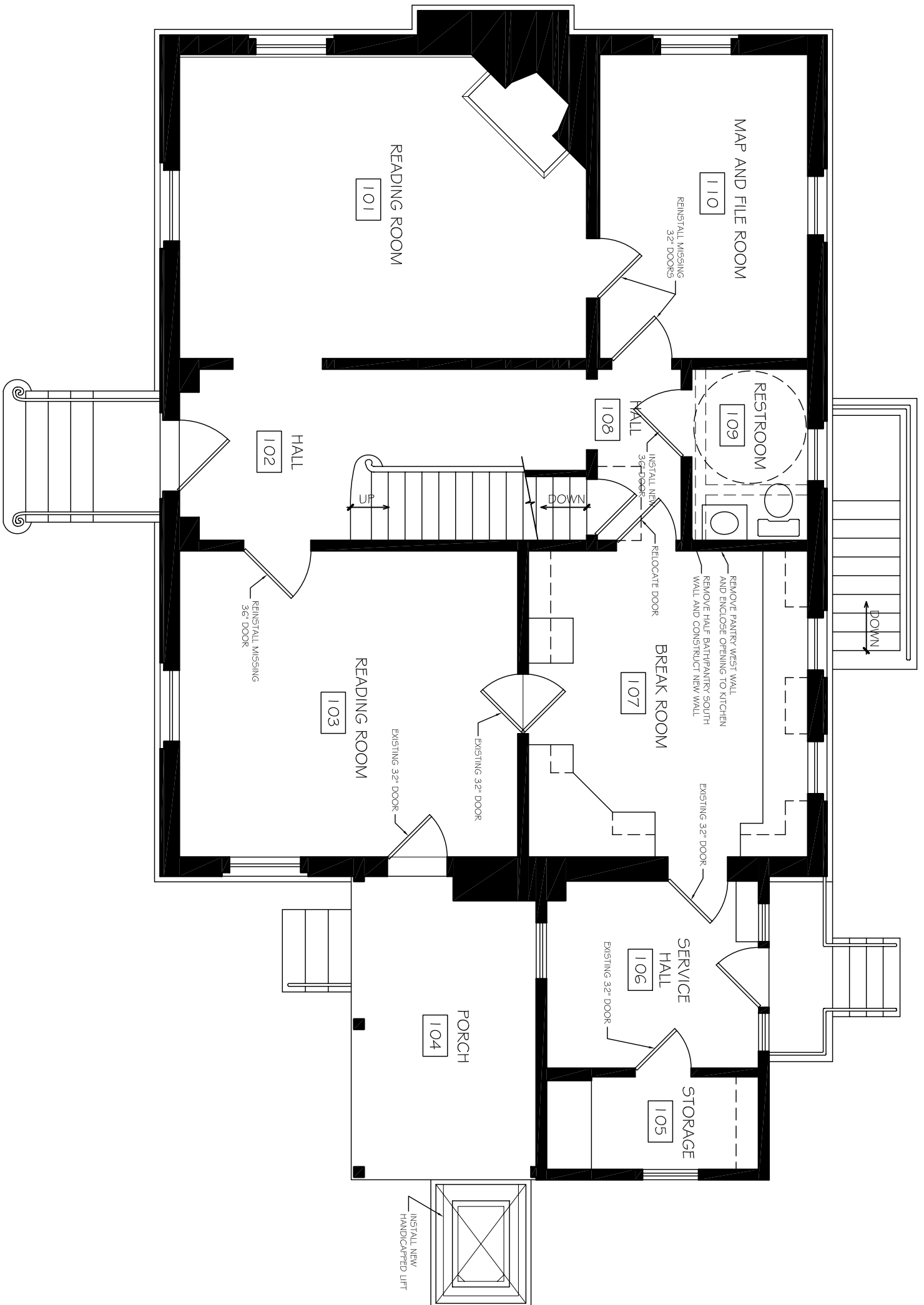

PREFERRED ULTIMATE TREATMENT - FIRST FLOOR PLAN

SCALE: 3/8" = 1'-0"

2006

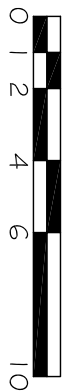

SUPERINTENDENT'S RESIDENCE
 GUILFORD COURTHOUSE NMP
 GREENSBORO, NORTH CAROLINA

JOSEPH K. OPPERMANN-ARCHITECT, P.A.
 WINSTON-SALEM, NORTH CAROLINA

JOB #:	0616
DATE:	08-30-2006
DRAWN BY:	JPW
REVISIONS:	
SHEET #:	1

APPENDIX E

Structural Assessment

DCF Engineering, Inc.

August 28, 2006

06017.D

Joseph K. Oppermann
Joseph K. Oppermann – Architect
PO Box 10417
Winston-Salem, NC 27108

Re: Structural Assessment
Guilford Courthouse
National Military Park
Superintendent's Residence
2332 New Garden Road
Greensboro, North Carolina

Dear Joe:

At your request we are providing this report of our visit to the Superintendent's Residence located at 2332 New Garden Road in Greensboro, North Carolina on August 28, 2006. Jenny Wilkins, from your office was present when I conducted a brief inspection of property. We met briefly with Charles E. Cranfield, park Superintendent. The purpose of this structural assessment is to determine the capacity of the existing structure to support loads associated with the change of occupancy to library and office.

DESCRIPTION

The Superintendent's House is a story and a half brick structure with a partial basement. The original plans, dated April 28, 1934, were produced by the U.S. Department of the Interior, National Park Service for the Superintendent's Residence, Guilford Courthouse National Military Park.

The framing consists of 2x10 floor joists spaced at 16 inches on center. The interior supports for the first floor consists of masonry walls or 6x10 timber girder which span a maximum of 7'-0" (clear). The roof rafters and collar ties are 2x8 at 16 inches on center with a 2x10 ridge. The rafters and collar ties form an A-frame roof structure which has a pitch equal to a rise of 11 to a run of 12. The maximum clear span of the floor system is 13'-8".

The perimeter walls are brick masonry interior foundation walls of reinforced concrete divide the crawl spaces (unexcavated areas) from the basement.

CONDITION

The structural condition of the house is good with very little deterioration to sheathing, framing, or masonry.

DISCUSSION AND ANALYSIS

The 2x10s which frame the residential structure are 2 inches (full dimension) in width by 9½ inches in depth. They appear to be equivalent to No. 2 Dense Southern Pine.

The minimum live load required for libraries and office occupancy in most building codes, including the 2002 Edition of the North Carolina State Building Code (2000 International Building Code with North Carolina Amendments) are as follows:

TABLE 1607.1
Minimum Uniformly Distributed Live Loads and Minimum Concentrated Live Loads⁹

Occupancy or Use	Uniform (psf)	Concentrated (lbs.)
Libraries		
Reading Rooms	60	1,000
Stack Rooms	150 ^b	1,000
Corridors above first floor	80	1,000
Office Buildings		
File and computer rooms shall be designed for heavier loads based on anticipated occupancy		
Lobbies and first floor corridors	100	2,000
Offices	50	2,000
Corridors above first floor	80	2,000

- b. The weight of books and shelving shall be computed using an assumed density of 65 pounds per cubic foot and converted to a uniformly distributed load; this load shall be used if it exceeds 150 pounds per square foot.

1607.4 Concentrated Loads. Floors and other similar surfaces shall be designed to support the uniformly distributed live load prescribed in Section 1607.2 or the concentrated load, in pounds (kilonewtons), given in Table 1607.1, whichever is produces greater load effects. Unless otherwise specified, the indicated concentration shall be assumed to be uniformly distributed over an area 2.5 feet square [6.25 ft² (0.58 m²)] and shall be located so as to produce the maximum load effects in the structural members.

We reviewed the capacity of the floor joists in accordance with design values provided in the 2001 Edition of the National Design Specification for Wood Construction published by the American Forest & Paper Association for No. 2 Dense visually graded Southern Pine 2 to 4 inches thick by 10 inches wide.

Bending (To grain)	$F_b = 1200$
Tension (Parallel)	$F_t = 625$
Shear (Parallel)	$F_v = 175 \text{ psi}$
Compression (Perpendicular)	$F_c = 660 \text{ psi}$
Compression (Parallel)	$F_c = 1650 \text{ psi}$
Modulus of Elasticity	$E = 1,700,000 \text{ psi}$

Utilizing the above parameters, the existing floor system is adequate to support a live load of 80 psf. This would be adequate to support both library reading room, corridors above the first floor and office occupancy. Floor framing in the adaptively re-used Superintendent's residence supporting book stacks or other heavy items such as files, file cabinets, or library equipment will have to be reinforced in areas where the existing floor joists span 13'-8".

Existing floor joists can be reinforced by sistering each existing joist with a second member, or by providing supplemental support consisting of a wood or steel beam supported by masonry or concrete piers or steel jacks.

For library shelving, located along the wall, to be supported primarily by the floor framing, no structural reinforcing is required where the joists run perpendicular to the wall shelves. We checked horizontal shear at the joist ends.

Where the floor joists are parallel to the wall with the shelves, then the first two joists will have to be reinforced. Two joists beneath the shelves should be reinforced with one C8x11.5 steel channel applied to each joist with 1/2 inch by 2 inch long lag screws spaced at 12 inches on center, staggered, with 4 inches on center vertical spacing between rows. The lag screws should be installed in proper lead holes in accordance with NDS specifications. Where the joist, closest to the wall, is actually resting on the wall, and in good condition, only one steel channel is required to reinforce the first joist from the wall.

Alternately, in areas with a crawl space below, where the joists run parallel to the wall, 4x4 x 2'-6" headers spaced at 4'-0" on center can be supported by a post and beam system consisting of 4x4 headers and 4x4 posts at 4'-0" on center resting on a 2'-0" square by 10 inch thick (minimum) concrete footing bearing on firm soil. All wood should be pressure treated.

CONCLUSIONS

In areas requiring a live load capacity greater than 80 psf will require that supplemental support be added in locations where the floor joists span approximately 13'-8".

The first floor stud wall between the Dining Room (Rm. No. 103) and the Kitchen (Rm. No. 107) can be removed altogether or relocated.

ACKNOWLEDGMENT

This report has been prepared for the exclusive use of Joseph K. Oppermann Architects, and your assignees for specific application to the referenced property in accordance with generally accepted engineering practice.

Our inspection consisted of visual observation only, made solely to determine the extent of the damage to the described building caused by the effects of Hurricane Katrina. Neither the inspection nor the report covers plumbing, mechanical, electrical, hydrological or geotechnical features.

No other warranty, expressed or implied, is made. These conclusions and recommendations may not reflect variations in conditions which could exist intermediate of the observed locations or in unexplored areas of the building. Should such variations become apparent during repairs, it may be necessary to re-evaluate our conclusions and recommendations based upon an on-site observation of the conditions.

We very much appreciate this opportunity to be of service. If you have comments or questions regarding this report, please do not hesitate to contact us.

Sincerely,
DCF Engineering, Inc.



David C. Fischetti, PE
President





As the nation's principal conservation agency, the Department of the Interior has responsibility for most of our nationally owned public lands and natural resources. This includes fostering sound use of our land and water resources; protecting our fish, wildlife, and biological diversity; preserving the environmental and cultural values of our national parks and historical places; and providing for the enjoyment of life through outdoor recreation. The department assesses our energy and mineral resources and works to ensure that their development is in the best interests of all our people by encouraging stewardship and citizen participation in their care. The department also has a major responsibility for American Indian reservation communities and for people who live in island territories under U.S. administration.

NPS D-41 January 2007