

EINHORN/YAFFEE/PRESCOTT

Historic Structure Report for

**BUILDING 125 (PAINT SHOP)
CHARLESTOWN NAVY YARD**

Boston National Historical Park
Boston, Massachusetts

Contract C452099005

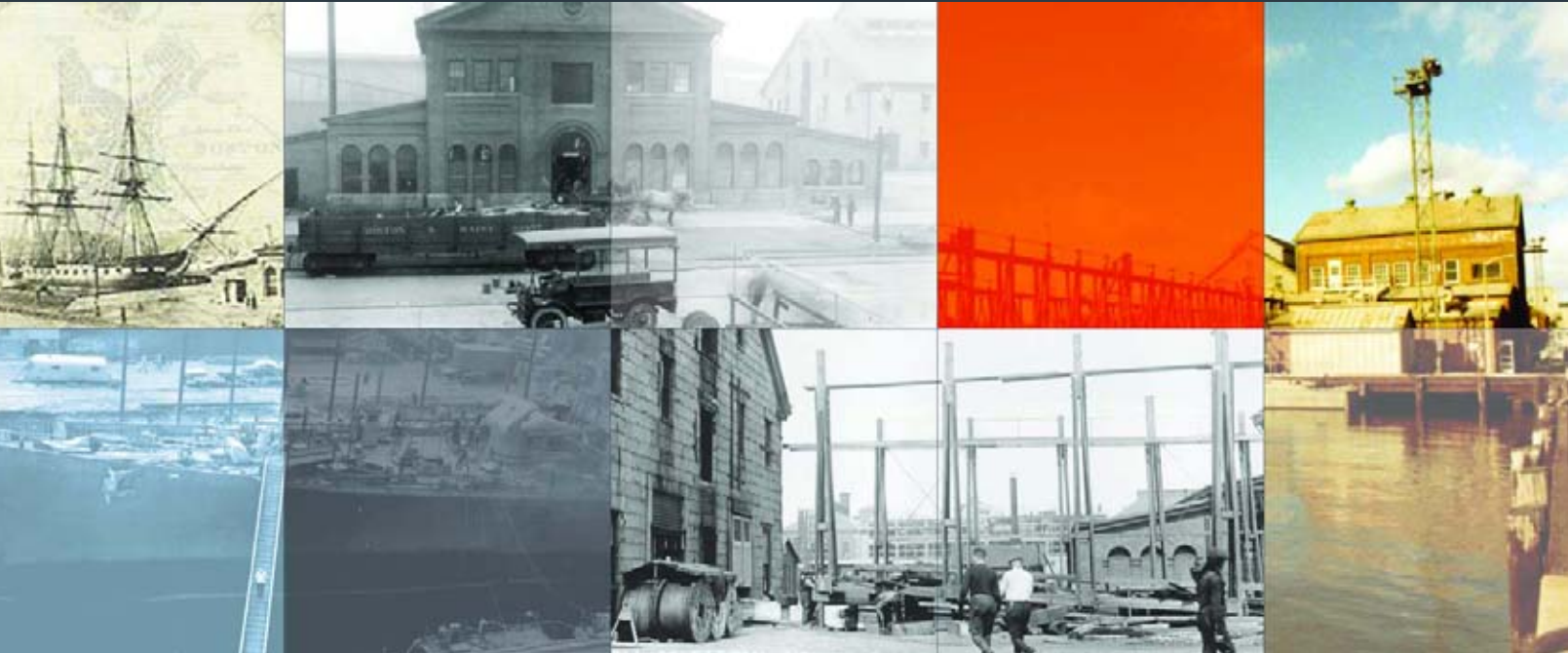

Einhorn Yaffee Prescott
Architecture & Engineering, P.C.
24 School Street
Boston, MA 02108

December 2003

TABLE OF CONTENTS

Preface and Acknowledgements	2
Site and Vicinity Plans	3
I. INTRODUCTION	
Administrative Data	4
Statement of Significance	4
II. CHARACTER DEFINING FEATURES	
Period of Significance	5
Character Defining Features	5
III. DEVELOPMENTAL HISTORY	
Historical Background and Context	8
Chronology of Development and Use	9
IV. CURRENT PHYSICAL DESCRIPTION	
General	27
Exterior	28
Interior	37
V. RECOMMENDATIONS	
Treatment and Use	46
Exterior Recommendations	46
Interior Recommendations	48
VI. APPENDIX	
Drawings	49

PREFACE AND ACKNOWLEDGEMENTS

This document has been written to fulfill the requirements for a historic structure report (HSR) on Building 125, located in that portion of the Boston Naval Shipyard, which is now the Charlestown Navy Yard unit of the Boston National Historical Park (BNHP). Because Building 125 is categorized as a “contributing structure”, of secondary significance to the site, the level of research required for this report was “thorough”, the second of three levels designated in the Director’s Order 28. As a consequence, the report is based on information gathered from readily accessible sources including interviews with Park Service personnel, field inspection and research in local archives. It is also limited in scope, focusing on the building’s developmental history and existing conditions so as to inform and facilitate the planning for its rehabilitation.

Historical information in this report was gathered from records of the Boston Naval Shipyard, which are currently held both by the National Park Service in the Charlestown Navy Yard and by the National Archives & Records Administration in Waltham, Massachusetts. Important contributions were also provided during conversations with Stephen Carlson, Historic Preservation Specialist for the Boston National Historical Park. The existing conditions drawings and analyses are based on drawings in the Park Service archives as well as on site investigations.

Special acknowledgement must be given to Stephen Carlson and Phil Hunt, museum specialist for the Boston National Historical Park, for their critical assistance in the archival research, and to Bill Barlow, F.A.I.A., BNHP Senior Historical Architect, who managed the contract for this report and contributed significantly to both its form and content.

This report was researched and written by Eric Ward, with oversight and editing assistance by David Fixler, Preservation Principal at Einhorn Yaffee Prescott.

SITE AND VICINITY PLANS



Figure 1: Vicinity map, with Boston National Historical Park Sites

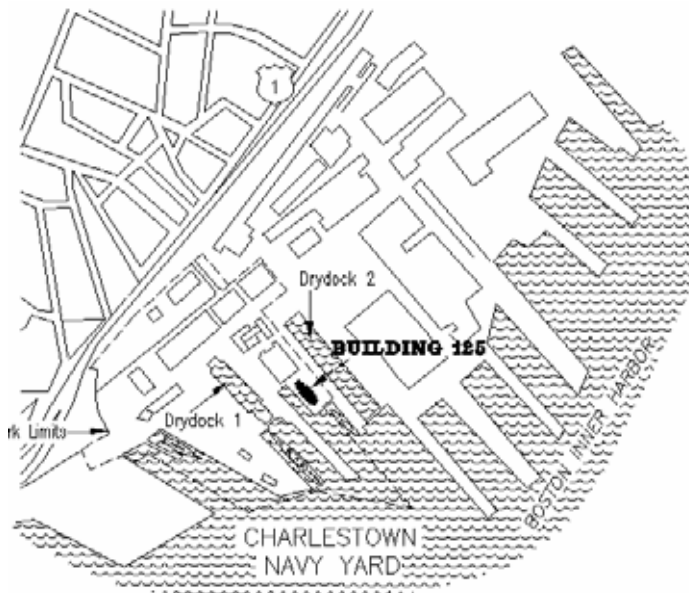

Figure 2: Site map of Charlestown Navy Yard

I. INTRODUCTION

ADMINISTRATIVE DATA

Building 125 a contributing structure within the Boston Naval Shipyard (also known as Charlestown Navy Yard), a National Historic Landmark District (National Register Number 66000134). The List of Classified Structures number for the building is #40051, Structure #125.

STATEMENT OF SIGNIFICANCE¹

The Charlestown Navy Yard is significant for its role in the construction, repair, and servicing of vessels of the United States Navy for the entire period of its existence from 1800 to 1974. Its buildings, cranes, docks and piers illustrate the industrial/technological revolution that established the United States as the world's greatest naval power of the 20th Century. It is also significant as the site of one of the first two naval drydocks in the United States, the location of the Navy's only ropewalk, and for technical innovations such as the invention of die-lock chain. The yard evolved throughout its history to meet changing needs of naval technologies, and the current site contains resources from all periods of its existence. The yard also contains two of the landing sites for British forces involved in the Battle of Bunker Hill. Although much of the current acreage of the yard is filled land, there is a potential that portions of the yard may contain archeological resources related to Native American and colonial use of the area prior to its purchase by the federal government as well as those related to its use by the Navy. The yard is also associated with several historically significant naval officers, as well as with a number of individuals who are significant in the fields of architecture and civil engineering.

Building 125, formerly the navy yard paint shop, was located between drydocks #1 and #2 to facilitate the painting of hulls. It housed a function vital to one of the navy yard's primary functions, the construction and refitting of naval vessels. It was one of the first yard buildings to include an electric elevator as part of its original design.

¹ Statement of Significance provided by Steve Carlson, BNHP Historic Preservation Specialist.

II. CHARACTER DEFINING FEATURES

PERIOD OF SIGNIFICANCE

Building 125 was the Navy Yard paint shop and served that role throughout its functional history with the Navy. As far as can be determined, there are no particularly significant historical events or persons associated with the building. Its historical significance is derived directly from its use, and the common yet vital role it played in the day-to-day operations of the yard. In light of this, its period of significance can be assumed to span its seven decades of active service. From a strict architectural perspective, the building was most intact and in its best condition around 1917 after completion of the north wing. Although not in the original plans, the north wing nevertheless made the building whole by completing its formal symmetry. The building underwent no significant alterations until a new elevator was installed in 1940. This included a prominent projection through the roof, but it was done with care, and was generally in character with the original building fabric.

It can be observed that the fortunes of the building mirrored those of the Navy Yard as a whole. Constructed at the turn of the century, during a period of vitality and renewal for the yard, the building maintained its architectural integrity through the next four decades to reach a functional zenith, along with the yard, during the Second World War. After that, as the Navy's need for the yard declined, so did the funding for its operations, personnel, and building maintenance. Whether coincidentally or as a direct result of this, all changes after World War II to the exterior of Building 125 were to the detriment of its character defining features. Most regrettable were the new door openings, altered windows, enlarged shipping door and removal of exterior trim.

This understanding should be the basis for any treatment program. Though Building 125 is clearly a building of secondary historical quality, and functional considerations should drive any rehabilitation plan, from a preservation perspective, the ultimate goal should be to reverse all of the post 1940 alterations to the exterior envelope.

CHARACTER DEFINING FEATURES

General

Building 125 remains today much as it was constructed nearly a century ago. Although new doors and windows have been cut into the exterior walls, existing doors have been enlarged and much of the architectural trim has been removed, the building form has changed little since the north wing was added in 1916-17. Its basic proportions and symmetry are key to the structure's remarkable presence, which projects even today in spite of its generally deteriorated condition. Essentially all of the extant original exterior materials are valuable character defining features of the building. The interior has been altered more than the exterior over the years, as would be expected in accommodating operational upgrades during 70 years as the navy yard paint shop; but it too has retained the rugged, unfinished, open character of its industrial roots. Retaining to

some extent this general character, more than any particular architectural feature, should be the objective of any adaptive re-use program, which will necessarily involve significant interior alterations.

Exterior Character Defining Features

Form: The basic form of the building, its symmetry and proportion, is fundamental to its architectural character.

Setting: Also vital to the building's character is its location, isolated on a pier between drydocks #1 and #2, surrounded by open space.

Brick Walls: Most of the original red brick exterior remains. Though much of the original corbelling was removed, all of the remaining masonry detailing is important: flat and half-round arches, raised pilasters and capitals and raised brick panels.

Granite Trim: The base of the building's center section rests on a rusticated, gray granite water table. Windowsills are also of the same granite.

Roof: Though repaired and repainted a number of times, the metal roof conforms to the original in material and scale. It has been painted both green and red. The existing ventilators, though replacements from 1962, are very close to the originals in size, form and location. Original skylights on the low south wing are gone, but wood covers mark their locations.

Windows: The existing wood windows are original except where they have been replaced with doors or, in two second floor locations, with picture windows.

Doorways: The sliding, wood main entrance door appears to be original or a very old replacement. The date of the hinged personnel door cut into the south leaf is unknown, but an irreversible part of the door now. No other exterior doors appear to be original or of any particular significance. Even the second floor shipping door, though similar to the original, is a replacement from 1952 that is part of a renovation that was detrimental to the building's façade.

Landscape Features: There is no historic significance to any of the landscape features. The immediate site has been paved, raising the grade at the building line at 4" to 8" above the original level. A restoration might investigate lowering the immediate grade to exposed some of the lower granite features now covered.

Interior Character Defining Features

General: The openness of the first floor interior, with all the structural surfaces exposed and painted, retains the industrial character that has always defined the building's use.

Structure: All structural members and surfaces - brick walls, exposed steel trusses, concrete ceilings - are important character defining features. This is not to say that new openings cannot

be made, or old openings filled; such changes are in keeping with the flexible, practical nature of the spaces.

Flooring: The concrete slabs of the first floor are fitting to the industrial character, but not original. They probably cover the original brick paving, which is likely not restorable.

Lighting: Though much of the existing lighting dates back to the latest period of the building's Navy use, none of the fixtures are themselves valuable. Important is the general character of the light fixtures: straightforward industrial fixtures, pendant mounted from the structural ceilings.

Circulation Core: The second floor stair is original and the elevator dates to 1939. Neither is sufficiently valuable in itself to warrant saving, since they do not meet current codes and would be of no use in a renovated space.

Second Floor Office Finishes: These offices date to the 1950's and contain no significant floor wall or ceiling finishes.

Equipment: Paint mixers in the South Wing (Room 103), though probably not original to the building, are representative of the equipment that was key to the building's use and history. The option of retaining and displaying one or more of them within the building should be explored.

Other Fabric: A portion of the original trolley rail remains in the South Wing (Room 103). This rail was a prominent and important feature in the building, also representative of its industrial use. The trolley rail suspended above the second floor was installed in 1952 along with the shipping door revisions and is not valuable.

III. DEVELOPMENTAL HISTORY

HISTORICAL BACKGROUND AND CONTEXT²

During its first 100 years of operation Charlestown Navy Yard was used primarily for the manufacture and storage of naval equipment. Several important ships had been constructed at the yard during the War of 1812 and Civil War, and its granite drydock, completed in 1833, saw steady use through the century repairing ships for both the Navy and for private ship owners. But the manufacture of rope, anchors, chain and sails remained the yard's most important work.

Major changes occurred in the Navy in the 1890's and especially around the time of the Spanish American War in 1898. Not only was this a naval war with the accompanying increase in naval activity and spending, it also transformed the United States into a maritime power with new possessions to defend in the Caribbean and Pacific oceans. During this period the Navy underwent a major modernization and expansion, commissioning many new steel vessels and improving shipyards around the country to maintain them. These were technically complicated that required more maintenance than previous ships; their steel hulls were especially prone to deterioration and organic buildup and needed to be cleaned and repainted two or three times per year. In 1898 Congress authorized the construction of four new drydocks around the country, including a second granite drydock at Boston Navy Yard (as it was known at the time), to provide maintenance and repairs on even the largest ships of the fleet. This began a new era for the Charlestown yard, as it became a major port for maintenance and repair continuing through the first and second world wars.

The original paint shop was located in Building 10 at the west side of the yard until 1900 when construction on the site forced the painters into temporary quarters. Their building was eventually moved to the east side of Wharf #1, but it was too small to be re-occupied as a paint shop. Around this time construction of the new Drydock #2 had just begun, and since its primary use in servicing the new naval fleet would be for the repainting of steel ship hulls, it made sense then that a new paint shop be erected nearby. A location was selected on the newly extended west pier of the Drydock #2, also a short distance to Drydock #1 which was to remain active in servicing smaller craft. The new building was to be of fireproof construction and large enough for the material stores, paint mixing machines, offices and support facilities (lunchroom, lockers, toilet facilities) for the painting staff that worked both in the building and in the drydocks.

² Information for this section derived from Charlestown Navy Yard, 1890-1973, Frederick R. Black, Cultural Resources Management Study No. 20, Boston National Historical Park, 1988.



Figure 3: The site prior to the construction of Building 125. Building 24(background) exists today, but building 25 (foreground) was moved to another site at the yard in ca. 1875. (Undated Photograph)

CHRONOLOGY OF DEVELOPMENT AND USE

Design (1902-1903)

The paint shop, designated Building 125, was designed sometime around 1902-1903. The first schematic drawings found in NPS archives are dated March 31, 1903, and include relatively detailed plans sections and elevations very close to the final working drawings, which were begun August 13, 1903 and submitted on February 8, 1904. Research for this report has not determined with certainty where the design of the building originated, but it is probable that architects in the Washington D.C. Bureau of Yards and Docks were responsible for the design, a carefully proportioned classical composition which was very similar to other buildings erected at this time in navy yards around the country.³ The schematic drawing had no title block and was signed by an Assistant Naval Constructor (signature illegible) that was not seen again on the construction drawings, which were clearly done locally with a “Navy Yard, Boston, Mass” title block. They were submitted by C. M. Parks, Civil Engineer, USN, and approved by Mordecai Endicott, Chief

³ Conversation with Steve Carlson

of Bureau, Yards and Docks. The structural design for the building was also done locally as evidenced by the original computation sheets with a Boston Navy Yard heading that were found in the archives.

The gracefully detailed building exceeded the requirements of its utilitarian function. It featured a two-story center section (3,000 s.f. per floor) topped by a gable roof with roman-pitch pediments expressed in corbelled brick and copper cornices. The roof, shown with a north/south ridge in the schematic drawing, was rotated 90 degrees in the construction drawings to align the pediments with the main (east) façade. Single story, shed roofed wings extended to the north (1,000 s.f.) and south (2,000 s.f.). The exterior walls were constructed of red brick, articulated by pilasters with corbelled brick capitals and resting on a rusticated granite water table. Sets of three large double-hung wood windows filled the recessed bays between pilasters. Although shown as 9/9 rectangular windows in the schematic drawings, they were changed in the construction drawings to 6/6 windows with half-circle transoms on the first floor. The only oddity of this classical composition was the second extension of the south wing, which was clad in flat, unornamented brick. This wing upset the general symmetry of the building. Perhaps it was afterthought that came late in the design (a careful look at the schematic floor plan shows a line separating the south wing, while the bearing walls are unbroken elsewhere in the drawing), or perhaps it was an alteration to a design used elsewhere. In any case, the designer clearly wanted to de-emphasize the wing by omitting its ornamentation in an effort to maintain the classical symmetry of the east and west facades.

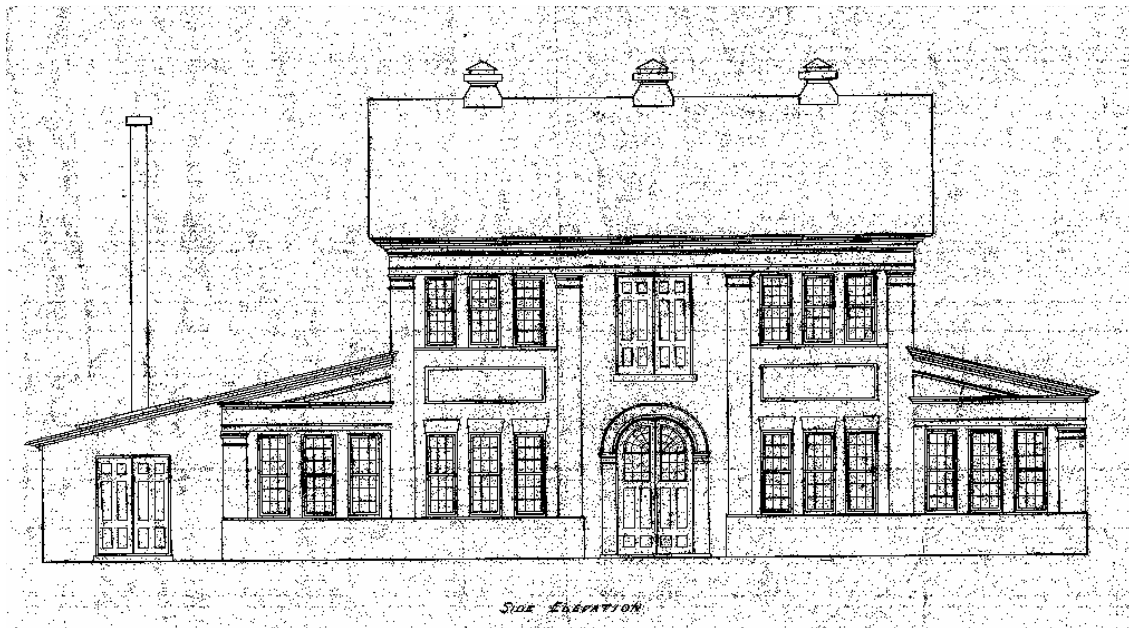

Figure 4: East elevation shown in schematic drawing (3/31/03). Even at this stage, the south storage wing was planned, but the omission of detail on it suggests an attempt to impose symmetry on the facade.



Figure 5: East elevation shown in construction drawings (2/08/04). Note that the gable roof has been rotated 90° to align the pediment with the east façade. Windows have also been changed from 9/9 to 6/6, with half-round transoms on the first floor windows.

Consistent with the other new buildings being constructed by the Navy around this time, Building 125 was to be durable and non-combustible. It was constructed on piles, with concrete encased steel foundation girders, brick bearing walls and steel framed concrete floors and roofs. Large windows provided plenty of natural light to the interior, which was essentially without finishes – painted brick walls, unfinished brick and concrete floors and exposed steel pipes as radiators.

The first floor of the main space was designated for paint mixing, with a large work table in the center of the room and paint mixing equipment along the west wall. Two columns shown in the middle of this space in the schematic design drawings were eliminated in the construction drawings and replaced by two massive (5 foot deep) warren trusses supporting the second floor, presumably to permit more flexible, column-free space. A trolley track for handling heavy loads and equipment was suspended from the overhead structure at thirteen feet above the floor; it started at the main entrance doors and looped around the main space and through narrow doors into the south wing. Wood-framed wire mesh partitions surrounded the main work area and a small “brush locker”, providing security for the tools and materials by separating them from the circulation corridor running between the entrance doors and locker/washroom in the north wing, which was probably open to all paint shop personnel. The stair and freight elevator to the second floor were located in the northeast corner of the space. This was the first elevator designed into a new building in the yard, though others were being inserted into existing buildings around this time in an effort to improve operational speed and efficiency in the shops.

The second floor was left mostly open, designated “Varnish & Polishing Room”, with only small office and storage rooms in its southeast corner. The hoisting machine for this original elevator was located adjacent to the elevator (this would be moved to a penthouse machine room when the elevator was replaced). Material handling was facilitated by a trolley beam at the center of the

floor, running east/west and cantilevered four feet through a bi-parting shipping door in the east wall.

The south half of the south wing was designed for volatile storage (“Tanks for Oil, Naptha, Alcohol, etc.”) and was separated from the rest of the building by a 16” masonry wall penetrated by one fireproof personnel door. Loading access was provided through double doors on the east exterior wall. Near the center of the north wall was a 20” diameter steel stack with openings near the floor and just below the roof to provide passive ventilation for the space. This stack was a prominent exterior feature on the building, extending 34’ above the roof. Though space was amply illuminated through two very large (12’x6’-9”) skylights, there was only one small window in the south exterior wall.

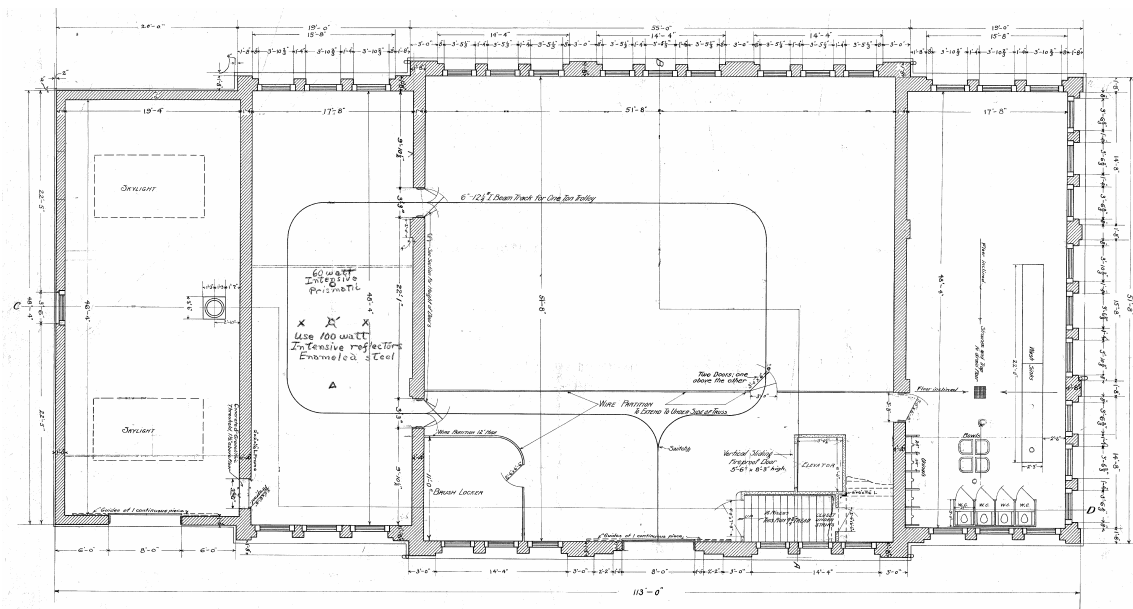

Figure 6: First floor plan from construction documents (2/8/02). Electrical notes on the plan were from a later lighting renovation.

Construction (1905-1906)

A construction contract for \$31,000 was signed with Connors Brothers Construction Company on August 16, 1904. Perhaps the piles were placed around that time, but the start of foundation work was delayed until April of the following year by the construction of a culvert between Drydocks #1 and #2 that ran directly below the building site. The foundation reinforcing steel was also late in being delivered. The building was substantially complete and turned over to the Navy in August 1906, with the final touches including painting of the roof and installation of electrical wiring completed by Navy personnel. The total construction cost exceeded the appropriation by \$4.13.



Figure 7: Foundations under construction (July 1905). Note the recently completed and flooded Drydock 2 in the background.



Figure 8: View from the northwest of walls rising (September 1905). One of the two steel warren trusses that will support the second floor is visible above the walls. This is the last construction progress photograph in the NPS archives, though undoubtedly regular photographs documenting the work were made.

North Wing Addition (1916)

Ten years after its construction the toilet and locker rooms were remodeled, and the building was expanded to the north to accommodate new lunch and shower rooms. An exterior door in the north wall of the new lunchroom provided direct outside access to these spaces for paint shop personnel, most of whom worked outside of the building on the ships under repair. The extension was probably driven by the significant increase in numbers of workmen brought to the yard with World War I looming. Whatever its practical impetus, this expansion provided the designers an opportunity to balance the building's massing with a wing to the north that mirrored the paint storage wing to the south. But unlike the featureless south storage wing, the new addition exterior was designed with brick details and windows to blend with the richer articulation on the rest of the building. Its structural system differed from the original, however, in that the roof was built with wood decking and rafters and the foundations were placed on spread footings. This use of a different construction system was possibly due to the fact that the extension was constructed by day laborers working directly for the Navy Yard. The installation of pile foundations and a concrete slab roof would have been much more complicated work and would have required bringing in an outside contractor like the one that constructed the original building. They must have assumed the spread footings were sufficient for a lightly loaded single story wing, but the new wing settled shortly after construction, causing cracks in the floors and masonry walls that are still evident today.

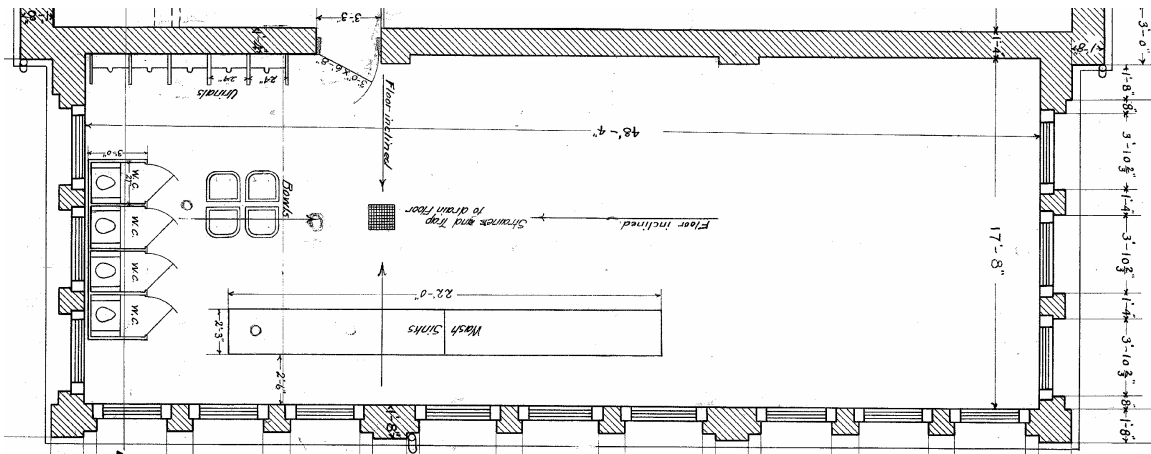

Figure 10: Toilet and locker room plan of original north wing. Access was through main space only.

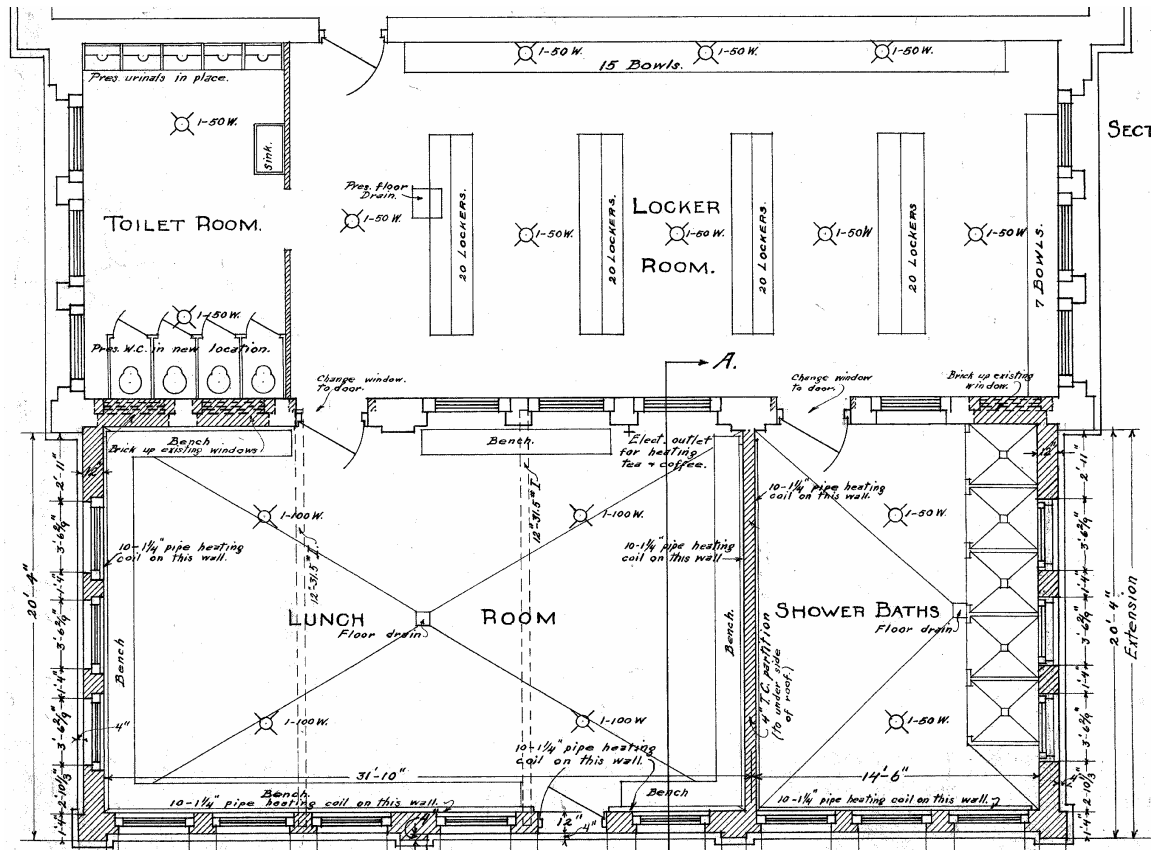

Figure 11: Plan of the north wing addition (10/31/1916). The new exterior door in the north wall (bottom of this drawing) provided for the first time a separate access to these expanded facilities, which were probably used by all the paint shop personnel working on ships in the adjacent drydocks.



Figure 12: North wing extension under construction (December 1916). Note the wood rafters. The original building's roofs were all constructed of concrete on steel rafters.



Figure 13: East elevation at completion of north wing extension (1917).

South Wing Substation (prior to 1918)

The south wing, originally constructed for volatile materials storage, was partitioned shortly after the building's completion to create an electrical substation. It was accessible through a new door installed in the south wall. The original door appears to be part of a wire mesh partition covering the opening, which would be a reasonable way to provide adequate ventilation to the substation. The opening was later filled with a pair of steel doors – perhaps after the electrical equipment was moved. Two new windows were also installed in the west wall of the space as part of the work. The skylight in the roof above the room was left unchanged.



Figure 14: View from the south in an undated photograph taken between spring 1917 (when the north wing was finished) and summer 1918 (when the marine railway construction began). Note the new substation door in the west side of the south wall. The opening at the center of this wall is the original wood window, which exists today.

Marine Railway (1918)

In 1918 a marine railway was constructed in the former dock area just a few feet west of Building 125. It consisted of a wooden cradle on steel tracks that could raise smaller craft out of the water for maintenance. It was faster and more efficient to use than the drydocks, which could now be reserved for the larger naval vessels. Although Building 125 was not physically affected by the construction of the marine railway, the site around it was significantly altered and the activity in the paint shop was increased with the added maintenance capability.



Figure 15: Pier west of Building 125 prior to start of construction on the marine railway. In the foreground are remnants of Building 110, the former Pitch House. Note the two windows to the substation in the west wall the south wing, identifiable by the newly mortared masonry surrounding them. (1918)



Figure 16: Completed marine railway with its wooden cradle raised (May 1919).

Temporary South Shed (1939)

A photograph from 1939 shows a large temporary shed connected to the south side of Building 125. No physical or other documentary evidence of the shed has been found, and its use is unknown.



Figure 17: Temporary shed attached to south wing (Sept. 1939). The new elevator penthouse is visible on the north side of the main roof.

New Freight Elevator (1939)

The Navy was continually making changes to the equipment and operational layout of the paint shop through the decades after its construction. For the most part these changes had little effect on the building's appearance, but both its interior and exterior were affected when a new elevator was installed in 1939. The original 2,000 lb. capacity freight elevator was the first to be installed as original equipment in a new building at the Navy Yard (several retrofit elevators were being installed in other buildings around this time). It was installed in a 5 ft. by 6 ft. plastered terracotta hoistway, with a 3 ft.-6 in. deep pit. Its hoisting machine was located on the second floor adjacent to the elevator, probably to limit its height and avoid a projection through the roof.

The original elevator evidently was determined to be too small, and in an effort to improve loading access to the second floor, specifications were prepared in 1939 for a replacement 4,000 lb. freight elevator. The specifications were for a combined project that also included a new 2,500 lb. elevator for building 114. The new elevator for Building 125 required a deeper (4 ft.) pit and an enlarged brick hoistway (9ft. 8 in. by 7ft. 5in.) that was constructed adjacent to the existing concrete stair between first and second floors. Apparently space on the second floor had

become valuable enough that the new elevator hoistway included a mezzanine for an overhead traction machine, which projected through the roof on the north side of the ridge. The portion of the masonry shaft above the roof was clad in copper and capped with a steel-framed skylight.

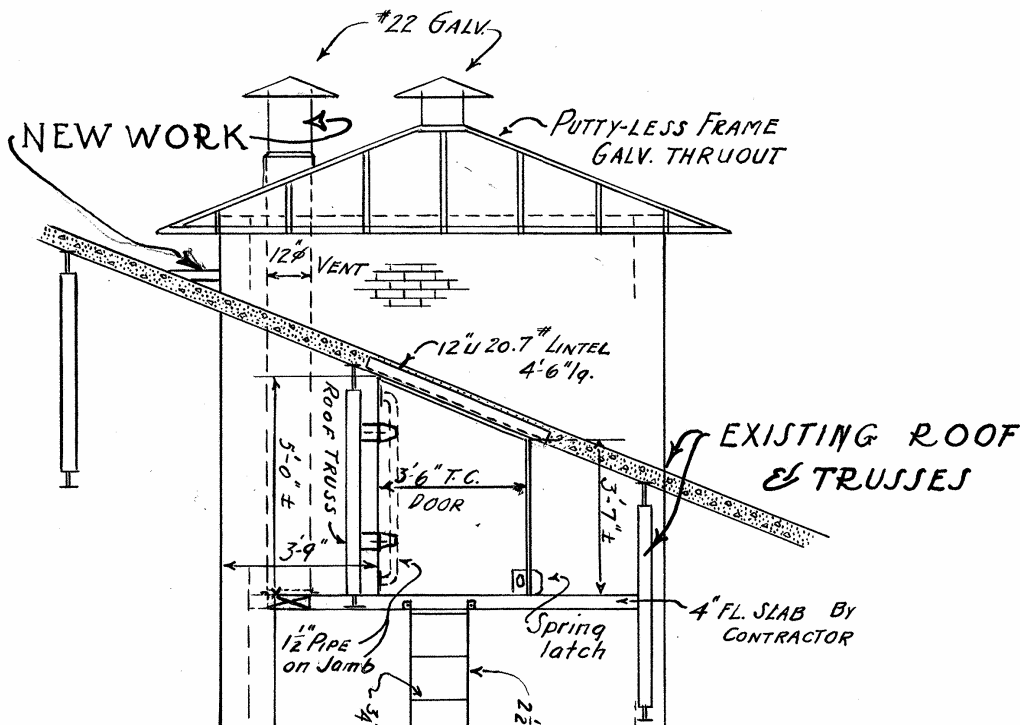

Figure 18: Drawing (2/23/1939) of new elevator roof projection. Note that masonry enclosure was built around the existing roof trusses.

Second Floor Shipping Door (1951)

The second floor had always been used for paint and material storage as well as the sign painting shop. Loading access to the second floor was by means of the freight elevator, enlarged in 1939, and a shipping door over the main entrance. A steel trolley beam projected through this door and ran the full width of the space at 8 ft. above the floor. By 1951, loading operations had badly damaged the head of this door. The following memorandum from the Design Division Superintendent was in response to a Maintenance Department request for its repair:

- “1. Subject beneficial suggestion recommends that the cornice on the Paint Shop at DD#2 be repaired and that a protective shield be placed around it directly above the door to prevent future damage. The suggestion also recommends that the “I” beam protruding from the upper door be removed.

2. That part of the suggestion recommending that the cornice be repaired is good and should be carried out. However, the I-beam should not be removed but should be used for the purpose originally intended which is to lift loads from the ground to the second floor instead of using large cranes to lift the loads and swinging them into the second floor in such a way that the crane cable damages the cornice. It is recommended that a motorized hoist be installed on the monorail instead of the existing hand type to facilitate lifting the loads, the load would then be brought up to the building either by truck and removed therefrom by hoist or could be deposited on the ground by the large crane and picked up by the hoist, avoiding damage to the building. The proper size hoist should be determined by consulting the activity as to the weights to be lifted.”⁴

The archives contain a drawing dated July 16, 1952 for increasing the height of the shipping door by four feet and installing a new crane beam to improve loading into the second floor. Apparently this work was done about this time, or at least by November of 1955 when the change is first seen in a photograph. The door head, which was originally aligned with the adjacent windows and comfortably centered in its recessed brick panel, was raised (awkwardly) to the underside of the brick corbel above. Corbelled brick brackets were added to each side of the door head, probably in an attempt to resolve the architectural problem. The work included a new trolley beam raised more than three feet to 11 ft. 9in. above the floor.

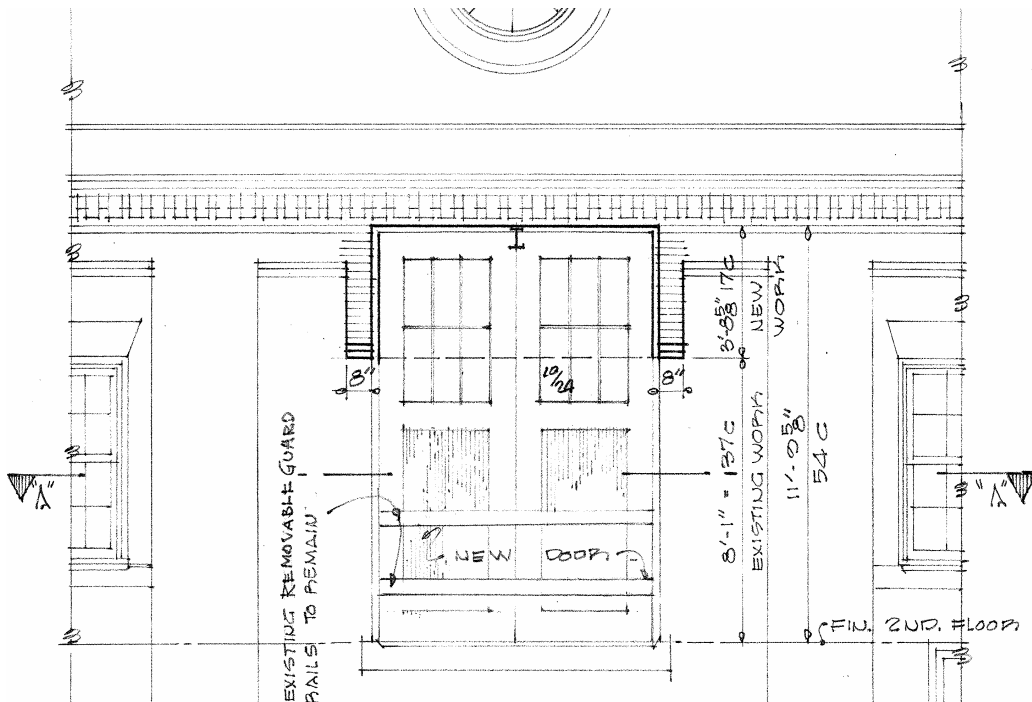

Figure 19: Drawing of new shipping door (1952). The door head originally aligned with the adjacent windows.

⁴ Memorandum from BNY Design Division Superintendent, 8/6/1951; NPS Archives

Interior Alterations (1950's)

After using Building 125 for over 40 years, the Navy began to consider general alterations and operational improvements early in 1950. About this time the Navy was also interested in relocating additional painting equipment from South Boston to the area around the paint shop and Drydocks #1 and #2. A study completed in March 1953 determined there was no space for a new storage building and, instead, presented a conceptual plan to for a total renovation of Building 125 and expansion of the second floor by 6,000 s.f. Fortunately for the architectural integrity of the building, the plan was deemed too ambitious and was not pursued.

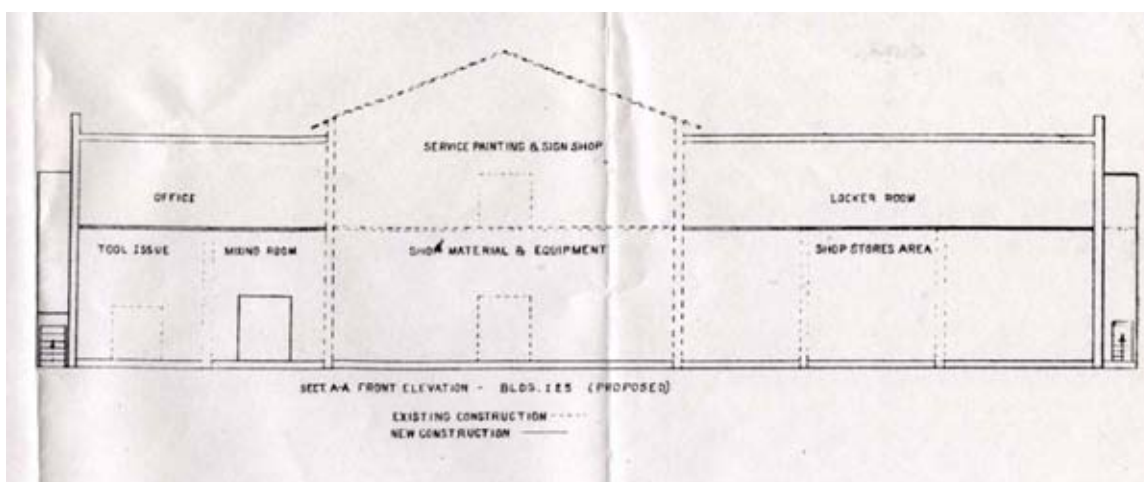

Figure 20: Section sketch (1/26/1953) of proposed enlargement of Building 125. If executed, this renovation would have consumed the original building.

Paint Shop and Design Division personnel continued to explore ways to improve the building's operational layout through the 1950's. They were also very concerned about correcting safety deficiencies originally flagged in 1952 but held up by the larger planning efforts. The hazardous paint mixing areas had never been isolated from other building operations nor fitted with explosion proof electrical lighting and equipment. By April 1955 a new plan and cost estimate had been prepared for major alterations within the building envelope. The plan included moving the shop offices from the first floor south wing to the second floor. Paint mixing and storage, previously located on both floors, would be consolidated on the first floor and separated by existing brick fire walls. The office move and some of the first floor work was probably completed around 1956. Apparently the Master Painter wanted better views from his new southeast corner office and replaced four original double-hung windows with two fixed picture windows on each side of the corner. Also during this renovation the second window from the west side of the south elevation was enlarged and converted to an egress door, with a wooden fire escape stair over the south wing roof to the ground.

Based on a drawing dated September 5, 1957, the first floor renovation was probably completed several years after the office move. The high south wing, which was already separated from adjacent spaces with fireproof masonry walls, became the new paint mixing room. The high,

narrow doors to this space through which the trolley beam ran were probably filled at this time and replaced with one new sliding fireproof door on the west side. The fire egress door through the west wall of the first floor main space was probably also installed at this time.

Exterior Repairs (1962-63)

In 1962 drawings and specifications were prepared for an exterior rehabilitation of roofs, cornices, downspouts and gutters on Buildings 125, 104 and 42C. For Building 125, this meant the removal of all the original corbelled brick and copper that articulated pediments on the east and west facades and gave weight and clarity to the roof edges. These areas were replaced with flat brickwork and simple, rectangular copper rake trim and gutters. Much of the character of the building facades was lost through this maintenance project. The following justification was noted on the cover sheet of the allotment cost estimate (which totaled \$35,400 – just slightly over the original construction cost):

“The cornices, gutters and roofs have been repaired on numerous occasions and further repairs are not economically wise. This deteriorated condition has made complete rehabilitation mandatory and further delay will only result in excessive maintenance and repair costs.”⁵

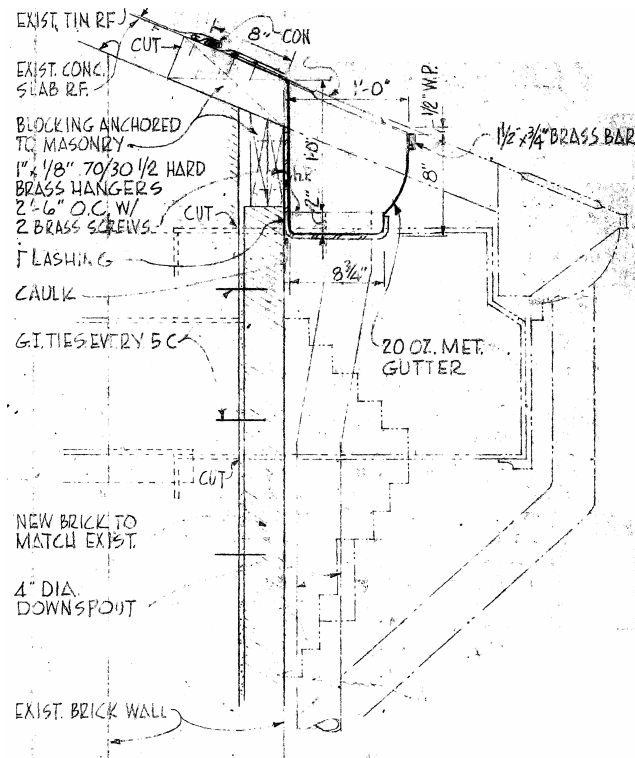

Figure 21: Detail from drawing calling for the removal of original brick and metal cornice (2/19/1962).

⁵ Note on cover of cost estimate for special allotment, Project M1-61 (3/5/62); NPS archives.

The project also included replacement of the three rooftop ventilators and repainting the tin covered roofs. The specifications called for the metal roof to be coated with asphaltum paint and finished with “Flintkote Decoralt” paint in a green color. Though research for this report did not uncover evidence of the original roof color, photographs indicate that the roof was painted red prior to this project. The green color was selected to blend with the copper trim, which was specified to be treated with acid after installation to achieve the “weathered green” patina of the existing copper downspouts.

Floor Repairs (1963)

The original drawings indicate brick paving over 6” concrete slabs for all ground level floors except the toilet/locker room of the north wing. Some of the brick finish remained until at least March 27, 1963, the date of a memorandum in the NPS archives that reported on an investigation into settlement of the brick pavement in the “South Leanto”. The condition was determined not to be hazardous but due to overloading during World War II. It recommended an overlay of minimum 2” concrete. Since no brick paving is exposed currently in the building (with the exception of a small area of exposed brick in the south wing), it is possible that the rest of the building received a concrete finish around this time as well.

Closing of the Navy Yard and Boston National Historical Park (1973-1974)

After years of declining activity, the Boston Navy Yard was closed in 1973. Much of the yard came under the jurisdiction of the Boston Redevelopment Authority, which would direct its revitalization with commercial and residential development. But the oldest portion of the yard, including Building 125, was set aside for preservation, and in 1974 was placed under the control of the National Park Service as part of Boston National Historical Park. Along with this transition came the return to the yard’s historic name: Charlestown Navy Yard.

New Boiler (1974-1977)

The steam heating system that served buildings throughout the yard was decommissioned when the Navy turned the property over to its new owners. Plans, dated October 1974, were prepared by the Navy for an independent gas fired boiler to serve Building 125, located in the west end of the original (high) north wing. The work was not done however, because the Navy’s budget was restricted to maintaining only those major structures (Buildings 4/5, 22, 24 and 136) that continued to be occupied at this time.⁶ Instead, the building was mothballed without heat until the Park Service installed a new boiler in 1978. A drawing in the archives, dated September 1977, shows the revised boiler room in the west end of the north wing as it was constructed and exists today.

⁶ Conversation with Steve Carlson.

Curatorial Services

After installing a heating system, the National Park Service initially used the building without any significant alterations for curatorial resources, housing artifacts in the former shop spaces on the first floor and both staff and archives in the existing second floor offices. This use continued until 1990, when the Curatorial Branch moved to Building 107. In accordance with a revised General Management Plan (3/20/1987), the Park Service submitted plans to install a public exhibition on the history of the Navy Yard in the main first floor space. This exhibition required only minor alterations to the building, including removal of the wire mesh partitions, the installation of new lighting and security systems and the repainting of exposed wall, ceiling and floor surfaces. This work was completed in 1991 and continues to occupy the space as of the writing of this report.



Figure 22: The main first floor space when initially used for general curatorial storage by the Park Service. View is looking south along the west wall. (02/1978)

Second Floor Building Occupants

After the Curatorial Branch moved, the second floor offices were occupied, without any significant changes, by various tenants, including the Pennies Campaign for the U.S.S. Constitution, the New England Steamship Foundation, the Freedom Trail Foundation and the Boston Redevelopment Authority.

North Wing Alterations (1988)

New England Historic Seaport, Inc., a non-profit organization with a small boat building operation moved into the north wing of the building in 1988. The organization's original request included taking over the north and south wings, with an additional 12'x30' metal clad addition to the south wing. This addition was rejected by the Park Service as not consistent with the General Management Plan for the park, and the south wing was never occupied, but the former locker and washroom spaces (not including the boiler room) were converted to a workshop through renovations that included the construction of wooden workbenches and a timber-framed loft over three-quarters of the higher, south space. A small toilet room was also installed in the northeast corner of this space, and power and lighting systems were upgraded. In 1989 a sign, identifying the space as the "Boston Boat Shop, New England Historic Seaport", was erected over the coiling door in the east exterior wall (no documentation was found establishing the date when this coiling door was installed). The north wing continues to be occupied by this tenant as of the writing of this report.

South Wing Tenants

The south half of the south wing was divided into a two rooms by a terracotta wall, originally to accommodate in the smaller western space an electrical substation. The Navy has continued to occupy the larger, east room for the storage of metal shop materials used in maintaining *U.S.S. Constitution*. The smaller west room was occupied in renovated and occupied in November 1997 by the Massachusetts Institute of Technology for an experimental fish hatchery operation. They installed water tanks on the first floor and constructed a small wooden loft for offices above. Both users occupy the space as of the writing of this report.

Roof Repairs (1994)

Leaking roofs required the Park Service to make general repairs in 1994. The work consisted of replacing damaged panels of the sheet metal roofing and coating the entire roof with a liquid membrane. The current color of the membrane is gray. To facilitate this work, the wooden fire escape over the south wing roof was removed and replaced in kind.

IV. CURRENT PHYSICAL DESCRIPTION

GENERAL

Building 125 has retained much of its original character and is in relatively good condition for a building with a century of heavy usage. It has avoided major alterations because until recently, it was employed for one purpose, as a paint shop, with operations and equipment that changed little during its period of use. Consistently restricted Navy Department budgets also limited funds for alterations not clearly warranted by operational benefits or safety requirements; the one major expansion to threaten the building's original integrity, proposed in the 1960's, apparently foundered for lack of economic justification. On the other hand, budgetary restrictions were also responsible for limiting maintenance of buildings at the Navy Yard, particularly after the Second World War. The articulated cornices of Building 125 were allowed to deteriorate to the point that they were less expensive to remove than to repair. For the most part though, the building's basic character defining features have remained because it is a simple structure, constructed of rugged materials that have been able to withstand years of hard use.



Figure 23: View of east façade. Corbelled brick cornices delineating the pediment and roof eaves were removed in the 1960's. (1/15/03)

EXTERIOR

Masonry

The building is constructed of red, water-struck brick laid in common bond, articulated with brick pilasters that divide each façade of the main block into three equal recessed panels. The original corbelled brick cornices that emphasized the roof edges and formed pediments on the east and west facades are now gone, replaced by flat brick infills that contrast slightly with the adjacent original bricks. The main block and adjacent wings rest on a 3 ft. high gray granite water table. The masonry walls are in generally in good condition, with some efflorescence indicating minor water infiltration problems at a few locations. There are no serious cracks to suggest structural or settlement problems; old cracks that do occur at the joint between the original building and the north wing appear to have stabilized and are clearly due to differential settlement caused by their different foundation systems. The mortar joints appear also to be in good condition overall, with perhaps 10%-15% repointing required at the time of this report.

Roofs

The roofs are clad with metal shingles, coated with a gray liquid membrane, over the original structural concrete roof decks. Each roof area is edged with copper rake trim and drained to copper gutters and downspouts. Perhaps some of the metal shingles are original, but major roof repairs in the 1960s and again in 1994 included significant repairs, new gutters and trim, and new membrane coatings; as a result, the roof systems appear to be in excellent condition. Rooftop assemblies also appear to be in good repair, including the elevator penthouse, ridge ventilators, and miscellaneous exhaust hoods over the north wing. The wooden fire escape over the north wing roof was rebuilt during the 1994 roof repair project.



Figure 24: View of roof over the north wing. The flat metal shingles are clad with a gray liquid membrane. The wooden fire escape was rebuilt in the 1994. (1/15/03)

Windows

Most of the original wood, double-hung windows are intact. Their painted finish has been neglected and is typically cracked and peeling, with some wood deterioration evident, but visual inspection indicates that the windows should be restorable with minor repairs and new paint. All first floor windows (and second floor windows on the south side) have expanded metal security screens screwed directly to the window brick moldings.



Figure 25: Typical first floor window with expanded metal security screen. (1/15/03)

The original windows have been lost at five locations on the first floor. An egress door through the west wall of the first floor main space replaced one window without affecting the original masonry opening (figure 32). But new door openings through the north and east walls of the north wing altered the original arch-topped window openings, which were partially filled (figures 27 and 28).

Eight original windows have been lost on the second floor. In the southeast corner three windows were fitted with single light sash, apparently without affecting the wood frames or masonry openings (figures 23 and 26). At this same corner, however, four original windows were lost and their masonry openings were rebuilt to accommodate two horizontally oriented fixed windows. At the west side of the south elevation the masonry opening of a window was also enlarged to install the existing egress door (figure 24).



Figure 26: New windows were installed at the southeast corner of the second floor in the 1950's, including the fixed and two 1/1 double hung windows pictured here. The 6/6 window to the left is original. (1/15/03)

Doors

The building contained only four exterior doors after the north extension was completed in 1917. Three of those have definitely been replaced over the years: a) the single door of the north elevation was expanded to the current pair (figures 27 and 28), b) the double sliding doors in the east wall of the south wing were replaced with a pair of hinged doors in a rebuilt masonry opening (figure 29), and c) the second floor loading door was replaced in an enlarged opening in the 1950's (figures 19 and 23). The main entrance door (figure 30) is probably original even though it differs from the door shown in the east elevation construction drawing – it is difficult to know for sure since the archives contain no detailed drawings and the doors are open in all of the original photographs. It is also difficult to know whether the hinged personnel door in the south leaf is original or was cut in at a later date. In any case, the entrance door is sliding door like the original, with panel and sticking details appropriate to the period. Though exhibiting significant wear from years of hard use, it is in relatively good condition and quite restorable.



Figure 27: This ca. 1917 photograph of the north wall shows the original exterior single door opening within a typical brick arch.



Figure 28: This pair of doors in the north wall replaced the original single door that fit into the center arch. Window openings to the left and right were filled-in. (1/15/03)



Figure 29: This hinged pair of doors in the east wall of the south wing replaced the original sliding doors. The opening was also rebuilt, with a concrete header replacing the former brick jack arch. (1/15/03)



Figure 30: Main entrance door. This is probably original, though this is difficult to verify. (1/15/03)

Four non-original doors have been installed in the building's exterior walls. Shortly after the building's construction a new opening was installed in the south elevation to provide access and ventilation to a new electrical substation. Originally protected by a wire mesh panel and door, it is now filled with a pair of wood doors (figure 31). Two original windows have also been replaced with egress doors. A new door in the west wall of the first floor main space was installed within an existing window opening; short runs of stairs both inside and outside bridge the granite water table and radiation pipes to access the door (figure 32). But the second floor egress door over the south wing roof required enlarging the window opening (figures 24 and 31). Finally, two original windows were removed and the granite water table sliced to make an 8 ft. wide opening for the coiling door in the east wall of the north wing (figure 33).



Figure 31: View of the building's southwest corner. The opening now with the pair of doors was constructed for an electrical substation in this location shortly after the building was completed. The two windows in the west wall were added at the same time. (1/15/03)



Figure 32: Fire door and stair through an original window opening in the west wall of the main space. (1/15/03)



Figure 33: This coiling door in the east wall of the north wing replaced two original windows. The granite water table was also cut to make the opening. (1/15/03)

Signage

Wood building number (“125”) signs on the north and south facades and a “Baxter Road” sign at the northeast corner are probably original. The paint on them is cracked and peeling, but they appear to be restorable. Other signage placed recently by NPS tenants should eventually be removed.



Figure 34: Building number sign. Two (probably original) signs are on the building, attached to the north and south facades. (1/15/03)

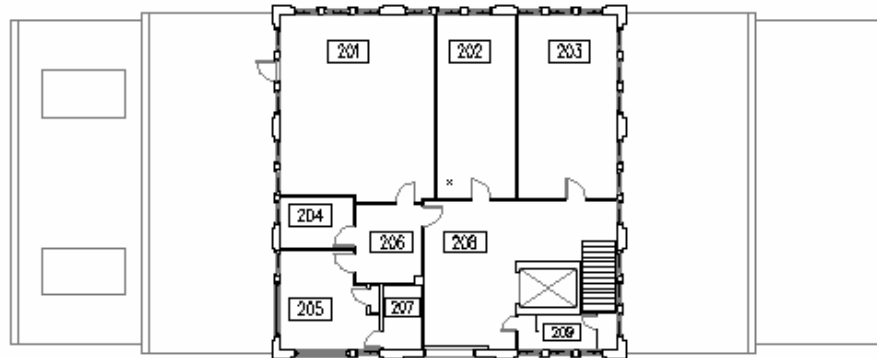

SECOND FLOOR PLAN

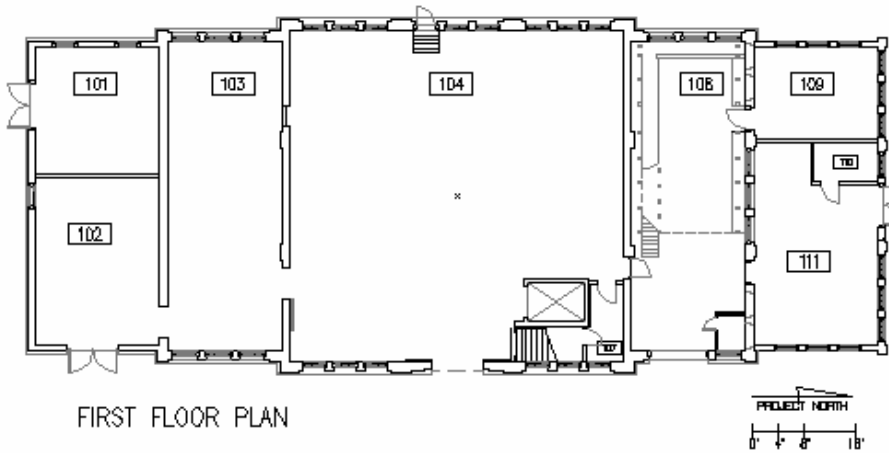

FIRST FLOOR PLAN

Figure 35: First and Second Floor Diagrams. Room numbers have been arbitrarily assigned to spaces for identification in this report.

INTERIOR

General

The building's interior is generally open and unfinished, befitting its industrial heritage. First floor spaces exhibit the original exposed, painted brick walls and concrete ceilings, but the original first level brick floor pavement has been covered throughout with concrete. The circulation core in the northeast corner of the main volume includes the original concrete stair, the 1939 freight elevator and toilets rooms of mixed vintage. On the first floor, the north and south wings have been partitioned and adapted to meet the requirements of their current tenants - but with the basic open, unfinished character maintained. The second floor retains the partitions and finishes of its office conversion of the 1950's, used now by a mix of occupants.

Room 101 (West End of Low South Wing)

The previously open south storage wing for volatile materials was divided with a plastered terracotta partition to create an electrical substation in this space, with a new pair of doors in the south exterior brick wall. The electrical substation equipment is now gone and the space is currently occupied by an experimental fish hatchery operation run by the Massachusetts Institute of Technology. A wooden mezzanine has been constructed along the east and north sides of the space to support administrative spaces above the fish tanks on the ground level. Apart from plumbing and electrical utilities for this operation, the space is unfinished. The original skylight over the space has been covered with plywood. No evidence of the original glazing frame remains.

Room 102 (East End of Low South Wing)

This is the remainder of the original open space, divided from Rm. 101 by a partially plastered terracotta partition. As in Room 101, the skylight has been removed and the opening covered in plywood. The single original south wall window provides natural light in the space. Uneven settlement of the floor is evident at the west side of the space where some of the original brick pavement is visible in the floor that is otherwise paved in concrete. A leaking radiator is responsible for moisture on the floor at the north side of the space. The Navy currently uses the space for metal shop storage.



Figure 36: View of room 102 looking west. The space is used for the storage of metal materials to maintain U.S.S. Constitution. (1/15/03)

Room 103 – South High Wing

This space was originally constructed as a materials storage room, connected to the adjacent main space by two high, narrow doors through which ran a steel trolley rail. The rail, which originally looped through the adjacent main space, exists now only in this room. Used at some point for the paint shop offices, this space was converted to the paint mixing room as part of general renovations in the 1950's. Two large, mixing vats remain in the room as artifacts of one of the building's primary functions, and perhaps consideration should be given to preserving and displaying them somewhere in the building. The original north wall doors have both been altered, the west opening filled entirely with brick and the east door filled above an enlarged 7' high opening, which is currently protected by a sliding fireproof door. A hinged fireproof door in the south wall leading to Room 102 is probably original. The concrete floor of this space probably covers original brick paving.



Figure 37: View of Room 103 from east, as abandoned by the Navy. Note the paint mixers along the north wall that remain in the same location today. They could be preserved as an exhibit of primary paint shop equipment. (1/15/03)

Room 104 – First Floor Main Space

This room has a 19'-6" high ceiling and is 52' square, without any columns thanks to two massive steel trusses that support the second floor. It was the central room of the paint shop, containing workstations and material stores. The work areas were originally separated with wire mesh partitions from the circulation area that linked the entrance door to the stair/elevator core

and the locker room in the north wing. The wire mesh partitions have been removed, as has the original ceiling-hung trolley beam, which started at the main entrance doors and looped through this space and into adjacent south wing. The two doors into the south wing have also been altered, as noted in the description of Room 103 above. Other alterations to the room's original finishes include the existing concrete floor, which (according to the drawings) was originally paved with brick, the freight elevator hoistway, which was enlarged in 1939, and the fire escape door through a window opening in the west wall. The fire protection service valve is also located in a wooden enclosure at the south side of the main entrance.

This room currently houses a Park Service interpretive exhibit of the Navy Yard history that was installed in 1991. Improvements made to the space for this exhibit include new lighting (additional fixtures selected to match those existing at the time of the installation), exhibit kiosks and displays, new paint throughout and improved finishes (ceramic tile and new fixtures) in the restroom (107) beneath the second floor stair.



Figure 38: View to egress door in west wall of main space, Rm. 104. (1/15/03)

Room 108 – North High Wing

This space, which was constructed with the lockers, wash sinks and toilets used by all the paint shop personnel, originally had no exterior door and was accessible only through the main space, Room 104. Though re-arranged, it continued with the same use after the new wing to the north was constructed in 1916 with a shower and lunchroom. But at some point prior to 1953 the locker area was converted to a shop storage area, which was enlarged to eliminate the toilet room by 1966, and an 8' wide coiling door had been inserted into the east wall. In 1988, when the building was under control of the Park Service, a non-profit organization, New England Historic Seaport remodeled the space as a wood working shop, installing the existing wood framed mezzanine and ground floor workbenches, as well as a small toilet enclosure in the northeast corner.



Figure 39: View looking west in north wing Room 105 showing existing wood framed loft. (1/15/03)

Room 111 – North Low Wing

This room was constructed as a lunchroom extension to the original building in 1916. It was constructed with exterior materials and details similar to the original building, but on spread footings rather than piles, and with a wooden roof structure instead of the steel-framed concrete used on the earlier sections. Settlement cracks that are visible in the floor and walls where this extension attaches to the original construction most likely appeared shortly after construction due to the use of spread footings. Sometime prior to 1953 the space was converted for machine shop use, and included sand blasting equipment. The storage closet (Room 110) in the northwest corner was also constructed by this date for use as an alcohol locker. At some point (though the date is not clear from any documentation) the single north wall door was enlarged as a pair of doors, cutting awkwardly into the adjacent arched window bay. New England Historic Seaport took over the space without significant alterations as part of its woodworking shop in 1988, a use that continues to the present.



Figure 40: View of Room 106 looking south to wall that was originally the north exterior wall prior to the construction of the north extension. Note that the roof in this space is framed with wood. (1/15/03)

Room 109 – Boiler Room

This was originally built as a shower room in the 1916 extension, but it was being used as a storage room by 1953. The Park Service installed boilers in the room sometime around 1977, providing the building for the first time with an independent heating system.

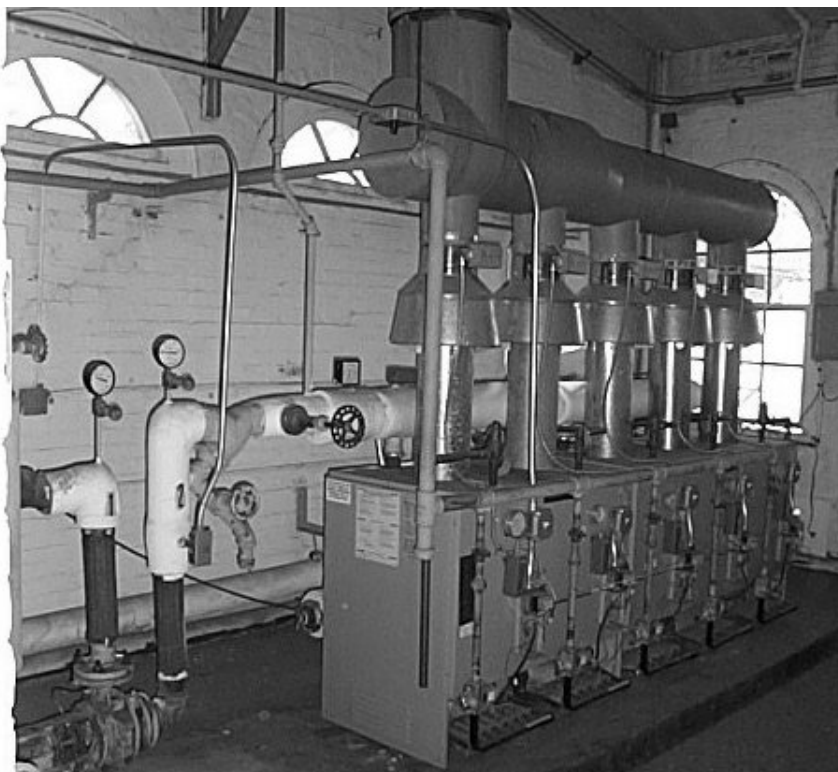

Figure 41: View to northwest in Room 107, the boiler room. Since this space was originally constructed as a shower room, the west wall windows were built as shown with fixed transoms only. (1/15/03)

Stair

The painted, cast-in-place concrete stair in the northeast corner of the center mass is original. With 7-3/4 in. risers and 9-1/2 in. treads, it does not meet current egress code requirements.



Figure 42: Stair to second floor from Room 104. The stair is original, but the freight elevator (left) replaced the original in 1939. (1/15/03)

Elevator

The existing elevator, including the brick hoistway and metal-clad penthouse for the machine room, were constructed in 1939 to replace an earlier elevator that had a smaller plan and did not penetrate the roof (the original machinery was located adjacent to the hoistway on the second floor). The 4,000 lb. capacity freight elevator with vertical bi-parting entrance doors is maintained and used by the Park Service and their second floor tenants, but it does not meet code requirements for use as a passenger elevator.

Second floor – Rooms 201 through 209

The current arrangement and most finishes of offices on the second floor probably date to a general renovation completed by the Navy around 1956. Partitions on the floor are generally constructed of gypsum wallboard on wooden stud framing, with some wire mesh on wood stud dividers. Ceilings in the offices are typically of acoustic tile, at approximately 11'-4" above the floor. Floor finishes in the offices range from carpet to vinyl asbestos tile. The corridor area (Room 208) at the stair and elevator landing is open to the underside of the roof structure. A pull-down ladder provides access from this area to the attic space above the offices.



Figure 43: View of second floor corridor. The existing offices were constructed in the 1950's, enclosed by 12' high GWB partitions with suspended ceilings. The corridor is open to the steel trusses of the roof structure above the offices. (1/15/03)



Figure 44: Typical second floor office interior. Exterior brick walls are exposed. (1/15/03)

IV. RECOMMENDATIONS

TREATMENT AND USE

Building 125 has been only minimally altered since its days as a paint shop. The interior finishes and fittings were always utilitarian, though, and there isn't much inside the building that would warrant special attention for preservation, or that would preclude a substantial rehabilitation to accommodate new uses. The goal of any such rehabilitation should be to maintain the open, industrial quality of the original interior spaces. The National Park Service's General Management Plan (1987) calls for Building 125 to be used for exhibits and public gatherings. The use of the building for administrative offices would also be appropriate. To accommodate any new uses the building will require some major alterations, including new toilets, code complying egress stairs, a new elevator and new MEP systems; this work will necessarily have a significant impact on all of the existing spaces. In any case, the most important space in the building is the first floor of the center volume, where the greatest effort should be made to preserve the existing character.

The historical value of the building is embodied to a much greater extent in its exterior. The volume remains as originally constructed (with the 1916 extension) and should not be altered in any significant way. Much of the original exterior masonry and windows remain as well, and should definitely be preserved. On the other hand, after 1940 a number of envelope modifications were made that were detrimental to the building's architectural and historical integrity. As a long-term goal the building should be restored to its pre-WWII condition by reversing, where possible, the insensitive window, door and architectural trim alterations. Funds for any near-term work will undoubtedly be limited, so the initial focus should be on the stabilization of the building envelope to prevent further deterioration.

As previously stated in this report, Building 125 is not noteworthy for an association with any particular historical event or person. Its historic value is as a contributing structure to the Boston Naval Shipyard Landmark District, within which it has occupied a prominent location for almost a century, but it is also a handsome building in its own right, with carefully proportioned classical form and features. The building needs rehabilitation to address the deterioration of its exterior envelope; with updated interior systems and finishes, it can also serve a much more useful role for the park than it does currently. The work required on and in the building will include substantial physical changes, so the recommendations in this report have to acknowledge the need for flexibility treating the remaining original fabric.

EXTERIOR RECOMMENDATIONS

1. The basic form of the building and current exterior features should not be changed. The basic footprint and profile of the building should remain essentially as finished in 1917.
2. Non-original projections on the roofs should remain. The elevator penthouse on the north side of the main roof is not original, but it is in keeping with the rest of the building and should remain (even if the elevator hoistway within the building is relocated). Similarly, the rooftop ventilators are close enough to the originals that they should be retained.

3. Although a wooden fire escape stair over the south wing roof has existed in some form for many years, it is not considered a character defining feature and may be removed.
4. Original skylights on the south wing roof, now missing, can be replicated if deemed beneficial to the new use.
5. Existing, original wood windows should be restored. If energy conservation is an issue, interior storms should be installed to maintain the appearance of the windows from outside. Existing wire mesh security screens on all first floor windows might be original, or they might be replacements of those installed shortly after the building was completed, but they will probably not be desirable for any new building use and may be removed.
6. Replication of the original masonry openings and wood windows where altered in the southeast corner of the second floor would be desirable. If initial renovation funds are limited, this could be pursued as a long-term goal.
7. Similarly, it would be desirable to restore the original conditions at non-original exterior door openings on the first floor, especially on the east façade. Funds may preclude this work in the near term, and functional requirements for a new use in the building might determine that some doors should remain, or others be added. If new doors are required, they should be located within the original window without any alterations to the masonry surrounds.
8. Two existing windows in the west elevation of the south wing are not original, but were installed shortly after the building was constructed. These simple rectangular openings with flat brick arches are sympathetic to the unarticulated masonry enclosure of this wing. It is recommended that they remain and serve as models for any new openings that might be required in the wing's south wall for new interior uses.
9. The main entrance wood doors are sliding doors and would not be usable after the building is renovated. They should be retained, even if concealed in a permanently open position.
10. The shipping door on the second floor was enlarged in 1952, and the result was very unfortunate for the proportions of the main facade. It is recommended that the original masonry opening be restored, but restoration of the original wooden door would probably not be desirable for the future interior use of the second floor, so the opening might be filled instead with a window.
11. The replication of the missing original eave and pediment trim should be a long-term goal. Its removal in the 1960's was a major loss to the architectural character of the building. But this work would be for aesthetic reasons only, and may not be possible within a near term project of limited funds.
12. Original wood "125" signs should be preserved and retained.

INTERIOR RECOMMENDATIONS

1. The building contains very little interior fabric that is of historic significance. Interior renovations should be driven by the requirements of the new use, including those of function, safety and energy conservation. Nevertheless, any renovation should be as sympathetic as possible to the building's historical character.
2. To the greatest extent possible, the original industrial quality of the interior should be retained in a renovation, especially in the main first floor space. Important elements defining this quality are the exposed, painted masonry walls and the exposed steel structural members. It is also important to retain, as much as possible, the general openness of the spaces. Simple, suspended light fixtures should be used, and mechanical systems can be exposed.
3. Existing concrete floor finishes in the first floor, though appropriate to the building, are not original (except perhaps in the north wing). Restoring the original brick paving would be desirable but possibly not feasible with a limited budget.
4. Salvaging and displaying at least one of the remaining paint mixing machines as an artifact of the building's original use would be desirable.
5. The remaining original trolley track in the high south wing should be retained as original fabric, even if it is eventually covered by suspended finishes.

V. APPENDIX

DRAWINGS

HABS DRAWINGS (EXISTING CONDITIONS):

HSR-1	Cover Sheet
HSR-2	Floor Plans
HSR-3	Roof Plan
HSR-4	Elevations

ARCHIVE DRAWINGS:

Schematic Design Drawing (1903)
Foundation Plan (1904)
First Floor Plan (1904)
Second Floor Plan (1904)
East Elevation (1904)
Longitudinal Section (1904)
Cross Section (1904)
Window Details (1905)
North Extension (1916)
New Elevator (1939)
Interior Revisions (1921)
Shipping Door Alterations (1952)
Exterior Alterations (1961)
Interior Revisions (1964)
Boiler Room

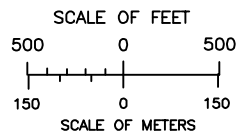
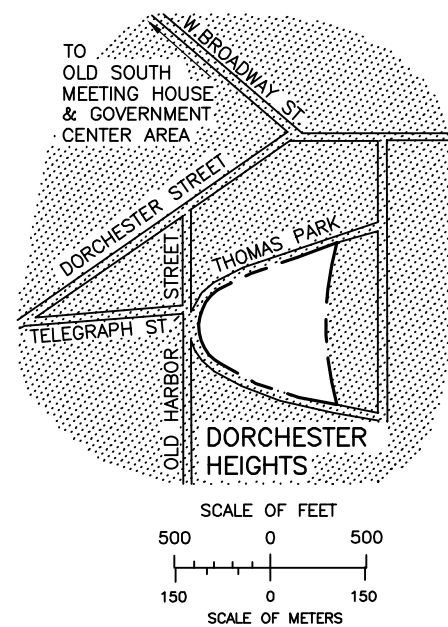
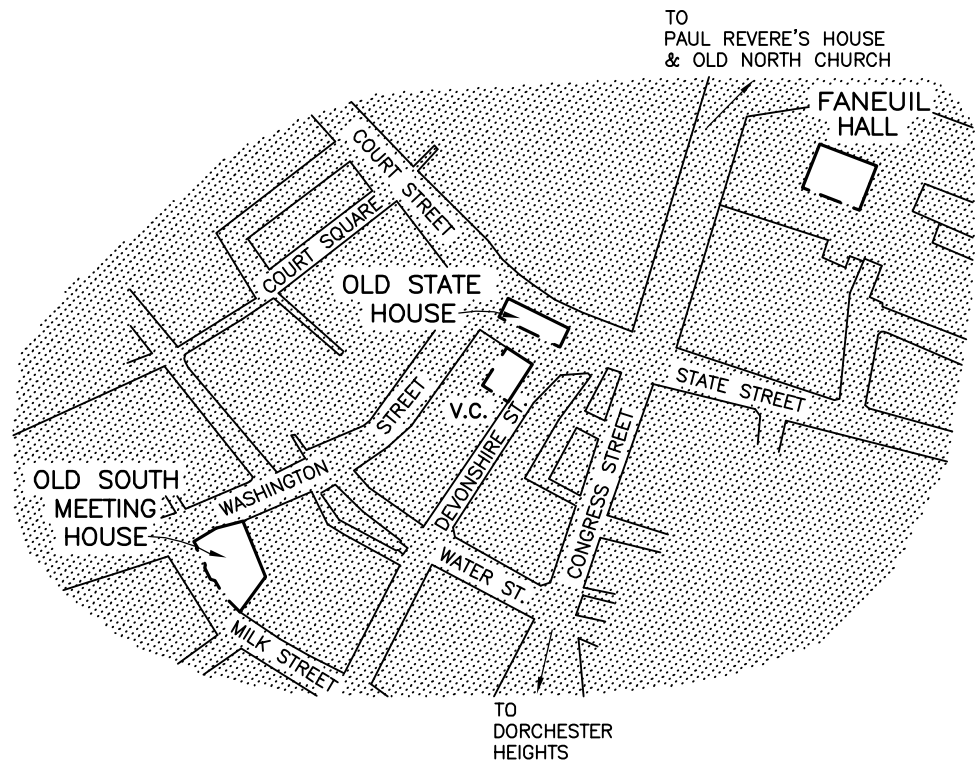
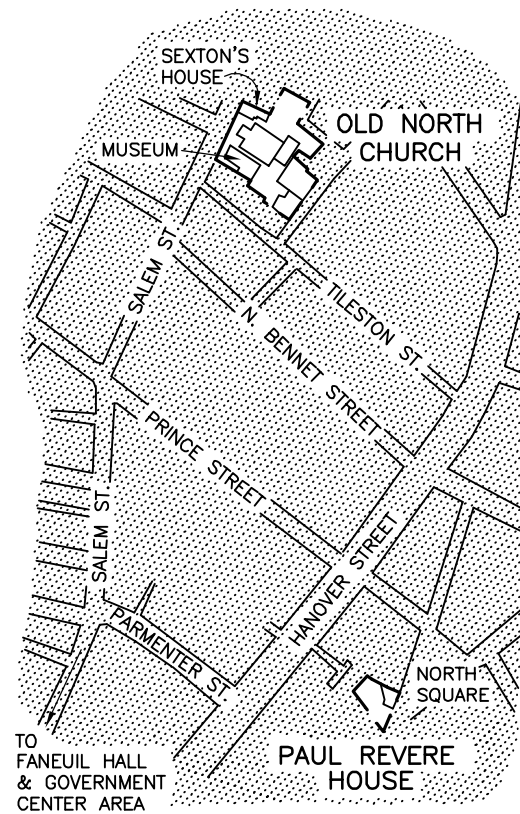
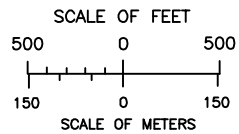
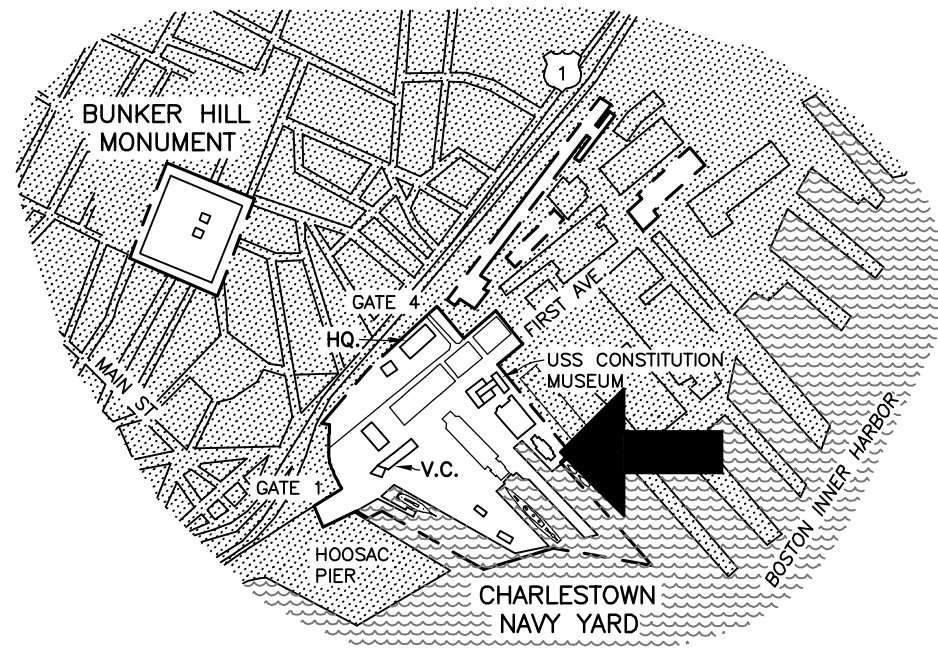

LEGEND

- — — HISTORICAL PARK BOUNDARY
- V.C. VISITOR CENTER
- HQ. PARK HEADQUARTERS

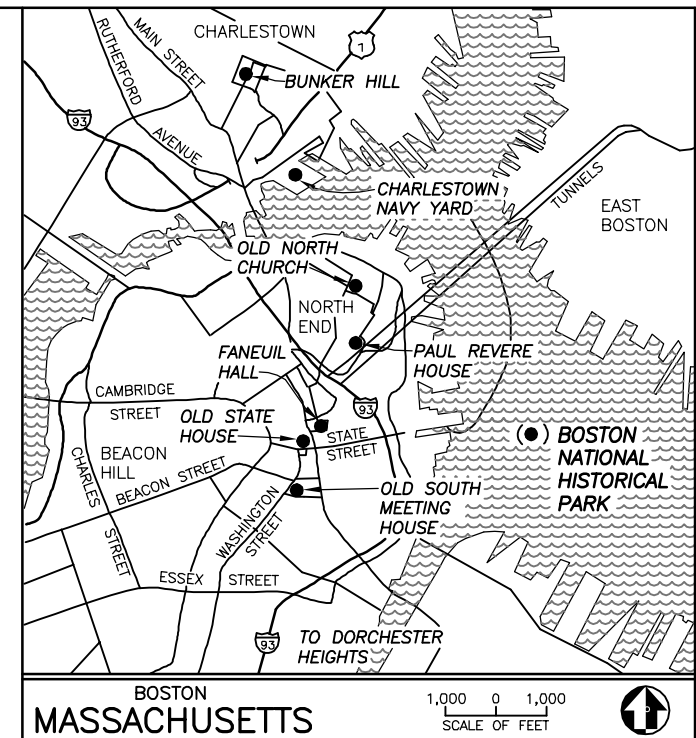

BOSTON NATIONAL HISTORICAL PARK



	UNITED STATES DEPARTMENT OF THE INTERIOR NATIONAL PARK SERVICE DENVER SERVICE CENTER	TITLE OF DRAWING BUILDING 125 LOCATION WITHIN PARK	DRAWING NO. HSR-1
		NAME OF PARK BOSTON NATIONAL HISTORICAL PARK REGION COUNTY STATE NORTHEAST SUFFOLK MASSACHUSETTS	PKG. NO. SHEET BOST 118 1 OF 4

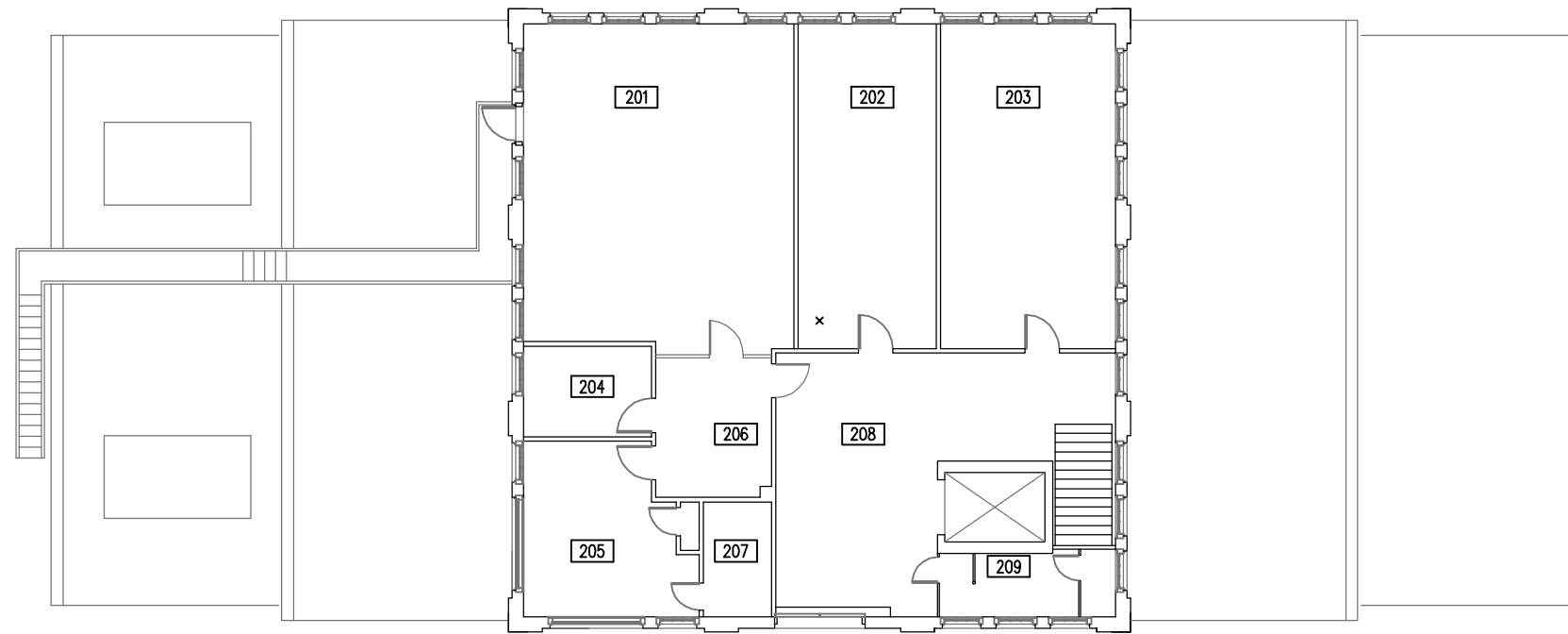

SECOND FLOOR PLAN

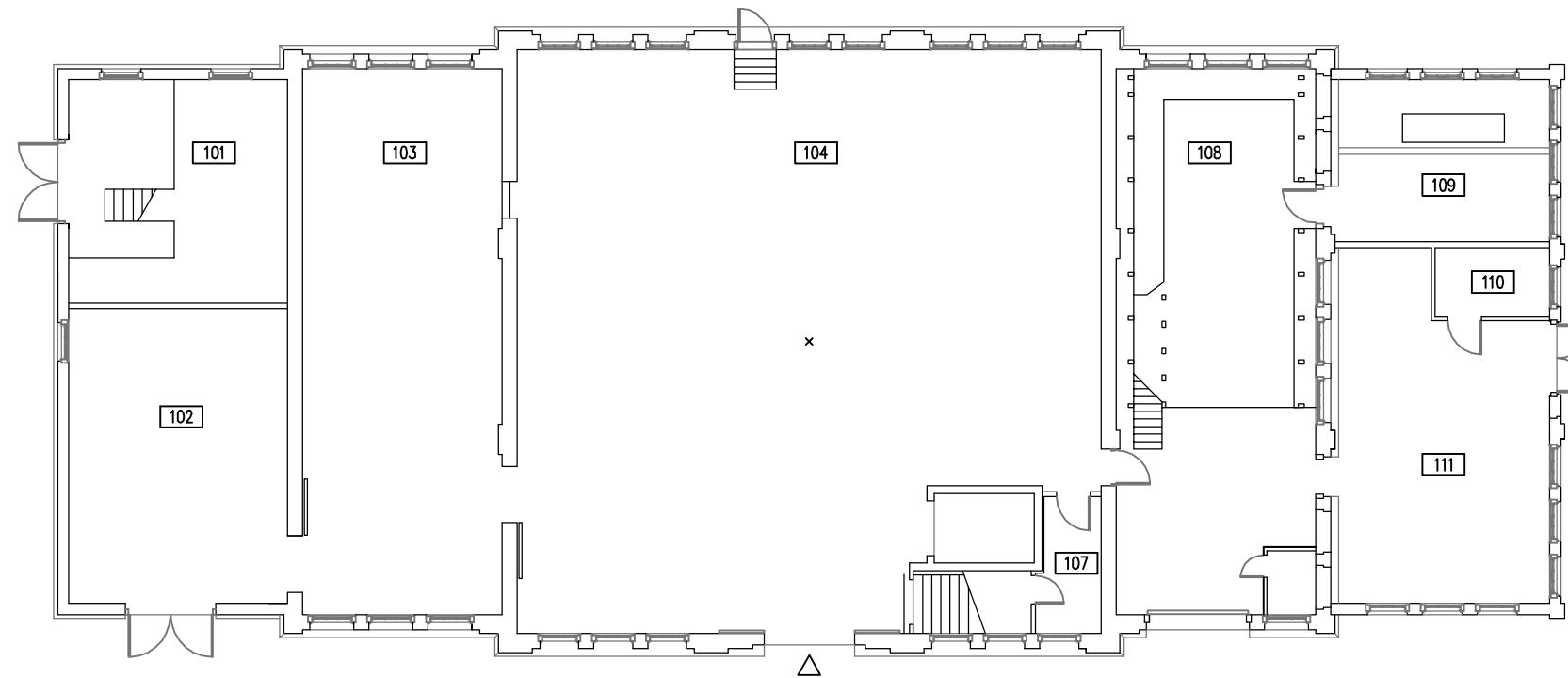

GROUND FLOOR PLAN

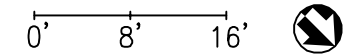

DESIGNED: ADD EW	SUB SHEET NO. HSR2	TITLE OF SHEET BUILDING 125 FLOOR PLANS	DRAWING NO. —
TECH. REVIEW:		Charlestown Navy Yard Boston National Historical Park	PKG. NO. SHEET — 2
DATE: 5/14/03			— OF 4

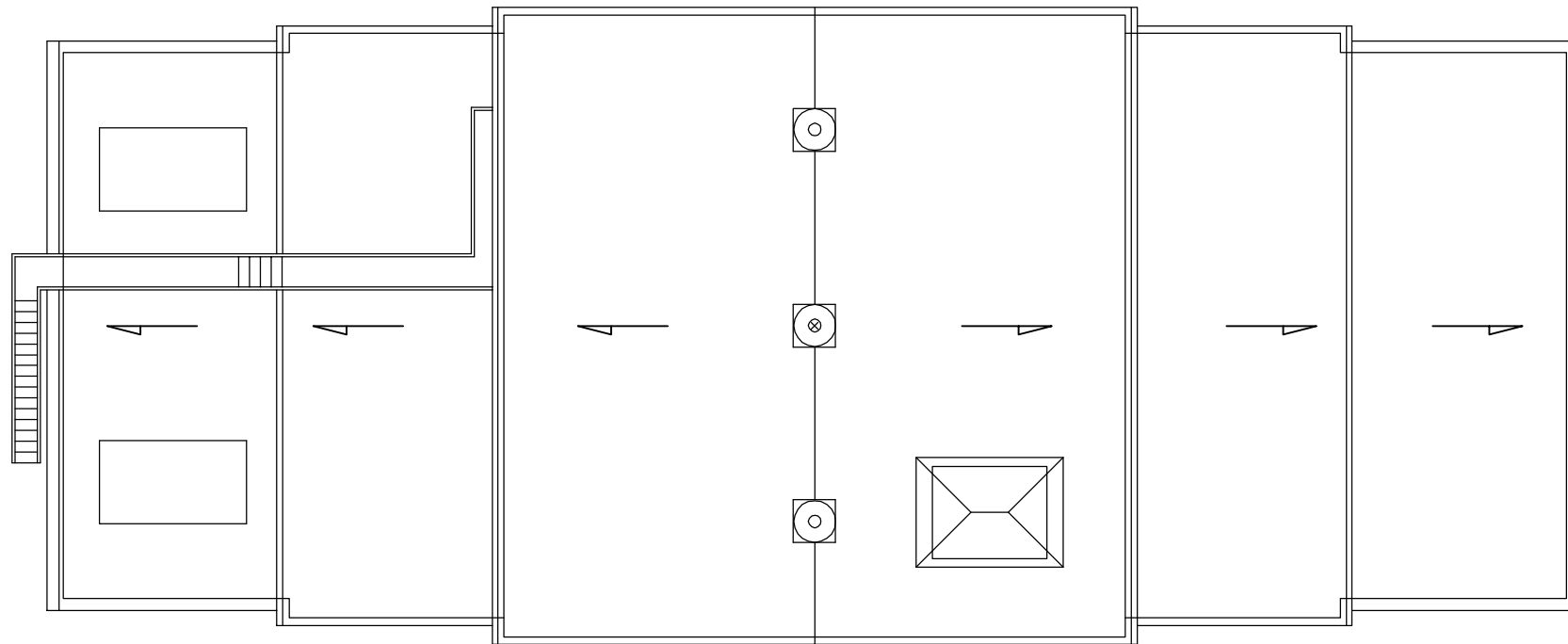

ROOF PLAN

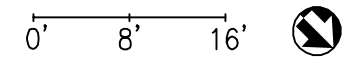

DESIGNED: EW	SUB SHEET NO. HSR3	TITLE OF SHEET ROOF PLAN Building 125	DRAWING NO. _____
TECH. REVIEW:		Charlestown Navy Yard Boston National Historical Park	PKG. NO. _____ SHEET 3
DATE: 5/14/03			OF 4



EAST ELEVATION



NORTH ELEVATION



WEST ELEVATION



SOUTH ELEVATION

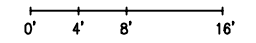

DESIGNED: GAD EW	SUB SHEET NO. HSR4	TITLE OF SHEET ELEVATIONS Building 125	DRAWING NO. _____
TECH. REVIEW:		Charlestown Navy Yard Boston National Historical Park	PKG. NO. _____
DATE: 5/14/03			SHEET 4
			OF 4



Front Elevation



Side Elevation



Rear Elevation

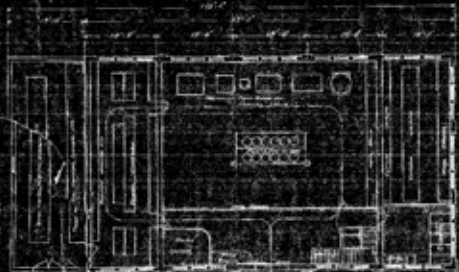

Floor Plan

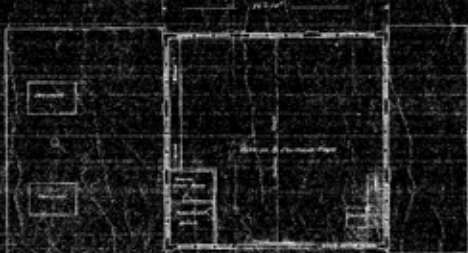

Section



Section

NOT TO SCALE
NOT TO BE USED FOR CONSTRUCTION
NOT TO BE USED FOR CONSTRUCTION
NOT TO BE USED FOR CONSTRUCTION

PROPOSED PAINT SHOP
FOR
C. & B. DEPT., BOSTON NAVY YARD
JAN 18 1913

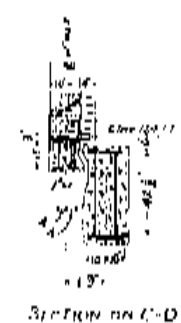
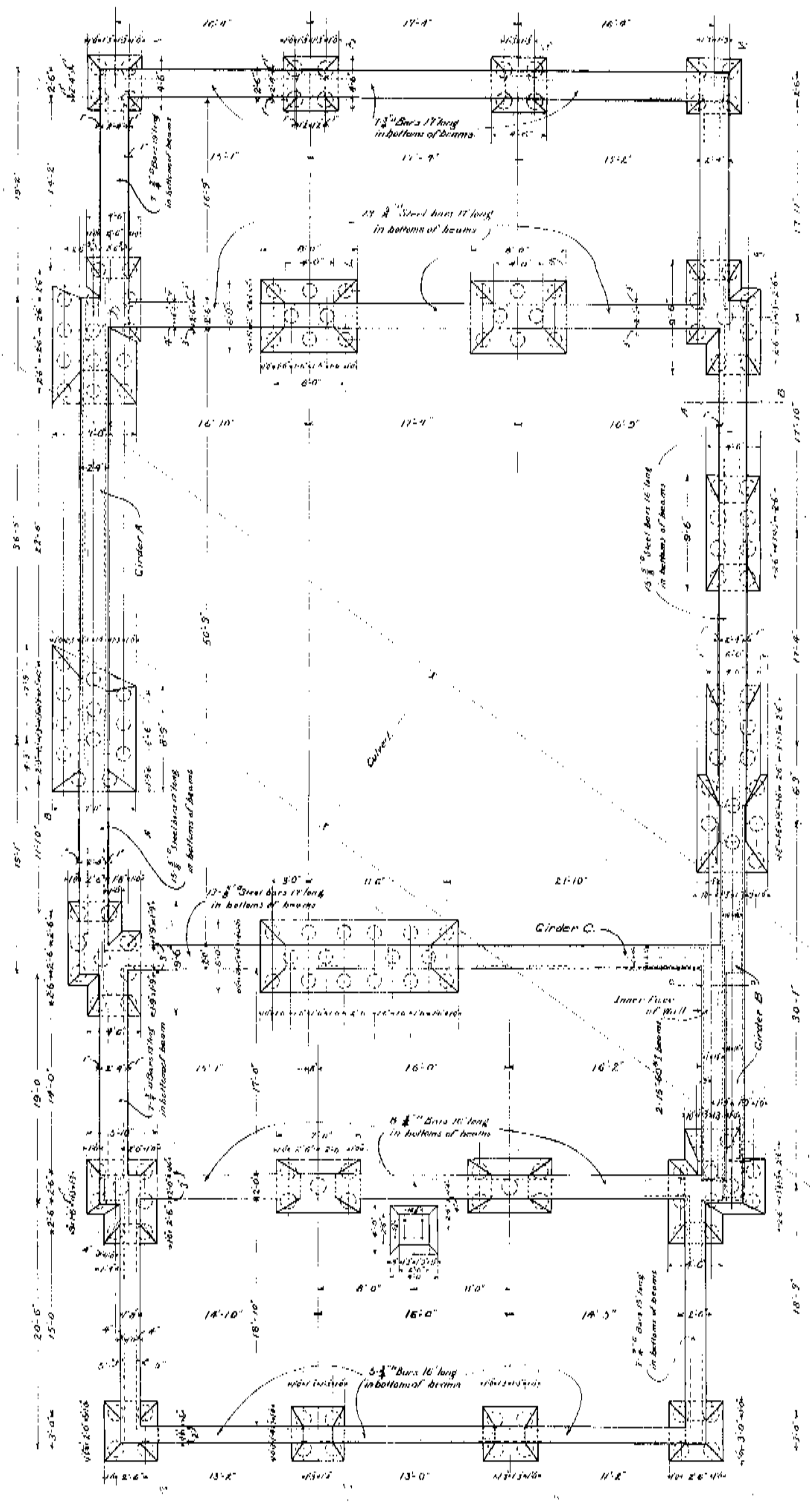

SECTION ON A-B

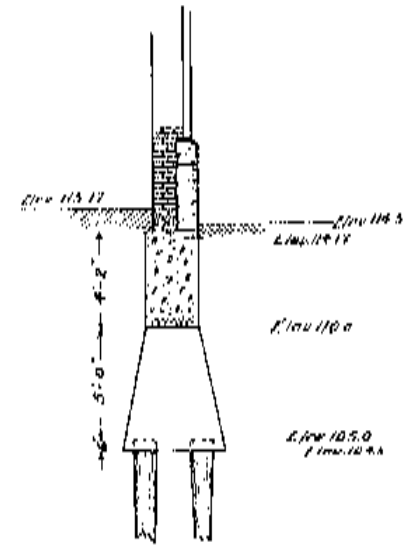

Vertical Dimensions are the same for all Wall Foundations
Horizontal Dimensions are shown on Plan.

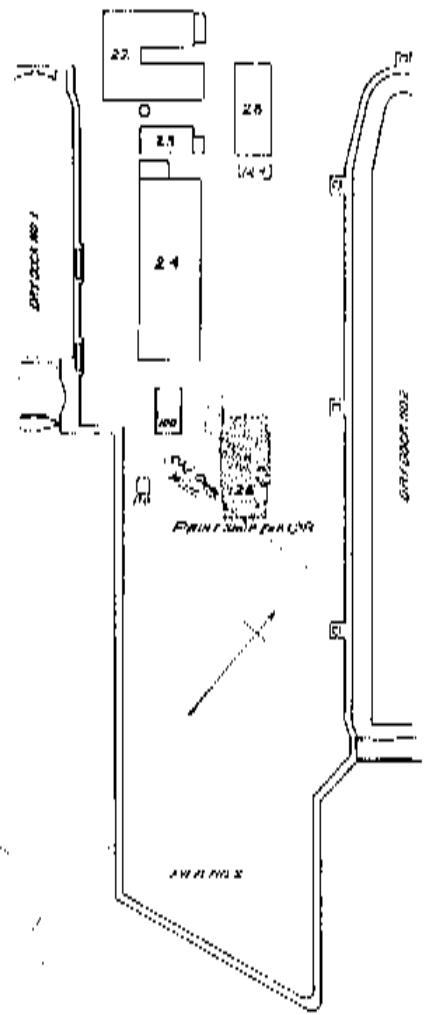

F. 125	NAVY YARD, BOSTON, MASS.	Sh. 2
FEBRUARY 21, 1904		
BUILDING No. 125. PAINT SHOP FOR C. and R. Foundation Plan.		
SCALE: 1/4" = 1'-0" (SEE 1-17)		
APPROVED:	RESPECTFULLY SUBMITTED:	
<i>[Signature]</i>	<i>[Signature]</i>	
CHIEF OF BUREAU YARDS AND DOCKS	CIVIL ENGINEER U. S. N.	

111 A
1/21/04

ACCOMPANYING SPECIFICATION T.A.A.

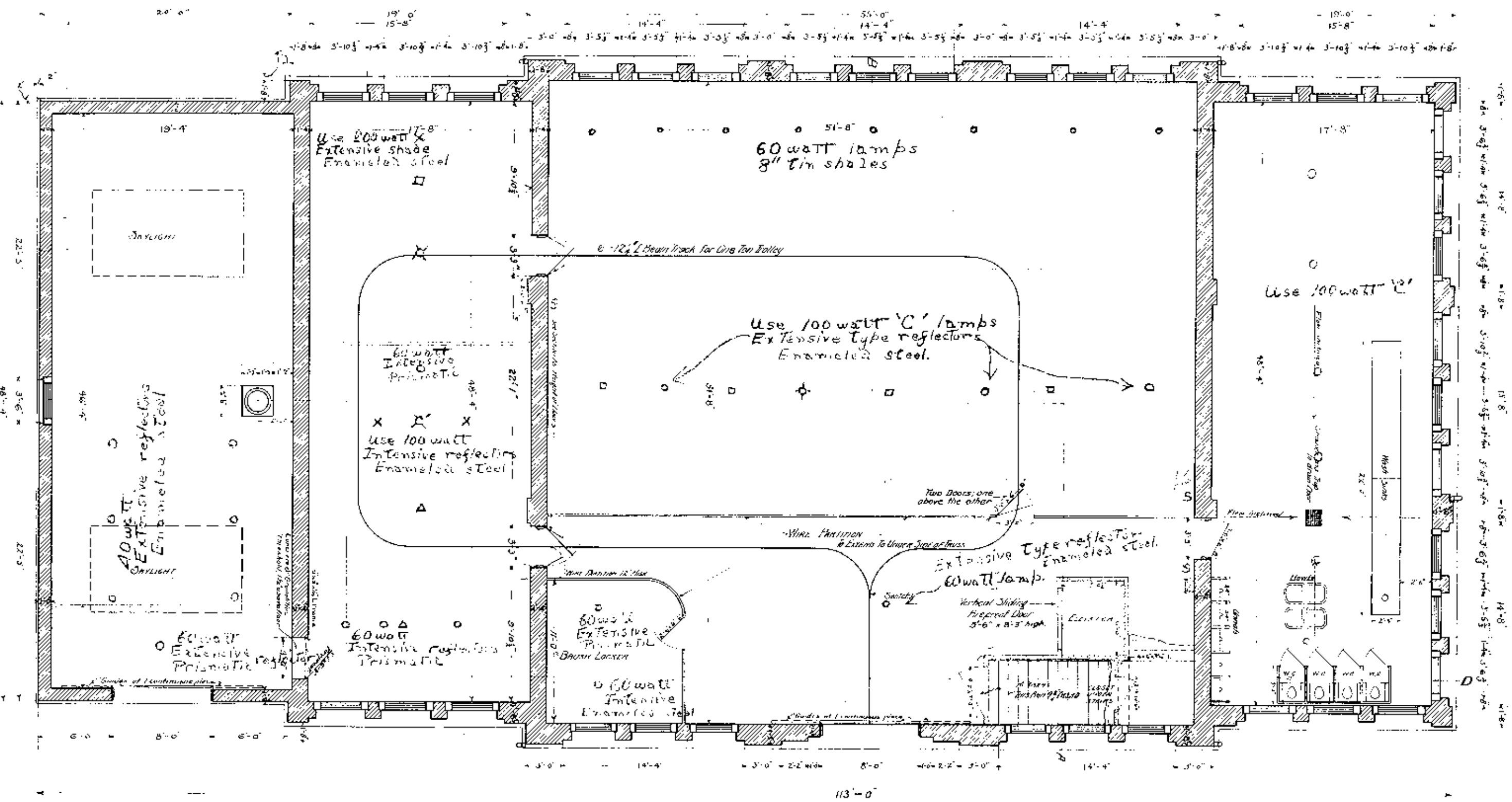

Information Regarding Lighting Buildings
First Floor

- = Present drop to be discontinued
- c = Present drop
- △ = Present junction box
- ⊕ = Present large unit
- x = Proposed new unit

Note - Men's room to be equipped with 100 watt lamps

E. 125
 NAVY YARD, BOSTON, MASS.
 FEBRUARY 8, 1904
 BUILDING No. 125
 PAINT SHOP FOR C. and R.
 First Floor Plan.
 SCALE 1/4" = 1'-0"
 APPROVED: *Edmund C. ...*
 CHIEF OF BUREAU, YARDS AND DOCKS.
 RESPECTFULLY SUBMITTED: *Edmund C. ...*
 CIVIL ENGINEER U. S. N.

H. H. B.
 7/1/01

NO. 125
 DATE 01
 20/23/04

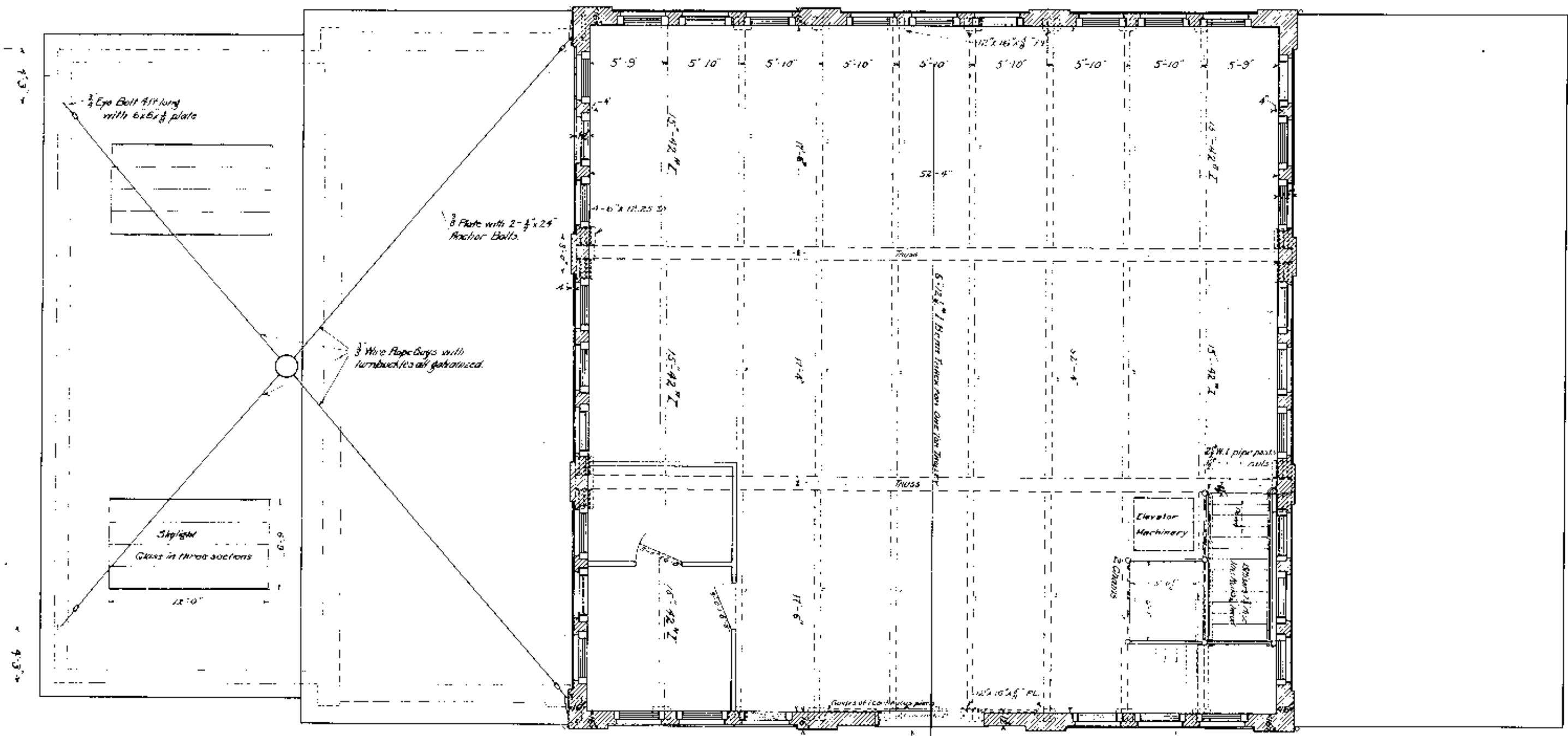

NOTE - WINDOW SPACING SAME AS FIRST STORY PLAN

*Information Regarding Lighting Bldg 125
 Second Floor*

- Indicates Drop Lights in place.
- ⊙ Indicates 300 Watt Tungsten Lights now in place.
- × Indicates new drop light to be placed.

F. 125 NAVY YARD, BOSTON, MASS. **Sh. 4**

BUILDING No. 125
 PAINT SHOP FOR C. and R.
 Second Floor Plan.

APPROVED: *[Signature]*
 CHIEF OF BUREAU, YARDS AND DOCKS.

RESPECTFULLY SUBMITTED:
[Signature]
 CIVIL ENGINEER U. S. N.

SCALE 1/4" = 1'-0"

FEBRUARY 8-1904

ARCHITECT: SUPERVISOR, 1889



F. 125

NAVY YARD, BOSTON, MASS.

Sh. 5

FEBRUARY 8, 1904

BUILDING No. 125
PAINT SHOP FOR C. and R.
Front Elevation.

APPROVED:

RESPECTFULLY SUBMITTED

CHIEF OF BUREAU YARDS AND DOCKS
CIVIL ENGINEER U. S. N.

ACCOMPANYING SPECIFICATION 125-1

H.L.M.
JAN 20 1904

FEBRUARY 8 - 1904.

BUILDING No. 125
PAINT SHOP FOR C. and R.
Longitudinal Section.

APPROVED: *C. W. Beckwith*
CHIEF OF BUREAU, TANKS AND DRUMS.
RESPECTFULLY SUBMITTED: *C. W. Beckwith*
CIVIL ENGINEER, U. S. N.

NOTE: All gullers to be supported by steel angles 4 1/2" x 3" x 1/2" connected to steel work of roof or to 2x4 steel lookouts 2 ft apart built into walls. Gutter angles shall pitch 1/4" per foot.

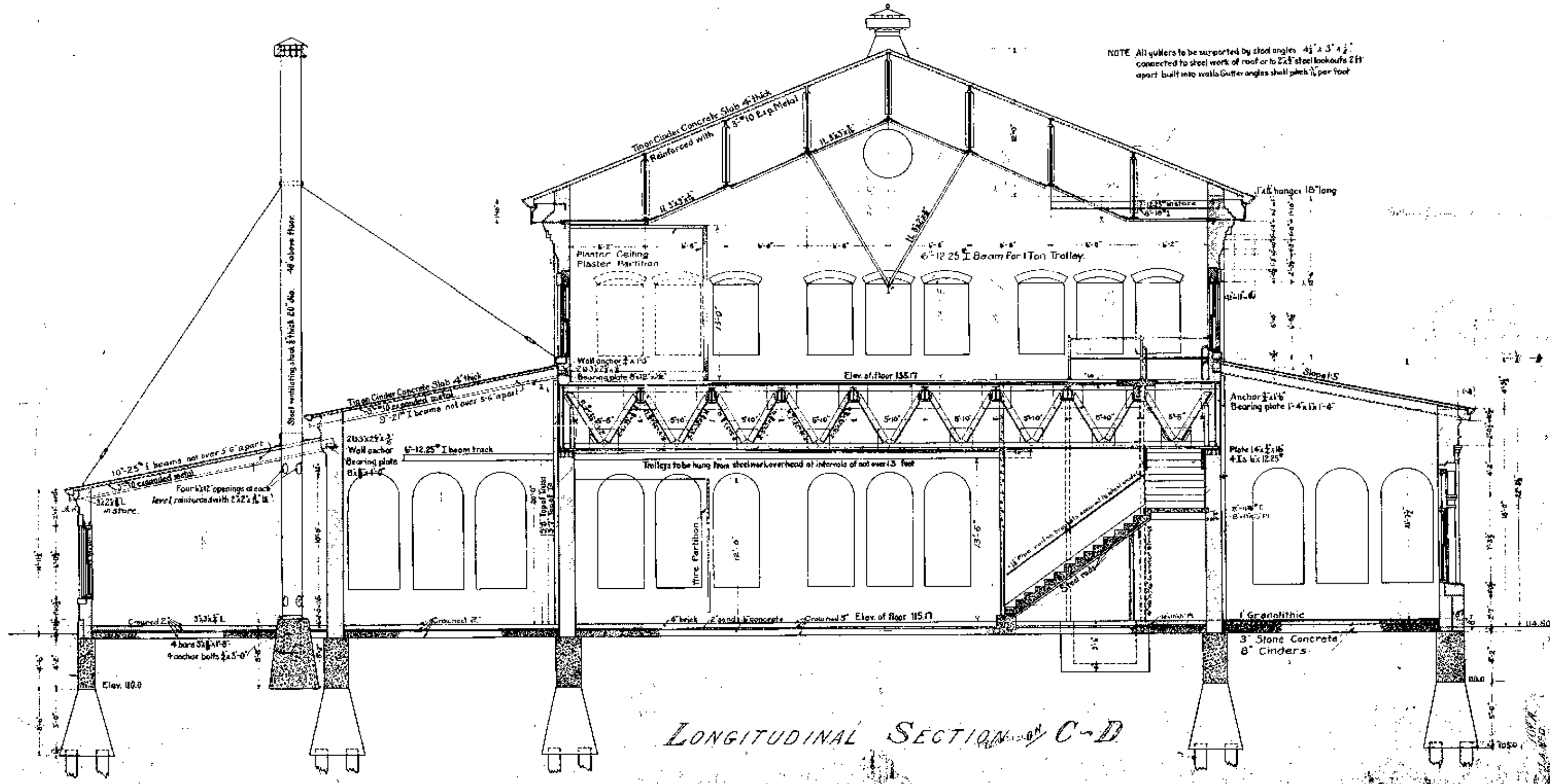

LONGITUDINAL SECTION of C-D

ACCOMPANYING SPECIFICATION 125-4

Q. 1117
 C. W. M. 23
 No. 1143
 JAN. 1901

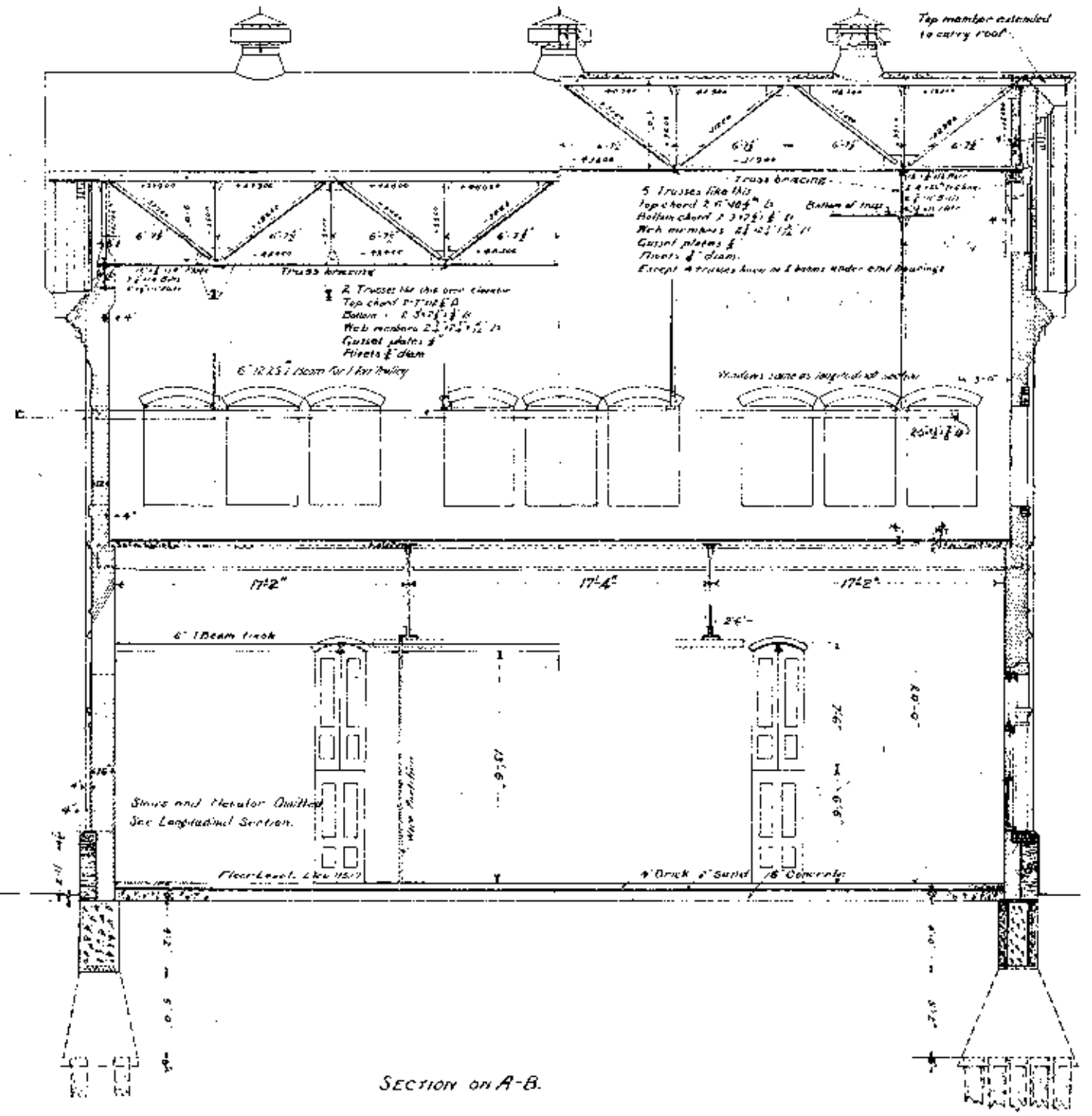
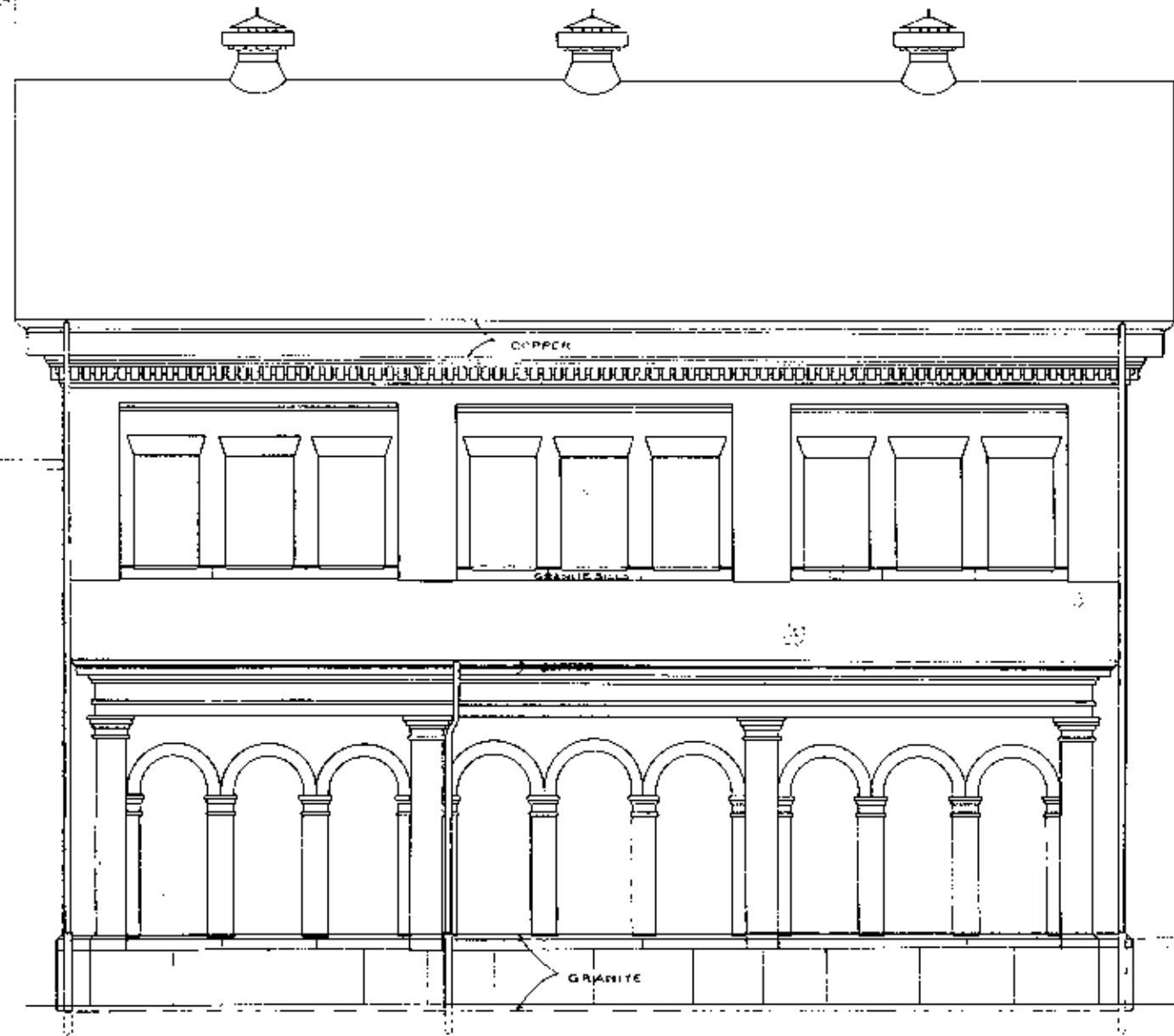

SECTION ON A-B.

APPROVED:
Walter D. Wood
 CHIEF OF BUREAU, YARDS AND DOCKS

Scale 1/4" = 1'-0"

RESPECTFULLY SUBMITTED
W. D. Wood
 CIVIL ENGINEER U. S. N.

F. 125

NAVY YARD, BOSTON, MASS.

February 8-1901

SH. 6

BUILDING No. 125
 PAINT SHOP FOR C. and R.
 End Elevation and Transverse Section.

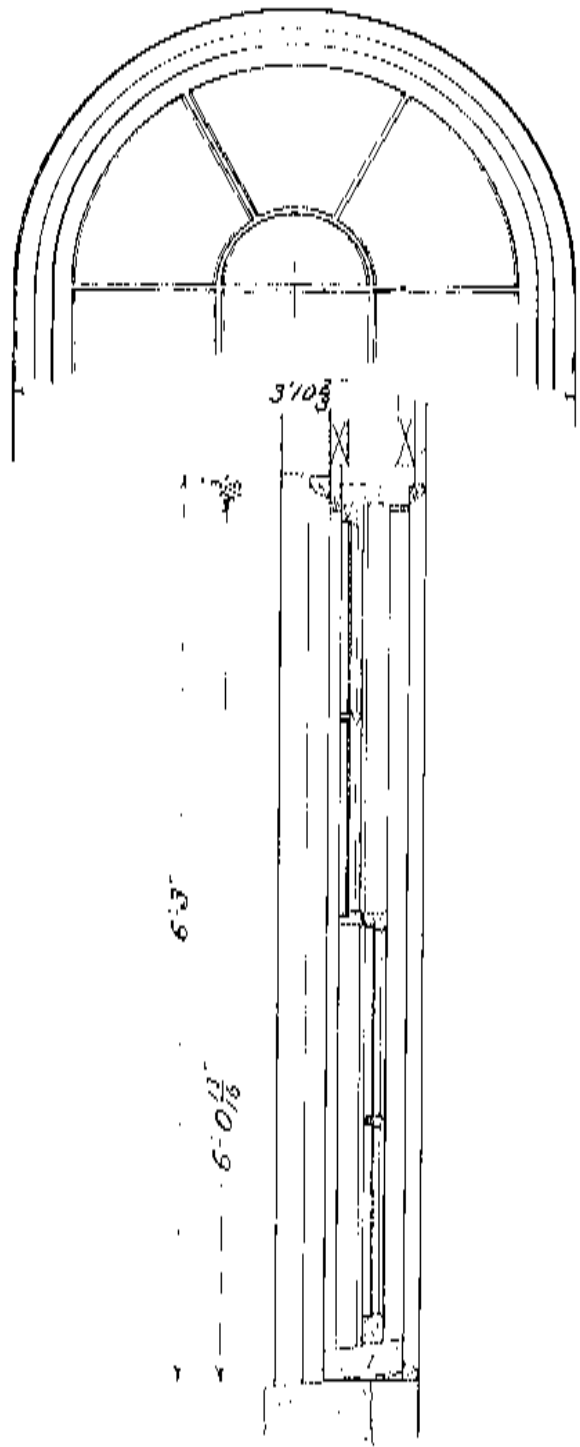

Outside second story windows.

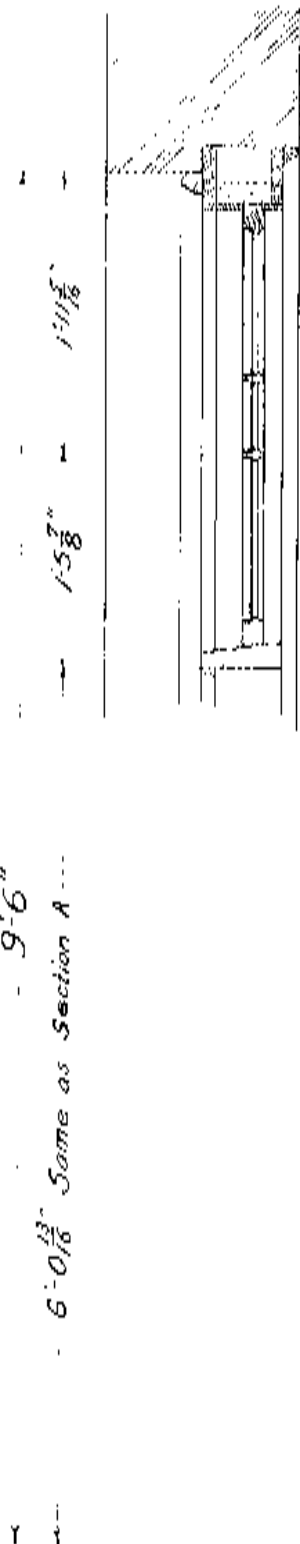

Section for windows having opening of 3'-10 2/3".

Outside first story windows.

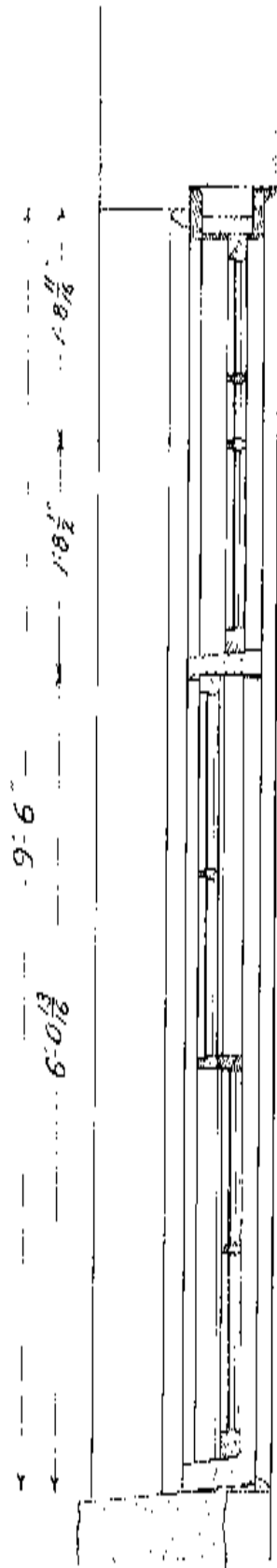

Section for windows having openings of 3'-5 1/3" and 3'-6 2/3".

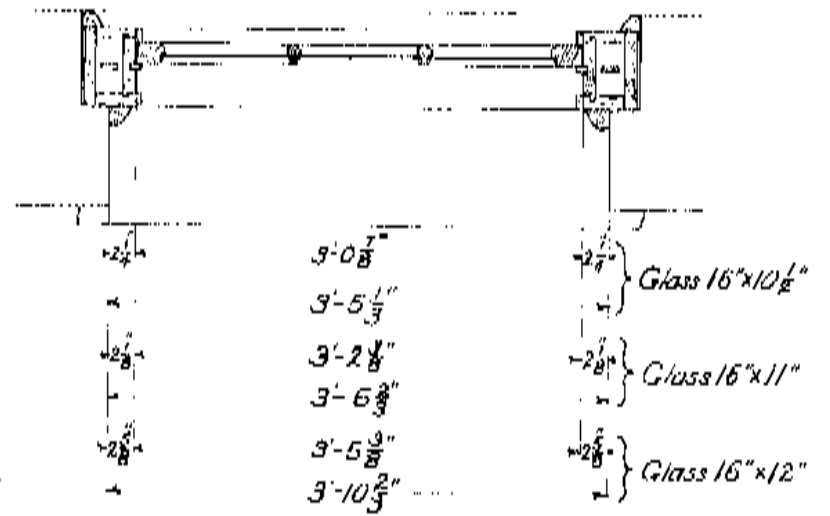
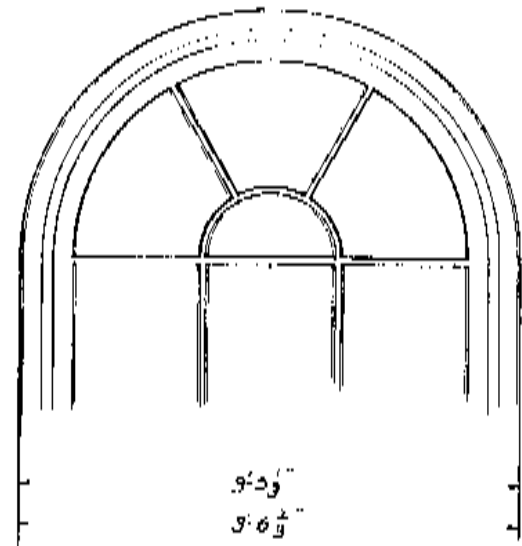

Horizontal section of all windows.

F. 125

NAVY YARD, BOSTON, MASS.

Sh. 25

MARCH 14 1900

BUILDING No. 125
PAINT SHOP FOR C. and R.
Plan Showing Window Sections.

SCALE 1/2 IN. = 1 FT.

C. M. Parke
CIVIL ENGINEER U. S. N.

11 W. A.
12 W. W.
13 W. W.
14 W. W.
15 W. W.

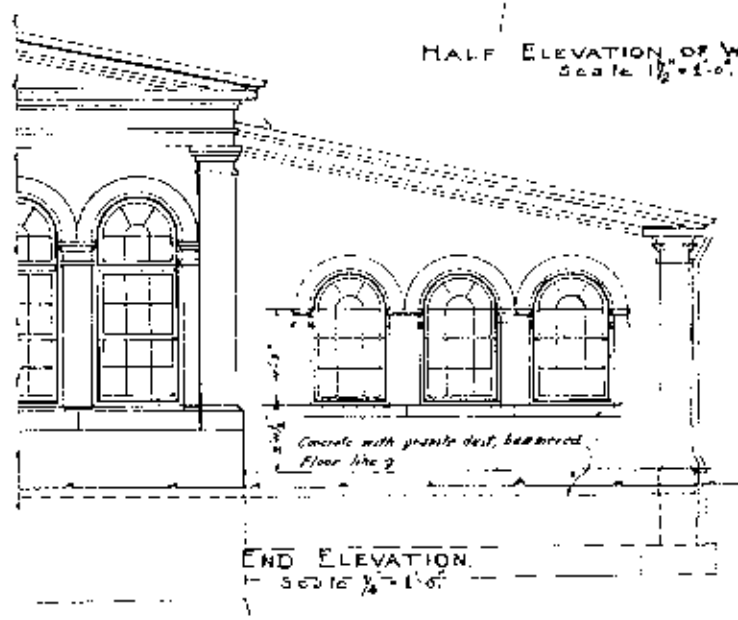
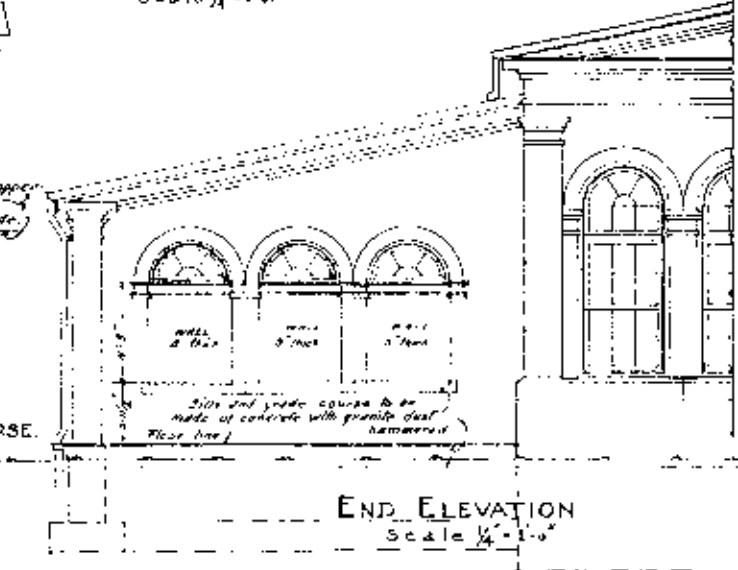
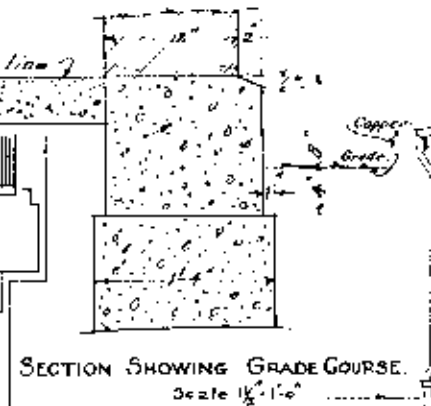
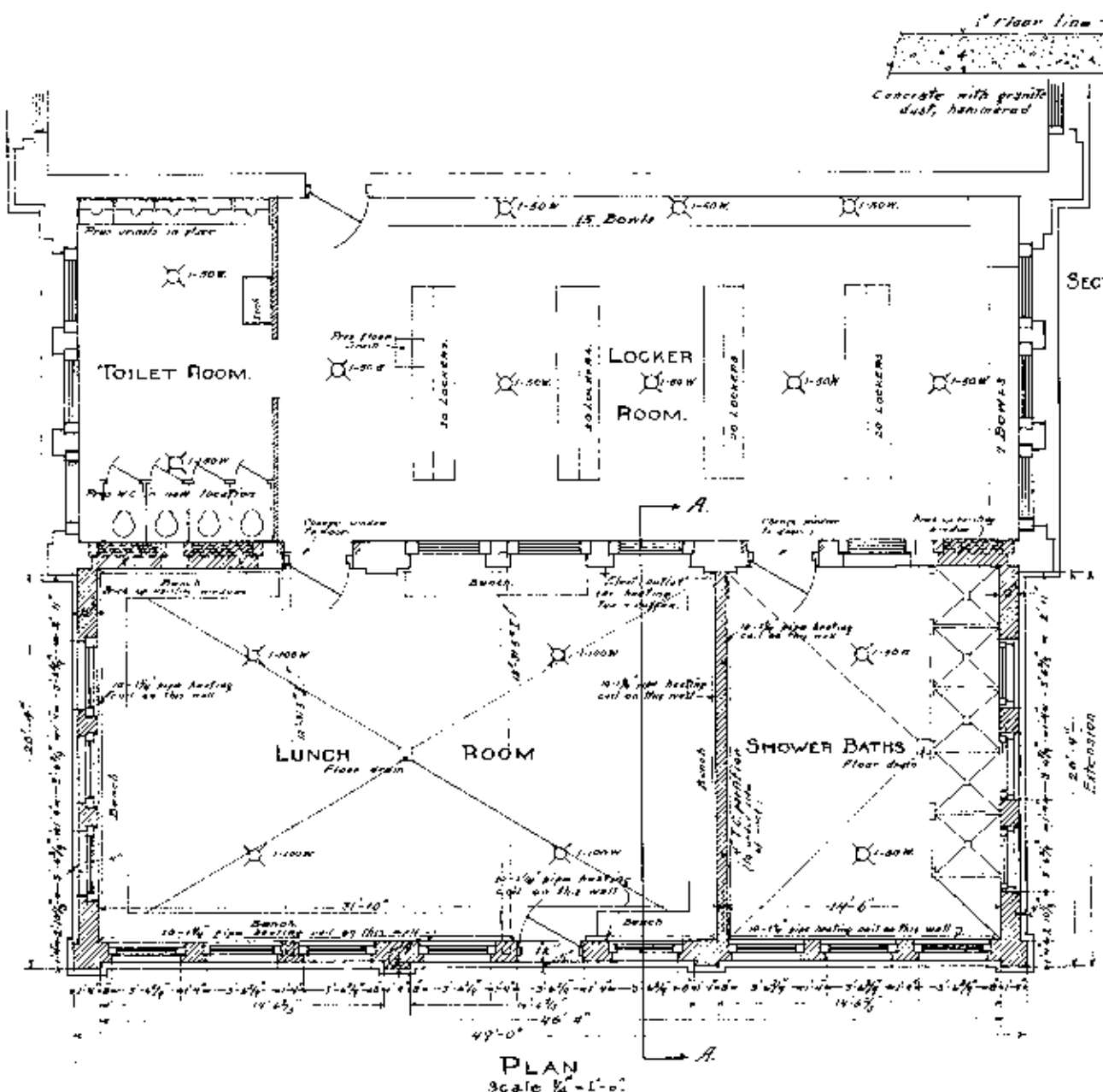
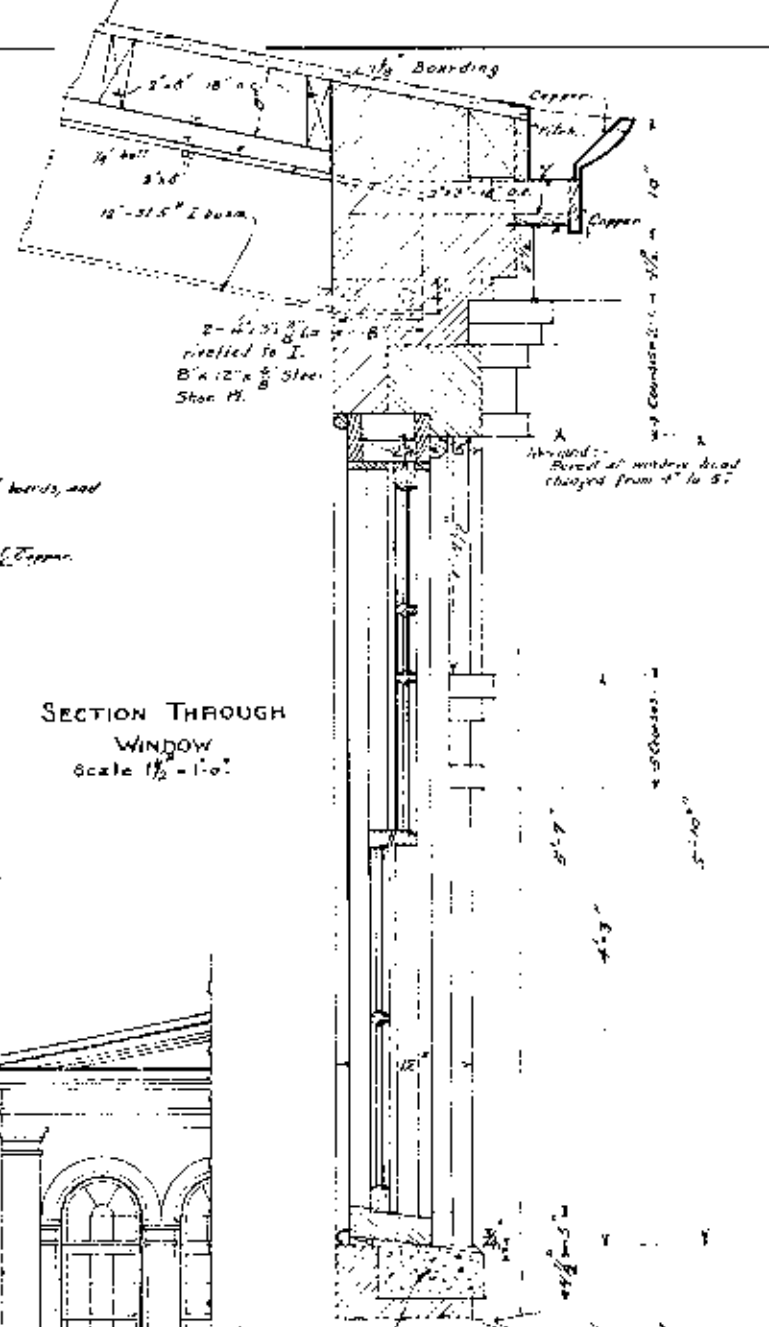
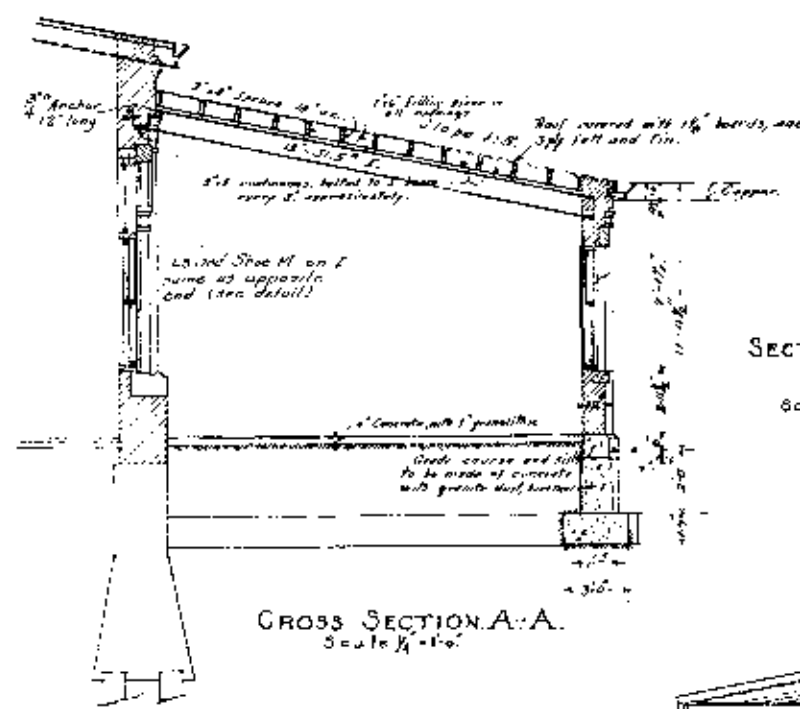
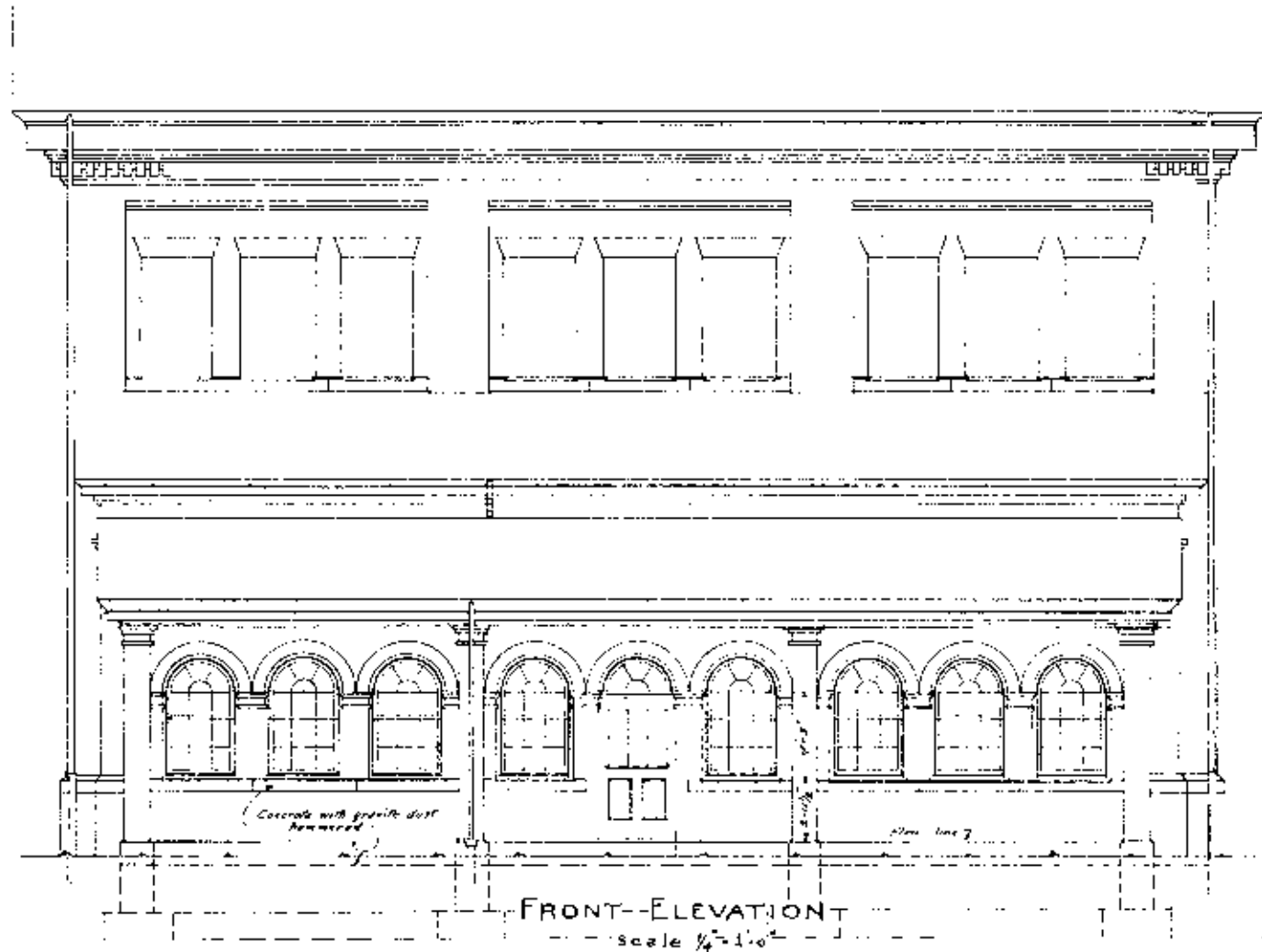

66364 125-41.
BUILDING No. 125,
U. S. NAVY YARD, BOSTON, MASS.
PROPOSED EXTENSION TO BLDG 125
TO BE USED AS LUNCH ROOM.

HRA
M.L.F.
H.L.F.
HWA

SCALE as noted.
RECOMMENDED BY
CIVIL ENGINEER, U.S.N.
BUREAU OF YARDS & DOCKS
DEPARTMENT OF THE NAVY
APPROVED
CHIEF OF BUREAU.

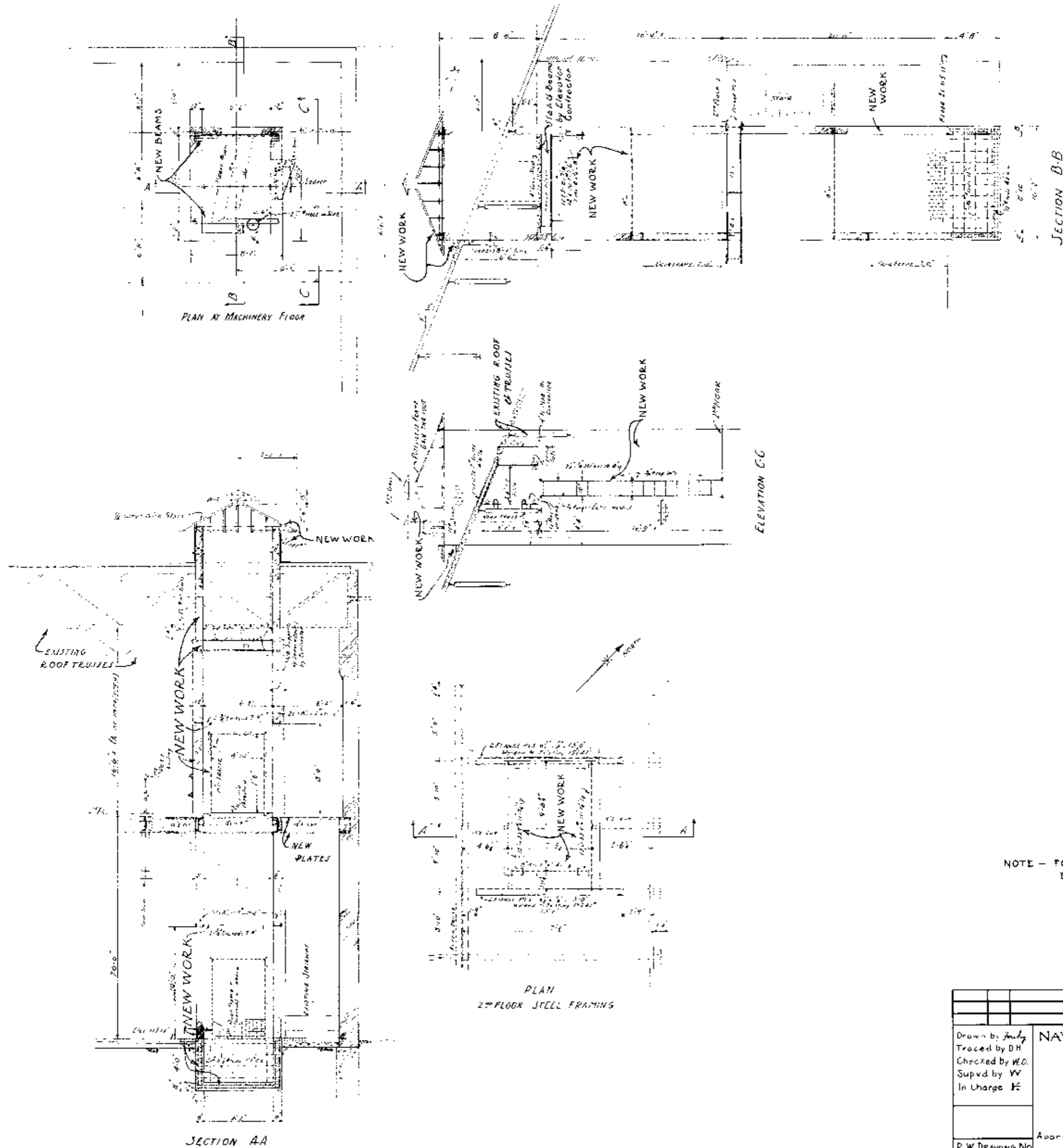

NOTE - FOR DRAWING OF NEW ELEVATOR P.W. 125 45

Drawn by <i>Amby</i>	NAVY YARD BOSTON, MASS.
Traced by <i>DH</i>	
Checked by <i>W.C.</i>	
Supd by <i>W</i>	
In Charge <i>K</i>	BUILDING No 125 ALTERATIONS FOR NEW ELEVATOR.
P. W. Drawing No	Approved FEB. 23, 1939.
125-46	<i>R. W. Deane</i> PUBLIC WORKS OFFICER



6374 J.R.T.Y.
 REF. IS DWG 4 FROM 350-154 OF 11/27/56

3/24/57 H.L.G. S.C.A. E.S.
 1/27 - 11/27/57

SYMBOL		DESCRIPTION		DATE	APPROVAL
REVISIONS					
P.W.O. DRAWING NO.		DEPARTMENT OF THE NAVY		BUREAU OF YARDS & DOCKS	
25 33		NAVAL SHIPYARD		BOSTON, MASS.	
DESIGNED	DATE	CHECKED	DATE	APPROVED	DATE
DRWN	11/27/56	H.L.G.	11/27/56	<i>[Signature]</i>	11/27/56
TRACED					
PROJ. NO.		SCALE		SPEC	

Paul F. Blaska

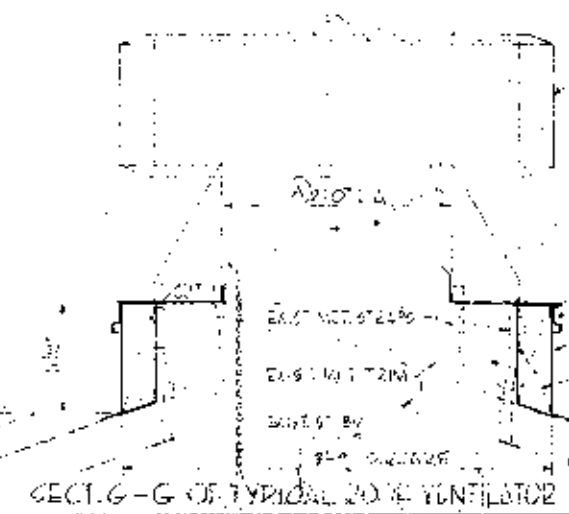
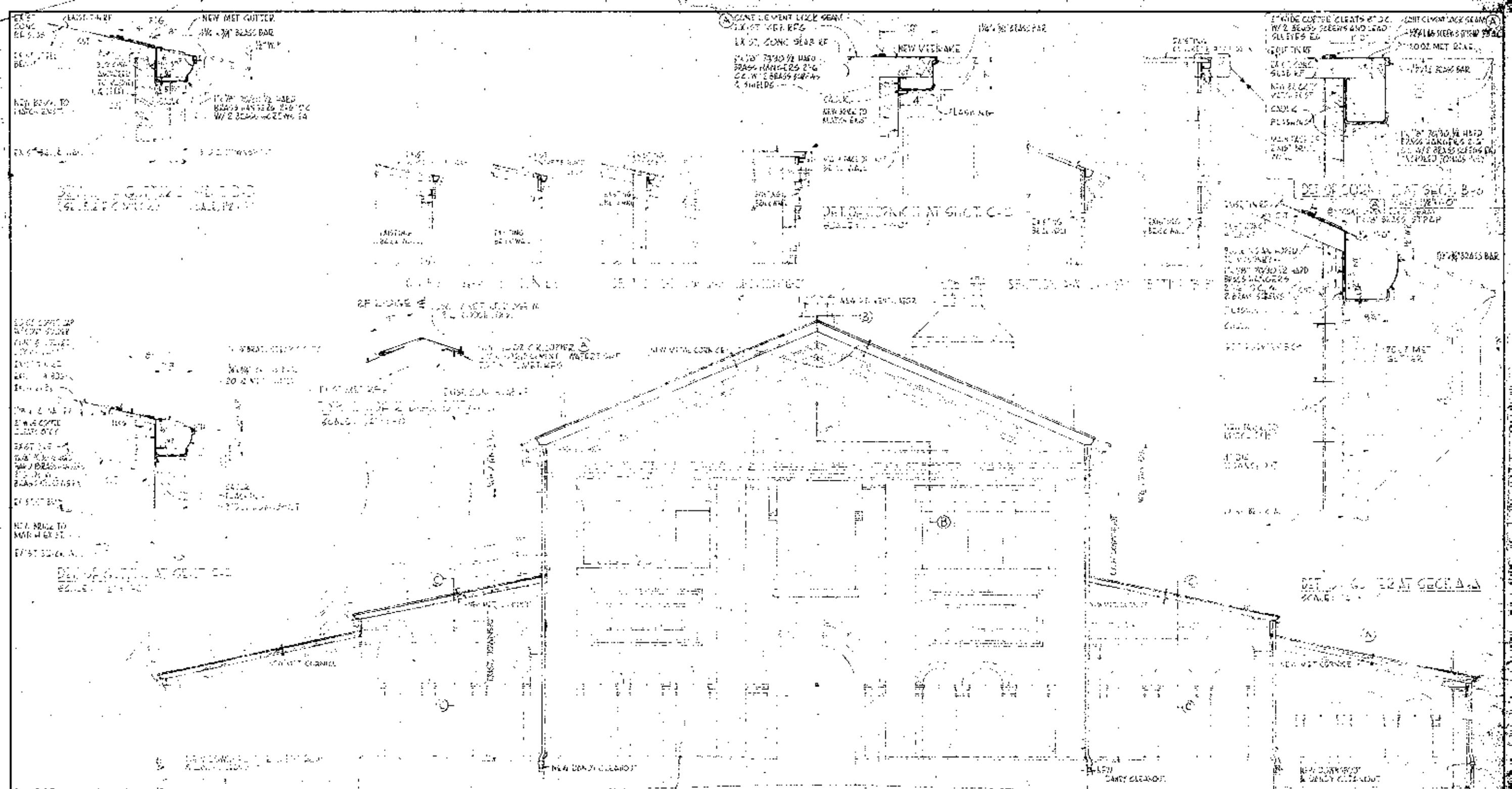

- PART ELEVATION & DETAILS
(WEATHER ELEVATION & PART DETAILS EXCEPT FOR WOOD STRUCTURE)
- 20 IN. GOLD ROLLED COPPER (ROOFING)
 - 36 IN. GOLD ROLLED COPPER COPPER DAMPER WITH IN - 50*
 - BRASS SCREWS
 - BASE FLASHING - 20 IN. GOLD ROLLED COPPER
 - 4 IN. W. CON. ATTACH TO EXIST. MET STEPS W/ #2 BRASS SCREWS & WASHERS
 - 20 IN. WATER-TIGHT PLASTIC CON. SEAL
 - EXIST. TR. RFG
 - EXIST. CONCR. SLAB
- SCALE: 1/2" = 1'-0"

GRAPHIC SCALES

1" = 0' 0"

1/2" = 0' 0"

1/4" = 0' 0"

1/8" = 0' 0"

1/16" = 0' 0"

1/32" = 0' 0"

1/64" = 0' 0"

1/128" = 0' 0"

1/256" = 0' 0"

1/512" = 0' 0"

1/1024" = 0' 0"

1/2048" = 0' 0"

1/4096" = 0' 0"

1/8192" = 0' 0"

1/16384" = 0' 0"

1/32768" = 0' 0"

1/65536" = 0' 0"

1/131072" = 0' 0"

1/262144" = 0' 0"

1/524288" = 0' 0"

1/1048576" = 0' 0"

1/2097152" = 0' 0"

1/4194304" = 0' 0"

1/8388608" = 0' 0"

1/16777216" = 0' 0"

1/33554432" = 0' 0"

1/67108864" = 0' 0"

1/134217728" = 0' 0"

1/268435456" = 0' 0"

1/536870912" = 0' 0"

1/1073741824" = 0' 0"

1/2147483648" = 0' 0"

1/4294967296" = 0' 0"

1/8589934592" = 0' 0"

1/17179869184" = 0' 0"

1/34359738368" = 0' 0"

1/68719476736" = 0' 0"

1/137438953472" = 0' 0"

1/274877906944" = 0' 0"

1/549755813888" = 0' 0"

1/1099511627776" = 0' 0"

1/2199023255552" = 0' 0"

1/4398046511104" = 0' 0"

1/8796093022208" = 0' 0"

1/17592186044416" = 0' 0"

1/35184372088832" = 0' 0"

1/70368744177664" = 0' 0"

1/140737488355328" = 0' 0"

1/281474976710656" = 0' 0"

1/562949953421312" = 0' 0"

1/1125899906842624" = 0' 0"

1/2251799813685248" = 0' 0"

1/4503599627370496" = 0' 0"

1/9007199254740992" = 0' 0"

1/18014398509481984" = 0' 0"

1/36028797018963968" = 0' 0"

1/72057594037927936" = 0' 0"

1/144115188075855872" = 0' 0"

1/288230376151711744" = 0' 0"

1/576460752303423488" = 0' 0"

1/1152921504606846976" = 0' 0"

1/2305843009213693952" = 0' 0"

1/4611686018427387904" = 0' 0"

1/9223372036854775808" = 0' 0"

1/18446744073709551616" = 0' 0"

1/36893488147419103232" = 0' 0"

1/73786976294838206464" = 0' 0"

1/147573952589676412928" = 0' 0"

1/295147905179352825856" = 0' 0"

1/590295810358705651712" = 0' 0"

1/1180591620717411303424" = 0' 0"

1/2361183241434822606848" = 0' 0"

1/4722366482869645213696" = 0' 0"

1/9444732965739290427392" = 0' 0"

1/18889465931478580854784" = 0' 0"

1/37778931862957161709568" = 0' 0"

1/75557863725914323419136" = 0' 0"

1/151115727451828646838272" = 0' 0"

1/302231454903657293676544" = 0' 0"

1/604462909807314587353088" = 0' 0"

1/1208925819614629174706176" = 0' 0"

1/2417851639229258349412352" = 0' 0"

1/4835703278458516698824704" = 0' 0"

1/9671406556917033397649408" = 0' 0"

1/19342813113834066795298816" = 0' 0"

1/38685626227668133590597632" = 0' 0"

1/77371252455336267181195264" = 0' 0"

1/154742504910672534362390528" = 0' 0"

1/309485009821345068724781056" = 0' 0"

1/618970019642690137449562112" = 0' 0"

1/1237940039285380274899124224" = 0' 0"

1/2475880078570760549798248448" = 0' 0"

1/4951760157141521099596496896" = 0' 0"

1/9903520314283042199192993792" = 0' 0"

1/19807040628566084398385987584" = 0' 0"

1/39614081257132168796771975168" = 0' 0"

1/79228162514264337593543950336" = 0' 0"

1/158456325028528675187087900672" = 0' 0"

1/316912650057057350374175801344" = 0' 0"

1/633825300114114700748351602688" = 0' 0"

1/1267650600228229401496703205376" = 0' 0"

1/2535301200456458802993406410752" = 0' 0"

1/5070602400912917605986812821504" = 0' 0"

1/10141204801825835211973625643008" = 0' 0"

1/20282409603651670423947251286016" = 0' 0"

1/40564819207303340847894502572032" = 0' 0"

1/81129638414606681695789005144064" = 0' 0"

1/162259276829213363391578002288128" = 0' 0"

1/324518553658426726783156004576256" = 0' 0"

1/649037107316853453566312009152512" = 0' 0"

1/1298074214633706907132624018240224" = 0' 0"

1/2596148429267413814265248036480448" = 0' 0"

1/5192296858534827628530496072960896" = 0' 0"

1/10384593717069655257060992145917952" = 0' 0"

1/20769187434139310514121984291835904" = 0' 0"

1/41538374868278621028243968583671808" = 0' 0"

1/83076749736557242056487937167343616" = 0' 0"

1/166153499473114484112975874334687232" = 0' 0"

1/332306998946228968225951748669374464" = 0' 0"

1/664613997892457936451903497338748928" = 0' 0"

1/132922799578491587290380699467747856" = 0' 0"

1/265845599156983174580761398935495712" = 0' 0"

1/531691198313966349161522797870991424" = 0' 0"

1/1063382396627932698323045595741982848" = 0' 0"

1/2126764793255865396646091191483965696" = 0' 0"

1/4253529586511730793292182382967931392" = 0' 0"

1/8507059173023461586584364765935862784" = 0' 0"

1/17014118346046923173168729531871725568" = 0' 0"

1/34028236692093846346337459063743451136" = 0' 0"

1/68056473384187692692674918127486902272" = 0' 0"

1/136112946768375385385349836254973804544" = 0' 0"

1/272225893536750770770699672509947609088" = 0' 0"

1/544451787073501541541399345019895218176" = 0' 0"

1/1088903574147003083082798690039790436352" = 0' 0"

1/21778071482940061661655973800795808726848" = 0' 0"

1/43556142965880123323311947601591617533696" = 0' 0"

1/87112285931760246646623895203183235067136" = 0' 0"

1/1742245718355204932932477904063646013344" = 0' 0"

1/3484491436710409865864955808126728206688" = 0' 0"

1/6968982873420819731729911616253456413376" = 0' 0"

1/13937965746841639463459823232506912266752" = 0' 0"

1/27875931493683278926919646465013824533504" = 0' 0"

1/55751862987366557853839292930027648667008" = 0' 0"

1/111503725974733115707678585860055297334112" = 0' 0"

1/223007451949466231415357171720110584468224" = 0' 0"

1/44601490389893246283071434344022168936448" = 0' 0"

1/89202980779786492566142868688044337872896" = 0' 0"

1/178405961559572985132285737376088675745792" = 0' 0"

1/356811923119145970264571474752177351491584" = 0' 0"

1/713623846238291940529142949504354702983072" = 0' 0"

1/1427247692476583881058285899008709405966144" = 0' 0"

1/2854495384953167762116571798017418811322288" = 0' 0"

1/5708990769906335524233143596034837622644576" = 0' 0"

1/11417981539812671048466287192069674445289152" = 0' 0"

1/22835963079625342096932574384139348890579264" = 0' 0"

1/4567192615925068419386514876827869778115808" = 0' 0"

1/9134385231850136838773029753655739556231616" = 0' 0"

1/18268770477100273677546059507311479112423232" = 0' 0"

1/36537540954200547355092119014622958224846464" = 0' 0"

1/730750819084010947101842380292459164496928" = 0' 0"

1/1461501638168021894203684640584918328979552" = 0' 0"

1/2923003276336043788407369281169836657959104" = 0' 0"

1/584600655267208757681473856233967331591808" = 0' 0"

1/1169201310534417515362947712467934663183616" = 0' 0"

1/2338402621068835030725895424935869326367232" = 0' 0"

1/4676805242137670061451790849871738652734464" = 0' 0"

1/93536104842753401229035816997434773054688" = 0' 0"

1/187072209685506802458071639994869546109376" = 0' 0"

1/374144419371013604916143279989739092218752" = 0' 0"

1/748288838742027209832286559979478184437504" = 0' 0"

1/1496577677484054391664573159958956368875008" = 0' 0"

1/2993155354968108783329146319917913377750112" = 0' 0"

1/5986310709936217566658292639835826755500224" = 0' 0"

1/11972621419872435133316585279671653511000448" = 0' 0"

1/23945242839744870266633170559343307022000896" = 0' 0"

1/47890485679489740533266341118686614044001792" = 0' 0"

1/9578097135897948106653268223737322808800384" = 0' 0"

1/19156194271795896213306536447474645617600768" = 0' 0"

1/38312388543591792426613072895949291235201536" = 0' 0"

1/76624777087183584853226145791898582470403072" = 0' 0"

1/15324955417436716970645229158397176944060144" = 0' 0"

1/30649910834873433941290458316794353888120288" = 0' 0"

1/61299821669746867882580916633588707776404576" = 0' 0"

1/122599643339493735765161833267177415552809152" = 0' 0"

1/245199286678987471530323666534354831105618304" = 0' 0"

1/490398573357974943060647333068709662211136208" = 0' 0"

1/980797146715949886121294666137419324422272416" = 0' 0"

1/196159429343189977224258933227483848844454432" = 0' 0"

1/3923188586863799544485178664549676976889088" = 0' 0"

1/7846377173727599088970357329099353937778176" = 0' 0"

1/15692754347455198177940714658198670775556352" = 0' 0"

1/31385508694910396355881429116397341551112704" = 0' 0"

1/6277101738982079271177285823279468310222528" = 0' 0"

1/12554203477964158542354571646558966204445152" = 0' 0"

1/2510840695592831708470914329311793240889024" = 0' 0"

1/5021681391185663416941828658623586481778048" = 0' 0"

1/10043362782371326833883657317247172963556096" = 0' 0"

1/20086725564742653667767314634494345927112192" = 0' 0"

1/40173451129485307335534629268988691454224384" = 0' 0"

1/8034690225897061467110925853797738290844768" = 0' 0"

1/16069380451794122934221851707595476581689536" = 0' 0"

1/32138760903588245868443703415190953163379104" = 0' 0"

1/6427752180717649173688740683038190632675808" = 0' 0"

1/12855504361435298347377481366077801255351616" = 0' 0"

1/25711008722870596694754962732155602510703232" = 0' 0"

1/514220174457411933895099254643112050214064" = 0' 0"

1/1028440348914823867790198509286224100428128" = 0' 0"

1/2056880697829647735580397018572448200856256" = 0' 0"

1/4113761395659295471160794037144896401712512" = 0' 0"

1/8227522791318590942321588074289788803425024" = 0' 0"

1/16455045782637181884643176148595777666850496" = 0' 0"

1/32910091565274363769286352297191555333700992" = 0' 0"

1/65820183130548727538572704594383106674001984" = 0' 0"

1/131640366261097455077145409188762213348003968" = 0' 0"

1/263280732522194910154290818377524426696007936" = 0' 0"

1/526561465044389820308581636755048853392015872" = 0' 0"

1/1053122930088779640617163273510097706784031744" = 0' 0"

1/2106245860177559281234326547020195413568063488" = 0' 0"

1/4212491720355118562468653094040390827136126976" = 0' 0"

1/8424983440710237124937306188080781654272253952" = 0' 0"

1/1684996688142047444987461377616156330854450784" = 0' 0"

1/336999337628409488997492275523231266168891536" = 0' 0"

1/673998675256818977994984551046424532337783072" = 0' 0"

1/1347997350513637955989969022088490644675566144" = 0' 0"

1/2695994701027275911979938044176981293351132288" = 0' 0"

1/5391989402054551823959876088353962566702264576" = 0' 0"

1/10783978804109103647919752176707925133404511152" = 0' 0"

1/21567957608218207295839504353415850266809022304" = 0' 0"

1/43135915216436414591679008706831700533618044608" = 0' 0"

1/86271830432872829183358017413663401067236091216" = 0' 0"

1/172543660865745658366716034827326802134472182432" = 0' 0"

1/34508732173149131673343206965465360426894426464" = 0' 0"

1/690174643462982633466864139309307208537888512128" = 0' 0"

1/138034928692596526693372827861861417075777024256" = 0' 0"

1/276069857385193053386745655723722824151554444512" = 0' 0"

1/552139714770386106773491311447445648303108889024" = 0' 0"

1/1104279429540772213546982622894891366606217778048" = 0' 0"

1/220855885908154442709396524578978273321243556096" = 0' 0"

1/441711771816308885418793049157956546642487112192" = 0' 0"

1/883423543632617770837586098315913113328944224384" = 0' 0"

1/1766847087265235541675172196631262266568888448768" = 0' 0"

1/353369417453047108335034439326252453313777779536" = 0' 0"

1/706738834906094216670068878652504906627555559072" = 0' 0"

1/1413477669812188433340137773305009813325111118144" = 0' 0"

1/2826955339624376866680275466610019666452222236288" = 0' 0"

1/5653910679248753733360550933220039333284444472576" = 0' 0"

1/11307821358497507466721101866440078666488888445152" = 0' 0"

1/2261564271699501493344220373288015333297777789024" = 0' 0"

1/4523128543399002986688440746576028666595555578048" = 0' 0"

1/9046257086798005973376881493155257333191111156096" = 0' 0"

1/18092514173596011946753762986310554666382222312192" = 0' 0"

1/36185028347192023893507525972621109333644444624384" = 0' 0"

1/723700

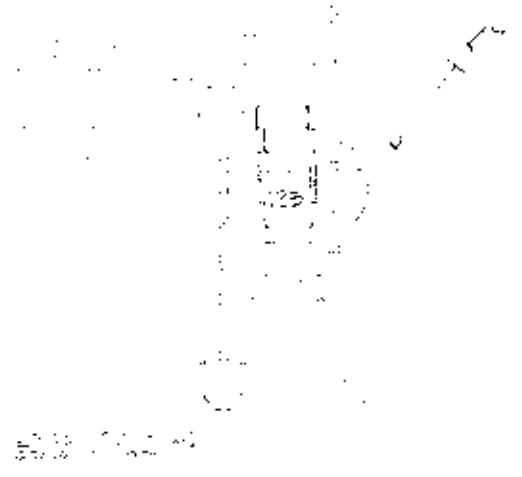
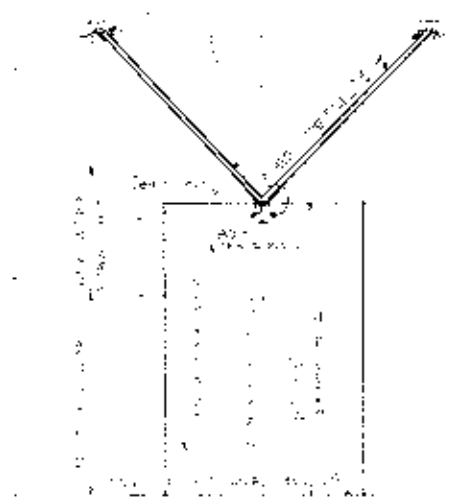
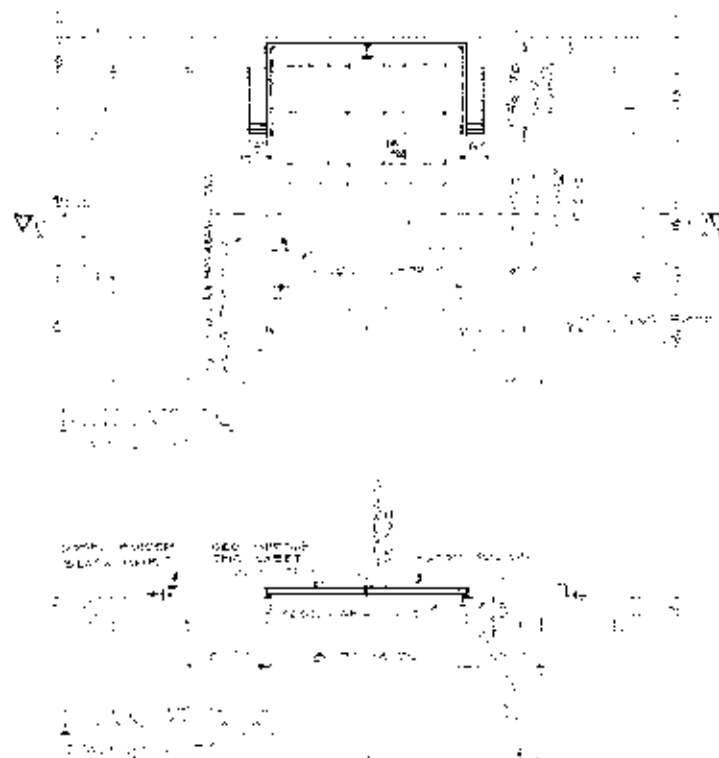

DIMENSIONS
 SEE SHEET
 THE SHEET

THIS DRAWING IS TO BE USED FOR THE
 CONSTRUCTION OF THE
 STRUCTURE SHOWN HEREON.
 ALL DIMENSIONS ARE TO FACE UNLESS
 OTHERWISE SPECIFIED.
 MATERIALS TO BE USED SHALL BE AS
 SPECIFIED IN THE NOTES.
 THE CONTRACTOR SHALL BE RESPONSIBLE
 FOR OBTAINING ALL NECESSARY
 PERMITS AND APPROVALS.
 THE CONTRACTOR SHALL BE RESPONSIBLE
 FOR OBTAINING ALL NECESSARY
 PERMITS AND APPROVALS.

SECTION A-A
 SECTION B-B
 SECTION C-C
 SECTION D-D
 SECTION E-E
 SECTION F-F
 SECTION G-G
 SECTION H-H
 SECTION I-I
 SECTION J-J
 SECTION K-K
 SECTION L-L
 SECTION M-M
 SECTION N-N
 SECTION O-O
 SECTION P-P
 SECTION Q-Q
 SECTION R-R
 SECTION S-S
 SECTION T-T
 SECTION U-U
 SECTION V-V
 SECTION W-W
 SECTION X-X
 SECTION Y-Y
 SECTION Z-Z

BOSTON NAVAL SHIPYARD
 BOSTON, MASS.

Revision	Date	Appr.	Description	By
P. W. DRAWING NO.		BOSTON NAVAL SHIPYARD		
100-100		BOSTON, MASS.		
Designed	10/10/50	BY: [Signature]		
Drawn	10/10/50	BY: [Signature]		
Date	10/10/50	BY: [Signature]		
Checked	10/10/50	BY: [Signature]		
Unit Supr.	10/10/50	BY: [Signature]		
Dist. Supr.	10/10/50	BY: [Signature]		
SCALE	AS SHOWN	APPROVED	[Signature]	
PROJ. NO.	100-100	DATE	10/10/50	By: [Signature]
[Signature]		[Signature]		

BOSTON NAVAL SHIPYARD
 BOSTON, MASS.

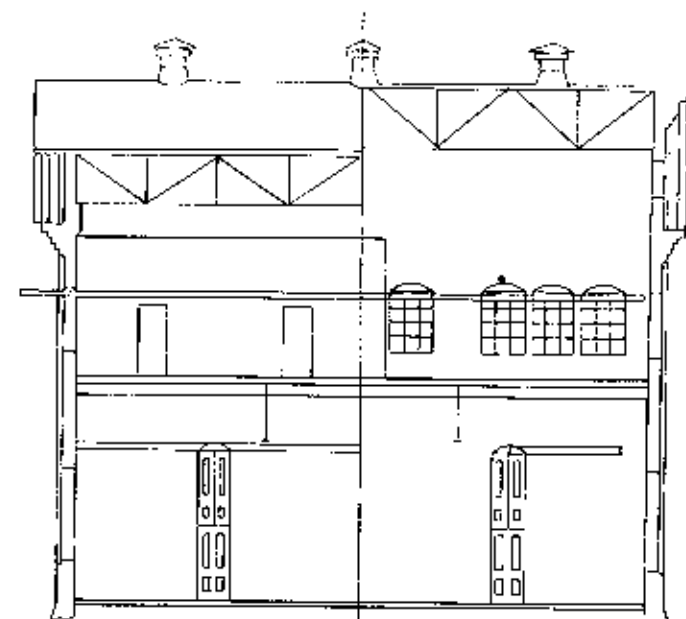
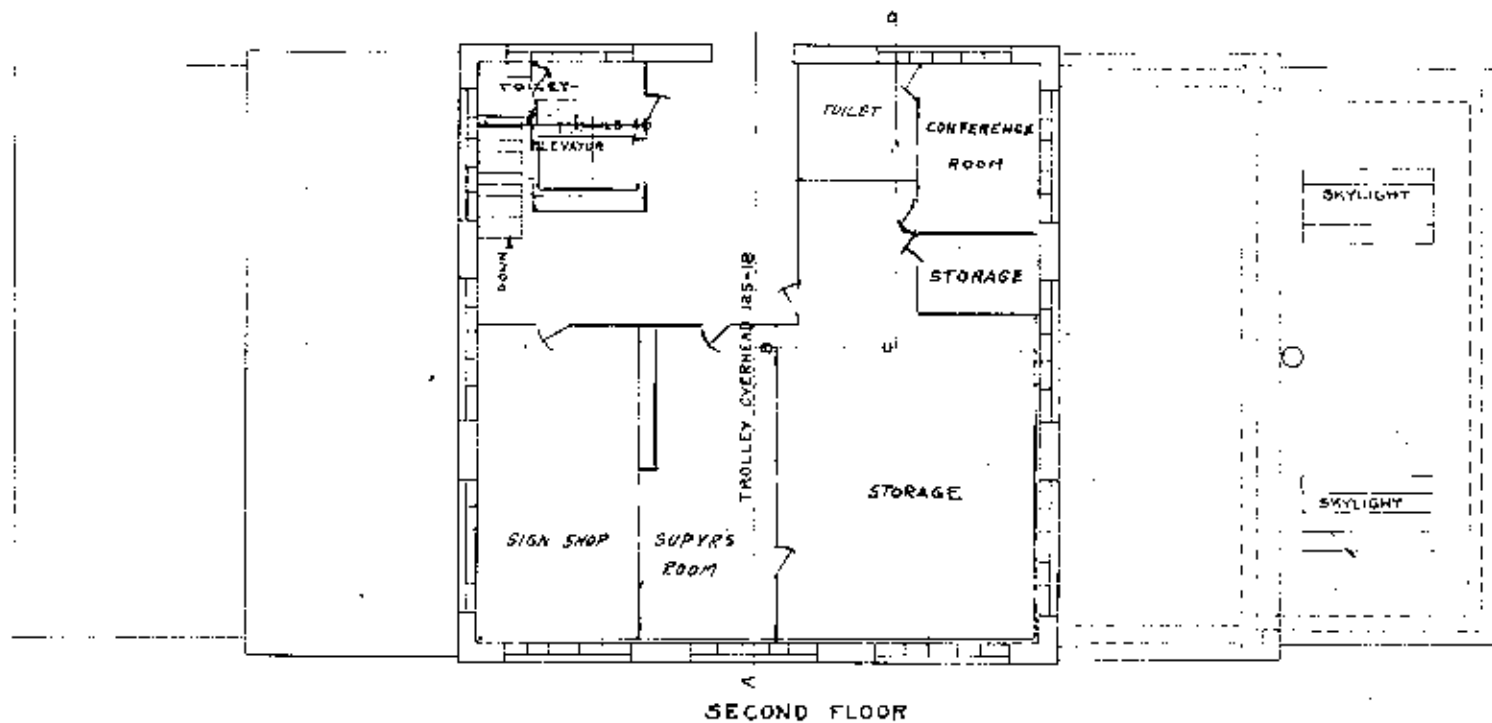

SECTION ABCD

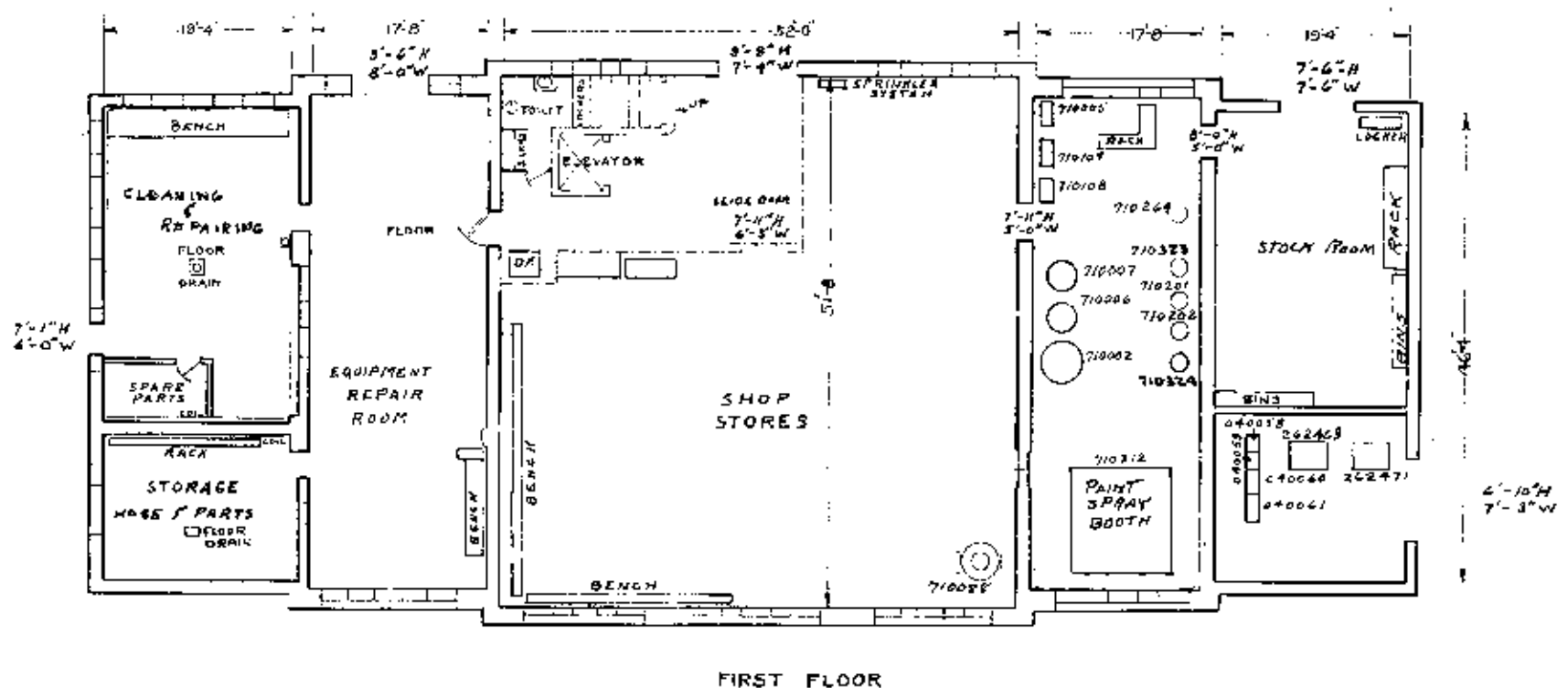

FIRST FLOOR

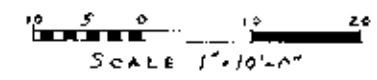
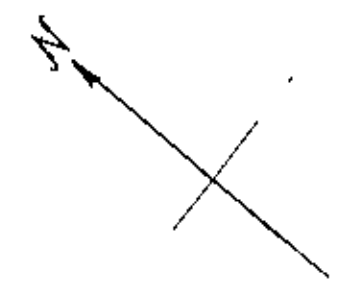

PAINT SHOP
 BUILDING NUMBER 125
 ARRANGEMENT OF EQUIPMENT
 NAVY YARD, BOSTON

DRAWN BY J.C.G.
 TRACED BY J.C.G.
 CHECKED BY W.J.M.

REVISIONS				REVISIONS			
DATE	APPROD DATE	APPROD DATE	APPROD DATE	APPROD DATE	APPROVED DATE	APPROVED DATE	APPROVED DATE
JAN 1944	DEC 30, 1934	JUNE 1941	JUN 1942	APR 1945	JULY 1 1922	JULY 1 1924	JULY 1 1928
JUNE 1944	JULY 1936	MAR 1942	MAR 1944	SEP 1945	JAN 31 1923	JULY 1 1926	JULY 1 1930
JULY 1944	JULY 1932	JULY 1944	JULY 1944	SEP 1945	JULY 1 1923	NOV 15 1926	DEC 30 1932

A. H. Gage, U.S.N.
 MANAGER
 PLAN NO. 30161
 SHEET NO. 1
 DATE JUNE 30, 1921

100

100

100

100

100

100

100