



Aviation Rulemaking Advisory Committee Fuel Tank Inerting Harmonization Working Group

Submitted jointly by:
AEA, AECMA, AIA, ALPA,
API, ATA, FAA, IAM, JAA,
and NADA/F

Team Reports

June 2001



Association of European Airlines

*NATIONAL AIR DISASTER
ALLIANCE/FOUNDATION*



Air Transport Association of America

European Association
of Aerospace Industries



This page intentionally left blank.

Safety Task Team Report

TABLE OF CONTENTS

APPENDIX A	TASKING STATEMENT.....	A-1
APPENDIX B	ARAC FUEL TANK INERTING HARMONIZATION GROUP ORGANIZATION.....	B-1
APPENDIX C	GROUND-BASED INERTING DESIGNS TASK TEAM FINAL REPORT.....	C-1
	TABLE OF CONTENTS.....	C-iii
	LIST OF FIGURES.....	C-v
APPENDIX D	ONBOARD INERTING DESIGNS TASK TEAM FINAL REPORT.....	D-1
	TABLE OF CONTENTS.....	D-iii
	LIST OF FIGURES.....	D-viii
APPENDIX E	AIRPORT FACILITIES TASK TEAM FINAL REPORT.....	E-1
	TABLE OF CONTENTS.....	E-iii
	LIST OF FIGURES.....	E-iv
APPENDIX F	AIRPLANE OPERATION AND MAINTENANCE TASK TEAM FINAL REPORT.....	F-1
	TABLE OF CONTENTS.....	F-iii
	LIST OF FIGURES.....	F-vi
APPENDIX G	ESTIMATING AND FORECASTING TASK TEAM FINAL REPORT.....	G-1
	TABLE OF CONTENTS.....	G-iii
	LIST OF FIGURES.....	G-iv
APPENDIX H	SAFETY ANALYSIS TASK TEAM FINAL REPORT.....	H-1
	TABLE OF CONTENTS.....	H-iii
	LIST OF FIGURES.....	H-iv
APPENDIX I	RULEMAKING TASK TEAM FINAL REPORT.....	I-1
	TABLE OF CONTENTS.....	I-iii

This page intentionally left blank.

GLOSSARY

AC	advisory circular
AD	Airworthiness Directive
AEA	Association of European Airlines
AECMA	European Association of Aerospace Industries
AIA	Aerospace Industries Association
ALPA	Airline Pilots Association
API	American Petroleum Institute
APU	auxiliary power unit
ARAC	Aviation Rulemaking Advisory Committee
ASM	air separator module
ASTM D	an ASTM test designation
ASTM	American Society for Testing and Materials
ATA	Air Transport Association of America
ATB	air turnback
BITE	built-in test equipment
CBT	computer-based training
CFR	Code of Federal Regulations
CMR	certification maintenance requirement
CRC	Coordinating Research Council
CWT	center wing tank
DDG	dispatch deviation guide
DOT	Department of Transportation
EPA	Environmental Protection Agency
ER	extended range
ERA-7	an additive for CO ₂ -enriched fuel
ETOPS	extended twin operations
FAR	Federal Aviation Regulation
FHA	functional hazard analysis
FTHWG	Fuel Tank Harmonization Working Group
FTIHWG	Fuel Tank Inerting Harmonization Working Group
GBI	ground-based inerting
GBIS	ground-based inerting system
GN ₂	gaseous nitrogen
GPM	gallons per minute
HCWT	heated center wing tank
HWG	Harmonization Working Group
IAMAW	International Association of Machinist Aerospace Workers
IATA	International Air Transport Association
JAA	Joint Airworthiness Authorities
JAR	Joint Aviation Requirements

LFL	lower flammability limit
MEL	minimum equipment list
MMEL	master minimum equipment list
MO	modification order
MSG-3	Maintenance Steering Group—Version 3
MTBF	mean time between failures
MTBMA	mean time between maintenance actions
MTBUR	mean time between unscheduled removal
NEA	nitrogen-enriched air
NIOSH	National Institute of Occupational Safety and Health
NPRM	Notice of Proposed Rulemaking
NSF	nitrogen-saturated fuel
NTSB	National Transportation Safety Board
OBI	onboard ground inerting
OBGIS	onboard ground inerting system
OBI	onboard inerting
OBIGGS	onboard inert gas generating system
OEM	original equipment manufacturer
OSHA	Occupational Safety and Health Administration
p/m	parts per million
PRV	pressure-regulating valve
PSA	pressure-swing adsorption
SB	service bulletin
SCF	standard cubic feet
SCFM	standard cubic feet per minute
SFAR	Special Federal Aviation Regulation
TC	type certificate
TCAS	traffic collision avoidance system
UFL	upper flammability limit
VOC	volatile organic compound

Appendix A
Tasking Statement

This page intentionally left blank.

Tasking Statement

[4910-13]

DEPARTMENT OF TRANSPORTATION

Federal Aviation Administration

Aviation Rulemaking Advisory Committee - New Task

AGENCY: Federal Aviation Administration (FAA), DOT.

ACTION: Notice of a new task assignment for the Aviation Rulemaking Advisory Committee (ARAC).

SUMMARY: Notice is given of a new task assigned to and accepted by the Aviation Rulemaking Advisory Committee (ARAC). This notice informs the public of the activities of ARAC.

FOR FURTHER INFORMATION CONTACT: Anthony F. Fazio, Director, Office of Rulemaking, ARM-1, Federal Aviation Administration, 800 Independence Avenue, SW., Washington, DC 20591; telephone (202) 267-9677 or fax (202) 267-5075.

SUPPLEMENTARY INFORMATION:

Background

The FAA has established an Aviation Rulemaking Advisory Committee to provide advice and recommendations to the FAA Administrator, through the Associate Administrator for Regulation and Certification, on the full range of the FAA's rulemaking activities with respect to aviation-related issues. This includes obtaining advice and recommendations on the FAA's commitment to harmonize its Federal Aviation Regulations and practices with Europe and Canada.

The Task

This notice is to inform the public that the FAA has asked ARAC to provide advice and recommendation on the following harmonization task:

The ARAC Executive Committee will establish a Fuel Tank Inerting Harmonization Working Group. The Fuel Tank Inerting Harmonization Working Group will prepare a report to the FAA that provides recommended regulatory text for new rulemaking and the data needed for the FAA to evaluate the options for implementing new regulations that would require eliminating or significantly reducing the development of flammable vapors in fuel tanks on in-service, new production, and new type design transport category airplanes. The level of reduction in flammable vapors that would be proposed in this FAA rulemaking would be based on achieving the lowest flammability level that could be provided by a design that would meet FAA regulatory evaluation requirements. This effort is an extension of the previous work performed by the Fuel Tank Harmonization Working Group.

The report should contain a detailed discussion of the technical issues associated with the prevention of, or reduction in, the exposure of fuel tanks to a flammable environment through the use of the following inerting design methods, and any other inerting methods determined by the Working Group, or its individual members, to merit consideration.

Ground-Based Inerting: The system shall inert fuel tanks that are located near significant heat sources or do not cool at a rate equivalent to an unheated wing tank using ground based nitrogen gas supply equipment. The affected fuel tanks shall be inerted once the airplane reaches the gate and while the airplane is on the ground between flights.

On-Board Ground-Inerting: The system shall inert fuel tanks that are located near significant heat sources or are not cooled at a rate equivalent to an unheated wing tank using on-board nitrogen gas generating equipment. The affected fuel tanks shall be inerted while the airplane is on the ground between flights.

On-Board Inert Gas Generating System (OBIGGS): The system shall inert all fuel tanks with an on-board nitrogen gas generating system such that the tanks remain inert during normal ground and typical flight operations. Non-normal operations are not to be included in the OBIGGS mission requirements. For example, the tanks should remain inert during normal takeoff, climb, cruise, descent, landing, and ground operations (except for ground maintenance operations when the fuel tank must be purged for maintenance access); however, the fuel tanks do not need to remain inert during non-normal operations such as during an emergency descent.

For the purposes of this task, an "unheated wing tank" is a conventional aluminum structure, integral tank of a subsonic transport wing, with minimum heat input from aircraft systems or other fuel tanks that are heated. This is the same definition provided in draft Advisory Circular 25.981-2X that was made available for comment by the notice published in the Federal Register on February 2, 2000.

The report shall provide detailed discussion of technical considerations (both pro and con), as well as comparisons between each of the above design methods for incorporation into the following portion of the large transport airplane fleet: (a) in-service airplanes, (b) new production airplanes, and (c) new airplane designs. Because the working group may consist of members having differing views regarding the technical issues associated with inerting fuel tanks, the report should include discussion of such views and any supporting information provided by the membership.

In developing recommendations to the FAA, the report should also include consideration of the following:

1. The threat of fuel tank explosions used in the analysis should include explosions due to internal and external tank ignition sources for the major fuel system designs making up the transport fleet, as defined in the July 1998 ARAC Fuel Tank Harmonization Working Group report. The service history in the analysis should be further developed to include incidents involving post crash fuel tank fires. The FAA awarded a research contract to develop a database that may be useful in this endeavor. This data should be evaluated when determining what benefits may be derived from implementing ground based or on-board inerting systems. The report is titled, A Benefit Analysis for Nitrogen Inerting of Aircraft Fuel Tanks Against Ground Fire Explosion, Report Number DOT/FAA/AR-99/73, dated December 1999.
2. The evaluation of ground-based inerting should consider:
 - a. The benefits and risks of limiting inerting of fuel tanks to only those times when conditions, such as lower fuel quantities or higher temperature days, could create flammable vapors in the fuel tank. This concept would be analogous to deicing of aircraft when icing conditions exist.
 - b. Various means of supplying nitrogen (e.g., liquid, gaseous separation technology; centralized plant and/or storage with pipeline distribution system to each gate, individual trucks to supply each airplane after refueling, individual separation systems at each gate, etc.), and which means would be most effective at supplying the quantity of nitrogen needed at various airports within the United States and, separately, other areas of the world.
 - c. Methods of introducing the nitrogen gas into the affected fuel tanks that should be considered include displacing the oxygen in fuel tanks with nitrogen gas, saturating the fuel with nitrogen in ground storage facilities (for example, in the trucks or central storage tanks), injecting nitrogen directly into the fuel as the fuel is loaded onto the airplane, and combinations of methods.
 - d. The benefits and risks of limiting inerting of fuel tanks to only those fuel tanks located near significant heat sources, such as center wing tanks located above air conditioning packs.
3. The evaluation of on-board ground-inerting should consider the benefits and risks of limiting inerting of fuel tanks to only those fuel tanks located near significant heat sources, such as center wing tanks located above air conditioning packs.

Tasking Statement

4. The evaluation of the cost of an OBIGGS for application to new type designs should assume that the design can be optimized in the initial airplane design phase to minimize the initial and recurring costs of a system.
5. Evaluations of all systems should include consideration of methods to minimize the cost of the system. For example, reliable designs with little or no redundancy should be considered, together with recommendations for dispatch relief authorization using the master minimum equipment list (MMEL) in the event of a system failure or malfunction that prevents inerting one or more affected fuel tanks.
6. Information regarding the secondary effects of utilizing these systems (e.g., increased extracted engine power, engine bleed air supply, maintenance impact, airplane operational performance detriments, dispatch reliability, etc.) must be analyzed and provided in the report.
7. In the event that the working group does not recommend implementing any of the approaches described in this tasking statement, the team must identify all technical limitations for that system and provide an estimate of the type of improvement in the concept (i.e., manufacturing, installation, operation and maintenance cost reduction, etc.; and/or additional safety benefit required) that would be required to make it practical in the future.
8. In addition, guidance is sought that will describe analysis and/or testing that should be conducted for certification of all systems recommended.

Unless the working group produces data that demonstrates otherwise, for the purposes of this study a fuel tank is considered inert when the oxygen content of the ullage (vapor space) is less than ten per cent by volume.

The ground-based inerting systems shall provide sufficient nitrogen to inert the affected fuel tanks while the airplanes are on the ground after landing and before taking off for the following flight. In addition to the ground equipment requirements and airframe modifications required for the nitrogen distribution system, any airframe modifications required to keep the fuel tank inert during ground operations, takeoff, climb, and cruise, until the fuel tank temperatures fall below the lower flammability range, should be defined.

The on-board ground inerting systems shall be capable of inerting the affected fuel tanks while the airplane is on the ground after touchdown and before taking off for the following flight. As for the ground-based inerting system, in addition to the inert gas supply equipment and distribution system, any airframe modifications required to keep the fuel tank inert during ground operations, takeoff, climb, and cruise, until the time the fuel tank temperatures fall below the lower flammability range, should be defined. Consideration should be given to operating the on-board inert gas generating system during some phases of flight as an option to installing equipment that might otherwise be necessary (e.g., vent system valves) to keep the fuel tank inert during those phases of flight, and as a cost tradeoff that could result in reduced equipment size requirements.

The data in the report will be used by the FAA in evaluating if a practical means of inerting fuel tanks can be found for the in-service fleet, new production airplanes, and new airplane designs. The FAA may propose regulations to further require reducing the level of flammability in fuel tanks if studies, including this ARAC task and independent FAA research and development programs, indicate that a means to significantly reduce or eliminate the flammable environment in fuel tanks, beyond that already proposed in Notice 99-18, is practical. Such a proposal would be consistent with the recommendations made by the ARAC Fuel Tank Harmonization Working Group in their July 1998 report.

The report shall be submitted to the FAA within 12 months after the date of this notice.

ARAC Acceptance of Task

ARAC has accepted this task and has chosen to assign it to a new Fuel Tank Inerting Harmonization Working Group. The new working group will serve as staff to the ARAC Executive Committee to assist

ARAC in the analysis of the assigned task. Working group recommendations must be reviewed and approved by ARAC. If ARAC accepts the working group's recommendations, it will forward them to the FAA as ARAC recommendations.

The Fuel Tank Inerting Harmonization Working Group should coordinate with other harmonization working groups, organizations, and specialists as appropriate. The working group will identify to ARAC the need for additional new working groups when existing groups do not have the appropriate expertise to address certain tasks.

Working Group Activity

The Fuel Tank Inerting Harmonization Working Group is expected to comply with the procedures adopted by ARAC. As part of the procedures, the working group is expected to:

1. Recommend a work plan for completion of the task, including the rationale supporting such a plan, for consideration at the ARAC Executive Committee meeting held following the establishment and selection of the working group.
2. Give a detailed conceptual presentation of the proposed recommendations, prior to proceeding with the work stated in item 3 below.
3. Draft a report and/or any other collateral documents the working group determines to be appropriate.
4. Provide a status report at each meeting of the ARAC Executive Committee.

Participation in the Working Group

The Fuel Tank Inerting Harmonization Working Group will be composed of experts having an interest in the assigned task. Participants of the working group should be prepared to devote a significant portion of their time to the ARAC task for a 12-month period. A working group member need not be a representative or a member of the committee.

An individual who has expertise in the subject matter and wishes to become a member of the working group should contact: Regina L. Jones, ARM-23, Office of Rulemaking, Federal Aviation Administration, 800 Independence Avenue, SW., Washington, DC 20591; telephone (202) 267-9822, fax (202) 267-5075, or e-mail Regina.Jones@faa.gov, expressing that desire, describing his or her interest in the tasks, and stating the expertise he or she would bring to the working group. All requests to participate must be received no later than August 11, 2000. The requests will be reviewed by the ARAC chair, the executive director, and the working group chair, and the individuals will be advised whether or not requests can be accommodated.

The Secretary of Transportation has determined that the formation and use of ARAC are necessary and in the public interest in connection with the performance of duties imposed on the FAA by law.

Meetings of the ARAC Executive Committee will be open to the public. Meetings of the Fuel Tank Inerting Harmonization Working Group will not be open to the public, except to the extent that individuals with an interest and expertise are selected to participate. No public announcement of working group meetings will be made.

Issued in Washington, DC, on July 10, 2000

/s/ Anthony F. Fazio
Executive Director
Aviation Rulemaking Advisory Committee

Appendix B

ARAC Fuel Tank Inerting Harmonization Group Organization

This page intentionally left blank.

ARAC Fuel Tank Inerting Harmonization Group Organization

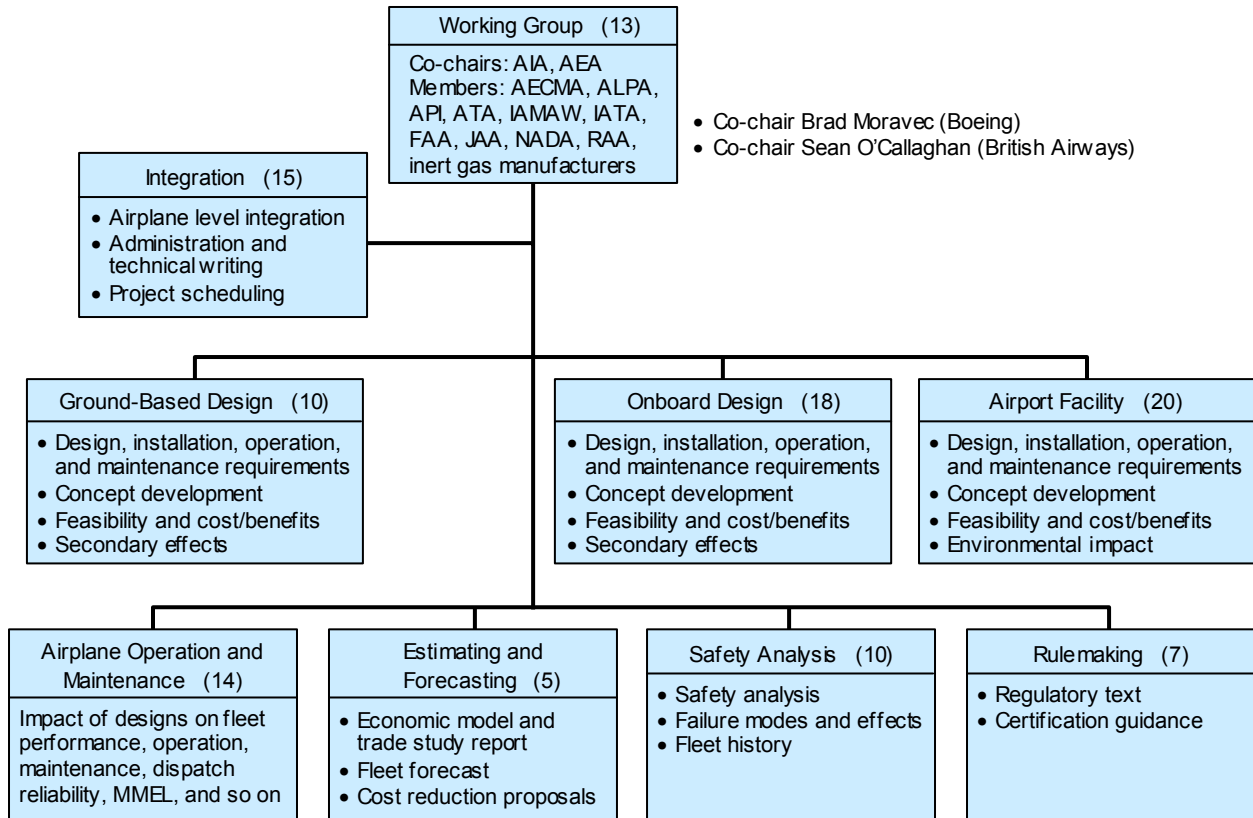

297925J2-001R1

Figure 1.2.1-1. ARAC FTIHWG Team Leaders

This page intentionally left blank.

Appendix C

Ground-Based Inerting Designs Task Team Final Report

This page intentionally left blank.

TABLE OF CONTENTS

1.0	ABSTRACT	C-1
2.0	INTRODUCTION.....	C-1
3.0	BACKGROUND.....	C-2
4.0	APPLICABILITY	C-2
5.0	SYSTEM DESIGN ASSUMPTIONS	C-3
6.0	DESIGN CONSIDERATIONS.....	C-3
6.1	Specific Inert Gas Selection.....	C-3
6.2	Basic Inert Gas Introduction.....	C-4
6.2.1	Ullage Washing.....	C-5
6.2.2	Fuel Scrubbing.....	C-5
6.2.3	Fuel Flow Injection.....	C-6
6.2.4	Combinations	C-6
6.3	Ullage Gas Distribution.....	C-6
6.3.1	Ullage Washing Through Existing Refueling Manifold.....	C-6
6.3.2	Ullage Washing Through Existing Fuel Tank Vent System.....	C-7
6.3.3	Ullage Washing Through a Dedicated Distribution Manifold.....	C-7
6.3.4	Alternatives for Gas Distribution.....	C-7
6.4	Servicing Considerations.....	C-7
6.5	Other System Considerations	C-8
6.6	MMEL/Maintenance Considerations.....	C-8
6.7	System Costs.....	C-9
6.8	Environmental Issues.....	C-9
7.0	GROUND SUPPLY REQUIREMENTS	C-9
7.1	NEA Purity	C-9
7.2	NEA Volumes Required.....	C-10
7.3	Ground Supply Pressure	C-12
7.4	Ground Based Gas Supplies	C-13
8.0	GENERAL AIRPLANE SYSTEM DESIGN	C-14
8.1	General System Layout	C-14
8.2	Servicing Interface.....	C-16
8.3	Servicing Panel Location.....	C-16
8.4	General System Design Analysis.....	C-17
8.5	Ground and Flight Testing Experience.....	C-18
8.6	System Controls.....	C-19
8.7	System Operation and Servicing	C-20
8.8	Auxiliary Tank Design Issues.....	C-20
8.8.1	Auxiliary Tank Pressurization Alternative.....	C-21
9.0	EQUIPMENT REQUIRED.....	C-21
9.1	NEA Servicing Interface.....	C-21
9.1.1	Witness Drains	C-22
9.1.2	Isolation Valve	C-22
9.1.3	Non-Return Valve.....	C-22
9.1.4	Thermal Relief Valve.....	C-23
9.1.5	Indication and Control	C-23
9.1.6	Drain Valves	C-23
9.1.7	Placards.....	C-23
9.2	Auxiliary Tanks	C-23
9.3	Additional Equipment Required.....	C-23

Ground-Based Inerting Designs Task Team Final Report

10.	INSTALLATION REQUIREMENTS	C-23
10.1	New Design	C-23
10.2	In-Production	C-24
10.3	Retrofit.....	C-24
10.4	Auxiliary Tank Installations	C-24
11.0	SYSTEM IMPACT ON OTHER SYSTEMS	C-24
11.1	Pump Performance	C-25
11.2	Impact on Fuel Quantity Indication System (FQIS) Performance.....	C-25
11.3	Impacts on Cross Vented Systems.....	C-25
11.4	Potential Impact on Fuel Properties.....	C-25
12.0	SYSTEM SAFETY	C-25
13.0	SYSTEM WEIGHT	C-26
14.0	EVALUATION OF REDUCTION IN EXPOSURE TO FLAMMABLE ATMOSPHERE	C-26
14.1	Reduction in Exposure to Flammable Atmosphere Analysis	C-26
14.2	Alternate Method for Reduction of Flammable Atmosphere for Auxiliary Fuel Tanks ...	C-28
14.3	Background Information on Flammability	C-29
14.3.1	Inerting.....	C-30
15.0	CERTIFICATION COMPLIANCE	C-34
16.0	PRO AND CONS OF THE SELECTED DESIGN CONCEPT	C-36
17.0	MAJOR ISSUES AND RESOLUTIONS	C-36

LIST OF FIGURES

7.1-1	Ullage Cost as a Function of Purity.....	C-10
7.2-1	Flight Test Actual Purge Volume to Ullage Oxygen Content Relationship (737NG Testing).....	C-11
7.2-2	Theoretical NEA Purge Volume to Ullage Oxygen Content Relationship.....	C-12
8.1-1	System Schematic for Airplane With Center Wing Tanks.....	C-15
8.1-2	System Schematic for Airplane With Auxiliary Fuel Tank(s).....	C-16
8.4-1	System Manifold Lengths and Diameters.....	C-18
8.5-1	FAA/Boeing (B737NG) Flight Test Results Showing Effects of Crossventing.....	C-19
13.0-1	Estimated System Weights.....	C-26
14.1-1	Flammability Exposure Results for the Ground-Based Inerting System.....	C-27
14.3-1	JP-8 (Jet A) Flammability and Vapor Pressure.....	C-29
14.3-2	Aircraft Fuel Flash Point as a Function of Altitude and Temperature.....	C-30
14.3.1-1	Maximum Oxygen Content for Inerting System Flammability as a Function of Fuel Type.....	C-31
14.3.1-2	Tank Combustibility With Gun Fire as a Function of Oxygen and Fuel Content.....	C-32
14.3.1-3	Fuel Tank Combustion Overpressure Versus Oxygen Concentration.....	C-33
14.3.1-4	Effects of Dissolved Oxygen Released From the Fuel on Ullage Oxygen Concentrations.....	C-34

This page intentionally left blank.

1.0 ABSTRACT

The following documents the technical considerations of the design of a ground based inerting system for aircraft. This system would function to further minimize the flammability of fuel tanks through the use of an inerting gas provided by a ground source to reduce the naturally occurring oxygen in the ullage (airspace) above the fuel. Reducing the oxygen content of the ullage to 10% or less inhibits the flammability of the ullage, thereby reducing the probability of a potential aircraft fuel tank ignition event.

2.0 INTRODUCTION

The design of the ground based inerting system presented here has been the result of careful examination of the technical parameters and considerations, and those parameters required and defined in the FAA Tasking Statement 4910-13; Fuel Tank Inerting Harmonization Working Group (FTIHWG). This Tasking Statement requires various means of inerting fuel tanks to be considered. While this time restraint prevented the examination of design details required for the actual inerting design implementation on a specific aircraft model, it has allowed a ground based design to be evaluated sufficiently to identify the potential benefits and complications.

The aircraft design presented here is for a system that would allow inert gas to be distributed in the center wing tanks (heated or unheated), and auxiliary tanks as requested in the Tasking Statement. Inert gas generation takes place in the airport facility and is then transported to the aircraft via pipeline or servicing truck. A servicing hose with a special interface coupling only used for the introduction of inert gas to the aircraft is utilized. Each aircraft would be certified through testing to validate the specific volume of inert gas required to reduce the fuel tank oxygen concentration to a level below that considered flammable. The Tasking Statement defines that level as 10% oxygen.

The design presented here is a generic system that would apply to any size or configuration aircraft. For the purposes of this report and evaluation, the system is defined in terms of the standard aircraft sizes and definitions derived in the previous Aviation Rulemaking Advisory Committee (ARAC) study completed in 1998. The following airplane configurations will form a standard basis for this study:

ARAC Large Aircraft

ARAC Medium Aircraft

ARAC Small Aircraft

ARAC Regional Turbofan

ARAC Regional Turboprop

ARAC Bizjet

It should be noted that because this study is concerned with the center and auxiliary tanks only, per the Tasking Statement, the ARAC Regional Turboprop is not addressed in this study since it has no center tanks per ARAC definition. The ARAC Bizjet also has no center tank per ARAC definition, but information gained late in the study became available that indicated some Bizjets have center tanks and thus they have been included in this ground based inerting study to the extent possible.

Numerous airplane configurations exist in the world aircraft community and these ARAC configurations allow a study to be conducted with configuration baselines for design and cost estimating purposes. Because there are differences between the ARAC standard aircraft and the specific aircraft designs of the world, the designs developed herein would require detail changes to actually implement into existing airplane models or future airplane models.

It should also be noted that, in general, less precise technical information was known about the structure and systems of regional turbofan, regional turboprop and business jets, as compared to the larger commercial based models. While this is not considered to be a significant issue due to the generic nature

of this GBI design and the adaptability of the design, it is noted here for reference. Also, to avoid confusion regarding the ARAC airplane class terminology, the business jets based on standard commercial airplane configurations are included with their respective commercial classes rather than the ARAC Bizjet category.

Some manufacturers may choose to approach the detail aircraft design in an alternate fashion based on their specific design philosophy. The design study in this report would not preclude these different approaches to the task. However, it has been assumed that all designs would utilize standard features for minimization of operational costs. For example, it is assumed a standard inerting gas interface for servicing would be used. The world aircraft community would utilize this standard interface configuration unless an aircraft manufacturer at some future date chooses to market a product with a different standard and impose this impact on their customer's operations. This study has assumed the servicing pressure maximum would be standardized as well to protect all the aircraft being serviced. If a manufacturer desires a new pressure standard, this new standard must include built-in features for protection of the original existing systems, both onboard and in the ground servicing equipment.

3.0 BACKGROUND

The 1998 ARAC report recommended that additional study be conducted on Ground Based Inerting (GBI) of aircraft fuel tanks to minimize their flammability. The current ARAC activity requires a detailed assessment of fuel tank inerting to be carried out to identify the issues associated with inerting airplane fuel tanks. This ARAC study examines a number of methods of inerting. The focus of this particular section of the overall report is the Ground Based Inerting system. The general design configuration that is considered the best alternative is described in detail along with the supporting arguments for the decisions made. The basic design is for gaseous nitrogen or Nitrogen Enriched Air (NEA) to be supplied from a ground based source to a servicing hose. This servicing hose would be connected to the airplane and the gaseous nitrogen or NEA would then be distributed inside the aircraft by a simple manifold to outlets in each bay or space of each affected tank. This design configuration forms the basis for the design presented here.

The designs considered here have been derived by a team with experience in aircraft fuel systems, gas production/ handling, and research in fuel tank flammability.

4.0 APPLICABILITY

The Tasking Statement for this study specifically designated this system to be applicable for all aircraft fuel tanks that are not cooled at a rate similar to a wing fuel tank. As such, there are a number of aircraft designs that are not required to have inerting systems installed in their fuel tanks by the Tasking Statement. The owners or manufacturers of those aircraft could choose to install a ground based inerting system without regulatory direction at their option.

The proposed ground based inerting system design, control, and operation are applicable to newly designed commercial aircraft, in-production commercial aircraft and in-service commercial aircraft as stated in the FAA Tasking Statement. Newly designed aircraft would incorporate the requirements of the rule to integrate the ground based inerting system during the initial design phases. In-production aircraft would require that the system be integrated into the manufacture of the aircraft concurrently with production in a manner that minimizes the impact to production, retains the certified design, and meets the requirements of the rule. In-service aircraft would be covered by Service Bulletin action with a timetable prescribed by the rule.

Auxiliary fuel tanks that are not cooled at the rate equivalent to wing tanks are also applicable to actions of this study as directed by the Tasking Statement. Auxiliary fuel tanks are typically located within either the forward or rear cargo compartment and are connected to the center fuel tank and/or center fuel tank system plumbing. Because of their location within the fuselage, shielded from the outside air stream and temperatures, all auxiliary tanks of this typical configuration are subject to this study and installation of a

Ground-Based Inerting Designs Task Team Final Report

ground based inerting system. These auxiliary tanks may be pressurized tanks or unpressurized tanks depending on the tank design, but both types of systems would utilize the same type of ground based inerting hardware if required. It should be stated that even though all typical auxiliary fuel tanks are applicable to this study, the schedule did not allow detailed assessment of all aircraft auxiliary fuel tank installations to confirm space is available for the provisions required for the proposed inerting system.

5.0 SYSTEM DESIGN ASSUMPTIONS

In order to perform the design and analysis for the ground based inerting system in the time allowed by the Tasking Statement, a number of assumptions have been made based on the Tasking Statement requirements with the general oversight of the ARAC Working Group. The assumptions have been documented and are explained below:

- A 10% oxygen concentration constitutes an inert tank for the sake of the exposure/risk analysis in this study.
- Oxygen concentration measurement in fuel tanks to be inerted is not necessary to ensure tank is inert to required levels.
- Aircraft will receive a minimum of 95% NEA (5% oxygen maximum by volume) from a ground source which is available upon demand at all required gate and/or operational areas.
- The discharge of NEA from the aircraft vents does not require any special precautions or procedures to eliminate any associated hazards.
- Fuel tanks to be inerted are defined by the Tasking Statement as all tanks that do not cool at a rate equivalent to the main wing tanks. This includes non-cooled auxiliary tanks mounted inside the fuselage, but not tail or trim tanks since they are located away from heat sources and are subject to exposed ambient air similar to main wing tanks.
- The airport NEA supply pressure at the servicing interface to the airplane is controlled by the ground equipment to ensure the delivered static pressure does not exceed the maximum allowable value for the aircraft type being serviced.
- For the purposes of estimating in this study, 95% NEA delivered at 1.7 times the tank volume (as demonstrated by FAA/Boeing testing on a B737NG) provides 8% ullage oxygen concentration by volume. This 8% oxygen concentration is assumed to maintain a sufficient fuel tank inert level during ground operations and initial flight operations before the oxygen concentration becomes great enough to exceed the 10% maximum required by the Tasking Statement.
- The ground based inerting system is designed to not require “scrubbed” fuel to be effective. No on-board fuel scrubbing is being provided by, or proposed for, the ground based inerting system. If scrubbed fuel is considered to be desirable or is determined to provide a cost effective benefit, the scrubbing will be accomplished by ground equipment or facilities.
- The exact NEA flow rate is not critical to ensure the required oxygen concentration on a volume basis is achieved. A wide range of flow rates could be accommodated and still achieve the required oxygen concentration in the tank. In general, system pressure, NEA purity, and total volume are required parameters instead of flow rate.

6.0 DESIGN CONSIDERATIONS

6.1 SPECIFIC INERT GAS SELECTION

A number of different gases or inert gases are available for use in the inerting task. Each of these gases have drawbacks as discussed below. The Tasking Statement specifically states that the ground based inerting system should consider using ground based nitrogen supply equipment. Nitrogen has been

identified in previous research as a good alternative for inerting. Nitrogen continues to be considered the best gas for this application. However, other gases have been examined per request of other members of the ARAC task team as a part of this study.

Carbon dioxide based systems were proposed as an alternative to nitrogen, partly because the heavier molecular weight was expected to keep the gases in fuel tanks better than nitrogen. There have been past military studies of inerting with carbon dioxide. These studies concluded the higher solubility of carbon dioxide in jet fuel would have a negative affect on fuel pump performance that could result in loss of engine fuel feed. This would introduce an unacceptable risk. In addition, inerting with carbon dioxide can result in production of carbonic acids. The potential of introducing carbonic acids to fuel tanks and the resulting corrosion potential on system components and structure was unacceptable. We have no data to indicate these concerns have been eliminated, thus we concluded carbon dioxide was not a good alternative to nitrogen. In addition, testing by the FAA and Boeing have shown the loss of nitrogen due to its molecular weight to be small, and thus not a major factor leading to the need for this alternate gas.

Use of argon gas was also proposed as an alternative to nitrogen, because its' heavier molecular weight was expected to keep the gases in fuel tanks better than nitrogen as well. Argon is currently available only in smaller quantities. Air consists of roughly 78% nitrogen, 21% oxygen and 1% argon gas. Argon production is very scarce as compared to nitrogen and considerably more expensive. Argon is very similar to oxygen in molecular size, and thus requires expensive liquefaction processes to produce. The world demand for argon gas for inerting systems would push or exceed the available supplies as well as driving the cost higher. The current cost of argon is already in excess of 100 times more than nitrogen. In addition, it is believed that argon has a higher solubility in fuel than nitrogen. There is concern that fuel exposed to high argon gas levels could result in higher dissolved gas content in the fuel which could also lead to fuel pump performance problems. Thus we concluded argon was also not a good alternative to nitrogen.

No system utilizing an inert gas other than nitrogen has shown itself to be without basic problems and drawbacks. Nitrogen and specifically NEA is considered the preferred choice for the inerting gas for a ground based inerting system. It is readily available, inexpensive, and with the emergence of membrane separation technologies, easy to use in large scale industrial applications. Nitrogen and NEA have the advantage in that they have been used in military applications for fuel tank inerting for a number of years. As such, there is some information available on its in-service performance. Not all applications have met with the reliability desired of them, but the body of information is there to better refine the inerting system designs. While NEA is readily available commercially, a drawback to nitrogen, and in fact any inerting gas for a GBI system is that its availability at airports is limited. Providing the necessary volumes required to inert the aircraft fleet will require a very large increase in gas generation capacity. That infrastructure issue is addressed elsewhere in this report. Safety is also considered a drawback for nitrogen, as with other gases that displace oxygen, since it poses confined space hazards. Even with this safety issue and the airport facilities availability issue, NEA is considered the inerting gas of choice.

6.2 BASIC INERT GAS INTRODUCTION

The method of introducing nitrogen gas into the fuel tanks was a basic design parameter evaluated. Displacement of oxygen with the inerting nitrogen is the primary requirement of the inerting system. In general, the inerting gas can be introduced into the fuel tank ullage by using the following methods:

- “Ullage washing”
- “Fuel scrubbing”
- “Fuel flow injection”
- Some combination of any, or all of these

6.2.1 Ullage Washing

Ullage washing, or the displacement of the oxygen in the space above the fuel (ullage), would give the best efficiency since the inert gases could be better directed to purge the total fuel tank ullage of gases including oxygen. This process could also be scheduled at any time during the airplane turn around. This method would require a special inert gas servicing interface and distribution system to supply inerting gases to that servicing interface. This approach does not remove any oxygen dissolved in the fuel that will evolve from the fuel during climb due to the altitude pressure decrease. Oxygen evolution does have some effect, but testing showed it to be a small impact on the oxygen level, except when the tank is relatively full. Further, when the tank is relatively full the effects of fuel consumption, which draws ambient air into the tank, causes the rapid loss of the inert levels, thus overshadowing oxygen evolution from the fuel. One could compensate for this oxygen evolution on climb by lowering the oxygen content below the 10% when inerting before takeoff to allow some room for the oxygen to come out of solution and not have the fuel tank oxygen concentration rise above the 10% maximum to minimize flammability. Directly injecting NEA into the fuel tanks through ullage washing, whether they are full, partially full, or empty is considered the best option for the basic introduction of the inerting gases onboard for a GBI system. This method would be controllable, predictable, and certifiable even though a new servicing connection is required.

6.2.2 Fuel Scrubbing

Fuel scrubbing, or the “washing” of fuel with nitrogen, is the method of processing the fuel to strip the oxygen gases out of the fuel down to levels that would not evolve oxygen above a certain level in the fuel tanks during climb. Fuel contains dissolved oxygen and as the pressure above the fuel is reduced during climb this oxygen will tend to be evolved out of the fuel into the tank ullage. Since this oxygen will raise the oxygen concentration in the ullage, the effect of replacing this dissolved oxygen with nitrogen was considered to maintain the lower oxygen levels as long as possible. Fuel scrubbing for GBI can be accomplished in two basic methods:

1. **Fuel Scrubbing Using Onboard Scrubbers and Ground Supplied NEA.** One method of scrubbing which has been used on a limited number of military aircraft types is an ‘ASPI’ type scrubber. This unit, if installed onboard, would be supplied by a ground source of NEA. This type of scrubbing generally requires a higher purity of NEA than the 95% assumed for ullage washing in this study. Assuming the scrubbing NEA supply is the same supply used for ullage washing, this requires simultaneous refueling and ullage washing to accomplish the fuel scrubbing task. If the process of scrubbing was carried out after the ullage washing, then any oxygen released during the scrubbing would dilute the NEA in the ullage if not vented elsewhere. Procedures would therefore be required. This process would also take away some of the flexibility of when the inerting operation could be carried out. It is unclear what impact, if any, this would have on the cost of GBI, but it is generally accepted that it would cost more to have this procedural requirement. It is unlikely a significant benefit would be garnered from this type of scrubbing. Although not examined in detail, this type of scrubbing unit is not considered to be readily adaptable to inerting tanks that are not refueled.

Other methods of scrubbing fuel onboard the aircraft using ground based NEA could be developed such as a specialized scrubbing manifold or other onboard scrubbing equipment. These systems are also not considered to be effective enough to justify their usage at this point.

2. **Fuel Scrubbing Using Dedicated Scrubbing NEA at the Fuel Farm or Fuel Truck.** The method deemed to be most practical is fuel scrubbing with dedicated NEA at the fuel farm or fuel truck. This method requires no additional aircraft equipment or procedural modifications to implement. It is generally considered the most cost-effective method of scrubbing as the fuel is scrubbed in bulk before deposit into the aircraft. For airport hydrant systems, a large scrubber would scrub the fuel before being pumped out of the airport fuel farm. For airports with only trucks, every truck could be

equipped with a portable fuel scrubber that is transported in tow or mounted on the truck, or there could be a central scrubbing facility at the fuel storage area where the trucks receive their fuel load.

Fuel scrubbing also effectively saturates the fuel with nitrogen which would introduce nitrogen to the fuel tanks when refueling to some degree as the nitrogen comes out of solution due to agitation. The primary means for the nitrogen to come out of solution is the ambient pressure decrease as the airplane goes up in altitude. However, as the fuel is used at altitude the nitrogen levels would not be able to keep up with the volumetric decrease in the tanks due to fuel burn, and air would be brought in via the vent system to effectively increase the oxygen levels. This system also does not displace the oxygen in the ullage when tanks are not required to be filled, or are only partially filled. This study of GBI was primarily based on center tanks and center tanks are not filled on the majority of flights due to flight lengths that are less than the maximum of which the aircraft is capable. Because of this, a GBI system based solely on refueling with scrubbed or nitrogen saturated fuel does not comply with the Tasking Statement and would not be considered effective enough for consideration especially when the additional airplane complications, airplane weight penalty, and airport complications are factored in.

6.2.3 Fuel Flow Injection

Fuel Flow Injection, or directly injecting nitrogen into the fuel as it is being loaded into the airplane also has the drawback of not inerting the tanks when the tanks are not loaded with fuel or are partially loaded. It does have the same positive aspect as fuel scrubbing of allowing nitrogen to come out of solution as the airplane is climbing, but this method was not considered acceptable for the same basic reasons as fuel scrubbing.

6.2.4 Combinations

Combinations of these methods could be utilized, but no combination has shown itself to be effective enough to consider based on either the airport facilities or airplane equipment required versus the potential gains in inerting effectivity. The limited evolution of oxygen during climb can be addressed by ways having less impact including using higher purity NEA or slightly longer NEA loading times. Flight testing also showed that ullage washing was sufficient to accomplish the inerting task. The further complication and expense of any combination is not considered required to accomplish the GBI inerting task of ensuring the tanks are inert while the airplane is on the ground.

6.3 ULLAGE GAS DISTRIBUTION

It was postulated that ullage washing could be accomplished in one of three ways:

1. Through the existing refueling manifold
2. Through the existing aircraft fuel tank vent system
3. Through a dedicated distribution manifold

It was also determined that ullage washing and fuel scrubbing in combination could be accomplished by utilizing the best method for tank ullage washing and one of two primary scrubbing philosophies if scrubbing was to be considered.

6.3.1 Ullage Washing Through Existing Refueling Manifold

It was determined that providing NEA to the fuel tanks via the refueling manifold was not practical because it precluded simultaneous refueling and inerting of fuel tanks. It was determined, due to the short turn-around time of many operational aircraft and the length of time associated with inerting a large center-wing tank that inerting and refueling would have to occur simultaneously for some operations. Precluding this would have a substantial impact on the turn-around times of certain operations. Also, introducing inert gas in this manner is not particularly efficient or desirable. The refuel distribution tube

placement is optimized for fluid flow into the individual tanks. This would not yield efficient distribution of the inert gases or efficient purging of the oxygen from the tanks. Ullage washing through the existing refueling manifold was rejected for these reasons.

6.3.2 Ullage Washing Through Existing Fuel Tank Vent System

Using the fuel tank vent for inerting was not considered viable because, similar to inerting through refueling manifold, it would provide a poor distribution of inerting gas, requiring significant increase in the amount of inerting gas required to inert a given tank. This could also have significant impact on the cost of GBI in the commercial fleet. In addition, many aircraft tanks only have one vent. This would not allow simultaneous tank venting during refueling operations and the NEA loading for inerting. It was found in testing that those tanks that have more than one vent would need to install some modification to make the multiple vent systems act like a single vent system to minimize the loss of nitrogen and the accompanying increase in oxygen concentration in the tanks. As a consequence, inerting through the existing vent system could result in over-pressurization during refueling. This has significant system safety issues for refueling operations and would require additional redesign of the vent system to maintain the existing level of refueling safety.

6.3.3 Ullage Washing Through a Dedicated Distribution Manifold

It was concluded that the preferred method for ullage washing would be through a dedicated distribution manifold installed in all tanks requiring inerting. This distribution manifold would have a dedicated servicing interface port for a NEA supply hose to be connected during ground operations. The design approach considered most effect and evaluated was a manifold with outlets mounted high in the tank. These outlets would direct the nitrogen flow throughout the tank helping to mix and circulate the ullage space for expulsion through the vent system as NEA entered the tank. This oxygen-rich ullage would be displaced out through the airplane vent system to reduce the oxygen concentration down to the required level. This design was tested in the FAA/Boeing flight tests and is the preferred option for most aircraft designs available today.

6.3.4 Alternatives for Gas Distribution

One alternative method for this would be to have the injection of the nitrogen be accomplished via a dedicated manifold located on the bottom of the tanks to allow the nitrogen to bubble up through the fuel when fuel was present. While this system has the advantage of helping purge oxygen directly from the fuel through the bubbling process, or effectively scrubbing the fuel to some extent, it also requires additional manifold plumbing be installed to help distribute the nitrogen throughout the entire tank. Without this additional manifold distribution plumbing to spread the distribution of NEA over the entire tank area, there is a potential that areas of the tanks may not reach the required oxygen level without some additional period of time to allow equilibrium to take place. It may be possible to use this design type, but implementation of the design would require careful consideration of the tank geometry to optimize the inert gas distribution in a timely manner.

6.4 SERVICING CONSIDERATIONS

A study of servicing turn around times for the standard ARAC airplane models concluded that turn around times of approximately 20 minutes for small commercial aircraft, and 55 minutes for large aircraft are not uncommon with today's operating schedules. Wherever possible, operators may also use the turn around time to recover any schedule delays. For example, they might reduce aircraft cleaning time and passenger loading times to recover time. Therefore, one aim of this system is to give the operator the greatest flexibility as to when the inerting process is actually performed so minimal delays will be incurred. This design presented here is centered around balancing minimum turn around times with the other system design requirements to minimize the impact to the airlines.

The design was developed to minimize the need for extra servicing equipment such as ladders or step stools to the maximum extent possible. The proposed sites for the servicing interface locations have been chosen to minimize requirements for special servicing equipment and minimize interference with existing service trucks and personnel.

6.5 OTHER SYSTEM CONSIDERATIONS

Another system design consideration for ground based inerting systems was to factor in the temperature effects that could effect the need to inert on a specific day. There would be no flammability benefit to inert if the temperature of the day, tank, and fuel were below those values where the fuel would become flammable either on the ground, or during the ensuing flight. While this is possible to implement, the necessary procedures would be difficult to coordinate due to delays that often occur in dispatch and departure. An additional study to determine the manner in which temperatures guidelines could be determined and utilized in-service would be required since factors such as fuel quantity, refueling sequencing, heat load from external heat sources, and ambient temperatures could influence the guidelines. If such an approach is pursued, it is not considered to significantly reduce the ground based infrastructure requirements, since most airports would still need to be able to inert airplanes due to the annual range of ambient temperatures experienced.

For tanks that are partially or completely loaded with fuel prior to flight, the consumption of fuel during flight would lead to a loss of the inert levels early in the cruise phase of flight. A method of extending the period in which the oxygen concentration level in the fuel tank ullage remains below the required level would be to provide an additional supply of NEA from onboard storage tanks. The airplane fuel tanks would be inerted by supplying ground based NEA to the servicing interface which would connect directly to the onboard storage tanks at higher pressures than the 5.0 psi maximum defined for the baseline system to maximize the tank storage capabilities. These storage tanks would feed the fuel tanks through a primary pressure regulator and a secondary backup pressure regulator for safety to maintain the 5.0 psi maximum servicing pressure. Other system complexity may be required to ensure discharge pressure from the storage tanks does not cause fuel tank pressure limits to be exceeded.

As an example, the following table gives an indication of the storage volume required to maintain the center tank on the Large ARAC aircraft category below the 10% oxygen threshold given by the Tasking Statement. The following table shows the storage volume required as a function of the initial storage pressure to maintain the ullage inert while the fuel volume is used down to 50% full assuming the tank was initially full. The estimate is also based on a gas temperature of 0 degrees C and a cruise altitude of 35,000 feet.

Storage Pressure (psi)	Storage Volume (Nm ³)
5	10
20	5.2
100	1.4

Other onboard storage tank design concerns include the additional weight and complexity of the system, the physical size of the onboard storage tanks to be effective, and the safety and maintenance issues associated with large high pressure tanks carried on board. Because of these concerns with this storage tank concept, this design possibility has not been pursued further in this study.

6.6 MMEL/MAINTENANCE CONSIDERATIONS

Per the Tasking Statement, MMEL relief will be available for situations where the ground based NEA supply is not available for airplane inerting.

The simple concept and the use of mature technology for the equipment in the system should ensure the system achieves a reliability level that is acceptable for commercial aircraft operations, without the need to build in system redundancy. This approach also means that there are only a very limited number of

Ground-Based Inerting Designs Task Team Final Report

failures that will prevent the system from allowing the tanks to be inerted. In the case of the more likely failures, i.e., failure of the shut off valve, maintenance procedures can be devised which will still allow the airplane to be dispatched with the tanks inerted. This aspect is considered further in the Safety Analysis Team Appendix H and the Airline Operations & Maintenance Team Appendix F.

6.7 SYSTEM COSTS

System costs are examined in detail in the Estimating and Forecasting Team Appendix G.

6.8 ENVIRONMENTAL ISSUES

The GBI system may introduce additional VOCs to the atmosphere as a result of the ullage washing procedure. Since the center tanks would be inerted every flight, the ullage and its associated VOCs from residual fuel would be exhausted out the vent system at each turn around whether the center tank was utilized or not. The detailed environmental analysis of this GBI system is beyond the scope of the Tasking Statement and is not addressed here.

7.0 GROUND SUPPLY REQUIREMENTS

7.1 NEA PURITY

Nitrogen Enriched Air (NEA) purity effects a number of different aspects of the ground based inerting system, however the primary effect on the aircraft system is one of varying the volume of NEA required to be loaded. The precise volume would be determined during development (analysis and testing) testing of the particular aircraft model and would be for a particular purity of NEA. NEA purity can also have an effect on the initial design to support the desired turn times to inert the aircraft. NEA 95% (95% nitrogen and 5% oxygen) was recommended for use in this inerting study in the beginning. Later, it was determined that NEA of slightly higher nitrogen concentration of 97 % or 98 % may be more desirable from overall cost and commercial standpoint. (See Figure 7.1-1 below). The cost of the gas is slightly higher for the higher purity, but the volume required to inert the fuel tank would be less. Consequently, the price of the total load of NEA may be lower.

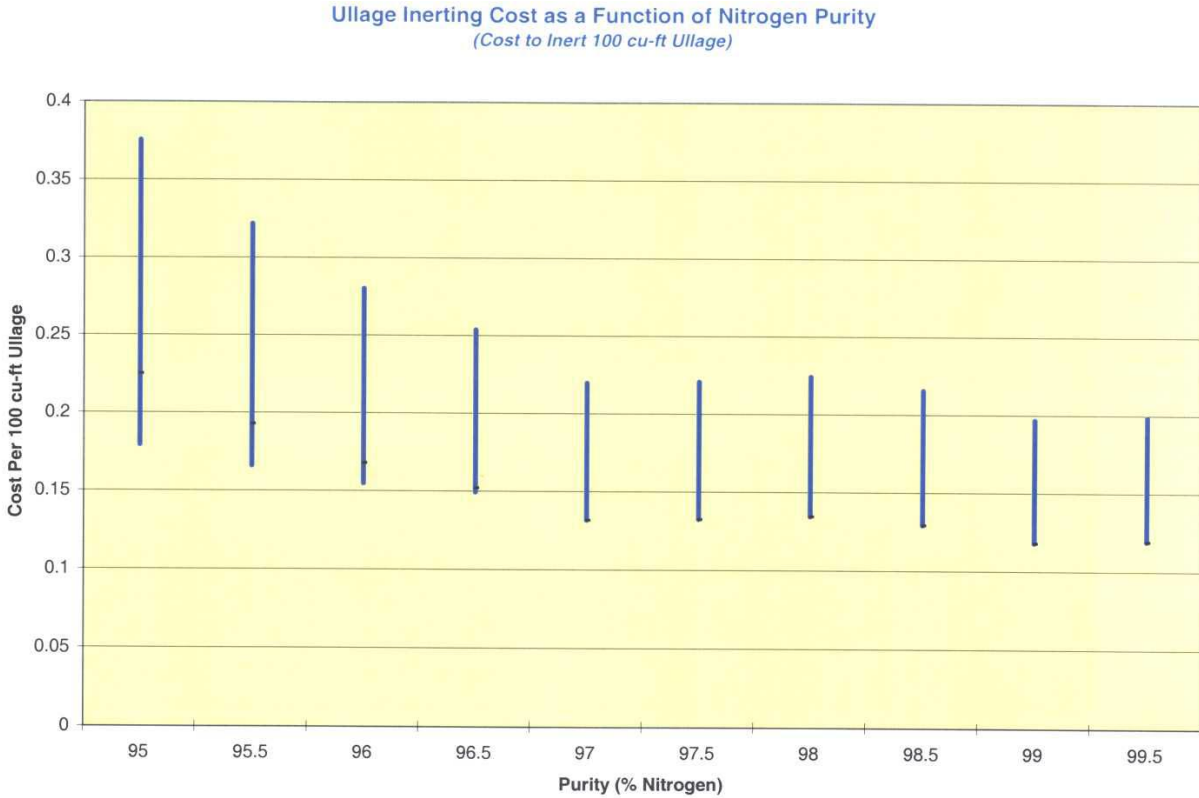

Figure 7.1-1. Ullage Cost as a Function of Purity

7.2 NEA VOLUMES REQUIRED

The volume of NEA gas required to inert the fuel tanks to a reduced oxygen level is a function of the design of specific aircraft and the detail design of the NEA manifold installed in it. Early laboratory testing indicated that the required NEA volume was 1.5 times the total volume of the tank using 95% NEA to obtain an ullage oxygen concentration of 8%. 8% oxygen was considered a good target oxygen concentration for ground-based inerting as it is below the 10% level stated in the Tasking Statement, thus allowing for some dissipation during ground and initial flight operations and some variation in the inerting process. The volume exchange necessary was refined with actual aircraft testing that was conducted on a Boeing 737NG as part of a FAA test program. That aircraft, which was modified with the installation of an NEA distribution manifold, required 1.7 times the total volume of the fuel tanks being inerted when using 95% NEA (see figure 7.2-1). As a result, 1.7 has been used for calculations in this study. It should be noted however, that this factor would vary from aircraft to aircraft due to the variations in different aircraft models and different manifold designs. Each aircraft design will require testing to determine the NEA volume required to bring the oxygen level in the fuel tank down to the required level for that airplane design. The manifold will use outlets that will be configured to help mix the ullage gases in the tank to the maximum degree possible before they are pushed out the tank vent system by the incoming NEA. More efficient mixing and purging of the ullage gases will allow the NEA volumes to be less for a given tank configuration and manifold design.

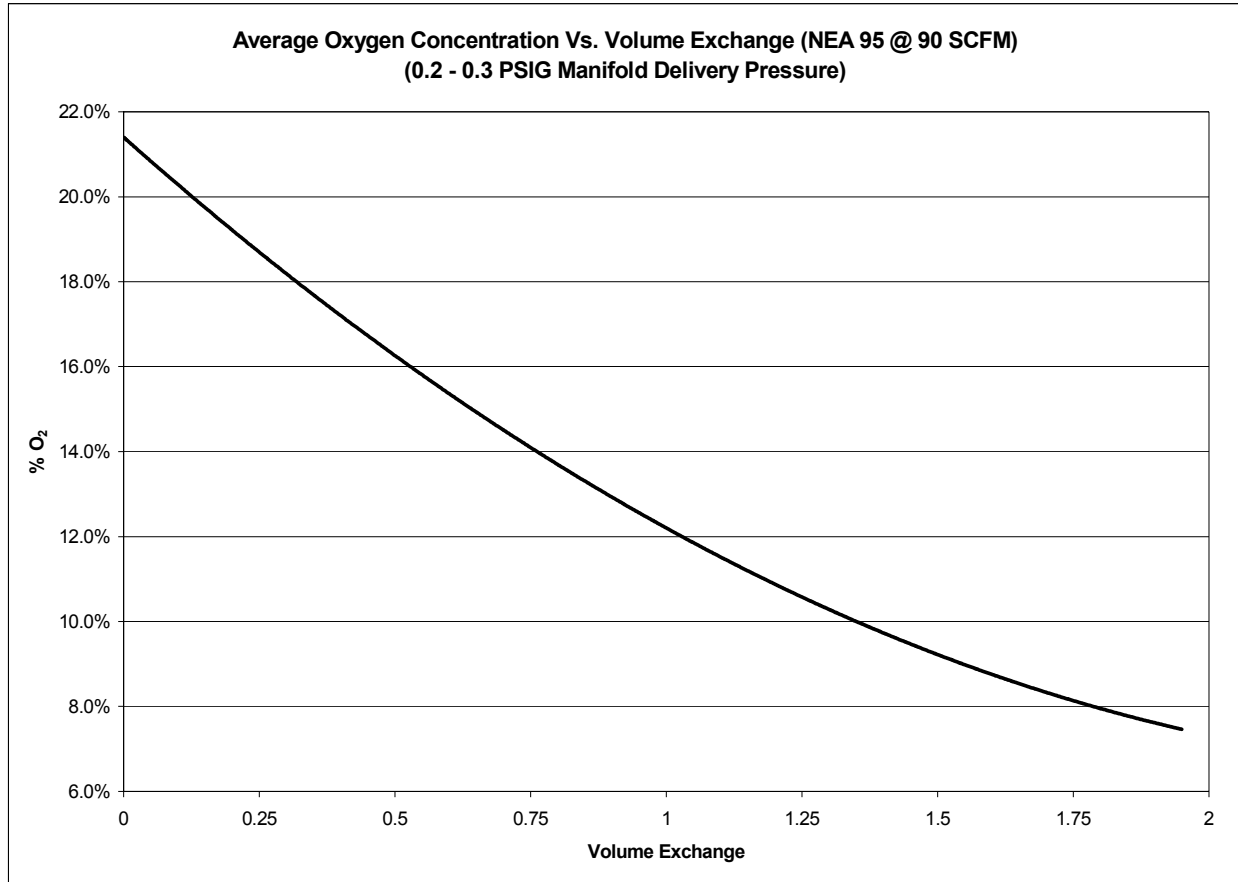

Figure 7.2-1. Flight Test Actual Purge Volume to Ullage Oxygen Content Relationship (737NG Testing)

The theoretical curves (supplied by a gas supplier) for the amount of nitrogen to purge a tank at various purities are shown in figure 7.2-2. This closely supports the actual test findings determined in the 737NG testing that took place in support of this study.

Inerting Curves for Various NEA Purities (Based on 100 cu-ft Ullage)

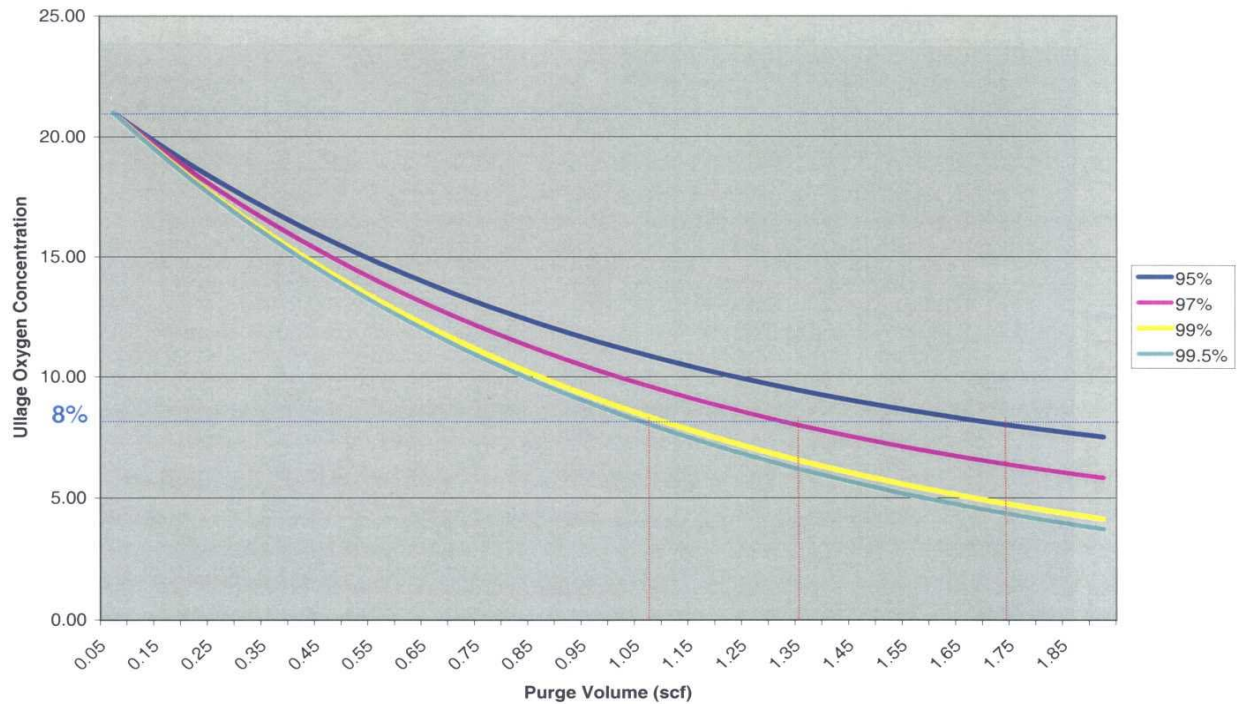

Figure 7.2-2. Theoretical NEA Purge Volume to Ullage Oxygen Content Relationship

The NEA volume required also depends on the NEA purity. A study recently performed by the FAA shows the evolution of the volumetric tank exchange as a function of the NEA oxygen percentage: “Inerting of a vented aircraft fuel tank test article with Nitrogen Enriched Air” reference DOT/FAA/AR-01/6. Inerting a tank with NEA 94% requires 1.9 volumes of NEA, as compared to requiring only 1.1 volumes with NEA 98%.

7.3 GROUND SUPPLY PRESSURE

The airport facilities supplying NEA would be required to be controlled to insure the delivered static pressure does not exceed the maximum allowable value. In order to prevent overpressurization and resulting structural damage to the fuel tank (wing), the maximum static allowable pressure has been determined to be 5.0 psi for most all aircraft. This provides a balance between aircraft structure safety for most of the world’s aircraft and the pressure required to quickly service those aircraft with a minimum turn time. All airport facilities and all ground servicing equipment would be required to deliver no more than 5.0 psi static maximum. Secondary overpressure protection must also be provided by the airport facility or ground servicing equipment to ensure the aircraft would not be damaged in the event of a primary pressure regulation failure.

Aircraft models that require the maximum pressure to be some value less than 5.0 psi static pressure would be required to carry onboard pressure regulation to reduce the pressure to the value required for that model. These models would include some models of Business Jets, some auxiliary fuel tanks, and some early aircraft models with fuel bladder cells where their maximum static pressure are typically 0.5 psi. The design of these systems would require secondary onboard pressure protection in addition to the primary pressure regulation to preclude overpressurization.

Ground-Based Inerting Designs Task Team Final Report

The introduction of onboard over pressure protection does have undesirable side effects. Procedures would need to be in place to regularly check for dormant failures of these devices, and the additional design issue of locating these devices where their discharge does not introduce additional hazards to the aircraft or personnel. One alternative approach would be for ground equipment to be designed to have two independent pressure supplies with mutually independent servicing interface connections. The disadvantage of this is that the equipment would require two different servicing interface connectors on each piece of NEA servicing equipment and careful design to ensure the pressure supplies could not be cross connected in any case. This extra complexity would also have additional cost implications.

7.4 GROUND BASED GAS SUPPLIES

There are several methods to produce nitrogen and Nitrogen Enriched Gas (NEA), but the two basic methods are as follows:

1. **Off-Site Production:** The classical method to provide nitrogen is the distillation of ambient air. This separation process produces high quantities of nitrogen at high purity. This scheme is generally one where liquid nitrogen is produced at a plant and it is then transported through pipelines or with trucks to the final user location. The liquid nitrogen is stored in insulated storage and it is heated and vaporized to produce gaseous nitrogen. In general, liquid nitrogen is used where high quality nitrogen and large quantities of nitrogen are desired. If liquid nitrogen systems are used for aircraft inerting, the liquid nitrogen must be in gaseous form before entering the airplane, and a temperature above the minimum certified temperature for the airplane fuel tanks and equipment.
2. **On-Site Production:** On-site production involves installation of a nitrogen generation unit installed at the customer site for production of on-demand gas. The heart of this on-site equipment is typically an Air Separation Module (ASM), composed of polymeric fibers. The driving force of the separation process is a difference of pressure between the gas sent into the membrane and the atmospheric pressure. Hence, ASMs are fed with compressed air typically powered with electricity. The gas produced is either stored in buffers or directly sent to the process requiring the gas, or in this specific case, the aircraft. This process allows production of Nitrogen Enriched Air (NEA) with oxygen contents varying from 5% to 0.1% or less. The choice of the oxygen percentage present in the NEA is made by a simple adjustment in the equipment. Flow delivered by on-site equipment can vary from 10 to 3000 Nm³/h (Normal cubic meters per hour), depending on the size of the equipment.

Numerous on-site options for the airplane inerting itself exist. One option would be to install a nitrogen generator at each concourse with distribution of the NEA to each gate through a network of pipes and hoses. For remote airplane parking or smaller airports, other options include the following:

1. Mobile nitrogen generators mounted on trucks or trailers that could be moved near the airplane for fuel tank inerting. The NEA generator would produce and feed the fuel tank directly.
2. Mobile nitrogen generators mounted on trucks or trailers combined with mobile storage. The NEA generator would continuously fill the storage and NEA is taken from the storage to inert the airplanes. This could reduce the size of the generator with a resulting decrease in power consumption.
3. Mobile storage filled at a nitrogen refilling station located at or near the airport. This solution would lead to requirements for equipment with large volumetric capacities, and the additional burden of the logistics of getting the correct amount of NEA to the airplane at the right time to support the desired turnaround time.

The details of this part of the design are considered by the Airport Facility Team. The methods for supplying nitrogen or NEA may vary around the world, but the GBI system can accommodate any method provided it has the common servicing interface and the required pressures and purity levels.

8.0 GENERAL AIRPLANE SYSTEM DESIGN

The final design of the GBI system will be aircraft specific, being dependent on the basic design philosophies/principles of the manufacturer. For this generic study, the inerting system described can be considered as one incorporating all the features likely to be necessary on any GBI system installation. They may not all be required or desired any specific design. Including all these potential features does not overcomplicate the system being described, since the overall concept remains basically simple. To keep the system simple, the approach has been to assume that the aircraft will be supplied with a fixed volume of NEA irrespective of the amount of fuel in the tank when the operation is carried out. This volume is determined during the inerting design of the aircraft. During certification tests, this volume would be supplied at a minimum NEA purity allowed and a worse case pressure. It is accepted that the required volume is a larger volume of NEA than may be theoretically necessary. This approach also ensures that the system concept is not dependent on new technologies or complex ground procedures.

8.1 GENERAL SYSTEM LAYOUT

NEA will be supplied to the aircraft from a dedicated truck or distribution network present at all airports or aircraft servicing facilities. NEA will be delivered to the fuel tanks via a dedicated manifold within the aircraft fuel tanks. The review of various aircraft indicated that the type of internal structures can vary between aircraft models. On some aircraft types, the applicable tanks are divided by ribs into what can be considered as discrete cells, and in other tanks, they are basically open type structures. The internal layout and details of the distribution network to achieve the required dispersion of NEA will therefore be aircraft specific. Plumbing that is routed within the pressurized compartment or in confined spaces will be doubled walled to prevent hazardous leakage.

A valve will be mounted close to the tank wall to provide a means of isolating the internal portion of the tank from the plumbing that extends from the fuel tank wall to the NEA servicing interface. A second valve for redundancy maybe required, and these may be either manual valves, electrically actuated valves, or check valves or a combination depending on the features desired. This portion of plumbing must also be carefully designed to minimize the potential for fuel spillage after damage from a gear-up landing. This plumbing most likely will be routed up as far as possible and then back down again either inside the tank or outside the tank in an attempt to keep fuel from collecting at the servicing interface from normal operations. This portion of plumbing would be double walled if it is mounted in an enclosed space for personnel safety. A witness drain would be installed either as part of the servicing interface coupling assembly or very near the servicing interface to identify when the valves are leaking between the tank and the servicing interface. A second witness drain would be installed to confirm the integrity of the double walled plumbing.

Drain valves may be necessary in the manifold design to keep fuel from collecting in the manifold and preventing the expected NEA flow characteristics. This would not be a recognizable fault to the servicing person. Careful evaluation of the pressures available and the potential for a fuel-plugged areas would be required. Consideration for water collection and freezing would also be required when evaluating for the installation of drain valves and their placement.

Design of the manifold may include shaped and sized nozzles to better direct the NEA for more efficient purging of the tank. Other designs may only require an outlet cut to a certain size in the plumbing. These details are not addressed in this report other than to recognize them as design options.

The schematic for a standard configuration aircraft is shown in Figure 8.1-1.

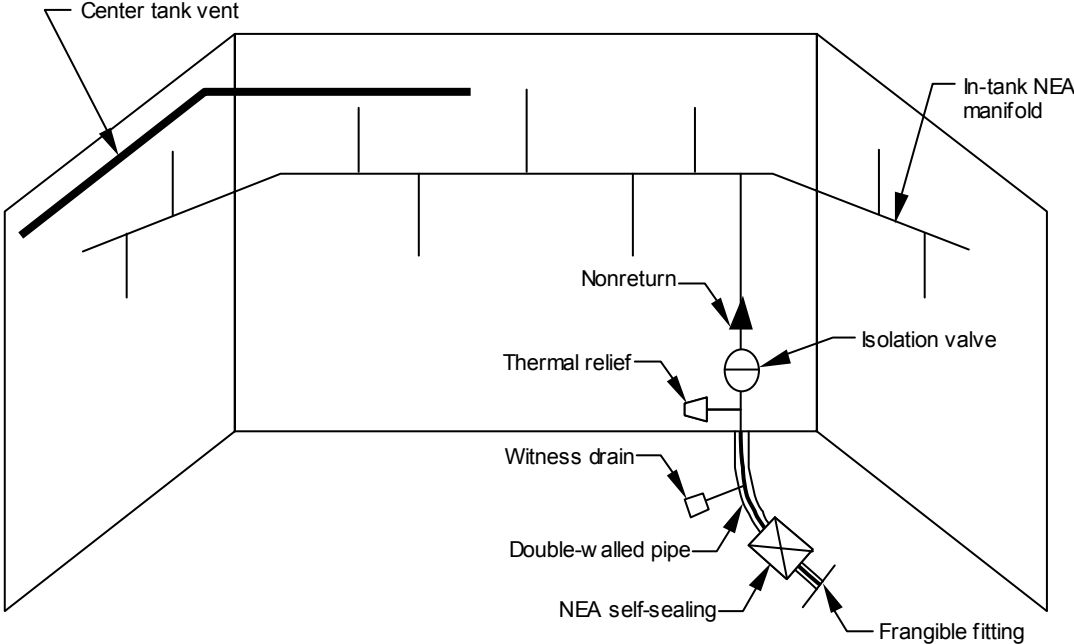

297925J2-045

Figure 8.1-1. System Schematic for Airplane With Center Wing Tanks

Auxiliary fuel tanks, when installed in the aircraft, will be serviced with NEA from the same servicing interface location. A schematic of the system for an airplane with auxiliary fuel tank(s) is shown in Figure 8.1-2.

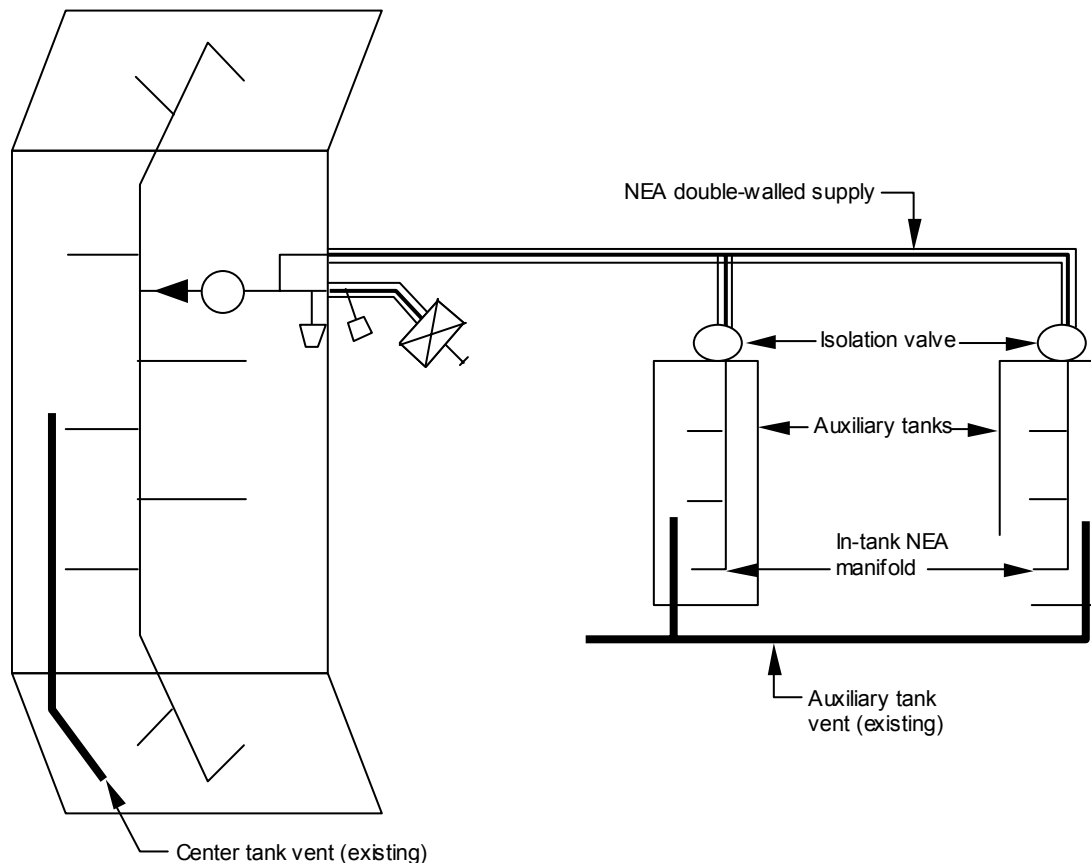

297925J2-046

Figure 8.1-2. System Schematic for Airplane with Auxiliary Fuel Tank(s)

8.2 SERVICING INTERFACE

The ground based inerting design requires development of a new airplane servicing interface for the NEA servicing hoses. This new design would preclude interconnection of other servicing hoses or devices to protect the various airplane systems including the inerting system. The potential design would incorporate a frangible self-sealing coupling interface to prevent damage to the aircraft in the event the hose or coupling itself is forcibly removed. The servicing interface would be designed to not pose a safety hazard if any part or the entire servicing interface assembly and/or installation is damaged or forcibly removed from the aircraft, as in a wheels up landing.

8.3 SERVICING PANEL LOCATION

The new service panel will be located in the aircraft to accept the new NEA servicing interface coupling and hose. Due to this study being limited in scope to center wing and auxiliary tanks, the NEA servicing interface location has been located near the fuselage of the aircraft to minimize tubing installations. However, the specific location of the NEA servicing point will be a detail design task for each aircraft type. The location should be chosen to minimize system design and aircraft structure impacts, as well as, providing as much consideration for other servicing efforts being carried out in the same area. Most notably, interference with baggage handling personnel would need to be minimized. The ATA has suggested that small/regional aircraft would prefer the NEA connection on the aircraft right side, and all other aircraft would prefer the servicing location be on the left side. The location should also be chosen to

Ground-Based Inerting Designs Task Team Final Report

minimize the safety hazard if any part or the entire servicing interface assembly and/or installation is damaged or forcibly remove from the aircraft.

Other locations considered did not exhibit desirable servicing environments. Landing gear attached locations are not desirable due to the complexity of plumbing and equipment in a harsh, moveable environment. Location towards the front or rear of the fuselage is not desirable, as additional tubing is required to connect to the center wing tank adding routing complexity and system weight. Rear fuselage locations also may be further from the ground in many models requiring other ground equipment like ladders or step stools. Wheel well locations are not desirable from a personnel safety and aircraft safety concern. If the servicing panel is mounted in the wheel well area, additional personnel training would be required to allow entry due to the complexity of the equipment in the area. The wheel well areas are also more confined, and as such, hold more risk for personnel due to the potential for a confined space exposure to undetectable gases including NEA. The servicing point should also be located so as to facilitate the easy movements of the NEA servicing personnel to the maximum degree possible. Presently it is believed that the wing-to-body fairing under the wing provides the most reasonable site for the NEA servicing location. Other locations may be more suitable on smaller aircraft. The addition of a servicing panel door in the fairing would be required in this location, but may not be required in all locations depending on the airplane design. This location was also chosen to minimize the wing structure impact and simplify the design for in-service and production aircraft installations by minimizing the plumbing runs in the wing to hookup to a wing mounted servicing interface

8.4 GENERAL SYSTEM DESIGN ANALYSIS

The ground based inerting system has been sized to load the required NEA volume in the generic sized ARAC configurations in the following times:

ARAC Large aircraft	20 minutes
ARAC Medium aircraft	15 minutes
ARAC Small aircraft	10 minutes
ARAC Regional turbofan	10 minutes
ARAC Regional turbofan	----- (not fitted with center tanks)
ARAC Bizjet	10 minutes -- (ARAC and most not fitted with center tanks)

These times do not include time to connect/disconnect the ground equipment. The time to connect is projected to be no more than 5 minutes, and the time to disconnect and provide paperwork to the pilot is projected to be no more than 5 minutes, or a total of 10 minutes per aircraft NEA servicing. These times were chosen to eliminate or minimize any gate delays to allow for short aircraft turn times. Longer times would not significantly change the aircraft design cost, but could provide less impact to existing aircraft structure due to the decrease in the required diameter for the NEA manifold and tubing. Airport Facilities will need to optimize the airport capability to handle the peaks through equipment sizing or accumulators. (See the Airport Facilities appendix)

The general GBI system was analyzed to estimate the flow performance with typically sized tubing and manifolds. As would be expected, the performance depends on a number of parameters that can be varied. Those parameters included the tubing and manifold diameters, the tubing lengths, the flow velocities, the various fuel tank volumes, NEA flow rates desired, and time to complete the required servicing. Tubing and manifold diameters were kept as small as practical to keep to minimize the structural modification and weight aspect of the design as much as possible. The tubing lengths are a function of the tank configuration and size of the specific model. The flow velocities were minimized to be consistent with existing Environmental Control System (ECS) recommendations to minimize erosion, noise, and other

adverse gas flow effects. The volume of each fuel tank was determined and multiplied by the number of volumes required to reduce the oxygen content to 8% or below as determined by flight testing. That number was determined to be 1.7 times the ullage volume as described elsewhere in this Appendix. The various ARAC airplane configurations with and without auxiliary fuel tanks were estimated to have the basic manifold plumbing lengths and diameters in figure 8.4-1.

Model	Manifold Length-Total	Diameter
ARAC Large aircraft	75 feet	2.0 inch
ARAC Medium aircraft	50 feet	1.5 inch
ARAC Small aircraft	25 feet	1.0 inch
ARAC Regional turbofan	15 feet	0.5 inch
ARAC Regional turboprop	not included	Not included
ARAC Bizjet	15 feet	0.5 inch

Model	Length between center tank and aux tank	Diameter	Manifold Length-Inside tank	Diameter
ARAC Large aircraft with aux tank	50 ft double wall external to tank	2 in internal diameter/3 in external diameter	15 ft inside tank	2 in diameter
ARAC Medium aircraft with aux tank	50 ft double wall external to tank	2 in internal diameter/3 in external diameter	15 ft inside tank	2 in diameter
ARAC Small aircraft with aux tank	42ft double wall external to tank	1.5in internal diameter/2.5in external diameter	13ft inside tank	1in diameter
ARAC Regional turbofan aircraft & ARAC Bizjet aircraft with aux tank	30ft double wall external to tank	1.0in internal diameter/2.0 in external diameter	10ft inside tank	1in diameter

Figure 8.4-1. System Manifold Lengths and Diameters

This design information was used to model and analyze the basic system for overall system performance. The results were then utilized to balance the design within the desired turn around times.

8.5 GROUND AND FLIGHT TESTING EXPERIENCE

Ground and flight test was performed on a B737NG airplane in February of 2001 to better understand the issues applicable to the ground based inerting system. A temporary inerting system was installed in a customer’s new B737NG prior to delivery. System installation and testing was performed over several weeks. The test airplane was equipped with instrumentation to record pertinent variables for future analysis. Oxygen sensors were installed in eight locations to sample the ullage space in the center tank of the airplane. The system required considerable review and analysis to confirm it was safe for personnel and the aircraft. NEA was supplied by a ground based NEA generator located adjacent to the airplane. By changing the two primary variables, fuel load and NEA loading sequencing, various GBI system scenarios were run to further understand the impact of the primary variables. Tests were also performed to better understand the impact of having a fuel tank with multiple vents. Testing did not use scrubbed fuel.

Testing has shown that multiple center fuel tank vents can result in the flow of ambient air through the tank ullage and result in the loss of the desired inert oxygen levels after the NEA inerting process (see figure 8.5-1). Local wind and certain flight situations accelerated this loss. All airplane designs that utilize more than one vent per tank may exhibit this behavior. When one of the two vents installed on the test airplane was blocked, the ability to retain the desired oxygen level was considerably enhanced. The test airplane maintained an oxygen level below 10% through taxi, takeoff, climb, and into cruise (see figure 8.5-1).

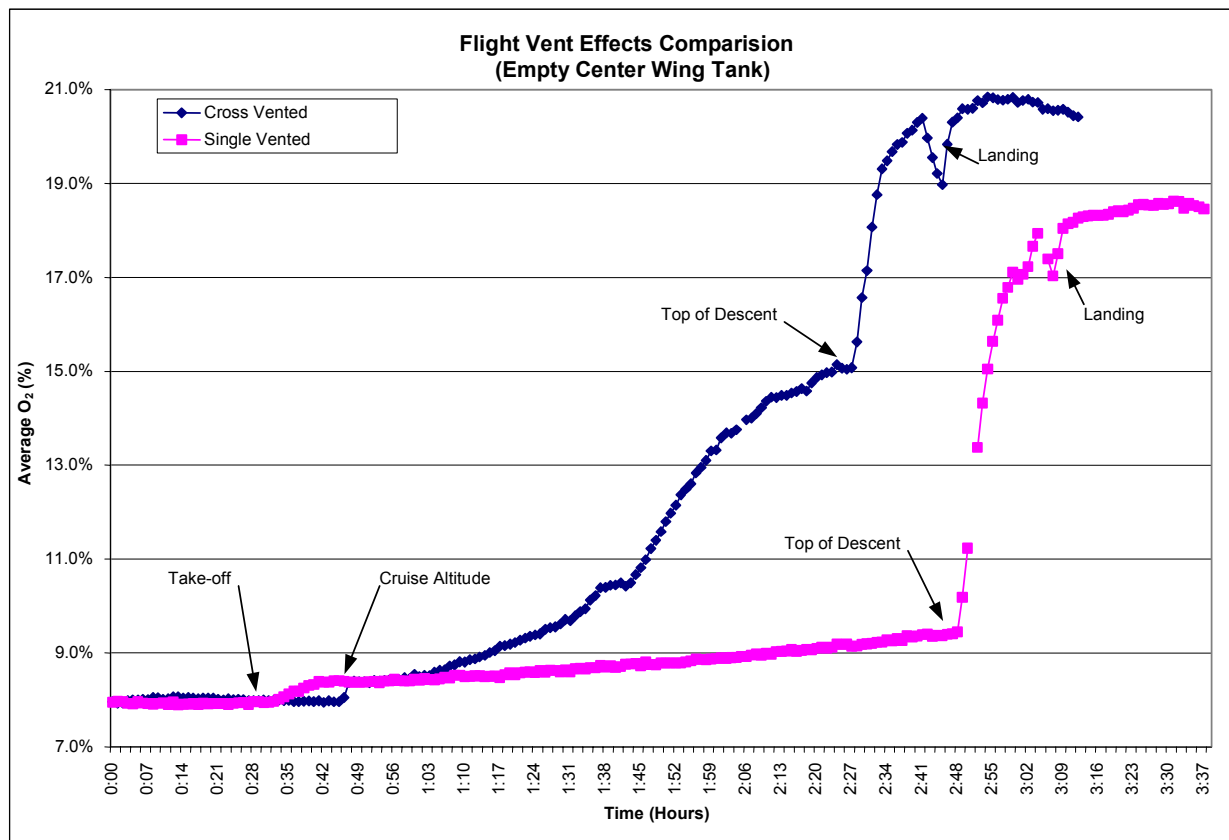

Figure 8.5-1. FAA/Boeing (B737NG) Flight Test Results Showing Effects of Crossventing

Testing also showed the evolution of gases out of the fuel did occur as the altitude increased. This effect did not induce a significant oxygen level change when fuel levels in the CWT were low (i.e., less than 20%) at takeoff. Fuel scrubbing could reduce this effect. However, because the CWT is the last tank typically filled and the majority of flights occur with low or empty CWT fuel levels, the majority of flights would not benefit from fuel scrubbing. Further, CWT’s with high fuel levels at takeoff lose their inert levels early during cruise due to ambient air in-flow to replace the fuel consumed. Thus, fuel scrubbing would only slightly change the GBI fleet exposure analysis of tanks with high fuel levels at takeoff. Overall, it was concluded fleet wide GBI performance would not be significantly enhanced by the use of scrubbed fuel.

Testing also showed that there was some difference in the oxygen levels when the sequencing of the NEA gas loading was changed around the refueling event, but here again it was not considered to be significant enough to impair the system. The ability to be able to have the GBI occur at any time in the airplane ground turn around time independent of the refueling was demonstrated.

8.6 SYSTEM CONTROLS

A control panel near the NEA filling point would be provided. This panel would contain the following items:

1. A switch to operate the NEA isolation valve for each tank, if installed
2. An indicator light for each valve, if installed
3. A placard clearly indicating the required volume of NEA, purity, and pressure requirements

Additional control of the NEA tank isolation valve may also be required depending on airplane system details and the supply pressure of the NEA. This control would cause the inlet valve to close under refuel overflow conditions thus limiting any tank over-pressure condition.

Certain Auxiliary tank configurations would require specific manual procedures to supply each tank with a suitable quantity of NEA during the ground operation to minimize the amount of NEA to be supplied.

8.7 SYSTEM OPERATION AND SERVICING

The system may be operated at any time throughout the aircraft gate time available. The system may be operated before the refueling operation commences, during the refueling process, or after the refueling process has ceased. The quantity of NEA will be the same by definition in any refueling scenario to simplify the NEA servicing processes.

One particular quantity of NEA at a specified pressure range will be required for each aircraft model. Supplemental Type Certificates (STC) or other modification involving the fuel system may require different amounts of NEA for similar aircraft and this must be clearly defined on placard at the NEA servicing location and in the Airplane Flight Manual. Detailed operational differences of the GBI system may be slightly different between manufacturers, but the intent is for them to be similar in operation.

A printed NEA flowmeter output receipt would be provided to the pilot at the end of every NEA servicing provides the check that the NEA has been loaded and the volume loaded is correct. The ideal NEA flowmeter system would print the quantity, minimum purity and minimum pressure for the pilots' comparison to the AFM.

Future aircraft designs may utilize a more sophisticated control over the NEA servicing activity, including the volume of nitrogen delivered. Onboard aircraft computers and information from the ground based equipment could work together to optimize the NEA delivery particularly when the NEA is added after refueling. Ground equipment manufacturers and facilities designers may want to work with the aircraft manufacturers to ensure this option is made possible and interface requirements are defined. That detailed definition is out of the scope of this study.

Typical NEA servicing instructions:

1. Open access panel.
2. Verify servicing equipment/source meets aircraft placard requirements for pressure and NEA purity.
3. Connect the servicing hose with the aircraft NEA servicing location and lock in place.
4. Select the isolation valve open. Verify indicator light illuminates confirm valve has opened.
5. Add required volume of NEA as identified on the placard.
6. Close isolation valve and verify indicator light extinguishes.
7. Unlock and disconnect NEA servicing hose coupling.
8. Fill in control sheet to indicate operation has occurred and amount of NEA added if not printed in sheet by flowmeter.
9. Verify the volume delivered meets or exceeds the required volume on the NEA servicing placard.
10. Deliver NEA servicing sheet to the flight crew.

8.8 AUXILIARY TANK DESIGN ISSUES

For aircraft fitted with auxiliary fuel tanks, system operation and equipment arrangement for inerting the tanks would be similar to that for a center tank installation. Aircraft with center tanks and auxiliary tanks installed would utilize a common NEA service interface connection and associated controls. The procedures to inert the auxiliary fuel tanks would be the same as the center tank, except for the potential

Ground-Based Inerting Designs Task Team Final Report

difference in NEA volume required. The aircraft plumbing would be arranged to split and balance the incoming NEA flow so that each tank receives the correct volume of NEA. This would allow the auxiliary tanks to be inerted at the same time as the center tanks to minimize impacts on turn around time. It also may be possible to use the auxiliary tank refueling line for inerting due to the configuration and smaller size of the tank. Certification testing would be required to show proper inerting in all tanks.

The plumbing between the center tank and the auxiliary tanks (in all locations within the pressurized cabin area) must be double walled to preclude NEA leaks from entering the pressurized passenger area. In addition, the introduction of the ground based inerting system for aircraft auxiliary tanks would require modifications to cargo compartment panels, linings, and new rubber auxiliary tank liners where so equipped. Additional penetrations will be required through structure and the center wing tanks to route the required tubing to deliver NEA to the auxiliary tanks.

Suppliers of auxiliary fuel tanks that are not covered under the original airplane certification must obtain a Supplemental Type Certificate (STC) to install an auxiliary fuel tank system. If properly integrated, the fuel tank distribution manifold and auxiliary tank NEA distribution system would be interconnected to utilize a single servicing interface location. The auxiliary tank system would be designed such that the inert gas supplied by the ground system at the single servicing interface location provides sufficient NEA to inert the auxiliary tanks and the normal airplane fuel tanks with no additional interaction by ground personnel. The actual volume of inert gas required would be determined at certification and would be clearly shown on the placard directly adjacent to the servicing interface location. Other systems may be possible that include automatic sequencing of the inerting system valves to control the NEA distribution. These interactive systems would be required to demonstrate that they meet the applicable requirements at certification while minimizing servicing personnel induced error.

STC providers would be solely responsible for showing that the original airplane inerting system certification was not degraded when the STC auxiliary tank(s) were fitted to the modified airplane. This may include conducting the complete airplane inerting certification testing over to verify the total airplane inerting system meets the applicable requirements. New placards showing the new NEA volumes would be required at the servicing interface location. Auxiliary tanks fitted by the original airplane manufacturer prior to certification would be covered as part the routine certification process.

8.8.1 Auxiliary Tank Pressurization Alternative

Some auxiliary tank designs reviewed transfer fuel using pressurized air. Pressurizing the tank means that the tank ullage is effectively at a lower altitude. This results in a higher fuel LFL and thus a higher fuel temperature is required to produce a flammable atmosphere within the tank. Therefore, an alternative method of achieving a lower flammability exposure for auxiliary tanks may be to increase the pressurization level in the tanks at all times, or convert tanks which are open vented, to pressurized systems. Application of this technique may show that the resulting flammability exposure is similar to that which would have been achieved by inerting (see discussion of auxiliary tanks in Flammability Exposure Analysis Appendix J). In order to provide this alternative, all design factors and considerations affecting the design and safety must be addressed including, but not limited to, structural considerations, venting, loss of cargo bay pressurization, etc.

9.0 EQUIPMENT REQUIRED

The following equipment is required for inerting with a ground based inerting system:

9.1 NEA SERVICING INTERFACE

As stated earlier, the ground based inerting design requires development of a new airplane servicing interface for the NEA servicing hoses. A new worldwide engineering standard for the servicing interface coupling halves would need to be developed and controlled in a similar manner to the current refuel coupling. This interface would consist of a nozzle portion attached to the servicing hose and a matching

airplane mounted receptacle. The interface would be designed to prevent incorrect connections of other servicing hoses or devices to protect the various airplane systems, including the inerting system. The design would incorporate a frangible self-sealing coupling interface to prevent damage to the aircraft in the event the hose or coupling itself is forcibly removed. An example of this might be a NEA servicing truck driving away still connected to the aircraft interface or a NEA servicing hose being snagged by other service vehicles driving away. The coupling design and materials would be required to be a non-sparking design to prevent ignition sources where fuel is or could be present. This non-sparking requirement would also include all potential failure modes.

As presently envisioned, the interface would include at least one internal check valve. The insertion and engagement of the ground hose end of the interface would actuate this check valve. This would allow NEA pressure into the interface coupling followed by the check valve(s) opening to the fuel tank. The purpose of this timing is to prevent fuel from draining into the hose assembly and allowing the pressure of the NEA to push back the fuel if any has leaked into the manifold assembly. The insertion and engagement of the two halves of the servicing interface could be a manual operation similar to a refueling single point coupling, or an automatic mechanism. The method chosen should be standardized to ensure servicing commonality. The automatic mechanism is preferred from an overall system standpoint to assist less skilled or trained personnel to safely service the inerting system. A witness drain to identify leakage past the isolation or nonreturn valves may also be required here.

Each aircraft manufacturer would have the option of integrating a servicing interface module into their particular model or designing something specific for their airplanes using the standard coupling interface. The NEA servicing interface would ideally be a modular design and assembly that could be produced by an aerospace component supplier. The assembly would consist of the servicing interface for the NEA servicing hose describe above and a generic mounting configuration that would allow easy mounting adaptation to various models. This mounting configuration may include mounts to attach the service doors required in the fairing application. Since all fairings would be different, this service door design would need to be flexible and yet provide some degree of commonality to maximize manufacturing efficiency and minimize cost.

9.1.1 Witness Drains

A witness drain would be required to detect leakage in the double walled portions of tubing exterior to the fuel tank. This could also be accomplished by routing the inter-shroud drains to overboard drain masts if those masts drain while on the ground. This would give ground personnel and the pilots visibility if the double walled tubing (or hose) configurations are leaking fuel. Gaseous leakage would be difficult to detect on a daily basis. A maintenance plan would be required to do leak checks on this double walled tubing at reasonable intervals to ensure the secondary barrier is intact.

9.1.2 Isolation Valve

An isolation valve may be required to isolate the tank from the external tubing. It is envisioned that this valve would be an electrically operated valve and mounted directly to the internal surface of the tank.

9.1.3 Non-Return Valve

A non-return valve (check valve) to prevent backflow of fuel into the NEA supply would be required internal to the center tank at the main NEA manifold penetration into the tank. It is envisioned that this valve could be mounted directly to the tank wall surface if the isolation valve was not required.

Ground-Based Inerting Designs Task Team Final Report

9.1.4 Thermal Relief Valve

Thermal relief valves are required to relieve any pressure that may build up in the tubing due to temperatures changes. Thermal relief valves may be incorporated into the other valves or equipment present in the system.

9.1.5 Indication and Control

A control switch and position lamp for the isolation valve may be required. This switch and indicator would be required to be intrinsically safe or environmentally/hermetically sealed in a manner to not present a potential ignition source due to the potential presence of fuel. Any control hardware located near the NEA interface would also be required to be housed or protected to not present a potential ignition source.

9.1.6 Drain Valves

Drain valves may be required in the tubing and/or manifold where locations do not drain fuel to minimize interference with the trapped fuel and the incoming inerting gases. Drain valves would not be necessary where the design could be shown to always clear itself and provide the proper volume of inerting gas.

9.1.7 Placards

Placards would be affixed to those areas requiring cautionary and/or safety instructions, and placards would be provided directly adjacent to the interface coupling servicing installation area. The servicing coupling placard would clearly identify the certified, NEA volume to be loaded on the aircraft. Placards would be clearly readable and of materials consistent with the usage.

9.2 AUXILIARY TANKS

Auxiliary fuel tanks would require similar equipment as the main center tanks in the aircraft. Auxiliary fuel tanks are envisioned to be inerted through the same NEA servicing coupling as the center tanks. As such, the auxiliary tanks could receive their inert gas from the same manifold. Depending on how the system is designed and operated, it may require additional control circuitry for the auxiliary tank isolation valves to control the time the auxiliary tank isolation valves are open. This would be to ensure that a sufficient volume of inert gas is distributed to the auxiliary tank as the center tanks are being inerted. The details of this are presented at this time due to the variability of auxiliary tank systems.

9.3 ADDITIONAL EQUIPMENT REQUIRED

Aircraft designed with crossvented fuel tanks will need to have the vent system design modified and demonstrate methods to minimize NEA exchanges due to the crossventing configurations. This is envisioned as a low cracking pressure bi-directional flapper check valve that is installed in all but one vent passages used for the center tanks. These changes will need to be implemented carefully to take all vent system design issues into account. These changes will also need to account for interaction by auxiliary fuel tanks.

10.0 INSTALLATION REQUIREMENTS

10.1 NEW DESIGN

The design of a ground based inerting system requires the careful and balanced selection of a number of design parameters to optimize the system's performance versus the aircraft servicing time. The prime requirement of the system will be to distribute the NEA to achieve a reduced oxygen concentration to comply with the rule and the specific certification.

No major concerns are seen with the GBI inerting concept, assuming the design is launched in the early phase of the design. During the design cycle the system would be subject to design reviews, safety assessment, zonal analysis, etc. The manifold design, structural penetrations, wiring and service point

location would be worked in the basic design phase. Routing of any electrical controls or circuits associated with any of the equipment used would need to be implemented carefully to not introduce any new hazards. Location of the servicing interface point would need to consider not only the location of the servicing trucks, but be located so as not to introduce additional hazards in the event of a wheels up landing. Accessibility of the servicing interface connection would need to consider the acceptability of servicing steps/platform if necessary.

Installation requirements for all designs will be very similar. Installations for new designs will have the most flexibility to optimize plumbing and its associated placement. It is expected the NEA manifold would be mounted as close to the top of the tank as possible. This would be to ensure that the maximum mixing and venting of the tank gases occurs to efficiently purge the fuel tanks of oxygen with the minimum quantity of NEA in any refueling scenario. Effort to minimize the formation of fuel collection sites within the manifold should be made. This may include drain valves in those designs that may not be capable of clearing these fuel obstructions through the normal NEA servicing procedures and the servicing pressures available.

10.2 IN-PRODUCTION

Optimum manifold design in terms of weight and location may not be possible due to other systems installed and limitations on location of structure penetrations. Optimum plumbing configurations and lengths may not be possible due to the restrictions on getting plumbing into the airplane after assembly. Modifications to tank venting arrangements may be required on certain aircraft types. This will require additional design and certification activity over and above that required to demonstrate the effectiveness of the modification for inerting the tank. Depending on the location of the servicing interface point, redesign of a section of the external aircraft body fairing may be required including the introduction of a specific access panel to gain access to the servicing point. Airline spares will be impacted.

10.3 RETROFIT

Concerns expressed for the in-production design are equally applicable. If modifications to the tank installation or areas around the fuel tank have been made to the aircraft since the original delivery then further additional design work and adaptations may be required.

10.4 AUXILIARY TANK INSTALLATIONS

Generally, the comments above also apply to auxiliary tanks. Several additional concerns also apply:

- The need for double walled tubing in the pressurized areas will further complicate tube routing in areas where space is already constrained by other systems.
- If more than one auxiliary tank is installed it will be necessary to balance the flow of NEA between the tanks. This may require a NEA volume greater than that currently envisaged of 1.7 times the total ullage or other design changes unknown at this time.
- Some auxiliary tanks include bladders inside the tanks. This will complicate redesign because of the need for new bladders to accommodate new tubing penetrations and routing in the tank.
- Modification of cargo bay liners will be required, due to the new plumbing penetrations.

11.0 SYSTEM IMPACT ON OTHER SYSTEMS

Because the NEA may be dissolved in the fuel differently than other gases, there may be some impact of other systems in the aircraft. Those impacts must thoroughly investigated to ensure a detrimental effect is not introduced by these inerting systems. The detailed testing required to ensure safe and proper operation of these systems is beyond the scope of this report, other than to address and note these concerns in a general manner. The concerns are as follows:

11.1 PUMP PERFORMANCE

NEA coming out of solution from the fuel, particularly when the aircraft climbs, may be different from the evolution of air or other existing dissolved gases. Those differences most likely would be explained as a function of bubble size and/or the rate the bubbles are evolving from the fuel. The ability of the engine pumps, fuel boost pumps and ejector style pumps to successfully prime, pump, and reprime in a predictable manner identical to past performance is essential. If it were demonstrated that this was not the case, then all fuel pumping equipment would require re-qualification at considerable expense. Further, these differences would require evaluation of engine feed operational issues and it is likely to require re-certification testing, again at considerable expense.

11.2 IMPACT ON FUEL QUANTITY INDICATION SYSTEM (FQIS) PERFORMANCE

The effects of nitrogen inerting on the various fuel measurement techniques are not fully understood at this time. The process of injecting the NEA into the fuel tanks may have effects including:

- Introducing larger quantities of dissolved nitrogen into the fuel
- Potential for displacing other dissolved gases in the fuel
- Causing the formation of bubbles both in the fuel and on the fuel surface
- Causing the bubbles to manifest themselves differently than before
- Changing the properties of the fuel

Detailed testing of the chemical and physical effects of nitrogen inerting in this new environment should be done to insure that the functional integrity of the various fuel measurement techniques are not degraded. The consequences of these changes may effect the accuracy or reliability of the specific FQIS measurement techniques and equipment used. That would need to be carefully studied and characterized to ensure there were no side effects in-service. That detailed testing is beyond the scope of this report.

11.3 IMPACTS ON CROSS VENTED SYSTEMS

“Cross vented” venting systems, or those that have center tank vents that run out to both wing tips, appear to be less desirable for inerting systems. The potential for flow through the tanks between the two vent locations can produce a scavenging effect that will cause the ullage to exchange with the outside air in a short period of time. This increases the oxygen content in the tank to rise as the outside air is brought in. Those airplanes that have these venting systems would be required to design a means to retain low oxygen contents in the ullage space.

11.4 POTENTIAL IMPACT ON FUEL PROPERTIES

Through the process of inerting the fuel tank ullage, the lighter fractions contained in the fuel are removed. The effect of this change on fuel properties has not been characterized for the engines and their performance. Detailed testing to characterize this issue is beyond the scope of this report.

12.0 SYSTEM SAFETY

The primary focus of the GBI design team was to carefully and thoroughly evaluate ground based inerting systems with a heavy emphasis on not introducing new safety hazards for either personnel or the airplanes. While the safety impacts of the GBI system are discussed in detail elsewhere in this report, the primary safety concerns of this system are stated here again for reference. The safety concerns are primarily associated with the following:

- The use of nitrogen, NEA, or other oxygen displacing gas in confined spaces.
- The flow of oxygen depleted gases from the aircraft wingtip vents.

- Overpressurization of the wing structure due to malfunction of the ground or airplane mounted inert gas pressurization equipment.
- Minimizing new safety hazards associated with a “wheels up” landing. This is primarily a servicing interface location issue.
- Minimizing new ignition source hazards associated with incorporation of a GBI system. Non-sparking materials and components at the servicing interface coupling, careful use of electrical components, and minimizing new electrostatics issues due to the ullage purging are examples.
- Safeguards to prevent fuel spillage

13.0 SYSTEM WEIGHT

The estimated weight required for each ARAC aircraft is outlined below to assess the system impacts on the aircraft performance and it’s associated economic impact. Weights for the ARAC Turbofan, Turboprop and Bizjets are estimates based on the ARAC Small aircraft data as detailed information on the actual systems and configurations were not known. The ARAC Turboprop is not included below because that configuration does not have a center tank by definition. The ARAC Bizjet does not have a center tank by definition, but information that some Bizjets have a center tank in reality became available late in the study and these configurations are shown as well. Figure 13.0-1 lists the estimated weights for the various systems.

ARAC Standard Configuration Model	Total Weight US Pounds	Total Equipment Weight US Pounds	Total Plumbing Weight (including couplings) US Pounds	Total Other Installation Weights (including brackets, bonding jumpers, structure modifications, and hardware) US Pounds)
Large Aircraft	54	6	36	12
Medium Aircraft	34	6	20	8
Small Aircraft	22	6	10	6
Turbofan	15	5	7	3
Turboprop	---	---	---	---
Bizjet	15	5	7	3
Aux tank for Large	45	3	39	3
Aux tank for Medium	45	3	39	3
Aux tank for Small	47	13	27	7

Note: 1. Auxiliary tank weights listed are for the tank equipment and its associated external manifold equipment only. Does not include the associated additional airplane structural and systems weights.

Note: 2. Auxiliary tank weights for the Small aircraft is based on tanks located in both the front and the rear cargo areas of the aircraft.

Figure 13.0-1. Estimated System Weights

14.0 EVALUATION OF REDUCTION IN EXPOSURE TO FLAMMABLE ATMOSPHERE

14.1 REDUCTION IN EXPOSURE TO FLAMMABLE ATMOSPHERE ANALYSIS

The methodology of analyzing flammability exposure is explained in the main body of this report in Section 4.2 Flammability. Utilizing this modeling approach, the baseline flammability for the Large, Medium and Small Transport categories were performed and the corresponding values are shown in figure 14.1-1 below. As noted in the discussion on modeling, these values do not represent any specific airplane, only a generic configuration selected to represent an airplane in this category.

Incorporating GBI on these airplanes is analyzed based on the following assumptions:

- Every airplane is inerted with the volume of 95% NEA necessary to reduce the oxygen content to 8% with an empty tank. Thus, flights with a partially full center tank actually start at less than 8% oxygen.

Ground-Based Inerting Designs Task Team Final Report

- The inerting is a step function inserted at halfway through the “time at gate after refueling”. Additional modeling refinement was not made to model the actual inerting flow time or a random distribution of when the inerting may occur during the gate time, as would occur in actual implementation. However, it is expected that the results presented here are similar.
- The model assumes no loss of nitrogen during steady state cruise. Depending upon the openness of the tank venting and the duration of the flight, there may be some loss not accounted for in this analysis.

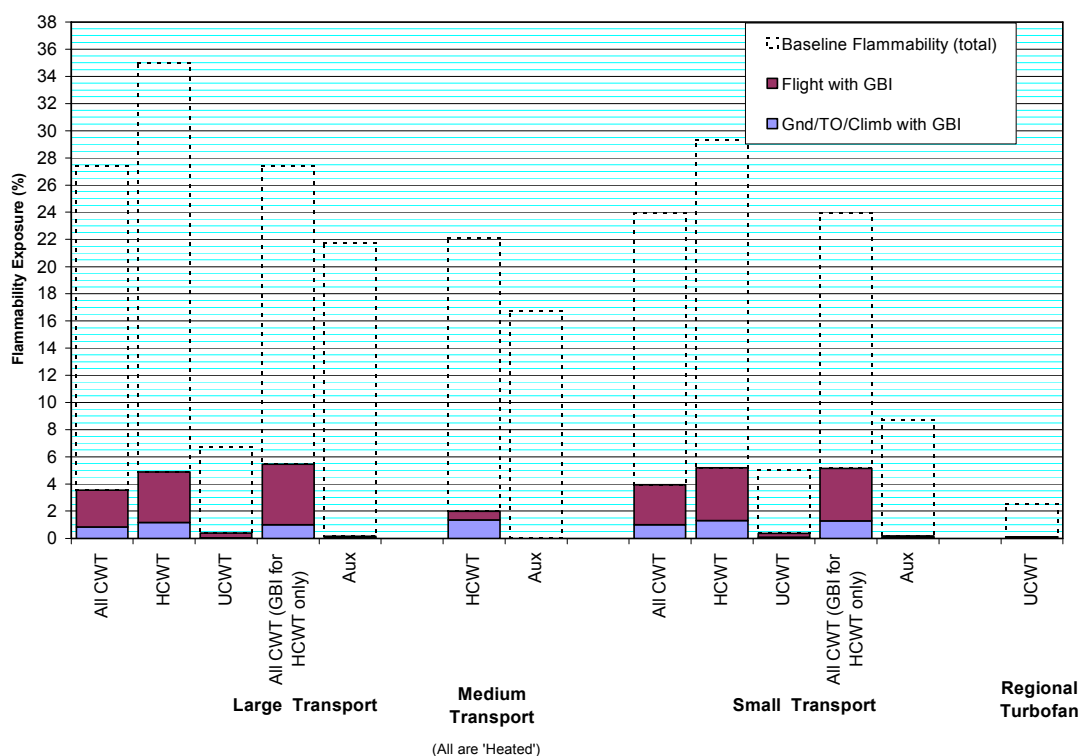

Figure 14.1-1. Flammability Exposure Results for the Ground-Based Inerting System

The results of the analysis are that the fleet wide (All CWT) Flammability Exposure after GBI is as shown in figure 14.1-1 for the Large, Medium and Small Transports. The “All CWT” values represent a combination (per the ARAC estimated distribution) of the Heated Center Wing Tanks (HCWT) and the Unheated Center Wing Tanks (UCWT) values. Also shown are the individual values for the HCWT and the UCWT generic airplanes. The difference in the exposures between the different sizes of transport airplanes is a function of the generic definition of the models, and demonstrates the variation from model to model that would exist due to difference in tank sizes, mission profiles and other variables. Also shown is the effect of GBI on an ARAC defined Regional Turbofan airplane, which has an unheated center tank.

Per the Tasking Statement, GBI has been analyzed only for tanks which do not cool at a rate equivalent to a wing tank. Therefore, wing tanks, the regional turboprops, and the business jets are not included in the analysis as they do not include tanks that fit this criterion.

The tasking statement also asks for the effect of limiting GBI to airplanes with only Heated Center Wing Tanks (HCWT). As shown in the numbers, the largest benefit is for HCWT airplanes, as the baseline flammability of the UCWT airplanes is already approximately the same as the HCWT with GBI. Therefore, limiting GBI to airplanes with HCWTs would result in only a modest increase in fleet wide flammability exposure. Note that GBI for only HCWTs, which is defined as Scenario 11 in the Estimating

and Forecasting section (Section 11.0) of the main report, has been used in the Executive Summary Information (Section 1.0).

Auxiliary tanks were also evaluated and the results are also shown in Figure 14.1-1. As shown, for airplanes with unpressurized auxiliary tanks, GBI would significantly reduce the flammability. The use of pressurized auxiliary tank systems may be an alternative method of reducing the flammability as discussed below.

14.2 ALTERNATE METHOD FOR REDUCTION OF FLAMMABLE ATMOSPHERE FOR AUXILIARY FUEL TANKS

Estimated Percentage of Fleet equipped with Auxiliary Tanks:

ARAC Transport Category	Heritage Boeing	Heritage MDC	Airbus	Total Fleet Percent	Fleet Percent Ambient Pressure	Fleet Percent Pressurized Tanks
Large	1%	15%	-	5%	5%	-
Medium	0.1%	-	5%	2.5%	-	2.5%
Small	5%	20%	4%	8%	5%	3%

Flammability is highly dependent upon the usage of the auxiliary tank. While only a fraction of the fleet has auxiliary tanks, it is estimated that the usage of the tanks on the specific airplanes equipped with auxiliary tanks would be similar to the overall usage of center tank fuel for the entire fleet. Therefore, we are assuming 20% of flights on airplanes equipped with auxiliary tanks load some fuel in the auxiliary tanks.

Flammability is dependent on tank ullage pressure. The pressure decrease associated with cruise altitude results in an effective decrease in the Lower Flammability Limit (LFL) temperature of about 40 degrees F. By maintaining the tank pressure at a lower altitude, the LFL decrease is less. Designs that maintain auxiliary tank pressure exist. For the purposes of this estimate, we have assumed they maintain a 20,000 foot altitude pressure during cruise. Auxiliary tanks are not exposed to temperature increase from A/C packs and are located in the cargo areas. Thus, flammability is a function of the ground ambient temperature, the cruise cargo area temperature and the tank ullage pressure.

Given the above factors, the baseline flammability of auxiliary tanks are calculated as:

ARAC Transport Category	Fleet Size - Ambient Pressure Aux Tanks	Flammability Exposure -Ambient Pressure Aux Tanks		Fleet Size - Pressurized Aux Tanks	Flammability Exposure - Pressurized Aux Tanks (20,000 feet)
Large	5%	22%		-	3.0%
Medium	-	17%		2.5%	2.2%
Small	5%	9%		3%	3.2%

Finally, maintaining auxiliary tank pressure altitude at or below 10,000 feet can further limit the LFL decrease at cruise and thus limit flammability.

ARAC Transport Category	Flammability- (10,000 feet) Pressure Tanks
Large	0.3%
Medium	0.4%
Small	0.6%

Thus, an auxiliary tank pressurized to 10,000 foot altitude is approximately equivalent to GBI. It is expected that modifying or replacing auxiliary tanks to utilize pressurized systems limited to 10,000 foot

ambient pressure altitudes would be an acceptable (and potentially preferred) alternative to incorporating GBI on auxiliary tanks.

14.3 BACKGROUND INFORMATION ON FLAMMABILITY

The critical combustion concentrations are known as the limits of flammability of the system and are defined as the fuel-lean, or lower flammability limit (LFL), and the fuel-rich, or upper flammability limit (UFL). When fuel is raised above the LFL, the fuel/air vapor mixture it produces (once it reaches an equilibrium state, will be flammable). If the temperature is too high, the fuel/air vapor mixture may be too rich (too much fuel) to be flammable. Likewise, when the mixture temperature is decreased, the fuel condenses and the mixture decreases. See figure 14.3-1 for an illustration of these concepts for JP-8, which is similar to Jet A and Jet A1 fuel used for commercial jet aviation.

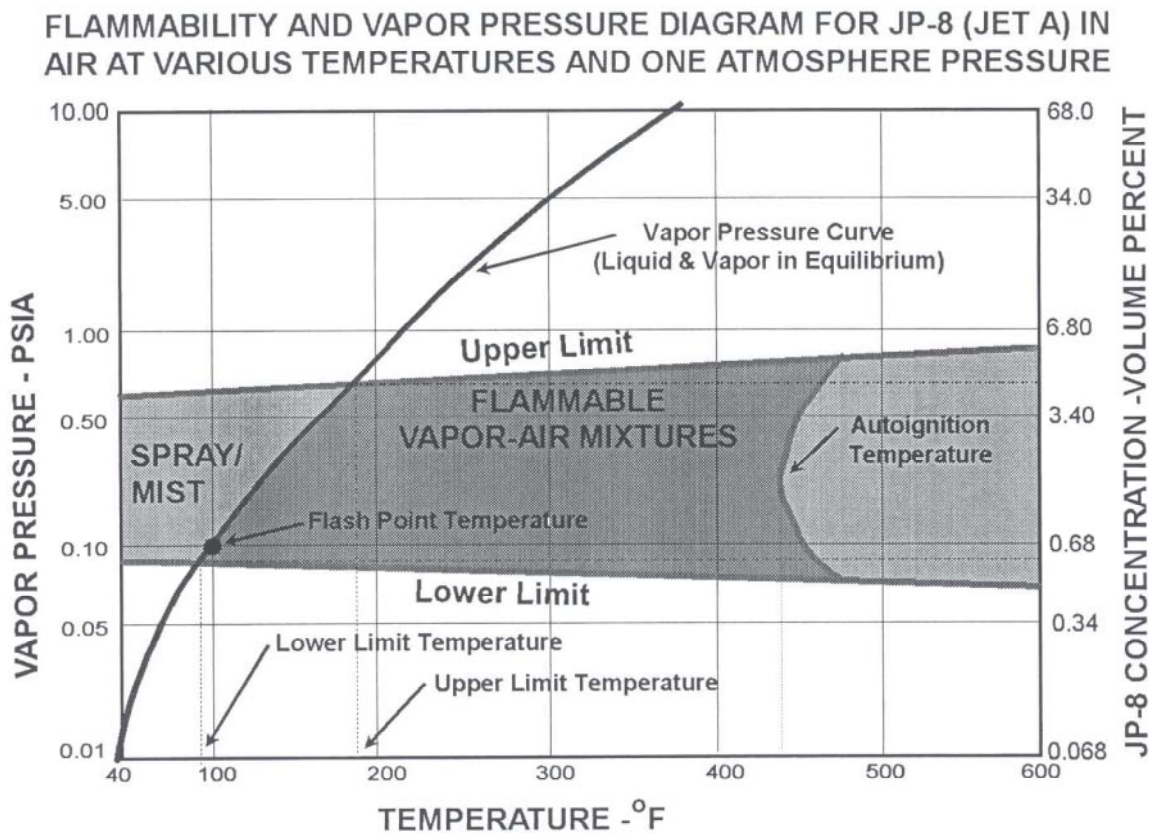

Figure 14.3-1. JP-8 (Jet A) Flammability and Vapor Pressure

Regarding Figure 14.3-1, it should be noted that the flash point of the fuel varies with each batch, but the specified minimum for Jet A is 100F. The flash point of the fuel is determined by a closed cup method, which correlates somewhat with the LFL. This test is conducted at ambient conditions, the amount of oxygen is fixed and the ignition source is specified. Note that the flash point of a given batch of fuel is about 10F above the LFL. The flash point will decrease with a decreasing ambient pressure. Correspondingly, the pressure, and therefore altitude, affect the LFL and UFL's. This is illustrated in figure 14.3-2 for several aviation fuels. As the pressure in the fuel tank is reduced during ascent, the effective flammability range is lowered as is shown in figure 14.3-2.

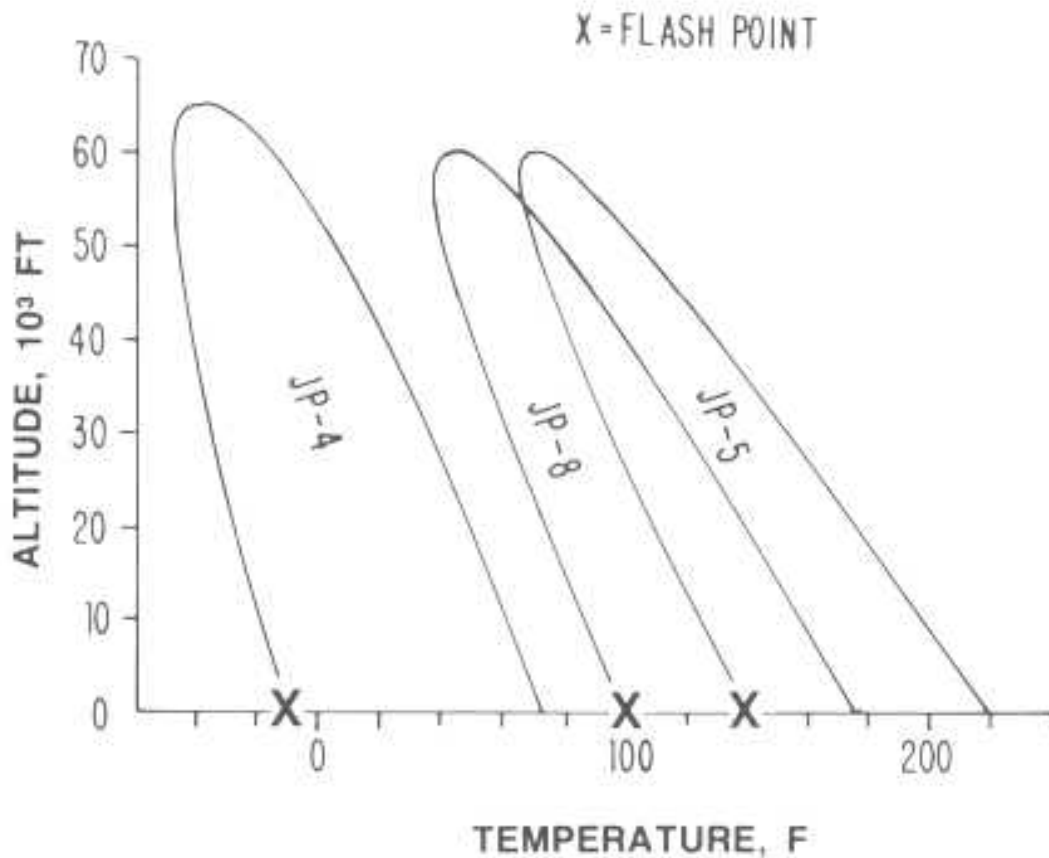

Figure 14.3-2. Aircraft Fuel Flash Point as a Function of Altitude and Temperature

14.3.1 Inerting

Figure 14.3.1-1 shows the recommended oxygen percentage for aviation fuels is 9% which indicates no explosions are possible if the level of oxygen inside the fuel tank is 9% or lower. The “maximum recommended oxygen percentage” applies to maintaining an inert atmosphere for protection against unexpected or unlikely sources of ignition. Further by starting out at a lower oxygen content, the inert level will remain longer in the ullage. This level should be maintained for as long as possible throughout the flight profile.

Ground-Based Inerting Designs Task Team Final Report

Maximum Permissible Oxygen Percentage to Prevent Ignition of Flammable Gases and Vapors Using Nitrogen and Carbon Dioxide for Inerting

	N-Air		CO ₂ -Air	
	O ₂ Percent Above Which Ignition Can Take Place	Maximum Recommended O ₂ Percent	O ₂ Percent Above Which Ignition Can Take Place	Maximum Recommended O ₂ Percent
Acetone	13.5	11	15.5	12.5
Benzene (Benzol)	11	9	14	11
Butadiene	10	8	13	10.5
Butane	12	9.5	14.5	11.5
Butene-1	11.5	9	14	11
Carbon Disulfide	5	4	8	6.5
Carbon Monoxide	5.5	4.5	6	5
Cyclopropane	11.5	9	14	11
Dimethylbutane	12	9.5	14.5	11.5
Ethane	11	9	13.5	11.0
Ether	—	—	13	10.5
Ether (Diethyl)	10.5	8.5	13	10.5
Ethyl Alcohol	10.5	8.5	13	10.5
Ethylene	10	8	11.5	9
Gasoline	11.5	9	14	11
Gasoline 73-100				
Octane	12	9.5	15	12
100-130 Octane	12	9.5	15	12
115-145 Octane	12	9.5	14.5	11.5
Hexane	12	9.5	14.5	11.5
Hydrogen	5	4	6	5
Hydrogen Sulfide	7.5	6	11.5	9
Isobutane	12	9.5	15	12
Isopentane	12	9.5	14.5	11.5
JP-1 Fuel	10.5	8.5	14	11
JP-3 Fuel	12	9.5	14	11
JP-4 Fuel	11.5	9	14	11
Kerosene	11	9	14	11
Methane	12	9.5	14.5	11.5
Methyl Alcohol	10	8	13.5	11
Natural Gas (Pittsburgh)	12	9.5	14	11
Neopentane	12.5	10	15	12
n-Heptane	11.5	9	14	11
Pentane	11.5	9	14.5	11.5
Propane	11.5	9	14	11
Propylene	11.5	9	14	11

Notes to Table

1. Data in this Table were obtained from publication of the U.S. Bureau of Mines.
2. Data were determined by laboratory experiments conducted at atmospheric temperature and pressure. Vapor-air inert-gas samples were placed in explosion tubes and exposed to a small electric spark or open flame.
3. In the absence of reliable data, the U.S. Bureau of Mines or other recognized authority should be consulted.
4. The "Maximum Recommended O₂ Percent" applies only to maintaining an inert atmosphere for protection against unexpected or unlikely sources of ignition. Much higher factors of safety are required for conditions where sources of ignition are deliberately applied such as hot work. See Purging, Paragraph 223.

Figure 14.3.1-1. Maximum Oxygen Content for Inerting System Flammability as a Function of Fuel Type

Figure 14.3.1-2, 14.3.1-3 and 14.3.1-4 are included for additional reference.

Figure 14.3.1-2 contains data for military gun fire testing on inert tanks. While this data is included for reference, the military data demonstrates that the 9% oxygen level is supportive of a non-explosive, safe, and survivable environment.

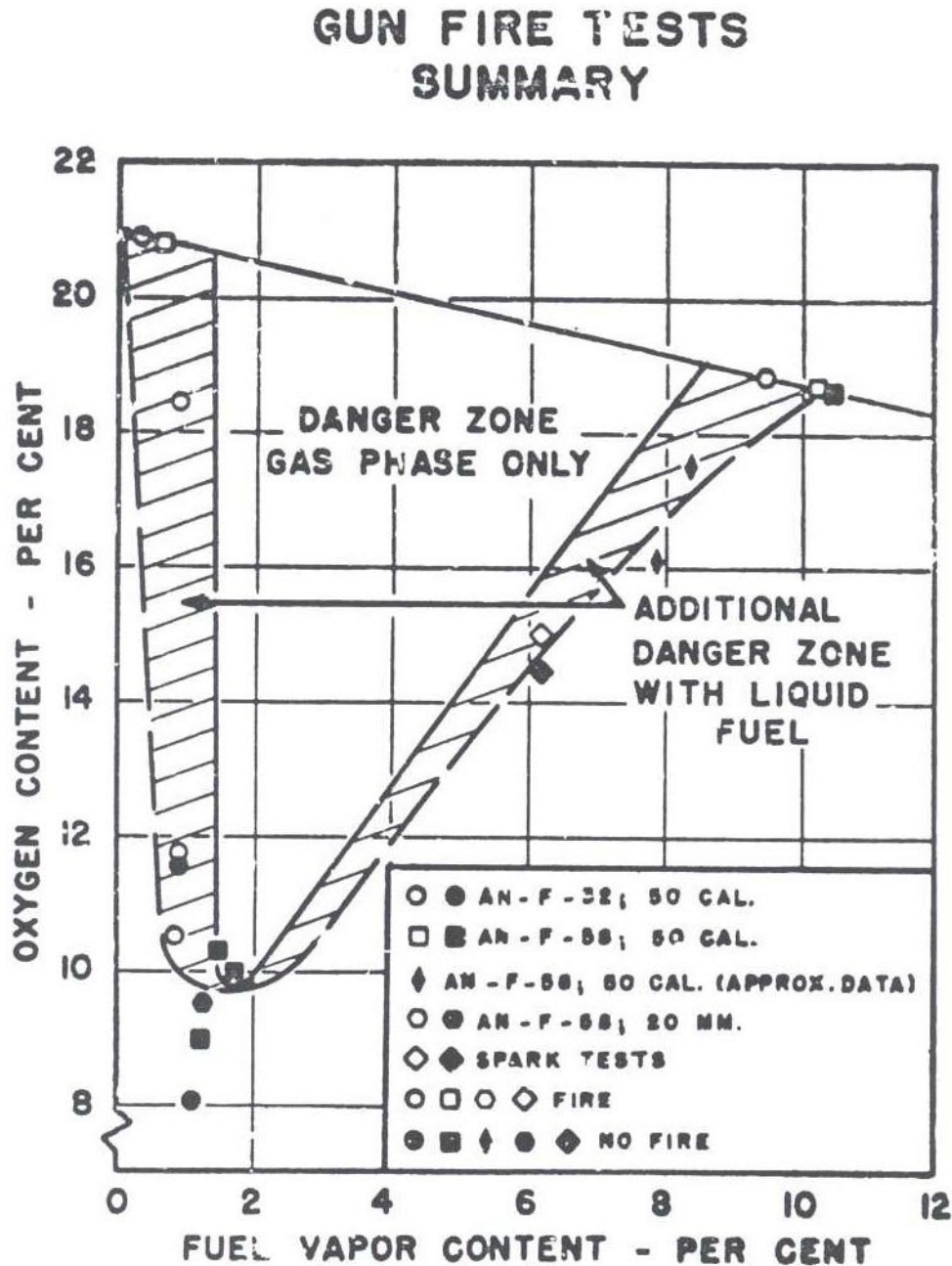

Figure 14.3.1-2. Tank Combustibility With Gun Fire as a Function of Oxygen and Fuel Content

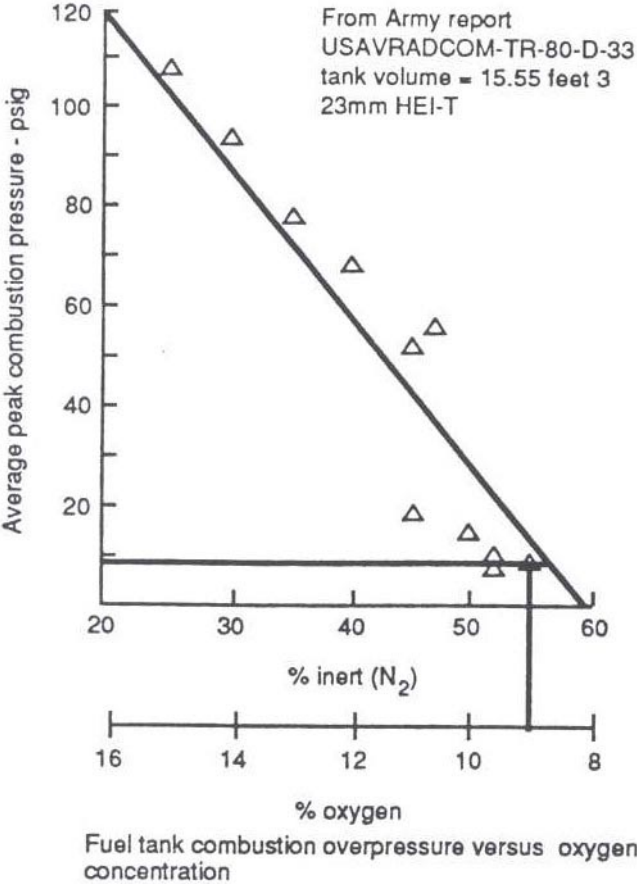
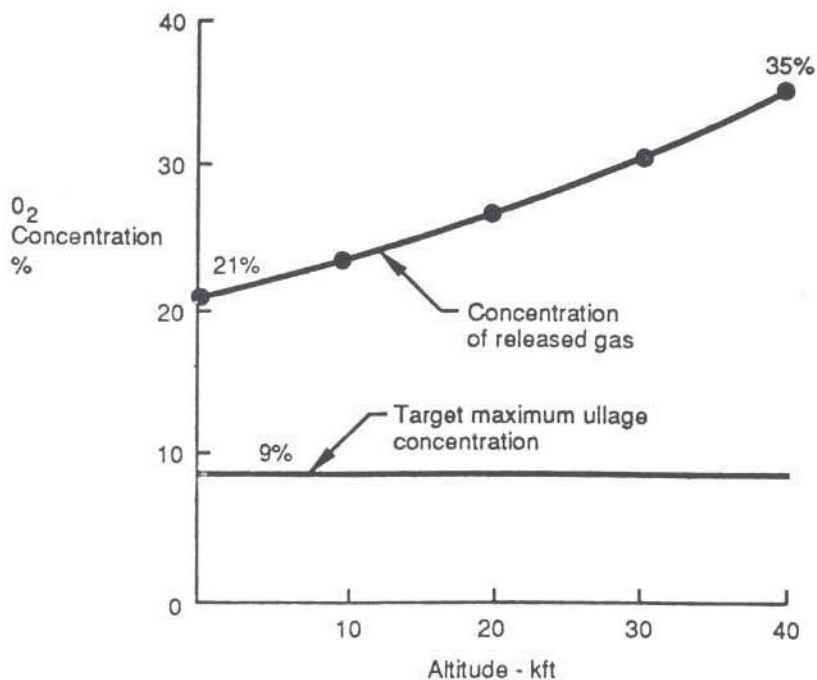

Figure 14.3.1-3. Fuel Tank Combustion Overpressure Versus Oxygen Concentration



Unprotected fuel tank ullage oxygen concentration versus altitude

Effect of Ullage Oxygen Concentrations on Fuel Tank Vulnerability

Figure 14.3.1-4. Effects of Dissolved Oxygen Released From the Fuel on Ullage Oxygen Concentrations

After an evaluation of additional literature, it is evident that a minimum 9% oxygen level should be considered for complete fuel tank inerting. The 9% oxygen level (or lower) gives a longer sustained inert level throughout the flight profile. If the 9% is to be utilized rather than the 10% mentioned in the Tasking Statement, then it would only increase the volume of NEA to be added. It would not fundamentally change the system design concept

15.0 CERTIFICATION COMPLIANCE

Certification and compliance to a new fuel tank flammability rule utilizing ground based inerting systems as the method of compliance would likely be based on demonstration testing. The certification of each aircraft model, or variation thereof, would likely require actual aircraft testing on each new, variation, or retrofit design. The purpose of the testing would be to verify that the operation of the GBI system on that particular aircraft would result in reducing the oxygen level below a value set forth in the rule in all areas of the fuel tanks for which the rule required. The testing would also validate the quantity and quality of NEA required for the particular aircraft manifold design. This would establish the certified volume of NEA at a particular purity and pressure range that would be required to be loaded into the aircraft to meet the requirements of the rule. In addition, it is likely that flight testing would be necessary on each aircraft design type to validate that the inert levels are maintained adequately during flight to demonstrate compliance with the new rule.

Other means of compliance certification may be utilized if they can be shown to accurately represent, model, and duplicate the inerting process in actual aircraft testing. Any modeling system would require a demonstration in parallel with an aircraft inerting system testing to validate the modeling system. This alternate method of showing compliance to the rule would likely only be accepted after FAA approval and validation with actual aircraft testing.

Ground-Based Inerting Designs Task Team Final Report

It is assumed that guidance on the detailed parameters associated with the certification testing would be discussed in the Advisory Circulars associated with the new rule. The Advisory Circular would also provide guidance on a method to certify the aircraft model. Testing, test equipment, and test procedures would be conducted in a manner consistent with that prescribed in the Advisory Circular, unless the associated FAA Certification Office accepted another means of demonstrating compliance. Compliance of each aircraft model would likely require instrumentation of an actual aircraft fitted with the new ground based inerting equipment to be tested. Testing would then be conducted monitoring the oxygen concentration in the fuel tanks applicable to verify that the concentration does not exceed the maximum levels set forth in the rule. Guidance on the oxygen sensor placement, distribution, and mounting in the fuel tanks being tested would also be provided in the Advisory Circular.

It is expected that each new aircraft model, or variation thereof, would be required to carry adequate placarding to insure the servicing of the ground based inerting system meets the parameters required to insure the system operates per its original certification.

If an aircraft is subsequently changed or modified by Supplemental Type Certificate, or other change medium, after the original issuance of the type certificate, the new or affected GBI system operation and effectiveness would require re-testing to show the proper oxygen levels are obtained with the new design. Revised Placarding would be required to clearly identify the new configuration and its associated new total NEA requirements. Placarding on same or similar models that may have minor changes due to certification activities beyond the original certification should employ methods to clearly make the certification differences known to those servicing the aircraft. These differences could be, as an example, color or size variations in the placarding.

To demonstrate that the reduced oxygen level has been achieved and is retained in the tank as predicted, it is anticipated that the following series of ground and flight tests will be required:

1. For center tank installations, the operation of the NEA distribution system will need to be demonstrated over a range of initial tank conditions of:
 - a. Tank at unusable quantity, but not sumped
 - b. Tank at 50% capacity
 - c. Tank maximum declared volume with required expansion space
2. It will also be necessary to demonstrate the ullage conditions when refueling is carried out simultaneously with loading NEA. The objective of the test would be to show that the required oxygen concentration is achieved in the ullage space when the specified quantity of NEA is added even as the refueling process is taking place. For this test where refueling and NEA are added simultaneously, the objective would be to demonstrate correct dispersion and concentration of the NEA is achieved when the specified NEA quantity has been added within a time interval shown by analysis, or additional testing, as an acceptable range.
3. For auxiliary fuel tank installations where the vent system is through the center tank, the same series of center tank tests would be necessary to demonstrate the auxiliary fuel tank inerting system. The exception to this is that testing would be an additional requirement to demonstrate that the auxiliary tank system meets the requirements regardless of the level of center tank fuel. The operational characteristics of the individual systems would determine the extent of their test program in order to fully demonstrate the system operation.
4. Flight testing to demonstrate the fuel tank retains the required oxygen concentration over a determined test period including a take off and climb will be required. During the climb the effects of maneuvers will need to be demonstrated. The extent of this testing is unknown at this time, but most likely the test would be performed starting with the inerted tanks initially empty, partially full, and then full. For aircraft with auxiliary tanks, a similar series of tests may need to be performed. The

specifics of that testing is also unknown at this time. During these flight tests a means of continuously sampling the oxygen content of the ullage will be required.

16.0 PRO AND CONS OF THE SELECTED DESIGN CONCEPT

Pros

- Proposed system design concept is simple with the least effect on airplane.
- Involves little technical complexity
- Utilizes current technology components
- Does not introduce any new installation technology
- System operation is straightforward in that it is not sequenced with the refuel operation and does not require any knowledge of the actual fuel load.

Cons

- Does not remain inert for 100% of the flight cycles. Introduction of air due to fuel consumption, and ground time after landing but before inerting, may result in still being flammable on hot days.
- Dependent on significant airport infrastructure
- Low NEA supply pressure required to avoid over pressurizing the aircraft tanks
- New standard required to be developed for the aircraft interface coupling
- Amount of NEA supplied may be in excess of that required to achieve the inert levels when the tanks is already partially, or completely full.
- Requires special / unique maintenance practices.
- Increased volatile organic compounds (VOC) emissions.

17.0 MAJOR ISSUES AND RESOLUTIONS

- GBI use on aircraft on is dependent upon high capital investment for airport NEA production and servicing systems, not currently available at any airports.
- To allow the aircraft to be purged from the ground based distribution system at any airport location a new standard interface coupling must be developed and controlled by a recognized authority. The timescale for acceptance of this standard and the availability of hardware must be compatible with the regularity requirements.
- The correct purging of the tank ullage is dependent upon the performance of the ground supply. A specification will be required to control pressure /flow performance and integrity of the ground equipment. The required volume to correctly purge the tank ullage will be defined following aircraft tests. The specification of the ground equipment will therefore need to be established before the aircraft tests can be performed.
- Some of the ground equipment requirements (i.e., delivery pressure) are driven by the need to consider the potential requirements to retrofit the system onto existing aircraft. The ground equipment is must be defined so that it does not constrain future aircraft designs.

Appendix D

Onboard Inerting Designs Task Team Final Report

This page intentionally left blank.

TABLE OF CONTENTS

1.0 OBGIS.....	D-1
1.1 REQUIREMENTS.....	D-1
1.2 DATA SUPPLIED FROM OTHER SOURCES.....	D-1
1.2.1 Aircraft Turn Times.....	D-1
1.2.2 Generic Aircraft Types.....	D-2
1.2.3 Generic Aircraft Fuel Tank Volumes.....	D-3
1.4 CONCEPT DEVELOPMENT.....	D-3
1.4.1 Concept Characteristics.....	D-4
1.4.2 Generic Concept Development.....	D-4
1.4.3 Down-Selection.....	D-8
1.4.4 Cryogenic Distillation System – Reasons for Discontinuing Concept.....	D-9
1.5 FINAL CONCEPT DESCRIPTION.....	D-9
1.5.1 Operating Concept.....	D-10
1.5.2 Component Functional Description.....	D-11
1.6 SYSTEM SIZING AND PERFORMANCE.....	D-14
1.6.1 Key Sizing Parameters.....	D-14
1.6.2 Parametric Sizing Curves.....	D-14
1.6.3 System Results.....	D-20
1.6.4 Flammability Exposure.....	D-21
1.7 WEIGHT.....	D-23
1.7.1 Air Separation Modules.....	D-26
1.7.2 Compressor.....	D-26
1.7.3 Heat Exchanger/Cooling Fan.....	D-26
1.7.4 Other Components.....	D-26
1.8 VOLUME.....	D-27
1.8.1 Air Separation Modules.....	D-29
1.8.2 Compressor.....	D-29
1.8.3 Heat Exchanger/Cooling Fan.....	D-29
1.8.4 Other Components.....	D-29
1.9 ELECTRICAL POWER.....	D-29
1.9.1 Air Separation Modules.....	D-31
1.9.2 Compressor.....	D-31
1.9.3 Heat Exchanger/Cooling Fan.....	D-31
1.9.4 Other Components.....	D-31
1.10 RELIABILITY.....	D-31
1.10.1 Air Separation Modules.....	D-36
1.10.2 Compressor.....	D-36
1.10.3 Heat Exchanger/Cooling Fan.....	D-36
1.10.4 Other Components.....	D-36
1.11 COST.....	D-36
1.11.1 Acquisition Cost.....	D-36
1.11.2 Design & Certification.....	D-41
1.11.3 Operating Costs.....	D-41
1.11.4 Maintenance Costs.....	D-41
1.11.5 Installation Costs.....	D-42
1.12 SAFETY.....	D-42
1.12.1 Normal Operation.....	D-42
1.12.2 System Leaks.....	D-42

1.12.3	Component Failure	D-43
1.12.4	Catastrophic Failure.....	D-43
1.13	INSTALLATION.....	D-43
1.13.1	Possible Equipment Installation in Unpressurized Areas	D-44
1.13.2	Possible Equipment Installation in Pressurized Areas.....	D-49
1.13.3	Aircraft Interfaces.....	D-51
1.13.4	Other Installation Considerations	D-52
1.14	PROS AND CONS OF SYSTEM DESIGN CONCEPT	D-52
1.15	MAJOR ISSUES / MITIGATION	D-53
2.0	HYBRID OBGIS.....	D-55
2.1	REQUIREMENTS	D-55
2.2	DATA SUPPLIED FROM OTHER SOURCES.....	D-55
2.2.1	Aircraft Turn Times and System Operational Times.....	D-55
2.2.2	Generic Aircraft Types	D-56
2.2.3	Generic Aircraft Fuel Tank Volumes	D-56
2.3	ASSUMPTIONS	D-56
2.4	CONCEPT DEVELOPMENT	D-56
2.4.1	Concept Development Process	D-57
2.5	FINAL CONCEPT DESCRIPTION	D-57
2.5.1	Operating Concept.....	D-58
2.5.2	Component Functional Description.....	D-59
2.6	SYSTEM SIZING AND PERFORMANCE.....	D-60
2.6.1	Key Sizing Parameters.....	D-60
2.6.2	Parametric Sizing Curves	D-60
2.6.3	Results	D-65
2.6.4	Flammability Exposure.....	D-67
2.7	WEIGHT	D-69
2.7.1	Air Separation Modules.....	D-72
2.7.2	Compressor.....	D-72
2.7.3	Heat Exchanger/Cooling Fan.....	D-72
2.7.4	Other Components.....	D-72
2.8	VOLUME.....	D-72
2.8.1	Air Separation Modules.....	D-74
2.8.2	Compressor.....	D-74
2.8.3	Heat Exchanger/Cooling Fan.....	D-74
2.8.4	Other Components.....	D-74
2.9	ELECTRICAL POWER.....	D-74
2.9.1	Air Separation Modules.....	D-76
2.9.2	Compressor.....	D-76
2.9.3	Heat Exchanger/Cooling Fan.....	D-76
2.9.4	Other Components.....	D-76
2.10	RELIABILITY	D-76
2.10.1	Air Separation Modules.....	D-81
2.10.2	Compressor.....	D-81
2.10.3	Heat Exchanger.....	D-81
2.10.4	Other Components.....	D-81
2.11	COST.....	D-81
2.11.1	Acquisition Cost	D-81
2.11.2	Design & Certification.....	D-86
2.11.3	Operating Costs	D-86
2.11.4	Maintenance Costs.....	D-87

Onboard Inerting Designs Task Team Final Report

2.11.5	Installation Costs	D-87
2.12	SAFETY	D-87
2.12.1	Normal Operation	D-87
2.12.2	System Leaks	D-87
2.12.3	Component Failure	D-88
2.12.4	Catastrophic Failure	D-88
2.13	INSTALLATION	D-88
2.14	PROS AND CONS OF SYSTEM DESIGN CONCEPT	D-89
2.15	MAJOR ISSUES/MITIGATION	D-90
3.0	FULL-TIME OBIGGS	D-91
3.1	REQUIREMENTS	D-91
3.2	DATA SUPPLIED FROM OTHER SOURCES	D-91
3.2.1	Aircraft Turn Times	D-91
3.2.2	Generic Aircraft Types	D-91
3.2.3	Fuel Tank Volumes	D-91
3.2.4	Bleed Air	D-91
3.2.5	Cabin Pressure	D-92
3.3	ASSUMPTIONS	D-92
3.4	CONCEPT DEVELOPMENT	D-93
3.4.1	Concept Characteristics	D-93
3.4.2	Generic OBIGGS concept	D-93
3.5	CONCEPT DESCRIPTIONS	D-96
3.5.1	Large and Medium Transport	D-97
3.5.2	Small Transport, Regional Turbofan and Turboprop, and Business Jet	D-100
3.6	SYSTEM SIZING AND PERFORMANCE	D-102
3.6.1	Sizing Criteria	D-102
3.6.2	Parametric Sizing Curves	D-102
3.6.3	System Results	D-105
3.6.4	Flammability Exposure	D-108
3.7	WEIGHT	D-108
3.7.1	Air Separation Modules	D-113
3.7.2	Compressor	D-113
3.7.3	Heat Exchanger/Cooling Fan	D-113
3.7.4	Other Components	D-114
3.8	VOLUME	D-116
3.8.1	Air Separation Modules	D-118
3.8.2	Compressor	D-118
3.8.3	Heat Exchanger/Cooling Fan	D-118
3.8.4	Other Components	D-118
3.9	ELECTRICAL POWER	D-118
3.9.1	Air Separation Modules	D-121
3.9.2	Compressor	D-121
3.9.3	Heat Exchanger/Cooling Fan	D-121
3.9.4	Other Components	D-121
3.10	RELIABILITY	D-121
3.10.1	Air Separation Modules	D-130
3.10.2	Compressor	D-130
3.10.3	Heat Exchanger/Cooling Fan	D-130
3.10.4	Other Components	D-130
3.11	COST	D-130
3.11.1	Acquisition Cost	D-130

3.11.2	Design & Certification Cost	D-137
3.11.3	Operating Cost	D-137
3.11.4	Maintenance Cost	D-138
3.11.5	Installation Cost	D-138
3.12	SAFETY	D-138
3.12.1	Normal Operations	D-138
3.12.2	System Leaks	D-139
3.12.3	Component Failures	D-139
3.12.4	Catastrophic Failures	D-139
3.13	INSTALLATION	D-139
3.14	PROS AND CONS OF SYSTEM DESIGN CONCEPT	D-140
3.15	MAJOR ISSUES/MITIGATION	D-141
3.15.1	High Electrical Power Consumption	D-141
3.15.2	Potential Interference With Cabin Re-Pressurization During Descent	D-143
4.0	HYBRID OBIGGS	D-144
4.1	REQUIREMENTS	D-144
4.2	DATA SUPPLIED FROM OTHER SOURCES	D-144
4.2.1	Aircraft Turn Times	D-144
4.2.2	Generic Aircraft Types	D-145
4.2.3	Generic Aircraft Fuel Tank Volumes	D-145
4.2.4	Bleed Air	D-145
4.2.5	Cabin Pressure	D-145
4.3	ASSUMPTIONS	D-145
4.4	CONCEPT DEVELOPMENT	D-146
4.5	CONCEPT DESCRIPTIONS	D-147
4.6	SYSTEM SIZING AND PERFORMANCE	D-149
4.6.1	Sizing Criteria	D-149
4.6.2	Parametric Sizing Curves	D-150
4.6.3	System Results	D-154
4.6.4	Flammability Exposure	D-156
4.7	WEIGHT	D-158
4.7.1	Air Separation Modules	D-161
4.7.2	Compressor	D-161
4.7.3	Heat Exchanger/Cooling Fan	D-161
4.7.4	Other Components	D-162
4.8	VOLUME	D-163
4.8.1	Air Separation Modules	D-166
4.8.2	Compressor	D-166
4.8.3	Heat Exchanger/Cooling Fan	D-166
4.8.4	Other Components	D-166
4.9	ELECTRICAL POWER	D-166
4.9.1	Air Separation Modules	D-169
4.9.2	Compressor	D-169
4.9.3	Heat Exchanger/Cooling Fan	D-169
4.9.4	Other Components	D-169
4.10	RELIABILITY	D-169
4.10.1	Air Separation Modules	D-178
4.10.2	Compressor	D-178
4.10.3	Heat Exchanger/Cooling Fan	D-178
4.10.4	Other Components	D-178
4.11	COST	D-178

Onboard Inerting Designs Task Team Final Report

4.11.1	Acquisition Cost	D-178
4.11.2	Design & Certification Cost	D-183
4.11.3	Operating Cost	D-184
4.11.4	Maintenance Cost	D-184
4.11.5	Installation Cost	D-184
4.12	SAFETY	D-184
4.12.1	Normal Operations	D-184
4.12.2	System Leaks	D-185
4.12.3	Component Failures	D-185
4.12.4	Catastrophic Failures	D-185
4.13	INSTALLATION	D-186
4.14	PROS AND CONS OF SYSTEM DESIGN CONCEPT	D-186
4.15	MAJOR ISSUES/MITIGATION	D-187
5.0	CONCLUSION	D-188
	ADDENDUM	D-192
A1	AIR SEPARATION TECHNOLOGY DETAILED DESCRIPTIONS AND SIZING	
	METHODOLOGY	D-192
A1.1	PERMEABLE MEMBRANE SUMMARY	D-192
A1.1.1	System Sizing (Full-Time and Hybrid OBIGGS)	D-194
A1.1.2	NEA Concentration (Full-Time and Hybrid OBIGGS)	D-194
A1.1.3	Effects of Feed Air Temperature (Full-Time and Hybrid OBIGGS)	D-195
A1.2	PRESSURE-SWING ADSORPTION (PSA) SUMMARY	D-195
A1.3	CRYOGENIC DISTILLATION SUMMARY	D-197
A1.3.1	The Cryogenic Distillation Inerting System	D-198
A1.3.2	System Sizing Methodology	D-199
A2	COMPRESSOR DESCRIPTIONS AND SIZING METHODOLOGY	D-200
A2.1	INTRODUCTION	D-200
A2.2	ELECTRICAL DRIVE MOTORS	D-202
A2.2.1	Inductive	D-202
A2.2.2	Permanent Magnet	D-205
A2.3	TURBINE DRIVES	D-206
A2.4	BEARING CHOICES	D-207
A2.4.1	Rolling Element Bearings	D-207
A2.4.2	Magnetic Bearings	D-208
A2.4.3	Air Bearings	D-209
A2.5	PISTON COMPRESSORS	D-209
A2.6	SCREW COMPRESSORS	D-211
A2.6.1	Description	D-211
A2.6.2	Optimal CFM Range/Limitations	D-212
A2.6.3	Typical Parameters	D-212
A2.7	CENTRIFUGAL COMPRESSORS	D-213
A2.7.1	Description	D-213
A2.7.2	Typical Parameters vs CFM (weight, eff., etc.)	D-214
A2.7.3	Optimal CFM Range/Limitations	D-214
A3	HEAT EXCHANGER/FAN SIZING METHODOLOGY	D-214

LIST OF FIGURES

1.2.1-1.	FTIHWG Aircraft Pre-flight Times	D-1
1.2.1-2.	Summary of Aircraft Turn Times	D-2
1.2.1-3.	FTIHWG Aircraft Turn Times	D-2
1.2.3-1.	Generic Aircraft Fuel Tank Volumes	D-3
1.4.2-1.	System Evaluation Summary	D-6
1.4.2-2.	Baseline Concept - Bleed Air Only	D-7
1.4.2-3.	Exhaust Eductor System Concept	D-7
1.4.2-4.	Bleed Assisted Closed Loop System Concept	D-7
1.4.2-5.	Closed Loop System Concept	D-8
1.5-1.	OBI System Schematic Diagram	D-9
1.5-2.	OBI System Component List	D-10
1.6.2-1.	NEA Flow vs Tank Volume	D-15
1.6.2-2.	Weight vs NEA Flow	D-16
1.6.2-3.	Volume vs NEA Flow	D-17
1.6.2-4.	Power vs NEA Flow	D-18
1.6.2-5.	Cost vs NEA Flow	D-19
1.6.3-1.	OBI Air Consumption, Power, Volume and Weights for Center Tanks	D-20
1.6.3-2.	OBI Air Consumption, Power, Volume and Weights for All Tanks	D-21
1.6.4-1.	Flammability Exposure Results for the OBI Systems PSA ASM	D-22
1.6.4-2.	Flammability Exposure Results for the OBI Systems Membrane ASM	D-23
1.7-1.	Summary of OBI Component Weights – Membrane Systems	D-24
1.7-2.	Summary of OBI Component Weights – PSA Systems	D-25
1.7.4-1.	Ducting Length and Diameter	D-27
1.7.4-2.	Compressor Wiring	D-27
1.8-1.	Summary of OBI Component Volumes – Membrane Systems	D-28
1.8-2.	Summary of OBI Component Volumes – PSA Systems	D-28
1.9-1.	Summary of OBI Component Power Consumption – Membrane Systems	D-30
1.9-2.	Summary of OBI Component Power Consumption – PSA Systems	D-30
1.10-1.	Summary of OBI MTBMA – Membrane Systems	D-32
1.10-2.	Summary of OBI MTBMA – PSA Systems	D-33
1.10-3.	Summary of OBI MTBF – Membrane Systems	D-34
1.10-4.	Summary of OBI MTBF – PSA Systems	D-35
1.11.1-1.	Summary of OBI Costs – Membrane Systems	D-38
1.11.1-2.	Summary of OBI Costs – PSA Systems	D-39
1.13.1-1.	Potential Installation Area in Main Landing Gear Bay on a Typical Large Transport Aircraft	D-45
1.13.1-2.	Potential Installation Area in Main Landing Gear Bay on a Typical Large Transport Aircraft (Additional Location)	D-45
1.13.1-3.	Potential Installation Area in Right Wheel Well on a Typical Medium Transport Aircraft	D-46
1.13.1-4.	Potential Installation Area in Left Wheel Well on a Typical Medium Transport Aircraft	D-46
1.13.1-5.	Potential Installation Area in Left Wheel Well on a Typical Small Transport Aircraft	D-46
1.13.1-6.	Potential Installation Area in Right Wheel Well on a Typical Small Transport Aircraft	D-47
1.13.1-7.	Potential Installation Area in Belly Fairing on a Typical Large Transport Aircraft (Left Side, Looking Aft)	D-47

Onboard Inerting Designs Task Team Final Report

1.13.1-8.	Potential Installation Area in Belly Fairing on a Typical Large Transport Aircraft (Left Side, Looking Down).....	D-48
1.13.1-9.	Potential Installation Area in Belly Fairing on a Typical Large Transport Aircraft (Additional Location).....	D-48
1.13.1-10.	Potential Installation Area Behind Aft Bulkhead on a Typical Large Transport Aircraft	D-49
1.13.1-11.	Potential Installation Area Behind Aft Bulkhead on a Typical Large Transport Aircraft (Additional Location).....	D-49
1.13.2-1.	Potential Installation Area Forward of Aft Bulkhead on a Typical Small Transport Aircraft	D-50
1.13.2-2.	Potential Installation Area Forward of Aft Bulkhead on a Typical Medium Transport Aircraft	D-50
1.13.2-3.	Potential Installation Area Forward of Aft Bulkhead on a Typical Large Transport Aircraft	D-51
2.2.1-1.	FTHWG Aircraft Pre-Flight Times.....	D-55
2.2.1-2.	FTIHWG Aircraft Turn Times.....	D-55
2.2.1-3.	Hybrid OBGI Inerting Times.....	D-56
2.2.3-1.	Generic Aircraft Fuel Tank Volumes.....	D-56
2.5-1.	Hybrid OBGI System Schematic Diagram	D-58
2.5-2.	Hybrid OBGI System Component List.....	D-58
2.6.2-1.	NEA Flow vs. Tank Volume.....	D-61
2.6.2-2.	Weight vs. NEA Flow.....	D-62
2.6.2-3.	Volume vs. NEA Flow.....	D-63
2.6.2-4.	Power vs. NEA Flow	D-64
2.6.2-5.	Cost vs. NEA Flow	D-65
2.6.3-1.	Hybrid OBGIS Air Consumption, Power, Volume and Weights for Center Tanks.....	D-66
2.6.3-2.	Hybrid OBGIS Air Consumption, Power, Volume and Weights for All Tanks	D-67
2.6.4-1.	Flammability Exposure Results for the Hybrid OBGI Membrane System.....	D-68
2.6.4-2.	Flammability Exposure Results for the Hybrid OBGI PSA System.....	D-68
2.7-1.	Summary of Hybrid OBGIS Component Weights – Membrane Systems	D-70
2.7-2.	Summary of OBGIS Component Weights – PSA Systems	D-71
2.8-1.	Summary of Hybrid OBGIS Component Volumes – Membrane Systems	D-73
2.8-2.	Summary of Hybrid OBGIS Component Volumes – PSA Systems.....	D-73
2.9-1.	Summary of Hybrid OBGIS Component Power Consumption – Membrane Systems.....	D-75
2.9-2.	Summary of Hybrid OBGIS Component Power Consumption – PSA Systems.....	D-75
2.10-1.	Summary of Hybrid OBGIS MTBMA – Membrane Systems	D-77
2.10-2.	Summary of Hybrid OBGIS MTBMA – PSA Systems	D-78
2.10-3.	Summary of Hybrid OBGIS MTBF – Membrane Systems	D-79
2.10-4.	Summary of Hybrid OBGIS MTBF – PSA Systems	D-80
2.11.1-1.	Summary of Hybrid OBGIS Costs – Membrane Systems	D-83
2.11.1-2.	Summary of Hybrid OBGIS Costs – PSA Systems.....	D-84
2.11.1-3.	Comparison of Hybrid OBGIS Costs to OBGIS Costs.....	D-85
3.2.3-1.	Generic Aircraft Fuel Tank Volumes.....	D-91
3.2.4-1.	Bleed Air Availability.....	D-92
3.2.5-1.	Cabin Pressure Schedule.....	D-92
3.4.2-1.	Generic OBIGGS Concept Schematic	D-94
3.5-1.	System Characteristics for Each Model and Technology	D-96
3.5.1-1.	Large and Medium Transport Membrane and PSA Inerting Systems	D-98
3.5.1-2.	Cryogenic Distillation Inerting System.....	D-99
3.5.2-1.	Simplified Membrane and PSA OBIGGS Concept for Small Aircraft.....	D-101
3.6.2-1.	NEA Flow vs Tank Volume.....	D-102

Onboard Inerting Designs Task Team Final Report

3.6.2-2	Weight vs NEA Flow	D-103
3.6.2-3.	Volume vs NEA Flow	D-103
3.6.2-4.	Power vs NEA Flow	D-104
3.6.2-5.	Cost vs NEA Flow	D-104
3.6.2-6.	Full-Time OBIGGS NEA Oxygen Concentrations.....	D-105
3.6.3-1.	OBIGGS Air Consumption, Power, Volume, and Weights for Center Tanks.....	D-106
3.6.3-2.	OBIGGS Air Consumption, Power, Volume, and Weights for Center and Main Tanks	D-107
3.6.3-3.	OBIGGS Air Consumption, Power, Volume, and Weights for Center, Main, and Auxiliary Tanks.....	D-108
3.7-1.	Summary of OBIGGS Weights—Membrane Systems	D-109
3.7-2.	Summary of OBIGGS Weights—PSA Systems	D-110
3.7-3.	Summary of OBIGGS Weights—Cryogenic Distillation Systems (Sheet 1 of 2).....	D-111
3.7-3.	Summary of OBIGGS Weights—Cryogenic Distillation Systems (Sheet 2 of 2).....	D-112
3.7.4-1.	Compressor Wire Lengths.....	D-114
3.7.4-2.	Ducting Length and Diameter	D-114
3.7.4-3.	Permeable Membrane Full-Time OBIGGS “Other” Component Weight.....	D-115
3.7.4-4.	Pressure-Swing Adsorption Full-Time OBIGGS “Other” Component Weight.....	D-115
3.7.4-5.	Cryogenic Distillation Full-Time OBIGGS “Other” Component Weight.....	D-115
3.8-1.	Summary of OBIGGS Volume—Membrane Systems.....	D-117
3.8-2.	Summary of OBIGGS Volumes—PSA Systems	D-117
3.8-3.	Summary of OBIGGS Volumes—Cryogenic Distillation Systems.....	D-117
3.9-1.	Summary of OBIGGS Electrical Power—Membrane Systems	D-120
3.9-2.	Summary of OBIGGS Electrical Power—PSA Systems.....	D-120
3.9-3.	Summary of OBIGGS Electrical Power—Cryogenic Distillation Systems.....	D-120
3.10-1.	Summary of OBIGGS MTBMA—Membrane Systems	D-122
3.10-2.	Summary of OBIGGS MTBMA—PSA Systems	D-123
3.10-3.	Summary of OBIGGS MTBMA—Cryogenic Distillation Systems (Sheet 1 of 2)	D-124
3.10-3.	Summary of OBIGGS MTBMA—Cryogenic Distillation Systems (Sheet 2 of 2)	D-125
3.10-4.	Summary of OBIGGS MTBF—Membrane Systems.....	D-126
3.10-5.	Summary of OBIGGS MTBF—PSA Systems	D-127
3.10-6.	Summary of OBIGGS MTBF—Cryogenic Distillation Systems (Sheet 1 of 2)	D-128
3.10-6.	Summary of OBIGGS MTBF—Cryogenic Distillation Systems (Sheet 2 of 2)	D-129
3.11.1-1.	Summary of OBIGGS Costs—Membrane Systems.....	D-132
3.11.1-2.	Summary of OBIGGS Costs—PSA Systems	D-134
3.11.1-3.	Summary of OBIGGS Costs—Cryogenic Distillation Systems (Sheet 1 of 2)	D-134
3.11.1-3.	Summary of OBIGGS Costs—Cryogenic Distillation Systems (Sheet 2 of 2)	D-135
3.15.1.1-1.	Potential Power Conservation Concept for Large Aircraft Membrane or PSA OBIGGS	D-142
3.15.1.2-1.	Electrical Power and Weight for the Improved Cryogenic Distillation Components With Vacuum Jacketing	D-143
4.2.1-1.	FTHWG Aircraft Pre-Flight Times.....	D-144
4.2.1-2.	FTIHWG Minimum Turn-Times	D-144
4.2.3-1.	Generic Aircraft Fuel Tank Volumes.....	D-145
4.2.4-1.	Bleed Air Availability.....	D-145
4.2.5-1.	Cabin Pressure Schedule.....	D-145
4.5-1.	System Characteristic for Each Model and Technology.....	D-147
4.5-2.	Membrane and PSA Hybrid OBIGGS Concept.....	D-148
4.5-3.	Cryogenic Distillation Hybrid OBIGGS Concept.....	D-148
4.6.1-1.	Flammability Exposure vs. NEA Flow for a Large Transport CWT, PSA Hybrid OBIGGS	D-149
4.6.2-1.	NEA Flow vs. Tank Volume—Center, Wing, and Auxiliary Tanks	D-150

Onboard Inerting Designs Task Team Final Report

4.6.2-2.	NEA Flow vs. Tank Volume—Center Tanks Only	D-151
4.6.2-3.	Weight vs. NEA Flow	D-151
4.6.2-4.	Volume vs. NEA Flow	D-152
4.6.2-5.	Power vs. NEA Flow	D-152
4.6.2-6.	Cost vs. NEA Flow	D-153
4.6.2-7.	Hybrid OBIGGS NEA Oxygen Concentrations.....	D-153
4.6.3-1.	Hybrid OBIGGS Air Consumption, Power, Volume, and Weights for Center Tanks	D-154
4.6.3-2.	Hybrid OBIGGS Air Consumption, Power, Volume, and Weights for Center and Main Tanks.....	D-155
4.6.3-3.	Hybrid OBIGGS Air Consumption, Power, Volume, and Weights for Center, Main, and Auxiliary Tanks.....	D-156
4.6.4-1.	Membrane Hybrid OBIGGS Flammability Exposure.....	D-157
4.6.4-2.	Pressure-Swing Adsorption Hybrid OBIGGS Flammability Exposure	D-157
4.6.4-3.	Cryogenic Distillation Hybrid OBIGGS Flammability Exposure	D-158
4.7-1.	Summary of OBIGGS Weights—Membrane Systems	D-159
4.7-2.	Summary of OBIGGS Weights—PSA Systems	D-159
4.7-3.	Summary of OBIGGS Weights—Cryogenic Distillation Systems.....	D-160
4.7.4-1.	Permeable Membrane Hybrid OBIGGS Other Component Weight.....	D-162
4.7.4-2.	Pressure-Swing Adsorption Hybrid OBIGGS Other Component Weight.....	D-162
4.7.4-3.	Cryogenic Distillation Hybrid OBIGGS Other Component Weight	D-163
4.8-1.	Summary of OBIGGS Volume—Membrane Systems.....	D-164
4.8-2.	Summary of OBIGGS Volumes—PSA Systems	D-164
4.8-3.	Summary of OBIGGS Volumes—Cryogenic Distillation Systems.....	D-165
4.9-1.	Summary of OBIGGS Electrical Power—Membrane Systems	D-167
4.9-2.	Summary of OBIGGS Electrical Power—PSA Systems.....	D-167
4.9-3.	Summary of OBIGGS Electrical Power—Cryogenic Distillation Systems.....	D-168
4.10-1.	Summary of Hybrid OBIGGS MTBMA—Membrane Systems	D-170
4.10-2.	Summary of Hybrid OBIGGS MTBMA—PSA Systems	D-171
4.10-3.	Summary of Hybrid OBIGGS MTBMA—Cryogenic Distillation Systems (Sheet 1 of 2).....	D-172
4.10-3.	Summary of Hybrid OBIGGS MTBMA—Cryogenic Distillation Systems (Sheet 2 of 2).....	D-173
4.10-4.	Summary of Hybrid OBIGGS MTBF—Membrane Systems	D-174
4.10-5.	Summary of Hybrid OBIGGS MTBF—PSA Systems	D-175
4.10-6.	Summary of Hybrid OBIGGS MTBF—Cryogenic Distillation Systems (Sheet 1 of 2).....	D-176
4.10-6.	Summary of Hybrid OBIGGS MTBF—Cryogenic Distillation Systems (Sheet 2 of 2).....	D-177
4.11.1-1.	Summary of OBIGGS Costs—Membrane Systems.....	D-180
4.11.1-2.	Summary of OBIGGS Costs—PSA Systems	D-180
4.11.1-3.	Summary of OBIGGS Costs—Cryogenic Distillation Systems	D-181
4.11.1-4.	Comparison of OBIGGS Costs to Hybrid OBIGGS Costs.....	D-181
4.11.1.4-1.	Permeable Membrane Hybrid OBIGGS Other Component Cost	D-182
4.11.1.4-2.	Pressure-Swing Adsorption Hybrid OBIGGS Other Component Cost.....	D-183
4.11.1.4-3.	Cryogenic Distillation Hybrid OBIGGS Other Component Cost.....	D-183
5-1.	Performance in Large Transport	D-188
5-2.	System Impact to Large Transport.....	D-189
5-3.	Performance in Medium Transport	D-189
5-4.	System Impacts to Medium Transport	D-189
5-5.	Performance in Small Transport	D-190

Onboard Inerting Designs Task Team Final Report

5-6.	System Impacts to Small Transport	D-190
A1.1-1.	Fiber Cross Section	D-193
A1.1-2.	Membrane Module Schematic	D-193
A1.2-1.	PSA Block Diagram	D-196
A1.3-1.	Cryogenic Distillation Fuel Tank Inerting System Concept	D-197
A1.3.1-1.	Cryogenic Distillation Fuel Tank Inerting System Schematic	D-198
A2.1-1.	Compression Cycle	D-200
A2.1-2.	Compressor Inter-Stage Cooling	D-201
A2.2.1-1.	D-202
A2.2.1-2.	Induction Motor Rotor	D-203
A2.2.1-3.	D-204
A2.2.2-1.	PM Motor Schematic	D-205
A2.2.2-2.	PM Motor Design Variations	D-205
A2.2.2-3.	Typical Operating Parameters for a 55 kW PM Motor	D-206
A2.3-1.	Radial Turbine Cross Section	D-206
A2.4.1-1.	Rolling Element Bearing General Construction	D-208
A2.5-1.	Two-Stage Piston Compressor	D-209
A2.5-2.	Piston Compressor Sizing for 40 psig Discharge Pressure	D-210
A2.5-3.	Piston Compressor Efficiency	D-210
A2.6-1.	Screw Compressor	D-211
A2.6-2.	D-212
A2.7-1.	Centrifugal Compressor Geometry	D-213

Onboard Inerting Designs Task Team Final Report

i. TASKING STATEMENT ABSTRACT

The Tasking Statement specifies three forms of onboard inerting systems: an onboard ground inerting (OBGI) system; an onboard inert gas generating system (OBIGGS); and a simplified OBIGGS system.

The OBGI system function is to inert fuel tanks near significant heat sources or fuel tanks that do not cool as fast as wing tanks do. Essentially this system is equivalent to the ground-based inerting system except that the source of inert gas is carried onboard the aircraft.

The OBIGGS system function is to inert all fuel tanks during normal aircraft operations. A “non-normal” operation is defined as an emergency descent and is interpreted by the team to mean any rarely occurring maneuver that would cause enough ambient air to enter the fuel tank that the oxygen concentration exceeds 10 % (the FAA defined level for fuel tank inerting in this study).

The Team interprets the FAA’s intent for the hybrid to be a simplification of the typical military OBIGGS system. The Tasking Statement requires that the OBIGGS system be operated at times when it ordinarily would not be to avoid implementing inerting support systems such as climb/dive vent valves.

In addition, the evaluation of these systems must consider ways to minimize cost. This should be achieved with reliable designs with little or no redundancy and by recommending ways to provide dispatch relief when the inerting system, or a portion of it, fails. The evaluation also needs to account for secondary effects to the airplane that might impact its performance, maintenance, and dispatch.

The team is also to provide guidance for the analysis and testing of inerting systems or, if no system can be recommended the team is to identify the technical limitations of the system and what improvements would be required for the system to be feasible in the future

ii. TEAM OBJECTIVES

Meet the Tasking Statement. The team defined a simple schematic for the OBGI and OBIGGS systems. The team took advantage of the minimum equipment list provision in the Tasking Statement to simplify the systems. Both system concepts were “bare bones” i.e. they have no redundancy and no “extra” systems, such as the C-17 type of climb/dive vent valves, were included.

Subsequently, two hybrid systems were derived, one from the baseline OBGI system and one from the baseline OBIGGS system.

Additional Tasks. The Working Group proposed an additional task for the hybrid system. Although the hybrid was smaller than the OBIGGS system, its weight and electrical demand were still considerable. The Working Group proposed a low-flow system that allowed some amount of exposure to a flammable, non-inert ullage. The purpose of this task was to determine if the system could become significantly smaller for a slight increase in exposure.

iii. GENERAL APPROACH

After the initial schematic development, the Onboard Design Team was divided into two sub-teams. Initially, one team was tasked with defining an OBGI system and the other was tasked with defining an OBIGGS system. The hybrid was deferred.

The sub-teams were asked to define concepts for the OBGI and OBIGGS systems, determine the feasibility of the systems, define any secondary effects to the airplane for these systems, and define the operation and maintenance requirements of the systems.

After these concepts were defined and feasibility was determined, each sub-team was asked to define a hybrid design derived from their individual concepts. The Tasking Statement only requested a hybrid based on the OBIGGS concept but it appeared both systems might yield viable hybrids. Each team eliminated the system’s primary constraint to achieve a smaller, cheaper system. In the case of the

Onboard Inerting Designs Task Team Final Report

OBIGGS hybrid, the design was not required to inert the fuel tanks during descent. The OBGI hybrid took advantage of additional time during taxi, from landing rollout to the terminal, to inert the fuel tanks.

Finally, the additional task for a low-flow OBIGGS hybrid was studied in stages and compared to the ground-based inerting and OBGI systems for flammability exposure. The final hybrid system was sized to provide similar exposure at various stages of flight as the ground-based and OBGI systems.

The team consisted of interested parties from several companies. Each of the team members was supported by members of their company. The talents and time invested by each of the members and support personnel are greatly appreciated, as the job could not have been done without their assistance. The companies involved in this team were:

- Aero Controlex
- Airbus
- Air Liquide/Medal
- BAE
- Boeing
- Creare
- FAA Tech Center
- Litton
- Parker Aero
- Shaw Aero
- Smiths Industries
- Valcor
- US Air Force
- US Navy

Onboard Inerting Designs Task Team Final Report

1.0 OBGIS

The On-Board Ground Inerting System (OBGIS) is one of four main system categories studied by the 2000 ARAC FTIHWG Onboard Airplane Design Task Team. The Onboard team studied the system size for a variety of “modeled” aircraft center wing and auxiliary fuel tanks. In addition, the Team performed additional analysis, in excess of the Tasking Statement’s requirements, by determining the system size for all fuel tanks. The team also defined the physical size and weight of the multitude of components needed to support OBGIS. Finally, power and air consumption needs were defined.

1.1 REQUIREMENTS

There are several main requirements for the OBGIS design that were considered during the Team’s design efforts:

Oxygen Concentration at Pushback. All applicable fuel tank ullage volumes are to have an oxygen concentration of 10% maximum before the aircraft is pushed back from the gate. This requirement allowed a direct comparison with the ground based inerting design concept.

Nitrogen as Inerting Agent. As required by the tasking statement, the Team only considered on-board nitrogen gas inerting equipment.

Equipment Location. All equipment needed to inert the aircraft is installed on the airframe, except for diagnostic equipment.

Redundancy. The tasking statement encourages a simple system with little or no redundancy.

1.2 DATA SUPPLIED FROM OTHER SOURCES

Data was taken from various sources so that the Team could define the OBGIS concept. This included aircraft fuel tank sizes, mission profiles, and aircraft turn times.

1.2.1 Aircraft Turn Times

The mission scenarios that were used in the July 1998 ARAC Fuel Tank Harmonization Working Group Report had turn times listed for the various aircraft. The turn times can be seen summarized in Figure 1.2.1-1 below:

Generic Aircraft	Pre-flight Time (Minutes)
Turbofan	20
Turboprop	20
Business Jet	45
Small	45
Medium	60
Large	90

Figure 1.2.1-1. FTIHWG Aircraft Pre-flight Times

To ensure the turn times being used were representative of the aircraft in service today, a survey was conducted of several major airlines. They were asked to supply the times that they were currently using as part of their normal operations today. Airlines that responded to the survey were Airborne, Aloha, America West, British Airways, Continental, Delta, Northwest, Southwest, UPS, and Virgin. A summary of the data collected can be seen in Figure 1.2.1-2 below:

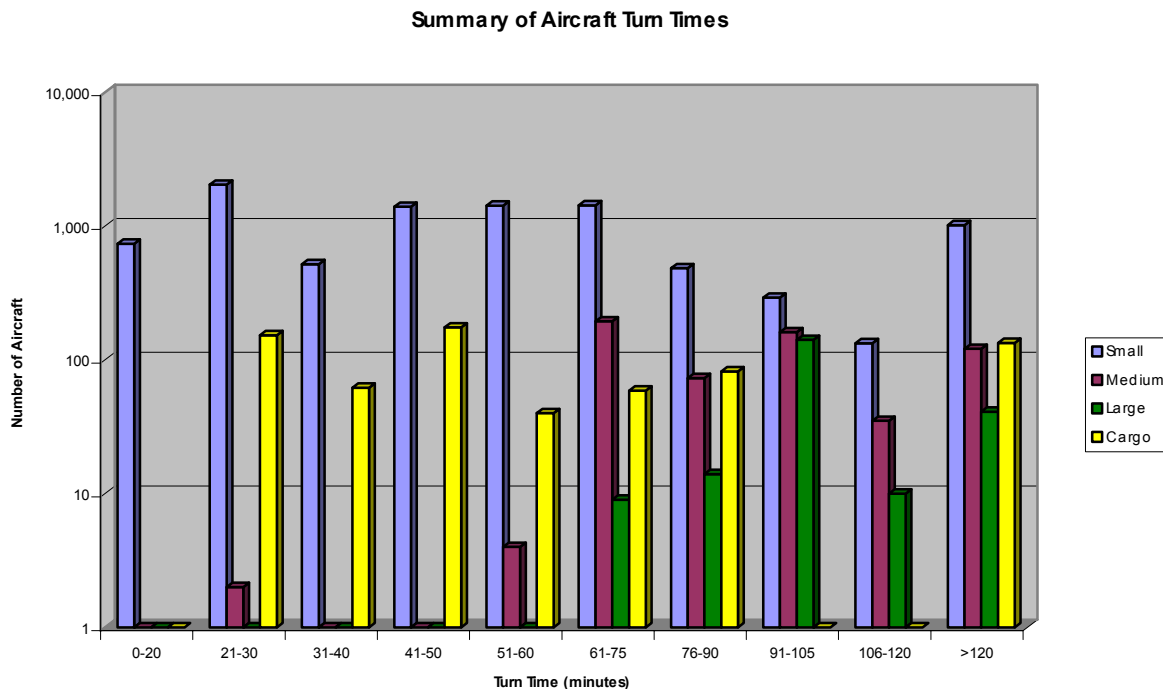

Figure 1.2.1-2. Summary of Aircraft Turn Times

The FTIHWG made the decision to modify the Aircraft turn times to the values seen in Figure 1.2.1-3 below. These values were used in the sizing of the components for the various OBGI systems because the working group concluded that they were representative of the in-service fleet.

Generic Aircraft	Turn Time (Minutes)
Turbofan	15
Turboprop	15
Business Jet	60
Small	20
Medium	45
Large	60

Figure 1.2.1-3. FTIHWG Aircraft Turn Times

1.2.2 Generic Aircraft Types

The FTIHWG made the decision to use the same generic aircraft data and mission scenarios that were used in the July 1998 ARAC Fuel Tank Harmonization Working Group Report. These generic airplane definitions and missions were used in assessing potential system designs under consideration by the various task teams. Mission profile data such as weight, altitude, Mach number, fuel remaining in each tank and aircraft attitude as a function of time was included for each generic airplane type. Temperature profiles were also included in the mission profiles.

The worst-case flight conditions for sizing OBGIS were determined to be the shortest-ranged flights provided. Low fuel loads, for any given fuel tank configuration, result in the largest ullage volumes to inert and the largest system size.

1.2.3 Generic Aircraft Fuel Tank Volumes

For all system sizing the 1998 ARAC Generic Aircraft fuel tank sizes were used. These are listed in Figure 1.2.3-1.

Generic Aircraft	CWT Volume (Gal.)	CWT + Wing Tank Volume (Gal.)	CWT + Wing + Aux Tank Volume (Gal.)
Turbofan	816	3,264	N/A
Turboprop	N/A	1,428	N/A
Business Jet	N/A	6,273	N/A
Small	3,060	5,100	7,600
Medium	10,200	24,480	27,480
Large	25,500	55,080	58,080

Figure 1.2.3-1. Generic Aircraft Fuel Tank Volumes

1.3 ASSUMPTIONS

The following are the assumptions that the Team developed and used for the system design and analysis.

Initial Oxygen Concentration. The starting oxygen content in the ullage is always 20.9%.

Hydraulic Power Availability. The task team assumed that hydraulic power to operate OBGIS equipment was not available while the aircraft was on the ground. To use hydraulic power it would be necessary to upgrade the existing on-board systems. This would in many cases be costly and difficult and would require a system review on a case-by-case basis.

Electrical Power Available From the Aircraft Gate. The task team assumed that sufficient ground power could be made available to operate an OBGIS system. This power could be made available from either a ground cart or from a connection made directly to the terminal electrical system. This would allow the on-board system to operate on the ground without either the APU or aircraft engines operating.

Electrical Power Available From Aircraft Sources. The task team assumed for the design that sufficient aircraft power could be made available to operate an OBGIS system. This would allow the on-board system to operate on the ground with either the APU or aircraft engines operating. This source of power would be used when gate power is not available.

Compressed Air. The availability of aircraft bleed air was assumed not to be available at all times because some local laws prohibit engine or APU operation at the gate. The assumption was made that an alternate source of compressed air was required.

Vent Systems Modifications. It was assumed that necessary vent system modifications will be made to prevent cross-venting during crosswind conditions.

1.4 CONCEPT DEVELOPMENT

The system is required to provide ullage inerting in the aircraft fuel tanks prior to take-off using on-board equipment. The main objective was to define system parameters, such as cost, weight, performance and size, for comparison purposes with OBGIS systems and ground-based systems. The effectiveness of the system was predicted using FAA-supplied flammability exposure computer models, which were also used by both the OBGIS and ground-based teams.

The approach was to define a system that would minimize the impact and required changes for retrofit to existing aircraft and provide optimum efficiency for new aircraft designs. This required that issues related to system operation be addressed, such as on-board resources available to operate the system, available space, weight, cost, and necessary aircraft modifications. The most crucial issue was the power available to run the system. On-board power is available on aircraft in several forms, such as pressurized air, hydraulic power, and electricity. Each of the available air separation module (ASM) technologies, capable of generating nitrogen enriched air (NEA) for use to inert aircraft fuel tanks, requires that pressurized air be supplied to the ASM. The system was therefore required to convert the available power

to airflow at an elevated pressure for delivery to the ASM and subsequent NEA delivery to the fuel tanks. System efficiency, safety and failure protection were major considerations. These parameters also dictated the addition of components to the system.

1.4.1 Concept Characteristics

The generic OBGI concept involves a variety of possible solutions, which the Team evaluated. The following items were evaluated.

Pressurized Air Supply. Several ASM supply sources were considered. It was determined that the air should be pressurized to the outlet pressure of the aircraft APU allowing system operation when the primary air source is not available. A three-to-one (3:1) pressure ratio was chosen to match the most common APU compressor ratio. For the larger aircraft tank applications, high NEA flow and maintenance issues dictated multiple components in parallel and the provision for a start contactor on the compressor.

In addition to the above, the following compressor and electric motor technologies were identified:

- Screw-type, positive displacement
- Vane-type, positive displacement
- Piston, positive displacement
- Rotor dynamic (Radial, mixed flow, axial)
- Free piston (diesel) engine
- Three-phase induction motor
- Brushless DC motors
- Switched reluctance motors

Preconditioning. Other system equipment was required to ensure that the air supplied to the ASM is cooled and filtered. This equipment included a heat exchanger with cooling fan and a coalescing filter.

Air Separation. The technologies for the ASMs were defined as membrane, pressure swing adsorption (PSA), and cryogenic distillation. Each of these operates at differing levels of efficiency, depending on NEA flow requirements, and therefore required different amounts of pressurized air for a given condition. The NEA flow was defined by the size of the tank to be inerted and the amount of time available to operate the system at the gate after hook-up and before pushback.

Distribution. A means of NEA distribution to the fuel tanks was required to ensure delivery and adequate mixing. It was determined that the NEA distribution would be common to any OBGI design and would not be significantly affected by the choice of ASM technology.

Control. A system controller is required to provide signals to operate the compressor, cooling system, and ensure proper system valve operation. It was determined that the controller would be common to any OBGI design and would not be significantly affected by the choice of ASM technology.

1.4.2 Generic Concept Development

Taking the previous characteristics into account, system concepts were generated for the candidate ASM technologies. There were some considerations regarding the type of concepts that would be viable:

- The use of high pressure NEA storage with its associated compressor in a system was highly undesirable because of the perceived unreliability of such systems.

Onboard Inerting Designs Task Team Final Report

- The technology associated with the concepts should be either in current use, or be near-term and low-risk.

The concepts that resulted from the process are summarized below. The concepts are presented in terms of a baseline, air/energy supply alternatives, and ASM configurations and technologies.

Concepts Evaluated. The baseline concept (Concept 1) is shown in Figure 1.4.2-2. Concepts 2 through 6 are similar with variations to the bleed air source. Concept 7 (Figure 1.4.2-3) illustrates a configuration in which improved ASM efficiency is achieved by applying vacuum to the ASM waste port with an OEA eductor. Concept 8 (Figure 1.4.2-4) illustrates a system in which bleed air is used to recirculate ullage gas through the ASM and back into the fuel tank. Concept 9 (Figure 1.4.2-5) is similar to Concept 8 except that an electric blower drives the ullage gas recirculation.

All of the concepts require conditioning by a heat exchanger and a coalescing filter to control the bleed air temperature to the ASM and to remove any free water. All of the concepts employ a controller to regulate the air supply temperature and the flow into the ASM such that the required concentration and purity of NEA is delivered.

Onboard Inerting Designs Task Team Final Report

Concept No.	Title (Fig. Ref.)	Analysis	Conclusion
System Concepts			
1	Engine Bleed Only (1.4.2-2)	<ul style="list-style-type: none"> Works only when main engines on. Small part of the on -ground time. Implies a larger system. Can tap off the bleed air gallery. Expected to result in a large ASM – superseded by 4 & 6 	Rejected
2	APU Only (1.4.2-2)	<ul style="list-style-type: none"> Operational restrictions to use of APU. Ground use of APU not allowed by some airport authorities. APU has no spare flow capacity on hot days on retrofit aircraft. Larger system because of limited flow / pressure. Superseded by 4 & 6 	Rejected
3	Air Cart Only (1.4.2-2)	<ul style="list-style-type: none"> Only available at the gate. Not universally available. Additional ground equipment investment. Labor cost of connection. Superseded by 6 	Rejected
4 Retrofit	Engine APU & Ground Cart (1.4.2-2)	<ul style="list-style-type: none"> Restricted by availability unless ECS (Cabin Cooling) degraded, as protection needed most on hot days: needs an excess of air to ECS packs. Superseded by 6 	Rejected
4 New	Engine APU & Ground Cart (1.4.2-2)	<ul style="list-style-type: none"> Can design for required bleed capacity BUT still restricted by availability. 	Consider
5	Compressor. Electrically, hydraulic or bleed-air driven from the aircraft power sources (1.4.2-2)	<ul style="list-style-type: none"> Easier installation. Power may be restricted at gate. Increases size and weight. Less impact on ECS. Spare Power is 10kW per engine, may be restricted on ground. Not available on ground. Only useful to boost low pressure/high flow bleed air. 	Rejected
5a	Compressor (1.4.2-2)	<ul style="list-style-type: none"> Electrically driven from a ground power supply. If power requirements are within the rating of existing supplies provided at the gate, expected to be viable. 	Consider
6	Integrated Air supply (1.4.2-2)	<ul style="list-style-type: none"> Combines the electric compressor with bleed air as an alternative source. Gives the operator some flexibility in the event that a compressor fails as either an engine or APU can be run if ambient conditions are such that the flammability risk is high. 	Preferred
7	ASM with eductor or suction pump (1.4.2-3)	<ul style="list-style-type: none"> An optimization of ASM (membrane & PSA) Eductor requires additional bleed air. Suction Pump requires integration with compressor. 	Consider
8	Closed Loop. Bleed air assisted (1.4.2-4)	<ul style="list-style-type: none"> Smaller, reduced hydrocarbon emissions. Only works with additional compressor. ASM has to be hydrocarbon compatible. Risk of contamination. Compressing fuel vapor air mix considered a safety hazard. Unproven technology. Dependent on Bleed Air supply 	Rejected
9	Closed Loop (1.4.2-5)	<ul style="list-style-type: none"> Smaller, reduced hydrocarbon emissions. Only works with additional compressor. ASM has to be hydrocarbon compatible. Risk of contamination. Compressing fuel vapor air mix considered a safety hazard. Unproven technology. 	Rejected
ASM Technologies			
	Cryogenic	Viable ASM technology	Consider
	Membrane	Viable ASM technology	Consider
	PSA	Viable ASM technology.	Consider

Figure 1.4.2-1. System Evaluation Summary

Onboard Inerting Designs Task Team Final Report

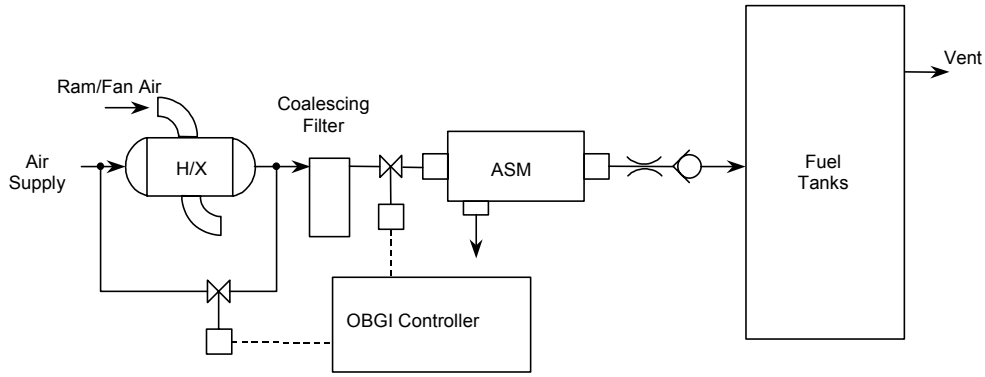

Figure 1.4.2-2. Baseline Concept - Bleed Air Only

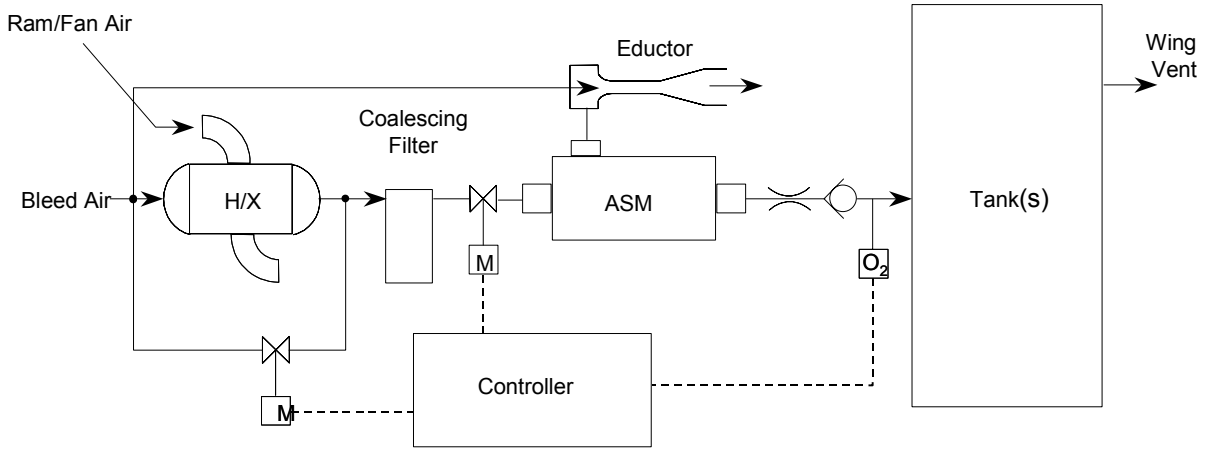
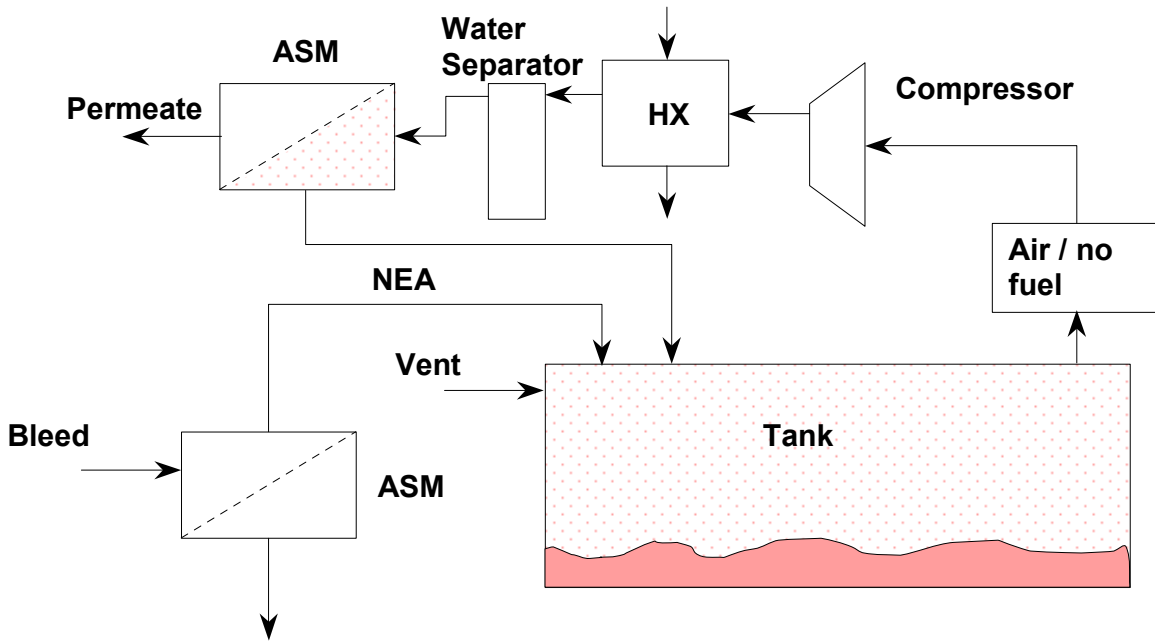

Figure 1.4.2-3. Exhaust Eductor System Concept



Concept 7 - Closed Loop System - Bleed assisted

Figure 1.4.2-4. Bleed Assisted Closed Loop System Concept

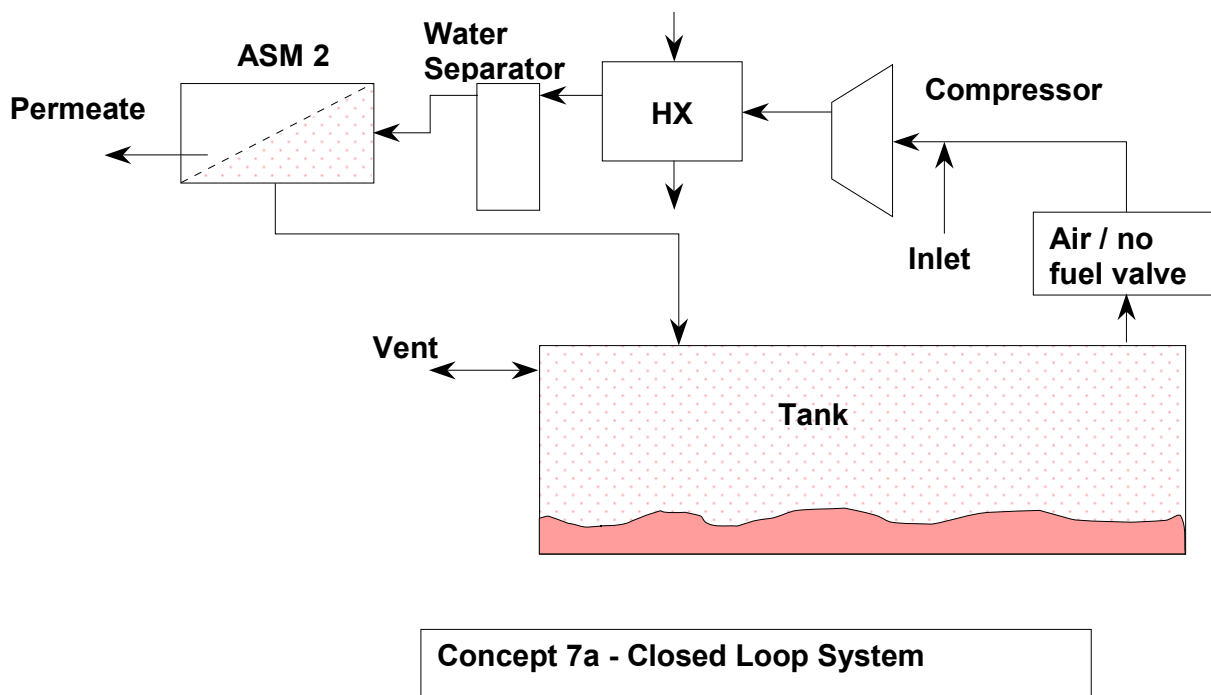

Figure 1.4.2-5. Closed Loop System Concept

1.4.3 Down-Selection

The initial design study for the ASM Technology down selection was concerned with just the ASM alternatives and their impact upon the major components in the other two sub systems, namely the integrated air supply and temperature control subsystems. It was clear that for OGBI, turnaround time was a main system design driver.

The preferred source of pressurized air was a subsystem that integrated a compressor, driven from a ground power source and bleed air available from the aircraft engines or APU. It will be seen that this choice fixed the operating pressure of the OGBI System to that of the APU, namely to a pressure ratio of 3:1. This meant that any reduction in ASM size that might be gained from a higher supply pressure ratio could not be exploited. It was judged, however that the operational flexibility of using either ground power or bleed air out-weighed this. Furthermore, this relatively low-pressure ratio avoided the increased complexity needed to handle the potentially higher air temperatures associated with higher pressure ratios. Examples of increased complexity were two-stage compression, inter-cooling and duct insulation to avoid exposed surface temperatures above fuel auto-ignition temperature, assumed to be 450°F. With regard to the ground power source, it was concluded that the most readily available source was electrical power, and the most convenient form was the existing 400 Hz, three-phase supply provided for other aircraft systems when at the gate.

An initial order-of-magnitude sizing estimate was made for the identified cryogenic distillation, PSA and membrane ASM types. It was found that unless the cryogenic system could be run in the air to exploit the inherent liquid gas storage capability and so reduce the instantaneous gas generation rate required, it was an order of magnitude larger than the other two systems. Operation in the air was explicitly outside the terms of reference for the OGBI and for this reason the cryogenic ASM technology was not taken forward into the full study.

A generic OGBI concept was created that was not specific to either compressor or ASM technology but identified in more detail the components necessary to implement the functions described earlier.

1.4.4 Cryogenic Distillation System – Reasons for Discontinuing Concept

The cryogenic distillation technology is not well suited to an OBI system. Before producing nitrogen gas from ambient air, certain parts of the cryogenic distillation system must be cooled to cryogenic temperatures. This cool-down time must be minimized to allow ample time to make nitrogen gas from the ambient air for fuel tank inerting at the gate. For full-time and hybrid OBIGGS, the cryogenic distillation system makes and store liquid nitrogen during periods of low demand. This liquid is then used at the start of the next day to quickly cool down to cryogenic temperatures. No opportunity exists to make liquid for OBI. Thus, the cryogenic refrigerator must supply all of the cooling for the OBI system. The resulting cryogenic refrigerator would be heavy and would consume more electrical power than is available. The cryogenic distillation system was therefore not investigated further as a realistic option for OBI.

1.5 FINAL CONCEPT DESCRIPTION

The schematic of the final OBI system concept is depicted in Figure 1.5-1. The components identified within each of the OBI subsystems are summarized in Figure 1.5-2.

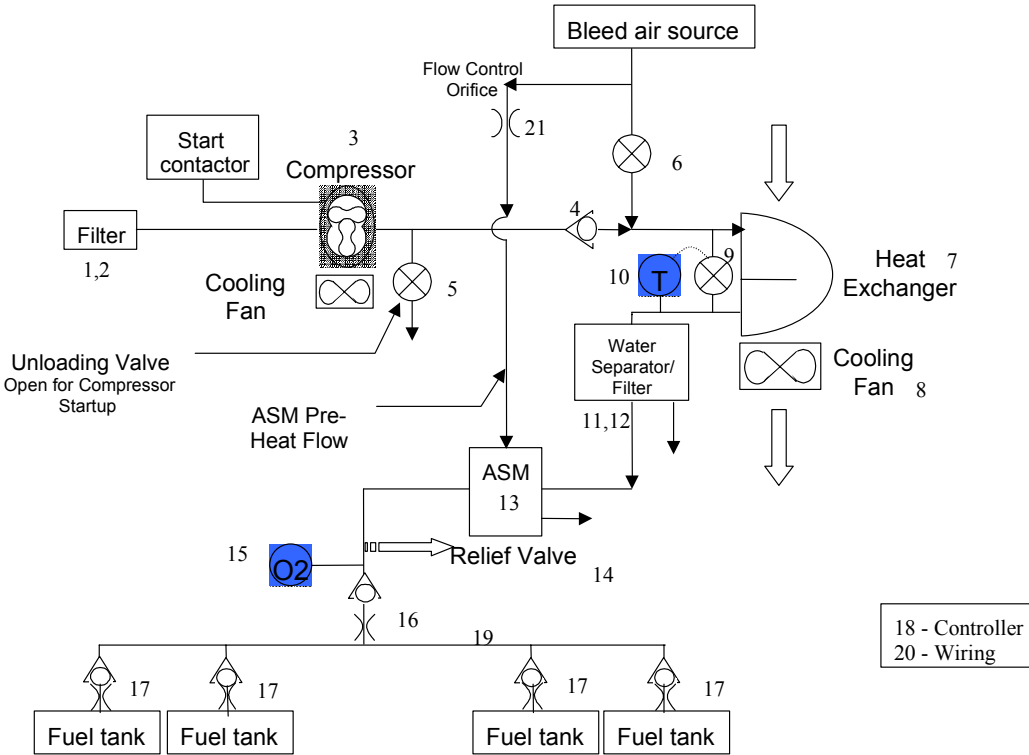

Figure 1.5-1. OBI System Schematic Diagram

Component	Item Number	Component	Item Number
Compressor inlet air filter assembly	1	Water separator/filter assembly	11
Compressor inlet air filter element	2	Water separator/filter element	12
Compressor, cooling & start system	3	Air separation module	13
Compressor discharge check valve	4	Relief valve	14
Compressor unloading valve	5	Oxygen sensor	15
Bleed Air shutoff valve	6	ASM check valve & restrictor assembly	16
Heat exchanger	7	Fuel tank check valve	17
Cooling fan & ram ducts assembly	8	Controller / control card	18
Heat Exchanger bypass valve	9	Ducting	19
Temperature sensor & controller	10	Wiring	20
		Bleed Orifice & duct	21

Figure 1.5-2. OBGI System Component List

1.5.1 Operating Concept

The system is arranged to replace the air in the tank ullage with nitrogen enriched air (NEA), thereby reducing its flammability. The main device used to accomplish this is the Air Separation Module (ASM), which separates ambient air into nitrogen, oxygen, and the other constituents of air. The ASM requires that the air be compressed to force it through the device. During the compression process, the air is heated, and must subsequently be cooled before it is supplied to the tanks. This is accomplished by use of a heat exchanger, which rejects the heat to ambient air. A distribution system ensures that the NEA is supplied to the fuel tanks in a manner that assumes a relatively uniform concentration throughout the tanks.

An electrically powered compressor pressurises ambient air for the ASM. The air is filtered prior to entry into the compressor inlet, to prolong compressor life. For some aircraft types / sizes, the power requirement for the compressor is relatively high, which dictates the use of a start contactor and pressure unloading valve. These allow the compressor to start, while avoiding high power surges during wind-up. The unloading valve helps accomplish this by reducing the compressor back-pressure, and consequently reducing the start-up power load. The compressor outlet requires a check valve, to prevent reverse flow through the compressor and filter.

An alternate source of pressurized air for the system is engine bleed air. This is introduced into the system downstream of the compressor, and is controlled by a shut-off valve, which also acts to prevent reverse flow to the engine bleed system when in the closed position.

In its pressurised form, from either the compressor or the engine bleed air system, the air will be at an elevated temperature. Prior to flowing to the ASM, it must therefore be cooled to ensure that it is sufficiently cool to prevent damage of the ASM, and to prevent hot gas flowing to the fuel tanks. Cooling of the air is accomplished by the use of an air-to-air heat exchanger. In the event that the air is already sufficiently cool, as may be associated with cold climates, the heat exchanger may be by-passed through the temperature control valve. The temperature control valve will modulate the bypass flow to optimize the temperature of the airflow.

As the air exits the heat exchanger, it is again filtered to a finer level than the primary filter, and ensures that the airflow is acceptable for the ASM. The secondary filter also filters engine bleed air in the event that air is supplied from this source. The filter assembly also reduces the relative humidity of the air by separating water vapor and ejecting it in liquid form from the aircraft through a drain line.

The ASM accepts warm pressurized air from the upstream system and discharges NEA to the fuel tanks. A second ASM outlet port discharges oxygen enriched air (OEA) to the ambient air around the aircraft.

Onboard Inerting Designs Task Team Final Report

Concentrated OEA may be a fire hazard so it must be mixed with ambient air. The discharge port must be designed to ensure the mixing.

At the ASM outlet, a relief valve ensures that tank over-pressure conditions are avoided in the event of a refuel system failure during refuel operations. This is accomplished by jettison of the NEA during the refuel failure condition, which results in normal refuel failure tank over pressure protection.

Flow to the fuel tanks is controlled by means of fixed restrictions which are designed to balance the flow to the individual fuel tanks. Flow balance ensures that tank NEA ullage concentrations are relatively uniform. The restrictors also feature check valves which, together with the in-line check valve, provide dual redundant reverse flow protection against hydrocarbon contamination of the ASM.

1.5.2 Component Functional Description

The following provides a brief description of the components incorporated in the developed OBGIS concept.

1.5.2.1 Inlet Filter

The inlet filter provides filtration for the air prior to entry into the compressor, and subsequently to the heat exchanger, ASM and fuel tanks. It is a line-mounted unit, consisting of a housing and replaceable filter element. Filter technology identical to current cabin air filters is used, with known performance and filter cartridge replacement requirements.

1.5.2.2 Compressor, Start Contactor, Compressor Cooling Fan

The compressor is an electrically powered device, with integral cooling. Technologies considered for the compressor centered on screw-type, and centrifugal rotating groups. Efficiency optimization of these various types of compressor will dictate the optimum application. The Team considered that details of this would be subject to detail application design, and may vary by aircraft model. Compressing the airflow by a factor of three results in significant heating. Integral cooling of the electric motor and case will therefore be required, and was included for purposes of component definition. The rotating group within the compressor housing may rotate at relative high speeds. Containment of the rotor section is therefore required, to prevent high velocity impingement of rotor fragments on other adjacent components in the event of rotor failure. Rotor clearances were optimized for the purposes of sizing and efficiency calculations. This demands pre-filtration to prevent excessive wear with contaminated air.

Two types of compressor were considered for each of the aircraft and system types. These were the positive displacement screw type and the centrifugal (CF) roto-dynamic type. The latter type are generally lighter and less expensive but have a limitation that they do not readily scale down to small sizes. Rotational speeds become high (in excess of 100,000 rpm) and efficiency reduces owing to small flow passages and high gas velocity. The minimum practical size of CF compressor was taken as a 10kW shaft power machine for the study. A further consideration was that above 15 kW the compressor motor needs a start winding and contactor to reduce the initial current surge. The view was that with this level of current transient there was a risk that the whole electrical power distribution system of the aircraft would be adversely affected. Thus above 30kW shaft power, two or more compressors are proposed.

Larger aircraft applications therefore demand high torque on start-up, and a start contactor is necessary, to ensure that the compressor motor remains as small and compact as possible, while maintaining the ability to overcome high torque at start-up. Similarly, a compressor-unloading valve is necessary to reduce torque at start-up due to backpressure. Air flow for the larger applications, and for some ASM technologies, demand the use of two compressors in parallel due to their high power requirements.

The screw and CF compressors were estimated to have similar efficiencies of 70%. The thermodynamic efficiency of the CF compressor was slightly better than that of the screw compressor. However the CF compressor had additional mechanical losses owing to the need for a step up gear box to increase the shaft

speed from that of the three phase induction motor at 23,000 rpm, to that of the compressor disc. The compressor disc speed depended upon the mass flow requirement of each aircraft and system type but was in the range of 70,000 to 130,000 rpm.

1.5.2.3 Compressor Discharge Check Valve

The check valve is necessary to prevent back-flow through the compressor when the system is operated by the bleed air source only. This is a simple in-line unit with integral poppet and return spring, similar to existing units used in aircraft pneumatic and fuel systems.

1.5.2.4 Compressor Unloading Valve

The line-mounted valve allows depressurization of the compressor outlet during startup, as previously described. This may be of either motor-operated butterfly valve design or a solenoid-operated poppet valve. The valve architecture is identical to existing aircraft fuel and pneumatic valves.

1.5.2.5 Bleed Air Isolation Valve

The bleed air isolation valve allows engine bleed air to supply the ASM. This is a similar valve to the compressor-unloading valve, and also of either the motor-operated butterfly valve type or solenoid-operated poppet valve type. In the event that the available air may only be tapped from a location prior to the aircraft pre-cooler, the bleed air valve may need to control air at a temperature that is higher than the unloading valve. It is expected that this will not require that the valve be of stainless steel construction. If temperatures are higher than anticipated in this evaluation, the weight and cost impact of stainless steel usage may need to be considered.

1.5.2.6 Heat Exchanger

A conventional plate / fin contra-flow heat exchanger was used for this application. Its configuration is conventional and of similar construction to current fuel / oil / air heat exchangers used in high quantities on current aircraft. The unit is self-contained, including headers, and in-line tube connectors. An electrically powered cooling fan, with associated ducting, is used to provide cooling air.

1.5.2.7 Heat Exchanger Temperature Control Valve

This valve provides temperature control of the air down stream of the heat exchanger, by selective bypass of the heat exchanger. It is a motor-operated butterfly valve controlled by the system controller, as a function of heat exchanger outlet temperature. It is necessarily a relatively complex valve, in that it must modulate the flow, rather than being of a simple on-off design.

1.5.2.8 Temperature Sensor

Similar to existing thermocouple temperature sensors, it provides active temperature data to the system controller.

1.5.2.9 Water Separator / Filter

This device removes and discards free water in the compressed air flow. It also provides additional filtration of the air, because the air may be contaminated when supplied from the bleed air source. This is similar to existing aircraft units and sized, based on airflow requirements, from empirical data. The unit has a removable filter element to allow maintenance of the unit, and is line-mounted.

1.5.2.10 Air Separation Module

The ASM receives pressurized air from the system, and separates it into two outlet airflows. NEA is provided to the fuel tank ullage. OEA is mix with ambient air and ejected. ASMs that have been cold-

Onboard Inerting Designs Task Team Final Report

soaked at altitude may require 5 to 15 minutes of operation to warm and provide their optimum NEA. To get optimum flow immediately when the OBG system is started, provision has been made to use a small amount of engine bleed air to warm the ASM in flight. Regardless of the technology used, the unit is self-contained and line-mounted. It is expected to be sized for a given application, but will be of modular design, using existing sub-component sizing.

1.5.2.11 Relief Valve

The relief valve is necessary to allow harmless venting of the NEA flow in the event of fuel system refuel failure conditions. Current aircraft fuel systems are usually sized to prevent over-pressure conditions inside the tanks, in the event that a refuel valve fails to close when the tank is full. The addition of NEA flow into the tank could increase the pressure in the tank during this condition, such that the tank is over-pressurized. The relief valve would be opened for this condition, thereby by-passing the tank. The unit is of either a motor operated butterfly design, or solenoid-operated configuration, similar to existing aircraft system units.

1.5.2.12 ASM Discharge Check Valve and Restrictor

This provides redundant back flow prevention in the event that a fuel tank check valve fails open. It therefore protects the ASM from fuel / vapor back flow that would otherwise significantly degrade ASM performance. The unit also provides a backpressure to the ASM while flowing, necessary to optimize its efficiency.

1.5.2.13 Fuel Tank Check Valve and Restrictor

Similar to the ASM check valve assembly, this unit prevents back flow of fuel / vapor to the ASM. The restrictor provides a means of balancing the flow to each of the tanks.

1.5.2.14 Ducting

Conventional aluminium aircraft ducting is used to flow air to the ASM and NEA to the fuel tanks. This will feature conventional flexible couplings with O ring seals, to provide axial and angular motion required for relative motion during flight and tolerance build-up during manufacture. Minimum wall thickness' are used to minimize weight, but must be damage tolerant. Double containment may be required where NEA flow passes through the pressurized cabin, to prevent nitrogen contamination of the cabin air after failure of the primary tube wall. This will be minimized by the close location of the ASM relative to the fuel tanks. Similarly, stainless steel ducting is required for the ducts between the compressor and the heat exchanger, due to the elevated temperature of the airflow. Close-coupling the compressor and heat exchanger will also minimize this.

1.5.2.15 Controller

The system controller provides the actuation signals to the various components in the system. This includes such items as the control signal to start the compressor, open the unloading valve, modulate the temperature control valve etc. It is a digital microprocessor based unit, and may be integrated as a card on an existing aircraft computer or as a separate computer on older aircraft. Some health monitoring and failure annunciation may be included in the software.

1.5.2.16 Wiring

Power wires and control signal wires are included in the system to allow connection to the power source, and connect the controller with system components. This is defined as conventional system wiring.

1.5.2.17 Flow Control Orifice

The flow control orifice uses a small bleed flow of warm air to be used to maintain the ASM temperature during protracted high altitude flights. This is a simple plate orifice or metered tube design.

1.6 SYSTEM SIZING AND PERFORMANCE

The ullage was required to be inert to 10% O₂ at pushback from the gate, to simplify comparison with the ground-based system. Parameters such as ASM efficiency and fuel tank volumes were primary factors for system sizing. The ASM performance determines the amount of feed air needed to make the NEA needed to fill the fuel tank(s). The feed air quantity and the ambient temperature then size the compressor and the feed air heat exchanger.

The primary tool used by the Team for determining the performance of the system was the FAA inerting computer model. This analysis tool determines flammability exposure of the fuel tank ullage during the mission.

The key parameters explored to optimize the OBGIS System components were the effect of feed pressure, NEA oxygen content, feed air temperature, and turn-time (the time available to operate the system prior to pushback from the gate).

1.6.1 Key Sizing Parameters

The OBGIS system NEA flow rate (and, therefore, the system size, cost, and weight) is directly proportional to the minimum aircraft turn-time, as this dictates the time available to operate the system.

Another key parameter is the ASM feed pressure. Because the system can operate on engine or APU bleed air, it was sized using the minimum pressure available from existing aircraft bleed air pressure data. This consideration had an effect on the size and weight of the ASM selected.

The system heat exchangers use ambient air to cool the hot ASM feed air to the temperature that the ASM can tolerate. In order to predict the cooling loads on the system, 111°F ambient air temperature was used as the worst-case ambient air heat sink. This detail dictates the size and weight of the cooling system, because the PSA ASM feed air had to be cooled to 125°F. Membrane ASMs operate efficiently at 180°F and were sized accordingly to minimize the size of the cooling system. However, operating the membrane ASMs at this temperature requires more feed air than operating at cooler temperatures. Figure 1.6.1-1 also shows the effect of temperature on performance.

The NEA flow rate required to inert the tank is a function of the NEA purity generated by the system. The OBGIS weight, volume, power consumption, and cost results in this report are based on membrane NEA purity of 6.76% oxygen and PSA purity of 7.4% oxygen. An analysis was done by the Team to insure there was not a high dependency of system weight and size on NEA concentration. This analysis was done by performing several sizing iterations using the inerting model and only varying the concentration of the NEA.

Through the entire range of purity, the weight of the system changed only 5%. (Note: the weights in the chart only consider the main system components.) This was ignored for the purposes of this report because the Team considered the savings minimal and overall the fleet-wide savings would be negligible.

1.6.2 Parametric Sizing Curves

The results of the system analysis were the weight, volume, electrical power consumption, and acquisition cost for the various aircraft models. These results are plotted as parametric charts in Figures 1.6.2-1 through 1.6.2-5.

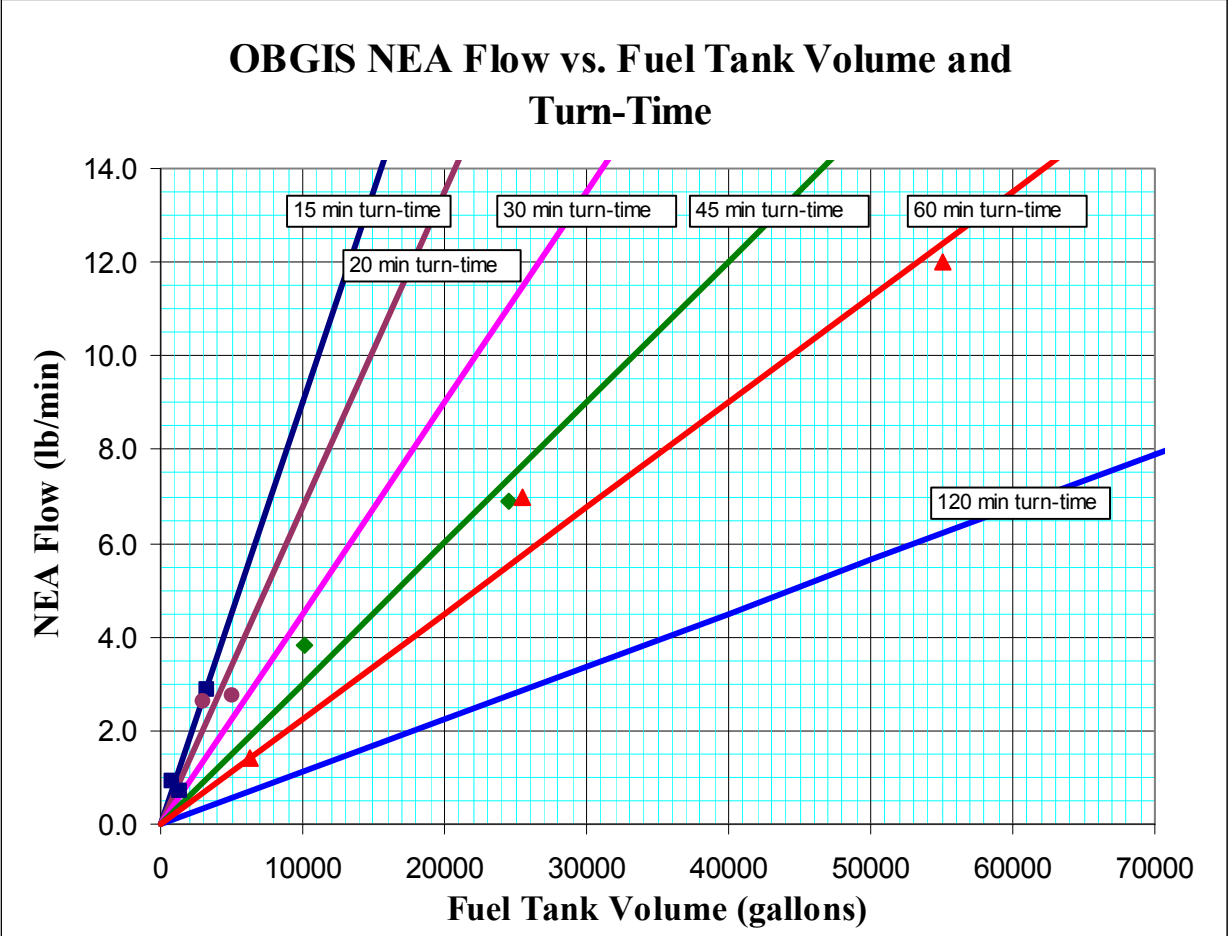

Figure 1.6.2-1. NEA Flow vs Tank Volume

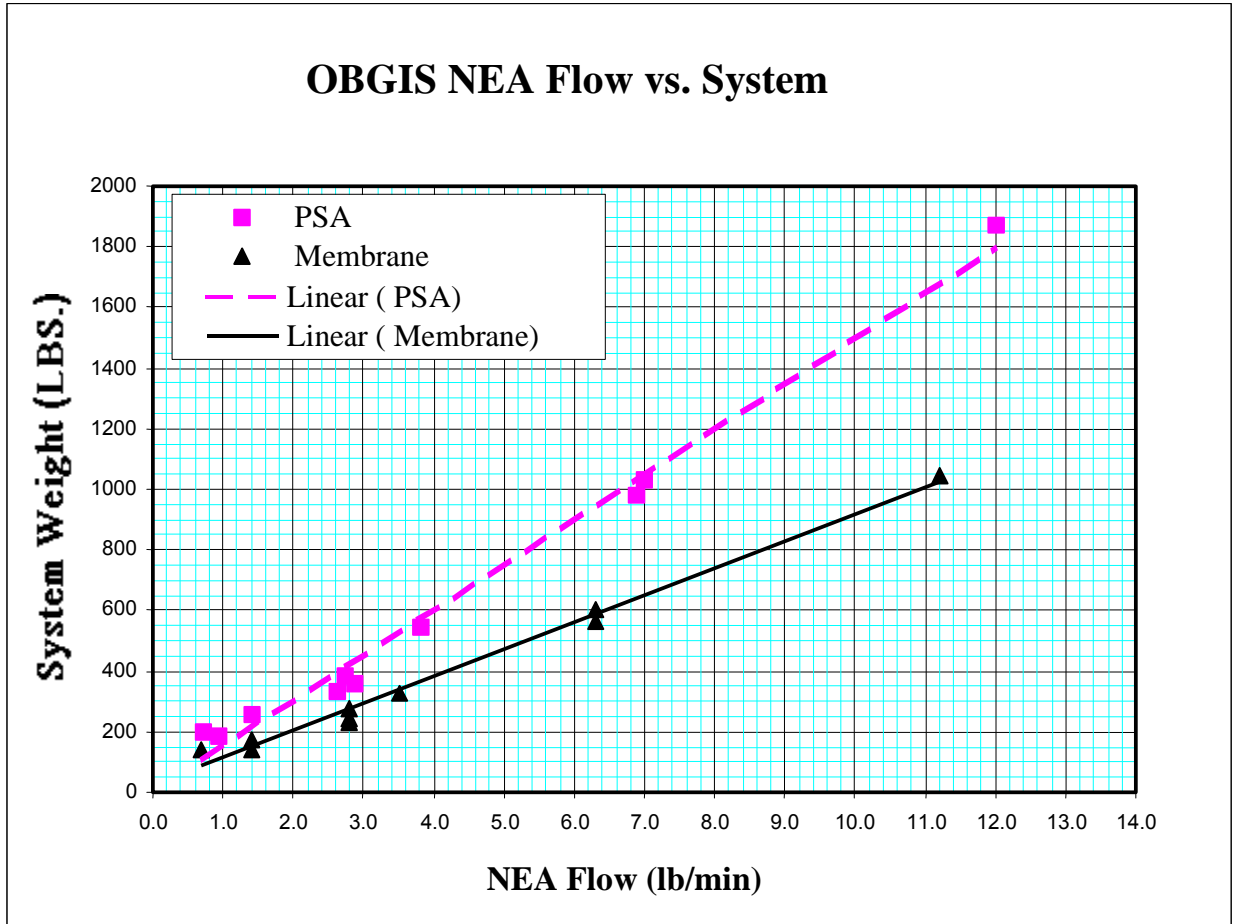

Figure 1.6.2-2. Weight vs NEA Flow

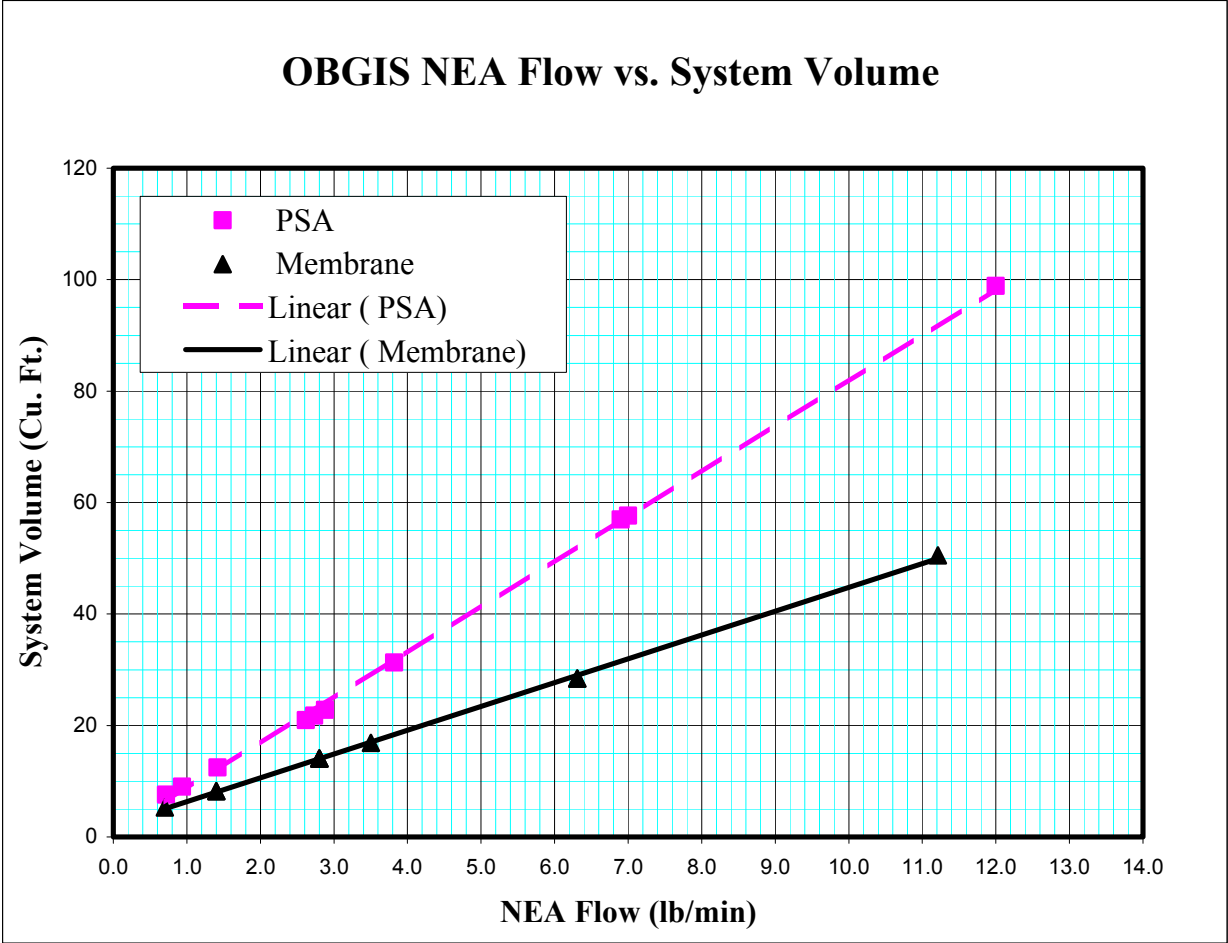

Figure 1.6.2-3. Volume vs NEA Flow

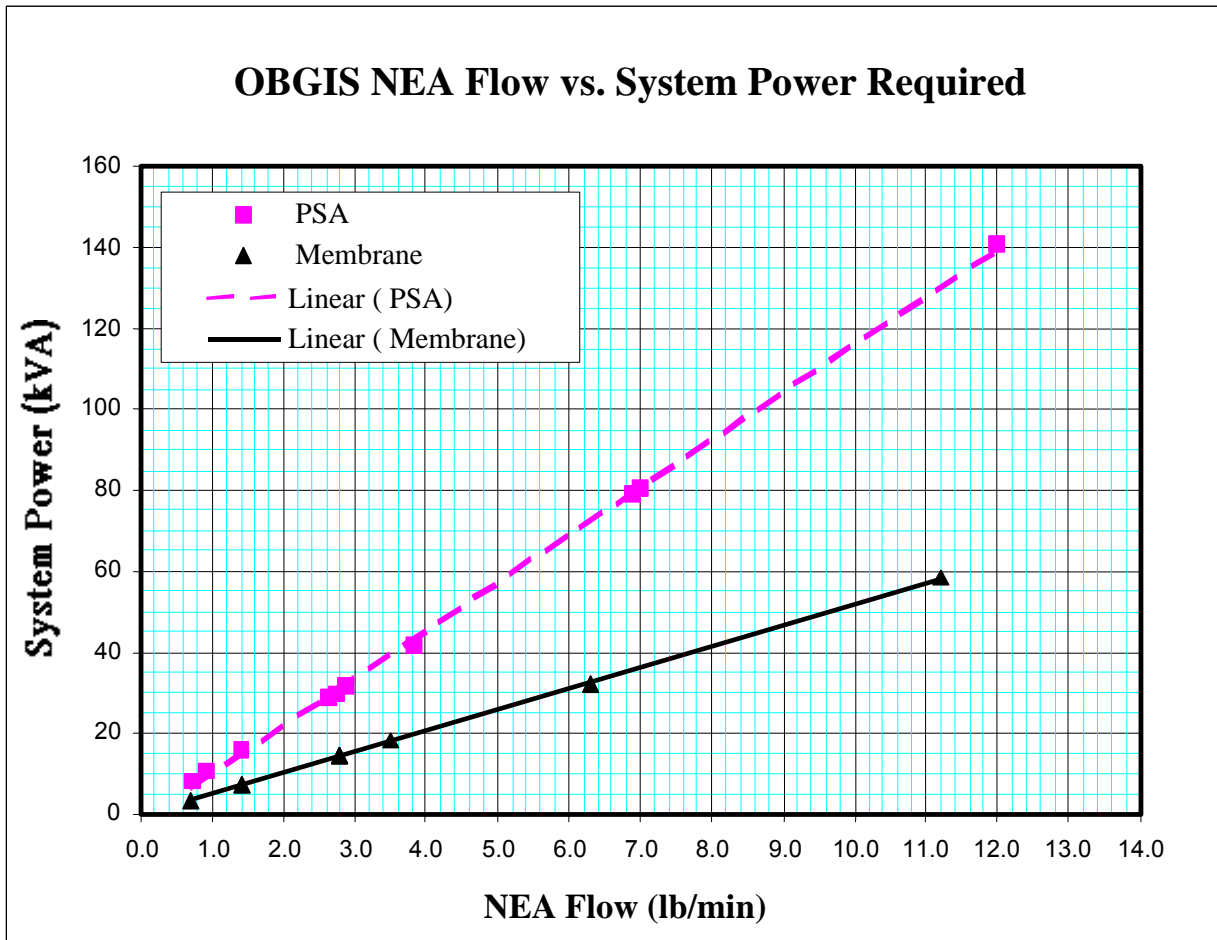

Figure 1.6.2-4. Power vs NEA Flow

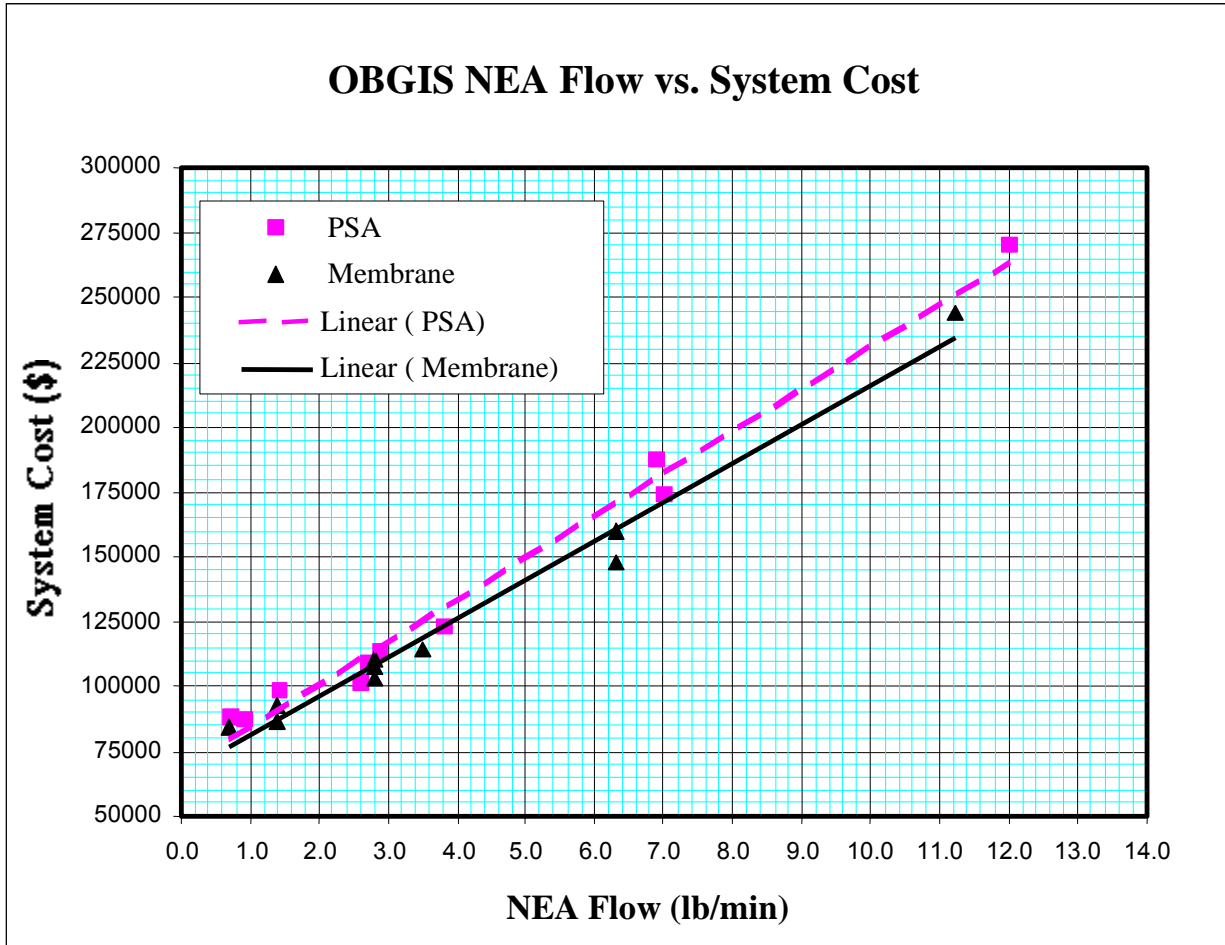

Figure 1.6.2-5. Cost vs NEA Flow

These charts allow system sizing for any aircraft model not specifically studied in this report. Figure 1.6.2-1 plots the NEA flow required for an OBGIS to inert the fuel tanks before pushback based on fuel tank volume and turn-time. Figures 1.6.2-2 through 1.6.2-5 then provide estimation of OBGIS system weight (pounds), system volume (cubic feet), required electrical power (kVA), and system cost (dollars). Cost data are for initial acquisition only of the systems themselves and are provided for comparison purposes; they do not include any other costs such as certification or integration by the aircraft manufacturer or commercial airline. The charts are based on NEA purity of approximately 7% oxygen and may not be valid for different NEA purity.

The following examples of the use of the charts are for an aircraft with a total fuel capacity of 15,000 gallons (including main, center wing, and auxiliary tanks) and a minimum turn-time of 45 minutes:

Membrane System: Figure 1.6.2-1 indicates that 4.5 pounds per minute of NEA at 7%O₂ is required to inert the 15,000 gallon tank volume within 45 minutes. Figures 1.6.2-2 through 1.6.2-5 show that a membrane OBGIS which produces 4.5 lbs/min of NEA7 weighs approximately 425 pounds, occupies 22 cubic feet, consumes 24 kVA of electrical power, and has initial costs of \$135,000.

PSA System: Figure 1.6.2-1 again indicates that 4.5 lbs/min of NEA7 are required. Figures 1.6.2-2 through 1.6.2-5 show that a PSA OBGIS would weigh approximately 675 pounds, occupy 37 cubic feet, consume 52 kVA of electrical power, and cost \$140,000.

1.6.3 System Results

The OBGIS air consumption, weight, electrical power requirements, and volume for the different models and tank configurations are plotted in the bar charts in Figures 1.6.3-1 and 1.6.3-2.

OBGI - Center Wing Tank

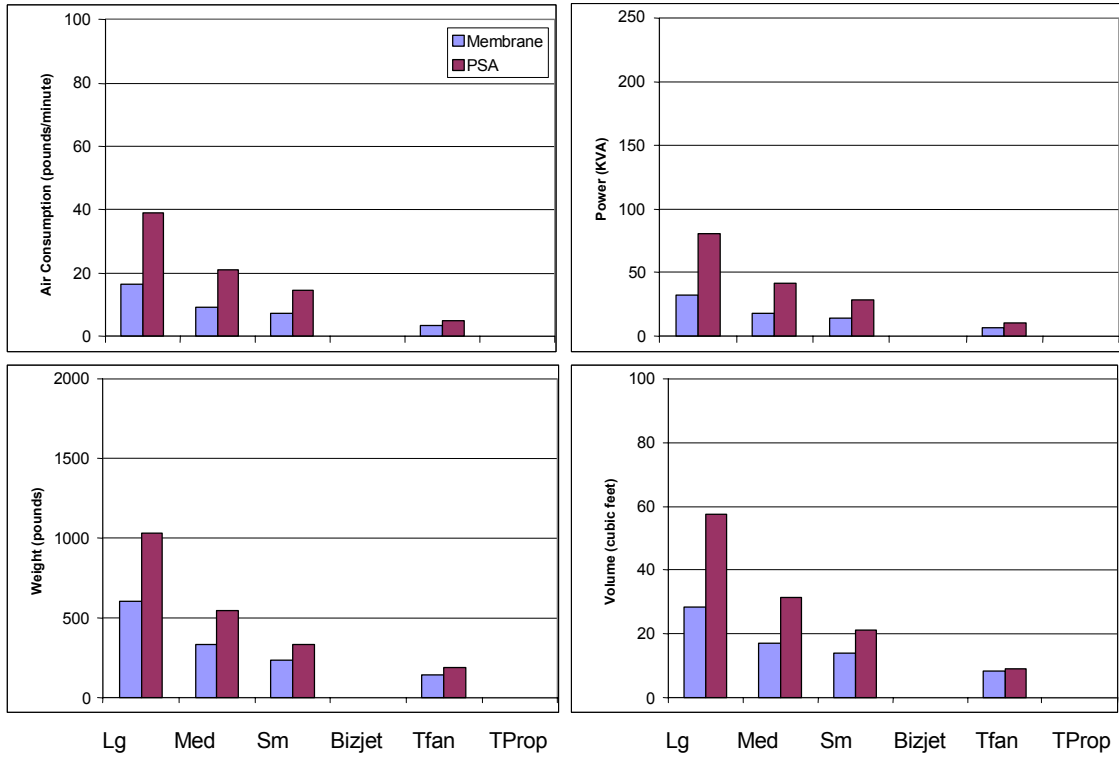

Figure 1.6.3-1. OBGIS Air Consumption, Power, Volume and Weights for Center Tanks

OBGI - All Tanks

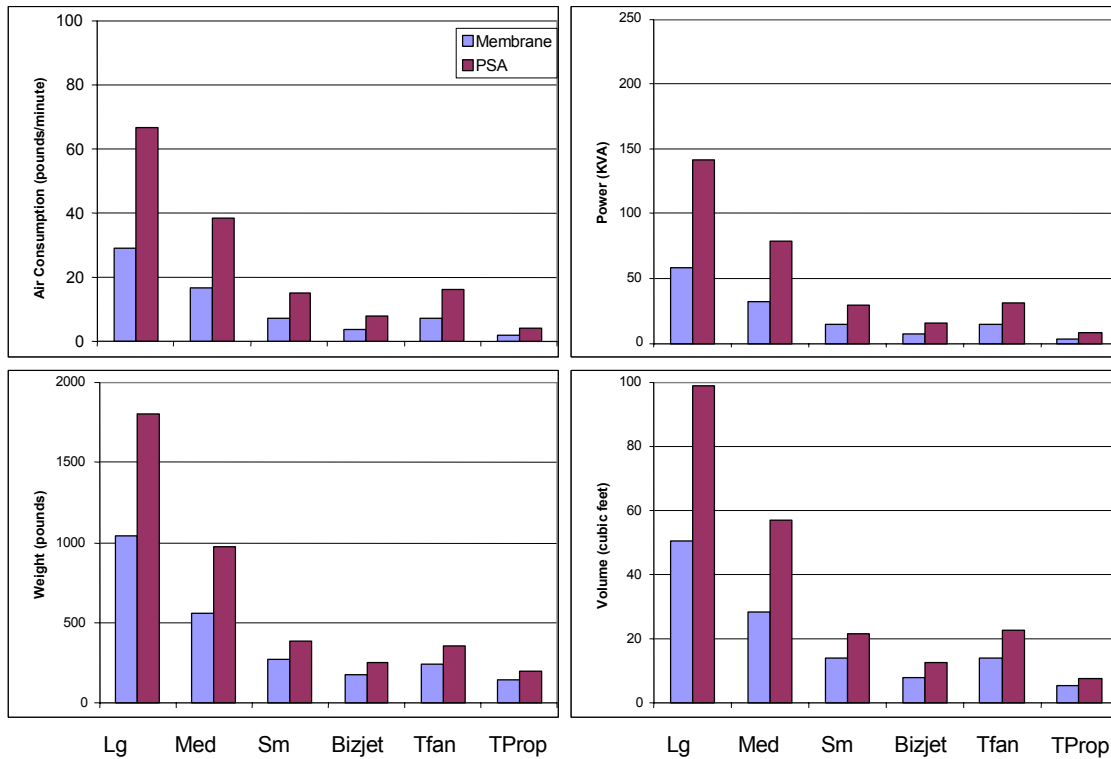

Figure 1.6.3-2. OBGIS Air Consumption, Power, Volume and Weights for All Tanks

1.6.4 Flammability Exposure

Flammability exposure for each of the generic aircraft types was determined for each fuel tank type by simulating 5,000 random flights. Both the PSA and membrane ASM systems were evaluated based on the system sizing that ensured tanks were inert at pushback from the gate for all ground scenarios. Flammability exposure results for the OBGI systems are shown in Figures 1.6.4-1 and 1.6.4-2. A comparison of OBGI system performance to other fuel tank inerting options is provided in Section 5.

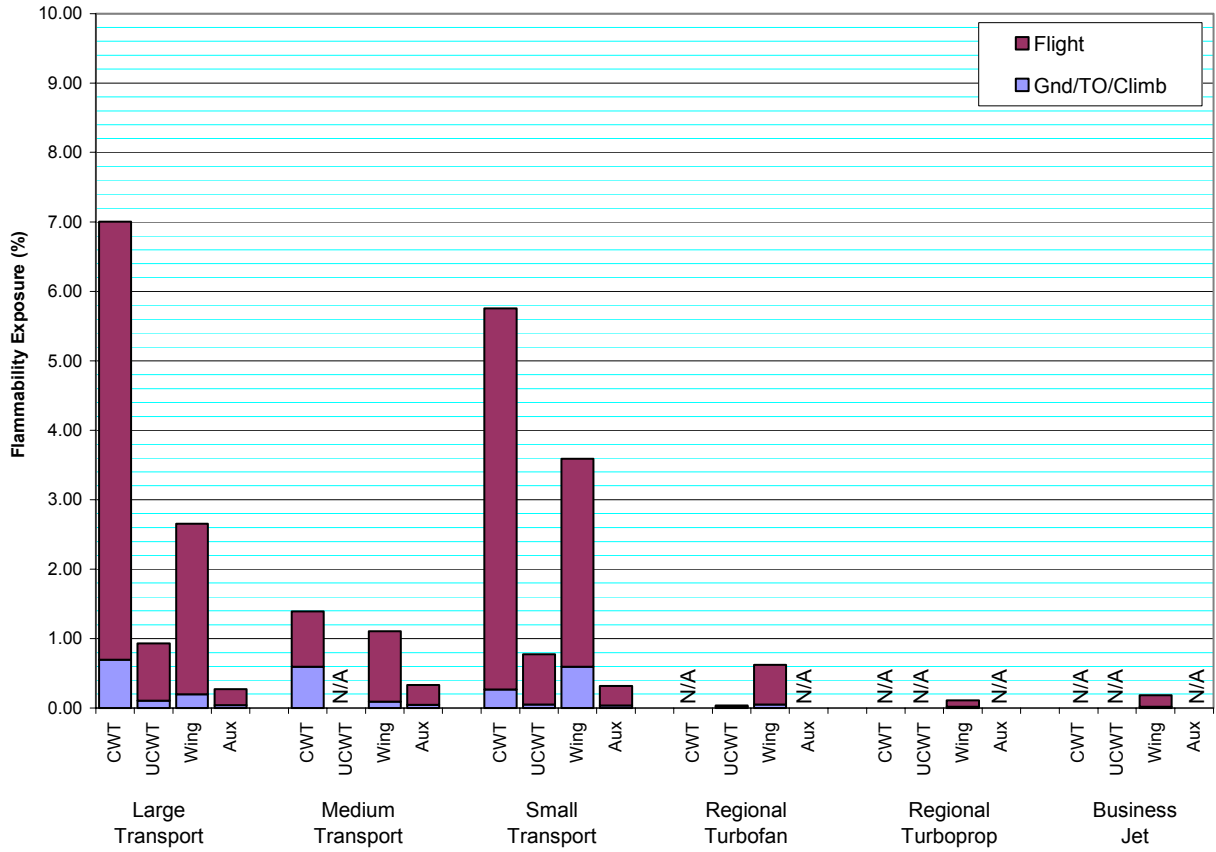

Figure 1.6.4-1. Flammability Exposure Results for the OBGI Systems PSA ASM

Onboard Inerting Designs Task Team Final Report

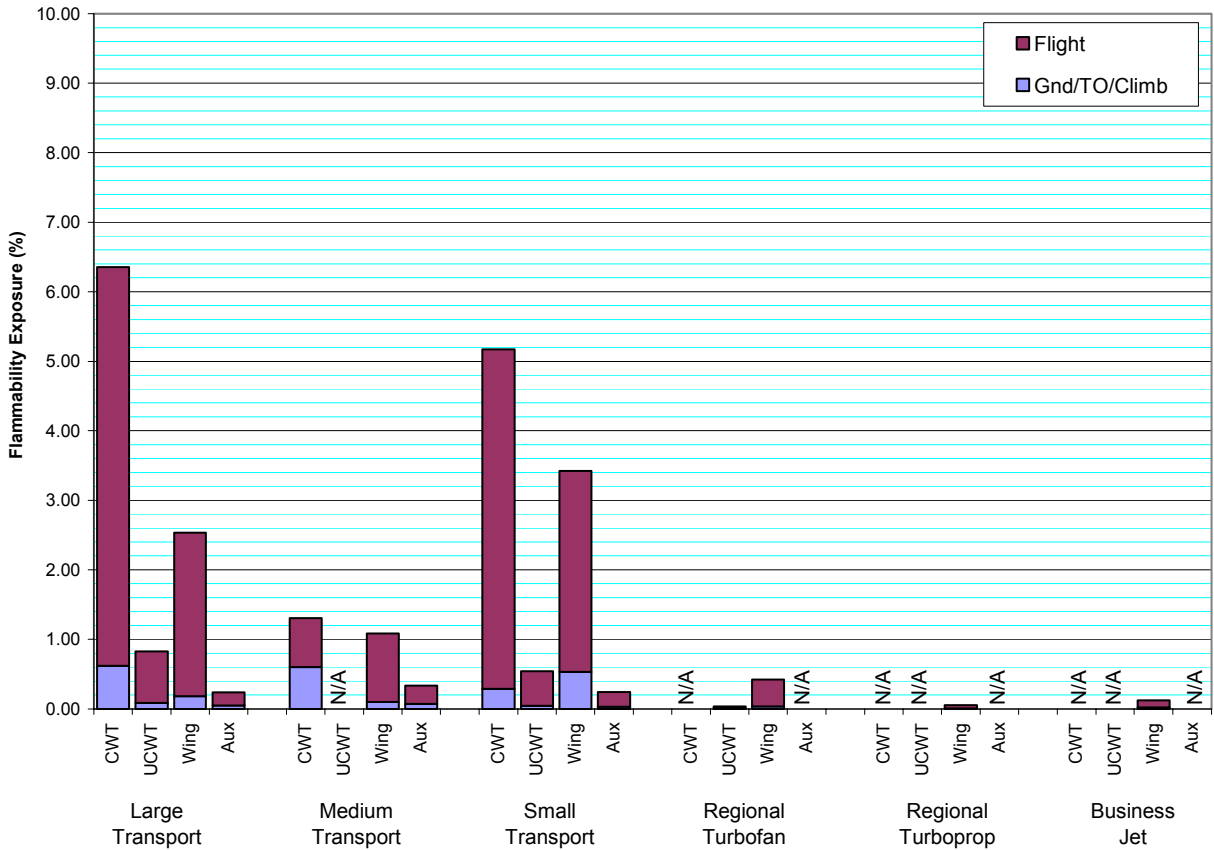

Figure 1.6.4-2. Flammability Exposure Results for the OBGI Systems Membrane ASM

Total flammability exposure represents the total flight and ground time spent flammable and not inert as a percentage of the total flight and ground time. The portion of the total flammability exposure corresponding to gate time, taxi out, takeoff and climb segments were separately summed, to allow for direct comparisons of each inerting option in the portion of the mission where the risk of an explosion was higher. Because the FAA flammability model conservatively uses sea level criteria at altitude, the total exposure is not necessarily the best measure for comparing overall performance between inerting system types. For instance, a one-percent reduction in flammability exposure during cruise does not represent the same benefit as a one-percent reduction on the ground.

1.7 WEIGHT

Figures 1.7-1 and 1.7-2 summarize the weight data developed by the Onboard Design Task Team for the membrane and PSA OBGI systems for each of the ARAC generic aircraft. Each table provides the total weight for the “major” and “other” components identified for each system. “Other” components include such items as wiring, ducting and valves, and their total estimated weights have been combined.

Onboard Inerting Designs Task Team Final Report

Weight Summary Table - Membrane Systems (Lbs.)										
Component	Large Transport		Medium Transport		Small Transport		Turbo Prop	Turbo Fan		BizJet
	All Tanks	CWT Only	All Tanks	CWT Only	All Tanks	CWT Only	All Tanks	All Tanks	CWT Only	All Tanks
Main Parts										
Compressor, cooling & start system	62.2	35.4	35.4	22.3	19.0	19.0	9.2	19.0	12.5	12.5
Heat exchanger	5.0	4.8	4.8	2.3	3.0	3.0	0.6	3.5	0.7	1.1
Cooling fan & ram ducts assembly	7.1	7.3	7.3	6.5	5.3	5.3	0.6	4.8	2.9	2.4
Air separation module	320.0	180.0	180.0	100.0	80.0	80.0	20.0	80.0	40.0	40.0
Main Parts Sub-Total	394.3	227.5	227.5	131.1	107.3	107.3	30.4	107.3	56.0	56.0
Other Parts										
Compressor inlet air filter assy	6.0	4.0	4.0	4.0	4.0	4.0	4.0	4.0	4.0	4.0
Compressor inlet air filter element	0.0	0.0	0.0	0.0	0.0	0.0	0.0	0.0	0.0	0.0
Compressor discharge check valve	1.5	1.5	1.3	1.2	1.0	1.0	0.8	1.2	1.0	1.5
Compressor unloading valve	3.0	3.0	3.0	3.0	2.0	2.0	2.0	2.2	2.0	2.5
Bleed Air shutoff valve	3.5	3.5	3.0	3.0	2.5	2.5	2.5	2.8	2.5	2.5
Heat Exchanger bypass valve	1.2	1.2	1.0	1.0	0.8	0.8	0.7	0.8	0.8	1.0
Temperature sensor & controller	0.3	0.3	0.3	0.3	0.3	0.3	0.3	0.3	0.3	0.3
Water separator/filter assy	10.0	7.0	7.0	7.0	7.0	7.0	7.0	7.0	7.0	7.0
Water separator/filter element	0.0	0.0	0.0	0.0	0.0	0.0	0.0	0.0	0.0	0.0
ASM check valve & restrictor assy	0.5	0.5	0.5	0.5	0.5	0.5	0.5	0.5	0.5	0.5
Relief valve	1.9	1.9	1.5	1.5	1.0	1.0	0.8	1.0	1.2	1.5
Fuel tank check valve	1.8	1.8	1.8	1.8	1.8	1.8	1.8	1.8	1.8	1.8
Controller / control card	5.5	5.5	5.5	5.5	5.5	5.5	5.5	5.5	5.5	5.5
Ducting	133.2	44.2	115.8	30.4	52.5	16.8	38.1	38.1	9.5	38.1
Wiring	15.0	15.0	15.0	15.0	15.0	15.0	15.0	15.0	15.0	15.0
Bleed Orifice & Duct	3.0	3.0	3.0	3.0	3.0	3.0	3.0	3.0	3.0	3.0
Compressor Wiring	236.2	118.1	56.7	34.8	15.4	15.4	3.3	12.8	4.1	4.1
Installation Hardware	118.5	65.7	67.0	36.5	32.9	27.6	17.3	30.5	17.1	21.6
Structural Modifications	100.0	100.0	50.0	50.0	20.0	20.0	10.0	10.0	10.0	10.0
Other Parts Sub-Total	641.0	376.1	336.3	198.5	165.2	124.1	112.6	136.5	85.3	119.9
System Totals	1035.4	603.7	563.8	329.5	272.5	231.4	143.0	243.8	141.3	175.9
Oxygen sensor	1.5	1.5	1.5	1.5	1.5	1.5	1.5	1.5	1.5	1.5

Figure 1.7-1. Summary of OBGIS Component Weights – Membrane Systems

Onboard Inerting Designs Task Team Final Report

Weight Summary Table - PSA Systems (Lbs.)										
Component	Large Transport		Medium Transport		Small Transport		Turbo Prop	Turbo Fan		BizJet
	All Tanks	CWT Only	All Tanks	CWT Only	All Tanks	CWT Only	All Tanks	All Tanks	CWT Only	All Tanks
Main Parts										
Compressor, cooling & start system	135.4	78.4	77.4	43.7	32.8	31.8	13.0	34.3	15.1	19.9
Heat exchanger	64.2	37.2	32.6	19.3	13.4	12.9	3.2	14.3	4.3	10.0
Cooling fan & ram ducts assembly	23.0	13.2	17.0	9.1	8.7	8.5	6.6	8.8	6.7	4.0
Air separation module	586.0	333.0	327.0	188.0	141.0	132.0	50.0	144.0	65.0	80.0
Main Parts Sub-Total	808.6	461.8	454.1	260.1	196.0	185.2	72.8	201.4	91.1	113.9
Other Parts										
Compressor inlet air filter assy	11.0	8.0	8.0	6.0	4.0	4.0	4.0	4.0	4.0	4.0
Compressor inlet air filter element	0.0	0.0	0.0	0.0	0.0	0.0	0.0	0.0	0.0	0.0
Compressor discharge check valve	2.0	2.0	2.0	1.5	1.0	1.0	0.8	1.2	1.0	1.5
Compressor unloading valve	3.0	3.0	3.0	2.5	2.0	2.0	2.0	2.2	2.0	2.5
Bleed Air shutoff valve	4.0	4.0	4.0	3.0	2.5	2.5	2.5	2.8	2.5	2.5
Heat Exchanger bypass valve	1.2	1.2	1.2	1.2	0.8	0.8	0.7	0.8	0.8	1.2
Temperature sensor & controller	0.3	0.3	0.3	0.3	0.3	0.3	0.3	0.3	0.3	0.3
Water separator/filter assy	18.0	13.0	13.0	10.0	7.0	7.0	7.0	7.0	7.0	7.0
Water separator/filter element	0.0	0.0	0.0	0.0	0.0	0.0	0.0	0.0	0.0	0.0
Relief valve	1.9	1.9	1.9	1.5	0.8	1.0	0.8	1.0	1.2	1.5
ASM check valve & restrictor assy	0.5	0.5	0.5	0.5	0.5	0.5	0.5	0.5	0.5	0.5
Fuel tank check valve	2.5	2.5	2.5	2.5	2.5	2.5	2.5	2.5	2.5	2.5
Controller / control card	5.5	5.5	5.5	5.5	5.5	5.5	5.5	5.5	5.5	5.5
Ducting	133.2	44.2	115.8	30.4	52.5	16.8	38.1	38.1	9.5	38.1
Wiring	15.0	15.0	15.0	15.0	15.0	15.0	15.0	15.0	15.0	15.0
Bleed Orifice & Duct	3.0	3.0	3.0	3.0	3.0	3.0	3.0	3.0	3.0	3.0
Compressor Wiring	472.3	236.2	177.1	88.6	23.2	23.2	7.8	19.4	6.5	12.8
Installation Hardware	289.9	132.1	121.0	64.7	47.5	40.5	24.5	45.7	22.9	31.8
Structural Modifications	100.0	100.0	50.0	50.0	20.0	20.0	10.0	10.0	10.0	10.0
Other Parts Sub-Total	1063.3	559.3	510.9	276.2	181.1	138.7	118.2	151.6	87.1	131.7
System Totals	1871.9	1021.1	964.9	536.3	377.1	323.9	191.0	352.9	178.3	245.6
Oxygen sensor	1.5	1.5	1.5	1.5	1.5	1.5	1.5	1.5	1.5	1.5

Figure 1.7-2. Summary of OBGIS Component Weights – PSA Systems

1.7.1 Air Separation Modules

Permeable Membranes. The proposed ASM's are an assembly of a hollow fiber membrane module in an aluminum lightweight aircraft quality pressure vessel. The hollow fiber membrane module is constructed with manufacturing methods and technology that are used commonly in the industrial gas generation industry. The aluminum housing is configured to meet the mounting requirements of the ASM and service conditions for aircraft mounting.

The ASM weight includes the hollow fiber membrane module, the inlet/outlet headers and the connections to the NEA and feed air manifolds/tubing. The structural modification weight required, where the ASM interfaces with the aircraft structure, was accounted for separately. The NEA flow rate for each of the different aircraft sizes and tank volumes determined the total number of a single standard size of ASMs required to meet the flow requirements. With the known weight for the standard ASM the total weight for each aircraft ASM was calculated.

PSA. The PSA air separator calculations were made empirically. A production OBIGGS ASM was operated in the lab at the altitudes and supply pressures consistent with the OBGIS study. The product gas output flows were scaled upward or downward to meet the NEA requirements from the inert gas simulations, as discussed previously.

The weight of the molecular sieve needed to produce the gas was likewise scaled upward or downward based on NEA flow. The structural weight including the mounting structure and sieve containers was also scaled, although some economies of scaling were assumed, similar to existing PSA systems.

1.7.2 Compressor

The compressor weight includes compressor, motor, motor cooling fan and start contactor. Ducting which interfaces with the aircraft structure or plumbing was accounted for separately. The weight estimates were based on design schemes prepared for 15kW shaft power compressors of the screw and centrifugal type. From this, a linear metric of weight as a function of power was generated. It is considered that this tends to give an overestimate of weight for high power machines and an underestimate for low power machines, which is conservative in the weight critical cases. Above 30kW shaft power, two or more compressors are proposed.

1.7.3 Heat Exchanger/Cooling Fan

The heat exchanger and cooling fan were sized by vendors of aircraft quality heat exchangers and cooling fans. The heat exchangers and cooling fans for each aircraft were sized to cool air from the compressor to the appropriate ground temperature limits (125 degrees Fahrenheit for the PSA systems and 165 degrees Fahrenheit for the membrane systems) using 111 degrees Fahrenheit ambient air. An effort was made to minimize the overall size of the system by performing parametrics on heat exchanger and fan sizes to determine the best overall system.

Heat exchanger and cooling fan weights were determined for each of the aircraft and system types. Heat exchanger weight includes the core, inlet/outlet headers, and connections to the mating tubing. The weight of the cooling fan includes the fan and any ducting between the fan and the heat exchanger. Ducting which interfaces with the aircraft structure or plumbing was accounted for separately.

1.7.4 Other Components

The weight of the other components in the system is mainly dependent on the required airflow or NEA flow. The higher flows associated with the larger aircraft demand larger components than those used in the smaller aircraft applications. The specific methods used to estimate the weight of the other components is discussed below.

Onboard Inerting Designs Task Team Final Report

Filters. A large supplier of aircraft filters estimated the weight of the filters for the different models, based on the required airflow rates.

Valves. The system valves were also sized as a function of airflow, and based on existing components used in similar aircraft systems, to ensure that the pressure drop across the unit is acceptable.

Ducting. The ducting weight was based on the lengths and diameters in Figure 1.7.4-1. The duct material was assumed to be .032 aluminum for all models. It was assumed that flexible couplings are required every two feet and the mounting hardware adds 50 percent to the total duct weight. It was also assumed that the ASM could be located close to the fuel tanks, which would preclude the need for any significant length of double-walled tubing, and that the compressor and the heat exchanger would be located close together so that the length of additional high temperature stainless steel ducting is also negligible.

Aircraft Type	Length (feet)	Diameter (inches)
Large Transport	266	3.0
Medium Transport	217	2.5
Small Transport	125	2.0
Regional Turbofan	120	1.5
Regional Turboprop	120	1.5
Business Jet	120	1.5

Figure 1.7.4-1. Ducting Length and Diameter

Compressor Wiring. The compressor power-supply wiring parameters were based on the lengths and gauge size shown in Figure 1.7.4-2. The wiring material was assumed to be Mil-W-22759/41B, 600 volt, nickel-plated high strength copper conductors with cross-linked ETFE insulation and jacket and a service temperature range of -65 to +200degC.

Aircraft Type	Length (feet)	Wire Size Mem-brane (AWG)	Wire Size PSA (AWG)
Large Transport	120	41-2	41-2
Medium Transport	90	41-2	41-4 (41-6)
Small Transport	60	41-6	41-8
Regional Turbofan	50	41-6 (41-10)	41-8 (41-12)
Regional Turboprop	50	41-10	41-14
Business Jet	60	41-8	41-12

(Numbers in parentheses are CWT systems when different from all tanks)

Figure 1.7.4-2. Compressor Wiring

Installation Hardware. The installation hardware for each system was calculated as a function of the weight of the installed components. The hardware weight was calculated based on commercial aircraft experience as 15% of the installed component weight.

Structural Modifications. Based on weight of the installed components, the Team assigned values for the weight of the material that would have to be added to the structure to support the new equipment.

1.8 VOLUME

Figures 1.8-1 and 1.8-2 summarize the volume data developed by the Task Team for the membrane and PSA OBGI systems for each of the ARAC generic aircraft. Each table provides the total volume for the “major” and “other” components identified for each system necessary to inert the fuel tank. “Other” components include such items as wiring, ducting and valves, and their total estimated volumes have been combined.

Onboard Inerting Designs Task Team Final Report

Volume Summary Table - Membrane Systems (Cu Ft)										
Component	Large Transport		Medium Transport		Small Transport		Turbo Prop	Turbo Fan		BizJet
	All Tanks	CWT Only	All Tanks	CWT Only	All Tanks	CWT Only	All Tanks	All Tanks	CWT Only	All Tanks
Main Parts										
Compressor, cooling & start system	1.08	0.62	0.62	0.36	0.29	0.29	0.10	0.29	0.16	0.16
Heat exchanger & Fan	0.50	0.28	0.28	0.17	0.15	0.15	0.03	0.15	0.07	0.07
Air separation module	13.90	7.82	7.82	7.82	3.47	3.47	0.87	3.47	1.74	1.74
Main Parts Sub-Total	15.5	8.7	8.7	8.3	3.9	3.9	1.0	3.9	2.0	2.0
Other Parts Sub-Total	35.05	19.73	19.73	12.03	10.12	10.12	4.29	10.12	6.24	6.24
System Totals	50.5	28.4	28.4	20.4	14.0	14.0	5.3	14.0	8.2	8.2

Figure 1.8-1. Summary of OBGIS Component Volumes – Membrane Systems

Volume Summary Table - PSA Systems (Cu Ft)										
Component	Large Transport		Medium Transport		Small Transport		Turbo Prop	Turbo Fan		BizJet
	All Tanks	CWT Only	All Tanks	CWT Only	All Tanks	CWT Only	All Tanks	All Tanks	CWT Only	All Tanks
Main Parts										
Compressor, cooling & start system	2.41	1.40	1.38	0.78	0.57	0.54	0.18	0.59	0.22	0.31
Heat exchanger & Fan	2.93	1.69	1.66	0.88	0.63	0.60	0.18	0.66	0.21	0.32
Air separation module	23.27	13.57	13.38	13.57	5.30	5.08	1.40	5.58	1.81	2.75
Main Parts Sub-Total	28.6	16.7	16.4	15.2	6.5	6.2	1.8	6.8	2.2	3.4
Other Parts Sub-Total	70.25	41.00	40.53	22.22	15.28	14.74	5.81	15.97	6.77	9.06
System Totals	98.9	57.7	57.0	37.4	21.8	21.0	7.6	22.8	9.0	12.4

Figure 1.8-2. Summary of OBGIS Component Volumes – PSA Systems

Onboard Inerting Designs Task Team Final Report

1.8.1 Air Separation Modules

Permeable Membrane. The volume of the proposed air separation module includes the Hollow Fiber Membrane Module, the inlet/outlet headers and the connections to the NEA and Feed air manifolds/tubing. The NEA flow rate for each of the different aircraft sizes and tank volumes determined the total number of a single standard size of ASMs required to meet the flow requirements. With the known volume for the standard ASM the total volume for each aircraft ASM was calculated.

PSA. The PSA air separator calculations were made empirically. A production OBIGGS air separator was operated in the lab at the supply pressure consistent with the ARAC study. The product gas output flows were scaled upward or downward to meet the product gas needs that resulted from the inert gas simulations as discussed previously.

The volume of PSA air separator was therefore scaled from a production unit based on the projected quantity of molecular sieve needed vs. the actual molecular sieve present in the production unit.

1.8.2 Compressor

Compressor types (screw or centrifugal) were selected and volumes were determined for each of the aircraft and system types in a similar manner and to the same considerations of compressor scalability as outlined in the section concerning weight. The compressor volume includes compressor, motor, motor cooling fan and start contactor. Ducting which interfaces with the aircraft structure or plumbing was accounted for separately. The volume estimates were based on design schemes prepared for 15kW shaft power compressors of the screw and centrifugal types. From this a linear metric of volume as a function of power was generated. It is considered that this tends to give an overestimate of volume for high power machines and an underestimate for low power machines, which is generally conservative with regard space envelop constraints. Above 30kW shaft power, two or more compressors are proposed.

1.8.3 Heat Exchanger/Cooling Fan

Heat exchanger and cooling fan volumes were determined for each of the aircraft and system types. Heat exchanger volume includes the core, inlet/outlet headers, and connections to the mating tubing. The volume of the cooling fan includes the fan and any ducting between the fan and the heat exchanger. Ducting which interfaces with the aircraft structure or plumbing was accounted for separately.

1.8.4 Other Components

In a manner similar to that of the weight, component volumes were individually computed as a function of airflow, NEA flow and power. Some components do not scale in a linear fashion with flow, however. As an example of this phenomenon, motor actuated valves often use a common valve actuator for smaller and larger valves, for spares cost considerations. Therefore the volume of the actuator portion of the valve may not change for an increased flow condition. The majority of component volumes were therefore scaled or derived from existing components for similar applications on aircraft. Duct volume and wire volume were a simple computation based on length and diameter.

1.9 ELECTRICAL POWER

Figures 1.9-1 and 1.9-2 summarize the electrical power data developed by the Onboard Design Task Team for the membrane and PSA OBI systems for each of the ARAC generic aircraft. Each table provides the total electrical power for the “major” and “other” components identified for each system “Other” components include such items as wiring, motors and valves, and their total estimated electrical power have been combined.

Onboard Inerting Designs Task Team Final Report

Electrical Power Summary Table - Membrane Systems (kVa)										
Component	Large Transport		Medium Transport		Small Transport		Turbo Prop	Turbo Fan		BizJet
	All Tanks	CWT Only	All Tanks	CWT Only	All Tanks	CWT Only	All Tanks	All Tanks	CWT Only	All Tanks
Main Parts										
Compressor, cooling & start system	57.63	31.85	31.85	17.64	14.10	14.10	3.49	14.10	7.00	7.00
Heat exchanger & Fan	0.66	0.37	0.37	0.26	0.25	0.25	0.00	0.25	0.08	0.08
Air separation module	0.00	0.00	0.00	0.00	0.00	0.00	0.00	0.00	0.00	0.00
Main Parts Sub-Total	58.3	32.2	32.2	17.9	14.3	14.3	3.5	14.3	7.1	7.1
Other Parts Sub-Total	0.10	0.10	0.10	0.10	0.10	0.10	0.10	0.10	0.10	0.10
System Totals	58.4	32.3	32.3	18.0	14.4	14.4	3.6	14.4	7.2	7.2

Figure 1.9-1. Summary of OBGIS Component Power Consumption – Membrane Systems

Electrical Power Summary Table - PSA Systems (kVa)										
Component	Large Transport		Medium Transport		Small Transport		Turbo Prop	Turbo Fan		BizJet
	All Tanks	CWT Only	All Tanks	CWT Only	All Tanks	CWT Only	All Tanks	All Tanks	CWT Only	All Tanks
Main Parts										
Compressor, cooling & start system	130.52	75.24	74.15	40.83	29.09	27.91	7.63	30.70	9.90	15.07
Heat exchanger & Fan	9.18	4.57	4.40	0.60	0.34	0.34	0.27	0.34	0.33	0.34
Air separation module	1.06	0.62	0.61	0.62	0.24	0.23	0.00	0.26	0.08	0.13
Main Parts Sub-Total	140.8	80.4	79.2	42.0	29.7	28.5	7.9	31.3	10.3	15.5
Other Parts Sub-Total	0.10	0.10	0.10	0.10	0.10	0.10	0.00	0.10	0.10	0.10
System Totals	140.9	80.5	79.3	42.1	29.8	28.6	7.9	31.4	10.4	15.6

Figure 1.9-2. Summary of OBGIS Component Power Consumption – PSA Systems

Onboard Inerting Designs Task Team Final Report

1.9.1 Air Separation Modules

Permeable Membrane. The permeable membrane air separation modules do not consume any electrical power. Membrane technology is passive and has no moving parts.

PSA. Power consumption numbers are relatively low, since the mechanism to operate the PSA distribution valve is pneumatic. The electrical power is consumed by simple timing and power circuits that operate the pneumatic control valves.

1.9.2 Compressor

Compressor types (screw or CF) were selected and powers were determined for each of the aircraft and system types in a similar manner to the compressor scalability as outlined in the section concerning weight.

The compressor is driven by an electric motor supplied from a ground power source external to the aircraft. The compressors for each aircraft were sized to supply the mass flow of air required as input to each of the differing ASM types. The shaft power of the compressor is a function of the mass flow, pressure ratio and inlet temperature. The maximum power design point for the compressors was Sea level and the maximum ambient temperature operating condition was 110°F. An effort was made to minimize the electrical power requirement by investigating alternative architectures such as two-stage compression with inter-cooling. It was found that power reduction with these features was small.

1.9.3 Heat Exchanger/Cooling Fan

Heat exchanger and cooling fan power were determined for each of the aircraft and system types. The heat exchanger requires no power to operate. The cooling fan power requirement was determined based on the cooling air flow rate and pressure rise requirements. The system was designed to minimize the cooling fan power requirements wherever possible.

1.9.4 Other Components

The power consumption of the other system components are minimal compared with that of the compressor. The only units that consume power are the valves; most of the time they are dormant and consume no power. The exception to this is the temperature control valve, which uses a small amount of power on a continuous basis to modulate the outlet temperature of the heat exchanger. This power is very small compared to the compressor and fan power requirements.

1.10 RELIABILITY

Figures 1.10-1 through 1.10-4 summarize OBGIS reliability in terms of mean-time-between-maintenance-actions (MTBMA), and mean-time-between-failure (MTBF) developed by the Task Team for the membrane and PSA systems for each of the generic aircraft. Other components include such items as wiring, motors and valves, and their total estimated reliability have been combined. The airplane operations and maintenance team used this component data as a starting point for the system level reliability estimates.

Onboard Inerting Designs Task Team Final Report

Reliability Summary Table - Membrane Systems MTBMA (Hrs)										
Component	Large Transport		Medium Transport		Small Transport		Turbo Prop	Turbo Fan		BizJet
	All Tanks	CWT Only	All Tanks	CWT Only	All Tanks	CWT Only	All Tanks	All Tanks	CWT Only	All Tanks
Main Parts										
Compressor, cooling & start system	7,000	7,000	7,000	7,000	7,000	7,000	7,000	7,000	7,000	7,000
Heat exchanger	100,000	100,000	100,000	100,000	100,000	100,000	100,000	100,000	100,000	100,000
Cooling fan & ram ducts assembly	25,000	25,000	25,000	25,000	25,000	25,000	25,000	25,000	25,000	25,000
Air separation module	30,000	30,000	30,000	30,000	30,000	30,000	30,000	30,000	30,000	30,000
Other Parts										
Compressor inlet air filter assy	100,000	100,000	100,000	100,000	100,000	100,000	100,000	100,000	100,000	100,000
Compressor inlet air filter element	4,000	4,000	4,000	4,000	4,000	4,000	4,000	4,000	4,000	4,000
Compressor discharge check valve	100,000	100,000	100,000	100,000	100,000	100,000	100,000	100,000	100,000	100,000
Compressor unloading valve	50,000	50,000	50,000	50,000	50,000	50,000	50,000	50,000	50,000	50,000
Bleed Air shutoff valve	50,000	50,000	50,000	50,000	50,000	50,000	50,000	50,000	50,000	50,000
Heat Exchanger bypass valve	50,000	50,000	50,000	50,000	50,000	50,000	50,000	50,000	50,000	50,000
Temperature sensor & controller	50,000	50,000	50,000	50,000	50,000	50,000	50,000	50,000	50,000	50,000
Water separator/filter assy	100,000	100,000	100,000	100,000	100,000	100,000	100,000	100,000	100,000	100,000
Water separator/filter element	4,000	4,000	4,000	4,000	4,000	4,000	4,000	4,000	4,000	4,000
ASM check valve & restrictor assy	100,000	100,000	100,000	100,000	100,000	100,000	100,000	100,000	100,000	100,000
Relief valve	50,000	50,000	50,000	50,000	50,000	50,000	50,000	50,000	50,000	50,000
Fuel tank check valve	100,000	100,000	100,000	100,000	100,000	100,000	100,000	100,000	100,000	100,000
Controller / control card	10,000	10,000	10,000	10,000	10,000	10,000	10,000	10,000	10,000	10,000
Ducting	10,000,000	10,000,000	10,000,000	10,000,000	10,000,000	10,000,000	10,000,000	10,000,000	10,000,000	10,000,000
Wiring	10,000,000	10,000,000	10,000,000	10,000,000	10,000,000	10,000,000	10,000,000	10,000,000	10,000,000	10,000,000
Bleed Orifice & Duct	10,000,000	10,000,000	10,000,000	10,000,000	10,000,000	10,000,000	10,000,000	10,000,000	10,000,000	10,000,000
Compressor Wiring	10,000,000	10,000,000	10,000,000	10,000,000	10,000,000	10,000,000	10,000,000	10,000,000	10,000,000	10,000,000
Installation Hardware	10,000,000	10,000,000	10,000,000	10,000,000	10,000,000	10,000,000	10,000,000	10,000,000	10,000,000	10,000,000
Structual Modifications	10,000,000	10,000,000	10,000,000	10,000,000	10,000,000	10,000,000	10,000,000	10,000,000	10,000,000	10,000,000
Oxygen sensor	26,933	26,933	26,933	26,933	26,933	26,933	26,933	26,933	26,933	26,933

Figure 1.10-1. Summary of OBIGGS MTBMA – Membrane Systems

Onboard Inerting Designs Task Team Final Report

Reliability Summary Table - PSA Systems MTBMA (Hrs)										
Component	Large Transport		Medium Transport		Small Transport		Turbo Prop	Turbo Fan		BizJet
	All Tanks	CWT Only	All Tanks	CWT Only	All Tanks	CWT Only	All Tanks	All Tanks	CWT Only	All Tanks
Main Parts										
Compressor, cooling & start system	7,000	7,000	7,000	7,000	7,000	7,000	7,000	7,000	7,000	7,000
Heat exchanger	100,000	100,000	100,000	100,000	100,000	100,000	100,000	100,000	100,000	100,000
Cooling fan & ram ducts assembly	25,000	25,000	25,000	25,000	25,000	25,000	25,000	25,000	25,000	25,000
Air separation module	8,000	8,000	8,000	8,000	8,000	8,000	8,000	8,000	8,000	8,000
Other Parts										
Compressor inlet air filter assy	100,000	100,000	100,000	100,000	100,000	100,000	100,000	100,000	100,000	100,000
Compressor inlet air filter element	4,000	4,000	4,000	4,000	4,000	4,000	4,000	4,000	4,000	4,000
Compressor discharge check valve	100,000	100,000	100,000	100,000	100,000	100,000	100,000	100,000	100,000	100,000
Compressor unloading valve	50,000	50,000	50,000	50,000	50,000	50,000	50,000	50,000	50,000	50,000
Bleed Air shutoff valve	50,000	50,000	50,000	50,000	50,000	50,000	50,000	50,000	50,000	50,000
Heat Exchanger bypass valve	50,000	50,000	50,000	50,000	50,000	50,000	50,000	50,000	50,000	50,000
Temperature sensor & controller	50,000	50,000	50,000	50,000	50,000	50,000	50,000	50,000	50,000	50,000
Water separator/filter assy	100,000	100,000	100,000	100,000	100,000	100,000	100,000	100,000	100,000	100,000
Water separator/filter element	4,000	4,000	4,000	4,000	4,000	4,000	4,000	4,000	4,000	4,000
ASM check valve & restrictor assy	50,000	50,000	50,000	50,000	50,000	50,000	50,000	50,000	50,000	50,000
Relief valve	50,000	50,000	50,000	50,000	50,000	50,000	50,000	50,000	50,000	50,000
Fuel tank check valve	100,000	100,000	100,000	100,000	100,000	100,000	100,000	100,000	100,000	100,000
Controller / control card	10,000	10,000	10,000	10,000	10,000	10,000	10,000	10,000	10,000	10,000
Ducting	10,000,000	10,000,000	10,000,000	10,000,000	10,000,000	10,000,000	10,000,000	10,000,000	10,000,000	10,000,000
Wiring	10,000,000	10,000,000	10,000,000	10,000,000	10,000,000	10,000,000	10,000,000	10,000,000	10,000,000	10,000,000
Bleed Orifice & Duct	10,000,000	10,000,000	10,000,000	10,000,000	10,000,000	10,000,000	10,000,000	10,000,000	10,000,000	10,000,000
Compressor Wiring	10,000,000	10,000,000	10,000,000	10,000,000	10,000,000	10,000,000	10,000,000	10,000,000	10,000,000	10,000,000
Installation Hardware	10,000,000	10,000,000	10,000,000	10,000,000	10,000,000	10,000,000	10,000,000	10,000,000	10,000,000	10,000,000
Structual Modifications	10,000,000	10,000,000	10,000,000	10,000,000	10,000,000	10,000,000	10,000,000	10,000,000	10,000,000	10,000,000
Oxygen sensor	26,933	26,933	26,933	26,933	26,933	26,933	26,933	26,933	26,933	26,933

Figure 1.10-2. Summary of OBIGGS MTBMA – PSA Systems

Onboard Inerting Designs Task Team Final Report

Reliability Summary Table - Membrane Systems MTBF (Hrs)										
Component	Large Transport		Medium Transport		Small Transport		Turbo Prop	Turbo Fan		BizJet
	All Tanks	CWT Only	All Tanks	CWT Only	All Tanks	CWT Only	All Tanks	All Tanks	CWT Only	All Tanks
Main Parts										
Compressor, cooling & start system	100,000	100,000	100,000	100,000	100,000	100,000	100,000	100,000	100,000	100,000
Heat exchanger	100,000	100,000	100,000	100,000	100,000	100,000	100,000	100,000	100,000	100,000
Cooling fan & ram ducts assembly	25,000	25,000	25,000	25,000	25,000	25,000	25,000	25,000	25,000	25,000
Air separation module	30,000	30,000	30,000	30,000	30,000	30,000	30,000	30,000	30,000	30,000
Other Parts										
Compressor inlet air filter assy	100,000	100,000	100,000	100,000	100,000	100,000	100,000	100,000	100,000	100,000
Compressor inlet air filter element	100,000	100,000	100,000	100,000	100,000	100,000	100,000	100,000	100,000	100,000
Compressor discharge check valve	100,000	100,000	100,000	100,000	100,000	100,000	100,000	100,000	100,000	100,000
Compressor unloading valve	50,000	50,000	50,000	50,000	50,000	50,000	50,000	50,000	50,000	50,000
Bleed Air shutoff valve	50,000	50,000	50,000	50,000	50,000	50,000	50,000	50,000	50,000	50,000
Heat Exchanger bypass valve	50,000	50,000	50,000	50,000	50,000	50,000	50,000	50,000	50,000	50,000
Temperature sensor & controller	50,000	50,000	50,000	50,000	50,000	50,000	50,000	50,000	50,000	50,000
Water separator/filter assy	100,000	100,000	100,000	100,000	100,000	100,000	100,000	100,000	100,000	100,000
Water separator/filter element	100,000	100,000	100,000	100,000	100,000	100,000	100,000	100,000	100,000	100,000
ASM check valve & restrictor assy	100,000	100,000	100,000	100,000	100,000	100,000	100,000	100,000	100,000	100,000
Relief valve	50,000	50,000	50,000	50,000	50,000	50,000	50,000	50,000	50,000	50,000
Fuel tank check valve	100,000	100,000	100,000	100,000	100,000	100,000	100,000	100,000	100,000	100,000
Controller / control card	10,000	10,000	10,000	10,000	10,000	10,000	10,000	10,000	10,000	10,000
Ducting	10,000,000	10,000,000	10,000,000	10,000,000	10,000,000	10,000,000	10,000,000	10,000,000	10,000,000	10,000,000
Wiring	10,000,000	10,000,000	10,000,000	10,000,000	10,000,000	10,000,000	10,000,000	10,000,000	10,000,000	10,000,000
Bleed Orifice & Duct	10,000,000	10,000,000	10,000,000	10,000,000	10,000,000	10,000,000	10,000,000	10,000,000	10,000,000	10,000,000
Compressor Wiring	10,000,000	10,000,000	10,000,000	10,000,000	10,000,000	10,000,000	10,000,000	10,000,000	10,000,000	10,000,000
Installation Hardware	10,000,000	10,000,000	10,000,000	10,000,000	10,000,000	10,000,000	10,000,000	10,000,000	10,000,000	10,000,000
Structural Modifications	10,000,000	10,000,000	10,000,000	10,000,000	10,000,000	10,000,000	10,000,000	10,000,000	10,000,000	10,000,000
Oxygen sensor	26,933	26,933	26,933	26,933	26,933	26,933	26,933	26,933	26,933	26,933

Figure 1.10-3. Summary of OBIGGS MTBF – Membrane Systems

Onboard Inerting Designs Task Team Final Report

Reliability Summary Table - PSA Systems MTBF (Hrs)										
Component	Large Transport		Medium Transport		Small Transport		Turbo Prop	Turbo Fan		BizJet
	All Tanks	CWT Only	All Tanks	CWT Only	All Tanks	CWT Only	All Tanks	All Tanks	CWT Only	All Tanks
Main Parts										
Compressor, cooling & start system	100,000	100,000	100,000	100,000	100,000	100,000	100,000	100,000	100,000	100,000
Heat exchanger	100,000	100,000	100,000	100,000	100,000	100,000	100,000	100,000	100,000	100,000
Cooling fan & ram ducts assembly	25,000	25,000	25,000	25,000	25,000	25,000	25,000	25,000	25,000	25,000
Air separation module	34,000	34,000	34,000	34,000	34,000	34,000	34,000	34,000	34,000	34,000
Other Parts										
Compressor inlet air filter assy	100,000	100,000	100,000	100,000	100,000	100,000	100,000	100,000	100,000	100,000
Compressor inlet air filter element	100,000	100,000	100,000	100,000	100,000	100,000	100,000	100,000	100,000	100,000
Compressor discharge check valve	100,000	100,000	100,000	100,000	100,000	100,000	100,000	100,000	100,000	100,000
Compressor unloading valve	50,000	50,000	50,000	50,000	50,000	50,000	50,000	50,000	50,000	50,000
Bleed Air shutoff valve	50,000	50,000	50,000	50,000	50,000	50,000	50,000	50,000	50,000	50,000
Heat Exchanger bypass valve	50,000	50,000	50,000	50,000	50,000	50,000	50,000	50,000	50,000	50,000
Temperature sensor & controller	50,000	50,000	50,000	50,000	50,000	50,000	50,000	50,000	50,000	50,000
Water separator/filter assy	100,000	100,000	100,000	100,000	100,000	100,000	100,000	100,000	100,000	100,000
Water separator/filter element	100,000	100,000	100,000	100,000	100,000	100,000	100,000	100,000	100,000	100,000
ASM check valve & restrictor assy	50,000	50,000	50,000	50,000	50,000	50,000	50,000	50,000	50,000	50,000
Relief valve	50,000	50,000	50,000	50,000	50,000	50,000	50,000	50,000	50,000	50,000
Fuel tank check valve	100,000	100,000	100,000	100,000	100,000	100,000	100,000	100,000	100,000	100,000
Controller / control card	10,000	10,000	10,000	10,000	10,000	10,000	10,000	10,000	10,000	10,000
Ducting	10,000,000	10,000,000	10,000,000	10,000,000	10,000,000	10,000,000	10,000,000	10,000,000	10,000,000	10,000,000
Wiring	10,000,000	10,000,000	10,000,000	10,000,000	10,000,000	10,000,000	10,000,000	10,000,000	10,000,000	10,000,000
Bleed Orifice & Duct	10,000,000	10,000,000	10,000,000	10,000,000	10,000,000	10,000,000	10,000,000	10,000,000	10,000,000	10,000,000
Compressor Wiring	10,000,000	10,000,000	10,000,000	10,000,000	10,000,000	10,000,000	10,000,000	10,000,000	10,000,000	10,000,000
Installation Hardware	10,000,000	10,000,000	10,000,000	10,000,000	10,000,000	10,000,000	10,000,000	10,000,000	10,000,000	10,000,000
Structual Modifications	10,000,000	10,000,000	10,000,000	10,000,000	10,000,000	10,000,000	10,000,000	10,000,000	10,000,000	10,000,000
Oxygen sensor	26,933	26,933	26,933	26,933	26,933	26,933	26,933	26,933	26,933	26,933

Figure 1.10-4. Summary of OBIGGS MTBF – PSA Systems

1.10.1 Air Separation Modules

Reliability estimates were developed for OBGIS membrane and pressure-swing adsorption air separation equipment.

Permeable Membrane. The membrane module consists of a membrane fiber bundle contained in a metal housing. There are no moving parts. The most likely failure causes are contamination and over-temperature damage. The OBGIS concepts include upstream filtration and redundant temperature sensors to minimize the possibility of these failures. There are commercial membrane modules that have operated continuously for many years without failure. There is no scheduled maintenance requirement for the membrane modules.

PSA. The PSA hardware consists of a distribution valve that is pilot operated by relatively small pneumatic valves and controlled by a timing circuit. Also included are air and product manifolds, molecular sieve beds, and purge orifices. The distribution valve assembly contains two wear parts, which are recommended to be serviced at 6000 to 8000 hour intervals. The Mean-Time-Between-Failure estimate in the summary table assumes a scheduled overhaul is performed every 8000 hours.

1.10.2 Compressor

The compressor reliability for screw-type units is based on a recommended service interval of 7000 hours. The centrifugal compressors use a different bearing technology that does not require periodic servicing. Suppliers of existing flight-worthy equipment provided the reliability estimates.

1.10.3 Heat Exchanger/Cooling Fan

The heat exchanger and cooling fan reliability estimates are based on commercial aircraft experience and were provided by suppliers of existing flight-worthy equipment.

1.10.4 Other Components

Reliability estimates for the other OBGIS components were based on commercial aircraft experience with similar components. Common reliability estimates were used for the components that were used in all of the systems to ensure a fair comparison between the different inerting concepts and technologies.

1.11 COST

The On-Board Design Task Team estimated the initial acquisition costs for the membrane and PSA OBGIS systems for each of the ARAC generic aircraft. Design and certification, operations, maintenance, and installation costs for the OBGIS are described later in this section. The Estimating and Forecasting Team used this data to analyze the cost-benefit.

1.11.1 Acquisition Cost

Figures 1.11.1-1 and 1.11.1-2 summarize the OBGIS costs developed by the Task Team for the membrane and PSA systems, respectively, for each of the generic aircraft. No costs were developed for OBGIS systems using cryogenic distillation ASM technology as this technology had been eliminated from consideration. Each table provides the total cost for the individual components identified for each system. Except for the regional turboprop and business jet aircraft, two sets of costs are provided for each of the generic aircraft, one for components required to provide inerting for all tanks and another for components required to provide inerting for CWT only. The estimated component costs include the amortized non-recurring development costs. Several component costs were also integrated into the cost for the next higher assembly. The cost of the cabin air filter element and water separator/filter element was included in the costs for the cabin air filter assembly and the water separator/filter assembly, respectively; and the

Onboard Inerting Designs Task Team Final Report

cost of the cooling fan was integrated into the cost of the heat exchanger. The team also separately estimated the cost for an on-board oxygen sensor, though this cost was not included in the system totals.

Acquisition costs for OBGI systems were developed by the participating vendors of the Onboard Design Task Team using the following guidelines:

- Final rule requiring fuel tank inerting becomes effective in year 2004.
- Production of the first certified system occurs in year 2009.
- Retrofit of existing aircraft is completed by year 2014.
- Continued production of OBGI systems for new production aircraft is through year 2020.
- As of year 2000, existing fleet of in-service aircraft is 13,813 aircraft, per Campbell Hill survey of world fleet forecast data provided by ATA.
- Average annual new aircraft production rate is 837 aircraft per year, per Campbell Hill survey of world fleet forecast data provided by ATA.
- When applying Campbell Hill survey of world fleet forecast data, between 5,500 and 5,800 shipsets per year total would be produced by the OBGI vendors starting in 2009 and running through 2014.
- When applying Campbell Hill survey of world fleet forecast data, continued production of between 980 and 1,300 shipsets per year would occur by the OBGI vendors starting in 2015 and running through 2020.
- Each vendor assumed a market share of 30%.
- New designs are assumed to be optimized to minimize non-recurring and recurring costs. The time frame for non-recurring efforts was estimated as 39 months.
- Non-recurring development costs were amortized into the per-system pricing provided by each vendor.

Onboard Inerting Designs Task Team Final Report

Cost Summary Table - Membrane Systems (\$)										
Component	Large Transport		Medium Transport		Small Transport		Turbo Prop	Turbo Fan		BizJet
	All Tanks	CWT Only	All Tanks	CWT Only	All Tanks	CWT Only	All Tanks	All Tanks	CWT Only	All Tanks
Main Parts										
Compressor, cooling & start system	15287	7764	7764	7201	7061	7061	6640	7061	6780	6780
Heat exchanger	7830	4450	4450	4012	3413	3632	2668	3632	2989	2989
Cooling fan & ram ducts assembly	1949	2168	2168	1949	2168	1949	693	1949	1112	1112
Air separation module	100160	56340	56340	31300	25040	25040	6260	25040	12520	12520
Main Parts Sub-Total	125227	70722	70722	44462	37681	37681	16261	37681	23401	23401
Other Parts										
Compressor inlet air filter assy	500	350	350	350	350	350	350	350	350	350
Compressor inlet air filter element	0	0	0	0	0	0	0	0	0	0
Compressor discharge check valve	475	475	425	425	275	300	250	400	300	475
Compressor unloading valve	1560	1560	1560	1560	1350	1300	1250	1450	1450	1560
Bleed Air shutoff valve	1250	1250	1250	1250	1100	1150	1100	1250	1250	1250
Heat Exchanger bypass valve	2000	2000	2000	2000	2000	2000	2000	2000	2000	2000
Temperature sensor & controller	2000	2000	2000	2000	2000	2000	2000	2000	2000	2000
Water separator/filter assy	5000	5000	5000	5000	5000	5000	5000	5000	5000	5000
Water separator/filter element	0	0	0	0	0	0	0	0	0	0
ASM check valve & restrictor assy	185	185	185	185	185	185	185	185	185	185
Relief valve	680	680	580	500	450	500	450	500	500	550
Fuel tank check valve	675	675	675	675	675	675	675	675	675	675
Controller / control card	40000	40000	40000	40000	40000	40000	40000	40000	40000	40000
Ducting	45470	8840	23160	6080	10500	3360	7620	7620	1900	7620
Wiring	750	750	750	750	750	750	750	750	750	750
Bleed Orifice & Duct	300	300	300	300	300	300	300	300	300	300
Compressor Wiring	4471	2236	811	541	310	310	64	286	75	75
Installation Hardware	5925	3285	3351	1823	1647	1379	867	1525	856	1082
Structual Modifications	2000	2000	1000	1000	400	400	200	200	200	200
Other Parts Sub-Total	113242	71585	83397	64439	67292	59959	63061	64490	57791	64072
System Totals	238468	142308	154119	108901	104973	97641	79323	102172	81192	87473
Oxygen sensor	6000	6000	6000	6000	6000	6000	6000	6000	6000	6000

Figure 1.11.1-1. Summary of OBGIS Costs – Membrane Systems

Onboard Inerting Designs Task Team Final Report

Cost Summary Table - PSA Systems (\$)										
Component	Large Transport		Medium Transport		Small Transport		Turbo Prop	Turbo Fan		BizJet
	All Tanks	CWT Only	All Tanks	CWT Only	All Tanks	CWT Only	All Tanks	All Tanks	CWT Only	All Tanks
Main Parts										
Compressor, cooling & start system	31179	15985	15942	8120	7654	7608	6804	7718	6894	7099
Heat exchanger	55326	32534	32006	5203	11681	11227	4833	12300	4340	6279
Cooling fan & ram ducts assembly	7879	4847	4804	14371	2531	2498	973	2577	1989	2130
Air separation module	65000	40000	42000	28000	19000	19000	12000	25000	16000	18000
Main Parts Sub-Total	159384	93366	94752	55694	40867	40333	24610	47595	29224	33508
Other Parts										
Compressor inlet air filter assy	500	500	500	350	350	350	350	350	350	350
Compressor inlet air filter element	0	0	0	0	0	0	0	0	0	0
Compressor discharge check valve	525	525	525	450	275	300	250	400	300	475
Compressor unloading valve	1560	1560	1560	1560	1350	1300	1250	1450	1450	1560
Bleed Air shutoff valve	1350	1350	1350	1350	1100	1150	1100	1250	1250	1250
Heat Exchanger bypass valve	2000	2000	2000	2000	2000	2000	2000	2000	2000	2000
Temperature sensor & controller	2000	2000	2000	2000	2000	2000	2000	2000	2000	2000
Water separator/filter assy	8000	8000	8000	5000	5000	5000	8000	5000	5000	5000
Water separator/filter element	0	0	0	0	0	0	0	0	0	0
Relief valve	680	680	680	550	450	500	450	500	500	550
ASM check valve & restrictor assy	185	185	185	185	185	185	185	185	185	185
Fuel tank check valve	925	925	925	925	925	925	925	925	925	925
Controller / control card	40000	40000	40000	40000	40000	40000	40000	40000	40000	40000
Ducting	26640	8840	23160	6080	10500	3360	7620	7620	1900	7620
Wiring	750	750	750	750	750	750	750	750	750	750
Bleed Orifice & Duct	300	300	300	300	300	300	300	300	300	300
Compressor Wiring	8943	4471	3354	1677	361	361	122	301	0	259
Installation Hardware	14495	6604	6052	3237	2374	2027	1224	2285	1143	1589
Structual Modifications	2000	2000	1000	1000	400	400	200	200	200	200
Other Parts Sub-Total	110853	78105	89755	65053	66345	58958	64876	63316	56153	62627
System Totals	270237	171471	184507	120747	107212	99291	89486	110911	85377	96135
Oxygen sensor	6000	6000	6000	6000	6000	6000	6000	6000	6000	6000

Figure 1.11.1-2. Summary of OBGIS Costs – PSA Systems

1.11.1.1 Air Separation Modules

Cost estimates were developed for OBGIS membrane and pressure-swing adsorption air separation equipment.

Permeable Membrane. For the membrane-based ASMs, cost, weight, volume, and purity analyses performed by the ASM supplier indicated no sizable benefit to developing new membrane units for the ARAC generic aircraft. Thus membrane costs were developed based on commercially available off-the-shelf membrane units. Common costs were applied for common-sized membrane and PSA ASMs across all OBGIS and OBIGGS concepts, where applicable.

PSA. The costs of the PSA separators were estimated with the assumption that the molecular sieve beds and mechanical assembly would not be off-the-shelf, but that there is no technical risk in developing these items. The supplier applied trends from current PSA hardware to derive competitive costs. However, these costs were adjusted as the ASM filter and controller would not be integrated into the ASM assembly for commercial aircraft, in contrast to current PSA systems fielded on some U.S. military aircraft.

1.11.1.2 Compressor

Compressor costs were established for the two compressor types, screw and CF. A linear cost model as a function of compressor shaft power, was derived using vendor-estimated costs for 15 kW and 30 kW compressors of both compressor types. From this model, compressor costs were established as a function of compressor type, power required, and number of compressors required. As compressor design requirements were established and iterated for each of the aircraft models, the Task Team applied this metric to derive the optimum compressor configuration and cost.

1.11.1.3 Heat Exchanger/Cooling Fan

Heat exchanger costs were established from a vendor-derived cost model to develop costs for compact heat exchangers with fan cooling. Heat exchanger costs included the core, inlet/outlet headers, and connections to the mating tubing. The cost of the cooling fan included the fan and any ducting between the fan and the heat exchanger. Ducting that interfaces with the aircraft structure or plumbing was accounted for separately under other OBGIS system parts. Heat exchanger costs were baselined against commercially available equipment and scaled as a function of heat exchanger flow rate required to provide stable-temperature input airflow to the ASM and the cooling airflow output required by the cooling fan. As heat exchanger design requirements were established and iterated for each of the aircraft models, the Task Team applied this metric to derive the optimum heat exchanger and cooling fan costs.

1.11.1.4 Other Components

Original equipment manufacturer (OEM) costs were assumed for the majority of all components other than the ASMs, compressors, and heat exchangers with cooling fans. Cost information for valves, the temperature sensor, and ASM controller are based on production costs plus a spares factor. Exceptions to the OEM pricing include ASM water separator/filter costs, which are based on ROM estimates provided by a filter vendor, and the ASM controller, which was estimated by scaling from the cost for a commercially-available controller used in aircraft subsystems applications. Other costs applied commonly across all OBGIS and OBIGGS concepts include the following:

- Ducting - cost estimated at \$200/lb
- Wiring - cost estimated at \$50/lb
- Installation Hardware - cost estimated at \$50/lb
- Structural Modifications - cost estimated at \$20/lb

Onboard Inerting Designs Task Team Final Report

- Ram Ducting - cost estimated at \$200/lb

1.11.2 Design & Certification

Design and certification man-hour estimates were developed by the Working Group to encompass the engineering hours required by an aircraft manufacturer for modifications and additions to fuel system components, interfaces, structure, instruments or displays, wiring, tubing, ducting, avionics software and, if required, relocation of other equipment on each aircraft. Non-recurring design costs for OBGIS components were amortized into the component costs listed in the previous summary cost tables.

The design and certification man-hour estimates were applied by the E&F team as part of the analysis to determine OBGIS cost benefit and are described in the E&F team final report. These estimates address design and certification of OBGIS systems to inert all tanks on a new first of a model aircraft and on derivative model aircraft for all of the generic aircraft. They also address design and certification of OBGIS systems to inert CWT's only on a new first of a model aircraft and on derivative model aircraft, which only applies to the generic large, medium, and small transports, and to the generic regional turbo fan aircraft.

Neither FAA nor JAA will assess additional certification costs for OBGIS. However, non-U.S. governmental authorities may assess additional costs related to the certification of OBGIS systems. For example, JAA indicates that the CAA-UK will charge airlines for all certification costs, including engineering man hours, whereas DGAC France will charge airlines only for the travel costs associated with an OBGIS certification effort. These potential additional costs were not included in the design and certification cost estimates.

1.11.3 Operating Costs

Recurring OBGIS operating costs evaluated by the E&F team encompassed frequency of delays, delay time, OBGIS system weight, performance loss, and additional training required for ground and flight crews. The Task Team developed system weights for use in the E&F cost models. The team also applied a method for determining performance loss due to an on-board inerting system as described in report AFWAL-TR-82-2115, Aircraft Fuel Tank Inerting System, and provided resulting performance loss values to the E&F team. This method evaluates by mission segment the performance loss in lbs-fuel and dollars/flight-hour associated with additional aircraft resource demands (i.e., bleed air, electrical power) and increased weight due to the on-board inerting system. This methodology was applied to determine performance losses associated with the bleed air consumption and electrical power demands required by OBGIS. Performance loss associated with system weight is the predominant element in performance loss, which was determined by the E&F team using the methodology applied in the previous ARAC FTHWG effort. All other recurring OBGIS operating costs were developed by the E&F and Airplane Operations and Maintenance (O&M) teams.

1.11.4 Maintenance Costs

Recurring OBGIS operating costs evaluated by the ARAC E&F team encompassed mean time between unscheduled repair (MTBUR) and hours for maintenance checks, inspections, removals, unscheduled maintenance, maintenance training, and confined space entry labor. The On-Board Design Task Team developed estimates for MTBMA and MTBF for each system component. These values were provided to the O&M team who then compared them to values of comparable components used currently on commercial aircraft. Those comparable values were then used to develop average MTBUR values for use by the E&F team in estimating recurring maintenance costs. For components currently not in service on commercial aircraft, such as the ASMs, the O&M team evaluated the on-board team's MTBF and MTBMA values and identified, based on their commercial aviation expertise, values to apply as MTBUR. Typically, these values were similar to the on-board team's MTBMA values. All of the other

mentioned recurring OBGIS maintenance cost elements were provided to the E&F team by the O&M team.

1.11.5 Installation Costs

Installation cost associated with OBGIS systems are described in the E&F team final report. No installation costs were developed by the On-Board Design Task Team.

1.12 SAFETY

The inclusion of an OBGIS on an aircraft introduces a number of new or increased safety concerns. These concerns can be divided into normal operation, system leaks, component failure, and catastrophic failure. It should be noted that since the system only operates on the ground, when the aircraft is at the gate, that these hazards, except as noted, only exist during that time and not during taxi or flight of the aircraft.

1.12.1 Normal Operation

The hazards associated with the normal operation of an OBGIS are the discharge of oxygen enriched waste gas, the venting of NEA out of the fuel vent, the possibility of fuel tank over pressure during refuel over-fill, and those associated with electrical wiring and high temperature components.

Oxygen-Rich Waste Gas. Oxygen-rich waste gas could be a fire hazard and should be vented in an area with no potential ignition sources. If possible it should be vented in an area and in a manner where it will be quickly diluted.

NEA Around Fuel Vent. NEA vented from the fuel tank vent could create breathing problems if inhaled. Testing during the inerting of a 737 aircraft indicated that the exiting NEA was rapidly diluted and posed little hazards. A placard warning near the vent should be sufficient.

Increased Tank Overpressure During Refuel Failure. The operation of the OBGIS during a fueling over fill may exacerbate the issue of tank overpressure. The system should be designed to limit inlet pressure to the tank and quickly relieve pressure. This is accomplished in the outline system by the inclusion of an NEA relief valve down stream of the ASM.

Electrical Wiring. Electrical requirements of the system add to the amount of electrical wiring in the aircraft and the potential for electrical related smoke or fire in the aircraft. These safety concerns can be minimized through normal design practice.

High Component Temperatures. The operating temperature of some components may exceed 400 degrees F and should be placarded as such.

1.12.2 System Leaks

Various system leaks could occur and create safety concerns. Leaks could include hot air, NEA, OEA and fuel vapor.

Compressor Discharge Air Leaks. Compressed air between compressor and heat exchanger could be in the range of 400 degrees F. It should be treated the same as bleed air ducting, and may require overheat detection.

NEA Leaks. The NEA line from the ASM to fuel tank could produce an environment, in a confined space, with a reduced oxygen level. The line should, wherever possible, be run in an area of high ventilation. Where it does run in a confined space with low ventilation the line should feature double containment.

Oxygen-Rich Waste Gas Leaks. The O₂ waste line from the air separation module could produce an environment, in a confined space, with an elevated oxygen level. The line should, wherever possible, be run in an area of high ventilation and the absence of ignition sources. Where it does run in a confined

Onboard Inerting Designs Task Team Final Report

space with low ventilation or in an area with any possible ignition sources, the line should feature double containment.

Fuel Backflow Into ASM. Fuel vapor from the fuel tank can backflow through the NEA line into the ASM and compressor. Check valves should be installed in the system to prevent this from occurring. This hazard could occur at any time since it is not dependent on system operation.

1.12.3 Component Failure

It is possible that a component in the system could fail and create a hazardous condition while the system continues to operate.

Compressor Overheat. A compressor overheat could cause a potential fire hazard. Thermal cutout protection should be incorporated.

Heat Exchanger Overheat. NEA being too hot could cause a safety problem by possibly damaging the system and pumping high temperature gas into the fuel tank. Thermal cutout protection would provide mitigation from this hazard.

Rotating Equipment Sparks. Sparks or flames could occur in the system lines and protection should be provided by flame arrestors and/or spark arrestors in-line.

1.12.4 Catastrophic Failure

Catastrophic failure of the system could occur with the failure of the high speed rotating parts of the compressor or a pressure vessel burst.

Uncontained Rotating Equipment Failure. Uncontained rotating equipment failure could cause a hazard. The system design should provide containment for such failures.

Pressure Vessel Burst. Although pressure in the system is only 30 psig, a pressure vessel burst could occur and should be designed for.

1.13 INSTALLATION

The OBGIS installation will require extensive airplane interfaces and can be installed in unpressurized or pressurized areas (or both), depending on the equipment size and the space available on the particular airplane model.

Specific aircraft installation locations or impacts cannot be provided at this time. The scope of this study has determined approximate component and system weight and volume based on the assumptions detailed in the Weight and Volume sections. When a system is developed in the future for a particular airplane model, it should be done with possible locations and size constraints provided for that airplane model. Since that level of detail was not available for this study, the installation was investigated on a generic level. Therefore, the installation areas and items in the following sub-sections are intended to provide a guideline for future development of an OBGIS. The limited analysis of the available space on actual aircraft indicated that the installation would be most difficult on the smaller aircraft models. Installation on a small transport may require that the inerting equipment be distributed into multiple locations or even take up cargo space.

There are four different implementation scenarios that will have different installation impacts:

New Designs. For aircraft not yet on the drawing board, the system installation can be optimally integrated simultaneously with the design of the other aircraft systems. This scenario is the simplest of the four.

Frozen Design, Not Yet in Production. For aircraft already designed, even though not yet in production, the installation challenges are greater. Other equipment may have to be relocated or the

OBGIS components may have to be installed in sub-optimal locations. Bleed air, hydraulic, and electrical sources may have to be re-evaluated to ensure they can supply the OBGIS requirements.

In-Production. For aircraft that are still being produced, it is possible that production changes could be made on aircraft not yet delivered to install the entire OBGIS or a portion of this system to simplify future retrofit. Previously delivered aircraft would have to be retrofitted. The retrofit installations will likely be complicated by space limitations from other systems and further complicated by customer-specific modifications.

Out-of-Production. All aircraft that are no longer in production would have to be retrofitted. The same complications due to other systems and customer modifications would apply.

Structural modifications will be required for installing equipment onto previously delivered airplanes. Attachment hardware must be added to support the equipment installation, and be designed to support any possible airplane load situation. Any wiring routed to equipment located in the unpressurized areas will be required to be shielded.

The following characteristics are desirable for the installation of the OBGIS components. If such locations are not available on a given aircraft model, the installation will be more complicated (though not necessarily infeasible).

Unpressurized. The ASM OEA outlet exhausts to ambient pressure. Further, if the air separation equipment is located outside of the pressurized area, it would not need to be shrouded to keep leaking NEA out of the cabin. Unpressurized locations also reduce the complexity of the ram ducting, the distribution tubing, and the number of penetrations through the pressure shell.

Ventilated. A ventilated compartment reduces potential hazards from NEA leakage because it doesn't create the hazard of a confined space to maintenance and other personnel.

Close to Fuel Tanks. If the OBGIS components can be located close to the fuel tanks, less ducting is required.

1.13.1 Possible Equipment Installation in Unpressurized Areas

There are several unpressurized areas on typical large, medium, and small transport aircraft where OBGIS equipment might be installed. These areas include the air conditioning pack bay, wing root, wheel well, belly fairing, and behind the aft bulkhead.

Air Conditioning Pack Bay. On some airplanes, it will be possible to locate the OBGIS equipment in the A/C Pack Bay. This provides convenient access to a bleed source (except on airplanes where the engines are not wing mounted) and uncomplicated access to ram air. Any parts and ducting located in this area will be required to have the appropriate flammable fluid leakage zone protection. None of the distribution system will be required to have double walled tubing, since all of the equipment is in the unpressurized area.

Wing Root. On some airplanes, it will be possible to locate the OBGIS equipment in the wing root. This provides convenient access to a bleed source (except on airplanes where the engines are not wing mounted). Access to ram air will be more difficult, as it will have to be routed through more structure to reach this area. Any parts and ducting located in this area may be required to have the appropriate flammable fluid leakage zone protection. None of the distribution system will be required to have double walled tubing, since all of the equipment is in the unpressurized area.

Wheel Well. On some airplanes, it will be possible to locate OBGIS equipment in the wheel well, although in this installation it would not be likely to be possible to fit all of the equipment together in one location. In this location access to a bleed source will be more difficult, more so on airplanes where the engines are not wing mounted. Access to cooling air will be more difficult, as it will have to be routed through more structure to reach this area. Any parts and ducting located in this area may be required to

Onboard Inerting Designs Task Team Final Report

have the appropriate flammable fluid leakage zone protection. None of the distribution system will be required to have double walled tubing, since all of the equipment is in the unpressurized area. Photographs of possible wheel well locations on a typical large, medium, and small transport aircraft are shown in Figures 1.13.1-1 through 1.13.1-6.

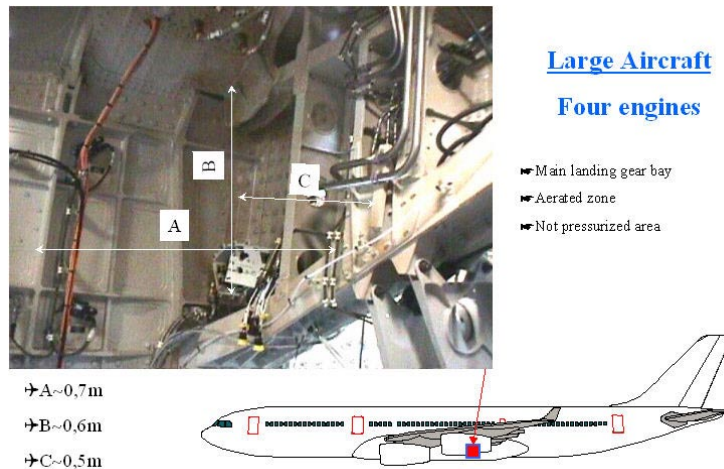

Figure 1.13.1-1. Potential Installation Area in Main Landing Gear Bay on a Typical Large Transport Aircraft

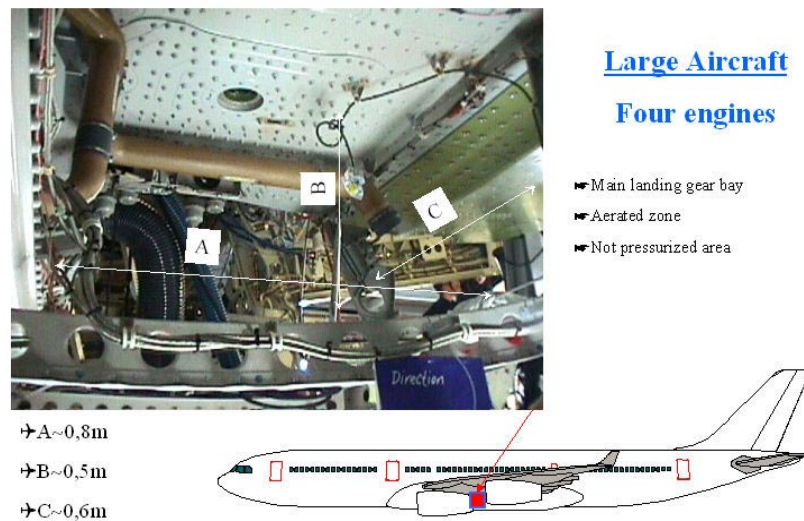

Figure 1.13.1-2. Potential Installation Area in Main Landing Gear Bay on a Typical Large Transport Aircraft (Additional Location)

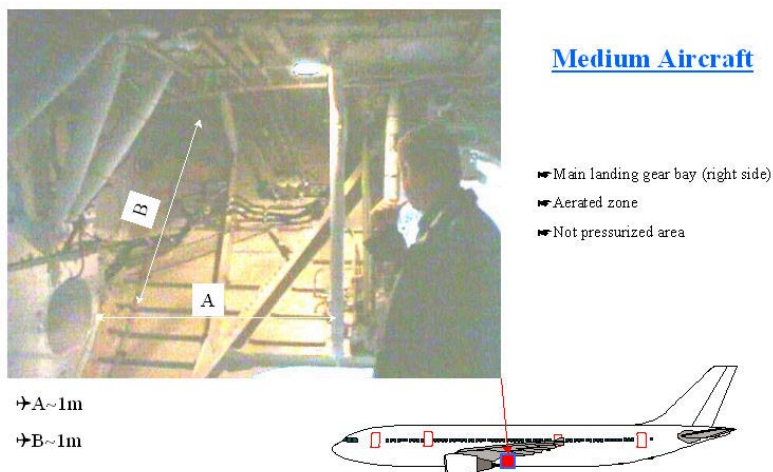

Figure 1.13.1-3. Potential Installation Area in Right Wheel Well on a Typical Medium Transport Aircraft

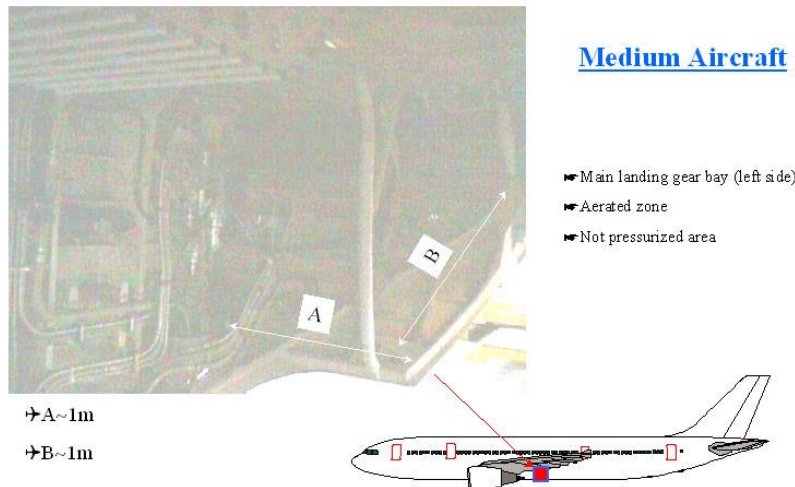

Figure 1.13.1-4. Potential Installation Area in Left Wheel Well on a Typical Medium Transport Aircraft

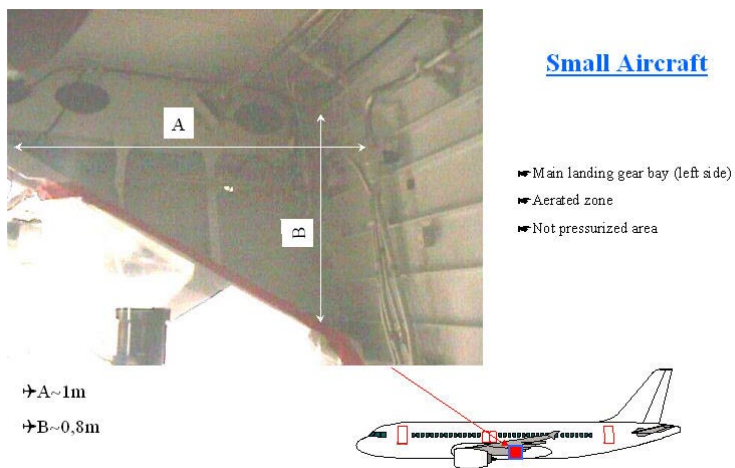

Figure 1.13.1-5. Potential Installation Area in Left Wheel Well on a Typical Small Transport Aircraft

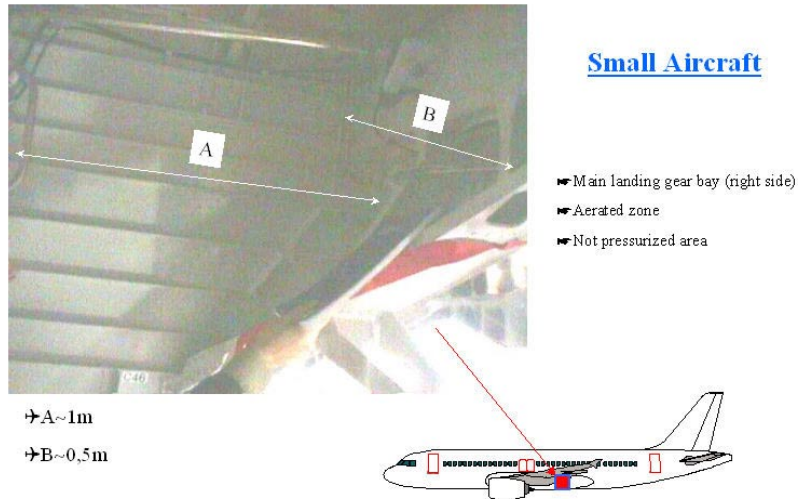

Figure 1.13.1-6. Potential Installation Area in Right Wheel Well on a Typical Small Transport Aircraft

Belly Fairing. Some aircraft have a belly fairing in which OBGIS equipment could be located. This location is unpressurized with good access to bleed air, cooling air, and a convenient overboard waste connection. It is a flammable fluid leakage zone and the equipment would have to have the appropriate protection. Photographs of possible belly fairing locations on a typical large transport aircraft are shown in Figures 1.13.1-7 through 1.13.1-9.

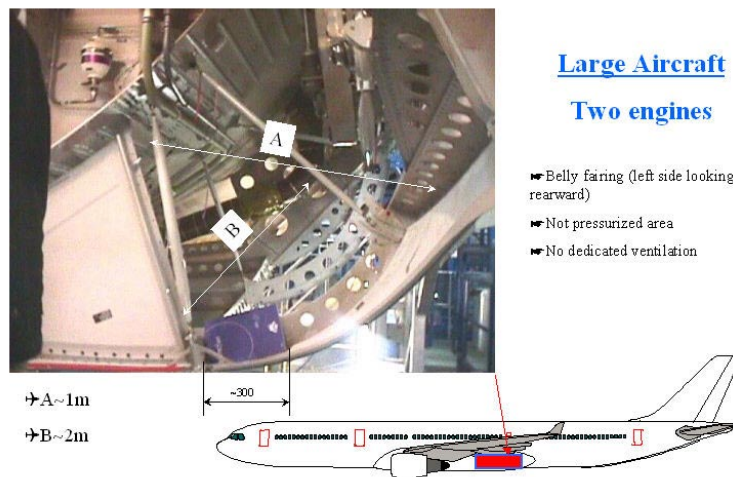

Figure 1.13.1-7. Potential Installation Area in Belly Fairing on a Typical Large Transport Aircraft (Left Side, Looking Aft)

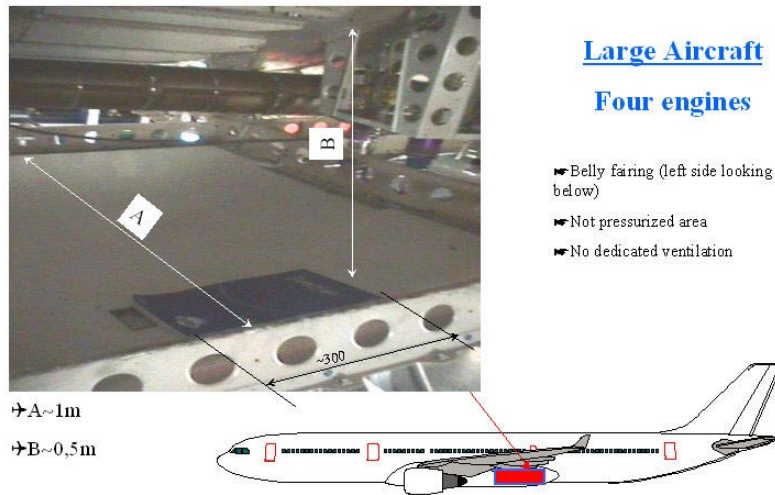

Figure 1.13.1-8. Potential Installation Area in Belly Fairing on a Typical Large Transport Aircraft (Left Side, Looking Down)

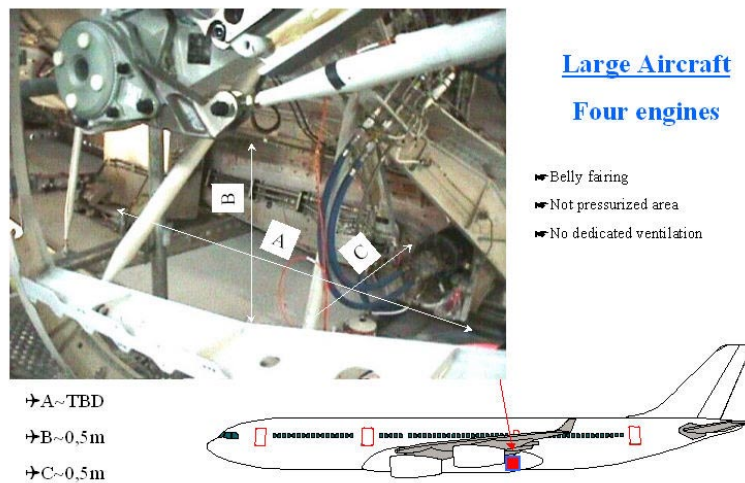

Figure 1.13.1-9. Potential Installation Area in Belly Fairing on a Typical Large Transport Aircraft (Additional Location)

Behind Aft Bulkhead. Some aircraft have an unpressurized area near the tail behind the aft bulkhead. This area would not have flammable fluid leakage concerns, but the bleed air connection could be difficult. Further, the distribution lines to the fuel tanks would be long and would have to be double-walled since they would pass through the pressurized area to reach the fuel tanks. In addition, the weight of the system may adversely affect the aircraft center of gravity. Photographs of possible locations behind the aft bulkhead on a typical large transport aircraft are shown in Figures 1.13.1-10 and 1.13.1-11.

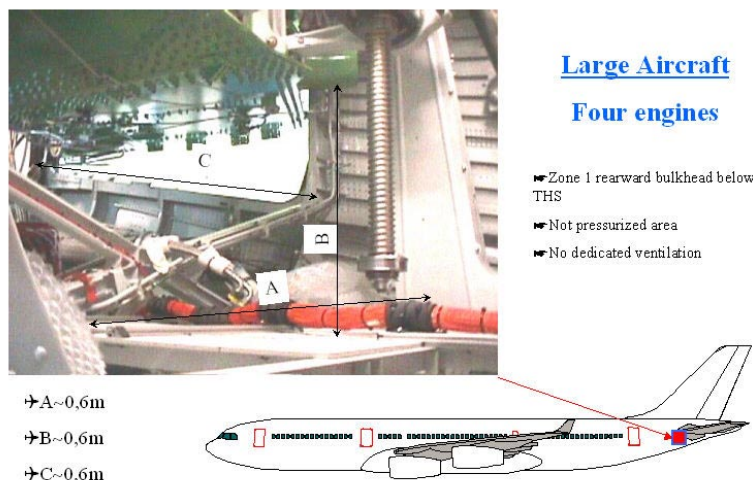

Figure 1.13.1-10. Potential Installation Area Behind Aft Bulkhead on a Typical Large Transport Aircraft

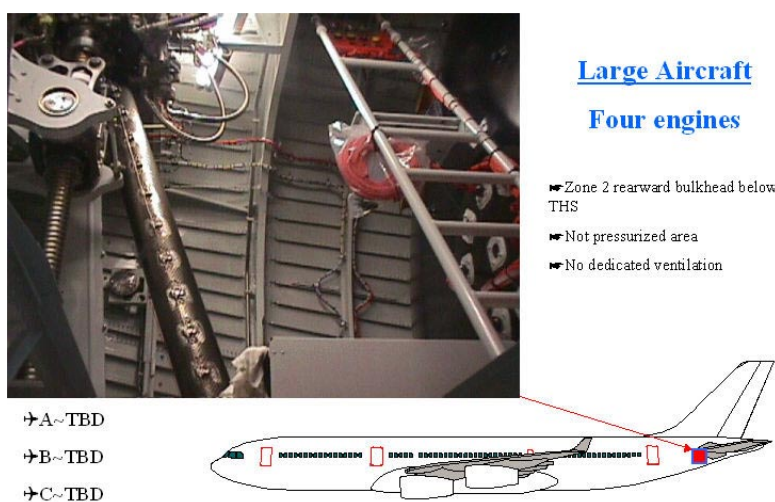

Figure 1.13.1-11. Potential Installation Area Behind Aft Bulkhead on a Typical Large Transport Aircraft (Additional Location)

1.13.2 Possible Equipment Installation in Pressurized Areas

If the OBGIS equipment cannot be installed in an unpressurized area of the airplane, there are several potential pressurized areas on typical large, medium, and small transport aircraft where OBGIS equipment might be installed. These include the areas forward of the aft bulkhead and the cargo bay.

Forward of Aft Bulkhead. There is space forward of the aft bulkhead on some aircraft. The area is pressurized and would require shrouding and/or ventilation provisions. Cooling air and overboard connections would require fuselage penetrations. The bleed air connection would also require a long run of insulated ducting. The distribution tubing would be long and would have to be double-wall in case of leakage. The location is not in a flammable fluid leakage zone. Photographs of possible locations forward of the aft bulkhead on typical large, medium and small transport aircraft are shown in Figures 1.13.2-1 through 1.13.2-3.

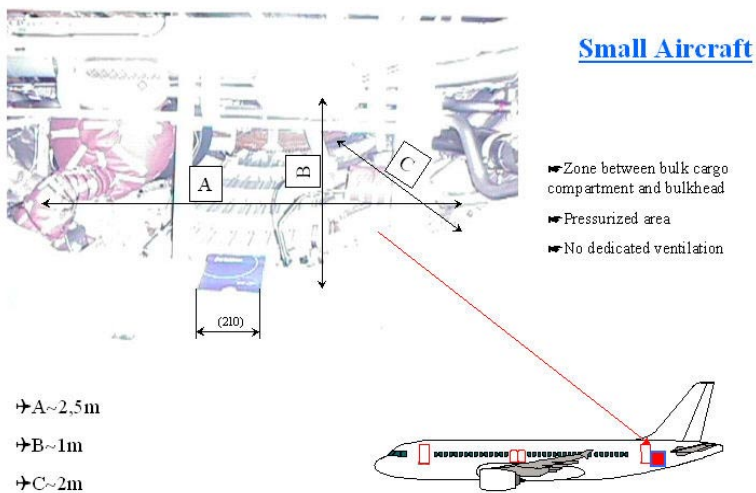

Figure 1.13.2-1. Potential Installation Area Forward of Aft Bulkhead on a Typical Small Transport Aircraft

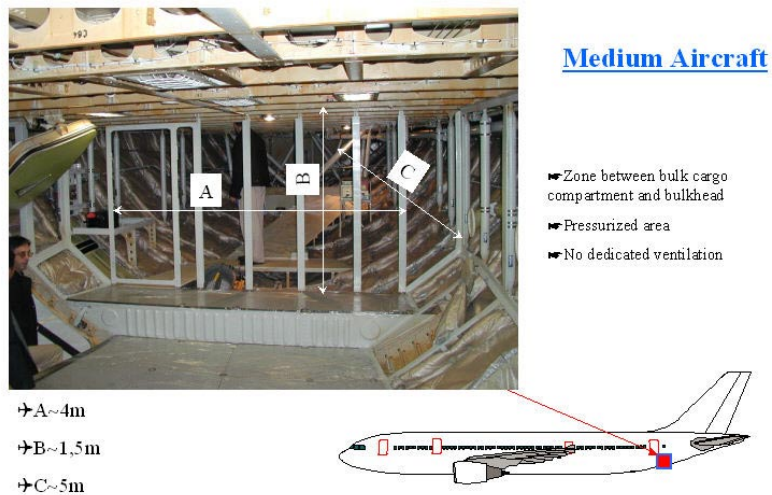

Figure 1.13.2-2. Potential Installation Area Forward of Aft Bulkhead on a Typical Medium Transport Aircraft

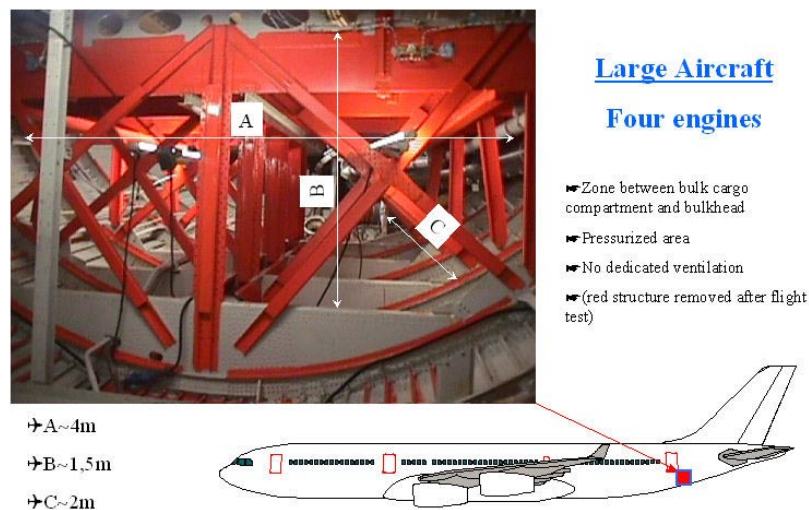

Figure 1.13.2-3. Potential Installation Area Forward of Aft Bulkhead on a Typical Large Transport Aircraft

Cargo Bay. Installing the equipment in the cargo bay allows the equipment to be packaged together to reduce the space utilized. However, installing the equipment in the cargo bay will reduce the available cargo volume, resulting in a cargo payload penalty. There are also other difficulties: The bleed air inlet must now enter into the pressurized area, and be insulated anywhere inside the pressurized area. An enclosure must be added around all of the OBGIS equipment. This enclosure may need to be insulated to prevent heat from entering the cargo bay, and must be resistant to possible damage from cargo handling. The cooling air must now enter and exit the pressurized area, which will make this a heavier installation. The waste gas must be routed outside of the pressurized area, and possibly be shielded to prevent leaks into the pressurized area. The distribution system must be shielded to prevent leaks into the pressurized area. In addition, it may a requirement to certify the cargo fire protection with the OBGIS equipment installed.

1.13.3 Aircraft Interfaces

Distribution System. A distribution system must be installed to deliver the NEA to the desired fuel tanks. Applicable mounting hardware and possible structural modifications must be accounted for. The distribution system must be sized to minimize the pressure drop by using the maximum diameter compatible with the installation constraints. Pipes feeding the tanks and installed in, or passing through, pressurized areas, must be shrouded in case of NEA leakage. Drains should be installed at the lowest point of the feeding pipes to avoid water accumulation.

Controller/Control Card. A controller/control card must be designed and added to control the OBGIS equipment. This controller/control card may be mounted near the equipment, in an equipment rack, or in a card file, depending on the type of controller/control card utilized.

Wiring. Wiring must be added between the controller/control card and all components controlled by the controller/control card. Any wiring installed in an unpressurized area must be protected against more extreme environmental conditions. In addition, extra precaution must be utilized when adding wiring in a flammable leakage zone. Depending on location, wiring may need to be segregated for protection against engine rotor or tire burst.

Indications. The necessary indications need to be added to the flight crew interface for the applicable airplane to allow the maintenance and flight crews to determine the OBGIS health. This information will be used to determine when the airplane can be dispatched, when corrective action must be taken by the

flight crew (if applicable), and when maintenance action must be performed. The cockpit wiring will be affected.

1.13.4 Other Installation Considerations

The following other considerations must be evaluated in selecting potential OBGIS installation locations:

Uncontained Engine Rotor or Tire Burst. If possible, the OBGIS components should be installed outside of the engine rotor burst or tire burst zones.

Flammable Fluid Leakage Zones. Any equipment located within a flammable fluid leakage zone will require special precautions.

Temperature Environment. The compressor and heat exchanger operate at high temperatures and will have to be thermally insulated to protect nearby structure and equipment. Similarly, the OBGIS equipment will have to be designed to withstand the temperature environment of the compartment in which it is located.

Noise. The compressor and fan installations will have to minimize the noise transmitted to the cabin or to the areas where ground personnel frequently work.

1.14 PROS AND CONS OF SYSTEM DESIGN CONCEPT

System Effectiveness and Limitations. The design concept of the onboard ground inerting system is to have a self contained system on the aircraft that will operate only when the aircraft is on the ground and at the gate. The system will provide an inert atmosphere in the “protected” tanks at some time during the gate stay of the aircraft. The system is designed to inert the “protected” tanks in the shortest turn time for the type of aircraft it is installed on. Therefore, on short turn times the aircraft “protected” tanks may remain non-inert for a large portion of the gate time. However, the “protected” tanks will be inerted at any time in excess of the shortest turn time.

At all times the protected tanks are inerted, with an O₂ level less than 10% at time of push back from the gate. Under most conditions, the protected tanks will stay inert through taxi, climb, and into cruise. Protected tanks with very little or no fuel will stay inerted, for most flights, until the descent. The more fuel in the tank, the earlier the tank will become non-inert. A full tank that is used during taxi and/or climb may become non-inert during those phases of flight, albeit the tank ullage may not be flammable. Although the system does not provide for inerting of the tanks 100% of the time, it does provide inerting when the tanks are most likely to be flammable.

System Safety. The installation of the system adds additional hazards to the aircraft, which must be mitigated. The hazards include electrical wiring, high-speed rotation machinery, ducting carrying NEA and OEA and additional penetrations into the fuel tank. The design of the system should be such to minimize or eliminate the hazards. The safety section contains a more detailed analysis of all the hazards and means of mitigation. It should be noted that since the system only operates on the ground at the gate, almost all of the hazards are only at that time, and not during taxi or flight.

System Cost. There is a cost associated with the design, installation, certification, operation and maintenance of an OBGIS. Those costs can be broken down into: 1) cost of the system, 2) cost of system operation, and 3) maintenance cost of the system. The cost of the system includes design and construction as well as certification and installation. The system operation costs include those associated with the carriage of additional weight and possible shift in center of gravity of the aircraft, possible increase in drag, and the additional use of electrical power. The maintenance cost includes maintenance of the OBGIS and to other systems, such as electrical generators, affected by it. A more detailed breakdown of costs can be found in the Cost Section.

System Environmental Impact. The main impact to the environment from an OBGIS is the possible increase in fuel vapors being forced overboard as the nitrogen is injected into the fuel tank. The amount of

Onboard Inerting Designs Task Team Final Report

fuel vapor that is vented depends on the fuel air mixture and ullage volume, at the time of inerting, as well as other variables. Testing has shown that present designed cross-vented fuel tanks, under certain wind conditions, can vent fuel vapors into the atmosphere. A redesign for the OBGIS would minimize that venting, thus helping to offset some of the fuel vapor lost during the inerting process.

The installation of an OBGIS would reduce the number of fuel tank explosions, thus reducing the amount of spilled fuel both on the ground and in the atmosphere.

In addition to the fuel vapor there is a potential issue with the addition of noise from the compressor/fan.

The use of dry NEA may reduce corrosion and condensation in the protected tanks depending on the conditions at the airports where the airplane is operated.

1.15 MAJOR ISSUES / MITIGATION

The OBGIS system has been defined by the Team based on the operating parameters defined during the study period or by others, such as the 1998 Fuel Tank Harmonization Working Group (FTHWG) ARAC. The parameters which had most of the effect on system sizing were the time available at the gate to operate the system, and the size of the tanks to be inerted. The time available to operate the system was determined by the shortest expected time available. This was a major factor particularly for the small and medium transport aircraft, where the minimum gate time was short, thereby dictating a large, high-capacity system. An alternative to this approach would be to use a gate time which relates to the average or fleet majority gate time, thereby significantly reducing system size, cost and weight. In this instance, airlines which require short turn-around times could use up-rated systems (larger compressors / ASMs), and the majority of the fleet would not pay the penalty associated with a short turn around time which they do not require. The ultimate effect of this consideration has not been evaluated by this study.

Several existing aircraft were analyzed to derive data for the conclusions of this study. However not all existing aircraft could be evaluated, due to time constraints. Issues such as available space and details of electrical equipment power ratings, vary significantly from aircraft to aircraft. System feasibility, although a major factor in this study cannot and does not consider all aircraft applications. Space may not be available to accommodate OBGIS in all aircraft. One possibility is to install the OBGIS system in the baggage space but there will be a cost impact to the operators due to lost revenue. This cost was not evaluated during this study.

Technology available to the Team at the time of the conduct of the study dictated feasibility to a certain extent, and detail features to a great extent. In the time required to enforce the requirements of the rulemaking that will be the ultimate result of this report, other, more advanced technologies may be available. As the Team was unable to predict such developments, the rulemaking recommendation was thus derived from currently available technology, with its associated limitations.

The Team approached the study with the intention of defining the feasibility of Onboard Ground operating systems, and their relative performance compared to other possible solutions. Detail design for all configurations of existing aircraft could not be evaluated in the available time. Such aircraft-specific designs were not attempted; it was concluded that detail design should be conducted when rulemaking compliance is defined. Details of these designs may at that time, conclude that some parameters do not appear feasible, or may result in different weight, cost or size. The Team concludes, however, that ultimately no parameters will be infeasible, albeit that other items may be affected.

Not all-possible permutations of tank size, aircraft type and turn around times (among other parameters) were evaluated in the study. The Team has, however, attempted to provide enough empirical data and predictive analysis that the reader may extrapolate the information presented herein to other specific application conditions and sizes.

A major objective for the study was to produce predictions of flammability exposure for the system. This was based on the FAA-produced predictive analysis software, with its inherent assumptions. Limited

testing has concluded that the assumptions are sound, and the predictive analysis is of sufficient quality for these comparative studies. However, not all operating conditions which have been analytically simulated as part of this study have been verified by experiment, and may therefore ultimately result in divergence from the actual ultimate performance.

Onboard Inerting Designs Task Team Final Report

2.0 HYBRID OBGIS

The hybrid On-Board Ground Inerting System (OBGIS) is one of four main system categories studied by the 2000 ARAC FTIHWG Onboard Airplane Design Task Team. The term ‘hybrid’, as used here, refers to a potentially smaller system that leverages additional ground time available to operate the system. The Onboard team studied the system size for a variety of “modeled” aircraft center wing and auxiliary fuel tanks. In addition, the Team performed additional analysis, in excess of the Tasking Statement’s requirements, by determining the system size for all fuel tanks. The team also defined the physical size and weight of the multitude of components needed to support the hybrid OBGIS. Finally, power and air consumption needs were defined.

2.1 REQUIREMENTS

There are several main requirements for the hybrid OBGIS concept that were considered during the Team’s system design efforts. These are identical to those of the baseline OBGIS system and are discussed under requirements in Section 1 of this report.

All applicable fuel tanks were to have a 10% oxygen content in the tank ullages before the aircraft is pushed back from the gate, using nitrogen generating equipment installed on the airframe. Also, the system does not require redundancy of components.

2.2 DATA SUPPLIED FROM OTHER SOURCES

Data was taken from various sources so that the Team could define the hybrid OBGIS concept. This included aircraft fuel tank sizes, mission profiles, and aircraft turn times.

2.2.1 Aircraft Turn Times and System Operational Times

As with the baseline OBGIS system, the aircraft pre-flight times were derived from the July 1998 ARAC FTIHWG as summarized in Figure 2.2.1-1 below:

Generic Aircraft	Pre-flight Time (Minutes)
Turbofan	20
Turboprop	20
Business Jet	45
Small	45
Medium	60
Large	90

Figure 2.2.1-1. FTIHWG Aircraft Pre-Flight Times

To ensure the turn times being used were representative of in-service aircraft, the airline survey described in Section 1 of this report was conducted for several major airlines. The FTIHWG made the decision to modify the aircraft turn times to the values seen in Figure 2.2.1-2 below. These values were used in the sizing of the components for the system, being representative of the in-service fleet.

Generic Aircraft	Turn Time (Minutes)
Turbofan	15
Turboprop	15
Business Jet	60
Small	20
Medium	45
Large	60

Figure 2.2.1-2. FTIHWG Aircraft Turn Times

For the hybrid OBG system, the time available for system operation after touchdown, during the taxi-in period may be added to this, to define the total system operational time available for the inerting process. Using in-service available data, the FTIHWG determined that 5 minutes should be added to this taxi-in time, to derive the total inerting time listed in Figure 2.2.1-3.

Generic Aircraft	Inerting Time (Minutes)
Turbofan	20
Turboprop	20
Business Jet	65
Small	25
Medium	50
Large	65

Figure 2.2.1-3. Hybrid OBG Inerting Times

2.2.2 Generic Aircraft Types

The FTIHWG made the decision to use the same generic aircraft data and mission scenarios that were used in the July 1998 ARAC FTHWG report. As with the baseline OBG system, these generic airplane definitions and missions were used in assessing the operational parameters. Discussion of the data is included in the ‘Generic Aircraft Types’ part of Section 1 of this report. As with the baseline OBG system, the worst-case flight conditions were the shortest-ranged flights.

2.2.3 Generic Aircraft Fuel Tank Volumes

For all system sizing the 1998 ARAC generic aircraft fuel tank sizes listed in Figure 2.2.3-1 were used.

Generic Aircraft	CWT Volume (Gal.)	CWT + Wing Tank Volume (Gal.)	CWT + Wing + Aux Tank Volume (Gal.)
Turbofan	816	3,264	N/A
Turboprop	N/A	1,428	N/A
Business Jet	N/A	6,273	N/A
Small	3,060	5,100	7,600
Medium	10,200	24,480	27,480
Large	25,500	55,080	58,080

Figure 2.2.3-1. Generic Aircraft Fuel Tank Volumes

2.3 ASSUMPTIONS

The assumptions for the hybrid OBGIS are identical to those described under OBGIS assumptions.

The initial oxygen concentration was assumed to be 20.9%. The team assumed that hydraulic power on the aircraft to operate OBGIS equipment was not available while the aircraft was on the ground. The team assumed for the design that sufficient ground power could be made available to operate a hybrid OBG system. The team assumed that sufficient power could be made available to operate a hybrid OBG system from on-board sources during taxi-in. This would allow the system to operate on the ground with either the APU or aircraft engines operating. This source of power would be used when either the aircraft is taxiing or when gate power is not available.

2.4 CONCEPT DEVELOPMENT

The hybrid OBG system was developed to optimize the concept of system operation on the ground only, using on-board equipment. The baseline OBG system assumed that the only available time for system operation was while the aircraft was at the gate. As the time at the gate available for system operation was a major system sizing parameter, the Team decided that additional ground operation time would provide the opportunity to reduce the size, cost and weight of the system. The OBG hybrid accomplishes

Onboard Inerting Designs Task Team Final Report

this by operating the system from the time of touchdown, through taxi-in (using the engine bleed air pressure source to operate the system), gate hook-up, and up to the time of pushback. This provides the additional time of touchdown to hook-up, when compared to the baseline OBG system. Otherwise, the system architecture and operating parameters are identical to the baseline OBG system.

The elements of system development and configuration considerations are therefore identical to the baseline OBG system. For details of this, please refer to the ‘Concept Development’ paragraphs of Section 1 of this report. This includes the basic requirement to provide inerting of the fuel tank ullage spaces to an oxygen content of 10% at pushback, for the six standard aircraft models. The baseline OBG system uses available power at the gate. Membrane and PSA solutions were considered for the ASM, supplied by air at a pressure ratio of three-to-one (3:1) from the available sources. Other system equipment is required to filter, cool and distribute the air to the fuel tanks.

2.4.1 Concept Development Process

The hybrid OBG system was developed directly from the baseline OBG system, being of identical architecture and operation; the difference being that the hybrid system operates for a longer period of time on the ground prior to flight.

The concept development process was therefore identical to that of the baseline OBG system, as detailed in the ‘Concept Development Process’ part of Section 1 of this report. This details consideration of nine concepts, including aspects of the air pressure source and ASM configurations. Many of these considerations were eventually incorporated into the basic system architecture to provide the benefits of optional air pressure sources and optimized ASM architecture. It was assumed that for the hybrid OBG system, the operation after touchdown and prior to gate hook-up would be achieved by the use of engine bleed air and that sufficient air is available. This is a reasonable assumption, as the demand on the bleed air system is normally low during the time that the aircraft is taxiing to the gate. In the event that this is not the case, the compressor could be operated to supply the required airflow. The assumption that electrical power is available during this time is also reasonable, as electrical load is also typically low.

2.5 FINAL CONCEPT DESCRIPTION

The hybrid OBG system architecture is identical to that of the baseline OBG system, and is depicted in Figure 2.5-1. The components identified within each of the hybrid OBG subsystems are summarized in Figure 2.5-2.

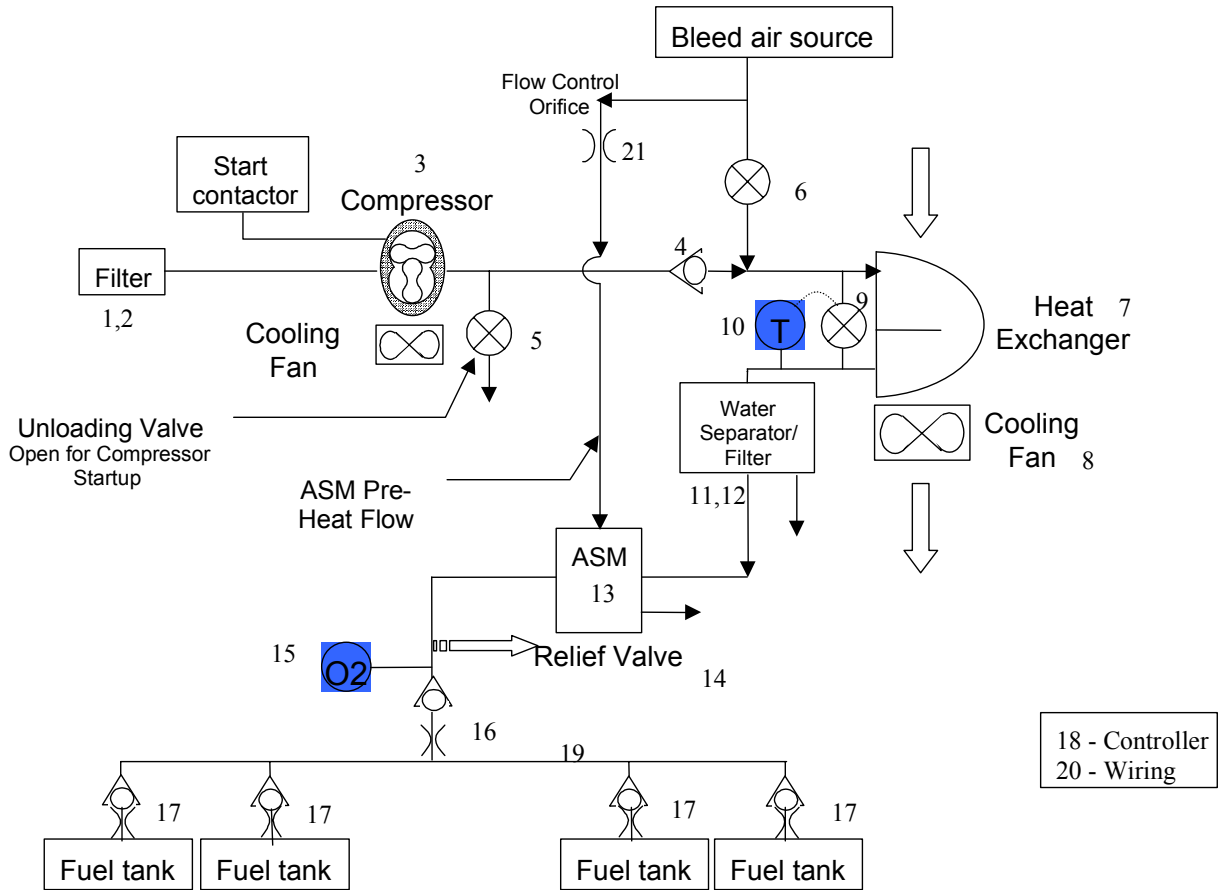

Figure 2.5-1. Hybrid OBGI System Schematic Diagram

Component	Item Number	Component	Item Number
Compressor inlet air filter assembly	1	Water separator/filter assembly.	11
Compressor inlet air filter element	2	Water separator/filter element	12
Compressor, cooling & start system	3	Air separation module	13
Compressor discharge check valve	4	Relief valve	14
Compressor unloading valve	5	Oxygen sensor	15
Bleed Air shutoff valve	6	ASM check valve & restrictor assembly	16
Heat exchanger	7	Fuel tank check valve	17
Cooling fan & ram ducts assembly	8	Controller / control card	18
Heat Exchanger bypass valve	9	Ducting	19
Temperature sensor & controller	10	Wiring	20
		Bleed Orifice & duct	21

Figure 2.5-2. Hybrid OBGI System Component List

2.5.1 Operating Concept

As with the baseline OBGI system, the system is arranged to replace the air in the tank ullage with NEA, thereby reducing its flammability. The main device used to accomplish this is the ASM which separates ambient air into nitrogen, oxygen, and the other constituents of air. The system requires a compressor and a heat exchanger, to compress and subsequently cool the air, which is then distributed to the fuel tanks via a distribution manifold.

Onboard Inerting Designs Task Team Final Report

An electrically powered compressor pressurises ambient air for the ASM. The air is filtered prior to entry into the compressor inlet, to prolong compressor life.. For some aircraft types / sizes, the power requirement for the compressor is relatively high, which dictates the use of a start contactor and pressure unloading valve. These allow the compressor to start, while avoiding high power surges during wind-up. The unloading valve helps accomplish this by reducing the compressor backpressure, and consequently reducing the start-up power load. The compressor outlet requires a check valve, to prevent reverse flow through the compressor and filter.

An alternate source of pressurized air for the system is engine bleed air. This is introduced into the system downstream of the compressor, and is controlled by a shut-off valve, which also acts to prevent reverse flow to the engine bleed system when in the closed position.

In its pressurized form, from either the compressor or the engine bleed air system, the air will be at an elevated temperature. Prior to flowing to the ASM, it must therefore be cooled to ensure that it is sufficiently cool to prevent damage of the ASM, and to prevent hot gas flowing to the fuel tanks. Cooling of the air is accomplished by the use of an air-to-air heat exchanger. In the event that the air is already sufficiently cool as may be associated with cold climates, the heat exchanger may be by-passed through the temperature control valve. The temperature control valve will modulate the bypass flow to optimize the temperature of the airflow.

As the air exits the heat exchanger, it is again filtered to a finer level than the primary filter, and ensures that the airflow is acceptable for the ASM. The secondary filter also filters engine bleed air in the event that air is supplied from this source. The filter assembly also removes entrained moisture from the air by separating water vapor and ejecting it in liquid form from the aircraft through a drain line.

The ASM accepts warm pressurized air from the upstream system and discharges NEA to the fuel tanks. A second ASM outlet port discharges oxygen enriched air (OEA) to the ambient air around the aircraft. Concentrated OEA may be a fire hazard so it must be mixed with ambient air. The discharge port must be designed to ensure the mixing.

At the ASM outlet, a relief valve ensures that tank over pressure conditions are avoided in the event of a refuel system failure during refuel operations. This is accomplished by jettison of the NEA during the refuel failure condition, which results in normal refuel failure tank over pressure protection.

Flow to the fuel tanks is controlled by means of fixed restrictions that are designed to balance the flow to the individual fuel tanks. Flow balance ensures that tank NEA ullage concentrations are relatively uniform. The restrictors also feature check valves that together with the in-line check valve, provide dual redundant reverse flow protection against hydrocarbon contamination of the ASM.

2.5.2 Component Functional Description

The functions of the components in the hybrid OBGI system are identical to the baseline OBGI system. The ‘Component Functional Description’ part of Section 1 of this report details these component functions. The components included in this section are as listed below:

- Inlet Filter
- Compressor, Start Contactor, Compressor Cooling Fan
- Compressor Discharge Check Valve
- Compressor Unloading Valve
- Bleed Air Isolation Valve
- Heat Exchanger
- Heat Exchanger Temperature Control Valve

- Temperature Sensor
- Water Separator / Filter
- Air Separation Module
- Relief Valve
- ASM Discharge Check Valve and Restrictor
- Fuel Tank Check Valve and Restrictor
- Ducting
- Controller
- Wiring
- Flow Control Orifice

2.6 SYSTEM SIZING AND PERFORMANCE

As with the baseline OBG system, the sizing of hybrid OBG system for the various generic aircraft is a function of several key parameters. The main ones are the efficiency of the separating technology used in the system, the size of the fuel tank to be inerted, and the amount of time available to inert the tank. The resulting analysis will provide the weight, volume, power consumption, and cost of the system.

2.6.1 Key Sizing Parameters

Sizing for hybrid OBG systems are identical to those considered for the baseline OBG system, namely fuel tank volume, aircraft turn time, and ASM feed pressure and temperature. These parameters are described in further detail in Section 1 under OBG key sizing parameters.

The increased operating time on the ground for hybrid OBG systems, relative to the baseline OBG systems, due to the added time for taxi-in, serves to reduce the necessary hybrid OBG system NEA flow rate.

2.6.2 Parametric Sizing Curves

The parametric sizing methodology for the hybrid OBG system was the same as that for the baseline OBG system. The results of the system analysis were the weight, volume, input power, and inlet air for the various aircraft models. These results are plotted as parametric charts. The charts are shown in Figures 2.6.2-1 through 2.6.2-5. The data for the systems that include auxiliary tanks was scaled from the other systems based on tank volume.

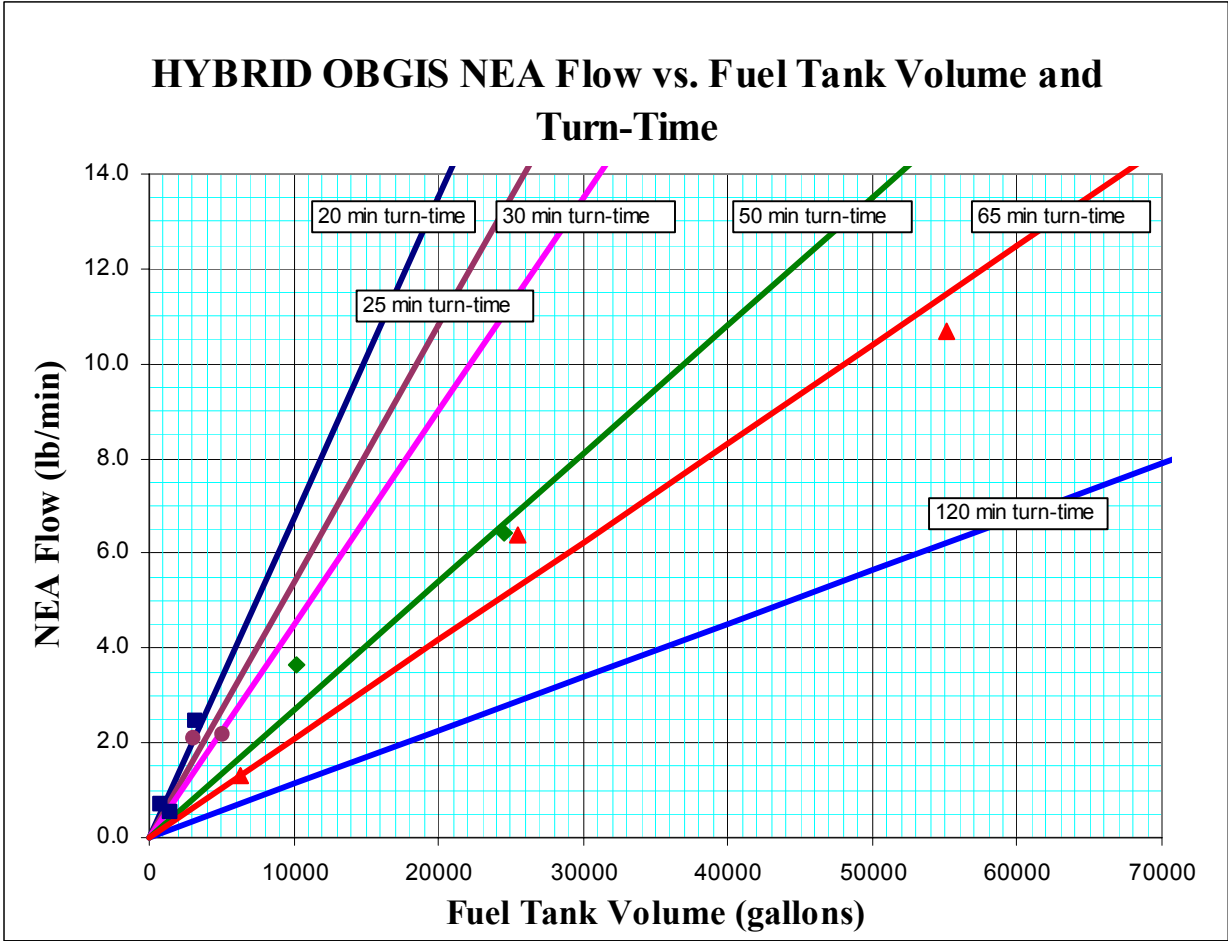

Figure 2.6.2-1. NEA Flow vs. Tank Volume

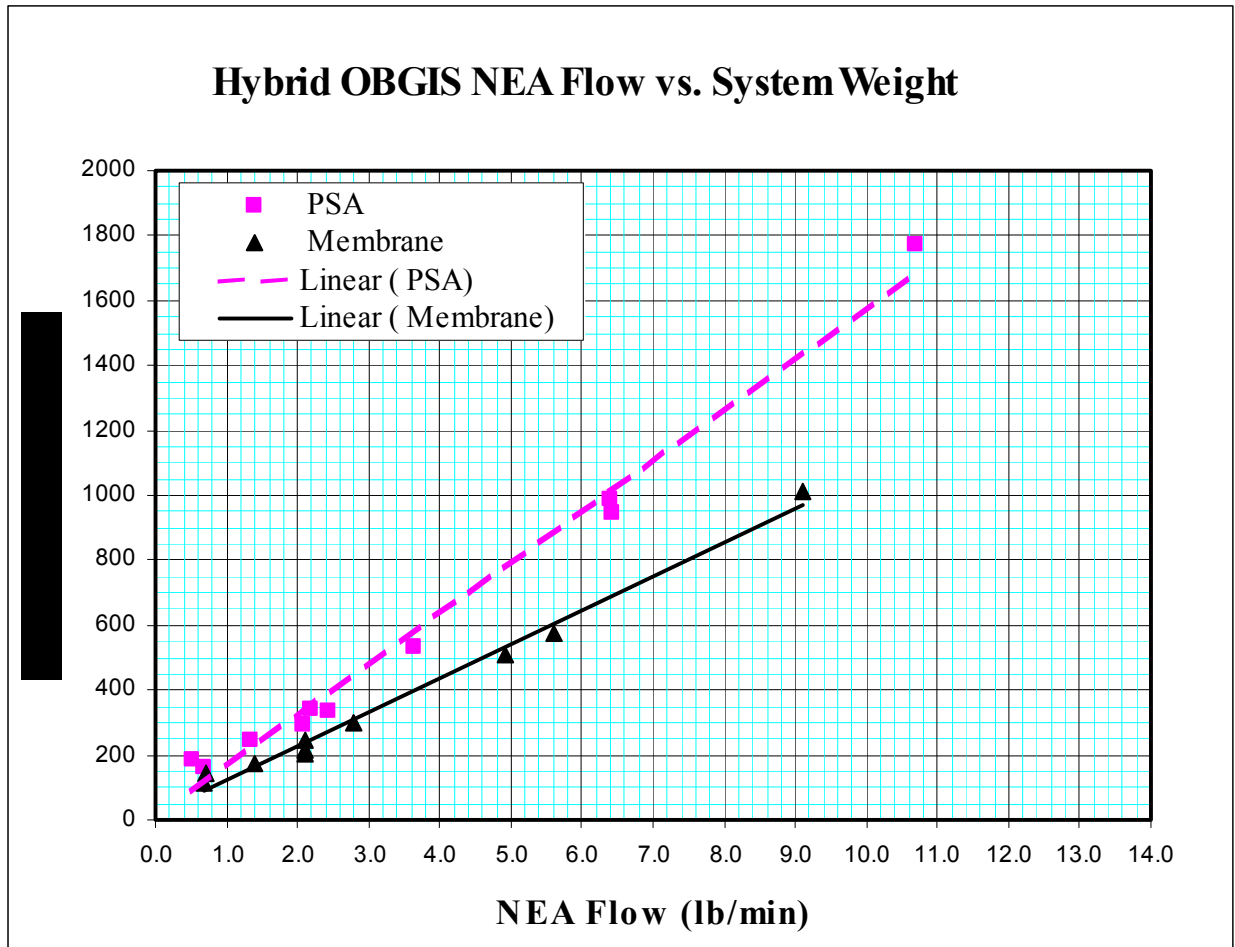

Figure 2.6.2-2. Weight vs. NEA Flow

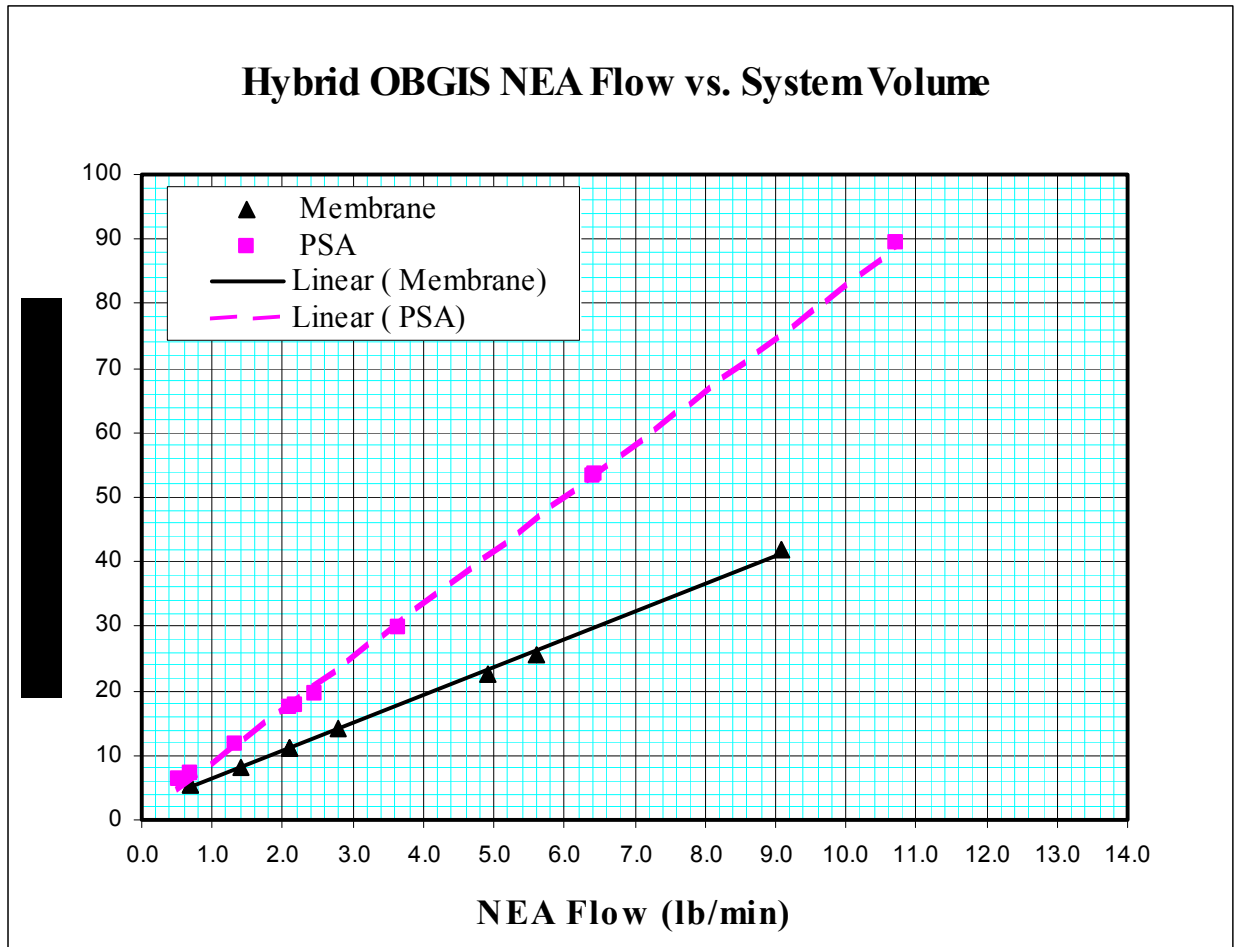

Figure 2.6.2-3. Volume vs. NEA Flow

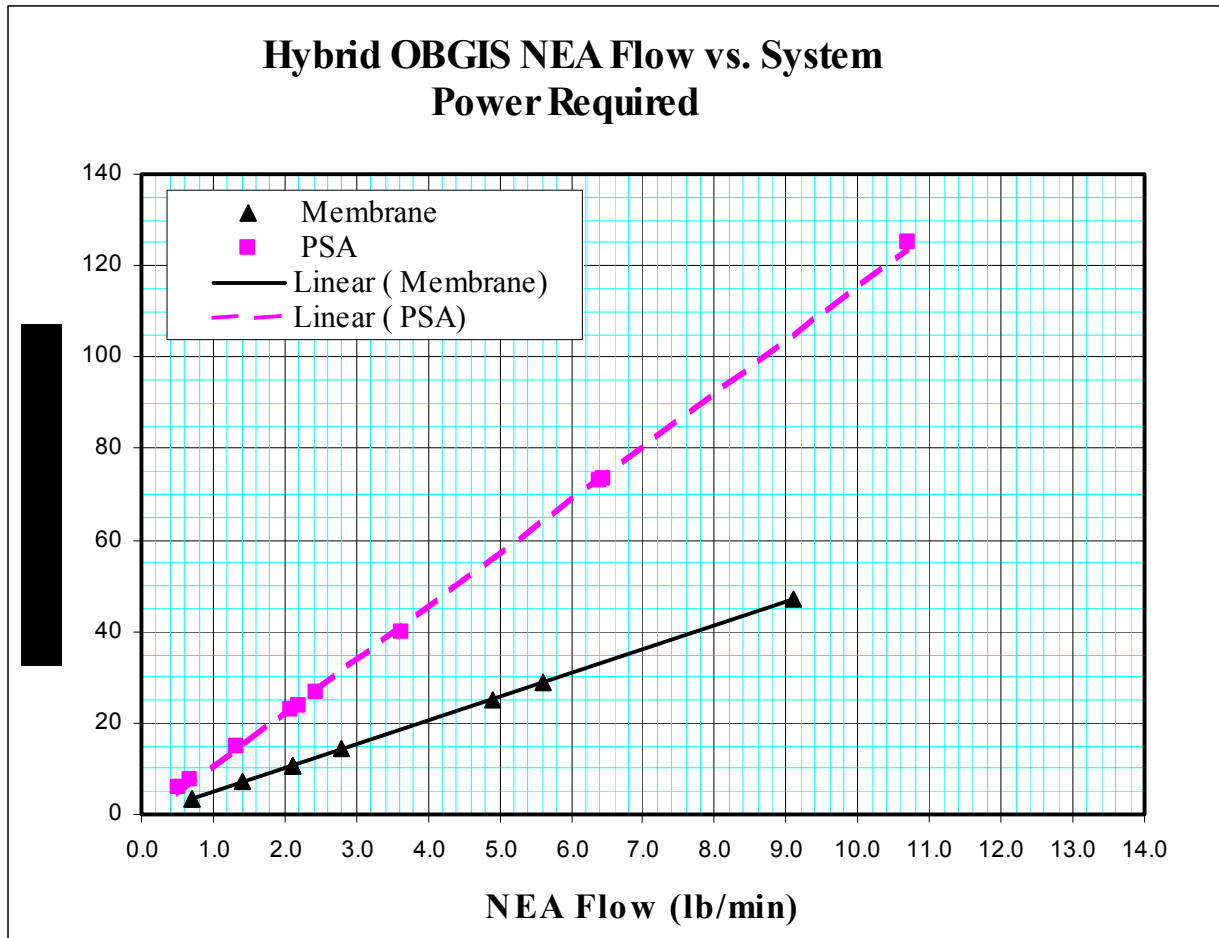

Figure 2.6.2-4. Power vs. NEA Flow

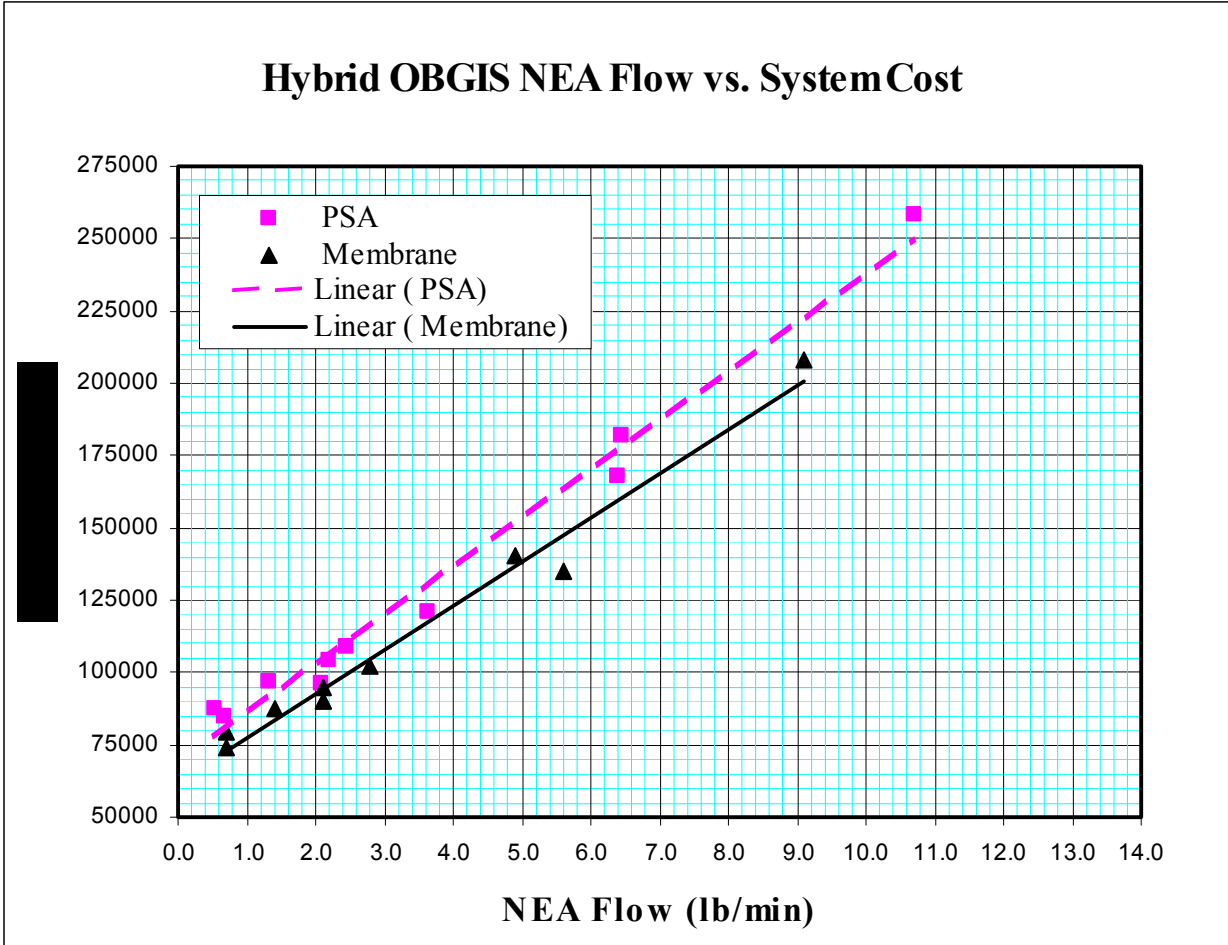

Figure 2.6.2-5. Cost vs. NEA Flow

These charts allow system sizing for any aircraft models not specifically studied in this report. Figure 2.6.2-1 plots NEA flow versus fuel tank volume and turn-time to allow for estimation of the hybrid OBGIS system NEA flow requirement for a given aircraft. Figures 2.6.2-2 through 2.6.2-5 then provide estimation of hybrid OBGIS system weight (pounds), system volume (cubic feet), required electrical power (kilowatts), and system cost (dollars). Cost data are for initial acquisition only of the systems themselves and are provided for comparison purposes; they do not include any other costs such as certification or integration by the aircraft manufacturer or commercial airline. The charts are used identically as the example provided for the baseline OBGIS system in Section 1. The charts were generated for NEA flow with an oxygen concentration of about 7% and may not be valid for different NEA purity.

2.6.3 Results

Summary results of the hybrid OBGIS air consumption, weight, electrical power usage, and volume for the different aircraft models and tank configurations are plotted in the bar charts in Figures 2.6.3-1 and 2.6.3-2.

Hybrid OBGIS - Center Wing Tank

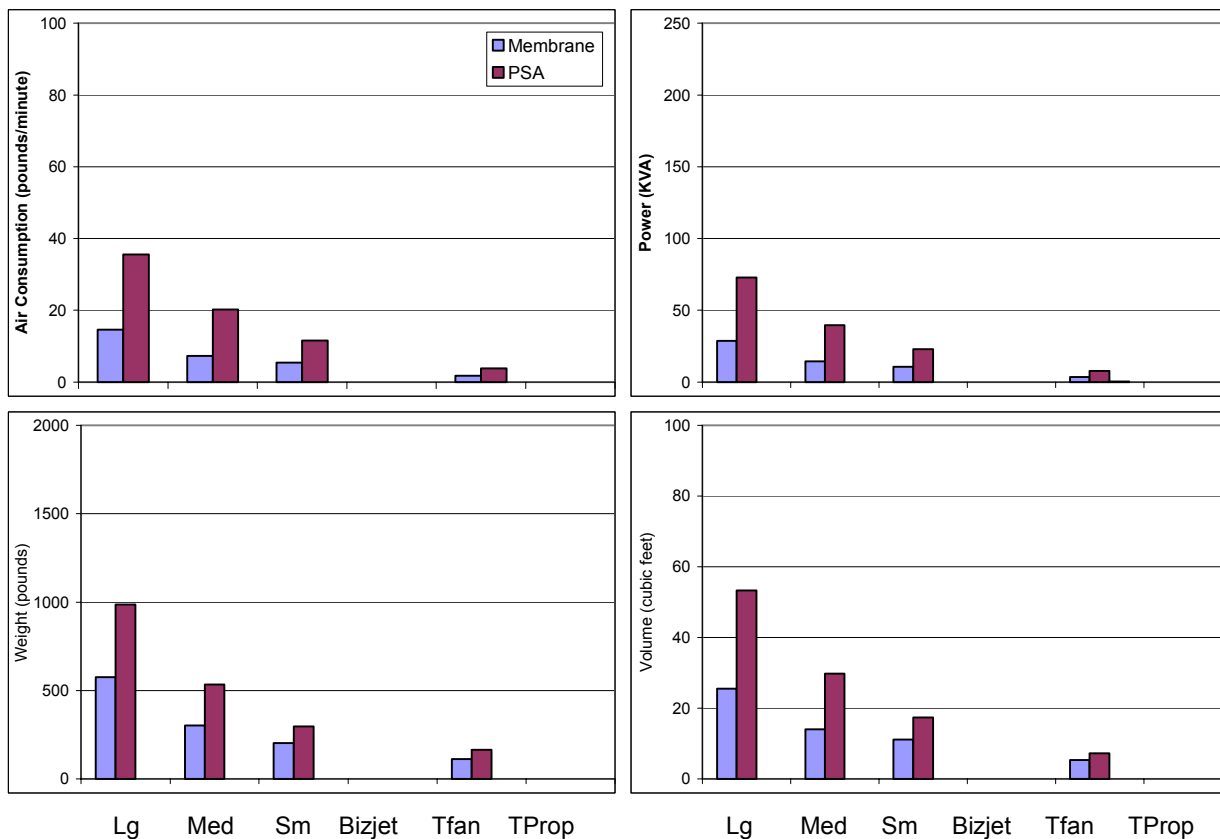

Figure 2.6.3-1. Hybrid OBGIS Air Consumption, Power, Volume and Weights for Center Tanks

Hybrid OBGIS - All Tanks

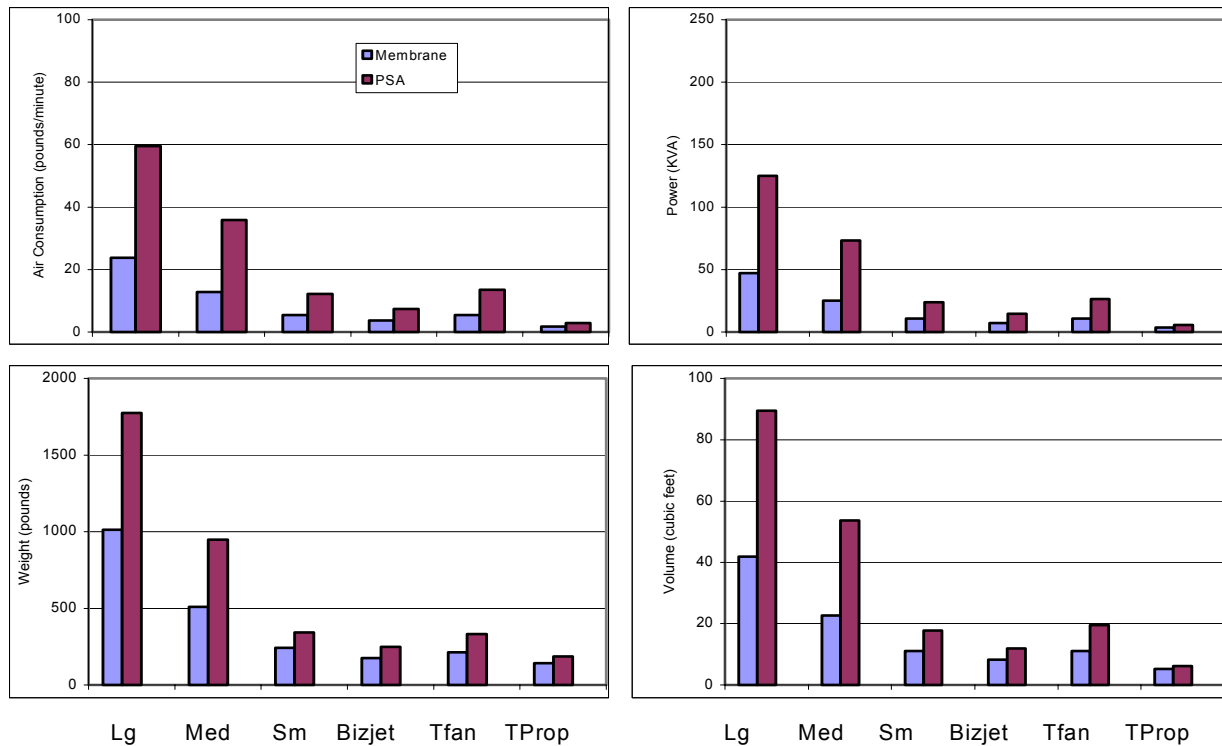

Figure 2.6.3-2. Hybrid OBGIS Air Consumption, Power, Volume and Weights for All Tanks

2.6.4 Flammability Exposure

The methodology to compute the flammability exposure for the hybrid OBGIS system for each of the generic aircraft types was identical to that of the baseline OBGIS system. This is detailed in the flammability exposure discussion in Section 1 of this report. A comparison of the hybrid OBGIS system performance to other fuel tank inerting options is shown Section 5.0 of this report. The specific flammability exposure for the system is shown in Figure 2.6.4-1 and 2.6.4-2.

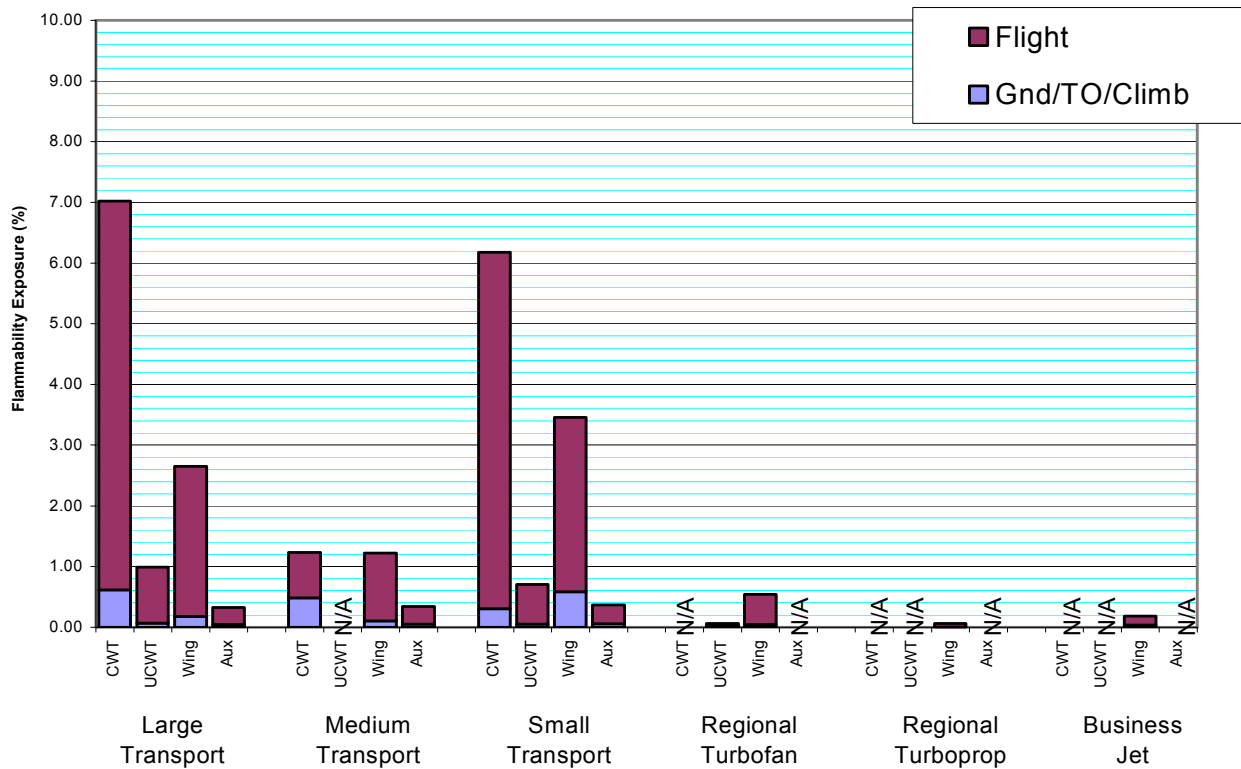

Figure 2.6.4-1. Flammability Exposure Results for the Hybrid OBGI Membrane System

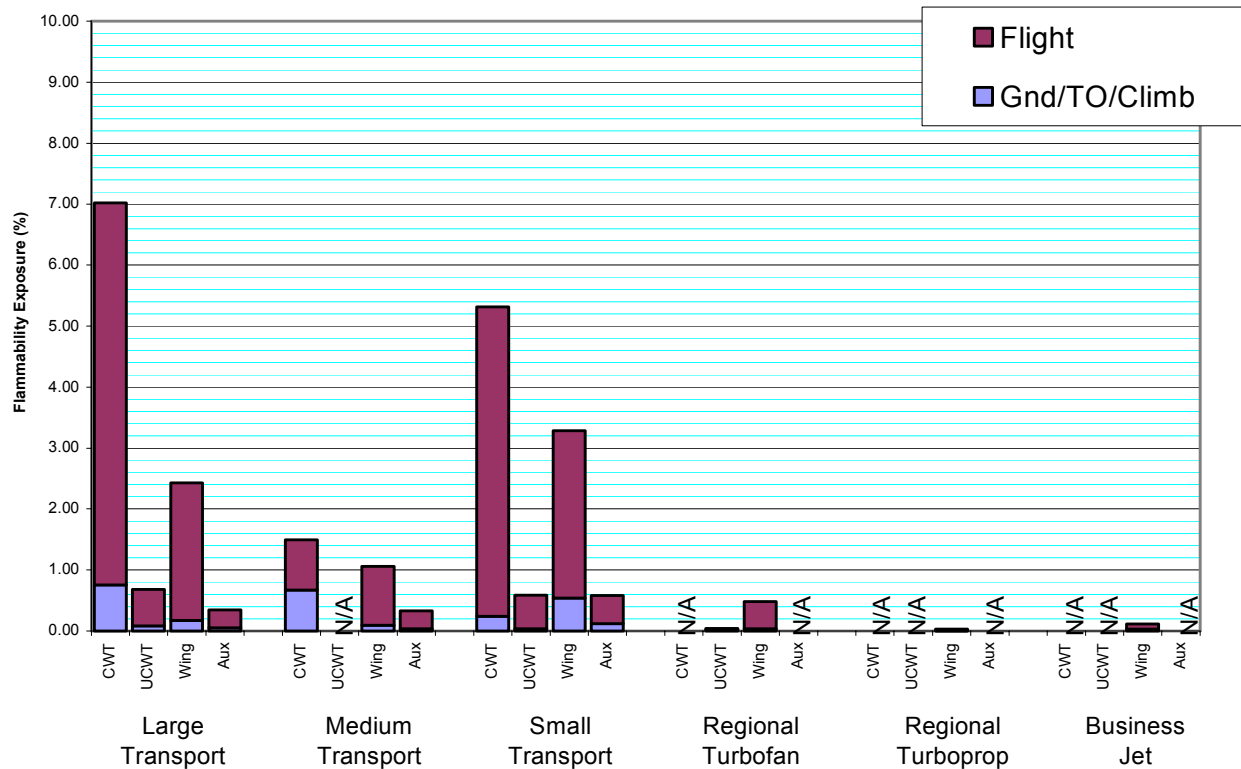

Figure 2.6.4-2. Flammability Exposure Results for the Hybrid OBGI PSA System

Onboard Inerting Designs Task Team Final Report

Total flammability exposure represents the total flight and ground time spent flammable and not inert as a percentage of the total flight and ground time. The portion of the total flammability exposure corresponding to gate time, taxi out, takeoff and climb segments were separately summed together to allow for direct comparisons of each inerting option where the risk of an explosion was higher.

2.7 WEIGHT

Figures 2.7-1 and 2.7-2 summarize the weight data developed by the Onboard Design Task Team for the membrane and PSA hybrid OBGIS systems for each of the ARAC generic aircraft. Each table provides the total weight for the “major” and “other” components identified for each system. “Other” components include such items as wiring, ducting and valves, and their total estimated weights have been combined.

Onboard Inerting Designs Task Team Final Report

Weight Summary Table - Membrane Systems (Lbs.)										
Component	Large Transport		Medium Transport		Small Transport		Turbo Prop	Turbo Fan		BizJet
	All Tanks	CWT Only	All Tanks	CWT Only	All Tanks	CWT Only	All Tanks	All Tanks	CWT Only	All Tanks
Main Parts										
Compressor, cooling & start system	51.9	32.1	28.8	19.0	15.7	15.7	9.2	15.7	9.2	12.5
Heat exchanger	8.6	4.8	4.8	1.8	2.1	2.1	0.6	1.8	0.6	1.1
Cooling fan & ram ducts assembly	8.9	6.0	5.3	6.5	3.8	3.8	0.6	4.1	0.6	2.4
Air separation module	260.0	160.0	140.0	80.0	60.0	60.0	20.0	60.0	20.0	40.0
Main Parts Sub-Total	329.4	202.9	178.9	107.3	81.6	81.6	30.4	81.6	30.4	56.0
Other Parts										
Compressor inlet air filter assy	6.0	4.0	4.0	4.0	4.0	4.0	4.0	4.0	4.0	4.0
Compressor inlet air filter element	0.0	0.0	0.0	0.0	0.0	0.0	0.0	0.0	0.0	0.0
Compressor discharge check valve	1.5	1.5	1.3	1.2	1.0	1.0	0.8	1.2	1.0	1.5
Compressor unloading valve	3.0	3.0	3.0	3.0	2.0	2.0	2.0	2.2	2.0	2.5
Bleed Air shutoff valve	3.5	3.5	3.0	3.0	2.5	2.5	2.5	2.8	2.5	2.5
Heat Exchanger bypass valve	1.2	1.2	1.0	1.0	0.8	0.8	0.7	0.8	0.8	1.0
Temperature sensor & controller	0.3	0.3	0.3	0.3	0.3	0.3	0.3	0.3	0.3	0.3
Water separator/filter assy	10.0	7.0	7.0	7.0	7.0	7.0	7.0	7.0	7.0	7.0
Water separator/filter element	0.0	0.0	0.0	0.0	0.0	0.0	0.0	0.0	0.0	0.0
ASM check valve & restrictor assy	0.5	0.5	0.5	0.5	0.5	0.5	0.5	0.5	0.5	0.5
Relief valve	1.9	1.9	1.5	1.5	0.8	1.0	0.8	1.0	1.2	1.5
Fuel tank check valve	1.8	1.8	1.8	1.8	1.8	1.8	1.8	1.8	1.8	1.8
Controller / control card	5.5	5.5	5.5	5.5	5.5	5.5	5.5	5.5	5.5	5.5
Ducting	178.2	44.2	115.8	30.4	52.5	16.8	38.1	38.1	9.5	38.1
Wiring	15.0	15.0	15.0	15.0	15.0	15.0	15.0	15.0	15.0	15.0
Bleed Orifice & Duct	3.0	3.0	3.0	3.0	3.0	3.0	3.0	3.0	3.0	3.0
Compressor Wiring	236.2	118.1	58.7	34.8	15.4	15.4	3.3	12.8	4.1	4.1
Installation Hardware	116.6	62.0	60.0	32.9	29.1	23.7	17.3	26.6	13.3	21.6
Structural Modifications	100.0	100.0	50.0	50.0	20.0	20.0	10.0	10.0	10.0	10.0
Other Parts Sub-Total	684.1	372.4	331.3	194.9	161.1	120.3	112.6	132.6	81.4	119.9
System Totals	1013.5	575.3	510.2	302.2	242.8	201.9	143.0	214.3	111.8	175.9
Oxygen sensor	1.5	1.5	1.5	1.5	1.5	1.5	1.5	1.5	1.5	1.5

Figure 2.7-1. Summary of Hybrid OBGIS Component Weights – Membrane Systems

Onboard Inerting Designs Task Team Final Report

Weight Summary Table - PSA Systems (Lbs.)										
Component	Large Transport		Medium Transport		Small Transport		Turbo Prop	Turbo Fan		BizJet
	All Tanks	CWT Only	All Tanks	CWT Only	All Tanks	CWT Only	All Tanks	All Tanks	CWT Only	All Tanks
Main Parts										
Compressor, cooling & start system	119.0	72.4	72.8	41.8	27.5	26.5	11.1	30.0	12.7	19.0
Heat exchanger	23.0	32.5	16.6	19.3	13.4	9.6	3.2	14.3	4.3	6.9
Cooling fan & ram ducts assembly	54.8	13.2	29.4	8.1	5.4	8.5	5.4	6.0	5.3	6.5
Air separation module	541.0	312.0	309.0	180.0	114.0	110.0	43.0	127.0	50.0	76.0
Main Parts Sub-Total	737.8	430.1	427.9	249.2	160.3	154.7	62.7	177.3	72.3	108.4
Other Parts										
Compressor inlet air filter assy	11.0	8.0	8.0	6.0	4.0	4.0	4.0	4.0	4.0	4.0
Compressor inlet air filter element	0.0	0.0	0.0	0.0	0.0	0.0	0.0	0.0	0.0	0.0
Compressor discharge check valve	2.0	2.0	2.0	1.5	1.0	1.0	0.8	1.2	1.0	1.5
Compressor unloading valve	3.0	3.0	3.0	2.5	2.0	2.0	2.0	2.2	2.0	2.5
Bleed Air shutoff valve	4.0	4.0	4.0	3.0	2.5	2.5	2.5	2.8	2.5	2.5
Heat Exchanger bypass valve	1.2	1.2	1.2	1.2	0.8	0.8	0.7	0.8	0.8	1.2
Temperature sensor & controller	0.3	0.3	0.3	0.3	0.3	0.3	0.3	0.3	0.3	0.3
Water separator/filter assy	18.0	13.0	13.0	10.0	7.0	7.0	7.0	7.0	7.0	7.0
Water separator/filter element	0.0	0.0	0.0	0.0	0.0	0.0	0.0	0.0	0.0	0.0
Relief valve	1.9	1.9	1.9	1.5	0.8	1.0	0.8	1.0	1.2	1.5
ASM check valve & restrictor assy	0.5	0.5	0.5	0.5	0.5	0.5	0.5	0.5	0.5	0.5
Fuel tank check valve	2.5	2.5	2.5	2.5	2.5	2.5	2.5	2.5	2.5	2.5
Controller / control card	5.5	5.5	5.5	5.5	5.5	5.5	5.5	5.5	5.5	5.5
Ducting	178.2	44.2	115.8	30.4	52.5	16.8	38.1	38.1	9.5	38.1
Wiring	15.0	15.0	15.0	15.0	15.0	15.0	15.0	15.0	15.0	15.0
Bleed Orifice & Duct	3.0	3.0	3.0	3.0	3.0	3.0	3.0	3.0	3.0	3.0
Compressor Wiring	472.3	236.2	177.1	88.6	23.2	23.2	7.8	19.4	6.5	12.8
Installation Hardware	218.4	115.6	117.1	63.1	42.1	36.0	23.0	42.1	20.0	31.0
Structural Modifications	100.0	100.0	50.0	50.0	20.0	20.0	10.0	10.0	10.0	10.0
Other Parts Sub-Total	1036.9	542.8	506.9	274.6	175.8	134.1	116.6	147.9	84.3	130.9
System Totals	1774.6	973.0	934.8	523.7	336.0	288.8	179.3	325.2	156.6	239.3
Oxygen sensor	1.5	1.5	1.5	1.5	1.5	1.5	1.5	1.5	1.5	1.5

Figure 2.7-2. Summary of OBGIS Component Weights – PSA Systems

2.7.1 Air Separation Modules

Permeable membrane. The hollow fiber membrane module construction is identical to that of the baseline OBGI system, as described in Section 1. The ASM weight includes the hollow fiber membrane module, the inlet/outlet headers and the connections to the NEA, feed air manifolds/tubing. The NEA flow rate for each of the different aircraft sizes and tank volumes determined the total number of a standard size ASM's required to meet the flow requirements.

PSA. The PSA air separator calculations were made empirically based on an existing production OBIGGS air separator. The methodology for the use of these data is identical to that of the baseline OBGI system, as detailed in Section 1 of this report.

The weight of the molecular sieve needed to produce the gas was similarly scaled upward or downward based on NEA flow. The structural weight (such as the mounting structure and sieve containers) was also scaled upward or downward, although some economies of scaling were assumed, similar to the relationship observed between various existing PSA units.

2.7.2 Compressor

The compressor was sized by vendors of existing aircraft and ground-based compressors. The compressor for each aircraft model was sized in a manner that is identical to that of the baseline OBGI system, as detailed in Section 1.

As with the baseline OBGI system, the compressor weight includes the rotating group and housing, integral fan cooling, lubrication system, connections to the mating tubing, and start contactor when applicable (larger aircraft types). Ducting which interfaces with the aircraft structure or plumbing was accounted for separately.

2.7.3 Heat Exchanger/Cooling Fan

The heat exchanger and cooling fan were sized by vendors of existing aircraft heat exchangers and cooling fans. The heat exchangers and cooling fans for each aircraft model were sized in a manner that is identical to that of the baseline OBGI system, as detailed in Section 1.

Heat exchanger weight includes the core, inlet/outlet headers, and connections to the mating tubing. The weight of the cooling fan includes the fan and any ducting between the fan and the heat exchanger. Ducting which interfaces with the aircraft structure or plumbing was accounted for separately.

2.7.4 Other Components

The weight of the other components in the system was mainly dependent on the required airflow or NEA flow. The higher flows associated with the larger aircraft demand components that are larger than those used in the smaller aircraft applications. The weight of filters, system valves, ducting, tube supports and brackets and the power cable was computed in a manner identical to that of the baseline OBGI system, as detailed in Section 1.

2.8 VOLUME

Figures 2.8-1 and 2.8-2 summarize the volume data developed by the Onboard Design Task Team for the membrane and PSA hybrid OBGI systems for each of the ARAC generic aircraft. Each table provides the total volume for the "major" and "other" components identified for each system. "Other" components include such items as wiring, ducting and valves, and their total estimated volumes have been combined.

Onboard Inerting Designs Task Team Final Report

Volume Summary Table - Membrane Systems (Cu Ft)										
Component	Large Transport		Medium Transport		Small Transport		Turbo Prop	Turbo Fan		BizJet
	All Tanks	CWT Only	All Tanks	CWT Only	All Tanks	CWT Only	All Tanks	All Tanks	CWT Only	All Tanks
Main Parts										
Compressor, cooling & start system	0.88	0.55	0.49	0.29	0.23	0.23	0.10	0.23	0.10	0.16
Heat exchanger & Fan	0.41	0.25	0.22	0.15	0.11	0.11	0.03	0.11	0.03	0.07
Air separation module	11.29	6.95	6.08	6.95	2.61	2.61	0.87	2.61	0.87	1.74
Main Parts Sub-Total	12.6	7.8	6.8	7.4	2.9	2.9	1.0	2.9	1.0	2.0
Other Parts Sub-Total	29.25	17.80	15.87	10.12	8.18	8.18	4.29	8.18	4.29	6.24
System Totals	41.8	25.5	22.7	17.5	11.1	11.1	5.3	11.1	5.3	8.2

Figure 2.8-1. Summary of Hybrid OBGI Component Volumes – Membrane Systems

Volume Summary Table - PSA Systems (Cu Ft)										
Component	Large Transport		Medium Transport		Small Transport		Turbo Prop	Turbo Fan		BizJet
	All Tanks	CWT Only	All Tanks	CWT Only	All Tanks	CWT Only	All Tanks	All Tanks	CWT Only	All Tanks
Main Parts										
Compressor, cooling & start system	2.14	1.29	1.29	0.74	0.46	0.44	0.14	0.51	0.17	0.29
Heat exchanger & Fan	2.62	1.53	1.54	0.83	0.50	0.48	0.16	0.56	0.18	0.30
Air separation module	20.70	12.40	12.50	12.40	4.20	4.10	1.00	4.70	1.30	2.60
Main Parts Sub-Total	25.5	15.2	15.3	14.0	5.2	5.0	1.3	5.8	1.6	3.2
Other Parts Sub-Total	63.95	38.10	38.34	21.23	12.62	12.33	4.88	13.83	5.60	8.68
System Totals	89.4	53.3	53.7	35.2	17.8	17.3	6.2	19.6	7.2	11.9

Figure 2.8-2. Summary of Hybrid OBGIS Component Volumes – PSA Systems

2.8.1 Air Separation Modules

Permeable membrane. The volume of the proposed air separation module includes the Hollow Fiber Membrane Module, the inlet/outlet headers and the connections to the NEA and Feed air manifolds/tubing. The methodology for the volume computation is identical to that of the baseline OBGI System, as detailed in Section 1 of this report.

PSA. The hybrid OBGI system PSA air separator volume calculations were made empirically. This was done in a manner that was identical to that of the baseline OBGI system, as detailed in Section 1 of this report. The result of this was the amount of sieve needed to produce the product gas for the system. The volume of PSA air separator was similarly scaled upward or downward based on the projected quantity of molecular sieve needed.

2.8.2 Compressor

The compressor volume was determined for each of the aircraft and system types. The compressor volume was derived in a manner that is identical to that of the baseline OBGI system, as detailed in Section 1.

As with the baseline OBGI system, the compressor volume includes the rotating group and housing, integral fan cooling, lubrication system, connections to the mating tubing, and start contactor when applicable (larger aircraft types).

2.8.3 Heat Exchanger/Cooling Fan

Heat exchanger and cooling fan volumes were determined for each of the aircraft and system types. Heat exchanger volume includes the core, inlet/outlet headers, and connections to the mating tubing. The volume of the cooling fan includes the fan and any ducting between the fan and the heat exchanger.

2.8.4 Other Components

In a manner similar to that of the weight, component volumes were individually computed as a function of airflow, NEA flow and power. The majority of component volumes were scaled or derived from existing components for similar applications on aircraft. The methodology for this is identical to that of the baseline OBGI system, as detailed in Section 1 of this report

2.9 ELECTRICAL POWER

Figures 2.9-1 and 2.9-2 summarize the electrical power data developed by the Onboard Design Task Team for the membrane and PSA hybrid OBGI systems for each of the ARAC generic aircraft. Each table provides the total electrical power for the “major” and “other” components identified for each system. “Other” components include such items as wiring, motors and valves, and their total estimated electrical powers have been combined.

Onboard Inerting Designs Task Team Final Report

Electrical Power Summary Table - Membrane Systems (kVa)										
Component	Large Transport		Medium Transport		Small Transport		Turbo Prop	Turbo Fan		BizJet
	All Tanks	CWT Only	All Tanks	CWT Only	All Tanks	CWT Only	All Tanks	All Tanks	CWT Only	All Tanks
Main Parts										
Compressor, cooling & start system	46.48	28.24	24.71	14.10	10.54	10.54	3.49	10.54	3.49	7.00
Heat exchanger & Fan	0.54	0.33	0.31	0.25	0.17	0.17	0.00	0.17	0.00	0.08
Air separation module	0.00	0.00	0.00	0.00	0.00	0.00	0.00	0.00	0.00	0.00
Main Parts Sub-Total	47.0	28.6	25.0	14.3	10.7	10.7	3.5	10.7	3.5	7.1
Other Parts Sub-Total	0.10	0.10	0.10	0.10	0.10	0.10	0.10	0.10	0.10	0.10
System Totals	47.1	28.7	25.1	14.4	10.8	10.8	3.6	10.8	3.6	7.2

Figure 2.9-1. Summary of Hybrid OBGIS Component Power Consumption – Membrane Systems

Electrical Power Summary Table - PSA Systems (kVa)										
Component	Large Transport		Medium Transport		Small Transport		Turbo Prop	Turbo Fan		BizJet
	All Tanks	CWT Only	All Tanks	CWT Only	All Tanks	CWT Only	All Tanks	All Tanks	CWT Only	All Tanks
Main Parts										
Compressor, cooling & start system	115.98	68.70	69.17	38.78	23.30	22.22	5.51	25.97	7.31	14.11
Heat exchanger & Fan	8.19	3.56	3.63	0.51	0.34	0.34	0.22	0.34	0.26	0.34
Air separation module	0.95	0.57	0.57	0.57	0.19	0.19	0.00	0.22	0.06	0.12
Main Parts Sub-Total	125.1	72.8	73.4	39.9	23.8	22.8	5.7	26.5	7.6	14.6
Other Parts Sub-Total	0.10	0.10	0.10	0.10	0.10	0.10	0.00	0.10	0.10	0.10
System Totals	125.2	72.9	73.5	40.0	23.9	22.9	5.7	26.6	7.7	14.7

Figure 2.9-2. Summary of Hybrid OBGI Component Power Consumption – PSA Systems

2.9.1 Air Separation Modules

Permeable membrane. As with the baseline OBGI system, the membrane air separator consumes no power.

PSA. The PSA power consumption projections were made empirically. The methodology for this is identical to that of the baseline OBGI system, as detailed in Section 1 of this report. The power consumption for the PSA air separator was scaled upward or downward based on the projected quantity of molecular sieve needed. Power consumption numbers are relatively low, since the mechanism to operate the PSA distribution valve is pneumatic.

2.9.2 Compressor

The compressor power was determined for each of the aircraft and system types. The compressor power was derived in a manner that is identical to that of the baseline OBGI system, as detailed in Section 1.

As with the baseline OBGI system, the compressor power includes the power for the rotating group, integral fan cooling, and lubrication system. For the larger aircraft types, multiple compressor assemblies were necessary to provide the required amount of airflow. The larger compressors also required start contactors to reduce the peak power draw on start-up.

2.9.3 Heat Exchanger/Cooling Fan

Heat exchanger and cooling fan power were determined for each of the aircraft and system types. The heat exchanger requires no power to operate. The cooling fan power requirement was determined based on the cooling air flow rate and pressure rise requirements in a manner identical to that of the baseline OBGI system, as detailed in Section 1 of this report.

2.9.4 Other Components

The power consumption of the other system components are minimal compared with that of the compressor. The only units that consume power are the valves; most of the time they are dormant and consume no power. The methodology for this is identical to that of the baseline OBGI system, as detailed in Section 1 of this report.

2.10 RELIABILITY

Figures 2.10-1 through 2.10-4 summarize the reliability data in terms of mean-time-between-maintenance-actions (MTBMA) and mean-time-between-failure (MTBF), as developed by the Onboard Design Task Team for the membrane and PSA hybrid OBGI systems for each of the ARAC generic aircraft. Each table provides the reliability for the “major” and “other” components identified for each system. “Other” components include such items as wiring, motors and valves, and their total estimated reliability have been combined. The Airplane Operations and Maintenance Team used this data as a starting point for the system level reliability estimates.

Onboard Inerting Designs Task Team Final Report

Reliability Summary Table - Membrane Systems MTBMA (Hrs)										
Component	Large Transport		Medium Transport		Small Transport		Turbo Prop	Turbo Fan		BizJet
	All Tanks	CWT Only	All Tanks	CWT Only	All Tanks	CWT Only	All Tanks	All Tanks	CWT Only	All Tanks
Main Parts										
Compressor, cooling & start system	7,000	7,000	7,000	7,000	7,000	7,000	7,000	7,000	7,000	7,000
Heat exchanger	100,000	100,000	100,000	100,000	100,000	100,000	100,000	100,000	100,000	100,000
Cooling fan & ram ducts assembly	25,000	25,000	25,000	25,000	25,000	25,000	25,000	25,000	25,000	25,000
Air separation module	20,000	20,000	20,000	20,000	20,000	20,000	20,000	20,000	20,000	20,000
Other Parts										
Compressor inlet air filter assy	100,000	100,000	100,000	100,000	100,000	100,000	100,000	100,000	100,000	100,000
Compressor inlet air filter element	4,000	4,000	4,000	4,000	4,000	4,000	4,000	4,000	4,000	4,000
Compressor discharge check valve	100,000	100,000	100,000	100,000	100,000	100,000	100,000	100,000	100,000	100,000
Compressor unloading valve	50,000	50,000	50,000	50,000	50,000	50,000	50,000	50,000	50,000	50,000
Bleed Air shutoff valve	50,000	50,000	50,000	50,000	50,000	50,000	50,000	50,000	50,000	50,000
Heat Exchanger bypass valve	50,000	50,000	50,000	50,000	50,000	50,000	50,000	50,000	50,000	50,000
Temperature sensor & controller	50,000	50,000	50,000	50,000	50,000	50,000	50,000	50,000	50,000	50,000
Water separator/filter assy	100,000	100,000	100,000	100,000	100,000	100,000	100,000	100,000	100,000	100,000
Water separator/filter element	4,000	4,000	4,000	4,000	4,000	4,000	4,000	4,000	4,000	4,000
ASM check valve & restrictor assy	100,000	100,000	100,000	100,000	100,000	100,000	100,000	100,000	100,000	100,000
Relief valve	50,000	50,000	50,000	50,000	50,000	50,000	50,000	50,000	50,000	50,000
Fuel tank check valve	100,000	100,000	100,000	100,000	100,000	100,000	100,000	100,000	100,000	100,000
Controller / control card	10,000	10,000	10,000	10,000	10,000	10,000	10,000	10,000	10,000	10,000
Ducting	10,000,000	10,000,000	10,000,000	10,000,000	10,000,000	10,000,000	10,000,000	10,000,000	10,000,000	10,000,000
Wiring	10,000,000	10,000,000	10,000,000	10,000,000	10,000,000	10,000,000	10,000,000	10,000,000	10,000,000	10,000,000
Bleed Orifice & Duct	10,000,000	10,000,000	10,000,000	10,000,000	10,000,000	10,000,000	10,000,000	10,000,000	10,000,000	10,000,000
Compressor Wiring	10,000,000	10,000,000	10,000,000	10,000,000	10,000,000	10,000,000	10,000,000	10,000,000	10,000,000	10,000,000
Installation Hardware	10,000,000	10,000,000	10,000,000	10,000,000	10,000,000	10,000,000	10,000,000	10,000,000	10,000,000	10,000,000
Structural Modifications	10,000,000	10,000,000	10,000,000	10,000,000	10,000,000	10,000,000	10,000,000	10,000,000	10,000,000	10,000,000
Oxygen sensor	26,933	26,933	26,933	26,933	26,933	26,933	26,933	26,933	26,933	26,933

Figure 2.10-1. Summary of Hybrid OBGI MTBMA – Membrane Systems

Onboard Inerting Designs Task Team Final Report

Reliability Summary Table - PSA Systems MTBMA (Hrs)										
Component	Large Transport		Medium Transport		Small Transport		Turbo Prop	Turbo Fan		BizJet
	All Tanks	CWT Only	All Tanks	CWT Only	All Tanks	CWT Only	All Tanks	All Tanks	CWT Only	All Tanks
Main Parts										
Compressor, cooling & start system	7,000	7,000	7,000	7,000	7,000	7,000	7,000	7,000	7,000	7,000
Heat exchanger	100,000	100,000	100,000	100,000	100,000	100,000	100,000	100,000	100,000	100,000
Cooling fan & ram ducts assembly	25,000	25,000	25,000	25,000	25,000	25,000	25,000	25,000	25,000	25,000
Air separation module	8,000	8,000	8,000	8,000	8,000	8,000	8,000	8,000	8,000	8,000
Other Parts										
Compressor inlet air filter assy	100,000	100,000	100,000	100,000	100,000	100,000	100,000	100,000	100,000	100,000
Compressor inlet air filter element	4,000	4,000	4,000	4,000	4,000	4,000	4,000	4,000	4,000	4,000
Compressor discharge check valve	100,000	100,000	100,000	100,000	100,000	100,000	100,000	100,000	100,000	100,000
Compressor unloading valve	50,000	50,000	50,000	50,000	50,000	50,000	50,000	50,000	50,000	50,000
Bleed Air shutoff valve	50,000	50,000	50,000	50,000	50,000	50,000	50,000	50,000	50,000	50,000
Heat Exchanger bypass valve	50,000	50,000	50,000	50,000	50,000	50,000	50,000	50,000	50,000	50,000
Temperature sensor & controller	50,000	50,000	50,000	50,000	50,000	50,000	50,000	50,000	50,000	50,000
Water separator/filter assy	100,000	100,000	100,000	100,000	100,000	100,000	100,000	100,000	100,000	100,000
Water separator/filter element	4,000	4,000	4,000	4,000	4,000	4,000	4,000	4,000	4,000	4,000
ASM check valve & restrictor assy	50,000	50,000	50,000	50,000	50,000	50,000	50,000	50,000	50,000	50,000
Relief valve	50,000	50,000	50,000	50,000	50,000	50,000	50,000	50,000	50,000	50,000
Fuel tank check valve	100,000	100,000	100,000	100,000	100,000	100,000	100,000	100,000	100,000	100,000
Controller / control card	10,000	10,000	10,000	10,000	10,000	10,000	10,000	10,000	10,000	10,000
Ducting	10,000,000	10,000,000	10,000,000	10,000,000	10,000,000	10,000,000	10,000,000	10,000,000	10,000,000	10,000,000
Wiring	10,000,000	10,000,000	10,000,000	10,000,000	10,000,000	10,000,000	10,000,000	10,000,000	10,000,000	10,000,000
Bleed Orifice & Duct	10,000,000	10,000,000	10,000,000	10,000,000	10,000,000	10,000,000	10,000,000	10,000,000	10,000,000	10,000,000
Compressor Wiring	10,000,000	10,000,000	10,000,000	10,000,000	10,000,000	10,000,000	10,000,000	10,000,000	10,000,000	10,000,000
Installation Hardware	10,000,000	10,000,000	10,000,000	10,000,000	10,000,000	10,000,000	10,000,000	10,000,000	10,000,000	10,000,000
Structual Modifications	10,000,000	10,000,000	10,000,000	10,000,000	10,000,000	10,000,000	10,000,000	10,000,000	10,000,000	10,000,000
Oxygen sensor	26,933	26,933	26,933	26,933	26,933	26,933	26,933	26,933	26,933	26,933

Figure 2.10-2. Summary of Hybrid OBGI MTBMA – PSA Systems

Onboard Inerting Designs Task Team Final Report

Reliability Summary Table - Membrane Systems MTBF (Hrs)										
Component	Large Transport		Medium Transport		Small Transport		Turbo Prop	Turbo Fan		BizJet
	All Tanks	CWT Only	All Tanks	CWT Only	All Tanks	CWT Only	All Tanks	All Tanks	CWT Only	All Tanks
Main Parts										
Compressor, cooling & start system	100,000	100,000	100,000	100,000	100,000	100,000	100,000	100,000	100,000	100,000
Heat exchanger	100,000	100,000	100,000	100,000	100,000	100,000	100,000	100,000	100,000	100,000
Cooling fan & ram ducts assembly	25,000	25,000	25,000	25,000	25,000	25,000	25,000	25,000	25,000	25,000
Air separation module	20,000	20,000	20,000	20,000	20,000	20,000	20,000	20,000	20,000	20,000
Other Parts										
Compressor inlet air filter assy	100,000	100,000	100,000	100,000	100,000	100,000	100,000	100,000	100,000	100,000
Compressor inlet air filter element	100,000	100,000	100,000	100,000	100,000	100,000	100,000	100,000	100,000	100,000
Compressor discharge check valve	100,000	100,000	100,000	100,000	100,000	100,000	100,000	100,000	100,000	100,000
Compressor unloading valve	50,000	50,000	50,000	50,000	50,000	50,000	50,000	50,000	50,000	50,000
Bleed Air shutoff valve	50,000	50,000	50,000	50,000	50,000	50,000	50,000	50,000	50,000	50,000
Heat Exchanger bypass valve	50,000	50,000	50,000	50,000	50,000	50,000	50,000	50,000	50,000	50,000
Temperature sensor & controller	50,000	50,000	50,000	50,000	50,000	50,000	50,000	50,000	50,000	50,000
Water separator/filter assy	100,000	100,000	100,000	100,000	100,000	100,000	100,000	100,000	100,000	100,000
Water separator/filter element	100,000	100,000	100,000	100,000	100,000	100,000	100,000	100,000	100,000	100,000
ASM check valve & restrictor assy	100,000	100,000	100,000	100,000	100,000	100,000	100,000	100,000	100,000	100,000
Relief valve	50,000	50,000	50,000	50,000	50,000	50,000	50,000	50,000	50,000	50,000
Fuel tank check valve	100,000	100,000	100,000	100,000	100,000	100,000	100,000	100,000	100,000	100,000
Controller / control card	10,000	10,000	10,000	10,000	10,000	10,000	10,000	10,000	10,000	10,000
Ducting	10,000,000	10,000,000	10,000,000	10,000,000	10,000,000	10,000,000	10,000,000	10,000,000	10,000,000	10,000,000
Wiring	10,000,000	10,000,000	10,000,000	10,000,000	10,000,000	10,000,000	10,000,000	10,000,000	10,000,000	10,000,000
Bleed Orifice & Duct	10,000,000	10,000,000	10,000,000	10,000,000	10,000,000	10,000,000	10,000,000	10,000,000	10,000,000	10,000,000
Compressor Wiring	10,000,000	10,000,000	10,000,000	10,000,000	10,000,000	10,000,000	10,000,000	10,000,000	10,000,000	10,000,000
Installation Hardware	10,000,000	10,000,000	10,000,000	10,000,000	10,000,000	10,000,000	10,000,000	10,000,000	10,000,000	10,000,000
Structural Modifications	10,000,000	10,000,000	10,000,000	10,000,000	10,000,000	10,000,000	10,000,000	10,000,000	10,000,000	10,000,000
Oxygen sensor	26,933	26,933	26,933	26,933	26,933	26,933	26,933	26,933	26,933	26,933

Figure 2.10-3. Summary of Hybrid OBG I MTBF – Membrane Systems

Onboard Inerting Designs Task Team Final Report

Reliability Summary Table - PSA Systems MTBF (Hrs)										
Component	Large Transport		Medium Transport		Small Transport		Turbo Prop	Turbo Fan		BizJet
	All Tanks	CWT Only	All Tanks	CWT Only	All Tanks	CWT Only	All Tanks	All Tanks	CWT Only	All Tanks
Main Parts										
Compressor, cooling & start system	100,000	100,000	100,000	100,000	100,000	100,000	100,000	100,000	100,000	100,000
Heat exchanger	100,000	100,000	100,000	100,000	100,000	100,000	100,000	100,000	100,000	100,000
Cooling fan & ram ducts assembly	25,000	25,000	25,000	25,000	25,000	25,000	25,000	25,000	25,000	25,000
Air separation module	34,000	34,000	34,000	34,000	34,000	34,000	34,000	34,000	34,000	34,000
Other Parts										
Compressor inlet air filter assy	100,000	100,000	100,000	100,000	100,000	100,000	100,000	100,000	100,000	100,000
Compressor inlet air filter element	100,000	100,000	100,000	100,000	100,000	100,000	100,000	100,000	100,000	100,000
Compressor discharge check valve	100,000	100,000	100,000	100,000	100,000	100,000	100,000	100,000	100,000	100,000
Compressor unloading valve	50,000	50,000	50,000	50,000	50,000	50,000	50,000	50,000	50,000	50,000
Bleed Air shutoff valve	50,000	50,000	50,000	50,000	50,000	50,000	50,000	50,000	50,000	50,000
Heat Exchanger bypass valve	50,000	50,000	50,000	50,000	50,000	50,000	50,000	50,000	50,000	50,000
Temperature sensor & controller	50,000	50,000	50,000	50,000	50,000	50,000	50,000	50,000	50,000	50,000
Water separator/filter assy	100,000	100,000	100,000	100,000	100,000	100,000	100,000	100,000	100,000	100,000
Water separator/filter element	100,000	100,000	100,000	100,000	100,000	100,000	100,000	100,000	100,000	100,000
ASM check valve & restrictor assy	50,000	50,000	50,000	50,000	50,000	50,000	50,000	50,000	50,000	50,000
Relief valve	50,000	50,000	50,000	50,000	50,000	50,000	50,000	50,000	50,000	50,000
Fuel tank check valve	100,000	100,000	100,000	100,000	100,000	100,000	100,000	100,000	100,000	100,000
Controller / control card	10,000	10,000	10,000	10,000	10,000	10,000	10,000	10,000	10,000	10,000
Ducting	10,000,000	10,000,000	10,000,000	10,000,000	10,000,000	10,000,000	10,000,000	10,000,000	10,000,000	10,000,000
Wiring	10,000,000	10,000,000	10,000,000	10,000,000	10,000,000	10,000,000	10,000,000	10,000,000	10,000,000	10,000,000
Bleed Orifice & Duct	10,000,000	10,000,000	10,000,000	10,000,000	10,000,000	10,000,000	10,000,000	10,000,000	10,000,000	10,000,000
Compressor Wiring	10,000,000	10,000,000	10,000,000	10,000,000	10,000,000	10,000,000	10,000,000	10,000,000	10,000,000	10,000,000
Installation Hardware	10,000,000	10,000,000	10,000,000	10,000,000	10,000,000	10,000,000	10,000,000	10,000,000	10,000,000	10,000,000
Structural Modifications	10,000,000	10,000,000	10,000,000	10,000,000	10,000,000	10,000,000	10,000,000	10,000,000	10,000,000	10,000,000
Oxygen sensor	26,933	26,933	26,933	26,933	26,933	26,933	26,933	26,933	26,933	26,933

Figure 2.10-4. Summary of Hybrid OBGI MTBF – PSA Systems

Onboard Inerting Designs Task Team Final Report

2.10.1 Air Separation Modules

Reliability figures for two ASM technologies were developed for hybrid OBGI Systems: membrane, PSA.

Membranes. As with the basic hybrid OBGI system, membrane system reliability was based on all major and minor components needed for a standard membrane unit. The membrane module, as defined by the ARAC Onboard Design Team consists of a membrane module contained in a metal housing.

PSA. As with the basic hybrid OBGI system, the PSA hardware, as defined by the ARAC Onboard Design Team consists of a distribution valve that is pilot operated by relatively small pneumatic valves and controlled by a timing circuit, air and product manifolds, molecular sieve beds, and purge orifices. The distribution valve assembly contains two parts that are subject to wear, which should be serviced at 6000 to 8000 hour intervals. The MTBF estimate for the PSA separator in the summary table is based on a scheduled overhaul every 8000 hours.

2.10.2 Compressor

The compressor reliability for screw-type units is based on a recommended service interval of 7000 hours. The centrifugal compressors used different bearing technology which do not require periodic servicing. As with the baseline OBGI system described in Section 1, the reliability figures included in the referenced table were provided by vendors of existing flight and ground-based equipment

2.10.3 Heat Exchanger

The heat exchanger reliability values are based on commercial aircraft heat exchanger experience, provided by vendors of existing flight-worthy equipment.

2.10.4 Other Components

As with the baseline OBGI system described in Section 1 of this report, the Team estimated the reliability of the other components based on their experience with similar existing ECS and fuel system components. Common reliability estimates were used when the same components were used in different systems, so that fair comparisons could be made between technologies and concepts.

2.11 COST

The On-Board Design Task Team estimated the initial acquisition costs for the membrane and PSA hybrid OBGI systems for each of the ARAC generic aircraft. Design and certification, operations, maintenance, and installation costs for the hybrid OBGI systems are described later in this section. Inclusion of those costs to determine hybrid OBGIS cost benefit was performed by the Estimating and Forecasting (E&F) Team and is described in their final report.

2.11.1 Acquisition Cost

Figures 2.11.1-1 and 2.11.1-2 summarize the hybrid OBGIS costs developed by the On-Board Design Task Team for the membrane and PSA inerting systems, respectively, for each of the ARAC generic aircraft. Figure 2.11.1-3 compares total OBGI system costs to hybrid OBGI system costs. Each table provides the total cost for the individual components identified for each system. Except for the regional turboprop and business jet aircraft, two sets of costs are provided for each ARAC generic aircraft, one for inerting all tanks and another for inerting center wing tanks (CWT) only. Common costs were applied for similar components across both OBGI systems and hybrid OBGI systems. The estimated component costs include the amortized non-recurring development costs. Several component costs were also integrated into the cost for the next higher assembly similar to same components used in OBGI systems.

The team also separately estimated the cost for an on-board oxygen sensor, though this cost was not included in the system totals.

Onboard Inerting Designs Task Team Final Report

Cost Summary Table - Membrane Systems (\$)										
Component	Large Transport		Medium Transport		Small Transport		Turbo Prop	Turbo Fan		BizJet
	All Tanks	CWT Only	All Tanks	CWT Only	All Tanks	CWT Only	All Tanks	All Tanks	CWT Only	All Tanks
Main Parts										
Compressor, cooling & start system	14845	7621	7481	7061	6920	6920	6640	6920	6640	6780
Heat exchanger	6476	4001	3931	3632	2673	2673	2668	2892	2668	2989
Cooling fan & ram ducts assembly	1949	2168	2168	1949	2168	2168	693	1949	693	1112
Air separation module	81380	50080	43820	25040	18780	18780	6260	18780	6260	12520
Main Parts Sub-Total	104650	63869	57400	37681	30541	30541	16261	30541	16261	23401
Other Parts										
Compressor inlet air filter assy	350	350	350	350	350	350	350	350	350	350
Compressor inlet air filter element	0	0	0	0	0	0	0	0	0	0
Compressor discharge check valve	475	475	425	425	275	300	250	400	300	475
Compressor unloading valve	1560	1560	1560	1560	1350	1300	1250	1450	1450	1560
Bleed Air shutoff valve	1250	1250	1250	1250	1100	1150	1100	1250	1250	1250
Heat Exchanger bypass valve	2000	2000	2000	2000	2000	2000	2000	2000	2000	2000
Temperature sensor & controller	2000	2000	2000	2000	2000	2000	2000	2000	2000	2000
Water separator/filter assy	5000	5000	5000	5000	5000	5000	5000	5000	5000	5000
Water separator/filter element	0	0	0	0	0	0	0	0	0	0
ASM check valve & restrictor assy	185	185	185	185	185	185	185	185	185	185
Relief valve	680	680	580	500	450	500	450	500	500	550
Fuel tank check valve	675	675	675	675	675	675	675	675	675	675
Controller / control card	40000	40000	40000	40000	40000	40000	40000	40000	40000	40000
Ducting	35640	8840	23160	6080	10500	3360	7620	7620	1900	7620
Wiring	750	750	750	750	750	750	750	750	750	750
Bleed Orifice & Duct	300	300	300	300	300	300	300	300	300	300
Compressor Wiring	4471	2236	811	541	310	310	64	259	75	75
Installation Hardware	5828	3100	3002	1645	1453	1187	867	1332	664	1082
Structual Modifications	2000	2000	1000	1000	400	400	200	200	200	200
Other Parts Sub-Total	103165	71400	83047	64261	67098	59767	63061	64271	57599	64072
System Totals	207815	135270	140448	101943	97639	90307	79323	94811	73861	87473
Oxygen sensor	6000	6000	6000	6000	6000	6000	6000	6000	6000	6000

Figure 2.11.1-1. Summary of Hybrid OBGI Costs – Membrane Systems

Onboard Inerting Designs Task Team Final Report

Cost Summary Table - PSA Systems (\$)										
Component	Large Transport		Medium Transport		Small Transport		Turbo Prop	Turbo Fan		BizJet
	All Tanks	CWT Only	All Tanks	CWT Only	All Tanks	CWT Only	All Tanks	All Tanks	CWT Only	All Tanks
Main Parts										
Compressor, cooling & start system	24101	20237	15744	8038	7425	7383	6720	7531	6792	7061
Heat exchanger	48756	29108	29380	16292	8480	8879	3347	10351	3744	5880
Cooling fan & ram ducts assembly	7879	4847	4804	2255	3340	2498	1970	2577	1989	2130
Air separation module	61000	38000	40000	27000	17000	17000	12000	23000	14000	17000
Main Parts Sub-Total	141736	92193	89928	53585	36245	35760	24037	43459	26524	32071
Other Parts										
Compressor inlet air filter assy	500	500	500	350	350	350	350	350	350	350
Compressor inlet air filter element	0	0	0	0	0	0	0	0	0	0
Compressor discharge check valve	525	525	525	450	275	300	250	400	300	475
Compressor unloading valve	1560	1560	1560	1560	1350	1300	1250	1450	1450	1560
Bleed Air shutoff valve	1250	1350	1350	1350	1100	1150	1100	1250	1250	1250
Heat Exchanger bypass valve	2000	2000	2000	2000	2000	2000	2000	2000	2000	2000
Temperature sensor & controller	2000	2000	2000	2000	2000	2000	2000	2000	2000	2000
Water separator/filter assy	8000	8000	8000	5000	5000	5000	5000	5000	5000	5000
Water separator/filter element	0	0	0	0	0	0	0	0	0	0
Relief valve	680	680	680	550	450	500	450	500	500	550
ASM check valve & restrictor assy	185	185	185	185	185	185	185	185	185	185
Fuel tank check valve	925	925	925	925	925	925	925	925	925	925
Controller / control card	40000	40000	40000	40000	40000	40000	40000	40000	40000	40000
Ducting	35640	8840	23160	6080	10500	3360	7620	7620	1900	7620
Wiring	750	750	750	750	750	750	750	750	750	750
Bleed Orifice & Duct	300	300	300	300	300	300	300	300	300	300
Compressor Wiring	8943	4471	3354	1677	361	361	122	301	0	259
Installation Hardware	10922	5778	5855	3155	2107	1798	1149	2104	1002	1548
Structual Modifications	2000	2000	1000	1000	400	400	200	200	200	200
Other Parts Sub-Total	116179	77280	89559	64972	66078	58729	61800	63135	56012	62586
System Totals	257915	169472	179487	118557	102323	94489	85837	106594	82536	94657
Oxygen sensor	6000	6000	6000	6000	6000	6000	6000	6000	6000	6000

Figure 2.11.1-2. Summary of Hybrid OBGIS Costs – PSA Systems

Onboard Inerting Designs Task Team Final Report

System	Large Transport		Medium Transport		Small Transport		Turbo Prop	Turbo Fan		BizJet
	All Tanks	CWT Only	All Tanks	CWT Only	All Tanks	CWT Only	All Tanks	All Tanks	CWT Only	All Tanks
OBGIS - Membrane	238,468	142,308	154,119	108,901	104,973	97,641	79,323	102,172	81,192	87,473
OBGIS Hybrid - Membrane	207,815	135,270	140,448	101,943	97,639	90,307	79,323	94,811	73,861	87,473
OBGIS - PSA	270,237	171,471	184,507	120,747	107,212	99,291	89,486	110,911	85,377	96,135
OBGIS Hybrid - PSA	257,915	169,472	179,487	118,557	102,323	94,489	85,837	106,594	82,536	94,657

Figure 2.11.1-3. Comparison of Hybrid OBGIS Costs to OBGIS Costs

2.11.1.1 Air Separation Modules

Hybrid OBGI membrane and PSA ASM costs were developed similarly to those costs developed for OBGI systems. Common costs were applied for common ASM components across all OBGI and OBIGGS concepts.

2.11.1.2 Compressor

Compressor costs for hybrid OBGI systems were developed similarly to those costs developed for OBGI systems.

2.11.1.3 Heat Exchanger/Cooling Fan

Heat exchanger and cooling fan costs for hybrid OBGI systems were developed similarly to those costs developed for OBGI systems.

2.11.1.4 Other Components

Costs for all other hybrid OBGI system components were developed similarly to those costs developed for OBGI systems.

2.11.2 Design & Certification

Design and certification man-hour estimates were developed by the Working Group to encompass the engineering hours required by an aircraft manufacturer for modifications and additions to fuel system components, interfaces, structure, instruments or displays, wiring, tubing, ducting, avionics software and, if required, relocation of other equipment on each aircraft. Non-recurring design costs for hybrid OBGI system components (e.g., ASMs) were amortized into the component costs listed in the previous summary cost tables.

The design and certification man-hour estimates were applied by the E&F team as part of their analysis to determine hybrid OBGI system cost benefit and are described in the E&F team final report. These estimates address design and certification of hybrid OBGI systems to inert all tanks on a new first of a model aircraft and on derivative model aircraft for all of the ARAC generic aircraft. They also address design and certification of hybrid OBGI systems to inert CWTs only on a new first of a model aircraft and on derivative model aircraft, which only applies to the generic large, medium, and small transports, and to the generic regional turbo fan aircraft.

Neither FAA nor JAA will assess additional certification costs for hybrid OBGI systems. However, non-U.S. governmental authorities may assess additional costs related to the certification of hybrid OBGI systems. For example, JAA indicates that the CAA-UK will charge airlines for all certification costs, including engineering man hours, whereas DGAC France will charge airlines only for the travel costs associated with an hybrid OBGI systems certification efforts. These potential additional costs were not included in the design and certification cost estimates.

2.11.3 Operating Costs

Recurring hybrid OBGI system operating costs were developed similarly to those costs developed for OBGI systems. Recurring cost impacts attributed to frequency of delays, delay time, and additional training required for ground and flight crews were assumed to be the same as for OBGI systems. Since hybrid OBGI system resource requirements are constrained to the ground turn time mission segment plus additional time during taxi (to include landing and rollout), system weight remains the predominant element in performance loss versus other losses associated with aircraft resources (i.e., bleed air, electrical power).

Onboard Inerting Designs Task Team Final Report

2.11.4 Maintenance Costs

Recurring hybrid OBG system maintenance costs were developed similarly to those costs developed for OBG systems. Except for MTBUR, hours estimated for all other recurring Hybrid OBG system maintenance costs were assumed to be the same as for OBG systems.

2.11.5 Installation Costs

Installation cost associated with hybrid OBG systems are described in the E&F team final report. No installation costs were developed by the On-Board Design Task Team.

2.12 SAFETY

The inclusion of the hybrid OBG System on an aircraft introduces a number of new or increased safety concerns. These concerns can be divided into four distinct areas. They are normal operation, system leaks, component failure, and catastrophic failure. It should be noted that since the system only operates on the ground, when the aircraft is at the gate and during taxi-in, that these hazards (except as noted) only exist during that time and not during taxi-out or flight of the aircraft.

2.12.1 Normal Operation

The hazards associated with the normal operation of the hybrid OBG system are the discharge of oxygen enriched waste gas, the venting of NEA out of the fuel vent, the possibility of fuel tank over pressure during refuel over-fill, and those associated with electrical wiring and high temperature components.

Oxygen-rich waste gas. Oxygen-rich waste gas could be a fire hazard and should be vented in an area with no potential ignition sources. It should be vented in an area and in a manner where it will be quickly diluted.

NEA around fuel vent. NEA vented from the fuel tank vent could create breathing problems, if inhaled. Testing during the inerting of a 737 aircraft indicated that the exiting NEA was rapidly diluted and results in a small hazard. A placard warning near the vent should be sufficient to mitigate this issue.

Increased tank overpressure during refuel failure. The operation of the hybrid OBG system during a refuel over-fill condition, may exacerbate the problem of tank overpressure. The system is configured to limit inlet NEA flow to the tank in this event, such that the flow is relieved over-board and is not additional to the tank pressure.

Electrical wiring. Electrical requirements of the system add to the amount of electrical wiring in the aircraft and the potential for electrical related smoke or fire in the aircraft. These safety concerns can be minimized through normal design practice.

High component temperature. The operating temperature of some components may exceed 400 degrees F and should be placarded as such.

2.12.2 System Leaks

Various system leaks could occur and create safety concerns. Leaks could include hot air, NEA, OEA and fuel vapor.

Compressor discharge air leaks. Compressed air between compressor/bleed air supply and heat exchanger could be at a temperature of the order of 400 degrees F. It should be treated the same as bleed air ducting, and may require overheat detection. A very small amount of bleed flow will be provided during flight to keep the system warm, therefore in-flight overheat detection may also be necessary.

NEA leaks. The NEA line from the ASM to fuel tank could produce an environment, in a confined space, with a reduced oxygen level. The line should, wherever possible, be run in an area of high

ventilation. Where it does run in a confined space with low ventilation the duct may be required to be of double containment design.

Oxygen-rich waste gas leaks. The OEA waste line could produce an environment, in a confined space, with an elevated oxygen level. The line should, wherever possible, be run in an area of high ventilation and where there is an absence of ignition sources. When it does run in a confined space with low ventilation or in an area with any possible ignition sources, the duct may be required to be of double containment design.

Fuel backflow into ASM. Check valves should be installed in system to prevent fuel vapor from the fuel tank flowing back through the NEA line into the system. This hazard could occur at any time since it is not dependent on system operation.

2.12.3 Component Failure

It is possible that a component of the system could fail and create a hazardous condition as the system continues to operate.

Compressor overheat. A compressor overheat could cause a potential fire hazard. Thermal cutout protection should be incorporated to mitigate this risk.

Heat exchanger overheat. NEA being too hot (heat exchanger by-pass valve failure) could cause a safety problem by possibly damaging the system and flowing high temperature gas into the fuel tank. Thermal system cutout protection would provide mitigation from this hazard.

Rotating equipment sparks. Sparks or flames could occur in the system lines and protected should be provided by flame arrestors in line.

2.12.4 Catastrophic Failure

Catastrophic failure of the system could occur with the failure of the high speed rotating parts of the compressor or a pressure vessel burst.

Uncontained rotating equipment failure. Uncontained rotating equipment failure could cause a hazard. The compressor design should provide containment for such failures.

Pressure vessel burst. Although pressure in the system is relatively low at 30 psig, a pressure vessel burst could occur and should be designed for.

2.13 INSTALLATION

The installation objectives and concerns for the hybrid OBG system are identical to those already discussed for the baseline OBG system, described in Section 1 of this report. Specific design solutions for the many different aircraft models that would be affected by an inerting rule were beyond the scope of this study. The installation challenges are expected to be greater for retrofits where other systems already occupy many locations and customer-specific modifications may require different installation approaches for the same aircraft model. In some areas, structural modifications will be needed to support the additional weight of the new components.

As with the baseline OBG system, the optimal installation locations are unpressurized, ventilated, and close to the fuel tanks. If locations that meet these criteria cannot be found, the installations will be more complex.

Several existing aircraft models were surveyed for potential installation locations. Unpressurized locations in the air conditioning pack bay, wing root, wheel well, belly fairing, and behind the aft pressure bulkhead were examined. Pressurized locations exist in the cargo compartments and in a space forward of the aft bulkhead on some aircraft. Use of cargo space for inerting equipment carries the additional cost

Onboard Inerting Designs Task Team Final Report

of the displaced cargo capacity. Installation locations on typical large, medium, and small transports are similar to those depicted for OBG (Section 1).

As with the baseline OBG system, the NEA distribution system must be sized for pressure drop, be double-walled within pressurized areas, and include drains for condensation. The system controller may be rack-mounted, part of a card file, or remotely located near the inerting equipment depending on the aircraft model. Wiring between the controller and components will require different degrees of protection depending on its location. The expected cockpit interface is an on/off switch and a fail light as with the baseline OBG system. The installation will also require additional protection if located within an engine rotor burst, tire burst, or flammable fluid leakage zone. The compressor and heat exchanger will be thermally insulated to prevent temperature damage to other equipment. The compressor must be installed to minimize noise transmission.

2.14 PROS AND CONS OF SYSTEM DESIGN CONCEPT

Effectiveness and Limitations. The design concept of the hybrid OBG system is to have a self-contained system on the aircraft that will operate only when the aircraft is on the ground during taxi-in and at the gate. The system will provide an inert atmosphere in the “protected” (all tanks, or center tank only) tanks at some time during the gate stay of the aircraft. The system is designed to inert the “protected” tanks in the shortest turn time plus the taxi-in time, for the type of aircraft it is installed on. Therefore, for short turn times the aircraft “protected” tanks may be non-inert for a large portion of the gate time. However, the “protected” tanks will be inert at any time in excess of the shortest turn time. Under most conditions, the protected tanks will stay inert through taxi-out, climb, and into cruise. Protected tanks with very little or no fuel will stay inert until the descent, for most flights. A full tank that is used during taxi and/or climb may become non-inert during those phases of flight. Although the system does not provide for inerting of the tanks 100% of the time, it does provide inerting when the tanks are most likely to be flammable.

Safety. As described in the safety part of this Section, the installation of the system adds additional hazards to the aircraft, which must be mitigated. The design of the system should be such to minimize or eliminate the hazards. It should be noted that since the system only operates on the ground during taxi-in and at the gate, almost all of the hazards are only at that time, and not during taxi or flight. The system greatly minimizes the time a flammable mixture is present in a protected tank.

Cost. There is a cost associated with the design, installation, certification, operation and maintenance of a hybrid OBG system. Those costs can be broken down into the cost of the system, cost of system operation, and maintenance cost of the system. The cost of the system includes design and construction as well as certification and installation. The system operation costs include those associated with the carriage of additional weight and possible shift in center of gravity of the aircraft, possible increase in drag, and the additional use of electrical power during the taxi-in phase particularly. The maintenance cost includes maintenance of the hybrid OBG and to other systems, such as electrical generators, which are effected by it.

Environmental Impact. The main impact to the environment from a hybrid OBG system is the possible increase in fuel vapors being forced overboard as the nitrogen is injected into the fuel tank. The amount of fuel vapor that is vented depends on the fuel air mixture and tank ullage volume at the time of inerting, as well as many other variables. Testing has shown that present designed cross-vented fuel tanks, under certain wind conditions, can vent fuel vapors into the atmosphere. A redesign of this for the hybrid OBG system would minimize that venting helping to offset some of the fuel vapor lost during the inerting process.

The installation of a hybrid OBG system would, as shown previously, reduce the number of fuel tank explosions, thus reducing the amount of spilled fuel both on the ground and in the atmosphere.

In addition to the fuel vapor there is a potential problem with the addition of noise from the compressor/fan.

The use of dry NEA may reduce corrosion and condensation in the protected tanks depending on the conditions at the airports where the airplane is operated.

2.15 MAJOR ISSUES/MITIGATION

As with the baseline OBG system, the hybrid OBG system has been defined by the Team based on the operating parameters defined during the study period or by others, such as the 1998 Fuel Tank Harmonization Working Group (FTHWG) ARAC. The parameters that had most of the effect on system sizing were the time available at the gate to operate the system, and the size of the tanks to be inerted. The time available to operate the system was determined by the shortest expected gate time available, plus the taxi-in time prior to gate hook-up. These were major factors particularly for the small and medium transport aircraft, where the minimum gate time was short, thereby dictating a large, high-capacity system. As with the baseline OBG system, an alternative to this approach would be to use a gate time which relates to the average or fleet majority gate time, thereby significantly reducing system size, cost and weight. The ultimate effect of this consideration has not been evaluated by this study.

Several existing aircraft were analyzed to derive data for the conclusions of this study. However not all existing aircraft could be evaluated, due to time constraints. System feasibility, although a major factor in this study, was not considered for all aircraft applications. Space may not be available to accommodate Hybrid OBG in all aircraft. One possibility is to install the Hybrid OBG system in the baggage space but there will be a cost impact to the operators due to lost revenue. This cost was not evaluated during this study.

Technology available to the Team at the time of the conduct of the study dictated feasibility to a certain extent, and detail features to a great extent. In the time required to enforce the requirements of the rulemaking that will be the ultimate result of this report, other, more advanced technologies may be available. As the Team was unable to predict such developments, the rulemaking recommendation was thus derived from currently available technology, with its associated limitations.

The team approached the study with the intention of defining the feasibility of Hybrid OBG systems, and their relative performance compared to other possible solutions. Detail design for all configurations of existing aircraft could not be evaluated in the available time. Such aircraft-specific designs were not attempted; it was concluded that detail design should be conducted when rulemaking compliance is defined. Details of these designs may at that time, conclude that some parameters do not appear feasible, or may result in different weight, cost or size. The team concludes, however, that ultimately no parameters will be infeasible, albeit that other items may be affected.

Not all-possible permutations of tank size, aircraft type and turn around times (among other parameters) were evaluated in the study. The team has, however, attempted to provide enough empirical data and predictive analysis that the reader may extrapolate the information presented herein to other specific application conditions and sizes.

A major objective for the study was to produce predictions of flammability exposure for the system. This was based on the FAA-produced predictive analysis software, with its inherent assumptions. Limited testing has concluded that the assumptions are sound, and the predictive analysis is of sufficient quality for these comparative studies. However, not all of the operating conditions that have been analytically simulated as part of this study have been verified by experiment, and may therefore ultimately result in divergence from the actual ultimate performance.

Onboard Inerting Designs Task Team Final Report

3.0 FULL-TIME OBIGGS

The full-time On-board Inert Gas Generating System (OBIGGS) is one of four main system categories studied by the 2000 ARAC FTIHWG Onboard Airplane Design Task Team. The on-board team studied systems that were sized to provide inerting for various fuel tank configurations of six generic models. The team also defined the physical size and weight of the components that make up the OBIGGS. Finally, power and air consumption needs were defined.

3.1 REQUIREMENTS

The OBIGGS is required to keep the oxygen concentration in the ullage of all fuel tanks below 10% by volume throughout all mission phases. The system produces nitrogen as the inerting agent and all equipment is installed on the airframe, except for certain diagnostic equipment. The system does not require redundancy of components.

3.2 DATA SUPPLIED FROM OTHER SOURCES

Data was taken from various sources so that the team could define the full-time OBIGGS concept. This included aircraft turn times, generic aircraft definition and mission profiles, fuel tank sizes, bleed air data, and cabin pressure schedules.

3.2.1 Aircraft Turn Times

Turn times do not affect full-time OBIGGS sizing since the aircraft will normally land with inert fuel tanks and remain inert while at the gate.

3.2.2 Generic Aircraft Types

The FTIHWG made the decision to use the same generic aircraft data and mission scenarios that were used in the July 1998 ARAC FTHWG Report. As with the other on-board systems, these generic airplane definitions and missions were used in assessing the operational parameters. Discussion of the data is included in the 'Generic Aircraft Types' part of Section 1 of this report and the complete definitions and missions compiled during the 1998 FTHWG effort are included as an attachment to this report. As with the other systems, the worst-case flight conditions were the shortest-ranged flights.

3.2.3 Fuel Tank Volumes

The 1998 Generic Aircraft fuel tank sizes listed in Figure 3.2.3-1 were used for all system sizing.

Generic Aircraft	CWT Volume (Gal.)	CWT + Wing Tank Volume (Gal.)	CWT + Wing + Aux Tank Volume (Gal.)
Turbofan	816	3,264	N/A
Turboprop	N/A	1,428	N/A
Business Jet	N/A	6,273	N/A
Small	3,060	5,100	7,600
Medium	10,200	24,480	27,480
Large	25,500	55,080	58,080

Figure 3.2.3-1. Generic Aircraft Fuel Tank Volumes

3.2.4 Bleed Air

The team determined that bleed air availability for OBIGGS is limited. The team received the generic bleed air data listed in Figure 3.2.4-1 from airframe manufacturers.

Flight segment	Sufficient Flow available	Pressure available	Temperature
Ground, APU	no	25 to 54 psia	325 to 430°F
TTT	no	45 psia	350 to 380°F
Climb	yes	40 to 55 psia	330 to 380°F
Cruise	yes	25 to 40 psia	350 to 380°F
Idle descent	no	20 to 35 psia	350 to 380°F

Figure 3.2.4-1. Bleed Air Availability

3.2.5 Cabin Pressure

The team received the typical cabin pressures listed in Figure 3.2.5-1 for the six aircraft models from airframe manufacturers.

Altitude, feet	Cabin pressure, psia
0	14.7
5,000	14.3
10,000	13.9
15,000	13.5
20,000	13.2
25,000	12.8
30,000	12.4
35,000	12.0
40,000	11.2
45,000	10.9
50,000	10.9
55,000	10.9

Figure 3.2.5-1. Cabin Pressure Schedule

3.3 ASSUMPTIONS

The following are assumptions that the team developed and used for the analysis.

Initial Oxygen Concentration. The starting oxygen concentration in the ullage is assumed to be equal to the final concentration from the previous flight. However, for the first flight of the day or following maintenance actions, the oxygen concentration is assumed to be 20.9% by volume.

Hydraulic Power Availability. Even though the full-time OBIGGS does not have to routinely operate between flights, it will have to be capable of ground operation for initialization every morning and following maintenance. The team assumed that aircraft hydraulic power to operate OBIGGS equipment was not available while at the gate. It was further assumed that in order to utilize hydraulic power to operate OBIGGS in flight, it would be necessary to upgrade the existing on-board systems.

Electrical Power at Aircraft Gate. The aircraft fuel tanks will land inert and inerting will continue through taxi to the gate. Based on the limited test data that is available, the team assumed that inerting through taxi is sufficient to offset any increase in oxygen concentration during the refueling operation. The team assumed that sufficient ground power could be made available to operate the OBIGGS to initialize the fuel tanks for the first flight of the day or following maintenance.

Electrical Power in Flight. The team assumed that sufficient electrical power from the aircraft generators was available to operate the OBIGGS in flight.

Cabin Air Supply. The team assumed that the cabin air that normally exhausts through the outflow valve is available to the OBIGGS.

Ullage Mixing. It was assumed that as air enters the fuel vent system during a descent, that it quickly mixes with the ullage and with the inert gas produced during the descent.

Onboard Inerting Designs Task Team Final Report

Vent System Modifications. It was assumed that necessary vent system modifications would be made to prevent cross-venting during crosswind conditions.

Fuel Tank Initialization. The team assumed that an extended ground time would be allowed to initialize the tanks for the first flight of the day and following maintenance actions.

3.4 CONCEPT DEVELOPMENT

3.4.1 Concept Characteristics

In developing the full-time OBIGGS concept, the following fundamental system characteristics were defined:

Air Separation Technologies. The team evaluated three different methods of generating NEA: permeable membranes, pressure-swing adsorption, and cryogenic distillation. All three methods remove oxygen from a pressurized, conditioned air stream leaving a nitrogen-rich source that can be supplied to the fuel tanks. Detailed descriptions of the three methods and how the sizing analysis was performed can be found in Addenda A1, A2, and A3.

Continuous Flow vs. Storage. Both continuous flow and storage-based OBIGGS were studied in this report. The permeable membrane and the pressure swing-adsorption systems are continuous flow systems. They provide a continuous flow of inert gas to the fuel tanks during the flight and on the ground when the engines are operating.

The cryogenic distillation system also provides a continuous flow of inert gas during these conditions. In addition, low-pressure (~35 psia) cryogenic liquid is made and stored during periods of low demand (e.g. cruise) to initialize the tanks and cool-down the system prior to the first flight of the following day.

Each system has advantages and disadvantages. For example, continuous flow systems do not have the hardware or the safety concerns associated with storage, but systems with storage capability have a shorter initialization time for the first flight of the day and require less input power.

No Fuel Tank Vent Valves or Tank Pressurization. Adding fuel tank vent valves to pressurize the fuel tank reduces the required NEA flow rate during descent, but slows down initialization unless provisions are made to bypass the vent valves until initialization is over. Vent valves would require back-up valves, new sensors and indications to prevent catastrophic structural damage when the vent valves fail closed. The cost of this redundancy and instrumentation was judged not to be worth the relatively small allowable tank pressures defined for the six generic aircraft models, so vent valves were not included in the full-time OBIGGS concepts studied. For new designs, if the fuel tank structure was designed for higher pressures, the full-time OBIGGS savings in reduced electrical power, weight, volume, and acquisition cost might offset the weight and cost of the vent valves and the increased structural weight and cost.

3.4.2 Generic OBIGGS concept

The team initially defined a generic OBIGGS concept that applied to all six generic aircraft (Figure 3.4.2-1) with the three different inerting technologies. It was later found that some characteristics of the generic concept were more valuable on some aircraft models and that an OBIGGS optimized for one particular model may not be identical to a system optimized for a different aircraft. Detailed descriptions of the concept as applied to each of the six generic aircraft models are in the Concept Description section below.

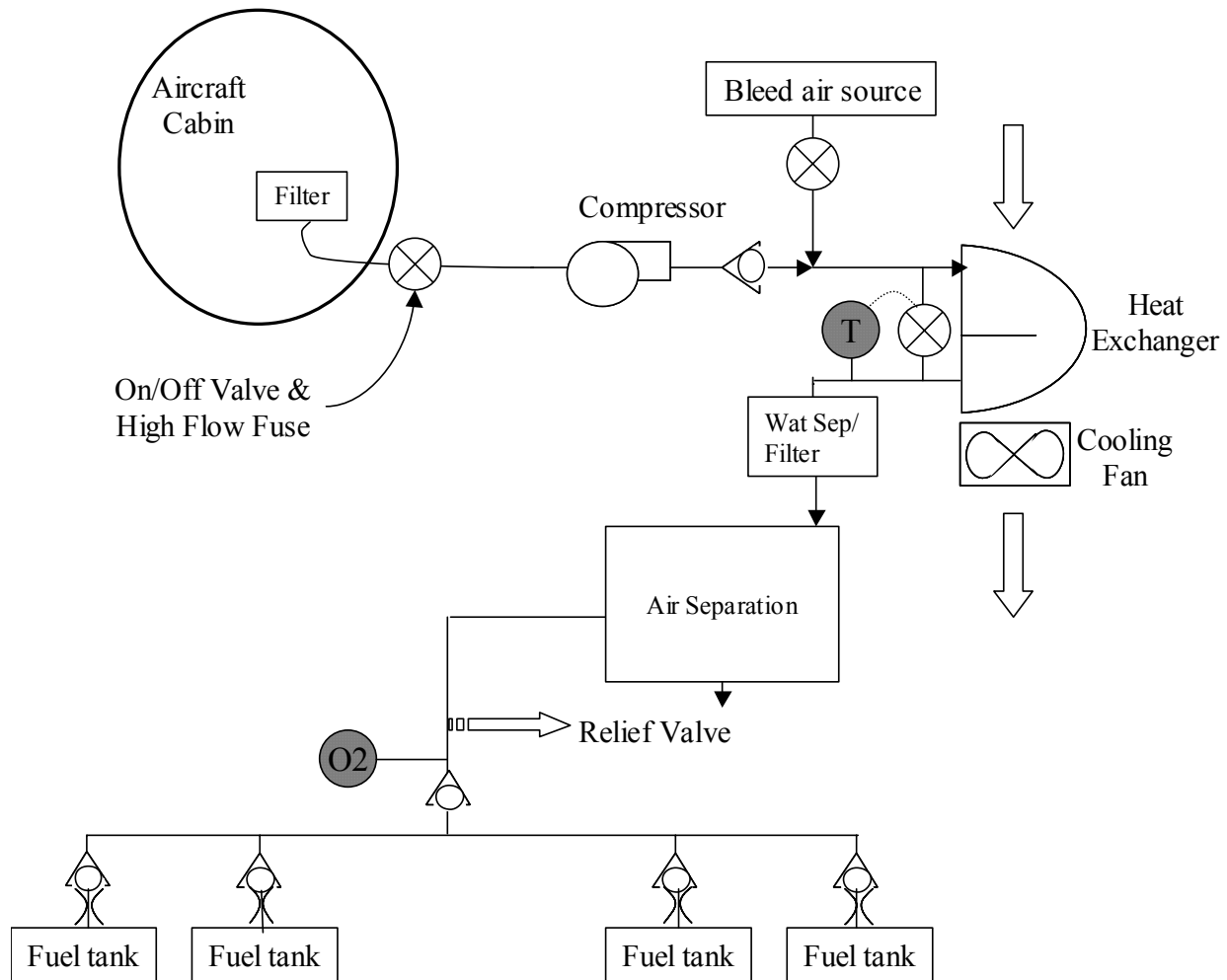

Figure 3.4.2-1. Generic OBIGGS Concept Schematic

Filtration. There are two filters in the generic OBIGGS concept. The first is a simple filter at the cabin air compressor inlet intended to keep dust and foreign objects out of the compressor. The second is immediately upstream of the air separation equipment and includes a high efficiency particulate and water separator to remove the solid and liquid particulates from the ASM inlet. Some permeable membranes lose efficiency when exposed to certain hydrocarbons and an appropriate hydrocarbon element would be incorporated into this filter as needed.

OBIGGS Shutoff Valve. The OBIGGS shutoff valve opens to allow cabin air into the OBIGGS. The valve contains a flow fuse that will automatically close the valve when the airflow is higher than the maximum normal rate to prevent the cabin from depressurizing in the event of a burst duct outside of the pressure shell.

Compressor. The first air source considered for a full-time OBIGGS was the engine bleed air system. However, there were disadvantages to this approach: the available pressures during descent were less than desired for any of the air separation technologies; diverting air from the air conditioning packs would negatively affect the cabin temperatures; the anti-icing systems would be impacted for operations during descent through icing; and the APU cannot always be run to supply bleed air at the gate (the full-time OBIGGS doesn't typically run between flights, but does need to initialize the tanks on the ground before the first flight of the day). These led the team toward an independent source of bleed air. An electric motor-powered compressor supplied by air from the cabin was selected for the generic OBIGGS concept. Hydraulic or turbine powered compressors were rejected, because those power sources are not usually

Onboard Inerting Designs Task Team Final Report

available at the gate. By using cabin air instead of ram air, the compressor size and electrical power is significantly reduced (to produce 40 psia at cruise altitude, a cabin pressure compressor requires a pressure ratio of 4:1 while a ram air compressor requires a pressure ratio of 13:1). A 4:1 pressure ratio was selected for the initial generic concept, because it was the highest pressure ratio typically attainable with a single stage compressor. The specific type of compressor (piston, vane, screw, or centrifugal) was later selected for each model, as the airflow rates required by the different technologies were determined.

Unloading Valve. The unloading valve opens to reduce the compressor motor loads during start-up. After the motor is running at normal speed, the unloading valve closes. The system controller commands the unloading valve position.

Temperature Control. Each of the three different inerting technologies requires a different inlet temperature. The permeable membranes operate at peak efficiency with inlet temperatures at around 180 degrees Fahrenheit. The pressure-swing adsorption and cryogenic distillation systems require inlet temperatures closer to room temperature. The generic OBIGGS concept uses a ram air-cooled heat exchanger that is sized for the worst- case heat load. A modulating bypass valve bypasses the heat exchanger to control the ASM inlet temperature. Redundant temperature sensors prevent damage to the downstream ASM in the event of a sensor failure. An electric fan draws cooling air through the heat exchanger for ground operations.

Air Separation. The three different air separation technologies produce NEA from a stream of conditioned, high pressure air. The permeable membrane air separator consists of a large bundle of hollow fibers; each fiber has a porous skin. The pressurized air flows through the inner diameter of the hollow fibers and oxygen molecules preferentially permeate through the fiber walls to an overboard waste port. Some nitrogen molecules also permeate overboard, but the flow that comes out of the hollow fiber is NEA.

The pressure-swing adsorption air separator consists of two parallel beds filled with a molecular sieve material. The material in each bed has many adsorption sites that preferentially adsorb oxygen while at pressure. Within a few seconds the adsorption sites saturate with oxygen and a valve shuttles to connect the pressure to the fresh sieve bed and to connect the saturated bed to an overboard waste port. Exposed to the pressure swing, the oxygen desorbs from the saturated molecular sieve and is exhausted. The cycle then repeats with the two sieve beds alternating between pressure and exhaust. Again the product flow is NEA.

The cryogenic distillation air separator consists of a cryocooler that cools the inlet air flow until it is partially liquefied. The two-phase mixture flows into the distillation column where the nitrogen is separated from the air flow. The high-purity (>99%) nitrogen product can be in the form of a liquid or a gas or both. The oxygen enriched waste gas exits from the column waste port. Other recuperative heat exchangers are included to increase the thermodynamic efficiency of the system and to warm the NEA before it is supplied to the fuel tanks. The gaseous NEA is distributed directly to the fuel tanks. The liquid NEA is stored in a cryogenic dewar that is used to quickly initialize the system and inert the fuel tanks for the first flight of the day.

More details of the theory behind each air separation technology are in Addenda A1, A2, and A3.

Flow Schedule. A very simple OBIGGS would produce enough NEA flow at a constant rate and oxygen concentration so that the tanks would remain inert during descent and simply exhaust the excess overboard during the other phases of flight, when less NEA is needed. However by reducing the NEA flow during cruise, the operating costs are reduced, the membrane and PSA produce better quality NEA, and the fuel tanks will reach a lower oxygen concentration over time. Similar benefits apply to the cryogenic distillation system, but it produces high-purity (> 99%) NEA gass all the time, regardless of the flow rate.

The generic full-time OBIGGS concept studied supplies a lower NEA flow rate to the tanks during cruise than during descent. This is accomplished with a valve located downstream of the ASM, called the high flow valve on the schematic. The high flow valve has a fixed leakage rate that provides a significant flow restriction when closed and very little restriction when open. A typical compressor will not be capable of supplying air at both high and low airflow rates. To avoid the need for two separate compressors, the full-time OBIGGS concept uses the cabin pressure compressor to supply the air to the ASM for high flow and bleed air from the engine for low flow. Because the engine bleed is not used during descent or ground operations, the disadvantages of an exclusively bleed air supplied system, discussed in the Compressor paragraph above, are not applicable.

An electronic system controller determines the phase of flight and commands the high flow valve, the bleed shutoff valve, and the compressor to the proper state.

Relief Valve. A relief valve is included that is capable of porting all of the system product flow out of the tanks in the event of a rapid pressure rise in the fuel tank due to fuel overflow.

Distribution Orifices. Orifices in the distribution lines split the flow between tanks so that proportionally more NEA flow is directed to the tanks with the largest ullage at descent fuel levels.

3.5 CONCEPT DESCRIPTIONS

The final concept descriptions for each model and ASM technology are tabulated in Figure 3.5-1. The differences between the generic concept and the final concept for each model can be seen in the table and are discussed below.

	Number of Compressors	Compressor Pressure Ratio	Number of Compressor Stages	Compressor Precooler and Inter-cooler	Air Separation Module Inlet Temperature	Lower NEA Flow Rate during Cruise
Generic Concept						
Membrane	1	4:1	1	No	180F	Yes
PSA	1	4:1	1	No	75F	Yes
Cryo	1	4:1	1	No	75F	Yes
Large Transport						
Membrane	2	6:1	2	Yes	140F	Yes
PSA	2	5:1	2	Yes	75F	Yes
Cryo	1	3:1	1	No	75F	Yes
Medium Transport						
Membrane	1	6:1	2	Yes	140F	Yes
PSA	1	5:1	2	Yes	75F	Yes
Cryo	1	3:1	1	No	75F	Yes
Small Transport						
Membrane	1	4:1	1	No	180F	Yes
PSA	1	4:1	1	No	75F	Yes
Cryo	1	4:1	1	No	75F	Yes
Regional Turboprop						
Membrane	1	4:1	1	No	180F	No
PSA	1	4:1	1	No	75F	Yes
Cryo	1	4:1	1	No	75F	Yes
Regional Turbofan						
Membrane	1	4:1	1	No	180F	Yes
PSA	1	4:1	1	No	75F	Yes
Cryo	1	4:1	1	No	75F	Yes
Business Jet						
Membrane	1	4:1	1	No	180F	Yes
PSA	1	4:1	1	No	75F	Yes
Cryo	1	4:1	1	No	75F	Yes

Figure 3.5-1. System Characteristics for Each Model and Technology

3.5.1 Large and Medium Transport

Based on the OBIGGS concept, the team defined the size of the OBIGGS system on each of the aircraft models for each of the ASM technologies. It became obvious that the electrical power requirement for the Large and Medium Transports (LT and MT) was too high to be realistically available (100-150 kVA). The team examined the concepts to determine whether refinements for the LT and MT could be developed that would reduce the electrical power demand to a more reasonable level. This analysis successfully identified a series of refinements to the concept that resulted in power consumption that is still high, but limited to the descent phase when more power is available (galleys are off, etc.) These refinements are discussed below. A detailed schematic for the large and medium transport aircraft membrane and PSA inerting systems is shown in Figure 3.5.1-1 and includes these refinements to lower the power consumption. The cryogenic distillation system power requirements for the LT and MT were lower than the membrane or the PSA, but further power reductions were achieved by using bleed air during the climb and cruise phase, instead of using the cabin pressure compressor as the exclusive bleed source. A detailed schematic for the cryogenic distillation inerting system is shown in Figure 3.5.1-2.

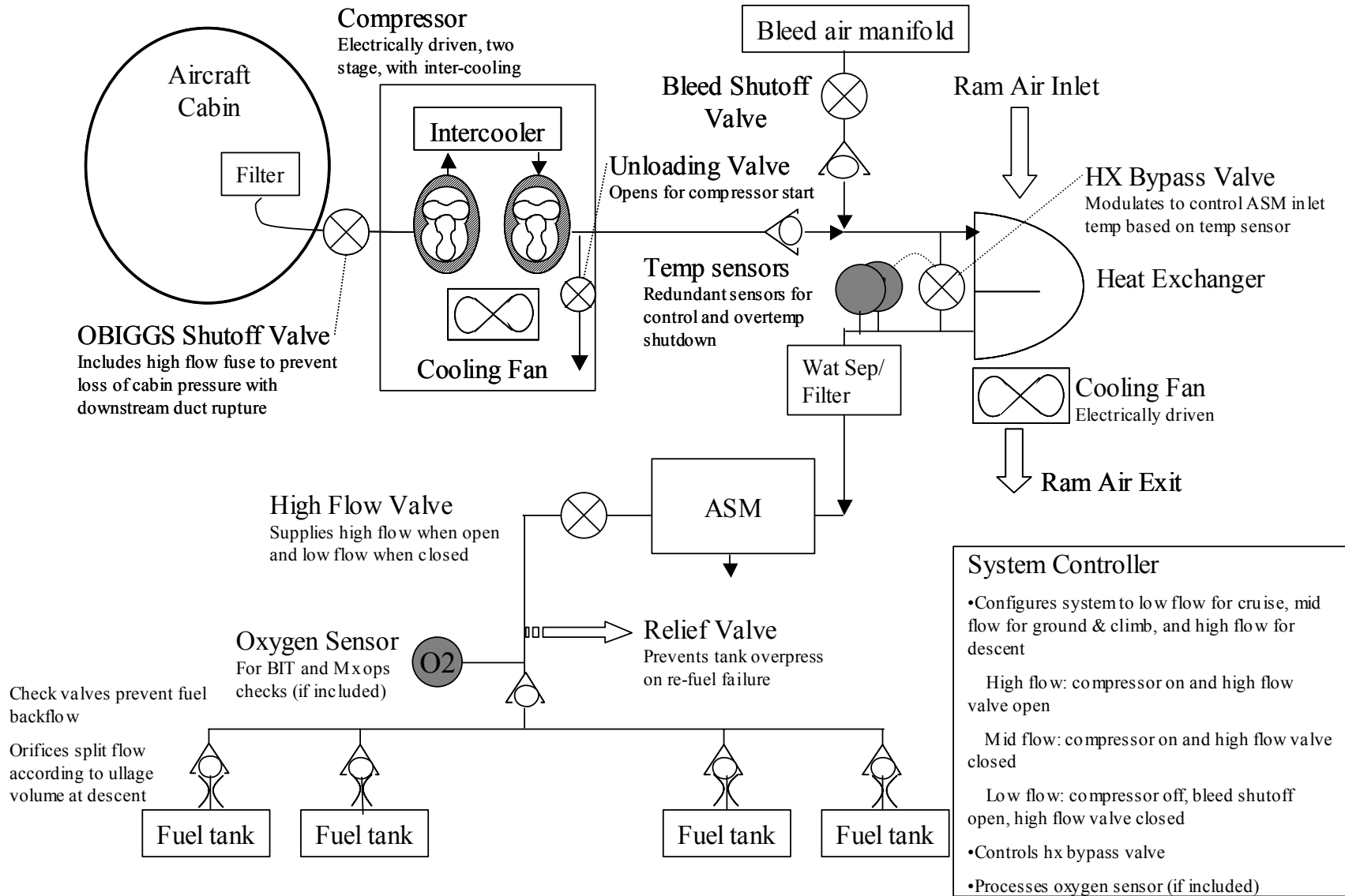

Figure 3.5.1-1. Large and Medium Transport Membrane and PSA Inerting Systems

Onboard Inerting Designs Task Team Final Report

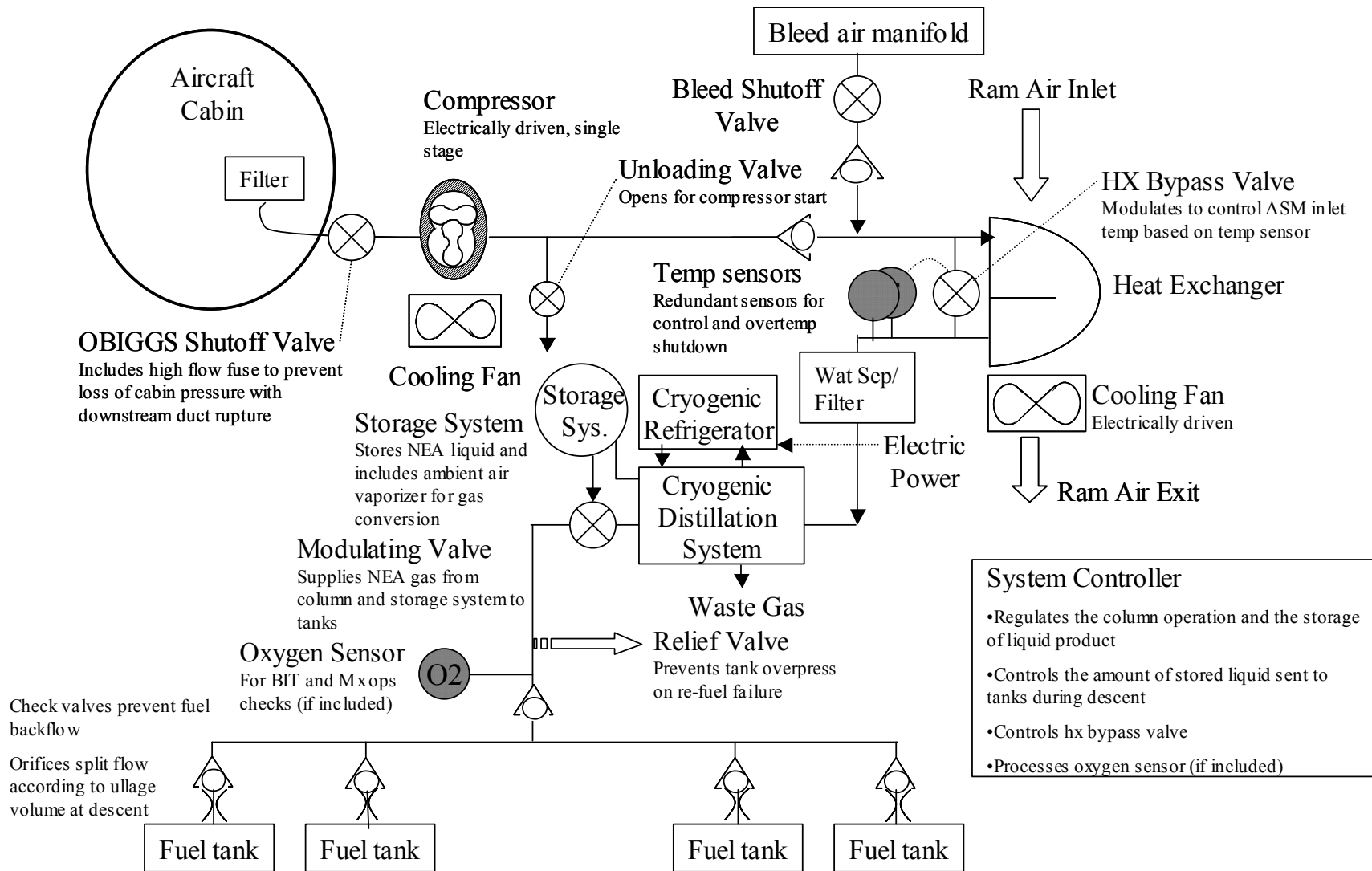

Figure 3.5.1-2. Cryogenic Distillation Inerting System

Use of Bleed Air During Climb. Most of the power consumption was from the compressor, which was operated during climb and descent for the generic OBIGGS concept (the compressor was off for low flow during cruise). The first refinement for the LT and MT membrane and PSA systems was to use the bleed air system as the air source during climb, instead of the compressor. Because the engines are at climb power settings, the bleed pressures and flows are sufficient to generate good quality NEA. The air conditioning and anti-icing systems should have enough pressure to operate normally during the climb. With this refinement, the highest power phases of operation were limited to descent for all of the ASM technologies and ground initialization for the membrane and PSA. The cryogenic distillation system uses stored liquid to initialize on the ground.

Two-Stage Precooled and Inter-Cooled Compressor. To reduce power during descent, a two stage compressor with precooled inlet air and an inter-cooler were incorporated into the LT and MT membrane and PSA concepts. At the higher inlet pressures, the ASMs can produce the same quality NEA with less feed air flow which translates to lower compressor electrical power required. The precooler and inter-cooler cause the compressor to operate more efficiently and further reduce the power demand.

Improved Low Flow Performance. By further restricting the NEA flow rate at low flow (increased restriction in the high flow valve) the NEA produced by the membrane and PSA can be less than 1% oxygen. The cryogenic distillation system always makes NEA that is less than 1% oxygen. Because of the longer cruise times associated with the LT and MT, the oxygen concentration in the tank can effectively reach the 1% O₂ level. By starting the descent with this low oxygen concentration in the tanks, a lower rate of NEA can be supplied to the tanks while ambient air is entering the tanks.

Lower Membrane Inlet Temperature. By controlling the inlet temperature to 140 degrees Fahrenheit, instead of 180, the membrane ASM uses less compressed air but incurs a weight penalty.

Initialization With Only One Compressor. A motor for a single compressor, for the membrane or PSA LT system, is too big to start due to the in-rush current. This was resolved with two compressors in parallel to provide the same air flow. The power demand is reduced by running only one of the two compressors when the system is operated on the ground (to initialize the fuel tanks for the first flight of the day or following maintenance).

3.5.2 Small Transport, Regional Turbofan and Turboprop, and Business Jet

When the high flow rates were determined for the four smaller aircraft models, there was not enough difference between the low flow and high flow rates to justify the minor, additional complexity associated with a dual flow membrane or PSA system. Even though unnecessary, all of the membrane and PSA systems in this report, except the Regional Turboprop membrane system, were sized with high and low flow settings. There is not enough difference between the single flow and the dual flow systems to affect the results of the study. While a dual flow schedule should be evaluated for any OBIGGS application, the generic model results indicate that there are diminishing returns as the aircraft size decreases. A detailed schematic of the simplified full-time OBIGGS membrane and PSA concepts for the smaller aircraft models is shown in Figure 3.5.2-1. The cryogenic concept remains unchanged for the smaller aircraft models.

Onboard Inerting Designs Task Team Final Report

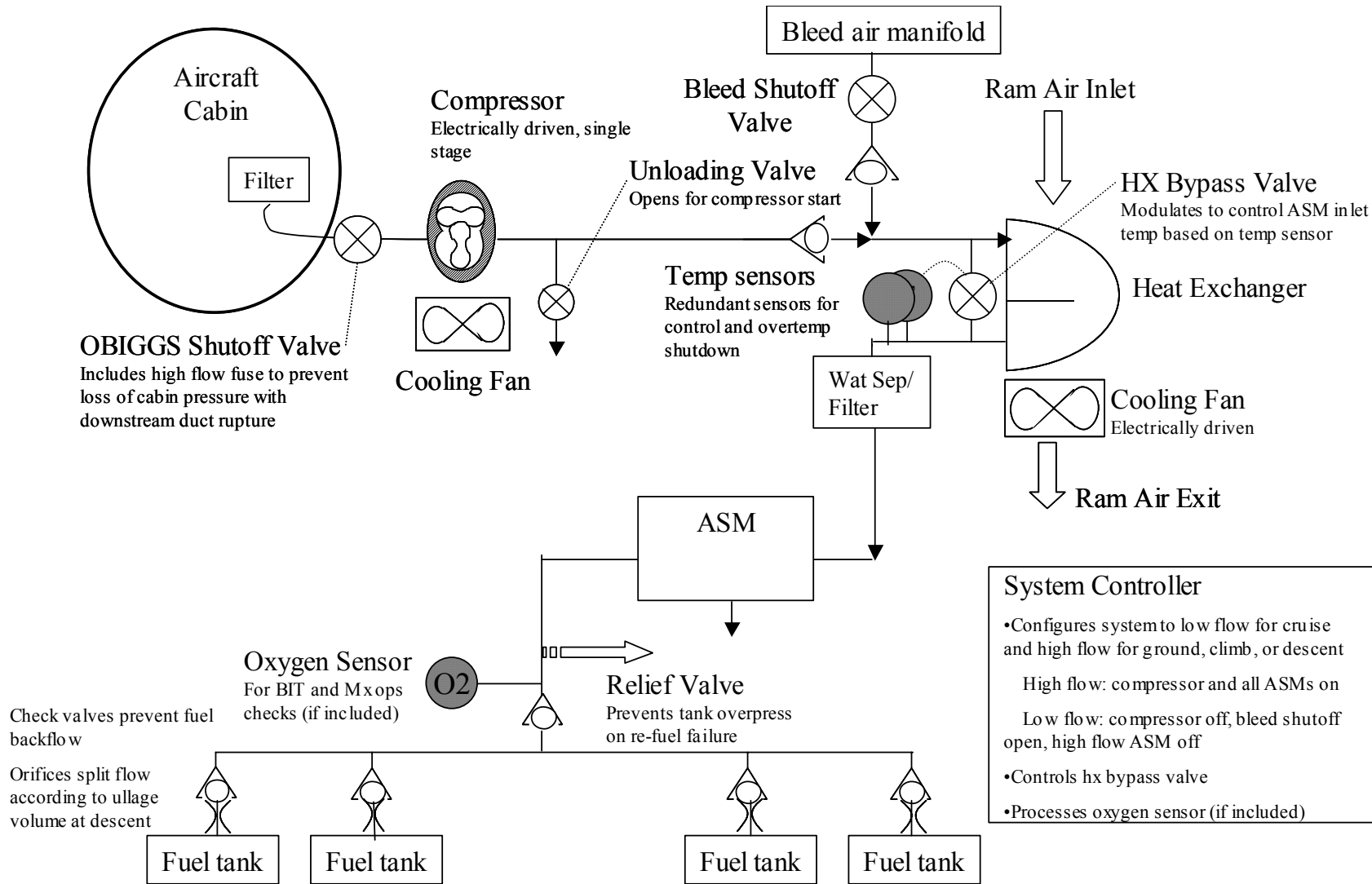

Figure 3.5.2-1. Simplified Membrane and PSA OBIGGS Concept for Small Aircraft

3.6 SYSTEM SIZING AND PERFORMANCE

3.6.1 Sizing Criteria

The required NEA high flow rate for a full-time OBIGGS is determined by the descent. The other factors that affect NEA demand (ullage cooling, fuel burn, and oxygen evolution during climb) all turned out to be of lesser magnitude. The short mission is more severe than the longer missions, because of the lower starting fuel quantities. The low fuel quantities result in large ullage volumes that take longer to inert early in the flight. Also, the shorter cruise segments result in less system operating time and so the tank concentration, at the top of descent, is higher for the short mission.

The team determined the required NEA flows for each model and tank configuration using the aircraft and mission data from the 1998 FTHWG and the FAA-supplied inerting model. The team used the inerting model to confirm that the tank oxygen concentrations did not exceed the 10% inert limit during any phase of the short, medium, or long missions for any of the OBIGGS concepts.

The turn-time does not affect the NEA flow rate required for the full-time OBIGGS. Because the ullage is inert on landing, the system is not required to operate while the aircraft is at the gate. The team assumed that any oxygen that might evolve from the new fuel would be offset by the system operation during taxi in and out of the gate.

After the NEA flows were determined, the ASM suppliers sized the air separation equipment and calculated the feed air flow that would be required to produce the NEA. This allowed the sizes of the compressor, heat exchangers, and other equipment to be estimated.

3.6.2 Parametric Sizing Curves

The system weights, volumes, peak power consumption, and acquisition costs of the full-time OBIGGS for the generic aircraft models and tank configurations are plotted in parametric sizing curves for easy interpolation to other aircraft models. To use the curves, the required NEA flow for OBIGGS is found in Figure 3.6.2-1 based on the tank size. For that NEA flow, the system weight, volume, electrical power consumption, and acquisition cost can be estimated from Figures 3.6.2-2 through 3.6.2-5.

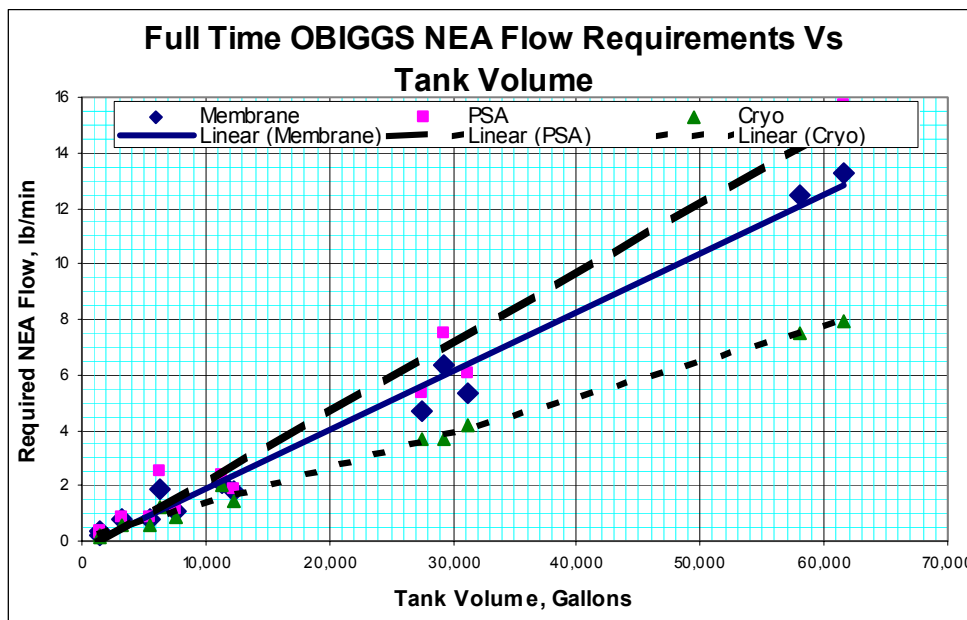

Figure 3.6.2-1. NEA Flow vs Tank Volume

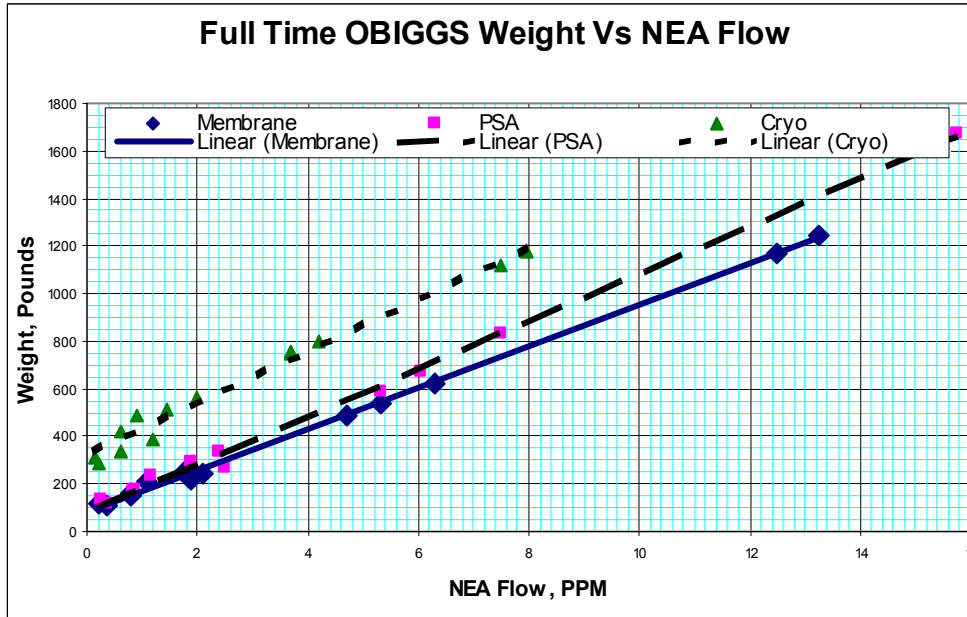

Figure 3.6.2-2. Weight vs NEA Flow

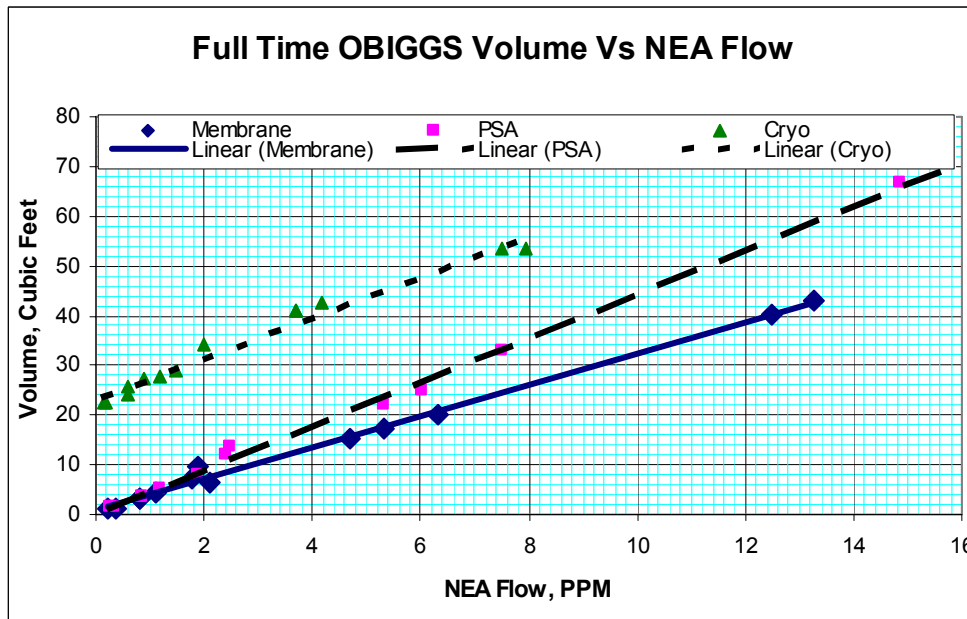

Figure 3.6.2-3. Volume vs NEA Flow

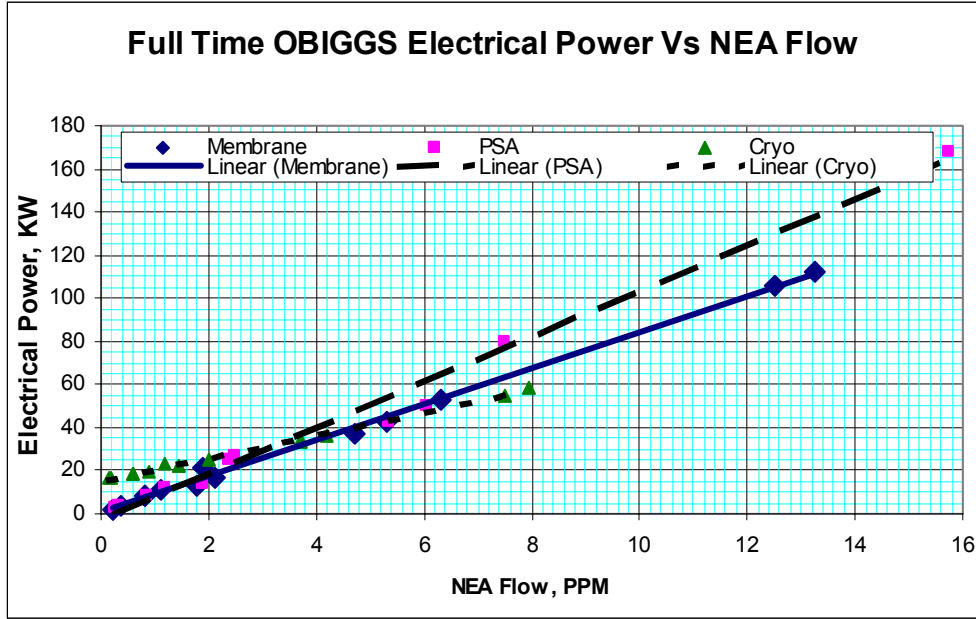

Figure 3.6.2-4. Power vs NEA Flow

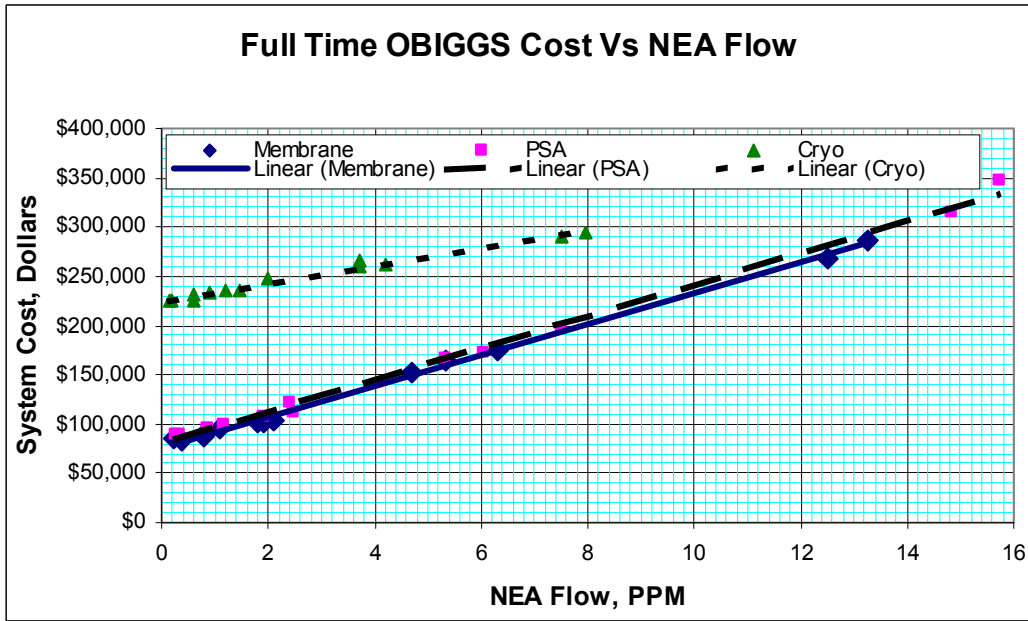

Figure 3.6.2-5. Cost vs NEA Flow

The NEA flow rate referenced in the parametric sizing curves is the high flow rate required during descent. The low flow rate used during cruise does not affect the equipment sizing. The NEA oxygen concentrations, for each ASM technology and flight phase that were used to generate the curves, are tabulated in Figure 3.6.2-6. The parametric sizing curves are not valid for other NEA oxygen concentrations.

Onboard Inerting Designs Task Team Final Report

	Ground	Climb	Cruise	Descent
Membrane	7.5%	5%	3%	5%
PSA	7%	5.3%	4.3%	8.1%
Cryo	1%	1%	1%	1%

Figure 3.6.2-6. Full-Time OBIGGS NEA Oxygen Concentrations

A quick look at Figures 3.6.2-2 to 3.6.2-5 can give the mistaken impression that the cryogenic distillation system is not competitive with the other inerting technologies. Because the cryogenic distillation system requires significantly lower NEA flows for the same tank volume, the actual system parameters must be calculated for a given model to get a valid comparison.

The following examples demonstrate membrane, PSA, and cryogenic distillation system sizing for an aircraft with a total fuel capacity of 35,000 gallons (including all main and center wing tanks plus auxiliary tanks):

Membrane System. Figure 3.6.2-1 shows that a 35,000 gallon tank capacity requires approximately 7 pounds per minute of NEA at membrane purity. Figures 3.6.2-2 to 3.6.2-5 indicate that a membrane system to produce 7 lb/min of NEA weighs approximately 700 lbs, occupies 23 cubic feet, requires 60 kVA of electrical power during descent, and has initial acquisition costs of \$180,000.

PSA System. Figure 3.6.2-1 shows that about 8.5 pounds per minute of NEA at PSA purity are required. Figures 3.6.2-2 to 3.6.2-5 indicate that the corresponding PSA system weighs approximately 950 pounds, occupies 38 cubic feet, requires 88 kVA of electrical power during descent, and has initial acquisition costs of \$220,000.

Cryogenic Distillation System. Figure 3.6.2-1 shows that about 4.5 pounds per minute of NEA at cryo purity are required. Figures 3.6.2-2 to 3.6.2-5 indicate that the corresponding cryogenic distillation system weighs approximately 825 pounds, occupies 42 cubic feet, requires 45 kVA of peak electrical power and has initial acquisition costs of \$260,000.

3.6.3 System Results

The system weight, volume, peak electrical power consumed, and initial acquisition cost for the OBIGGS sized for each model and tank configuration are shown in Figures 3.6.3-1 through 3.6.3-3.

OBIGGS - Center Wing Tank

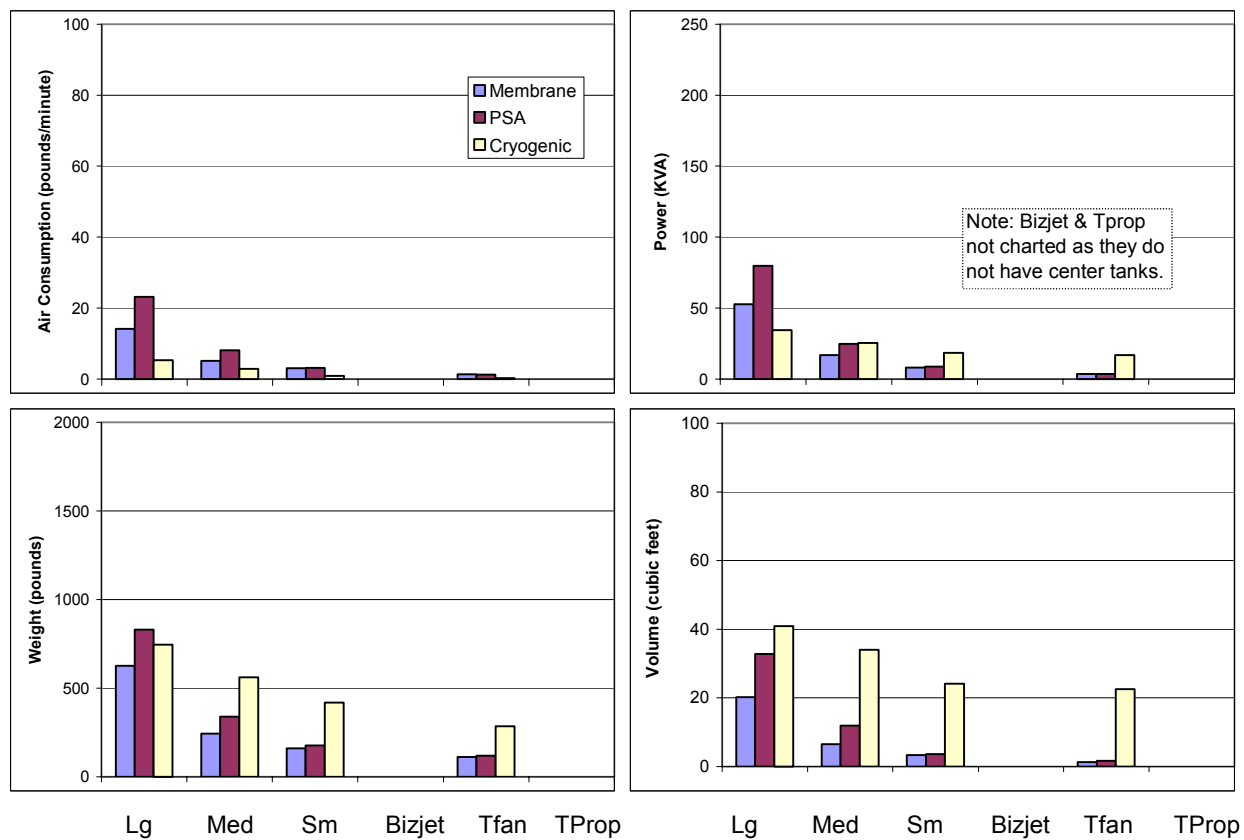

Figure 3.6.3-1. OBIGGS Air Consumption, Power, Volume, and Weights for Center Tanks

OBIGGS - Center & Wing Tanks

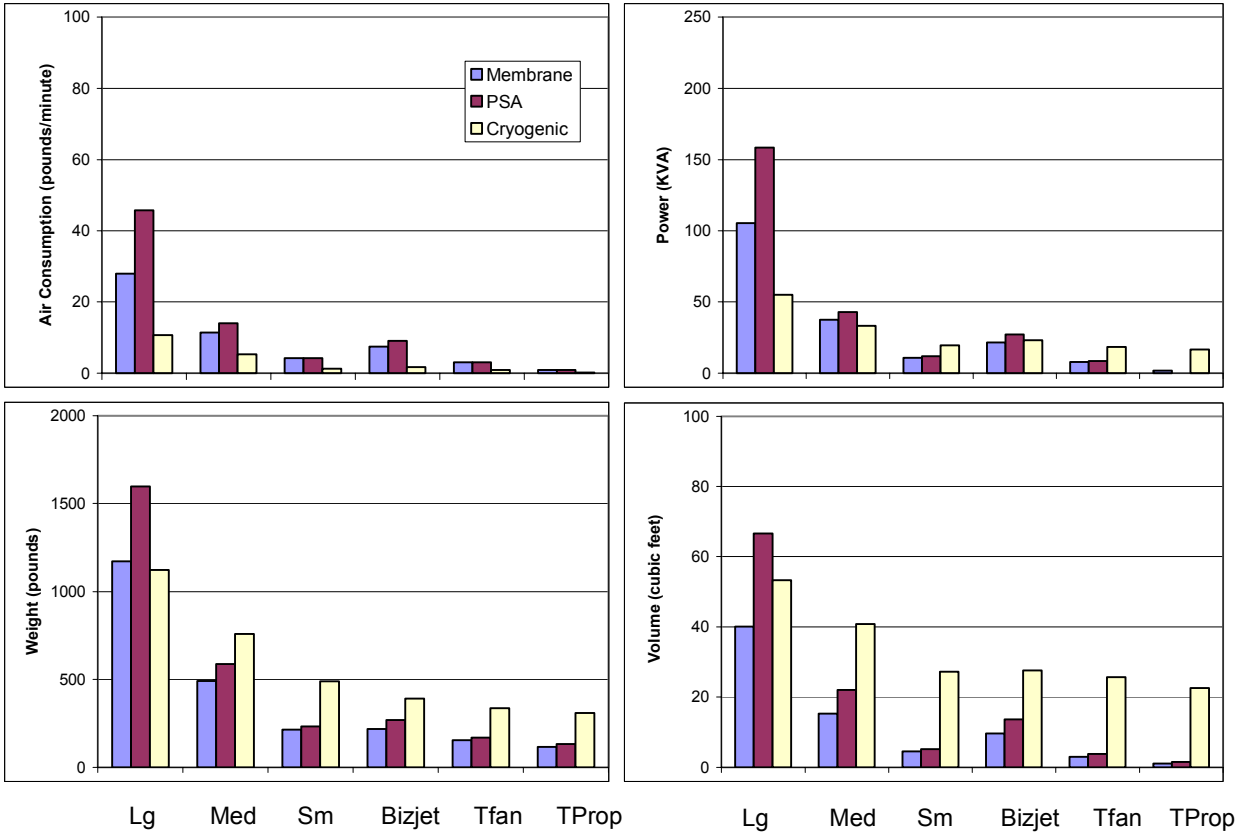

Figure 3.6.3-2. OBIGGS Air Consumption, Power, Volume, and Weights for Center and Main Tanks

OBIGGS - Center, Wing & Aux Tanks

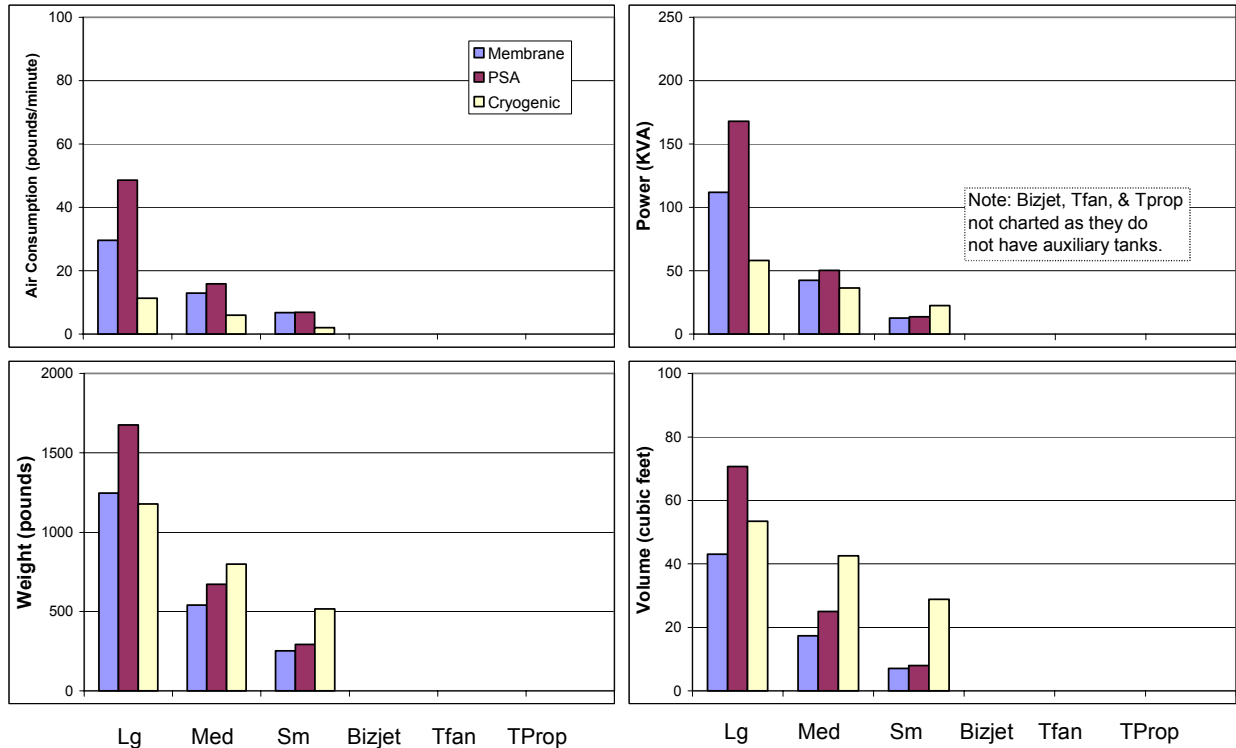

Figure 3.6.3-3. OBIGGS Air Consumption, Power, Volume, and Weights for Center, Main, and Auxiliary Tanks

3.6.4 Flammability Exposure

The full-time OBIGGS was designed to maintain an inert ullage concentration for all normal ground and flight conditions. During emergency conditions or operation with the system failed, the tanks may not remain inert. As a result, there remains a very small flammability exposure for the full time OBIGGS. A comparison of OBIGGS performance with the other fuel tank inerting options is shown in the Conclusions.

3.7 WEIGHT

Figures 3.7-1 through 3.7-3 summarize the OBIGGS weights for the membrane, PSA, and cryogenic distillation inerting systems for each of the generic aircraft. Each table provides the total weight for the “major” and “other” components identified for each system. “Other” components include such items as wiring, ducting, and valves, and their total estimated weights have been combined.

Onboard Inerting Designs Task Team Final Report

Membrane System Component	LT CWT+Main Shipset Weight (lbm)	MT CWT+Main Shipset Weight (lbm)	ST CWT+Main Shipset Weight (lbm)	RTF CWT+Main Shipset Weight (lbm)	RTP CWT+Main Shipset Weight (lbm)	BzJ CWT+Main Shipset Weight (lbm)	LT CWT Only Shipset Weight	MT CWT Only Shipset Weight	ST CWT Only Shipset Weight (lbm)	RTF CWT Only Shipset Weight (lbm)	LT CWT+Main +Aux Shipset Weight (lbm)	MT CWT+Main+ Aux Shipset Weight (lbm)	ST CWT+Main +Aux Shipset Weight
Major Components:													
Compressor	93.4	34.2	15.1	10.9	2.6	12.2	46.6	15.3	11.0	4.9	99.2	39.0	24.4
Heat exchanger / fan	58	23.7	13.5	9.8	5	15.4	29.3	10.6	9.9	4.4	65.7	26.8	21.9
Air separation module	234	90	27.5	20	5.4	54	118.2	36.9	20.1	9.0	248.0	102.0	44.6
	=====	=====	=====	=====	=====	=====	=====	=====	=====	=====	=====	=====	=====
Major component sub-totals	385	148	56	41	13	82	194	63	41	18	413	168	91
Other Components:													
Cabin air filter assv	6	4	4	4	4	4	**	**	**	**	**	**	**
OBIGGS shutoff valve	4	3	3	3	3	3	**	**	**	**	**	**	**
Precooler	20	10	n/a	n/a	n/a	n/a	**	n/a	n/a	n/a	**	**	n/a
Inter-cooler	20	10	n/a	n/a	n/a	n/a	**	n/a	n/a	n/a	**	**	n/a
Temperature sensor	0.3	0.15	n/a	n/a	n/a	n/a	**	n/a	n/a	n/a	**	**	n/a
Bypass valve	6	2.5	n/a	n/a	n/a	n/a	**	n/a	n/a	n/a	**	**	n/a
Compressor unloading valve	6	3	2	2	2	2	**	**	**	**	**	**	**
Compressor discharge check valve	1	0.75	0.75	0.5	0.5	0.75	**	**	**	**	**	**	**
Bleed shutoff valve	3	2.5	2.5	2.5	2.5	2.5	**	**	**	**	**	**	**
Bleed check valve	1	0.75	0.75	0.75	0.75	0.75	**	**	**	**	**	**	**
Bypass valve	3	2.5	2.5	2.5	2.5	2.5	**	**	**	**	**	**	**
Temperature sensor	0.3	0.3	0.3	0.3	0.3	0.3	**	**	**	**	**	**	**
Water separator/filter assv	10	7	7	7	7	7	**	**	**	**	**	**	**
High flow valve	3	2.5	2.5	2.5	n/a	2.5	**	**	**	**	**	**	**
Relief valve	2.5	2	2.0	2	2	2	**	**	**	**	**	**	**
Fuel tank check valve	2.5	2.5	2.5	2.5	2.5	2.5	**	**	**	**	**	**	**
Controller / control card	5.5	5.5	5.5	5.5	5.5	5.5	**	**	**	**	**	**	**
Ducting	178	116	52.5	38	38	38	**	**	**	**	**	**	**
Wiring	15	10	5.0	5	5	8	**	**	**	**	**	**	**
Installation Hardware	71.1	30.2	12.9	10.5	6.0	16.7	**	**	**	**	**	**	**
Structural Modifications	100	50	20.0	10	10	10	**	**	**	**	**	**	**
Ram Ducting	60	30	15.0	10	10	10	**	**	**	**	**	**	**
Compressor wiring	301	58.7	15.4	4.1	1.7	12.8	**	**	**	**	**	**	**
Overheat sensors	1	1	1	1	1	1	**	**	**	**	**	**	**
	=====	=====	=====	=====	=====	=====	=====	=====	=====	=====	=====	=====	=====
Other component sub-totals	820	355	157	114	104	132	449	186	119	92	868	388	178
System Totals	1206	503	213	154	117	213	643	249	160	110	1281	556	269
On-board oxygen sensor (not included in system totals)	1.5	1.5	1.5	1.5	1.5	1.5	1.5	1.5	1.5	1.5	1.5	1.5	1.5

** Indicates scaled data

Figure 3.7-1. Summary of OBIGGS Weights—Membrane Systems

Onboard Inerting Designs Task Team Final Report

PSA System Component	LT CWT+Main Shipset Weight (lbm)	MT CWT+Main Shipset Weight (lbm)	ST CWT+Main Shipset Weight (lbm)	RTF CWT+Main Shipset Weight (lbm)	RTP CWT+Main Shipset Weight (lbm)	BzJ CWT+Main Shipset Weight (lbm)	LT CWT Only Shipset Weight	MT CWT Only Shipset Weight	ST CWT Only Ship- set Weight (lbm)	RTF CWT Only Ship- set Weight (lbm)	LT CWT+Main +Aux Shipset Weight (lbm)	MT CWT+Main+ Aux Shipset Weight (lbm)	ST CWT+Main +Aux Ship- set Weight
Maior Components:													
Compressor	140	39.1	16.3	11.8	3.3	15.3	70.4	22.6	12.0	4.8	148.4	45.7	26.5
Heat exchanger / fan	177	54.2	12.5	9	6	34.9	89.4	31.3	9.2	3.7	187.6	61.4	20.3
Air separation module	315	115	44.3	34	15.6	75	153.0	69.4	31.2	18.1	333.9	130.3	71.9
Maior component sub-totals	632	208	73	55	25	125	313	123	52	27	670	237	119
Other Components:													
Cabin air filter assy	8	4	4	4	4	4	**	**	**	**	**	**	**
OBIGGS shutoff valve	4	3	3	3	3	3	**	**	**	**	**	**	**
Precooler	20	10	n/a	n/a	n/a	n/a	**	n/a	n/a	n/a	**	**	n/a
Inter-cooler	20	10	n/a	n/a	n/a	n/a	**	n/a	n/a	n/a	**	**	n/a
Temperature sensor	0.3	0.15	n/a	n/a	n/a	n/a	**	n/a	n/a	n/a	**	**	n/a
Bypass Valve	6	2.5	n/a	n/a	n/a	n/a	**	n/a	n/a	n/a	**	**	n/a
Compressor unloading valve	6	3	2	2	2	2	**	**	**	**	**	**	**
Compressor discharge check valve	1	0.75	0.75	0.5	0.5	0.75	**	**	**	**	**	**	**
Bleed shutoff valve	3	2.5	2.5	2	2	2.5	**	**	**	**	**	**	**
Bleed check valve	1	0.75	0.75	0.5	0.5	0.75	**	**	**	**	**	**	**
Bypass valve	3	2.5	2.5	2	2	2.5	**	**	**	**	**	**	**
Temperature sensor	0.3	0.3	0.3	0.3	0.3	0.3	**	**	**	**	**	**	**
Water separator/filter assv	13	7	7	7	7	7	**	**	**	**	**	**	**
High flow valve	3	2.5	2.5	2.5	2.5	2.5	**	**	**	**	**	**	**
Relief valve	2.5	2	2	2	2	2	**	**	**	**	**	**	**
Fuel tank check valve	2.5	2.5	2.5	2.5	2.5	2.5	**	**	**	**	**	**	**
Controller / control card	5.5	5.5	5.5	5.5	5.5	5.5	**	**	**	**	**	**	**
Ducting	178	116	52.5	38	38	38	**	**	**	**	**	**	**
Wiring	15	10	5	5	5	8	**	**	**	**	**	**	**
Installation Hardware	108.8	39.3	15.4	12.5	8.0	23.3	**	**	**	**	**	**	**
Structural Modifications	100	50	20	10	10	10	**	**	**	**	**	**	**
Ram Ducting	60	30	15	10	10	10	**	**	**	**	**	**	**
Compressor wiring	452	88.6	15.4	4.1	1.7	12.8	**	**	**	**	**	**	**
Overheat sensors	1	1	1	1	1	1	**	**	**	**	**	**	**
	=====	=====	=====	=====	=====	=====	=====	=====	=====	=====	=====	=====	=====
Other component sub-totals	1014	394	160	114	107	138	449	186	119	92	868	388	178
System Totals	1646	602	233	169	132	264	762	309	171	119	1538	625	297
On-board oxygen sensor (not included in system totals)	1.5	1.5	1.5	1.5	1.5	1.5	1.5	1.5	1.5	1.5	1.5	1.5	1.5

** Indicates scaled data

Figure 3.7-2. Summary of OBIGGS Weights—PSA Systems

Onboard Inerting Designs Task Team Final Report

Cryogenic Distillation System Component	LT CWT+Main Shipset Weight (lbm)	MT CWT+Main Shipset Weight (lbm)	ST CWT+Main Shipset Weight (lbm)	RTF CWT+Main Shipset Weight (lbm)	RTP CWT+Main Shipset Weight (lbm)	BzJ CWT+Main Shipset Weight (lbm)	LT CWT Only Shipset Weight	MT CWT Only Shipset Weight	ST CWT Only Shipset Weight (lbm)	RTF CWT Only Shipset Weight (lbm)	LT CWT+Main +Aux Shipset Weight (lbm)	MT CWT+Main+ Aux Shipset Weight (lbm)	ST CWT+Main +Aux Shipset Weight
Major Components:													
Compressor	27	12.2	2.8	2.6	0.3	4.3	13.5	6.6	1.8	0.6	28.6	13.8	4.5
Heat exchanger / fan	42.5	21.3	2.4	2.2	1.3	6.8	21.3	11.6	1.5	0.5	45.1	24.1	3.9
Cryo Air Separation Components:													
Inlet shutoff valve	5	**	4	3	3	5	**	**	**	**	**	**	**
Cryocooler bleed air valve	5	**	4	3	3	5	**	**	**	**	**	**	**
Flow sensor	0.1	**	0.1	0.1	0.1	0.1	**	**	**	**	**	**	**
Molecular sieve control valves	10	**	8	6	6	10	**	**	**	**	**	**	**
Molecular sieve system	50	**	2.5	9	2.5	16	**	**	**	**	**	**	**
Purge heat exchanger	5	**	5	5	5	5	**	**	**	**	**	**	**
Purge heat exchanger valve-Air Side	5	**	4	4	4	5	**	**	**	**	**	**	**
Purge heat exchanger valve-Waste Side	5	**	4	4	4	5	**	**	**	**	**	**	**
LNEA Dewar Cooldown Valve	5	**	4	4	4	4	**	**	**	**	**	**	**
Inlet Recuperator	120	**	44	12	6	16	**	**	**	**	**	**	**
Inlet cooler	3	**	3	3	3	3	**	**	**	**	**	**	**
Cryocooler	195	**	161	135	127	130	**	**	**	**	**	**	**
LNEA Dewar	100	**	50	0	0	0	**	**	**	**	**	**	**
Dewar level sensor	0.5	**	0.5	0	0	0	**	**	**	**	**	**	**
Distillation column	40	**	15	15	15	16	**	**	**	**	**	**	**
Distillation column gas valve	5	**	4	4	3	5	**	**	**	**	**	**	**
Distillation column liquid valve	5	**	4	4	3	5	**	**	**	**	**	**	**
	=====	=====	=====	=====	=====	=====	=====	=====	=====	=====	=====	=====	=====
Cryo component subtotals	559	414	317	211	189	230	414	338	283	173	580	440	330
Major component subtotals	628	448	322	216	190	241	449	356	286	174	654	478	338
Other Components:													
Cabin air filter assy	4	4	4	4	4	4	**	**	**	**	**	**	**

** Indicates scaled data

Figure 3.7-3. Summary of OBIGGS Weights—Cryogenic Distillation Systems (Sheet 1 of 2)

Onboard Inerting Designs Task Team Final Report

Cryogenic Distillation System Component	LT CWT+Main Shipset Weight (lbm)	MT CWT+Main Shipset Weight (lbm)	ST CWT+Main Shipset Weight (lbm)	RTF CWT+Main Shipset Weight (lbm)	RTP CWT+Main Shipset Weight (lbm)	BzJ CWT+Main Shipset Weight (lbm)	LT CWT Only Shipset Weight (lbm)	MT CWT Only Shipset Weight (lbm)	ST CWT Only Shipset Weight (lbm)	RTF CWT Only Shipset Weight (lbm)	LT CWT+Main +Aux Shipset Weight (lbm)	MT CWT+Main+ Aux Shipset Weight (lbm)	ST CWT+Main +Aux Shipset Weight (lbm)
OBIGGS shutoff valve	4	2	2	2	2	2	**	**	**	**	**	**	**
Compressor unloading valve	3	3	2	2	2	2	**	**	**	**	**	**	**
Compressor discharge check valve	0.5	0.5	0.5	0.5	0.5	0.5	**	**	**	**	**	**	**
Bleed shutoff valve	2.5	2	2	2	2	2	**	**	**	**	**	**	**
Bleed check valve	0.5	0.5	0.5	0.5	0.5	0.5	**	**	**	**	**	**	**
Bypass valve	2.5	2	2	2	2	2	**	**	**	**	**	**	**
Temperature sensor	0.3	0.3	0.3	0.3	0.3	0.3	**	**	**	**	**	**	**
Water separator/filter assy	7	7	7	7	7	7	**	**	**	**	**	**	**
Temperature sensor	0.15	0.15	0.15	0.15	0.15	0.15	**	**	**	**	**	**	**
Relief valve	2.5	1.5	1.5	1.5	1.5	1.5	**	**	**	**	**	**	**
Fuel tank check valve	2.5	2.5	2.5	2.5	2.5	2.5	**	**	**	**	**	**	**
Controller / control card	5.5	5.5	5.5	5.5	5.5	5.5	**	**	**	**	**	**	**
Ducting	178	116	52.5	38	38	38	**	**	**	**	**	**	**
Wiring	15	10	5	5	5	5	**	**	**	**	**	**	**
Installation Hardware	83.8	62.7	47.6	31.8	28.5	34.4	**	**	**	**	**	**	**
Structural Modifications	65	45	25	10	10	25	**	**	**	**	**	**	**
Ram Ducting	15	12	10	10	10	10	**	**	**	**	**	**	**
Compressor wiring	78	23.1	1.5	1.4	0.4	2.8	**	**	**	**	**	**	**
Overheat sensors	1	1	1	1	1	1	**	**	**	**	**	**	**
	=====	=====	=====	=====	=====	=====	=====	=====	=====	=====	=====	=====	=====
Other component sub-totals	471	301	173	127	123	146	449	186	119	92	868	388	178
System Totals	1099	748	495	343	313	387	898	542	405	266	1522	866	516
On-board oxygen sensor (not included in system totals)	1.5	1.5	1.5	1.5	1.5	1.5	1.5	1.5	1.5	1.5	1.5	1.5	1.5

** Indicates scaled data

Figure 3.7-3. Summary of OBIGGS Weights—Cryogenic Distillation Systems (Sheet 2 of 2)

Onboard Inerting Designs Task Team Final Report

3.7.1 Air Separation Modules

Weights were developed for OBIGGS membrane, pressure-swing adsorption, and cryogenic distillation air separation equipment.

Permeable Membrane. Membrane weight was based on a standard module size of 18 pounds. Knowing the total flow for each of the 6 aircraft models and the flow capabilities of a standard module, simple division determines the number of modules required. This number of modules multiplied by the module weight yielded the total weight for the ASMs.

Pressure-Swing Adsorption. The PSA air separator calculations were made empirically. A production OBIGGS air separator manufactured by the PSA supplier was operated in an altitude chamber at the altitudes and supply pressures consistent with the ARAC study. At each altitude, the air consumption, product flow and product purity was measured. The downstream flow was restricted with a simple throttling device. The throttling valve was set to produce a nominal 10% oxygen level in the NEA product at approximately sea level to simulate high flow. A separate set of tests were run with the throttling valve set to produce NEA at 7% oxygen to verify low flow performance.

Based on the testing, the weight of the molecular sieve needed for each model was estimated from the number of separators needed to produce the required NEA at high flow. The structural weight (such as the mounting structure and sieve containers) was also scaled upward or downward based on supplier experience, although some economies of scaling were assumed.

Cryogenic Distillation. The weight of the cryogenic distillation system was not determined by scaling. Based on prior experience and design data, the team developed relationships for each component based upon critical parameters. For example, the inlet airflow was related to the volume and weight of the inlet recuperator. This relationship was not linear. Each component was characterized in this way and each system was uniquely specified for the particular aircraft and tank configuration.

3.7.2 Compressor

Compressor weight was based on the number, size, and type needed for each ASM technology. The compressor weight includes the compressor, motor, motor cooling fan and start contactor. The weight estimates were based on design schemes prepared for 15kW shaft power compressors of the screw and centrifugal type. From this a linear metric of weight as a function of power was generated. It is considered that this tends to give an overestimate of weight for high power machines and an underestimate for low power machines, which is conservative in the weight-critical cases. Above 30kW shaft power, two or more compressors are proposed.

3.7.3 Heat Exchanger/Cooling Fan

The heat exchangers and cooling fans were sized by suppliers of aircraft quality heat exchangers and cooling fans. The heat exchangers and cooling fans for each aircraft were sized to cool air from the compressor to the appropriate ground temperature limits (125 degrees Fahrenheit for the PSA and cryogenic distillation systems and 165 degrees Fahrenheit for the membrane systems) using 111 degrees Fahrenheit ambient air as the heat sink. For OBIGGS, the heat exchanger and cooling fan sizes were also evaluated at the worst-case in-flight conditions to ensure that all requirements were met. An effort was made to minimize the overall size of the system by performing parametrics on heat exchanger and fan sizes to determine the best overall system. The final results are based on a system that had favorable weight, volume, power and costs numbers.

Heat exchanger and cooling fan weights were determined for each of the aircraft and system types. Heat exchanger weight includes the core, inlet/outlet headers, and connections to the mating tubing. The weight of the cooling fan includes the fan and any ducting between the fan and the heat exchanger. Ducting which interfaces with the aircraft structure or plumbing was accounted for separately.

3.7.4 Other Components

The team estimated the weight of each of the "Other" Components in the full-time OBIGGS for several of the different model and tank configurations for the three air separation technologies. The estimates were based on similar equipment used in existing ECS and fuel systems.

Compressor Wiring. The compressor wiring weight was based on four wires per compressor that would run half of the fuselage length (the approximate length from the aircraft electrical power centers to the ideal compressor locations near the wing). This resulted in compressor wire data presented in Figure 3.7.4-1. The wire gage was based on the compressor operating current for each model.

Aircraft	Length (feet)
Large Transport	120
Medium Transport	90
Small Transport	60
Regional Turbofan	50
Regional Turboprop	60
Business Jet	50

Figure 3.7.4-1. Compressor Wire Lengths

Ducting. The ducting weight was based on the lengths and diameters in Figure 3.7.4-2. The lengths were approximated from the aircraft dimensions and the diameters were based on the air flow rates sized for each model. The duct material was assumed to be .032 aluminum for all models. Flexible couplings were assumed to be required every two feet and the mounting hardware was assumed to add 50 percent to the total duct weight. It was assumed that the air separation module could be located somewhere close to the fuel tanks, which would preclude the need for double-walled tubing. It was also assumed that the compressor and the heat exchanger would be located close together so that the length of high temperature ducting would also be negligible.

Aircraft	Length (feet)	Diameter (inches)
Large Transport	266	3.0
Medium Transport	217	2.5
Small Transport	125	2.0
Regional Turbofan	120	1.5
Regional Turboprop	120	1.5
Business Jet	120	1.5

Figure 3.7.4-2. Ducting Length and Diameter

Installation Hardware. The installation hardware weight was estimated as 15 percent of the weight of the components that would be mounted with external hardware (ducting installation hardware was included in the duct weight and not here).

Scaled Data. After the detailed estimates were completed for a range of different systems, the total "Other" Component weights for the remaining tank configurations were estimated as a function of NEA flow. The results are shown in Figures 3.7.4-3, 3.7.4-4, and 3.7.4-5. The systems for which every component was estimated are depicted by solid symbols and the scaled data are the empty symbols.

Onboard Inerting Designs Task Team Final Report

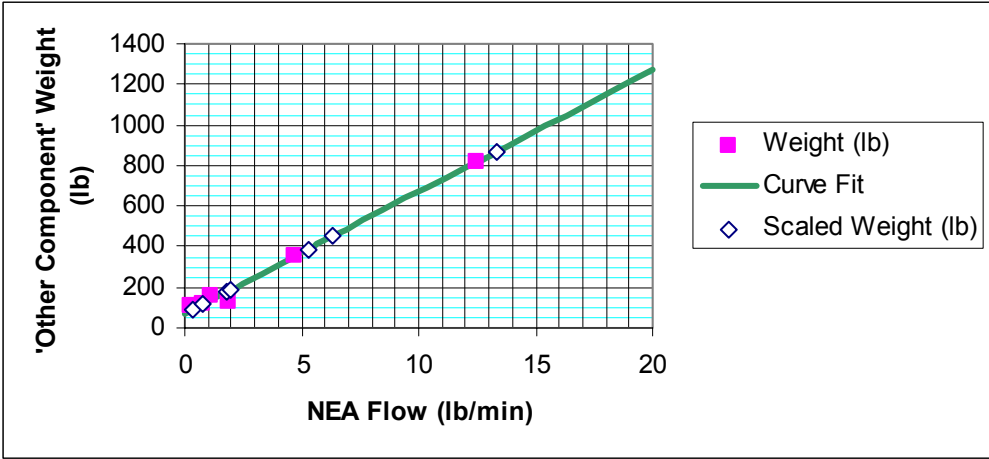

Figure 3.7.4-3. Permeable Membrane Full-Time OBIGGS "Other" Component Weight

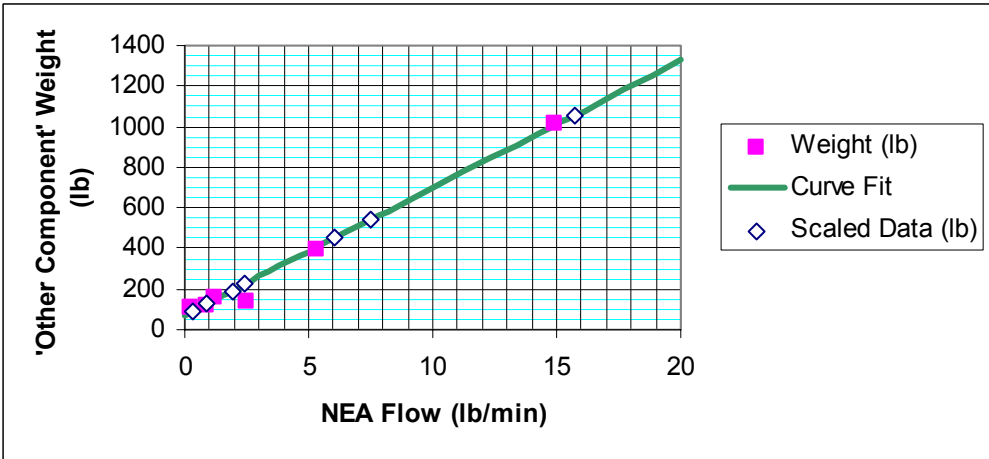

Figure 3.7.4-4. Pressure-Swing Adsorption Full-Time OBIGGS "Other" Component Weight

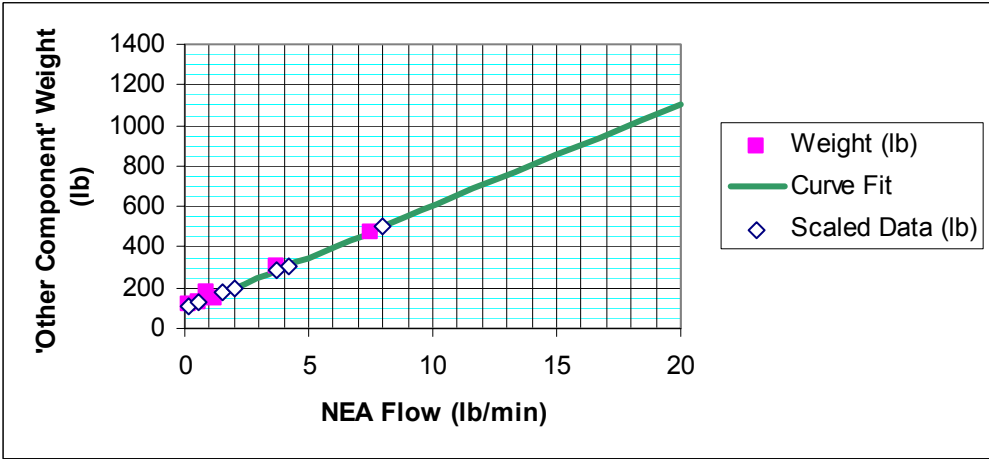

Figure 3.7.4-5. Cryogenic Distillation Full-Time OBIGGS "Other" Component Weight

3.8 VOLUME

Figures 3.8-1 through 3.8-3 summarize the OBIGGS volumes for the membrane, PSA, and cryogenic distillation inerting systems for each of the generic aircraft. Each table provides the total volume for the “major” and “other” components identified for each system. “Other” components include such items as wiring, ducting, and valves, and their total estimated volumes have been combined.

Onboard Inerting Designs Task Team Final Report

Membrane System Component	LT CWT+Main Shipset Volume (cu ft)	MT CWT+Main Shipset Volume (cu ft)	ST CWT+Main Shipset Volume (cu ft)	RTF CWT+Main Shipset Volume (cu ft)	RTP CWT+Main Shipset Volume (cu ft)	BzJ CWT+Main Shipset Volume (cu ft)	LT CWT Only Shipset Volume (cu ft)	MT CWT Only Shipset Volume (cu ft)	ST CWT Only Ship- set Volume (cu ft)	RTF CWT Only Ship- set Volume (cu ft)	LT CWT+Main+ Aux Shipset Volume (cu ft)	MT CWT+Main+ Aux Shipset Volume (cu ft)	ST CWT+Main+ Aux Shipset Volume (cu ft)
Maioir Components:													
Compressor	1.435	0.510	0.190	0.138	0.033	0.366	0.716	0.227	0.139	0.062	1.523	0.578	0.209
Heat exchanger / fan	2.678	1.092	0.220	0.160	0.102	0.713	1.353	0.490	0.161	0.072	3.034	1.238	0.357
Air separation module	9.230	3.500	1.100	0.710	0.220	2.130	4.661	1.435	0.805	0.320	9.784	3.966	1.784
	=====	=====	=====	=====	=====	=====	=====	=====	=====	=====	=====	=====	=====
Maioir component sub-totals	13.34	5.10	1.51	1.01	0.35	3.21	6.73	2.15	1.11	0.45	14.34	5.78	2.35
Other component sub-totals	26.69	10.20	3.02	2.02	0.71	6.42	13.46	4.31	2.21	0.91	28.68	11.56	4.70
Svstem Totals	40.03	15.31	4.53	3.02	1.06	9.63	20.19	6.46	3.32	1.36	43.02	17.34	7.05

Figure 3.8-1. Summary of OBIGGS Volume—Membrane Systems

Psa system Component	LT CWT+Main Shipset Volume (cu ft)	MT CWT+Main Shipset Volume (cu ft)	ST CWT+Main Shipset Volume (cu ft)	RTF CWT+Main Shipset Volume (cu ft)	RTP CWT+Main Shipset Volume (cu ft)	BzJ CWT+Main Shipset Volume (cu ft)	LT CWT Only Shipset Volume (cu ft)	MT CWT Only Shipset Volume (cu ft)	ST CWT Only Ship- set Volume (cu ft)	RTF CWT Only Ship- set Volume (cu ft)	LT CWT+Main+ Aux Shipset Volume (cu ft)	MT CWT+Main+ Aux Shipset Volume (cu ft)	ST CWT+Main+ Aux Shipset Volume (cu ft)
Maioir Components:													
Compressor	2.151	0.582	0.206	0.149	0.041	0.459	1.082	0.336	0.151	0.060	2.281	0.680	0.227
Heat exchanger / fan	8.058	2.467	0.307	0.221	0.158	1.589	4.069	1.425	0.225	0.090	8.541	2.795	0.497
Air separation module	12.000	4.300	1.200	0.880	0.310	2.500	5.787	2.203	0.839	0.386	12.720	4.872	1.946
	=====	=====	=====	=====	=====	=====	=====	=====	=====	=====	=====	=====	=====
Maioir component sub-totals	22.21	7.35	1.71	1.25	0.51	4.55	10.94	3.96	1.21	0.54	23.54	8.35	2.67
Other component sub-totals	44.42	14.70	3.43	2.50	1.02	9.10	21.88	7.93	2.43	1.07	47.08	16.69	5.34
Svstem Totals	66.63	22.04	5.14	3.75	1.53	13.64	32.82	11.89	3.64	1.61	70.63	25.04	8.01

Figure 3.8-2. Summary of OBIGGS Volumes—PSA Systems

Cryogenic Distillaton System Component	LT CWT+Main Shipset Volume (cu ft)	MT CWT+Main Shipset Volume (cu ft)	ST CWT+Main Shipset Volume (cu ft)	RTF CWT+Main Shipset Volume (cu ft)	RTP CWT+Main Shipset Volume (cu ft)	BzJ CWT+Main Shipset Volume (cu ft)	LT CWT Only Shipset Volume (cu ft)	MT CWT Only Shipset Volume (cu ft)	ST CW Only Ship- set Volume (cu ft)	RTF CWT Only Ship- set Volume (cu ft)	LT CWT+Main+ Aux Shipset Volume (cu ft)	MT CWT+Main+ Aux Shipset Volume (cu ft)	ST CWT+Main+ Aux Shipset Volume (cu ft)
Maioir Components:													
Compressor	0.630	0.274	0.062	0.042	0.009	0.127	0.311	0.148	0.042	0.014	0.668	0.310	0.101
Heat exchanger / fan	1.887	0.943	0.076	0.069	0.050	0.300	0.943	0.515	0.048	0.017	2.000	1.069	0.123
Crvo component subtotals	33.000	26.000	18.000	17.000	15.000	18.000	26.000	22.000	16.000	15.000	33.000	27.000	19.000
	=====	=====	=====	=====	=====	=====	=====	=====	=====	=====	=====	=====	=====
Maioir component subtotals	35.52	27.22	18.14	17.11	15.06	18.43	27.25	22.66	16.09	15.03	35.67	28.38	19.22
Other component sub-totals	17.76	13.61	9.07	8.56	7.53	9.21	13.63	11.33	8.04	7.52	17.83	14.19	9.61
Svstem Totals	53.27	40.83	27.21	25.67	22.59	27.64	40.88	33.99	24.13	22.55	53.50	42.57	28.84

Figure 3.8-3. Summary of OBIGGS Volumes—Cryogenic Distillation Systems

3.8.1 Air Separation Modules

Volumes were developed for OBIGGS membrane, pressure-swing adsorption, and cryogenic distillation air separation equipment.

Permeable Membrane. Membrane volume was based on a standard module size of 0.75 cubic feet. Knowing the total flow for each of the 6 aircraft models and the flow capabilities of a standard module, simple division determined the number of modules required. This number of modules multiplied by the module volume yielded the total volume for the ASMs.

Pressure-Swing Adsorption. The PSA air separator calculations were made empirically as described in the weight section above. The NEA flow rate of a given PSA separator operating at high flow conditions was measured in the lab. The volume of the PSA separators were then determined from the number of units required to produce the NEA flow for each aircraft model.

Cryogenic Distillation. The volume of the cryogenic distillation system was determined in the same manner as the weight. Scaling was not used to determine component volume. Rather, each system was uniquely sized for the particular application.

3.8.2 Compressor

Compressor volume estimates were based on the number, size, and type needed for each ASM technology. Compressor types (screw or centrifugal) were selected for each aircraft model with the same considerations of power and compressor scalability as outlined in the weight section above. The compressor volume includes the compressor, motor, motor cooling fan and start contactor. The volume estimates were based on design schemes prepared for 15kW shaft power compressors of the screw and centrifugal types. From this a linear metric of volume as a function of power was generated. It is considered that this tends to give an overestimate of volume for high power machines and an underestimate for low power machines, which is generally conservative with regard to space envelope constraints. Above 30kW shaft power, two or more compressors are proposed.

3.8.3 Heat Exchanger/Cooling Fan

Heat exchanger and cooling fan volumes were determined for each of the aircraft and system types. Heat exchanger volume includes the core, inlet/outlet headers, and connections to the mating tubing. The volume of the cooling fan includes the fan and any ducting between the fan and the heat exchanger. Ducting which interfaces with the aircraft structure or plumbing was accounted for separately.

3.8.4 Other Components

The team estimated the volume of each of the "Other" Components in the full-time OBIGGS by multiplying the volume of the major components by 2.0 for the membrane and PSA systems and by .5 for the cryogenic distillation system. The multipliers were derived by comparing the volume of the "major" components to the major component volume and total volume occupied by typical ECS installations on existing commercial aircraft. The multiplier for the cryo system is lower, because the major components are larger than the comparable ECS systems. The total volume for all of the equipment will always be greater than the sum of the major components, because of duct bend radius limitations, the need to leave space for maintenance access, and the competition for space with other systems and equipment.

3.9 ELECTRICAL POWER

Figures 3.9-1 through 3.9-3 summarize the OBIGGS electrical power consumption estimates developed for the membrane, PSA, and cryogenic distillation inerting systems for each of the ARAC aircraft standards that were modeled. Each table provides the total peak electrical power for the "major" and

Onboard Inerting Designs Task Team Final Report

“other” components identified for each system. “Other” components include such items as wiring, motors, and valves, and their total estimated electrical powers have been combined.

Onboard Inerting Designs Task Team Final Report

Membrane System Component	LT CWT+Main Shipset Elect Pwr (kVA)	MT CWT+Main Shipset Elect Pwr (kVA)	ST CWT+Main Shipset Elect Pwr (kVA)	RTF CWT+Main Shipset Elect Pwr (kVA)	RTP CWT+Main Shipset Elect Pwr (kVA)	BzJ CWT+Main Shipset Elect Pwr (kVA)	LT CWT Only Shipset Elect Pwr (kVA)	MT CWT Only Shipset Elect Pwr (kVA)	ST CWT Only Ship- set Elect Pwr (kVA)	RTF CWT Only Ship- set Elect Pwr (kVA)	LT CWT+Main+ Aux Shipset Elect Pwr (kVA)	MT CWT+Main+ Aux Shipset Elect Pwr (kVA)	ST CWT+Main+ Aux Shipset Elect Pwr (kVA)
Major Components:													
Compressor	104.501	37.116	10.464	7.596	1.817	21.402	52.137	16.568	7.657	3.417	110.932	42.111	12.228
Heat exchanger / fan	0.770	0.314	0.300	0.218	0.020	0.205	0.389	0.141	0.220	0.098	0.816	0.356	0.487
Air separation module	0.000	0.000	0.000	0.000	0.000	0.000	0.000	0.000	0.000	0.000	0.000	0.000	0.000
	=====	=====	=====	=====	=====	=====	=====	=====	=====	=====	=====	=====	=====
Major component sub-totals	105.27	37.43	10.76	7.81	1.84	21.61	52.53	16.71	7.88	3.51	111.75	42.47	12.71
Other component sub-totals	0.10	0.10	0.10	0.10	0.10	0.10	0.10	0.10	0.10	0.10	0.10	0.10	0.10
System Totals	105.37	37.53	10.86	7.91	1.94	21.71	52.63	16.81	7.98	3.61	111.85	42.57	12.81

Figure 3.9-1. Summary of OBIGGS Electrical Power—Membrane Systems

Membrane System Component	LT CWT+Main Shipset Elect Pwr (kVA)	MT CWT+Main Shipset Elect Pwr (kVA)	ST CWT+Main Shipset Elect Pwr (kVA)	RTF CWT+Main Shipset Elect Pwr (kVA)	RTP CWT+Main Shipset Elect Pwr (kVA)	BzJ CWT+Main Shipset Elect Pwr (kVA)	LT CWT Only Shipset Elect Pwr (kVA)	MT CWT Only Shipset Elect Pwr (kVA)	ST CWT Only Ship- set Elect Pwr (kVA)	RTF CWT Only Ship- set Elect Pwr (kVA)	LT CWT+Main+ Aux Shipset Elect Pwr (kVA)	MT CWT+Main+ Aux Shipset Elect Pwr (kVA)	ST CWT+Main+ Aux Shipset Elect Pwr (kVA)
Major Components:													
Compressor	156.677	42.361	11.348	8.196	2.281	26.862	78.808	24.451	8.303	3.325	166.157	49.550	13.275
Heat exchanger / fan	1.400	0.429	0.320	0.231	0.029	0.276	0.707	0.248	0.234	0.094	1.484	0.486	0.519
Air separation module	0.275	0.100	0.025	0.020	0.010	0.060	0.139	0.048	0.018	0.011	0.292	0.113	0.041
	=====	=====	=====	=====	=====	=====	=====	=====	=====	=====	=====	=====	=====
Major component sub-totals	158.35	42.89	11.69	8.45	2.32	27.20	79.65	24.75	8.56	3.43	167.93	50.15	13.83
Other component sub-totals	0.10	0.10	0.10	0.10	0.10	0.10	0.10	0.10	0.10	0.10	0.10	0.10	0.10
System Totals	158.45	42.99	11.79	8.55	2.42	27.30	79.75	24.85	8.66	3.53	168.03	50.25	13.93

Figure 3.9-2. Summary of OBIGGS Electrical Power—PSA Systems

Membrane System Component	LT CWT+Main Shipset Elect Pwr (kVA)	MT CWT+Main Shipset Elect Pwr (kVA)	ST CWT+Main Shipset Elect Pwr (kVA)	RTF CWT+Main Shipset Elect Pwr (kVA)	RTP CWT+Main Shipset Elect Pwr (kVA)	BzJ CWT+Main Shipset Elect Pwr (kVA)	LT CWT Only Shipset Elect Pwr (kVA)	MT CWT Only Shipset Elect Pwr (kVA)	ST CWT Only Ship- set Elect Pwr (kVA)	RTF CWT Only Ship- set Elect Pwr (kVA)	LT CWT+Main+ Aux Shipset Elect Pwr (kVA)	MT CWT+Main+ Aux Shipset Elect Pwr (kVA)	ST CWT+Main+ Aux Shipset Elect Pwr (kVA)
Major Components:													
Compressor	34.690	15.104	3.436	2.295	0.475	7.004	17.109	8.163	2.291	0.765	36.772	17.081	5.543
Heat exchanger / fan	0.300	0.150	0.010	0.009	0.000	0.048	0.150	0.082	0.006	0.002	0.318	0.170	0.016
Cryo component subtotals	20.000	18.000	16.000	16.000	16.000	16.000	17.000	17.000	16.000	16.000	21.000	19.000	17.000
	=====	=====	=====	=====	=====	=====	=====	=====	=====	=====	=====	=====	=====
Major component subtotals	54.99	33.25	19.45	18.30	16.48	23.05	34.26	25.25	18.30	16.77	58.09	36.25	22.56
Other component sub-totals	0.10	0.10	0.10	0.10	0.10	0.10	0.10	0.10	0.10	0.10	0.10	0.10	0.10
System Totals	55.09	33.35	19.55	18.40	16.58	23.15	34.36	25.35	18.40	16.87	58.19	36.35	22.66

Figure 3.9-3. Summary of OBIGGS Electrical Power—Cryogenic Distillation Systems

3.9.1 Air Separation Modules

Electrical power estimates were developed for the OBIGGS membrane, pressure-swing adsorption, and cryogenic distillation air separation equipment.

Permeable Membrane. Membrane modules do not require any electrical power.

Pressure-Swing Adsorption. Electrical power consumption for PSA separators is low, since the mechanism to operate the PSA distribution valve is pneumatic. The electrical power is consumed by simple timing and power circuits that operate the pneumatic control valves.

Cryogenic Distillation. Almost all of the electrical power needed for the cryogenic distillation system is used by the cryogenic refrigerator. The supplier's database of analytical calculations and system tests was used to specify the power requirements of the cryogenic refrigeration systems for this study. As in the case of the weight and volume, no scaling was used to determine the cryogenic distillation electrical power requirements.

3.9.2 Compressor

Compressor electrical power was based on the number, size, and type needed for each ASM technology. Compressor types (screw or centrifugal) were selected and electrical power was determined for each aircraft model with the same considerations of power and compressor scalability as outlined in the weight section.

The compressors for each aircraft were sized for the mass flow of supply air required to each of the differing ASM types. The shaft power of the compressor is a function of the mass flow, pressure ratio and inlet temperature. For full-time OBIGGS, the maximum power design point for the compressors was sea level and the maximum ambient temperature operating condition was 110°F. An effort was made to minimize the electrical power requirement by investigating two-stage compressors with inter-cooling. This was selected for the Large and Medium Transport membrane and PSA OBIGGS.

3.9.3 Heat Exchanger/Cooling Fan

Heat exchanger and cooling fan power were determined for each of the aircraft and system types. The heat exchanger requires no power to operate. The cooling fan power requirement was determined based on the cooling air flow rate and pressure rise requirements. The system was designed to minimize the cooling fan power requirements whenever possible.

3.9.4 Other Components

The team estimated the total electrical power required by the "Other" Components in the full-time OBIGGS as 0.1 kVA for all models and tank configurations. This represents a reasonable average power draw of the controller, sensors, and bypass valve which are active all the time and the intermittent power draw of the other valves that only move when commanded.

3.10 RELIABILITY

Figures 3.10-1 through 3.10-6 summarize the OBIGGS component reliability estimates, in terms of Mean-Time-Between-Maintenance-Actions (MTBMA) and Mean-Time-Between-Failure (MTBF), developed for the membrane, PSA, and cryogenic distillation inerting systems for each of the generic aircraft. Each table provides the reliability for the "major" and "other" components identified for each system. "Other" components include such items as wiring, motors and valves, and their total estimated electrical powers have been combined. The Airplane Operations and Maintenance Team used this component data as a starting point for the system level reliability estimates.

Onboard Inerting Designs Task Team Final Report

Membrane System Component	LT CWT+Main Component MTBMA (hrs)	MT CWT+Main Component MTBMA (hrs)	ST CWT+Main Component MTBMA (hrs)	RTF CWT+Main Component MTBMA (hrs)	RTP CWT+Main Component MTBMA (hrs)	BzJ CWT+Main Component MTBMA (hrs)	LT CWT Only Component MTBMA (hrs)	MT CWT Only Component MTBMA (hrs)	ST CWT Only Component MTBMA (hrs)	RTF CWT Only Component MTBMA (hrs)	LT CWT+Main+ Aux Component MTBMA (hrs)	MT CWT+Main+ Aux Component MTBMA (hrs)	ST CWT+Main+ Aux Component MTBMA (hrs)
Major Components:													
Compressor	7,000	7,000	7,000	7,000	7,000	7,000	7,000	7,000	7,000	7,000	7,000	7,000	7,000
Heat exchanger	100,000	100,000	100,000	100,000	100,000	100,000	100,000	100,000	100,000	100,000	100,000	100,000	100,000
Cooling Fan	25,000	25,000	25,000	25,000	25,000	25,000	25,000	25,000	25,000	25,000	25,000	25,000	25,000
Air separation module	30,000	30,000	30,000	30,000	30,000	30,000	30,000	30,000	30,000	30,000	30,000	30,000	30,000
Other Components:													
Cabin air filter assy	100,000	100,000	100,000	100,000	100,000	100,000	100,000	100,000	100,000	100,000	100,000	100,000	100,000
Cabin air filter element	4,000	4,000	4,000	4,000	4,000	4,000	4,000	4,000	4,000	4,000	4,000	4,000	4,000
OBIGGS shutoff valve	50,000	50,000	50,000	50,000	50,000	50,000	50,000	50,000	50,000	50,000	50,000	50,000	50,000
Precooler	100,000	100,000	n/a	n/a	n/a	n/a	100,000	n/a	n/a	n/a	100,000	100,000	n/a
Inter-cooler	100,000	100,000	n/a	n/a	n/a	n/a	100,000	n/a	n/a	n/a	100,000	100,000	n/a
Temperature sensor	50,000	50,000	n/a	n/a	n/a	n/a	50,000	n/a	n/a	n/a	50,000	50,000	n/a
Bypass valve	50,000	50,000	n/a	n/a	n/a	n/a	50,000	n/a	n/a	n/a	50,000	50,000	n/a
Compressor unloading valve	50,000	50,000	50,000	50,000	50,000	50,000	50,000	50,000	50,000	50,000	50,000	50,000	50,000
Compressor discharge check valve	100,000	100,000	100,000	100,000	100,000	100,000	100,000	100,000	100,000	100,000	100,000	100,000	100,000
Bleed shutoff valve	50,000	50,000	50,000	50,000	50,000	50,000	50,000	50,000	50,000	50,000	50,000	50,000	50,000
Bleed check valve	100,000	100,000	100,000	100,000	100,000	100,000	100,000	100,000	100,000	100,000	100,000	100,000	100,000
Bypass valve	50,000	50,000	50,000	50,000	50,000	50,000	50,000	50,000	50,000	50,000	50,000	50,000	50,000
Temperature sensor	50,000	50,000	50,000	50,000	50,000	50,000	50,000	50,000	50,000	50,000	50,000	50,000	50,000
Water separator/filter assy	100,000	100,000	100,000	100,000	100,000	100,000	100,000	100,000	100,000	100,000	100,000	100,000	100,000
Water separator/filter element	4,000	4,000	4,000	4,000	4,000	4,000	4,000	4,000	4,000	4,000	4,000	4,000	4,000
High flow valve	50,000	50,000	50,000	50,000	50,000	50,000	50,000	50,000	50,000	50,000	50,000	50,000	50,000
Relief valve	50,000	50,000	50,000	50,000	50,000	50,000	50,000	50,000	50,000	50,000	50,000	50,000	50,000
Fuel tank check valve	100,000	100,000	100,000	100,000	100,000	100,000	100,000	100,000	100,000	100,000	100,000	100,000	100,000
Controller / control card	10,000	10,000	10,000	10,000	10,000	10,000	10,000	10,000	10,000	10,000	10,000	10,000	10,000
Ducting	10,000,000	10,000,000	10,000,000	10,000,000	10,000,000	10,000,000	10,000,000	10,000,000	10,000,000	10,000,000	10,000,000	10,000,000	10,000,000
Wiring	10,000,000	10,000,000	10,000,000	10,000,000	10,000,000	10,000,000	10,000,000	10,000,000	10,000,000	10,000,000	10,000,000	10,000,000	10,000,000
Installation Hardware	10,000,000	10,000,000	10,000,000	10,000,000	10,000,000	10,000,000	10,000,000	10,000,000	10,000,000	10,000,000	10,000,000	10,000,000	10,000,000
Structural Modifications	10,000,000	10,000,000	10,000,000	10,000,000	10,000,000	10,000,000	10,000,000	10,000,000	10,000,000	10,000,000	10,000,000	10,000,000	10,000,000
Ram Ducting	10,000,000	10,000,000	10,000,000	10,000,000	10,000,000	10,000,000	10,000,000	10,000,000	10,000,000	10,000,000	10,000,000	10,000,000	10,000,000
Compressor wiring	10,000,000	10,000,000	10,000,000	10,000,000	10,000,000	10,000,000	10,000,000	10,000,000	10,000,000	10,000,000	10,000,000	10,000,000	10,000,000
Overheat sensors	50,000	50,000	50,000	50,000	50,000	50,000	50,000	50,000	50,000	50,000	50,000	50,000	50,000
On-board oxygen sensor (information only)	26,933	26,933	26,933	26,933	26,933	26,933	26,933	26,933	26,933	26,933	26,933	26,933	26,933

Figure 3.10-1. Summary of OBIGGS MTBMA—Membrane Systems

Onboard Inerting Designs Task Team Final Report

PSA System Component	LT CWT+Main Component MTBMA (hrs)	MT CWT+Main Component MTBMA (hrs)	ST CWT+Main Component MTBMA (hrs)	RTF CWT+Main Component MTBMA (hrs)	RTP CWT+Main Component MTBMA (hrs)	BzJ CWT+Main Component MTBMA (hrs)	LT CWT Only Component MTBMA (hrs)	MT CWT Only Component MTBMA (hrs)	ST CWT Only Component MTBMA (hrs)	RTF CWT Only Component MTBMA (hrs)	LT CWT+Main+ Aux Component MTBMA (hrs)	MT CWT+Main+ Aux Component MTBMA (hrs)	ST CWT+Main+ Aux Component MTBMA (hrs)
Major Components:													
Compressor	7,000	7,000	7,000	7,000	7,000	7,000	7,000	7,000	7,000	7,000	7,000	7,000	7,000
Heat exchanger	100,000	100,000	100,000	100,000	100,000	100,000	100,000	100,000	100,000	100,000	100,000	100,000	100,000
Cooling Fan	25,000	25,000	25,000	25,000	25,000	25,000	25,000	25,000	25,000	25,000	25,000	25,000	25,000
Air separation module	8,000	34,000	34,000	34,000	34,000	34,000	8,000	34,000	34,000	34,000	8,000	34,000	34,000
Other Components:													
Cabin air filter assv	100,000	100,000	100,000	100,000	100,000	100,000	100,000	100,000	100,000	100,000	100,000	100,000	100,000
Cabin air filter element	4,000	4,000	4,000	4,000	4,000	4,000	4,000	4,000	4,000	4,000	4,000	4,000	4,000
OBIGGS shutoff valve	50,000	50,000	50,000	50,000	50,000	50,000	50,000	50,000	50,000	50,000	50,000	50,000	50,000
Precooler	100,000	100,000	n/a	n/a	n/a	n/a	100,000	n/a	n/a	n/a	100,000	100,000	n/a
Inter-cooler	100,000	100,000	n/a	n/a	n/a	n/a	100,000	n/a	n/a	n/a	100,000	100,000	n/a
Temperature sensor	50,000	50,000	n/a	n/a	n/a	n/a	50,000	n/a	n/a	n/a	50,000	50,000	n/a
Bypass valve	50,000	50,000	n/a	n/a	n/a	n/a	50,000	n/a	n/a	n/a	50,000	50,000	n/a
Compressor unloading valve	50,000	50,000	50,000	50,000	50,000	50,000	50,000	50,000	50,000	50,000	50,000	50,000	50,000
Compressor discharge check valve	100,000	100,000	100,000	100,000	100,000	100,000	100,000	100,000	100,000	100,000	100,000	100,000	100,000
Bleed shutoff valve	50,000	50,000	50,000	50,000	50,000	50,000	50,000	50,000	50,000	50,000	50,000	50,000	50,000
Bleed check valve	100,000	100,000	100,000	100,000	100,000	100,000	100,000	100,000	100,000	100,000	100,000	100,000	100,000
Bypass valve	50,000	50,000	50,000	50,000	50,000	50,000	50,000	50,000	50,000	50,000	50,000	50,000	50,000
Temperature sensor	50,000	50,000	50,000	50,000	50,000	50,000	50,000	50,000	50,000	50,000	50,000	50,000	50,000
Water separator/filter assv	100,000	100,000	100,000	100,000	100,000	100,000	100,000	100,000	100,000	100,000	100,000	100,000	100,000
Water separator/filter element	4,000	4,000	4,000	4,000	4,000	4,000	4,000	4,000	4,000	4,000	4,000	4,000	4,000
High flow valve	50,000	50,000	50,000	50,000	50,000	50,000	50,000	50,000	50,000	50,000	50,000	50,000	50,000
Relief valve	50,000	50,000	50,000	50,000	50,000	50,000	50,000	50,000	50,000	50,000	50,000	50,000	50,000
Fuel tank check valve	100,000	100,000	100,000	100,000	100,000	100,000	100,000	100,000	100,000	100,000	100,000	100,000	100,000
Controller / control card	10,000	10,000	10,000	10,000	10,000	10,000	10,000	10,000	10,000	10,000	10,000	10,000	10,000
Ducting	10,000,000	10,000,000	10,000,000	10,000,000	10,000,000	10,000,000	10,000,000	10,000,000	10,000,000	10,000,000	10,000,000	10,000,000	10,000,000
Wiring	10,000,000	10,000,000	10,000,000	10,000,000	10,000,000	10,000,000	10,000,000	10,000,000	10,000,000	10,000,000	10,000,000	10,000,000	10,000,000
Installation Hardware	10,000,000	10,000,000	10,000,000	10,000,000	10,000,000	10,000,000	10,000,000	10,000,000	10,000,000	10,000,000	10,000,000	10,000,000	10,000,000
Structural Modifications	10,000,000	10,000,000	10,000,000	10,000,000	10,000,000	10,000,000	10,000,000	10,000,000	10,000,000	10,000,000	10,000,000	10,000,000	10,000,000
Ram Ducting	10,000,000	10,000,000	10,000,000	10,000,000	10,000,000	10,000,000	10,000,000	10,000,000	10,000,000	10,000,000	10,000,000	10,000,000	10,000,000
Compressor wiring	10,000,000	10,000,000	10,000,000	10,000,000	10,000,000	10,000,000	10,000,000	10,000,000	10,000,000	10,000,000	10,000,000	10,000,000	10,000,000
Overheat sensors	50,000	50,000	50,000	50,000	50,000	50,000	50,000	50,000	50,000	50,000	50,000	50,000	50,000
On-board oxygen sensor (information only)	26,933	26,933	26,933	26,933	26,933	26,933	26,933	26,933	26,933	26,933	26,933	26,933	26,933

Figure 3.10-2. Summary of OBIGGS MTBMA—PSA Systems

Onboard Inerting Designs Task Team Final Report

Cryogenic Distillation System Component	LT CWT+Main Component MTBMA (hrs)	MT CWT+Main Component MTBMA (hrs)	ST CWT+Main Component MTBMA (hrs)	RTF CWT+Main Component MTBMA (hrs)	RTP CWT+Main Component MTBMA (hrs)	BzJ CWT+Main Component MTBMA (hrs)	LT CWT Only Component MTBMA (hrs)	MT CWT Only Component MTBMA (hrs)	ST CWT Only Component MTBMA (hrs)	RTF CWT Only Component MTBMA (hrs)	LT CWT+Main+ Aux Component MTBMA (hrs)	MT CWT+Main+ Aux Component MTBMA (hrs)	ST CWT+Main+ Aux Component MTBMA (hrs)
Major Components:													
Compressor	7.000	7.000	7.000	7.000	7.000	7.000	7.000	7.000	7.000	7.000	7.000	7.000	7.000
Heat exchanger	100.000	100.000	100.000	100.000	100.000	100.000	100.000	100.000	100.000	100.000	100.000	100.000	100.000
Cooling fan	25.000	25.000	25.000	25.000	25.000	25.000	25.000	25.000	25.000	25.000	25.000	25.000	25.000
Crvo Air Separation Compo-													
Inlet shutoff valve	50.000	50.000	50.000	50.000	50.000	50.000	50.000	50.000	50.000	50.000	50.000	50.000	50.000
Cryocooler bleed air valve	50.000	50.000	50.000	50.000	50.000	50.000	50.000	50.000	50.000	50.000	50.000	50.000	50.000
Flow sensor	20.000	20.000	20.000	20.000	20.000	20.000	20.000	20.000	20.000	20.000	20.000	20.000	20.000
Molecular sieve control valves	50.000	50.000	50.000	50.000	50.000	50.000	50.000	50.000	50.000	50.000	50.000	50.000	50.000
Molecular sieve svstem	50.000	50.000	50.000	50.000	50.000	50.000	50.000	50.000	50.000	50.000	50.000	50.000	50.000
Purge heat exchanger	80.000	100.000	100.000	100.000	100.000	100.000	80.000	100.000	100.000	100.000	80.000	100.000	100.000
Purge heat exchanger valve-Air Side	50.000	50.000	50.000	50.000	50.000	50.000	50.000	50.000	50.000	50.000	50.000	50.000	50.000
Purge heat exchanger valve-Waste Side	50.000	50.000	50.000	50.000	50.000	50.000	50.000	50.000	50.000	50.000	50.000	50.000	50.000
LNEA Dewar Cooldown Valve	50.000	50.000	50.000	50.000	50.000	50.000	50.000	50.000	50.000	50.000	50.000	50.000	50.000
Inlet Recuperator	60.000	100.000	100.000	100.000	100.000	100.000	60.000	100.000	100.000	100.000	60.000	100.000	100.000
Inlet cooler	80.000	100.000	100.000	100.000	100.000	100.000	80.000	100.000	100.000	100.000	80.000	100.000	100.000
Cryocooler	8.000	8.000	8.000	8.000	8.000	8.000	8.000	8.000	8.000	8.000	8.000	8.000	8.000
LNEA Dewar	75.000	75.000	75.000	n/a	n/a	n/a	75.000	75.000	75.000	n/a	75.000	75.000	75.000
Dewar level sensor	50.000	50.000	50.000	n/a	n/a	n/a	50.000	50.000	50.000	n/a	50.000	50.000	50.000
Distillation column	50.000	50.000	50.000	50.000	50.000	50.000	50.000	50.000	50.000	50.000	50.000	50.000	50.000
Distillation column gas valve	50.000	50.000	50.000	50.000	50.000	50.000	50.000	50.000	50.000	50.000	50.000	50.000	50.000
Distillation column liquid valve	50.000	50.000	50.000	50.000	50.000	50.000	50.000	50.000	50.000	50.000	50.000	50.000	50.000
Other Components:													
Cabin air filter assv	100.000	100.000	100.000	100.000	100.000	100.000	100.000	100.000	100.000	100.000	100.000	100.000	100.000
Cabin air filter element	4.000	4.000	4.000	4.000	4.000	4.000	4.000	4.000	4.000	4.000	4.000	4.000	4.000
OBIGGS shutoff valve	50.000	50.000	50.000	50.000	50.000	50.000	50.000	50.000	50.000	50.000	50.000	50.000	50.000
Compressor	7.000	7.000	7.000	7.000	7.000	7.000	7.000	7.000	7.000	7.000	7.000	7.000	7.000
Compressor unloading valve	50.000	50.000	50.000	50.000	50.000	50.000	50.000	50.000	50.000	50.000	50.000	50.000	50.000
Compressor discharge check valve	100.000	100.000	100.000	100.000	100.000	100.000	100.000	100.000	100.000	100.000	100.000	100.000	100.000
Bleed shutoff valve	50.000	50.000	50.000	50.000	50.000	50.000	50.000	50.000	50.000	50.000	50.000	50.000	50.000
Bleed check valve	100.000	100.000	100.000	100.000	100.000	100.000	100.000	100.000	100.000	100.000	100.000	100.000	100.000

Figure 3.10-3. Summary of OBIGGS MTBMA—Cryogenic Distillation Systems (Sheet 1 of 2)

Onboard Inerting Designs Task Team Final Report

Cryogenic Distillation System Component	LT CWT+Main Component MTBMA (hrs)	MT CWT+Main Component MTBMA (hrs)	ST CWT+Main Component MTBMA (hrs)	RTF CWT+Main Component MTBMA (hrs)	RTP CWT+Main Component MTBMA (hrs)	BzJ CWT+Main Component MTBMA (hrs)	LT CWT Only Component MTBMA (hrs)	MT CWT Only Component MTBMA (hrs)	ST CWT Only Component MTBMA (hrs)	RTF CWT Only Component MTBMA (hrs)	LT CWT+Main+ Aux Component MTBMA (hrs)	MT CWT+Main+ Aux Component MTBMA (hrs)	ST CWT+Main+ Aux Component MTBMA (hrs)
Bypass valve	50,000	50,000	50,000	50,000	50,000	50,000	50,000	50,000	50,000	50,000	50,000	50,000	50,000
Temperature sensor	50,000	50,000	50,000	50,000	50,000	50,000	50,000	50,000	50,000	50,000	50,000	50,000	50,000
Water separator/filter assv	100,000	100,000	100,000	100,000	100,000	100,000	100,000	100,000	100,000	100,000	100,000	100,000	100,000
Water separator/filter element	4,000	4,000	4,000	4,000	4,000	4,000	4,000	4,000	4,000	4,000	4,000	4,000	4,000
Temperature sensor	50,000	50,000	50,000	50,000	50,000	50,000	50,000	50,000	50,000	50,000	50,000	50,000	50,000
Relief valve	50,000	50,000	50,000	50,000	50,000	50,000	50,000	50,000	50,000	50,000	50,000	50,000	50,000
Fuel tank check valve	100,000	100,000	100,000	100,000	100,000	100,000	100,000	100,000	100,000	100,000	100,000	100,000	100,000
Controller / control card	10,000	10,000	10,000	10,000	10,000	10,000	10,000	10,000	10,000	10,000	10,000	10,000	10,000
Ducting	10,000,000	10,000,000	10,000,000	10,000,000	10,000,000	10,000,000	10,000,000	10,000,000	10,000,000	10,000,000	10,000,000	10,000,000	10,000,000
Wiring	10,000,000	10,000,000	10,000,000	10,000,000	10,000,000	10,000,000	10,000,000	10,000,000	10,000,000	10,000,000	10,000,000	10,000,000	10,000,000
Installation Hardware	10,000,000	10,000,000	10,000,000	10,000,000	10,000,000	10,000,000	10,000,000	10,000,000	10,000,000	10,000,000	10,000,000	10,000,000	10,000,000
Structural Modifications	10,000,000	10,000,000	10,000,000	10,000,000	10,000,000	10,000,000	10,000,000	10,000,000	10,000,000	10,000,000	10,000,000	10,000,000	10,000,000
Ram Ducting	10,000,000	10,000,000	10,000,000	10,000,000	10,000,000	10,000,000	10,000,000	10,000,000	10,000,000	10,000,000	10,000,000	10,000,000	10,000,000
Compressor wiring	10,000,000	10,000,000	10,000,000	10,000,000	10,000,000	10,000,000	10,000,000	10,000,000	10,000,000	10,000,000	10,000,000	10,000,000	10,000,000
Overheat sensors	50,000	50,000	50,000	50,000	50,000	50,000	50,000	50,000	50,000	50,000	50,000	50,000	50,000
On-board oxygen sensor (information only)	26,933	26,933	26,933	26,933	26,933	26,933	26,933	26,933	26,933	26,933	26,933	26,933	26,933

Figure 3.10-3. Summary of OBIGGS MTBMA—Cryogenic Distillation Systems (Sheet 2 of 2)

Onboard Inerting Designs Task Team Final Report

Membrane System Component	LT CWT+Main Component MTBF (hrs)	MT CWT+Main Component MTBF (hrs)	ST CWT+Main Component MTBF (hrs)	RTF CWT+Main Component MTBF (hrs)	RTP CWT+Main Component MTBF (hrs)	BzJ CWT+Main Component MTBF (hrs)	LT CWT Only Component MTBF (hrs)	MT CWT Only Component MTBF (hrs)	ST CWT Only Component MTBF (hrs)	RTF CWT Only Component MTBF (hrs)	LT CWT+Main+ Aux Component MTBF (hrs)	MT CWT+Main+ Aux Component MTBF (hrs)	ST CWT+Main+ Aux Component MTBF (hrs)
Maior Components:													
Compressor	100,000	100,000	100,000	100,000	100,000	100,000	100,000	100,000	100,000	100,000	100,000	100,000	100,000
Heat exchanger	100,000	100,000	100,000	100,000	100,000	100,000	100,000	100,000	100,000	100,000	100,000	100,000	100,000
Cooling Fan	25,000	25,000	25,000	25,000	25,000	25,000	25,000	25,000	25,000	25,000	25,000	25,000	25,000
Air separation module	30,000	30,000	30,000	30,000	30,000	30,000	30,000	30,000	30,000	30,000	30,000	30,000	30,000
Other Components:													
Cabin air filter assv	100,000	100,000	100,000	100,000	100,000	100,000	100,000	100,000	100,000	100,000	100,000	100,000	100,000
OBIGGS shutoff valve	50,000	50,000	50,000	50,000	50,000	50,000	50,000	50,000	50,000	50,000	50,000	50,000	50,000
Precooler	100,000	100,000	n/a	n/a	n/a	n/a	100,000	n/a	n/a	n/a	100,000	100,000	n/a
Inter-cooler	100,000	100,000	n/a	n/a	n/a	n/a	100,000	n/a	n/a	n/a	100,000	100,000	n/a
Temperature sensor	50,000	50,000	n/a	n/a	n/a	n/a	50,000	n/a	n/a	n/a	50,000	50,000	n/a
Bypass valve	50,000	50,000	n/a	n/a	n/a	n/a	50,000	n/a	n/a	n/a	50,000	50,000	n/a
Compressor unloading valve	50,000	50,000	50,000	50,000	50,000	50,000	50,000	50,000	50,000	50,000	50,000	50,000	50,000
Compressor discharge check valve	100,000	100,000	100,000	100,000	100,000	100,000	100,000	100,000	100,000	100,000	100,000	100,000	100,000
Bleed shutoff valve	50,000	50,000	50,000	50,000	50,000	50,000	50,000	50,000	50,000	50,000	50,000	50,000	50,000
Bleed check valve	100,000	100,000	100,000	100,000	100,000	100,000	100,000	100,000	100,000	100,000	100,000	100,000	100,000
Bypass valve	50,000	50,000	50,000	50,000	50,000	50,000	50,000	50,000	50,000	50,000	50,000	50,000	50,000
Temperature sensor	50,000	50,000	50,000	50,000	50,000	50,000	50,000	50,000	50,000	50,000	50,000	50,000	50,000
Water separator/filter assv	100,000	100,000	100,000	100,000	100,000	100,000	100,000	100,000	100,000	100,000	100,000	100,000	100,000
High flow valve	50,000	50,000	50,000	50,000	50,000	50,000	50,000	50,000	50,000	50,000	50,000	50,000	50,000
Relief valve	50,000	50,000	50,000	50,000	50,000	50,000	50,000	50,000	50,000	50,000	50,000	50,000	50,000
Fuel tank check valve	100,000	100,000	100,000	100,000	100,000	100,000	100,000	100,000	100,000	100,000	100,000	100,000	100,000
Controller / control card	10,000	10,000	10,000	10,000	10,000	10,000	10,000	10,000	10,000	10,000	10,000	10,000	10,000
Ducting	10,000,000	10,000,000	10,000,000	10,000,000	10,000,000	10,000,000	10,000,000	10,000,000	10,000,000	10,000,000	10,000,000	10,000,000	10,000,000
Wiring	10,000,000	10,000,000	10,000,000	10,000,000	10,000,000	10,000,000	10,000,000	10,000,000	10,000,000	10,000,000	10,000,000	10,000,000	10,000,000
Installation Hardware	10,000,000	10,000,000	10,000,000	10,000,000	10,000,000	10,000,000	10,000,000	10,000,000	10,000,000	10,000,000	10,000,000	10,000,000	10,000,000
Structural Modifications	10,000,000	10,000,000	10,000,000	10,000,000	10,000,000	10,000,000	10,000,000	10,000,000	10,000,000	10,000,000	10,000,000	10,000,000	10,000,000
Ram Ducting	10,000,000	10,000,000	10,000,000	10,000,000	10,000,000	10,000,000	10,000,000	10,000,000	10,000,000	10,000,000	10,000,000	10,000,000	10,000,000
Compressor wiring	10,000,000	10,000,000	10,000,000	10,000,000	10,000,000	10,000,000	10,000,000	10,000,000	10,000,000	10,000,000	10,000,000	10,000,000	10,000,000
Overheat sensors	50,000	50,000	50,000	50,000	50,000	50,000	50,000	50,000	50,000	50,000	50,000	50,000	50,000
On-board oxygen sensor (information only)	26,933	26,933	26,933	26,933	26,933	26,933	26,933	26,933	26,933	26,933	26,933	26,933	26,933

Figure 3.10-4. Summary of OBIGGS MTBF—Membrane Systems

Onboard Inerting Designs Task Team Final Report

PSA System Component	LT CWT+Main Component MTBF (hrs)	MT CWT+Main Component MTBF (hrs)	ST CWT+Main Component MTBF (hrs)	RTF CWT+Main Component MTBF (hrs)	RTP CWT+Main Component MTBF (hrs)	BzJ CWT+Main Component MTBF (hrs)	LT CWT Only Component MTBF (hrs)	MT CWT Only Component MTBF (hrs)	ST CWT Only Component MTBF (hrs)	RTF CWT Only Component MTBF (hrs)	LT CWT+Main+ Aux Component MTBF (hrs)	MT CWT+Main+ Aux Component MTBF (hrs)	ST CWT+Main+ Aux Component MTBF (hrs)
Major Components:													
Compressor	100,000	100,000	100,000	100,000	100,000	100,000	100,000	100,000	100,000	100,000	100,000	100,000	100,000
Heat exchanger	100,000	100,000	100,000	100,000	100,000	100,000	100,000	100,000	100,000	100,000	100,000	100,000	100,000
Cooling Fan	25,000	25,000	25,000	25,000	25,000	25,000	25,000	25,000	25,000	25,000	25,000	25,000	25,000
Air separation module	34,000	34,000	34,000	34,000	34,000	34,000	34,000	34,000	34,000	34,000	34,000	34,000	34,000
Other Components:													
Cabin air filter assv	100,000	100,000	100,000	100,000	100,000	100,000	100,000	100,000	100,000	100,000	100,000	100,000	100,000
OBIGGS shutoff valve	50,000	50,000	50,000	50,000	50,000	50,000	50,000	50,000	50,000	50,000	50,000	50,000	50,000
Precooler	100,000	100,000	n/a	n/a	n/a	n/a	100,000	n/a	n/a	n/a	100,000	100,000	n/a
Inter-cooler	100,000	100,000	n/a	n/a	n/a	n/a	100,000	n/a	n/a	n/a	100,000	100,000	n/a
Temperature sensor	50,000	50,000	n/a	n/a	n/a	n/a	50,000	n/a	n/a	n/a	50,000	50,000	n/a
Bypass valve	50,000	50,000	n/a	n/a	n/a	n/a	50,000	n/a	n/a	n/a	50,000	50,000	n/a
Compressor unloading valve	50,000	50,000	50,000	50,000	50,000	50,000	50,000	50,000	50,000	50,000	50,000	50,000	50,000
Compressor discharge check valve	100,000	100,000	100,000	100,000	100,000	100,000	100,000	100,000	100,000	100,000	100,000	100,000	100,000
Bleed shutoff valve	50,000	50,000	50,000	50,000	50,000	50,000	50,000	50,000	50,000	50,000	50,000	50,000	50,000
Bleed check valve	100,000	100,000	100,000	100,000	100,000	100,000	100,000	100,000	100,000	100,000	100,000	100,000	100,000
Bypass valve	50,000	50,000	50,000	50,000	50,000	50,000	50,000	50,000	50,000	50,000	50,000	50,000	50,000
Temperature sensor	50,000	50,000	50,000	50,000	50,000	50,000	50,000	50,000	50,000	50,000	50,000	50,000	50,000
Water separator/filter assv	100,000	100,000	100,000	100,000	100,000	100,000	100,000	100,000	100,000	100,000	100,000	100,000	100,000
High flow valve	50,000	50,000	50,000	50,000	50,000	50,000	50,000	50,000	50,000	50,000	50,000	50,000	50,000
Relief valve	50,000	50,000	50,000	50,000	50,000	50,000	50,000	50,000	50,000	50,000	50,000	50,000	50,000
Fuel tank check valve	100,000	100,000	100,000	100,000	100,000	100,000	100,000	100,000	100,000	100,000	100,000	100,000	100,000
Controller / control card	10,000	10,000	10,000	10,000	10,000	10,000	10,000	10,000	10,000	10,000	10,000	10,000	10,000
Ducting	10,000,000	10,000,000	10,000,000	10,000,000	10,000,000	10,000,000	10,000,000	10,000,000	10,000,000	10,000,000	10,000,000	10,000,000	10,000,000
Wiring	10,000,000	10,000,000	10,000,000	10,000,000	10,000,000	10,000,000	10,000,000	10,000,000	10,000,000	10,000,000	10,000,000	10,000,000	10,000,000
Installation Hardware	10,000,000	10,000,000	10,000,000	10,000,000	10,000,000	10,000,000	10,000,000	10,000,000	10,000,000	10,000,000	10,000,000	10,000,000	10,000,000
Structural Modifications	10,000,000	10,000,000	10,000,000	10,000,000	10,000,000	10,000,000	10,000,000	10,000,000	10,000,000	10,000,000	10,000,000	10,000,000	10,000,000
Ram Ducting	10,000,000	10,000,000	10,000,000	10,000,000	10,000,000	10,000,000	10,000,000	10,000,000	10,000,000	10,000,000	10,000,000	10,000,000	10,000,000
Compressor wiring	10,000,000	10,000,000	10,000,000	10,000,000	10,000,000	10,000,000	10,000,000	10,000,000	10,000,000	10,000,000	10,000,000	10,000,000	10,000,000
Overheat sensors	50,000	50,000	50,000	50,000	50,000	50,000	50,000	50,000	50,000	50,000	50,000	50,000	50,000
On-board oxygen sensor (information only)	26,933	26,933	26,933	26,933	26,933	26,933	26,933	26,933	26,933	26,933	26,933	26,933	26,933

Figure 3.10-5. Summary of OBIGGS MTBF—PSA Systems

Onboard Inerting Designs Task Team Final Report

Cryogenic Distillation System Component	LT CWT+Main Component MTBF (hrs)	MT CWT+Main Component MTBF (hrs)	ST CWT+Main Component MTBF (hrs)	RTF CWT+Main Component MTBF (hrs)	RTP CWT+Main Component MTBF (hrs)	BzJ CWT+Main Component MTBF (hrs)	LT CWT Only Component MTBF (hrs)	MT CWT Only Component MTBF (hrs)	ST CWT Only Component MTBF (hrs)	RTF CWT Only Component MTBF (hrs)	LT CWT+Main+ Aux Component MTBF (hrs)	MT CWT+Main+ Aux Component MTBF (hrs)	ST CWT+Main+ Aux Component MTBF (hrs)
Major Components:													
Compressor	100,000	100,000	100,000	100,000	100,000	100,000	100,000	100,000	100,000	100,000	100,000	100,000	100,000
Heat exchanger	100,000	100,000	100,000	100,000	100,000	100,000	100,000	100,000	100,000	100,000	100,000	100,000	100,000
Cooling fan	25,000	25,000	25,000	25,000	25,000	25,000	25,000	25,000	25,000	25,000	25,000	25,000	25,000
Cryo Air Separation Com-													
Inlet shutoff valve	50,000	50,000	50,000	50,000	50,000	50,000	50,000	50,000	50,000	50,000	50,000	50,000	50,000
Cryocooler bleed air valve	50,000	50,000	50,000	50,000	50,000	50,000	50,000	50,000	50,000	50,000	50,000	50,000	50,000
Flow sensor	20,000	20,000	20,000	20,000	20,000	20,000	20,000	20,000	20,000	20,000	20,000	20,000	20,000
Molecular sieve control	50,000	50,000	50,000	50,000	50,000	50,000	50,000	50,000	50,000	50,000	50,000	50,000	50,000
Molecular sieve system	50,000	50,000	50,000	50,000	50,000	50,000	50,000	50,000	50,000	50,000	50,000	50,000	50,000
Purge heat exchanger	80,000	100,000	100,000	100,000	100,000	100,000	80,000	100,000	100,000	100,000	80,000	100,000	100,000
Purge heat exchanger	50,000	50,000	50,000	50,000	50,000	50,000	50,000	50,000	50,000	50,000	50,000	50,000	50,000
Purge heat exchanger valve-Waste Side	50,000	50,000	50,000	50,000	50,000	50,000	50,000	50,000	50,000	50,000	50,000	50,000	50,000
LNEA Dewar Cooldown Valve	50,000	50,000	50,000	50,000	50,000	50,000	50,000	50,000	50,000	50,000	50,000	50,000	50,000
Inlet Recuperator	60,000	100,000	100,000	100,000	100,000	100,000	60,000	100,000	100,000	100,000	60,000	100,000	100,000
Inlet cooler	80,000	100,000	100,000	100,000	100,000	100,000	80,000	100,000	100,000	100,000	80,000	100,000	100,000
Cryocooler	8,000	8,000	8,000	8,000	8,000	8,000	8,000	8,000	8,000	8,000	8,000	8,000	8,000
LNEA Dewar	75,000	75,000	75,000	n/a	n/a	n/a	75,000	75,000	75,000	n/a	75,000	75,000	75,000
Dewar level sensor	50,000	50,000	50,000	n/a	n/a	n/a	50,000	50,000	50,000	n/a	50,000	50,000	50,000
Distillation column	50,000	50,000	50,000	50,000	50,000	50,000	50,000	50,000	50,000	50,000	50,000	50,000	50,000
Distillation column gas	50,000	50,000	50,000	50,000	50,000	50,000	50,000	50,000	50,000	50,000	50,000	50,000	50,000
Distillation column liquid	50,000	50,000	50,000	50,000	50,000	50,000	50,000	50,000	50,000	50,000	50,000	50,000	50,000
Other Components:													
Cabin air filter assy	100,000	100,000	100,000	100,000	100,000	100,000	100,000	100,000	100,000	100,000	100,000	100,000	100,000
OBIGGS shutoff valve	50,000	50,000	50,000	50,000	50,000	50,000	50,000	50,000	50,000	50,000	50,000	50,000	50,000
Compressor	100,000	100,000	100,000	100,000	100,000	100,000	100,000	100,000	100,000	100,000	100,000	100,000	100,000
Compressor unloading	50,000	50,000	50,000	50,000	50,000	50,000	50,000	50,000	50,000	50,000	50,000	50,000	50,000
Compressor discharge	100,000	100,000	100,000	100,000	100,000	100,000	100,000	100,000	100,000	100,000	100,000	100,000	100,000
Bleed shutoff valve	50,000	50,000	50,000	50,000	50,000	50,000	50,000	50,000	50,000	50,000	50,000	50,000	50,000
Bleed check valve	100,000	100,000	100,000	100,000	100,000	100,000	100,000	100,000	100,000	100,000	100,000	100,000	100,000
Bypass valve	50,000	50,000	50,000	50,000	50,000	50,000	50,000	50,000	50,000	50,000	50,000	50,000	50,000
Temperature sensor	50,000	50,000	50,000	50,000	50,000	50,000	50,000	50,000	50,000	50,000	50,000	50,000	50,000

Figure 3.10-6. Summary of OBIGGS MTBF—Cryogenic Distillation Systems (Sheet 1 of 2)

Onboard Inerting Designs Task Team Final Report

Cryogenic Distillation System Component	LT CWT+Main Component MTBF (hrs)	MT CWT+Main Component MTBF (hrs)	ST CWT+Main Component MTBF (hrs)	RTF CWT+Main Component MTBF (hrs)	RTP CWT+Main Component MTBF (hrs)	BzJ CWT+Main Component MTBF (hrs)	LT CWT Only Component MTBF (hrs)	MT CWT Only Component MTBF (hrs)	ST CWT Only Component MTBF (hrs)	RTF CWT Only Component MTBF (hrs)	LT CWT+Main+ Aux Component MTBF (hrs)	MT CWT+Main+ Aux Component MTBF (hrs)	ST CWT+Main+ Aux Component MTBF (hrs)
Water separator/filter assy	100,000	100,000	100,000	100,000	100,000	100,000	100,000	100,000	100,000	100,000	100,000	100,000	100,000
Temperature sensor	50,000	50,000	50,000	50,000	50,000	50,000	50,000	50,000	50,000	50,000	50,000	50,000	50,000
Relief valve	50,000	50,000	50,000	50,000	50,000	50,000	50,000	50,000	50,000	50,000	50,000	50,000	50,000
Fuel tank check valve	100,000	100,000	100,000	100,000	100,000	100,000	100,000	100,000	100,000	100,000	100,000	100,000	100,000
Controller / control card	10,000	10,000	10,000	10,000	10,000	10,000	10,000	10,000	10,000	10,000	10,000	10,000	10,000
Ducting	10,000,000	10,000,000	10,000,000	10,000,000	10,000,000	10,000,000	10,000,000	10,000,000	10,000,000	10,000,000	10,000,000	10,000,000	10,000,000
Wiring	10,000,000	10,000,000	10,000,000	10,000,000	10,000,000	10,000,000	10,000,000	10,000,000	10,000,000	10,000,000	10,000,000	10,000,000	10,000,000
Installation Hardware	10,000,000	10,000,000	10,000,000	10,000,000	10,000,000	10,000,000	10,000,000	10,000,000	10,000,000	10,000,000	10,000,000	10,000,000	10,000,000
Structural Modifications	10,000,000	10,000,000	10,000,000	10,000,000	10,000,000	10,000,000	10,000,000	10,000,000	10,000,000	10,000,000	10,000,000	10,000,000	10,000,000
Ram Ducting	10,000,000	10,000,000	10,000,000	10,000,000	10,000,000	10,000,000	10,000,000	10,000,000	10,000,000	10,000,000	10,000,000	10,000,000	10,000,000
Compressor wiring	10,000,000	10,000,000	10,000,000	10,000,000	10,000,000	10,000,000	10,000,000	10,000,000	10,000,000	10,000,000	10,000,000	10,000,000	10,000,000
Overheat sensors	50,000	50,000	50,000	50,000	50,000	50,000	50,000	50,000	50,000	50,000	50,000	50,000	50,000
On-board oxygen sensor (information only)	26,933	26,933	26,933	26,933	26,933	26,933	26,933	26,933	26,933	26,933	26,933	26,933	26,933

Figure 3.10-6. Summary of OBIGGS MTBF—Cryogenic Distillation Systems (Sheet 2 of 2)

3.10.1 Air Separation Modules

Reliability estimates were developed for OBIGGS membrane, pressure-swing adsorption, and cryogenic distillation air separation equipment.

Permeable Membrane. The membrane module consists of a membrane fiber bundle contained in a metal housing. There are no moving parts. The most likely failure causes are contamination and over-temperature damage. The OBIGGS concepts include upstream filtration and redundant temperature sensors to minimize the possibility of these failures. There are commercial membrane modules that have operated continuously for many years without failure. There is no scheduled maintenance requirement for the membrane modules.

Pressure-Swing Adsorption. The PSA hardware consists of a distribution valve that is pilot operated by relatively small pneumatic valves and controlled by a timing circuit. Also included are air and product manifolds, molecular sieve beds, and purge orifices. The distribution valve assembly contains two wear parts, which are recommended to be serviced at 6000 to 8000 hour intervals. The Mean-Time-Between-Failure estimate in the summary table assumes a scheduled overhaul is performed every 8000 hours.

Cryogenic Distillation. The cryogenic system consists of several components including heat exchangers, valves, a cryogenic refrigerator (cryocooler), and distillation columns. The reliability estimates for the valves, heat exchangers, and columns were provided by the specifications from various component suppliers for off-the-shelf items. The reliability estimates obtained from the component suppliers for the heat exchangers and the valves were reduced by the Team to conform to reliability values for other systems. Thus, the actual reliability for the cryogenic distillation system is slightly higher than the values presented in this report. The reliability value for the cryogenic refrigerator is a conservative estimate.

3.10.2 Compressor

The compressor reliability for screw-type units is based on a recommended service interval of 7000 hours. The centrifugal compressors use a different bearing technology that does not require periodic servicing. Suppliers of existing flight-worthy equipment provided the reliability estimates.

3.10.3 Heat Exchanger/Cooling Fan

The heat exchanger and cooling fan reliability estimates are based on commercial aircraft experience and were provided by suppliers of existing flight-worthy equipment.

3.10.4 Other Components

Reliability estimates for the other OBIGGS components were based on commercial aircraft experience with similar components. Common reliability estimates were used for the components that were used in all of the systems to ensure a fair comparison between the different inerting concepts and technologies.

3.11 COST

The Team estimated the initial acquisition costs for the membrane, PSA, and cryogenic distillation OBIGGS for each of the generic aircraft. Design and certification, operations, maintenance, and installation costs for the OBIGGS are described later in this section. Inclusion of those costs to determine cost benefit was performed by the Estimating and Forecasting (E&F) team and is described in the E&F team final report.

3.11.1 Acquisition Cost

Acquisition costs for OBIGGS systems were developed by the participating suppliers on the team following the same guidelines as used for OBI acquisition, which include:

Onboard Inerting Designs Task Team Final Report

- Final rule requiring fuel tank inerting becomes effective in year 2004.
- Production of the first certified system occurs in year 2009.
- Retrofit of existing aircraft is completed by year 2014.
- Continued production of OBIGGS for new production aircraft is through year 2020.
- As of year 2000, existing fleet of in-service aircraft is 13,813 aircraft, per Campbell Hill survey of world fleet forecast data provided by ATA.
- Average annual new aircraft production rate is 837 aircraft per year, per Campbell Hill survey of world fleet forecast data provided by ATA.
- When applying Campbell Hill survey of world fleet forecast data, between 5,500 and 5,800 shipsets per year total would be produced by the OBIGGS suppliers starting in 2009 and running through 2014.
- When applying Campbell Hill survey of world fleet forecast data, continued production of between 980 and 1,300 shipsets per year would occur by the OBIGGS suppliers starting in 2015 and running through 2020.
- Each supplier assumed a market share of 30%.
- New designs are assumed to be optimized to minimize non-recurring and recurring costs. The time frame for non-recurring efforts was estimated as 39 months.
- Non-recurring development costs were amortized into the per-system pricing provided by each supplier.

Figures 3.11.1-1 through 3.11.1-3 summarize the OBIGGS acquisition costs developed by the team for the membrane, PSA, and cryogenic distillation inerting systems for each of the generic aircraft. In Figures 3.11-1 through 3.11-3 the total cost for the individual components is identified for each system to provide inerting of main tanks and CWTs, CWTs only, and all tanks (main tanks, CWTs and auxiliary tanks). The estimated component costs include the amortized non-recurring development costs. The team also separately estimated the cost for an on-board oxygen sensor, though this cost was not included in the system totals.

Onboard Inerting Designs Task Team Final Report

Membrane System Component	LT CWT+Main Shipset Cost (\$)	MT CWT+Main Shipset Cost (\$)	ST CWT+Main Shipset Cost (\$)	RTF CWT+Main Shipset Cost (\$)	RTP CWT+Main Shipset Cost (\$)	BzJ CWT+Main Shipset Cost (\$)	LT CWT Only Shipset Cost (\$)	MT CWT Only Shipset Cost (\$)	ST CWT Only Shipset Cost (\$)	RTF CWT Only Shipset Cost (\$)	LT CWT+Main+ Aux Shipset Cost (\$)	MT CWT+Mai Aux Shipset Cost (\$)	ST CWT+Main+ Aux Shipset Cost (\$)
Maior Components:													
Compressor	49,122	8,415	10,392	10,198	9,807	6,598	15,779	7,438	10,202	9,915	25,225	15,303	6,146
Heat exchanger/fan	33,397	15,134	3,804	3,462	3,109	10,761	18,130	8,203	3,469	2,963	37,839	16,807	4,581
Air separation module	68,575	26,375	7,912	5,275	5,275	13,187	34,630	10,814	5,792	2,374	72,690	29,883	12,833
	=====	=====	=====	=====	=====	=====	=====	=====	=====	=====	=====	=====	=====
Major component sub-totals	151,094	49,924	22,108	18,935	18,191	30,546	68,540	26,454	19,463	15,252	135,753	61,993	23,560
Other Components:													
Cabin air filter assv	350	350	350	350	350	350	**	**	**	**	**	**	**
OBIGGS shutoff valve	2,000	2,000	2,000	2,000	2,000	2,000	**	**	**	**	**	**	**
Precooler	8,000	4,000	n/a	n/a	n/a	n/a	**	**	n/a	n/a	**	**	n/a
Inter-cooler	8,000	4,000	n/a	n/a	n/a	n/a	**	**	n/a	n/a	**	**	n/a
Temperature sensor	2,000	1,000	n/a	n/a	n/a	n/a	**	**	n/a	n/a	**	**	n/a
Bypass valve	4,000	2,000	n/a	n/a	n/a	n/a	**	**	n/a	n/a	**	**	n/a
Compressor unloading valve	3,120	1,560	1,350	1,560	1,250	1,560	**	**	**	**	**	**	**
Compressor discharge check valve	475	425	275	475	250	475	**	**	**	**	**	**	**
Bleed shutoff valve	1,250	1,250	1,100	1,250	1,100	1,250	**	**	**	**	**	**	**
Bleed check valve	475	425	275	475	250	475	**	**	**	**	**	**	**
Bypass valve	2,000	2,000	2,000	2,000	2,000	2,000	**	**	**	**	**	**	**
Temperature sensor	2,000	2,000	2,000	2,000	2,000	2,000	**	**	**	**	**	**	**
Water separator/filter assv	5,000	5,000	5,000	5,000	5,000	5,000	**	**	**	**	**	**	**
High flow valve	1,250	1,250	1,100	1,250	0	1,250	**	**	**	**	**	**	**
Relief valve	680	580	450	550	450	550	**	**	**	**	**	**	**
Fuel tank check valve	675	675	675	675	675	675	**	**	**	**	**	**	**
Controller / control card	40,000	40,000	40,000	40,000	40,000	40,000	**	**	**	**	**	**	**
Ducting	35,600	23,200	10,500	7,600	7,600	7,600	**	**	**	**	**	**	**
Wiring	750	500	250	250	250	400	**	**	**	**	**	**	**
Installation Hardware	3,555	1,510	644	527	300	836	**	**	**	**	**	**	**
Structural Modifications	2,000	1,000	400	200	200	200	**	**	**	**	**	**	**
Ram Ducting	12,000	6,000	3,000	2,000	2,000	2,000	**	**	**	**	**	**	**
Compressor wiring	5,976	811	310	75	58	259	**	**	**	**	**	**	**
Overheat sensors	1,000	1,000	1,000	1,000	1,000	1,000	**	**	**	**	**	**	**
	=====	=====	=====	=====	=====	=====	=====	=====	=====	=====	=====	=====	=====
Other component sub-totals	142,156	102,536	72,679	69,237	66,733	69,880	106,000	78,000	70,000	67,000	151,000	103,000	77,000
System Totals	293,250	152,460	94,787	88,171	84,925	100,426	174,540	104,454	89,463	82,252	286,753	164,993	100,560
On-board oxygen sensor (not included)	6,000	6,000	6,000	6,000	6,000	6,000	6,000	6,000	6,000	6,000	6,000	6,000	6,000

**Indicates scaled data

Figure 3.11.1-1. Summary of OBIGGS Costs—Membrane Systems

Onboard Inerting Designs Task Team Final Report

PSA System Component	LT CWT+Main Shipset Cost (\$)	MT CWT+Main Shipset Cost (\$)	ST CWT+Main Shipset Cost (\$)	RTF CWT+Main Shipset Cost (\$)	RTP CWT+Main Shipset Cost (\$)	BzJ CWT+Main Shipset Cost (\$)	LT CWT Only Shipset Cost (\$)	MT CWT Only Shipset Cost (\$)	ST CWT Only Shipset Cost (\$)	RTF CWT Only Shipset Cost (\$)	LT CWT+Main+ Aux Shipset Cost (\$)	MT CWT+Mai Aux Shipset Cost (\$)	ST CWT+Main+ Aux Shipset Cost (\$)
Major Components:													
Compressor	18,000	9,000	11,000	10,239	9,838	6,868	17,047	7,813	10,246	9,909	41,151	15,656	6,197
Heat exchanger/fan	85,000	28,000	5,000	4,413	3,266	18,752	44,041	17,085	4,438	3,308	89,636	31,047	6,729
Air separation module	46,000	20,000	11,000	12,000	9,000	17,000	22,000	15,000	10,000	10,000	48,760	22,660	17,842
	=====	=====	=====	=====	=====	=====	=====	=====	=====	=====	=====	=====	=====
Major component sub-totals	149,000	57,000	27,000	26,651	22,105	42,620	83,089	39,898	24,684	23,217	179,547	69,363	30,768
Other Components:													
Cabin air filter assv	500	350	350	350	350	350	**	**	**	**	**	**	**
OBIGGS shutoff valve	2,000	2,000	2,000	2,000	2,000	2,000	**	**	**	**	**	**	**
Precooler	8,000	4,000	n/a	n/a	n/a	n/a	**	**	n/a	n/a	**	**	n/a
Inter-cooler	8,000	4,000	n/a	n/a	n/a	n/a	**	**	n/a	n/a	**	**	n/a
Temperature sensor	2,000	1,000	n/a	n/a	n/a	n/a	**	**	n/a	n/a	**	**	n/a
Bypass Valve	4,000	2,000	n/a	n/a	n/a	n/a	**	**	n/a	n/a	**	**	n/a
Compressor unloading valve	3,120	1,560	1,100	1,560	1,250	1,560	**	**	**	**	**	**	**
Compressor discharge check valve	475	425	275	475	250	475	**	**	**	**	**	**	**
Bleed shutoff valve	1,250	1,250	1,100	1,250	1,100	1,250	**	**	**	**	**	**	**
Bleed check valve	475	425	275	475	250	475	**	**	**	**	**	**	**
Bypass valve	2,000	2,000	2,000	2,000	2,000	2,000	**	**	**	**	**	**	**
Temperature sensor	2,000	2,000	2,000	2,000	2,000	2,000	**	**	**	**	**	**	**
Water separator/filter assv	8,000	5,000	5,000	5,000	5,000	5,000	**	**	**	**	**	**	**
High flow valve	1,250	1,250	1,100	0	1,100	1,250	**	**	**	**	**	**	**
Relief valve	680	580	450	550	450	550	**	**	**	**	**	**	**
Fuel tank check valve	675	675	675	675	675	675	**	**	**	**	**	**	**
Controller / control card	40,000	40,000	40,000	40,000	40,000	40,000	**	**	**	**	**	**	**
Ducting	35,600	23,200	10,500	7,600	7,600	7,600	**	**	**	**	**	**	**
Wiring	750	500	250	250	250	400	**	**	**	**	**	**	**
Installation Hardware	5,442	1,963	772	623	399	1,163	**	**	**	**	**	**	**
Structural Modifications	2,000	1,000	400	200	200	200	**	**	**	**	**	**	**
Ram Ducting	12,000	6,000	3,000	2,000	2,000	2,000	**	**	**	**	**	**	**
Compressor wiring	8,964	1,677	310	75	58	259	**	**	**	**	**	**	**
Overheat sensors	1,000	1,000	1,000	1,000	1,000	1,000	**	**	**	**	**	**	**
	=====	=====	=====	=====	=====	=====	=====	=====	=====	=====	=====	=====	=====
Other component sub-totals	150,181	103,855	72,557	68,083	67,932	70,207	114,000	81,000	71,000	67,000	167,000	104,000	77,000
System Totals	299,181	160,855	99,557	94,735	90,037	112,827	197,089	120,898	95,684	90,217	346,547	173,363	107,768
On-board oxygen sensor (not included in system totals)	6,000	6,000	6,000	6,000	6,000	6,000	6,000	6,000	6,000	6,000	6,000	6,000	6,000

**Indicates scaled data

Onboard Inerting Designs Task Team Final Report

Figure 3.11.1-2. Summary of OBIGGS Costs—PSA Systems

Cryogenic Distillation System Component	LT CWT+Main Shipset Cost (\$)	MT CWT+Main Shipset Cost (\$)	ST CWT+Main Shipset Cost (\$)	RTF CWT+Main Shipset Cost (\$)	RTP CWT+Main Shipset Cost (\$)	BzJ CWT+Main Shipset Cost (\$)	LT CWT Only Shipset Cost (\$)	MT CWT Only Shipset Cost (\$)	ST CWT Only Shipset Cost (\$)	RTF CWT Only Shipset Cost (\$)	LT CWT+Main+ Aux Shipset Cost (\$)	MT CWT+Mai Aux Shipset Cost (\$)	ST CWT+Main+ Aux Shipset Cost (\$)
Major Components:													
Compressor	10,891	10,256	9,816	9,805	10,000	9,953	10,842	10,236	9,839	9,736	12,172	10,840	10,059
Heat exchanger/fan	14,181	8,368	3,007	2,966	3,000	4,404	8,368	5,725	2,842	2,653	14,879	9,141	3,288
Cryo Air Separation Components:													
Inlet shutoff valve	400	400	400	400	400	400	**	**	**	**	**	**	**
Cryocooler bleed air valve	300	300	300	300	300	300	**	**	**	**	**	**	**
Flow sensor	300	300	300	300	300	300	**	**	**	**	**	**	**
Molecular sieve control valves	2,000	2,000	2,000	2,000	2,000	2,000	**	**	**	**	**	**	**
Molecular sieve system	15,000	7,500	7,500	7,500	7,500	15,000	**	**	**	**	**	**	**
Purge heat exchanger	4,500	4,500	4,500	4,500	4,500	4,500	**	**	**	**	**	**	**
Purge heat exchanger valve-Air Side	2,000	2,000	2,000	2,000	2,000	2,000	**	**	**	**	**	**	**
Purge heat exchanger valve-Waste Side	2,000	2,000	2,000	2,000	2,000	2,000	**	**	**	**	**	**	**
LNEA Dewar Cooldown Valve	500	500	500	500	500	500	**	**	**	**	**	**	**
Inlet Recuperator	5,500	5,500	5,500	5,500	5,500	5,500	**	**	**	**	**	**	**
Inlet cooler	4,000	4,000	4,000	4,000	4,000	4,000	**	**	**	**	**	**	**
Cryocooler	100,000	100,000	100,000	100,000	100,000	100,000	**	**	**	**	**	**	**
LNEA Dewar	10,000	5,000	5,000	0	0	0	**	**	**	**	**	**	**
Dewar level sensor	200	200	200	200	200	200	**	**	**	**	**	**	**
Distillation column	10,000	10,000	10,000	10,000	10,000	10,000	**	**	**	**	**	**	**
Distillation column gas valve	2,000	2,000	2,000	2,000	2,000	2,000	**	**	**	**	**	**	**
Distillation column liquid valve	2,000	2,000	2,000	2,000	2,000	2,000	**	**	**	**	**	**	**
	=====	=====	=====	=====	=====	=====	=====	=====	=====	=====	=====	=====	=====
Cryo component subtotals	160,700	148,200	148,200	143,200	143,200	150,700	155,075	155,075	148,200	143,200	160,700	151,950	148,200
Major component subtotals	185,772	166,824	161,023	155,970	156,200	165,057	174,284	171,037	160,881	155,589	187,751	171,931	161,547
Other Components:													
Cabin air filter assy	350	350	350	350	350	350	**	**	**	**	**	**	**
OBIGGS shutoff valve	2,000	2,000	2,000	2,000	2,000	2,000	**	**	**	**	**	**	**

**Indicates scaled data

Figure 3.11.1-3. Summary of OBIGGS Costs—Cryogenic Distillation Systems (Sheet 1 of 2)

Onboard Inerting Designs Task Team Final Report

Cryogenic Distillation System Component	LT CWT+Main Shipset Cost (\$)	MT CWT+Main Shipset Cost (\$)	ST CWT+Main Shipset Cost (\$)	RTF CWT+Main Shipset Cost (\$)	RTP CWT+Main Shipset Cost (\$)	BzJ CWT+Main Shipset Cost (\$)	LT CWT Only Shipset Cost (\$)	MT CWT Only Shipset Cost (\$)	ST CWT Only Shipset Cost (\$)	RTF CWT Only Shipset Cost (\$)	LT CWT+Main+ Aux Shipset Cost (\$)	MT CWT+Mai Aux Shipset Cost (\$)	ST CWT+Main+ Aux Shipset Cost (\$)
Compressor unloading valve	1,560	1,560	1,100	1,560	1,100	1,560	**	**	**	**	**	**	**
Compressor discharge check valve	475	425	275	475	250	475	**	**	**	**	**	**	**
Bleed shutoff valve	1,250	1,250	1,100	1,250	1,100	1,250	**	**	**	**	**	**	**
Bleed check valve	475	425	275	475	250	475	**	**	**	**	**	**	**
Bypass valve	2,000	2,000	2,000	2,000	2,000	2,000	**	**	**	**	**	**	**
Temperature sensor	2,000	2,000	2,000	2,000	2,000	2,000	**	**	**	**	**	**	**
Water separator/filter assy	5,000	5,000	5,000	5,000	5,000	5,000	**	**	**	**	**	**	**
Temperature sensor	1,000	1,000	1,000	1,000	1,000	1,000	**	**	**	**	**	**	**
Relief valve	680	580	450	550	450	450	**	**	**	**	**	**	**
Fuel tank check valve	675	675	675	675	675	675	**	**	**	**	**	**	**
Controller / control card	40,000	40,000	40,000	40,000	40,000	40,000	**	**	**	**	**	**	**
Ducting	35,600	23,200	10,500	7,600	7,600	7,600	**	**	**	**	**	**	**
Wiring	750	500	250	250	250	250	**	**	**	**	**	**	**
Installation Hardware	4,191	3,136	2,379	1,592	1,423	1,719	**	**	**	**	**	**	**
Structural Modifications	1,300	900	500	200	200	500	**	**	**	**	**	**	**
Ram Ducting	3,000	2,400	2,000	2,000	2,000	2,000	**	**	**	**	**	**	**
Compressor wiring	1,081	465	57	48	33	33	**	**	**	**	**	**	**
Overheat sensors	1,000	1,000	1,000	1,000	1,000	1,000	**	**	**	**	**	**	**
	=====	=====	=====	=====	=====	=====	=====	=====	=====	=====	=====	=====	=====
Other component sub-totals	104,387	88,866	72,911	70,025	68,681	70,337	85,000	77,000	71,000	69,000	106,000	89,000	75,000
System Totals	290,159	255,690	233,934	225,995	224,881	235,394	259,284	248,037	231,881	224,589	293,751	260,931	236,547
On-board oxygen sensor (not included in system totals)	6,000	6,000	6,000	6,000	6,000	6,000	6,000	6,000	6,000	6,000	6,000	6,000	6,000

**Indicates scaled data

Figure 3.11.1-3. Summary of OBIGGS Costs—Cryogenic Distillation Systems (Sheet 2 of 2)

3.11.1.1 Air Separation Modules

Cost estimates were developed for OBIGGS membrane, pressure-swing adsorption, and cryogenic distillation air separation equipment.

Permeable Membrane. For the membrane-based ASMs, cost, weight, volume, and purity analyses performed by the ASM supplier indicated no sizable benefit to developing new membrane units for the generic aircraft. Thus membrane costs were developed based on commercially available off-the-shelf membrane units. Common costs were applied for common-sized membrane and PSA ASMs across all OBGIS and OBIGGS concepts, where applicable.

Pressure-Swing Adsorption. The costs of the PSA separators were estimated with the assumption that the molecular sieve beds and mechanical assembly would not be off-the-shelf, but that there is no technical risk in developing these items. The supplier applied trends from current PSA hardware to derive competitive costs. However, these costs were adjusted as the ASM filter and controller would not be integrated into the ASM assembly for commercial aircraft, in contrast to current PSA systems fielded on some U.S. military aircraft.

Cryogenic Distillation. The cryogenic distillation system costs were estimated with the assumption that the cryogenic refrigerator and distillation column would be new manufacture items (i.e., these items are typically not stocked on a shelf) but no new development would be associated with these items. Costs for other cryogenic distillation OBIGGS components are based on commercially available items.

3.11.1.2 Compressor

Compressor costs for OBIGGS were developed similarly to those costs developed for OBGIS systems. Compressor costs were established for two compressor types, screw and centrifugal. A linear cost model was derived using supplier-estimated costs for 15 kW and 30 kW compressors of both compressor types, and compressor costs were established as a function of compressor type, power required, and number of compressors required. As compressor design requirements were established and iterated for each of the ARAC aircraft models, the team applied this metric to derive the optimum compressor configuration and cost. For membrane and PSA inerting systems, for the large transport and medium transport aircraft models, costs for compressor precooler and intercooler components were extrapolated from the heat exchanger costs developed for the regional turbofan aircraft model.

3.11.1.3 Heat Exchanger/Cooling Fan

Heat exchanger costs for membrane, PSA, and cryogenic distillation OBIGGS were developed similarly to those costs developed for OBGIS systems by applying a supplier-derived linear cost model to develop costs for compact heat exchangers with fan cooling. Heat exchanger costs included the core, inlet/outlet headers, and connections to the mating tubing. The cost of the cooling fan included the fan and any ducting between the fan and the heat exchanger. Ducting that interfaces with the aircraft structure or plumbing was accounted for separately under other OBIGGS parts. Heat exchanger costs were baselined against commercially available equipment and scaled as a function of heat exchange rate required to provide stable-temperature input airflow to the ASM and the cooling airflow output required by the cooling fan. The cost of the cooling fan was integrated into the cost for the heat exchanger.

3.11.1.4 Other Components

Costs for all other membrane, PSA, and cryogenic distillation OBIGGS components were developed similarly to costs for other components developed for OBGIS systems. Original equipment manufacturer (OEM) costs were assumed for the majority of all components other than the ASMs, compressors, and heat exchangers with cooling fans. Common costs were applied for components common across OBGIS and OBIGGS concepts. Exceptions to the OEM pricing include ASM water separator/filter costs, which

Onboard Inerting Designs Task Team Final Report

are based on rough order of magnitude (ROM) estimates provided by a filter supplier, and the ASM controller, which was estimated by scaling from the cost for a commercially-available controller used in aircraft subsystem applications. Other costs applied commonly across all OBGIS and OBIGGS concepts include the following:

- Ducting - cost estimated at \$200/lb
- Wiring - cost estimated at \$50/lb
- Installation Hardware - cost estimated at \$50/lb
- Structural Modifications - cost estimated at \$20/lb
- Ram Ducting - cost estimated at \$200/lb

3.11.2 Design & Certification Cost

Design and certification man-hour estimates were developed by the Working Group to encompass the engineering hours required by an aircraft manufacturer for modifications and additions to fuel system components, interfaces, structure, instruments or displays, wiring, tubing, ducting, avionics software and, if required, relocation of other equipment on each aircraft. As mentioned previously, the Team developed OBIGGS component costs, and the non-recurring design costs for the components (e.g., ASMs) were amortized into the component costs listed in the previous summary cost tables.

The design and certification man-hour estimates were applied by the E&F team as part of their analysis to determine OBIGGS cost benefit and are described in the E&F team final report. These estimates address design and certification of OBIGGS systems to inert all tanks on a new first of a model aircraft and on derivative model aircraft for all of the generic aircraft. They also address design and certification of OBIGGS systems to inert CWTs only on a new first of a model aircraft and on derivative model aircraft, which only applies to the generic large, medium, and small transports, and to the generic regional turbo fan aircraft.

Neither FAA nor JAA will assess additional certification costs for OBIGGS. However, non-U.S. governmental authorities may assess additional costs related to the certification of OBIGGS systems. For example, JAA indicates that the CAA-UK will charge airlines for all certification costs, including engineering man hours, whereas DGAC France will charge airlines only for the travel costs associated with an OBIGGS certification effort. These potential additional costs were not included in the design and certification cost estimates.

3.11.3 Operating Cost

Recurring OBIGGS operating costs evaluated by the ARAC estimating and forecasting (E&F) team encompassed frequency of delays, delay time, OBIGGS system weight, performance loss, and additional training required for ground and flight crews. The On-Board Design Task Team developed system weights for use in the E&F cost models. The team also applied a method for determining performance loss due to an on-board inerting system as described in report AFWAL-TR-82-2115, Aircraft Fuel Tank Inerting System, and provided resulting performance loss values to the E&F team. This method evaluates by mission segment the performance loss in lbs-fuel and dollars/flight-hour associated with additional aircraft resource demands (i.e., bleed air, electrical power) and increased weight due to the on-board inerting system. This methodology was applied to determine performance losses associated with the bleed air consumption and electrical power demands required by OBIGGS. Performance loss associated with system weight is the predominant element in performance loss, which was determined by the E&F team using the methodology applied in the previous ARAC FTHWG effort. All other recurring OBIGGS operating costs were developed by the E&F and Airplane Operations and Maintenance (O&M) teams.

3.11.4 Maintenance Cost

Recurring full-time OBIGGS operating costs evaluated by the ARAC E&F team encompassed mean time between unscheduled repair (MTBUR) and hours for maintenance checks, inspections, removals, unscheduled maintenance, maintenance training, and confined space entry labor. The On-Board Design Task Team developed estimates for MTBMA and MTBF for each system component. These values were provided to the O&M team who then compared them to values of comparable components used currently on commercial aircraft. Those comparable values were then used to develop average MTBUR values for use by the E&F team in estimating recurring maintenance costs. For components currently not in service on commercial aircraft, such as the ASMs, the O&M team evaluated the on-board team's MTBF and MTBMA values and identified, based on their commercial aviation expertise, values to apply as MTBUR. Typically, these values were similar to the on-board team's MTBMA values. All of the other aforementioned recurring full-time OBIGGS maintenance cost elements were provided to the E&F team by the O&M team.

3.11.5 Installation Cost

Installation cost associated with OBIGGS systems are described in the E&F team final report. No installation costs were developed by the On-Board Design Task Team.

3.12 SAFETY

The inclusion of an OBIGGS on an aircraft introduces a number of new or increased safety concerns. These concerns can be divided into normal operations, system leaks, component failures, and catastrophic failures.

3.12.1 Normal Operations

The hazards associated with the normal operation of the OBIGGS system are the discharge of oxygen enriched waste gas, the venting of NEA out of the fuel vent, the possibility of fuel tank over pressure during refuel over-fill, and those associated with electrical wiring and high temperature components, and possible disruption of cabin airflow patterns.

Oxygen-Rich Waste Gas. Oxygen-rich waste gas could be a fire hazard and should be vented in an area with no potential ignition sources. If possible it should be vented in an area where it will be quickly diluted.

NEA Around Fuel Vent. NEA vented from the fuel tank vent could create breathing problems, if inhaled. Testing during the inerting of a 737 aircraft indicated that the exiting NEA was rapidly diluted and posed little hazards. A placard warning near the vent should be sufficient.

Increased Tank Overpressure During Refuel Failure. The operation of the OBIGGS during a fueling over-fill may exacerbate the problem of tank overpressure. The system should be designed to limit inlet pressure to the tank and quickly relieve pressure.

Electrical Wiring. Electrical requirements of the system add to the amount of electrical wiring in the aircraft and the potential for electrical related smoke or fire in the aircraft. These safety concerns can be minimized through normal design practice.

High Component Temperatures. The operating temperature of some components may exceed 400 degrees F and should be placarded as such.

Cabin Airflow Patterns. The use of cabin air as inlet air to the compressor could cause a change in cabin airflow patterns, which could be hazardous during smoke or fire conditions. The air should be taken from as close to the out flow valve as possible. The new airflow patterns should be determined for compliance with the certification base of the aircraft.

Onboard Inerting Designs Task Team Final Report

3.12.2 System Leaks

Various system leaks could occur and create safety concerns. Leaks could include hot air, NEA, OEA and fuel vapor.

Compressor Discharge Air Leaks. Compressed air between compressor and heat exchanger could be in the range of 400 degrees F. It should be treated the same as bleed air ducting, and may require overheat detection.

NEA Leaks. The NEA line from the ASM to fuel tank could produce an environment, in a confined space, with a reduced oxygen level. The line should, wherever possible, be run in an area of high ventilation. Where it does run in a confined space with low ventilation the line should be a double line.

Oxygen-Rich Waste Gas Leaks. The waste line from the air separation module carries oxygen-rich air and could produce an environment, in a confined space, with an elevated oxygen level. The line should, wherever possible, be run in an area of high ventilation and the absence of ignition sources. Where it does run in a confined space with low ventilation or in an area with any possible ignition sources, the line should be a double line.

Fuel Backflow Into ASM. Fuel vapor from the fuel tank back through the NEA line into the system. Check valves should be installed in system to prevent this from occurring. This hazard could occur at any time since it is not dependent on system operation.

Cryogenic Liquid Leaks. A cryogenic system could leak liquid nitrogen or liquid air possibly causing damage to surrounding materials. Protection for this occurrence should be provided.

3.12.3 Component Failures

It is possible that a component of the system could fail and create a hazardous condition as the system continues to operate.

Compressor Overheat. A compressor overheat could cause a potential fire hazard. Thermal cutout protection should be incorporated.

Heat Exchanger Overheat. NEA being too hot could cause a safety problem by possibly damaging the system and pumping high temperature gas into the fuel tank. Thermal cutout protection would provide mitigation from this hazard.

Rotating Equipment Sparks. Sparks or flames could occur in the system lines and protected should be provided by flame arrestors in line.

Overpressure From Trapped Cryogenic Liquids. A failure in the refrigeration components of a cryogenic system could cause an over pressure and should be prevented through the use of relief valves.

3.12.4 Catastrophic Failures

Uncontained Rotating Equipment Failure. Uncontained rotating equipment failure could cause a hazard. The system design should provide containment for such failures.

Pressure Vessel Burst. Overpressure in the system could cause a pressure vessel burst and should be designed for.

In-Flight Loss of Cabin Pressure. Failure between pressurized and unpressurized areas could result in an in-flight loss of cabin pressure and would require the installation of a high flow fuse and shutoff valve.

3.13 INSTALLATION

The installation objectives and concerns for the full-time OBIGGS are identical to those already discussed for the OBGIS. Specific design solutions for the many different aircraft models that would be affected by an inerting rule were beyond the scope of this study. The installation challenges are expected to be

greater for retrofits where other systems already occupy many locations and customer-specific modifications may require different installation approaches for the same aircraft model. In some areas, structural modifications will be needed to support the additional weight of the new components.

As with the OBGIS, the best installation locations are unpressurized, ventilated, and close to the fuel tanks. If locations that meet these criteria cannot be found, the installations will be more complicated.

Several existing aircraft models were surveyed for potential installation locations. Unpressurized locations in the air conditioning pack bay, wing root, wheel well, belly fairing, and behind the aft pressure bulkhead were examined. Pressurized locations exist in the cargo compartments and in a space forward of the aft bulkhead on some aircraft. Use of cargo space for inerting equipment carries the additional cost of the displaced cargo capacity. Typical installation locations on generic small, medium, and large transports are similar to those depicted for OBGIS (Section 1).

As with the OBGIS, the NEA distribution system must be sized for pressure drop, be double-walled within pressurized areas, and include drains for condensation. The system controller may be rack-mounted, part of a card file, or remotely located near the inerting equipment depending on the aircraft model. Wiring between the controller and components will require different degrees of protection depending on its location. The expected cockpit interface is an on/off switch and a fail light as with the OBGIS. The installation will also require additional protection if located within an engine rotor burst, tire burst, or flammable fluid leakage zone. The compressor and heat exchanger will be thermally insulated to prevent temperature damage to other equipment. The compressor must be installed to minimize noise transmission.

3.14 PROS AND CONS OF SYSTEM DESIGN CONCEPT

Effectiveness and Limitations. Full-time OBIGGS reduces the tank flammability exposure through all phases of flight and is more effective than any of the other inerting concepts studied. However, there is still a small flammability exposure since the equipment is defined as not required for flight; there is no redundancy to back up in-flight failures; and the system is not sized for faster than normal descents. Since the tanks are inert the vast majority of the time, the full-time OBIGGS is very effective against randomly occurring one-time ignition sources like lightning or a fuel-pump failure. However, because the tanks will eventually be flammable, the full-time OBIGGS may only delay an explosion for repetitive, undetected ignition sources like electrical arcing or an inadequate static bond. Unlike the ground-based inerting concepts, the full-time OBIGGS does not require a minimum time on the ground to be inert for the next flight. Further, no ground support equipment or personnel are required for operation of the system.

Safety. The installation of the system adds additional hazards to the aircraft, which must be mitigated. The hazards include electrical wiring, high-speed rotation machinery, ducting carrying nitrogen-enriched air and oxygen enriched air and additional penetrations into the fuel tank, and the fuselage. The design of the system should be such to minimize or eliminate the hazards. The safety section contains a more detailed description of all the hazards and means of mitigation. It should be noted that since the system operates during all phases of flight the hazards could exist at any time.

The system greatly minimizes the time a flammable mixture is present in a protected tank, thus greatly reducing the probability of a fuel tank explosion. For a more detailed discussion on the risk reduction see the section on flammability reduction.

Cost. There is a cost associated with the design, installation, certification, operation and maintenance of an OBIGGS. Those costs can be broken down into the cost of the system, the cost of system operation, and the cost of system maintenance. The cost of the system includes design and construction as well as certification and installation. The system operation costs include those associated with the additional weight and possible shift in center of gravity of the aircraft, possible increase in drag, and the additional use of electrical power. The full-time OBIGGS is heavier than the Ground-Based Inerting equipment that

Onboard Inerting Designs Task Team Final Report

would be carried on board the aircraft, but lighter than the OBGIS. It uses electrical power in-flight and a small amount of bleed air. The maintenance cost includes maintenance of the OBIGGS and to other systems, such as electrical generators, affected by it. A more detailed breakdown of costs can be found in the Cost Section.

Designs are presently being explored that use a similar system for fire suppression in aircraft cargo compartments. If successful, it would allow for a dual role for the OBIGGS, thus offsetting some of the overall system weight and cost. It should be noted that on-demand OBIGGS, with no storage capability, used for fire suppression would cost more than the estimates in this report, because the system would be required for flight. This would either require additional redundancy or an increase in the expected number of flight delays, cancellations, and turn-backs.

Environmental Impact. The main impact to the environment from an OBIGGS is the possible increase in fuel vapors being forced overboard as the nitrogen is injected into the fuel tank. The amount of fuel vapor that is vented depends on the fuel air mixture and ullage volume, at the time of inerting, as well as many other variables. Testing has shown that presently designed cross-vented fuel tanks under certain wind conditions can vent fuel vapors into the atmosphere. A redesign for the OBIGGS would minimize that venting, thus helping to offset some of the fuel vapor lost during the inerting process.

The installation of an OBIGGS would, as shown previously, reduce the number of fuel tank explosions, thus reducing the amount of spilled fuel both on the ground and in the atmosphere.

In addition to the fuel vapor there is a potential problem with the addition of noise from the compressor/fan.

The use of dry nitrogen as an inerting agent may reduce corrosion and condensation in the protected tanks depending on the conditions at the airports where the airplane is operated.

3.15 MAJOR ISSUES/MITIGATION

3.15.1 High Electrical Power Consumption

The full-time OBIGGS on the larger aircraft (Large and Medium Transports) requires high electrical power consumption during the descent phase of flight. The cryogenic distillation system uses the least electrical power of the full-time systems with the demand fairly balanced throughout the flight profile. The membrane system uses almost no power during the ground, climb, and cruise phases and then consumes a significant amount during descent. The power usage during descent is high while the power available to run the system is unknown. The pressure-swing adsorption system has a similar power consumption profile to the membrane system, but the power required for descent is higher than for the membrane system.

3.15.1.1 Power Reduction Scheme for Membrane and PSA

Some refinement of the concept, as already discussed in Concept Development, has already been performed to reduce the power consumption on the larger aircraft and additional improvement is possible. Further power reduction for both membrane or PSA systems could likely be achieved with the concept shown in Figure 3.15.1.1-1 in which the NEA out of the ASM is used to drive the second compression stage. By eliminating the electric motor drive from the second compressor the system power draw is reduced by about half. The cold NEA from the turbine is used as a heat sink to reduce the amount of ram air needed. Though not shown on the schematic, the turbine inlet NEA could be heated in the one of the heat exchangers to increase the turbine power drive and provide additional post-compression cooling.

The team did not have time to study the above concept in detail within the study period. If not practical, other methods of driving one or both compressor stages with a ram air turbine or hydraulic motor could also reduce the membrane or PSA system electrical load during descent.

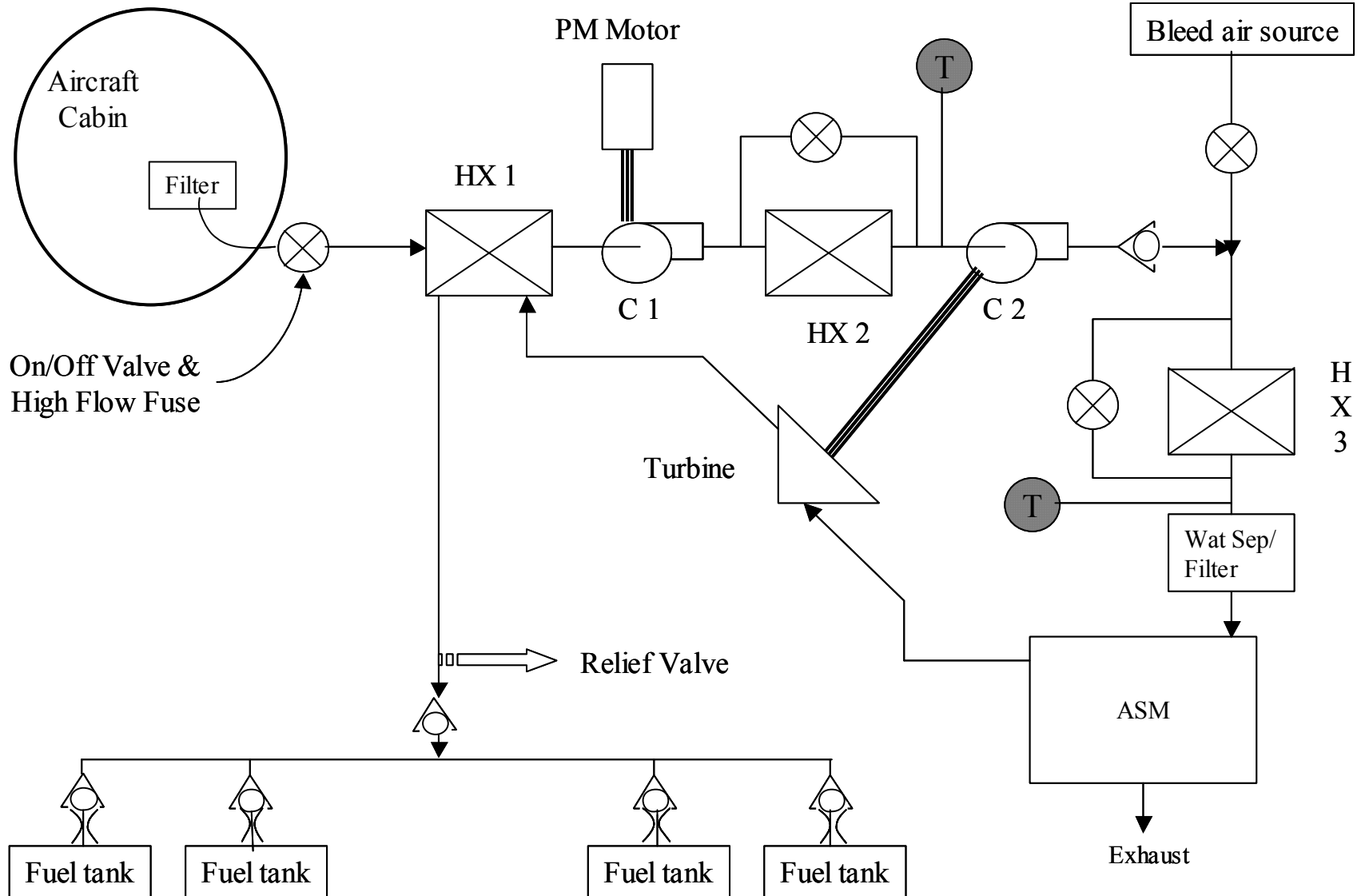

Figure 3.15.1.1-1. Potential Power Conservation Concept for Large Aircraft Membrane or PSA OBIGGS

3.15.1.2 Power Reduction Scheme for Cryogenic Distillation

The cryogenic refrigerator in the cryogenic distillation OBIGGS provides cooling to partially liquefy incoming air and to make up for heat exchanger losses. Heat exchanger losses account for about half of the refrigerator power for the cryogenic distillation OBIGGS described in this report. The feasibility and practicality of vacuum jacketing the heat exchangers has been confirmed by the heat exchanger supplier and could reduce the electrical power by 40% or more. Power reductions increase, as the aircraft becomes smaller, because the heat leaks are constant and thus become a larger portion of the total refrigeration load with decreasing aircraft size.

On the other hand, weight reductions improve as the aircraft size decreases because the cryocooler is a larger fraction of the system weight for smaller aircraft. Figure 3.15.1.2-1 gives the actual electrical power and weight values for full-time inerting of the CWT from the LT through the ST.

	Present Cryo OBIGGS			Improved Cryo OBIGGS		
	LT-CWT	MT-CWT	ST-CWT	LT-CWT	MT-CWT	ST-CWT
Electrical Power (kVA)	17	17	16	8	7	6
Weight (lbs.)	414	338	283	401	298	238

Figure 3.15.1.2-1. Electrical Power and Weight for the Improved Cryogenic Distillation Components With Vacuum Jacketing

3.15.2 Potential Interference With Cabin Re-Pressurization During Descent

Compressing cabin air instead of ram air significantly reduces the weight and electrical power required for the system. The air conditioning system constantly supplies air to the cabin, some of which exits the cabin through a modulating outflow valve, which controls cabin pressure, and the remainder leaks out through the fuselage. The cabin leakage rate is directly proportional to the aircraft altitude (higher altitude means higher leakage). During descent, the outflow valve drives toward closed to slowly re-pressurize the cabin. If the aircraft leakage exceeds the maintenance manual limit, drawing air from the cabin for a full-time OBIGGS will slow down the re-pressurization of the aircraft until the aircraft reaches the altitude at which the leakage decreases to the point that the outflow valve can again regulate the cabin pressure. This condition is much more likely to affect older aircraft, which may leak more. Although this is only a problem when the cabin leakage exceeds the maintenance manual limit, the ops and maintenance team has included an estimate of the increased maintenance labor to fix cabin leakage more frequently than would otherwise be required.

4.0 HYBRID OBIGGS

The hybrid On-Board Inert Gas Generating System (OBIGGS) is one of four main system categories studied by the 2000 ARAC FTIHWG Onboard Airplane Design Task Team. The term ‘hybrid’, as used here, refers to a potentially smaller system that does not require the fuel tanks to be inert during descent. The on-board team studied systems that were sized to provide inerting for various fuel tank configurations of six generic models. The team also defined the physical size and weight of the components that make up the hybrid OBIGGS. Finally, power and air consumption needs were defined.

4.1 REQUIREMENTS

The NEA flow rate for the hybrid OBIGGS is sufficient to produce the same flammability exposure during the ground and climb phases as the ground-based systems. This requirement allowed a direct comparison with the GBI and OBI systems. As such, the hybrid OBIGGS does not necessarily keep the tanks inert through all mission phases.

Like the other on-board systems, the hybrid OBIGGS produces nitrogen as the inerting agent and all equipment is installed on the airframe, except for certain diagnostic equipment. The system does not require redundancy.

4.2 DATA SUPPLIED FROM OTHER SOURCES

Data was taken from various sources so that the team could define the hybrid OBIGGS concept. This included aircraft turn times, generic aircraft definition and mission profiles, fuel tank sizes, bleed air data, and cabin pressure schedules.

4.2.1 Aircraft Turn Times

As with the OBI systems, the aircraft pre-flight times were initially derived from the July 1998 ARAC FTIHWG as summarized in Figure 4.2.1-1 below:

Generic Aircraft	Pre-flight Time (Minutes)
Turbofan	20
Turboprop	20
Business Jet	45
Small	45
Medium	60
Large	90

Figure 4.2.1-1. FTIHWG Aircraft Pre-Flight Times

To ensure the turn times were representative of in-service aircraft, the airline survey described in Section 1 of this report was conducted for several major airlines. The FTIHWG made the decision to modify the aircraft turn times to the values seen in Figure 4.2.1-2 below. These values were used as the minimum turn-times in the hybrid OBIGGS sizing analysis, since they were representative of the in-service fleet.

Generic Aircraft	Turn Time (Minutes)
Turbofan	15
Turboprop	15
Business Jet	60
Small Transport	20
Medium Transport	45
Large Transport	60

Figure 4.2.1-2. FTIHWG Minimum Turn-Times

Onboard Inerting Designs Task Team Final Report

4.2.2 Generic Aircraft Types

The FTIHWG made the decision to use the same generic aircraft data and mission scenarios that were used in the July 1998 ARAC FTHWG Report. As with the baseline OBI System, these generic airplane definitions and missions were used in assessing the operational parameters. Discussion of the data is included in the 'Generic Aircraft Types' part of Section 1 of this report and the complete definitions and missions compiled during the previous FTHWG effort are included as an attachment to the Working Group report. As with the other systems, the worst-case flight conditions are the shortest-ranged flights.

4.2.3 Generic Aircraft Fuel Tank Volumes

The 1998 ARAC Generic Aircraft fuel tank sizes listed in Figure 4.2.3-1 were used for all system sizing.

Generic Aircraft	CWT Volume (Gal.)	CWT + Wing Tank Volume (Gal.)	CWT + Wing + Aux Tank Volume (Gal.)
Turbofan	816	3,264	N/A
Turboprop	N/A	1,428	N/A
Business Jet	N/A	6,273	N/A
Small	3,060	5,100	7,600
Medium	10,200	24,480	27,480
Large	25,500	55,080	58,080

Figure 4.2.3-1. Generic Aircraft Fuel Tank Volumes

4.2.4 Bleed Air

The team determined that bleed air availability for the hybrid OBI is limited. The team received the generic bleed air data listed in Figure 4.2.4-1 from airframe manufacturers.

Flight segment	Sufficient Flow available	Pressure available	Temperature
Ground, APU	no	25 to 54 psia	325 to 430°F
Ground idle	no	45 psia	350 to 380°F
Climb	yes	40 to 55 psia	330 to 380°F
Cruise	yes	25 to 40 psia	350 to 380°F
Idle descent	no	20 to 35 psia	350 to 380°F

Figure 4.2.4-1. Bleed Air Availability

4.2.5 Cabin Pressure

The team received the typical cabin pressures listed in Figure 4.2.5-1 for the six aircraft models from airframe manufacturers.

Altitude, feet	Cabin pressure, psia
0	14.7
5,000	14.3
10,000	13.9
15,000	13.5
20,000	13.2
25,000	12.8
30,000	12.4
35,000	12.0
40,000	11.2
45,000	10.9
50,000	10.9
55,000	10.9

Figure 4.2.5-1. Cabin Pressure Schedule

4.3 ASSUMPTIONS

The following are assumptions that the team developed and used for the analysis.

Initial Oxygen Concentration. The starting oxygen concentration in the ullage is assumed to be equal to the final concentration from the previous flight. However, for the first flight of the day or following maintenance actions, the oxygen concentration is assumed to be 20.9% by volume.

Hydraulic Power Availability. The team assumed that aircraft hydraulic power to operate the hybrid OBIGGS is not available while at the gate. It was further assumed that in order to utilize hydraulic power to operate the system in flight, it would be necessary to upgrade the existing on-board systems.

Electrical Power at Aircraft Gate. The team assumed that sufficient ground power could be made available to operate the hybrid OBIGGS.

Electrical Power in Flight. The team assumed that sufficient electrical power from the aircraft generators is available to operate the hybrid OBIGGS in flight.

Cabin Air Supply. The team assumed that the cabin air that normally exhausts through the outflow valve is available to the system.

Ullage Mixing. It was assumed that as air enters the fuel vent system during a descent, that it quickly mixes with the ullage and with the inert gas produced during the descent.

Vent System Modifications. It was assumed that necessary vent system modifications would be made to prevent cross-venting during crosswind conditions.

Fuel Tank Initialization. The team assumed that an extended ground time would be allowed to initialize the tanks for the first flight of the day and following maintenance actions.

4.4 CONCEPT DEVELOPMENT

Similar to Full-Time OBIGGS. The hybrid OBIGGS is a simplification of the full-time OBIGGS concept that achieves most of the flammability reduction with a significantly smaller system. The hybrid OBIGGS concept uses smaller versions of the same type of components as the full-time system. Both the hybrid and full-time systems process compressed cabin air in an air separation module to create NEA that is distributed to the fuel tanks. Permeable membrane, pressure-swing adsorption, and cryogenic distillation air separation technologies were all evaluated for use in a potential hybrid OBIGGS. A complete explanation of the Concept Development is in the full-time OBIGGS section and more information about the three air separation technologies is in Addenda A1, A2, and A3.

Lower NEA Flow. The NEA flow rates in the hybrid OBIGGS are greatly reduced from the full-time OBIGGS (the hybrid flows are approximately 25 per cent of full-time OBIGGS for both the medium and large transports and approximately 12 percent for the other four models). The NEA flow in the full-time system is primarily driven by the worst-case requirement to keep the tanks inert during descent. The hybrid OBIGGS takes advantage of the fact that the fuel and ullage are typically cold during descent, so the oxygen concentration in the tanks can exceed the 10% inert limit during this flight phase with little increase in flammability exposure.

Single NEA Flow Rate. The hybrid OBIGGS generates NEA at a single, constant flow rate during all phases of flight and ground operations, rather than the full-time OBIGGS approach of generating multiple flow rates dependant on flight phase. The membrane and PSA hybrid systems distribute the NEA as it is generated.

The cryogenic distillation hybrid OBIGGS also generates NEA at a constant rate through all phases of flight and distributes all the NEA generated during ground, climb, and descent. During cruise, the cryo system distributes a lower NEA flow rate to the fuel tanks and stores the remainder as liquid NEA which will be used the next morning to initialize the tanks and the system.

Onboard Inerting Designs Task Team Final Report

4.5 CONCEPT DESCRIPTIONS

The generic hybrid OBIGGS concept was applied to all six aircraft models and tank configurations with no obvious feasibility issues. The concept descriptions of the hybrid OBIGGS for each model and ASM technology are tabulated in Figure 4.5-1. For future implementation, if the membrane or PSA size or power consumption is determined too large for a given model, the air consumption and electrical power required could be further reduced, with a small increase in system complexity, by incorporating a low flow setting during cruise. Detailed schematics of the membrane, PSA and cryogenic distillation hybrid OBIGGS concepts are shown in Figures 4.5-2 and 4.5-3.

	Number of Compressors	Compressor Pressure Ratio	Number of Compressor Stages	Compressor Precooler and Inter-cooler	Air Separation Module Inlet Temperature	Lower NEA Flow Rate during Cruise
Generic Concept						
Membrane	1	4:1	1	No	180F	No
PSA	1	4:1	1	No	75F	No
Cryo	1	3:1	1	No	75F	Yes
Large Transport						
Membrane	1	4:1	1	No	180F	No
PSA	1	4:1	1	No	75F	No
Cryo	1	3:1	1	No	75F	Yes
Medium Transport						
Membrane	1	4:1	1	No	180F	No
PSA	1	4:1	1	No	75F	No
Cryo	1	3:1	1	No	75F	Yes
Small Transport						
Membrane	1	4:1	1	No	180F	No
PSA	1	4:1	1	No	75F	No
Cryo	1	3:1	1	No	75F	Yes
Regional Turboprop						
Membrane	1	4:1	1	No	180F	No
PSA	1	4:1	1	No	75F	No
Cryo	1	3:1	1	No	75F	Yes
Regional Turbofan						
Membrane	1	4:1	1	No	180F	No
PSA	1	4:1	1	No	75F	No
Cryo	1	3:1	1	No	75F	Yes
Business Jet						
Membrane	1	4:1	1	No	180F	No
PSA	1	4:1	1	No	75F	No
Cryo	1	3:1	1	No	75F	Yes

Figure 4.5-1. System Characteristic for Each Model and Technology

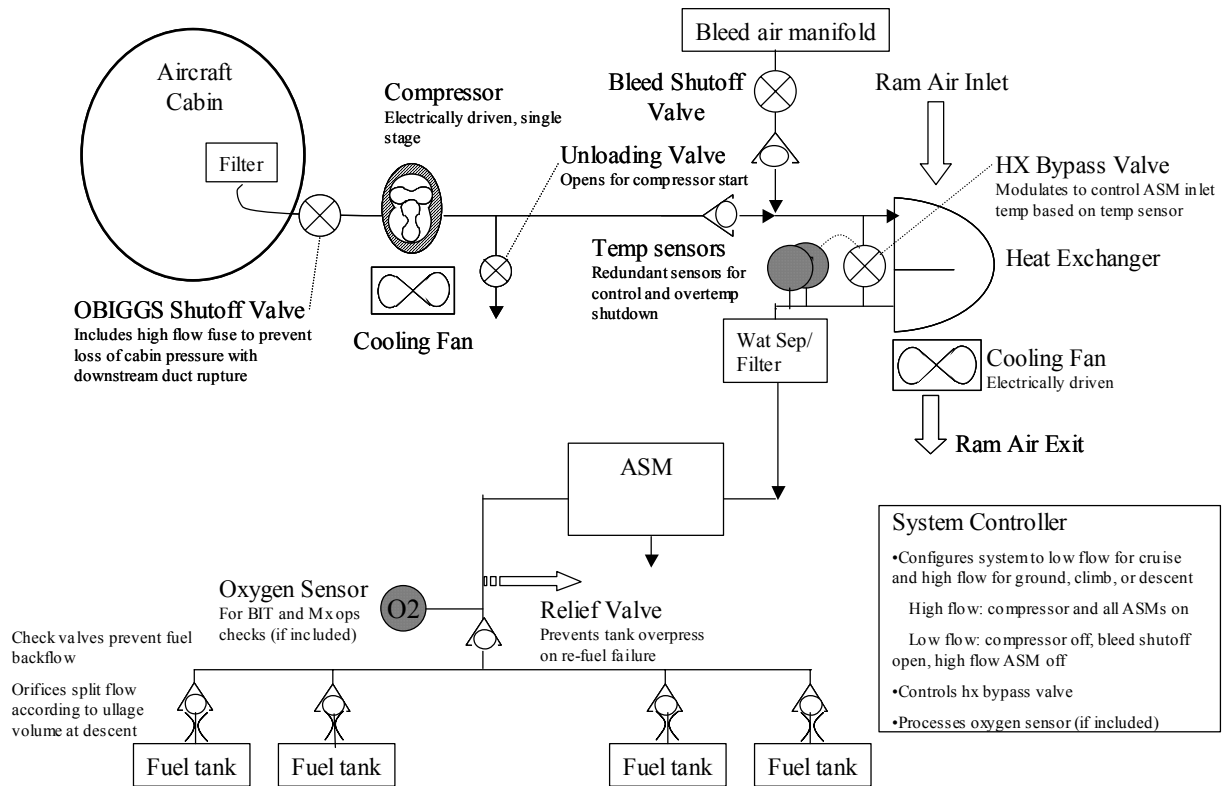

Figure 4.5-2. Membrane and PSA Hybrid OBIGGS Concept

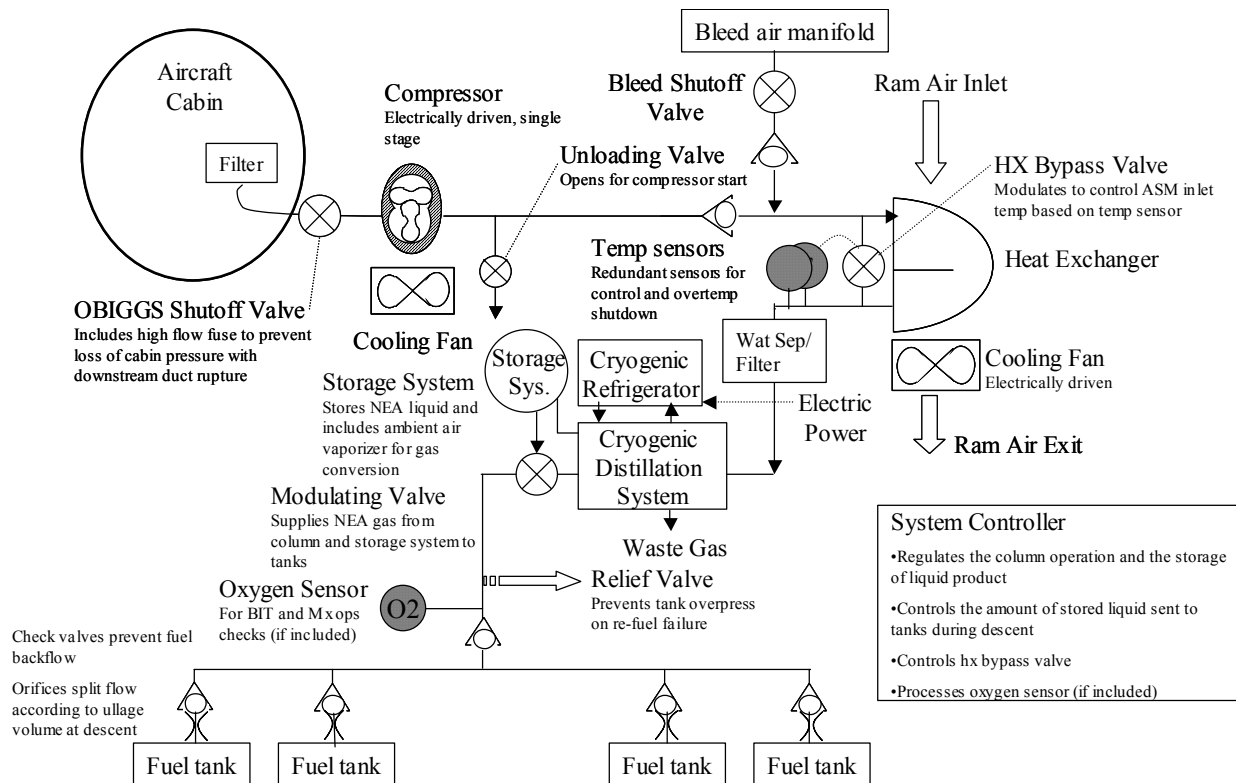

Figure 4.5-3. Cryogenic Distillation Hybrid OBIGGS Concept

4.6 SYSTEM SIZING AND PERFORMANCE

4.6.1 Sizing Criteria

The NEA flow rates for the hybrid OBIGGS were selected so that the ground and climb flammability exposure for each model and tank configuration would be equivalent to that of the ground-based options evaluated for that model. The ground and climb exposures were used instead of the total exposure, because the flammability model conservatively applies sea level flammability criteria at altitude. A very small hybrid OBIGGS would produce an apparent reduction in total flammability, but most of the gain would occur during cruise (where the true risk is overstated) with very little improvement during the ground or climb phases. Since all of the recent accidents have occurred on the ground or in climb, the actual benefit of such a system is minimal. By using the equivalent ground and climb exposure, the team ensured that the performance of hybrid OBIGGS was equivalent to the GBI, OBGI, and the hybrid OBGI. Because the hybrid OBIGGS continues to operate during flight, the total flammability exposures for the hybrid systems are lower than the ground-based systems.

An example of the relationship between NEA flow rate and flammability exposure for a large transport, center wing tank hybrid OBIGGS supplied by a PSA separator is shown in Figure 4.6.1-1. Both the total and ground/climb exposures are shown. The exposure with no NEA flow is equivalent to the aircraft without inerting. Once the relationship between flammability and NEA flow was determined for each model and tank, the selected exposure dictated the required NEA flow and component sizes.

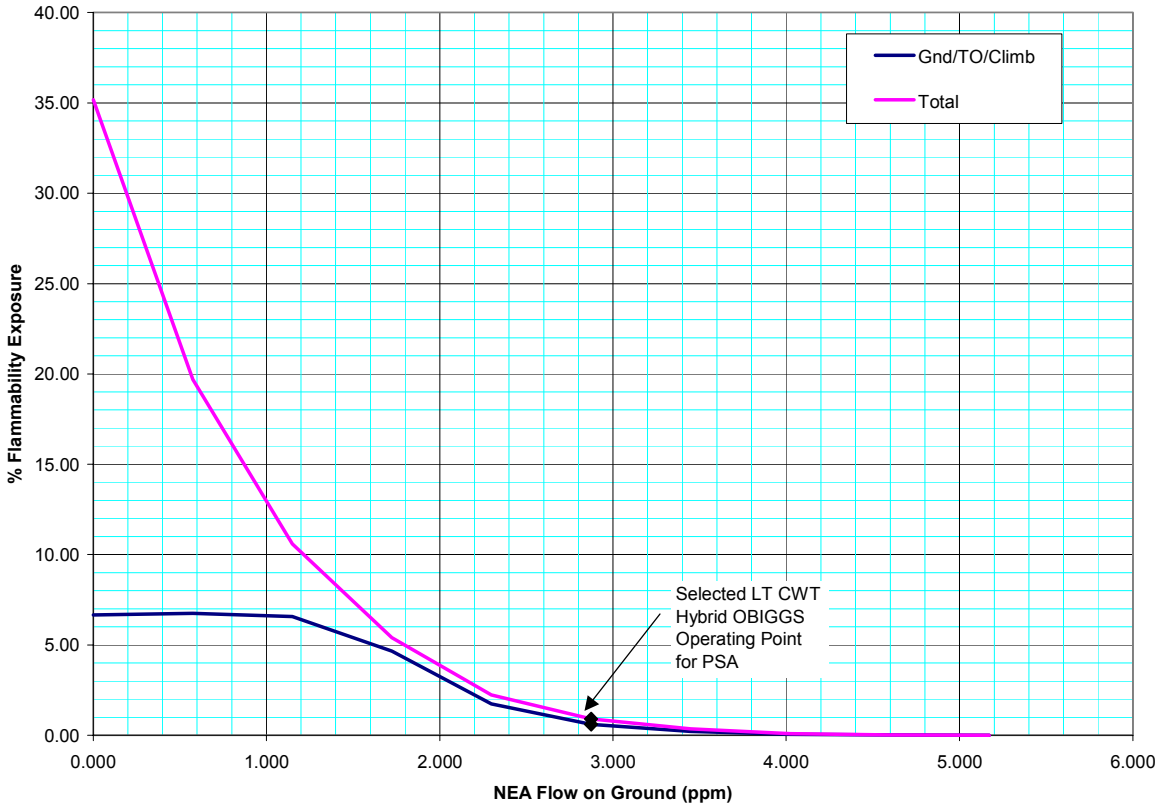

Figure 4.6.1-1. Flammability Exposure vs. NEA Flow for a Large Transport CWT, PSA Hybrid OBIGGS

4.6.2 Parametric Sizing Curves

The system weights, volumes, peak power consumption, and acquisition costs of the hybrid OBIGGS for the generic aircraft models and tank configurations are plotted in parametric sizing curves for easy interpolation to other aircraft models. To use the curves, the required NEA flow (to produce similar ground and climb flammability exposure with the ground-based systems) is found in Figure 4.6.2-1 or 4.6.2-2 based on tank size. For that NEA flow, the system weight, volume, electrical power consumption, and acquisition cost can be estimated from Figures 4.6.2-3 through 4.6.2-6. For future cost-benefit analyses, the NEA flow is broken out separately, to facilitate evaluation of systems with different NEA flows that produce other flammability exposure results

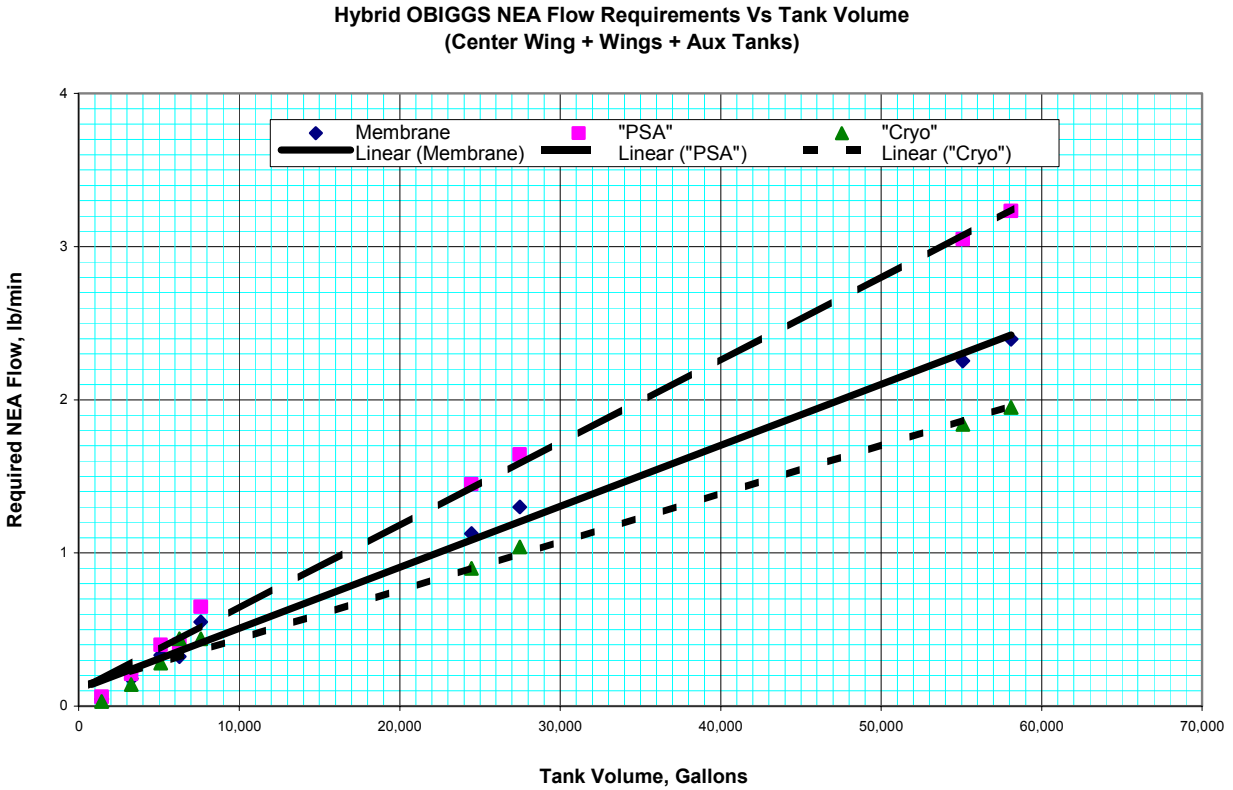

Figure 4.6.2-1. NEA Flow vs. Tank Volume—Center, Wing, and Auxiliary Tanks

**Hybrid OBIGGS NEA Flow Requirements Vs Tank Volume
(Center Wing Tanks Only)**

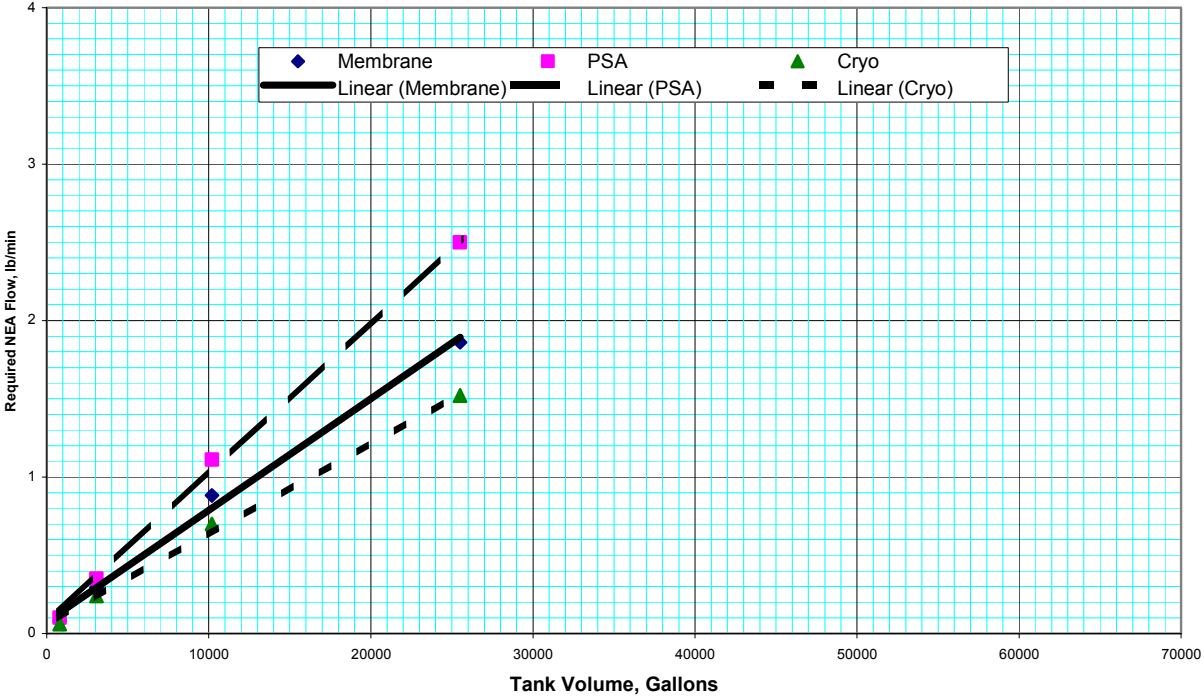

Figure 4.6.2-2. NEA Flow vs. Tank Volume—Center Tanks Only

Hybrid OBIGGS Weight Vs NEA Flow

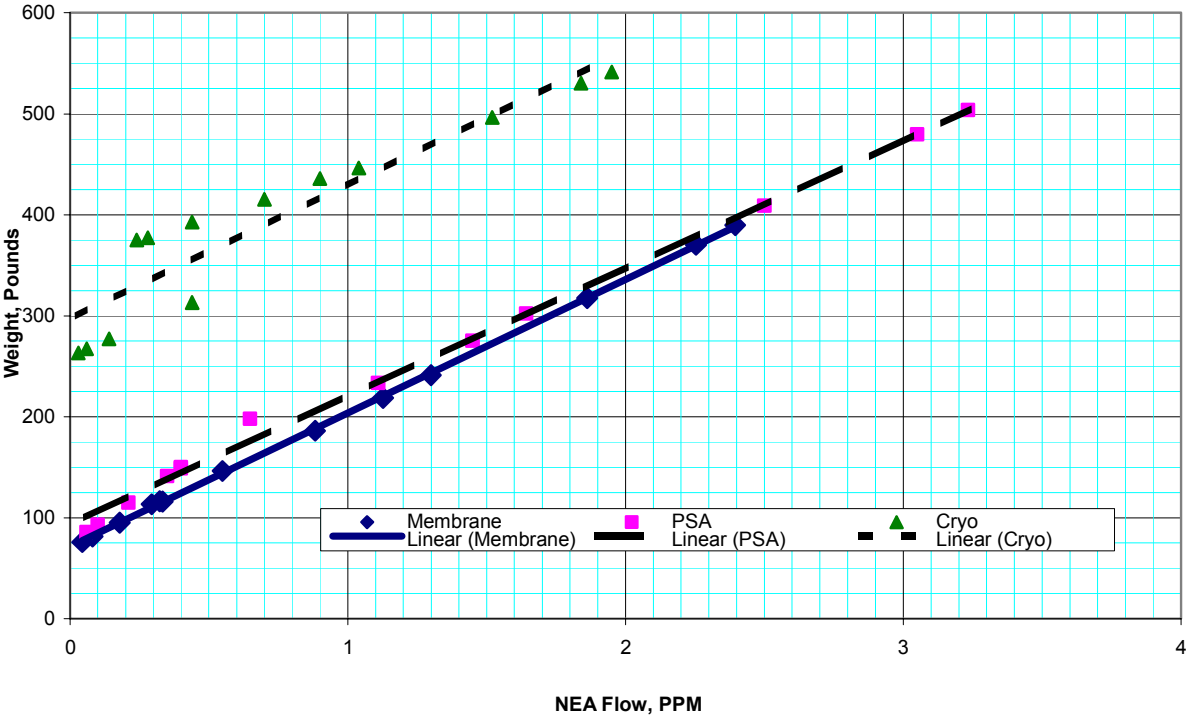

Figure 4.6.2-3. Weight vs. NEA Flow

Hybrid OBIGGS Volume Vs NEA Flow

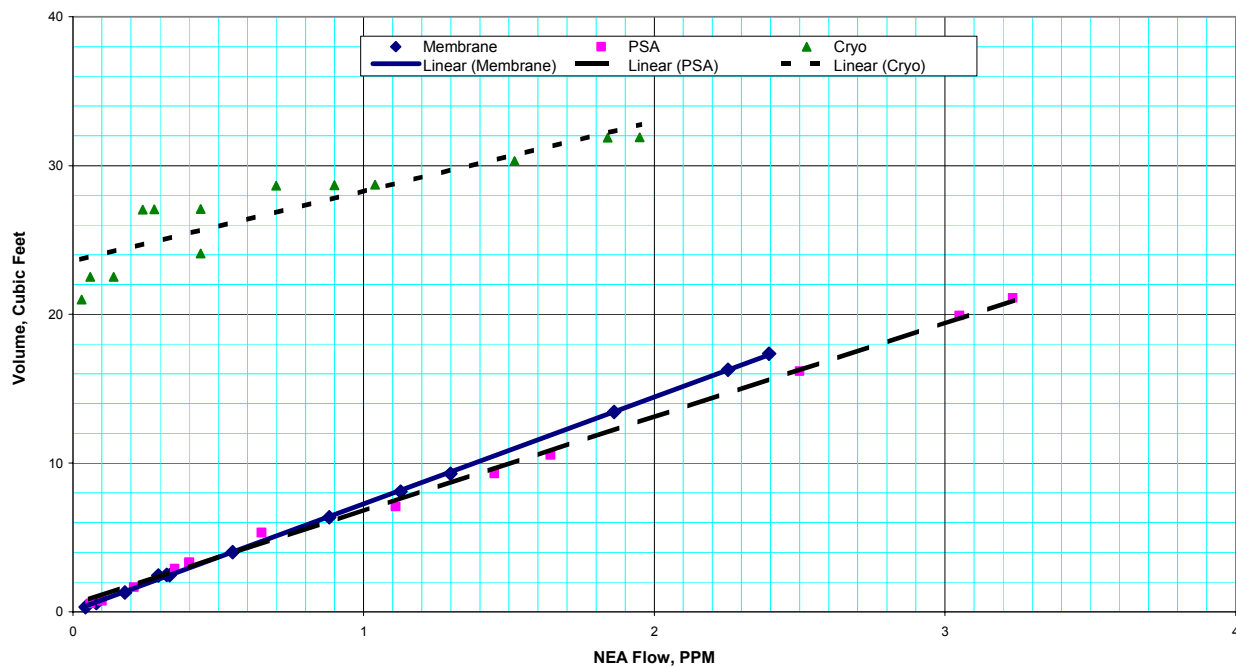

Figure 4.6.2-4. Volume vs. NEA Flow

Hybrid OBIGGS Electrical Power Vs NEA Flow

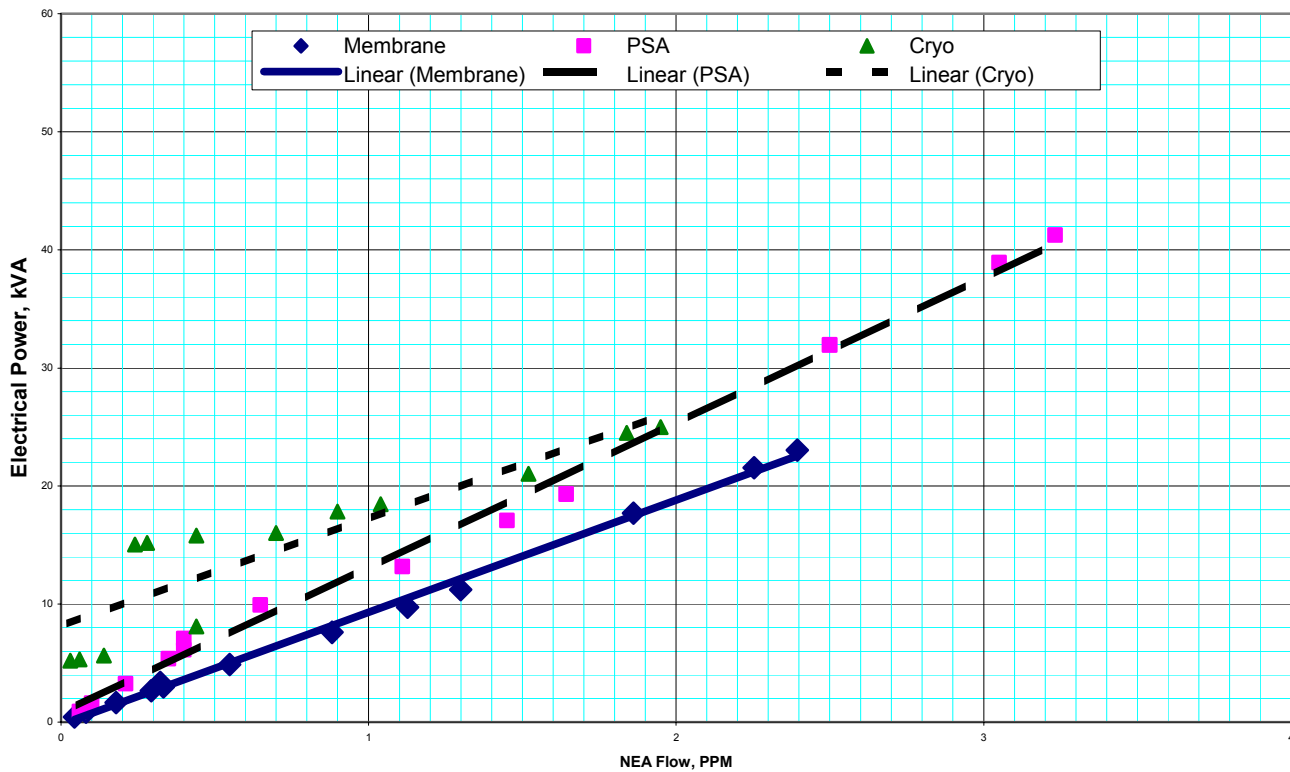

Figure 4.6.2-5. Power vs. NEA Flow

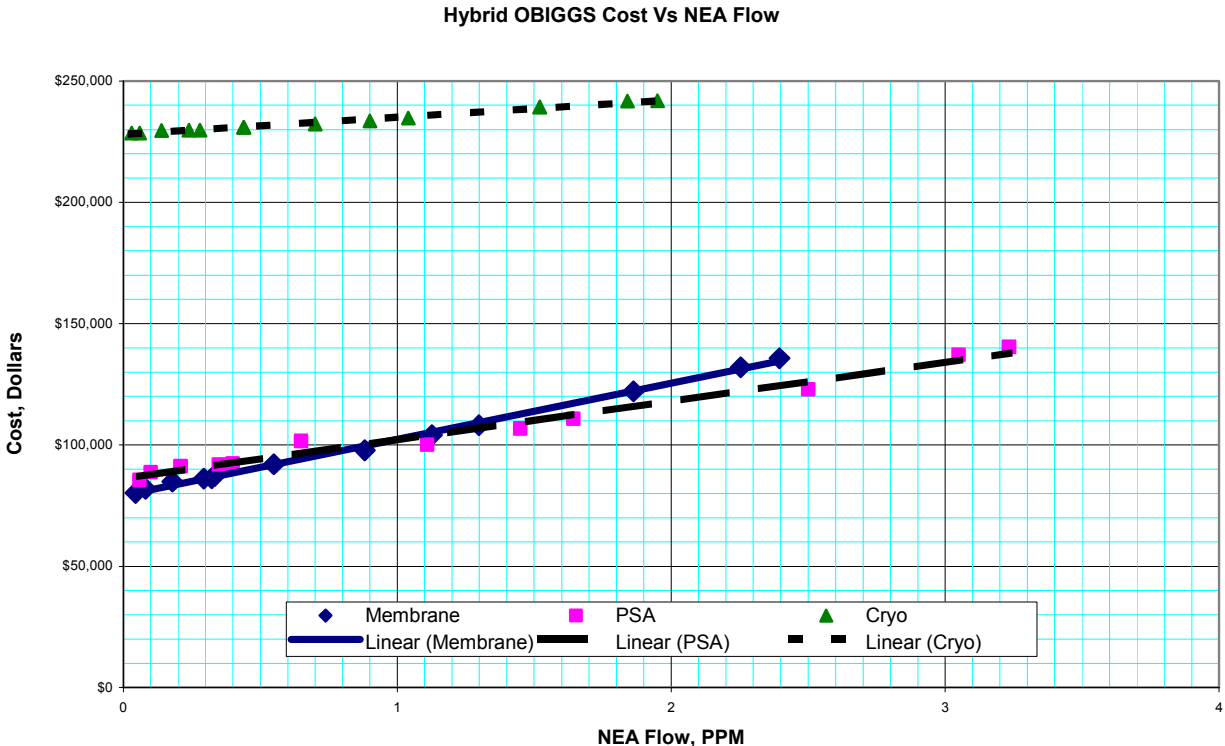

Figure 4.6.2-6. Cost vs. NEA Flow

A heated center wing tank requires significantly more hybrid OBIGGS NEA flow to lower the flammability exposure than other tank types. To account for this difference, the NEA flow required for hybrid OBIGGS systems that supply center tanks only are plotted separately (Figure 4.6.2-2) from the flows required for combined center, wing, and auxiliary tanks (Figure 4.6.2-1). The full-time OBIGGS NEA flows reported in the previous section are much less sensitive to the difference between center and other tank types and don't require a separate curve.

The NEA flow rate referenced in the parametric sizing curves is the nominal hybrid OBIGGS flow rate at sea level. The NEA oxygen concentrations, for each ASM technology and flight phase that were used to generate the curves, are tabulated in Figure 4.6.2-7. The parametric sizing curves are not valid for other NEA oxygen concentrations.

	Ground	Climb	Cruise	Descent
Membrane	5%	3.5%	3.5%	3.5%
PSA	7.3%	5.5%	4.3%	5.5%
Cryo	1%	1%	1%	1%

Figure 4.6.2-7. Hybrid OBIGGS NEA Oxygen Concentrations

A quick look at Figures 4.6.2-3 to 4.6.2-6 can give the mistaken impression that the cryogenic distillation system is not competitive with the other inerting technologies. Because the cryogenic distillation system requires significantly lower NEA flows for the same tank volume, the actual system parameters must be calculated for a given model to get a valid comparison.

The following examples demonstrate membrane, PSA, and cryogenic distillation system sizing for an aircraft with a total fuel capacity of 35,000 gallons (including all main and center wing tanks plus auxiliary tanks):

- Membrane System: Figure 4.6.2-1 indicates that a 35,000 gallon tank capacity requires approximately 1.5 pounds per minute of NEA at the membrane system purity. Figures 4.6.2-3 to 4.6.2-6 show that a membrane system to produce 1.5 lb/min of NEA weighs approximately 270 lbs, occupies 11 cubic feet, requires 14 kVA of electrical power during descent, and has initial acquisition costs of \$115,000.
- PSA System: Figure 4.6.2-1 shows that about 2 pounds per minute of NEA at PSA purity are required. Figures 4.6.2-3 to 4.6.2-6 indicate that the corresponding PSA system weighs approximately 350 pounds, occupies 13 cubic feet, requires 25 kVA of electrical power during descent, and has initial acquisition costs of \$120,000.
- Cryogenic Distillation System: Figure 4.6.2-1 shows that 1.25 pounds per minute of NEA at cryo purity are required. Figures 4.6.2-3 to 4.6.2-6 indicate that the corresponding cryogenic distillation system weighs approximately 460 pounds, occupies 29 cubic feet, requires 19 kVA of peak electrical power and has initial acquisition costs of \$235,000.

4.6.3 System Results

The system weight, volume, peak electrical power consumed, and initial acquisition cost for the hybrid OBIGGS sized for each model and tank configuration are shown in Figures 4.6.3-1 through 4.6.3-3. These results are based on a hybrid OBIGGS that produces the same flammability exposure during ground and climb as the GBI, OBGI, and hybrid OBGI systems. Larger or smaller hybrid systems could be sized using other flammability exposure criteria.

Hybrid OBIGGS - Center Wing Tank

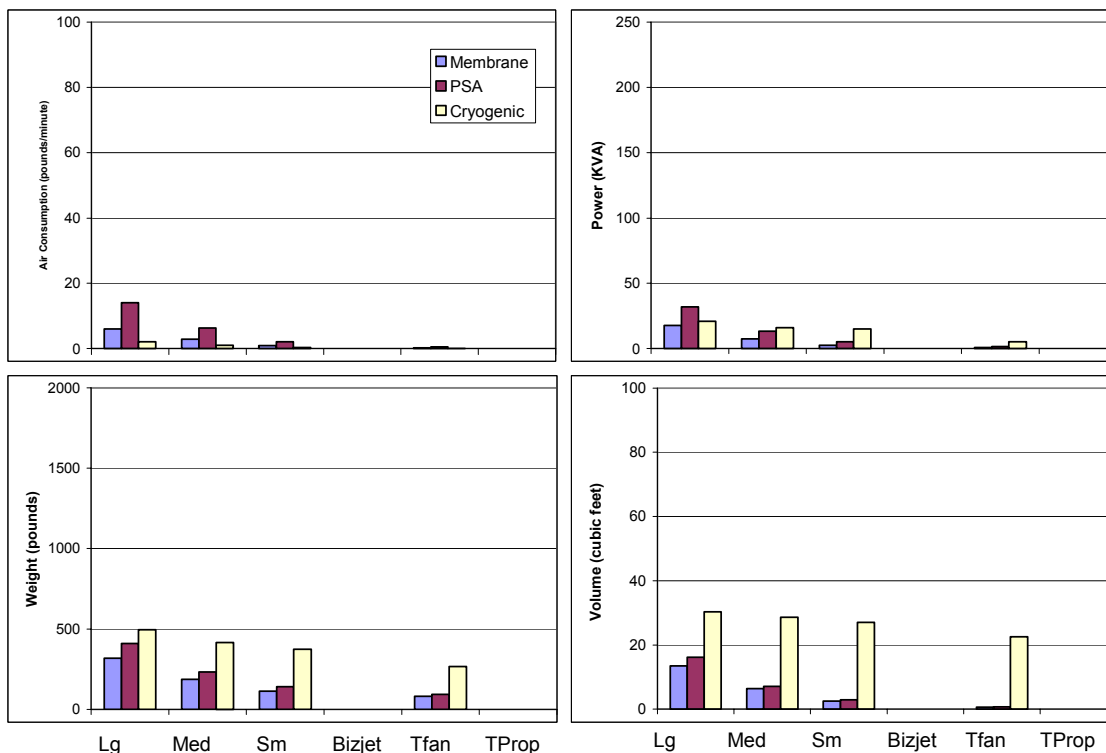

Figure 4.6.3-1. Hybrid OBIGGS Air Consumption, Power, Volume, and Weights for Center Tanks

Hybrid OBIGGS - Center Wing & Wing Tank

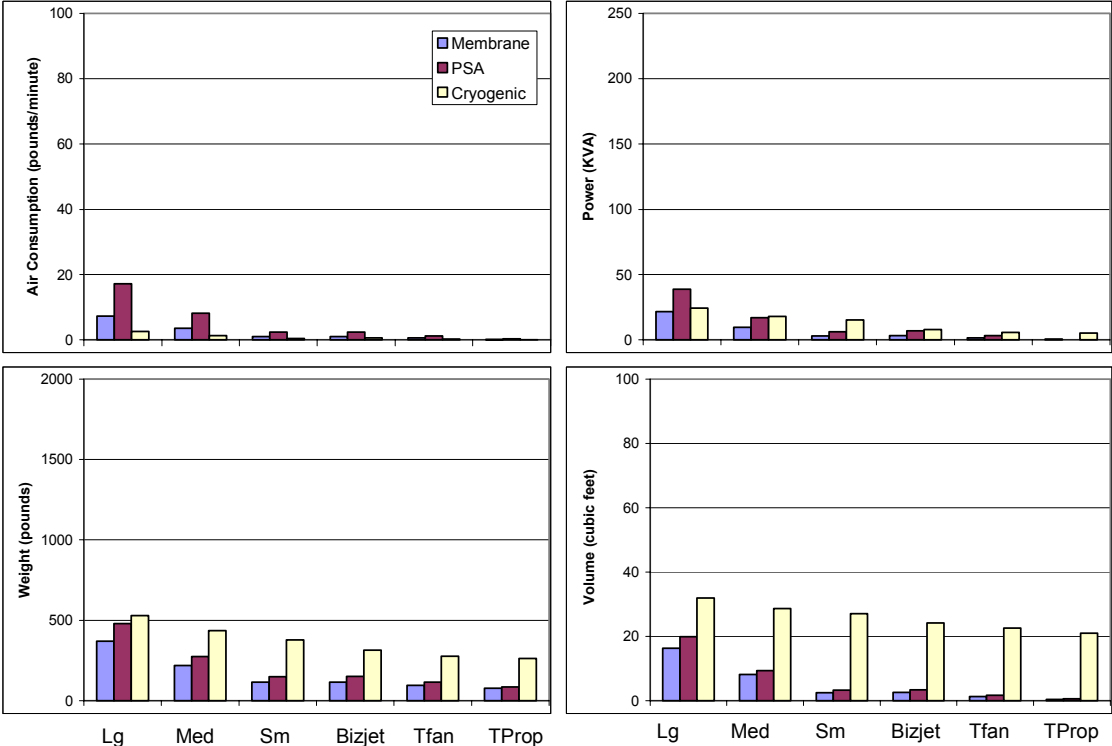

Figure 4.6.3-2. Hybrid OBIGGS Air Consumption, Power, Volume, and Weights for Center and Main Tanks

Hybrid OBIGGS - Center, Wing, & Aux Tank

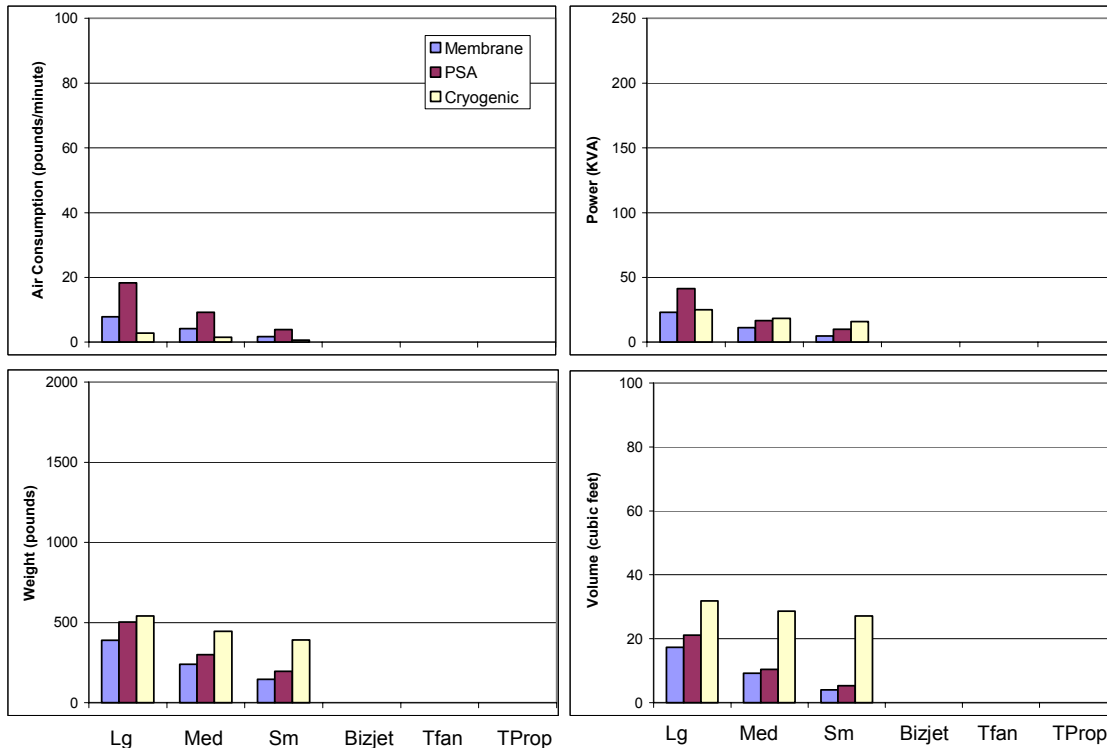

Figure 4.6.3-3. Hybrid OBIGGS Air Consumption, Power, Volume, and Weights for Center, Main, and Auxiliary Tanks

4.6.4 Flammability Exposure

The total and ground/climb flammability exposures for the hybrid OBIGGS with each of the three air separation technologies applied to each model and tank type are shown in Figures 4.6.4-1 to 4.6.4-3. A flammability exposure comparison between the different inerting concepts studied can be found in the Conclusions.

Onboard Inerting Designs Task Team Final Report

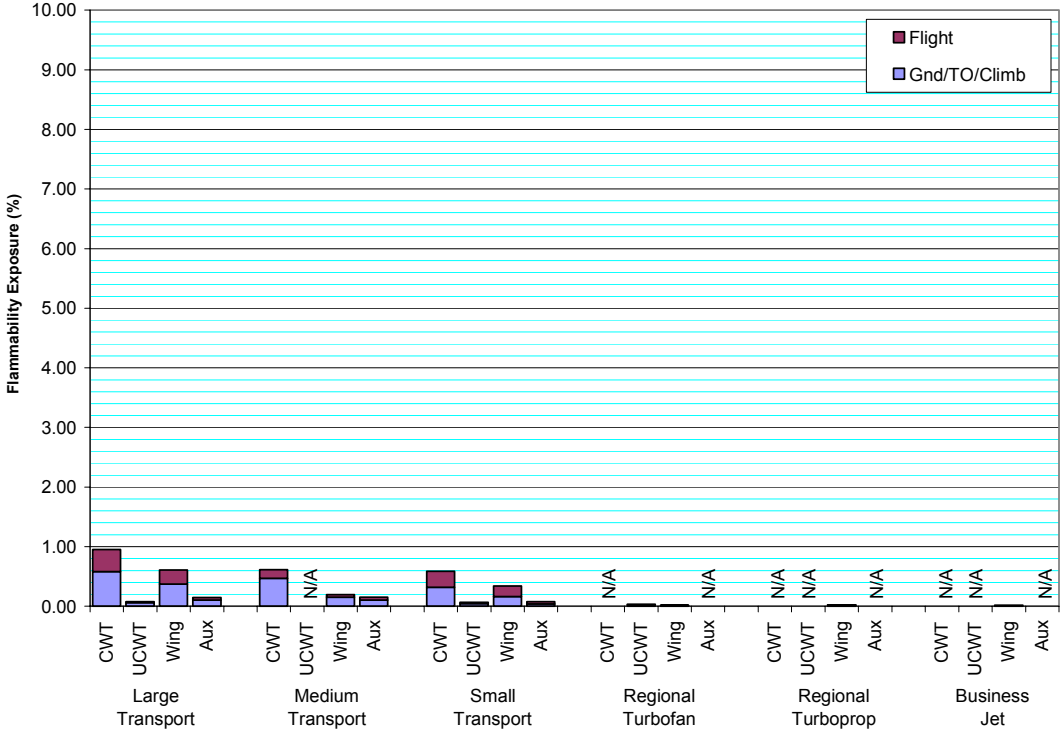

Figure 4.6.4-1. Membrane Hybrid OBIGGS Flammability Exposure

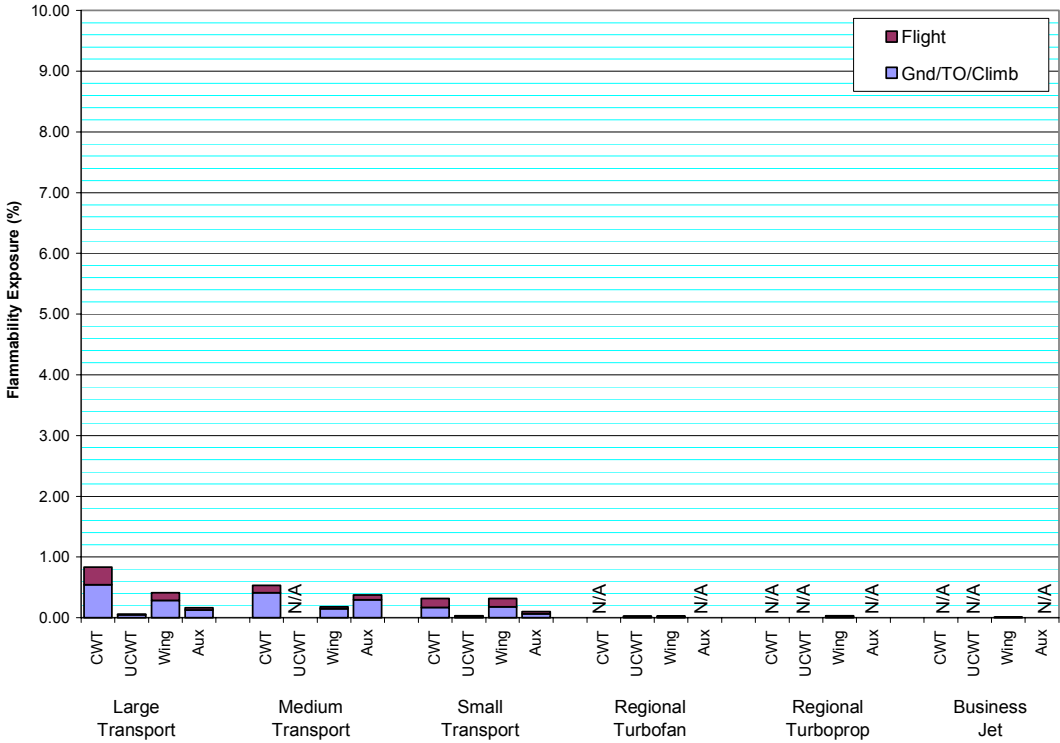

Figure 4.6.4-2. Pressure-Swing Adsorption Hybrid OBIGGS Flammability Exposure

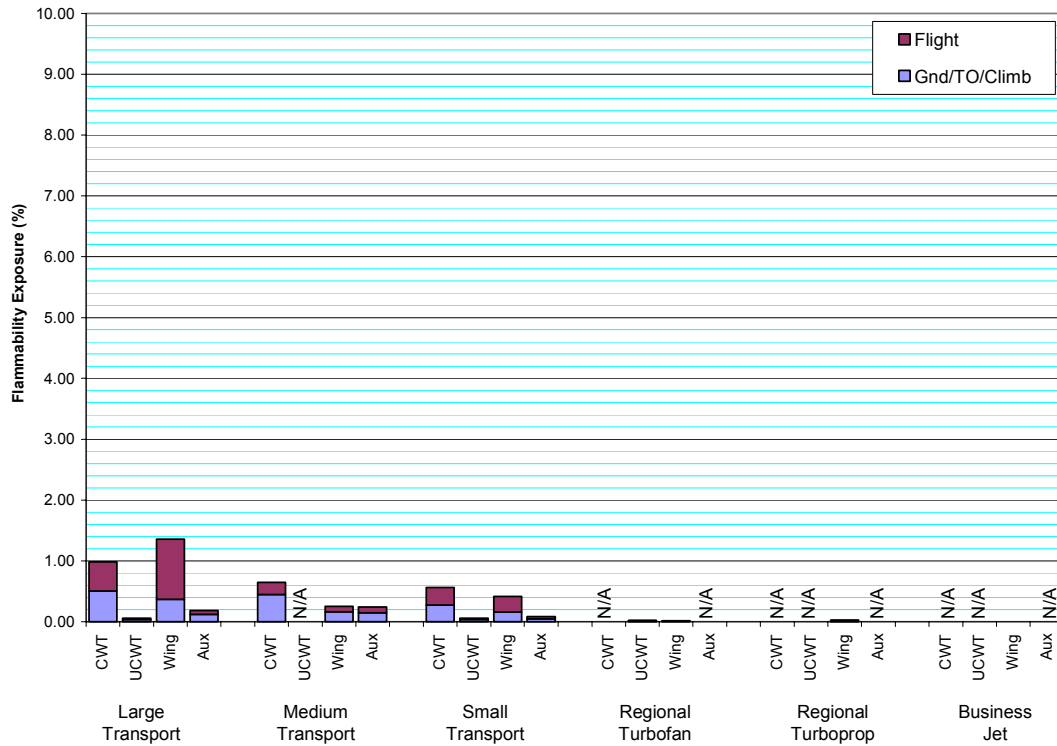

Figure 4.6.4-3. Cryogenic Distillation Hybrid OBIGGS Flammability Exposure

4.7 WEIGHT

Figures 4.7-1 through 4.7-3 summarize the hybrid OBIGGS weights for the membrane, PSA, and cryogenic distillation inerting systems for each of the ARAC generic aircraft. Each table provides the total weight for the “major” and “other” components identified for each system. “Other” components include such items as wiring, ducting, and valves, and their total estimated weights have been combined.

Onboard Inerting Designs Task Team Final Report

Membrane System Component	LT CWT+Main Shipset Weight (lbm)	MT CWT+Main Shipset Weight (lbm)	ST CWT+Main Shipset Weight (lbm)	RTF CWT+Main Shipset Weight (lbm)	RTP CWT+Main Shipset Weight (lbm)	BzJ CWT+Main Shipset Weight (lbm)	LT CWT Only Shipset Weight (lbm)	MT CWT Only Shipset Weight (lbm)	ST CWT Only Shipset Weight (lbm)	RTF CWT Only Shipset Weight (lbm)	LT CWT+Main+Aux Shipset Weight (lbm)	MT CWT+Main+Aux Shipset Weight (lbm)	ST CWT+Main+Aux Shipset Weight (lbm)
Major Components:													
Compressor	12.2	5.5	4.2	2.2	0.5	4.7	10.0	4.3	3.7	1.1	13.1	6.3	6.9
Heat exchanger/fan	10.0	4.4	0.8	0.4	0.1	0.8	8.0	3.2	0.7	0.2	10.7	5.2	1.3
Air separation module	119.0	59.5	18.0	9.5	2.3	18.0	98.3	46.8	18.0	4.3	126.9	68.6	29.2
	=====	=====	=====	=====	=====	=====	=====	=====	=====	=====	=====	=====	=====
Major component sub-totals	141	69	23	12	3	23	116	54	22	6	151	80	37
Other component sub-totals	229	149	93	83	73	93	201	132	91	76	239	161	109
System Totals	370	218	116	95	76	116	317	186	113	82	390	241	146
On-board oxygen sensor (not included in system totals)	1.5	1.5	1.5	1.5	1.5	1.5	1.5	1.5	1.5	1.5	1.5	1.5	1.5

Figure 4.7-1. Summary of OBIGGS Weights—Membrane Systems

PSA System Component	LT CWT+Main Shipset Weight (lbm)	MT CWT+Main Shipset Weight (lbm)	ST CWT+Main Shipset Weight (lbm)	RTF CWT+Main Shipset Weight (lbm)	RTP CWT+Main Shipset Weight (lbm)	BzJ CWT+Main Shipset Weight (lbm)	LT CWT Only Shipset Weight (lbm)	MT CWT Only Shipset Weight (lbm)	ST CWT Only Shipset Weight (lbm)	RTF CWT Only Shipset Weight (lbm)	LT CWT+Main+Aux Shipset Weight (lbm)	MT CWT+Main+Aux Shipset Weight (lbm)	ST CWT+Main+Aux Shipset Weight (lbm)
Major Components:													
Compressor	29	13	8	4	1	10	24	10	7	2	31	12	14
Heat exchanger/fan	24	14	4	2	1	4	20	12	4	1	25	15	7
Air separation module	136	74	37	23	10	37	114	61	35	13	144	84	60
	=====	=====	=====	=====	=====	=====	=====	=====	=====	=====	=====	=====	=====
Major component sub-totals	189	100	50	30	12	51	158	82	46	16	200	111	81
Other component sub-totals	291	175	99	85	74	99	251	151	95	77	304	189	117
System Totals	480	275	149	115	86	150	409	233	141	93	504	300	198
On-board oxygen sensor (not included in system totals)	1.5	1.5	1.5	1.5	1.5	1.5	1.5	1.5	1.5	1.5	1.5	1.5	1.5

Figure 4.7-2. Summary of OBIGGS Weights—PSA Systems

Onboard Inerting Designs Task Team Final Report

Cryogenic Distillation System Component	LT CWT+Main Shipset Weight (lbm)	MT CWT+Main Shipset Weight (lbm)	ST CWT+Main Shipset Weight (lbm)	RTF CWT+Main Shipset Weight (lbm)	RTP CWT+Main Shipset Weight (lbm)	BzJ CWT+Main Shipset Weight (lbm)	LT CWT Only Shipset Weight (lbm)	MT CWT Only Shipset Weight (lbm)	ST CWT Only Shipset Weight (lbm)	RTF CWT Only Shipset Weight (lbm)	LT CWT+Main+Aux Shipset Weight (lbm)	MT CWT+Main+Aux Shipset Weight (lbm)	ST CWT+Main+Aux Shipset Weight (lbm)
Major Components:													
Compressor	11.8	5.3	1.5	0.8	0.1	2.8	9.8	4.1	1.3	0.3	12.6	6.1	2.4
Heat exchanger/fan	5.5	2.7	0.8	0.4	0.1	1.3	4.5	2.1	0.7	0.2	5.8	3.1	1.3
Air separation module	321.0	283.0	261.0	169.0	161.0	187.0	306.0	274.0	261.0	164.0	325.0	285.0	267.0
	=====	=====	=====	=====	=====	=====	=====	=====	=====	=====	=====	=====	=====
Major component sub-totals	338	291	263	170	161	191	320	280	263	165	343	294	271
Other component sub-totals	192	145	114	107	102	122	176	135	112	103	198	152	122
System Totals	530	436	377	277	263	313	496	415	375	268	541	446	393
On-board oxygen sensor (not included in system totals)	1.5	1.5	1.5	1.5	1.5	1.5	1.5	1.5	1.5	1.5	1.5	1.5	1.5

Figure 4.7-3. Summary of OBIGGS Weights—Cryogenic Distillation Systems

4.7.1 Air Separation Modules

Weights were developed for hybrid OBIGGS membrane, pressure-swing adsorption, and cryogenic distillation air separation equipment.

Permeable Membrane. Membrane weight was based on a standard module size of 18 pounds. Knowing the total flow for each of the 6 aircraft models and the flow capabilities of a standard module, simple division determined the number of modules required. This numbers of modules multiplied by the module weight yielded the total weight for the membrane ASM.

Pressure-Swing Adsorption. The PSA air separator calculations were made empirically. A production OBIGGS air separator manufactured by the PSA supplier, was operated in an altitude chamber at the altitudes and supply pressures consistent with the study. At each altitude, the air consumption, product flow and product purity was measured. The fuel tank orifices were simulated with a simple throttling device that was not adjusted during the test. The throttling valve was set to produce a nominal 7% oxygen level in the NEA product at sea level?.

Based on the testing, the weight of the molecular sieve needed for each model was estimated from the number of separators needed to produce the required NEA flows. The structural weight (such as the mounting structure and sieve containers) was also scaled upward or downward based on supplier experience, although some economies of scaling were assumed.

Cryogenic Distillation. The weight of the cryogenic distillation system was not determined by scaling. Based on prior experience and design data, the team developed relationships for each component based upon critical parameters. For example, the inlet air flow was related to the volume and weight of the inlet recuperator. This relationship was not linear. Each component was characterized in this way and each system was uniquely specified for the particular aircraft and tank configuration.

4.7.2 Compressor

Compressor weight was based on the number, size, and type needed for each ASM technology and aircraft model. The compressor weight includes the compressor, motor, motor cooling fan and start contactor. The weight estimates were based on design schemes prepared for 15kW shaft power compressors of the screw and centrifugal type. From this a linear metric of weight as a function of power was generated. It is considered that this tends to give an overestimate of weight for high power machines and an underestimate for low power machines, which is conservative in the weight-critical cases. Above 30kW shaft power, two or more compressors are proposed.

4.7.3 Heat Exchanger/Cooling Fan

The heat exchangers and cooling fans were sized by suppliers of aircraft quality compact heat exchangers and cooling fans. The heat exchangers and cooling fans for each aircraft were sized to cool air from the compressor to the appropriate ground temperature limits (125 degrees Fahrenheit for the PSA and cryogenic distillation systems and 165 degrees Fahrenheit for the membrane systems using 111 degrees Fahrenheit ambient air as the heat sink. For hybrid OBIGGS, the heat exchanger and cooling fan sizes were also evaluated at the worst-case in-flight conditions to ensure that all requirements were met. An effort was made to minimize the overall size of the system by performing parametrics on heat exchanger and fan sizes to determine the best overall system. The final results are based on a system that had favorable weight, volume, power and costs numbers.

Heat exchanger and cooling fan weights were determined for each of the aircraft and system types. Heat exchanger weight includes the core, inlet/outlet headers, and connections to the mating tubing. The weight of the cooling fan includes the fan and any ducting between the fan and the heat exchanger. Ducting which interfaces with the aircraft structure or plumbing was accounted for separately.

4.7.4 Other Components

The team estimated the total weight of the "Other" Components for the hybrid OBIGGS by scaling the other component totals sized for the full-time OBIGGS. The full-time other component weights were plotted against NEA flow rate and the hybrid NEA flow rates fall well within the range. The results for the three technologies are shown in Figures 4.7.4-1, 4.7.4-2, and 4.7.4-3. The full-time systems for which every component was estimated are depicted by solid symbols and the scaled hybrid data are the empty symbols.

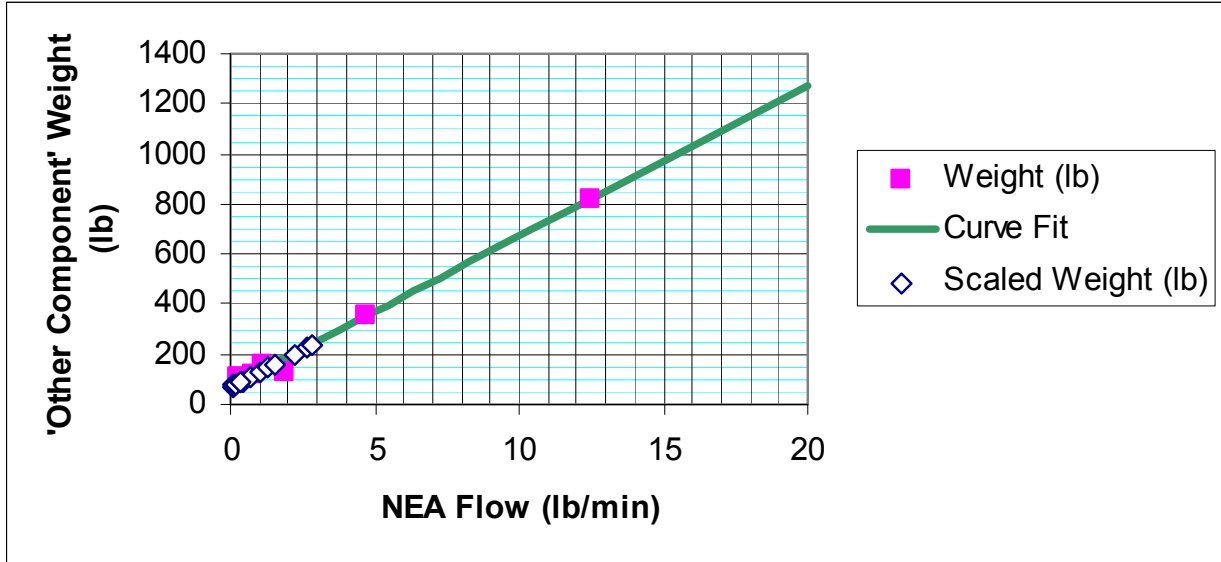

Figure 4.7.4-1. Permeable Membrane Hybrid OBIGGS Other Component Weight

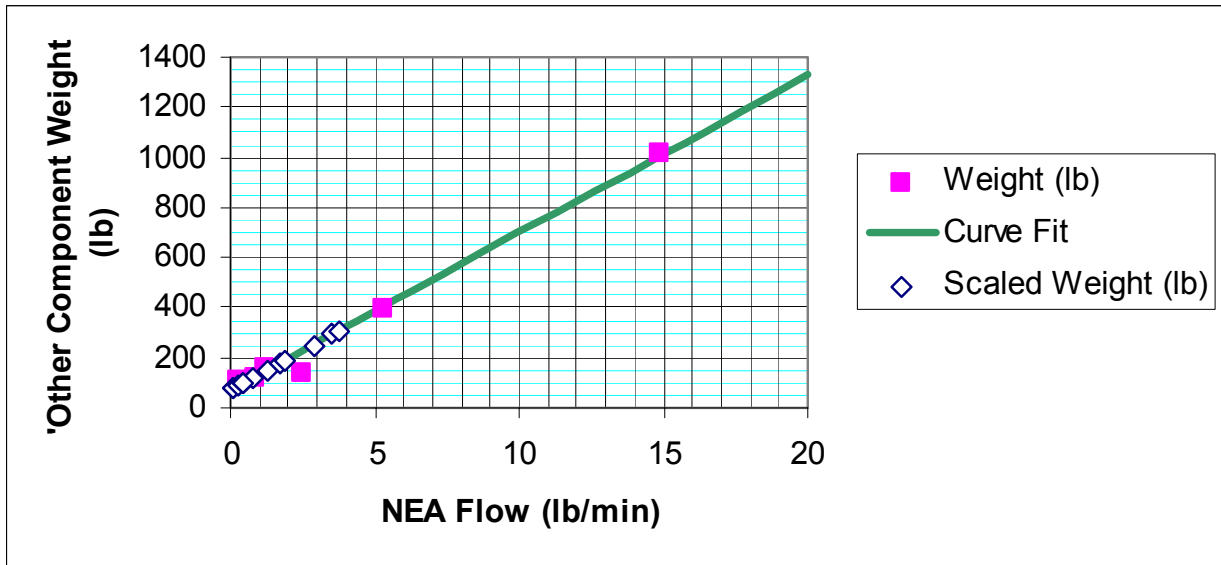

Figure 4.7.4-2. Pressure-Swing Adsorption Hybrid OBIGGS Other Component Weight

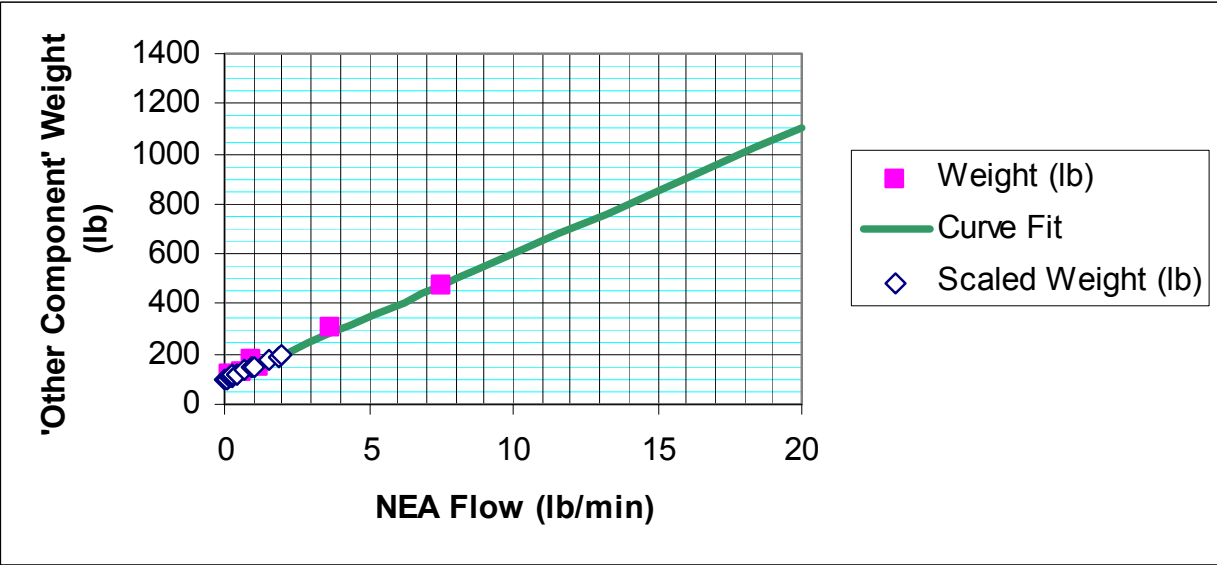

Figure 4.7.4-3. Cryogenic Distillation Hybrid OBIGGS Other Component Weight

4.8 VOLUME

Figures 4.8-1 through 4.8-3 summarize the hybrid OBIGGS volumes for the membrane, PSA, and cryogenic distillation inerting systems for each of the ARAC generic aircraft. Each table provides the total volume for the “major” and “other” components identified for each system. “Other” components include such items as wiring, ducting, and valves, and their total estimated volumes have been combined.

Onboard Inerting Designs Task Team Final Report

Membrane System Component	LT CWT+Main Shipset Volume (cu ft)	MT CWT+Main Shipset Volume (cu ft)	ST CWT+Main Shipset Volume (cu ft)	RTF CWT+Main Shipset Volume (cu ft)	RTP CWT+Main Shipset Volume (cu ft)	BzJ CWT+Main Shipset Volume (cu ft)	LT CWT Only Shipset Volume (cu ft)	MT CWT Only Shipset Volume (cu ft)	ST CWT Only Shipset Volume (cu ft)	RTF CWT Only Shipset Volume (cu ft)	LT CWT+Main+Aux Shipset Volume (cu ft)	MT CWT+Main+Aux Shipset Volume (cu ft)	ST CWT+Main+Aux Shipset Volume (cu ft)
Major Components:													
Compressor	0.229	0.154	0.042	0.023	0.005	0.047	0.189	0.120	0.037	0.010	0.245	0.177	0.069
Heat exchanger/fan	0.116	0.053	0.014	0.007	0.002	0.014	0.094	0.039	0.012	0.003	0.124	0.063	0.023
Air separation module	4.970	2.480	0.750	0.400	0.096	0.800	2.510	1.114	0.549	0.180	5.268	2.810	1.217
	=====	=====	=====	=====	=====	=====	=====	=====	=====	=====	=====	=====	=====
Major component sub-totals	5.32	2.69	0.81	0.43	0.10	0.86	2.79	1.27	0.60	0.19	5.64	3.05	1.31
Other component sub-totals	10.63	5.37	1.61	0.86	0.21	1.72	5.59	2.55	1.20	0.39	11.27	6.10	2.62
System Totals	15.95	8.06	2.42	1.29	0.31	2.58	8.38	3.82	1.79	0.58	16.91	9.15	3.93

Figure 4.8-1. Summary of OBIGGS Volume—Membrane Systems

PSA System Component	LT CWT+Main Shipset Volume (cu ft)	MT CWT+Main Shipset Volume (cu ft)	ST CWT+Main Shipset Volume (cu ft)	RTF CWT+Main Shipset Volume (cu ft)	RTP CWT+Main Shipset Volume (cu ft)	BzJ CWT+Main Shipset Volume (cu ft)	LT CWT Only Shipset Volume (cu ft)	MT CWT Only Shipset Volume (cu ft)	ST CWT Only Shipset Volume (cu ft)	RTF CWT Only Shipset Volume (cu ft)	LT CWT+Main+Aux Shipset Volume (cu ft)	MT CWT+Main+Aux Shipset Volume (cu ft)	ST CWT+Main+Aux Shipset Volume (cu ft)
Major Components:													
Compressor	0.653	0.281	0.107	0.056	0.014	0.124	0.533	0.215	0.094	0.027	0.693	0.329	0.174
Heat exchanger/fan	0.682	0.320	0.087	0.046	0.011	0.087	0.556	0.244	0.076	0.021	0.724	0.364	0.142
Air separation module	5.300	2.500	0.900	0.450	0.160	0.900	4.300	1.900	0.800	0.200	5.618	2.833	1.460
	=====	=====	=====	=====	=====	=====	=====	=====	=====	=====	=====	=====	=====
Major component sub-totals	6.64	3.10	1.09	0.55	0.19	1.11	5.39	2.36	0.97	0.25	7.03	3.53	1.78
Other component sub-totals	13.27	6.20	2.19	1.10	0.37	2.22	10.78	4.72	1.94	0.50	14.07	7.05	3.55
System Totals	19.91	9.30	3.28	1.66	0.56	3.33	16.17	7.08	2.91	0.74	21.10	10.58	5.33

Figure 4.8-2. Summary of OBIGGS Volumes—PSA Systems

Onboard Inerting Designs Task Team Final Report

Cryogenic Distillation System Component	LT CWT+Main Shipset Volume (cu ft)	MT CWT+Main Shipset Volume (cu ft)	ST CWT+Main Shipset Volume (cu ft)	RTF CWT+Main Shipset Volume (cu ft)	RTP CWT+Main Shipset Volume (cu ft)	BzJ CWT+Main Shipset Volume (cu ft)	LT CWT Only Shipset Volume (cu ft)	MT CWT Only Shipset Volume (cu ft)	ST CWT Only Shipset Volume (cu ft)	RTF CWT Only Shipset Volume (cu ft)	LT CWT+Main+Aux Shipset Volume (cu ft)	MT CWT+Main+Aux Shipset Volume (cu ft)	ST CWT+Main+Aux Shipset Volume (cu ft)
Major Components:													
Compressor	0.149	0.067	0.019	0.010	0.002	0.035	0.123	0.052	0.017	0.004	0.158	0.077	0.031
Heat exchanger/fan	0.106	0.052	0.016	0.008	0.002	0.025	0.087	0.040	0.014	0.003	0.112	0.060	0.025
Cryo component subtotals	21.000	19.000	18.000	15.000	14.000	16.000	20.000	19.000	18.000	15.000	21.000	19.000	18.000
	=====	=====	=====	=====	=====	=====	=====	=====	=====	=====	=====	=====	=====
Major component sub-totals	21.26	19.12	18.04	15.02	14.00	16.06	20.21	19.09	18.03	15.01	21.27	19.14	18.06
Other component sub-totals	10.63	9.56	9.02	7.51	7.00	8.03	10.11	9.55	9.02	7.50	10.64	9.57	9.03
System Totals	31.88	28.68	27.05	22.53	21.01	24.09	30.32	28.64	27.05	22.51	31.91	28.71	27.08

Figure 4.8-3. Summary of OBIGGS Volumes—Cryogenic Distillation Systems

4.8.1 Air Separation Modules

Volumes were developed for hybrid OBIGGS membrane, pressure-swing adsorption, and cryogenic distillation air separation equipment.

Permeable Membrane. Membrane volume was based on a standard module size of .75 cubic feet. Knowing the total flow for each of the 6 aircraft models and the flow capabilities of a standard module, simple division determined the number of modules required. This numbers of modules multiplied by the module volume yielded the total volume for the ASM.

Pressure-Swing Adsorption. The PSA air separator calculations were made empirically as described in the weight section above. The NEA flow rate of a given PSA separator operating at the designated oxygen concentration was measured in the lab. The volume of the PSA separators were then determined from the number of units required to produce the NEA flow for each model.

Cryogenic Distillation. The volume of the cryogenic distillation system was determined in the same manner as the weight. Scaling was not used to determine component volume. Rather, each system was uniquely sized for the particular application.

4.8.2 Compressor

Compressor volume estimates were based on the number, size, and type needed for each ASM technology. Compressor types (screw or centrifugal) were selected for each aircraft model with the same considerations of power and compressor scalability as outlined in the weight section above. The compressor volume includes the compressor, motor, motor cooling fan and start contactor. The volume estimates were based on design schemes prepared for 15kW shaft power compressors of the screw and centrifugal types. From this a linear metric of volume as a function of power was generated. It is considered that this tends to give an overestimate of volume for high power machines and an underestimate for low power machines, which is generally conservative with regard to space envelope constraints. Above 30kW shaft power, two or more compressors are proposed.

4.8.3 Heat Exchanger/Cooling Fan

Heat exchanger and cooling fan volumes were determined for each of the aircraft and system types. Heat exchanger volume includes the core, inlet/outlet headers, and connections to the mating tubing. The volume of the cooling fan includes the fan and any ducting between the fan and the heat exchanger. Ducting which interfaces with the aircraft structure or plumbing was accounted for separately.

4.8.4 Other Components

As for full-time OBIGGS, the team estimated the volume of the "Other" Components in the hybrid OBIGGS by multiplying the volume of the major components by 2.0 for the membrane and PSA systems and by .5 for the cryogenic distillation system.

4.9 ELECTRICAL POWER

Figures 4.9-1 through 4.9-3 summarize the hybrid OBIGGS electrical power consumption estimates for the membrane, PSA, and cryogenic distillation inerting systems for each of the generic aircraft. Each table provides the total peak electrical power for the "major" and "other" components identified for each system. "Other" components include such items as wiring, motors, and valves, and their total estimated electrical powers have been combined.

Onboard Inerting Designs Task Team Final Report

Membrane System Component	LT CWT+Main Shipset Elect Pwr (kVA)	MT CWT+Main Shipset Elect Pwr (kVA)	ST CWT+Main Shipset Elect Pwr (kVA)	RTF CWT+Main Shipset Elect Pwr (kVA)	RTP CWT+Main Shipset Elect Pwr (kVA)	BzJ CWT+Main Shipset Elect Pwr (kVA)	LT CWT Only Shipset Elect Pwr (kVA)	MT CWT Only Shipset Elect Pwr (kVA)	ST CWT Only Shipset Elect Pwr (kVA)	RTF CWT Only Shipset Elect Pwr (kVA)	LT CWT+Main+Aux Shipset Elect Pwr (kVA)	MT CWT+Main+Aux Shipset Elect Pwr (kVA)	ST CWT+Main+Aux Shipset Elect Pwr (kVA)
Major Components:													
Compressor	21.143	9.523	2.895	1.555	0.341	3.260	17.365	7.423	2.560	0.739	22.590	10.972	4.800
Heat exchanger/fan	0.309	0.114	0.000	0.000	0.000	0.000	0.241	0.071	0.000	0.000	0.335	0.143	0.000
Air separation module	0.000	0.000	0.000	0.000	0.000	0.000	0.000	0.000	0.000	0.000	0.000	0.000	0.000
	=====	=====	=====	=====	=====	=====	=====	=====	=====	=====	=====	=====	=====
Major component sub-totals	21.45	9.64	2.90	1.55	0.34	3.26	17.61	7.49	2.56	0.74	22.92	11.11	4.80
Other component sub-totals	0.10	0.10	0.10	0.10	0.10	0.10	0.10	0.10	0.10	0.10	0.10	0.10	0.10
System Totals	21.55	9.74	3.00	1.65	0.44	3.36	17.71	7.59	2.66	0.84	23.02	11.21	4.90

Figure 4.9-1. Summary of OBIGGS Electrical Power—Membrane Systems

PSA System Component	LT CWT+Main Shipset Elect Pwr (kVA)	MT CWT+Main Shipset Elect Pwr (kVA)	ST CWT+Main Shipset Elect Pwr (kVA)	RTF CWT+Main Shipset Elect Pwr (kVA)	RTP CWT+Main Shipset Elect Pwr (kVA)	BzJ CWT+Main Shipset Elect Pwr (kVA)	LT CWT Only Shipset Elect Pwr (kVA)	MT CWT Only Shipset Elect Pwr (kVA)	ST CWT Only Shipset Elect Pwr (kVA)	RTF CWT Only Shipset Elect Pwr (kVA)	LT CWT+Main+Aux Shipset Elect Pwr (kVA)	MT CWT+Main+Aux Shipset Elect Pwr (kVA)	ST CWT+Main+Aux Shipset Elect Pwr (kVA)
Major Components:													
Compressor	38.363	16.584	5.890	3.091	0.784	6.808	31.399	12.684	5.153	1.473	40.685	18.800	9.567
Heat exchanger/fan	0.340	0.340	0.136	0.071	0.018	0.136	0.340	0.340	0.119	0.033	0.340	0.340	0.221
Air separation module	0.120	0.057	0.016	0.008	0.002	0.016	0.100	0.044	0.014	0.004	0.127	0.065	0.026
	=====	=====	=====	=====	=====	=====	=====	=====	=====	=====	=====	=====	=====
Major component sub-totals	38.82	16.98	6.04	3.17	0.80	6.96	31.84	13.07	5.29	1.51	41.15	19.20	9.81
Other component sub-totals	0.10	0.10	0.10	0.10	0.10	0.10	0.10	0.10	0.10	0.10	0.10	0.10	0.10
System Totals	38.92	17.08	6.14	3.27	0.90	7.06	31.94	13.17	5.39	1.61	41.25	19.30	9.91

Figure 4.9-2. Summary of OBIGGS Electrical Power—PSA Systems

Onboard Inerting Designs Task Team Final Report

Cryogenic Distillation System Component	LT CWT+Main Shipset Elect Pwr (kVA)	MT CWT+Main Shipset Elect Pwr (kVA)	ST CWT+Main Shipset Elect Pwr (kVA)	RTF CWT+Main Shipset Elect Pwr (kVA)	RTP CWT+Main Shipset Elect Pwr (kVA)	BzJ CWT+Main Shipset Elect Pwr (kVA)	LT CWT Only Shipset Elect Pwr (kVA)	MT CWT Only Shipset Elect Pwr (kVA)	ST CWT Only Shipset Elect Pwr (kVA)	RTF CWT Only Shipset Elect Pwr (kVA)	LT CWT+Main+Aux Shipset Elect Pwr (kVA)	MT CWT+Main+Aux Shipset Elect Pwr (kVA)	ST CWT+Main+Aux Shipset Elect Pwr (kVA)
Major Components:													
Compressor	8.229	3.678	1.069	0.535	0.102	1.946	6.795	2.860	0.916	0.229	8.722	4.265	1.680
Heat exchanger/fan	0.166	0.081	0.025	0.013	0.003	0.040	0.137	0.063	0.022	0.005	0.175	0.094	0.040
Cryo component subtotals	16.000	14.000	14.000	5.000	5.000	6.000	14.000	13.000	14.000	5.000	16.000	14.000	14.000
	=====	=====	=====	=====	=====	=====	=====	=====	=====	=====	=====	=====	=====
Major component sub-totals	24.39	17.76	15.09	5.55	5.10	7.99	20.93	15.92	14.94	5.23	24.90	18.36	15.72
Other component sub-totals	0.10	0.10	0.10	0.10	0.10	0.10	0.10	0.10	0.10	0.10	0.10	0.10	0.10
System Totals	24.49	17.86	15.19	5.65	5.20	8.09	21.03	16.02	15.04	5.33	25.00	18.46	15.82

Figure 4.9-3. Summary of OBIGGS Electrical Power—Cryogenic Distillation Systems

Onboard Inerting Designs Task Team Final Report

4.9.1 Air Separation Modules

Electrical power estimates were developed for the hybrid OBIGGS membrane, pressure-swing adsorption, and cryogenic distillation air separation equipment.

Permeable Membrane. Membrane modules do not require any electrical power.

Pressure-Swing Adsorption. Electrical power consumption for PSA separators is low, since the mechanism to operate the PSA distribution valve is pneumatic. The electrical power is consumed by simple timing and power circuits that operate the pneumatic control valves.

Cryogenic Distillation. Almost all of the electrical power needed for the cryogenic distillation system is used by the cryogenic refrigerator. The supplier's database of analytical calculations and system tests was used to specify the power requirements of the cryogenic refrigeration systems for this study. As in the case of the weight and volume, no scaling was used to determine the cryogenic distillation electrical power requirements.

4.9.2 Compressor

Compressor electrical power was based on the number, size, and type needed for each ASM technology. Compressor types (screw or centrifugal) were selected and electrical power was determined for each aircraft model with the same considerations of power and compressor scalability as outlined in the weight section.

The compressors for each aircraft were sized for the mass flow of supply air required to each of the differing ASM types. The shaft power of the compressor is a function of the mass flow, pressure ratio and inlet temperature.

4.9.3 Heat Exchanger/Cooling Fan

Heat exchanger and cooling fan power were determined for each of the aircraft and system types. The heat exchanger requires no power to operate. The cooling fan power requirement was determined based on the cooling air flow rate and pressure rise requirements. The system was designed to minimize the cooling fan power requirements whenever possible.

4.9.4 Other Components

As for the other on-board systems, the team estimated the total electrical power required by the other components in the hybrid OBIGGS as 0.1 kVA for all models and tank configurations.

4.10 RELIABILITY

Figures 4.10-1 through 4.10-6 summarize the hybrid OBIGGS component reliability estimates, in terms of Mean-Time-Between-Maintenance-Actions (MTBMA) and Mean-Time-Between-Failure (MTBF), developed by the for the membrane, PSA, and cryogenic distillation inerting systems for each of the ARAC generic aircraft. Each table provides the reliability for the "major" and "other" components identified for each system. "Other" components include such items as wiring, motors, and valves, and their total estimated electrical powers have been combined. The Airplane Operations and Maintenance Team used this component data as a starting point for the system level reliability estimates.

Onboard Inerting Designs Task Team Final Report

Membrane System Component	LT	MT	ST	RTF	RTP	BzJ	LT	MT	ST	RTF	LT	MT	ST
	CWT+Main Component MTBMA (hrs)	CWT+Main Component MTBMA (hrs)	CWT+Main Component MTBMA (hrs)	CWT+Main Component MTBMA (hrs)	CWT+Main Component MTBMA (hrs)	CWT+Main Component MTBMA (hrs)	CWT Only Component MTBMA (hrs)	CWT Only Component MTBMA (hrs)	CWT Only Component MTBMA (hrs)	CWT Only Component MTBMA (hrs)	CWT+Main+Aux Component MTBMA (hrs)	CWT+Main+Aux Component MTBMA (hrs)	CWT+Main+Aux Component MTBMA (hrs)
Major Components:													
Compressor	7,000	7,000	7,000	7,000	7,000	7,000	7,000	7,000	7,000	7,000	7,000	7,000	7,000
Heat exchanger	100,000	100,000	100,000	100,000	100,000	100,000	100,000	100,000	100,000	100,000	100,000	100,000	100,000
Cooling Fan	25,000	25,000	25,000	25,000	25,000	25,000	25,000	25,000	25,000	25,000	25,000	25,000	25,000
Air separation module	30,000	30,000	30,000	30,000	30,000	30,000	30,000	30,000	30,000	30,000	30,000	30,000	30,000
Other Components:													
Cabin air filter assy	100,000	100,000	100,000	100,000	100,000	100,000	100,000	100,000	100,000	100,000	100,000	100,000	100,000
Cabin air filter element	4,000	4,000	4,000	4,000	4,000	4,000	4,000	4,000	4,000	4,000	4,000	4,000	4,000
OBIGGS shutoff valve	50,000	50,000	50,000	50,000	50,000	50,000	50,000	50,000	50,000	50,000	50,000	50,000	50,000
Compressor unloading valve	50,000	50,000	50,000	50,000	50,000	50,000	50,000	50,000	50,000	50,000	50,000	50,000	50,000
Compressor discharge check valve	100,000	100,000	100,000	100,000	100,000	100,000	100,000	100,000	100,000	100,000	100,000	100,000	100,000
Bleed shutoff valve	50,000	50,000	50,000	50,000	50,000	50,000	50,000	50,000	50,000	50,000	50,000	50,000	50,000
Bleed check valve	100,000	100,000	100,000	100,000	100,000	100,000	100,000	100,000	100,000	100,000	100,000	100,000	100,000
Bypass valve	50,000	50,000	50,000	50,000	50,000	50,000	50,000	50,000	50,000	50,000	50,000	50,000	50,000
Temperature sensor	50,000	50,000	50,000	50,000	50,000	50,000	50,000	50,000	50,000	50,000	50,000	50,000	50,000
Water separator/filter assy	100,000	100,000	100,000	100,000	100,000	100,000	100,000	100,000	100,000	100,000	100,000	100,000	100,000
Water separator/filter element	4,000	4,000	4,000	4,000	4,000	4,000	4,000	4,000	4,000	4,000	4,000	4,000	4,000
High flow valve	50,000	50,000	50,000	50,000	50,000	50,000	50,000	50,000	50,000	50,000	50,000	50,000	50,000
Relief valve	50,000	50,000	50,000	50,000	50,000	50,000	50,000	50,000	50,000	50,000	50,000	50,000	50,000
Fuel tank check valve	100,000	100,000	100,000	100,000	100,000	100,000	100,000	100,000	100,000	100,000	100,000	100,000	100,000
Controller/control card	10,000	10,000	10,000	10,000	10,000	10,000	10,000	10,000	10,000	10,000	10,000	10,000	10,000
Ducting	10,000,000	10,000,000	10,000,000	10,000,000	10,000,000	10,000,000	10,000,000	10,000,000	10,000,000	10,000,000	10,000,000	10,000,000	10,000,000
Wiring	10,000,000	10,000,000	10,000,000	10,000,000	10,000,000	10,000,000	10,000,000	10,000,000	10,000,000	10,000,000	10,000,000	10,000,000	10,000,000
Installation Hardware	10,000,000	10,000,000	10,000,000	10,000,000	10,000,000	10,000,000	10,000,000	10,000,000	10,000,000	10,000,000	10,000,000	10,000,000	10,000,000
Structural Modifications	10,000,000	10,000,000	10,000,000	10,000,000	10,000,000	10,000,000	10,000,000	10,000,000	10,000,000	10,000,000	10,000,000	10,000,000	10,000,000
Ram Ducting	10,000,000	10,000,000	10,000,000	10,000,000	10,000,000	10,000,000	10,000,000	10,000,000	10,000,000	10,000,000	10,000,000	10,000,000	10,000,000
Compressor wiring	10,000,000	10,000,000	10,000,000	10,000,000	10,000,000	10,000,000	10,000,000	10,000,000	10,000,000	10,000,000	10,000,000	10,000,000	10,000,000
Overheat sensors	50,000	50,000	50,000	50,000	50,000	50,000	50,000	50,000	50,000	50,000	50,000	50,000	50,000
On-board oxygen sensor (information only)	26,933	26,933	26,933	26,933	26,933	26,933	26,933	26,933	26,933	26,933	26,933	26,933	26,933

Figure 4.10-1. Summary of Hybrid OBIGGS MTBMA—Membrane Systems

Onboard Inerting Designs Task Team Final Report

PSA System Component	LT	MT	ST	RTF	RTP	BzJ	LT	MT	ST	RTF	LT	MT	ST
	CWT+Main Component MTBMA (hrs)	CWT+Main Component MTBMA (hrs)	CWT+Main Component MTBMA (hrs)	CWT+Main Component MTBMA (hrs)	CWT+Main Component MTBMA (hrs)	CWT+Main Component MTBMA (hrs)	CWT Only Component MTBMA (hrs)	CWT Only Component MTBMA (hrs)	CWT Only Component MTBMA (hrs)	CWT Only Component MTBMA (hrs)	CWT+Main+Aux Component MTBMA (hrs)	CWT+Main+Aux Component MTBMA (hrs)	CWT+Main+Aux Component MTBMA (hrs)
Major Components:													
Compressor	7,000	7,000	7,000	7,000	7,000	7,000	7,000	7,000	7,000	7,000	7,000	7,000	7,000
Heat exchanger	100,000	100,000	100,000	100,000	100,000	100,000	100,000	100,000	100,000	100,000	100,000	100,000	100,000
Cooling Fan	25,000	25,000	25,000	25,000	25,000	25,000	25,000	25,000	25,000	25,000	25,000	25,000	25,000
Air separation module	8,000	8,000	8,000	8,000	8,000	8,000	8,000	8,000	8,000	8,000	8,000	8,000	8,000
Other Components:													
Cabin air filter assy	100,000	100,000	100,000	100,000	100,000	100,000	100,000	100,000	100,000	100,000	100,000	100,000	100,000
Cabin air filter element	4,000	4,000	4,000	4,000	4,000	4,000	4,000	4,000	4,000	4,000	4,000	4,000	4,000
OBIGGS shutoff valve	50,000	50,000	50,000	50,000	50,000	50,000	50,000	50,000	50,000	50,000	50,000	50,000	50,000
Compressor unloading valve	50,000	50,000	50,000	50,000	50,000	50,000	50,000	50,000	50,000	50,000	50,000	50,000	50,000
Compressor discharge check valve	100,000	100,000	100,000	100,000	100,000	100,000	100,000	100,000	100,000	100,000	100,000	100,000	100,000
Bleed shutoff valve	50,000	50,000	50,000	50,000	50,000	50,000	50,000	50,000	50,000	50,000	50,000	50,000	50,000
Bleed check valve	100,000	100,000	100,000	100,000	100,000	100,000	100,000	100,000	100,000	100,000	100,000	100,000	100,000
Bypass valve	50,000	50,000	50,000	50,000	50,000	50,000	50,000	50,000	50,000	50,000	50,000	50,000	50,000
Temperature sensor	50,000	50,000	50,000	50,000	50,000	50,000	50,000	50,000	50,000	50,000	50,000	50,000	50,000
Water separator/filter assy	100,000	100,000	100,000	100,000	100,000	100,000	100,000	100,000	100,000	100,000	100,000	100,000	100,000
Water separator/filter element	4,000	4,000	4,000	4,000	4,000	4,000	4,000	4,000	4,000	4,000	4,000	4,000	4,000
High flow valve	50,000	50,000	50,000	50,000	50,000	50,000	50,000	50,000	50,000	50,000	50,000	50,000	50,000
Relief valve	50,000	50,000	50,000	50,000	50,000	50,000	50,000	50,000	50,000	50,000	50,000	50,000	50,000
Fuel tank check valve	100,000	100,000	100,000	100,000	100,000	100,000	100,000	100,000	100,000	100,000	100,000	100,000	100,000
Controller/control card	10,000	10,000	10,000	10,000	10,000	10,000	10,000	10,000	10,000	10,000	10,000	10,000	10,000
Ducting	10,000,000	10,000,000	10,000,000	10,000,000	10,000,000	10,000,000	10,000,000	10,000,000	10,000,000	10,000,000	10,000,000	10,000,000	10,000,000
Wiring	10,000,000	10,000,000	10,000,000	10,000,000	10,000,000	10,000,000	10,000,000	10,000,000	10,000,000	10,000,000	10,000,000	10,000,000	10,000,000
Installation Hardware	10,000,000	10,000,000	10,000,000	10,000,000	10,000,000	10,000,000	10,000,000	10,000,000	10,000,000	10,000,000	10,000,000	10,000,000	10,000,000
Structural Modifications	10,000,000	10,000,000	10,000,000	10,000,000	10,000,000	10,000,000	10,000,000	10,000,000	10,000,000	10,000,000	10,000,000	10,000,000	10,000,000
Ram Ducting	10,000,000	10,000,000	10,000,000	10,000,000	10,000,000	10,000,000	10,000,000	10,000,000	10,000,000	10,000,000	10,000,000	10,000,000	10,000,000
Compressor wiring	10,000,000	10,000,000	10,000,000	10,000,000	10,000,000	10,000,000	10,000,000	10,000,000	10,000,000	10,000,000	10,000,000	10,000,000	10,000,000
Overheat sensors	50,000	50,000	50,000	50,000	50,000	50,000	50,000	50,000	50,000	50,000	50,000	50,000	50,000
On-board oxygen sensor (information only)	26,933	26,933	26,933	26,933	26,933	26,933	26,933	26,933	26,933	26,933	26,933	26,933	26,933

Figure 4.10-2. Summary of Hybrid OBIGGS MTBMA—PSA Systems

Onboard Inerting Designs Task Team Final Report

Cryogenic Distillation System Component	LT	MT	ST	RTF	RTP	BzJ	LT	MT	ST	RTF	LT	MT	ST
	CWT+Main Component MTBMA (hrs)	CWT+Main Component MTBMA (hrs)	CWT+Main Component MTBMA (hrs)	CWT+Main Component MTBMA (hrs)	CWT+Main Component MTBMA (hrs)	CWT+Main Component MTBMA (hrs)	CWT Only Component MTBMA (hrs)	CWT Only Component MTBMA (hrs)	CWT Only Component MTBMA (hrs)	CWT Only Component MTBMA (hrs)	CWT+Main+Aux Component MTBMA (hrs)	CWT+Main+Aux Component MTBMA (hrs)	CWT+Main+Aux Component MTBMA (hrs)
Major Components:													
Compressor	7,000	7,000	7,000	7,000	7,000	7,000	7,000	7,000	7,000	7,000	7,000	7,000	7,000
Heat exchanger	100,000	100,000	100,000	100,000	100,000	100,000	100,000	100,000	100,000	100,000	100,000	100,000	100,000
Cooling Fan	25,000	25,000	25,000	25,000	25,000	25,000	25,000	25,000	25,000	25,000	25,000	25,000	25,000
Cryo Air Separation Components:													
Inlet shutoff valve	50,000	50,000	50,000	50,000	50,000	50,000	50,000	50,000	50,000	50,000	50,000	50,000	50,000
Cryocooler bleed air valve	50,000	50,000	50,000	50,000	50,000	50,000	50,000	50,000	50,000	50,000	50,000	50,000	50,000
Flow sensor	20,000	20,000	20,000	20,000	20,000	20,000	20,000	20,000	20,000	20,000	20,000	20,000	20,000
Molecular sieve control valves	50,000	50,000	50,000	50,000	50,000	50,000	50,000	50,000	50,000	50,000	50,000	50,000	50,000
Molecular sieve system	50,000	50,000	50,000	50,000	50,000	50,000	50,000	50,000	50,000	50,000	50,000	50,000	50,000
Purge heat exchanger	80,000	100,000	100,000	100,000	100,000	100,000	80,000	100,000	100,000	100,000	80,000	100,000	100,000
Purge heat exchanger valve-Air Side	50,000	50,000	50,000	50,000	50,000	50,000	50,000	50,000	50,000	50,000	50,000	50,000	50,000
Purge heat exchanger valve-Waste Side	50,000	50,000	50,000	50,000	50,000	50,000	50,000	50,000	50,000	50,000	50,000	50,000	50,000
LNEA Dewar Cool-down Valve	50,000	50,000	50,000	50,000	50,000	50,000	50,000	50,000	50,000	50,000	50,000	50,000	50,000
Inlet Recuperator	60,000	100,000	100,000	100,000	100,000	100,000	60,000	100,000	100,000	100,000	60,000	100,000	100,000
Inlet cooler	80,000	100,000	100,000	100,000	100,000	100,000	80,000	100,000	100,000	100,000	80,000	100,000	100,000
Cryocooler	8,000	8,000	8,000	8,000	8,000	8,000	8,000	8,000	8,000	8,000	8,000	8,000	8,000
LNEA Dewar	75,000	75,000	75,000	n/a	n/a	n/a	75,000	75,000	75,000	n/a	75,000	75,000	75,000
Dewar level sensor	50,000	50,000	50,000	n/a	n/a	n/a	50,000	50,000	50,000	n/a	50,000	50,000	50,000
Distillation column	50,000	50,000	50,000	50,000	50,000	50,000	50,000	50,000	50,000	50,000	50,000	50,000	50,000
Distillation column gas valve	50,000	50,000	50,000	50,000	50,000	50,000	50,000	50,000	50,000	50,000	50,000	50,000	50,000
Distillation column liquid valve	50,000	50,000	50,000	50,000	50,000	50,000	50,000	50,000	50,000	50,000	50,000	50,000	50,000

Figure 4.10-3. Summary of Hybrid OBIGGS MTBMA—Cryogenic Distillation Systems (Sheet 1 of 2)

Onboard Inerting Designs Task Team Final Report

Cryogenic Distillation System Component	LT	MT	ST	RTF	RTP	BzJ	LT	MT	ST	RTF	LT	MT	ST
	CWT+Main Component MTBMA (hrs)	CWT+Main Component MTBMA (hrs)	CWT+Main Component MTBMA (hrs)	CWT+Main Component MTBMA (hrs)	CWT+Main Component MTBMA (hrs)	CWT+Main Component MTBMA (hrs)	CWT Only Component MTBMA (hrs)	CWT Only Component MTBMA (hrs)	CWT Only Component MTBMA (hrs)	CWT Only Component MTBMA (hrs)	CWT+Main+Aux Component MTBMA (hrs)	CWT+Main+Aux Component MTBMA (hrs)	CWT+Main+Aux Component MTBMA (hrs)
Other Components:													
Cabin air filter assy	100,000	100,000	100,000	100,000	100,000	100,000	100,000	100,000	100,000	100,000	100,000	100,000	100,000
Cabin air filter element	4,000	4,000	4,000	4,000	4,000	4,000	4,000	4,000	4,000	4,000	4,000	4,000	4,000
OBIGGS shutoff valve	50,000	50,000	50,000	50,000	50,000	50,000	50,000	50,000	50,000	50,000	50,000	50,000	50,000
Compressor	7,000	7,000	7,000	7,000	7,000	7,000	7,000	7,000	7,000	7,000	7,000	7,000	7,000
Compressor unloading valve	50,000	50,000	50,000	50,000	50,000	50,000	50,000	50,000	50,000	50,000	50,000	50,000	50,000
Compressor discharge check valve	100,000	100,000	100,000	100,000	100,000	100,000	100,000	100,000	100,000	100,000	100,000	100,000	100,000
Bleed shutoff valve	50,000	50,000	50,000	50,000	50,000	50,000	50,000	50,000	50,000	50,000	50,000	50,000	50,000
Bleed check valve	100,000	100,000	100,000	100,000	100,000	100,000	100,000	100,000	100,000	100,000	100,000	100,000	100,000
Bypass valve	50,000	50,000	50,000	50,000	50,000	50,000	50,000	50,000	50,000	50,000	50,000	50,000	50,000
Temperature sensor	50,000	50,000	50,000	50,000	50,000	50,000	50,000	50,000	50,000	50,000	50,000	50,000	50,000
Water separator/filter assy	100,000	100,000	100,000	100,000	100,000	100,000	100,000	100,000	100,000	100,000	100,000	100,000	100,000
Water separator/filter element	4,000	4,000	4,000	4,000	4,000	4,000	4,000	4,000	4,000	4,000	4,000	4,000	4,000
Temperature sensor	50,000	50,000	50,000	50,000	50,000	50,000	50,000	50,000	50,000	50,000	50,000	50,000	50,000
Relief valve	50,000	50,000	50,000	50,000	50,000	50,000	50,000	50,000	50,000	50,000	50,000	50,000	50,000
Fuel tank check valve	100,000	100,000	100,000	100,000	100,000	100,000	100,000	100,000	100,000	100,000	100,000	100,000	100,000
Controller/control card	10,000	10,000	10,000	10,000	10,000	10,000	10,000	10,000	10,000	10,000	10,000	10,000	10,000
Ducting	10,000,000	10,000,000	10,000,000	10,000,000	10,000,000	10,000,000	10,000,000	10,000,000	10,000,000	10,000,000	10,000,000	10,000,000	10,000,000
Wiring	10,000,000	10,000,000	10,000,000	10,000,000	10,000,000	10,000,000	10,000,000	10,000,000	10,000,000	10,000,000	10,000,000	10,000,000	10,000,000
Installation Hardware	10,000,000	10,000,000	10,000,000	10,000,000	10,000,000	10,000,000	10,000,000	10,000,000	10,000,000	10,000,000	10,000,000	10,000,000	10,000,000
Structural Modifications	10,000,000	10,000,000	10,000,000	10,000,000	10,000,000	10,000,000	10,000,000	10,000,000	10,000,000	10,000,000	10,000,000	10,000,000	10,000,000
Ram Ducting	10,000,000	10,000,000	10,000,000	10,000,000	10,000,000	10,000,000	10,000,000	10,000,000	10,000,000	10,000,000	10,000,000	10,000,000	10,000,000
Compressor wiring	10,000,000	10,000,000	10,000,000	10,000,000	10,000,000	10,000,000	10,000,000	10,000,000	10,000,000	10,000,000	10,000,000	10,000,000	10,000,000
Overheat sensors	50,000	50,000	50,000	50,000	50,000	50,000	50,000	50,000	50,000	50,000	50,000	50,000	50,000
On-board oxygen sensor (information only)	26,933	26,933	26,933	26,933	26,933	26,933	26,933	26,933	26,933	26,933	26,933	26,933	26,933

Figure 4.10-3. Summary of Hybrid OBIGGS MTBMA—Cryogenic Distillation Systems (Sheet 2 of 2)

Onboard Inerting Designs Task Team Final Report

Membrane System Component	LT	MT	ST	RTF	RTP	BzJ	LT	MT	ST	RTF	LT	MT	ST
	CWT+Main Component MTBMA (hrs)	CWT+Main Component MTBMA (hrs)	CWT+Main Component MTBMA (hrs)	CWT+Main Component MTBMA (hrs)	CWT+Main Component MTBMA (hrs)	CWT+Main Component MTBMA (hrs)	CWT Only Component MTBMA (hrs)	CWT Only Component MTBMA (hrs)	CWT Only Component MTBMA (hrs)	CWT Only Component MTBMA (hrs)	CWT+Main+Aux Component MTBMA (hrs)	CWT+Main+Aux Component MTBMA (hrs)	CWT+Main+Aux Component MTBMA (hrs)
Major Components:													
Compressor	100,000	100,000	100,000	100,000	100,000	100,000	100,000	100,000	100,000	100,000	100,000	100,000	100,000
Heat exchanger	100,000	100,000	100,000	100,000	100,000	100,000	100,000	100,000	100,000	100,000	100,000	100,000	100,000
Cooling Fan	25,000	25,000	25,000	25,000	25,000	25,000	25,000	25,000	25,000	25,000	25,000	25,000	25,000
Air separation module	30,000	30,000	30,000	30,000	30,000	30,000	30,000	30,000	30,000	30,000	30,000	30,000	30,000
Other Components:													
Cabin air filter assy	100,000	100,000	100,000	100,000	100,000	100,000	100,000	100,000	100,000	100,000	100,000	100,000	100,000
OBIGGS shutoff valve	50,000	50,000	50,000	50,000	50,000	50,000	50,000	50,000	50,000	50,000	50,000	50,000	50,000
Compressor unloading valve	50,000	50,000	50,000	50,000	50,000	50,000	50,000	50,000	50,000	50,000	50,000	50,000	50,000
Compressor discharge check valve	100,000	100,000	100,000	100,000	100,000	100,000	100,000	100,000	100,000	100,000	100,000	100,000	100,000
Bleed shutoff valve	50,000	50,000	50,000	50,000	50,000	50,000	50,000	50,000	50,000	50,000	50,000	50,000	50,000
Bleed check valve	100,000	100,000	100,000	100,000	100,000	100,000	100,000	100,000	100,000	100,000	100,000	100,000	100,000
Bypass valve	50,000	50,000	50,000	50,000	50,000	50,000	50,000	50,000	50,000	50,000	50,000	50,000	50,000
Temperature sensor	50,000	50,000	50,000	50,000	50,000	50,000	50,000	50,000	50,000	50,000	50,000	50,000	50,000
Water separator/filter assy	100,000	100,000	100,000	100,000	100,000	100,000	100,000	100,000	100,000	100,000	100,000	100,000	100,000
High flow valve	50,000	50,000	50,000	50,000	50,000	50,000	50,000	50,000	50,000	50,000	50,000	50,000	50,000
Relief valve	50,000	50,000	50,000	50,000	50,000	50,000	50,000	50,000	50,000	50,000	50,000	50,000	50,000
Fuel tank check valve	100,000	100,000	100,000	100,000	100,000	100,000	100,000	100,000	100,000	100,000	100,000	100,000	100,000
Controller/control card	10,000	10,000	10,000	10,000	10,000	10,000	10,000	10,000	10,000	10,000	10,000	10,000	10,000
Ducting	10,000,000	10,000,000	10,000,000	10,000,000	10,000,000	10,000,000	10,000,000	10,000,000	10,000,000	10,000,000	10,000,000	10,000,000	10,000,000
Wiring	10,000,000	10,000,000	10,000,000	10,000,000	10,000,000	10,000,000	10,000,000	10,000,000	10,000,000	10,000,000	10,000,000	10,000,000	10,000,000
Installation Hardware	10,000,000	10,000,000	10,000,000	10,000,000	10,000,000	10,000,000	10,000,000	10,000,000	10,000,000	10,000,000	10,000,000	10,000,000	10,000,000
Structural Modifications	10,000,000	10,000,000	10,000,000	10,000,000	10,000,000	10,000,000	10,000,000	10,000,000	10,000,000	10,000,000	10,000,000	10,000,000	10,000,000
Ram Ducting	10,000,000	10,000,000	10,000,000	10,000,000	10,000,000	10,000,000	10,000,000	10,000,000	10,000,000	10,000,000	10,000,000	10,000,000	10,000,000
Compressor wiring	10,000,000	10,000,000	10,000,000	10,000,000	10,000,000	10,000,000	10,000,000	10,000,000	10,000,000	10,000,000	10,000,000	10,000,000	10,000,000
Overheat sensors	50,000	50,000	50,000	50,000	50,000	50,000	50,000	50,000	50,000	50,000	50,000	50,000	50,000
On-board oxygen sensor (information only)	26,933	26,933	26,933	26,933	26,933	26,933	26,933	26,933	26,933	26,933	26,933	26,933	26,933

Figure 4.10-4. Summary of Hybrid OBIGGS MTBF—Membrane Systems

Onboard Inerting Designs Task Team Final Report

PSA System Component	LT	MT	ST	RTF	RTP	BzJ	LT	MT	ST	RTF	LT	MT	ST
	CWT+Main Component MTBMA (hrs)	CWT+Main Component MTBMA (hrs)	CWT+Main Component MTBMA (hrs)	CWT+Main Component MTBMA (hrs)	CWT+Main Component MTBMA (hrs)	CWT+Main Component MTBMA (hrs)	CWT Only Component MTBMA (hrs)	CWT Only Component MTBMA (hrs)	CWT Only Component MTBMA (hrs)	CWT Only Component MTBMA (hrs)	CWT+Main+Aux Component MTBMA (hrs)	CWT+Main+Aux Component MTBMA (hrs)	CWT+Main+Aux Component MTBMA (hrs)
Major Components:													
Compressor	100,000	100,000	100,000	100,000	100,000	100,000	100,000	100,000	100,000	100,000	100,000	100,000	100,000
Heat exchanger	100,000	100,000	100,000	100,000	100,000	100,000	100,000	100,000	100,000	100,000	100,000	100,000	100,000
Cooling Fan	25,000	25,000	25,000	25,000	25,000	25,000	25,000	25,000	25,000	25,000	25,000	25,000	25,000
Air separation module	34,000	34,000	34,000	34,000	34,000	34,000	34,000	34,000	34,000	34,000	34,000	34,000	34,000
Other Components:													
Cabin air filter assy	100,000	100,000	100,000	100,000	100,000	100,000	100,000	100,000	100,000	100,000	100,000	100,000	100,000
OBIGGS shutoff valve	50,000	50,000	50,000	50,000	50,000	50,000	50,000	50,000	50,000	50,000	50,000	50,000	50,000
Compressor unloading valve	50,000	50,000	50,000	50,000	50,000	50,000	50,000	50,000	50,000	50,000	50,000	50,000	50,000
Compressor discharge check valve	100,000	100,000	100,000	100,000	100,000	100,000	100,000	100,000	100,000	100,000	100,000	100,000	100,000
Bleed shutoff valve	50,000	50,000	50,000	50,000	50,000	50,000	50,000	50,000	50,000	50,000	50,000	50,000	50,000
Bleed check valve	100,000	100,000	100,000	100,000	100,000	100,000	100,000	100,000	100,000	100,000	100,000	100,000	100,000
Bypass valve	50,000	50,000	50,000	50,000	50,000	50,000	50,000	50,000	50,000	50,000	50,000	50,000	50,000
Temperature sensor	50,000	50,000	50,000	50,000	50,000	50,000	50,000	50,000	50,000	50,000	50,000	50,000	50,000
Water separator/filter assy	100,000	100,000	100,000	100,000	100,000	100,000	100,000	100,000	100,000	100,000	100,000	100,000	100,000
High flow valve	50,000	50,000	50,000	50,000	50,000	50,000	50,000	50,000	50,000	50,000	50,000	50,000	50,000
Relief valve	50,000	50,000	50,000	50,000	50,000	50,000	50,000	50,000	50,000	50,000	50,000	50,000	50,000
Fuel tank check valve	100,000	100,000	100,000	100,000	100,000	100,000	100,000	100,000	100,000	100,000	100,000	100,000	100,000
Controller/control card	10,000	10,000	10,000	10,000	10,000	10,000	10,000	10,000	10,000	10,000	10,000	10,000	10,000
Ducting	10,000,000	10,000,000	10,000,000	10,000,000	10,000,000	10,000,000	10,000,000	10,000,000	10,000,000	10,000,000	10,000,000	10,000,000	10,000,000
Wiring	10,000,000	10,000,000	10,000,000	10,000,000	10,000,000	10,000,000	10,000,000	10,000,000	10,000,000	10,000,000	10,000,000	10,000,000	10,000,000
Installation Hardware	10,000,000	10,000,000	10,000,000	10,000,000	10,000,000	10,000,000	10,000,000	10,000,000	10,000,000	10,000,000	10,000,000	10,000,000	10,000,000
Structural Modifications	10,000,000	10,000,000	10,000,000	10,000,000	10,000,000	10,000,000	10,000,000	10,000,000	10,000,000	10,000,000	10,000,000	10,000,000	10,000,000
Ram Ducting	10,000,000	10,000,000	10,000,000	10,000,000	10,000,000	10,000,000	10,000,000	10,000,000	10,000,000	10,000,000	10,000,000	10,000,000	10,000,000
Compressor wiring	10,000,000	10,000,000	10,000,000	10,000,000	10,000,000	10,000,000	10,000,000	10,000,000	10,000,000	10,000,000	10,000,000	10,000,000	10,000,000
Overheat sensors	50,000	50,000	50,000	50,000	50,000	50,000	50,000	50,000	50,000	50,000	50,000	50,000	50,000
On-board oxygen sensor (information only)	26,933	26,933	26,933	26,933	26,933	26,933	26,933	26,933	26,933	26,933	26,933	26,933	26,933

Figure 4.10-5. Summary of Hybrid OBIGGS MTBF—PSA Systems

Onboard Inerting Designs Task Team Final Report

Cryogenic Distillation System Component	LT	MT	ST	RTF	RTP	BzJ	LT	MT	ST	RTF	LT	MT	ST
	CWT+Main Component MTBMA (hrs)	CWT+Main Component MTBMA (hrs)	CWT+Main Component MTBMA (hrs)	CWT+Main Component MTBMA (hrs)	CWT+Main Component MTBMA (hrs)	CWT+Main Component MTBMA (hrs)	CWT Only Component MTBMA (hrs)	CWT Only Component MTBMA (hrs)	CWT Only Component MTBMA (hrs)	CWT Only Component MTBMA (hrs)	CWT+Main+Aux Component MTBMA (hrs)	CWT+Main+Aux Component MTBMA (hrs)	CWT+Main+Aux Component MTBMA (hrs)
Major Components:													
Compressor	100,000	100,000	100,000	100,000	100,000	100,000	100,000	100,000	100,000	100,000	100,000	100,000	100,000
Heat exchanger	100,000	100,000	100,000	100,000	100,000	100,000	100,000	100,000	100,000	100,000	100,000	100,000	100,000
Cooling Fan	25,000	25,000	25,000	25,000	25,000	25,000	25,000	25,000	25,000	25,000	25,000	25,000	25,000
Cryo Air Separation Components:													
Inlet shutoff valve	50,000	50,000	50,000	50,000	50,000	50,000	50,000	50,000	50,000	50,000	50,000	50,000	50,000
Cryocooler bleed air valve	50,000	50,000	50,000	50,000	50,000	50,000	50,000	50,000	50,000	50,000	50,000	50,000	50,000
Flow sensor	20,000	20,000	20,000	20,000	20,000	20,000	20,000	20,000	20,000	20,000	20,000	20,000	20,000
Molecular sieve control valves	50,000	50,000	50,000	50,000	50,000	50,000	50,000	50,000	50,000	50,000	50,000	50,000	50,000
Molecular sieve system	50,000	50,000	50,000	50,000	50,000	50,000	50,000	50,000	50,000	50,000	50,000	50,000	50,000
Purge heat exchanger	80,000	100,000	100,000	100,000	100,000	100,000	80,000	100,000	100,000	100,000	80,000	100,000	100,000
Purge heat exchanger valve-Air Side	50,000	50,000	50,000	50,000	50,000	50,000	50,000	50,000	50,000	50,000	50,000	50,000	50,000
Purge heat exchanger valve-Waste Side	50,000	50,000	50,000	50,000	50,000	50,000	50,000	50,000	50,000	50,000	50,000	50,000	50,000
LNEA Dewar Cool-down Valve	50,000	50,000	50,000	50,000	50,000	50,000	50,000	50,000	50,000	50,000	50,000	50,000	50,000
Inlet Recuperator	60,000	100,000	100,000	100,000	100,000	100,000	60,000	100,000	100,000	100,000	60,000	100,000	100,000
Inlet cooler	80,000	100,000	100,000	100,000	100,000	100,000	80,000	100,000	100,000	100,000	80,000	100,000	100,000
Cryocooler	8,000	8,000	8,000	8,000	8,000	8,000	8,000	8,000	8,000	8,000	8,000	8,000	8,000
LNEA Dewar	75,000	75,000	75,000	n/a	n/a	n/a	75,000	75,000	75,000	n/a	75,000	75,000	75,000
Dewar level sensor	50,000	50,000	50,000	n/a	n/a	n/a	50,000	50,000	50,000	n/a	50,000	50,000	50,000
Distillation column	50,000	50,000	50,000	50,000	50,000	50,000	50,000	50,000	50,000	50,000	50,000	50,000	50,000
Distillation column gas valve	50,000	50,000	50,000	50,000	50,000	50,000	50,000	50,000	50,000	50,000	50,000	50,000	50,000
Distillation column liquid valve	50,000	50,000	50,000	50,000	50,000	50,000	50,000	50,000	50,000	50,000	50,000	50,000	50,000

Figure 4.10-6. Summary of Hybrid OBIGGS MTBF—Cryogenic Distillation Systems (Sheet 1 of 2)

Onboard Inerting Designs Task Team Final Report

Cryogenic Distillation System Component	LT	MT	ST	RTF	RTP	BzJ	LT	MT	ST	RTF	LT	MT	ST
	CWT+Main Component MTBMA (hrs)	CWT+Main Component MTBMA (hrs)	CWT+Main Component MTBMA (hrs)	CWT+Main Component MTBMA (hrs)	CWT+Main Component MTBMA (hrs)	CWT+Main Component MTBMA (hrs)	CWT Only Component MTBMA (hrs)	CWT Only Component MTBMA (hrs)	CWT Only Component MTBMA (hrs)	CWT Only Component MTBMA (hrs)	CWT+Main+Aux Component MTBMA (hrs)	CWT+Main+Aux Component MTBMA (hrs)	CWT+Main+Aux Component MTBMA (hrs)
Other Components:													
Cabin air filter assy	100,000	100,000	100,000	100,000	100,000	100,000	100,000	100,000	100,000	100,000	100,000	100,000	100,000
OBIGGS shutoff valve	50,000	50,000	50,000	50,000	50,000	50,000	50,000	50,000	50,000	50,000	50,000	50,000	50,000
Compressor	100,000	100,000	100,000	100,000	100,000	100,000	100,000	100,000	100,000	100,000	100,000	100,000	100,000
Compressor unloading valve	50,000	50,000	50,000	50,000	50,000	50,000	50,000	50,000	50,000	50,000	50,000	50,000	50,000
Compressor discharge check valve	100,000	100,000	100,000	100,000	100,000	100,000	100,000	100,000	100,000	100,000	100,000	100,000	100,000
Bleed shutoff valve	50,000	50,000	50,000	50,000	50,000	50,000	50,000	50,000	50,000	50,000	50,000	50,000	50,000
Bleed check valve	100,000	100,000	100,000	100,000	100,000	100,000	100,000	100,000	100,000	100,000	100,000	100,000	100,000
Bypass valve	50,000	50,000	50,000	50,000	50,000	50,000	50,000	50,000	50,000	50,000	50,000	50,000	50,000
Temperature sensor	50,000	50,000	50,000	50,000	50,000	50,000	50,000	50,000	50,000	50,000	50,000	50,000	50,000
Water separator/filter assy	100,000	100,000	100,000	100,000	100,000	100,000	100,000	100,000	100,000	100,000	100,000	100,000	100,000
Temperature sensor	50,000	50,000	50,000	50,000	50,000	50,000	50,000	50,000	50,000	50,000	50,000	50,000	50,000
Relief valve	50,000	50,000	50,000	50,000	50,000	50,000	50,000	50,000	50,000	50,000	50,000	50,000	50,000
Fuel tank check valve	100,000	100,000	100,000	100,000	100,000	100,000	100,000	100,000	100,000	100,000	100,000	100,000	100,000
Controller/control card	10,000	10,000	10,000	10,000	10,000	10,000	10,000	10,000	10,000	10,000	10,000	10,000	10,000
Ducting	10,000,000	10,000,000	10,000,000	10,000,000	10,000,000	10,000,000	10,000,000	10,000,000	10,000,000	10,000,000	10,000,000	10,000,000	10,000,000
Wiring	10,000,000	10,000,000	10,000,000	10,000,000	10,000,000	10,000,000	10,000,000	10,000,000	10,000,000	10,000,000	10,000,000	10,000,000	10,000,000
Installation Hardware	10,000,000	10,000,000	10,000,000	10,000,000	10,000,000	10,000,000	10,000,000	10,000,000	10,000,000	10,000,000	10,000,000	10,000,000	10,000,000
Structural Modifications	10,000,000	10,000,000	10,000,000	10,000,000	10,000,000	10,000,000	10,000,000	10,000,000	10,000,000	10,000,000	10,000,000	10,000,000	10,000,000
Ram Ducting	10,000,000	10,000,000	10,000,000	10,000,000	10,000,000	10,000,000	10,000,000	10,000,000	10,000,000	10,000,000	10,000,000	10,000,000	10,000,000
Compressor wiring	10,000,000	10,000,000	10,000,000	10,000,000	10,000,000	10,000,000	10,000,000	10,000,000	10,000,000	10,000,000	10,000,000	10,000,000	10,000,000
Overheat sensors	50,000	50,000	50,000	50,000	50,000	50,000	50,000	50,000	50,000	50,000	50,000	50,000	50,000
On-board oxygen sensor (information only)	26,933	26,933	26,933	26,933	26,933	26,933	26,933	26,933	26,933	26,933	26,933	26,933	26,933

Figure 4.10-6. Summary of Hybrid OBIGGS MTBF—Cryogenic Distillation Systems (Sheet 2 of 2)

Onboard Inerting Designs Task Team Final Report

4.10.1 Air Separation Modules

Reliability estimates were developed for hybrid OBIGGS membrane, pressure-swing adsorption, and cryogenic distillation air separation equipment.

Permeable Membrane. The membrane module consists of a membrane fiber bundle contained in a metal housing. There are no moving parts. There is no scheduled maintenance requirement for the membrane modules.

Pressure-Swing Adsorption. The PSA hardware consists of a distribution valve that is pilot operated by relatively small pneumatic valves and controlled by a timing circuit. Also included are air and product manifolds, molecular sieve beds, and purge orifices. The distribution valve assembly contains two wear parts, which are recommended to be serviced at 6000 to 8000 hour intervals. The Mean-Time-Between-Failure estimate in the summary table assumes a scheduled overhaul is performed every 8000 hours.

Cryogenic Distillation. The cryogenic system consists of several components including heat exchangers, valves, a cryogenic refrigerator (cryocooler), and distillation columns. The reliability estimates for the valves, heat exchangers, and columns were provided by the specifications from various component suppliers for off-the-shelf items. The reliability estimates obtained from the component suppliers for the heat exchangers and the valves were reduced by the Team to conform to reliability values for other systems. Thus, the actual reliability for the cryogenic distillation system is slightly higher than the values presented in this report. The reliability value for the cryogenic refrigerator is a conservative estimate.

4.10.2 Compressor

The compressor reliability for screw-type units is based on a recommended service interval of 7000 hours. The centrifugal compressors use a different bearing technology that does not require periodic servicing. Suppliers of existing flight-worthy equipment provided the reliability estimates.

4.10.3 Heat Exchanger/Cooling Fan

The heat exchanger and cooling fan reliability estimates are based on commercial aircraft experience and were provided by suppliers of existing flight-worthy equipment.

4.10.4 Other Components

Reliability estimates for the other components of the hybrid OBIGGS were based on commercial aircraft experience with similar components.

4.11 COST

The Team estimated the initial acquisition costs for the membrane, PSA, and cryogenic distillation inerting systems for each of the generic aircraft. Design and certification, operations, maintenance, and installation costs for the hybrid OBIGGS are described later in this section. Inclusion of those costs to determine cost benefit was performed by the Estimating and Forecasting (E&F) Team and is described in the E&F team final report.

4.11.1 Acquisition Cost

Figures 4.11.1-1 through 4.11.1-3 summarize the hybrid OBIGGS acquisition costs developed by the team for the membrane, PSA, and cryogenic distillation inerting systems for each of the ARAC generic aircraft. The acquisition costs for the hybrid OBIGGS were developed according to the same guidelines as described for OBIGGS and OBGI systems acquisition. Figure 4.11.1-4 compares the totals of the OBIGGS costs to the hybrid OBIGGS costs. In Figures 4.11-1 through 4.11-3 the total cost for the individual components is identified for each system to provide inerting of main tanks and CWTs, CWTs only, and all tanks (main tanks, CWTs and auxiliary tanks). The estimated component costs include the

Onboard Inerting Designs Task Team Final Report

amortized non-recurring development costs. The team also separately estimated the cost for an on-board oxygen sensor, though this cost was not included in the system totals.

Onboard Inerting Designs Task Team Final Report

Membrane System Component	LT CWT+Main Shipset Cost (\$)	MT CWT+Main Shipset Cost (\$)	ST CWT+Main Shipset Cost (\$)	RTF CWT+Main Shipset Cost (\$)	RTP CWT+Main Shipset Cost (\$)	BzJ CWT+Main Shipset Cost (\$)	LT CWT Only Shipset Cost (\$)	MT CWT Only Shipset Cost (\$)	ST CWT Only Shipset Cost (\$)	RTF CWT Only Shipset Cost (\$)	LT CWT+Main+Aux Shipset Cost (\$)	MT CWT+Main+Aux Shipset Cost (\$)	ST CWT+Main+Aux Shipset Cost (\$)
Major Components:													
Compressor	\$7,656	\$7,103	\$9,880	\$9,789	\$9,707	\$9,905	\$7,476	\$7,003	\$9,857	\$9,734	\$7,724	\$7,172	\$10,009
Heat exchanger/fan	\$7,558	\$5,550	\$4,108	\$3,808	\$3,544	\$4,091	\$6,860	\$5,112	\$4,033	\$3,624	\$7,824	\$5,849	\$4,532
Air separation module	\$34,880	\$17,447	\$5,275	\$5,275	\$2,000	\$5,275	\$28,814	\$13,649	\$5,275	\$2,638	\$37,188	\$20,097	\$8,493
	=====	=====	=====	=====	=====	=====	=====	=====	=====	=====	=====	=====	=====
Major component sub-totals	\$50,094	\$30,100	\$19,263	\$18,872	\$15,251	\$19,271	\$43,150	\$25,765	\$19,165	\$15,996	\$52,737	\$33,118	\$23,033
Other Components:	\$82,000	\$74,000	\$68,000	\$66,000	\$65,000	\$67,000	\$79,000	\$72,000	\$67,000	\$66,000	\$83,000	\$75,000	\$69,000
System Totals	\$132,094	\$104,100	\$87,263	\$84,872	\$80,251	\$86,271	\$122,150	\$97,765	\$86,165	\$81,996	\$135,737	\$108,118	\$92,033
On-board oxygen sensor (not included in system totals)	\$6,000	\$6,000	\$6,000	\$6,000	\$6,000	\$6,000	\$6,000	\$6,000	\$6,000	\$6,000	\$6,000	\$6,000	\$6,000

Figure 4.11.1-1. Summary of OBIGGS Costs—Membrane Systems

PSA System Component	LT CWT+Main Shipset Cost (\$)	MT CWT+Main Shipset Cost (\$)	ST CWT+Main Shipset Cost (\$)	RTF CWT+Main Shipset Cost (\$)	RTP CWT+Main Shipset Cost (\$)	BzJ CWT+Main Shipset Cost (\$)	LT CWT Only Shipset Cost (\$)	MT CWT Only Shipset Cost (\$)	ST CWT Only Shipset Cost (\$)	RTF CWT Only Shipset Cost (\$)	LT CWT+Main+Aux Shipset Cost (\$)	MT CWT+Main+Aux Shipset Cost (\$)	ST CWT+Main+Aux Shipset Cost (\$)
Major Components:													
Compressor	\$15,562	\$7,624	\$10,083	\$9,893	\$9,737	\$10,145	\$8,497	\$7,394	\$10,033	\$9,784	\$15,701	\$7,790	\$10,331
Heat exchanger/fan	\$15,291	\$8,385	\$4,105	\$3,364	\$2,757	\$4,105	\$12,889	\$6,921	\$3,903	\$2,925	\$16,081	\$9,219	\$5,070
Air separation module	\$21,000	\$16,000	\$10,000	\$11,000	\$8,000	\$10,000	\$19,000	\$14,000	\$10,000	\$10,000	\$22,260	\$18,128	\$16,220
	=====	=====	=====	=====	=====	=====	=====	=====	=====	=====	=====	=====	=====
Major components sub-totals	\$51,853	\$32,009	\$24,188	\$24,257	\$20,494	\$24,250	\$40,386	\$28,315	\$23,936	\$22,709	\$54,042	\$35,137	\$31,622
Other Components:	\$88,000	\$76,000	\$68,000	\$67,000	\$65,000	\$68,000	\$84,000	\$73,000	\$68,000	\$66,000	\$89,000	\$77,000	\$70,000
System Totals	\$139,853	\$108,009	\$92,188	\$91,257	\$85,494	\$92,250	\$124,386	\$101,315	\$91,936	\$88,709	\$143,042	\$112,137	\$101,622
On-board oxygen sensor (not included in system totals)	\$6,000	\$6,000	\$6,000	\$6,000	\$6,000	\$6,000	\$6,000	\$6,000	\$6,000	\$6,000	\$6,000	\$6,000	\$6,000

Figure 4.11.1-2. Summary of OBIGGS Costs—PSA Systems

Onboard Inerting Designs Task Team Final Report

Cryogenic Distillation System Component	LT CWT+Main Shipset Cost (\$)	MT CWT+Main Shipset Cost (\$)	ST CWT+Main Shipset Cost (\$)	RTF CWT+Main Shipset Cost (\$)	RTP CWT+Main Shipset Cost (\$)	BzJ CWT+Main Shipset Cost (\$)	LT CWT Only Shipset Cost (\$)	MT CWT Only Shipset Cost (\$)	ST CWT Only Shipset Cost (\$)	RTF CWT Only Shipset Cost (\$)	LT CWT+Main+Aux Shipset Cost (\$)	MT CWT+Main+Aux Shipset Cost (\$)	ST CWT+Main+Aux Shipset Cost (\$)
Major Components:													
Compressor	10,241	9,933	9,756	9,720	9,691	9,816	10,144	9,877	9,746	9,700	10,274	9,973	9,798
Heat exchanger/fan	4,436	3,475	2,841	2,698	2,585	3,004	4,109	3,270	2,800	2,616	4,549	3,618	3,004
Air separation module	150,075	148,200	148,200	148,200	148,200	148,200	150,075	148,200	148,200	148,200	150,075	148,200	148,200
	=====	=====	=====	=====	=====	=====	=====	=====	=====	=====	=====	=====	=====
Major component sub-totals	164,752	161,608	160,797	160,618	160,476	161,020	164,328	161,348	160,746	160,515	164,898	161,791	161,002
Other Components:	77,000	72,000	69,000	69,000	68,000	70,000	75,000	71,000	69,000	68,000	77,000	73,000	70,000
System Totals	241,752	233,608	229,797	229,618	228,476	231,020	239,328	232,348	229,746	228,515	241,898	234,791	231,002
On-board oxygen sensor (not included in system totals)	6,000	6,000	6,000	6,000	6,000	6,000	6,000	6,000	6,000	6,000	6,000	6,000	6,000

Figure 4.11.1-3. Summary of OBIGGS Costs—Cryogenic Distillation Systems

System	LT CWT+Main Shipset Cost (\$)	MT CWT+Main Shipset Cost (\$)	ST CWT+Main Shipset Cost (\$)	RTF CWT+Main Shipset Cost (\$)	RTP CWT+Main Shipset Cost (\$)	BzJ CWT+Main Shipset Cost (\$)	LT CWT Only Shipset Cost (\$)	MT CWT Only Shipset Cost (\$)	ST CWT Only Shipset Cost (\$)	RTF CWT Only Shipset Cost (\$)	LT CWT+Main+Aux Shipset Cost (\$)	MT CWT+Main+Aux Shipset Cost (\$)	ST CWT+Main+Aux Shipset Cost (\$)
Membrane - OBIGGS	\$293,250	\$152,460	\$94,787	\$88,171	\$84,925	\$100,426	\$174,540	\$104,454	\$89,463	\$82,252	\$286,753	\$164,993	\$100,560
Membrane - Hybrid OBIGGS	\$132,094	\$104,100	\$87,263	\$84,872	\$80,251	\$86,271	\$122,150	\$97,765	\$86,165	\$81,996	\$135,737	\$108,118	\$92,033
PSA - OBIGGS	\$299,181	\$160,855	\$99,557	\$94,735	\$90,037	\$112,827	\$197,089	\$120,898	\$95,684	\$90,217	\$346,547	\$173,363	\$107,768
PSA - Hybrid OBIGGS	\$139,853	\$108,009	\$92,188	\$91,257	\$85,494	\$92,250	\$124,386	\$101,315	\$91,936	\$88,709	\$143,042	\$112,137	\$101,622
Cryogenic Distillation - OBIGGS	\$290,159	\$255,690	\$233,934	\$225,995	\$224,881	\$235,394	\$259,284	\$248,037	\$231,881	\$224,589	\$293,751	\$260,931	\$236,547
Cryogenic Distillation - Hybrid OBIGGS	\$241,752	\$233,608	\$229,797	\$229,618	\$228,476	\$231,020	\$239,328	\$232,348	\$229,746	\$228,515	\$241,898	\$234,791	\$231,002

Figure 4.11.1-4. Comparison of OBIGGS Costs to Hybrid OBIGGS Costs

4.11.1.1 Air Separation Modules

The hybrid OBIGGS air separation module costs were estimated by the equipment suppliers based on their experience with similar flight worthy equipment.

4.11.1.2 Compressor

Compressor costs for the hybrid OBIGGS were estimated by the equipment suppliers based on their experience with similar flight worthy equipment.

4.11.1.3 Heat Exchanger/Cooling Fan

Heat exchanger and cooling fan costs for the hybrid OBIGGS were estimated by the equipment suppliers based on their experience with similar flight worthy equipment.

4.11.1.4 Other Components

The team estimated the total cost of the ‘Other Components’ for the hybrid OBIGGS by scaling the other component totals sized for the full-time OBIGGS. The full-time other component costs were plotted against NEA flow rate and the hybrid NEA flow rates fall well within the range. The results for the three technologies are shown in Figures 4.11.1.4-1, 4.11.1.4-2, and 4.11.1.4-3. The full-time systems for which every component was estimated are depicted by solid symbols and the scaled hybrid data are the empty symbols.

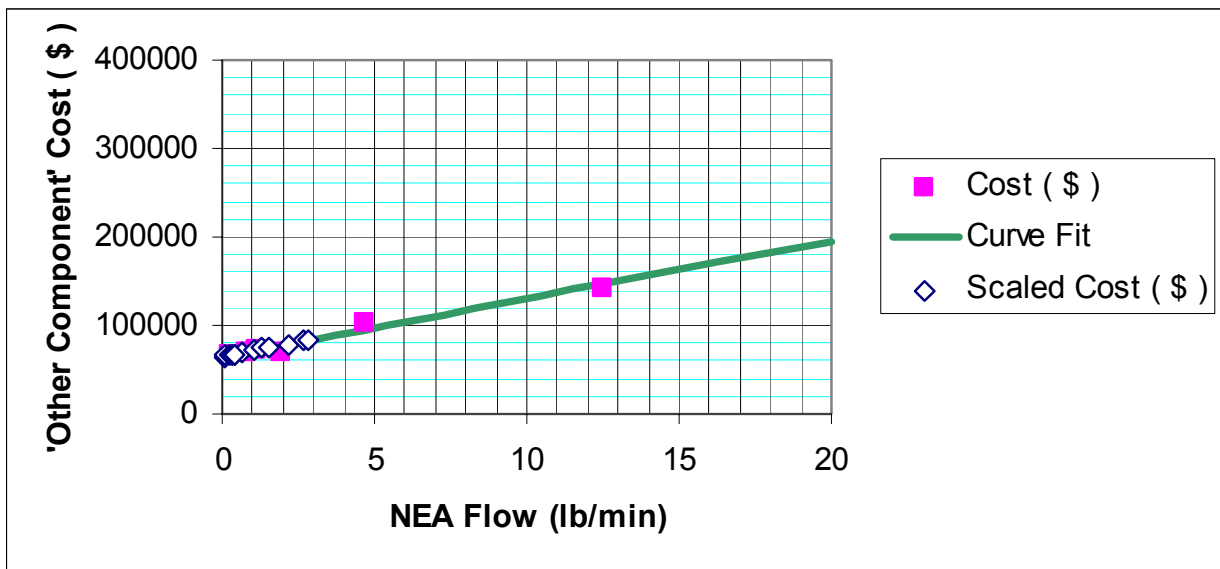

Figure 4.11.1.4-1. Permeable Membrane Hybrid OBIGGS Other Component Cost

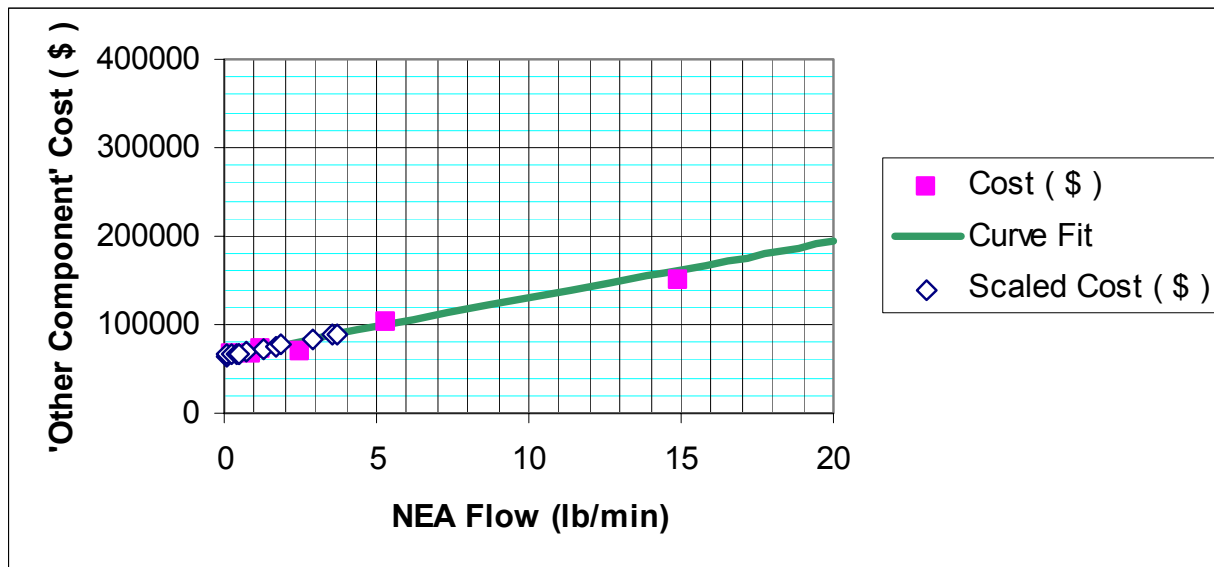

Figure 4.11.1.4-2. Pressure-Swing Adsorption Hybrid OBIGGS Other Component Cost

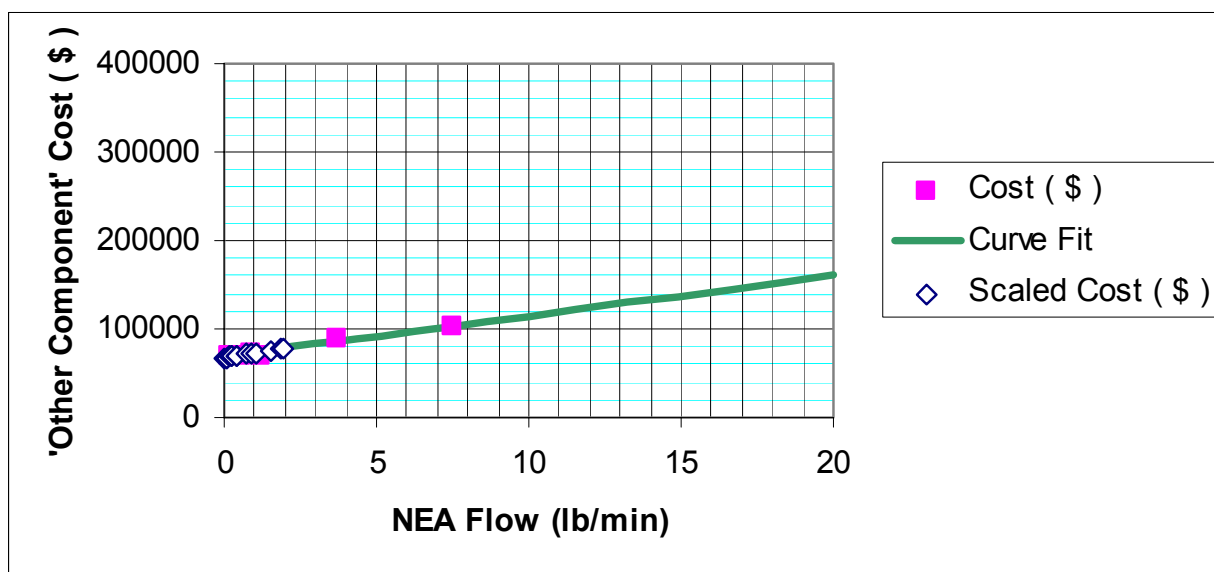

Figure 4.11.1.4-3. Cryogenic Distillation Hybrid OBIGGS Other Component Cost

4.11.2 Design & Certification Cost

Design and certification man-hour estimates developed by Working Group for full-time OBIGGS were also applied to hybrid OBIGGS. Non-recurring design costs for hybrid OBIGGS components (e.g., ASMs) were amortized into the component costs listed in the previous summary cost tables.

The design and certification man-hour estimates were applied by the E&F team as part of their analysis to determine hybrid OBIGGS cost benefit and are described in the E&F team final report. These estimates address design and certification of hybrid OBIGGS to inert all tanks on a new first of a model aircraft and on derivative model aircraft for all of the generic aircraft. They also address design and certification of hybrid OBIGGS to inert CWTs only on a new first of a model aircraft and on derivative model aircraft,

which only applies to the generic large, medium, and small transports, and to the generic regional turbo fan aircraft.

Neither FAA nor JAA will assess additional certification costs for hybrid OBIGGS. However, non-U.S. governmental authorities may assess additional costs related to the certification of the hybrid OBIGGS. For example, JAA indicates that the CAA-UK will charge airlines for all certification costs, including engineering man hours, whereas DGAC France will charge airlines only for the travel costs associated with hybrid OBIGGS certification efforts. These potential additional costs were not included in the design and certification cost estimates.

4.11.3 Operating Cost

Recurring hybrid OBIGGS operating costs were developed similarly to those costs developed for OBIGGS. Recurring cost impacts attributed to frequency of delays, delay time, and additional training required for ground and flight crews were assumed to be the same as for OBIGGS.

4.11.4 Maintenance Cost

Recurring hybrid OBIGGS maintenance costs were developed similarly to those costs developed for OBIGGS. Except for MTBUR, hours estimated for all other recurring hybrid OBIGGS maintenance costs were assumed to be the same as for OBIGGS.

4.11.5 Installation Cost

Installation costs for the hybrid OBIGGS were provided by the Project Integration and Airplane Operations and Maintenance Teams and evaluated by the E&F team for new design, in production, and in service aircraft.

4.12 SAFETY

The inclusion of a hybrid OBIGGS on an aircraft introduces a number of new or increased safety concerns. These concerns can be divided into normal operations, system leaks, component failures, and catastrophic failures.

4.12.1 Normal Operations

The hazards associated with the normal operation of the hybrid OBIGGS system are the discharge of oxygen enriched waste gas, the venting of NEA out of the fuel vent, the possibility of fuel tank over pressure during refuel over-fill, and those associated with electrical wiring and high temperature components, and possible disruption of cabin airflow patterns.

Oxygen-Rich Waste Gas. Oxygen-rich waste gas could be a fire hazard and should be vented in an area with no potential ignition sources. If possible it should be vented in an area where it will be quickly diluted.

NEA Around Fuel Vents. NEA vented from the fuel tank vent could create breathing problems, if inhaled. Testing during the inerting of a 737 aircraft indicated that the exiting NEA was rapidly diluted and posed little hazards. A placard warning near the vent should be sufficient.

Increased Tank Overpressure During Refuel Failure. The operation of the hybrid OBIGGS during a fueling over-fill may exacerbate the problem of tank overpressure. The system should be designed to limit inlet pressure to the tank and quickly relieve pressure.

Electrical Wiring. Electrical requirements of the system add to the amount of electrical wiring in the aircraft and the potential for electrical related smoke or fire in the aircraft. These safety concerns can be minimized through normal design practice.

Onboard Inerting Designs Task Team Final Report

High Temperature Components. The operating temperature of some components may exceed 400 degrees F and should be placarded as such.

Cabin Airflow Patterns. The use of cabin air as inlet air to the compressor could cause a change in cabin airflow patterns, which could be hazardous during smoke or fire conditions. The air should be taken from as close to the out flow valve as possible. The new airflow patterns should be determined for compliance with the certification base of the aircraft.

4.12.2 System Leaks

Various system leaks could occur and create safety concerns. Leaks could include hot air, NEA, OEA and fuel vapor.

Compressor Discharge Air Leaks. Compressed air between compressor and heat exchanger could be in the range of 400 degrees F. It should be treated the same as bleed air ducting, and may require overheat detection.

NEA Leaks. The NEA line from the ASM to fuel tank could produce an environment, in a confined space, with a reduced oxygen level. The line should, wherever possible, be run in an area of high ventilation. Where it does run in a confined space with low ventilation the line should be a double line.

Oxygen-Rich Waste Gas Leaks. The waste line from the air separation module carries oxygen-rich air and could produce an environment, in a confined space, with an elevated oxygen level. The line should, wherever possible, be run in an area of high ventilation and the absence of ignition sources. Where it does run in a confined space with low ventilation or in an area with any possible ignition sources, the line should be a double line.

Fuel Backflow Into ASM. Fuel vapor from the fuel tank back through the NEA line into the system. Check valves should be installed in system to prevent this from occurring. This hazard could occur at any time since it is not dependent on system operation.

Cryogenic Liquid Leaks. A cryogenic system could leak liquid nitrogen or liquid air possibly causing damage to surrounding materials. Protection for this occurrence should be provided.

4.12.3 Component Failures

It is possible that a component of the system could fail and create a hazardous condition as the system continues to operate.

Compressor Overheat. A compressor overheat could cause a potential fire hazard. Thermal cutout protection should be incorporated.

Heat Exchanger Overheat. NEA being too hot could cause a safety problem by possibly damaging the system and pumping high temperature gas into the fuel tank. Thermal cutout protection would provide mitigation from this hazard.

Rotating Equipment Sparks. Sparks or flames could occur in the system lines and protected should be provided by flame arrestors in line.

Overpressure From Trapped Cryogenic Liquids. A failure in the refrigeration components of a cryogenic system could cause an overpressure and should be prevented through the use of relief valves.

4.12.4 Catastrophic Failures

Uncontained Rotating Equipment Failure. Uncontained rotating equipment failure could cause a hazard. The system design should provide containment for such failures.

Pressure Vessel Burst. Overpressure in the system could cause a pressure vessel burst and should be designed for.

In-Flight Loss of Cabin Pressure. Failure between pressurized and unpressurized areas could result in an in-flight loss of cabin pressure and would require the installation of a high flow fuse and shutoff valve.

4.13 INSTALLATION

The installation objectives and concerns for the hybrid OBIGGS are identical to those already discussed for the other on-board systems. Specific design solutions for the many different aircraft models that would be affected by an inerting rule were beyond the scope of this study. The installation challenges are expected to be greater for retrofits where other systems already occupy many locations and customer-specific modifications may require different installation approaches for the same aircraft model. In some areas, structural modifications will be needed to support the additional weight of the new components.

As with the other on-board systems, the best installation locations are unpressurized, ventilated, and close to the fuel tanks. If locations that meet these criteria cannot be found, the installations will be more complicated.

Several existing aircraft models were surveyed for potential installation locations. Unpressurized locations in the air conditioning pack bay, wing root, wheel well, belly fairing, and behind the aft pressure bulkhead were examined. Pressurized locations exist in the cargo compartments and in a space forward of the aft bulkhead on some aircraft. Use of cargo space for inerting equipment carries the additional cost of the displaced cargo capacity. Typical installation locations on generic small, medium, and large transports are similar to those depicted for OBI (Section 1).

As with the other on-board systems, the NEA distribution system must be sized for pressure drop, be double-walled within pressurized areas, and include drains for condensation. The system controller may be rack-mounted, part of a card file, or remotely located near the inerting equipment depending on the aircraft model. Wiring between the controller and components will require different degrees of protection depending on its location. The expected cockpit interface is an on/off switch and a fail light. The installation will also require additional protection if located within an engine rotor burst, tire burst, or flammable fluid leakage zone. The compressor and heat exchanger will be thermally insulated to prevent temperature damage to other equipment. The compressor must be installed to minimize noise transmission.

4.14 PROS AND CONS OF SYSTEM DESIGN CONCEPT

Effectiveness and Limitations. The hybrid OBIGGS was sized so that the flammability exposure during the ground and climb was equivalent to that of the ground-based inerting concepts. Therefore, the overall flammability exposure for the hybrid OBIGGS is better than the ground-based, because the hybrid provides additional protection in flight. While not as good as the full-time OBIGGS, the flammability exposure for the hybrid OBIGGS is low enough to offer effective protection against randomly occurring one-time ignition sources like lightning or a fuel pump failure. Because the tanks will eventually be flammable, the hybrid OBIGGS will likely only delay an explosion for repetitive, undetected ignition sources like electrical arcing or an inadequate static bond.

The hybrid OBIGGS reduces the flammability exposure very significantly with a much smaller system than the full-time OBIGGS. As with the full-time OBIGGS, no ground support equipment or personnel are required for operation of the system. The hybrid OBIGGS is heavier than the Ground-Based Inerting equipment that would be carried on board the aircraft, but weighs less than the full-time OBIGGS or the On-Board Ground Based Inerting systems.

Safety. The installation of the system adds additional hazards to the aircraft, which must be mitigated. The hazards include electrical wiring, high-speed rotation machinery, ducting carrying nitrogen-enriched air and oxygen enriched air and additional penetrations into the fuel tank, and the fuselage. The design of

Onboard Inerting Designs Task Team Final Report

the system should be such to minimize or eliminate the hazards. The safety section contains a more detailed description of all the hazards and means of mitigation. It should be noted that since the system operates during all phases of flight the hazards could exist at any time.

The system greatly minimizes the time a flammable mixture is present in a protected tank, thus greatly reducing the probability of a fuel tank explosion. For a more detailed discussion on the risk reduction see the section on flammability reduction.

Cost. There is a cost associated with the design, installation, certification, operation and maintenance of a hybrid OBIGGS. Those costs can be broken down into the cost of the system, the cost of system operation, and the cost of system maintenance. The cost of the system includes design and construction as well as certification and installation. The system operation costs include those associated with the additional weight and possible shift in center of gravity of the aircraft, possible increase in drag, and the additional use of electrical power. The maintenance cost includes maintenance of the hybrid OBIGGS and other systems, such as electrical generators, affected by it. The lower air consumption rates for the hybrid also lower the operating costs of diverting electrical power, bleed air, and ram air relative to the full-time OBIGGS.

Designs are presently being explored that use a similar system for fire suppression in aircraft cargo compartments. If successful, it would allow for a dual role for the hybrid OBIGGS, thus offsetting some of the overall system weight and cost. It should be noted that an on-demand hybrid OBIGGS, with no storage capability, used for fire suppression would cost more than the estimates in this report, because the system would be required for flight. This would either require additional redundancy or an increase in the expected number of flight delays, cancellations, and turn-backs.

Environmental Impact. The main impact to the environment from a hybrid OBIGGS is the possible increase in fuel vapors being forced overboard as the nitrogen is injected into the fuel tank. The amount of fuel vapor that is vented depends on the fuel air mixture and ullage volume, at the time of inerting, as well as many other variables. Testing has shown that presently designed cross-vented fuel tanks under certain wind conditions can vent fuel vapors into the atmosphere. A redesign for the hybrid OBIGGS would minimize that venting, thus helping to offset some of the fuel vapor lost during the inerting process.

The installation of a hybrid OBIGGS would, as shown previously, reduce the number of fuel tank explosions, thus reducing the amount of spilled fuel both on the ground and in the atmosphere.

In addition to the fuel vapor there is a potential problem with the addition of noise from the compressor/fan.

The use of dry nitrogen as an inerting agent may reduce corrosion and condensation in the protected tanks depending on the conditions at the airports where the airplane is operated.

4.15 MAJOR ISSUES/MITIGATION

The Major Issues of the full-time OBIGGS also apply to the hybrid OBIGGS. There are no separate major issues identified with the hybrid OBIGGS.

5.0 CONCLUSION

The Onboard Design Team studied onboard ground inerting (OBGI), a simplified OBIGGS (compared to a military system), a hybrid OBGI where the inerting time was increased, and a hybrid OBIGGS tailored to match the flammability exposure of ground-based inerting. The systems were simplified by removing redundancy in accordance with the minimum-equipment-list-provision in the Tasking Statement.

The inerting systems reduce the flammability exposure of fuel tanks. The following flammability comparison charts show the average performance of the inerting systems studied compared to fuel tanks that have not been inerted. (Ref Figures 5-1, 5-3, and 5-5 for the Large, Medium, and Small Transports) The OBIGGS system nominally provides full-time protection; however, this does not account for the times when the aircraft departs with the OBIGGS system inoperative. The actual flammability exposure is somewhat more than zero and depends on the reliability of the system chosen.

Below the flammability exposure charts are summary tables for the impact of the system on the aircraft. (Ref Figures 5-2, 5-4, and 5-6) The impact is measured in airflow required to feed the air separator modules, electrical power required to run the compressor, weight and volume of the system.

By comparing systems, it's obvious that the Hybrid OBIGGS has the least impact on the aircraft. The flammability exposure it provides is equal to or, in some cases, better than the other systems.

Future aircraft could be designed to provide the resources required to operate an inerting system. However, it is unknown if in-production airplanes can accommodate any of these systems due to the electrical power demands.

Large Transport Flammability Comparison
Average of Inerting Systems in Category

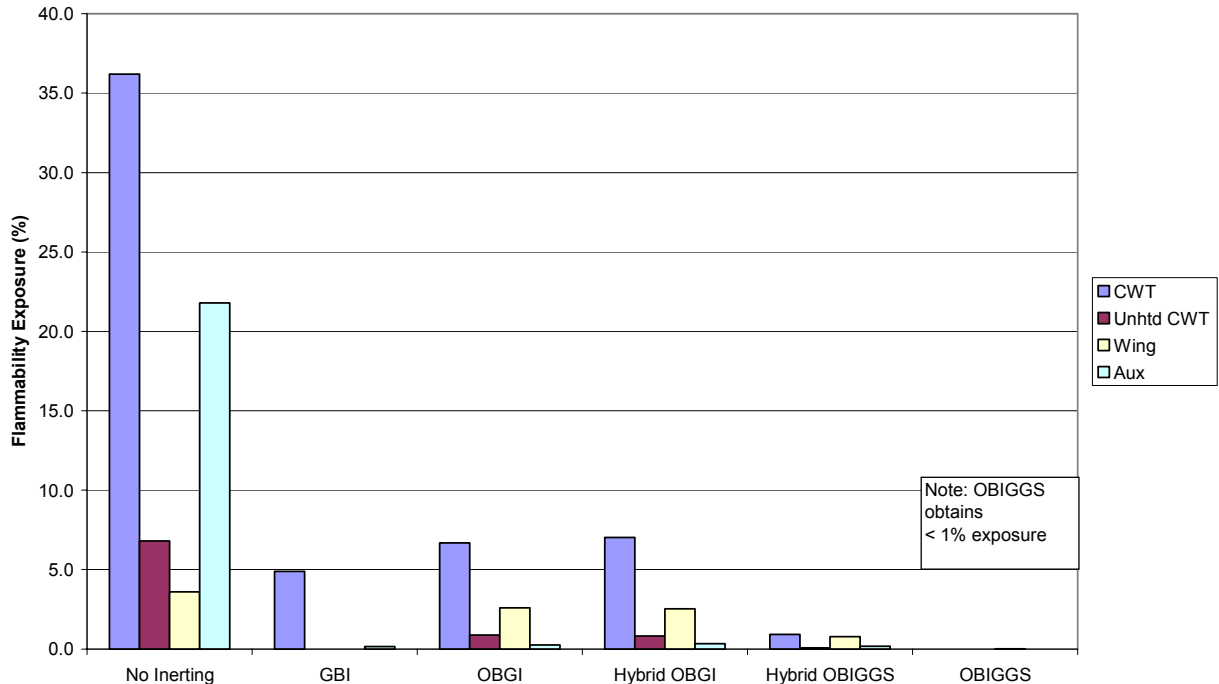

Figure 5-1. Performance in Large Transport

Onboard Inerting Designs Task Team Final Report

	OBGI	Hybrid OBGI	Hybrid OBIGGS	OBIGGS
Air Flow (lb/min)	48	42	9	30
Power (KVA)	100	86	28	113
Weight (lbs)	1458	1394	460	1367
Volume (cubic ft)	75	66	23	56

Figure 5-2. System Impact to Large Transport

Medium Transport Flammability Comparison Average of Inerting Systems in Category

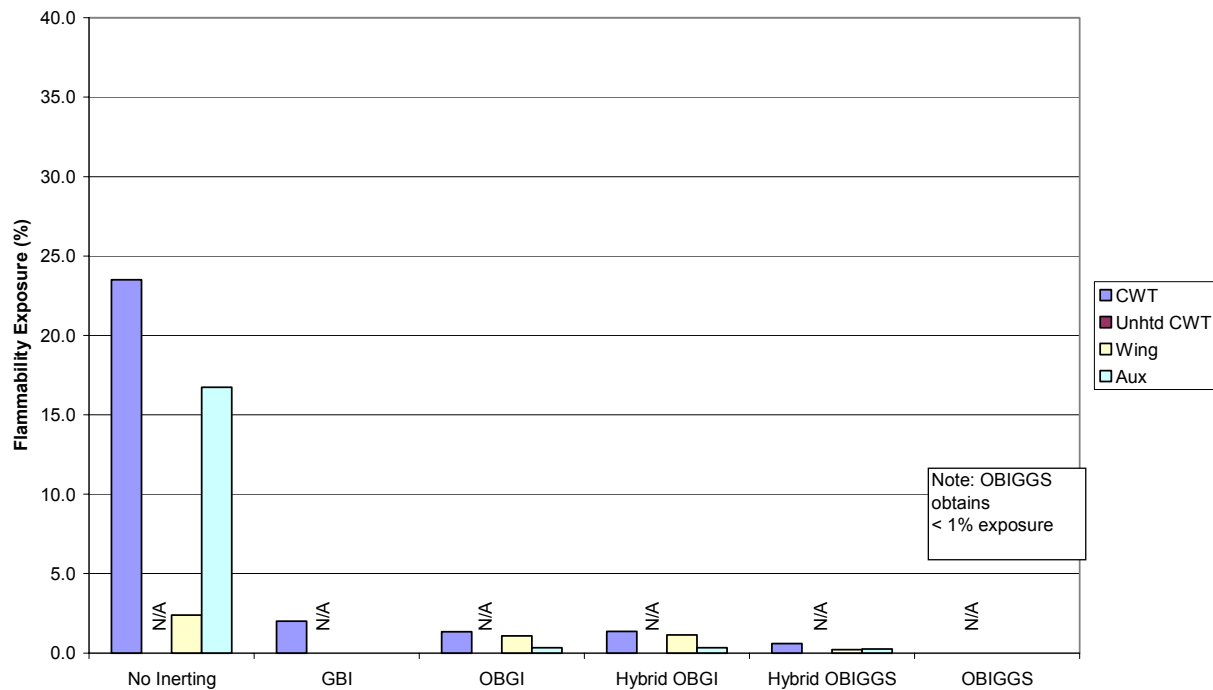

Figure 5-3. Performance in Medium Transport

	OBGI	Hybrid OBGI	Hybrid OBIGGS	OBIGGS
Air Flow (lb/min)	27	24	4	12
Power (KVA)	56	49	15	43
Weight (lbs)	771	729	310	670
Volume (cubic ft)	43	38	15	28

Figure 5-4. System Impacts to Medium Transport

In the flammability chart, the unhtd CWT is not zero but rather it was not analyzed because there are no aircraft in the category that have unheated center wing tanks.

Small Transport Flammability Comparison
Average of Inerting Systems in Category

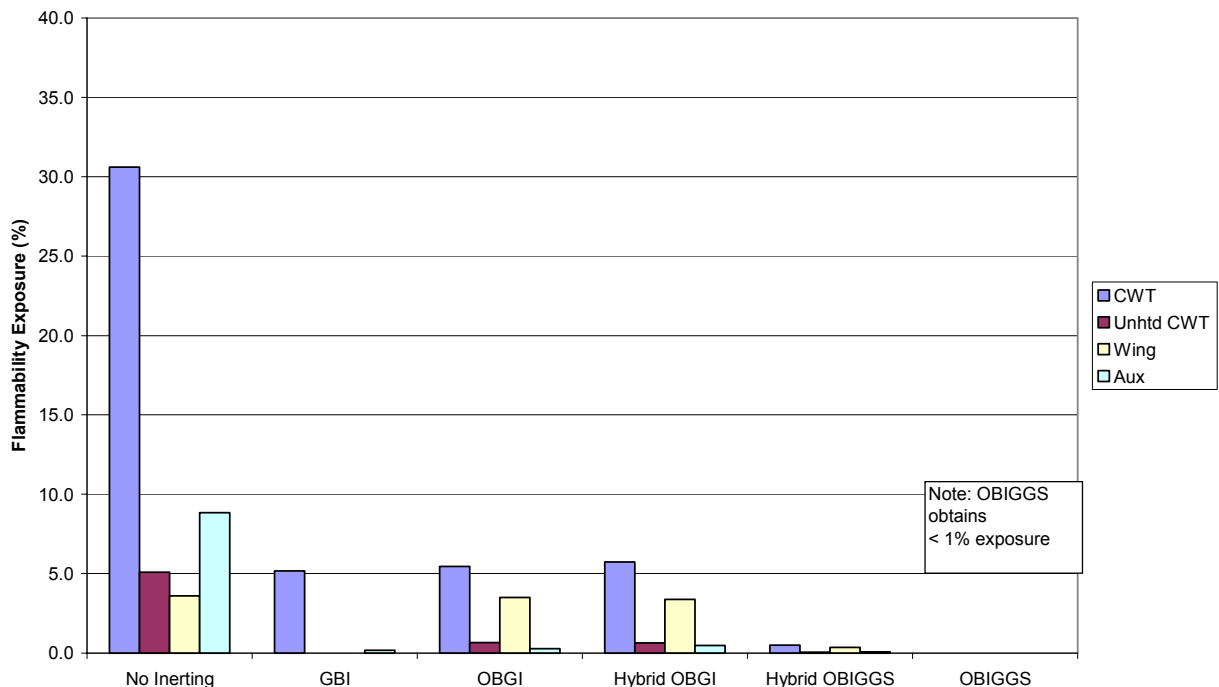

Figure 5-5. Performance in Small Transport

	OBGI	Hybrid OBGI	Hybrid OBIGGS	OBIGGS
Air Flow (lb/min)	11	9	1	5
Power (KVA)	22	17	8	16
Weight (lbs)	328	293	214	354
Volume (cubic ft)	18	14	11	15

Figure 5-6. System Impacts to Small Transport

Conclusions

The Onboard Design Task Team determined the following:

- Engine bleed air may not always be available to supply OBGIS and hybrid OBGIS on in-service and in-production aircraft.
- Engine bleed air is insufficient to supply OBIGGS and hybrid OBIGGS during descent and on the ground on in-service and in-production aircraft.
- However, a system could be designed into a new aircraft if the system requirements are established prior to specifying engine, APU, and ECS performance. This does not imply there is a cost benefit to this action, only that it's technically possible.
- The availability of electrical power to operate a compressor all of the time for any of the systems is unknown. A study of power available by mission phase will be required for the ARAC Executive Committee or FAA to properly evaluate inerting system operation, at a later date.
- Proving the feasibility of the inerting systems requires specific aircraft design information that was not available.

Onboard Inerting Designs Task Team Final Report

- The PSA and the membrane systems were not shown to be infeasible for OBGI and hybrid OBGI.
- The PSA, membrane, and cryogenic distillation systems were not shown to be infeasible for OBIGGS and hybrid OBIGGS.
- The power availability study, mentioned above, is needed to determine if the systems are infeasible in their present form and require modification to the inerting system, aircraft, or airport to be feasible.
- The flammability model requires improvements to be valid as a certification tool. It does, however, provide a relative measure of a system's capability.

Recommendations

- A comprehensive study of electrical power available on several different size aircraft should be undertaken by the FAA or ARAC to establish the capability to power inerting systems on in-service and in-production aircraft.
- Improve the flammability model to more accurately:
 - predict flammability at altitude.
 - predict inert level at altitude.
- Combine an ignition energy model with the flammability model to establish a certification tool and provide it to industry for comment and validation.
- Continue research into polymers and membranes focused on improving their efficiency and performance. This should include studies to improve the temperature performance of the membranes.
- Investigate vacuum-jacketed, high-effectiveness heat exchangers and lighter, more efficient cryogenic refrigerators.
- Investigate using a turbo-compressor to recover energy from the ASM and avoid the penalty of a second electric compressor.

ADDENDUM

A1 AIR SEPARATION TECHNOLOGY DETAILED DESCRIPTIONS AND SIZING METHODOLOGY

A1.1 PERMEABLE MEMBRANE SUMMARY

Hollow fiber permeable membranes can be used to create nitrogen enriched air or NEA for aircraft fuel tank inerting. Low weight and high reliability are essential requirements for components used aboard an aircraft system. For this reason membranes have high permeability which translates into weight savings, high selectivity to maintain energy efficiency, and high reliability because they are a passive technology which requires no moving parts.

The polymeric hollow fiber permeable membranes currently manufactured for nitrogen separation from compressed air are essentially a molecular filter and today's modern membranes are manufactured using several different techniques. This discussion is going to be limited to asymmetric composite type membranes which are one of the modern membranes in wide use today. Air separation asymmetric composite membranes are a multi-layer laminate hollow fiber that is manufactured with an efficient single-step coextrusion solution-spinning process developed over 30 years ago by chemical manufacturing companies, the early pioneers of the technology. The separation efficiency, permeation rates, and mechanical durability of the membrane are optimized via the selection of high-performance polymers for each layer. The selection of these polymers is based on years of dedicated research that included the testing of thousands of different polymers for both permeance and selectivity.

Polymers are classified by their glass-transition temperature where the glassy type have high-T_g, are easily manufacturable, and are extremely durable in gas separation service. The polymers in membrane service today have glass transition temperatures in excess 200°C (425°F). Through extensive research and development, polymers are selected for the construction of membranes that offer a technology that is extremely efficient, light weight, and reliable. Many membrane modules that were placed in N₂ service at 165psig and above 9 to 10 years ago are still in service today.

The terms permeance and selectivity are used to define the membrane performance. Permeance of a gas across a polymeric membrane is based on the solubility of the gas in the polymer as well as the rate of the gas diffusion through the membrane. That is, in order for a gas to permeate across the membrane, the gas must dissolve in the membrane material, diffuse across the thickness of the membrane layer, and then desorb into the permeate phase. The rate of solution and desorption in the membrane material are very fast, so the limiting step to the rate of flow across the membrane is the rate of diffusion within the polymer. Each constituent of a mixed gas, like air, has its own flow rate values or permeance across the membrane. For air, there are values for the nitrogen and oxygen permeances, and the ratio of these flow rates is a measure of the efficiency at which the membrane will operate. The ratio of these permeance values is called selectivity. Each of the different membrane manufacturers today offer the highest combination of permeance and selectivity that their manufacturing process and polymer will permit.

The membrane performance is also a function of pressure across the membrane separation layer, which creates driving force for permeation across the membrane. Simply stated, for an on board system, feed pressure and temperature are significant variables of the system that can impact performance. The higher the system operating pressure, the more NEA flow per unit surface area is available. This increased flow rate can be directly translated into a lower system weight.

Earlier it was mentioned that the fiber has a composite structure. To give you a better idea of what the fiber looks like, refer to Figure A1.1-1 below. The picture is a cross section of a typical permeable hollow fiber magnified many times. Currently the technology exists to manufacture hollow fiber, like the one shown in the figure, with outside diameters in the range of 150 to 600 μm and inside diameters from 80 to 500μm, depending on the application. The bulk of the cross-section of these fibers is a rugged porous support layer, which supports a thin, dense highly selective skin where the gas separation takes

Onboard Inerting Designs Task Team Final Report

place. The total thickness of this skin is only a few microns and it is the outer skin of this layer, whose thickness is measured in angstroms, that determines the membrane performance. As is, these fibers today can operate at temperatures up to 100°C (212°F).

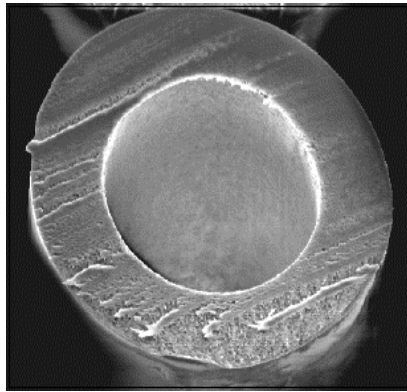

Figure A1.1-1. Fiber Cross Section

A schematic of a hollow fiber membrane module can be seen below in Figure A1.1-2. The hollow fiber membrane technology is passive by definition, that is, there are no moving, high-maintenance parts required for the gas separation to take place.

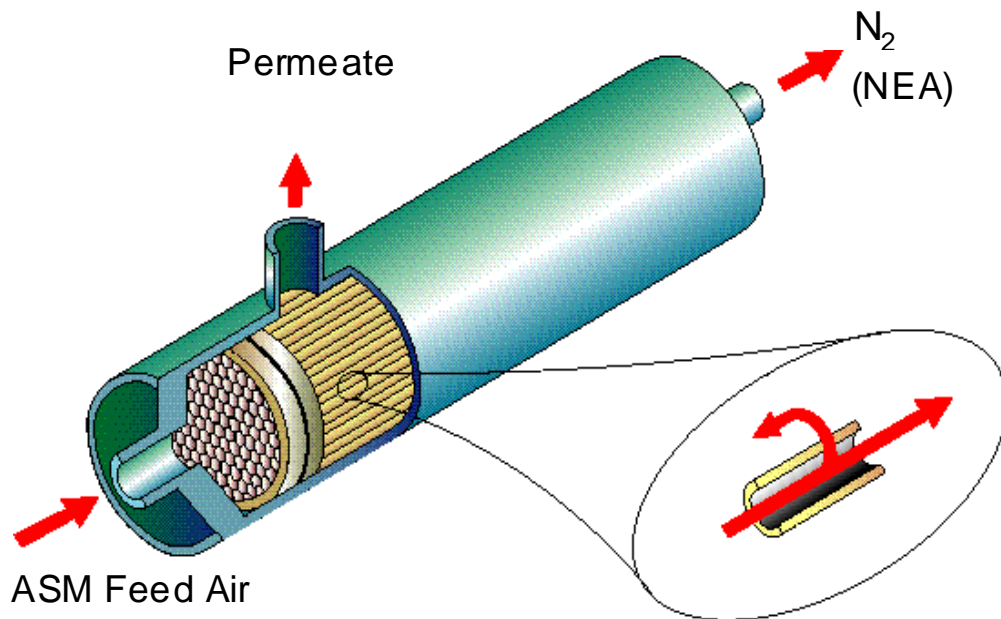

Figure A1.1-2. Membrane Module Schematic

Compressed air is simply introduced at the feed end of the module at the proper temperature and pressure. Regulation of the NEA flow ensures that the product gas will be at the proper oxygen level. A by-product of the membrane performance is that the dew point of the NEA is considerably lower than the feed air. This is due to the fact that the water vapor in the feed air is more permeable than the oxygen (by approximately 100X). This means the NEA to be directed into the fuel tank is very dry, even if the feed air is fully saturated with water.

Another critical part of the ASM is the tube sheet which is the epoxy closing at either end of the fiber bundle (see the above membrane module schematic). This provides the seal that allows the separation of the product gas stream from the permeate stream. The technology of tube sheets has greatly developed for

ASM manufacturing. Resin materials have been developed based on a combination of physical properties, hot/wet aging properties of the resins, and manufacturability of the materials. Tube sheet components have an excellent CTE (coefficient of thermal expansion) match which leads to excellent thermal cycling resistance and fatigue resistance of the membrane modules.

A1.1.1 System Sizing (Full-Time and Hybrid OBIGGS)

Membrane cartridges are produced in standard sizes, that is approximately 6 inch in diameters and 36 inches long. These standard cartridges have fixed NEA outlet performance at specific inlet conditions of temperature and pressure. The mechanics of changing the performance of a cartridge, purity and flow, is accomplished by changing a flow control orifice downstream of the cartridges. Restricting the flow and maintaining the pressure will decrease the oxygen concentration. Once the system designer has specified the operating conditions for the aircraft, it is a simple task to pick the proper number of cartridges to meet the systems needs for NEA flow based on the temperature, pressure and available feed flows.

The systems for each of the 6 modeled aircraft types were sized by using a software simulation. The large, medium and small transport aircraft, plus the Business Jet had three types of mission profiles, long, medium and short; and the other two model aircraft had only one mission profile. Each mission profile included such items as; fuel tank volumes of the different tank configurations, re-fueling rates, percent ullages, burn rates for the different phase of a flight, altitudes, flight distance, ambient temperatures, and amounts of time spent at each of the different phases of the mission. The program calculated the required NEA flow, with a given purity, based on the type of inerting being studied, that is, full time or hybrid. A full time system was sized to provide a 10 percent maximum oxygen concentration under all conditions. Hybrid systems were sized to provide a minimum flammability exposure as scaled down from an arbitrary system.

The total NEA flow, as determined by the program, was divided by the amount of NEA produced by a standard cartridge at sea level conditions to determine the number of cartridges needed. Corresponding to the cartridge's NEA flow is the required feed flow needed by the cartridge. This feed flow, times the number of cartridges is the amount of total feed flow required by the system which determines the overall system size. Once the feed flow is known, the orifice is sized and set for sea level conditions. The inerting system as designed has a fixed compressor ratio. The compressor draws inlet air from the aircraft cabin (whose pressure varies from 14.7 psia at sea level to 10.7 psia at altitudes of 8000 feet or more) rather than from outside. The pressure to the inlet of the cartridge will then vary with the aircraft's altitude. The membrane cartridges perform better at higher pressures. The reduced pressure combined with the fixed orifice results in a reduced flow for the cartridges as the aircraft gain altitude. The reduction in pressure/flow results in the cartridges producing higher purity NEA. The cartridge also benefits from the altitude increase because the lower pressure at the waste outlet improves the productivity of the cartridge. In other words, the reduction in performance caused by the decrease in inlet pressure from the altitude increase, is fractionally increased by the decrease in ambient pressure at the waste port. The cartridge performance at altitude is approximately 80-85 percent of the sea level performance.

After the amount of feed flow has been determined, the system's heat exchanger and compressor were sized. Calculated from these sizes are corresponding weight, volume, electrical power and cost. These values were then analyzed and it was found that the driving size parameter was electrical power. The NEA flow and purity were varied, along with the temperature and pressures and the program re-run to calculate new parametric values. These different systems were evaluated iteratively until a system was sized and designed to provide the least amount of electrical power consumption.

A1.1.2 NEA Concentration (Full-Time and Hybrid OBIGGS)

The NEA concentration varied with the different flight phases. The full time OBIGGS reacts as follows. Typically the concentration of the oxygen would be 7 percent while on the ground. Once the aircraft

Onboard Inerting Designs Task Team Final Report

departed and started the climb phase the NEA would drop to 5 percent for altitudes above 8000 feet. This is due to decreased flow and pressure from the effect of the altitude increases. The flow mode again changes in the cruise phase, because the system changes air supply from the compressor to engine bleed (low flow mode). The low flow through the cartridge reduces the concentration to the 3 percent range. As the aircraft starts descent the system would go back to high flow mode at 5 percent. Under the 8000 feet altitude the concentration will again go back to 7 percent.

In the hybrid OBIGGS the system reacts as follows. Concentration of the oxygen was set to 5 percent while on the ground. Once the aircraft departed and started the climb phase the NEA would drop to 3.5 percent above 8000 feet altitude. This again is due to decreased flow and pressure from the effect of the altitude increases. The flow mode did not change because the hybrid system is a single flow system, but could be changed to a dual flow system if necessary. As the aircraft descended the concentration would change from 3.5 percent back to 5 percent at the 8000 feet altitude.

A1.1.3 Effects of Feed Air Temperature (Full-Time and Hybrid OBIGGS)

Membrane performance is directly affected by temperature. The conversion ratio of NEA from feed air increases as the temperature decreases, however the amount of both NEA and feed decreases at a ratio less than the ratio above. This simply means as the cartridge inlet temperature drops, it will require more cartridges to produce the same NEA amounts as at the higher inlet temperature, but at a favorable decrease for the amount of feed air required. To gain the full benefit of the temperature decrease the pressure must also be increased, like in the systems designed for the large and medium transport model. These systems were designed to minimize the power consumption, but their gain was offset by weight, volume and cost increase (though less than the power impact).

A1.2 PRESSURE-SWING ADSORPTION (PSA) SUMMARY

PSA is a logical choice to consider for inerting commercial aircraft. It is used on a majority of the military applications that currently fly with OBIGGS. It has proven to be reliable and effective and is not susceptible to damage by normal levels of contaminants in bleed air. It is easily scalable in size and may be packaged in a variety of shapes and sizes. This may be useful in fitting such equipment into the available spaces on the commercial airframes that exist today that were not designed with inerting in mind.

Background. The pressure-swing-adsorption (PSA) process uses pressure as the controlling adsorption/desorption variable. In this process, the oxygen in pressurized air is adsorbed in a bed of molecular sieve, while the nitrogen passes through. The nitrogen sieve utilizes synthetic zeolites which are crystalline minerals with a large number of channels and cavities of atomic dimensions. Zeolites selectively adsorb almost any size molecule based on the strength of molecular interaction, size of the gas molecule, temperature, and pressure.

When the molecular sieve in the bed has become nearly saturated, the bed is vented to atmosphere. This causes most of the oxygen-adsorbed gases to be desorbed and discharged from the bed. Simultaneously when producing nitrogen, some of the enriched product gas from the other molecular sieve bed is flushed back through the bed to further lower the partial pressure of the adsorbed gases in the bed and to complete the desorption process. The use of two beds, which are pressurized and flushed alternately, provides a continuous flow of product gas and ensures sufficient pressure for the flushing operation. As the pressure swing increases with altitude, the efficiency of the process increases.

Block Diagram. Refer to the PSA functional block diagram, Figure A1.2-1 for the following operational description.

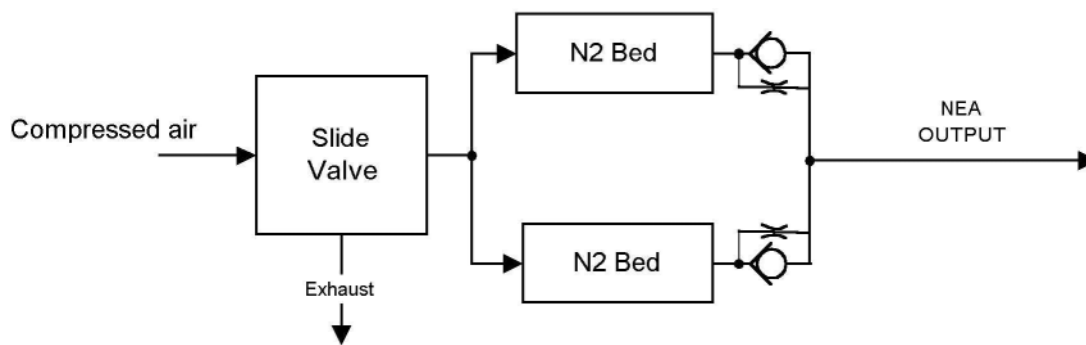

Figure A1.2-1. PSA Block Diagram

Compressed air (bleed or compressor air) is conditioned by the system heat exchanger and filter and then flows to the pilot-pressure driven slide valve, which sequentially ports it to the molecular sieve beds.

The two nitrogen beds are cycled alternately by the slide valve between the pressurization or nitrogen-producing mode and the vented, regenerative, oxygen-purging mode. The nitrogen enriched air (NEA) product gas from the pressurized bed flows through the bed check valves, and on to the fuel-tank-inerting distribution lines.

Slide Valve. Pressure-swing cycling of the molecular sieve beds is accomplished using a reciprocating slide valve. The valve is activated by two opposing air cylinders, which are pressurized and vented by pilot solenoid valves. When one cylinder is pressurized, the other is vented, and the valve is pushed to one side. This pressurizes one nitrogen bed and vents the other. An electronic timing circuit in the controller causes the solenoid valves to change state. The slide valve moves to the other side, and the other bed is pressurized while the original bed is vented.

Bed Check Valves and Purge Orifices. The check valves direct the output of the producing bed to the concentrator outlet. A purge orifice at the outlet end of each bed allows some product gas to flow into the non-producing bed, causing a rapid evacuation of the stored oxygen.

ASM Sizing Methodology. Most PSA hardware has been sized for weight-specific performance and not air conservation. Where air consumption becomes the primary driver, measures can be taken to reduce PSA air consumption below the baseline values used for this ARAC study.

The PSA air separator sizing calculations were made empirically. A production PSA air separator manufactured by one of the participating OBIGGS vendors was operated in an altitude chamber at the altitudes and supply pressures consistent with the ARAC study. At each altitude, the key physical performance parameters were measured: air consumption, product flow and product purity. For OBIGGS work, two sets of purity curves were produced, “low flow” at a nominal 7% oxygen level at lab altitude, and “high flow” at a nominal 10% oxygen level at lab altitude. Product gas flows were established by a simple throttling device that was not adjusted during the test (except to change from “low” flow to “high” flow), to simulate the various fuel tank orifices. The product gas outputs were scaled upward or downward to meet the product gas needs that resulted from the inert gas simulations. The scale factors were generally driven by high flow gas rates, so that a surplus of “low flow” would be available.

Further, for the OBIGGS effort, some data was taken at 1% inert gas, at altitudes related to the medium and large transport, to ensure that a third flow was practical. It was determined that the desired (low) flows of 1.2 lb./minute for the medium transport and 2.0 lb/minute for the large transport were achievable with the PSA ASM’s that were sized. These “very low” flows were not carried out at low altitudes as there was no need to do so.

A1.3 CRYOGENIC DISTILLATION SUMMARY

The cryogenic distillation inerting system evaluated for the generic aircraft is an adaptation to the commercial aircraft environment of military technology currently in development for the Air Force's C-17 aircraft. A simplified schematic of the approach is shown in Figure A1.3-1. Bleed air from the engines is first filtered and dried in the inlet air cleaning system. The air is then liquefied and passed through a cryogenic distillation column where it is separated into oxygen and nitrogen. Cryogenic distillation column technology is very mature and has been used for years in Naval applications with excellent reliability and performance. High purity (>99% nitrogen) liquid and gaseous product can be extracted from the column simultaneously or independently. The cold product and waste streams from the distillation process are used to pre-cool the incoming air to minimize the amount of cooling that the cryogenic refrigerator must supply. The refrigerator is based on a reverse-Brayton technology developed for spacecraft sensor cooling. This refrigerator is very similar to the air-cycle machines currently on passenger aircraft. The cryogenic refrigerator requires electrical input power and rejects heat to the environment.

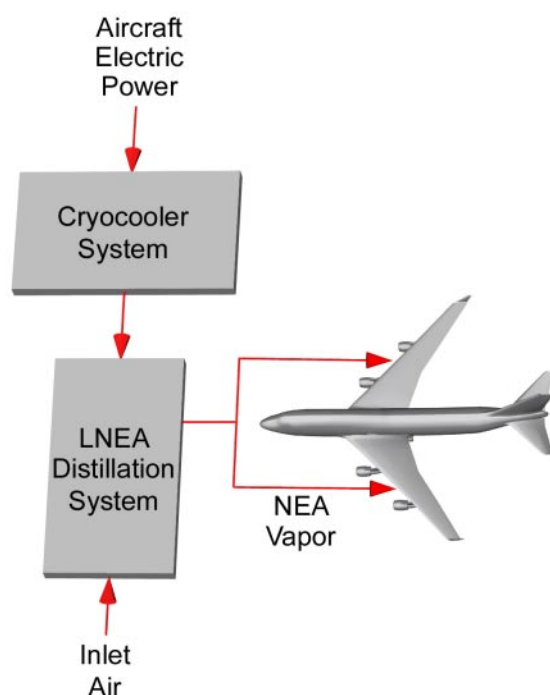

Figure A1.3-1. Cryogenic Distillation Fuel Tank Inerting System Concept

A full-time cryogenic distillation inerting system has several advantages over other available technologies for fuel tank inerting for large transports. For these large aircraft, the weight and volume are comparable to the minimum competing system while the electrical power and bleed air requirements are both several times lower. The disadvantage of the cryogenic distillation inerting system is that it does not scale well to smaller aircraft due to the weight and cool-down requirements of the components. Membrane or PSA-based systems are the best choice of the available technology for small transport, regional turboprop, regional turbofan, or a business jet.

The ability to store liquid makes the cryogenic distillation inerting system uniquely able to quickly cool-down and inert at the start of each day and provide *zero-power, full-time ground inerting*. The full-time system is sized such that sufficient liquid is made during periods of low demand (i.e. cruise) to (a) cool the cryogenic components to their operating temperatures while inerting the fuel tanks at the start of the

day and (b) keep the tanks inert during refueling. This sizing strategy ensures that the system initialization time will be short (<1 hour) and the fuel tanks will be inert 100% of the time.

A1.3.1 The Cryogenic Distillation Inerting System

The next few paragraphs describe the subsystem components within the cryogenic distillation inerting system. Figure A1.3.1-1 illustrates where each of these components fit into the overall system.

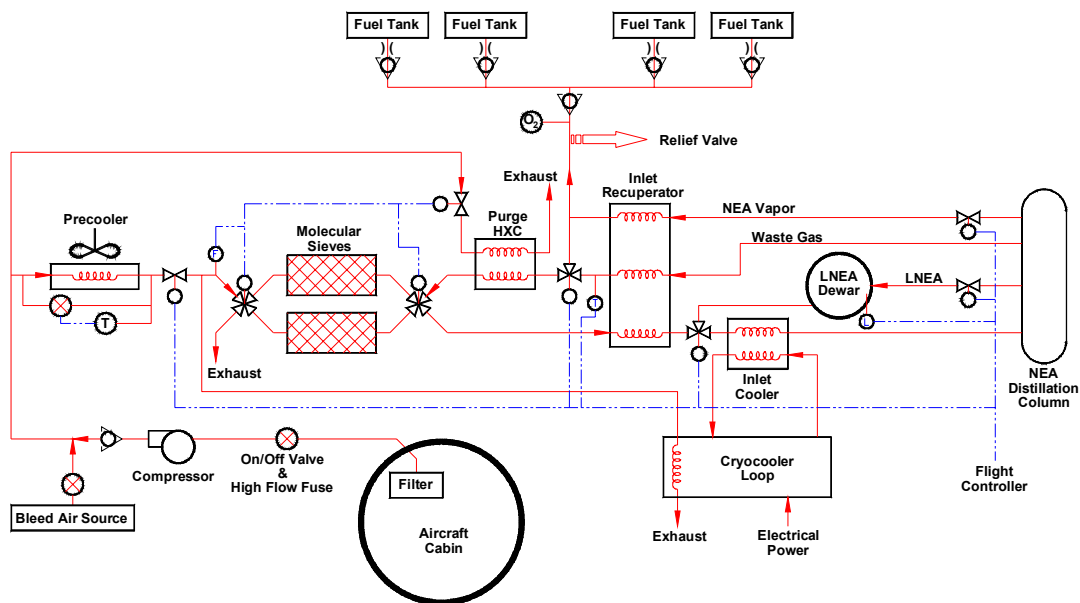

Figure A1.3.1-1. Cryogenic Distillation Fuel Tank Inerting System Schematic

Inlet Air Subsystem. The cryogenic distillation inerting system requires a supply of pressurized air. The Team assumed that this high-pressure air supply would be supplied by compressed air from one or more engines at a pressure of approximately 45 psia or greater and a temperature of 317 K or lower. This air contains vapors that are considered to be contaminants to the cryogenic distillation system. The most notable contaminants are water vapor and CO₂. These contaminants must be removed prior to entering critical cryogenic components. If they are not removed, the resulting frozen buildup could cause small heat exchanger passages to plug and/or cause valves to operate improperly. Consequently, an air cleanup system has been designed to remove the water and CO₂ vapors. This subsystem employs molecular sieve beds to remove the water vapor and the CO₂. The molecular sieves are regenerated with warmed waste gas, and they have been designed to operate without fixed cycle times due to the varying inlet air flow rate experienced during a typical mission. The sieves are cycled when the total mass of waste gas through the regenerating molecular sieve equals a fixed, known value. Downstream of the molecular sieves, any remaining water vapor or CO₂ in the air stream will freeze out harmlessly in the inlet recuperator, by design. This recuperator also precools the inlet air, recovers valuable thermal energy from the waste flows or the exiting NEA gas, and helps to minimize the required cryocooler capacity.

Cryogenic Refrigerator. The cryogenic refrigerator subsystem is based on a single-stage reverse-Brayton cryocooler technology. The system consists of an electrically-driven compressor that compresses the cycle gas, neon in this case. The heat of compression is removed by the aftercooler that rejects heat to an open-loop air stream of either bleed air or ram air. The compressed and cooled cycle gas enters the recuperator where it is further cooled to approximately 98 K. This cold gas is then expanded through a turboalternator, and it experiences a further drop in temperature to about 84 K. Work is absorbed in the turboalternator by using an electrical stator and a rotating permanent magnet to generate electrical power, which is dissipated in a bank of electrical resistors. The colder and now lower pressure

Onboard Inerting Designs Task Team Final Report

gas absorbs energy in the liquid oxygen (LOX) and liquid nitrogen enriched air (LNEA) heat exchangers and is warmed to about 92.5 K. This gas then passes back through the recuperator where it cools the counter-flowing, high-pressure gas stream.

Core Distillation Column Technology. After passing through the inlet air subsystem, the then clean, dry, and somewhat cold bleed air gets further cooled and partially liquefied by the cryocooler subsystem. The two-phase mixture of air then enters the distillation column, which is designed to produce 99% pure NEA vapor. To recover 90% of the available nitrogen from the air, the cryogenic distillation inerting system was designed with dual columns. These dual columns act like one tall column without the height penalty.

The NEA column is called a rectifying column. The inlet air stream is injected into the bottom of the column. This vapor then travels upward through the packing material and interacts with the down-flowing, oxygen-depleted liquid. The oxygen-depleted liquid strips the oxygen from the vapor so that the vapor exiting the top of the packing material has a purity of greater than 99% nitrogen. The nitrogen vapor is condensed by a reflux condenser, which is fed by the column bottom.

The key to making cryogenic distillation inerting technology practical for aircraft applications is to develop compact distillation columns capable of operating in an aircraft environment. Key environmental concerns include vibration and tilt. Tilt-insensitive column designs have been developed with the assistance of a distillation column manufacturer that utilize advanced trays to make the compact column tilt and vibration insensitive. Previous distillation column testing has demonstrated that vibration loads characteristic of those encountered on military cargo aircraft have no detrimental effect on distillation column performance.

Gaseous Nitrogen Enriched Air (GNEA) Delivery. This subsystem provides direct delivery of GNEA from the top of the distillation column to the fuel tanks. The cold (~90 K), low-pressure (~40 psia) GNEA passes through the inlet recuperator. The GNEA is warmed to nearly ambient temperature (290-300 K) by cooling the counter-flowing inlet air stream in the high-effectiveness inlet recuperator. Recovering the cooling capacity from the product flow is key to significantly reducing the required cryocooler capacity.

Liquid Nitrogen Enriched Air (LNEA) Storage and Delivery. This subsystem provides storage and delivery of LNEA to support ground operations and initialization. The LNEA is stored in a standard aircraft cryogenic dewar. When the fuel tanks call for NEA, the LNEA from the dewars passes the inlet recuperator. The LNEA is vaporized and warmed by cooling the counter-flowing inlet air stream or by a separate vaporizer. The system may also produce liquid during periods of low demand for the next day's cool-down or to support inerting on the ground.

A1.3.2 System Sizing Methodology

Cryogenic distillation inerting system sizing is driven by the size of the cryogenic refrigerator, which is fixed by the liquid production requirement. To produce nitrogen gas, the cryogenic refrigerator must provide enough cooling to make up for heat leaks and inlet recuperator ineffectiveness. To produce nitrogen liquid, the cryogenic refrigerator must have additional capacity to liquefy the product. In the case of the cryogenic distillation inerting systems sized for the generic aircraft, the thermal capacity of the cryogenic refrigerator is within the range of machines that have been manufactured previously in terms of cooling capacity and load temperature. From other internal projects and parallel efforts for the military, we have empirical data for the other system components such as the column, the heat exchangers, and the storage dewar(s). Using this information in combination with proprietary thermodynamic process models, systems were sized based on the inert gas flow and liquid production requirements for a particular aircraft. The inert gas flows were fixed by FAA models of typical missions for various aircraft sizes. The liquid production flow rates were established by: (a) the need to cool the cryogenic components and provide inert gas at the start of the day and (b) the requirement to keep the fuel tanks

inert during refueling. The aircraft utilization time was fixed at 15 hours per day based on input from aircraft operators.

The cryogenic distillation technology is well suited to OBIGGS and hybrid OBIGGS for large and medium transports but is not well suited to an On-Board Ground Inerting (OBGI) system. The major driver for the system sizing for OBGI is the cool-down time. Because the inerting system cannot operate in flight, the system cannot make liquid nitrogen during periods of low demand for cool-down and initialization, as it can in the case of full-time or hybrid OBIGGS. For OBGI, the cryogenic refrigerator supplies all of the cooling for the system during the limited ground time. This makes the system too heavy and demanding of electric power. The cryogenic distillation system was therefore not investigated further as a realistic option for OBGI.

A2 COMPRESSOR DESCRIPTIONS AND SIZING METHODOLOGY

A2.1 INTRODUCTION

Compressors are widely used to increase the pressure of gas or vapor phase fluids. Energy is supplied to drive the compressor, and most of this energy is converted into fluid pressure increase. There are various ways of supplying energy, such as electric motors and turbines. Likewise, there are several types of compressors available including piston, radial vane, screw, centrifugal, and axial vane compressors. There are also other types of compressors that are less commonly used. Each type of compressor has advantages and limitations that will be discussed under the descriptions below. The types of compressors most appropriate for the inerting systems discussed in this report are the piston, screw and centrifugal compressors.

A typical compression cycle is shown in Figure A2.1-1. The compression cycle follows a process line such that $pv^n = \text{constant}$. The value of n varies depending on the cycle design and the compressor design. The cycle is said to be isentropic when the value of n equals the ratio of specific heats, k . For air, $k = 1.4$. The shaded area in the figure is proportional to the work to compress the fluid. This area will depend on the value of n . Compressor analysis can be simplified if the concept of efficiency is introduced.

Compressor efficiency η , is defined as the ratio of work for isentropic compression to the actual work of compression between two pressures. Using this concept it is possible to analyze compressor performance using isentropic relationships and correct the results for real effects.

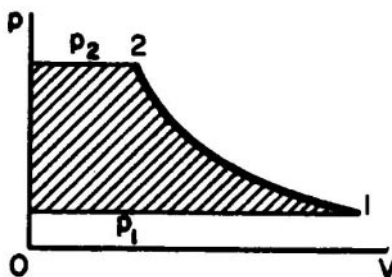

Figure A2.1-1. Compression Cycle

There are a number of relations that are useful in analyzing compressor performance. The pressure ratio r is defined as the ratio of outlet to inlet pressures p_2/p_1 . The outlet absolute temperature T_{2i} for isentropic conditions and inlet absolute temperature T_1 is:

$$\frac{T_{2i}}{T_1} = r^{\frac{k-1}{k}}$$

Knowing T_{2i} and efficiency, the actual exit temperature T_2 can be found from the relationship:

Onboard Inerting Designs Task Team Final Report

$$\eta = \frac{T_{2i} - T_1}{T_2 - T_1}$$

Finally, the power required P to run the compressor with a mass flow rate of m for a gas with specific heat at constant pressure of c_p is calculated as:

$$P = mc_p(T_2 - T_1)$$

The operational parameters of “dynamic” compressors (screw and centrifugal) are volume flow (Q), head or discharge pressure (H), and speed (N). These operational variables can be expressed in a single term called *specific speed* N_s .

$$N_s = \frac{N\sqrt{Q}}{H^{\frac{3}{4}}}$$

A certain value of specific speed leads to similar flow conditions in geometrically similar machines. The specific speed is usually evaluated at the point of best efficiency, and defines the general type of machine required. Low values of specific speed imply low values of Q and high values of H. High specific speed implies high values of Q and low values of H. For a given head and capacity the use of a high specific speed means a smaller machine and this usually results in less cost.

Overall compressor cycle efficiency can be improved by cooling the fluid between stages of compression. For example, the performance of a two stage centrifugal compressor can be improved by cooling between the two stages. It is most convenient to consider a temperature-entropy diagram for the process. This is shown in Figure A2.1-2.

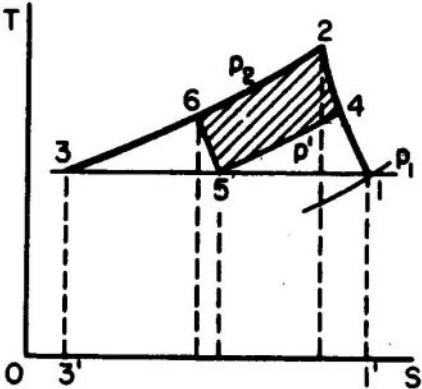

Figure A2.1-2. Compressor Inter-Stage Cooling

The line 12 represents the compression from p_1 to p_2 for a single stage of compression. The constant pressure line 23 represents cooling of the fluid to its inlet temperature. The work required for this process is the area 1'1233'. If two stages of compression are used with inter-stage cooling, 14 represents the compression from p_1 to an intermediate pressure p' . Inter-stage cooling occurs at constant pressure process 45, and the second stage of compression from p' to pressure p_2 is 56. Finally, constant pressure cooling 63. The work for this process is 1'145633', and the savings is represented by the area 4265. The work savings is maximized when the intermediate pressure $p' = \sqrt{p_1 p_2}$.

A2.2 ELECTRICAL DRIVE MOTORS

A2.2.1 Inductive

The induction motor is constructed from two electromagnetic components, the stator and the rotor.

The stator has a three phase winding, connected to a three phase alternating current power supply, producing a rotating magnetic field. Inside the stator is the rotor with a polyphase winding consisting of copper or aluminium bars set in the rotor slots interconnected by rings at each end of the rotor.

The rotating magnetic field induces currents in the conductors of the rotor as in the secondary windings of a transformer. These currents oppose the magnetic field changes that set them up, generating forces that act on the rotor bars as a torque so as to cause rotation in the direction of the magnetic field. If the rotor has the same angular velocity as the magnetic field then no current induced, therefore when a torque load is applied, the rotor is slowed down and runs with slip. This slip is typically less than 5%.

Figure A2.2.1-1 is a schematic showing the principle of the induction motor.

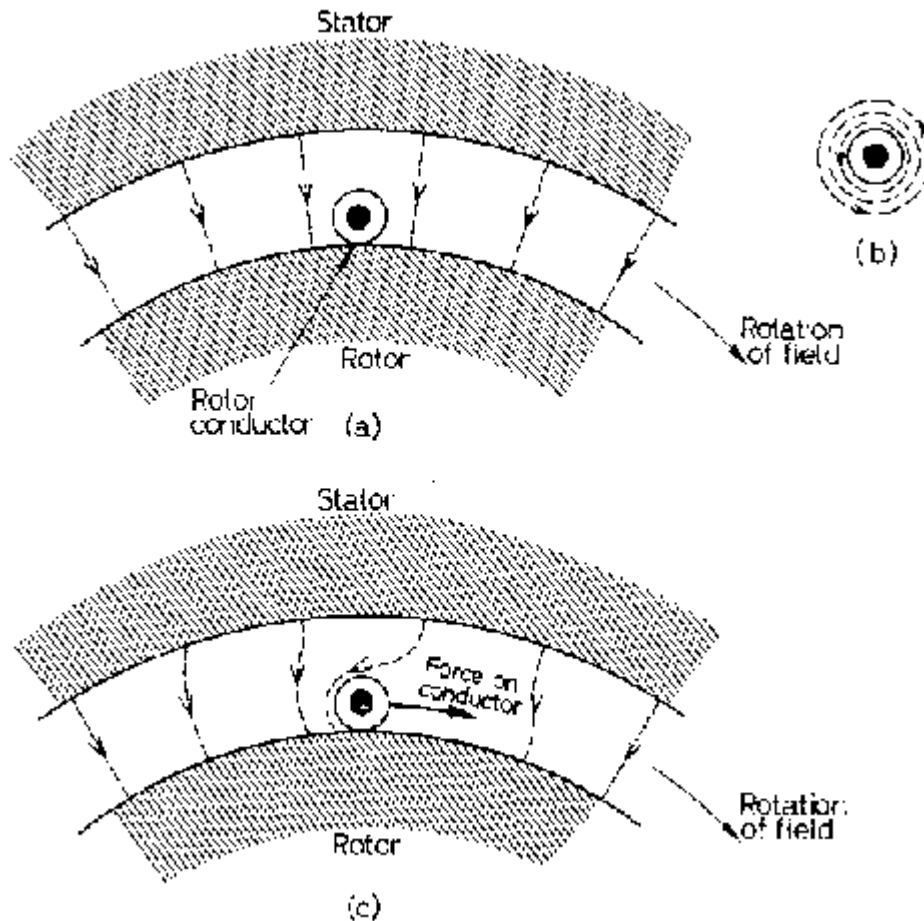

Figure A2.2.1-1.

Onboard Inerting Designs Task Team Final Report

Figure A 2.2.1-2 shows a rotor. Skewed Aluminium rotor bars may be seen within a laminated iron rotor stack.



Figure A2.2.1-2. Induction Motor Rotor

The electrical supply is the aircraft standard of 400 Hz, 115 Volts line to line, three phase, alternating current.

Figure A 2.2.1-3 shows the torque/speed and efficiency curves of a 40 kWatt motor as might be used in an Onboard Inerting solution. The operating efficiency is 90%.

An induction motor may be designed for a no-load rotor speed that is an integral fraction of the supply frequency. For a 400 Hz supply the nominal speeds are: 24,000, 12,000, 8,000, 6,000, 4,800 rpm and so on. It can be seen from the torque/speed curve in Figure A 2.2.1-3 that to a first approximation the motor is a fixed speed device for a given supply frequency.

The power to weight ratio of the induction motor is a function of design speed; the trend being, the higher the speed the lower the weight for a given power. However, for reasons of magnetic circuit design a motor designed for 24,000 rpm is about the same weight as for 12,000 rpm. In this Onboard Inerting System design study, the nominal motor speed was selected as a 24,000 rpm. This gave an efficient operating point for a screw compressor with a direct drive, and in the case of the centrifugal compressor, minimised the ratio of the gear box required to increase the drive speed to that of the compressor wheel.

The weight of the motor is approximately proportional to the shaft power output. The following expression was used in the study.

$$\text{Weight (lbm)} = 0.95 \text{ Power (kWatts)}$$

This weight is inclusive of the motor housing, bearings, lubrication and cooling system. It is exclusive of the supply cable, contactor and aircraft installation for ram air to cool the motor.

A characteristic of an induction motor is, that if started direct on line, a transient current of up to three times the normal running value occurs.

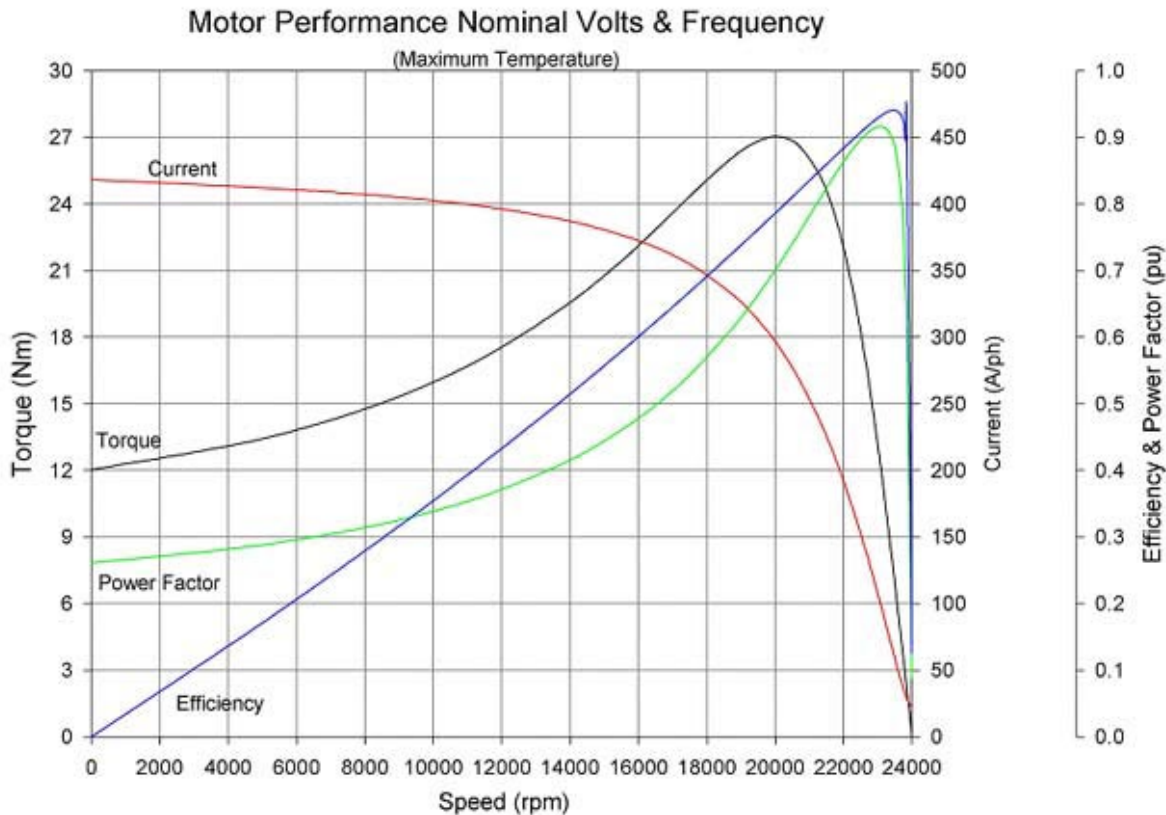

Figure A2.2.1-3.

It is considered that motors of greater than 15kW shaft power would require a start winding and associated contactors to prevent other equipment on the aircraft electrical system from being disturbed by the surge current.

30kW shaft power is greater than any induction motor currently used on an aircraft and it was assumed that multiple units would be used to deliver higher powers than this as they could be started in sequence,

The 400 Hz, three phase supply is standard for existing passenger transport aircraft and thus the induction motor described above is appropriate for retrofit installations.

Future aircraft however are expected to have variable frequency 3 phase supplies. This will not affect the Onboard Ground Inerting Systems that will still take power from either a fixed frequency APU or the external ground supply. However in the case of Full Time On Board Inerting and the Hybrid system. The variation in frequency and hence motor and compressor speed is likely to be of the order of 2 to 1. The acceptability of this depends on how engine speed varies with OBIGGS duty cycle.

It may therefore be necessary to drive the motor with a 3 phase inverter.

The primary advantages of the induction motor is its simplicity of construction which results in high reliability. Indeed induction motors in aircraft fuel and hydraulic system achieve mean times between failures in excess of 100,000 hours. This is greater than other motor types because of the absence of electronic power switching and control devices that are within brushless motor and drives and inverters.

The power density, when operated from a 400 Hz is about 1.0lbm/kW. This is because of the absence of any external additional power electronics and associated cooling subsystems. In addition the magnetic

Onboard Inerting Designs Task Team Final Report

flux density in the machine is not limited by the saturation properties of the permanent magnetic materials.

A2.2.2 Permanent Magnet

Magnetically a permanent magnet motor (PM motor) works on the same principal as an induction motor, magnetic fields between the rotor and stator exert a torque on the rotor which rotates it. In the case of a permanent magnet motor, the magnetic field from the rotor is provided by permanent magnets instead of by coils, as is the case for induction motors. Permanent magnet motors therefore do not require a commutator ring to cycle electrical power to the rotor coils. Instead, the rotor position is sensed by magnetic sensors (usually Hall effect sensors) and the stator voltages controlled to be in the proper relative phase to the rotating rotor. The control of the voltages to each stator coil is provided by an electronic controller commonly referred to as an inverter. A typical system schematic is shown in Figure A2.2.2-1.

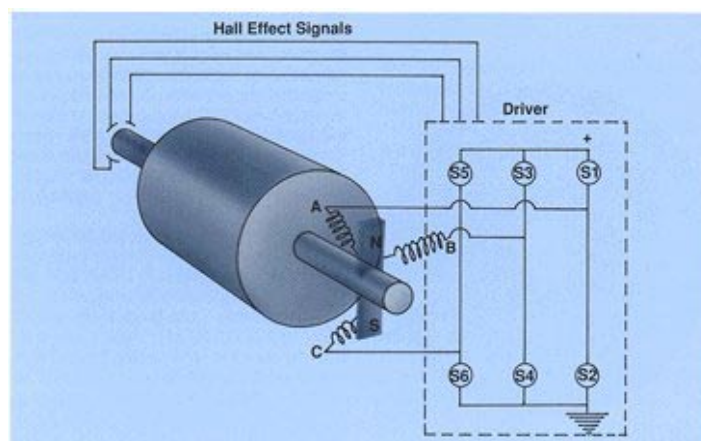

Figure A2.2.2-1. PM Motor Schematic

There are two types of brushless motors; the type that has an outer rotating magnet assembly, and the “inside out” type that has an inner rotating magnet assembly. The latter design is most suitable for applications requiring a shaft drive. These variations are shown below in Figure A2.2.2-2.

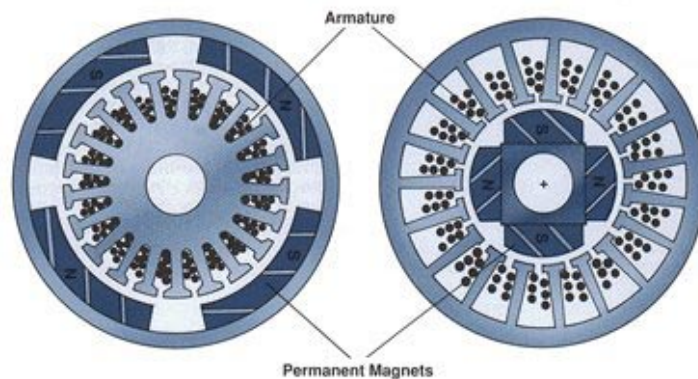

Figure A2.2.2-2. PM Motor Design Variations

PM motors have an operating efficiency between 90 and 98%. This is due to not requiring electrical current to generate the rotor magnetic field including associated winding losses, and because the voltage to the stator coils is precisely timed by the inverter (power factor of unity). Figure A2.2.2-3 shows a typical operating curve for a motor rated at 55 kW continuous.

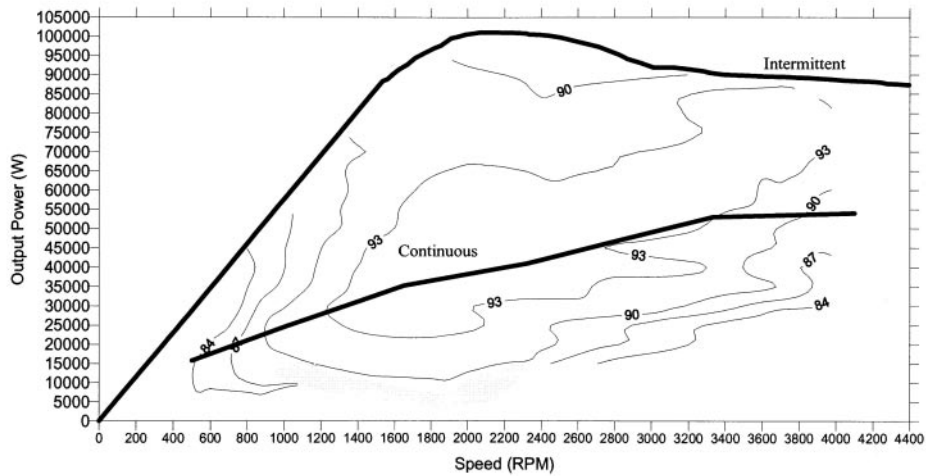
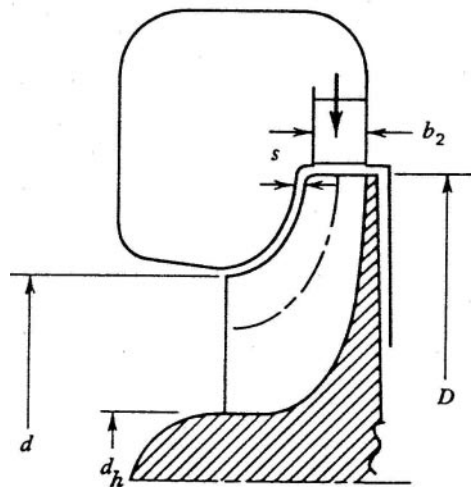

Figure A2.2.2-3. Typical Operating Parameters for a 55 kW PM Motor

The primary advantages of PM motors are high power to volume, long life with no brushes to wear, and high efficiency. Disadvantages are heat dissipation requirements due to high power densities, and the need for a power inverter. An estimate of motor weight is 2.8 pounds/kW. Motor volume can be estimated as 25 inch³/kW.

A2.3 TURBINE DRIVES

A radial turbine is just the opposite of a centrifugal compressor (Figure A2.3- 1 depicts a radial turbine cross section). Their design and basic energy relations are similar to centrifugal compressors. The term radial usually refers to a radial inflow type turbine with rotor blade inlet angles of 90 degrees (straight radial blades). The direction of the flow path is reversed, meaning that the flow, after passing through the radially arranged nozzle, enters the rotor in a radial direction flowing towards the axis and is discharged from the rotor in the axial direction.



$$\epsilon = \frac{D}{d}$$

Figure A2.3-1. Radial Turbine Cross Section

Onboard Inerting Designs Task Team Final Report

The energy transfer between the fluid and the rotor is rather simple. High-pressure fluid from the inlet chamber (scroll) flows to stationary blades. The blades can take the form of vanes or holes and are called stators or nozzles. The function of the nozzles is to direct the fluid tangentially into the rotating rotor at a slightly lower pressure and higher velocity (expansion). The blading in the rotor is designed such that further expansion takes place to the exit. Kinetic energy is converted to mechanical energy (torque) in the turning of fluid flow in the blading resulting in a pressure difference across the blades. The difference in the entering to exit tangential velocity provides the energy per unit mass flowing exchanged between fluid and rotor and is proportional to a total temperature drop. Leaving velocity can then be recovered at exit by slowing the fluid velocity through diffusion (increasing fluid flow area).

The operational parameters of the turbine are volume flow (Q), expansion head (H), and speed (N). Volume flow for the turbine is defined as the exit volume flow instead of inlet volume flow, as for the compressor. These operational variables can be expressed in a term called *specific speed* N_s . A certain value of specific speed leads to similar flow conditions in geometrically similar machines. Low diameter ratios (rotor-exit tip diameter to rotor-inlet tip diameter) are desired for lower specific speed designs and higher diameter ratios for higher specific speed designs up to an imposed limit of 0.70.

$$N_s = \frac{N\sqrt{Q}}{H^{\frac{3}{4}}}$$

Turbines are designed to convert fluid energy into mechanical energy and the major performance factor is the ratio of the actual shaft work produced to the energy supplied. The energy available to the rotor is the sum of the inlet fluid kinetic energy and the energy available from pressure drop across the rotor. Efficiency of turbines is typically 75 to 85%. Nozzle and rotor losses account for most of the losses for low specific speed designs and exit velocity losses account for the major efficiency loss for high specific designs. An important consideration for the rotor flow path design is the rotor exit conditions. Uniform flow distribution and nearly swirl-free exit is desired to obtain high efficiencies.

The major advantage of radial turbines is their application in small expansion machines (small gas turbines, turbo-expanders, turbo-compressors and turbo-chargers) owing to their ruggedness and relatively simple manufacture. One limitation of the radial turbine is introduced by the radial inward flow in that a rather high exit velocity may be required due to the expansion of the fluid and the restricted flow area at the exit.

A2.4 BEARING CHOICES

A2.4.1 Rolling Element Bearings

Rolling element bearings are constructed by enclosing balls or rollers between an inner and outer track or race. The inner track moves upon the balls or rollers in the ideal case with pure rolling and without sliding associated with plain bearings. The manufacture of rolling element bearings with the necessary precision to operate at high speed with a long life is a mature technology. The general construction is shown in figure A2.4.1-1.

For high speed applications such as the motor and compressor bearings, the rotating assemblies would be mounted in angular contact hybrid bearings.

Hybrid bearings are so called as they are constructed with hardened steel races with ceramic balls. The races are typically a martensitic steel alloyed with nitrogen which substantially improves corrosion resistance at high temperatures and also improves material toughness strength and fatigue life. The balls are silicon nitride controlled by a one piece phenolic cage. The ceramic balls are harder, stiffer and lighter than steel with a lower coefficient of thermal expansion resulting in lower centrifugal forces, lower vibration levels, less heat build up, reduced ball skidding and thermo mechanical stability. The rotational speed capability of hybrid bearings is 50% more than that required for compressor or motor.



Figure A2.4.1-1. Rolling Element Bearing General Construction

The disadvantage of rolling element bearings is that they require lubrication and have a finite life. Careful seal design is required to ensure that oil does not migrate into the compressor discharge and contaminate the ASM. This is made easier by the compressor discharge pressure being greater than the ambient pressure within the motor and compressor bearing case. With respect to the life of hybrid bearings, this is typically 10,000 hours running time.

The main advantage of rolling element bearings is their relatively low cost, good reliability within the operating life and tolerance to transient interruptions in the lubricant or power supply.

A2.4.2 Magnetic Bearings

Magnetic bearings employ the magnetic force generated by a electrical coil-magnetic material pair of elements to keep the shaft positioned properly. At each bearing location on the shaft two such electromagnetic actuators will be required, perpendicular to each other, to properly maintain shaft position. This can be implemented by including a section of magnetic material on the shaft, and by placing two coils at 90 degree orientation. A thrust bearing is also necessary, which can be accomplished with a single coil.

In order to control the position of the shaft at each bearing location it is necessary to have a position sensor that works in conjunction with each positioning coil. Shaft position is fed to a control which adjusts current to the coil so as to maintain a precalibrated position. A complete shaft bearing system for typical compressors considered in this report will consume 3 to 5 amps of 28 VDC power.

The controller must provide protection for the bearing system during startup and shut down. During startup it is necessary to ensure that power is supplied to the bearings before the compressor shaft is rotated by the prime mover. Likewise on shut down the controller must ensure that power remains to the bearings during spin-down, until completely stopped. These functions are easily incorporated using modern microprocessor based control systems.

The major advantages of magnetic bearings are first, since there is no metal contact there is no wear to be concerned about. While other bearing types, such as roller bearings, require periodic replacement,

Onboard Inerting Designs Task Team Final Report

magnetic bearings do not. Second, since there is no lubrication used with magnetic bearings, there are no hydrocarbons present to contaminate the Air Separation Module elements.

A2.4.3 Air Bearings

Air bearings are used for high speed shafts when it is desirable to minimize friction. The design of air bearings is similar to the design of bearings that use other fluid lubricants such as oil, except that for most practical cases air compressibility must also be considered. The compressibility parameter Λ is important for air bearing design.

$$\Lambda = \frac{6\mu\omega}{P_a m^2}$$

In the above equation μ is fluid viscosity, ω is rotational speed (radians/sec.), P_a is fluid pressure and m is diametrical clearance ratio (diametrical clearance/diameter). Details of air bearing design can be found in Elrod and Burgdorfer, Proceedings First International Symposium on Gas-lubricated Bearings, 1959, and Raimondi, Trans. ASLE, vol. IV, 1961.

Air bearings can become unstable under certain conditions, exhibiting a phenomenon known as swirl. The air used to lubricate the bearings must be free from any particulate matter, as the bearing clearances must be small to support the loads. Also, an air bearing develops its load carrying capacity through rotation of the shaft. If the shaft remains stationary while loads are applied damage can result to the bearing surfaces. This might be the case for example if a compressor is shut down during flight and landing, and turned on only while on the ground.

A2.5 PISTON COMPRESSORS

The piston compressor is a positive displacement, intermittent flow machine and operates at a fixed volume in its basic configuration. Capacity may be regulated in a single or double acting cylinder with single or multiple stage configuration. A piston compressor is generally used where low flow/high pressure output is needed. For a single stage compressor, an output pressure of 80 psig at 5 SCFM is realistic. Increasing the number of stages in a compressor results in the ability to substantially increase output pressure. This type of compressor is shown below in Figure A2.5-1 and would be applicable, in a flight version, for small air flow, on-board applications.

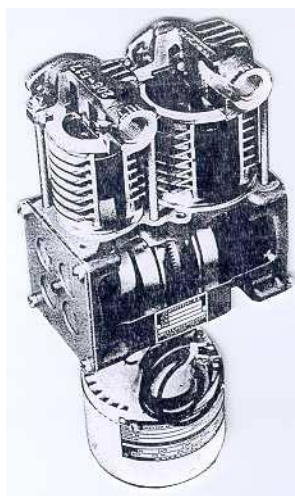

Figure A2.5-1. Two-Stage Piston Compressor

Figure A2.5-2 identifies some typical upper limit piston compressor performance characteristics. A discharge pressure of 40 psig was selected.

Power (HP)	Pressure (psig)	Flow (CFM)	Power Consumption (kW)	Approximate Weight (lbs.)	Approximate Volume (cu-ft.)
1/4	40	1.8	0.19	35	0.85
1/3	40	1.9	0.24	40	0.90
1/2	40	2.65	0.37	45	0.98
3/4	40	4.25	0.56	50	1.07
1	40	6.4	0.75	70	1.80
1-1/2	40	8	1.12	80	2.00

Figure A2.5-2. Piston Compressor Sizing for 40 psig Discharge Pressure

Piston compressors are available in both lubricated and non-lubricated models. The lubricated compressor is by far more widely used with post separation hardware required for clean, oil-less air. Labyrinth piston compressors use non-contact seals that sacrifice efficiency for low maintenance and oil free discharge air.

Piston compressors require cylinder cooling. This is usually provided by a water jacket (larger compressors) or by air cooling (smaller compressors).

Compressor efficiencies are affected by different parameters such as pressure ratio, air temperature, cooling ability, air density. Figure A2.5-3 provides a fair representation of compressor efficiency at standard ambient temperature and atmosphere.

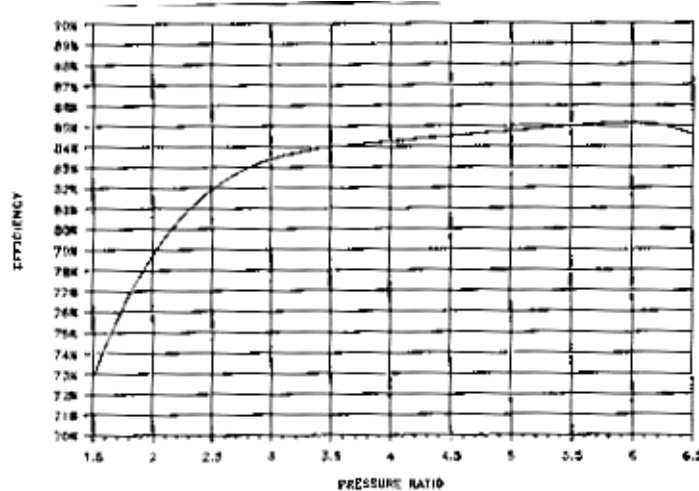

Figure A2.5-3. Piston Compressor Efficiency

Though piston compressors vary greatly in size, capacity and configuration, the following advantage/disadvantage comparison will serve provide some basic input.

Piston Compressor Advantages:

- High discharge pressure capacity
- Can start under load
- Matured technology
- Oil-less discharge air (if optimized)
- Direct drive or offset drive capabilities

Disadvantages of Piston Compressors:

- Low discharge air flow
- Cylinder cooling required
- Large size (when compared to vane, screw and some centrifugal compressors)

A2.6 SCREW COMPRESSORS

A2.6.1 Description

A screw compressor is a positive displacement, continuous flow machine and operates at a fixed volume and compression ratio. Capacity may be regulated by a varying the operating speed but with some loss of efficiency. A screw compressor is generally used where intermediate flow and pressure is required.

The operating principle is similar to that of a piston compressor in that fluid is drawn first into an expanding volume, trapped within that volume, compressed and finally expelled into a receiver.

Figure A2.6-1 shows a schematic of a screw compressor.

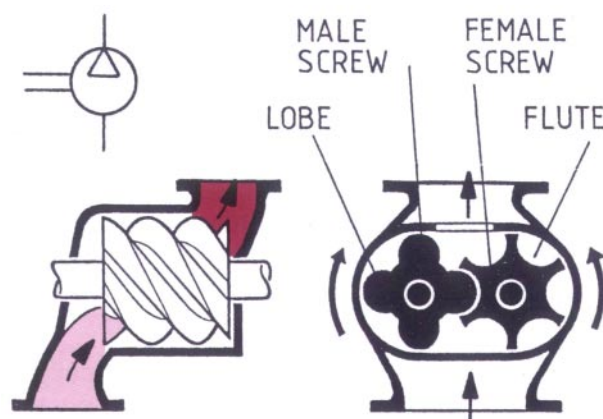

Figure A2.6-1. Screw Compressor

The compressor has two rotors that have helical lobes that closely interlock. The rotors are precisely synchronised by timing gears that maintain the small clearances between the lobes without contact. The circumference of the rotors are sealed by closely fitting intersecting cylinders. The timing gears are sealed from rotors and are oil lubricated, however the rotors themselves are oil free.

Figure A2.6-2 illustrates the function of the compressor. Gas enters through a port at one end of the cylinders, is trapped and compressed until a port at the other end is exposed by the end face of the lobes allowing the gas to be delivered. The timing of the exit port allows time compression to take place giving good efficiency at the end design compression ratio.

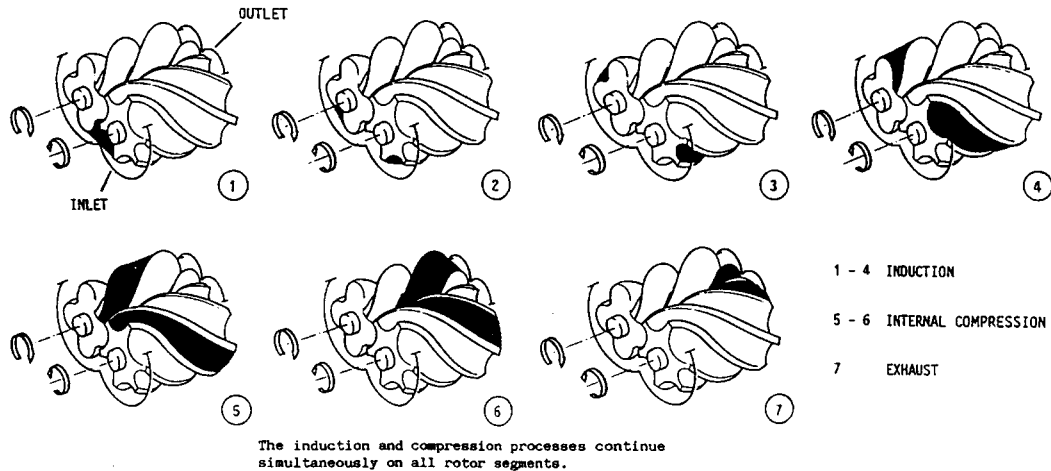

Figure A2.6-2.

Screw Compressor Advantages

- Can start underload
- Mature technology
- Oil-free discharge
- Direct drive or offset drive capability
- No contacting seals to wear

Disadvantages of Screw Compressors

- Cooling of the housing required
- Large and heavy compared with centrifugal compressors

A2.6.2 Optimal CFM Range/Limitations

Screw compressors may be scaled from fractions of lbm/min to hundreds of lbm/min. Their construction limits the differential pressure to of the order of 100 psig. This is because at high differential pressure the rotors are deflected and increased clearances between rotors and casing are required. This compromises efficiency through increased internal leakage. Efficiency also is reduced as flow decreases to the order of 1 lbm/min. This is because clearances do not scale with size and internal leakage again becomes significant.

A2.6.3 Typical Parameters

For a single stage compressor running at sea level with a 4:1 compression ratio the following approximations may be made for weight and volume.

$$\begin{aligned} \text{lbs} &= 3.2 \text{ lbm/min} \\ \text{Ft}^3 &= 0.037 \text{ lbm/min} \end{aligned}$$

A2.7 CENTRIFUGAL COMPRESSORS

A2.7.1 Description

A centrifugal compressor is a “dynamic” machine. That is, the fluid to be compressed is not positively contained but is continually in steady flow through the machine, undergoing changes of pressure primarily by means of dynamic effects. Unlike other types of compressors, when the machine motion is stopped, the fluid will pass to some other state controlled by the surroundings. Figure A2.7-1 depicts centrifugal compressor geometry.

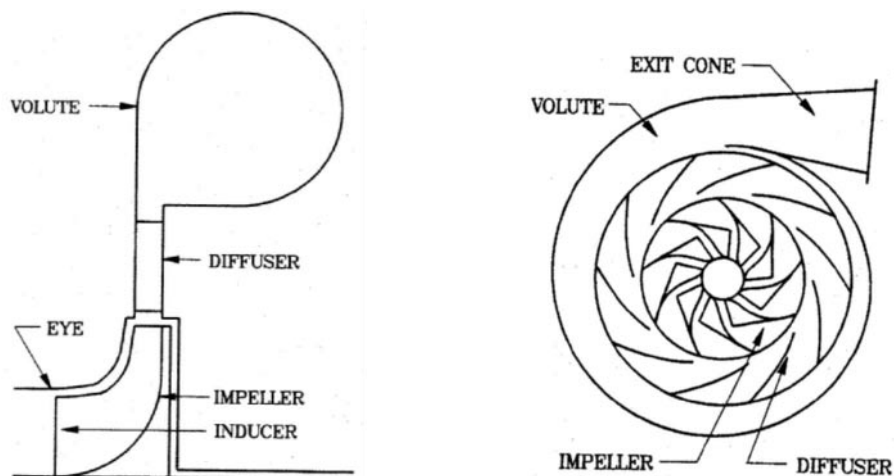

A2.7-1. Centrifugal Compressor Geometry

The energy transfer between the fluid and the rotor is rather simple. Fluid enters the impeller (called an “eye”) and passes through the impeller, guided by blades, and is discharged at the tip. The velocity of the exiting fluid is higher than entering. This change of fluid velocity is dynamic head or dynamic pressure. To provide useful energy, the dynamic head must be converted into static head or static pressure in a fixed casing following the rotor. This conversion is called diffusion, and is simply reducing the high discharge velocity exiting the rotor by increasing flow area and converting the velocity energy into pressure.

Efficiency of a centrifugal compressor is defined as the ratio of useful energy in the fluid at final discharge to the mechanical energy supplied to the rotor. If the mechanical energy supplied to the rotor includes energy absorbed by bearings, lands, couplings, etc., the efficiency is an overall efficiency. Mechanical loss tends to be a higher proportion at low speeds than at high speeds. Typical maximum efficiency of centrifugal compressors of pressure ratio up to 2 is near 82%, and for pressure ratio up to 4 is 78%. For multi-stage industrial type compressors efficiencies of 60 to 70% are typical.

The advantages of centrifugal compressors are simplicity and ruggedness of construction. They provide wide range of operation between surging and choking limits and less severe surging behavior. Centrifugal compressors provide greater possibility of flexibility of performance by use of adjustable pre-whirl and diffuser vanes. If inter-stage cooling is introduced, the tangential discharge of circular cross-section of the radial centrifugal compressor is well suited for heat exchanger connection.

Centrifugal compressors are limited by the stress in the rotor. As rotor speed is increased, the rotor stresses also increase. Similarly, as rotor diameter increases stresses also increase. There is also a limitation on the rotor tip speed remaining subsonic to avoid shock wave losses. Centrifugal compressors operate at speeds up to 100,000 RPM. Centrifugal compressors generally operate in the specific speed range from 40 to 900, which for air implies flows in the range of 200 to 200,000 CFM or 15 to 15,000 PPM. The maximum pressure ratio is approximately 4 to 1. When operating at the low end of a designed

flow range, centrifugal compressors may experience surge, which can lead to unsteady flow conditions and damage to the equipment.

For a two stage compressor running at a pressure ratio of 4 to 1, the following approximations can be used for volume and weight.

$$FT^3 = 0.6 + 0.0035PPM + 0.0004PPM^2$$

$$LBS = 25 + 0.6PPM + 0.01PPM^2$$

These relationships apply for air flows in the range of 5 to 60 PPM. For a single stage compressor running at a pressure ratio of 1.5 to 1 use 40% of the above estimates.

A2.7.2 Typical Parameters vs CFM (weight, eff., etc.)

A2.7.3 Optimal CFM Range/Limitations

A3 HEAT EXCHANGER/FAN SIZING METHODOLOGY

Suppliers of aircraft-quality compact heat exchangers and cooling fans sized the heat exchangers and cooling fans. The heat exchangers and cooling fans for each aircraft were sized to cool air from the compressor to the appropriate ground temperature limits. The ground limit for the PSA and cryogenic distillation systems is 125 degrees Fahrenheit. The membrane has a ground limit of 165 degrees Fahrenheit. The heat exchanger and cooling fan for each aircraft was designed assuming a maximum ambient air heat sink temperature of 111 degrees Fahrenheit. For OBIGGS and hybrid OBIGGS, the heat exchanger and cooling fan sizes were also evaluated at the worst-case in-flight conditions to ensure that all of the temperature requirements were met. An effort was made to minimize the overall size of the system by trading of heat exchanger size with fan flow to determine the best overall system. The final results are based on a system that had favorable weight, volume, power and costs numbers.

Weight, volume, power consumption and cost data were determined for a number of the systems analyzed. The remaining system's heat exchanger and cooling fan sizes were determined by interpolation of this data.

Heat exchanger data includes the core, inlet/outlet headers, and connections to the mating tubing. Data for the cooling fan includes the fan and any ducting between the fan and the heat exchanger. Ducting which interfaces with the aircraft structure or plumbing was accounted for separately.

Appendix E

Airport Facilities Task Team Final Report

This page intentionally left blank.

TABLE OF CONTENTS

INTRODUCTION..... E-1

1.0 FUEL SCRUBBING AT THE TANK FARM..... E-1

 1.1 FUEL SCRUBBING SYSTEM OPERATION AND MAINTENANCE E-4

 1.2 COST OF FUEL SCRUBBING APPLICATION AT O’HARE AIRPORT E-5

2.0 METHODS OF HOLDING “N₂ SCRUBBED” JET FUEL STORED IN THE REFUELING TANKERS E-5

 2.1 GAS SUPPLY E-8

3.0 FUEL COOLING..... E-9

4.0 CO₂ FUEL SATURATION..... E-10

 4.1 SYSTEM DESIGN CONCEPT E-10

 4.2 ENVIRONMENTAL EVALUATION (KNOWN ISSUES) E-10

 4.3 ISSUES..... E-10

 4.3.1 Cavitation..... E-10

 4.3.2 Corrosion E-11

5.0 ULLAGE WASHING E-11

 5.1 ASSUMPTIONS E-13

 5.2 MOBILE ULLAGE WASHING DESCRIPTION E-13

6.0 ENVIRONMENTAL ISSUES FOR FUEL SCRUBBING SYSTEM CONCEPT..... E-15

 6.1. POTENTIAL IMPACT ON FUEL PERFORMANCE FROM ULLAGE WASHING AND FUEL SCRUBBING..... E-16

 6.1.1 Concerns..... E-16

 6.1.2 Preliminary Laboratory Analysis..... E-17

 6.1.3 Future Work..... E-18

7.0 LABORATORY REPORTS E-18

ADDENDUM 1: AIR BP LABORATORY REPORT E-18

 7.1 SUMMARY E-18

 7.2 BACKGROUND..... E-18

 7.3 APPARATUS..... E-19

 7.4 METHOD..... E-19

 7.5 RESULTS AND DISCUSSION..... E-20

 7.6 ADDITIONAL TESTS E-20

 7.7 CONCLUSIONS E-21

ATTACHMENT A E-27

ATTACHMENT B..... E-30

ATTACHMENT C..... E-35

ATTACHMENT D E-36

8.0 ECONOMICS E-37

 8.1 ESTIMATE LEGEND AND LINE ITEM EXPLANATIONS..... E-39

9.0 CONCLUSIONS AND RECOMMENDATIONS..... E-41

 9.1 CONCLUSIONS E-41

 9.2 RECOMMENDATIONS E-42

LIST OF FIGURES

1-1.	Current Tank Farm Configuration	E-2
1-2.	Illustration of Fuel Farm Piping with Added Fuel Scrubbing Unit	E-3
1-3.	Complete Aspect of Fuel Scrubbing Operation	E-4
5-1.	Membrane Gas Generator at Concourse for Ullage Washing	E-11
5-2.	Typical Metering Station NEA Flow and Pressure Control	E-12
7-1.	E-19
7-1.	Vapor Analysis, Nitrogen Sparge 21°C	E-23
7-2.	Vapor Analysis Carbon Dioxide Sparge 21°C	E-23
7-3.	Jet Fuel Inspection Data, Nitrogen Sparge 21°C	E-24
7-4.	Jet Fuel Inspection Data, Carbon Dioxide Sparge 21°C	E-25
A2.	Experimental Apparatus	E-29
A3.	Detail of Sparging in Closed Flask	E-29
B2.	Closed Flask With Sparger	E-34
B3.	Open Cylinder With Sparger	E-34
8-1.	ARAC Facility Estimate—Mobile Ullage System	E-37
8-2.	ARAC Facility Estimate—Fixed Ullage System (Sheet 1 of 2).....	E-37
8-2.	ARAC Facility Estimate—Fixed Ullage System (Sheet 2 of 2).....	E-38
8-3.	ARAC Facility Estimate—Fixed Scrubber System.....	E-38
8-4.	ARAC Facility Estimate—Mobile Scrubber System (Sheet 1 of 2).....	E-38
8-4.	ARAC Facility Estimate—Mobile Scrubber System (Sheet 2 of 2).....	E-39

INTRODUCTION

The Federal Register of July 14, 2000 (Vol. 65, No. 136, pgs. 43800-43802) announced the formation of a new Aviation Rulemaking Advisory Committee (ARAC) with a "Tasking Statement" covering the formation of an Aircraft Fuel Tank Inerting Harmonization Working Group.

The tasking statement requested that the ARAC provide, among other tasks, methods of introducing nitrogen gas into the affected airplane fuel tanks to displace the oxygen in the ullage space and to saturate the fuel with nitrogen in ground storage facilities, e.g., in the trucks or central storage tanks (Ref. Section 2.c of the Tasking Statement). The process of saturating the fuel with nitrogen will be referred to as "fuel scrubbing" herein.

Concepts and design methodology for systems that accomplish the above referenced tasks have been developed. The concepts detailed in this Appendix E will describe the systems for: scrubbing the jet fuel of intrained O₂ while the fuel is in bulk storage tanks at the airport fuel storage facility; they will describe the mobile vehicle fleet that will be necessary to transport the fuel to the wing of the aircraft at airports where hydrant systems are not installed or where airplanes are parked in non-hydrant supplied remote locations; they will describe the production facilities necessary to generate NEA locally and the distribution system necessary to deliver NEA to the wing of the aircraft for Ullage Washing; they will briefly describe a patented system proposed to cool the fuel in order to provide an alternative to scrubbing and washing and; they will describe a patented system proposed to scrub the fuel with an alternate inert gas-CO₂.

This Appendix will also discuss issues associated with environmental concerns as it relates to fuel scrubbing and ullage washing as well as the effect of these processes on the performance properties of today's jet fuels.

Scoping Statement

- The Airport Facilities Task Team will investigate and develop design concepts covering the following areas associated with airplane fuel tank inerting:
- The installation, operation and maintenance requirements for an on-field inert gas generation, bulk fuel scrubbing with NEA and airplane fuel tank ullage washing system.
- System configurations to provide fuel scrubbing and ullage washing for various size airports and fuel handling (hydrant or mobile) processes.
- The physical impact on airport facility utility infrastructure resulting from the incorporation of an on-field NEA inerting system.
- The technical impediments, if any, associated with a suitable system design if the objective appears to be impractical or cost prohibitive.
- The economic impact associated with a viable method of delivering gaseous NEA and NEA saturated fuel into the wing of the airplane.

1.0 FUEL SCRUBBING AT THE TANK FARM

In order to prevent the O₂ inherently dissolved in the liquid fuel from coming out of solution and polluting the previously washed fuel tank ullage as the aircraft climbs, it may be required to scrub the fuel of O₂ before loading on the plane. The logical place to do this job is at the fuel farm where the fuel is inventoried and allowed to settle before being pumped into the hydrant system. However, because of the ability of Jet A-1 fuel to preferentially absorb O₂ from air, the entire purpose of the processing technology at the fuel farm needs to be removal of O₂ dissolved in the liquid fuel, preventing it from re-entering the fuel after treatment and dealing with environmental issues, such as VOC emissions, present at the tank

farm. Due to the more aggressive gas/fuel contacting that would occur if the fuel scrubbing technology were implemented, it is anticipated that VOC emissions would be higher than current levels, causing the need for the VOC abatement equipment. In addition to the processing technology at the farm, there is also a certain amount of LN₂ storage to back up the gas generation equipment to enhance reliability, as done at the concourse for ullage washing.

This fuel farm processing system is comprised of specialized gas generating and application equipment. The HIGH-PURITY GAS GENERATOR SKID (99.999% inerts) is used to strip the fuel of dissolved O₂ and to blanket the fuel storage tanks at the farm with N₂ to prevent re-entry of O₂ from air. The FUEL SCRUBBING UNIT, which is a gas/liquid fuel contacting system, uses the pure product gas from the HIGH PURITY GAS GENERATOR SKID to replace the O₂ in the fuel with N₂. TANK BLANKETING MANAGEMENT SYSTEMS control the pressure and O₂ concentration in the headspace above the fuel in the individual large storage tanks at the farm. Finally, emissions of fuel vapors from the fuel storage tanks, and vent gas from the FUEL SCRUBBING UNIT, will be controlled using an ENVIRONMENTAL ABATEMENT SYSTEM that employs liquid N₂ to cryo-condense the VOC vapors from the vent stream and return it to the fuel tanks. Essentially, all of these technologies work as separate unit operations at the fuel farm to ensure the delivery of fuel to the concourse that is scrubbed of oxygen.

To more easily understand the implementation of these various technologies to achieve fuel scrubbing, it is useful to consider the existing fuel tank farm at a typical airport. The simplest configuration is illustrated with three tanks in Figure 1-1 below. Liquid fuel from the pipeline continuously fills the tanks as the hydrant system is being supplied from them on a variable basis. The maximum flowrates for an airport the size of O'Hare can be filled and withdrawal rates in excess of 4,000 and 18,000 GPM, respectively. The cycle typically sees a piston of liquid fuel filling one tank as a similar flowrate of VOC laden air exits the vent to maintain constant pressure. Elsewhere, another tank is being drawn down, aspirating ambient air into the headspace to break any vacuum that is formed by the retreating liquid. The third tank rests for about 24 hours to settle out any liquid water that may be present in the system.

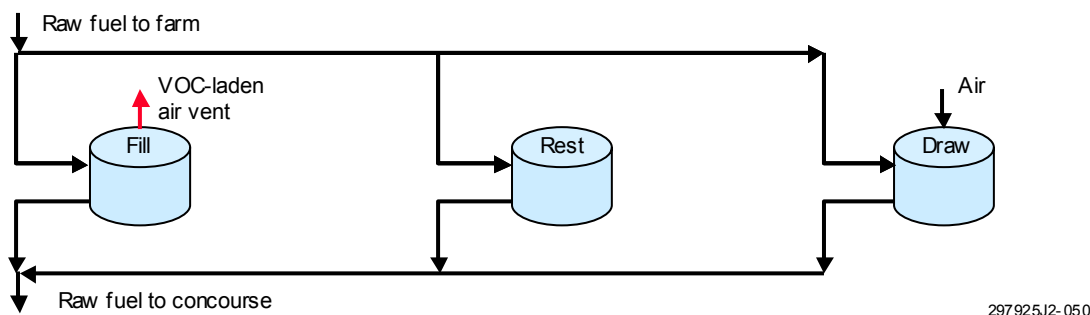
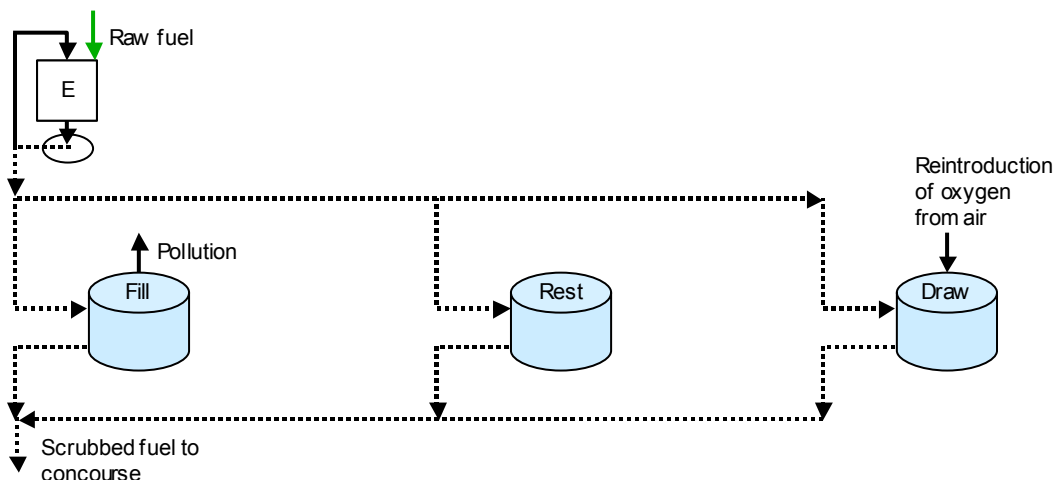

Figure 1-1. Current Tank Farm Configuration

The concept of fuel scrubbing is easily illustrated with some relatively minor additions to the current piping configuration at a fuel farm. This is shown in Figure 1-2 below, entitled Illustration of Fuel Farm Piping with Added Fuel Scrubbing Unit. With this new approach, raw fuel, containing 50 to 100 PPM of dissolved O₂, enters the FUEL SCRUBBING UNIT and is stripped of the O₂ via intimate contact with a stream of high purity N₂ gas. The N₂ replaces the O₂ dissolved in the liquid and dilutes the O₂ gas given off by the fuel. Approximately 2 volumes of N₂ gas are required for each volume of fuel processed. The end result is a fuel that is scrubbed of oxygen down to about 5 PPM. It has been estimated that the off-gas that exits the FUEL SCRUBBING UNIT unit contains about 1.5% O₂, as well as about 0.5% VOC vapors.



297925J2-051

Figure 1-2. Illustration of Fuel Farm Piping with Added Fuel Scrubbing Unit

However, two issues still remain with this level of solution. The off gas that is displaced from the fuel tank being filled and the gas that is vented from the FUEL SCRUBBING UNIT, both of which contain some O₂ gas and fuel vapors, will pollute the air if not treated. In addition, O₂ in the air that would be aspirated into the fuel tank being drawn down, will ruin the fuel treatment job previously done by the FUEL SCRUBBING UNIT. Additional technology needs to be added to what is shown in Figure 1-2 to avoid these problems in order to meet all of the previously mentioned objectives for fuel scrubbing.

In the complete fuel scrubbing concept, as shown in Figure 1-3, the ENVIRONMENTAL ABATEMENT SYSTEM and TANK BLANKETING MANAGEMENT SYSTEM units have been integrated into the fuel farm to control pollution from VOC emissions and protect the re-oxygenation of the scrubbed fuel in the tanks.

The TANK BLANKETING MANAGEMENT SYSTEMS, mounted one per tank, automate the N₂ blanketing of the tank headspace by measuring and controlling the pressure and O₂ content of the gas above the fuel. The inlet valve is opened to introduce high-purity N₂ from the HIGH PURITY GAS GENERATOR SKID (not shown) to drive up the pressure and/or decrease the gaseous O₂ content. Similarly, if the pressure is too high, the vent valve is opened to exhaust some headspace gas into the low pressure gas header. Thus the tanks are continuously maintained at a given pressure and O₂ level, such as 8-inches W.C. and 1% O₂, respectively.

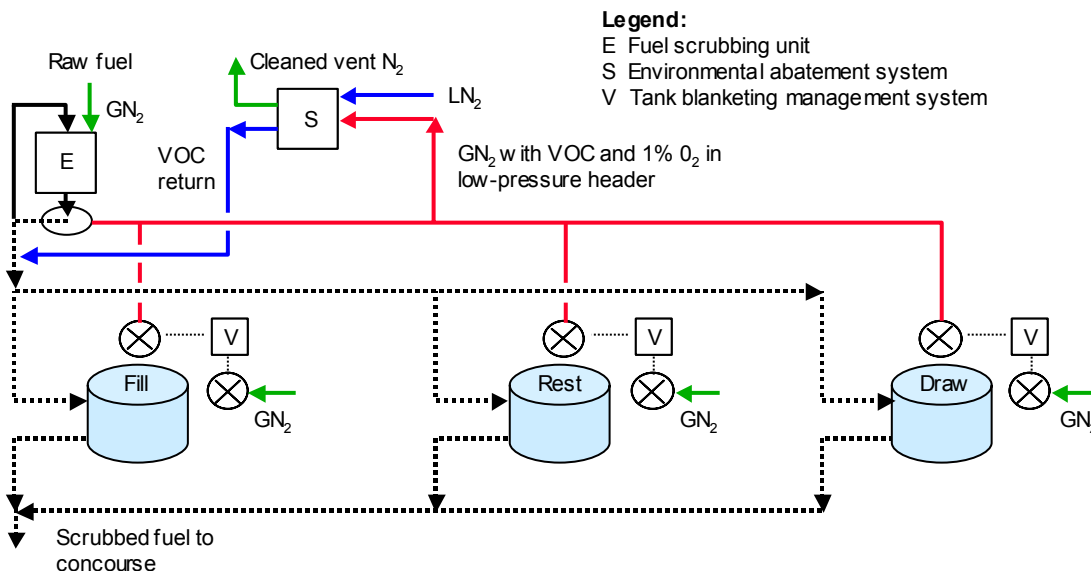

297925J2-052

Figure 1-3. Complete Aspect of Fuel Scrubbing Operation

A low-pressure header connects all of the vent valves on the fuel tanks and the gas vent from the FUEL SCRUBBING UNIT with the inlet of the ENVIRONMENTAL ABATEMENT SYSTEM. The fan on the ENVIRONMENTAL ABATEMENT SYSTEM will be used to control the back pressure within this low-pressure header. A target of about 5-inches W.C. has been selected for this header pressure which should be sufficiently low to easily exhaust gas from the fuel tanks and FUEL SCRUBBING UNIT.

The process gas flowing through the ENVIRONMENTAL ABATEMENT SYSTEM then contacts stages of increasingly cold heat exchangers to remove nearly 100% of the VOC's by condensation driven by LN₂. The liquid fuel is then sent back into the scrubbed fuel line that flows to the storage tank being filled. This is done so as not to deplete any compounds out of the normal JET A-1 mixture. The process gas, which has been stripped of fuel vapors, it then vented to the air, or possibly compressed and sent to the concourse for ullage washing, if a suitable pipeline is available. The spent N₂ gas, which was vaporized to cool the ENVIRONMENTAL ABATEMENT SYSTEM, is pure and will be sent to the high-purity N₂ header being fed by the HIGH PURITY GAS GENERATOR SKID.

1.1 FUEL SCRUBBING SYSTEM OPERATION AND MAINTENANCE

Maintenance requirements at an airport equipped with fuel scrubbing technology at the fuel farm would be moderate. The equipment is a bit more orientated towards chemical operations compared to the system for ullage washing. The endeavor would need a higher level of supervision with probably one employee overseeing the operation on a 24/7 basis. However, due to the reasonably passive nature of the heat transfer and gas generation systems, the maintenance & operating support for the farm would not be excessive. In most Air Liquide customer installations, equipment skids of the type used for fuel scrubbing typically run unattended.

Like the membrane skids, the HIGH PURITY GAS GENERATOR SKID would require the support typical for a large compressed air/filtration system. Oil and filter changes and bearing life issues on the compressors, filter drainage and carbon tower replacement for filtration and instrument calibration would require periodic attention. In addition, the LN₂ storage tank to supply the HIGH PURITY GAS GENERATOR SKID & ENVIRONMENTAL ABATEMENT SYSTEM would need refilling. The FUEL SCRUBBING UNIT is a passive gas/liquid contacting unit that would need little support except instrument cleaning & calibration. TANK BLANKETING MANAGEMENT SYSTEMS would need a semi-annual change of the oxygen cell, as well as typical instrument calibration. The

Airport Facilities Task Team Final Report

ENVIRONMENTAL ABATEMENT SYSTEM unit would require some mechanical support for the fan (lubrication, bearings, etc.), solenoid coil replacement, instrument calibration and liquid VOC pump service. It is anticipated that operation & maintenance duties would be handled by chemical technicians or engineers with a reasonably high skill level.

1.2 COST OF FUEL SCRUBBING APPLICATION AT O'HARE AIRPORT

The cost to implement fuel scrubbing for the eight fuel tanks currently at O'Hare Airport has been estimated in a preceding section. The estimate includes the installed capital cost for the HIGH PURITY GAS GENERATOR SKID, FUEL SCRUBBING UNIT, ENVIRONMENTAL ABATEMENT SYSTEM and TANK BLANKETING MANAGEMENT SYSTEMS, along with interconnecting piping, foundations and electrical service upgrades. As with ullage washing, it is intended that Air Liquide would install and service the major equipment while the airport would be responsible for the piping and electrical to battery limits. Note that the cost of the HIGH PURITY GAS GENERATOR SKID and additional LN2 storage will be on a gas charge or leased basis.

A description of the components in the N₂ based fuel scrubbing design is as follows:

- QTY(3) HIGH PURITY GAS GENERATOR SKID; 46,000 SCFH at 100 PSI & 99.99% N₂ w/13,000 Gal LN₂ Tank, Vaporizer and Buffer Tank(includes foundation & lights)
- QTY(2) 13,000 Gal LN₂ Tanks for additional capacity
- QTY(1) 2000' of 150 PSI N₂ piping, 6-inch, SCH 40 steel to FUEL SCRUBBING UNIT & Fuel Tanks.
- QTY(1) FUEL SCRUBBING UNIT to treat 4550 GPM of JET A-1; 1000 Gal Liquid/Gas Separator, PID control.
- QTY(2) Low Pressure Regulator for FUEL SCRUBBING UNIT off gas return to L.P. gas header; 1200 SCFM; 100 PSI in/1 PSI out.
- QTY(1) 2000' of 12" piping for Low Pressure Gas Header from FUEL SCRUBBING UNIT to Fuel Tanks; Sch 40, steel.
- QTY(8) TANK BLANKETING MANAGEMENT SYSTEMS for fuel tank; pressure & O₂ control; incl. H.P. N₂ B-fly valve.
- QTY(1) ENVIRONMENTAL ABATEMENT SYSTEM for recovery of VOC; 2400 SCFM Flow with 1% VOC; Incl. 2 parallel trains of multi-stage condensers; 98% VOC recovery.
- QTY(1) 200' of 2" super-insulated piping with 6" of Calcium Silicate jacket for LN₂ to ENVIRONMENTAL ABATEMENT SYSTEM.
- QTY(1) TeleFLO Telemonitoring Package; 100 I/O w/RS-285 network & custom screen.
- QTY(1) Electrical service connection for Concourse, 2600Amps at 480 VAC, 3P

2.0 METHODS OF HOLDING "N₂ SCRUBBED" JET FUEL STORED IN THE REFUELING TANKERS

System Concept

Propose design/modification changes to "in-service" and newly manufactured aircraft refueling (tanker type) vehicles which will enable "scrubbed fuel" to be transported from airport storage to the wing of the aircraft.

Design Description

- During fueling, tanker inward venting is required to prevent collapse of the refueler tank

- Predominantly less than “tank full” delivery requires nitrogen to be supplied to the refueling tanker vents to prevent fuel contamination
- Tankers also utilize small “in-breathing” vents that thread into the manhole cover assemblies
- These vents automatically protect the tank from collapse during volumetric contraction of the stored fuel during decreases in ambient temperature
- Current design of typical vapor recovery system equipment does not provide for integration of these vents within the vapor recovery system
- All vents will need to be inter-connected within a system that will be feed by a N₂ supply. To accomplish this, modification of the tanker will be required
- Relocation of the in-breathing vents may require welding modification to the tank vessel. If so, these modifications would need to be completed at a facility certified to make such repairs
- After modification, tankers will mirror function of a “typical” vapor recovery system found on vehicle transporting flammable liquids on public highways
- These vehicles are required by the Code of Federal Regulations (40 CFR, Part 60) to be tested at the time of initial installation and then periodically thereafter to ensure vapor tightness
- It would seem advisable to require this testing/re-certification be mandated within the ruling

System Design Description

- Modifications include, relocation of in-breathing vent to a point that vapor recovery vent hoods and associated piping can connect all tank vents to common nitrogen supply
- psig N₂ pressure stream will be supplied to the vapor recovery system at all times
- The N₂ supply can be from stored gaseous or liquid nitrogen vessels mounted on each tanker vehicle
- Handling LN₂ will present a host of additional training and conversion issues, so gaseous nitrogen is presented for review in this report
- Our example is based upon the quantity of gaseous nitrogen required to fully displace the product dispensed from a 10,000 gallon capacity refueling tanker (approx. 1400 cu. ft.)
- If commercially available 300 cu. ft. high pressure gas cylinders were used, five tanks would be required mounted to the vehicle to accomplish one full fuel tank delivery
- Liquid nitrogen could be used, carried in a much small vessel (dewar) as it gases at a rate of 93 SCF per gallon. However vaporizers required to convert the liquid to gas with out freeze-up presents a spaces available problem on most existing units
- Given the volume of nitrogen required to hold tankers inert, it would appear a land-based connection to the tanker at the gate, using the same stream available for ullage washing the aircraft, is optimal
- 1 psig out-breathing vents will be installed in the nitrogen supply piping to vent excess pressure to atmosphere protecting the tanker against thermal expansion
- A pressure sensor in the nitrogen piping system will also be required. This sensor will shut-down the pumping operation to prevent collapse of the tank if a negative pressure (vacuum of 26 mbars) is sensed within the nitrogen supply system
- This safety system would be interconnected with the vehicle pumping system to close the tank internal valve, disengage the pump, or stop the engine based upon the original system design

Airport Facilities Task Team Final Report

- To provide a constant 1 psig nitrogen pressure to hold scrubbed fuel inert overnight or short-term storage will require much less nitrogen
- Again, for the purpose of this report, the 10,000 tanker referenced above will see a maximum volumetric shrinkage of approximately 200 gallons, based upon a 40°F change in ambient temperature
- 200 gallon reduction in fuel quantity x .1337 (conversion factor to CF) = 27 SCF of gaseous nitrogen required to prevent negative tank pressure in this extreme case
- Standard 300 cu. ft. high-pressure (2000 psig) nitrogen cylinder/s could hold a 10,000 gallon capacity refueler inert for a period of approximately ten days or longer

Impact on Current Airports

- To maintain a nitrogen blanket on top of scrubbed jet fuel, a land-based source of nitrogen will need to be provided to supply the tanker make-up venting during fuel delivery
- Proper sizing of the nitrogen supply system to be used for aircraft fuel tank ullage washing can provide a collateral benefit in this area
- When servicing remotely parked or operated aircraft where a land-based supply is not available, a mobile nitrogen dispensing vehicle will be required
- At a minimum, this will add to already congested ramp areas and will require additional personnel
- Typical infrastructure impact associated with additional personnel working within the existing facilities will apply

Safety Assessment

- Possible benefits associated with use of liquid nitrogen are outweighed by training issues associated with handling cryogenic liquids
- Addition of a mobile nitrogen supply vehicle in some locations (and as a back-up for land-based nitrogen delivery systems) will create additional congestion hazards
- Inerting tankers with nitrogen will pose additional risks associated with confined space entry of all tanks for inspection and cleaning
- All confined space (tank) entry procedures will need to be reviewed and amended to identify that the space is totally void of oxygen and cannot sustain life for any period of time

Environmental Evaluation (Identified)

- Modification of tanks to include vapor recovery type equipment along with blanket of nitrogen to prevent re-oxygenation of fuel may reduce VOC emissions at the airport
- This benefit will come if corresponding vapor recovery piping is present at the fuel farm to receive these vapors during re-loading of the tanker

Economic Evaluation

- Tanker modifications required will in most cases cause the vehicle to be taken to a certified tank welding/repair facility
- Estimated cost of modifications will range between approximately \$3,800 for 3,000/5,000 gallon capacity refuelers to \$6,800 per unit for larger capacity refuelers up to 17,500 gallons, excluding transportation
- Yearly pressure/vacuum testing (CFR 40, Part 60) will add re-occurring costs of approximate \$600 per tanker for inspection.

- Other costs associated with manpower requirements are covered separately in other sections of the report

2.1 GAS SUPPLY

The airport facility team looked at the supply of three potential gases as possible candidates for fuel tank inerting – NEA (gaseous and liquid), CO₂, and Argon. Gaseous NEA was found to be the best candidate for use.

Gaseous N₂

Gaseous N₂ can be generated on site using ASMs. Systems can be sized for various types of operations, only requirement is electrical power. Redundancy can be obtained by use of liquid N₂ or additional compressors. Issues:

- Large Power requirements
- Need adequate real estate for installation.
- Systems will require high pressure for distribution. Aircraft fuel tanks have very low pressure restrictions. Accurate and reliable pressure control will be critical.

Liquid N₂

Liquid N₂ is primarily being considered for a backup to the fixed gaseous systems. It may have applications for mobile ullage washing for large transports. Issues:

- Cannot be produced on site.
- Cryogenic liquid will require special handling.

CO₂

There was concern about the ability of the gas industry to meet the estimated 1300 ton/day increase in demand that inerting and fuel scrubbing would create CO₂. The team contacted Barbara Heydorn, author of the SRI Chemical Economics Handbook on CO₂, to get a forecast on the impact this much increase in CO₂ demand for commercial aviation use would have. Barbara gave us the following comments:

- Given enough lead time, say 2-3 years, Industrial Gas companies would obtain capacity to meet the extra demand, BUT the market would be different than it is today. The new capacity would come from lower purity feedstreams or from sources that are farther away from demand centers. Lower purity feed streams mean higher costs to purify and therefore higher FOB prices. Sources further from demand centers mean higher distribution costs therefore higher prices.
- Volatility in supply and pricing could be a problem for commercial aviation use. CO₂ is usually a byproduct of a chemical process. Many of those processes are susceptible to natural gas prices. For example, with the current high price for natural gas, many ammonia producers are not operating. All the CO₂ that was usually available from ammonia producers dried up.
- Three areas that do not currently have enough supply appear to be where commercial aviation demand could be the highest -- the Northeast US (La Guardia, Newark, JFK, Boston), Florida (Miami, Orlando, Tampa) and Southern California (Los Angeles). In the past 5 years there have been many allocations and interruptions in supply to those areas.

Airport Facilities Task Team Final Report

Argon

Argon was suggested as an alternative to NEA. The theory was that due to argon's higher molecular weight, it would perform better in cross-vented tanks. The team was unable to find any evidence to support this. Since argon is not as readily available as NEA and the cost was estimated to be ten times as much as NEA, argon was not pursued further.

3.0 FUEL COOLING

This concept was insufficiently developed to allow the AFT to fully evaluate it and develop the economics of the proposed concept. Also, since this is basically a form of fuel scrubbing, a means to inert the CWT would be required.

System Description

The fuel-cooling concept consists of both refrigerating fuel and/or washing the airplane fuel tank ullages with inert gas. The two separate processes may be used separately or combined. The cooling systems supply fuel to the airplane at less than 40 degrees F. Cooling facilities (located away from congestion) cool the entire airport fuel supply (hydrant and/or truck) to less than 40 degrees F. Inerting gas for ullage washing is stored (located away from congestion) and transported to the airplane on gas service vehicles in a cryogenic phase and converted to a gaseous phase as needed for ullage washing.

Impact on the Airport

Fuel cooling installations are designed to result in a minimal addition to airport gate congestion as all fixed cooling facilities are installed at or in the vicinity the fuel farm which is away from the gate areas. As the entire airport fuel supply will be cooled to a lesser temperature, to meet the massive peak flow demands caused by banks of airplane arrivals, thermal energy will be manufactured and stored in thermal banks or ice tanks. The stored cold energy will be applied to the fuel supply en masse. Large airport facilities will be of substantial size and require full time staffing. In locations where space at the fuel farm is limited, cooling systems can be located off the airport and cold energy brought to the fuel farm hydrant via pipeline. Hydrant modification involves installation of in-line heat exchangers at or near the fuel farm. Power demand will be substantial and likely exceed available power supplies at or near the fuel farm.

Pros and Cons

1. Small & Medium Airport

Small and medium size airports can obtain self-contained, semi-permanent, packaged cooling and gassing units avoiding the complexities of nitrogen manufacturing equipment.

2. Empty tanks

Under these circumstances, ullage washing with an inert gas is relied upon until flight conditions naturally make the tank non-flammable.

3. More than just the CWT

The cooled fuel concept and inerting gas injection extends the flammability reductions into all tanks, not only the CWT.

Environmental Impact

1. Airplane vented VOC emissions and their contribution to air pollution must be studied further.

2. Static charging of the fuel and its effect must be studied further.

3. The effect of precipitating water from solution during cooling and its effect upon filtration equipment must be studied further. The effect of precipitating water from solution during cooling and its effect upon airplane flight performance must be studied further.

4.0 CO₂ FUEL SATURATION

This concept was insufficiently developed to allow the AFT to fully evaluate it and develop the economics of proposed concept. Before a full evaluation can be done more study will be required. Areas that will need more work are details of the actual components that would be required by the ground portion of the system, modifications required by the fueling vehicles to maintain the CO₂ in solution, the aircraft modifications that would be necessary, and a further study of the availability of CO₂.

Issues have also been raised regarding the possible impacts on pump cavitation and possible corrosion due to the possible formation of carbonic acid in the presence of water. These would have to be resolved before this can be pursued further. Also since this is basically a form of fuel scrubbing, a means of inerting the empty CWT would be required.

4.1 SYSTEM DESIGN CONCEPT

The system consists of a CO₂ (commercially available gas) and jet fuel mixing apparatus, which preloads the jet fuel with CO₂. In one variation of the Airport Facility System, the CO₂ is derived from a liquefied CO₂ storage tank, converted to CO₂ gas and mixed in the Jet-A in a gas absorber tower (at an optimum gas-to-fuel ratio). Thereafter the CO₂-enriched fuel is stored in a fuel shipping tank having a floating pan (the combination tank and pan maintain the desired gas-to-fuel ratio of the treated fuel). The CO₂-enriched fuel is then transferred as needed from the shipping tank to all aircraft re-fueling sites using the existing fuel pipeline and hydrant systems (for hub airports) or the existing truck delivery system (at non-hub airports).

4.2 ENVIRONMENTAL EVALUATION (KNOWN ISSUES)

As an environmental benefit there may be reductions in engine exhaust soot particulate due to the mixing of >0.1 volumes of CO₂ in kerosene-based fuels. For example in EPA Test Data soot reductions in the range of 20-25% are seen with concentrations of 20-45% CO₂ in Diesel #2 (a close cousin to jet fuel). Soot reductions up to 60% were recorded in a variety of other calibrated emissions tests performed on Diesel fuel at different independent test facilities. It is not known if similar effects would be obtained in aircraft operations. Depending on the method that would be required to scrub the fuel with CO₂, an increase in VOC emissions similar to those found with NEA scrubbing could be possible.

4.3 ISSUES

Two of the major issues that have been identified are covered below. The solutions offered are those of the system developer and have not be evaluated by the AFT for effectiveness or cost. More research would be needed.

4.3.1 Cavitation

Absorbed air concentrations in Jet Fuel are known to reach gas-to-fuel ratios as high as 15% in Jet Fuel, which to date have not produced fuel pump cavitation problems. Nonetheless, the literature indicates that the presence of bubbles facilitates cavitation (NOTE: CO₂-enriched fuel is comprised of CO₂ *micro-bubbles*). Although the concentrations of CO₂ in the proposed CO₂-enriched fuel might be expected to exceed 15%, experimentation with boost pumps is needed to determine 1.) if cavitation will in fact, be an issue, and if so, 2.) what is the lowest gas concentration of *micro-bubbles* that causes cavitation?

There are two basic solutions to reducing inert gas in fuel before the gas-enriched fuel reaches a boost pump: 1) the use of a centrifugal pump prior to the boost pump to separate gas from the fuel, 2) the use of high-area contactors that have a medium not wet by the fuel but that does attract gas bubbles (this system can be made with no moving parts and with no power source). Both approaches are being examined by the developer of the system.

4.3.2 Corrosion

There was concern about corrosion on aluminum surfaces in fuel tanks. Corrosion is caused by the presence of carbonic acid. Carbonic acid is formed when enough CO₂ contacts free water. When very high concentrations of CO₂ were tested in fuel, a very small amount of fuel was converted to organic acids, but there was no detectable change in the energy content of the fuel. The carbonic acid Aircraft fuel tanks are equipped with and regularly employ water-scavenging means. Hydrant and Refueler truck fuel systems also remove water from fuel before it is pumped aboard an aircraft. Other water drying approaches may also be a possibility.

5.0 ULLAGE WASHING

Washing the ullage of O₂ gas in an airplane fuel tank has been proposed in order to eliminate, or greatly reduce, the ability of an ignition source in the tank from causing constant-volume combustion of the fuel vapors present. Simply stated, fuel vapors cannot burn unless a sufficient amount of oxygen is available to support and propagate the combustion. The ullage in the airplane fuel tank is washed with a lower NEA, 97% to 98% purity, to remove a large portion of the O₂ gas from the air that is initially present in the ullage. The 97 to 98% NEA stream is produced using a membrane gas generator skid.

The 97 to 98% NEA purity was chosen to be the most cost effective inerting agent, as it is less expensive than higher purity gas but contains half the O₂ content of a 95% inert product. The volume of gas for the inerting duty has been chosen by the Ground Based Design Team to be 1.7 times the volume of the airplane tank to be washed, based on an empty tank. Under these conditions of inerting agent purity and volume, tests have shown those O₂ levels of less than 9% will be produced within the ullage space of an empty fuel tank. Therefore, no O₂ meter for gas analysis will be needed to verify ullage washing, which helps to minimize complexity. More importantly, with tanks that are even partially full of fuel, the O₂ content is expected to be reduced to even lower than the 9% level, due to the larger number of actual volumes of NEA flowing through the system.

NEA is generated continuously, from air, using membrane gas separation technology. Essentially, air is compressed, filtered of solid particles and liquid aerosols and fed to bundles of hollow fiber polymeric membranes where the CO₂, O₂ and water vapor is removed from the N₂ stream. These gaseous impurities are vented at low pressure while the high-pressure enriched N₂ product, at 97 to 98% purity, exits the skid, via a surge tank. Backed up with a storage vessel of liquid N₂ (LN₂) and a vaporizer a continuous seamlessly transfer of NEA through the gas supply lines will be assured. It is envisioned that one large membrane gas generator skid and back up LN₂ tank would be supplied per airport concourse, mainly to minimize the need for long piping runs between terminals. The NEA would then flow through a header, which would be located along the roof of each concourse, at a pressure of about 150 PSIG. The header is anticipated to be constructed of 2-inch diameter, Type K copper tubing. This header would feed an array of metering stations, located one per gate, to supply gas to the airplanes for ullage washing under controlled flow and pressure conditions. A diagram of the membrane gas generator skid at a given concourse is shown below in figure 5-1.

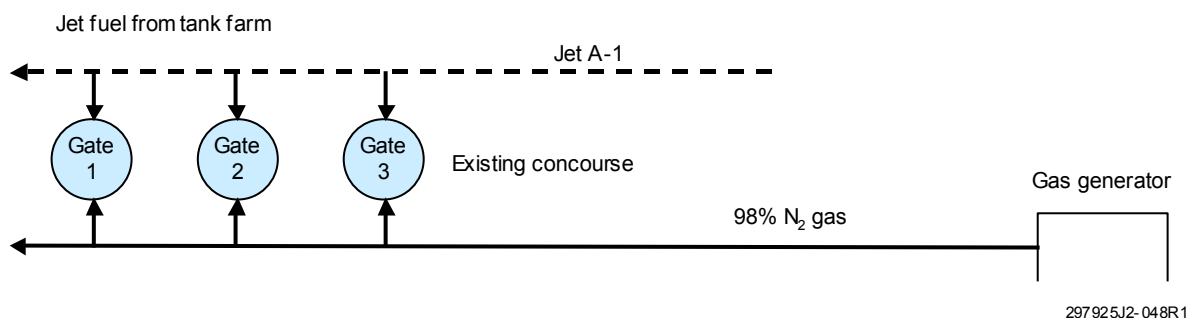
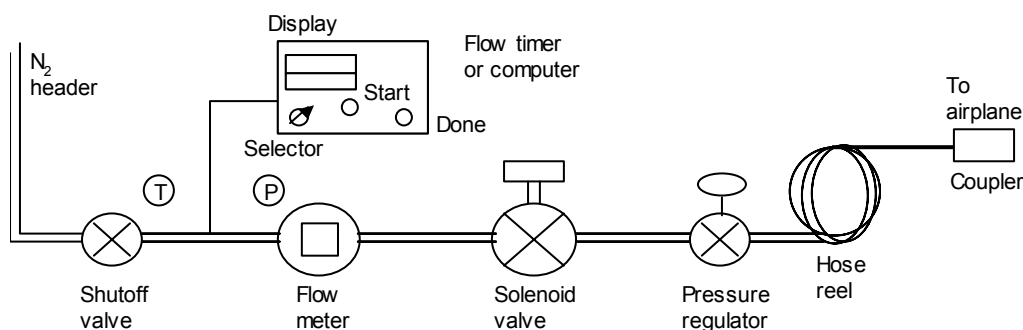

Figure 5-1. Membrane Gas Generator at Concourse for Ullage Washing

At multiple concourse airports it would be prudent to consider the inter-connection of membrane skids between terminals, with a larger manifold. While the capital cost to achieve this would not be insignificant, the benefit would be an additional level of redundancy, without LN₂ backup if one skid were down for extended maintenance.

The metering stations, for injecting NEA gas under flow & pressure controlled conditions at each terminal gate, are shown pictorially in Figure 5-2. The station is connected to the concourse NEA header on one end, and to a specially designed connector on the airplane at the other end. The function of this system is to reduce the O₂ content in the ullage space on the airplane by supplying a given amount of low pressure NEA to the ullage from a high-pressure source. A solenoid valve and a pressure regulator are used to initiate and complete a period of constant gas flow rate to the airplane. By maintaining this constant flow for a time appropriate for a given airplane, NEA is then injected into the ullage. The gas is made available by the regulator at a pressure of only a few pounds per square inch gauge (PSIG). In case of maintenance needs, the shut off valve would be used to block off the station. The hose reel allows for connection from the station typically located at the end of the jet-bridge, to the airplane.



297925J2-049

Figure 5-2. Typical Metering Station NEA Flow and Pressure Control

The heart of the gas metering station is the flow meter, flow control terminal and flow valve. The flow control terminal comprises a lockable weather- proof housing that contains a flow computer and delivery receipt printer. The gas metering station would be designed to operate in an unheated, outdoor service environment (temperature, moisture and vibration) under applicable electrical safety classifications. As previously described, the flow meter and flow computer delivers a pre-set quantity of NEA to the aircraft's tank ullage. The delivery of this gas to the ullage is measured with reference to standard conditions (i.e. 60°F and 1 atmosphere). Hence, the required pre-set amount of gas is delivered regardless of the ambient temperature or source gas pressure.

The flow computer is essentially a device to allow gas to flow to the airplane ullage for a given amount of time, and then to display the actual volume of gas injected. The flow computer would include a selector to choose the type of airplane being inerted, a start button to control the solenoid valve, an indicator light to show when the job is done and a dual display to illustrate required and injected gas volumes. In addition, the unit could be configured so that the operator is required to perform a security check (e.g., input an authorization code) to initially access the system. Stored within the flow computer would be the appropriate inerting times which will, at a given constant gas flow rate, produce an inert ullage space above the fuel (or in the event of an empty tank – complete tank contents) in the airplane tank.

As an example, if an operator is required to inert a 737, he would connect the coupler to the plane, select the appropriate volume on the selector and verify the correct pressure value on the flow control display. The upper display on the flow computer would show the volume required for ullage washing of a 737 aircraft, say 1360 SCF. The operator would then depress the Start button. A NEA flow of 100 SCFM would occur for 13.6 minutes to produce the recommended volume of NEA for the 737 in this example. Then the indicator light would illuminate (indicating the task is done) and the solenoid valve shut. The

Airport Facilities Task Team Final Report

lower display would read 1360 SCF based upon a total of the cumulative gas flow through the metering system, at standard conditions. If the value were low, an option would exist for the operator to adjust for more NEA into the ullage to satisfy the requirement. He could either verbally inform the crew that the plane has been inerted, or a written receipt could be printed to do the same. Delivery of this data could also be sent via a suitable communications link to a central computer, if required.

It became obvious that ullage washing systems will have to be customized for each airport. However, the major components required for design of a fixed, ground based ullage washing system for various classifications (sizes) of airports may be found in the generic layouts presented in Appendix E.

5.1 ASSUMPTIONS

- During the study assumptions had to be made by the Working Group and the AFT. The following are the assumptions that the AFT used in developing the design concepts for the ullage washing systems.
- The process was not to affect the airplane turn time. This was a goal agreed upon by the Working Group.
- Other studies have assumed that the inerting would be done after fueling. While this would reduce the amount of start when the airplane arrived at the gate (i.e., empty tanks). This was according NEA required, it would have possibly increased the aircraft turn times
- Only the CWT would be inerted.
- 800 SCF was used as the average gas requirement. This is the volume of the small generic airplane model used in the study.
- 1.7 times ullage volume would be required to perform the task. Testing that had been done showed various ranges of volume to accomplish the inerting. The team settled on this figure. It may be possible in actual operation the amount of NEA required could be more or less.
- Fixed system sized for a utilization of 0 to 2.4 times the average to handle peak operations. At large hub airports the aircraft arrive in banks. This creates a high demand over a very short period of time. The systems will need to be able to recover between banks. The amount of real estate available may also limit the size of the backup storage.
- A maximum of 15 min to inert a small airplane. This was based on the average turn times supplied by the Maintenance and Operations team.
- Large and medium airports would use fixed equipment as the primary means for gas supply, and small airports would use mobile equipment. The team felt this would be the most practical approach.

5.2 MOBILE ULLAGE WASHING DESCRIPTION

Where it is not practical to supply a land-based source of nitrogen to ullage wash airplane fuel tanks at the loading gate, remote-mobile nitrogen dispensing equipment will be required. This equipment can be either mobile nitrogen generating equipment, or LN₂ tankers, with vaporizers to convert the liquid to a gas.

Two factors have influenced selection of nitrogen generating equipment over LN₂ and vaporizing equipment for presentation in this report:

- Training and related safety issues associated with handling cryogenic liquids
- Cost of ongoing purchase of LN₂ as compared with costs of generation of gaseous N₂ directly from the air using compressors and high purity nitrogen membranes

Design of mobile ullage washing vehicles will emphasize ease of operation, by allowing operators to select predetermined automatic cycle times specific to each aircraft type. Vehicles will be designed with a

high volume output screw-type compressor, appropriate filter, high purity nitrogen separators, specially designed meter, pressurized nitrogen storage tanks and related automated control system. A vehicle brake interlock system is required to ensure delivery hoses/nozzles are properly stowed, prior to release of the vehicle brakes.

The overall size of mobile NEA generating equipment could become an issue due to the quantity of high purity membranes required. When consideration is given to ullage washing large transport category aircraft center fuel tanks, as well as possibly providing “make-up” nitrogen to hold refueling tankers inert, size clearly becomes an issue.

Current ramp congestion dictates mobile “ullage washing” vehicles utilize the smallest package/footprint possible to accomplish the task.

It is estimated that to service remotely parked or operated aircraft, especially freighters, and as back-up for land-based system, mobile ullage washing vehicles will typically number from 65-85% of the number of refueling tankers operating at a particular airport. The addition of mobile inerting processes at the terminal gate is certain to exacerbate complications associated with congestion around the aircraft. There are a number of existing services associated with airport ground operations including fueling, baggage handling, food, and cleaning services among others. All operations require vehicles to travel to and from the aircraft in a very short period of time. There exists an increased risk of accidents during operations attributable to the inerting process. The addition of the inerting process could decrease the available time to conduct all other ground operations, further adding to the risk.

At small airports or at foreign airports with a U.S. only implementation, it may be more cost effective to have all mobile equipment when compared to fixed infrastructure costs.

All problems generally associated with a significant increase in personnel staffing while operating within the same physical area will be present.

Small to medium size transport aircraft mobile inerting vehicle:

- Where remote ullage washing for medium size transport aircraft and smaller is required, a mobile nitrogen-generating vehicle can be provided in a very user-friendly package.
- This vehicle would also utilize a high-flow rate air compressor to supply large volumes (270 CFM) of air to a high purity nitrogen membrane separation system.
- However, the smaller demand for air pressure will allow the compressor to be powered by the chassis power-plant/drive-line via a transfer case.
- A unit of this type could typically manufacturer 97% pure gaseous nitrogen at a rate of 6,500 CFH while only having a footprint comparable to that of a typical hydrant system dispenser (approximately 20' OAL x 8' OAW x 9' OAH).

Large transport aircraft inerting vehicle -using liquid nitrogen vaporizer:

- Another consideration for mobile ullage washing of larger transport which could easily be used for all aircraft size categories is conversion of liquid nitrogen
- Liquid nitrogen converts at a rate one gallon of liquid nitrogen to 93.1 CF of gaseous N₂
- Equipment size is dictated by providing adequate vaporizing units to prevent freezing up.
- For this study, a concept vehicle having a 400-gallon LN₂ storage tank and adequate vaporizers to convert 193 gallon into 18,000 CF of gas within a 20 minute period are used.

6.0 ENVIRONMENTAL ISSUES FOR FUEL SCRUBBING SYSTEM CONCEPT

General environmental issues are addressed as part of this document to identify basic direct and indirect environmental impacts with the fuel-scrubbing concept discussed within this section of the overall report. The impacts fall into the following categories:

- VOC emissions
- The airport environment
- Other environmental issues

Values and quantities of undesirable materials and impacts are not quantified in this section of the report. Instead, the impacts are identified as they generally relate to existing airport and airline environmental initiatives. Quantification of these impacts is deferred until a more thorough and complete analysis can be completed (presumably after a specific SYSTEM CONCEPT is selected for further development.) Other than the VOC emissions, which could be mitigated by a costly vapor recovery system, the environmental impact resulting from the implementation of fuel scrubbing is assumed to be relatively minor.

Environmental protection infrastructure must be added to each airport fuel storage facility. The systems and equipment include pumps and other electric motor driven equipment, aboveground liquid nitrogen storage tanks, gas tanks and piping.

VOC Emissions

- Installation of vapor recovery system. Data from a simple experiment from two different sources indicate that substantial amount of light hydrocarbon molecules would be stripped from the fuel during the scrubbing process. A vapor recovery system would be an essential component of this system to mitigate this adverse impact on the environment.
- All refueler trucks, that serve aircraft parked in remote or in the cargo areas or at an airport where there is no hydrant system, have to be modified. A nitrogen generating unit added to the rear of the vehicle will maintain an inert atmosphere in the tank head space and maintain a slight positive pressure in the tank by replenishing with nitrogen while the tank fuel level is being drawn down during aircraft refueling. During the refilling cycle of the refueler a means of capturing vented emissions would have to be developed. These modifications may result in an increase in VOC emissions from this intermediate mobile fuel storage.

Airport Environment

- Truck traffic to deliver liquid nitrogen to the tank farm area results in additional use of fossil fuels.
- The increase in the number of Ground Service Equipment (GSE) vehicles mandated by this system will add to the emissions from the internal combustion engines that power them.

Other Environmental Considerations

- Environmental remediation of land. Any building activities atop the airport tank farm site will require that existing environmental remediation methods be altered and/or that remediation be undertaken prior to the construction of any supporting infrastructure.
- Indirect impacts include items such as negatively influencing airport, city and regional air quality.

Summary

- No positive environmental impacts (improvements to the environment) were identified for any of the concepts in this report.

- No data are available on the soil condition of any given site nor is quantified air emission data available to establish an emission baseline. A baseline would be useful in measuring incremental impacts to the environment.

6.1. POTENTIAL IMPACT ON FUEL PERFORMANCE FROM ULLAGE WASHING AND FUEL SCRUBBING

The Federal Register of July 14, 2000 (Vol. 65, No. 136, pgs. 43800-43802) announced the formation of a new Aviation Rulemaking Advisory Committee (ARAC) with a “Tasking Statement” covering the formation of an Aircraft Fuel Tank Inerting Harmonization Working Group.

The tasking statement requested that the ARAC provide, among other tasks, methods of introducing nitrogen gas into the affected fuel tanks to displace the oxygen in the ullage space and to saturate the fuel with nitrogen in ground storage facilities, e.g., in the trucks or central storage tanks. The process of saturating the fuel with nitrogen will be referred to as “fuel scrubbing” herein.

A concept and design methodology for a system that proposes to accomplish the above referenced tasks has been developed. However, during the conceptual deliberations as to how an effective system might be designed, manufactured, installed and made operational, concern arose with respect to the effects ullage washing and fuel scrubbing may have on the performance characteristics of aviation turbine fuel. In addition, there were concerns expressed about the environmental impact resulting from the inerting process, especially as a consequence of fuel scrubbing which involves vigorously mixing nitrogen gas with a high flow fuel stream.

This report subsection is intended to summarize the concerns, the findings of preliminary laboratory analysis performed by two oil company task team members, and recommendations for further study of the fuel tank inerting scenario.

6.1.1 Concerns

Concerns were raised that ullage washing and fuel scrubbing would degrade certain performance properties of jet fuel by driving off the “light weight molecular ends” of the fuel. The “light ends” influence several specification properties of jet fuel including distillation, flash point and freezing point. Another concern expressed was the uncertainty of how these processes might impact the re-light-at-altitude characteristics of the fuel. Questions were also raised regarding the performance of additive packages, e.g., anti-oxidants, anti-static additive, added to the fuel to enhance or modify particular characteristics of the fuel.

In order to obtain a broader perspective on these questions and other issues, a notice was circulated via the ASTM committee charged with Aviation Turbine Fuel specification (ASTM D-1655) maintenance asking all U. S. and non-U. S. Refineries, engine, airframe and component manufacturers to provide feedback and/or information they may have on the performance characteristics of fuel subjected to ullage washing and/or scrubbing. Because these inerting concepts were new to many of the responders, more questions were raised than answers received. The additional concerns expressed ranged from complete engine re-certification may be required, to the other extreme where it was believed nitrogen inerting would improve at least the fuel stability characteristics and therefore would be a benefit.

The last area of concern that arose during discussions of the fuel inerting concept was that involving environmental considerations. Again, flowing nitrogen gas over a partially filled fuel tank and/or the vigorous mixing of nitrogen gas with fuel during the scrubbing process would, according to general opinion, result in significant volatile organic compound (VOC) release to the atmosphere at the airports’ fuel storage depot. These VOCs would aggravate the already thorny issue of air pollution on and around today’s airports. Feedback and factual data was requested from stakeholders, including the U. S. Environmental Protection Agency (EPA). Again, more questions than answers came from this inquiry.

Airport Facilities Task Team Final Report

6.1.2 Preliminary Laboratory Analysis

AirBP and Texaco performed elementary experiments on ullage washing and fuel scrubbing using nitrogen and carbon dioxide gases (final reports are addenda to this section).

Preliminary results of these experiments indicate that ullage washing and fuel scrubbing with nitrogen gas has little effect on the conventional properties of jet fuel. However, a measurable change in vapor pressure occurred from fuel scrubbing and the CO₂ scrubbed fuel exhibited an increase in acid number. Significant quantities of VOCs were released during both processes regardless of the inert gas used. The VOC release may lead to serious health and safety issues that must be addressed.

First, the physical properties change; in one experiment it was shown that there is an increase in the fuel's vapor pressure after the scrubbing process. This vapor pressure increase phenomenon is not totally understood at this time; however, it does suggest that there may be a deleterious effect in controlling the flammability of the aircraft fuel tank headspace atmosphere. The increase in vapor pressure may affect the performance of the different fuel pumping devices used on today's aircraft.

There was also a decrease in the fuel's electrical conductivity, which will require further investigation. Changes in this fuel property will require a full understanding of the phenomenon because of fuel handling safety and additive performance issues.

A significant release (addressed further in this summary) of VOCs occurred during the ullage washing and scrubbing processes which obviously changes the bulk fuel composition. The removal and recombining of the VOC condensate, after a vapor recovery process, will require additional study to ensure that there is no deleterious effect on engine performance due to a reconstituted fuel blend. Although no statistical difference was measured in the fuel's distillation characteristics, flash point or freezing point, a more thorough analysis of these properties should be performed to verify the preliminary findings. Additionally, because the loss of these light-ends may effect altitude re-light, a thorough analysis of this characteristic should also be carried out, unfortunately this analysis could not be done in the time allotted to this project.

The experiments conducted using CO₂ as the scrubbing gas (CO₂ injection was one of the inerting processes considered during the team's discussions, but time did not allow for a complete conceptualization of this technique) showed a much greater effect on vapor pressure than N₂ and also caused the Acid Number of the bulk fuel to increase. This finding was not totally unexpected because prior experience has shown that with water laden (including dissolved water) mixtures and subsequent CO₂ saturation, carbonic acid may form as a by-product of this chemistry. Obviously the formation of any compound that may enhance or accelerate corrosion of the aircraft fuel tanks is not a desirable attribute of a fuel.

Second, the industrial health and safety issues; the experiments indicated that the carcinogen Benzene may be concentrated in the vapor phase at concentrations that could exceed the 0.1% (wt) limit established for regulating a material as toxic. Obviously, this matter is of the greatest concern with regard to employee health and the environment surrounding the airports' bulk storage depot and will have to be addressed.

An additional employee and facility safety problem is also introduced when fuel is exposed to the scrubbing process and this is the extremely flammable vapor atmosphere created by the light-end VOC emissions. Very careful attention will have to be taken in the design of any mechanical equipment used to recover and dispose of these VOCs.

Ullage washing will result in the release of a low oxygen, high inert gas concentration mixture (N₂ or CO₂) from the center wing tank vents. Persons working in and around this area may be exposed to air with an oxygen level below that which is required to sustain normal respiration. The hazard level will increase as the number of aircraft in a localized area undergoing the inerting process increase. This asphyxiation hazard must be studied in more depth before any large-scale inerting is implemented.

Third, the environmental impact issues; the ullage washing and fuel scrubbing processes have been shown to release a significant amount of VOCs. These VOC releases were measured in the 1%+ (volume) range during the experiments. To put this volume number in perspective it represents a release of an equivalent volume of 21,000+ gallons of jet fuel from a typical 50,000-barrel (2.1m gal.) storage tank found at many airports. This release would be expected to occur each time a fuel receipt of this size is received into storage and subsequently processed through the scrubbing cycle. The environmental, as well as the economic, impact of releases of this magnitude will require careful design and operation of costly vapor recovery systems near the bulk storage facilities. As more regulatory pressure is exerted on today's management and operators to "clean up the air" on and around the airport, release of additional pollutants, caused by some new process, becomes unacceptable regardless of the perceived benefits.

The EPA representative queried during the "get-some-feedback" process succinctly put future work on this issue into perspective by recommending a "1) literature search for theoretical and experimental analysis of the effects of fuel tank inerting or similar fuel treatments on engine exhaust emissions, 2) explicit discussion, involving appropriate experts of this concern in FAA rulemaking activities relating to fuel tank inerting; and 3) experimental research to validate expectations regarding impacts of inerting methods on engine exhaust emissions."

6.1.3 Future Work

As the foregoing indicates there are a number of issues that need to be addressed, better understood, and solutions found before ullage washing and/or fuel scrubbing is implemented on a large scale. The following is only a short list of the issues that come to mind:

- The characteristics of scrubbed fuel performance in today's turbine engines need further investigation.
- The impact of ullage washing and fuel scrubbing on employee health and safety will have to be better understood so appropriate action can be taken.

The impact of ullage washing and fuel scrubbing on the environment will have to undergo an extensive review. There was not enough time or readily available information during this ARAC project to become fully knowledgeable on the subject and propose concept designs around the impediments identified.

7.0 LABORATORY REPORTS

ADDENDUM 1:

AIR BP LABORATORY REPORT

Nitrogen/Carbon Dioxide Inerting of Jet Fuel Tanks

7.1 SUMMARY

A limited study to evaluate the impact of ullage washing and fuel scrubbing using carbon dioxide and nitrogen on the properties of jet fuel has been performed. Displaced vapor was found to contain up to 18 mg/liter light hydrocarbons, which on condensation would give a volatile, highly flammable liquid similar to gasoline. The liquid jet fuel remained largely unchanged after exposure to nitrogen, however, exposure to carbon dioxide resulted in a significant increase in vapor pressure (+16.7 kPa) and acidity ($\geq +0.041$ mgKOH/g).

7.2 BACKGROUND

Air BP performed a study to examine the use of nitrogen and carbon dioxide gases to inert jet aircraft fuel tanks and remove dissolved oxygen from the fuel. This study examined fuel quality before and after nitrogen/carbon dioxide has been introduced, and the composition of the vapor above the fuel.

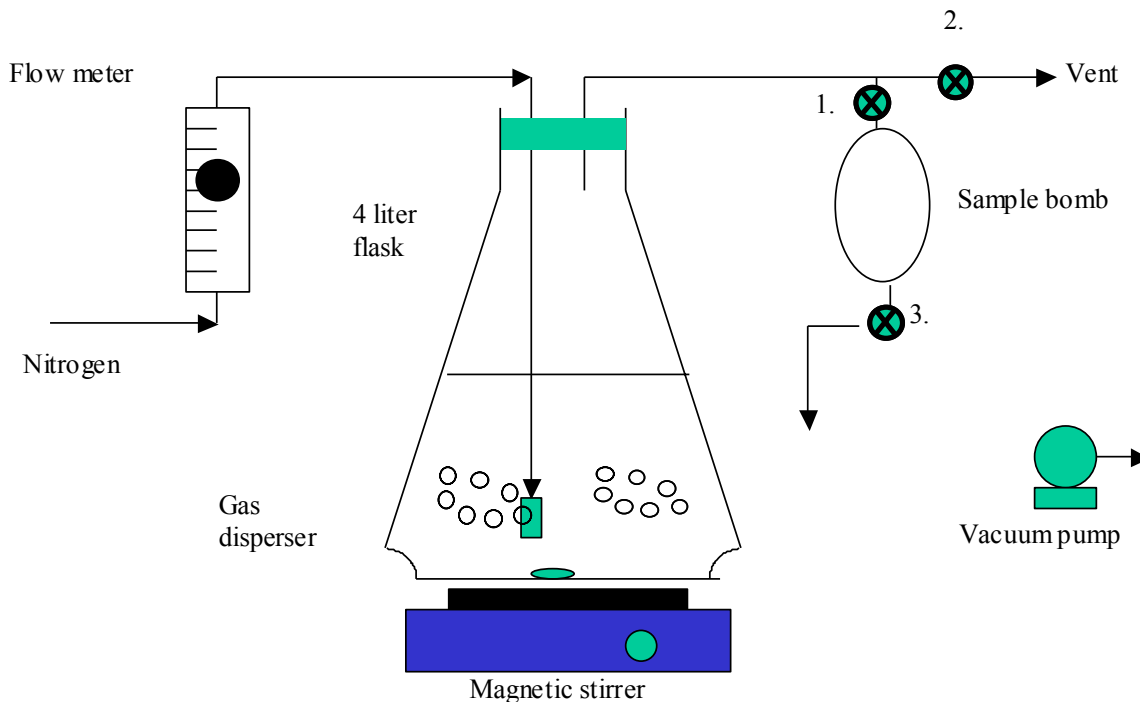

Figure 7-1.

7.3 APPARATUS

Figure 7-1 provides a schematic diagram of the apparatus.

7.4 METHOD

1. Three liters of commercial jet fuel, reference number W01/067, was introduced into the 4-liter sample flask.
2. The temperature of the fuel was recorded.
3. Valves 1 and 2 were set such that nitrogen would flow via valve 2 to vent.
4. Nitrogen was introduced into the fuel at a steady flow rate of 380 ml/min.
5. The sample vessel was evacuated and connected to the line.
6. Valve 1 was opened to draw vapor into the sample vessel.
7. Valve 2 was then shut while simultaneously opening valve 3 such that all vapor flowing from the flask would pass through the sample vessel.
8. After a period of 20 minutes, the sample vessel was sealed while simultaneously opening valve 2.
9. Steps 3.5 to 3.8 were repeated to give a second sample 40 minutes after the start of the experiment. Both samples were then analysed by gas chromatography.
10. The liquid fuel was transferred from the sample flask to an epoxy lined can, air displaced from the headspace with nitrogen, sealed and analysed.
11. Steps 3.1 to 3.10 were repeated with a fresh sample of jet but the nitrogen flowing into the flask was set to only pass over, rather than through, the liquid.
12. Steps 3.1 to 3.11 were repeated with a fresh sample of fuel but the nitrogen was replaced with carbon dioxide.

7.5 RESULTS AND DISCUSSION

Vapor Phase

Vapor phase analysis for the nitrogen and carbon dioxide studies are provided in Tables 7-1 and 7-2 respectively. The hydrocarbon concentration in the vapor phase showed some time dependence, particularly for the nitrogen sparge through liquid fuel which increased from 8.1 mg/liter at 20 minutes to 17.8 mg/liter at 40 minutes. This was significantly higher than other results obtained and may warrant further investigation. In general, gas sparge over, rather than through the fuel gave slightly lower concentrations of hydrocarbon in the vapor. The chemical species present were indicative of light hydrocarbons left entrained in the fuel during manufacture. Condensation and recovery of such hydrocarbons would give a product similar in hazard to motor gasoline, i.e. high vapor pressure, low flash point and requiring carcinogenic labelling due to the presence of benzene.

Liquid Phase

Liquid phase analysis, featuring standard jet fuel inspection data, for nitrogen and carbon dioxide studies after 40 minutes gas sparge, are provided in Tables 7-3 and 7-4. Nitrogen sparge had very little effect, if any, on the properties of the jet fuel. However, carbon dioxide gave a significant increase in fuel acidity, $\geq +0.041$ mgKOH/g above base fuel level. This could potentially result in product failing the ASTM D1655 specification of 0.10 mgKOH/g maximum. The sparged samples themselves exceed European Def Stan 91-91 limits of 0.015 mgKOH/g maximum.

7.6 ADDITIONAL TESTS

Vapor Phase

The observation that a significant amount of light hydrocarbons were still present in jet fuel following manufacture was confirmed by a further experiment. A second sample of jet fuel was sparged with nitrogen as in Section 3 and the vapor phase analysed by GC-Mass Spectrometry. The spectra confirmed the species present, Table 7-5. Benzene concentration was significantly lower on a pro-rata basis compared to the previous samples, possibly indicating a link with the original crude oil used to manufacture the fuel.

Gas Entrained in Fuel

Following the experiment where carbon dioxide was sparged into the fuel, it was observed that a sample stored in a one liter can was under pressure. A further simple experiment was undertaken to investigate this effect. One liter samples of base fuel were sparged through the liquid phase with nitrogen and carbon dioxide for ca. 20 minutes. A sample of fuel was taken for vapor pressure determination using standard industry apparatus (ASTM D5191). In addition, each fuel was subjected to low pressure utilizing a vacuum line and any unusual effects observed.

Results were determined as:

	DVPE kPa	Observations under nominal vacuum
Base fuel.	0.9	No gas bubbles.
Base fuel following nitrogen sparge through liquid.	1.7	Few gas bubbles in liquid.
Base fuel following carbon dioxide sparge through liquid.	17.6	Many gas bubbles in liquid.

Results suggest that fuels sparged with carbon dioxide have the potential to solubilize a significant amount of gas. This is later released when the fuel experiences lower pressure/higher temperature. The vapor pressure of the fuel is also increased to a level typical of jet B/wide-cut aviation fuel. Nitrogen gives a similar, but much lower, effect.

Airport Facilities Task Team Final Report

Literature [1,2] data for the solubility of the two gases in hydrocarbons support these observations:

1 atm, 25 °C	n-Octane	n-Nonane	n-Decane
Nitrogen g/kg Hydrocarbon ml/kg Hydrocarbon*	0.327 262	0.287 230	0.247 198
Carbon Dioxide g/kg Hydrocarbon ml/kg Hydrocarbon*	4.648 2366	4.845 2467	5.567 2834

* Assuming ideal gas at standard temperature and pressure

Given the known risk to safety from vapor bubbles forming in aircraft fuel systems, for example through the use of jet B, this effect is important and warrants further investigation.

Thermal Stability

Removal of oxygen from jet fuel by sparging with an inert gas may have the potential to increase jet fuel thermal stability. A limited test was undertaken to examine this effect using a fuel of JFTOT rating 3 'Abnormal, Peacock'. The fuel was sparged with nitrogen for a period of 40 minutes as detailed in Section 3. JFTOT was then determined with no air sparge:

	Reference	JFTOT
Base fuel	W01/046	3AP
Nitrogen into liquid phase	W01/048	>4P
Nitrogen above liquid phase	W01/050	4P

Thus, for the sample of jet fuel tested, the thermal stability was not improved following nitrogen sparge.

7.7 CONCLUSIONS

Vapor Phase

- The vapor phase above jet fuel contains a proportion of light hydrocarbons which have become entrained in the fuel during manufacture.
- When recovered and liquefied, the vapor phase hydrocarbons form a highly flammable, volatile mixture of low flash point unlike the original jet fuel but similar to motor gasoline.
- Benzene may be concentrated to such an extent in the recovered vapor to render the liquefied product carcinogenic (>0.1% benzene).
- In the case of nitrogen, passing gas through the fuel gave a greater concentration of hydrocarbons in the vapor phase than passing gas over the fuel. Some time dependence was observed which might require further investigation.
- Based on the results, a large aircraft receiving 200,000 liters of fuel could potentially emit about 4 kg of hydrocarbon vapor for recovery.

Liquid Phase

- No significant effect on product quality, using standard test methods, was observed following exposure of fuel to nitrogen.
- An increase in fuel acidity ($\geq +0.041$ mgKOH/g) was observed following exposure of fuel to carbon dioxide. The resultant fuel failed European Defence Standard specifications of 0.015 mgKOH/g maximum.
- Additional tests indicated the vapor pressure of the fuel increased when gases had been sparged through the liquid. Nitrogen and carbon dioxide sparge resulted in a +0.8 kPa and + 16.7 kPa rise in fuel vapor pressure respectively. On exposure to low pressure, both fuels exhibited the formation of gas bubbles in the liquid phase. Given the risk to safety from vapor formation in aircraft fuel systems, this effect warrants further investigation.

References

- [1] Makranczy, J; Megyery-Balog, Mrs. K; Ruzs, L.; Patyi, L; Hung. J. Ind. Chem. 1976 4(2), 269-280.
- [2] Tong Jingshan; Gao Guanghua; Wang Xiagong; Qinghua Dazue Xuebao 1988, 28(3), 28-32.

Airport Facilities Task Team Final Report

	Gas through liquid phase		Gas over liquid phase	
	20 minutes W01/073 mg/liter	40 minutes W01/074 mg/liter	20 minutes W01/075 mg/liter	40 minutes W01/076 mg/liter
C3	0.1	0.1	0	0
C4	0.2	0.5	0.2	0.2
C5	0.6	1.2	0.6	0.6
C6	1.8	3.7	1.8	1.5
C7	2.7	5.5	2.3	2.6
Benzene	0.3	0.5	0.2	0.2
C8	1.8	5.1	2.6	3.3
Toluene	0.6	1.2	0.2	0.4
TOTAL*	8.1	17.8	8.1	8.9

Table 7-1. Vapor Analysis, Nitrogen Sparge 21 °C

	Gas through liquid phase		Gas over liquid phase	
	20 minutes W01/091 mg/liter	40 minutes W01/092 mg/liter	20 minutes W01/093 mg/liter	40 minutes W01/094 mg/liter
C3	0.1	0.1	0	0
C4	0.2	0.3	0.2	0.1
C5	0.6	0.6	0.6	0.4
C6	1.7	1.8	1.4	1.2
C7	2.3	2.4	1.9	1.8
Benzene	0.2	0.2	0.2	0.2
C8	2.0	2.3	1.9	1.7
Toluene	0.4	0.5	0.4	0.3
TOTAL*	7.5	8.2	6.6	5.7

• Total excludes trace components >C8 carbon number which were not determinable.

Table 7-2. Vapor Analysis Carbon Dioxide Sparge 21 °C

Airport Facilities Task Team Final Report

ANALYSIS	Base Fuel	Base fuel after 40 minute N ₂ sparge through liquid	Base fuel after 40 minute N ₂ wash over liquid	UNITS
D1319 FIA Aromatics	17.7	17.7	18.1	% v/v
D1322 Smoke point	25.0	25.0	25.0	mm
D3338 Specific Energy	43.256	43.257	43.245	MJ/kg
D381 Existent Gum (Steam)	<1	<1	<1	mg/100ml
D3948 WSIM (microsep)	83	93	79	-
IP365 Composite Density	798.7	798.7	798.7	kg/m ³
D4294 Sulfur	<0.01	<0.01	0.01	% m/m
D86 Initial Boiling Point	149.9	150.3	147.7	°C
D86 05 % Recovered	162.9	162.7	162.4	°C
D86 10 % Recovered	166.3	166.7	166.1	°C
D86 20 % Recovered	171.9	172.2	171.4	°C
D86 30 % Recovered	177.8	178.3	177.8	°C
D86 40 % Recovered	184.3	184.1	183.9	°C
D86 50 % Recovered	190.9	191.1	190.9	°C
D86 60 % Recovered	198.4	198.5	198.3	°C
D86 70 % Recovered	206.9	207.0	206.9	°C
D86 80 % Recovered	217.1	217.1	217.0	°C
D86 90 % Recovered	230.5	230.5	230.5	°C
D86 95 % Recovered	241.6	241.7	241.7	°C
D86 Final Boiling Point	258.8	260.9	257.9	°C
D86 Loss	0.4	0.3	0.7	% v/v
D86 Recovery	98.4	98.4	98.3	% v/v
D86 Residue	1.2	1.3	1.0	% v/v
IP16 Freeze point	-58.0	-57.2	-57.2	°C
IP154 Copper Corrosion 2Hrs @100 °C	1A	1B	1B	-
IP170 Flashpoint	40.5	40.0	40.0	°C
IP274 Conductivity	175	125	117	
IP274 Temperature	20	22	22	°C
IP289 Water Reaction Interface Rating	1B	1B	1B	-
IP30 Doctor Test	N	N	N	-
IP323 JFTOT Pressure Difference	0	0	0	mmHg
IP323 JFTOT Visual tube rating	1	1	1	-
IP354 Total Acidity	0.006	0.006	0.006	mg KOH/g
KV at -20 °C	3.482	3.451	3.464	cSt

Table 7-3. Jet Fuel Inspection Data, Nitrogen Sparge 21°C

Airport Facilities Task Team Final Report

ANALYSIS	Base Fuel	Base fuel after 40 minute CO ₂ sparge through liquid	Base fuel after 40 minute CO ₂ wash over liquid	UNITS
D1319 FIA Aromatics	17.7	18.1	17.5	% v/v
D1322 Smoke point	25.0	24.0	24.0	mm
D1840 Naphthalenes		1.55	1.88	% v/v
D3338 Specific Energy	43.256	43.244	43.252	MJ/kg
D381 Existent Gum (Steam)	<1	1	0	mg/100ml
D3948 WSIM (microsep)	83	92	91	-
IP365 Composite Density	798.7	799.0	799.1	kg/m ³
D4294 Sulfur	<0.01	<0.01	0.01	% m/m
D86 Initial Boiling Point	149.9	148.2	148.2	°C
D86 05 % Recovered	162.9	162.2	161.9	°C
D86 10 % Recovered	166.3	165.5	165.6	°C
D86 20 % Recovered	171.9	171.9	172.2	°C
D86 30 % Recovered	177.8	178.1	177.4	°C
D86 40 % Recovered	184.3	184.2	184.0	°C
D86 50 % Recovered	190.9	190.8	191.0	°C
D86 60 % Recovered	198.4	198.7	198.7	°C
D86 70 % Recovered	206.9	207.2	207.1	°C
D86 80 % Recovered	217.1	217.2	217.0	°C
D86 90 % Recovered	230.5	230.5	231.2	°C
D86 95 % Recovered	241.6	242.6	243.7	°C
D86 Final Boiling Point	258.8	257.8	257.8	°C
D86 Loss	0.4	0.7	1.0	% v/v
D86 Recovery	98.4	98.1	97.8	% v/v
D86 Residue	1.2	1.2	1.2	% v/v
D5901 Freeze point	-58.0	-57.2	-57.3	°C
IP154 Copper Corrosion 2Hrs @100 °C	1A	1A	1A	-
IP170 Flashpoint	40.5	40.5	41.0	°C
IP274 Conductivity	175	120	118	
IP274 Temperature	20	22	22	°C
IP289 Water Reaction Interface Rating	1B	1B	1B	-
IP30 Doctor Test	N	N	N	-
IP323 JFTOT Pressure Difference	0	0	0	mmHg
IP323 JFTOT Visual tube rating	1	1	1	-
IP354 Total Acidity	0.006	0.066	0.047	mg KOH/g
KV at -20 °C	3.482	3.441	3.435	cSt

Table 7-4. Jet Fuel Inspection Data, Carbon Dioxide Sparge 21 °C

Component	W01/050 Relative Amount
Isobutane	4.9
n-Butane	10.2
Pentanes	37.1
Hexanes	10.8
Methylcyclopentane	1.9
Benzene	<0.6
Heptanes	4.9
Methylcyclohexane	5.9
Toluene	4.0
Octanes	12.4
Ethylcyclohexane	1.9
Xylenes	2.5
Nonanes	3.1
Decanes	0.6

Table 7-5 GC-Mass Spectrometry Analysis of Vapor Recovered From Jet Fuel Sparged With Nitrogen

**ADDENDUM 2
TEXACO INC. LABORATORY REPORT**

The following is a final summary report with results of the testing conducted here at Beacon for the ARAC Steering Committee. Also attached are the original reports of the two sets of experiments as Attachments A and B and the gas chromatography studies as Attachments C and D.

The initial set of experiments involved sparging nitrogen through a flask containing commercial jet A fuel. The flask was closed with a stopper and vapors were allowed to escape through a glass tube. Details may be found in Attachment A.

The second set of experiments independently included both closed flask and open cylinder testing. The closed flask set up simulated the interior of a closed tank (and replicated the first experiments), and the open cylinder was a more scientific approach to study the effects of the fuel after bubbling nitrogen through it, but allowing virtually all gases to escape from the container (minimum condensation). Details of this work may found in Attachment B.

Despite the various experimental arrangements and conditions, results indicated there was little or no change to properties tested for compliance with ASTM D 1655, Standard Specification for Aviation Turbine Fuels. However, in the second experiment, visual observations of the open cylinder and analysis of the fuel by gas chromatography (GC) clearly indicated the loss of lighter components from the base fuel. This report, attached as Attachment C, elaborates on the techniques used to arrive at the GC results.

As noted in Attachment B, several samples from each condition were taken and GC analysis was repeated on each sample. This provided confidence in the final analysis and helped to identify any outliers in the data set. Because of the distribution of hydrocarbon species, the fuel was segmented into groups based on the molecular weight (carbon number) of the components. It was determined that by separating the fuel into four groups, the analysis could be simplified while still retaining the accuracy required for statistical significance.

The groups were identified as:

1. C6-C10 alkanes and C1-C3 alkyl substituted cyclohexanes;
2. C11-C14 alkanes and C4-C7 alkyl substituted cyclohexanes;
3. C15-C16 alkanes and C8-C9 alkyl substituted cyclohexanes;
4. C17-C20 alkanes and C10 alkyl substituted cyclohexane.

Chromatographic subtraction was used to facilitate the analysis. For each hydrocarbon group, the areas under the peaks were measured or calculated at the before-sparging and after-sparging conditions then compared to each other. The differences were considered to be the losses attributed to outgassing and kinetic expulsion of lighter ends from the base fuel during sparging. Because the hydrocarbon molecular weight distribution within the fuel varied from C6 to C20 alkanes and from C1 to C10 alkyl substituted cyclohexanes, it was necessary to develop specific scales for each hydrocarbon group so that areas could be determined accurately. Chromatographs that typify the results are included as Appendix C.

As noted in the report, the commercial jet fuel (as purchased from the airport) consisted of 10 volume percent (vol%) of the lightest material (Group 1), 40 vol% moderate material (Group 2), 40 vol% heavier material (Group 3), and 10 vol% heaviest material (Group 4). As expected, most of the hydrocarbons displaced by scrubbing came from Group 1 with lesser amounts being lost as molecular weight (and group number) increased. There was no loss of hydrocarbon from the heaviest group. The volumetric loss determined by GC analysis was corroborated with visual inspection of the open cylinder. Details of the study are contained within Attachments B and C.

Airport Facilities Task Team Final Report

At your request, a second analysis to quantify and qualify aromatic loss from the base fuel was performed on the retained samples from the previous experiments. This analysis was conducted using a double-column GC, the results of which are attached as Attachment D.

ATTACHMENT A

2 sub-samples of commercial jet fuel (Jet A) were sparged with gaseous nitrogen, then subjected to full ASTM D 1655 testing and analysis by gas chromatography (GC). A third sub-sample (the unsparged airport sample) was also analyzed using these techniques so that results could be compared.

Attachment A1 contains the properties listed in Table 1 of ASTM D 1655, Standard Specification for Aviation Turbine Fuels (Volume 05.01, Annual Book of Standards, 2000). In addition to the requirements of Table 1, Attachment A1 also contains all ASTM D 1655 test results and other pertinent information. Where duplicate runs were made (density and net heat of combustion) an additional line was added and both results are reported.

To facilitate the experiment and based on laboratory requirements for testing, commercial jet fuel was purchased locally and stored in a laboratory at 70°F ambient temperature.

Set-Up: A 4000 milliliter (mL) sub-sample was placed in a 4000 mL flask and a sparger was inserted so that it just cleared the bottom of the flask. Gaseous nitrogen with a purity of 99.999% (maximum moisture = 1 ppm, maximum oxygen = 1 ppm, maximum hydrocarbon content = 0.5 ppm) was used throughout the experiment, and was regulated to flow 350 mL/minute. Using Tygon® tubing, the 4000 mL flask was attached to a 250 mL condensing flask which was partially submerged in liquid nitrogen. The condensing flask was connected to another 250 mL flask which was vented into the hood through a water bath. Although liquid was captured in the condensing flask, it was not possible to extract it without immediate vaporization; thus no analysis could be made of the condensate. Following the initial 20 minute sparging phase, a small sample was taken for gas chromatography and approximately 2000 mL was poured into two separate containers for ASTM D 1655 tests. The sparger was replaced and the experiment was continued for an additional 1 hour 40 minutes. At that time the nitrogen flow was stopped, another small sample was taken for gas chromatography, and the remaining fuel was transferred to two separate containers to await ASTM D 1655 testing. The experimental apparatus is shown in Attachments A2 and A3.

Observations/Conclusions: among the three samples (Airport, 20 Minute Sparge, 120 Minute Sparge) most ASTM D 1655 test results varied little or none from each other. However, density and heat of combustion values changed measurably between samples from the sparging process, and the samples were re-tested about two days after the original tests to verify the differences. Interestingly, the re-runs indicated now consistent, albeit different than the original, results across the three samples. This was in direct conflict with the earlier results and caused a great deal of apprehension among those working on this project. It is hypothesized that immediately following sparging the fuel/ullage is in a state of non-equilibrium (during outgassing) and that after some period of time the fuel/ullage equilibrates. Depending on the composition of the vapors, this could explain the changes in both density and heat of combustion, and their eventual (and inevitable) return to a state of equilibrium. The second experiment will be designed to investigate these possibilities. It should also be noted that although the gas chromatography analysis is incomplete at this writing, the chromatographs indicate obvious changes to the composition of the fuel during sparging. It is hoped that the GC identification of the hydrocarbon species driven out of the fuel during sparging will corroborate the differences observed in density and heat of combustion.

Attachment A1

Detailed Requirements for ASTM D 1655, Jet A Fuel						
Property (January 23, 2001)	Sample					Test Method
	D 1655	Airport	20 Minute N ₂ Sparging	120 Minute N ₂ Sparging		
		ID 3342	ID 3343	ID 3344		
COMPOSITION						
Acidity, total mg KOH/g	max	0.10	n/a	n/a	n/a	
Aromatics, vol %	max	25	20.0	20.2	19.9	
Sulfur, mercaptan, weight %	max	0.003	n/a	n/a	n/a	
Sulfur, total weight %	max	0.30	0.085	0.085	0.086	XRF
VOLATILITY						
Distillation temperature, °C:						D 86
Initial boiling point, temperature		n/a	168.1	168.4	169.3	
5% recovered, temperature		n/a	182.7	181.5	182.3	
10% recovered, temperature	max	205	185.9	184.7	184.9	
20% recovered, temperature	max	...	194.3	193.0	194.2	
30% recovered, temperature		n/a	201.5	200.4	200.9	
40% recovered, temperature		n/a	209.0	207.5	208.1	
50% recovered, temperature	max	report	216.6	215.3	216.0	
60% recovered, temperature		n/a	224.4	223.5	223.9	
70% recovered, temperature		n/a	233.3	232.5	232.9	
80% recovered, temperature		n/a	243.7	242.7	242.9	
90% recovered, temperature	max	report	256.9	256.0	256.2	
95% recovered, temperature		n/a	268.8	268.4	268.0	
Final boiling point, temperature	max	300	282.9	281.5	281.5	
Distillation residue, %	max	1.5	0.9	1.0	0.9	
Distillation loss, %	max	1.5	1.3	1.5	1.1	
Flash point, °C	min	38	51.0	51.5	51.5	D 56
Density at 15°C, kg/m ³		775-840	809.7	796.8	809.6	D 4052
API gravity			43.2	46.0	43.2	Conv.
Density, second run				809.6		D 4052
API Gravity, second run				43.2		Conv.
Vapor pressure, 38°C, kPa	max	...	19.2	7.1	10.1	Conv.
Vapor pressure, 38°C, psi			0.19	0.07	0.10	D 5191
FLUIDITY						
Freezing point, °C	max	-40	-43.8	-44.0	-44.0	D 5901
Viscosity -20°C, mm ² /s	max	8.0	n/a	n/a	n/a	
			1.41@40C	1.41@40C	1.41@40C	D 445
COMBUSTION						
Net heat of combustion, MJ/kg	min	42.8	47.825	46.120	45.930	D 4809
Net heat of combustion, 2nd Run			46.090	46.085	46.080	D 4809
Smoke point, mm	min	25				
CORROSION						
Copper strip, 2 h at 100°C	max	No. 1	1a	1a	1a	D 130
STABILITY						
Thermal:						
Filter pressure drop, mm Hg	max	25	0.1	0.1	0.0	D 3241
Tube deposit less than		Code 3	3	3	3	
CONTAMINANTS						
Existent gum, mg/100 mL	max	7	3	2	2	D 381
Water reaction:						
Interface rating	max	1b	1	2/1b	1b	
ADDITIVES						
Electrical conductivity, pS/m			n/a	n/a	n/a	

Attachment A2. Experimental Apparatus

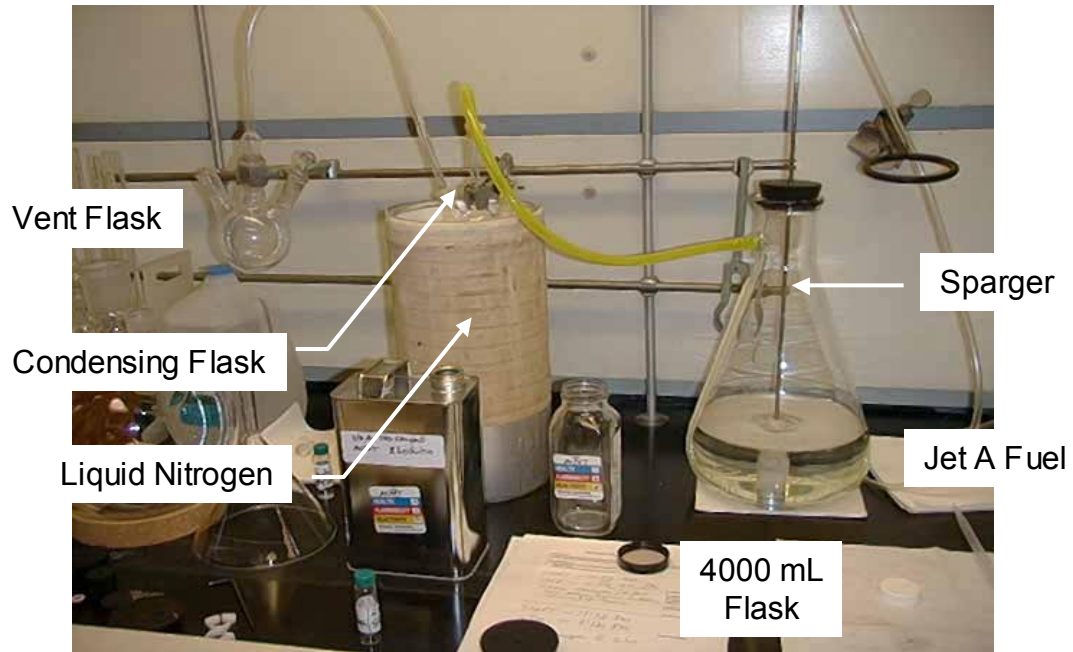

Experimental Apparatus

Attachment A3. Detail of Sparging in Closed Flask

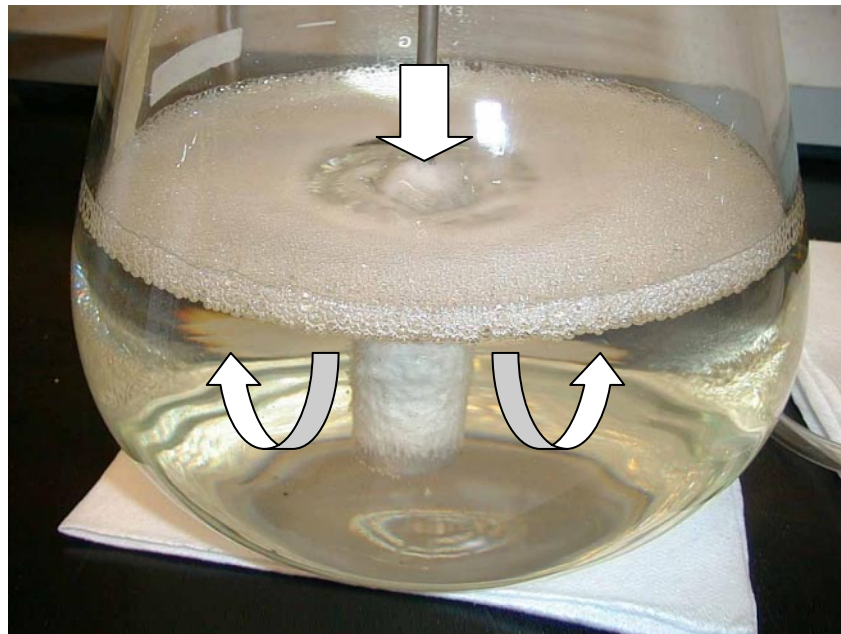

ATTACHMENT B

Commercial jet fuel (Jet A) was scrubbed with gaseous nitrogen, then subjected to analysis by gas chromatography (GC), ASTM D 4052¹, and ASTM D 4809². The physical tests were conducted based on results of previous testing (complete ASTM D 1655, Standard Specification for Aviation Turbine Fuels) of jet fuel from the same base source. In that experiment, it was determined that nitrogen scrubbing affected only density and heat content.

The experimental design is explained below, and Attachment B1 contains the results of ASTM D 4052 and ASTM D 4809. The same commercial jet fuel that was used for the first experiment was stored at 70°F, and was also used for this experiment.

Design Set-Up, Closed Flask: A 4000 milliliter (mL) sub-sample was placed in a 4000 mL Erlenmeyer flask and a sparger was inserted so that it just cleared the bottom of the flask. The flask was placed in a laboratory hood with airflow of 166 cubic feet per minute with the front glass at 12 inches above the threshold. Gaseous nitrogen with a purity of 99.999%³ was used throughout the experiment, and was regulated to flow 350 mL/minute at 120 kPa pressure. Using Tygon® tubing, the 4000 mL flask was attached to a 250 mL condensing flask, which was partially submerged in liquid nitrogen. The condensing flask was connected to another 250 mL flask, which was vented into the hood. Following the initial 20 minute sparging phase, a sample was drawn from the top, center of the flask with a pipette, and three 15 mL test tubes were filled with fuel and sealed with rubber stopples. Also, two 65 mL glass bottles were filled and sealed with plastic caps. To help determine whether stratification of the upper flask volume had occurred, the fuel in the flask was then stirred for approximately one minute until homogeneously mixed and then another sample was drawn and three additional test tubes and two additional bottles were filled and sealed. Two thousand milliliters were then removed from the flask to replicate the previous experiment. The sparger was replaced and the experiment was continued for an additional 1 hour 40 minutes. At that time the nitrogen flow was stopped and a sample was drawn from the top, center of the fuel in the flask with a pipette, and three 15 mL test tubes were filled with fuel and sealed with rubber stopples. Again, two 65 mL bottles were filled and sealed with plastic caps. The fuel in the flask was again stirred for approximately one minute until the fuel was homogeneously mixed and another sample was drawn and three additional test tubes and two additional bottles were filled and sealed. The closed-flask experimental apparatus is shown in Appendix B2.

Design Set-Up, Open Flask: A 325 milliliter (mL) sub-sample was placed in a 500 mL open cylinder and a sparger was inserted so that it just cleared the bottom of the cylinder. Gaseous nitrogen with a purity of 99.999%⁴ was used throughout the experiment, and was regulated to flow 180 mL/minute at a pressure of 120 kPa. The top of the cylinder was completely open to the hood. As in the closed-flask experiment, the nitrogen scrubbing was conducted while in a laboratory hood that had an air flow of 166 cubic feet per minute with the front glass at 12 inches above the threshold. Following the initial 20 minute sparging phase, a sample was drawn from the cylinder with a pipette, and three 15 mL test tubes were filled with fuel and sealed with rubber stopples. Also, two 65 mL glass bottles were filled and sealed with plastic caps. The sparger was then replaced and the experiment was continued for an additional 1 hour 40 minutes. At that time the nitrogen flow was stopped and a sample was drawn from the cylinder with a pipette, and three 15 mL test tubes were filled with fuel and sealed with rubber stopples. Again, two 65 mL glass bottles were filled and sealed with plastic caps. The open cylinder experimental apparatus is shown in Appendix B3.

¹ ASTM D 4052: Standard Test Method for Density and Relative Density of Liquids by Digital Density Meter

² ASTM D 4809: Standard Test Method for Heat of Combustion of Liquid Hydrocarbon Fuels by Bomb Calorimeter (Precision Method)

³ Maximum moisture = 1 ppm, maximum oxygen = 1 ppm, maximum hydrocarbon content = 0.5 ppm

⁴ Maximum moisture = 1 ppm, maximum oxygen = 1 ppm, maximum hydrocarbon content = 0.5 ppm

Airport Facilities Task Team Final Report

Observations/Conclusions: Based on results of ASTM D 4052 and D 4809, there appears to be virtually no change between unscrubbed base fuel, 20 minute scrubbed fuel, and 120 minute scrubbed fuel, whether scrubbing occurred in a closed flask (see Attachment B2), or open flask (see Attachment B3). These results also refute the possibility that significant stratification occurred at the top of the closed flask during sparging, because results from stirred and unstirred samples showed no differences. Although an exchange of gases or condensation and recombining of evaporated fuel with the base fuel (closed flask) may or may not have taken place, the bulk fuel properties (per ASTM D 4052 and D 4809) were not affected.

The density and net heat of combustion results (required in ASTM D 1655, Standard Specification for Aviation Turbine Fuels) indicated no changes to the fuel during scrubbing. However, visual examination of the cylinder and GC analysis of samples indicated a loss of approximately 4 mL (1.2 volume %) of fuel during scrubbing and a change in fuel composition attributed to this operation.

Gas Chromatography Analysis of Changes due to Nitrogen Scrubbing:

There are measurable, statistically significant changes in the chromatogram indicating that scrubbing at the rates used in the lab (180 mL/min, @ 120 kPa N₂,) drives off a portion of the fuel.

The speciation of which fractions and how much are being driven off is presented below:

- Alkanes (C6–C12)
- Alkylcyclohexane (C1-C5) substituted cyclohexane

With much less or no change in the higher molecular weight

- Alkanes (C13-C20)
- Alkylcyclohexanes (C6-C10) substituted alkyl cyclohexanes.

In addition heavier somewhat branched two ring aliphatic compounds showing little change.

Isoprenoids (substituted bicyclo C15 and C16 compounds) show little change.

The open cylinder experiment yielded the following distribution and loss:

From the 325 mL, open cylinder, 120 minute scrubbed sample the following changes were measured:

1. There is a 10% loss from scrubbing of the lightest fuel compounds (initially 10% of the AvJet A): **(C6-C10 alkanes), and (C1-C3 alkyl substituted cycloalkanes)** (1% of original 325 mL)
2. There is a 0.4% loss from scrubbing of the moderate weight compounds (initially 40% of the AvJet A): **(C11-C14 alkanes) and (C4-C7 alkyl substituted cycloalkanes)** (0.16% of original 325 mL)
3. There is a 0.1% loss from scrubbing of the heavier weight compounds (initially 40% of the AvJet A): **(C15–C16 alkanes) and (C8-C9 alkyl substituted cycloalkanes)** (0.01% of original 325 mL)
4. There is no loss from scrubbing of the heaviest weight compounds (initially 10% of the AvJet A): (C17-C20 alkanes) and (C10 alkyl substituted cycloalkanes)

Note: Based on the Gas Chromatography 3.8 mL out of 325 mL of fuel should be lost from the scrubbing.

Independent visual volumetric measurements of the remaining fuel in the cylinder indicated 4 mL (1.2 vol.%) of fuel was lost. This supports the Gas Chromatography work directly. The hydrocarbon distribution follows an exponentially decreasing loss with increasing carbon number:

Airport Facilities Task Team Final Report

Distribution of Hydrocarbon Types with Scrubbing

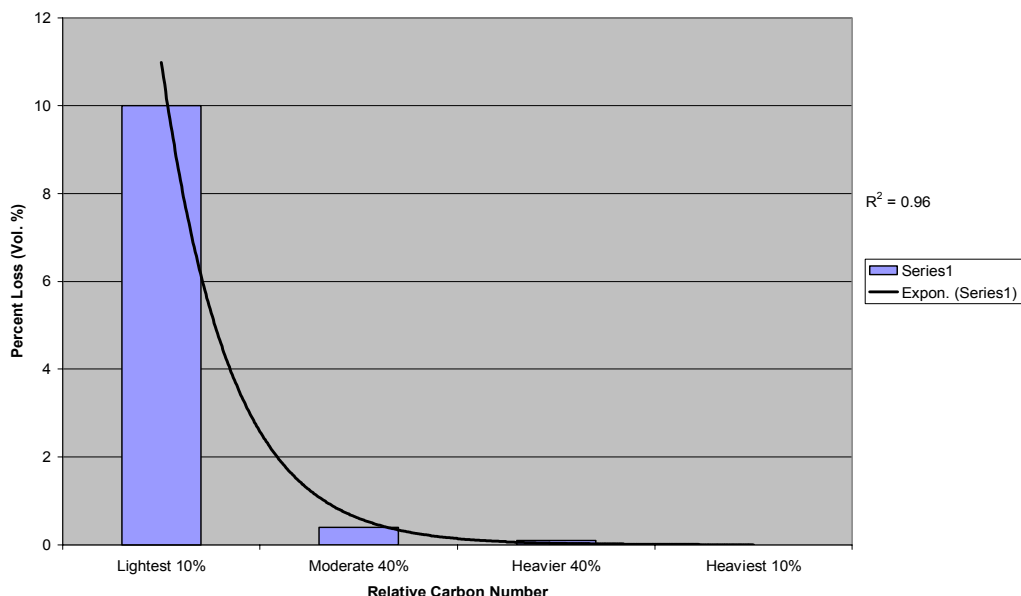

While results of the physical tests (ASTM D 4052 and D 4809) showed virtually no change to the “bulk” properties of the fuel, gas chromatography analyses clearly indicated changes to hydrocarbon distribution. Furthermore, the bulk properties are tolerant of this 1.2 volume % loss of boiling-point dependent hydrocarbons and their distribution within the fuel as illustrated in the figure above. However, the reader should take heed of the conditions under which these experiments were conducted. Note especially the flow and pressure of nitrogen, hood air flow, and quantities of fuel used. Although the fractions that were driven out of the fuel by nitrogen scrubbing could not be captured for analysis, the technique of chromatogram subtraction (as used here) is quite accurate and provides reliable insight as to the dynamic nature of these experiments.

Attachment B1

Sample ID	Description	ASTM D 4052	ASTM D 4809 (MJ/kg)
		0.8095	46.1
3451	Closed Flask, 20 Minute Sparge, Top	0.8094	46.3
3452	Closed Flask, 20 Minute Sparge, Stirred	0.8095	46.0
3453	Closed Flask, 20 Minute Sparge, Stirred	0.8094	46.1
3454	Closed Flask, 120 Minute Sparge, Top	0.8095	46.1
3455	Closed Flask, 120 Minute Sparge, Top	0.8094	46.1
3456	Closed Flask, 120 Minute Sparge, Stirred	0.8095	46.0
3457	Closed Flask, 120 Minute Sparge, Stirred	0.8094	46.1
3458	Open Cylinder, 20 Minute Sparge	0.8093	46.1
3459	Open Cylinder, 20 Minute Sparge	0.8094	46.0
3460	Open Cylinder, 120 Minute Sparge	0.8094	46.2
3461	Open Cylinder, 120 Minute Sparge	0.8095	46.1

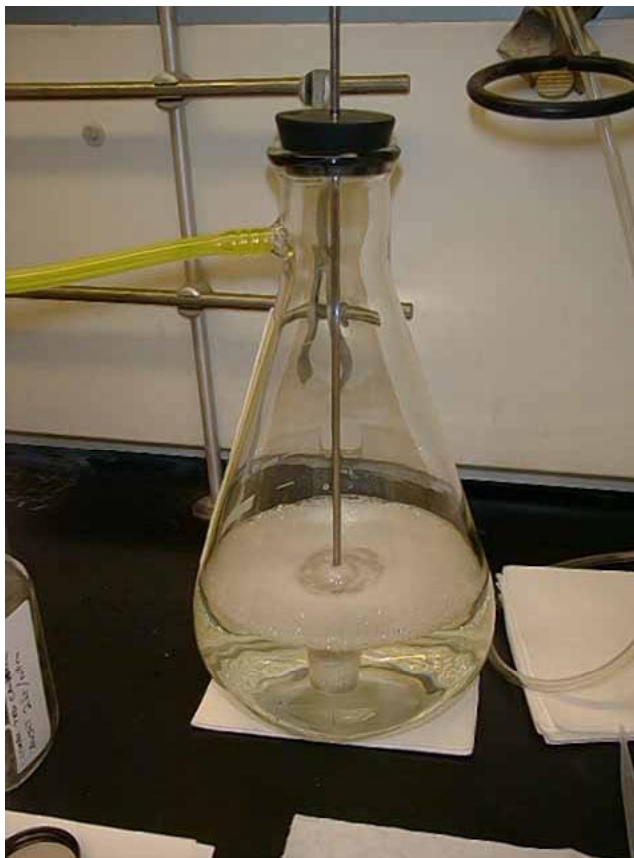

Attachment B2. Closed Flask With Sparger



Attachment B3. Open Cylinder With Sparger

ATTACHMENT C

Typical GC chromatograms: Jet A base fuel studied before and after 120 minutes of nitrogen scrubbing. The chromatogram with the higher peak heights (especially at early elution time and lower carbon no.) is that of the original starting fuel before scrubbing. As time increases the differences clearly diminish indicating the heavier components are not removed by the scrubbing.

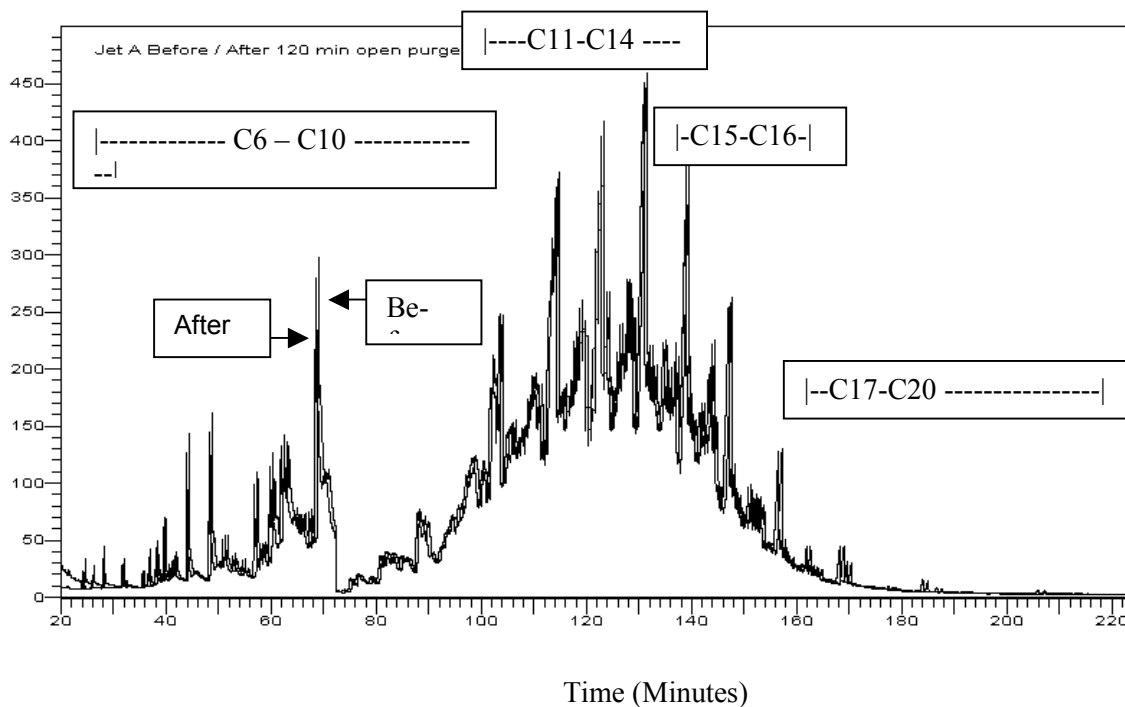

20 – 100 minutes, Group 1: C6-C10 alkanes and C1-C3 alkyl substituted cycloalkanes
 100 –140 minutes, Group 2: C11-C14 alkanes and C4-C7 alkyl substituted cycloalkanes
 140 – 160 minutes, Group 3: C15-C16 alkanes and C8-C9 alkyl substituted cycloalkanes
 160 - 220 minutes, Group 4: C17-C20 alkanes and C10 alkyl substituted cycloalkanes

The experimental parameters include:

Varian model STAR 3600 Cx Gas Chromatograph
 Using a Supelco 2-4160 PETROCOL DH 100 M x 0.25 mm and 0.5 micron film
 1 microliter injection using a Hamilton # 7101 1 microliter syringe
 Initial column Temp: 35 (C)
 Initial column Hold time 15 minutes
 Program 1 rate in degree (C) per minute 1.0
 Program 1 hold time 20
 Program 2 final column temp (C) 200
 Program 2 rate in degree (C) per minute 2.0
 Program 2 hold time 95
 Injector Temp (C) 300
 Detector Temp (C) 300
 FID Attenuation 8
 A two step ramp was used such that at 72.36 minutes the FID range changed from 8 to 11
 Total time 225 minutes

ATTACHMENT D

Retains from original fuel scrubbing experiments were reviewed to determine the concentration of benzene and toluene by a Gas Chromatography procedure developed to be more suitable for low concentrations of benzene in complex mixtures. The procedure includes:

- Increasing the sample size from 1 to 4 microliters
- Calculating benzene and toluene concentration based on:
 - The same GC experimental conditions for D3606
 - Varian Model 3700 Gas chromatograph
 - Column A: 8 m x 3.2 mm column with 10% (m/m) dimethylpolysiloxane in Chromosorb W, 60-80 mesh;
 - Column B a 4.6 m x 3.2 mm 20% (m/m) TCEP on Chromosorb P, 80 – 100 mesh.

The ratio of the integrated peak area of the analyte peak to that of the methyl-ethyl ketone internal standard peak.

Finding the relationship of analyte concentration to peak area ratio from measurements of a certified D3606 standard where the concentrations of the analytes (benzene and toluene) are known.

The results of these analyses are given in the table below:

Sample ID	Benzene		Toluene		% Removed	
	Vol. %	(ppm)	Vol.%	(ppm)	Benzene	Toluene
Basefuel Jet A	0.00575	(57.5)	0.108	(1080)	0.00	0.0
Closed Flask 20 min	0.00574	(57.4)	0.108	(1080)	0.17	0.0
Closed Flask 120 min	0.00569	(56.9)	0.108	(1080)	1.04	0.0
Open Cylinder 20 min	0.00475	(47.5)	0.100	(1000)	17.39	8.0
Open Cylinder 120 min	0.00465	(46.5)	0.100	(1000)	19.13	8.0

In general the Closed Flask scrubbing removes from a fraction at 20 minutes up to 1 percent at 2 hrs. In contrast, the Open Cylinder scrubbing removes 17% of the fuel’s benzene in as little as 20 minutes, which increases to 19 % removal after 2 hrs. As we saw in the overall chemical emission case, the Closed Flask allows condensation back to the liquid.

Airport Facilities Task Team Final Report

8.0 ECONOMICS

Cost estimates were determined using the design concepts developed by the team and typical airport construction practices.

Figures 8-1 through 8-4 are economic evaluations of the inerting systems considered by the Working Group for each type of airport. The estimates used a standard form common to each estimate. The economic evaluation was broken into two parts, capital (non recurring) and operation (recurring) costs.

The evaluations include only the cost of construction and maintenance; operator labor costs are not included.

Capital				
Description	Cost per mobile unit, K	Airport size		
		Large	Medium	Small
Number of mobile units		12	7	2
• System and truck	330	3960	2310	660
• Parking and site preparation	1	12	7	2
• Piping, hoses, reels, other	0	0	0	0
• Electrical power upgrades	0	0	0	0
• Engineering and soft costs (19%)	1	12	7	2
• Contingency (25%)	83	996	581	166
Total	415	4980	2905	830

Operational costs per month				
Description	Cost per mobile unit, K	Airport size		
		Large	Medium	Small
Number of mobile units		12	7	2
• Rent at \$1.0/ft	4	48	28	8
• Lease system if applicable	0	0	0	0
• System maintenance	1	12	7	2
• Power cost (if not already included)	2	24	14	4
• Maintenance and operation	.5	6	3.5	1
Total	7.5	90	52.5	15

Note: All figures are in thousands of U.S. dollars.

Figure 8-1. ARAC Facility Estimate—Mobile Ullage System

Capital				
Description	Cost per concourse, K	Airport size		
		Large	Medium	Small
Number of concourses		9	2	NA
• System	0	0	0	—
• Site preparation	35	315	70	—
• Piping, hoses, reels, other	408	3,672	816	—
• Electrical power upgrades	500	4,500	1000	—
• Engineering and soft costs (19%)	179	1,613	358	—
• Contingency (25%)	281	2,525	562	—
Total	1,403	12,624	2806	NA

Notes:

- Concourse is 20 gates.
- All figures are in thousands of U.S. dollars.

Figure 8-2. ARAC Facility Estimate—Fixed Ullage System (Sheet 1 of 2)

Operational costs per month				
Description	Cost per concourse, K	Airport size		
		Large	Medium	Small
Number of concourses		9	2	NA
• Rent at \$20/ft	2	18	4	—
• Lease system if applicable	0	0	0	—
• System maintenance	1	9	2	—
• Maintenance and operation	Per Airport	25	13	—
Total		52	19	NA

Note: All figures are in thousands of U.S. dollars.

Figure 8-2. ARAC Facility Estimate—Fixed Ullage System (Sheet 2 of 2)

Capital				
Description	Cost per tank, K	Airport size		
		Large	Medium	Small
Per tank at one fuel facility		20	4	2
• System	0	0	0	0
• Site preparation	20	400	80	40
• Piping, hoses, reels, other	101	2,014	403	201
• Electrical power upgrades	30	600	120	60
• Engineering and soft costs (19%)	29	573	115	57
• Contingency (25%)	45	897	179	90
Total	224	4,483	897	448

Operational costs per month				
Description	Cost per gal/ min delivered, K	Airport size		
		Large	Medium	Small
Thousands of gallons per minute		4.5	1.0	0.4
• Rent at \$1.0/ft	2	7	2	1
• Lease system if applicable	1	2	1	0
• System maintenance	1	5	1	0
• Inert gas cost	26	117	26	10
• Power cost (if not already included)	0	0	0	0
• Maintenance and operation	2	9	2	1
Total	31	140	31	12

Note: All figures are in thousands of U.S. dollars.

Figure 8-3. ARAC Facility Estimate—Fixed Scrubber System

Capital				
Description	Cost per truck, K	Airport size		
		Large	Medium	Small
Number of existing refuelers		14	9	4
• System and truck	8	112	72	32
• Parking and site preparation	0	0	0	0
• Piping, hoses, reels, other	0	0	0	0
• Electrical power upgrades	0	0	0	0
• Engineering and soft costs (19%)	0	0	0	0
• Contingency (25%)	2	28	18	8
Total	10	140	90	40

Figure 8-4. ARAC Facility Estimate—Mobile Scrubber System (Sheet 1 of 2)

Airport Facilities Task Team Final Report

Operational costs per month				
Description	Cost per truck, K	Airport size		
		Large	Medium	Small
Number of refuelers		14	9	4
• Rent at \$1.0/ft	0	0	0	0
• Lease system if applicable	0	0	0	0
• System maintenance	1	7	5	2
• Inert gas cost	0	0	0	0
• Power cost (if not already included)	1	7	5	2
• Maintenance and operation	1	7	5	2
Total	2	21	14	6

Note: All figures are in thousands of U.S. dollars.

Figure 8-4. ARAC Facility Estimate—Mobile Scrubber System (Sheet 2 of 2)

8.1 ESTIMATE LEGEND AND LINE ITEM EXPLANATIONS

General

The estimates for each type of airport and each CONCEPT estimated used a form that is common to each estimate. The form was broken into two pieces, CAPITAL and OPERATION

CAPITAL: Capital costs are those outlays made to design, install and commission a system (CONCEPT). Included in the CAPITAL estimates are (1) System/Truck costs, (2) Parking and Site Prep costs, (3) Piping, hoses and reels for fixed systems, (4) Electrical Power upgrades, (5) Engineering and soft costs, (6) Contingencies.

OPERATION: Monthly operational costs are those outlays necessary to operate the system (CONCEPT) and are exclusive of capital costs. Depreciation is ignored. Included in the OPERATION estimates are (7) Rent, (8) System (CONCEPT) lease, (9) System (CONCEPT) maintenance, (10) Inert gas costs for delivered (not generated) gas, (11) Power costs (if not already included in other line items, and (12) Maintenance and Operation costs.

Each 'outlay' is defined for reference below:

1. SYSTEM/TRUCK COSTS

- a) Generators
- b) Storage Tanks LN₂
- c) Controls
- d) Power, Lights and Distribution from Supply (See Item 4 for electrical supply infrastructure)
- e) System Enclosure (if any)
- f) Rolling Equipment (if applicable)

2. PARKING AND SITE COSTS

- a) Fence
- b) Rooms / Walls / etc.
- c) Site Lighting
- d) Ramp Striping
- e) Barricades

3. PIPING / HOSES / REELS / ETC. FOR FIXED SYSTEMS (CONCEPTS)
 - a) Piping
 - b) Hoses
 - c) Gate Distribution elements to aircraft
4. ELECTRICAL POWER UPGRADES
 - a) Utility Sets a New Service
 - b) New Supply Switch board
 - c) Space Costs / New Electrical Room
5. ENGINEERING and SOFT COSTS
 - a) Design 6 %
 - b) Construction Administration 3 %
 - c) Program Management 6 %
 - d) Construction Management 3 %
 - e) Permit and related costs 1 %
 - f) Infrastructure Survey \$25,000 each Concourse
 - g) Subtotal 19 % + \$25,000
6. CONTINGENCIES in CAPITAL BUDGET
 - a) Unforeseen conditions
 - b) Conceptual Unknowns
7. RENT
 - a) Lease for Concourse space @ \$20/yr
 - b) Lease for Site space @ \$1/month per foot
8. SYSTEM LEASE COST
 - a) Inert Gas Generating System Lease cost (if applicable)
9. SYSTEM MAINTENANCE
 - a) Inert Gas Generating System maintenance costs by manufacturer (if applicable)
10. INERT GAS COSTS
 - a) Delivery Costs
 - b) Capitalized System Cost
 - c) Gas Cost
 - d) Back-up Gas costs
 - e) Power/energy for System
 - f) Depreciation of System (if manufacturer builds this in)

Airport Facilities Task Team Final Report

11. POWER COSTS

- a) Monthly power costs to run the system (if not built in to other line items)

12. AIRPORT MAINTENANCE & OPERATION

- a) Labor to maintain Metering, Piping / Connections, etc.
- b) Labor to Operate @ \$22.00/hr.
- c) Space Parts
- d) Accounting
- e) Testing and Airport Certification

9.0 CONCLUSIONS AND RECOMMENDATIONS

9.1 CONCLUSIONS

Based on the work performed the team reached the following conclusions:

Ground-Based Inerting

Supplying NEA for ground-based inerting is technically possible. It was beyond the task of this team to do a full analysis to determine if GBI was practical from a cost/benefit standpoint. Large and medium airports would use a fixed system supplemented with mobile equipment for remote operations. Small airports would be served with mobile equipment. Each airport is unique and the systems would have to be custom designed. This could impact the overall cost.

Gas Supply

Gaseous NEA generated using Air Separation Modules (ASM) would be the most practical gas to use for GBI due to the ability to make it on-site. This reduces the labor and costs associated with the delivery and storage of other gases. Cryogenic liquid nitrogen may have some limited application such as remote inerting of large transport category aircraft.

Fuel Scrubbing

The purpose of delivering nitrogen-saturated fuel into the airplane during normal fueling and refueling operations is to minimize the outgassing of entrained oxygen during the takeoff, climb, and cruise flight envelope to supplement the benefit of ground-based inerting. Because of the potential impact on fuel properties, the complexity of the processes required, and the costs the team concluded that fuel scrubbing was not practical. Fuel scrubbing adds nothing to the protection of the empty CWT.

Fuel Cooling

Fuel cooling does not by itself address the issue of the empty CWT. While fuel cooling will reduce fuel tank flammability, it will only do so in those tanks that have fuel added. It still requires a means of providing an inert gas for ullage washing the empty tanks. This will add to the cost and therefore it was concluded that fuel cooling was not feasible for the purpose of this study.

Standards

A global standard would need to be developed for the components of the system systems that interface with the aircraft, i.e. connections, metering systems, pressure control, safety system, etc. There would also need to be standards for the mobile equipment.

9.2 RECOMMENDATIONS

The AFT recommends that the FAA continue to research ways to supply NEA to the aircraft. Specifically, they should build a pilot plant that closely simulates the conditions that would occur in actual use. They should also research the use of liquid NEA to remotely inert the large transport category aircraft.

Appendix F
Airplane Operation and Maintenance
Task Team Final Report

This page intentionally left blank.

TABLE OF CONTENTS

1.0 INTRODUCTION.....	F-1
1.1 THE TASK.....	F-1
1.2 THE TEAM.....	F-1
1.2.1 Modification/Retrofit Sub-team.....	F-1
1.2.2 Scheduled Maintenance Sub-team.....	F-2
1.2.3 Unscheduled Maintenance Sub-team.....	F-2
1.2.4 Flight/Ground Operation Sub-team.....	F-2
2.0 METHODOLOGY.....	F-2
2.1 DATA REVIEW.....	F-2
2.2 INERTING SYSTEM CONCEPT REVIEW.....	F-3
2.3 MODIFICATION.....	F-3
2.3.1 General.....	F-3
2.3.2 Engineering.....	F-4
2.3.3 Technical Publications.....	F-4
2.3.4 Material Control and Kits.....	F-4
2.3.5 Project Estimation.....	F-5
2.3.6 Airplane Out of Service Time Estimate.....	F-5
2.3.7 Maintenance Training.....	F-5
2.4 MEL RELIEF.....	F-6
2.4.1 Primary Assumptions.....	F-6
2.4.2 Frequency of Dispatch on MEL.....	F-6
2.4.3 Flight Delays.....	F-7
2.5 SCHEDULED MAINTENANCE.....	F-7
2.5.1 Maintenance Labor-Hours.....	F-8
2.5.2 Cycles vs. Operating Time.....	F-8
2.5.3 Additional Maintenance Tasks.....	F-9
2.6 UNSCHEDULED MAINTENANCE.....	F-9
2.6.1 Component Reliability.....	F-9
2.6.2 MTBF vs. MTBUR.....	F-10
2.6.3 Airplane Utilization Rate.....	F-10
2.6.4 System Reliability.....	F-10
2.6.5 System Annual Utilization Rates.....	F-10
2.6.6 System Annual Failure Rate.....	F-10
2.6.7 System Maintenance Workload.....	F-10
2.7 FLIGHT OPERATIONS.....	F-11
2.8 GROUND OPERATIONS.....	F-11
3.0 MAINTENANCE IMPACTS.....	F-12
3.1 INTRODUCTION.....	F-12
3.2 MODIFICATION AND RETROFIT.....	F-12
3.3 MEL RELIEF.....	F-12
3.4 SCHEDULED MAINTENANCE.....	F-12
3.5 UNSCHEDULED MAINTENANCE.....	F-13
3.6 MAINTENANCE SAFETY.....	F-14
3.6.1 General.....	F-14
3.6.2 Confined Spaces.....	F-14
3.6.3 Gaseous Nitrogen.....	F-15
3.6.4 Liquid Nitrogen.....	F-15
3.6.5 Gaseous Oxygen.....	F-16

Airplane Operation and Maintenance Task Team Final Report

3.7 MAINTENANCE TRAINING	F-16
4.0 OPERATIONAL IMPACTS.....	F-16
4.1 INTRODUCTION.....	F-16
4.2 FLIGHT OPERATIONS.....	F-16
4.2.1 Schedule Impact	F-17
4.2.2 Airplane Out-of-Service Time.....	F-17
4.2.3 MEL Relief.....	F-17
4.2.4 Lost Revenue.....	F-17
4.2.5 Flight Operations Safety	F-18
4.2.6 Flight Operations Training	F-18
4.3 GROUND OPERATIONS	F-18
4.3.1 Ground Operations Safety	F-18
4.3.2 Ground Operations Training.....	F-19
4.3.3 Ground Servicing.....	F-19
5.0 GROUND BASED INERTING SYSTEM	F-20
5.1 MODIFICATION.....	F-20
5.2 SCHEDULED MAINTENANCE	F-21
5.2.1 Scheduled Maintenance Tasks.....	F-21
5.2.2 Additional Maintenance Labor-Hours.....	F-21
5.3 UNSCHEDULED MAINTENANCE	F-21
5.3.1 System Reliability.....	F-21
5.3.2 Cost to Carry.....	F-22
5.4 FLIGHT OPERATIONS.....	F-22
5.5 GROUND OPERATIONS	F-23
5.5.1 GBI Ullage Washing Labor Estimate	F-23
5.5.2 Potential Future System Improvements.....	F-24
6.0 ON-BOARD GROUND INERTING SYSTEM	F-25
6.1 MODIFICATION.....	F-25
6.2 SCHEDULED MAINTENANCE	F-26
6.2.1 Scheduled Maintenance Tasks.....	F-26
6.2.2 Additional Maintenance Labor-Hours.....	F-26
6.3 UNSCHEDULED MAINTENANCE	F-27
6.3.1 System Annual Utilization Rate	F-27
6.3.2 System Reliability.....	F-27
6.3.3 System Annual Failure Rate	F-27
6.3.4 Unscheduled Maintenance Labor Estimate	F-28
6.3.5 Inerting System Availability.....	F-29
6.3.6 MEL Dispatch Relief Effect.....	F-30
6.3.7 Delay Hours per Year	F-31
6.4 FLIGHT OPERATIONS.....	F-32
6.5 GROUND OPERATIONS	F-32
7.0 ON-BOARD INERTING GAS GENERATING SYSTEM.....	F-33
7.1 MODIFICATION.....	F-33
7.2 SCHEDULED MAINTENANCE	F-33
7.2.1 Scheduled Maintenance Tasks.....	F-33
7.2.2 Pressure Check	F-34
7.2.3 Additional Maintenance Labor-Hours.....	F-34
7.3 UNSCHEDULED MAINTENANCE	F-34
7.3.1 System Annual Utilization Rate	F-35
7.3.2 Component Reliability.....	F-35
7.3.3 System Reliability.....	F-36

Airplane Operation and Maintenance Task Team Final Report

7.3.4 System Annual Failure Rate	F-36
7.3.5 Unscheduled Maintenance Labor Estimate	F-37
7.3.6 Annual Labor Costs	F-38
7.3.7 System Weight.....	F-39
7.3.8 Cost to Carry per Airplane per Year (\$)	F-39
7.3.9 System Availability	F-39
7.3.10 Delays per Year (Hours).....	F-40
7.3.11 MMEL Repair Period	F-41
7.3.12 Cancellation/Delay Costs.....	F-42
7.3.13 Personnel Safety	F-42
7.3.14 OBIGGS Effects on Other Airplane Systems.....	F-43
7.4 FLIGHT OPERATIONS.....	F-45
7.5 GROUND OPERATIONS	F-45
8.0 HYBRID ON-BOARD INERTING SYSTEMS.....	F-45
9.0 CONCLUSION	F-45
REFERENCE.....	F-46
ADDENDUM F.A.1 MODIFICATION COST & LABOR-HOUR ESTIMATION	F-A1-1
ADDENDUM F.A.2 MODIFICATION PROJECT LABOR-HOUR ESTIMATION	F-A2-1
ADDENDUM F.A.3 MODIFICATION LABOR-HOUR ESTIMATION FOR BUSINESS JETS	F-A3-1
ADDENDUM F.B.1 SCHEDULED MAINTENANCE TASKS AND ADDITIONS LABOR-HOURS	F-B1-1
ADDENDUM F.C.1 UN-SCHEDULED MAINTENANCE DATA GROUND BASED INERTING SYSTEM.....	F-C1-1
ADDENDUM F.C.2 UN-SCHEDULED MAINTENANCE DATA ON-BOARD GROUND INERTING SYSTEM.....	F-C2-1
ADDENDUM F.C.3 UN-SCHEDULED MAINTENANCE DATA ON-BOARD INERTING GAS GENERATING SYSTEM	F-C3-1
ADDENDUM F.D.1 CONFINED SPACE ENTRY LABOR & SAFETY EQUIPMENT ESTIMATE	F-D1-1

LIST OF FIGURES

1-1.	Team Structure.....	F-1
2-1.	Flight Delay Assumptions	F-7
2-2.	Airplane Average Utilization by Category	F-8
2-3.	Average Fleetwide Maintenance Intervals	F-8
2-4.	Airplane Average Utilization by Category	F-10
3-1.	Personnel Hazards	F-15
4-1.	Average Minimum Turn Times	F-17
5-1.	Modification Estimations for Ground Based Inerting Systems	F-20
5-2.	Scheduled Maintenance Times	F-21
5-3.	GBI System Reliability and Maintainability Analysis.....	F-22
5-4.	GBI Ullage Washing Labor Estimate	F-24
6-1.	Modification Estimations for On-Board Ground Inerting Systems	F-26
6-2.	Scheduled Maintenance Times	F-26
6-3.	OBTI System Annual Utilization Rate.....	F-27
6-4.	Predicted OBTI System Annual Failure Rate	F-28
6-5.	Annual Unscheduled Maintenance Labor Estimate per Airplane.....	F-28
6-6.	Impact of MEL Relief on System Availability	F-29
6-7.	OBTI System Availability.....	F-30
6-8.	MEL Dispatch Relief Effect	F-31
6-9.	Annual OBTI System Flight Delay Hours	F-32
7-1.	Modification Estimations for On-Board Inerting Gas Generating Systems	F-33
7-2.	Cryogenic System—Scheduled Maintenance Times	F-34
7-3.	Membrane System—Scheduled Maintenance Times	F-34
7-4.	System Annual Utilization Rate	F-35
7-5.	System MTBUR	F-36
7-6.	System Annual Failure Rate	F-37
7-7.	Additional Annual Labor Hours	F-38
7-8.	Additional Annual Labor Costs (\$)	F-39
7-9.	System Availability (10 Days MMEL Relief).....	F-40
7-10.	Delays per Year (Hours).....	F-41
7-11.	MMEL Repair Interval/Service Cancellations (%).....	F-41
7-12.	Cancellation/Delay Costs.....	F-42
7-13.	Comparisons of Costs and Repair Intervals.....	F-42
7-14.	OBTIGGS Power Requirements (kVA).....	F-44

GLOSSARY

A	A letter for airplane maintenance interval
AD	Airworthiness Directive
ALPA	Airline Pilots Association
AOG	Airplane on Ground
ARAC	Aviation Rulemaking Advisory Committee
ASM	air separator module
ATA	Air Transport Association of America
ATB	air turn back
BITE	built-in test equipment
C	A letter for airplane maintenance interval
CBT	computer-based training
CWT	center wing tank
DDG	dispatch deviation guide
e.g.	for example
ER	extended range
FAA	Federal Aviation Administration
FAR	Federal Aviation Regulation; fuel/air ratio
GBI(S)	ground-based inerting (system)
HWG	Harmonization Working Group
JAA	Joint Aviation Authorities
LRU	line-replaceable unit
LS	lump sum
MEL	minimum equipment list
MMEL	master minimum equipment list
MO	modification order
MSG-3	Maintenance Steering Group—volume 3
MTBF	mean time between failure
MTBUR	mean time between unscheduled removal
NEA	nitrogen-enriched air
NIOSH	national institute for occupational safety and health
NTOF	National Traumatic Occupational Fatalities
O ₂	oxygen
OBGI(S)	onboard ground inerting (system)
OBIGG(S)	onboard inert gas generating (system)
OEM	original equipment manufacturer
OSHA	Occupational Safety and Health Administration
PC, PCA	preconditioned air
PRV	pressure relief valve

Airplane Operation and Maintenance Task Team Final Report

PSA	pressure-swing adsorption
SB	service bulletin
TCAS	traffic collision avoidance system
U.S.	United States

1.0 INTRODUCTION

1.1 THE TASK

The Airplane Operations & Maintenance Task Team was assembled by the Working Group to support the Fuel Tank Inerting Study. The primary functions of this team were to.

- Review operational and maintenance data on existing fuel tank inerting systems.
- Evaluate the impact of the proposed inerting system design concepts on airplane operations, maintenance, and fleet planning.
- Evaluate the cost impact of the various proposed inerting system concepts on flight operations, ground operations, and maintenance
- Provide technical expertise in the area of airplane operations and maintenance to the other working group teams.
- Document the results of the Team’s findings.

1.2 THE TEAM

The Team’s membership was comprised of individuals with extensive experience in airplane flight operations, maintenance, ground operations, engineering, and aviation regulations.

To divide the workload and to address all impacts on operations and maintenance the Team splited up into four sub-teams. The sub-teams are:

- Modification/Retrofit,
- Scheduled Maintenance,
- Un-scheduled Maintenance/Reliability, and
- Flight/Ground Operations.

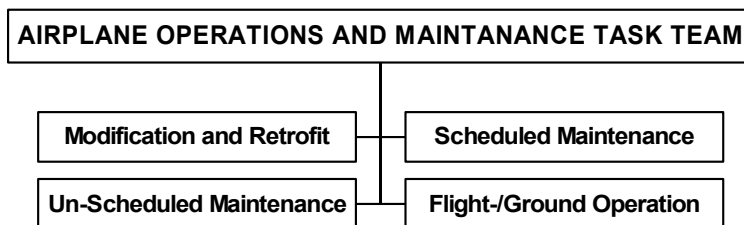

Figure 1-1. Team Structure

1.2.1 Modification/Retrofit Sub-team

This sub-team identified and quantified the costs and impact associated with modification of each of the existing airplane types to install the various inerting systems. The sub-team assumed that the modification would be done per an airplane manufacturer’s service bulletin (SB) that provided modification data, and that the manufacturer would make available modification kits. The sub-team considered two different modification scenarios: First, the airplane is modified during a regularly scheduled heavy maintenance check. Second, the airplane is modified during a dedicated maintenance visit. The advantage of the first scenario is that access to most maintenance areas is already open for the regular maintenance check, which would reduce the total labor requirement, cost of modification, and airplane time out of service.

They developed data and estimations for each of the airplane/system combinations. These estimates were to include but not be limited to material/kit costs, modification labor-hours, engineering support

Airplane Operation and Maintenance Task Team Final Report

requirements, technical publication revisions, airplane time out of revenue service, spares and training requirements, and any other issues related to the retrofit of inerting systems on existing airplane.

1.2.2 Scheduled Maintenance Sub-team

This sub-team identified and quantified the costs and impact associated with the routine maintenance of the inerting system as well as any effects the inerting systems might have on the maintenance requirements of other airplane systems or equipment.

The sub-team developed data for each of the airplane/system combinations. This data would include but would not be limited to airplane and component maintenance tasks, task intervals, task labor-hours, estimate of annual scheduled maintenance labor-hours, annual material costs, and the impact on check schedules, tooling requirements, and all other aspects of scheduled maintenance.

1.2.3 Unscheduled Maintenance Sub-team

This sub-team identified and quantified and quantifying the costs and impacts associated with the non-routine maintenance of the inerting system. They would also work with the Design, Rulemaking, and Safety Teams to define master minimum equipment list (MMEL) requirements and limitations.

They also developed data for the cost and impact of unscheduled maintenance on each of the airplane/system combinations, including but not limited to:

- Line maintenance tasks,
- Line maintenance labor-hours for troubleshooting/repair based on reliability data
- Delay and cancellation rates
- Airplane-on-ground (AOG) time
- Line maintenance training requirements and costs
- Component overhaul interval, labor, and material costs

And all other impacts related to unscheduled maintenance and system reliability as measured in mean time between failures (MTBF) or mean time between unscheduled removals (MTBUR).

1.2.4 Flight/Ground Operation Sub-team

This sub-team identified and quantified the operational issues, impact, and costs associated with flight operations and gate or ramp operations needed to support airplane equipped with inerting systems for each of the inerting systems concepts. They also analyzed and developed data relating to training requirements, airplane servicing, flight dispatch requirements and resources, cost-to-carry estimates, flight operating manual procedures, and manual revisions for each of the airplane/system combinations.

2.0 METHODOLOGY

2.1 DATA REVIEW

The Team's first task was to search for and review all available documentation relating to the operation, maintainability, and reliability of airplane fuel tank inerting systems. Searches of libraries and databases belonging to U.S. and European regulatory agencies, the Airplane Pilots Association (ALPA), the petroleum industry, airplane manufacturers, and U.S. military services were conducted as well as a search of the Internet.

For the most part, very little publicly available data on airplane fuel tank inerting systems exists. The Team did identify some reports, primarily FAA studies, including one on the modification of a DC-9 to

Airplane Operation and Maintenance Task Team Final Report

incorporate a fuel tank inerting system 30 years ago. With the exception of the data produced as a result of the 1998 ARAC Fuel Tank Harmonization Working Group and a year 2000 FAA Technical Center report on ground-based inerting, none of these reports included any operational or maintenance data relevant to the current study.

Several military fuel tank inerting system applications similar to those being considered for this study were identified. However, the Team could obtain very little operational, maintenance, or reliability data on those systems because that data is classified.

2.2 INERTING SYSTEM CONCEPT REVIEW

As information became available from the Ground Based and On-Board inerting Design teams the Operations and Maintenance team began reviewing the systems to identify operational and maintainability considerations for each of the concepts. Each of the concepts was initially evaluated to identify how it might impact airplane flight operations, ground operations, dispatch reliability, maintainability, and training requirements. The potential impact to passengers, crews, and maintenance personnel safety was also considered.

After this initial evaluation, the Team split up into sub-teams to begin detailed analyses. The four sub-teams addressed Modification/Retrofit, Scheduled Maintenance, Unscheduled Maintenance/Reliability, and Airplane Flight/Ground Operations.

2.3 MODIFICATION

2.3.1 General

The inerting systems would be installed via modification or retrofit. The original equipment manufacturers (OEM) would retrofit airplanes in production. The OEMs would also need to provide modification to operators via a service bulletin. Operators, maintenance facilities, or OEMs will modify in-service airplanes.

An FAA approved OEM service bulletin for retrofit of an inerting system should be available before any final rule compliance date is set for retrofit of in-service airplanes. Failure to do this has caused problems for operators in the past. For example, in 1998 the FAA issued an Airworthiness Directive (AD) for 747-100/200/300/SP/SR series airplanes to change the wire separation requirements for Fuel Quantity Indicating System (FQIS) wiring. Although an approved retrofit solution was not available, a 3-year AD compliance time for airplane modification was set. The FAA expected the OEM to complete design changes, gain approval and make a service bulletin available within 1 year of the effective date of the AD. This would allow the operators two years to modify their affected fleet. However, FAA approved retrofit solutions did not become available until almost 24 months into the compliance period, thereby significantly impacting the operator's ability to complete the modifications within the remaining compliance time. Because of the potential for delays in the design approval, it is critical that prior to the establishment of any compliance date requiring installation of an inerting system, an approved service bulletin must be available. This will insure that operators have sufficient time to complete the modifications within the compliance period of a rule.

Due to the scope of the modification, it must be accomplished during a heavy maintenance check or a special visit. Estimates have been developed for both scenarios.

The modification estimations are split into two major parts. The first is the non-recurring costs that comprise engineering time, technical publication changes, and material control. The labor-hour estimate for these nonrecurring costs is the same for all airplane categories. The nonrecurring estimates shown in attachment A-1 are per airplane type per operator. The second part of the modification estimate includes recurring costs and comprises actual airplane modification time. This portion of the estimate is per airplane.

The total modification costs and labor-hours estimation is shown in addendum F.A.1. A short description of each topic is presented below.

2.3.2 Engineering

Before a modification can be accomplished, the operators engineering department must review the OEM service bulletin to determine applicability and check for variations in airplane configurations. Then the modification order (MO) must be written, including creation of the necessary drawings and job cards, and coordinate with the maintenance and material planning organizations. After the MO has been completed and is ready for production, engineering has to create the necessary tracking numbers and maintain the records for all components and their trends. The maintenance program must be updated prior to release of the first modified airplanes. The engineer assigned to this modification becomes the project manager. In addition to the above-mentioned responsibilities, he/she will be assisting and monitoring the progress of this modification.

2.3.3 Technical Publications

The introduction of the inerting system affects the following technical publications:

- Airplane Maintenance Manual
- Illustrated Part Catalog
- Component Maintenance Manual
- Airplane Flight Manual
- Flight Operations Manual
- Structural Repair Manual
- Fuelling Manual
- Ramp Maintenance Manual
- General Maintenance Manual (including company procedures)
- Wiring Diagram Manual
- Weight and Balance Manual

In the modification estimation analyses, the Team assumes that the normal revision procedures of the airplane manufacturer are used. The estimated time is the time that is required to revise the manuals.

2.3.4 Material Control and Kits

The inerting system introduces new serialized parts and consumable parts. Those new parts have to be added to the company's databases. Due to the lack of data on the inerting system, the material cost of consumables is not taken into account.

Prior to the establishment of any compliance date requiring installation of an inerting system, modification kits must be available and the airframe manufacture should coordinate the flow of kits to the operators. In this way, large operators will not adversely affect the availability of kits for smaller operators

Kit costs—the price of the kit, storage costs, and the labor-hours needed to check it—are not taken into account because of the large variation between airplanes, which prevents the use of detailed generic data and pricing.

Airplane Operation and Maintenance Task Team Final Report

2.3.5 Project Estimation

For the modification estimation, the following airplane types were used as examples of each of the six category airplanes:

- Large airplane type category—Boeing 747 series.
- Medium airplane type category—Boeing 767 and MD11.
- Small airplane type category—Boeing 737.
- Regional fan airplane type category—Fokker 28 and 70.
- Regional prop airplane type category—No airplane¹.
- Business jet airplane type category- Gulfstream IV.

Addendum F.A.2 shows the task with the labor-hours to do the project. For this estimation, it is assumed that the airplane has integrated tanks. Rubber cells are used by the Fokker 28/70/100 series airplanes and as auxiliary tanks on some other transport airplanes. Introduction of the inerting system requires modification or redesign of the rubber cells. For the regional turbofan airplane category, estimates for airplanes with bag-tank (rubber cells) are made as well. Neither is the time that is required for moving or replacing existing installations to accommodate the piping of the inerting system.

The engineering support requirements (e.g., engineering, technical publications, material management) for retrofit of an operator fleet are based on a nominal fleet size.

2.3.6 Airplane Out of Service Time Estimate

To estimate the downtime for the airplane, the following assumptions are made:

- Modification is accomplished on a five-day workweek.
- There are three shifts each with 10 people (5 mechanics, 3 avionics, and 2 sheet metal workers).

2.3.7 Maintenance Training

The basic training requirement for this fuel tank inerting modification consists of classroom lectures, use of the jet airplane maintenance fundamentals, computer-based training (CBT) courseware, basic training workshops, and practical training on in-service airplane at a maintenance organization. A substantial amount of time is needed to educate and train the professional maintenance technicians who will be responsible for safely handling and maintaining airplanes that are equipped with inerting systems.

Operator maintenance and ground training departments, and vendor and manufacturer training departments, will need a substantial amount of time to create and present all necessary training materials for the different kinds of inerting systems. The diversity of airplane fleets and available inerting systems will compound this challenge.

Existing training manuals will need to be revised to reflect airplane modifications and operational requirements posed by fuel tank inerting.

There are significant differences in training regulations between the various countries. An accurate estimation would require knowing the exact number of licensed mechanics and the average number of

¹For the regional prop airplane types no estimation is made, this because the Team could not find a company that does the maintenance for propeller airplanes with a center wing tank. Fokker Services, who did the estimation for the regional turbofan airplanes, indicated that the Fokker 27, 50 and 60 airplanes, which are turboprop airplanes, do not have a center wing tank.

licensed mechanics per airplane per operator. An additional factor is the fact that some operators contract with training centers to educate their maintenance personnel. Due to these and other factors the Team was not able to make a labor-hours estimate for training costs. However the Team described the impact on maintenance training due to the introduction of inerting systems.

2.4 MEL RELIEF

The Federal Aviation Regulations (FAR) require that all equipment installed on an airplane be in compliance with the airworthiness standards and operating rules must be operative. However, the FARs also permits the publication of a minimum equipment list (MEL) where compliance with certain equipment requirements is not necessary in the interests of safety under all operating conditions. Experience has shown that with the various levels of redundancy designed into an airplane, operation of every system or installed component may not be necessary when the remaining operative equipment can provide an acceptable level of safety. Under the MEL, dispatch relief is granted for listed components and systems for specific periods of time before the system or component must be repaired or made operational. If repair is not made before the specified time period expires, the airplane may not be flown again until the repairs are made. The FAA uses several standard “repair intervals” that range from one flight to 120 days.

2.4.1 Primary Assumptions

As defined in the Tasking Statement, “Evaluations of all systems should include consideration of methods to minimize the cost of the system. For example, reliable designs with little or no redundancy should be considered, together with recommendations for dispatch relief authorization using the master minimum equipment list (MMEL) in the event of a system failure or malfunction that prevents inerting one or more affected fuel tanks. The Working Group in general and the Airplane Operations and Maintenance Task Team specifically felt that these instructions were contradictory to the normal application of the MMEL.

These assumptions vastly affect the maintenance and operational costs for an airplane equipped with a fuel tank inerting system. Requiring system redundancy would greatly increase the cost and complexity of the inerting system. System redundancy would also greatly increase maintenance and operating costs.

Likewise, if dispatch relief were not available on a system without redundancy, the maintenance requirements would be greatly increased. In addition, the rate of flight delays and cancellations would increase significantly because the system would have to be repaired before flight.

After lengthy discussions at the Team and Working Group levels it was decided to proceed with the evaluation using the guidelines in the tasking statements. However, it must be understood that airplane operations and maintenance costs would significantly increase with a change to either of these assumptions. Because all of the working group’s analysis is based on these two assumptions, changing them would invalidate most of the results.

For purposes of the study, the Airplane Operations and Maintenance Task Team made an attempt to evaluate the impact of a Category B or three-day repair interval and a Category C or 10-day repair interval. The impact was evaluated based on the reliability of the system, the typical amount of ground time between flights, and the typical maintenance capture rate or the frequency that an airplane overnights at a maintenance base. An effort was also made to predict the impact of having no dispatch relief, which essentially meant that one or more flights would be cancelled while repairs were being accomplished. While these estimates are not comprehensive, they suggest the potential impact of the various options.

2.4.2 Frequency of Dispatch on MEL

To determine how frequently an airplane might be dispatched with the inerting system inoperative, the average annual flight hours for the specific airplane type was divided by the inerting system reliability factor of mean time between unscheduled removals (MTBUR) to determine the typical frequency of

Airplane Operation and Maintenance Task Team Final Report

inerting system failures. Available time to troubleshoot and repair the system between flights is typically very short. Therefore, the assumption was made that, given the availability of dispatch relief per the MEL, maintenance would probably place the system on MEL and dispatch the airplane with the system inoperative rather than creating a lengthy flight delay.

2.4.3 Flight Delays

To dispatch an airplane with a system or component on MEL, some minimal amount of troubleshooting by a mechanic is required to identify the problem and verify that the system is safe for continued flight in its existing condition. The mechanic must also check the MEL to determine if there are maintenance procedures to deactivate or reconfigure the system prior to dispatch. The mechanic must then fill out the proper paperwork to place the system on MEL and release the airplane. The shorter the turn time, the more likely a significant flight delay would occur. The availability of maintenance is also a factor because the number of available mechanics is very limited at many airports. Typical flight delays can range from a few minutes to several hours depending on the maintenance workload at the time, weather conditions, and so on. To reflect the potential impact on flight schedules for each dispatch on MEL, the following flight delay times (Figure 2-1) were assumed based on the typical turn time for that category airplane.

Airplane Category	Flight Delay per MEL Dispatch
Large Transport	30 Minutes
Medium Transport	45 Minutes
Small Transport	60 Minutes
Regional Turbofan	60 Minutes
Regional Turboprop	60 Minutes
Business jet	60 Minutes

Figure 2-1. Flight Delay Assumptions

The annual number of delays and delay time is then a function of the number of times the system fails and must be put on MEL times the estimated delay time per MEL dispatch.

2.5 SCHEDULED MAINTENANCE

The Scheduled Maintenance sub-team was tasked with identifying and quantifying the costs and impact associated with the routine maintenance of an inerting system. Each of the proposed inerting systems was to be addressed for each of the six airplane types. (Airplanes had been grouped according to standard seating configuration and the airplane models were then placed into the six categories under consideration.) However, due to the size and complexity of the On-board Inerting concepts, analysis was not completed for Turbofan, Turboprop, and business jet category airplanes.

Scheduled maintenance requirements should be minimal based on the following assumptions:

- Most components will be maintained on condition.
- The design of the system will be such that the risk of an undetected accumulation of nitrogen in spaces occupied by people or animals in flight or on the ground will be minimized.
- Failure of the inerting system will not provide any immediate risk to the airplane or its occupants.

A Boeing 757 (small airplane category) was chosen to establish a baseline of maintenance tasks and intervals. From there, it was believed that maintenance intervals and data could be established for other airplane categories by scaling the B757 data as applicable.

In order to facilitate the calculation of scheduled maintenance labor-hours for each of the selected inerting systems, average utilization rates (Figure 2-2) and maintenance intervals were obtained from Boeing and Airbus for all their jetliner models. From this information, the average maintenance intervals were calculated and are presented in Figure 2-3. This information was used to determine the frequency, or

Airplane Operation and Maintenance Task Team Final Report

portion, of each maintenance check per year. From that, the average additional labor-hours per year required for scheduled maintenance of an inerting system could be established.

Airplane Category	Daily flight hours (hrs.)	Annual flight hours (hrs.)	Flights per day (avg. no.)	Min. Turn time (min.)
Large Transport	11.18	4081	2	60
Medium Transport	7.65	2792	3.5	45
Small Transport	7.86	2869	7	20
Regional Turbofan	5.8	2117	7.1	15
Regional Turboprop	8.1	2957	6.8	15
Business jet	1.37	500	1.5	60

Figure 2-2. Airplane Average Utilization by Category

Airplane Category	Check Intervals (hours)		
	A	C	Heavy
Large Transport	650	5,000*	4C
Medium Transport	500	4,350**	4C
Small Transport	500	6,000**	4C
Regional Turbofan	400	4,000	4C
Regional Turboprop	500	3,200	9,600
Business jet	400	4,000	16,000

* = or 24 months ** = or 18 months

Figure 2-3. Average Fleetwide Maintenance Intervals

2.5.1 Maintenance Labor-Hours

Maintenance labor-hours were estimated for the model B757 airplane. These labor-hours were to be scaled to determine the additional scheduled maintenance labor-hours for other airplane categories, but no significant differences between categories were discovered. From the information available, components between airplane categories do not vary significantly. Although the size of components may differ, the scheduled maintenance labor-hours needed to inspect and/or remove and replace these components does not. When compared with a small airplane type, medium and large airplane types will require additional labor-hours during a heavy check to inspect the wiring and ducting because of the additional wiring and tubing.

Scheduled maintenance tasks and inspection intervals for components within each concept were obtained using tasks and intervals for similar components on existing airplanes, or components performing similar functions on the V-22 Osprey. It is important to note that the V-22 Osprey currently operates with Fuel Tank Nitrogen Inerting System.

To obtain the estimated labor-hours for each maintenance task for similar components (e.g., components in ATA² 21, 28, and 36) used in-service airplane models were identified, and maintenance personnel were then queried as to whether the labor-hours per task were reasonable. The reason that this estimate was based partly on the expertise of the maintenance personnel is that the actual locations of components would not be known until an inerting system is actually designed.

2.5.2 Cycles vs. Operating Time

It is important to note that the Ground Based Inerting System (GBIS) and the On Board Ground Inerting System (OBGIS) maintenance intervals are based on cycles and an average system operating time per

²Airplane manuals are divided in chapters according the ATA standards. Each chapter described a specific airplane system. The ATA chapters referred here are respective “Air-conditioning” (ATA 21), “Fuel System” (ATA 28), and “Pneumatic System” (ATA 36).

Airplane Operation and Maintenance Task Team Final Report

cycle. On Board Inerting Gas Generator System (OBIGGS) maintenance intervals are based on flight hours plus ground operating time.

Scheduled maintenance for the Ground Based Inerting system was excluded at the heavy check for small, medium, and large airplanes. Due to the limited amount of equipment internal to the airplane or the fuel tanks, it was assumed that C-check inspections would suffice.

The team excluded scheduled maintenance for the GBIS at the heavy check for small, medium, and large airplanes. Because the amount of equipment internal to the airplane or the fuel tanks is limited, we assumed that C-check inspections would suffice.

Scheduled maintenance for the Ground Based Inerting System on business jets would be required on an annual basis.

2.5.3 Additional Maintenance Tasks

There are numerous maintenance checks that will be required but cannot be evaluated until final designs are determined. These would include, but are not necessarily limited to, pre-departure checks (BITE checks, fault checks, extended range checks, and so on) as well as pre-tank entry checks (which will be dependent upon the actual operator and/or equivalent of OSHA). In addition, unusual scheduled tasks based on the system chosen (e.g., daily warm-up period for membrane OBIGGS) are not included here.

There are other scheduled maintenance items that cannot be included because of the peculiarities of each system, because they will not be known until the system has been designed. Without knowing the design life of many of the components to be used in the proposed inerting systems, the labor-hours required for scheduled removals could not be estimated. These include specific consumables, other than filters, that are only required by the design itself (e.g., liquid nitrogen for the cryogenic inerting system).

It was recognized that a true picture of the maintenance program could only be achieved by performing an MSG-3³ analysis. However, lack of design data prevented that from being accomplished for this report.

2.6 UNSCHEDULED MAINTENANCE

2.6.1 Component Reliability

As mentioned earlier in this report, there is little or no existing documentation relating to the operation, maintainability, and reliability of airplane fuel tank inerting systems. The challenge for the Team has been to develop a reasonably accurate method to estimate the reliability of the fuel tank inerting system design concepts.

After a review of each of the design concepts, the similarity between the proposed inerting systems and other existing airplane systems became evident. For many of the components, there are even strong similarities with fuel, pneumatic, and air conditioning system components currently used on commercial airplanes. In fact, there is a possibility that some existing valves, sensors, or fans currently used in other systems could be used in an inerting system. Therefore, for each inerting system component, as many similar airplane components were identified as possible. The information on similar components and available reliability data for those components were gathered and averaged. For components that are unique to the inerting systems, such as air separation modules, the manufacturers' estimates of the components' reliability were used.

³MSG-3 (Maintenance Steering Group – Version 3) is a document produced by the Air Transport Association of America that outlines a decision and selection process for determining the scheduled maintenance requirements initially projected for an airplane system or power plant

2.6.2 MTBF vs. MTBUR

It was determined that the mean time between unscheduled removals (MTBUR) rather than the system mean time between failures (MTBF) would be a better indicator of the impact on the airplane maintenance requirements and operational performance. MTBUR factors in some of the typical maintenance inefficiencies in system troubleshooting and repair and, therefore more accurately reflects the real-world problems encountered in airplane maintenance.

2.6.3 Airplane Utilization Rate

To assure uniform and consistent analyses methods when evaluating the impact to maintenance and operations, airplane utilization rates were determined for each of the study category airplanes based on industry data (Figure 2-4). These utilization rates included daily and annual airplane flight hours as well as the number of daily operations per airplane. Industry data was also used to determine minimum turn times with input from airplane representatives on the Working Group (Figure 2-4).

Airplane Category	Daily flight hours (hrs.)	Annual flight hours (hrs.)	Flights per day (avg. no.)	Min. Turn time (min.)
Large Transport	11.18	4081	2	60
Medium Transport	7.65	2792	3.5	45
Small Transport	7.86	2869	7	20
Regional Turbofan	5.8	2117	7.1	15
Regional Turboprop	8.1	2957	6.8	15
Business jet	1.37	500	1.5	60

Figure 2-4. Airplane Average Utilization by Category

2.6.4 System Reliability

The system reliability was then simply calculated as an inverse sum of the MTBUR inverses. The same method was used to determine the system reliability for each of the inerting system concepts.

2.6.5 System Annual Utilization Rates

Because of differences in the operating requirements and characteristics of each inerting system design concept, the amount a specific system operates varies. System operating time is important because it directly affects system reliability and therefore operating costs. To account for these differences, the system annual utilization rates were developed based on the operating requirements for each inerting system concept and each category of airplane.

2.6.6 System Annual Failure Rate

The inerting system failure rate was determined by multiplying the system MTBUR by the system annual utilization rate for the category airplane. This rate was then used as an estimate of the frequency that the airplane would be dispatched with the system inoperative (MEL). Along with the MEL repair interval requirements, it was used to estimate the percentage of time the system would be operational.

2.6.7 System Maintenance Workload

To determine the amount of additional workload an inerting system would add to an airplane’s maintenance requirements, some assumptions about the location of the inerting system components had to be made. Working with the design teams, the likely locations of components were identified. Identifying potential locations on some airplane types was relatively easy. On the 747, for example, an area beneath the center wing tank adjacent to the air-conditioning packs was determined to be large enough for an on-board system and it met most of the design and safety requirements. This location would also provide good maintenance accessibility. On other airplanes, space was found to be very limited. Many of these spaces were inside the fuselage pressure vessel, raising safety concerns, and they tended to have poor

Airplane Operation and Maintenance Task Team Final Report

accessibility for maintenance. On some airplanes, space inside wheel wells and wing-to-body fairings was determined to be available. In many others, the only potential locations tended to be in the aft fuselage area just forward or behind the aft pressure bulkhead. The Team also considered differences in access time due to the time necessary to purge the fuel tanks because of the differences in fuel tank volumes.

Based on this survey of potential locations, estimates were developed for troubleshooting, removal, and installation of each component. From this estimate and the components' predicted failure rate, a maintenance labor estimate was developed for the system aboard each airplane type.

2.7 FLIGHT OPERATIONS

In order for Team to evaluate this process and come to the conclusions and recommendations stated further in this document, several implications and assumptions needed to be applied uniformly. First and foremost was the assumption that in the event that the inerting system was inoperative or that ground inerting equipment was not available, a means to dispatch the airplane without the fuel tanks inerted must be defined. Much discussion went into this decision, ranging from requiring inerting on every flight regardless of circumstances to treating the system as supplementary only. In the event MEL or dispatch relief was not available, operators would incur major limitations. The scope of such limitations could be so great as to cause changes to entire route structures. Airports without the capability to provide nitrogen or maintenance procedures would not be available as alternates, refueling stops, or for diversions as their use would have the potential to ground airplanes and passengers short of their destinations. If the inerting systems were required for safety of flight additional air turn-backs, flight cancellations and delays would also have to be considered. This and the guidelines set forth in the Tasking Statement led the Team to a final premise. Consequently, the Team's evaluation and methodology regarded the system as being a safety enhancement system similar to the present TCAS systems required on airplanes today.

The cost-to-carry estimates are a function of the weight of the system and the cost of the fuel to carry the additional load. The loss of revenue due to the decrease in useful load on flights routinely operating at maximum gross weight is also considered. Because determination of the cost associated with the production of power and resultant drag incurred by on board system designs requires detailed design data, these costs have not been quantified.

Flight crew procedures and associated training expenses were derived from past typical training events similar to the requirements of the proposed system. It was also assumed that the FAA as a training aid from a high-level or general standpoint would publish an Advisory Circular.

2.8 GROUND OPERATIONS

The effect an inerting system has on ground operations depends on the system concept being considered. Training, ground handling and line maintenance requirements were considered along with the associated costs. To accomplish this, a conceptual model of operations with ground based & on-board inerting systems were developed based on the inerting system concepts and airplane operational experience.

The Team also assumes that the FAA will provide guidelines in Advisory Circular material addressing training specifically for Operators and Technicians. Recent modifications to Boeing 737 center fuel tanks, along with the installation of the Smoke Detection and Fire Suppression system in class "D" cargo compartments, allowed the Team to draw some interesting parallels in the processes under review. Based on the modification and training requirements involving the aforementioned systems, a generic description of the model is as follows:

Training programs for line maintenance technicians should cover system operation, MMEL processes and special procedures, including troubleshooting procedures. While Operator training requirements, internal policies and procedures vary widely, task specific training for technicians accomplishing the initial airplane modification should be implemented. A separate or additional program dealing with nitrogen safety and usage

should be developed for those individuals working around the airplane during the inerting process. This team estimates that eight hours (8) of initial, and four hours (4) of annual recurrent training would be required for each technician.

3.0 MAINTENANCE IMPACTS

3.1 INTRODUCTION

The retrofit and operation of any of the proposed inerting systems will significantly effect airplane maintenance programs & schedules, dispatch reliability, the maintenance work load in the line environment, and the safety of the maintenance personnel.

3.2 MODIFICATION AND RETROFIT

It is the conclusion of this Team that due to the scope of the modifications, most operators would not be able to schedule the modifications to incorporate the inerting system during an airplane's regular heavy maintenance visit (see addendum F.A.1). The large number of additional labor-hours would extend the scheduled maintenance visit so much that it would interfere with the airline's maintenance schedules. Operators must complete the maintenance requirements on schedule or risk grounding airplanes. Therefore, most operators would likely start-up dedicated modification lines or contract the modifications out to other maintenance facilities. The disadvantage of this approach is that the existing access that is available during heavy maintenance visits is lost. This increases the total labor-hours required for the modification slightly. Another disadvantage of this approach is it may cause a worldwide problem with the hangar availability. The Team estimated that approximately 100 dedicated hangars would be necessary for modification of the existing fleet during the proposed compliance period. When the operators need to do the modification in a special modification line extra slots are necessary, this may result in insufficient hangar space.

Because of the number of airplanes effected, the Airplane Operations & Maintenance team has serious concerns about the availability of enough trained Airplane Maintenance Technicians that would be required to modify the airplanes in the proposed compliance period. Completing the modification of all the effected airplane in a seven-year period would require 3000 - 4000 trained Maintenance Technicians working full time.

3.3 MEL RELIEF

As discussed earlier, the assumption of dispatch relief for the fuel tank inerting system is fundamental to estimating its potential impact on airplane operations and maintenance. If the assumption changes, the approach taken to evaluate the scheduled maintenance requirements would also need to change, resulting in a significant increase in estimated time and costs.

If a typical airplane could not dispatch an airplane with its inerting system inoperative, the airplane might have to be taken out of service to repair failed inerting systems. The result would be a heightened burden on the airplane's line maintenance functions to get the airplane back into service. Therefore, airplanes would most likely focus on the inerting system's scheduled maintenance program, driving many components off the airplane for overhaul earlier in an attempt to reduce system failures in service. This would significantly increase the scheduled-maintenance, overhaul, and operating costs for the inerting system.

3.4 SCHEDULED MAINTENANCE

Scheduled maintenance impact, as shown in the specific inerting design concept sections, reflects access, inspection of component, and closure but does not reflect any non-routine correction of discrepancies. Nor does it include the cost of any special equipment or tooling that may be required to accomplish the inspections.

Airplane Operation and Maintenance Task Team Final Report

Scheduled maintenance impact, as shown in each specific inerting design concept sections, does not reflect any of the costs related to the airplane's modification. Instead, it begins after the inerting system has been incorporated.

The heavy check inspections shown for the different inerting design concepts do not reflect any additional manpower that might be required to comply with safety requirements on fuel tank entry into confined spaces with NEA present.

Airplane fuselage seal deterioration occurs because of increasing airplane age, and pressure decay checks allow discovery of seals, which require replacement or rework. The use of cabin air as a supply for the inerting system increases the demand on the airplane air-conditioning packs. Consequently, the maximum allowable cabin leakage rate will have to be maintained at a lower level to ensure that the airplane air-conditioning packs will be able to continue to maintain the required cabin pressurization.

For the On-Board Inerting Gas Generator system, extra labor-hours have been added to the C-check and heavy check to perform a fuselage pressure decay check and rectification because of the use of cabin air as supply for the inerting system. Operator experience has shown that airplanes that are currently in service periodically require this pressure decay check in order to maintain limits prescribed in airplane maintenance manuals.

The extra labor-hours are averages obtained from those operators whose maintenance program currently require fuselage pressure decay checks.

3.5 UNSCHEDULED MAINTENANCE

Each of the design concepts that were included in this study, from the least complex (ground-based inerting) to the more complex (onboard inerting gas generating system), will impact line maintenance, as would the introduction of any new system onto an airplane. From a general perspective, the introduction of a new system—and hence the introduction of new components or line replaceable units (LRU)—will impact line maintenance by affecting airplane dispatch reliability.

In simple terms, the more components there are, the less reliable the system, which results in a lower overall airplane dispatch reliability rate. The reliability of each component or LRU, and specifically its MTBUR, directly relates to an unscheduled line maintenance activity. This, in turn, means an increase in labor-hours (troubleshooting, component access, and component removal and replacement times), material and labor costs, and most likely an increase in airplane delays and cancellations. Additionally, the introduction of a new system and its components can impact other systems by affecting access to their components, thus affecting unrelated component replacement times.

As discussed previously, the specific impact on line maintenance due to the introduction of inerting is best evaluated by looking at component MTBUR data for similar or related systems. Additionally, the impact on other systems due to operation of the various inerting systems must be considered. For example, the proposed OBIGGS design concept extracts cabin air as an air source during certain flight phases. Although a scheduled maintenance task to accomplish a periodic fuselage pressure decay check will need to be implemented as indicated earlier, cabin air extraction will undoubtedly affect airplane pressurization, especially on older airplanes, leading to unscheduled maintenance activities and associated costs to isolate and rectify air losses. The impact to line/unscheduled maintenance varies depending on the inerting system utilized. These differences are discussed in more detail in each of the system design concepts sections. Unscheduled maintenance costs associated with component overhaul (including labor and material costs) and costs associated with special equipment and tooling were not included in the analysis due to insufficient data.

Finally, special precautions must be enforced when performing line maintenance on some inerting system components (depending on their location), such as confined space entry procedures. Additional hazards associated with gaseous or liquid nitrogen must also be considered. These special precautions and

additional hazards result in increased line maintenance costs through increased training (both initial and recurring), equipment, and procedural/policy implementation costs. The specific issue related to maintenance personnel safety associated with nitrogen inerting systems is discussed in more detail in section 3.5 below. Also, because of the unique safety precautions associated with performing line maintenance tasks on inerting system components, specially trained line maintenance personnel (similar to wet cell entry-skilled personnel) may be required. Some airplane operations may opt to utilize contracted personnel to perform such tasks.

3.6 MAINTENANCE SAFETY

3.6.1 General

Nitrogen and other inert gases are not normally dangerous, but when used in confined spaces they can create oxygen-deficient atmospheres that can be deadly. Nitrogen is especially hazardous, because it cannot be detected by human senses and can cause injury or death within minutes. In the United States, at least 21 people have died in 18 separate incidents between 1990—when more stringent requirements were adopted—and 1996, involving the use of nitrogen in confined spaces. Every year in the United Kingdom, work in confined spaces kills an average of 15 people across a wide range of industries, from those involving complex plants to those using simple storage vessels. Fatalities include not only people working in confined spaces, but also those who try to rescue them without proper training or equipment. Still more people are seriously injured.

The health risk to ground and maintenance personnel servicing airplanes that use nitrogen inerting technology is present not only in the fuel tanks themselves, but also in the location of the nitrogen-generating equipment. Wherever possible, such equipment should be located outside the airplane pressure hull. However, this is not possible on all airplanes. Therefore, it will be necessary to ensure that safety systems and procedures are in place to protect the airplanes and personnel working in and around them.

The following sections highlight some of the hazards associated with operating fuel tank inerting systems on commercial transports and the risks they pose to the airplane, its occupants, and maintenance personnel.

3.6.2 Confined Spaces

The Occupational Safety and Health Administration (OSHA) defines a confined space as a space that by design

- Has limited openings for entry and exit.
- Has unfavorable natural ventilation.
- Is not intended for continuous employee occupancy.

OSHA further defines a “permit-required confined space” as a confined space with

- Hazardous atmosphere potential.
- Potential for engulfment.
- Inwardly converging walls.
- Any other recognized safety hazard.

By this definition, all airplane fuel tanks meet the OSHA definition of a permit-required confined space. If the tanks were to be inerted, the current requirement to ventilate fuel tanks before entering will be critical. In addition, other locations under consideration for housing nitrogen-generating equipment, such as cargo holds, wheel wells, wing-to-body fairings, and APU bays, may also be considered confined

Airplane Operation and Maintenance Task Team Final Report

spaces. As such, appropriate entry procedures must be in place to minimize the risk to workers entering these spaces. These areas should be clearly marked and workers thoroughly educated regarding both the hazards of confined space entry and the insidious nature of nitrogen asphyxiation and death.

The costs associated with implementing these additional confined-space entry procedures worldwide are estimated at \$39.8 million for safety equipment and an additional \$28.3 million per year in labor (see addendum F.D.1 in appendix F). Even with these procedures in place, accidents will continue to happen as a result of people bypassing or simply ignoring the procedures, as is proven annually by the current record of injuries and fatalities.

3.6.3 Gaseous Nitrogen

The most significant hazard associated with exposure to nitrogen is breathing the resulting oxygen-deficient atmosphere. Normal atmosphere is made up of approximately 21% oxygen, 78% nitrogen, and 1% argon, with smaller amounts of other gases. Nitrogen, which is colorless, odorless, and generally imperceptible to normal human senses, requires the use of oxygen-monitoring equipment to detect oxygen-deficient atmospheres. Despite its nontoxic profile, nitrogen can be quite deadly if not properly handled.

It is not necessary for nitrogen to displace all the 21% of oxygen normally found in air to become harmful to people. OSHA requires that oxygen levels be maintained at or above 19.5% to prevent injury to workers. Figure 3-1 summarizes the expected symptoms at various oxygen concentrations for people who are in good health.

Oxygen Concentration (% vol.)	Symptoms	Maximum Exposure
19.5%	None	N/A
14 – 19.5%	Labored breathing, particularly at higher workloads	N/A
12 – 14%	Physical and intellectual performance impaired, Increased heart rate	N/A
10 – 12%	Rapid breathing, dizziness, disorientation, nausea, blue lips	10 Minutes
8 – 10%	Loss of control, gasping, white face, vomiting, collapse	50% of people will not survive 6 Minutes 100% of people will not survive 8 Minutes
4 – 8%	Coma, Death	40 seconds 2 Minutes
< 4%	Death	Seconds

Figure 3-1. Personnel Hazards

The very nature of oxygen deficiency is that the victim becomes the poorest judge of when he or she is suffering from its insidious effects. Victims may well not be aware of their condition and could fall unconscious without ever being aware of the danger.

3.6.4 Liquid Nitrogen

For OBIGGS, which uses cryogenic methods, liquid nitrogen presents its own specific hazards. Although relatively safe from the point of view of toxicity, liquid nitrogen—in common with all cryogen—presents the following hazards:

- Cold burns, frostbite, and hypothermia from the intense cold.
- Over-pressurization from the large volume expansion.
- Fire from condensation of oxygen.
- Asphyxiation in oxygen-deficient atmospheres.

Skin contact with liquid nitrogen can cause tissue to freeze, resulting in severe burns. The extremely low temperature of the cryogenic liquid causes these burns, not by a chemical action. Liquid nitrogen contacting the aircraft structure may cause degradation of materials—especially deterioration of composites and stress cracks in aluminum—resulting in possible structural failure.

The risk of oxygen-deficient atmospheres when using liquid nitrogen arises from the vast expansion of the substance as it boils or vaporizes. Just one liter of liquid may produce around 700 liters of gas at atmospheric pressure, displacing significant quantities of breathable air if the gas is released in a confined space, such as an aircraft fuel tank or pressure hull. The problem is compounded by nitrogen's tendency to accumulate at low levels where it is less easily dispersed than the ambient atmosphere. Even an apparently small spillage could lead to dangerously low oxygen levels, presenting a serious hazard to personnel and other occupants in the area.

Another potential hazard when using cryogenics is the risk of oxygen condensation from the atmosphere due to the extreme cold. Liquid oxygen is highly flammable, and may also create locally oxygen-enriched atmospheres carrying a greatly increased risk of fire or explosion, should an ignition source be present.

3.6.5 Gaseous Oxygen

Produced as a byproduct of the nitrogen generation process, gaseous oxygen presents its own potential hazards. The OBIGGS concepts are designed to vent oxygen overboard. However, some form of leak detection would need to be in place. Failure to do so may result in an oxygen-rich atmosphere with associated risk of fire and explosions. Many materials, such as clothing, that would normally only smolder in air will burn vigorously in an oxygen-enriched atmosphere, making it essential that staff members are alerted to high oxygen concentrations so that the risk of fire can be minimized.

3.7 MAINTENANCE TRAINING

To provide a safe working environment, operators are required to provide maintenance training prior to introduction of an inerting system. Training instructors have to modify their schedules, additional instructors may need to be hired, and training personnel will have to attend the vendors' and manufactures' classes. Afterward, these instructors have to spend time adapting vendors' training materials to their operator's standard. Only after the new training materials are finished and approved by the local regulatory authorities can regularly scheduled classes begin for maintenance and ground support personnel. The variety of airplane fleets and available inerting systems will require the mechanics and ground support personnel to be trained for all systems applicable to all airplane types in the operator's fleet. This fuel tank inerting training requirement will consist of classroom lectures; use of the jet airplane maintenance fundamentals, CBT courseware, and basic training workshops, as well as practical training on in-service airplane after the new systems is introduced.

4.0 OPERATIONAL IMPACTS

4.1 INTRODUCTION

The installation and operation of a fuel tank inerting system onboard an airplane significantly effects the daily operations of that airplane, the flight crew and ground support personnel. The system reliability will have an effect on flight schedules and airplane dispatchability. Flight crews will have to monitor the system to maintain operational safety. Ground support personnel will have to service ground based systems and everyone working on or around the airplane will have to maintain awareness of the potential hazards associated working around large quantities of nitrogen.

4.2 FLIGHT OPERATIONS

Potential impacts having the greatest effect on flight operations consist primarily of schedule effects, MEL and dispatch relief, lost revenue, operational safety, and training. The follow is a briefly discussion of the severity of the impact in relation to the degree of restriction chosen in a final rule. The impact

Airplane Operation and Maintenance Task Team Final Report

spectrum ranges from inerting having a relatively minor affect on flight operations to it being impractical in service.

4.2.1 Schedule Impact

Potential impacts to flight schedules will vary greatly depending on the type of inerting system used, the type of operation and the availability of MEL/dispatch relief. Schedule delays due to inadequate turn times are likely to become significant in those operations that today routinely turn their airplanes around in less time than the systems were designed to accommodate. These types of delays are most likely to occur while using the ground based inerting design. To minimize the potential impact on flight operations, average minimum turn time data was collected from operators to determine the design goals for the inerting system concepts. Refer to Figure 4-1 below. The Ground Based Inerting and On-board design teams with the goal of minimizing the impact of inerting time on airplane turn times used this data. Under normal situations, the concept design goals should preclude the requirement for extended gate time. However, some operators with very quick airplane turns could still be affected.

Aircraft Category	Average Minimum Turn Time (Minutes)	Average Aircraft Cycles Per Day	Airplane Annual Utilization Rate
Small Transport	20	7	2869
Medium Transport	45	3.5	2792
Large Transport	60	2	4081
Business Jet	60	1	500
Regional Turboprop	15	6.8	2117
Regional Turbofan	15	7.1	2957

Figure 4-1. Average Minimum Turn Times

The costs associated with such delays may be quantified by taking the percentage of flights that normally operate below the minimum scheduled allotment and multiplying it by the industry-standard delay costs for each minute incurred.

MEL/dispatch relief or lack thereof, has the greatest potential to escalate costs exponentially. For this reason, the following section more fully addresses this issue. The installation implementation time for this proposal may also have a great effect if the modification cannot be accomplished during normally scheduled maintenance visits. If this proves to be the case, airplane out-of-service costs and drastically increased maintenance and hangar requirements will further escalate costs greatly as shown in addendum F.A.1.

4.2.2 Airplane Out-of-Service Time

For most operators, it would not be possible to schedule the inerting modification project during a regular heavy maintenance visit. The reason is the scope of the project (see appendix F, addendum F.A.1). The large number of required labor-hours would significantly extend the maintenance visit, which in turn would disturb the airplane's operational schedule.

4.2.3 MEL Relief

As discussed earlier the potential impact of MEL/dispatch relief or the lack thereof can not be emphasized enough, especially for on-board inerting systems. Without dispatch relief, every system malfunction would likely result in one or more flight cancellations. With estimated system failure rates ranging from 2-6 per year for each airplane the average operator could experience 1000-2000 additional flight delays and cancellations per year.

4.2.4 Lost Revenue

The factor associated with lost revenue is only an issue on the percentage of flights operating at or near maximum take-off weight for the specific flight. All other flights are not taken into consideration simply

because the additional weight of the inerting system would not be expected to effect the planned revenue load, see the different design sections in this report⁴ for costs associated with this function. Cost to carry, however, must be applied to all systems on every flight. This is a function of the inerting system design weight multiplied by the average industry cost per pound to demonstrate the increased fuel burn required supporting the system, see the different design sections in the report⁴ for industry average costs to carry specified weights. Please note that these costs will vary greatly according to fluctuations in fuel prices. The costs associated with producing the power to run the systems such as electrical load, bleed load, or drag, will also need to be considered.

4.2.5 Flight Operations Safety

The major safety issues relating to flight operations are in regard to NEA leaking into the cockpit or passenger cabin, or the accumulation of highly concentrated O₂ at or near a fuel source. Due to these concerns, it is recommended that nitrogen/oxygen level sensors be installed to provide a warning case of a leak in critical areas. Flight crews and cabin crews will also need to be trained on how to react in the event of such an alarm. Under normal conditions in-flight, the air-conditioning system onboard the airplane will supply sufficient fresh air to prevent leaks from reducing the oxygen level in the cabin. However, under abnormal conditions and on the ground this may not be the case. Therefore, it is strongly believed that this warning system will be required to prevent subsequent loss of life in case of an unknown failure.

4.2.6 Flight Operations Training

Flight operations training for this purpose will consist of training requirements for both pilots and dispatchers. A general course should be administered to both sectors describing the benefits and hazards associated with nitrogen inerting systems. Also, a review of the basic fire triangle and flammability characteristics of jet fuel should be accomplished to familiarize both groups with the dangers associated with warm ullage temperatures. This will allow them to establish operational practices, such as ground air-cart usage on warm days, to control these circumstances. Dispatchers will also need to be trained to understand any dispatch deviation requirements necessary for dispatch with an inerting system inoperative. Pilot training requirements vary greatly depending on equipment type, inerting design, and operational environment. For example, a corporate pilot operating in or out of a remote airport may have greater responsibilities than a pilot may in airline type operations. A typical training program operated in-house would consist of a training bulletin followed up by a regularly scheduled module during recurrent training. Outside or contracted training would typically consist of a training program established by a commercial training facility and administered during special training events. Both would greatly benefit from an Advisory Circular provided by the FAA to assist operators with development of training materials.

4.3 GROUND OPERATIONS

Installation and operation of any inerting system will effect ground operation regardless of which inerting concept is considered. Introduction of any of the systems will add new considerations whether it be safety, new tasks, or dealing with new support equipment. Obviously the Ground Based Inerting system has the largest impact on ground operations because of the servicing requirement prior to each flight.

4.3.1 Ground Operations Safety

The safety-training course for ground operations should include the hazards of nitrogen and other inert gases. Some gases such as nitrogen are particularly insidious because of their poor warning properties.

⁴For the GBIS see section 5.3.2 *Cost to Carry* and for the OBIGGS see section 7.3.8 *Cost to Carry per Airplane per Year* (\$).

Airplane Operation and Maintenance Task Team Final Report

Oxygen-depleted environments from the inerting process have been reported to cause fatalities to workers in confined spaces. The National Institute for Occupational Safety and Health (NIOSH) has provided data from a ten-year study (NTOF data) pertaining to the number of victims in single and multiple fatalities for all types of confined-space incidents.

A startling 585 separate fatal incidents in confined spaces claiming 670 victims occurred within the 10-year study period. This data strongly underscores the need for increased ground operational safety requirements by all operators prior to introducing any inerting system. Due to the nature of this type of gas, confined areas—such as cargo bins and equipment bays—are particularly susceptible to this hazard.

The minimum recommendation of this ARAC committee is that all ground operation personnel should be aware of these dangers and know what to do in the event that something goes wrong using nitrogen to accomplish the inerting process. Airport fire, rescue, and safety personnel would also require additional training on the uses of nitrogen and confined-space rescue in airplane fuel tanks.

The possibility of over pressurizing the airplane fuel tanks is also a serious safety concern when using nitrogen to inert the ullage space of airplane fuel tanks. Having technicians who have had the recommended training perform the inerting tasks safely and efficiently should alleviate this concern.

4.3.2 Ground Operations Training

Mandatory awareness training is recommended on the dangers of using nitrogen in the quantities required to inert airplane fuel tanks. As mentioned above, an eight-hour initial program should be provided for all technicians involved with installation and servicing.

Up to a four-hour annual recurrent program is also recommended to maintain the heightened awareness on the hazards of working with nitrogen in these volumes. As an example, one hour could include a video on servicing while another hour encompasses troubleshooting and servicing. The remainder of the time can be utilized for applicable system training and open discussions. Other groups working on and around the airplane should also be aware of the dangers associated with nitrogen. These groups should receive recurrent safety training annually. These different groups should include but are not limited to cleaners, fuelers, baggage handlers, caterers, ticket/customer service agents, flight attendants and pilots. The video for example may adequately educate these individuals on the dangers and cautions involved with nitrogen inerting.

For maintenance training purposes, a \$75/hour cost rate provided by the FAA, and discussed in the Estimating & Forecast Team Report (Appendix G), establishes a value for estimating an operator's cost to have a technician install, service, and be properly trained for the continuing performance of these functions. All other group rates will vary respectively.

4.3.3 Ground Servicing

With the above-mentioned dangers of using nitrogen to inert airplane fuel tanks, ground service employees should not perform the servicing of airplane with GBI systems unless they are specifically trained maintenance technicians for the required inerting task. With the continual industry concerns with on-time performance, having the technician in place will help in facilitating that process. Numerous discussions took place on this topic and this group concluded that, after the system has been in operation for several years, reconsideration could be given on who should perform the inerting task.

Trained technicians with a thorough understanding of the system and the consequences of improper operation would be better prepared to monitor and interrupt the inerting process at any time for diagnosis and troubleshooting of system anomalies. To enhance on-time performance, having a technician in place will provide the operator with immediate troubleshooting capability for a system discrepancy during the inerting process, thus minimizing any ground delay due to maintenance problems associated with the inerting system. This process would require technicians in all airplane stations, and considerations should

be given to contract maintenance personnel requirements at locations not staffed by operator-employed technicians.

5.0 GROUND BASED INERTING SYSTEM

This section discusses the modification of in-service aircraft to install a ground based inerting system. The overall effect of ground based inerting systems on airplane operations and maintenance requirements are also described.

5.1 MODIFICATION

In Figure 5-1 the modification estimations for the GBIS are shown. For all airplane categories estimations were made for both a regular heavy maintenance visit and a special visit. However, for corporate and business airplanes (part 91 Operators) the modification would likely be accomplished at the factory service centers. For this airplane category there is only special visit estimates shown. A detailed table with costs and labor-hours is shown in addendum F.A.1 and F.A.2.

For the regional fan airplane types estimation for airplanes with bag-tanks (rubber cells) was made as well. The Team felt that this had to be estimated to determine how many extra man-hours would be required to do the project.

For the regional turboprop airplane types no estimation was made, because the Team could not find a company that does the maintenance for turboprop airplanes with a center wing tank. It should be noted that, Fokker Services, who did the estimates for the regional turbofan airplanes, indicated that there are very few if any turboprop airplanes that have a center wing tank.

On the left side of Figure 5-1 the project estimated labor-hours are shown for the different airplane categories. On the right side the general labor-hours are shown. These labor-hours are equal for all airplane categories. See addendum F.A.1 and F.A.2 for detailed data of the estimate.

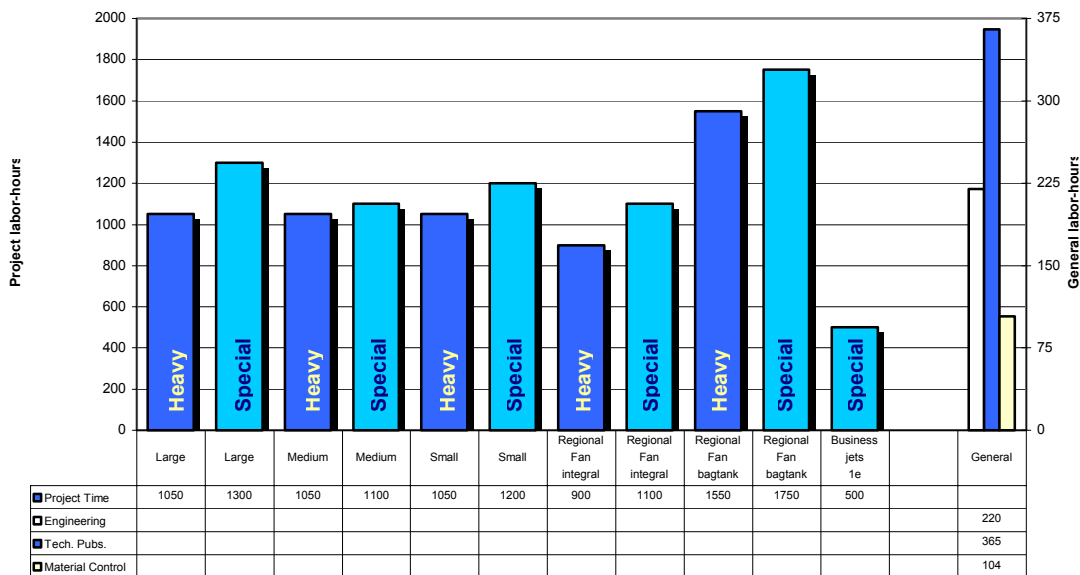

Figure 5-1. Modification Estimations for Ground Based Inerting Systems

5.2 SCHEDULED MAINTENANCE

5.2.1 Scheduled Maintenance Tasks

A list of scheduled maintenance tasks was developed using the Ground Based Inerting system schematic provided by the Ground Based Inerting team. Each component illustrated in the schematic was evaluated individually and tasks were written accordingly.

These tasks included inspections, replacements, and operational/functional checks of the various components that make up the system. These tasks were assigned to the various scheduled checks (A, C, 2C and Heavy) and labor hours for each task were estimated. Figures F5.2.1-1 through Figure F5.2.1-6 (found in addendum F.B.1) lists these tasks for each of the airplane types.

It was assumed that tasks completed at a C-check, would also be completed at a 2C-check. Similar assumptions were made for the 2C-check (i.e. they would be accomplished at the Heavy check).

5.2.2 Additional Maintenance Labor-Hours

Figure 5-2 shows the estimate of additional scheduled maintenance man-hours that would be required at each check to maintain a Ground Based Inerting system.

Airplane category	Additional A-check hours	Additional C-check hours	Additional 2C-check hours	Additional heavy check hours	Average additional labor-hours per year
Business jet	2	5	7	17	16.46
Turboprop	2	5	7	17	16.46
Turbofan	2	5	15	17	17.21
Small	2	5	17	17	34.65
Medium	2	5	21	21	32.93
Large	2	5	25	25	34.74

Figure 5-2. Scheduled Maintenance Times

5.3 UNSCHEDULED MAINTENANCE

As per the tasking statements, the design basis for the GBI system is to inert fuel tanks that are located near significant heat sources or do not cool at a rate equivalent to an unheated wing tank. Hence, the design concept for the GBI system considered only center wing tanks and auxiliary tanks. Additionally, since the GBI system only operates on the ground, the system operation time was based on the average turn times. The basic design of a GBI system for airplanes without auxiliary tanks is considered relatively simple and the detailed design concept was discussed previously in this report.

5.3.1 System Reliability

For the purpose of conducting a reliability and maintainability analysis, the following system components were evaluated:

- Non-return valve
- Isolation valve with integral thermal relief valve
- Self sealing coupling incorporating a frangible fitting
- Ducting (including distribution manifold and double wall tubing)
- Wiring

For airplanes with center wing and auxiliary tanks, the system components would include the same components as a center wing tank installation with the addition of one non-return valve and one isolation valve per auxiliary tank plus interconnect ducting. The impact of including auxiliary tanks in the

reliability and maintainability analysis was considered minor, as it would simply increase the quantity of non-return valves and isolation valves depending on the number of auxiliary tanks installed. This would affect the component Mean Time Between Unscheduled Removal (MTBUR) for the non-return valve and isolation valve, however the exclusion of the auxiliary tank components is considered well within the margin of error of the total system analysis. As a result, only the center wing tank components noted above were considered in the analysis.

Additionally, the need for a pressure regulating valve (PRV) that would limit the delivery pressure of the NEA on some business jets and regional airplanes due to fuel tank construction was discussed in the system design concept above. Conceptually, the PRV could be part of the airplane system or the airport delivery equipment. Because of this and the limited applicability of the PRV, this component was not considered in the analysis.

As with each of the system design concepts the component reliability was evaluated based on similar components. Once the individual component MTBUR was determined, the system MTBUR was estimated to be 9,783 hours. Because of the systems simplicity the GBI system had the highest level of reliability and is the only system with reliability levels considered acceptable for commercial airline service.

The system MTBUR was used for each of the six-transport category airplanes. There was no attempt to determine whether the system MTBUR would vary between the different categories, due to system size or operational differences. It was felt that any differences were well within the margin of error used to calculate the system MTBUR.

The system annual failure rate was then calculated based on the system MTBUR and yearly utilization rate for the respective airplane.

As discussed in the Methodology section, the annual delay time was determined based on standard delay rate assumption for each airplane type.

As described earlier, each airplane type was then looked at separately to determine component removal and replacement time, access time and troubleshooting time. The system maintenance labor hours/year were determined based on the summation of the individual component removal, replacement, access, and troubleshooting time multiplied by the component annual failure rate (Figure 5-3).

Category	Large	Medium	Small	Regional turbofan	Regional turboprop	Business
Annual failure rate	0.42	0.29	0.29	0.22	0.3	0.11
Standard delay rate (1 delay = XX min)	30	45	60	60	60	60
Annual delay time (min/year)	13	13	17	13	18	7
Unscheduled maintenance labor (hr/year)	3.13	1.96	2.02	1.35	1.89	0.77

Figure 5-3. GBI System Reliability and Maintainability Analysis

5.3.2 Cost to Carry

A cost to carry value for the GBI system was calculated based on system weights provided by the design team. System weights were provided for large, medium and small airplane types and included weights of components listed above as well other equipment that were not included in the analysis, such as brackets and ground straps. The calculated cost to carry value represents the costs associated with the additional weight of the system over one year of operation.

5.4 FLIGHT OPERATIONS

Ground based inerting has the least impact to flight operations in that there would be no on-board operating systems to monitor or control. There would only be the calculation of the quantity of NEA to on load at the ramp, which would be a dispatch/ramp office function, to be verified by the operating crew.

Airplane Operation and Maintenance Task Team Final Report

The object has been to design the servicing apparatus so that this function can be accomplished within the average minimum established turn times and thus not creates delays, although scheduled very short turn flights could be impacted. Very little flight crew training should be necessary, but dispatch and ramp office personnel must be proficient in calculating and verification of the procedure. Dispatch requirements need to be thoroughly established with regard to conditions of non-availability of NEA supply and the existing conditions of take off and flight from a station. Airport usage for scheduled or alternate operations will have to be evaluated and indeed route structures could be impacted by non-availability of NEA.

5.5 GROUND OPERATIONS

This group easily established the GBI system as one of the most labor-intensive of all proposed inerting methods researched to date. This is partly due to the fact that the GBI system would require that a dedicated Technician be present during the inerting process while parked on the ramp, or at the gate. The GBI system is also solely dependent on the airport infrastructure.

For the purposes of the gate operation, airplanes would undergo servicing procedures something similar as follows:

A technician will attach the inerting hose from a dedicated source. This source may either be from the terminal (Jetway) or tanker based. After the inerting value is given, the valves are opened to allow the flow of nitrogen into the tank. At the end of the operation, the technician closes the valves completing the process. When the inerting equipment has been secured, the Technician will provide the flight crew an inerting slip. This slip will verify the flight number, date and quantity of inerting gas loaded, along with a signature of individual who performed the task. The flight crew would then check the quantities against the flight release. This would allow normal servicing and through-flight responsibilities such as log book items, and maintenance checks to be accomplished as they are in the present gate environment. Inerting times would be proportional to the type of airplane.

Inerting trucks would also be utilized at small airports and in remote areas of the airport and maintenance facilities, to allow maintenance to inert tank when the airplane is away from the gate.

The ground inerting process would be unique in that while the inerting system is not flight critical, it is one of the few aircraft systems that gives the flight crew no indication or means to verify if the process has been accomplished. The person monitoring the inerting process would be solely responsible for compliance with the inerting requirements. Because ground service positions are generally held by low skilled personnel and historically, aviation turn over rates for ground service employees vs. the Maintenance Technician is significantly higher.

As a result, the team came to the conclusion that the inerting would have to be accomplished by a trained maintenance technician. Discussion regarding the reduction in costs for labor did take place during these ARAC meetings. In the early stages of “aircraft single point refueling systems”, the technician was exclusive to this work and still is in many countries. As the system became more automated and reliable, less aircraft specific personnel were able to successfully accomplish this task. The inerting process should mirror this model. It was concluded that in the future, the job function could be reevaluated, but for the initial phase, it is imperative this is performed by a technician.

5.5.1 GBI Ullage Washing Labor Estimate

The fuel tank ullage washing or inerting process is very similar to and is accomplished in parallel with the airplane fueling process. The Operations & Maintenance team reviewed the proposed ullage washing procedure and developed a labor estimate for this process. The labor estimate uses the inerting time developed for each airplane category by the GBI design team. Ten minutes was added to the inerting time

Airplane Operation and Maintenance Task Team Final Report

for connection and disconnection of the ground service unit to the airplane and to complete the paperwork require to sign off the inerting process as completed. This resulted in an estimated amount of time for each airplane category required for a technician to inert an airplane fuel tank. These estimates were then multiplied by the number of daily operations for each airplane type and by a 30% lost labor rate to account for the mechanics non-productive time. The result is the daily and annual labor estimate for ullage washing as shown in Figure 5-4.

GBI Ullage Washing Labor						
Aircraft	World Daily Operations	Inerting Time Per Turn (min.)	Connect/Disconnect Time per Turn (min.)	Lost Labor Rate	Labor Minutes per Turn	Daily Labor Hours
Business Jet		15	10	0.3	36	
Turboprop	20,000	10	10	0.3	29	9524
Turbofan	10,000	10	10	0.3	29	4762
Small Transport	48,167	10	10	0.3	29	22937
Medium Transport	5,142	15	10	0.3	36	3061
Large Transport	4,599	20	10	0.3	43	3285
				Total Daily Labor Hours		43568
				Annual Labor Hours		15,902,355

Figure 5-4. GBI Ullage Washing Labor Estimate

Nitrogen inerting stations could be mounted on the jet-ways or terminal buildings at major airport similar to the preconditioned (PC) air systems currently in use at most major U.S. airports. The specifics of this type of system will be expanded on in the portion of the report provided by the facilities team. At airports that currently use PC air systems at the gate, the ramifications placing inerting equipment in the vicinity of these units must be considered to preclude the possibility of nitrogen from being vented into the cabin.

At major hubs during nitrogen dispensing at gate areas, the major airport hubs can utilize a Jetway system that mirrors the preconditioned (PC) air systems currently in use at most major United States airports. Individual nitrogen hoses with a central supply would be affixed to all jetways and or terminal buildings. The specifics of this type of system will be expanded on in the portion of the report provided by the facilities team. Considerations should be given though to the airports that currently have PC air in place and the ramifications of inerting while the PC air is connected to the airplane and in use.

In the event that a centralized system is not available at places such as regional or smaller airports, tanker trucks or their equivalent, would provide nitrogen to operators at these areas. Airplane size and flight schedules would determine the demand for these airports.

Procedures would also have to be established for airplanes that divert into stations that do not have sufficient nitrogen quantities for the inerting process.

Complications combined with experience requirements should also be of consideration when determining the long-term effects of having, verses not having qualified Technicians available to perform the inerting tasks. This may also hold true for the initial MEL process on through flights.

5.5.2 Potential Future System Improvements

The basic philosophy for the Ground Based Inerting system as it is discussed in this study is to supply a standard volume of nitrogen to a fuel tank prior to each flight. This standard volume would be based on the assumption of a maximum ullage space or that the tank is empty. If the tank contains a quantity of fuel, this would result in more nitrogen being used than is necessary to inert the tank. The excess nitrogen would then be discarded through the tank vent system. The philosophy satisfies the inerting requirement but results in an increased nitrogen requirement and more VOC's being released in the atmosphere. This may be a problem in some of the more environmentally sensitive areas in Europe and the U.S.

Airplane Operation and Maintenance Task Team Final Report

One long-range solution to this problem would be to adjust the volume of nitrogen used to inert the tank based on the amount of fuel in the tank. When the fuel load for a flight is determined the nitrogen load would also be calculated and included on the fueling sheet. This would require a change to the software used to calculate the fuel load at a one-time cost of \$5000 to \$500,000 per operator, depending on the kind of fuel load program used. Dispatchers would also need to be trained to determine the volume of NEA required. This was considered as a future improvement to the GBI inerting process and therefore these costs are not taken into account in the modification estimations.

Further possibilities for future system improvements could include an on-board inerting computer. The inerting computer would provide the maintenance Technician the means to select a specific tank and fuel quantity. Once the information is entered, the computer calculates the proper inerting value for that tank. A monitoring function keeps the technician aware of any inerting anomalies. Sensors automatically close the inerting valves when the process is complete. Once the servicing door is closed, the computer could also provide a signal to the flight deck in case of inerting discrepancies or system. Built in test equipment at the panel could also allow Technicians to test line replaceable units and perform maintenance checks. Such a system may streamline the inerting process.

6.0 ON-BOARD GROUND INERTING SYSTEM

This section discusses the modification of in-service aircraft to install an On-Board Ground Inerting System. The overall effect of OBGIS on airplane operations and maintenance requirements are also described.

6.1 MODIFICATION

In Figure 6-1 the modification estimations for the OBGIS are shown. Due A survey of regional and business jet aircraft indicated that insufficient space is available to accommodate an OBGIS system in the unpressurized areas these category airplanes. As a result these airplanes have been excluded from this estimate. Estimations are made for both a regular heavy maintenance visit and a special visit.

The modification estimations for the OBGIS are based on the estimations of the OBIGGS, however since the OBGIS are only designed for the center wing tank and auxiliary tanks the labor estimates have been reduced to account for installation differences. The following reductions are used:

- For the large airplane category: 300 man-hours
- For the medium airplane category: 250 man hours,
- For the small airplane category: 200 man-hours.

On the left side of Figure 6-1 the estimated modification labor-hours per aircraft are shown for the different airplane categories. On the right side the general support labor-hours are shown. The support labor-hours are incurred on a per operator basis as opposed to per aircraft and are approximately the same for all airplane categories. See addendum F.A.1 and F.A.2 for detailed data of the estimate.

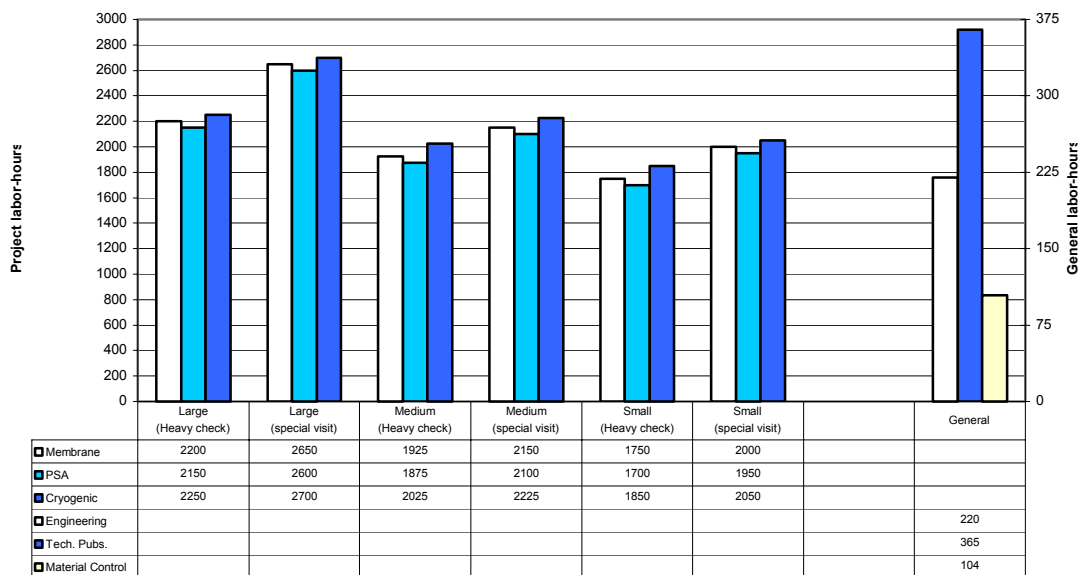

Figure 6-1. Modification Estimations for On-Board Ground Inerting Systems

6.2 SCHEDULED MAINTENANCE

6.2.1 Scheduled Maintenance Tasks

A list of scheduled maintenance tasks was developed using the On Board Ground Inerting system schematic provided by the On-Board Design team. Each component illustrated in the schematic was evaluated individually and tasks were written accordingly. These tasks included inspections, replacements, and operational/functional checks of the various components that make up the system.

Tasks were assigned to the various checks (A, C, 2C, and heavy) and labor-hours for each task were estimated. Figures F6.2.1-1 through Figure F6.2.1-6 (found in addendum F.B.1) contain a complete list of these tasks. The team assumed that tasks completed at a C-check would also be completed at a 2C-check. Similar assumptions were made for the 2C-check (i.e., they would be accomplished at the heavy check).

The OBGIS consists of several more components than the GBIS. Thus, additional tasks are required, substantially increasing the additional labor-hours required in the 2C- and heavy checks.

Because the size and complexity of the onboard ground inerting (OBGI) concept made the system infeasible for turbofan, turboprop, and business jet category airplanes, analysis was not completed for these airplanes.

6.2.2 Additional Maintenance Labor-Hours

Figure 6-2 below shows the estimate of additional scheduled maintenance man-hours that would be required at each check to maintain an On Board Ground Inerting system.

Airplane category	Additional A-check hours	Additional C-check hours	Additional 2C-check hours	Additional heavy check hours	Average additional labor-hours per year
Small	3	4	18	51	50.55
Medium	3	4	18	55	48.31
Large	3	4	18	59	46.51

Figure 6-2. Scheduled Maintenance Times

6.3 UNSCHEDULED MAINTENANCE

The OBGIS which consists of approximately 26 major components is significantly more complex than the GBIS,. Like the full OBIGGS, the airplane system is self-sufficient, which is the reason for the increased complexity.

6.3.1 System Annual Utilization Rate

Although the Onboard Ground Inerting System equipment is very similar to the full OBIGGS system, the operating philosophy is significantly different. Unlike OBIGGS the classic On-board Ground based Inerting system operates only while the airplane is at the gate. Therefore the operating time on the OBGIS system is significantly less than for full OBIGGS over the same period of time reducing the wear & tear on system components. To account for the reduced operating time the System Annual Utilization rate for OBGIS is based on the typical gate time and number of daily operations for each category airplane.

Airplane category	Aircraft usage rate, flight-hours/year	OBGIS system operational time, hours/year
Large transport	4,081	1,095
Medium transport	2,792	1278
Small transport	2,869	1,916
Regional turbofan	2957	1080
Regional turboprop	2117	1034
Business jet	500	365

Figure 6-3. OBGIS System Annual Utilization Rate

6.3.2 System Reliability

As with the unscheduled maintenance analysis on the other system concepts the reliability of the On-board Ground Inerting systems components was primarily based on a comparison to similar components currently in use on commercial airplane. The tables in Addendum F.C.2 show the estimated MTBF and MTBUR for individual system components. The significant decrease in the reliability level of the OBGIS system as compared to the Ground Based Inerting system is due to the increased complexity of the system. The increase in the number of parts and the introduction of lower reliability, higher maintenance components such as compressors and air separation modules decreases the system reliability by a factor of 10 times. The OBGIS system Mean Time Between Unscheduled Removals was calculated to be 945 hours for the PSA system and 960 hours for the membrane system. The difference between the systems is due to the slightly higher reliability of the membrane air separation module.

Because similar component reliability data for a range of component sizes was not available the analysis assumes that the reliability of the OBGIS system is the same for all sizes of airplane. In reality system reliability may vary with the systems size but the purposes of this study the variation is assumed to be well within the margin of error for the reliability estimate.

6.3.3 System Annual Failure Rate

The annual failure rate for the inerting systems is a function of its reliability (MTBUR) and the System Annual Utilization rate. Using OBGIS system Annual Utilization rate, the frequency of inerting system failures on each airplane was predicted to be approximately two failures per year for an OBGIS system.

The system annual failure rate is significant because it is an indicator of how maintenance intensive the inerting system is and what the level of impact the system will have on flight operations. In the case of the OBGIS system an operator with a fleet of 300 airplanes could expect to have to address 600 additional maintenance problems per year due to the inerting system.

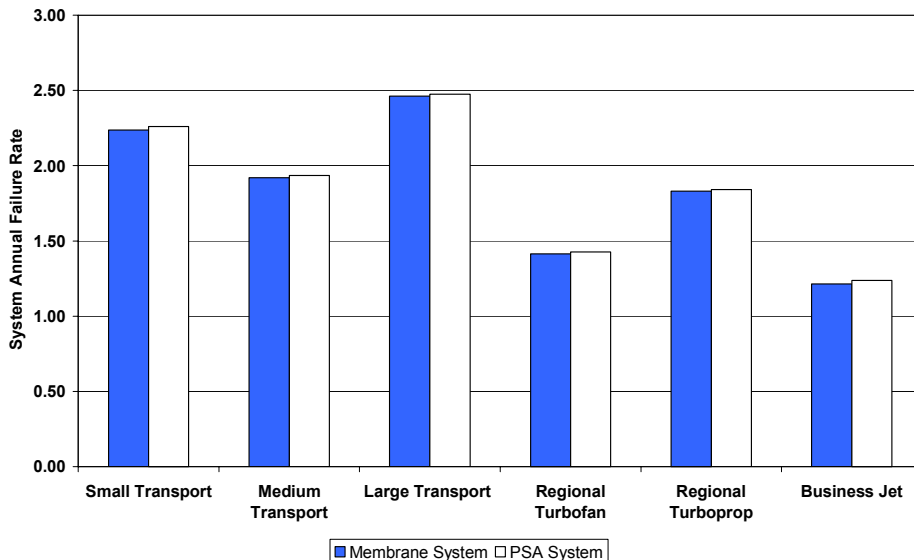

Figure 6-4. Predicted OBG System Annual Failure Rate

6.3.4 Unscheduled Maintenance Labor Estimate

As with other system concepts, a survey of potential component locations was done for each of the category airplane. Based on this survey, estimates were developed for troubleshooting, removal and installation of each component. The tables in Addendum F.C.2 detail the troubleshooting, removal and installation labor hour assumptions. Probable component locations, size and weight were considered in developing this estimate. The labor estimate and the components predicted failure rate were used to estimate annual unscheduled maintenance labor rate for the OBG system on each airplane type and is summarized below.

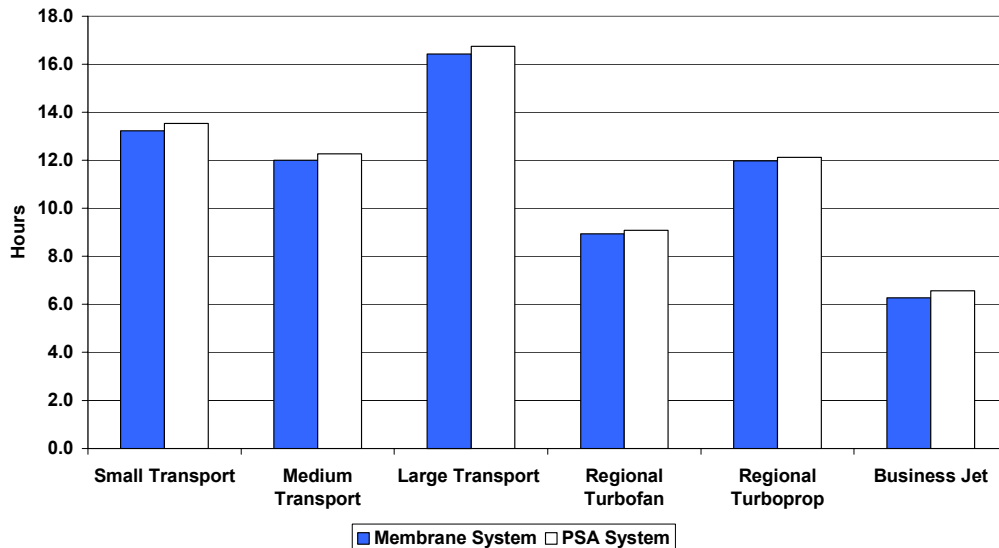

Figure 6-5. Annual Unscheduled Maintenance Labor Estimate per Airplane

6.3.5 Inerting System Availability

The availability of an OBGI system is a function of the system reliability and the repair interval assumed for MEL dispatch relief. For example, if the system has an annual system failure rate of 2 failures per year and the MEL dispatch relief allows a 3 day repair interval the inerting system maybe assumed to be inoperative 6 days per year. Another way to look at system availability is as a percentage of departures. If the airplane typically has 7 departures per day as the small transport does, then the airplane would depart on 42 flights per year out of 2555 with the inerting system inoperative. Assuming that an inerting system would remain inoperative for the maximum allowable number of days is a worst-case scenario. In reality, the systems would likely spend 50-75% of the allowable time on MEL, but for the purposes of this study, it is assumed that the full repair interval is used all the time. When considering the effect of the number of days a system is allowed to remain on MEL that decreasing the number of days improves the system availability but comes at a cost in terms of increased flight delays, cancellations, and operating costs.

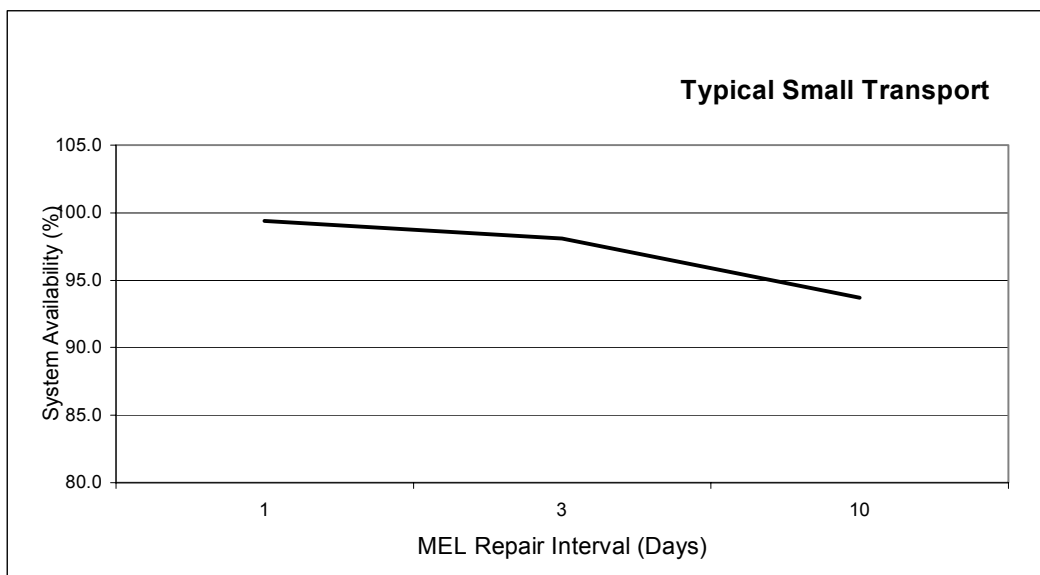

Figure 6-6. Impact of MEL Relief on System Availability

Figure 6-7 shows the expected OBGI system availability for each category aircraft based on 10 day MEL relief availability.

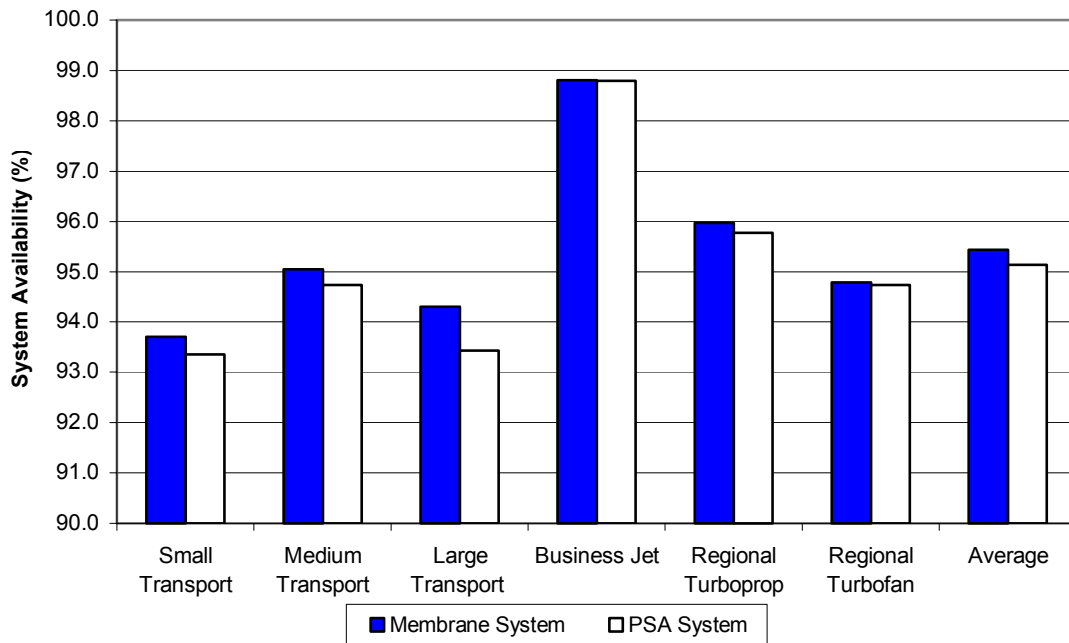

Figure 6-7. OBGI System Availability

6.3.6 MEL Dispatch Relief Effect

The effect of the MEL dispatch relief assumption is discussed in detail in Section 10 of this report. The availability of MEL dispatch relief for none critical aircraft systems and the length of time allowed before the system must be repaired has a large impact the airplanes dispatch reliability and cost of operation. As an illustration the number of delays and cancellations an operator might experience for a typical small transport airplane equipped with an OBGI system was calculated. This estimate is based on the projected OBGI system annual failure rate and some assumptions about the frequency of delays and cancellations based on a system failure.

If no MEL dispatch relief is available there is a high probability the system failure would result in multiple flight cancellations. If dispatch is available the likelihood of flight delays and cancellations decreases as more time is allowed to route the aircraft to a location were maintenance is available. The system can then be repaired during an overnight maintenance visit. The specific assumptions used here are based on typical operator experience and are presented in Appendix F.

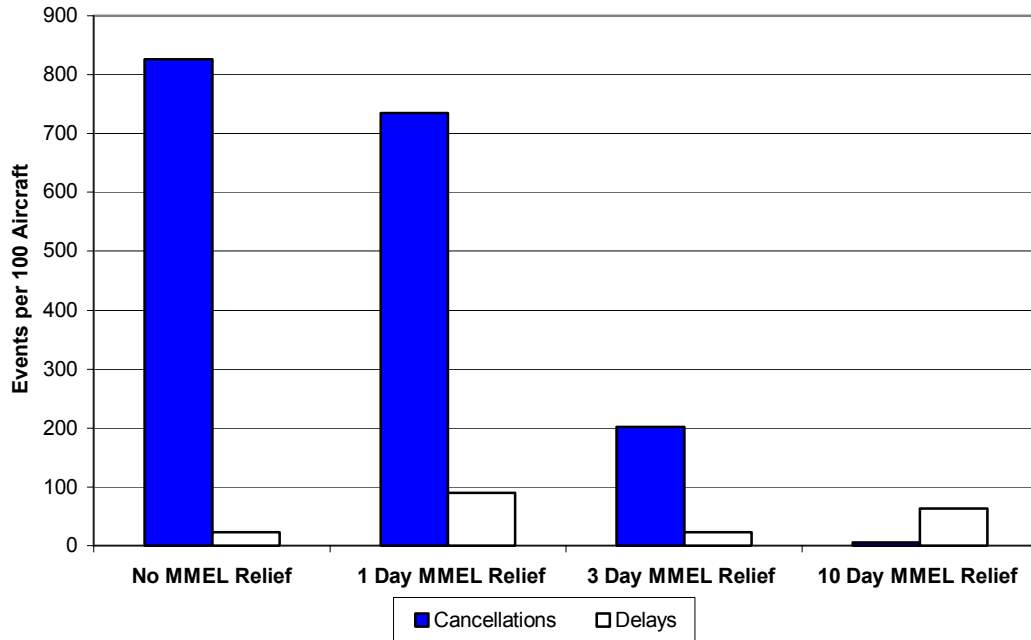

Figure 6-8. MEL Dispatch Relief Effect

6.3.7 Delay Hours per Year

An estimate of the effect of inerting system failures on flight departure schedules was made based on the OBGI systems annual failure rate. The delay assumptions used for this estimate were discussed earlier under the "Flight Delay" analysis methodology; section 2.4.3. Although not every system failure causes a delay, it is equally true that a single maintenance delay frequently causes multiple down line delays due to a cascade effect in the daily flight schedule. The number of delays and delay hours per year effect customer service. The airlines, through experience have determined the impact of the reduction in customer satisfaction due to delays on operational revenue. Flight delays also effect operating costs through schedule changes, down line flight cancellations, and lost passengers.

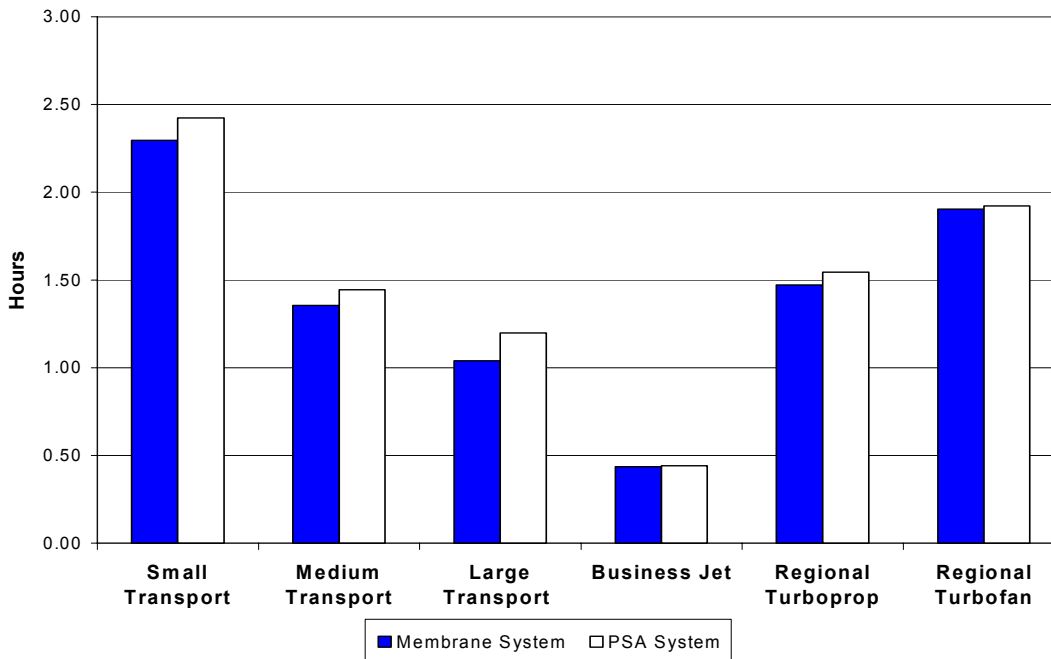

Figure 6-9. Annual OBG System Flight Delay Hours

6.4 FLIGHT OPERATIONS

The on-board ground inerting system allows for the availability of NEA for ground inerting techniques to be employed at any airport that the airplane is deployed to if an adequate electric power source is available. The system is designed to have adequate output to preclude delays beyond what are considered average turn times for that airplane. The system is designed to require minimal activation and supervision by the flight crew with little or no cockpit instrumentation and a simple on/off switch being redundant to automatic activation. Training for flight crew would be mostly educational to the system protections and functions and characteristics. Since it is largely automatic and if inoperative there would be additional training for crew and dispatchers in MEL provisions in order to allow dispatch of the airplane if repair is not possible at a station. The system should be designed to be failsafe so that no hazard is presented by its operation to passenger or ground personnel.

A moderate weight penalty is incurred in carrying this system on board and manifested in additional fuel burn. However, there is no power drain requirement during flight.

6.5 GROUND OPERATIONS

Both GBIS and OBGIS are operating only on the ground. The major difference between GBI and OBGIS is that inerting with the OBGIS is accomplished without the requirement for additional airport facilities, except for additional ground-power requirements. The OBGIS is a self-contained airplane system.

Maintenance training requirements should be incorporated within the initial training programs similar to those discussed earlier, but tailored to this specific design. One of the concerns that differ from the GBI is that the OBGIS would require constant monitoring, particularly while fuel tanks are being inerted before the first flight of the day. The system design is such that the systems will have to be turned on 2 hr before the first flight of the day. Once power is put on the airplane and the inerting system is turned on, a normal safety procedure requires that a maintenance technician must monitor the airplane for problems. This does not necessarily mean that an maintenance technician must sit in the cockpit, but someone must be close enough to respond to alarms or other problems. Activation and monitoring the airplane an hour earlier than is currently required adds a significant work to line maintenance during an already busy time of day.

Airplane Operation and Maintenance Task Team Final Report

Other added responsibilities would be to ensure that the cabin is ventilated properly to ensure there is no possibility for a buildup of nitrogen in the cabin. These tasks would typically be the responsibility of the remain overnight technician. In the event a flight crewmember is not available, then a qualified technician should also monitor the inerting process during all through-flights. All other maintenance concerns typically go hand in hand with the concerns mentioned earlier with the GBIS.

7.0 ON-BOARD INERTING GAS GENERATING SYSTEM

This section discusses the modification of in-service aircraft to install an On-Board Inert Gas Generating System. The overall effect of OBIGGS on airplane operations and maintenance requirements are also described.

7.1 MODIFICATION

In Figure 7-1 the modification estimations for the OBIGGS are shown. Due to insufficient space for the OBIGGS in the unpressurized areas of regional fan, regional prop, and business jet category airplanes, these airplanes have been excluded from this report. For the other airplane categories estimations are made for both a regular heavy maintenance visit and a special visit. A detailed table with costs and labor-hours is shown in addendum F.A.1 and F.A.2.

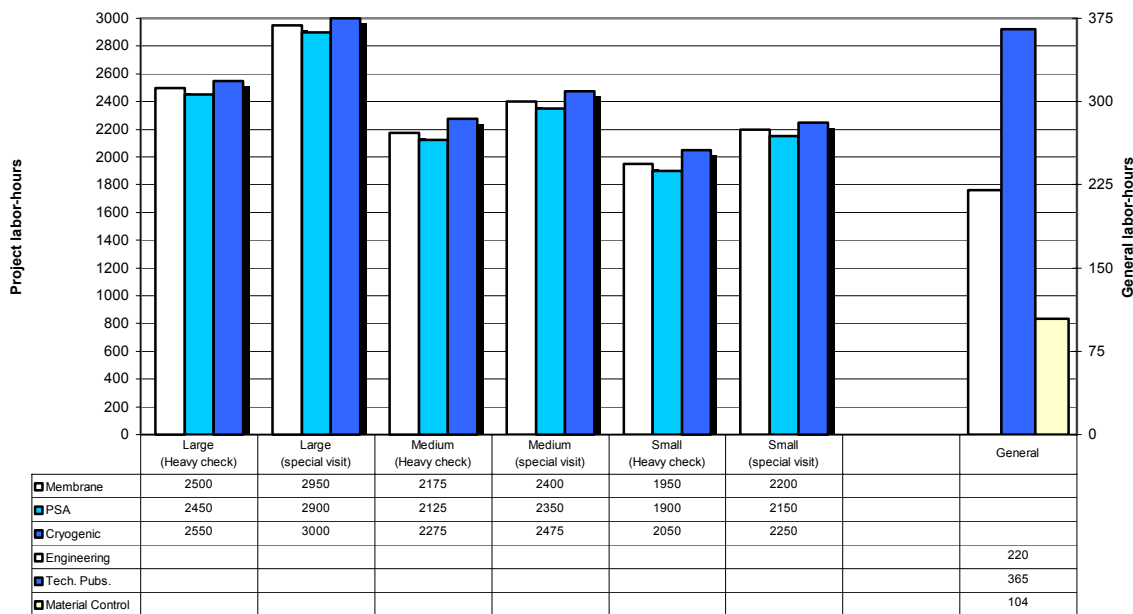

Figure 7-1. Modification Estimations for On-Board Inerting Gas Generating Systems

After installation of the OBIGGS systems it may be required to do an operational test flight. These test flight costs are not taken into account in the estimations.

7.2 SCHEDULED MAINTENANCE

7.2.1 Scheduled Maintenance Tasks

Concepts for two types of On-Board Inert Gas Generating Systems (OBIGGS) were developed, and considered separately by the Scheduled Maintenance sub-team. A list of scheduled maintenance tasks for an On-Board Inert Gas Generating Cryogenic System and for an On Board Inert Gas Generating Membrane System was developed using the system schematics provided by the On Board Design team. Each component illustrated in the schematic was evaluated individually and tasks were written

accordingly. These tasks included inspections, replacements, and operational/functional checks of the various components that make up the system. These tasks were assigned to the various checks (A, C, 2C and Heavy) and labor hours for each task were estimated. Figures F7.2.1-1 through Figure F7.2.1-6 (found in addendum F.B.1.) lists these tasks for each of the airplane types.

It was assumed that tasks completed at a C-check, would also be completed at a 2C-check. Similar assumptions were made for the 2C-check tasks (i.e. they would be accomplished at the Heavy check (or 4C-check equivalent)).

Both of the OBIGGS concepts consist of unique components, which require additional tasks when compared with the GBI and OBI systems. Thus, additional tasks are required, substantially increasing the extra man-hours required in the C, 2C and Heavy checks.

Due to the size and complexity of the OBIGGS concept, analysis was not completed for Turbofan, Turboprop, and business jets category airplanes.

7.2.2 Pressure Check

Extra labor-hours have been added to each C-check and Heavy check to perform a fuselage pressure decay check and rectification. OBIGGS uses cabin air as a supply for the inerting system, which increases the demand on the airplane air-conditioning packs. Consequently, the maximum allowable cabin leakage rate will have to be maintained at a lower level to ensure that the airplane air-conditioning packs will be able to continue to maintain the required cabin pressurization.

7.2.3 Additional Maintenance Labor-Hours

Figure 7-2 below shows the estimate of additional scheduled maintenance man-hours that would be required at each check to maintain a On-Board Inert Gas Generating Cryogenic System. And similarly, Figure 7-3 below shows the estimate of additional scheduled maintenance man-hours that would be required at each check to maintain an On-Board Inert Gas Generating Membrane System.

Airplane category	Additional A-check hours	Additional C-check hours	Additional 2C-check hours	Additional heavy check hours	Average additional labor-hours per year
Small	3	55	74	87	124.03
Medium	3	55	74	91	126.03
Large	3	55	74	95	115.52

Figure 7-2. Cryogenic System—Scheduled Maintenance Times

Airplane category	Additional A-check hours	Additional C-check hours	Additional 2C-check hours	Additional heavy check hours	Average additional labor-hours per year
Small	3	50	65	76	113.96
Medium	3	50	65	80	114.58
Large	3	50	65	84	105.77

Figure 7-3. Membrane System—Scheduled Maintenance Times

7.3 UNSCHEDULED MAINTENANCE

The full OBIGGS inerting system is the most complex system of all the design concepts studied. The characteristics that make OBIGGS different for other systems studied from a reliability and maintainability standpoint are its size and its operating time.

Because OBIGGS operates during all phases of flight it has an additional effect on other airplane systems. The demand the inerting system puts on the airplane electrical power generation, cabin pressurization and engine bleed air systems will reduce the reliability and increase the maintenance requirements for these systems.

Airplane Operation and Maintenance Task Team Final Report

The larger size and weight of the components in the OBIGGS system will make performing maintenance more difficult and in some cases may create an additional safety risk when lifting of the components during removal and installation.

7.3.1 System Annual Utilization Rate

The system annual utilization rate for OBIGGS reflects the amount of time that any of the systems would operate in one year. This figure was calculated from the airplane daily utilization rate plus the minimum turn times, multiplied by the number of daily cycles. The Large transport airplane with a high daily rate had the highest system annual utilization rate, the small transport coming a close second due to its high daily cycles.

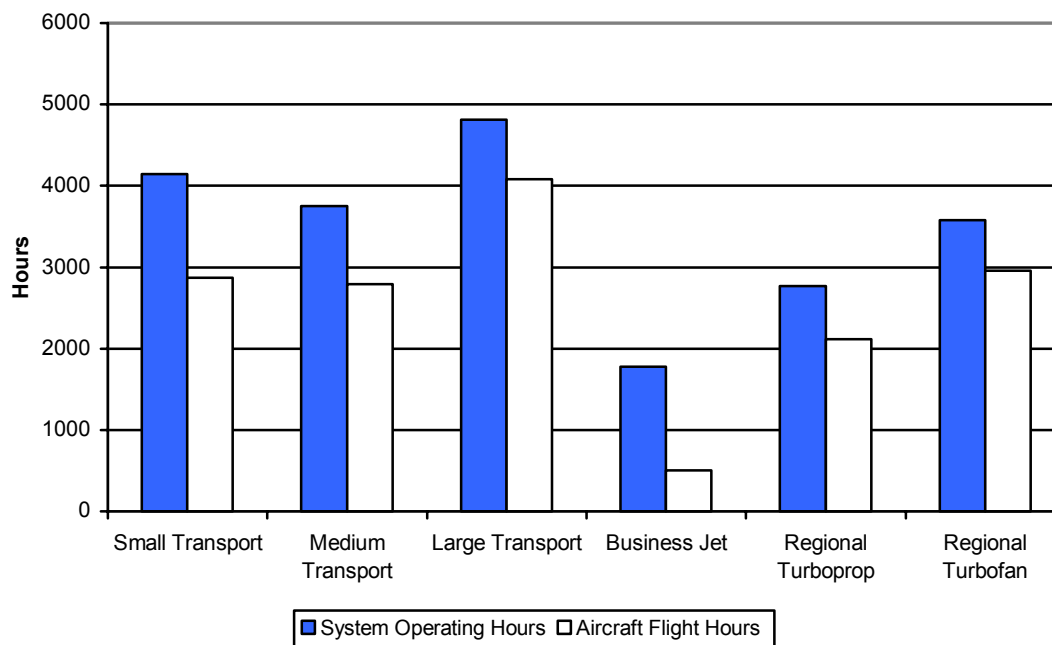

Figure 7-4. System Annual Utilization Rate

7.3.2 Component Reliability

To estimate the impact and related costs associated with the operation & maintenance of an OBIGGS system it was necessary to first establish a likely system reliability figure. From the system design it was possible to compile a list of components for each system. In most cases it was possible to use historical data from similar components to suggest a OBIGGS component mean time between unscheduled removal MTBUR. Where possible, more than one similar component was used.

One example of component reliability calculation was the OBIGGS shutoff valve. This valve would typically be a motorized butterfly type valve, which is to be found in many positions on different airplanes. Several similar valves were identified and using the historical component MTBUR data from more than one operator an average MTBUR figure was calculated. The OBIGGS design team suggested an MTBF of 50,000 hrs, the average MTBUR figure was in fact calculated at 38,315 hrs. This differential was expected and indeed confirmed that this method of MTBUR calculation was valid

Where insufficient historical data was available, a mean time between failure MTBF figure, set by the system design team, or a most likely figure, based on team members experience, was used.

Establishing the component reliability in the form of a MTBUR figure was crucial in determining the system reliability and in enabling the Team to determine not only the component and system annual failure rate but also overall impact on airplane maintenance and operations that result from system failures.

- System Weight
- Cost to carry per airplane per year (\$)
- System Availability (driven by no of days MMEL. relief)
- Delays Per Year (Hours)
- Delay Costs Per Airplane Per Year (\$) and
- MMEL relief ranging from none to 120 days.

7.3.3 System Reliability

The MTBUR for the system was then determined from the individual component estimates.

An effort was made to determine the difference in MTBUR between airplane categories. Where there was sufficient component data available we found that there was little difference in MTBUR’s between the different airplane sizes. It was felt that it did not prove to be a significant factor in further calculations. Therefore with the resources available these figures were not developed further.

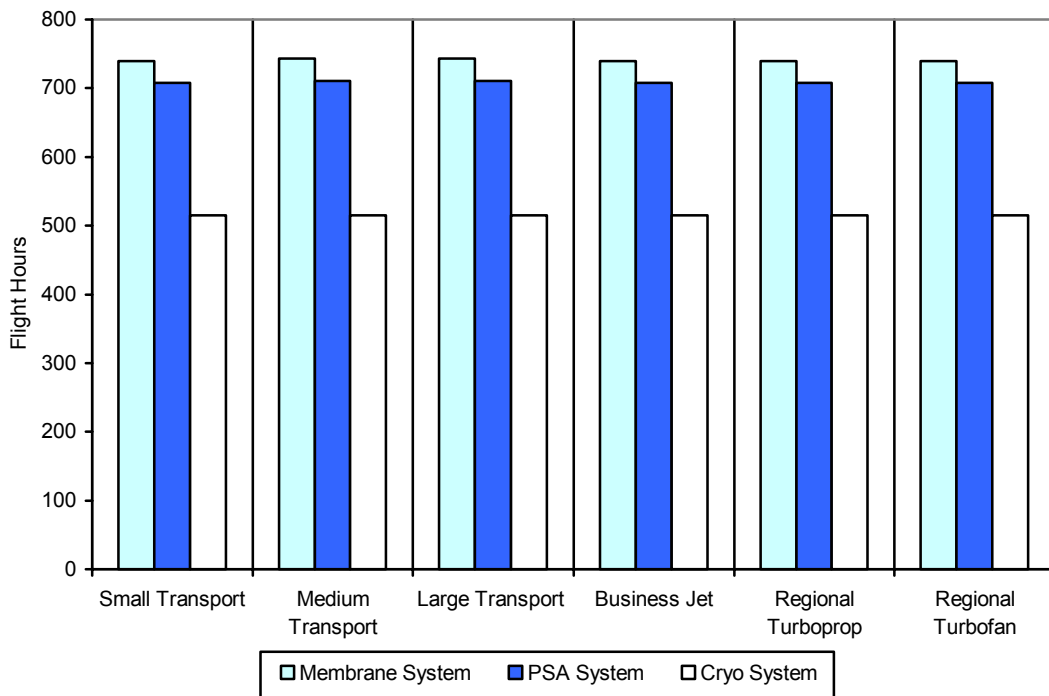

Figure 7-5. System MTBUR

7.3.4 System Annual Failure Rate

Using the component MTBURs and the airplane yearly utilization rate the annual failure rate for each component was calculated. The system annual failure rate was the sum of these component annual failure rates.

Airplane Operation and Maintenance Task Team Final Report

As expected due to the increased system complexity and the maturity of the cryogenic a PSA system technology, the OBIGGS system has a much higher predicted failure rate. This calculation was crucial for many further calculations such as the system availability and the effects of different MMEL repair periods.

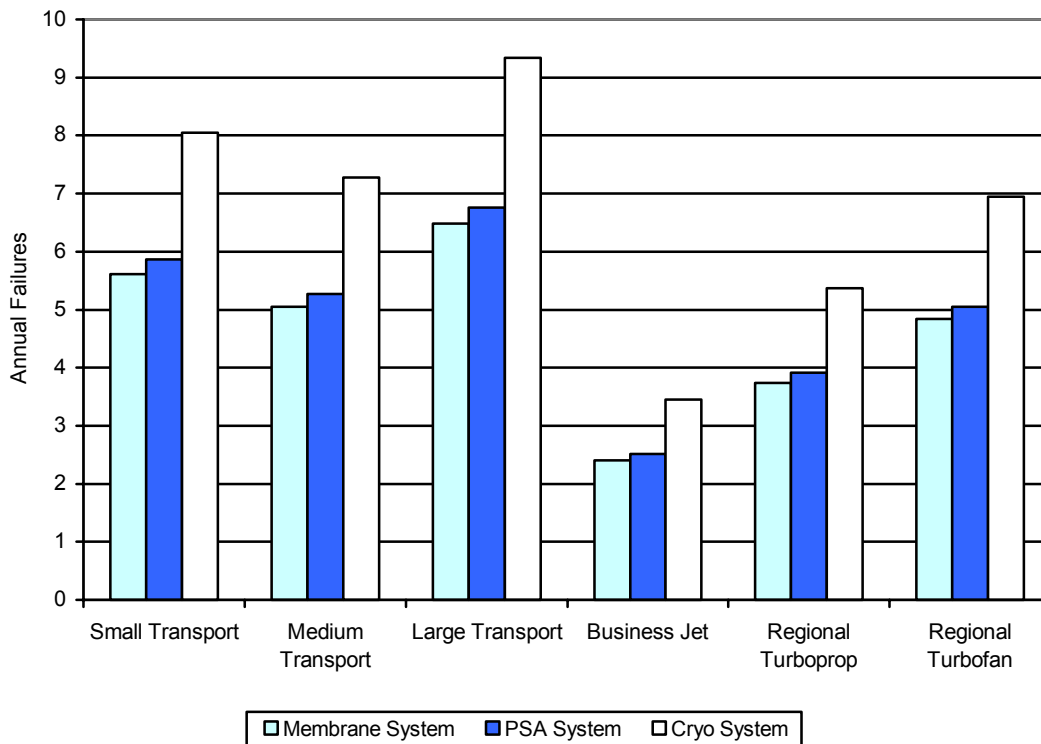

Figure 7-6. System Annual Failure Rate

7.3.5 Unscheduled Maintenance Labor Estimate

The amount of additional workload an OBIGGS system would add to an airplane maintenance requirements is a function of the annual failure rate and the component maintenance time, which in turn is a combination of the following:

- Component Removal & Replacement Time
- Component Access Time
- Trouble-Shooting Time

To calculate the labor hours per year some assumptions have been made as to the locations of the components. For example the heaviest components would be located in areas that would allow access with lifting equipment, e.g., air conditioning bay or wing to body fairing areas. Each component was individually assessed and the time to troubleshoot, access and remove and replace estimated based on similar tasks on existing airplanes.

The figures calculated refer only to the hours taken to rectify OBIGGS failures. It does not take into consideration the additional hours to maintain other airplane systems that are required to support OBIGGS (i.e. electrical or pneumatic systems) or systems effected by OBIGGS (i.e., cabin pressurization).

These figures may appear to be minimal but where an operator has many airplanes arriving and departing within a short period of time existing staffing levels may not be able to perform the rectification tasks and additional staff will need to be recruited. This additional manpower requirement is very difficult to quantify and has not been included. Therefore, the labor hour estimate is presented as an indicator of the requirement for an increased number of maintenance technicians.

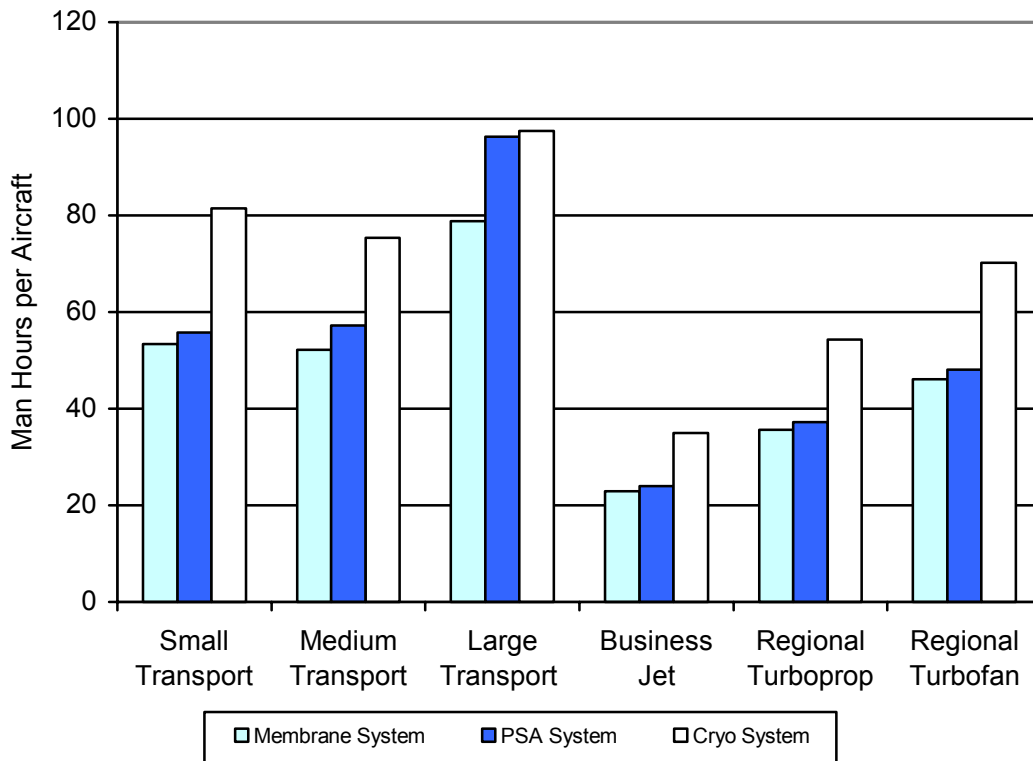

Figure 7-7. Additional Annual Labor Hours

7.3.6 Annual Labor Costs

This is a product of the additional unscheduled labor hours per year and the FAA’s standard burdened labor rate for airplane maintenance technicians of \$75/ hour

The costs shown are for the additional labor hours only. Operators may have to hire additional staff to fulfill these requirements, resulting in an increased financial burden for recruitment, administration and training of the required staff.

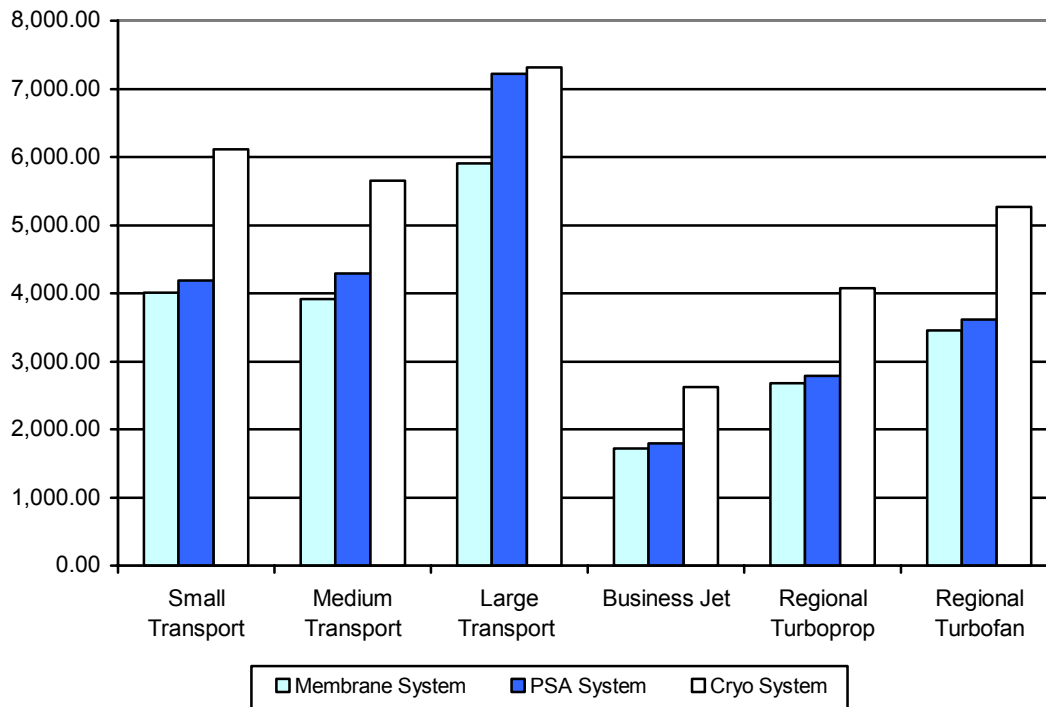

Figure 7-8. Additional Annual Labor Costs (\$)

7.3.7 System Weight

System weight has been calculated from the sum of the component weights specified by the design teams. The additional weight of the system installed on an airplane will not be limited to just the additional components. This estimate does not include the added weight of structural modifications to support heavy components.

Many operators are trying hard to reduce the weight of their airplanes in an effort to achieve best economy.

This system weight has been used to calculate the cost to carry per airplane per year (\$)

7.3.8 Cost to Carry per Airplane per Year (\$)

The cost to carry value is a figure given just to carry the additional weight of the system on an airplane for one year and represents the additional fuel burn. It is calculated from the system weight and a variable input, Cost To Carry Per lb. Per Year \$.

7.3.9 System Availability

System availability is a product of System Annual Failure Rate and the variable input, MMEL repair interval. For example, if the system has a failure rate of 5 times per year and has 10 days MMEL relief the worst case scenario could mean that it is inoperative for 50 days per year or 14% of the time. This would result in a system availability rate of 86%.

As mentioned earlier in this report the potential impact of three-day and ten- day MEL repair intervals were evaluated. Because system repairs are frequently accomplished in less time then the allowed per the MEL repair interval limits, assumptions were made concerning the average amount of time an inerting system would be inoperative under MEL relief. Under the two-day MEL relief repair interval it is

assumed that the average system would be inoperative for 2 days. For the ten-day MEL relief repair interval the average system would be inoperative for 7 days.

The complexity of OBIGGS and the immaturity of both the PSA & Cryogenic inerting technology result in a relatively high System annual failure rate, which drives the system availability rate down. Information from the Safety Analysis Team suggested a system availability of 97.5% is desired to ensure that the predicted benefits of the concept are ensured. On most OBIGGS systems, to achieve over 97% availability an MMEL repair interval of 1 day is required but will seriously impact airline operations.

The chart below shows a comparison of the system availability of the membrane system with one, three and 10 days relief.

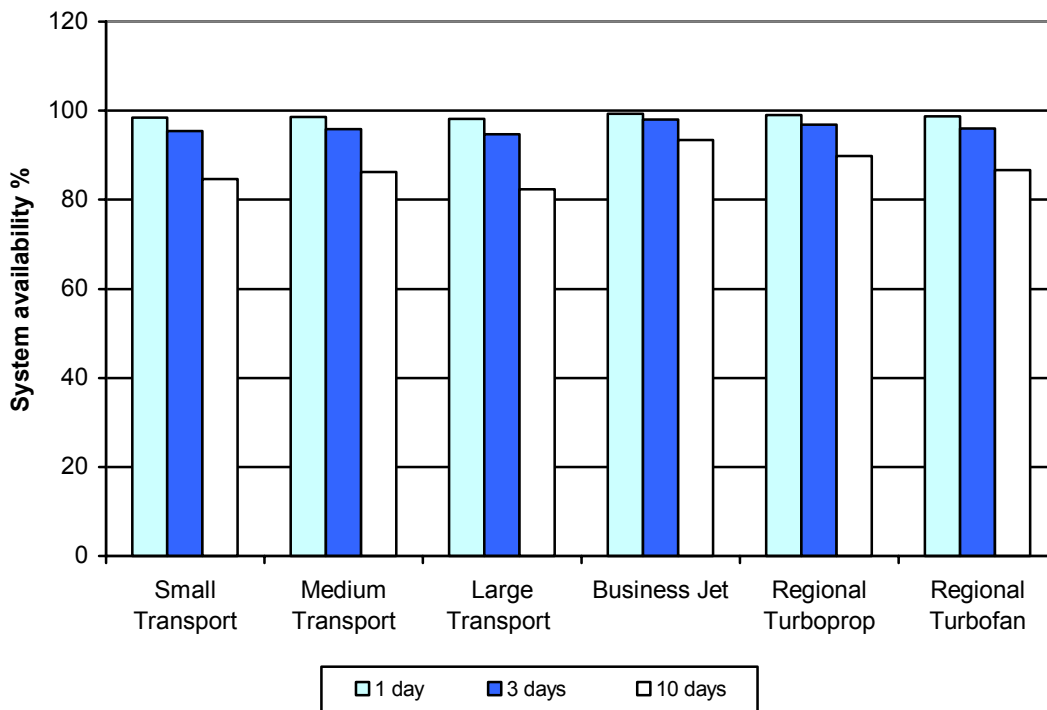

Figure 7-9. System Availability (10 Days MMEL Relief)

7.3.10 Delays per Year (Hours)

This figure has been arrived at by making a Delay Assumption that if an airplane has a fault in the system it will take a period of time for the mechanics to assess the situation, perform any maintenance action in accordance with the MMEL and complete any paperwork. Each airplane type has a delay assumption value which when multiplied by the component annual failure rate results in a total time delay for each component. The sum of the component delays results in the total annual system delay time, (hours).

World reliability figures are measured against delays and cancellations. Customers are often driven by such figures and operators make every effort to ensure on time departures. Such delays and cancellations not only directly effect operators with costs of customer accommodation and remuneration but loss of repeat custom and reputation are effected.

The causes of such delays and cancellations are actively pursued by operators with a view to reducing them to the minimum, adding another system to the airplanes which could effect such figures is of great importance to operators.

Airplane Operation and Maintenance Task Team Final Report

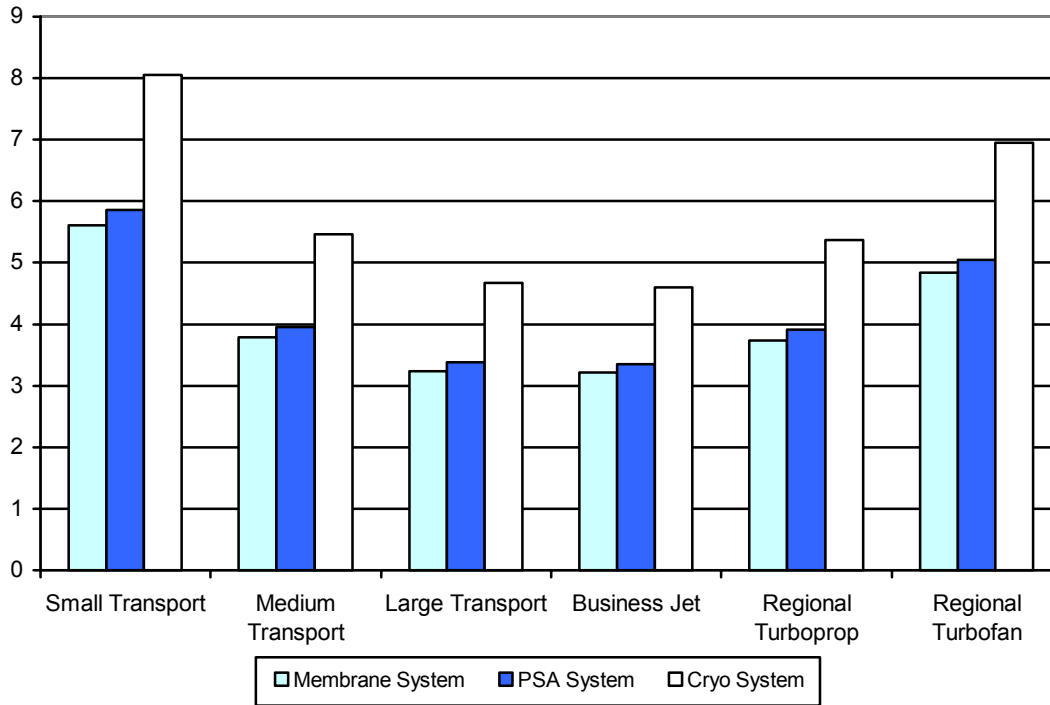

Figure 7-10. Delays per Year (Hours)

7.3.11 MMEL Repair Period

It was possible to estimate the financial effects of the different MMEL repair periods.

The repair periods studied include one, three and ten days relief. As previously discussed a one day repair period will result in the fleet system availability average being above 98%, three days would be 95.5% and ten days would mean a fleet system availability of 85.1%

It was necessary to presume what percentage of the annual failure rate would result in cancellations and correspondingly delays. These were judged accordingly with the different MMEL repair periods. These percentages can be seen in the chart below.

As an example: for the small transport airplane with a one day repair period 20% of the annual system failures will result in cancellations and 80% of failures will result in a delay equal to the delay assumption.

MMEL Repair Interval/ Service Cancellation			
	1 day	3 days	10 days
Small Transport	20%	5%	3%
Medium Transport	18%	4%	2%
Large Transport	15%	3%	1%
Business Jet	18%	4%	2%
Regional Turboprop	20%	5%	3%
Regional Turbofan	20%	5%	3%

Figure 7-11. MMEL Repair Interval/Service Cancellations (%)

7.3.12 Cancellation/Delay Costs

Operators quantify cancellations and delays at rates that were deemed as propriety information but the figures used were agreed as a good representation of the costs involved and is shown in the chart below.

Cancellation / Delay Costs \$		
	Cancellation \$ per event	Delay \$ per hour
Small Transport	\$7,600	\$6,000
Medium Transport	\$20,000	\$8,490
Large Transport	\$32,600	\$10,980
Business Jet	\$7,600	\$6,000
Regional Turboprop	\$7,600	\$6,000
Regional Turbofan	\$7,600	\$6,000

Figure 7-12. Cancellation/Delay Costs

The following chart shows the predicted relationship between the MMEL repair period and the cancellation and delay costs for the membrane system only across the six airplane types. Where a cancellation is experienced it is presumed that half of the flights for that airplane for that day will be lost. This was felt appropriate for all airplane types except the large transport airplanes where both of the flights for that day will be lost. The figures reflect this assumption accordingly.

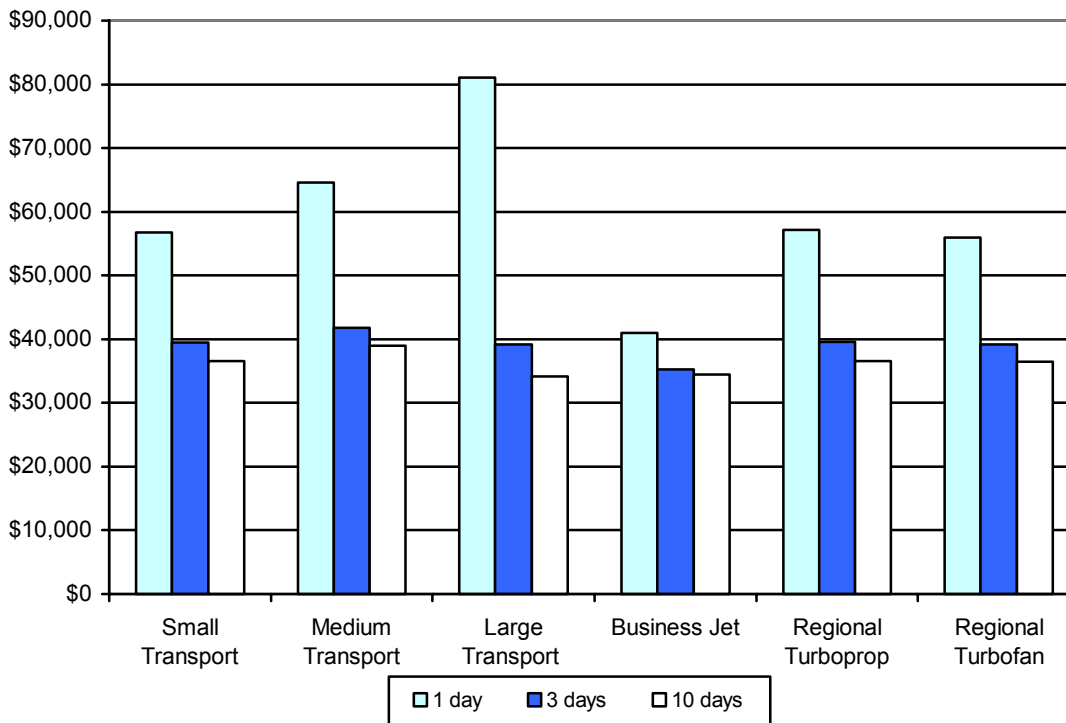

Figure 7-13. Comparisons of Costs and Repair Intervals

7.3.13 Personnel Safety

It is a major concern, for the operators and ground service agencies that by installing an inerting system the safety of personnel could be threatened. The danger to personnel entering confined spaces that could be contaminated with NEA is a real possibility. With an OBIGGS system that is operating all the time the airplane is in service and the possibility of the NEA atmosphere remaining in confined spaces after

Airplane Operation and Maintenance Task Team Final Report

service it is a very real possibility that this system could damage or take more lives than it is intended to save. In most developed countries health and safety legislation is adhered to a lot of the time but in designing a system that reduces oxygen in some of the airplane confined spaces we could be building a trap for people to fall into.

Another major concern is the size and weight of some of the components in the various systems. These range from lightweight valves and other components to heavy compressors, heat exchangers, cryocoolers and air separation modules. These range in weight from 100 lbs. to over 225 lbs. There is a recognized need for specialist lifting equipment but the risk of damage and injury from falling heavy components would exist where it previously did not.

7.3.14 OBIGGS Effects on Other Airplane Systems

The installation of an OBIGGS system on an airplane will effect the reliability and cost of operation for other airplane systems. The OBIGGS system concepts studied by this working group would add a very large additional electrical load on the airplane electrical system. The OBIGGS system also relies on the airplane pneumatic system as a supplemental air supply increasing the demand on this system. Last but not least in an attempt to reduce the size and power requirements of the OBIGGS air compressors the design team chose to take the systems supply air from the passenger cabin. This will put an additional demand on the cabin air-conditioning & pressurization systems.

Electrical Power Generation

The power requirements of the OBIGGS systems may exceed the current available power.

For example, it can be seen from the chart below that the large transport airplanes will require between 115 and 145 KVA. A typical B747 Classic will produce a max continuous rate of 216 KVA of which 175 KVA is required in cruise leaving a maximum of 41 KVA. A further consideration is that this remaining power would be distributed between four power supply buses that cannot be permanently linked together.

A B747-400 can produce more power due to greater capacity generators but greater loads are required and the remaining power is again spread between power supply buses that cannot be permanently linked.

Depending on the airplane the increased power demands may require an increase to the capacity of the power generating system. The cost of increasing the electrical system capacity and the cost of maintaining a larger system were not calculated. Increasing system capacity would require larger generators, heavier wiring, and modifications to the electrical busses to handle the loads. This may not even be an option on some airplanes due to engine limitations. Needless to say these changes would be expensive and time consuming.

Increased capacity power generating systems will increase unscheduled maintenance requirements. This additional unscheduled maintenance figure has not been quantified either.

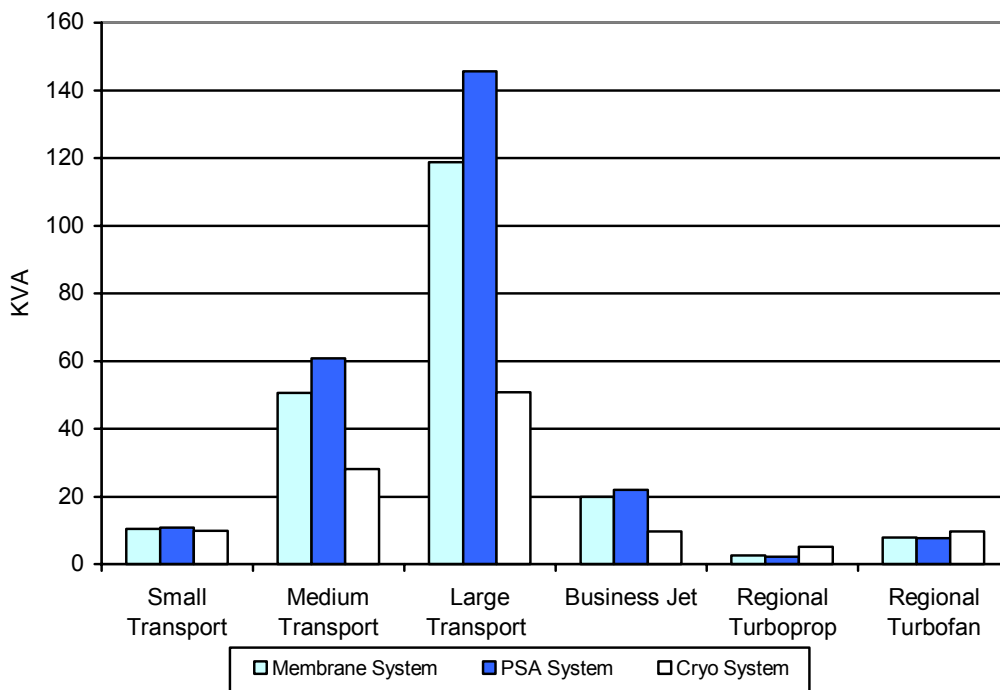

Figure 7-14. OBIGGS Power Requirements (kVA)

Airplane Pressurization System

As previously discussed in the scheduled maintenance section, extra man-hours have been added to the scheduled maintenance checks to perform a fuselage pressure decay check and accomplish repairs. Most operators’ experience that has shown that airplanes, which are currently in service, periodically require this pressure decay check in order to maintain leakage limits prescribed in airplane maintenance manuals.

Because OBIGGS take air off the cabin, operators will have to reduce the allowable cabin air leakage rate to compensate for the demand and maintain a safety margin.

Should a leak occur during operation it may not allow the OBIGGS system, which uses some cabin air pressure, to be operated and instead of allowing the airplane to continue in service until the next scheduled pressure decay check immediate rectification will be required.

These extra-unscheduled maintenance costs have not been quantified.

Bleed Air System

Bleed air is also used by OBIGGS systems. Where this system interfaces with OBIGGS, utilization and associated scheduled & unscheduled maintenance will be increased. This increase in unscheduled maintenance has again not been quantified.

Stock Holding

The amount of spare components required to be held by an operator to ensure a reliable system varies according to system reliability, number of airplanes operated and the type of operation, ETOPS etc. It was not possible to make a detailed study of the costs for all systems and airplane types but from the figures already calculated it was possible to see that a pool of spares of \$900,000 plus would be required to operate one airplane with a membrane system. This figure is a conservative estimate and does not take into account the storage, transportation, administration or capital investment costs or indeed any lease fees.

7.4 FLIGHT OPERATIONS

OBIGGS provides full time inerting protection in normal operations including descent, landing and post landing incidents that might present a tank ignition hazard. The system should be designed to be fully automatic and to be automatically shed in the case of engine power, electrical, bleed source or cabin pressure failures. It is assumed that it will be monitored by the flight management systems and annunciation of failure modes will be provided to the flight crew for recording in the maintenance log. Little if any cockpit instrumentation should be provided since inerting is considered to be a safety enhancement with MEL provisions and the crew is not expected to trouble shoot it to reactivate the system or discontinue routing operations. Some basic descriptions of the inerting concept and the OBIGGS equipment, location, power sources, heat exchangers, etc. need to be provided as additional training but should be limited to need to know. "If the crew cannot affect it, don't train for it." Both flight crew and dispatch personnel will be trained as far as MEL operating rules and the airplane may need to be re-routed to a suitable repair facility. The OBIGGS system will draw power, bleed air, and incur drag from intercooler openings and the increased fuel burn costs and will result in reduced range and endurance. Some long haul and international routes could be impacted.

7.5 GROUND OPERATIONS

The Onboard Gas Generating System after installation ideally would solve many of the ground base concerns and issues expressed earlier. It is the group's opinion that a continual monitoring system be installed on the flight deck to insure proper inerting is taking place during the more critical phases of the airplane route structure such as taxi and takeoff. Any anomalies should immediately put on a master caution light to alert the flight crew. The flight crew would then have the ability to shut the system down if need be. Such as the APU fire warning system on many commercial airplanes, an aural warning system should be considered while the airplane is on the ground, in the event this system malfunctions without a flight crewmember on board.

A valid concern was raised with the possibility of nitrogen entering the cabin during continuous inerting with this system. Considerations should be given to redundancy with the material used to enhance safety for passengers and crewmembers. An example would be using double wall pipe for plumping purposes, and installing nitrogen sensors in the cabin.

Maintenance training procedures fall within the above mentioned training recommendations, and would merely be tailored again to the system desired for installation.

8.0 HYBRID ON-BOARD INERTING SYSTEMS

From an airplane operations and maintenance perspective there is very little difference between the full OBGI/OBIGG systems and the hybrid systems. The Airplane Operations & Maintenance Team looked at the hybrid systems but when it was determined that the system were nearly identical from this perspective, further work was discontinued. The reader may assume that the maintenance, operations and modifications impact described in the OBGIS and OBIGGS sections applies to the hybrid systems.

9.0 CONCLUSION

Although the fuel tank inerting system may enhance the safety of the airplanes fuel systems, there are several areas that still need to be addressed. The following are the concerns of this task group:

- The tasking statement does not clarify if inerting systems are classified as a safety system or fuel system enhancement. The assumption that inerting systems are not required for safety of flight and are designed and maintained as such is fundamental to the conclusions of this report.
- Any inerting system would introduce additional safety risks to flight crew, passengers, and maintenance personnel. Additional safety procedures would need to be put in place to mitigate these risks.

Airplane Operation and Maintenance Task Team Final Report

- If implemented, the requirement to retrofit inerting systems may place an unacceptable burden on the aircraft maintenance industry. Depending on the time scales there may not be sufficient facilities or personnel available to embody the modifications.
- The poor reliability of current on-board inerting system technology would restrict the introduction of fuel tank inerting systems on commercial aircraft. An improvement in reliability by an order of magnitude would be required to make them operationally viable.
- The implementation costs would be extremely high. Even if the inerting equipment was provided and installed for free, the cost to carry, maintenance and operational costs would exceed the benefits calculated in this document.

For all proposed inerting systems, additional maintenance labor hours will be required to maintain the system. This may require:

- The extension of the regular scheduled maintenance checks
- Additional maintenance checks
- Unscheduled unserviceability
- Contract maintenance assistance
- Additional hangar space

All of the above would lead to an increase in maintenance costs. Figures F3.3-1 through F3.3-6 in addendum F.B.1. compare the additional maintenance labor-hour estimates for each proposed system by airplane category.

REFERENCE

1. Occupational Safety & Health Administration (OSHA), *Accidents Database*. UK Health & Safety Executive, Safe Work in Confined Spaces.
2. Major Phillip Parker, *USAF School of Aerospace Medicine*, Potential Health Effects of Nitrogen Inerting of Commercial Airline Fuel Systems - Dec 2000

ADDENDUM F.A.1

MODIFICATION COST & LABOR-HOUR ESTIMATION

to

APPENDIX F

AIRPLANE OPERATION AND MAINTENANCE

FINAL REPORT

Airplane Operation and Maintenance Task Team Final Report

This page intentionally left blank.

MODIFICATION COST & LABOR-HOUR ESTIMATION

GROUND BASED INERTING SYSTEM

LARGE AIRPLANE CATEGORY

Task	Number of Persons	Rate	Special Program		D/M - Check		Description
			Man Hours	Cost	Man Hours	Cost	
NON-RECURRING							
Engineering							
Service Bulletin review	1	\$ 110	30	\$ 3,300	30	\$ 3,300	Evaluating Service Bulletin
Engineering Data	1	\$ 50	35	\$ 1,750	35	\$ 1,750	Enters the work card requirements into the data base.
Engineering Drafting	1	\$ 110	25	\$ 2,750	25	\$ 2,750	Creates the necessary drawings and figures necessary for the project.
Inventory Planning	1	\$ 110	20	\$ 2,200	20	\$ 2,200	Reviews the Engineering BOM and does all material provisions and allocations
Planning	1	\$ 110	20	\$ 2,200	20	\$ 2,200	Reviews the Engineering Project and provides information for accomplishment.
Maintenance Programs	1	\$ 110	35	\$ 3,850	35	\$ 3,850	Reviews the Engineering Project for effect on other projects, tasks and jobcards.
Records	1	\$ 50	10	\$ 500	10	\$ 500	Creates the necessary Project tracking numbers and maintains the records.
Quality Assurance	1	\$ 50	25	\$ 1,250	25	\$ 1,250	Reviews the Engineering Project for Regulatory compliance.
Reliability	1	\$ 50	20	\$ 1,000	20	\$ 1,000	Tracks and maintains the records for all the components and their trends. FAR requirement.
Tech Publications							
Manuals: AMM	1	\$ 50	25	\$ 1,250	25	\$ 1,250	Aircraft Maintenance Manual
IPC	1	\$ 50	20	\$ 1,000	20	\$ 1,000	Illustrated Parts List
CMM	1	\$ 50	10	\$ 500	10	\$ 500	Component Maintenance Manual
AFM	1	\$ 50	10	\$ 500	10	\$ 500	Aircraft Flight Manual
FOM	1	\$ 50	10	\$ 500	10	\$ 500	Flight Operations Manual
SRM	1	\$ 50	10	\$ 500	10	\$ 500	Structural Repair Manual
FUELLING	1	\$ 50	15	\$ 750	15	\$ 750	Fuelling Manual
RMM	1	\$ 50	10	\$ 500	10	\$ 500	Ramp Manual
GMM	1	\$ 50	40	\$ 2,000	40	\$ 2,000	General Maintenance Manual that includes Company's Procedures
WDM	2	\$ 50	150	\$ 7,500	150	\$ 7,500	Wire Diagram Manual
Training Documentation	1	\$ 75	15	\$ 1,125	15	\$ 1,125	Making of necessary training documentation
Training Material				\$ 1,000		\$ 1,000	Material
Material Control							
Rotable parts	1	\$ 50	43	\$ 2,125	43	\$ 2,125	Make known the Routable into the company systems
Consumable parts	1	\$ 50	25	\$ 1,250	25	\$ 1,250	Make known the Consumables into the company systems
Spares estimation	1	\$ 50	8	\$ 400	8	\$ 400	The amount of spares depending on the MTBUR
Tooling	1	\$ 50	30	\$ 1,500	30	\$ 1,500	Make known the Tooling into the company systems
RECURRING							
Project's Estimated Time							
Accomplishment	10	\$ 75	1300	\$ 97,500	1050	\$ 78,750	See Addendum F.A.2 for detailed tasks
Engineering support	1	\$ 110	100	\$ 11,000	100	\$ 11,000	Support to hangar during modification
Kit costs							Kit costs is not included. Design Team didn't provided the data.
Kit Storage costs							No kit data available
Extra down time airplane				\$ 2,000,000		\$ -	Extra time airplane is on ground due to this modification. Including lost of revenue & hangar space.
Training							
Instructors	1	\$ 110	15	\$ 1,650	15	\$ 1,650	This is the cost for 1 training class only. A correct estimation was not feasible. Giving class + preparation time
Training Classroom				\$ 5,000		\$ 5,000	Average rent cost for classroom
Training Mechanics	16	\$ 110	8	\$ 14,080	8	\$ 14,080	Number of mechanics that follows the class.
Total NON-Recurring	25		641	\$ 41,200	641	\$ 41,200	Per airplane type/ per operator
Total Recurring	28		1423	\$ 2,129,230	1173	\$ 110,480	Per airplane

MODIFICATION COST & LABOR-HOUR ESTIMATION

ON-BOARD GROUND INERTING SYSTEM

LARGE AIRPLANE CATEGORY - MEMBRANE

Task	Number of Persons	Rate	Special Program		D/M - Check		Description
			Man Hours	Cost	Man Hours	Cost	
NON-RECURRING							
Engineering							
Service Bulletin review	1	\$ 110	30	\$ 3,300	30	\$ 3,300	Evaluating Service Bulletin
Engineering Data	1	\$ 50	35	\$ 1,750	35	\$ 1,750	Enters the work card requirements into the data base.
Engineering Drafting	1	\$ 110	25	\$ 2,750	25	\$ 2,750	Creates the necessary drawings and figures necessary for the project.
Inventory Planning	1	\$ 110	20	\$ 2,200	20	\$ 2,200	Reviews the Engineering BOM and does all material provisions and allocations
Planning	1	\$ 110	20	\$ 2,200	20	\$ 2,200	Reviews the Engineering Project and provides information for accomplishment.
Maintenance Programs	1	\$ 110	35	\$ 3,850	35	\$ 3,850	Reviews the Engineering Project for effect on other projects, tasks and jobcards.
Records	1	\$ 50	10	\$ 500	10	\$ 500	Creates the necessary Project tracking numbers and maintains the records.
Quality Assurance	1	\$ 50	25	\$ 1,250	25	\$ 1,250	Reviews the Engineering Project for Regulatory compliance.
Reliability	1	\$ 50	20	\$ 1,000	20	\$ 1,000	Tracks and maintains the records for all the components and their trends. FAR requirement.
Tech Publications							
Manuals: AMM	1	\$ 50	25	\$ 1,250	25	\$ 1,250	Aircraft Maintenance Manual
IPC	1	\$ 50	20	\$ 1,000	20	\$ 1,000	Illustrated Parts List
CMM	1	\$ 50	10	\$ 500	10	\$ 500	Component Maintenance Manual
AFM	1	\$ 50	10	\$ 500	10	\$ 500	Aircraft Flight Manual
FOM	1	\$ 50	10	\$ 500	10	\$ 500	Flight Operations Manual
SRM	1	\$ 50	10	\$ 500	10	\$ 500	Structural Repair Manual
FUELLING	1	\$ 50	15	\$ 750	15	\$ 750	Fuelling Manual
RMM	1	\$ 50	10	\$ 500	10	\$ 500	Ramp Manual
GMM	1	\$ 50	40	\$ 2,000	40	\$ 2,000	General Maintenance Manual that includes Company's Procedures
WDM	2	\$ 50	150	\$ 7,500	150	\$ 7,500	Wire Diagram Manual
Training Documentation	1	\$ 75	15	\$ 1,125	15	\$ 1,125	Making of necessary training documentation
Training Material				\$ 1,000		\$ 1,000	Material
Material Control							
Routable parts	1	\$ 50	43	\$ 2,125	43	\$ 2,125	Make known the Routable into the company systems
Consumable parts	1	\$ 50	25	\$ 1,250	25	\$ 1,250	Make known the Consumables into the company systems
Spares estimation	1	\$ 50	8	\$ 400	8	\$ 400	The amount of spares depending on the MTBUR
Tooling	1	\$ 50	30	\$ 1,500	30	\$ 1,500	Make known the Tooling into the company systems
RECURRING							
Project's Estimated Time							
Accomplishment	10	\$ 75	2650	\$ 198,750	2200	\$ 165,000	See Addendum F.A.2 for detailed tasks
Engineering support	1	\$ 110	100	\$ 11,000	100	\$ 11,000	Support to hangar during modification
Kit costs							Kit costs is not included. Design Team didn't provided the data.
Kit Storage costs							No kit data available
Extra down time airplane				\$ 2,000,000		\$ -	Extra time airplane is on ground due to this modification. Including lost of revenue & hangar space.
Training							
Instructors	1	\$ 110	15	\$ 1,650	15	\$ 1,650	This is the cost for 1 training class only. A correct estimation was not feasible. Giving class + preparation time
Training Classroom				\$ 5,000		\$ 5,000	Average rent cost for classroom
Training Mechanics	16	\$ 110	8	\$ 14,080	8	\$ 14,080	Number of mechanics that follows the class.
Total NON-Recurring	25		641	\$ 41,200	641	\$ 41,200	Per airplane type/ per operator
Total Recurring	28		2773	\$ 2,230,480	2323	\$ 196,730	Per airplane

MODIFICATION COST & LABOR-HOUR ESTIMATION
ON-BOARD GROUND INERTING SYSTEM
 LARGE AIRPLANE CATEGORY - PRESSURE SWING ADSORBITION

Task	Number of Persons	Rate	Special Program		D/M - Check		Description
			Man Hours	Cost	Man Hours	Cost	
NON-RECURRING							
Engineering							
Service Bulletin review	1	\$ 110	30	\$ 3,300	30	\$ 3,300	Evaluating Service Bulletin
Engineering Data	1	\$ 50	35	\$ 1,750	35	\$ 1,750	Enters the work card requirements into the data base.
Engineering Drafting	1	\$ 110	25	\$ 2,750	25	\$ 2,750	Creates the necessary drawings and figures necessary for the project.
Inventory Planning	1	\$ 110	20	\$ 2,200	20	\$ 2,200	Reviews the Engineering BOM and does all material provisions and allocations
Planning	1	\$ 110	20	\$ 2,200	20	\$ 2,200	Reviews the Engineering Project and provides information for accomplishment.
Maintenance Programs	1	\$ 110	35	\$ 3,850	35	\$ 3,850	Reviews the Engineering Project for effect on other projects, tasks and jobcards.
Records	1	\$ 50	10	\$ 500	10	\$ 500	Creates the necessary Project tracking numbers and maintains the records.
Quality Assurance	1	\$ 50	25	\$ 1,250	25	\$ 1,250	Reviews the Engineering Project for Regulatory compliance.
Reliability	1	\$ 50	20	\$ 1,000	20	\$ 1,000	Tracks and maintains the records for all the components and their trends. FAR requirement.
Tech Publications							
Manuals: AMM	1	\$ 50	25	\$ 1,250	25	\$ 1,250	Aircraft Maintenance Manual
IPC	1	\$ 50	20	\$ 1,000	20	\$ 1,000	Illustrated Parts List
CMM	1	\$ 50	10	\$ 500	10	\$ 500	Component Maintenance Manual
AFM	1	\$ 50	10	\$ 500	10	\$ 500	Aircraft Flight Manual
FOM	1	\$ 50	10	\$ 500	10	\$ 500	Flight Operations Manual
SRM	1	\$ 50	10	\$ 500	10	\$ 500	Structural Repair Manual
FUELLING	1	\$ 50	15	\$ 750	15	\$ 750	Fuelling Manual
RMM	1	\$ 50	10	\$ 500	10	\$ 500	Ramp Manual
GMM	1	\$ 50	40	\$ 2,000	40	\$ 2,000	General Maintenance Manual that includes Company's Procedures
WDM	2	\$ 50	150	\$ 7,500	150	\$ 7,500	Wire Diagram Manual
Training Documentation	1	\$ 75	15	\$ 1,125	15	\$ 1,125	Making of necessary training documentation
Training Material				\$ 1,000		\$ 1,000	Material
Material Control							
Routable parts	1	\$ 50	43	\$ 2,125	43	\$ 2,125	Make known the Routable into the company systems
Consumable parts	1	\$ 50	25	\$ 1,250	25	\$ 1,250	Make known the Consumables into the company systems
Spares estimation	1	\$ 50	8	\$ 400	8	\$ 400	The amount of spares depending on the MTBUR
Tooling	1	\$ 50	30	\$ 1,500	30	\$ 1,500	Make known the Tooling into the company systems
RECURRING							
Project's Estimated Time							
Accomplishment	10	\$ 75	2600	\$ 195,000	2150	\$ 161,250	See Addendum F.A.2 for detailed tasks
Engineering support	1	\$ 110	100	\$ 11,000	100	\$ 11,000	Support to hangar during modification
Kit costs							Kit costs is not included. Design Team didn't provided the data.
Kit Storage costs							No kit data available
Extra down time airplane				\$ 2,000,000		\$ -	Extra time airplane is on ground due to this modification. Including lost of revenue & hangar space.
Training							
Instructors	1	\$ 110	15	\$ 1,650	15	\$ 1,650	This is the cost for 1 training class only. A correct estimation was not feasible. Giving class + preparation time
Training Classroom				\$ 5,000		\$ 5,000	Average rent cost for classroom
Training Mechanics	16	\$ 110	8	\$ 14,080	8	\$ 14,080	Number of mechanics that follows the class.
Total NON-Recurring	25		641	\$ 41,200	641	\$ 41,200	Per airplane type/ per operator
Total Recurring	28		2723	\$ 2,226,730	2273	\$ 192,980	Per airplane

MODIFICATION COST & LABOR-HOUR ESTIMATION

ON-BOARD GROUND INERTING SYSTEM

LARGE AIRPLANE CATEGORY - CRYOGENIC

Task	Number of Persons	Rate	Special Program		D/M - Check		Description
			Man Hours	Cost	Man Hours	Cost	
NON-RECURRING							
Engineering							
Service Bulletin review	1	\$ 110	30	\$ 3,300	30	\$ 3,300	Evaluating Service Bulletin
Engineering Data	1	\$ 50	35	\$ 1,750	35	\$ 1,750	Enters the work card requirements into the data base.
Engineering Drafting	1	\$ 110	25	\$ 2,750	25	\$ 2,750	Creates the necessary drawings and figures necessary for the project.
Inventory Planning	1	\$ 110	20	\$ 2,200	20	\$ 2,200	Reviews the Engineering BOM and does all material provisions and allocations
Planning	1	\$ 110	20	\$ 2,200	20	\$ 2,200	Reviews the Engineering Project and provides information for accomplishment.
Maintenance Programs	1	\$ 110	35	\$ 3,850	35	\$ 3,850	Reviews the Engineering Project for effect on other projects, tasks and jobcards.
Records	1	\$ 50	10	\$ 500	10	\$ 500	Creates the necessary Project tracking numbers and maintains the records.
Quality Assurance	1	\$ 50	25	\$ 1,250	25	\$ 1,250	Reviews the Engineering Project for Regulatory compliance.
Reliability	1	\$ 50	20	\$ 1,000	20	\$ 1,000	Tracks and maintains the records for all the components and their trends. FAR requirement.
Tech Publications							
Manuals: AMM	1	\$ 50	25	\$ 1,250	25	\$ 1,250	Aircraft Maintenance Manual
IPC	1	\$ 50	20	\$ 1,000	20	\$ 1,000	Illustrated Parts List
CMM	1	\$ 50	10	\$ 500	10	\$ 500	Component Maintenance Manual
AFM	1	\$ 50	10	\$ 500	10	\$ 500	Aircraft Flight Manual
FOM	1	\$ 50	10	\$ 500	10	\$ 500	Flight Operations Manual
SRM	1	\$ 50	10	\$ 500	10	\$ 500	Structural Repair Manual
FUELLING	1	\$ 50	15	\$ 750	15	\$ 750	Fuelling Manual
RMM	1	\$ 50	10	\$ 500	10	\$ 500	Ramp Manual
GMM	1	\$ 50	40	\$ 2,000	40	\$ 2,000	General Maintenance Manual that includes Company's Procedures
WDM	2	\$ 50	150	\$ 7,500	150	\$ 7,500	Wire Diagram Manual
Training Documentation	1	\$ 75	15	\$ 1,125	15	\$ 1,125	Making of necessary training documentation
Training Material				\$ 1,000		\$ 1,000	Material
Material Control							
Routable parts	1	\$ 50	43	\$ 2,125	43	\$ 2,125	Make known the Routable into the company systems
Consumable parts	1	\$ 50	25	\$ 1,250	25	\$ 1,250	Make known the Consumables into the company systems
Spares estimation	1	\$ 50	8	\$ 400	8	\$ 400	The amount of spares depending on the MTBUR
Tooling	1	\$ 50	30	\$ 1,500	30	\$ 1,500	Make known the Tooling into the company systems
RECURRING							
Project's Estimated Time							
Accomplishment	10	\$ 75	2700	\$ 202,500	2250	\$ 168,750	See Addendum F.A.2 for detailed tasks
Engineering support	1	\$ 110	100	\$ 11,000	100	\$ 11,000	Support to hangar during modification
Kit costs							Kit costs is not included. Design Team didn't provided the data.
Kit Storage costs							No kit data available
Extra down time airplane				\$ 2,000,000		\$ -	Extra time airplane is on ground due to this modification. Including lost of revenue & hangar space.
Training							
Instructors	1	\$ 110	15	\$ 1,650	15	\$ 1,650	This is the cost for 1 training class only. A correct estimation was not feasible. Giving class + preparation time
Training Classroom				\$ 5,000		\$ 5,000	Average rent cost for classroom
Training Mechanics	16	\$ 110	8	\$ 14,080	8	\$ 14,080	Number of mechanics that follows the class.
Total NON-Recurring	25		641	\$ 41,200	641	\$ 41,200	Per airplane type/ per operator
Total Recurring	28		2823	\$ 2,234,230	2373	\$ 200,480	Per airplane

MODIFICATION COST & LABOR-HOUR ESTIMATION

ON-BOARD INERTING GAS GENERATING SYSTEM

LARGE AIRPLANE CATEGORY - MEMBRANE

Task	Number of Persons	Rate	Special Program		D/M - Check		Description
			Man Hours	Cost	Man Hours	Cost	
NON-RECURRING							
Engineering							
Service Bulletin review	1	\$ 110	30	\$ 3,300	30	\$ 3,300	Evaluating Service Bulletin
Engineering Data	1	\$ 50	35	\$ 1,750	35	\$ 1,750	Enters the work card requirements into the data base.
Engineering Drafting	1	\$ 110	25	\$ 2,750	25	\$ 2,750	Creates the necessary drawings and figures necessary for the project.
Inventory Planning	1	\$ 110	20	\$ 2,200	20	\$ 2,200	Reviews the Engineering BOM and does all material provisions and allocations
Planning	1	\$ 110	20	\$ 2,200	20	\$ 2,200	Reviews the Engineering Project and provides information for accomplishment.
Maintenance Programs	1	\$ 110	35	\$ 3,850	35	\$ 3,850	Reviews the Engineering Project for effect on other projects, tasks and jobcards.
Records	1	\$ 50	10	\$ 500	10	\$ 500	Creates the necessary Project tracking numbers and maintains the records.
Quality Assurance	1	\$ 50	25	\$ 1,250	25	\$ 1,250	Reviews the Engineering Project for Regulatory compliance.
Reliability	1	\$ 50	20	\$ 1,000	20	\$ 1,000	Tracks and maintains the records for all the components and their trends. FAR requirement.
Tech Publications							
Manuals: AMM	1	\$ 50	25	\$ 1,250	25	\$ 1,250	Aircraft Maintenance Manual
IPC	1	\$ 50	20	\$ 1,000	20	\$ 1,000	Illustrated Parts List
CMM	1	\$ 50	10	\$ 500	10	\$ 500	Component Maintenance Manual
AFM	1	\$ 50	10	\$ 500	10	\$ 500	Aircraft Flight Manual
FOM	1	\$ 50	10	\$ 500	10	\$ 500	Flight Operations Manual
SRM	1	\$ 50	10	\$ 500	10	\$ 500	Structural Repair Manual
FUELLING	1	\$ 50	15	\$ 750	15	\$ 750	Fuelling Manual
RMM	1	\$ 50	10	\$ 500	10	\$ 500	Ramp Manual
GMM	1	\$ 50	40	\$ 2,000	40	\$ 2,000	General Maintenance Manual that includes Company's Procedures
WDM	2	\$ 50	150	\$ 7,500	150	\$ 7,500	Wire Diagram Manual
Training Documentation	1	\$ 75	15	\$ 1,125	15	\$ 1,125	Making of necessary training documentation
Training Material				\$ 1,000		\$ 1,000	Material
Material Control							
Routable parts	1	\$ 50	43	\$ 2,125	43	\$ 2,125	Make known the Routable into the company systems
Consumable parts	1	\$ 50	25	\$ 1,250	25	\$ 1,250	Make known the Consumables into the company systems
Spares estimation	1	\$ 50	8	\$ 400	8	\$ 400	The amount of spares depending on the MTBUR
Tooling	1	\$ 50	30	\$ 1,500	30	\$ 1,500	Make known the Tooling into the company systems
RECURRING							
Project's Estimated Time							
Accomplishment	10	\$ 75	2950	\$ 221,250	2500	\$ 187,500	See Addendum F.A.2 for detailed tasks
Engineering support	1	\$ 110	100	\$ 11,000	100	\$ 11,000	Support to hangar during modification
Kit costs							Kit costs is not included. Design Team didn't provided the data.
Kit Storage costs							No kit data available
Extra down time airplane				\$ 2,000,000		\$ -	Extra time airplane is on ground due to this modification. Including lost of revenue & hangar space.
Training							
Instructors	1	\$ 110	15	\$ 1,650	15	\$ 1,650	This is the cost for 1 training class only. A correct estimation was not feasible. Giving class + preparation time
Training Classroom				\$ 5,000		\$ 5,000	Average rent cost for classroom
Training Mechanics	16	\$ 110	8	\$ 14,080	8	\$ 14,080	Number of mechanics that follows the class.
Total NON-Recurring	25		641	\$ 41,200	641	\$ 41,200	Per airplane type/ per operator
Total Recurring	28		3073	\$ 2,252,980	2623	\$ 219,230	Per airplane

MODIFICATION COST & LABOR-HOUR ESTIMATION

ON-BOARD INERTING GAS GENERATING SYSTEM

LARGE AIRPLANE CATEGORY - PRESSURE SWING ADSORPTION

Task	Number of Persons	Rate	Special Program		D/M - Check		Description
			Man Hours	Cost	Man Hours	Cost	
NON-RECURRING							
Engineering							
Service Bulletin review	1	\$ 110	30	\$ 3,300	30	\$ 3,300	Evaluating Service Bulletin
Engineering Data	1	\$ 50	35	\$ 1,750	35	\$ 1,750	Enters the work card requirements into the data base.
Engineering Drafting	1	\$ 110	25	\$ 2,750	25	\$ 2,750	Creates the necessary drawings and figures necessary for the project.
Inventory Planning	1	\$ 110	20	\$ 2,200	20	\$ 2,200	Reviews the Engineering BOM and does all material provisions and allocations
Planning	1	\$ 110	20	\$ 2,200	20	\$ 2,200	Reviews the Engineering Project and provides information for accomplishment.
Maintenance Programs	1	\$ 110	35	\$ 3,850	35	\$ 3,850	Reviews the Engineering Project for effect on other projects, tasks and jobcards.
Records	1	\$ 50	10	\$ 500	10	\$ 500	Creates the necessary Project tracking numbers and maintains the records.
Quality Assurance	1	\$ 50	25	\$ 1,250	25	\$ 1,250	Reviews the Engineering Project for Regulatory compliance.
Reliability	1	\$ 50	20	\$ 1,000	20	\$ 1,000	Tracks and maintains the records for all the components and their trends. FAR requirement.
Tech Publications							
Manuals: AMM	1	\$ 50	25	\$ 1,250	25	\$ 1,250	Aircraft Maintenance Manual
IPC	1	\$ 50	20	\$ 1,000	20	\$ 1,000	Illustrated Parts List
CMM	1	\$ 50	10	\$ 500	10	\$ 500	Component Maintenance Manual
AFM	1	\$ 50	10	\$ 500	10	\$ 500	Aircraft Flight Manual
FOM	1	\$ 50	10	\$ 500	10	\$ 500	Flight Operations Manual
SRM	1	\$ 50	10	\$ 500	10	\$ 500	Structural Repair Manual
FUELLING	1	\$ 50	15	\$ 750	15	\$ 750	Fuelling Manual
RMM	1	\$ 50	10	\$ 500	10	\$ 500	Ramp Manual
GMM	1	\$ 50	40	\$ 2,000	40	\$ 2,000	General Maintenance Manual that includes Company's Procedures
WDM	2	\$ 50	150	\$ 7,500	150	\$ 7,500	Wire Diagram Manual
Training Documentation	1	\$ 75	15	\$ 1,125	15	\$ 1,125	Making of necessary training documentation
Training Material				\$ 1,000		\$ 1,000	Material
Material Control							
Routable parts	1	\$ 50	43	\$ 2,125	43	\$ 2,125	Make known the Routable into the company systems
Consumable parts	1	\$ 50	25	\$ 1,250	25	\$ 1,250	Make known the Consumables into the company systems
Spares estimation	1	\$ 50	8	\$ 400	8	\$ 400	The amount of spares depending on the MTBUR
Tooling	1	\$ 50	30	\$ 1,500	30	\$ 1,500	Make known the Tooling into the company systems
RECURRING							
Project's Estimated Time							
Accomplishment	10	\$ 75	2900	\$ 217,500	2450	\$ 183,750	See Addendum F.A.2 for detailed tasks
Engineering support	1	\$ 110	100	\$ 11,000	100	\$ 11,000	Support to hangar during modification
Kit costs							Kit costs is not included. Design Team didn't provided the data.
Kit Storage costs							No kit data available
Extra down time airplane				\$ 2,000,000		\$ -	Extra time airplane is on ground due to this modification. Including lost of revenue & hangar space.
Training							
Instructors	1	\$ 110	15	\$ 1,650	15	\$ 1,650	This is the cost for 1 training class only. A correct estimation was not feasible. Giving class + preparation time
Training Classroom				\$ 5,000		\$ 5,000	Average rent cost for classroom
Training Mechanics	16	\$ 110	8	\$ 14,080	8	\$ 14,080	Number of mechanics that follows the class.
Total NON-Recurring	25		641	\$ 41,200	641	\$ 41,200	Per airplane type/ per operator
Total Recurring	28		3023	\$ 2,249,230	2573	\$ 215,480	Per airplane

MODIFICATION COST & LABOR-HOUR ESTIMATION

ON-BOARD INERTING GAS GENERATING SYSTEM

LARGE AIRPLANE CATEGORY - CRYOGENIC

Task	Number of Persons	Rate	Special Program		D/M - Check		Description
			Man Hours	Cost	Man Hours	Cost	
NON-RECURRING							
Engineering							
Service Bulletin review	1	\$ 110	30	\$ 3,300	30	\$ 3,300	Evaluating Service Bulletin
Engineering Data	1	\$ 50	35	\$ 1,750	35	\$ 1,750	Enters the work card requirements into the data base.
Engineering Drafting	1	\$ 110	25	\$ 2,750	25	\$ 2,750	Creates the necessary drawings and figures necessary for the project.
Inventory Planning	1	\$ 110	20	\$ 2,200	20	\$ 2,200	Reviews the Engineering BOM and does all material provisions and allocations
Planning	1	\$ 110	20	\$ 2,200	20	\$ 2,200	Reviews the Engineering Project and provides information for accomplishment.
Maintenance Programs	1	\$ 110	35	\$ 3,850	35	\$ 3,850	Reviews the Engineering Project for effect on other projects, tasks and jobcards.
Records	1	\$ 50	10	\$ 500	10	\$ 500	Creates the necessary Project tracking numbers and maintains the records.
Quality Assurance	1	\$ 50	25	\$ 1,250	25	\$ 1,250	Reviews the Engineering Project for Regulatory compliance.
Reliability	1	\$ 50	20	\$ 1,000	20	\$ 1,000	Tracks and maintains the records for all the components and their trends. FAR requirement.
Tech Publications							
Manuals: AMM	1	\$ 50	25	\$ 1,250	25	\$ 1,250	Aircraft Maintenance Manual
IPC	1	\$ 50	20	\$ 1,000	20	\$ 1,000	Illustrated Parts List
CMM	1	\$ 50	10	\$ 500	10	\$ 500	Component Maintenance Manual
AFM	1	\$ 50	10	\$ 500	10	\$ 500	Aircraft Flight Manual
FOM	1	\$ 50	10	\$ 500	10	\$ 500	Flight Operations Manual
SRM	1	\$ 50	10	\$ 500	10	\$ 500	Structural Repair Manual
FUELLING	1	\$ 50	15	\$ 750	15	\$ 750	Fuelling Manual
RMM	1	\$ 50	10	\$ 500	10	\$ 500	Ramp Manual
GMM	1	\$ 50	40	\$ 2,000	40	\$ 2,000	General Maintenance Manual that includes Company's Procedures
WDM	2	\$ 50	150	\$ 7,500	150	\$ 7,500	Wire Diagram Manual
Training Documentation	1	\$ 75	15	\$ 1,125	15	\$ 1,125	Making of necessary training documentation
Training Material				\$ 1,000		\$ 1,000	Material
Material Control							
Routable parts	1	\$ 50	43	\$ 2,125	43	\$ 2,125	Make known the Routable into the company systems
Consumable parts	1	\$ 50	25	\$ 1,250	25	\$ 1,250	Make known the Consumables into the company systems
Spares estimation	1	\$ 50	8	\$ 400	8	\$ 400	The amount of spares depending on the MTBUR
Tooling	1	\$ 50	30	\$ 1,500	30	\$ 1,500	Make known the Tooling into the company systems
RECURRING							
Project's Estimated Time							
Accomplishment	10	\$ 75	3000	\$ 225,000	2550	\$ 191,250	See Addendum F.A.2 for detailed tasks
Engineering support	1	\$ 110	100	\$ 11,000	100	\$ 11,000	Support to hangar during modification
Kit costs							Kit costs is not included. Design Team didn't provided the data.
Kit Storage costs							No kit data available
Extra down time airplane				\$ 2,000,000		\$ -	Extra time airplane is on ground due to this modification. Including lost of revenue & hangar space.
Training							
Instructors	1	\$ 110	15	\$ 1,650	15	\$ 1,650	This is the cost for 1 training class only. A correct estimation was not feasible. Giving class + preparation time
Training Classroom				\$ 5,000		\$ 5,000	Average rent cost for classroom
Training Mechanics	16	\$ 110	8	\$ 14,080	8	\$ 14,080	Number of mechanics that follows the class.
Total NON-Recurring	25		641	\$ 41,200	641	\$ 41,200	Per airplane type/ per operator
Total Recurring	28		3123	\$ 2,256,730	2673	\$ 222,980	Per airplane

MODIFICATION COST & LABOR-HOUR ESTIMATION

GROUND BASED INERTING SYSTEM

MEDIUM AIRPLANE CATEGORY

Task	Number of Persons	Rate	Special Program		D/M - Check		Description
			Man Hours	Cost	Man Hours	Cost	
NON-RECURRING							
Engineering							
Service Bulletin review	1	\$ 110	30	\$ 3,300	30	\$ 3,300	Evaluating Service Bulletin
Engineering Data	1	\$ 50	35	\$ 1,750	35	\$ 1,750	Enters the work card requirements into the data base.
Engineering Drafting	1	\$ 110	25	\$ 2,750	25	\$ 2,750	Creates the necessary drawings and figures necessary for the project.
Inventory Planning	1	\$ 110	20	\$ 2,200	20	\$ 2,200	Reviews the Engineering BOM and does all material provisions and allocations
Planning	1	\$ 110	20	\$ 2,200	20	\$ 2,200	Reviews the Engineering Project and provides information for accomplishment.
Maintenance Programs	1	\$ 110	35	\$ 3,850	35	\$ 3,850	Reviews the Engineering Project for effect on other projects, tasks and jobcards.
Records	1	\$ 50	10	\$ 500	10	\$ 500	Creates the necessary Project tracking numbers and maintains the records.
Quality Assurance	1	\$ 50	25	\$ 1,250	25	\$ 1,250	Reviews the Engineering Project for Regulatory compliance.
Reliability	1	\$ 50	20	\$ 1,000	20	\$ 1,000	Tracks and maintains the records for all the components and their trends. FAR requirement.
Tech Publications							
Manuals: AMM	1	\$ 50	25	\$ 1,250	25	\$ 1,250	Aircraft Maintenance Manual
IPC	1	\$ 50	20	\$ 1,000	20	\$ 1,000	Illustrated Parts List
CMM	1	\$ 50	10	\$ 500	10	\$ 500	Component Maintenance Manual
AFM	1	\$ 50	10	\$ 500	10	\$ 500	Aircraft Flight Manual
FOM	1	\$ 50	10	\$ 500	10	\$ 500	Flight Operations Manual
SRM	1	\$ 50	10	\$ 500	10	\$ 500	Structural Repair Manual
FUELLING	1	\$ 50	15	\$ 750	15	\$ 750	Fuelling Manual
RMM	1	\$ 50	10	\$ 500	10	\$ 500	Ramp Manual
GMM	1	\$ 50	40	\$ 2,000	40	\$ 2,000	General Maintenance Manual that includes Company's Procedures
WDM	2	\$ 50	150	\$ 7,500	150	\$ 7,500	Wire Diagram Manual
Training Documentation	1	\$ 75	15	\$ 1,125	15	\$ 1,125	Making of necessary training documentation
Training Material				\$ 1,000		\$ 1,000	Material
Material Control							
Routable parts	1	\$ 50	43	\$ 2,125	43	\$ 2,125	Make known the Routable into the company systems
Consumable parts	1	\$ 50	25	\$ 1,250	25	\$ 1,250	Make known the Consumables into the company systems
Spares estimation	1	\$ 50	8	\$ 400	8	\$ 400	The amount of spares depending on the MTBUR
Tooling	1	\$ 50	30	\$ 1,500	30	\$ 1,500	Make known the Tooling into the company systems
RECURRING							
Project's Estimated Time							
Accomplishment	10	\$ 75	1100	\$ 82,500	1050	\$ 78,750	See Addendum F.A.2 for detailed tasks
Engineering support	1	\$ 110	100	\$ 11,000	100	\$ 11,000	Support to hangar during modification
Kit costs							Kit costs is not included. Design Team didn't provided the data.
Kit Storage costs							No kit data available
Extra down time airplane						\$ -	Extra time airplane is on ground due to this modification. Including lost of revenue & hangar space.
Training							
Instructors	1	\$ 110	15	\$ 1,650	15	\$ 1,650	This is the cost for 1 training class only. A correct estimation was not feasible. Giving class + preparation time
Training Classroom				\$ 5,000		\$ 5,000	Average rent cost for classroom
Training Mechanics	16	\$ 110	8	\$ 14,080	8	\$ 14,080	Number of mechanics that follows the class.
Total NON-Recurring	25		641	\$ 41,200	641	\$ 41,200	Per airplane type/ per operator
Total Recurring	28		1223	\$ 114,230	1173	\$ 110,480	Per airplane

MODIFICATION COST & LABOR-HOUR ESTIMATION

ON-BOARD GROUND INERTING SYSTEM

MEDIUM AIRPLANE CATEGORY - MEMBRANE

Task	Number of Persons	Rate	Special Program		D/M - Check		Description
			Man Hours	Cost	Man Hours	Cost	
NON-RECURRING							
Engineering							
Service Bulletin review	1	\$ 110	30	\$ 3,300	30	\$ 3,300	Evaluating Service Bulletin
Engineering Data	1	\$ 50	35	\$ 1,750	35	\$ 1,750	Enters the work card requirements into the data base.
Engineering Drafting	1	\$ 110	25	\$ 2,750	25	\$ 2,750	Creates the necessary drawings and figures necessary for the project.
Inventory Planning	1	\$ 110	20	\$ 2,200	20	\$ 2,200	Reviews the Engineering BOM and does all material provisions and allocations
Planning	1	\$ 110	20	\$ 2,200	20	\$ 2,200	Reviews the Engineering Project and provides information for accomplishment.
Maintenance Programs	1	\$ 110	35	\$ 3,850	35	\$ 3,850	Reviews the Engineering Project for effect on other projects, tasks and jobcards.
Records	1	\$ 50	10	\$ 500	10	\$ 500	Creates the necessary Project tracking numbers and maintains the records.
Quality Assurance	1	\$ 50	25	\$ 1,250	25	\$ 1,250	Reviews the Engineering Project for Regulatory compliance.
Reliability	1	\$ 50	20	\$ 1,000	20	\$ 1,000	Tracks and maintains the records for all the components and their trends. FAR requirement.
Tech Publications							
Manuals: AMM	1	\$ 50	25	\$ 1,250	25	\$ 1,250	Aircraft Maintenance Manual
IPC	1	\$ 50	20	\$ 1,000	20	\$ 1,000	Illustrated Parts List
CMM	1	\$ 50	10	\$ 500	10	\$ 500	Component Maintenance Manual
AFM	1	\$ 50	10	\$ 500	10	\$ 500	Aircraft Flight Manual
FOM	1	\$ 50	10	\$ 500	10	\$ 500	Flight Operations Manual
SRM	1	\$ 50	10	\$ 500	10	\$ 500	Structural Repair Manual
FUELLING	1	\$ 50	15	\$ 750	15	\$ 750	Fuelling Manual
RMM	1	\$ 50	10	\$ 500	10	\$ 500	Ramp Manual
GMM	1	\$ 50	40	\$ 2,000	40	\$ 2,000	General Maintenance Manual that includes Company's Procedures
WDM	2	\$ 50	150	\$ 7,500	150	\$ 7,500	Wire Diagram Manual
Training Documentation	1	\$ 75	15	\$ 1,125	15	\$ 1,125	Making of necessary training documentation
Training Material				\$ 1,000		\$ 1,000	Material
Material Control							
Routable parts	1	\$ 50	43	\$ 2,125	43	\$ 2,125	Make known the Routable into the company systems
Consumable parts	1	\$ 50	25	\$ 1,250	25	\$ 1,250	Make known the Consumables into the company systems
Spares estimation	1	\$ 50	8	\$ 400	8	\$ 400	The amount of spares depending on the MTBUR
Tooling	1	\$ 50	30	\$ 1,500	30	\$ 1,500	Make known the Tooling into the company systems
RECURRING							
Project's Estimated Time							
Accomplishment	10	\$ 75	2150	\$ 161,250	1925	\$ 144,375	See Addendum F.A.2 for detailed tasks
Engineering support	1	\$ 110	100	\$ 11,000	100	\$ 11,000	Support to hangar during modification
Kit costs							Kit costs is not included. Design Team didn't provided the data.
Kit Storage costs							No kit data available
Extra down time airplane							Extra time airplane is on ground due to this modification. Including lost of revenue & hangar space.
Training							
Instructors	1	\$ 110	15	\$ 1,650	15	\$ 1,650	This is the cost for 1 training class only. A correct estimation was not feasible. Giving class + preparation time
Training Classroom				\$ 5,000		\$ 5,000	Average rent cost for classroom
Training Mechanics	16	\$ 110	8	\$ 14,080	8	\$ 14,080	Number of mechanics that follows the class.
Total NON-Recurring	25		641	\$ 41,200	641	\$ 41,200	Per airplane type/ per operator
Total Recurring	28		2273	\$ 192,980	2048	\$ 176,105	Per airplane

MODIFICATION COST & LABOR-HOUR ESTIMATION
ON-BOARD GROUND INERTING SYSTEM
 MEDIUM AIRPLANE CATEGORY - PRESSURE SWING ADSORPTION

Task	Number of Persons	Rate	Special Program		D/M - Check		Description
			Man Hours	Cost	Man Hours	Cost	
NON-RECURRING							
Engineering							
Service Bulletin review	1	\$ 110	30	\$ 3,300	30	\$ 3,300	Evaluating Service Bulletin
Engineering Data	1	\$ 50	35	\$ 1,750	35	\$ 1,750	Enters the work card requirements into the data base.
Engineering Drafting	1	\$ 110	25	\$ 2,750	25	\$ 2,750	Creates the necessary drawings and figures necessary for the project.
Inventory Planning	1	\$ 110	20	\$ 2,200	20	\$ 2,200	Reviews the Engineering BOM and does all material provisions and allocations
Planning	1	\$ 110	20	\$ 2,200	20	\$ 2,200	Reviews the Engineering Project and provides information for accomplishment.
Maintenance Programs	1	\$ 110	35	\$ 3,850	35	\$ 3,850	Reviews the Engineering Project for effect on other projects, tasks and jobcards.
Records	1	\$ 50	10	\$ 500	10	\$ 500	Creates the necessary Project tracking numbers and maintains the records.
Quality Assurance	1	\$ 50	25	\$ 1,250	25	\$ 1,250	Reviews the Engineering Project for Regulatory compliance.
Reliability	1	\$ 50	20	\$ 1,000	20	\$ 1,000	Tracks and maintains the records for all the components and their trends. FAR requirement.
Tech Publications							
Manuals: AMM	1	\$ 50	25	\$ 1,250	25	\$ 1,250	Aircraft Maintenance Manual
IPC	1	\$ 50	20	\$ 1,000	20	\$ 1,000	Illustrated Parts List
CMM	1	\$ 50	10	\$ 500	10	\$ 500	Component Maintenance Manual
AFM	1	\$ 50	10	\$ 500	10	\$ 500	Aircraft Flight Manual
FOM	1	\$ 50	10	\$ 500	10	\$ 500	Flight Operations Manual
SRM	1	\$ 50	10	\$ 500	10	\$ 500	Structural Repair Manual
FUELLING	1	\$ 50	15	\$ 750	15	\$ 750	Fuelling Manual
RMM	1	\$ 50	10	\$ 500	10	\$ 500	Ramp Manual
GMM	1	\$ 50	40	\$ 2,000	40	\$ 2,000	General Maintenance Manual that includes Company's Procedures
WDM	2	\$ 50	150	\$ 7,500	150	\$ 7,500	Wire Diagram Manual
Training Documentation	1	\$ 75	15	\$ 1,125	15	\$ 1,125	Making of necessary training documentation
Training Material				\$ 1,000		\$ 1,000	Material
Material Control							
Routable parts	1	\$ 50	43	\$ 2,125	43	\$ 2,125	Make known the Routable into the company systems
Consumable parts	1	\$ 50	25	\$ 1,250	25	\$ 1,250	Make known the Consumables into the company systems
Spares estimation	1	\$ 50	8	\$ 400	8	\$ 400	The amount of spares depending on the MTBUR
Tooling	1	\$ 50	30	\$ 1,500	30	\$ 1,500	Make known the Tooling into the company systems
RECURRING							
Project's Estimated Time							
Accomplishment	10	\$ 75	2100	\$ 157,500	1875	\$ 140,625	See Addendum F.A.2 for detailed tasks
Engineering support	1	\$ 110	100	\$ 11,000	100	\$ 11,000	Support to hangar during modification
Kit costs							Kit costs is not included. Design Team didn't provided the data.
Kit Storage costs							No kit data available
Extra down time airplane							Extra time airplane is on ground due to this modification. Including lost of revenue & hangar space.
Training							
Instructors	1	\$ 110	15	\$ 1,650	15	\$ 1,650	This is the cost for 1 training class only. A correct estimation was not feasible. Giving class + preparation time
Training Classroom				\$ 5,000		\$ 5,000	Average rent cost for classroom
Training Mechanics	16	\$ 110	8	\$ 14,080	8	\$ 14,080	Number of mechanics that follows the class.
Total NON-Recurring	25		641	\$ 41,200	641	\$ 41,200	Per airplane type/ per operator
Total Recurring	28		2223	\$ 189,230	1998	\$ 172,355	Per airplane

MODIFICATION COST & LABOR-HOUR ESTIMATION

ON-BOARD GROUND INERTING SYSTEM

CRYOGENIC AIRPLANE CATEGORY - CRYOGENIC

Task	Number of Persons	Rate	Special Program		D/M - Check		Description
			Man Hours	Cost	Man Hours	Cost	
NON-RECURRING							
Engineering							
Service Bulletin review	1	\$ 110	30	\$ 3,300	30	\$ 3,300	Evaluating Service Bulletin
Engineering Data	1	\$ 50	35	\$ 1,750	35	\$ 1,750	Enters the work card requirements into the data base.
Engineering Drafting	1	\$ 110	25	\$ 2,750	25	\$ 2,750	Creates the necessary drawings and figures necessary for the project.
Inventory Planning	1	\$ 110	20	\$ 2,200	20	\$ 2,200	Reviews the Engineering BOM and does all material provisions and allocations
Planning	1	\$ 110	20	\$ 2,200	20	\$ 2,200	Reviews the Engineering Project and provides information for accomplishment.
Maintenance Programs	1	\$ 110	35	\$ 3,850	35	\$ 3,850	Reviews the Engineering Project for effect on other projects, tasks and jobcards.
Records	1	\$ 50	10	\$ 500	10	\$ 500	Creates the necessary Project tracking numbers and maintains the records.
Quality Assurance	1	\$ 50	25	\$ 1,250	25	\$ 1,250	Reviews the Engineering Project for Regulatory compliance.
Reliability	1	\$ 50	20	\$ 1,000	20	\$ 1,000	Tracks and maintains the records for all the components and their trends. FAR requirement.
Tech Publications							
Manuals: AMM	1	\$ 50	25	\$ 1,250	25	\$ 1,250	Aircraft Maintenance Manual
IPC	1	\$ 50	20	\$ 1,000	20	\$ 1,000	Illustrated Parts List
CMM	1	\$ 50	10	\$ 500	10	\$ 500	Component Maintenance Manual
AFM	1	\$ 50	10	\$ 500	10	\$ 500	Aircraft Flight Manual
FOM	1	\$ 50	10	\$ 500	10	\$ 500	Flight Operations Manual
SRM	1	\$ 50	10	\$ 500	10	\$ 500	Structural Repair Manual
FUELLING	1	\$ 50	15	\$ 750	15	\$ 750	Fuelling Manual
RMM	1	\$ 50	10	\$ 500	10	\$ 500	Ramp Manual
GMM	1	\$ 50	40	\$ 2,000	40	\$ 2,000	General Maintenance Manual that includes Company's Procedures
WDM	2	\$ 50	150	\$ 7,500	150	\$ 7,500	Wire Diagram Manual
Training Documentation	1	\$ 75	15	\$ 1,125	15	\$ 1,125	Making of necessary training documentation
Training Material				\$ 1,000		\$ 1,000	Material
Material Control							
Routable parts	1	\$ 50	43	\$ 2,125	43	\$ 2,125	Make known the Routable into the company systems
Consumable parts	1	\$ 50	25	\$ 1,250	25	\$ 1,250	Make known the Consumables into the company systems
Spares estimation	1	\$ 50	8	\$ 400	8	\$ 400	The amount of spares depending on the MTBUR
Tooling	1	\$ 50	30	\$ 1,500	30	\$ 1,500	Make known the Tooling into the company systems
RECURRING							
Project's Estimated Time							
Accomplishment	10	\$ 75	2225	\$ 166,875	2025	\$ 151,875	See Addendum F.A.2 for detailed tasks
Engineering support	1	\$ 110	100	\$ 11,000	100	\$ 11,000	Support to hangar during modification
Kit costs							Kit costs is not included. Design Team didn't provided the data.
Kit Storage costs							No kit data available
Extra down time airplane							Extra time airplane is on ground due to this modification. Including lost of revenue & hangar space.
Training							
Instructors	1	\$ 110	15	\$ 1,650	15	\$ 1,650	This is the cost for 1 training class only. A correct estimation was not feasible. Giving class + preparation time
Training Classroom				\$ 5,000		\$ 5,000	Average rent cost for classroom
Training Mechanics	16	\$ 110	8	\$ 14,080	8	\$ 14,080	Number of mechanics that follows the class.
Total NON-Recurring	25		641	\$ 41,200	641	\$ 41,200	Per airplane type/ per operator
Total Recurring	28		2348	\$ 198,605	2148	\$ 183,605	Per airplane

MODIFICATION COST & LABOR-HOUR ESTIMATION

ON-BOARD INERTING GAS GENERATING SYSTEM

MEDIUM AIRPLANE CATEGORY - MEMBRANE

Task	Number of Persons	Rate	Special Program		D/M - Check		Description
			Man Hours	Cost	Man Hours	Cost	
NON-RECURRING							
Engineering							
Service Bulletin review	1	\$ 110	30	\$ 3,300	30	\$ 3,300	Evaluating Service Bulletin
Engineering Data	1	\$ 50	35	\$ 1,750	35	\$ 1,750	Enters the work card requirements into the data base.
Engineering Drafting	1	\$ 110	25	\$ 2,750	25	\$ 2,750	Creates the necessary drawings and figures necessary for the project.
Inventory Planning	1	\$ 110	20	\$ 2,200	20	\$ 2,200	Reviews the Engineering BOM and does all material provisions and allocations
Planning	1	\$ 110	20	\$ 2,200	20	\$ 2,200	Reviews the Engineering Project and provides information for accomplishment.
Maintenance Programs	1	\$ 110	35	\$ 3,850	35	\$ 3,850	Reviews the Engineering Project for effect on other projects, tasks and jobcards.
Records	1	\$ 50	10	\$ 500	10	\$ 500	Creates the necessary Project tracking numbers and maintains the records.
Quality Assurance	1	\$ 50	25	\$ 1,250	25	\$ 1,250	Reviews the Engineering Project for Regulatory compliance.
Reliability	1	\$ 50	20	\$ 1,000	20	\$ 1,000	Tracks and maintains the records for all the components and their trends. FAR requirement.
Tech Publications							
Manuals: AMM	1	\$ 50	25	\$ 1,250	25	\$ 1,250	Aircraft Maintenance Manual
IPC	1	\$ 50	20	\$ 1,000	20	\$ 1,000	Illustrated Parts List
CMM	1	\$ 50	10	\$ 500	10	\$ 500	Component Maintenance Manual
AFM	1	\$ 50	10	\$ 500	10	\$ 500	Aircraft Flight Manual
FOM	1	\$ 50	10	\$ 500	10	\$ 500	Flight Operations Manual
SRM	1	\$ 50	10	\$ 500	10	\$ 500	Structural Repair Manual
FUELLING	1	\$ 50	15	\$ 750	15	\$ 750	Fuelling Manual
RMM	1	\$ 50	10	\$ 500	10	\$ 500	Ramp Manual
GMM	1	\$ 50	40	\$ 2,000	40	\$ 2,000	General Maintenance Manual that includes Company's Procedures
WDM	2	\$ 50	150	\$ 7,500	150	\$ 7,500	Wire Diagram Manual
Training Documentation	1	\$ 75	15	\$ 1,125	15	\$ 1,125	Making of necessary training documentation
Training Material				\$ 1,000		\$ 1,000	Material
Material Control							
Routable parts	1	\$ 50	43	\$ 2,125	43	\$ 2,125	Make known the Routable into the company systems
Consumable parts	1	\$ 50	25	\$ 1,250	25	\$ 1,250	Make known the Consumables into the company systems
Spares estimation	1	\$ 50	8	\$ 400	8	\$ 400	The amount of spares depending on the MTBUR
Tooling	1	\$ 50	30	\$ 1,500	30	\$ 1,500	Make known the Tooling into the company systems
RECURRING							
Project's Estimated Time							
Accomplishment	10	\$ 75	2400	\$ 180,000	2175	\$ 163,125	See Addendum F.A.2 for detailed tasks
Engineering support	1	\$ 110	100	\$ 11,000	100	\$ 11,000	Support to hangar during modification
Kit costs							Kit costs is not included. Design Team didn't provided the data.
Kit Storage costs							No kit data available
Extra down time airplane						\$ -	Extra time airplane is on ground due to this modification. Including lost of revenue & hangar space.
Training							
Instructors	1	\$ 110	15	\$ 1,650	15	\$ 1,650	This is the cost for 1 training class only. A correct estimation was not feasible. Giving class + preparation time
Training Classroom				\$ 5,000		\$ 5,000	Average rent cost for classroom
Training Mechanics	16	\$ 110	8	\$ 14,080	8	\$ 14,080	Number of mechanics that follows the class.
Total NON-Recurring	25		641	\$ 41,200	641	\$ 41,200	Per airplane type/ per operator
Total Recurring	28		2523	\$ 211,730	2298	\$ 194,855	Per airplane

MODIFICATION COST & LABOR-HOUR ESTIMATION

ON-BOARD INERTING GAS GENERATING SYSTEM

MEDIUM AIRPLANE CATEGORY - PRESSURE SWING ADSORPTION

Task	Number of Persons	Rate	Special Program		D/M - Check		Description
			Man Hours	Cost	Man Hours	Cost	
NON-RECURRING							
Engineering							
Service Bulletin review	1	\$ 110	30	\$ 3,300	30	\$ 3,300	Evaluating Service Bulletin
Engineering Data	1	\$ 50	35	\$ 1,750	35	\$ 1,750	Enters the work card requirements into the data base.
Engineering Drafting	1	\$ 110	25	\$ 2,750	25	\$ 2,750	Creates the necessary drawings and figures necessary for the project.
Inventory Planning	1	\$ 110	20	\$ 2,200	20	\$ 2,200	Reviews the Engineering BOM and does all material provisions and allocations
Planning	1	\$ 110	20	\$ 2,200	20	\$ 2,200	Reviews the Engineering Project and provides information for accomplishment.
Maintenance Programs	1	\$ 110	35	\$ 3,850	35	\$ 3,850	Reviews the Engineering Project for effect on other projects, tasks and jobcards.
Records	1	\$ 50	10	\$ 500	10	\$ 500	Creates the necessary Project tracking numbers and maintains the records.
Quality Assurance	1	\$ 50	25	\$ 1,250	25	\$ 1,250	Reviews the Engineering Project for Regulatory compliance.
Reliability	1	\$ 50	20	\$ 1,000	20	\$ 1,000	Tracks and maintains the records for all the components and their trends. FAR requirement.
Tech Publications							
Manuals: AMM	1	\$ 50	25	\$ 1,250	25	\$ 1,250	Aircraft Maintenance Manual
IPC	1	\$ 50	20	\$ 1,000	20	\$ 1,000	Illustrated Parts List
CMM	1	\$ 50	10	\$ 500	10	\$ 500	Component Maintenance Manual
AFM	1	\$ 50	10	\$ 500	10	\$ 500	Aircraft Flight Manual
FOM	1	\$ 50	10	\$ 500	10	\$ 500	Flight Operations Manual
SRM	1	\$ 50	10	\$ 500	10	\$ 500	Structural Repair Manual
FUELLING	1	\$ 50	15	\$ 750	15	\$ 750	Fuelling Manual
RMM	1	\$ 50	10	\$ 500	10	\$ 500	Ramp Manual
GMM	1	\$ 50	40	\$ 2,000	40	\$ 2,000	General Maintenance Manual that includes Company's Procedures
WDM	2	\$ 50	150	\$ 7,500	150	\$ 7,500	Wire Diagram Manual
Training Documentation	1	\$ 75	15	\$ 1,125	15	\$ 1,125	Making of necessary training documentation
Training Material				\$ 1,000		\$ 1,000	Material
Material Control							
Routable parts	1	\$ 50	43	\$ 2,125	43	\$ 2,125	Make known the Routable into the company systems
Consumable parts	1	\$ 50	25	\$ 1,250	25	\$ 1,250	Make known the Consumables into the company systems
Spares estimation	1	\$ 50	8	\$ 400	8	\$ 400	The amount of spares depending on the MTBUR
Tooling	1	\$ 50	30	\$ 1,500	30	\$ 1,500	Make known the Tooling into the company systems
RECURRING							
Project's Estimated Time							
Accomplishment	10	\$ 75	2350	\$ 176,250	2125	\$ 159,375	See Addendum F.A.2 for detailed tasks
Engineering support	1	\$ 110	100	\$ 11,000	100	\$ 11,000	Support to hangar during modification
Kit costs							Kit costs is not included. Design Team didn't provided the data.
Kit Storage costs							No kit data available
Extra down time airplane						\$ -	Extra time airplane is on ground due to this modification. Including lost of revenue & hangar space.
Training							
Instructors	1	\$ 110	15	\$ 1,650	15	\$ 1,650	This is the cost for 1 training class only. A correct estimation was not feasible. Giving class + preparation time
Training Classroom				\$ 5,000		\$ 5,000	Average rent cost for classroom
Training Mechanics	16	\$ 110	8	\$ 14,080	8	\$ 14,080	Number of mechanics that follows the class.
Total NON-Recurring	25		641	\$ 41,200	641	\$ 41,200	Per airplane type/ per operator
Total Recurring	28		2473	\$ 207,980	2248	\$ 191,105	Per airplane

MODIFICATION COST & LABOR-HOUR ESTIMATION

ON-BOARD INERTING GAS GENERATING SYSTEM

MEDIUM AIRPLANE CATEGORY - CRYOGENIC

Task	Number of Persons	Rate	Special Program		D/M - Check		Description
			Man Hours	Cost	Man Hours	Cost	
NON-RECURRING							
Engineering							
Service Bulletin review	1	\$ 110	30	\$ 3,300	30	\$ 3,300	Evaluating Service Bulletin
Engineering Data	1	\$ 50	35	\$ 1,750	35	\$ 1,750	Enters the work card requirements into the data base.
Engineering Drafting	1	\$ 110	25	\$ 2,750	25	\$ 2,750	Creates the necessary drawings and figures necessary for the project.
Inventory Planning	1	\$ 110	20	\$ 2,200	20	\$ 2,200	Reviews the Engineering BOM and does all material provisions and allocations
Planning	1	\$ 110	20	\$ 2,200	20	\$ 2,200	Reviews the Engineering Project and provides information for accomplishment.
Maintenance Programs	1	\$ 110	35	\$ 3,850	35	\$ 3,850	Reviews the Engineering Project for effect on other projects, tasks and jobcards.
Records	1	\$ 50	10	\$ 500	10	\$ 500	Creates the necessary Project tracking numbers and maintains the records.
Quality Assurance	1	\$ 50	25	\$ 1,250	25	\$ 1,250	Reviews the Engineering Project for Regulatory compliance.
Reliability	1	\$ 50	20	\$ 1,000	20	\$ 1,000	Tracks and maintains the records for all the components and their trends. FAR requirement.
Tech Publications							
Manuals: AMM	1	\$ 50	25	\$ 1,250	25	\$ 1,250	Aircraft Maintenance Manual
IPC	1	\$ 50	20	\$ 1,000	20	\$ 1,000	Illustrated Parts List
CMM	1	\$ 50	10	\$ 500	10	\$ 500	Component Maintenance Manual
AFM	1	\$ 50	10	\$ 500	10	\$ 500	Aircraft Flight Manual
FOM	1	\$ 50	10	\$ 500	10	\$ 500	Flight Operations Manual
SRM	1	\$ 50	10	\$ 500	10	\$ 500	Structural Repair Manual
FUELLING	1	\$ 50	15	\$ 750	15	\$ 750	Fuelling Manual
RMM	1	\$ 50	10	\$ 500	10	\$ 500	Ramp Manual
GMM	1	\$ 50	40	\$ 2,000	40	\$ 2,000	General Maintenance Manual that includes Company's Procedures
WDM	2	\$ 50	150	\$ 7,500	150	\$ 7,500	Wire Diagram Manual
Training Documentation	1	\$ 75	15	\$ 1,125	15	\$ 1,125	Making of necessary training documentation
Training Material				\$ 1,000		\$ 1,000	Material
Material Control							
Routable parts	1	\$ 50	43	\$ 2,125	43	\$ 2,125	Make known the Routable into the company systems
Consumable parts	1	\$ 50	25	\$ 1,250	25	\$ 1,250	Make known the Consumables into the company systems
Spares estimation	1	\$ 50	8	\$ 400	8	\$ 400	The amount of spares depending on the MTBUR
Tooling	1	\$ 50	30	\$ 1,500	30	\$ 1,500	Make known the Tooling into the company systems
RECURRING							
Project's Estimated Time							
Accomplishment	10	\$ 75	2475	\$ 185,625	2275	\$ 170,625	See Addendum F.A.2 for detailed tasks
Engineering support	1	\$ 110	100	\$ 11,000	100	\$ 11,000	Support to hangar during modification
Kit costs							Kit costs is not included. Design Team didn't provided the data.
Kit Storage costs							No kit data available
Extra down time airplane						\$ -	Extra time airplane is on ground due to this modification. Including lost of revenue & hangar space.
Training							
Instructors	1	\$ 110	15	\$ 1,650	15	\$ 1,650	This is the cost for 1 training class only. A correct estimation was not feasible. Giving class + preparation time
Training Classroom				\$ 5,000		\$ 5,000	Average rent cost for classroom
Training Mechanics	16	\$ 110	8	\$ 14,080	8	\$ 14,080	Number of mechanics that follows the class.
Total NON-Recurring	25		641	\$ 41,200	641	\$ 41,200	Per airplane type/ per operator
Total Recurring	28		2598	\$ 217,355	2398	\$ 202,355	Per airplane

MODIFICATION COST & LABOR-HOUR ESTIMATION

GROUND BASED INERTING SYSTEM

LARGE AIRPLANE CATEGORY

Task	Number of Persons	Rate	Special Program		D/M - Check		Description
			Man Hours	Cost	Man Hours	Cost	
NON-RECURRING							
Engineering							
Service Bulletin review	1	\$ 110	30	\$ 3,300	30	\$ 3,300	Evaluating Service Bulletin
Engineering Data	1	\$ 50	35	\$ 1,750	35	\$ 1,750	Enters the work card requirements into the data base.
Engineering Drafting	1	\$ 110	25	\$ 2,750	25	\$ 2,750	Creates the necessary drawings and figures necessary for the project.
Inventory Planning	1	\$ 110	20	\$ 2,200	20	\$ 2,200	Reviews the Engineering BOM and does all material provisions and allocations
Planning	1	\$ 110	20	\$ 2,200	20	\$ 2,200	Reviews the Engineering Project and provides information for accomplishment.
Maintenance Programs	1	\$ 110	35	\$ 3,850	35	\$ 3,850	Reviews the Engineering Project for effect on other projects, tasks and jobcards.
Records	1	\$ 50	10	\$ 500	10	\$ 500	Creates the necessary Project tracking numbers and maintains the records.
Quality Assurance	1	\$ 50	25	\$ 1,250	25	\$ 1,250	Reviews the Engineering Project for Regulatory compliance.
Reliability	1	\$ 50	20	\$ 1,000	20	\$ 1,000	Tracks and maintains the records for all the components and their trends. FAR requirement.
Tech Publications							
Manuals: AMM	1	\$ 50	25	\$ 1,250	25	\$ 1,250	Aircraft Maintenance Manual
IPC	1	\$ 50	20	\$ 1,000	20	\$ 1,000	Illustrated Parts List
CMM	1	\$ 50	10	\$ 500	10	\$ 500	Component Maintenance Manual
AFM	1	\$ 50	10	\$ 500	10	\$ 500	Aircraft Flight Manual
FOM	1	\$ 50	10	\$ 500	10	\$ 500	Flight Operations Manual
SRM	1	\$ 50	10	\$ 500	10	\$ 500	Structural Repair Manual
FUELLING	1	\$ 50	15	\$ 750	15	\$ 750	Fuelling Manual
RMM	1	\$ 50	10	\$ 500	10	\$ 500	Ramp Manual
GMM	1	\$ 50	40	\$ 2,000	40	\$ 2,000	General Maintenance Manual that includes Company's Procedures
WDM	2	\$ 50	150	\$ 7,500	150	\$ 7,500	Wire Diagram Manual
Training Documentation	1	\$ 75	15	\$ 1,125	15	\$ 1,125	Making of necessary training documentation
Training Material				\$ 1,000		\$ 1,000	Material
Material Control							
Routable parts	1	\$ 50	43	\$ 2,125	43	\$ 2,125	Make known the Routable into the company systems
Consumable parts	1	\$ 50	25	\$ 1,250	25	\$ 1,250	Make known the Consumables into the company systems
Spares estimation	1	\$ 50	8	\$ 400	8	\$ 400	The amount of spares depending on the MTBUR
Tooling	1	\$ 50	30	\$ 1,500	30	\$ 1,500	Make known the Tooling into the company systems
RECURRING							
Project's Estimated Time							
Accomplishment	10	\$ 75	1200	\$ 90,000	1050	\$ 78,750	See Addendum F.A.2 for detailed tasks
Engineering support	1	\$ 110	100	\$ 11,000	100	\$ 11,000	Support to hangar during modification
Kit costs							Kit costs is not included. Design Team didn't provided the data.
Kit Storage costs							No kit data available
Extra down time airplane						\$ -	Extra time airplane is on ground due to this modification. Including lost of revenue & hangar space.
Training							
Instructors	1	\$ 110	15	\$ 1,650	15	\$ 1,650	This is the cost for 1 training class only. A correct estimation was not feasible. Giving class + preparation time
Training Classroom				\$ 5,000		\$ 5,000	Average rent cost for classroom
Training Mechanics	16	\$ 110	8	\$ 14,080	8	\$ 14,080	Number of mechanics that follows the class.
Total NON-Recurring	25		641	\$ 41,200	641	\$ 41,200	Per airplane type/ per operator
Total Recurring	28		1323	\$ 121,730	1173	\$ 110,480	Per airplane

MODIFICATION COST & LABOR-HOUR ESTIMATION

ON-BOARD GROUND INERTING SYSTEM

SMALL AIRPLANE CATEGORY - MEMBRANE

Task	Number of Persons	Rate	Special Program		D/M - Check		Description
			Man Hours	Cost	Man Hours	Cost	
NON-RECURRING							
Engineering							
Service Bulletin review	1	\$ 110	30	\$ 3,300	30	\$ 3,300	Evaluating Service Bulletin
Engineering Data	1	\$ 50	35	\$ 1,750	35	\$ 1,750	Enters the work card requirements into the data base.
Engineering Drafting	1	\$ 110	25	\$ 2,750	25	\$ 2,750	Creates the necessary drawings and figures necessary for the project.
Inventory Planning	1	\$ 110	20	\$ 2,200	20	\$ 2,200	Reviews the Engineering BOM and does all material provisions and allocations
Planning	1	\$ 110	20	\$ 2,200	20	\$ 2,200	Reviews the Engineering Project and provides information for accomplishment.
Maintenance Programs	1	\$ 110	35	\$ 3,850	35	\$ 3,850	Reviews the Engineering Project for effect on other projects, tasks and jobcards.
Records	1	\$ 50	10	\$ 500	10	\$ 500	Creates the necessary Project tracking numbers and maintains the records.
Quality Assurance	1	\$ 50	25	\$ 1,250	25	\$ 1,250	Reviews the Engineering Project for Regulatory compliance.
Reliability	1	\$ 50	20	\$ 1,000	20	\$ 1,000	Tracks and maintains the records for all the components and their trends. FAR requirement.
Tech Publications							
Manuals: AMM	1	\$ 50	25	\$ 1,250	25	\$ 1,250	Aircraft Maintenance Manual
IPC	1	\$ 50	20	\$ 1,000	20	\$ 1,000	Illustrated Parts List
CMM	1	\$ 50	10	\$ 500	10	\$ 500	Component Maintenance Manual
AFM	1	\$ 50	10	\$ 500	10	\$ 500	Aircraft Flight Manual
FOM	1	\$ 50	10	\$ 500	10	\$ 500	Flight Operations Manual
SRM	1	\$ 50	10	\$ 500	10	\$ 500	Structural Repair Manual
FUELLING	1	\$ 50	15	\$ 750	15	\$ 750	Fuelling Manual
RMM	1	\$ 50	10	\$ 500	10	\$ 500	Ramp Manual
GMM	1	\$ 50	40	\$ 2,000	40	\$ 2,000	General Maintenance Manual that includes Company's Procedures
WDM	2	\$ 50	150	\$ 7,500	150	\$ 7,500	Wire Diagram Manual
Training Documentation	1	\$ 75	15	\$ 1,125	15	\$ 1,125	Making of necessary training documentation
Training Material				\$ 1,000		\$ 1,000	Material
Material Control							
Routable parts	1	\$ 50	43	\$ 2,125	43	\$ 2,125	Make known the Routable into the company systems
Consumable parts	1	\$ 50	25	\$ 1,250	25	\$ 1,250	Make known the Consumables into the company systems
Spares estimation	1	\$ 50	8	\$ 400	8	\$ 400	The amount of spares depending on the MTBUR
Tooling	1	\$ 50	30	\$ 1,500	30	\$ 1,500	Make known the Tooling into the company systems
RECURRING							
Project's Estimated Time							
Accomplishment	10	\$ 75	2000	\$ 150,000	1750	\$ 131,250	See Addendum F.A.2 for detailed tasks
Engineering support	1	\$ 110	100	\$ 11,000	100	\$ 11,000	Support to hangar during modification
Kit costs							Kit costs is not included. Design Team didn't provided the data.
Kit Storage costs							No kit data available
Extra down time airplane							Extra time airplane is on ground due to this modification. Including lost of revenue & hangar space.
Training							
Instructors	1	\$ 110	15	\$ 1,650	15	\$ 1,650	This is the cost for 1 training class only. A correct estimation was not feasible. Giving class + preparation time
Training Classroom				\$ 5,000		\$ 5,000	Average rent cost for classroom
Training Mechanics	16	\$ 110	8	\$ 14,080	8	\$ 14,080	Number of mechanics that follows the class.
Total NON-Recurring	25		641	\$ 41,200	641	\$ 41,200	Per airplane type/ per operator
Total Recurring	28		2123	\$ 181,730	1873	\$ 162,980	Per airplane

MODIFICATION COST & LABOR-HOUR ESTIMATION
ON-BOARD GROUND INERTING SYSTEM
SMALL AIRPLANE CATEGORY - PRESSURE SWING ADSORBITION

Task	Number of Persons	Rate	Special Program		D/M - Check		Description
			Man Hours	Cost	Man Hours	Cost	
NON-RECURRING							
Engineering							
Service Bulletin review	1	\$ 110	30	\$ 3,300	30	\$ 3,300	Evaluating Service Bulletin
Engineering Data	1	\$ 50	35	\$ 1,750	35	\$ 1,750	Enters the work card requirements into the data base.
Engineering Drafting	1	\$ 110	25	\$ 2,750	25	\$ 2,750	Creates the necessary drawings and figures necessary for the project.
Inventory Planning	1	\$ 110	20	\$ 2,200	20	\$ 2,200	Reviews the Engineering BOM and does all material provisions and allocations
Planning	1	\$ 110	20	\$ 2,200	20	\$ 2,200	Reviews the Engineering Project and provides information for accomplishment.
Maintenance Programs	1	\$ 110	35	\$ 3,850	35	\$ 3,850	Reviews the Engineering Project for effect on other projects, tasks and jobcards.
Records	1	\$ 50	10	\$ 500	10	\$ 500	Creates the necessary Project tracking numbers and maintains the records.
Quality Assurance	1	\$ 50	25	\$ 1,250	25	\$ 1,250	Reviews the Engineering Project for Regulatory compliance.
Reliability	1	\$ 50	20	\$ 1,000	20	\$ 1,000	Tracks and maintains the records for all the components and their trends. FAR requirement.
Tech Publications							
Manuals: AMM	1	\$ 50	25	\$ 1,250	25	\$ 1,250	Aircraft Maintenance Manual
IPC	1	\$ 50	20	\$ 1,000	20	\$ 1,000	Illustrated Parts List
CMM	1	\$ 50	10	\$ 500	10	\$ 500	Component Maintenance Manual
AFM	1	\$ 50	10	\$ 500	10	\$ 500	Aircraft Flight Manual
FOM	1	\$ 50	10	\$ 500	10	\$ 500	Flight Operations Manual
SRM	1	\$ 50	10	\$ 500	10	\$ 500	Structural Repair Manual
FUELLING	1	\$ 50	15	\$ 750	15	\$ 750	Fuelling Manual
RMM	1	\$ 50	10	\$ 500	10	\$ 500	Ramp Manual
GMM	1	\$ 50	40	\$ 2,000	40	\$ 2,000	General Maintenance Manual that includes Company's Procedures
WDM	2	\$ 50	150	\$ 7,500	150	\$ 7,500	Wire Diagram Manual
Training Documentation	1	\$ 75	15	\$ 1,125	15	\$ 1,125	Making of necessary training documentation
Training Material				\$ 1,000		\$ 1,000	Material
Material Control							
Routable parts	1	\$ 50	43	\$ 2,125	43	\$ 2,125	Make known the Routable into the company systems
Consumable parts	1	\$ 50	25	\$ 1,250	25	\$ 1,250	Make known the Consumables into the company systems
Spares estimation	1	\$ 50	8	\$ 400	8	\$ 400	The amount of spares depending on the MTBUR
Tooling	1	\$ 50	30	\$ 1,500	30	\$ 1,500	Make known the Tooling into the company systems
RECURRING							
Project's Estimated Time							
Accomplishment	10	\$ 75	1950	\$ 146,250	1700	\$ 127,500	See Addendum F.A.2 for detailed tasks
Engineering support	1	\$ 110	100	\$ 11,000	100	\$ 11,000	Support to hangar during modification
Kit costs							Kit costs is not included. Design Team didn't provided the data.
Kit Storage costs							No kit data available
Extra down time airplane							Extra time airplane is on ground due to this modification. Including lost of revenue & hangar space.
Training							
Instructors	1	\$ 110	15	\$ 1,650	15	\$ 1,650	This is the cost for 1 training class only. A correct estimation was not feasible. Giving class + preparation time
Training Classroom				\$ 5,000		\$ 5,000	Average rent cost for classroom
Training Mechanics	16	\$ 110	8	\$ 14,080	8	\$ 14,080	Number of mechanics that follows the class.
Total NON-Recurring	25		641	\$ 41,200	641	\$ 41,200	Per airplane type/ per operator
Total Recurring	28		2073	\$ 177,980	1823	\$ 159,230	Per airplane

MODIFICATION COST & LABOR-HOUR ESTIMATION

ON-BOARD GROUND INERTING SYSTEM

SMALL AIRPLANE CATEGORY - CRYOGENIC

Task	Number of Persons	Rate	Special Program		D/M - Check		Description
			Man Hours	Cost	Man Hours	Cost	
NON-RECURRING							
Engineering							
Service Bulletin review	1	\$ 110	30	\$ 3,300	30	\$ 3,300	Evaluating Service Bulletin
Engineering Data	1	\$ 50	35	\$ 1,750	35	\$ 1,750	Enters the work card requirements into the data base.
Engineering Drafting	1	\$ 110	25	\$ 2,750	25	\$ 2,750	Creates the necessary drawings and figures necessary for the project.
Inventory Planning	1	\$ 110	20	\$ 2,200	20	\$ 2,200	Reviews the Engineering BOM and does all material provisions and allocations
Planning	1	\$ 110	20	\$ 2,200	20	\$ 2,200	Reviews the Engineering Project and provides information for accomplishment.
Maintenance Programs	1	\$ 110	35	\$ 3,850	35	\$ 3,850	Reviews the Engineering Project for effect on other projects, tasks and jobcards.
Records	1	\$ 50	10	\$ 500	10	\$ 500	Creates the necessary Project tracking numbers and maintains the records.
Quality Assurance	1	\$ 50	25	\$ 1,250	25	\$ 1,250	Reviews the Engineering Project for Regulatory compliance.
Reliability	1	\$ 50	20	\$ 1,000	20	\$ 1,000	Tracks and maintains the records for all the components and their trends. FAR requirement.
Tech Publications							
Manuals: AMM	1	\$ 50	25	\$ 1,250	25	\$ 1,250	Aircraft Maintenance Manual
IPC	1	\$ 50	20	\$ 1,000	20	\$ 1,000	Illustrated Parts List
CMM	1	\$ 50	10	\$ 500	10	\$ 500	Component Maintenance Manual
AFM	1	\$ 50	10	\$ 500	10	\$ 500	Aircraft Flight Manual
FOM	1	\$ 50	10	\$ 500	10	\$ 500	Flight Operations Manual
SRM	1	\$ 50	10	\$ 500	10	\$ 500	Structural Repair Manual
FUELLING	1	\$ 50	15	\$ 750	15	\$ 750	Fuelling Manual
RMM	1	\$ 50	10	\$ 500	10	\$ 500	Ramp Manual
GMM	1	\$ 50	40	\$ 2,000	40	\$ 2,000	General Maintenance Manual that includes Company's Procedures
WDM	2	\$ 50	150	\$ 7,500	150	\$ 7,500	Wire Diagram Manual
Training Documentation	1	\$ 75	15	\$ 1,125	15	\$ 1,125	Making of necessary training documentation
Training Material				\$ 1,000		\$ 1,000	Material
Material Control							
Routable parts	1	\$ 50	43	\$ 2,125	43	\$ 2,125	Make known the Routable into the company systems
Consumable parts	1	\$ 50	25	\$ 1,250	25	\$ 1,250	Make known the Consumables into the company systems
Spares estimation	1	\$ 50	8	\$ 400	8	\$ 400	The amount of spares depending on the MTBUR
Tooling	1	\$ 50	30	\$ 1,500	30	\$ 1,500	Make known the Tooling into the company systems
RECURRING							
Project's Estimated Time							
Accomplishment	10	\$ 75	2050	\$ 153,750	1850	\$ 138,750	See Addendum F.A.2 for detailed tasks
Engineering support	1	\$ 110	100	\$ 11,000	100	\$ 11,000	Support to hangar during modification
Kit costs							Kit costs is not included. Design Team didn't provided the data.
Kit Storage costs							No kit data available
Extra down time airplane							Extra time airplane is on ground due to this modification. Including lost of revenue & hangar space.
Training							
Instructors	1	\$ 110	15	\$ 1,650	15	\$ 1,650	This is the cost for 1 training class only. A correct estimation was not feasible. Giving class + preparation time
Training Classroom				\$ 5,000		\$ 5,000	Average rent cost for classroom
Training Mechanics	16	\$ 110	8	\$ 14,080	8	\$ 14,080	Number of mechanics that follows the class.
Total NON-Recurring	25		641	\$ 41,200	641	\$ 41,200	Per airplane type/ per operator
Total Recurring	28		2173	\$ 185,480	1973	\$ 170,480	Per airplane

MODIFICATION COST & LABOR-HOUR ESTIMATION

ON-BOARD INERTING GAS GENERATING SYSTEM

SMALL AIRPLANE CATEGORY - MEMBRANE

Task	Number of Persons	Rate	Special Program		D/M - Check		Description
			Man Hours	Cost	Man Hours	Cost	
NON-RECURRING							
Engineering							
Service Bulletin review	1	\$ 110	30	\$ 3,300	30	\$ 3,300	Evaluating Service Bulletin
Engineering Data	1	\$ 50	35	\$ 1,750	35	\$ 1,750	Enters the work card requirements into the data base.
Engineering Drafting	1	\$ 110	25	\$ 2,750	25	\$ 2,750	Creates the necessary drawings and figures necessary for the project.
Inventory Planning	1	\$ 110	20	\$ 2,200	20	\$ 2,200	Reviews the Engineering BOM and does all material provisions and allocations
Planning	1	\$ 110	20	\$ 2,200	20	\$ 2,200	Reviews the Engineering Project and provides information for accomplishment.
Maintenance Programs	1	\$ 110	35	\$ 3,850	35	\$ 3,850	Reviews the Engineering Project for effect on other projects, tasks and jobcards.
Records	1	\$ 50	10	\$ 500	10	\$ 500	Creates the necessary Project tracking numbers and maintains the records.
Quality Assurance	1	\$ 50	25	\$ 1,250	25	\$ 1,250	Reviews the Engineering Project for Regulatory compliance.
Reliability	1	\$ 50	20	\$ 1,000	20	\$ 1,000	Tracks and maintains the records for all the components and their trends. FAR requirement.
Tech Publications							
Manuals: AMM	1	\$ 50	25	\$ 1,250	25	\$ 1,250	Aircraft Maintenance Manual
IPC	1	\$ 50	20	\$ 1,000	20	\$ 1,000	Illustrated Parts List
CMM	1	\$ 50	10	\$ 500	10	\$ 500	Component Maintenance Manual
AFM	1	\$ 50	10	\$ 500	10	\$ 500	Aircraft Flight Manual
FOM	1	\$ 50	10	\$ 500	10	\$ 500	Flight Operations Manual
SRM	1	\$ 50	10	\$ 500	10	\$ 500	Structural Repair Manual
FUELLING	1	\$ 50	15	\$ 750	15	\$ 750	Fuelling Manual
RMM	1	\$ 50	10	\$ 500	10	\$ 500	Ramp Manual
GMM	1	\$ 50	40	\$ 2,000	40	\$ 2,000	General Maintenance Manual that includes Company's Procedures
WDM	2	\$ 50	150	\$ 7,500	150	\$ 7,500	Wire Diagram Manual
Training Documentation	1	\$ 75	15	\$ 1,125	15	\$ 1,125	Making of necessary training documentation
Training Material				\$ 1,000		\$ 1,000	Material
Material Control							
Routable parts	1	\$ 50	43	\$ 2,125	43	\$ 2,125	Make known the Routable into the company systems
Consumable parts	1	\$ 50	25	\$ 1,250	25	\$ 1,250	Make known the Consumables into the company systems
Spares estimation	1	\$ 50	8	\$ 400	8	\$ 400	The amount of spares depending on the MTBUR
Tooling	1	\$ 50	30	\$ 1,500	30	\$ 1,500	Make known the Tooling into the company systems
RECURRING							
Project's Estimated Time							
Accomplishment	10	\$ 75	2200	\$ 165,000	1950	\$ 146,250	See Addendum F.A.2 for detailed tasks
Engineering support	1	\$ 110	100	\$ 11,000	100	\$ 11,000	Support to hangar during modification
Kit costs							Kit costs is not included. Design Team didn't provided the data.
Kit Storage costs							No kit data available
Extra down time airplane						\$ -	Extra time airplane is on ground due to this modification. Including lost of revenue & hangar space.
Training							
Instructors	1	\$ 110	15	\$ 1,650	15	\$ 1,650	This is the cost for 1 training class only. A correct estimation was not feasible. Giving class + preparation time
Training Classroom				\$ 5,000		\$ 5,000	Average rent cost for classroom
	16			\$ -		\$ -	Number of mechanics that follows the class.
Flight Operations Engineering:							
							Reviews the Engineering Project creates new W&B sheets and performance penalties
Total Recurring	28		2315	\$ 182,650	2065	\$ 163,900	Per airplane
Reason of revision:					Estimated by:		Modification & Retrofit Sub Team

MODIFICATION COST & LABOR-HOUR ESTIMATION

ON-BOARD INERTING GAS GENERATING SYSTEM

SMALL AIRPLANE CATEGORY - PRESSURE SWING ADSORPTION

Task	Number of Persons	Rate	Special Program		D/M - Check		Description
			Man Hours	Cost	Man Hours	Cost	
NON-RECURRING							
Engineering							
Service Bulletin review	1	\$ 110	30	\$ 3,300	30	\$ 3,300	Evaluating Service Bulletin
Engineering Data	1	\$ 50	35	\$ 1,750	35	\$ 1,750	Enters the work card requirements into the data base.
Engineering Drafting	1	\$ 110	25	\$ 2,750	25	\$ 2,750	Creates the necessary drawings and figures necessary for the project.
Inventory Planning	1	\$ 110	20	\$ 2,200	20	\$ 2,200	Reviews the Engineering BOM and does all material provisions and allocations
Planning	1	\$ 110	20	\$ 2,200	20	\$ 2,200	Reviews the Engineering Project and provides information for accomplishment.
Maintenance Programs	1	\$ 110	35	\$ 3,850	35	\$ 3,850	Reviews the Engineering Project for effect on other projects, tasks and jobcards.
Records	1	\$ 50	10	\$ 500	10	\$ 500	Creates the necessary Project tracking numbers and maintains the records.
Quality Assurance	1	\$ 50	25	\$ 1,250	25	\$ 1,250	Reviews the Engineering Project for Regulatory compliance.
Reliability	1	\$ 50	20	\$ 1,000	20	\$ 1,000	Tracks and maintains the records for all the components and their trends. FAR requirement.
Tech Publications							
Manuals: AMM	1	\$ 50	25	\$ 1,250	25	\$ 1,250	Aircraft Maintenance Manual
IPC	1	\$ 50	20	\$ 1,000	20	\$ 1,000	Illustrated Parts List
CMM	1	\$ 50	10	\$ 500	10	\$ 500	Component Maintenance Manual
AFM	1	\$ 50	10	\$ 500	10	\$ 500	Aircraft Flight Manual
FOM	1	\$ 50	10	\$ 500	10	\$ 500	Flight Operations Manual
SRM	1	\$ 50	10	\$ 500	10	\$ 500	Structural Repair Manual
FUELLING	1	\$ 50	15	\$ 750	15	\$ 750	Fuelling Manual
RMM	1	\$ 50	10	\$ 500	10	\$ 500	Ramp Manual
GMM	1	\$ 50	40	\$ 2,000	40	\$ 2,000	General Maintenance Manual that includes Company's Procedures
WDM	2	\$ 50	150	\$ 7,500	150	\$ 7,500	Wire Diagram Manual
Training Documentation	1	\$ 75	15	\$ 1,125	15	\$ 1,125	Making of necessary training documentation
Training Material				\$ 1,000		\$ 1,000	Material
Material Control							
Routable parts	1	\$ 50	43	\$ 2,125	43	\$ 2,125	Make known the Routable into the company systems
Consumable parts	1	\$ 50	25	\$ 1,250	25	\$ 1,250	Make known the Consumables into the company systems
Spares estimation	1	\$ 50	8	\$ 400	8	\$ 400	The amount of spares depending on the MTBUR
Tooling	1	\$ 50	30	\$ 1,500	30	\$ 1,500	Make known the Tooling into the company systems
RECURRING							
Project's Estimated Time							
Accomplishment	10	\$ 75	2150	\$ 161,250	1900	\$ 142,500	See Addendum F.A.2 for detailed tasks
Engineering support	1	\$ 110	100	\$ 11,000	100	\$ 11,000	Support to hangar during modification
Kit costs							Kit costs is not included. Design Team didn't provided the data.
Kit Storage costs							No kit data available
Extra down time airplane						\$ -	Extra time airplane is on ground due to this modification. Including lost of revenue & hangar space.
Training							
Instructors	1	\$ 110	15	\$ 1,650	15	\$ 1,650	This is the cost for 1 training class only. A correct estimation was not feasible. Giving class + preparation time
Training Classroom				\$ 5,000		\$ 5,000	Average rent cost for classroom
Training Mechanics	16	\$ 110	8	\$ 14,080	8	\$ 14,080	Number of mechanics that follows the class.
Total NON-Recurring	25		641	\$ 41,200	641	\$ 41,200	Per airplane type/ per operator
Total Recurring	28		2273	\$ 192,980	2023	\$ 174,230	Per airplane

MODIFICATION COST & LABOR-HOUR ESTIMATION

ON-BOARD INERTING GAS GENERATING SYSTEM

SMALL AIRPLANE CATEGORY - CRYOGENIC

Task	Number of Persons	Rate	Special Program		D/M - Check		Description
			Man Hours	Cost	Man Hours	Cost	
NON-RECURRING							
Engineering							
Service Bulletin review	1	\$ 110	30	\$ 3,300	30	\$ 3,300	Evaluating Service Bulletin
Engineering Data	1	\$ 50	35	\$ 1,750	35	\$ 1,750	Enters the work card requirements into the data base.
Engineering Drafting	1	\$ 110	25	\$ 2,750	25	\$ 2,750	Creates the necessary drawings and figures necessary for the project.
Inventory Planning	1	\$ 110	20	\$ 2,200	20	\$ 2,200	Reviews the Engineering BOM and does all material provisions and allocations
Planning	1	\$ 110	20	\$ 2,200	20	\$ 2,200	Reviews the Engineering Project and provides information for accomplishment.
Maintenance Programs	1	\$ 110	35	\$ 3,850	35	\$ 3,850	Reviews the Engineering Project for effect on other projects, tasks and jobcards.
Records	1	\$ 50	10	\$ 500	10	\$ 500	Creates the necessary Project tracking numbers and maintains the records.
Quality Assurance	1	\$ 50	25	\$ 1,250	25	\$ 1,250	Reviews the Engineering Project for Regulatory compliance.
Reliability	1	\$ 50	20	\$ 1,000	20	\$ 1,000	Tracks and maintains the records for all the components and their trends. FAR requirement.
Tech Publications							
Manuals: AMM	1	\$ 50	25	\$ 1,250	25	\$ 1,250	Aircraft Maintenance Manual
IPC	1	\$ 50	20	\$ 1,000	20	\$ 1,000	Illustrated Parts List
CMM	1	\$ 50	10	\$ 500	10	\$ 500	Component Maintenance Manual
AFM	1	\$ 50	10	\$ 500	10	\$ 500	Aircraft Flight Manual
FOM	1	\$ 50	10	\$ 500	10	\$ 500	Flight Operations Manual
SRM	1	\$ 50	10	\$ 500	10	\$ 500	Structural Repair Manual
FUELLING	1	\$ 50	15	\$ 750	15	\$ 750	Fuelling Manual
RMM	1	\$ 50	10	\$ 500	10	\$ 500	Ramp Manual
GMM	1	\$ 50	40	\$ 2,000	40	\$ 2,000	General Maintenance Manual that includes Company's Procedures
WDM	2	\$ 50	150	\$ 7,500	150	\$ 7,500	Wire Diagram Manual
Training Documentation	1	\$ 75	15	\$ 1,125	15	\$ 1,125	Making of necessary training documentation
Training Material				\$ 1,000		\$ 1,000	Material
Material Control							
Routable parts	1	\$ 50	43	\$ 2,125	43	\$ 2,125	Make known the Routable into the company systems
Consumable parts	1	\$ 50	25	\$ 1,250	25	\$ 1,250	Make known the Consumables into the company systems
Spares estimation	1	\$ 50	8	\$ 400	8	\$ 400	The amount of spares depending on the MTBUR
Tooling	1	\$ 50	30	\$ 1,500	30	\$ 1,500	Make known the Tooling into the company systems
RECURRING							
Project's Estimated Time							
Accomplishment	10	\$ 75	2250	\$ 168,750	2050	\$ 153,750	See Addendum F.A.2 for detailed tasks
Engineering support	1	\$ 110	100	\$ 11,000	100	\$ 11,000	Support to hangar during modification
Kit costs							Kit costs is not included. Design Team didn't provided the data.
Kit Storage costs							No kit data available
Extra down time airplane						\$ -	Extra time airplane is on ground due to this modification. Including lost of revenue & hangar space.
Training							
Instructors	1	\$ 110	15	\$ 1,650	15	\$ 1,650	This is the cost for 1 training class only. A correct estimation was not feasible. Giving class + preparation time
Training Classroom				\$ 5,000		\$ 5,000	Average rent cost for classroom
Training Mechanics	16	\$ 110	8	\$ 14,080	8	\$ 14,080	Number of mechanics that follows the class.
Total NON-Recurring	25		641	\$ 41,200	641	\$ 41,200	Per airplane type/ per operator
Total Recurring	28		2373	\$ 200,480	2173	\$ 185,480	Per airplane

MODIFICATION COST & LABOR-HOUR ESTIMATION

GROUND BASED INERTING SYSTEM

REGIONAL TURBOFAN AIRPLANE CATEGORY

Task	Number of Persons	Rate	Special Program		D/M - Check		Description
			Man Hours	Cost	Man Hours	Cost	
NON-RECURRING							
Engineering							
Service Bulletin review	1	\$ 110	30	\$ 3,300	30	\$ 3,300	Evaluating Service Bulletin
Engineering Data	1	\$ 50	35	\$ 1,750	35	\$ 1,750	Enters the work card requirements into the data base.
Engineering Drafting	1	\$ 110	25	\$ 2,750	25	\$ 2,750	Creates the necessary drawings and figures necessary for the project.
Inventory Planning	1	\$ 110	20	\$ 2,200	20	\$ 2,200	Reviews the Engineering BOM and does all material provisions and allocations
Planning	1	\$ 110	20	\$ 2,200	20	\$ 2,200	Reviews the Engineering Project and provides information for accomplishment.
Maintenance Programs	1	\$ 110	35	\$ 3,850	35	\$ 3,850	Reviews the Engineering Project for effect on other projects, tasks and jobcards.
Records	1	\$ 50	10	\$ 500	10	\$ 500	Creates the necessary Project tracking numbers and maintains the records.
Quality Assurance	1	\$ 50	25	\$ 1,250	25	\$ 1,250	Reviews the Engineering Project for Regulatory compliance.
Reliability	1	\$ 50	20	\$ 1,000	20	\$ 1,000	Tracks and maintains the records for all the components and their trends. FAR requirement.
Tech Publications							
Manuals: AMM	1	\$ 50	25	\$ 1,250	25	\$ 1,250	Aircraft Maintenance Manual
IPC	1	\$ 50	20	\$ 1,000	20	\$ 1,000	Illustrated Parts List
CMM	1	\$ 50	10	\$ 500	10	\$ 500	Component Maintenance Manual
AFM	1	\$ 50	10	\$ 500	10	\$ 500	Aircraft Flight Manual
FOM	1	\$ 50	10	\$ 500	10	\$ 500	Flight Operations Manual
SRM	1	\$ 50	10	\$ 500	10	\$ 500	Structural Repair Manual
FUELLING	1	\$ 50	15	\$ 750	15	\$ 750	Fuelling Manual
RMM	1	\$ 50	10	\$ 500	10	\$ 500	Ramp Manual
GMM	1	\$ 50	40	\$ 2,000	40	\$ 2,000	General Maintenance Manual that includes Company's Procedures
WDM	2	\$ 50	150	\$ 7,500	150	\$ 7,500	Wire Diagram Manual
Training Documentation	1	\$ 75	15	\$ 1,125	15	\$ 1,125	Making of necessary training documentation
Training Material				\$ 1,000		\$ 1,000	Material
Material Control							
Routable parts	1	\$ 50	43	\$ 2,125	43	\$ 2,125	Make known the Routable into the company systems
Consumable parts	1	\$ 50	25	\$ 1,250	25	\$ 1,250	Make known the Consumables into the company systems
Spares estimation	1	\$ 50	8	\$ 400	8	\$ 400	The amount of spares depending on the MTBUR
Tooling	1	\$ 50	30	\$ 1,500	30	\$ 1,500	Make known the Tooling into the company systems
RECURRING							
Project's Estimated Time							
Accomplishment	10	\$ 75	1100	\$ 82,500	900	\$ 67,500	See Addendum F.A.2 for detailed tasks
Engineering support	1	\$ 110	100	\$ 11,000	100	\$ 11,000	Support to hangar during modification
Kit costs							Kit costs is not included. Design Team didn't provided the data.
Kit Storage costs							No kit data available
Extra down time airplane						\$ -	Extra time airplane is on ground due to this modification. Including lost of revenue & hangar space.
Training							
Instructors	1	\$ 110	15	\$ 1,650	15	\$ 1,650	This is the cost for 1 training class only. A correct estimation was not feasible. Giving class + preparation time
Training Classroom				\$ 5,000		\$ 5,000	Average rent cost for classroom
Training Mechanics	16	\$ 110	8	\$ 14,080	8	\$ 14,080	Number of mechanics that follows the class.
Total NON-Recurring	25		641	\$ 41,200	641	\$ 41,200	Per airplane type/ per operator
Total Recurring	28		1223	\$ 114,230	1023	\$ 99,230	Per airplane

MODIFICATION COST & LABOR-HOUR ESTIMATION

GROUND BASED INERTING SYSTEM

REGIONAL TURBOFAN AIRPLANE CATEGORY (WITH BLADDER TANKS)

Task	Number of Persons	Rate	Special Program		D/M - Check		Description
			Man Hours	Cost	Man Hours	Cost	
NON-RECURRING							
Engineering							
Service Bulletin review	1	\$ 110	30	\$ 3,300	30	\$ 3,300	Evaluating Service Bulletin
Engineering Data	1	\$ 50	35	\$ 1,750	35	\$ 1,750	Enters the work card requirements into the data base.
Engineering Drafting	1	\$ 110	25	\$ 2,750	25	\$ 2,750	Creates the necessary drawings and figures necessary for the project.
Inventory Planning	1	\$ 110	20	\$ 2,200	20	\$ 2,200	Reviews the Engineering BOM and does all material provisions and allocations
Planning	1	\$ 110	20	\$ 2,200	20	\$ 2,200	Reviews the Engineering Project and provides information for accomplishment.
Maintenance Programs	1	\$ 110	35	\$ 3,850	35	\$ 3,850	Reviews the Engineering Project for effect on other projects, tasks and jobcards.
Records	1	\$ 50	10	\$ 500	10	\$ 500	Creates the necessary Project tracking numbers and maintains the records.
Quality Assurance	1	\$ 50	25	\$ 1,250	25	\$ 1,250	Reviews the Engineering Project for Regulatory compliance.
Reliability	1	\$ 50	20	\$ 1,000	20	\$ 1,000	Tracks and maintains the records for all the components and their trends. FAR requirement.
Tech Publications							
Manuals: AMM	1	\$ 50	25	\$ 1,250	25	\$ 1,250	Aircraft Maintenance Manual
IPC	1	\$ 50	20	\$ 1,000	20	\$ 1,000	Illustrated Parts List
CMM	1	\$ 50	10	\$ 500	10	\$ 500	Component Maintenance Manual
AFM	1	\$ 50	10	\$ 500	10	\$ 500	Aircraft Flight Manual
FOM	1	\$ 50	10	\$ 500	10	\$ 500	Flight Operations Manual
SRM	1	\$ 50	10	\$ 500	10	\$ 500	Structural Repair Manual
FUELLING	1	\$ 50	15	\$ 750	15	\$ 750	Fuelling Manual
RMM	1	\$ 50	10	\$ 500	10	\$ 500	Ramp Manual
GMM	1	\$ 50	40	\$ 2,000	40	\$ 2,000	General Maintenance Manual that includes Company's Procedures
WDM	2	\$ 50	150	\$ 7,500	150	\$ 7,500	Wire Diagram Manual
Training Documentation	1	\$ 75	15	\$ 1,125	15	\$ 1,125	Making of necessary training documentation
Training Material				\$ 1,000		\$ 1,000	Material
Material Control							
Routable parts	1	\$ 50	43	\$ 2,125	43	\$ 2,125	Make known the Routable into the company systems
Consumable parts	1	\$ 50	25	\$ 1,250	25	\$ 1,250	Make known the Consumables into the company systems
Spares estimation	1	\$ 50	8	\$ 400	8	\$ 400	The amount of spares depending on the MTBUR
Tooling	1	\$ 50	30	\$ 1,500	30	\$ 1,500	Make known the Tooling into the company systems
RECURRING							
Project's Estimated Time							
Accomplishment	10	\$ 75	1750	\$ 131,250	1550	\$ 116,250	See Addendum F.A.2 for detailed tasks
Engineering support	1	\$ 110	100	\$ 11,000	100	\$ 11,000	Support to hangar during modification
Kit costs							Kit costs is not included. Design Team didn't provided the data.
Kit Storage costs							No kit data available
Extra down time airplane						\$ -	Extra time airplane is on ground due to this modification. Including lost of revenue & hangar space.
Training							
Instructors	1	\$ 110	15	\$ 1,650	15	\$ 1,650	This is the cost for 1 training class only. A correct estimation was not feasible. Giving class + preparation time
Training Classroom				\$ 5,000		\$ 5,000	Average rent cost for classroom
Training Mechanics	16	\$ 110	8	\$ 14,080	8	\$ 14,080	Number of mechanics that follows the class.
Total NON-Recurring	25		641	\$ 41,200	641	\$ 41,200	Per airplane type/ per operator
Total Recurring	28		1873	\$ 162,980	1673	\$ 147,980	Per airplane

MODIFICATION COST & LABOR-HOUR ESTIMATION

GROUND BASED INERTING SYSTEM

REGIONAL TURBOPROP AIRPLANE CATEGORY

Task	Number of Persons	Rate	Special Program		D/M - Check		Description
			Man Hours	Cost	Man Hours	Cost	
NON-RECURRING							
Engineering							
Service Bulletin review	1	\$ 110	30	\$ 3,300	30	\$ 3,300	Evaluating Service Bulletin
Engineering Data	1	\$ 50	35	\$ 1,750	35	\$ 1,750	Enters the work card requirements into the data base.
Engineering Drafting	1	\$ 110	25	\$ 2,750	25	\$ 2,750	Creates the necessary drawings and figures necessary for the project.
Inventory Planning	1	\$ 110	20	\$ 2,200	20	\$ 2,200	Reviews the Engineering BOM and does all material provisions and allocations
Planning	1	\$ 110	20	\$ 2,200	20	\$ 2,200	Reviews the Engineering Project and provides information for accomplishment.
Maintenance Programs	1	\$ 110	35	\$ 3,850	35	\$ 3,850	Reviews the Engineering Project for effect on other projects, tasks and jobcards.
Records	1	\$ 50	10	\$ 500	10	\$ 500	Creates the necessary Project tracking numbers and maintains the records.
Quality Assurance	1	\$ 50	25	\$ 1,250	25	\$ 1,250	Reviews the Engineering Project for Regulatory compliance.
Reliability	1	\$ 50	20	\$ 1,000	20	\$ 1,000	Tracks and maintains the records for all the components and their trends. FAR requirement.
Tech Publications							
Manuals: AMM	1	\$ 50	25	\$ 1,250	25	\$ 1,250	Aircraft Maintenance Manual
IPC	1	\$ 50	20	\$ 1,000	20	\$ 1,000	Illustrated Parts List
CMM	1	\$ 50	10	\$ 500	10	\$ 500	Component Maintenance Manual
AFM	1	\$ 50	10	\$ 500	10	\$ 500	Aircraft Flight Manual
FOM	1	\$ 50	10	\$ 500	10	\$ 500	Flight Operations Manual
SRM	1	\$ 50	10	\$ 500	10	\$ 500	Structural Repair Manual
FUELLING	1	\$ 50	15	\$ 750	15	\$ 750	Fuelling Manual
RMM	1	\$ 50	10	\$ 500	10	\$ 500	Ramp Manual
GMM	1	\$ 50	40	\$ 2,000	40	\$ 2,000	General Maintenance Manual that includes Company's Procedures
WDM	2	\$ 50	150	\$ 7,500	150	\$ 7,500	Wire Diagram Manual
Training Documentation	1	\$ 75	15	\$ 1,125	15	\$ 1,125	Making of necessary training documentation
Training Material				\$ 1,000		\$ 1,000	Material
Material Control							
Routable parts	1	\$ 50	43	\$ 2,125	43	\$ 2,125	Make known the Routable into the company systems
Consumable parts	1	\$ 50	25	\$ 1,250	25	\$ 1,250	Make known the Consumables into the company systems
Spares estimation	1	\$ 50	8	\$ 400	8	\$ 400	The amount of spares depending on the MTBUR
Tooling	1	\$ 50	30	\$ 1,500	30	\$ 1,500	Make known the Tooling into the company systems
RECURRING							
Project's Estimated Time							
Accomplishment	10	\$ 75		\$ -		\$ -	See Addendum F.A.2 for detailed tasks
Engineering support	1	\$ 110	100	\$ 11,000	100	\$ 11,000	Support to hangar during modification
Kit costs							Kit costs is not included. Design Team didn't provided the data.
Kit Storage costs							No kit data available
Extra down time airplane						\$ -	Extra time airplane is on ground due to this modification. Including lost of revenue & hangar space.
Training							
Instructors	1	\$ 110	15	\$ 1,650	15	\$ 1,650	This is the cost for 1 training class only. A correct estimation was not feasible. Giving class + preparation time
Training Classroom				\$ 5,000		\$ 5,000	Average rent cost for classroom
Training Mechanics	16	\$ 110	8	\$ 14,080	8	\$ 14,080	Number of mechanics that follows the class.
Total NON-Recurring	25		641	\$ 41,200	641	\$ 41,200	Per airplane type/ per operator
Total Recurring	28		123	\$ 31,730	123	\$ 31,730	Per airplane

MODIFICATION COST & LABOR-HOUR ESTIMATION

GROUND BASED INERTING SYSTEM

BUSSINESS JET AIRPLANE CATEGORY

Task	Number of Persons	Rate	Special Program		D/M - Check		Description
			Man Hours	Cost	Man Hours	Cost	
NON-RECURRING							
Engineering							
Service Bulletin review	1	\$ 110	30	\$ 3,300	30	\$ 3,300	Evaluating Service Bulletin
Engineering Data	1	\$ 50	35	\$ 1,750	35	\$ 1,750	Enters the work card requirements into the data base.
Engineering Drafting	1	\$ 110	25	\$ 2,750	25	\$ 2,750	Creates the necessary drawings and figures necessary for the project.
Inventory Planning	1	\$ 110	20	\$ 2,200	20	\$ 2,200	Reviews the Engineering BOM and does all material provisions and allocations
Planning	1	\$ 110	20	\$ 2,200	20	\$ 2,200	Reviews the Engineering Project and provides information for accomplishment.
Maintenance Programs	1	\$ 110	35	\$ 3,850	35	\$ 3,850	Reviews the Engineering Project for effect on other projects, tasks and jobcards.
Records	1	\$ 50	10	\$ 500	10	\$ 500	Creates the necessary Project tracking numbers and maintains the records.
Quality Assurance	1	\$ 50	25	\$ 1,250	25	\$ 1,250	Reviews the Engineering Project for Regulatory compliance.
Reliability	1	\$ 50	20	\$ 1,000	20	\$ 1,000	Tracks and maintains the records for all the components and their trends. FAR requirement.
Tech Publications							
Manuals: AMM	1	\$ 50	25	\$ 1,250	25	\$ 1,250	Aircraft Maintenance Manual
IPC	1	\$ 50	20	\$ 1,000	20	\$ 1,000	Illustrated Parts List
CMM	1	\$ 50	10	\$ 500	10	\$ 500	Component Maintenance Manual
AFM	1	\$ 50	10	\$ 500	10	\$ 500	Aircraft Flight Manual
FOM	1	\$ 50	10	\$ 500	10	\$ 500	Flight Operations Manual
SRM	1	\$ 50	10	\$ 500	10	\$ 500	Structural Repair Manual
FUELLING	1	\$ 50	15	\$ 750	15	\$ 750	Fuelling Manual
RMM	1	\$ 50	10	\$ 500	10	\$ 500	Ramp Manual
GMM	1	\$ 50	40	\$ 2,000	40	\$ 2,000	General Maintenance Manual that includes Company's Procedures
WDM	2	\$ 50	150	\$ 7,500	150	\$ 7,500	Wire Diagram Manual
Training Documentation	1	\$ 75	15	\$ 1,125	15	\$ 1,125	Making of necessary training documentation
Training Material				\$ 1,000		\$ 1,000	Material
Material Control							
Routable parts	1	\$ 50	43	\$ 2,125	43	\$ 2,125	Make known the Routable into the company systems
Consumable parts	1	\$ 50	25	\$ 1,250	25	\$ 1,250	Make known the Consumables into the company systems
Spares estimation	1	\$ 50	8	\$ 400	8	\$ 400	The amount of spares depending on the MTBUR
Tooling	1	\$ 50	30	\$ 1,500	30	\$ 1,500	Make known the Tooling into the company systems
RECURRING							
Project's Estimated Time							
Accomplishment	10	\$ 75	500	\$ 37,500		\$ -	See Addendum F.A.2 for detailed tasks
Engineering support	1	\$ 110	100	\$ 11,000	100	\$ 11,000	Support to hangar during modification
Kit costs							Kit costs is not included. Design Team didn't provided the data.
Kit Storage costs							No kit data available
Extra down time airplane						\$ -	Extra time airplane is on ground due to this modification. Including lost of revenue & hangar space.
Training							
Instructors	1	\$ 110	15	\$ 1,650	15	\$ 1,650	This is the cost for 1 training class only. A correct estimation was not feasible. Giving class + preparation time
Training Classroom				\$ 5,000		\$ 5,000	Average rent cost for classroom
Training Mechanics	16	\$ 110	8	\$ 14,080	8	\$ 14,080	Number of mechanics that follows the class.
Total NON-Recurring	25		641	\$ 41,200	641	\$ 41,200	Per airplane type/ per operator
Total Recurring	28		623	\$ 69,230	123	\$ 31,730	Per airplane

Airplane Operation and Maintenance Task Team Final Report

This page intentionally left blank.

ADDENDUM F.A.2

MODIFICATION PROJECT LABOR-HOUR ESTIMATION

to

APPENDIX F

AIRPLANE OPERATION AND MAINTENANCE

FINAL REPORT

This page intentionally left blank.

Airplane type: LARGE <i>(Boeing 747)</i>		Description: Ground Based Inerting Systems	Special Program	Heavy Check
Skill	Description	labor hours	labor hours	
	Accomplishment:			
Mech.	Dock and undock airplane and raise and lower airplane	43	0	
Mech.	Defuel and drain CW tank	4	0	
Mech.	Open, ventilate and close after modification CW tank	29	0	
Avio.	Open/close aft side of MEC	3	0	
Mech.	Remove/reinstall RH seats, carpet, floorpanels above RH cable raceway sta 1000-1265	29	0	
Avio.	Remove/reinstall floorprox,seat to seat cables and raceways RH sta 1000-1265	14	0	
Mech.	Remove/reinstall ceiling panels in fwd cargo compt. for access to cable raceways	7	0	
Mech.	Remove/install in A zone LH seats and side wall panels	7	0	
Avio.	Remove/install Captain seat and several panels/linings in flight deck	43	0	
Mech.	Clean various locations before modification	44	43	
Avio.	Install wiring between flight deck,MEC and new components located in airco. compt. 4	179	179	
Sht.mtl.	Install feed through structural provisions in CW tank aft skin at sta 1260	179	179	
Sht.mtl.	Install provisions for distribution manifold in CW tank	57	57	
Mech.	Install distribution manifold in CW tank	100	100	
Sht.mtl.	Install provisions for thermal relief valve and isolation valve installation	14	14	
Mech.	Install thermal relief valve and isolation valve	7	7	
Sht.mtl.	Modify lwr. panel for fill adaptor/components	57	57	
Sht.mtl.	Inst. provisions for double wall pipe,witness drain etc. from fill panel to CW tank sta 1260	14	14	
Mech.	Inst. double wall pipe,witness drain etc. from fill panel to CW tank sta 1260	21	21	
Mech/Avio	Test ground based distribution system (3x)	29	29	
Mech/Avio	Test several systems due to partial flight deck dismantling	100	100	
	Total labor-hours per aircraft	980	800	
Mech/Avio	Inspection mechanics/avionics	132	96	
Sht.mtl.	Install heat exchanger on header assy	32	32	
	Round off/unforeseen work	157	122	
	Total labor-hours including inspection	1300	1050	
NOTE: LABOR-HOURS BASED ON MINIMUM INFORMATION !!!				

Airplane type:		Description:	Special Program	Heavy Check
LARGE (Boeing 747)		ON-BOARD INERTING GAS GENERATING SYSTEM MEMBRANE		
Skill	Description	labor hours	labor hours	
	Accomplishment:			
Mech.	Dock and undock airplane and raise and lower airplane	71	0	
Mech.	Defuel and drain all fuel tanks	14	0	
Mech.	Open, ventilate and close after modification all fuel tanks	93	0	
Mech.	Remove/install various internal fuel tank panels LH and RH for access	100	100	
Mech.	Remove/install several wing to body fairing panels R.H.	43	0	
Mech.	Remove/install several sidewall and ceiling panels in fwd. cargo compt.R.H.	29	0	
Mech.	Remove/install several insulation blankets R.H.	14	0	
Mech.	Remove/install several seats, floorcovering and floorpanels in main cabin at sta.1000 R.H.	21	0	
Avio.	Remove/install floor prox etc in main cabin at sta.1000 R.H.	7	0	
Avio.	Open/close aft side of MEC	3	0	
Mech.	Remove/install in A zone LH seats and side wall panels	7	0	
Avio.	Remove/install Captain seat and several panels/linings in flight deck	43	0	
Mech.	Clean various locations before and after modification	74	69	
Avio.	Install wiring between flight deck,MEC and new components located in airco. compt. 4	286	286	
Sht.mtl.	Install provisions for filter installation in fwd. cargo compt. approx. at sta.980 RH	36	36	
Mech.	Install filter assy and element	7	7	
Sht.mtl.	Modify lwr. panel for fill adaptor/components	64	64	
Mech.	Install shut off valve and filter to shut off valve ducting	7	7	
Sht.mtl.	Install provision for compressor installation in airco compt. 4	36	36	
Mech.	Install compressor and shut off valve to compressor ducting	10	10	
Sht.mtl.	Install provisions for bleed air items	29	29	
Sht.mtl.	Total labor-hours per aircraft	57	57	
Mech.	Inspection mechanics/avionics	29	29	
Mech.	Install heat exchanger on header assy	7	7	
Sht.mtl.	Drill and fit new ram air inlet/outlet fairing panels	71	71	
Mech.	Assemble and install ram air inlet/outlet panels,doors and motors	14	14	
Avio.	Assemble and install ram air inlet/outlet panels,doors and motors	14	14	
Sht.mtl.	Install provisions for electrically driven cooling fan installation	10	10	
Avio.	Install cooling fan to ram air exit	7	7	
Sht.mtl.	Install provisions for water seperator/filter, low flow ASM and high flow ASM installation	131	131	
Mech.	Install water seperator/filter, low flow ASM and high flow ASM systems	29	29	
Avio.	Install water seperator/filter, low flow ASM and high flow ASM systems	29	29	
Mech.	Install ducting from heat exch.to water seperator/filter, low flow/high flow ASM systems	21	21	
Mech.	Install HX bypass valve and ducting	5	5	
Sht.mtl.	Install provisions for high flow valve and relief valve installation	21	21	
Mech.	Install high flow valve, relief valve and ducting	14	14	
Sht.mtl.	Install feed through structural provision in CW tank at sta. 1000	179	179	
Sht.mtl.	Install feed through and shut off valve provisions in fuselage skin (airco compt 4 to cabin)	64	64	
Mech.	Install ducting from relief valve to CW tank sta.1000	14	14	
Sht.mtl.	Install provisions for NEA gas distribution ducts in all 7 fuel tanks	143	143	
Mech.	Install NEA gas distribution system in all 7 fuel tanks	286	286	
Mech/Avio	Test cryogenic distillation system (3x)	50	50	
Mech/Avio	Test several systems due to partial flight deck dismantling	100	100	
	Total labor-hours per aircraft	2290	1940	
Mech/Avio	Inspection mechanics/avionics	290	220	
Sht.mtl.	Inspection sheetmetal	84	84	
	Round off/unforeseen work	286	256	
	Total labor-hours including inspection	2950	2500	
NOTE: LABOR-HOURS BASED ON MINIMUM INFORMATION !!!				

Airplane type:		Description:	Special Program	Heavy Check
LARGE (Boeing 747)		ON-BOARD INERTING GAS GENERATING SYSTEM PRESSURE SWING ABSORPTION		
Skill	Description	labor hours	labor hours	
	Accomplishment:			
Mech.	Dock and undock airplane and raise and lower airplane	71	0	
Mech.	Defuel and drain all fuel tanks	14	0	
Mech.	Open, ventilate and close after modification all fuel tanks	93	0	
Mech.	Remove/install various internal fuel tank panels LH and RH for access	100	100	
Mech.	Remove/install several wing to body fairing panels R.H.	43	0	
Mech.	Remove/install several sidewall and ceiling panels in fwd. cargo compt.R.H.	29	0	
Mech.	Remove/install several insulation blankets R.H.	14	0	
Mech.	Remove/install several seats, floorcovering and floorpanels in main cabin at sta.1000 R.H.	21	0	
Avio.	Remove/install floor prox etc in main cabin at sta.1000 R.H.	7	0	
Avio.	Open/close aft side of MEC	3	0	
Mech.	Remove/install in A zone LH seats and side wall panels	7	0	
Avio.	Remove/install Captain seat and several panels/linings in flight deck	43	0	
Mech.	Clean various locations before and after modification	74	74	
Avio.	Install wiring between flight deck,MEC and new components located in airco. compt. 4	286	286	
Sht.mtl.	Install provisions for filter installation in fwd. cargo compt. approx. at sta.980 RH	36	36	
Mech.	Install filter assy and element	7	7	
Sht.mtl.	Modify lwr. panel for fill adaptor/components	64	64	
Mech.	Install shut off valve and filter to shut off valve ducting	7	7	
Sht.mtl.	Install provision for compressor installation in airco compt. 4	36	36	
Mech.	Install compressor and shut off valve to compressor ducting	10	10	
Sht.mtl.	Install provisions for bleed air items	29	29	
Sht.mtl.	Total labor-hours per aircraft	57	57	
Mech.	Inspection mechanics/avionics	29	29	
Mech.	Install heat exchanger on header assy	7	7	
Sht.mtl.	Drill and fit new ram air inlet/outlet fairing panels	71	71	
Mech.	Assemble and install ram air inlet/outlet panels,doors and motors	14	14	
Avio.	Assemble and install ram air inlet/outlet panels,doors and motors	14	14	
Sht.mtl.	Install provisions for electrically driven cooling fan installation	10	10	
Avio.	Install cooling fan to ram air exit	7	7	
Sht.mtl.	Install provisions for water seperator/filter and ASM installation	100	100	
Mech.	Install water seperator/filter and ASM systems	21	21	
Avio.	Install water seperator/filter and ASM systems	21	21	
Mech.	Install ducting from heat exch.to water seperator/filter, low flow/high flow ASM systems	21	21	
Mech.	Install HX bypass valve and ducting	5	5	
Sht.mtl.	Install provisions for high flow valve and relief valve installation	21	21	
Mech.	Install high flow valve, relief valve and ducting	14	14	
Sht.mtl.	Install feed through structural provision in CW tank at sta. 1000	179	179	
Sht.mtl.	Install feed through and shut off valve provisions in fuselage skin (airco compt 4 to cabin)	64	64	
Mech.	Install ducting from relief valve to CW tank sta.1000	14	14	
Sht.mtl.	Install provisions for NEA gas distribution ducts in all 7 fuel tanks	143	143	
Mech.	Install NEA gas distribution system in all 7 fuel tanks	286	286	
Mech/Avio	Test cryogenic distillation system (3x)	50	50	
Mech/Avio	Test several systems due to partial flight deck dismantling	100	100	
	Total labor-hours per aircraft	2245	1900	
Mech/Avio	Inspection mechanics/avionics	287	218	
Sht.mtl.	Inspection sheetmetal	81	81	
	Round off/unforeseen work	287	251	
	Total labor-hours including inspection	2900	2450	
NOTE: LABOR-HOURS BASED ON MINIMUM INFORMATION !!!				

Airplane type:		Description:	Special Program	Heavy Check
LARGE (Boeing 747)		ON-BOARD INERTING GAS GENERATING SYSTEM CRYOGENIC		
Skill	Description	labor hours	labor hours	
	Accomplishment:			
Mech.	Dock and undock airplane and raise and lower airplane	71	0	
Mech.	Defuel and drain all fuel tanks	14	0	
Mech.	Open, ventilate and close after modification all fuel tanks	93	0	
Mech.	Remove/install various internal fuel tank panels LH and RH for access	100	100	
Mech.	Remove/install several wing to body fairing panels R.H.	43	0	
Mech.	Remove/install several sidewall and ceiling panels in fwd. cargo compt.R.H.	29	0	
Mech.	Remove/install several insulation blankets R.H.	14	0	
Mech.	Remove/install several seats, floorcovering and floorpanels in main cabin at sta.1000 R.H.	21	0	
Avio.	Remove/install floor prox etc in main cabin at sta.1000 R.H.	7	0	
Avio.	Open/close aft side of MEC	3	0	
Mech.	Remove/install in A zone LH seats and side wall panels	7	0	
Avio.	Remove/install Captain seat and several panels/linings in flight deck	43	0	
Mech.	Clean various locations before and after modification	74	74	
Avio.	Install wiring between flight deck,MEC and new components located in airco. compt. 4	286	286	
Sht.mtl.	Install provisions for filter installation in fwd. cargo compt. approx. at sta.980 RH	36	36	
Mech.	Install filter assy and element	7	7	
Sht.mtl.	Modify lwr. panel for fill adaptor/components	64	64	
Mech.	Install shut off valve and filter to shut off valve ducting	7	7	
Sht.mtl.	Install provision for compressor installation in airco compt. 4	36	36	
Mech.	Install compressor and shut off valve to compressor ducting	10	10	
Sht.mtl.	Install provisions for bleed air items	29	29	
Sht.mtl.	Total labor-hours per aircraft	57	57	
Mech.	Inspection mechanics/avionics	29	29	
Mech.	Install heat exchanger on header assy	7	7	
Sht.mtl.	Drill and fit new ram air inlet/outlet fairing panels	71	71	
Mech.	Assemble and install ram air inlet/outlet panels,doors and motors	14	14	
Avio.	Assemble and install ram air inlet/outlet panels,doors and motors	14	14	
Sht.mtl.	Install provisions for electrically driven cooling fan installation	10	10	
Avio.	Install cooling fan to ram air exit	7	7	
Sht.mtl.	Install provisions for storage syst.,cryogenic refrigerator and distillation syst.installation	171	171	
Mech.	Install storage,cryogenic refrigerator and distillation systems	36	36	
Avio.	Install storage,cryogenic refrigerator and distillation systems	36	36	
Mech.	Install ducting from heat exchanger to refrigerator,distillation and storage systems	21	21	
Mech.	Install HX bypass valve and ducting	5	5	
Sht.mtl.	Install provisions for modulating valve and relief valve installation	21	21	
Mech.	Install modulating valve, relief valve and ducting	14	14	
Sht.mtl.	Install feed through structural provision in CW tank at sta. 1000	179	179	
Sht.mtl.	Install feed through and shut off valve provisions in fuselage skin (airco compt 4 to cabin)	64	64	
Mech.	Install ducting from relief valve to CW tank sta.1000	14	14	
Sht.mtl.	Install provisions for NEA gas distribution ducts in all 7 fuel tanks	143	143	
Mech.	Install NEA gas distribution system in all 7 fuel tanks	286	286	
Mech/Avio	Test cryogenic distillation system (3x)	50	50	
Mech/Avio	Test several systems due to partial flight deck dismantling	100	100	
	Total labor-hours per aircraft	2345	2000	
Mech/Avio	Inspection mechanics/avionics	293	224	
Sht.mtl.	Inspection sheetmetal	88	88	
	Round off/unforeseen work	274	238	
	Total labor-hours including inspection	3000	2550	
NOTE: LABOR-HOURS BASED ON MINIMUM INFORMATION !!!				

Airplane type:		Description:	Special Program	Heavy Check
MEDIUM (Boeing 767)		Ground Based Inerting Systems		
Skill	Description	labor hours	labor hours	
	Accomplishment:			
Mech.	Dock and undock airplane and raise and lower airplane	14	0	
Mech.	Defuel and drain CW tank	3	0	
Mech.	Open, ventilate and close after modification CW tank	21	0	
Avio.	Open/close aft side of E/E	3	0	
Mech.	Remove/reinstall RH seats, carpet, floorpanels above RH cable raceway sta 933	29	0	
Avio.	Remove/reinstall floorprox,seat to seat cables and raceways RH sta 933	14	0	
Mech.	Remove/reinstall ceiling panels in aft cargo compt. for access to cable raceways	7	0	
Avio.	Remove/install Captain seat and several panels/linings in flight deck	43	0	
Mech.	Clean various locations before modification	44	43	
Avio.	Install wiring between flight deck, E/E and new components located in tail cone	179	157	
Sht.mtl.	Install feed through structural provisions in CW tank aft skin at sta 955	179	157	
Sht.mtl.	Install provisions for distribution manifold in CW tank	57	57	
Mech.	Install distribution manifold in CW tank	100	100	
Sht.mtl.	Install provisions for thermal relief valve and isolation valve installation	14	14	
Mech.	Install thermal relief valve and isolation valve	7	7	
Sht.mtl.	Modify lwr. panel for fill adaptor/components	57	57	
Sht.mtl.	Inst. provisions for double wall pipe,witness drain etc. from fill panel to CW tank sta 955	14	14	
Mech.	Inst. double wall pipe,witness drain etc. from fill panel to CW tank sta 955	21	21	
Mech/Avio	Test ground based distribution system (3x)	29	29	
Mech/Avio	Test several systems due to partial flight deck dismantling	100	100	
	Total manhours per aircraft	935	757	
Mech/Avio	Inspection mechanics/avionics	123	56	
Sht.mtl.	Inspection sheetmetal	32	48	
	Round off/unforeseen work	110	89	
	Total manhours including inspection	1200	950	
NOTE: LABOR-HOURS BASED ON MINIMUM INFORMATION !!!				

Airplane type:		Description:	Special Program	Heavy Check
MEDIUM (Boeing 767)		ON-BOARD INERTING GAS GENERATING SYSTEM MEMBRANE		
Skill	Description	labor hours	labor hours	
	Accomplishment:			
Mech.	Dock and undock airplane and raise and lower airplane	29	0	
Mech.	Defuel and drain all fuel tanks	14	0	
Mech.	Open, ventilate and close after modification all fuel tanks	43	0	
Mech.	Remove/install various internal fuel tank panels LH and RH for access	43	43	
Mech.	Remove/install several sidewall and ceiling panels in fwd. cargo compt.R.H.	29	0	
Mech.	Remove/install several insulation blankets R.H.	14	0	
Mech.	Remove/install several seats, floorcovering and floorpanels in main cabin at sta.933 R.H.	21	0	
Avio.	Remove/install floor prox etc in main cabin at sta.933 R.H.	7	0	
Avio.	Open/close aft side of E/E	3	0	
Avio.	Remove/install Captain seat and several panels/linings in flight deck	29	0	
Mech.	Clean various locations before and after modification	57	57	
Avio.	Install wiring between flight deck, E/E and new components located in tail cone	257	257	
Sht.mtl.	Install provisions for filter installation in bulk cargo compt. approx. at sta.1540 RH	36	36	
Mech.	Install filter assy and element	7	7	
Sht.mtl.	Modify lwr. panel for fill adaptor/components	64	64	
Mech.	Install shut off valve and filter to shut off valve ducting	7	7	
Sht.mtl.	Install provision for compressor installation in tail cone	36	36	
Mech.	Install compressor and shut off valve to compressor ducting	10	10	
Sht.mtl.	Install provisions for bleed air items	29	29	
Sht.mtl.	Install provisions for header/ heat exchanger installation in tail cone	57	57	
Mech.	Install header assy, bleed air items and compressor to header assy ducting	29	29	
Mech.	Install heat exchanger on header assy	7	7	
Sht.mtl.	Drill and fit new ram air inlet/outlet fairing panels	71	71	
Mech.	Assemble and install ram air inlet/outlet panels,doors and motors	14	14	
Avio.	Assemble and install ram air inlet/outlet panels,doors and motors	14	14	
Sht.mtl.	Install provisions for electrically driven cooling fan installation	10	10	
Avio.	Install cooling fan to ram air exit	7	7	
Sht.mtl.	Install provisions for storage syst.,cryogenic refrigerator and distillation syst.installation	129	131	
Mech.	Install storage,cryogenic refrigerator and distillation systems	29	29	
Avio.	Install storage,cryogenic refrigerator and distillation systems	29	29	
Mech.	Install ducting from heat exchanger to refrigerator,distillation and storage systems	21	21	
Mech.	Install HX bypass valve and ducting	5	5	
Sht.mtl.	Install provisions for modulating valve and relief valve installation	21	21	
Mech.	Install modulating valve, relief valve and ducting	14	14	
Sht.mtl.	Install feed through structural provision in CW tank at sta. 955	143	179	
Sht.mtl.	Install feed through and shut off valve provisions in fuselage skin (tail cone to cabin)	64	64	
Mech.	Install ducting from relief valve to CW tank sta.955	14	14	
Sht.mtl.	Install provisions for NEA gas distribution ducts in all 3 fuel tanks	107	107	
Mech.	Install NEA gas distribution system in all 3 fuel tanks	214	214	
Mech/Avio	Test cryogenic distillation system (3x)	50	50	
Mech/Avio	Test several systems due to partial flight deck dismantling	71	71	
	Total manhours per aircraft	1857	1706	
Mech/Avio	Inspection mechanics/avionics	218	180	
Sht.mtl.	Inspection sheetmetal	77	81	
	Round off/unforeseen work	248	233	
	Total manhours including inspection	2400	2200	
NOTE: LABOR-HOURS BASED ON MINIMUM INFORMATION !!!				

Airplane type:		Description:	Special Program	Heavy Check
MEDIUM (Boeing 767)		ON-BOARD INERTING GAS GENERATING SYSTEM PRESSURE SWING ABSORPTION		
Skill	Description	labor hours	labor hours	
	Accomplishment:			
Mech.	Dock and undock airplane and raise and lower airplane	29	0	
Mech.	Defuel and drain all fuel tanks	14	0	
Mech.	Open, ventilate and close after modification all fuel tanks	43	0	
Mech.	Remove/install various internal fuel tank panels LH and RH for access	43	43	
Mech.	Remove/install several sidewall and ceiling panels in fwd. cargo compt.R.H.	29	0	
Mech.	Remove/install several insulation blankets R.H.	14	0	
Mech.	Remove/install several seats, floorcovering and floorpanels in main cabin at sta.933 R.H.	21	0	
Avio.	Remove/install floor prox etc in main cabin at sta.933 R.H.	7	0	
Avio.	Open/close aft side of E/E	3	0	
Avio.	Remove/install Captain seat and several panels/linings in flight deck	29	0	
Mech.	Clean various locations before and after modification	57	64	
Avio.	Install wiring between flight deck, E/E and new components located in tail cone	257	257	
Sht.mtl.	Install provisions for filter installation in bulk cargo compt. approx. at sta.1540 RH	36	36	
Mech.	Install filter assy and element	7	7	
Sht.mtl.	Modify lwr. panel for fill adaptor/components	64	64	
Mech.	Install shut off valve and filter to shut off valve ducting	7	7	
Sht.mtl.	Install provision for compressor installation in tail cone	36	36	
Mech.	Install compressor and shut off valve to compressor ducting	10	10	
Sht.mtl.	Install provisions for bleed air items	29	29	
Sht.mtl.	Install provisions for header/ heat exchanger installation in tail cone	57	57	
Mech.	Install header assy, bleed air items and compressor to header assy ducting	29	29	
Mech.	Install heat exchanger on header assy	7	7	
Sht.mtl.	Drill and fit new ram air inlet/outlet fairing panels	71	71	
Mech.	Assemble and install ram air inlet/outlet panels,doors and motors	14	14	
Avio.	Assemble and install ram air inlet/outlet panels,doors and motors	14	14	
Sht.mtl.	Install provisions for electrically driven cooling fan installation	10	10	
Avio.	Install cooling fan to ram air exit	7	7	
Sht.mtl.	Install provisions for storage syst.,cryogenic refrigerator and distillation syst.installation	100	100	
Mech.	Install storage,cryogenic refrigerator and distillation systems	21	21	
Avio.	Install storage,cryogenic refrigerator and distillation systems	21	21	
Mech.	Install ducting from heat exchanger to refrigerator,distillation and storage systems	21	21	
Mech.	Install HX bypass valve and ducting	5	5	
Sht.mtl.	Install provisions for modulating valve and relief valve installation	21	21	
Mech.	Install modulating valve, relief valve and ducting	14	14	
Sht.mtl.	Install feed through structural provision in CW tank at sta. 955	143	179	
Sht.mtl.	Install feed through and shut off valve provisions in fuselage skin (tail cone to cabin)	64	64	
Mech.	Install ducting from relief valve to CW tank sta.955	14	14	
Sht.mtl.	Install provisions for NEA gas distribution ducts in all 3 fuel tanks	107	107	
Mech.	Install NEA gas distribution system in all 3 fuel tanks	214	214	
Mech/Avio	Test cryogenic distillation system (3x)	50	50	
Mech/Avio	Test several systems due to partial flight deck dismantling	71	71	
	Total manhours per aircraft	1814	1668	
Mech/Avio	Inspection mechanics/avionics	215	179	
Sht.mtl.	Inspection sheetmetal	74	77	
	Round off/unforeseen work	247	225	
	Total manhours including inspection	2350	2150	
NOTE: LABOR-HOURS BASED ON MINIMUM INFORMATION !!!				

Airplane type:		Description:	Special Program	Heavy Check
MEDIUM (Boeing 767)		ON-BOARD INERTING GAS GENERATING SYSTEM CRYOGENIC		
Skill	Description	labor hours	labor hours	
	Accomplishment:			
Mech.	Dock and undock airplane and raise and lower airplane	29	0	
Mech.	Defuel and drain all fuel tanks	14	0	
Mech.	Open, ventilate and close after modification all fuel tanks	43	0	
Mech.	Remove/install various internal fuel tank panels LH and RH for access	43	43	
Mech.	Remove/install several sidewall and ceiling panels in fwd. cargo compt.R.H.	29	0	
Mech.	Remove/install several insulation blankets R.H.	14	0	
Mech.	Remove/install several seats, floorcovering and floorpanels in main cabin at sta.933 R.H.	21	0	
Avio.	Remove/install floor prox etc in main cabin at sta.933 R.H.	7	0	
Avio.	Open/close aft side of E/E	3	0	
Avio.	Remove/install Captain seat and several panels/linings in flight deck	29	0	
Mech.	Clean various locations before and after modification	57	74	
Avio.	Install wiring between flight deck, E/E and new components located in tail cone	257	257	
Sht.mtl.	Install provisions for filter installation in bulk cargo compt. approx. at sta.1540 RH	36	36	
Mech.	Install filter assy and element	7	7	
Sht.mtl.	Modify lwr. panel for fill adaptor/components	64	64	
Mech.	Install shut off valve and filter to shut off valve ducting	7	7	
Sht.mtl.	Install provision for compressor installation in tail cone	36	36	
Mech.	Install compressor and shut off valve to compressor ducting	10	10	
Sht.mtl.	Install provisions for bleed air items	29	29	
Sht.mtl.	Install provisions for header/ heat exchanger installation in tail cone	57	57	
Mech.	Install header assy, bleed air items and compressor to header assy ducting	29	29	
Mech.	Install heat exchanger on header assy	7	7	
Sht.mtl.	Drill and fit new ram air inlet/outlet fairing panels	71	71	
Mech.	Assemble and install ram air inlet/outlet panels,doors and motors	14	14	
Avio.	Assemble and install ram air inlet/outlet panels,doors and motors	14	14	
Sht.mtl.	Install provisions for electrically driven cooling fan installation	10	10	
Avio.	Install cooling fan to ram air exit	7	7	
Sht.mtl.	Install provisions for storage syst.,cryogenic refrigerator and distillation syst.installation	171	171	
Mech.	Install storage,cryogenic refrigerator and distillation systems	36	36	
Avio.	Install storage,cryogenic refrigerator and distillation systems	36	36	
Mech.	Install ducting from heat exchanger to refrigerator,distillation and storage systems	21	21	
Mech.	Install HX bypass valve and ducting	5	5	
Sht.mtl.	Install provisions for modulating valve and relief valve installation	21	21	
Mech.	Install modulating valve, relief valve and ducting	14	14	
Sht.mtl.	Install feed through structural provision in CW tank at sta. 955	143	179	
Sht.mtl.	Install feed through and shut off valve provisions in fuselage skin (tail cone to cabin)	64	64	
Mech.	Install ducting from relief valve to CW tank sta.955	14	14	
Sht.mtl.	Install provisions for NEA gas distribution ducts in all 3 fuel tanks	107	107	
Mech.	Install NEA gas distribution system in all 3 fuel tanks	214	214	
Mech/Avio	Test cryogenic distillation system (3x)	50	50	
Mech/Avio	Test several systems due to partial flight deck dismantling	71	71	
	Total manhours per aircraft	1914	1778	
Mech/Avio	Inspection mechanics/avionics	221	186	
Sht.mtl.	Inspection sheetmetal	81	85	
	Round off/unforeseen work	234	251	
	Total manhours including inspection	2450	2300	
NOTE: LABOR-HOURS BASED ON MINIMUM INFORMATION !!!				

Airplane type: MEDIUM <i>(MD11)</i>		Description: Ground Based Inerting Systems	Special Program	Heavy Check
Skill	Description	labor hours	labor hours	
	Accomplishment:			
Mech.	Dock and undock airplane and raise and lower airplane	14	0	
Mech.	Defuel, drain and vent aux tank	14	0	
Mech.	Open and close after modification aux tank	7	0	
Avio.	Open/close aft side of avionics compartment	3	0	
Mech.	Remove/reinstall RH seats, carpet, floorpanels	14	0	
Avio.	Remove/reinstall floorprox, seat to seat cables and raceways RH sta 1000-1265	0	0	
Mech.	Remove/reinstall ceiling panels in fwd cargo compt. for access to cable raceways	7	0	
Avio.	Remove/install Captain seat and several panels/linings in flight deck	29	0	
Mech.	Clean various locations before modification	36	36	
Avio.	Install wiring between flight deck, avio comp and new components located in zone 114	114	114	
Sht.mtl.	Install feed through structural provisions in aux tank	143	143	
Sht.mtl.	Install provisions for distribution manifold in aux tank	50	50	
Mech.	Install distribution manifold in aux tank	86	86	
Sht.mtl.	Install provisions for thermal relief valve and isolation valve installation	14	14	
Mech.	Install thermal relief valve and isolation valve	7	7	
Sht.mtl.	Modify lwr. panel for fill adaptor/components	57	57	
Sht.mtl.	Inst. provisions for double wall pipe, witness drain etc. from fill panel to aux tank	21	21	
Mech.	Inst. double wall pipe, witness drain etc. from fill panel to aux tank	29	29	
Mech/Avio	Test ground based distribution system (3x)	29	29	
Mech/Avio	Test several systems due to partial flight deck dismantling	71	71	
	Total manhours per aircraft	746	657	
Mech/Avio	Inspection mechanics/avionics	92	96	
Sht.mtl.	Inspection sheetmetal	29	32	
	Round off/unforeseen work	133	122	
	Total manhours including inspection	1000	1050	
NOTE: LABOR-HOURS BASED ON MINIMUM INFORMATION !!!				

Airplane type:		Description:	Special Program	Heavy Check
MEDIUM (MD11)		ON-BOARD INERTING GAS GENERATING SYSTEM MEMBRANE		
Skill	Description	labor hours	labor hours	
	Accomplishment:			
Mech.	Dock and undock airplane and raise and lower airplane	29	0	
Mech.	Defuel, drain, purge and vent all fuel tanks	33	0	
Mech.	Open and close after modification all fuel tanks	43	0	
Mech.	Remove/install various internal fuel tank panels LH and RH for access	100	100	
Mech.	Remove/install several sidewall and ceiling panels in fwd. cargo compt.R.H.	14	0	
Mech.	Remove/install several insulation blankets R.H.	14	0	
Mech.	Remove/install several seats, floorcovering and floorpanels in cabin	14	0	
Avio.	Open/close aft side of avionics compartment	3	0	
Avio.	Remove/install Captain seat and several panels/linings in flight deck	29	0	
Mech.	Clean various locations before and after modification	57	54	
Avio.	Install wiring between flight deck, avio comp and new components located in zone 114	214	214	
Sht.mtl.	Install provisions for filter installation in fwd. cargo compartment	29	29	
Mech.	Install filter assy and element	3	3	
Sht.mtl.	Modify lwr. panel for fill adaptor/components	43	43	
Mech.	Install shut off valve and filter to shut off valve ducting	6	6	
Sht.mtl.	Install provision for compressor installation in zone 114	29	29	
Mech.	Install compressor and shut off valve to compressor ducting	9	9	
Sht.mtl.	Install provisions for bleed air items	21	21	
Sht.mtl.	Install provisions for header/ heat exchanger installation in zone 114	43	43	
Mech.	Install header assy, bleed air items and compressor to header assy ducting	29	29	
Mech.	Install heat exchanger on header assy	6	6	
Sht.mtl.	Drill and fit new ram air inlet/outlet fairing panels	75	75	
Mech.	Make split in ram air duct	7	7	
Avio.	Assemble and install ram air inlet/outlet panels,doors and motors	20	20	
Sht.mtl.	Install provisions for electrically driven cooling fan installation	25	25	
Avio.	Install cooling fan to ram air exit	7	7	
Sht.mtl.	Install provisions for water seperator/filter, low flow ASM and high flow ASM installation	129	129	
Mech.	Install water seperator/filter, low flow ASM and high flow ASM systems	29	29	
Avio.	Install water seperator/filter, low flow ASM and high flow ASM systems	29	29	
Mech.	Install ducting from heat exch.to water seperator/filter, low flow/high flow ASM systems	14	14	
Mech.	Install HX bypass valve and ducting	4	4	
Sht.mtl.	Install provisions for high flow valve and relief valve installation	21	21	
Mech.	Install high flow valve, relief valve and ducting	14	14	
Sht.mtl.	Install feed through structural provision in upper aux tank	143	143	
Sht.mtl.	Install feed through and relief valve provisions in fuselage skin (zone 114 to cabin)	71	71	
Mech.	Install ducting from relief valve to upper aux tank	14	14	
Sht.mtl.	Install provisions for NEA gas distribution ducts in all 5 fuel tanks (tail tank not included)	129	129	
Mech.	Install NEA gas distribution system in all 5 fuel tanks	257	257	
Mech/Avio	Test cryogenic distillation system (3x)	43	43	
Mech/Avio	Test several systems due to partial flight deck dismantling	71	71	
	Total manhours per aircraft	1869	1688	
Mech/Avio	Inspection mechanics/avionics	222	186	
Sht.mtl.	Inspection sheetmetal	76	76	
	Round off/unforeseen work	233	201	
	Total manhours including inspection	2400	2150	
NOTE: LABOR-HOURS BASED ON MINIMUM INFORMATION !!!				

Airplane type:		Description:	Special Program	Heavy Check
MEDIUM (MD11)		ON-BOARD INERTING GAS GENERATING SYSTEM PRESSURE SWING ABSORPTION		
Skill	Description	labor hours	labor hours	
	Accomplishment:			
Mech.	Dock and undock airplane and raise and lower airplane	29	0	
Mech.	Defuel, drain, purge and vent all fuel tanks	33	0	
Mech.	Open and close after modification all fuel tanks	43	0	
Mech.	Remove/install various internal fuel tank panels LH and RH for access	100	100	
Mech.	Remove/install several sidewall and ceiling panels in fwd. cargo compt.R.H.	14	0	
Mech.	Remove/install several insulation blankets R.H.	14	0	
Mech.	Remove/install several seats, floorcovering and floorpanels in cabin	14	0	
Avio.	Open/close aft side of avionics compartment	3	0	
Avio.	Remove/install Captain seat and several panels/linings in flight deck	29	0	
Mech.	Clean various locations before and after modification	57	57	
Avio.	Install wiring between flight deck, avio comp and new components located in zone 114	214	214	
Sht.mtl.	Install provisions for filter installation in fwd. cargo compartment	29	29	
Mech.	Install filter assy and element	3	3	
Sht.mtl.	Modify lwr. panel for fill adaptor/components	43	43	
Mech.	Install shut off valve and filter to shut off valve ducting	6	6	
Sht.mtl.	Install provision for compressor installation in zone 114	29	29	
Mech.	Install compressor and shut off valve to compressor ducting	9	9	
Sht.mtl.	Install provisions for bleed air items	21	21	
Sht.mtl.	Install provisions for header/ heat exchanger installation in zone 114	43	43	
Mech.	Install header assy, bleed air items and compressor to header assy ducting	29	29	
Mech.	Install heat exchanger on header assy	6	6	
Sht.mtl.	Drill and fit new ram air inlet/outlet fairing panels	75	75	
Mech.	Make split in ram air duct	7	7	
Avio.	Assemble and install ram air inlet/outlet panels,doors and motors	20	20	
Sht.mtl.	Install provisions for electrically driven cooling fan installation	25	25	
Avio.	Install cooling fan to ram air exit	7	7	
Sht.mtl.	Install provisions for water seperator/filter and ASM installation	100	100	
Mech.	Install water seperator/filter and ASM systems	21	21	
Avio.	Install water seperator/filter and ASM systems	21	21	
Mech.	Install ducting from heat exch.to water seperator/filter, low flow/high flow ASM systems	14	14	
Mech.	Install HX bypass valve and ducting	4	4	
Sht.mtl.	Install provisions for high flow valve and relief valve installation	21	21	
Mech.	Install high flow valve, relief valve and ducting	14	14	
Sht.mtl.	Install feed through structural provision in upper aux tank	143	143	
Sht.mtl.	Install feed through and relief valve provisions in fuselage skin (zone 114 to cabin)	71	71	
Mech.	Install ducting from relief valve to upper aux tank	14	14	
Sht.mtl.	Install provisions for NEA gas distribution ducts in all 5 fuel tanks (tail tank not included)	129	129	
Mech.	Install NEA gas distribution system in all 5 fuel tanks	257	257	
Mech/Avio	Test cryogenic distillation system (3x)	43	43	
Mech/Avio	Test several systems due to partial flight deck dismantling	71	71	
	Total manhours per aircraft	1826	1648	
Mech/Avio	Inspection mechanics/avionics	219	184	
Sht.mtl.	Inspection sheetmetal	73	73	
	Round off/unforeseen work	231	196	
	Total manhours including inspection	2350	2100	
NOTE: LABOR-HOURS BASED ON MINIMUM INFORMATION !!!				

Airplane type:		Description:	Special Program	Heavy Check
MEDIUM (MD11)		ON-BOARD INERTING GAS GENERATING SYSTEM CRYOGENIC		
Skill	Description	labor hours	labor hours	
	Accomplishment:			
Mech.	Dock and undock airplane and raise and lower airplane	29	0	
Mech.	Defuel, drain purge and vent all fuel tanks	33	0	
Mech.	Open and close after modification all fuel tanks	43	0	
Mech.	Remove/install various internal fuel tank panels LH and RH for access	100	100	
Mech.	Remove/install several sidewall and ceiling panels in fwd. cargo compt.R.H.	14	0	
Mech.	Remove/install several insulation blankets R.H.	14	0	
Mech.	Remove/install several seats, floorcovering and floorpanels in cabin	14	0	
Avio.	Remove/install floor prox etc in main cabin at sta.1000 R.H.	0	0	
Avio.	Open/close aft side of avionics compartment	3	0	
Avio.	Remove/install Captain seat and several panels/linings in flight deck	29	0	
Mech.	Clean various locations before and after modification	57	57	
Avio.	Install wiring between flightdeck, avionics comp and new components located in zone 114.	214	214	
Sht.mtl.	Install provisions for filter installation in fwd. cargo compartment.	29	29	
Mech.	Install filter assy and element	3	3	
Sht.mtl.	Modify lwr. panel for fill adaptor/components	43	43	
Mech.	Install shut off valve and filter to shut off valve ducting	6	6	
Sht.mtl.	Install provision for compressor installation in zone 114	29	29	
Mech.	Install compressor and shut off valve to compressor ducting	9	9	
Sht.mtl.	Install provisions for bleed air items	21	21	
Sht.mtl.	Install provisions for header/ heat exchanger installation in zone 114	43	43	
Mech.	Install header assy, bleed air items and compressor to header assy ducting	29	29	
Mech.	Install heat exchanger on header assy	6	6	
Sht.mtl.	Drill and fit new ram air inlet/outlet fairing panels	75	75	
Mech.	Make split in ram air duct	7	7	
Avio.	Assemble and install ram air inlet/outlet panels,doors and motors	25	25	
Sht.mtl.	Install provisions for electrically driven cooling fan installation	9	9	
Avio.	Install cooling fan to ram air exit	7	7	
Sht.mtl.	Install provisions for storage syst.,cryogenic refrigerator and distillation syst.installation	171	171	
Mech.	Install storage,cryogenic refrigerator and distillation systems	43	43	
Avio.	Install storage,cryogenic refrigerator and distillation systems	36	36	
Mech.	Install ducting from heat exchanger to refrigerator,distillation and storage systems	17	17	
Mech.	Install HX bypass valve and ducting	4	4	
Sht.mtl.	Install provisions for modulating valve and relief valve installation	21	21	
Mech.	Install modulating valve, relief valve and ducting	14	14	
Sht.mtl.	Install feed through structural provision in upper aux tank	143	143	
Sht.mtl.	Install feed through and relief valve provisions in fuselage skin (zone 114 to cabin)	71	71	
Mech.	Install ducting from relief valve to upper aux tank	14	14	
Sht.mtl.	Install provisions for NEA gas distribution ducts in all 5 fuel tanks (tail tank not included)	129	129	
Mech.	Install NEA gas distribution system in 5 fuel tanks	257	257	
Mech/Avio	Test cryogenic distillation system (3x)	43	43	
Mech/Avio	Test several systems due to partial flight deck dismantling	71	71	
	Total manhours per aircraft	1925	1746	
Mech/Avio	Inspection mechanics/avionics	228	192	
Sht.mtl.	Inspection sheetmetal	78	78	
	Round off/unforeseen work	269	233	
	Total manhours including inspection	2500	2250	
NOTE: LABOR-HOURS BASED ON MINIMUM INFORMATION !!!				

Airplane type: SMALL <i>(Boeing 737)</i>		Description: Ground Based Inerting Systems	Special Program	Heavy Check
Skill	Description	labor hours	labor hours	
	Accomplishment:			
Mech.	Dock and undock airplane and raise and lower airplane	11	0	
Mech.	Defuel and drain CW tank	3	0	
Mech.	Open, ventilate and close after modification CW tank	14	0	
Avio.	Open/close aft side of E/E	3	0	
Mech.	Remove/reinstall RH seats, carpet, floorpanels above RH cable raceway	29	0	
Avio.	Remove/reinstall floorprox, seat to seat cables and raceways RH	14	0	
Mech.	Remove/reinstall ceiling panels in aft cargo compt. for access to cable raceways	7	0	
Avio.	Remove/install Captain seat and several panels/linings in flight deck	43	0	
Mech.	Clean various locations before modification	44	43	
Avio.	Install wiring between flight deck, E/E and new components located in tail cone	179	157	
Sht.mtl.	Install feed through structural provisions in CW tank aft skin	179	157	
Sht.mtl.	Install provisions for distribution manifold in CW tank	57	57	
Mech.	Install distribution manifold in CW tank	100	100	
Sht.mtl.	Install provisions for thermal relief valve and isolation valve installation	14	14	
Mech.	Install thermal relief valve and isolation valve	7	7	
Sht.mtl.	Modify lwr. panel for fill adaptor/components	57	57	
Sht.mtl.	Inst. provisions for double wall pipe, witness drain etc. from fill panel to CW tank	14	14	
Mech.	Inst. double wall pipe, witness drain etc. from fill panel to CW tank	21	21	
Mech/Avio	Test ground based distribution system (3x)	29	29	
Mech/Avio	Test several systems due to partial flight deck dismantling	100	100	
	Total manhours per aircraft	925	757	
Mech/Avio	Inspection mechanics/avionics	121	96	
Sht.mtl.	Inspection sheetmetal	32	32	
	Round off/unforeseen work	122	122	
	Total manhours including inspection	1200	1050	
NOTE: LABOR-HOURS BASED ON MINIMUM INFORMATION !!!				

Airplane type:		Description:	Special Program	Heavy Check
SMALL (Boeing 737)		ON-BOARD INERTING GAS GENERATING SYSTEM MEMBRANE		
Skill	Description	labor hours	labor hours	
	Accomplishment:			
Mech.	Dock and undock airplane and raise and lower airplane	20	0	
Mech.	Defuel and drain all fuel tanks	14	0	
Mech.	Open, ventilate and close after modification all fuel tanks	31	0	
Mech.	Remove/install various internal fuel tank panels LH and RH for access	14	14	
Mech.	Remove/install several sidewall and ceiling panels in aft. cargo compt.R.H.	20	0	
Mech.	Remove/install several insulation blankets R.H.	14	0	
Mech.	Remove/install several seats, floorcovering and floorpanels in main cabin R.H.	21	0	
Avio.	Remove/install floor prox etc in main cabin R.H.	7	0	
Avio.	Open/close aft side of E/E	3	0	
Avio.	Remove/install Captain seat and several panels/linings in flight deck	29	0	
Mech.	Clean various locations before and after modification	29	29	
Avio.	Install wiring between flight deck,E/E and new components located in tail cone	214	214	
Sht.mtl.	Install provisions for filter installation in Aft cargo compt. RH	36	36	
Mech.	Install filter assy and element	7	7	
Sht.mtl.	Modify lwr. panel for fill adaptor/components	64	64	
Mech.	Install shut off valve and filter to shut off valve ducting	7	7	
Sht.mtl.	Install provision for compressor installation in tail cone	36	36	
Mech.	Install compressor and shut off valve to compressor ducting	10	10	
Sht.mtl.	Install provisions for bleed air items	29	29	
Sht.mtl.	Install provisions for header/ heat exchanger installation in tail cone	57	57	
Mech.	Install header assy, bleed air items and compressor to header assy ducting	29	29	
Mech.	Install heat exchanger on header assy	7	7	
Sht.mtl.	Drill and fit new ram air inlet/outlet fairing panels	71	71	
Mech.	Assemble and install ram air inlet/outlet panels,doors and motors	14	14	
Avio.	Assemble and install ram air inlet/outlet panels,doors and motors	14	14	
Sht.mtl.	Install provisions for electrically driven cooling fan installation	10	10	
Avio.	Install cooling fan to ram air exit	7	7	
Sht.mtl.	Install provisions for water seperator/filter, low flow ASM and high flow ASM installation	129	129	
Mech.	Install water seperator/filter, low flow ASM and high flow ASM systems	29	24	
Avio.	Install water seperator/filter, low flow ASM and high flow ASM systems	29	24	
Mech.	Install ducting from heat exch.to water seperator/filter, low flow/high flow ASM systems	21	21	
Mech.	Install HX bypass valve and ducting	5	5	
Sht.mtl.	Install provisions for high flow valve and relief valve installation	21	21	
Mech.	Install high flow valve, relief valve and ducting	14	14	
Sht.mtl.	Install feed through structural provision in CW tank	121	121	
Sht.mtl.	Install feed through and shut off valve provisions in fuselage skin (tail cone to cabin)	64	64	
Mech.	Install ducting from relief valve to CW tank	14	14	
Sht.mtl.	Install provisions for NEA gas distribution ducts in all 3 fuel tanks	107	107	
Mech.	Install NEA gas distribution system in all 3 fuel tanks	214	214	
Mech/Avio	Test cryogenic distillation system (3x)	50	50	
Mech/Avio	Test several systems due to partial flight deck dismantling	64	64	
	Total manhours per aircraft	1701	1531	
Mech/Avio	Inspection mechanics/avionics	191	157	
Sht.mtl.	Inspection sheetmetal	75	75	
	Round off/unforeseen work	234	188	
	Total manhours including inspection	2200	1950	
NOTE: LABOR-HOURS BASED ON MINIMUM INFORMATION !!!				

Airplane type:		Description:	Special Program	Heavy Check
SMALL (Boeing 737)		ON-BOARD INERTING GAS GENERATING SYSTEM PRESSURE SWING ABSORPTION		
Skill	Description	labor hours	labor hours	
	Accomplishment:			
Mech.	Dock and undock airplane and raise and lower airplane	20	0	
Mech.	Defuel and drain all fuel tanks	14	0	
Mech.	Open, ventilate and close after modification all fuel tanks	31	0	
Mech.	Remove/install various internal fuel tank panels LH and RH for access	14	14	
Mech.	Remove/install several sidewall and ceiling panels in aft. cargo compt.R.H.	20	0	
Mech.	Remove/install several insulation blankets R.H.	14	0	
Mech.	Remove/install several seats, floorcovering and floorpanels in main cabin R.H.	21	0	
Avio.	Remove/install floor prox etc in main cabin R.H.	7	0	
Avio.	Open/close aft side of E/E	3	0	
Avio.	Remove/install Captain seat and several panels/linings in flight deck	29	0	
Mech.	Clean various locations before and after modification	36	36	
Avio.	Install wiring between flight deck, E/E and new components located in tail cone	214	214	
Sht.mtl.	Install provisions for filter installation in bulk cargo compt. RH	36	36	
Mech.	Install filter assy and element	7	7	
Sht.mtl.	Modify lwr. panel for fill adaptor/components	64	64	
Mech.	Install shut off valve and filter to shut off valve ducting	7	7	
Sht.mtl.	Install provision for compressor installation in tail cone	36	36	
Mech.	Install compressor and shut off valve to compressor ducting	10	10	
Sht.mtl.	Install provisions for bleed air items	29	29	
Sht.mtl.	Install provisions for header/ heat exchanger installation in tail cone	57	57	
Mech.	Install header assy, bleed air items and compressor to header assy ducting	29	29	
Mech.	Install heat exchanger on header assy	7	7	
Sht.mtl.	Drill and fit new ram air inlet/outlet fairing panels	71	71	
Mech.	Assemble and install ram air inlet/outlet panels,doors and motors	14	14	
Avio.	Assemble and install ram air inlet/outlet panels,doors and motors	14	14	
Sht.mtl.	Install provisions for electrically driven cooling fan installation	10	10	
Avio.	Install cooling fan to ram air exit	7	7	
Sht.mtl.	Install provisions for water seperator/filter and ASM installation	93	93	
Mech.	Install water seperator/filter and ASM systems	19	19	
Avio.	Install water seperator/filter and ASM systems	19	19	
Mech.	Install ducting from heat exch.to water seperator/filter, low flow/high flow ASM systems	21	21	
Mech.	Install HX bypass valve and ducting	5	5	
Sht.mtl.	Install provisions for high flow valve and relief valve installation	21	21	
Mech.	Install high flow valve, relief valve and ducting	14	14	
Sht.mtl.	Install feed through structural provision in CW tank	121	121	
Sht.mtl.	Install feed through and shut off valve provisions in fuselage skin (tail cone to cabin)	64	64	
Mech.	Install ducting from relief valve to CW tank	14	14	
Sht.mtl.	Install provisions for NEA gas distribution ducts in all 3 fuel tanks	107	107	
Mech.	Install NEA gas distribution system in all 3 fuel tanks	214	214	
Mech/Avio	Test PSA system (3x)	50	50	
Mech/Avio	Test several systems due to partial flight deck dismantling	64	64	
	Total manhours per aircraft	1651	1490	
Mech/Avio	Inspection mechanics/avionics	188	156	
Sht.mtl.	Inspection sheetmetal	71	71	
	Round off/unforeseen work	240	183	
	Total manhours including inspection	2150	1900	
NOTE: LABOR-HOURS BASED ON MINIMUM INFORMATION !!!				

Airplane type:		Description:	Special Program	Heavy Check
SMALL (Boeing 737)		ON-BOARD INERTING GAS GENERATING SYSTEM CRYOGENIC		
Skill	Description	labor hours	labor hours	
	Accomplishment:			
Mech.	Dock and undock airplane and raise and lower airplane	20	0	
Mech.	Defuel and drain all fuel tanks	14	0	
Mech.	Open, ventilate and close after modification all fuel tanks	31	0	
Mech.	Remove/install various internal fuel tank panels LH and RH for access	14	14	
Mech.	Remove/install several sidewall and ceiling panels in aft. cargo compt.R.H.	20	0	
Mech.	Remove/install several insulation blankets R.H.	14	0	
Mech.	Remove/install several seats, floorcovering and floorpanels in main cabin R.H.	21	0	
Avio.	Remove/install floor prox etc in main cabin R.H.	7	0	
Avio.	Open/close aft side of E/E	3	0	
Avio.	Remove/install Captain seat and several panels/linings in flight deck	29	0	
Mech.	Clean various locations before and after modification	36	36	
Avio.	Install wiring between flight deck,E/E and new components located in tail cone	214	214	
Sht.mtl.	Install provisions for filter installation in aft cargo compt.RH	36	36	
Mech.	Install filter assy and element	7	7	
Sht.mtl.	Modify lwr. panel for fill adaptor/components	64	64	
Mech.	Install shut off valve and filter to shut off valve ducting	7	7	
Sht.mtl.	Install provision for compressor installation in Tail Cone	36	36	
Mech.	Install compressor and shut off valve to compressor ducting	10	10	
Sht.mtl.	Install provisions for bleed air items	29	29	
Sht.mtl.	Install provisions for header/ heat exchanger installation in tail cone	57	57	
Mech.	Install header assy, bleed air items and compressor to header assy ducting	29	29	
Mech.	Install heat exchanger on header assy	7	7	
Sht.mtl.	Drill and fit new ram air inlet/outlet fairing panels	71	71	
Mech.	Assemble and install ram air inlet/outlet panels,doors and motors	14	14	
Avio.	Assemble and install ram air inlet/outlet panels,doors and motors	14	14	
Sht.mtl.	Install provisions for electrically driven cooling fan installation	10	10	
Avio.	Install cooling fan to ram air exit	7	7	
Sht.mtl.	Install provisions for storage syst.,cryogenic refrigerator and distillation syst.installation	171	171	
Mech.	Install storage,cryogenic refrigerator and distillation systems	36	36	
Avio.	Install storage,cryogenic refrigerator and distillation systems	36	36	
Mech.	Install ducting from heat exchanger to refrigerator,distillation and storage systems	21	21	
Mech.	Install HX bypass valve and ducting	5	5	
Sht.mtl.	Install provisions for modulating valve and relief valve installation	21	21	
Mech.	Install modulating valve, relief valve and ducting	14	14	
Sht.mtl.	Install feed through structural provision in CW tank	121	121	
Sht.mtl.	Install feed through and shut off valve provisions in fuselage skin (tail cone to cabin)	64	64	
Mech.	Install ducting from relief valve to CW tank	14	14	
Sht.mtl.	Install provisions for NEA gas distribution ducts in all 3 fuel tanks	107	107	
Mech.	Install NEA gas distribution system in all 3 fuel tanks	214	214	
Mech/Avio	Test cryogenic distillation system (3x)	50	50	
Mech/Avio	Test several systems due to partial flight deck dismantling	64	64	
	Total manhours per aircraft	1764	1603	
Mech/Avio	Inspection mechanics/avionics	195	163	
Sht.mtl.	Inspection sheetmetal	79	79	
	Round off/unforeseen work	212	205	
	Total manhours including inspection	2250	2050	
NOTE: LABOR-HOURS BASED ON MINIMUM INFORMATION !!!				

Airplane type: SMALL <i>(Boeing 737)</i>		Description: Ground Based Inerting Systems	Special Program	Heavy Check
Skill	Description	labor hours	labor hours	
	Accomplishment:			
Mech.	Dock and undock airplane and raise and lower airplane	11	0	
Mech.	Defuel and drain CW tank	3	0	
Mech.	Open, ventilate and close after modification CW tank	14	0	
Avio.	Open/close aft side of E/E	3	0	
Mech.	Remove/reinstall RH seats, carpet, floorpanels above RH cable raceway	29	0	
Avio.	Remove/reinstall floorprox, seat to seat cables and raceways RH	14	0	
Mech.	Remove/reinstall ceiling panels in aft cargo compt. for access to cable raceways	7	0	
Avio.	Remove/install Captain seat and several panels/linings in flight deck	43	0	
Mech.	Clean various locations before modification	44	43	
Avio.	Install wiring between flight deck, Avionics comp. and new components in center section	157	157	
Sht.mtl.	Install feed through structural provisions in CW tank aft skin	157	157	
Sht.mtl.	Install provisions for distribution manifold in CW tank	57	57	
Mech.	Install distribution manifold in CW tank	100	100	
Sht.mtl.	Install provisions for thermal relief valve and isolation valve installation	14	14	
Mech.	Install thermal relief valve and isolation valve	7	7	
Sht.mtl.	Modify lwr. panel for fill adaptor/components	14	14	
Mech.	Inst. double wall pipe, witness drain etc. from fill panel to CW tank	21	21	
Mech/Avio	Test ground based distribution system (3x)	29	29	
Mech/Avio	Test several systems due to partial flight deck dismantling	100	100	
	Total manhours per aircraft	824	699	
Mech/Avio	Inspection mechanics/avionics	116	91	
Sht.mtl.	Inspection sheetmetal	24	24	
	Round off/unforeseen work	135	85	
	Total manhours including inspection	1100	900	
NOTE: LABOR-HOURS BASED ON MINIMUM INFORMATION !!!				

Airplane type: SMALL <i>(Boeing 737)</i>		Description: Ground Based Inerting Systems	Special Program	Heavy Check
Skill	Description	labor hours	labor hours	
	Accomplishment:			
Mech.	Dock and undock airplane and raise and lower airplane	11	0	
Mech.	Defuel and drain CW tank	3	0	
Mech.	Open, ventilate and close after modification CW tank	14	0	
Avio.	Open/close aft side of E/E	3	0	
Mech.	Remove/reinstall RH seats, carpet, floorpanels above RH cable raceway	29	0	
Avio.	Remove/reinstall floorprox, seat to seat cables and raceways RH	14	0	
Mech.	Remove/reinstall ceiling panels in aft cargo compt. for access to cable raceways	7	0	
Avio.	Remove/install Captain seat and several panels/linings in flight deck	43	0	
Mech.	Clean various locations before modification	44	43	
Avio.	Install wiring between flight deck, Avionics comp. and new components in center section	157	157	
Mech.	Remove, install and leak-check 7 center wing bagtank cells	150	150	
Shop	Modify 7 CW bagtank cells	150	150	
Sht.mtl.	Install feed through structural provisions in CW tank aft skin	157	157	
Sht.mtl.	Install provisions for distribution manifold in CW tank	150	150	
Mech.	Install distribution manifold in CW tank	100	100	
Mech.	Modify lwr. panel for fill adaptor/components	100	100	
Sht.mtl.	Install provisions for thermal relief valve and isolation valve installation	14	14	
Mech.	Install thermal relief valve and isolation valve	7	7	
Sht.mtl.	Inst. provisions for double wall pipe, witness drain etc. from fill panel to CW tank	14	14	
Mech.	Inst. double wall pipe, witness drain etc. from fill panel to CW tank	21	21	
Mech/Avio	Test ground based distribution system (3x)	29	29	
Mech/Avio	Test several systems due to partial flight deck dismantling	100	100	
	Total manhours per aircraft	1317	1192	
Mech/Avio	Inspection mechanics/avionics	196	171	
Sht.mtl.	Inspection sheetmetal	34	34	
	Round off/unforeseen work	203	153	
	Total manhours including inspection	1750	1550	
NOTE: LABOR-HOURS BASED ON MINIMUM INFORMATION !!!				

ADDENDUM F.A.3

***MODIFICATION LABOR-HOUR ESTIMATION for
BUSSINESS JETS***

**to
APPENDIX F**

**AIRPLANE OPERATION AND MAINTENANCE
FINAL REPORT**



Mark S. Reed
Sr. Vice President
Maintenance

April 23, 2001

RE: NPRM for Fuel System Modifications (Nitrogen Inerting)

Dear Mr. Peters,

Attached you will find several documents compiled by our Quality Control and Maintenance Scheduling departments. They expand on the information we briefly discussed during our conversation on April 18th. Hopefully, this material will improve your technical familiarity with the business-class aircraft we operate.

In the attachments you will find:

- A two page matrix showing; aircraft we operate on our air carrier certificate, whether or not they have center line fuel storage, and any potential heat sources adjacent to that fuel storage
- Simple maintenance manual references and diagrams for the systems described above
- A table showing routine fuel tank inspection intervals as well as heavy inspection intervals that would most likely be used to incorporate a major modification to the fuel tanks/system.

Executive Jet, Inc.
4111 Bridgeway Ave.
Columbus, OH 43219
Tel. (614) 239-2929
Fax (614) 239-2072
mreed@netjets.com

One other question presented was "How long would we estimate for a modification of this scope?" Without any engineering data, I can only estimate based on experience with other system changes that I believe would be similar. A very *rough order of magnitude* estimate would be 350 to 500 man-hours, but that is highly speculative.

I hope this information helps. If we can be of any further assistance, feel free to contact us.

Sincerely,

A handwritten signature in black ink, appearing to read "M. Reed", written in a cursive style.

Mark Reed

Executive Jet is a Berkshire Hathaway Inc. company

ADDENDUM F.B.1

SCHEDULED MAINTENANCE TASKS
and
ADDITIONAL LABOR-HOURS

to
APPENDIX F

AIRPLANE OPERATION AND MAINTENANCE
FINAL REPORT

This page intentionally left blank.

Airplane Operation and Maintenance Task Team Final Report

Task	Interval	Labor-hours
Operational check of entire system	A	3
Operational check of High flow ASM	C	2
Operational check of Low flow ASM	C	2
Functional check of entire system	2C	6
Functional check of Compressor	2C	2
Inspect High Flow Check Valve	2C	1
Inspect High Flow Shut Off Valve	2C	1
Inspect Controller / control card	2C	1
Inspect Oxygen Sensor	2C	1
Remove & Replace Filters	2C	1
Remove & Replace Nitrogen check valves	2C	1
Remove & Replace Heat Exchanger	4C	6
Inspect Manifolds/Ducts	4C	4
Inspect Wiring	4C	4
Inspect Bypass Valve	4C	1
Inspect Check valve Center wing	4C	1
Inspect Check valve L/H wing	4C	1
Inspect Check valve R/H wing	4C	1
Inspect Fuel Tank Check Valve	4C	1
Inspect Water separator	4C	1
Inspect Bleed Air Check Valve	4C	1
Inspect Bleed Air Shut Off Valve	4C	1
Inspect Compressor check valve	4C	1
Inspect Compressor discharge overheat switch	4C	1
Inspect Cooling fan	4C	1
Inspect Cooling fan overheat sensor	4C	1
Inspect Flow Control Orifice	4C	1
Inspect Heat Exchanger - check valve	4C	1
Inspect Over Temperature sensor	4C	1
Inspect Relief valve	4C	1
Inspect Start Contactor	4C	1
Inspect Unloading Valve	4C	1
Inspect Water separator filter	4C	1

Figure F6.2.1-1 - OBGI Maintenance Tasks - Business Jet Category

Airplane Operation and Maintenance Task Team Final Report

Task	Interval	Labor-hours
Operational check of entire system	A	3
Operational check of High flow ASM	C	2
Operational check of Low flow ASM	C	2
Functional check of entire system	2C	6
Functional check of Compressor	2C	2
Inspect High Flow Check Valve	2C	1
Inspect High Flow Shut Off Valve	2C	1
Inspect Controller / control card	2C	1
Inspect Oxygen Sensor	2C	1
Remove & Replace Filters	2C	1
Remove & Replace Nitrogen check valves	2C	1
Remove & Replace Heat Exchanger	4C	6
Inspect Manifolds/Ducts	4C	4
Inspect Wiring	4C	4
Inspect Bypass Valve	4C	1
Inspect Check valve Center wing	4C	1
Inspect Check valve L/H wing	4C	1
Inspect Check valve R/H wing	4C	1
Inspect Fuel Tank Check Valve	4C	1
Inspect Water separator	4C	1
Inspect Bleed Air Check Valve	4C	1
Inspect Bleed Air Shut Off Valve	4C	1
Inspect Compressor check valve	4C	1
Inspect Compressor discharge overheat switch	4C	1
Inspect Cooling fan	4C	1
Inspect Cooling fan overheat sensor	4C	1
Inspect Flow Control Orifice	4C	1
Inspect Heat Exchanger - check valve	4C	1
Inspect Over Temperature sensor	4C	1
Inspect Relief valve	4C	1
Inspect Start Contactor	4C	1
Inspect Unloading Valve	4C	1
Inspect Water separator filter	4C	1

Figure F6.2.1-3 - OBGI Maintenance Tasks - Turbofan Category

Airplane Operation and Maintenance Task Team Final Report

Task	Interval	Labor-hours
Operational check of entire system	A	3
Operational check of High flow ASM	C	2
Operational check of Low flow ASM	C	2
Functional check of entire system	2C	6
Functional check of Compressor	2C	2
Inspect High Flow Check Valve	2C	1
Inspect High Flow Shut Off Valve	2C	1
Inspect Controller / control card	2C	1
Inspect Oxygen Sensor	2C	1
Remove & Replace Filters	2C	1
Remove & Replace Nitrogen check valves	2C	1
Remove & Replace Heat Exchanger	4C	6
Inspect Manifolds/Ducts	4C	6
Inspect Wiring	4C	6
Inspect Bypass Valve	4C	1
Inspect Check valve Center wing	4C	1
Inspect Check valve L/H wing	4C	1
Inspect Check valve R/H wing	4C	1
Inspect Fuel Tank Check Valve	4C	1
Inspect Water separator	4C	1
Inspect Bleed Air Check Valve	4C	1
Inspect Bleed Air Shut Off Valve	4C	1
Inspect Compressor check valve	4C	1
Inspect Compressor discharge overheat switch	4C	1
Inspect Cooling fan	4C	1
Inspect Cooling fan overheat sensor	4C	1
Inspect Flow Control Orifice	4C	1
Inspect Heat Exchanger - check valve	4C	1
Inspect Over Temperature sensor	4C	1
Inspect Relief valve	4C	1
Inspect Start Contactor	4C	1
Inspect Unloading Valve	4C	1
Inspect Water separator filter	4C	1

Figure F6.2.1-5 - OBGI Maintenance Tasks - Medium Transport Category

Airplane Operation and Maintenance Task Team Final Report

Task	Interval	Labor-hours
Operational check of entire system	A	3
Operational check of High flow ASM	C	2
Operational check of Low flow ASM	C	2
Functional check of entire system	2C	6
Functional check of Compressor	2C	2
Inspect High Flow Check Valve	2C	1
Inspect High Flow Shut Off Valve	2C	1
Inspect Controller / control card	2C	1
Inspect Oxygen Sensor	2C	1
Remove & Replace Filters	2C	1
Remove & Replace Nitrogen check valves	2C	1
Remove & Replace Heat Exchanger	4C	6
Inspect Manifolds/Ducts	4C	4
Inspect Wiring	4C	4
Inspect Bypass Valve	4C	1
Inspect Check valve Center wing	4C	1
Inspect Check valve L/H wing	4C	1
Inspect Check valve R/H wing	4C	1
Inspect Fuel Tank Check Valve	4C	1
Inspect Water separator	4C	1
Inspect Bleed Air Check Valve	4C	1
Inspect Bleed Air Shut Off Valve	4C	1
Inspect Compressor check valve	4C	1
Inspect Compressor discharge overheat switch	4C	1
Inspect Cooling fan	4C	1
Inspect Cooling fan overheat sensor	4C	1
Inspect Flow Control Orifice	4C	1
Inspect Heat Exchanger - check valve	4C	1
Inspect Over Temperature sensor	4C	1
Inspect Relief valve	4C	1
Inspect Start Contactor	4C	1
Inspect Unloading Valve	4C	1
Inspect Water separator filter	4C	1

Figure F6.2.1-2 - OBGI Maintenance Tasks - Turboprop Category

Airplane Operation and Maintenance Task Team Final Report

Task	Interval	Labor-hours
Operational check of entire system	A	3
Operational check of High flow ASM	C	2
Operational check of Low flow ASM	C	2
Functional check of entire system	2C	6
Functional check of Compressor	2C	2
Inspect High Flow Check Valve	2C	1
Inspect High Flow Shut Off Valve	2C	1
Inspect Controller / control card	2C	1
Inspect Oxygen Sensor	2C	1
Remove & Replace Filters	2C	1
Remove & Replace Nitrogen check valves	2C	1
Remove & Replace Heat Exchanger	4C	6
Inspect Manifolds/Ducts	4C	4
Inspect Wiring	4C	4
Inspect Bypass Valve	4C	1
Inspect Check valve Center wing	4C	1
Inspect Check valve L/H wing	4C	1
Inspect Check valve R/H wing	4C	1
Inspect Fuel Tank Check Valve	4C	1
Inspect Water separator	4C	1
Inspect Bleed Air Check Valve	4C	1
Inspect Bleed Air Shut Off Valve	4C	1
Inspect Compressor check valve	4C	1
Inspect Compressor discharge overheat switch	4C	1
Inspect Cooling fan	4C	1
Inspect Cooling fan overheat sensor	4C	1
Inspect Flow Control Orifice	4C	1
Inspect Heat Exchanger - check valve	4C	1
Inspect Over Temperature sensor	4C	1
Inspect Relief valve	4C	1
Inspect Start Contactor	4C	1
Inspect Unloading Valve	4C	1
Inspect Water separator filter	4C	1

Figure F6.2.1-4 - OBGI Maintenance Tasks - Small Transport Category

Airplane Operation and Maintenance Task Team Final Report

Task	Interval	Labor-hours
Operational check of entire system	A	3
Operational check of High flow ASM	C	2
Operational check of Low flow ASM	C	2
Functional check of entire system	2C	6
Functional check of Compressor	2C	2
Inspect High Flow Check Valve	2C	1
Inspect High Flow Shut Off Valve	2C	1
Inspect Controller / control card	2C	1
Inspect Oxygen Sensor	2C	1
Remove & Replace Filters	2C	1
Remove & Replace Nitrogen check valves	2C	1
Remove & Replace Heat Exchanger	4C	6
Inspect Manifolds/Ducts	4C	8
Inspect Wiring	4C	8
Inspect Bypass Valve	4C	1
Inspect Check valve Center wing	4C	1
Inspect Check valve L/H wing	4C	1
Inspect Check valve R/H wing	4C	1
Inspect Fuel Tank Check Valve	4C	1
Inspect Water separator	4C	1
Inspect Bleed Air Check Valve	4C	1
Inspect Bleed Air Shut Off Valve	4C	1
Inspect Compressor check valve	4C	1
Inspect Compressor discharge overheat switch	4C	1
Inspect Cooling fan	4C	1
Inspect Cooling fan overheat sensor	4C	1
Inspect Flow Control Orifice	4C	1
Inspect Heat Exchanger - check valve	4C	1
Inspect Over Temperature sensor	4C	1
Inspect Relief valve	4C	1
Inspect Start Contactor	4C	1
Inspect Unloading Valve	4C	1
Inspect Water separator filter	4C	1

Figure F6.2.1-6 - OBGI Maintenance Tasks - Large Transport Category

Airplane Operation and Maintenance Task Team Final Report

Task	Interval	Labor-hours
Operational check of entire system	A	3
Pressure/Decay Check & rectification	C	24
Functional check of Compressor	C	2
Inspect Bypass Valve	C	1
Inspect Cryo-Cooler	C	1
Inspect Distillation Column - gas valve	C	1
Inspect Distillation Column - liquid valve	C	1
Inspect Fuel Tank Check Valve	C	1
Inspect Inlet Cooler	C	1
Inspect Inlet Recuperator	C	1
Inspect Water separator	C	1
Inspect Bleed Air Check Valve	C	1
Inspect Bleed Air Shut Off Valve	C	1
Inspect Compressor check valve	C	1
Inspect Compressor discharge overheat switch	C	1
Inspect Controller / control card	C	1
Inspect Cooling fan	C	1
Inspect Cooling fan overheat sensor	C	1
Inspect Cryocooler bleed air valve	C	1
Inspect Dewar level sensor	C	1
Inspect Heat Exchanger - check valve	C	1
Inspect High Flow Sensor	C	1
Inspect Inlet shutoff valve	C	1
Inspect LNEA Dewar Cooldown Valve	C	1
Inspect Molecular sieve control valve	C	1
Inspect On / Off check valve & High flow fuse	C	1
Inspect Over Temperature sensor	C	1
Inspect Oxygen Sensor	C	1
Inspect Purge Heat Exchanger - Air Valve	C	1
Inspect Purge Heat Exchanger - Waste Valve	C	1
Inspect Relief valve	C	1
Remove & Replace Cabin Filters	C	1
Functional check of entire system	2C	6
Remove & Replace Heat Exchanger	2C	6
Remove & Replace Molecular sieves	2C	4
Inspect Distillation Column	2C	2
Remove & Replace Nitrogen check valves	2C	1
Inspect Manifolds/Ducts	4C	4
Inspect Wiring	4C	4
Inspect LNEA Dewar	4C	2
Inspect Check valve Center wing	4C	1
Inspect Check valve L/H wing	4C	1
Inspect Check valve R/H wing	4C	1

Figure F7.2.1-1 - OBIGGS (Cryogenic) Maintenance Tasks - Small Transport Category

Airplane Operation and Maintenance Task Team Final Report

Task	Interval	Labor-hours
Operational check of entire system	A	3
Pressure/Decay Check & rectification	C	24
Functional check of Compressor	C	2
Operational check of High flow ASM	C	2
Operational check of Low flow ASM	C	2
Inspect Bypass Valve	C	1
Inspect Fuel Tank Check Valve	C	1
Inspect Water separator	C	1
Inspect Bleed Air Check Valve	C	1
Inspect Bleed Air Shut Off Valve	C	1
Inspect Compressor check valve	C	1
Inspect Compressor discharge overheat switch	C	1
Inspect Controller / control card	C	1
Inspect Cooling fan	C	1
Inspect Cooling fan overheat sensor	C	1
Inspect Heat Exchanger - check valve	C	1
Inspect High Flow Check Valve	C	1
Inspect High Flow Shut Off Valve	C	1
Inspect Low/High check valve	C	1
Inspect On / Off check valve & High flow fuse	C	1
Inspect Over Temperature sensor	C	1
Inspect Oxygen Sensor	C	1
Inspect Relief valve	C	1
Remove & Replace Cabin Filters	C	1
Inspect Water separator filter	C	1
Functional check of entire system	2C	8
Remove & Replace Heat Exchanger	2C	6
Remove & Replace Nitrogen check valves	2C	1
Inspect Manifolds/Ducts	4C	4
Inspect Wiring	4C	4
Inspect Check valve Center wing	4C	1
Inspect Check valve L/H wing	4C	1
Inspect Check valve R/H wing	4C	1

Figure F7.2.1-4 - OBIGGS (Membrane) Maintenance Tasks - Small Transport Category

Airplane Operation and Maintenance Task Team Final Report

Task	Interval	Labor-hours
Operational check of entire system	A	3
Pressure/Decay Check & rectification	C	24
Functional check of Compressor	C	2
Inspect Bypass Valve	C	1
Inspect Cryo-Cooler	C	1
Inspect Distillation Column - gas valve	C	1
Inspect Distillation Column - liquid valve	C	1
Inspect Fuel Tank Check Valve	C	1
Inspect Inlet Cooler	C	1
Inspect Inlet Recuperator	C	1
Inspect Water separator	C	1
Inspect Bleed Air Check Valve	C	1
Inspect Bleed Air Shut Off Valve	C	1
Inspect Compressor check valve	C	1
Inspect Compressor discharge overheat switch	C	1
Inspect Controller / control card	C	1
Inspect Cooling fan	C	1
Inspect Cooling fan overheat sensor	C	1
Inspect Cryocooler bleed air valve	C	1
Inspect Dewar level sensor	C	1
Inspect Heat Exchanger - check valve	C	1
Inspect High Flow Sensor	C	1
Inspect Inlet shutoff valve	C	1
Inspect LNEA Dewar Cooldown Valve	C	1
Inspect Molecular sieve control valve	C	1
Inspect On / Off check valve & High flow fuse	C	1
Inspect Over Temperature sensor	C	1
Inspect Oxygen Sensor	C	1
Inspect Purge Heat Exchanger - Air Valve	C	1
Inspect Purge Heat Exchanger - Waste Valve	C	1
Inspect Relief valve	C	1
Remove & Replace Cabin Filters	C	1
Functional check of entire system	2C	6
Remove & Replace Heat Exchanger	2C	6
Remove & Replace Molecular sieves	2C	4
Inspect Distillation Column	2C	2
Remove & Replace Nitrogen check valves	2C	1
Inspect Manifolds/Ducts	4C	6
Inspect Wiring	4C	6
Inspect LNEA Dewar	4C	2
Inspect Check valve Center wing	4C	1
Inspect Check valve L/H wing	4C	1
Inspect Check valve R/H wing	4C	1

Figure F7.2.1-2 - OBIGGS (Cryogenic) Maintenance Tasks - Medium Transport Category

Airplane Operation and Maintenance Task Team Final Report

Task	Interval	Labor-hours
Operational check of entire system	A	3
Pressure/Decay Check & rectification	C	24
Functional check of Compressor	C	2
Operational check of High flow ASM	C	2
Operational check of Low flow ASM	C	2
Inspect Bypass Valve	C	1
Inspect Fuel Tank Check Valve	C	1
Inspect Water separator	C	1
Inspect Bleed Air Check Valve	C	1
Inspect Bleed Air Shut Off Valve	C	1
Inspect Compressor check valve	C	1
Inspect Compressor discharge overheat switch	C	1
Inspect Controller / control card	C	1
Inspect Cooling fan	C	1
Inspect Cooling fan overheat sensor	C	1
Inspect Heat Exchanger - check valve	C	1
Inspect High Flow Check Valve	C	1
Inspect High Flow Shut Off Valve	C	1
Inspect Low/High check valve	C	1
Inspect On / Off check valve & High flow fuse	C	1
Inspect Over Temperature sensor	C	1
Inspect Oxygen Sensor	C	1
Inspect Relief valve	C	1
Remove & Replace Cabin Filters	C	1
Inspect Water separator filter	C	1
Functional check of entire system	2C	8
Remove & Replace Heat Exchanger	2C	6
Remove & Replace Nitrogen check valves	2C	1
Inspect Manifolds/Ducts	4C	6
Inspect Wiring	4C	6
Inspect Check valve Center wing	4C	1
Inspect Check valve L/H wing	4C	1
Inspect Check valve R/H wing	4C	1

Figure F7.2.1-5 - OBIGGS (Membrane) Maintenance Tasks - Medium Transport Category

Airplane Operation and Maintenance Task Team Final Report

Task	Interval	Labor-hours
Operational check of entire system	A	3
Pressure/Decay Check & rectification	C	24
Functional check of Compressor	C	2
Inspect Bypass Valve	C	1
Inspect Cryo-Cooler	C	1
Inspect Distillation Column - gas valve	C	1
Inspect Distillation Column - liquid valve	C	1
Inspect Fuel Tank Check Valve	C	1
Inspect Inlet Cooler	C	1
Inspect Inlet Recuperator	C	1
Inspect Water separator	C	1
Inspect Bleed Air Check Valve	C	1
Inspect Bleed Air Shut Off Valve	C	1
Inspect Compressor check valve	C	1
Inspect Compressor discharge overheat switch	C	1
Inspect Controller / control card	C	1
Inspect Cooling fan	C	1
Inspect Cooling fan overheat sensor	C	1
Inspect Cryocooler bleed air valve	C	1
Inspect Dewar level sensor	C	1
Inspect Heat Exchanger - check valve	C	1
Inspect High Flow Sensor	C	1
Inspect Inlet shutoff valve	C	1
Inspect LNEA Dewar Cooldown Valve	C	1
Inspect Molecular sieve control valve	C	1
Inspect On / Off check valve & High flow fuse	C	1
Inspect Over Temperature sensor	C	1
Inspect Oxygen Sensor	C	1
Inspect Purge Heat Exchanger - Air Valve	C	1
Inspect Purge Heat Exchanger - Waste Valve	C	1
Inspect Relief valve	C	1
Remove & Replace Cabin Filters	C	1
Functional check of entire system	2C	6
Remove & Replace Heat Exchanger	2C	6
Remove & Replace Molecular sieves	2C	4
Inspect Distillation Column	2C	2
Remove & Replace Nitrogen check valves	2C	1
Inspect Manifolds/Ducts	4C	8
Inspect Wiring	4C	8
Inspect LNEA Dewar	4C	2
Inspect Check valve Center wing	4C	1
Inspect Check valve L/H wing	4C	1
Inspect Check valve R/H wing	4C	1

Figure F7.2.1-3 - OBIGGS (Cryogenic) Maintenance Tasks - Large Transport Category

Airplane Operation and Maintenance Task Team Final Report

Task	Interval	Labor-hours
Operational check of entire system	A	3
Pressure/Decay Check & rectification	C	24
Functional check of Compressor	C	2
Operational check of High flow ASM	C	2
Operational check of Low flow ASM	C	2
Inspect Bypass Valve	C	1
Inspect Fuel Tank Check Valve	C	1
Inspect Water separator	C	1
Inspect Bleed Air Check Valve	C	1
Inspect Bleed Air Shut Off Valve	C	1
Inspect Compressor check valve	C	1
Inspect Compressor discharge overheat switch	C	1
Inspect Controller / control card	C	1
Inspect Cooling fan	C	1
Inspect Cooling fan overheat sensor	C	1
Inspect Heat Exchanger - check valve	C	1
Inspect High Flow Check Valve	C	1
Inspect High Flow Shut Off Valve	C	1
Inspect Low/High check valve	C	1
Inspect On / Off check valve & High flow fuse	C	1
Inspect Over Temperature sensor	C	1
Inspect Oxygen Sensor	C	1
Inspect Relief valve	C	1
Remove & Replace Cabin Filters	C	1
Inspect Water separator filter	C	1
Functional check of entire system	2C	8
Remove & Replace Heat Exchanger	2C	6
Remove & Replace Nitrogen check valves	2C	1
Inspect Manifolds/Ducts	4C	8
Inspect Wiring	4C	8
Inspect Check valve Center wing	4C	1
Inspect Check valve L/H wing	4C	1
Inspect Check valve R/H wing	4C	1

Figure F7.2.1-6 - OBIGGS (Membrane) Maintenance Tasks - Large Transport Category

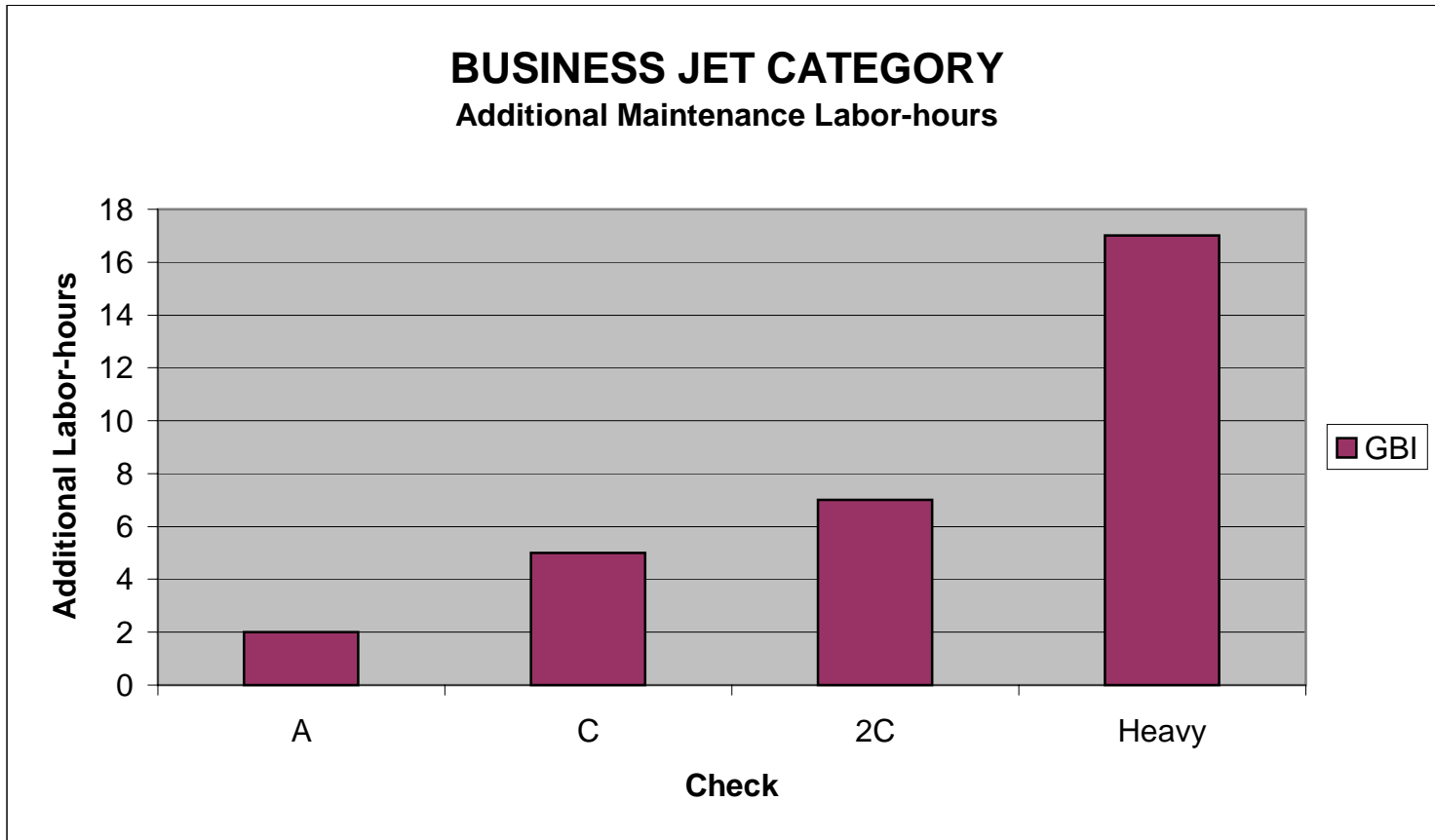

Figure F3.3-1 - Additional Maintenance Labor-hours - Business Jet Category

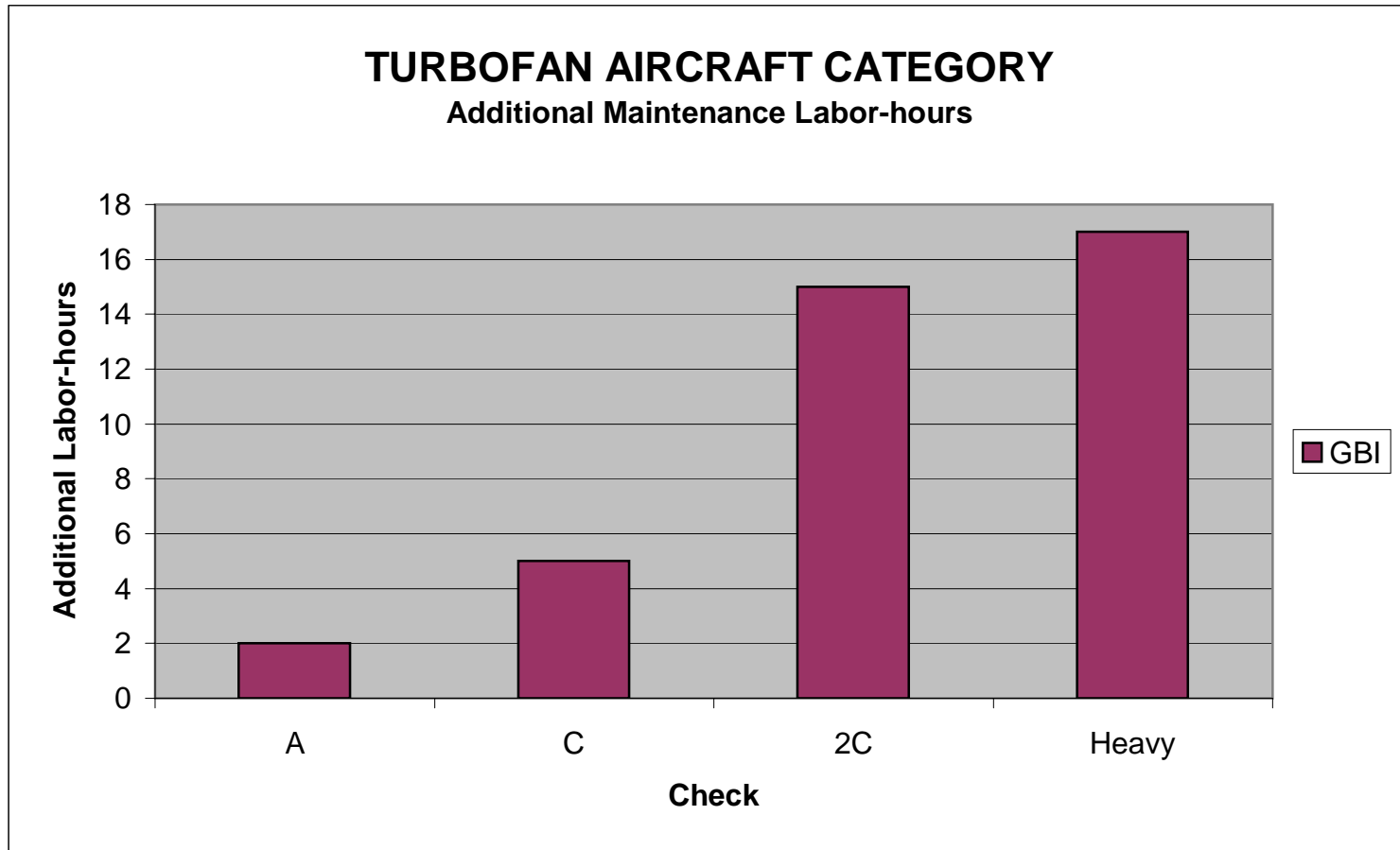

Figure F3.3-2 - Additional Maintenance Labor-hours - Turbofan Category

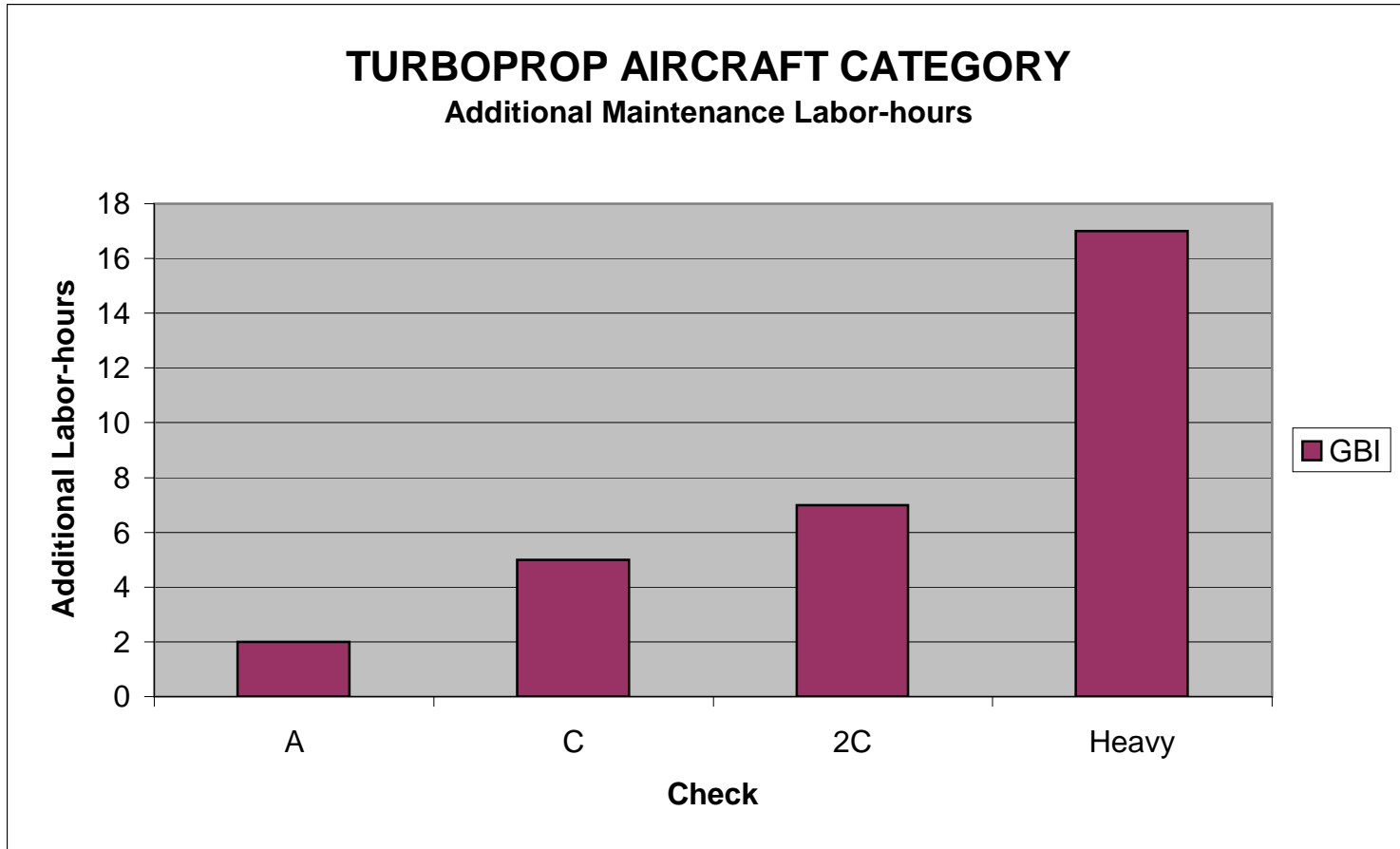

Figure F3.3-3 - Additional Maintenance Labor-hours - Turboprop Category

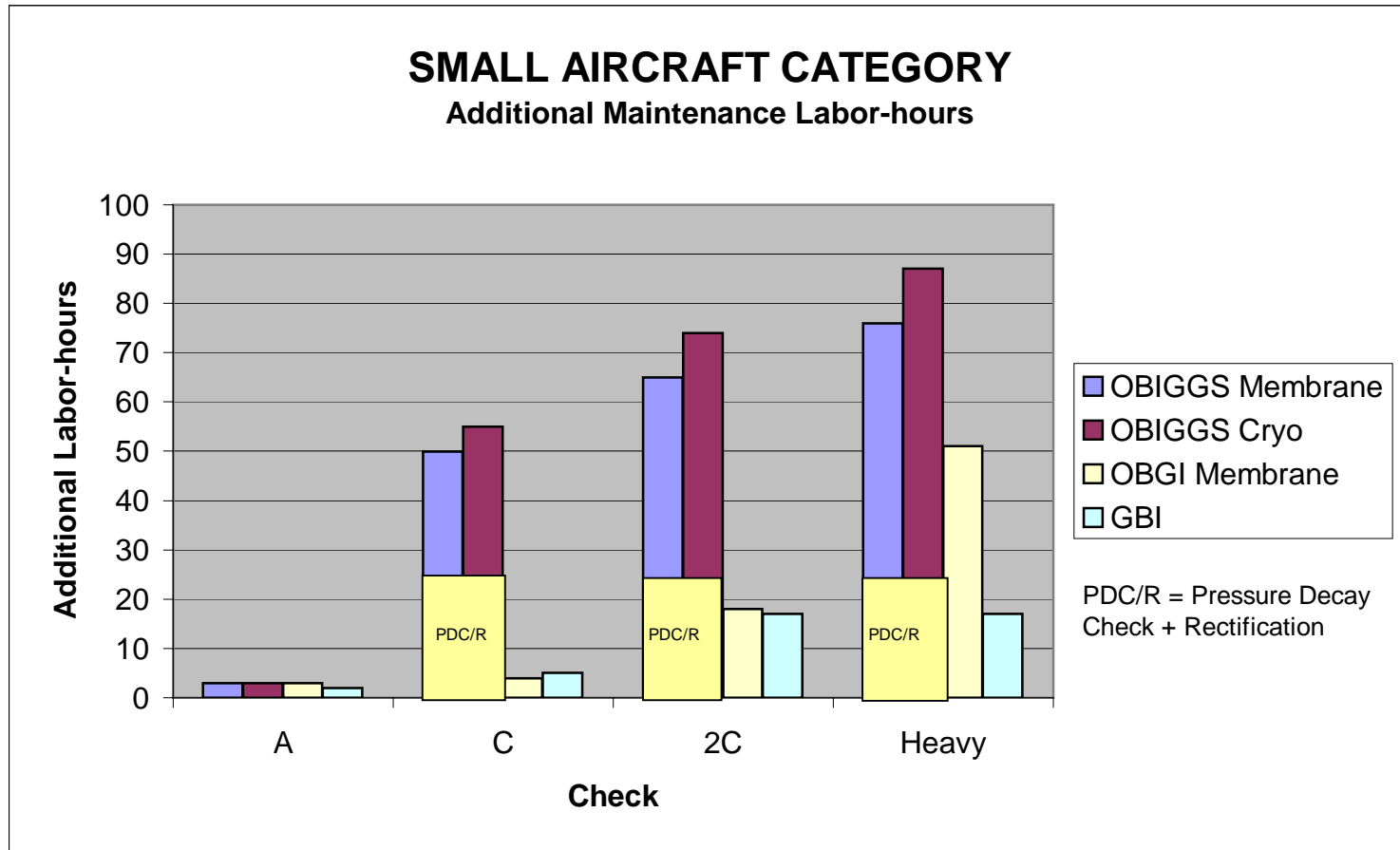

Figure F3.3-4 - Additional Maintenance Labor-hours - Small Aircraft Category

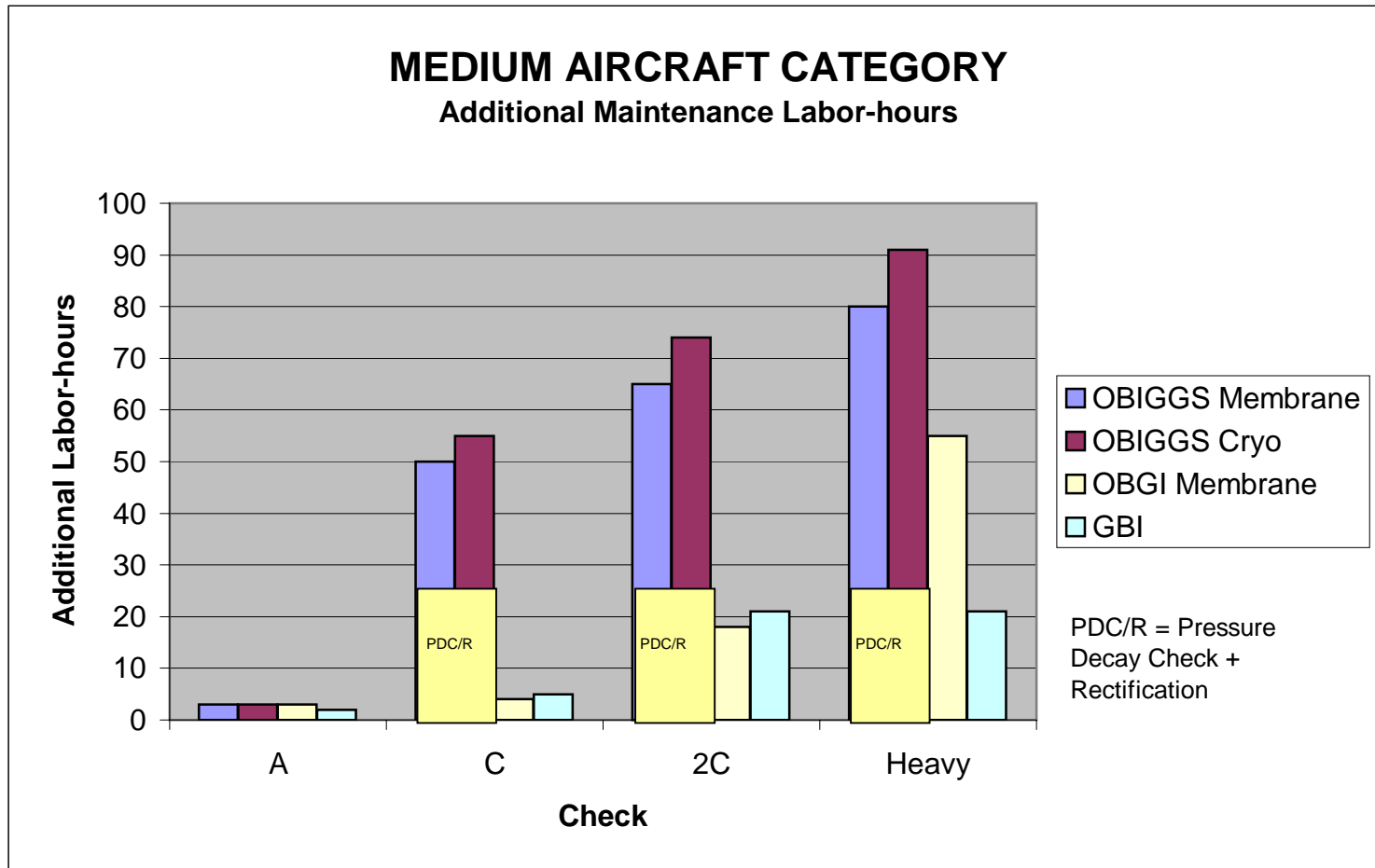

Figure F3.3-5 - Additional Maintenance Labor-hours - Medium Aircraft Category

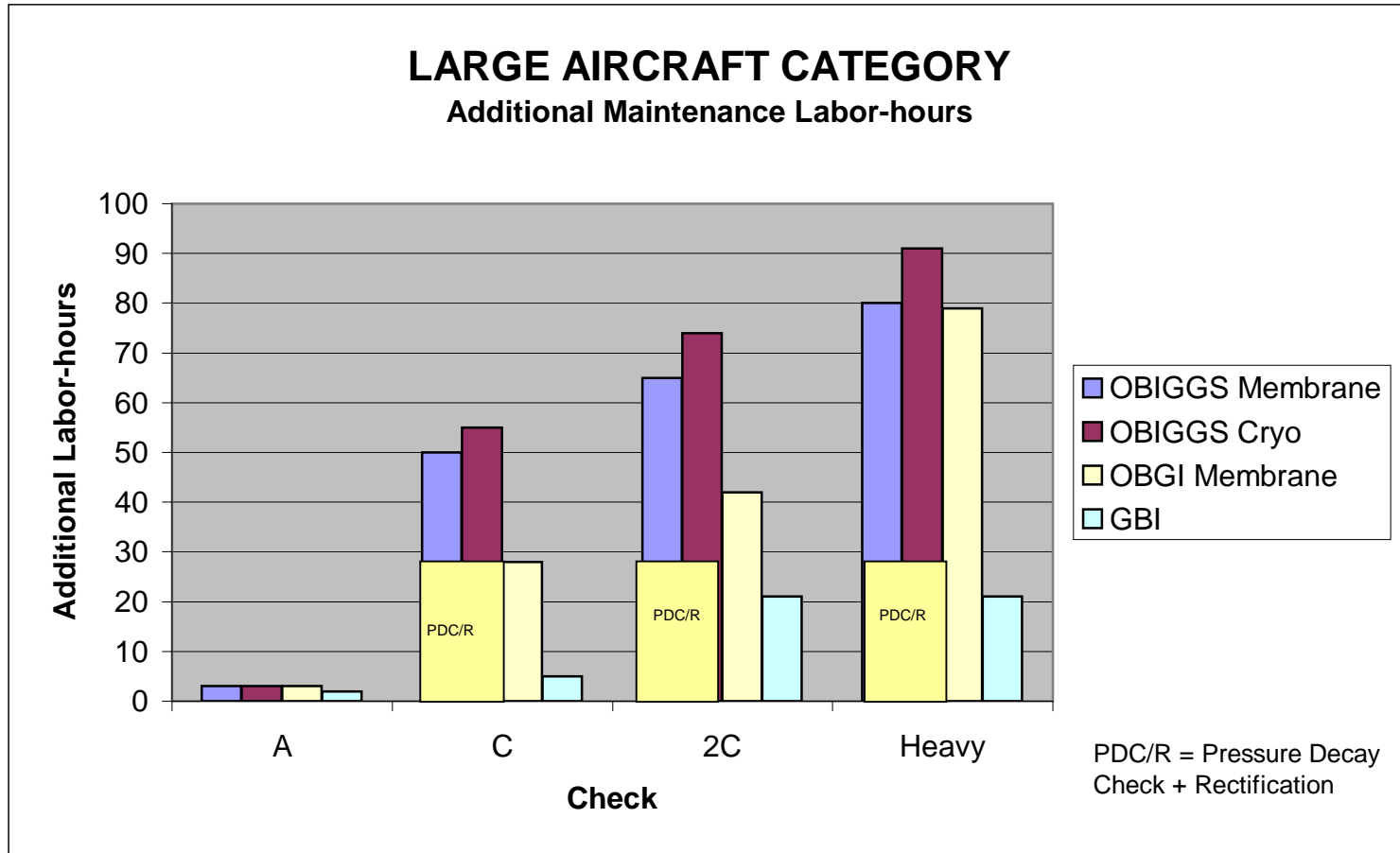

Figure F3.3-6 - Additional Maintenance Labor-hours - Large Aircraft Category

This page intentionally left blank.

ADDENDUM F.C.1

***UN-SCHEDULED MAINTENANCE DATA
GROUND BASED INERTING SYSTEM***

to

APPENDIX F

**AIRPLANE OPERATION AND MAINTENANCE
FINAL REPORT**

Airplane Operation and Maintenance Task Team Final Report

This page intentionally left blank.

Airplane Operation and Maintenance Task Team Final Report

Large Transport

Component	Unit MTBMA	Unit MTBF	Quantity /Shipset	Single Component MTBUR Calc (Hrs)	Component MTBUR Calc (System) (Hrs)	Removal & Replacement Time Man Hours	Access Time Man Hours	Trouble-Shooting Time Man Hours	Annual Failure Rate	Labor Hours Per Year
Isolation valve (including thermal relief valve)	187,770	208,600	1	24,446	24,446	2	7	1	0.17	1.67
Non return valve	362,028	402,253	1	41,995	41,995	1	7	1	0.10	0.87
Self sealing coupling (including frangible fitting)	422,535	469,483	1	80,000	80,000	1	1	0.5	0.05	0.13
Ducting (including double wall pipe and distribution manifold)	10,000,000	10,000,000	1	80,000	80,000	2	2	1	0.05	0.26
Wiring	10,000,000	10,000,000	1	80,000	80,000	1	2	1	0.05	0.20
System Totals			5		9,783				0.42	3.13

Medium Transport

Component	Unit MTBMA	Unit MTBF	Quantity /Shipset	Single Component MTBUR Calc (Hrs)	Component MTBUR Calc (System) (Hrs)	Removal & Replacement Time Man Hours	Access Time Man Hours	Trouble-Shooting Time Man Hours	Annual Failure Rate	Labor Hours Per Year
Isolation valve (including thermal relief valve)	187,770	208,600	1	24,446	24,446	2	6	1	0.11	1.03
Non return valve	362,028	402,253	1	41,995	41,995	1	6	1	0.07	0.53
Self sealing coupling (including frangible fitting)	422,535	469,483	1	80,000	80,000	1	1	0.5	0.03	0.09
Ducting (including double wall pipe and distribution manifold)	10,000,000	10,000,000	1	80,000	80,000	2	2	1	0.03	0.17
Wiring	10,000,000	10,000,000	1	80,000	80,000	1	2	1	0.03	0.14
System Totals			5		9,783				0.29	1.96

Small Transport

Component	Unit MTBMA	Unit MTBF	Quantity /Shipset	Single Component MTBUR Calc (Hrs)	Component MTBUR Calc (System) (Hrs)	Removal & Replacement Time Man Hours	Access Time Man Hours	Trouble-Shooting Time Man Hours	Annual Failure Rate	Labor Hours Per Year
Isolation valve (including thermal relief valve)	187,770	208,600	1	24,446	24,446	2	6	1	0.12	1.06

Airplane Operation and Maintenance Task Team Final Report

Non return valve	362,028	402,253	1	41,995	41,995	1	6	1	0.07	0.55
Self sealing coupling (including frangible fitting)	422,535	469,483	1	80,000	80,000	1	1	0.5	0.04	0.09
Ducting (including double wall pipe and distribution manifold)	10,000,000	10,000,000	1	80,000	80,000	2	2	1	0.04	0.18
Wiring	10,000,000	10,000,000	1	80,000	80,000	1	2	1	0.04	0.14
System Totals			5		9,783				0.29	2.02

Regional Turbofan

Component	Unit MTBMA	Unit MTBF	Quantity /Shipset	Single Component MTBUR Calc (Hrs)	Component MTBUR Calc (System) (Hrs)	Removal & Replacement Time Man Hours	Access Time Man Hours	Trouble-Shooting Time Man Hours	Annual Failure Rate	Labor Hours Per Year
Isolation valve (including thermal relief valve)	187,770	208,600	1	24,446	24,446	2	5	1	0.09	0.69
Non return valve	362,028	402,253	1	41,995	41,995	1	5	1	0.05	0.35
Self sealing coupling (including frangible fitting)	422,535	469,483	1	80,000	80,000	1	1	0.5	0.03	0.07
Ducting (including double wall pipe and distribution manifold)	10,000,000	10,000,000	1	80,000	80,000	2	2	1	0.03	0.13
Wiring	10,000,000	10,000,000	1	80,000	80,000	1	2	1	0.03	0.11
System Totals			5		9,783				0.22	1.35

Regional Turboprop

Component	Unit MTBMA	Unit MTBF	Quantity /Shipset	Single Component MTBUR Calc (Hrs)	Component MTBUR Calc (System) (Hrs)	Removal & Replacement Time Man Hours	Access Time Man Hours	Trouble-Shooting Time Man Hours	Annual Failure Rate	Labor Hours Per Year
Isolation valve (including thermal relief valve)	187,770	208,600	1	24,446	24,446	2	5	1	0.12	0.97
Non return valve	362,028	402,253	1	41,995	41,995	1	5	1	0.07	0.49
Self sealing coupling (including frangible fitting)	422,535	469,483	1	80,000	80,000	1	1	0.5	0.04	0.09
Ducting (including double wall pipe and distribution manifold)	10,000,000	10,000,000	1	80,000	80,000	2	2	1	0.04	0.18
Wiring	10,000,000	10,000,000	1	80,000	80,000	1	2	1	0.04	0.15
System Totals			5		9,783				0.30	1.89

Business Jet

Airplane Operation and Maintenance Task Team Final Report

Component	Unit MTBMA		Quantity /Shipset	Single Component MTBUR Calc (Hrs)	Component MTBUR Calc (System) (Hrs)	Removal & Replacement Time Man Hours	Access Time Man Hours	Trouble-Shooting Time Man Hours	Annual Failure Rate	Labor Hours Per Year
	Unit MTBMA	Unit MTBF								
Isolation valve (including thermal relief valve)	187,770	208,600	1	24,446	24,446	2	6	1	0.02	0.18
Non return valve	362,028	402,253	1	41,995	41,995	1	6	1	0.01	0.10
Self sealing coupling (including frangible fitting)	422,535	469,483	1	80,000	80,000	1	1	0.5	0.01	0.02
Ducting (including double wall pipe and distribution manifold)	10,000,000	10,000,000	1	80,000	80,000	2	2	1	0.01	0.03
Wiring	10,000,000	10,000,000	1	80,000	80,000	1	2	1	0.01	0.03
System Totals			5		9,783				0.05	0.35

Airplane Operation and Maintenance Task Team Final Report

This page intentionally left blank.

ADDENDUM F.C.2

***UN-SCHEDULED MAINTENANCE DATA
ON-BOARD GROUND INERTING SYSTEM***

to

APPENDIX F

**AIRPLANE OPERATION AND MAINTENANCE
FINAL REPORT**

Airplane Operation and Maintenance Task Team Final Report

This page intentionally left blank.

Airplane Operation and Maintenance Task Team Final Report

**ON-BOARD GROUND INERTING SYSTEM PARTS LIST
DUAL FLOW MEMBRANE - Reliability Estimate Data**

Component	Unit MTBMA	Unit MTBF	Quantity /Shipset	Single Component MTBUR Calc (Hrs)	Component MTBUR Calc (System) (Hrs)	Removal & Replacement Time Man Hours	Access Time Man Hours	Trouble-Shooting Time Man Hours	Annual Failure Rate	Labor Hours Per Year	Delays Per Year (Minutes)
Small Transport											
Cabin air filter assy	100,000	100,000	1	100,000	100,000	1	1	1	0.03	0.09	1.72
Cabin air filter element	4,000	10,000,000	1	8,000	8,000	1	1	1	0.24	0.72	14.37
Compressor unloading valve	50,000	50,000	1	38,315	38,315	1	0.5	0.5	0.05	0.10	3.00
Compressor	7,000	100,000	1	11,096	11,096	2	0.5	0.5	0.17	0.52	10.36
Compressor discharge check valve	100,000	100,000	1	34,119	34,119	1	0.5	1.5	0.06	0.17	3.37
Bleed shutoff valve	50,000	50,000	1	48,856	48,856	1	1	1	0.06	0.18	3.52
Bleed check valve	100,000	100,000	1	34,119	34,119	1	1	1	0.08	0.25	5.05
Heat exchanger	100,000	100,000	1	11,621	11,621	2	1	1	0.25	0.99	14.81
Cooling fan	25,000	25,000	1	58,561	58,561	1	1	0.5	0.03	0.08	1.96
Bypass valve	50,000	50,000	1	47,737	47,737	1	1	1	0.04	0.12	2.41
Temperature sensor	50,000	50,000	2	52,494	26,247	2	2	4	0.11	0.87	6.56
Water separator/filter assy	100,000	100,000	1	53,789	53,789	1	1	1	0.05	0.16	3.20
Water separator/filter element	4,000	10,000,000	1	4,000	4,000	1	1	1	0.48	1.44	28.74
Air separation module	30,000	30,000	1	20,000	20,000	2	1	6	0.10	0.86	5.75
Relief valve	50,000	50,000	1	53,306	53,306	2	1	2	0.04	0.18	2.16
Oxygen sensor	26,933	26,933	1	26,933	26,933	1	1	1	0.11	0.32	6.39
Fuel tank check valve	100,000	100,000	5	100,000	20,000	1	24	8	0.14	4.73	8.61
Controller / control card	10,000	10,000	1	10,000	10,000	1	1	2	0.19	0.77	11.50
Ducting	10,000,000	10,000,000	1	80,000	80,000	6	2	2	0.04	0.36	2.15
Wiring	10,000,000	10,000,000	1	80,000	80,000	6	2	8	0.04	0.57	2.15
System Totals			25		960	35	44.5	44	2.30	13.48	137.79

Airplane Operation and Maintenance Task Team Final Report

**ON-BOARD GROUND INERTING SYSTEM PARTS LIST
DUAL FLOW MEMBRANE - Reliability Estimate Data**

Component	Unit MTBMA	Unit MTBF	Quantity /Shipset	Single Component MTBUR Calc (Hrs)	Component MTBUR Calc (System) (Hrs)	Removal & Replacement Time Man Hours	Access Time Man Hours	Trouble-Shooting Time Man Hours	Annual Failure Rate	Labor Hours Per Year	Delays Per Year (Minutes)
Medium Transport											
Cabin air filter assy	100,000	100,000	1	100,000	100,000	1	1	1	0.03	0.08	1.26
Cabin air filter element	4,000	10,000,000	1	8,000	8,000	1	1	1	0.16	0.48	7.19
Compressor unloading valve	50,000	50,000	1	38,315	38,315	1	0.5	0.5	0.03	0.07	1.50
Compressor	7,000	100,000	1	11,096	11,096	3	0.5	0.5	0.12	0.46	5.18
Compressor discharge check valve	100,000	100,000	1	34,119	34,119	1	0.5	1.5	0.04	0.11	1.68
Bleed shutoff valve	50,000	50,000	1	48,856	48,856	1	1	1	0.06	0.17	2.57
Bleed check valve	100,000	100,000	1	34,119	34,119	1	1	1	0.08	0.25	3.68
Heat exchanger	100,000	100,000	1	11,621	11,621	4	1	1	0.24	1.44	10.81
Cooling fan	25,000	25,000	1	58,561	58,561	1	1	0.5	0.02	0.05	0.98
Bypass valve	50,000	50,000	1	47,737	47,737	1	1	1	0.03	0.08	1.20
Temperature sensor	50,000	50,000	2	52,494	26,247	1	1	2	0.11	0.43	4.79
Water separator/filter assy	100,000	100,000	1	53,789	53,789	1	1	1	0.05	0.16	2.34
Water separator/filter element	4,000	10,000,000	1	4,000	4,000	1	1	1	0.32	0.96	14.37
Air separation module	30,000	30,000	1	20,000	20,000	9	2	6	0.06	1.09	2.87
Relief valve	50,000	50,000	1	53,306	53,306	2	1	2	0.02	0.12	1.08
Oxygen sensor	26,933	26,933	1	26,933	26,933	1	1	1	0.10	0.31	4.67
Fuel tank check valve	100,000	100,000	5	100,000	20,000	1	24	8	0.14	4.61	6.28
Controller / control card	10,000	10,000	1	10,000	10,000	1	1	2	0.13	0.51	5.75
Ducting	10,000,000	10,000,000	1	80,000	80,000	6	2	2	0.03	0.35	1.57
Wiring	10,000,000	10,000,000	1	80,000	80,000	6	2	8	0.03	0.56	1.57
System Totals			25		960	44	44.5	42	1.81	12.28	81.35

Airplane Operation and Maintenance Task Team Final Report

**ON-BOARD GROUND INERTING SYSTEM PARTS LIST
DUAL FLOW MEMBRANE - Reliability Estimate Data**

Component	Unit MTBMA	Unit MTBF	Quantity /Shipset	Single Component MTBUR Calc (Hrs)	Component MTBUR Calc (System) (Hrs)	Removal & Replacement Time Man Hours	Access Time Man Hours	Trouble-Shooting Time Man Hours	Annual Failure Rate	Labor Hours Per Year	Delays Per Year (Minutes)
Large Transport											
Cabin air filter assy	100,000	100,000	1	100,000	100,000	1	1	1	0.04	0.12	1.22
Cabin air filter element	4,000	10,000,000	1	8,000	8,000	1	1	1	0.14	0.41	4.11
Compressor unloading valve	50,000	50,000	1	38,315	38,315	1	0.5	0.5	0.03	0.06	0.86
Compressor	7,000	100,000	1	11,096	11,096	18	2	1	0.10	2.07	2.96
Compressor discharge check valve	100,000	100,000	1	34,119	34,119	1	0.5	1.5	0.03	0.10	0.96
Bleed shutoff valve	50,000	50,000	1	48,856	48,856	1	1	1	0.08	0.25	2.51
Bleed check valve	100,000	100,000	1	34,119	34,119	1	1	1	0.12	0.36	3.59
Heat exchanger	100,000	100,000	1	11,621	11,621	4	1	1	0.35	2.11	10.53
Cooling fan	25,000	25,000	1	58,561	58,561	1	1	0.5	0.02	0.05	0.56
Bypass valve	50,000	50,000	1	47,737	47,737	1	1	1	0.02	0.07	0.69
Temperature sensor	50,000	50,000	2	52,494	26,247	1	1	2	0.16	0.62	4.66
Water separator/filter assy	100,000	100,000	1	53,789	53,789	1	1	1	0.08	0.23	2.28
Water separator/filter element	4,000	10,000,000	1	4,000	4,000	1	1	1	0.27	0.82	8.21
Air separation module	30,000	30,000	1	20,000	20,000	18	2	6	0.05	1.42	1.64
Relief valve	50,000	50,000	1	53,306	53,306	2	1	2	0.02	0.10	0.62
Oxygen sensor	26,933	26,933	1	26,933	26,933	1	1	1	0.15	0.45	4.55
Fuel tank check valve	100,000	100,000	5	100,000	20,000	1	24	8	0.20	6.73	6.12
Controller / control card	10,000	10,000	1	10,000	10,000	1	1	2	0.11	0.44	3.29
Ducting	10,000,000	10,000,000	1	80,000	80,000	6	2	2	0.05	0.51	1.53
Wiring	10,000,000	10,000,000	1	80,000	80,000	6	2	8	0.05	0.82	1.53
System Totals			25		960	68	46	42.5	2.08	17.74	62.41

Airplane Operation and Maintenance Task Team Final Report

**ON-BOARD GROUND INERTING SYSTEM PARTS LIST
DUAL FLOW MEMBRANE - Reliability Estimate Data**

Component	Unit MTBMA	Unit MTBF	Quantity /Shipset	Single Component MTBUR Calc (Hrs)	Component MTBUR Calc (System) (Hrs)	Removal & Replacement Time Man Hours	Access Time Man Hours	Trouble-Shooting Time Man Hours	Annual Failure Rate	Labor Hours Per Year	Delays Per Year (Minutes)
Business Jet											
Cabin air filter assy	100,000	100,000	1	100,000	100,000	1	1	1	0.01	0.02	0.30
Cabin air filter element	4,000	10,000,000	1	8,000	8,000	1	1	1	0.05	0.14	2.74
Compressor unloading valve	50,000	50,000	1	38,315	38,315	1	0.5	0.5	0.01	0.02	0.57
Compressor	7,000	100,000	1	11,096	11,096	2	0.5	0.5	0.03	0.10	1.97
Compressor discharge check valve	100,000	100,000	1	34,119	34,119	1	0.5	1.5	0.01	0.03	0.64
Bleed shutoff valve	50,000	50,000	1	48,856	48,856	1	1	1	0.01	0.03	0.61
Bleed check valve	100,000	100,000	1	34,119	34,119	1	1	1	0.01	0.04	0.88
Heat exchanger	100,000	100,000	1	11,621	11,621	2	1	1	0.04	0.17	2.58
Cooling fan	25,000	25,000	1	58,561	58,561	1	1	0.5	0.01	0.02	0.37
Bypass valve	50,000	50,000	1	47,737	47,737	1	1	1	0.01	0.02	0.46
Temperature sensor	50,000	50,000	2	52,494	26,247	2	2	4	0.02	0.15	1.14
Water separator/filter assy	100,000	100,000	1	53,789	53,789	1	1	1	0.01	0.03	0.56
Water separator/filter element	4,000	10,000,000	1	4,000	4,000	1	1	1	0.09	0.27	5.48
Air separation module	30,000	30,000	1	20,000	20,000	2	1	6	0.02	0.16	1.10
Relief valve	50,000	50,000	1	53,306	53,306	2	1	2	0.01	0.03	0.41
Oxygen sensor	26,933	26,933	1	26,933	26,933	1	1	1	0.02	0.06	1.11
Fuel tank check valve	100,000	100,000	5	100,000	20,000	1	24	8	0.03	0.83	1.50
Controller / control card	10,000	10,000	1	10,000	10,000	1	1	2	0.05	0.20	3.00
Ducting	10,000,000	10,000,000	1	80,000	80,000	6	2	2	0.01	0.06	0.38
Wiring	10,000,000	10,000,000	1	80,000	80,000	6	2	8	0.01	0.10	0.38
System Totals			25		960	35	44.5	44	0.44	2.48	26.18

Airplane Operation and Maintenance Task Team Final Report

**ON-BOARD GROUND INERTING SYSTEM PARTS LIST
DUAL FLOW MEMBRANE - Reliability Estimate Data**

Component	Unit MTBMA	Unit MTBF	Quantity /Shipset	Single Component MTBUR Calc (Hrs)	Component MTBUR Calc (System) (Hrs)	Removal & Replacement Time Man Hours	Access Time Man Hours	Trouble-Shooting Time Man Hours	Annual Failure Rate	Labor Hours Per Year	Delays Per Year (Minutes)
Regional Turboprop											
Cabin air filter assy	100,000	100,000	1	100,000	100,000	1	1	1	0.02	0.06	1.27
Cabin air filter element	4,000	10,000,000	1	8,000	8,000	1	1	1	0.13	0.39	7.76
Compressor unloading valve	50,000	50,000	1	38,315	38,315	1	0.5	0.5	0.03	0.05	1.62
Compressor	7,000	100,000	1	11,096	11,096	2	0.5	0.5	0.09	0.28	5.59
Compressor discharge check valve	100,000	100,000	1	34,119	34,119	1	0.5	1.5	0.03	0.09	1.82
Bleed shutoff valve	50,000	50,000	1	48,856	48,856	1	1	1	0.04	0.13	2.60
Bleed check valve	100,000	100,000	1	34,119	34,119	1	1	1	0.06	0.19	3.72
Heat exchanger	100,000	100,000	1	11,621	11,621	2	1	1	0.18	0.73	10.93
Cooling fan	25,000	25,000	1	58,561	58,561	1	1	0.5	0.02	0.04	1.06
Bypass valve	50,000	50,000	1	47,737	47,737	1	1	1	0.02	0.06	1.30
Temperature sensor	50,000	50,000	2	52,494	26,247	2	2	4	0.08	0.65	4.84
Water separator/filter assy	100,000	100,000	1	53,789	53,789	1	1	1	0.04	0.12	2.36
Water separator/filter element	4,000	10,000,000	1	4,000	4,000	1	1	1	0.26	0.78	15.51
Air separation module	30,000	30,000	1	20,000	20,000	2	1	6	0.05	0.47	3.10
Relief valve	50,000	50,000	1	53,306	53,306	2	1	2	0.02	0.10	1.16
Oxygen sensor	26,933	26,933	1	26,933	26,933	1	1	1	0.08	0.24	4.72
Fuel tank check valve	100,000	100,000	5	100,000	20,000	1	24	8	0.05	1.71	3.10
Controller / control card	10,000	10,000	1	10,000	10,000	1	1	2	0.21	0.85	12.70
Ducting	10,000,000	10,000,000	1	80,000	80,000	6	2	2	0.03	0.26	1.59
Wiring	10,000,000	10,000,000	1	80,000	80,000	6	2	8	0.03	0.42	1.59
System Totals			25		960	35	44.5	44	1.47	7.61	88.35

Airplane Operation and Maintenance Task Team Final Report

**ON-BOARD GROUND INERTING SYSTEM PARTS LIST
DUAL FLOW MEMBRANE - Reliability Estimate Data**

Component	Unit MTBMA	Unit MTBF	Quantity /Shipset	Single Component MTBUR Calc (Hrs)	Component MTBUR Calc (System) (Hrs)	Removal & Replacement Time Man Hours	Access Time Man Hours	Trouble-Shooting Time Man Hours	Annual Failure Rate	Labor Hours Per Year	Delays Per Year (Minutes)
Regional Turbofan											
Cabin air filter assy	100,000	100,000	1	100,000	100,000	1	1	1	0.03	0.09	1.77
Cabin air filter element	4,000	10,000,000	1	8,000	8,000	1	1	1	0.13	0.40	8.10
Compressor unloading valve	50,000	50,000	1	38,315	38,315	1	0.5	0.5	0.03	0.06	1.69
Compressor	7,000	100,000	1	11,096	11,096	2	0.5	0.5	0.10	0.29	5.84
Compressor discharge check valve	100,000	100,000	1	34,119	34,119	1	0.5	1.5	0.03	0.09	1.90
Bleed shutoff valve	50,000	50,000	1	48,856	48,856	1	1	1	0.06	0.18	3.63
Bleed check valve	100,000	100,000	1	34,119	34,119	1	1	1	0.09	0.26	5.20
Heat exchanger	100,000	100,000	1	11,621	11,621	2	1	1	0.25	1.02	15.26
Cooling fan	25,000	25,000	1	58,561	58,561	1	1	0.5	0.02	0.05	1.11
Bypass valve	50,000	50,000	1	47,737	47,737	1	1	1	0.02	0.07	1.36
Temperature sensor	50,000	50,000	2	52,494	26,247	2	2	4	0.11	0.90	6.76
Water separator/filter assy	100,000	100,000	1	53,789	53,789	1	1	1	0.05	0.16	3.30
Water separator/filter element	4,000	10,000,000	1	4,000	4,000	1	1	1	0.27	0.81	16.20
Air separation module	30,000	30,000	1	20,000	20,000	2	1	6	0.05	0.49	3.24
Relief valve	50,000	50,000	1	53,306	53,306	2	1	2	0.02	0.10	1.22
Oxygen sensor	26,933	26,933	1	26,933	26,933	1	1	1	0.11	0.33	6.59
Fuel tank check valve	100,000	100,000	5	100,000	20,000	1	24	8	0.15	4.88	8.87
Controller / control card	10,000	10,000	1	10,000	10,000	1	1	2	0.30	1.18	17.74
Ducting	10,000,000	10,000,000	1	80,000	80,000	6	2	2	0.04	0.37	2.22
Wiring	10,000,000	10,000,000	1	80,000	80,000	6	2	8	0.04	0.59	2.22
System Totals			25		960	35	44.5	44	1.90	12.32	114.20

Airplane Operation and Maintenance Task Team Final Report

ON-BOARD GROUND INERTING SYSTEM PARTS LIST

THREE-FLOW PRESSURE-SWING ADSORPTION - Reliability Estimate Data

Component	Unit MTBMA	Unit MTBF	Quantity /Shipset	Single Component MTBUR Calc (Hrs)	Component MTBUR Calc (System) (Hrs)	Removal & Replacement Time Man Hours	Access Time Man Hours	Trouble-Shooting Time Man Hours	Annual Failure Rate	Labor Hours Per Year	Delays Per Year (Minutes)
Small Transport											
Cabin air filter assy	100,000	100,000	1	100,000	100,000	1	1	1	0.03	0.09	1.72
Cabin air filter element	4,000	10,000,000	1	8,000	8,000	1	1	1	0.24	0.72	14.37
Compressor unloading valve	50,000	50,000	1	38,315	38,315	1	0.5	0.5	0.05	0.10	3.00
Compressor	7,000	100,000	1	11,096	11,096	2	1	0.5	0.17	0.60	10.36
Compressor discharge check valve	100,000	100,000	1	34,119	34,119	1	0.5	1.5	0.06	0.17	3.37
Bleed shutoff valve	50,000	50,000	1	48,856	48,856	1	1	1	0.06	0.18	3.52
Bleed check valve	100,000	100,000	1	34,119	34,119	1	1	1	0.08	0.25	5.05
Heat exchanger	100,000	100,000	1	11,621	11,621	2	1	1	0.25	0.99	14.81
Cooling fan	25,000	25,000	1	58,561	58,561	1	1	0.5	0.03	0.08	1.96
Bypass valve	50,000	50,000	1	47,737	47,737	1	1	1	0.04	0.12	2.41
Temperature sensor	50,000	50,000	2	52,494	26,247	1	1	2	0.11	0.44	6.56
Water separator/filter assy	100,000	100,000	1	53,789	53,789	1	1	1	0.05	0.16	3.20
Water separator/filter element	4,000	10,000,000	1	4,000	4,000	1	1	1	0.48	1.44	28.74
Air separation module	34,000	34,000	1	15,000	15,000	2	1	6	0.13	1.15	7.67
Relief valve	50,000	50,000	1	53,306	53,306	2	1	2	0.04	0.18	2.16
Oxygen sensor	26,933	26,933	1	26,933	26,933	1	1	1	0.11	0.32	6.39
Fuel tank check valve	100,000	100,000	5	100,000	20,000	1	24	8	0.14	4.73	8.61
Controller / control card	10,000	10,000	1	10,000	10,000	1	1	2	0.29	1.15	17.21
Ducting	10,000,000	10,000,000	1	80,000	80,000	6	2	2	0.04	0.36	2.15
Wiring	10,000,000	10,000,000	1	80,000	80,000	6	2	8	0.04	0.57	2.15
System Totals			25		945	34	44	42	2.42	13.79	145.42

Airplane Operation and Maintenance Task Team Final Report

ON-BOARD GROUND INERTING SYSTEM PARTS LIST

THREE-FLOW PRESSURE-SWING ADSORPTION - Reliability Estimate Data

Component	Unit MTBMA	Unit MTBF	Quantity /Shipset	Single Component MTBUR Calc (Hrs)	Component MTBUR Calc (System) (Hrs)	Removal & Replacement Time Man Hours	Access Time Man Hours	Trouble-Shooting Time Man Hours	Annual Failure Rate	Labor Hours Per Year	Delays Per Year (Minutes)
Medium Transport											
Cabin air filter assy	100,000	100,000	1	100,000	100,000	1	1	1	0.03	0.08	1.26
Cabin air filter element	4,000	10,000,000	1	8,000	8,000	1	1	1	0.16	0.48	7.19
Compressor unloading valve	50,000	50,000	1	38,315	38,315	1	0.5	0.5	0.03	0.07	1.50
Compressor	7,000	100,000	1	11,096	11,096	3	0.5	0.5	0.12	0.46	5.18
Compressor discharge check valve	100,000	100,000	1	34,119	34,119	1	0.5	1.5	0.04	0.11	1.68
Bleed shutoff valve	50,000	50,000	1	48,856	48,856	1	1	1	0.06	0.17	2.57
Bleed check valve	100,000	100,000	1	34,119	34,119	1	1	1	0.08	0.25	3.68
Heat exchanger	100,000	100,000	1	11,621	11,621	4	1	1	0.24	1.44	10.81
Cooling fan	25,000	25,000	1	58,561	58,561	1	1	0.5	0.02	0.05	0.98
Bypass valve	50,000	50,000	1	47,737	47,737	1	1	1	0.03	0.08	1.20
Temperature sensor	50,000	50,000	2	52,494	26,247	1	1	2	0.11	0.43	4.79
Water separator/filter assy	100,000	100,000	1	53,789	53,789	1	1	1	0.05	0.16	2.34
Water separator/filter element	4,000	10,000,000	1	4,000	4,000	1	1	1	0.32	0.96	14.37
Air separation module	34,000	34,000	1	15,000	15,000	9	2	6	0.09	1.45	3.83
Relief valve	50,000	50,000	1	53,306	53,306	2	1	2	0.02	0.12	1.08
Oxygen sensor	26,933	26,933	1	26,933	26,933	1	1	1	0.05	0.14	2.13
Fuel tank check valve	100,000	100,000	5	100,000	20,000	1	24	8	0.14	4.61	6.28
Controller / control card	10,000	10,000	1	10,000	10,000	1	1	2	0.28	1.12	12.57
Ducting	10,000,000	10,000,000	1	80,000	80,000	6	2	2	0.03	0.35	1.57
Wiring	10,000,000	10,000,000	1	80,000	80,000	6	2	8	0.03	0.56	1.57
System Totals			25		945	44	44.5	42	1.92	13.08	86.59

Airplane Operation and Maintenance Task Team Final Report

ON-BOARD GROUND INERTING SYSTEM PARTS LIST

THREE-FLOW PRESSURE-SWING ADSORPTION - Reliability Estimate Data

Component	Unit MTBMA	Unit MTBF	Quantity /Shipset	Single Component MTBUR Calc (Hrs)	Component MTBUR Calc (System) (Hrs)	Removal & Replacement Time Man Hours	Access Time Man Hours	Trouble-Shooting Time Man Hours	Annual Failure Rate	Labor Hours Per Year	Delays Per Year (Minutes)
Large Transport											
Cabin air filter assy	100,000	100,000	1	100,000	100,000	1	1	1	0.04	0.12	1.22
Cabin air filter element	4,000	10,000,000	1	8,000	8,000	1	1	1	0.14	0.41	4.11
Compressor unloading valve	50,000	50,000	1	38,315	38,315	1	0.5	0.5	0.03	0.06	0.86
Compressor	7,000	100,000	1	11,096	11,096	20	3	1	0.10	2.37	2.96
Compressor discharge check valve	100,000	100,000	1	34,119	34,119	1	0.5	1.5	0.03	0.10	0.96
Bleed shutoff valve	50,000	50,000	1	48,856	48,856	1	1	1	0.08	0.25	2.51
Bleed check valve	100,000	100,000	1	34,119	34,119	1	1	1	0.12	0.36	3.59
Heat exchanger	100,000	100,000	1	11,621	11,621	9	2	1	0.35	4.21	10.53
Cooling fan	25,000	25,000	1	58,561	58,561	1	1	0.5	0.02	0.05	0.56
Bypass valve	50,000	50,000	1	47,737	47,737	1	1	1	0.02	0.07	0.69
Temperature sensor	50,000	50,000	2	52,494	26,247	1	1	2	0.16	0.62	4.66
Water separator/filter assy	100,000	100,000	1	53,789	53,789	1	1	1	0.08	0.23	2.28
Water separator/filter element	4,000	10,000,000	1	4,000	4,000	1	1	1	0.27	0.82	8.21
Air separation module	34,000	34,000	1	15,000	15,000	18	2	6	0.07	1.90	2.19
Relief valve	50,000	50,000	1	53,306	53,306	2	1	2	0.02	0.10	0.62
Oxygen sensor	26,933	26,933	1	26,933	26,933	1	1	1	0.15	0.45	4.55
Fuel tank check valve	100,000	100,000	5	100,000	20,000	1	24	8	0.20	6.73	6.12
Controller / control card	10,000	10,000	1	10,000	10,000	1	1	2	0.41	1.63	12.24
Ducting	10,000,000	10,000,000	1	80,000	80,000	6	2	2	0.05	0.51	1.53
Wiring	10,000,000	10,000,000	1	80,000	80,000	6	2	8	0.05	0.82	1.53
System Totals			25		945	75	48	42.5	2.40	21.81	71.92

Airplane Operation and Maintenance Task Team Final Report

ON-BOARD GROUND INERTING SYSTEM PARTS LIST

THREE-FLOW PRESSURE-SWING ADSORPTION - Reliability Estimate Data

Component	Unit MTBMA	Unit MTBF	Quantity /Shipset	Single Component MTBUR Calc (Hrs)	Component MTBUR Calc (System) (Hrs)	Removal & Replacement Time Man Hours	Access Time Man Hours	Trouble-Shooting Time Man Hours	Annual Failure Rate	Labor Hours Per Year	Delays Per Year (Minutes)
Business Jet											
Cabin air filter assy	100,000	100,000	1	100,000	100,000	1	1	1	0.01	0.02	0.30
Cabin air filter element	4,000	10,000,000	1	8,000	8,000	1	1	1	0.05	0.14	2.74
Compressor unloading valve	50,000	50,000	1	38,315	38,315	1	0.5	0.5	0.01	0.02	0.57
Compressor	7,000	100,000	1	11,096	11,096	2	1	0.5	0.03	0.12	1.97
Compressor discharge check valve	100,000	100,000	1	34,119	34,119	1	0.5	1.5	0.01	0.03	0.64
Bleed shutoff valve	50,000	50,000	1	48,856	48,856	1	1	1	0.01	0.03	0.61
Bleed check valve	100,000	100,000	1	34,119	34,119	1	1	1	0.01	0.04	0.88
Heat exchanger	100,000	100,000	1	11,621	11,621	2	1	1	0.04	0.17	2.58
Cooling fan	25,000	25,000	1	58,561	58,561	1	1	0.5	0.01	0.02	0.37
Bypass valve	50,000	50,000	1	47,737	47,737	1	1	1	0.01	0.02	0.46
Temperature sensor	50,000	50,000	2	52,494	26,247	1	1	2	0.02	0.08	1.14
Water separator/filter assy	100,000	100,000	1	53,789	53,789	1	1	1	0.01	0.03	0.56
Water separator/filter element	4,000	10,000,000	1	4,000	4,000	1	1	1	0.09	0.27	5.48
Air separation module	34,000	34,000	1	15,000	15,000	2	1	6	0.02	0.22	1.46
Relief valve	50,000	50,000	1	53,306	53,306	2	1	2	0.01	0.03	0.41
Oxygen sensor	26,933	26,933	1	26,933	26,933	1	1	1	0.02	0.06	1.11
Fuel tank check valve	100,000	100,000	5	100,000	20,000	1	24	8	0.03	0.83	1.50
Controller / control card	10,000	10,000	1	10,000	10,000	1	1	2	0.05	0.20	3.00
Ducting	10,000,000	10,000,000	1	80,000	80,000	6	2	2	0.01	0.06	0.38
Wiring	10,000,000	10,000,000	1	80,000	80,000	6	2	8	0.01	0.10	0.38
System Totals			25		945	34	44	42	0.44	2.48	26.54

Airplane Operation and Maintenance Task Team Final Report

ON-BOARD GROUND INERTING SYSTEM PARTS LIST

THREE-FLOW PRESSURE-SWING ADSORPTION - Reliability Estimate Data

Component	Unit MTBMA	Unit MTBF	Quantity /Shipset	Single Component MTBUR Calc (Hrs)	Component MTBUR Calc (System) (Hrs)	Removal & Replacement Time Man Hours	Access Time Man Hours	Trouble-Shooting Time Man Hours	Annual Failure Rate	Labor Hours Per Year	Delays Per Year (Minutes)
Regional Turboprop											
Cabin air filter assy	100,000	100,000	1	100,000	100,000	1	1	1	0.02	0.06	1.27
Cabin air filter element	4,000	10,000,000	1	8,000	8,000	1	1	1	0.13	0.39	7.76
Compressor unloading valve	50,000	50,000	1	38,315	38,315	1	0.5	0.5	0.03	0.05	1.62
Compressor	7,000	100,000	1	11,096	11,096	2	1	0.5	0.09	0.33	5.59
Compressor discharge check valve	100,000	100,000	1	34,119	34,119	1	0.5	1.5	0.03	0.09	1.82
Bleed shutoff valve	50,000	50,000	1	48,856	48,856	1	1	1	0.04	0.13	2.60
Bleed check valve	100,000	100,000	1	34,119	34,119	1	1	1	0.06	0.19	3.72
Heat exchanger	100,000	100,000	1	11,621	11,621	2	1	1	0.18	0.73	10.93
Cooling fan	25,000	25,000	1	58,561	58,561	1	1	0.5	0.02	0.04	1.06
Bypass valve	50,000	50,000	1	47,737	47,737	1	1	1	0.02	0.06	1.30
Temperature sensor	50,000	50,000	2	52,494	26,247	1	1	2	0.08	0.32	4.84
Water separator/filter assy	100,000	100,000	1	53,789	53,789	1	1	1	0.04	0.12	2.36
Water separator/filter element	4,000	10,000,000	1	4,000	4,000	1	1	1	0.26	0.78	15.51
Air separation module	34,000	34,000	1	15,000	15,000	2	1	6	0.07	0.62	4.14
Relief valve	50,000	50,000	1	53,306	53,306	2	1	2	0.02	0.10	1.16
Oxygen sensor	26,933	26,933	1	26,933	26,933	1	1	1	0.08	0.24	4.72
Fuel tank check valve	100,000	100,000	5	100,000	20,000	1	24	8	0.11	3.49	6.35
Controller / control card	10,000	10,000	1	10,000	10,000	1	1	2	0.21	0.85	12.70
Ducting	10,000,000	10,000,000	1	80,000	80,000	6	2	2	0.03	0.26	1.59
Wiring	10,000,000	10,000,000	1	80,000	80,000	6	2	8	0.03	0.42	1.59
System Totals			25		945	34	44	42	1.54	9.27	92.63

Airplane Operation and Maintenance Task Team Final Report

ON-BOARD GROUND INERTING SYSTEM PARTS LIST

THREE-FLOW PRESSURE-SWING ADSORPTION - Reliability Estimate Data

Component	Unit MTBMA	Unit MTBF	Quantity /Shipset	Single Component MTBUR Calc (Hrs)	Component MTBUR Calc (System) (Hrs)	Removal & Replacement Time Man Hours	Access Time Man Hours	Trouble-Shooting Time Man Hours	Annual Failure Rate	Labor Hours Per Year	Delays Per Year (Minutes)
Regional Turbofan											
Cabin air filter assy	100,000	100,000	1	100,000	100,000	1	1	1	0.03	0.09	1.77
Cabin air filter element	4,000	10,000,000	1	8,000	8,000	1	1	1	0.13	0.40	8.10
Compressor unloading valve	50,000	50,000	1	38,315	38,315	1	0.5	0.5	0.03	0.06	1.69
Compressor	7,000	100,000	1	11,096	11,096	2	1	0.5	0.10	0.34	5.84
Compressor discharge check valve	100,000	100,000	1	34,119	34,119	1	0.5	1.5	0.03	0.09	1.90
Bleed shutoff valve	50,000	50,000	1	48,856	48,856	1	1	1	0.06	0.18	3.63
Bleed check valve	100,000	100,000	1	34,119	34,119	1	1	1	0.09	0.26	5.20
Heat exchanger	100,000	100,000	1	11,621	11,621	2	1	1	0.25	1.02	15.26
Cooling fan	25,000	25,000	1	58,561	58,561	1	1	0.5	0.02	0.05	1.11
Bypass valve	50,000	50,000	1	47,737	47,737	1	1	1	0.02	0.07	1.36
Temperature sensor	50,000	50,000	2	52,494	26,247	1	1	2	0.11	0.45	6.76
Water separator/filter assy	100,000	100,000	1	53,789	53,789	1	1	1	0.05	0.16	3.30
Water separator/filter element	4,000	10,000,000	1	4,000	4,000	1	1	1	0.27	0.81	16.20
Air separation module	34,000	34,000	1	15,000	15,000	2	1	6	0.07	0.65	4.32
Relief valve	50,000	50,000	1	53,306	53,306	2	1	2	0.02	0.10	1.22
Oxygen sensor	26,933	26,933	1	26,933	26,933	1	1	1	0.11	0.33	6.59
Fuel tank check valve	100,000	100,000	5	100,000	20,000	1	24	8	0.15	4.88	8.87
Controller / control card	10,000	10,000	1	10,000	10,000	1	1	2	0.30	1.18	17.74
Ducting	10,000,000	10,000,000	1	80,000	80,000	6	2	2	0.04	0.37	2.22
Wiring	10,000,000	10,000,000	1	80,000	80,000	6	2	8	0.04	0.59	2.22
System Totals			25		945	34	44	42	1.92	12.08	115.28

ADDENDUM F.C.3

***UN-SCHEDULED MAINTENANCE DATA
ON-BOARD INERTING GAS GENERATING SYSTEM***

to

APPENDIX F

**AIRPLANE OPERATION AND MAINTENANCE
FINAL REPORT**

Airplane Operation and Maintenance Task Team Final Report

This page intentionally left blank.

OBIGGS Data Sheet

Variable Input

	Aircraft Daily Utilization Rate - Flt Hrs	Aircraft Cycles Per Day	Minimum Turn Time Minutes	Minimum Daily Operating Hours (Includes Ground Ops Time)	Minimum Yearly Operating Hours (Includes Ground Ops Time)	Aircraft Annual Flight Hours	Aircraft pressure Check (Hours)
Small Transport	7.86	7	30	11	4146	2869	0
Medium Transport	7.65	4	45	10	3750	2792	0
Large Transport	11.18	2	60	13	4811	4081	0
Business Jet	1.37	4	60	5	1778	500	0
Regional Turboprop	5.8	7	15	8	2765	2117	0
Regional Turbofan	8.1	7	15	10	3577	2957	0

	Labour Costs \$	Delay Assumption - 1 delay = XX Minutes	Cost Per Minute Delay (\$)	Minutes delay due to extended turn time	Delay Costs \$ per hr	Cancelation Costs \$ per event	Cancelation Costs \$ per day
Small Transport	\$75	60	\$100	5	\$6,000.00	\$7,600	\$53,200
Medium Transport	\$75	45	\$142	5	\$8,490.00	\$20,000	\$70,000
Large Transport	\$75	30	\$183	5	\$10,980.00	\$32,600	\$65,200
Business Jet	\$75	60	\$100	5	\$6,000.00	\$7,600	\$26,600
Regional Turboprop	\$75	60	\$100	5	\$6,000.00	\$7,600	\$53,960
Regional Turbofan	\$75	60	\$100	5	\$6,000.00	\$7,600	\$51,680

M MEL Relief Study

	M MEL Repair Interval/ Service Cancellation				
	None	1 day	3 days	10 days	120 days
Small Transport	90%	20%	5%	3%	0%
Medium Transport	80%	18%	4%	2%	0%
Large Transport	70%	15%	3%	1%	0%
Business Jet	80%	18%	4%	2%	0%
Regional Turboprop	90%	20%	5%	3%	0%
Regional Turbofan	90%	20%	5%	3%	0%

	M MEL Impact No relief - Costs \$			Cancelation Costs	Delay Costs
	Membrane System	PSA System	Cryo System	\$ per day	\$ per hr
Small Transport	\$137,662.84	\$143,719.28	\$197,480.10	\$26,600	\$6,000
Medium Transport	\$164,216.51	\$171,441.17	\$235,571.87	\$35,000	\$8,490
Large Transport	\$265,267.43	\$276,937.80	\$380,531.43	\$65,200	\$10,980
Business Jet	\$66,419.23	\$69,341.33	\$95,279.72	\$13,300	\$6,000
Regional Turboprop	\$139,581.37	\$145,722.21	\$200,232.26	\$26,980	\$6,000
Regional Turbofan	\$133,825.78	\$139,713.41	\$191,975.76	\$25,840	\$6,000

	M MEL Impact 1 day relief - Costs \$			Cancelation Costs	Delay Costs
	Membrane System	PSA System	Cryo System	\$ per day	\$ per hr
Small Transport	\$56,770.49	\$59,268.10	\$81,438.41	\$26,600	\$6,000
Medium Transport	\$64,631.69	\$67,475.15	\$92,715.46	\$35,000	\$8,490
Large Transport	\$81,041.00	\$84,606.38	\$116,254.94	\$65,200	\$10,980
Business Jet	\$41,029.58	\$42,834.67	\$58,857.76	\$13,300	\$6,000
Regional Turboprop	\$57,196.83	\$59,713.19	\$82,050.00	\$26,980	\$6,000
Regional Turbofan	\$55,917.82	\$58,377.90	\$80,215.22	\$25,840	\$6,000

	M MEL Impact 3 day relief - Costs \$			Cancelation Costs	Delay Costs
	Membrane System	PSA System	Cryo System	\$ per day	\$ per hr
Small Transport	\$39,436.42	\$41,171.42	\$56,572.33	\$26,600	\$6,000
Medium Transport	\$41,823.56	\$43,663.57	\$59,996.73	\$35,000	\$8,490
Large Transport	\$39,171.36	\$40,894.69	\$56,192.10	\$65,200	\$10,980
Business Jet	\$35,296.44	\$36,849.30	\$50,633.45	\$13,300	\$6,000
Regional Turboprop	\$39,543.01	\$41,282.69	\$56,725.23	\$26,980	\$6,000
Regional Turbofan	\$39,223.25	\$40,948.87	\$56,266.54	\$25,840	\$6,000

	M MEL Impact 10 day relief - Costs \$			Cancelation Costs	Delay Costs
	Membrane System	PSA System	Cryo System	\$ per day	\$ per hr
Small Transport	\$36,547.41	\$38,155.30	\$52,427.99	\$26,600	\$6,000
Medium Transport	\$38,932.39	\$40,645.21	\$55,849.29	\$35,000	\$8,490
Large Transport	\$34,147.00	\$35,649.29	\$48,984.56	\$65,200	\$10,980
Business Jet	\$34,477.42	\$35,994.24	\$49,458.54	\$13,300	\$6,000
Regional Turboprop	\$36,600.70	\$38,210.94	\$52,504.44	\$26,980	\$6,000
Regional Turbofan	\$36,440.82	\$38,044.03	\$52,275.09	\$25,840	\$6,000

	M MEL Impact 120 day relief - Costs \$			Cancelation Costs	Delay Costs
	Membrane System	PSA System	Cryo System	\$ per day	\$ per hr
Small Transport	\$33,658.40	\$35,139.19	\$48,283.64	\$26,600	\$6,000
Medium Transport	\$35,719.97	\$37,291.46	\$51,241.02	\$35,000	\$8,490
Large Transport	\$30,797.43	\$32,152.36	\$44,179.53	\$65,200	\$10,980
Business Jet	\$33,658.40	\$35,139.19	\$48,283.64	\$13,300	\$6,000
Regional Turboprop	\$33,658.40	\$35,139.19	\$48,283.64	\$26,980	\$6,000
Regional Turbofan	\$33,658.40	\$35,139.19	\$48,283.64	\$25,840	\$6,000

	Costs per year - Membrane system only (one event per day)				
	None	1 day	3 days	10 days	120 days
Small Transport	\$137,663	\$56,770	\$39,436	\$36,547	\$33,658
Medium Transport	\$164,217	\$64,632	\$41,824	\$38,932	\$35,720
Large Transport	\$265,267	\$81,041	\$39,171	\$34,147	\$30,797
Business Jet	\$66,419	\$41,030	\$35,296	\$34,477	\$33,658
Regional Turboprop	\$139,581	\$57,197	\$39,543	\$36,601	\$33,658
Regional Turbofan	\$133,826	\$55,918	\$39,223	\$36,441	\$33,658

Airplane Operation and Maintenance Task Team Final Report

**FULL-TIME OBIGGS PARTS LIST
CRYOGENIC DISTILLATION**

Component	Unit weight (lbs)	Unit MTBMA	Unit MTBF	Quantity /Shipset	Component MTBUR Calc	Removal & Replacement Time Man Hours	Access Time Man Hours	Trouble-Shooting Time Man Hours	Annual Failure Rate	Labour Hours Per Year	Delays Per Year (Minutes)
Small Transport											
Cabin air filter assy	6	100,000	100,000	1	100,000	1	1	1	0.04	0.12	2.49
Cabin air filter element		4,000	10,000,000	1	8,000	1	1	1	0.52	1.55	31.10
OBIGGS shutoff valve	4	50,000	50,000	1	38,315	1	0.5	0.5	0.11	0.22	6.49
Compressor	16	7,000	100,000	1	11,096	2	0.5	0.5	0.37	1.12	22.42
Compressor discharge check valve	1	100,000	100,000	1	34,119	1	0.5	1.5	0.12	0.36	7.29
Bleed shutoff valve	3	50,000	50,000	1	48,856	1	1	1	0.08	0.25	5.09
Bleed check valve	1	100,000	100,000	1	34,119	1	1	1	0.12	0.36	7.29
Heat exchanger	14	100,000	100,000	1	11,621	2	1	1	0.36	1.43	21.41
Cooling fan	0	25,000	25,000	1	58,561	1	1	0.5	0.07	0.18	4.25
Bypass valve	3	50,000	50,000	1	47,737	1	1	1	0.09	0.26	5.21
Temperature sensor	0.15	50,000	50,000	2	26,247	2	2	4	0.16	1.26	9.48
Water separator/filter assy	10	100,000	100,000	1	53,789	1	1	1	0.08	0.23	4.63
Water separator/filter element		4,000	10,000,000	1	4,000	1	1	1	1.04	3.11	62.20
Low flow air separation module	18	30,000	30,000	1	20,000	2	1	6	0.21	1.87	12.44
High flow shutoff valve	3	50,000	50,000	1	48,856	1	1	1	0.08	0.25	5.09
High flow air separation module	18	80,000	80,000	1	15,000	2	1	6	0.28	2.49	16.59
High flow check valve	1	100,000	100,000	1	41,995	1	1	1	0.10	0.30	5.92
Relief valve	2.5	50,000	50,000	1	53,306	2	1	2	0.08	0.39	4.67
Oxygen sensor	1.5	26,933	26,933	1	26,933	1	1	1	0.15	0.46	9.24
Fuel tank check valve	0.5	100,000	100,000	5	4,000	1	24	8	1.04	34.21	62.20
Controller / control card	5.5	10,000	10,000	1	10,000	1	1	2	0.41	1.66	24.88
Ducting	345	10,000,000	10,000,000	1	80,000	6	2	2	0.05	0.52	3.11
Wiring	15	10,000,000	10,000,000	1	80,000	6	2	8	0.05	0.83	3.11
System Totals	468.15			28	739	39	47.5	52	5.61	53.44	336.58

Airplane Operation and Maintenance Task Team Final Report

**FULL-TIME OBIGGS PARTS LIST
CRYOGENIC DISTILLATION**

Component	Unit weight (lbs)	Unit MTBMA	Unit MTBF	Quantity /Shipset	Component MTBUR Calc	Removal & Replacement Time Man Hours	Access Time Man Hours	Trouble-Shooting Time Man Hours	Annual Failure Rate	Labour Hours Per Year	Delays Per Year (Minutes)
Medium Transport											
Cabin air filter assy	6	100,000	100,000	1	100,000	1	1	1	0.04	0.11	1.69
Cabin air filter element		4,000	10,000,000	1	8,000	1	1	1	0.47	1.41	21.10
OBIGGS shutoff valve	4	50,000	50,000	1	38,315	1	0.5	0.5	0.10	0.20	4.40
Compressor	102	7,000	100,000	1	12,000	3	0.5	0.5	0.31	1.25	14.06
Compressor discharge check valve	1	100,000	100,000	1	34,119	1	0.5	1.5	0.11	0.33	4.95
Bleed shutoff valve	3	50,000	50,000	1	48,856	1	1	1	0.08	0.23	3.45
Bleed check valve	1	100,000	100,000	1	34,119	1	1	1	0.11	0.33	4.95
Heat exchanger	36	100,000	100,000	1	11,621	4	1	1	0.32	1.94	14.52
Cooling fan	0	25,000	25,000	1	58,561	1	1	0.5	0.06	0.16	2.88
Bypass valve	3	50,000	50,000	1	47,737	1	1	1	0.08	0.24	3.54
Temperature sensor	0.15	50,000	50,000	2	26,247	1	1	2	0.14	0.57	6.43
Water separator/filter assy	10	100,000	100,000	1	53,789	1	1	1	0.07	0.21	3.14
Water separator/filter element		4,000	10,000,000	1	4,000	1	1	1	0.94	2.81	42.19
Low flow air separation module	64	30,000	30,000	1	20,000	9	2		0.19	2.06	8.44
High flow shutoff valve	3	50,000	50,000	1	48,856	1	1	1	0.08	0.23	3.45
High flow air separation module	42.5	80,000	80,000	1	15,000	9	2	6	0.25	4.25	11.25
High flow check valve	1	100,000	100,000	1	41,995	1	1	1	0.09	0.27	4.02
Relief valve	2.5	50,000	50,000	1	53,306	2	1	2	0.07	0.35	3.17
Oxygen sensor	1.5	26,933	26,933	1	26,933	1	1	1	0.14	0.42	6.27
Fuel tank check valve	0.5	100,000	100,000	5	4,000	1	24	8	0.94	30.94	42.19
Controller / control card	5.5	10,000	10,000	1	10,000	1	1	2	0.38	1.50	16.88
Ducting	345	10,000,000	10,000,000	1	80,000	6	2	2	0.05	0.47	2.11
Wiring	15	10,000,000	10,000,000	1	80,000	6	2	8	0.05	0.75	2.11
System Totals	646.65			28	743	55	48.5	44	5.05	51.02	227.18

Airplane Operation and Maintenance Task Team Final Report

**FULL-TIME OBIGGS PARTS LIST
CRYOGENIC DISTILLATION**

Component	Unit weight (lbs)	Unit MTBMA	Unit MTBF	Quantity /Shipset	Component MTBUR Calc	Removal & Replacement Time Man Hours	Access Time Man Hours	Trouble-Shooting Time Man Hours	Annual Failure Rate	Labour Hours Per Year	Delays Per Year (Minutes)
Large Transport											
Cabin air filter assy	6	100,000	100,000	1	100,000	1	1	1	0.05	0.14	1.44
Cabin air filter element		4,000	10,000,000	1	8,000	1	1	1	0.60	1.80	18.04
OBIGGS shutoff valve	4	50,000	50,000	1	38,315	1	0.5	0.5	0.13	0.25	3.77
Compressor	188	7,000	100,000	1	12,000	18	2	1	0.40	8.42	12.03
Compressor discharge check valve	1	100,000	100,000	1	34,119	1	0.5	1.5	0.14	0.42	4.23
Bleed shutoff valve	3	50,000	50,000	1	48,856	1	1	1	0.10	0.30	2.95
Bleed check valve	1	100,000	100,000	1	34,119	1	1	1	0.14	0.42	4.23
Heat exchanger	58	100,000	100,000	1	11,621	4	1	1	0.41	2.48	12.42
Cooling fan	0	25,000	25,000	1	58,561	1	1	0.5	0.08	0.21	2.46
Bypass valve	3	50,000	50,000	1	47,737	1	1	1	0.10	0.30	3.02
Temperature sensor	0.15	50,000	50,000	2	26,247	1	1	2	0.18	0.73	5.50
Water separator/filter assy	10	100,000	100,000	1	53,789	1	1	1	0.09	0.27	2.68
Water separator/filter element		4,000	10,000,000	1	4,000	1	1	1	1.20	3.61	36.08
Low flow air separation module	110	30,000	30,000	1	20,000	18	2	6	0.24	6.25	7.22
High flow shutoff valve	3	50,000	50,000	1	48,856	1	1	1	0.10	0.30	2.95
High flow air separation module	67	80,000	80,000	1	15,000	18	2	6	0.32	8.34	9.62
High flow check valve	1	100,000	100,000	1	41,995	1	1	1	0.11	0.34	3.44
Relief valve	2.5	50,000	50,000	1	53,306	2	1	2	0.09	0.45	2.71
Oxygen sensor	1.5	26,933	26,933	1	26,933	1	1	1	0.18	0.54	5.36
Fuel tank check valve	0.5	100,000	100,000	5	4,000	1	24	8	1.20	39.69	36.08
Controller / control card	5.5	10,000	10,000	1	10,000	1	1	2	0.48	1.92	14.43
Ducting	345	10,000,000	10,000,000	1	80,000	6	2	2	0.06	0.60	1.80
Wiring	15	10,000,000	10,000,000	1	80,000	6	2	8	0.06	0.96	1.80
System Totals	825.15			28	743	88	50	50.5	6.48	78.76	194.27

Airplane Operation and Maintenance Task Team Final Report

**FULL-TIME OBIGGS PARTS LIST
CRYOGENIC DISTILLATION**

Component	Unit weight (lbs)	Unit MTBMA	Unit MTBF	Quantity /Shipset	Component MTBUR Calc	Removal & Replacement Time Man Hours	Access Time Man Hours	Trouble-Shooting Time Man Hours	Annual Failure Rate	Labour Hours Per Year	Delays Per Year (Minutes)
Business Jet											
Cabin air filter assy	6	100,000	100,000	1	100,000	1	1	1	0.02	0.05	1.07
Cabin air filter element		4,000	10,000,000	1	8,000	1	1	1	0.22	0.67	13.33
OBIGGS shutoff valve	4	50,000	50,000	1	38,315	1	0.5	0.5	0.05	0.09	2.78
Compressor	16	7,000	100,000	1	11,096	2	0.5	0.5	0.16	0.48	9.61
Compressor discharge check valve	1	100,000	100,000	1	34,119	1	0.5	1.5	0.05	0.16	3.13
Bleed shutoff valve	3	50,000	50,000	1	48,856	1	1	1	0.04	0.11	2.18
Bleed check valve	1	100,000	100,000	1	34,119	1	1	1	0.05	0.16	3.13
Heat exchanger	14	100,000	100,000	1	11,621	2	1	1	0.15	0.61	9.18
Cooling fan	0	25,000	25,000	1	58,561	1	1	0.5	0.03	0.08	1.82
Bypass valve	3	50,000	50,000	1	47,737	1	1	1	0.04	0.11	2.23
Temperature sensor	0.15	50,000	50,000	2	26,247	2	2	4	0.07	0.54	4.06
Water separator/filter assy	10	100,000	100,000	1	53,789	1	1	1	0.03	0.10	1.98
Water separator/filter element		4,000	10,000,000	1	4,000	1	1	1	0.44	1.33	26.66
Low flow air separation module	18	30,000	30,000	1	20,000	2	1	6	0.09	0.80	5.33
High flow shutoff valve	3	50,000	50,000	1	48,856	1	1	1	0.04	0.11	2.18
High flow air separation module	18	80,000	80,000	1	15,000	2	1	6	0.12	1.07	7.11
High flow check valve	1	100,000	100,000	1	41,995	1	1	1	0.04	0.13	2.54
Relief valve	2.5	50,000	50,000	1	53,306	2	1	2	0.03	0.17	2.00
Oxygen sensor	1.5	26,933	26,933	1	26,933	1	1	1	0.07	0.20	3.96
Fuel tank check valve	0.5	100,000	100,000	5	4,000	1	24	8	0.44	14.66	26.66
Controller / control card	5.5	10,000	10,000	1	10,000	1	1	2	0.18	0.71	10.67
Ducting	345	10,000,000	10,000,000	1	80,000	6	2	2	0.02	0.22	1.33
Wiring	15	10,000,000	10,000,000	1	80,000	6	2	8	0.02	0.36	1.33
System Totals	468.15			28	739	39	47.5	52	2.40	22.91	144.29

Airplane Operation and Maintenance Task Team Final Report

FULL-TIME OBIGGS PARTS LIST
CRYOGENIC DISTILLATION

Component	Unit weight (lbs)	Unit MTBMA	Unit MTBF	Quantity /Shipset	Component MTBUR Calc	Removal & Replacement Time Man Hours	Access Time Man Hours	Trouble-Shooting Time Man Hours	Annual Failure Rate	Labour Hours Per Year	Delays Per Year (Minutes)
Regional Turboprop											
Cabin air filter assy	6	100,000	100,000	1	100,000	1	1	1	0.03	0.08	1.66
Cabin air filter element		4,000	10,000,000	1	8,000	1	1	1	0.35	1.04	20.74
OBIGGS shutoff valve	4	50,000	50,000	1	38,315	1	0.5	0.5	0.07	0.14	4.33
Compressor	16	7,000	100,000	1	11,096	2	0.5	0.5	0.25	0.75	14.95
Compressor discharge check valve	1	100,000	100,000	1	34,119	1	0.5	1.5	0.08	0.24	4.86
Bleed shutoff valve	3	50,000	50,000	1	48,856	1	1	1	0.06	0.17	3.40
Bleed check valve	1	100,000	100,000	1	34,119	1	1	1	0.08	0.24	4.86
Heat exchanger	14	100,000	100,000	1	11,621	2	1	1	0.24	0.95	14.28
Cooling fan	0	25,000	25,000	1	58,561	1	1	0.5	0.05	0.12	2.83
Bypass valve	3	50,000	50,000	1	47,737	1	1	1	0.06	0.17	3.48
Temperature sensor	0.15	50,000	50,000	2	26,247	2	2	4	0.11	0.84	6.32
Water separator/filter assy	10	100,000	100,000	1	53,789	1	1	1	0.05	0.15	3.08
Water separator/filter element		4,000	10,000,000	1	4,000	1	1	1	0.69	2.07	41.47
Low flow air separation module	18	30,000	30,000	1	20,000	2	1	6	0.14	1.24	8.29
High flow shutoff valve	3	50,000	50,000	1	48,856	1	1	1	0.06	0.17	3.40
High flow air separation module	18	80,000	80,000	1	15,000	2	1	6	0.18	1.66	11.06
High flow check valve	1	100,000	100,000	1	41,995	1	1	1	0.07	0.20	3.95
Relief valve	2.5	50,000	50,000	1	53,306	2	1	2	0.05	0.26	3.11
Oxygen sensor	1.5	26,933	26,933	1	26,933	1	1	1	0.10	0.31	6.16
Fuel tank check valve	0.5	100,000	100,000	5	4,000	1	24	8	0.69	22.81	41.47
Controller / control card	5.5	10,000	10,000	1	10,000	1	1	2	0.28	1.11	16.59
Ducting	345	10,000,000	10,000,000	1	80,000	6	2	2	0.03	0.35	2.07
Wiring	15	10,000,000	10,000,000	1	80,000	6	2	8	0.03	0.55	2.07
System Totals	468.15			28	739	39	47.5	52	3.74	35.63	224.44

Airplane Operation and Maintenance Task Team Final Report

**FULL-TIME OBIGGS PARTS LIST
CRYOGENIC DISTILLATION**

Component	Unit weight (lbs)	Unit MTBMA	Unit MTBF	Quantity /Shipset	Component MTBUR Calc	Removal & Replacement Time Man Hours	Access Time Man Hours	Trouble-Shooting Time Man Hours	Annual Failure Rate	Labour Hours Per Year	Delays Per Year (Minutes)
Regional Turbofan											
Cabin air filter assy	6	100,000	100,000	1	100,000	1	1	1	0.04	0.11	2.15
Cabin air filter element		4,000	10,000,000	1	8,000	1	1	1	0.45	1.34	26.83
OBIGGS shutoff valve	4	50,000	50,000	1	38,315	1	0.5	0.5	0.09	0.19	5.60
Compressor	16	7,000	100,000	1	11,096	2	0.5	0.5	0.32	0.97	19.34
Compressor discharge check valve	1	100,000	100,000	1	34,119	1	0.5	1.5	0.10	0.31	6.29
Bleed shutoff valve	3	50,000	50,000	1	48,856	1	1	1	0.07	0.22	4.39
Bleed check valve	1	100,000	100,000	1	34,119	1	1	1	0.10	0.31	6.29
Heat exchanger	14	100,000	100,000	1	11,621	2	1	1	0.31	1.23	18.47
Cooling fan	0	25,000	25,000	1	58,561	1	1	0.5	0.06	0.15	3.66
Bypass valve	3	50,000	50,000	1	47,737	1	1	1	0.07	0.22	4.50
Temperature sensor	0.15	50,000	50,000	2	26,247	2	2	4	0.14	1.09	8.18
Water separator/filter assy	10	100,000	100,000	1	53,789	1	1	1	0.07	0.20	3.99
Water separator/filter element		4,000	10,000,000	1	4,000	1	1	1	0.89	2.68	53.66
Low flow air separation module	18	30,000	30,000	1	20,000	2	1	6	0.18	1.61	10.73
High flow shutoff valve	3	50,000	50,000	1	48,856	1	1	1	0.07	0.22	4.39
High flow air separation module	18	80,000	80,000	1	15,000	2	1	6	0.24	2.15	14.31
High flow check valve	1	100,000	100,000	1	41,995	1	1	1	0.09	0.26	5.11
Relief valve	2.5	50,000	50,000	1	53,306	2	1	2	0.07	0.34	4.03
Oxygen sensor	1.5	26,933	26,933	1	26,933	1	1	1	0.13	0.40	7.97
Fuel tank check valve	0.5	100,000	100,000	5	4,000	1	24	8	0.89	29.51	53.66
Controller / control card	5.5	10,000	10,000	1	10,000	1	1	2	0.36	1.43	21.46
Ducting	345	10,000,000	10,000,000	1	80,000	6	2	2	0.04	0.45	2.68
Wiring	15	10,000,000	10,000,000	1	80,000	6	2	8	0.04	0.72	2.68
System Totals	468.15			28	739	39	47.5	52	4.84	46.10	290.36

Airplane Operation and Maintenance Task Team Final Report

FULL-TIME OBIGGS PARTS LIST
CRYOGENIC DISTILLATION

Component	Unit weight (lbs)	Unit MTBMA	Unit MTBF	Quantity /Shipset	Component MTBUR Calc	Removal & Replacement Time Man Hours	Access Time Man Hours	Trouble-Shooting Time Man Hours	Annual Failure Rate	Labour Hours Per Year	Delays Per Year (Minutes)
Small Transport											
Cabin air filter assy	6	100,000	100,000	1	100,000	1	1	1	0.04	0.12	2.49
Cabin air filter element		4,000	10,000,000	1	8,000	1	1	1	0.52	1.55	31.10
OBIGGS shutoff valve	4	50,000	50,000	1	38,315	1	0.5	0.5	0.11	0.22	6.49
Compressor	17	7,000	100,000	1	11,096	2	1	0.5	0.37	1.31	22.42
Compressor discharge check valve	1	100,000	100,000	1	34,119	1	0.5	1.5	0.12	0.36	7.29
Bleed shutoff valve	3	50,000	50,000	1	48,856	1	1	1	0.08	0.25	5.09
Bleed check valve	1	100,000	100,000	1	34,119	1	1	1	0.12	0.36	7.29
Heat exchanger	13	100,000	100,000	1	11,621	2	1	1	0.36	1.43	21.41
Cooling fan	0	25,000	25,000	1	58,561	1	1	0.5	0.07	0.18	4.25
Bypass valve	3	50,000	50,000	1	47,737	1	1	1	0.09	0.26	5.21
Temperature sensor	0.15	50,000	50,000	2	26,247	1	1	2	0.16	0.63	9.48
Water separator/filter assy	10	100,000	100,000	1	53,789	1	1	1	0.08	0.23	4.63
Water separator/filter element		4,000	10,000,000	1	4,000	1	1	1	1.04	3.11	62.20
Air separation module	44	34,000	34,000	1	5,000	2	1	6	0.83	7.46	49.76
High flow valve	3	50,000	50,000	1	48,856	1	1	1	0.08	0.25	5.09
Relief valve	2.5	50,000	50,000	1	53,306	2	1	2	0.08	0.39	4.67
Oxygen sensor	1.5	26,933	26,933	1	26,933	1	1	1	0.15	0.46	9.24
Fuel tank check valve	0.5	100,000	100,000	5	4,000	1	24	8	1.04	34.21	62.20
Controller / control card	5.5	10,000	10,000	1	10,000	1	1	2	0.41	1.66	24.88
Ducting	345	10,000,000	10,000,000	1	80,000	6	2	2	0.05	0.52	3.11
Wiring	15	10,000,000	10,000,000	1	80,000	6	2	8	0.05	0.83	3.11
System Totals	475.45			26	708	35	45	43	5.86	55.81	351.39

Airplane Operation and Maintenance Task Team Final Report

FULL-TIME OBIGGS PARTS LIST
CRYOGENIC DISTILLATION

Component	Unit weight (lbs)	Unit MTBMA	Unit MTBF	Quantity /Shipset	Component MTBUR Calc	Removal & Replacement Time Man Hours	Access Time Man Hours	Trouble-Shooting Time Man Hours	Annual Failure Rate	Labour Hours Per Year	Delays Per Year (Minutes)
Medium Transport											
Cabin air filter assy	6	100000	100000	1	100000	1	1	1	0.03750375	0.11251125	1.68766875
Cabin air filter element		4,000	10,000,000	1	8,000	1	1	1	0.47	1.41	21.10
OBIGGS shutoff valve	4	50,000	50,000	1	38,315	1	0.5	0.5	0.10	0.20	4.40
Compressor	123	7,000	100,000	1	12,000	3	0.5	0.5	0.31	1.25	14.06
Compressor discharge check valve	1	100,000	100,000	1	34,119	1	0.5	1.5	0.11	0.33	4.95
Bleed shutoff valve	3	50,000	50,000	1	48,856	1	1	1	0.08	0.23	3.45
Bleed check valve	1	100,000	100,000	1	34,119	1	1	1	0.11	0.33	4.95
Heat exchanger	95	100,000	100,000	1	11,621	4	1	1	0.32	1.94	14.52
Cooling fan	0	25,000	25,000	1	58,561	1	1	0.5	0.06	0.16	2.88
Bypass valve	3	50,000	50,000	1	47,737	1	1	1	0.08	0.24	3.54
Temperature sensor	0.15	50,000	50,000	2	26,247	1	1	2	0.14	0.57	6.43
Water separator/filter assy	10	100,000	100,000	1	53,789	1	1	1	0.07	0.21	3.14
Water separator/filter element		4,000	10,000,000	1	4,000	1	1	1	0.94	2.81	42.19
Air separation module	156.95	34,000	34,000	1	5,000	9	2		0.75	8.25	33.75
High flow valve	3	50,000	50,000	1	48,856	1	1	1	0.08	0.23	3.45
Relief valve	2.5	50,000	50,000	1	53,306	2	1	2	0.07	0.35	3.17
Oxygen sensor	1.5	26,933	26,933	1	26,933	1	1	1	0.14	0.42	6.27
Fuel tank check valve	0.5	100,000	100,000	5	4,000	1	24	8	0.94	30.94	42.19
Controller / control card	5.5	10,000	10,000	1	10,000	1	1	2	0.38	1.50	16.88
Ducting	345	10,000,000	10,000,000	1	80,000	6	2	2	0.05	0.47	2.11
Wiring	15	10,000,000	10,000,000	1	80,000	6	2	8	0.05	0.75	2.11
System Totals	776.1			26	711.4175143	45	45.5	37	5.271693379	52.69053751	237.2262021

Airplane Operation and Maintenance Task Team Final Report

FULL-TIME OBIGGS PARTS LIST
CRYOGENIC DISTILLATION

Component	Unit weight (lbs)	Unit MTBMA	Unit MTBF	Quantity /Shipset	Component MTBUR Calc	Removal & Replacement Time Man Hours	Access Time Man Hours	Trouble-Shooting Time Man Hours	Annual Failure Rate	Labour Hours Per Year	Delays Per Year (Minutes)
Large Transport											
Cabin air filter assy	6	100000	100000	1	100000	1	1	1	0.048107	0.144321	1.44321
Cabin air filter element		4,000	10,000,000	1	8,000	1	1	1	0.60	1.80	18.04
OBIGGS shutoff valve	4	50,000	50,000	1	38,315	1	0.5	0.5	0.13	0.25	3.77
Compressor	229	7,000	100,000	1	12,000	20	3	1	0.40	9.62	12.03
Compressor discharge check valve	1	100,000	100,000	1	34,119	1	0.5	1.5	0.14	0.42	4.23
Bleed shutoff valve	3	50,000	50,000	1	48,856	1	1	1	0.10	0.30	2.95
Bleed check valve	1	100,000	100,000	1	34,119	1	1	1	0.14	0.42	4.23
Heat exchanger	177	100,000	100,000	1	11,621	18	2	1	0.41	8.69	12.42
Cooling fan	0	25,000	25,000	1	58,561	1	1	0.5	0.08	0.21	2.46
Bypass valve	3	50,000	50,000	1	47,737	1	1	1	0.10	0.30	3.02
Temperature sensor	0.15	50,000	50,000	2	26,247	1	1	2	0.18	0.73	5.50
Water separator/filter assy	10	100,000	100,000	1	53,789	1	1	1	0.09	0.27	2.68
Water separator/filter element		4,000	10,000,000	1	4,000	1	1	1	1.20	3.61	36.08
Air separation module	181	34,000	34,000	1	5,000	18	2	6	0.96	25.02	28.86
High flow valve	3	50,000	50,000	1	48,856	1	1	1	0.10	0.30	2.95
Relief valve	2.5	50,000	50,000	1	53,306	2	1	2	0.09	0.45	2.71
Oxygen sensor	1.5	26,933	26,933	1	26,933	1	1	1	0.18	0.54	5.36
Fuel tank check valve	0.5	100,000	100,000	5	4,000	1	24	8	1.20	39.69	36.08
Controller / control card	5.5	10,000	10,000	1	10,000	1	1	2	0.48	1.92	14.43
Ducting	345	10,000,000	10,000,000	1	80,000	6	2	2	0.06	0.60	1.80
Wiring	15	10,000,000	10,000,000	1	80,000	6	2	8	0.06	0.96	1.80
System Totals	988.15			26	711.4175143	85	49	43.5	6.76213321	96.24700457	202.8639963

Airplane Operation and Maintenance Task Team Final Report

FULL-TIME OBIGGS PARTS LIST
CRYOGENIC DISTILLATION

Component	Unit weight (lbs)	Unit MTBMA	Unit MTBF	Quantity /Shipset	Component MTBUR Calc	Removal & Replacement Time Man Hours	Access Time Man Hours	Trouble-Shooting Time Man Hours	Annual Failure Rate	Labour Hours Per Year	Delays Per Year (Minutes)
Business Jet											
Cabin air filter assy	6	100000	100000	1	100000	1	1	1	0.017775	0.053325	1.0665
Cabin air filter element		4,000	10,000,000	1	8,000	1	1	1	0.22	0.67	13.33
OBIGGS shutoff valve	4	50,000	50,000	1	38,315	1	0.5	0.5	0.05	0.09	2.78
Compressor	17	7,000	100,000	1	11,096	2	1	0.5	0.16	0.56	9.61
Compressor discharge check valve	1	100,000	100,000	1	34,119	1	0.5	1.5	0.05	0.16	3.13
Bleed shutoff valve	3	50,000	50,000	1	48,856	1	1	1	0.04	0.11	2.18
Bleed check valve	1	100,000	100,000	1	34,119	1	1	1	0.05	0.16	3.13
Heat exchanger	13	100,000	100,000	1	11,621	2	1	1	0.15	0.61	9.18
Cooling fan	0	25,000	25,000	1	58,561	1	1	0.5	0.03	0.08	1.82
Bypass valve	3	50,000	50,000	1	47,737	1	1	1	0.04	0.11	2.23
Temperature sensor	0.15	50,000	50,000	2	26,247	1	1	2	0.07	0.27	4.06
Water separator/filter assy	10	100,000	100,000	1	53,789	1	1	1	0.03	0.10	1.98
Water separator/filter element		4,000	10,000,000	1	4,000	1	1	1	0.44	1.33	26.66
Air separation module	44.3	34,000	34,000	1	5,000	2	1	6	0.36	3.20	21.33
High flow valve	3	50,000	50,000	1	48,856	1	1	1	0.04	0.11	2.18
Relief valve	2.5	50,000	50,000	1	53,306	2	1	2	0.03	0.17	2.00
Oxygen sensor	1.5	26,933	26,933	1	26,933	1	1	1	0.07	0.20	3.96
Fuel tank check valve	0.5	100,000	100,000	5	4,000	1	24	8	0.44	14.66	26.66
Controller / control card	5.5	10,000	10,000	1	10,000	1	1	2	0.18	0.71	10.67
Ducting	345	10,000,000	10,000,000	1	80,000	6	2	2	0.02	0.22	1.33
Wiring	15	10,000,000	10,000,000	1	80,000	6	2	8	0.02	0.36	1.33
System Totals	475.45			26	707.9958632	35	45	43	2.510607889	23.92410081	150.6364734

Airplane Operation and Maintenance Task Team Final Report

FULL-TIME OBIGGS PARTS LIST
CRYOGENIC DISTILLATION

Component	Unit weight (lbs)	Unit MTBMA	Unit MTBF	Quantity /Shipset	Component MTBUR Calc	Removal & Replacement Time Man Hours	Access Time Man Hours	Trouble-Shooting Time Man Hours	Annual Failure Rate	Labour Hours Per Year	Delays Per Year (Minutes)
Regional Turboprop											
Cabin air filter Assy	6	100000	100000	1	100000	1	1	1	0.02764875	0.08294625	1.658925
Cabin air filter element		4,000	10,000,000	1	8,000	1	1	1	0.35	1.04	20.74
OBIGGS shutoff valve	4	50,000	50,000	1	38,315	1	0.5	0.5	0.07	0.14	4.33
Compressor	17	7,000	100,000	1	11,096	2	1	0.5	0.25	0.87	14.95
Compressor discharge check valve	1	100,000	100,000	1	34,119	1	0.5	1.5	0.08	0.24	4.86
Bleed shutoff valve	3	50,000	50,000	1	48,856	1	1	1	0.06	0.17	3.40
Bleed check valve	1	100,000	100,000	1	34,119	1	1	1	0.08	0.24	4.86
Heat exchanger	13	100,000	100,000	1	11,621	2	1	1	0.24	0.95	14.28
Cooling fan	0	25,000	25,000	1	58,561	1	1	0.5	0.05	0.12	2.83
Bypass valve	3	50,000	50,000	1	47,737	1	1	1	0.06	0.17	3.48
Temperature sensor	0.15	50,000	50,000	2	26,247	1	1	2	0.11	0.42	6.32
Water separator/filter Assy	10	100,000	100,000	1	53,789	1	1	1	0.05	0.15	3.08
Water separator/filter element		4,000	10,000,000	1	4,000	1	1	1	0.69	2.07	41.47
Air separation module	44.3	34,000	34,000	1	5,000	2	1	6	0.55	4.98	33.18
High flow valve	3	50,000	50,000	1	48,856	1	1	1	0.06	0.17	3.40
Relief valve	2.5	50,000	50,000	1	53,306	2	1	2	0.05	0.26	3.11
Oxygen sensor	1.5	26,933	26,933	1	26,933	1	1	1	0.10	0.31	6.16
Fuel tank check valve	0.5	100,000	100,000	5	4,000	1	24	8	0.69	22.81	41.47
Controller / control card	5.5	10,000	10,000	1	10,000	1	1	2	0.28	1.11	16.59
Ducting	345	10,000,000	10,000,000	1	80,000	6	2	2	0.03	0.35	2.07
Wiring	15	10,000,000	10,000,000	1	80,000	6	2	8	0.03	0.55	2.07
System Totals	475.45			26	707.9958632	35	45	43	3.905213496	37.21358549	234.3128097

Airplane Operation and Maintenance Task Team Final Report

FULL-TIME OBIGGS PARTS LIST
CRYOGENIC DISTILLATION

Component	Unit weight (lbs)	Unit MTBMA	Unit MTBF	Quantity /Shipset	Component MTBUR Calc	Removal & Replacement Time Man Hours	Access Time Man Hours	Trouble-Shooting Time Man Hours	Annual Failure Rate	Labour Hours Per Year	Delays Per Year (Minutes)
Regional Turbofan											
Cabin air filter Assy	6	100000	100000	1	100000	1	1	1	0.03577	0.10731	2.1462
Cabin air filter element		4,000	10,000,000	1	8,000	1	1	1	0.45	1.34	26.83
OBIGGS shutoff valve	4	50,000	50,000	1	38,315	1	0.5	0.5	0.09	0.19	5.60
Compressor	17	7,000	100,000	1	11,096	2	1	0.5	0.32	1.13	19.34
Compressor discharge check valve	1	100,000	100,000	1	34,119	1	0.5	1.5	0.10	0.31	6.29
Bleed shutoff valve	3	50,000	50,000	1	48,856	1	1	1	0.07	0.22	4.39
Bleed check valve	1	100,000	100,000	1	34,119	1	1	1	0.10	0.31	6.29
Heat exchanger	13	100,000	100,000	1	11,621	2	1	1	0.31	1.23	18.47
Cooling fan	0	25,000	25,000	1	58,561	1	1	0.5	0.06	0.15	3.66
Bypass valve	3	50,000	50,000	1	47,737	1	1	1	0.07	0.22	4.50
Temperature sensor	0.15	50,000	50,000	2	26,247	1	1	2	0.14	0.55	8.18
Water separator/filter Assy	10	100,000	100,000	1	53,789	1	1	1	0.07	0.20	3.99
Water separator/filter element		4,000	10,000,000	1	4,000	1	1	1	0.89	2.68	53.66
Air separation module	44.3	34,000	34,000	1	5,000	2	1	6	0.72	6.44	42.92
High flow valve	3	50,000	50,000	1	48,856	1	1	1	0.07	0.22	4.39
Relief valve	2.5	50,000	50,000	1	53,306	2	1	2	0.07	0.34	4.03
Oxygen sensor	1.5	26,933	26,933	1	26,933	1	1	1	0.13	0.40	7.97
Fuel tank check valve	0.5	100,000	100,000	5	4,000	1	24	8	0.89	29.51	53.66
Controller / control card	5.5	10,000	10,000	1	10,000	1	1	2	0.36	1.43	21.46
Ducting	345	10,000,000	10,000,000	1	80,000	6	2	2	0.04	0.45	2.68
Wiring	15	10,000,000	10,000,000	1	80,000	6	2	8	0.04	0.72	2.68
System Totals	475.45			26	707.9958632	35	45	43	5.052289407	48.14430863	303.1373644

FULL-TIME OBIGGS PARTS LIST
CRYOGENIC DISTILLATION

Component	Unit weight (lbs)	Unit MTBMA	Unit MTBF	Quantity /Shipset	Component MTBUR Calc	Removal & Replacement Time Man Hours	Access Time Man Hours	Trouble-Shooting Time Man Hours	Annual Failure Rate	Labour Hours Per Year	Delays Per Year (Minutes)
Small Transport											
Cabin air filter assy	6	100,000	100,000	1	100,000	1	1	1	0.04	0.12	2.49
Cabin air filter element		4000	10,000,000	1	8,000	1	1	1	0.52	1.55	31.10
OBIGGS shutoff valve	4	50,000	50,000	1	38,315	1	0.5	0.5	0.11	0.22	6.49
Compressor	3	7,000	100,000	1	11,096	1	0.5	0.5	0.37	0.75	22.42
Compressor discharge check valve	1	100,000	100,000	1	34,119	1	0.5	1.5	0.12	0.36	7.29
Bleed shutoff valve	3	50,000	50,000	1	48,856	1	1	1	0.08	0.25	5.09
Bleed check valve	1	100,000	100,000	1	34,119	1	1	1	0.12	0.36	7.29
Heat exchanger	0	100,000	100,000	1	11,621	1	1	1	0.36	1.07	21.41
Cooling fan	0	25,000	25,000	1	58,561	1	1	0.5	0.07	0.18	4.25
Bypass valve	3	50,000	50,000	1	47,737	1	1	1	0.09	0.26	5.21
Temperature sensor	0.15	50,000	50,000	2	26,247	1	1	2	0.16	0.63	9.48
Water separator/filter assy	10	100,000	100,000	1	53,789	1	1	1	0.08	0.23	4.63
Water separator/filter element		4000	10,000,000	1	4,000	1	1	1	1.04	3.11	62.20
Inlet shutoff valve	4	50,000	50,000	1	35,000	1	1	2	0.12	0.47	7.11
Crycooler bleed air valve	4	50,000	50,000	1	35,000	1	1	2	0.12	0.47	7.11
Flow sensor	0.1	20,000	20,000	1	20,000	1	10	2	0.21	2.70	12.44
Molecular sieve control valves	4	50,000	50,000	2	10,000	1	10	4	0.41	6.22	24.88
Molecular sieves	2.5	50,000	50,000	1	50,000	1	10	4	0.08	1.24	4.98
Purge heat exchanger	5	100,000	100,000	1	15,000	1	10	4	0.28	4.15	16.59
Purge heat exchanger valve-Air Side	4	50,000	50,000	1	35,000	1	10	4	0.12	1.78	7.11
Purge heat exchanger valve-Waste Side	4	50,000	50,000	1	35,000	1	10	4	0.12	1.78	7.11
LINEA Dewar Cooldown Valve	4	50,000	50,000	1	35,000	1	10	2	0.12	1.54	7.11
Inlet Recuperator	44	100,000	100,000	1	15,000	1	10	4	0.28	4.15	16.59
Inlet cooler	3	100,000	100,000	1	100,000	1	10	2	0.04	0.54	2.49
Cryocooler	117	8,000	8,000	1	8,000	6	2	4	0.52	6.22	31.10
LINEA Dewar	0	75,000	75,000	1	75,000	1	1	4	0.06	0.33	3.32
Dewar level sensor	0	50,000	50,000	1	50,000	1	1	2	0.08	0.33	4.98
Distillation column	6	50,000	50,000	1	50,000	1	1	4	0.08	0.50	4.98
Distillation column gas valve	4	50,000	50,000	1	35,000	1	1	2	0.12	0.47	7.11
Distillation column liquid valve	4	50,000	50,000	1	35,000	1	1	2	0.12	0.47	7.11
Temperature sensor	0.15	50,000	50,000	2	17,498	1	1	2	0.24	0.95	14.22
Relief valve	2.5	50,000	50,000	1	53,306	2	1	2	0.08	0.39	4.67
Oxygen sensor	1.5	26,933	26,933	1	26,933	1	1	1	0.15	0.46	9.24
Fuel tank check valve	0.5	100,000	100,000	5	4,000	1	24	8	1.04	34.21	62.20
Controller / control card	5.5	10,000	10,000	1	10,000	1	1	2	0.41	1.66	24.88
Ducting	345	10,000,000	10,000,000	1	80,000	6	2	2	0.05	0.52	3.11
Wiring	15	10,000,000	10,000,000	1	80,000	6	2	8	0.05	0.83	3.11
System Totals	611			44	515	53	142.5	90	8.05	81.48	482.84

FULL-TIME OBIGGS PARTS LIST
CRYOGENIC DISTILLATION

Component	Unit weight (lbs)	Unit MTBMA	Unit MTBF	Quantity /Shipset	Component MTBUR Calc	Removal & Replacement Time Man Hours	Access Time Man Hours	Trouble-Shooting Time Man Hours	Annual Failure Rate	Labour Hours Per Year	Delays Per Year (Minutes)
Medium Transport											
Cabin air filter assy	6	100,000	100,000	1	100,000	1	1	1	0.04	0.11	1.69
Cabin air filter element		4000	10,000,000	1	8,000	1	1	1	0.47	1.41	21.10
OBIGGS shutoff valve	4	50,000	50,000	1	38,315	1	0.5	0.5	0.10	0.20	4.40
Compressor	14.5	7,000	100,000	1	11,096	3	0.5	0.5	0.34	1.35	15.21
Compressor discharge check valve	1	100,000	100,000	1	34,119	1	0.5	1.5	0.11	0.33	4.95
Bleed shutoff valve	3	50,000	50,000	1	48,856	1	1	1	0.08	0.23	3.45
Bleed check valve	1	100,000	100,000	1	34,119	1	1	1	0.11	0.33	4.95
Heat exchanger	0	100,000	100,000	1	11,621	4	1	1	0.32	1.94	14.52
Cooling fan	0	25,000	25,000	1	58,561	1	1	0.5	0.06	0.16	2.88
Bypass valve	3	50,000	50,000	1	47,737	1	1	1	0.08	0.24	3.54
Temperature sensor	0.15	50,000	50,000	2	26,247	1	1	2	0.14	0.57	6.43
Water separator/filter assy	10	100,000	100,000	1	53,789	1	1	1	0.07	0.21	3.14
Water separator/filter element		4000	10,000,000	1	4,000	1	1	1	0.94	2.81	42.19
Inlet shutoff valve	4	50,000	50,000	1	35,000	1	1	2	0.11	0.43	4.82
Cryocooler bleed air valve	4	50,000	50,000	1	35,000	1	1	2	0.11	0.43	4.82
Flow sensor	0.1	20,000	20,000	1	20,000	1	10	2	0.19	2.44	8.44
Molecular sieve control valves	4	50,000	50,000	2	10,000	1	10	4	0.38	5.63	16.88
Molecular sieves	2.5	50,000	50,000	1	50,000	1	10	4	0.08	1.13	3.38
Purge heat exchanger	5	100,000	100,000	1	15,000	1	10	4	0.25	3.75	11.25
Purge heat exchanger valve-Air Side	4	50,000	50,000	1	35,000	1	10	4	0.11	1.61	4.82
Purge heat exchanger valve-Waste Side	4	50,000	50,000	1	35,000	1	10	4	0.11	1.61	4.82
LINEA Dewar Cooldown Valve	4	50,000	50,000	1	35,000	1	10	2	0.11	1.39	4.82
Inlet Recuperator	82	80,000	80,000	1	15,000	1	10	4	0.25	3.75	11.25
Inlet cooler	3	100,000	100,000	1	100,000	1	10	2	0.04	0.49	1.69
Cryocooler	156	8,000	8,000	1	8,000	6	2	4	0.47	5.63	21.10
LINEA Dewar	0	75,000	75,000	1	75,000	1	1	4	0.05	0.30	2.25
Dewar level sensor	0	50,000	50,000	1	50,000	1	1	2	0.08	0.30	3.38
Distillation column	6	50,000	50,000	1	50,000	1	1	4	0.08	0.45	3.38
Distillation column gas valve	4	50,000	50,000	1	35,000	1	1	2	0.11	0.43	4.82
Distillation column liquid valve	4	50,000	50,000	1	35,000	1	1	2	0.11	0.43	4.82
Temperature sensor	0.15	50,000	50,000	2	17,498	1	1	2	0.21	0.86	9.64
Relief valve	2.5	50,000	50,000	1	53,306	2	1	2	0.07	0.35	3.17
Oxygen sensor	1.5	26,933	26,933	1	26,933	1	1	1	0.14	0.42	6.27
Fuel tank check valve	0.5	100,000	100,000	5	4,000	1	24	8	0.94	30.94	42.19
Controller / control card	5.5	10,000	10,000	1	10,000	1	1	2	0.38	1.50	16.88
Ducting	345	10,000,000	10,000,000	1	80,000	6	2	2	0.05	0.47	2.11
Wiring	15	10,000,000	10,000,000	1	80,000	6	2	8	0.05	0.75	2.11
System Totals	699			44	515	58	142.5	90	7.28	75.34	327.54

FULL-TIME OBIGGS PARTS LIST
CRYOGENIC DISTILLATION

Component	Unit weight (lbs)	Unit MTBMA	Unit MTBF	Quantity /Shipset	Component MTBUR Calc	Removal & Replacement Time Man Hours	Access Time Man Hours	Trouble-Shooting Time Man Hours	Annual Failure Rate	Labour Hours Per Year	Delays Per Year (Minutes)
Large Transport											
Cabin air filter assy	6	100,000	100,000	1	100,000	1	1	1	0.05	0.14	1.44
Cabin air filter element		4000	10,000,000	1	8,000	1	1	1	0.60	1.80	18.04
OBIGGS shutoff valve	4	50,000	50,000	1	38,315	1	0.5	0.5	0.13	0.25	3.77
Compressor	26	7,000	100,000	1	11,096	3	0.5	0.5	0.43	1.73	13.01
Compressor discharge check valve	1	100,000	100,000	1	34,119	1	0.5	1.5	0.14	0.42	4.23
Bleed shutoff valve	3	50,000	50,000	1	48,856	1	1	1	0.10	0.30	2.95
Bleed check valve	1	100,000	100,000	1	34,119	1	1	1	0.14	0.42	4.23
Heat exchanger	0	100,000	100,000	1	11,621	6	1	1	0.41	3.31	12.42
Cooling fan	0	25,000	25,000	1	58,561	1	1	0.5	0.08	0.21	2.46
Bypass valve	3	50,000	50,000	1	47,737	1	1	1	0.10	0.30	3.02
Temperature sensor	0.15	50,000	50,000	2	26,247	1	1	2	0.18	0.73	5.50
Water separator/filter assy	10	100,000	100,000	1	53,789	1	1	1	0.09	0.27	2.68
Water separator/filter element		4000	10,000,000	1	4,000	1	1	1	1.20	3.61	36.08
Inlet shutoff valve	4	50,000	50,000	1	35,000	1	1	2	0.14	0.55	4.12
Crycooler bleed air valve	4	50,000	50,000	1	35,000	1	1	2	0.14	0.55	4.12
Flow sensor	0.1	20,000	20,000	1	20,000	1	10	2	0.24	3.13	7.22
Molecular sieve control valves	4	50,000	50,000	2	10,000	1	10	4	0.48	7.22	14.43
Molecular sieves	2.5	50,000	50,000	1	50,000	1	10	4	0.10	1.44	2.89
Purge heat exchanger	5	100,000	100,000	1	15,000	1	10	4	0.32	4.81	9.62
Purge heat exchanger valve-Air Side	4	50,000	50,000	1	35,000	1	10	4	0.14	2.06	4.12
Purge heat exchanger valve-Waste Side	4	50,000	50,000	1	35,000	1	10	4	0.14	2.06	4.12
LINEA Dewar Cooldown Valve	4	50,000	50,000	1	35,000	1	10	2	0.14	1.79	4.12
Inlet Recuperator	120	60,000	60,000	1	15,000	1	10	4	0.32	4.81	9.62
Inlet cooler	3	100,000	100,000	1	100,000	1	10	2	0.05	0.63	1.44
Cryocooler	195	8,000	8,000	1	8,000	6	2	4	0.60	7.22	18.04
LINEA Dewar	0	75,000	75,000	1	75,000	1	1	4	0.06	0.38	1.92
Dewar level sensor	0	50,000	50,000	1	50,000	1	1	2	0.10	0.38	2.89
Distillation column	6	50,000	50,000	1	50,000	1	1	4	0.10	0.58	2.89
Distillation column gas valve	4	50,000	50,000	1	35,000	1	1	2	0.14	0.55	4.12
Distillation column liquid valve	4	50,000	50,000	1	35,000	1	1	2	0.14	0.55	4.12
Temperature sensor	0.15	50,000	50,000	2	17,498	1	1	2	0.27	1.10	8.25
Relief valve	2.5	50,000	50,000	1	53,306	2	1	2	0.09	0.45	2.71
Oxygen sensor	1.5	26,933	26,933	1	26,933	1	1	1	0.18	0.54	5.36
Fuel tank check valve	0.5	100,000	100,000	5	4,000	1	24	8	1.20	39.69	36.08
Controller / control card	5.5	10,000	10,000	1	10,000	1	1	2	0.48	1.92	14.43
Ducting	345	10,000,000	10,000,000	1	80,000	6	2	2	0.06	0.60	1.80
Wiring	15	10,000,000	10,000,000	1	80,000	6	2	8	0.06	0.96	1.80
System Totals	788			44	515	60	142.5	90	9.34	97.47	280.10

FULL-TIME OBIGGS PARTS LIST
CRYOGENIC DISTILLATION

Component	Unit weight (lbs)	Unit MTBMA	Unit MTBF	Quantity /Shipset	Component MTBUR Calc	Removal & Replacement Time Man Hours	Access Time Man Hours	Trouble-Shooting Time Man Hours	Annual Failure Rate	Labour Hours Per Year	Delays Per Year (Minutes)
Business Jet											
Cabin air filter assy	6	100,000	100,000	1	100,000	1	1	1	0.02	0.05	1.07
Cabin air filter element		4000	10,000,000	1	8,000	1	1	1	0.22	0.67	13.33
OBIGGS shutoff valve	4	50,000	50,000	1	38,315	1	0.5	0.5	0.05	0.09	2.78
Compressor	3	7,000	100,000	1	11,096	1	0.5	0.5	0.16	0.32	9.61
Compressor discharge check valve	1	100,000	100,000	1	34,119	1	0.5	1.5	0.05	0.16	3.13
Bleed shutoff valve	3	50,000	50,000	1	48,856	1	1	1	0.04	0.11	2.18
Bleed check valve	1	100,000	100,000	1	34,119	1	1	1	0.05	0.16	3.13
Heat exchanger	0	100,000	100,000	1	11,621	1	1	1	0.15	0.46	9.18
Cooling fan	0	25,000	25,000	1	58,561	1	1	0.5	0.03	0.08	1.82
Bypass valve	3	50,000	50,000	1	47,737	1	1	1	0.04	0.11	2.23
Temperature sensor	0.15	50,000	50,000	2	26,247	1	1	2	0.07	0.27	4.06
Water separator/filter assy	10	100,000	100,000	1	53,789	1	1	1	0.03	0.10	1.98
Water separator/filter element		4000	10,000,000	1	4,000	1	1	1	0.44	1.33	26.66
Inlet shutoff valve	4	50,000	50,000	1	35,000	1	1	2	0.05	0.20	3.05
Crycooler bleed air valve	4	50,000	50,000	1	35,000	1	1	2	0.05	0.20	3.05
Flow sensor	0.1	20,000	20,000	1	20,000	1	10	2	0.09	1.16	5.33
Molecular sieve control valves	4	50,000	50,000	2	10,000	1	10	4	0.18	2.67	10.67
Molecular sieves	2.5	50,000	50,000	1	50,000	1	10	4	0.04	0.53	2.13
Purge heat exchanger	5	100,000	100,000	1	15,000	1	10	4	0.12	1.78	7.11
Purge heat exchanger valve-Air Side	4	50,000	50,000	1	35,000	1	10	4	0.05	0.76	3.05
Purge heat exchanger valve-Waste Side	4	50,000	50,000	1	35,000	1	10	4	0.05	0.76	3.05
LNEA Dewar Cooldown Valve	4	50,000	50,000	1	35,000	1	10	2	0.05	0.66	3.05
Inlet Recuperator	44	100,000	100,000	1	15,000	1	10	4	0.12	1.78	7.11
Inlet cooler	3	100,000	100,000	1	100,000	1	10	2	0.02	0.23	1.07
Cryocooler	117	8,000	8,000	1	8,000	6	2	4	0.22	2.67	13.33
LNEA Dewar	0	75,000	75,000	1	75,000	1	1	4	0.02	0.14	1.42
Dewar level sensor	0	50,000	50,000	1	50,000	1	1	2	0.04	0.14	2.13
Distillation column	6	50,000	50,000	1	50,000	1	1	4	0.04	0.21	2.13
Distillation column gas valve	4	50,000	50,000	1	35,000	1	1	2	0.05	0.20	3.05
Distillation column liquid valve	4	50,000	50,000	1	35,000	1	1	2	0.05	0.20	3.05
Temperature sensor	0.15	50,000	50,000	2	17,498	1	1	2	0.10	0.41	6.10
Relief valve	2.5	50,000	50,000	1	53,306	2	1	2	0.03	0.17	2.00
Oxygen sensor	1.5	26,933	26,933	1	26,933	1	1	1	0.07	0.20	3.96
Fuel tank check valve	0.5	100,000	100,000	5	4,000	1	24	8	0.44	14.66	26.66
Controller / control card	5.5	10,000	10,000	1	10,000	1	1	2	0.18	0.71	10.67
Ducting	345	10,000,000	10,000,000	1	80,000	6	2	2	0.02	0.22	1.33
Wiring	15	10,000,000	10,000,000	1	80,000	6	2	8	0.02	0.36	1.33
System Totals	611			44	515	53	142.5	90	3.45	34.93	206.98

FULL-TIME OBIGGS PARTS LIST
CRYOGENIC DISTILLATION

Component	Unit weight (lbs)	Unit MTBMA	Unit MTBF	Quantity /Shipset	Component MTBUR Calc	Removal & Replacement Time Man Hours	Access Time Man Hours	Trouble-Shooting Time Man Hours	Annual Failure Rate	Labour Hours Per Year	Delays Per Year (Minutes)
Regional Turboprop											
Cabin air filter assy	6	100,000	100,000	1	100,000	1	1	1	0.03	0.08	1.66
Cabin air filter element		4000	10,000,000	1	8,000	1	1	1	0.35	1.04	20.74
OBIGGS shutoff valve	4	50,000	50,000	1	38,315	1	0.5	0.5	0.07	0.14	4.33
Compressor	3	7,000	100,000	1	11,096	1	0.5	0.5	0.25	0.50	14.95
Compressor discharge check valve	1	100,000	100,000	1	34,119	1	0.5	1.5	0.08	0.24	4.86
Bleed shutoff valve	3	50,000	50,000	1	48,856	1	1	1	0.06	0.17	3.40
Bleed check valve	1	100,000	100,000	1	34,119	1	1	1	0.08	0.24	4.86
Heat exchanger	0	100,000	100,000	1	11,621	1	1	1	0.24	0.71	14.28
Cooling fan	0	25,000	25,000	1	58,561	1	1	0.5	0.05	0.12	2.83
Bypass valve	3	50,000	50,000	1	47,737	1	1	1	0.06	0.17	3.48
Temperature sensor	0.15	50,000	50,000	2	26,247	1	1	2	0.11	0.42	6.32
Water separator/filter assy	10	100,000	100,000	1	53,789	1	1	1	0.05	0.15	3.08
Water separator/filter element		4000	10,000,000	1	4,000	1	1	1	0.69	2.07	41.47
Inlet shutoff valve	4	50,000	50,000	1	35,000	1	1	2	0.08	0.32	4.74
Cryocooler bleed air valve	4	50,000	50,000	1	35,000	1	1	2	0.08	0.32	4.74
Flow sensor	0.1	20,000	20,000	1	20,000	1	10	2	0.14	1.80	8.29
Molecular sieve control valves	4	50,000	50,000	2	10,000	1	10	4	0.28	4.15	16.59
Molecular sieves	2.5	50,000	50,000	1	50,000	1	10	4	0.06	0.83	3.32
Purge heat exchanger	5	100,000	100,000	1	15,000	1	10	4	0.18	2.76	11.06
Purge heat exchanger valve-Air Side	4	50,000	50,000	1	35,000	1	10	4	0.08	1.18	4.74
Purge heat exchanger valve-Waste Side	4	50,000	50,000	1	35,000	1	10	4	0.08	1.18	4.74
LNEA Dewar Cooldown Valve	4	50,000	50,000	1	35,000	1	10	2	0.08	1.03	4.74
Inlet Recuperator	44	100,000	100,000	1	15,000	1	10	4	0.18	2.76	11.06
Inlet cooler	3	100,000	100,000	1	100,000	1	10	2	0.03	0.36	1.66
Cryocooler	117	8,000	8,000	1	8,000	6	2	4	0.35	4.15	20.74
LNEA Dewar	0	75,000	75,000	1	75,000	1	1	4	0.04	0.22	2.21
Dewar level sensor	0	50,000	50,000	1	50,000	1	1	2	0.06	0.22	3.32
Distillation column	6	50,000	50,000	1	50,000	1	1	4	0.06	0.33	3.32
Distillation column gas valve	4	50,000	50,000	1	35,000	1	1	2	0.08	0.32	4.74
Distillation column liquid valve	4	50,000	50,000	1	35,000	1	1	2	0.08	0.32	4.74
Temperature sensor	0.15	50,000	50,000	2	17,498	1	1	2	0.16	0.63	9.48
Relief valve	2.5	50,000	50,000	1	53,306	2	1	2	0.05	0.26	3.11
Oxygen sensor	1.5	26,933	26,933	1	26,933	1	1	1	0.10	0.31	6.16
Fuel tank check valve	0.5	100,000	100,000	5	4,000	1	24	8	0.69	22.81	41.47
Controller / control card	5.5	10,000	10,000	1	10,000	1	1	2	0.28	1.11	16.59
Ducting	345	10,000,000	10,000,000	1	80,000	6	2	2	0.03	0.35	2.07
Wiring	15	10,000,000	10,000,000	1	80,000	6	2	8	0.03	0.55	2.07
System Totals	611			44	515	53	142.5	90	5.37	54.33	321.96

FULL-TIME OBIGGS PARTS LIST
CRYOGENIC DISTILLATION

Component	Unit weight (lbs)	Unit MTBMA	Unit MTBF	Quantity /Shipset	Component MTBUR Calc	Removal & Replacement Time Man Hours	Access Time Man Hours	Trouble-Shooting Time Man Hours	Annual Failure Rate	Labour Hours Per Year	Delays Per Year (Minutes)
Regional Turbofan											
Cabin air filter assy	6	100,000	100,000	1	100,000	1	1	1	0.04	0.11	2.15
Cabin air filter element		4000	10,000,000	1	8,000	1	1	1	0.45	1.34	26.83
OBIGGS shutoff valve	4	50,000	50,000	1	38,315	1	0.5	0.5	0.09	0.19	5.60
Compressor	3	7,000	100,000	1	11,096	1	0.5	0.5	0.32	0.64	19.34
Compressor discharge check valve	1	100,000	100,000	1	34,119	1	0.5	1.5	0.10	0.31	6.29
Bleed shutoff valve	3	50,000	50,000	1	48,856	1	1	1	0.07	0.22	4.39
Bleed check valve	1	100,000	100,000	1	34,119	1	1	1	0.10	0.31	6.29
Heat exchanger	0	100,000	100,000	1	11,621	1	1	1	0.31	0.92	18.47
Cooling fan	0	25,000	25,000	1	58,561	1	1	0.5	0.06	0.15	3.66
Bypass valve	3	50,000	50,000	1	47,737	1	1	1	0.07	0.22	4.50
Temperature sensor	0.15	50,000	50,000	2	26,247	1	1	2	0.14	0.55	8.18
Water separator/filter assy	10	100,000	100,000	1	53,789	1	1	1	0.07	0.20	3.99
Water separator/filter element		4000	10,000,000	1	4,000	1	1	1	0.89	2.68	53.66
Inlet shutoff valve	4	50,000	50,000	1	35,000	1	1	2	0.10	0.41	6.13
Crycooler bleed air valve	4	50,000	50,000	1	35,000	1	1	2	0.10	0.41	6.13
Flow sensor	0.1	20,000	20,000	1	20,000	1	10	2	0.18	2.33	10.73
Molecular sieve control valves	4	50,000	50,000	2	10,000	1	10	4	0.36	5.37	21.46
Molecular sieves	2.5	50,000	50,000	1	50,000	1	10	4	0.07	1.07	4.29
Purge heat exchanger	5	100,000	100,000	1	15,000	1	10	4	0.24	3.58	14.31
Purge heat exchanger valve-Air Side	4	50,000	50,000	1	35,000	1	10	4	0.10	1.53	6.13
Purge heat exchanger valve-Waste Side	4	50,000	50,000	1	35,000	1	10	4	0.10	1.53	6.13
LINEA Dewar Cooldown Valve	4	50,000	50,000	1	35,000	1	10	2	0.10	1.33	6.13
Inlet Recuperator	44	100,000	100,000	1	15,000	1	10	4	0.24	3.58	14.31
Inlet cooler	3	100,000	100,000	1	100,000	1	10	2	0.04	0.47	2.15
Cryocooler	117	8,000	8,000	1	8,000	6	2	4	0.45	5.37	26.83
LINEA Dewar	0	75,000	75,000	1	75,000	1	1	4	0.05	0.29	2.86
Dewar level sensor	0	50,000	50,000	1	50,000	1	1	2	0.07	0.29	4.29
Distillation column	6	50,000	50,000	1	50,000	1	1	4	0.07	0.43	4.29
Distillation column gas valve	4	50,000	50,000	1	35,000	1	1	2	0.10	0.41	6.13
Distillation column liquid valve	4	50,000	50,000	1	35,000	1	1	2	0.10	0.41	6.13
Temperature sensor	0.15	50,000	50,000	1	26,247	1	1	2	0.14	0.55	8.18
Relief valve	2.5	50,000	50,000	1	53,306	2	1	2	0.07	0.34	4.03
Oxygen sensor	1.5	26,933	26,933	2	17,498	1	1	1	0.20	0.61	12.27
Fuel tank check valve	0.5	100,000	100,000	5	4,000	1	24	8	0.89	29.51	53.66
Controller / control card	5.5	10,000	10,000	1	10,000	1	1	2	0.36	1.43	21.46
Ducting	345	10,000,000	10,000,000	1	80,000	6	2	2	0.04	0.45	2.68
Wiring	15	10,000,000	10,000,000	1	80,000	6	2	8	0.04	0.72	2.68
System Totals	611			44	515	53	142.5	90	6.95	70.23	416.74

Airplane Operation and Maintenance Task Team Final Report

This page intentionally left blank.

ADDENDUM F.D.1

***CONFINED SPACE ENTRY LABOR & SAFETY EQUIPMENT
ESTIMATE***

to

APPENDIX F

**AIRPLANE OPERATION AND MAINTENANCE
FINAL REPORT**

This page intentionally left blank.

Confined Space Entry Added Labor

System Concept	Aircraft	Inerting System Maint. Access per year	Other Maint. Access per Year	Additional M/H per entry	Annual M/H per Aircraft	Number of Aircraft	Annual Cost	
Ground Based Inerting	Business Jet	0.1	6	0.75	4.6	8600	\$2,950,875	
	Turboprop	0.3	6	1.5	9.5	2000	\$1,417,500	
	Turbofan	0.2	6	1.5	9.3	1000	\$697,500	
	Small Transport	0.3	6	1.5	9.4	8600	\$6,088,724	
	Medium Transport	0.3	6	1.5	9.4	1400	\$989,954	
	Large Transport	0.4	6	1.5	9.6	2000	\$1,443,853	
	Total							\$13,588,406
On-Board Ground Based Inerting	Membrane Business Jet	1.2	6	0.75	5.4	8600	\$3,483,000	
	Membrane Turboprop	1.8	6	1.5	11.7	2000	\$1,755,000	
	Membrane Turbofan	1.4	6	1.5	11.1	1000	\$832,500	
	Membrane Small Transport	2.2	6	1.5	12.4	8600	\$7,970,757	
	Membrane Medium Transport	1.9	6	1.5	11.9	1400	\$1,247,379	
	Membrane Large Transport	2.5	6	1.5	12.7	2000	\$1,904,119	
Total							\$17,192,755	
On-Board Inert Gas Generating	Membrane Business Jet	3.2	6	0.75	6.9	8600	\$4,455,238	
	Membrane Turboprop	3.7	6	1.5	14.6	2000	\$2,191,645	
	Membrane Turbofan	4.8	6	1.5	16.3	1000	\$1,219,430	
	Membrane Small Transport	5.6	6	1.5	17.4	8600	\$11,232,416	
	Membrane Medium Transport	5.0	6	1.5	16.6	1400	\$1,740,133	
	Membrane Large Transport	6.5	6	1.5	18.7	2000	\$2,807,054	
	Total							\$23,645,917
	Cryogenic Business Jet	4.6	6	0.75	8.0	8600	\$5,129,934	
	Cryogenic Turboprop	5.4	6	1.5	17.0	2000	\$2,557,357	
	Cryogenic Turbofan	6.9	6	1.5	19.4	1000	\$1,456,387	
	Cryogenic Small Transport	8.0	6	1.5	21.1	8600	\$13,590,737	
	Cryogenic Medium Transport	7.3	6	1.5	19.9	1400	\$2,091,391	
	Cryogenic Large Transport	9.3	6	1.5	23.0	2000	\$3,450,721	
	Total							\$28,276,527

Airplane Operation and Maintenance Task Team Final Report

Confined Space Entry Safety Equipment Costs

	Gates	Maintenance Facilities	Gates per Kit	Kit Cost	Total Cost
121 Carriers	50,000	5000	10	\$ 3,977.92	\$19,889,600
Air Freight Operations			2	\$ 3,977.92	\$9,944,800
Corporate Aircraft			2	\$ 3,977.92	\$9,944,800
Total					\$39,779,200

Confined Space Entry Safety Equipment Quote

Quantity	Model	Description	Each	Total
1	1810-3606-0011	Industrial Scientific LTX312 Monitor with LEL & Oxygen Sensors	\$ 1,096.68	\$ 1,096.68
1	1810-2251	Charger	\$ 56.01	\$ 56.01
1	1810-1238	Calibration Gas unit, oxygen & pentane	\$ 114.33	\$ 114.33
1	1810-1766	Calibration Regulator	\$ 137.20	\$ 137.20
1	EF175XX	Ram Fan Model 75 Axial Blower, Explosion proof motor, ABS Carbon filled Housing. 2500cfm	\$ 999.95	\$ 999.95
2	1225C	12" Reinforced Conductive Duct, 25 feet	\$ 651.25	\$ 1,302.50
1	DC12	12" Duct to Duct coupler	\$ 51.25	\$ 51.25
2	BG12	Carrying case, duct	\$ 75.00	\$ 150.00
1	312	12" Duct Adapter	\$ 70.00	\$ 70.00
Total				\$ 3,977.92

Appendix G

Estimating and Forecasting Task Team Final Report

This page intentionally left blank.

TABLE OF CONTENTS

1.0 SCOPE AND DEFINITION	G-1
2.0 COST-BENEFIT ANALYSIS SUMMARY	G-2
3.0 GASEOUS VERSUS LIQUID NITROGEN.....	G-66

LIST OF FIGURES

G-1.	Scenario Information Sheet	3
G-2.	Airplane Forecast—World Fleet.....	4
G-3.	Airplane Forecast—World Fleet, Passenger Only.....	5
G-4.	Airplane Forecast—U.S. Fleet.....	6
G-5.	Airplane Forecast—U.S. Fleet, Passenger Only.....	7
G-6.	Airport Forecast—World and United States.....	8
G-7.	Accident Cost Data	9
G-8.	Cost Summary of World Fleet.....	10
G-9.	Scenario 1—Onboard Ground Inerting, HCWT Only, Large, Medium, Small Transports, PSA/Membrane Systems (World)	11
G-10.	Scenario 2—Onboard Ground Inerting, All Fuselage Tanks, Large, Medium, Small Transports, PSA/Membrane Systems (World)	12
G-11.	Scenario 3—Hybrid Onboard Ground Inerting, HCWT Only, Large, Medium, Small Transports, PSA/Membrane Systems (World)	13
G-12.	Scenario 4—Hybrid Onboard Ground Inerting, All Fuselage Tanks, Large, Medium, Small Transports, PSA/Membrane Systems (World)	14
G-13.	Scenario 5—OBIGGS, All Tanks, Large and Medium Transports, Membrane Systems, and Small Transports, PSA/Membrane Systems (World).....	15
G-14.	Scenario 7—Hybrid OBIGGS, HCWT Only, Large and Medium Transports, Membrane Systems, and Small Transports, PSA/Membrane Systems (World).....	16
G-15.	Scenario 9—Hybrid OBIGGS, All Tanks, Large and Medium Transports, Membrane Systems, and Small Transports, PSA/Membrane Systems (World).....	17
G-16.	Scenario 11—Ground-Based Inerting, HCWT Only, All Transports (World).....	18
G-17.	Scenario 12—Ground-Based Inerting, All Fuselage Tanks, All Transports (World).....	19
G-18.	Scenario 13—OBIGGS, All Tanks, Large and Medium Transports, Cryogenic Systems, and Small Transports, PSA/Membrane Systems (World)	20
G-19.	Scenario 14—Hybrid OBIGGS, HCWT Only, Large and Medium Transports, Cryogenic Systems, and Small Transports, PSA/Membrane Systems (World).....	21
G-20.	Scenario 15—Hybrid OBIGGS, All Tanks, Large and Medium Transports, Cryogenic Systems, and Small Transports, PSA/Membrane Systems (World).....	22
G-21.	Scenario 16—Onboard Liquid Nitrogen Inerting (World).....	23
G-22.	Cost Summary of World Fleet Passenger Only	24
G-23.	Scenario 1—Onboard Ground Inerting, HCWT Only, Large, Medium, Small Transports, PSA/Membrane Systems (World, Passenger Only).....	25
G-24.	Scenario 2—Onboard Ground Inerting, All Fuselage Tanks, Large, Medium, Small Transports, PSA/Membrane Systems (World, Passenger Only)	26
G-25.	Scenario 3—Hybrid Onboard Ground Inerting, HCWT Only, Large, Medium and Small Transports, PSA/Membrane Systems (World, Passenger Only)	27
G-26.	Scenario 4—Hybrid Onboard Ground Inerting, All Fuselage Tanks, Large, Medium, Small Transports, PSA/Membrane Systems (World, Passenger Only)	28
G-27.	Scenario 5—OBIGGS, All Tanks, Large and Medium Transports, Membrane Systems, and Small Transports, PSA/Membrane Systems (World, Passenger Only)	29
G-28.	Scenario 7—Hybrid OBIGGS, HCWT Only, Large and Medium Transports, Membrane Systems, and Small Transports, PSA/Membrane Systems (World, Passenger Only).....	30
G-29.	Scenario 9—Hybrid OBIGGS, All Tanks, Large and Medium Transports, Membrane Systems, and Small Transports, PSA/Membrane Systems (World, Passenger Only).....	31
G-30.	Scenario 11—Ground-Based Inerting, HCWT Only, All Transports (World, Passenger Only)	32

Estimating and Forecasting Task Team Final Report

G-31.	Scenario 12—Ground-Based Inerting, All Fuselage Tanks, All Transports (World, Passenger Only).....	33
G-32.	Scenario 13—OBIGGS, All Tanks, Large and Medium Transports, Cryogenic Systems, and Small Transports, PSA/Membrane Systems (World, Passenger Only).....	34
G-33.	Scenario 14—Hybrid OBIGGS, HCWT Only, Large and Medium Transports, Cryogenic Systems, and Small Transports, PSA/Membrane Systems (World, Passenger Only).....	35
G-34.	Scenario 15—Hybrid OBIGGS, All Tanks, Large and Medium Transports, Cryogenic Systems, and Small Transports, PSA/Membrane Systems (World, Passenger Only).....	36
G-35.	Scenario 16—Onboard Liquid Nitrogen Inerting (World, Passenger Only).....	37
G-36.	Cost Summary of U.S. Fleet.....	38
G-37.	Scenario 1—Onboard Ground Inerting, HCWT Only, Large, Medium, Small Transports, PSA/Membrane Systems (U.S.).....	39
G-38.	Scenario 2—Onboard Ground Inerting, All Fuselage Tanks, Large, Medium, Small Transports, PSA/Membrane Systems (U.S.).....	40
G-39.	Scenario 3—Hybrid Onboard Ground Inerting, HCWT Only, Large, Medium, and Small Transports, PSA/Membrane Systems (U.S.).....	41
G-40.	Scenario 4—Hybrid Onboard Ground Inerting, All Fuselage Tanks, Large, Medium, and Small Transports, PSA/Membrane Systems (U.S.).....	42
G-41.	Scenario 5—OBIGGS, All Tanks, Large and Medium Transports, Membrane Systems, and Small Transports, PSA/Membrane Systems (U.S.).....	43
G-42.	Scenario 7—Hybrid OBIGGS, HCWT Only, Large and Medium Transports, Membrane Systems, and Small Transports, PSA/Membrane Systems (U.S.).....	44
G-43.	Scenario 9—Hybrid OBIGGS, All Tanks, Large and Medium Transports, Membrane Systems, and Small Transports, PSA/Membrane Systems (U.S.).....	45
G-44.	Scenario 11—Ground-Based Inerting, HCWT Only, All Transports (U.S.).....	46
G-45.	Scenario 12—Ground-Based Inerting, All Fuselage Tanks, All Transports (U.S.).....	47
G-46.	Scenario 13—OBIGGS, All Tanks, Large and Medium Transports, Cryogenic Systems, and Small Transports, PSA/Membrane Systems (U.S.).....	48
G-47.	Scenario 14—Hybrid OBIGGS, HCWT Only, Large and Medium Transports, Cryogenic Systems, and Small Transports, PSA/Membrane Systems (U.S.).....	49
G-48.	Scenario 15—Hybrid OBIGGS, All Tanks, Large and Medium Transports, Cryogenic Systems, and Small Transports, PSA/Membrane Systems (U.S.).....	50
G-49.	Scenario 16—Onboard Liquid Nitrogen Inerting (U.S.).....	51
G-50.	Cost Summary of U.S. Fleet, Passenger Only.....	52
G-51.	Scenario 1—Onboard Ground Inerting, HCWT Only, Large, Medium, Small Transports, PSA/Membrane Systems (U.S., Passenger Only).....	53
G-52.	Scenario 2—Onboard Ground Inerting, All Fuselage Tanks, Large, Medium, Small Transports, PSA/Membrane Systems (U.S., Passenger Only).....	54
G-53.	Scenario 3—Hybrid Onboard Ground Inerting, HCWT Only, Large, Medium, Small Transports, PSA/Membrane Systems (U.S., Passenger Only).....	55
G-54.	Scenario 4—Hybrid Onboard Ground Inerting, All Fuselage Tanks, Large, Medium, Small Transports, PSA/Membrane Systems (U.S., Passenger Only).....	56
G-55.	Scenario 5—OBIGGS, All Tanks, Large and Medium Transports, Membrane Systems, and Small Transports, PSA/Membrane Systems (U.S., Passenger Only).....	57
G-56.	Scenario 7—Hybrid OBIGGS, HCWT Only, Large and Medium Transports, Membrane Systems, and Small Transports, PSA/Membrane Systems (U.S., Passenger Only).....	58
G-57.	Scenario 9—Hybrid OBIGGS, All Tanks, Large and Medium Transports, Membrane Systems, and Small Transports, PSA/Membrane Systems (U.S., Passenger Only).....	59
G-58.	Scenario 11—Ground-Based Inerting, HCWT Only, All Transports (U.S., Passenger Only).....	60
G-59.	Scenario 12—Ground-Based Inerting, All Fuselage Tanks, All Transports (U.S., Passenger Only).....	61

G-60.	Scenario 13—OBIGGS, All Tanks, Large and Medium Transports, Cryogenic Systems, and Small Transports, PSA/Membrane Systems (U.S., Passenger Only)	62
G-61.	Scenario 14—Hybrid OBIGGS, HCWT Only, Large and Medium Transports, Cryogenic Systems, and Small Transports, PSA/Membrane Systems (U.S., Passenger Only)	63
G-62.	Scenario 15—Hybrid OBIGGS, All Tanks, Large and Medium Transports, Cryogenic Systems, and Small Transports, PSA/Membrane Systems (U.S., Passenger Only)	64
G-63.	Scenario 16—Onboard Liquid Nitrogen Inerting (U.S. Fleet, Passenger Only)	65
G-64.	Liquid Nitrogen System Weight	66

1.0 SCOPE AND DEFINITION

The FTIHWG cost-benefit analysis includes the large, medium, and small airplane categories. The regional turboprop, regional turboprop, and business jet categories were excluded because they would have had just a small impact on the overall safety benefit, and including their costs would have significantly and disproportionately increased the cost-benefit ratio.

For each of the fuel tank inerting systems described in this report, the total cost is given over the 16-year study period (2005 through 2020). This total cost includes the initial airplane and airport modification costs plus the accumulated annual recurring costs. Airplane nonrecurring costs include engineering design for the modifications and additions to fuel system components, interfaces, instruments or displays, relocation of other equipment, wiring, tubing or ducting, and avionics software or modules. The nonrecurring engineering costs also include changes to documents (e.g., Specs, ICDs); manuals (e.g., AFM, Opts, MM); production change records; laboratory, ground, and flight tests; and FAA/JAA certification. These costs also include major-supplier parts and assemblies, tubing, wiring, ducting, Service Bulletin and kitting costs (retrofit), and special tooling for installation.

For airlines, costs include engineering and training costs, installation labor, and airplane downtime. The airplane downtime cost estimates were based on the cost to lease a comparable airplane during the retrofit period. It was assumed that 80% of the airplanes would be retrofitted during a major check and 20% were retrofitted outside of the major check cycle. For the large-airplane category, the estimated downtime was 9 days for retrofitting during a major check, and 11 days for retrofitting outside of a major check. A medium-category airplane was assumed to take 8 days during a major check and 10 days outside of a major check. For the small-category airplane, the retrofit was assumed to take 7 days during a major check and 9 days outside of a major check.

Airplane annual recurring costs include training, maintenance checks, inspections, removals, unscheduled maintenance, airplane delays. The annual weight penalty per 1,000 lb is \$165,532 for a large airplane, \$131,802 for a medium airplane, and \$62,004 for a small airplane. The cost of the weight penalty was based on values from the 1998 ARAC study.

The ground-based inerting (GBI) system costs include the costs for a fixed hydrant system and a mobile truck-based system for large- and medium-size airports. Small and foreign airports have only a mobile system. The nonrecurring airport costs include engineering design, system installation labor (including relocation of other equipment), parts and materials, and tooling. The annual recurring costs include the cost of the N₂ required for ullage washing, the ground service labor for inerting, and N₂ system maintenance, inspection, and training.

For the onboard ground inerting systems (OBGI), the airport costs included the additional ground support equipment for providing required electrical power at large and medium-sized airports. It was assumed that the airplane's APU would be used at small airports. It was assumed that the Onboard Inert Gas Generating System (OBIGGS) required no ground support equipment.

The overall airplane and airport costs for each system was calculated by multiplying the recurring and nonrecurring airplane costs by the appropriate number of airplanes. It was assumed that all airplanes built after 2007 would have the inerting system installed and that airplanes built before 2007 would require a retrofit. The airport costs were calculated by multiplying the number of large, medium, and small airports by their respective recurring and nonrecurring costs. For the US-only implementation cases, it was assumed that all B, C, and D category airports in the United States would be modified and that 158 foreign airports that are currently serviced by US operators would also be modified.

For several reasons, the airport costs estimated in this study are higher than the values listed in the FAA report DOT/FAA/AR-00/19, "The Cost of Implementing Ground Based Fuel Tank Inerting in the Commercial Fleet," dated May 2000. The FAA study only estimated the airport costs; no airplane costs were included. The FAA estimated that the airport cost of a US ground-based system for inerting heated

center wing tanks would be \$800 million US over a 10-year period starting in 2003. In contrast, this FTIHWG study estimates that the airport recurring and nonrecurring costs would be approximately \$6.8 billion US over a 16-year period.

The primary reasons for this difference in anticipated costs between the above-referenced FAA study and the ARAC study presented here is that the FTIHWG:

- Used a study period 60 percent longer than the FAA's because of the long time required to fully implement fuel tank inerting.
- Assumed higher nonrecurring airport cost primarily because it factors in higher equipment costs required to support remote airplane parking at large and medium airports.
- Included more airports in its study—whereas the FAA assumes 50 large airports and 350 small airports, this study assumes 31 large airports, 37 medium airports, and 354 small airports as well as 158 foreign airports served by US operators.
- Assumed a burdened-labor rate of \$25 per hour for ground service workers, which is nearly twice the burdened-labor rate assumed by the FAA study.
- Assumed ground-servicing hours two to three times higher, depending on airplane model, based on an underlying assumption that the worker would not leave the airplane hook-up unattended while the fuel tank was being serviced with nitrogen.
- Assumed that each airplane model would be serviced with the same amount of nitrogen, regardless of fuel load, thus requiring significantly more total nitrogen.
- Projects a 30% rise in the cost of nitrogen (from \$0.10 per 100 cubic feet to \$0.13 per 100 cubic feet) as forecast by an industrial gas company.
- Assumed 3% annual inflation in the cost of parts and labor.

The benefit values presented in this report are based on the assumption that 85% of fuel-tank-related accidents would occur in the air and the remaining 15% on the ground. Also included were the benefits of enhanced occupant survival in airplane accidents resulting from other causes, in which inerting could potentially prevent a post-crash fuel tank fire or explosion. Benefit values in this document do not reflect the confined-space hazard that wide-scale adoption of fuel tank inerting would introduce in the commercial fleet and in related ground-support areas. See section 4 for more information about benefits.

2.0 COST-BENEFIT ANALYSIS SUMMARY

The following charts include the list of scenarios evaluated, the airplane and airport forecasts, standard airplane model data, accident cost data, and the cost-benefit summaries for each scenario. Note that scenarios 6, 8, and 10 have been combined with 5, 7 and 9 respectively.

Estimating and Forecasting Task Team Final Report

Inerting Scenario Summary Information

Below are all of the scenario's address in the model. Note #6, 8, and 10 have been combined with 5,7, and 9. Small Transports, PSA/Membrane Systems have been added to 13-15 to have equal coverage as the other scenario's.

Scenario	Benefits used for Small
1 On-Board Ground Inerting HCWT only, Large, Medium, Small Transports, PSA/Membrane Systems	
2 On-Board Ground Inerting All Fuselage Tanks, Large, Medium, Small Transports, PSA/Membrane Systems	
3 Hybrid On-Board Ground Inerting HCWT only, Large, Medium, Small Transports, PSA/Membrane Systems	
4 Hybrid On-Board Ground Inerting All Fuselage Tanks, Large, Medium, Small Transports, PSA/Membrane Systems	
5 OBIGGS, All Tanks, Large and Medium Transports, Membrane Systems, & Small Transports, PSA/Membrane Systems	From 6
6 OBIGGS, All Tanks, Small Transports, PSA and Membrane Systems	
7 Hybrid OBIGGS, HCWT only, Large and Medium Transports, Membrane Systems, & Small Transports, PSA/Membrane Systems	From 8
8 Hybrid OBIGGS, HCWT only, Small Transports, PSA and Membrane Systems	
9 Hybrid OBIGGS, All Tanks, Large and Medium Transports, Membrane Systems, & Small Transports, PSA/Membrane Systems	From 10
10 Hybrid OBIGGS, All Tanks, Small Transports, PSA and Membrane Systems	
11 Ground Based Inerting HCWT only, All Transports	
12 Ground Based Inerting All Fuselage Tanks, All Transports	
13 OBIGGS, All Tanks, Large and Medium Transports, Cryogenics Systems, & Small Transports, PSA/Membrane Systems	From 6
14 Hybrid OBIGGS, HCWT only, Large and Medium Transports, Cryogenics Systems, & Small Transports, PSA/Membrane Systems	From 8
15 Hybrid OBIGGS, All Tanks, Large and Medium Transports, Cryogenics Systems, & Small Transports, PSA/Membrane Systems	From 10
16 On-Board Liquid Nitrogen Inerting	

All Scenario dollars are in Year 2000 US\$'s

The Airplane Non-Recurring costs are divided into First-of-a-model and derivative model costs. The First-of-a-Model costs are for the design, analysis and certification for the first of an airplane type. The derivative Model costs are for the subsequent airplanes of that type.

The Recurring Airplane costs are on an annual per-airplane basis

The Airport costs based on Large, Medium or Small airports plus 4 or 2 truck Mobile unit for foreign airports if the model is US only

Figure G-1. Scenario Information Sheet

Estimating and Forecasting Task Team Final Report

Note: Actual value of the Fleet were adjusted for each scenario based on the appropriate tank mix.

Active Scenario:			Tank Mix Values for Active Scenario								Tank Mix ON/OFF(1/0):													
Scenario 16 - On-Board Liquid Nitrogen Inerting			In-Service				New				1													
			Large	Medium	Small	Regional Jet	Large	Medium	Small	Regional Jet	As provided by Alan B Hedge[SMTP:ahedge@air-econ.com] The Campbell-Hill Aviation Group, Inc.													
			100%	100%	100%	0%	100%	100%	100%	0%														
			ARAC Distribution		50-99 (Regional + Biz Jet)			100-210 (Small)			(211-400)/2 (Medium)			400-600+ (211-400)/2 (Large)										
Operator	World																							
Mission	Type	Category	Data	2000	2001	2002	2003	2004	2005	2006	2007	2008	2009	2010	2011	2012	2013	2014	2015	2016	2017	2018	2019	2020
Pax	Retain	xRegional Jet	1381	1383	1310	1325	1330	1349	1357	1363	1356	1348	1339	1333	1323	1317	1294	1299	1290	1280	1271	1244	1229	
		Small Transport	7506	7515	7314	7353	7406	7453	7441	7423	7393	7360	7323	7275	7242	7214	7157	7119	7082	7054	7004	6963	6930	
		Medium Transport	1088	1085	1084.5	1082	1080	1078.5	1074.5	1068.5	1065	1061.5	1055.5	1048	1039.5	1031.5	1027.5	1020.5	1010.5	996.5	981	967.5	952.5	
		Large Transport	1619	1617	1615.5	1614	1612	1609.5	1596.5	1582.5	1565	1551.5	1516.5	1466	1439.5	1419.5	1402.5	1388.5	1368.5	1351.5	1324	1301.5	1283.5	
	New	xRegional Jet	190	361	579	678	703	730	763	800	864	935	1001	1071	1143	1214	1304	1377	1467	1570	1662	1792	1918	
		Small Transport	389	865	1486	1824	2009	2220	2513	2858	3239	3674	4103	4610	5089	5576	6134	6656	7228	7792	8406	9031	9669	
		Medium Transport	61.5	126	182	241	282	327.5	383	439.5	502	565.5	642	728.5	814	885.5	966	1060	1156	1249	1357	1464	1582.5	
		Large Transport	68.5	152	232	321	389	460.5	553	648.5	757	864.5	1001	1162.5	1304	1428.5	1559	1706	1859	2004	2172	2339	2516.5	
Freighter	Retain	xRegional Jet	43	43	40	40	40	40	40	42	42	42	42	42	42	42	42	43	43	43	43	43	43	
		Small Transport	798	796	702	705	711	706	717	726	727	729	726	714	703	687	676	665	658	648	639	628	621	
		Medium Transport	306.5	316.5	312	314.5	318.5	319	320	324.5	324.5	326	326.5	326	326	326.5	327	328	327.5	326.5	325.5	324.5	323.5	
		Large Transport	344.5	354.5	350	352.5	356.5	357	359	364.5	366.5	369	371.5	373	377	378.5	382	386	388.5	390.5	391.5	387.5	390.5	
	New	xRegional Jet	0	1	9	11	14	19	22	25	30	34	38	43	49	55	60	68	74	80	90	97	106	
		Small Transport	0	32	159	204	250	300	360	437	511	567	635	711	781	866	972	1076	1200	1310	1419	1521	1643	
		Medium Transport	4.5	12	33.5	54.5	73.5	90	111.5	141.5	164.5	193	220.5	250.5	277	313	353.5	397	435	481.5	525.5	574.5	631.5	
		Large Transport	13.5	27	52.5	75.5	97.5	114	137.5	170.5	196.5	227	255.5	286.5	317	354	396.5	447	486	535.5	585.5	642.5	704.5	
Grand Total		13813	14686	15461	16195	16672	17173	17748	18414	19103	19847	20596	21440	22266	23108	24053	25036	26073	27112	28196	29320	30544		

Figure G-2. Airplane Forecast—World Fleet

Estimating and Forecasting Task Team Final Report

Note: Actual value of the Fleet were adjusted for each scenario based on the appropriate tank mix.

Active Scenario:			Tank Mix Values for Active Scenario								Tank Mix ON/OFF(1/0):												
Scenario 16 - On-Board Liquid Nitrogen Inerting			In-Service				New				As provided by Alan B Hedge[SMTP:ahedge@air-econ.com] The Campbell-Hill Aviation Group, Inc.												
			Large	Medium	Small	Regional Jet	Large	Medium	Small	Regional Jet													
			100%	100%	100%	0%	100%	100%	100%	0%													
Operator: World - PAX Only			ARAC Distribution								50-99 (Regional + Biz Jet) 100-210 (Small) (211-400)/2 (Medium) 400-600+ (211-400)/2 (Large)												
Mission	Type	Category	Data																				
			2000	2001	2002	2003	2004	2005	2006	2007	2008	2009	2010	2011	2012	2013	2014	2015	2016	2017	2018	2019	2020
Pax	Retain	xRegional Jet	1381	1383	1310	1325	1330	1349	1357	1363	1356	1348	1339	1333	1323	1317	1294	1299	1290	1280	1271	1244	1229
		Small Transport	7506	7515	7314	7353	7406	7453	7441	7423	7393	7360	7323	7275	7242	7214	7157	7119	7082	7054	7004	6963	6930
		Medium Transport	1088	1085	1084.5	1082	1080	1078.5	1074.5	1068.5	1065	1061.5	1055.5	1048	1039.5	1031.5	1027.5	1020.5	1010.5	996.5	981	967.5	952.5
		Large Transport	1619	1617	1615.5	1614	1612	1609.5	1596.5	1582.5	1565	1551.5	1516.5	1466	1439.5	1419.5	1402.5	1388.5	1368.5	1351.5	1324	1301.5	1283.5
	New	xRegional Jet	190	361	579	678	703	730	763	800	864	935	1001	1071	1143	1214	1304	1377	1467	1570	1662	1792	1918
		Small Transport	389	865	1486	1824	2009	2220	2513	2858	3239	3674	4103	4610	5089	5576	6134	6656	7228	7792	8406	9031	9669
		Medium Transport	61.5	126	182	241	282	327.5	383	439.5	502	565.5	642	728.5	814	885.5	966	1060	1156	1249	1357	1464	1582.5
	Large Transport	68.5	152	232	321	389	460.5	553	648.5	757	864.5	1001	1162.5	1304	1428.5	1559	1706	1859	2004	2172	2339	2516.5	
Freighter	Retain	xRegional Jet	0	0	0	0	0	0	0	0	0	0	0	0	0	0	0	0	0	0	0	0	0
		Small Transport	0	0	0	0	0	0	0	0	0	0	0	0	0	0	0	0	0	0	0	0	0
		Medium Transport	0	0	0	0	0	0	0	0	0	0	0	0	0	0	0	0	0	0	0	0	0
		Large Transport	0	0	0	0	0	0	0	0	0	0	0	0	0	0	0	0	0	0	0	0	0
	New	xRegional Jet	0	0	0	0	0	0	0	0	0	0	0	0	0	0	0	0	0	0	0	0	0
		Small Transport	0	0	0	0	0	0	0	0	0	0	0	0	0	0	0	0	0	0	0	0	0
		Medium Transport	0	0	0	0	0	0	0	0	0	0	0	0	0	0	0	0	0	0	0	0	0
	Large Transport	0	0	0	0	0	0	0	0	0	0	0	0	0	0	0	0	0	0	0	0	0	
Grand Total		12303	13104	13803	14438	14811	15228	15681	16183	16741	17360	17981	18694	19394	20086	20844	21626	22461	23297	24177	25102	26081	

Figure G-3. Airplane Forecast—World Fleet, Passenger Only

Estimating and Forecasting Task Team Final Report

Note: Actual value of the Fleet were adjusted for each scenario based on the appropriate tank mix.

Active Scenario:			Tank Mix Values for Active Scenario								Tank Mix ON/OFF(1/0):												
Scenario 16 - On-Board Liquid Nitrogen Inerting			In-Service				New				1												
			Large	Medium	Small	Regional Jet	Large	Medium	Small	Regional Jet	As provided by Alan B Hedge[SMTP:ahedge@air-econ.com] The Campbell-Hill Aviation Group, Inc.												
			100%	100%	100%	0%	100%	100%	100%	0%													
Operator: US-Operator			ARAC Distribution								50-99 (Regional + Biz Jet) 100-210 (Small) (211-400)/2 (Medium) 400-600+ (211-400)/2 (Large)												
Mission	Type	Category	Data																				
			2000	2001	2002	2003	2004	2005	2006	2007	2008	2009	2010	2011	2012	2013	2014	2015	2016	2017	2018	2019	2020
Pax	Retain	xRegional Jet	527	525	509	511	510	509	509	508	508	507	507	504	482	446	389	389	383	378	378	365	353
		Small Transport	3384	3380	3315	3297	3280	3267	3255	3247	3234	3220	3210	3194	3178	3172	3153	3130	3100	3098	3084	3088	3095
		Medium Transport	265	263.5	261.5	262	262.5	263.5	264	264.5	265.5	265.5	262	260.5	261.5	263	265	265	264.5	266	267	267.5	267.5
		Large Transport	322	321.5	319.5	321	321.5	323.5	325	326.5	327.5	328.5	326	325.5	327.5	330	333	334	334.5	337	339	341.5	342.5
	New	xRegional Jet	111	218	325	358	360	362	369	380	389	401	415	430	444	486	532	550	578	611	635	680	720
		Small Transport	181	408	687	839	891	954	1053	1180	1320	1482	1645	1817	1996	2172	2371	2575	2791	2992	3209	3419	3623
		Medium Transport	28.5	49	59	66.5	73	78.5	89.5	97	105.5	115	128.5	144.5	155.5	167	179	195	211.5	223.5	239.5	253.5	271
		Large Transport	29.5	50	60	67.5	74	79.5	90.5	98	106.5	116	129.5	145.5	156.5	168	180	196	212.5	224.5	240.5	254.5	272
Freighter	Retain	xRegional Jet	17	17	14	14	14	14	14	14	14	14	14	14	14	14	14	14	14	14	14	14	14
		Small Transport	570	570	518	514	512	504	492	485	484	482	481	477	474	468	464	462	462	461	456	452	452
		Medium Transport	218	226.5	223	223.5	224	224	224.5	226.5	227.5	227	227.5	228.5	230	230	230.5	230.5	230	229.5	230.5	230.5	227.5
		Large Transport	225	233.5	230	230.5	231	231	231.5	234.5	236.5	236	237.5	239.5	242	242	243.5	245.5	246	246.5	249.5	250.5	249.5
	New	xRegional Jet	0	0	5	6	6	9	10	11	13	14	15	17	19	21	23	25	27	29	33	35	37
		Small Transport	0	29	106	143	180	223	271	314	361	406	452	507	557	614	675	733	800	865	940	1012	1088
		Medium Transport	3	8.5	24.5	40.5	51.5	63	76	92.5	107.5	126.5	144.5	164.5	181.5	205	226.5	254	279	307	335	363.5	400.5
		Large Transport	5	10.5	26.5	42.5	53.5	65	79	95.5	110.5	129.5	147.5	167.5	184.5	208	229.5	257	282	310	338	366.5	403.5
Grand Total			5886	6310	6683	6936	7044	7170	7353	7574	7810	8070	8342	8636	8903	9206	9508	9855	10215	10592	10988	11393	11816

Figure G-4. Airplane Forecast—U.S. Fleet

Estimating and Forecasting Task Team Final Report

Note: Actual value of the Fleet were adjusted for each scenario based on the appropriate tank mix.

Active Scenario:			Tank Mix Values for Active Scenario								Tank Mix ON/OFF(1/0):												
Scenario 16 - On-Board Liquid Nitrogen Inerting			In-Service				New				As provided by Alan B Hedge[SMTP:ahedge@air-econ.com] The Campbell-Hill Aviation Group, Inc.												
			Large	Medium	Small	Regional Jet	Large	Medium	Small	Regional Jet													
			100%	100%	100%	0%	100%	100%	100%	0%													
Operator: US-Operator - PAX			ARAC Distribution: 50-99 (Regional + Biz Jet) 100-210 (Small) (211-400)/2 (Medium) 400-600+ (211-400)/2 (Large)																				
Mission	Type	Category	Data																				
			2000	2001	2002	2003	2004	2005	2006	2007	2008	2009	2010	2011	2012	2013	2014	2015	2016	2017	2018	2019	2020
Pax	Retain	xRegional Jet	527	525	509	511	510	509	509	508	508	507	507	504	482	446	389	389	383	378	378	365	353
		Small Transport	3384	3380	3315	3297	3280	3267	3255	3247	3234	3220	3210	3194	3178	3172	3153	3130	3100	3098	3084	3088	3095
		Medium Transport	265	263.5	261.5	262	262.5	263.5	264	264.5	265.5	265.5	262	260.5	261.5	263	265	264.5	266	267	267.5	267.5	
		Large Transport	322	321.5	319.5	321	321.5	323.5	325	326.5	327.5	328.5	326	325.5	327.5	330	333	334	334.5	337	339	341.5	342.5
	New	xRegional Jet	111	218	325	358	360	362	369	380	389	401	415	430	444	486	532	550	578	611	635	680	720
		Small Transport	181	408	687	839	891	954	1053	1180	1320	1482	1645	1817	1996	2172	2371	2575	2791	2992	3209	3419	3623
		Medium Transport	28.5	49	59	66.5	73	78.5	89.5	97	105.5	115	128.5	144.5	155.5	167	179	195	211.5	223.5	239.5	253.5	271
		Large Transport	29.5	50	60	67.5	74	79.5	90.5	98	106.5	116	129.5	145.5	156.5	168	180	196	212.5	224.5	240.5	254.5	272
Freighter	Retain	xRegional Jet	0	0	0	0	0	0	0	0	0	0	0	0	0	0	0	0	0	0	0	0	0
		Small Transport	0	0	0	0	0	0	0	0	0	0	0	0	0	0	0	0	0	0	0	0	0
		Medium Transport	0	0	0	0	0	0	0	0	0	0	0	0	0	0	0	0	0	0	0	0	0
		Large Transport	0	0	0	0	0	0	0	0	0	0	0	0	0	0	0	0	0	0	0	0	0
	New	xRegional Jet	0	0	0	0	0	0	0	0	0	0	0	0	0	0	0	0	0	0	0	0	0
		Small Transport	0	0	0	0	0	0	0	0	0	0	0	0	0	0	0	0	0	0	0	0	0
		Medium Transport	0	0	0	0	0	0	0	0	0	0	0	0	0	0	0	0	0	0	0	0	0
		Large Transport	0	0	0	0	0	0	0	0	0	0	0	0	0	0	0	0	0	0	0	0	
Grand Total			4848	5215	5536	5722	5772	5837	5955	6101	6256	6435	6623	6821	7001	7204	7402	7634	7875	8130	8392	8669	8944

Figure G-5. Airplane Forecast—U.S. Fleet, Passenger Only

Airport Data for Inerting Support													
<i>Note: Driven by Fleet Control Page</i>													
Operator: World													
	US Only Airports	World Airport	Current Airport Data										
Large Airport	31	85	85										
Medium Airport	37	101	101										
Small Airport	354	1014	1014										
Non US - 4 Truck Support	83		0										
Non US - 2 Truck Support	75		0										
Cum Conversion %:	14%	29%	43%	57%	71%	86%	100%	100%	100%	100%	100%	100%	100%
Cum Converted Airports													
	2008	2009	2010	2011	2012	2013	2014	2015	2016	2017	2018	2019	2020
Large Airport	12	24	36	49	61	73	85	85	85	85	85	85	85
Medium Airport	14	29	43	58	72	87	101	101	101	101	101	101	101
Small Airport	145	290	435	579	724	869	1,014	1,014	1,014	1,014	1,014	1,014	1,014
Non US - 4 Truck Support	-	-	-	-	-	-	-	-	-	-	-	-	-
Non US - 2 Truck Support	-	-	-	-	-	-	-	-	-	-	-	-	-
Annual Airport Conversion													
Large Airport	12	12	12	12	12	12	12	-	-	-	-	-	-
Medium Airport	14	14	14	14	14	14	14	-	-	-	-	-	-
Small Airport	145	145	145	145	145	145	145	-	-	-	-	-	-
Non US - 4 Truck Support	-	-	-	-	-	-	-	-	-	-	-	-	-
Non US - 2 Truck Support	-	-	-	-	-	-	-	-	-	-	-	-	-

Figure G-6. Airport Forecast—World and United States

Estimating and Forecasting Task Team Final Report

Provided by: <i>Allen Mattes[SMTP:Allen.Mattes@faa.gov]</i>											
AIRPLANE CATEGORY	LOAD FACTORS										
>300	75.00%										
210-300	73.00%										
100-209	71.00%										
REGIONAL JET	60.00%										
TURBOPROP	60.00%										
BIZJET	40.00%										
VALUE OF A FATALITY	\$2.70										
FATALITY RATE IN-FLIGHT	100.00%										
FATALITY RATE ON-THE GROUND	10.00%										
LOSSES FROM AN IN-FLIGHT EXPLOSION											
AIRPLANE CATEGORY		AVG. A/C SIZE	AVG. NUM. PAX	AVG. NUM. CREW	AVG. NUM. FATALITIES	OF PAX	VALUE OF A/C	VALUE OF GROUND DAMAGE	COST OF ACCIDENT INVESTIGATION		TOTAL COST OF ACCIDENT
>300		350.00	263	12	275	\$741.15	\$75.00	\$5.00	\$33.00		\$854.15
210-300		255.00	186	9	195	\$526.91	\$60.00	\$4.00	\$28.00		\$618.91
100-209		154.50	110	7	117	\$315.08	\$25.00	\$3.00	\$23.00		\$366.08
REGIONAL JET		65.00	39	5	44	\$118.80	\$17.00	\$3.00	\$20.00		\$158.80
TURBOPROP		45.00	27	4	31	\$83.70	\$9.00	\$2.00	\$15.00		\$109.70
BIZJET		11.00	4	3	7	\$19.98	\$7.00	\$1.00	\$10.00		\$37.98
LOSSES FROM AN ON-THE-GROUND EXPLOSION											
AIRPLANE CATEGORY		AVG. A/C SIZE	AVG. NUM. PAX	AVG. NUM. CREW	AVG. NUM. FATALITIES	VALUE OF PAX	VALUE OF A/C	VALUE OF GROUND DAMAGE	COST OF ACCIDENT INVESTIGATION		TOTAL COST OF ACCIDENT
>300		350.00	263	12	27	\$74.12	\$75.00	\$0.50	\$10.00		\$159.62
210-300		255.00	186	9	20	\$52.69	\$60.00	\$0.40	\$8.00		\$121.09
100-209		154.50	110	7	12	\$31.51	\$25.00	\$0.30	\$6.00		\$62.81
REGIONAL JET		65.00	39	5	4	\$11.88	\$17.00	\$0.20	\$4.00		\$33.08
TURBOPROP		45.00	27	4	3	\$8.37	\$9.00	\$0.10	\$3.00		\$20.47
BIZJET		11.00	4	3	1	\$2.00	\$7.00	\$0.10	\$2.00		\$11.10

Figure G-7. Accident Cost Data

Summary of Inerting Scenario Results World

Values in Millions	Scenario 1 - On-Board Ground Inerting HCWT only, Large, Medium, Small Transports, PSA/Membrane Systems	Scenario 2 - On-Board Ground Inerting All Fuselage Tanks, Large, Medium, Small Transports, PSA/Membrane Systems	Scenario 3 - Hybrid On-Board Ground Inerting HCWT only, Large, Medium, Small Transports, PSA/Membrane Systems	Scenario 4 - Hybrid On-Board Ground Inerting HCWT Fuselage tanks, Large, Medium, Small Transports, PSA/Membrane Systems	Scenario 5 - OBIGGS, All Tanks, Large and Medium Transports, Membrane Systems, & Small Transports, PSA/Membrane Systems	Scenario 7 - Hybrid OBIGGS, HCWT only, Large and Medium Transports, Membrane Systems, & Small Transports, PSA/Membrane Systems	Scenario 8 - Hybrid OBIGGS, All Tanks, Large and Medium Transports, Membrane Systems, & Small Transports, PSA/Membrane Systems	Scenario 9 - Hybrid OBIGGS, All Tanks, Large and Medium Transports, Membrane Systems, & Small Transports, PSA/Membrane Systems	Scenario 10 - Ground Based Inerting HCWT only, All Tanks, All Transports	Scenario 11 - Ground Based Inerting HCWT only, All Transports, Cryogenics Systems, & Small Transports, PSA/Membrane Systems	Scenario 12 - OBIGGS, All Tanks, Large and Medium Transports, Cryogenics Systems, & Small Transports, PSA/Membrane Systems	Scenario 13 - Hybrid OBIGGS, HCWT only, Large and Medium Transports, PSA/Membrane Systems	Scenario 14 - Hybrid OBIGGS, All Tanks, Large and Medium Transports, PSA/Membrane Systems	Scenario 15 - Hybrid OBIGGS, All Tanks, Large and Medium Transports, PSA/Membrane Systems	Scenario 16 - On-Board Liquid Nitrogen Inerting	
Total \$ Cost with Inflation	25,321	41,901	24,415	38,349	47,601	21,476	32,969	22,973	26,203	57,021	34,569	45,797	77,735	-	-	-
NPV in 2005 of Cost	11,592	18,509	11,240	17,035	20,775	9,896	14,936	10,374	11,885	24,605	15,440	20,405	31,527	-	-	-
Total Benefits	597	1,037	591	1,032	1,202	701	1,186	668	1,109	1,202	701	1,186	1,202	-	-	-
NPV in 2005 of Benefits	219	381	217	379	441	257	435	245	407	441	257	435	441	-	-	-

Figure G-8. Cost Summary of World Fleet

Scenario 1 - On-Board Ground Inerting HCWT only, Large, Medium, Small Transports, PSA/Membrane Systems

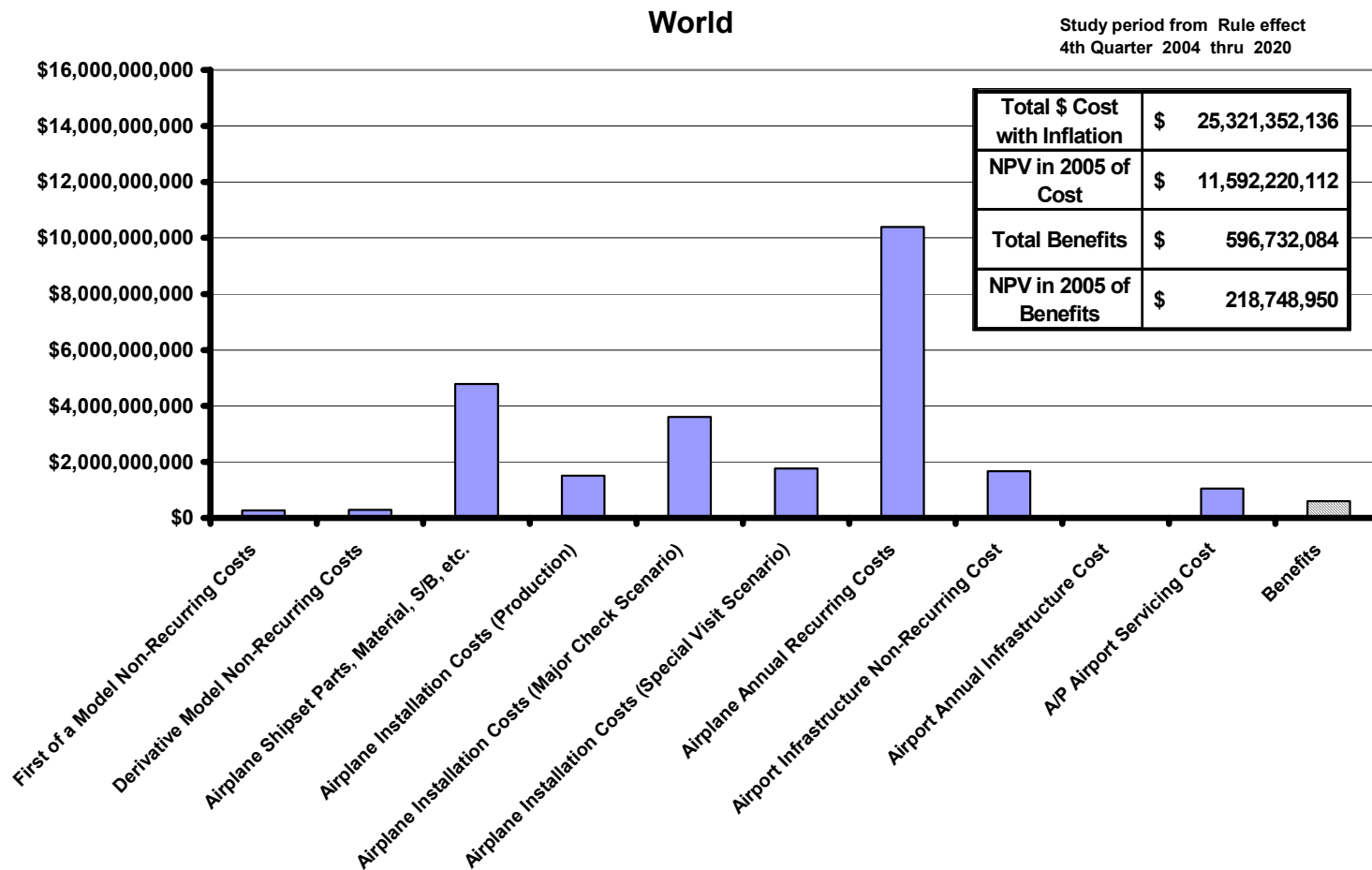

Figure G-9. Scenario 1—Onboard Ground Inerting, HCWT Only, Large, Medium, Small Transports, PSA/Membrane Systems (World)

Scenario 2 - On-Board Ground Inerting All Fuselage Tanks, Large, Medium, Small Transports, PSA/Membrane Systems

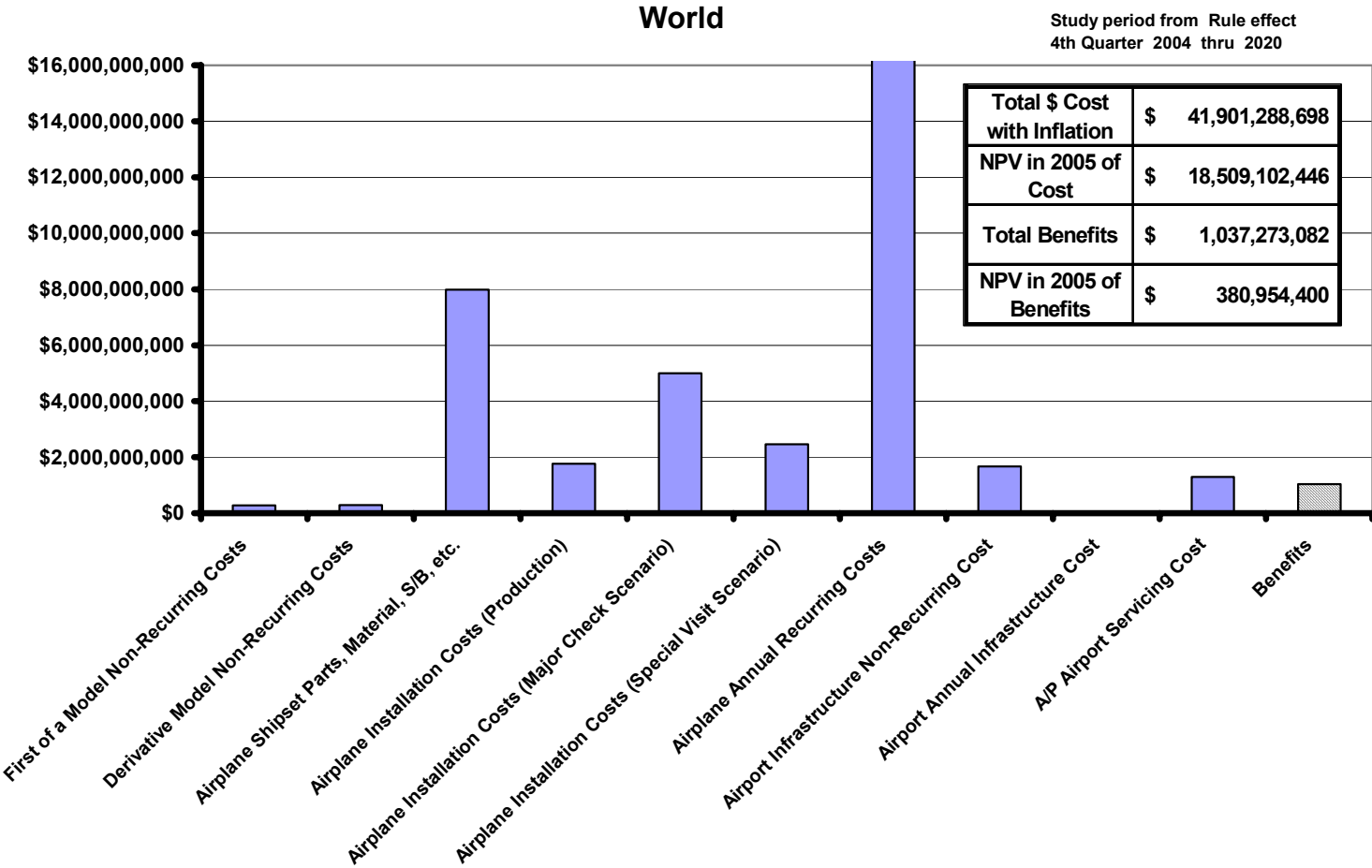

Figure G-10. Scenario 2—Onboard Ground Inerting, All Fuselage Tanks, Large, Medium, Small Transports, PSA/Membrane Systems (World)

Scenario 3 - Hybrid On-Board Ground Inerting HCWT only, Large, Medium, Small Transports, PSA/Membrane Systems

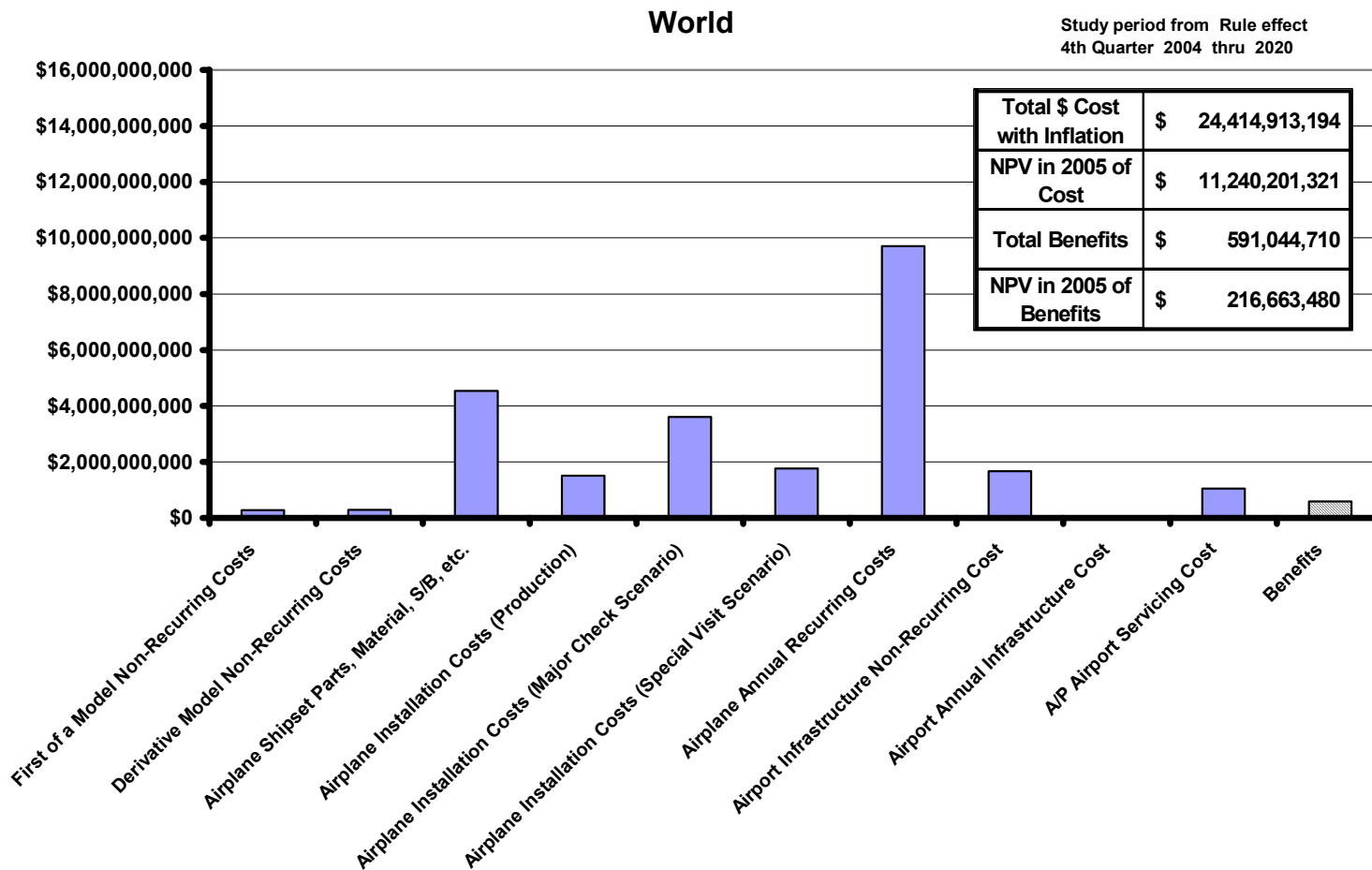

Figure G-11. Scenario 3—Hybrid Onboard Ground Inerting, HCWT Only, Large, Medium, Small Transports, PSA/Membrane Systems (World)

Scenario 4 - Hybrid On-Board Ground Inerting All Fuselage Tanks, Large, Medium, Small Transports, PSA/Membrane Systems

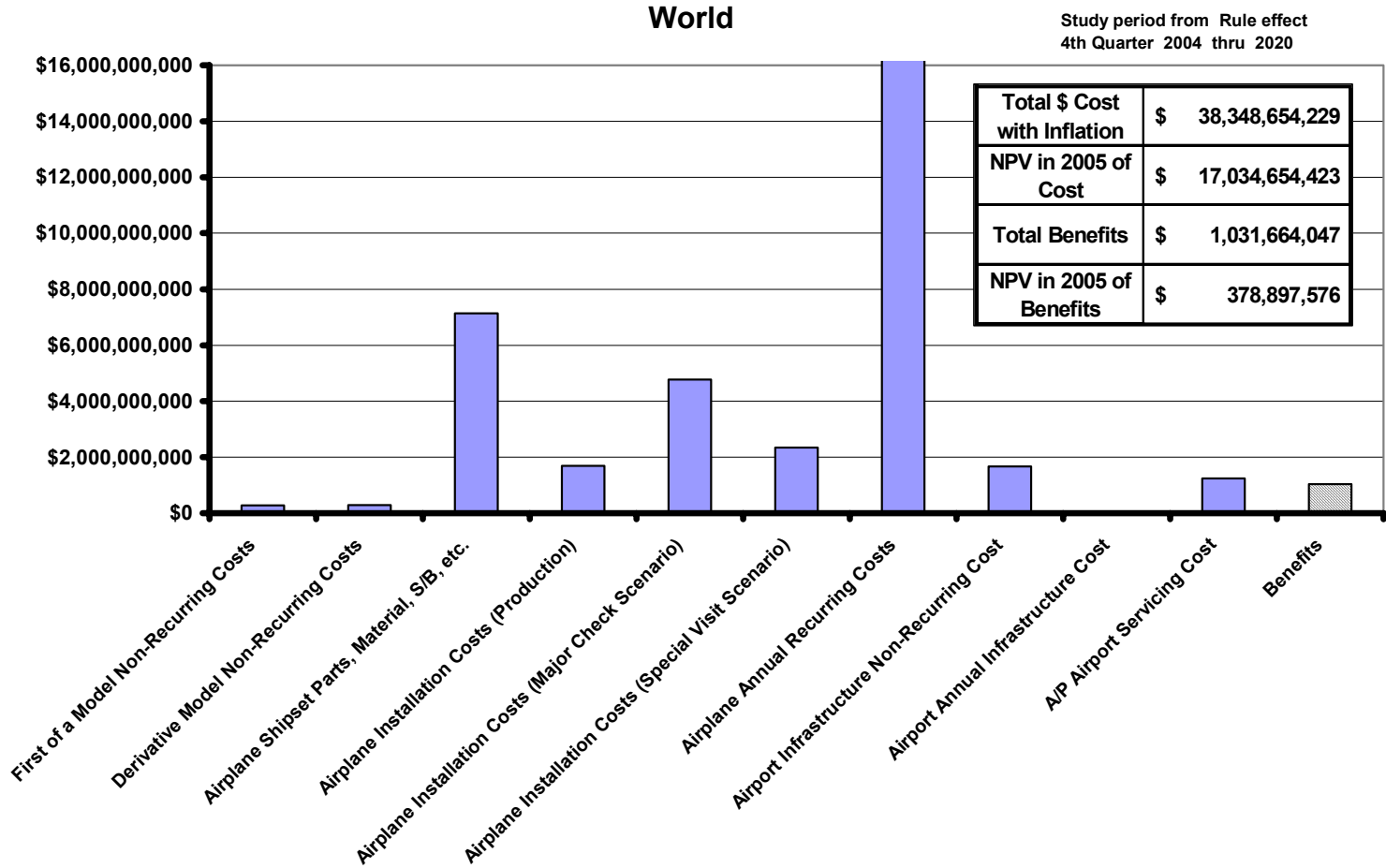

Figure G-12. Scenario 4—Hybrid Onboard Ground Inerting, All Fuselage Tanks, Large, Medium, Small Transports, PSA/Membrane Systems (World)

Scenario 5 - OBIGGS, All Tanks, Large and Medium Transports, Membrane Systems, & Small Transports, PSA/Membrane Systems

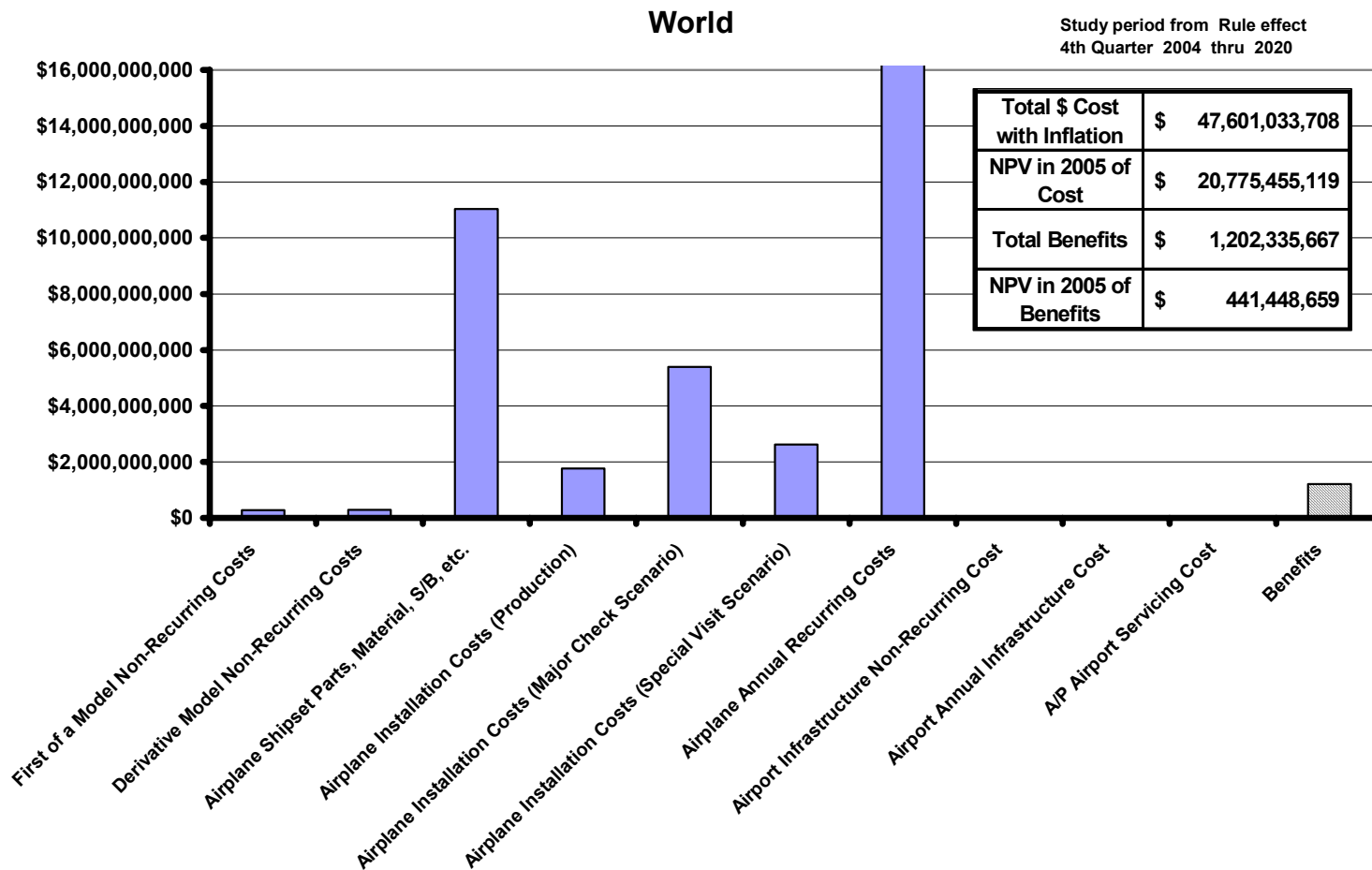

Figure G-13. Scenario 5—OBIGGS, All Tanks, Large and Medium Transports, Membrane Systems, and Small Transports, PSA/Membrane Systems (World)

Scenario 7 - Hybrid OBIGGS, HCWT only, Large and Medium Transports, Membrane Systems, & Small Transports, PSA/Membrane Systems

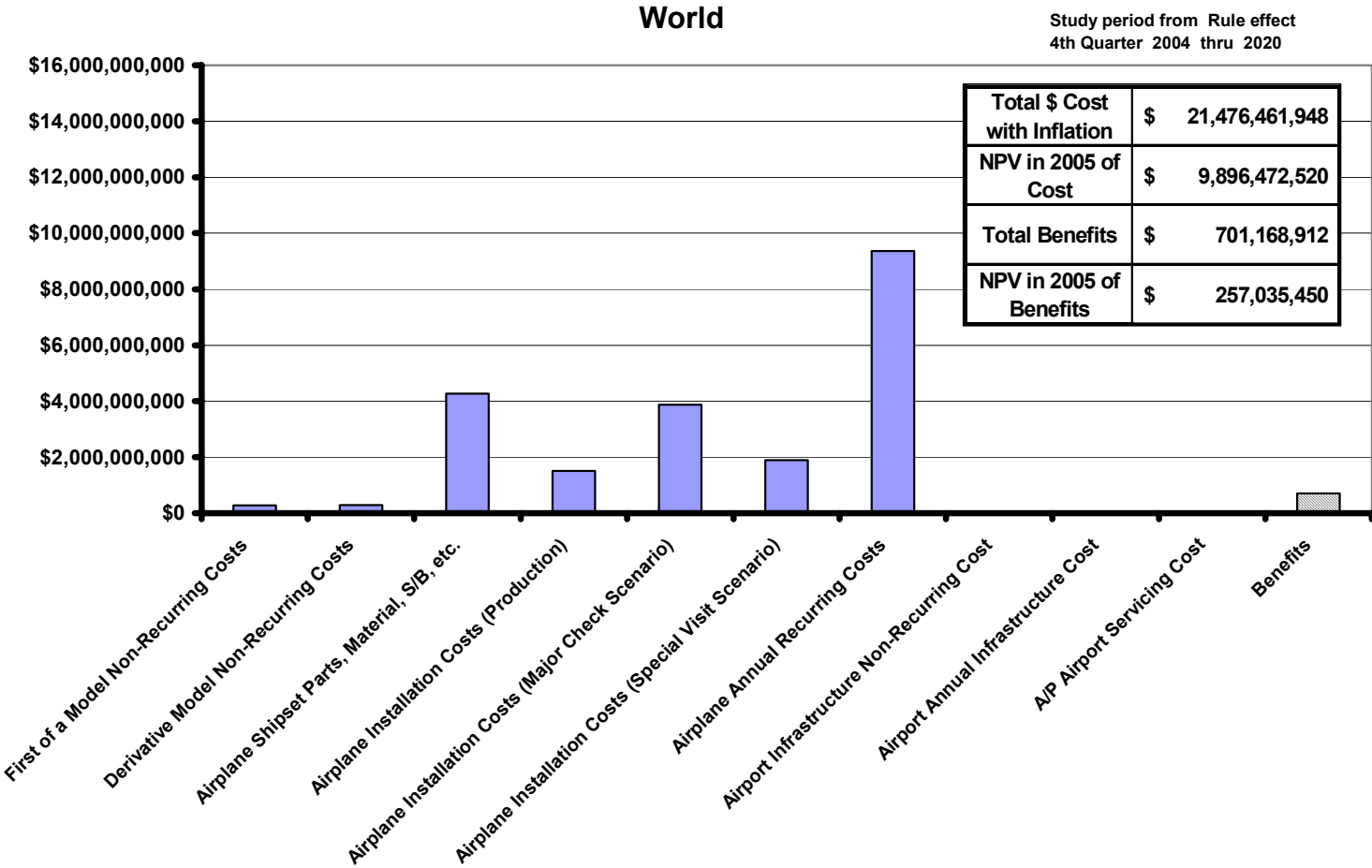

Figure G-14. Scenario 7—Hybrid OBIGGS, HCWT Only, Large and Medium Transports, Membrane Systems, and Small Transports, PSA/Membrane Systems (World)

Scenario 9 - Hybrid OBIGGS, All Tanks, Large and Medium Transports, Membrane Systems, & Small Transports, PSA/Membrane Systems

World

Study period from Rule effect
4th Quarter 2004 thru 2020

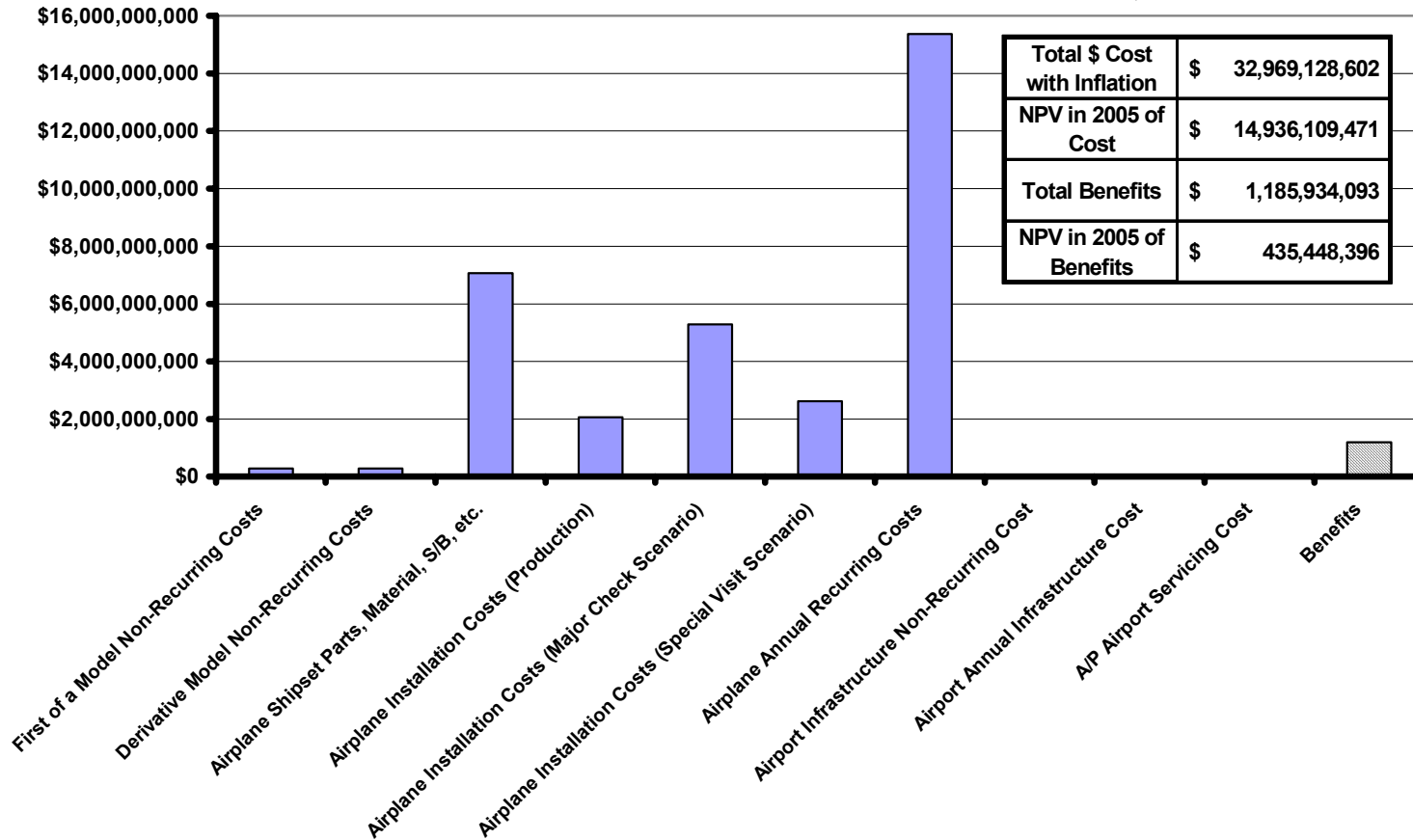

Figure G-15. Scenario 9—Hybrid OBIGGS, All Tanks, Large and Medium Transports, Membrane Systems, and Small Transports, PSA/Membrane Systems (World)

Scenario 11 - Ground Based Inerting HCWT only, All Transports

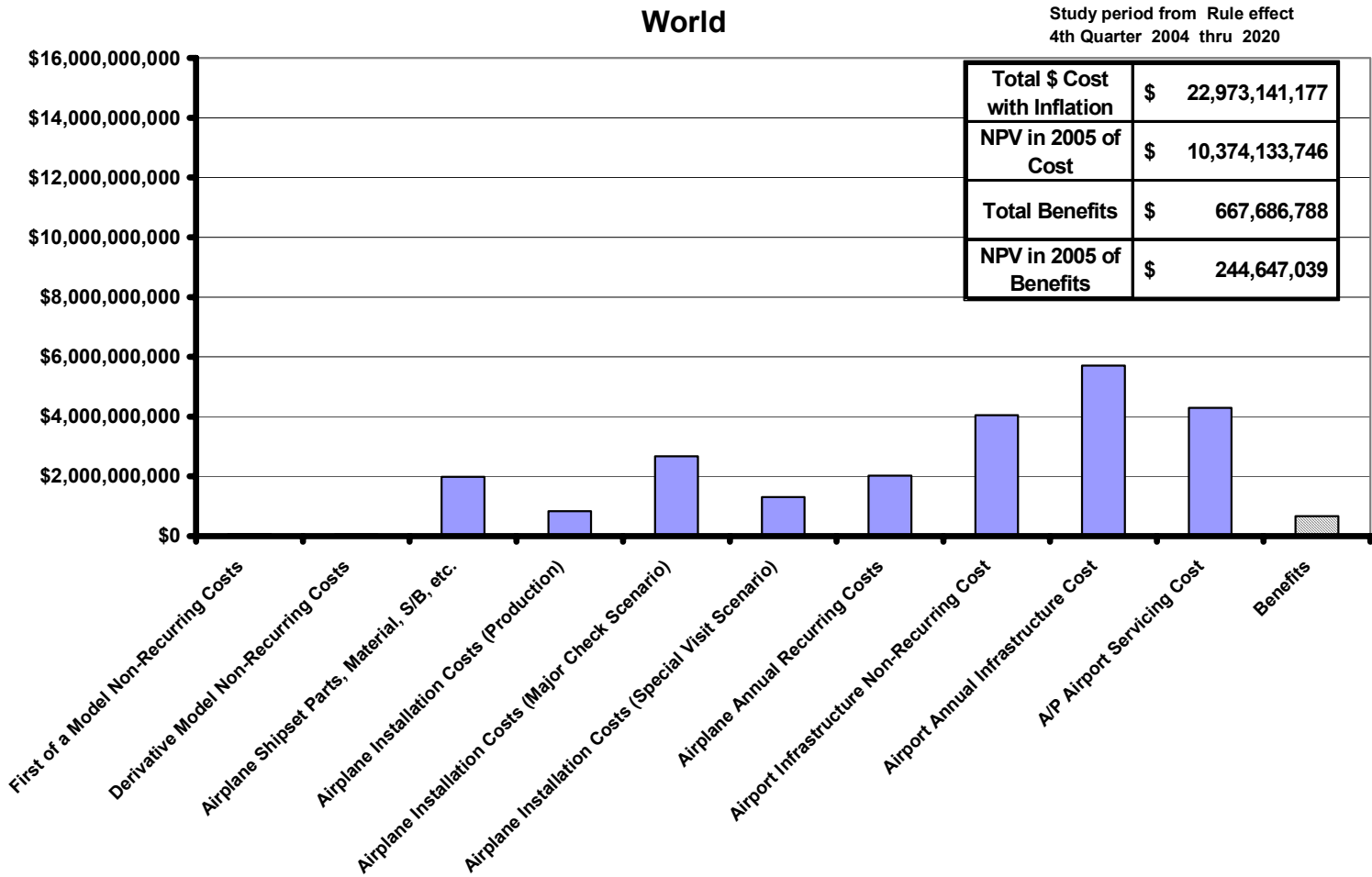

Figure G-16. Scenario 11—Ground-Based Inerting, HCWT Only, All Transports (World)

Scenario 12 - Ground Based Inerting All Fuselage Tanks, All Transports

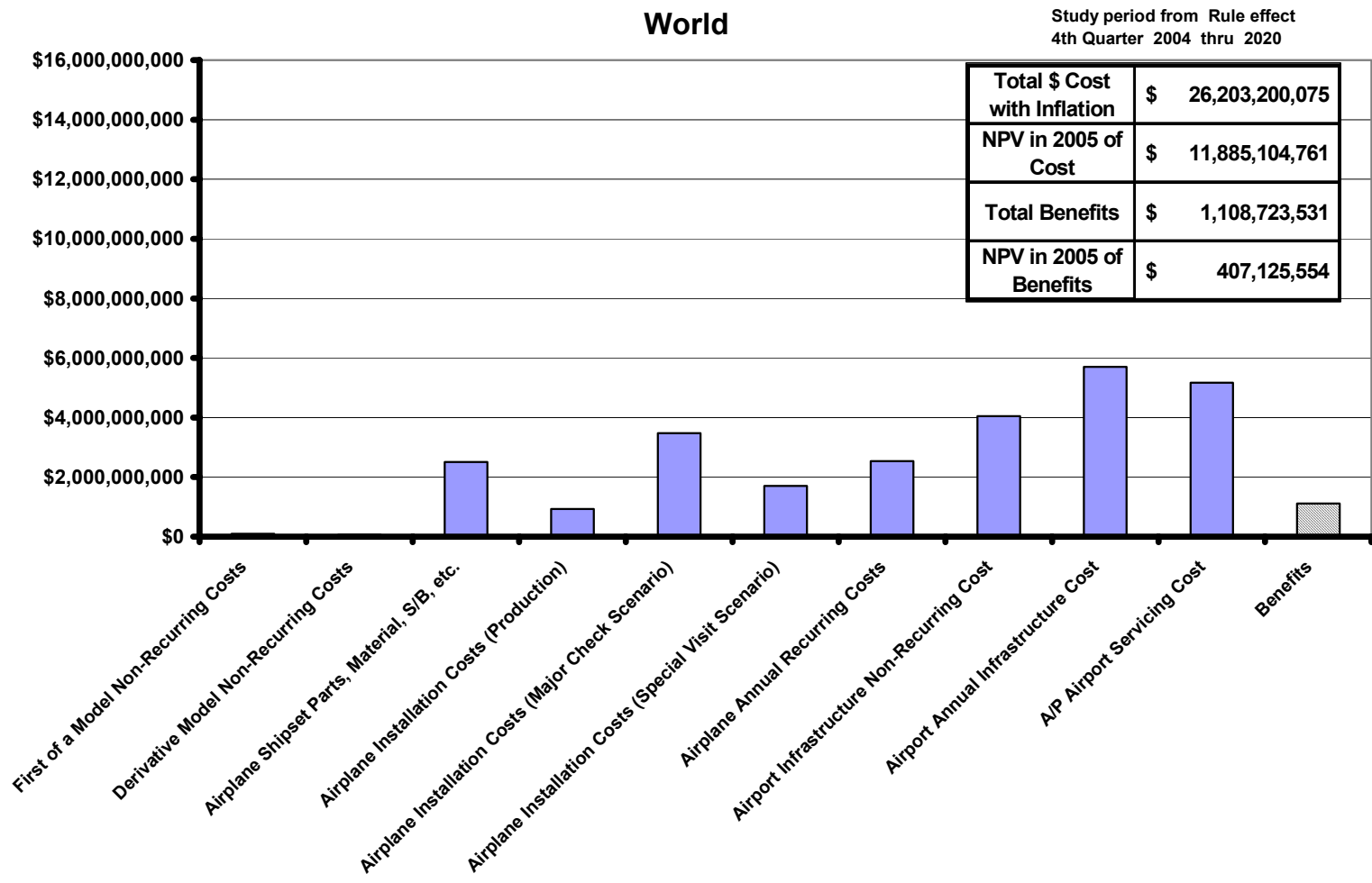

Figure G-17. Scenario 12—Ground-Based Inerting, All Fuselage Tanks, All Transports (World)

Scenario 13 - OBIGGS, All Tanks, Large and Medium Transports, Cryogenics Systems, & Small Transports, PSA/Membrane Systems

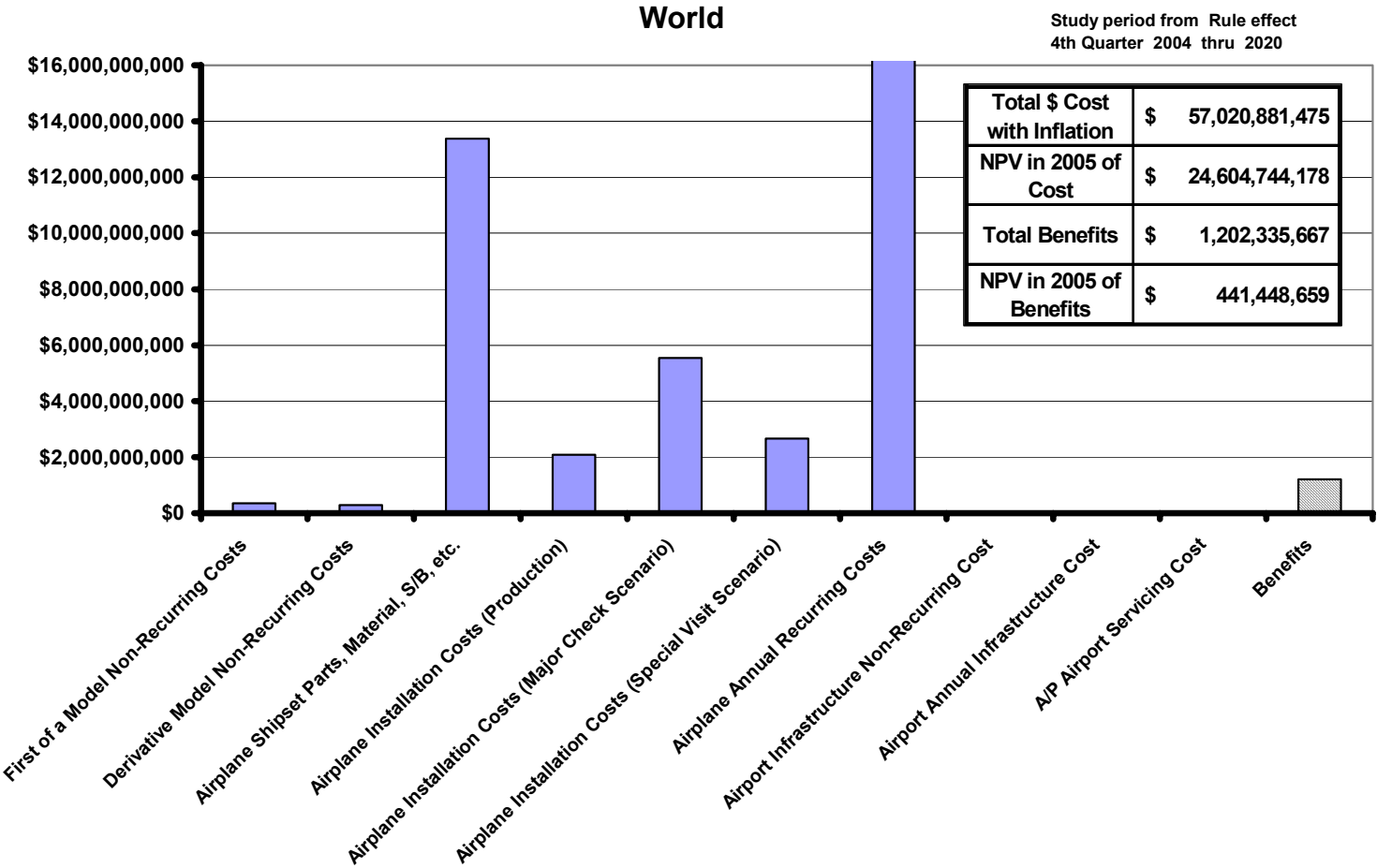

Figure G-18. Scenario 13—OBIGGS, All Tanks, Large and Medium Transports, Cryogenic Systems, and Small Transports, PSA/Membrane Systems (World)

Scenario 14 - Hybrid OBIGGS, HCWT only, Large and Medium Transports, Cryogenics Systems, & Small Transports, PSA/Membrane Systems

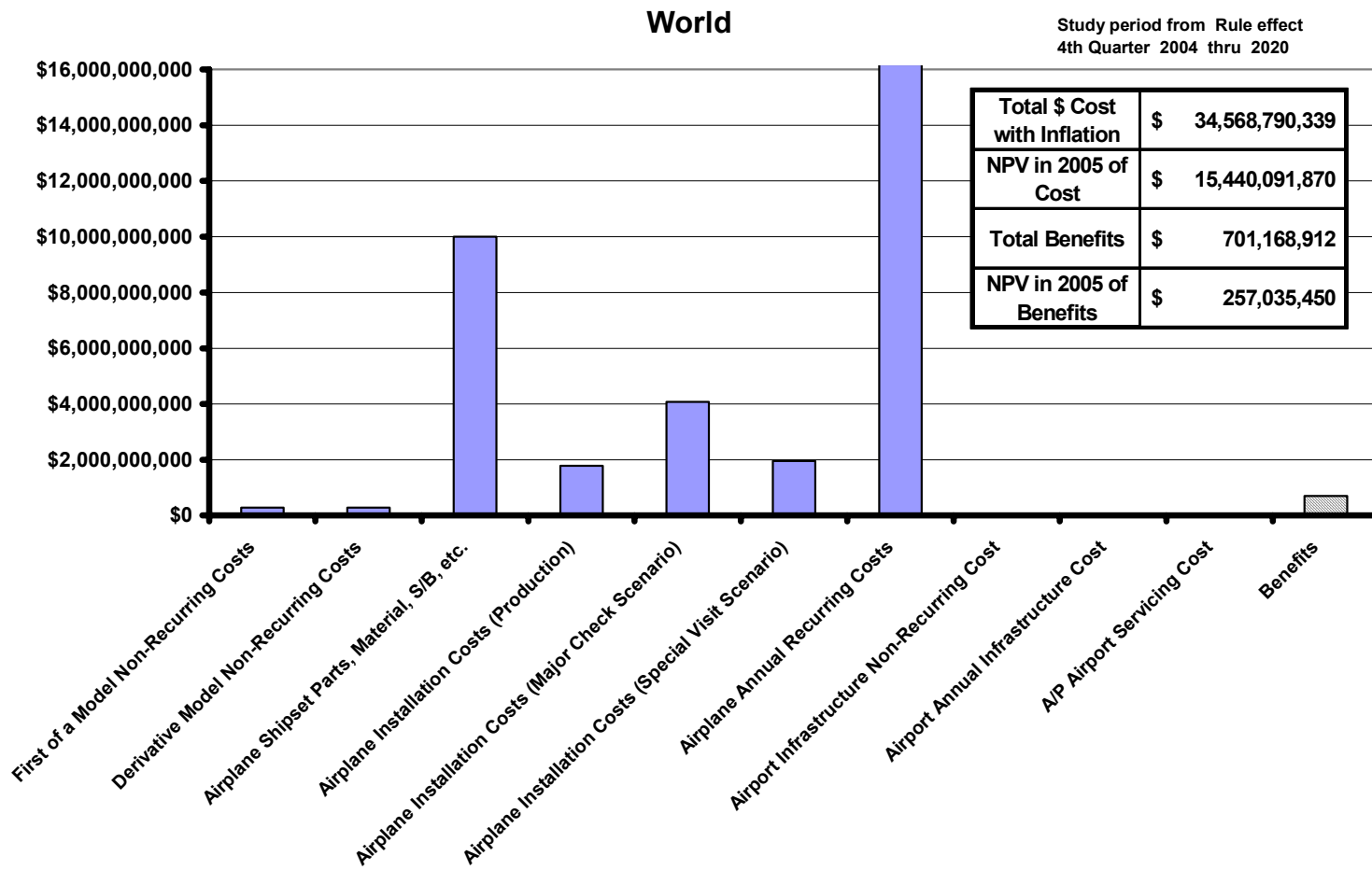

Figure G-19. Scenario 14—Hybrid OBIGGS, HCWT Only, Large and Medium Transports, Cryogenic Systems, and Small Transports, PSA/Membrane Systems (World)

Scenario 15 - Hybrid OBIGGS, All Tanks, Large and Medium Transports, Cryogenics Systems, & Small Transports, PSA/Membrane Systems

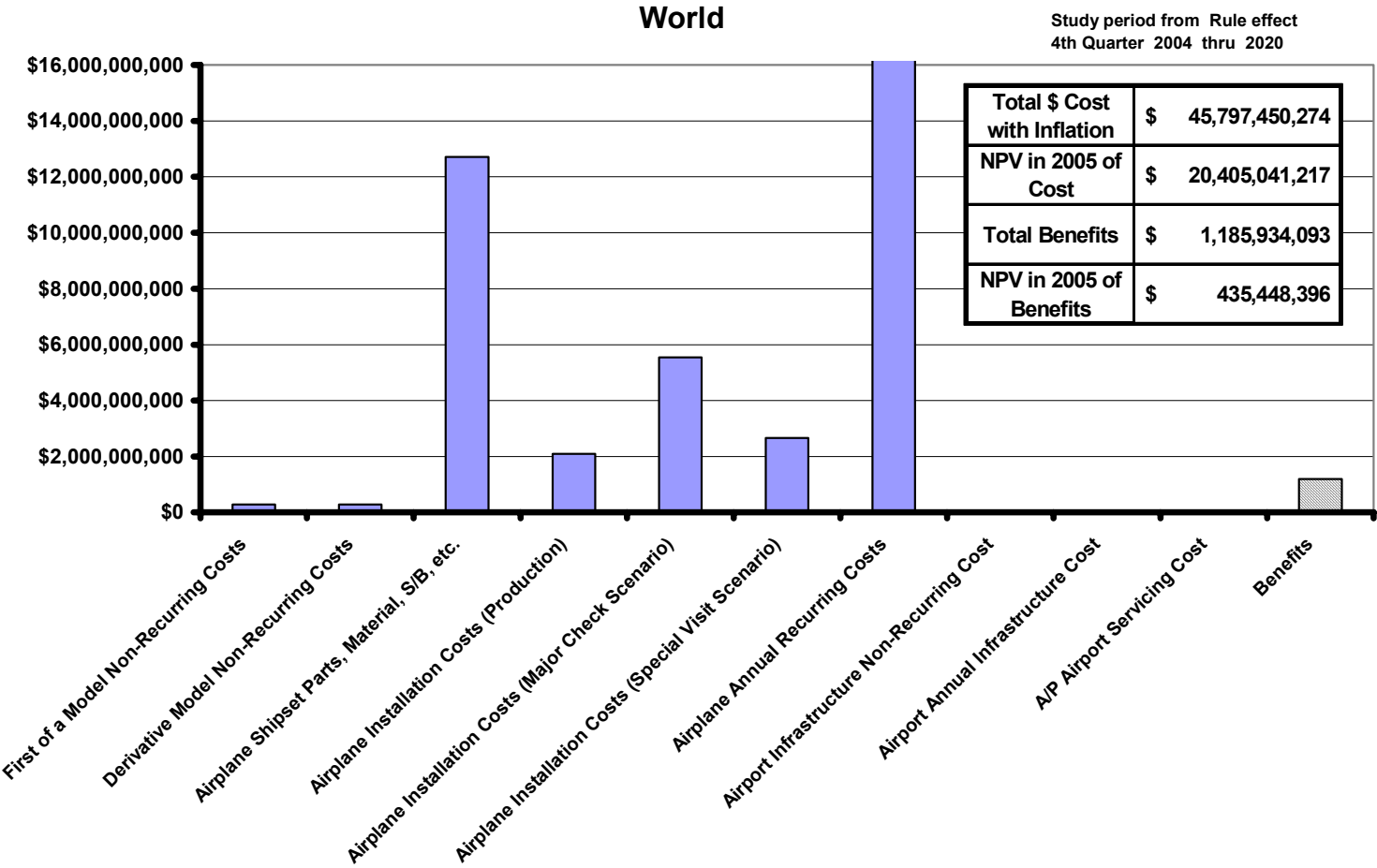

Figure G-20. Scenario 15—Hybrid OBIGGS, All Tanks, Large and Medium Transports, Cryogenic Systems, and Small Transports, PSA/Membrane Systems (World)

Scenario 16 - On-Board Liquid Nitrogen Inerting

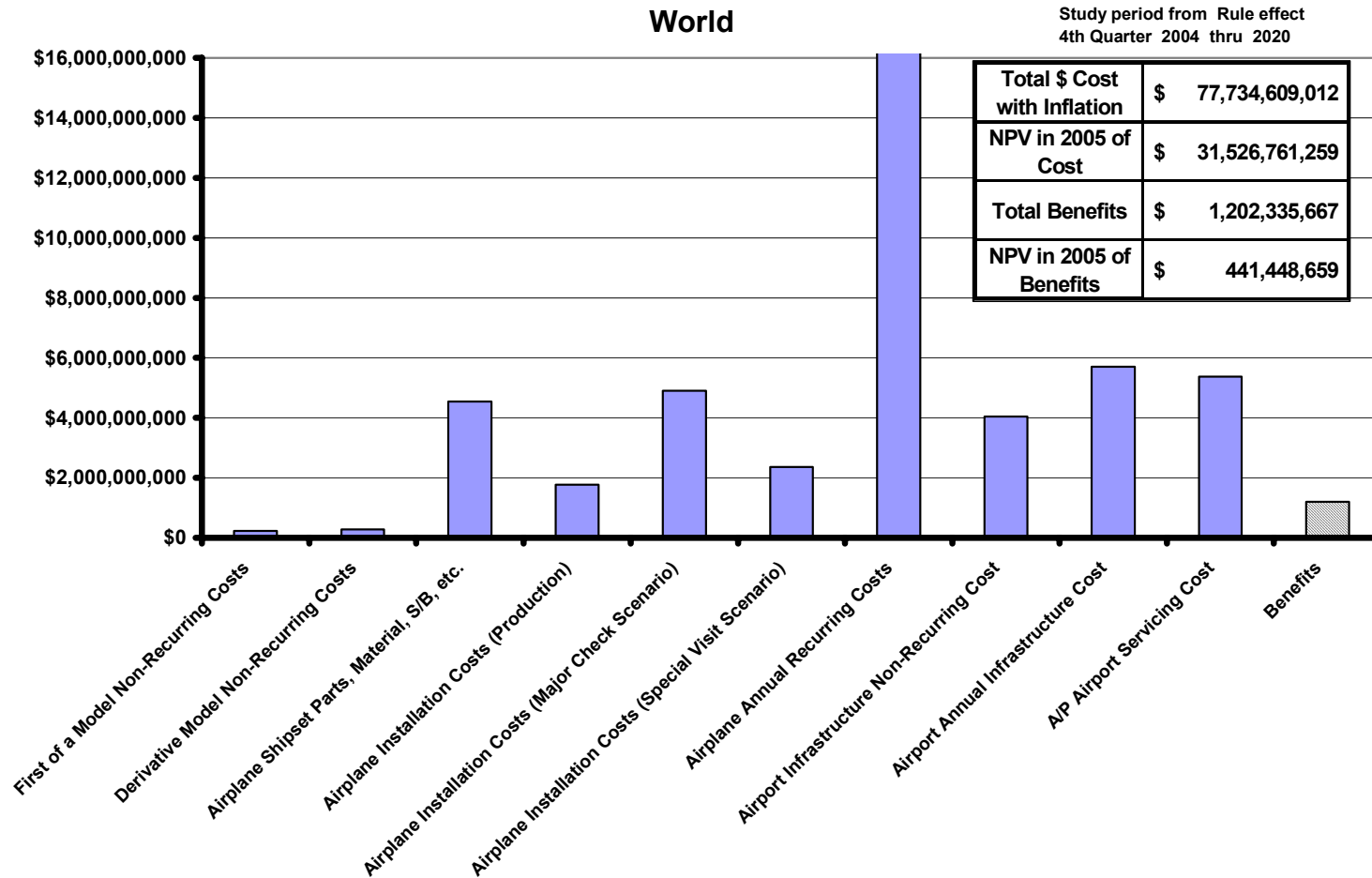

Figure G-21. Scenario 16—Onboard Liquid Nitrogen Inerting (World)

Summary of Inerting Scenario Results World - PAX Only

Values in Millions	Scenario 1 - On-Board Ground Inerting HCWT only, Large, Medium, Small Transports, PSA Membrane Systems	Scenario 2 - On-Board Ground Inerting All Fuselage Tanks, Large, Medium, Small Transports, PSA Membrane Systems	Scenario 3 - Hybrid On-Board Ground Inerting HCWT only, Large, Medium, Small Transports, PSA Membrane Systems	Scenario 4 - Hybrid On-Board Ground Inerting HCWT Fuselage Tanks, Large, Medium, Small Transports, PSA Membrane Systems	Scenario 5 - OBIGGS, All Tanks, Large and Medium Transports, Membrane Systems, & Small Transports, PSA Membrane Systems	Scenario 7 - Hybrid OBIGGS, HCWT only, Large and Medium Transports, Membrane Systems, & Small Transports, PSA Membrane Systems	Scenario 9 - Hybrid OBIGGS, All Tanks, Large and Medium Transports, Membrane Systems, & Small Transports, PSA Membrane Systems	Scenario 11 - Ground Based Inerting HCWT only, All Tanks, All Transports	Scenario 12 - Ground Based Inerting HCWT only, All Transports, PSA Membrane Systems	Scenario 13 - OBIGGS, All Tanks, Large and Medium Transports, Cryogenics Systems, & Small Transports, PSA Membrane Systems	Scenario 14 - Hybrid OBIGGS, HCWT only, Large and Medium Transports, PSA Membrane Systems	Scenario 15 - Hybrid OBIGGS, All Tanks, Large and Medium Transports, PSA Membrane Systems	Scenario 16 - On-Board Liquid Nitrogen Inerting			
Total \$ Cost with Inflation	21,474	34,897	20,722	32,007	39,168	18,015	27,575	21,285	24,085	47,094	28,866	38,157	65,236	-	-	-
NPV in 2005 of Cost	9,936	15,576	9,644	14,371	17,248	8,376	12,590	9,600	10,907	20,489	12,994	17,129	26,698	-	-	-
Total Benefits	597	1,037	591	1,032	1,202	701	1,186	668	1,109	1,202	701	1,186	1,202	-	-	-
NPV in 2005 of Benefits	219	381	217	379	441	257	435	245	407	441	257	435	441	-	-	-

Figure G-22. Cost Summary of World Fleet Passenger Only

Scenario 1 - On-Board Ground Inerting HCWT only, Large, Medium, Small Transports, PSA/Membrane Systems

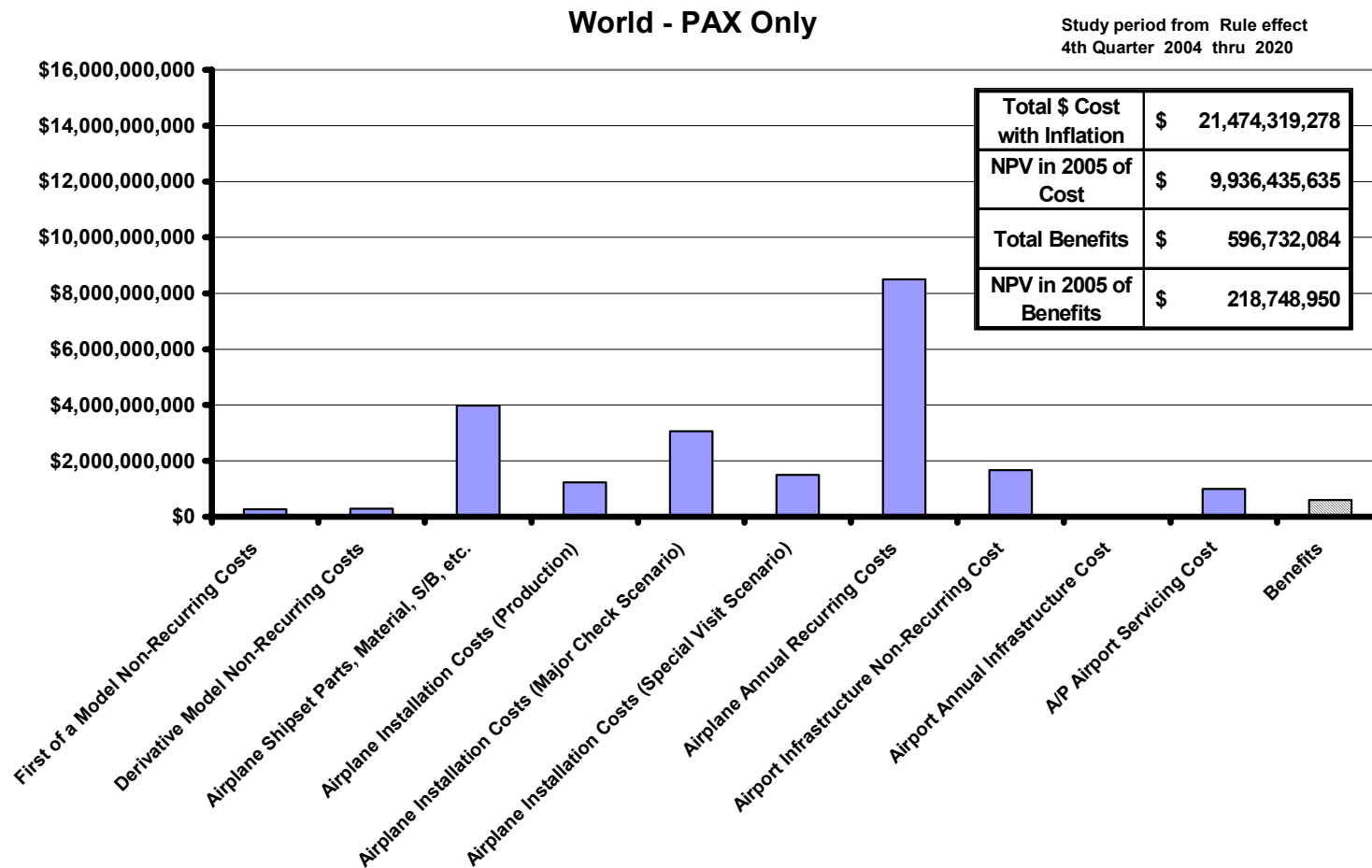

Figure G-23. Scenario 1—Onboard Ground Inerting, HCWT Only, Large, Medium, Small Transports, PSA/Membrane Systems (World, Passenger Only)

Scenario 2 - On-Board Ground Inerting All Fuselage Tanks, Large, Medium, Small Transports, PSA/Membrane Systems

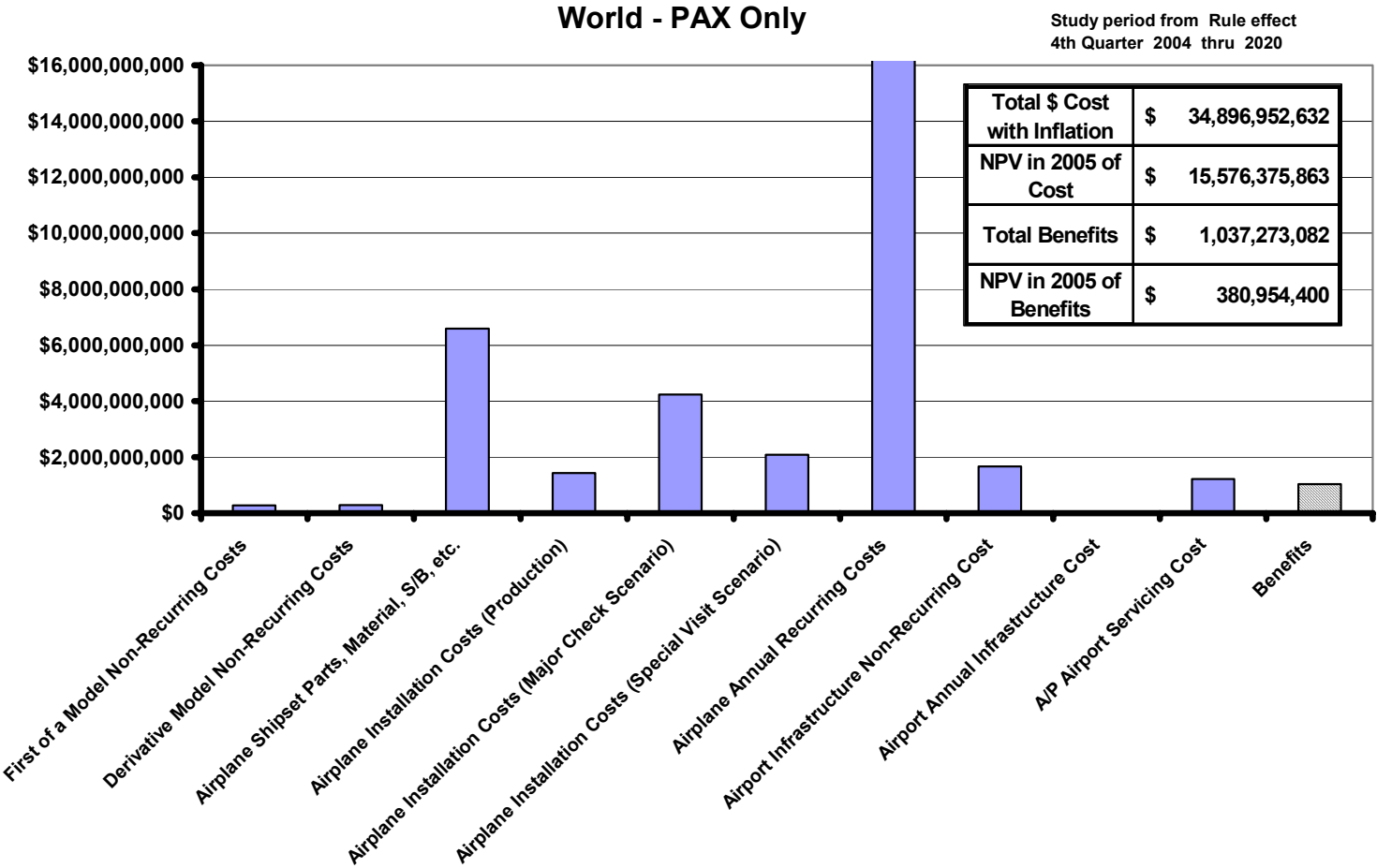

Figure G-24. Scenario 2—Onboard Ground Inerting, All Fuselage Tanks, Large, Medium, Small Transports, PSA/Membrane Systems (World, Passenger Only)

Scenario 3 - Hybrid On-Board Ground Inerting HCWT only, Large, Medium, Small Transports, PSA/Membrane Systems

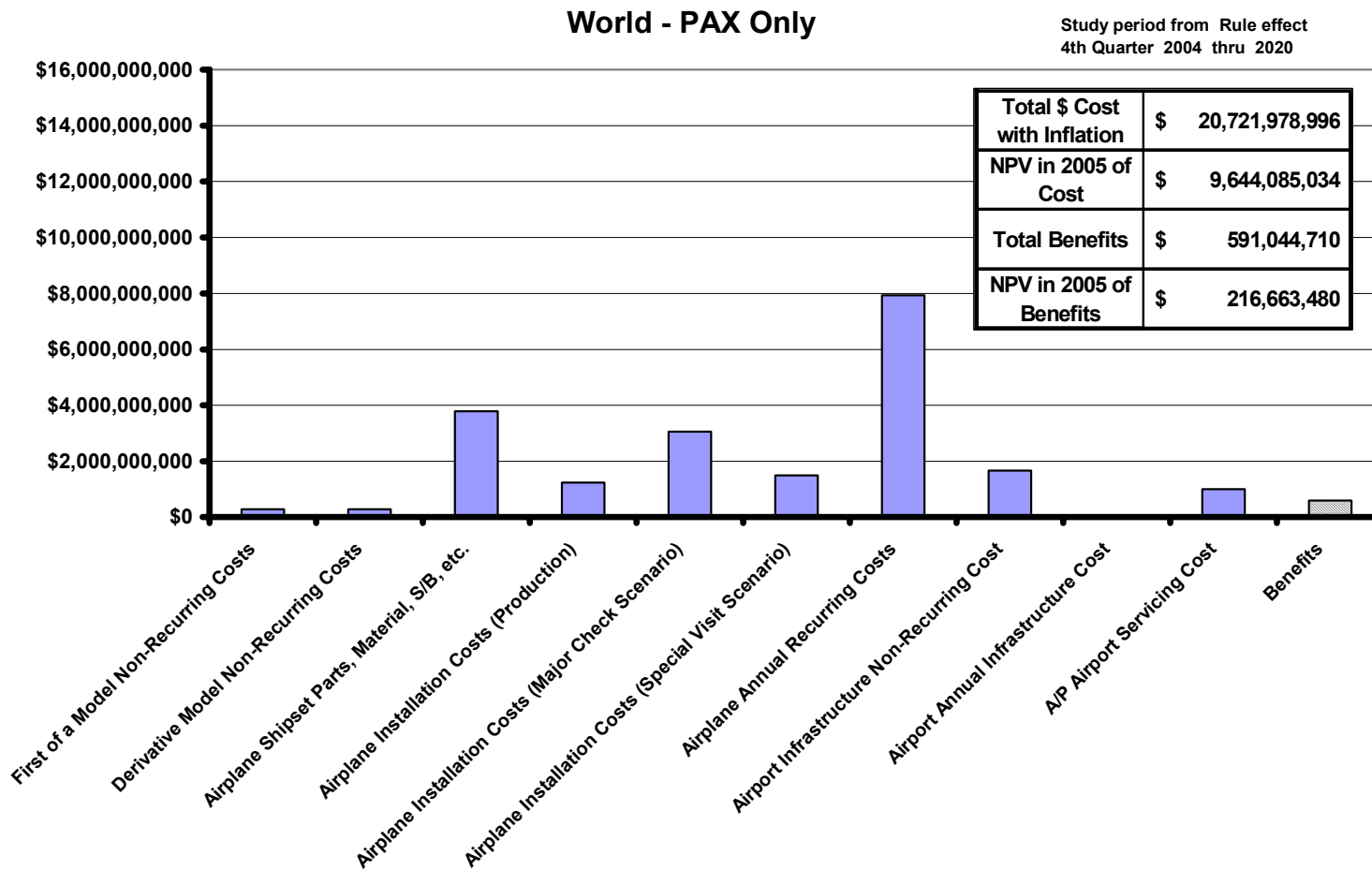

Figure G-25. Scenario 3—Hybrid Onboard Ground Inerting, HCWT Only, Large, Medium and Small Transports, PSA/Membrane Systems (World, Passenger Only)

Scenario 4 - Hybrid On-Board Ground Inerting All Fuselage Tanks, Large, Medium, Small Transports, PSA/Membrane Systems

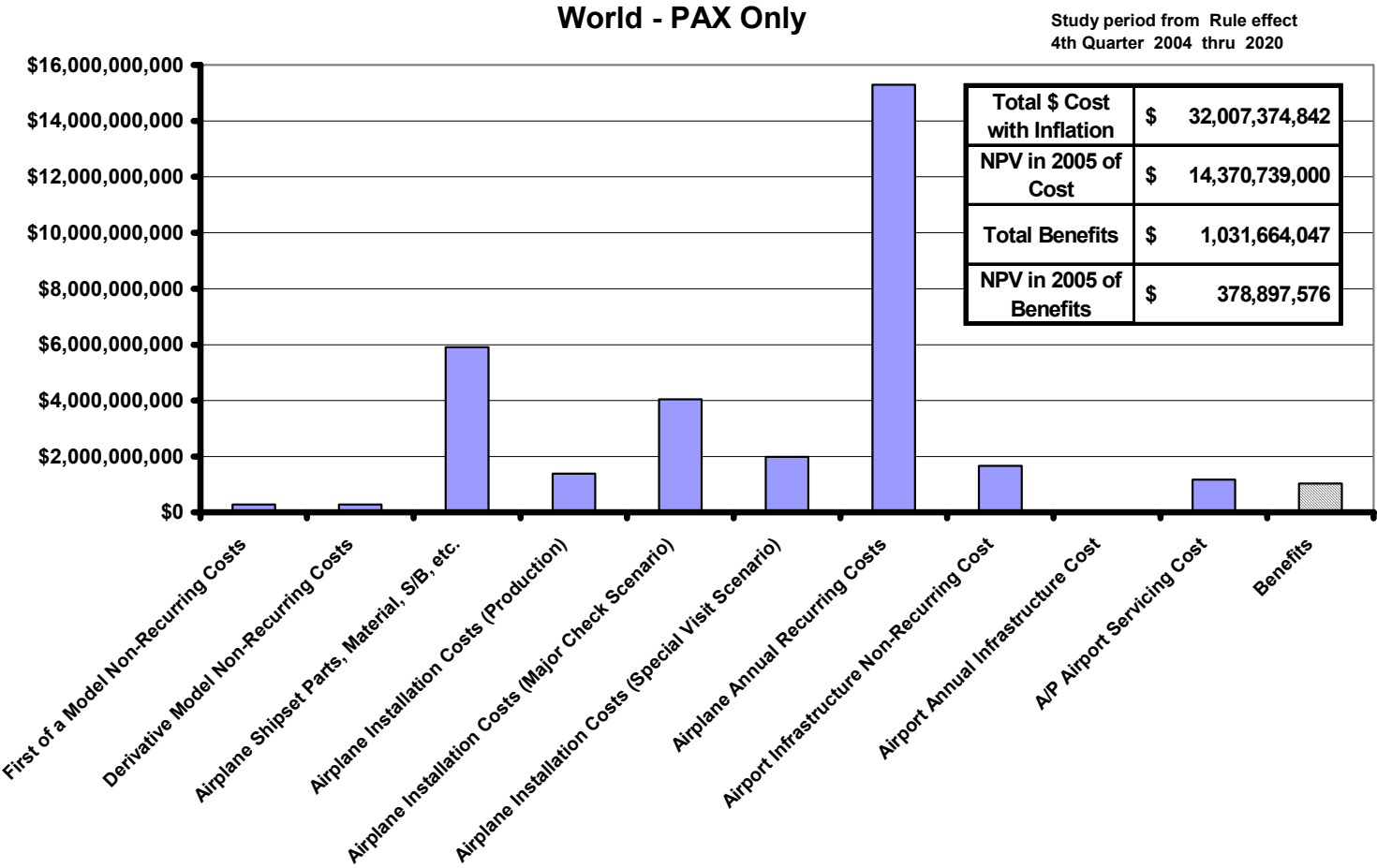

Figure G-26. Scenario 4—Hybrid Onboard Ground Inerting, All Fuselage Tanks, Large, Medium, Small Transports, PSA/Membrane Systems (World, Passenger Only)

Scenario 5 - OBIGGS, All Tanks, Large and Medium Transports, Membrane Systems, & Small Transports, PSA/Membrane Systems

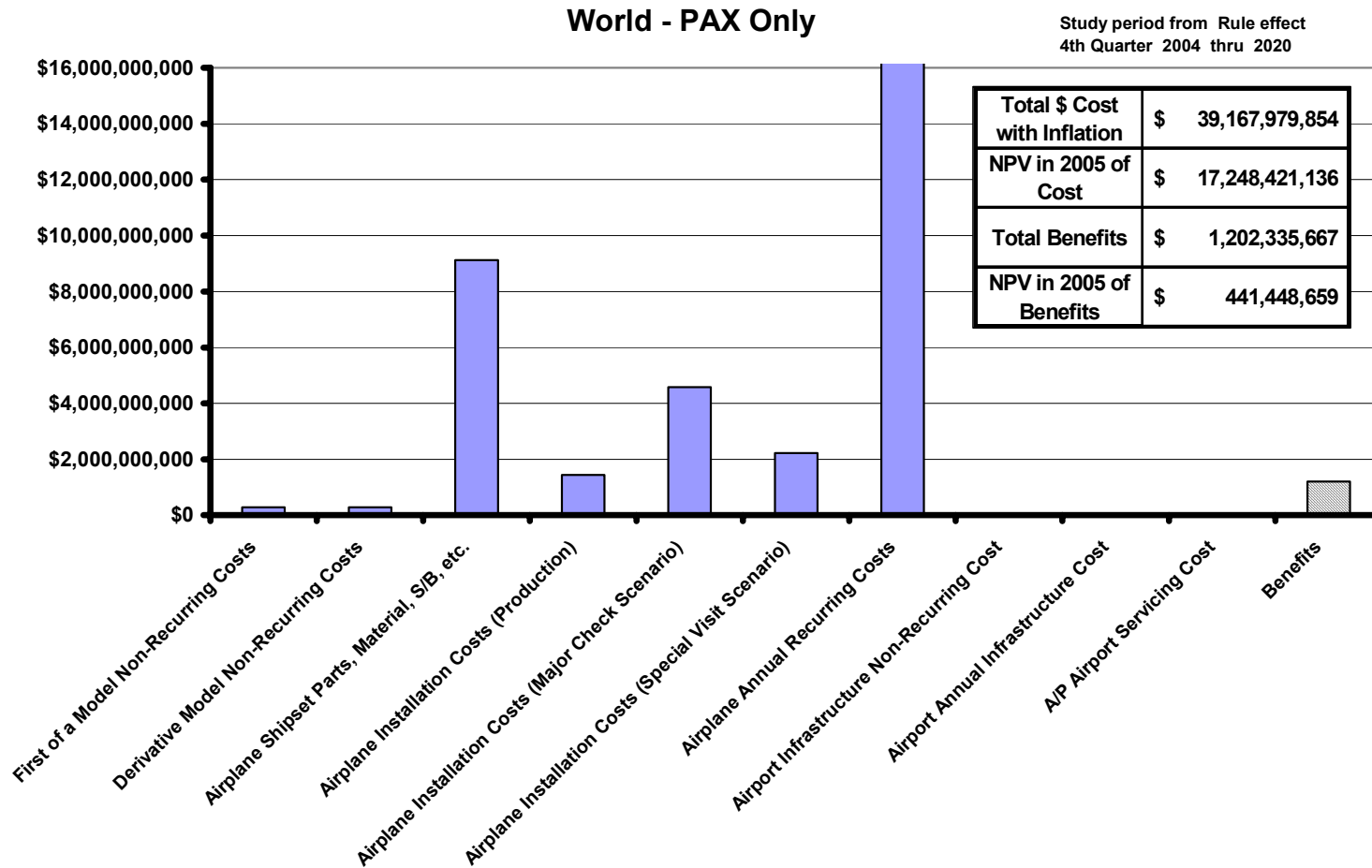

Figure G-27. Scenario 5—OBIGGS, All Tanks, Large and Medium Transports, Membrane Systems, and Small Transports, PSA/Membrane Systems (World, Passenger Only)

Scenario 7 - Hybrid OBIGGS, HCWT only, Large and Medium Transports, Membrane Systems, & Small Transports, PSA/Membrane Systems

World - PAX Only

Study period from Rule effect
4th Quarter 2004 thru 2020

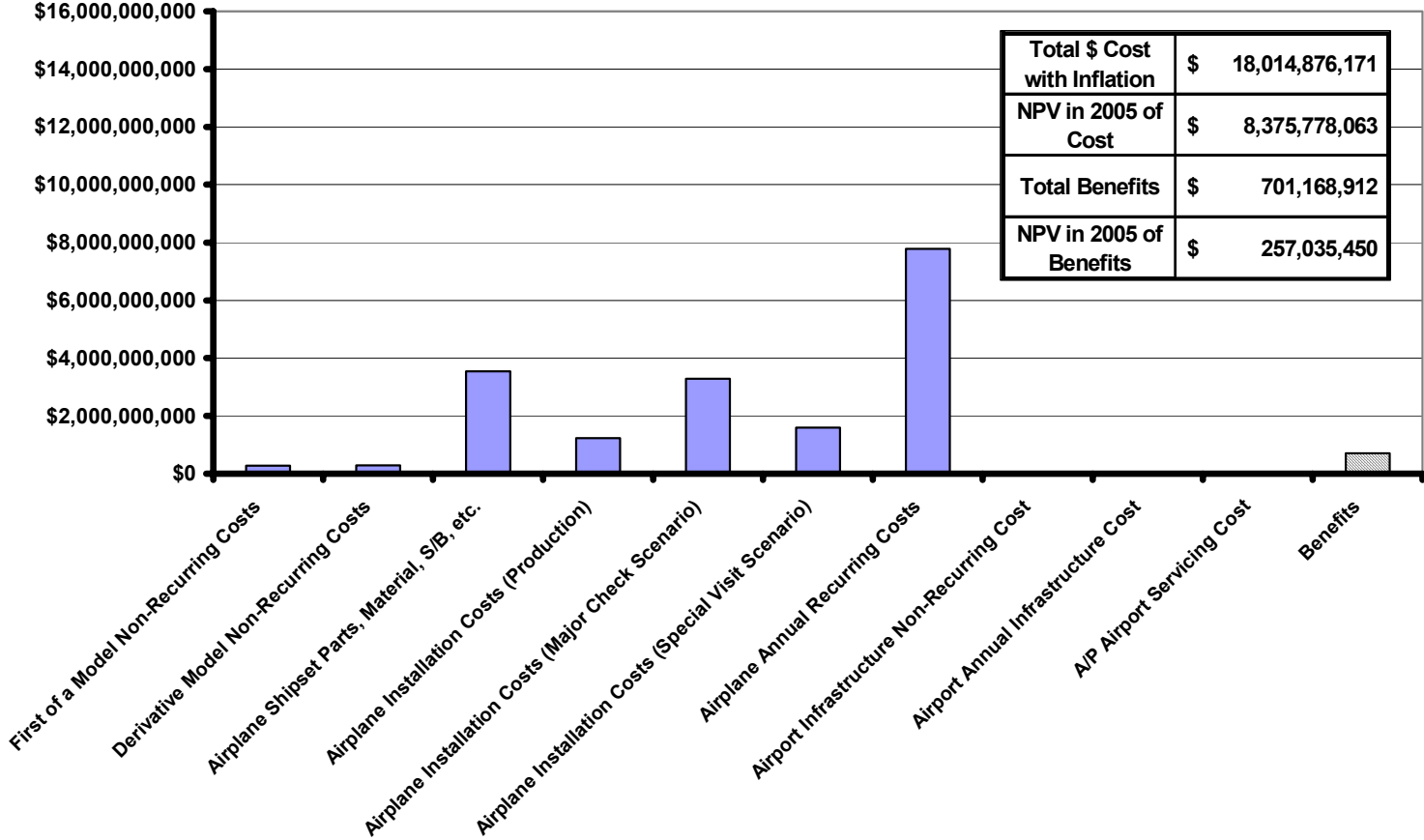

Figure G-28. Scenario 7—Hybrid OBIGGS, HCWT Only, Large and Medium Transports, Membrane Systems, and Small Transports, PSA/Membrane Systems (World, Passenger Only)

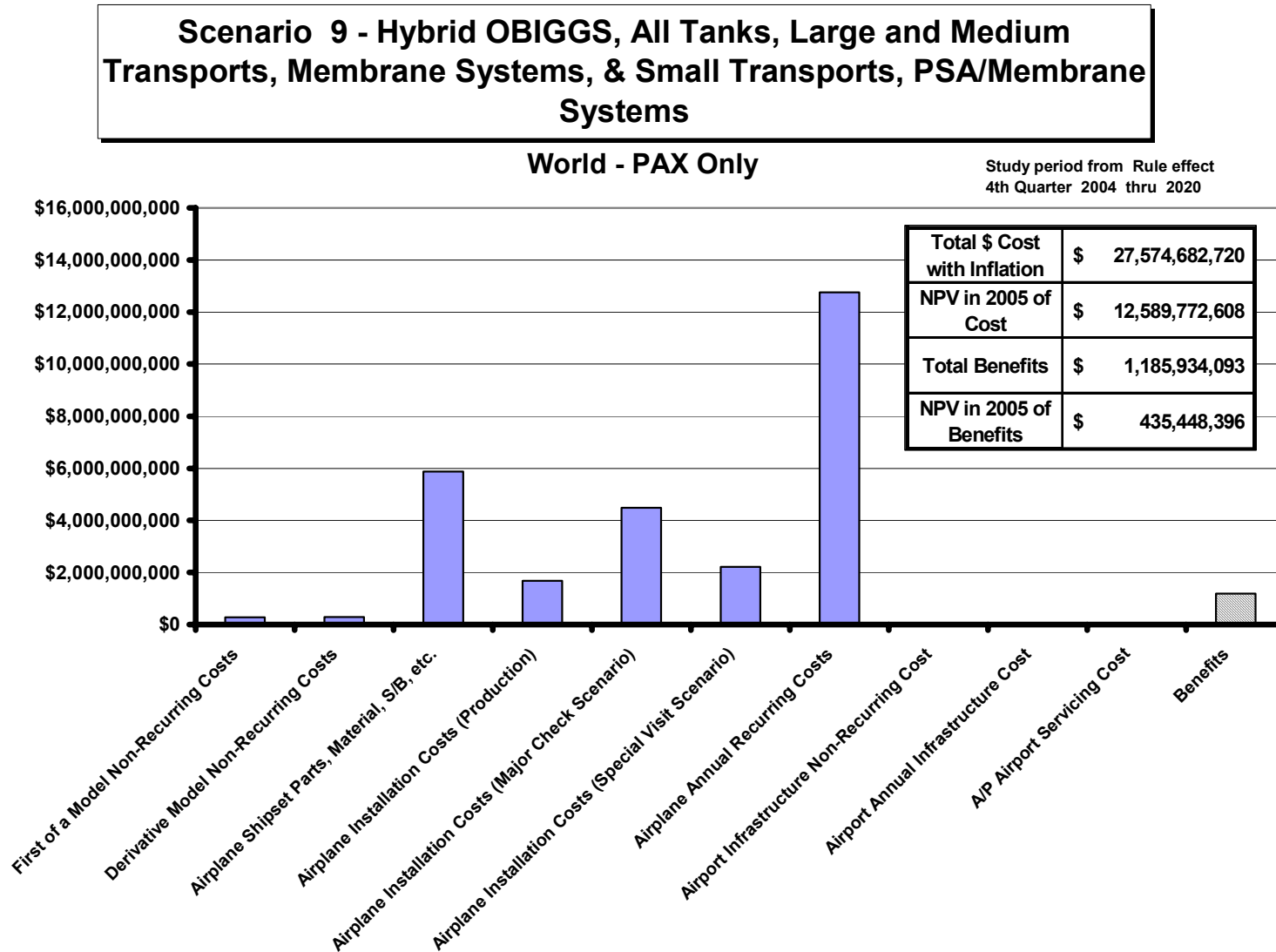

Figure G-29. Scenario 9—Hybrid OBIGGS, All Tanks, Large and Medium Transports, Membrane Systems, and Small Transports, PSA/Membrane Systems (World, Passenger Only)

Scenario 11 - Ground Based Inerting HCWT only, All Transports

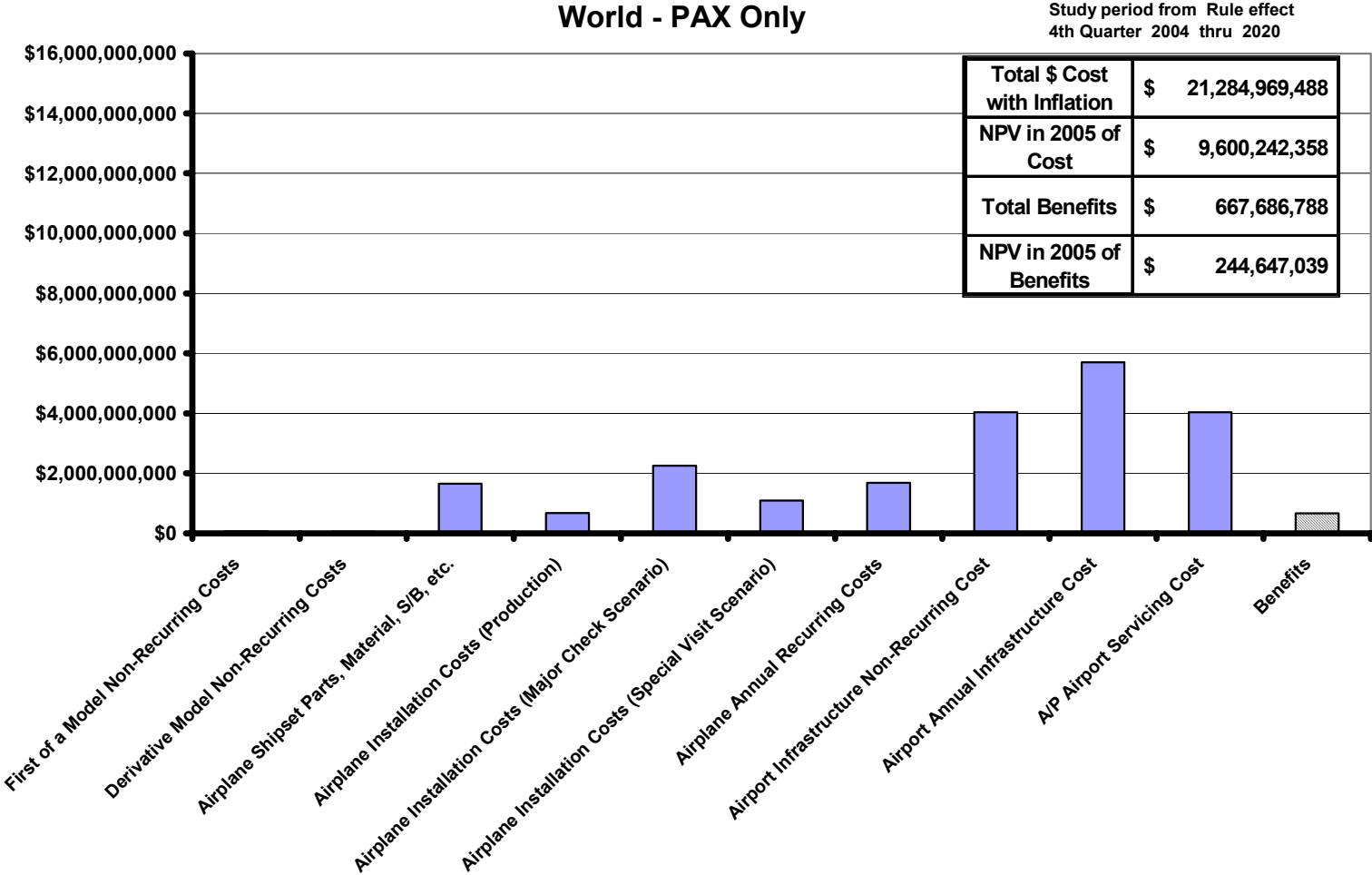

Figure G-30. Scenario 11—Ground-Based Inerting, HCWT Only, All Transports (World, Passenger Only)

Scenario 12 - Ground Based Inerting All Fuselage Tanks, All Transports

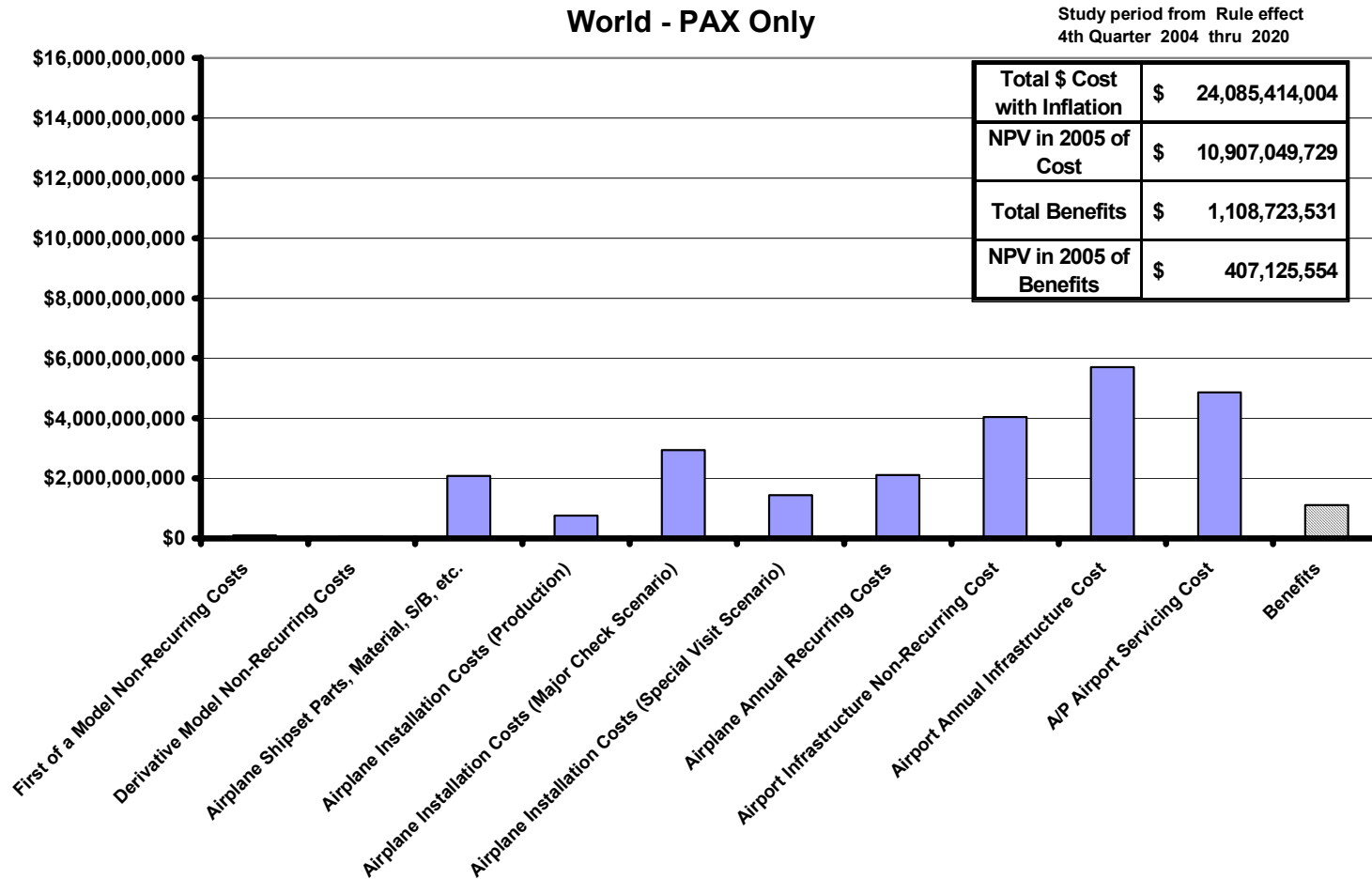

Figure G-31. Scenario 12—Ground-Based Inerting, All Fuselage Tanks, All Transports (World, Passenger Only)

Scenario 13 - OBIGGS, All Tanks, Large and Medium Transports, Cryogenics Systems, & Small Transports, PSA/Membrane Systems

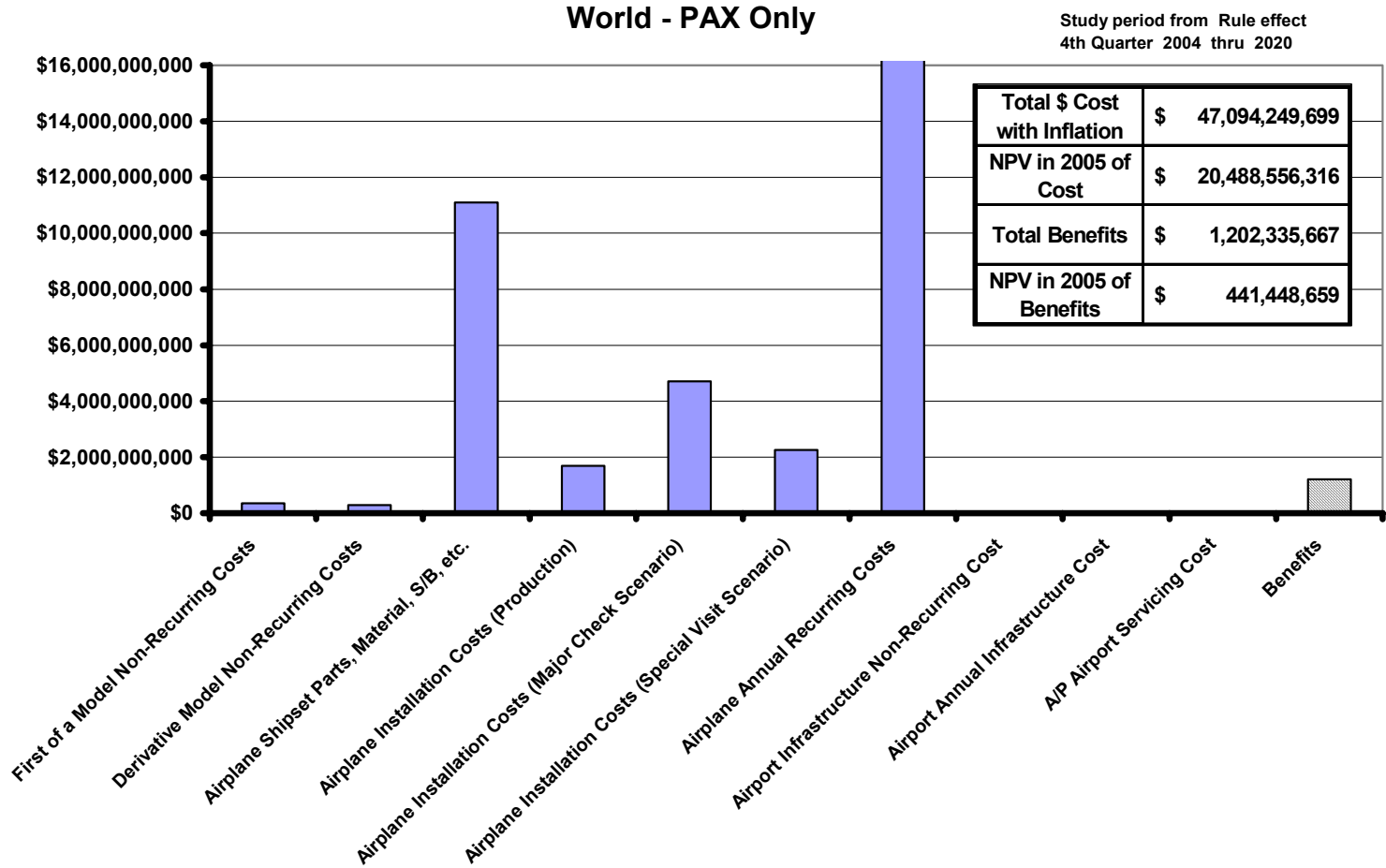

Figure G-32. Scenario 13—OBIGGS, All Tanks, Large and Medium Transports, Cryogenic Systems, and Small Transports, PSA/Membrane Systems (World, Passenger Only)

Scenario 14 - Hybrid OBIGGS, HCWT only, Large and Medium Transports, Cryogenics Systems, & Small Transports, PSA/Membrane Systems

World - PAX Only

Study period from Rule effect
4th Quarter 2004 thru 2020

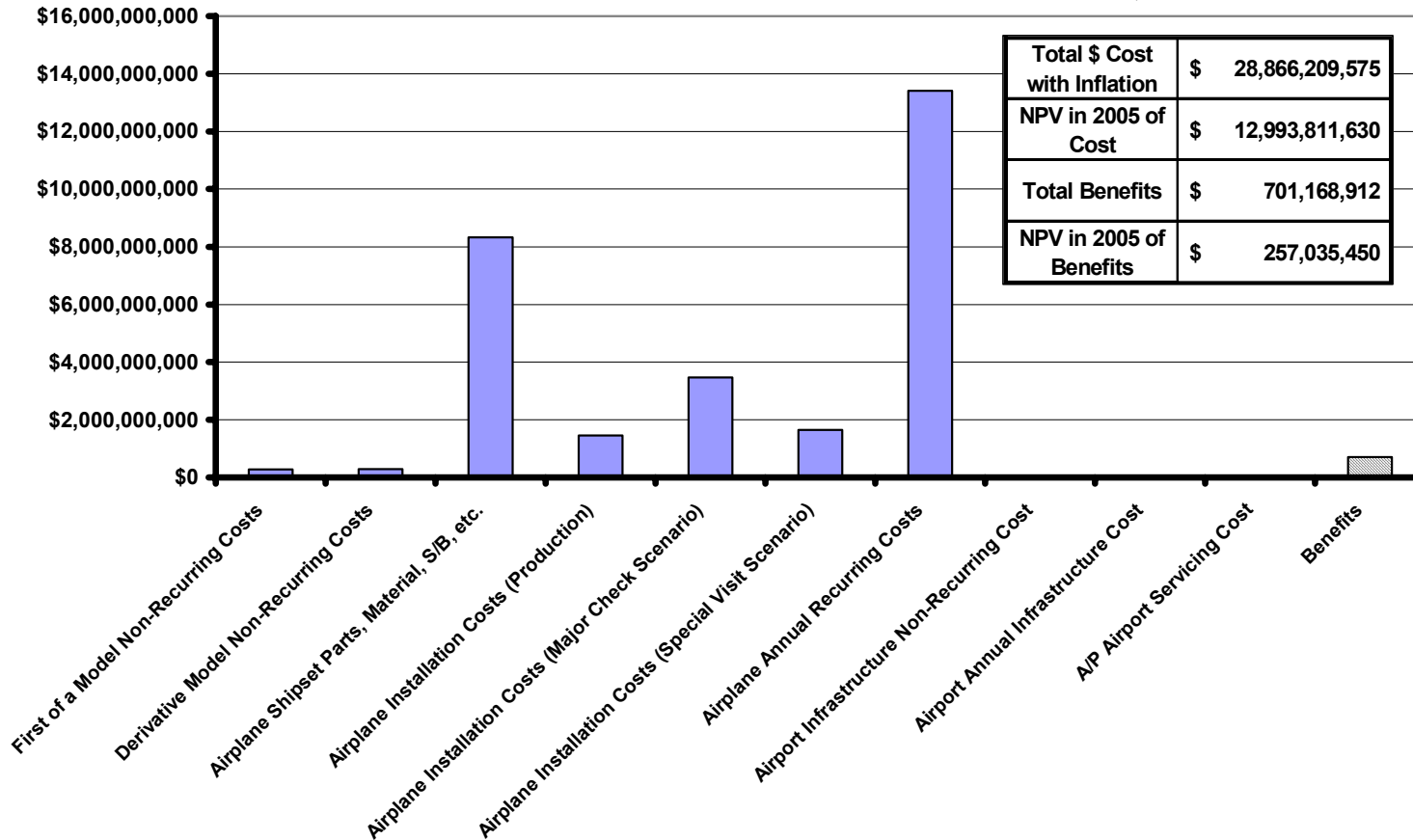

Figure G-33. Scenario 14—Hybrid OBIGGS, HCWT Only, Large and Medium Transports, Cryogenic Systems, and Small Transports, PSA/Membrane Systems (World, Passenger Only)

Scenario 15 - Hybrid OBIGGS, All Tanks, Large and Medium Transports, Cryogenics Systems, & Small Transports, PSA/Membrane Systems

World - PAX Only

Study period from Rule effect
4th Quarter 2004 thru 2020

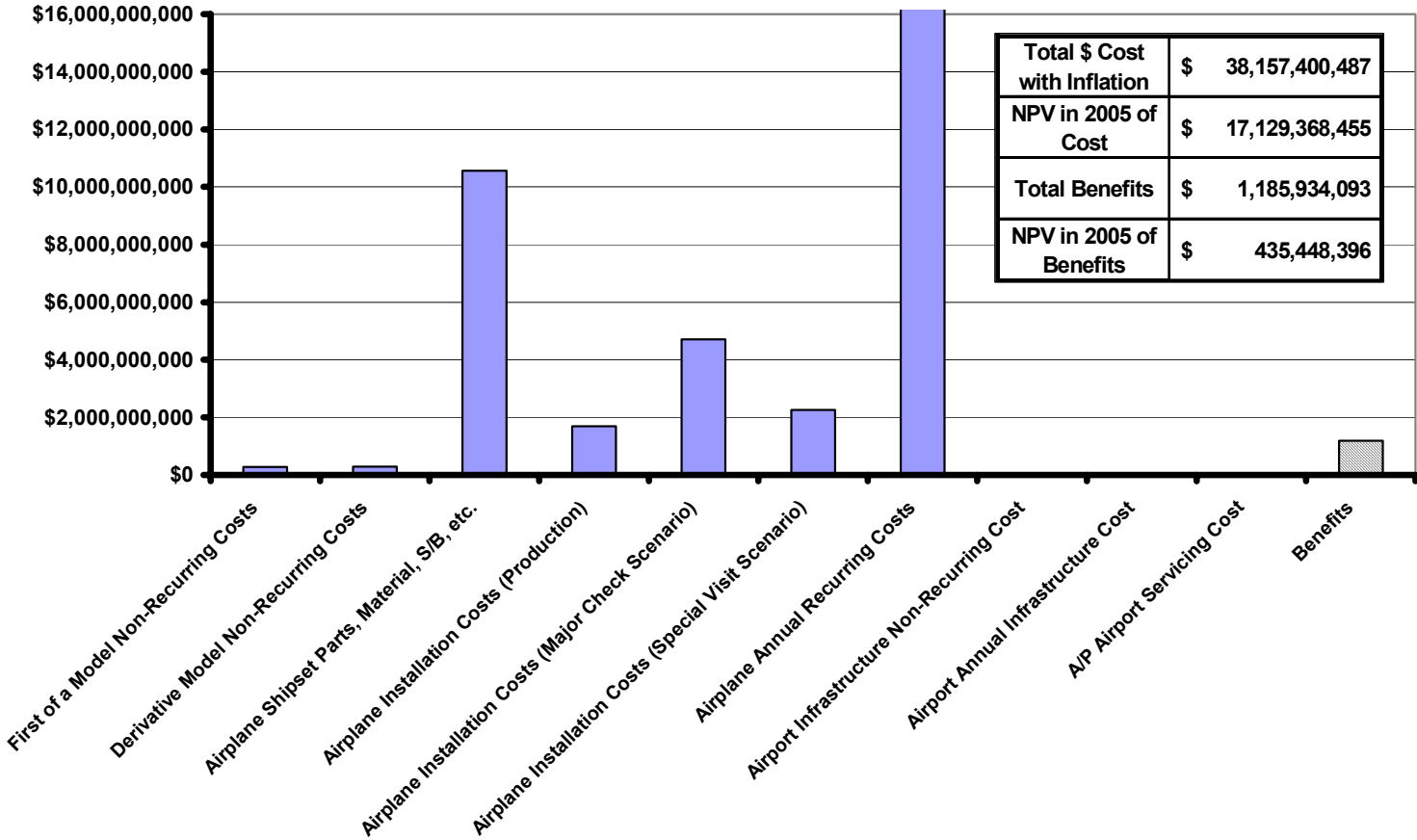

Figure G-34. Scenario 15—Hybrid OBIGGS, All Tanks, Large and Medium Transports, Cryogenic Systems, and Small Transports, PSA/Membrane Systems (World, Passenger Only)

Scenario 16 - On-Board Liquid Nitrogen Inerting

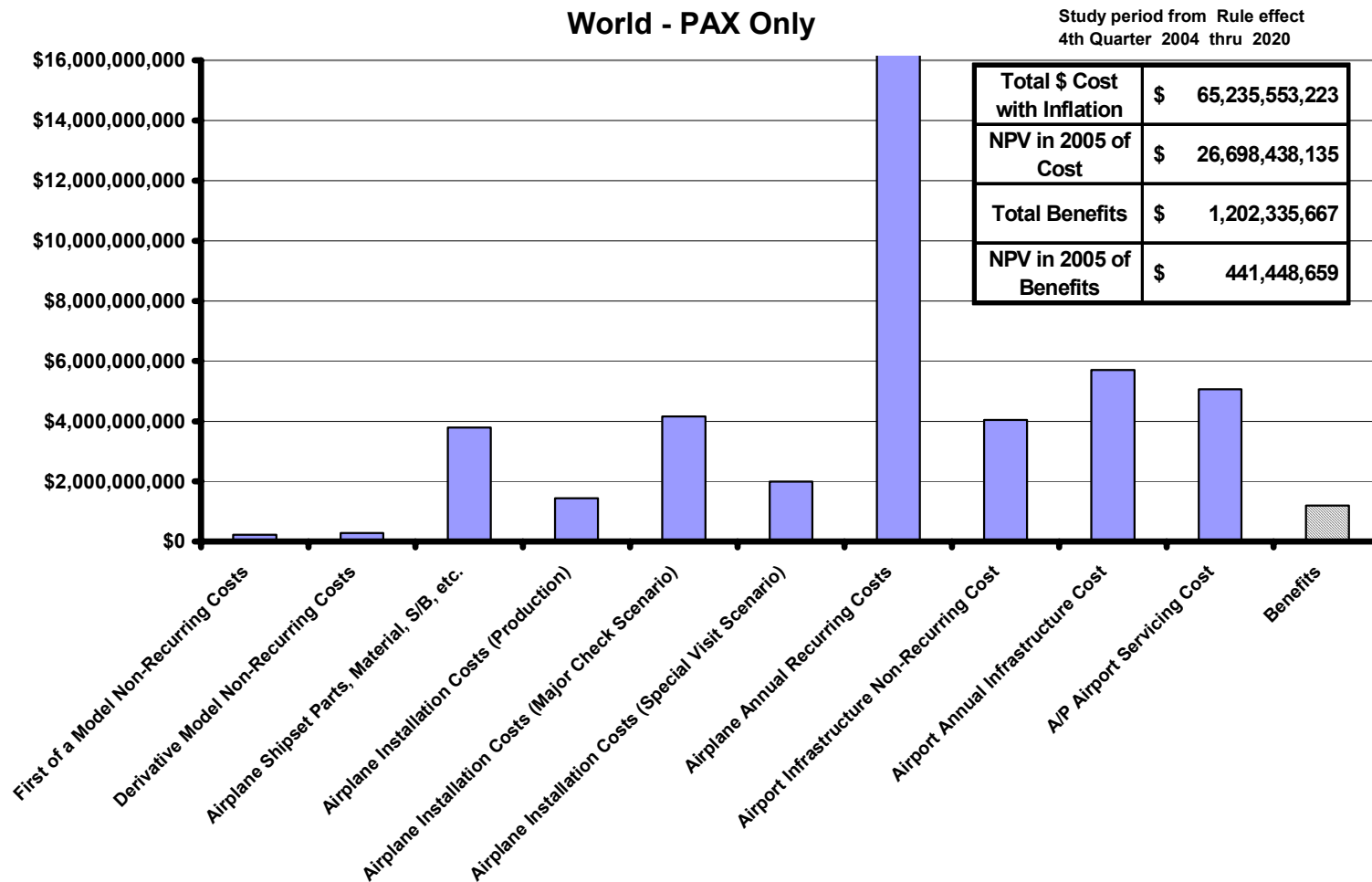

Figure G-35. Scenario 16—Onboard Liquid Nitrogen Inerting (World, Passenger Only)

Summary of Inerting Scenario Results

US-Operator

Values in Millions

	Scenario 1 - On-Board Ground Inerting HCWT only, Large, Medium, Small Transports, PSA Membrane Systems	Scenario 2 - On-Board Ground Inerting HCWT only, Large, Medium, Small Transports, PSA Membrane Systems	Scenario 3 - Hybrid On-Board Ground Inerting HCWT only, Large, Medium, Small Transports, PSA Membrane Systems	Scenario 4 - Hybrid On-Board Ground Inerting HCWT only, Large, Medium, Small Transports, PSA Membrane Systems	Scenario 5 - OBIGGS, All Tanks, Large and Medium Transports, Membrane Systems, & Small Transports, PSA Membrane Systems	Scenario 7 - Hybrid OBIGGS, HCWT only, Large and Medium Transports, Membrane Systems, & Small Transports, PSA Membrane Systems	Scenario 9 - Hybrid OBIGGS, All Tanks, Large and Medium Transports, Membrane Systems, & Small Transports	Scenario 11 - Ground Based Inerting HCWT only, All Tanks, All Transports	Scenario 12 - Ground Based Inerting HCWT only, All Tanks, All Transports	Scenario 13 - OBIGGS, All Tanks, Large and Medium Transports, Cryogenics Systems, & Small Transports, PSA Membrane Systems	Scenario 14 - Hybrid OBIGGS, HCWT only, Large and Medium Transports, Cryogenics Systems, & Small Transports, PSA Membrane Systems	Scenario 15 - Hybrid OBIGGS, All Tanks, Large and Medium Transports, Cryogenics Systems, & Small Transports, PSA Membrane Systems	Scenario 16 - On-Board Liquid Nitrogen Inerting			
Total \$ Cost with Inflation	10,082	15,367	9,744	14,203	17,047	8,606	12,680	10,429	11,588	20,924	13,586	17,414	27,692	-	-	-
NPV in 2005 of Cost	4,849	7,099	4,721	6,613	7,753	4,165	5,968	4,758	5,314	9,357	6,299	8,015	11,656	-	-	-
Total Benefits	233	434	231	432	497	274	492	258	459	497	274	492	497	-	-	-
NPV in 2005 of Benefits	86	159	85	159	183	101	181	95	169	183	101	181	183	-	-	-

Figure G-36. Cost Summary of U.S. Fleet

Scenario 1 - On-Board Ground Inerting HCWT only, Large, Medium, Small Transports, PSA/Membrane Systems

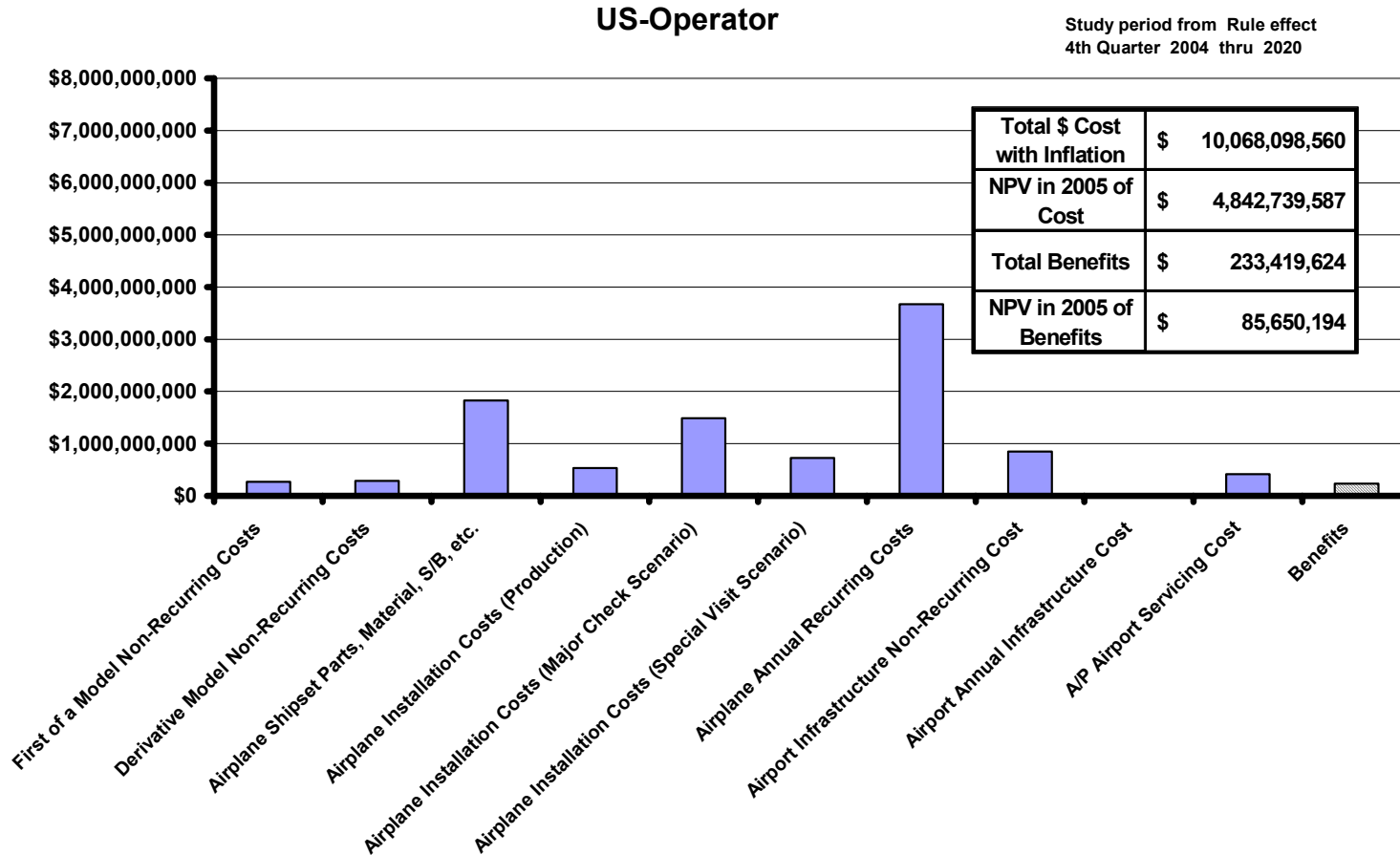

Figure G-37. Scenario 1—Onboard Ground Inerting, HCWT Only, Large, Medium, Small Transports, PSA/Membrane Systems (U.S.)

Scenario 2 - On-Board Ground Inerting All Fuselage Tanks, Large, Medium, Small Transports, PSA/Membrane Systems

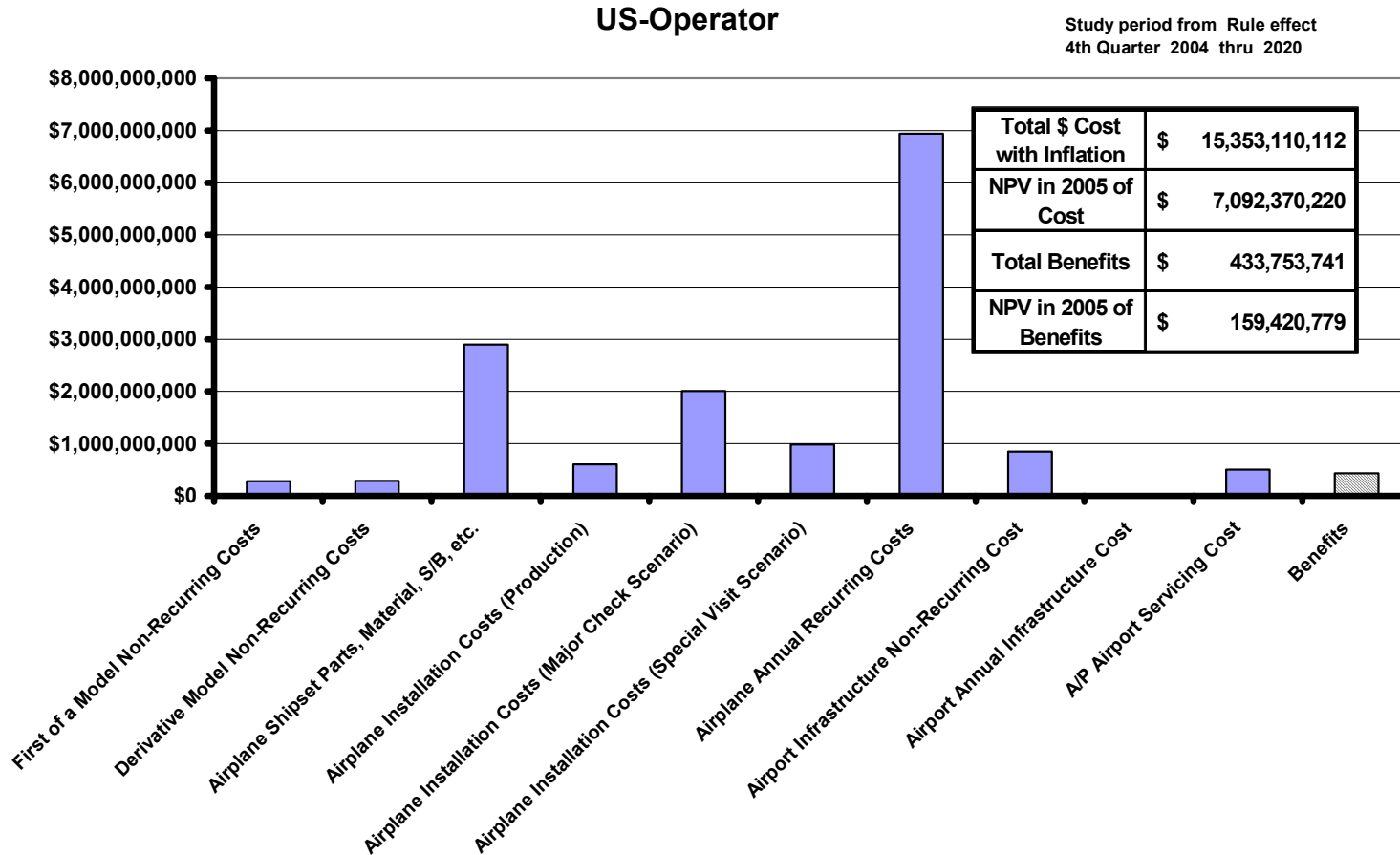

Figure G-38. Scenario 2—Onboard Ground Inerting, All Fuselage Tanks, Large, Medium, Small Transports, PSA/Membrane Systems (U.S.)

Scenario 3 - Hybrid On-Board Ground Inerting HCWT only, Large, Medium, Small Transports, PSA/Membrane Systems

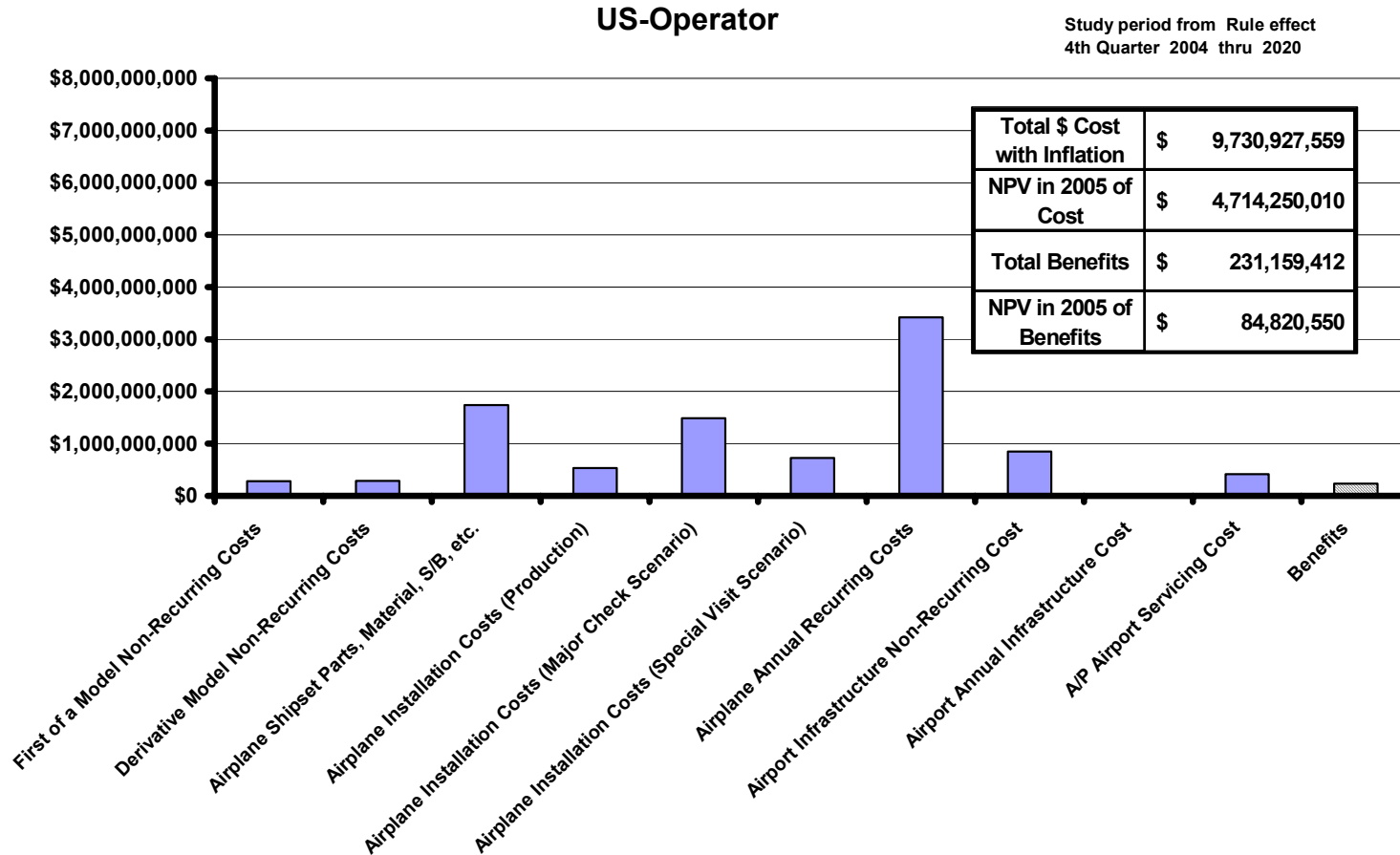

Figure G-39. Scenario 3—Hybrid Onboard Ground Inerting, HCWT Only, Large, Medium, and Small Transports, PSA/Membrane Systems (U.S.)

Scenario 4 - Hybrid On-Board Ground Inerting All Fuselage Tanks, Large, Medium, Small Transports, PSA/Membrane Systems

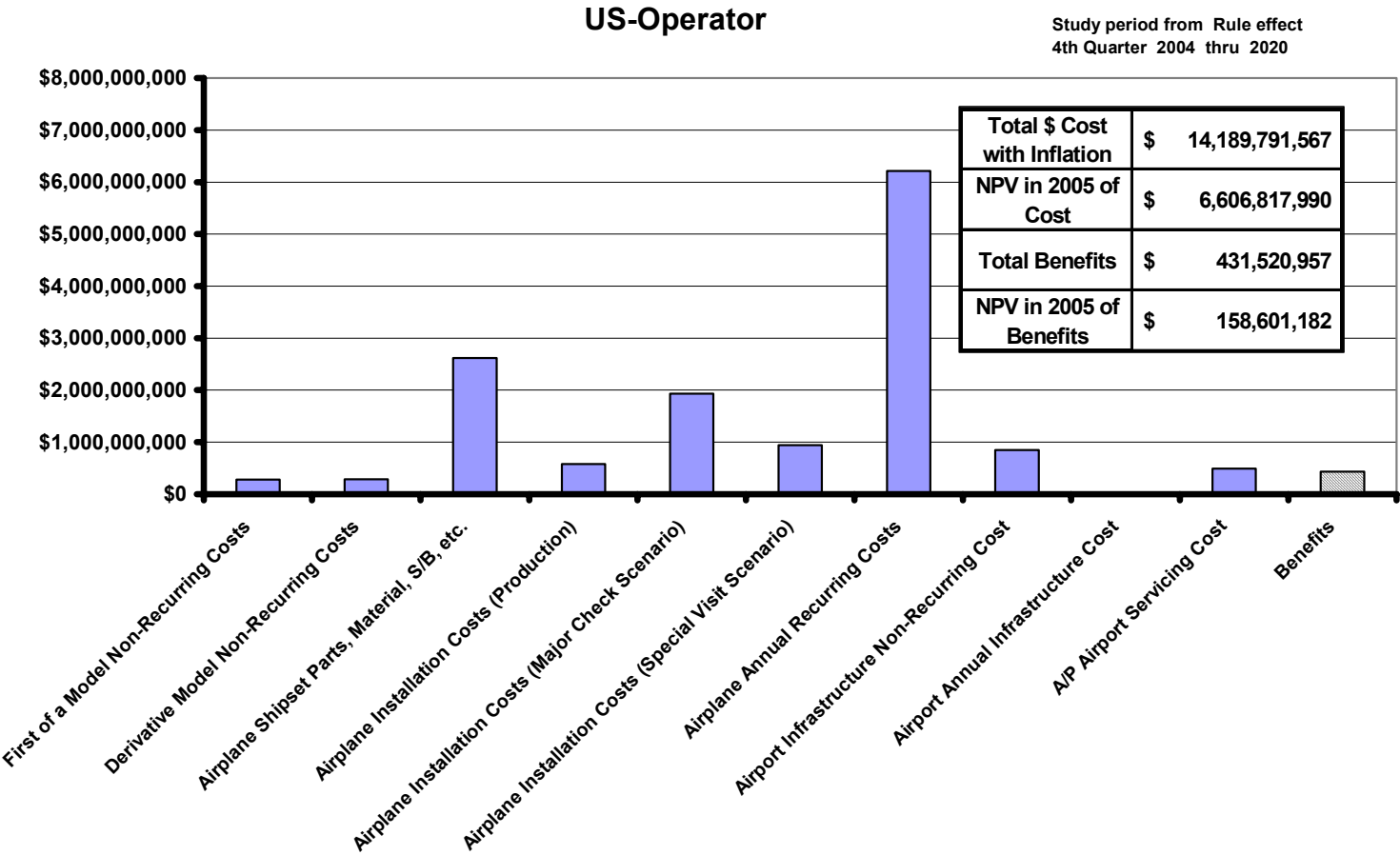

Figure G-40. Scenario 4—Hybrid Onboard Ground Inerting, All Fuselage Tanks, Large, Medium, and Small Transports, PSA/Membrane Systems (U.S.)

Scenario 5 - OBIGGS, All Tanks, Large and Medium Transports, Membrane Systems, & Small Transports, PSA/Membrane Systems

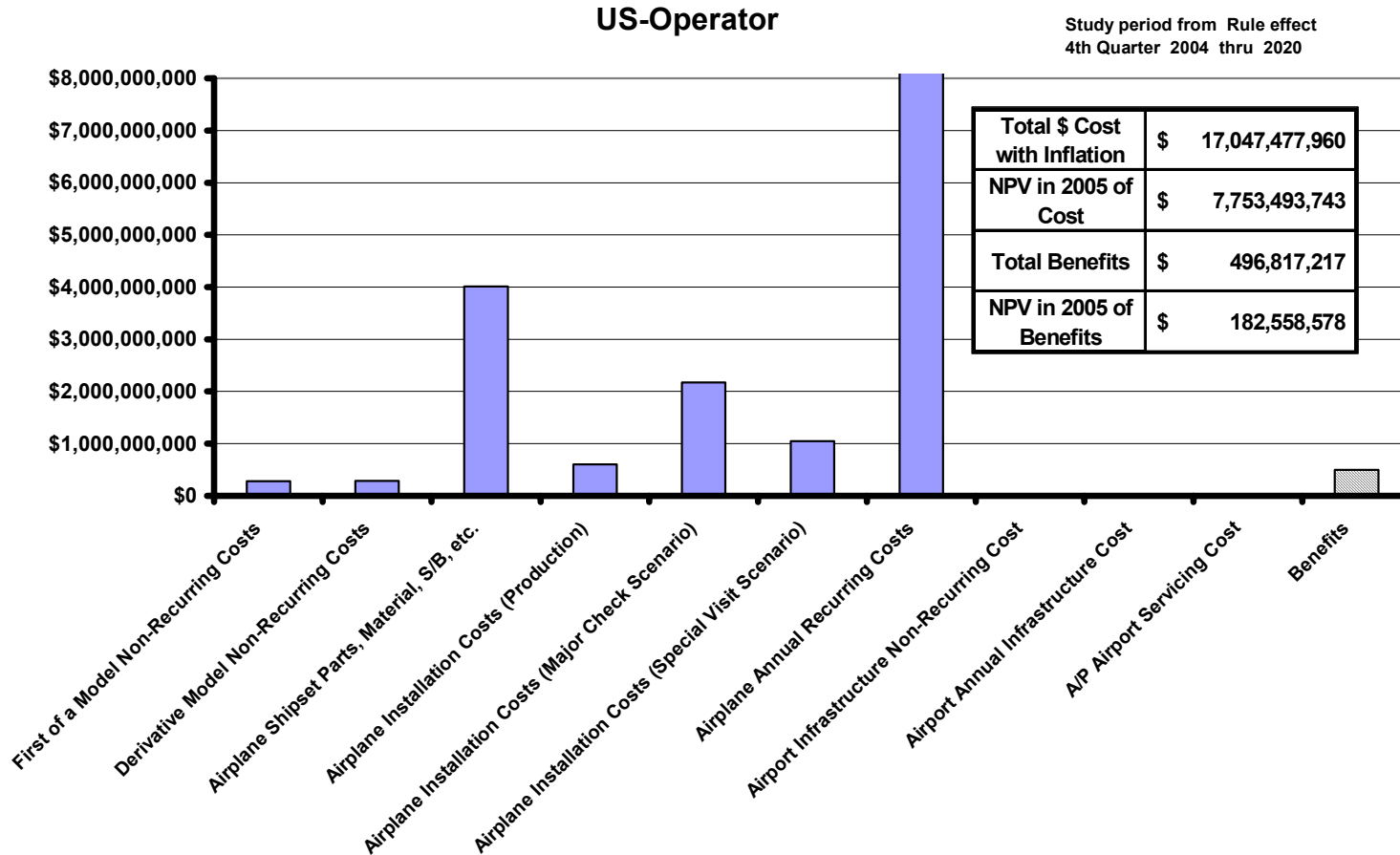

Figure G-41. Scenario 5—OBIGGS, All Tanks, Large and Medium Transports, Membrane Systems, and Small Transports, PSA/Membrane Systems (U.S.)

Scenario 7 - Hybrid OBIGGS, HCWT only, Large and Medium Transports, Membrane Systems, & Small Transports, PSA/Membrane Systems

US-Operator

Study period from Rule effect
4th Quarter 2004 thru 2020

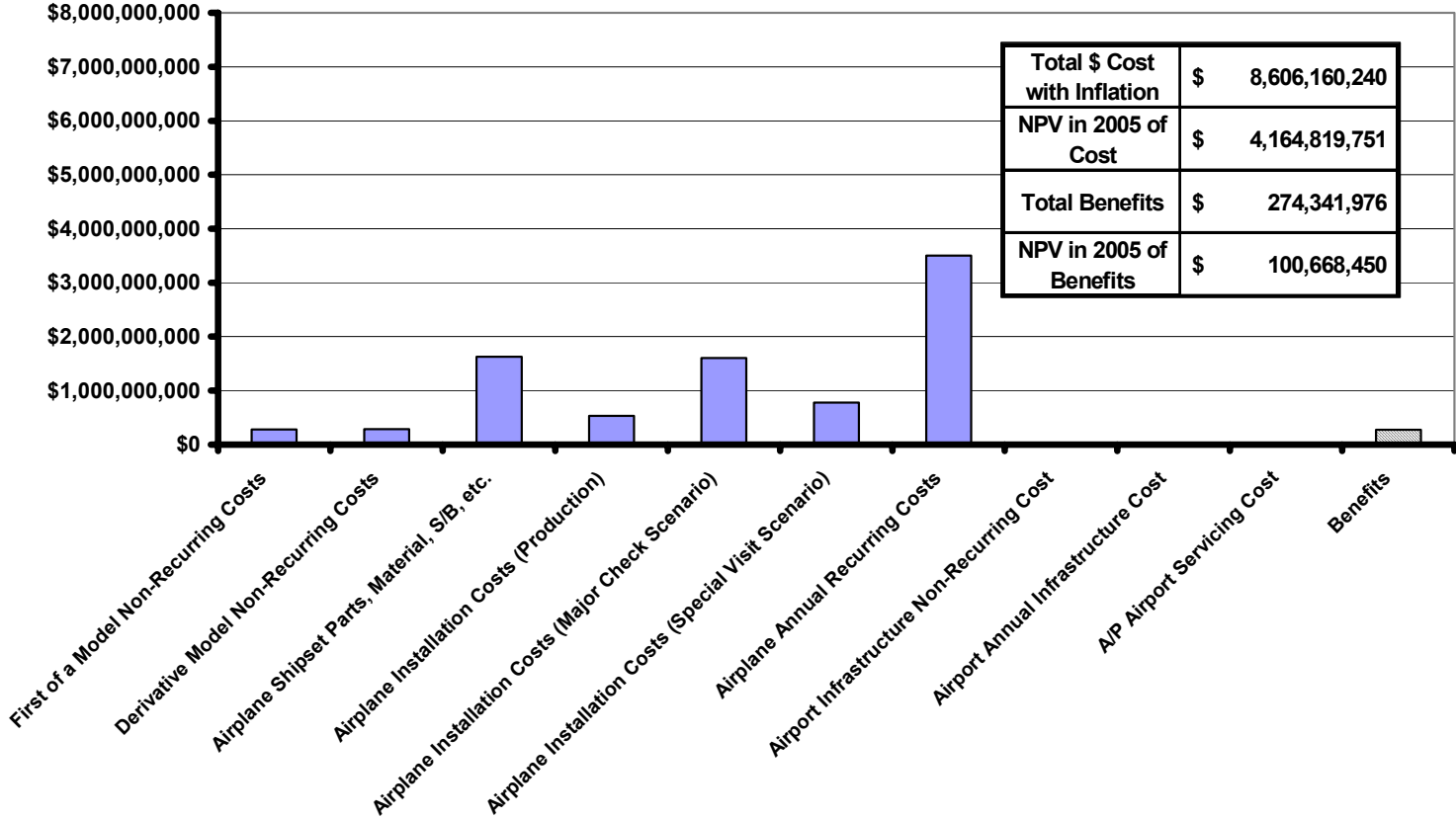

Figure G-42. Scenario 7—Hybrid OBIGGS, HCWT Only, Large and Medium Transports, Membrane Systems, and Small Transports, PSA/Membrane Systems (U.S.)

**Scenario 9 - Hybrid OBIGGS, All Tanks, Large and Medium
Transports, Membrane Systems, & Small Transports, PSA/Membrane
Systems**

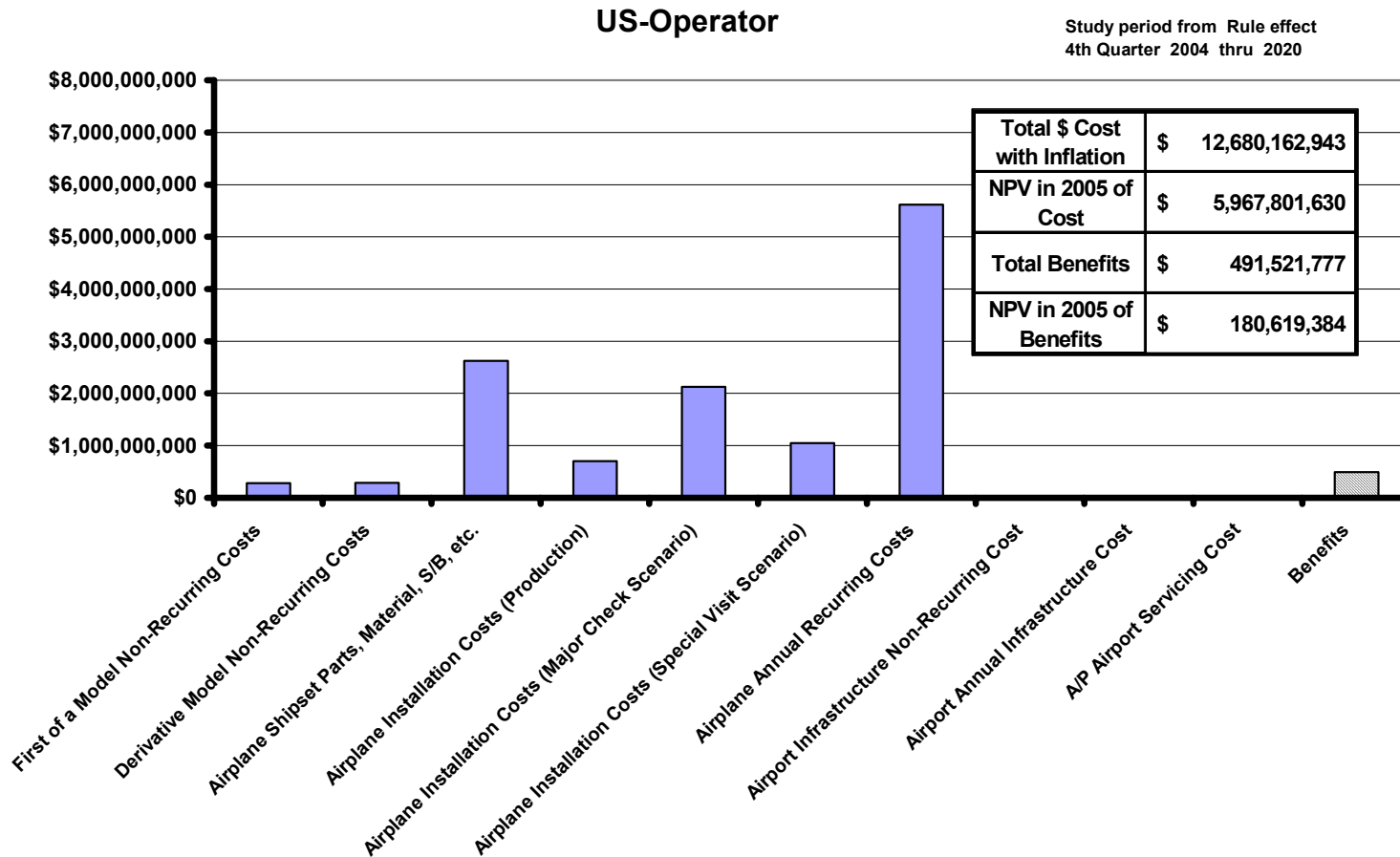

Figure G-43. Scenario 9—Hybrid OBIGGS, All Tanks, Large and Medium Transports, Membrane Systems, and Small Transports, PSA/Membrane Systems (U.S.)

Scenario 11 - Ground Based Inerting HCWT only, All Transports

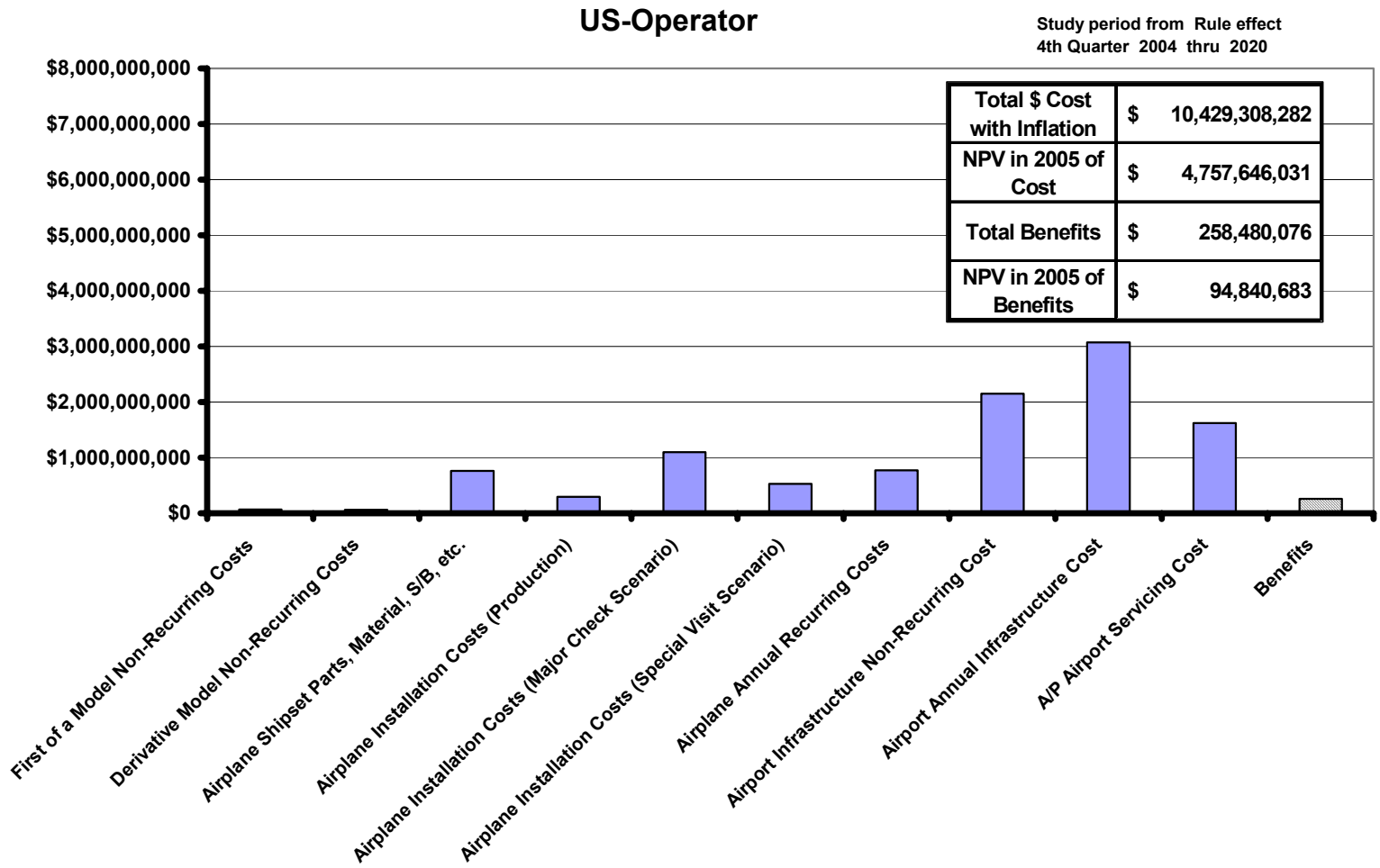

Figure G-44. Scenario 11—Ground-Based Inerting, HCWT Only, All Transports (U.S.)

Scenario 12 - Ground Based Inerting All Fuselage Tanks, All Transports

US-Operator

Study period from Rule effect
4th Quarter 2004 thru 2020

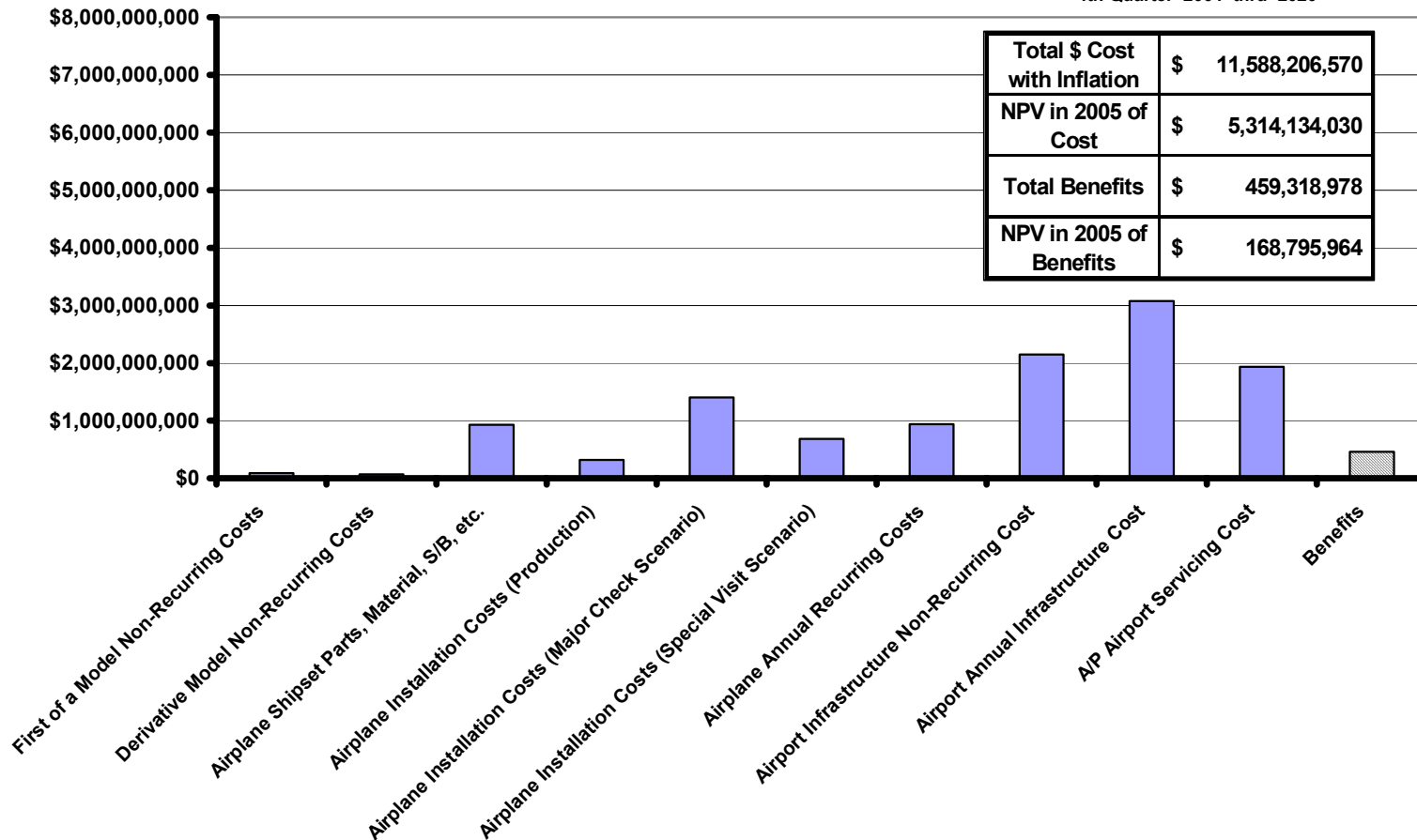

Figure G-45. Scenario 12—Ground-Based Inerting, All Fuselage Tanks, All Transports (U.S.)

Scenario 13 - OBIGGS, All Tanks, Large and Medium Transports, Cryogenics Systems, & Small Transports, PSA/Membrane Systems

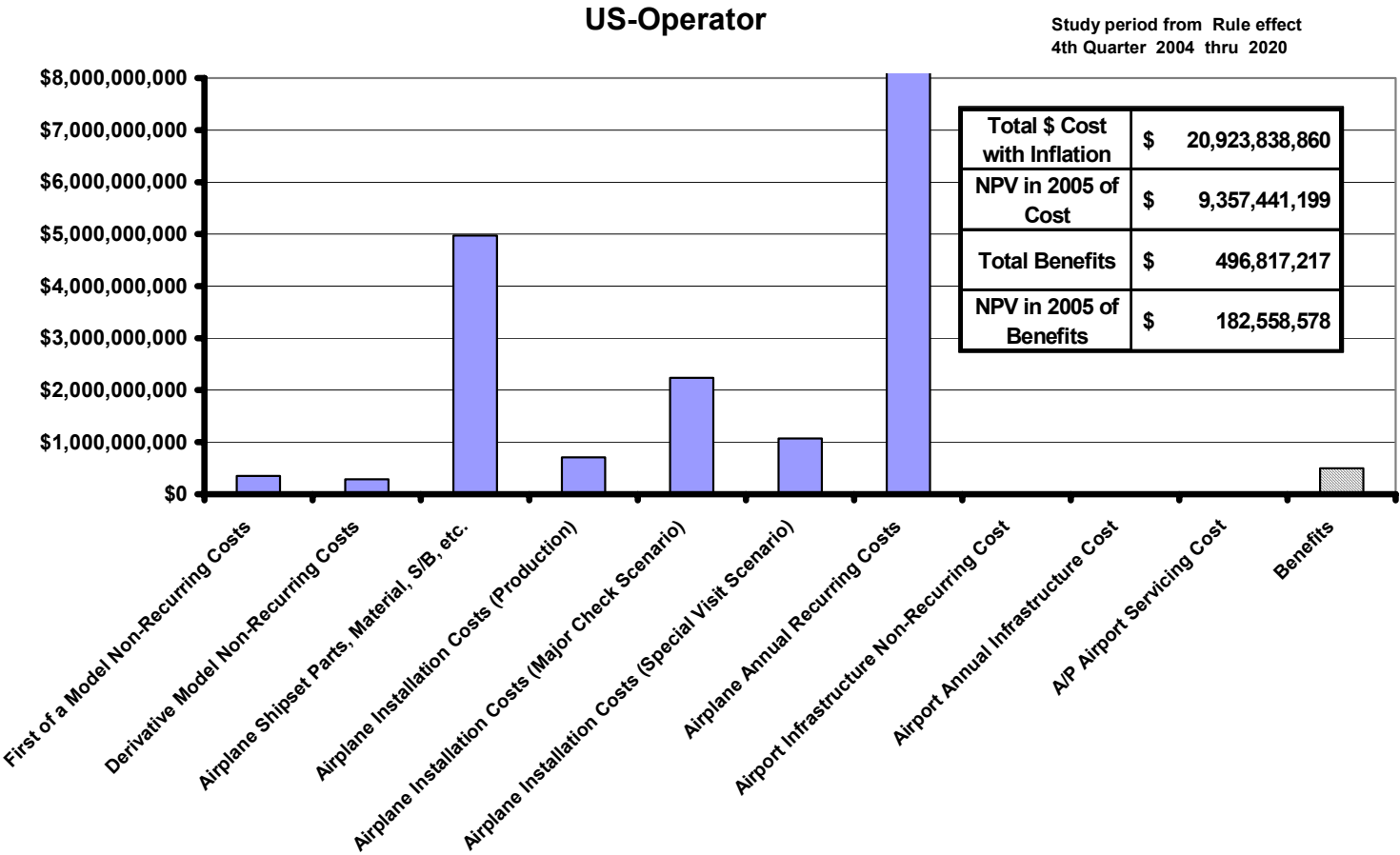

Figure G-46. Scenario 13—OBIGGS, All Tanks, Large and Medium Transports, Cryogenic Systems, and Small Transports, PSA/Membrane Systems (U.S.)

Scenario 14 - Hybrid OBIGGS, HCWT only, Large and Medium Transports, Cryogenics Systems, & Small Transports, PSA/Membrane Systems

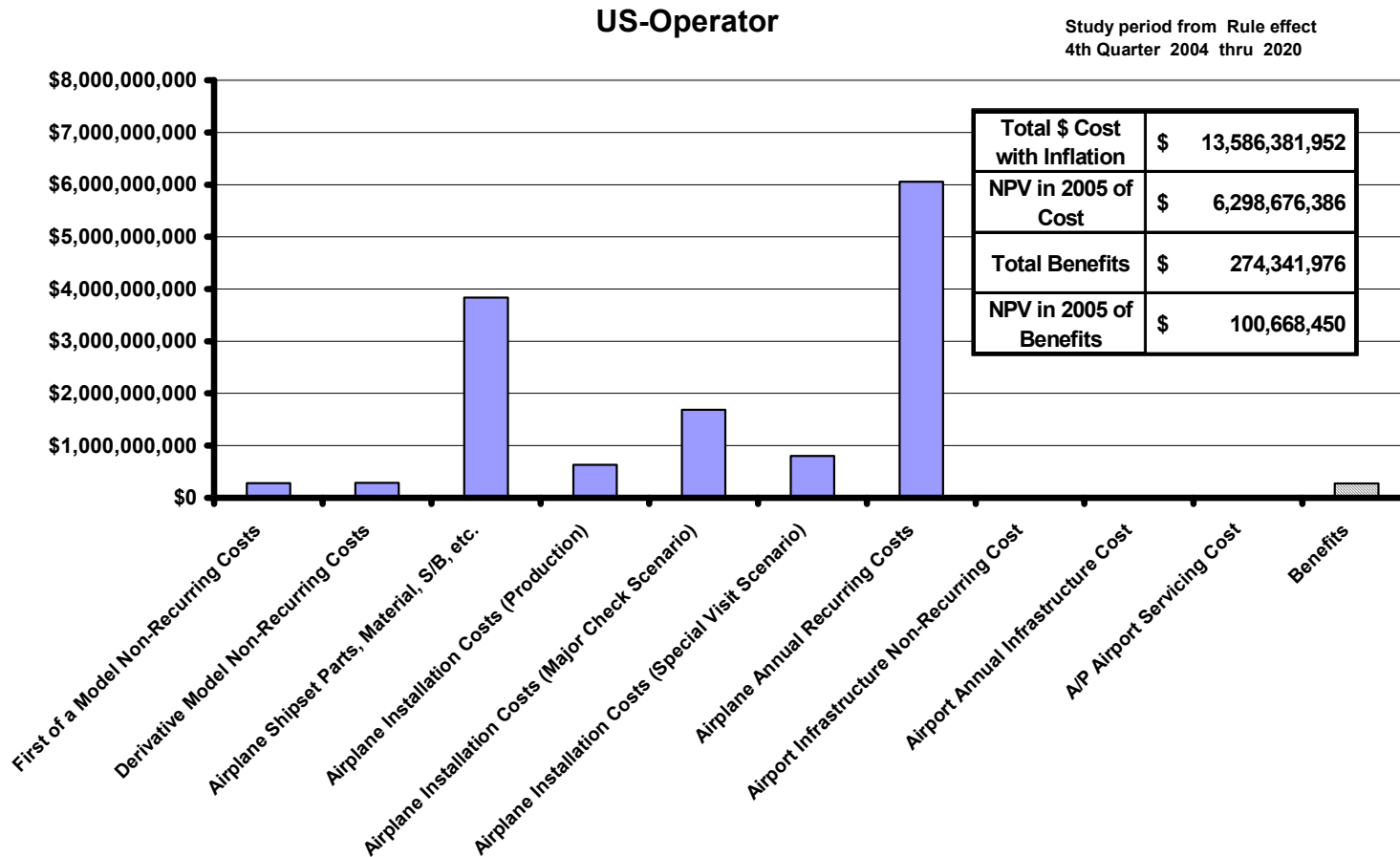

Figure G-47. Scenario 14—Hybrid OBIGGS, HCWT Only, Large and Medium Transports, Cryogenic Systems, and Small Transports, PSA/Membrane Systems (U.S.)

Scenario 15 - Hybrid OBIGGS, All Tanks, Large and Medium Transports, Cryogenics Systems, & Small Transports, PSA/Membrane Systems

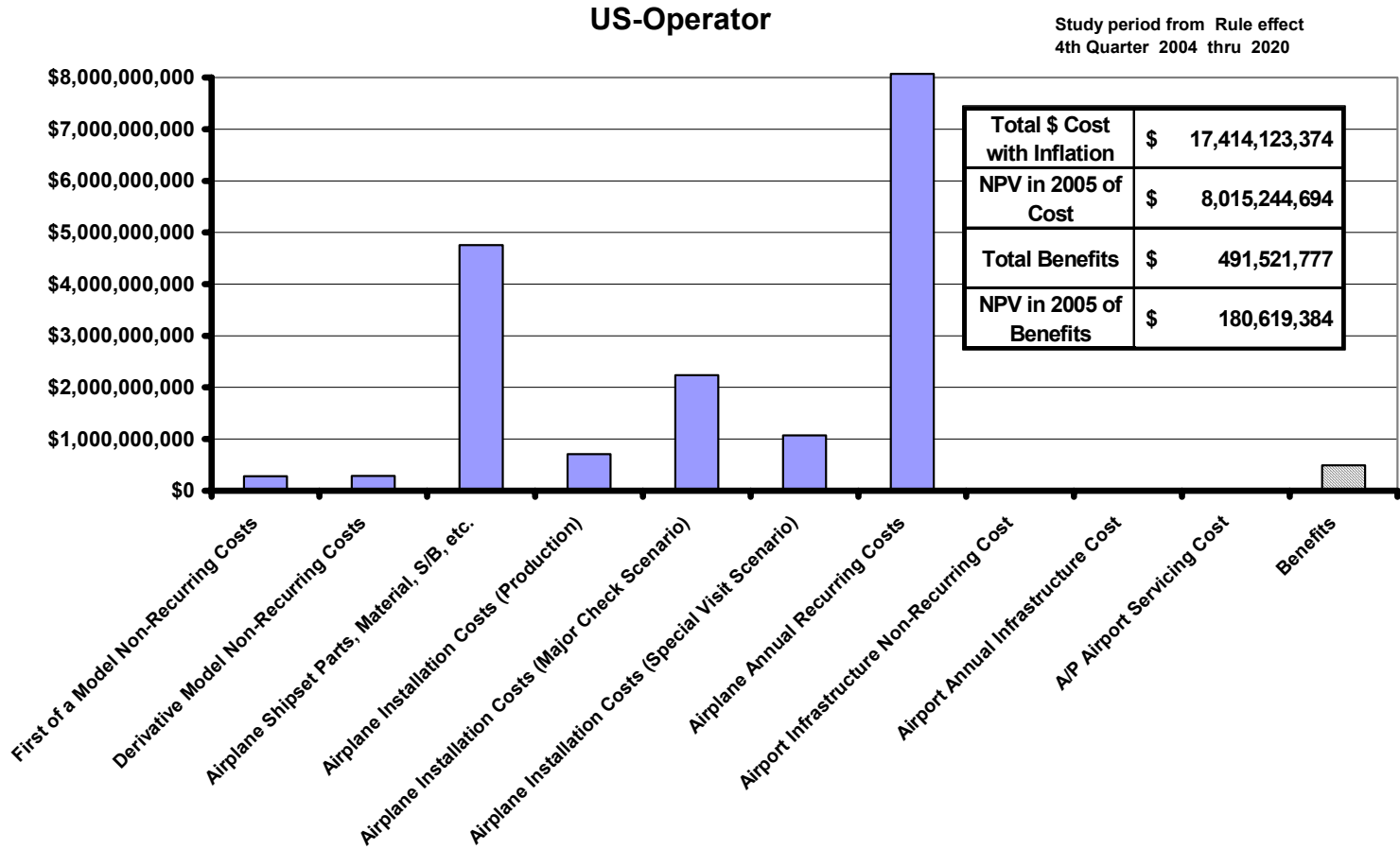

Figure G-48. Scenario 15—Hybrid OBIGGS, All Tanks, Large and Medium Transports, Cryogenic Systems, and Small Transports, PSA/Membrane Systems (U.S.)

Scenario 16 - On-Board Liquid Nitrogen Inerting

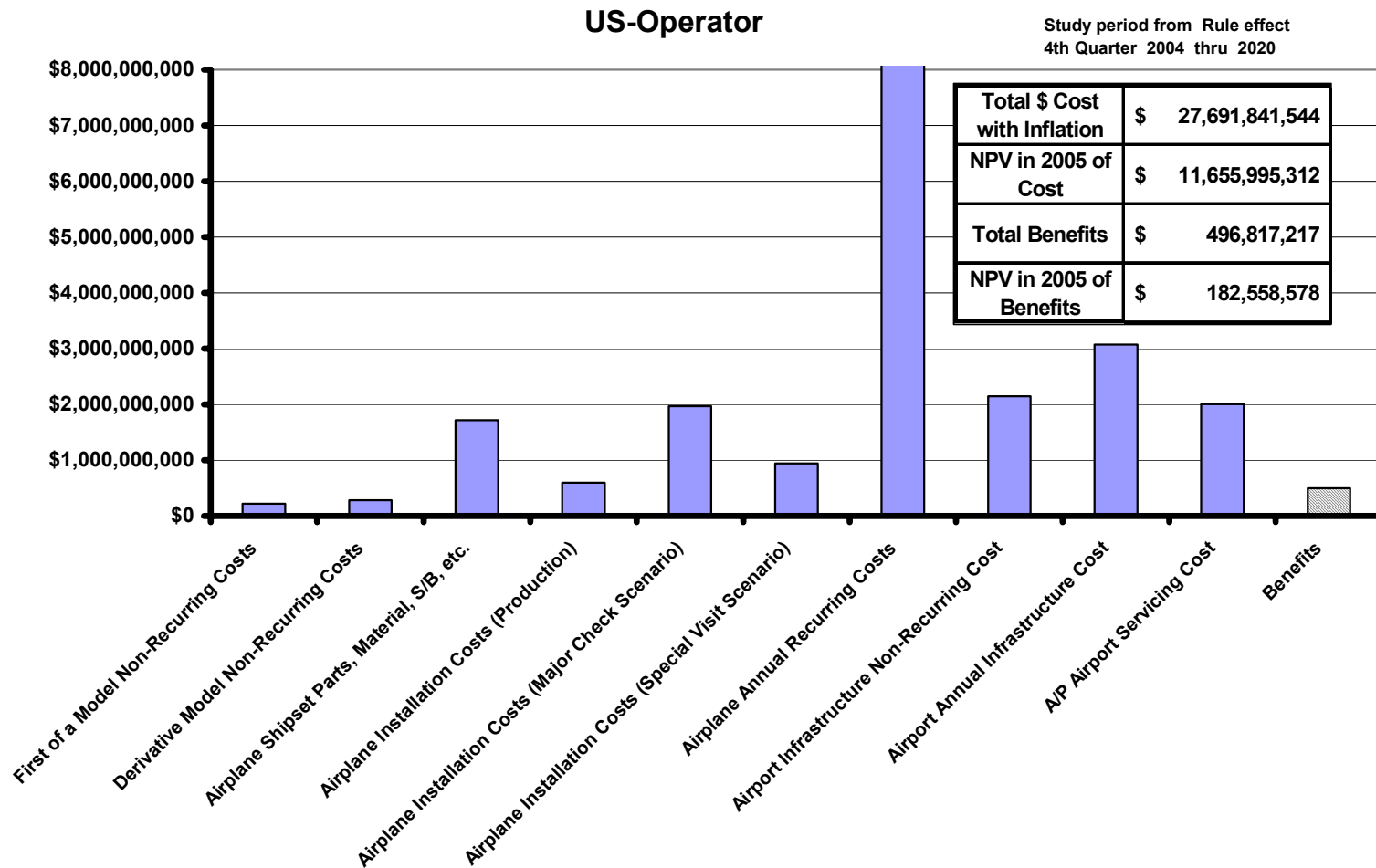

Figure G-49. Scenario 16—Onboard Liquid Nitrogen Inerting (U.S.)

Summary of Inerting Scenario Results US-Operator - PAX Only

Values in Millions

	Scenario 1 - On-Board Ground Inerting HCWT only, Large, Medium, Small Transports, PSA Membrane Systems	Scenario 2 - On-Board Ground Inerting All Fuselage Tanks, Large, Medium, Small Transports, PSA Membrane Systems	Scenario 3 - Hybrid On-Board Ground Inerting HCWT only, Large, Medium, Small Transports, PSA Membrane Systems	Scenario 4 - Hybrid On-Board Ground Inerting HCWT Fuselage Tanks, Large, Medium, Small Transports, PSA Membrane Systems	Scenario 5 - OBIGGS, All Tanks, Large and Medium Transports, Membrane Systems, & Small Transports, PSA Membrane Systems	Scenario 7 - Hybrid OBIGGS, HCWT only, Large and Medium Transports, Membrane Systems, & Small Transports, PSA Membrane Systems	Scenario 9 - Hybrid OBIGGS, HCWT only, Large and Medium Transports, Membrane Systems, & Small Transports, PSA Membrane Systems	Scenario 11 - Ground Based Inerting HCWT only, All Tanks, All Transports	Scenario 12 - Ground Based Inerting All Fuselage Transports, Cryogenics Systems, & Small Transports, PSA Membrane Systems	Scenario 13 - OBIGGS, All Tanks, Large and Medium Transports, Cryogenics Systems, & Small Transports, PSA Membrane Systems	Scenario 14 - Hybrid OBIGGS, HCWT only, Large and Medium Transports, Membrane Systems, & Small Transports, PSA Membrane Systems	Scenario 15 - Hybrid OBIGGS, All Tanks, Large and Medium Transports, Cryogenics Systems, & Small Transports, PSA Membrane Systems	Scenario 16 - On-Board Liquid Nitrogen Inerting			
Total \$ Cost with Inflation	7,588	10,898	7,352	10,149	11,675	6,349	9,194	9,321	10,207	14,550	9,868	12,474	19,817	-	-	-
NPV in 2005 of Cost	3,768	5,215	3,678	4,896	5,491	3,166	4,442	4,246	4,672	6,698	4,692	5,884	8,598	-	-	-
Total Benefits	233	434	231	432	497	274	492	258	459	497	274	492	497	-	-	-
NPV in 2005 of Benefits	86	159	85	159	183	101	181	95	169	183	101	181	183	-	-	-

Figure G-50. Cost Summary of U.S. Fleet, Passenger Only

Scenario 1 - On-Board Ground Inerting HCWT only, Large, Medium, Small Transports, PSA/Membrane Systems

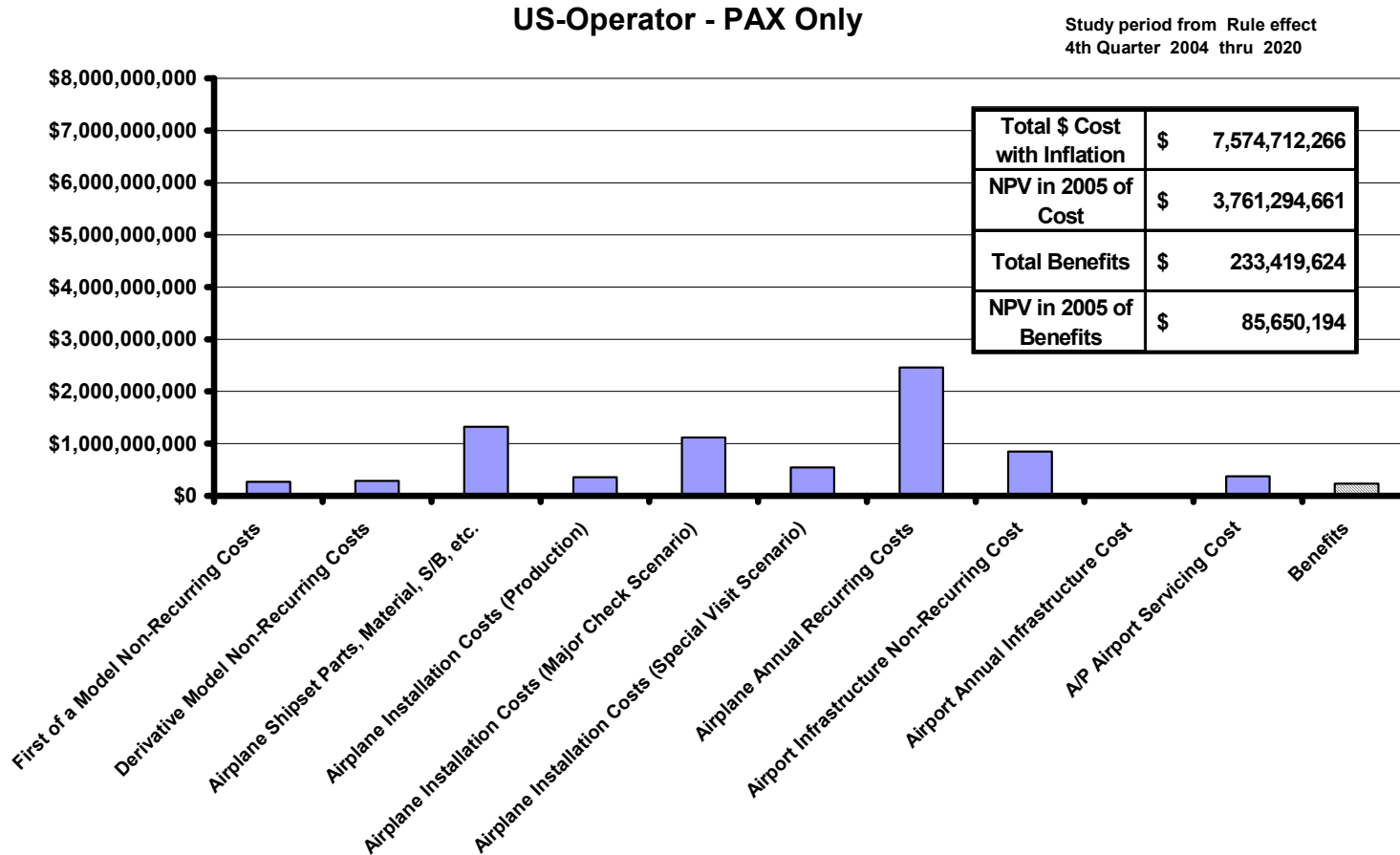

Figure G-51. Scenario 1—Onboard Ground Inerting, HCWT Only, Large, Medium, Small Transports, PSA/Membrane Systems (U.S., Passenger Only)

Scenario 2 - On-Board Ground Inerting All Fuselage Tanks, Large, Medium, Small Transports, PSA/Membrane Systems

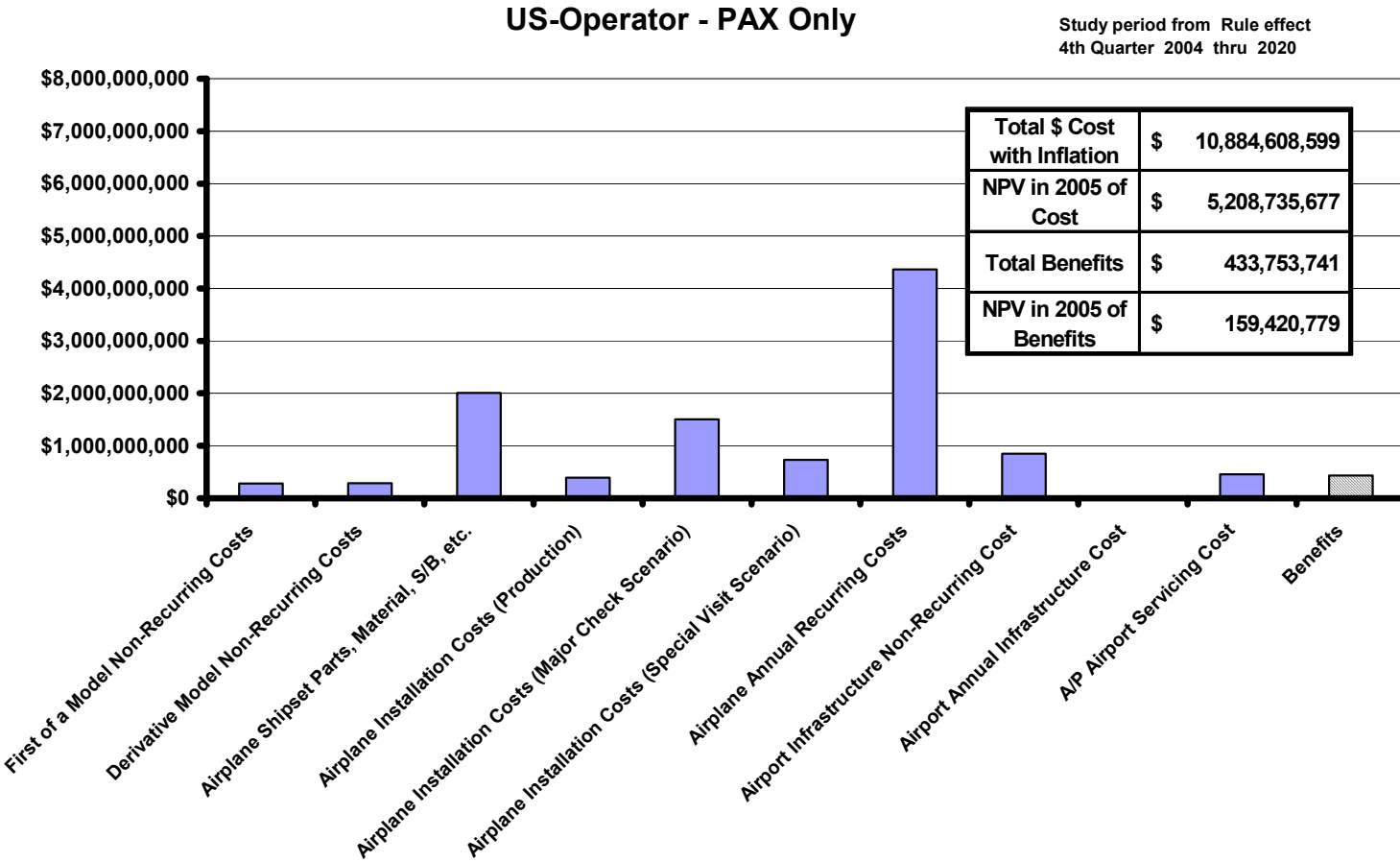

Figure G-52. Scenario 2—Onboard Ground Inerting, All Fuselage Tanks, Large, Medium, Small Transports, PSA/Membrane Systems (U.S., Passenger Only)

Scenario 3 - Hybrid On-Board Ground Inerting HCWT only, Large, Medium, Small Transports, PSA/Membrane Systems

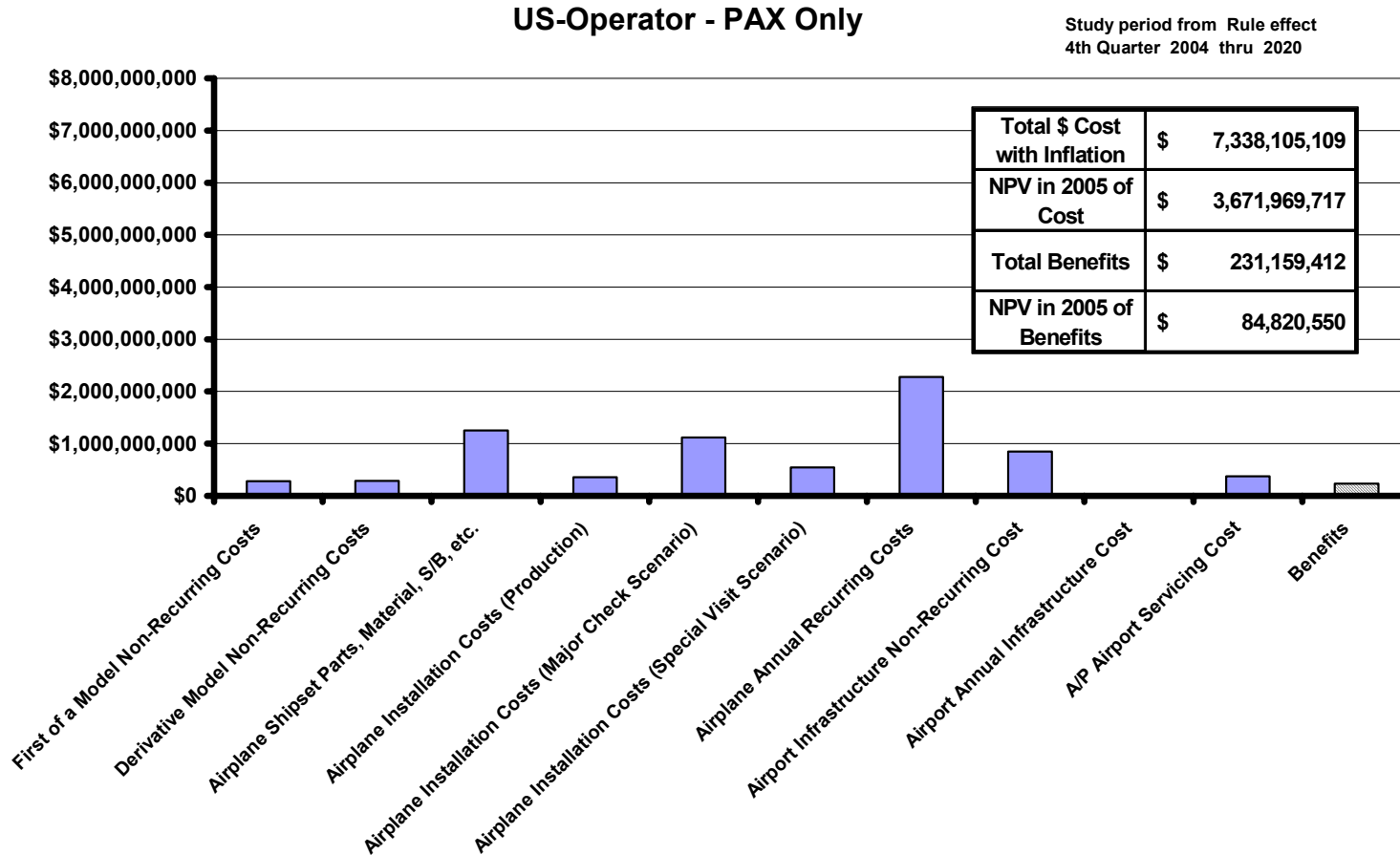

Figure G-53. Scenario 3—Hybrid Onboard Ground Inerting, HCWT Only, Large, Medium, Small Transports, PSA/Membrane Systems (U.S., Passenger Only)

Scenario 4 - Hybrid On-Board Ground Inerting All Fuselage Tanks, Large, Medium, Small Transports, PSA/Membrane Systems

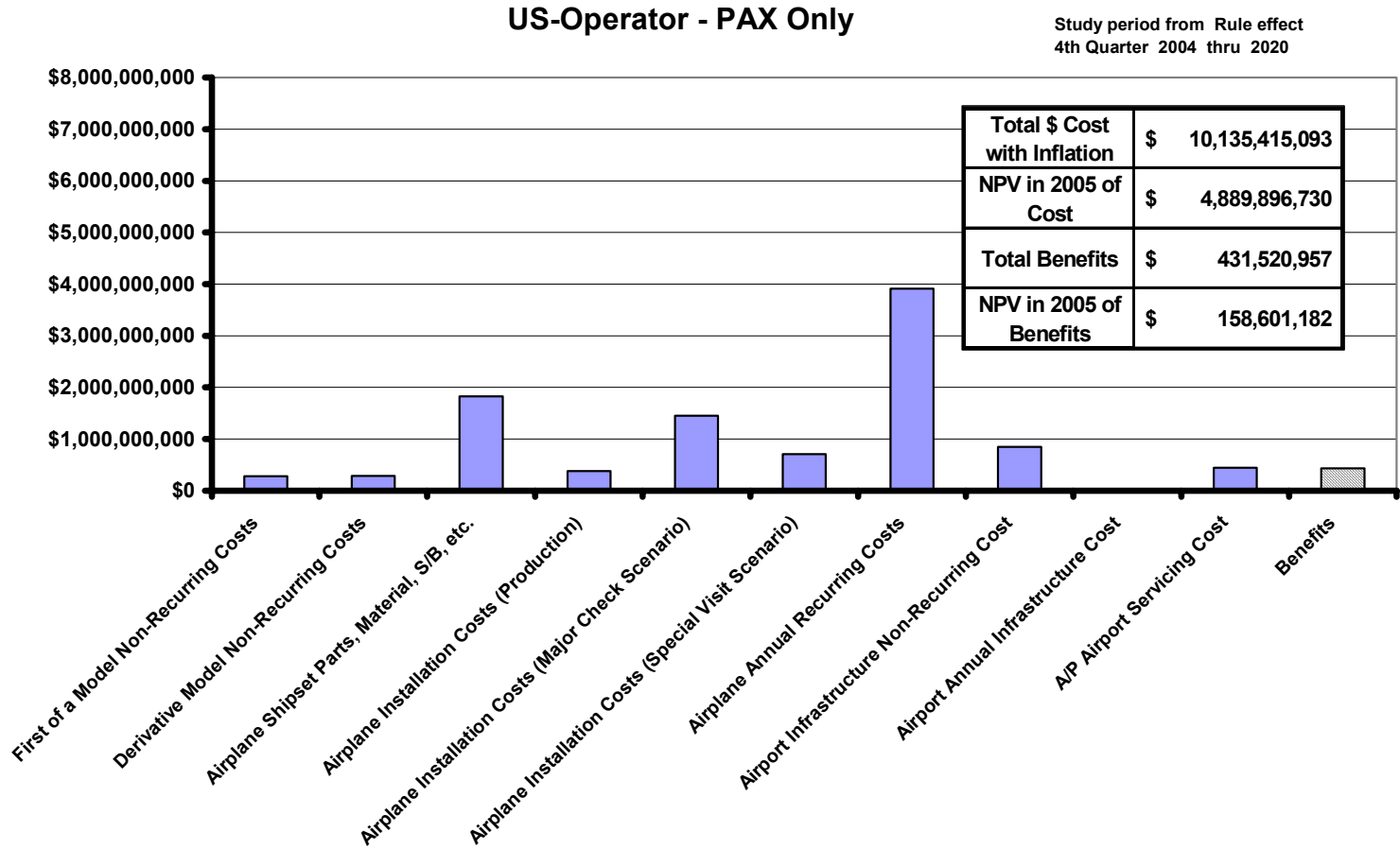

Figure G-54. Scenario 4—Hybrid Onboard Ground Inerting, All Fuselage Tanks, Large, Medium, Small Transports, PSA/Membrane Systems (U.S., Passenger Only)

Scenario 5 - OBIGGS, All Tanks, Large and Medium Transports, Membrane Systems, & Small Transports, PSA/Membrane Systems

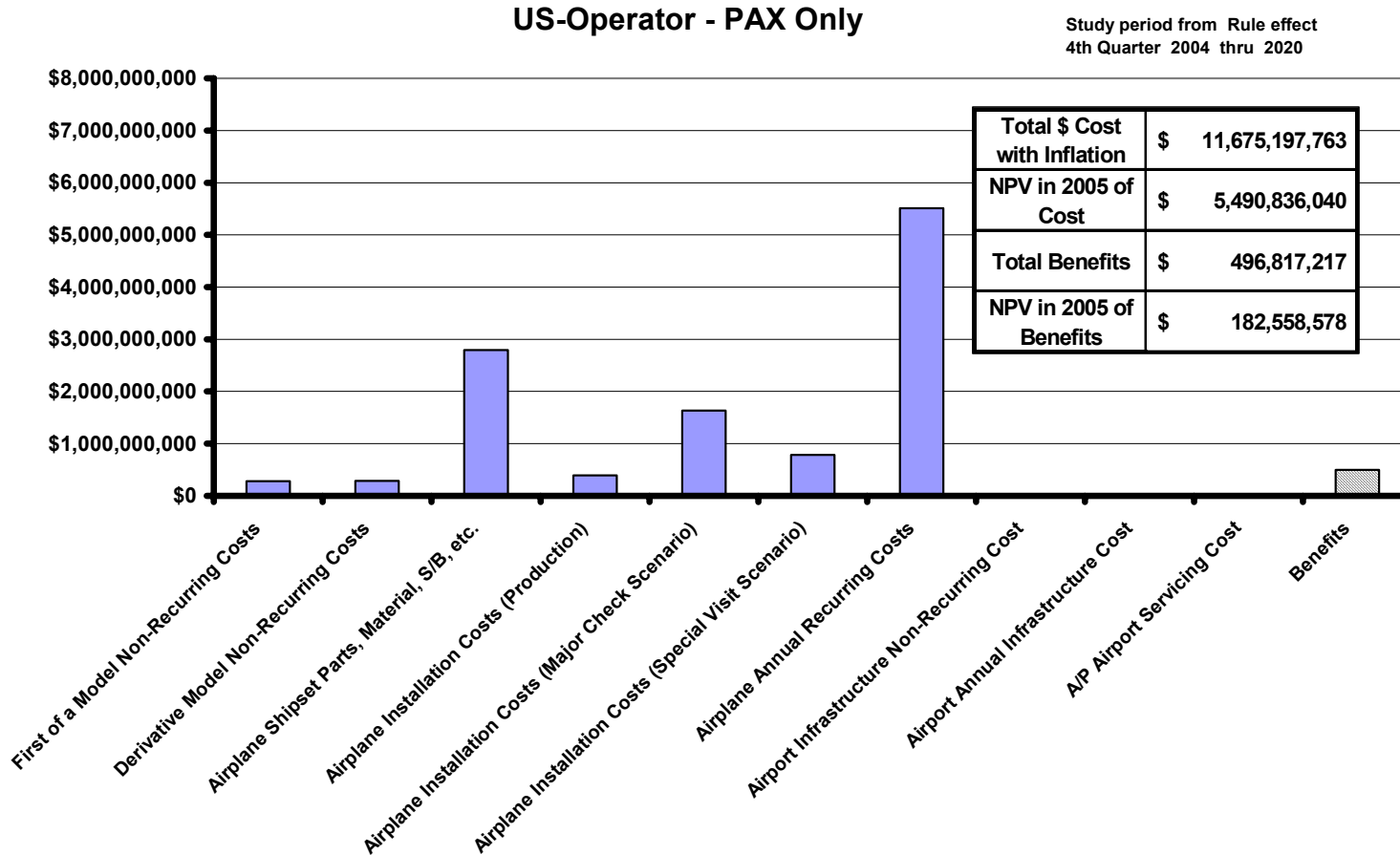

Figure G-55. Scenario 5—OBIGGS, All Tanks, Large and Medium Transports, Membrane Systems, and Small Transports, PSA/Membrane Systems (U.S., Passenger Only)

Scenario 7 - Hybrid OBIGGS, HCWT only, Large and Medium Transports, Membrane Systems, & Small Transports, PSA/Membrane Systems

US-Operator - PAX Only

Study period from Rule effect
4th Quarter 2004 thru 2020

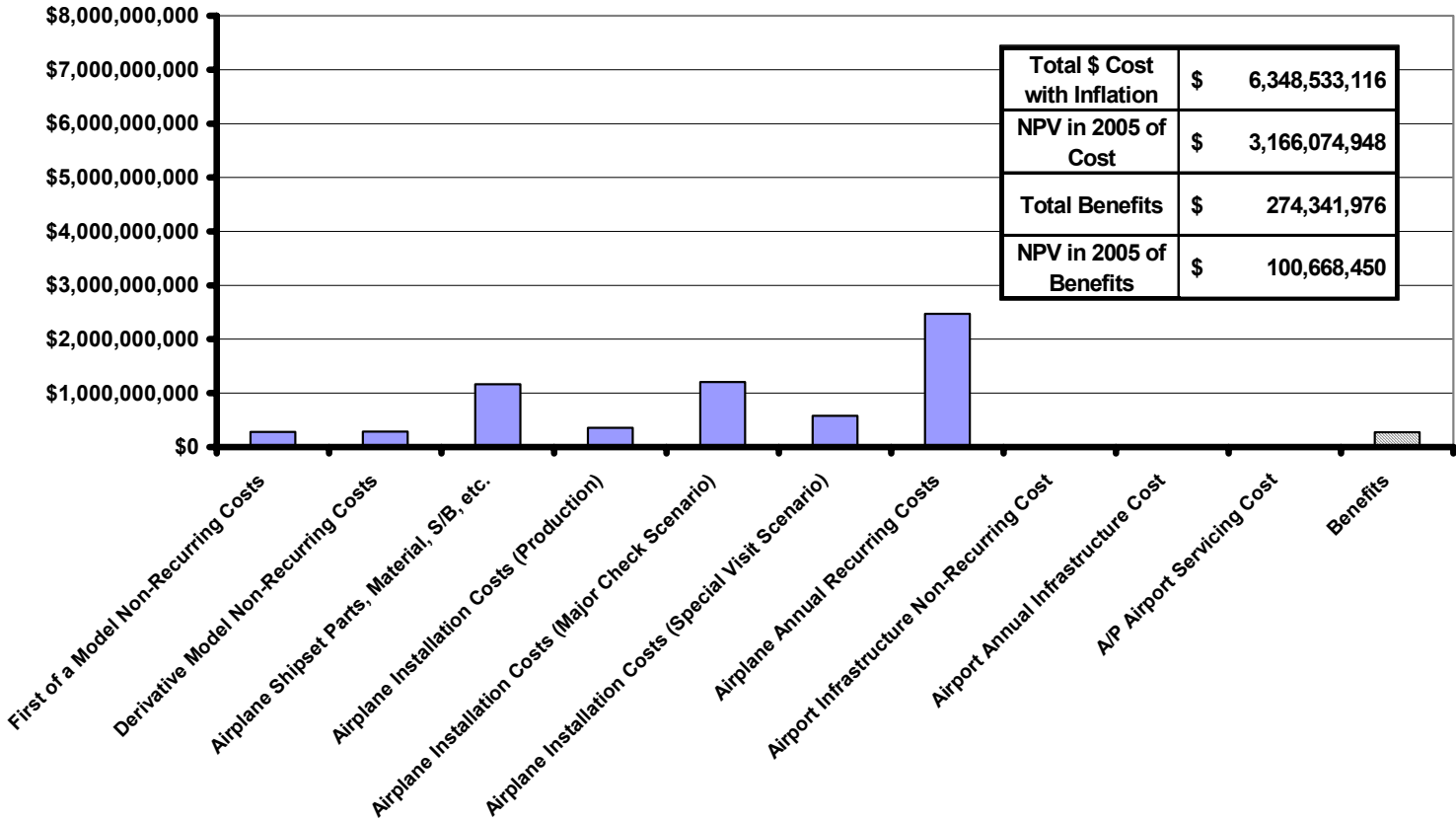

Figure G-56. Scenario 7—Hybrid OBIGGS, HCWT Only, Large and Medium Transports, Membrane Systems, and Small Transports, PSA/Membrane Systems (U.S., Passenger Only)

Scenario 9 - Hybrid OBIGGS, All Tanks, Large and Medium Transports, Membrane Systems, & Small Transports, PSA/Membrane Systems

US-Operator - PAX Only

Study period from Rule effect
4th Quarter 2004 thru 2020

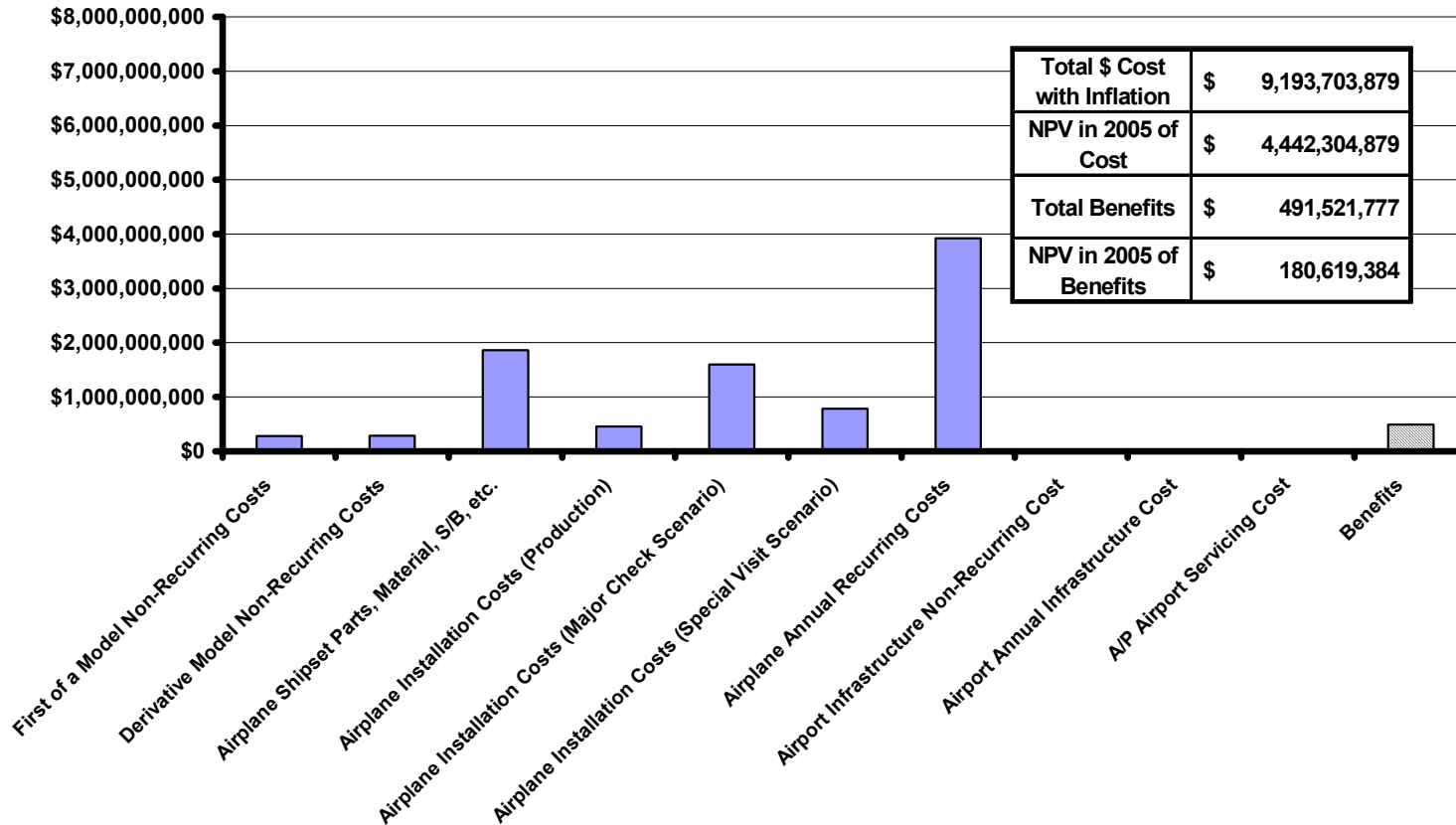

Figure G-57. Scenario 9—Hybrid OBIGGS, All Tanks, Large and Medium Transports, Membrane Systems, and Small Transports, PSA/Membrane Systems (U.S., Passenger Only)

Scenario 11 - Ground Based Inerting HCWT only, All Transports

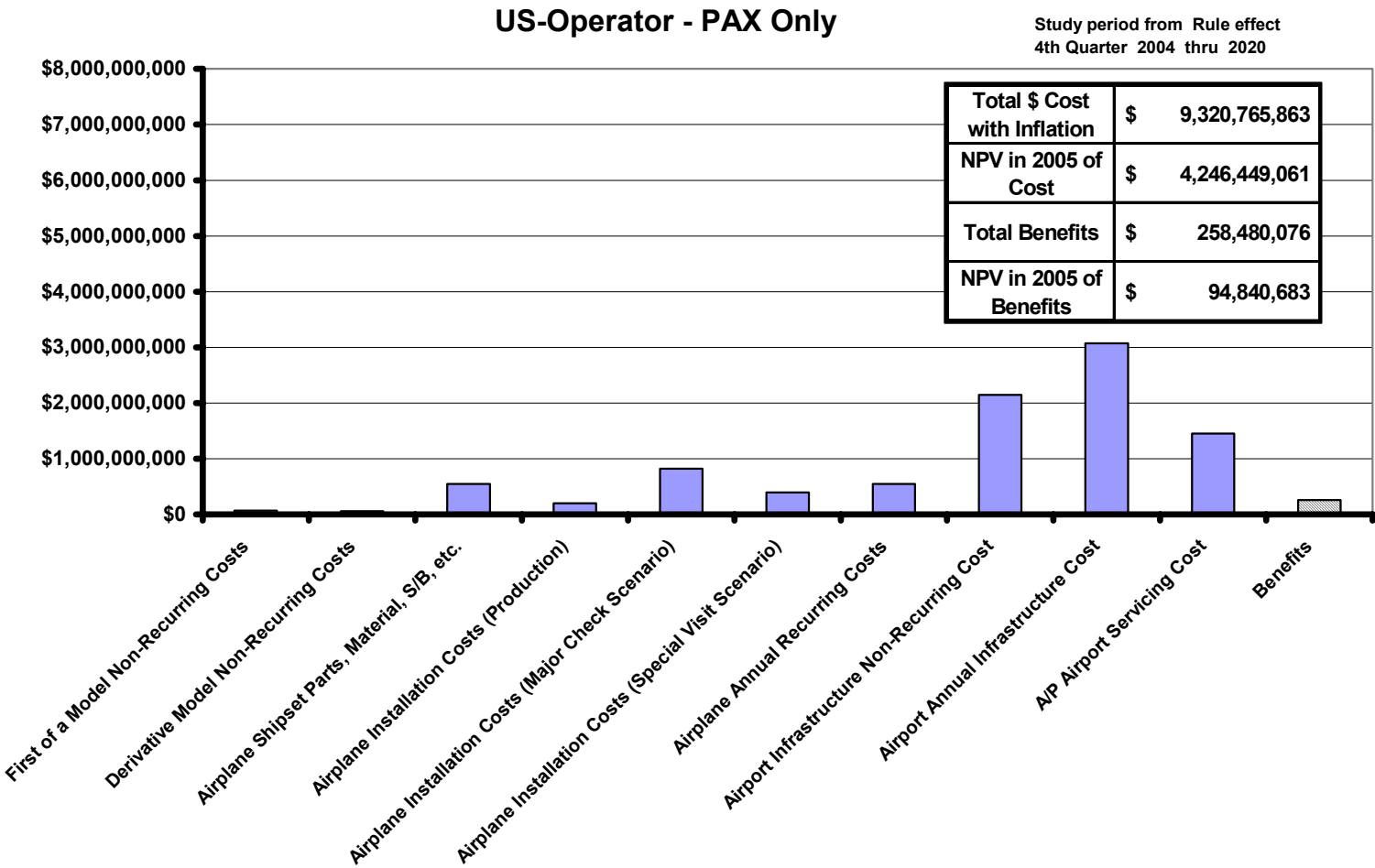

Figure G-58. Scenario 11—Ground-Based Inerting, HCWT Only, All Transports (U.S., Passenger Only)

Scenario 12 - Ground Based Inerting All Fuselage Tanks, All Transports

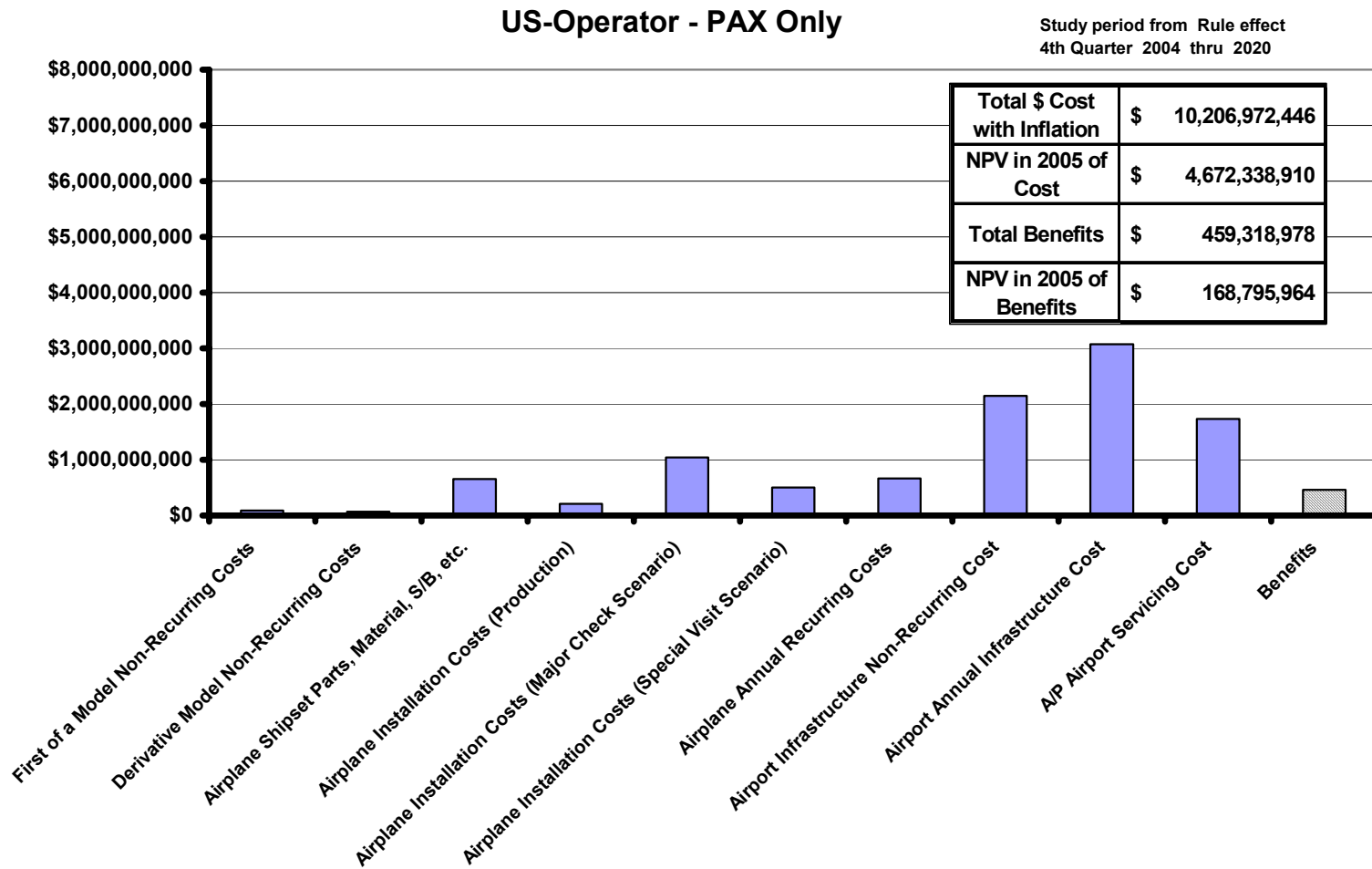

Figure G-59. Scenario 12—Ground-Based Inerting, All Fuselage Tanks, All Transports (U.S., Passenger Only)

Scenario 13 - OBIGGS, All Tanks, Large and Medium Transports, Cryogenics Systems, & Small Transports, PSA/Membrane Systems

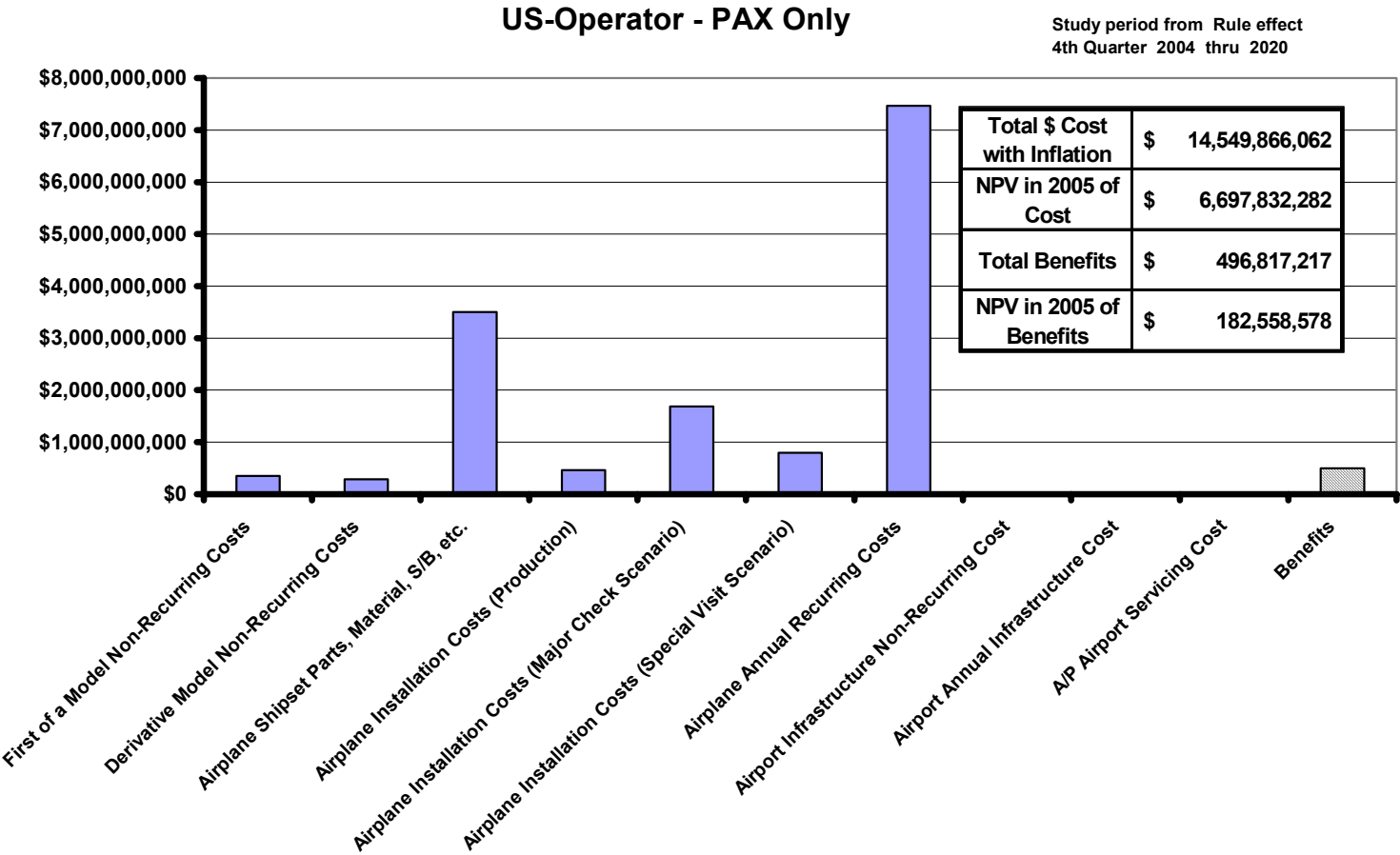

Figure G-60. Scenario 13—OBIGGS, All Tanks, Large and Medium Transports, Cryogenic Systems, and Small Transports, PSA/Membrane Systems (U.S., Passenger Only)

**Scenario 14 - Hybrid OBIGGS, HCWT only, Large and Medium
Transports, Cryogenics Systems, & Small Transports, PSA/Membrane
Systems**

US-Operator - PAX Only

Study period from Rule effect
4th Quarter 2004 thru 2020

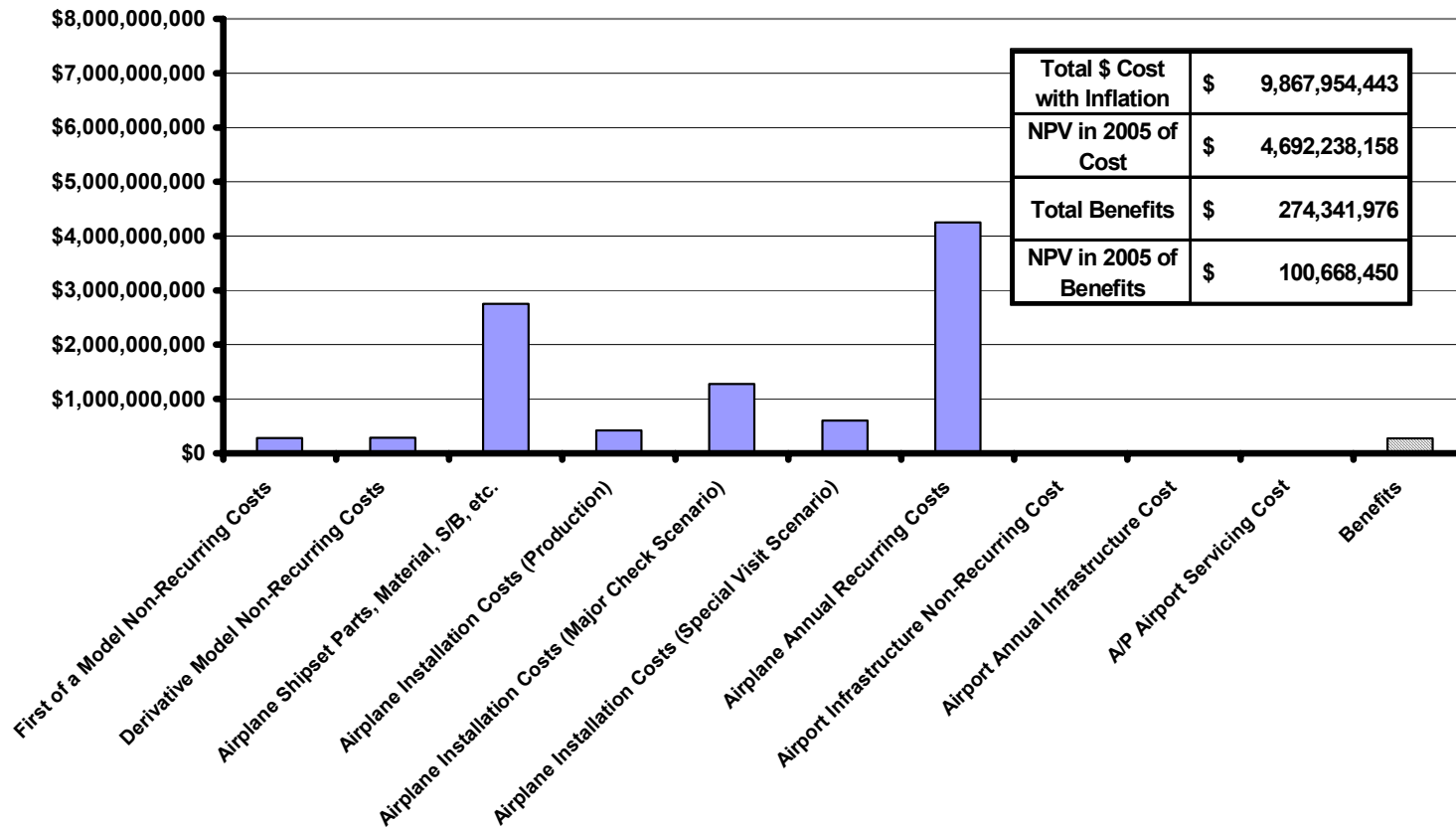

Figure G-61. Scenario 14—Hybrid OBIGGS, HCWT Only, Large and Medium Transports, Cryogenic Systems, and Small Transports, PSA/Membrane Systems (U.S., Passenger Only)

Scenario 15 - Hybrid OBIGGS, All Tanks, Large and Medium Transports, Cryogenics Systems, & Small Transports, PSA/Membrane Systems

US-Operator - PAX Only

Study period from Rule effect
4th Quarter 2004 thru 2020

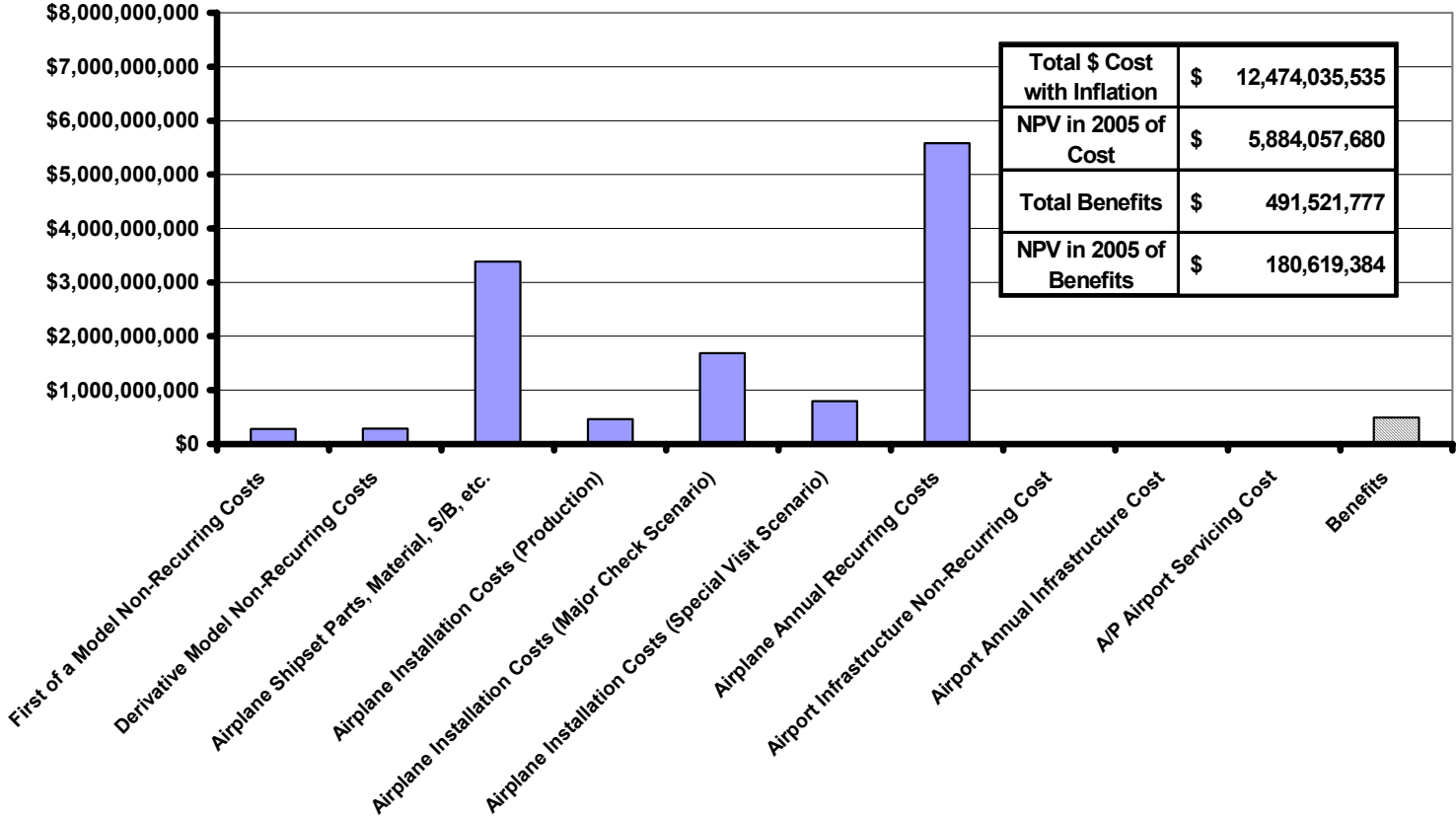

Figure G-62. Scenario 15—Hybrid OBIGGS, All Tanks, Large and Medium Transports, Cryogenic Systems, and Small Transports, PSA/Membrane Systems (U.S., Passenger Only)

Scenario 16 - On-Board Liquid Nitrogen Inerting

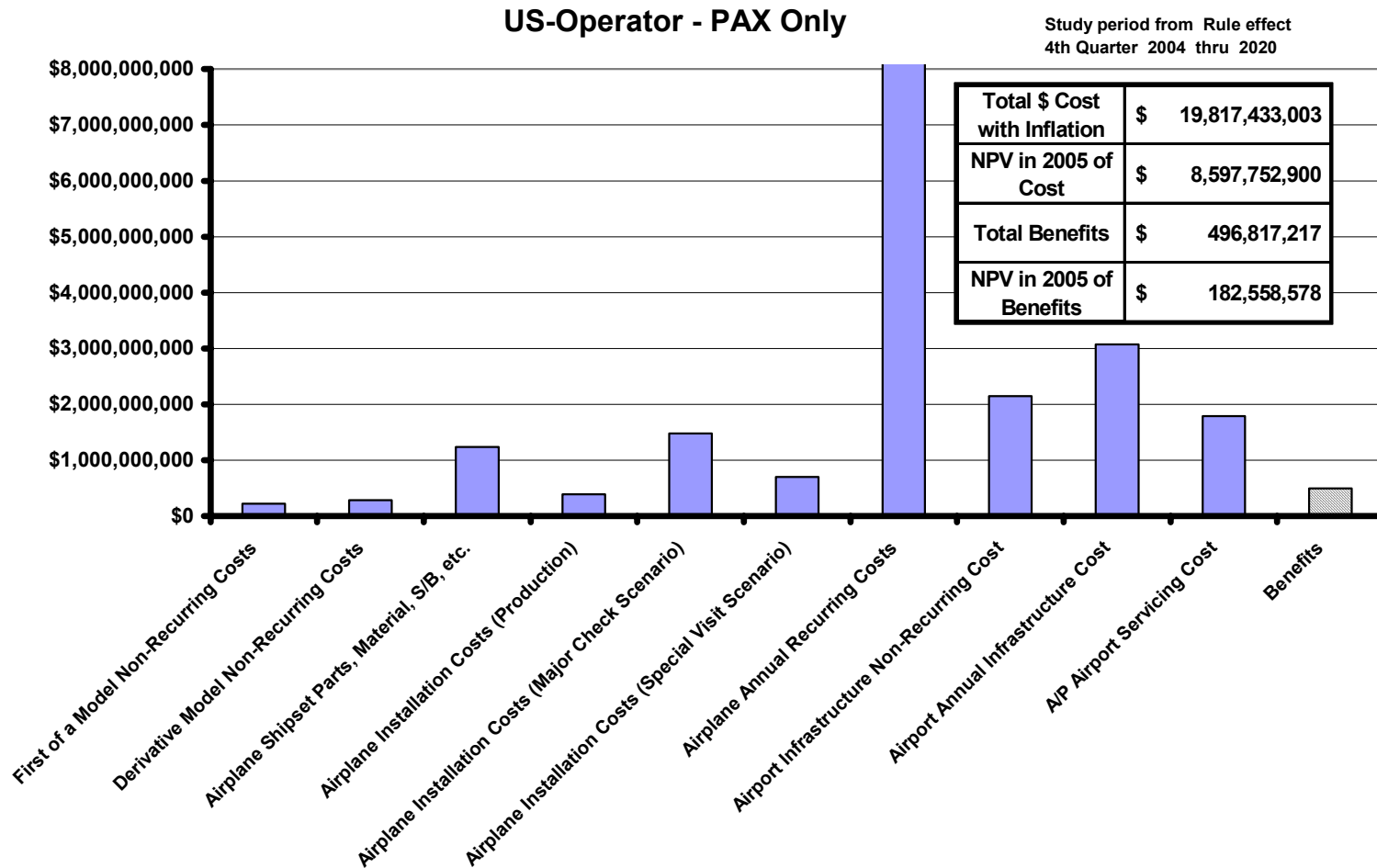

Figure G-63. Scenario 16—Onboard Liquid Nitrogen Inerting (U.S. Fleet, Passenger Only)

3.0 GASEOUS VERSUS LIQUID NITROGEN

The first 15 scenarios evaluated in this study feature gaseous nitrogen systems. The 16th scenario features a liquid nitrogen system. This ARAC study focused on gaseous nitrogen generating systems rather than stored liquid nitrogen systems because gas generating systems are less expensive and less hazardous. The early inerting systems, such as that aboard the Lockheed C-5 Galaxy military transport, used stored liquid nitrogen. Those systems were heavy and relied on a large ground-support system. As technology has advanced, onboard gas-generating inerting systems like OBIGGS have become more practical. The system weight and inlet airflow and pressure to volume of nitrogen produced has vastly improved. All of the recently designed and installed nitrogen inerting systems on military aircraft have been of the OBIGGS type. A brief cost analysis of the liquid nitrogen (LN₂) system is included to provide a comparison of costs relative to the other inerting systems. The safety benefits of the LN₂ system are assumed to be similar to OBIGGS.

The main advantage of a stored liquid nitrogen system is that it does not require aircraft bleed air or significant aircraft power to operate. However, such systems incur penalties that include higher weight than for air separation (i.e., gas generation) technology, on-board system complexity, and the need for a ground-based nitrogen supply system. The computed LN₂ weight is based on carrying enough LN₂ for three flights. The amount assumed carried reflects a proposal for a closed-loop control system that minimizes the amount of LN₂ required. As proposed, this system relies on oxygen sensing in the fuel tank and a control system that releases enough LN₂ to keep the tank inert. Ideally, this system would require only enough N₂ to fill the ullage once per flight.

The system described above has been sized to inert all fuel tanks on the airplane. The oxygen sensing and control system has not yet been demonstrated on a commercial airplane. The weights presented in figure G-64 are based on the FAA study “Performance of a DC-9 Aircraft Liquid Nitrogen Fuel Tank Inerting System,” published in 1972.

	Large airplane	Medium airplane	Small airplane
LN ₂ weight (lb)	1,282	570	119
Storage, plumbing, controls, etc., weight (lb)	1,770	786	164
Total weight (lb)	3,052	1,356	283

Figure G-64. Liquid Nitrogen System Weight

Liquid nitrogen systems require the cryogenic transport and storage of nitrogen in liquid form, which boils at -195°C or -315°F. Transport, storage, and handling of LN₂ requires precautions to prevent severe skin burns on contact. Also, a broken bottle or distribution line may rapidly flood an enclosed area with nitrogen, causing asphyxiation. Because of the dangers and hazards associated with handling LN₂, it was assumed that a mechanic, and not ground service workers, would be required to fill the airplane storage tanks.

It was assumed that the LN₂ would be generated and stored at each airport, so the LN₂ cost is the same as the gaseous N₂ costs. Although the airplane would be serviced once for every three flights, the cost of the labor is three times higher because it requires a mechanic instead of ground service workers. Consequently, the ground servicing costs would be about the same as for the GBI system.

It was assumed that the design, development, certification, and implementation costs for the LN₂ system are similar to the other systems evaluated in this study. The cost analysis for the LN₂ system includes only the large, medium and small airplanes. The total cost over the 16-year study period includes the initial airplane and airport modification costs and the accumulated annual recurring costs. Airplane nonrecurring costs include engineering design for the modifications and additions to fuel system components, interfaces, instruments or displays, relocation of other equipment, wiring, tubing or ducting, and avionics software or modules. The nonrecurring engineering costs also include changes to documents (e.g., Specs, ICDs); manuals (e.g., AFM, Opts, MM); production change records; laboratory, ground, and flight tests; and FAA/JAA certification. The costs also include major-supplier parts and assemblies, tubing, wiring,

Estimating and Forecasting Task Team Final Report

ducting, Service Bulletin and kitting costs (retrofit), and special tooling for installation. These costs were based on the costs of the GBI airplane system with the addition of an LN₂ storage tank and an oxygen sensing and control system. The airline recurring and nonrecurring costs were based on the installation and operating costs of an onboard system. Although the closed-loop oxygen sensing system is more complex than an OBIGGS, it was assumed the maintenance and delay costs would be similar.

Appendix H
Safety Analysis Task Team Final Report

This page intentionally left blank.

TABLE OF CONTENTS

1. INTRODUCTION.....	H-1
2. WORKING PRACTICES	H-2
3. REVIEW OF SERVICE HISTORY	H-2
3.1 Methodology	H-2
3.2 Analysis of Previous Tank Explosion Events	H-4
3.3 Service History Conclusions	H-5
4.0 SAFETY ASSESSMENT	H-7
4.1 Methodology	H-7
4.2 Functional Hazard Analysis	H-7
4.3 Personnel Hazards	H-8
4.4 Safety Benefit Analysis	H-8
4.4.1 Ground Based Inerting.....	H-11
4.4.2 On-Board Ground Inerting (OBGI)	H-12
4.4.3 On-Board Inert Gas Generating System (OBIGGS).....	H-12
4.4.4 Hybrid Inert Gas Generating Systems	H-13
4.4.5 Post Impact Fuel Tank Fire/Explosion	H-15
4.5 Safety Assessment Summary and Conclusions	H-16
ATTACHMENT A - DETAILS OF PREVIOUS TANK EXPLOSIONS.....	H-17
ATTACHMENT B - ANALYSIS PARAMETERS AND SUMMARY INFORMATION	H-31

LIST OF FIGURES

1.	Summary of Operational Events.....	H-3
2.	Summary of Refuelling and Ground Maintenance Events	H-4
4.4-1.	HCWT Operating Hours, Fuel Tank Explosion Accidents and Statistical HCWT Accident Rate.....	H-9
4.4-2.	Worldwide Statistical Forecast Fuel Tank Explosion Accidents.....	H-10
4.4-3.	U.S. Statistical Forecast Fuel Tank Explosion Accidents.....	H-10
4.4.1-1.	US Statistical Cumulative Accidents with Ground Based Inerting	H-11
4.4.1-2.	Accidents Avoided by Ground Based Inerting	H-11
4.4.2-1.	US Statistical Cumulative Accidents with On-Board Ground Inerting	H-12
4.4.2-2.	Accidents Avoided by On-Board Ground Inerting.....	H-12
4.4.3-1.	US Statistical Cumulative Accidents with OBIGGS	H-13
4.4.3-2.	Accidents Avoided by OBIGGS.....	H-13
4.4.4-1.	US Statistical Cumulative Accidents with Hybrid OBIGGS.....	H-14
4.4.4-2.	Accidents Avoided by Hybrid OBIGGS	H-14
4.4.4-3.	US Statistical Cumulative Accidents with Hybrid OBGI.....	H-15
4.4.4-4.	Accidents Avoided by Hybrid OBGI.....	H-15
4.5-1.	Accident Forecast Summary Information.....	H-16
4.5-2.	Fuel Tank Explosion Accident Rate Comparison.....	H-16
B-1.	Baseline Flammability and Flammability after inerting by tank type and design concept	H-31
B-2.	Tank Type Distribution by Generic Airplane Family.....	H-32
B-3.	Operating Hour Information	H-32
B-4.	Accident Forecast Summary Information.....	H-32

Safety Analysis Task Team Final Report

1. INTRODUCTION

This report describes the work carried out by the Safety Task Team to accomplish the tasks outlined below.

The objectives for the safety task team were derived from the Tasking Statement for the Fuel Tank Inerting Harmonization Working Group (FTIHWG), as published in the Federal Register on 14 July, 2000. The Tasking Statement included the following guidance:

“The threat of fuel tank explosions used in the analysis should include explosions due to internal and external tank ignition sources for the major fuel system designs making up the transport fleet, as defined in the July 1998 ARAC Fuel Tank Harmonization Working Group Report. The service history in the analysis should be further developed to include incidents involving post crash fuel tank fires. The FAA awarded a research contract to develop a database that may be useful in this endeavor. This data should be evaluated when determining what benefits may be derived from implementing ground based or on-board inerting systems. The report is titled, A Benefit Analysis for Nitrogen Inerting of Aircraft Fuel Tanks Against Ground Fire Explosion, Report Number DOT/FAA/AR-99/73, dated December 1999.”

This task was assigned to the Safety Task Team and was further developed into the following sub-tasks:

1. Carry out a detailed analysis of previous tank explosion events documented in the 1998 ARAC Fuel Tank Harmonization Working Group Report.
2. The objective was to understand how past actions may influence future events and to determine a basis for forecasting future events.
3. Based on the service history review from item 1, develop a methodology to forecast the number of accidents that may be avoided in the future if an Inerting system were implemented.

The objective was to quantify the number of accidents avoided due to the achievable flammability reduction of each of the design concepts as applied to each of the generic airplane families under consideration.

4. Determine safety benefits associated with post impact fuel tank fire/explosion.
5. Evaluate potential new hazards created by Inerting fuel tanks.

The objective was to use a Functional Hazard Analysis to identify potential new hazards.

2. WORKING PRACTICES

The Safety Task Team was comprised of five members. One was an airline specialist in flight safety investigations. One was an airline general manager in charge of aircraft systems engineering. A third was a combustion scientist. Another was a national resource specialist for fuel system design out of the aircraft certification office of the FAA. And the last member came from an airplane safety engineering background with an aircraft manufacturer.

The group held regular reviews of its progress through data exchange, through dedicated task team meetings, and through presentations and reviews of its work in front of the Working Group.

3 REVIEW OF SERVICE HISTORY

The service history of the transport airplane fleet (including turbofan and turboprop airplanes) over the last 40 years was examined, and information regarding known instances of fuel tank explosion due to internal or external ignition sources (other than those caused by post-impact crash events) was assembled. Post-impact fuel tank fire/explosion events are handled separately in section 4.4.5. The starting point was the table of events contained in the 1998 Fuel Tank Harmonization Working Group Final Report as suggested by the Tasking Statement.

3.1 Methodology

Attachment A contains a detailed description of each event and the findings of the investigating authority. A description of the mitigating actions taken subsequent to the event to prevent its recurrence is also included in the accident descriptions.

The 16 tank explosion events are summarized on Tables 1 and 2. They have been separated into Operational Events (i.e., those occurring on an airplane where passenger-carrying flight was intended), and Refuelling & Ground Maintenance Events. They are grouped by cause (Lightning, Engine Separation, Refuelling, Maintenance, etc.), and are then categorized by operational phase, ignition source, type of fuel tank involved, and fuel type.

Groundrules were established to guide the evaluation. First, it was determined that a forecast of future events should be based on the residual risk of recurrence of past events. In addition, the forecast should only include events for which inerting would be effective at preventing. As such it was the judgement of the team that accidents where the fuel tank was breached before the ignition would not be used to forecast future events.

In addition, the effectiveness of the actions taken subsequent to the event to prevent its recurrence were judged based on:

- Identification of the ignition source
- Confidence level that mitigating action addressed the ignition source
- Implementation level of the mitigating action/s

With these data and groundrules in place, a trend and residual risk analysis was then conducted.

Safety Analysis Task Team Final Report

Table 1. Summary of Operational Events

		1963 Lightning Elkton 707	1976 Lightning Madrid 747	1965 UCEF/Eng sep San Fran- cisco 707	1970 Eng Sep Toronto DC-8	1990 Eng Sep New Delhi 747-200	1992 Eng Sep Marseilles 707	1989 Sabotage Bogota 727	1990 Unknown Manila 737-300	1996 Unknown New York 747
Operational Phase	Inflight	•	•	•	•	•	•	•		•
	On Ground Operations								•	
	Ground Main- tenance									
	Refuelling									
Ignition Source	Lightning	•	•							
	Overwing Fire - Inflight			•	•	•	•			
	Static Dis- charge									
	Sabotage						•			
	Unknown							•	•	
Tank Type	Main (Wing) = W Center = C	W	W	W	W	W	W	C	C	C
Fuel Type		JP-4 / Jet A	JP-4 / Jet A	Jet A	JP 4	Jet A	Jet A	Jet A	Jet A	Jet A
Mitigating action taken to minimize or prevent recurrence of root cause	Airplane De- sign Change	• Flow-thru' vent; surge tank sup- pression	• Improved bonding inside tank	• Redun- dant con- trol of spar shutoff valve	• Spoiler Lockout Mechan- ism					• Flame Arrestors on Pump Inlets
	Hardware Inspection Requirements					• Mid-spar attach't repeat inspec- tion		• 12 Ser- vice Bul- letins	• 12 Ser- vice Bul- letins	
	Ground Sup- port Equip- ment Change									
	Maintenance Program / Procedures Revised					•			•	•
	Operations Bulletin								•	
	Improved Airport Secu- rity							•		•
	None									
Unknown										
Recurring Event			• Different cause							•

Table 2. Summary of Refuelling and Ground Maintenance Events

		1970 Refuelling Minneapolis 727	1970 Refuelling Minneapolis 727	1973 Refuelling Toronto DC-8	1989 Refuelling Washington Beechjet 400	1967 Ground Maint. Taiwan 727	1974 Ground Maint. Travis AFB DC-8	1982 Parked Montreal DC-9
Operational Phase	Inflight							
	On Ground Operations							
	Ground Maintenance					•	•	•
	Refuelling	•	•	•	•			
Ignition Source	Lightning							
	Overwing Fire - Inflight							
	Static Discharge	•	•		•	•		
	Sabotage							
	Unknown			•			•	• Suspect dry running boost pump
Tank Type	Wing = W Rear Aux = RA Center = C Fwd Aux = FA	C	C	W	RA	C	W	FA
Fuel Type		Jet A	Jet A	JP-4 / Jet A	Jet A / JP-4	Jet A	JP-4	Jet A
Mitigating action taken to minimize or prevent recurrence of root cause	Airplane Design Change				• Installed conductive foam			
	Hardware Inspection Requirements							
	Ground Support Equipment Change		• "Anti-static" filters introduced					
	Maintenance Program / Procedures Revised			• (probable outcome)		•	•	• (probable outcome)
	Operations Bulletin							
	Improved Airport Security							
	None	•						
	Unknown							
Recurring Event		•						

3.2 Analysis of Previous Tank Explosion Events

As stated earlier, the starting point for the analysis was the table of events contained in the 1998 Fuel Tank Harmonization Working Group final report. The events contained in that report were based on FAA Notice on Fuel Tank Ignition Prevention Measures published in the Federal Register on April 3, 1997. The data sources used were accident and incident reports provided by investigating organizations, regulatory authorities, and original equipment manufacturers' safety-related databases. The level of details reported in the early events was sometimes limited, dependent on the event location in the world and the type of event (whether it involved an internal or external ignition source).

Late in the study for this ARAC, a fuel tank explosion in Bangkok, Thailand occurred. While it is understood that the accident investigation is ongoing, the NTSB has released information indicating the wreckage shows evidence that the heated center wing fuel tank (CWT) exploded and that the ignition

Safety Analysis Task Team Final Report

source has yet to be determined. The team has not been involved in the investigation and does not wish to publish findings in advance of the investigating authority. However, this event appears to fit the guidelines set forth by the tasking statement and the team decided to include it as a statistical data point on which to base the forecast of future accidents.

From Tables 1 and 2, certain patterns and trends emerge:

- There are 8 wing tank events, and 8 involving center or fuselage tanks
- In the wing tank events, 5 out of 8 involved the use of wide-cut fuel (JP-4/Jet B)
- In the wing tank events, 5 out of 8 occurred in flight
- All the wing tank events involved external ignition sources - there are no known wing tank explosions due to internal ignition sources in approximately 900 million hours of flight operations
- There were only 2 explosions due to lightning strike, with the last event in 1976
- All the center tank events involved the use of Jet A/Jet A-1 fuel
- In the center tank events, 6 out of 8 occurred on the ground
- There are 9 operational events, and 7 refuelling and ground maintenance events

From the data, there is a difference in the respective safety levels of wing tanks and center tanks.

All the wing tank events have been due to known, external ignition sources (lightning strikes, over-wing fire, refueling, maintenance error) - there are no known internal ignition sources in over 900 million hours of operation that resulted in a tank explosion. Corrective actions to prevent recurrence of these wing tank events have been in place for many years, and have been demonstrated to be effective.

Over the years, center tanks have accumulated considerably fewer operating hours than wing tanks (for example, a B-737 has two wing tanks and one center tank, and therefore accumulates wing tank hours at twice the rate of center tank hours). Since the equipment in wing and center tanks are very similar, i.e. there are similar types and numbers of potential ignition sources, one would expect there to be significantly fewer center tank events than wing tank events. Actually the numbers of events are approximately equal. The reason is that center tanks are more flammable and potential ignition sources in wing tanks are submerged more often.

With the exception of the three most recent center tank events, and the 1989 Bogota event, the causes of all the other events have been addressed by actions designed to prevent or minimize their recurrence. The 1989 Bogota accident involved a breach of the fuel tank, which violated one of the ground rules this team established as the basis for forecasting future events.

For the three most recent center tank events the exact ignition sources have not been identified. While corrective actions to identify and minimize potential ignition sources are now being put in place, a means to reduce flammability particularly in heated center wing tanks is needed.

The team concluded that the 1990/Manila, 1996/New York, and 2001/Bangkok events should form the basis for forecasting future events.

3.3 Service History Conclusions

This study identified and analyzed 16 known instances of fuel tank explosions due to internal or external ignition sources over the last 40 years of transport aircraft operations worldwide. Post impact fuel tank fire/explosion was not addressed in this section, but is addressed in section 4.4.5. The following conclusions have been drawn:

- There is a close relationship between the incidence of explosions in wing tanks and the use of wide-cut fuel.
- Wing tanks operating with Jet A type fuel have demonstrated an acceptable safety record.
- In comparison, heated center tanks and fuselage-mounted tanks are more vulnerable to explosion in the presence of ignition sources.
- The three most recent events (1990/Manila, 1996/New York, 2001/Bangkok), form the basis for forecasting future events.

4.0 SAFETY ASSESSMENT

4.1 Methodology

The safety assessments described in this section allow some comparisons to be made regarding the safety impacts of the various options relative to each other. They also provide an indication of the complexity or levels of redundancy, which such systems may require in order to meet certification requirements.

4.2 Functional Hazard Analysis

Since some of the inerting concepts involve technologies that currently are not fully mature or proven in a commercial airline environment, rigorous and detailed safety analyses down to component level could not be carried out with confidence. However a top-level functional hazard analysis (FHA) was performed.

This typically looks at the effects of the system not operating when required, and operating when not required, and identifies the severity of these failure conditions (using the guidance contained in Advisory Circular AC 25.1309-1A). The following functional failures were analyzed:

1. To keep the oxygen concentration inside the tank below the level which will support combustion
2. To keep the tank differential pressure within limits
3. To prevent leakage of inert gas into the passenger cabin, flight deck, or enclosed spaces that may be occupied by maintenance personnel
4. To neither endanger the occupants nor adversely affect continued safe flight as a result of failure of equipment containing high energy rotors.

The functional failures are documented below.

Function: (1) To keep the oxygen concentration inside the tank below the level which will support combustion

Functional Failure	Failure Condition Effect on (A) System, (B) Aircraft, (C) Occupants	Classification	Probability Requirement	Safety Design Implications
Fails to inert when expected to.	(A) Ignition possible if ignition source present (other systems might prevent structural damage (explosion) (B) None unless ignition source present (C) None unless ignition source present	Minor	N/A	Loss of protection returns tank to pre-mod condition, i.e. only vulnerable to flammable vapor ignition if flammable atmosphere <u>and</u> ignition source present
Operates inadvertently during tank maintenance	(A) Oxygen concentration inside tank depleted (B) None (C) Asphyxiation of maintenance personnel	Hazardous	1 x 10 ⁻⁷ per hour	Preclude operation when fuel tanks are open.

Function: (2) To keep the tank differential pressure within limits

Functional Failure	Failure Condition Effect on (A) System, (B) Aircraft, (C) Occupants	Classification	Probability Requirement	Safety Design Implications
Allows tank differential to exceed maximum positive limits	(A) Wing over-pressure deformation (B) Loss of structural integrity (C) Multiple loss of life	Catastrophic	1 x 10 ⁻⁹ per hour	A means, independent of the inerting system, may be required to avoid hazardous deformation.
Allows tank differential to exceed maximum negative limits	(A) Wing under-pressure deformation (B) Loss of structural integrity (C) Multiple loss of life	Catastrophic	1 x 10 ⁻⁹ per hour	A means, independent of the inerting system, may be required to avoid hazardous deformation.

Function: (3) To prevent leakage of inert gas into the passenger cabin, flight deck, or enclosed spaces that may be occupied by maintenance personnel

Functional Failure	Failure Condition Effect on (A) System, (B) Aircraft, (C) Occupants	Classification	Probability Requirement	Safety Design Implications
Transfers inert gas into cabin or enclosed spaces	(A) Possible loss of tank inerting (B) Possible incapacitation of pilots (C) Incapacitation/death of some occupants before oxygen masks deployed	Minor Catastrophic Hazardous	1×10^{-9} per hour 1×10^{-7} per hour	System designed to avoid introduction of hazardous quantity of Nitrogen into the cabin, flight deck or enclosed spaces.

Function: (4) To neither endanger the occupants nor adversely affect continued safe flight as a result of failure of equipment containing high energy rotors.

Functional Failure	Failure Condition Effect on (A) System, (B) Aircraft, (C) Occupants	Classification	Probability Requirement	Safety Design Implications
Adjacent system damage or injury to passengers	(A) Possible damage to multiple flight critical systems (B) Breach of pressure vessel (C) Injury/death of some occupants	Hazardous Minor Hazardous	1×10^{-7} per hour 1×10^{-7} per hour	A means to contain high energy rotor failure.

4.3 Personnel Hazards

These hazards are documented in section 4.4 of the main body of this report and in appendix F, the Airplane Operations and Maintenance Task Team report.

4.4 Safety Benefit Analysis

The safety benefit forecast approach was based on the conclusions drawn from the service history review. Specifically, it was observed that the tank explosion rate is not the same for all tank types. Further it was concluded that there are similar types and numbers of potential ignition sources, so one would expect the ignition source occurrence rate to be essentially the same for all tanks. It follows then that the difference in tank (i.e., wing vs heated center wing tank) explosion rates is due to the fact that the flammability exposure is not the same for all tanks. Please refer to figure B-1 in Attachment B for the baseline flammability exposure levels predicted by a computer model developed by the FAA and refined by this ARAC. Furthermore, there are differences in the exposure to potential ignition sources. For example, on average, ignition sources in wing tanks are submerged more often than in center wing tanks.

The explosion rate for heated center wing tanks was calculated from the 3 events mentioned earlier. Explosion rates for each of the other tank types were determined based on their exposure to flammable vapors and the likelihood that the potential ignition source would not be submerged. Figure 4.4-1 shows the three events on which the analysis was based. It also shows a close correlation between heated center wing tank operating hours and events that has resulted in an approximately constant accident rate over the last 12 years.

Worldwide Cumulative Heated Center Wing Tank (HCWT)
Operating Hours, Accidents and Rate vs. Time

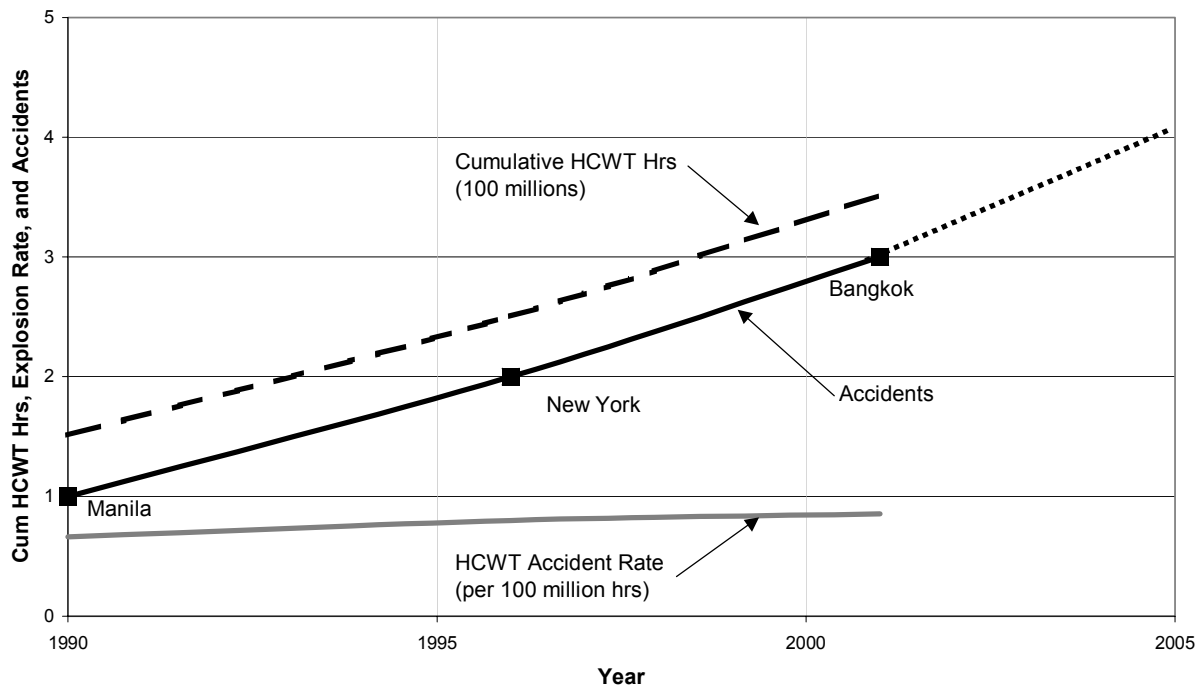

Figure 4.4-1. HCWT Operating Hours, Fuel Tank Explosion Accidents and Statistical HCWT Accident Rate

Figure 4.4-2 shows the total worldwide fuel tank accident forecast. This is the baseline accident forecast if no action were taken to preclude future events. Of the accidents forecast in Figure 4.4-2, approximately 90% are predicted to involve heated center wing tanks. Figure 4.4-3 shows the U.S. forecast, which is based the worldwide explosion rate and U.S. operated airplane operating hours (~46% of the worldwide operating hours).

In Figure 4.4-2 the avoided accidents analysis takes into account predicted reductions in accident rate of 75% attributable to SFAR No. 88. The 75% reduction had been estimated by the 1998 FTHWG. In addition, the Safety Team had reviewed the 1998 report and fuel tank safety enhancements as a result of recent AD actions and other improvements. Although consensus was not reached by the FTIHWG, the majority of the HWG considered that using the 75% predicted reduction in fuel tank explosions was reasonable.

Worldwide Forecast Cumulative Accidents

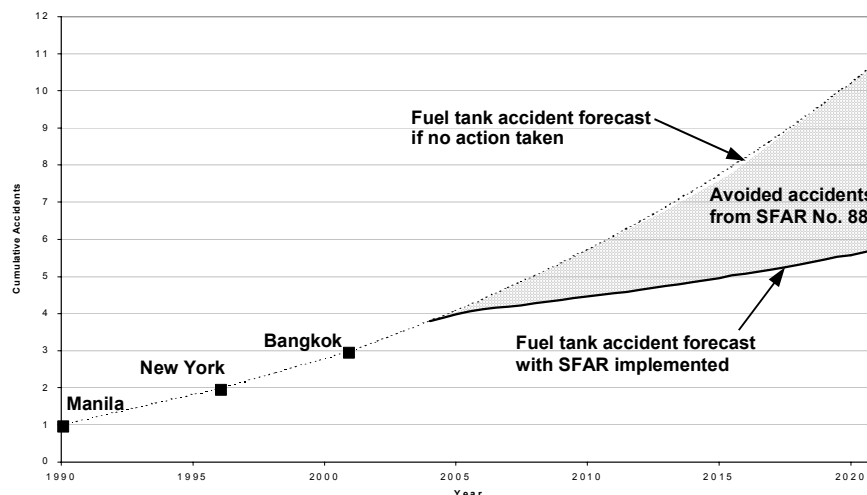

Figure 4.4-2. Worldwide Statistical Forecast Fuel Tank Explosion Accidents

U.S. Forecast Cumulative Accidents

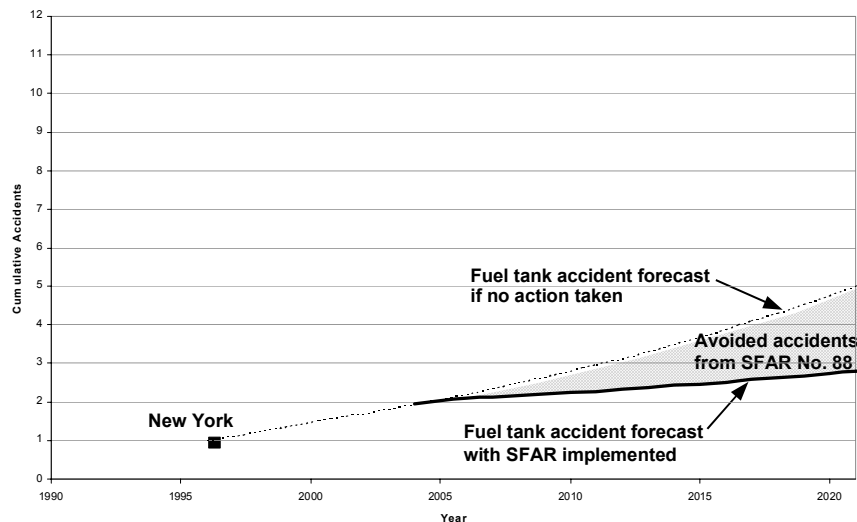

Figure 4.4-3. U.S. Statistical Forecast Fuel Tank Explosion Accidents

The observations and conclusions discussed in this section formed the basis for the baseline fuel tank explosion accident forecast.

The accidents that could be avoided due to inerting is expressed by the following equation:

$$\# \text{ Accidents Avoided} = [(P_{acc})(T_{hrs/flt hr})(H_{cum} - H_{inop})(1 - IGN_{red})]F_{lam}$$

Where:

P_{acc} = Tank explosion rate (by tank type)

$T_{hrs/flt hr}$ = Tank hours per flight hour

Safety Analysis Task Team Final Report

H_{cum} = Cum hrs over study period with sys implemented

H_{inop} = Cum hrs when system inop and on MEL

IGN_{red} = Ignition source reduction factor (due to SFAR NO. 88)

F_{lam} = Flammability reduction factor, fractional portion of risk removed due to inerting

In addition to SFAR NO. 88 effectiveness, the calculated accident rate, mix of tank types, forecast fleet growth, system availability, and achievable flammability reduction all contribute to the number of forecast avoided accidents. These parameters are given in Attachment B. Design implementation assumptions are documented in the Estimating and Forecasting Team Final Report.

4.4.1 Ground Based Inerting

Figure 4.4.1-1 shows the impact that ground based inerting could have on reducing future accidents over the study period. Figure 4.4.1-2 gives a breakdown by generic airplane family of the accidents that could be avoided by ground based inerting if implemented in the U.S. only. The figure also provides a multiplier to determine the breakdown of avoided accidents by generic airplane family if inerting were applied worldwide. For example there would be 4.02 times as many accidents avoided worldwide vs. the U.S. for a Large Transport. This is simply based on the operating hour ratio for each generic airplane category.

U.S. Forecast Cumulative Accidents Ground Based Inerting

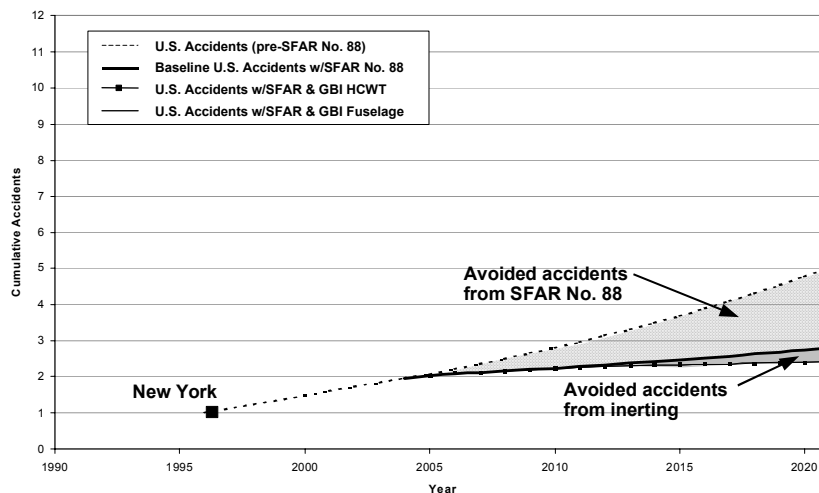

Figure 4.4.1-1. US Statistical Cumulative Accidents with Ground Based Inerting

	Large	Med	Small	R-Fan	R-Prp	Bizjet	Total
U.S. Accidents Avoided by applying GBI to heated CWT only	0.06	0.04	0.28	N/A	N/A	N/A	0.38
U.S. Accidents Avoided by applying GBI to all fuselage tanks	0.06	0.04	0.29	0.00	N/A	N/A	0.39
Multiplier to Calculate Worldwide Accidents Avoided	4.02	2.31	1.92	2.25	2.48	1.28	

Figure 4.4.1-2. Accidents Avoided by Ground Based Inerting

4.4.2 On-Board Ground Inerting (OBGI)

Figure 4.4.2-1 shows the impact that on-board ground inerting could have on reducing future accidents over the study period. Figure 4.4.2-2 gives a breakdown by generic airplane family of the accidents that could be avoided by on-board ground inerting if implemented in the U.S. only. The figure also provides a multiplier to determine the breakdown of avoided accidents by generic airplane family if inerting were applied worldwide. For example there would be 4.02 times as many accidents avoided worldwide vs. the U.S. for a Large Transport. This is simply based on the operating hour ratio for each generic airplane category.

U.S. Forecast Cumulative Accidents OBGI

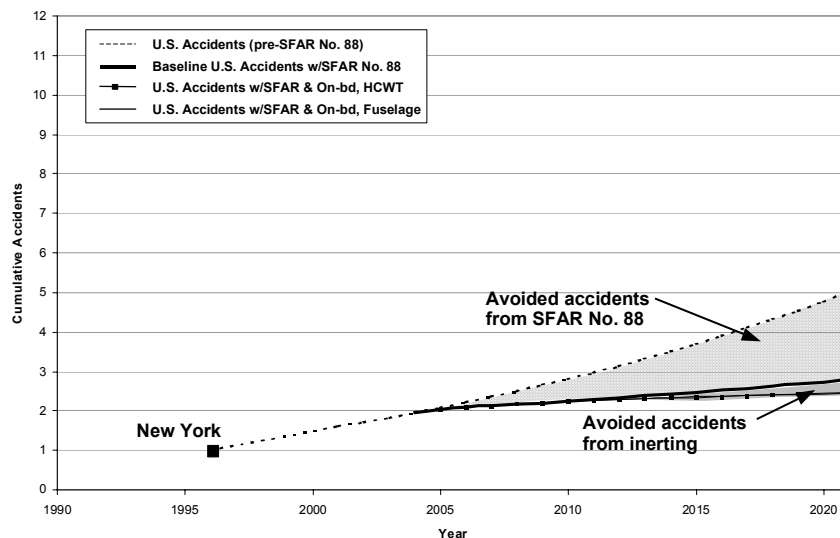

Figure 4.4.2-1. US Statistical Cumulative Accidents with On-Board Ground Inerting

	Large	Med	Small	R-Fan	R-Prp	Bizjet	Total
U.S. Accidents Avoided by applying OBGI to heated CWT only	0.05	0.04	0.25	N/A	N/A	N/A	0.34
U.S. Accidents Avoided by applying OBGI to all fuselage tanks	0.06	0.04	0.26	0.00	N/A	N/A	0.35
Multiplier for Calculating Worldwide Accidents Avoided	4.02	2.31	1.92	2.25	2.48	1.28	

Figure 4.4.2-2. Accidents Avoided by On-Board Ground Inerting

4.4.3 On-Board Inert Gas Generating System (OBIGGS)

Figure 4.4.3-1 shows the impact that OBIGGS could have on reducing future accidents over the study period. Figure 4.4.3-2 gives a breakdown by generic airplane family of the accidents that could be avoided by OBIGGS if implemented in the U.S. only. The figure also provides a multiplier to determine the breakdown of avoided accidents by generic airplane family if inerting were applied worldwide. For example there would be 4.02 times as many accidents avoided worldwide vs. the U.S. for a Large Transport. This is simply based on the operating hour ratio for each generic airplane category.

U.S. Forecast Cumulative Accidents OBIGGS

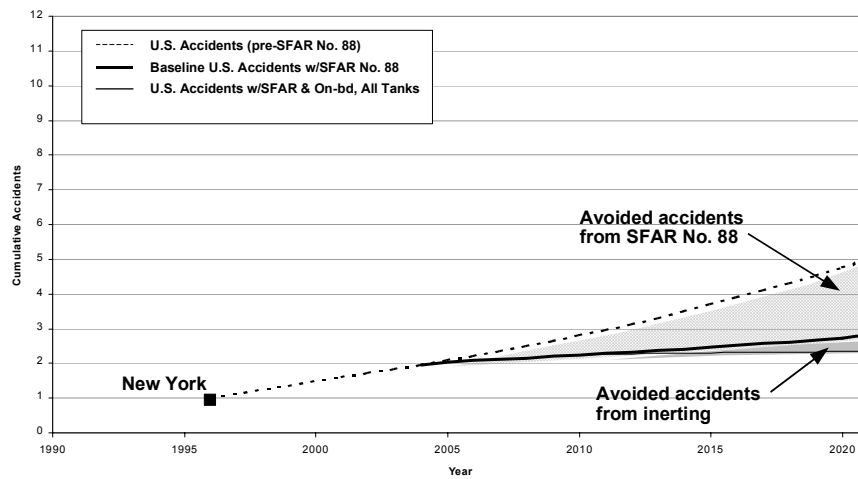

Figure 4.4.3-1. US Statistical Cumulative Accidents with OBIGGS

	Large	Med	Small	R-Fan	R-Prp	Bizjet	Total
U.S. Accidents Avoided by applying OBIGGS to all tanks	0.07	0.05	0.33	N/A	N/A	N/A	0.45
Multiplier for Calculating Worldwide Accidents Avoided	4.02	2.31	1.92	2.25	2.48	1.28	

Figure 4.4.3-2. Accidents Avoided by OBIGGS

4.4.4 Hybrid Inert Gas Generating Systems

Figure 4.4.4-1 shows the impact that Hybrid OBIGGS could have on reducing future accidents over the study period. Figure 4.4.4-2 gives a breakdown by generic airplane family of the accidents that could be avoided by Hybrid OBIGGS if implemented in the U.S. only. The figure also provides a multiplier to determine the breakdown of avoided accidents by generic airplane family if inerting were applied worldwide. For example there would be 4.02 times as many accidents avoided worldwide vs. the U.S. for a Large Transport. This is simply based on the operating hour ratio for each generic airplane category.

U.S. Forecast Cumulative Accidents Hybrid OBIGGS

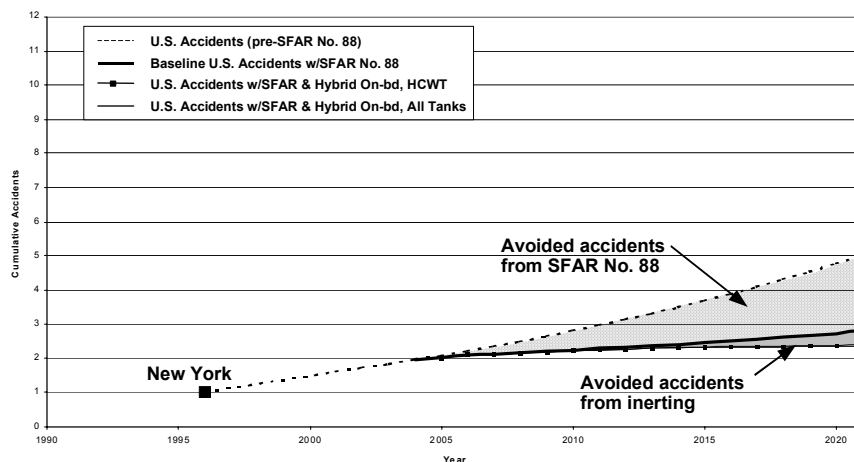

Figure 4.4.4-1. US Statistical Cumulative Accidents with Hybrid OBIGGS

	Large	Med	Small	R-Fan	R-Prp	Bizjet	Total
U.S. Accidents Avoided by applying Hybrid OBIGGS to heated CWT only	0.06	0.04	0.30	N/A	N/A	N/A	0.40
U.S. Accidents Avoided by applying Hybrid OBIGGS to all tanks	0.07	0.05	0.32	0.00	N/A	N/A	0.44
Multiplier for Calculating Worldwide Accidents Avoided	4.02	2.31	1.92	2.25	2.48	1.28	

Figure 4.4.4-2. Accidents Avoided by Hybrid OBIGGS

Figure 4.4.4-3 shows the impact that Hybrid OBGI could have on reducing future accidents over the study period. Figure 4.4.4-4 gives a breakdown by generic airplane family of the accidents that could be avoided by Hybrid OBGI if implemented in the U.S. only. The figure also provides a multiplier to determine the breakdown of avoided accidents by generic airplane family if inerting were applied worldwide. For example there would be 4.02 times as many accidents avoided worldwide vs. the U.S. for a Large Transport. This is simply based on the operating hour ratio for each generic airplane category.

U.S. Forecast Cumulative Accidents Hybrid OBGI

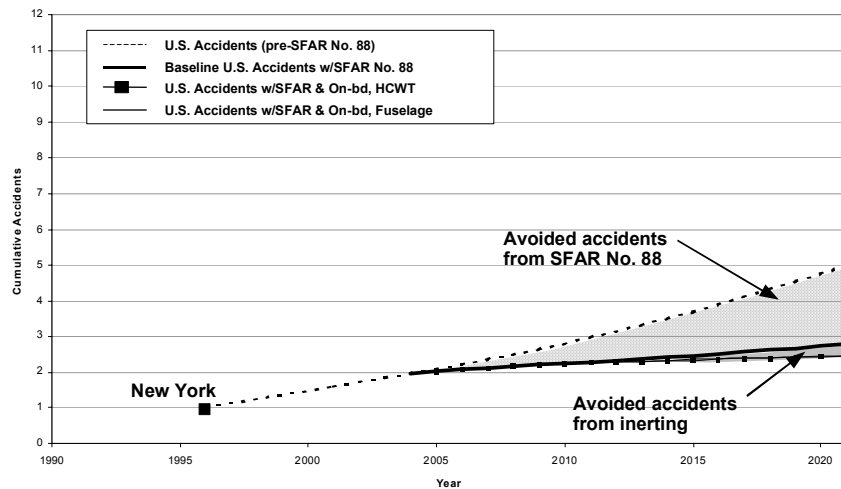

Figure 4.4.4-3. US Statistical Cumulative Accidents with Hybrid OBGI

	Large	Med	Small	R-Fan	R-Prp	Bizjet	Total
U.S. Accidents Avoided by applying Hybrid OBGI to heated CWT only	0.05	0.04	0.24	N/A	N/A	N/A	0.33
U.S. Accidents Avoided by applying Hybrid OBGI to all fuselage tanks	0.06	0.04	0.25	0.00	N/A	N/A	0.35
Multiplier for Calculating Worldwide Accidents Avoided	4.02	2.31	1.92	2.25	2.48	1.28	

Figure 4.4.4-4. Accidents Avoided by Hybrid OBGI

4.4.5 Post Impact Fuel Tank Fire/Explosion

As suggested by the tasking statement, the safety task team evaluated the data provided by DOT/FAA/AR-99/73, "A Benefit Analysis for Nitrogen Inerting of Aircraft Fuel Tanks Against Ground Fire Explosion." The safety team accepted the findings of this report and chose to not duplicate effort in this area. The report considered 13 survivable accidents in which a fuel tank explosion occurred, but was not the prime cause of the accident. Each of the accidents were analyzed to assess the number of lives that might be saved if nitrogen inerting systems were used. The predicted number of lives saved per year from this analysis were reported as:

Ground nitrogen inerting - center tank only	0.3
Ground nitrogen inerting - all fuel tanks	2.4
Onboard nitrogen inerting - all fuel tanks	6.0

Using this data, the forecast number of lives saved over the study period was determined. Based on the assumed annual fleet growth rates and the inerting system implementation assumptions, it is forecast that ground based inerting of the center fuel tank would save 5 lives over the study period. Similarly, onboard inerting of all fuel tanks would save 101 lives over the study period.

The report concludes:

"The predicted potential number of lives saved per year is relatively small compared to other survivability factors. One of the reasons that nitrogen inerting may not be effective, in terms of saving lives in the 13 accidents analyzed, is that in many cases fuel tanks were ruptured when the

aircraft impacted the ground. Any nitrogen in the fuel tanks is likely to have escaped with the spilled fuel. The system is only effective when the fuel tanks are not significantly ruptured."

4.5 Safety Assessment Summary and Conclusions

Over the past twelve years, the fuel tank explosion rate has been essentially constant. Based on this observation, and the forecast fleet growth, the occurrence of fuel tank explosions will be more frequent in the future. Ignition source reduction activities associated with SFAR NO. 88 will provide a reduction in the fuel tank explosion rate.

Figure 4.5-1 shows the pre-SFAR No. 88 fuel tank explosion accident rate for each of the generic airplane families. Figure 4.5-2, shows how the accident rate is reduced due to the FTIHWG interpretation of the SFAR No. 88, GBI and OBIGGS benefits.

When evaluating the data in figure 4.5-1 and figure 4.5-2, it is important to understand that inerting systems offer little benefit to three (Regional Turbofan, Regional Turboprop, and Bizjet) of the six generic airplane families. This is because none have heated center wing tanks, and flammability of the wing tanks is already low. Furthermore, onboard systems were not found to be practical for these airplanes. One might expect the estimated mean time to the next accident for the OBIGGS scenario in figure 4.5-2 for example to be much longer. Indeed for airplanes equipped with OBIGGS (Large, Medium, Small Transports) it is much longer (on the order of 100 years). However, when forecasting so far into the future (and maintaining the unconstrained fleet growth assumption, see Attachment B) the Regional Turbofan, Regional Turboprop, and Bizjet's each contribute more to the forecast. Thus rather than the estimated mean time to the next accident being on the order of 100 years, it is forecast to be 51 years.

The flammability levels achieved by inerting systems can result in a significant improvement in the accident rate.

	Large	Med	Small	R-Fan	R-Prp	Bizjet	Total
Accident Rate pre-SFAR No. 88	8×10^{-9}	8×10^{-9}	8×10^{-9}	6×10^{-10}	1×10^{-10}	4×10^{-10}	5×10^{-9} (weighted avg)

Figure 4.5-1. Accident Forecast Summary Information

	Pre-SFAR No. 88	With SFAR No. 88 Fully Implemented	With SFAR and GBI of Heated CWT Fully Implemented	With SFAR and OBIGGS of All Tanks Fully Implemented
Estimated Mean Time to next Accident in the US after full implementation in year 2015	4	16	36	51
Statistical Explosion Rate per operating hour for entire fleet (weighted average of all six generic airplane families)	5×10^{-9}	1.3×10^{-9}	3×10^{-10}	1.5×10^{-10}

Figure 4.5-2. Fuel Tank Explosion Accident Rate Comparison

ATTACHMENT A - DETAILS OF PREVIOUS TANK EXPLOSIONS

Attachment A contains a detailed description of each event and the findings of the investigating authority, each followed by a description of the mitigating actions taken subsequent to the event to prevent its recurrence. The 16 events have been grouped initially into broad categories which characterize their circumstances, i.e. engine separation events, lightning strike events, ground maintenance events, refuelling events, “others” and those where the cause remains unknown.

Engine Separation Events

1.	Date:	28 June 1965	Flight phase:	Takeoff climb
	Aircraft:	Boeing 707	Tank type:	Main reserve tank
	Location:	San Francisco	Fuel type:	Jet A

Summary of Event

Approximately 39 seconds after takeoff No.4 engine experienced an uncontained engine failure resulting in separation of the engine from the wing. The loss of the engine resulted in mechanical damage to the wing and a severe fire. The fire triggered a low order explosion in the No.4 reserve tank which resulted in the loss of the lower wing skin, lower stringers, and spar chord flanges. The loss of these components resulted in the loss of wing integrity which allowed the outer wing panel to fail and separate from the wing. The ensuing fire was extinguished by the closing of the main fuel shutoff valve either by the first officer or the flight engineer.

There was evidence of fire on the separated wing section, on the remaining wing around the point of separation, and on the No.4 engine. Fire was observed by ground witnesses, passengers and crew members, and photographed, in color, from the ground and by a passenger. The flight crew was alerted to the fire when an intermittent fire warning was observed while they were going through the engine shutdown procedure following the failure of the No.4 engine. The first officer then actuated the fire selector lever for the No.4 engine and discharged both fire extinguisher bottles to the engine. The fire was observed streaming from the right wing. Fuel was still streaming from the No.4 tank area after landing until the fire department plugged the hole in the bottom of the tank. The area around the fuel spill and the wing stub were foamed as a preventative measure while the passengers were disembarking from the aircraft.

Analysis

A disk failure resulted in an explosive failure of the No.4 engine and its separation from the wing due to high vibration and out of balance oscillation of the rotating parts of the engine. The right outer wing received so much damage to the lower load-bearing skin and associated structure that capability of the wing to sustain in-flight loads were reduced below the loads imposed, and the outer wing panel separated from the wing. Fuel from the engine fuel line was then being pumped directly into the airstream. This fuel was ignited by an undetermined source shortly after the engine separated and resulted in an explosive separation of a portion of the lower wing skin. It is believed that dangling wires from the engine separation sequence ignited the fuel. The fire was sustained by the continued supply of fuel through the engine fuel line until the flight engineer or the first officer shutoff the main fuel supply either by activating the fuel shutoff valve to the closed position or actuating the fire selector handle.

The disintegration of the third stage turbine disk cut the engine in two pieces and threw turbine debris into the wing inboard of the engine pylon. The two engine sections, each supported by only one mount on the strut, began to oscillate and separated from the wing in approximately four seconds. The strut failures were caused by the oscillation, possibly coupled with mechanical damage from flying engine parts. The engine fuel line pulled from the strut closure rib when the engine separated from the wing. Fuel was pumped through this line for an estimated 99 seconds at a rate of approximately 30,000 pounds per hour, until the fuel valve was shut off by the action of either the first officer or the flight engineer. A second

fuel source was the fuel line on the forward face of the main spar which had a loosened fitting that leaked and supplied fuel for a fire over the strut center spar between the front spar and the nacelle closure rib. A third possible flammable fluid source was the ruptured slat hydraulic line on the inboard gap cover area.

The source of the ignition cannot be determined, but the possible sources included the engine exhaust, hot turbine parts, or arcing from exposed electrical leads. The latter is the most probable source because there was an appreciable time lapse between observation of the fuel spray and ignition. The fuel sources wetted much of the upper wing surface before ignition occurred.

The fact that No.4 main tank was full of fuel probably prevented more extensive fire damage to that area of the upper wing surface because the fuel acted as a heat sink. The fire in this area reached temps ranging from approximately 870 - 1165°F, based on damage caused to the metal.

The damage to the right outboard wing section top and bottom skin and ribs could only have been caused by an over-pressure in the reserve tank. This is demonstrated particularly by the manner in which the lower skin separated from the aircraft. The entire panel was forced straight down, taking the attaching flanges of both spars with it. This is plainly the result of a low order explosion. The source of ignition for this explosion could not be determined but could have been auto-ignition, burn through, or hot surface ignition from a localized hot spot.

The final separation of the wing followed the explosion in the reserve tank. The wing separation is not believed to have been simultaneous with the explosion. The indications of yaw and vertical oscillation on the flight recorder readout and the location of the wreckage on the ground indicate that the wing section remained on the aircraft approximately 10-11 seconds after the separation of the lower skin panel.

The heat damage to the wing structure was not considered to have been a major factor in the wing failure. Rather, the loss of lower skin panel, stringer, mid spar chord flanges reduced the load carrying capability of the wing below that required to support a 1 “g” condition, thus leading to the failure.

Laboratory tests of the fuel samples taken from the six remaining fuel tanks on the aircraft revealed no significant deviation from the specification established for Jet A turbine engine fuel. It was estimated that the fuel temperature in the tanks at the time of the accident was between 70-80°F. The flammability limit of Jet A fuel was reported by the FAA to be from 90-170°F. Ambient temperature prior to the flight were recorded as 77°F.

Mitigating Actions Taken:

Airplane design change were made to incorporate redundant wiring paths to close spar and engine high pressure valves when the fuel shutoff or fire handle switch is activated. Engine assembly procedures were modified to ensure proper running clearances.

There has been no recurrence of an engine uncontained failure leading to separation of the wing since design changes.

2.	Date:	July 1970	Flight phase:	Go-around
	Aircraft:	McDonnell Douglas DC-8	Tank type:	Wing tank
	Location:	Toronto	Fuel type:	JP-4

Over the threshold of runway 32 at about 60 feet agl, the first officer deployed, instead of arming, the ground spoilers causing a rapid descent until striking the ground. The captain tried to compensate by applying full power and rotating the airplane to initiate a go-around. However, the airplane hit hard at 18 feet per second, number 4 engine separated and number 3 engine partially separated. Somewhere in the sequence of the engine separation from the wing, leaking fuel that may have been ignited by dangling wires causing some explosions. The airplane continued with go-around while trailing fuel and fire. Airplane climbed to 3,100 feet and commenced a turn for a second approach. The right wing separated above the number 3 engine, the airplane rolled over and struck the ground . The airplane crashed 2.5

Safety Analysis Task Team Final Report

minutes following touchdown and approximately 8.5 miles from runway 32. The FAA has reported that JP-4 fuel was being used. Ambient conditions were reported as warm and sunny.

Mitigating Action Taken:

As a result of this accident, the FAA issued an airworthiness directive (AD) requiring placard warnings against in-flight deployment of ground spoilers by DC-8 operators. Following a non-fatal accident some three years after this crash, the FAA issued another AD requiring that all aircraft of the type be fitted with spoiler locking mechanisms to prevent such an occurrence.

3.	Date:	7 May 1990	Flight phase:	Landing
	Aircraft:	Boeing 747-200	Tank type:	No 1 wing tank
	Location:	New Delhi, India	Fuel type:	Jet A

A 747-200 operating a flight from London to New Delhi landed at Delhi at 0915 local time. The flight crew reported there were no problems experienced with the No. 1 engine during the London-Delhi flight. Touchdown and engine transition to reverse thrust were reported as normal. Shortly after the engines reached full reverse, all No. 1 engine indications apparently went to zero. The flight crew was not aware of the nature or extent of the problem at this point as there was no engine fire warning. Another 747, which had landed five minutes earlier, advised the 747-200 they had a large fire on the left wing in the area of No. 1 engine. The crew reportedly pulled the No. 1 fire handle and discharged the fire extinguisher. The tower also noted the fire and alerted the aircraft and the airport fire department. The fire department was already aware of the situation and had four fire engines on the scene within two minutes of first noting the fire. The fire was reportedly extinguished within eight minutes of the first report.

All 175 passengers and 20 crew members were evacuated using the five main deck slides on the right side of the aircraft. All five slides deployed normally and were used. There were no reported injuries of anyone on board. The aircraft apparently touched down between one and two thousand feet from approach end of the runway. Weather was clear and dry with little or no wind and the temperature was 35°C. First evidence of the No. 1 engine inlet cowl contacting the runway was at three thousand feet. Spatters of molten aluminium were first noted at above five thousand feet from approach end. The aircraft stopped ten thousand feet from approach end slightly to left of center. The No. 1 engine was in a near vertical position. The engine had rotated around the mid spar attach points with the nose cowl resting on the runway and the exhaust plug and engine tail pipe jammed against the wing lower surface. The No. 1 strut upper link forward attach fuse pin was sheared. Pieces of fractured fuse pin remained in the upper link forward clevis fitting and associated strut attach lug. The aft end of the diagonal brace was detached from its associated fitting on the lower wing skin and the associated fuse pin was completely missing, and could not be found. Failure of these two strut attach points allowed the front of the engine to drop, contacting the runway. All equipment in the No. 1 strut sail boat area was destroyed by impact with strut aft bulkhead, engine exhaust pipe, tail cone and subsequent fire.

The No. 1 engine fuel supply line separated at the wiggins fitting between strut bulkhead and wing front spar. All wire bundles to the engine appeared to have been broken due to tension caused by the strut rotating to a vertical position. All leading edge flaps and leading edge fiberglass panels severely burned inboard and outboard of No. 1 strut. The outboard end of the outboard trailing edge flap was severely burned. The outboard flap track fairing was totally consumed by fire. The inboard end of the outboard aileron was severely burned. The outboard spoilers 1 and 2 and the trailing edge fiberglass panels inboard and outboard of the No. 1 strut was severely burned. The left wing tip was drooping down outboard of the No. 1 strut at about 15 degrees. There was evidence of extreme heating and warping of upper wing skin above the No. 1 strut. The upper wing skin was pulled loose from the forward and aft spar webs outboard of the No. 1 strut. Vent stringers were split open longitudinally. All upper wing skin rivets were pulled through the skin in the area of the surge tank. The lower wing skin was scorched in area of surge tank.

Analysis

In brief summary, the fuel from the ruptured fuel line and hydraulics in the strut were ignited by the hot engine and exhaust, followed by auto ignition of residual fuel in the reserve and surge tanks due to external heating. Fuel supply to the fire was terminated prior to the aircraft coming to rest and flammable wing and subsystem material continued to burn until extinguished by ground personnel.

Following forward strut pin failure and engine dropping nose down:

- Fuel is discharged at approximately 100 gpm into air stream prior to engine spar valve closure due to fuel line separation from front spar coupling. Fuel is washed under and possibly over wing and into leading edge cavity due to both forward speed of aircraft and due to thrust reverser air from engine.
- Due to engine exhaust/tailpipe being rotated up which forced diagonal brace into the hydraulic reservoirs in strut aft fairing, reservoir is crushed and 10 gallon (U.S.) hydraulic fluid is released.
- Fuel and/or hydraulic fluid is ignited on hot engine tail cone/nozzle.
- Hot engine exhaust gases and/or fuel fire heat the lower surface of reserve tank. Reserve tank is empty, but air is heated in excess of fuel AIT (auto ignition temperature). Residual undrainable fuel is approximately one U.S. gallon.
- Heated air or burning fuel vapor reaches surge tank through the reserve tank vent line. Fire initiates in surge tank due to residual fuel vapors and temperature in excess of AIT for fuel. Hot front spar at surge tank due to leading edge fire could also have been the ignition source.
- Main tank No. 1, because of fuel acting as a heat sink, remains "cool".
- Wing leading edge receives fuel spray or mist due to engine thrust reverser air or free stream air dispersion. Prior to fuel shutoff, during landing roll, fuel attaches to flap torque tubes and interior flap surfaces, and subsequently burns. Resin binding agents in fiberglass honeycomb panels will burn when fed by heat of fuel fire. Fuel was shut off prior to the end of the landing roll as evidenced by soot being confined to aft portions of strut and aft part of core cowl.

Fire damage to aft end of engine is primarily to exterior cowling and exterior surface of nozzle. Inner steel nozzle does not appear fire damaged. This is considered a consequence of external fuel or hydraulic fluid falling or spraying on aft end.

An assessment of the cause of the wing overpressure has been made. This assessment, in conjunction with visual inspection of the damage indicates that an in-tank explosion occurred which destroyed the integrity of the torque box by separating the wing panels and spars from their internal support structure. Further damage occurred after the overpressure due to inertia loads imposed during landing rollout.

The engine separation was found to be due to a maintenance error when re-assembling the components of the strut linkages.

Mitigating Action Taken

Procedural changes were implemented at the specific airline to ensure existing instructions for engine retention hardware installation were properly followed.

- | | | | | |
|----|-----------|--------------------------------|---------------|-----------------------|
| 4. | Date: | 31 March 1992 | Flight phase: | Climb |
| | Aircraft: | Boeing 707 | Tank type: | No 4 wing tank |
| | Location: | Near Marseilles, France | Fuel type: | Jet A |

As the aircraft was climbing towards flight level 330, both right engines separated from the wing. The No.3 inboard pylon fitting fractured and subsequently released the engine under power which then

Safety Analysis Task Team Final Report

impacted the No.4 engine causing it to separate also. The crew succeeded in controlling the aircraft and landed gear and flaps down with the right wing on fire. The aircraft rolled off the runway to the left of centerline and all crew members evacuated the aircraft safely and the firemen extinguished the fire.

The trailing edge of the wing was totally burnt in the area between both engines. The inboard and outboard flaps had completely disappeared, revealing the burnt operating mechanisms. The inboard aileron was severely damaged. Moreover, the examination of the inboard wing box identified the marks of an inner explosion on fuel tank No.4. This explosion seemed to be at the origin of significant deteriorations affecting the wing stiffness. This explosion had caused the displacement of the inner ribs of this tank. The wing stiffness was particularly damaged on the front and aft spars. Thus, it appeared that the right wing was severely damaged first because of a fire and then because of an inner explosion at the fuel tank No.4.

Note: All right wing valves, transfer and shutoff valves operated normally, when tested. The shutoff valves were found in the fully closed position and the transfer valves were found in the open position which matched the cockpit switch positions. The fuel leakage on the leading edge of the wing near engine No.3 could not have been caused by a closing failure of the shutoff valve. Damage (collateral) of the piping following the pylon detachment could be the cause of the leak. The exact location of the leak could not be detected.

During all of the descent at speeds greater than 220 kt, it is probable that the fuel leak carried on without the fuel catching fire, as the conditions for ignition (depression of the upperwing, speed....) were not achieved and the vaporized fuel was not in contact with the electrical short-circuits of the damaged cabling loom located on engine No.3 leading edge. These conditions changed during the last turn as a consequence of the semi-extension of the flaps. The speed reduced (between 220 and 190 kt), the depression on the upper wing decreased and the turbulence increased. Then, it was possible that under the effect of the electric arcs of the short-circuits quoted above, the fuel ignited, as the conditions of the kerosene-air mixture became optimal for burning. The fire was violent as the condition of the upper wing demonstrated, particularly at the trailing edge. This intense fire had destroyed the trailing edge as well as the flaps and left evidence of overheating over the whole of aft part of the right fuselage side. The air traffic controller advised that the right wing was on fire at 08:33:28 hrs and the landing touchdown occurred at 08:35:35 hrs. Consequently, the right wing fire lasted for at least two minutes.

The accident report did not provide a good rationale for the explosion in the No.4 main tank. It is believed that during the intense fire the wing structure may have weakened and fire progressed to the air-fuel mixture in the tank.

Mitigating Action Taken

An airworthiness directive was issued to inspect the pylon/strut mid-spar fittings at 1500 hours or 600 cycles.

Lightning Strike Events

5.	Date:	8 December 1963	Flight phase:	Holding
	Aircraft:	Boeing 707	Tank type:	Wing (reserve) tank
	Location:	Elkton, Maryland	Fuel type:	Jet A / JP-4 mix

The flight was in a holding pattern at 5,000 feet awaiting an instrument approach to Philadelphia airport from Baltimore, when it was struck by lightning. Immediately thereafter, the aircraft was observed to be on fire. A large portion of the left wing separated in flight and the aircraft crashed in flames near Elkton, Maryland. The probable cause was lightning induced ignition of the fuel/air mixture in the No.1 reserve fuel tank with resulting explosive disintegration of the left outer wing and loss of airplane control.

Fuel onboard at the time of the accident was approximately a 68% Jet A / 32% JP-4 by volume mix. It was estimated that fuel temperatures were 42°F in the reserve tank and 46°F in the main tanks. Considering all factors it was concluded the fuel vapors in all tanks were within the flammability limits. Multiple lightning-strike marks were found on the left wing tip. Although much effort was expended, the physical evidence failed to disclose the precise mechanism of ignition which triggered the explosion in the left reserve fuel tank.

Mitigating Action Taken

A fire suppression system was installed on some airplanes which consisted of a light-triggered fire extinguishing system in the wing surge tank. Additionally, some airplanes had a flow-through vent system installed. An FAA Advisory Circular 20-53 was developed to define lightning strike zones.

Since incorporation of the above design changes and practices, there has not been a recurrence of a lightning strike event on the 707/720 model.

6. Date:	9 May 1976	Flight phase:	Approach
Aircraft:	Boeing 747-IIAF	Tank type:	Wing tank
Location:	Madrid	Fuel type:	Jet A / JP-4 mix

The airplane was being operated as a military logistic flight to McGuire AFB with an enroute stop at Madrid, Spain. During descent for the approach at 6,000 feet, the airplane was struck by lightning which resulted in an explosion and separation of the left wing causing loss of control. Prior to the event, the crew requested ATC vectors around severe thunderstorm activity. The fuel onboard was a mixture of 58% JP-4 and 42% Jet A type.

At the time of the accident the weather was cloudy with rain and lightning, but good visibility. At least two witnesses reported seeing lightning strike the airplane. Parts from the left wing, including a section of the left wing tip, were the first found along the flight path wreckage.

Evidence of lightning strike, pitting and localized burn areas typical of lightning attachment were found on the left wing tip and on the vertical fin at the VOR antenna.

The fire centers were located in the wing tip, in the outboard end of No.1 fuel tank, and the outboard end of No.2 fuel tank. These fire centers were independent and not interconnected. There was no pattern to the fire, heat, and soot damage in the reserve tank. In the area of the No.2 tank, the fire, heat, and soot damage pattern on the inner part of the wing indicated that a fuel fire moved inboard behind the rear spar and along the trailing edge. At the wing root, the fire pattern extended fore and aft along the fuselage. The fuel for this fire obviously came from the No.2 tank from which the upper wing skin cover plank was gone.

Findings and Plausible Hypothesis

The aircraft was fueled with a mixture of JP-4 and Jet A fuels. Lightning struck the aircraft an instant before an explosion. The first wreckage on the ground contained a considerable number of parts of the left wing outboard of the No.1 engine. Damage to the wing in the area of the No.1 fuel tank is the result of a low order explosion. The ullage of the No.1 tank contained a flammable mixture of fuel and air. Pressures provided by the ignited fuel were sufficient to cause the damage. Three fires occurred in No.2 tank, No.1 tank, and the wing tip surge tank. The crushing or collapsing of the fuel tube in the No.1 tank required an application of pressure only available from an explosion. The pressure required to detach the stringers and skin from the wing were in the range of typical pressures developed by an explosion. The first deposit of wreckage formed a pattern of light objects downwind and heavy objects upwind, which is not compatible with gusting or turbulent wind conditions but is compatible with an explosion in calm or steady wind conditions. The H.F. antenna and wing tip edge were snapped off the wing by inertial loads developed by an oscillating outer wing. The loosening of the stringer/plank unit from the wing destroyed the aft wing

Safety Analysis Task Team Final Report

box of the wing. Extreme engine oscillations developed as a result of the wing box damage. The loss of the rear box structure allowed the wing to twist torsionally and to deflect up and down about the rear spar. The first objects along the flight path were units from the inside of No.1 fuel tank. The three fire areas within the left wing contained electrical devices. The highest level of residual magnetic field was along the rear spar aft of the No.1 tank. A motor that operates a fuel valve normally mounted in this position was never found. Damage to the fuel tank access doors could only result from pressure from inside. No structural loads were applied to these doors. The 28Hz oscillations superimposed on the power line were in the area of the third harmonic of the wing oscillations (9Hz) which were attributed to engine fan rub in the early service history of the 747. The inertial damage to the extreme wing tip (H.F. antenna and coupler) could result only if the inboard section of the wing tip was still attached to inner wing. Throttle lever vibration in synchronization with the wing oscillations was observed during previous incidents. The damage to the wing tip cannot be caused by gust loads or aerodynamic loads. They were due to wing oscillations. The wing oscillations were the result of rear box failure. The deformation to rib WS 1168 was caused by pressure loads prior to its departure from the wing along with the jettison fuel line. The flight control difficulty mentioned on the CVR was probably related to the outer wing damage. The crossover vent duct for the forward outboard end of the No.1 tank was severely fire damaged, and the aft end was never recovered.

Fuel Tank Flammability Evaluation Results

Based on these calculations of the fuel and ullage conditions, the fuel/air mixture in portions of the ullage may be such as to permit ignition at the time of a descent through 10,000 feet.

Analysis

Consensus of the highly specialized investigation team was that an explosion occurred at or near the aft outboard corner of the No.1 Tank.

Conclusion from the Accident Report

After analyzing all of the available evidence, it is concluded that the most probable sequence of events which culminated with multiple structural failures and separation of the wing began with an ignition of the fuel vapors in the No.1 fuel tank. The damage to the structure in the area of the tank provided positive indications of an explosion. The possibility that the explosion was a secondary result of an initial structural failure caused by excessive aerodynamic forces developed during high velocity gusts and turbulence cannot be completely dismissed; however, the evidence and the probabilities of an aircraft encountering these unique environmental conditions make this hypothesis less supportable.

Mitigating Action Taken

A design change was incorporated that basically improved bonding (electrical grounding) where plumbing passes through the wing spar to further dissipate the voltage difference.

There has been no recurrence of a lightning strike related explosion to this model airplane or any other fleet airplane since this event in more than 246 million flights.

Ground Maintenance Events

7.	Date:	17 September 1967	Flight phase:	Ground maintenance
	Aircraft:	Boeing 727	Tank type:	Center
	Location:	Taiwan	Fuel type:	Jet A

The airplane was undergoing routine scheduled maintenance of the interior of the left wing tank. Both No.1 (wing) and No.2 (cheek tank) tanks had been drained and were open. Tank No.1 had been purged and No.2 tank was to be purged. A flash fire occurred followed in a few seconds by an explosion which ruptured the integral section comprising the RH end of tank No.2. An 8 ft. by 12 ft. section of upper wing

structure was blown off. A small fire flared up in the damaged area which was quickly put out. There were 74 people in the immediate area. 16 persons were injured; five of these received serious injuries.

The precise source of ignition could not be determined. However, the following information was obtained in the ensuing investigation:

An explosion-proof light was illuminating the interior of the electronics compartment and was still functioning after the explosion. There was no evidence to indicate that it had been plugged in coincident with the event. All power was off the airplane, the ground power unit had been shutdown nearly two hours earlier, and the battery had been removed.

The lead man in charge of tank purging stated that purging with portable CO₂ bottles had been completed within tank No.1, and that the CO₂ equipment had been laid down, and that the crew had been instructed to open up the RH access door of tank No.2 before purging that tank. No checks had been made of explosive vapor concentration either internally or externally.

The tank purging procedure used is noted to be contrary to the procedure recommended in the OEM manual. One of the more severely burned mechanics, interviewed later in the hospital, was stated to have corroborated the above. The FAA personnel had come to the conclusion that tank No.2 was being purged through the LH access opening at the time. They based their assumption on the statement that the CO₂ equipment had just been laid down on a work stand, and that the most seriously burned mechanic was standing on a stand near the LH No.2 tank, not No.1.

It was noted that metallic parts in the CO₂ discharge assembly might produce a spark and also that the static electricity discharges from the fiber horn or nozzle on portable CO₂ bottles have been historically a cause of fuel fires.

A mechanic was filing a piece of light gage stainless steel, making a nut retainer, in a wheel well area. Another was making a layout on another piece of metal. The first man, who received burns on exposed skin areas, reported that he felt pain and ran from the area. He did not report noting the origin of the explosion.

The only ground leads specifically identified were connected to the RH landing gear, rather than to the grounding lug provided on a RH gear door, and to the rear fuselage. Whether or not ground leads were attached to the work stands, as recommended by the OEM, was not determined due to confused activities following the explosion. A large crew of workmen were reported to be cleaning (but not polishing i.e., using buffers or polishing compounds) with cans of solvent, brushes and cloths. After the explosion, several of the cans of solvent were noted to be on fire. Electrical outlets were non-explosion proof; however, none was reported as being used, at the time, except for the connection to the light in the electrical compartment.

No precautions had been taken to limit access or post warnings in the area. The FAA considers that any of the 74 men in the area might have created a spark which could have ignited fumes in the area.

Mitigating Action Taken

The CO₂ bottle flow rates were reduce and the discharge nozzles inspected and reworked. There is no known recurrence of this event for these specific causes.

8.	Date:	23 March 1974	Flight phase:	Ground maintenance
	Aircraft:	McDonnell Douglas DC-8	Tank type:	Wing
	Location:	Travis AFB, California	Fuel type:	JP-4

Upon arrival at Travis Air Force Base from a Military Charter flight, a routine maintenance "A" check was being accomplished including maintenance action in response to the flight crew reports of inflight

Safety Analysis Task Team Final Report

mechanical irregularities that appeared on the previous two flight legs. One of the crew log reports was an inoperative No.1 fuel boost pump.

Access to the boost pump was made through the top of the wing. This was done by removing the No.1 main fuel tank access cover, located behind and slightly outboard of the number 2 engine pylon. Affected circuit breakers for the fuel system had been opened. The tank contained approximately 3,000 pounds of JP-4 fuel. The boost pump was partially submerged in fuel. The total fuel on the aircraft was 25,000 pounds. External power from a ground power unit was connected to the aircraft.

Removal and re-installation of a different boost pump was completed. An operational check of the pump was then attempted and failed. Two of three circuit breakers for the AC three phase pump opened and no boost pressure was noted. It is noteworthy that the same two circuit breakers had opened while enroute on a prior flight leg which resulted in a log book write up "No.1 main boost pump inop". Maintenance replaced the fuel boost pump with the second pump to see if the malfunction could be cleared. Electrical power from an external power unit was reconnected after a "low fuel" warning signal was activated. Inspection of the newly installed fuel boost pump electrical connector was conducted.

At 2008 PDT an explosion occurred in the left wing center section. The upper wing surface between nos. 1 and 2 engines was blown forward and away from the airplane centerline some 250 feet from the airplane. A fire then began which engulfed the entire left wing, fuselage, and inboard right wing. Evidence from the recovered fuel boost pumps and connectors revealed no evidence of burning. The explosion resulted in hull loss, and one fatality.

The investigation also points to an external ground power unit that was supplying power to the aircraft while tank maintenance was being performed. It also mentions a flashlight which one of the mechanics on the wing had in his possession which had a broken "flasher" switch i.e. the switch that allows the user to momentarily activate the light without locking it on or off. Most of the recommendations from everyone involved focused on procedures to prevent another accident. No conclusive evidence of an ignition source was established.

Mitigating Action Taken

The mitigation action taken for this event has yet to be determined.

Refuelling Events

9.	Date:	3 May 1970	Flight phase:	Refuelling
	Aircraft:	Boeing 727	Tank type:	Center
	Location:	Minneapolis	Fuel type:	Jet A

The airplane was being refuelled using a single-point refuelling system. About 2,000 lbs of fuel had been loaded when a heavy muffled explosion occurred in the No.2 (cheek tank). A puff of gray smoke came from the LH wing tip vent. Fuelling was immediately terminated, all electrical power on the airplane was cut off, the APU was shutdown, and the aircraft was de-fuelled.

No injuries had occurred. No damage was apparent from an external check of the aircraft. The damage was largely confined to the secondary structure within the No.2 tank on the LH side of the airplane. When inspecting the tank, it was found that the structure above the top level of the fuel was heavily soot blackened. The ribs visible from the front spar access hole exhibited heavy deflection and distortion and the stringers were also damaged. Some pulled rivets were noticeable in the LH wing. The formed covers for the fuel boost pump were "hydro-pressed" down over both the RH and LH pumps, but no leaks had developed.

No faults in the electrical systems of the aircraft in and around tank No.2 were found. It is presumed, in the absence of any electrical sources, that ignition resulted from a static discharge within the No.2 tank.

Time of day was 8:28 am. Fuel temperature was 55°F. Flash point of samples was: Tank #1-118°F, Tank #2 - 120°F, Tank #3 - 110°F and the Storage tank from which the fuel was loaded was 127°F.

At the time of the event the following airplane systems were operating; the APU was operating and the LH pack was on to heat the cabin, All navigation lights on. No boost pumps were on.

The duration of the fuelling was approximately 5 minutes with the No.2 tank 31% full.

Mitigating Action Taken

No mitigating action taken since no root cause for an ignition source was found.

10.	Date:	23 December 1970	Flight phase:	Refuelling
	Aircraft:	Boeing 727	Tank type:	Center
	Location:	Minneapolis	Fuel type:	Jet A

The airplane was being refuelled using under-wing refuelling at the RH wing station. Approximately 3,000 pounds of fuel had been loaded when a muffled explosion was heard. Fuelling was immediately stopped and a minor leak was noticed coming from the area of the inboard boost pump in the LH wing. There was no fire and no injuries to any of the servicing personnel. Over-pressure damage to the aircraft's No.2 fuel tank was extensive but minor in nature.

The aircraft was being readied for its next departure. Besides the refuelling operations, other activity around the aircraft included baggage loading and de-icing operations. Some light snow was being stirred around by a wind that was blowing from the left to the right wing at 18 knots with gusts to 24 knots. The outside ambient temperature was +8°F.

After about 5 minutes of fuelling with kerosene type A (Jet A) , a harsh muffled explosion shook the aircraft with a large white cloud of smoke or vapor issuing from the LH wing root area and continuing for about 30 seconds. The outboard boost pump cavity access door was split in two with half flying across the apron and half still dangling from the opening. Fuel was leaking from the cavity area in a stream about the size of a pencil diameter. The fueller immediately dropped the "dead man" switch and closed both fuelling nozzles. The fire department was then summoned, and they hosed down the area.

Subsequent examination of the aircraft revealed minor exterior physical damage, most noticeable being the blown-off access door, collapsed and fractured number 2 tank LH fuel boost pump cavity housing, and popped rivet heads on the number 2 tank LH upper skin area. Interior physical damage was quite extensive within the number 2 fuel tank. Both the No.1 and No.3 tanks were undamaged. Evidence of soot deposits were found within the left and right hand surge tanks, the number 2 fuel tank, and at each wing tip fuel tank vent scoop area.

The investigation that followed the incident indicated that the probable cause of the explosion was delivery by the ground fuelling system of highly charged fuel into the airplane. However, the investigation was unable to pinpoint the exact source of ignition that triggered the combustion of the fuel vapor. The evidence is very strong, however, that the source of ignition was static discharge internal to the number 2 fuel tank.

Time of day was 6:18 am. Fuel temperature was 31°F. Flash point of samples was: Tank #1-119°F, Tank #2 - 118°F, Tank #3 - 124°F and the Storage tank from which the fuel was loaded was 121°F.

At the time of the event the following airplane systems were operating: APU, all navigation lights on, No.2 tank boost pumps on and all crossfeed valves open.

The duration of the fuelling was approximately 5 minutes with No.2 tank 32% full.

Safety Analysis Task Team Final Report

Mitigating Action Taken

The paper element filter separators in the ground refuelling equipment were replaced with filters that did not create electrostatic charging.

There has been no recurrence of a refuelling related event to this model since changes were made.

11. Date: **21 June 1973** Flight phase: **Refuelling**
Aircraft: **McDonnell Douglas DC-8** Tank type: **Wing**
Location: **Toronto** Fuel type: **JP-4 / Jet A mix**

The airplane was at the gate and a ground power unit was connected to the airplane's electrical system when a fuel tank explosion blew off pieces of the right wing top skin and spar structure. Burning fuel rapidly engulfed the right wing. The aircraft was destroyed and two ramp servicing personnel were seriously burned.

The aircraft was being fuelled with Jet B (JP-4), but examination of the left wing tanks revealed a fairly even mix of Jet A-1 and Jet B. Some Jet A-1 was already in the tanks. The ambient temperature was 76°F.

Shortly thereafter an explosion occurred in the right wing. A 20 foot long piece of wing upper skin covering the forward portion of number 3 alternate and number 4 main tank was blown high into the air and landed about 100 feet to the right of the aircraft. Flames erupted from the right wing and burning fuel was sprayed onto a man on a conveyor who leaped off toward the rear of the aircraft. This explosion was followed almost immediately by another which blew a 10 foot long piece of the upper wing skin from the aft section of the number 3 alternate tank to a position forward and to the left of the aircraft. The loss of this skin allowed the right wing to collapse, hinging from the bottom skin. Burning fuel ran from the ruptured number 4 tank and fuel manifold over the leading and trailing edges of the wing. The fueller under the right wing ran toward the front of the aircraft through the fire that now extended to the ground and he was doused with burning fuel. Both the refueller and the cargo handler were seriously burned. No passengers had boarded the aircraft. The nine crew members aboard evacuated through the loading bridge.

The findings of the Canadian Department of Transportation were that the initial explosion occurred in the number 3 alternate tank and that the fuel vapor was ignited in the wing vent system. The source of ignition of fuel vapor in the wing tank vent system could not be definitely determined, but was suspected to have originated outside the aircraft.

Mitigating Action Taken

It is believed that no direct action was taken since it appeared that ignition of the fuel vapor had taken place outside the aircraft adjacent to the vent outlet.

12. Date: **6 June 1989** Flight phase: **Refuelling**
Aircraft: **Beechjet 400** Tank type: **Aux Tank**
Location: **Washington D.C.** Fuel type: **JP-4 / Jet A mix**

The aircraft departed early in the morning from Jackson, Mississippi enroute to New Orleans. Early in the afternoon the airplane returned to Jackson and was refuelled with JP-4. At approximately 4:00 p.m. CST the airplane departed from Jackson enroute to National Airport in Washington, DC. After arrival in Washington, the crew spent approximately one hour securing the airplane before departing for the hotel. Line service then began refuelling operations. Operations manager advised that the fuel truck was grounded to the airplane and also to the fuel ramp grounding point. Main wings were topped off first with Jet A fuel. Line personnel then began to service the aft tanks. Prior to service, there was approximately 200 pounds of fuel remaining in the tanks. After pumping five gallons into the aft tank through the aft filler port, line personnel reported hearing a hissing noise followed by a bang. Fuel surged out of the filler

opening and covered the line service personnel. At this point, refuelling was terminated and the pilots were contacted. At the time of refuelling there were thunderstorms in the area at the time of refuelling. Shortly after the refuelling operations began, heavy rain began falling in the area of the airport.

Fuel was later noted dripping from the underside of the airplane. After the cabin interior seats were removed to gain access to the aft fuel tank, it was found to be torn loose from all 14 fuselage attach points. The tank had expanded significantly from internal pressure. The forward access panels on the tank were removed for internal viewing. The inside of the tank exhibited very heavy carbon deposits throughout the tank and especially on the upper surface of the horizontal support frames within the tank. These deposits indicate some type of fire or detonation occurred inside the tank.

The investigation concluded the most probable cause was that during refuelling of the interconnected fuselage and auxiliary tanks, an electrostatic discharge occurred which resulted from charged fuel entering the aft auxiliary tank from the fuselage tank. The fuselage mounted tank had a blue foam installed in the tank to protect against rotor burst threats. The foam being used at the time was determined to have low conductivity characteristics and was able to build up an electrostatic charge which subsequently discharged in the aft tank that did not have the protective foam installed.

Mitigating Action Taken

Final action resulted in an airworthiness directive to replace the blue foam with a more conductive foam and install additional bonding and grounding to the subject fuel tank.

Other - Parked in Hanger

13.	Date:	2 June 1982	Flight phase:	Parked
	Aircraft:	McDonnell Douglas DC-9	Tank type:	Fwd Aux Tank
	Location:	Montreal	Fuel type:	Jet A-1

While the airplane was parked in the hangar, it is believed that a fuel boost pump located in the forward auxiliary fuel tank had been left on and overheated, causing an over-pressure in the (de-fuelled) tank, and a subsequent fire which destroyed the aircraft. Structural analysis of the auxiliary tank did not show signs of an “explosion” but did show signs of rapid over-pressure in the tank. The residual fuel in the forward auxiliary fuel tank (estimated at 2.6-3 US gallons) was insufficient for pump priming; therefore there was no motor cooling which resulted in excessive fuel vapor generation within the tank. The exact source of ignition could not be determined during the investigation but out of the four electrically operated components in the auxiliary tank, three could be ruled out as spark producing agents. These are: the fuel quantity probes and the float switch which were not energized and the fuel pressure switch which was found in good condition and its electrical wiring is installed in a metal tube. The fourth item, the transfer pump power supply harness, is the most probable source of sparks. Examination of electrical assemblies on other aircraft indicated burned sockets and pins at the pump connector. The burn marks were the result of arcing. If a faulty connector has a secondary failure at the harness pressure seal, a spark could ignite a critical fuel vapor/air mixture. Considered a serious over-pressure event.

Mitigating Action Taken

No aircraft-related action was taken since this was treated as an industrial accident rather than an event affecting airworthiness.

14.	Date:	11 May 1990	Flight phase:	Climb
	Aircraft:	Boeing 727-100	Tank type:	Center tank
	Location:	Bogota, Colombia	Fuel type:	Jet A

The airplane was climbing through 10,000 feet when an explosion occurred. Investigator reports discovered evidence of a bomb explosion. Close examination of the aircraft structure revealed evidence

Safety Analysis Task Team Final Report

on the RH side of the passenger cabin between the emergency overwing exits. The evidence indicated the force generated by the blast compromised the structural integrity in this area causing a fuel tank rupture, fire, and inflight structural breakup of the right wing. The local ambient temperature reported at the airport was 52°F.

Cause Unknown

15. Date:	11 May 1990	Flight phase:	Parked / Push Back
Aircraft:	Boeing 737-300	Tank type:	Center tank
Location:	Manila, Philippines	Fuel type:	Jet A

While being pushed back from the gate, the center tank exploded and burned. At the time of the explosion, the engines were not running and the aircraft electrical power and air-conditioning were supplied by the Auxiliary Power Unit (APU). Preliminary evidence indicates that ignition of the fuel-air mixture in the center fuel tanks was the cause of the explosion and subsequent fire. The investigation focused on the center fuel tank, which was determined to be the source of the explosion, and the possibility of an explosive or incendiary device, an external source of ignition or mechanical and/or electrical failure as a source of ignition. The investigation found no evidence of a bomb, an incendiary device, or sabotage. The investigation has yet to reveal the exact ignition source.

At the time of the accident, all the fuel boost pumps were in the “on” position. The center fuel tank had not been filled since 9th March 1990. During the pushback of the airplane the center fuel tank low pressure light illuminated, indicating that the center fuel tank had been emptied of all usable fuel. Laboratory examination of the fuel samples from the airplane and fuel storage tanks indicates that the fuel vapor in the center tank would have had a flash point of between 112 - 117°F. The ambient temperature at the time of the accident was 95°F. The fuel was estimated to be approximately 115°F based on samples of fuel drawn from other similar airplanes following the incident. It was estimated that approximately 90 pounds of fuel was in the center tank.

Of the 114 passengers and six crew members, eight were fatally injured and 30 sustained injuries.

Mitigating Action Taken

Boeing published an all operators bulletin reminding flight crews to not operate the center boost pumps when no usable fuel was available in center tank.

16. Date:	17 July 1996	Flight phase:	Climb
Aircraft:	Boeing 747-100	Tank type:	Center tank
Location:	New York	Fuel type:	Jet A

The airplane was climbing near 13,800 feet (msl) when an inflight explosion occurred in the center wing fuel tank approximately 13 minutes after takeoff, resulting in loss of structural integrity inflight. The center wing tank was estimated to contain approximately 100 gallons of fuel. Prior to dispatch of the airplane, the air-conditioning air cycle machines, located under the center wing tank, had been operating for up to 2 hours. The center wing tank estimated fuel temperatures was 113-115°F. At the altitude and temperatures of the event, the fuel tank air/vapor mixtures were considered to be flammable. The fuel type was Jet A. There were 230 fatal injuries including the flight crew.

Mitigating Action Taken

A series of service bulletins have been issued against the B-747 series, covering fuel pump electrical installation inspections, addition of a scavenge pump flame arrestor, and inspections and replacements of FQIS wiring and probes.

For the B-737 series (which has a similar fuel system), bulletins covering fuel tank system component and wiring inspections, and flame arrestors in the vent system are being incorporated.

ATTACHMENT B - ANALYSIS PARAMETERS AND SUMMARY INFORMATION

This Attachment documents the parameters used in the forecast as discussed in section 4.4

Figure B-1 provides the baseline flammability levels for each of the generic airplanes and tank types predicted using a computer model developed by the FAA and refined by this ARAC. In addition a breakdown by tank type is provided of the flammability levels after inerting.

Baseline Flammability by Tank Type	Large	Med	Small	R-Fan	R-Prp	Bizjet
Heated CWT	36.2	23.5	30.6	N/A	N/A	N/A
Unheated CWT	6.8	N/A	5.1	2.6	N/A	N/A
Aux Tank	21.8	16.7	8.8	N/A	N/A	N/A
Wing Tank	3.6	2.4	3.6	1.6	0.7	1.6
Heated CWT Flammability after inerting						
GBI	4.9	2.0	5.2	N/A	N/A	N/A
OBI	6.7	1.4	5.5	N/A	N/A	N/A
OBI, Hybrid	7.0	1.4	5.8	N/A	N/A	N/A
OBIIGGS	0.0	0.0	0.0	N/A	N/A	N/A
OBIIGGS Hybrid	0.9	0.6	0.3	N/A	N/A	N/A
Unheated CWT Flammability after inerting						
GBI	0.4	N/A	0.4	0.1	N/A	N/A
OBI	0.9	N/A	0.7	0.0	N/A	N/A
OBI, Hybrid	0.8	N/A	0.6	0.1	N/A	N/A
OBIIGGS	0.0	N/A	0.0	0.0	N/A	N/A
OBIIGGS, Hybrid	0.1	N/A	0.1	0.0	N/A	N/A
Aux Tank Flammability after inerting						
GBI	0.2	0.2	0.2	N/A	N/A	N/A
OBI	0.3	0.3	0.3	N/A	N/A	N/A
OBI, Hybrid	0.3	0.3	0.5	N/A	N/A	N/A
OBIIGGS	0.0	0.0	0.0	N/A	N/A	N/A
OBIIGGS, Hybrid	0.2	0.3	0.1	N/A	N/A	N/A
Wing Tank Flammability after inerting						
OBIIGGS	0.0	0.0	0.0	0.0	0.0	0.0
OBIIGGS, Hybrid	0.8	0.2	0.4	0.02	0.02	0.01

Figure B-1. Baseline Flammability and Flammability after inerting by tank type and design concept

Figure B-2 shows the tank mix by generic airplane family, the tank mix data was taken from the 1998 Fuel Tank Harmonization Working Group final report.

Tank/Airplane Fleet Combination	Percent of Fleet with Tank, Year 2000	Percent of Fleet with Tank, Year 2020 (Column left blank if no change from year 2000 assumed)
Heated CWT, Large Transport	64	84
Heated CWT, Medium Transport	78	88
Heated CWT, Small Transport	72	84
Heated CWT, Regional Turbofan	0	
Heated CWT, Regional Turboprop	0	
Heated CWT, Bizjet	0	
Heated or Unheated CWT, Large Transport	92	
Heated or Unheated CWT, Medium Transport	78	88
Heated or Unheated CWT, Small Transport	97	
Heated or Unheated CWT, Regional Turbofan	50	
Heated or Unheated CWT, Regional Turboprop	0	
Heated or Unheated CWT, Bizjet	0	
Wing Tank, Large Transport	100	
Wing Tank, Medium Transport	100	
Wing Tank, Small Transport	100	
Wing Tank, Regional Turbofan	100	
Wing Tank, Regional Turboprop	100	

Wing Tank, Bizjet	100	
Aux Tank, Amb Press, Large Transport	5	
Aux Tank, Amb Press, Medium Transport	0	
Aux Tank, Amb Press, Small Transport	5	
Aux Tank, Amb Press, Regional Turbofan	0	
Aux Tank, Amb Press, Regional Turboprop	0	
Aux Tank, Amb Press, Bizjet	0	

Figure B-2. Tank Type Distribution by Generic Airplane Family

Figure B-3 provide the operating hour information that formed the basis for the forecast. The data was assembled using OEM data where available. The remaining flight hour information was obtained from an independent company that records this information. Bizjet data were unavailable, but an OEM provided an estimate for Bizjet utilization.

	Large	Med	Small	R-Fan	R-Prp	Bizjet	Total
Cumulative Operating Hours Through Year 2000	1.2×10^8	0.5×10^8	4.2×10^8	0.2×10^8	2.4×10^8	0.7×10^8	9.2×10^8
Annual Worldwide Operating Hours, Year 2000	7.4×10^6	3.3×10^6	19.4×10^6	3.3×10^6	14.7×10^6	5.2×10^6	53.3×10^6
Annual N-registered Operating Hours, Year 2000	1.8×10^6	1.4×10^6	10.1×10^6	1.5×10^6	5.9×10^6	4.0×10^6	24.7×10^6

Figure B-3. Operating Hour Information

Figure B-4 gives a breakdown of the estimated pre-SFAR No. 88 accident rate based on the three most recent events. In addition the forecast worldwide-unconstrained fleet growth values are shown. These were derived from the Campbellhill World Jet Fleet Forecast (2000-2020) conducted for the Air Transport Association and were used to forecast fleet operating hours in the future. Finally, the figure shows the forecast accident breakdown by generic airplane family.

	Large	Med	Small	R-Fan	R-Prp	Bizjet	Total
Accident Rate pre-SFAR No. 88	8×10^{-9}	8×10^{-9}	8×10^{-9}	6×10^{-10}	1×10^{-10}	4×10^{-10}	5×10^{-9} (weighted avg)
Forecast Annual Fleet Growth (percent)	4.9	4.4	3.9	4.2	2.9	3.4	3.6 (weighted avg)
Forecast Worldwide Operating Hours, Year 2001 through 2020	2.5×10^8	1.1×10^8	6×10^8	1.1×10^8	4×10^8	1.5×10^8	16.1×10^8
Forecast Worldwide Accidents pre-SFAR No. 88	~2	~1	~5	~0	~0	~0	~8

Figure B-4. Accident Forecast Summary Information

The tasking statement asked that the team consider that MEL relief would be available. The team assumed that if 10 day MEL relief were granted, the average repair deferral time would be 5 days. Based on the system reliability predictions made by the Airplane Operations and Maintenance Task Team, this resulted in an average system availability of 91% for onboard systems and 99.5% for ground based inerting. These were factored in to the forecast as discussed in section 4.4.

Appendix I
Rulemaking Task Team Final Report

This page intentionally left blank.

TABLE OF CONTENTS

1.0 RULEMAKING TEAM’S TASK..... I-1

2.0 METHODOLOGY USED TO ACHIEVE THE TASK I-1

3.0 14 CFR EVALUATION I-2

 3.1 Determination of 14 CFR Sections To Be Evaluated..... I-2

 3.2 Analyses of the Regulatory Impact on Existing 14 CFR Codes..... I-3

 3.2.1 General Review Procedures..... I-3

 3.2.2 Review of 14 CFR Part 21..... I-3

 3.2.3 Review of 14 CFR Part 25..... I-4

 3.2.4 Review of 14 CFR Part 34..... I-11

 3.2.5 Review of 14 CFR Part 43..... I-11

 3.2.6 Review of 14 CFR Part 121 (Also Applicable to Parts 91, 125, and 129) I-12

 3.2.7 Review of 14 CFR Part 139..... I-16

 3.3 Development of Guidance Material for Fuel Tank Inerting Systems I-18

 3.3.1 Methodology Used to Develop the Inerting System Guidance Material..... I-18

 3.3.2 Guidance Material - Design and Certification of a Fuel Tank Inerting System I-18

 3.3.3 Guidance Material—Operation and Maintenance of a Fuel Tank Inerting System..... I-22

 3.4 Flammability Regulatory Text Evaluation and Proposal I-26

 3.4.1 Methodology Used to Develop the Flammability Regulatory Text Recommendation I-26

 3.4.2 Parameters That Lead to Controlling Fuel Tank Ullage Environment..... I-26

 3.4.3 Regulatory Text Expectation..... I-27

 3.4.4 Regulatory Text as Associated to Aircraft Safety Objectives I-27

 3.4.5 Regulatory Text Proposals..... I-28

 3.4.6 Conclusion..... I-32

 3.4.7 Guidance Material Associated to the Regulatory Text..... I-32

 3.5 Certification Cost Assessment..... I-35

ATTACHMENT 1 GUIDANCE MATERIAL - FUEL TANK INERTING SYSTEM - DESIGN, INSTALLATION AND CERTIFICATION I-37

ATTACHMENT 2 GUIDANCE MATERIAL - FUEL TANK INERTING SYSTEM - OPERATION AND MAINTENANCE I-55

This page intentionally left blank.

Rulemaking Task Team Final Report

This report summarizes the work done by the rulemaking task team in support of the overall arac fuel tank inerting harmonization working group task.

1.0 RULEMAKING TEAM'S TASK

The rulemaking team's task was defined in accordance to the FTIHWG's tasking statement. It was defined as follows:

1. To review existing regulations/advisory material/continued airworthiness instructions regarding the subject of eliminating or reducing the flammable environment in airplane fuel tank systems.
2. To prepare and coordinate within the HWG a regulatory text, for use in new rulemaking initiatives by the FAA, that would eliminate or significantly reduce the flammable environment in airplane fuel tank systems. The tasking statement stated that the recommendation proposal would be based on achieving the lowest flammability level that could be provided by [an inerting system] design that would meet FAA regulatory evaluation requirements.
3. For all system concepts recommended, develop and propose guidance material that describes the necessary analysis and/or testing that may be required to show compliance with the new regulatory text for certification and continued airworthiness.

2.0 METHODOLOGY USED TO ACHIEVE THE TASK

The methodology used by the rulemaking task team to achieve the task was as follows:

Basic Assumptions:

The rulemaking team assumed that both ground-based inerting and on-board inerting designs need to be certified and utilized. This assumption was made because the practicality of either design was unknown.

1. Determination of 14 CFR sections to be evaluated

The team determined which Title 14 of the U.S. Code of Federal Regulations (14 CFR) sections might be impacted by the two inerting-designs by examining the aircraft utilization. The team confirmed that, at a minimum, aircraft certification, aircraft maintenance and operational approval and airport facilities may be impacted. The team concluded that an assessment of the major issues affecting the 14 CFR could easily be transferred to a JAR assessment if final rulemaking was pursued.

2. Analyses of the regulatory impact on existing 14 CFR codes

The team then used the design concepts, developed by the other FTIHWG teams, to analyze the impact on the existing regulations/advisory material/continued airworthiness instructions. This analysis was done throughout the FTIHWG process in order to ensure that all design issues were accounted for in the final 14 CFR change recommendations.

3. Development of guidance material

Guidance material was developed to support the 14 CFR change proposals.

4. Flammability regulatory text proposals

Finally, regulatory text proposals that could be used by the FAA to regulate an airplane's fuel tank environment on the level of flammability reduction achieved by a practicable inerting system design concept were proposed to the Harmonization Working Group (HWG). The rulemaking team highlighted the pros and cons of each proposal, including its possible certification interpretations and its capability to allow an inerting system as an acceptable means of compliance.

5. Certification Cost Assessment

The regulatory team estimated a certification cost for both ground and on-board inerting systems. The costs were then inputted into the regulatory evaluation cost forecast.

6. HWG flammability regulatory text recommendation

The HWG was tasked to decide which proposal, if any, to recommend. The HWG's recommendation would be based on the outcome of the cost/benefit evaluation performed by the FTIHWG.

3.0 14 CFR EVALUATION

3.1 DETERMINATION OF 14 CFR SECTIONS TO BE EVALUATED

The team identified and conducted a review of the 14 CFR sections relating to aircraft certification, aircraft maintenance and operational approval and airport facilities. The 14 CFR 1-1-00 Edition as published by the U.S. Federal Aviation Administration, DOT was used as the review basis.

The European Joint Aviation Requirements (JARs) were not used as a reference basis because of the lack of JAR operational regulatory (JAR ops) expertise on the rulemaking team.

The rulemaking team concluded that the lack of JAR ops expertise and the lack of an in-depth review of the JARs did not deter the overall review objectives. The team knew that the 14 CFR and JAR part 25 aircraft certification requirements are very similar and that any differences are already documented. The team also knew that the intent of both 14 CFR and JAR operational regulations are similar. Therefore, the team decided that JAR experts could evaluate their codes, as appropriate, if a clear and concise explanation of the regulation assessment is provided.

Aircraft Certification

The rulemaking team assessed:

- 14 CFR part 21 - Aircraft -Certification Procedures for Products and Parts
- 14 CFR part 25 -Airworthiness Standards: Transport Category Airplanes

Both of these sections are utilized when certifying a Transport Category airplane and were the affected by the FAA's ignition source prevention activity (SFAR No. 88).

Other aircraft type certification standards such as 14 CFR part 23 -Airworthiness Standards: normal, utility, acrobatic and commuter category airplanes, were not assessed. The rulemaking team decided that the FAA could use the recommendations made for 14 CFR part 21 and 14 CFR part 25 to assess and to modify, if necessary, similar 14 CFR parts.

Maintenance and Operational Approval

The rulemaking team identified and assessed the following 14 CFR sections that relate to aircraft maintenance and operations:

- Part 43 - Maintenance, Preventative Maintenance, Rebuilding, and Alteration
- Part 91 - General Operating and Flight Rules
- Part 121 - Operating requirements: Domestic, flag and supplemental operations
- Part 125 - Certification and operations: Airplanes having a seating capacity of 20 or more passengers or a maximum payload capacity of 6,000 or more
- Part 129 - Operations: Foreign air carriers and foreign operators of U.S.-registered aircraft engaged in common carriage

The part 43 assessment was carried out independently.

Rulemaking Task Team Final Report

The other parts were assessed using part 121. That is, the team assumed that any change applicable to part 121 could be read over to parts 91/125/129. This assumption was made based on FAA's ignition source prevention activity (NPRM 99-18/SFAR No. 88 effective June 6, 2001).

The team did not consider Part 135 - operating requirements: Commuter and On-Demand Operations. The rulemaking team decided that the FAA could adapt the recommendations made for 14 CFR part 91/121/125/129 to other similar 14 CFR parts.

Airport Facilities

The rulemaking team identified and assessed 14 CFR part 139: Certification and Operations: Land Airports Serving Certain Air Carriers.

Environment

The rulemaking team identified and assessed 14 CFR part 34, Fuel Venting and Exhaust Emission Requirements for Turbine Engine Powered Airplanes. The team discussed whether to review ICAO regulations, but decided that ICAO regulations were very similar to 14 CFR part 34. Any conclusions made for 14 CFR part 34 could be used to initiate changes in other regulatory codes, e.g. ICAO, JAR.

3.2 ANALYSES OF THE REGULATORY IMPACT ON EXISTING 14 CFR CODES

3.2.1 General Review Procedures

The rulemaking team assessed each 14 CFR individually.

The team identified the purpose of each CFR part.

It then used engineering judgement and certification experience to conduct an evaluation of each section's regulations considering:

- both ground and on-board inerting system design concepts
- the possibility to introduce inerting systems via retroactive rulemaking (Special Federal Aviation Regulation - SFAR).

The review procedure was refined for each CFR part and is detailed in each subsection below. The procedure refinement was needed in order to ensure the completeness of the evaluation.

3.2.2 Review of 14 CFR Part 21

14 CFR part 21 provides aircraft certification procedures for products and parts.

Review Purpose

The purpose of the rulemaking's team review was to see if any of the current certification procedures would need to be changed if inerting systems were implemented on transport category airplanes.

Review Procedure

The rulemaking team evaluated 14 CFR part 21 considering:

- a. Type certification / modification activities
- b. Retroactive rule action - SFAR

The group's review basis was as follows:

“For the two certification considerations above, “Do the 14 CFR part 21 regulations permit an inerting system to be certified on a transport category airplane?” If yes, then no changes should be proposed. If no, then state the change.

Because this section concerns procedures, the group decided that the conclusions reached would be equally applicable for ground and on-board inerting systems.

Review Conclusions

a. Type certification / modification activities

The current regulations are sufficient. No changes are proposed.

b. Retroactive rule action - SFAR

Any retroactive rule action initiated by the FAA would require a change to 14 CFR part 21, the Special Federal Aviation Regulations (SFAR) section.

The SFAR regulatory action would need to state the aircraft applicability and the required compliance, including the task accomplishment statement and FAR 25 rule references, the time frame for compliance and the reference to any maintenance or inspection activities.

3.2.3 Review of 14 CFR Part 25

14 CFR part 25 provides airworthiness standards for transport category airplanes; the standards that are used to certify an aircraft, its systems and components.

Review Purpose

The purpose of the rulemaking team's review was to:

- identify which regulations would be part of an inerting system's overall certification compliance plan
- identify if any of the existing regulations need to be modified or if any new regulations need to be created (besides the flammability rule itself) due to the uniqueness of the inerting system's design
- prepare a performance-based flammability regulatory text based on the level of flammability reduction achieved by a practicable inerting system design concept that could be recommended for incorporation into 14 CFR part 25.

Review Procedure

The rulemaking team decided to breakdown this assessment into two parts:

1. the assessment of the regulatory text that require an inerting system to be installed on an aircraft (performance-based flammability regulatory text or *flammability rule*)
2. the assessment of the rules governing the design of the inerting systems (*inerting system rule*)

Part 1 - Implementation of an inerting system via 14 CFR part 25 - Flammability rule

Prior to initiating the FTIHWG, the FAA had proposed via NPRM 99-18 a performance-based flammability regulatory proposal. The Industry made a counter-proposal to the FAA as part of the docket's comments.

The task team decided to use these two proposals as a working basis for any future regulatory text proposals.

Because these two proposals were general in nature and both allowed for an inerting system to be implemented, the team decided to conduct an evaluation of the inerting system itself in order to make sure that all certification issues were understood.

Once the FTIHWG completed its inerting systems' evaluations, then the "implementation" regulatory text (flammability rule) proposals would be revisited.

Rulemaking Task Team Final Report

A comprehensive discussion of how the team assessed the regulatory text that would cause the implementation of an inerting system (performance-based flammability regulatory text) is found in section entitled “Flammability Regulatory Text Evaluation and Proposal”.

Part 2 - Inerting system design vs 14 CFR part 25

The impact of the proposed inerting systems on the 14 CFR part 25 code were determined by conducting a certification compliance evaluation of the FTIHWG’s ground based and on-board inerting design concepts.

1. Identification of technical considerations

The team first identified the technical considerations that are addressed within 14 CFR part 25. Three technical considerations for the system were identified:

- safety
- design, including installation requirements
- performance

2. Identification of subtopics within the identified technical considerations

These three categories were further subdivided as follows:

a. Safety

- Fire protection, explosion proof
- System safety analysis: FHA, FMEA
- Overpressure protection for fuel tank / airplane
- Crashworthiness
- Venting and drainage protections
- Ignition source isolation evaluation
- Physiological effects

b. Design, including installation requirements

- Mechanical systems: integrity of components and system integration
- Electrical systems: integrity of components and system integration
- NEA distribution capability; assurance that the design maintains an inert condition as declared.
- Influence of fuel types on the performance of the inert system
- Structural: structural integrity of components and system integration
- Retention of the fuel tank’s structural integrity (i.e. tank is not over pressurized)
- Control systems: software and hardware
- Incorporation of lessons learned, as applicable
- Line routing flexibility and support, including system layout
- Effect of rotorburst

- Identification of aircraft flight conditions excluded from the evaluation (example rapid descent)
- Assurance that other fuel system and engine functions and safety features are not significantly affected (i.e. fuel sensor indications, warning and automatic stop features, refuel sequences, tank transfers, ...)
- NEA supply specification
- Design objectives; level of redundancy
- Aircraft flammability characteristics within applicant's flight operation envelope and environmental envelope level (needed to substantiate performance considerations).

c. Performance Considerations

- Identification of the system's performance versus flight phase. The systems performance criteria were taken from the tasking statement.
 - For ground based inerting, it was assumed that the system would provide inert gas to the aircraft fuel tank(s) once the airplane reaches the gate, while the aircraft is on the ground between flights and the tanks should remain inert during taxi for takeoff, takeoff, climb and cruise.
 - For on-board ground inerting, it was assumed that the system would provide inert gas to the aircraft fuel tank(s) once the airplane reaches the gate, while the aircraft is on the ground between flights and the tanks should remain inert during taxi for takeoff, takeoff, climb and cruise.

3. Review basis

For each of the subtopics above, the team answered the following questions, once for ground based inerting - component and system level, and once for on-board inerting - component and system level:

- a. *WHY* - Identified the certification concern.
- b. *APPLICANT ACTION* - Identified the design considerations and acceptable methods of compliance that could be used to address the certification concern (of (a)).
- c. *REFERENCE* - Identified the associated 14 CFR part 25 paragraph and identified any areas where the existing paragraphs were insufficient to address the proposed design concepts.

The insufficiencies were recorded and identified as potential 14 CFR part 25 change proposals that are needed in order to accommodate fuel tank inerting systems within the existing regulatory framework.

Review Conclusions

Part 1 - Implementation of an inerting system - Flammability rule

This assessment was conducted separately. The conclusions are found in section entitled "Flammability Regulatory Text Evaluation and Proposal".

Rulemaking Task Team Final Report

Part 2 - Inerting system design vs 14 CFR part 25

The review identified a total of:

- three (3) insufficiencies in 14 CFR 1-1-00 Edition
- thirty six (36) applicable paragraphs in 14 CFR 1-1-00 Edition
- three (3) new concerns unique to inerting systems

Due to the number of considerations that must be regulated within a fuel system inerting design, the team recommends that if inerting systems are to be installed on transport category airplanes, then a dedicated 14 CFR part 25 paragraph, entitled “Fuel Tank Inerting System” should be adopted. This paragraph should be worded in such a way that it can apply to both ground and on board inerting systems. A proposed wording is given below:

Inerting System Regulatory Text Proposal

“§25.xxx Fuel Tank Inerting System

If, in order to show compliance with §25.981(c), a fuel tank inerting system is installed,

- (a) the fuel tank inerting system must not, under normal and failure conditions:
 - (i) allow any inerting agent leakage into the pressurized or personnel compartments, or confined spaces; and
 - (ii) allow overpressure of the fuel system.
- (b) The fuel tank inerting system must have:
 - (i) A connecting port such that a cross connection with any other supply line is not possible (applicable if supplied by an external inerting gas source).
 - (ii) At each inerting agent filler opening and each aircraft opening leading to direct contact with the inert gas, a placard at or near the filler cover or opening with the words “Fuel tank inerting” and the agent denomination.
 - (iii) A means to prevent the escape of hazardous quantities of fuel from the system in the case of loss of system supply pressure.
 - (iv) A shutoff or isolation means, whose failure to function is evident, that prevents undesirable system functioning and possible fuel leakage.
 - (v) A tolerance to variable inerting gas pressures or surges in the gas delivery system.
- (c) Cautions (placards) and warnings (indication system) should be provided to prevent unintentional entry into a confined space filled with a hazardous inert gas.
- (d) The characteristics and designation of the inert gas that ensure correct operation of the fuel tank inerting system shall be recorded in the operating limitations section of the Aircraft Flight Manual or equivalent.”

a. Insufficiencies

1. Placards

First insufficiency was found in reviewing the physiological effects of inerting. Because nitrogen enriched air (NEA) is a hazardous substance, the team determined that a placard should be mandated to advise maintenance personnel of the presence of NEA. This mandate can only be enforced via a change to 14 CFR part 25.

The team recommends that the existing 14 CFR §25.1557 - “Miscellaneous markings and placards” - be used to mandate this placard. An additional paragraph (e) “fuel tank inerting systems” can be easily added. This recommendation is applicable to any type of inerting system.

Conclusion:

Add a paragraph (e) to §25.1557 to state that any opening in the aircraft leading to direct contact with NEA should have a placard or be marked with the word “nitrogen” or “NEA” at or near the opening

OR

Create a new fuel system inerting paragraph and include this concern. (see §25.xxx (b)(ii))

2. Ground Based NEA Inerting Filler Connection

Second insufficiency was found when reviewing the ground-based inerting coupling (filler connection). The team determined that the process of filling the tank with NEA could be hazardous if certain design precautions were not taken. For instance, there could be undesirable physiological effects if NEA leaked to other parts of the aircraft or undesirable electrostatic effects if fuel was pumped through NEA distribution system. The list below provides a minimum number of design precautions to be taken. These precautions are similar to those mandated within §25.973 - Fuel Tank Filler Connection.

- Ensure that NEA cannot enter into any part of the aircraft other than the tank itself
- Ensure that the refuel hose connection and the NEA gas hose connection are incapable of cross connection
- Each NEA gas cap must provide a tight seal
- If appropriate (design dependent), provide for electrically bonding the airplane to the NEA inerting ground equipment.

The above design precautions can only be assured if a change to 14 CFR part 25 is initiated.

Therefore, the team recommends that, for ground based inerting systems only, either 14 CFR part 25 §25.973 be amended to include provisions for NEA gas coupling connector or a 14 CFR part 25 paragraph be created to include the above provisions.

Conclusion:

Add a new paragraph to 14 CFR part 25 or amend §25.973 to ensure that the Ground Based NEA Inerting Filler Connection meets the same safety standards as the Fuel Tank Filler Connection and to ensure that the refuel hose and the NEA gas hose cannot be cross connected.

OR

Create a new fuel system inerting paragraph and include this concern. (see §25.xxx (b)(i))

3. Ground Based NEA Inerting - Pressurized system

The third insufficiency was found when reviewing ground based inerting components. NEA is added to the tank via a pressurized ground system. The team therefore determined that the safety precautions for introducing pressurized NEA to the aircraft would be similar to those already mandated for fuel in 14 CFR §25.979 - Pressure Fueling System. Specifically, the team examined four subparagraphs of 25.979: §25.979(a) - addresses the manifold connection, §25.979(b) - addresses the shutoff means, §25.979(c) - addresses prevention of damage to the fuel system in case of shut off valve failure and 25.979(d) - addresses the pressure fueling system structural capability.

Rulemaking Task Team Final Report

Similar to §25.979(a), the team determined that the ground based inerting system should have means to prevent the escape of hazardous quantities of fuel from the system (via backflow) in the case of loss of pressure to the NEA supply.

Similar to §25.979(b), the team determined that a shutoff means/isolation valve is needed to prevent undesirable system functioning and possible fuel leakage. If the applicant chooses to incorporate a mechanical shut-off means/isolation valve, then the failure to close should be evident by design. If a motorized or automatic shutoff means is incorporated then an indication is needed.

Similar to §25.979(c), the team was concerned if failure of the NEA inerting system shut off means could damage the fuel tanks. The design team stated that because it's a constant pressure flow, any failure to close would result in excess NEA being vented out.

Similar to §25.979(d), the NEA inerting system would have to be shown tolerant to variable inerting gas pressures. The safety objective should be similar to the 25.979(d) requirements. However, further research and/or experience on the system may show that other design limits are appropriate.

Conclusion:

For ground based inerting designs only, add a new paragraph to 14 CFR part 25 or amend §25.979 to ensure that the pressurized NEA inerting system:

- (a) prevents the escape of hazardous quantities of fuel from the system (via backflow) in the case of loss of pressure to the NEA supply - §25.979(a)
- (b) shutoff means/isolation valve is incorporated to prevent undesirable system functioning and possible fuel leakage and that its failure to function is evident - §25.979(b)
- (c) not applicable - §25.979(c)
- (d) the NEA inerting system should be shown to be tolerant to variable inerting gas pressures or surges in the gas delivery system - §25.979(d)

OR

Create a new fuel system inerting paragraph and include this concern.(see §25.xxx (b)(iii), (b)(iv) and (b)(v)).

b. Applicable paragraphs

The following 14 CFR part 25 paragraphs were found to be pertinent in showing that an inerting system (ground or on-board) is airworthy:

- §25.365 Pressurized compartment loads
- §25.729(f) Wheels and tire failure
- §25.863 Flammable fluid fire protection
- §25.901 Installation
- §25.903 Engines
- §25.954 Fuel system lightning protection
- §25.965 Fuel tank tests
- §25.975 Fuel tank vents and carburetor vapor vents
- §25.981 Fuel tank temperature
- §25.993 Fuel system lines and fittings

- §25.994 Fuel system components
- §25.1181-1207 Powerplant Fire Protection
- §25.1141 Powerplant controls: general
- §25.1301 Function and installation
- §25.1309 Equipment, systems, and installations
- §25.1316 System Lightning Protection
- §25.1353(a) Electrical Equipment and Installations
- §25.1431(c) Electrical Equipment
- §25.1438 Pressurization and pneumatic systems
- §25.1461 Equipment containing high energy rotors
- §25.1529 Instructions for Continued Airworthiness
- §25.1541 Markings and Placards: General
- §25.1581 General Aeroplane Flight Manual section

These paragraphs will be referenced within the guidance material. The utilization and the means to demonstrate compliance to each paragraph are design and applicant specific.

Conclusion

A minimum of thirty six (36) other 14 CFR 25 paragraphs were identified as pertinent to demonstrating the airworthiness of a fuel tank inerting system.

c. New Concerns

Three new issues were raised that are unique to fuel tank inerting systems and that are not found in the current 14 CFR part 25. They are:

- Hazards due to inert gas leakage
- Hazards to the fuel system
- Inert gas characteristics and specification to ensure the system integrity

Hazards due to inert gas leakage

NEA is considered a hazardous substance. NEA is especially hazardous because it cannot be detected by human senses (odorless and colorless) and can cause injury or death within minutes. For this reason any leakage of NEA into the pressurized or personnel compartments or confined spaces requiring maintenance must be avoided and warnings must be incorporated in case of the system's failure to retain NEA. A regulation is therefore needed to ensure that all design and procedural precautions are taken.

Hazards to the fuel system

Inputting inert gas into the fuel system may cause the fuel system to overpressure. This could lead to a catastrophic failure. A regulation is therefore needed to ensure that all design and procedural precautions are taken.

Rulemaking Task Team Final Report

Inert Gas Characteristics and Specification

The fuel tank inerting system is designed to work with a certain type of inert gas. If another type of inert gas is used, then the system's integrity cannot be ensured. A regulation is therefore needed to ensure that the correct inert gas is used / generated for the certified system.

3.2.4 Review of 14 CFR Part 34

14 CFR part 34 provides fuel venting and exhaust emission requirements for turbine engine powered airplanes.

Review Purpose

The purpose of the rulemaking's team review was to determine if the emissions exhausted from fuel tank vents were regulated and how.

Review Procedure

The rulemaking team reviewed the 14 CFR part 34 paragraphs to determine whether any paragraphs dealt with emissions emitted from fuel tank vent exhausts or from fueling trucks. If a paragraph was found, then it was to be evaluated for change or for reference in any potential guidance material. If no paragraphs were found, then this was to be documented with a possible recommendation for future evaluation.

Review Conclusions

The team found no 14 CFR part 34 paragraphs that regulated the pollution emitted from fuel tank vent exhausts or from fueling trucks. 14 CFR part 34 only regulates the intentional discharge of liquid fuel to the atmosphere that is drained from the nozzle manifold after the aircraft gas turbine engines are shut down.

Some members of the FTIHWG stated that there were state or county laws that forced fuel trucks to recuperate their fumes. The applicability of these regulations was outside the scope of the tasking statement and was not further evaluated.

If inerting is pursued on a large scale and fuel tank vent exhaust emissions are regulated by the U.S. Environmental Protection Agency (EPA) or equivalent, then it is recommended that the appropriate part of 14 CFR (or equivalent) be used as the vehicle to introduce any new aircraft regulatory requirements.

3.2.5 Review of 14 CFR Part 43

14 CFR part 43 provides standards for maintenance, preventive maintenance, rebuilding and alterations.

Review Purpose

The purpose of the review was to determine whether any changes were needed to the 14 CFR part 43 standards due to the uniqueness of an inerting design.

Review Procedure

The rulemaking team reviewed the standards within 14 CFR part 43 to determine if any changes were needed. If a change was identified, then it was recorded. If no changes were identified, then the rulemaking team would issue a recommendation stating that the standards, as written, can accommodate inerting systems.

Review Conclusions

The rulemaking team determined that the 14 CFR part 43 standards did not need to be modified; today's standards can adequately accommodate an inerting system.

3.2.6 Review of 14 CFR Part 121 (Also Applicable to Parts 91/125/129)

14 CFR part 121 provides standards for operating requirements of domestic, flag and supplemental operations.

Review Purpose

The purpose of the rulemaking team's review was to determine the changes required within 14 CFR part 121 in order to accommodate an aircraft operating with a ground based or on-board fuel tank inerting system.

The recommendations from this review can be read over to other 14 CFR parts that provide operating requirements for transport category airplanes.

Review Procedure

The basis for the rulemaking's team review was:

- the design concepts defined by the FTIHWG's ground based and on-board design teams
- the results obtained from the 14 CFR part 25 assessment
- regulatory precedences set by operationally similar systems, e.g. aircraft de-icing

Using the above basis, the assessment of the 14 CFR part 121 standard was conducted.

The assessment results were provided to members of the FTIHWG's maintenance team for further review. The team issued the final recommendations based on the maintenance team's inputs.

Review Conclusions

a. General

The team determined that the type of inerting design and the final decisions by the designers, airlines and operators would highly influence the type of changes needed to 14 CFR operational sections.

The group recognized that issues concerning the reviewed 14 CFR sections may go well beyond the conclusions made below. Under the FAA system, the PIC (pilot in command) is ultimately responsible for the system (i.e. FARs' 121.533, .535, .537), and not the fueler, not the airport management and not the maintenance personnel. This means that the PIC will ultimately be held responsible for:

- (a) determining whether the fuel tanks have been properly inerted prior to takeoff, independent of the system (ground or on-board)
- (b) determining whether an on-board system can, or cannot, perform its intended function (see FAR 121.563)
- (c) deciding what to do in the event of on-board or ground based failures

The PIC's responsibilities as noted in (b) and (c) imply that there must be:

- some cockpit system/indication for determining that the fuel has been inerted to the correct levels in applicable tanks and that it stays that way, i.e. there is no harmful leakage
- abnormal procedures developed based on sensors, cockpit indications and associated caution/warnings indications

The group also acknowledged that, if inerting systems were embodied, considerations on how to grant MMEL relief, per prescribed FAA procedures, needs to be further studied. The number of potential installations, the complexity of the installations and the method by which the installations are introduced all influence allowed MMEL. Based on the information presented within the ARAC FTIHWG, the

Rulemaking Task Team Final Report

rulemaking-team’s operational specialists determined that granting of MMEL relief of any inerting system may be complex.

b. All Inerting Systems

Three specific concerns that relate to all inerting systems were identified:

- (1) The requirement to have an approved operational and maintenance program
- (2) Assurance that NEA (oxygen depleted air) can not physically harm passengers and crew
- (3) Statement of when and under what conditions aircraft may need a fuel tank inerting system

Approved operational and maintenance program

The team recommends that the regulatory change be presented in a new 14 CFR 121 (or equivalent) paragraph, in a manner similar to §121.629 - Operation in Icing Conditions. In this way, all of the information can be found in one place and not dispersed between a variety of paragraphs.

The fuel tank inerting paragraph should include the following:

- Statement of the dispatch or release condition of an aircraft containing a fuel tank inerting system
- Requirement for an approved fuel tank inerting program including details:
 - of how the certificate holder determines that he/she needs to inert the aircraft fuel tanks
 - who is responsible for this decision
 - the procedures for implementing this decision
 - the specific duties and responsibilities of each operational position
 - initial and annual recurrent ground training and testing for all personnel affected
- identification of system limitations, e.g. minimum time to inert upon landing or prior to takeoff
- definition of the confined space procedures for the inerting system
- creation of communication procedures
- identification of flight crew’s role at dispatch and at landing
- identification of the NEA’s specifications/characteristics
- a paragraph that states under what general conditions the more specific requirements are alleviated

This proposed regulatory paragraph should include or reference specific concerns that are only relevant to ground based inerting operations or on-board inerting operations. These specifics are discussed later.

NEA’s Physiological effects

Because nitrogen enriched air (oxygen depleted air) can physically harm passengers and crew in confined spaces without adequate ventilation, it is proposed to amend §121.229(c) - Location of fuel tanks - in order to state that NEA gas should be isolated from personnel compartments. The isolation should be shown for NEA gas present in both the fuel tank(s) and the inerting system equipment (pipes, valve, etc.)

The team discussed whether this was not already implicit by stating “fume proof enclosure”. It was decided that because no one has ever certified an inerting system on a transport category airplane, and no one has actually analyzed the system’s routings and consequences to the aircraft, that it is preferable to that NEA gas should be isolated from personnel compartments.

Conditions under which a fuel tank inerting system is installed

If the FAA decides to mandate fuel tank inerting systems, then the perceived role of this system should be stated within 14 CFR part 121 (or equivalent).

The team recommends creating a new §121.300 paragraph to state when and under what conditions aircraft may need a fuel tank inerting system. This may be accomplished by a sentence stating that a fuel tank inerting system may be installed on an aircraft as a means to meet the requirements of §25.xxxx of this chapter in effect on a given date.

An alternative recommendation is to modify §121.316 - Fuel tanks, using the same sentence concept.

Conclusion - all inerting systems

A significant amount of changes would have to be made to introduce inerting systems into transport category airplanes day to day operation. The concepts for rule basis changes have been identified. Specifics need to be developed with an appropriate group of experts using a design concept that is proposed for in-service use.

c. Ground Based Inerting System

The team's basis for regulatory changes specific to ground based inerting was established on two facts:

- Ground based inerting is a specific action that requires a specific, independent procedure.
- Ground based inerting cannot be accomplished without the complementary airport facilities

The operational program will be developed using procedures inherent to the ground based inerting design concept.

Because ground based inerting requires interface with the airport and ground personnel (the system is not contained to the aircraft), the team recommends that the new fuel tank regulatory paragraph make references to other applicable paragraphs within 14 CFR. The team proposes that 5 additional 14 CFR 121 paragraphs be modified (or concepts be included within the new fuel tank inerting paragraph):

- (1) §121.97 - Airports: Required Data : add NEA supply capability under (b)(1) Airports
- (2) §121.105 - Servicing and Maintenance Facilities: include NEA supply capability in equipment example
- (3) §121.117 - Airports: Required Data: add NEA supply capability under (b)(1) Airports
- (4) §121.123 - Servicing Maintenance Facilities: include NEA supply capability in equipment example
- (5) 121.135(b)(8) - Contents - Information Contained in the Manual: add new equipment, (b)(25), concerning inerting facilities or modify (b)(18) to add inerting to the refueling procedures

Conclusion- Ground Based Inerting:

For ground based inerting systems, an additional five other paragraphs need to be created/modified. The concepts of what these paragraphs should contain have been identified. Specific regulatory changes should be reviewed with the operational specialists using a design concept that is proposed for in-service use.

d. On-Board Inerting System

The team's basis for regulatory changes specific to on-board inerting was established considering:

- On-board inerting is a system integral to the aircraft; airport facilities are not needed
- The activation of the on-board system would be done on the aircraft (automatically or manual)

Rulemaking Task Team Final Report

The team did not identify any specific paragraphs for change.

The team determined that the operational program would be developed using procedures inherent to the on-board inerting design concept.

The team identified a potential MMEL impact with on-board inerting that may eventually lead to regulatory changes for pressure vessels. More aircraft everyday are affected by the loss of air from an aging pressure vessel, due to leaks, especially with the classic or aging aircraft. With air being drawn from the pressure vessel for inerting, along with a normal ongoing loss of cabin pressure, the situation exists that it will take the operation of all air conditioning packs to maintain cabin pressure. If this becomes the case, the concern is that operators will lose current MEL relief of operating or dispatching with an inoperative pack in order to assure cabin pressure as well as an operating inerting system.

If an on-board ground system is developed than the ground based and on-board recommendations should both be considered, recognizing that the airport facility requirements would be different (on-board ground - electrical source requirement; ground-based inerting - NEA supply requirement).

Conclusion- On-Board Inerting System:

For on-board inerting systems, no additional paragraphs were identified for creation or modification. If pressure vessel air is used for inerting, regulatory changes may need to be implemented somewhere in the 14 CFR code to ensure cabin air pressure is maintained as the aircraft ages or if it is dispatched on MEL relief with an inoperative pack. On-board ground inerting system may require the regulatory modifications as described under ground based inerting, recognizing that the airport facility requirements would be different (on-board ground - electrical source requirement; ground-based inerting - NEA supply requirement). Specific regulatory changes should be reviewed with the operational specialists using a design concept that is proposed for in-service use.

e. Retroactive rule action

If the FAA decides to initiate any retroactive rule action, it will initiate a change to 14 CFR Part 21 - Certification Procedures for products and parts, Special Federal Aviation Regulations (SFAR) section. The SFAR will state the applicability and the required compliance, including the task accomplishment statement and FAR 25 rule references, the time frame for compliance and the reference to any maintenance or inspection activities.

FAR 121.300 will have to be updated to be in line with the SFAR rule change. The new 121 rule will have to provide provisions concerning time required to introduce the new rule, aircraft effected, operational requirements and any grandfather clauses (especially if there is a time factor linked to equipping domestic and foreign airports).

If the FAA initiates retroactive rulemaking, the team recommends that the appropriate specialists within the Aircraft Evaluation Group work as a team to write the requirements. Specific concern to the rulemaking team is the treatment of an inerting system on MMEL/MEL (master minimum equipment list)/(minimum equipment list) treatment, especially if Airworthiness Directives are issued by the design directorate because §121.628(b)(1) will have to be enforced. §121.628(b)(1) states: "The following instruments and equipment may not be included in the Minimum Equipment List: (1) instruments and equipment that are either specifically or otherwise required by the airworthiness requirements under which the airplane is type certificated and which are essential for safe operations under all operating conditions."

The group notes that the Aircraft Evaluation Group is responsible for §121.628 - Inoperable Instruments and Equipment - and not the certification and airworthiness branch.

Conclusion - retroactive rule

A retroactive rule would be initiated by FAA decision and by a simultaneous change to 14 CFR part 21 and 14 CFR part 121 (or equivalent). The retroactive rule needs to be closely coordinated within both the FAA's certification / airworthiness standard branch and the Aircraft Evaluation Group. The FAA needs to consider carefully any retroactive rule action versus its impact on the MMEL/MEL.

f. Impact on 14 CFR part 121 (or equivalent) Subpart L, N and T

The team examined the impact of introducing a fuel tank inerting system on Subpart L - Maintenance, Preventive Maintenance and Alterations, Subpart N - Training Program and Subpart T - Flight Operations.

Given the amount of knowledge that the team has on the inerting systems and their impact on aircraft operations, the team does not recommend any specific changes to Subpart L, N or T.

However, the team recognizes that there will be a need for specific training on the embodied inerting system. This training may have to be regulated within 14 CFR part 121 (or equivalent). The regulatory text would be in line with the system's complexity. For instance, specific requirements may be instituted to ensure that a person is adequately trained for ground based servicing of an aircraft with NEA, especially if the aircraft is being serviced from gas bottles, so that the wrong gas is not put into the tanks, e.g. oxygen inputted instead of NEA.

Conclusion - Impact on 14 CFR part 121 (or equivalent) Subparts L, N and T

There are no recommendations for modifications to Subparts L, N and T based on today's knowledge of the systems. The current wording is sufficient in order to ensure proper training on inerting systems. Modifications or new paragraphs may need to be introduced once an inerting system is actually proposed for in-service use.

3.2.7 Review of 14 CFR Part 139

14 CFR part 139 provides standards for certification and operations of land airports serving certain air carriers.

Review Purpose

The purpose of the review was to determine whether any changes were needed to the 14 CFR part 139 standards due to the airport services needed to support an inerting design.

Review Procedure

The rulemaking team reviewed the standards within 14 CFR part 139 to determine if any changes were needed. If a change was identified, then it was recorded. If no changes were identified, then the rulemaking team would issue a recommendation stating that the standards, as written, can accommodate inerting systems.

Review Conclusions

The team's review identified one change to 14 CFR part 139 standards, if ground based inerting is implemented. No changes to 14 CFR part 139 were identified if on board inerting is implemented.

The change identified concerns §139.321 paragraph(b) - Handling and Storing of Hazardous Substances and Materials. Paragraph (b) states that

“Each certificate holder shall establish and maintain standards acceptable to the Administrator for protecting against fire and explosions in storing, dispensing, and otherwise handling fuel, lubricants, and oxygen (other than articles and materials that are, or are intended to be, aircraft cargo) on the airport.

Rulemaking Task Team Final Report

These standards shall cover facilities, procedures, and personnel training and shall address at least the following:

- (1) Grounding and bonding.
- (2) Public protection.
- (3) Control of access to storage areas.
- (4) Fire safety in fuel farm and storage areas.
- (5) Fire safety in mobile fuelers, fueling pits, and fueling cabinets.
- (6) After January 1, 1989, training of fueling personnel in fire safety in accordance with paragraph (e) of this section.
- (7) The fire code of the public body having jurisdiction over the airport.”

If one considers NEA as the hazardous substance, then §139.321 should be modified to add a paragraph that regulates the handling of NEA. This regulation should discuss fire safety issues, as well as confined space entry and handling issues.

If one considers that hazardous substance is the flammable vapor in the aircraft fuel tanks, and that these flammable vapors are generated by the flow of fuel from a fueling operator into the tank, then an item (b)(8) can be created. Item (b)(8)’s purpose would be to ensure the airport controls the hazard presented by an aircraft fuel tank with flammable vapors. If this option is chosen, then the airport would need to ensure:

- a. A supply of NEA inert gas, in sufficient quantities, is available in order to fuel tank ullage wash all commercially operated aircraft serving the certified airport.
- b. facilities, procedures and personnel training standards in place to protect against in-tank explosion of flammable vapors of fuel tanks on commercially operated aircraft parked upon the premises of the certified airport.
- c. all commercially operated aircraft departing the certified airport has been provide the opportunity to have its fuel tank ullage washed with inert NEA gas within “x” hours of its next departure from the certified airport.

Conclusion

If ground based inerting is pursued and the airport facilities are responsible for providing the NEA inert gas to the airport, then a revision to 14 CFR 139 is needed.

The revision can be justified in one of two ways. The first way is to regulate the safety of the public and airport when handling NEA. The second way is to regulate the hazard of the airplane and state that the airport must ensure that this hazard doesn’t exist.

The revised regulatory text should address:

- availability of NEA gas
- facility, procedures and personnel training standards
- infrastructure to ensure aircraft are inerted within a minimum time before its next departure

More specific wording was not developed because of the immaturity and impracticality of ground-based inerting.

3.3 DEVELOPMENT OF GUIDANCE MATERIAL FOR FUEL TANK INERTING SYSTEMS

Upon completion of the fuel tank inerting regulatory assessment, the rulemaking team began its development of guidance material for use in designing, certifying and operating a fuel tank inerting system.

As with the regulatory evaluation, both ground based and on-board systems were considered within the development of the guidance material.

This section provides:

- the methodology used to develop the guidance material
- elements of the proposed guidance material
 - design/certifications
 - operation
- recommendations for future work

3.3.1 Methodology Used to Develop the Inerting System Guidance Material

The regulatory text change review identified four core subjects:

1. Retroactive rule - SFAR (14 CFR parts 21 and 121)
2. Design and certification (14 CFR parts 25 and 34)
3. Operation and maintenance (14 CFR parts 43, 91, 121, 125 and 129)
4. Airport Facilities (14 CFR part 139)

The rulemaking team opted to develop guidance material for two of the four subjects:

- Design and certification (14 CFR parts 25 and 34)
- Operation and maintenance (14 CFR parts 43, 91, 121, 125 and 129)

The team determined that the retroactive rule did not need associated guidance material by nature and that the FTIHWG's airport facilities team was addressing the airport facilities issues.

The team was split by expertise. The design specialists drafted the design and certification guidance material. The operational specialists drafted the operation and maintenance guidance material.

Both teams drafted the guidance material assuming that the decision had already been made to fit a fuel tank inerting system (ground or on-board) on the aircraft. (See section entitled "Flammability Regulatory Text Evaluation and Proposal" for guidance material associated to the flammability regulatory text - how to evaluate the aircraft to decide if an inerting system needs to be fitted.)

3.3.2 Guidance Material - Design and Certification of a Fuel Tank Inerting System

This section describes the objective and proposed content of guidance material associated to the design and certification of a fuel tank inerting system. The complete guidance material proposal is found in Attachment 1 of this report.

The guidance material was derived using the fuel tank inerting systems design proposals of the two FTIHWG design teams and the regulatory evaluation assessment.

The team recommends that this guidance material be refined using real fuel tank inerting design concepts that are proposed for in-service aircraft.

Rulemaking Task Team Final Report

3.3.2.1 Objective

The objective of the team was to develop guidance material that provides information and guidance on the design, installation and certification of a NEA inerting system.

This material could then be used, if desired, to create an Advisory Circular pertaining to fuel tank inerting systems.

3.3.2.2 Assumptions

The team assumed that the applicant chose to install a NEA inerting system on one or all of its aircraft's fuel tanks. The design objective of the system is to reduce or eliminate the flammable environment created in the fuel tank's fuel/air vapor ullage (means by which to show compliance to FAR/JAR 25.xxx).

The team assumed that this guidance material would be harmonized between the US Federal Aviation Administration (FAA) and Joint Aviation Authority (JAA) prior to its publication.

The team took for granted that this guidance material would not become mandatory and would not constitute a regulation. It's purpose is to provide the applicant with advice and a method of compliance that has been found acceptable to the FAA / JAA (certifying Authorities).

3.3.2.3 Background

The team determined that if the guidance material is transformed into a stand-alone advisory circular, then a background section should be included as part of the advisory circular. If the guidance material is included in an existing advisory circular then the background section should be reviewed and updated as appropriate.

The team proposed a background section in its guidance material proposal, Attachment 1. This section states the conditions under which the guidance material proposal was drafted. The contents of this section may become obsolete as the subject matures.

3.3.2.4 Related Documents

The team then went on to list all the documents that were known to its members and that were relevant to this fuel tank inerting design and certifications.

Five categories of documents were identified:

- a. Related 14 CFR part 25 and part 34 paragraphs
- b. Published or draft FAA Advisory Circulars
- c. Society of Automotive Engineers (SAE) documents
- d. Military specifications
- e. Other publications

The purpose of the document list is to assist designers in finding supplementary information.

If this guidance material is transformed into an advisory circular, the team recommends that this listing be double checked in order to make sure that this list is not obsolete.

3.3.2.5 Definitions and Abbreviations

The team recorded all definitions and abbreviations that it felt were pertinent to a fuel-tank inerting system designer and certifier.

Some of the definitions proposed within this guidance material are supplementary to or different from those proposed by the FAA in AC 25.981-2.

3.3.2.6 Inerting System Design Concepts

The team decided that the guidance material should explain the general concept of fuel tank inerting and then explain the fundamental principles behind different fuel-tank inerting design concepts. The material developed by the FTIHWG design teams was used as the basis for the design concept explanations.

The purpose of the general concept section is to explain what is fuel tank inerting and what is its effect on the fuel/air vapor environment within the fuel tank.

The purpose of the different fuel-tank inerting design-concept sections was to identify the:

1. general principles of the inerting design
2. flight phases for which the design is most likely effective
3. general impact on the aircraft design and the aircraft operation (system criteria / operational impact, including airport facilities interface)
4. specific concerning unique equipment, e.g. air separator module (ASM)

3.3.2.7 System Installation Considerations

Fuel tanks become inert because of the operation of a system - the fuel tank inerting system.

The guidance material identifies some of the inerting system's installation considerations.

Specifically, the guidance material discusses design of the

- Distribution system
- Vent system
- Indications

3.3.2.8 Aircraft Interfaces

The fuel tank inerting system needs to be integrated with the other aircraft systems and needs to comply with all relevant 14 CFR part 25 paragraphs.

Review of the FTIHWG's identified, the following aircraft systems that may need to interface with a fuel tank inerting design:

- Electrical
- Engine bleed air
- Cabin pressurization
- Refuel

The guidance material provides installation considerations that are specific to inerting systems.

3.3.2.9 Certification Plan / Compliance Demonstration

This section of the guidance material provides general certification guidance by providing suggestion on what should be included within the fuel-tank inerting's certification plan.

The guidance material suggests that the certification plan should include:

Rulemaking Task Team Final Report

- a. A description of the fuel-tank's inerting design and operation
- b. A definition of the safety assessment activities and its inter-relationship with other activities within the design approval process
- c. An analysis that demonstrates the system's effectiveness and operating characteristics
- d. A test program definition where the test program is defined as ground, flight and/or laboratory testing.

The certification plan should be submitted by the applicant and approved by the Authority. The complexity of the certification plan will depend on the newness of the inerting's design, the newness of the aircraft installation and the experience of the applicant in designing and certifying.

3.3.2.10 Continued Airworthiness / Maintenance Considerations

The applicant will need to define the fuel-tank inerting's continued airworthiness requirements and an associated maintenance program.

The guidance material recommends that established industry procedures are used.

The team notes, however, that this section may need to be enhanced once an actual system evaluation is performed.

3.3.2.11 Nitrogen Enriched Air (NEA): Precautions to Respect

Nitrogen Enriched Air is a hazardous substance. Design precautions should be taken to avoid that any person comes in contact with NEA. Various studies have shown that improper handling of NEA or entry into a confined space without precautions can be deadly.

The guidance material states the above. The guidance material also suggests that the designer become familiar with OSHA confined space requirements. In this way the design and associated maintenance procedures can ensure that all possible precautions be built into the system to prevent bodily harm and death.

3.3.2.12 Environmental Impact

The FTIHWG determined that there would be some additional hydrocarbons spewed from the fuel tank due to inerting. The quantity was not determined. The quantity would also depend on the type of inerting system installed.

The team also determined that 14 CFR part 34 does not regulate fuel tank emissions.

However, the team was not sure if particular airports or foreign airports had different emission considerations.

The purpose of this guidance material section is to alert the designer that:

- NEA inerting displaces VOCs (increases the amount of hydrocarbons put into the atmosphere)
- Possible airport restrictions may require additional vapor recuperation techniques

3.3.2.13 Master Minimum Equipment List (MMEL) Assessment

The FTIHWG recommends that a fuel tank inerting system be considered for dispatch under the MMEL.

The guidance material makes this recommendation. It also states that the MMEL should be determined using standard industry procedures.

3.3.2.14 Final Recommendations

The guidance material developed complements that already published in AC 25.981-2. AC 25.981-2 describes the general concept of an inerting system, where as this proposal not only discusses the general concept but specific design considerations.

If the FAA decides to encourage inerting system installations on aircraft, the team recommends that either AC 25.981-2 be expanded to include fuel-tank inerting design considerations or a specific AC entitled “Fuel Tank Inerting Design and Certification” be created.

It is recommended that any Advisory Circular be re-reviewed using an actual certified inerting design. The design considerations recommended in this guidance material are based on hypothetical designs. The lessons learned during an actual design project may assist others in designing and certifying aircraft.

3.3.3 Guidance Material—Operation and Maintenance of a Fuel Tank Inerting System

This section describes the objective and proposed content of guidance material associated to the operation and maintenance of a fuel tank inerting system and to the receipt of an approved fuel tank inerting program. The complete guidance material proposal is found in Attachment 2 of this Appendix.

The guidance material was derived using the fuel tank inerting systems design proposals of the two FTIHWG design teams, the regulatory evaluation assessment and guidance material written on systems that interface with airport facilities or systems that are implemented because of environmental concerns.

The team recommends that this guidance material be refined using real fuel tank inerting design concepts that are proposed for in-service aircraft.

3.3.3.1 Objective

The objective of the team was to develop guidance material that provides:

- information and guidance on the operation and maintenance of a NEA inerting system
- guidance in obtaining approval of a fuel tank inerting program

This material could then be used, if desired, to create an Advisory Circular pertaining to fuel tank inerting systems.

3.3.3.2 Assumptions

The team assumed that the aircraft had a fuel tank inerting system (ground or on-board) installed and that the applicant (AC user) is an operator seeking to gain approval of its fuel tank inerting maintenance and operation program

The team assumed that this guidance material would be harmonized between the US Federal Aviation Administration (FAA) and Joint Aviation Authority (JAA) prior to its publication.

The team took for granted that this guidance material would not become mandatory and would not constitute a regulation. It’s purpose is to provide the applicant with advice and a method of compliance that has been found acceptable to the FAA / JAA (certifying Authorities).

3.3.3.3 Background

The team determined that if the guidance material is transformed into a stand-alone advisory circular, then a background section should be included as part of the advisory circular. The information contained in this section should be similar to the information contained in the design and certification design advisory material, with any specific information being included for relevant to operations and maintenance.

The guidance material, in Attachment 2, proposes a background section.

Rulemaking Task Team Final Report

3.3.3.4 Related Documents

The team then went on to list all the documents that were known to its members and that were relevant to this subject.

This list should be similar to the list produced for the design and certification advisory material. Any specific maintenance or operational documents, that do not influence design changes, should be quoted.

If this guidance material is transformed into an advisory circular, the team recommends that this listing be double checked in order to make sure that this list is not obsolete.

3.3.3.5 Definitions and Abbreviations

The team recorded all definitions and abbreviations that it felt were pertinent to the operation and maintenance of a fuel-tank inerting system. The definition list should be similar to the list included in the design and certification guidance material.

3.3.3.6 Fuel Tank Inerting Program Parts

The team determined that any fuel tank inerting operation and maintenance program would contain six parts:

1. Management plan
2. Dispatch conditions, including any timetables
3. Operations Manual - Inerting operational procedures
4. Maintenance program - maintenance manual
5. Training
6. Health and Safety Standards

Note: Emissions: Local airport emission requirements may have to be evaluated against the possible excess of fuel tank emissions resulting from inerting. (Emissions effects will be design and aircraft dependent.)

3.3.3.7 Management Plan

A management plan is a detailed description of the operational responsibilities and procedures associated with the implementation and conduct of the certificate holder's "fuel tank inerting program". The management plan may differ depending on the type of inerting system.

The purpose of the management plan is to ensure operational control (ensure proper execution of a fuel tank inerting program).

The management plan needs to be submitted and approved by the FAA. It should include:

- the name of the manager responsible for the overall fuel tank inerting program,
- this manager's organization including the individual group (task) managers, their functions and responsibilities against each applicable 14 CFR
- the specific elements covered by the plan. The elements should either be detailed within a specific document or be cross referenced to other internal documents

Specific elements for which the management organization needs to be detailed and approved are:

- a. operations
- b. maintenance

- c. aircraft servicing on ground
- d. others deemed critical to the management and operation of the fuel-tank inerting system

3.3.3.8 Dispatch Conditions, Including Any Timetables

Certain design features - aircraft (e.g. fuel tank's vent system) or fuel tank inerting system - may impose certain utilization conditions or limitations. These conditions / limitations may be related to time, outside ambient temperatures, flight phase, fuel tank loading or a set of multiple conditions.

If a limitation exists, then the certificate holder's program should define operational responsibilities and should develop procedures to instruct the flight crew, aircraft dispatchers, flight followers, and maintenance and ground personnel on the condition limitations, evaluation of these limitations and the resultant action to take. The procedures should include gate procedures, communication procedures with the ground and flight crew and coordination with ATC (air traffic control)

The limitations should be supported by the manufacturer's design data.

3.3.3.9 Operations Manual—Inerting Operational Procedures

Operational procedures associated to the fuel tank inerting system installed on the aircraft type should be approved as part of an operator's initial operational manual approval or as a revision to that manual, the Airport Handling Manual and/or the Minimum Equipment List.

Procedures most likely needing changing are flight preparation procedures and ground handling instructions.

A quality assurance program should be put into place in accordance with the management plan and applicable 14 CFR regulations.

The MEL should be developed based on the manufacturer's recommendations and the operator's operational policies and national operational requirements.

3.3.3.10 Maintenance Program—Maintenance Manual

Maintenance procedures for the fuel tank inerting system installed on the aircraft type should be approved as part of an operator's initial maintenance manual approval or as a revision to that manual.

Special emphasis should be put on the development and implementation of all procedures and precautions implemented because of inerting and in particular - handling of NEA, e.g., fuel tank purge procedures (open and confined spaces), fuel tank entry procedures and NEA handling policies.

For ground based inerting, the characteristics / specification of the NEA that will be used to inert the fuel tanks should be defined and recorded in the appropriate manuals.

For on-board inerting, particular attention should be paid to the efficiency (service life) of the air separator module (NEA producing capability), noting that NEA will not be produced if this component does not perform its intended function.

3.3.3.11 Training

Initial and recurrent ground training and testing for all affected personnel (e.g. aircraft dispatchers, ground crews, contract personnel, flight crew, etc.) need to be put in place.

The training syllabi should be adapted to each discipline and to the type of inerting system installed on the aircraft. For maintenance personnel, specific attention should be placed on the dangers of NEA and precautions to take when working in confined spaces.

Rulemaking Task Team Final Report

A quality assurance program should be put into place in accordance with the management plan and applicable 14 CFR regulations.

3.3.3.12 Health and Safety Standards

The operator's health and safety standards should be updated to include working with NEA. Specific areas may include but are not limited to:

- NEA handling
- Emergency care procedures
- Working in confined spaces
- Identification of health risks
- Identification of protective clothing

3.3.3.13 Emissions

Local airport emission requirements may have to be evaluated against the possible excess of fuel tank emissions resulting from inerting. (Emissions effects will be design and aircraft dependent.)

If the evaluation indicates there is a necessity to recover the VOCs, then procedures would have to be adopted accordingly and recorded within the management plan and the manual. Training courses would also need to incorporate these differences within the affected disciplines' course.

3.3.3.14 Final Recommendations

The guidance material developed within the FTIHWG describes the steps needed to obtain approval of a fuel tank inerting Operation and Maintenance Program. There is no other known recommended guidance material or Advisory Circulars existing in the public domain.

If the FAA decides to encourage inerting system installations on aircraft, the team recommends that this guidance material be used to issue an Advisory Circular entitled "Fuel Tank Inerting Operational Program Approval".

It is recommended that any Advisory Circular be re-reviewed using an actual operation and maintenance program developed for use on a certified fuel tank inerting system. The lessons learned during the implementation of the operation and maintenance program may assist others in any future implementation exercise.

3.4 FLAMMABILITY REGULATORY TEXT EVALUATION AND PROPOSAL

The rulemaking team was tasked to develop a regulatory text that could be used to regulate the fuel tank ullage environment. The FAA requested the team to develop a performance-based text where the performance criterion was defined as flammability.

The FAA's tasking statement set down the following ground rules by which the team was strictly bound:

- for the proposed regulatory text, fuel-tank inerting could be an acceptable method of compliance
- flammability was to be treated independently from fuel tank ignition prevention
- "performance-based" definition provides the applicant with a set of design requirements, not a prescriptive design requirement
- "flammability" definition - the susceptibility of the fuel/air vapor (ullage) present in a fuel tank to igniting readily or to exploding
- flammability reduction only through fuel tank inerting was to be considered by the FTIHWG, which was asked not to address or consider other methods for controlling the flammability of fuel tank ullage

3.4.1 Methodology Used to Develop the Flammability Regulatory Text Recommendation

In order to provide and substantiate a regulatory text recommendation, the team:

- identified the key parameters that could lead to controlling the fuel tank ullage environment
- identified the perceived regulatory expectations
- defined how the regulatory text may be associated to aircraft safety objectives
- proposed an outline for an evaluation standard that could be used to ensure an equivalent safety level across all product lines, including percent exposure

Regulatory text proposals were developed and evaluated (pros and cons) using the results of the above investigation.

3.4.2 Parameters That Lead to Controlling Fuel Tank Ullage Environment

The key parameters that could lead to controlling the fuel tank ullage environment were identified. This list served as the regulatory text word source. That is, in order to meet the tasking-statement's objective, the regulatory text had to be written using a variation of this word list or "parameters". The following list of "parameters" was identified:

- Flammability
- Flammable vapors
- Vapors
- Oxygen content
- Ullage
- Inerting
- Environment
- exposure

Rulemaking Task Team Final Report

- Minimization
- Development
- practical
- Limit
- control
- Ignition energy
- Temperature
- Center wing tank
- Heated center wing tank
- Body tank / auxiliary (“aux”) tanks / aircraft center tank (ACT)
- Wing tanks
- Trim tank / horizontal stabilizer tank
- Flight phase: ground operation (gate), taxi to take-off, take-off, climb, cruise, descent, landing, taxi into the gate

3.4.3 Regulatory Text Expectation

The team agreed that the primary purpose of the flammability regulatory text was to reduce the risk of a fuel tank explosion by reducing or eliminating the flammable environment that exists in the fuel tank’s ullage space.

It was agreed that flammable environment did not pose a hazard to the aircraft in isolation. The hazard was posed only if an ignition source with sufficient energy came in contact with an ullage environment that could support combustion (fuel is in its flammable range and the oxygen content is high enough to support combustion). If one or both of the items contributing to the hazardous situation were removed then fire/explosion of the fuel tank would not occur.

Recalling the task team’s ground rules for regulatory text development, the team determined that the regulatory text should:

- Equate “flammable environment control” to demonstrating that the ullage environment can not support combustion if it comes in contact with a spark.
- Ensure that the applicant controls the environment either by demonstrating that the:
 - fuel is not in the flammable range (varies with temperature, fuel type and altitude), or
 - oxygen content is too low to support combustion

The acceptable design or procedural methods and substantiation that achieve the regulatory text’s expectations are left up to the applicant.

The effectiveness and conditions under which the design/procedures need to function/be enforced should be dictated by the aircraft’s design and overall safety features.

3.4.4 Regulatory Text as Associated to Aircraft Safety Objectives

The team agreed that the regulation of fuel tank flammability could be a contributing element in preventing the aircraft “fuel tank explosion”. This conclusion was based on the circumstantial evidence

and the lack of specific cause findings in the recent fuel tank explosion accidents (see the safety section of the FTIHWG's report).

The team discussed what level of safety (per 14 CFR part 25, §25.1309) and hence redundancy should the system be required to have. This question remained unanswerable.

The tasking statement did not allow the team to examine the system as a whole versus the aircraft event "fuel tank explosion". This type of assessment would have backed out the flammability system's safety level and redundancy level because the applicant would have determined when the other features on the aircraft left the aircraft at risk. The residual risk (when and how much) would have determined the type and safety level of flammability reduction measures.

The tasking statement required that the flammability regulatory text to be independent of the other aircraft-design features. This situation did not allow other features of the aircraft to be used to set the safety and redundancy level for the system. The tasking statement provided guidance on safety level (safety enhancement) and redundancy (none). However, some group members stated that the tasking statement's assumptions were not realistic. In a "real-world" certification exercise, the applicant would either be forced to identify the "risk" condition and eliminate it or if the "risk condition" could not be identified, to design a system that ensures a flammability exposure as close to zero as possible. Both the severe design objectives and the aircraft operational reliability objectives would back out the system redundancy. In fact, most group members agreed that the system would have to be redundant to become feasible for a day-to-day transport category airplane use.

Within this discussion the team determined that any flammability regulation should ensure the "risk" condition, as defined by the accident statistics, should be assessed and found acceptable. This "risk" condition, called from now on, the "accident risk condition", was identified to be:

- aircraft operating under hot day conditions
- center wing tank empty with heat being inputted
- ground or climb phase

The group also agreed that due to uncertainty of how the accidents occurred, the "accident risk condition" should not be considered as the only risk condition. Any regulatory text and associated guidance material should ensure that similar or new-risk conditions are not created in other fuel tanks besides the center tank.

For instance an evaluation of the other tanks should be undertaken, when the fuel tank is empty or the primary potential ignition sources are uncovered (e.g. pumps). This evaluation should determine whether the fuel tank ullage enters the flammable zone and under what conditions. The design could then be altered to ensure that the risk is mitigated.

3.4.5 Regulatory Text Proposals

Regulatory text proposals were developed based on discussions of the previous section and FTIHWG Terms of Reference guidelines. Each regulatory text proposal was recorded. Pros and cons of each proposal were evaluated against the conditions discussed. A representative sample of regulatory text proposals is given below. The team used these options along with the work from the other FTIHWG groups to make a final regulatory proposal to the HWG.

Rulemaking Task Team Final Report

Option A

Section 25.981 (c) Flammable Fuel Vapors

Limit the development of flammable conditions in the fuel tanks, based on the intended fuel types, to less than X% of the expected fleet operational time defined in appendix X,

or

Provide means to mitigate the effects of an ignition of fuel vapors within the fuel tanks such that any damage caused by an ignition will not prevent continued safe flight and landing

Pros:

- provides choices on how to control the fuel tank ullage environment
- words “limit” and “development” are performance based terms that can be interpreted within the preamble and guidance material
- an Appendix can be used to standardize the evaluation criteria
- provides an alternative means of compliance - control of aircraft structural integrity and not control of the fire triangle provided through the “or” option
- allows for a compliance interpretation so that all fuel tanks need to be studied

Cons:

- because the X% is based on the overall average fleet operational time, the specific risk areas as defined by the accident statistics may be overlooked
- the results may vary due to a choice of mission parameters; mission parameters chosen may not resemble the actual operation of the aircraft
- due to variations in aircraft designs and missions, the derivation of a common industry standard X% may prove to be difficult
- the same design precautions may be able to be achieved by looking at a specific type of operation and not a fleet average

Option B

Section 25.981 (c) Center Wing Tank Ullage Environment

- (i) under ground conditions, assess the center wing tank’s thermal characteristics to show that the development of flammable conditions is limited (or an alternative wording with the same intent - limit the development of flammable ullage)
- (ii) provide means to mitigate the effects of an ignition of fuel vapors within the fuel tanks such that any damage caused by an ignition will not prevent continued safe flight and landing.

Pros:

- specifies the condition which is the major contributor to the risk “ground conditions”
- words “limit” and “development” are performance based terms that can be interpreted within the preamble and guidance material

- specifies the type of evaluation that needs to be done in order to take a design decision on how to manage fire triangle
- provides an alternative means of compliance - control of aircraft structural integrity and not control of the fire triangle provided through the “or” option
- states that an evaluation needs to be performed
- design objective is inherent and is not subjected to an interpretive percent value

Cons:

- does not require all fuel tanks to be assessed; too restrictive per tasking statement
- does not require an examination of the thermal characteristics under all flight phases to examine the state of the ullage environment
- The acceptable standard for “limiting” may change with time; an acceptable approach and design may not be acceptable for a future product due to a change of philosophy by an individual certifying authority

Option C

Section 25.981 Fuel tank ignition prevention

- (c) If systems adjacent to fuel tanks could cause significant heat transfer to the tanks:
 - (i) Means to reduce heating of fuel tanks by adjacent systems shall be provided; or...
 - (ii) Equivalent flammability reduction means shall be provided to offset flammability increases that would otherwise result from heating; or...
 - (iii) Means to mitigate the effects of an ignition of fuel vapors within fuel tanks shall be provided such that no damage caused by an ignition will prevent continued safe flight and landing.

Pros:

- Provides multiple options of controlling the environment and states that any one of the options are equally acceptable
- Is responsive to the issue of temperature’s effect on fuel tank ullage flammability
- Precludes the use of design methods that result in a relatively high likelihood that flammable vapors will develop in fuel tanks
- Provides a measurable design objective - flammability level in a heated tank shall be near that of an unheated tank
- “means to reduce heat” and “equivalent flammability reduction” can be described in guidance material

Cons:

- Does not meet the tasking statement because it is too specific in terms of the role of temperature within the evaluation

Rulemaking Task Team Final Report

Option D

Section 25.981 Fuel tank ignition prevention

- (c) If ignition sources can develop in the fuel tanks, then
 - (i) evaluate the fuel tank ullage flammability to determine whether any type or group of tanks have flammability characteristics significantly different than the others
 - (ii) if different, then provide justification to show:
 - (a) that all practical precautions have been taken to equate the tank or tanks to within 5°C (10+°F) of the slowest cooling tank on the aircraft , or
 - (b) that the fuel tank ullage environment is made non-flammable (inert), or
 - (c) means to mitigate the effects of an ignition of fuel vapors within fuel tanks shall be provided such that no damage caused by an ignition will prevent continued safe flight and landing.

Pros:

- states that if a tank does not have any ignition sources in the tank then the environment does not have to be considered
- requires an evaluation of all fuel tanks
- provides a performance comparison basis (tanks of the same aircraft)
- provides a flammability performance target via the cool down rate (temperature) or suppression of the flammable environment (inert)
- Implicates the notion that body tanks should be similar to wing tanks understanding that there is a physical difference between the two tank concepts

Cons:

- Does not meet the tasking statement because it speaks about the role of ignition sources within the environmental analysis assessment
- May not be practical to apply to in-service aircraft
- Temperature delta may not be considered prescriptive

Option E - FAR Amendment 25-102

Section 25.981(c) The fuel tank installation must include:

- (1) Means to minimize the development of flammable vapors in the fuel tanks (in the context of this rule, “minimize” means to incorporate practicable design methods to reduce the likelihood of flammable vapors), or
- (2) Means to mitigate the effects of ignition of fuel vapors within fuel tanks such that no damage caused by an ignition

Pros:

- Word “minimize” and “development” are performance based term that can be interpreted within the preamble and guidance material
- provides an alternative means of compliance - control of aircraft structural integrity and not control of the fire triangle provided through the “or” option
- design objective is inherent and is not subjected to an interpretive percent value

- implies that all fuel tanks and all flight/ground conditions are implicated in the evaluation
- Provides multiple options of controlling the environment and states that any one of the options are equally acceptable
- States the meaning of minimize with the rule text

Cons:

- a specific Appendix imposing an evaluation method is not proposed in the regulatory text
- it is up to the applicant to show “minimization”; the guidance material and preamble will provide guidance on how to “minimize”
- “minimize” does not provide a measurable goal. It is up to the applicant and regulating authority to determine that the design is satisfactory. This may lead to inconsistent level of safety.
- The acceptable standard for minimization may change with time; an acceptable approach and design may not be acceptable for a future product due to a change of philosophy by an individual certifying authority

3.4.6 Conclusion

After much deliberation, the team decided that the existing regulatory text introduced by FAR Amendment 25-102 best met the requirement of the tasking statement (Option E).

Inerting systems could be evaluated against the word practicable. That is, if the inerting system were found to be practicable then it would become the minimum standard; if not practicable then some other means of flammable reduction would become the minimum standard.

The team decided to discard the other options because it was:

- Option A: impractical to impose a numerical limitation due to the lack of an industry agreed pass/fail criteria.
- Option B: flight phase limiting; “risk” may occur in a flight phase other than ground
- Option C: primary means of compliance is through heat control; this is too restrictive for inerting and the tasking statement
- Option D: linked to ignition source control and therefore outside of the tasking statement; impractical to impose a numerical limitation due to the lack of an industry agreed pass/fail criteria

3.4.7 Guidance Material Associated to the Regulatory Text

The rulemaking team agreed that the flammability regulatory text should be associated to some guidance material.

The purpose of the guidance material is to define the “standard” by which the applicant’s product is going to be evaluated and judged acceptable. It should be used to identify the design and/or procedures that are needed to ensure the safety of the aircraft design. The guidance material should not identify how to design a system. For example, the guidance material associated to this rule should not provide advice to an applicant on how to design and operate a fuel tank inerting system.

The “standard” should be subdivided into four subtopics:

1. The circumstances for conducting an assessment of flammability
2. Decision to pursue regulatory text evaluation

Rulemaking Task Team Final Report

3. Assessment of the flammability - the state under which the product needs to be placed in order to obtain the parameters needed to make a judgement on performance (similar to the playing field and the rules of the game.)
4. The standard itself - the basis on which the compliance decision will be based (determination of compliance)

The team agreed that an acceptable performance based rule is one in which the regulatory text and the standard are compatible and ensure an equivalent safety level across all product lines.

Development of the “standard” limited by the tasking statement

The tasking statement limited the team’s ability to develop a flammability “standard”.

The tasking statement required the team to determine whether fuel tank inerting could be used as the practicable industry standard to show compliance to a flammability regulatory text. The FAA considered that Subtopics 1-3 were addressed by its Advisory Circular AC 25.981-2. Therefore, the rulemaking team only addressed subtopic 4.

Development of a “standard” excluding the tasking statement instructions

Some team members felt if the FTIHWG was to endorse or create a flammability regulatory text, then all subtopics within the “standard” definition should be addressed irrespective of the tasking statement.

The team decided to discuss each subtopic and document its general concerns. These concerns could then be expanded as appropriate to the regulatory text development.

Circumstances For Conducting An Assessment Of Flammability

AC 25.981-2 provides guidance in this area.

However, some team members felt that a flammability rule should not be applied to fuel tank ullage if all of the mechanical and electrical potential ignition sources were removed.

This determination could be made by developing qualitative pass/fail criteria; no credit is given for probability of failure. The design either complies with the condition “pass” or does not comply with the condition “fail”.

If the applicant passes the checklist then the flammability regulatory text is not applicable.

Decision to pursue regulatory text evaluation

The team agreed that the purpose of the flammability regulatory text needed to be clearly stated within the guidance material.

The aircraft design goal (aircraft safety objective) needs to be stated. Any performance-based words - “minimized”, “limit”, etc. - need to be defined. The definition can be specified as a specific goal (X% flammability exposure) or by a design assessment associated to a pass/fail criterion.

Some team members felt that the guidance material should give credit for mitigation of ignition sources via one of two means:

1. Protection of the tank from structural and systems damage in case that ignition of fuel/vapor air mixture took.

An example of an acceptable means is the use of appropriate foam. The fuel tank is filled with a type of foam that ensures the control of the pressure rise following an ignition of the fuel/air vapor mixture.

2. Snubbing of the spark prior to its coming in contact with the flammable fuel/air vapor mixture (an ignition is not created).

Assessment of the flammability

AC 25.981-2 provides a method to determine the average flammability exposure of a given tank.

Some team members raised concerns over whether an average flammability exposure calculation really provides the correct type of assessment needed to prevent the “accident risk”.

It was estimated that at least seven parameters needed to be assessed to determine if the “accident risk” has been mitigated. They are:

1. *Influence of outside ambient air temperature* - ISA / ISA +23°C (73.4°F) variation can be used to determine operational limitations and measure the effectiveness of any design/operational changes based on outside conditions.
2. *Effect of fuel loading on the fuel tank heat transfer characteristics* - the results can be used to show the thermodynamic influence of fuel on the overall ullage cooling behavior and resultant flammability exposure.
3. *Thermodynamic characteristics of each equipment/system* - the results can be used to identify the contribution of each equipment/system to the overall ullage characteristics. This in turn can be used to identify design changes or operational constraints (master minimum equipment list, ground operation procedures).
4. *Influence of ground operation time* - the results can be used to understand the influence of ground operation on the fuel tank ullage temperature. The results can be used to substantiate design decisions or operational procedures.
5. *Identification of hot spots* - the results can identify whether there is a local change in the flammability characteristics of the ullage.
6. *Differences/similarities between the tanks* - the results can identify whether any tank has an unusual thermodynamic characteristic as compared to the others. This reason for this difference can be evaluated and the used to determine if any design or operational actions need to be taken.
7. *Identification of the magnitude that a design is influenced by natural physical properties versus by design choices* - the results can be used to establish a comparison basis with ambient conditions. The results from the unheated configuration show the flammability exposure characteristic of the design based only on fuel loading, pressure and aerodynamic effects. The results from the heated configuration show the influence of the internal fuel system mechanical components and the adjacent systems on the flammability exposure. The comparison of heated and unheated results can be used to show the direct benefit on flammability exposure of any design or operational changes under a certain fuel loading and outside ambient air condition.

Team members agreed that probably both the average risk and specific risk were needed to ensure that all hazards were addressed within the design.

Determination of compliance

Team members voiced concerns over the utilization of the interpretative words such as “minimize” or “limit the development”.

Experience on past projects have shown that differing opinions between the applicant and Authority of what constitutes “minimize” or “limit” has led to costly delays in some certification programs.

Industry team members encouraged the FAA and JAA to work with them as an industry group, to develop a process and associated numerical conditions by which applicable can be judged. An example of a process, is a flow chart that provides acceptable design conditions and choices on how to proceed

Rulemaking Task Team Final Report

depending on conditions. An example of a numerical condition is an average flammability exposure percentage or a temperature limit.

3.5 CERTIFICATION COST ASSESSMENT

Below are list of activities required for certification of a fuel tank inerting means. This estimate is for one model aircraft and is not specific to a Ground Base or On-Board fuel tank inerting system. This estimate does not include design and installation of the system.

a. Qualification Testing (Assumed 4 New Parts) – 1,440 Hours Total

- 1) Review & Approve Qualification Test Procedures/Plans for New Parts (1 Man – One Month per plan)

Approximate Hours = $1 * 160 * 4 = 640$ hours (includes conformity request)

- 2) Witness Testing (1 Man - One Month)

Approximate Hours = 160 hours

- 3) Review and Approve Qualification Test Reports (1 Man - One Month per report)

Approximate Hours = $1 * 160 * 4 = 640$ hours

b. Lab Development/Testing – 6,500 Hours Total

- 1) We need to make sure we can distribute the gas throughout the tank and that the individual components function as a system. This requires planning, coordination, tank design & fabrication, system check out, test conduct, documentation and facility restoration.

Approximate Labor Hours = 6,100 hours

Approximate Material Cost = \$ 40,000 = $40,000/100 = 400$ hours

Airplane Testing - 16,049 Hours Total

- 2) Write Engineering Work Authorization (1 Man - Two Week)

Approximate Hours = $1 * 40 * 2 = 80$ hours

- 3) Write/Review Detailed Ground Test Plans and Flight Test Tip Sheets (3 Man – One Month)

Approximate Hours = $3 * 160 = 480$ hours

- 4) Conformity Inspection/Instrumentation/Shop Support/Flight Test Support (based on 737-NG FAA test)

Approximate Hours = 13,765 hours

- 5) Ground Test Portion (Ground Crew 3, Test Engineers 2, System Engineers 2, FAA Representative 1, Airplane Ground Test Hours of 68 based on 737-NG FAA test)

Approximate Hours = $(3 + 2 + 2 + 1) * 68 = 544$ hours

a) Demonstrate Fuel Tank Inerting Procedures

b) Ensure tank remains inert during prolonged ground operations with X-Wind

- 6) Flight Test Portion (Flight Crew 2, Ground Crew 3, Test Engineers 2, System Engineers 2, FAA Representative 1, Airplane Flight Test hours of 54 based on 737-NG FAA test)

Approximate Hours = $(2 + 3 + 2 + 2 + 1) * 54 = 540$ hours

- a) Demonstrate that Fuel Tank (s) remain inert during applicable phases of flight (taxi, takeoff, climb, cruise) with different fuel loads.

- 7) Propulsion Laboratory/Flight Test Reports (2 Man - Two Months)

Approximate Hours = $2 * 160 * 2 = 640$ hours

- c. Certification Documents – 2880 Hours Total

- 1) Prepare and submit a Certification Plan (1 Man Month)

Approximate Hours = $1 * 160 = 160$ hours

- 2) System Description & Analysis Report Including the System Safety Assessment (Two Man – Three Months)

Approximate Hours = $2 * 160 * 3 = 960$ hours

- 3) Ground & Flight Test Reports (2 Man - Three Months)

Approximate Hours = $2 * 160 * 3 = 960$ hours

- 4) FAA coordination (1 Man Month)

Approximate Hours = $1 * 160 = 160$ hours

- 5) Support Flight Operations Evaluations Board & MSG-3 Analysis (1 Man Month)

Approximate Hours = $1 * 160 = 160$ hours

- 6) Engine Rotor Burst Analysis Applicable only to the On-Board Inerting System (3 Man Months)

Approximate Hours = $3 * 160 = 480$ hours

Sum Total = 26,869 hours (approximately 6 Man – Two Years)

**ATTACHMENT 1
GUIDANCE MATERIAL -**

FUEL TANK INERTING SYSTEM - DESIGN, INSTALLATION AND CERTIFICATION

1. Purpose

The intent of this section is to tell the reader what is in this guidance material and how it can be used. An example of how this section could read is provided below:

“This advisory material provides information and guidance on the design, installation and certification of a NEA inerting system.

An applicant may choose to install a NEA inerting system within one or all of its aircraft’s fuel tanks in order to reduce or eliminate the flammable environment created by the fuel tank’s fuel/air vapor ullage (means by which to shown compliance to FAR/JAR 25.xxx).

The guidance provided within this advisory material is harmonized with the US Federal Aviation Administration (FAA) and Joint Aviation Authority (JAA) and is intended to provide a method of compliance that has been found acceptable. As with all AC material, it is not mandatory and does not constitute a regulation.”

2. Background

This section should include background material that is compatible with both the Advisory Circular that it’s published in and the regulation that it’s supporting. The background material drafted below provides the circumstances under which this guidance material was drafted. It is recommended that this section be revised upon publication of any of this material.

“Following the TWA 800 accident, both the NTSB and the FAA, questioned whether reducing or eliminating the flammable fuel tank environment could improve aircraft safety by further reducing the risk of a fuel tank explosion.

Traditionally, fuel tank explosions are prevented, by ensuring that there are no ignition sources within the flammable fuel-tank environment. Since the TWA 800 accident, the emphasis on fuel-tank ignition source prevention has increased. Both in-service and new type certificated aircraft have improved the robustness of their fuel-tank ignition source prevention designs. The FAA has issued a change to the FARs (FAR Amendments 21-78, 25-102, 91-266, 121-282, 125-36 and 129-30) in order to ensure that fuel-tank ignition sources are prevented.

However, even with the increased robustness of fuel-tank ignition source prevention, the FAA has concluded that a safety benefit may be achieved if the applicants took precautions to minimize the fuel/air flammable environment (termed the “flammable vapors”) on future airplanes.

The FAA, therefore, proposed a change to FAR 25 via NPRM 99-18 (published in Amendment 25-102) to add a requirement, §25.981(c), such that

“The fuel tank installation must include:

- (1) Means to minimize the development of flammable vapors in the fuel tanks (in the context of this rule, “minimize means to incorporate practicable design methods to reduce the likelihood of flammable vapors), *or*
- (2) Means to mitigate the effects of an ignition of fuel vapors within fuel tanks such that any damage caused by an ignition will not prevent continued safe flight and landing.”

The FAA has also published an associated guidance material (AC No. 25.981-2, entitled “Fuel Tank Flammability Minimization”) to complement FAR §25.981(c). The FAA stated that the purpose of this AC is to provide “information and guidance concerning compliance with the airworthiness standards for transport category airplanes pertaining to minimizing the formation or mitigation hazards from flammable fuel air mixtures within fuel tanks”.

Fuel tank inerting is suggested in Section 7.(a) of the AC as a means to reduce the flammable environment within a fuel tank. In fact, section 7.(a) states that “Fuel tank inerting is a highly effective means of reducing or eliminating the flammability exposure within a given fuel tank.”

When a FAA sponsored study (FAA Report DOT/FAA/AR-00/19) that fuel tank inerting was not only an efficient but economically viable solution, the FAA formed the ARAC Fuel Tank Inerting Harmonization Working Group. One of this group’s tasks was to formulate guidance material that could be used in designing an inerting system.

The guidance material presented herewith is the result of this task group. Its purpose is to provide a comprehensive guide on the considerations that an applicant should give to developing, installing and certificating a NEA inerting system.

3. Related Documents

Related Federal Aviation Regulations. (FAR Sections (limited to FAR 25))

An initial review of the 14 CFR part 25 sections shows that the following paragraphs prescribe the design requirements for the substantiation and certification of a NEA inerting system as presented within the ARAC FTIHWG. This should be reviewed prior to the publication of any Advisory Material.

- 1) Paragraph that directly leads to fuel tank inerting
 - §25.981(c) Flammability minimization
- 2) new paragraph:
 - §25.xxx Fuel Tank Inerting System
 - others, if created
- 3) applicable paragraphs to fuel systems, installation, indications
 - §25.365 Pressurized compartment loads
 - §25.729(f) Wheels and tire failure
 - §25.863 Flammable fluid fire protection
 - §25.901 Installation
 - §25.903 Engines
 - §25.954 Fuel system lightning protection
 - §25.965 Fuel tank tests
 - §25.975 Fuel tank vents and carburetor vapor vents
 - §25.981 Fuel tank temperature
 - §25.993 Fuel system lines and fittings
 - §25.994 Fuel system components
 - §25.1181-1207 Powerplant Fire Protection
 - §25.1141 Powerplant controls: general
 - §25.1301 Function and installation
 - §25.1309 Equipment, systems, and installations
 - §25.1316 System Lightning Protection
 - §25.1353(a) Electrical Equipment and Installations
 - §25.1431(c) Electrical Equipment
 - §25.1438 Pressurization and pneumatic systems
 - §25.1461 Equipment containing high energy rotors
 - §25.1529 Instructions for Continued Airworthiness
 - §25.1541 Markings and Placards: General
 - §25.1581 General Aeroplane Flight Manual section

Advisory Material

Rulemaking Task Team Final Report

An initial review of existing FAA advisory circulars identified a number of Advisory Circulars that may be of assistance to the applicant when designing, substantiating and certification an inerting system as presented within the ARAC FTIHWG. This list would need to be updated at the time of publication of any Advisory Circular.

1) Existing Advisory Circulars or other standards

AC 25-8 Auxiliary Fuel System Installations, dated 5/2/86

AC 25-53A Protection of Aircraft Fuel Systems Against Fuel Vapor Ignition Due to Lightning, dated 4/12/85

AC 25.981-1B Fuel Tank Ignition Sources Prevention Guidelines, dated 4/18/01

AC 25.981-2 Fuel Tank Flammability Minimization, dated 4/18/01

2) Other Guidance Material Under Development within the FTIHWG

Guidance material - Operation and Maintenance of a Fuel Tank Inerting

Society of Automotive Engineers (SAE) Documents

The following documents published by the Society of Automotive Engineers may be useful when designing, substantiating and certifying a fuel tank inerting system as presented within the ARAC FTIHWG. This list would need to be updated at the time of publication of any Advisory Circular.

- 1) SAE AIR 5128 "Electrical Bonding of Aircraft Fuel System Plumbing Systems," (January 1997).
- 2) SAE AIR 4170, "Reticulated Polyurethane Safety Foam Explosion Suppressant Material for Fuel Systems and Dry Bays"
- 3) SAE AIR 1903 "Aircraft Inerting Systems." (Draft)
- 4) SAE AIR 1662, "Minimization of Electrostatic Hazards in Aircraft Fuel Systems," (October 1984).

Military Specifications

The military specification reference is came from AC 25.981-2. No other published information from the military was made available to the ARAC FTIHWG. An enhanced research may be performed at the time of publication of a draft Advisory Circular.

- 1) MIL-B-83054, Baffle and Inerting Material, Aircraft Fuel Tank (March 1984)

Other

Some other publications were identified as being useful when designing, substantiating and certifying an inerting system as presented within the ARAC FTIHWG. An enhanced research may be performed at the time of publication of a draft Advisory Circular.

This list may need to be expanded, as more information becomes published:

- 1) FAA Document DOT/FAA/AR-98/26, Review of the Flammability Hazard of Jet A Fuel Vapor in Civil Transport Aircraft Fuel Tanks, June 1998. (A copy of this report can be obtained through the National Technical Information Service (NTIS), Springfield, Virginia 22161, or at the following web site address: <http://www.fire.tc.faa.gov>)
- 2) Aviation Rulemaking Advisory Committee, Fuel Tank Harmonization Working Group, Final Report, July 1998 (a copy of this report may be obtained on line from the U.S. Department of Transportation (DOT) electronic docket, Docket No. FAA-1998-4183, at the following web site address: <http://dms.dot.gov>)

- 3) “Effects of Fuel Slosh and Vibration on the Flammability Hazards of Hydrocarbon Turbine Fuels Within Aircraft Fuel Tanks,” Technical report AFAPL-TR-70-65 (November 1970), Edwin E. Ott. (Contact Airforce Aero Propulsion Laboratory, Airforce Systems Command, Wright-Patterson Air Force Base Ohio.)
- 4) FAA Order 8110.34A, “Procedures for the Use of Fuels for Turbine Powered Aircraft,” March 1980.
- 5) FAA Document DOT/FAA/AR-99/65, “Mass Loading Effect on Fuel Vapor Concentrations in Aircraft Fuel Tank Ullage”
- 6) FAA Document DOT/FAA/AR-00/19, “The Cost of Implementing Ground Based Fuel Tank Inerting in the Commercial Fleet”, May 2000
- 7) Aviation Rulemaking Advisory Committee, Fuel Tank Inerting Harmonization Working Group, Final Report
- 8) OSHA Standard Number 1910.146 - Permit-required confined spaces subpart J, General Environmental Controls

4. Definitions / Abbreviations

The definitions and abbreviations listed hereunder are those that may be pertinent to the design and certification of a fuel tank inerting system. Some of the definitions are different than those appearing in AC 25.981-1 and/or -2 and are marked as such.

- a) ASM: Air separator module - either a passive permeable membrane system that relies on polymer membranes to separate nitrogen from air or a molecular sieve system that adsorbs oxygen from the air
- b) Center wing tank: A fuel tank located in the aircraft’s wing box but located within the fuselage of the aircraft.
- c) Flammable: Flammable, with respect to a fluid or gas, flammable means susceptible to igniting readily or to exploding. (14 CFR Part 1, Definitions).
- d) Flammability exposure: “Exposure” refers to the mission time where a combination of items in a fire triangle, required to obtain combustion, exists. The fire triangle consists of oxygen, flammable fuel, and an ignition source. If any one of these is removed, combustion will not occur.

Note: Because fuel flammability varies with fuel temperature, fuel type and fuel altitude, exposure may vary based on the heat transfer characteristics of a fuel tank. For instance, any fuel tank that presents a large surface area to the airstream could have a smaller exposure than a fuel tank within the fuselage.

- e) Flammability range: The pressure (i.e., altitude)/temperature domain where the fuel vapor/air mixture is flammable. This domain is dependent on the type of fuel used.
- f) Fuel air ratio (FAR): The ratio of the weight of fuel vapor to the weight of air in the ullage.
- g) Fuel scrubbing: Use of inerting gas to dilute the dissolved oxygen in the fuel.

Fuel scrubbing involves the injection of inert gas in a stream of fuel. The fuel is divided in multiple small streams which provides a large fuel surface area. The inert gas is mixed with these streams and absorbed by the fuel surface. This dilutes the oxygen concentration of the air already in the fuel.

To remain inert, the fuel must be placed in a tank with inert ullage. (Otherwise, it will absorb oxygen and give up nitrogen.)

Once the fuel is scrubbed and the aircraft enters its climb and early portion of the cruise flight phase, the inert gas (mostly nitrogen) will evolve out of the fuel to the ullage.

Rulemaking Task Team Final Report

- h) Fuel tank: An aircraft volume containing fuel. Tanks contain both liquid fuel and, in the vapor space or ullage space, a fuel vapor/air mixture, with some water vapor, depending on the relative humidity in the tank.
- i) Fuel types: Different fuels are approved for use in turbine powered airplanes. The most widely used fuel types are JET-A/JET-A1 and JET-B (JP-4), per ASTM Specification D1655-99, "Standard Specification for Aviation Turbine Fuels." The approved fuel types for a given airplane type are listed in the Airplane Flight Manual (AFM). Each fuel type has its own properties; those directly related to flammability are "flash point" and "distillation" characteristics. Property differences can occur in a given fuel type as a result of variations in the source crude oil properties and the refining process used to produce the fuel.
- j) Heated fuel tank: Fuel tanks that experience a rapid rise in temperature due to the adjacent system equipment.
- k) Inert fuel tank: Fuel tank inerting, as applied to aircraft fuel tanks, can be defined as the inclusion of a gas, in the ullage prior to ignition of the vapor, that will suppress that ignition, independent of the fuel air mixture.
- l) Inert gas: A gas that will not oxidize. In fuel tanks, the ullage is considered inert when the O₂ concentration is approximately 10% or less (unless future data shows otherwise), when nitrogen is used as the inert gas.
- m) Lean Fuel Vapor/Air Mixture: A fuel vapor mixture that has insufficient concentration of fuel molecules below that which will support combustion.
- n) NEA: Nitrogen enriched air - a gas with nitrogen purity of 90-98%.
- o) Operational time: The time from the start of preparing the airplane for flight, (turning on the auxiliary power unit (APU) /ground power, starting the environmental control systems etc.), through the actual flight and landing, and through the time to disembark any payload, passengers and crew.
- p) Rich Fuel Vapor/Air Mixture: A fuel vapor/air mixture that contains a concentration of fuel molecules above that which will support combustion
- q) Ullage or ullage space: The volume within the tank not occupied by liquid fuel.
- r) Ullage washing: Use of inert gas to dilute the air above the fuel (ullage).
- s) Unheated fuel tank: a fuel tank that is not heated
(AC 25.981-2 definition - A conventional aluminum structure, integral tank of a subsonic transport wing, with minimum heat input from the aircraft systems or other fuel tanks that are heated.)
- t) Wing tank: A fuel tank located within the aircraft's wing.

Note: Generally, any tank that presents a large surface area to the airstream could be considered to have the same exposure as a wing tank. For example, fuel tanks in the horizontal or vertical stabilizer, wing-mounted pods, or externally-mounted fuselage or fairing tanks.

5. Inerting System Design Concepts

Various NEA inerting system design concepts exist. Each proposed system design concept may provide a different level of flammability protection to the aircraft.

The intent of this proposed section is to provide the applicant with general information regarding the different concepts of NEA inerting systems and general level of flammability protection that can be expected from each concept.

The applicant can then use this information to assess, which, if any, NEA inerting system could be pursued for its aircraft application.

a.) General fuel tank inerting concept

This section explains what fuel tank inerting is and its effect on the fuel/air vapor environment within the fuel tank.

Fuel tank inerting, as applied to aircraft fuel tanks, can be defined as the inclusion of a gas in the ullage prior to ignition of the vapor that will suppress that ignition, independent of the fuel air mixture. The gas used can be one that simply reduces the oxygen available for combustion, such as NEA, or one that chemically interferes with the combustion process, such as Halon 1301.

This advisory material discusses only inerting systems using NEA. Therefore, the fuel tank inerting definition can be simplified to read “fuel tank inerting is the process of displacing air from the fuel tank with an inert gas (NEA) in order to decrease the probability of combustion”.

Military studies (SAE document 1903, “Aircraft Inerting Systems”) show that the oxygen content of the fuel tank ullage should be less than 9% in order to prevent fuel tank combustion after tank penetration by a high-energy incendiary (HEI) round.

For commercial applications, minimum oxygen concentration needed to prevent catastrophic fuel tank rupture may vary by tank design. Studies indicate that a 10% by volume oxygen concentration level is sufficient to prevent combustion and subsequent catastrophic consequences, in the unlikely event of an ignition source in the fuel tank.

Further research is ongoing to evaluate the effect on commercial aircraft fuel tanks, if the minimum oxygen concentration level is increased. These results may be used as a basis for new design criteria when available.

b.) Ground Based Inerting

The purpose of this section is to state:

- (1) the general principles of ground based inerting
- (2) flight phases for which ground based inerting is effective
- (3) the general impact on the aircraft design and the aircraft operation (system criteria / operational impact, including airport facilities interface)

b.1) General principles of ground based inerting

A ground based inerting system ensures ullage washing using a source of inerting gas at the airport (external to the aircraft) and a dedicated aircraft NEA distribution system.

The NEA is supplied to the fuel tanks, by an external ground source, via a dedicated line connected to the aircraft at a specific connector. The ground connection point is a type, which only allows connection to the appropriate ground equipment. It should be positioned as to minimize interference with baggage handling and other ground departure activities.

The NEA is distributed to the fuel tanks via an aircraft distribution system. The pipe that goes between the connection and the fuel tank wall should be doubled walled in order to ensure that a single failure does not release NEA into the pressurized area or an enclosed space. The manifold installed in the tank contains a series of outlets/nozzles that discharge the NEA. Initial testing done by the FAA on a B737, showed that the volume required to inert the tank ullage is approximately 1.7 times the maximum ullage space.

Rulemaking Task Team Final Report

The ground source supply should be controlled to ensure that the delivered pressure does not exceed the allowable value for the aircraft type being serviced. The maximum supply pressure required to avoid exceeding tank design limits differ for each aircraft design.

The typical time to inert a large transport category aircraft is estimated to be around 20 minutes.

b.2) Flight phase for which ground based inerting is effective

The effectiveness of ground based inerting depends on the outside ambient air temperature, the amount of fuel in the tank(s), the aircraft vent system and the fuel type.

FAA sponsored testing on a B737, showed that ground based inerting may be effective during the ground, taxi, takeoff, climb and a portion of the cruise flight phase (with the possibility of retaining the effectiveness until the top of descent).

b.3) General impact on the aircraft design and the aircraft operation

Ground based inerting system has an effect on the aircraft design, the airport facilities needed to dispatch the aircraft and the aircraft departure procedures. Ground based inerting may have an effect on the aircraft turnaround time.

The advantages of a ground based inerting system are:

- there is a minimal impact on the aircraft weight,
- system complexity limited; system is relatively simple
- aircraft system interfaces are minimized
- standard approach to supply every aircraft with a set volume of NEA (1.7 times the maximum ullage volume) can be used
- direct aircraft cost and certification cost are minimized

The disadvantage of this system is :

- complexity and cost linked to the airport facilities and infrastructure
- recurring labor costs to provide the NEA to the aircraft
- limited protection during climb and some of cruise (depends on initial fuel load)
- only inerts center wing tank..

The overall system's operational complexity will vary depending on the amount of system automatism. For example, a non-complex system's operation could consist of:

- connecting the ground supply to the aircraft
- selecting the isolation valve open
- adding an appropriate volume of NEA
- closing the isolation valve
- disconnecting the NEA supply
- filling in a control sheet to indicate that the operation has been carried out and to record the amount of NEA added. The sheet will be passed to the flight crew for confirmation that the correct quantity was loaded.

The amount of equipment added to the aircraft will again depend on the system's complexity and the number of tanks to be inerted. Some specific design features to consider are listed hereunder:

- ensure that there is no damage to the aircraft in the event of the aircraft moving while the ground equipment is still connected: consider inclusion of a self sealing coupling incorporating a frangible device
- detect for fuel leakage into the pipe: consider installing a witness drain
- isolate the tank from an external pipe: consider installing an isolation valve

- prevent backflow of the fuel in the event of loss of pressure in the NEA supply: consider incorporating a non-return valve
- relieve any pressure that may build up in the pipe due to temperature changes: consider installing a thermal relief valve
- indication of the isolation valve functioning: consider installation of a control switch and caption lamp
- ensure that a single failure does not release NEA into the pressurized area or an enclosed space: consider double walled pipes between the connection to the tanks

Note: The ground connection coupling used in this design should be associated to an industry standard. This industry standard needs to be developed if GBI is pursued.

Other issues that need to be considered are:

- need for dedicated ground personnel
- impact on overall ground servicing operations
- impact on the airport; infrastructure, equipment, etc.
- potential environmental issues from venting the tanks overboard

c.) On Board Ground Based Inerting (OBGI), including hybrid system

The purpose of this section is to state:

- (1) the general principles of on-board ground based inerting
- (2) flight phases for which on-board ground based inerting is effective
- (3) the general impact on the aircraft design and the aircraft operation (system criteria / operational impact, including airport facilities interface)
- (4) Air separator module

c.1) General principles of on-board ground based inerting

An on-board ground based inerting system ensures ullage washing, on the ground only, via a system that carries all equipment necessary to inert the fuel tanks on board the aircraft.

This system does not operate in-flight. This system assumes that the selected fuel tanks are inert prior to leaving the terminal gate.

NEA is produced by equipment located on the aircraft. This NEA is then fed into an aircraft distribution system similar to the GBI system.

NEA is produced by forcing air through an ASM. The air must be conditioned prior to entering the ASM - temperature / water content / purity.

The system's operational objectives, amount of NEA to be produced and delivered to the aircraft's fuel system, must be assessed for each aircraft design. For instance, assumptions such as the minimum turn around time to get the tanks inert, the air source (outside or APU), the gate operational restrictions for the APU need to be considered prior to undertaking the design.

As with GBI, the system should be designed to ensure its compatibility with the fuel tank pressure limits.

The estimated time to inert a large transport category aircraft is 60 minutes.

A hybrid OBGI system can be designed. A hybrid OBGI would only run during taxi-in and taxi-out. It provide less protections than a sized OBGI system, but would reduce the system's weight, volume, power and air consumption.

Rulemaking Task Team Final Report

c.2) Flight phase for which on-board ground based inerting is effective

The effectiveness of on-board ground based inerting depends on the outside ambient air temperature, the amount of fuel in the tank(s), the aircraft vent system, the fuel type and the capacity and operating time of the system.

The effectiveness of this system is similar to that of ground based inerting (see b.(2)).

c.3) General impact on the aircraft design and the aircraft operation

On-board ground based inerting system has an effect on the aircraft design, the airport facilities needed to dispatch the aircraft and the aircraft departure procedures. On-board ground based inerting may have an effect on the aircraft turnaround time.

The advantages of an on-board ground based inerting system are:

- it can use airport resources such as air carts or electrical carts for power
- there is no operational impact between this system and other aircraft systems;
- certification activities are simplified compared to an on-board in-flight system
- aircraft is self sufficient; it is a better solution for remote airports

The disadvantages of an on-board ground based inerting system are:

- the size and the weight of the system
- the cost linked to the airport facilities (less than for ground based inerting)
- hull/skin penetration necessary for the compressor's ram air inlet and exhaust, as well as for the heat exchangers
- affect on engine/aircraft performance
- increased electrical power usage at the gate; requires a dedicated power source
- compressor and cooling fan noise
- increase in maintenance exclusion zones on ground
- provides limited protection during climb and some of cruise (depending on initial fuel load)
- poor reliability

The overall system's operational complexity will vary depending on the amount of system automatism. For example, a typical OBG system, that is not redundant, not cross-vented, has no warm up times for the ASMs and does not affect turn around time, could consist of:

- providing air to the system via an electrically driving air compressor (or alternative bleed air source)
- conditioning the air to enter into the ASMs - temperature, water content, purity
- producing the nitrogen via an ASM
- controlling the O₂ content
- distributing the NEA to the aircraft fuel tanks
- the operational control of the system, start and shutoff of the system, could be performed semi-automatically
- a recording system to state that the NEA has been added to the aircraft fuel tanks should be envisaged

The amount of equipment added to the aircraft will again depend on the system's complexity and the number of tanks to be inerted. Some specific design features to consider are listed hereunder:

compressor:

- containment features or location chosen so as to mitigate the effects of uncontained rotating equipment failure
- thermal cut-out features or ice / FOD prevention features to prevent motor overheat

- spark or flame arrestors incorporated in the compressor inlet and exits to avoid generation and propagation of sparks

ducts / vents:

- external temperature elements to automatically shutoff the system when an overheat is detected
- double walled ducting to limit the chance of NEA leakage into the pressurized section of the aircraft
- ventilation to avoid built up of NEA
- oxygen rich vents located away from fuel sources so as to not create a fire hazard
- bonding the tubing of the distribution system to prevent the creation of static electricity at high velocity flow rates of NEA

valves / sensors:

- pressure relief system to avoid fuel tank overpressure
- temperature monitoring sensors to avoid hot air being pumped into fuel tanks and increasing the risk of fuel tank explosion

general:

- development of confined entry space procedures
- air monitoring system (O2 level)
- system to ensure hot gas is not input into the tanks
- features to prevent icing of components, especially the ASM or water separator/filter
- indication system providing information on how system is operating

Other issues that need to be considered are:

- air inlet and exhaust for compressor and heat exchangers require hull/skin penetration
- potential risk from oxygen by-product
- appropriate space on the aircraft needed to fit the equipment
- potential environmental issues from venting the tanks overboard

c.4) Air separator module

The air separator module is a line replaceable unit and should be easily accessible by maintenance personnel.

The choice of ASM is up to the system designer.

One choice may be a passive permeable membrane system that relies on polymer membranes to separate nitrogen from air.

A second choice may be a molecular sieve system that adsorbs oxygen from the air.

Considerations that should be taken within the design choice are:

- Durability
- Sensitivity to hydrocarbon contamination
- Sensitivity to water contamination

d.) On-Board Inert Gas Generating System (OBIGGS) including Hybrid System

The purpose of this section is to state:

- (1) the general principles of on-board inert gas generating system
- (2) flight phases for which on-board inert gas generating system is effective

Rulemaking Task Team Final Report

- (3) the general impact on the aircraft design and the aircraft operation (system criteria / operational impact, including airport facilities interface)
- (4) Air separator module

d.1) General principles of on-board inert gas generating system

An on-board inert gas generating system, OBIGGS, generates and distributes inert gas to selected fuel tanks at all times during the flight.

The OBIGGS design definition should be compatible with the system operational objectives (flammability exposure level).

Full time operation: This type of OBIGGS system is recommended for applicants that want to stay inert throughout the flight envelope. The system design is generally driven by the aircraft descent and descent rate because the system tries to produce enough inert gas to equalize the fuel tanks and to prevent ambient air from entering the fuel tank. This type of design keeps the system inert at all times.

Hybrid system - Intermittent or low-flow operation: This type of OBIGGS system is recommended when some small exposure time is permitted and when the system size is a concern. The system selectively applies inerting to certain tanks during a specific portion of the aircraft profile. For example, this system would typically not need to be sized for descent due to the minimal exposure time of the descent (compared to the takeoff, climb and cruise) or because the fuel and ullage in the tank may have cooled off during flight.

The distribution of the NEA is via an aircraft distribution system, similar to that both the GBI and OBI system.

The NEA is produced by forcing conditioned (temperature / water content / purity) air through an ASM. The air source is the aircraft - either aircraft cabin air or bleed air.

OBIGGS is not operated on the ground so it has no effect on turn around time. OBIGGS is not operated on the ground because it is continuously topping up the tanks.

As with all inerting systems, the OBIGGS system should be designed to ensure its compatibility with the fuel tank pressure limits. For OBIGGS, if cabin air is used as the source, particular attention needs to be paid to the aircraft pressurization requirements.

d.2) Flight phase for which on-board ground based inerting is effective

A full time OBIGGS system is effective during all flight phases.

A hybrid system (an intermittent or low flow system) is effective during a selected number of flight phases. The system designer chooses these flight phases.

d.3) General impact on the aircraft design and the aircraft operation

OBIGGS has an affect on the entire aircraft design. It does not have an affect on the aircraft turn around time because it is continually topping up the tanks throughout the flight.

OBIGGS is sized to inert during normal ground and typical flight operations. Normal operations include normal takeoff, climb, cruise, descent, landing and ground operations. Emergency descent is not a normal operation. The driving case for the design is normal descent.

The advantages of an OBIGGS system are:

- All fuel tanks are inerted through all phases of flight
- Aircraft is self sufficient; it can be used at all airports
- Reduced corrosion and condensation in the fuel tanks

The disadvantages of an OBIGGS system are:

- The size and weight of the system
- Engine / aircraft performance are affected
- Hull/skin penetration necessary for the compressor's ram air inlet and exhaust, as well as for heat exchangers
- Drag penalties from heat exchanger ram inlet, exit and ASM waste exit
- Potential interference with cabin re-pressurization during descent
- If air is drawn from the cabin, cabin air distribution patterns may be affected
- Compressor and cooling fan noise
- Decreased thrust recovery from the outflow valve
- High pressure ratio compressor

The overall system's operational complexity will vary depending on the amount of system automatism. For example, a typical OBIGGS system, that is not redundant, not cross-vented, does not effect turn around time, uses bleed air as its source during climb and cruise and cabin air as its source during descent, and is not operated between flights could consist of :

- Providing air to the system via the aircraft cabin or bleed air source via an electrically driven compressor (6:1 for large and medium transport, 4:1 for all others)
- Conditioning the air to enter the ASM - temperature, water content, purity
- Producing NEA via an ASM
- Controlling the O2 content and pressure prior to NEA entering the fuel tanks
- Distributing the NEA to the aircraft fuel tanks
- The operational control of the system, start and shutoff of the system, could be performed automatically with a manual override in case of system failure
- A method to ensure that NEA is being added to the aircraft fuel tanks should be envisaged

The amount of equipment added to the aircraft will depend on the system's complexity and the number of tanks to be inerted. Some specific design features to consider are listed here under:

compressor:

- containment features or location chosen so as to mitigate the effects of uncontained rotating equipment failure
- thermal cut-out features or ice / FOD prevention features to prevent motor overheat
- spark or flame arrestors incorporated in the compressor inlet and exits to avoid generation and propagation of sparks

ducts / vents:

- external temperature elements to automatically shutoff the system when an overheat is detected
- double walled ducting to limit the chance of NEA leakage into the pressurized section of the aircraft
- ventilation to avoid built up of NEA
- oxygen rich vents located away from fuel sources so as to not create a fire hazard
- bonding the tubing of the distribution system to prevent the creation of static electricity at high velocity flow rates of NEA

valves / sensors:

- pressure relief system to avoid fuel tank overpressure

Rulemaking Task Team Final Report

- temperature monitoring sensors to avoid hot air being pumped into fuel tanks and increasing the risk of fuel tank explosion
- rapid shutoff of the shutoff valve by a high flow fuse or similar equipment, near the fuselage penetration, in order to prevent loss of cabin pressurization

general:

- development of confined entry space procedures
- air monitoring system (O2 level)
- system to ensure hot gas is not input into the tanks
- features to prevent icing of components, especially the ASM or water separator/filter
- indication system providing information on how system is operating

Other issues that need to be considered are:

- air inlet and exhaust for compressor and heat exchangers require hull/skin penetration
- potential risk from oxygen by-product
- appropriate space on the aircraft needed to fit the equipment
- potential environmental issues from venting the tanks overboard

d.4) Air separator module

The air separator module is a line replaceable unit and should be easily accessible by maintenance personnel.

The choice of ASM is up to the system designer.

One choice may be a passive permeable membrane system that relies on polymer membranes to separate nitrogen from air.

A second choice may be a molecular sieve system that adsorbs oxygen from the air.

Considerations that should be taken within the design choice are:

- Durability
- Sensitivity to hydrocarbon contamination
- Sensitivity to water contamination

6. Certification Plan / Compliance Demonstration

Any inerting system is an integral part of the fuel system. A certification plan needs to be developed in order to demonstrate the airworthiness of the system itself, including its compatibility with the surrounding systems (fuel, air, ...)

This section provides general certification guidance by providing suggestions on what could be included within the certification plan.

a.) Description:

Describe the fuel-tank inerting system design and operation.

The design description should include a description of the type of inerting system chosen, a system schematic, its interface with other aircraft systems including the cockpit, its interface with external services (for instances it needs NEA supplied from a source outside the aircraft).

The operational description should include the flight phases for which the system will be operated.

b.) Safety Assessment:

The applicant should define the safety assessment activities and their interrelationship with other activities within the design approval process.

FAR/JAR 25.1309 and its associated guidance material should be used as the basis of the assessment.

Compliance with FAR 25.901(c) should be demonstrated.

The analysis should identify any maintenance and or flight crew indications and procedures required to maintain aircraft safety as a result of fuel-tank inerting system installation.

c.) Analysis:

Analysis can be used to demonstrate the systems effectiveness and operating characteristics.

The first analysis is the flammability exposure analysis. If the applicant wishes to establish the benefit that the fuel tank inerting system has then the analysis should be done with and without the system installed.

The second type of analysis concerns the system operating characteristics. The analysis may be used to show the predicted effectiveness of the system. Its impact on other aircraft systems and its behavior under critical flight or electrical loading conditions should be evaluated.

A similarity analysis may be done to show the correct functioning of comparable systems or components.

d.) Testing: ground test, flight test and laboratory test

Ground / Flight Testing

A ground and/or flight test program should be established based on the newness of the design concept.

A flight and/or ground test program can be used to demonstrate that the fuel tank inerting system, including the NEA distribution system, is functioning as intended.

Laboratory Testing

Laboratory testing should be used, as required, for component test qualification.

e.) Compliance reports

The type of compliance reports should be provided within the certification plan.

Examples of the types of reports that may be provided are:

- System description and analysis
- System safety analysis
- Ground and flight analysis
- Component qualification reports

7. System installation considerations

Fuel tanks become inert because of the system operation. If the system is not installed and maintained correctly it can become in and of itself a hazard to the aircraft.

The fuel tank inerting system produces (OBGI and OBIGGS) and distributes NEA to one or more fuel tanks and vents the displaced fuel tank ullage overboard.

a.) Distribution system

The NEA distribution system is both external and internal to the fuel tank(s). Its purpose is to deliver NEA to the tanks.

Rulemaking Task Team Final Report

External to the tank

Because NEA is a hazardous substance, design precautions should be taken to avoid and to detect NEA leakage. Design precautions such as double walled pipes, isolation-valves, seals between interfaces and leak detection devices should be considered within the design. The distribution piping should be routed through the non-pressurized portion of the bulkhead in order to minimize the risk of leakage into the cabin.

Internal to the tank

Distribution system should be constructed in order to ensure a homogenous distribution of NEA throughout the tank. Appropriate precautions should be taken to ensure that the tank is not over-pressurized and that fuel does not contaminate the NEA distribution system. The distribution system should be bonded such that static electricity at high velocity flow rates of NEA does not create an ignition source.

b.) Vent system

The fuel tank vent system affects the efficiency of the inerting system.

Open vent system

Virtually all commercial vent-systems are designed to allow ambient air to flow into the tanks due to pressure differences between the tank and ambient.

The inert gas will freely flow out of the vent system. The system design should therefore be sized to accommodate for this loss. For OBIGGS systems, because the tanks are being kept inert all the time, the flow of the inert gas must be sufficient to limit the increase of oxygen content in the ullage due to ambient air influx.

Open, cross-vent flow

Some aircraft types vent the fuel tanks to multiple vent boxes (cross vent flow). This vent arrangement may permit a crosswind to ventilate the tanks with ambient air on the ground and/or in-flight. (FAA flight testing on a B737 showed that this type of system did not retain the NEA under ground based inerting conditions.) The effect of this type of vent should be tested.

Closed vent

Some military aircraft close the vent system with specialized check valves in order to retain inert gas in the fuel tanks. The check valves require a differential pressure to open. This feature adds a level of complexity to the vent system.

If this type of system is used, structural stresses on the wing structure should be carefully analyzed and be accounted for in the basic design. A fuel tank with an open vent will normally have some positive (expanding) or negative (contracting) pressures occurring during climb and descent until the ambient air equalizes with the pressure inside the tank. A closed-vent system exaggerates this effect by requiring the air at the high-pressure area to overcome the check valve's spring.

In a similar manner, a closed-vent system may increase the structural stress due to overflowing fuel from a fuel tank. For example, a fill valve may fail to close allowing a fuel tank to overfill into the vent system. Two-phase flow can develop when this overfill is combined with air pressure being expelled from other tanks. The addition of the backpressure from the check valve's spring will add to the total pressure within the fuel tank.

A check valve that fails closed may cause the fuel tank structure to experience high loads. For example, a check valve that failed closed on the ground would prevent air from exiting during climb resulting in a large pressure attempting to expand the fuel tank structure. A check valve that failed closed in flight

would prevent air from entering the tank during descent resulting in the ambient air attempting to crush the tank structure. Redundant check valves would alleviate these stresses.

In addition, if the fuel tank is directly supplying an engine a vacuum will develop within the tank as fuel is consumed unless air can replace the fuel. Redundant check valves would avoid the possibility of engine flameout.

In addition to redundant check valves, a tank pressure indication for the flight crew should be considered. Upon indication, the crew could reduce the climb or descent rate or level off to minimize the structural stress.

c.) Indications: cockpit, maintenance

Indications should be provided such that the user of the inerting system knows the system's condition (operational status). The type of indication should be compatible with the inerting system's design and complexity.

The user of the system should be able to know whether the system is:

- on or off,
- pressurized
- malfunctioning

For automatic systems, a manual override could be considered.

Because the inerting system is considered an added level of protection above that provided by the design features of the ignition system, it is defined by the FAA (AC 25.981-2) as a "safety enhancing" system and is not considered an "essential system". This means that no in-flight indication to the flight crew or any associated flight crew procedures would be needed (except possible if the automatic shutoff of the system fails) for enroute failure of the inerting system.

8. Aircraft Interfaces

The fuel tank inerting system needs to be integrated with the other aircraft systems and need to comply with all relevant 14 CFR part 25 paragraphs.

The fuel tank inerting systems considered within the ARAC FTIHWG showed the systems interface with, at a minimum, the electrical, air and refuel systems. The systems also affect structure and rotorburst considerations.

This section details design considerations for electrical, air and refuel systems.

Electrical system

Inerting systems can place large demands on the electrical system so it is imperative that this be taken into account during the design phase. At a minimum, an onboard system that generates inert gas will require power for a controller, control valves, heat exchanger fans, and sensors. Some designs will require power for precooler fans, additional control valves, and compressors. The power requirements may be upwards of 30 KVA or more depending on aircraft fuel tank size, number of tanks to be inerted, and the desired level of exposure.

For ground operation of the inerting equipment, ground electrical service plugs should be reviewed to ensure they have adequate capacity for the electrical power requirement. The ground service bus should also be reviewed for adequate capacity to handle the inerting system as well as the other systems that are typically operating during ground servicing. In addition, the capacity of the ground power supply should be considered to avoid overload.

For in-flight operation of the inerting equipment, in addition to the items mentioned for ground operation, consideration should be given to emergency power conditions. For example, many aircraft implement

Rulemaking Task Team Final Report

“load-shedding” which removes power from nonessential equipment in the event of generator failure. The inerting equipment should not jeopardize safe flight so system designers should consider “shedding” this equipment. Design items that should be included in this evaluation are: fleet-level exposure to a non-inert, flammable fuel tank; availability of power from the remaining generator(s) when one generator becomes inoperative; cost effectiveness of upgrading the power system to larger generator capacity; and cost effectiveness of “shedding” other nonessential equipment.

Engine bleed air system

Onboard systems that separate nitrogen from air require a source for that air. Some aircraft will elect to use engine or APU bleed air as the source.

Membrane and PSA separators generally require fuel vapor and oil to be separated from the bleed air prior to entering the separator. Water and water vapor will also adversely affect PSA separators, requiring a water separator for removal.

Environmental control systems and potable water systems also rely on bleed air for operation. The environmental control system regulates its demand for bleed air. A regulator failure can cause pressure surges in the system, which may adversely affect the inerting system. Sufficient analysis and testing should be performed to ensure the interaction between the environmental and inerting systems (and other systems drawing bleed air) don't pose a safety hazard to the aircraft or engines in the event of component failures.

Cabin pressurization system

Some aircraft may supply the air separators by compressing cabin air in lieu of, or in addition to, the engine bleed air supply. Another option is to compress engine bleed air when it's available and use compressed cabin air at other times.

Filters

The air separator module will benefit from an air filter to keep out small particles. The compressor may require a filter to keep large particles from jamming the rotor possibly causing a rotor hazard or flammability hazard.

Water separator

PSA modules are sensitive to moisture and will need to be dried once wetted. This can adversely affect system performance and should be avoided by the addition of a water separator upstream of the module(s).

Isolation valve and high-flow fuse

An isolation valve, or another means to shutoff flow, will prevent system operation during failure conditions. For example, when one of the air conditioning packs has failed and the air supply to the cabin is just sufficient for the passengers, the inerting system must be shutoff. In addition, a duct rupture downstream of the valve could quickly evacuate the cabin. This can be prevented by incorporating a “high flow” fuse that closes when the air flow exceeds the needs of the inerting system.

Redundant check valves (to avoid fuel fumes in cabin)

The inerting system couples the cabin and fuel tanks with a system of plumbing. FAR 25.967(e) requires the cabin to be separated from fuel tanks via a fume proof and fuel proof enclosure. Typically redundant check valves in series are employed in plumbing systems to prevent fumes or fuel from entering the cabin.

Refuel systems

Inerting systems operated on ground should be compatible with the refuel system, so as to avoid overpressure of the fuel tanks and to not interfere with the gauging system and the shutoff system.

If ground based inerting is used, the ground connection coupling should be to the defined industry standard.

9. Continued Airworthiness/Maintenance Considerations

The inerting system is part of the aircraft installation and therefore should meet the requirements of FAR §25.1529.

Because nitrogen is a hazardous substance, maintenance procedures should be defined in order to meet OSHA confined space requirements (OSHA No. 1910.146). Placards and environmental monitoring systems should be put in place in order to minimize the risk to the maintenance personnel.

The appropriate warning information should be included in the Maintenance Manuals. Particular attention should be paid to the ventilation systems.

10. Nitrogen Enriched Air (NEA): Precautions to Respect

Nitrogen and other inert gases are not normally dangerous but when used in confined spaces they can quickly create oxygen deficient atmosphere that can be deadly. Nitrogen is especially hazardous because it cannot be detected by human senses and can cause injury and death within minutes. In the US at least 21 people have died in 18 separate accidents between 1990 to 1996 involving the use of nitrogen in confined spaces, even with strict health and safety procedures in place. On the average, work in confined spaces kills 15 people every year in the UK across a wide range of industries, from those involving complex plant through to simple storage vessels. In addition, a number of people are seriously injured. Those killed include not only people working in the confined space but those who try to rescue them without proper training.

The health risk to ground and maintenance personnel servicing the aircraft employing nitrogen inerting technology is present not only in the fuel tanks themselves but in the location of the nitrogen generating equipment. Wherever possible such equipment should be located outside the pressure hull, however, this is not possible on the majority of production aircraft. Therefore, it will be necessary to ensure that safety system and procedures are in place to protect the aircraft and personnel working in and around them.

More detail concerning confined spaces can be found in reference 8.

11. Evaluation of the Effects on Emissions

Inerting with NEA causes additional VOCs (volatile organic compounds) to be displaced from the fuel tank. The increase in VOCs depends on the tank size and the amount ullage space (fuel quantity present in the tank).

Today, there are no 14 CFR regulations controlling fuel tank vent exhaust. However, some airports with the US and foreign airports may have local restriction on VOCs.

If these restrictions exist, then an assessment of the VOC content may need to be initiated along with a vapor recuperation system.

12. Master Minimum Equipment Assessment

The FAA state in AC 25.981-2 that an inerting system is not a flight critical system and that airplanes may be dispatched with the system inoperative for short periods of time, provided the overall exposure to flammable vapors, including dispatch with the system inoperative, meets its flammability requirements.

The standard industry method should therefore be used to propose MMEL relief, along with a proposal stating the conditions under which the system can be inoperative

**ATTACHMENT 2
GUIDANCE MATERIAL - FUEL TANK INERTING SYSTEM - OPERATION AND
MAINTENANCE**

Purpose

The purpose of this guidance material is to provide advice in obtaining approval of a fuel tank inerting program.

A fuel tank inerting program is only needed if a fuel tank inerting system is installed on an aircraft.

Background

This guidance material was created by the FTIHWG as part of its operational regulatory assessment of fuel tank inerting systems. A fuel inerting system is installed to render the fuel tank environment non-flammable.

The background section should be expanded if this guidance material is ever made into an Advisory Circular.

Related Material

List other applicable ACs and industry standards including health and safety standards.

The FARs that would be referenced here would depend on the type of inerting system certified on the aircraft.

The references in the design guidance material could be used as applicable.

Other references to add, if determined applicable at the time of the Advisory Circular publication are:

- 3.1 (National Fire Protection Agency)NFPA 410 chapter 4 Aircraft Fuel Maintenance
- 3.2 OSHA Standard Number 1910.146 - Permit-required confined spaces subpart J, General Environmental Controls
- 3.3 Confined Space by Eric LeBreton - Canadian Transport Emergency Centre , Canutec Web site

Definitions

The type of definitions may be the same as those listed in the design guidance material. Specific definitions related to the operation of a NEA inerting system may be added based on an actual system design..

- a). ASM: Air separator module - either a passive permeable membrane system that relies on polymer membranes to separate nitrogen from air or a molecular sieve system that adsorbs oxygen from the air
- b). Center wing tank: A fuel tank located in the aircraft's wing box but located within the fuselage of the aircraft.
- c). Flammable: Flammable, with respect to a fluid or gas, flammable means susceptible to igniting readily or to exploding. (14 CFR Part 1, Definitions).
- d). Flammability exposure: "Exposure" refers to the mission time where a combination of items in a fire triangle, required to obtain combustion, exists. The fire triangle consists of oxygen, flammable fuel, and an ignition source. If any one of these is removed, combustion will not occur.

Note: Because fuel flammability varies with fuel temperature, fuel type and fuel altitude, exposure may vary based on the heat transfer characteristics of a fuel tank. For instance, any fuel tank that presents a large surface area to the airstream could have a smaller exposure than a fuel tank within the fuselage.

- e). Flammability range: The pressure (i.e., altitude)/temperature domain where the fuel vapor/air mixture is flammable. This domain is dependent on the type of fuel used.
- f). Fuel air ratio (FAR): The ratio of the weight of fuel vapor to the weight of air in the ullage.
- g). Fuel tank: An aircraft volume containing fuel. Tanks contain both liquid fuel and, in the vapor space or ullage space, a fuel vapor/air mixture, with some water vapor, depending on the relative humidity in the tank.
- h). Fuel types: Different fuels are approved for use in turbine powered airplanes. The most widely used fuel types are JET-A/JET-A1 and JET-B (JP-4), per ASTM Specification D1655-99, "Standard Specification for Aviation Turbine Fuels." The approved fuel types for a given airplane type are listed in the Airplane Flight Manual (AFM). Each fuel type has its own properties; those directly related to flammability are "flash point" and "distillation" characteristics. Property differences can occur in a given fuel type as a result of variations in the source crude oil properties and the refining process used to produce the fuel.
- i). Heated fuel tank: Fuel tanks that experience a rapid rise in temperature due to the adjacent system equipment.
- j). Inert fuel tank: Fuel tank inerting, as applied to aircraft fuel tanks, can be defined as the inclusion of a gas, in the ullage prior to ignition of the vapor, that will suppress that ignition, independent of the fuel air mixture.
- k). Inert gas: A gas that will not oxidize. In fuel tanks, the ullage is considered inert when the O₂ concentration is approximately 10% or less (unless future data shows otherwise), when nitrogen is used as the inert gas.
- l). Lean Fuel Vapor/Air Mixture: A fuel vapor mixture that has insufficient concentration of fuel molecules below that which will support combustion.
- m). NEA: Nitrogen enriched air - a gas with nitrogen purity of 90-98%.
- n). Operational time: The time from the start of preparing the airplane for flight, (turning on the auxiliary power unit (APU) /ground power, starting the environmental control systems etc.), through the actual flight and landing, and through the time to disembark any payload, passengers and crew.
- o). Rich Fuel Vapor/Air Mixture: A fuel vapor/air mixture that contains a concentration of fuel molecules above that which will support combustion
- p). Ullage or ullage space: The volume within the tank not occupied by liquid fuel.
- q). Ullage washing: Use of inert gas to dilute the air above the fuel (ullage).
- r). Unheated fuel tank: a fuel tank that is not heated
(AC 25.981-2 definition - A conventional aluminum structure, integral tank of a subsonic transport wing, with minimum heat input from the aircraft systems or other fuel tanks that are heated.)
- s). Wing tank: A fuel tank located within the aircraft's wing.
Note: Generally, any tank that presents a large surface area to the airstream could be considered to have the same exposure as a wing tank. For example, fuel tanks in the horizontal or vertical stabilizer, wing-mounted pods, or externally-mounted fuselage or fairing tanks.

Fuel Tank Inerting Program Elements

- a.) Management plan: a detailed description of the operational responsibilities and procedures associated with the implementation and conduct of the certificate holder's "fuel tank inerting program".

Note: the management plan may differ depending on the type of inerting system.

Rulemaking Task Team Final Report

- b.) Establishment of inerting timetables/dispatch conditions: (design dependent) a set of timetables associated to the effectiveness of the inerting process. These timetables may need to associate inerting with arrival or departure time, ambient air temperature, etc.. For GBI there may be a “validity time”. Associated limitations need to be defined, provided and used by the certificate holder’s personnel.
- c.) Establishment of inerting operational procedures: Aircraft inerting procedures and responsibilities need to be defined - aircraft arrival, dispatch, maintenance
- d.) Establishment of maintenance program: a maintenance program and associated precautions
- e.) Training: Initial and recurrent ground training and testing for all affected personnel (e.g. aircraft dispatchers, ground crews, contract personnel, flight crew, etc.) need to be put in place. The type of training will be system dependent (GBI / OBIGGS)
- f.) Health and Safety Standards: Health and safety standards will need to be revised to include the use of nitrogen.

Note: Emissions: Local airport emission requirements may have to be evaluated against the possible excess of fuel tank vent emissions (VoCs) resulting from inerting. (Emission effects will be design and aircraft dependent.)

Management plan

Purpose of the plan is to ensure that operational control (ensure proper execution of a fuel tank inerting program).

The plan needs to be submitted and approved by the FAA. The plan includes :

- the manager responsible for the overall fuel tank inerting program,
- this manager’s organization including the individual group (task) managers, their functions and responsibilities against each applicable FAR
- the specific elements covered by the plan. The elements should either be detailed within a specific document or be cross referenced to other internal documents

Specific elements for which the management organization needs to be detailed and approved are:

a) Operations:

The management position responsible for ensuring that all elements of the inerting program are developed, integrated and coordinated needs to be identified. This person is responsible for ensuring that the plan and program are circulated and implemented throughout the organization to those people who have duties, responsibilities and functions to accomplish within the overall program plan. The plan should consider the following:

- for each airport where fuel tanks will be inerted, determine who will be responsible for operational procedures linked to inerting
- specify the functions, duties, responsibilities, instructions and procedures to be used by flight crew members, air dispatchers and management dispatch personnel for safely accomplishing inerting (ground procedures) and dispatching an aircraft with an inert fuel tank(s)
- if inerting is linked to a “validity time”, then define a detailed procedure to re-perform the fuel tank inerting and re-dispatch the aircraft. Coordination with the ATC, ground operation personnel, flight crewmembers, dispatchers or flight followers, contract personnel and management personnel should be detailed. Consideration of whether GBI can be done with passengers on board needs to be accounted for in the final plan.

- Ensure oversight of the program

b) Maintenance:

Identify who is responsible for ensuring that enough trained and qualified personnel, as well as adequate facilities and equipment are available at each airport where fuel tank inerting operations are expected. The management plan should:

- ensure that all necessary maintenance elements of management plan and fuel tank inerting program have been developed (in accordance with the aircraft type and manufacturers recommendations), integrated and coordinated.
- Detail the duties, responsibilities and function of this plan and ensure that this has been circulated and implemented by the persons assigned to perform the specific duties.
- Ensure management oversight of the program
- Incorporate a detailed description of the maintenance portion of the fuel tank inerting program in the certificate holder's manuals for use and guidance of maintenance, ground, flight crew, contract and management personnel.

c) Aircraft Servicing on Ground

The interface of fuel tank inerting procedure with the other pre-departure activities needs to be detailed and diffused. Management of activities such as refueling, baggage/cargo loading, catering services, toilet servicing, etc. need to be integrated and coordinated with the fuel tank inerting activity.

Precautions, including the dangers of what could happen if these precautions are not respected, that need to be taken by persons providing these other interface services should be developed, diffused and implemented.

Establishment of inerting timetables/dispatch conditions

Certain design features - fuel tank and vent system or the inerting system - may have certain limitations. The limitations may be related to time, outside ambient temperatures or fuel tank loading.

These limitations are design dependent and will be defined by the OEM. Not all designs will have limitation conditions!

Operational procedures should be established in order to ensure that these limitations are respected.

If one of these limitations exists, then the certificate holder's program should define operational responsibilities and should develop procedures to instruct the flight crew, aircraft dispatchers, flight followers, and maintenance and ground personnel on the condition limitations, evaluation of these limitations and the resultant action to take. The procedures should include gate procedures, communication procedures with the ground and flight crew and coordination with ACT.

The limitations should be supported by the manufacturer's design data.

a) "Validity Time"

For ground based inerting, the effect of inerting may be time limited; that is the fuel tank ullage may only stay inert for a certain period of time.

For on board inerting, the inerting system may have to be started a certain minimum time prior to dispatch. If its operation is interrupted (or stopped), then the effect of inerting may be time limited

The "validity time" clock starts from the time the inerting process is completed and stops when the aircraft pushes back from the gate.

Rulemaking Task Team Final Report

Procedures to determine the action if the “validity time” is exceeded shall be detailed and defined in the certificate holder’s program.

b) Outside Air Temperature

Fuel tanks may only have to be inerted when the ambient temperature is above a certain limit. This limit is dependent on the fuel tank design and shall be provided by the manufacturer.

A procedure, and the associated responsibility definition, should be put into place to define when inerting is needed based solely on outside air temperature. The procedure should define the effect of the increase/decrease of temperature with time of day and the projected weather forecast.

c) Fuel Tank Loading

Fuel tank inerting may only be needed if the fuel tank is being dispatched not full. This limit is dependent on the fuel tank design and shall be provided by the manufacturer.

A procedure, and the associated responsibility definition, should be put into place to define when inerting is needed based solely on fuel tank loading.

d) Multiple conditions

A multiple set of conditions may need to exist in order to forego fuel tank inerting. The manufacturer shall define these conditions.

A procedure, and the associated responsibility definition, should be put into place to define when inerting is needed. Particular attention should be paid to the decision criteria used and the communication of the decision.

Operations Manual

a) General

Operational procedures regarding the fuel tank inerting system install on the aircraft type should be approved as part of an operator’s initial operational manual approval or as a revision to that manual.

A quality assurance program should be put into place in accordance with the management plan and applicable FAR regulations.

b) Operating Procedures

Specific attention should be paid to the impact that fuel tank inerting has on the flight preparation instructions and the ground handling instructions. Each aircraft manufacturer (or fuel tank inerting system supplier) should provide the operator with system operating instructions / recommendations. These instructions may vary depending on the type of fuel tank inerting system installed.

Flight preparation procedures may be impacted, if the operator needs to determine whether or not the fuel tank needs to be inerted. The decision criteria, developed under section 7.0, should be used, as appropriate.

Ground handling instructions should include,

- Safety precautions to be taken when inerting (GBI)
- Changes that inerting brings to current procedures or precautions, such as fuel mixing precautions
- Embarking and disembarking passengers while the fuel tanks are being inerted
- Crew procedures that will ensure the proper precautions are taken to avoid NEA vapors from entering the cabin while passengers and/or flight crew are on board. (Manufacturer recommendation - design dependent.)

- Safety precaution on the ramp - identification of areas that should be avoided by passengers/flight crew embarking / disembarking /inspecting the airplane due to the presence of NEA
- Start-up procedure (OBIGGS)
- Communication instructions

It is noted that the Airport Handling Manual may need to be updated due to the presence of an inerting system.

The operator may opt to create a dedicated fuel-tank inerting section within its ground handling procedure section of the operating manual. The management plan (section 6.0), the timetable/dispatch conditions (section 7.0), fuel tank inerting procedures, communication procedures and cockpit preparation procedures could be discussed within this dedicated section.

c) Minimum Equipment List (MEL)

The presence of a fuel tank inerting system may impact the operator's MEL.

As with other systems, the MEL for a fuel tank inerting system should be developed based on the manufacturer's recommendations and the operator's operational policies and national operational requirements.

The MEL determination will be made considering that an acceptable level of safety is maintained with this system non-operational. Specific compensating factors, which may allow the acceptable level to be maintained are: appropriate operating limitations, transfer of the function to another system, alternative means to produce a similar effect.

The Technical Log will be used to record when and why the aircraft's fuel tank inerting system is dispatched on MEL. Any operational limitations should also be noted. The rectification of this MEL item should also be recorded in the Technical Log and include the details of the rectification as well as a statement that the MEL item has been removed.

Maintenance Manual

a) General

Maintenance procedures for the fuel tank inerting system installed on the aircraft type should be approved as part of an operator's initial maintenance manual approval or as a revision to that manual.

A quality assurance program should be put into place in accordance with the management plan and applicable FAR regulations.

b) NEA Handling Policies

Special emphasis should be put on the development and implementation of all procedures and precautions implemented because of inerting and in particular - handling of NEA. This includes:

- Fuel tank purge procedures - open and confined spaces
- Fuel tank entry procedures
- Precautions around fuel tank vents
- Precautions around NEA supply trucks
- Recuperation of fuel tank vent gas (recuperation of VoCs)
- Special clothing or protection gear
- emergency care in case of asphyxiation by NEA

Rulemaking Task Team Final Report

- NEA handling procedures

c) NEA specifications / characteristics

GBI - The characteristics / specification of the NEA that will be used to inert the fuel tanks should be defined and recorded in the appropriate manuals.

OBIGGS - Particular attention should be paid to the efficiency (service life) of the air separator module (nitrogen producing capability), noting that nitrogen will not be produced if this component does not perform its intended function.

Training Requirements

All persons involved in the maintenance, dispatch and operation of the aircraft need to receive initial and recurrent training on the functioning, operation and procedures associated to the fuel tank inerting system, as well as the danger of nitrogen if these procedures are not respected. These persons are:

- Flight crew
- Dispatcher
- Ground personnel
- Contractor
- Maintenance personnel

The training syllabi should be adapted to each discipline and to the type of inerting system installed on the aircraft. However, each course should include:

- A description of the inerting system, including its purpose
- The benefits and potential dangers of the system
- Hazards and handling of NEA
- A description of the management plan and communication process - overall process of who is involved and the specific role of the discipline being trained
 - The specific requirements of the program and the duties, responsibilities and functions detailed in the program
- Emergency care procedures if nitrogen asphyxiation occurs
- A test or qualification examine

For maintenance personnel, specific attention should be placed on the dangers of nitrogen and precautions to take when working in confined spaces.

The operator should ensure that its initial and recurrent training program for each discipline is described in detail and documented in the company's training requirements.

Health and Safety Standards

The operator's health and safety standards should be updated to include working with NEA. Specific areas may include but are not limited to:

- NEA handling
- Emergency care procedures

- Working in confined spaces
- Identification of health risks
- Identification of protective clothing

Emissions

Certain countries may have national regulations concerning the amount of VOCs released into the atmosphere.

Each operator must assess the environmental impact using the manufacturer emissions estimation and the national environmental regulation.

The result of this assessment may lead to the mandatory recovery of the VOCs or the prohibition of fuel tank inerting within the national airspace. If this happens ground or flight procedures would have to be adopted accordingly and recorded within the management plan and the manual. Training courses would also need to incorporate these differences within the affected disciplines' course.