



## Department of Energy

Washington, DC 20585

May 11, 1999

The Honorable John T. Conway  
Chairman  
Defense Nuclear Facilities Safety Board  
625 Indiana Avenue, N.W.  
Suite 700  
Washington, D.C. 20004-2901

Dear Mr. Chairman:

The Department has devoted considerable attention and resources to better understand the lightning phenomena and its effects on nuclear weapons operations. The Board's assistance in this effort has been instrumental in the achievement of enhanced safety margin and improved facility capabilities through bonding and surge suppression upgrades.

In response to your letter of March 25, 1999, enclosed please find the Lightning Protection Project Team Report on the risk from lightning in Pantex nuclear explosive areas. The report includes the current status of the lightning protection enhancement effort at Pantex. It is anticipated that the report will be periodically updated to reflect any significant changes (e.g., National Laboratories' retest of 12-96 catenary system). Updates to the report will be made available to the Defense Nuclear Facilities Safety Board (DNFSB) Pantex Site Representative.

The Lightning Project Plan is a deliverable under the DNFSB Recommendation 98-2 Implementation Plan, Commitment 5.1.4 (due June 1999), and will constitute the Department's detailed path forward regarding this issue.

If you have any questions, please contact Steve Goodrum, at (806) 477-3180, or have your staff contact Dave Chaney, at (301) 903-8308.

Sincerely,

A handwritten signature in black ink, appearing to read "Gene Ives".

Gene Ives  
Deputy Assistant Secretary  
for Military Application and  
Stockpile Management  
Defense Programs

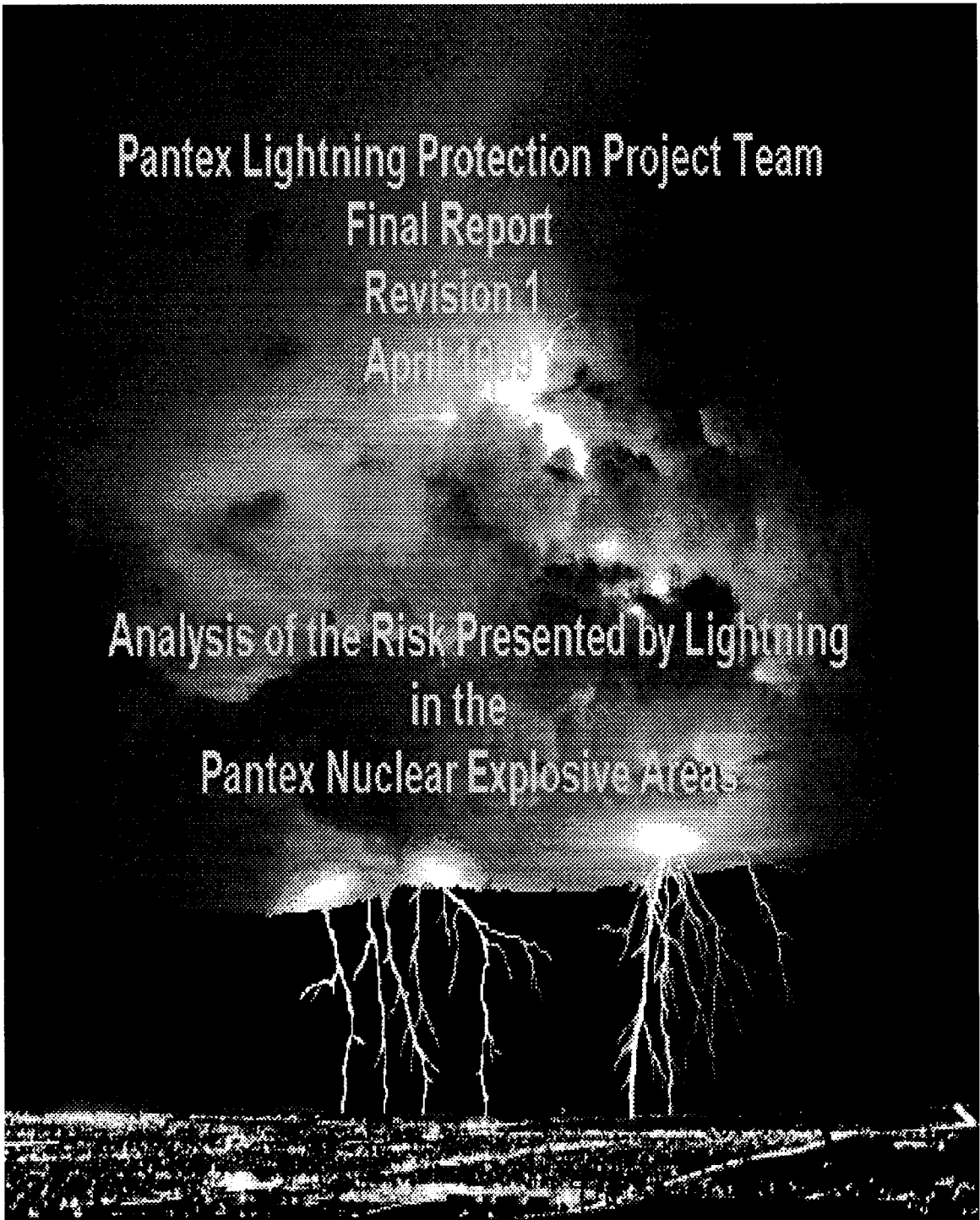
Enclosure

cc w/enclosure:  
M. Whitaker, S-3.1



Pantex Lightning Protection Project Team  
Final Report  
Revision 1  
April 1993

Analysis of the Risk Presented by Lightning  
in the  
Pantex Nuclear Explosive Areas



## Executive Summary

The lightning protection systems protecting nuclear explosive facilities at the Department of Energy's (DOE) Pantex Plant, operated by Mason & Hanger Corporation (MHC), consist of either integral air terminals or catenary ground wires. New analysis indicates that these systems, by themselves, may not provide an adequate level of protection for the high explosives and nuclear material located in these reinforced concrete facilities.

Rocket-triggered lightning tests performed by Sandia National Laboratories (SNL), for the Department of Defense (DoD), demonstrated conclusively that, even when a lightning return stroke attaches directly to an air terminal, almost all of the lightning current will flow on the steel reinforcement of the facility. While the risk to nuclear explosive safety is difficult to quantify, lightning current is capable of producing voltages within the facility that are potentially hazardous to weapon systems and components during the assembly/disassembly process. The lightning protection upgrade effort is managed and tracked through the Lightning Protection Project and Program Plan, which is part of the Integrated Weapons Activity Plan.

Catenary ground wire systems, if properly implemented, may offer some improvement in protection compared to a direct strike to the facility. However, the strike may miss the wire and attach to the facility, or arc from the wire to the facility. In addition, lightning current flowing on the catenary wire will induce image currents on the steel reinforcement of the facility and, thus, produce voltages in the interior of the facility that are of the same order of magnitude as those produced by direct strikes. Enhancing the existing catenary wire protection systems, through the addition of more wires, can reduce the probability of a strike to the protected facilities; however, some risk of a direct strike will still remain. Although enhancing these systems may reduce the electrical environment within the nuclear explosive areas (NEAs), the induced voltages would continue to be sufficient to pose a hazard.

Lightning can be expected to strike within the Zone 12 region of the Pantex Plant approximately 2.2 times per year, based on historical meteorological data. Depending upon its size, or footprint, an individual bay or cell located within Zone 12 is expected to be struck by lightning approximately once every 70 years. It should be noted that the once per 70-year probability is for any lightning strike, not the less frequent 99th percentile strike that the analysis in this report is based on.

Since the effects of lightning within an NEA cannot be eliminated, the lightning protection philosophy adopted by the Lightning Protection Project Team (LPPT) is to prevent lightning current from flowing onto a weapon. It is assumed that the current will find a path off of the weapon. In no case is spurious or fortuitous arcing relied upon to achieve nuclear safety. Rather a control must be established to prevent each postulated scenario whereby lightning current could flow on the weapon. The cornerstone of this philosophy is the Faraday cage/isolation lightning protection methodology, the essential elements of which are: (1) the reinforcing steel in the roof, walls, and floor provide a basic, but imperfect Faraday cage, (2) all metallic penetrations into the interior are bonded to the

reinforcing steel as close as possible to their points of entry, (3) transient voltage surge suppression must be installed to prevent differential-mode over voltages from entering the controlled environment, and (4) clear-air isolation or dielectric insulation adequate for the worst case voltage environment must be provided for the weapon at all times.

Given the heavily steel-reinforced concrete construction of the Pantex NEAs, the implementation of the Faraday cage/isolation protection methodology appears to be the most effective means for providing protection from the effects of lightning. Utilizing the steel reinforcement of the NEAs as a Faraday cage does not result in a completely safe condition in the NEA. This approach ultimately relies on facility personnel to maintain electrical isolation, through dielectric insulation or standoff, sufficient for the maximum potential interior voltage. To provide increased reliability, additional controls may be necessary. These controls may include one or more of the following: 1) protective covers for critical components; 2) maintaining additional standoff distance; 3) suspending operations during lightning warnings; 4) providing dielectric insulation that is adequate for the voltage produced by an unbonded penetration; 5) the installation of multiple bonds; surge suppression on AC and communication circuits.

A lightning warning capability is necessary to allow sensitive operations conducted in unprotected facilities, or in facilities for which adequate isolation cannot be provided, to be suspended when lightning is present in the vicinity of the Pantex Plant. Suspension of an operation involves maintaining the sensitive component at a distance, from any walls or penetrations, which is sufficient for the voltage produced by unbonded penetrations, or placing it in a container that provides equivalent protection. Hoisting operations and other operations for which sufficient protection cannot be provided are prohibited in most facilities during lightning warnings because adequate dielectric insulation cannot yet be provided. The LPPT is currently evaluating the lightning detection capabilities at Pantex to determine if facility management has adequate warning to suspend operations before lightning is present in the area.

Low power testing is ongoing to further refine the analysis of the voltage/current environments produced in the Pantex NEAs as a result of a lightning strike. Dielectric insulation is installed and/or standoff distances are currently being enforced based on the maximum voltage potentially present in a particular facility if all penetrations are bonded.

Faraday cage boundaries have been defined for all of the NEAs. The determination that the rebar is electrically continuous was made based on construction drawings and photographs, as well as knowledge of construction techniques. Low power testing by SNL and Lawrence Livermore National Laboratory (LLNL) has confirmed the integrity of the Faraday cage formed by the rebar in several facilities. With the exception of Building 12-60, Bay 1, and 12-104, bay 16, the bonding of metallic penetrations has been completed. Surge suppression has been evaluated and, where necessary, upgraded for the 120V power circuits entering any of the bays and cells in Zone 12. The LPPT has developed a recommendation to address surge suppression for communication circuits. MHC is currently reviewing this recommendation. In the interim, the lack of adequate

surge suppression for communication circuits is being addressed by providing the necessary standoff distance.

Because of the risk of arcing from unbonded penetrations in the ramp areas, unrestricted transportation through the ramps is currently being allowed only for those systems/components in containers that have been demonstrated, through analysis, to be able to provide protection from the effects of a direct lightning strike. The movement of all other sensitive systems/components is suspended during lightning warnings.

This report assumes that the weapon systems and components, particularly detonators, offer no intrinsic protection from the effects of lightning. This assumption was made because adequate data for the multitude of components used the weapon systems that are or may be assembled/dismantled in the Pantex NEAs could not be readily obtained during the LPPT's initial efforts.

The risk from lightning is both real and manageable. However, it should be noted that there is no readily realizable, single engineered control that will provide complete protection from the effects of lightning in the Pantex NEAs. Given the design and construction of the Pantex NEAs, based on the testing/analyses performed to date, and the current knowledge of lightning protection systems, implementing the Faraday cage/isolation protection scheme is the most effective approach for providing protection from the effects of lightning.

The LPPT is continuing to work toward completing the implementation of the Faraday cage/isolation protection methodology at Pantex. The LPPT is also investigating improved controls, including transportation carts and catenary wire systems, to provide an additional margin of safety beyond that provided by the current implementation of the Faraday cage approach.

## TABLE OF CONTENTS

<b>Executive Summary .....</b>	<b>2</b>
<b>Acronyms.....</b>	<b>7</b>
<b>Abbreviations for Scientific and Engineering Terms .....</b>	<b>8</b>
<b>1.0 Introduction.....</b>	<b>9</b>
<b>2.0 Hazard Analysis.....</b>	<b>11</b>
2.1 Lightning.....	11
2.2 Lightning Probability .....	13
2.3 Voltages and Currents.....	15
2.5 Lightning Protection.....	17
2.5.1 Catenary Systems.....	17
2.5.2 Integral Systems .....	18
2.5.3 Surge Suppression Technologies .....	18
2.5.3.1 Surge Suppression at Pantex.....	20
2.6 Maximum Voltages/Currents in Nuclear Explosive Areas .....	21
2.6.1 SNL Test Methodology .....	22
2.6.2 SNL Facility Analysis Methodology .....	23
2.6.2.1 Bays.....	28
2.6.2.2 Cells.....	30
2.6.2.3 Ramps .....	31
2.6.3 LLNL Lightning Threat Assessment Technique .....	33
Table 1. Summary of bay, cell and ramp types at Pantex.....	37
<b>3.0 Vulnerability Assessment .....</b>	<b>39</b>
<b>4.0 Alternative Lightning Protection Methodologies.....</b>	<b>40</b>
4.1 External Lightning Protection Systems.....	40
4.2 Faraday Cage/Isolation.....	44
Table 2. Maximum voltage produced by an unbonded penetration. ....	45
Table 3. Maximum facility voltage .....	46
<b>5.0 Controls .....</b>	<b>48</b>
5.1 Lightning Protection Systems.....	48
5.2 Faraday Cage.....	48
Table 4. Standoff required for unbonded penetrations .....	50
Table 5. Standoff required for bonded penetrations.....	51
5.3 Bonding.....	52
Table 6. Penetration bonding status.....	54
5.4 Surge Suppression.....	54
5.5 Covers/Containers.....	56

<b>5.6</b>	<b>Detection/Warning.....</b>	<b>57</b>
<b>5.7</b>	<b>Insulation/Isolation .....</b>	<b>58</b>
<b>6.0</b>	<b>Recommendations .....</b>	<b>60</b>
<b>6.1</b>	<b>Lightning Detection .....</b>	<b>60</b>
<b>6.2</b>	<b>Standoff/isolation requirements .....</b>	<b>60</b>
<b>6.3</b>	<b>Catenary lightning protection systems.....</b>	<b>61</b>
<b>6.4</b>	<b>Protection for full up weapons.....</b>	<b>61</b>
<b>6.5</b>	<b>Roof slot bonding .....</b>	<b>61</b>
<b>6.6</b>	<b>Surge Suppression.....</b>	<b>61</b>
<b>6.7</b>	<b>Further testing .....</b>	<b>62</b>
<b>6.8</b>	<b>Improved bonding connections .....</b>	<b>62</b>
<b>7.0</b>	<b>Path Forward .....</b>	<b>63</b>
<b>8.0</b>	<b>References .....</b>	<b>65</b>
<b>9.0</b>	<b>LPPT Membership .....</b>	<b>68</b>

## Acronyms

AAO	Department of Energy Amarillo Area Office
ABCD	Authorization Basis Controls Document
AL	Department of Energy Albuquerque Operations Office
BIO	Basis for Interim Operation
C-G	Cloud-to-ground
CSSM	Critical Safety Systems Manual
DAF	Device Assembly Facility
DoD	Department of Defense
DOE	Department of Energy
DP	Department of Energy Defense Programs Office
EFM	Electric Field Mill
EI	Engineering Instruction
EMP	Electromagnetic Pulse
GDT	Gas Discharge Tube
HPM	High Power Microwaves
IC	Input Circuitry
I-C	Intracloud Lightning
LANL	Los Alamos National Laboratory
LLNL	Lawrence Livermore National Laboratory
LLPS	Lightning Location and Protection System
LPPT	Lightning Protection Project Team
MHC	Mason & Hanger Corporation
MOV	Metal-oxide Varistor
MSAD	Mechanical Safe-Arm Detonator
NEA	Nuclear Explosive Area
NESS	Nuclear Explosive Safety Study
NFPA	National Fire Protection Association
NLDN	National Lightning Detection Network
NOAA	National Oceanic and Atmospheric Administration
NTS	Nevada Test Site
OC	Operations Center
PC	Personal Computer
RAMS	Radiation Alarm Monitoring System
RF	Radio Frequency
SNL	Sandia National Laboratories
SPMS	Static Potential Monitoring System
STS	Stockpile-to-Target Sequence
TSR	Technical Safety Requirement
TVSS	Transient Voltage Surge Suppression



## Abbreviations for Scientific and Engineering Terms

ampere	A	megavolt	MV
alternating current	AC	meter	m
cycles per second	Hz	microseconds	$\mu s$
electrical conductance	G	millisecond	ms
electric potential	V	nanohenry	nH
inch	in. or "	time constant	$\tau$
inductance	L	volts per meter	V/m
kiloampere	kA	surface current density	<b>K</b>
kilocycles per second	kHz	magnetic field intensity	<b>H</b>
kilovolt	kV		

## **1.0 Introduction**

The LPPT was formed in October 1997 to evaluate concerns regarding the adequacy of the lightning protection afforded to collocated high explosives and nuclear material at the Pantex Plant. SNL identified these concerns as the result of work done in preparation for W79 dismantlement activities. The results of rocket-triggered lightning tests conducted for the DoD, and knowledge of the Pantex NEAs, led SNL to conclude that the existing lightning protection systems may not afford the level of protection necessary to ensure nuclear safety for the operations conducted in the Pantex NEAs.

The initial efforts of the LPPT were focused on the activities conducted in the nuclear explosive assembly bays and cells as well as transportation through the ramps. The weapon storage activities that take place in Zone 4 West were not addressed during this effort. The complete weapon assemblies stored in Zone 4 were deemed to be less vulnerable to the effects of lightning than the partial assemblies that exist in the bays, cells, and ramps during disassembly or evaluation activities. The weapons stored in the Zone 4 facilities are in full-up configurations or have additional protection afforded by their shipping containers. The storage magazines found in Zone 4 are identical to the explosive storage magazines used at many DoD and DOE sites and are currently being evaluated by both Departments' explosive safety committees. An evaluation of the risk posed by lightning to these structures will be included in LPPT's follow-up effort to examine facilities other than the NEAs.

LPPT membership included representatives from Sandia National Laboratories; LLNL; Los Alamos National Laboratory (LANL); Mason & Hanger Corporation; the Department of Energy's Defense Programs Office (DP), Albuquerque Operations Office (AL), and Amarillo Area Office (AAO). The LPPT was tasked with analyzing the risk from lightning, determining the controls necessary to mitigate the risk, and developing an approach for implementing and formally documenting the requirements for the preservation of any necessary controls.

This report documents the progress of the LPPT's efforts to date and identifies those areas where additional work is required. Since many of the LPPT's activities are not scheduled to be completed until December 1999, it is expected that this report will be revised, if necessary, to include any additional information. Because it is more mature and has been verified with rocket-triggered testing, this report relies extensively on the analyses performed by SNL, as well as the results of the ongoing testing of Pantex facilities being performed by both SNL and LLNL.

The report consists of three sections: hazard analysis, vulnerability assessment, and controls. The hazard analysis section defines the magnitude of the voltage/current that may be present in an NEA as the result of a lightning strike. The original objective of the vulnerability assessment was to evaluate the susceptibility of individual weapon systems and components to the voltage/current environment determined in the hazard analysis. However, because the vulnerabilities of the different systems are similar, an adequate

vulnerability assessment can be accomplished by evaluating the hazards in the NEAs and assuming that the critical components of all systems, with the exception of those with Mechanical Safe-Arm Detonators (MSADs), are equally vulnerable. The philosophy employed by the LPPT was to provide protection for all weapon systems and components assuming those critical nuclear safety components could be exposed at any time during the dismantlement process. The controls section identifies the controls, engineered and administrative, necessary to implement a lightning protection system appropriate for the Pantex NEAs, given our current understanding of the hazard and the vulnerabilities of the critical components.

## 2.0 Hazard Analysis

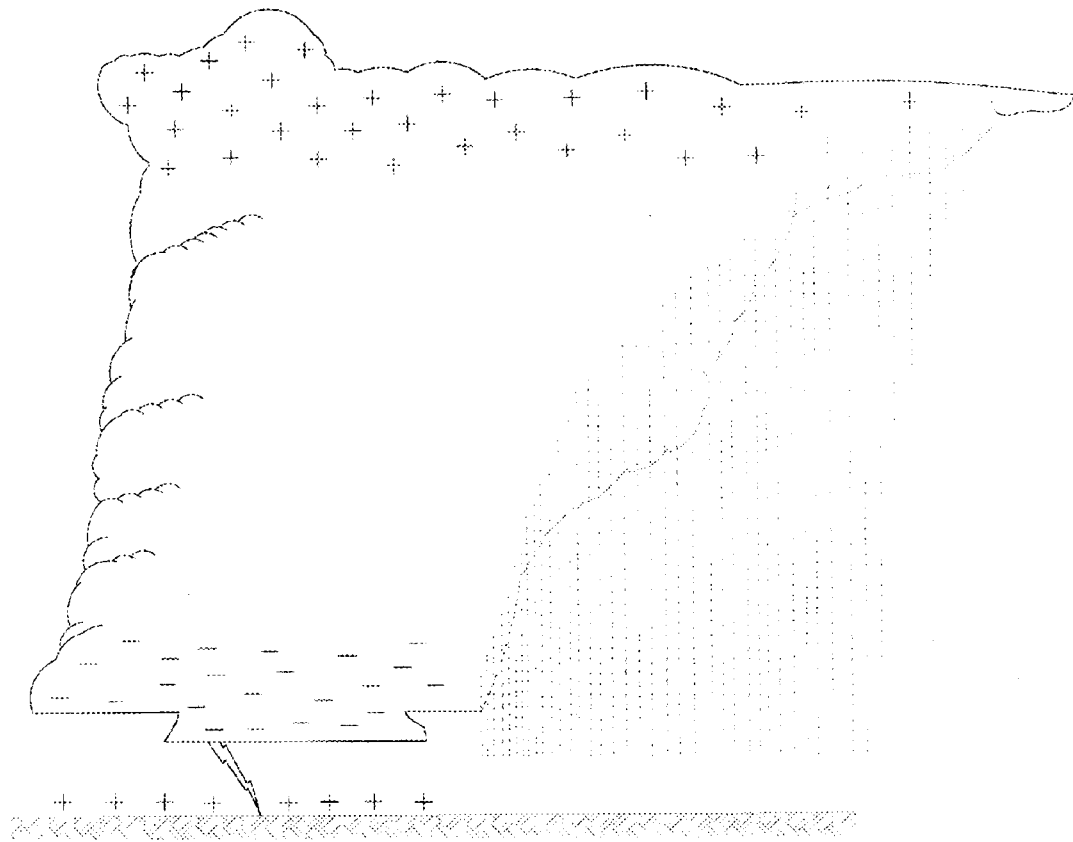
The objective of the hazard analysis phase of the project is to determine the magnitude of the voltages and currents that may potentially exist in a nuclear explosive area resulting from a lightning strike. This phase has been further subdivided in three areas: a discussion of the lightning phenomena, lightning protection systems, and conditions in a nuclear explosive area resulting from a lightning strike. The lightning phenomena section will examine the probability of a lightning strike, the voltages/currents involved in a strike, and detection methods available for use in issuing lightning warnings. The second section will evaluate the degree of protection afforded by the lightning protection systems currently in use at Pantex. The final section of the hazard analysis will determine the worst case (maximum) voltages/currents that may exist in a nuclear explosive area as the result of a lightning strike.

### 2.1 Lightning

A detailed description of the complete lightning process is beyond the scope of this document. For a more thorough explanation of the lightning process, the reader should consult the report "Lightning - Understanding It and Protecting Systems from its Effects," by R. T. Hasbrouck [1]. The scope of this discussion is limited to the atmospheric conditions that produce lightning, how lightning protection and detection systems work, and the need for these systems.

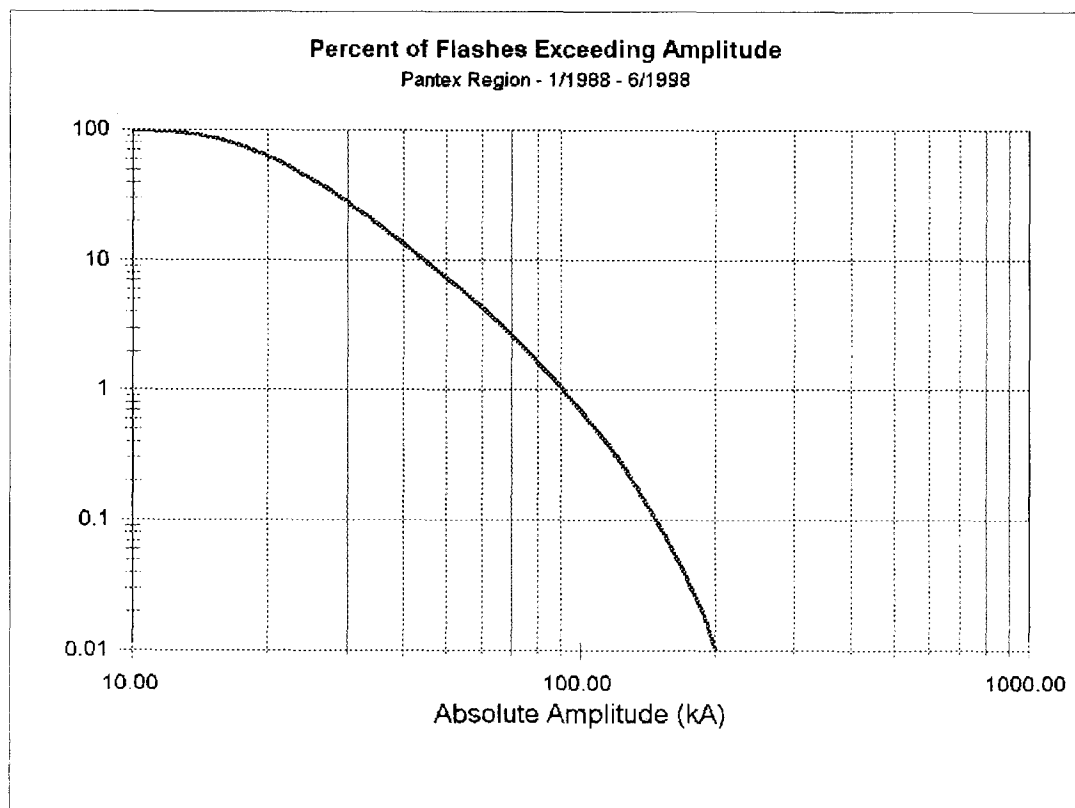
Lightning strikes the earth's surface an average of 6,000 times per minute, and is responsible for hundreds of millions of dollars in damages [2]. A direct strike to a facility can start fires; damage electrical, communications, and computer systems; and, in rare instances, injure or kill a building's occupants.

When we see lightning and/or hear thunder, we are observing the manifestation of a dramatic and sudden electrical charge transfer on the order of tens of Coulombs (1 Coulomb =  $6.24 \times 10^{18}$  electrons). This transfer occurs in a few hundred milliseconds. A simple cloud model consists of two vertically separated regions, with the base being negatively charged. The negative charge at the base of the cloud causes an image charge in the earth pushing away electrons at the surface. The electric field in the region between the negatively charged cloud base and the positively charged earth increases as the cloud becomes more polarized. When charge separation within a cloud causes the electric field to exceed a critical value, a breakdown, evidenced by a lightning discharge, occurs [1-4]. Figure 1 is an illustration of this process.



**Figure 1. Charge polarization within a thundercloud**

In most cases, as the electric field between the bottom of the cloud and the ground increases, a leader of negative charge advances from the cloud toward the earth in a series of steps, forming an ionized channel. This channel, which is called the stepped leader, carries the potential of the bottom of the cloud toward the earth. As this leader nears the earth, the negatively charged stepped leader causes upward streamers to occur from grounded objects, such as trees and buildings. As the stepped leader nears one or more of these streamers, the electric field increases in proportion to the inverse of the decreasing distance. The intervening air eventually breaks down, forming an ionized channel along which one or more high-current return strokes carry the charge stored on the step leader to ground. This charge transfer momentarily neutralizes the negative charge at the base of the cloud. In 25 to 50% of all cloud-to-ground (C-G) a continuing current will flow via the junction streamer and channel. After the current stops flowing, a new leader may reionize the already existing channel, producing a subsequent return stroke. Each return stroke has a duration of approximately 0.1 milliseconds. Return strokes, which are perceived by the human eye as flickering, usually number less than 10; however, as many as 40 have been recorded in one flash. Return stroke amplitude is lognormally distributed in nature. Although statistics vary, the 1-% level is believed to be approximately 200 kA. Based on historical data (See Figure 2) for lightning in the vicinity of Pantex, the 200 kA return stroke represents the 0.1-% level.



**Figure 2. Flash peak current distribution at Pantex**

Positive C-G flashes, in which positive charge is transferred to Earth from the P-region, mid to upper region of a thunderstorm, occur much less frequently than negative strokes (10% of all C-Gs are positive) [1]. A positive C-G stroke emerges as a stepless leader from much higher in the cloud and thus has a much higher potential. Peak currents that can exceed 300 kiloamperes (kA) [1].

## **2.2 Lightning Probability**

The 1993 SNL report [5] estimated the expected number of flashes at Pantex to range between 104 and 226 per year. The expected number of flashes in Zone 12 was calculated to be between 1.0 and 2.2 per year. The Pantex lightning flash data for the years 1991-1993 indicated that an average of 207 flashes per year [5] strike the Pantex Plant. The number of flashes from 1993 to the present could not be obtained from the Pantex Lightning Location and Protection System (LLPS) due to an inability to extract the data from the system without shutting down the system's monitoring capability. However, data from 1988 to 1998 was obtained from the National Lightning Detection Network (NLDN), which uses the same sensors used by the Pantex LLPS [7].

The probability that an object or facility will be struck by lightning is difficult to quantify with certainty. However, there are methods for making these estimates based on the

height and area of a facility. One method involves multiplying a facility's lightning attractive area by the local ground flash density [5, 6]. The lightning attractive area,  $A_{eff}$ , is a function of an object's surface area and height, and for a rectangular structure is determined from the following equation

$$A_{eff} = LW + \pi r_a^2 + 2r_a(L + W),$$

Where  $L$  and  $W$  are the building's length and width, respectively, and  $r_a$  is the building's capture radius. For a circular building, the lightning attractive area is given by

$$A_{eff} = \pi(r_c + r_a)^2$$

where  $r_c$  is the radius of the facility. The capture radius,  $r_a$ , for both types of facilities is calculated using

$$r_a = 80\sqrt{h} \left[ e^{-0.02h} - e^{-0.05h} \right] + 400 \left[ 1 - e^{-0.0001h^2} \right]$$

where  $h$  is the height of the structure in meters. If the distance between two structures is less than  $2r_a$ , half the separation distance should be used instead of  $r_a$ .

Using data from the Pantex LLPS, Merewether and Chen [5] calculated a ground flash density of 2.3 to 5.2 flashes per square kilometer per year for the area around the Pantex Plant. Using the published detection efficiency of 80%, a conservative estimate of the flash density may be taken as 6.0 flashes per square kilometer per year and including airlocks and ramps in the building dimensions, an individual bay in Building 12-64 is expected to be struck by lightning once every 78 years [6]. The probability of an individual bay or cell being struck ranges from once every 6 years to once every 78 years. For comparison, Fredlund and Kimball [7], based on flash data obtained from the National Lightning Detection Network, calculated a ground flash density for a 10-mile radius around Zone 12 of 2.8 flashes per square kilometer per year.

Pantex has experienced several lightning strikes to structures/equipment. In the late 1970s, the fire alarm system at a firing site was struck. A transformer mounted on an overhead pole near Building 11-54 was struck in 1986. Lightning struck the ground near a security station east of Building 12-26 in 1992. In 1994, there was a grass fire in Zone 2 that was attributed to lightning. In 1997 a wooden pole was struck near Building 12-52.

For the purposes of hazard analysis, a lightning flash in Zone 12 is considered an anticipated, or likely, operational occurrence. While the worst case strokes of 200 kA will occur less frequently, the controls available to mitigate lightning strikes are primarily governed by the nature of lightning and the high probability that it will occur. The magnitude of the strike is only a secondary consideration. The additional costs and

operational penalties of tailoring the necessary controls to the worst case stroke should not be a significant factor in relation to the level of safety achieved.

### 2.3 Voltages and Currents

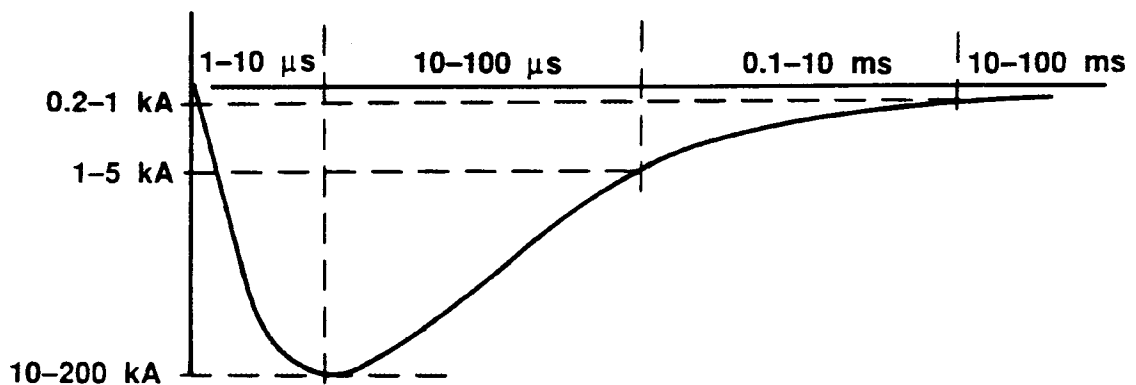
The following information on the characteristics of lightning is taken from the SNL report by Fisher and Uman [8] on recommended lightning parameters for Stockpile-to-Target sequences (STS).

<u>Return Stroke Parameters</u>	<u>maximum</u>	<u>median</u>
a. Peak Current (kA)	200	30
b. Time to Peak ( $\mu$ s)	0.1-15	3
c. Max. Rate of Current Rise (kA/ $\mu$ s)	400	150
d. Time to decay to half peak ( $\mu$ s)	10-500	50
e. Amplitude of continuing current (A)	30-700	150
f. Duration of Continuing current (ms)	500	150

#### Flash Parameters

a. Number of strokes	>20	4
b. Interstroke interval (ms)	10-500	60
c. Total flash duration (ms)	30-1000	180
d. Total charge transfer (C)	350	15
e. Action [ $\int I^2 dt$ ] ( $A^2 \cdot s$ )	$3 \times 10^6$	$5 \times 10^4$

The action integral  $W/R = \int I^2 dt$ , where  $W$  = energy in joules,  $t$  = return stroke duration,  $R$  = resistance in ohms, and  $I$  = current in amps, is a measure of the total energy that could be delivered to a resistive load from a single flash. The return stroke current rises rapidly to its peak value and falls off more slowly (See Figure 3).



**Figure 3. An approximation of the waveform of the return stroke's current**



Because the STS data is consistent with data published in other, more recent, reports, the 1-% stroke parameters from the STS are used to determine the magnitude of the voltages and currents that may be present in a nuclear explosive area. Based on historical data at Pantex from 1988 to June 1998, the 200-kA peak current represents the 0.1-% stroke.

## 2.4 Lightning Detection

There are a variety of ways to detect lightning. Lightning warnings can be based on cloud-  
electrification measurements, detection of intracloud (I-C) electrical discharges, or the  
detection and tracking of C-G flashes from frontal storms.

The electric field mill (EFM) is commonly used to measure the magnitude and polarity of the  
DC electric field at the earth's surface. The EFM utilizes a fixed electrode (stator) connected to  
ground through a current measuring circuit. The stator is alternately exposed to and blocked  
from the electric field by a grounded, rotating, conductive plate (rotor), producing an  
alternating voltage proportional to the electric field at the earth's surface. The fair-weather  
electric field at the earth's surface is typically on the order of 150 volts per meter (V/m) [4].  
Because of the presence of dust and wind, the fair-weather electric field at Pantex is typically in  
the 300-400 V/m range. When charged clouds move into the area, the distribution of charge  
within the cloud causes the local electric field on the surface to change significantly from its  
fair-weather value. Whenever a lightning discharge occurs, the charged base of the cloud is  
temporarily neutralized, which is accompanied by a corresponding change in the electric field at  
the earth's surface.

Electrical discharge activity can be detected using visual or electro-optical methods as well as  
by the electromagnetic radiation produced by a flash. Visual detection relies on an observer to  
detect the flash. Electro-optical sensors are capable of detecting I-C lightning in daylight,  
which is not visible to the unaided eye. Since I-C lightning typically precedes C-G lightning by  
ten minutes or more [1], electro-optical sensors can provide advance warning of a C-G flash.  
The electromagnetic radiation produced by cloud discharges, sometimes known as  
atmospherics, can be detected with a suitable radio frequency receiver.

C-G lightning can be located and tracked by detecting its radiated electromagnetic signals at  
several distant locations and triangulating. Direction finding involves the use of multiple  
antennas to receive the magnetic component of the C-G radiation providing a bearing from the  
receiver site. Two or more of these antennas can locate the C-G flash by triangulation. At  
each site, an electric field antenna is also needed to provide a signal that is analyzed to verify  
that a lightning flash has actually occurred.

The Pantex Plant uses two systems to provide forecasts of, and real-time indication of,  
lightning and static potential conditions. These systems consist of three electric field mills  
(EFMs) and four electromagnetic lightning detectors to provide information to the Pantex  
Plant 24-hour Operations Center (OC). The OC issues lightning warnings when conditions  
warrant.

The personal computer (PC) based Static Potential Monitoring System (SPMS) provides real-time static potential information from three EFM's located on the Plant: north of the west entry gate; south of Building 12-103; and near Firing Site #1. The Sun® workstation-based Lightning Location and Protection System (LLPS) provides real-time and historical C-G lightning tracking for a 200-mile radius around the Pantex Plant. The location of a strike is determined by triangulation of a specific radio frequency produced by lightning. Magnetic/electrical detectors are located near Boys Ranch, Pampa, Happy, and Clarendon, Texas, and are connected by modem to the Sun® workstation located in the OC. These detectors are stand-alone and are not tied into the National Lightning Detection Network (NLDN)

## **2.5 Lightning Protection**

Lightning protection assumes that a strike is inevitable and attempts to provide a controlled path for the current to follow to ground. A classical lightning protection system consists of three main elements; a strike termination system to provide the attachment point for the lightning channel; a system of down conductors to convey the lightning current to ground; and a grounding system to provide a low impedance return path to earth. The complete path would, in the ideal case, provide zero resistance and zero inductance terminating in a zero resistance ground. In addition to the catenary (overhead-wire) and integral (air terminal) systems, and masts, lightning protection also includes surge (over- voltage) suppression on electrical circuits.

The lightning protection systems in use at Pantex include the integral or air terminal system, the catenary ground wire system, and a system of surge protection for electrical power. The first two systems are intended to protect the building from the effect of a direct attachment of a lightning stroke to the building. The surge suppression systems are installed to prevent damage to equipment and nuclear explosive assemblies from voltage transients on the power lines. These systems are a requirement of the DOE Explosives Safety Manual and all buildings that contain explosives are currently equipped with lightning protection systems.

### **2.5.1 Catenary Systems**

This system consists of a wire, or wires, suspended over the facility, usually from a system of poles or masts and, as necessary, guy wires. The overhead wire, or catenary, is then connected to a grounding system. The catenary system is designed to intercept the strike before it can contact the facility and dissipate the energy to ground. However, because of the extensive steel reinforcement in the Pantex Zone 12 NEAs, currents are induced in the roof and walls that could result in significant interior voltages even if the catenary system is completely effective in intercepting strikes. The overhead wires must also be positioned far enough from the facility to prevent an arc from forming between the wire and the facility.

The use of the catenary system is a fairly recent addition to the lightning protection program at Pantex. Several nuclear explosive facilities (12-84W, 12-98, 12-99, 12-104) that were constructed after 1984 at Pantex are protected by catenary systems.

### **2.5.2 Integral Systems**

Integral systems utilize a series of air terminals, or lightning rods, mounted directly on the facility. The air terminals are connected together and to a grounding system. The National Fire Protection Association's (NFPA) Lightning Protection Code, NFPA 780 [9], specifies the requirements for the installation of integral lightning protection systems.

The integral lightning protection system was originally installed at Pantex during World War II and continued to be the preferred lightning protection system until the mid 1980s. The system is easily recognized by the air terminals, or "lightning rods," on the peak of the roofline and all of the equipment that extends above the surrounding roof. The air terminals are attached to a conductor that typically runs the length of the building and is brought down the opposite sides of the building with down conductors. These down conductor are attached to a buried ground ring electrode called a counterpoise. This conductor, plus the ground rods, constitutes the grounding system.

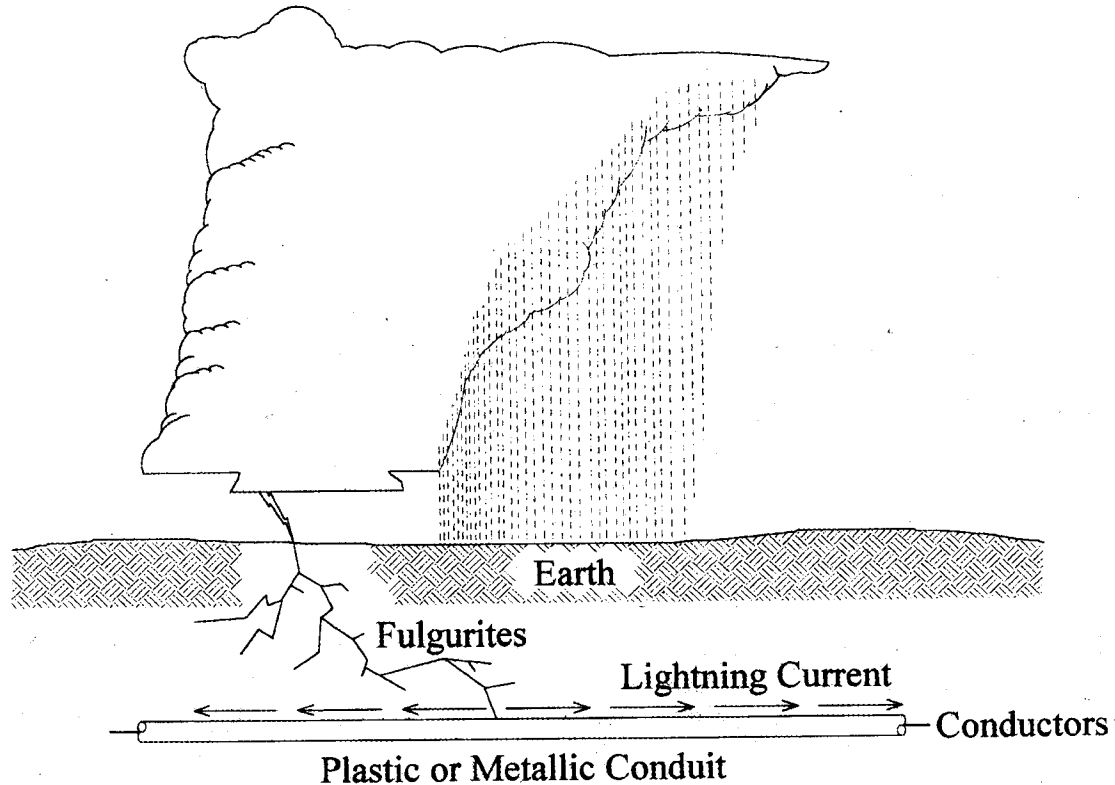
Based on the results of the SNL Rocket Triggered Lightning Test Program [10-12], integral systems are of limited value in reducing the voltages that may exist inside a steel reinforced concrete structure. The SNL testing showed that, when an air terminal is struck, the majority of the lightning current flows on the reinforcing steel rather than on the lightning protection system because the surge impedance of a reinforced concrete structure is typically much lower than the surge impedance of the lightning protection system. Consequently, the voltage between any two points inside the facility (e.g., between the overhead crane hoist and a workstand) is determined by the properties of, and especially by discontinuities in, the steel reinforcement of the facility.

### **2.5.3 Surge Suppression Technologies**

Another essential element of lightning protection is surge suppression for the electrical power supply system and other conductors entering the NEA. Fuses and circuit breakers installed in these systems cannot act quickly enough to protect equipment from lightning induced transient voltages. To provide adequate protection, Transient Voltage Surge Suppression (TVSS) devices must limit both the common mode (to ground) and differential mode (between conductors) voltages on these conductors and provide a path to ground that will dissipate the energy in the transient. These devices also provide protection against the effects of transients originating from sources other than lightning, such as switching and motor starting transients. In normal operation, surge suppression does not affect the normal operation of the protected circuit.

Lightning can produce transients on circuits both directly and indirectly. The direct attachment of a lightning strike to utility line or pole is a common event. TVSSs are a

necessity for these applications and have a good reputation of successful performance when selected using waveform parameters from ANSI Standard C62.11 [13]. Additionally, indirect effects of lightning frequently result from inductive or resistive coupling. Although induced effects are more common for overhead power lines, buried lines are not immune to the effects of lightning (See Figure 4).



**Figure 4. Example of lightning induced transient on buried power lines**

The first line of protection from these transients is usually provided at the electrical substation. Spark gaps and gas discharge tubes (GDTs) are the most common devices used at this level because of their ability to dissipate high surge currents.

Spark gaps are the oldest and most commonly used TVSS in power distribution systems. The spark gap device consists of two carbon block electrodes separated by an air gap, usually 3 to 4 mils apart. One electrode is connected to ground and the other to the power conductor. When a transient over-voltage appears on the line, its energy is dissipated to ground through the arc that forms between the electrodes. These devices can conduct large currents while maintaining a voltage across the arc that is low and essentially independent of the amount of current being conducted.

Spark gap devices have serious shortcomings. One is the large variation in arcing voltages. A nominal 3-mil gap will arc at anywhere from 300 to 1000V. This variation

limits applicability to primary transient voltage suppression with more precise TVSSs being needed to keep voltage transients within acceptable levels. Another is the relatively slow response time, which could allow a surge through before the device functions. In addition, the open spark presents a hazard if this type of device is used in a potentially flammable atmosphere.

The gas discharge tube (GDT) is also commonly used in power distribution. The GDT is made up of two metallic conductors, separated by about 10 to 15 mils, encapsulated in a glass envelope that is filled with gas at low pressure. Gas tubes have a higher current-carrying capability and longer life than spark gaps. The possibility of gas leakage, with the resultant loss of protection, has limited the use of these devices.

Both the spark gap and GDT are crowbar-type devices [1]. In the case of a crowbar-type device, transient voltage in excess of the specified level will cause the device to transition to a short circuit resulting in a nearly zero voltage on the protected circuit. In typical applications, the crowbar device will remain conducting until a fuse opens the circuit.

In contrast to crowbar devices, varistors and zener diodes provide a precise clamping voltage. Varistors (usually metal-oxide varistors (MOVs)) have very fast response times and are commonly used to protect less sensitive circuits. Zeners (usually transient-absorption zeners called *transorbs*) are commonly used to protect sensitive electronics. Below the clamping or threshold voltage, varistors and Zener diodes are essentially non-conducting [14]. Above the clamping voltage, the device represents low impedance path, shunting the surge current to ground.

Once power supply voltages are stepped down, protected from large external surges and inside a protected building, most sources of high-energy transients have been eliminated. However, many connected loads are subject to damage at lower voltage levels. Common practice is to provide more precise protection at the electrical outlet and/or at the load itself.

### **2.5.3.1 Surge Suppression at Pantex**

At Pantex, surge protection begins at the entrance of the primary voltage system into the main substations. The Plant's primary distribution is dual-fed from the local utility. The main transformers step the 115 kV transmission voltage down to the distribution voltage of 12,470 /7200 volts. In addition to an air terminal system, both substations are protected by MOV type TVSS devices.

The distribution lines are then routed underground in plastic or steel conduit that are protected by heavily reinforced concrete duct banks. The underground installation limits the places that a lightning stroke can enter the system. The steel reinforcing in the duct banks gives a measure of protection to the conduits from groundstroke lightning. The high voltage cables are pulled into the conduits and a metallic shield protects the conductors.

The buried cables are routed to various substations to be further stepped down to the building feed voltage, generally 480 volts. Both the primary and secondary sides of the step-down transformers are protected by MOV type TVSS devices.

Since buried cables are not immune to the effects of lightning, TVSS devices are also needed where the electrical service enters the building. This is particularly true when the lines are routed through plastic conduit.

In all Pantex nuclear facilities, a third set of TVSS devices (MOVs) is installed after the voltage is stepped down to 120/208 volts. This level has been validated in accordance with the LPPT developed validation procedure. MOVs are also found in the AC-powered testers used on weapon systems to provide a final level of protection against transient voltages.

In addition to AC power, a number of communication circuits (fire detection/alarm, the ARGUS system, telephone, Radiation Alarm Monitoring System (RAMS), public address system, etc.) penetrate the facility structure of the Pantex Zone 12 NEAs. With the exception of the telephone and the ARGUS system, these systems are not surge protected. The existing surge suppression provided on the ARGUS and telephone systems is located too far from the bay or cell to provide effective protection in the interior of the NEA.

## **2.6 Maximum Voltages/Currents in Nuclear Explosive Areas**

The Zone 12 NEAs at Pantex include assembly/disassembly bays and cells, special purpose facilities, and enclosed ramps through which weapons systems and components are transported. The SNL rocket triggered lightning tests [10-12] demonstrated that a significant portion of lightning current will flow to earth through the steel reinforcing members rather than the lightning protection system. Because of the extensive use of reinforcing steel in the construction of the Pantex bays and cells, these facilities tend to function like a Faraday cage (metallic enclosure) when interacting with lightning. To a lesser extent, the same effect is exhibited in the ramps.

If the NEAs were ideal Faraday cages, the contents would be completely protected from the effects of lightning. Unfortunately, the need for electric power, signal circuits, and other utilities requires that the Faraday cage be penetrated by power cables and metallic conduit/piping. In addition to the rebar spacing, the degree of electrical interconnection of the reinforcing members in the roof, walls, and floors strongly influences the facility's ability to function as a Faraday cage in providing lightning protection.

Both SNL and LLNL have performed tests on various NEAs at Pantex, as well as other sites, in an attempt to quantify the interior environment that would result from lightning striking an air terminal or protrusion. Because it has been verified by rocket-triggered testing, much of the discussion that follows is based on SNL test results and analysis.

### 2.6.1 SNL Test Methodology

The SNL testing methodology consists of exciting the lightning protection system with a low-frequency AC signal and measuring the corresponding electric fields within the facility. The testing is designed to determine the electrical connectivity of the major current-carrying conductors. In simple cases, the test can also determine a transfer function relating the interior voltage to the current applied to the lightning protection system. This transfer function can then be used to extrapolate the interior voltages produced from the currents that would flow in the event of a lightning strike. The voltages and currents obtained from the transfer function are consistent with those produced in rocket-triggered lightning tests. Rebar resistance and separation between the rebar and the lightning protection system limit the test frequencies to a range of frequencies from 10 kilohertz (kHz) to 1 MHz which is consistent with the dominant portion of the lightning frequency spectrum.

The test equipment consists of three main systems - an excitation system, an antenna system, and a receiver system. The three systems are shown in Figure 5. The excitation system consists of a function generator set to produce 10 or 15 V peak-to-peak into a 50-ohm load. One lead is connected to the lightning protection system and the other lead is connected to four ground rods. The antenna system consists of an active electric field antenna, which is connected by fiber-optic cable to a receiver. Because of the low fields produced in the test, a background noise survey is conducted to select "quiet" frequencies between 10 kHz and 500 kHz.

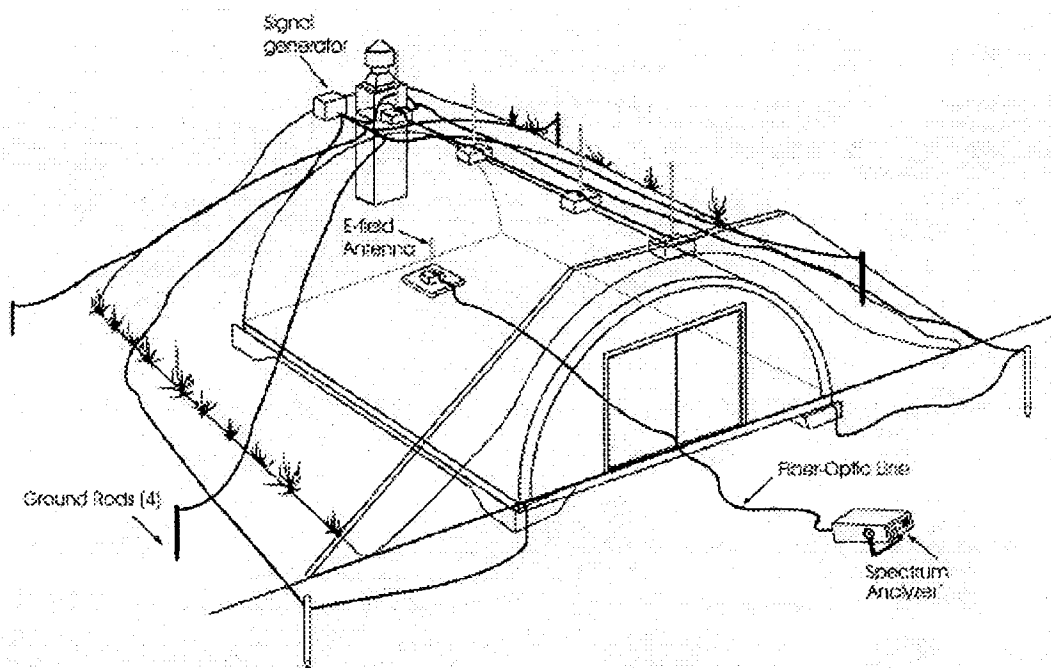


Figure 5. SNL Rebar continuity test setup

The electric field can then be measured at any point within the facility. From these measurements, knowing the antenna output and the injected current, a transfer impedance can be calculated. This transfer impedance is modeled with a two- or three-parameter equivalent circuit, which is then used to infer information about the connectivity of major current carrying conductors.

### 2.6.2 SNL Facility Analysis Methodology

Due to the differences in construction between the various facilities in use at Pantex, the approach is to identify the dominant mechanism for producing voltages in each facility and then to estimate the maximum voltage that may exist as a result of a severe, 99th percentile lightning flash. Assuming that all metallic penetrations are bonded, the dominant mechanism is either joint resistance or slot voltage. A metallic conductor penetrating the facility structure that is not electrically bonded to the structural members presents a much more significant hazard. An unbonded penetration has the potential to transmit MV level voltages directly to the interior of the bay [5].

Since the overhead crane is a likely mechanism for completing an electrical circuit that includes the weapon/component, SNL has analyzed the amount of short-circuit current available in the bays and cells from the overhead crane for a 99th percentile lightning strike. Depending upon the location of the crane, the available current can range from 934 A to 1.64 kA in a cell.

Individual analyses, taking into account facility specific details, have been completed for all of the bays and cells.

As demonstrated by rocket triggered testing, for a reinforced concrete structure, almost all of the lightning current will flow on the rebar because the surge impedance of the rebar is much lower than the surge impedance of the lightning protection system. For this reason, the lightning protection system can be ignored for most facilities.

Since it is difficult to assign a reduction factor for the fraction of current reaching a cell as the result of a strike to the top of the gravel gertie, the full lightning current is assumed to be injected directly onto the cell walls at the worst possible point. This point is at the top inside edge of the ring beam. Consider the canonical problem of a buried impedance sphere of radius  $r_0$ . For a total current  $I$  injected at the point  $\theta = 0$ , assuming uniform leakage current (in A/m<sup>2</sup>), the surface current density is

$$K_{\theta}(\theta) = \frac{I}{4\pi r_0} \cot(\theta/2)$$



The sheet inductance for a single layer of rebar is given by [15]

$$L_s \cong \frac{\mu_0 s}{2\pi} \ln\left(\frac{s}{\pi d}\right)$$

where  $s$  and  $d$  are the rebar spacing and diameter, respectively, and  $\mu_0 = 4\pi \times 10^{-7}$  H/m is the permeability of free space. For a two-layer reinforced concrete structure, the transfer inductance is the parallel combination of two such layers of rebar, separated by an inductance  $\mu_0 \Delta$ , for the separation between the two layers. Thus, the combined transfer inductance for the two-layer geometry is

$$L_t = \frac{L_s^2}{\mu_0 \Delta + 2L_s}$$

The voltage between the poles is

$$V \cong L_t \frac{\partial}{\partial t} \int_{\theta_0}^{\pi} K_{\theta}(\theta) r_0 d\theta$$

where  $r_0 \theta_0$  is taken as a rebar spacing  $s$ . The result is

$$V \cong L_t \frac{\partial I}{\partial t} \frac{1}{2\pi} \ln(2r_0 / s)$$

For a cell, the effective radius is approximately  $r_0 = 18$  ft, the rebar spacing, diameter, and separation are  $s = 12$  in,  $d = 0.5$  in, and  $\Delta = 8$  in, respectively. Substituting these parameters into the above equations, and assuming a worst-case  $\partial I / \partial t = 400$  kA/ $\mu$ s, yields  $L_t = 30.5$  nH, and a peak voltage of 7.0 kV.

In addition to the above, there is an inductive contribution to the total voltage due to current division among the few conductors nearest the attachment point. Assuming 4 radial wires emanating from the attachment point, where each wire inductance may be estimated from the free-space inductance

$$L_w = \frac{\mu_0 s}{2\pi} \left[ \ln\left(\frac{4s}{d}\right) - \frac{3}{4} \right]$$

and also assuming that the current divides between the two layers according to the planar circuit model described above, the drive-point voltage is

$$V_{dp} \approx \frac{1}{2} L_w \frac{\partial I}{\partial t} (L_t / L_s)$$

The above parameters give  $V_{dp} \approx 5.7$  kV. Adding the two contributions, the worst-case peak voltage due to rebar inductance evaluates to 12.7 kV.

With the exception of the newer cells and some special purpose bays, the interior electrical environment (assuming all penetrations are bonded) is primarily determined by the discontinuities in the rebar. The physical makeup of these discontinuities will determine the mechanism for voltage production. In the case where there is no electrical path for current to flow to ground, the current must cross the joint and the resistance of the joint will be the dominant voltage producing mechanism. However, if there are connections across the discontinuity, resulting in a partial discontinuity, the current will flow along the rebar and cross the discontinuity at these connections.

Calculating the resistance is a straightforward process. For buried conductors, it can be assumed that the leakage current per unit h over the entire surface is constant. If all interior surfaces are in intimate contact with the ground, the fraction of current that crosses a given plane is equal to the surface area below the plane divided by the total area of the structure. The current crossing a floor-to-wall joint would be

$$I_j \cong I_0 \left( A^{floor} / A^{total} \right)$$

where  $I_0$  is the total input current.

The conductance of the joint can be bounded by using the conductance per unit length of a parallel wire transmission line

$$G \cong \pi\sigma / \ln(2s/d)$$

where  $s$  is the distance between the horizontal rebar and the floor mesh or rebar,  $d$  is the geometric mean diameter of the horizontal rebar and the floor mesh, and  $\sigma$  is the conductivity of the concrete and soil (assumed equal). Assuming uniform current density crossing the joint, the joint resistance would be

$$R_j = I/(G\ell),$$

where  $\ell$  is the total length of the joint. The joint voltage is the product of the joint resistance,  $R_j$ , and the current crossing the joint,  $I_j$ .

In the case where the rebar has a partial discontinuity, as in some blast relief designs where the roof is hinged on one side and does not have rebar connections on the other three, the lowest impedance path is predominantly around the slot formed by the two sections of rebar. Because of the finite inductance of this path, the flow of current generates a voltage distribution across that slot that reaches a maximum at its midpoint. This voltage represents a source for driving currents on interior circuits.

The slot inductance consists of two parts: an external inductance associated with the global magnetic energy field outside the slot, and an internal inductance associated with the local magnetic energy in the slot. The external inductance is given by

$$L^{ext} = \mu_0 \frac{\pi}{\Omega}$$

where  $\mu_0 = 4\pi \times 10^{-7}$  H/m is the permeability of free space. The fatness parameter is given by

$$\Omega = 2 \ln\left(\frac{8\ell}{w}\right) - \frac{14}{3},$$

where  $\ell$  and  $w$  are the length and width (gap) of the slot.

When two or more pairs of conductors are involved in carrying the current at the slot, the total inductance is modified to account for the local inductance in the slot. Because the slot width is typically much smaller than the spacing between conductors carrying current of the same polarity, the local inductance per unit length is accurately approximated by  $1/N$  times the inductance of a single pair of conductors, i.e.,

$$L^{int} \cong \frac{1}{N} \frac{\mu_0}{\pi} \ln\left(\frac{w}{a}\right)$$

where  $N$  is the number of pairs of conductors at the slot.

If the rebar at the slot consists of a single pair of conductors, as is the case in Building 12-64, the total inductance per unit length is given by the equations for  $L^{ext}$  and  $\Omega$  discussed above; otherwise, the combined inductance per unit length,  $L'$ , is equal to the parallel combination of  $L^{ext}$  and  $L^{int}$ , i.e.,

$$L' = L^{int} // L^{ext}$$

where the notation “//” is used to denote the parallel combination of circuit elements.

The maximum voltage at the center of the slot is most conveniently calculated in terms of the Norton equivalent circuit. Defining the output terminals of the equivalent circuit to be at the center of the slot, the inductance seen looking back into the network is

$$L^{slot} = (L'h) // (L'h)$$

where  $h = \ell/2$  is the halflength of the slot.

Similarly, the slot conductance per unit length is approximately

$$G \cong \frac{N\pi\sigma}{\cosh^{-1}(w/d)} \cong \frac{N\pi\sigma}{\ln(2w/d)}$$

From the low-frequency expansions for the admittance seen looking into the end of a short-circuited transmission line, the Norton equivalent slot conductance may be shown to be

$$G^{slot} \cong \frac{2}{3} Gh,$$

taking into account both sides of the transmission line.

To complete the solution, the Norton equivalent short-circuit current is needed, which is the current that would flow through a shorting post at the center of the slot. Depending on the location of the assumed lightning attachment point, the short-circuit current is typically between 15 and 50 percent of the full lightning current. If the Norton short-circuit current is of the form of a double-exponential,

$$I^{sc} = \hat{I}^{sc} [e^{-\alpha t} - e^{-\beta t}],$$

the voltage can be obtained by solving a first-order linear ordinary differential equation in the time domain or by inverse transforming the corresponding frequency-domain expression. The result is

$$V(t) = L^{slot} \hat{I}^{sc} \left[ \frac{\beta e^{-\beta t}}{(1 - \beta\tau_c)} - \frac{\alpha e^{-\alpha t}}{(1 - \alpha\tau_c)} - \frac{(\beta - \alpha)e^{-t/\tau_c}}{(1 - \alpha\tau_c)(1 - \beta\tau_c)} \right],$$

where the circuit time constant  $\tau_c = L^{slot} G^{slot}$ .

If the fall time is much longer than the rise time and the time constant of the circuit, a closed-form approximation for the peak voltage can be obtained. Differentiating and setting the result to zero leads to the following expression for the peak time

$$t_{pk} \cong \frac{\ln(\beta\tau_c)}{\beta - 1/\tau_c},$$

where all terms multiplying  $\alpha$  have been neglected. The peak voltage is thus

$$V^{max} \cong L^{slot} \hat{I}^{sc} \frac{\beta}{1 - \beta\tau_c} [e^{-\beta t_{pk}} - e^{-t_{pk}/\tau_c}]$$

$$\alpha \ll \beta$$

$$\alpha \ll 1/\tau_c.$$

Taking Building 12-64 as an example, a slot length,  $\ell$ , is 52', rebar-to-rebar separation,  $w$ , is 4 inches, and a circuit time constant,  $\tau_c$ , of 147 ns, the peak voltage is 97 kV.

### 2.6.2.1 Bays

Most assembly and disassembly operations are carried out in a family of structures that are divided into separate rooms called "bays." These structures are designed to provide protection from the effects of an accidental detonation of high explosives. The structures are covered with earth to enhance the resistance to internal detonations and to afford a level of protection from fragments and blast overpressures from adjacent bays. The bay structures were constructed at various times and employ different methods of blast mitigation.

The bays in Building 12-64 are the oldest bays in use for assembly and disassembly operations. These bays were constructed in the late 1960s and were designed with an 18" thick reinforced concrete wall, roof structure, and floor. The sections are heavily reinforced with #5 reinforcing bars for horizontal reinforcing and #8 and #9 bars for vertical reinforcing. The floor structure contains double rebar mats and the operating areas are reinforced with the same spacing and size of rebar as the walls. The roof structure is designed with a plane of weakness to allow the roof to fail in a blast event and vent the gasses and shock wave upward. The roof is also designed to break into fragments that will not overload the adjacent bay roofs. Compacted earth was placed between the bays to absorb the blast wave without transmitting the shock to adjacent bays. The doors into the bays are a blast resistant design and are anchored to the walls with reinforcing dowels.

Dowels are also used to connect the walls to the floor, and to portions of the roof, in many of the NEAs. Dowels are short sections of reinforcing rod used to increase load capacity by increasing the available cross section of steel in the corners. In the case of a floor-wall connection, the dowels are wire-tied to the horizontal reinforcing in the floor and the horizontal reinforcing in the wall. In addition to distributing the load between the walls and the floor, the interconnection of the dowels assures an electrically continuous path between the walls and the floor, as well as between the walls and the hinged side of the roof.

The bays in Building 12-64 are protected by an integral lightning protection system with air terminals on the high points of the building and a grounding counterpoise around the structure. If all of the metallic penetrations are bonded, the dominant voltage mechanism is the slot voltage produced by the venting roof. Applying the theory used for the calculation of slot voltage and, assuming a lightning rate of current change of  $400 \text{ kA}/\mu\text{s}$ , yields a maximum voltage of 97 kV for the small bays and 98 kV for the large bays.

Building 12-84 consists of two distinct types of bays. The eastern portion of the facility employs a heavily reinforced common wall structure to resist the effects of a detonation, while the western portion uses earth separation between bays to accomplish the blast

resistance. The bays in the eastern part of the facility are reinforced with a laced reinforcing system with #7 & 8 reinforcing bars on 8" centers. The inner and outer mats are laced with #7 reinforcing bars. Common walls between the bays are typically 4'-8" thick and both sides of the common walls are covered with corrugated sheet metal spall shields to protect the workers in adjacent bays from any fragments of the wall concrete that might be ejected during a blast event. The doors are a blast resistant design. Each bay has an inner and outer set of doors. The doors are interlocked such that one door must be closed before the other door can open. The bays in the eastern portion of the facility are protected from lightning effects by an air terminal system. If all of the metallic penetrations are bonded, the dominant voltage mechanism is the slot voltage produced by the venting roof. The roof was designed with separators to limit the size of concrete projectiles to 1'x1'x5' in the event of an internal explosion. The largest slot length is five feet. Applying the theory used for the calculation of slot voltage, assuming a lightning rate of current change of 400 kA/ $\mu$ s, yields a maximum voltage of 33 kV.

The bays in the western section of Building 12-84 use the earth separation method of blast resistance. The walls are not as heavily reinforced and are somewhat thinner, 2'-2" thick versus 4'-8" thick, and not as much lacing is used in the reinforcing. In these bays, the walls are connected to the floor with diagonal dowels. The blast door system was designed with interlocks to keep one set of doors from opening before the other. The doors were designed to resist a detonation similar to the eastern part of the building. The western part of Building 12-84 is protected by an overhead conductor lightning protection system with surge protection on the 120V building services similar to Building 12-84 east. The walls and floor are electrically connected and there are no electrical discontinuities in the roof slabs. The dominant voltage mechanism, assuming all of the penetrations are bonded, is the 86 foot slot around the side and back walls for blast relief. Because of the effective length of this slot, the voltage produced by a 400-kA/ $\mu$ s lightning strike would be 115 kV.

The bays in Building 12-99 are similar to the bays in the west side of Building 12-84 with earth separation between the bays. The reinforcing is similar to straight reinforcing bars in the walls, roof, and floor with lacing rebar in the roof structure. An overhead conductor system and a surge protection system, similar to Building 12-84, protects Building 12-99 West. Because the Building 12-99 bays utilize the same roof design as the 12-84 west bays, the maximum voltage produced by a 400-kA/ $\mu$ s return stroke will be 115 kV if all of the penetrations are bonded.

The blast relief design employed in Building 12-104 is similar to that used in Building 12-64. The roof is constructed with two symmetrical halves, which are hinged about the front and back walls to form an "H"-shaped slot in the roof. Assuming that all of the metallic penetrations bonded and a return stroke rate of current rise of 400-kA/ $\mu$ s, the maximum voltage produced by a lightning strike will be 84 kV.

SNL testing of bay 2 in Building 12-60, which is of a steel arched design unlike any of the aforementioned bays, indicated that the maximum voltage resulting from a severe lightning

strike, between different points, was 4 kV [16], except for the region in the immediate vicinity of the rear wall. Near the rear wall the maximum voltage is 23 kV [16]. Both of these values assume that all metallic penetrations have been bonded. The region within one foot of the rear wall is controlled administratively. The risk posed by voltages at the 4 kV level is minimal and can easily be mitigated.

#### 2.6.2.2 Cells

The assembly cell structures at the Pantex plant consist of a reinforced circular structure, or Round Room, with a layer of gravel for a roof structure. A reinforced concrete corridor provides access to the Round Room from the covered ramps. Along the corridor there are mechanical rooms, cubicles for the staging of materials, and blast relief structures cast into the concrete roof structure. The materials move in and out of the cell through a series of interlocked blast doors that are shaped like a bow. They are designed to wedge into the doorjamb structure and increase the sealing properties of the doors. Personnel enter and leave the cell through a personnel corridor. A revolving door allows entry into the corridor that leads to the Round Room. A pair of interlocked doors is also present in the personnel corridor to assist in sealing the cell from the main ramp.

The Building 12-44 complex is comprised of seven cells, numbered from one to eight (excluding seven). The number 7 cell was never constructed. This family of cells was constructed around 1958. These cells employ the integral system of lightning protection. The penetrations into the Round Room have been bonded, at the point of entry into the Round Room, to a steel doorframe, which is attached directly to the reinforcing bars in the walls. The inner vertical reinforcing in the Building 12-44 Cells is spaced 18" on center and 6" on center horizontally for the first 9'-0" off the floor and 12" on center from there to the ring beam that encircles the Round Room. The outer vertical reinforcing is staggered from the inner reinforcing by 9" and is spaced on the same centers as the inner reinforcing. The horizontal reinforcing is spaced at 9" on center to 8'-0" above the floor and 12" on center to the top of the wall. The inner and outer vertical reinforcing bars are #4s. The inner horizontal reinforcing bars are #5s and the outer horizontal reinforcing bars are #4s. The floor is reinforced with a wire reinforcing mesh, 8 gage on 6" centers each way. The floor is not connected to the walls with dowels. This isolation of the floor from the walls significantly increases the voltage between the two during a lightning event. If all of the metallic penetrations are bonded, the dominant mechanism for producing voltage in the Building 12-44 cells is the resistive joint at the intersection of the walls and the floor. Both rebar continuity testing and capacitance measurements suggest that the reinforcing mesh in the floor is electrically isolated from the reinforcing steel in the walls. By applying the analysis used to calculate joint resistance and assuming a severe 200 kA return stroke, the maximum voltage in the Building 12-44 cells is calculated to be 141 kV. This result is consistent with the preliminary results obtained from the SNL testing which concluded that the maximum floor-to-ceiling voltage would be 121 kV.

Buildings 12-85 and 12-96 are cells that were constructed under the same contract around 1985. These cells are similar in construction to the Building 12-44 cells with a few

notable exceptions. The reinforcing patterns in the walls are more symmetrical with #4 rebars at 12" centers vertically and #5 rebars at 9" on center vertically on the inside face and #5 rebars 6" on center on the outer face. The floor is more heavily reinforced with #5s on 12" centers in two mats, one 3/4" from the surface of the slab on the top mat and 3" clear from the bottom of the slab. The minimum slab thickness is 12". The floor is doweled to the walls with #8 dowels on 12" centers. This feature ensures that the floor and walls are electrically continuous. These cells are protected by an air terminal lightning protection system.

The Building 12-98 complex, Cells 1-4, was constructed around 1987. The individual cells are constructed in a similar fashion to Buildings 12-85 and 12-96. The cells are protected with a catenary or overhead conductor lightning protection system.

Analysis performed by SNL concluded that the maximum lightning induced voltages between different points within a cell, with the exception of the 12-44 cells, is on the order of 10 kV [5] if the rebar in the walls is bonded to the floor rebar assuming a 360-kA/ $\mu$ s return stroke. A 400-kA/ $\mu$ s return stroke would result in an interior voltage environment of approximately 13 kV. The risk posed by voltages at these levels is minimal and can easily be mitigated.

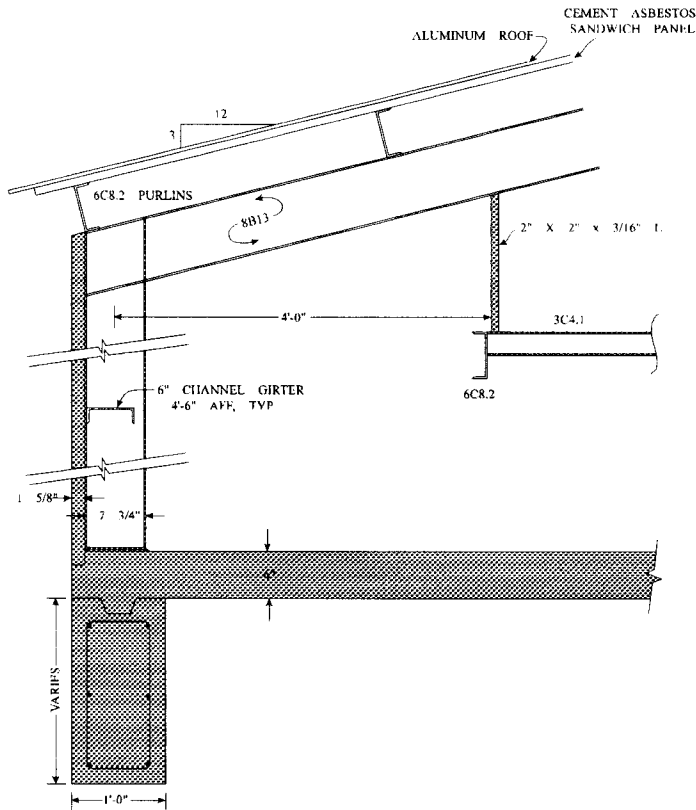
### **2.6.2.3 Ramps**

Ramps throughout the plant are of varying construction; however, most ramps share the structural features shown in Figure 6. The ramp is built on a one-foot wide concrete footing with a 6-in-thick reinforced concrete floor. The walls consist of vertical I-beams, 20' on center, and horizontal channel girders, covered by either 1-5/8" thick panels of cement-asbestos (Cemesto) siding or two layers of 22-gauge sheet metal. In some areas, one wall of the ramp is of I-beam construction, while the other wall is a reinforced concrete retaining wall for a common earth covering. The vertical I-beams are nominally 8" deep, with 4-in-wide flanges, while the horizontal channel girder is 6" wide and is typically mounted 4'-6" above the finished floor. The transverse framing members of the roof are also 8-in-deep steel I-beams, which support five or six steel purlins that run the full length of the ramp. The roof is decked with sheet metal. The outside dimensions of the ramp are typically 12' to 14'-6" wide by 12' high at the peak. The minimum clearance from the finished floor to the bottom of the pipe supports is typically 8'-3".

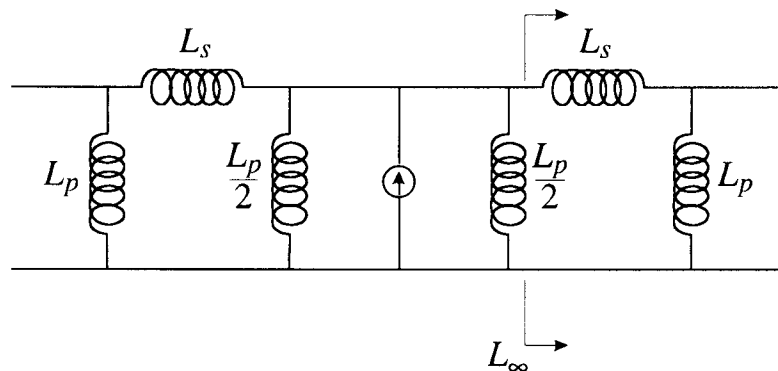
Unbonded penetrations are an issue in the ramps, as they are for the bays and cells. They have the ability to transmit very large voltages from outside the ramps into the ramps. However, ignoring the possible presence of unbonded penetrations, it is possible to estimate the maximum voltage present in the ramps due to severe lightning. The type of ramp that is expected to produce the worst case voltage, with the previous qualification, is constructed with steel I-beams in the roof and both walls. The large number of horizontal I-beams, steel trusses, conducting pipes, and conduits allow the roof to be adequately approximated by a perfectly conducting sheet; the vertical I-beams result in a shunt impedance to ground. Neglecting all resistive effects and the inductance of the reinforcing



steel in the floor, the equivalent circuit for a long section of ramp can be approximated by the inductive ladder network shown in Figure 7, where it is assumed that lightning strikes an air terminal near one of the vertical I-beams.



**Figure 6. Typical ramp construction features**



**Figure 7. Ladder network model for ramp analysis**

In the network analysis,  $L_s$  is the series inductance associated with the ramp roof, and  $L_p$  is the parallel inductance of the vertical supports. The circuit elements are approximated by the formulas:

$$L_s = \mu_0 \frac{h}{w} s$$

$$L_p = \frac{1}{2} \frac{\mu_0}{2\pi} h \ln \left( \frac{s/2}{a_{eff}} \right),$$

where  $h$  and  $w$  are the height and width of the ramp, respectively,  $s$  is the spacing between the vertical beams, and  $a_{eff}$  is the effective radius of the vertical I-beam supports (note that  $L_s$  neglects the compensating effects due to the transverse inductance of current on the underside of the roof and the inductance of the top of the roof to ground). From the ladder circuit model, the total inductance of the network is

$$L_{in} = \frac{1}{2} \left[ \frac{\frac{L_p}{2} L_\infty}{\frac{L_p}{2} + L_\infty} \right]$$

where

$$L_\infty = \frac{1}{2} \left[ L_s + \sqrt{L_s^2 + 4L_s L_p} \right]$$

Substituting  $h = 10$  ft,  $w = 13.5$  ft,  $s = 20$  ft, and  $a_{eff} = 1.5$  in yields a total input impedance of  $0.30 \mu\text{H}$ , and a maximum open-circuit voltage, assuming a  $400\text{-kA}/\mu\text{s}$  return stroke,

$$V_{oc} = L_{in} \left. \frac{\partial I}{\partial t} \right|_{\max} = 122 \text{ kV}$$

The two I-beams near the source carry 91 percent of the total current.

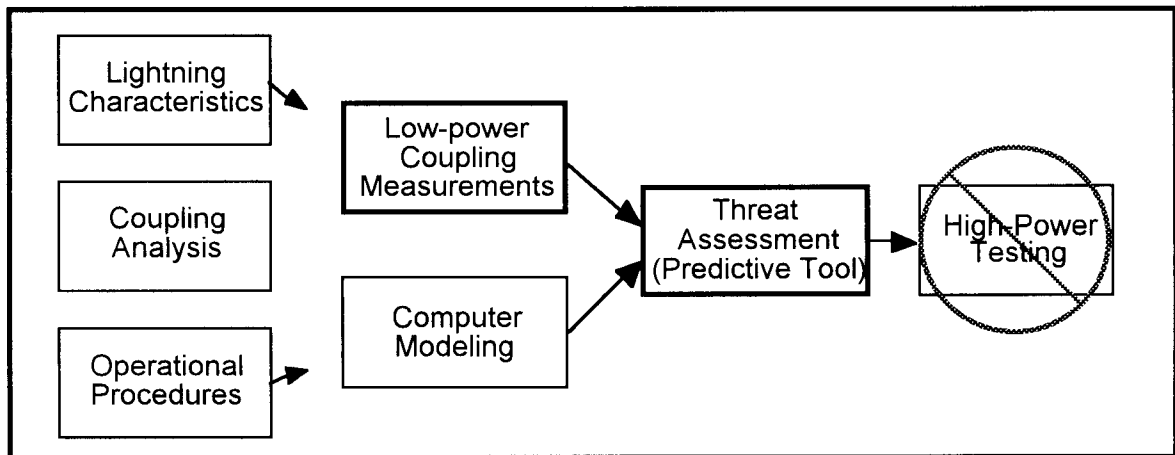
In addition to being present in the ramp, this voltage could be transferred to the interior of a bay or cell through an unbonded penetration. Of course, an unbonded penetration into the ramp could be at a much higher potential relative to the ramp structure, and this higher potential could be then transmitted into a bay or cell.

### 2.6.3 LLNL Lightning Threat Assessment Technique

LLNL has developed a technique based on low-power point-to-point measurements to assess the vulnerability of high-value facilities against lightning. This technique is a subset of a more general methodology developed by Livermore to quantify radio frequency (RF) vulnerability. RF threats include lightning, nuclear-generated electromagnetic pulses (EMP) and high-power microwaves (HPM). This approach was applied to the Nevada Test Site (NTS) Device Assembly Facility (DAF) [17] to assess lightning vulnerability.

Pantex is continuing its program to bond penetrations in the bays and cells to reduce the lightning threat. Even after bonding, some residual voltage will remain. With LLNL's measurement based analysis, worst-case hazards can be predicted for different cell and bay types.

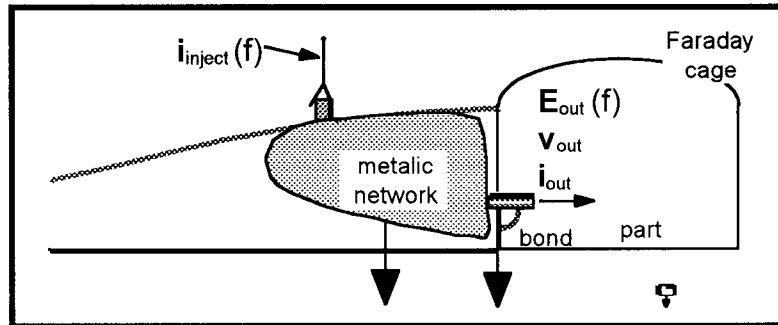
The LLNL lightning threat assessment technique (See Figure 8) consists of a site survey, low-power RF measurement, and computer analysis of the data. Lightning induced currents and voltages on metallic penetrations in bays and cells can be calculated. It is important to estimate the possible cell voltages and currents for two reasons: (1) the voltage level is needed to determine a safe standoff distance between the penetrations and any vulnerable weapon component (2) the currents must be diverted by the bonding wires from the penetrations to the Faraday cage. The current level determines the amount of energy that may potentially be delivered to weapon component.



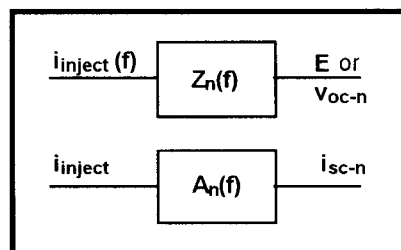
**Figure 8. Lightning threat assessment technique.**

LLNL's methodology normally includes some high-power testing to validate the predictive model. However, at Pantex this step was omitted because of potential safety concerns. LLNL's measurements were compared to SNL's field measurements.

The purpose of the site survey is to estimate the facility vulnerability and guide the test plan. The evaluation is based on visual inspection, knowledge of lightning and coupling phenomena, and an understanding of plant operations and possible risks. Testing consists of injecting low-power RF signals onto external metallic structures that might be struck by lightning. Inside the facility, the resulting currents and voltages on penetrations were measured (See Figure 9). These are point-to-point measurements. A good example of an injection point is an air terminal mounted above an air duct to divert the strike away from the duct. Examples of indoor penetrations are electrical conduits, water lines, and air ducts. These measurements produce coupling transfer functions in the frequency domain (See Figure 10). Based on the spectral content of the lightning current, measurements start at 10 kHz and end at a few megahertz.

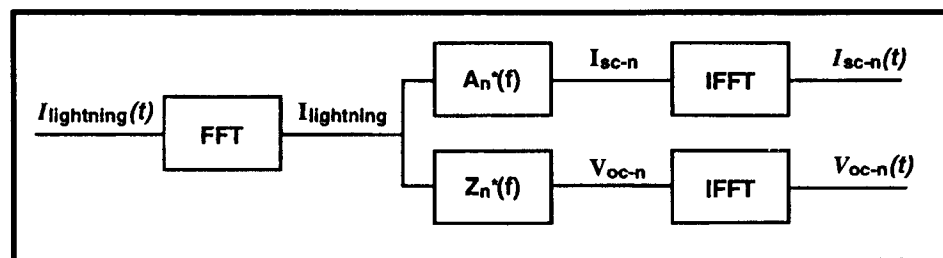


**Figure 9. Point-to-point low-power measurement technique generates a coupling transfer function for metallic penetrations.**



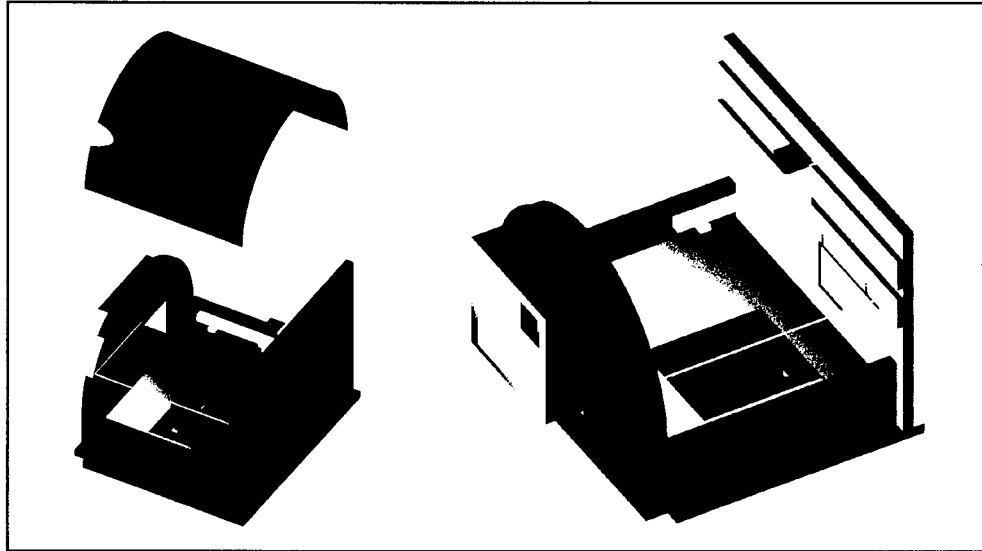
**Figure 10. Low-power measurements produce the attenuation and impedance functions.**

The transfer functions are the core components of a linear model for calculating lightning generated penetration voltages (referenced to ground) and currents. Using a computer, the transfer functions are stimulated with a full lightning waveform (See Figure 11). The interior bay and cell currents and voltages can then be calculated for the different penetrations. Different lightning profiles can be evaluated to determine the worst threat for different cell or bay types. The key characteristics are a maximum peak current of 200 kA, a rise time of 100 ns, and a maximum rate of current rise of 400 kA/ $\mu$ s.



**Figure 11. Computer modeling of lightning threat produces estimates of penetration current and voltage levels.**

Computerized lightning threat simulation is a predictive tool. Normally, it would be validated with some high-power tests. However, this step was omitted due to safety concerns. Instead, analysis of the test results is supplemented with computer models of the facilities. These high-resolution time domain models aid in the understanding of the low-power measurements (See Figure 12).



**Figure 12. Computer model of Dynamic Balancing Facility for electromagnetic analysis by LLNL's code.**

Energy from a lightning strike can be conveyed to a critical component by two paths: directly on conductors and through the air with the electromagnetic fields. The measured frequency domain transfer function cannot always be used to extrapolate to lightning levels directly. This is because of the limited number of drive and measurement points available and because nonlinear arcing processes may change the dominant current pathways as the current amplitude is increased over the six orders of magnitude from test levels to actual lightning levels. Therefore, considerable insight, together with analytical models, must be used to accomplish the extrapolation.

To completely characterize the lightning induced voltages and currents in a bay, cell, or ramp, a full lightning stroke would have to be injected. While this can and has been done by others, it is very difficult, time consuming and hazardous in an operating facility. In a well-constructed facility, the low-power measurements provide transfer functions that are appropriate for extrapolation. This has been confirmed by SNL's rocket triggered lightning tests of ammunition storage igloos.

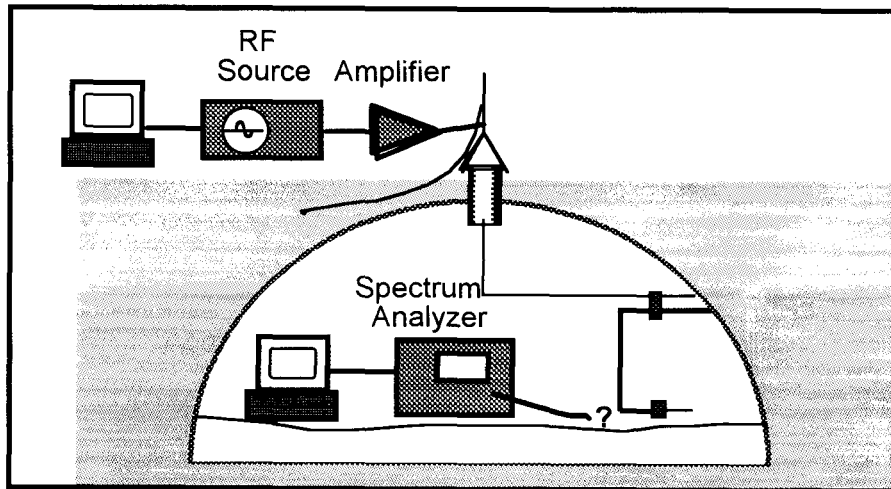
It should be noted that low-power measurement techniques may overestimate the threat to facilities that have floors and walls that are not electrically connected or have unbonded metallic penetrations. As an example, at an unconnected wall-floor joint concrete or air breakdown, which does not occur during low-power measurements, may reduce the interior voltages.

LLNL is measuring coupling in both old and new cells as well as the newer bay types. This effort has been initially focused on bays and cells with the worst postulated defects. However, facility availability must also be considered. Table 1 summarizes the different types of bays, cells and ramps.

	<b>Lightning Protection</b>	<b>Construction</b>	<b>Vintage</b>
<b>Bays</b>			
12 – 50	Integral	Steel arch	Late 60's
12 – 60	Integral	Steel arch	Late 60's
12 – 64	Integral	Steel reinforced concrete (RC)	Late 60's
12 – 84 East	Integral	RC & steel plate	Late 80's
12 – 84 West	Catenary	RC	Late 80's
12 – 99	Catenary	RC	Late 80's
12 – 104	Catenary	RC	Late 80's
<b>Cells</b>			
12 – 44	Integral	RC, floor floated	Late 50's
12 – 85, 96	Integral	RC	About '85
12 – 98	Catenary	RC	About '87
<b>Ramps</b>			
Type 1	Integral	RC floor, cemesto/transite wall, sheet metal roof	Early 50's
Type 2	Varies	RC cement and RC walls, sheet metal roof	1980's

**Table 1. Summary of bay, cell and ramp types at Pantex.**

The transfer functions are measured with a computer coordinated RF source and spectrum analyzer. This highly sensitive technique does not require a connection between the transmitter and receiver, as shown in Figure 13. Pantex personnel have determined that the LLNL procedure is safe.



**Figure 13. Pantex transfer functions are measured with RF source and spectrum analyzer.**

The goal of the assessment is to estimate the worst-case voltage and current for the different types of bays and cells. Data is acquired at several test points to provide confidence that the worst-case voltage and current have been measured. A standoff distance can be determined from this voltage.

The results of the LLNL testing of Building 12-44, Cell 1 indicate a maximum floor-to-ceiling voltage of 108 kV [18] when extrapolated to worst-case lightning levels. This result is consistent with the preliminary maximum floor-to-ceiling voltage determined by SNL of 121 kV.

### 3.0 Vulnerability Assessment

In well interconnected, steel reinforced concrete structures at Pantex (i.e., cells), with all penetrations bonded to the reinforcing steel at their points of entry, the maximum voltage is on the order of 13 kV. The maximum short-circuit current was calculated to be on the order of 1000 A. In reinforced concrete structures, where the reinforcing steel is not continuous across critical construction joints, or where the penetrations are not bonded to the reinforcing steel, the maximum voltages and currents are much larger. The maximum voltage in this case is on the order of a few hundred kV and the maximum current is on the order of a few tens of thousands of amps. In this section, this environment is compared to the safety thresholds of nuclear explosive components. Based on input from the National Laboratories [19, 20], weapon systems in full up configurations were considered to be adequately protected from the effects of lightning. In addition, SNL has provided the specific configuration [19] required before all lightning protection features are in place for weapon systems, except for the B53 and W62, processed at Pantex.

Typical lightning strikes contain significantly greater peak power than that required for initiating detonators. It is likely that any portion of a lightning discharge that is able to create an arc to an exposed detonator cable can deliver enough energy to the cable to initiate the detonators.

In most situations, the detonator cables are protected from the application of unintended energy. However, during assembly/disassembly the protective features may not be in place and cannot be relied upon to provide electrical isolation. The detonator cables provide some protection. For example, cables on modern systems are tested to at least 5 kV and samples of new cables have withstood over 13 kV before insulation breakdown. Insulating covers are also placed over the cable connectors. Cable configurations are also controlled by procedures. These features are effective for preventing direct contact to charged equipment and facility structural elements. Some weapon systems incorporate MSADs, which provide additional protection from lightning. Although weapon design features provide some protection from the lightning threat, they are not, by themselves, adequate for the worst-case lightning environment and thus should be thought of as positive measures rather than controls.



## 4.0 Alternative Lightning Protection Methodologies

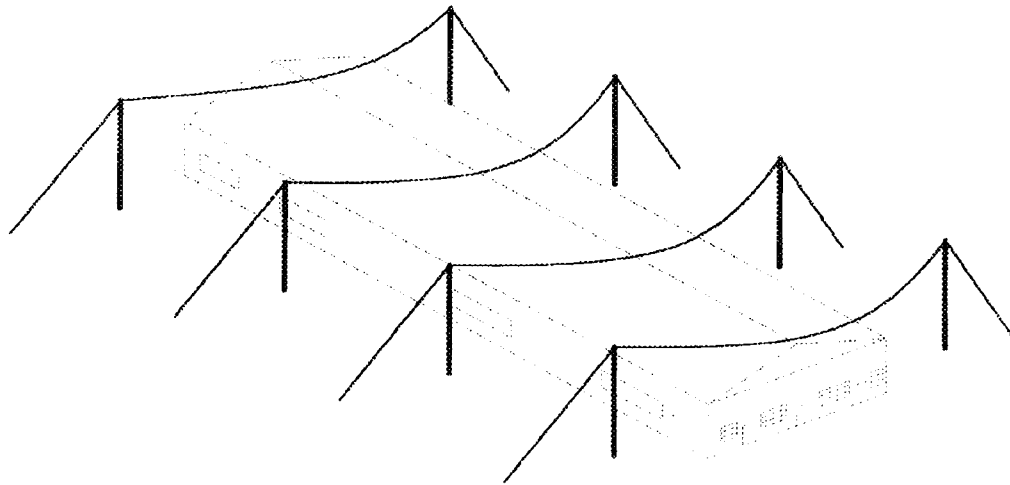
### 4.1 External Lightning Protection Systems

The previous sections have emphasized the Faraday cage/isolation approach to lightning protection. In this section an alternative methodology, based on the enhancement of a traditional catenary system, is investigated. The idea being to prevent a direct attachment to the facility, thereby minimizing the effects within the NEA.

Consider the catenary system illustrated in Figure 14. The spacing between horizontal wires can be estimated by applying Love's formula for striking distance,  $d_s$

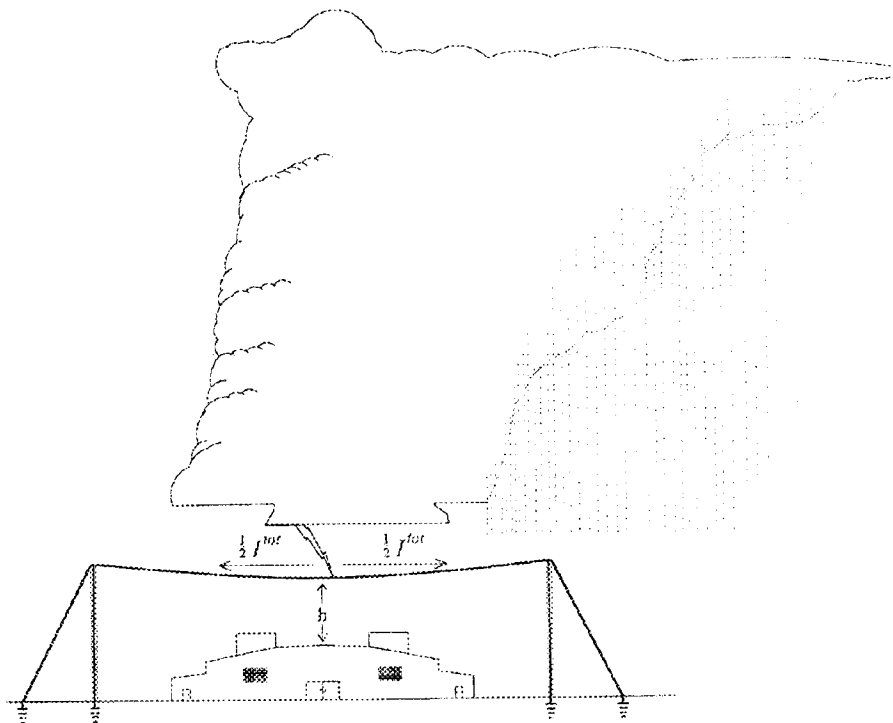
$$d_s = 10I^{0.65}$$

where  $I$  is in kA and  $d_s$  is in meters. Assuming a small initial return stroke of 2 kA (a typical minimum), the striking distance would be 15.7 m. To be effective, the spacing should be less than  $2d_s$ , or approximately 30 m. According to guidance in Golde [21], the spacing between horizontal wires over "danger structures" should be 20 m or less.

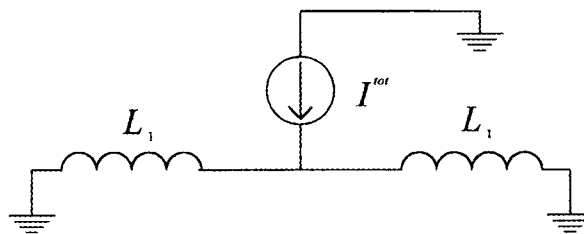


**Figure 14. Example of catenary protection system.**

Assuming that lightning strikes at the center of the wire as depicted in Figure 15, the equivalent circuit would look like Figure 16.



**Figure 15. Catenary wires at height  $h$  above protected structure.**



**Figure 16. Equivalent circuit for Figure 12**

To be effective, the height ( $h$ ) of the wire above the protected facility must be sufficient to prevent an arc from forming between the wire and the facility. In addition, the height should be such that the resulting electrical environment within the facility is reduced to a level that is not a safety concern for any of the weapon systems/components likely to be present. Both of these topics are discussed in the following paragraphs.

First, the minimum height of the wire above the facility is determined. Because the building is large relative to the height of the wire, the inductance per unit length of the catenary is approximately the inductance of a wire over an infinite ground plane, i.e.

$$L = (\mu_0/2\pi)\ln(4h/d) \text{ H/m}$$

For  $h = 40$  ft and  $d = 0.25$  in.s evaluates to  $L = 1.79 \mu\text{H/m}$ . Assuming a strike to the midpoint of a 175 ft catenary wire, the one-way inductance  $L_1$  is  $47.7 \mu\text{H}$ . Using the 99th percentile return stroke waveform, with  $(\partial I/\partial t)|_{\max} = 400 \text{ kA}/\mu\text{s}$ , the voltage from the strike point to the bay is

$$V_{\max} = (L_1/2)(\partial I/\partial t)|_{\max} = 9.54 \text{ MV}.$$

The corresponding arcing distance is computed assuming an effective dielectric strength of 750 kV/m for a horizontal wire-plane air gap,

$$d_a = V_{\max}/E_{\max} = (9.54 \text{ MV})/(750 \text{ kV/m}) = 41.8 \text{ ft},$$

and thus, for this example, the building is just within arcing distance.

The interior environment for a lightning strike in a structure protected by a catenary system of such a design would be calculated using a similar approach. Starting with the incident magnetic field,

$$H^{inc} = I^{tot}/4\pi\rho, \quad \rho = h.$$

The surface short-circuit current density on the bay is given by

$$\mathbf{K}_t^{sc} = 2\hat{n} \times \mathbf{H}^{inc}$$

where  $\mathbf{H}^{inc}$  is the incident magnetic field.

Using Building 12-84 as an example, the Norton equivalent inductance and conductance are

$$L^{stot} = 1.08 \mu\text{H}$$

and

$$G^{stot} = 180 \text{ mS},$$

respectively. The Norton equivalent short-circuit current is

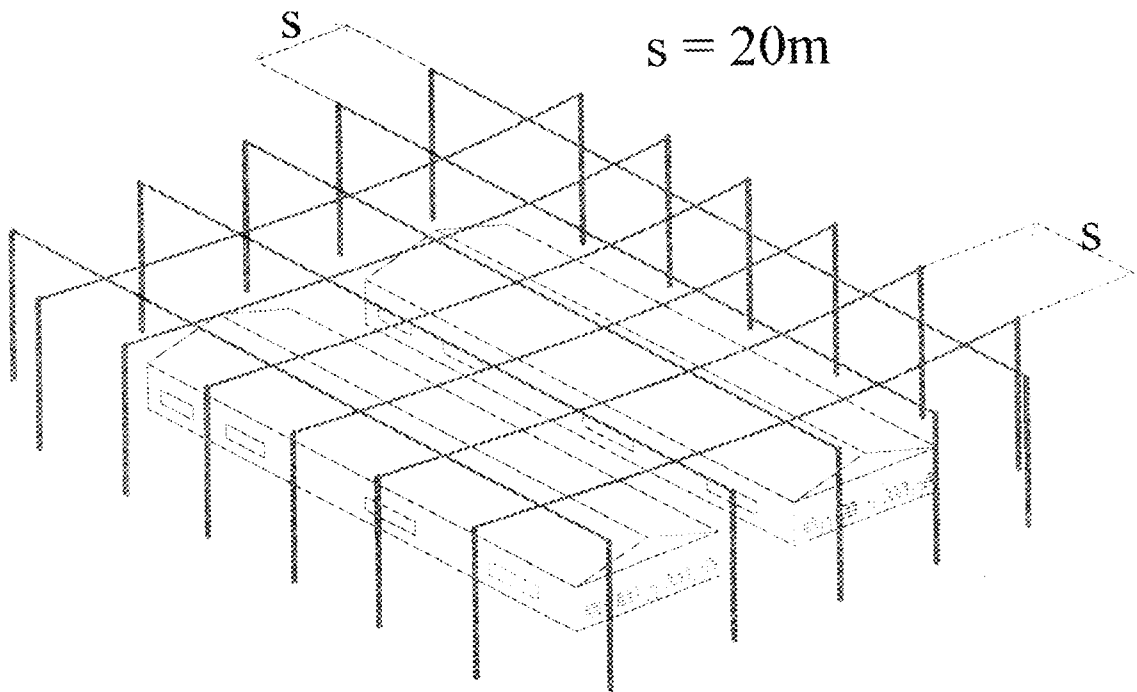
$$I^{sc} = h_0 \frac{I^{tot}}{2\pi\rho} \left( 2 - \frac{h_0}{h} \right),$$

where  $h_0$  is the halfwidth of the bay and  $h$  is the halflength of the slot, as before, and  $\rho$  is the height of the wire above the roof. The peak slot voltage (and thus the maximum voltage available inside the facility) assuming  $h_0 = \rho = 30$  ft' is

$$V^{max} \cong L^{slot} \hat{I}^{sc} \frac{\beta}{1 - \beta\tau_c} \left[ e^{-\beta t_{pk}} - e^{-t_{pk}/\tau_c} \right] = 31.4 \text{ kV, inductive,}$$

which represents a reduction in the interior voltage environment of more than a factor of three when compared to the 115 kV previously calculated. A voltage of 30 kV is still above the dielectric strength of detonator cable insulation, for example, and thus isolation would still be required. (Bonding conductors, placed across the slot, can provide significant reductions in the maximum voltage at minimal cost.)

An alternate design is shown in Figure 17.



**Figure 17. Example of catenary system using additional wires**

A strike to a wire at the midpoint of the spacing depicted in Figure 17 would be analogous to the situation shown in Figure 15. Half of the current would flow in each direction until it further divides at the intersection of two wires. A strike to the intersection of two wires would result in one fourth of the total lightning current flowing in each direction.

Doubling the number of wires results in approximately half of the peak voltage and half of the arcing distance.

It can be shown, analytically and by testing, that, if a down conductor approaches the wall of a facility, the induced voltages can exceed those of a direct strike. This effect will occur for distances comparable to the dimensions of the facility facing the down conductor.

Increasing the number of overhead conductors can reduce the interior voltages; however, the reduced voltages are sufficiently large that bonding and isolation would still be required. The initial cost for installing a catenary wire system with 20m spacing to protect all the Pantex Zone 12 NEAs (bays and cells only) was estimated at roughly \$3 million. Additionally, the possibility of a direct strike to the facility (i.e., the strike fails to attach to the wires) would still exist. Protection for electrical conductors and metallic penetrations, which may originate outside the protected area, would still be required.

#### **4.2 Faraday Cage/Isolation**

A more expeditious approach, given that enhancing the existing lightning protection systems will not eliminate the problem of hazardous voltages in the NEAs, is to determine the worst case voltage/current environment for the NEAs based on the implementation of the Faraday cage approach to lightning protection. Once this environment is established, electrical isolation, sufficient for these voltages/currents, can be provided either through the use of dielectric insulation or standoff distances from the walls and penetrations of the facility. If electrical isolation sufficient for these maximum current and voltages can be provided, the bay or cell can reasonably accommodate any weapon assembly or disassembly operation regardless of its electrical sensitivity.

The boundaries of the Faraday cage are defined and maintained to limit the interior voltage gradients so that isolation can be provided. In order to establish an effective Faraday cage, all conductive penetrations must be bonded to the structural steel of the cage and surge suppression must be provided for the electrical signal/power conductors. A complete implementation of this approach can significantly lower the maximum open-circuit voltage in the interior of the cage, but, because the structural steel of the Pantex NEAs does not form a perfect Faraday cage, not eliminate it entirely. Based on a 400-kA/ $\mu$ s return stroke, an interior environment on the order of 13kV/900A is expected for the best cells. In the few bays without venting roofs, the floor-to-ceiling electrical environment is expected to be 7 kV. Electrical isolation, either through standoff distances or dielectric insulation, can then be utilized to protect sensitive components from these reduced voltages.

The effectiveness of the Faraday cage provided by the facility structure is strongly influenced by both the number of reinforcing members and the degree of electrical interconnection of the reinforcing members in the roof, walls, and floors. Based on the SNL testing and analysis performed to date, the following are the maximum voltages available in the various Pantex NEAs with both bonded and unbonded penetrations.

Unbonded Penetrations  
Dominant Voltage

Maximum LPS Type	Facility	Mechanism	Voltage
Integral	12-44	Unbonded penetrations	441 kV*
	12-50	Unbonded penetrations	TBD
	12-60	Unbonded penetrations	TBD
	12-64 (1-9)	Unbonded penetrations	210 kV
	12-64 (10-17)	Unbonded penetrations	300 kV
	12-84 E	Unbonded penetrations	256 kV
	12-85	Unbonded Penetrations	156 kV
	12-96	Unbonded Penetrations	156 kV
Catenary	12-84 W	Unbonded penetrations	219 kV
	12-98	Unbonded penetrations	241 kV
	12-99	Unbonded penetrations	194 kV
	12-104	Unbonded penetrations	144 kV

\* The presence of the electrical discontinuity between the wall and the floor of the Round Room complicates the analysis. SNL is currently evaluating the voltage produced by an unbonded penetration in Building 12-44. This voltage is the sum of the voltage produced by the wall-floor joint and the worst unbonded penetration voltage found so far.

**Table 2. Maximum voltage produced by an unbonded penetration.**

### Bonded Penetrations

LPS Type	Facility	Dominant Voltage Mechanism	Voltage (calculated)	Voltage (tested)
Integral	12-44	Wall-floor joint	141 kV	121 kV
	12-50	Wall-floor joint	TBD	
	12-60	Wall-floor joint	*	23 kV
	12-64 (1-9)	Blast relief design	97 kV	
	12-64 (10-17)	Blast relief design	98 kV	**
	12-84 E	Roof separators	33 kV	
	12-85	Rebar Inductance	13 kV	
	12-96	Rebar inductance	13 kV	380kV***
	Catenary	12-84W	Blast relief design	115 kV
12-98		Rebar inductance	13 kV	
12-99		Blast relief design	115 kV	
12-104		Blast relief design	84 kV	

\* The voltage for 12-60 has not yet been determined analytically. The voltage environment was determined based on SNL testing of Bay 2.

\*\* SNL has tested Building 12-64, Bays 13 and 14, and Building 12-84, Bay 19; however, reports documenting the results have not yet been completed.

\*\*\* The tested voltage is based on an LLNL test of the catenary lightning protection system near Building 12-96 rather than direct excitation of the facility structure.

**Table 3. Maximum facility voltage**

Because the penetrations in the ramps have not been bonded, the dominant voltage mechanism in the ramps is the unbonded penetrations, resulting in maximum potential electric fields in the MV/m[5] range. If the ramp penetrations were bonded to the structural steel supports, the dominant voltage mechanism would be the structural steel of the ramps, resulting in a maximum voltage of 122 kV. Unrestricted transportation through the ramps is currently being allowed only for those systems/components with containers that have been approved by a Nuclear Explosive Safety Study (NESS). The containers are considered adequate have been determined by SNL to provide protection from the direct attachment of a 99th percentile lightning strike. The transportation containers used for the W56, W69, W79, and the W87 have been analyzed by SNL [22-25]. With the exception of the W79 transportation cart, all have been found to provided adequate protection. SNL has made recommendations for modifying the cart to improve its lightning protection capabilities. The transportation cart for the W56 is the only transportation cart that is currently NESS approved. The movement of all other sensitive systems/components is suspended during lightning warnings.

The Faraday cage/isolation approach, as it is being implemented for the Pantex NEAs is a conservative means of providing the necessary protection for weapon systems and components, especially when utilizing isolation adequate for unbonded penetration. If isolation is provided that is sufficient for the voltages produced by unbonded penetrations, the bonds would not have to be relied upon for protection and should be considered as an additional defense-in-depth barrier.

Although a traditional lightning protection system will divert at least some fraction of the current (five percent for an air terminal system and substantially more for a properly designed catenary system), no credit was taken for the existing lightning protection systems. Worst case (99th percentile) lightning parameters, current and rate of current change, were used in all calculations. No credit is taken for any of the protective features designed into the weapon system/component. The steel reinforcing members of the facility and the bonds are essentially passive components requiring little or no maintenance. At least four layers, including the MOVs in the testers themselves, of surge suppression are provided for 120V AC-powered electrical test equipment that is directly attached to the weapon system. Dielectric insulation, such as air and vacuum hoses, must be tested to the maximum facility-specific voltage levels before it is relied upon. The implementation of the isolation requirements has relied on the posting of a placard in the bay or cell indicating the required standoff distance. The implementation of standoff distance could be improved by defining and controlling the facility layout necessary to provide the required standoff distances. A defined layout will also simplify the verification process.

A substantial safety margin can be provided if insulation/standoff distances that are adequate for the voltages produced by unbonded penetrations are implemented. For some facilities this additional standoff amounts to as much as 84 inches, which is adequate for a voltage level of 580 kV. At these distances, complete protection is provided even if one or more bonds fail completely.



## **5.0 Controls**

The purpose of the controls phase of the project is to determine the administrative and engineered controls necessary to mitigate the threat to those weapons systems and components deemed to be at risk from the effects of lightning. Based on our current understanding of the lightning hazard, the best available method for mitigating the effects of lightning in the Pantex NEAs is to implement a Faraday cage in each of the bays or cells and then provide isolation/insulation for the maximum potential voltage that may be developed in that particular facility. When adequate isolation cannot be provided, the operations must be suspended and the sensitive components put in a safe configuration during lightning warnings. The LPPT has developed a procedure [26] for use in validating the implementation of the initial set of controls. These controls include the Faraday cage; bonding of metallic penetrations; AC power surge suppression; and electrical isolation, including standoff and insulation.

### **5.1 Lightning Protection Systems**

As discussed previously, the existing lightning protection systems, catenary wires and integral, are of limited effectiveness in preventing the effects of lightning from entering the Pantex NEAs. For the type of construction utilized in these facilities, the integral and catenary wire lightning protection systems are of value primarily for preventing external arc damage to the facility. These systems should be inspected and maintained in accordance with the requirements of the current DOE Explosives Safety Manual, DOE M 440.1-1, which requires a visual inspection at least annually and an electrical inspection at least every 47 months. These inspection requirements are less stringent than the NFPA's requirements for a visual inspection every seven months and an electrical tests every 14 months [9]. Since these systems provided some benefit, primarily in preventing arcing damage to the facility, they should retained and continue to be maintained at the current levels.

### **5.2 Faraday Cage**

Based on our current understanding, the most effective approach for providing lightning protection in the Pantex NEAs is to utilize the structural steel of the facility as a Faraday cage. The Faraday cage formed by the rebar will limit the interior voltages to levels for which isolation or insulation can be provided without significantly impacting operations.

The highest calculated voltages, excluding transportation in the ramps, are found in the bays and the Building 12-44 cells. Installing additional bonding to bridge the discontinuities in the rebar can substantially reduce the relatively large voltages in the bays, attributable to the blast roof design. The additional bonding reduces the effective length of the slot formed by the rebar discontinuity, thereby reducing the slot voltage. The high voltages in the Building 12-44 cells are due to the absence of connections between the reinforcing steel of the walls and the floor. Because the floor utilizes reinforcing mesh

rather than rebar, installing engineered bonds is not a viable option for reducing the voltage produced by the floor/wall discontinuity.

Although the voltage environment in the interior of the facilities is limited due to the Faraday cage formed by the rebar, conductive penetrations, such as air or water lines, have the potential to transmit electric fields of the MV/m [5] level directly into the interior. In order to derive the benefits of the Faraday cage, all conducting penetrations must be bonded to the Faraday cage as close as possible to their entry points.

Inside a bonded facility (except for Building 12-44), the voltage waveform is inductive or proportional to the derivative of the input current. For this waveform, the average dielectric strength of air is 900 kV/m. A safety margin of two is used in calculating the required standoff. The required isolation distance,  $d_{so}$ , is

$$d_{so} = 2 \times \frac{V}{\left(9 \frac{kV}{cm}\right)}$$

where  $V$  is the maximum interior voltage.

The dominant voltage producing mechanism in the Building 12-44 Cells is the resistive joint at the intersection of the walls and the floor. A dielectric strength of 550 kV/m is used for air in this case. The required isolation distance,  $d_{so}$ , is

$$d_{so} = 2 \times \frac{V}{\left(5.5 \frac{kV}{m}\right)}$$

where  $V$  is the maximum interior voltage. Preliminary low-power testing by SNL of Building 12-44, Cell 1, determined that the maximum voltage would be 121 kV and that the voltage was inductive, indicating at least one bond between the floor and the walls. Since the voltage was inductive, the required standoff of 20 in. provides a safety margin of 3.7.

If a facility has unbonded penetrations, the maximum voltage that can be developed between a penetration and the reinforcing steel is limited only by the dielectric strength of the air and concrete separating the penetration from the rebar. In cases where the metallic penetrations have not been bonded, interim isolation distances were calculated assuming a dielectric strength of 30 kV/cm for concrete and 5.5 kV/cm for air. The maximum voltage produced by an unbonded penetration is:

$$V^{\max} = d_c \times 30 \frac{kV}{cm} + d_{air} \times 5.5 \frac{kV}{cm}$$

Where  $d_c$  is the depth of the concrete cover and  $d_{air}$  is the air gap between the penetration and the wall.

The maximum arcing distance is:

$$d_a = \frac{V^{\max}}{5.5 \frac{kV}{cm}}$$

The safety margin of two is applied when computing standoff distance.

A conservative air isolation of 84 inches, which is adequate for a voltage level of 580 kV, is used for those facilities for which the maximum voltage produced by an unbonded penetration has not yet been computed. The following are the standoff (air isolation) distances for each of the NEAs assuming all metallic penetrations are unbonded.

Facility	Unbonded Penetrations	
	Maximum Voltage	Air Isolation
12-44*	441 kV	64 in.
12-50	TBD	84 in.
12-60	TBD	84 in.
12-64(1-9)	210 kV	30 in.
12-64(10-17)	300 kV	43 in.
12-84E	256 kV	37 in.
12-84W	219 kV	32 in.
12-85	156 kV	22 in.
12-96	156 kV	22 in.
12-98	241 kV	35 in.
12-99	194 kV	28 in.
12-104	144 kV	21 in.

\* The presence of the electrical discontinuity between the wall and the floor of the Round Room complicates the analysis. SNL is currently evaluating the voltage produced by an unbonded penetration in Building 12-44. This voltage is the sum of the voltage produced by the wall-floor joint and the worst unbonded penetration voltage found so far.

**Table 4. Standoff required for unbonded penetrations**

The following are the standoff (air isolation) distances for each of the NEAs assuming all metallic penetrations are bonded to the cage at the point of entry.

Facility	Bonded Penetrations Maximum Voltage	Air Isolation
12-44	141 kV	20 in.
12-50	TBD	TBD
12-60 Bay2	23 kV	12 in.**
12-64(1-9)*	97 kV	8.5 in.
12-64(10-17)*	98 kV	8.5 in.
12-84E*	33 kV	3 in.
12-84W*	115 kV	10 in.
12-85	13 kV	1 in.
12-96	13 kV	1 in.
12-98	13 kV	1 in.
12-99*	115 kV	10 in.
12-104*	84 kV	7.5 in.

\* Slot inductance is the dominant voltage producing mechanism for these facilities. These voltages can be reduced significantly by installing bonds to bridge the slot.

\*\* The approved Basis for Interim Operation (BIO) requires a 12-inch standoff. Using the criteria discussed previously for determining standoff would result in a standoff of approximately 2 inches.

**Table 5. Standoff required for bonded penetrations**

Low power transfer impedance testing using the methods developed by SNL and LLNL can be used to confirm the electrical connectivity of the rebar. Tests performed to date show little variance from the calculated values. Because the calculations assume rebar connectivity, the testing provides a high degree of confidence that the rebar is connected electrically and that corrosion, even in facilities constructed between 10 to 40 years ago, has not significantly reduced the electrical connectivity. Since an entire facility (or portion of a facility in some cases) is constructed at the same time using the same techniques and materials, the electrical connectivity and corrosion rates should be the same for all the individual NEAs within that facility. Therefore, low power testing of one bay or cell in each facility every five years should provide adequate assurance of the status of the electrical connectivity of the steel reinforcing elements. This testing interval is approximately consistent with the electrical testing requirements of the current DOE Explosives Safety Manual for electrical testing of lightning protection systems. The structural steel elements of the facility are less subject to damage or corrosion than an external system.

The Faraday cage boundaries have been defined and documented for most of the Zone 12 NEAs. The Faraday cage for the Building 12-44 cells is the Round Room. The Faraday cage boundaries for the remaining cells includes the other areas inside the inner equipment door. The Faraday cage boundary for a bay it is typically the bay itself; however, the equipment interlock area is included for some bays. The determination that the rebar is electrically continuous was made using construction drawings and specifications, knowledge of construction techniques, and photographs taken at various stages of construction. Low power testing by both SNL and LLNL has confirmed the integrity of the Faraday cage formed by the rebar in several facilities.

Since the facility structure is a safety class system, any modification, such as a new penetration, has to go through the configuration control process. This will ensure that any new penetrations are bonded to the rebar. To allow for configuration management of the controls, complete documentation packages that were used to implement the Faraday cage, including isolation, are retained for each modified facility. These packages include copies of any work orders, engineering analyses, drawings, photographs, construction specifications, and test results necessary to demonstrate the adequacy of the lightning protection enhancements.

### **5.3 Bonding**

A bond is a short conductor between two metal objects, in this case the metallic penetration and the Faraday cage, that maintains them at the same potential during a lightning flash. When a bond is required, it is typically made to the reinforcing steel in the wall or an embedded steel channel that is electrically connected to the rebar. Bonding conductors must be #6 AWG wire, or larger [27, 28]. The bonds must as short as possible while avoiding sharp bends [28], and should not exceed the nominal rebar spacing of one foot unless necessary to avoid an obstruction or to find an acceptable bonding point. The one-foot bond length was established based on the rebar spacing in the cells to allow the bond to be long enough to reach the nearest rebar. The resistance between the penetration and a reference ground for the Faraday cage should not be more than 1.5 ohms. The 1.5-ohm specification is based on experience installing compression fittings for the bonds in the Pantex NEAs as indicative of a good bond.

Unbonded metallic penetrations have the potential for producing the highest electric fields (see Table 4) in the bays and cells. Ensuring that these penetrations are electrically bonded to the steel reinforcement of the facility is essential for ensuring the safety of the operations performed in the NEAs. By virtue of the construction techniques (wire ties and unistrut supports) used to build these facilities, it is expected that most of the metallic penetrations are electrically bonded to the rebar. However, since this intrinsic bonding could not be readily verified, an engineered bond was installed to connect each penetration to the rebar at the closest available point.

Two types of engineered bonds have been employed in the lightning protection enhancement effort. Penetration bonding should be installed to reduce the voltage developed between a remotely grounded metallic penetration and the Faraday cage. The inductance of the bond will cause a voltage to be developed across the bonding conductor; however, this voltage will be smaller than the voltage that can be developed across the air and concrete separation between the cage and the penetration. Roof slot bonding should be installed to reduce the effective slot length of the rebar discontinuity formed by the blast relief design of the roofs in most of the assembly/disassembly bays, thus reducing the slot voltage developed.

Building 12-60, Bay 2, is the only facility that currently has surveillance requirements for these items. The current requirements for this facility are: a mechanical check of the

bonds every 2 years; a resistance check of the bonds every 5 years; low power testing of the Faraday cage structure every 5 years; inspection of the surge arresters every 2 years. In the absence of test data, these inspection intervals appear to be adequate.

A graded approach was applied to the penetration bonding effort to ensure that those facilities processing sensitive components received priority. The facilities were divided into four groups based on the types of operations performed in them.

Category 1: Facilities directly involved in the processing (assembly, disassembly and/or evaluation) of nuclear explosive assemblies, where weapon assemblies are potentially configured such that the bay/cell must function as a Faraday cage rather than the outer weapon case.

Category 2: Facilities directly involved in the processing (linac bays and manifold bay operations) or storage of nuclear explosive assemblies/subassemblies, where weapon assemblies/subassemblies are configured such that the outer weapon case functions as a Faraday cage.

Category 3: Facilities directly involved in the processing or staging (e.g., paint or vacuum chamber operations, sandbag bays) of nuclear explosive assemblies/subassemblies are configured such that the outer weapon case functions as a Faraday cage.

Category 4: Facilities that are not currently involved in the processing or storage of nuclear explosive assemblies/subassemblies, either because the facility processes only non-nuclear explosive test or evaluation units, SNM materials, is inactive or has not been put into operation.

The following is the current status of the ongoing effort to implement bonding and other enhancements for all of the NEAs:

Facility	<u>Pantex NEAs</u>			
	Penetration Bonding*	Surge Suppression	Air Standoff Bonded	Air Standoff Unbonded
12-44	Complete	Complete	20 in.	64 in.
12-50	Not initiated	Complete	TBD	84 in.**
12-60 (1)	Not initiated	Complete	3 in.	84 in.**
12-60 (2)	Complete	Complete	12 in.	12 in.
12-64(1-9)	Complete	Complete	8.5 in.	30 in.
12-64(10-17)	Complete	Complete	8.5 in.	43 in.
12-84E	Complete	Complete	3 in.	37 in.
12-84W	Complete	Complete	10 in.	32 in.
12-85	Complete	Complete	1 in.	22 in.
12-96	Complete	Complete	1 in.	56 in.
12-98	Complete	Complete	1 in.	34.5 in.
12-99	Complete	Complete	10 in.	28 in.
12-104	Ongoing***	Complete	7.5 in.	21 in.

\* Status of penetration bonding in Category 1 and 2 facilities. No Category 3 or Category 4 facilities have been bonded yet.

\*\* A standoff of 84 in. is used because the maximum voltage produced by an unbonded penetration has not been determined for this facility.

\*\*\* Building 12-104, Bay 16 (Category 2) and Building 12-60, Bay 1, which process weapons in the full up configuration, have not yet been bonded.

**Table 6. Penetration bonding status**

The only facilities for which roof slot bonding has been completed are Building 12-84, Bays 16 and 18.

SNL has developed a testing methodology that can be used to verify the bonding of metallic penetrations. The tester injects current on one side of the Faraday cage and measures the current that passes through the wall. If the penetration is intrinsically bonded, the current passing through the wall will be a small fraction of the injected current as the bulk of the current will be shorted to ground at the intrinsic bond(s). Intrinsic bonds are considered to be more reliable than engineered bonds and provide improved electrical performance by virtue of their lower inductance connection to rebar. To date, the only penetrations that have been checked for intrinsic bonding are the penetrations near the work area in Building 12-98, Cell 1. MHC is currently assembling a penetration tester of the SNL design to provide an in-house capability to verify intrinsic bonding.

#### **5.4 Surge Suppression**

Because fuses and circuit breakers cannot protect from lightning induced transient voltages on power lines, surge arresters are needed to limit the voltages between power

distribution lines (phases, neutral, and ground). These are an essential element of any lightning protection system. The LPPT has developed the following minimum criteria for AC power surge suppression to assure that lightning induced transients do not pose a significant concern in the Pantex NEAs [29]:

- MOV type surge arresters should be installed in the distribution panel (120/208V) nearest the Faraday cage. If the wiring is enclosed in metallic conduit, the conduit is bonded to the cage, and the conduit is electrically continuous between the Faraday cage and the MOVs, they may be located in the ramp or the equipment room.
- Because they are capable of handling higher currents, gas tube type surge arresters or high energy MOVs should be installed upstream of the MOVs in the distribution panel. To obtain the benefit of both devices, the gas tubes/high energy MOVs must be separated from the MOVs in the distribution panel by some distance or a transformer.
- In order to provide a common reference, continuous metallic conduit/housings from the bay or cell to the MOVs and from the MOVs to the gas tubes must be provided and maintained.
- Surge suppressors must be installed on each current carrying phase to ground and on the neutral to ground.

To limit the phase-to-ground voltage, the ground side of the suppressors are connected to the extension of the Faraday cage through a low inductance ground connection. The extension of the Faraday cage, in this case, the metallic conduit, must be electrically continuous from the cage to the ground connection. In most cases continuity can be established visually or through electrical testing. However, in certain situations, such as when conduit is routed under a concrete slab, construction specifications and drawings/photographs are relied upon to establish electrical continuity. This ground connection must be less than one foot in length. The one-foot length was established to be consistent with the nominal rebar spacing and penetration bond length.

Since ground reference (point where the conduit is bonded to the rebar) for the surge suppression may be at a different potential than the floor (assumed path off of the weapon), isolation or standoff from the equipment may still be required. Assuming that the conduit is bonded to the rebar, the potential difference between the conduit and the floor could be as high as the maximum bonded voltage (see Table 3) depending on the location where the conduit penetrates the Faraday cage. Note too that lightning current flowing through the conduit bond wire(s) is another source of potential difference. If the conduit enters the Faraday cage through the floor and has been demonstrated to be intrinsically bonded, minimal isolation would be required because there would be no common-mode voltage developed between the electrical equipment and the floor.



The Pantex facilities currently have high energy MOV type suppressors installed at the 12,470 V distribution transformers, MOVs installed at the 480V side of the substation, and MOVs at the 120/208 V distribution panels. The surge suppressors at the 120/208 V and 480 V levels were validated in accordance with the LPPT developed validation procedure. Validation of the lightning protection enhancements is also required for the MHC Weapon Process or Cycle Start readiness Checklist, PX-3322 [32]. During the validation process it was found that all of these recommendations were met, allowing for the use of high energy MOVs instead of gas tubes on the 480 V circuits, except for the one-foot connection length requirement. Those connections that were found to be in excess of one foot in length were shortened to comply with the length requirements of the validation procedure developed by the LPPT.

The communication circuits (fire detection/alarm, the ARGUS system, telephone, RAMS, public address system, etc.) penetrating the Faraday cage structure of the Pantex NEAs are not currently surge protected. Since these circuits are installed in metallic conduit, the threat from lightning is small. At lightning frequencies (10 kHz to 1 MHz) the skin depth of steel ranges from is 0.003 to 0.0003 inches, respectively [30], which is substantially less than the thickness of metallic conduit. Due to the skin effect the current will flow on the outside surface of the conduit and there should be minimal coupling with the communication circuits inside. However, the possibility of lightning either striking the conductors directly or arcing to them cannot be ruled out as there are places within the ramps where the conductors are not protected by conduit. The LPPT has developed a recommendation [31] for providing surge protection for these circuits. MHC is currently evaluating the feasibility of implementing the LPPT surge suppression recommendations for all of the Pantex NEAs. Preliminary cost estimates are in excess of \$5 million. Ensuring that unbonded standoff distance is maintained from this equipment can provide equivalent protection from potential voltage surges on these circuits. Another option would be to ensure that all of the conductors are completely enclosed in metallic conduit and bonded standoff is provided from the equipment attached to these circuits.

## **5.5 Covers/Containers**

Because the ramps do not afford adequate lightning protection, unrestricted transportation through the ramps is currently being allowed only for weapon systems in a full up configuration and those systems/components with NESS approved containers. The approved containers have been determined by SNL to provide protection from the direct attachment of 99th percentile lightning. The transportation containers used for the W56, W69, W79, and the W87 have been analyzed by SNL [22-25]. With the exception of the W79 transportation cart, all have been found to provide adequate protection. SNL has provided recommendations for modifying the W79 cart to improve its lightning protection capabilities. The movement of all other sensitive systems/components is suspended during lightning warnings. Should a lightning warning occur during a move, the move is completed. The W56 transportation cart is currently the only NESS approved transportation cart.

## 5.6 Detection/Warning

During lightning warnings, operations in cells, which have fully implemented bonding and isolation requirements, most operations can continue with no restrictions. Certain operations, such as those involving AC powered testers, are required to be suspended during lightning warnings regardless of the bonding/isolation status of the facility. Lightning warnings result in the suspension of operations in facilities/operations that have not yet incorporated dielectric isolation or standoff distances sufficient for their maximum bonded voltages. A hoist isolation strap, which has been tested to 10 kV, is used for lifting operations in the cells. In addition, because the metallic penetrations of the ramps have not been bonded, only those systems transported in containers that have been determined to be capable of providing adequate protection against direct lightning are moved through the ramps during lightning warnings. The transportation of partial weapon assemblies in unapproved containers is also halted. The Plant Shift Superintendent (PSS) issues lightning warnings when any one of the following conditions [33] is detected:

- The LLPS detects a C-G strike within 10 miles of the Plant
- SPMS readings greater than 2 kV/m on any two EFMs and the LLPS detects a C-G strike within 25 miles of the Plant
- SPMS readings greater than 2 kV/m on any two EFMs and Next Generation Weather Surveillance Radar (NEXRAD) indications of reflectivity greater than 35 dBz
- SPMS readings greater than 10 kV/m on any two EFMs
- Lightning is sighted or thunder is heard.

In order to provide a backup capability for the LLPS, Pantex is upgrading the current detection system so that the PSS will be capable of accessing data from the National Lightning Detection Network in the event communication with the sensors is lost. The OC has ordered industrial grade modems to improve the reliability of communications between the lightning sensors and the data analyzer. The PSS can visually monitor the local atmospheric conditions using the closed circuit television cameras mounted on top of the water tower. The combination of tower height and the flat terrain ensure that these cameras are capable of observing storms/lightning for considerable distances. The PSS also has the the real-time NEXRAD system and human spotters in the event of an SPMS failure. The SPMS is considered to be in alarm (indicating an electric field of 2 kV/m) in the event of a system failure. The NEXRAD system is relied upon as a backup for detecting locally forming thunderstorms.

The PSS can also receive weather forecasts and other information from the Weather Channel, local television weather reports, the National Weather Service, National Oceanic and Atmospheric Administration (NOAA) radio, and various onsite personnel, such as the security force. Onsite personnel are instructed to contact the OC by telephone or radio if they see lightning or hear thunder.

The PSS uses the Public Address System, the Pager System, and the Orbacom Radio System to issue lightning warnings. Most personnel receive warnings via the public address system, which is audible in virtually all areas in and around the NEAs. All Facility Managers (FMs) and Assistant Facility Managers (AFMs) also receive an alphanumeric page alerting them to the warnings. Upon receipt of the page, the FMs and AFMs are required to immediately confirm that the personnel in each operating bay or cell within their facilities is aware that lightning warnings are in effect and that the required actions are understood. When these confirmations are completed, the FMs and AFMs notify the PSS. Warnings can also be given using automated telephone notification, pager notification, plant radio, and manual telephone. Figure 18 is a graphical representation of the Pantex lightning detection and warning systems.

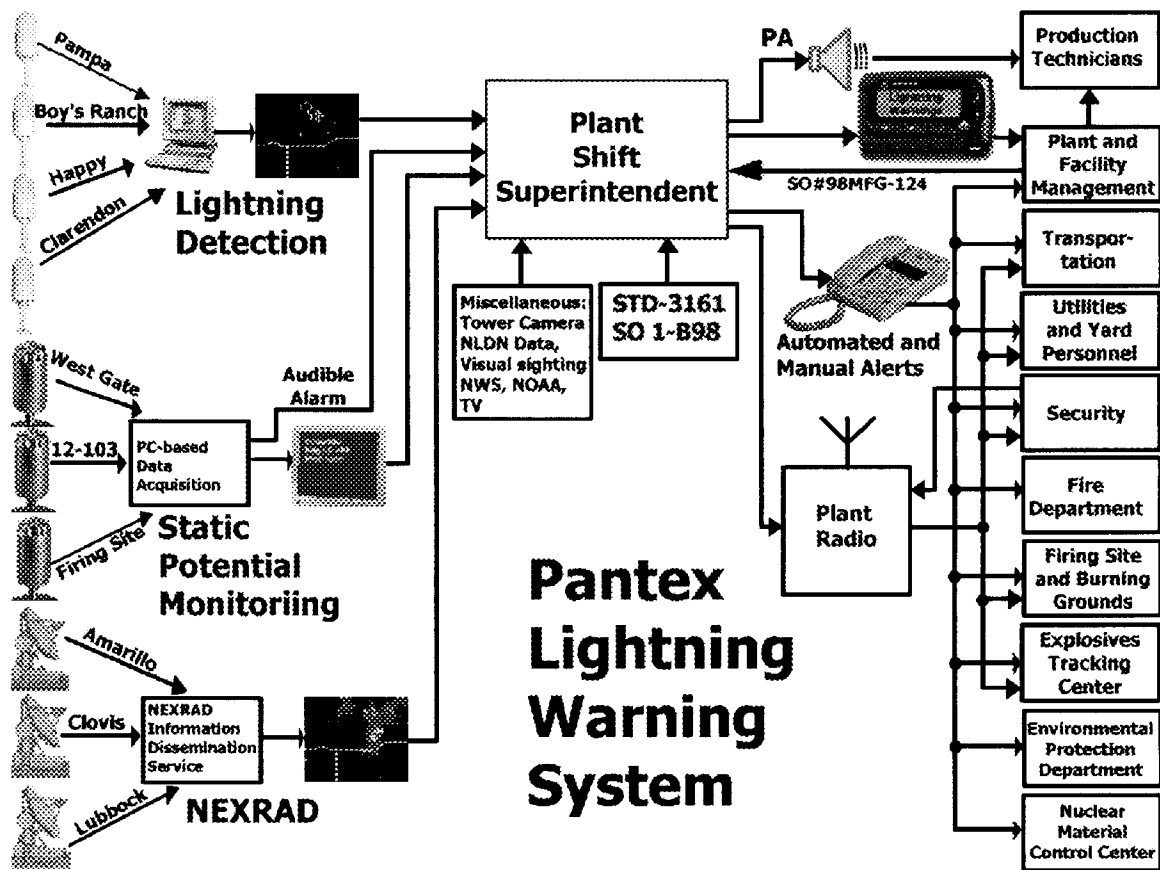


Figure 18. Pantex lightning detection and warning system

### 5.7 Insulation/Isolation

Dielectric insulation and standoff are currently being provided at a level which is sufficient assuming all penetrations are bonded. Electrical isolation requirements are currently implemented through Revision E of the Lightning Protection EI. This revision was issued

while the electrical isolation requirements (required standoff for each facility) were in a state of flux and contains numerous implementation weaknesses. The draft Technical Safety Requirements (TSRs) address many of these issues, including the defense-in-depth approach and unbonded standoff from communication circuits.

## **6.0 Recommendations**

### **6.1 Lightning Detection**

The lightning warning criterion of “greater than 10,000 volts/meter displayed on two or more field mills” should be revised. The high winds and dusty environment may justify a relatively high warning level to prevent frequent false alarms; however, given that the maximum signal available is 10,000 volts/meter, it is unlikely that this criterion will be effective in producing reliable and early warnings.

The Pantex lightning detection and warning systems provide a variety of methods for detecting lightning and issuing warnings. However, the linchpin of both systems is the PSS. The PSS is responsible for both the interpretation of detection data and the actions necessary to ensure that the appropriate personnel receive warnings. During the off-shift hours the OC is manned only by the PSS and backup coverage is not available. Since this time period also corresponds to the period of peak lightning activity, and the PSS is also the Facility Manager designee for a number of facilities during the off-shift, some form of backup coverage should be considered.

Due to the multiplicity of interrelated actions that must occur for lightning to be detected and a lightning warning issued and confirmed by all impacted operations, the ability to suspend operations during lightning warnings is the least reliable of the current controls. To the extent possible, controls should be developed to minimize reliance on this system.

### **6.2 Standoff/isolation requirements**

The current standoff/isolation requirements in place in the cells (with the exception for Building 12-44) should be increased to the level that would provide protection from a 99th percentile lightning strike. The current maximum bonded voltage of 10 kV was arrived at by assuming a maximum rate of current rise of 360 kA/ $\mu$ s rather than the recommended worst –case level of 400 kA/ $\mu$ s. The higher value would result in a maximum bonded voltage in these facilities of 13 kV. In addition, the hoist isolation device that is currently in use will need to be demonstrated to be capable of providing at least 13 kV of isolation.

To improve the reliability of standoff/isolation, a more conservative defense-in-depth approach should be implemented. This approach allows three alternative methods for achieving the necessary isolation/insulation: provide isolation/insulation adequate for the voltage produced by unbonded penetrations; provide isolation/insulation, assuming bonded penetrations, provided that the penetrations have one engineered bond installed and are intrinsically bonded to the facility rebar; provide isolation/insulation, assuming bonded penetrations, provided that the penetrations have two engineered bonds installed. Since implementation would involve different standoff requirements, depending on the type of bonding, the current practice of posting a single distance in each bay or cell would

be inadequate. The required standoff would either have to be marked on the floor or barriers provided to ensure the operating personal do not inadvertently violate the standoff requirement. A system of marking the required standoff distance on the floor should be implemented.

### **6.3 Catenary lightning protection systems**

Initial LLNL test results indicate that the presence of a catenary lightning protection or a nearby light pole may result in interior voltages that are substantially higher than the maximum level at which the current controls are capable of providing protection. Since this test by LLNL of a catenary lightning protection system calls into question the adequacy of the isolation distances in many of the NEAs, additional testing/analysis of these systems is of paramount importance. Although the test method used for the Building 12-96 catenary may have been flawed, a retest of this catenary should be performed as soon as possible to determine effects of the catenary system on facility voltages.

### **6.4 Protection for full up weapons**

SNL has defined the configurations in which the weapon lightning protection features are in place for most of the systems processed at Pantex. As long as these configurations are maintained, additional controls for lightning protection should not be necessary. In those cases where SNL has not provided this information, B53 and W62, the same controls that are required for partial assemblies should be applied.

### **6.5 Roof slot bonding**

Roof slot bonding should be implemented to reduce the effective slot length of the rebar discontinuity formed by the blast relief design of the roofs in most of the assembly/disassembly bays, thus reducing the slot voltage developed. With the exception of Building 12-60, Bay 1, and 12-104 Bay 16, penetration bonding has been completed for all of the Category 1 and Category 2 NEAs. However, roof slot bonding has only been accomplished for Building 12-84, Bays 16 and 18. The preliminary DC hi-pot testing, performed at Pantex, of the current hoist isolation straps indicates that they will provide isolation for at least 50 kV with a relative humidity of up to 90%. If the roof slots are bonded, the use of these straps would allow hoisting operations to be conducted during lightning warnings in any bay, reducing the reliance on the lightning detection and warning system. The standoff/isolation requirements for the bays could also be substantially reduced.

### **6.6 Surge Suppression**

The LPPT has not yet developed specific surveillance or maintenance criteria for the surge suppressors installed on the AC power circuits entering the NEAs. This is expected to be

a follow-on effort. In the interim, the manufacturer's recommendations for surveillance and maintenance should be followed.

The communication circuits entering the NEAs are not currently surge suppressed. The LPPT has developed a recommendation for installing surge suppression on these circuits; however, it will be expensive and require a long time to implement. In the interim, unbonded standoff should be provided from the equipment attached to these circuits and any other metallic objects near these circuits. Alternatively, because the conduit enclosing these circuits is an effective shield if it is continuous, the exposed portions of these circuits should be enclosed in conduit. If complete electrically continuous metallic conduit is provided, the standoff requirement could be reduced to the bonded level.

### **6.7 Further testing**

The current hazard analysis is analytically based. Only a few facilities have been tested to confirm the analytical results. However, because the actual degree of rebar electrical interconnectivity can only be determined through low-power testing, the low-power testing program should include at least one bay or cell in each facility. Rocket-triggered testing should also be performed on a facility similar to one of the Pantex NEAs to confirm the low-power test results.

Low power testing of one bay or cell in each facility should be performed initially every five years to provide adequate assurance of the status of the electrical connectivity of the steel reinforcing elements and engineered bonds. This testing interval could be lengthened based on trends derived from the initial test results.

### **6.8 Improved bonding connections**

An improved bonding lug has been developed under a joint effort with the US Army that provides a more reliable connection with the facility rebar. This new connector should be used on all new installations and on all modifications of existing installations.

## 7.0 Path Forward

Although the lightning protection enhancement program is well underway, there is a substantial amount of work that remains to be done before that program is complete and stable.

The necessity for applying the lightning protection controls discussed in this report to full weapon systems continues to be evaluated.

Maintenance/inspection criteria, including initial acceptance procedures, for the controls necessary to implement the Faraday cage isolation approach are still being developed. Additional work also needs to be done to develop a methodology for assuring the integrity of the bonds and the electrical continuity of the reinforcing steel. The inspection procedures for the existing lightning protection systems should be upgraded to the NFPA inspection intervals for the NEAs.

The SNL analysis techniques utilized to determine the voltage/current environment in the Pantex NEAs correlate closely with the results obtained from rocket-triggered lightning tests of reinforced concrete structures. However, rocket-triggered lightning tests of assembly bay and cell type facilities should be performed to ensure that there are no features unique to these facilities, and unaccounted for in the models, that would result in a voltage environment that is significantly different from the analyzed values. In addition to seeking a review of the analysis completed so far by other lightning experts, the LPPT will attempt to locate similar structures that can be made available for this type of testing.

While an overhead wire lightning protection system is generally believed to offer more protection than an integral system, there is the possibility that a strike to the overhead wire may produce higher voltages in the interior of the protected facility. LLNL testing of the catenary protection system near Building 12-96 indicated that the interior voltages produced by a strike to the catenary could be as high as 380 kV [34]. Since this result is much worse than the predicted interior voltage environment of 10 kV, SNL and LLNL will be testing, during the summer of 1999, the Building 12-96 catenary system in an attempt to validate the results. LLNL has also developed a proposal to test catenary protection systems using rocket-triggered lightning to validate the results.

MHC has procured all components necessary to perform penetration testing. The design is the same as the SNL developed penetration tester and will allow for the in-house capability to determine intrinsic bonding. SNL has already provided the procedure for testing penetrations for intrinsic bonding.

The LPPT has initiated a review of the Pantex lightning detection/warning capabilities to determine both the reliability and timeliness of the warnings. A separate report is being prepared to document the capabilities and limitations of these systems.



Because the criteria for implementing the Faraday cage/isolation (isolation is being increased to the unbonded penetration levels) approach in the Pantex NEAs are continually being refined, the controls are being instituted with an Engineering Instruction (EI) and in some cases a facility/operation specific analysis by SNL. The first four revisions of the EI primarily incorporated changes in facility status with regard to penetration bonding. Each time a group of facilities was bonded, the isolation matrix in the EI was changed to reflect the less restrictive standoff requirement. Revision E, which has not been issued, of the EI incorporates the defense in depth approach, which required a larger standoff or multiple/intrinsic bonding. The EI is a temporary procedure mechanism that allowed the controls to be easily modified as additional work is done to further refine the lightning induced electrical environment within the NEAs. The defense in depth requirements in Revision E of the EI will be incorporated into the Technical Safety Requirement (TSR) upgrade and are scheduled to be submitted to DOE in April 1999. The Basis for Interim Operation (BIO), Critical Safety Systems Manual (CSSM), and the Activity Based Controls Documents (ABCDs) will also need to be upgraded to reflect this methodology. The LPPT will provide the necessary changes/additions to these documents to the Risk Management Department for processing.

## 8.0 References

- [1] R. T. Hasbrouck, "Lightning - Understanding It and Protecting Systems from Its Effects," UCRL-53925, Lawrence Livermore National Laboratory, Livermore, CA, April 10, 1989.
- [2] German, J., "Sandia-led research may zap old beliefs about lightning protection at critical facilities," Sandia National Laboratories news release, April 25, 1997.
- [3] Cummins, K. L., et al, "The U. S. National Lightning Detection Network™ and Applications of Cloud-to-Ground Lightning Data by Electric Power Utilities," IEEE Transactions on Electromagnetic Compatibility, Vol. 40, No. 4, November 1998.
- [4] Viemeister, P. E., "The Lightning Book," MIT Press, April 1972.
- [5] Merewether, K. O. and K. C. Chen, Evaluation of the Electromagnetic Effects due to Direct Lightning to Nuclear Explosive Areas at Pantex, SAND93-2517, November 1993.
- [6] Merewether, K. O., "Lightning Safety Considerations," Letter to H. Berman (MHC), July 7, 1997.
- [7] Fredlund, J. and J. Kimball, "Analysis of Lightning Flash Data for Area Surrounding Pantex," May 1998.
- [8] Fisher, R. J. and M. A. Uman, "Recommended Baseline Direct-Strike Lightning Environment for Stockpile-to-Target Sequences," SAND89-0192, May 1989.
- [9] NFPA 780, Lightning Protection Code, National Fire Protection Association, Quincy MA, 1997.
- [10] Morris, M. E., et al., Rocket-Triggered Lightning Studies for the Protection of Critical Assets, IEEE Transactions On Industry Applications, Vol. 30, No. 3, May/June 1994.
- [11] Schnetzer, G. H. and R. J. Fisher, "1991 Rocket-Triggered Lightning Test of the DoD Security Operations Test Site (SOTS) Munitions Storage Bunker, Ft. McClellan, Alabama," SAND91-2343, February 1992.
- [12] Schnetzer, G. H., et al., 1994 Triggered Lightning Test Program: Measured Responses of a Reinforced Concrete Building Under Direct Lightning Attachments, SAND95-1551/1, August 1995.

- [13] ANSI Standard C62.11, "Standard for Metal-Oxide Surge Arresters for Alternating Current Systems," 1993.
- [14] Hart, W. C. and Malone, E. W., "Lightning and Lightning Protection," 1979.
- [15] Lee, K. S. H., editor, *EMP Interaction: Principles, Techniques, and Reference Data*, Revised Printing, Hemisphere, New York, 1986, pp. 464-467.
- [16] Merewether, K. O., et al., Lightning Protection System Evaluation for the Pantex Dynamic Balancing Facility, August 27, 1997.
- [17] Zacharias, R. A. (LLNL), R. S. Collier (EMA Inc.), et al., "The DAF Lightning Threat and Immunity Estimates for Nuclear Explosive Safety", UCRL-ID-125453, February 1996.
- [18] Ong, M. M. and R. A. Anderson, "Coupling Measurement and Lightning Threat Assessment Report for Pantex Cell 12-44-1," UCRL-ID-131942.
- [19] Knapp, C., "Require Lightning protection for Weapon Assemblies," memorandum to K. Tolk (MHC), September 23, 1998.
- [20] Hogan, B., "Concurrence With LPT Recommendations," memorandum to K. Tolk (MHC), July 20, 1998.
- [21] Golde, R. H. *Lightning, Volume 2, Lightning Protection*, Academic Press, New York, 1977.
- [22] Merewether, K. O. and L. K. Warne, "Staging of Partially Disassembled W69 Warheads," memorandum to distribution, October 8, 1997.
- [23] Jorgenson, R. E., et al., "Analysis of Lightning Protection Provided by the W56 Transportation Cart," memorandum to A. Scruggs (MHC), November 12, 1998.
- [24] Jorgenson, R. E., et al., "Analysis of Lightning Protection Provided by the W79 Transportation Cart," memorandum to A. Scruggs (MHC), January 22, 1999.
- [25] Jorgenson, R. E., et al., "Analysis of Lightning Protection Provided by the W87 Transportation Cart," memorandum to A. Scruggs (MHC), January 29, 1999.
- [26] Amarillo Area Office, Procedure AAO-LPT-1, Revision 0, "Lightning Protection Interim Validation Procedure."
- [27] Merewether, K. O., et al., "Thermal Response of a Cylindrical Conductor Carrying Lightning Currents," draft report, June 12, 1998.

- [28] Tobias, J. M., "Testing of Ground Conductors with Artificially Generated Lightning Current," IEEE Transactions on Industry Applications, Vol. 32, No. 3, May/June 1996.
- [29] Lightning Protection Project Team, "Surge Suppression Recommendations for Nuclear Explosive Areas," memorandum to W. S. Goodrum (AAO), December 2, 1997.
- [30] Ott, H. W., "Noise Reduction Techniques in Electronic Systems," John Wiley & Sons, 1988.
- [31] Scruggs, C. A., "Surge Suppression Recommendations for Communication Systems used in the Nuclear Explosive Areas," memorandum to D. C. Brunell (AAO), October 29, 1998.
- [32] Mason & Hanger Corporation, Form, PX-3322, "Weapon Process or Cycle Start Readiness Checklist," Issue #13, February 26, 1999.
- [33] Mason & Hanger Corporation, Plant Standard STD-3161, "Electrical Storm and Severe Weather Precautionary Procedures," Issue #9, June 24, 1998.
- [34] Ong, M. M., et al., "Coupling Measurement and Lightning Threat Assessment for Pantex Cell 12-96 and Catenary Protection System," UCRL-ID-133134, November 1998.

## 9.0 LPPT Membership

### **Alan Scruggs (MHC), Leader**

Alan Scruggs received a B. S. degree in mechanical engineering in 1984 and a Master of Engineering degree in 1991, both from Texas Tech University, Lubbock, Texas. He received a Professional Engineering license from the State of Texas in 1990. His fourteen years of experience at the Pantex Plant include project engineering and management of construction projects ranging from \$2,000 upgrades to \$22 million facilities. For the past six years Mr. Scruggs has worked in the Risk Management Department where he was responsible for implementing the Department of Energy's Unreviewed Safety Question (USQ) process. He has authored reports documenting consequence analysis methodology performed in support of Pantex tritium staging facilities and Cell facilities. Mr. Scruggs' interests include amateur radio, severe thunderstorm spotting/chasing for the National Weather Service, muscle car restoration, and astronomy.

### **Richard Fitch (MHC)**

Richard Fitch received a B. S. degree in Business Administration in 1993 from Wayland Baptist University, Amarillo Texas. His nineteen years at the Pantex Plant include 12 years as a Production Technician, Operations Manager, and Assistant Facility Manager. For the past 5 years Richard has been the Facility Manager of building 12-104/104A at the Pantex plant. He oversees the daily operations for the existing stockpile weapons at Pantex. He also maintains a facility with over 250,000 sq. ft. of floor space. Mr Fitch's interests include, off road vehicles, officiating and coaching volleyball, Boy Scouts, and coaching boys baseball.

### **Kim Merewether (SNL)**

Kim Merewether received a B.S. degree from the University of New Mexico, Albuquerque, NM, USA, in 1983, an M.S. degree from the University of Illinois, Champaign-Urbana, IL, in 1986, and a Ph.D. degree from the University of Illinois in 1989, all in electrical engineering. His research interests include remote sensing of the upper atmosphere, scattering from periodic surfaces, finite-difference analysis of complex structures, lightning protection philosophy, and general numerical modeling techniques in electromagnetics.

### **Mike Ong (LLNL)**

Dr. Ong has 27 years of experience as a design engineer, analyst, and group leader. He worked five years in industry before joining Lawrence Livermore National Laboratory in 1979. He received a Ph.D. from UC Davis in Engineering in 1982. In the middle 1980's, his group developed imaging systems to support the development of the nuclear-driven x-

ray laser. In the early 1990's, Mike worked as an effects analyst in support of high-power microwaves and nuclear generated EMP. He is currently developing innovative RF techniques for DoD projects and LLNL defense and counter-terrorism programs. His interests include EM, instrumentation, analog circuits, and motivational psychology.

**Bob Anderson (LLNL)**

Bob holds an MS and BS in Electronic Engineering, from the Naval Postgraduate School and California State Polytechnic University. He has been at LLNL for the past 34 years and has made major contributions in several of the high visibility programs at Livermore. His experience includes: electrical initiation system design and testing, electromagnetic pulse and lightning protection systems, high power microwave experiments, laser driven shock wave experiments, and nuclear weapons testing at the Nevada Test Site. He has authored and co-authored many papers describing contributions to this work. In addition, he has participated as the LLNL representative on several Nuclear Explosive Safety Study Groups relating to the work at the Nevada Test Site.

**Dick Yactor (LANL)**

Dick Yactor received a B. S. degree in electrical engineering in 1966 and an MBA in 1972, both from the Illinois Institute of Technology. His experience includes detonator development, quality control, surveillance, reliability assessments, and modeling in the Detonation Systems and Technology Group at Los Alamos since 1977. While working at Motorola Inc. prior to 1977, he designed mobile communications systems, pager receivers, and digital control systems.

**John Fredlund (DOE-DP)**

John Fredlund has worked at DOE since April of 1990. His DOE experience includes analysis and review of nuclear safety documentation, authorization basis and safety basis documents, requirements, design proposals, and systems design. His main areas of review are instrumentation and control, electronic systems, and electrical power. He has actively participated in preparation of several nuclear safety Rules, Orders, Implementation Guide (the one for DOE O 420.1), and Standards (1073, 3003, 3009, and more). He represents DOE/Defense Programs to oversight groups, other programs and agencies, and contractors. Mr. Fredlund is the chair and sponsor a working group on backup electrical power systems. He has participated in several Operational Readiness Reviews and Readiness Assessments at such facilities as TA-55, Weapons Engineering Tritium Facility (WETF), and Lawrence Livermore Bldg. 332.

**Jose G. (Willy) Molina (DOE-AL)**

Mr. Molina's education includes a Bachelor of Science Degree in Electrical Engineering, a Diploma in Electronics Technology and Graduate studies in Construction Engineering & Management. His twenty years of government service includes experience with the

Department of Defense (DoD) and the Department of Energy (DOE). While at the Department of Energy since 1987 Mr. Molina has served as a subject matter expert in Electrical Safety, Occupational Safety, Safety Analysis and Performance Assessment. Mr. Molina also served as the DOE-wide Electrical Safety Committee Chairperson for several years. Prior to coming to the DOE, Mr. Molina worked for the US Army Corps of Engineers (COE) as an Electrical Engineer involved in military facility design, construction, and inspection. Additional DoD work includes performing research and development activities for the US Air Force Weapons Laboratory on the Strategic Defense Initiative Program laser weaponry systems. Mr. Molina also worked several years for the Naval Weapons Evaluation Facility, Nuclear Weapons Safety performing safety analyses on nuclear and conventional weapons and systems.

**Robert Young (DOE-AAO)**

Robert Young has a Bachelor's of Science degree in Electrical Engineering Union College, Schenectady, New York. Presently, Robert is a General Engineer for the Department of Energy, Amarillo Area Office, specializing in explosives safety, with responsibilities including all aspects of occupational safety and health. He has five years of experience in oversight of Department of Energy Explosives Safety Programs and four years experience in the oversight of various Department of Energy Occupational Safety Programs. He is responsible for oversight and technical assistance in the areas of occupational safety and health, explosives safety, and electrical safety. He was previously employed by Atlas Wireline Services as a field engineer responsible for both open and cased hole oil/gas well logging, and completion services.