

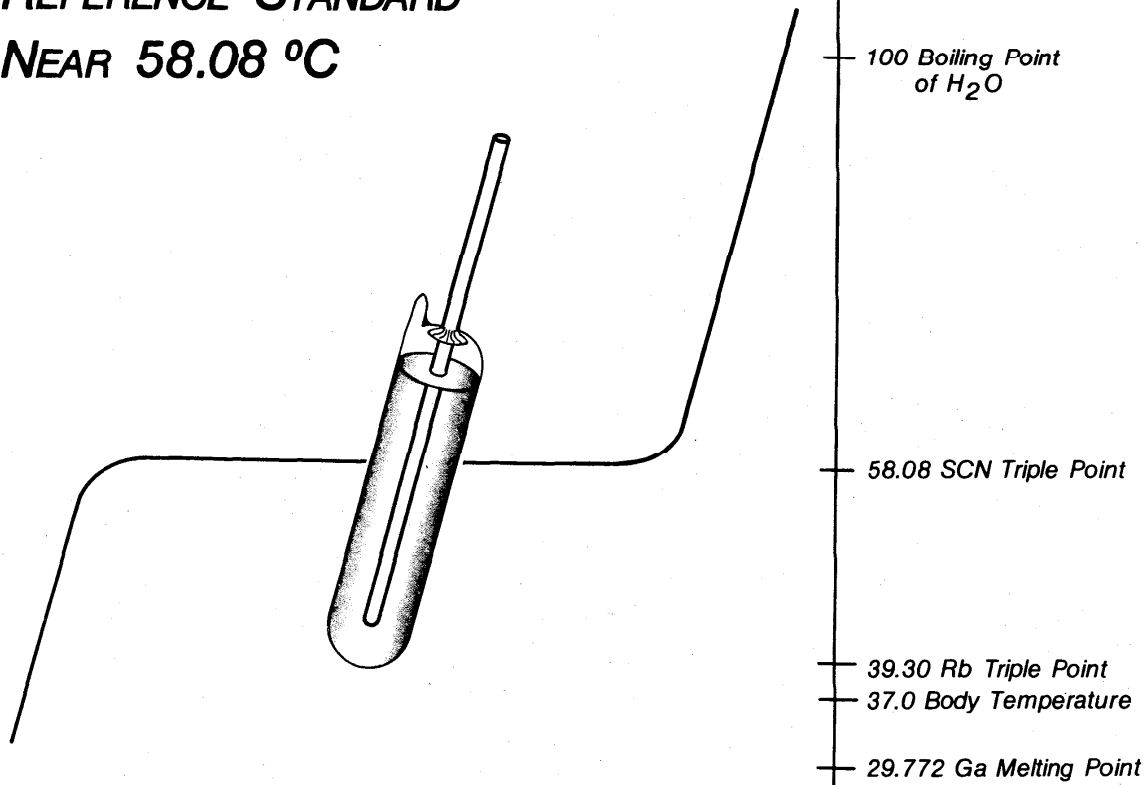

NBS SPECIAL PUBLICATION **260-101**

U.S. DEPARTMENT OF COMMERCE/National Bureau of Standards

**SRM 1970: SUCCINONITRILE TRIPLE-
POINT STANDARD — A TEMPERATURE
REFERENCE STANDARD
NEAR 58.08 °C**



The National Bureau of Standards¹ was established by an act of Congress on March 3, 1901. The Bureau's overall goal is to strengthen and advance the nation's science and technology and facilitate their effective application for public benefit. To this end, the Bureau conducts research and provides: (1) a basis for the nation's physical measurement system, (2) scientific and technological services for industry and government, (3) a technical basis for equity in trade, and (4) technical services to promote public safety. The Bureau's technical work is performed by the National Measurement Laboratory, the National Engineering Laboratory, the Institute for Computer Sciences and Technology, and the Institute for Materials Science and Engineering.

The National Measurement Laboratory

Provides the national system of physical and chemical measurement; coordinates the system with measurement systems of other nations and furnishes essential services leading to accurate and uniform physical and chemical measurement throughout the Nation's scientific community, industry, and commerce; provides advisory and research services to other Government agencies; conducts physical and chemical research; develops, produces, and distributes Standard Reference Materials; and provides calibration services. The Laboratory consists of the following centers:

- Basic Standards²
- Radiation Research
- Chemical Physics
- Analytical Chemistry

The National Engineering Laboratory

Provides technology and technical services to the public and private sectors to address national needs and to solve national problems; conducts research in engineering and applied science in support of these efforts; builds and maintains competence in the necessary disciplines required to carry out this research and technical service; develops engineering data and measurement capabilities; provides engineering measurement traceability services; develops test methods and proposes engineering standards and code changes; develops and proposes new engineering practices; and develops and improves mechanisms to transfer results of its research to the ultimate user. The Laboratory consists of the following centers:

- Applied Mathematics
- Electronics and Electrical Engineering²
- Manufacturing Engineering
- Building Technology
- Fire Research
- Chemical Engineering²

The Institute for Computer Sciences and Technology

Conducts research and provides scientific and technical services to aid Federal agencies in the selection, acquisition, application, and use of computer technology to improve effectiveness and economy in Government operations in accordance with Public Law 89-306 (40 U.S.C. 759), relevant Executive Orders, and other directives; carries out this mission by managing the Federal Information Processing Standards Program, developing Federal ADP standards guidelines, and managing Federal participation in ADP voluntary standardization activities; provides scientific and technological advisory services and assistance to Federal agencies; and provides the technical foundation for computer-related policies of the Federal Government. The Institute consists of the following centers:

- Programming Science and Technology
- Computer Systems Engineering

The Institute for Materials Science and Engineering

Conducts research and provides measurements, data, standards, reference materials, quantitative understanding and other technical information fundamental to the processing, structure, properties and performance of materials; addresses the scientific basis for new advanced materials technologies; plans research around cross-country scientific themes such as nondestructive evaluation and phase diagram development; oversees Bureau-wide technical programs in nuclear reactor radiation research and nondestructive evaluation; and broadly disseminates generic technical information resulting from its programs. The Institute consists of the following Divisions:

- Ceramics
- Fracture and Deformation³
- Polymers
- Metallurgy
- Reactor Radiation

¹Headquarters and Laboratories at Gaithersburg, MD, unless otherwise noted; mailing address Gaithersburg, MD 20899.

²Some divisions within the center are located at Boulder, CO 80303.

³Located at Boulder, CO, with some elements at Gaithersburg, MD.

Standard Reference Materials:

SRM 1970: Succinonitrile Triple-Point Standard—A Temperature Reference Standard Near 58.08 °C

B. W. Mangum

Temperature and Pressure Division
Center for Basic Standards
National Measurement Laboratory
National Bureau of Standards
Gaithersburg, MD 20899

Samir El-Sabban

National Institute of Standards
Cairo, Egypt

Sponsored by:

Office of Standard Reference Materials
National Measurement Laboratory
National Bureau of Standards
Gaithersburg, MD 20899

Issued March 1986

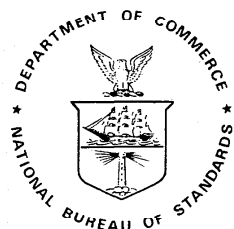

U.S. DEPARTMENT OF COMMERCE, Malcolm Baldrige, Secretary
NATIONAL BUREAU OF STANDARDS, Ernest Ambler, Director

Library of Congress Catalog Card Number: 86-600505

National Bureau of Standards Special Publication 260-101
Natl. Bur. Stand. (U.S.), Spec. Publ. 260-101, 21 pages (Mar. 1986)
CODEN: XNBSAV

U.S. GOVERNMENT PRINTING OFFICE
WASHINGTON: 1986

For sale by the Superintendent of Documents, U.S. Government Printing Office, Washington, DC 20402

Preface

Standard Reference Materials (SRM's) as defined by the National Bureau of Standards (NBS) are well-characterized materials, produced in quantity and certified for one or more physical or chemical properties. They are used to assure the accuracy and compatibility of measurements throughout the Nation. SRM's are widely used as primary standards in many diverse fields in science, industry, and technology, both within the United States and throughout the world. They are also used extensively in the fields of environmental and clinical analysis. In many applications, traceability of quality control and measurement processes to the national measurement system is carried out through the mechanism and use of SRM's. For many of the Nation's scientists and technologists it is therefore of more than passing interest to know the details of the measurements made at NBS in arriving at the certified values of the SRM's produced. An NBS series of papers, of which this publication is a member, called the NBS Special Publication - 260 Series, is reserved for this purpose.

The 260 Series is dedicated to the dissemination of information on different phases of the preparation, measurement, certification and use of NBS SRM's. In general, much more detail will be found in these papers than is generally allowed, or desirable, in scientific journal articles. This enables the user to assess the validity and accuracy of the measurement processes employed, to judge the statistical analysis, and to learn details of techniques and methods utilized for work entailing the greatest care and accuracy. These papers also should provide sufficient additional information not found on the certificate so that new applications in diverse fields not foreseen at the time the SRM was originally issued will be sought and found.

Inquiries concerning the technical content of this paper should be directed to the author(s). Other questions concerned with the availability, delivery, price, and so forth, will receive prompt attention from:

Office of Standard Reference Materials
National Bureau of Standards
Gaithersburg, MD 20899

Stanley D. Rasberry, Chief
Office of Standard Reference Materials

OTHER NBS PUBLICATIONS IN THIS SERIES

- Catalog of NBS Standard Reference Materials (1984-85 edition), Catherine H. Hudson, ed., NBS Spec. Publ. 260 (February 1984). \$5.50* SN003-003-02558-5.
- Michaelis, R. E., and Wyman, L. L. Standard Reference Materials: Preparation of White Cast Iron Spectrochemical Standards. NBS Misc. Publ. 260-1 (June 1964). COM74-11061**
- Michaelis, R. E., Wyman, L. L., and Flitsch, R., Standard Reference Materials: Preparation of NBS Copper-Base Spectrochemical Standards. NBS Misc. Publ. 260-2 (October 1964). COM74-11063**
- Michaelis, R. E., Yakowitz, H., and Moore, G. A., Standard Reference Materials: Metallographic Characterization of an NBS Spectrometric Low-Alloy Steel Standard. NBS Misc. Publ. 260-3 (October 1964). COM74-11060**
- Hague, J. L. Mears, T. W., and Michaelis, R. E., Standard Reference Materials: Sources of Information, NBS Misc. Publ. 260-4 (February 1965). COM74-11059
- Alvarez, R., and Flitsch R., Standard Reference Materials: Accuracy of Solution X-Ray Spectrometric Analysis of Copper-Base Alloys. NBS Misc. Publ. 260-5 (March 1965). PB168068**
- Shultz, J. I., Standard Reference Materials: Methods for the Chemical Analysis of White Cast Iron Standards, NBS Misc. Publ. 260-6 (July 1965). COM74-11068**
- Bell, R. K., Standard Reference Materials: Methods for the Chemical Analysis of NBS Copper-Base Spectrochemical Standards. NBS Misc. Publ. 260-7 (October 1965). COM74-11067**
- Richmond, M.S., Standard Reference Materials: Analysis of Uranium Concentrates at the National Bureau of Standards. NBS Misc. Publ. 260-8 (December 1965). COM74-11066**
- Anspach, S. C., Cavallo, L. M. Garfinkel, S. B. Hutchinson, J. M. R., and Smith, C. N., Standard Reference Materials: Half Lives of Materials Used in the Preparation of Standard Reference Materials of Nineteen Radioactive Nuclides Issued by the National Bureau of Standards NBS Misc. Publ. 260-9 (November 1965). COM74-11065**
- Yakowitz, H., Vieth, D. L., Heinrich, K. F. J., and Michaelis, R. E., Standard Reference Materials: Homogeneity Characterization of NBS Spectrometric Standards II: Cartridge Brass and Low-Alloy Steel, NBS Misc. Publ. 260-10 (December 1965). COM74-11064**
- Napolitano, A., and Hawkins, E. G., Standard Reference Materials: Viscosity of Standard Lead-Silica Glass, NBS Misc. Publ. 260-11 (November 1966). NBS Misc. Publ. 260-11**
- Yakowitz, H., Vieth, D. L., and Michaelis, R. E., Standard Reference Materials: Homogeneity Characterization of NBS Spectrometric Standards III: White Cast Iron and Stainless Steel Powder Compact, NBS Misc. Publ. 260-12 (September 1966). NBS Misc. Publ. 260-12**
- Spijkerman, J. L., Snediker, D. K., Ruegg, F. C., and DeVoe, J. R., Standard Reference Materials: Mossbauer Spectroscopy Standard for the Chemical Shift of Iron Compounds, NBS Misc. Publ. 260-13 (July 1967). NBS Misc. Publ. 260-13**
- Menis, O., and Sterling, J. T., Standard Reference Materials: Determination of Oxygen in Ferrous Materials - SRM 1090, 1091, and 1092, NBS Misc. Publ. 260-14 (September 1966). NBS Misc. Publ. 260-14**
- Passaglia, E., and Shouse, P. J., Standard Reference Materials: Recommended Method of Use of Standard Light-Sensitive Paper for Calibrating Carbon Arcs Used in Testing Textiles for Colorfastness to Light, NBS Misc. Publ. 260-15 (June 1967). (Replaced by NBS Spec. Publ. 260-41.)
- Yakowitz, H., Michaelis, R. E., and Vieth, D. L., Standard Reference Materials: Homogeneity Characterization of NBS Spectrometric Standards IV: Preparation and Microprobe Characterization of W-20% MO Alloy Fabricated by Powder Metallurgical Methods, NBS Spec. Publ. 260-16 (January 1969). COM74-11062**
- Catanzaro, E. J., Champion, C. E., Garner, E. L., Marinenko, G., Sappenfield, K. M., and Shields, W. R., Standard Reference Materials: Boric Acid; Isotopic and Assay Standard Reference Materials, NBS Spec. Publ. 260-17 (February 1970). Out of Print.
- Geller, S. B., Mantek, P.A., and Cleveland, N. G., Standard Reference Materials: Calibration of NBS Secondary Standard Magnetic Tape (Computer Amplitude Reference) Using the Reference Tape Amplitude Measurement "Process A," NBS Spec. Publ. 260-18 (November 1969). (See NBS Spec. Publ. 260-29.)
- Paule, R. C., and Mandel, J., Standard Reference Materials: Analysis of Interlaboratory Measurements on the Vapor Pressure of Gold (Certification of Standard Reference Material 745), NBS Spec. Publ. 260-19 (January 1970). PB190071**
- Paule, R. C., and Mandel, J., Standard Reference Materials: Analysis of Interlaboratory Measurements on the Vapor Pressures of Cadmium and Silver, NBS Spec. Publ. 260-21 (January 1971). COM74-11359**
- Yakowitz, H., Fiori, C. E., and Michaelis, R. E., Standard Reference Materials: Homogeneity Characterization of Fe-3 Si Alloy, NBS Spec. Publ. 260-22 (February 1971). COM74-11357**
- Napolitano, A., and Hawkins, E. G., Standard Reference Materials: Viscosity of a Standard Borosilicate Glass, NBS Spec. Publ. 260-23 (December 1970). COM71-00157**
- Sappenfield, K. M., Marineko, G., and Hague, J. L., Standard Reference Materials: Comparison of Redox Standards, NBS Spec. Publ. 260-24 (January 1972). COM72-50058**

- Hicho, G. E., Yakowitz, H., Rasberry, S. D., and Michaelis, R. E., Standard Reference Materials: A Standard Reference Material Containing Nominally Four Percent Austenite, NBS Spec. Publ. 260-25 (February 1971). COM74-11356**
- Martin, J. F., Standard Reference Materials: National Bureau of Standards-US Steel Corporation Joint Program for Determining Oxygen and Nitrogen in Steel, NBS Spec. Publ. 260-26 (February 1971). 85 cents* PB 81176620
- Garner, E. L., Machlan, L. A., and Shields, W. R., Standard Reference Materials: Uranium Isotopic Standard Reference Materials, NBS Spec. Publ. 260-27 (April 1971). COM74-11358**
- Heinrich, K. F. J., Myklebust, R. L., Rasberry, S. D., and Michaelis, R. E., Standard Reference Materials: Preparation and Evaluation of SRM's 481 and 482 Gold-Silver and Gold-Copper Alloys for Microanalysis, NBS Spec. Publ. 260-28 (August 1971). COM71-50365**
- Geller, S. B., Standard Reference Materials: Calibration of NBS Secondary Standard Magnetic Tape (Computer Amplitude Reference) Using the Reference Tape Amplitude Measurement "Process A-Model 2," NBS Spec. Publ. 260-29 (June 1971). COM71-50282
- Gorozhanina, R. S., Freedman, A. Y., and Shaievitch, A. B. (translated by M. C. Selby), Standard Reference Materials: Standard Samples Issued in the USSR (A Translation from the Russian). NBS Spec. Publ. 260-30 (June 1971). COM71-50283**
- Hust, J. G., and Sparks, L. L., Standard Reference Materials: Thermal Conductivity of Electrolytic Iron SRM 734 from 4 to 300 K, NBS Spec. Publ. 260-31 (November 1971). COM71-50563**
- Mavrodineanu, R., and Lazar, J. W., Standard Reference Materials: Standard Quartz Cuvettes, for High Accuracy Spectrophotometry, NBS Spec. Publ. 260-32 (December 1973). 55 cents* SN003-003-01213-1
- Wagner, H. L., Standard Reference Materials: Comparison of Original and Supplemental SRM 705, Narrow Molecular Weight Distribution Polystyrene, NBS Spec. Publ. 260-33 (May 1972). COM72-50526**
- Sparks, L. L., and Hust, J. G., Standard Reference Materials: Thermoelectric Voltage, NBS Spec. Publ. 260-34, (April 1972). COM72-50371**
- Sparks, L. L., and Hust, J. G., Standard Reference Materials: Thermal Conductivity of Austenitic Stainless Steel, SRM 735 from 5 to 280 K, NBS Spec. Publ. 260-35 (April 1972). 35 cents* COM72-50368**
- Cali, J. P., Mandel, J., Moore, L. J., and Young, D. S., Standard Reference Materials: A Referee Method for the Determination of Calcium in Serum, NBS SRM 915, NBS Spec. Publ. 260-36 (May 1972). COM72-50527**
- Shultz, J. I. Bell, R. K. Rains, T. C., and Menis, O., Standard Reference Materials: Methods of Analysis of NBS Clay Standards, NBS Spec. Publ. 260-37 (June 1972). COM72-50692**
- Richmond, J. C., and Hsia, J. J., Standard Reference Materials: Preparation and Calibration of Standards of Spectral Specular Reflectance, NBS Spec. Publ. 260-38 (May 1972). COM72-50528**
- Clark, A. F., Denson, V.A., Hust, J. G., and Powell, R. L., Standard Reference Materials: The Eddy Current Decay Method for Resistivity Characterization of High-Purity Metals, NBS Spec. Publ. 260-39 (May 1972). COM72-50529**
- McAdie, H. G., Garn, P.D., and Menis, O., Standard Reference Materials: Selection of Thermal Analysis Temperature Standards Through a Cooperative Study (SRM 758, 759, 760), NBS Spec. Publ. 260-40 (August 1972.) COM72-50776**
- Wood, L. A., and Shouse, P. J., Standard Reference Materials: Use of Standard Light-Sensitive Paper for Calibrating Carbon Arcs Used in Testing Textiles for Colorfastness to Light, NBS Spec. Publ. 260-41 (August 1972) COM72-50775**
- Wagner, H. L. and Verdier, P. H., eds., Standard Reference Materials: The Characterization of Linear Polyethylene, SRM 1475, NBS Spec. Publ. 260-42 (September 1972). COM72-50944**
- Yakowitz, H., Ruff, A. W., and Michaelis, R. E., Standard Reference Materials: Preparation and Homogeneity Characterization of an Austenitic Iron-Chromium-Nickel Alloy, NBS Spec. Publ. 260-43 (November 1972). COM73-50760**
- Schooley, J. F., Soulen, R. J., Jr., and Evans, G. A., Jr., Standard Reference Materials: Preparation and Use of Superconductive Fixed Point Devices, SRM 767, NBS Spec. Publ. 260-44 (December 1972). COM73-50037**
- Greifer, B., Maienthal, E. J., Rains, T. C., and Rasberry, S. D., Standard Reference Materials: Powdered Lead-Based Paint, SRM 1579, NBS Spec. Publ. 260-45 (March 1973). COM73-50226**
- Hust, J. G., and Giarratano, P. J., Standard Reference Materials: Thermal Conductivity and Electrical Resistivity Standard Reference Materials: Austenitic Stainless Steel, SRM's 735 and 798, from 4 to 1200 K, NBS Spec. Publ. 260-46 (March 1975). SN003-003-01278-5*
- Hust, J. G., Standard Reference Materials: Electrical Resistivity of Electrolytic Iron, SRM 797, and Austenitic Stainless Steel, SRM 798, from 5 to 280 K, NBS Spec. Publ. 260-47 (February 1974). COM74-50176**
- Mangum, B. W., and Wise, J. A., Standard Reference Materials: Description and Use of Precision Thermometers for the Clinical Laboratory, SRM 933 and SRM 934, NBS Spec. Publ. 260-48 (May 1974). 60 cents* SN003-003-01278-5
- Carpenter, B. S., and Reimer, G. M., Standard Reference Materials: Calibrated Glass Standards for Fission Track Use, NBS Spec. Publ. 260-49 (November 1974). COM74-51185

- Hust, J. G., and Giarratano, P. J., Standard Reference Materials: Thermal Conductivity and Electrical Resistivity Standard Reference Materials: Electrolytic Iron, SRM's 734 and 797 from 4 to 1000 K, NBS Spec. Publ. 260-50 (June 1975). \$1.00* SN003-003-01425-7
- Mavrodineanu, R., and Baldwin, J. R., Standard Reference Materials: Glass Filters As a Standard Reference Material for Spectrophotometry; Selection; Preparation; Certification; Use-SRM 930, NBS Spec. Publ. 260-51 (November 1975). \$1.90* SN003-003-01481-8
- Hust, J. G., and Giarratano, P. J., Standard Reference Materials: Thermal Conductivity and Electrical Resistivity Standard Reference Materials 730 and 799, from 4 to 3000 K, NBS Spec. Publ. 260-52 (September 1975). \$1.05* SN003-003-01464-8
- Durst, R. A., Standard Reference Materials: Standardization of pH Measurements, NBS Spec. Publ. 260-53 (December 1975, Revised). \$1.05 SN003-003-01551-2
- Burke, R. W., and Mavrodineanu, R., Standard Reference Materials: Certification and Use of Acidic Potassium Dichromate Solutions as an Ultraviolet Absorbance Standard, NBS Spec. Publ. 260-54 (August 1977). \$3.00* SN003-003-01828-7
- Ditmars, D. A., Cezairliyan, A., Ishihara, S., and Douglas, T. B., Standard Reference Materials: Enthalpy and Heat Capacity; Molybdenum SRM 781, from 273 to 2800 K, NBS Spec. Publ. 260-55 (September 1977). \$2.20* SN003-003-01836-8
- Powell, R. L., Sparks, L. L., and Hust, J. G., Standard Reference Materials: Standard Thermocouple Materials, Pt.67: SRM 1967, NBS Spec. Publ. 260-56 (February 1978). \$2.20* SN003-003-018864
- Cali, J. P. and Plebanski, T., Guide to United States Reference Materials, NBS Spec. Publ. 260-57 (February 1978). \$2.20* PB 277173
- Barnes, J. D., and Martin, G. M., Standard Reference Materials: Polyester Film for Oxygen Gas Transmission Measurements SRM 1470, NBS Spec. Publ. 260-58 (June 1979) \$2.00* SN003-003-02077
- Chang, T., and Kahn, A. H. Standard Reference Materials: Electron Paramagnetic Resonance Intensity Standard; SRM 2601, NBS Spec. Publ. 260-59 (August 1978) \$2.30* SN003-003-01975-5
- Velapoldi, R. A., Paule, R. C., Schaffer, R., Mandel, J., and Moody, J. R., Standard Reference Materials: A Reference Method for the Determination of Sodium in Serum, NBS Spec. Publ. 260-60 (August 1978). \$3.00* SN003-003-01978-0
- Verdier, P. H., and Wagner, H. L., Standard Reference Materials: The Characterization of Linear Polyethylene (SRM 1482, 1483, 1484), NBS Spec. Publ. 260-61 (December 1978). \$1.70* SN003-003-02006-1
- Soulen, R. J., and Dove, R. B., Standard Reference Materials: Temperature Reference Standard for Use Below 0.5 K (SRM 768). NBS Spec. Publ. 260-62 (April 1979). \$2.30* SN003-003-02047-8
- Velapoldi, R. A., Paule, R. C., Schaffer, R., Mandel, J., Machlan, L. A., and Gramlich, J. W., Standard Reference Materials: A Reference Method for the Determination of Potassium in Serum. NBS Spec. Publ. 260-63 (May 1979). \$3.75* SN003-003-02068
- Velapoldi, R. A., and Mielenz, K. D., Standard Reference Materials: A Fluorescence Standard Reference Material Quinine Sulfate Dihydrate (SRM 936), NBS Spec. Publ. 260-64 (January 1980). \$4.25* SN003-003-02148-2
- Marinenko, R. B., Heinrich, K. F. J., and Ruegg, F. C., Standard Reference Materials: Micro-Homogeneity Studies of NBS Standard Reference Materials, NBS Research Materials, and Other Related Samples. NBS Spec. Publ. 260-65 (September 1979). \$3.50* SN003-003-02114-1
- Venable, W. H., Jr., and Eckerle, K. L., Standard Reference Materials: Didymium Glass Filters for Calibrating the Wavelength Scale of Spectrophotometers (SRM 2009, 2010; 2013). NBS Spec. Publ. 260-66 (October 1979). \$3.50* SN003-003-02127-0
- Velapoldi, R. A., Paule, R. C., Schaffer, R., Mandel, J., Murphy, T. J., and Gramlich, J. W., Standard Reference Materials: A Reference Method for the Determination of Chloride in Serum, NBS Spec. Publ. 260-67 (November 1979). \$3.75* SN003-003-02136-9
- Mavrodineanu, R. and Baldwin, J. R., Standard Reference Materials: Metal-On-Quartz Filters as a Standard Reference Material for Spectrophotometry-SRM 2031, NBS Spec. Publ. 260-68 (April 1980). \$4.25* SN003-003-02167-9
- Velapoldi, R. A., Paule, R. C., Schaffer, R., Mandel, J., Machlan, L. A., Garner, E. L., and Rains, T. C., Standard Reference Materials: A Reference Method for the Determination of Lithium in Serum, NBS Spec. Publ. 260-69 (July 1980). \$4.25* SN003-003-02214-4
- Marinenko, R. B., Biancanello, F., Boyer, P. A., Ruff, A. W., DeRobertis, L., Standard Reference Materials: Preparation and Characterization of an Iron-Chromium-Nickel Alloy for Microanalysis, NBS Spec. Publ. 260-70 (May 1981). \$2.50* SN003-003-02328-1
- Seward, R. W., and Mavrodineanu, R., Standard Reference Materials: Summary of the Clinical Laboratory Standards Issued by the National Bureau of Standards, NBS Spec. Publ. 260-71 (November 1981). \$6.50* SN003-003-02381-7
- Reeder, D.J., Coxon, B., Enagonio, D., Christensen, R. G., Schaffer, R., Howell, B. F., Paule, R. C., Mandel, J., Standard Reference Materials: SRM 900, Antiepilepsy Drug Level Assay Standard, NBS Spec. Publ. 260-72 (June 1981). \$4.25* SN003-003-02329-9

- Interrante, C. G., and Hicho, G. E., Standard Reference Materials: A Standard Reference Material Containing Nominally Fifteen Percent Austenite (SRM 486), NBS Spec. Publ. 260-73 (January 1982). \$2.75* SN003-003-02386-8
- Marinenko, R. B., Standard Reference Materials: Preparation and Characterization of K-411 and K-414 Mineral Glasses for Microanalysis: SRM 470. NBS Spec. Publ. 260-74 (April 1982). \$3.50 SN003-003-023-95-7
- Weidner, V. R., and Hsia, J. J., Standard Reference Materials: Preparation and Calibration of First Surface Aluminum Mirror Specular Reflectance Standards (SRM 2003a), NBS Spec. Publ. 260-75 (May 1982). \$3.75 SN003-003-023-99-0
- Hicho, G. E. and Eaton, E. E., Standard Reference Materials: A Standard Reference Material Containing Nominally Five Percent Austenite (SRM 485a), NBS Spec. Publ. 260-76 (August 1982). \$3.50 SN003-003-024-33-3
- Furukawa, G. T., Riddle, J. L., Bigge, W. G., and Pfeiffer, E. R., Standard Reference Materials: Application of Some Metal SRM's as Thermometric Fixed Points, NBS Spec. Publ. 260-77 (August 1982). \$6.00 SN003-003-024-34-1
- Hicho, G. E. and Eaton, E. E., Standard Reference Materials: Standard Reference Material Containing Nominally Thirty Percent Austenite (SRM 487), NBS Spec. Publ. 260-78 (September 1982). \$3.75* SN003-003-024-35-0
- Richmond, J. C., Hsia, J. J., Weidner, V. R., and Wilmering, D. B., Standard Reference Materials: Second Surface Mirror Standards of Specular Spectral Reflectance (SRM's 2023, 2024, 2025), NBS Spec. Publ. 260-79 (October 1982). \$4.50* SN003-003-024-47-3
- Schaffer, R., Mandel, J., Sun, T., Cohen, A., and Hertz, H. S., Standard Reference Materials: Evaluation by an ID/MS Method of the AACC Reference Method for Serum Glucose, NBS Spec. Publ. 260-80 (October 1982). \$4.75* SN003-003-024-43-1
- Burke, R. W., and Mavrodineanu, R. (NBS retired), Standard Reference Materials: Accuracy in Analytical Spectrophotometry, NBS Spec. Publ. 260-81 (April 1983). \$6.00* SN003-003-024-8
- Weidner, V. R., Standard Reference Materials: White Opal Glass Diffuse Spectral Reflectance Standards for the Visible Spectrum (SRM's 2015 and 2016). NBS Spec. Publ. 260-82 (April 1983). \$3.75* SN003-003-024-89-9**
- Bowers, G. N., Jr., Alvarez, R., Cali, J. P. (NBS retired), Eberhardt, K. R., Reeder, D. J., Schaffer, R., Uriano, G. A., Standard Reference Materials: The Measurement of the Catalytic (Activity) Concentration of Seven Enzymes in NBS Human Serum SRM 909, NBS Spec. Publ. 260-83 (June 1983). \$4.50* SN003-003-024-99-6
- Gills, T. E., Seward, R. W., Collins, R. J., and Webster, W. C., Standard Reference Materials: Sampling, Materials Handling, Processing, and Packaging of NBS Sulfur in Coal Standard Reference Materials, 2682, 2683, 2684, and 2685, NBS Spec. Publ. 260-84 (August 1983). \$4.50* SN003-003-025-20-8
- Swyt, D. A., Standard Reference Materials: A Look at Techniques for the Dimensional Calibration of Standard Microscopic Particles, NBS Spec. Publ. 260-85 (September 1983). \$5.50* SN003-003-025-21-6
- Hicho, G. E. and Eaton, E. E., Standard Reference Materials: A Standard Reference Material Containing Two and One-Half Percent Austenite, SRM 488, NBS Spec. Publ. 260-86 (December 1983). \$1.75* SN003-003-025-41-1
- Mangum, B. W., Standard Reference Materials: SRM 1969: Rubidium Triple-Point - A Temperature Reference Standard Near 39.30 °C, NBS Spec. Publ. 260-87 (December 1983). \$2.25* SN003-003-025-44-5
- Gladney, E. S., Burns, C. E., Perrin, D. R., Roelandts, I., and Gills, T. E., Standard Reference Materials: 1982 Compilation of Elemental Concentration Data for NBS Biological, Geological, and Environmental Standard Reference Materials. Spec. Publ. 260-88 (March 1984). \$7.00* SN003-003-02565-8
- Hust, J. G., Standard Reference Materials: A Fine-Grained, Isotropic Graphite for Use as NBS Thermophysical Property RM's from 5 to 2500 K, NBS Spec. Publ. 260-89 (September 1984). \$4.50* SN003-003-02608-5
- Hust, J. G., and Lankford, A. B., Standard Reference Materials: Update of Thermal Conductivity and Electrical Resistivity of Electrolytic Iron, Tungsten, and Stainless Steel, NBS Spec. Publ. 260-90 (September 1984). \$3.00* SN003-003-02609-3
- Goodrich, L. F., Vecchia, D. F., Pittman, E. S., Ekin, J. W., and Clark, A. F., Standard Reference Materials: Critical Current Measurements on an NbTi Superconducting Wire Standard Reference Material, NBS Spec. Publ. 260-91 (September 1984). \$2.75* SN003-003-02614-0
- Carpenter, B. S., Standard Reference Materials: Calibrated Glass Standards for Fission Track Use (Supplement to NBS Spec. 260-49). NBS Spec. Publ. 260-92 (September 1984). \$1.50* SN003-003-02610-7
- Ehrstein, J., Preparation and Certification of Standard Reference Materials for Calibration of Spreading Resistance Probes, NBS Spec. Publ. 260-93 (January 1985). \$2.25* SN003-003-02633-6
- Gills, T. E., Koch, W. F., Stolz, J. W., Kelly, W. R., Paulsen, P. J., Colbert, J. C., Kirklin, D. R., Pei, P.T.S., Weeks, S., Lindstrom, R. M., Fleming, R. F., Greenberg, R. R., and Paule, R. C., Methods and Procedures Used at the National Bureau of Standards to Certify Sulfur in Coal SRM's for Sulfur Content, Calorific Value, Ash Content, NBS Spec. Publ. 260-94 (December 1984). \$2.25* SN003-003-02629-8
- Mulholland, G. W., Hartman, A. W., Hembree, G. G., Marx, E., and Lettieri, T. R., Standard Reference Materials: Development of a 1 μ m Diameter Particle Size Standard, SRM 1690, NBS Spec. Publ. 260-95 (May 1985). SN003-003-02665-4

- Carpenter, B. S., Gramlich, J. W., Greenberg, R. R., and Machlan, L. A., Standard Reference Materials: Uranium-235 Isotopic Abundance Standard Reference Materials for Gamma Spectrometry Measurements, NBS Spec. Publ. 260-96 (In Preparation).
- Mavrodineanu, R. and Gills, T. E., Standard Reference Materials: Summary of the Coal, Ore, Mineral, Rock, and Refractory Standards Issued by the National Bureau of Standards, NBS Spec. Publ. 260-97 (September 1985).
- Hust, J. G., Standard Reference Materials: Glass Fiberboard SRM for Thermal Resistance, NBS Spec. Publ. 260-98 (August 1985). SN003-003-02674-3
- Callanan, J. E., Sullivan, S. A., and Vecchia, D. F., Standard Reference Materials: Feasibility Study for the Development of Standards Using Differential Scanning Calorimetry, NBS Spec. Publ. 260-99 (August 1985). SN003-003-02675-1
- Taylor, J. K., Standard Reference Materials: Handbook for SRM Users, NBS Spec. Publ. 260-100 (In Press).
- Mangum, B. W., Standard Reference Materials: SRM 1970, Succinonitrile Triple-Point Standard: A Temperature Reference Standard Near 58.08 °C, NBS Spec. Publ. 260-101 (In Preparation).
- Weidner, V. R., Mavrodineanu, R., Mielenz, K. D., Velapoldi, R. A., Eckerle, K. L., and Adams, B., Standard Reference Materials: Holmium Oxide Solution Wavelength Standard from 240-650 nm, SRM 2034, NBS Spec. Publ. 260-102 (In Press).
- Hust, J. G., Standard Reference Materials: Glass Fiberblanket SRM for Thermal Resistance, NBS Spec. Publ. 260-103 (September 1985). SN003-003-02687-5
- Mavrodineanu, R. and Alvarez, R., Standard Reference Materials: Summary of the Biological and Botanical Standards Issued by the National Bureau of Standards, NBS Spec. Publ. 260-104 (November 1985).
- Mavrodineanu, R. and Rasberry, S.D., Standard Reference Materials: Summary of the Environmental Research, Analysis, and Control Standards Issued by the National Bureau of Standards, NBS Spec. Publ. 260-105.
- * Send order with remittance to Superintendent of Documents, US Government Printing Office Washington, DC 20402. Remittance from foreign countries should include an additional one-fourth of the purchase price for postage.
- ** May be ordered from: National Technical Information Services (NTIS). Springfield Virginia 22161.

SRM 1970 : Succinonitrile Triple-Point Standard—A Temperature Reference Standard Near 58.08 °C

B. W. Mangum

National Bureau of Standards, Gaithersburg, MD 20899

and

Samir El-Sabbar

National Institute of Standards, Cairo, Egypt

Accepted: August 8, 1985

Triple-point-of-succinonitrile cells have been tested and established as Standard Reference Material (SRM) 1970. Of the 115 cells tested, 109 were accepted as SRM 1970. Five of the 115 cells had triple-point temperatures lower than 58.0785 °C (the low-temperature limit established for SRM 1970) and, consequently, were rejected. One of the 115 cells broke during tests on it. The mean value of the triple-point temperatures (obtained by freezing) of the 109 cells is 58.0796 ± 0.0015 °C, where the uncertainty is the total estimated uncertainty relative to the International Practical Temperature Scale of 1968, Amended Edition of 1975. The standard deviation of the triple-point temperatures is 0.48 mK. The purity of the succinonitrile of the SRM 1970 cells is estimated to range from 99.999,97% to 99.999,84%. The preparation of the cells, the various tests performed on them, and the procedure recommended for their use are described.

Key words: SRM 1970; standard reference materials; succinonitrile; thermometry; temperature fixed point.

1. Introduction

Accurate temperature measurements and control are necessary for many tests conducted in clinical and biomedical laboratories in order to obtain accurate and meaningful results which form the basis for the diagnosis and treatment of diseases. Temperature fixed points at temperature values near those at which specific tests are conducted can be used as *the* reference temperatures for those tests. This simplifies temperature measure-

ments and significantly improves the precision and accuracy of clinical measurements and results.

The calibration of thermometers is performed, either directly or indirectly, through the use of temperature fixed points. Because temperature fixed points provide reproducible environments, they have been the basis for practical temperature scales, such as the International Practical Temperature Scale of 1968, Amended Edition of 1975 (IPTS-68(75) [1]¹), and they are used in the calibration of thermometers on those scales. In addition to the defining fixed points of the scales, there are other equilibrium states which are internationally recognized as secondary reference points [2]. Those points may be used for calibration of thermometers which do not operate over the entire range of the defining fixed points

About the Authors: B. W. Mangum is with the Temperature and Pressure Division in NBS' Center for Basic Standards where Samir El-Sabbar served as a guest scientist.

¹ Numbers in brackets indicate literature references.

of the IPTS-68(75) and when a comparison calibration against a primary standard is not practicable. The feasibility of the use of the triple-point temperature of succinonitrile (SCN) as a temperature reference point near 58.08 °C has been investigated [3,4,5] and the quality of this fixed point has been found to be very high, the point containing most of the features desired in a fixed point.

Based on the previous work [4,5], we have developed an SCN triple-point Standard Reference Material (SRM). It is designated SRM 1970—the Succinonitrile Triple-Point Standard, and it is available from the Office of Standard Reference Materials (OSRM) of the National Bureau of Standards (NBS). These SRM devices are easy to use and with them one can confidently expect to achieve a calibration point with an uncertainty no greater than ± 0.0015 K.

The remainder of this publication describes SRM 1970, the tests performed on the cells of SCN, the conditions under which the cells were tested, the results obtained from testing 109 SRM 1970 cells, and the procedure recommended for using the cells for calibration of thermometers.

2. Experimental Details

2.1 Preparation of SCN Triple-Point Cells

a) Cell Design

Previous experience [4,5] with SCN led to the design shown in figure 1 for the triple-point cells constituting SRM 1970. These cells, sealed under vacuum, contain approximately 60 grams of high-purity SCN and are designed to be used with small thermometers, those not exceeding 4.5 mm (0.180 inches) in diameter. The thermometer well of a cell will accommodate most precision thermistor thermometers, many platinum resistance thermometers, and most diode thermometers.

b) Purification of SCN and Filling of the Triple-Point Cells

The SCN used for SRM 1970 was purified by the zone-refining technique by Prof. M. E. Glicksman and his students at Rensselaer Polytechnic Institute. The apparatus used for the zone-refining was a modified version of that described previously by M. E. Glicksman et al. [3].

Three pyrex cells were attached to the zone-refining tube of the second stage of refining so that three cells could be prepared from the purest half of the purified material of that second stage. Each of the two stages of purification consisted of at least 20 passes through the 6 zones of the zone-refining furnace. This amount of puri-

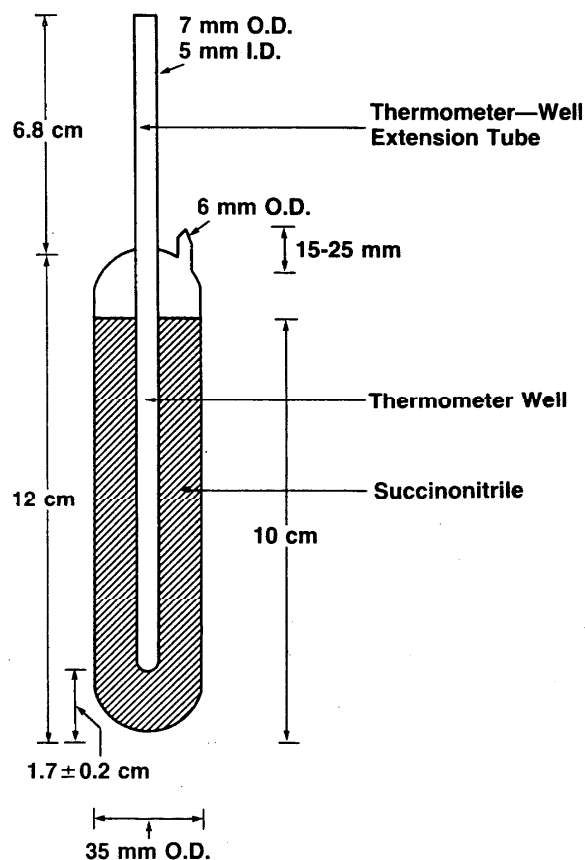

Figure 1—Cross-sectional drawing of the succinonitrile triple-point cell.

fication had been determined previously by one of us (BWM) [6] to be the minimum required if three cells were to be routinely obtained from each zone-refined lot. During the early part of the second stage of zone-refining, the three pyrex cells were washed several times with the purified SCN.

2.2 Testing of SCN Triple-Point Cells for SRM 1970

Using the inner-sheath technique, the freezing behaviors of 115 cells were studied in a well-stirred constant-temperature oil bath maintained at 56.880 °C. Some preliminary tests were made prior to testing the cells to determine the optimum bath temperature to be used for the freezing experiments, consistent with a reasonable time for the freeze. The temperature selected was 56.880 °C.

Prior to a freezing experiment, the SCN was melted by immersing the cell in a water bath at about 80 °C. When the material had completely melted, the cell was removed from the bath and its exterior dried. The cell was inverted several times to obtain a uniform distribu-

tion of any impurities present in the sample. Then a cold copper rod was inserted into the thermometer well, which contained a small amount of light mineral oil, to initiate the growth of an SCN sheath around the well. When the sheath appeared to be 2 to 3 mm thick, the rod was removed. This sheath provided an inner liquid-solid interface which the thermometer sensed. Once the sheath had formed, the cell was placed in the constant-temperature oil bath and a thermistor thermometer was inserted into the thermometer well. A second liquid-solid interface then formed along the outer wall of the cell. After the cell was placed in the oil bath, temperature measurements were begun and they were made at regular intervals until complete solidification of the SCN in the cell. These tests were made with groups of three cells at a time.

2.3 Apparatus Used in the Realization of the Triple-Points of the SCN Cells

a) Constant Temperature Bath

A constant temperature bath was used to study the freezing behavior of all cells tested for suitability as SRM 1970. The bath has a 10.6-liter capacity; such baths are commercially available. A light mineral oil (a dimethylpolysiloxane) with a 17-centistokes viscosity at 40 °C was used as a bath medium. The bath has both a cooling and a heating system and its temperature was controlled by their combined effect. The cooling was obtained by passing a stream of pressurized air at room-temperature through the cooling coil. The heater, and consequently the whole bath, was controlled by a commercially-available proportional controller with a thermistor as a sensing element. By this means, it was possible to maintain a uniform bath temperature, constant to ± 0.5 mK, for a time much longer than that needed for a freezing or a melting experiment. This high level of temperature control, however, is not necessary in the normal use of SRM 1970.

b) Thermometers

Bead-in-glass probe-type thermistor thermometers were used in this investigation. They were calibrated over the range 0 °C to 70 °C against a standard platinum resistance thermometer (SPRT), all located in a copper block immersed in a constant-temperature oil bath. The copper block, a high-capacity, good thermal conductor, ensured thermal equilibrium among the thermistors and with the SPRT, and damped any sudden temperature fluctuations. The measurements of the SPRT resistances, from which the temperatures of calibration were obtained, were made with a Cutkosky 400-Hz bridge [7] which, with a strip-chart recorder, has an

equivalent temperature resolution of about 1.5 μ K and an inaccuracy of about 0.01 mK. The SPRT itself had been calibrated previously on the IPTS-68(75) in the NBS Platinum Resistance Thermometer Calibration Laboratory using the same bridge. A constant-current source and high-quality 6 $\frac{1}{2}$ -digit digital voltmeter (DVM) were used for potentiometric measurements of the thermistors. The uncertainty of the resistance measurements of the thermistor thermometers corresponded to about ± 0.25 mK. By fitting the equation

$$1/T = A + B \log R + C(\log R)^2 + D(\log R)^3 \quad (1)$$

to the data, where T is the temperature in kelvins and R is the thermistor resistance in ohms at temperature T , the constants A , B , C and D were determined. The temperature value then derived from eq (1) for a measured thermistor-thermometer resistance agreed with that measured with the SPRT to within ± 1 mK.

c) Temperature Measurement System

The temperature measuring system used in testing the cells for suitability as SRM 1970 was the same automated one used in calibrating the thermistor thermometers and it consisted of a microcomputer, a 6 $\frac{1}{2}$ -digit DVM, a constant-current source, a standard resistor, and the calibrated thermistor thermometers [5].

3. Results and Discussion

3.1 Freezing Experiments

During previous work on SCN [4,5], it was found that the fastest and easiest way of producing a temperature plateau for calibration of thermometers was by the freezing technique, using the inner sheath method, rather than by the melting technique. Adopting this technique for testing the cells for suitability as SRM 1970, we conducted freezing experiments on a cell in the oil bath maintained at 57.480 °C, 57.180 °C and 56.880 °C in order to ascertain a reasonable bath temperature at which to test all of the remaining cells. The results for three freezes of cell A-1/3 in a bath at 57.480 °C are shown in figure 2; those for the cell in a bath at 57.180 °C are shown in figure 3; and those for the cell in a bath at 56.880 °C are shown in figure 4. We depict the combined results of these freezes of A-1/3 in figure 5, which shows that although the times required for the freezes vary with the temperature of the bath, as expected, the temperatures of the plateaus are unaffected by the bath temperature. Based on these results, it was decided to test all cells in a bath maintained at 56.880 °C, a temperature that does not require an unreasonable amount of time for measurements.

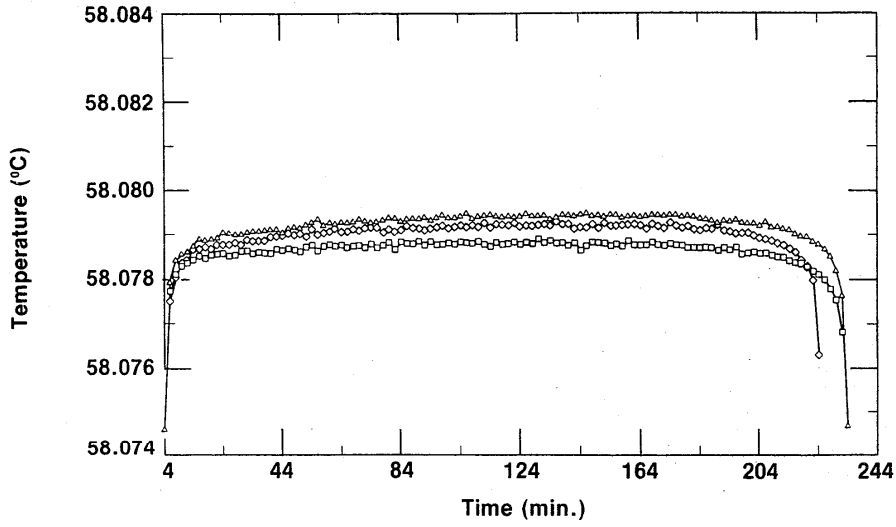

Figure 2-Freezing curves of sample A-1/3 obtained on different days, each time in an oil bath maintained at 57.480 °C.

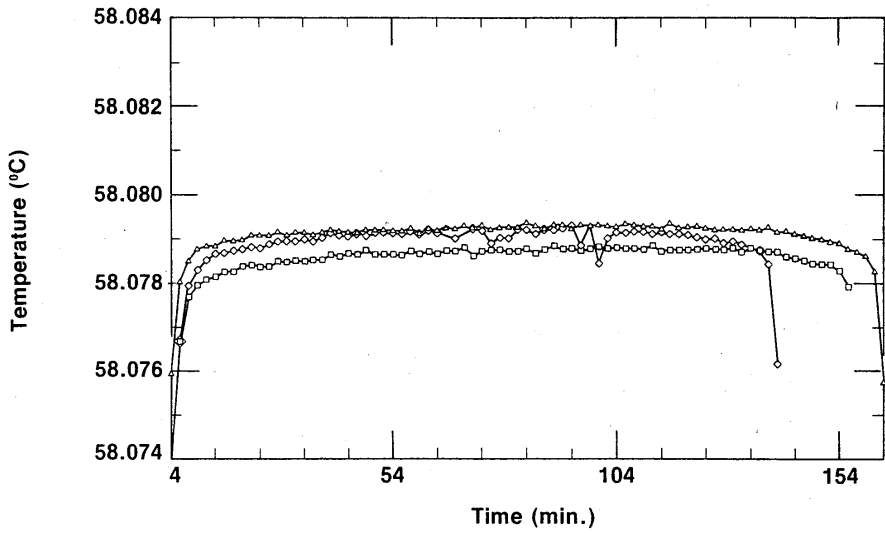

Figure 3-Freezing curves of sample A-1/3 obtained on different days, each time in an oil bath maintained at 57.180 °C.

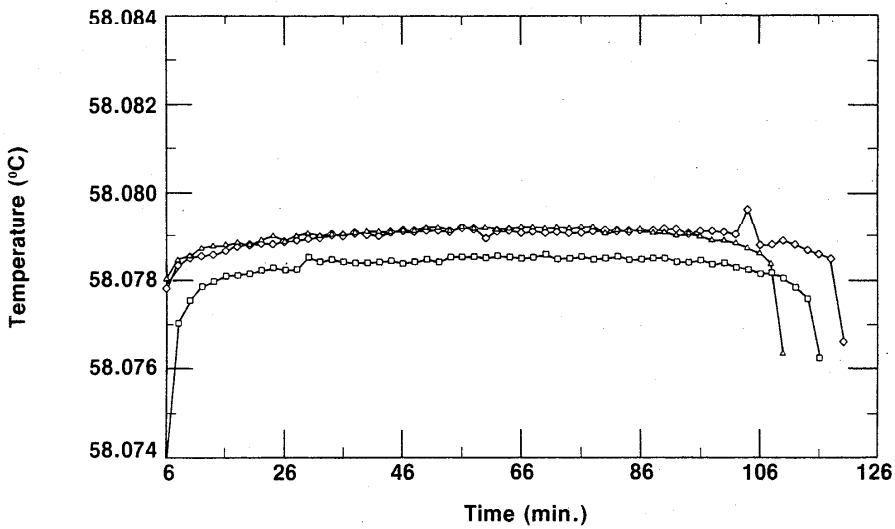

Figure 4-Freezing curves of sample A-1/3 obtained on different days, each time in an oil bath maintained at 56.880 °C.

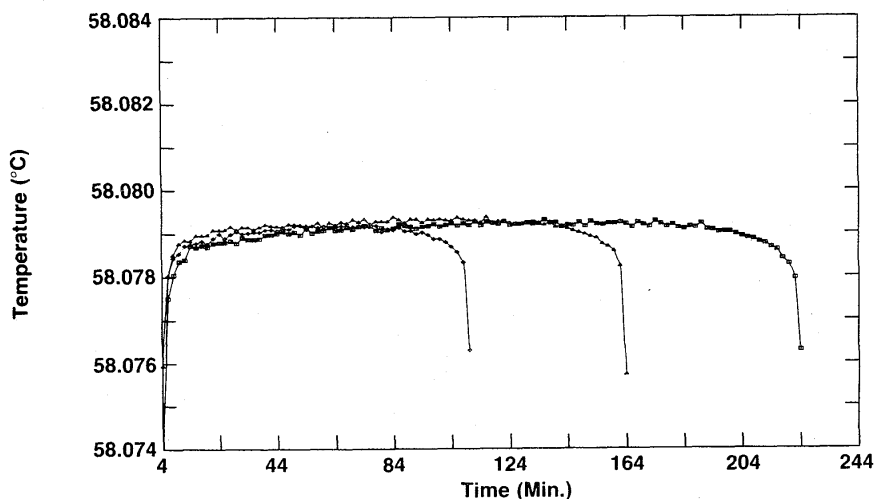

Figure 5—Freezing curves of SRM 1970 cell A-1/3 in constant temperature baths at three different temperatures. The data represented by ■ were obtained with the cell in a bath at 57.480 °C, those data represented by ▲ were obtained with the cell in a bath at 57.180 °C, and those data represented by ◆ were obtained with the cell in a bath at 56.880 °C.

Figures 2, 3, and 4 also show the irreproducibility of the freezing curves of A-1/3. The spread among the three curves of figure 2 is 0.7 mK, that for the curves of figure 3 is 0.6 mK, and that for the curves of figure 4 is 0.8 mK. We see, however, that the plateaus of the individual curves in figures 2, 3, and 4 are fairly flat and that the freezing range of any given curve is about 0.5 mK. The initial rapid rise in temperature indicated by the thermistor thermometer is due primarily to the temperature of the oil and thermistor in the thermometer well of the cell rising to the temperature of the SCN liquid-solid interface. The curvature at the ends of the freezes is due mainly to the low thermal conductivity of the SCN [8]. Also, the small but gradual increase in temperature during about the first two-thirds of any given freeze is attributed to the low thermal conductivity of SCN. The small but gradual decrease in temperature during the last one-third of a freeze is attributed to the low thermal conductivity of SCN, to increased concentration of impurities in the liquid SCN due to rejection of those impurities at the solid-liquid interface as the SCN solidifies, and to decreased effective immersion of the thermistor thermometer because of the way the outer solid-liquid interface progresses inward.

It can be seen from figure 5 that even with the temperature of the bath set 1.2 °C below the triple-point temperature of SCN, there is still a plateau lasting about 2 hours, a sufficient time for most calibrations. If longer times are required for calibrations, the bath temperature must be set closer to the triple-point value of the SCN.

As indicated in section 2, the column of the second stage of the zone-refining apparatus normally contained enough SCN to fill three cells from the top half (the purest part and that which constituted a "lot") of the column. The cells were given a designation ending with -1/X, -2/X or -3/3. The letter X represents either the

number 2, indicating that only two cells (-1/2 and -2/2) were filled from that lot, or the number 3, indicating that three cells (-1/3, -2/3 and -3/3) are in the lot. The first cell to be filled would normally be considered to be the purest of a lot, the second cell to be filled the next purest, and the third cell to be filled the least pure. In some cases, however, one could envision cells designated -2/X being purer than cells designated -1/X due to the washing of the empty (contaminated?) cells and the impurity not being removed from the first portion of the SCN in the subsequent zone refining. The spread of the triple-point temperatures of the cells of SCN of a given lot is an indication of the relative purity of those cells. Figures 6, 7, and 8 show freezing curves of three groups of cells, each group constituting a lot. All of the freezing curves were obtained at the same bath temperature using the same technique of freezing. The behavior portrayed in these figures is typical of all the lots of SRM 1970. Figure 6 displays freezing curves of cells L28-1/3, L28-2/3, and L28-3/3; these cells belong to lot L28. The temperatures of the plateaus of these cells have a spread of 1.3 mK. Figures 7 and 8 display the curves obtained during freezing of cells L25-1/3, L25-2/3 and L25-3/3, which belong to lot L25, and cells L34-1/3, L34-2/3 and L34-3/3, which belong to lot L34, respectively. The curves obtained during freezing of lot L25 show a spread of about 0.1 mK while those of lot L34 have a spread of about 0.8 mK. We see that all of the curves of figures 6, 7, and 8 are rather flat, with freezing ranges of about 0.5 mK, ranges which are due primarily to curvature near the ends of the freezes. These small freezing ranges indicate high purity.

We see from figures 6, 7, and 8 that the differences in temperature values of the plateaus of the different cells of a given lot are small but the temperatures are, nevertheless, not exactly the same. This is primarily because

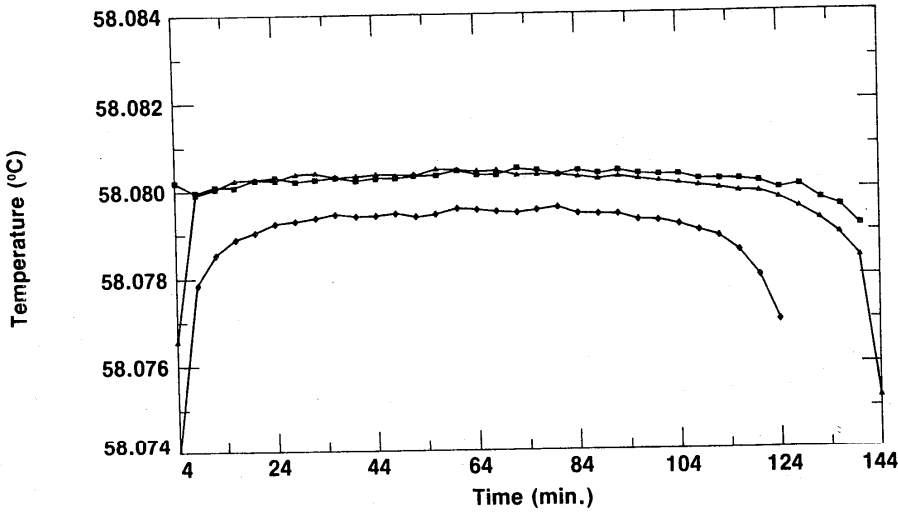

Figure 6-Freezing curves of the three cells of lot L28 obtained in a bath at 56.880 °C. ■ represent data for L28-1/3, ▲ represent data for L28-2/3, and ◆ represent data for L28-3/3.

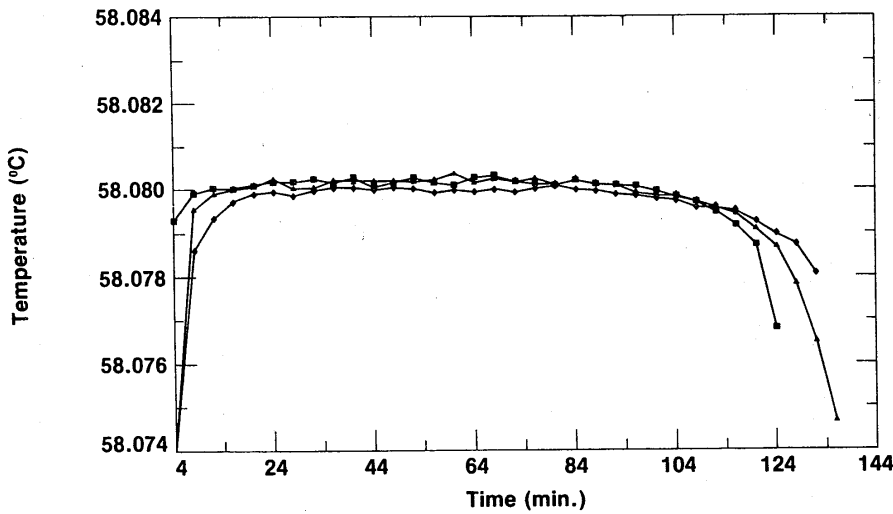

Figure 7-Freezing curves of the three cells of lot L25 obtained in a bath at 56.880 °C. ■ represent data for L25-1/3, ▲ represent data for L25-2/3, and ◆ represent data for L25-3/3.

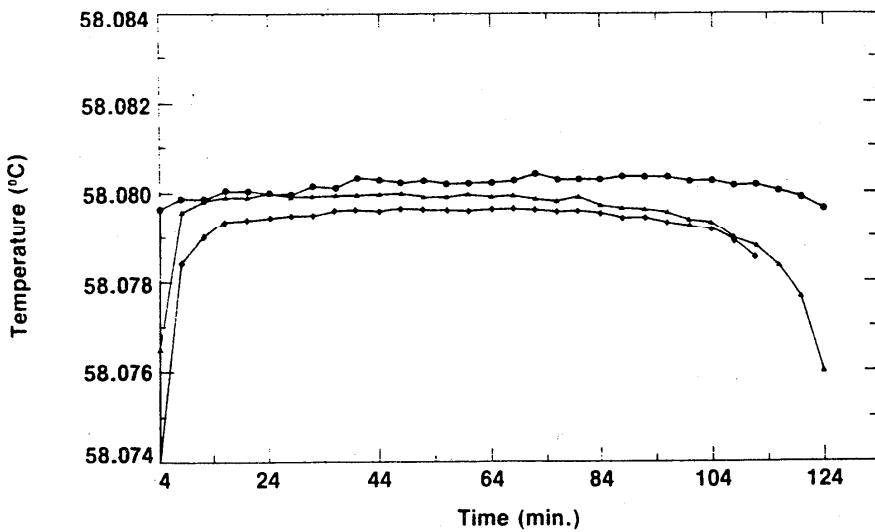

Figure 8-Freezing curves of the three cells of lot L34 obtained in a bath at 56.880 °C. ● represent data for L34-1/3, ▲ represent data for L34-2/3, and ◆ represent data for L34-3/3.

the cells were filled with SCN from different sections on the same zone-refining column and the purity varies along the column. The results for the cells of lot L34, shown in figure 8, as well as the results for cells of lots L28 and L25, shown in figures 6 and 7, respectively, demonstrate that the purities of the cells belonging to a given lot have different values and that generally they are in the sequence discussed above. The freezing curves of the three samples of lot L34, taken from the same zone-refining tube, clearly demonstrate how impurities affect the triple-point values of the SCN. It is seen in figure 8 that the first sample has a plateau during freezing which has the highest temperature of any sample of that lot. The third cell, L34-3/3, was the last sample in that lot to be extracted from the column and it has a plateau with the lowest temperature, while sample L34-2/3 is purer since it was the second sample to be taken from the column. This distribution of temperatures of the plateaus is as expected from purification of a material by zone refining.

The spread of the temperature values of the plateaus of the curves obtained during freezing of the cells of each of the 39 lots of SRM 1970 cells are shown in figure 9. This shows that the spread ranges from 0.1 mK to 1.3 mK. Only four lots, however, have a spread in temperature exceeding 0.9 mK, and those have a spread of 1.3 mK. These results indicate that the cells of SRM 1970 are of high purity.

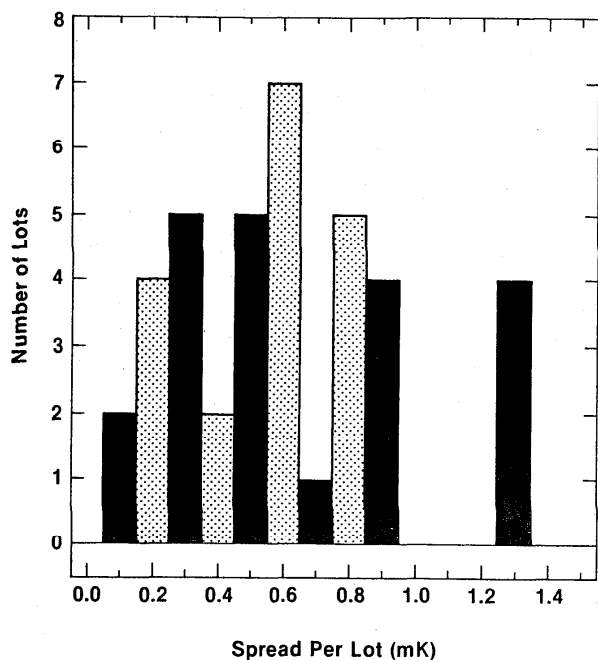

Figure 9-Histogram of the spread of the temperatures of the plateaus of the freezing curves of the cells of a given lot.

Our results indicate that in general, then, the purity of the cells of a given lot is such that the first extracted sample (comprising the -1/X cell) is the purest, the second cell filled is the next purest, and the last cell (the third cell) will be the most impure. Histograms of the triple-point temperatures for the cells labelled -1/X, -2/X, and -3/3 are presented in figure 10. The highest plateau temperature measured for any cell was 58.0806 °C, as indicated in the histograms for cells labelled -1/X and -2/X. Although the lowest temperature indicated in the histograms is 58.0785 °C, five cells with triple-point temperatures below that value were tested but were rejected as being unsuitable to qualify as SRM 1970. Consequently, they are not included in the histograms. The bottom section of figure 10 shows that the values of the 39 cells with designations -1/X have the

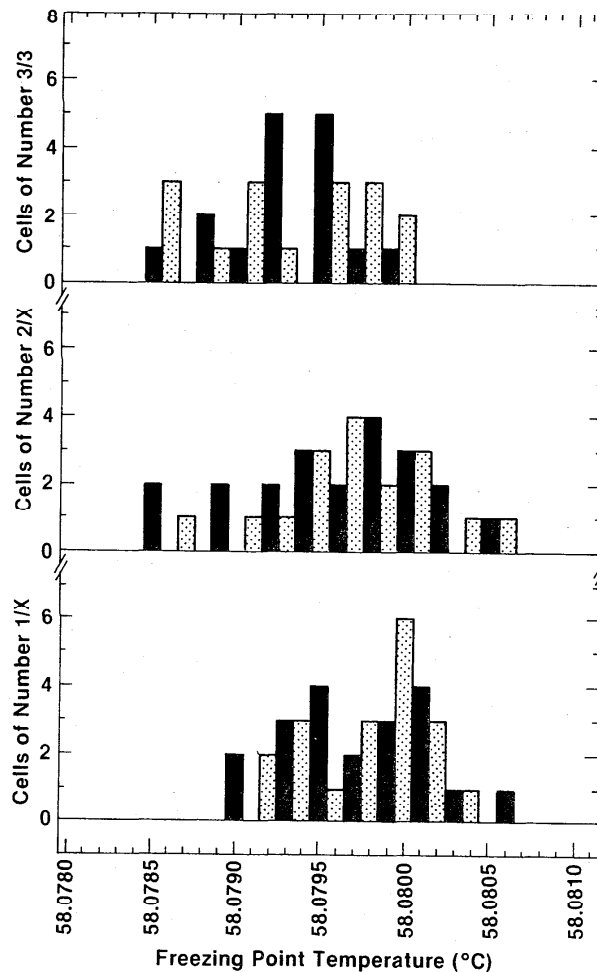

Figure 10-Histograms of the triple-point temperatures obtained by freezing of all of the SRM 1970 cells. The histogram at the bottom of the figure is for cells designated -1/X; that in the middle of the figure is for cells designated -2/X; and that at the top of the figure is for cells designated -3/3.

smallest spread of triple-point temperatures and a mean value (58.0797 °C) which is slightly higher than that of the other groups of cells (those designated -2/X and -3/3). Also, no cell of the bottom portion of figure 10 has a triple-point temperature below 58.0790 °C. The middle section of figure 10 shows that the 38 cells with designations -2/X are spread over the entire range from 58.0785 °C to 58.0806 °C, with a mean value of 58.0796 °C, a value only slightly less than that for the group of cells designated -1/X. The top section of figure 10 shows the distribution of the 32 cells designated -3/3. These cells have triple-point temperatures ranging from 58.0785 °C to 58.0800 °C, with a mean value of 58.0793 °C.

In order to demonstrate the reproducibility of the triple-point temperatures observed for the SRM 1970 cells, we present four typical freezing curves in figures 11 and 12. In figure 11, we display two freezing curves

of cell D-3/3, obtained on different days in a bath at the same temperature and using the same thermistor thermometer. This shows the excellent reproducibility that is obtainable with most of the cells comprising SRM 1970. In figure 12, the freezing curves characteristic of cell K-2/3 are presented. As shown there, the curves did not reproduce exactly, but the spread was less than 1 mK. The results in figure 12 are typical of those for cells with the greatest irreproducibility. All 109 SCN cells accepted as SRMs were tested for reproducibility in the manner just described. In figure 13, we present a histogram which indicates that each of the cells had freezing curves which repeated to within a value lying between 0.0 mK and 0.8 mK. Figure 13 shows that 77% of the cells, i.e., 84 cells, have a spread of ≤ 0.3 mK and only 25 cells had freezing curves with plateaus that differed by amounts ranging from 0.4 to 0.8 mK.

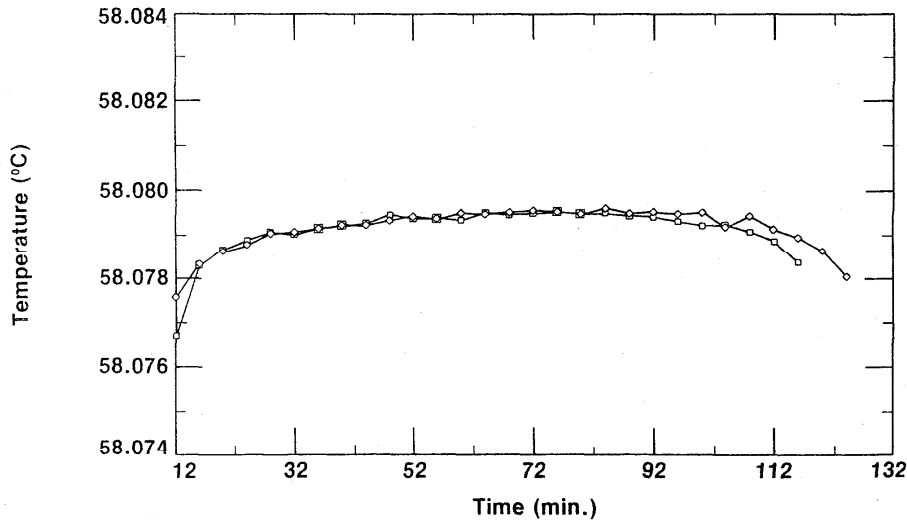

Figure 11—Freezing curves of cell D-3/3 obtained on different days in a bath at 56.880 °C, showing reproducibility.

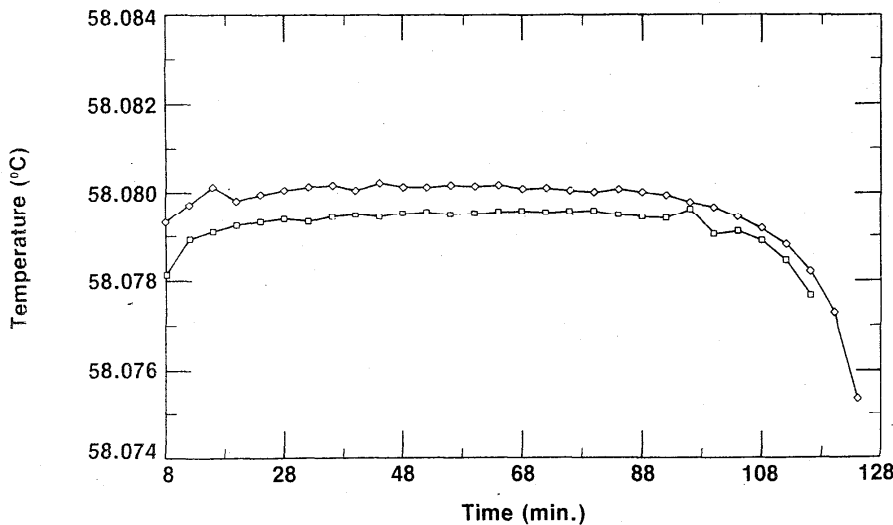

Figure 12—Freezing curves of cell K-2/3 obtained on different days in a bath at 56.880 °C, showing reproducibility.

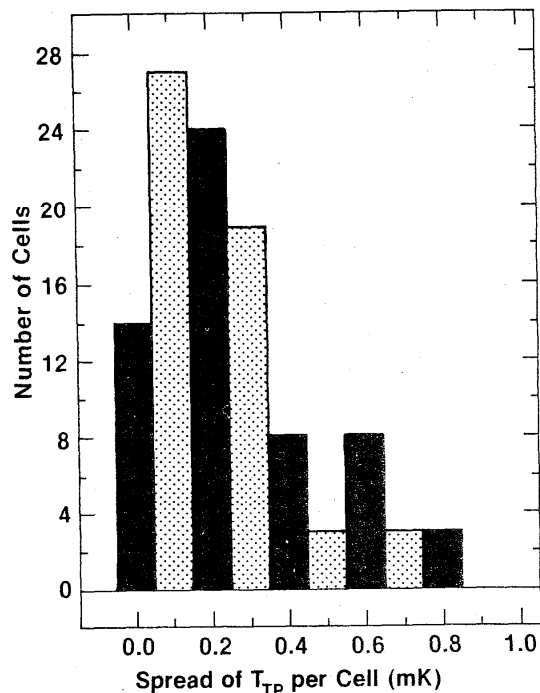

Figure 13—Histogram of the spread of the triple-point temperatures of each of the cells of SRM 1970, as determined from freezing curves.

As indicated previously, we obtained 115 cells of SCN to investigate for suitability as SRM 1970. Of these, 109 were accepted as the standard reference material; five were rejected because the temperatures of the plateaus of their freezing curves had values below 58.0785 °C, and one cell broke. The histogram shown in figure 14 represents the distribution of the triple-point temperatures of 111 of the 115 cells considered in our study. It is shown that the triple-point values of the 111 cells are distributed over a temperature range of 2.6 mK, i.e., from 58.0780 °C to 58.0806 °C, with the two cells having triple-point temperatures below 58.0785 °C being rejected as unsuitable for SRM 1970. All of the five cells rejected for SRM 1970 belonged to the group designated -3/3. The mean triple-point temperature of the 109 cells accepted as SRM 1970 is 58.0796 °C, with a standard deviation of 0.48 mK and a standard error of 0.04 mK.

3.2 Determination of Purity

The reproducibility of the plateau of the freezing curve of a sample and the depression of the triple-point/freezing-point temperature is a function of the purity of that sample [9-11]. Similarly, the purity determines, in

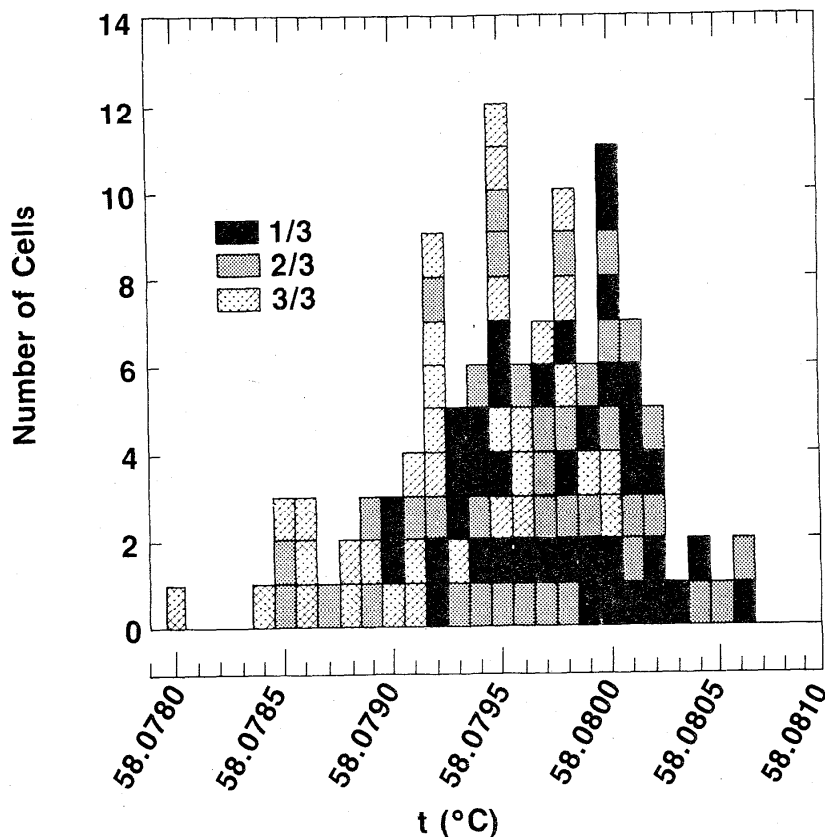

Figure 14—Histogram of the triple-point temperatures of the 109 cells of SCN accepted as SRM 1970, plus those of two cells with temperatures below 58.0785 °C, which, consequently, were rejected as being unsuitable for SRM 1970.

a major way, the melting behavior of a sample [9-11]. Both of these methods, of course, are nondestructive and can be used for any SRM 1970 cell. In using melting curves to estimate the purity of the SCN used as SRM 1970, three cells were selected with triple-point temperatures distributed over the range of temperatures observed for the plateaus of all the cells. One sample chosen was L27-2/3, with a triple-point value of 58.0804 °C; another cell chosen was L20-2/3, with a triple-point temperature of 58.0787 °C; the third cell selected was L26-2/3, which has a triple-point temperature of 58.0795 °C. Prior to the melting experiments from which the purities were to be determined, the cells were prepared as follows. The SCN was completely melted by placing the cells in a water bath at about 80 °C. Then the cells were removed, wrapped with paper towels, placed in dewars, and a slow stream of air directed into their thermometer wells to cause the SCN to freeze slowly from inside outwards. This technique of freezing causes the impurities that have distribution coefficients with values less than 1.0 (impurities rejected on freezing) to be more concentrated on the outermost parts of the cells. After the SCN had solidified and cooled to room temperature, the cells were immersed in a constant temperature bath, maintained at a temperature of 58.38 °C, and their temperatures monitored as the SCN melted. Melting curves of the three cells are presented in figure 15.

Assuming that the law of dilute solutions [12,13] is valid for our samples, the purity can be estimated by using the equation [9]

$$X = \frac{A(T_{f1} - T_{f2})}{[(1/f1) - (1/f2)]} \quad (2)$$

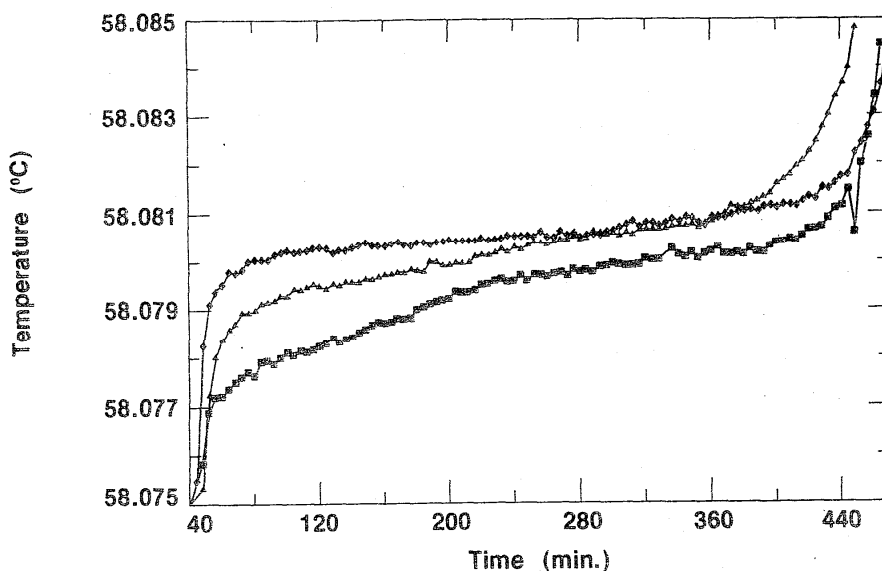

Figure 15—Melting curves of cells L20-2/3, L26-2/3 and L27-2/3 obtained in a bath maintained at 58.380 °C. ■ represent data obtained for cell L20-2/3, ▲ represent data obtained for cell L26-2/3, and ◆ represent data obtained for cell L27-2/3.

where X is the total mole fraction of impurities in the sample, T_{f1} and T_{f2} are the temperatures when the fractions melted are $f1$ and $f2$, respectively, and A is the cryoscopic constant ($=0.004318 \text{ K}^{-1}$ for SCN). The constant A can be calculated from the equation

$$A = \frac{\Delta H}{RT_0^2} \quad (3)$$

where R is the gas constant ($8.314 \text{ J mol}^{-1} \text{ K}^{-1}$), ΔH is the latent heat of fusion ($3703.45 \text{ J mol}^{-1}$ for SCN), and T_0 is the melting-point temperature in kelvins. Although the plateaus are not perfectly flat (i.e., there is a finite melting range), the temperature difference between the bath and the SCN is essentially constant, and thus the absorption of heat per unit time by the sample during melting is nearly constant. Consequently, the fraction of SCN melted can be considered to be directly proportional to the time elapsed during the melting and eq (2) can be rewritten as

$$X_2 = \frac{A(T_{t1} - T_{t2})}{[(1/t1) - (1/t2)]} \quad (4)$$

where $f1$ and $f2$ have been replaced by $t1$ and $t2$, respectively.

Since the three melting curves shown in figure 15 do not have perfectly flat plateaus and since that for L20-2/3 has an odd shape, we selected various parts of each curve for possible use in estimating the impurity content. The results of the calculations are given in table 1. Values of $f2$ (or $t2$) greater than 0.8 were not used

Table 1. Mole fraction of impurities for three cells (representative of all 109 cells of SRM 1970 certified to date), determined by using different parts of the melting curves.

(t1, t2)	X		
	L27-2/3	L26-2/3	L20-2/3
(0.1,0.5)	0.000,000,162	0.000,000,593	0.000,001,510
(0.1,0.6)	0.000,000,207	0.000,000,725	0.000,001,553
(0.1,0.7)	0.000,000,302	0.000,000,755	0.000,001,611
(0.1,0.8)	0.000,000,394	0.000,000,888	0.000,001,627
(0.2,0.5)	0.000,000,288	0.000,001,151	0.000,001,870
(0.2,0.6)	0.000,000,388	0.000,001,424	0.000,001,941
(0.2,0.7)	0.000,000,604	0.000,001,450	0.000,002,054
(0.2,0.8)	0.000,000,805	0.000,001,726	0.000,002,071
(0.3,0.7)	0.000,000,906	0.000,002,491	0.000,002,718
(0.3,0.8)	0.000,001,242	0.000,002,900	0.000,002,692
Best estimates:			
of X	0.000,000,3	0.000,000,7	0.000,001,6
of Purity	99.999,97%	99.999,93%	99.999,84%

because at values greater than that the temperatures of the thermometers were already being influenced by the environment external to the cells. As indicated in table 1, 10 different sections of each curve were used to estimate the amount of impurity. In these determinations of impurities, eq (4) is most sensitive over about the first 50% of the melt. Consequently, we gave that section of the curves the greatest weight in estimating the amount of impurities present. The measurements on the three samples, representative of all the SRM 1970 cells, then, lead to estimates of the purities ranging from 99.999,97% to 99.999,84%, as listed in table 1.

4. Recommended Procedure for Use of SRM 1970 in Calibration of Thermometers

To obtain the best results in calibrating thermometers using SRM 1970, the SCN should be totally melted, a thin sheath of solid SCN prepared around the thermometer well, the cell placed in an appropriate constant-temperature environment, and the SCN slowly frozen while calibrating the thermometers.

The constant-temperature environment should be a well-stirred fluid bath (preferably containing a light purified mineral oil) maintained at a temperature between 56.88 ± 0.05 °C and 58.02 ± 0.05 °C. Since the SRM 1970 cells are approximately 18 cm long, the bath should be at least 20 cm deep from the top level of the oil. The cell or cells should be mounted vertically in a suitable holder in such a way that the cells are completely immersed below the level of the oil.

A temperature controller capable of controlling the bath to ± 0.02 °C is preferred, but one could use a bath controller^d to only ± 0.05 °C, or even ± 0.1 °C.

The detailed procedure preferred for calibrating a thermometer through the use of an SRM 1970 SCN triple-point cell is as follows: First, get a well-stirred oil bath to a temperature between 56.88 ± 0.05 °C and 58.02 ± 0.05 °C and maintain it at that point. Melt the sample by immersing the cell in a water bath at about 80 °C. After the SCN has completely melted, remove the cell from the bath and invert it several times to ensure a thorough mixing of the liquid material (SCN and all impurities) inside the cell. Dry the cell, put a small amount of oil in the thermometer well, and insert a cold copper rod into the well. After the formation of what appears to be a 2 to 3 mm sheath of the SCN around the thermometer well, put the cell into the temperature-controlled bath, using a holder to support the cell. Insert the thermometer to be calibrated in the thermometer well of the cell, wait 10 to 15 minutes, then read the indication of the thermometer. The *correct* temperature of the thermometer at that time is the value indicated on the SRM certificate.

If more than one thermometer is to be calibrated, the second and succeeding thermometers should be allowed 5 to 10 minutes to reach thermal equilibrium with the freezing SCN in the cell before obtaining measurements on them. The smaller the mass of the thermometer and the closer the temperature of the thermometer is to that of the fixed point, the shorter the length of time required for equilibrium.

If the minimum recommended temperature of the environment of the cell (56.88 °C) is used, there should be

a minimum time of about 90 minutes available for calibration from the time the SCN sheath is prepared. If more than about 75% of the SCN has solidified and if more calibrations are needed, remove the SCN cell, repeat the previous procedure to prepare a new inner sheath, and put the cell back into the oil bath (or other controlled environment) for further calibration work. These consecutive freezing and melting processes may be repeated as often as required.

5. Summary and Conclusions

In certifying cells of SCN for SRM 1970, 115 cells of purified SCN were tested, 5 of them were rejected because their freezing values were below 58.0785 °C, and one was broken. The remaining 109 samples were accepted as suitable for the temperature standard reference material. The triple-point temperatures of all the cells accepted for SRM 1970 ranged between 58.0806 °C and 58.0785 °C, with a mean value of 58.0796 °C, a standard deviation of 0.48 mK and a standard error of 0.04 mK.

In realizing the fixed points of these cells, the freezing technique was found to be more convenient than that of melting because of the greater flatness of the freezing curves. Each of the cells showed a high degree of reproducibility, with the observed temperature values of the plateaus differing by no more than 0.8 mK. These properties make the cells very attractive as a temperature reference standard for the calibration of thermometers near 58.08 °C.

The SCN used was of high purity; that is clear from the fact that the spread of freezing -point - temperatures values per lot did not exceed 1.3 mK. The amount of impurities estimated to be present in the SCN of the 109 cells of SRM 1970 has values ranging from 3×10^{-7} to 1.6×10^{-6} , equivalent to a purity of the SCN ranging from 99.999,97% to 99.999,84%. This is a very high purity for an organic material.

Thermometers with diameters no greater than 4.5 mm may be calibrated in these SRM 1970 cells.

6. References

- [1] The International Practical Temperature Scale of 1968, Amended Edition of 1975, *Metrologia* **12**, 7-17 (1976).
- [2] Bureau International des Poids et Mesures, Monograph, Supplementary Information for the IPTS-68 and the EPT-76, Pavillon de Breteuil, F-92310 Sevres (1983).
- [3] Glicksman, M. E.; P. W. Voorhees and R. Setzko, The triple-point equilibria of succinonitrile—its assessment as a temperature standard, in *Temperature: Its Measurement and Control in Science and Industry 5*, American Institute of Physics: New York, NY, 321-326 (1982).
- [4] Mangum, B. W., The succinonitrile triple-point standard: a fixed point to improve the accuracy of temperature measurements in the clinical laboratory, *Clin. Chem.* **29**, 1380-1384 (1983).
- [5] Mangum, B. W., Triple point of succinonitrile and its use in the calibration of thermistor thermometers, *Rev. Sci. Instrum.* **54**, 1687-1692 (1983).
- [6] Mangum, B. W., private communication.
- [7] Cutkosky, R. D., An ac resistance thermometer bridge, *J. Res. Natl. Bur. Stand. (U.S.)* **74C**, 15-18 (1970).
- [8] Smit, W. M., Errors occurring in the determination of temperature-heat content curves, *Anal. Chim. Acta* **17**, 23-35 (1957).
- [9] Smit, W. M., Melting curves (temperature-heat content curves) as criteria for purity, *Recul Trav. Chim. des Pays-Bas.* **75**, 1309-1320 (1956).
- [10] Furukawa, G. T.; J. L. Riddle, W. R. Bigge, and E. R. Pfeiffer, Application of some metal SRM's as thermometric fixed points, *Natl. Bur. Stand. (U.S.) Spec. Publ.* 260-77, Supt. of Documents, U.S. Gov't. Printing Office: Washington, DC 20402 (1982).
- [11] Riddle, J. L.; G. T. Furukawa and H. H. Plumb, Platinum resistance thermometry, NBS Monograph 126, Supt. of Documents, U.S. Gov't Printing Office: Washington, DC 20402 (1973).
- [12] Lewis, G. N., and M. Randall, *Thermodynamics and Free Energy of Chemical Substances*, McGraw-Hill Book Co.: New York, NY, p. 238 (1923).
- [13] White, W. P., Estimating impurities by means of the melting point curve, *J. Phys. Chem.* **24**, 393-416 (1920).