



Part One

The Accident

“Building rockets is hard.” Part of the problem is that space travel is in its infancy. Although humans have been launching orbital vehicles for almost 50 years now – about half the amount of time we have been flying airplanes – contrast the numbers. Since *Sputnik*, humans have launched just over 4,500 rockets towards orbit (not counting suborbital flights and small sounding rockets). During the first 50 years of aviation, there were over one million aircraft built. Almost all of the rockets were used only once; most of the airplanes were used more often.

There is also the issue of performance. Airplanes slowly built their performance from the tens of miles per hour the Wright Brothers initially managed to the 4,520 mph that Major William J. Knight flew in the X-15A-2 research airplane during 1967. Aircraft designers and pilots would slightly push the envelope, stop and get comfortable with where they were, then push on. Orbital rockets, by contrast, must have all of their performance on the first (and often, only) flight. Physics dictates this – to reach orbit, without falling back to Earth, you have to exceed about 17,500 mph. If you cannot vary performance, then the only thing left to change is the amount of payload – the rocket designers began with small payloads and worked their way up.

Rockets, by their very nature, are complex and unforgiving vehicles. They must be as light as possible, yet attain outstanding performance to get to orbit. Mankind is, however, getting better at building them. In the early days as often as not the vehicle exploded on or near the launch pad; that seldom happens any longer. It was not that different from early airplanes, which tended to crash about as often as they flew. Aircraft seldom crash these days, but rockets still fail between two-and-five percent of the time. This is true of just about any launch vehicle – Atlas, Delta, Soyuz, Shuttle – regardless of what nation builds it or what basic configuration is used; they all fail about the same amount of the time. Building and launching rockets is still a very dangerous business, and will continue to be so for the foreseeable future while we gain experience at it. It is unlikely that launch-

ing a space vehicle will ever be as routine an undertaking as commercial air travel – certainly not in the lifetime of anybody who reads this. The scientists and engineers continually work on better ways, but if we want to continue going into outer space, we must continue to accept the risks.

Part One of the report of the Columbia Accident Investigation Board is organized into four chapters. In order to set the background for further discussion, Chapter 1 relates the history of the Space Shuttle Program before the *Challenger* accident. The events leading to the original approval of the Space Shuttle Program are recounted, as well as an examination of some of the promises made in order to gain that approval. In retrospect, many of these promises could never have been achieved. Chapter 2 documents the final flight of *Columbia*. As a straightforward record of the event, it contains no findings or recommendations. Chapter 3 reviews five analytical paths – aerodynamic, thermodynamic, sensor data timeline, debris reconstruction, and imaging evidence – to show that all five independently arrive at the same conclusion. Chapter 4 describes the investigation into other possible physical factors that might have contributed to the accident, but were subsequently dismissed as possible causes.



Sunrise aboard *Columbia*
on Flight Day 7.

The launch of STS-107 on January 16, 2003.





The Evolution of the Space Shuttle Program

More than two decades after its first flight, the Space Shuttle remains the only reusable spacecraft in the world capable of simultaneously putting multiple-person crews and heavy cargo into orbit, of deploying, servicing, and retrieving satellites, and of returning the products of on-orbit research to Earth. These capabilities are an important asset for the United States and its international partners in space. Current plans call for the Space Shuttle to play a central role in the U.S. human space flight program for years to come.

The Space Shuttle Program's remarkable successes, however, come with high costs and tremendous risks. The February 1 disintegration of *Columbia* during re-entry, 17 years after *Challenger* was destroyed on ascent, is the most recent reminder that sending people into orbit and returning them safely to Earth remains a difficult and perilous endeavor.

It is the view of the Columbia Accident Investigation Board that the *Columbia* accident is not a random event, but rather a product of the Space Shuttle Program's history and current management processes. Fully understanding how it happened requires an exploration of that history and management. This chapter charts how the Shuttle emerged from a series of political compromises that produced unreasonable expectations – even myths – about its performance, how the *Challenger* accident shattered those myths several years after NASA began acting upon them as fact, and how, in retrospect, the Shuttle's technically ambitious design resulted in an inherently vulnerable vehicle, the safe operation of which exceeded NASA's organizational capabilities as they existed at the time of the *Columbia* accident. The Board's investigation of what caused the *Columbia* accident thus begins in the fields of East Texas but reaches more than 30 years into the past, to a series of economically and politically driven decisions that cast the Shuttle program in a role that its nascent technology could not support. To understand the cause of the *Columbia* accident is to understand how a program promising reliability and cost efficiency resulted instead in a developmental vehicle that never achieved the fully operational status NASA and the nation accorded it.

1.1 GENESIS OF THE SPACE TRANSPORTATION SYSTEM

The origins of the Space Shuttle Program date to discussions on what should follow Project Apollo, the dramatic U.S. missions to the moon.¹ NASA centered its post-Apollo plans on developing increasingly larger outposts in Earth orbit that would be launched atop Apollo's immense Saturn V booster. The space agency hoped to construct a 12-person space station by 1975; subsequent stations would support 50, then 100 people. Other stations would be placed in orbit around the moon and then be constructed on the lunar surface. In parallel, NASA would develop the capability for the manned exploration of Mars. The concept of a vehicle – or Space Shuttle – to take crews and supplies to and from low-Earth orbit arose as part of this grand vision (see Figure 1.1-1). To keep the costs of these trips to a minimum, NASA intended to develop a fully reusable vehicle.²



Figure 1.1-1. Early concepts for the Space Shuttle envisioned a reusable two-stage vehicle with the reliability and versatility of a commercial airliner.

NASA's vision of a constellation of space stations and journeying to Mars had little connection with political realities of the time. In his final year in office, President Lyndon Johnson gave highest priority to his Great Society programs and to dealing with the costs and domestic turmoil associated with the Vietnam war. Johnson's successor, President Richard Nixon, also had no appetite for another large, expensive, Apollo-like space commitment. Nixon rejected NASA's ambitions with little hesitation and directed that the agency's budget be cut as much as was politically feasible. With NASA's space station plans deferred and further production of the Saturn V launch vehicle cancelled, the Space Shuttle was the only manned space flight program that the space agency could hope to undertake. But without space stations to service, NASA needed a new rationale for the Shuttle. That rationale emerged from an intense three-year process of technical studies and political and budgetary negotiations that attempted to reconcile the conflicting interests of NASA, the Department of Defense, and the White House.³

1.2 MERGING CONFLICTING INTERESTS

During 1970, NASA's leaders hoped to secure White House approval for developing a fully reusable vehicle to provide routine and low cost manned access to space. However, the staff of the White House Office of Management and Budget, charged by Nixon with reducing NASA's budget, was skeptical of the value of manned space flight, especially given its high costs. To overcome these objections, NASA turned to justifying the Space Shuttle on economic grounds. If the same vehicle, NASA argued, launched all government and private sector payloads and if that vehicle were reusable, then the total costs of launching and maintaining satellites could be dramatically reduced. Such an economic argument, however, hinged on the willingness of the Department of Defense to use the Shuttle to place national security payloads in orbit. When combined, commercial, scientific, and national security payloads would require 50 Space Shuttle missions per year. This was enough to justify – at least on paper – investing in the Shuttle.

Meeting the military's perceived needs while also keeping the cost of missions low posed tremendous technological hurdles. The Department of Defense wanted the Shuttle to carry a 40,000-pound payload in a 60-foot-long payload bay and, on some missions, launch and return to a West Coast launch site after a single polar orbit. Since the Earth's surface – including the runway on which the Shuttle was to land – would rotate during that orbit, the Shuttle would need to maneuver 1,100 miles to the east during re-entry. This "cross-range" requirement meant the Orbiter required large delta-shaped wings and a more robust thermal protection system to shield it from the heat of re-entry.

Developing a vehicle that could conduct a wide variety of missions, and do so cost-effectively, demanded a revolution in space technology. The Space Shuttle would be the first reusable spacecraft, the first to have wings, and the first with a reusable thermal protection system. Further, the Shuttle would be the first to fly with reusable, high-pressure hydrogen/oxygen engines, and the first winged vehicle to transition from orbital speed to a hypersonic glide during re-entry.

Even as the design grew in technical complexity, the Office of Management and Budget forced NASA to keep – or at least promise to keep – the Shuttle's development and operating costs low. In May 1971, NASA was told that it could count on a maximum of \$5 billion spread over five years for any new development program. This budget ceiling forced NASA to give up its hope of building a fully reusable two-stage vehicle and kicked off an intense six-month search for an alternate design. In the course of selling the Space Shuttle Program within these budget limitations, and therefore guaranteeing itself a viable post-Apollo future, NASA made bold claims about the expected savings to be derived from revolutionary technologies not yet developed. At the start of 1972, NASA leaders told the White House that for \$5.15 billion they could develop a Space Shuttle that would meet all performance requirements, have a lifetime of 100 missions per vehicle, and cost \$7.7 million per flight.⁴ All the while, many people, particularly those at the White House Office of Management and Budget, knew NASA's in-house and external economic studies were overly optimistic.⁵

Those in favor of the Shuttle program eventually won the day. On January 5, 1972, President Nixon announced that the Shuttle would be "designed to help transform the space frontier of the 1970s into familiar territory, easily accessible for human endeavor in the 1980s and 90s. This system will center on a space vehicle that can shuttle repeatedly from Earth to orbit and back. *It will revolutionize transportation into near space, by routinizing it.* [emphasis added]"⁶ Somewhat ironically, the President based his decision on grounds very different from those vigorously debated by NASA and the White House budget and science offices. Rather than focusing on the intricacies of cost/benefit projections, Nixon was swayed by the political benefits of increasing employment in key states by initiating a major new aerospace program in the 1972 election year, and by a geopolitical calculation articulated most clearly by NASA Administrator James Fletcher. One month before the decision, Fletcher wrote a memo to the White House stating, "For the U.S. not to be in space, while others do have men in space, is unthinkable, and a position which America cannot accept."⁷

The cost projections Nixon had ignored were not forgotten by his budget aides, or by Congress. A \$5.5 billion ceiling imposed by the Office of Management and Budget led NASA to make a number of tradeoffs that achieved savings in the short term but produced a vehicle that had higher operational costs and greater risks than promised. One example was the question of whether the "strap-on" boosters would use liquid or solid propellants. Even though they had higher projected operational costs, solid-rocket boosters were chosen largely because they were less expensive to develop, making the Shuttle the first piloted spacecraft to use solid boosters. And since NASA believed that the Space Shuttle would be far safer than any other spacecraft, the agency accepted a design with no crew escape system (see Chapter 10.)

The commitments NASA made during the policy process drove a design aimed at satisfying conflicting requirements: large payloads and cross-range capability, but also low development costs and the even lower operating costs of a "routine" system. Over the past 22 years, the resulting ve-

hicle has proved difficult and costly to operate, riskier than expected, and, on two occasions, deadly.

It is the Board's view that, in retrospect, the increased complexity of a Shuttle designed to be all things to all people created inherently greater risks than if more realistic technical goals had been set at the start. Designing a reusable spacecraft that is also cost-effective is a daunting engineering challenge; doing so on a tightly constrained budget is even more difficult. Nevertheless, the remarkable system we have today is a reflection of the tremendous engineering expertise and dedication of the workforce that designed and built the Space Shuttle within the constraints it was given.

In the end, the greatest compromise NASA made was not so much with any particular element of the technical design, but rather with the premise of the vehicle itself. NASA promised it could develop a Shuttle that would be launched almost on demand and would fly many missions each year. Throughout the history of the program, a gap has persisted between the rhetoric NASA has used to market the Space Shuttle and operational reality, leading to an enduring image of the Shuttle as capable of safely and routinely carrying out missions with little risk.

1.3 SHUTTLE DEVELOPMENT, TESTING, AND QUALIFICATION

The Space Shuttle was subjected to a variety of tests before its first flight. However, NASA conducted these tests somewhat differently than it had for previous spacecraft.⁸ The Space Shuttle Program philosophy was to ground-test key hardware elements such as the main engines, Solid Rocket Boosters, External Tank, and Orbiter separately and to use analytical models, not flight testing, to certify the integrated Space Shuttle system. During the Approach and Landing Tests (see Figure 1.3-1), crews verified that the Orbiter could successfully fly at low speeds and land safely; however, the Space Shuttle was not flown on an unmanned orbital test flight prior to its first mission – a significant change in philosophy compared to that of earlier American spacecraft.



Figure 1.3-1. The first Orbiter was Enterprise, shown here being released from the Boeing 747 Shuttle Carrier Aircraft during the Approach and Landing Tests at Edwards Air Force Base.

The significant advances in technology that the Shuttle's design depended on led its development to run behind schedule. The date for the first Space Shuttle launch slipped from March 1978 to 1979, then to 1980, and finally to the spring of 1981. One historian has attributed one year of this delay "to budget cuts, a second year to problems with the main engines, and a third year to problems with the thermal protection tiles."⁹ Because of these difficulties, in 1979 the program underwent an exhaustive White House review. The program was thought to be a billion dollars over budget, and President Jimmy Carter wanted to make sure that it was worth continuing. A key factor in the White House's final assessment was that the Shuttle was needed to launch the intelligence satellites required for verification of the SALT II arms control treaty, a top Carter Administration priority. The review reaffirmed the need for the Space Shuttle, and with continued White House and Congressional support, the path was clear for its transition from development to flight. NASA ultimately completed Shuttle development for only 15 percent more than its projected cost, a comparatively small cost overrun for so complex a program.¹⁰

The Orbiter that was destined to be the first to fly into space was *Columbia*. In early 1979, NASA was beginning to feel the pressure of being behind schedule. Despite the fact that only 24,000 of the 30,000 Thermal Protection System tiles had been installed, NASA decided to fly *Columbia* from the manufacturing plant in Palmdale, California, to the Kennedy Space Center in March 1979. The rest of the tiles would be installed in Florida, thus allowing NASA to maintain the appearance of *Columbia's* scheduled launch date. Problems with the main engines and the tiles were to leave *Columbia* grounded for two more years.

1.4 THE SHUTTLE BECOMES "OPERATIONAL"

On the first Space Shuttle mission, STS-1,¹¹ *Columbia* carried John W. Young and Robert L. Crippen to orbit on April 12, 1981, and returned them safely two days later to Edwards Air Force Base in California (see Figure 1.4-1). After three years of policy debate and nine years of development, the Shuttle returned U.S. astronauts to space for the first time since the Apollo-Soyuz Test Project flew in July 1975. Post-flight inspection showed that *Columbia* suffered slight damage from excess Solid Rocket Booster ignition pressure and lost 16 tiles, with 148 others sustaining some damage. Over the following 15 months, *Columbia* was launched three more times. At the end of its fourth mission, on July 4, 1982, *Columbia* landed at Edwards where President Ronald Reagan declared to a nation celebrating Independence Day that "beginning with the next flight, the *Columbia* and her sister ships will be *fully operational*, ready to provide *economical and routine access to space* for scientific exploration, commercial ventures, and for tasks related to the national security" [emphasis added].¹²

There were two reasons for declaring the Space Shuttle "operational" so early in its flight program. One was NASA's hope for quick Presidential approval of its next manned space flight program, a space station, which would not move forward while the Shuttle was still considered developmental. The second reason was that the nation was sud-



Figure 1.4-1. The April 12, 1981, launch of STS-1, just seconds past 7 a.m., carried astronauts John Young and Robert Crippen into an Earth orbital mission that lasted 54 hours.

denly facing a foreign challenger in launching commercial satellites. The European Space Agency decided in 1973 to develop Ariane, an expendable launch vehicle. Ariane first flew in December 1979 and by 1982 was actively competing with the Space Shuttle for commercial launch contracts. At this point, NASA still hoped that revenue from commercial launches would offset some or all of the Shuttle's operating costs. In an effort to attract commercial launch contracts, NASA heavily subsidized commercial launches by offering services for \$42 million per launch, when actual costs were more than triple that figure.¹³ A 1983 NASA brochure titled *We Deliver* touted the Shuttle as "the most reliable, flexible, and cost-effective launch system in the world."¹⁴



Figure 1.4-2. The crew of STS-5 successfully deployed two commercial communications satellites during the first "operational" mission of the Space Shuttle.

Between 1982 and early 1986, the Shuttle demonstrated its capabilities for space operations, retrieving two communications satellites that had suffered upper-stage misfires after launch, repairing another communications satellite on-orbit, and flying science missions with the pressurized European-built Spacelab module in its payload bay. The Shuttle took into space not only U.S. astronauts, but also citizens of Germany, Mexico, Canada, Saudi Arabia, France, the Netherlands, two payload specialists from commercial enterprises, and two U.S. legislators, Senator Jake Garn and Representative Bill Nelson. In 1985, when four Orbiters were in operation, the vehicles flew nine missions, the most launched in a single calendar year. By the end of 1985, the Shuttle had launched 24 communications satellites (see Figure 1.4-2) and had a backlog of 44 orders for future commercial launches.

On the surface, the program seemed to be progressing well. But those close to it realized that there were numerous problems. The system was proving difficult to operate, with more maintenance required between flights than had been expected. Rather than needing the 10 working days projected in 1975 to process a returned Orbiter for its next flight, by the end of 1985 an average of 67 days elapsed before the Shuttle was ready for launch.¹⁵

Though assigned an operational role by NASA, during this period the Shuttle was in reality still in its early flight-test stage. As with any other first-generation technology, operators were learning more about its strengths and weaknesses from each flight, and making what changes they could, while still attempting to ramp up to the ambitious flight schedule NASA set forth years earlier. Already, the goal of launching 50 flights a year had given way to a goal of 24 flights per year by 1989. The per-mission cost was more than \$140 million, a figure that when adjusted for inflation was seven times greater than what NASA projected over a decade earlier.¹⁶ More troubling, the pressure of maintaining the flight schedule created a management atmosphere that increasingly accepted less-than-specification performance of various components and systems, on the grounds that such deviations had not interfered with the success of previous flights.¹⁷

1.5 THE CHALLENGER ACCIDENT

The illusion that the Space Shuttle was an operational system, safe enough to carry legislators and a high-school teacher into orbit, was abruptly and tragically shattered on the morning of January 28, 1986, when *Challenger* was destroyed 73 seconds after launch during the 25th mission (see Figure 1.5-1). The seven-member crew perished.

To investigate, President Reagan appointed the 13-member Presidential Commission on the Space Shuttle Challenger Accident, which soon became known as the Rogers Commission, after its chairman, former Secretary of State William P. Rogers.¹⁸ Early in its investigation, the Commission identified the mechanical cause of the accident to be the failure of the joint of one of the Solid Rocket Boosters. The Commission found that the design was not well understood by the engineers that operated it and that it had not been adequately tested.



Figure 1.5-1. the Space Shuttle Challenger was lost during ascent on January 28, 1986, when an O-ring and seal in the left Solid Rocket Booster failed.

When the Rogers Commission discovered that, on the eve of the launch, NASA and a contractor had vigorously debated the wisdom of operating the Shuttle in the cold temperatures predicted for the next day, and that more senior NASA managers were unaware of this debate, the Commission shifted the focus of its investigation to “NASA management practices, Center-Headquarters relationships, and the chain of command for launch commit decisions.”¹⁹ As the investigation continued, it revealed a NASA culture that had gradually begun to accept escalating risk, and a NASA safety program that was largely silent and ineffective.

The Rogers Commission report, issued on June 6, 1986, recommended a redesign and recertification of the Solid Rocket Motor joint and seal and urged that an independent body oversee its qualification and testing. The report concluded that the drive to declare the Shuttle operational had put enormous pressures on the system and stretched its resources to the limit. Faulting NASA safety practices, the Commission also called for the creation of an independent NASA Office of Safety, Reliability, and Quality Assurance, reporting directly to the NASA Administrator, as well as structural changes in program management.²⁰ (The Rogers Commission findings and recommendations are discussed in more detail in Chapter 5.) It would take NASA 32 months before the next Space Shuttle mission was launched. During this time, NASA initiated a series of longer-term vehicle upgrades, began the construction of the Orbiter *Endeavour* to replace *Challenger*, made significant organizational changes, and revised the Shuttle manifest to reflect a more realistic flight rate.

The *Challenger* accident also prompted policy changes. On August 15, 1986, President Reagan announced that the Shuttle would no longer launch commercial satellites. As a result of the accident, the Department of Defense made a decision to launch all future military payloads on expendable launch vehicles, except the few remaining satellites that required the Shuttle’s unique capabilities.

In the seventeen years between the *Challenger* and *Columbia* accidents, the Space Shuttle Program achieved significant successes and also underwent organizational and managerial changes. The program had successfully launched several important research satellites and was providing most of the “heavy lifting” of components necessary to build the International Space Station (see Figure 1.5-2). But as the Board subsequently learned, things were not necessarily as they appeared. (The post-*Challenger* history of the Space Shuttle Program is the topic of Chapter 5.)



Figure 1.5-2. The International Space Station as seen from an approaching Space Shuttle.

1.6 CONCLUDING THOUGHTS

The Orbiter that carried the STS-107 crew to orbit 22 years after its first flight reflects the history of the Space Shuttle Program. When *Columbia* lifted off from Launch Complex 39-A at Kennedy Space Center on January 16, 2003, it superficially resembled the Orbiter that had first flown in 1981, and indeed many elements of its airframe dated back to its first flight. More than 44 percent of its tiles, and 41 of the 44 wing leading edge Reinforced Carbon-Carbon (RCC) panels were original equipment. But there were also many new systems in *Columbia*, from a modern “glass” cockpit to second-generation main engines.

Although an engineering marvel that enables a wide-variety of on-orbit operations, including the assembly of the International Space Station, the Shuttle has few of the mission capabilities that NASA originally promised. It cannot be launched on demand, does not recoup its costs, no longer carries national security payloads, and is not cost-effective enough, nor allowed by law, to carry commercial satellites. Despite efforts to improve its safety, the Shuttle remains a complex and risky system that remains central to U.S. ambitions in space. *Columbia*’s failure to return home is a harsh reminder that the Space Shuttle is a developmental vehicle that operates not in routine flight but in the realm of dangerous exploration.

ENDNOTES FOR CHAPTER 1

The citations that contain a reference to "CAIB document" with CAB or CTF followed by seven to eleven digits, such as CAB001-0010, refer to a document in the Columbia Accident Investigation Board database maintained by the Department of Justice and archived at the National Archives.

¹ George Mueller, Associate Administrator for Manned Space Flight, NASA, "Honorary Fellowship Acceptance," address delivered to the British Interplanetary Society, University College, London, England, August 10, 1968, contained in John M. Logsdon, Ray A. Williamson, Roger D. Launius, Russell J. Acker, Stephen J. Garber, and Jonathan L. Friedman, editors, *Exploring the Unknown: Selected Documents in the History of the U.S. Civil Space Program Volume IV: Accessing Space*, NASA SP-4407 (Washington: Government Printing Office, 1999), pp. 202-205.

² For detailed discussions of the origins of the Space Shuttle, see Dennis R. Jenkins, *Space Shuttle: The History of the National Space Transportation System - The First 100 Missions* (Cape Canaveral, FL: Specialty Press, 2001); T. A. Heppenheimer, *The Space Shuttle Decision: NASA's Search for a Reusable Space Vehicle*, NASA SP-4221 (Washington: Government Printing Office, 1999; also published by the Smithsonian Institution Press, 2002); and T. A. Heppenheimer, *Development of the Space Shuttle, 1972-1981* (Washington: Smithsonian Institution Press, 2002). Much of the discussion in this section is based on these studies.

³ See John M. Logsdon, "The Space Shuttle Program: A Policy Failure?" *Science*, May 30, 1986 (Vol. 232), pp. 1099-1105 for an account of this decision process. Most of the information and quotes in this section are taken from this article.

⁴ See also comments by Robert F. Thompson, Columbia Accident Investigation Board Public Hearing, April 23, 2003, in Appendix G.

⁵ Heppenheimer, *The Space Shuttle Decision*, pp. 278-289, and Roger A. Pielke, Jr., "The Space Shuttle Program: 'Performance vs. Promise,'" Center for Space and Geosciences Policy, University of Colorado, August 31, 1991; Logsdon, "The Space Shuttle Program: A Policy Failure?" pp. 1099-1105.

⁶ Quoted in Jenkins, *Space Shuttle*, p. 171.

⁷ Memorandum from J. Fletcher to J. Rose, Special Assistant to the President, November 22, 1971; Logsdon, John, "The Space Shuttle Program: A Policy Failure?" *Science*, May 30, 1986, Volume 232, pp. 1099-1105.

⁸ The only actual flight tests conducted of the Orbiter were a series of Approach and Landing Tests where *Enterprise* (OV-101) was dropped from its Boeing 747 Shuttle Carrier Aircraft while flying at 25,000 feet. These tests - with crews aboard - demonstrated the low-speed handling capabilities of the Orbiter and allowed an evaluation of the vehicle's landing characteristics. See Jenkins, *Space Shuttle*, pp. 205-212 for more information.

⁹ Heppenheimer, *Development of the Space Shuttle*, p. 355.

¹⁰ As Howard McCurdy, a historian of NASA, has noted: "With the now-familiar Shuttle configuration, NASA officials came close to meeting their cost estimate of \$5.15 billion for phase one of the Shuttle program. NASA actually spent \$9.9 billion in real year dollars to take the Shuttle through design, development and initial testing. This sum, when converted to fixed year 1971 dollars using the aerospace price deflator, equals \$5.9 billion, or a 15 percent cost overrun on the original estimate for phase one. Compared to other complex development programs, this was not a large cost overrun." See Howard McCurdy, "The Cost of Space Flight," *Space Policy* 10 (4) p. 280. For a program budget summary, see Jenkins, *Space Shuttle*, p. 256.

¹¹ STS stands for Space Transportation System. Although in the years just before the 1986 *Challenger* accident NASA adopted an alternate Space Shuttle mission numbering scheme, this report uses the original STS flight designations.

¹² President Reagan's quote is contained in President Ronald Reagan, "Remarks on the Completion of the Fourth Mission of the Space Shuttle *Columbia*," July 4, 1982, p. 870, in *Public Papers of the Presidents of the United States: Ronald Reagan* (Washington: Government Printing Office, 1982-1991). The emphasis noted is the Board's.

¹³ "Pricing Options for the Space Shuttle," Congressional Budget Office Report, 1985.

¹⁴ The quote is from page 2 of the *We Deliver* brochure, reproduced in *Exploring the Unknown Volume IV*, p. 423.

¹⁵ NASA Johnson Space Center, "Technology Influences on the Space Shuttle Development," June 8, 1986, p. 1-7.

¹⁶ The 1971 cost-per-flight estimate was \$7.7 million; \$140.5 million dollars in 1985 when adjusted for inflation becomes \$52.9 million in 1971 dollars or nearly seven times the 1971 estimate. "Pricing Options for the Space Shuttle."

¹⁷ See Diane Vaughan, *The Challenger Launch Decision: Risky Technology, Culture, and Deviance at NASA* (Chicago: The University of Chicago Press, 1996).

¹⁸ See John M. Logsdon, "Return to Flight: Richard H. Truly and the Recovery from the Challenger Accident," in Pamela E. Mack, editor, *From Engineering to Big Science: The NACA and NASA Collier Trophy Research Project Winners*, NASA SP-4219 (Washington: Government Printing Office, 1998) for an account of the aftermath of the accident. Much of the account in this section is drawn from this source.

¹⁹ Logsdon, "Return to Flight," p. 348.

²⁰ *Presidential Commission on the Space Shuttle Challenger Accident* (Washington: Government Printing Office, June 6, 1986).



Columbia's Final Flight

Space Shuttle missions are not necessarily launched in the same order they are planned (or “manifested,” as NASA calls the process). A variety of scheduling, funding, technical, and – occasionally – political reasons can cause the shuffling of missions over the course of the two to three years it takes to plan and launch a flight. This explains why the 113th mission of the Space Shuttle Program was called STS-107. It would be the 28th flight of *Columbia*.

While the STS-107 mission will likely be remembered most for the way it ended, there was a great deal more to the dedicated science mission than its tragic conclusion. The planned microgravity research spanned life sciences, physical sciences, space and earth sciences, and education. More than 70 scientists were involved in the research that was conducted by *Columbia*'s seven-member crew over 16 days. This chapter outlines the history of STS-107 from its mission objectives and their rationale through the accident and its initial aftermath. The analysis of the accident's causes follows in Chapter 3 and subsequent chapters.

2.1 MISSION OBJECTIVES AND THEIR RATIONALES

Throughout the 1990s, NASA flew a number of dedicated science missions, usually aboard *Columbia* because it was equipped for extended-duration missions and was not being used for Shuttle-Mir docking missions or the assembly of the International Space Station. On many of these missions, *Columbia* carried pressurized Spacelab or SPACEHAB modules that extended the habitable experiment space available and were intended as facilities for life sciences and microgravity research.

In June 1997, the Flight Assignment Working Group at Johnson Space Center in Houston designated STS-107, tentatively scheduled for launch in the third quarter of Fiscal Year 2000, a “research module” flight. In July 1997, several committees of the National Academy of Science's Space Studies Board sent a letter to NASA Administrator Daniel Goldin recommending that NASA dedicate several future Shuttle missions to microgravity and life sciences. The purpose would be to train scientists to take full advantage of the International Space Station's research capabilities once it became operational, and to reduce the gap between the last planned Shuttle science

mission and the start of science research aboard the Space Station.¹ In March 1998, Goldin announced that STS-107, tentatively scheduled for launch in May 2000, would be a multi-disciplinary science mission modeled after STS-90, the Neurolab mission scheduled later in 1998.² In October 1998, the Veterans Affairs and Housing and Urban Development and Independent Agencies Appropriations Conference Report expressed Congress' concern about the lack of Shuttle-based science missions in Fiscal Year 1999, and added \$15 million to NASA's budget for STS-107. The following year the Conference Report reserved \$40 million for a second science mission. NASA cancelled the second science mission in October 2002 and used the money for STS-107.

In addition to a variety of U.S. experiments assigned to STS-107, a joint U.S./Israeli space experiment – the Mediterranean-Israeli Dust Experiment, or MEIDEX – was added to STS-107 to be accompanied by an Israeli astronaut as part of an international cooperative effort aboard the Shuttle similar to those NASA had begun in the early 1980s. *Triana*, a deployable Earth-observing satellite, was also added to the mission to save NASA from having to buy a commercial launch to place the satellite in orbit. Political disagreements between Congress and the White House delayed *Triana*, and the satellite was replaced by the Fast Reaction Experiments Enabling Science, Technology, Applications, and Research (FREESTAR) payload, which was mounted behind the SPACEHAB Research Double Module.³



Figure 2.1-1. Columbia, at the launch pad on January 15, 2003.

Schedule Slippage

STS-107 was finally scheduled for launch on January 11, 2001. After 13 delays over two years, due mainly to other missions taking priority, *Columbia* was launched on January 16, 2003 (see Figure 2.1-1). Delays may take several forms. When any delay is mentioned, most people think of a Space Shuttle sitting on the launch pad waiting for launch. But most delays actually occur long before the Shuttle is configured for a mission. This was the case for STS-107 – of the 13 delays, only a few occurred after the Orbiter was configured for flight; most happened earlier in the planning process. Three specific events caused delays for STS-107:

- **Removal of *Triana*:** This Earth-observing satellite was replaced with the FREESTAR payload.
- **Orbiter Maintenance Down Period:** *Columbia*'s depot-level maintenance took six months longer than originally planned, primarily to correct problems encountered with Kapton wiring (see Chapter 4). This resulted in the STS-109 Hubble Space Telescope service mission be-

ing launched before STS-107 because it was considered more urgent.

- **Flowliner cracks:** About one month before the planned July 19, 2002 launch date for STS-107, concerns about cracks in the Space Shuttle Main Engine propellant system flowliners caused a four-month grounding of the Orbiter fleet. (The flowliner, which is in the main propellant feed lines, mitigates turbulence across the flexible bellows to smooth the flow of propellant into the main engine low-pressure turbopump. It also protects the bellows from flow-induced vibration.) First discovered on *Atlantis*, the cracks were eventually discovered on each Orbiter; they were fixed by welding and polishing. The grounding delayed the exchange of the Expedition 5 International Space Station crew with the Expedition 6 crew, which was scheduled for STS-113. To maintain the International Space Station assembly sequence while minimizing the delay in returning the Expedition 5 crew, both STS-112 and STS-113 were launched before STS-107.

COLUMBIA

Columbia was named after a Boston-based sloop commanded by Captain Robert Gray, who noted while sailing to the Pacific Northwest a flow of muddy water fanning from the shore, and decided to explore what he deemed the "Great River of the West." On May 11, 1792, Gray and his crew maneuvered the *Columbia* past the treacherous sand bar and named the river after his ship. After a week or so of trading with the local tribes, Gray left without investigating where the river led. Instead, Gray led the *Columbia* and its crew on the first U.S. circumnavigation of the globe, carrying otter skins to Canton, China, before returning to Boston in 1793.

In addition to *Columbia* (OV-102), which first flew in 1981, *Challenger* (OV-099) first flew in 1983, *Discovery* (OV-103) in 1984, and *Atlantis* (OV-104) in 1985. *Endeavour* (OV-105), which replaced *Challenger*, first flew in 1992. At the time of the launch of STS-107, *Columbia* was unique since it was the last remaining Orbiter to have an internal airlock on the mid-deck. (All the Orbiters originally had internal airlocks, but all excepting *Columbia* were modified to provide an external docking mechanism for flights to *Mir* and the International Space Station.) Because the airlock was not located in the payload bay, *Columbia* could carry longer payloads such as the *Chandra* space telescope, which used the full length of the payload bay. The internal airlock made the mid-deck more cramped than those of other Orbiters, but this was less of a problem when one of the laboratory modules was installed in the payload bay to provide additional habitable volume.

Columbia had been manufactured to an early structural standard that resulted in the airframe being heavier than the later Orbiters. Coupled with a more-forward center of gravity because of the internal airlock, *Columbia* could not carry as much payload weight into orbit as the other Orbiters. This made *Columbia* less desirable for missions to the International Space Station, although planning was nevertheless underway to modify *Columbia* for an International Space Station flight sometime after STS-107.

The Crew

The STS-107 crew selection process followed standard procedures. The Space Shuttle Program provided the Astronaut Office with mission requirements calling for a crew of seven. There were no special requirements for a rendezvous, extra-vehicular activity (spacewalking), or use of the remote manipulator arm. The Chief of the Astronaut Office announced the crew in July 2000. To maximize the amount of science research that could be performed, the crew formed two teams, Red and Blue, to support around-the-clock operations.

Crew Training

The Columbia Accident Investigation Board thoroughly reviewed all pre-mission training (see Figure 2.1-2) for the STS-107 crew, Houston Mission Controllers, and the Ken-



Figure 2.1-2. Ilan Ramon (left), Laurel Clark, and Michael Anderson during a training exercise at the Johnson Space Center.



Left to right: David Brown, Rick Husband, Laurel Clark, Kalpana Chawla, Michael Anderson, William McCool, Ilan Ramon.

Rick Husband, Commander. Husband, 45, was a Colonel in the U.S. Air Force, a test pilot, and a veteran of STS-96. He received a B.S. in Mechanical Engineering from Texas Tech University and a M.S. in Mechanical Engineering from California State University, Fresno. He was a member of the Red Team, working on experiments including the European Research In Space and Terrestrial Osteoporosis and the Shuttle Ozone Limb Sounding Experiment.

William C. McCool, Pilot. McCool, 41, was a Commander in the U.S. Navy and a test pilot. He received a B.S. in Applied Science from the U.S. Naval Academy, a M.S. in Computer Science from the University of Maryland, and a M.S. in Aeronautical Engineering from the U.S. Naval Postgraduate School. A member of the Blue Team, McCool worked on experiments including the Advanced Respiratory Monitoring System, Biopack, and Mediterranean Israeli Dust Experiment.

Michael P. Anderson, Payload Commander and Mission Specialist. Anderson, 43, was a Lieutenant Colonel in the U.S. Air Force, a former instructor pilot and tactical officer, and a veteran of STS-89. He received a B.S. in Physics/Astronomy from the University of Washington, and a M.S. in Physics from Creighton University. A member of the Blue Team, Anderson worked with experiments including the Advanced Respiratory Monitoring System, Water Mist Fire Suppression, and Structures of Flame Balls at Low Lewis-number.

David M. Brown, Mission Specialist. Brown, 46, was a Captain in the U.S. Navy, a naval aviator, and a naval flight surgeon. He received a B.S. in Biology from the College of William and Mary and a M.D. from Eastern Virginia Medical School. A member

of the Blue Team, Brown worked on the Laminar Soot Processes, Structures of Flame Balls at Low Lewis-number, and Water Mist Fire Suppression experiments.

Kalpana Chawla, Flight Engineer and Mission Specialist. Chawla, 41, was an aerospace engineer, a FAA Certified Flight Instructor, and a veteran of STS-87. She received a B.S. in Aeronautical Engineering from Punjab Engineering College, India, a M.S. in Aerospace Engineering from the University of Texas, Arlington, and a Ph.D. in Aerospace Engineering from the University of Colorado, Boulder. A member of the Red Team, Chawla worked with experiments on Astroculture, Advanced Protein Crystal Facility, Mechanics of Granular Materials, and the Zeolite Crystal Growth Furnace.

Laurel Clark, Mission Specialist. Clark, 41, was a Commander (Captain-Select) in the U.S. Navy and a naval flight surgeon. She received both a B.S. in Zoology and a M.D. from the University of Wisconsin, Madison. A member of the Red Team, Clark worked on experiments including the Closed Equilibrated Biological Aquatic System, Sleep-Wake Actigraphy and Light Exposure During Spaceflight, and the Vapor Compression Distillation Flight Experiment.

Ilan Ramon, Payload Specialist. Ramon, 48, was a Colonel in the Israeli Air Force, a fighter pilot, and Israel's first astronaut. Ramon received a B.S. in Electronics and Computer Engineering from the University of Tel Aviv, Israel. As a member of the Red Team, Ramon was the primary crew member responsible for the Mediterranean Israeli Dust Experiment (MEIDEX). He also worked on the Water Mist Fire Suppression and the Microbial Physiology Flight Experiments Team experiments, among others.

THE CREW



kenedy Space Center Launch Control Team. Mission training for the STS-107 crew comprised 4,811 hours, with an additional 3,500 hours of payload-specific training. The Ascent/Entry Flight Control Team began training with the STS-107 crew on October 22, 2002, and participated in 16 integrated ascent or entry simulations. The Orbiter Flight Control team began training with the crew on April 23, 2002, participating in six joint integrated simulations with the crew and payload customers. Seventy-seven Flight Control Room operators were assigned to four shifts for the STS-107 mission. All had prior certifications and had worked missions in the past.

The STS-107 Launch Readiness Review was held on December 18, 2002, at the Kennedy Space Center. Neither NASA nor United Space Alliance noted any training issues for launch controllers. The Mission Operations Directorate noted no crew or flight controller training issues during the January 9, 2003, STS-107 Flight Readiness Review. According to documentation, all personnel were trained and certified, or would be trained and certified before the flight. Appendix D.1 contains a detailed STS-107 Training Report.

Orbiter Preparation

Board investigators reviewed *Columbia's* maintenance, or “flow” records, including the recovery from STS-109 and preparation for STS-107, and relevant areas in NASA’s Problem Reporting and Corrective Action database, which contained 16,500 Work Authorization Documents consisting of 600,000 pages and 3.9 million steps. This database maintains critical information on all maintenance and modification work done on the Orbiters (as required by the Orbiter Maintenance Requirements and Specifications Document). It also maintains Corrective Action Reports that document problems discovered and resolved, the Lost/Found item database, and the Launch Readiness Review and Flight Readiness Review documentation (see Chapter 7).

The Board placed emphasis on maintenance done in areas of particular concern to the investigation. Specifically, records for the left main landing gear and door assembly and left wing leading edge were analyzed for any potential contributing factors, but nothing relevant to the cause of the accident was discovered. A review of Thermal Protection System tile maintenance records revealed some “non-conformances” and repairs made after *Columbia's* last flight, but these were eventually dismissed as not relevant to the investigation. Additionally, the Launch Readiness Review and Flight Readiness Review records relating to those systems and the Lost/Found item records were reviewed, and no relevance was found. During the Launch Readiness Review and Flight Readiness Review processes, NASA teams analyzed 18 lost items and deemed them inconsequential. (Although this incident was not considered significant by the Board, a further discussion of foreign object debris may be found in Chapter 4.)

Payload Preparation

The payload bay configuration for STS-107 included the SPACEHAB access tunnel, SPACEHAB Research Double Module (RDM), the FREESTAR payload, the Orbital Ac-

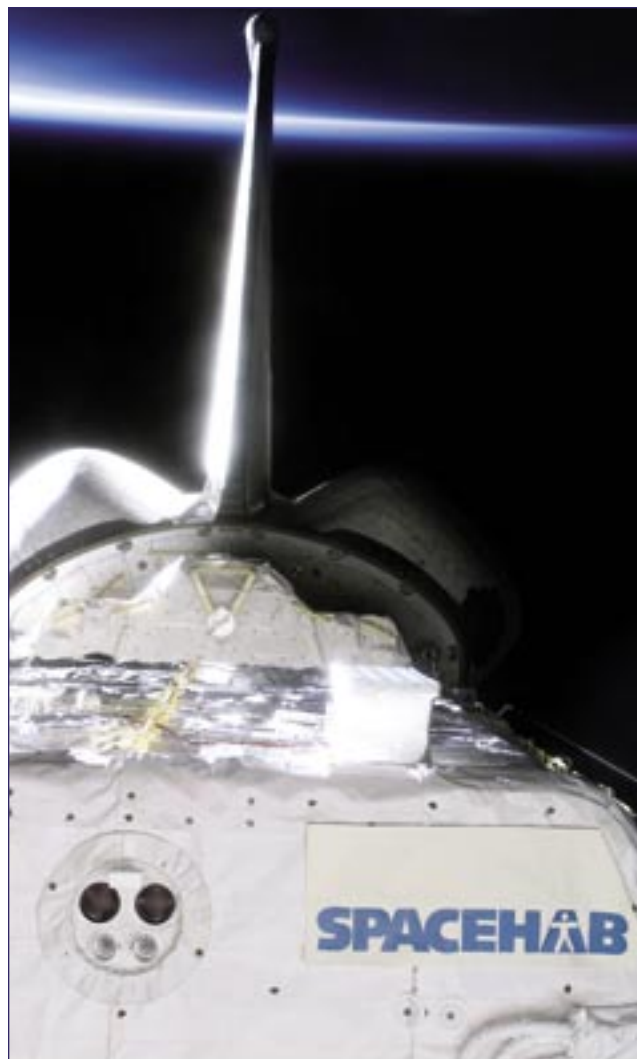
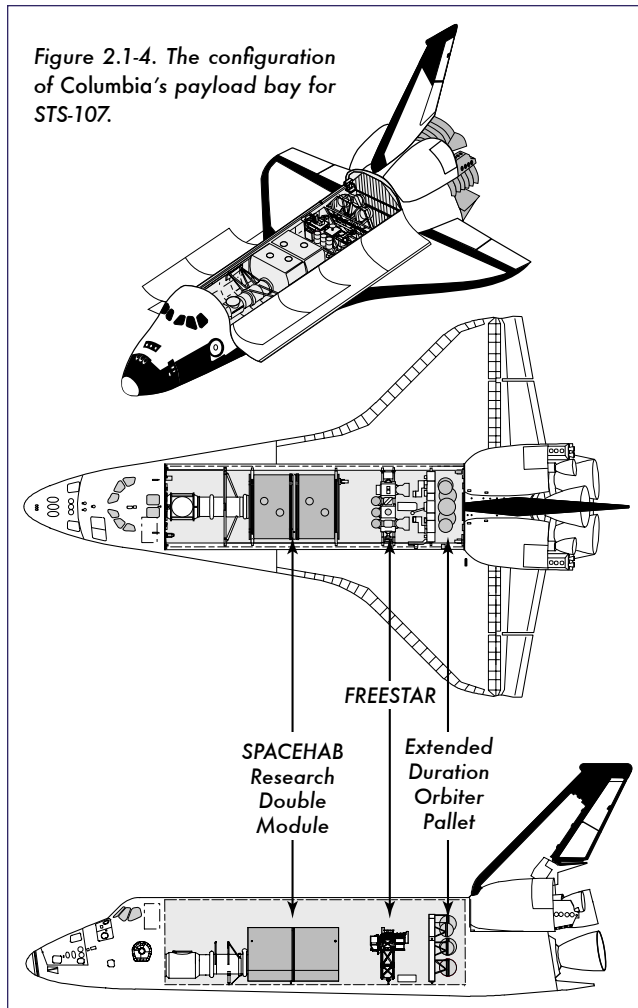

Figure 2.1-3. The SPACEHAB Research Double Module as seen from the aft flight deck windows of Columbia during STS-107. A thin slice of Earth's horizon is visible behind the vertical stabilizer.

celeration Research Experiment, and an Extended Duration Orbiter pallet to accommodate the long flight time needed to conduct all the experiments. Additional experiments were stowed in the Orbiter mid-deck and on the SPACEHAB roof (see Figures 2.1-3 and 2.1-4). The total liftoff payload weight for STS-107 was 24,536 pounds. Details on STS-107 payload preparations and on-orbit operations are in Appendix D.2.

Payload readiness reviews for STS-107 began in May 2002, with no significant abnormalities reported throughout the processing. The final Payload Safety Review Panel meeting prior to the mission was held on January 8, 2003, at the Kennedy Space Center, where the Integrated Safety Assessments conducted for the SPACEHAB and FREESTAR payloads were presented for final approval. All payload physical stresses on the Orbiter were reported within acceptable limits. The Extended Duration Orbiter pallet was loaded into the aft section of the payload bay in High Bay 3 of the Orbiter Processing Facility on April 25, 2002. The SPACEHAB



and FREESTAR payloads were loaded horizontally on March 24, with an Integration Verification Test on June 6. The payload bay doors were closed on October 31 and were not opened prior to launch. (All late stow activities at the launch pad were accomplished in the vertical position using the normal crew entry hatch and SPACEHAB access tunnel.) Rollover of the Orbiter to the Vehicle Assembly Building for mating to the Solid Rocket Boosters and External Tank occurred on November 18. Mating took place two days later, and rollout to Launch Complex 39-A was on December 9.

Unprecedented security precautions were in place at Kennedy Space Center prior to and during the launch of STS-107 because of prevailing national security concerns and the inclusion of an Israeli crew member.

SPACEHAB was powered up at Launch minus 51 (L-51) hours (January 14) to prepare for the late stowing of time-critical experiments. The stowing of material in SPACEHAB once it was positioned vertically took place at L-46 hours and was completed by L-31 hours. Late middeck payload stowage, required for the experiments involving plants and insects, was performed at the launch pad. Flight crew equipment loading started at L-22.5 hours, while middeck experiment loading took place from Launch minus 19 to 16 hours. Fourteen experiments, four of which were powered, were loaded, all without incident.

2.2 FLIGHT PREPARATION

NASA senior management conducts a complex series of reviews and readiness polls to monitor a mission's progress toward flight readiness and eventual launch. Each step requires written certification. At the final review, called the Flight Readiness Review, NASA and its contractors certify that the necessary analyses, verification activities, and data products associated with the endorsement have been accomplished and "indicate a high probability for mission success." The review establishes the rationale for accepting any remaining identifiable risk; by signing the Certificate of Flight Readiness, NASA senior managers agree that they have accomplished all preliminary items and that they agree to accept that risk. The Launch Integration Manager oversees the flight preparation process.

STS-107 Flight Preparation Process

The flight preparation process reviews progress toward flight readiness at various junctures and ensures the organization is ready for the next operational phase. This process includes Project Milestone Reviews, three Program Milestone Reviews, and the Flight Readiness Review, where the Certification of Flight Readiness is endorsed.

The **Launch Readiness Review** is conducted within one month of the launch to certify that Certification of Launch Readiness items from NSTS-08117, Appendices H and Q, Flight Preparation Process Plan, have been reviewed and acted upon. The STS-107 Launch Readiness Review was held at Kennedy Space Center on December 18, 2002. The Kennedy Space Center Director of Shuttle Processing chaired the review and approved continued preparations for a January 16, 2003, launch. Onboard payload and experimental status and late stowage activity were reviewed.

A **Flight Readiness Review**, which is chaired by the Office of Space Flight Associate Administrator, usually occurs about two weeks before launch and provides senior NASA management with a summary of the certification and verification of the Space Shuttle vehicle, flight crew, payloads, and rationales for accepting residual risk. In cases where the Flight Preparation Process has not been successfully completed, Certification of Flight Readiness exceptions will be made, and presented at the Pre-Launch Mission Management Team Review for disposition. The final Flight Readiness Review for STS-107 was held on January 9, 2003, a week prior to launch. Representatives of all organizations except Flight Crew, Ferry Readiness, and Department of Defense Space Shuttle Support made presentations. Safety, Reliability & Quality Assurance summarized the work performed on the Ball Strut Tie Rod Assembly crack, defective booster connector pin, booster separation motor propellant paint chip contamination, and STS-113 Main Engine 1 nozzle leak (see Appendix E.1 for the briefing charts). None of the work performed on these items affected the launch.

Certificate of Flight Readiness: No actions were assigned during the Flight Readiness Review. One exception was included in the Certificate of Flight Readiness pending the completion of testing on the Ball Strut Tie Rod Assembly.

Testing was to be completed on January 15. This exception was to be closed with final flight rationale at the STS-107 Pre-launch Mission Management Team meeting. All principal managers and organizations indicated their readiness to support the mission.

Normally, a Mission Management Team – consisting of managers from Engineering, System Integration, the Space Flight Operations Contract Office, the Shuttle Safety Office, and the Johnson Space Center directors of flight crew operations, mission operations, and space and life sciences – convenes two days before launch and is maintained until the Orbiter safely lands. The Mission Management Team Chair reports directly to the Shuttle Program Manager.

The Mission Management Team resolves outstanding problems outside the responsibility or authority of the Launch and Flight Directors. During pre-launch, the Mission Management Team is chaired by the Launch Integration Manager at Kennedy Space Center, and during flight by the Space Shuttle Program Integration Manager at Johnson Space Center. The guiding document for Mission Management operations is NSTS 07700, Volume VIII.

A **Pre-launch Mission Management Team Meeting** occurs one or two days before launch to assess any open items or changes since the Flight Readiness Review, provide a GO/NO-GO decision on continuing the countdown, and approve changes to the Launch Commit Criteria. Simultaneously, the Mission Management Team is activated to evaluate the countdown and address any issues remaining from the Flight Readiness Review. STS-107's Pre-launch Mission Management Team meeting, chaired by the Acting Manager of Launch Integration, was held on January 14, some 48 hours prior to launch, at the Kennedy Space Center. In addition to the standard topics, such as weather and range support, the Pre-Launch Mission Management Team was updated on the status of the Ball Strut Tie Rod Assembly testing. The exception would remain open pending the presentation of additional test data at the Delta Pre-Launch Mission Management Team review the next day.

The **Delta Pre-Launch Mission Management Team Meeting** was also chaired by the Acting Manager of Launch Integration and met at 9:00 a.m. EST on January 15 at the Kennedy Space Center. The major issues addressed concerned the Ball Strut Tie Rod Assembly and potential strontium chromate contamination found during routine inspection of a (non-STS-107) spacesuit on January 14. The contamination concern was addressed and a toxicology analysis determined there was no risk to the STS-107 crew. A poll of the principal managers and organizations indicated all were ready to support STS-107.

A **Pre-Tanking Mission Management Team Meeting** was also chaired by the Acting Manager of Launch Integration. This meeting was held at 12:10 a.m. on January 16. A problem with the Solid Rocket Booster External Tank Attachment ring was addressed for the first time. Recent mission life capability testing of the material in the ring plates revealed static strength properties below minimum requirements. There were concerns that, assuming worst-case flight

NASA TIMES

Like most engineering or technical operations, NASA generally uses Coordinated Universal Time (UTC, formerly called Greenwich Mean Time) as the standard reference for activities. This is, for convenience, often converted to local time in either Florida or Texas – this report uses Eastern Standard Time (EST) unless otherwise noted. In addition to the normal 24-hour clock, NASA tells time via several other methods, all tied to specific events. The most recognizable of these is “T minus (T–)” time that counts down to every launch in hours, minutes, and seconds. NASA also uses a less precise “L minus” (L–) time that tags events that happens days or weeks prior to launch. Later in this report there are references to “Entry Interface plus (EI+)” time that counts, in seconds, from when an Orbiter begins re-entry. In all cases, if the time is “minus” then the event being counted toward has not happened yet; if the time is “plus” then the event has already occurred.

environments, the ring plate would not meet the safety factor requirement of 1.4 – that is, able to withstand 1.4 times the maximum load expected in operation. Based on analysis of the anticipated flight environment for STS-107, the need to meet the safety factor requirement of 1.4 was waived (see Chapter 10). No Launch Commit Criteria violations were noted, and the STS-107 final countdown began. The loading of propellants into the External Tank was delayed by some 70 minutes, until seven hours and 20 minutes before launch, due to an extended fuel cell calibration, a liquid oxygen replenish valve problem, and a Launch Processing System reconfiguration. The countdown continued normally, and at T–9 minutes the Launch Mission Management Team was polled for a GO/NO-GO launch decision. All members reported GO, and the Acting Manager of Launch Integration gave the final GO launch decision.

Once the Orbiter clears the launch pad, responsibility passes from the Launch Director at the Kennedy Space Center to the Flight Director at Johnson Space Center. During flight, the mission is also evaluated from an engineering perspective in the Mission Evaluation Room, which is managed by Vehicle Engineering Office personnel. Any engineering analysis conducted during a mission is coordinated through and first presented to the Mission Evaluation Room, and is then presented by the Mission Evaluation Room manager to the Mission Management Team.

2.3 LAUNCH SEQUENCE

The STS-107 launch countdown was scheduled to be about 24 hours longer than usual, primarily because of the extra time required to load cryogenics for generating electricity and water into the Extended Duration Orbiter pallet, and for final stowage of plants, insects, and other unique science payloads. SPACEHAB stowage activities were about 90 minutes behind schedule, but the overall launch countdown was back on schedule when the communication system check was completed at L–24 hours.

At 7 hours and 20 minutes prior to the scheduled launch on January 16, 2003, ground crews began filling the External Tank with over 1,500,000 pounds of cryogenic propellants. At about 6:15 a.m., the Final Inspection Team began its visual and photographic check of the launch pad and vehicle. Frost had been noted during earlier inspections, but it had dissipated by 7:15 a.m., when the Ice Team completed its inspection.

Heavy rain had fallen on Kennedy Space Center while the Shuttle stack was on the pad. The launch-day weather was 65 degrees Fahrenheit with 68 percent relative humidity, dew point 59 degrees, calm winds, scattered clouds at 4,000 feet, and visibility of seven statute miles. The forecast weather for Kennedy Space Center and the Transoceanic Abort Landing sites in Spain and Morocco was within launch criteria limits.

At about 7:30 a.m. the crew was driven from their quarters in the Kennedy Space Center Industrial Area to Launch Complex 39-A. Commander Rick Husband was the first crew member to enter *Columbia*, at the 195-foot level of the launch tower at 7:53 a.m. Mission Specialist Kalpana Chawla was the last to enter, at 8:45 a.m. The hatch was closed and locked at 9:17 a.m.

The countdown clock executed the planned hold at the T-20 minute-mark at 10:10 a.m. The primary ascent computer software was switched over to the launch-ready configuration, communications checks were completed with all crew members, and all non-essential personnel were cleared from the launch area at 10:16 a.m. Fifteen minutes later the countdown clock came out of the planned hold at the T-9 minutes, and at 10:35 a.m., the GO was given for Auxiliary Power Unit start. STS-107 began at 10:39 a.m. with ignition of the Solid Rocket Boosters (see Figure 2.3-1).

Wind Shear

Before a launch, balloons are released to determine the direction and speed of the winds up to 50,000 to 60,000 feet. Various Doppler sounders are also used to get a wind profile, which, for STS-107, was unremarkable and relatively constant at the lower altitudes.

Columbia encountered a wind shear about 57 seconds after launch during the period of maximum dynamic pressure (max-q). As the Shuttle passed through 32,000 feet, it experienced a rapid change in the out-of-plane wind speed of minus 37.7 feet per second over a 1,200-foot altitude range. Immediately after the vehicle flew through this altitude range, its sideslip (beta) angle began to increase in the negative direction, reaching a value of minus 1.75 degrees at 60 seconds.

A negative beta angle means that the wind vector was on the left side of the vehicle, pushing the nose to the right and increasing the aerodynamic force on the External Tank bipod strut attachment. Several studies have indicated that the aerodynamic loads on the External Tank forward attach bipod, and also the interacting aerodynamic loads between the External Tank and the Orbiter, were larger than normal but within design limits.

Predicted and Actual I-Loads

On launch day, the General-Purpose Computers on the Orbiter are updated with information based on the latest observations of weather and the physical properties of the vehicle. These “I-loads” are initializing data sets that contain elements specific to each mission, such as measured winds, atmospheric data, and Shuttle configuration. The I-loads output target angle of attack, angle of sideslip, and dynamic pressure



Figure 2.3-1. The launch of Columbia on STS-107.

as a function of Mach number to ensure that the structural loads the Shuttle experiences during ascent are acceptable.

After the accident, investigators analyzed *Columbia's* ascent loads using a reconstruction of the ascent trajectory. The wing loads measurement used a flexible body structural loads assessment that was validated by data from the Modular Auxiliary Data System recorder, which was recovered from the accident debris. The wing loads assessment included crosswind effects, angle of attack (alpha) effects, angle of sideslip (beta) effects, normal acceleration (g), and dynamic pressure (q) that could produce stresses and strains on the Orbiter's wings during ascent. This assessment showed that all Orbiter wing loads were approximately 70 percent of their design limit or less throughout the ascent, including the previously mentioned wind shear.

The wind shear at 57 seconds after launch and the Shuttle stack's reaction to it appears to have initiated a very low frequency oscillation, caused by liquid oxygen sloshing inside the External Tank,⁴ that peaked in amplitude 75 seconds after launch and continued through Solid Rocket Booster separation at 127 seconds after launch. A small oscillation is not unusual during ascent, but on STS-107 the amplitude was larger than normal and lasted longer. Less severe wind shears at 95 and 105 seconds after launch contributed to the continuing oscillation.

An analysis of the External Tank/Orbiter interface loads, using simulated wind shear, crosswind, beta effects, and liquid oxygen slosh effects, showed that the loads on the External Tank forward attachment were only 70 percent of the design certification limit. The External Tank slosh study confirmed that the flight control system provided adequate stability throughout ascent.

The aerodynamic loads on the External Tank forward attach bipod were analyzed using a Computational Fluid Dynamics simulation, that yielded axial, side-force, and radial loads, and indicated that the external air loads were well below the design limit during the period of maximum dynamic pressure and also when the bipod foam separated.

Nozzle Deflections

Both Solid Rocket Boosters and each of the Space Shuttle Main Engines have exhaust nozzles that deflect ("gimbal") in response to flight control system commands. Review of the STS-107 ascent data revealed that the Solid Rocket Booster and Space Shuttle Main Engine nozzle positions twice exceeded deflections seen on previous flights by a factor of 1.24 to 1.33 and 1.06, respectively. The center and right main engine yaw deflections first exceeded those on previous flights during the period of maximum dynamic pressure, immediately following the wind shear. The deflections were the flight control system's reaction to the wind shear, and the motion of the nozzles was well within the design margins of the flight control system.

Approximately 115 seconds after launch, as booster thrust diminished, the Solid Rocket Booster and Space Shuttle Main Engine exhaust nozzle pitch and yaw deflections ex-

ceeded those seen previously by a factor of 1.4 and 1.06 to 1.6, respectively. These deflections were caused by lower than expected Reusable Solid Rocket Motor performance, indicated by a low burn rate; a thrust mismatch between the left and right boosters caused by lower-than-normal thrust on the right Solid Rocket Booster; a small built-in adjustment that favored the left Solid Rocket Booster pitch actuator; and flight control trim characteristics unique to the Performance Enhancements flight profile for STS-107.⁵

The Solid Rocket Booster burn rate is temperature-dependent, and behaved as predicted for the launch day weather conditions. No two boosters burn exactly the same, and a minor thrust mismatch has been experienced on almost every Space Shuttle mission. The booster thrust mismatch on STS-107 was well within the design margin of the flight control system.

Debris Strike

Post-launch photographic analysis showed that one large piece and at least two smaller pieces of insulating foam separated from the External Tank left bipod (-Y) ramp area at 81.7 seconds after launch. Later analysis showed that the larger piece struck *Columbia* on the underside of the left wing, around Reinforced Carbon-Carbon (RCC) panels 5 through 9, at 81.9 seconds after launch (see Figure 2.3-2). Further photographic analysis conducted the day after launch revealed that the large foam piece was approximately 21 to 27 inches long and 12 to 18 inches wide, tumbling at a minimum of 18 times per second, and moving at a relative velocity to the Shuttle Stack of 625 to 840 feet per second (416 to 573 miles per hour) at the time of impact.

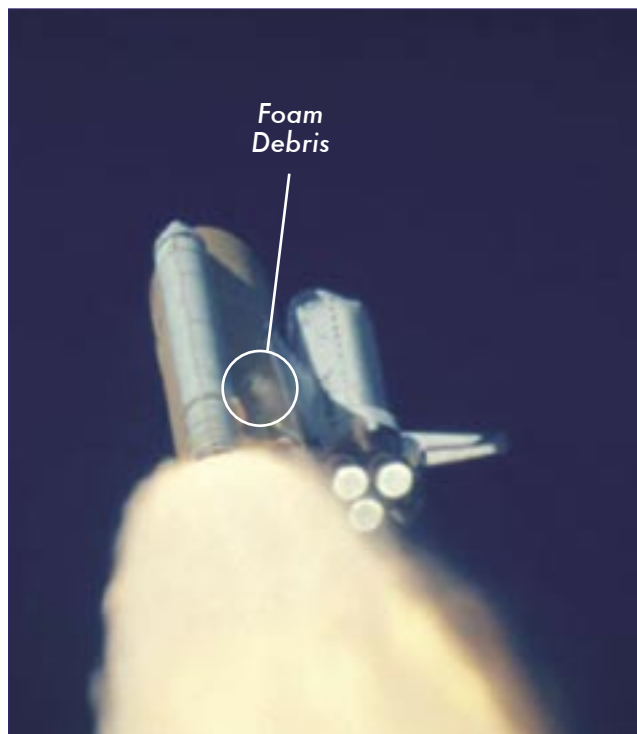

Figure 2.3-2. A shower of foam debris after the impact on *Columbia's* left wing. The event was not observed in real time.

Arrival on Orbit

Two minutes and seven seconds after launch, the Solid Rocket Boosters separated from the External Tank. They made a normal splashdown in the Atlantic Ocean and were subsequently recovered and returned to the Kennedy Space Center for inspection and refurbishment. Approximately eight and a half minutes after launch, the Space Shuttle Main Engines shut down normally, followed by the separation of the External Tank. At 11:20 a.m., a two-minute burn of the Orbital Maneuvering System engines began to position *Columbia* in its proper orbit, inclined 39 degrees to the equator and approximately 175 miles above Earth.

2.4 ON-ORBIT EVENTS

By 11:39 a.m. EST, one hour after launch, *Columbia* was in orbit and crew members entered the “post-insertion timeline.” The crew immediately began to configure onboard systems for their 16-day stay in space.

Flight Day 1, Thursday, January 16

The payload bay doors were opened at 12:36 p.m. and the radiator was deployed for cooling. Crew members activated the Extended Duration Orbiter pallet (containing extra propellants for power and water production) and FREESTAR, and they began to set up the SPACEHAB module (see Figure 2.4-1). The crew then ran two experiments with the Advanced Respiratory Monitoring System stationary bicycle in SPACEHAB.

The crew also set up the Bioreactor Demonstration System, Space Technology and Research Students Bootes, Osteoporosis Experiment in Orbit, Closed Equilibrated Biological Aquatic System, Miniature Satellite Threat Reporting System, and Biopack, and performed Low Power Transceiver communication tests.

Flight Day 2, Friday, January 17

The Ozone Limb Sounding Experiment 2 began measuring the ozone layer, while the Mediterranean Israeli Dust Experiment (MEIDEX) was set to measure atmospheric aerosols over the Mediterranean Sea and the Sahara Desert. The Critical Viscosity of Xenon 2 experiment began studying the fluid properties of Xenon.

The crew activated the SPACEHAB Centralized Experiment Water Loop in preparation for the Combustion Module 2 and Vapor Compression Distillation Flight Experiment and also activated the Facility for Absorption and Surface Tension, Zeolite Crystal Growth, Astroculture, Mechanics of Granular Materials, Combined Two Phase Loop Experiment, European Research In Space and Terrestrial Osteoporosis, Biological Research in Canisters, centrifuge configurations, Enhanced Orbiter Refrigerator/Freezer Operations, and Microbial Physiological Flight Experiment.

Not known to Mission Control, the *Columbia* crew, or anyone else, between 10:30 and 11:00 a.m. on Flight Day 2, an object drifted away from the Orbiter. This object, which subsequent

analysis suggests may have been related to the debris strike, had a departure velocity between 0.7 and 3.4 miles per hour, remained in a degraded orbit for approximately two and a half days, and re-entered the atmosphere between 8:45 and 11:45 p.m. on January 19. This object was discovered after the accident when Air Force Space Command reviewed its radar tracking data. (See Chapter 3 for additional discussion.)

Flight Day 3, Saturday, January 18

The crew conducted its first on-orbit press conference. Because of heavy cloud cover over the Middle East, MEIDEX objectives could not be accomplished. Crew members began an experiment to track metabolic changes in their calcium levels. The crew resolved a discrepancy in the SPACEHAB Video Switching Unit, provided body fluid samples for the Physiology and Biochemistry experiment, and activated the Vapor Compression Distillation Flight Experiment.

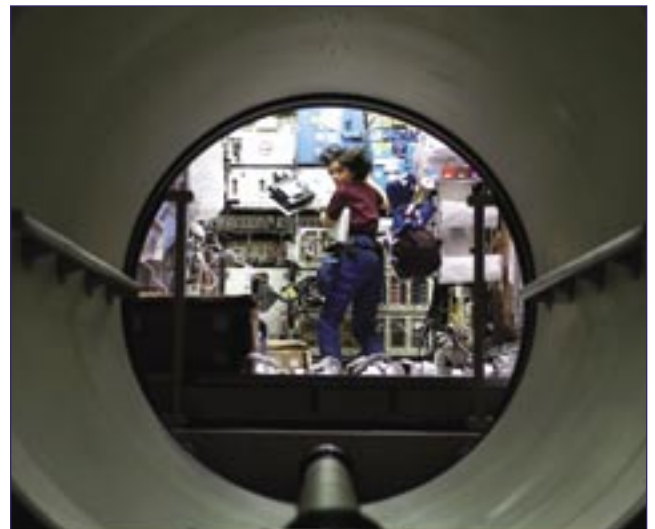

Figure 2.4-1. The tunnel linking the SPACEHAB module to the Columbia crew compartment provides a view of Kalpana Chawla working in SPACEHAB.

Flight Day 4, Sunday, January 19

Husband, Chawla, Clark, and Ramon completed the first experiments with the Combustion Module 2 in SPACEHAB, which were the Laminar Soot Processes, Water Mist Fire suppression, and Structure of Flame Balls at Low Lewis number. The latter studied combustion at the limits of flammability, producing the weakest flame ever to burn: each flame produced one watt of thermal power (a birthday-cake candle, by comparison, produces 50 watts).

Experiments on the human body’s response to microgravity continued, with a focus on protein manufacturing, bone and calcium production, renal stone formation, and saliva and urine changes due to viruses. Brown captured the first ever images of upper-atmosphere “sprites” and “elves,” which are produced by intense cloud-to-ground electromagnetic impulses radiated by heavy lightning discharges and are associated with storms near the Earth’s surface.

The crew reported about a cup of water under the SPACEHAB module sub-floor and significant amounts clinging to the Water Separator Assembly and Aft Power Distribution Unit. The water was mopped up and Mission Control switched power from Rotary Separator 1 to 2.

Flight Day 5, Monday, January 20

Mission Control saw indications of an electrical short on Rotary Separator 2 in SPACEHAB; the separator was powered down and isolated from the electrical bus. To reduce condensation with both Rotary Separators off, the crew had to reduce the flow in one of *Columbia's* Freon loops to SPACEHAB in order to keep the water temperature above the dew point and prevent condensation from forming in the Condensing Heat Exchanger. However, warmer water could lead to higher SPACEHAB cabin temperatures; fortunately, the crew was able to keep SPACEHAB temperatures acceptable and avoid condensation in the heat exchanger.

Flight Day 6, Tuesday, January 21

The temperature in the SPACEHAB module reached 81 degrees Fahrenheit. The crew reset the temperature to acceptable levels, and Mission Control developed a contingency plan to re-establish SPACEHAB humidity and temperature control if further degradation occurred. The Miniature Satellite Threat Reporting System, which detects ground-based radio frequency sources, experienced minor command and telemetry problems.

Flight Day 7, Wednesday, January 22

Both teams took a half day off. MEIDEX tracked thunderstorms over central Africa and captured images of four sprites and two elves as well as two rare images of meteoroids entering Earth's atmosphere. Payload experiments continued in SPACEHAB, with no further temperature complications.

Flight Day 8, Thursday, January 23

Eleven educational events were completed using the low-power transceiver to transfer data files to and from schools in Maryland and Massachusetts. The Mechanics of Granular Materials experiment completed the sixth of nine tests. Biopack shut down, and attempts to recycle the power were unsuccessful; ground teams began developing a repair plan.

Mission Control e-mailed Husband and McCool that post-launch photo analysis showed foam from the External Tank had struck the Orbiter's left wing during ascent. Mission Control relayed that there was "no concern for RCC or tile damage" and because the phenomenon had been seen before, there was "absolutely no concern for entry." Mission Control also e-mailed a short video clip of the debris strike, which Husband forwarded to the rest of the crew.

Flight Day 9, Friday, January 24

Crew members conducted the mission's longest combustion test. Spiral moss growth experiments continued, as well as Astroculture experiments that harvested samples of oils from

roses and rice flowers. Experiments in the combustion chamber continued. Although the temperature in SPACEHAB was maintained, Mission Control estimated that about a half-gallon of water was unaccounted for, and began planning in-flight maintenance for the Water Separator Assembly.



David Brown stabilizes a digital video camera prior to a press conference in the SPACEHAB Research Double Module aboard Columbia during STS-107.

Flight Day 10, Saturday, January 25

Experiments with bone cells, prostate cancer, bacteria growth, thermal heating, and surface tension continued. MEIDEX captured images of plumes of dust off the coasts of Nigeria, Mauritania, and Mali. Images of sprites were captured over storms in Perth, Australia. Biopack power could not be restored, so all subsequent Biopack sampling was performed at ambient temperatures.

Flight Day 11, Sunday, January 26

Vapor Compression Distillation Flight Experiment operations were complete; SPACEHAB temperature was allowed to drop to 73 degrees Fahrenheit. Scientists received the first live Xybian digital downlink images from MEIDEX and confirmed significant dust in the Middle East. The STARS experiment hatched a fish in the aquatic habitat and a silk moth from its cocoon.

Flight Day 12, Monday, January 27

Combustion and granular materials experiments concluded. The combustion module was configured for the Water Mist experiment, which developed a leak. The Microbial Physiol-

ogy Flight Experiment expended its final set of samples in yeast and bacteria growth. The crew made a joint observation using MEIDEX and the Ozone Limb Sounding Experiment. MEIDEX captured images of dust over the Atlantic Ocean for the first time.

Flight Day 13, Tuesday, January 28

The crew took another half day off. The Bioreactor experiment produced a bone and prostate cancer tumor tissue sample the size of a golf ball, the largest ever grown in space. The crew, along with ground support personnel, observed a moment of silence to honor the memory of the men and women of *Apollo 1* and *Challenger*. MEIDEX was prepared to monitor smoke trails from research aircraft and bonfires in Brazil. Water Mist runs began after the leak was stopped.

Flight Day 14, Wednesday, January 29

Ramon reported a giant dust storm over the Atlantic Ocean that provided three days of MEIDEX observations. Ground teams confirmed predicted weather and climate effects and found a huge smoke plume in a large cumulus cloud over the Amazon jungle. BIOTUBE experiment ground teams reported growth rates and root curvatures in plant and flax roots different from anything seen in normal gravity on Earth. The crew received procedures from Mission Control for vacuum cleanup and taping of the Water Separator Assembly prior to re-entry. Temperatures in two Biopack culture chambers were too high for normal cell growth, so several Biopack experiments were terminated.

Flight Day 15, Thursday, January 30

Final samples and readings were taken for the Physiology and Biochemistry team experiments. Husband, McCool, and Chawla ran landing simulations on the computer training system. Husband found no excess water in the SPACEHAB sub-floor, but as a precaution, he covered several holes in the Water Separator Assembly.

Flight Day 16, Friday, January 31

The Water Mist Experiment concluded and the combustion module was closed. MEIDEX made final observations of dust concentrations, sprites, and elves. Husband, McCool, and Chawla completed their second computer-based landing simulation. A flight control system checkout was performed satisfactorily using Auxiliary Power Unit 1, with a run time of 5 minutes, 27 seconds.

After the flight control system checkout, a Reaction Control System “hot-fire” was performed during which all thrusters were fired for at least 240 milliseconds. The Ku-band antenna and the radiator on the left payload bay door were stowed.

Flight Day 17, Saturday, February 1

All onboard experiments were concluded and stowed, and payload doors and covers were closed. Preparations were completed for de-orbit, re-entry, and landing at the Kennedy



Rick Husband works with the Biological Research in Canister experiment on Columbia’s mid-deck.

Space Center. Suit checks confirmed that proper pressure would be maintained during re-entry and landing. The payload bay doors were closed. Husband and McCool configured the onboard computers with the re-entry software, and placed *Columbia* in the proper attitude for the de-orbit burn.

2.5 DEBRIS STRIKE ANALYSIS AND REQUESTS FOR IMAGERY

As is done after every launch, within two hours of the lift-off the Intercenter Photo Working Group examined video from tracking cameras. An initial review did not reveal any unusual events. The next day, when the Intercenter Photo Working Group personnel received much higher resolution film that had been processed overnight, they noticed a debris strike at 81.9 seconds after launch.

A large object from the left bipod area of the External Tank struck the Orbiter, apparently impacting the underside of the left wing near RCC panels 5 through 9. The object’s large size and the apparent momentum transfer concerned Intercenter Photo Working Group personnel, who were worried that *Columbia* had sustained damage not detectable in the limited number of views their tracking cameras captured. This concern led the Intercenter Photo Working Group Chair to request, in anticipation of analysts’ needs, that a high-resolution image of the Orbiter on-orbit be obtained by the Department of Defense. By the Board’s count, this would be the first of three distinct requests to image *Columbia* on-orbit. The exact chain of events and circumstances surrounding the movement of each of these requests through Shuttle Program Management, as well as the ultimate denial of these requests, is a topic of Chapter 6.

After discovering the strike, the Intercenter Photo Working Group prepared a report with a video clip of the impact and sent it to the Mission Management Team, the Mission Evaluation Room, and engineers at United Space Alliance and Boeing. In accordance with NASA guidelines, these contractor and NASA engineers began an assessment of potential impact damage to *Columbia*’s left wing, and soon formed a Debris Assessment Team to conduct a formal review.

The first formal Debris Assessment Team meeting was held on January 21, five days into the mission. It ended with the highest-ranking NASA engineer on the team agreeing to bring the team's request for imaging of the wing on-orbit, which would provide better information on which to base their analysis, to the Johnson Space Center Engineering Management Directorate, with the expectation the request would go forward to Space Shuttle Program managers. Debris Assessment Team members subsequently learned that these managers declined to image *Columbia*.

Without on-orbit pictures of *Columbia*, the Debris Assessment Team was restricted to using a mathematical modeling tool called Crater to assess damage, although it had not been designed with this type of impact in mind. Team members concluded over the next six days that some localized heating damage would most likely occur during re-entry, but they could not definitively state that structural damage would result. On January 24, the Debris Assessment Team made a presentation of these results to the Mission Evaluation Room, whose manager gave a verbal summary (with no data) of that presentation to the Mission Management Team the same day. The Mission Management Team declared the debris strike a "turnaround" issue and did not pursue a request for imagery.

Even after the Debris Assessment Team's conclusion had been reported to the Mission Management Team, engineers throughout NASA and Mission Control continued to exchange e-mails and discuss possible damage. These messages and discussions were generally sent only to people within the senders' area of expertise and level of seniority.



William McCool talks to Mission Control from the aft flight deck of *Columbia* during STS-107.

2.6 DE-ORBIT BURN AND RE-ENTRY EVENTS

At 2:30 a.m. EST on February 1, 2003, the Entry Flight Control Team began duty in the Mission Control Center. The Flight Control Team was not working any issues or problems related to the planned de-orbit and re-entry of *Columbia*. In particular, the team indicated no concerns about the debris impact to the left wing during ascent, and treated the re-entry like any other.

The team worked through the de-orbit preparation checklist and re-entry checklist procedures. Weather forecasters, with the help of pilots in the Shuttle Training Aircraft, evaluated landing site weather conditions at the Kennedy Space Center. At the time of the de-orbit decision, about 20 minutes before the initiation of the de-orbit burn, all weather observations and forecasts were within guidelines set by the flight rules, and all systems were normal.

Shortly after 8:00 a.m., the Mission Control Center Entry Flight Director polled the Mission Control room for a GO/NO-GO decision for the de-orbit burn, and at 8:10 a.m., the Capsule Communicator notified the crew they were GO for de-orbit burn.

As the Orbiter flew upside down and tail-first over the Indian Ocean at an altitude of 175 statute miles, Commander Husband and Pilot McCool executed the de-orbit burn at 8:15:30 a.m. using *Columbia's* two Orbital Maneuvering System engines. The de-orbit maneuver was performed on the 255th orbit, and the 2-minute, 38-second burn slowed the Orbiter from 17,500 mph to begin its re-entry into the atmosphere. During the de-orbit burn, the crew felt about 10 percent of the effects of gravity. There were no problems during the burn, after which Husband maneuvered *Columbia* into a right-side-up, forward-facing position, with the Orbiter's nose pitched up.

Entry Interface, arbitrarily defined as the point at which the Orbiter enters the discernible atmosphere at 400,000 feet, occurred at 8:44:09 a.m. (Entry Interface plus 000 seconds, written EI+000) over the Pacific Ocean. As *Columbia* descended from space into the atmosphere, the heat produced by air molecules colliding with the Orbiter typically caused wing leading-edge temperatures to rise steadily, reaching an estimated 2,500 degrees Fahrenheit during the next six minutes. As superheated air molecules discharged light, astronauts on the flight deck saw bright flashes envelop the Orbiter, a normal phenomenon.

At 8:48:39 a.m. (EI+270), a sensor on the left wing leading edge spar showed strains higher than those seen on previous *Columbia* re-entries. This was recorded only on the Modular Auxiliary Data System, and was not telemetered to ground controllers or displayed to the crew (see Figure 2.6-1).

At 8:49:32 a.m. (EI+323), traveling at approximately Mach 24.5, *Columbia* executed a roll to the right, beginning a pre-planned banking turn to manage lift, and therefore limit the Orbiter's rate of descent and heating.

At 8:50:53 a.m. (EI+404), traveling at Mach 24.1 and at approximately 243,000 feet, *Columbia* entered a 10-minute period of peak heating, during which the thermal stresses were at their maximum. By 8:52:00 a.m. (EI+471), nearly eight minutes after entering the atmosphere and some 300 miles west of the California coastline, the wing leading-edge temperatures usually reached 2,650 degrees Fahrenheit. *Columbia* crossed the California coast west of Sacramento at 8:53:26 a.m. (EI+557). Traveling at Mach 23 and 231,600 feet, the Orbiter's wing leading edge typically reached more than an estimated 2,800 degrees Fahrenheit.



Columbia streaking over the Very Large Array radio telescope in Socorro, New Mexico.

Now crossing California, the Orbiter appeared to observers on the ground as a bright spot of light moving rapidly across the sky. Signs of debris being shed were sighted at 8:53:46 a.m. (EI+577), when the superheated air surrounding the Orbiter suddenly brightened, causing a noticeable streak in the Orbiter's luminescent trail. Observers witnessed another four similar events during the following 23 seconds, and a bright flash just seconds after *Columbia* crossed from California into Nevada airspace at 8:54:25 a.m. (EI+614), when the Orbiter was traveling at Mach 22.5 and 227,400 feet. Witnesses observed another 18 similar events in the next four minutes as *Columbia* streaked over Utah, Arizona, New Mexico, and Texas.

In Mission Control, re-entry appeared normal until 8:54:24 a.m. (EI+613), when the Maintenance, Mechanical, and Crew Systems (MMACS) officer informed the Flight Director that four hydraulic sensors in the left wing were indicating "off-scale low," a reading that falls below the minimum capability of the sensor. As the seconds passed, the Entry Team continued to discuss the four failed indicators.

At 8:55:00 a.m. (EI+651), nearly 11 minutes after *Columbia* had re-entered the atmosphere, wing leading edge temperatures normally reached nearly 3,000 degrees Fahrenheit. At 8:55:32 a.m. (EI+683), *Columbia* crossed from Nevada into Utah while traveling at Mach 21.8 and 223,400 ft. Twenty seconds later, the Orbiter crossed from Utah into Arizona.

At 8:56:30 a.m. (EI+741), *Columbia* initiated a roll reversal, turning from right to left over Arizona. Traveling at Mach 20.9 and 219,000 feet, *Columbia* crossed the Arizona-New Mexico state line at 8:56:45 (EI+756), and passed just north of Albuquerque at 8:57:24 (EI+795).

Around 8:58:00 a.m. (EI+831), wing leading edge temperatures typically decreased to 2,880 degrees Fahrenheit. At 8:58:20 a.m. (EI+851), traveling at 209,800 feet and Mach 19.5, *Columbia* crossed from New Mexico into Texas, and about this time shed a Thermal Protection System tile, which was the most westerly piece of debris that has been recovered.

Searchers found the tile in a field in Littlefield, Texas, just northwest of Lubbock. At 8:59:15 a.m. (EI+906), MMACS informed the Flight Director that pressure readings had been lost on both left main landing gear tires. The Flight Director then told the Capsule Communicator (CAPCOM) to let the crew know that Mission Control saw the messages and was evaluating the indications, and added that the Flight Control Team did not understand the crew's last transmission.

At 8:59:32 a.m. (EI+923), a broken response from the mission commander was recorded: "Roger, [cut off in mid-word] ..." It was the last communication from the crew and the last telemetry signal received in Mission Control. Videos made by observers on the ground at 9:00:18 a.m. (EI+969) revealed that the Orbiter was disintegrating.

2.7 EVENTS IMMEDIATELY FOLLOWING THE ACCIDENT

A series of events occurred immediately after the accident that would set the stage for the subsequent investigation.

NASA Emergency Response

Shortly after the scheduled landing time of 9:16 a.m. EST, NASA declared a "Shuttle Contingency" and executed the Contingency Action Plan that had been established after the *Challenger* accident. As part of that plan, NASA Administrator Sean O'Keefe activated the International Space Station and Space Shuttle Mishap Interagency Investigation Board at 10:30 a.m. and named Admiral Harold W. Gehman Jr., U.S. Navy, retired, as its chair.

Senior members of the NASA leadership met as part of the Headquarters Contingency Action Team and quickly notified astronaut families, the President, and members of Congress. President Bush telephoned Israeli Prime Minister Ariel Sharon to inform him of the loss of *Columbia* crew member Ilan Ramon, Israel's first astronaut. Several hours later, President Bush addressed the nation, saying, "The *Columbia* is lost. There are no survivors."



The Orbiter has a large glowing field surrounding it in this view taken from Mesquite, Texas, looking south.



Taken at the same time as the photo at left, but from Hewitt, Texas, looking north.

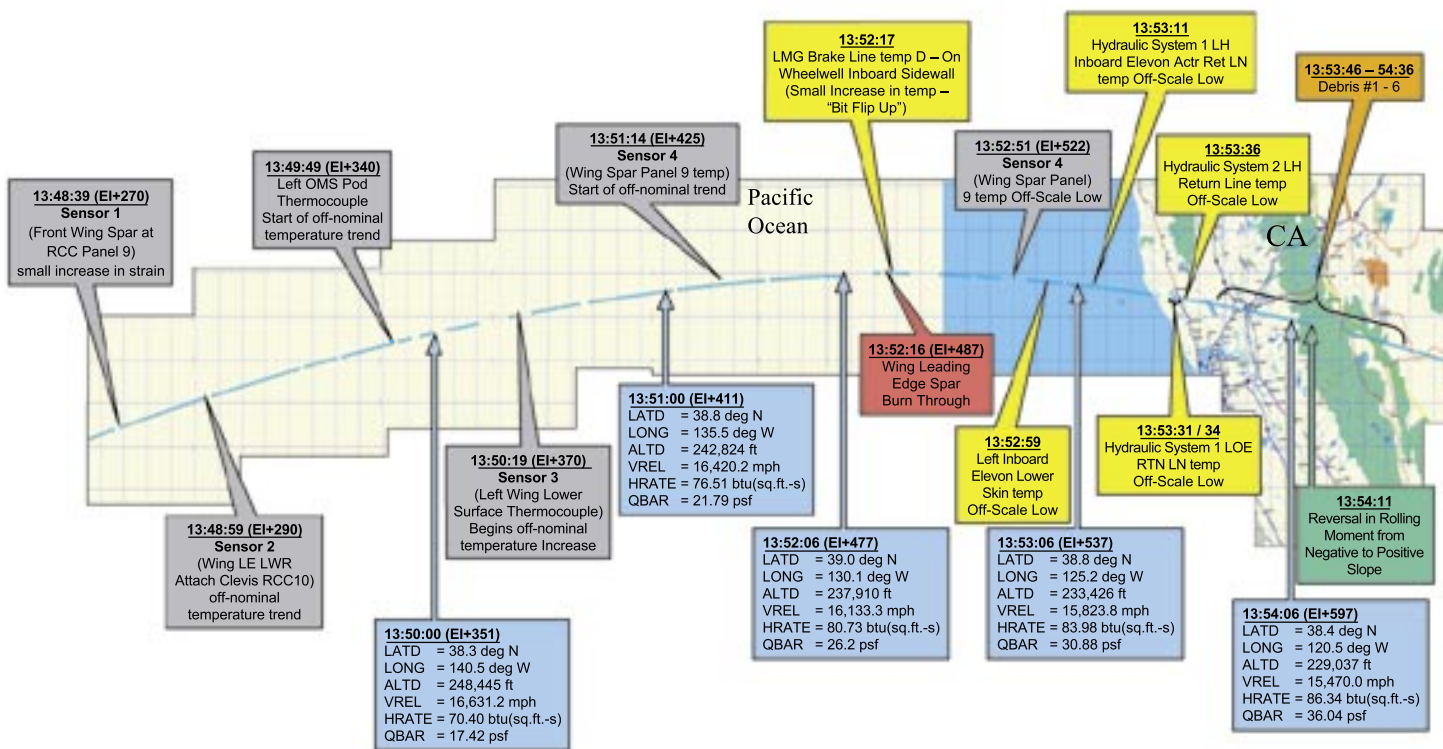

Figure 2.6-1. This simplified timeline shows the re-entry path of Columbia on February 1, 2003. The information presented here is a composite of sensor data telemetered to the ground combined with data from the Modular Auxiliary Data System recorder recovered after the accident. Note that the first off-nominal reading was a small increase in a strain gauge at the front wing spar behind RCC panel 9-left. The chart is color-coded: blue boxes contain position, attitude, and velocity information; orange boxes indicate when debris was shed from the Orbiter; green boxes are significant aerodynamic control events; gray boxes contain sensor information from the Modular Auxiliary Data System; and yellow boxes contain telemetered sensor information. The red boxes indicate other significant events.



This view was taken from Dallas. (Robert McCullough/© 2003 The Dallas Morning News)



This video was captured by a Danish crew operating an AH-64 Apache helicopter near Fort Hood, Texas.

STS-107 Re-entry Trajectory and Timeline (First Off-Nominal Event to Loss of Signal)

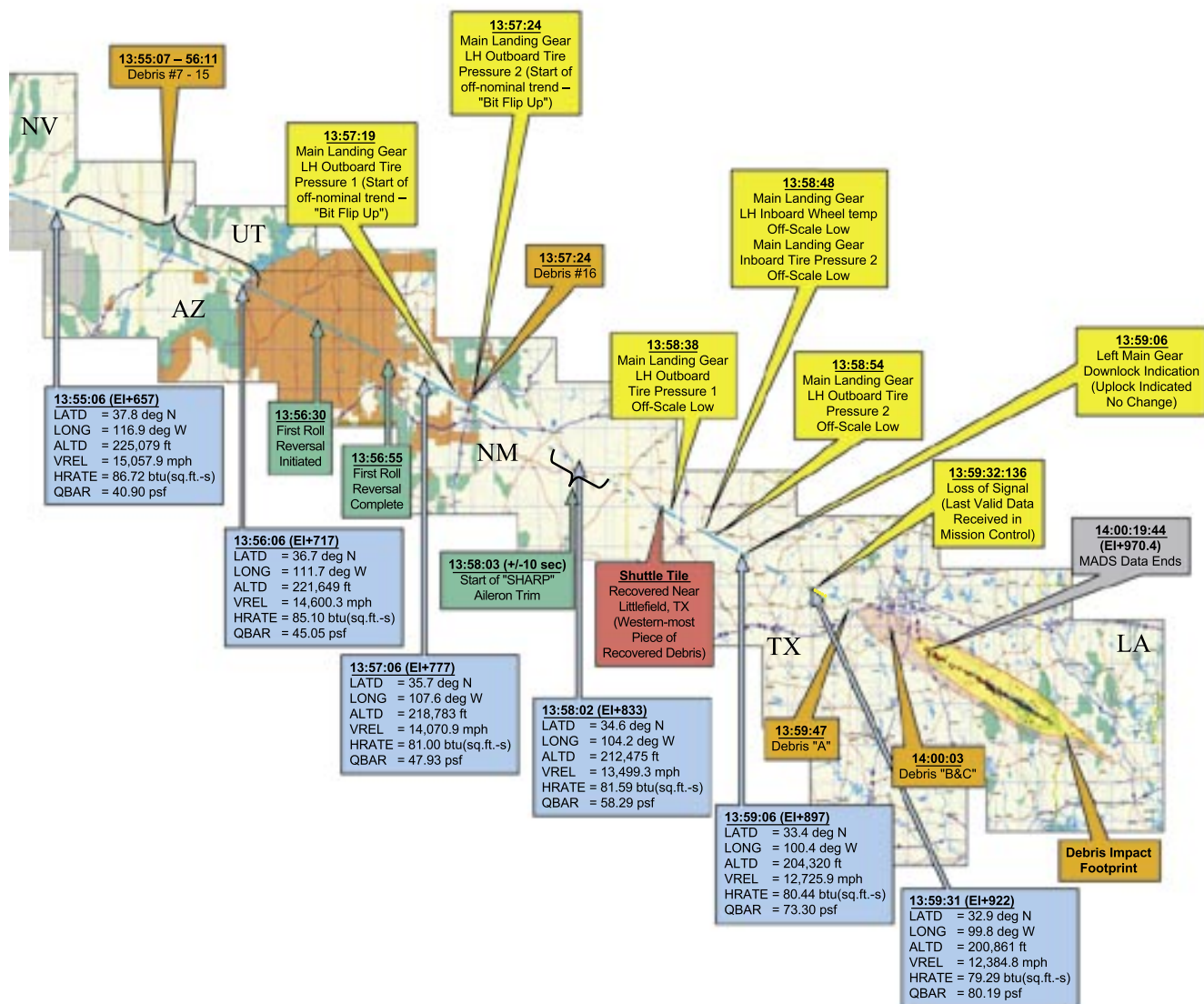

MISSION CONTROL CENTER COMMUNICATIONS



At 8:49 a.m. Eastern Standard Time (EI+289), the Orbiter's flight control system began steering a precise course, or drag profile, with the initial roll command occurring about 30 seconds later. At 8:49:38 a.m., the Mission Control Guidance and Procedures officer called the Flight Director and indicated that the "closed-loop" guidance system had been initiated.

The Maintenance, Mechanical, and Crew Systems (MMACS) of the Flight Director (Flight) had the following exchange beginning at 8:54:24 a.m. (EI+613).

MMACS: "Flight – MMACS."
 Flight: "Go ahead, MMACS."
 MMACS: "FYI, I've just lost four separate temperature transducers on the left side of the vehicle, hydraulic return temperatures. Two of them on system one and one in each of systems two and three."
 Flight: "Four hyd [hydraulic] return temps?"
 MMACS: "To the left outboard and left inboard elevon."
 Flight: "Okay, is there anything common to them? DSC [discrete signal conditioner] or MDM [multiplexer-demultiplexer] or anything? I mean, you're telling me you lost them all at exactly the same time?"
 MMACS: "No, not exactly. They were within probably four or five seconds of each other."
 Flight: "Okay, where are those, where is that instrumentation located?"
 MMACS: "All four of them are located in the aft part of the left wing, right in front of the elevons, elevon actuators. And there is no commonality."
 Flight: "No commonality."

At 8:56:02 a.m. (EI+713), the conversation between the Flight Director and the MMACS officer continues:

Flight: "MMACS, tell me again which systems they're for."
 MMACS: "That's all three hydraulic systems. It's ... two of them are to the left outboard elevon and two of them to the left inboard."
 Flight: "Okay, I got you."

The Flight Director then continues to discuss indications with other Mission Control Center personnel, including the Guidance, Navigation, and Control officer (GNC).

Flight: "GNC – Flight."
 GNC: "Flight – GNC."
 Flight: "Everything look good to you, control and rates and everything is nominal, right?"
 GNC: "Control's been stable through the rolls that we've done so far, flight. We have good trims. I don't see anything out of the ordinary."
 Flight: "Okay. And MMACS, Flight?"
 MMACS: "Flight – MMACS."
 Flight: "All other indications for your hydraulic system indications are good."
 MMACS: "They're all good. We've had good quantities all the way across."
 Flight: "And the other temps are normal?"
 MMACS: "The other temps are normal, yes sir."
 Flight: "And when you say you lost these, are you saying that they went to zero?" [Time: 8:57:59 a.m., EI+830]
 "Or, off-scale low?"
 MMACS: "All four of them are off-scale low. And they were all staggered. They were, like I said, within several seconds of each other."
 Flight: "Okay."

At 8:58:00 a.m. (EI+831), Columbia crossed the New Mexico-Texas state line. Within the minute, a broken call came on the air-to-ground voice loop from Columbia's commander, "And, uh, Hou ..." This was followed by a call from MMACS about failed tire pressure sensors at 8:59:15 a.m. (EI+906).

MMACS: "Flight – MMACS."
 Flight: "Go."
 MMACS: "We just lost tire pressure on the left outboard and left inboard, both tires."

[continued on next page]

The Flight Director then told the Capsule Communicator (CAPCOM) to let the crew know that Mission Control saw the messages and that the Flight Control Team was evaluating the indications and did not copy their last transmission.

CAPCOM: “And Columbia, Houston, we see your tire pressure messages and we did not copy your last call.”

Flight: “Is it instrumentation, MMACS? Gotta be ...”

MMACS: “Flight – MMACS, those are also off-scale low.”

At 8:59:32 a.m. (EI+923), Columbia was approaching Dallas, Texas, at 200,700 feet and Mach 18.1. At the same time, another broken call, the final call from Columbia’s commander, came on the air-to-ground voice loop:

Commander: “Roger, [cut off in mid-word] ...”

This call may have been about the backup flight system tire pressure fault-summary messages annunciated to the crew onboard, and seen in the telemetry by Mission Control personnel. An extended loss of signal began at 08:59:32.136 a.m. (EI+923). This was the last valid data accepted by the Mission Control computer stream, and no further real-time data updates occurred in Mission Control. This coincided with the approximate time when the Flight Control Team would expect a short-duration loss of signal during antenna switching, as the onboard communication system automatically reconfigured from the west Tracking and Data Relay System satellite to either the east satellite or to the ground station at Kennedy Space Center. The following exchange then took place on the Flight Director loop with the Instrumentation and Communication Office (INCO):

INCO: “Flight – INCO.”

Flight: “Go.”

INCO: “Just taking a few hits here. We’re right up on top of the tail. Not too bad.”

The Flight Director then resumes discussion with the MMACS officer at 9:00:18 a.m. (EI+969).

Flight: “MMACS – Flight.”

MMACS: “Flight – MMACS.”

Flight: “And there’s no commonality between all these tire pressure instrumentations and the hydraulic return instrumentations.”

MMACS: “No sir, there’s not. We’ve also lost the nose gear down talkback and the right main gear down talkback.”

Flight: “Nose gear and right main gear down talkbacks?”

MMACS: “Yes sir.”

At 9:00:18 a.m. (EI+969), the postflight video and imagery analyses indicate that a catastrophic event occurred. Bright flashes suddenly enveloped the Orbiter, followed by a dramatic change in the trail of superheated air. This is considered the most likely time of the main breakup of Columbia. Because the loss of signal had occurred 46 seconds earlier, Mission Control had no insight into this event. Mission Control continued to work the loss-of-signal problem to regain communication with Columbia:

INCO: “Flight – INCO, I didn’t expect, uh, this bad of a hit on comm [communications].”

Flight: “GC [Ground Control officer] how far are we from UHF? Is that two-minute clock good?”

GC: “Affirmative, Flight.”

GNC: “Flight – GNC.”

Flight: “Go.”

GNC: “If we have any reason to suspect any sort of controllability issue, I would keep the control cards handy on page 4-dash-13.”

Flight: “Copy.”

At 9:02:21 a.m. (EI+1092, or 18 minutes-plus), the Mission Control Center commentator reported, “Fourteen minutes to touchdown for Columbia at the Kennedy Space Center. Flight controllers are continuing to stand by to regain communications with the spacecraft.”

Flight: “INCO, we were rolled left last data we had and you were expecting a little bit of ratty comm [communications], but not this long?”

INCO: “That’s correct, Flight. I expected it to be a little intermittent. And this is pretty solid right here.”

Flight: “No onboard system config [configuration] changes right before we lost data?”

INCO: “That is correct, Flight. All looked good.”

Flight: “Still on string two and everything looked good?”

INCO: “String two looking good.”

The Ground Control officer then told the Flight Director that the Orbiter was within two minutes of acquiring the Kennedy Space Center ground station for communications, “Two minutes to MILA.” The Flight Director told the CAPCOM to try another communications check with Columbia, including one on the UHF system (via MILA, the Kennedy Space Center tracking station):

CAPCOM: “Columbia, Houston, comm [communications] check.”

CAPCOM: “Columbia, Houston, UHF comm [communications] check.”

At 9:03:45 a.m. (EI+1176, or 19 minutes-plus), the Mission Control Center commentator reported, “CAPCOM Charlie Hobough calling Columbia on a UHF frequency as it approaches the Merritt Island (MILA) tracking station in Florida. Twelve-and-a-half minutes to touchdown, according to clocks in Mission Control.”

MMACS: “Flight – MMACS.”

Flight: “MMACS?”

MMACS: “On the tire pressures, we did see them go erratic for a little bit before they went away, so I do believe it’s instrumentation.”

Flight: “Okay.”

The Flight Control Team still had no indications of any serious problems onboard the Orbiter. In Mission Control, there was no way to know the exact cause of the failed sensor measurements, and while there was concern for the extended loss of signal, the recourse was to continue to try to regain communications and in the meantime determine if the other systems, based on the last valid data, continued to appear as expected. The Flight Director told the CAPCOM to continue to try to raise Columbia via UHF:

CAPCOM: “Columbia, Houston, UHF comm [communications] check.”

CAPCOM: “Columbia, Houston, UHF comm [communications] check.”

GC: “Flight – GC.”

Flight: “Go.”

GC: “MILA not reporting any RF [radio frequency] at this time.”

[continued on next page]

[continued from previous page]

INCO: “Flight – INCO, SPC [stored program command] just should have taken us to STDN low.” *[STDN is the Space Tracking and Data Network, or ground station communication mode]*

Flight: “Okay.”

Flight: “FDO, when are you expecting tracking?” *[FDO is the Flight Dynamics Officer in the Mission Control Center]*

FDO: “One minute ago, Flight.”

GC: “And Flight – GC, no C-band yet.”

Flight: “Copy.”

CAPCOM: “Columbia, Houston, UHF comm [communications] check.”

INCO: “Flight – INCO.”

Flight: “Go.”

INCO: “I could swap strings in the blind.”

Flight: “Okay, command us over.”

INCO: “In work, Flight.”

At 09:08:25 a.m. (EI+1456, or 24 minutes-plus), the Instrumentation and Communications Officer reported, “Flight – INCO, I’ve commanded string one in the blind,” which indicated that the officer had executed a command sequence to Columbia to force the onboard S-band communications system to the backup string of avionics to try to regain communication, per the Flight Director’s direction in the previous call.

GC: “And Flight – GC.”

Flight: “Go.”

GC: “MILA’s taking one of their antennas off into a search mode [to try to find Columbia].”

Flight: “Copy. FDO – Flight?”

FDO: “Go ahead, Flight.”

Flight: “Did we get, have we gotten any tracking data?”

FDO: “We got a blip of tracking data, it was a bad data point, Flight. We do not believe that was the Orbiter *[referring to an errant blip on the large front screen in the Mission Control, where Orbiter tracking data is displayed.]* We’re entering a search pattern with our C-bands at this time. We do not have any valid data at this time.”

By this time, 9:09:29 a.m. (EI+1520), Columbia’s speed would have dropped to Mach 2.5 for a standard approach to the Kennedy Space Center.

Flight: “OK. Any other trackers that we can go to?”

FDO: “Let me start talking, Flight, to my navigator.”

At 9:12:39 a.m. (E+1710, or 28 minutes-plus), Columbia should have been banking on the heading alignment cone to line up on Runway 33. At about this time, a member of the Mission Control team received a call on his cell phone from someone who had just seen live television coverage of Columbia breaking up during re-entry. The Mission Control team member walked to the Flight Director’s console and told him the Orbiter had disintegrated.

Flight: “GC, – Flight. GC – Flight?”

GC: “Flight – GC.”

Flight: “Lock the doors.”

Having confirmed the loss of Columbia, the Entry Flight Director directed the Flight Control Team to begin contingency procedures.

In order to preserve all material relating to STS-107 as evidence for the accident investigation, NASA officials impounded data, software, hardware, and facilities at NASA and contractor sites in accordance with the pre-existing mishap response plan.

At the Johnson Space Center, the door to Mission Control was locked while personnel at the flight control consoles archived all original mission data. At the Kennedy Space Center, mission facilities and related hardware, including Launch Complex 39-A, were put under guard or stored in secure warehouses. Officials took similar actions at other key Shuttle facilities, including the Marshall Space Flight Center and the Michoud Assembly Facility.

Within minutes of the accident, the NASA Mishap Investigation Team was activated to coordinate debris recovery efforts with local, state, and federal agencies. The team initially operated out of Barksdale Air Force Base in Louisiana and soon after in Lufkin, Texas, and Carswell Field in Fort Worth, Texas.

Debris Search and Recovery

On the morning of February 1, a crackling boom that signaled the breakup of *Columbia* startled residents of East Texas. The long, low-pitched rumble heard just before 8:00 a.m. Central Standard Time (CST) was generated by pieces of debris streaking into the upper atmosphere at nearly 12,000 miles per hour. Within minutes, that debris fell to the ground. Cattle stampeded in Eastern Nacogdoches County. A fisherman on Toledo Bend reservoir saw a piece splash down in the water, while a woman driving near Lufkin almost lost control of her car when debris smacked her windshield. As 911 dispatchers across Texas were flooded with calls reporting sonic booms and smoking debris, emergency personnel soon realized that residents were encountering the remnants of the Orbiter that NASA had reported missing minutes before.

The emergency response that began shortly after 8:00 a.m. CST Saturday morning grew into a massive effort to decontaminate and recover debris strewn over an area that in Texas alone exceeded 2,000 square miles (see Figure 2.7-1). Local fire and police departments called in all personnel, who began responding to debris reports that by late afternoon were phoned in at a rate of 18 per minute.

Within hours of the accident, President Bush declared East Texas a federal disaster area, enabling the dispatch of emergency response teams from the Federal Emergency Management Agency and Environmental Protection Agency. As the day wore on, county constables, volunteers on horseback, and local citizens headed into pine forests and bushy thickets in search of debris and crew remains, while National Guard units mobilized to assist local law-enforcement guard debris sites. Researchers from Stephen F. Austin University sent seven teams into the field with Global Positioning System units to mark the exact location of debris. The researchers and later searchers then used this data to update debris distribution on detailed Geographic Information System maps.

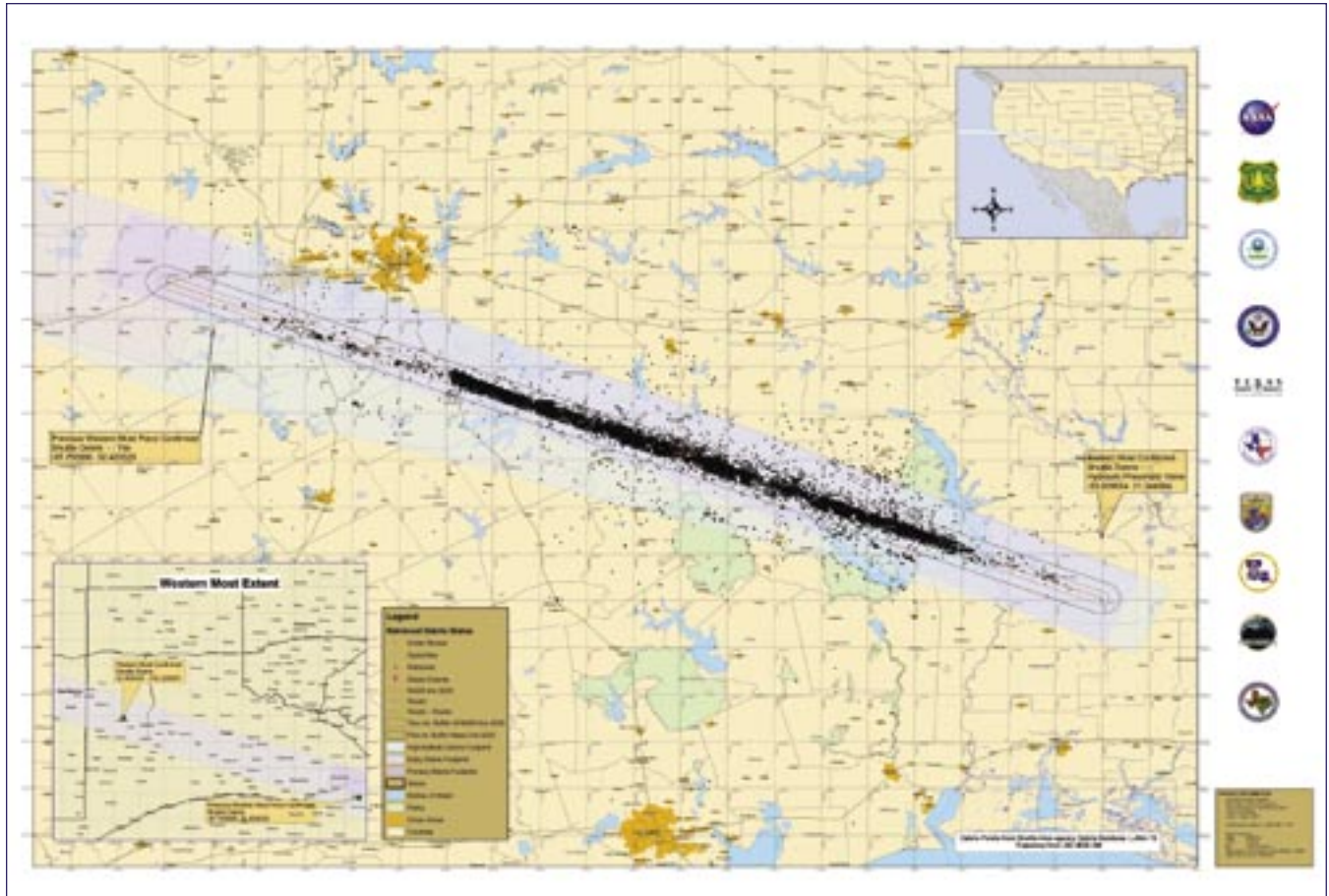

Figure 2.7-1. The debris field in East Texas spread over 2,000 square miles, and eventually over 700,000 acres were searched.

Public Safety Concerns

From the start, NASA officials sought to make the public aware of the hazards posed by certain pieces of debris, as well as the importance of turning over all debris to the authorities. *Columbia* carried highly toxic propellants that maneuvered the Orbiter in space and during early stages of re-entry. These propellants and other gases and liquids were stored in pressurized tanks and cylinders that posed a danger to people who might approach Orbiter debris. The propellants, monomethyl hydrazine and nitrogen tetroxide, as well as concentrated ammonia used in the Orbiter's cooling systems, can severely burn the lungs and exposed skin when encountered in vapor form. Other materials used in the Orbiter, such as beryllium, are also toxic. The Orbiter also contains various pyrotechnic devices that eject or release items such as the Ku-Band antenna, landing gear doors, and hatches in an emergency. These pyrotechnic devices and their triggers, which are designed to withstand high heat and therefore may have survived re-entry, posed a danger to people and livestock. They had to be removed by personnel trained in ordnance disposal.

In light of these and other hazards, NASA officials worked with local media and law enforcement to ensure that no one on the ground would be injured. To determine that Orbiter debris did not threaten air quality or drinking water, the Envi-

ronmental Protection Agency activated Emergency Response and Removal Service contractors, who surveyed the area.

Land Search

The tremendous efforts mounted by the National Guard, Texas Department of Public Safety, and emergency personnel from local towns and communities were soon overwhelmed by the expanding bounds of the debris field, the densest region of which ran from just south of Fort Worth, Texas, to Fort Polk, Louisiana. Faced with a debris field several orders of magnitude larger than any previous accident site, NASA and Federal Emergency Management Agency officials activated Forest Service wildland firefighters to serve as the primary search teams. As NASA identified the areas to be searched, personnel and equipment were furnished by the Forest Service.

Within two weeks, the number of ground searchers exceeded 3,000. Within a month, more than 4,000 searchers were flown in from around the country to base camps in Corsicana, Palestine, Nacogdoches, and Hemphill, Texas. These searchers, drawn from across the United States and Puerto Rico, worked 12 hours per day on 14-, 21-, or 30-day rotations and were accompanied by Global Positioning System-equipped NASA and Environmental Protection Agency personnel trained to handle and identify debris.

Based on sophisticated mapping of debris trajectories gathered from telemetry, radar, photographs, video, and meteorological data, as well as reports from the general public, teams were dispatched to walk precise grids of East Texas pine brush and thicket (see Figure 2.7-2). In lines 10 feet apart, a distance calculated to provide a 75 percent probability of detecting a six-inch-square object, wildland firefighters scoured snake-infested swamps, mud-filled creek beds, and brush so thick that one team advanced only a few hundred feet in an entire morning. These 20-person ground teams systematically covered an area two miles to either side of the Orbiter's ground track. Initial efforts concentrated on the search for human remains and the debris corridor between Corsicana, Texas, and Fort Polk. Searchers gave highest priority to a list of some 20 "hot items" that potentially contained crucial information, including the Orbiter's General Purpose Computers, film, cameras, and the Modular Auxiliary Data System recorder. Once the wildland firefighters entered the field, recovery rates exceeded 1,000 pieces of debris per day.



Figure 2.7-2. Searching for debris was a laborious task that used thousands of people walking over hundreds of acres of Texas and Louisiana.

After searchers spotted a piece of debris and determined it was not hazardous, its location was recorded with a Global Positioning System unit and photographed. The debris was then tagged and taken to one of four collection centers at Corsicana, Palestine, Nacogdoches, and Hemphill, Texas. There, engineers made a preliminary identification, entered the find into a database, and then shipped the debris to Kennedy Space Center, where it was further analyzed in a hangar dedicated to the debris reconstruction.

Air Search

Air crews used 37 helicopters and seven fixed-wing aircraft to augment ground searchers by searching for debris farther out from the Orbiter's ground track, from two miles from the centerline to five miles on either side. Initially, these crews used advanced remote sensing technologies, including two satellite platforms, hyper-spectral and forward-looking infrared scanners, forest penetration radars, and imagery from Lockheed U-2 reconnaissance aircraft. Because of the densi-



Figure 2.7-3. Tragically, a helicopter crash during the debris search claimed the lives of Jules "Buzz" Mier (in black coat) and Charles Krenek (yellow coat).

ty of the East Texas vegetation, the small sizes of the debris, and the inability of sensors to differentiate Orbiter material from other objects, these devices proved of little value. As a result, the detection work fell to spotter teams who visually scanned the terrain. Air search coordinators apportioned grids to allow a 50 percent probability of detection for a one-foot-square object. Civil Air Patrol volunteers and others in powered parachutes, a type of ultralight aircraft, also participated in the search, but were less successful than helicopter and fixed-wing air crews in retrieving debris. During the air search, a Bell 407 helicopter crashed in Angelina National Forest in San Augustine County after a mechanical failure. The accident took the lives of Jules F. "Buzz" Mier Jr., a contract pilot, and Charles Krenek, a Texas Forest Service employee, and injured three others (see Figure 2.7-3).

Water Search

The United States Navy Supervisor of Salvage organized eight dive teams to search Lake Nacogdoches and Toledo Bend Reservoir, two bodies of water in dense debris fields. Sonar mapping of more than 31 square miles of lake bottom identified more than 3,100 targets in Toledo Bend and 326 targets in Lake Nacogdoches. Divers explored each target, but in murky water with visibility of only a few inches, underwater forests, and other submerged hazards, they recovered only one object in Toledo Bend and none in Lake Nacogdoches. The 60 divers came from the Navy, Coast Guard, Environmental Protection Agency, Texas Forest Service, Texas Department of Public Safety, Houston and Galveston police and fire departments, and Jasper County Sheriff's Department.

Search Beyond Texas and Louisiana

As thousands of personnel combed the Orbiter's ground track in Texas and Louisiana, other civic and community groups searched areas farther west. Environmental organizations and local law enforcement walked three counties of California coastline where oceanographic data indicated a high

probability of debris washing ashore. Prison inmates scoured sections of the Nevada desert. Civil Air Patrol units and other volunteers searched thousands of acres in New Mexico, by air and on foot. Though these searchers failed to find any debris, they provided a valuable service by closing out potential debris sites, including nine areas in Texas, New Mexico, Nevada, and Utah identified by the National Transportation Safety Board as likely to contain debris. NASA's Mishap Investigation Team addressed each of the 1,459 debris reports it received. So eager was the general public to turn in pieces of potential debris that NASA received reports from 37 U.S. states that *Columbia's* re-entry ground track did not cross, as well as from Canada, Jamaica, and the Bahamas.

Property Damage

No one was injured and little property damage resulted from the tens of thousands of pieces of falling debris (see Chapter 10). A reimbursement program administered by NASA distributed approximately \$50,000 to property owners who made claims resulting from falling debris or collateral damage from the search efforts. There were, however, a few close calls that emphasize the importance of selecting the ground track that re-entering Orbiters follow. A 600-pound piece of a main engine dug a six-foot-wide hole in the Fort Polk golf course, while an 800-pound main engine piece, which hit the ground at an estimated 1,400 miles per hour, dug an even larger hole nearby. Disaster was narrowly averted outside Nacogdoches when a piece of debris landed between two highly explosive natural gas tanks set just feet apart.

Debris Amnesty

The response of the public in reporting and turning in debris was outstanding. To reinforce the message that Orbiter debris was government property as well as essential evidence of the accident's cause, NASA and local media officials repeatedly urged local residents to report all debris immediately. For those who might have been keeping debris as souvenirs, NASA offered an amnesty that ran for several days. In the end, only a handful of people were prosecuted for theft of debris.

Final Totals

More than 25,000 people from 270 organizations took part in debris recovery operations. All told, searchers expended over 1.5 million hours covering more than 2.3 million acres, an area approaching the size of Connecticut. Over 700,000 acres were searched by foot, and searchers found over 84,000 individual pieces of Orbiter debris weighing more than 84,900 pounds, representing 38 percent of the Orbiter's dry weight. Though significant evidence from radar returns and video recordings indicate debris shedding across California, Nevada, and New Mexico, the most westerly piece of confirmed debris (at the time this report was published) was the tile found in a field in Littleton, Texas. Heavier objects with higher ballistic coefficients, a measure of how far objects will travel in the air, landed toward the end of the debris trail in western Louisiana. The most easterly debris pieces, including the Space Shuttle Main Engine turbopumps, were found in Fort Polk, Louisiana.

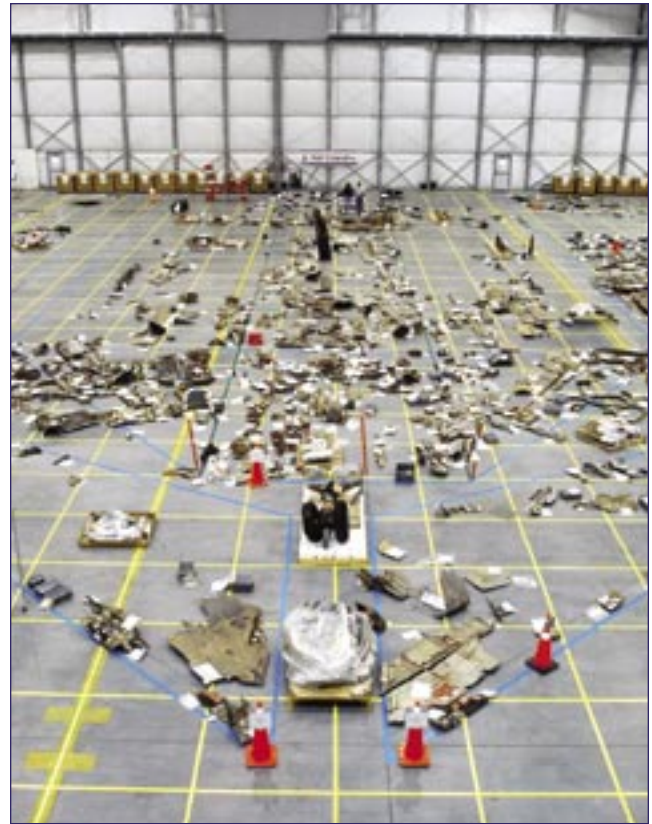

Figure 2.7-4. Recovered debris was returned to the Kennedy Space Center where it was laid out in a large hangar. The tape on the floor helped workers place each piece near where it had been on the Orbiter.

The Federal Emergency Management Agency, which directed the overall effort, expended more than \$305 million to fund the search. This cost does not include what NASA spent on aircraft support or the wages of hundreds of civil servants employed at the recovery area and in analysis roles at NASA centers.

The Importance of Debris

The debris collected (see Figure 2.7-4) by searchers aided the investigation in significant ways. Among the most important finds was the Modular Auxiliary Data System recorder that captured data from hundreds of sensors that was not telemetered to Mission Control. Data from these 800 sensors, recorded on 9,400 feet of magnetic tape, provided investigators with millions of data points, including temperature sensor readings from *Columbia's* left wing leading edge. The data also helped fill a 30-second gap in telemetered data and provided an additional 14 seconds of data after the telemetry loss of signal.

Recovered debris allowed investigators to build a three-dimensional reconstruction of *Columbia's* left wing leading edge, which was the basis for understanding the order in which the left wing structure came apart, and led investigators to determine that heat first entered the wing in the location where photo analysis indicated the foam had struck.

ENDNOTES FOR CHAPTER 2

The citations that contain a reference to "CAIB document" with CAB or CTF followed by seven to eleven digits, such as CAB001-0010, refer to a document in the Columbia Accident Investigation Board database maintained by the Department of Justice and archived at the National Archives.

¹ The primary source document for this process is NSTS 08117, Requirements and Procedures for Certification and Flight Readiness. CAIB document CTF017-03960413.

² Statement of Daniel S. Goldin, Administrator, National Aeronautics and Space Administration, before the Subcommittee on VA-HUD-Independent Agencies, Committee on Appropriations, House of Representatives, March 31, 1998. CAIB document CAB048-04000418.

³ Roberta L. Gross, Inspector General, NASA, to Daniel S. Goldin, Administrator, NASA, "Assessment of the Triana Mission, G-99-013, Final Report," September 10, 1999. See in particular footnote 3, concerning Triana and the requirements of the Commercial Space Act, and Appendix C, "Accounting for Shuttle Costs." CAIB document CAB048-02680269.

⁴ Although there is more volume of liquid hydrogen in the External Tank, liquid hydrogen is very light and its slosh effects are minimal and are generally ignored. At launch, the External Tank contains approximately 1.4 million pounds (140,000 gallons) of liquid oxygen, but only 230,000 pounds (385,000 gallons) of liquid hydrogen.

⁵ The Performance Enhancements (PE) flight profile flown by STS-107 is a combination of flight software and trajectory design changes that were introduced in late 1997 for STS-85. These changes to the ascent flight profile allow the Shuttle to carry some 1,600 pounds of additional payload on International Space Station assembly missions. Although developed to meet the Space Station payload lift requirement, a modified PE profile has been used for all Shuttle missions since it was introduced.



Accident Analysis

One of the central purposes of this investigation, like those for other kinds of accidents, was to identify the chain of circumstances that caused the *Columbia* accident. In this case the task was particularly challenging, because the breakup of the Orbiter occurred at hypersonic velocities and extremely high altitudes, and the debris was scattered over a wide area. Moreover, the initiating event preceded the accident by more than two weeks. In pursuit of the sequence of the cause, investigators developed a broad array of information sources. Evidence was derived from film and video of the launch, radar images of *Columbia* on orbit, and amateur video of debris shedding during the in-flight breakup. Data was obtained from sensors onboard the Orbiter – some of this data was downlinked during the flight, and some came from an on-board recorder that was recovered during the debris search. Analysis of the debris was particularly valuable to the investigation. Clues were to be found not only in the condition of the pieces, but also in their location – both where they had been on the Orbiter and where they were found on the ground. The investigation also included extensive computer modeling, impact tests, wind tunnel studies, and other analytical techniques. Each of these avenues of inquiry is described in this chapter.

Because it became evident that the key event in the chain leading to the accident involved both the External Tank and one of the Orbiter's wings, the chapter includes a study of these two structures. The understanding of the accident's physical cause that emerged from this investigation is summarized in the statement at the beginning of the chapter. Included in the chapter are the findings and recommendations of the Columbia Accident Investigation Board that are based on this examination of the physical evidence.

3.1 THE PHYSICAL CAUSE

The physical cause of the loss of *Columbia* and its crew was a breach in the Thermal Protection System on the leading edge of the left wing. The breach was initiated by a piece of insulating foam that separated from the left bipod ramp of the External Tank and struck the wing in the vicinity of the lower half of Reinforced Carbon-Carbon panel 8 at 81.9 seconds after launch. During re-entry, this breach in the Thermal

Protection System allowed superheated air to penetrate the leading-edge insulation and progressively melt the aluminum structure of the left wing, resulting in a weakening of the structure until increasing aerodynamic forces caused loss of control, failure of the wing, and breakup of the Orbiter.



Figure 3.1-1. Columbia sitting at Launch Complex 39-A. The upper circle shows the left bipod (-Y) ramp on the forward attach point, while the lower circle is around RCC panel 8-left.

3.2 THE EXTERNAL TANK AND FOAM

The External Tank is the largest element of the Space Shuttle. Because it is the common element to which the Solid Rocket Boosters and the Orbiter are connected, it serves as the main structural component during assembly, launch, and ascent. It also fulfills the role of the low-temperature, or cryogenic, propellant tank for the Space Shuttle Main Engines. It holds 143,351 gallons of liquid oxygen at minus 297 degrees Fahrenheit in its forward (upper) tank and 385,265 gallons of liquid hydrogen at minus 423 degrees Fahrenheit in its aft (lower) tank.¹

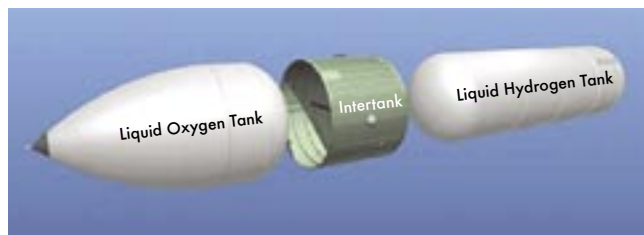

Figure 3.2-1. The major components of the External Tank.

Lockheed Martin builds the External Tank under contract to the NASA Marshall Space Flight Center at the Michoud Assembly Facility in eastern New Orleans, Louisiana.

The External Tank is constructed primarily of aluminum alloys (mainly 2219 aluminum alloy for standard-weight and lightweight tanks, and 2195 Aluminum-Lithium alloy for super-lightweight tanks), with steel and titanium fittings and attach points, and some composite materials in fairings and access panels. The External Tank is 153.8 feet long and 27.6 feet in diameter, and comprises three major sections: the liquid oxygen tank, the liquid hydrogen tank, and the intertank area between them (see Figure 3.2-1). The liquid oxygen and liquid hydrogen tanks are welded assemblies of machined and formed panels, barrel sections, ring frames, and dome and ogive sections. The liquid oxygen tank is pressure-tested with water, and the liquid hydrogen tank with compressed air, before they are incorporated into the External Tank assembly. STS-107 used Lightweight External Tank-93.

The propellant tanks are connected by the intertank, a 22.5-foot-long hollow cylinder made of eight stiffened aluminum alloy panels bolted together along longitudinal joints. Two of these panels, the integrally stiffened thrust panels (so called because they react to the Solid Rocket Booster thrust loads) are located on the sides of the External Tank where the Solid Rocket Boosters are mounted; they consist of single slabs of aluminum alloy machined into panels with solid longitudinal ribs. The thrust panels are joined across the inner diameter by the intertank truss, the major structural element of the External Tank. During propellant loading, nitrogen is used to purge the intertank to prevent condensation and also to prevent liquid oxygen and liquid hydrogen from combining.

The External Tank is attached to the Solid Rocket Boosters by bolts and fittings on the thrust panels and near the aft end of the liquid hydrogen tank. The Orbiter is attached to the Ex-

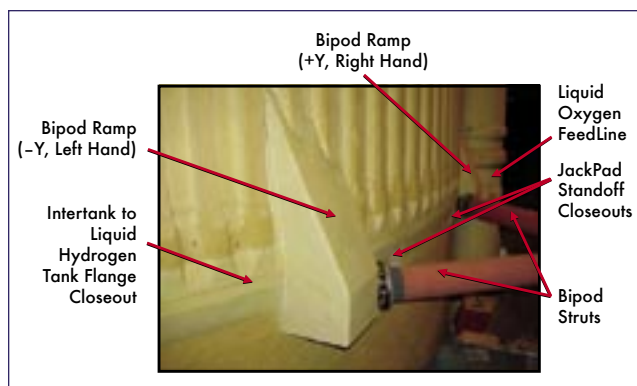

Figure 3.2-2. The exterior of the left bipod attachment area showing the foam ramp that came off during the ascent of STS-107.

ternal Tank by two umbilical fittings at the bottom (that also contain fluid and electrical connections) and by a “bipod” at the top. The bipod is attached to the External Tank by fittings at the right and left of the External Tank centerline. The bipod fittings, which are titanium forgings bolted to the External Tank, are forward (above) of the intertank-liquid hydrogen flange joint (see Figures 3.2-2 and 3.2-3). Each forging contains a spindle that attaches to one end of a bipod strut and rotates to compensate for External Tank shrinkage during the loading of cryogenic propellants.

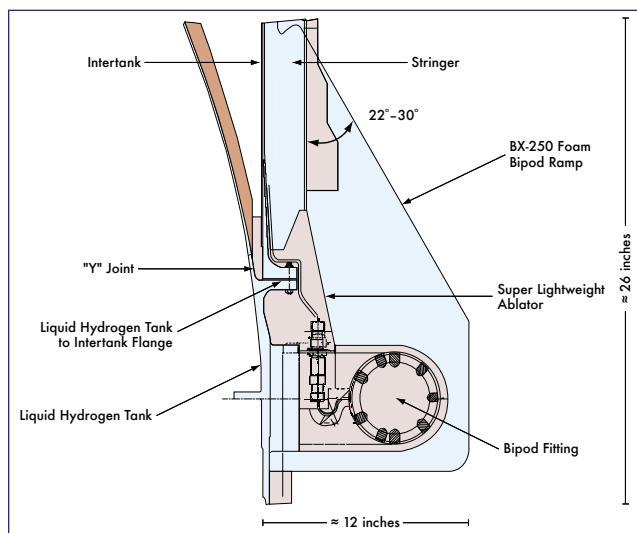

Figure 3.2-3. Cutaway drawing of the bipod ramp and its associated fittings and hardware.

External Tank Thermal Protection System Materials

The External Tank is coated with two materials that serve as the Thermal Protection System: dense composite ablators for dissipating heat, and low density closed-cell foams for high insulation efficiency.² (Closed-cell materials consist of small pores filled with air and blowing agents that are separated by thin membranes of the foam’s polymeric component.) The External Tank Thermal Protection System is designed to maintain an interior temperature that keeps the

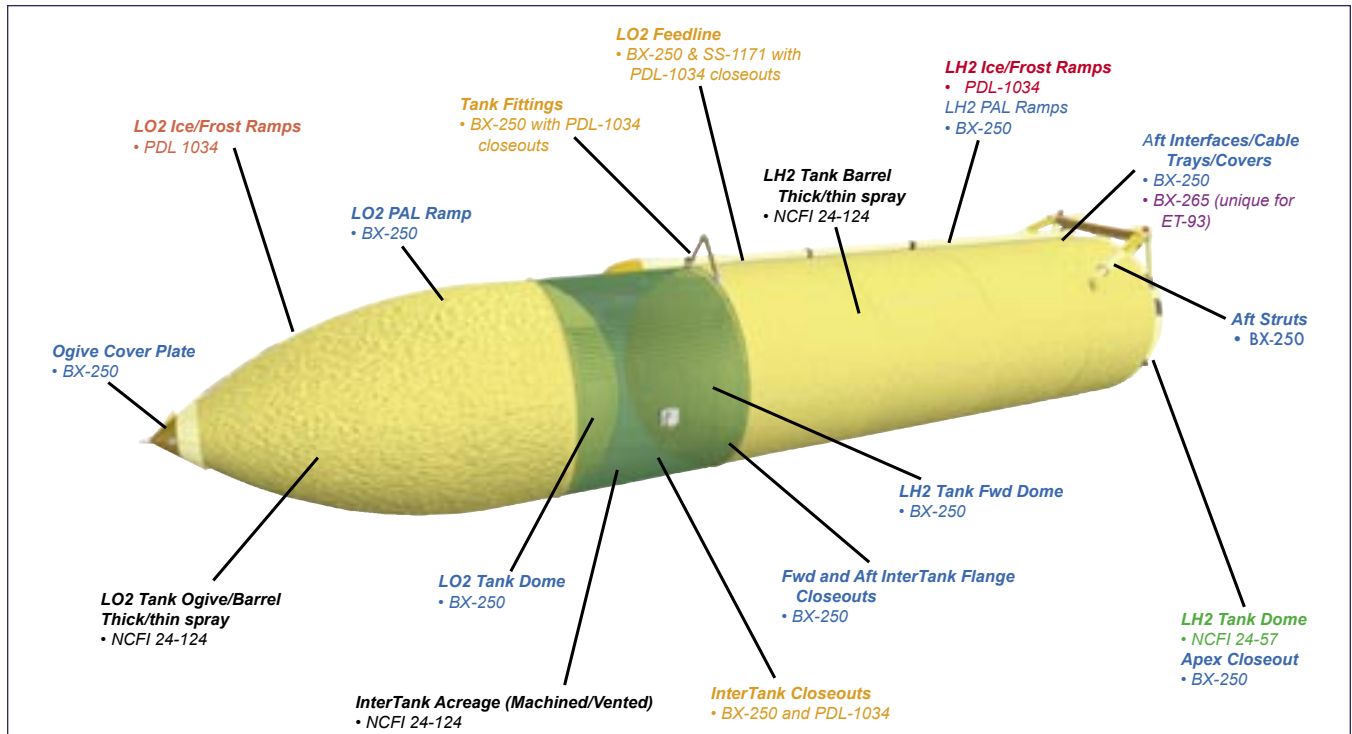

Figure 3.2-4. Locations of the various foam systems as used on ET-93, the External Tank used for STS-107.

oxygen and hydrogen in a liquid state, and to maintain the temperature of external parts high enough to prevent ice and frost from forming on the surface. Figure 3.2-4 summarizes the foam systems used on the External Tank for STS-107.

The adhesion between sprayed-on foam insulation and the External Tank's aluminum substrate is actually quite good, provided that the substrate has been properly cleaned and primed. (Poor surface preparation does not appear to have been a problem in the past.) In addition, large areas of the aluminum substrate are usually heated during foam application to ensure that the foam cures properly and develops the maximum adhesive strength. The interface between the foam and the aluminum substrate experiences stresses due to differences in how much the aluminum and the foam contract when subjected to cryogenic temperatures, and due to the stresses on the External Tank's aluminum structure while it serves as the backbone of the Shuttle stack. While these stresses at the foam-aluminum interface are certainly not trivial, they do not appear to be excessive, since very few of the observed foam loss events indicated that the foam was lost down to the primed aluminum substrate.

Throughout the history of the External Tank, factors unrelated to the insulation process have caused foam chemistry changes (Environmental Protection Agency regulations and material availability, for example). The most recent changes resulted from modifications to governmental regulations of chlorofluorocarbons.

Most of the External Tank is insulated with three types of spray-on foam. NCFI 24-124, a polyisocyanurate foam applied with blowing agent HCFC 141b hydrochlorofluorocar-

bon, is used on most areas of the liquid oxygen and liquid hydrogen tanks. NCFI 24-57, another polyisocyanurate foam applied with blowing agent HCFC 141b hydrochlorofluorocarbon, is used on the lower liquid hydrogen tank dome. BX-250, a polyurethane foam applied with CFC-11 chlorofluorocarbon, was used on domes, ramps, and areas where the foam is applied by hand. The foam types changed on External Tanks built after External Tank 93, which was used on STS-107, but these changes are beyond the scope of this section.

Metallic sections of the External Tank that will be insulated with foam are first coated with an epoxy primer. In some areas, such as on the bipod hand-sculpted regions, foam is applied directly over ablator materials. Where foam is applied over cured or dried foam, a bonding enhancer called Conathane is first applied to aid the adhesion between the two foam coats.

After foam is applied in the intertank region, the larger areas of foam coverage are machined down to a thickness of about an inch. Since controlling weight is a major concern for the External Tank, this machining serves to reduce foam thickness while still maintaining sufficient insulation.

The insulated region where the bipod struts attach to the External Tank is structurally, geometrically, and materially complex. Because of concerns that foam applied over the fittings would not provide enough protection from the high heating of exposed surfaces during ascent, the bipod fittings are coated with ablators. BX-250 foam is sprayed by hand over the fittings (and ablator materials), allowed to dry, and manually shaved into a ramp shape. The foam is visually

inspected at the Michoud Assembly Facility and also at the Kennedy Space Center, but no other non-destructive evaluation is performed.

Since the Shuttle's inaugural flight, the shape of the bipod ramp has changed twice. The bipod foam ramps on External Tanks 1 through 13 originally had a 45-degree ramp angle. On STS-7, foam was lost from the External Tank bipod ramp; subsequent wind tunnel testing showed that shallower angles were aerodynamically preferable. The ramp angle was changed from 45 degrees to between 22 and 30 degrees on External Tank 14 and later tanks. A slight modification to the ramp impingement profile, implemented on External Tank 76 and later, was the last ramp geometry change.

STS-107 Left Bipod Foam Ramp Loss

A combination of factors, rather than a single factor, led to the loss of the left bipod foam ramp during the ascent of STS-107. NASA personnel believe that testing conducted during the investigation, including the dissection of as-built hardware and testing of simulated defects, showed conclusively that pre-existing defects in the foam were a major factor, and in briefings to the Board, these were cited as a necessary condition for foam loss. However, analysis indicated that pre-existing defects alone were not responsible for foam loss.

The basic External Tank was designed more than 30 years ago. The design process then was substantially different than it is today. In the 1970s, engineers often developed particular facets of a design (structural, thermal, and so on) one after another and in relative isolation from other engineers working on different facets. Today, engineers usually work together on all aspects of a design as an integrated team. The bipod fitting was designed first from a structural standpoint, and the application processes for foam (to prevent ice formation) and Super Lightweight Ablator (to protect from high heating) were developed separately. Unfortunately, the structurally optimum fitting design, along with the geometric complexity of its location (near the flange between the intertank and the liquid hydrogen tank), posed many problems in the application of foam and Super Lightweight Ablator that would lead to foam-ramp defects.

Although there is no evidence that substandard methods were used to qualify the bipod ramp design, tests made nearly three decades ago were rudimentary by today's standards and capabilities. Also, testing did not follow the often-used engineering and design philosophy of "Fly what you test and test what you fly." Wind tunnel tests observed the aerodynamics and strength of two geometries of foam bipod enclosures (flat-faced and a 20-degree ramp), but these tests were done on essentially solid foam blocks that were not sprayed onto the complex bipod fitting geometry. Extensive material property tests gauged the strength, insulating potential, and ablative characteristics of foam and Super Lightweight Ablator specimens.

It was – and still is – impossible to conduct a ground-based, simultaneous, full-scale simulation of the combination of loads, airflows, temperatures, pressures, vibration, and acoustics the External Tank experiences during launch and

ascent. Therefore, the qualification testing did not truly reflect the combination of factors the bipod would experience during flight. Engineers and designers used the best methods available at the time: test the bipod and foam under as many severe combinations as could be simulated and then interpolate the results. Various analyses determined stresses, thermal gradients, air loads, and other conditions that could not be obtained through testing.

Significant analytical advancements have been made since the External Tank was first conceived, particularly in computational fluid dynamics (see Figure 3.2-5). Computational fluid dynamics comprises a computer-generated model that represents a system or device and uses fluid-flow physics and software to create predictions of flow behavior, and stress or deformation of solid structures. However, analysis must always be verified by test and/or flight data. The External Tank and the bipod ramp were not tested in the complex flight environment, nor were fully instrumented External Tanks ever launched to gather data for verifying analytical tools. The accuracy of the analytical tools used to simulate the External Tank and bipod ramp were verified only by using flight and test data from other Space Shuttle regions.

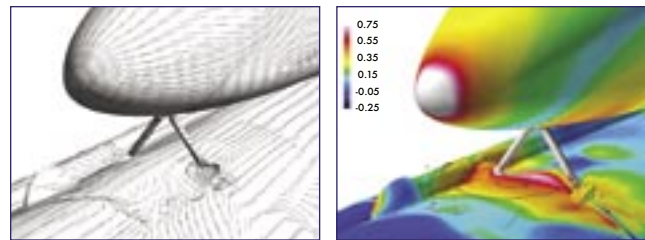

Figure 3.2-5. Computational Fluid Dynamics was used to understand the complex flow fields and pressure coefficients around bipod strut. The flight conditions shown here approximate those present when the left bipod foam ramp was lost from External Tank 93 at Mach 2.46 at a 2.08-degree angle of attack.

Further complicating this problem, foam does not have the same properties in all directions, and there is also variability in the foam itself. Because it consists of small hollow cells, it does not have the same composition at every point. This combination of properties and composition makes foam extremely difficult to model analytically or to characterize physically. The great variability in its properties makes for difficulty in predicting its response in even relatively static conditions, much less during the launch and ascent of the Shuttle. And too little effort went into understanding the origins of this variability and its failure modes.

The way the foam was produced and applied, particularly in the bipod region, also contributed to its variability. Foam consists of two chemical components that must be mixed in an exact ratio and is then sprayed according to strict specifications. Foam is applied to the bipod fitting by hand to make the foam ramp, and this process may be the primary source of foam variability. Board-directed dissection of foam ramps has revealed that defects (voids, pockets, and debris) are likely due to a lack of control of various combinations of parameters in spray-by-hand applications, which

is exacerbated by the complexity of the underlying hardware configuration. These defects often occur along “knit lines,” the boundaries between each layer that are formed by the repeated application of thin layers – a detail of the spray-by-hand process that contributes to foam variability, suggesting that while foam is sprayed according to approved procedures, these procedures may be questionable if the people who devised them did not have a sufficient understanding of the properties of the foam.

Subsurface defects can be detected only by cutting away the foam to examine the interior. Non-destructive evaluation techniques for determining External Tank foam strength have not been perfected or qualified (although non-destructive testing has been used successfully on the foam on Boeing’s new Delta IV booster, a design of much simpler geometry than the External Tank). Therefore, it has been impossible to determine the quality of foam bipod ramps on any External Tank. Furthermore, multiple defects in some cases can combine to weaken the foam along a line or plane.

“Cryopumping” has long been theorized as one of the processes contributing to foam loss from larger areas of coverage. If there are cracks in the foam, and if these cracks lead through the foam to voids at or near the surface of the liquid oxygen and liquid hydrogen tanks, then air, chilled by the extremely low temperatures of the cryogenic tanks, can liquefy in the voids. After launch, as propellant levels fall and aerodynamic heating of the exterior increases, the temperature of the trapped air can increase, leading to boiling and evaporation of the liquid, with concurrent buildup of pressure within the foam. It was believed that the resulting rapid increase in subsurface pressure could cause foam to break away from the External Tank.

“Cryoingestion” follows essentially the same scenario, except it involves gaseous nitrogen seeping out of the intertank and liquefying inside a foam void or collecting in the Super Lightweight Ablator. (The intertank is filled with nitrogen during tanking operations to prevent condensation and also to prevent liquid hydrogen and liquid oxygen from combining.) Liquefying would most likely occur in the circumferential “Y” joint, where the liquid hydrogen tank mates with the intertank, just above the liquid hydrogen-intertank flange. The bipod foam ramps straddle this complex feature. If pooled liquid nitrogen contacts the liquid hydrogen tank, it can solidify, because the freezing temperature of liquid nitrogen (minus 348 degrees Fahrenheit) is higher than the temperature of liquid hydrogen (minus 423 degrees Fahrenheit). As with cryopumping, cryoingested liquid or solid nitrogen could also “flash evaporate” during launch and ascent, causing the foam to crack off. Several paths allow gaseous nitrogen to escape from the intertank, including beneath the flange, between the intertank panels, through the rivet holes that connect stringers to intertank panels, and through vent holes beneath the stringers that prevent overpressurization of the stringers.

No evidence suggests that defects or cryo-effects alone caused the loss of the left bipod foam ramp from the STS-107 External Tank. Indeed, NASA calculations have suggested that during ascent, the Super Lightweight Ablator

remains just slightly above the temperature at which nitrogen liquefies, and that the outer wall of the hydrogen tank near the bipod ramp does not reach the temperature at which nitrogen boils until 150 seconds into the flight,³ which is too late to explain the only two bipod ramp foam losses whose times during ascent are known. Recent tests at the Marshall Space Flight Center revealed that flight conditions could permit ingestion of nitrogen or air into subsurface foam, but would not permit “flash evaporation” and a sufficient subsurface pressure increase to crack the foam. When conditions are modified to force a flash evaporation, the failure mode in the foam is a crack that provides pressure relief rather than explosive cracking. Therefore, the flight environment itself must also have played a role. Aerodynamic loads, thermal and vacuum effects, vibrations, stress in the External Tank structure, and myriad other conditions may have contributed to the growth of subsurface defects, weakening the foam ramp until it could no longer withstand flight conditions.

Conditions in certain combinations during ascent may also have contributed to the loss of the foam ramp, even if individually they were well within design certification limits. These include a wind shear, associated Solid Rocket Booster and Space Shuttle Main Engine responses, and liquid oxygen sloshing in the External Tank.⁴ Each of these conditions, alone, does not appear to have caused the foam loss, but their contribution to the event in combination is unknown.

Negligence on the part of NASA, Lockheed Martin, or United Space Alliance workers does not appear to have been a factor. There is no evidence of sabotage, either during production or pre-launch. Although a Problem Report was written for a small area of crushed foam near the left bipod (a condition on nearly every flight), this affected only a very small region and does not appear to have contributed to the loss of the ramp (see Chapter 4 for a fuller discussion). Nor does the basic quality of the foam appear to be a concern. Many of the basic components are continually and meticulously tested for quality before they are applied. Finally, despite commonly held perceptions, numerous tests show that moisture absorption and ice formation in the foam appears negligible.

Foam loss has occurred on more than 80 percent of the 79 missions for which imagery is available, and foam was lost from the left bipod ramp on nearly 10 percent of missions where the left bipod ramp was visible following External Tank separation. For about 30 percent of all missions, there is no way to determine if foam was lost; these were either night launches, or the External Tank bipod ramp areas were not in view when the images were taken. The External Tank was not designed to be instrumented or recovered after separation, which deprives NASA of physical evidence that could help pinpoint why foam separates from it.

The precise reasons why the left bipod foam ramp was lost from the External Tank during STS-107 may never be known. The specific initiating event may likewise remain a mystery. However, it is evident that a combination of variable and pre-existing factors, such as insufficient testing and analysis in the early design stages, resulted in a highly variable and complex foam material, defects induced by an imperfect

FOAM FRACTURE UNDER HYDROSTATIC PRESSURE

The Board has concluded that the physical cause of the breakup of *Columbia* upon re-entry was the result of damage to the Orbiter's Thermal Protection System, which occurred when a large piece of BX-250 foam insulation fell from the left (-Y) bipod assembly 81.7 seconds after launch and struck the leading edge of the left wing. As the External Tank is covered with insulating foam, it seemed to me essential that we understand the mechanisms that could cause foam to shed.

Many if not most of the systems in the three components of the Shuttle stack (Orbiter, External Tank, and Solid Rocket Boosters) are by themselves complex, and often operate near the limits of their performance. Attempts to understand their complex behavior and failure modes are hampered by their strong interactions with other systems in the stack, through their shared environment. The foam of the Thermal Protection System is no exception. To understand the behavior of systems under such circumstances, one must first understand their behavior in relatively simple limits. Using this understanding as a guide, one is much more likely to determine the mechanisms of complex behavior, such as the shedding of foam from the -Y bipod ramp, than simply creating simulations of the complex behavior itself.

I approached this problem by trying to imagine the fracture mechanism by which fluid pressure built up inside the foam could propagate to the surface. Determining this process is clearly key to understanding foam ejection through the heating of cryogenic fluids trapped in voids beneath the surface of the foam, either through "cryopumping" or "cryoingestion." I started by imagining a fluid under hydrostatic pressure in contact with the surface of such foam. It seemed clear that as the pressure increased, it would cause the weakest cell wall to burst, filling the adjacent cell with the fluid, and exerting the same hydrostatic pressure on all the walls of that cell. What happened next was unclear. It was possible that the next cell wall to burst would not be one of the walls of the newly filled cell, but some other cell that had been on the surface that was initially subjected to the fluid pressure. This seemed like a rather complex process, and I questioned my ability to include all the physics correctly if I tried to model it. Instead, I chose to perform an experiment that seemed straightforward, but which had a result I could not have foreseen.

I glued a 1.25-inch-thick piece of BX-250 foam to a 0.25-inch-thick brass plate. The 3-by-3-inch plate had a 0.25-inch-diameter hole in its center, into which a brass tube was soldered. The tube was filled with a liquid dye, and the air pressure above the dye could be slowly raised, using a battery-operated tire pump to which a pressure regulator was attached until the fluid was forced through the foam to its outer surface. Not knowing what to expect, the first time I tried this experiment with my graduate student, Jim Baumgardner, we did so out on the loading dock of the Stanford Physics Department. If this process were to mimic the cryoejection of foam, we expected a violent explosion when the pressure burst through the surface. To keep from being showered with dye, we put the assembly in a closed cardboard box, and donned white lab coats.

Instead of a loud explosion, we heard nothing. We found, though, that the pressure above the liquid began dropping once the gas pressure reached about 45 pounds per square inch. Releasing the pressure and opening the box, we found a thin crack, about a half-inch long, at the upper surface of the foam. Curious about the path the pressure had taken to reach the surface, I cut the foam off the brass plate, and made two vertical cuts through the foam in line with the crack. When I bent the foam in line with the crack, it separated into two sections along the crack. The dye served as a tracer for where the fluid had traveled in its path through the foam. This path was along a flat plane, and was

the shape of a teardrop that intersected perpendicular to the upper surface of the foam. Since the pressure could only exert force in the two directions perpendicular to this fault plane, it could not possibly result in the ejection of foam, because that would require a force perpendicular to the surface of the foam. I repeated this experiment with several pieces of foam and always found the same behavior.

I was curious why the path of the pressure fault was planar, and why it had propagated upward, nearly perpendicular to the outer surface of the foam. For this sample, and most of the samples that NASA had given me, the direction of growth of the foam was vertical, as evidenced by horizontal "knit lines" that result from successive applications of the sprayed foam. The knit lines are perpendicular to the growth direction. I then guessed that the growth of the pressure fault was influenced by the foam's direction of growth. To test this hypothesis, I found a piece of foam for which the growth direction was vertical near the top surface of the foam, but was at an approximately 45-degree angle to the vertical near the bottom. If my hypothesis were correct, the direction of growth of the pressure fault would follow the direction of growth of the foam, and hence would always intersect the knit lines at 90 degrees. Indeed, this was the case.

The reason the pressure fault is planar has to do with the fact that such a geometry can amplify the fluid pressure, creating a much greater stress on the cell walls near the outer edges of the teardrop, for a given hydrostatic pressure, than would exist for a spherical pressure-filled void. A pressure fault follows the direction of foam growth because more cell walls have their surfaces along this direction than along any other. The stiffness of the foam is highest when you apply a force parallel to the cell walls. If you squeeze a cube of foam in various directions, you find that the foam is stiffest along its growth direction. By advancing along the stiff direction, the crack is oriented so that the fluid pressure can more easily force the (nearly) planar walls of the crack apart.

Because the pressure fault intersects perpendicular to the upper surface, hydrostatic pressure will *generally* not lead to foam shedding. There are, however, cases where pressure *can* lead to foam shedding, but this will only occur when the fluid pressure exists over an area whose dimensions are large compared to the thickness of the foam above it, and roughly parallel to the outer surface. This would require a large structural defect within the foam, such as the delamination of the foam from its substrate or the separation of the foam at a knit line. Such large defects are quite different from the small voids that occur when gravity causes uncured foam to "roll over" and trap a small bubble of air.

Experiments like this help us understand how foam shedding does (and doesn't) occur, because they elucidate the properties of "perfect" foam, free from voids and other defects. Thus, this behavior represents the true behavior of the foam, free from defects that may or may not have been present. In addition, these experiments are fast and cheap, since they can be carried out on relatively small pieces of foam in simple environments. Finally, we can understand why the observed behavior occurs from our understanding of the basic physical properties of the foam itself. By contrast, if you wish to mimic left bipod foam loss, keep in mind that such loss could have been detected only 7 times in 72 instances. Thus, not observing foam loss in a particular experiment will not insure that it would never happen under the same conditions at a later time. NASA is now undertaking both kinds of experiments, but it is the simple studies that so far have most contributed to our understanding of foam failure modes.

Douglas Osheroff, Board Member

and variable application, and the results of that imperfect process, as well as severe load, thermal, pressure, vibration, acoustic, and structural launch and ascent conditions.

Findings:

- F3.2-1 NASA does not fully understand the mechanisms that cause foam loss on almost all flights from larger areas of foam coverage and from areas that are sculpted by hand.
- F3.2-2 There are no qualified non-destructive evaluation techniques for the as-installed foam to determine the characteristics of the foam before flight.
- F3.2-3 Foam loss from an External Tank is unrelated to the tank's age and to its total pre-launch exposure to the elements. Therefore, the foam loss on STS-107 is unrelated to either the age or exposure of External Tank 93 before launch.
- F3.2-4 The Board found no indications of negligence in the application of the External Tank Thermal Protection System.
- F3.2-5 The Board found instances of left bipod ramp shedding on launch that NASA was not aware of, bringing the total known left bipod ramp shedding events to 7 out of 72 missions for which imagery of the launch or External Tank separation is available.
- F3.2-6 Subsurface defects were found during the dissection of three bipod foam ramps, suggesting that similar defects were likely present in the left bipod ramp of External Tank 93 used on STS-107.
- F3.2-7 Foam loss occurred on more than 80 percent of the 79 missions for which imagery was available to confirm or rule out foam loss.
- F3.2-8 Thirty percent of all missions lacked sufficient imagery to determine if foam had been lost.
- F3.2-9 Analysis of numerous separate variables indicated that none could be identified as the sole initiating factor of bipod foam loss. The Board therefore concludes that a combination of several factors resulted in bipod foam loss.

Recommendation:

- R3.2-1 Initiate an aggressive program to eliminate all External Tank Thermal Protection System debris-shedding at the source with particular emphasis on the region where the bipod struts attach to the External Tank.

3.3 WING LEADING EDGE STRUCTURAL SUBSYSTEM

The components of the Orbiter's wing leading edge provide the aerodynamic load bearing, structural, and thermal control capability for areas that exceed 2,300 degrees Fahrenheit. Key design requirements included flying 100 missions with minimal refurbishment, maintaining the aluminum wing structure at less than 350 degrees Fahrenheit, withstanding a kinetic energy impact of 0.006 foot-pounds, and the ability to withstand 1.4 times the load ever expected in operation.⁵ The requirements specifically stated that the

REINFORCED CARBON-CARBON (RCC)

The basic RCC composite is a laminate of graphite-impregnated rayon fabric, further impregnated with phenolic resin and layered, one ply at a time, in a unique mold for each part, then cured, rough-trimmed, drilled, and inspected. The part is then packed in calcined coke and fired in a furnace to convert it to carbon and is made more dense by three cycles of furfuryl alcohol vacuum impregnation and firing.

To prevent oxidation, the outer layers of the carbon substrate are converted into a 0.02-to-0.04-inch-thick layer of silicon carbide in a chamber filled with argon at temperatures up to 3,000 degrees Fahrenheit. As the silicon carbide cools, "craze cracks" form because the thermal expansion rates of the silicon carbide and the carbon substrate differ. The part is then repeatedly vacuum-impregnated with tetraethyl orthosilicate to fill the pores in the substrate, and the craze cracks are filled with a sealant.

wing leading edge would not need to withstand impact from debris or ice, since these objects would not pose a threat during the launch phase.⁶

Reinforced Carbon-Carbon

The development of Reinforced Carbon-Carbon (RCC) as part of the Thermal Protection System was key to meeting the wing leading edge design requirements. Developed by Ling-Temco-Vought (now Lockheed Martin Missiles and Fire Control), RCC is used for the Orbiter nose cap, chin panel, forward External Tank attachment point, and wing leading edge panels and T-seals. RCC is a hard structural material, with reasonable strength across its operational temperature range (minus 250 degrees Fahrenheit to 3,000 degrees). Its low thermal expansion coefficient minimizes thermal shock and thermoelastic stress.

Each wing leading edge consists of 22 RCC panels (see Figure 3.3-1), numbered from 1 to 22 moving outward on each wing (the nomenclature is "5-left" or "5-right" to differentiate, for example, the two number 5 panels). Because the shape of the wing changes from inboard to outboard, each panel is unique.

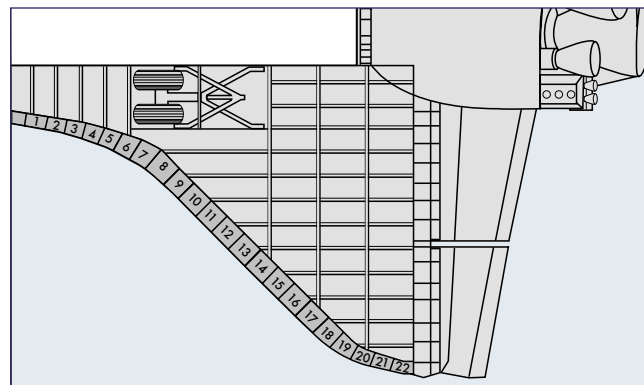

Figure 3.3-1. There are 22 panels of Reinforced Carbon-Carbon on each wing, numbered as shown above.

Wing Leading Edge Damage

The risk of micrometeoroid or debris damage to the RCC panels has been evaluated several times. Hypervelocity impact testing, using nylon, glass, and aluminum projectiles, as well as low-velocity impact testing with ice, aluminum, steel, and lead projectiles, resulted in the addition of a 0.03- to 0.06-inch-thick layer of Nextel-440 fabric between the Inconel foil and Cerachrome insulation. Analysis of the design change predicts that the Orbiter could survive re-entry with a quarter-inch diameter hole in the lower surfaces of RCC panels 8 through 10 or with a one-inch hole in the rest of the RCC panels.

RCC components have been struck by objects throughout their operational life, but none of these components has been completely penetrated. A sampling of 21 post-flight reports noted 43 hypervelocity impacts, the largest being 0.2 inch. The most significant low-velocity impact was to *Atlantis*' panel 10-right during STS-45 in March and April 1992. The damaged area was 1.9 inches by 1.6 inches on the exterior surface and 0.5 inches by 0.1 inches in the interior surface. The substrate was exposed and oxidized, and the panel was scrapped. Analysis concluded that the damage was caused by a strike by a man-made object, possibly during ascent. Figures 3.3-2 and 3.3-3 show the damage to the outer and inner surfaces, respectively.

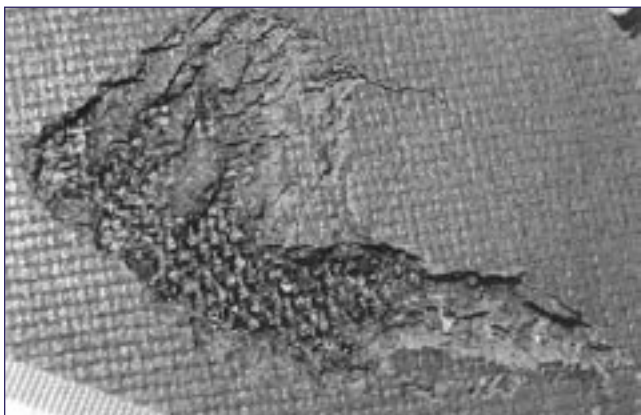

Figure 3.3-2. Damage on the outer surface of RCC panel 10-right from *Atlantis* after STS-45.

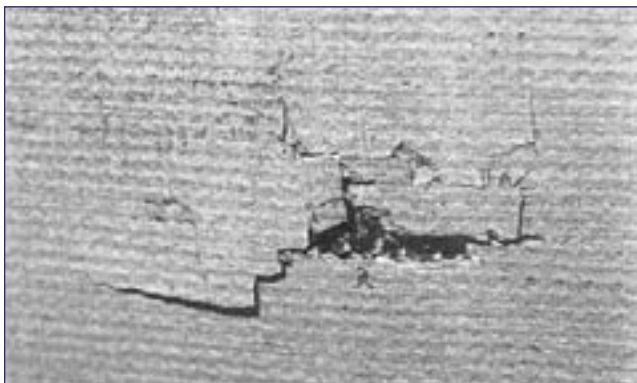

Figure 3.3-3. Damage on the inner surface of RCC panel 10-right from *Atlantis* after STS-45.

Leading Edge Maintenance

Post-flight RCC component inspections for cracks, chips, scratches, pinholes, and abnormal discoloration are primarily visual, with tactile evaluations (pushing with a finger) of some regions. Boeing personnel at the Kennedy Space Center make minor repairs to the silicon carbide coating and surface defects.

With the goal of a long service life, panels 6 through 17 are refurbished every 18 missions, and panels 18 and 19 every 36 missions. The remaining panels have no specific refurbishment requirement.

At the time of STS-107, most of the RCC panels on *Columbia*'s left wing were original equipment, but panel 10-left, T-seal 10-left, panel 11-left, and T-seal 11-left had been replaced (along with panel 12 on the right wing). Panel 10-left was tested to destruction after 19 flights. Minor surface repairs had been made to panels 5, 7, 10, 11, 12, 13, and 19 and T-seals 3, 11, 12, 13, 14, and 19. Panels and T-seals 6 through 9 and 11 through 17 of the left wing had been refurbished.

Reinforced Carbon-Carbon Mission Life

The rate of oxidation is the most important variable in determining the mission life of RCC components. Oxidation of the carbon substrate results when oxygen penetrates the microscopic pores or fissures of the silicon carbide protective coating. The subsequent loss of mass due to oxidation reduces the load the structure can carry and is the basis for establishing a mission life limit. The oxidation rate is a function of temperature, pressure, time, and the type of heating. Repeated exposure to the Orbiter's normal flight environment degrades the protective coating system and accelerates the loss of mass, which weakens components and reduces mission life capability.

Currently, mass loss of flown RCC components cannot be directly measured. Instead, mass loss and mission life reduction are predicted analytically using a methodology based on mass loss rates experimentally derived in simulated re-entry environments. This approach then uses derived re-entry temperature-time profiles of various portions of RCC components to estimate the actual re-entry mass loss.

For the first five missions of *Columbia*, the RCC components were not coated with Type A sealant, and had shorter mission service lives than the RCC components on the other Orbiters. (*Columbia*'s panel 9 has the shortest mission service life of 50 flights as shown in Figure 3.3-4.) The predicted life for panel/T-seals 7 through 16 range from 54 to 97 flights.⁷

Localized penetration of the protective coating on RCC components (pinholes) were first discovered on *Columbia* in 1992, after STS-50, *Columbia*'s 12th flight. Pinholes were later found in all Orbiters, and their quantity and size have increased as flights continue. Tests showed that pinholes were caused by zinc oxide contamination from a primer used on the launch pad.

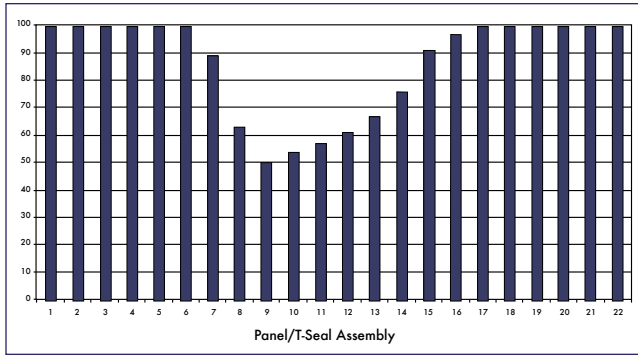

Figure 3.3-4. The expected mission life for each of the wing leading edge RCC panels on Columbia. Note that panel 9 has the shortest life expectancy.

In October 1993, panel 12-right was removed from *Columbia* after its 15th flight for destructive evaluation. Optical and scanning electron microscope examinations of 15 pinholes revealed that a majority occurred along craze cracks in the thick regions of the silicon carbide layer. Pinhole glass chemistry revealed the presence of zinc, silicon, oxygen, and aluminum. There is no zinc in the leading edge support system, but the launch pad corrosion protection system uses an inorganic zinc primer under a coat of paint, and this coat of paint is not always refurbished after a launch. Rain samples from the Rotating Support Structure at Launch Complex 39-A in July 1994 confirmed that rain washed the unprotected primer off the service structure and deposited it on RCC panels while the Orbiter sat on the launch pad. At the request of the Columbia Accident Investigation Board, rain samples were again collected in May 2003. The zinc

LEFT WING AND WING LEADING EDGE

The Orbiter wing leading edge structural subsystem consists of the RCC panels, the upper and lower access panels (also called carrier panels), and the associated attachment hardware for each of these components.

On *Columbia*, two upper and lower A-286 stainless steel spar attachment fittings connected each RCC panel to the aluminum wing leading edge spar. On later Orbiters, each upper and lower spar attachment fitting is a one-piece assembly.

The space between each RCC panel is covered by a gap seal, also known as a T-seal. Each T-seal, also manufactured from RCC, is attached to its associated RCC panel by two Inconel 718 attachment clevises. The upper and lower carrier panels, which allow access behind each RCC panel, are attached to the spar attachment fittings after the RCC panels and T-seals are installed. The lower carrier panel prevents superheated air from entering

the RCC panel cavity. A small space between the upper carrier panel and the RCC panel allows air pressure to equalize behind the RCC panels during ascent and re-entry.

The mid-wing area on the left wing, behind where the breach occurred, is supported by a series of trusses, as shown in red in the figure below. The mid-wing area is bounded in the front and back by the Xo1040 and Xo1191 cross spars, respectively. The numerical designation of each spar comes from its location along the Orbiter's X-axis; for example, the Xo1040 spar is 1,040 inches from the zero point on the X-axis. The cross spars provide the wing's structural integrity. Three major cross spars behind the Xo1191 spar provide the primary structural strength for the aft portion of the wing. The inboard portion of the mid-wing is the outer wall of the left wheel-well, and the outboard portion of the mid-wing is the wing leading edge spar, where the RCC panels attach.

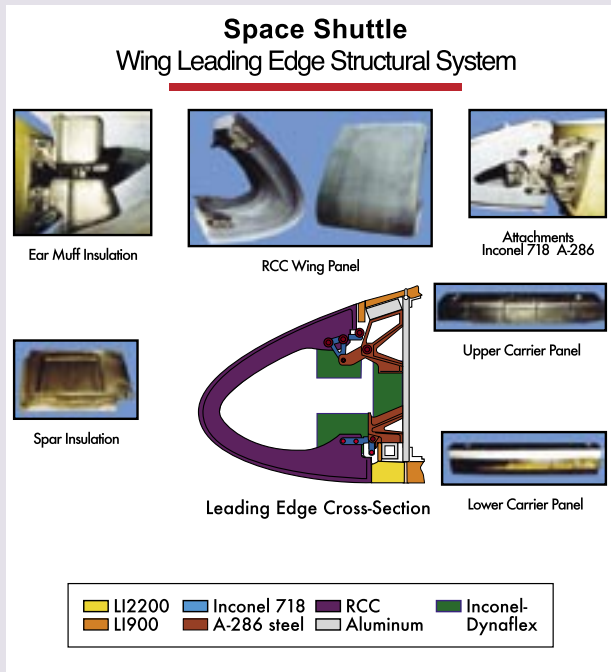

The Wing Leading Edge Structural System on Columbia.

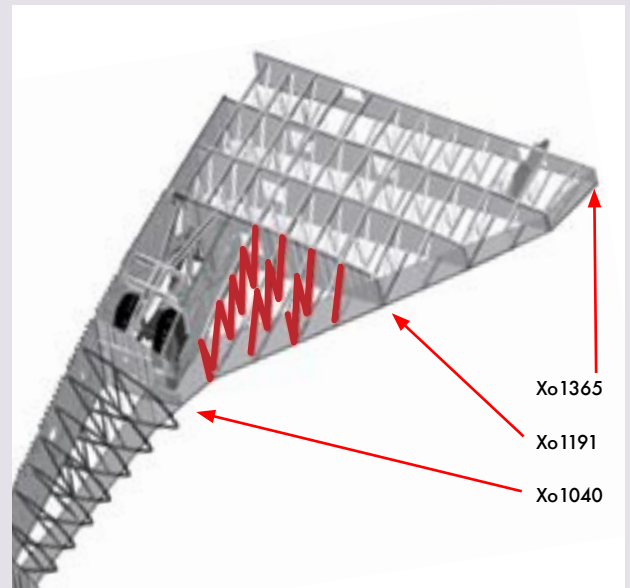

The major internal support structures in the mid-wing are constructed from aluminum alloy. Since aluminum melts at 1,200 degrees Fahrenheit, it is likely these truss tubes in the mid-wing were destroyed and wing structural integrity was lost.

fallout rate was generally less than previously recorded except for one location, which had the highest rate of zinc fallout of all the samples from both evaluations. Chemical analysis of the most recent rainwater samples determined the percentage of zinc to be consistently around nine percent, with that one exception.

Specimens with pinholes were fabricated from RCC panel 12-right and arc-jet-tested, but the arc-jet testing did not substantially change the pinhole dimensions or substrate oxidation. (Arc jet testing is done in a wind tunnel with an electrical arc that provides an airflow of up to 2,800 degrees Fahrenheit.) As a result of the pinhole investigation, the sealant refurbishment process was revised to include cleaning the part in a vacuum at 2,000 degrees Fahrenheit to bake out contaminants like zinc oxide and salt, and forcing sealant into pinholes.

Post-flight analysis of RCC components confirms that sealant is ablated during each mission, which increases subsurface oxidation and reduces component strength and mission life. Based on the destructive evaluation of *Columbia's* panel 12-right and various arc-jet tests, refurbishment intervals were established to achieve the desired service life.

In November 2001, white residue was discovered on about half the RCC panels on *Columbia*, *Atlantis*, and *Endeavour*. Investigations revealed that the deposits were sodium carbonate that resulted from the exposure of sealant to rainwater, with three possible outcomes: (1) the deposits are washed off, which decreases sealant effectiveness; (2) the deposits remain on the part's surface, melt on re-entry, and combine with the glass, restoring the sealant composition; or (3) the deposits remain on the part's surface, melt on re-entry, and flow onto metal parts.

The root cause of the white deposits on the surface of RCC parts was the breakdown of the sealant. This does not damage RCC material.

Non-Destructive Evaluations of Reinforced Carbon-Carbon Components

Over the 20 years of Space Shuttle operations, RCC has performed extremely well in the harsh environment it is exposed to during a mission. Within the last several years, a few instances of damage to RCC material have resulted in a re-examination of the current visual inspection process. Concerns about potential oxidation between the silicon carbide layer and the substrate and within the substrate has resulted in further efforts to develop improved Non-Destructive Evaluation methods and a better understanding of subsurface oxidation.

Since 1997, inspections have revealed five instances of RCC silicon carbide layer loss with exposed substrate. In November 1997, *Columbia* returned from STS-87 with three damaged RCC parts with carbon substrate exposed. Panel 19-right had a 0.04 inch-diameter by 0.035 inch-deep circular dimple, panel 17-right had a 0.1 inch-wide by 0.2 inch-long by 0.025-inch-deep dimple, and the Orbiter forward External Tank attachment point had a 0.2-inch by 0.15-inch

by 0.026-inch-deep dimple. In January 2000, after STS-103, *Discovery's* panel 8-left was scrapped because of similar damage (see Figure 3.3-5).

In April 2001, after STS-102, *Columbia's* panel 10-left had a 0.2-inch by 0.3-inch wide by 0.018-inch-deep dimple in the panel corner next to the T-seal. The dimple was repaired and the panel flew one more mission, then was scrapped because of damage found in the repair.

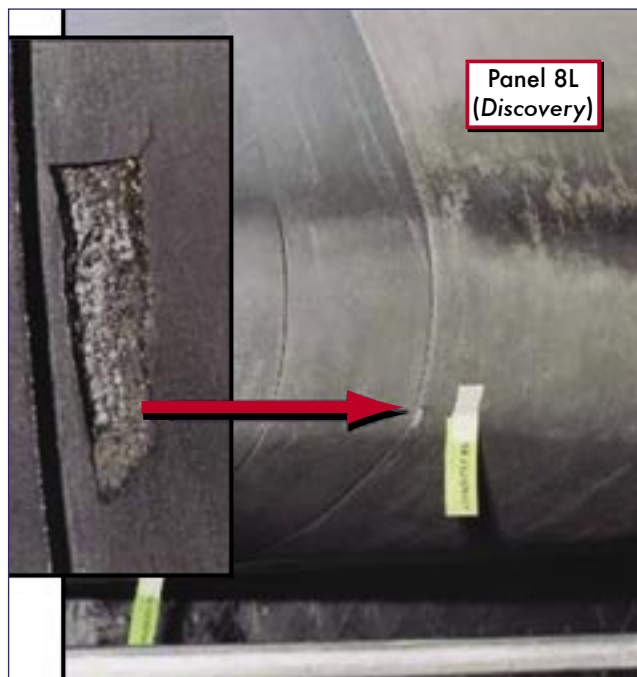

Figure 3.3-5. RCC panel 8-left from *Discovery* had to be scrapped after STS-103 because of the damage shown here.

Findings:

- F3.3-1 The original design specifications required the RCC components to have essentially no impact resistance.
- F3.3-2 Current inspection techniques are not adequate to assess structural integrity of the RCC components.
- F3.3-3 After manufacturer's acceptance non-destructive evaluation, only periodic visual and touch tests are conducted.
- F3.3-4 RCC components are weakened by mass loss caused by oxidation within the substrate, which accumulates with age. The extent of oxidation is not directly measurable, and the resulting mission life reduction is developed analytically.
- F3.3-5 To date, only two flown RCC panels, having achieved 15 and 19 missions, have been destructively tested to determine actual loss of strength due to oxidation.
- F3.3-6 Contamination from zinc leaching from a primer under the paint topcoat on the launch pad structure increases the opportunities for localized oxidation.

Recommendations:

- R3.3-1 Develop and implement a comprehensive inspection plan to determine the structural integrity of all Reinforced Carbon-Carbon system components. This inspection plan should take advantage of advanced non-destructive inspection technology.
- R3.3-2 Initiate a program designed to increase the Orbiter's ability to sustain minor debris damage by measures such as improved impact-resistant Reinforced Carbon-Carbon and acreage tiles. This program should determine the actual impact resistance of current materials and the effect of likely debris strikes.
- R3.3-3 To the extent possible, increase the Orbiter's ability to successfully re-enter the Earth's atmosphere with minor leading edge structural sub-system damage.
- R3.3-4 In order to understand the true material characteristics of Reinforced Carbon-Carbon components, develop a comprehensive database of flown Reinforced Carbon-Carbon material characteristics by destructive testing and evaluation.
- R3.3-5 Improve the maintenance of launch pad structures to minimize the leaching of zinc primer onto Reinforced Carbon-Carbon components.

3.4 IMAGE AND TRANSPORT ANALYSES

At 81.9 seconds after launch of STS-107, a sizable piece of foam struck the leading edge of *Columbia's* left wing. Visual evidence established the source of the foam as the left bipod ramp area of the External Tank. The widely accepted implausibility of foam causing significant damage to the wing leading edge system led the Board to conduct independent tests to characterize the impact. While it was impossible to determine the precise impact parameters because of uncertainties about the foam's density, dimensions, shape, and initial velocity, intensive work by the Board, NASA, and contractors provided credible ranges for these elements. The

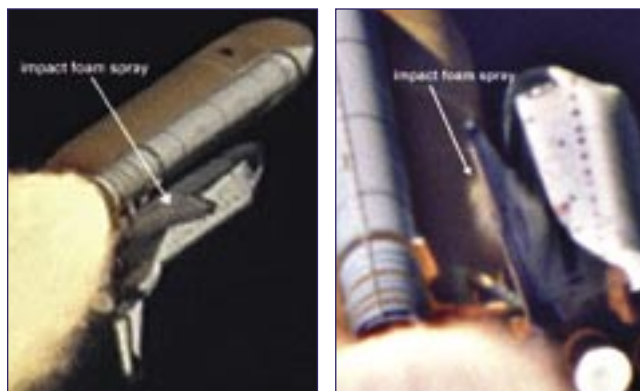

Figure 3.4-1 (color enhanced and "de-blurred" by Lockheed Martin Gaithersburg) and Figure 3.4-2 (processed by the National Imagery and Mapping Agency) are samples of the type of visual data used to establish the time of the impact (81.9 seconds), the altitude at which it occurred (65,860 feet), and the object's relative velocity at impact (about 545 mph relative to the Orbiter).

Board used a combination of tests and analyses to conclude that the foam strike observed during the flight of STS-107 was the direct, physical cause of the accident.

Image Analysis: Establishing Size, Velocity, Origin, and Impact Area

The investigation image analysis team included members from Johnson Space Center Image Analysis, Johnson Space Center Engineering, Kennedy Space Center Photo Analysis, Marshall Space Flight Center Photo Analysis, Lockheed Martin Management and Data Systems, the National Imagery and Mapping Agency, Boeing Systems Integration, and Langley Research Center. Each member of the image analysis team performed independent analyses using tools and methods of their own choosing. Representatives of the Board participated regularly in the meetings and deliberations of the image analysis team.

A 35-mm film camera, E212, which recorded the foam strike from 17 miles away, and video camera E208, which recorded it from 26 miles away, provided the best of the available evidence. Analysis of this visual evidence (see Figures 3.4-1 and 3.4-2) along with computer-aided design analysis, refined the potential impact area to less than 20 square feet in RCC panels 6 through 9 (see Figure 3.4-3), including a portion of the corresponding carrier panels and adjacent tiles. The investigation image analysis team found no conclusive visual evidence of post-impact debris flowing over the top of the wing.

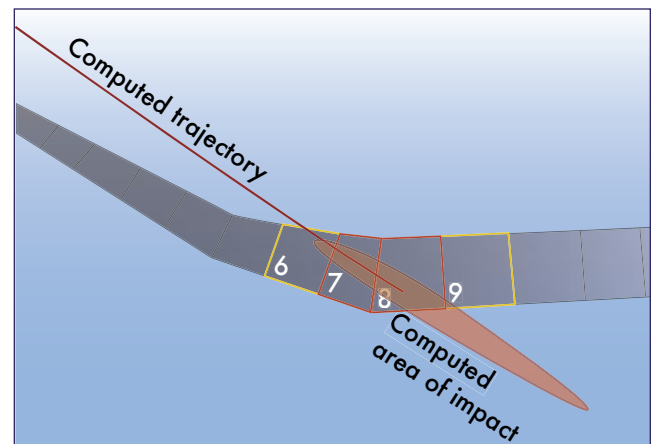

Figure 3.4-3: The best estimate of the site of impact by the center of the foam.

The image analysis team established impact velocities from 625 to 840 feet per second (about 400 to 600 mph) relative to the Orbiter, and foam dimensions from 21 to 27 inches long by 12 to 18 inches wide.⁸ The wide range for these measurements is due primarily to the cameras' relatively slow frame rate and poor resolution. For example, a 20-inch change in the position of the foam near the impact point would change the estimated relative impact speed from 675 feet per second to 825 feet per second. The visual evidence could not reveal the foam's shape, but the team was able to describe it as flat and relatively thin. The mass and hence the volume of the

foam was determined from the velocity estimates and their ballistic coefficients.

Image analysis determined that the foam was moving almost parallel to the Orbiter's fuselage at impact, with about a five-degree angle upward toward the bottom of the wing and slight motion in the outboard direction. If the foam had hit the tiles adjacent to the leading edge, the angle of incidence would have been about five degrees (the angle of incidence is the angle between the relative velocity of the projectile and the plane of the impacted surface). Because the wing leading edge curves, the angle of incidence increases as the point of impact approaches the apex of an RCC panel. Image and transport analyses estimated that for impact on RCC panel 8, the angle of incidence was between 10 and 20 degrees (see Figure 3.4-4).⁹ Because the total force delivered by the impact depends on the angle of incidence, a foam strike near the apex of an RCC panel could have delivered about twice the force as an impact close to the base of the panel.

Despite the uncertainties and potential errors in the data, the Board concurred with conclusions made unanimously by the post-flight image analysis team and concludes the information available about the foam impact during the mission was adequate to determine its effect on both the thermal tiles and RCC. Those conclusions made during the mission follow:

- The bipod ramp was the source of the foam.
- Multiple pieces of foam were generated, but there was no evidence of more than one strike to the Orbiter.
- The center of the foam struck the leading edge structural subsystem of the left wing between panels 6 to 9. The potential impact location included the corresponding carrier panels, T-seals, and adjacent tiles. (Based on further image analysis performed by the National Imagery and Mapping Agency, the transport analysis that follows, and forensic evidence, the Board concluded that a smaller estimated impact area in the immediate vicinity of panel 8 was credible.)
- Estimates of the impact location and velocities rely on timing of camera images and foam position measurements.
- The relative velocity of the foam at impact was 625 to 840 feet per second. (The Board agreed on a narrower speed range based on a transport analysis that follows.)
- The trajectory of the foam at impact was essentially parallel to the Orbiter's fuselage.
- The foam was making about 18 revolutions per second as it fell.
- The orientation at impact could not be determined.
- The foam that struck the wing was 24 (plus or minus 3) inches by 15 (plus or minus 3) inches. The foam shape could only be described as flat. (A subsequent transport analysis estimated a thickness.)
- Ice was not present on the external surface of the bipod ramp during the last Ice Team camera scan prior to launch (at approximately T-5 minutes).
- There was no visual evidence of the presence of other materials inside the bipod ramp.
- The foam impact generated a cloud of pulverized debris with very little component of velocity away from the wing.

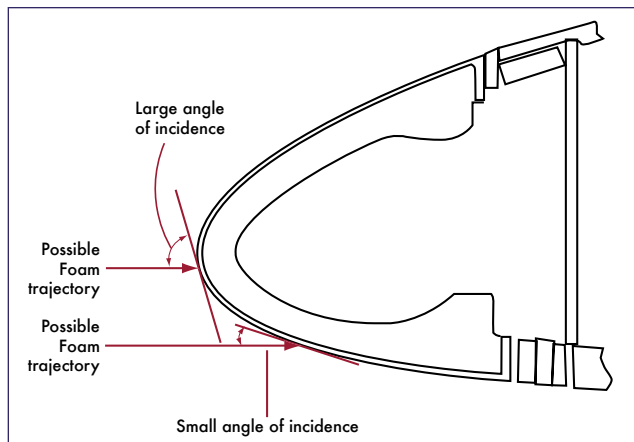

Figure 3.4-4. This drawing shows the curve of the wing leading edge and illustrates the difference the angle of incidence has on the effect of the foam strike.

- In addition, the visual evidence showed two sizable, traceable post-strike debris pieces with a significant component of velocity away from the wing.

Although the investigation image analysis team found no evidence of post-strike debris going over the top of the wing before or after impact, a colorimetric analysis by the National Imagery and Mapping Agency indicated the potential presence of debris material over the top of the left wing immediately following the foam strike. This analysis suggests that some of the foam may have struck closer to the apex of the wing than what occurred during the impact tests described below.

Imaging Issues

The image analysis was hampered by the lack of high resolution and high speed ground-based cameras. The existing camera locations are a legacy of earlier NASA programs, and are not optimum for the high-inclination Space Shuttle missions to the International Space Station and oftentimes

THE ORBITER "RAN INTO" THE FOAM

“How could a lightweight piece of foam travel so fast and hit the wing at 545 miles per hour?”

Just prior to separating from the External Tank, the foam was traveling with the Shuttle stack at about 1,568 mph (2,300 feet per second). Visual evidence shows that the foam debris impacted the wing approximately 0.161 seconds after separating from the External Tank. In that time, the velocity of the foam debris slowed from 1,568 mph to about 1,022 mph (1,500 feet per second). Therefore, the Orbiter hit the foam with a relative velocity of about 545 mph (800 feet per second). In essence, the foam debris slowed down and the Orbiter did not, so the Orbiter ran into the foam. The foam slowed down rapidly because such low-density objects have low ballistic coefficients, which means their speed rapidly decreases when they lose their means of propulsion.

	<i>Minimum Impact Speed (mph)</i>	<i>Maximum Impact Speed (mph)</i>	<i>Best Estimated Impact Speed (mph)</i>	<i>Minimum Volume (cubic inches)</i>	<i>Maximum Volume (cubic inches)</i>	<i>Best Estimated Volume (cubic inches)</i>
During STS-107	375	654	477	400	1,920	1,200
After STS-107	528	559	528	1,026	1,239	1,200

Figure 3.4-5. The best estimates of velocities and volumes calculated during the mission and after the accident based on visual evidence and computer analyses. Information available during the mission was adequate to determine the foam's effect on both thermal tiles and RCC.

cameras are not operating or, as in the case of STS-107, out of focus. Launch Commit Criteria should include that sufficient cameras are operating to track the Shuttle from liftoff to Solid Rocket Booster separation.

Similarly, a developmental vehicle like the Shuttle should be equipped with high resolution cameras that monitor potential hazard areas. The wing leading edge system, the area around the landing gear doors, and other critical Thermal Protection System elements need to be imaged to check for damage. Debris sources, such as the External Tank, also need to be monitored. Such critical images need to be downlinked so that potential problems are identified as soon as possible.

Transport Analysis: Establishing Foam Path by Computational Fluid Dynamics

Transport analysis is the process of determining the path of the foam. To refine the Board's understanding of the foam strike, a transport analysis team, consisting of members from Johnson Space Center, Ames Research Center, and Boeing, augmented the image analysis team's research.

A variety of computer models were used to estimate the volume of the foam, as well as to refine the estimates of its velocity, its other dimensions, and the impact location. Figure 3.4-5 lists the velocity and foam size estimates produced during the mission and at the conclusion of the investigation.

The results listed in Figure 3.4-5 demonstrate that reasonably accurate estimates of the foam size and impact velocity were available during the mission. Despite the lack of high-quality visual evidence, the input data available to assess the impact damage during the mission was adequate.

The input data to the transport analysis consisted of the computed airflow around the Shuttle stack when the foam was shed, the estimated aerodynamic characteristics of the foam, the image analysis team's trajectory estimates, and the size and shape of the bipod ramp.

The transport analysis team screened several of the image analysis team's location estimates, based on the feasible aerodynamic characteristics of the foam and the laws of physics. Optical distortions caused by the atmospheric density gradients associated with the shock waves off the Orbiter's nose, External Tank, and Solid Rocket Boosters may have compromised the image analysis team's three position estimates closest to the bipod ramp. In addition, the image analysis team's position estimates closest to the wing were compromised by the lack of two camera views and the shock

region ahead of the wing, making triangulation impossible and requiring extrapolation. However, the transport analysis confirmed that the image analysis team's estimates for the central portion of the foam trajectory were well within the computed flow field and the estimated range of aerodynamic characteristics of the foam.

The team identified a relatively narrow range of foam impact velocities and ballistic coefficients. The ballistic coefficient of an object expresses the relative influence of weight and atmospheric drag on it, and is the primary aerodynamic characteristic of an object that does not produce lift. An object with a large ballistic coefficient, such as a cannon ball, has a trajectory that can be computed fairly accurately without accounting for drag. In contrast, the foam that struck the wing had a relatively small ballistic coefficient with a large drag force relative to its weight, which explains why it slowed down quickly after separating from the External Tank. Just prior to separation, the speed of the foam was equal to the speed of the Shuttle, about 1,568 mph (2,300 feet per second). Because of a large drag force, the foam slowed to about 1,022 mph (1,500 feet per second) in about 0.2 seconds, and the Shuttle struck the foam at a relative

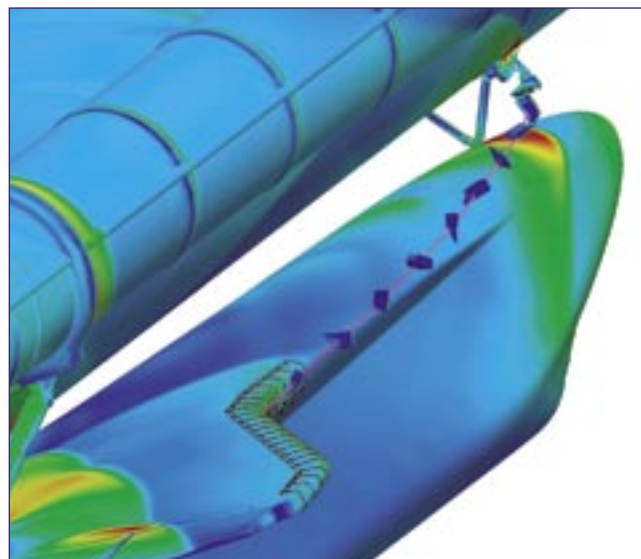

Figure 3.4-6. These are the results of a trajectory analysis that used a computational fluid dynamics approach in a program called CART-3D, a comprehensive (six-degree-of-freedom) computer simulation based on the laws of physics. This analysis used the aerodynamic and mass properties of bipod ramp foam, coupled with the complex flow field during ascent, to determine the likely position and velocity histories of the foam.

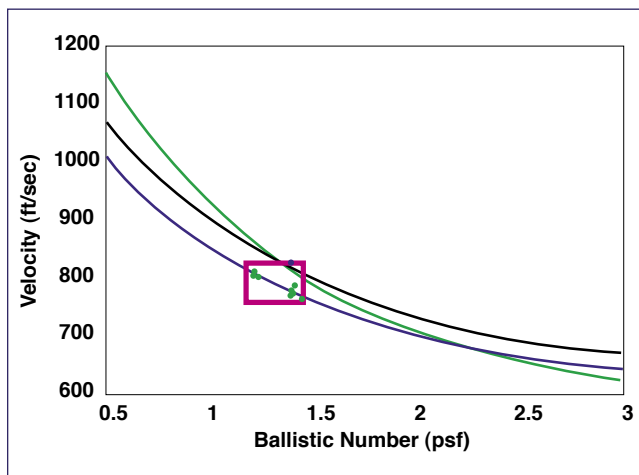

Figure 3.4-7. The results of numerous possible trajectories based on various assumed sizes, shapes, and densities of the foam. Either the foam had a slightly higher ballistic coefficient and the Orbiter struck the foam at a lower speed relative to the Orbiter, or the foam was more compact and the wing struck the foam at a higher speed. The “best fit” box represents the overlay of the data from the image analysis with the transport analysis computations. This data enabled a final selection of projectile characteristics for impact testing.

speed of about 545 mph (800 feet per second). (See Appendix D.8.)

The undetermined and yet certainly irregular shape of the foam introduced substantial uncertainty about its estimated aerodynamic characteristics. Appendix D.8 contains an independent analysis conducted by the Board to confirm that the estimated range of ballistic coefficients of the foam in Figure 3.4-6 was credible, given the foam dimension results from the image analyses and the expected range of the foam density. Based on the results in Figure 3.4-7, the physical dimensions of the bipod ramp, and the sizes and shapes of the available barrels for the compressed-gas gun used in the impact test program described later in this chapter, the Board and the NASA Accident Investigation Team decided that a foam projectile 19 inches by 11.5 inches by 5.5 inches, weighing 1.67 pounds, and with a weight density of 2.4 pounds per cubic foot, would best represent the piece of foam that separated from the External Tank bipod ramp and was hit by the Orbiter’s left wing. See Section 3.8 for a full discussion of the foam impact testing.

Findings:

- F3.4-1 Photographic evidence during ascent indicates the projectile that struck the Orbiter was the left bipod ramp foam.
- F3.4-2 The same photographic evidence, confirmed by independent analysis, indicates the projectile struck the underside of the leading edge of the left wing in the vicinity of RCC panels 6 through 9 or the tiles directly behind, with a velocity of approximately 775 feet per second.
- F3.4-3 There is a requirement to obtain and downlink

on-board engineering quality imaging from the Shuttle during launch and ascent.

- F3.4-4 The current long-range camera assets on the Kennedy Space Center and Eastern Range do not provide best possible engineering data during Space Shuttle ascents.
- F3.4-5 Evaluation of STS-107 debris impact was hampered by lack of high resolution, high speed cameras (temporal and spatial imagery data).
- F3.4-6 Despite the lack of high quality visual evidence, the information available about the foam impact during the mission was adequate to determine its effect on both the thermal tiles and RCC.

Recommendations:

- R3.4-1 Upgrade the imaging system to be capable of providing a minimum of three useful views of the Space Shuttle from liftoff to at least Solid Rocket Booster separation, along any expected ascent azimuth. The operational status of these assets should be included in the Launch Commit Criteria for future launches. Consider using ships or aircraft to provide additional views of the Shuttle during ascent.
- R3.4-2 Provide a capability to obtain and downlink high-resolution images of the External Tank after it separates.
- R3.4-3 Provide a capability to obtain and downlink high-resolution images of the underside of the Orbiter wing leading edge and forward section of both wings’ Thermal Protection System.

3.5 ON-ORBIT DEBRIS SEPARATION – THE “FLIGHT DAY 2” OBJECT

Immediately after the accident, Air Force Space Command began an in-depth review of its Space Surveillance Network data to determine if there were any detectable anomalies during the STS-107 mission. A review of the data resulted in no information regarding damage to the Orbiter. However, Air Force processing of Space Surveillance Network data yielded 3,180 separate radar or optical observations of the Orbiter from radar sites at Eglin, Beale, and Kirtland Air Force Bases, Cape Cod Air Force Station, the Air Force Space Command’s Maui Space Surveillance System in Hawaii, and the Navy Space Surveillance System. These observations, examined after the accident, showed a small object in orbit with *Columbia*. In accordance with the International Designator system, the object was named 2003-003B (*Columbia* was designated 2003-003A). The timeline of significant events includes:

1. January 17, 2003, 9:42 a.m. Eastern Standard Time: Orbiter moves from tail-first to right-wing-first orientation
2. January 17, 10:17 a.m.: Orbiter returns to tail-first orientation
3. January 17, 3:57 p.m.: First confirmed sensor track of object 2003-003B
4. January 17, 4:46 p.m.: Last confirmed sensor track for this date

5. January 18: Object reacquired and tracked by Cape Cod Air Force Station PAVE PAWS
6. January 19: Object reacquired and tracked by Space Surveillance Network
7. January 20, 8:45 – 11:45 p.m.: 2003-003B orbit decays. Last track by Navy Space Surveillance System

Events around the estimated separation time of the object were reviewed in great detail. Extensive on-board sensor data indicates that no unusual crew activities, telemetry data, or accelerations in Orbiter or payload can account for the release of an object. No external mechanical systems were active, nor were any translational (forward, backward, or sideways, as opposed to rotational) maneuvers attempted in this period. However, two attitude maneuvers were made: a 48-degree yaw maneuver to a left-wing-forward and payload-bay-to-Earth attitude from 9:42 to 9:46 a.m. EST), and

a maneuver back to the bay-to-Earth, tail-forward attitude from 10:17 to 10:21 a.m. It is possible that this maneuver imparted the initial departure velocity to the object.

Although various Space Surveillance Network radars tracked the object, the only reliable physical information includes the object's ballistic coefficient in kilograms per square meter and its radar cross-section in decibels per square meter. An object's radar cross-section relates how much radar energy the object scatters. Since radar cross-section depends on the object's material properties, shape, and orientation relative to the radar, the Space Surveillance Network could not independently estimate the object's size or shape. By radar observation, the object's Ultra-High Frequency (UHF) radar cross-section varied between 0.0 and minus 18.0 decibels per square meter (plus or minus 1.3 decibels), and its ballistic coefficient was known to be 0.1 kilogram per meter squared (plus or minus 15 percent). These two quantities were used to test and ultimately eliminate various objects.

ON-ORBIT COLLISION AVOIDANCE

The Space Control Center, operated by the 21st Space Wing's 1st Space Control Squadron (a unit of Air Force Space Command), maintains an orbital data catalog on some 9,000 Earth-orbiting objects, from active satellites to space debris, some of which may be as small as four inches. The Space Control Center ensures that no known orbiting objects will transit an Orbiter "safety zone" measuring 6 miles deep by 25 miles wide and long (Figure A) during a Shuttle mission by projecting the Orbiter's flight path for the next 72 hours (Figure B) and comparing it to the flight paths of all known orbiting or re-entering objects, which generally travel at 17,500 miles per hour. Whenever possible, the Orbiter moves tail-first while on orbit to minimize the chances of orbital debris or micrometeoroids impacting the cabin windscreen or the Orbiter's wing leading edge.

If an object is determined to be within 36-72 hours of colliding with the Orbiter, the Space Control Center notifies NASA, and the agency then determines a maneuver to avoid a collision. There were no close approaches to *Columbia* detected during STS-107.

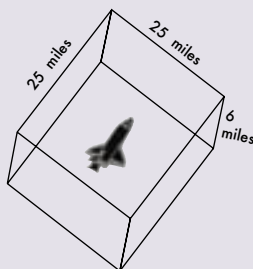

Figure A. Orbiter Safety Zone

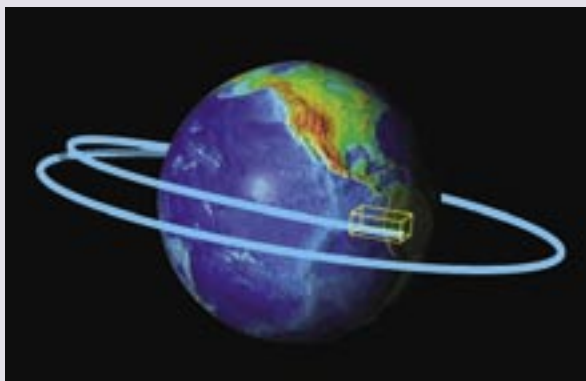

Figure B. Protecting the Orbiter's flight path

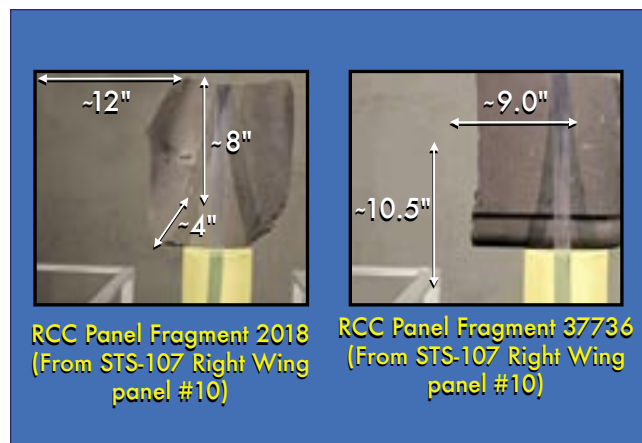

Figure 3.5-1. These representative RCC acreage pieces matched the radar cross-section of the Flight Day 2 object.

In the Advanced Compact Range at the Air Force Research Laboratory in Dayton, Ohio, analysts tested 31 materials from the Orbiter's exterior and payload bay. Additional supercomputer radar cross-section predictions were made for Reinforced Carbon-Carbon T-seals. After exhaustive radar cross-section analysis and testing, coupled with ballistic analysis of the object's orbital decay, only a fragment of RCC panel would match the UHF radar cross-section and ballistic coefficients observed by the Space Surveillance network. Such an RCC panel fragment must be approximately 140 square inches or greater in area to meet the observed radar cross-section characteristics. Figure 3.5-1 shows RCC panel fragments from *Columbia*'s right wing that represent those meeting the observed characteristics of object 2003-003B.¹⁰

Note that the Southwest Research Institute foam impact test on panel 8 (see Section 3.8) created RCC fragments that fell into the wing cavity. These pieces are consistent in size with the RCC panel fragments that exhibited the required physical characteristics consistent with the Flight Day 2 object.

Findings:

- F3.5-1 The object seen on orbit with *Columbia* on Flight Day 2 through 4 matches the radar cross-section and area-to-mass measurements of an RCC panel fragment.
- F3.5-2 Though the Board could not positively identify the Flight Day 2 object, the U.S. Air Force exclusionary test and analysis processes reduced the potential Flight Day 2 candidates to an RCC panel fragment.

Recommendations:

- None

3.6 DE-ORBIT/RE-ENTRY

As *Columbia* re-entered Earth's atmosphere, sensors in the Orbiter relayed streams of data both to entry controllers on the ground at Johnson Space Center and to the Modular Auxiliary Data System recorder, which survived the breakup of the Orbiter and was recovered by ground search teams. This data – temperatures, pressures, and stresses – came from sensors located throughout the Orbiter. Entry controllers were unaware of any problems with re-entry until telemetry data indicated errant readings. During the investigation data from these two sources was used to make aerodynamic, aerothermal, and mechanical reconstructions of re-entry that showed how these stresses affected the Orbiter.

The re-entry analysis and testing focused on eight areas:

1. Analysis of the Modular Auxiliary Data System recorder information and the pattern of wire runs and sensor failures throughout the Orbiter.
2. Physical and chemical analysis of the recovered debris to determine where the breach in the RCC panels likely occurred.
3. Analysis of videos and photography provided by the general public.
4. Abnormal heating on the outside of the Orbiter body. Sensors showed lower heating and then higher heating than is usually seen on the left Orbital Maneuvering System pod and the left side of the fuselage.
5. Early heating inside the wing leading edge. Initially, heating occurred inside the left wing RCC panels before the wing leading edge spar was breached.
6. Later heating inside the left wing structure. This analysis focused on the inside of the left wing after the wing leading edge spar had been breached.
7. Early changes in aerodynamic performance. The Orbiter began reacting to increasing left yaw and left roll, consistent with developing drag and loss of lift on the left wing.
8. Later changes in aerodynamic performance. Almost 600 seconds after Entry Interface, the left-rolling tendency of the Orbiter changes to a right roll, indicating an increase in lift on the left wing. The left yaw also increased, showing increasing drag on the left wing.

For a complete compilation of all re-entry data, see the

CAIB/NAIT Working Scenario (Appendix D.7) and the Re-entry Timeline (Appendix D.9). The extensive aerothermal calculations and wind tunnel tests performed to investigate the observed re-entry phenomenon are documented in NASA report NSTS-37398.

Re-Entry Environment

In the demanding environment of re-entry, the Orbiter must withstand the high temperatures generated by its movement through the increasingly dense atmosphere as it decelerates from orbital speeds to land safely. At these velocities, shock waves form at the nose and along the leading edges of the wing, intersecting near RCC panel 9. The interaction between these two shock waves generates extremely high temperatures, especially around RCC panel 9, which experiences the highest surface temperatures of all the RCC panels. The flow behind these shock waves is at such a high temperature that air molecules are torn apart, or “dissociated.” The air immediately around the leading edge surface can reach 10,000 degrees Fahrenheit; however, the boundary layer shields the Orbiter so that the actual temperature is only approximately 3,000 degrees Fahrenheit at the leading edge. The RCC panels and internal insulation protect the aluminum wing leading edge spar. A breach in one of the leading-edge RCC panels would expose the internal wing structure to temperatures well above 3,000 degrees Fahrenheit.

In contrast to the aerothermal environment, the aerodynamic environment during *Columbia*'s re-entry was relatively benign, especially early in re-entry. The re-entry dynamic pressure ranged from zero at Entry Interface to 80 pounds per square foot when the Orbiter went out of control, compared with a dynamic pressure during launch and ascent of nearly 700 pounds per square foot. However, the aerodynamic forces were increasing quickly during the final minutes of *Columbia*'s flight, and played an important role in the loss of control.

Orbiter Sensors

The Operational Flight Instrumentation monitors physical sensors and logic signals that report the status of various Orbiter functions. These sensor readings and signals are telemetered via a 128 kilobit-per-second data stream to the Mission Control Center, where engineers ascertain the real-time health of key Orbiter systems. An extensive review of this data has been key to understanding what happened to STS-107 during ascent, orbit, and re-entry.

The Modular Auxiliary Data System is a supplemental instrumentation system that gathers Orbiter data for processing after the mission is completed. Inputs are almost exclusively physical sensor readings of temperatures, pressures, mechanical strains, accelerations, and vibrations. The Modular Auxiliary Data System usually records only the mission's first and last two hours (see Figure 3.6-1).

The Orbiter Experiment instrumentation is an expanded suite of sensors for the Modular Auxiliary Data System that was installed on *Columbia* for engineering development purposes. Because *Columbia* was the first Orbiter launched,



Figure 3.6-1. The Modular Auxiliary Data System recorder, found near Hemphill, Texas. While not designed to withstand impact damage, the recorder was in near-perfect condition when recovered on March 19, 2003.

engineering teams needed a means to gather more detailed flight data to validate their calculations of conditions the vehicle would experience during critical flight phases. The instrumentation remained on *Columbia* as a legacy of the development process, and was still providing valuable flight data from ascent, de-orbit, and re-entry for ongoing flight analysis and vehicle engineering. Nearly all of *Columbia*'s sensors were specified to have only a 10-year shelf life, and in some cases an even shorter service life.

At 22 years old, the majority of the Orbiter Experiment instrumentation had been in service twice as long as its specified service life, and in fact, many sensors were already failing. Engineers planned to stop collecting and analyzing data once most of the sensors had failed, so failed sensors and wiring were not repaired. For instance, of the 181 sensors in *Columbia*'s wings, 55 had already failed or were producing questionable readings before STS-107 was launched.

Re-Entry Timeline

Times in the following section are noted in seconds elapsed from the time *Columbia* crossed Entry Interface (EI) over the Pacific Ocean at 8:44:09 a.m. EST. *Columbia*'s destruction occurred in the period from Entry Interface at 400,000 feet (EI+000) to about 200,000 feet (EI+970) over Texas. The Modular Auxiliary Data System recorded the first indications of problems at EI plus 270 seconds (EI+270). Because data from this system is retained onboard, Mission Control did not notice any troubling indications from telemetry data until 8:54:24 a.m. (EI+613), some 10 minutes after Entry Interface.

Left Wing Leading Edge Spar Breach (EI+270 through EI+515)

At EI+270, the Modular Auxiliary Data System recorded the first unusual condition while the Orbiter was still over the Pacific Ocean. Four sensors, which were all either inside

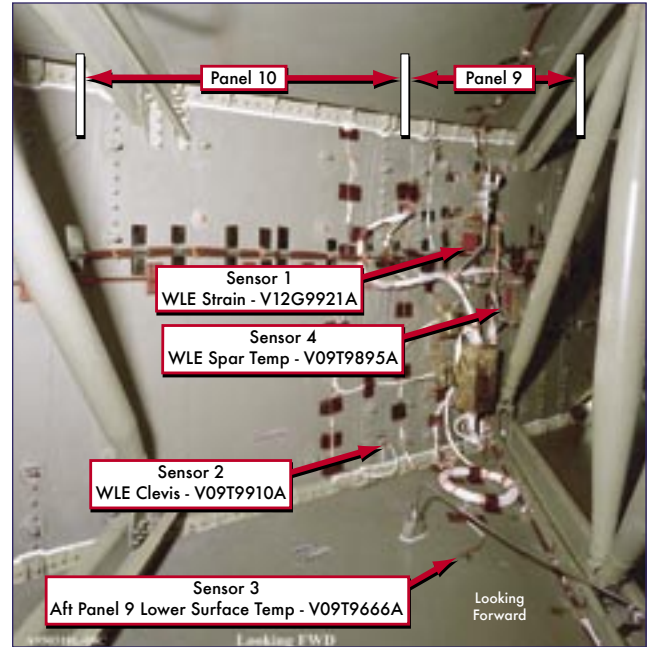

Figure 3.6-2. Location of sensors on the back of the left wing leading edge spar (vertical aluminum structure in picture). Also shown are the round truss tubes and ribs that provided the structural support for the mid-wing in this area.

or outside the wing leading edge spar near Reinforced Carbon-Carbon (RCC) panel 9-left, helped tell the story of what happened on the left wing of the Orbiter early in the re-entry. These four sensors were: strain gauge V12G9921A (Sensor 1), resistance temperature detector V09T9910A on the RCC clevis between panel 9 and 10 (Sensor 2), thermocouple V07T9666A, within a Thermal Protection System tile (Sensor 3), and resistance temperature detector V09T9895A (Sensor 4), located on the back side of the wing leading edge spar behind RCC panels 8 and 9 (see Figure 3.6-2).

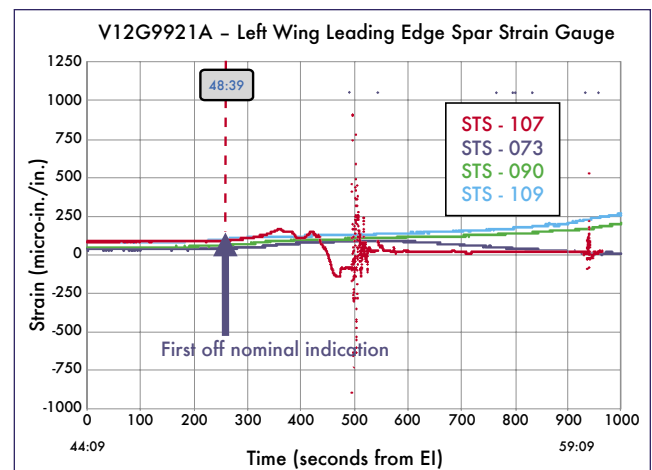

Figure 3.6-3. The strain gauge (Sensor 1) on the back of the left wing leading edge spar was the first sensor to show an anomalous reading. In this chart, and the others that follow, the red line indicates data from STS-107. Data from other Columbia re-entries, similar to the STS-107 re-entry profile, are shown in the other colors.

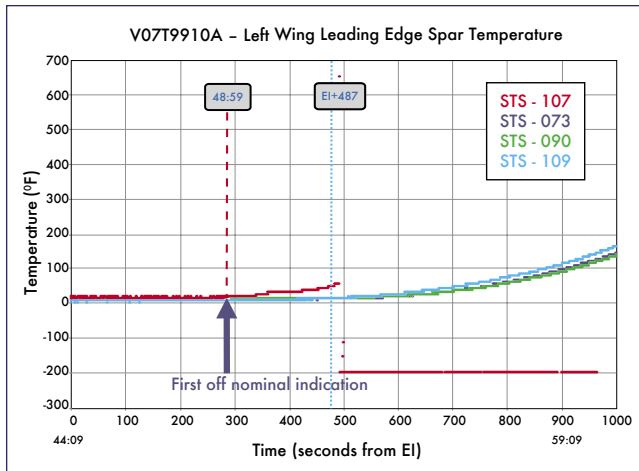

Figure 3.6-4. This temperature thermocouple (Sensor 2) was mounted on the outside of the wing leading edge spar behind the insulation that protects the spar from radiated heat from the RCC panels. It clearly showed an off-nominal trend early in the re-entry sequence and began to show an increase in temperature much earlier than the temperature sensor behind the spar.

Sensor 1 provided the first anomalous reading (see Figure 3.6-3). From EI+270 to EI+360, the strain is higher than that on previous *Columbia* flights. At EI+450, the strain reverses, and then peaks again in a negative direction at EI+475. The strain then drops slightly, and remains constant and negative until EI+495, when the sensor pattern becomes unreliable, probably due to a propagating soft short, or “burn-through” of the insulation between cable conductors caused by heating or combustion. This strain likely indicates significant damage to the aluminum honeycomb spar. In particular, strain reversals, which are unusual, likely mean there was significant high-temperature damage to the spar during this time.

At EI+290, 20 seconds after Sensor 1 gave its first anomalous reading, Sensor 2, the only sensor in the front of the

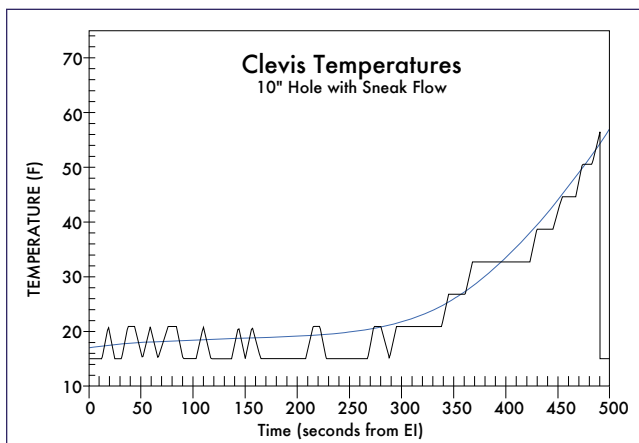

Figure 3.6-5. The analysis of the effect of a 10-inch hole in RCC panel 8 on Sensor 2 from EI to EI+500 seconds. The jagged line shows the actual flight data readings and the smooth line the calculated result for a 10-inch hole with some sneak flow of superheated air behind the spar insulation.

left wing leading edge spar, recorded the beginning of a gradual and abnormal rise in temperature from an expected 30 degrees Fahrenheit to 65 degrees at EI+493, when it then dropped to “off-scale low,” a reading that drops off the scale at the low end of the sensor’s range (see Figure 3.6-4). Sensor 2, one of the first to fail, did so abruptly. It had indicated only a mild warming of the RCC attachment clevis before the signal was lost.

A series of thermal analyses were performed for different sized holes in RCC panel 8 to compute the time required to heat Sensor 2 to the temperature recorded by the Modular Auxiliary Data System. To heat the clevis, various insulators would have to be bypassed with a small amount of leakage, or “sneak flow.” Figure 3.6-5 shows the results of these calculations for, as an example, a 10-inch hole, and demonstrates that with sneak flow around the insulation, the temperature profile of the clevis sensor was closely matched by the engineering calculations. This is consistent with the same sneak flow required to match a similar but abnormal ascent temperature rise of the same sensor, which further supports the premise that the breach in the leading edge of the wing occurred during ascent. While the exact size of the breach will never be known, and may have been smaller or larger than 10 inches, these analyses do provide a plausible explanation for the observed rises in temperature sensor data during re-entry.

Investigators initially theorized that the foam might have broken a T-seal and allowed superheated air to enter the wing between the RCC panels. However, the amount of T-seal debris from this area and subsequent aerothermal analysis showing this type of breach did not match the observed damage to the wing, led investigators to eliminate a missing T-seal as the source of the breach.

Although abnormal, the re-entry temperature rise was slow and small compared to what would be expected if Sensor 2 were exposed to a blast of superheated air from an assumed breach in the RCC panels. The slow temperature rise is at-

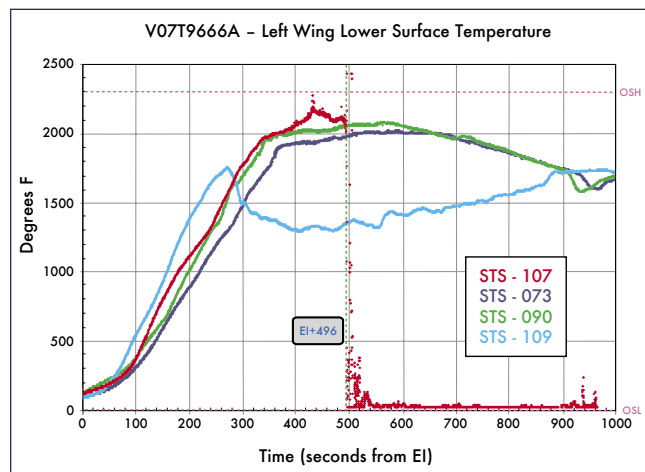

Figure 3.6-6. As early as EI+370, Sensor 3 began reading significantly higher than on previous flights. Since this sensor was located in a thermal tile on the lower surface of the left wing, its temperatures are much higher than those for the other sensors.

tributed to the presence of a relatively modest breach in the RCC, the thick insulation that surrounds the sensor, and the distance from the site of the breach in RCC panel 8 to the clevis sensor.

The readings of Sensor 3, which was in a thermal tile, began rising abnormally high and somewhat erratically as early as EI+370, with several brief spikes to 2,500 degrees Fahrenheit, significantly higher than the 2,000-degree peak temperature on a normal re-entry (Figure 3.6-6). At EI+496, this reading became unreliable, indicating a failure of the wire or the sensor. Because this thermocouple was on the wing lower surface, directly behind the junction of RCC panel 9 and 10, the high temperatures it initially recorded were almost certainly a result of air jetting through the damaged area of RCC panel 8, or of the normal airflow being disturbed by the damage. Note that Sensor 3 provided an external temperature measurement, while Sensors 2 and 4 provided internal temperature measurements.

Sensor 4 also recorded a rise in temperature that ended in an abrupt fall to off-scale low. Figure 3.6-7 shows that an abnormal temperature rise began at EI+425 and abruptly fell at EI+525. Unlike Sensor 2, this temperature rise was extreme, from an expected 20 degrees Fahrenheit at EI+425 to 40 degrees at EI+485, and then rising much faster to 120 degrees at EI+515, then to an off-scale high (a reading that climbs off the scale at the high end of the range) of 450 degrees at EI+522. The failure pattern of this sensor likely indicates destruction by extreme heat.

The timing of the failures of these four sensors and the path of their cable routing enables a determination of both the timing and location of the breach of the leading edge spar, and indirectly, the breach of the RCC panels. All the cables from these sensors, and many others, were routed into wiring harnesses that ran forward along the back side of the leading edge spar up to a cross spar (see Figure 3.6-8), where they passed through the service opening in the cross spar and then ran in front of the left wheel well before reaching interconnect panel 65P, where they entered the fuselage. All sensors with wiring in this set of harnesses failed between EI+487 to EI+497, except Sensor 4, which survived until EI+522. The diversity of sensor types (temperature, pressure, and strains) and their locations in the left wing indicates that they failed because their wiring was destroyed at spar burn-through, as opposed to destruction of each individual sensor by direct heating.

Examination of wiring installation closeout photographs (pictures that document the state of the area that are normally taken just before access is closed) and engineering drawings show five main wiring harness bundles running forward along the spar, labeled top to bottom as A through E (see Figure 3.6-8). The top four, A through D, are spaced 3 inches apart, while the fifth, E, is 6 inches beneath them. The separation between bundle E and the other four is consistent with the later failure time of Sensor 4 by 25 to 29 seconds, and indicates that the breach was in the upper two-thirds of the spar, causing all but one of the cables in this area to fail between EI+487 to EI+497. The breach then expanded vertically, toward the underside of the wing, causing Sensor 4 to fail 25 seconds

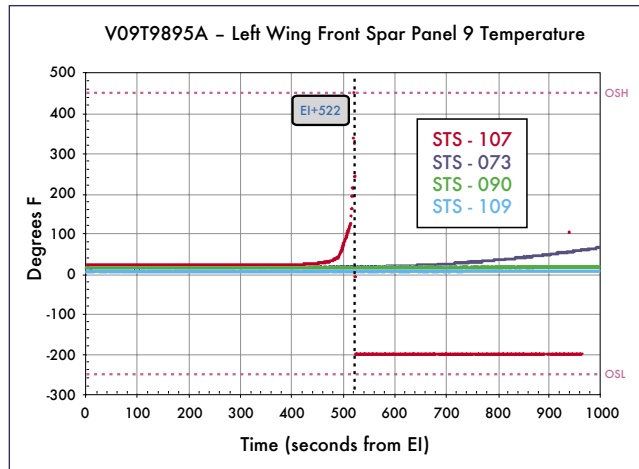

Figure 3.6-7. Sensor 4 also began reading significantly higher than previous flights before it fell off-scale low. The relatively late reaction of this sensor compared to Sensor 2, clearly indicated that superheated air started on the outside of the wing leading edge spar and then moved into the mid-wing after the spar was burned through. Note that immediately before the sensor (or the wire) fails, the temperature is at 450 degrees Fahrenheit and climbing rapidly. It was the only temperature sensor that showed this pattern.

later. Because the distance between bundle A and bundle E is 9 inches, the failure of all these wires indicates that the breach in the wing leading edge spar was at least 9 inches from top to bottom by EI+522 seconds.

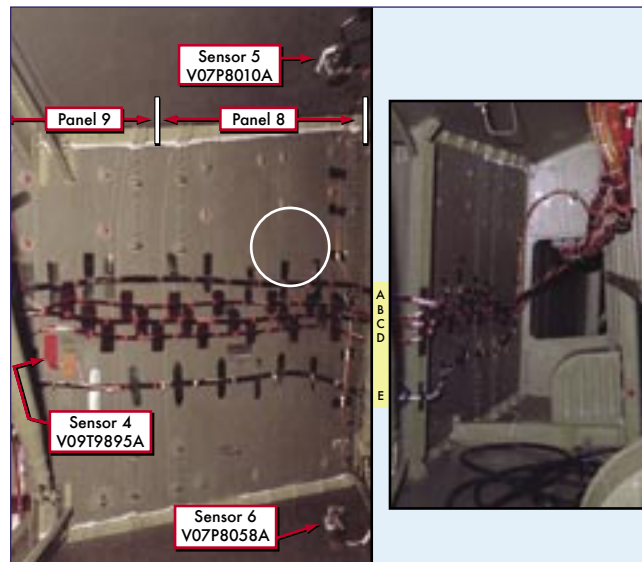

Figure 3.6-8. The left photo above shows the wiring runs on the backside of the wing leading edge behind RCC panel 8 – the circle marks the most likely area where the burn through of the wing leading edge spar initially occurred at EI+487 seconds. The right photo shows the wire bundles as they continue forward behind RCC panels 7 and 6. The major cable bundles in the upper right of the right photo carried the majority of the sensor data inside the wing. As these bundles were burned, controllers on the ground began seeing off-nominal sensor indications.

Also directly behind RCC panel 8 were pressure sensors V07P8010A (Sensor 5), on the upper interior surface of the wing, and V07P8058A (Sensor 6), on the lower interior surface of the wing. Sensor 5 failed abruptly at EI+497. Sensor 6, which was slightly more protected, began failing at EI+495, and failed completely at EI+505. Closeout photographs show that the wiring from Sensor 5 travels down from the top of the wing to join the uppermost harness, A, which then travels along the leading edge spar. Similarly, wiring from Sensor 6 travels up from the bottom of the wing, joins harness A, and continues along the spar. It appears that Sensor 5's wiring, on the upper wing surface, was damaged at EI+497, right after Sensor 1 failed. Noting the times of the sensor failures, and the locations of Sensors 5 and 6 forward of Sensors 1 through 4, spar burn-through must have occurred near where these wires came together.

Two of the 45 left wing strain gauges also recorded an anomaly around EI+500 to EI+580, but their readings were not erratic or off-scale until late in the re-entry, at EI+930. Strain gauge V12G9048A was far forward on a cross spar in the front of the wheel well on the lower spar cap, and strain gauge V12G9049A was on the upper spar cap. Their responses appear to be the actual strain at that location until their failure at EI+935. The exposed wiring for most of the left wing sensors runs along the front of the spar that crosses in front of the left wheel well. The very late failure times of these two sensors indicate that the damage did not spread into the wing cavity forward of the wheel well until at least EI+935, which implies that the breach was aft of the cross spar. Because the cross spar attaches to the transition spar behind RCC panel 6, the breach must have been aft (outboard) of panel 6. The superheated air likely burned through the outboard wall of the wheel well, rather than snaking forward and then back through the vent at the front of the wheel well. Had the gases flowed through the access opening in the cross spar and then through the vent into the wheel well, it is unlikely that the lower strain gauge wiring would have survived.

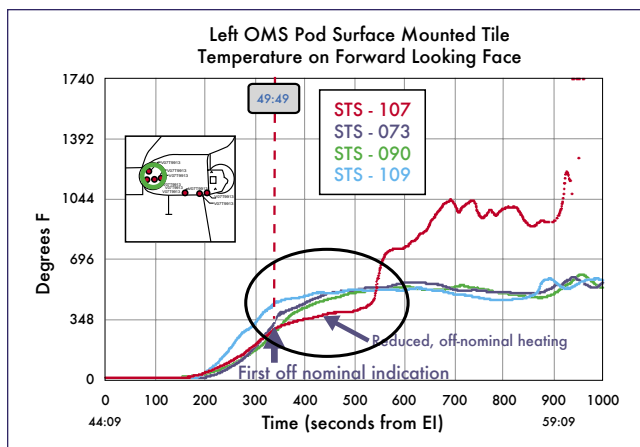

Figure 3.6-9. Orbital Maneuvering System (OMS) pod heating was initially significantly lower than that seen on previous Columbia missions. As wing leading edge damage later increased, the OMS pod heating increased dramatically. Debris recovered from this area of the OMS pod showed substantial pre-breakup heat damage and imbedded drops of once-molten metal from the wing leading edge in the OMS pod thermal tiles.

Finally, the rapid rise in Sensor 4 at EI+425, before the other sensors began to fail, indicates that high temperatures were responsible. Comparisons of sensors on the outside of the wing leading edge spar, those inside of the spar, and those in the wing and left wheel well indicate that abnormal heating first began on the outside of the spar behind the RCC panels and worked through the spar. Since the aluminum spar must have burned through before any cable harnesses attached to it failed, the breach through the wing leading edge spar must have occurred at or before EI+487.

Other abnormalities also occurred during re-entry. Early in re-entry, the heating normally seen on the left Orbital Maneuvering System pod was much lower than usual for this point in the flight (see Figure 3.6-9). Wind tunnel testing demonstrated that airflow into a breach in an RCC panel would then escape through the wing leading edge vents behind the upper part of the panel and interrupt the weak aerodynamic flow field on top of the wing. During re-entry, air normally flows into these vents to equalize air pressure across the RCC panels. The interruption in the flow field behind the wing caused a displacement of the vortices that normally hit the leading edge of the left pod, and resulted in a slowing of pod heating. Heating of the side fuselage slowed, which wind tunnel testing also predicted.

To match this scenario, investigators had to postulate damage to the tiles on the upper carrier panel 9, in order to allow sufficient mass flow through the vent to cause the observed decrease in sidewall heating. No upper carrier panels were found from panels 9, 10, and 11, which supports this hypothesis. Although this can account for the abnormal temperatures on the body of the Orbiter and at the Orbital Maneuvering System pod, flight data and wind tunnel tests confirmed that this venting was not strong enough to alter the aerodynamic force on the Orbiter, and the aerodynamic analysis of mission data showed no change in Orbiter flight control parameters during this time.

During re-entry, a change was noted in the rate of the temperature rise around the RCC chin panel clevis temperature sensor and two water supply nozzles on the left side of the fuselage, just aft of the main bulkhead that divides the crew cabin from the payload bay. Because these sensors were well forward of the damage in the left wing leading edge, it is still unclear how their indications fit into the failure scenario.

Sensor Loss and the Onset of Unusual Aerodynamic Effects (EI+500 through EI+611)

Fourteen seconds after the loss of the first sensor wire on the wing leading edge spar at EI+487, a sensor wire in a bundle of some 150 wires that ran along the upper outside corner of the left wheel well showed a burn-through. In the next 50 seconds, more than 70 percent of the sensor wires in three cables in this area also burned through (see Figure 3.6-10). Investigators plotted the wiring run for every left-wing sensor, looking for a relationship between their location and time of failure.

Only two sensor wires of 169 remained intact when the Modular Auxiliary Data System recorder stopped, indicat-

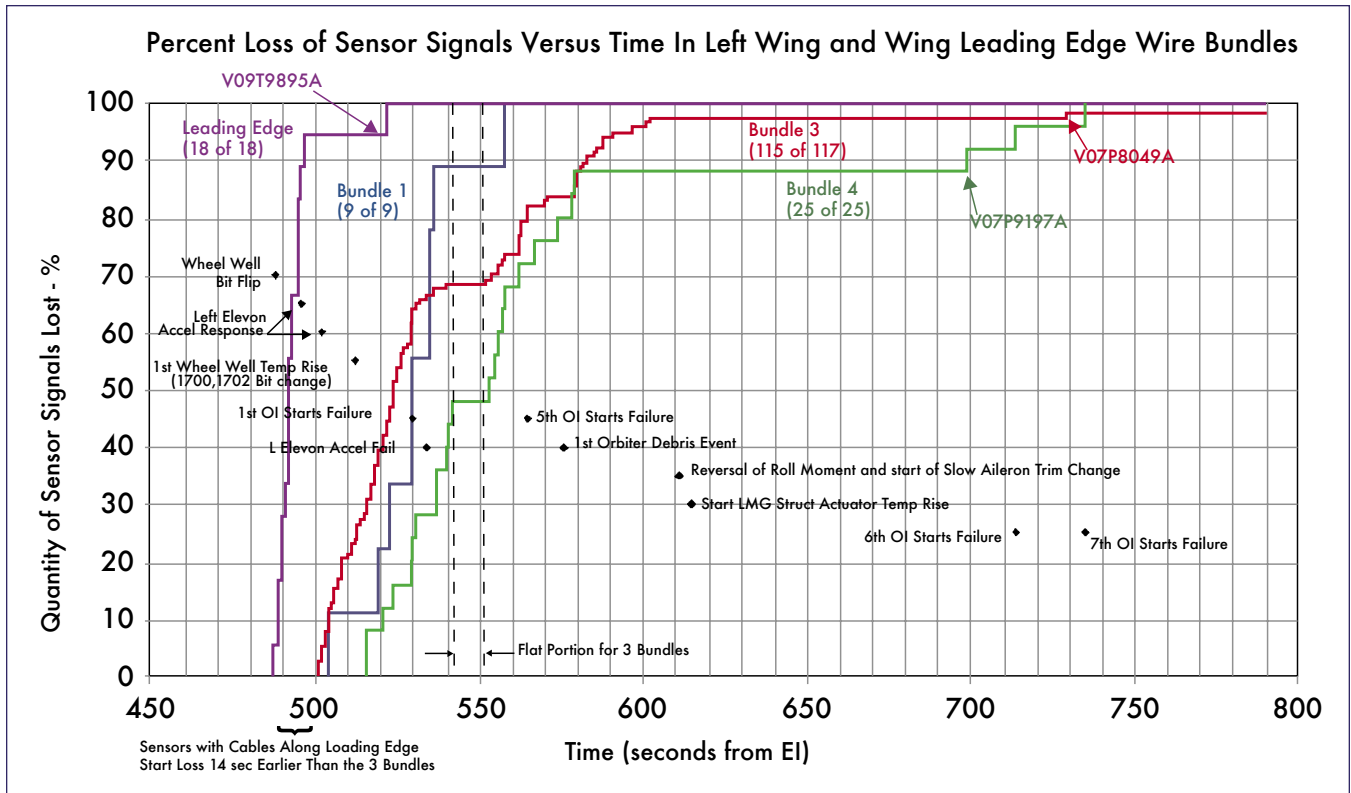

Figure 3.6-10. This chart shows how rapidly the wire bundles in the left wing were destroyed. Over 70 percent of the sensor wires in the wiring bundles burned through in under a minute. The black diamonds show the times of significant timeline sensor events.

ing that the burn-throughs had to occur in an area that nearly every wire ran through. To sustain this type of damage, the wires had to be close enough to the breach for the gas plume to hit them. Arc jet testing (in a wind tunnel with an electrical arc that provides up to a 2,800-degree Fahrenheit airflow) on a simulated wing leading edge spar and simulated wire bundles showed how the leading edge spar would burn through in a few seconds. It also showed that wire bundles would burn through in a timeframe consistent with those seen in the Modular Auxiliary Data System information and the telemetered data.

Later computational fluid dynamics analysis of the mid-wing area behind the spar showed that superheated air flowing into a breached RCC panel 8 and then interacting with the internal structure behind the RCC cavity (RCC ribs and spar insulation) would have continued through the wing leading edge spar as a jet, and would have easily allowed superheated air to traverse the 56.5 inches from the spar to the outside of the wheel well and destroy the cables (Figure 3.6-11). Controllers on the ground saw these first anomalies in the telemetry data at EI+613, when four hydraulic sensor cables that ran from the aft part of the left wing through the wiring bundles outside the wheel well failed.

Aerodynamic roll and yaw forces began to differ from those on previous flights at about EI+500 (see Figure 3.6-12). Investigators used flight data to reconstruct the aerodynamic forces acting on the Orbiter. This reconstructed data was then compared to forces seen on other similar flights of *Columbia*

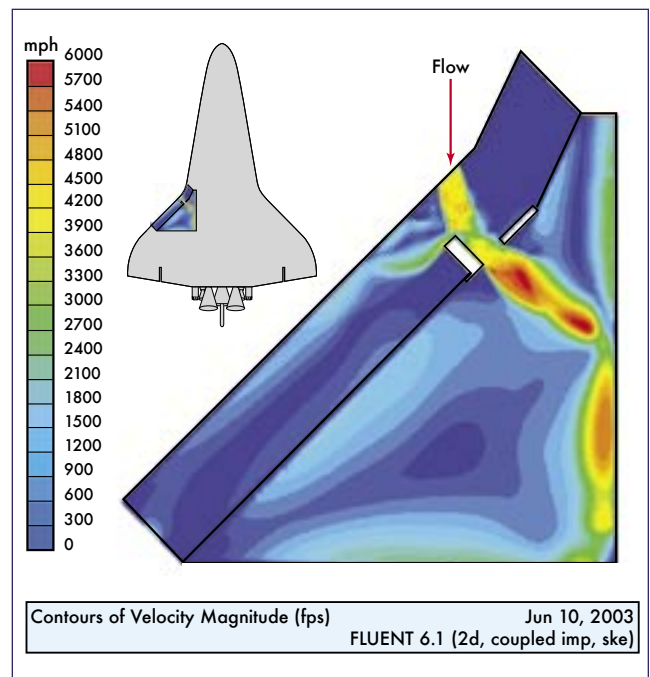

Figure 3.6-11. The computational fluid dynamics analysis of the speed of the superheated air as it entered the breach in RCC panel 8 and then traveled through the wing leading edge spar. The darkest red color indicates speeds of over 4,000 miles per hour. Temperatures in this area likely exceeded 5,000 degrees Fahrenheit. The area of detail is looking down at the top of the left wing.

of the upper slot carried molten wing leading edge material back to the pod. Temperatures far exceeded those seen on previous re-entries and further confirmed that the wing leading-edge damage was increasing.

By this time, superheated air had been entering the wing since EI+487, and significant internal damage had probably occurred. The major internal support structure in the mid-wing consists of aluminum trusses with a melting point of 1,200 degrees Fahrenheit. Because the ingested air may have been as hot as 8,000 degrees near the breach, it is likely that the internal support structure that maintains the shape of the wing was severely compromised.

As the Orbiter flew east, people on the ground continued to record the major shedding of debris. Investigators later scrutinized these videos to compare *Columbia's* re-entry with recordings of other re-entries and to identify the debris. The video analysis was also used to determine additional search areas on the ground and to estimate the size of various pieces of debris as they fell from the Orbiter.

Temperatures in the wheel well began to rise rapidly at EI+601, which indicated that the superheated air coming through the wing leading edge spar had breached the wheel well wall. At the same time, observers on the ground noted additional significant shedding of debris. Analysis of one of these “debris events” showed that the photographed object could have weighed nearly 190 pounds, which would have significantly altered *Columbia's* physical condition.

At EI+602, the tendency of the Orbiter to roll to the left in response to a loss of lift on the left wing transitioned to a right-rolling tendency, now in response to increased lift on the left wing. Observers on the ground noted additional significant shedding of debris in the next 30 seconds. Left yaw continued to increase, consistent with increasing drag on the left wing. Further damage to the RCC panels explains the increased drag on the left wing, but it does not explain the sudden increase in lift, which can be explained only by some other type of wing damage.

Investigators ran multiple analyses and wind tunnel tests to understand this significant aerodynamic event. Analysis showed that by EI+850, the temperatures inside the wing

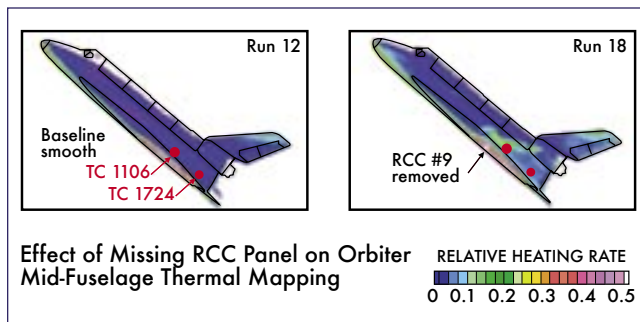
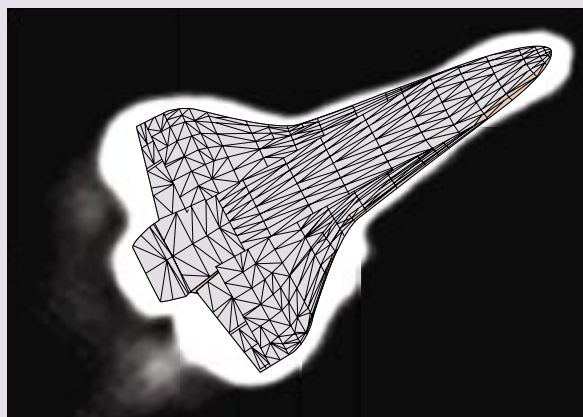

Figure 3.6-13. The effects of removing RCC panel 9 are shown in this figure. Note the brighter colors on the front of the OMS pod show increased heating, a phenomenon supported by both the OMS pod temperature sensors and the debris analysis.

THE KIRTLAND IMAGE

As *Columbia* passed over Albuquerque, New Mexico, during re-entry (around EI+795), scientists at the Air Force Starfire Optical Range at Kirtland Air Force Base acquired images of the Orbiter. This imaging had not been officially assigned, and the photograph was taken using commercial equipment located at the site, not with the advanced Starfire adaptive-optics telescope.



The image shows an unusual condition on the left wing, a leading-edge disturbance that might indicate damage. Several analysts concluded that the distortion evident in the image likely came from the modification and interaction of shock waves due to the damaged leading edge. The overall appearance of the leading-edge damage at this point on the trajectory is consistent with the scenario.

were high enough to substantially damage the wing skins, wing leading edge spar, and the wheel well wall, and melt the wing's support struts. Once structural support was lost, the wing likely deformed, effectively changing shape and resulting in increased lift and a corresponding increase in drag on the left wing. The increased drag on the left wing further increased the Orbiter's tendency to yaw left.

Loss of Vehicle Control (EI+612 through EI+970)

A rise in hydraulic line temperatures inside the left wheel well indicated that superheated air had penetrated the wheel well wall by EI+727. This temperature rise, telemetered to Mission Control, was noted by the Maintenance, Mechanical, and Crew Systems officer. The Orbiter initiated and completed its roll reversal by EI+766 and was positioned left-wing-down for this portion of re-entry. The Guidance and Flight Control Systems performed normally, although the aero-control surfaces (aileron trim) continued to counteract the additional drag and lift from the left wing.

At EI+790, two left main gear outboard tire pressure sensors began trending slightly upward, followed very shortly by going off-scale low, which indicated extreme heating of both the left inboard and outboard tires. The tires, with their large mass, would require substantial heating to produce the sensors' slight temperature rise. Another sharp change in the rolling tendency of the Orbiter occurred at EI+834, along



Figure 3.7-1. Comparison of amount of debris recovered from the left and right wings of Columbia. Note the amount of debris recovered from areas in front of the wheel well (the red boxes on each wing) were similar, but there were dramatic differences in the amount of debris recovered aft of each wheel well.

with additional shedding of debris. In an attempt to maintain attitude control, the Orbiter responded with a sharp change in aileron trim, which indicated there was another significant change to the left wing configuration, likely due to wing deformation. By EI+887, all left main gear inboard and outboard tire pressure and wheel temperature measurements were lost, indicating burning wires and a rapid progression of damage in the wheel well.

At EI+897, the left main landing gear downlock position indicator reported that the gear was now down and locked. At the same time, a sensor indicated the landing gear door was still closed, while another sensor indicated that the main landing gear was still locked in the up position. Wire burn-through testing showed that a burn-induced short in the downlock sensor wiring could produce these same contradictions in gear status indication. Several measurements on the strut produced valid data until the final loss of telemetry data. This suggests that the gear-down-and locked indication was the result of a wire burn-through, not a result of the landing gear actually deploying. All four corresponding proximity switch sensors for the right main landing gear remained normal throughout re-entry until telemetry was lost.

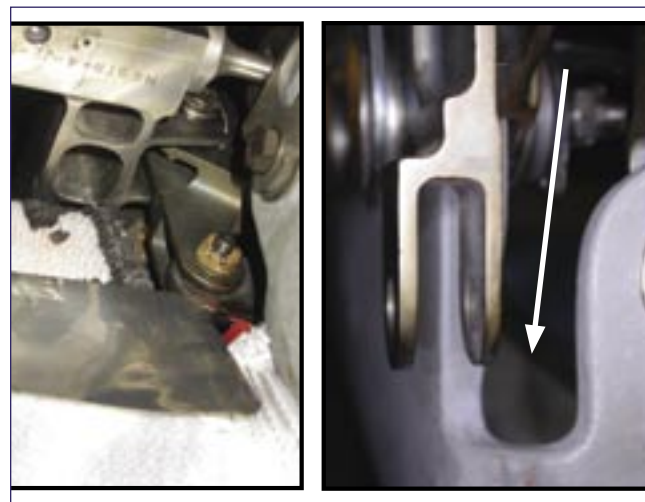

Figure 3.7-2. Each RCC panel has a U-shaped slot (see arrow) in the back of the panel. Once superheated air entered the breach in RCC panel 8, some of that superheated air went through this slot and caused substantial damage to the Thermal Protection System tiles behind this area.

Post-accident analysis of flight data that was generated after telemetry information was lost showed another abrupt change in the Orbiter's aerodynamics caused by a continued progression of left wing damage at EI+917. The data showed a significant increase in positive roll and negative yaw, again indicating another increase in drag on and lift from the damaged left wing. *Columbia's* flight control system attempted to compensate for this increased left yaw by firing all four right yaw jets. Even with all thrusters firing, combined with a maximum rate of change of aileron trim, the flight control system was unable to control the left yaw, and control of the Orbiter was lost at EI+970 seconds. Mission Control lost all telemetry data from the Orbiter at EI+923 (8:59:32 a.m.). Civilian and military video cameras on the ground documented the final breakup. The Modular Auxiliary Data System stopped recording at EI+970 seconds.

Findings:

- F3.6-1 The de-orbit burn and re-entry flight path were normal until just before Loss of Signal.
- F3.6-2 *Columbia* re-entered the atmosphere with a pre-existing breach in the left wing.
- F3.6-3 Data from the Modular Auxiliary Data System recorder indicates the location of the breach was in the RCC panels on the left wing leading edge.
- F3.6-4 Abnormal heating events preceded abnormal aerodynamic events by several minutes.
- F3.6-5 By the time data indicating problems was telemetered to Mission Control Center, the Orbiter had already suffered damage from which it could not recover.

Recommendations:

- R3.6-1 The Modular Auxiliary Data System instrumentation and sensor suite on each Orbiter should be maintained and updated to include current sensor and data acquisition technologies.
- R3.6-2 The Modular Auxiliary Data System should be redesigned to include engineering performance and vehicle health information, and have the ability to be reconfigured during flight in order to allow certain data to be recorded, telemetered, or both, as needs change.

3.7 DEBRIS ANALYSIS

The Board performed a detailed and exhaustive investigation of the debris that was recovered. While sensor data from the Orbiter pointed to early problems on the left wing, it could only isolate the breach to the general area of the left wing RCC panels. Forensics analysis independently determined that RCC panel 8 was the most likely site of the breach, and this was subsequently corroborated by other analyses. (See Appendix D.11.)

Pre-Breakup and Post-Breakup Damage Determination

Differentiating between pre-breakup and post-breakup damage proved a challenge. When *Columbia's* main body break-

up occurred, the Orbiter was at an altitude of about 200,000 feet and traveling at Mach 19, well within the peak-heating region calculated for its re-entry profile. Consequently, as individual pieces of the Orbiter were exposed to the atmosphere at breakup, they experienced temperatures high enough to damage them. If a part had been damaged by heat prior to breakup, high post-breakup temperatures could easily conceal the pre-breakup evidence. In some cases, there was no clear way to determine what happened when. In other cases, heat erosion occurred over fracture surfaces, indicating the piece had first broken and had then experienced high temperatures. Investigators concluded that pre- and post-breakup damage had to be determined on a part-by-part basis; it was impossible to make broad generalizations based on the gross physical evidence.

Amount of Right Wing Debris versus Left Wing Debris

Detailed analysis of the debris revealed unique features and convincing evidence that the damage to the left wing differed significantly from damage to the right, and that significant differences existed in pieces from various areas of the left wing. While a substantial amount of upper and lower right wing structure was recovered, comparatively little of the upper and lower left wing structure was recovered (see Figure 3.7-1).

The difference in recovered debris from the Orbiter's wings clearly indicates that after the breakup, most of the left wing succumbed to both high heat and aerodynamic forces, while the right wing succumbed to aerodynamic forces only. Because the left wing was already compromised, it was the first area of the Orbiter to fail structurally. Pieces were exposed to higher heating for a longer period, resulting in more heat damage and ablation of left wing structural material. The left wing was also subjected to superheated air that penetrated directly into the mid-body of the wing for a substantial period. This pre-heating likely rendered those components unable to absorb much, if any, of the post-breakup heating. Those internal and external structures were likely vaporized during post-breakup re-entry. Finally, the left wing likely lost significant amounts of the Thermal Protection System prior to breakup due to the effect of internal wing heating on the Thermal Protection System bonding materials, and this further degraded the left wing's ability to resist the high heat of re-entry after it broke up.

Tile Slumping and External Patterns of Tile Loss

Tiles recovered from the lower left wing yielded their own interesting clues. The left wing lower carrier panel 9 tiles sustained extreme heat damage (slumping) and showed more signs of erosion than any other tiles. This severe heat erosion damage was likely caused by an *outflow* of superheated air and molten material from behind RCC panel 8 through a U-shaped design gap in the panel (see Figure 3.7-2) that allows room for the T-seal attachment. Effluents from the back side of panel 8 would directly impact this area of lower carrier panel 9 and its tiles. In addition, flow lines in these tiles (see Figure 3.7-3) exhibit evidence of superheated airflow across their surface from the area of the RCC panel

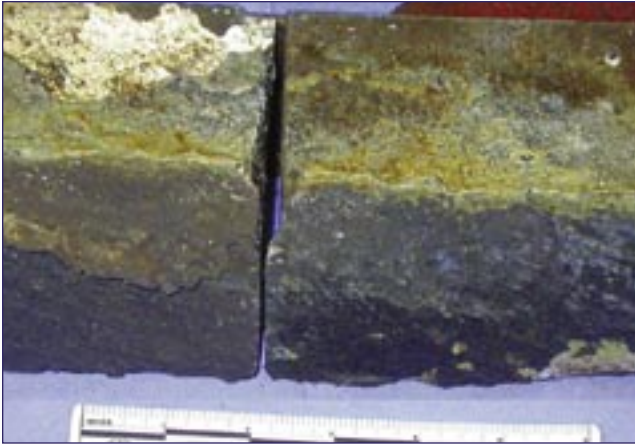

Figure 3.7-3. Superheated airflow caused erosion in tiles around the RCC panel 8 and 9 interface. The tiles shown are from behind the area where the superheated air exited from the slot in Figure 3.7-2. These tiles showed much greater thermal damage than other tiles in this area and chemical analysis showed the presence of metals only found in wing leading edge components.

8 and 9 interface. Chemical analysis shows that these carrier panel tiles were covered with molten Inconel, which is found in wing leading edge attachment fittings, and other metals coming from inside the RCC cavity. Slumping and heavy erosion of this magnitude is not noted on tiles from anywhere else on the Orbiter.

Failure modes of recovered tiles from the left and the right wing also differ. Most right wing tiles were simply broken off the wing due to aerodynamic forces, which indicates that they failed due to physical overload at breakup, not because of heat. Most of the tiles on the left wing behind RCC panels 8 and 9 show significant evidence of backside heating of the wing skin and failure of the adhesive that held the tiles on the wing. This pattern of failure suggests that heat penetrated the left wing cavity and then heated the aluminum skin from the inside out. As the aluminum skin was heated,

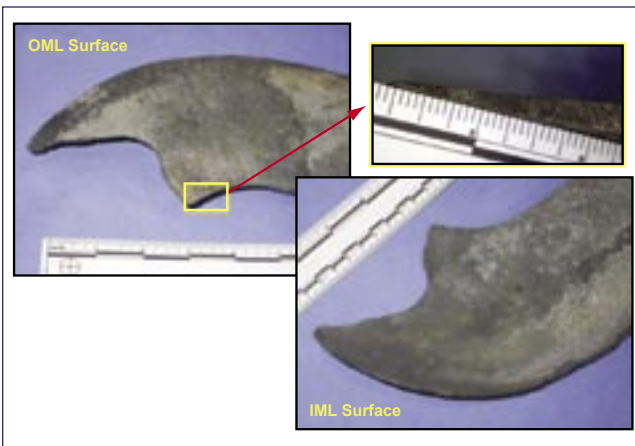

Figure 3.7-4. The outboard rib of panel 8 and the inboard rib of panel 9 showed signs of extreme heating and erosion. RCC erosion of this magnitude was not observed in any other location on the Orbiter.

the strength of the tile bond degraded, and tiles separated from the Orbiter.

Erosion of Left Wing Reinforced Carbon-Carbon

Several pieces of left wing RCC showed unique signs of heavy erosion from exposure to extreme heat. There was erosion on two rib panels on the left wing leading edge in the RCC panel 8 and 9 interface. Both the outboard rib of panel 8 and the inboard rib of panel 9 showed signs of extreme heating and erosion (see Figure 3.7-4). This erosion indicates that there was extreme heat behind RCC panels 8 and 9. This type of RCC erosion was not seen on any other part of the left or right wing.

Locations of Reinforced Carbon-Carbon Debris

The location of debris on the ground also provided evidence of where the initial breach occurred. The location of every piece of recovered RCC was plotted on a map and labeled according to the panel the piece originally came from. Two distinct patterns were immediately evident. First, it was clear that pieces from left wing RCC panels 9 through 22 had fallen the farthest west, and that RCC from left wing panels 1 through 7 had fallen considerably farther east (see Figure 3.7-5). Second, pieces from left wing panel 8 were

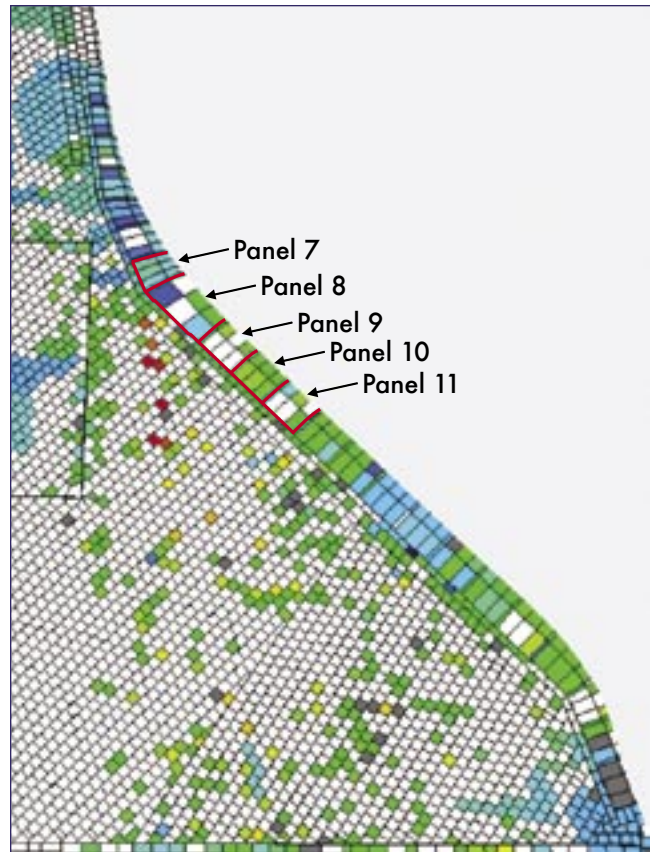

Figure 3.7-6. The tiles recovered farthest west all came from the area immediately behind left wing RCC panels 8 and 9. In the figure, each small box represents an individual tile on the lower surface of the left wing. The more red an individual tile appears, the farther west it was found.

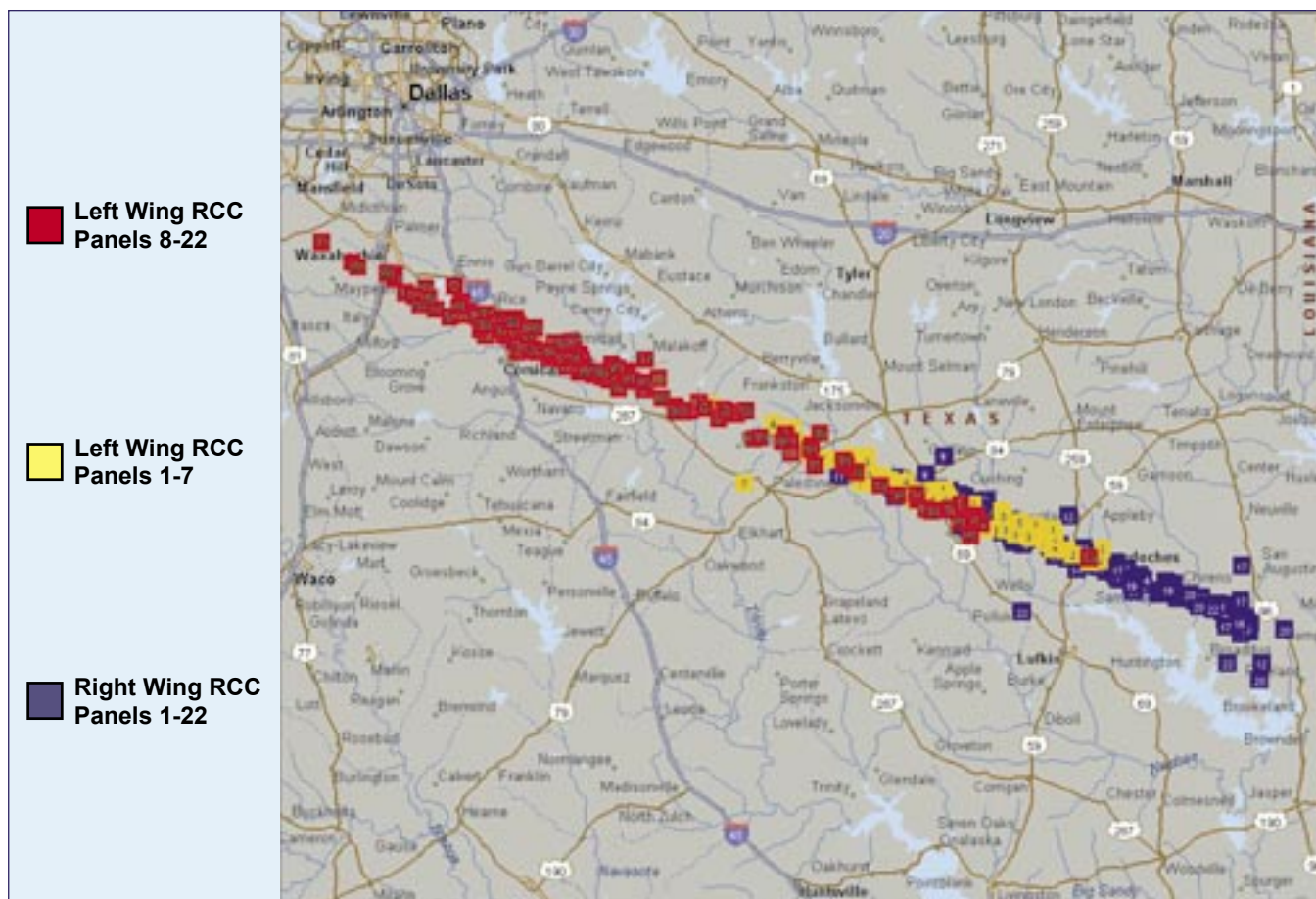

Figure 3.7-5. The location of RCC panel debris from the left and right wings, shown where it was recovered from in East Texas. The debris pattern suggested that the left wing failed before the right wing, most likely near left RCC panels 8 and 9.

found throughout the debris field, which suggested that the left wing likely failed in the vicinity of RCC panel 8. The early loss of the left wing from RCC panel 9 and outboard caused the RCC from that area to be deposited well west of the RCC from the inboard part of the wing. Since panels 1 through 7 were so much farther to the east, investigators concluded that RCC panels 1 through 7 had stayed with the Orbiter longer than had panels 8 through 22.

Tile Locations

An analysis of where tiles were found on the ground also yielded significant evidence of the breach location. Since most of the tiles are of similar size, weight, and shape, they would all have similar ballistic coefficients and would have behaved similarly after they separated from the Orbiter. By noting where each tile fell and then plotting its location on the Orbiter tile map, a distinctive pattern emerged. The tiles recovered farthest west all came from the area immediately behind the left wing RCC panel 8 and 9 (see Figure 3.7-6), which suggests that these tiles were released earlier than those from other areas of the left wing. While it is not conclusive evidence of a breach in this area, this pattern does suggest unique damage around RCC panels 8 and 9 that was not seen in other areas. Tiles from this area also showed evidence of a brown deposit that was not seen on tiles from any

other part of the Orbiter. Chemical analysis revealed it was an Inconel-based deposit that had come from inside the RCC cavity on the left wing (Inconel is found in wing leading edge attachment fittings). Since the streamlines from tiles with the brown deposit originate near left RCC panels 8 and 9, this brown deposit likely originated as an outflow of superheated air and molten metal from the panel 8 and 9 area.

Molten Deposits

High heat damage to metal parts caused molten deposits to form on some Orbiter debris. Early analysis of these deposits focused on their density and location. Much of the left wing leading edge showed some signs of deposits, but the left wing RCC panels 5 to 10 had the highest levels.

Of all the debris pieces recovered, left wing panels 8 and 9 showed the largest amounts of deposits. Significant but lesser amounts of deposits were also observed on left wing RCC panels 5 and 7. Right wing RCC panel 8 was the only right-wing panel with significant deposits.

Chemical and X-Ray Analysis

Chemical analysis focused on recovered pieces of RCC panels with unusual deposits. Samples were obtained from areas

in the vicinity of left wing RCC panel 8 as well as other left and right wing RCC panels. Deposits on recovered RCC debris were analyzed by cross-sectional optical and scanning electron microscopy, microprobe analysis, and x-ray diffraction to determine the content and layering of slag deposits. Slag was defined as metallic and non-metallic deposits that resulted from the melting of the internal wing structures. X-ray analysis determined the best areas to sample for chemical testing and to see if an overall flow pattern could be discerned.

The X-ray analysis of left wing RCC panel 8 (see Figure 3.7-7) showed a bottom-to-top pattern of slag deposits. In some areas, small spheroids of heavy metal were aligned vertically on the recovered pieces, which indicated a superheated airflow from the bottom of the panel toward the top in the area of RCC panel 8-left. These deposits were later determined by chemical analysis to be Inconel 718, probably from the wing leading edge attachment fittings on the spanner beams on RCC panels 8 and 9. Computational fluid dynamics modeling of the flow behind panel 8 indicated that the molten deposits would be laid down in this manner.

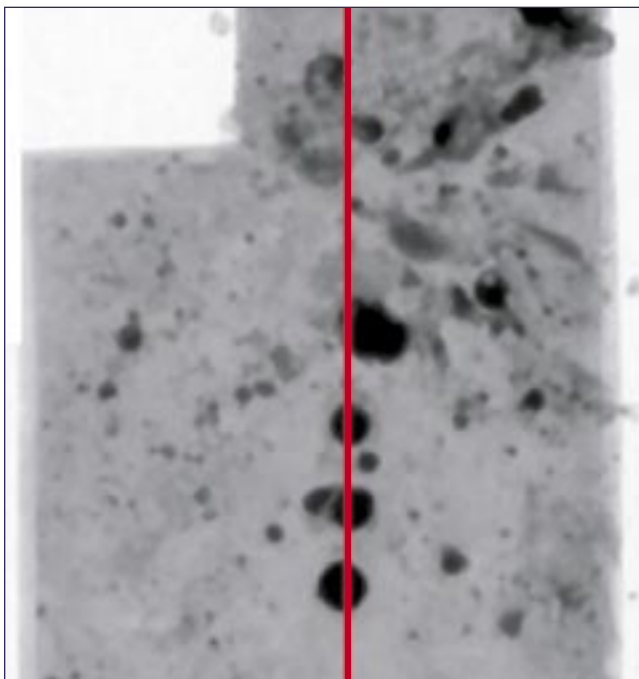

Figure 3.7-7. X-ray analysis of RCC panel 8-left showed a bottom-to-top pattern of slag deposits.

The layered deposits on panel 8 were also markedly different from those on all other left- and right-wing panels. There was much more material deposited on RCC panel 8-left. These deposits had a much rougher overall structure, including rivulets of Cerachrome slag deposited directly on the RCC. This indicated that Cerachrome, the insulation that protects the wing leading edge spar, was one of the first materials to succumb to the superheated air entering through the breach in RCC panel 8-left. Because the melting temperature of Cerachrome is greater than 3,200 degrees Fahrenheit, analysis indicated that materials in this area were exposed to extremely

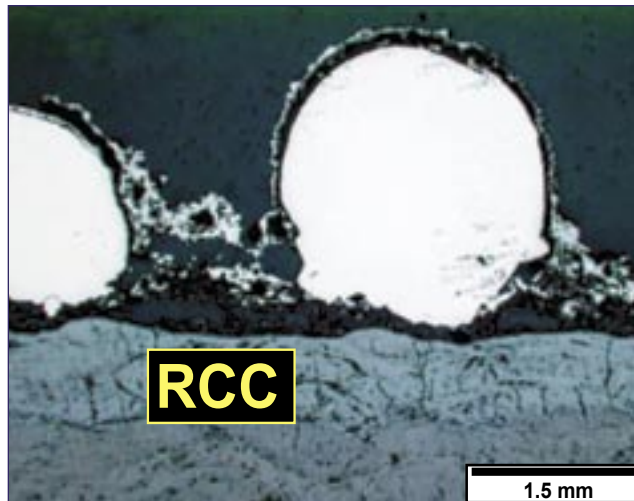

Figure 3.7-8. Spheroids of Inconel 718 and Cerachrome were deposited directly on the surface of RCC panel 8-left. This slag deposit pattern was not seen on any other RCC panels.

high temperatures for a long period. Spheroids of Inconel 718 were mixed in with the Cerachrome. Because these spheroids (see Figure 3.7-8) were directly on the surface of the RCC and also in the first layers of deposits, investigators concluded that the Inconel 718 spanner beam RCC fittings were most likely the first internal structures subjected to intense heating. No aluminum was detected in the earliest slag layers on RCC panel 8-left. Only one location on an upper corner piece, near the spar fitting attachment, contained A-286 stainless steel. This steel was not present in the bottom layer of the slag directly on the RCC surface, which indicated that the A-286 attachment fittings on the wing spar were not in the direct line of the initial plume impingement.

In wing locations other than left RCC panels 8 and 9, the deposits were generally thinner and relatively uniform. This suggests no particular breach location other than in left RCC panels 8 and 9. These other slag deposits contained primarily aluminum and aluminum oxides mixed with A-286, Inconel, and Cerachrome, with no consistent layering. This mixing of multiple metals in no apparent order suggests concurrent melting and re-depositing of all leading-edge components, which is more consistent with post-breakup damage than the organized melting and depositing of materials that occurred near the original breach at left RCC panels 8 and 9. RCC panel 9-left also differs from the rest of the locations analyzed. It was similar to panel 8-left on the inboard side, but more like the remainder of the samples analyzed on its outboard side. The deposition of molten deposits strongly suggests the original breach occurred in RCC panel 8-left.

Spanner Beams, Fittings, and Upper Carrier Panels

Spanner beams, fittings, and upper carrier panels were recovered from areas adjacent to most of the RCC panels on both wings. However, significant numbers of these items were not recovered from the vicinity of left RCC panels 6 to 10. None of the left wing upper carrier panels at positions 9, 10, or 11 were recovered. No spanner beam parts were recovered from

STS-107 CREW SURVIVABILITY

At the Board's request, NASA formed a Crew Survivability Working Group within two weeks of the accident to better understand the cause of crew death and the breakup of the crew module. This group made the following observations.

Medical and Life Sciences

The Working Group found no irregularities in its extensive review of all applicable medical records and crew health data. The Armed Forces Institute of Pathology and the Federal Bureau of Investigation conducted forensic analyses on the remains of the crew of *Columbia* after they were recovered. It was determined that the acceleration levels the crew module experienced prior to its catastrophic failure were not lethal. The death of the crew members was due to blunt trauma and hypoxia. The exact time of death – sometime after 9:00:19 a.m. Eastern Standard Time – cannot be determined because of the lack of direct physical or recorded evidence.

Failure of the Crew Module

The forensic evaluation of all recovered crew module/forward fuselage components did not show any evidence of over-pressurization or explosion. This conclusion is supported by both the lack of forensic evidence and a credible source for either sort of event.¹¹ The failure of the crew module resulted from the thermal degradation of structural properties, which resulted in a rapid catastrophic sequential structural breakdown rather than an instantaneous "explosive" failure.

Separation of the crew module/forward fuselage assembly from the rest of the Orbiter likely occurred immediately in front of the payload bay (between Xo576 and Xo582 bulkheads). Subsequent breakup of the assembly was a result of ballistic heating

and dynamic loading. Evaluations of fractures on both primary and secondary structure elements suggest that structural failures occurred at high temperatures and in some cases at high strain rates. An extensive trajectory reconstruction established the most likely breakup sequence, shown below.

The load and heat rate calculations are shown for the crew module along its reconstructed trajectory. The band superimposed on the trajectory (starting about 9:00:58 a.m. EST) represents the window where all the evaluated debris originated. It appears that the destruction of the crew module took place over a period of 24 seconds beginning at an altitude of approximately 140,000 feet and ending at 105,000 feet. These figures are consistent with the results of independent thermal re-entry and aerodynamic models. The debris footprint proved consistent with the results of these trajectory analyses and models. Approximately 40 to 50 percent, by weight, of the crew module was recovered.

The Working Group's results significantly add to the knowledge gained from the loss of *Challenger* in 1986. Such knowledge is critical to efforts to improve crew survivability when designing new vehicles and identifying feasible improvements to the existing Orbiters.

Crew Worn Equipment

Videos of the crew during re-entry that have been made public demonstrate that prescribed procedures for use of equipment such as full-pressure suits, gloves, and helmets were not strictly followed. This is confirmed by the Working Group's conclusions that three crew members were not wearing gloves, and one was not wearing a helmet. However, under these circumstances, this did not affect their chances of survival.

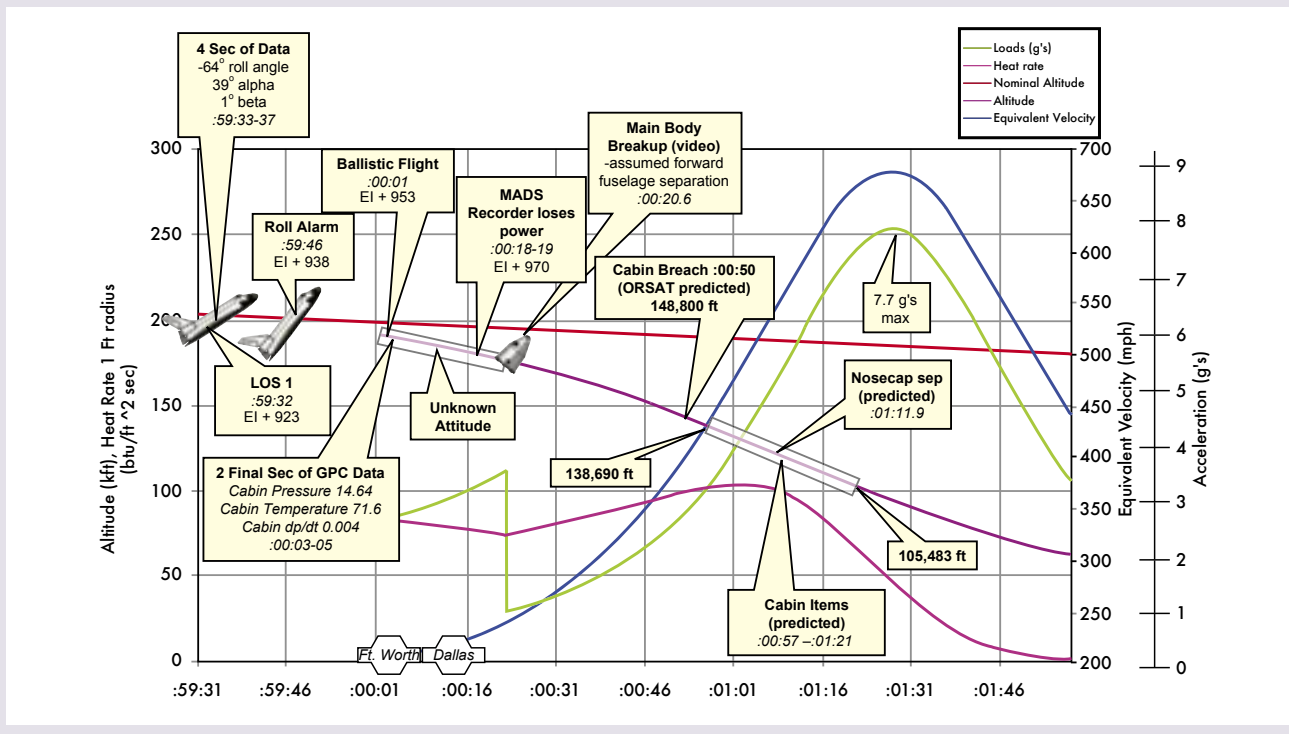

BOARD TESTING

NASA and the Board agreed that tests would be required and a test plan developed to validate an impact/breach scenario. Initially, the Board intended to act only in an oversight role in the development and implementation of a test plan. However, ongoing and continually unresolved debate on the size and velocity of the foam projectile, largely due to the Marshall Space Flight Center's insistence that, despite overwhelming evidence to the contrary, the foam could have been no larger than 855 cubic inches, convinced the Board to take a more active role. Additionally, in its assessment of potential foam damage NASA continued to rely heavily on the Crater model, which was used during the mission to determine that the foam-shedding event was non-threatening. Crater is a semi-empirical model constructed from Apollo-era data. Another factor that contributed to the Board's decision to play an active role in the test program was the Orbiter Vehicle Engineering Working Group's requirement that the test program be used to validate the Crater model. NASA failed to focus on physics-based pre-test predictions, the schedule priorities for RCC tests that were determined by transport analysis, the addition of appropriate test instrumentation, and the consideration of additional factors such as launch loads. Ultimately, in discussions with the Orbiter Vehicle Engineering Working Group and the NASA Accident Investigation Team, the Board provided test plan requirements that outlined the template for all testing. The Board directed that a detailed written test plan, with Board-signature approval, be provided before each test.

the left RCC panel 8 to 10 area. No upper or lower RCC fittings were recovered for left panels 8, 9, or 10. Some of this debris may not have been found in the search, but it is unlikely that all of it was missed. Much of this structure probably melted, and was burned away by superheated air inside the wing. What did not melt was so hot that when it broke apart, it did not survive the heat of re-entry. This supports the theory that superheated air penetrated the wing in the general area of RCC panel 8-left and caused considerable structural damage to the left wing leading edge spar and hardware.

Debris Analysis Conclusions

A thorough analysis of left wing debris (independent of the preceding aerodynamic, aerothermal, sensor, and photo data) supports the conclusion that significant abnormalities occurred in the vicinity of left RCC panels 8 and 9. The preponderance of debris evidence alone strongly indicates that the breach occurred in the bottom of panel 8-left. The unique composition of the slag found in panels 8 and 9, and especially on RCC panel 8-left, indicates extreme and prolonged heating in these areas very early in re-entry.

The early loss of tiles in the region directly behind left RCC panels 8 and 9 also supports the conclusion that a breach through the wing leading edge spar occurred here. This allowed superheated air to flow into the wing directly behind panel 8. The heating of the aluminum wing skin degraded tile adhesion and contributed to the early loss of tiles.

Severe damage to the lower carrier panel 9-left tiles is indicative of a flow out of panel 8-left, also strongly sug-

gesting that the breach in the RCC was through panel 8-left. It is noteworthy that it occurred only in this area and not in any other areas on either the left or the right wing lower carrier panels. There is also significant and unique evidence of severe "knife edges" erosion in left RCC panels 8 and 9. Lastly, the pattern of the debris field also suggests the left wing likely failed in the area of RCC panel 8-left.

The preponderance of unique debris evidence in and near RCC panel 8-left strongly suggests that a breach occurred here. Finally, the unique debris damage in the RCC panel 8-left area is completely consistent with other data, such as the Modular Auxiliary Data System recorder, visual imagery analysis, and the aerodynamic and aerothermal analysis.

Findings:

- F3.7-1 Multiple indications from the debris analysis establish the point of heat intrusion as RCC panel 8-left.
- F3.7-2 The recovery of debris from the ground and its reconstruction was critical to understanding the accident scenario.

Recommendations:

- None

3.8 IMPACT ANALYSIS AND TESTING

The importance of understanding this potential impact damage and the need to prove or disprove the impression that foam could not break an RCC panel prompted the investigation to develop computer models for foam impacts and undertake an impact-testing program of shooting pieces of foam at a mockup of the wing leading edge to re-create, to the extent practical, the actual STS-107 debris impact event.

Based on imagery analysis conducted during the mission and early in the investigation, the test plan included impacts on the lower wing tile, the left main landing gear door, the wing leading edge, and the carrier panels.

A main landing gear door assembly was the first unit ready for testing. By the time that testing occurred, however, analysis was pointing to an impact site in RCC panels 6 through 9. After the main landing gear door tests, the analysis and testing effort shifted to the wing leading edge RCC panel assemblies. The main landing gear door testing provided valuable data on test processes, equipment, and instrumentation. Insignificant tile damage was observed at the low impact angles of less than 20 degrees (the impact angle if the foam had struck the main landing gear door would have been roughly five degrees). The apparent damage threshold was consistent with previous testing with much smaller projectiles in 1999, and with independent modeling by Southwest Research Institute. (See Appendix D.12.)

Impact Test – Wing Leading Edge Panel Assemblies

The test concept was to impact flightworthy wing leading edge RCC panel assemblies with a foam projectile fired by

a compressed-gas gun. Target panel assemblies with a flight history similar to *Columbia's* would be mounted on a support that was structurally equivalent to *Columbia's* wing. The attaching hardware and fittings would be either flight certified or built to *Columbia* drawings. Several considerations influenced the overall RCC test design:

- RCC panel assemblies were limited, particularly those with a flight history similar to *Columbia's*.
- The basic material properties of new RCC were known to be highly variable and were not characterized for high strain rate loadings typical of an impact.
- The influence of aging was uncertain.
- The RCC's brittleness allowed only one test impact on each panel to avoid the possibility that hidden damage would influence the results of later impacts.
- The structural system response of RCC components, their support hardware, and the wing structure was complex.
- The foam projectile had to be precisely targeted, because the predicted structural response depended on the impact point.

Because of these concerns, engineering tests with fiberglass panel assemblies from the first Orbiter, *Enterprise*,¹² were used to obtain an understanding of overall system response to various impact angles, locations, and foam orientations. The fiberglass panel impact tests were used to confirm instrumentation design and placement and the adequacy of the overall test setup.

Test projectiles were made from the same type of foam as the bipod ramp on STS-107's External Tank. The projectile's mass and velocity were determined by the previously described "best fit" image and transport analyses. Because the precise impact point was estimated, the aiming point for any individual test panel was based on structural analyses to maximize the loads in the area being assessed without producing a spray of foam over the top of the wing. The angle of impact relative to the test panel was determined from

the transport analysis of the panel being tested. The foam's rotational velocity was accounted for with a three-degree increase in the impact angle.

Computer Modeling of Impact Tests

The investigation used sophisticated computer models to analyze the foam impact and to help develop an impact test program. Because an exhaustive test matrix to cover all feasible impact scenarios was not practical, these models were especially important to the investigation.

The investigation impact modeling team included members from Boeing, Glenn Research Center, Johnson Space Center, Langley Research Center, Marshall Space Flight Center, Sandia National Laboratory, and Stellingwerf Consulting. The Board also contracted with Southwest Research Institute to perform independent computer analyses because of the institute's extensive test and analysis experience with ballistic impacts, including work on the Orbiter's Thermal Protection System. (Appendix D.12 provides a complete description of Southwest's impact modeling methods and results.)

The objectives of the modeling effort included (1) evaluation of test instrumentation requirements to provide test data with which to calibrate the computer models, (2) prediction of stress, damage, and instrumentation response prior to the Test Readiness Reviews, and (3) determination of the flight conditions/loads (vibrations, aerodynamic, inertial, acoustic, and thermal) to include in the tests. In addition, the impact modeling team provided information about foam impact locations, orientation at impact, and impact angle adjustments that accounted for the foam's rotational velocity.

Flight Environment

A comprehensive consideration of the Shuttle's flight environment, including temperature, pressure, and vibration, was required to establish the experimental protocol.

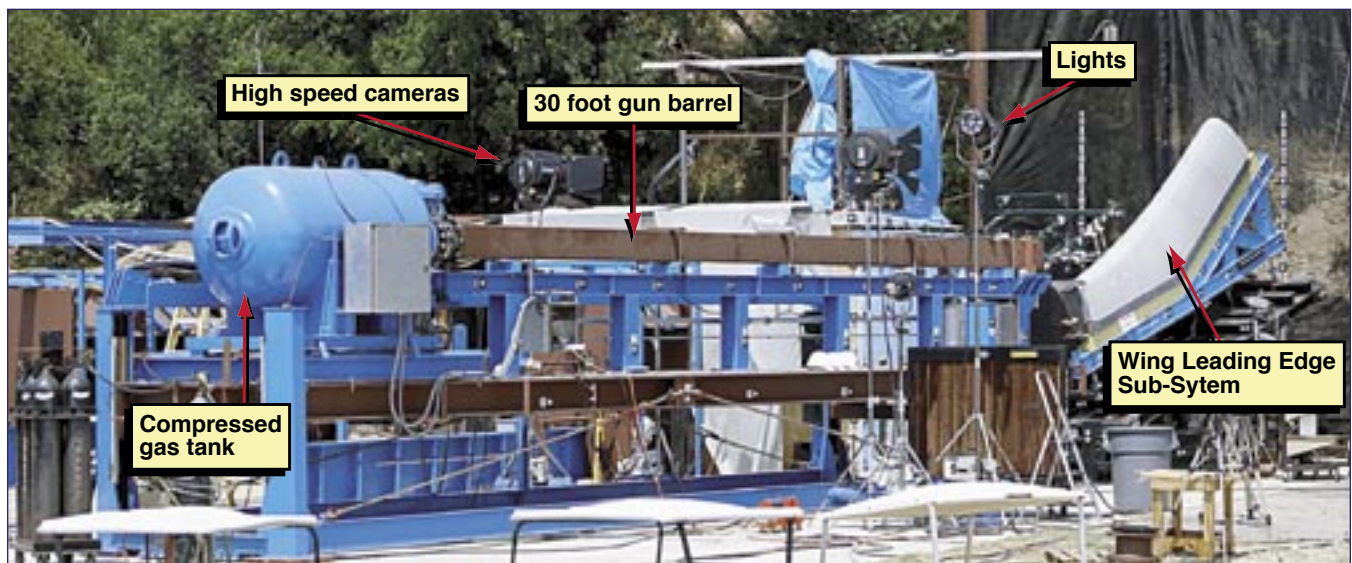

Figure 3.8-1. Nitrogen-powered gun at the Southwest Research Institute used for the test series.

Based on the results of Glenn Research Center sub-scale impact tests of how various foam temperatures and pressures influence the impact force, the Board found that full-scale impact tests with foam at room temperature and pressure could adequately simulate the conditions during the foam strike on STS-107.¹³

The structure of the foam complicated the testing process. The bipod ramp foam is hand-sprayed in layers, which creates “knit lines,” the boundaries between each layer, and the foam compression characteristics depend on the knit lines’ orientation. The projectiles used in the full-scale impact tests had knit lines consistent with those in the bipod ramp foam.

A primary concern of investigators was that external loads present in the flight environment might add substantial extra force to the left wing. However, analysis demonstrated that the only significant external loads on the wing leading edge structural subsystem at about 82 seconds into flight are due to random vibration and the pressure differences inside and outside the leading edge. The Board concluded that the flight environment stresses in the RCC panels and the attachment fittings could be accounted for in post-impact analyses if necessary. However, the dramatic damage produced by the impact tests demonstrated that the foam strike could breach the wing leading edge structure subsystem independent of any stresses associated with the flight environment. (Appendix D.12 contains more detail.)

Test Assembly

The impact tests were conducted at a Southwest Research Institute facility. Figure 3.8-1 shows the nitrogen gas gun that had evaluated bird strikes on aircraft fuselages. The gun was modified to accept a 35-foot-long rectangular barrel, and the target site was equipped with sensors and high-speed cameras that photographed 2,000 to 7,000 frames per second, with intense light provided by theater spotlights and the sun.

Test Impact Target

The leading edge structural subsystem test target was designed to accommodate the Board’s evolving determination of the

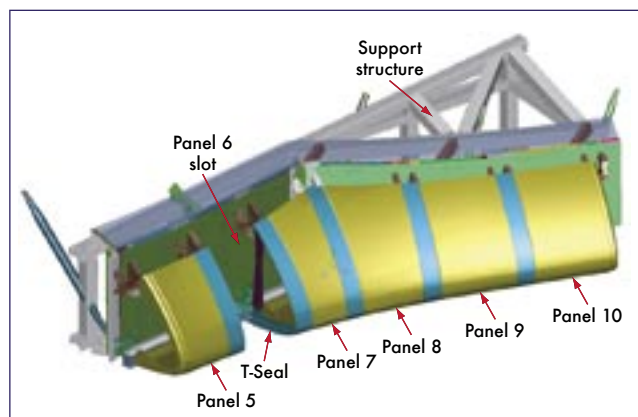

Figure 3.8-2. Test assembly that provided a structural mounting for RCC panel assemblies 5 to 10 and would accommodate some 200 sensors and other test equipment.

most likely point of impact. Initially, analysis pointed to the main landing gear door. As the imaging and transport teams refined their assessments, the likely strike zone narrowed to RCC panels 6 through 9. Because of the long lead time to develop and produce the large complex test assemblies, investigators developed an adaptable test assembly (Figure 3.8-2) that would provide a structurally similar mounting for RCC panel assemblies 5 to 10 and would accommodate some 200 sensors, including high-speed cameras, strain and deflection gauges, accelerometers, and load cells.¹⁴

Test Panels

RCC panels 6 and 9, which bracketed the likely impact region, were the first identified for testing. They would also permit a comparison of the structural response of panels with and without the additional thickness at certain locations.

Panel 6 tests demonstrated the complex system response to impacts. While the initial focus of the investigation had been on single panel response, early results from the tests with fiberglass panels hinted at “boundary condition” effects. Instruments measured high stresses through panels 6, 7, and 8. With this in mind, as well as forensic and sensor evidence that panel 8 was the likeliest location of the foam strike, the Board decided that the second RCC test should target panel 8, which was placed in an assembly that included RCC panels 9 and 10 to provide high fidelity boundary conditions. The decision to impact test RCC panel 8 was complicated by the lack of spare RCC components.

The specific RCC panel assemblies selected for testing had flight histories similar to that of STS-107, which was *Columbia’s* 28th flight. Panel 6 had flown 30 missions on *Discovery*, and Panel 8 had flown 26 missions on *Atlantis*.

Test Projectile

The preparation of BX-250 foam test projectiles used the same material and preparation processes that produced the foam bipod ramp. Foam was selected as the projectile material because foam was the most likely debris, and materials other than foam would represent a greater threat.



Figure 3.8-3. A typical foam projectile, which has marks for determining position and velocity as well as blackened outlines for indicating the impact footprint.

The testing required a projectile (see Figure 3.8-3) made from standard stock, so investigators selected a rectangular cross-section of 11.5 by 5.5 inches, which was within 15 percent of the footprint of the mean debris size initially estimated by image analysis. To account for the foam's density, the projectile length was cut to weigh 1.67 pounds, a figure determined by image and transport analysis to best represent the STS-107 projectile. For foam with a density of 2.4 pounds per cubic foot,¹⁵ the projectile dimensions were 19 inches by 11.5 inches by 5.5 inches.

Impact Angles

The precise impact location of the foam determined the impact angle because the debris was moving almost parallel to the Orbiter's fuselage at impact. Tile areas would have been hit at very small angles (approximately five degrees), but the curvature of the leading edge created angles closer to 20 degrees (see Figure 3.4-4).

The foam that struck *Columbia* on January 16, 2003, had both a translational speed and a rotational speed relative to the Orbiter. The translational velocity was easily replicated by adjusting the gas pressure in the gun. The rotational energy could be calculated, but the impact force depends on the material composition and properties of the impacting body and how the rotating body struck the wing. Because the details of the foam contact were not available from any visual evidence, analysis estimated the increase in impact energy that would be imparted by the rotation. These analyses resulted in a three-degree increase in the angle at which the foam test projectile would hit the test panel.¹⁶

The "clocking angle" was an additional consideration. As shown in Figure 3.8-4, the gun barrel could be rotated to change the impact point of the foam projectile on the leading edge. Investigators conducted experiments to determine if the corner of the foam block or the full edge would impart a

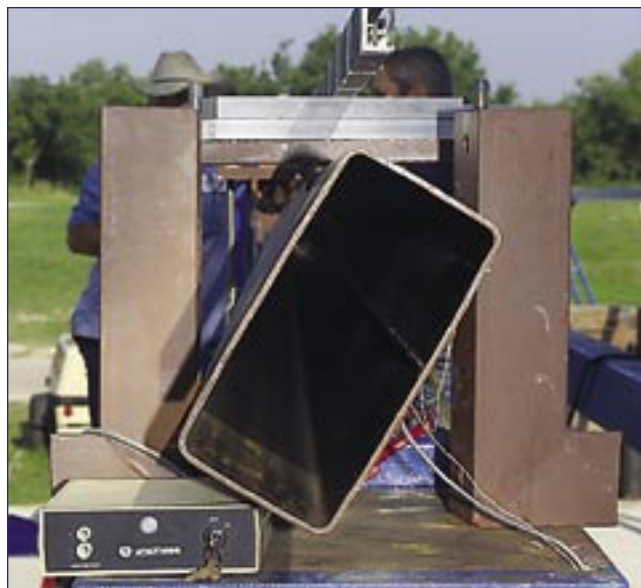

Figure 3.8-4. The barrel on the nitrogen gun could be rotated to adjust the impact point of the foam projectile.

greater force. During the fiberglass tests, it was found that a clocking angle of 30 degrees allowed the 11.5-inch-edge to fully contact the panel at impact, resulting in a greater local force than a zero degree angle, which was achieved with the barrel aligned vertically. A zero-degree angle was used for the test on RCC panel 6, and a 30-degree angle was used for RCC panel 8.

Test Results from Fiberglass Panel Tests 1-5

Five engineering tests on fiberglass panels (see Figure 3.8-5) established the test parameters of the impact tests on RCC panels. Details of the fiberglass tests are in Appendix D.12.

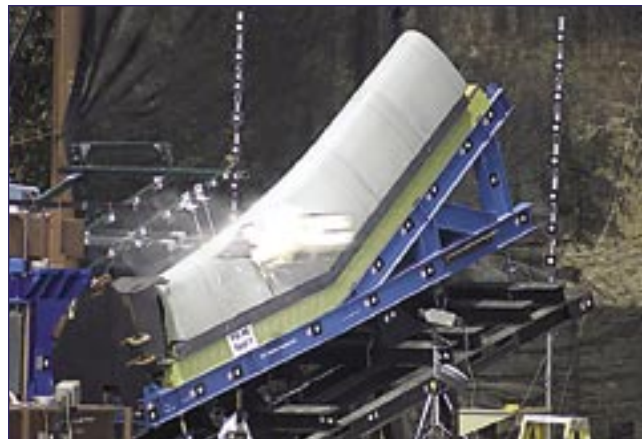

Figure 3.8-5. A typical foam strike leaves impact streaks, and the foam projectile breaks into shards and larger pieces. Here the foam is striking Panel 6 on a fiberglass test article.

Test Results from Reinforced Carbon-Carbon Panel 6 (From Discovery)

RCC panel 6 was tested first to begin to establish RCC impact response, although by the time of the test, other data had indicated that RCC panel 8-left was the most likely site of the breach. RCC panel 6 was impacted using the same parameters as the test on fiberglass panel 6 and developed a 5.5-inch crack on the outboard end of the panel that extended through the rib (see Figure 3.8-6). There was also a crack through the "web" of the T-seal between panels 6 and 7 (see Figure 3.8-7). As in the fiberglass test, the foam block deflected, or moved, the face of the RCC panel, creating a slit between the panel and the adjacent T-seal, which ripped the projectile and stuffed pieces of foam into the slit (see Figure 3.8-8). The panel rib failed at lower stresses than predicted, and the T-seal failed closer to predictions, but overall, the stress pattern was similar to what was predicted, demonstrating the need to incorporate more complete RCC failure criteria in the computational models.

Without further crack growth, the specific structural damage this test produced would probably not have allowed enough superheated air to penetrate the wing during re-entry to cause serious damage. However, the test did demonstrate that a foam impact representative of the debris strike at 81.9 seconds after launch could damage an RCC panel. Note that

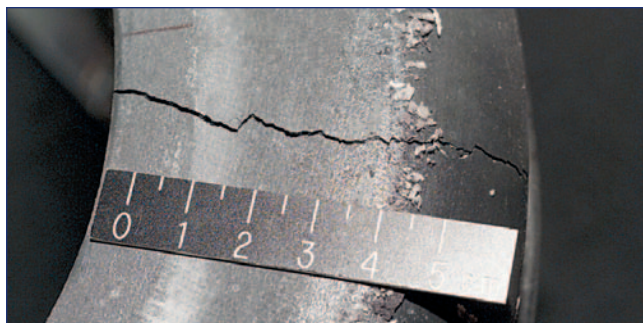

Figure 3.8-6. A 5.5-inch crack on the outboard portion of RCC Panel 6 during testing.

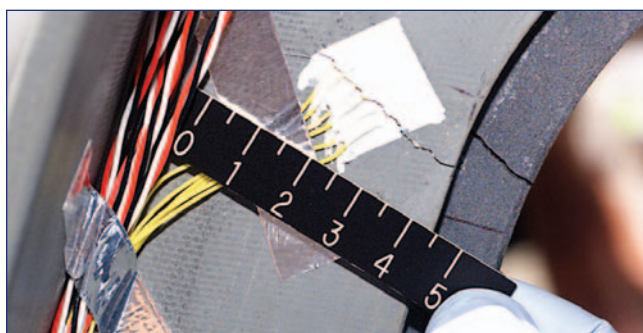

Figure 3.8-7. Two views of the crack in the T-seal between RCC Panels 6 and 7.

the RCC panel 6-left test used fiberglass panels and T-seals in panel 7, 8, 9, and 10 locations. As seen later in the RCC panel 8-left test, this test configuration may not have adequately reproduced the flight configuration. Testing of a full RCC panel 6, 7, and 8 configuration might have resulted in more severe damage.

Test Results from Reinforced Carbon-Carbon Panel 8 (From *Atlantis*)

The second impact test of RCC material used panel 8 from *Atlantis*, which had flown 26 missions. Based on forensic evidence, sensor data, and aerothermal studies, panel 8 was considered the most likely point of the foam debris impact on *Columbia*.

Based on the system response of the leading edge in the fiberglass and RCC panel 6 impact tests, the adjacent RCC panel assemblies (9 and 10) were also flown hardware. The reference 1.67-pound foam test projectile impacted panel 8

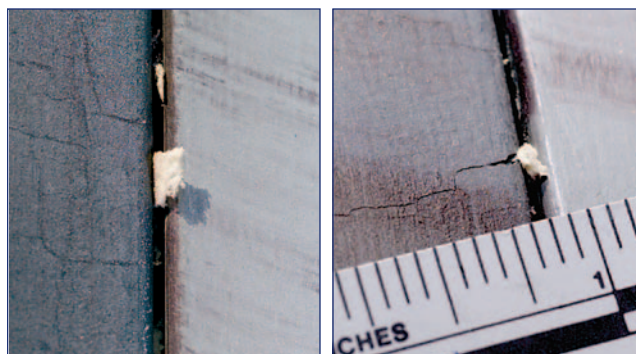

Figure 3.8-8. Two views of foam lodged into the slit during tests.



Figure 3.8-9. The large impact hole in Panel 8 from the final test.



Figure 3.8-10. Numerous cracks were also noted in RCC Panel 8.

at 777 feet per second with a clocking angle of 30 degrees and an angle of incidence of 25.1 degrees.

The impact created a hole roughly 16 inches by 17 inches, which was within the range consistent with all the findings of the investigation (see Figure 3.8-9). Additionally, cracks in the panel ranged up to 11 inches in length (Figure 3.8-10). The T-seal between panels 8 and 9 also failed at the lower outboard mounting lug.

Three large pieces of the broken panel face sheet (see Figure 3.8-11) were retained within the wing. The two largest pieces had surface areas of 86 and 75 square inches. While this test cannot exactly duplicate the damage *Columbia* incurred, pieces such as these could have remained in the wing cavity for some time, and could then have floated out of the damaged wing while the Orbiter was maneuvering in space. This scenario is consistent with the event observed on Flight Day 2 (see Section 3.5).

The test clearly demonstrated that a foam impact of the type *Columbia* sustained could seriously breach the Wing Leading Edge Structural Subsystem.

Conclusion

At the beginning of this chapter, the Board stated that the physical cause of the accident was a breach in the Thermal Protection System on the leading edge of the left wing. The breach was initiated by a piece of foam that separated from the left bipod ramp of the External Tank and struck the wing in the vicinity of the lower half of the Reinforced Carbon-Carbon (RCC) panel 8.

The conclusion that foam separated from the External Tank bipod ramp and struck the wing in the vicinity of panel 8 is documented by photographic evidence (Section 3.4). Sensor data and the aerodynamic and thermodynamic analyses (Section 3.6) based on that data led to the determination that the breach was in the vicinity of panel 8 and also accounted for the subsequent melting of the supporting structure, the spar, and the wiring behind the spar that occurred behind panel 8. The detailed examination of the debris (Section 3.7) also pointed to panel 8 as the breach site. The impact tests (Section 3.8) established that foam can breach the RCC, and also counteracted the lingering denial or discounting of the analytic evidence. Based on this evidence, the Board concluded that panel 8 was the site of the foam strike to *Columbia* during the liftoff of STS-107 on January 23, 2003.

Findings:

- F3.8-1 The impact test program demonstrated that foam can cause a wide range of impact damage, from cracks to a 16- by 17-inch hole.
- F3.8-2 The wing leading edge Reinforced Carbon-Carbon composite material and associated support hardware are remarkably tough and have impact capabilities that far exceed the minimal impact resistance specified in their original design requirements. Nevertheless, these tests demonstrate that this inherent toughness can be exceeded by

impacts representative of those that occurred during *Columbia's* ascent.

- F3.8-3 The response of the wing leading edge to impacts is complex and can vary greatly, depending on the location of the impact, projectile mass, orientation, composition, and the material properties of the panel assembly, making analytic predictions of damage to RCC assemblies a challenge.¹⁷
- F3.8-4 Testing indicates the RCC panels and T-seals have much higher impact resistance than the design specifications call for.
- F3.8-5 NASA has an inadequate number of spare Reinforced Carbon-Carbon panel assemblies.
- F3.8-6 NASA's current tools, including the Crater model, are inadequate to evaluate Orbiter Thermal Protection System damage from debris impacts during pre-launch, on-orbit, and post-launch activity.
- F3.8-7 The bipod ramp foam debris critically damaged the leading edge of *Columbia's* left wing.

Recommendations:

- R3.8-1 Obtain sufficient spare Reinforced Carbon-Carbon panel assemblies and associated support components to ensure that decisions related to Reinforced Carbon-Carbon maintenance are made on the basis of component specifications, free of external pressures relating to schedules, costs, or other considerations.
- R3.8-2 Develop, validate, and maintain physics-based computer models to evaluate Thermal Protection System damage from debris impacts. These tools should provide realistic and timely estimates of any impact damage from possible debris from any source that may ultimately impact the Orbiter. Establish impact damage thresholds that trigger responsive corrective action, such as on-orbit inspection and repair, when indicated.

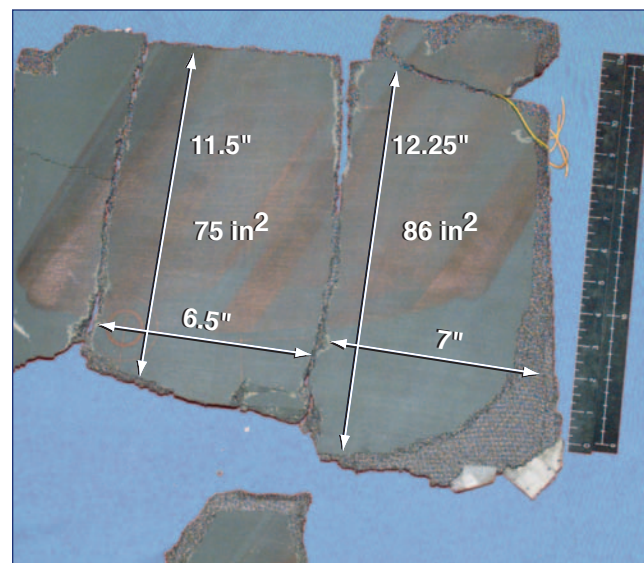

Figure 3.8-11. Three large pieces of debris from the panel face sheet were lodged within the hollow area behind the RCC panel.

ENDNOTES FOR CHAPTER 3

The citations that contain a reference to "CAIB document" with CAB or CTF followed by seven to eleven digits, such as CAB001-0010, refer to a document in the Columbia Accident Investigation Board database maintained by the Department of Justice and archived at the National Archives.

- ¹ See Dennis R. Jenkins, *Space Shuttle: The History of the National Space Transportation System – The First 100 Missions* (Cape Canaveral, FL, Specialty Press, 2001), pp. 421-424 for a complete description of the External Tank.
- ² Scotty Sparks and Lee Foster, "ET Cryoinsulation," CAIB Public Hearing, April 7, 2003. CAIB document CAB017-03140371.
- ³ Scotty Sparks and Steve Holmes, Presentation to the CAIB, March 27, 2003, CAIB document CTF036-02000200.
- ⁴ See the CAIB/NAIT Joint Working Scenario in Appendix D.7 of Volume II of this report.
- ⁵ Boeing Specification MJ070-0001-1E, "Orbiter End Item Specification for the Space Shuttle Systems, Part 1, Performance and Design Requirements, November 7, 2002.
- ⁶ *Ibid.*, Paragraph 3.3.1.8.16.
- ⁷ NSTS-08171, "Operations and Maintenance Requirements and Specifications Document (OMRSD)" File II, Volume 3. CAIB document CAB033-12821997.
- ⁸ Dr. Gregory J. Byrne and Dr. Cynthia A. Evans, "STS-107 Image Analysis Team Final Report in Support of the Columbia Accident Investigation," NSTS-37384, June 2003. CAIB document CTF076-15511657. See Appendix E.2 for a copy of the report.
- ⁹ R. J. Gomex et al, "STS-107 Foam Transport Final Report," NSNS-60506, August 2003.
- ¹⁰ This section based on information from the following reports: MIT Lincoln Laboratory "Report on Flight Day 2 Object Analysis;" Dr. Brian M. Kent, Dr. Kueichien C. Hill, and Captain John Gulick, "An Assessment of Potential Material Candidates for the 'Flight Day 2' Radar Object Observed During the NASA Mission STS-107 (Columbia)", Air Force Research Laboratory Final Summary Report AFRL-SNS-2003-001, July 20, 2003 (see Appendix E.2); Multiple briefings to the CAIB from Dr. Brian M. Kent, AFRL/SN (CAIB document CTF076-19782017); Briefing to the CAIB from HQ AFSPC/XPY, April 18, 2003 (CAIB document CAB066-13771388).
- ¹¹ The water tanks from below the mid-deck floor, along with both Forward Reaction Control System propellant tanks were recovered in good condition.
- ¹² *Enterprise* was used for the initial Approach and Landing Tests and ground tests of the Orbiter, but was never used for orbital tests. The vehicle is now held by the National Air and Space Museum. See Jenkins, *Space Shuttle*, pp. 205-223, for more information on *Enterprise*.
- ¹³ Philip Kopfinger and Wanda Sigur, "Impact Test Results of BX-250 In Support of the Columbia Accident Investigation," ETP-MS-03-021, July 17, 2003.
- ¹⁴ Details of the test instrumentation are in Appendix D.12.
- ¹⁵ Evaluations of the adjustments in the angle of incidence to account for rotation are in Appendix D.12.
- ¹⁶ The potential damage estimates had great uncertainty because the database of bending, tension, crushing, and other measures of failure were incomplete, particularly for RCC material.



Other Factors Considered

During its investigation, the Board evaluated every known factor that could have caused or contributed to the *Columbia* accident, such as the effects of space weather on the Orbiter during re-entry and the specters of sabotage and terrorism. In addition to the analysis/scenario investigations, the Board oversaw a NASA “fault tree” investigation, which accounts for every chain of events that could possibly cause a system to fail. Most of these factors were conclusively eliminated as having nothing to do with the accident; however, several factors have yet to be ruled out. Although deemed by the Board as unlikely to have contributed to the accident, these are still open and are being investigated further by NASA. In a few other cases, there is insufficient evidence to completely eliminate a factor, though most evidence indicates that it did not play a role in the accident. In the course of investigating these factors, the Board identified several serious problems that were not part of the accident’s causal chain but nonetheless have major implications for future missions.

In this chapter, a discussion of these potential causal and contributing factors is divided into two sections. The first introduces the primary tool used to assess potential causes of the breakup: the fault tree. The second addresses fault tree items and particularly notable factors that raised concerns for this investigation and, more broadly, for the future operation of the Space Shuttle.

4.1 FAULT TREE

The NASA Accident Investigation Team investigated the accident using “fault trees,” a common organizational tool in systems engineering. Fault trees are graphical representations of every conceivable sequence of events that could cause a system to fail. The fault tree’s uppermost level illustrates the events that could have directly caused the loss of *Columbia* by aerodynamic breakup during re-entry. Subsequent levels comprise all individual elements or factors that could cause the failure described immediately above it. In this way, all potential chains of causation that lead ultimately to the loss of *Columbia* can be diagrammed, and the behavior of every subsystem that was not a precipitating cause can be eliminated from consideration. Figure 4.1-1 depicts the fault tree structure for the *Columbia* accident investigation.

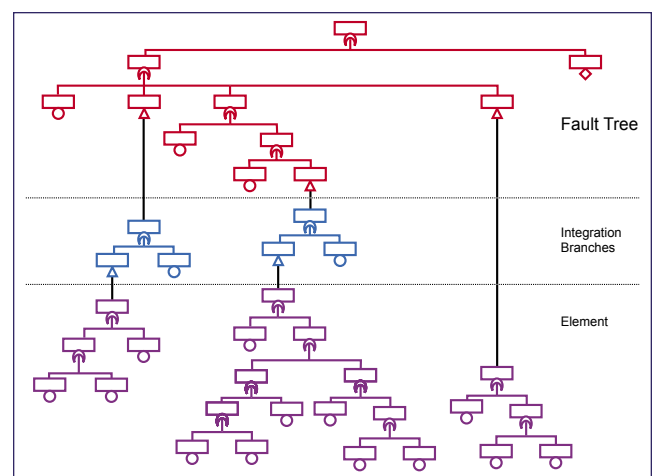

Figure 4.1-1. Accident investigation fault tree structure.

NASA chartered six teams to develop fault trees, one for each of the Shuttle’s major components: the Orbiter, Space Shuttle Main Engine, Reusable Solid Rocket Motor, Solid Rocket Booster, External Tank, and Payload. A seventh “systems integration” fault tree team analyzed failure scenarios involving two or more Shuttle components. These interdisciplinary teams included NASA and contractor personnel, as well as outside experts.

Some of the fault trees are very large and intricate. For instance, the Orbiter fault tree, which only considers events on the Orbiter that could have led to the accident, includes 234 elements. In contrast, the Systems Integration fault tree, which deals with interactions among parts of the Shuttle, includes 295 unique multi-element integration faults, 128 Orbiter multi-element faults, and 221 connections to the other Shuttle components. These faults fall into three categories: induced and natural environments (such as structural interface loads and electromechanical effects); integrated vehicle mass properties; and external impacts (such as debris from the External Tank). Because the Systems Integration team considered multi-element faults – that is, scenarios involving several Shuttle components – it frequently worked in tandem with the Component teams.

In the case of the *Columbia* accident, there could be two plausible explanations for the aerodynamic breakup of the Orbiter: (1) the Orbiter sustained structural damage that undermined attitude control during re-entry; or (2) the Orbiter maneuvered to an attitude in which it was not designed to fly. The former explanation deals with structural damage initiated before launch, during ascent, on orbit, or during re-entry. The latter considers aerodynamic breakup caused by improper attitude or trajectory control by the Orbiter's Flight Control System. Telemetry and other data strongly suggest that improper maneuvering was not a factor. Therefore, most of the fault tree analysis concentrated on structural damage that could have impeded the Orbiter's attitude control, in spite of properly operating guidance, navigation, and flight control systems.

When investigators ruled out a potential cascade of events, as represented by a branch on the fault tree, it was deemed "closed." When evidence proved inconclusive, the item remained "open." Some elements could be dismissed at a high level in the tree, but most required delving into lower levels. An intact Shuttle component or system (for example, a piece of Orbiter debris) often provided the basis for closing an element. Telemetry data can be equally persuasive: it frequently demonstrated that a system operated correctly until the loss of signal, providing strong evidence that the system in question did not contribute to the accident. The same holds true for data obtained from the Modular Auxiliary Data System recorder, which was recovered intact after the accident.

The closeout of particular chains of causation was examined at various stages, culminating in reviews by the NASA Orbiter Vehicle Engineering Working Group and the NASA Accident Investigation Team. After these groups agreed to close an element, their findings were forwarded to the Board for review. At the time of this report's publication, the Board had closed more than one thousand items. A summary of fault tree elements is listed in Figure 4.1-2.

Branch	Total Number of Elements	Number of Open Elements		
		Likely	Possible	Unlikely
Orbiter	234	3	8	6
SSME	22	0	0	0
RSRM	35	0	0	0
SRB	88	0	4	4
ET	883	6	0	135
Payload	3	0	0	0
Integration	295	1	0	1

Figure 4.1-2. Summary of fault tree elements reviewed by the Board.

The open elements are grouped by their potential for contributing either directly or indirectly to the accident. The first group contains elements that may have in any way contrib-

uted to the accident. Here, "contributed" means that the element may have been an initiating event or a *likely* cause of the accident. The second group contains elements that could not be closed and may or may not have contributed to the accident. These elements are *possible* causes or factors in this accident. The third group contains elements that could not be closed, but are *unlikely* to have contributed to the accident. Appendix D.3 lists all the elements that were closed and thus eliminated from consideration as a cause or factor of this accident.

Some of the element closure efforts will continue after this report is published. Some elements will never be closed, because there is insufficient data and analysis to unconditionally conclude that they did not contribute to the accident. For instance, heavy rain fell on Kennedy Space Center prior to the launch of STS-107. Could this abnormally heavy rainfall have compromised the External Tank bipod foam? Experiments showed that the foam did not tend to absorb rain, but the rain could not be ruled out entirely as having contributed to the accident. Fault tree elements that were not closed as of publication are listed in Appendix D.4.

4.2 REMAINING FACTORS

Several significant factors caught the attention of the Board during the investigation. Although it appears that they were not causal in the STS-107 accident, they are presented here for completeness.

Solid Rocket Booster Bolt Catchers

The fault tree review brought to light a significant problem with the Solid Rocket Booster bolt catchers. Each Solid Rocket Booster is connected to the External Tank by four separation bolts: three at the bottom plus a larger one at the top that weighs approximately 65 pounds. These larger upper (or "forward") separation bolts (one on each Solid Rocket Booster) and their associated bolt catchers on the External Tank provoked a great deal of Board scrutiny.

About two minutes after launch, the firing of pyrotechnic charges breaks each forward separation bolt into two pieces, allowing the spent Solid Rocket Boosters to separate from the External Tank (see Figure 4.2-1). Two "bolt catchers" on the External Tank each trap the upper half of a fired separation bolt, while the lower half stays attached to the Solid Rocket Booster. As a result, both halves are kept from flying free of the assembly and potentially hitting the Orbiter. Bolt catchers have a domed aluminum cover containing an aluminum honeycomb matrix that absorbs the fired bolt's energy. The two upper bolt halves and their respective catchers subsequently remain connected to the External Tank, which burns up on re-entry, while the lower halves stay with the Solid Rocket Boosters that are recovered from the ocean.

If one of the bolt catchers failed during STS-107, the resulting debris could have damaged *Columbia's* wing leading edge. Concerns that the bolt catchers may have failed, causing metal debris to ricochet toward the Orbiter, arose because the configuration of the bolt catchers used on Shuttle missions differs in important ways from the design used in

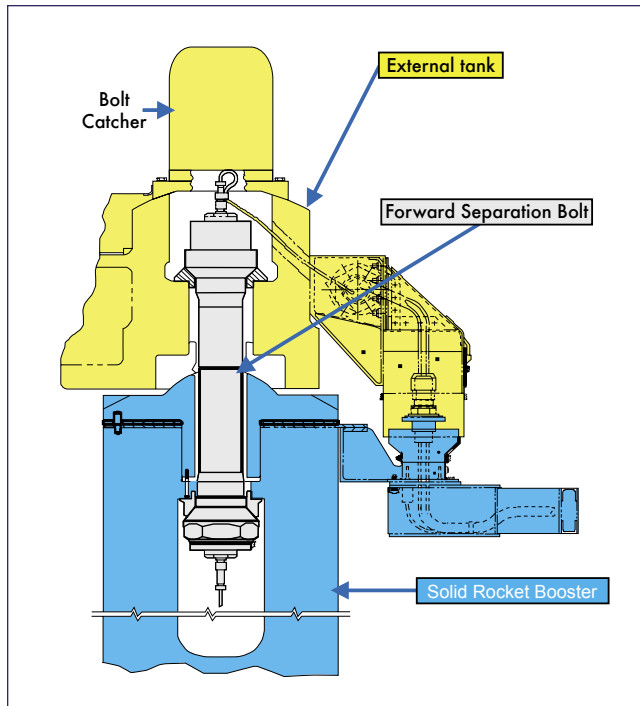

Figure 4.2-1. A cutaway drawing of the forward Solid Rocket Booster bolt catcher and separation bolt assembly.

initial qualification tests.¹ First, the attachments that currently hold bolt catchers in place use bolts threaded into inserts rather than through-bolts. Second, the test design included neither the Super Lightweight Ablative material applied to the bolt catcher apparatus for thermal protection, nor the aluminum honeycomb configuration currently used. Also, during these initial tests, temperature and pressure readings for the bolt firings were not recorded.

Instead of conducting additional tests to correct for these discrepancies, NASA engineers qualified the flight design configuration using a process called “analysis and similarity.” The flight configuration was validated using extrapolated test data and redesign specifications rather than direct testing. This means that NASA’s rationale for considering bolt catchers to be safe for flight is based on limited data from testing 24 years ago on a model that differs significantly from the current design.

Due to these testing deficiencies, the Board recognized that bolt catchers could have played a role in damaging *Columbia*’s left wing. The aluminum dome could have failed catastrophically, ablative coating could have come off in large quantities, or the device could have failed to hold to its mount point on the External Tank. To determine whether bolt catchers should be eliminated as a source of debris, investigators conducted tests to establish a performance baseline for bolt catchers in their current configuration and also reviewed radar data to see whether bolt catcher failure could be observed. The results had serious implications: Every bolt catcher tested failed well below the expected load range of 68,000 pounds. In one test, a bolt catcher failed at 44,000 pounds, which was two percent below the 46,000 pounds

generated by a fired separation bolt. This means that the force at which a separation bolt is predicted to come apart during flight could exceed the bolt catcher’s ability to safely capture the bolt. If these results are consistent with further tests, the factor of safety for the bolt catcher system would be 0.956 – far below the design requirement of 1.4 (that is, able to withstand 1.4 times the maximum load ever expected in operation).

Every bolt catcher must be inspected (via X-ray) as a final step in the manufacturing process to ensure specification compliance. There are specific requirements for film type/quality to allow sufficient visibility of weld quality (where the dome is mated to the mounting flange) and reveal any flaws. There is also a requirement to archive the film for several years after the hardware has been used. The manufacturer is required to evaluate the film, and a Defense Contract Management Agency representative certifies that requirements have been met. The substandard performance of the Summa bolt catchers tested by NASA at Marshall Space Flight Center and subsequent investigation revealed that the contractor’s use of film failed to meet quality requirements and, because of this questionable quality, there were “probable” weld defects in most of the archived film. Film of STS-107’s bolt catchers (serial numbers 1 and 19, both Summa-manufactured), was also determined to be substandard with “probable” weld defects (cracks, porosity, lack of penetration) on number 1 (left Solid Rocket Booster to External Tank attach point). Number 19 appeared adequate, though the substandard film quality leaves some doubt.

Further investigation revealed that a lack of qualified non-destructive inspection technicians and differing interpretations of inspection requirements contributed to this oversight. United Space Alliance, NASA’s agent in procuring bolt catchers, exercises limited process oversight and delegates actual contract compliance verification to the Defense Contract Management Agency. The Defense Contract Management Agency interpreted its responsibility as limited to certifying compliance with the requirement for X-ray inspections. Since neither the Defense Contract Management Agency nor United Space Alliance had a resident non-destructive inspection specialist, they could not read the X-ray film or certify the weld. Consequently, the required inspections of weld quality and end-item certification were not properly performed. Inadequate oversight and confusion over the requirement on the parts of NASA, United Space Alliance, and the Defense Contract Management Agency all contributed to this problem.

In addition, STS-107 radar data from the U.S. Air Force Eastern Range tracking system identified an object with a radar cross-section consistent with a bolt catcher departing the Shuttle stack at the time of Solid Rocket Booster separation. The resolution of the radar return was not sufficient to definitively identify the object. However, an object that has about the same radar signature as a bolt catcher was seen on at least five other Shuttle missions. Debris shedding during Solid Rocket Booster separation is not an unusual event. However, the size of this object indicated that it could be a potential threat if it came close to the Orbiter after coming off the stack.

Although bolt catchers can be neither definitively excluded nor included as a potential cause of left wing damage to *Columbia*, the impact of such a large object would likely have registered on the Shuttle stack's sensors. The indefinite data at the time of Solid Rocket Booster separation, in tandem with overwhelming evidence related to the foam debris strike, leads the Board to conclude that bolt catchers are unlikely to have been involved in the accident.

Findings:

- F4.2-1 The certification of the bolt catchers flown on STS-107 was accomplished by extrapolating analysis done on similar but not identical bolt catchers in original testing. No testing of flight hardware was performed.
- F4.2-2 Board-directed testing of a small sample size demonstrated that the "as-flown" bolt catchers do not have the required 1.4 margin of safety.
- F4.2-3 Quality assurance processes for bolt catchers (a Criticality 1 subsystem) were not adequate to assure contract compliance or product adequacy.
- F4.2-4 An unknown metal object was seen separating from the stack during Solid Rocket Booster separation during six Space Shuttle missions. These objects were not identified, but were characterized as of little to no concern.

Recommendations:

- R4.2-1 Test and qualify the flight hardware bolt catchers.

Kapton Wiring

Because of previous problems with its use in the Space Shuttle and its implication in aviation accidents, Kapton-insulated wiring was targeted as a possible cause of the *Columbia* accident. Kapton is an aromatic polyimide insulation that the DuPont Corporation developed in the 1960s. Because Kapton is lightweight, nonflammable, has a wide operating temperature range, and resists damage, it has been widely used in aircraft and spacecraft for more than 30 years. Each Orbiter contains 140 to 157 miles of Kapton-insulated wire, approximately 1,700 feet of which is inaccessible.

Despite its positive properties, decades of use have revealed one significant problem that was not apparent during its development and initial use: Kapton insulation can break down, leading to a phenomenon known as arc tracking. When arc tracking occurs, the insulation turns to carbon, or carbonizes, at temperatures of 1,100 to 1,200 degrees Fahrenheit. Carbonization is not the same as combustion. During tests unrelated to *Columbia*, Kapton wiring placed in an open flame did not continue to burn when the wiring was removed from the flame. Nevertheless, when carbonized, Kapton becomes a conductor, leading to a "soft electrical short" that causes systems to gradually fail or operate in a degraded fashion. Improper installation and mishandling during inspection and maintenance can also cause Kapton insulation to split, crack, flake, or otherwise physically degrade.² (Arc tracking is pictured in Figure 4.2-2.)

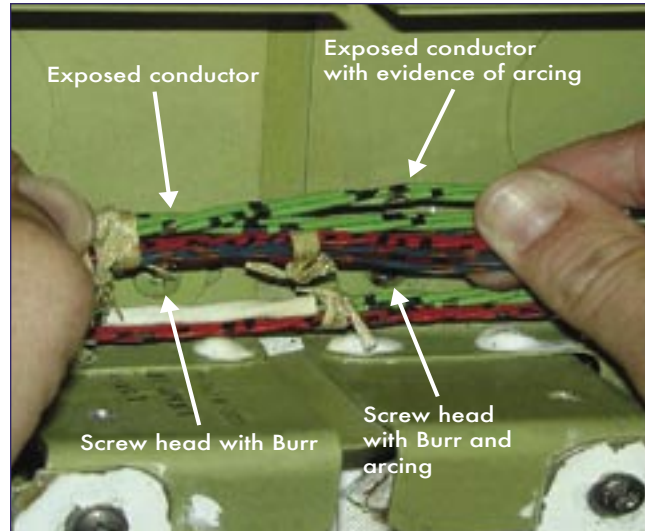

Figure 4.2-2. Arc tracking damage in Kapton wiring.

Perhaps the greatest concern is the breakdown of the wire's insulation when exposed to moisture. Over the years, the Federal Aviation Administration has undertaken extensive studies into wiring-related issues, and has issued Advisory Circulars (25-16 and 43.13-1B) on aircraft wiring that discuss using aromatic polyimide insulation. It was discovered that as long as the wiring is designed, installed, and maintained properly, it is safe and reliable. It was also discovered, however, that the aromatic polyimide insulation does not function well in high-moisture environments, or in installations that require large or frequent flexing. The military had discovered the potentially undesirable aspects of aromatic polyimide insulation much earlier, and had effectively banned its use on new aircraft beginning in 1985. These rules, however, apply only to pure polyimide insulation; various other insulations that contain polyimide are still used in appropriate areas.

The first extensive scrutiny of Kapton wiring on any of the Orbiters occurred during *Columbia*'s third Orbiter Major Modification period, after a serious system malfunction during the STS-93 launch of *Columbia* in July 1999. A short circuit five seconds after liftoff caused two of the six Main Engine Controller computers to lose power, which could have caused one or two of the three Main Engines to shut down. The ensuing investigation identified damaged Kapton wire as the cause of the malfunction. In order to identify and correct such wiring problems, all Orbiters were grounded for an initial (partial) inspection, with more extensive inspections planned during their next depot-level maintenance. During *Columbia*'s subsequent Orbiter Major Modification, wiring was inspected and redundant system wiring in the same bundles was separated to prevent arc tracking damage. Nearly 4,900 wiring nonconformances (conditions that did not meet specifications) were identified and corrected. Kapton-related problems accounted for approximately 27 percent of the nonconformances. This examination revealed a strong correlation between wire damage and the Orbiter areas that had experienced the most foot traffic during maintenance and modification.³

Other aspects of Shuttle operation may degrade Kapton wiring. In orbit, atomic oxygen acts as an oxidizing agent, causing chemical reactions and physical erosion that can lead to mass loss and surface property changes. Fortunately, actual exposure has been relatively limited, and inspections show that degradation is minimal. Laboratory tests on Kapton also confirm that on-orbit ultraviolet radiation can cause delamination, shrinkage, and wrinkling.



Figure 4.2-3. Typical wiring bundle inside Orbiter wing.

A typical wiring bundle is shown in Figure 4.2-3. Wiring nonconformances are corrected by rerouting, reclamping, or installing additional insulation such as convoluted tubing, insulating tape, insulating sheets, heat shrink sleeving, and abrasion pads (see Figure 4.2-4). Testing has shown that wiring bundles usually stop arc tracking when wires are physically separated from one another. Further testing under conditions simulating the Shuttle's wiring environment demonstrated that arc tracking does not progress beyond six inches. Based on these results, Boeing recommended that NASA separate all critical paths from larger wire bundles and individually protect them for a minimum of six inches beyond their separation points.⁴ This recommendation is being adopted through modifications performed during scheduled Orbiter Major Modifications. For example, analysis of telemetered data from 14 of *Columbia's* left wing sensors (hydraulic line/wing skin/wheel temperatures, tire pressures, and landing gear downlock position indication) provided failure signatures supporting the scenario of left-wing thermal intrusion, as opposed to a catastrophic failure (extensive arc tracking) of Kapton wiring. Actual NASA testing in the months following the accident, during which wiring bundles were subjected to intense heat (ovens, blowtorch, and arc jet), verified the failure signature analyses. Finally, extensive testing and analysis in years prior to STS-107 showed that, with the low currents and low voltages associated with the Orbiter's instrumentation system (such as those in the left wing), the probability of arc tracking is commensurately low.

Finding:

F4.2-5 Based on the extensive wiring inspections, maintenance, and modifications prior to STS-107, analysis of sensor/wiring failure signatures, and the alignment of the signatures with thermal intrusion into the wing, the Board found no evidence that Kapton wiring problems caused or contributed to this accident.

Recommendation:

R4.2-2 As part of the Shuttle Service Life Extension Program and potential 40-year service life, develop a state-of-the-art means to inspect all Orbiter wiring, including that which is inaccessible.

Crushed Foam

Based on the anticipated launch date of STS-107, a set of Solid Rocket Boosters had been stacked in the Vehicle Assembly Building and a Lightweight Tank had been attached to them. A reshuffling of the manifest in July 2002 resulted in a delay to the STS-107 mission.⁵ It was decided to use the already-stacked Solid Rocket Boosters for the STS-113 mission to the International Space Station. All flights to the International Space Station use Super Lightweight Tanks, meaning that the External Tank already mated would need to be removed and stored pending the rescheduled STS-107 mission. Since External Tanks are not stored with the bipod struts attached, workers at the Kennedy Space Center removed the bipod strut from the Lightweight Tank before it was lifted into a storage cell.⁶

Following the de-mating of the bipod strut, an area of crushed PDL-1034 foam was found in the region beneath where the left bipod strut attached to the tank's -Y bipod fitting. The region measured about 1.5 inches by 1.25 inches by 0.187 inches and was located at roughly the five o'clock position. Foam thickness in this region was 2.187 inches.

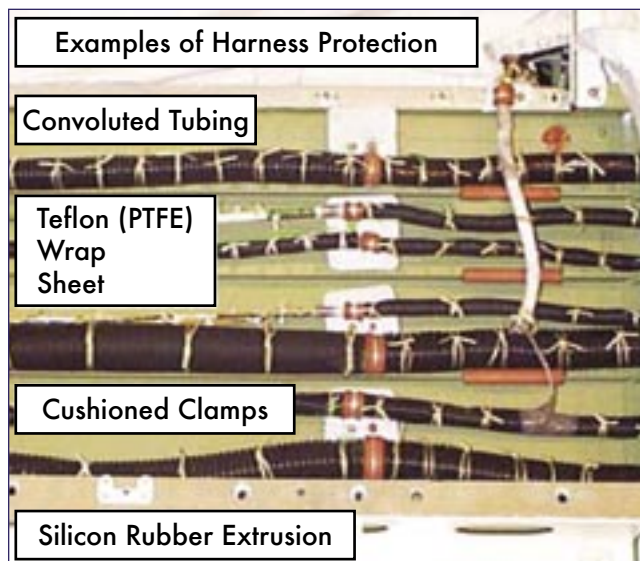

Figure 4.2-4. Typical wiring harness protection methods.

The crushed foam was exposed when the bipod strut was removed. This constituted an unacceptable condition and required a Problem Report write-up.⁷

NASA conducted testing at the Michoud Assembly Facility and at Kennedy Space Center to determine if crushed foam could have caused the loss of the left bipod ramp, and to determine if the limits specified in Problem Report procedures were sufficient for safety.⁸

Kennedy engineers decided not to take action on the crushed foam because it would be covered after the External Tank was mated to a new set of bipod struts that would connect it to *Columbia*, and the struts would sufficiently contain and shield the crushed foam.⁹ An inspection after the bipod struts were attached determined that the area of crushed foam was within limits specified in the drawing for this region.¹⁰

STS-107 was therefore launched with crushed foam behind the clevis of the left bipod strut. Crushed foam in this region is a routine occurrence because the foam is poured and shaved so that the mating of the bipod strut to the bipod fitting results in a tight fit between the bipod strut and the foam.

Pre-launch testing showed that the extent of crushed foam did not exceed limits.¹¹ In these tests, red dye was wicked into the crushed (open) foam cells, and the damaged and dyed foam was then cut out and examined. Despite the effects of crushing, the foam's thickness around the bipod attach point was not substantially reduced; the foam effectively maintained insulation against ice and frost. The crushed foam was contained by the bipod struts and was subjected to little or no airflow.

Finding:

F4.2-6 Crushed foam does not appear to have contributed to the loss of the bipod foam ramp off the External Tank during the ascent of STS-107.

Recommendations:

- None

Hypergolic Fuel Spill

Concerns that hypergolic (ignites spontaneously when mixed) fuel contamination might have contributed to the accident led the Board to investigate an August 20, 1999, hydrazine spill at Kennedy Space Center that occurred while *Columbia* was being prepared for shipment to the Boeing facility in Palmdale, California. The spill occurred when a maintenance technician disconnected a hydrazine fuel line without capping it. When the fuel line was placed on a maintenance platform, 2.25 ounces of the volatile, corrosive fuel dripped onto the trailing edge of the Orbiter's left inboard elevon. After the spill was cleaned up, two tiles were removed for inspection. No damage to the control surface skin or structure was found, and the tiles were replaced.¹²

United Space Alliance briefed all employees working with these systems on procedures to prevent another spill, and on

November 1, 1999, the Shuttle Operations Advisory Group was briefed on the corrective action that had been taken.

Finding:

F4.2-7 The hypergolic spill was not a factor in this accident.

Recommendations:

- None

Space Weather

Space weather refers to the action of highly energetic particles in the outer layers of Earth's atmosphere. Eruptions of particles from the sun are the primary source of space weather events, which fluctuate daily or even more frequently. The most common space weather concern is a potentially harmful radiation dose to astronauts during a mission. Particles can also cause structural damage to a vehicle, harm electronic components, and adversely affect communication links.

After the accident, several researchers contacted the Board and NASA with concerns about unusual space weather just before *Columbia* started its re-entry. A coronal mass ejection, or solar flare, of high-energy particles from the outer layers of the sun's atmosphere occurred on January 31, 2003. The shock wave from the solar flare passed Earth at about the same time that the Orbiter began its de-orbit burn. To examine the possible effects of this solar flare, the Board enlisted the expertise of the Space Environmental Center of the National Oceanic and Atmospheric Administration and the Space Vehicles Directorate of the Air Force Research Laboratory at Hanscom Air Force Base in Massachusetts.

Measurements from multiple space- and ground-based systems indicate that the solar flare occurred near the edge of the sun (as observed from Earth), reducing the impact of the subsequent shock wave to a glancing blow. Most of the effects of the solar flare were not observed on Earth until six or more hours after *Columbia* broke up. See Appendix D.5 for more on space weather effects.

Finding:

F4.2-8 Space weather was not a factor in this accident.

Recommendations:

- None

Asymmetric Boundary Layer Transition

Columbia had recently been through a complete refurbishment, including detailed inspection and certification of all lower wing surface dimensions. Any grossly protruding gap fillers would have been observed and repaired. Indeed, though investigators found that *Columbia*'s reputation for a rough left wing was well deserved prior to STS-75, quantitative measurements show that the measured wing roughness was below the fleet average by the launch of STS-107.¹³

Finding:

F4.2-9 A “rough wing” was not a factor in this accident.

Recommendations:

- None

Training and On-Orbit Performance

All mission-specific training requirements for STS-107 launch and flight control operators were completed before launch with no performance problems. However, seven flight controllers assigned to the mission did not have current recertifications at the time of the Flight Readiness Review, nor were they certified by the mission date. (Most flight controllers must recertify for their positions every 18 months.) The Board has determined that this oversight had no bearing on mission performance (see Chapter 6). The Launch Control Team and crew members held a full “dress rehearsal” of the launch day during the Terminal Countdown Demonstration Test. See Appendix D.1 for additional details on training for STS-107.

Because the majority of the mission was completed before re-entry, an assessment of the training preparation and flight readiness of the crew, launch controllers, and flight controllers was based on the documented performance of mission duties. All STS-107 personnel performed satisfactorily during the launch countdown, launch, and mission. Crew and mission controller actions were consistent with re-entry procedures.

There were a few incorrect switch movements by the crew during the mission, including the configuration of an inter-communications switch and an accidental bump of a rotational hand controller (which affected the Orbiter’s attitude) after the de-orbit burn but prior to Entry Interface. The inter-communications switch error was identified and then corrected by the crew; both the crew and Mission Control noticed the bump and took the necessary steps to place the Orbiter in the correct attitude. Neither of these events was a factor in the accident, nor are they considered training or performance issues. Details on STS-107 on-orbit operations are in Appendix D.2.

Finding:

F4.2-10 The Board concludes that training and on-orbit considerations were not factors in this accident.

Recommendations:

- None

Payloads

To ensure that a payload malfunction did not cause or contribute to the *Columbia* accident, the Board conducted a thorough examination of all payloads and their integration with the Orbiter’s systems. The Board reviewed all down-linked payload telemetry data during the mission, as well as

all payload hardware technical documentation. Investigators assessed every payload readiness review, safety review, and payload integration process used by NASA, and interviewed individuals involved in the payload process at both Johnson and Kennedy Space Centers.

The Board’s review of the STS-107 Flight Readiness Review, Payload Readiness Review, Payload Safety Review Panel, and Integrated Safety Assessments of experiment payloads on STS-107 found that all payload-associated hazards were adequately identified, accounted for, and appropriately mitigated. Payload integration engineers encountered no unique problems during SPACEHAB integration, there were no payload constraints on the launch, and there were no guideline violations during the payload preparation process.

The Board evaluated 11 payload anomalies, one of which was significant. A SPACEHAB Water Separator Assembly leak under the aft sub-floor caused an electrical short and subsequent shutdown of both Water Separator Assemblies. Ground and flight crew responses sufficiently addressed these anomalies during the mission. Circuit protection and telemetry data further indicate that during re-entry, this leak could not have produced a similar electrical short in SPACEHAB that might have affected the main Orbiter power supply.

The Board determined that the powered payloads aboard STS-107 were performing as expected when the Orbiter’s signal was lost. In addition, all potential “fault-tree” payload failures that could have contributed to the Orbiter breakup were evaluated using real-time downlinked telemetry, debris analysis, or design specification analysis. These analyses indicate that no such failures occurred.

Several experiments within SPACEHAB were flammable, used flames, or involved combustible materials. All down-linked SPACEHAB telemetry was normal through re-entry, indicating no unexpected rise in temperature within the module and no increases in atmospheric or hull pressures. All fire alarms and indicators within SPACEHAB were operational, and they detected no smoke or fire. Gas percentages within SPACEHAB were also within limits.

Because a major shift in the Orbiter’s center of gravity could potentially cause flight-control or heat management problems, researchers investigated a possible shifting of equipment in the payload bay. Telemetry during re-entry indicated that all payload cooling loops, electrical wiring, and communications links were functioning as expected, supporting the conclusion that no payload came loose during re-entry. In addition, there are no indications from the Orbiter’s telemetry that any flight control adjustments were made to compensate for a change in the Orbiter’s center of gravity, which indicates that the center of gravity in the payload bay did not shift during re-entry.

The Board explored whether the pressurized SPACEHAB module may have ruptured during re-entry. A rupture could breach the fuselage of the Orbiter or force open the payload bay doors, allowing hot gases to enter the Orbiter. All downlinked payload telemetry indicates that there was no decompression of SPACEHAB prior to loss of signal, and



(Above) The SPACEHAB Research Double Module (left) and Hitchhiker Carrier are lowered toward Columbia's payload bay on May 23, 2002. The Fast Reaction Experiments Enabling Science, Technology, Applications and Research (FREESTAR) is on the Hitchhiker Carrier.

(Below) Columbia's payload bay doors are ready to be closed over the SPACEHAB Research Double Module on June 14, 2002.



no dramatic increase in internal temperature or change in the air composition. This analysis suggests that the pressurized SPACEHAB module did not rupture during re-entry (see Appendix D.6.).

Finding:

F4.2-11 The payloads *Columbia* carried were not a factor in this accident.

Recommendations:

- None

Willful Damage and Security

During the Board's investigation, suggestions of willful damage, including the possibility of a terrorist act or sabotage by a disgruntled employee, surfaced in the media and on various Web sites. The Board assessed such theories, giving particular attention to the unprecedented security precautions taken during the launch of STS-107 because of prevailing national security concerns and the inclusion of an Israeli crew member.

Speculation that *Columbia* was shot down by a missile was easily dismissed. The Orbiter's altitude and speed prior to breakup was far beyond the reach of any air-to-air or surface-to-air missile, and telemetry and Orbiter support system data demonstrate that events leading to the breakup began at even greater altitudes.

The Board's evaluation of whether sabotage played any role included several factors: security planning and countermeasures, personnel and facility security, maintenance and processing procedures, and debris analysis.

To rule out an act of sabotage by an employee with access to these facilities, maintenance and processing procedures were thoroughly reviewed. The Board also interviewed employees who had access to the Orbiter.

The processes in place to detect anything unusual on the Orbiter, from a planted explosive to a bolt incorrectly torqued, make it likely that anything unusual would be caught during the many checks that employees perform as the Orbiter nears final closeout (closing and sealing panels that have been left open for inspection) prior to launch. In addition, the process of securing various panels before launch and taking closeout photos of hardware (see Figure 4.2-5) almost always requires the presence of more than one person, which means a saboteur would need the complicity of at least one other employee, if not more.

Debris from *Columbia* was examined for traces of explosives that would indicate a bomb onboard. Federal Bureau of Investigation laboratories provided analysis. Laboratory technicians took multiple samples of debris specimens and compared them with swabs from *Atlantis* and *Discovery*. Visual examination and gas chromatography with chemiluminescence detection found no explosive residues on any specimens that could not be traced to the Shuttle's pyrotech-

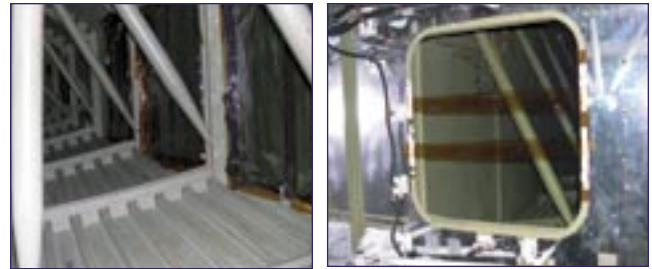

Figure 4.2-5. At left, a wing section open for inspection; at right, wing access closed off after inspection.

nic devices. Additionally, telemetry and other data indicate these pyrotechnic devices operated normally.

In its review of willful damage scenarios mentioned in the press or submitted to the investigation, the Board could not find any that were plausible. Most demonstrated a basic lack of knowledge of Shuttle processing and the physics of explosives, altitude, and thermodynamics, as well as the processes of maintenance documentation and employee screening.

NASA and its contractors have a comprehensive security system, outlined in documents like NASA Policy Directive 1600.2A. Rules, procedures, and guidelines address topics ranging from foreign travel to information security, from security education to investigations, and from the use of force to security for public tours.

The Board examined security at NASA and its related facilities through a combination of employee interviews, site visits, briefing reviews, and discussions with security personnel. The Board focused primarily on reviewing the capability of unauthorized access to Shuttle system components. Facilities and programs examined for security and sabotage potential included ATK Thiokol in Utah and its Reusable Solid Rocket Motor production, the Michoud Assembly Facility in Louisiana and its External Tank production, and the Kennedy Space Center in Florida for its Orbiter and overall integration responsibilities.

The Board visited the Boeing facility in Palmdale, California; Edwards Air Force Base in California; Stennis Space Center in Bay St. Louis, Mississippi; Marshall Space Flight Center near Huntsville, Alabama; and Cape Canaveral Air Force Station in Florida. These facilities exhibited a variety of security processes, according to each site's unique demands. At Kennedy, access to secure areas requires a series of identification card exchanges that electronically record each entry. The Michoud Assembly Facility employs similar measures, with additional security limiting access to a completed External Tank. The use of closed-circuit television systems complemented by security patrols is universal.

Employee screening and tracking measures appear solid across NASA and at the contractors examined by the Board. The agency relies on standard background and law enforcement checks to prevent the hiring of applicants with questionable records and the dismissal of those who may accrue such a record.

It is difficult for anyone to access critical Shuttle hardware alone or unobserved by a responsible NASA or contractor employee. With the exception of two processes when foam is applied to the External Tank at the Michoud Assembly Facility, there are no known final closeouts of any Shuttle component that can be completed with fewer than two people. Most closeouts involve at least five to eight employees before the component is sealed and certified for flight. All payloads also undergo an extensive review to ensure proper processing and to verify that they pose no danger to the crew or the Orbiter.

Security reviews also occur at locations such as the Transoceanic Abort Landing facilities. These sites are assessed prior to launch, and appropriate measures are taken to guarantee they are secure in case an emergency landing is required. NASA also has contingency plans in place, including dealing with bioterrorism.

Both daily and launch-day security at the Kennedy Space Center has been tightened in recent years. Each Shuttle launch has an extensive security countdown, with a variety of checks to guarantee that signs are posted, beaches are closed, and patrols are deployed. K-9 patrols and helicopters guard the launch area against intrusion.

Because the STS-107 manifest included Israel's first astronaut, security measures, developed with National Security Council approval, went beyond the normally stringent precautions, including the development of a Security Support Plan.

Military aircraft patrolled a 40-mile Federal Aviation Administration-restricted area starting nine hours before the launch of STS-107. Eight Coast Guard vessels patrolled a three-nautical-mile security zone around Kennedy Space Center and Cape Canaveral Air Force Station, and Coast Guard and NASA boats patrolled the inland waterways. Security forces were doubled on the day of the launch.

Findings:

- F4.2-12 The Board found no evidence that willful damage was a factor in this accident.
- F4.2-13 Two close-out processes at the Michoud Assembly Facility are currently able to be performed by a single person.
- F4.2-14 Photographs of every close out activity are not routinely taken.

Recommendation:

- R4.2-3 Require that at least two employees attend all final closeouts and intertank area hand-spraying procedures.

Micrometeoroids and Orbital Debris Risks

Micrometeoroids and space debris (often called "space junk") are among the most serious risk factors in Shuttle missions. While there is little evidence that micrometeoroids or space debris caused the loss of *Columbia*, and in fact

a review of on-board accelerometer data rules out a major strike, micrometeoroids or space debris cannot be entirely ruled out as a potential or contributing factor.

Micrometeoroids, each usually no larger than a grain of sand, are numerous and particularly dangerous to orbiting spacecraft. Traveling at velocities that can exceed 20,000 miles per hour, they can easily penetrate the Orbiter's skin. In contrast to micrometeoroids, orbital debris generally comes from destroyed satellites, payload remnants, exhaust from solid rockets, and other man-made objects, and typically travel at far lower velocities. Pieces of debris four inches or larger are catalogued and tracked by the U.S. Air Force Space Command so they can be avoided during flight.

NASA has developed computer models to predict the risk of impacts. The Orbital Debris Model 2000 (ORDEM2000) database is used to predict the probability of a micrometeoroid or space debris collision with an Orbiter, based on its flight trajectory, altitude, date, and duration. Development of the database was based on radar tracking of debris and satellite experiments, as well as inspections of returned Orbiters. The computer code BUMPER translates expected debris hits from ORDEM2000 into an overall risk probability for each flight. The worst-case scenario during orbital debris strikes is known as the Critical Penetration Risk, which can include the depressurization of the crew module, venting or explosion of pressurized systems, breaching of the Thermal Protection System, and damage to control surfaces.

NASA guidelines require the Critical Penetration Risk to be better than 1 in 200, a number that has been the subject of several reviews. NASA has made changes to reduce the probability. For STS-107, the estimated risk was 1 in 370, though the actual as-flown value turned out to be 1 in 356. The current risk guideline of 1 in 200 makes space debris or micrometeoroid strikes by far the greatest risk factor in the Probabilistic Risk Assessment used for missions. Although 1-in-200 flights may seem to be long odds, and many flights have exceeded the guideline, the cumulative risk for such a strike over the 113-flight history of the Space Shuttle Program is calculated to be 1 in 3. The Board considers this probability of a critical penetration to be unacceptably high. The Space Station's micrometeoroid and space debris protection system reduces its critical penetration risk to five percent or less over 10 years, which translates into a per-mission risk of 1 in 1,200 with 6 flights per year, or 60 flights over 10 years.

To improve crew and vehicle safety over the next 10 to 20 years, the Board believes risk guidelines need to be changed to compel the Shuttle Program to identify and, more to the point, reduce the micrometeoroid and orbital debris threat to missions.

Findings:

- F4.2-15 There is little evidence that *Columbia* encountered either micrometeoroids or orbital debris on this flight.

F4.2-16 The Board found markedly different criteria for margins of micrometeoroid and orbital debris safety between the International Space Station and the Shuttle.

Recommendation:

R4.2-4 Require the Space Shuttle to be operated with the same degree of safety for micrometeoroid and orbital debris as the degree of safety calculated for the International Space Station. Change the micrometeoroid and orbital debris safety criteria from guidelines to requirements.

Orbiter Major Modification

The Board investigated concerns that mistakes, mishaps, or human error during *Columbia's* last Orbiter Major Modification might have contributed to the accident. Orbiters are removed from service for inspection, maintenance, and modification approximately every eight flights or three years. *Columbia* began its last Orbiter Major Modification in September 1999, completed it in February 2001, and had flown once before STS-107. Several aspects of the Orbiter Major Modification process trouble the Board, and need to be addressed for future flights. These concerns are discussed in Chapter 10.

Findings:

F4.2-17 Based on a thorough investigation of maintenance records and interviews with maintenance personnel, the Board found no errors during *Columbia's* most recent Orbiter Major Modification that contributed to the accident.

Recommendations:

- None

Foreign Object Damage Prevention

Problems with the Kennedy Space Center and United Space Alliance Foreign Object Damage Prevention Program, which in the Department of Defense and aviation industry typically falls under the auspices of Quality Assurance, are related to changes made in 2001. In that year, Kennedy and Alliance redefined the single term "Foreign Object Damage" – an industry-standard blanket term – into two terms: "Processing Debris" and "Foreign Object Debris."

Processing Debris then became:

Any material, product, substance, tool or aid generally used during the processing of flight hardware that remains in the work area when not directly in use, or that is left unattended in the work area for any length of time during the processing of tasks, or that is left remaining or forgotten in the work area after the completion of a task or at the end of a work shift. Also any item, material or substance in the work area that should be found and removed as part of standard housekeeping, Hazard

Recognition and Inspection Program (HRIP) walk-downs, or as part of "Clean As You Go" practices.¹⁴

Foreign Object Debris then became:

Processing debris becomes FOD when it poses a potential risk to the Shuttle or any of its components, and only occurs when the debris is found during or subsequent to a final/flight Closeout Inspection, or subsequent to OMI S0007 ET Load SAF/FAC walkdown.¹⁵

These definitions are inconsistent with those of other NASA centers, Naval Reactor programs, the Department of Defense, commercial aviation, and National Aerospace FOD Prevention Inc. guidelines.¹⁶ They are unique to Kennedy Space Center and United Space Alliance.

Because debris of any kind has critical safety implications, these definitions are important. The United Space Alliance Foreign Object Program includes daily debris checks by management to ensure that workers comply with United Space Alliance's "clean as you go" policy, but United Space Alliance statistics reveal that the success rate of daily debris checks is between 70 and 86 percent.¹⁷

The perception among many interviewees is that these novel definitions mitigate the impact of Kennedy Mission Assurance-found Foreign Object Debris on the United Space Alliance award fee. This is because "Processing Debris" statistics do not directly affect the award fee. Simply put, in splitting "Foreign Object Damage" into two categories, many of the violations are tolerated. Indeed, with 18 problem reports generated on "lost items" during the processing of STS-107 alone, the need for an ongoing, thorough, and stringent Foreign Object Debris program is indisputable. However, with two definitions of foreign objects – Processing Debris and Foreign Object Debris – the former is portrayed as less significant and dangerous than the latter. The assumption that all debris will be found before flight fails to underscore the destructive potential of Foreign Object Debris, and creates an incentive to simply accept "Processing Debris."

Finding:

F4.2-18 Since 2001, Kennedy Space Center has used a non-standard approach to define foreign object debris. The industry standard term "Foreign Object Damage" has been divided into two categories, one of which is much more permissive.

Recommendation:

R4.2-5 Kennedy Space Center Quality Assurance and United Space Alliance must return to the straightforward, industry-standard definition of "Foreign Object Debris," and eliminate any alternate or statistically deceptive definitions like "processing debris."

ENDNOTES FOR CHAPTER 4

The citations that contain a reference to "CAIB document" with CAB or CTF followed by seven to eleven digits, such as CAB001-0010, refer to a document in the Columbia Accident Investigation Board database maintained by the Department of Justice and archived at the National Archives.

- ¹ SRB Forward Separation Bolt Test Plan, Document Number 90ENG-00XX, April 2, 2003. CAIB document CTF044-62496260.
- ² Cynthia Furse and Randy Haupt, "Down to the Wire," in the online version of the IEEE Spectrum magazine, accessed at <http://www.spectrum.ieee.org/WEBONLY/publicfeature/feb01/wire.html> on 2 August 2002.
- ³ Boeing Inspection Report, OV-102 J3, V30/V31 (Wire) Inspection Report, September 1999-February 2001. CAIB document CTF070-34793501.
- ⁴ Boeing briefing, "Arc Tracking Separation of Critical Wiring Redundancy Violations", present to NASA by Joe Daileida and Bill Crawford, April 18, 2001. CAIB document CAB033-43774435.
- ⁵ E-mail message from Jim Feeley, Lockheed Martin, Michoud Assembly Facility, April 24, 2003. This External Tank (ET-93) was originally mated to the Solid Rocket Boosters and bipod struts in anticipation of an earlier launch date for mission STS-107. Since Space Station missions require the use of a Super Light Weight Tank, ET-93 (which is a Light Weight Tank) had to be de-mated from the Solid Rocket Boosters so that they could be mated to such a Super Light Weight Tank. The mating of the bipod struts to ET-93 was performed in anticipation of an Orbiter mate. Once STS-107 was delayed and ET-93 had to be de-mated from the Solid Rocket Boosters, the bipod struts were also de-mated, since they are not designed to be attached to the External Tank during subsequent Solid Rocket Booster de-mate/mate operations.
- ⁶ "Production Info - Splinter Meeting," presented at Michoud Assembly Facility, March 13, 2002. TSPB ET-93-ST-003, "Bipod Strut Removal," August 1, 2002.
- ⁷ PR ET-93-TS-00073, "There Is An Area Of Crushed Foam From The Installation Of The -Y Bipod," August 8, 2002.
- ⁸ "Crushed Foam Testing." CAIB document CTF059-10561058.
- ⁹ PR ET-93-TS-00073, "There Is An Area Of Crushed Foam From The Installation Of The -Y Bipod," August 8, 2002; Meeting with John Blue, USA Engineer, Kennedy Space Center, March 10, 2003.
- ¹⁰ Lockheed Martin drawing 80911019109-509, "BIPOD INSTL,ET/ORB,FWD"
- ¹¹ "Crushed Foam Testing." CAIB document CTF059-10561058.
- ¹² Minutes of Orbiter Structures Telecon meeting, June 19, 2001, held with NASA, KSC, USA, JSC, BNA-Downey, Huntington Beach and Palmdale. CAIB document CAB033-38743888.
- ¹³ NASA Report NSTS-37398.
- ¹⁴ Standard Operating Procedure, Foreign Object Debris (FOD) Reporting, Revision A, Document Number SOP-O-0801-035, October 1, 2002, United Space Alliance, Kennedy Space Center, pg. 3.
- ¹⁵ Ibid, pg. 2.
- ¹⁶ "An effective FOD prevention program identifies potential problems, corrects negative factors, provides awareness, effective employee training, and uses industry "lessons learned" for continued improvement. There is no mention of Processing Debris, but the guidance does address potential Foreign Object Damage and Foreign Object Debris. While NASA has done a good job of complying with almost every area of this guideline, the document addresses Foreign Object investigations in a singular sense: "All incidents of actual or potential FOD should be reported and investigated. These reports should be directed to the FOD Focal Point who should perform tracking and trending analysis. The focal point should also assure all affected personnel are aware of all potential (near mishap) and actual FOD reports to facilitate feedback ('lessons learned')." "
- ¹⁷ Space Flight Operations Contract, Performance Measurement System Reports for January 2003, February 2003, USA004840, issue 014, contract NAS9-2000.