

DoD Logistics Roadmap



Overview



The DoD Logistics Roadmap...

- 1 ...establishes a DoD-wide framework for improving logistics capabilities and business processes
- 2 ...documents specific actions underway to achieve goals and objectives
- 3 ...documents performance targets for tracking and reporting progress
- 4 ...provides a basis for current and future capabilities assessment
- 5 ...facilitates communication with Congress, the GAO, and other outside agencies





The Roadmap is a living document...

... that establishes objectives adding fidelity and detail to logistics goals specified in the Guidance for the Development of the Force

Strategic Direction

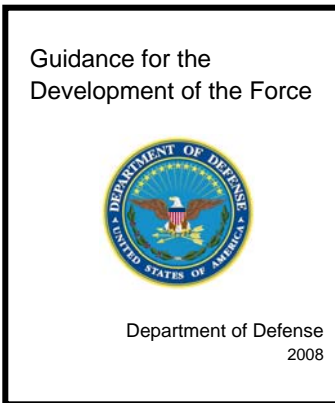

Provides a unified statement of what we want to do

DoD Logistics Roadmap

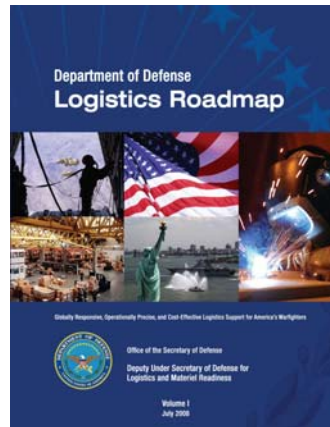

Defines a coherent framework for providing globally responsive, operationally precise, and cost-effective logistics capabilities to support America's warfighters

- **OSD senior logistics leaders establish objectives linked to logistics goals in GDF**
- **Joint team maps DoD Component initiatives and programs to objectives**

Assessment Process

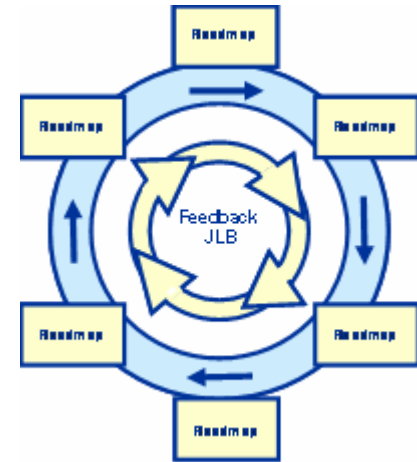

Institutionalized continuous assessment and feedback



The Guidance for the Development of the Force specified three logistics goals...

Strategic
Direction

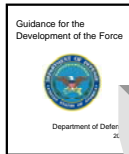

Provides a unified
statement of what
we want to do

DoD Logistics
Roadmap



- OSD senior logistics leaders establish objectives linked to logistics goals in GDF
- Joint team maps component

Assessment
Process



Guidance for the
Development of the Force



Department of Defense
2008

- **Unity of Effort**
- **Visibility**
- **Rapid and Precise Response**

Provides a unified statement of what we want to do



The Roadmap established objectives linked to goals, then identified initiatives and programs linked to objectives...

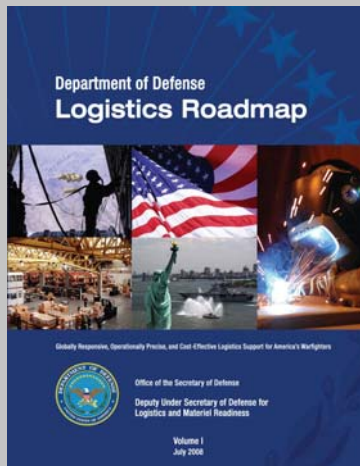

Defines a coherent framework for providing globally responsive, operationally precise, and cost-effective logistics capabilities to support America's warfighters

- OSD senior logistics leaders established objectives linked to logistics goals in GDF
- Focused on the Logistics Joint Capability Areas of
 - Supply
 - Maintain
 - Deployment & Distribution
- A collaborative and joint effort identified Component initiatives and programs supporting Roadmap objectives
- Joint team mapped DoD Component initiatives and programs to objectives



Assessments of Roadmap objectives...

Strategic Direction

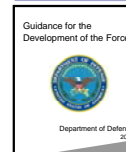

DoD Logistics Roadmap



- OSD senior logistics leaders establish objectives linked to logistics goals in GDF
- Joint team maps

Assessment Process

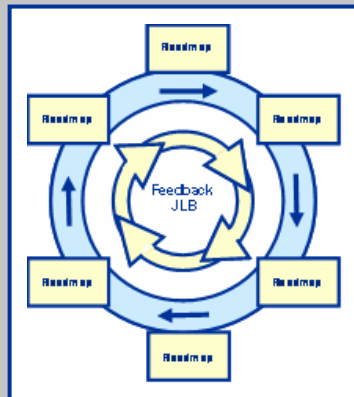
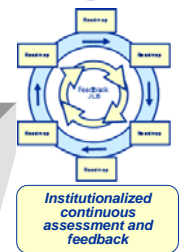

*Institutionalized
continuous
assessment and
feedback*

- Take a strategic look at progress toward achieving goals and objectives
- Identify capability and capacity
 - Gaps, shortfalls, and overlaps
 - Timing issues
 - Challenges
 - Resource issues
- Inform key DoD processes



The Roadmap process will inform...

... PPBE, FY10 QDR, and other DoD processes

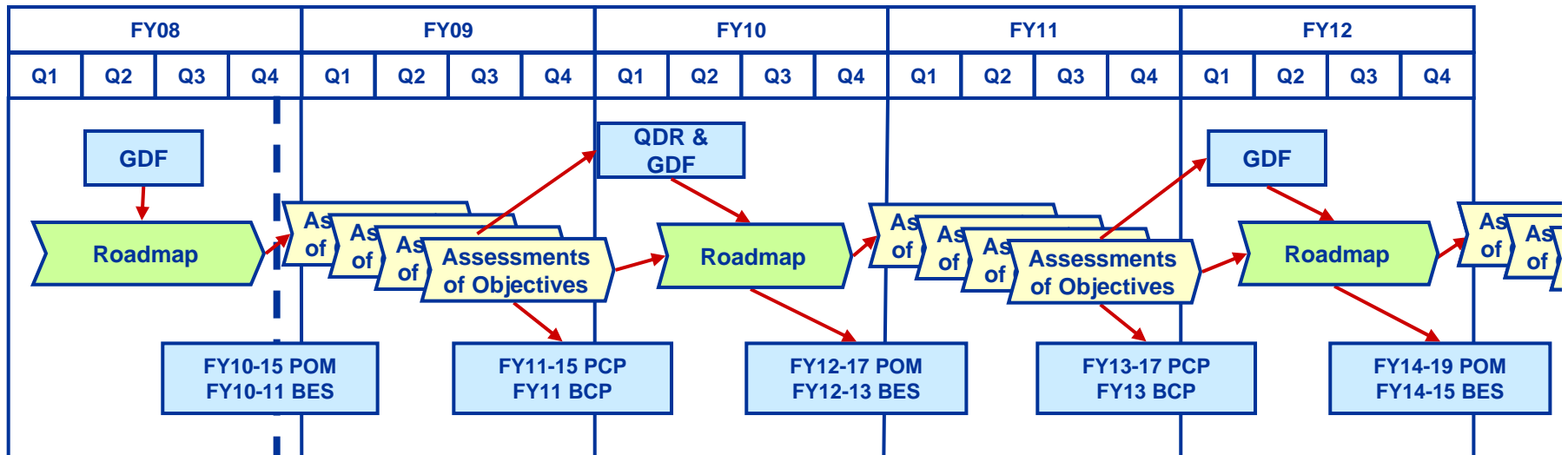

POM Program Objective Memorandum

PCP Program Change Proposal

BES Budget Estimate Submission

BCP Budget Change Proposal

Notional timeline



The DoD Logistics Roadmap has two volumes...

- Volume I has
 - An executive summary
 - A chapter that states the GDF logistics goals, establishes objectives to achieve the goals, and links the objectives to specific logistics capability areas
 - Four chapters that document specific actions underway or planned to achieve the objectives
 - A chapter that lays out the next steps in Roadmap application and development
 - Six appendices that provide background and details
- Volume II has two appendices that provide expanded information on each initiative and program of record identified in Volume I

Available at: http://www.acq.osd.mil/log/sci/executive_info.htm#Roadmap



For additional information contact...

Ms. Debra Bennett

Office of the Assistant Deputy Under
Secretary of Defense for Supply Chain
Integration

(703) 604-1080 Extension 201

Debra.Bennett@osd.mil