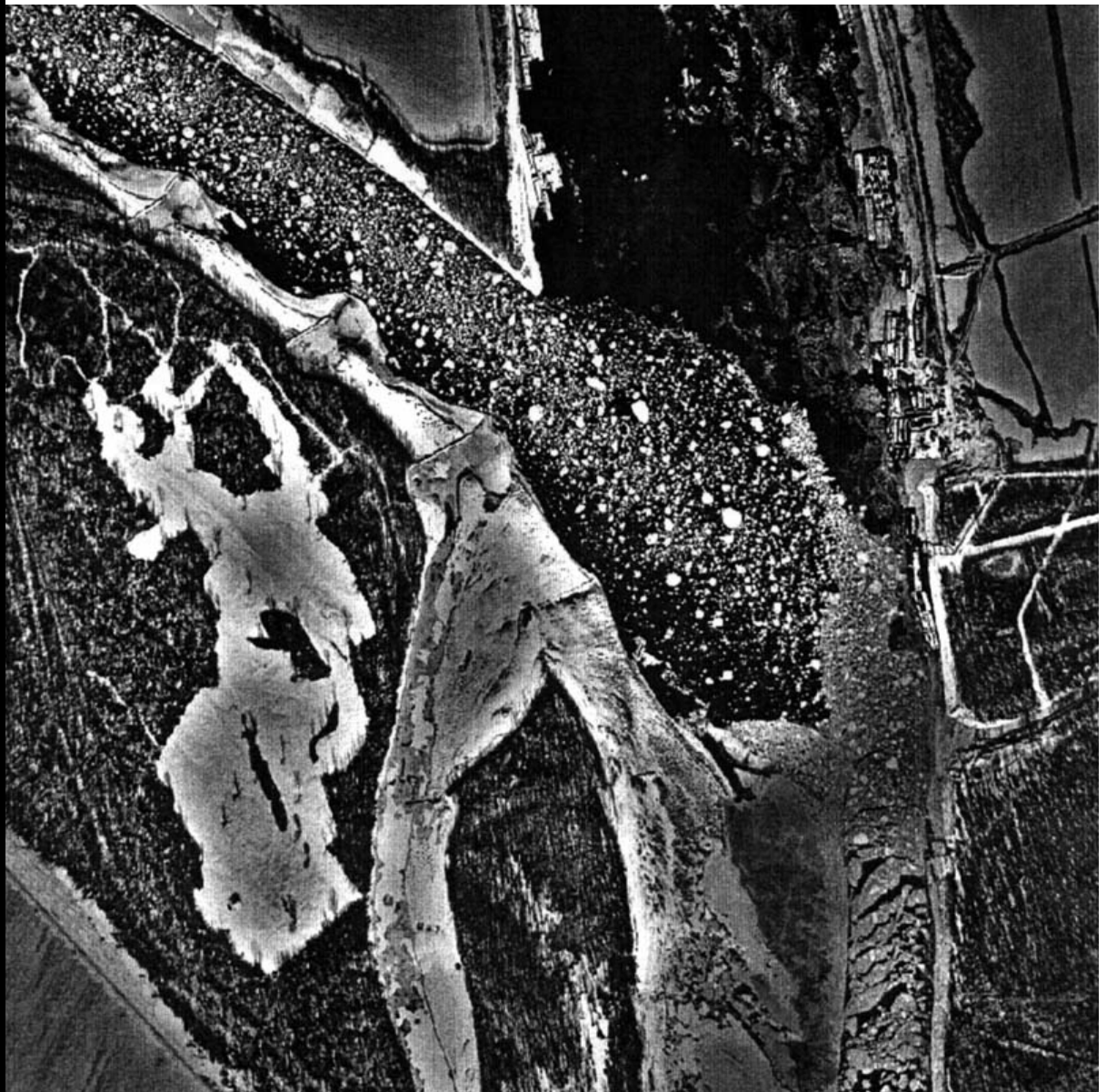


US Army Corps  
of Engineers®  
Cold Regions Research &  
Engineering Laboratory

## Ice Jams in River Confluences

Robert Ettema, Marian Muste, and Anton Kruger

May 1999



**Abstract:** Two laboratory models of confluences are corroborated with observations interpreted from field observations of ice jams in the vicinity of confluences. One model was used to identify the processes whereby ice can jam in confluences and to determine how selected parameters (e.g., confluence angle) influence them. The confluences of primary interest were those formed by channels whose beds are at about the same level. The second model was used to examine ice jam formation in the confluence of the Mississippi and Missouri Rivers. Three relatively complex processes were found to lead to ice jams: the merging of ice runs, hydrodynamic pressure from a confluent flow impacting an ice run from the second confluent channel, and ice congestion at a confluence bar. The latter process is a sig-

nificant factor triggering ice jams at the confluence of the Mississippi and Missouri Rivers. Also, three simple processes account for many ice jams at river confluences: ice blocked by an ice cover in the confluence, large ice pieces arching at the confluence, and ice entering a region of sluggish flow. The main practical contributions of the study are formulations for estimating the maximum rate of ice conveyance through channel confluences, and the confirmation of the efficacy of a series of bendway weirs to mitigate ice jam formation at the confluence of the Mississippi and Missouri Rivers. The bendway weirs have additional benefits, such as greatly reducing the amount of ice accumulating in the approach to the Chain-of-Rocks Canal, which is located at the confluence exit.

**Cover:** Drifting ice merging at the confluence of the Missouri and Mississippi Rivers, 16 December 1989.

**How to get copies of CRREL technical publications:**

Department of Defense personnel and contractors may order reports through the Defense Technical Information Center:

DTIC-BR SUITE 0944  
8725 JOHN J KINGMAN RD  
FT BELVOIR VA 22060-6218  
Telephone 1 800 225 3842  
E-mail help@dtic.mil  
msorders@dtic.mil  
WWW http://www.dtic.mil/

All others may order reports through the National Technical Information Service:

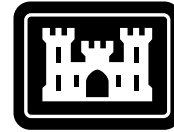
NTIS  
5285 PORT ROYAL RD  
SPRINGFIELD VA 22161  
Telephone 1 800 553 6847 or 1 703 605 6000  
1 703 487 4639 (TDD for the hearing-impaired)  
E-mail orders@ntis.fedworld.gov  
WWW http://www.ntis.gov

A complete list of all CRREL technical publications is available from

USACRREL (CEERD-IM-HL)  
72 LYME RD  
HANOVER NH 03755-1290  
Telephone 1 603 646 4338  
E-mail techpubs@crrel.usace.army.mil

**For information on all aspects of the Cold Regions Research and Engineering Laboratory, visit our World Wide Web site:**  
<http://www.crrel.usace.army.mil>

# CRREL Report 99-6



**US Army Corps  
of Engineers®**  
Cold Regions Research &  
Engineering Laboratory

## **Ice Jams in River Confluences**

Robert Ettema, Marian Muste, and Anton Kruger

May 1999

Prepared for  
OFFICE OF THE CHIEF OF ENGINEERS

Approved for public release; distribution is unlimited.

## **PREFACE**

This report was prepared by Dr. Robert Ettema, Professor and Research Engineer, Dr. Marian Muste, Research Engineer, and Dr. Anton Kruger, Research Engineer, Iowa Institute of Hydraulic Research, University of Iowa, Iowa City, Iowa. Funding for this work was provided by the U.S. Army Cold Regions Research and Engineering Laboratory (CRREL), Hanover, New Hampshire, under contract DACA 4303900, and St. Louis District, U.S. Army Corps of Engineers, Potamology Section, Hydrologic and Hydraulic Engineering Branch, St. Louis, Missouri.

The authors acknowledge with appreciation comments provided by the following people at various stages during the study: Dr. Jon Zufelt and Dr. Jean-Claude Tatinclaux of CRREL, Claude Strauser and Robert Davinroy of USACE—St. Louis District, and David Andres of Trillium Engineering and Hydrographics, Edmonton, Alberta, Canada.

The contents of this report are not to be used for advertising or promotional purposes. Citation of brand names does not constitute an official endorsement or approval of the use of such commercial products.

## CONTENTS

	Page
<a href="#">Preface .....</a>	<a href="#">ii</a>
<a href="#">Introduction .....</a>	<a href="#">1</a>
<a href="#">Literature review .....</a>	<a href="#">3</a>
<a href="#">Confluence flow and morphology .....</a>	<a href="#">9</a>
Flow features .....	11
Bathymetry of concordant-bed confluences .....	14
Bathymetry of discordant-bed confluences .....	15
<a href="#">Key parameters .....</a>	<a href="#">15</a>
Categories of ice movement through confluences .....	16
Ice drift through confluence .....	18
Confluence bathymetry .....	20
<a href="#">Jam process modeling .....</a>	<a href="#">22</a>
Model setup .....	22
Confluence configurations modeled .....	24
Model ice .....	24
Modeling procedure .....	25
<a href="#">Confluence jam processes .....</a>	<a href="#">25</a>
Simple jamming processes .....	25
Jamming of merging ice runs .....	26
Jamming due to flow impact .....	28
Jamming at a confluence bar .....	28
Ice jamming on a depositional bar .....	28
<a href="#">Selected observations .....</a>	<a href="#">29</a>
<a href="#">Formulation .....</a>	<a href="#">36</a>
Jamming of merging ice runs .....	38
Jamming due to flow impact .....	40
Jamming due to a confluence bar .....	41
<a href="#">Ice jams in the confluence of the Mississippi and Missouri Rivers .....</a>	<a href="#">41</a>
Weather and flow conditions associated with jamming .....	42
Confluence model .....	48
Flow and ice velocities .....	51
Model calibration and validation .....	52
Test program and procedure .....	53
Results .....	53
<a href="#">Literature cited .....</a>	<a href="#">59</a>
<a href="#">Abstract .....</a>	<a href="#">62</a>

## ILLUSTRATIONS

### Figure

1. Ice jam in the confluence of the Mississippi and Missouri Rivers .....	1
2. Confluence of the Yellowstone and Missouri Rivers .....	4
3. Ice jams in the confluence of the Mackenzie and Liard Rivers during 1978 through 1984 .....	6
4. Schematic of channel confluence with concordant bed levels .....	9
5. Schematic of channel confluence with discordant bed levels .....	10
6. Contraction coefficient at the maximum confluence constriction: $\mu = b_c/b_3$ , $\bar{Q} = Q_2/Q_3$ .....	13
7. Relationship between the orientation of the maximum scour depth, $\beta$ , confluence angle, $\alpha$ , and discharge ratio, $Q_r = Q_1/Q_2$ .....	17
8. Schematic of drifting ice pieces moving through a confluence .....	17
9. Schematic of ice layers moving through a confluence .....	18
10. Layout of the jam process model .....	23
11. View of the jam process model configured for a 45° confluence .....	23
12. Simple jamming mechanisms of confluences .....	26
13. Jamming of merging ice runs .....	27
14. Ice jamming at the confluence of the Iowa and Cedar Rivers .....	27
15. Jamming due to flow impact .....	28
16. Jamming due to ice congestion at confluence bars .....	29
17. Ice jamming at discordant-bed confluence with deltaic bars .....	29
18. Layout for the 180° confluence model .....	30
19. Ice in confluence: $Q_2/Q_1 = 2/3$ , $\alpha = 90^\circ$ , and $b_1/b_2 = 1.5$ .....	32
20. Ice in confluence: $Q_2/Q_1 = 3$ , $\alpha = 90^\circ$ , and $b_1/b_2 = 1.5$ .....	32
21. Ice in confluence: $Q_2/Q_1 = 2/3$ , $\alpha = 90^\circ$ , and $b_1/b_2 = 1.5$ , bathymetry modeled .....	33
22. Ice in confluence: $Q_2/Q_1 = 3$ , $\alpha = 90^\circ$ , and $b_1/b_2 = 1.5$ , bathymetry modeled .....	33
23. Ice in confluence: $Q_2/Q_1 = 3$ , $\alpha = 90^\circ$ , and $b_1/b_2 = 3$ .....	33
24. Ice in confluence: $Q_2/Q_1 = 2/3$ , $\alpha = 90^\circ$ , and $b_1/b_2 = 3$ .....	34
25. Ice in confluence: $Q_2/Q_1 = 6$ , $\alpha = 90^\circ$ , and $b_1/b_2 = 3$ .....	34
26. Ice in confluence: $Q_2/Q_1 = 2/3$ , $\alpha = 45^\circ$ , and $b_1/b_2 = 1.5$ .....	35
27. Ice in confluence: $Q_2/Q_1 = 3$ , $\alpha = 45^\circ$ , and $b_1/b_2 = 1.5$ .....	35
28. Ice in confluence: $Q_2/Q_1 = 0.6$ , $\alpha = 45^\circ$ , and $b_1/b_2 = 1.35$ .....	35
29. Ice in confluence: $Q_2/Q_1 = 0.6$ , $\alpha = 45^\circ$ , and $b_1/b_2 = 1.35$ , border ice ....	36
30. Lateral pressures associated with merging ice runs .....	37
31. Flow impact holds ice in channel 2 .....	38
32. Ice jam formation at confluence narrowed by a bar .....	39
33. Light ice run in the confluence of Mississippi and Missouri Rivers on 9 February 1989 .....	42
34. Record of flow discharges in the Mississippi and Missouri Rivers .....	43
35. Ice jam in the confluence of the Mississippi and Missouri Rivers on 26 January 1978 .....	46
36. Ice jam in the confluence of the Mississippi and Missouri Rivers on 9 January 1979 .....	46
37. Ice jam in the confluence of the Mississippi and Missouri Rivers on 10 February 1981 .....	47

38. Ice run in the confluence of the Mississippi and Missouri Rivers on 4 February 1985 .....	47
39. Location of the bendway weirs in the confluence of the Mississippi and Missouri Rivers .....	47
40. Layout of the hydraulic model .....	48
41. Bathymetry cross sections in the confluence of the Mississippi and Missouri Rivers .....	49
42. Photograph of the confluence of the Mississippi and Missouri Rivers model without bendway weirs .....	50
43. Photograph of the confluence of the Mississippi and Missouri Rivers model with bendway weirs .....	51
44. Video camera view of open-water flow through modeled confluence of the Mississippi and Missouri Rivers .....	52
45. Main flow features of the confluence of the Mississippi and Missouri Rivers .....	54
46. Vector plot of velocities for open water flow in Figure 44 .....	54
47. Ice congestion for the confluence with border ice (without bendway weirs) .....	55
48. Vector plot of velocities for ice and open water flow in Figure 47 .....	55
49. Open water flow through the confluence fitted with bendway weirs .....	56
50. Vector plot of velocities for open water flow in Figure 49 .....	56
51. Ice run through the confluence with bendway weirs .....	57
52. Vector plot of velocities for ice and open water flow in Figure 51 .....	57
53. Open water flow through the confluence with bendway weirs and eroded bar .....	58
54. Vector plot of velocities for open water flow in Figure 53 .....	58
55. Ice run through the confluence modeled with bendway weirs and eroded bar .....	59
56. Vector plot of velocities for ice and open water flow in Figure 55 .....	59

**TABLES**

Table

1. Flow characteristics employed in the small-scale model investigations .....	30
2. Aerial photographs of ice conveyance through Mississippi–Missouri confluence .....	43
3. Flow and environmental characteristics for three jam events .....	45

BLANK PAGE

[Go to contents page](#)



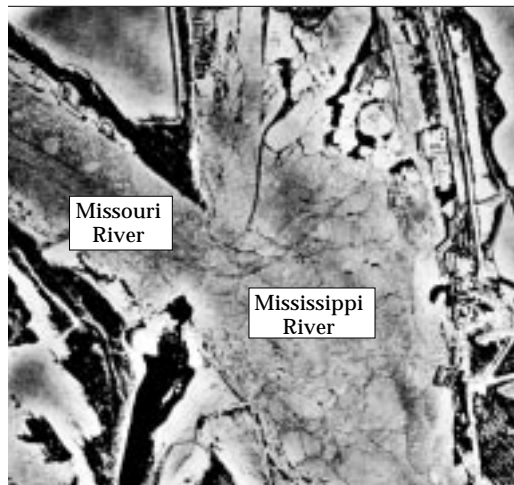
# Ice Jams in River Confluences

ROBERT ETTEMA, MARIAN MUSTE, AND ANTON KRUGER

## INTRODUCTION

Confluences are an integral connective feature of most watersheds. They comprise relatively short but complex reaches, in which two or more channels merge and concentrate flows of water and sediment from the upper reaches to lower reaches of a watershed. For many watersheds in cold regions, confluences also may concentrate ice formed in the upper reaches of a watershed, which are then conveyed downstream as ice runs. By virtue of their role in connecting channels and thereby concentrating ice within a watershed, confluences are perceived as locations especially prone to the occurrence of ice jams. Indeed, fairly numerous accounts exist of jams in the vicinity of a confluence. As discussed in this report, flow and ice concentration in a confluence may cause ice to jam within a confluence channel, within the confluence itself, or at some distance downstream of a confluence. Various mechanisms may trigger jams occur in the vicinity of confluences. Those mechanisms constitute the subject of this report, which presents the findings of a detailed investigation into ice jam formation at the confluence of two channels.

The study was motivated by a general concern that jams frequently occur at confluences and by specific concerns about ice jams formed at the confluence of the Missouri and Mississippi Rivers. A severe ice jam formed at this particular confluence is illustrated in Figure 1. The primary concern regarding ice jams at this confluence is their blockage of winter navigation between the Mississippi River and the Illinois River, which is confluent with the Mississippi River several kilometers upstream of its confluence with the Missouri River. In addition, ice jams damage and disrupt towboat



*Figure 1. Ice jam in the confluence of the Mississippi and Missouri Rivers.*

fleeting activities in the vicinity of the confluence, as well as damaging shoreline structures.

A further objective of the study is that its findings be of direct use in reducing the incidence of ice jams at confluences, and generally in numerical modeling of ice movement through channel confluences. The insights obtained are to be of use in the design of structural and bathymetric techniques for ice jam mitigation, notably at the confluence of the Mississippi and Missouri Rivers. Yet a further objective of the present study is that it formulate ice jam development in river confluences.

These objectives extend a survey by Tuthill and Mamone (1997) on the incidence of ice jams at confluences in the United States. The particular objective of their survey was to identify confluences for which structural mitigative techniques might be implemented, e.g., ice booms or ice retention barriers. Their study and this study were conducted as part of an overall CRREL effort focused on ice jams at river confluences.

The following tasks were conducted for the present study:

- Review published accounts of ice jams at confluences.
- Identify the main features of confluence flow and bathymetry.
- Identify the nondimensional parameters of importance for characterizing water flow and ice movement through confluences.
- Determine the mechanisms whereby ice jams develop at confluences.
- Formulate ice jam mechanisms.
- Investigate, as a case study, ice jam formation at the confluence of the Mississippi and Missouri Rivers. As part of this investigation, evaluate the likely effect on ice movement through the confluence of a set of bendway weirs (submerged, relatively long, broad-crested groins) to be placed opposite a point bar formed in the confluence.

Bendway weirs are used typically to shift channel thalweg toward the inner bank of a curved channel. They function to turn flow, increase flow resistance along one side of a channel, and to shift channel thalweg. The St. Louis District of the U.S. Army Corps of Engineers is to place a series of bendway weirs in the confluence in order to reduce the extent of a large bar formed in the confluence. The bar is evident in Figure 1.

In the broad context of channel connections within watersheds, possible several categories of channel confluences can be identified. The confluence type of primary concern for the present study comprises two inflow channels that merge into a single outflow channel. Another category of confluence comprises the merging of one channel in series with another channel of greatly different geometry. This type of channel confluence most notably includes a river flowing into a reservoir or lake, or a river issuing from a lake: in essence, a narrow channel connecting with an extremely wide channel. The present study does not closely examine ice jam formation in this latter class of confluence other than to review the reasons why jams commonly form in them.

The findings of the present study are based on two sets of laboratory experiments. One set was conducted to determine the processes whereby jams form at confluences. That set used a small-scale model built to simulate diverse combinations of confluence geometry and to evaluate the sensitivity of jamming mechanisms to selected parameters, such as relative magnitudes of confluent flows. The results of these experiments were augmented using information interpreted from

published accounts of ice jams in the vicinity of confluences. The second set of experiments focused on the confluence of the Missouri and Mississippi Rivers. It entailed a relatively large hydraulic model built to facilitate detailed measurement of flow field and ice movement velocities in the confluence before, during, and after the implementation of bendway weirs.

A numerical simulation study reported by Lui and Shen (1998), and Lui et al. (1998) augments the hydraulic model investigation reported here. The simulation confirms the findings from the hydraulic model, and it demonstrates the potential utility of numerical simulation for investigating ice accumulation processes at channel confluences.

## LITERATURE ON CONFLUENCE ICE JAMS

The literature on ice jams contains quite a few case study articles concerning ice jam formation in river confluences. Andres (1996, 1997, 1998), for instance, describes three situations in western Canada where jams result in recurrent flooding problems for towns located near confluences. In most situations, the principal mechanism leading to jam formation is straightforward: a stationary ice cover in the mainstem channel blocks ice conveyed by the confluent channel. There are, however, more complicated jam processes within a confluence.

From the literature, several factors clearly influence ice jam formation in confluences. The relative importance of each factor varies from confluence to confluence. A prominent factor is the confluence function of concentrating water flow and ice from higher reaches of a watershed. Ice quantities may increase abruptly at a confluence, possibly exceeding the capacity of its mainstem channel. A stationary ice cover in the mainstem channel may simply block ice on the confluent channel. Additionally, a simultaneous ice run from confluent channels may have difficulty merging in an ice run in the mainstem channel, to the extent that ice jams in one or both of the channels.

Confluence morphology may trigger ice jams. It usually is relatively complex, being characterized by marked variations in flow depth, flow velocity, slope, and the presence of depositional alluvial features. Alluvial bars typically form at locations where the flow's capacity to move bed sediment locally diminishes within a confluence. For instance, deltaic bars may form at the mouth of a channel confluent with a larger and more sluggish water body. Also, point bars may form within flow separation zones that develop when confluent flows merge within the curved planform of a confluence. Alluvial bars reduce surface area and depth of flow, thereby potentially congesting ice movement through a confluence.

An interesting side issue concerns the possible influences that ice jams may exert on confluence morphology. An ice jam constricts flow, possibly locally scouring an alluvial bed beneath the jam, especially at the jam toe (Wuebben 1988). In most situations, such scouring likely would be transitory and only alter bed morphology locally. Yet, in some situations, jam-induced scouring may conceivably activate substantial changes in confluence morphology. The overall subject of jam-induced scour requires further investigation, and it is beyond the scope of this report.

This section presents a literature review on ice jams for which river confluences played a significant role. To understand how the various factors lead to ice jam formation in the vicinity of a confluence, the principal features of water flow through confluences must be considered and how they modify confluence morphology. Those factors are considered in the subsequent section.

The confluence effect of concentrating ice in a watershed and delivering it to a downstream jam site is mentioned fairly frequently in accounts of jams (e.g., Michel 1972, Wuebben et al. 1995). Michel outlines a process, typical of many watersheds, whereby ice cover breakup begins in tributary channels and then progresses downstream to main stem channels. He suggests that daytime fluctuations in spring runoff flows have a greater destabilizing impact on ice covers in tributary channels than on ice covers in the main stem channel of a watershed. Therefore, in many watersheds, breakup of tributary ice covers precedes breakup on a main stem channel. Broken tributary ice accumulates at downstream ice-covered reaches. Further warming and flow increase lead to collapse of an ice reach and the occurrence of an ice run. In turn, the mass of ice in a run may be impeded by the next stable ice reach downstream, and form an ice jam of considerable size. With still further warming and flow increase, the ice reach and jam collapse, and another run ensues, possibly resulting in another jam downstream. It may take several runs for a watershed to release ice. Channel confluences inevitably play a significant role in the process of ice release from watersheds. It is in a confluence where rates of ice movement and flow may abruptly increase and where congestion may occur.

Wuebben and Gagnon (1995) describe ice jam formation in the Missouri River downstream of its confluence with the Yellowstone River in Montana. The two rivers drain water and ice from the northwest perimeter of the Missouri River watershed. The confluence alignment of these rivers is shown in Figure 2. Ice from the Yellowstone River, which has a significantly steeper gradient than does the Missouri River, typically breaks up first. Ice moves downstream until an intact ice cover in the Missouri River at the confluence halts its progress. Jams also have formed along the Missouri River a short distance downstream from the confluence. They occur when ice and water flow from the Yellowstone River are sufficiently large as to push some distance downstream through the ice cover on the Missouri River, before eventually jamming. They also may occur when the conflu-

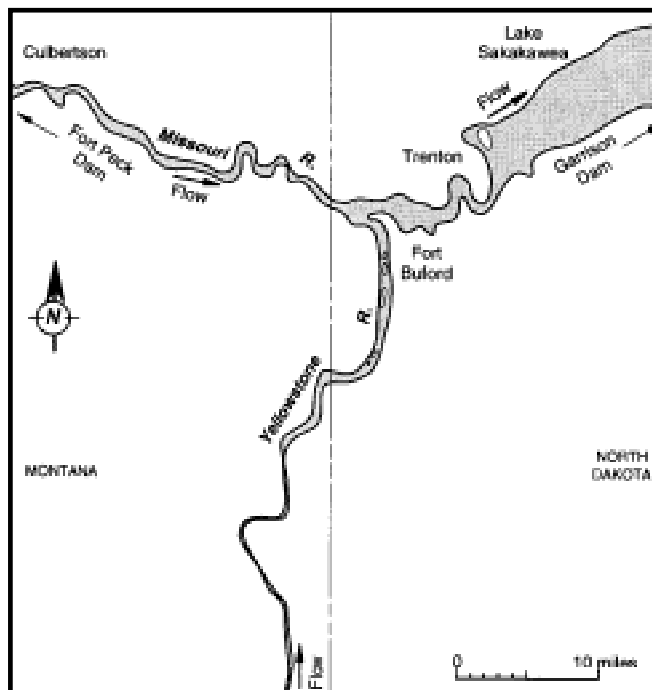


Figure 2. Confluence of the Yellowstone and Missouri Rivers (Tuthill and Mamone 1997).

ence jam releases. The jam sites are about 40 to 50 miles (65–80 km) upstream of Lake Sakakawea, a reservoir on the Missouri River. The extent to which Lake Sakakawea contributes to the incidence of ice jams is unclear. Its possible effects (channel aggradation, raised groundwater, and altered ice regime) on jam incidence have yet to be fully investigated (Wuebben and Gagnon 1995).

The literature contains several similar accounts of ice jams at the confluence of two rivers. Andres (1996, 1997, 1998) documents three cases of jams involving ice runs in a confluent channel blocked by a stationary ice cover breakup on the mainstem channel. One case occurs in Alberta at the confluence of the Smoky River and the Peace River, which is larger and has a more northern location (Andres 1996). The ice cover on the Smoky River breaks up first during spring, but is blocked by the intact cover on the Peace River. If breakup flows are sufficiently large in the Smoky River, ice jammed at the confluence may thrust through ice on the Peace River and produce a subsequent jam a short distance downstream in the Peace River. Ice on the McLeod River typically breaks up before ice on the Athabasca River, and it jams in the confluence of the two rivers in Alberta (Andres 1998). In some years, the jam develops in the Athabasca River at a short distance downstream of the confluence. A freezeup ice jam commonly occurs at the confluence of the Nechako and Fraser Rivers in British Columbia (Andres 1997). The Fraser River, the larger river, and of flatter slope, typically freezes over first.

Jasek (1997) describes an unusual case, in the Yukon Territory, of an ice jam formed at the confluence of the Porcupine River and its tributary the Bluefish River, in the Yukon Territory. The case is unusual because the jam was attributable to the formation of aufeis at the confluence. Aufeis forming in the Bluefish River encroached over and enveloped the ice cover formed over the Porcupine River. The aufeis thickened substantially and virtually dammed the Porcupine River.

Prowse (1986) presents the findings of an extensive investigation of ice jams formed in the Liard River at the confluence of the Liard and Mackenzie Rivers in the Northwest Territories, Canada. His study, which was conducted over a six-year period, 1978 through 1984, indicates that two factors led to jam formation in the Liard River at its confluence with the Mackenzie River. One factor was the presence of an ice cover in the Mackenzie River. When the Mackenzie is ice-covered at the confluence, ice cannot pass out of the Liard River. The other factor is the confluence morphology of the Liard and Mackenzie Rivers. The mouth of the Liard River opens relatively widely at the confluence and is marked by the presence of sand bars and islands, the latter having formed from the more permanent bars. Large ice pieces have difficulty moving through the mouth of the Liard River without arching or grounding. Arching of ice pieces at the mouth of the Liard may cause ice to jam in the Liard when open water conditions exist in the Mackenzie River. Figure 3 summarizes the ice jam conditions in the Liard River at the confluence for the years studied.

The literature contains accounts of jams formed in channels of complex morphology. White and Kay (1994), for example, describe the recurrent formation of ice jams in the meandering braided channel of the Loup River in Nebraska. During low flow conditions, such rivers comprise several subchannels that cause water flow to diverge and converge within the main channel. Chen (1986) describes similar difficulties for ice movement in the braided meandering channel of the lower Yellow River, above Lankao, China. The reach is relatively shallow and broad, containing numerous sand bars and stream forks. Drifting ice is liable to ground along the frontal edge of the bars and become clogged in the subchannel forks.

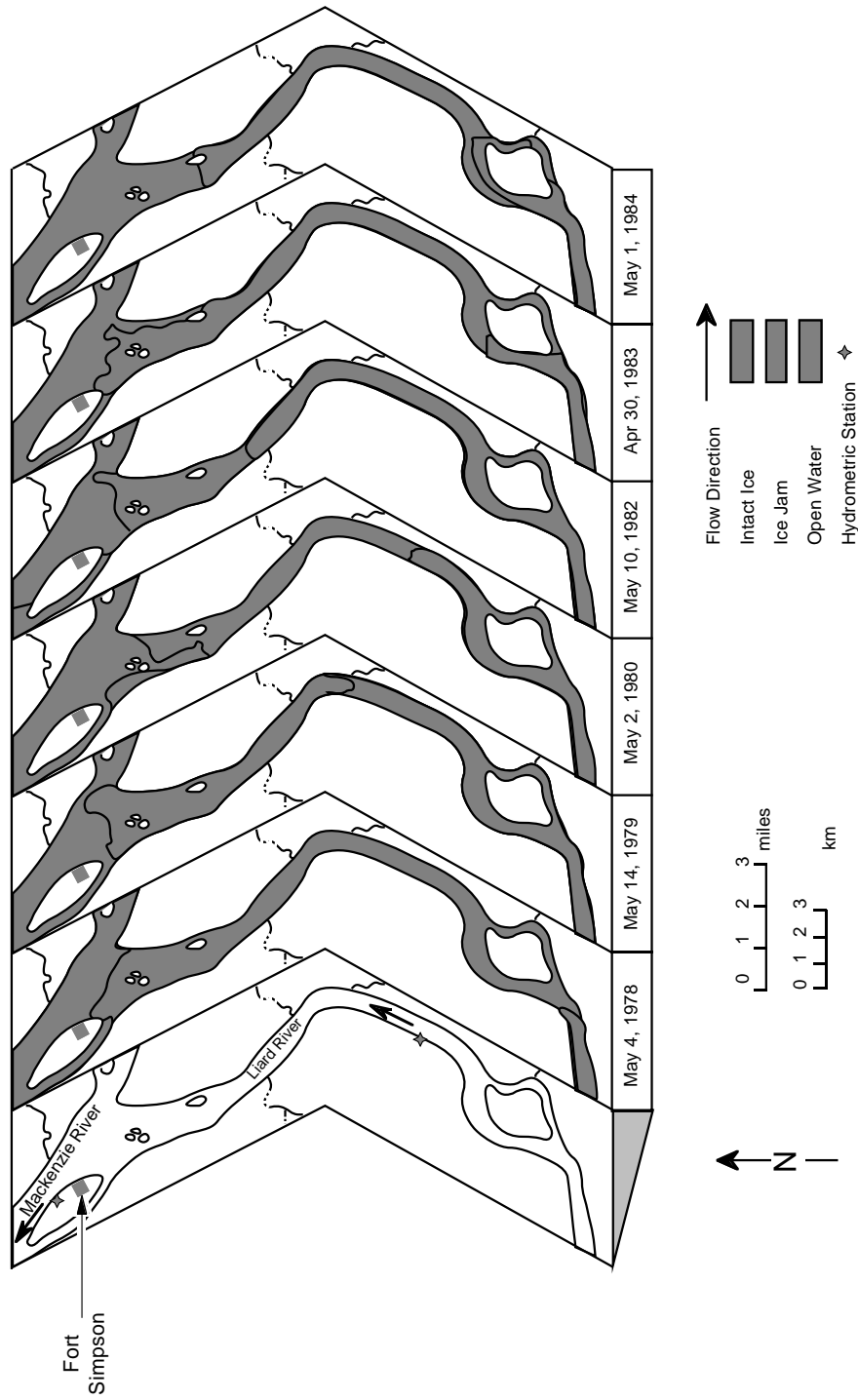


Figure 3. Ice jams in the confluence of the Mackenzie and Liard Rivers during 1978 through 1984. (After Prowse 1986.)



Complexity of confluence morphology is not dictated solely by considerations of alluvial erosion and deposition. The morphology of many confluences can largely be defined by the rock formations through which the confluent rivers flow. Such confluences can have quite unique features that lead to ice jamming. For example, the extensive set of studies concerning ice movement through the upper Niagara River provide insights into the merging of moving ice in a channel of complex morphology. The river's Chippawa and Tonawanda Channels merge in a wide confluence where a large area of shallow flow occurs over a resistant rock bed. This regularly causes drifting ice to be grounded and form a blockage in the confluence that may extend upstream into the confluent channels (Crissman 1998).

Several further articles describe ice jams formed where a river enters a reservoir or a lake. Judge et al. (1997), for instance, describe the formation of ice jams in the headwaters of shallow reservoirs (head ponds) used for hydropower generation in New Brunswick. They base their description on a numerical model of jam formation and on observations of ice jams formed in the headwaters of hydropower reservoirs along the Saint John River, New Brunswick. Ice jams also form at the mouth of the Winnipeg River where it enters Lake Winnipeg in Manitoba\*. Wuebben et al. (1995) provide background information on ice jams that form where the Aroostook River enters Tinker Reservoir, Maine. Beltaos and Burrell (1991) describe an instance where a backwater effect from a confluent river downstream contributes to a recurring jam in a mainstem river. The Restigouche River, New Brunswick, experiences ice jamming below the river's confluence with the steeper-sloped Upsalquitch River, which conveys substantial amounts of ice and water into the Restigouche River. The jam occurs in a reach affected by a backwater effect attributable to flow from a lower tributary, the Matapedia River.

The most extensive overview of ice jam formation at confluences is the survey of confluence jam sites reported by Tuthill and Mamone (1997). They cite 44 confluence sites in the United States known to have ice jam problems, and classify the sites into four groups of confluence type:

- Confluences of similar size rivers or channels.
- Confluences of different size rivers or channels.
- Rivers entering lakes.
- Lakes drained by rivers.

These groups are useful for establishing the relative incidence of ice jams. Subsequently an alternative grouping of confluence types is suggested in this report. The alternative grouping uses terminology coined by fluvial morphologists, and it simplifies the discussion of ice-jamming mechanisms at confluences.

Of the 44 sites, Tuthill and Mamone identify 15 as involving a river entering a lake or reservoir (e.g., Aroostook River entering Tinker Dam Reservoir). Of the remaining confluence sites, several sites involve two rivers in which one river is subject to a significant backwater condition. One site is the confluence of the Yellowstone River and the Missouri River upstream of Lake Sakakawea. The second site is the Salmon River merging with the Connecticut River at a reach subject to tidal slowing of river flow. An objective of the survey was to identify sites for which some form of structural remediation could be used to mitigate jam formation. They suggest that eight sites are potentially suitable for this purpose. Of them, six involve a river entering a lake or a reach of flow slowed by a substantial back-

---

\* R. Carson, ACRES International, Winnipeg, Manitoba, personal communication, 1998.

water condition. These sites relate to one confluent channel having sluggish or negligible flow velocities or covered by stationary ice. The seventh and eighth sites selected do not involve sluggish flows at the confluence. One site is a lake discharging into a river, which may be viewed as a series confluence of an extremely wide channel and a narrow channel. The other site is the confluence of two rivers, the Missouri and Mississippi. As discussed subsequently in the present report, the use of bendway weirs indeed would be effective in mitigating jam formation at the confluence of those two rivers.

The problem of ice jam formation in the confluence of the Mississippi and the Missouri Rivers was been investigated in three studies: USACE (1962), USACE (1977), and Stevens (1978). The two USACE studies document conditions attendant to jam events that occurred in 1962 and 1977. The focus of the study by Stevens (1978) is on various fundamental aspects of ice-jam formation in generic channels, rather than on the confluence of the Mississippi and Missouri Rivers per se.

The general mechanisms causing ice jams at the confluence of two channels are not discussed in Tuthill and Mamone's report. It focuses mainly on the eight confluences selected for consideration of structural mitigative measures. Nonetheless, a major proportion of jam problems at confluences may be hypothesized to occur for two reasons:

- Ice from one channel discharges into a channel that has a sluggish flow (a lake is a limiting example of this situation) or has a stationary ice cover.
- Bathymetric irregularities in confluence geometry retard ice discharge and initiate jams.

On the basis of Tuthill and Mamone's survey, situations where ice jams result from the merging of ice discharged from two confluent channels seem to be uncommon. For many large watersheds, the joint probability of ice discharging simultaneously from two channels into a confluence likely is relatively small. Therefore, the frequency of these jamming situations likely is small for rivers draining watersheds in significantly different hydrologic regions. Nonetheless, rivers draining closely adjoining hydrologic regions may experience ice runs at about the same time. Also, somewhat of an exception is ice discharge through confluent branches of a braided-meandering channel or a river channel that initially bifurcates around an island (e.g., the Upper Niagara River bifurcating then merging around Grand Island) or a large bar. Jamming of confluent ice discharges may be more likely for freezeup situations, when channels in an entire watershed form and convey ice, than in breakup situations, which arguably are more haphazard in their occurrence because of the greater diversity of factors affecting cover breakup.

The survey conducted by Tuthill and Mamone (1997), together with the information contained in the other ice jam literature reviewed, directed the present study toward addressing the following two aspects of ice jam formation at confluences:

- Determine the conditions needed for two confluent ice discharges to jam.
- Determine how confluence bathymetry may hamper ice movement through confluences.

In summary, ice jam literature reveals that confluences play important, but quite varied and inadequately understood, roles in the formation of ice jams in watersheds. Ice in confluences increases further the complexity of the flow, not only from the hydrodynamic point of view, but because thermal and mechanical phe-



nomena are also involved in such flow situations. The relative importance of the roles played by confluences likely varies with the drainage structure of a watershed, the way ice forms and moves through a watershed, and the local geomorphic features of the confluence region itself.

### CONFLUENCE MORPHOLOGY AND FLOW

Confluence morphology varies with differences in the relative magnitudes of water discharge, sediment-transport rate, and sediment size of the confluent channels. Taken together, these factors are embodied in the sizes and slopes of the confluent channels. On the basis of channel size and slope, confluences can be discussed in terms of the following two general morphologic types:

- Confluences of concordant bed channels. The bed levels of the two confluent channels are at about the same level and sufficiently similar in slope, so that water and sediment merge without deposition of sediment in the confluence. As depicted in Figure 4a and b, which show the main flow and bathymetric

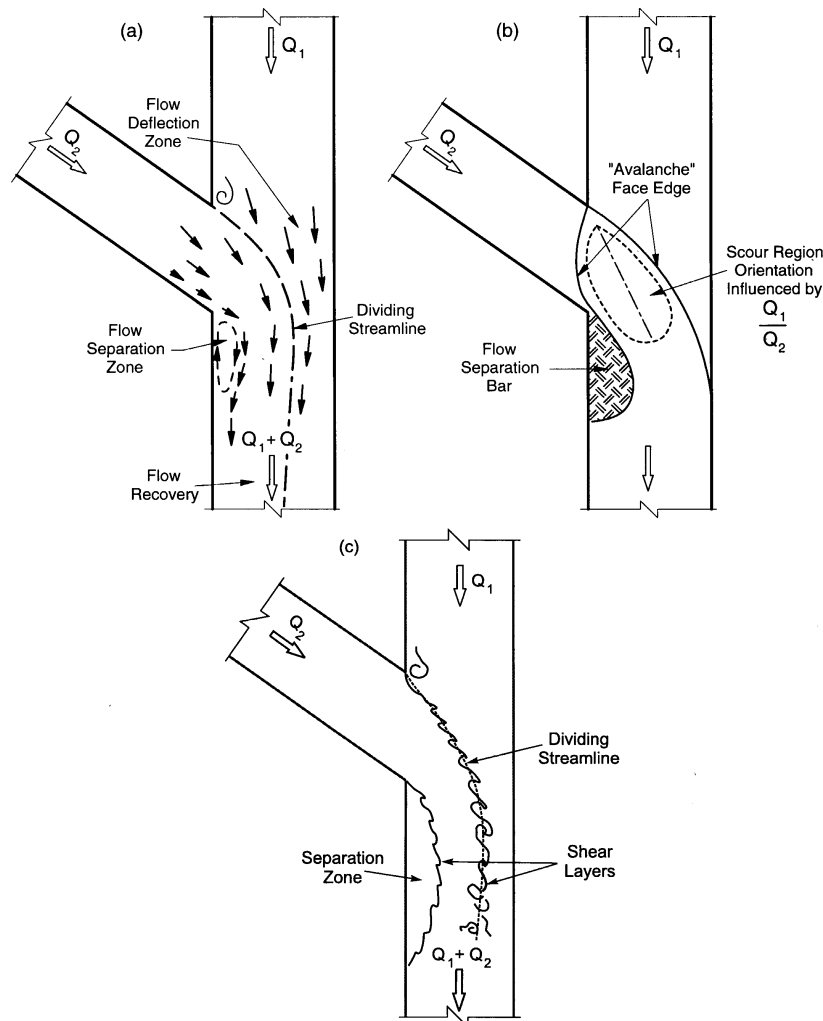


Figure 4. Schematic of channel confluence with concordant bed levels: (a) main flow features; (b) main bathymetric features; (c) illustration of the shear layers.

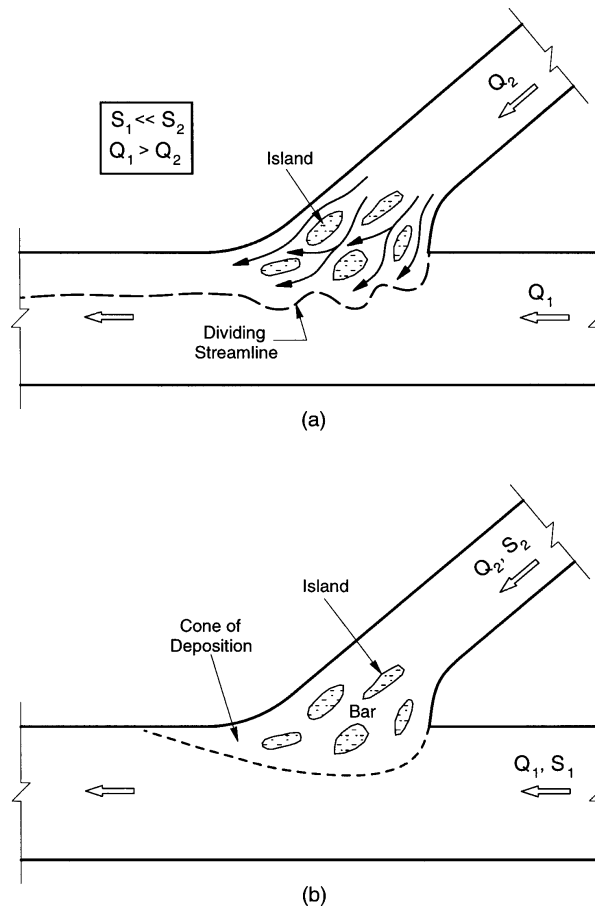


Figure 5. Schematic of channel confluence with discordant bed levels; (a) general flow features of the confluence; (b) the sediment alluvial cone.

features of this type of confluence, the distinguishing morphologic features are a bar formed in the flow separation zone and a deep scour beneath the zone of maximum flow velocity in the confluence. The confluence of the Mississippi and Missouri Rivers is of this type (Fig. 1).

- Confluences of discordant bed channels. The bed levels of the two confluent channels differ significantly in level and slope, so that the channel with the higher level and slope may develop a zone of sediment deposition, an alluvial fan, at its junction with the deeper and flatter channel. This type is depicted in Figures 5a and b, which show the main flow and bathymetric features. The confluence of the Liard and Mackenzie Rivers is of this type (see Fig. 32). The limiting example of this type is the river delta formed at the head of a lake or reservoir.

The first confluence classification coincides with the first confluence group suggested by Tuthill and Mamone (1997), i.e., confluence of similar size rivers or channels. The second classification encompasses the second three confluence groups suggested by Tuthill and Mamone. The situation of a river draining a lake is the reverse of a river flowing into a lake. Both situations may be treated as discordant channels: one in which the inflow diverges in area, the other in which the inflow converges. The classification is useful for examining the processes whereby ice

jams in river confluences. Each confluence type has its unique jamming process, as is discussed subsequently in this report.

Several of the same basic mechanisms cause ice to jam in both types of confluence. An obvious example is the jam that forms when a stationary (or very slow moving) ice blocks an ice run from one channel cover in a confluence. The differences in channel morphology, however, do result in different mechanisms for ice jam formation when the confluence is not initially blocked with ice. Ice jams in concordant bed confluences may be initiated because of a ice congestion in the vicinity of the bar. This mechanism has caused jamming in the confluence of the Mississippi and Missouri Rivers, for example. Ice jams in discordant bed confluences may initiate in the higher, steeper (and inevitably smaller) channel due to ice grounding on the sediment fan or ice arching between islands and bars exposed during low flow. This mechanism has caused ice jamming in the mouth of the Liard River at its confluence with the Mackenzie confluence, for example.

The present study primarily considers ice jams formed in confluences of concordant bed channels. Arguably, it is the more interesting confluence type to investigate. It also is the more common type for river confluences in the continental United States. The subject of ice jams triggered by ice grounding or arching in braided channels is left for a subsequent investigation.

### **Flow features**

Flow through a typical concordant bed channel confluence is illustrated in Figure 4a. It comprises the following principal features:

- A flow separation zone.
- A dividing streamline (or stream plane) that delineates the merging flows, and which actually is a shear layer.
- A small zone of flow stagnation at the apex of the confluence.
- A flow recovery zone.

These flow features make confluence flows comparatively complex and subject to the influences of many parameters, such as confluence angle and the relative magnitudes of discharge in each channel. Consequent to confluence flow complexity, the bathymetry of confluent alluvial channels may also be complex, as is illustrated in Figure 4b. The bathymetry is notable for the following principal features:

- A bar, which more or less occupies the flow-separation zone and is formed of bed sediment deposited in that zone.
- A zone of deep scour, which is approximately aligned with a portion of the dividing streamline.

In actuality, the dividing streamline is not a simple curve as shown in Figure 4a. It is a time-average representation of the plane between two merging flows. The plane lies in a shear layer marked by strong vortices that initiate mixing of the merging flows, as sketched in Figure 4c. The vortices significantly affect the extent of bed scour in the scour zone.

The potential difficulties for drifting ice to pass through a confluence soon become apparent when drifting ice is superimposed on the confluent channels. Not only must the two streams of moving ice merge, they must negotiate the complex flow field and bathymetry of a confluence. The two flow features of special significance for ice passage through a confluence are the dividing streamline and

the separation zone. The streamline delineates an interface profile for the merging streams of ice. The separation zone delineates a further contraction at the confluence. It also delineates the approximate extent of the confluence bar, on which ice may ground.

Confluence flow and bathymetry have received fairly extensive investigation. Notable studies on confluence flows are Taylor (1944), Modi et al. (1981), Ramamurthy et al. (1988), Fujita and Komura (1986), Best and Reid (1984, 1987), Hager (1989), Gurrum et al. (1997), and Hsu et al. (1998). Notable studies on confluence bathymetry include those reported by Komura (1973), Mosely (1976), Ashmore and Parker (1983), Best (1988), and Biron et al. (1996).

For the purpose of the present study, there is little point in furnishing an extensively detailed summary of these studies, except to briefly summarize what is known about the location of the dividing streamline, the magnitude of the separation zone, and the extent of the bar. Those features of confluence flow directly affect ice movement through a confluence of concordant bed channels.

#### *Location of dividing streamline*

No simple analytical relationship exists for predicting the location of the dividing streamline between confluent flows in an alluvial channel. A method for estimating its position in a confluence of flat bottom channels, however, has been developed by Fujita and Komura (1986).

Fujita and Komura (1986) used a mathematical model developed earlier by Modi et al. (1981) to analyze flow in confluences of rectangular channels. By applying potential flow theory and conformal mapping, the location of the dividing and separating streamline is obtained through numerical integration of complex functions. The equation for the dividing streamline is

$$x_d = \int_1^{\xi_2} F_R(\xi + i\eta_2) d\xi - \int_0^{\eta_2} F_I(1 + i\eta) d\eta \quad (1)$$

$$y_d = \pi + \int_1^{\xi_2} F_I(\xi + i\eta_2) d\xi + \int_0^{\eta_2} F_R(1 + i\eta) d\eta \quad (2)$$

for  $-\infty < \xi < 1$  and  $0 < \eta < \infty$ .  $F_R$  and  $F_I$  are the real and imaginary parts of the complex function

$$F(\zeta) = \frac{b_c}{\pi} \exp \left\{ \frac{2\alpha}{\pi} \ln \left[ (\zeta - 1)^{1/2} + \zeta^{1/2} \right] - \alpha i \right\} \left\{ -\frac{1}{\zeta} + \frac{1 - Q_r}{\zeta + c_k} + \frac{Q_r}{\zeta - c_l} \right\} \quad (3)$$

where  $b_c$  is the effective width of the channel (the width of the main channel diminished by the width of the separation zone,  $b_c = b_3 - b_s$ ),  $Q_r$  is the ratio of the tributary channel to the downstream discharge, and  $\alpha$  is the confluence angle. The coefficients  $c_k$  and  $c_l$  are functions of flow and confluence geometry,  $\zeta$  is the real axis of the upper half plane on to which the conformal mapping is represented, and  $\xi$  and  $\eta$  are the coordinates of the downstream corner of the confluent channels in the mapped plane obtained using the Schwarz-Christoffel theorem. The resultant expression for streamline location agrees well with the experimental results obtained by Fujita and Komura (1986) for a wide range of discharge and width ratios as well as confluence angles.

Equations 1 through 3 are cumbersome for most purposes related to ice conveyance and ice jam formation in confluences. A simpler, approximate procedure is

given below. This approximate method requires that the maximum width of the flow separation zone be first estimated, however.

*Extent of flow separation zone*

Several studies have investigated flow separation at a confluence of rectangular channels. Their results are useful for estimating the likely contraction of the flow area within a confluence. In addition, the size of the separation zone approximately coincides with the size of the bar found in confluences of concordant channels.

Laboratory experiments, conducted using rectangular channels, led Gurram et al. (1997) to the following semianalytical equation for the maximum width of the separation zone:

$$\frac{b_s}{b_3} = \frac{1}{2} \left( F_d - \frac{2}{3} \right)^2 + 0.45 \left( \frac{Q_2}{Q_3} \right)^{1/2} \left( \frac{\alpha}{90^\circ} \right) \tag{4}$$

- where  $b_s$  = the width of the separation zone,
- $b_3$  = the downstream width of the main branch,
- $F_d$  = the tailwater Froude number,
- $Q_2/Q_3$  = the discharge ratio between the lateral to the downstream discharges,
- $\alpha$  = the apex angle of the confluence.

Gurram et al. (1997) developed further equations for aspects of confluent flow, including the pressure force on the lateral sidewalls, the ratio of flow depths in the junction point, the momentum correction coefficient, and the lateral momentum contribution. They showed that these flow variables depend primarily on the discharge ratio, the tailwater Froude numbers, and the confluence angle.

Hsu et al. (1998) analytically and experimentally investigated flow in the confluence of two equally wide, rectangular channels oriented 90° to each other. Their work resulted in a set of somewhat sketchy curves for estimating the maximum width of the separation zone, as shown in Figure 6. In that figure, contraction coefficient  $\mu = b_c/b_3$ , and  $\bar{Q} = Q_2 / Q_3$ .

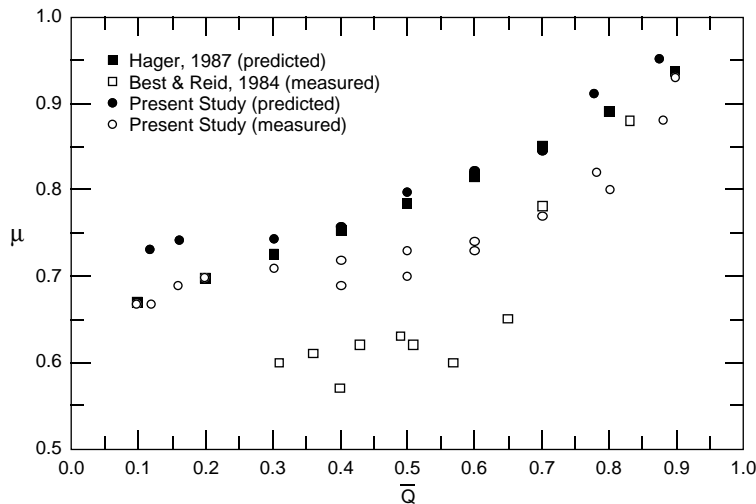


Figure 6. Contraction coefficient at the maximum confluence constriction;  $\mu = b_c/b_3$ ,  $\bar{Q} = Q_2/Q_3$ . (After Hsu et al. 1998.)

#### *Estimation of dividing streamline position*

Based on the foregoing method of estimating the extent of the separation zone, an approximate estimation is possible of the position of the dividing streamline that delineates flows merging from channels 1 and 2. If constant depth is assumed through the confluence, the dividing streamline location is proportional to the discharges of the contributing channels; i.e.,

$$\frac{b_3 - b_d}{b_d - b_s} = \frac{Q_1}{Q_2} \quad (5)$$

whence

$$b_d = \frac{Q_1 b_s + Q_2 b_3}{Q_1 + Q_2} \quad (6)$$

These equations, together with eq 4, can be used to estimate the approximate width of channel occupied by each merging ice run.

#### **Bathymetry of concordant bed confluences**

The confluence flow studies mentioned above deal with confluent channels of relatively simple geometry, usually rectangular and flat bottomed. The bathymetry of actual river confluences is not so simple, as Figures 4b and 5b illustrate for concordant bed and discordant bed confluences. The present section focuses on the bathymetry of concordant bed confluences, as is fairly typical of the confluence of more or less similar size channels, such as the confluence of the Missouri and Mississippi Rivers.

The bathymetry of concordant bed confluences includes zones of sediment scour and sediment deposition. The zones reflect regions of greater or reduced flow velocity. Best (1988) and Biron et al. (1996) provide useful descriptions of the bathymetry of concordant bed channels. Their descriptions are based on laboratory flume experiments and field observations.

An important bathymetric feature is the zone or line of maximum scour, whose position is closely related (if not identical) to the position of the dividing streamline. Figure 7 indicates the approximate relationship between the orientation of the line of maximum scour depth,  $\beta_s$ , and the apex angle of confluence,  $\alpha$ , for several discharge ratios,  $Q_r = Q_1/Q_2$ . One aspect of bathymetry that is not included in the descriptions published to date is the formation of a large dune at the downstream end of the scour region. Such a dune, perhaps termed a mega-dune, appears to form at the confluence of the Mississippi and Missouri Rivers.

It is very common for a portion of sediment transported into a confluence of concordant bed channels to become entrapped and accumulate within the flow separation zone. The accumulating sediment builds out as a bar that attains an equilibrium extent coinciding minimally with the extent of the average flow separation zone developed for the annual average discharge through the confluence. In actuality, the bar may oscillate in extent throughout a year, varying in concert with the magnitudes of inflow into the confluence. There appears to be little information published on the variation of bar size with flow conditions and overall confluence geometry. Additionally, bars may become stabilized by means of vegetation growth and tend to continually build outwards into the confluence. In so doing, they force the confluence outflow channel to shift laterally in a manner somewhat similar to the migration of meander bends in rivers.

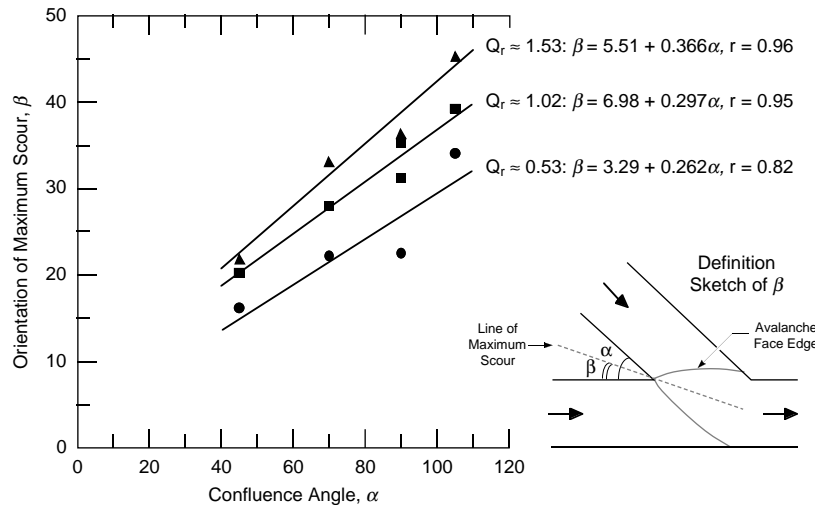


Figure 7. Relationship between the orientation of the maximum scour depth,  $\beta$ , confluence angle,  $\alpha$ , and discharge ratio,  $Q_r = Q_1/Q_2$ . (After Best 1988.)

### Bathymetry of discordant bed confluences

The literature on the bathymetry of confluences of discordant bed channels is quite extensive. The bathymetry typically features sediment depositional patterns, such as deltas, alluvial fans, and alluvial cones. These features are described by ASCE (1975), Richards (1982), Simons and Li (1982), and Chang (1988). They are accumulations of sediment deposited in approximately a fan-shaped pattern formed where a river or stream enters an area of flatter slope or emerges into a wider body of water. They commonly occur where a tributary draining steeper terrain enters a larger river.

In their study, Biron et al. (1996) found that bed level discordance changes the flow dynamics in three principal ways:

- The shear layer between the two confluent flows is distorted towards the shallower tributary and causes upwelling from the deeper channel into the shallower channel.
- Bed-level discordance and the rapid increase of flow area at the mouth of the lesser channel greatly reduce flow acceleration near the bed within the confluence.
- Bed-level discordance may eliminate mainstream flow deflection near the bed.

The shift of the shear layer and dividing streamline toward the smaller inflow channel may hamper ice movement from the smaller channel. The changes to the flow field, though, primarily affect sediment movement through the confluence and sediment depositional zones. They typically result in the development of a depositional cone, such as illustrated in Figure 5b. In terms of ice movement through such confluences, the main effect is ice grounding on sediment depositional features during periods of low flow.

### KEY PARAMETERS

It is useful to characterize flow, channel, and ice movement processes at confluences in terms of nondimensional parameters. A potentially large number of them may be needed for this purpose. A useful simplification is to consider the conflu-

ence as the intersection of two prismatic (rectangular) channels whose width greatly exceeds their depth. For the moment, therefore, the influences of confluence morphology (bars, islands, large dunes, rock outcrops, etc.) are not considered. Those influences are discussed later, once the key nondimensional parameters are identified for characterizing flow and ice movement through a confluence of rectangular channels.

The analysis does not take into account the influences of engineered features such as bridges, wharves, channel control structures, etc. The hydrologic influences of air temperature (as affecting freezing consolidation of drifting ice) and wind also are neglected. While these structural and hydrologic factors are very important, they do not play essential roles on ice movement through the confluence of prismatic channels, which is considered in the ensuing dimensional analysis. These approximations reduce the number of nondimensional parameters needed to describe the essential processes that occur when two flows of ice merge. Other, less significant simplifications are made subsequently in the analysis.

A further limitation of the ensuing dimensional analysis is the precise definition of incipient jamming. The analysis assumes incipient jamming occurs when the water and ice inflows to a confluence begin to exceed outflows of water and ice. Actually, there probably are shades or degrees of incipient jamming. Outflows of water and ice may be less than inflows and yet a jam may not have formed. Jam formation is an unsteady, interactive process in which water and ice flows adjust in accordance with, for example, changes in ice concentration and ice layer thickness.

### **Categories of ice movement through confluences**

It is helpful to categorize two conditions of ice movement through confluences:

- A layer of drifting ice pieces with a velocity slightly less than that of the water surface.
- A thickened layer of ice extending approximately the full width of the channel and moving with a velocity significantly less than the bulk velocity of water flow in the channel.

Each category has several subcategories, in accordance with the combination of ice discharge and water flow conditions in each confluent channel.

The distinction between drifting ice pieces and a moving layer of ice is useful, because the forces propelling the ice into the confluence differ between the two situations, and therefore differences arise between the sets of parameters needed to describe the two categories. Flow drag and impact forces on individual ice pieces, and the inertia of individual ice pieces, drive free-drifting ice pieces into a confluence. In contrast, boundary shear stress along the underside of an extensive accumulation of ice, together with streamwise component of accumulation weight, drive a moving accumulation of ice and possibly the momentum of the accumulation. For free drift of ice, individual ice piece size is important. It is less important in describing the behavior of an accumulation of ice, for which accumulation thickness and width are more important.

In addition, it is likely that differences occur in the way the two categories of confluent flows of ice merge. For example, significant shoving and thickening of the confluent accumulations would accompany the merging of two moving particulate accumulations (category 2). Shoving and thickening would likely not accompany the merging of confluent free-drifting ice pieces (category 1), at least



not until initial jamming has occurred. Instead, areal repacking of pieces may be a characteristic feature. No doubt there is a transition between the two categories.

The free-drift and contiguous-accumulation categories can be classified into subcategories that reflect different combinations of merging ice flows:

1. *Drifting ice pieces*

- a. Drift of ice pieces from one channel, while the other channel has no ice,
- b. Drift of ice pieces from both channels,
- c. Drift of ice pieces from one channel, while the other channel has a stationary ice cover,
- d. Drift of ice pieces from one channel, while the other channel has sluggish flow.

2. *Ice layer movement*

- a. A layer of ice discharges from one channel, while the other channel has no ice,
- b. A layer of ice discharges from both channels,
- c. A layer of ice discharges from one channel, while the other channel has a stationary ice cover,
- d. A layer of ice discharges from one channel, while the other channel has sluggish flow,
- e. A layer of ice discharges from one channel, while ice drifts freely in the other channel (same as 1c, if layer movement is slow).

The two sets of subcategories are illustrated generally in Figures 8 and 9. The categorization does not include a further level of subcategorization related to the circumstances of ice movement in the stem channel downstream of the confluence. For the moment, the condition of ice movement in the outflow channel will be assumed the same as that in the larger confluent channel. Common examples of this situation occur when the larger confluent channel and the outflow channel are subject to a significant backwater effect, and when one channel flows into a lake, which is the limiting condition of a channel flowing into a larger confluent channel with sluggish (or negligible) velocities.

The categorization is intended also to assist in defining the actual confluence conditions for which jams most usually occur. An important issue addressed during this study is whether ice jams at confluences are attributable to limits in the capacity of confluent prismatic

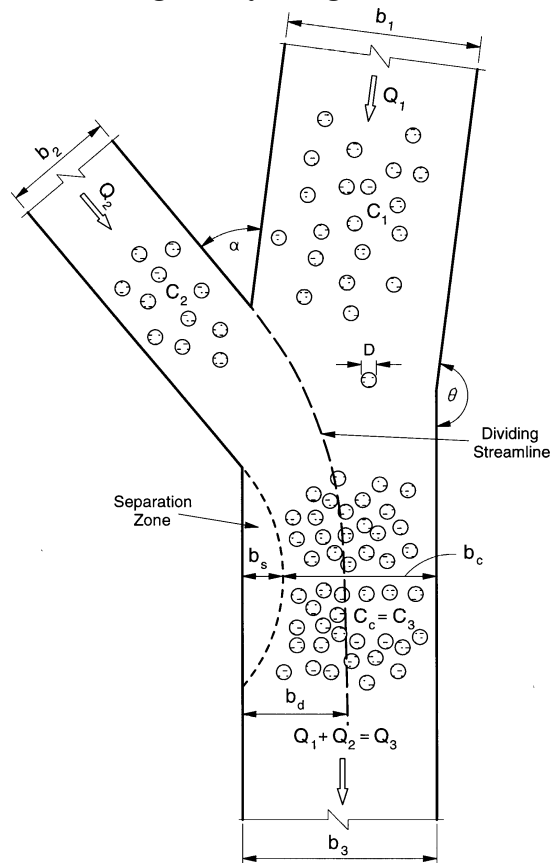


Figure 8. Schematic of drifting ice pieces moving through a confluence (subcategory 1a).

channels to convey ice and water, or whether jams usually occur because of local channel irregularities (e.g., alluvial bars, flow features, channel control structures).

### Ice drift through a confluence

Figure 8 indicates the variables associated with water and ice discharge through a confluence of two fixed-bed channels of rectangular cross section. The same size of ice piece is taken to be moving through both channels. The confluent inflow channels are designated with subscripts 1 and 2. The confluence outflow channel is designated with subscript 3. Variables at the most constricted section of the confluence, where the separation zone has maximum width, are designated with subscript *c*.

The discharge  $Q$ , unit discharge  $q$ , or a representative velocity  $V$  of flow in one of the channels shown in Figure 8 can be described using the variables  $Y$ ,  $b$ ,  $S$ , and  $k$ , e.g., by means of the Darcy-Weisbach equation for flow resistance. The terms are defined in Figure 8. Note

that, in this discussion, the variables  $Q$ ,  $q$ , or  $V$  can be used (with  $b$ ,  $Y$ , and  $k$ ) instead of channel slope,  $S$ . The present analysis uses  $Q$ , as it gives more meaningful parameters for describing confluent flows than do  $q$ ,  $V$ , or  $S$ . The fluid properties of concern are kinematic viscosity  $\nu$ , density  $\rho$ , and surface tension strength  $\sigma$ . The ice pieces, taken to be of uniform size, are describable using a characteristic plan dimension  $D$ , thickness  $h$ , density  $\rho_i$ , and friction coefficient for contact among ice pieces and with the channel banks  $\mu$ . The flow is driven by specific weight,  $\gamma = \rho g$ , with  $g$  = gravity acceleration. The discharge of free-drifting ice pieces moving at nearly the surface water velocity in a single channel can be described in terms of areal concentration  $C$ , and ice discharge,  $G \approx C(hb) (Q/bY) = C(h/Y)Q$ .

A total of 14 variables are needed to describe the discharge of free-drifting ice in a channel. To describe ice discharge in two channels, which differ only in geometry and discharges of water and ice, the number of variables increases to 21; added are  $Q$ ,  $Y$ ,  $b$ ,  $k$ ,  $C$ ,  $D$ , and  $h$  for the second channel. The material properties of water and ice are taken to be the same for all channels. To describe the merging of ice flow from two channels confluent into a single outflow channel, additional variables are needed to describe the orientation of the outflow channel relative to the confluent channels,  $\alpha$  and  $\theta$ , and the hydraulic characteristics of the outflow channel ( $Q_3$ ,  $b_3$ ,  $Y_3$ , and  $k_3$ ). The total number of variables is now 27.

For the simple case of no ice jamming, continuity of water, and ice discharges through the confluence without jam formation, the following equations are

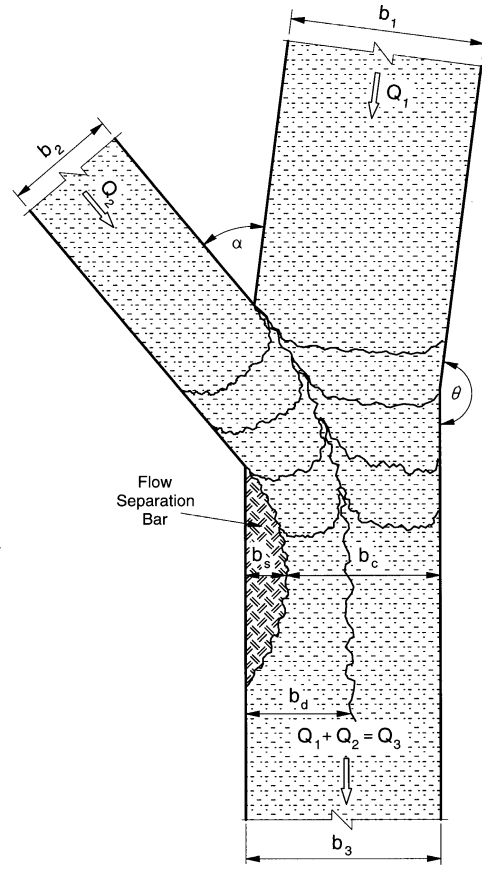


Figure 9. Schematic of ice layers moving through a confluence (subcategory 2b).

respectively for water,

$$Q_1 + Q_2 = Q_3 + \Delta V / \Delta t \quad (7)$$

and for ice,

$$G_1 + G_2 = G_3 + \Delta V_i / \Delta t. \quad (8)$$

In eq 7 and 8,  $\Delta V$  and  $\Delta V_i$  are changes in water volume and ice volume stored in the confluence reach during time period  $\Delta t$ , respectively. Up to the condition of incipient jamming in a confluence of river channels,  $\Delta V = 0$  and  $\Delta V_i = 0$  may be assumed. Once jamming initiates, ice inflow begins to exceed ice outflow from the confluence,  $\Delta V_i \geq 0$ , and water inflow may exceed outflow,  $\Delta V \geq 0$ .

Up to incipient jamming, eq 8 is simply

$$G_1 + G_2 = G_3 \quad (9)$$

or

$$(C[h/Y]Q)_1 + (C[h/Y]Q)_2 = (C[h/Y]Q)_3. \quad (10)$$

For water and ice conveyed by a river discharging into a reservoir or lake,  $Q_2 = 0$  and  $Q_3 \approx 0$ , such that

$$Q_1 = \Delta V / \Delta t \quad (11)$$

and  $G_2 = 0$ , and  $G_3 \approx 0$ , such that

$$G_1 = \Delta V_i / \Delta t. \quad (12)$$

The present analysis considers incipient ice jamming at a confluence of rivers and at a river discharging into a reservoir or lake. Under the assumption that ice piece dimensions,  $D$  and  $h$ , are the same for all channels, and that the channels have the same roughness,  $k$ , the number of variables reduces to  $27 - 4 = 23$ . If it is further assumed that the flows are subcritical, the effects of gravity  $g$  are treated by use of an open-channel discharge relationship for  $Q$ , and by specifying that ice floats. The influence of water viscosity,  $\nu$ , can be neglected if it is assumed that flow in the channels and around ice pieces is fully rough. For ice pieces in actual rivers, surface tension  $\sigma$  is negligible. The number of variables finally reduces to  $23 - 3 = 20$ .

The ice pieces are assumed here to move through the confluence as a single layer of ice pieces of a given size. The following functional relationship may be written for the areal concentration of ice discharge at the narrowest cross section of flow in the confluence outflow channel  $C_c$  as the dependent variable of interest:

$$C_c = f_d(Q_1, Q_2, b_1, b_2, b_c, Y_1, Y_2, Y_c, k, D, h, C_1, C_2, \alpha, \theta, \mu, \rho, \rho_i, g). \quad (13)$$

Equation 13 assumes that, for a confluence of rivers,  $Q_3 = Q_1 + Q_2$ , and for a confluence of river and reservoir or lake,  $Q_2, G_2 = 0$ , and eq 11 and 12 pertain. The 20 variables in eq 13 reduce to 16 nondimensional parameters, given three basic dimensions (length, mass, and time) involved with the volumetric discharge of ice through a confluence. If a dimensional analysis is carried out using  $D, Q_2$ , and  $\rho$  as the repeating variables, the following functional relationship emerges for the limiting condition of a single layer of free-drifting ice discharging through a confluence:

$$C_c = \varphi_{d1} \left( \frac{Q_1}{Q_2}, \frac{Q_2}{Db_2\sqrt{gD}}, \left(\frac{b}{D}\right)_{1,3}, \left(\frac{Y}{D}\right)_{1,2,3}, \frac{k}{D}, \frac{h}{D}, C_1, C_2, \alpha, \theta, \mu, \frac{\rho_i}{\rho} \right). \quad (14)$$

Equation 14 can be rearranged to relate channel widths in a more meaningful manner:

$$C_c = \varphi_{d2} \left( \frac{Q_1}{Q_2}, \frac{Q_2}{Db_2\sqrt{gD}}, \alpha, \theta, \frac{b_1}{b_2}, \frac{b_2}{b_3}, \frac{b_3}{D}, \frac{D}{h}, \frac{k}{D}, \left(\frac{h}{Y}\right)_{1,2,3}, C_1, C_2 \right). \quad (15)$$

These parameters are useful for describing how confluence flow conditions illustrated in Figure 8 influence ice movement and jamming in a simple confluence of prismatic channels. The diagnostic experiments conducted for the present study investigated the influences on  $C_c$  (i.e., jam initiation) of the first five parameters in eq 15. The experiments showed that jamming would occur for a narrow range of values for the concentrations  $C_1$  and  $C_2$ ; i.e., both values need to be close to the critical value of ice concentration for each channel. Alternatively, values of ice piece size relative to channel width,  $D/b_3$ , need to be sufficiently large such that ice pieces arch; usually, ice-piece width to channel width must exceed about 1/7 for arching to occur.

Several additional remarks should be made about the parameters in eq 15. An alternative combination of the first five parameters would produce the parameters  $b_c/b_3$  and  $b_{\text{bar}}/b_3$ , which define the maximum widths of the dividing streamline  $b_c$  and the bar  $b_{\text{bar}}$  relative to the width of the downstream channel  $b_3$ . These two terms are useful when discussing jam formation in confluences. The two terms define the extents of maximum flow contraction in the confluence.

Also, in the simple case of a single channel entering a lake,  $b_1/b_3 \approx 0$ ,  $b_2/b_3 = 1$ ,  $\theta = 180^\circ$ , and  $Q_1/(Q_1 + Q_2) \approx 1$ .

Equations 14 and 15 can be made more elaborate by including additional variables, such as different ice pieces and roughness conditions in the two confluent channels. For most confluences, the first nine parameters usually will be of far greater importance than the last parameters in eq 15. Only when the outflow channel is comparatively shallow or rough will the last parameters be important.

The effects of viscosity and surface tension become important when conducting hydraulic modeling using small pieces of model ice for simulating ice movement. Then, eq 15 should be expanded to include values of Reynolds number,  $QD/(v_bY)$ , and Weber number,  $\rho LQ^2/(bY)^2\sigma$ , for the channels.

### Ice layer movement through a confluence

Water flow in a channel with a moving layer of accumulated ice pieces, as illustrated in Figure 9, can be defined using its discharge,  $Q$ , and the variables  $Y$ ,  $b$ ,  $k$  and  $k_i$ . The volumetric rate of ice layer discharge  $G$  (a contiguous layer of accumulated ice pieces extending across the full width of the channel and moving at a speed less than the surface water speed in a single channel) can be written as a volumetric proportion  $\eta$  of the water discharge. Thus,  $G = \eta Q(1-p)^{-1}$ , in which the discharge rate of solid ice in the layer is  $\eta Q$ , and  $p$  is layer porosity. The material behavior of the layer can be defined using its thickness  $H$ , angle of internal resistance  $\phi$ , porosity  $p$ , the density of ice  $\rho_i$ , and friction between ice and banks  $\mu$ . As explained above, the effects of water viscosity and surface tension can be neglected for the scale of flows in rivers. Water density  $\rho$  must be retained for use with  $\rho_i$  as a variable, and with  $g$  in terms of specific weight  $\gamma$ .

Therefore, a minimum of 13 variables is needed to describe the discharge of a continuous layer of ice moving in a channel. The influences of gravity, which motivates the discharge of water and ice, relate to the discharge relationships for water and ice, and in the relationship between layer thickness  $H$  and ice discharge rate  $G$ .

To describe ice discharge in two channels that differ only in channel geometry and the discharges of water and ice, the number of variables increases to 20, adding, for the second channel,  $Q$ ,  $Y$ ,  $b$ ,  $k$ ,  $k_i$ ,  $H$ , and  $\eta$ . The material properties of water and ice, layer porosity, and friction are taken to be the same for all channels. To describe the merging of ice flow from two confluent channels, further variables are needed. The number of variables increases with the addition of variables describing the orientation of the outflow channel relative to the confluent channels ( $\alpha$  and  $\beta$ ) and the hydraulic characteristics of the outflow channel ( $Q_c$ ,  $b_c$ ,  $Y_c$ ,  $k$  and  $k_i$ ). The total number of variables is now 27.

The number of variables can be reduced to 23 if the roughness heights  $k$  and  $k_i$  are assumed the same for each channel.

For the simple case of no ice jamming (i.e., no significant channel storage of water and ice in the confluence), continuity of water, and ice discharge through the confluence without jam formation, gives respectively

$$Q_1 + Q_2 = Q_c \quad (16)$$

and, for ice discharge,

$$G_1 + G_2 = G_c \quad (17)$$

or

$$G_c = \eta_c Q_c (1-p)^{-1} = \eta_1 Q_1 (1-p)^{-1} + \eta_2 Q_2 (1-p)^{-1} \quad (18)$$

with ice discharge expressed as a volumetric proportion  $\eta$  of water discharge. However, for the limiting condition of incipient jamming, eq 11 pertains.

The pertinent variables may be assembled in the following functional relationship, for merging ice layers comprising ice a given size (small compared to channel width), with ice outflow as the dependent variable:

$$\eta = f_L(Q_1, Q_2, b_1, b_2, b_c, Y_1, Y_2, Y_c, k_b, k_i, \eta_1, \eta_2, H_1, H_2, p, \rho_i, \rho, g, \mu, \phi, \alpha, \theta). \quad (19)$$

The 23 variables in eq 19 reduce to 20 nondimensional parameters, given three basic dimensions (mass, length, and time) involved with ice discharge through a confluence. If the dimensional analysis is carried out using  $b_c$ ,  $Q_2$ , and  $\rho$  as the repeating variables, the following functional relationship emerges for the limiting condition of a single layer of free-drifting ice discharging through a confluence:

$$\eta = \phi_L \left( \frac{Q_1}{Q_2}, \frac{Q_2}{Db_2\sqrt{gD}}, \frac{b_1}{b_2}, \frac{b_2}{b_{3c}}, \left( \frac{Y}{b_c} \right)_{1,2,3}, \right. \\ \left. \frac{k_b}{b_3}, \frac{k_i}{b_3}, \eta_1, \eta_2, \frac{H_1}{b_3}, \frac{H_2}{b_3}, p, \frac{\rho_i}{\rho}, \phi, \mu, \alpha, \theta \right). \quad (20)$$

The foregoing analysis, though simplifying the actual processes, nonetheless leads to useful sets of nondimensional parameters for describing the general charac-

teristics of ice movement through confluences. The significance of selected key parameters was investigated using the diagnostic model.

### **Confluence bathymetry**

The influence on ice movement of confluence bathymetry can be inferred to a certain extent from the parameters in eq 15 and 20. As mentioned in the preceding section, the size of the bar approximates the size of the flow separation zone, though actually it may be slightly larger. Therefore, as an approximation, bar presence and its influence on ice movement are reflected partially in the magnitude of  $b_c/b_3$ . Bar presence, however, also is associated with substantial variations in flow depth through the confluence.

The shallow depths of flow around the bar have several adverse effects on ice movement through the confluence. Ice may ground in shallow water. The speed of ice movement in shallow water is commensurately reduced with shallower flow. Also, during periods of frigid weather, border ice may form rapidly from the edge of the bar, thereby even further reducing the surface area of flow available for ice movement.

## **JAM PROCESS MODELING**

A small-scale model was used to confirm the importance of the key parameters identified in eq 15 and 20, and to establish the principal processes limiting ice conveyance and leading to ice jam formation in confluences. Particular attention was given to determining influences on ice conveyance of flow and bathymetry features at confluences of concordant channels. Since the modeling required numerous alterations in channel orientation, size, and bathymetry, as well as variations in water and model ice flow rates, the model was kept small in overall size, flexible in flow circuitry, and simple in channel geometry.

The findings produced by the model are largely qualitative. They essentially comprise the description of two principal processes that limit ice movement through concordant channel confluences and lead to ice jam formation. The two processes are formulated in a subsequent section of this report. Both formulations can be used to quantify the limiting rates of ice movement through confluences.

### **Model setup**

The setup for the process model comprised the basic components of an elemental confluence of two concordant bed channels. The channels were rectangular in cross section and were built so that the angle between the two inflow channels could be adjusted. Channel widths were adjustable, but bed elevation was held constant for all the channels. Figure 10 shows the model setup, which also is depicted by the photograph in Figure 11.

Flow to the inflow channels discharged from a head box at the upstream end of each channel. Flow from the downstream confluent channel passed into a tail tank, from where it was recirculated by means of a pump to each head box. The flow rate to each inflow channel was controlled using a valve in each supply line and measured using orifice plate meters. Each confluent channel was sufficiently long that more or less uniform flow developed in the channel. Observation of water surface elevations confirmed that the flows were acceptably uniform. Flow visualization with dye confirmed that velocity profiles throughout the greater length of each channel conformed with steady, uniform flow in each channel. The

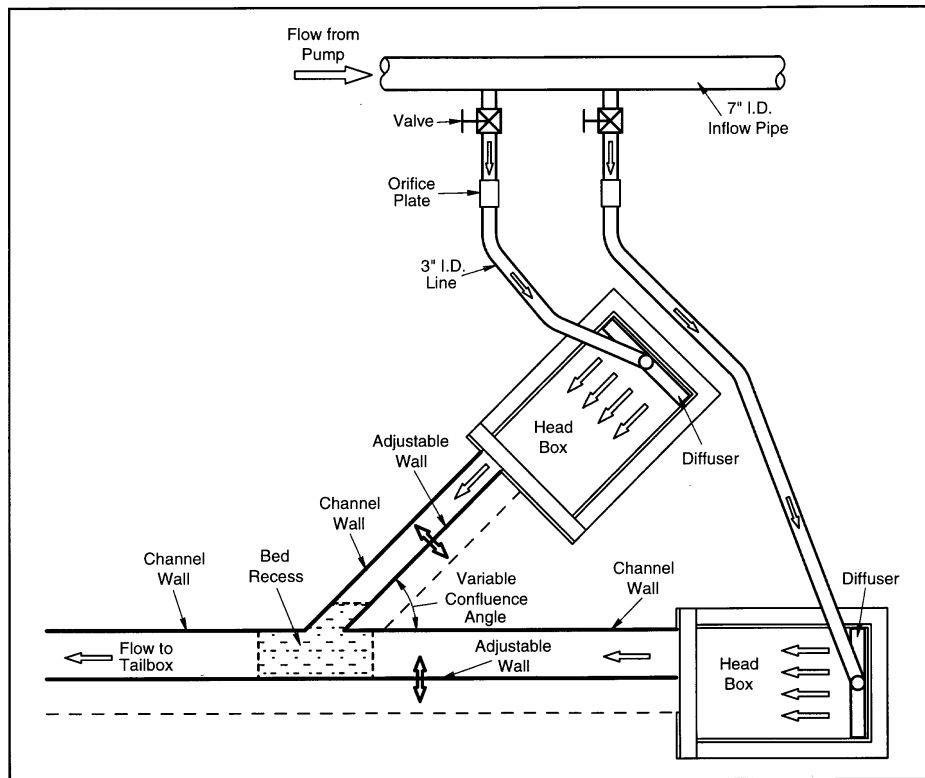


Figure 10. Layout of the jam process model.



Figure 11. View of the jam process model configured for a 45° confluence.

channel downstream of the confluence also was sufficiently long that it could re-establish uniform flow downstream of the confluence. A tail-gate positioned at the model exit section controlled the depth in the channel.

The model channels were constructed of sides formed of folded sheet metal placed on a plywood channel bed or base. The channel sides

were clipped together and anchored to the wood base by means of weights. This construction technique provided a flexible design that facilitated easy and quick re-arrangement of channel width and orientation. Most of the tests were conducted with a flatbed confluence. For selected confluence cases, the tests were repeated with simulated confluence bathymetry.

At the confluence, a piece of the wood bed was removable to create a recess in which the bathymetric features of an alluvial confluence could be reproduced. The features included those shown in Figures 10 and 11. Sand placed in the recess was shaped to simulate the confluence bathymetry shown in Figure 4b. The sand



used had the following properties: median diameter  $d_{50} = 1.28$  mm, geometric standard deviation = 1.22, and specific gravity = 2.71. The sand was immobile for the modeling flows used.

For the setup depicted in Figure 11, the model might be likened, in approximate terms, to the confluence of the Mississippi and Missouri Rivers, though vertically distorted in scale. Relative to those rivers, the model's approximate scales are 1:1,000 for horizontal lengths and 1:450 for vertical lengths.

Model scales for flow and velocities were selected in accordance with the similitude criterion based on densimetric Froude number,

$$\frac{V_r}{\sqrt{(\Delta\rho/\rho)_r g_r Y_r}} = 1$$

where  $V$  = velocity,

$g$  = gravitational acceleration,

$Y$  = flow depth,

$\Delta\rho = \rho - \rho_i$ ,

$\rho$  = density of water,

$\rho_i$  = density of ice,

and subscript  $r$  implies scale ratio (prototype/model).

This criterion leads to a velocity scale  $V_r = Y_r^{0.5} \approx 21$ , and a time scale for horizontal travel ratio,  $t_r = X_r Y_r^{-0.5} \approx 47$ , for the length scales given above and  $(\Delta\rho/\rho)_r = 1 = g_r$ .

### Confluence configurations modeled

The following confluence configurations were modeled:

- Channel widths— $b_1, b_3 = 217$  to  $480$  mm;  $b_2 = 160$  to  $217$  mm.
- Channel depths— $Y_1 = Y_2 = 25$  to  $50$  mm.
- Confluence apex angle— $\alpha = 0$  to  $180^\circ$ .
- Confluence external angle— $\theta = 90^\circ$  to  $180^\circ$ .

The modeling program encompassed the range of combinations of these channel configurations. The results of all combinations were not recorded in detail, as many combinations produced more or less the same ice movement and jamming behavior. Selected cases were investigated in closer detail when they showed distinct differences in jam formation.

### Model ice

Ice was modeled using polypropylene beads whose average diameter is 3 mm and whose specific gravity is 0.90. The beads are approximately spherical in shape. Model channel width relative to model ice piece diameter,  $b/D$ , varied from about 53 to 160. Model channel depth relative to model ice piece diameter,  $Y/D$ , varied from about 7 to 15.

The model ice was fed manually into each confluent channel. As the emphasis of the tests was on identifying the mechanisms of ice jamming in confluences, the model ice discharge into the channels was measured imprecisely. In fact, the conditions for confluence jamming revealed by the tests indicated that limits to ice passage through a confluence can be calculated quite directly. Therefore, there was little need for accurate measurement of ice discharge rates.



### **Modeling procedure**

Each set of tests with a confluence configuration involved establishing how the variation of confluent flow-rate ratio,  $Q_1/Q_2$ , affected ice conveyance through the confluence and modified the jamming mechanism.

Before each test, the flow was checked visually by means of dye to determine that inflow conditions were acceptable (i.e., no asymmetry of inflow or over-turbulent), and to confirm the uniformity of the flow profile along the confluent channels. For each test, all independent parameters were constant except for one, which was varied until a condition of ice jamming resulted in the model. The parameters most varied were concentrations of model ice flow in the channels, ratio of water discharge, and extent of bar developed in the simulated confluence. Typically, once satisfactory flow conditions were confirmed, the following modeling procedure entailed releasing model ice at various prescribed rates into both channels, then observing and recording the patterns of ice movement and accumulation as well as their effect on flow conditions.

Most of the tests were videotaped for subsequent further analysis. The video records were made with a CCD (charged-coupled device) camera mounted 1.53 m above the confluence. To enhance the resolution of the recorded images, the channel liners were painted white, whereas the model ice consisted of black beads. The video records enabled qualitative analysis of the temporal and spatial behavior of the conveyance of the ice layer in the model. For selected test cases, subsequent image processing using particle image velocity (PIV) software facilitated mapping of the whole field velocities of water flow and ice piece drift.

### **CONFLUENCE JAM PROCESSES**

The process modeling confirmed the simple processes that cause ice jams in confluences and, importantly, revealed the mechanics of four considerably more complex processes leading to ice jamming. The findings, therefore, are discussed in five parts:

1. Simple processes causing ice jams.
2. Jamming of merging ice runs.
3. Jamming due to flow impact.
4. Jamming at a confluence bar.
5. Jamming at deltaic bars.

The latter four mechanisms are potentially complex. The third jamming process can be demonstrated in laboratory conditions, but may be highly unlikely to occur in actual rivers or streams.

#### **Simple jamming processes**

Three relatively simple mechanisms result in ice jams at river confluences. They are sketched in Figures 12 and can be summarized as below:

- An ice run in one channel is blocked by stationary or slow-moving ice in the outflow channel (Fig. 12a).
- An ice run in one channel discharges into a larger channel in which flow currents are sluggish (Fig. 12b); an extreme, though common, example is a river entering a wide reservoir, lake, or coastal area.
- A run of relatively large ice pieces (compared with channel width) arch across the confluence (Fig. 12c).

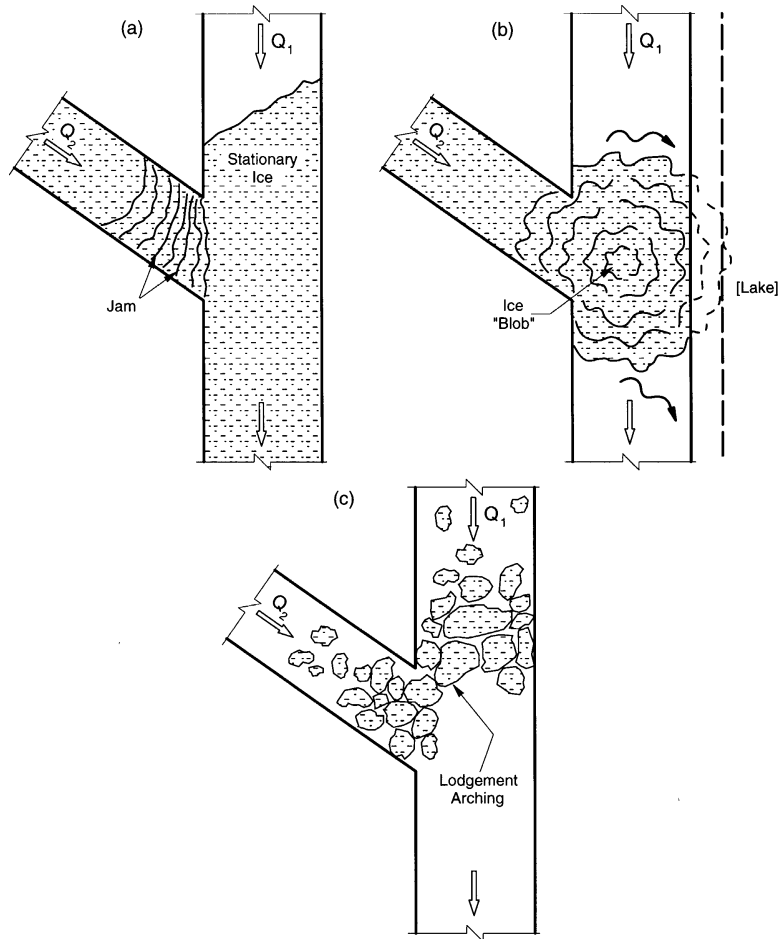


Figure 12. Simple jamming mechanisms of confluences: (a) stationary or slow moving ice in the main channel; (b) large main channel; (c) arching of the ice pieces across the confluence.

Each of these mechanisms reflects a limiting condition for the sets of nondimensional parameters identified in eq 15 and 20. The parameter  $C_1$ , for example, might be considered at a limiting condition when ice from channel 2 is blocked by stationary ice in channel 1 (Fig. 12a). The combination of parameters  $Q_1/Q_2$  and  $b_1/b_2$  may be considered at a limiting condition when ice from channel 2 discharges into a much wider channel with sluggish velocity (Fig. 12b) and essentially deposits a blob of ice. In simple terms, the parameter  $b_c/D$  is at a limiting condition when ice piece arching is the jam mechanism (Fig. 12c).

On the basis of the survey conducted by Tuthill and Mamone (1997), these three simple mechanisms appear to account for the preponderance of ice jams in the vicinity of confluences.

### Jamming of merging ice runs

Two ice runs merging in the confluence may cause one ice run to jam at a location immediately upstream of the confluence. This mechanism (Fig. 13) will occur if the upstream component of the lateral pressure exerted by ice discharging from one channel  $F_{\text{merge}}$  equals or exceeds the net force,  $\Sigma F$ , driving the ice in the second channel. The resultant jam forms in the second channel immediately, or a short

distance, upstream of the confluence. Figure 14 illustrates this jamming mechanism for ice merging at the confluence of the Iowa and Cedar Rivers near Columbus Junction, Iowa. Whereas ice continued moving through the Cedar River into the confluence, ice jammed in the Iowa River immediately upstream of the confluence.

The following four factors significantly influence jamming:

1. The relative location of the dividing streamline between the merging flows (see Fig. 8).
2. The relative magnitude of the flow-separation zone (see Fig. 8).
3. The proximity to incipient jamming in each inflow channel,  $C_1/C_{1max}$  or  $C_2/C_{2max}$ .
4. The increasing backwater effect created by ice congestion in the confluence.

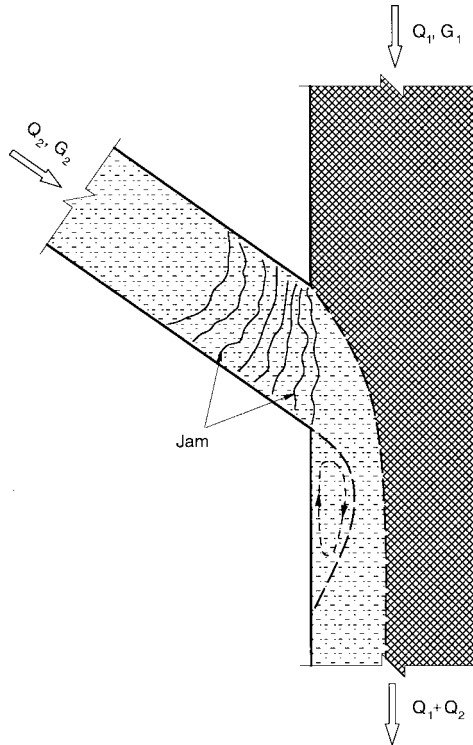


Figure 13. Jamming of merging ice runs.

The first and second factors reflect the influences of the parameter  $b_c/b_3$  and  $b_s/b_3$ , which combine the effects of confluence angles ( $\alpha, \theta$ ), the widths of the confluence channels ( $b_1/b_2, b_2/b_3$ ), and the relative magnitudes of the inflow discharges ( $Q_1/Q_2$ ). The third factor reflects the integral effect of the flow and ice parameters for each channel. The fourth factor is a feedback outcome of confluence congestion by accumulating ice; it reflects the interactive nature of jamming and flow. As a jam forms and begins retarding flow, flow depth increases at and upstream of the jam site, and flow velocity decreases commensurately. A decrease in flow velocity may hasten jam formation, because it reduces flow drag on the jam as it forms.

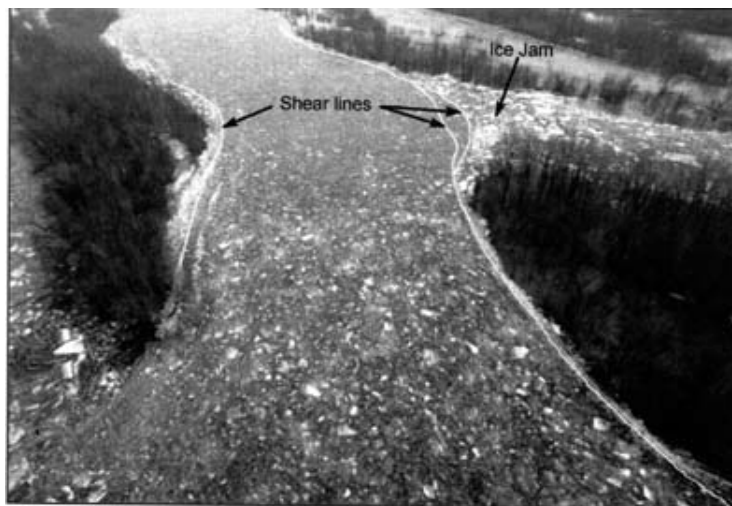


Figure 14. Ice jamming at the confluence of the Iowa and Cedar Rivers.

This jamming mechanism may occur when an ice run in one river must merge with an ice run in another river that is similar or larger in size. The jam typically will occur in the smaller river, immediately upstream of the confluence.

#### Jamming due to flow impact

When the flow from one confluent channel is considerably larger than flow from the second confluent channel, the dividing streamline can be pushed strongly to one side of the confluence. Ice drifting from the channel with the lesser flow is both retarded, because of the impact pressure exerted by the flow from the channel with the larger discharge, and it is constrained to move through the narrowed region of width  $b_3 - b_d$ , as depicted in Figure 15. Though feasible, this jamming process is likely to be rare in nature, because it is unlikely that the difference in flow velocities in the two confluent channels will differ so much that ice would be held back in the channel with the lesser discharge.

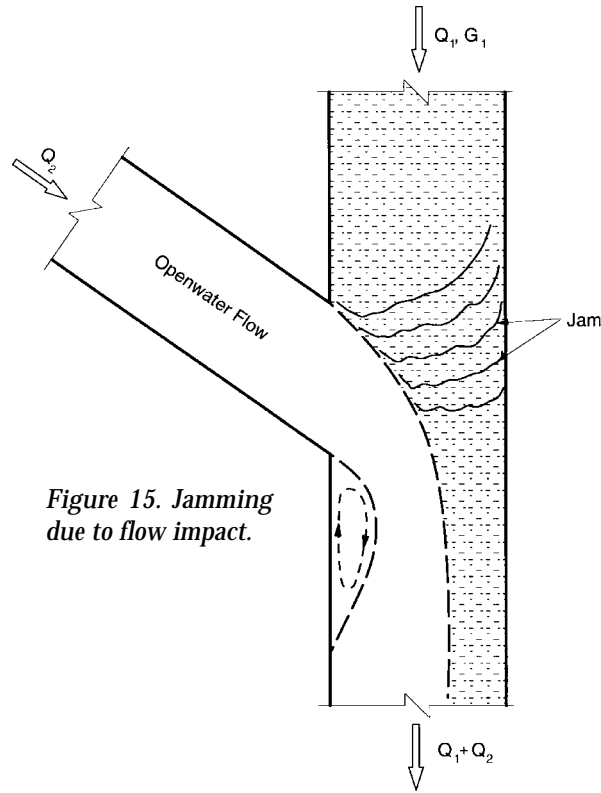


Figure 15. Jamming due to flow impact.

#### Jamming at a confluence bar

The model demonstrated the importance of the following additional factors for confluences of concordant bed, alluvial channels with a large exposed bar:

- Aggravated congestion of ice moving in the outflow channel narrowed by the presence of the bar.
- Grounding of ice in the shallow water around the bar.

These two factors, together with factors 1 through 4, contribute to the ice jam process illustrated in Figure 16. Ice congestion adjacent to the confluence bar results in a jam in the confluence. This mechanism may occur when ice enters the confluence from one inflow channel or from both.

The confluence jamming mechanisms illustrated in Figures 13, 15, and 16 can be formulated in a relatively simple manner, as described subsequently. It should be noted that factor 3, flow constriction and backwater development, reinforces the importance of including unsteady flow conditions when numerically modeling ice jam formation.

#### Ice jamming on depositional fan

For completeness of jamming situations, this situation is included here. It was not investigated with the model. Perhaps, it might be included as a simple (or obvious) jamming mechanism. As illustrated in Figure 17, during shallow flow

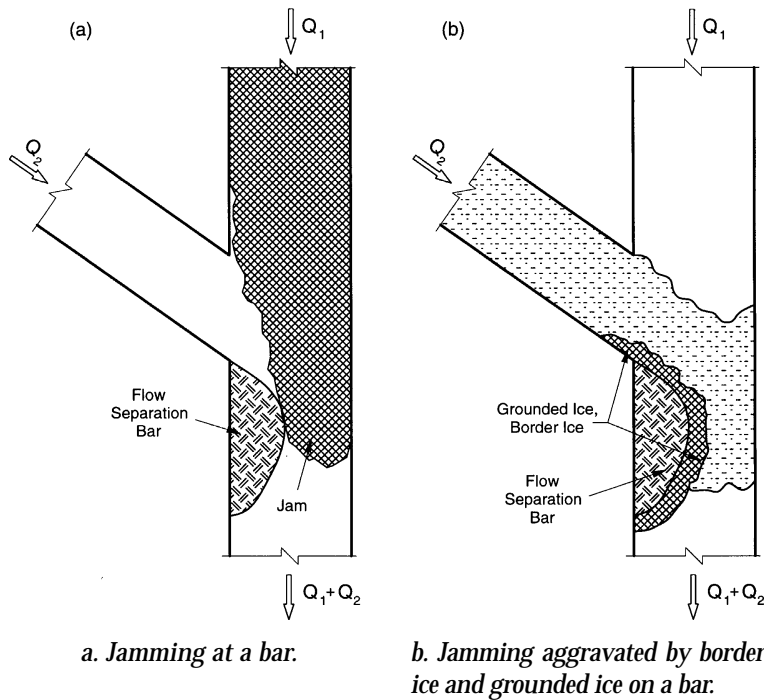


Figure 16. Jamming due to ice congestion at confluence bars. Note that jamming may occur for an ice run from either one or both channels.

conditions in both confluent channels, ice from the smaller channel may ground on exposed alluvial bars and dunes. Grounded ice may lead to arching of ice pieces and, thereby, to jam initiation.

### SELECTED OBSERVATIONS

A selection of observations from the process model are presented here to illustrate the two mechanisms described above and to show how they are affected by confluence angle  $\alpha$ , relative magnitudes of inflow discharge,  $Q_1/Q_2$ , and relative widths of inflow channel,  $b_1/b_2$ . Three confluence angles are considered,  $\alpha = 180^\circ$ ,  $90^\circ$ , and  $45^\circ$ . In the ensuing brief series of illustrative examples of observations from the small-scale model, channel 1 is the larger inflow channel, and the outflow channel is of the same dimensions. Channel 2 is the smaller inflow channel. Table 1 briefly summarizes the main observations.

#### $\alpha = 180^\circ$ confluence

Figure 18 depicts the model setup at this angle. The discharge ratio,  $Q_1/Q_2$ , was set successively at 0, 1, and 4. Forming a jam

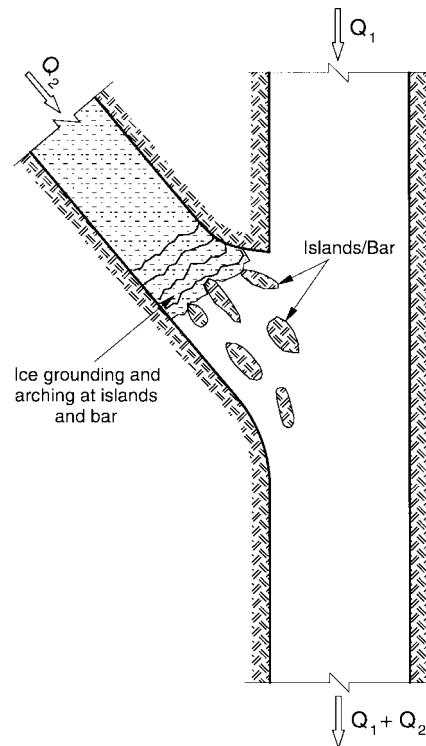
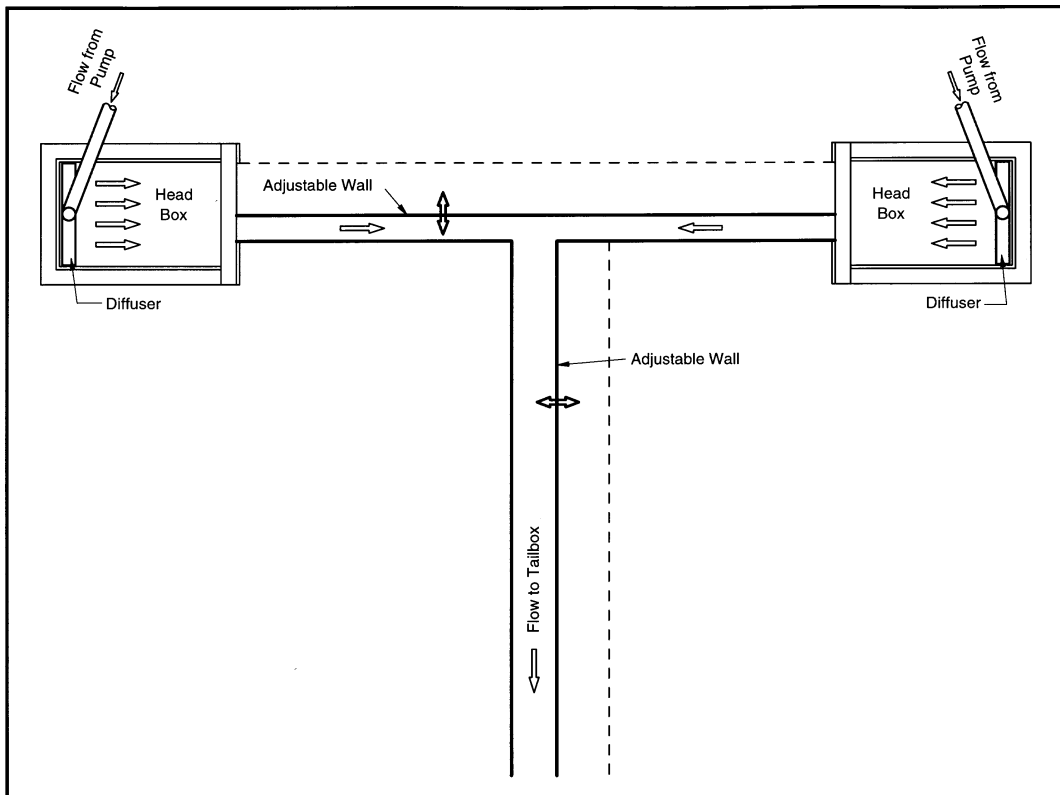


Figure 17. Ice jamming at discordant-bed confluence with deltaic bars.

**Table 1. Flow characteristics employed in the small-scale model investigations.**

Case no.	Confluence flow and geometry	Ice status
<b>90° Confluence</b>		
1	$Q_2/Q_1 = 2/3; b_1/b_2 = 1.5; b_2 = 16$ cm	Ice jam on channel 2
2	$Q_2/Q_1 = 3; b_1/b_2 = 1.5; b_2 = 16$ cm	Ice jam on channel 1
3	$Q_2/Q_1 = 2/3; b_1/b_2 = 1.5; b_2 = 16$ cm; bathymetry modeled	Severe jamming on channel 2
4	$Q_2/Q_1 = 3; b_1/b_2 = 1.5; b_2 = 16$ cm; bathymetry modeled	Severe jamming on channel 1
5	$Q_2/Q_1 = 3; b_1/b_2 = 3; b_2 = 16$ cm	Ice run
6	$Q_2/Q_1 = 2/3; b_1/b_2 = 3; b_2 = 16$ cm	Ice jam on channel 2
7	$Q_2/Q_1 = 6; b_1/b_2 = 3; b_2 = 16$ cm	Ice jamming on channel 1
<b>45° Confluence</b>		
1	$Q_2/Q_1 = 2/3; b_1/b_2 = 1.5; b_2 = 16$ cm	Ice jam on channel 2
2	$Q_2/Q_1 = 3; b_1/b_2 = 1.5; b_2 = 16$ cm	Ice jam on channel 1
3	$Q_2/Q_1 = 0.6; b_1/b_2 = 1.35; b_2 = 16$ cm	Ice run
4	$Q_2/Q_1 = 0.6; b_1/b_2 = 1.35; b_2 = 16$ cm; border ice	Severe jamming on channel 1



*Figure 18. Layout for the 180° confluence model.*

was difficult for this confluence orientation of the model, because the large-scale turbulence generated by the head-on merging of flows in the confluence helped move the ice pieces through the confluence.

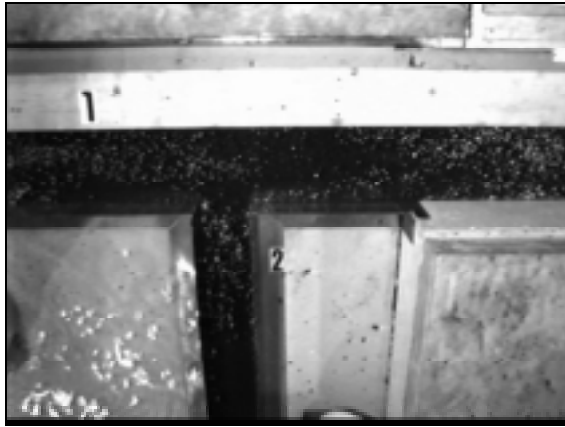
On the basis of the tests, it is possible to conclude that jamming would occur only for the extreme conditions of either a very wide outflow channel with negligible flow velocity, or an outflow channel whose surface is constricted for some or other reason (e.g., by an ice cover). Another extreme case that may cause jamming is for an immensely wide outflow channel (e.g., a lake or reservoir).

#### $\alpha = 90^\circ$ confluence

This confluence configuration was extensively tested, as it is relatively common. The full range of values for  $Q_1/Q_2$  and  $b_1/b_2$  were tested, with the ice discharges ( $G_1$  and  $G_2$ ) varied within a much narrower range of values near the transport capacity for both adjacent channels in order to hasten the possible onset of ice jam formation. The model ice moved in the channels as a bank-to-bank, single layer, or as closely packed patches with occasional water gaps. The tests showed jam formation to be sensitive to the ice discharge conditions in the confluent channels. Ice discharge rate in each channel had to be close to the ice discharge capacity of that channel for the small model ice pieces to jam. Selected cases are described below. The cases are listed in Table 1.

- Case 1:  $Q_2/Q_1 = 2/3$ ;  $b_1/b_2 = 1.5$ ;  $b_2 = 16$  cm. This case illustrates how ice discharging from one channel can be constricted by an ice run from the second channel, which has a larger discharge that pushes the dividing streamline close to the smaller channel. Jamming on channel 2 occurred, as illustrated in Figure 19, when the larger discharge and ice run in channel 1 forced the flow dividing streamline closer to the right (or inner) bank of channel 1 (looking downstream). In so doing, it choked the movement of ice from channel 2 (Fig. 19a). Consequently, ice jammed in channel 2. Once the ice run on channel 1 had passed, the jam stayed in place in channel 2 (Fig. 19b). Jamming in channel 2 was hastened by a backwater rise in the water level in channel 2.
- Case 2:  $Q_2/Q_1 = 3$ ;  $b_1/b_2 = 1.5$ ;  $b_2 = 16$  cm. This case shows how an ice run from the smaller confluent channel can cause a jam in the larger confluent channel when the smaller channel has a larger discharge. The set of three photographs presented in Figure 20 shows the confluence before, during, and after a jam develops in channel 1. Ice was released, at a constant rate, first in channel 1 as depicted in Figure 20a. It can be seen in this figure that the flow-separation line is well delineated by the drifting model ice. Ice in channel 1 jammed when the rate of ice release in channel 2 approached the limiting transport capacity for that channel at its given discharge (Fig. 20b). The jam lasted as long as the ice moved through channel 2. After the ice supply ceased, the ice jammed in channel 1 held for a while (Fig. 20c), then gradually released and flowed through the confluence. Had the jam been simulated in frigid air conditions, as may likely be the case in nature, the jam in channel 1 would have solidified and remained in place after the ice run from channel 2 had ended.
- Case 3:  $Q_2/Q_1 = 2/3$ ;  $b_1/b_2 = 1.5$ ;  $b_2 = 16$  cm, bar modeled. This example shows that the presence of a bar in the confluence exacerbates ice jamming. For identical upstream confluence conditions (both for ice and water) as in Case 1, the presence of a bar significantly altered the ice-jamming process and caused jamming to occur more quickly. Observation of the flow before jamming re-





a. During jamming.



b. After jamming.

Figure 19. Ice in confluence:  $Q_2/Q_1 = 2/3$ ,  $\alpha = 90^\circ$ , and  $b_1/b_2 = 1.5$ .



a. During jamming.



b. During jamming.



c. After jamming.

Figure 20. Ice in confluence:  $Q_2/Q_1 = 3$ ,  $\alpha = 90^\circ$ , and  $b_1/b_2 = 1.5$ .





Figure 21. Ice in confluence:  $Q_2/Q_1 = 2/3$ ,  $\alpha = 90^\circ$ , and  $b_1/b_2 = 1.5$ , bathymetry modeled.



Figure 22. Ice in confluence:  $Q_2/Q_1 = 3$ ,  $\alpha = 90^\circ$ , and  $b_1/b_2 = 1.5$ , bathymetry modeled.

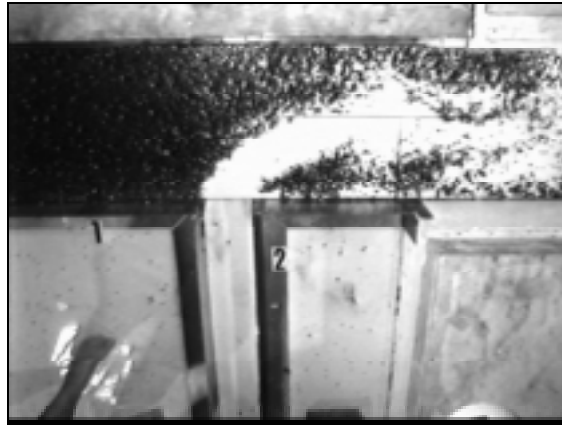


Figure 23. Ice in confluence:  $Q_2/Q_1 = 3$ ,  $\alpha = 90^\circ$ , and  $b_1/b_2 = 3$ .

vealed that the available surface area for ice movement through the confluence was much reduced. Also, the flow from channel 2 was necked more tightly than was the case without the bar. Jamming on channel 2 not only occurred quicker, but it occurred with a lesser ice transport rate than for the preceding example. Figure 21 illustrates ice jammed in channel 2.

- Case 4:  $Q_2/Q_1 = 3$ ;  $b_1/b_2 = 1.5$ ;  $b_2 = 16$  cm; bar modeled. This example further shows that the presence of a bar in the confluence exacerbates ice jamming. Increased discharge on channel 2, together with a bar present, rapidly caused a jam to form in channel 1, as illustrated in Figure 22. The jam was more severe in this case compared to Case 2 above, because the confluence region available for ice conveyance was reduced.
- Case 5:  $Q_2/Q_1 = 3$ ;  $b_1/b_2 = 3$ ;  $b_2 = 16$  cm. This example illustrates the influence on ice movement of widening of the main channel (i.e., decreasing  $b_d/b_3$ , while retaining  $Q_1/Q_2$ ). For the same discharge conditions as for the first example, the widened confluence was able to convey ice from channel 1 without jamming. Even though the greater width of channel enabled the dividing streamline to extend further into the main channel than was the case with the narrower main channel, jamming occurred as evident in Figure 23. Note the model ice pieces trapped in the separation zone indicate the extent of that zone.



Figure 24. Ice in confluence:  $Q_2/Q_1 = 2/3$ ,  $\alpha = 90^\circ$ , and  $b_1/b_2 = 3$ .



Figure 25. Ice in confluence:  $Q_2/Q_1 = 6$ ,  $\alpha = 90^\circ$ , and  $b_1/b_2 = 3$ .

- Case 6:  $Q_2/Q_1 = 2/3$ ;  $b_1/b_2 = 3$ ;  $b_2 = 16$  cm. A widened channel 1, with reduced discharge from channel 2, led to an ice jam in channel 2. As is evident in Figure 24, the extent of the separation zone diminished with decreased  $Q_2/Q_1$ , as did the distance to the dividing streamline,  $b_d$ . The dividing streamline, however, was sufficiently close to the entrance of channel 2 that it sufficiently contracted the flow from channel 2 and was thereby able to slow ice movement from channel 2. The upshot was jam formation in channel 2, as occurred for the same flow ratio when  $b_1/b_2 = 1.5$ .
- Case 7:  $Q_2/Q_1 = 6$ ;  $b_1/b_2 = 3$ ;  $b_2 = 16$  cm. This example demonstrates that a strong side flow from one confluent channel may lead to jamming in the second confluent channel conveying ice. In effect, when  $(b_3 - b_d)/b_3 > (b_d - b_s)/b_3$  the ice run from the larger inflow channel is greatly constrained. The greater water discharge from channel 2 pushed the dividing streamline far over toward the left side of the confluence. In so doing, it greatly reduced the space available for ice from channel 1 to pass through the confluence. Consequently, as shown in Figure 25, ice jammed in channel 1.

#### $\alpha = 45^\circ$ confluence

The apex angle of  $45^\circ$  was selected as being also being representative of numerous confluence situations. It approximately coincides with the angle for the confluence of the Mississippi and Missouri Rivers. The following four example cases illustrate general features of ice movement through confluences at this angle, and they provide site-specific insights for the confluence of the Mississippi and Missouri Rivers:

- Case 1:  $Q_2/Q_1 = 2/3$ ;  $b_1/b_2 = 1.5$ ;  $b_2 = 16$  cm. This example is similar to Case 1 for the  $90^\circ$  confluence. The effect of reduced apex angle was to increase ice conveyance capacity. A jam developed in channel 2, as shown in Figure 26; however, the jam was not as stable as for that in the  $90^\circ$  confluence example.
- Case 2:  $Q_2/Q_1 = 3$ ;  $b_1/b_2 = 1.5$ ;  $b_2 = 16$  cm. All flow characteristics for water and ice used for Case 2 of the  $90^\circ$  confluence are repeated in this example. The reduced apex angle moves the dividing streamline toward the right bank of the confluence and it reduces the extent of the separation region. Consequently, it was more difficult for a jam to form than for the  $90^\circ$  confluence.



Figure 26. Ice in confluence:  $Q_2/Q_1 = 2/3$ ,  $\alpha = 45^\circ$ , and  $b_1/b_2 = 1.5$ .

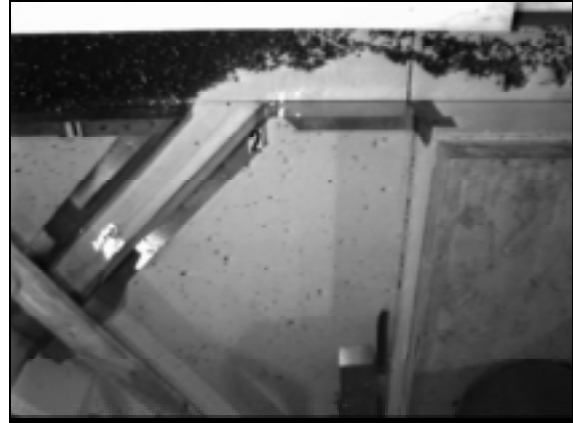


Figure 27. Ice in confluence:  $Q_2/Q_1 = 3$ ,  $\alpha = 45^\circ$ , and  $b_1/b_2 = 1.5$ .



Figure 28. Ice in confluence:  $Q_2/Q_1 = 0.6$ ,  $\alpha = 45^\circ$ , and  $b_1/b_2 = 1.35$ .

Figure 27 illustrates the approximate position of the dividing streamline and shows a jam formed in channel 1.

- Case 3:  $Q_2/Q_1 = 0.6$ ,  $Q_1 = Q_{\text{Mississippi}} = 40,000$  cfs ( $1133 \text{ m}^3/\text{s}$ );  $Q_2 = Q_{\text{Missouri}} = 25,000$  cfs ( $708 \text{ m}^3/\text{s}$ );  $b_1/b_2 = 1.35$ ;  $b_2 = 16$  cm. This case replicates the actual geometric and hydrodynamic characteristics of the confluence of the Mississippi and Missouri Rivers, except that the channels were rectangular in cross section. The selected discharges are based on an evaluation of ice jam conditions at the confluence, as discussed subsequently. In this example no jam formed. Ice from the simulated Missouri River passed through the confluence, as shown in Figure 28. This example indicates the significant role played by the bar in the actual confluence.
- Case 4: With bar and border ice in place (cf. aerial photograph from 9 January 1979 shown subsequently as Fig. 36);  $Q_2/Q_1 = 0.6$ ,  $Q_1 = Q_{\text{Mississippi}} = 40,000$  cfs;  $Q_2 = Q_{\text{Missouri}} = 25,000$  cfs;  $b_1/b_2 = 1.35$ ;  $b_2 = 16$  cm. This case was selected following an analysis of a sequence of jamming events at the confluence of the Mississippi and Missouri Rivers; the analysis is discussed in the next section of the report. The presence of the bar along the inner bank of the confluence and, during frigid conditions, the formation of border ice attached

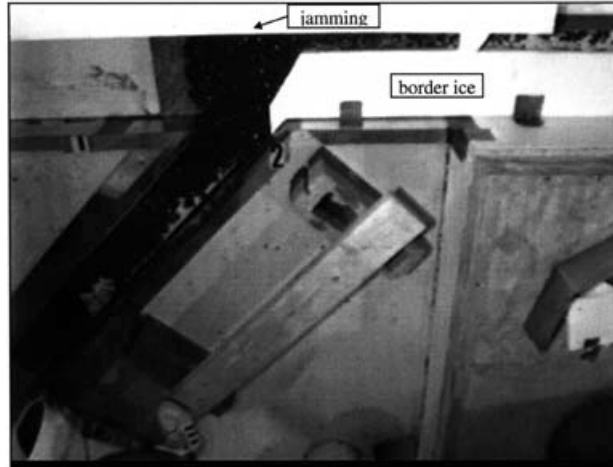


Figure 29. Ice in confluence:  $Q_2/Q_1 = 0.6$ ,  $\alpha = 45^\circ$ , and  $b_1/b_2 = 1.35$ , border ice.

to the bar greatly constricts the confluence. Figure 29 illustrates how rapidly jamming may occur. For the present modeling, the frozen bank was modeled using a Styrofoam sheet, which was suspended on the free surface to enable flow under the modeled frozen cover. The resultant ice jam concurs remarkably well with actual jam patterns at the confluence. Subsequent aerial photographs show those patterns.

It is evident from the foregoing examples that the likelihood of ice jam formation increases as the following parameter variations occur:

- Increasing apex angle,  $\alpha$ .
- Decreasing relative width of confluence,  $b_1/b_2$ .
- When both ice concentrations  $C_1$  and  $C_2$  are close to the conveyance capacity of the confluent channels.
- When  $0.25 > Q_1/Q_2 > 4$  (the values are nominal), such that the flow from the higher-flow channel shifts the dividing streamline close to the lesser-flow channel and may severely constrict ice movement from that channel.
- When the relative size of the flow separation zone (or  $b_s/b_3$ ) and, relatedly, the bar is such that confluence is significantly constricted.

## FORMULATION

The observations of model ice movement and jamming in the confluences simulated with the small-scale model reveal three mechanisms whereby ice likely may jam at a confluence. The following descriptions are based on a simplification of the complicated stress field that would develop between bands of moving ice:

1. Two ice runs merging in the confluence cause one ice run to jam at a location immediately upstream of the confluence. This mechanism is illustrated in Figure 30. The pressure along the interface between the merging ice results in a force  $F_{\text{merge}}$  that may be resolved into components acting either parallel ( $F'_{\text{merge1}}$  and  $F'_{\text{merge2}}$ ) or normal to the axis of each influent channel ( $F''_{\text{merge1}}$  and  $F''_{\text{merge2}}$ ). A jam occurs in channel 1, immediately upstream of the confluence if the additional force acting upstream along the bank of channel 1 ( $F'_{\text{merge1}} + \mu_1 F''_{\text{merge1}}$ ) equals or exceeds the net force  $\Sigma F$  driving the ice in

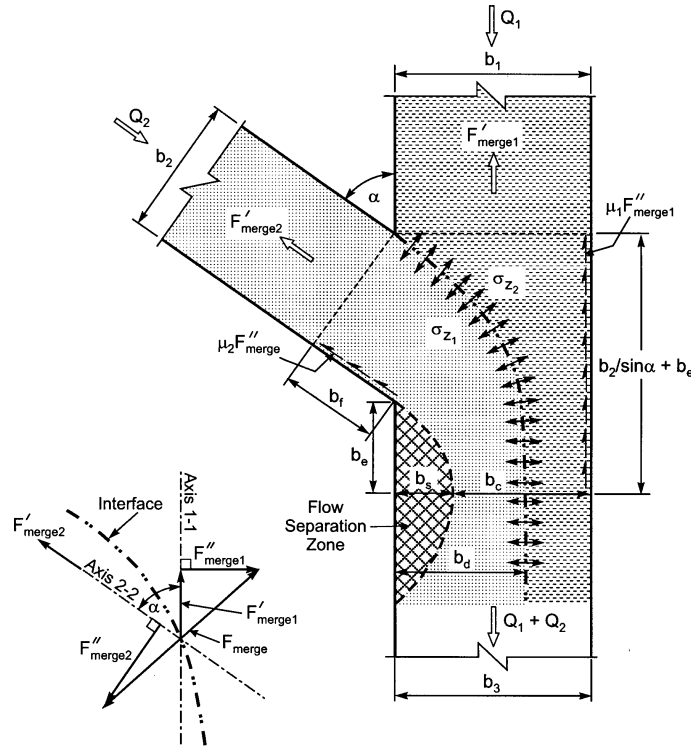


Figure 30. Lateral pressures associated with merging ice runs.

that channel. The term  $\mu_1 F''_{\text{merge1}}$  is the friction force acting upstream along the axis of channel 1;  $\mu_1$  is the friction coefficient between ice and confluence bank. The friction force is generated by the sideways force component  $F'_{\text{merge1}}$ , and it acts over the approximate length of bank shown in Figure 30. The downstream extent of the friction force is difficult to determine precisely, it likely does not extend further downstream than the section of greatest flow contraction adjoining the flow separation zone.

2. When the flow from one confluent channel is considerably larger than flow from the second confluent channel, which conveys ice, the dividing streamline can be pushed strongly to one side of the confluence. The change of momentum of the larger flow  $Q_1$  exerts a hydrodynamic reaction force that retards ice movement in the channel of lesser flow  $Q_2$ . The ice is constrained to a narrow band within the confluence entrance and backs up in influent channel 2, as shown in Figure 31. For this situation, the reaction force component acting along the axis of channel 2,  $F'_{\text{flow2}}$ , and the friction force,  $\mu_2 F''_{\text{flow2}}$ , retard ice movement from channel 2. Here,  $F'_{\text{flow2}}$  is the reaction force component acting normal to the axis of channel 2, and  $\mu_2$  is the friction coefficient between ice and bank. The friction force is generated along a short distance of bank, as indicated in Figure 31.
3. Ice congestion adjacent to the confluence bar results in a jam in the confluence. This mechanism may arise when an ice run entering the confluence is constricted by the presence of a bar, as illustrated in Figure 32, and jams at the bar. The ice run may occur from one inflow channel or from both.

The three mechanisms give rise to relatively straightforward criteria for determining whether an ice jam will occur. The first two mechanisms require that the

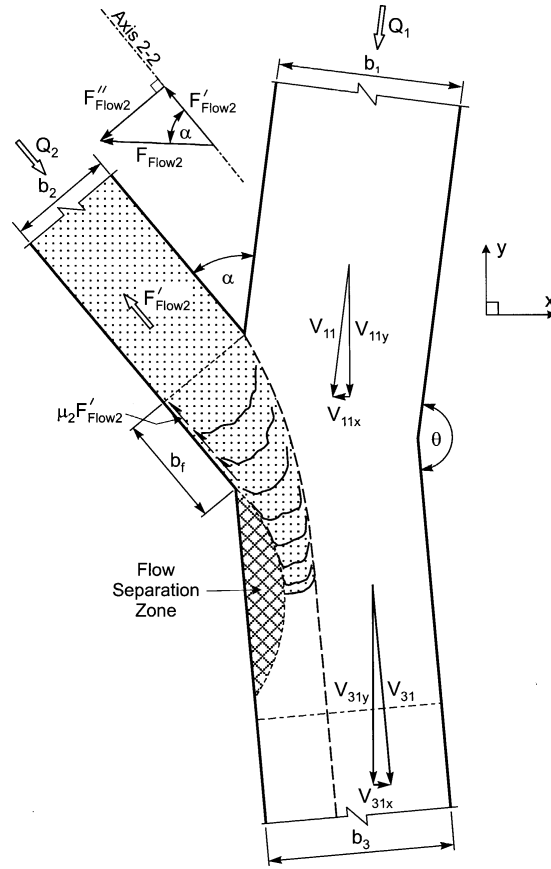


Figure 31. Flow impact holds ice in channel 2.

ice runs in question be near the ice conveyance capacity of the particular channels. The additional force associated with the merging of ice and water equals or exceeds the force increment needed to cause ice to jam in the confluent channel.

### 1. Jamming of merging ice runs

The first mechanism suggests the following criterion for use in assessing whether a jam will develop in one or other of the two confluent channels entering the confluence: ice moving in one confluent channel will jam if

$$\begin{aligned} \Sigma F - F_{\text{merge1}} - \mu_1 F''_{\text{merge1}} &= F_{\text{drag}} + F_{\text{weight}} - F_{\text{bank}} \\ - F_{\text{strength}} - F_{\text{merge1}} - \mu_1 F''_{\text{merge1}} &\leq 0 \end{aligned} \quad (21)$$

where  $F_{\text{drag}}$  = water drag force acting against the ice,

$F_{\text{weight}}$  = the streamwise component of weight of the moving ice,

$F_{\text{bank}}$  = bank friction acting against the ice in channel 1,

$F_{\text{strength}}$  = the internal strength of the ice.

These four forces are usual for ice jams in single channels. The further forces are  $F_{\text{merge1}} = \sigma_{z2} \eta_2 (b_d)$  and  $F''_{\text{merge1}} = \sigma_{z2} \eta_2 (b_2 / \sin \alpha + b_e)$ . The force  $F_{\text{merge1}}$  is approximated as the lateral pressure exerted by ice moving from channel 2,  $\sigma_{z2}$ , multiplied by the contact area normal to the direction of flow in channel 1,  $\eta_2 b_d$ . The



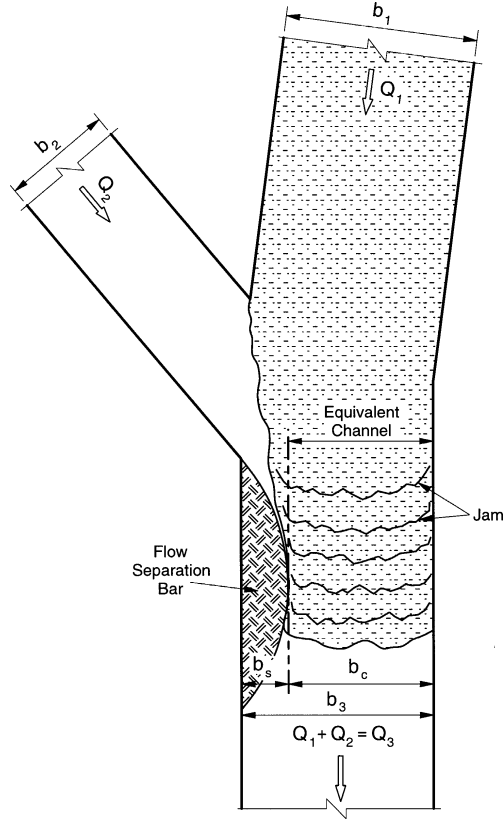


Figure 32. Ice jam formation at confluence narrowed by a bar.

force  $F''_{merge1}$  can be approximated as the lateral pressure exerted by ice moving from channel 2,  $\sigma_{z2}$ , multiplied by the contact area parallel to the direction of flow in channel 1,  $\eta_2(b_2/\sin \alpha + b_e)$ . The length  $b_e$  can only be estimated, because no predictive relationship presently exists for it. As an approximation,  $b_e \approx b_s$ , though  $b_e$  always exceeds  $b_s$ .

Ice will not jam if  $\Sigma F - F_{merge} > 0$ , because the net force driving ice in channel 2 is sufficient to overcome the additional resistance generated by the lateral pressure of ice moving from channel 1.

Equation 21 can be used in quasi-steady formulation of ice movement and jamming in confluences. A difficulty in the formulation is estimation of the width  $b_3 - b_c$ ; or rather  $b_c$ . For a one-dimensional formulation, an approximation would be to set  $b_3 - b_c \approx b_3$ . This approximation is somewhat crude, but reasonable given all the other uncertainties associated with estimation of jam behavior. Inclusion of  $F'_{merge1}$  and  $F''_{merge1}$  would modify the force formulation, such as proposed by Uzuner and Kennedy (1976), for a static floating ice jam:

$$\begin{aligned} \tau_{i1} \cos\left(\frac{\rho_1}{\rho} \frac{\partial \eta}{\partial x}\right)_1 + s_{i1} \rho g \eta_1 \sin(\theta + \varphi)_1 - \frac{\partial}{\partial x} (\eta_1 \sigma_{x1}) - \frac{\partial}{\partial y} (\eta_1 \tau_{xy1}) \\ - \sigma_{z2} \eta_2 \left(\frac{b_d}{b_1}\right) - \mu_1 \sigma_{z2} \eta_2 \left(\frac{b_s + b_2 / \sin \alpha}{b_1}\right) = 0 \end{aligned} \quad (22)$$

where  $\sigma_x$ ,  $\tau_{xy}$ ,  $\tau_i$ , are the normal stress in the streamwise direction, the shear stress at the banks, and the shear on the underside of the cover, respectively. The angle  $\theta$



is the slope of the bed, and  $(\theta + \varphi)$  is the slope of the water surface. In eq 22, the terms (reading from left to right) are  $F_{\text{drag}}$ ,  $F_{\text{weight}}$ ,  $F_{\text{strength}}$ ,  $F_{\text{bank}}$ ,  $F'_{\text{merge2}}/b_1$ , and  $F''_{\text{merge2}}/b_1$ .

For a two-dimensional formulation, the value of  $b_d$  and  $b_s$  would need to be estimated. They can be estimated approximately using eq 4 and 6. With the dividing streamline defined, it is then possible to obtain an approximate estimate of the additional forces acting to inhibit ice from channel 1 moving into the confluence.

Ice decelerates as it accumulates and congests the confluence. It thereby increases flow resistance and generates a backwater flow profile through the confluent channels. This process is not taken into account in the foregoing quasi-steady formulation of ice jams at confluences.

The equilibrium jam formulation given by eq 23, or a two-dimensional equivalent, can be used to estimate the conditions leading to ice-jam formation in confluent channels. In this regard, it is better suited for delineating the limiting conditions for ice movement through a confluence than is the process model used in the present study.

## 2. Jamming due to flow impact

This confluence jam mechanism requires that the flow from one influent channel be sufficiently large as to block ice movement from the second influent channel, as shown in Figure 31. The hydrodynamic reaction force generated by the larger flow,  $Q_1$ , impacting the ice may be resolved into a component,  $F'_{\text{flow2}}$ , acting upstream along the axis of channel 2 and a component,  $F''_{\text{flow2}}$ , acting normal to the axis of channel 2. This latter component would result in an additional friction force,  $\mu F''_{\text{flow2}}$ , between bank and ice over a short distance,  $b_f$ , as shown in Figure 31.

The force components could be estimated as

$$F'_{\text{flow2}} = \rho Q_1 (v'_{11x} - v'_{31x}) \eta_2 b_2 \quad (23)$$

and

$$F''_{\text{flow2}} = \mu_2 \rho Q_1 (v''_{11x} - v''_{31x}) (\eta_2 b \cot \alpha) \quad (24)$$

where  $v_{11x}$  and  $v_{31x}$  = lateral velocity components of flow from channel 1 through the confluence control volume indicated in Figure 31,

- $v''_{11x}$  = the component of  $v_{11x}$  acting along the axis of channel 2,
- $v''_{31x}$  = the component of  $v_{31x}$  acting along the axis of channel 2,
- $v'_{11x}$  = the component of  $v_{11x}$  acting normal to the axis of channel 2,
- $v'_{31x}$  = the component of  $v_{31x}$  acting normal to the axis of channel 2,
- $\eta_2$  = the average thickness of the layer of ice moving from channel 2.

The velocity vectors,  $v'_{11x}$ , etc., can be estimated for specific confluence geometries and flow rates.

An ice jam may develop in channel 2 when

$$\begin{aligned} \tau_{i2} \cos \left( \frac{\rho_i}{\rho} \frac{\partial \eta}{\partial x} \right)_2 + s_{i2} \rho g \eta_2 \sin(\theta + \varphi)_2 - \frac{\partial}{\partial x} (\eta_2 \sigma_{x2}) - \frac{\partial}{\partial y} (\eta_2 \tau_{xy2}) \\ - \rho Q_1 (v'_{11x} - v'_{31x}) \eta_2 - \mu_2 \rho Q_1 (v''_{11x} - v''_{31x}) (\eta_2 b \cot \alpha) / b_2 = 0. \end{aligned} \quad (25)$$

In eq 25, the terms (reading from left to right) are  $F_{\text{drag}}$ ,  $F_{\text{weight}}$ ,  $F_{\text{strength}}$ ,  $F_{\text{bank}}$ ,  $F'_{\text{flow2}}/b_2$ , and  $F''_{\text{flow2}}/b_2$ . This formulation is approximate, but it facilitates estimation of the confluence flow conditions needed for flow from one channel to impeded ice movement from the second channel. It would, of course, have to be adjusted to take into account other confluence geometries.

### 3. Jamming due to a confluence bar

The third mechanism for jam formation also can be formulated in an approximate manner. The likelihood of ice pieces arching across the narrowest section of a confluence, as in Figure 32, can be estimated using the estimation relationship for equilibrium jam thickness,  $\eta_{\text{eq}}$ , proposed by Beltaos (1995) for ice jams in straight channels. The likelihood that a thickened layer of ice will jam at the narrowest section of the confluence can be estimated by estimating the thickness of accumulated ice needed to jam in a channel of width equal to  $b_c = b_3 - b_s$ . Jamming will occur if the thickness is less or equal to an accumulation thickness estimate based on equivalence of cross-sectional areas of ice confluent into a flow channel of width  $b_3 - b_c$ ; i.e.,

$$\eta_c = \frac{1}{b_c} (b_1 \eta_1 + b_2 \eta_2) \leq \eta_{\text{eq}} \quad (26)$$

in which  $\eta_{\text{eq}}$  is the equilibrium thickness of an ice jam in a channel of width  $b_3 - b_c$  conveying a flow rate =  $Q_1 + Q_2$ .

Equation 26 can be used together with an equation for  $\eta_{\text{eq}}$ , as an approximate means to estimate jamming conditions for a range of geometric and flow conditions.

## ICE JAMS IN THE CONFLUENCE OF MISSISSIPPI AND MISSOURI RIVERS

Though ice jams form at intermittent frequencies in the confluence of the Mississippi and Missouri Rivers, they cause expensive disruptions to navigation on the Mississippi River and usually damage tow barges moored in fleeting areas along the Mississippi and Missouri Rivers. Figure 33, for example, depicts a jam at the confluence during February 1989.

The St. Louis District of the U.S. Army Corps of Engineers, the agency charged with maintaining navigation through the confluence reach of the Mississippi, needs to know how ice jams form at the confluence of the Mississippi and the Missouri Rivers. A major factor affecting jam formation appears to be a large bar, which is evident in the aerial photograph Figure 33. The likely mechanism causing ice jamming is ice congestion at the section of the confluence narrowed by the bar. The Corps recognizes that the bar partially impedes ice movement through the confluence and wishes to confirm that reducing its size would significantly improve ice movement through the confluence. The method selected and already partially implemented for reducing the extent of the bar entails the placement of bendway weirs through a portion of the confluence. The St. Louis District of the Corps wished also to confirm that the bendway weirs would create no inadvertent adverse effect on ice movement through the confluence.

The modeling work presented here was aimed at establishing the general features of ice movement and ice jamming in the Mississippi–Missouri confluence

and to determine the likely effectiveness of bar reduction in improving the ice conveyance capacity of the confluence. In addition, the modeling sought to determine whether the use of bendway weirs would contribute inadvertently to other problems for ice movement through the confluence. The modeling builds on the findings of the small-scale diagnostic model described above, translating their significance to the situation of an actual confluence of two rivers.

A precursory investigation was conducted of the weather and river flow factors to obtain background information concerning the flow and ice conditions typically prevailing when ice jams form in the confluence. Those conditions were simulated in the model.

#### **Weather and flow conditions associated with jamming**

A study of the conditions associated with ice jam formation at the confluence of the Mississippi and Missouri Rivers leads to the following findings:

- The Missouri River is the major source of ice contributing to the jam. Because of the ice retention action of the navigation structures along the Mississippi River, only a relatively small amount of ice enters the confluence from the Mississippi River.
- The ice from the Missouri River comprises mainly pans and floes of frazil ice generated during a freezeup of the Missouri River. Therefore, the confluence jam is a freezeup jam.
- A period of frigid air temperatures precedes and sometimes accompanies the jams.
- The jams occur when flow rates are low in both the Missouri and Mississippi Rivers. At low flow rates, the bar in the confluence is exposed and, relatedly, the surface area available for ice passage through the confluence is constricted. The constriction is further aggravated by the growth of border ice along the bar and in regions of sluggish flow in the confluence.

Table 2 lists ice events at the confluence. The list is too brief to provide reliable statistics on the frequency of ice jams. Jams sometimes have occurred in a succession of years; otherwise, they have not occurred for periods of about 5 to 10 years. Tuthill and Mamone (1997) suggest a tentative return period of 10 years for jams at the confluence.

The occurrence of jams can be linked directly to low flow rate through the confluence and frigid air over the rivers upstream of the confluence. For example, this linkage can be illustrated for ice jams that formed during the winters of 1977–78, 1978–79, and 1980–81. Table 3 briefly summarizes the main characteristics of the

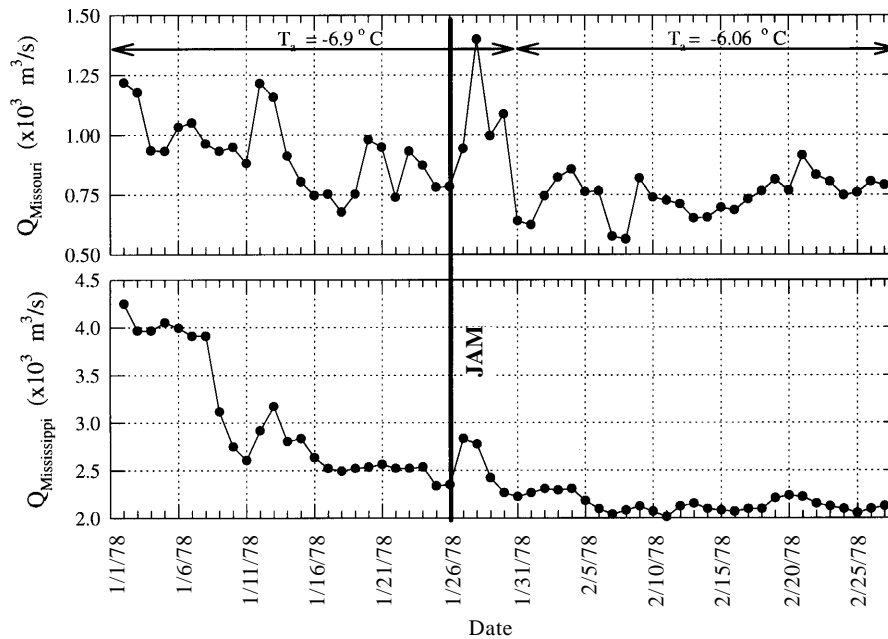


*Figure 33. Light ice run in the confluence of Mississippi and Missouri Rivers (9 Feb 1989).*

**Table 2. Aerial photographs of ice conveyance through Mississippi–Missouri confluence.**

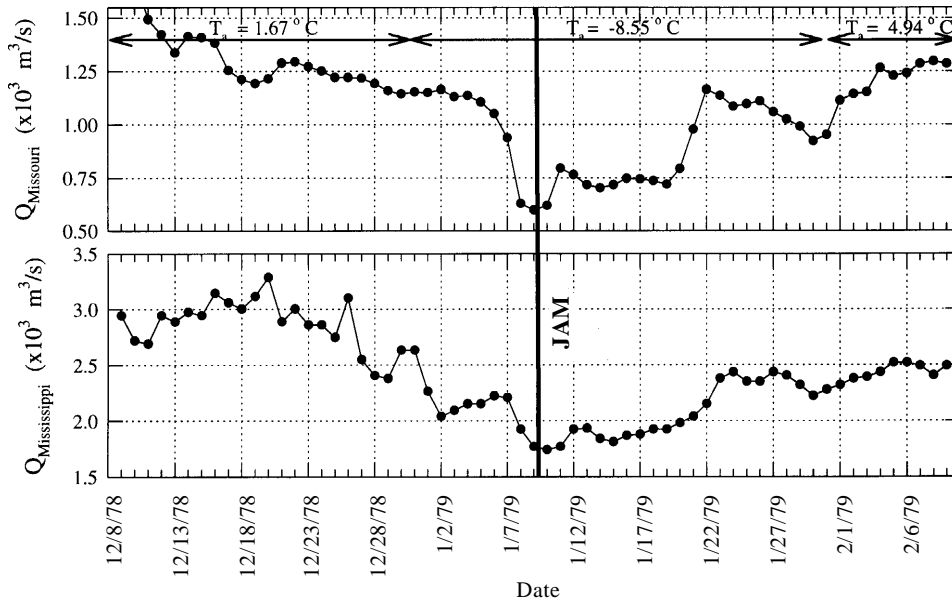
Date	Ice status	Ice source	Average monthly temperature	
			(°F)	(°C)
12/17/76	Congestion, no border ice	Missouri	28.5	-1.9
01/26/78	Jamming, border ice	Missouri	19.6	-8.8
01/09/79	Jamming, border ice	Missouri	16.6	-8.5
02/05/79	Light ice run, no border ice	Missouri	23.1	-4.9
02/10/81	Severe jamming, no border ice	Missouri and Mississippi	36.8	2.7
02/04/85	Heavy ice run, no border ice	Missouri	30.5	-0.8
02/09/89	Light ice run, no border ice, sand bar	Missouri	28.2	-2.1
12/16–20/89	Severe jamming (worst case), border ice	Missouri	24.1	-4.4
01/19/94	Heavy ice run, no border	Missouri	26.8	-2.8
01/09/96	Light ice run, no border	Missouri	N/A	N/A

ice jams occurring during these three winters. Figure 34 shows the daily average flow rate in the Missouri River during these periods. The flow rates were recorded at a stage gage located at Hermann, Missouri, a short distance upstream from the confluence. Also shown are the average monthly air temperatures at St. Louis, Missouri, during these periods, and the occurrence of jams in the confluence. Clearly the jams are freezeup jams the winters illustrated, occurring during periods of low discharge in the Missouri and Mississippi Rivers. The plots show that ice jams occur in the confluence when the flow rate in the Missouri River has dropped to about 20,000 cfs (566 m<sup>3</sup>/s) to 30,000 cfs (850 m<sup>3</sup>/s), and flow in the Mississippi

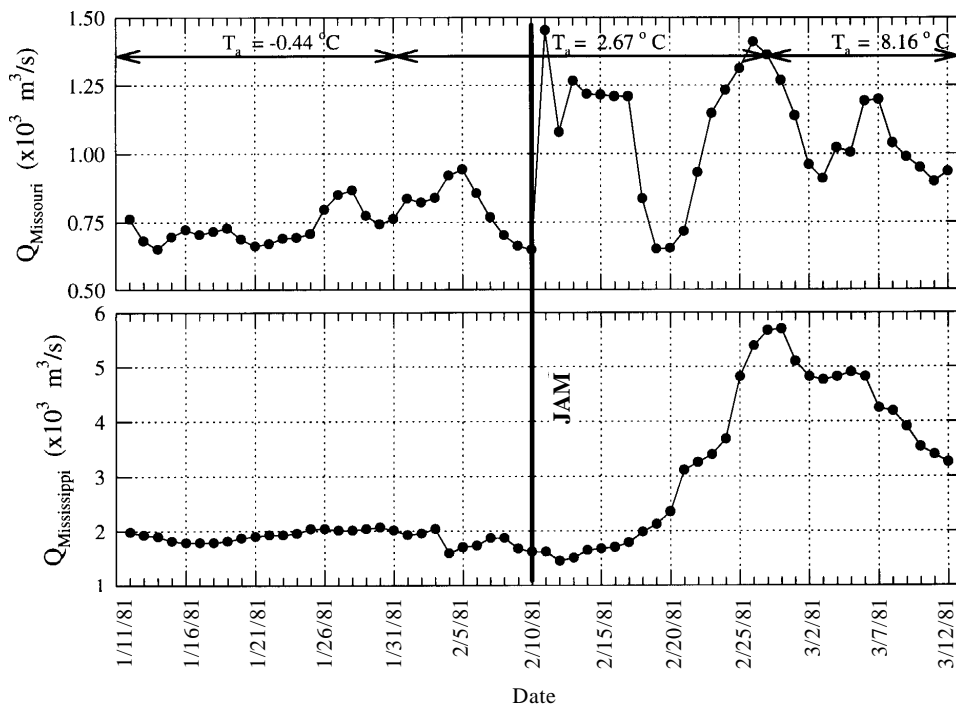


*a. For the period 2 January 1978 to 27 February 1978.*

*Figure 34. Record of flow discharges in the Mississippi and Missouri Rivers. Also indicated is the average monthly temperature for the region.*



b. For the period 9 December 1978 to 9 February 1979.



c. For the period 12 January 1981 to 12 March 1981.

Figure 34 (cont'd).

River entering the confluence is in the range of 50,000 cfs (1416 m<sup>3</sup>/s) to 75,000 cfs (2124 m<sup>3</sup>/s). The low flow rates in the Missouri usually coincide with low flows in the Mississippi River. The jams in the winters of 1977-78 and 1978-79 coincide with periods of typically frigid winter weather. On average, the winter weather during early 1981 was somewhat milder, though a brief cool period, not reflected by the monthly average air temperature, may have preceded the jam in that year.

**Table 3. Flow and environmental characteristics for three jam events.**

Date of the jamming	Missouri discharge at Herman, Missouri			Mississippi discharge upstream of confluence			Mississippi/Missouri	Temperature
	On day of jam $\times 10^3$ cfs (m <sup>3</sup> /s)	Reference interval average $\times 10^3$ cfs (m <sup>3</sup> /s)	Reference interval max/min $\times 10^3$ cfs (m <sup>3</sup> /s)	On day of jam $\times 10^3$ cfs (m <sup>3</sup> /s)	Reference interval average $\times 10^3$ cfs (m <sup>3</sup> /s)	Reference interval max/min $\times 10^3$ cfs (m <sup>3</sup> /s)	Discharge ratio on day of jam	Average for month of jam occurrence (°F) (°C)
01/26/78	28 (0.79)	30 (0.85)	50/20 (1.42/0.57)	55 (1.56)	60 (1.70)	100/51 (2.83/1.44)	1.96	19.6 -6.8
01/09/79	21 (0.59)	39 (1.10)	64/21 (1.81/0.59)	40 (1.13)	47 (1.33)	52/40 (1.33/1.13)	1.90	16.6 -8.5
02/10/81	22 (0.62)	32 (0.91)	51/23 (1.44/0.65)	35 (0.99)	63 (1.78)	150/28 (4.25/0.79)	1.60	36.8 2.7

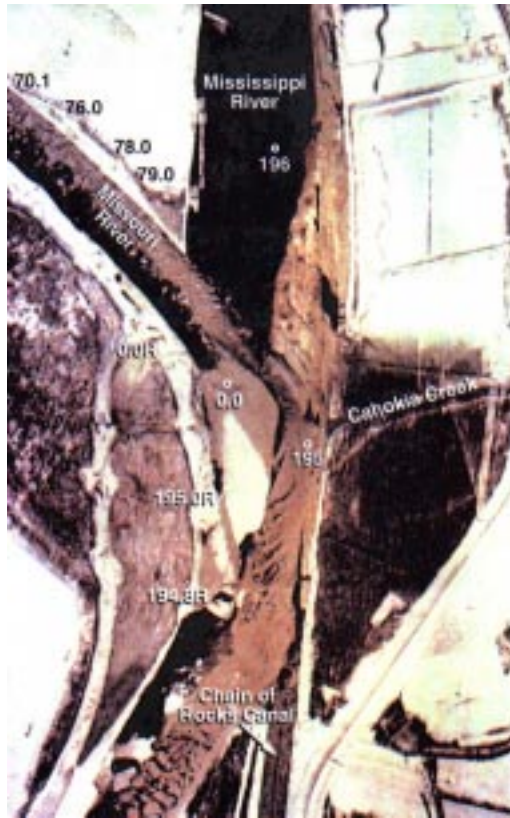
Note: Yearly Missouri discharges for the years of jam occurrences:

1978: Average 91,000 cfs (2577 m<sup>3</sup>/s) ; max/min = 340,000/19,000 cfs (9627/558 m<sup>3</sup>/s)

1979: Average 90,000 cfs (2548 m<sup>3</sup>/s); max/min = 280,000/21,000 cfs (7928/595 m<sup>3</sup>/s)

1981: Average 71,000 cfs (2010 m<sup>3</sup>/s); max/min = 271,000/23,000 cfs (7674/651 m<sup>3</sup>/s)





*Figure 35. Ice jam in the confluence of the Mississippi and Missouri Rivers on 26 January 1978.*

fluence of the Missouri and Mississippi Rivers indicates the significant adverse influence of the bar at a confluence. This finding is supported by observations at several other confluence locations and by the jam process modeling described above. It indicates that, to significantly increase the ice conveyance capacity of the confluence, the bar should be reduced in width. Indeed, this finding has been recognized by the Corps in their concern for increasing the ice conveyance capacity of the confluence of the Missouri and Mississippi Rivers. On the assumption that a reduced bar size would increase ice conveyance, the Corps has begun river engineering activities to reduce the bar. They have placed several submerged rows of rocks, termed bendway weirs, to force the thalweg of the confluence toward the bar, and thereby to diminish the bar by erosion. Figure 39 indicates

The photographs in Figures 35, 36, and 37 illustrate the three jams that occurred at the confluence during the winters of 1977–1978, 1978–79, and 1980–81. For all the jams, exposure of the bar during low flow conditions and extensive border-ice growth around the bar severely constricted ice discharging from the Missouri River. In addition, ice drifting with flow from the Mississippi River worsened the constriction.

When the bar was under water, during comparatively high flow rates in the Missouri and Mississippi Rivers, ice discharging from the Missouri River passed without undue congestion through the confluence. The Figure 38 photograph illustrates this condition for an ice run event on 4 February 1985. Even though this ice run involved a larger volume of ice than the ice-run events illustrated in Figures 35, 36, and 37, jamming did not occur.

In summary, study of the factors associated with ice jams in the con-



*Figure 36. Ice jam in the confluence of the Mississippi and Missouri Rivers on 9 January 1979.*





Figure 37. Ice jam in the confluence of the Mississippi and Missouri Rivers on 10 February 1981.



Figure 38. Ice run in the confluence of the Mississippi and Missouri Rivers on 4 February 1985.

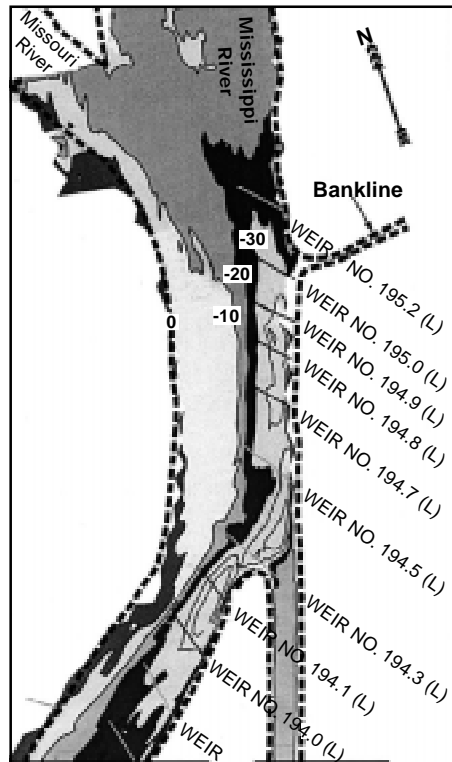


Figure 39. Location of the bendway weirs in the confluence of the Mississippi and Missouri Rivers (numbers are depths in feet).

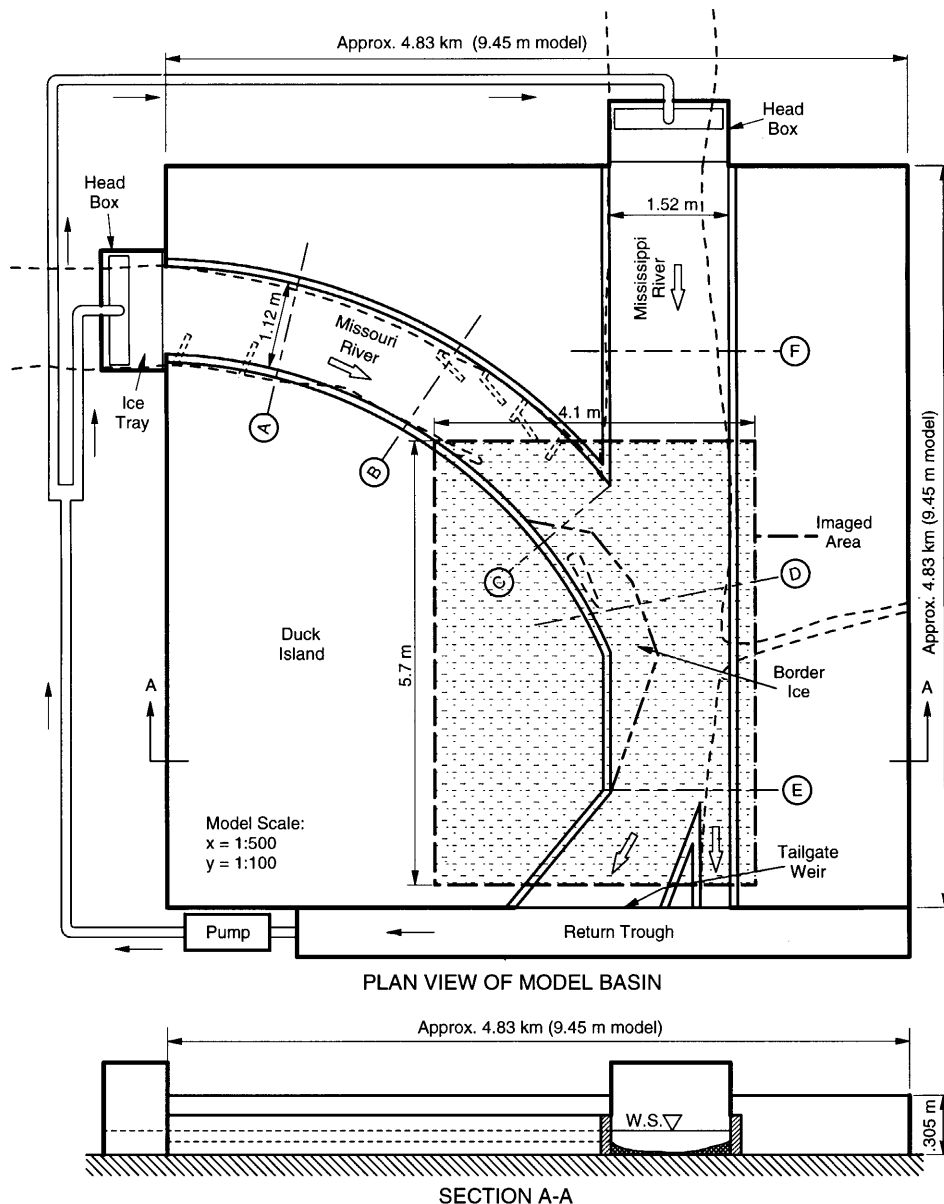
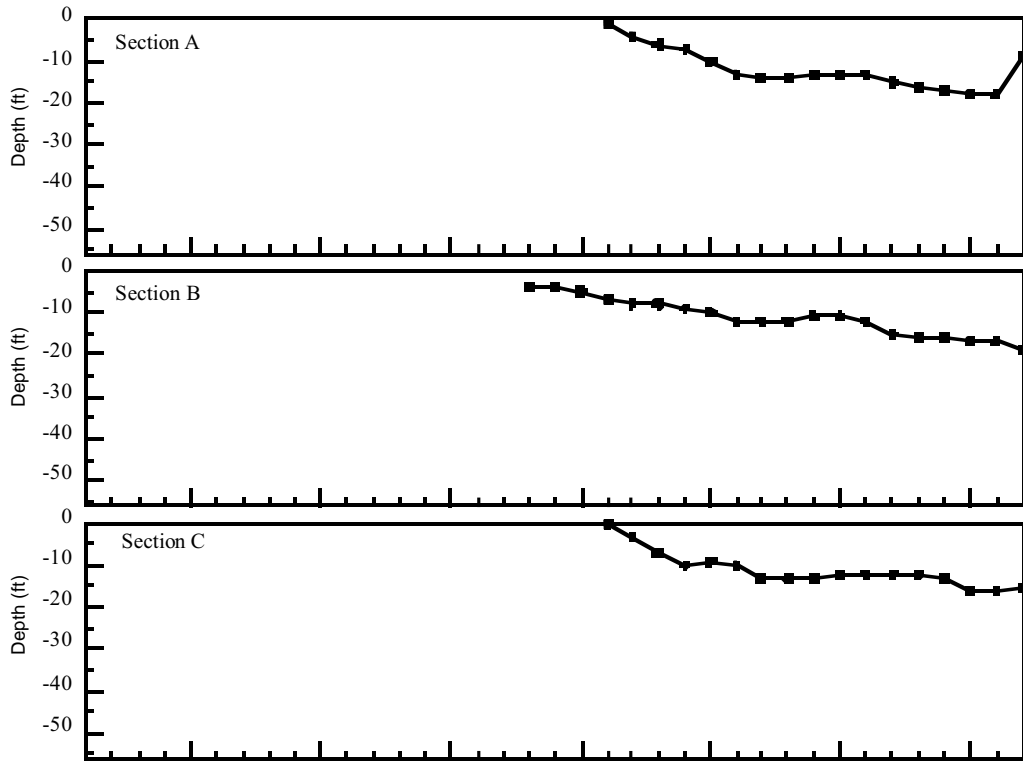


Figure 40. Layout of the hydraulic model.

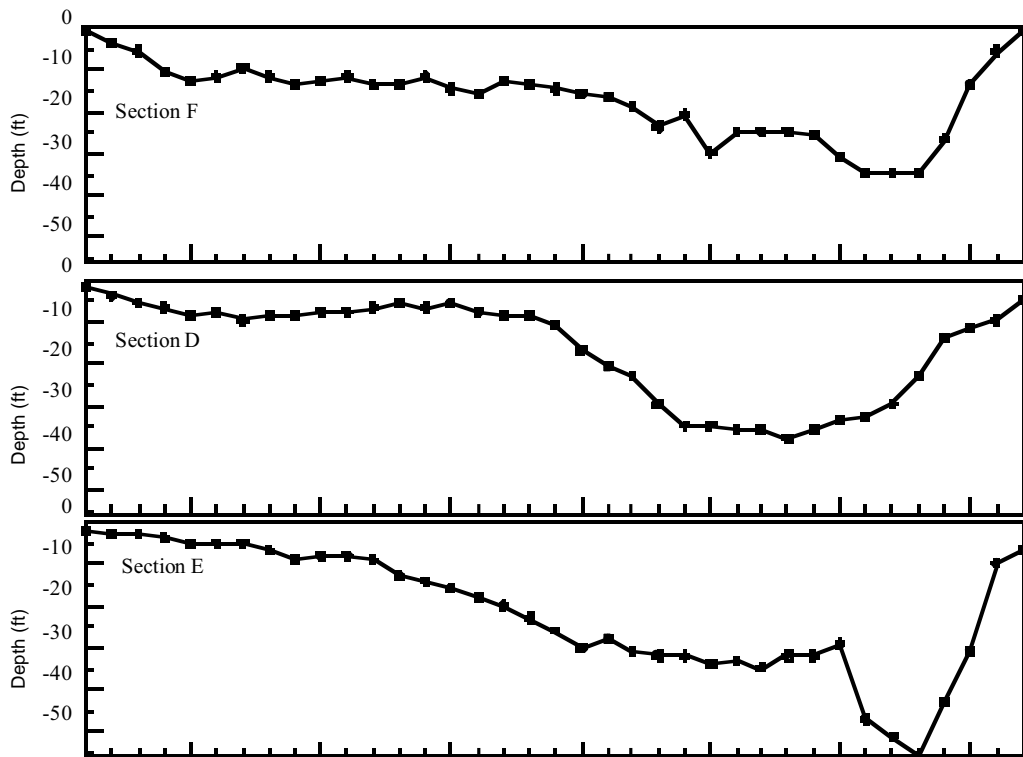
the location of the bendway weirs. The laboratory experiments described below were conducted to confirm that the bendway weirs would indeed increase the ice conveyance capacity of the confluence, and thereby substantially reduce the likelihood of ice jamming. A concern associated with the bendway weirs is that they do not aggravate ice passage in an unforeseen manner, such as creating other locations where ice might collect.

### Confluence model

The layout of the hydraulic model of the confluence of the Missouri and Mississippi Rivers is shown in Figure 40. The model replicated the confluence at a horizontal scale of 1:500 and a vertical scale of 1:100. It was built on a large plywood tray,  $9.5 \times 9.5$  m in plan dimensions. Flow was recirculated through the model by



Bathymetry for Missouri (A, B, C sections, 1994 survey)



Bathymetry for Mississippi (F, D, E sections, 1986 survey)

Figure 41. Bathymetry cross sections in the confluence of the Mississippi and Missouri Rivers.

means of a pump whose discharge bifurcates in two lines to the head tank of each channel. An overflow tailgate at the downstream end of the model is used to regulate water levels in the model.

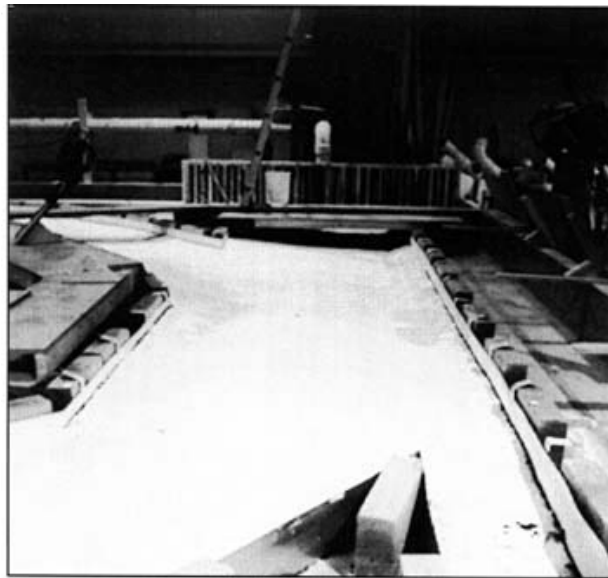
Four bathymetric conditions were simulated with the model:

1. Flatbed, rectangular channels.
2. Existing alluvial bathymetry.
3. Existing bathymetry fitted with bendway weirs.
4. Modified bathymetry (reduced size of bar) with bendway weirs.

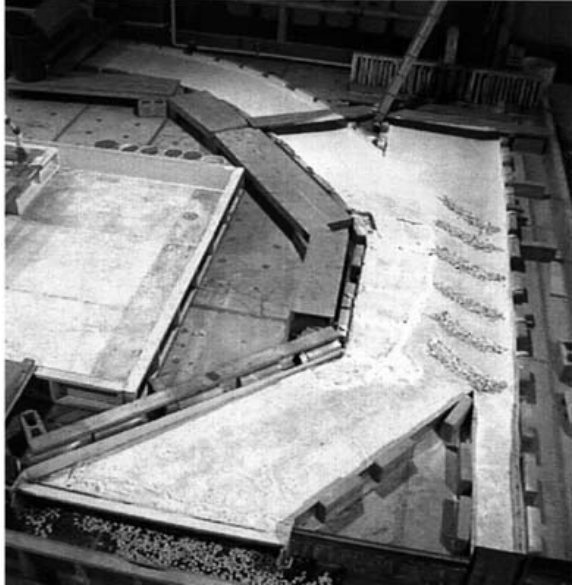
The model fitted with flatbed rectangular channels replicated the overall plan geometry of the confluence. It was used to observe the general features of flow through a confluence of similar proportions and flow conditions as those of the confluence of the Missouri and Mississippi Rivers. In particular, the model was used to relate the flow features of flow separation and dividing streamline with those estimated using eq 4 and 6.

The alluvial features replicated in the model were formed from a compilation of bathymetry determined during several hydrographic surveys of the Missouri and Mississippi Rivers. Though the surveys were not conducted at the same time, the compilation of data overlaps adequately so as to ensure that the model adequately represents the actual bathymetry of the confluence for the purpose of the present study. The bathymetric data for the Missouri River are from a survey made in August 1994. The data for the Mississippi River are from a survey made in September 1986. The bathymetry of the cross section common to both sets of data, cross section 0.00-MO-195.3 MIS, is the same. The cross sections used for modeling the confluence bathymetry are plotted in Figure 41. They comprise three cross sections for the Missouri River upstream of the confluence, one for the Mississippi River upstream of the confluence, and two cross sections in the confluence. Figure 42 provides a view of the model.

The modeled locations of the bendway weirs in the confluence coincide with the locations indicated in Figure 39. The model bendway weirs were constructed from rock chips (maximum dimension about 20 mm) piled in rows to approximately match the weir geometry recommended by Davinroy (1994). The weirs were level-crested, submerged, and directed upstream at an angle of 30 degrees relative to a line perpendicular to the established flow pattern. The crown elevation of the modeled weirs corresponds to a full-scale elevation 5 m below a low water reference plane (LWRP). The modeled weirs, by virtue of being formed from rock chips, were a little



*Figure 42. Photograph of the confluence of the Mississippi and Missouri Rivers model (without bendway weirs).*



*Figure 43. Photograph of the confluence of the Mississippi and Missouri Rivers model (with bendway weirs).*

wider than the equivalent full-scale width of 3.2 m. Figure 43 illustrates the model confluence fitted with the model bendway weirs.

In accordance with the findings of the background study into conditions leading to ice jam formation in the confluence, the model-scale flow rates selected for the Missouri and Mississippi Rivers were 25,000 cfs and 40,000 cfs, respectively. These flow rates are in the low flow ranges for which the confluence bar is exposed and the confluence constricted. In several respects these baseline model flow and ice conditions are approximately

those associated with the ice jam that occurred on 9 January 1979 (Fig. 36).

The model's scale flow rates were set in accordance with the criterion of Froude-number similitude (see, e.g., Zufelt and Ettema 1996). Water flow rates in both rivers were controlled using valves and measured using orifice meters positioned in the supply lines. Water depths were controlled using a sharp-crested, overflow tailgate.

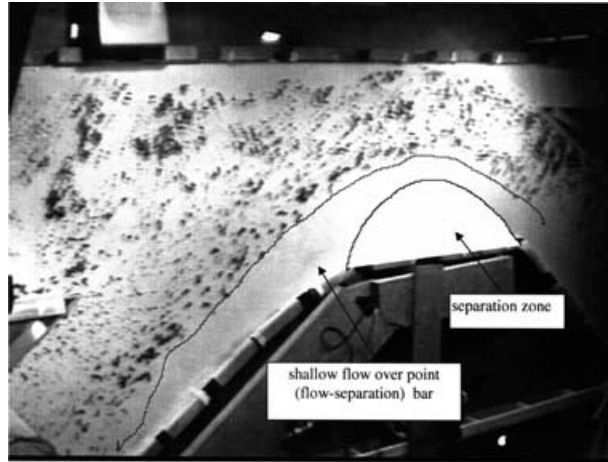
As ice jams at the confluence are primarily attributable to ice floes discharging from the Missouri River, ice was released into the modeled channel of the Missouri River. Ice was modeled using the same 3-mm-diam. polypropylene beads (specific gravity = 0.90) used for the diagnostic model. The equivalent full-scale diameter of the model ice is about 3 m. Ice release into the modeled Missouri channel was controlled using a hopper mounted above a variable speed, rotating conveyor belt. By varying belt speed, and by adjusting the opening of a slide gate above the belt, the rate of ice release would be varied into the model.

Border ice in the vicinity of the bar was modeled in a simple manner using a row of small bricks placed along a perimeter and representing the extent of border ice growth in the model confluence. The row of bricks was not watertight, so that water could flow at a sluggish rate through the area of simulated border ice, but model ice was constrained to the constricted channel through the confluence.

### **Flow and ice velocities**

The velocity fields of water flow and ice movement in the model confluence, for each bathymetric configuration, were determined using large-scale particle image velocimetry (LSPIV). The resultant vector plots of the velocity fields provided a useful quantitative method for analyzing spatial and temporal patterns of water flow and ice movement in the confluence. The whole fields of velocity portrayed in the vector plots are especially useful for studying the conditions incipient to ice jamming, because they quantitatively reveal how the ice responds all through the confluence area as jamming begins.

The details of the LSPIV technique are described by Ettema et al. (1997). In brief, the technique entailed use of a CCD camera for making videotapes of flow and ice movement in the confluence. The CCD camera was set 5.4 m above the model at an oblique angle, so that its view encompassed the confluence (see, for example, Figure 44 for a sample view). The whole field of flow in the confluence was determined from video records of the movement of black beads (the same material used for the model ice) sprinkled sparsely as tracer particles over the flow.



*Figure 44. Video camera view of open water flow through modeled confluence of the Mississippi and Missouri Rivers. The model replicates the bathymetry given on USACE charts.*

The whole field of model ice movement was determined in the same manner, except that additional tracer particles were sprinkled on the layer of model ice drifting into the confluence. The additional tracers were small white polypropylene squares. To enhance the resolution of the recorded images the bottom of the confluence was spray-painted white.

The video images from the CCD camera were recorded using a Sony EVO-9650 video recorder, and digitized using a frame-grabber (Matrox Meteor RGB). The digitized images (i.e., video frames) comprised  $640 \times 480$  pixels of 8-bit, gray-level resolution. A 133-MHz Pentium personal computer was used to process and store digitized video images. Custom software, written in the C language, was used to control the VCR and the frame-grabber during playback and frame grabbing. The subsequent image processing software, essentially a cross-correlation algorithm including software to correct the aerial distortion of the video image, was written in Fortran 77. A standard color monitor was used for on-line display of the video imaging.

### **Model calibration and validation**

Model calibration entailed adjustment of flow elevations to match flow rates through the confluence, and it entailed adjustment of model ice discharge rate to provide a single layer of model ice drifting over practically the full width of the modeled channel of the Missouri River. These calibrations required adjustment of the tailgate elevation to get the required flow elevations, adjustment of belt speed, and gate opening of the ice-feed hopper to obtain the required ice discharge rate.

A further calibration task required checking the accuracy of the LSPIV system. This task simply entailed comparing PIV velocities with those measured by timing hand-released tracers as they moved known distances in the model. As the dimensions of the area of interest and the period between images are preset, velocities follow directly. In actuality, this calibration step is not needed, but it provides additional confirmation of the PIV measurements. For the present modeling, the LSPIV proved not to be as useful as hoped. Inadequacy of lighting created a difficulty in distinguishing the model ice pieces, which are black, from the back-



ground of the model bed, which is a dull gray. The use of LSPIV was especially difficult in the region where the model bendway weirs were placed. The model ice did not stand out sufficiently from the rows of stones used to simulate the weirs. Repeated runs were needed to get adequate definition of the velocity vectors of ice movement and water current.

To check the general accuracy of the model, observations of ice movement and jam formation in the model were compared with aerial photographs of ice movement and ice jams in the actual confluence. In particular, the patterns of ice movement and jamming in the model were compared with the patterns evident in Figures 35 to 38. In overall terms the patterns observed in the model agreed very well with the patterns evident in those figures.

### **Test program and procedure**

Once the model was calibrated, the test program followed the sequence of confluence bathymetry conditions listed above. Flow rates and ice discharge rates were held constant for the sequence of tests.

The first step in a test was to illuminate the main flow patterns in the model confluence. This was done by means of flow visualization using dye released from a dye wand. Six experiments focused on the detailed ice flow structure were performed subsequently in the small-scale model.

### **Results**

The results of the model confirmed the findings of the diagnostic model. Consequently, they also confirmed that reduction of the bar size would increase the ice discharge capacity of confluence of the Missouri and Mississippi Rivers. The use of bendway weirs, in the locations indicated in Figure 39, should enhance ice movement through the confluence, provided they adequately reduce the size of the bar.

The ensuing discussion briefly describes the main observations and results of the tests with the model.

#### *Rectangular channels*

Flow through the confluence replicated with rectangular channels produced the flow features typical of a concordant bed confluence (Fig. 4a, c). Ettema et al. (1997) present LSPIV mapping of the surface velocities of water flow and ice drift for this case.

#### *Confluence with bar and without bendway weirs*

In this case the confluence is fitted with bathymetry, notably a bar, that simulates the bathymetry prior to installation of the bendway weirs (refer to Fig. 41 for typical bathymetric cross sections). Figure 44 shows the flow features identified from LSPIV mapping of flow velocities. The separation zone was readily evident in the model, as was the shear layer between the merging flows. A dividing streamline is indicated through the shear layer region. The extent of the flow separation zone approximately coincides with the bar in the confluence. The nonuniformity of flow depth across the channel, together with the presence of the bar, significantly alter the flow field in the confluence. The bar reduces the surface area of flow, as indicated in Figures 44 and 45. Additionally, the shallower flow depths flanking the bar and its approach along the southern bank of the Missouri River, concentrated the flow in the deeper portion (line of maximum scour) of the confluence. In consequence, flow velocities in the shallower zones are less than the velocities in deeper areas. LSPIV measurements of flow field are illustrated in Figure 46.



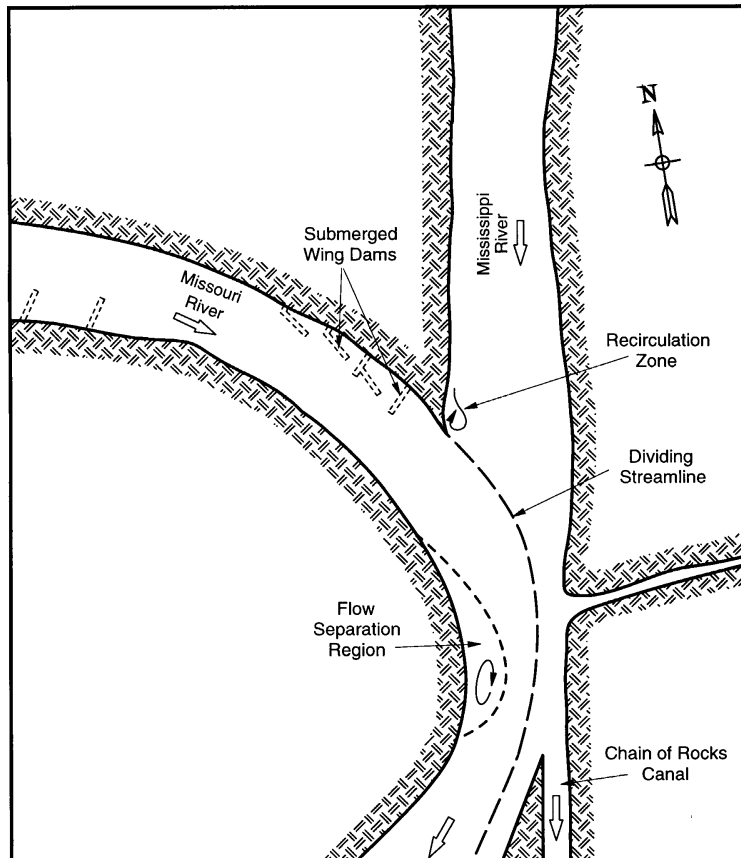


Figure 45. Main flow features of the confluence of the Mississippi and Missouri Rivers.

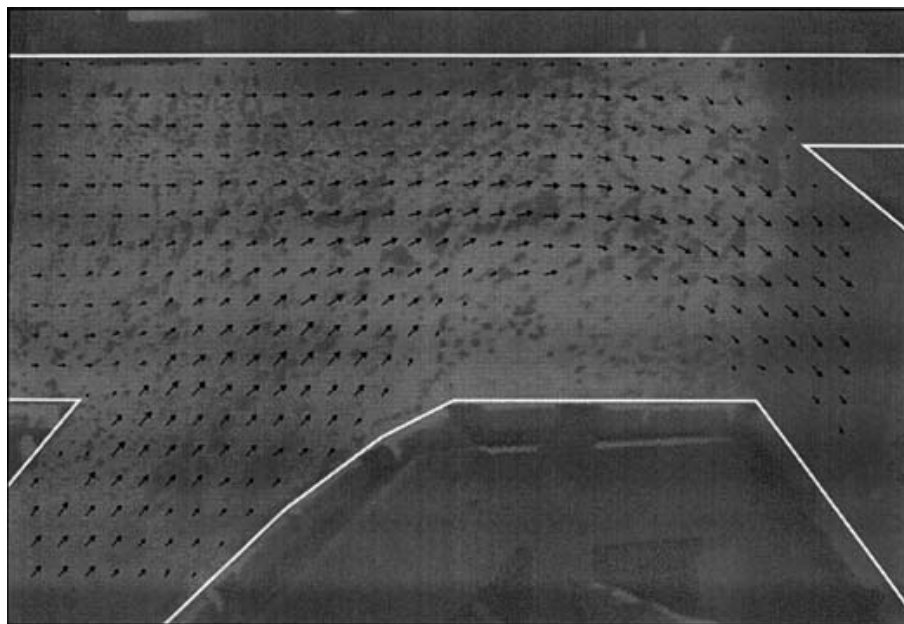


Figure 46. Vector plot of velocities for open water flow in Figure 44.

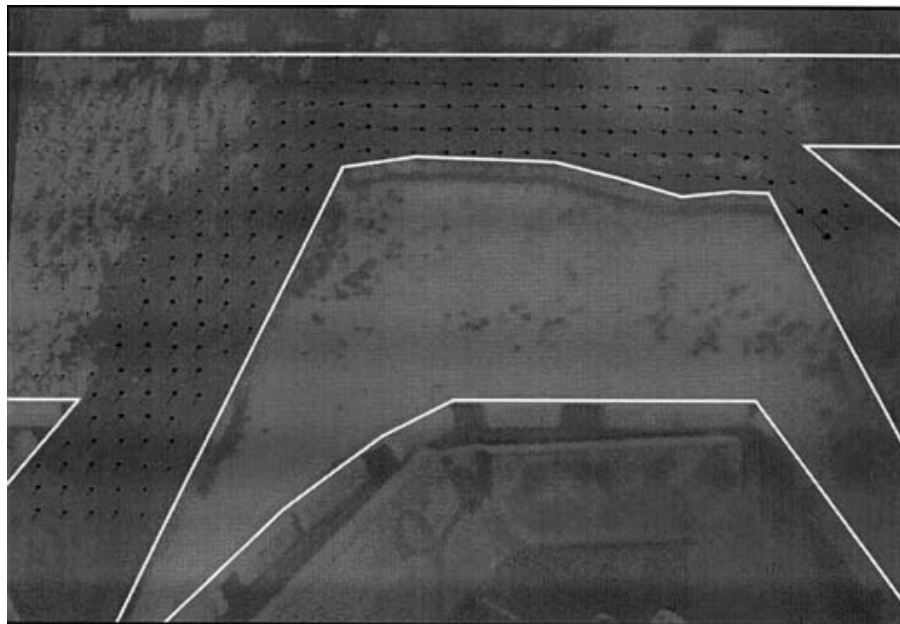
During frigid and low discharge conditions, the extent of the bar can be increased by the growth of border ice, and by possible grounding of drifting ice. The extended bar greatly constricts the confluence, as can be seen from Figures 35, 36, and 37. The simulated constriction in the model is shown in Figure 47. Also shown by this figure is the congestion and jamming of model ice in the modeled confluence. Ice conveyed from the Missouri channel quickly congests at the constricted section of the confluence.



*Figure 47. Ice congestion for the confluence with border ice (without bendway weirs).*

As it does, flow and ice drift velocities upstream of the confluence decrease, thereby hastening the onset of jamming. Vector plots of ice movement in the confluence for this condition are shown in Figure 48. The aggravated back-water effect created by the forming jam is evident in the acutely reduced magnitudes of flow velocities upstream of the constriction, especially in the Mississippi channel.

The findings from the hydraulic model are corroborated by findings from the numerical simulation reported by Lui and Shen (1998). Though their numerical simulation simulates smaller flow rates (flow rates in the Missouri and Mississippi Rivers each are assumed to be about 20,000 cfs) than used in the hydraulic model, it shows how a jam may readily develop in the confluence when the confluence



*Figure 48. Vector plot of velocities for ice and open water flow in Figure 47.*

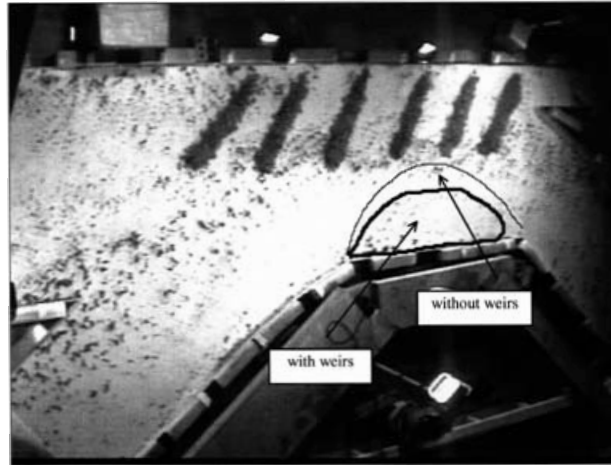
bar is exposed at low water level. As can be observed from Figures 35, 36, and 37, and as confirmed by the hydraulic model, surface area constriction by the exposed bar and border-ice growth from the bar causes drifting ice to congest and accumulate in the contraction.

#### *Confluence with bar and bendway weirs*

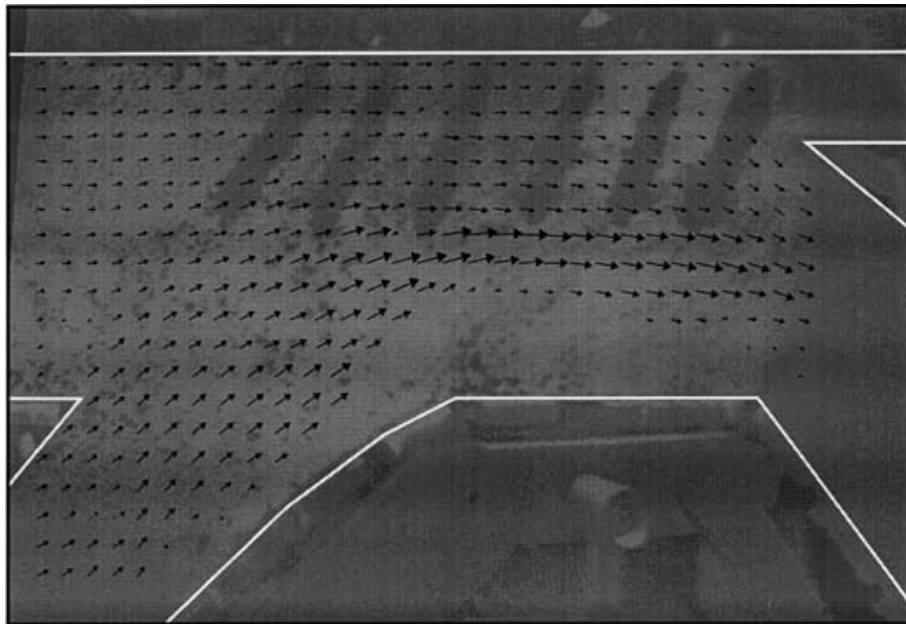
The six bendway weirs positioned in the confluence redistribute the flow such that the dividing streamline between the confluent inflows shifts across towards the bar.

Additionally, flow velocities over the bendway weirs decrease. They increase along the middle portion of the confluence and near the bar. The net effect is that the bendway weirs approximately halve the size of the flow separation region. This effect is indicated in Figure 49. It also is evident in the vector field of ice drift velocities at the water surface is shown in Figure 50.

The altered flow field in the confluence enhances ice movement through the confluence, and thereby increases its capacity to convey ice. The development of significant current through the bar area, together with the widening of the surface area of flow prevented drifting ice from slowing and congesting in the confluence. Further, the bendway weirs caused the flow of ice to move away from the outer



*Figure 49. Open water flow through the confluence fitted with bendway weirs. Indicated are the extents of the flow separation zone with and without the bendway weirs in place (note that the bar has not been removed).*

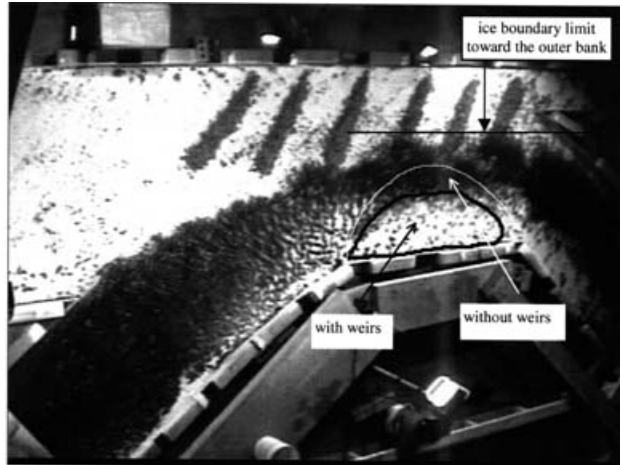


*Figure 50. Vector plot of velocities for open water flow in Figure 49.*

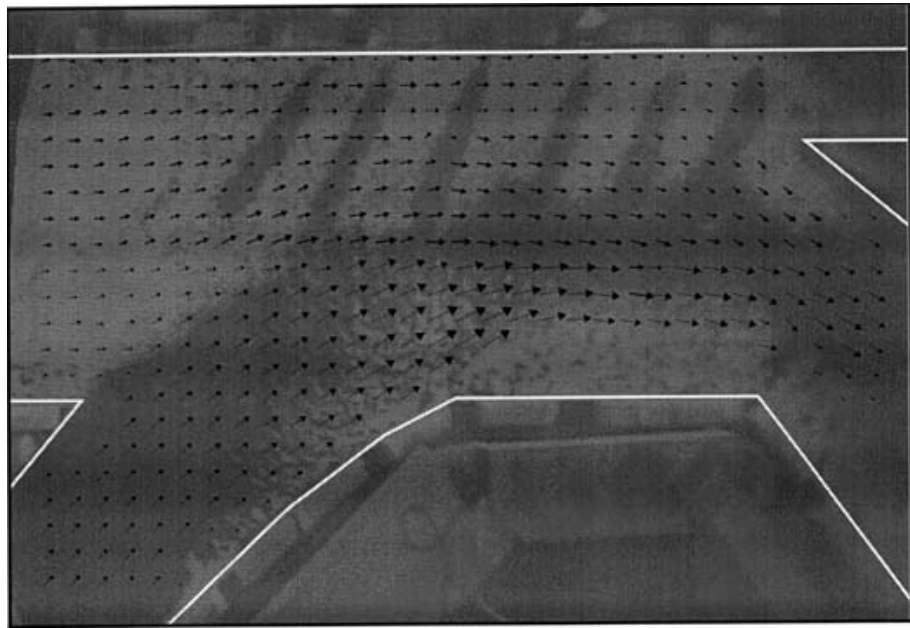
bank of the confluence (Fig. 51 and 52). On the basis of this test, it appears that the bendway weirs will dramatically reduce the incidence of ice jams in the confluence. This tentative conclusion, however, required verification by actually reducing the bar size in the model.

*Confluence with bendway weirs and reduced bar*

The increase in flow velocities along the confluence bar (and over the bar, during times of higher flow) would reduce the size of the bar by erosion. The effect of reduced bar size on ice conveyance through the confluence was simulated in a successive manner whereby the bar was reduced successive steps. Not all the steps are discussed here; only the final step is presented. The confluence bathymetry in the model was deepened to simulate a reduced bar size slightly less than the size of the separation zone in the confluence fitted with the bendway weirs. The resulting flow field is as depicted in the photograph of Figure 53 and the LSPIV mapping given as Figure 54. The widening of the confluence channel associated with the reduction in bar size slightly reduces the overall magnitude of flow velocities through the center of the confluence. In so doing, it additionally diminishes the size of the flow-separation zone; therefore the modeled bar size was chosen to be slightly less than the size of the flow separation zone. Although the bulk flow velocity is reduced, the increase in surface area of flow enhances the ice-conveyance capacity of the confluence.



*Figure 51. Ice run through the confluence with bendway weirs.*



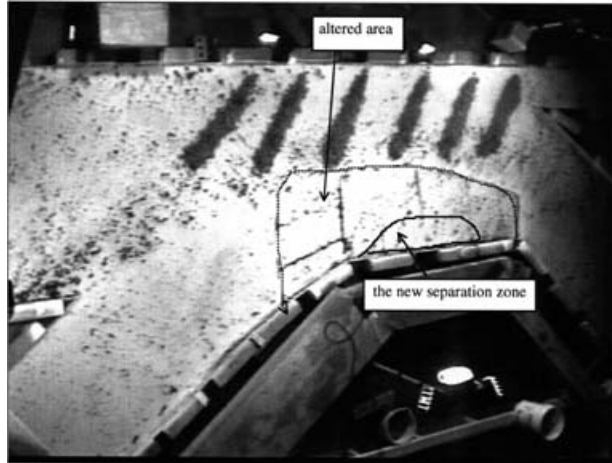
*Figure 52. Vector plot of velocities for ice and open water flow in Figure 51.*



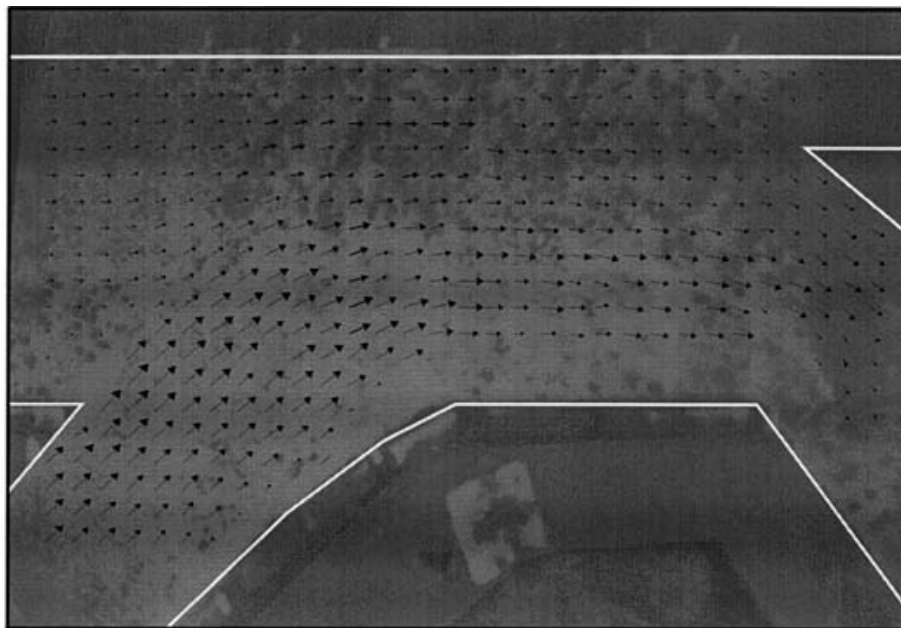
Figure 55 illustrates ice drift through the confluence for the reduced bar size. The vector field of ice drift velocities is shown in Figure 56. In summary, ice moved smoothly through the confluence without accumulation. This test, therefore, confirms the effectiveness of the series of bendway weirs.

A reduction in bar size produced several further useful practical consequences:

- The shift of the confluence thalweg toward the bar causes much less ice to accumulate in the upstream approach channel leading to the Chain-of-Rocks Canal. Bar reduction shifts the flow of ice away from the outer bank of the confluence, causing it instead to flow through the center of the confluence. This consequence would substantially improve the wintertime navigability of the confluence, even when ice jams do not form.
- The reduction in bar size would be amplified by a commensurate reduction in the extent of border ice growth in the confluence. This reduction also benefits the ice transport capacity in the confluence.
- The substantially widened flow area through the confluence makes it less likely for large ice pieces formed in the Mississippi River (downstream of Melvin Price Lock and Dam) to arch at the confluence with ice from the Missouri River.

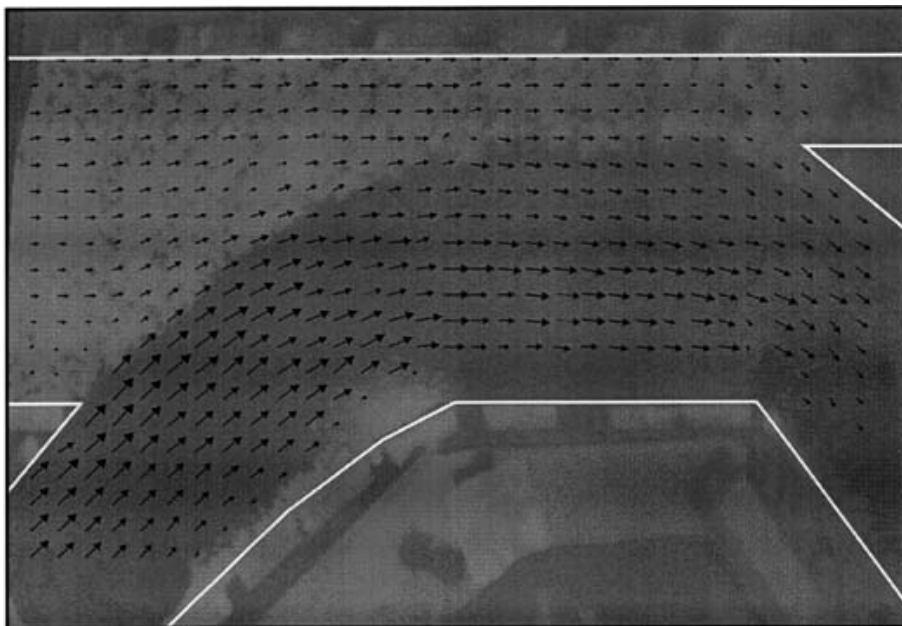
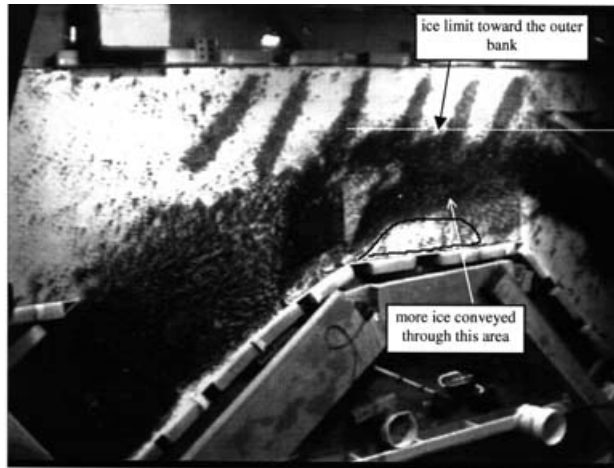


*Figure 53. Open water flow through the confluence with bendway weirs and eroded bar.*



*Figure 54. Vector plot of velocities for open water flow in Figure 53.*

*Figure 55. Ice run through the confluence modeled with bendway weirs and eroded bar.*



*Figure 56. Vector plot of velocities for ice and open water flow in Figure 55.*

An additional finding, related to item 1 above, is that the bendway weirs did not accumulate ice. This finding addresses a concern that the weirs could accumulate ice, either by virtue of the reduced flow velocities over the bendway weirs or by ice grounding on the weirs. The model showed no propensity for either of these effects to occur.

#### **LITERATURE CITED**

**Andres, D.** (1996) Ice formation and breakup at the town of Peace River: A study of regulated conditions, 1969–94. Report prepared for town of Peace River, British Columbia Hydro, and Alberta Environmental Protection, Trillium Engineering and Hydrographics Inc., Edmonton, Alberta, Canada.

**Andres, D.** (1997) Freeze-up ice jams on the Nechako River at Prince George: Analysis of the 1996 event. Report prepared for Alcan Smelters and Chemicals Ltd.,

Kitimat, British Columbia, Trillium Engineering and Hydrographics Inc., Edmonton, Alberta, Canada.

**Andres, D.** (1998) Analysis of ice jams and associated flood levels and ice forces on the McLeod River at Whitecourt. A letter report to Alberta Transportation and Utilities, Edmonton, Alberta, Trillium Engineering and Hydrographics Inc., Edmonton, Alberta, Canada.

**ASCE** (1975) *Sedimentation Engineering, Manual 54*. New York: American Society of Civil Engineers,

**Ashmore, P.E., and G. Parker** (1983) Confluence scour in coarse braided streams. *Journal of Water Resources Research*, **19**: 392–402.

**Beltaos, S.** (1995) *River Ice Jams*. Highlands Ranch, Colorado: Water Resources Publications, LLC.

**Beltaos, S., and B.C. Burrell** (1991) Case study of a grounded jam, Restigouche River, New Brunswick. In *Northern Hydrology: Selected Perspectives*, p. 1–16, Northern Hydrology Research Institute, Saskatoon, Saskatchewan.

**Best, J.L.** (1988) Sediment transport and bed morphology at river channel confluences. *Sedimentology*, **35**: 481–498.

**Best, J.L., and I. Reid** (1984) Separation zone at open channel junctions. *ASCE, Journal of Hydraulic Engineering*, **113**: 545–548.

**Best, J.L., and I. Reid** (1987) Closure to “Separation zone at open channel junctions.” *ASCE Journal of Hydraulic Engineering*, **110**: 1588–1594.

**Biron, P., J.L. Best, and A.G. Roy** (1996) Effect of bed discordance on flow dynamics at open channel confluences. *ASCE Journal of Hydraulic Engineering*, **122**: 676–682.

**Chang, H.H.** (1988) *Fluvial Processes in River Engineering*. New York: Wiley Interscience,

**Chen, Z.** (1986) Ice problems on the Yellow River. *IAHR Symposium on Ice*, Vol. 3, p. 25–47, Iowa City, Iowa.

**Crissman, R.D.** (1998) Hydropower and ice on the upper Niagara River. Final Report, New York Power Authority, Lewiston, N.Y.

**Davinroy, R.D.** (1994) The bendway weir concept in the Mississippi River. In *Proceedings of the International Navigation Congress, Seville, Spain*.

**Ettema, R., M. Muste, A. Kruger, and J. Zufelt** (1997) Factors influencing ice conveyance in river confluences. USA Cold Regions Research and Engineering Laboratory, Special Report 97-37.

**Fujita I., and S. Komura** (1986) Application of the free streamline theory to the flow at a confluence. In *Proceedings of the 5th Asian and Pacific Regional Division Congress, IAHR, Seoul, Korea*, p. 103–120.

**Gurram, S.K., K.S. Karki, and W.H. Hager** (1997) Subcritical junction flow. *Journal of Hydraulic Engineering*, **123**: 447–455.

**Hager, W.H.** (1989) Transition flow in channel junctions. *ASCE Journal of Hydraulic Engineering*, **115**: 243–259.

**Hsu, C.-C., F.-S. Wu, and W.-L. Lee** (1998) Flow at 90° equal-width open-channel junction. *ASCE Journal of Hydraulic Engineering*, **124**(2): 186–191.

**Jasek, M.** (1997) Ice jam flood mechanisms on the Porcupine River at Old Crow, Yukon Territory. In *Proceedings of 9<sup>th</sup> Workshop on River Ice, Fredericton, New Brunswick*, p. 351–370.

**Judge, D., S.T. Lavender, R. Carson, and S. Ismail** (1997) Headpond ice jams—Where will they occur? In *Proceedings of 9<sup>th</sup> Workshop on River Ice, Fredericton, New Brunswick*, p. 73–88.



- Komura, S.** (1973) River-bed variations at confluences. In *Proceedings of Symposium on River Mechanics, Bangkok*, p. 773–784.
- Lui, L., and H.T. Shen** (1998) Numerical simulation of Mississippi–Missouri River confluence ice conditions. Report 98-7, Dept. of Civil and Environmental Engineering, Clarkson University, Potsdam, N.Y.
- Lui, L., H.T. Shen, and A.M. Tuthill** (1998) A numerical model for river ice jam simulation. In *Proceedings, IAHR Ice Symposium, Potsdam, N.Y.*
- Michel, B.** (1972) Properties and processes of river and lake ice. In *Proceedings of the IAHS Symposium on the Role of Snow and Ice in Hydrology, Banff, Alberta*, p. 454–481.
- Modi, P.N., P.D. Ariel, and M.M. Danekar** (1981). Conformal mapping for channel junction flow. *ASCE Journal of Hydraulic Engineering*, **107**(HY12): 1713–1733.
- Mosely, M.P.** (1976) An experimental study of channel confluences. *Journal of Geology*, **84**: 535–562.
- Prowse, T.D.** (1986) Ice jam characteristics, Liard-Mackenzie Rivers confluence *Canadian Journal of Civil Engineering*, **13**: 653–665.
- Ramamurthy, A.S., L.B. Carballada, and M.D. Tran** (1988) Combining open channel flow at right angled confluences. *ASCE Journal of Hydraulic Engineering*, **114**: 1449–1460.
- Richards, K.** (1982) *Rivers: Form and process in alluvial channels*. London: Methuen.
- Simons, D. B., and R.M. Li** (1982) *Engineering Analysis of Fluvial Systems*. Simons, Li and Associates, Ft. Collins, Colorado.
- Stevens, G.T.** (1978) St. Louis District potomology study (LL-1). Report submitted to the St. Louis District, U.S. Army Corps of Engineers, St. Louis, Missouri.
- Taylor, E. H.** (1944) Flow characteristics at rectangular open-channel junction. *ASCE Journal of the Hydraulic Engineering Division*, **114** (HY12): 1449–1460.
- Tuthill, A., and A.C. Mamone** (1997) Selection of confluence sites with ice problems for structural solutions. USA Cold Regions Research and Engineering Laboratory, Special Report 97-4.
- USACE** (1962) Report on 1962 ice gorge in the Mississippi River. St. Louis District, U.S. Army Corps of Engineers, St. Louis, Missouri.
- USACE** (1977) Report on Mississippi River Ice 1976–1977. St. Louis District, U.S. Army Corps of Engineers, St. Louis, Missouri.
- Uzuner, M. S., and J.F. Kennedy** (1976) Theoretical model of river ice jams. *ASCE Journal of the Hydraulics Division*, **102**(HY9): 1365–1383.
- White, K.D., and R. Kay** (1994) Lower Platte River Ice Jam Flooding. U.S. Army Corps of Engineers, Omaha District and USA Cold Regions Research and Engineering Laboratory (CRREL), Hanover, N.H.
- Wuebben, J.L.** (1988) A preliminary study of scour under an ice jam. In *Proceedings of the 5<sup>th</sup> Workshop on Hydraulics of River Ice/Ice Jams, Winnipeg, Manitoba*, p. 137–146.
- Wuebben, J.L., and J.J. Gagnon** (1995) Ice jam flooding on the Missouri River near Williston, North Dakota. USA Cold Regions Research and Engineering Laboratory, Special Report 95-19.
- Wuebben, J.L., D.S. Deck, J.E. Zufelt, and J.-C. Tatinclaux** (1995) Ice Jam Flood assessment for the St. John River Basin. USA Cold Regions Research and Engineering Laboratory, Special Report 95-15.
- Zufelt, J.E., and R. Ettema** (1996) Model ice properties. USA Cold Regions Research and Engineering Laboratory, CRREL Report 96-1.

# REPORT DOCUMENTATION PAGE

Form Approved  
OMB No. 0704-0188

Public reporting burden for this collection of information is estimated to average 1 hour per response, including the time for reviewing instructions, searching existing data sources, gathering and maintaining the data needed, and completing and reviewing the collection of information. Send comments regarding this burden estimate or any other aspect of this collection of information, including suggestion for reducing this burden, to Washington Headquarters Services, Directorate for Information Operations and Reports, 1215 Jefferson Davis Highway, Suite 1204, Arlington, VA 22202-4302, and to the Office of Management and Budget, Paperwork Reduction Project (0704-0188), Washington, DC 20503.

1. AGENCY USE ONLY (Leave blank)		2. REPORT DATE May 1999		3. REPORT TYPE AND DATES COVERED	
4. TITLE AND SUBTITLE  Ice Jams in River Confluences				5. FUNDING NUMBERS  Contract No.: DACA 4303900	
6. AUTHORS  Robert Ettema, Marian Muste, and Anton Kruger					
7. PERFORMING ORGANIZATION NAME(S) AND ADDRESS(ES)  U.S. Army Cold Regions Research and Engineering Laboratory 72 Lyme Road Hanover, New Hampshire 03755-1290				8. PERFORMING ORGANIZATION REPORT NUMBER  CRREL Report 99-6	
9. SPONSORING/MONITORING AGENCY NAME(S) AND ADDRESS(ES)  Office of the Chief of Engineers Washington, DC 20314-1000				10. SPONSORING/MONITORING AGENCY REPORT NUMBER	
11. SUPPLEMENTARY NOTES For conversion of SI units to non-SI units of measurement, consult ASTM Standard E380-93, <i>Standard Practice for Use of the International System of Units</i> , published by the American Society for Testing and Materials, 100 Barr Harbor Drive., West Conshohocken, Pennsylvania 19428-2959.					
12a. DISTRIBUTION/AVAILABILITY STATEMENT  Approved for public release; distribution is unlimited.  Available from NTIS, Springfield, Virginia 22161				12b. DISTRIBUTION CODE	
13. ABSTRACT ( <i>Maximum 200 words</i> )  Two laboratory models of confluences are corroborated with observations interpreted from field observations of ice jams in the vicinity of confluences. One model was used to identify the processes whereby ice can jam in confluences and to determine how selected parameters (e.g., confluence angle) influence them. The confluences of primary interest were those formed by channels whose beds are at about the same level. The second model was used to examine ice jam formation in the confluence of the Mississippi and Missouri Rivers. Three relatively complex processes were found to lead to ice jams: the merging of ice runs, hydrodynamic pressure from a confluent flow impacting an ice run from the second confluent channel, and ice congestion at a confluence bar. The latter process is a significant factor triggering ice jams at the confluence of the Mississippi and Missouri Rivers. Also, three simple processes account for many ice jams at river confluences: ice blocked by an ice cover in the confluence, large ice pieces arching at the confluence, and ice entering a region of sluggish flow. The main practical contributions of the study are formulations for estimating the maximum rate of ice conveyance through channel confluences, and the confirmation of the efficacy of a series of bendway weirs to mitigate ice jam formation at the confluence of the Mississippi and Missouri Rivers. The bendway weirs have additional benefits, such as greatly reducing the amount of ice accumulating in the approach to the Chain-of-Rocks Canal, which is located at the confluence exit.					
14. SUBJECT TERMS  Bendway weirs Hydraulic models  Ice jams River confluences				15. NUMBER OF PAGES 70	
				16. PRICE CODE	
17. SECURITY CLASSIFICATION OF REPORT UNCLASSIFIED	18. SECURITY CLASSIFICATION OF THIS PAGE UNCLASSIFIED	19. SECURITY CLASSIFICATION OF ABSTRACT UNCLASSIFIED	20. LIMITATION OF ABSTRACT UL		