

APPENDIX B

Public Notices and Project Drawings

DRAFT



US Army Corps
of Engineers
Seattle District

COPY

Public Notice of Application for Permit

Regulatory Branch
Post Office Box 3755
Seattle, Washington 98124-3755
Telephone (206) 764-3495
ATTN: Olivia Romano, Project Manager

Public Notice Date: December 13, 2004
Expiration Date: January 13, 2005
Reference: 200001094
Name: Northwest Aggregates

Interested parties are hereby notified that an application has been received for a Department of the Army permit in accordance with Section 10 of the Rivers and Harbors Act of March 3, 1899, for certain work described below and shown on the enclosed drawings.

APPLICANT - Northwest Aggregates
Mr. Pete Stoltz
Post Office Box 1730
Seattle, Washington 98111
Telephone: (206) 768-7636

LOCATION - In East Passage, Puget Sound at Maury Island, King County, Washington.

WORK - To replace and extend an existing dock. The removal work consists of:

- a. The removal of the existing conveyor trestle, walkways, pier structures, eight dolphins, and four submerged piles.
- b. The removal of a total of 228 timber piles.

The proposed construction work consists of:

- a. Construction of a barge-loading conveyor tube with three, 4 to 6-pile support bents.
- b. Seven 6-pile berthing dolphins with fenders and aluminum catwalks.
- c. Installation of a maximum of 56 new steel piles.

The new dock will extend up to of 305 feet (ft) waterward of the mean high water line and will run 510 ft parallel to the shoreline. The new dock structure will cover a surface area of 7,796 square feet.

PURPOSE - To load barges with gravel from the existing upland gravel mine on Maury Island.

ADDITIONAL INFORMATION - The proposed project has been modified through the Endangered Species Act (ESA) consultation process and the local shoreline permit processes to reduce the potential impacts to the marine environment. The proposed project extends 120 ft waterward from the outer edge of the existing eelgrass beds to the face of the proposed dock. The conveyor tube is completely enclosed to prevent gravel

Y400

200001094

spillage from the mining area to the loader. A minimum of 3 ft will be maintained between the loaded barges and the substrate at Mean Lower Low Water line. The existing dock structure covers a surface area of 8,940 square feet. The existing sunken barges indicated on Sheet 6 of 19 will remain in place.

MITIGATION - The applicant has proposed a mitigation plan to mitigate for potential impacts from barge-loading operations. The mitigation plan address impacts from gravel spillage, shading, prop wash, and noise associated with operation of the barge-loading dock. A summary of mitigation measures include: dock extending 120 ft from the outer edge of the existing eelgrass beds; only one barge will be allowed at the dock at any one time; empty barges will remain 2,500 ft waterward of the dock while waiting to load; gravel barges and tugboats will not operate shoreward of the dolphins; tugboats will not operate on the shoreward side of barges at the dock; tugboat/barge configurations will approach and depart the dock at the slow speed as weather conditions will allow; haul-back system will be used to move the barge during loading; tugboats will "back" the barge away from the dock as weather conditions will allow; tugboats will not operate within 120 ft of the eelgrass beds; tugboat operators will avoid directing prop wash towards the shore and will avoid use of excessive thrust; a minimum distance of 3 ft will be maintained between the bottom of barges and the seabed; gravel conveyor will be completely enclosed; the conveyor will place the gravel in the center of barge; a manual limit switch will be installed on the conveyor to prevent the conveyor from operating when a barge is not in place to accept material; only barges with bin wall will be loaded and material will be at least 2 ft below the top of bin walls; a trained dock worker will remain stationed on the dock to observe barge-loading operations; tugboat crew will be trained to watch for situations in which the barge and conveyor are misaligned; barge-loading operations will be monitored by video cameras and periodic monitoring and reporting will be conducted to verify that barge-loading procedures are being followed and to confirm that the mitigation measures are successful. The mitigation plan is available for review upon request.

ENDANGERED SPECIES - The ESA of 1973, as amended, requires assessment of potential impacts to listed and proposed species. The bald eagle, (*Haliaeetus leucocephalus*), listed threatened; marbled murrelet (*Brachyramphus marmoratus*), listed threatened; coastal/Puget Sound bull trout, (*Salvelinus confluentus*), listed threatened; Puget Sound chinook, (*Oncorhynchus tshawytscha*), listed threatened; Steller sea lion, (*Eumetopias jubatus*), listed threatened; humpback whale, (*Eumetopias jubatus*), listed threatened; and leatherback sea turtle, (*Dermochelys coriacea*), listed endangered in the state of Washington (State), may occur in the proposed project area. The Corps made a determination of "likely to adversely affect" for bull trout, bald eagle, marbled murrelet, and chinook. A determination of "no effect" was made for Steller sea lion, humpback whale and leatherback sea turtle. Formal consultation under Section 7 of the ESA was initiated with National Marine Fisheries Service (NMFS) and U.S. Fish and Wildlife Service (USFWS) on May 9, 2003. As a result of the project modifications proposed by the applicant during consultation, the Corps requested the NMFS and USFWS to concur with a "may affect, not likely to adversely affect" determination for bull trout, bald eagle, marbled murrelet, and chinook. By letter dated February 10, 2004, NMFS concurred with the Corps determination of "may affect, but not likely to adversely affect" for chinook. USFWS, by letter dated April 8, 2004, concurred with Corps determination of "may affect, but not likely to adversely affect" for bull trout, bald eagle and marbled murrelet. Section 7 consultation has been completed.

ESSENTIAL FISH HABITAT - The Magnuson-Stevens Fishery Conservation and Management Act (MSA), as amended by the Sustainable Fisheries Act of 1996, requires all Federal agencies to consult with the NMFS on all actions, or proposed actions, permitted, funded, or undertaken by the agency, that may adversely affect Essential Fish Habitat (EFH). EFH for Pacific salmon, groundfish, coastal pelagic species occurs in the project area. The proposed action would impact approximately 3.0 acres of EFH for these species. The Corps determined that the proposed action would adversely affect designated EFH for federally managed fisheries in Washington waters. The Corps initiated EFH consultation with the NMFS on

May 9, 2003. By letter dated, February 10, 2004, NMFS indicated that the conservation measures included as part of the proposed action to address ESA concerns are adequate to avoid, minimize, or otherwise offset potential adverse impacts to EFH, conservation recommendations pursuant to MSA are not necessary. EFH consultation with NMFS has been completed.

CULTURAL RESOURCES - The District Engineer (DE) has reviewed the latest published version of the National Register of Historic Places, lists of properties determined eligible and other sources of information. The following is current knowledge of the presence or absence of historic properties and the effects of the undertaking upon these properties: There are no recorded historic properties within the permit area. The permit area has been so extensively modified by modern development that little likelihood exists for the proposed project to impinge upon an undisturbed historic property.

The DE invites responses to this public notice from Native American Nations or tribal governments, Federal, State, and local agencies, historical and archeological societies, and other parties likely to have knowledge of or concerns with historic properties in the area.

PUBLIC HEARING - Any person may request, in writing, within the comment period specified in this notice, that a public hearing be held to consider this application. Requests for public hearings shall state, with particularity, the reasons for holding a public hearing.

EVALUATION - The decision whether to issue a permit will be based on an evaluation of the probable impact, including cumulative impacts of the proposed activity on the public interest. That decision will reflect the national concern for both protection and utilization of important resources. The benefits, which reasonably may be expected to accrue from the proposal, must be balanced against its reasonably foreseeable detriments. All factors which may be relevant to the proposal will be considered, including the cumulative effects thereof; among those are conservation, economics, aesthetics, general environmental concerns, wetlands, historic properties, fish and wildlife values, flood hazards, floodplain values, land use, navigation, shoreline erosion and accretion, recreation, water supply and conservation, water quality, energy needs, safety, food and fiber production, mineral needs, considerations of property ownership, and, in general, the needs and welfare of the people.

The Corps is soliciting comments from the public; Federal, Native American Nations or tribal governments, State, and local agencies and officials; and other interested parties in order to consider and evaluate the impacts of this activity. Any comments received will be considered by the Corps to determine whether to issue, modify, condition or deny a permit for the work. To make this decision, comments are used to assess impacts on endangered species, historic properties, water quality, general environmental effects, and the other public interest factors listed above. Comments are used in the preparation of an Environmental Assessment and/or an Environmental Impact Statement pursuant to the National Environmental Policy Act. Comments are also used to determine the need for a public hearing and to determine the overall public interest of the activity.

ADDITIONAL EVALUATION - The State is reviewing this work for consistency with the approved Washington Coastal Zone Management Program.

This proposal is the subject of Shorelines Substantial Development Permit No. 04-009, and 461-08-560, which is in the process of being issued as directed by the Shoreline Hearing Board on November 3, 2004.

COMMENT AND REVIEW PERIOD - Conventional mail or email comments on this public notice will be accepted and made part of the record and will be considered in determining whether it would be in the public interest to authorize this proposal. In order to be accepted, email comments must originate from the author's email account and must include on the subject line of the email message the permit applicant's name and

200001094

reference number as shown below. All email comments should be sent to Olivia.H.Romano@usace.army.mil. Conventional mail comments should be sent to U.S. Army Corps of Engineers, Regulatory Branch, Post Office Box 3755, Seattle, Washington 98124-3755. Both conventional mail or email comments must include the permit applicant's name and reference number, as shown below, and the commentor's name, address, and phone number. All comments whether conventional mail or email must reach this office, no later than the expiration date of this public notice to ensure consideration. Please include the following name and reference number:

Northwest Aggregates, 200001094

Encl
Drawings (19)

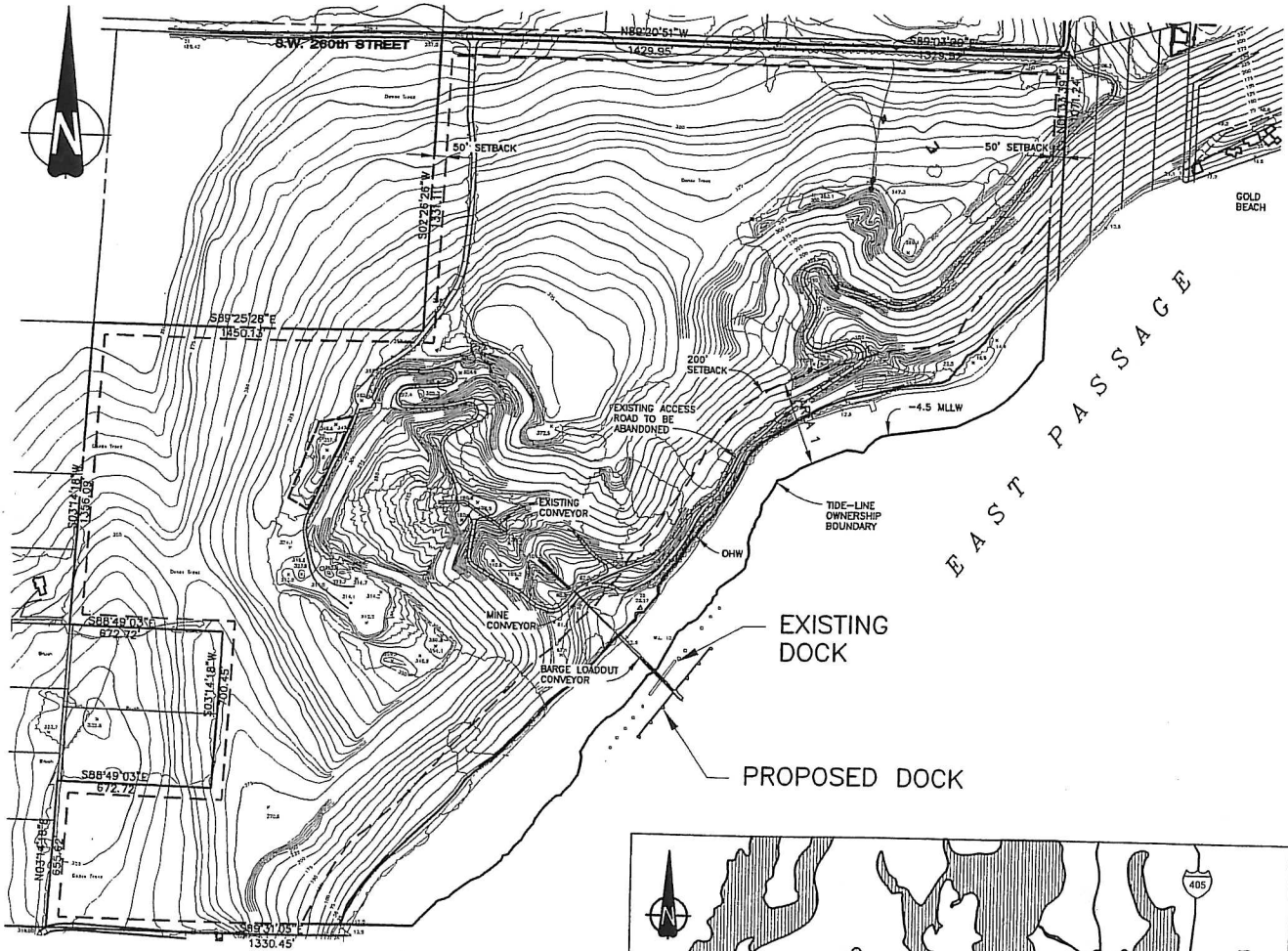

SITE MAP

1"=800'

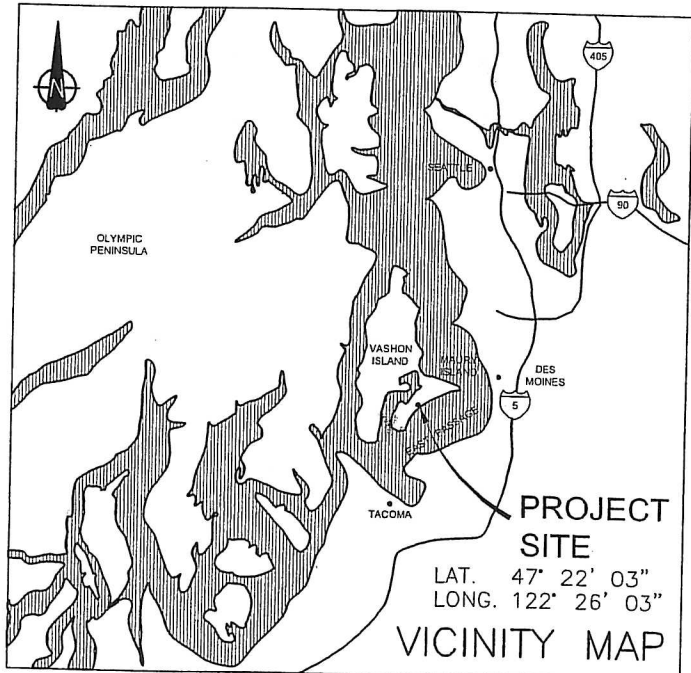

VICINITY MAP

LAT. 47° 22' 03"
LONG. 122° 26' 03"

PURPOSE:
PROVIDE MOORAGE FOR VESSELS TO
RECEIVE SAND AND GRAVEL BEING
TRANSFERRED OFF-SHORE

DATUM: MLLW

**MAURY ISLAND
PIER MODIFICATIONS**

SCALE: As Noted Above
NAME: NORTHWEST AGGREGATES
ADDRESS: 5975 E. MARGINAL WAY S.
P.O. BOX 1730
SEATTLE, WA 98111

PROPOSED: REPLACEMENT BARGE
LOADING STRUCTURE

IN: EAST PASSAGE
AT: MAURY ISLAND
COUNTY OF: KING
APPLICATION BY: NORTHWEST AGGREGATES

SHEET 1 OF 19 DATE: NOVEMBER 2003

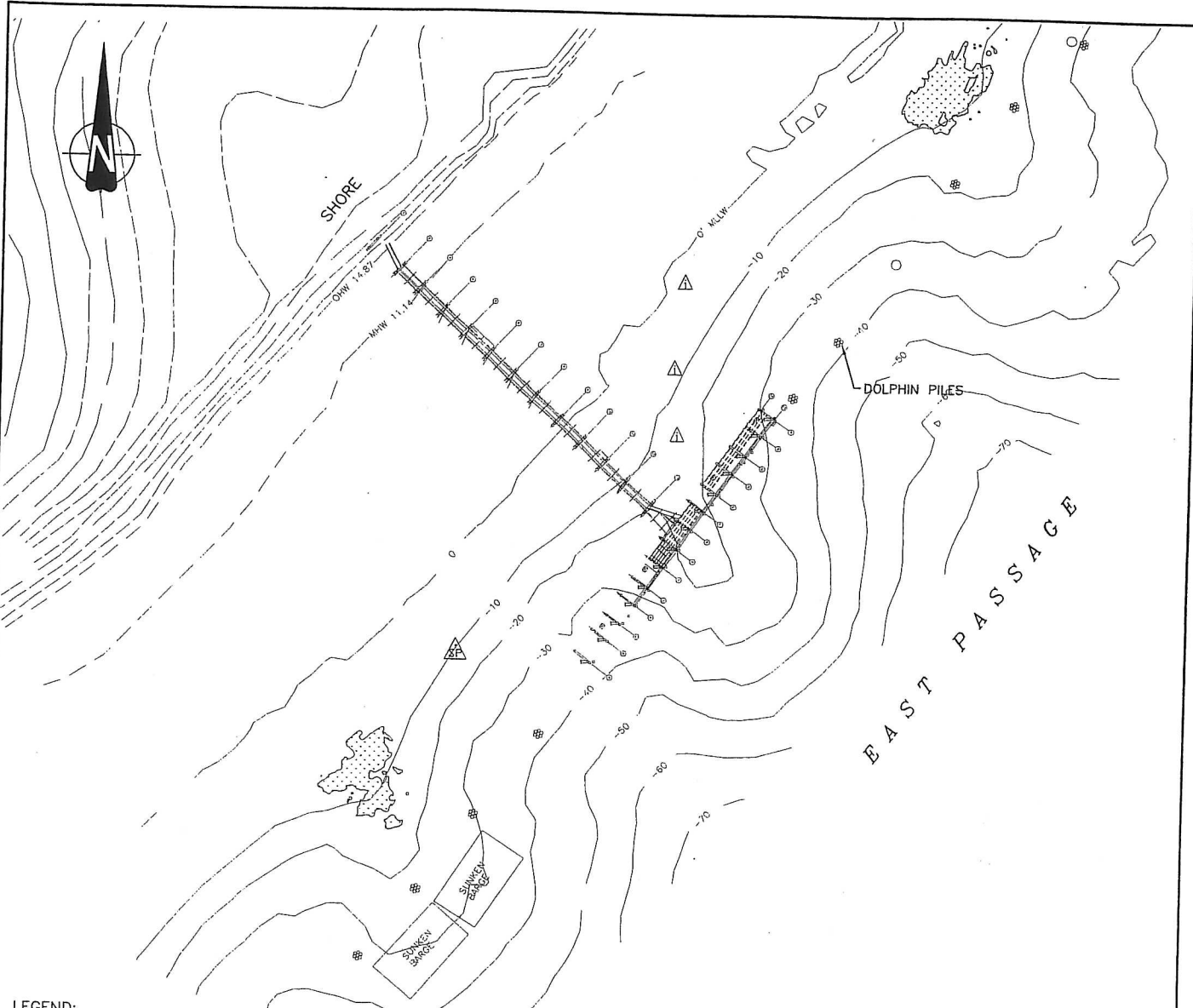

LEGEND:

- EELGRASS
- SMALL PATCH OF EELGRASS
- SINGLE SHOOT OF EELGRASS
- EXISTING ABOVE WATER TIMBER PILE DOLPHINS
- EXISTING SUBMERGED DOLPHINS

NOTE:

EELGRASS LOCATIONS TAKEN FROM PACIFIC INTERNATIONAL ENGINEERING SURVEY, JUL/AUG 2001.

BATHYMETRY (BLUE WATER ENGINEERING, 1999)

ACCORDING TO NOAA PUBLISHED INFORMATION N.G.V.D. 1929 IS 6.40 FEET HIGHER THAN MEAN LOWER LOW WATER (MLLW=0.0')
 ORDINARY HIGH WATER - LINE OF VEGETATION (OHV) = 14.87 FT
 HIGHEST OBSERVED WATER LEVEL (02/01/1975) = 13.97 FT
 MEAN HIGHER HIGH WATER (MHHW) = 12.05 FT
 MEAN HIGH WATER (MHW) = 11.14 FT
 MEAN TIDE LEVEL (MTL) = 7.01 FT
 *NATIONAL GEODETIC VERTICAL DATUM-1929 (NGVD) = 6.40 FT
 MEAN LOW WATER (MLW) = 2.88 FT
 MEAN LOWER LOW WATER (MLLW) = 0.00 FT
 LOWEST OBSERVED WATER LEVEL (12/24/1975) = -2.01 FT

EXISTING DOCK/DOLPHIN PLAN AND TOPOGRAPHY

PURPOSE:
 PROVIDE MOORAGE FOR VESSELS TO RECEIVE SAND AND GRAVEL BEING TRANSFERRED OFF-SHORE

DATUM: MLLW

MAURY ISLAND PIER MODIFICATIONS

SCALE: 1"=100'
NAME: NORTHWEST AGGREGATES
ADDRESS: 5975 E. MARGINAL WAY S.
 P.O. BOX 1730
 SEATTLE, WA 98111



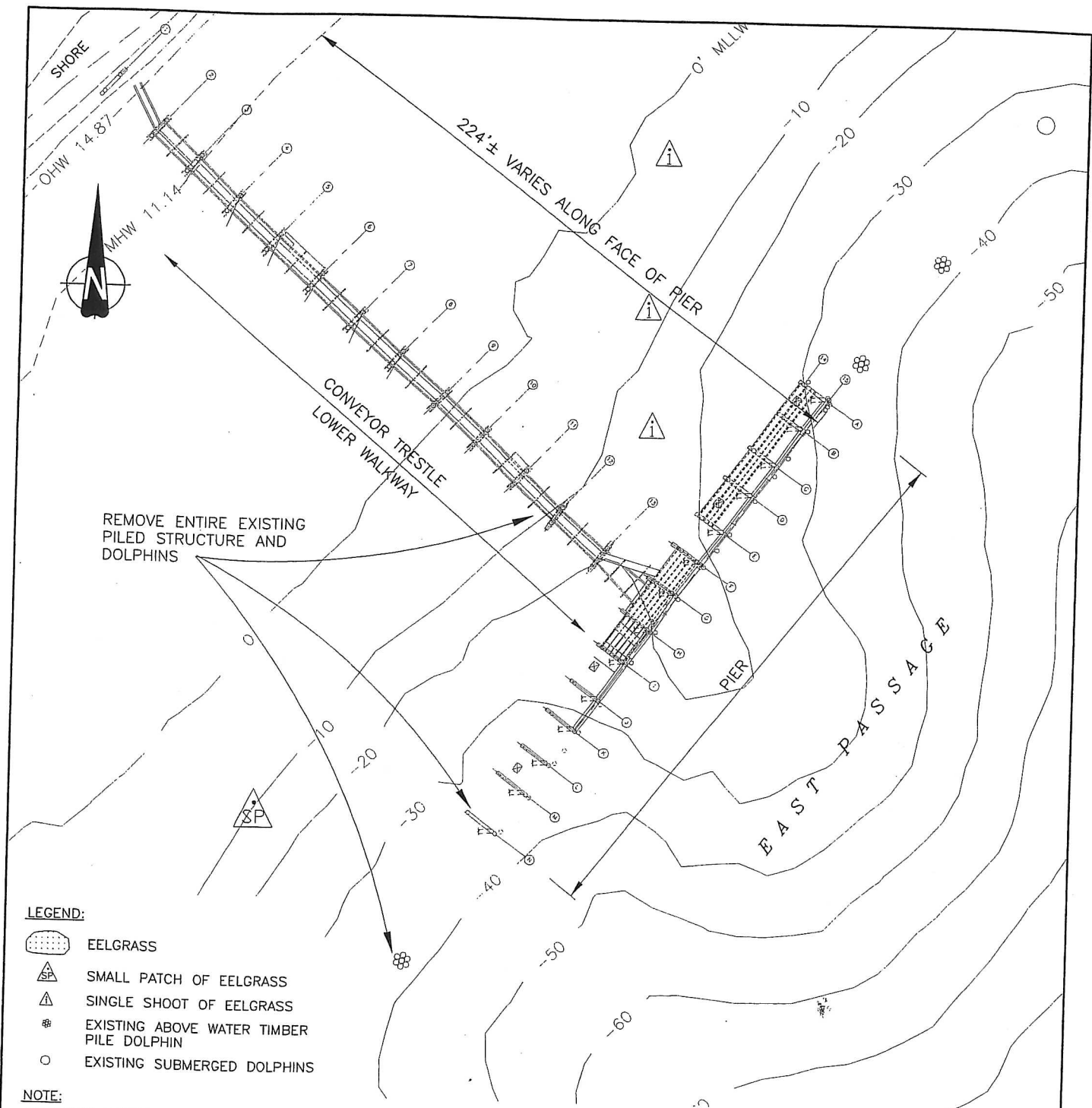

PROPOSED: REPLACEMENT BARGE LOADING STRUCTURE

IN: EAST PASSAGE
AT: MAURY ISLAND
COUNTY OF: KING
APPLICATION BY: NORTHWEST AGGREGATES

SHEET 2 OF 19 DATE: NOVEMBER 2003



LEGEND:

-  EELGRASS
-  SMALL PATCH OF EELGRASS
-  SINGLE SHOOT OF EELGRASS
-  EXISTING ABOVE WATER TIMBER PILE DOLPHIN
-  EXISTING SUBMERGED DOLPHINS

NOTE:

EELGRASS LOCATIONS TAKEN FROM PACIFIC INTERNATIONAL ENGINEERING SURVEY, JUL/AUG 2001.

BATHYMETRY (BLUE WATER ENGINEERING, 1999)

EXISTING LOWER LEVEL PLAN

PURPOSE:
PROVIDE MOORAGE FOR VESSELS TO RECEIVE SAND AND GRAVEL BEING TRANSFERRED OFF-SHORE

DATUM: MLLW

MAURY ISLAND PIER MODIFICATIONS

SCALE: 1"=50'

NAME: NORTHWEST AGGREGATES
ADDRESS: 5975 E. MARGINAL WAY S.
P.O. BOX 1730
SEATTLE, WA 98111

PROPOSED: REPLACEMENT BARGE LOADING STRUCTURE

IN: EAST PASSAGE
AT: MAURY ISLAND
COUNTY OF: KING
APPLICATION BY: NORTHWEST AGGREGATES

SHEET 3 OF 19 **DATE:** NOVEMBER 2003

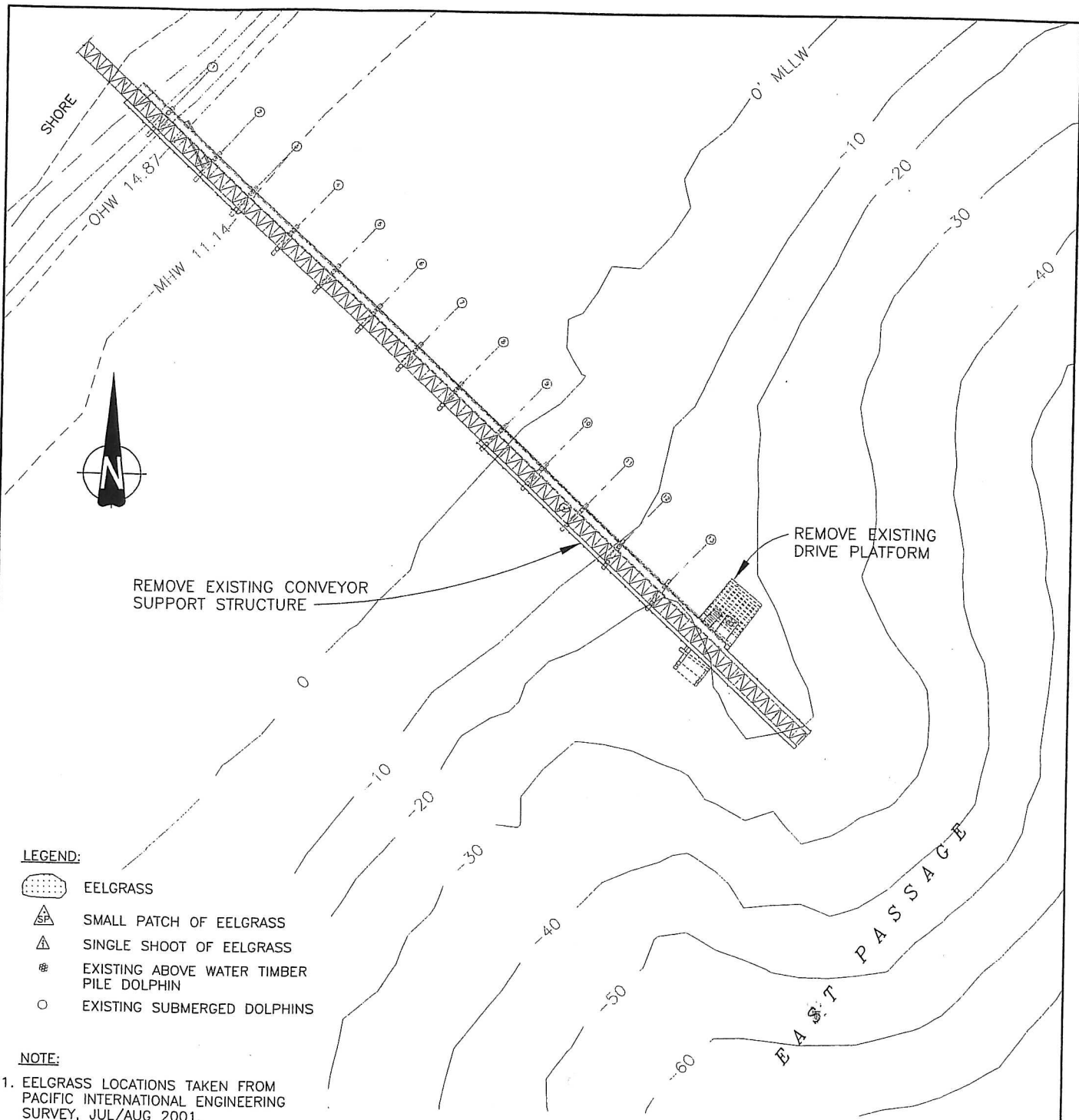

EXISTING UPPER LEVEL PLAN

- LEGEND:**
- EELGRASS
 - SMALL PATCH OF EELGRASS
 - SINGLE SHOOT OF EELGRASS
 - EXISTING ABOVE WATER PILE DOLPHIN
 - EXISTING SUBMERGED DOLPHINS

- NOTE:**
1. EELGRASS LOCATIONS TAKEN FROM PACIFIC INTERNATIONAL ENGINEERING SURVEY, JUL/AUG 2001.
 2. BATHYMETRY (BLUE WATER ENGINEERING, 1999)
 3. LOWER DOCK NOT SHOWN FOR CLARITY.

PURPOSE:
 PROVIDE MOORAGE FOR VESSELS TO RECEIVE SAND AND GRAVEL BEING TRANSFERRED OFF-SHORE

DATUM: MLLW

**MAURY ISLAND
 PIER MODIFICATIONS**

SCALE: 1"=50'

NAME: NORTHWEST AGGREGATES
ADDRESS: 5975 E. MARGINAL WAY S.
 P.O. BOX 1730
 SEATTLE, WA 98111

PROPOSED: REPLACEMENT BARGE LOADING STRUCTURE

IN: EAST PASSAGE
AT: MAURY ISLAND
COUNTY OF: KING
APPLICATION BY: NORTHWEST AGGREGATES

SHEET 4 OF 19 **DATE:** NOVEMBER 2003

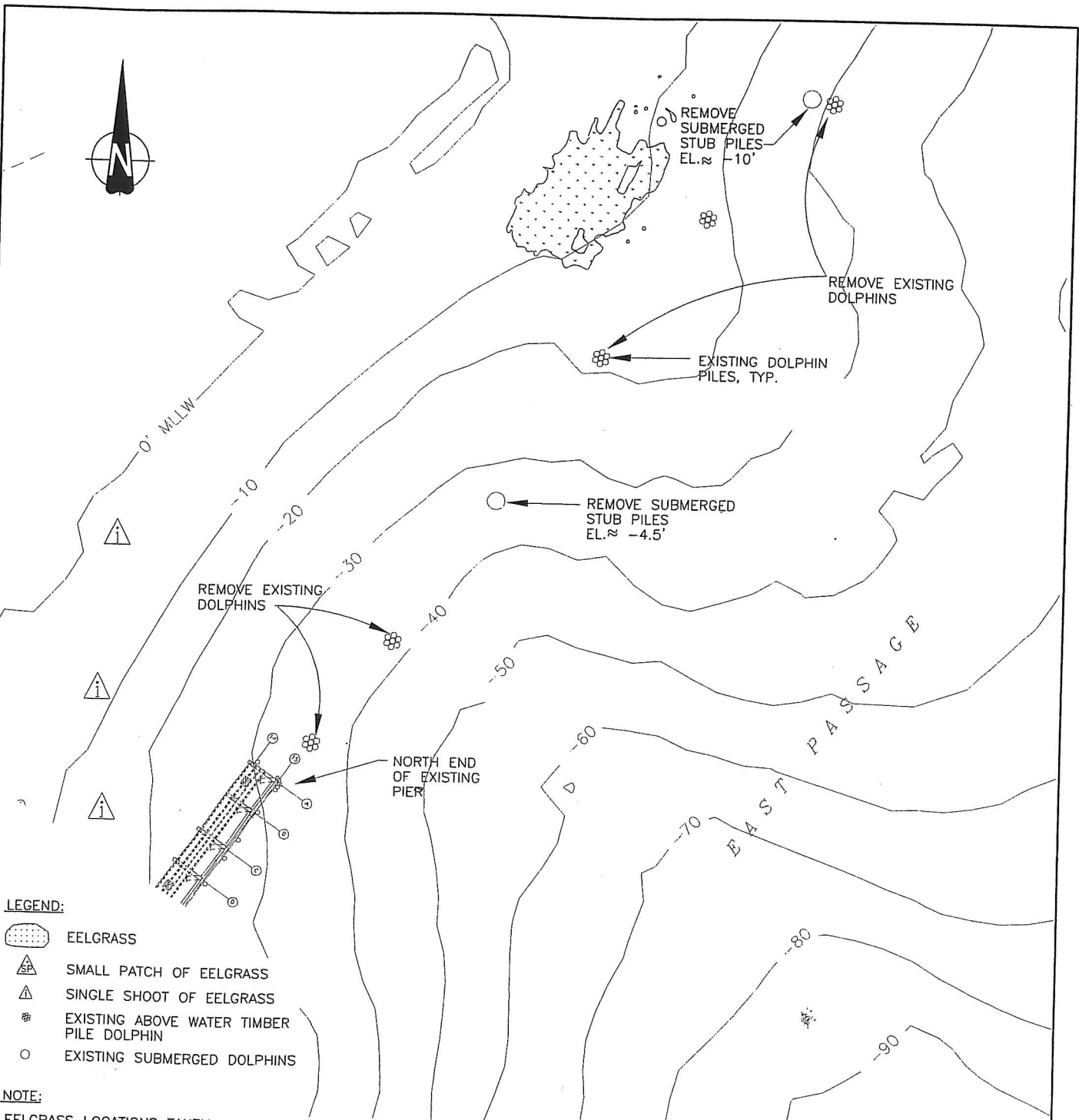

EXISTING PIER & DOLPHIN LAYOUT - NORTH

PURPOSE:
 PROVIDE MOORAGE FOR VESSELS TO RECEIVE SAND AND GRAVEL BEING TRANSFERRED OFF-SHORE

DATUM: MLLW

MAURY ISLAND PIER MODIFICATIONS

SCALE: 1"=50'

NAME: NORTHWEST AGGREGATES
ADDRESS: 5975 E. MARGINAL WAY S.
 P.O. BOX 1730
 SEATTLE, WA 98111

PROPOSED: REPLACEMENT BARGE LOADING STRUCTURE

IN: EAST PASSAGE
AT: MAURY ISLAND
COUNTY OF: KING
APPLICATION BY: NORTHWEST AGGREGATES

SHEET 5 OF 19 DATE: NOVEMBER 2003

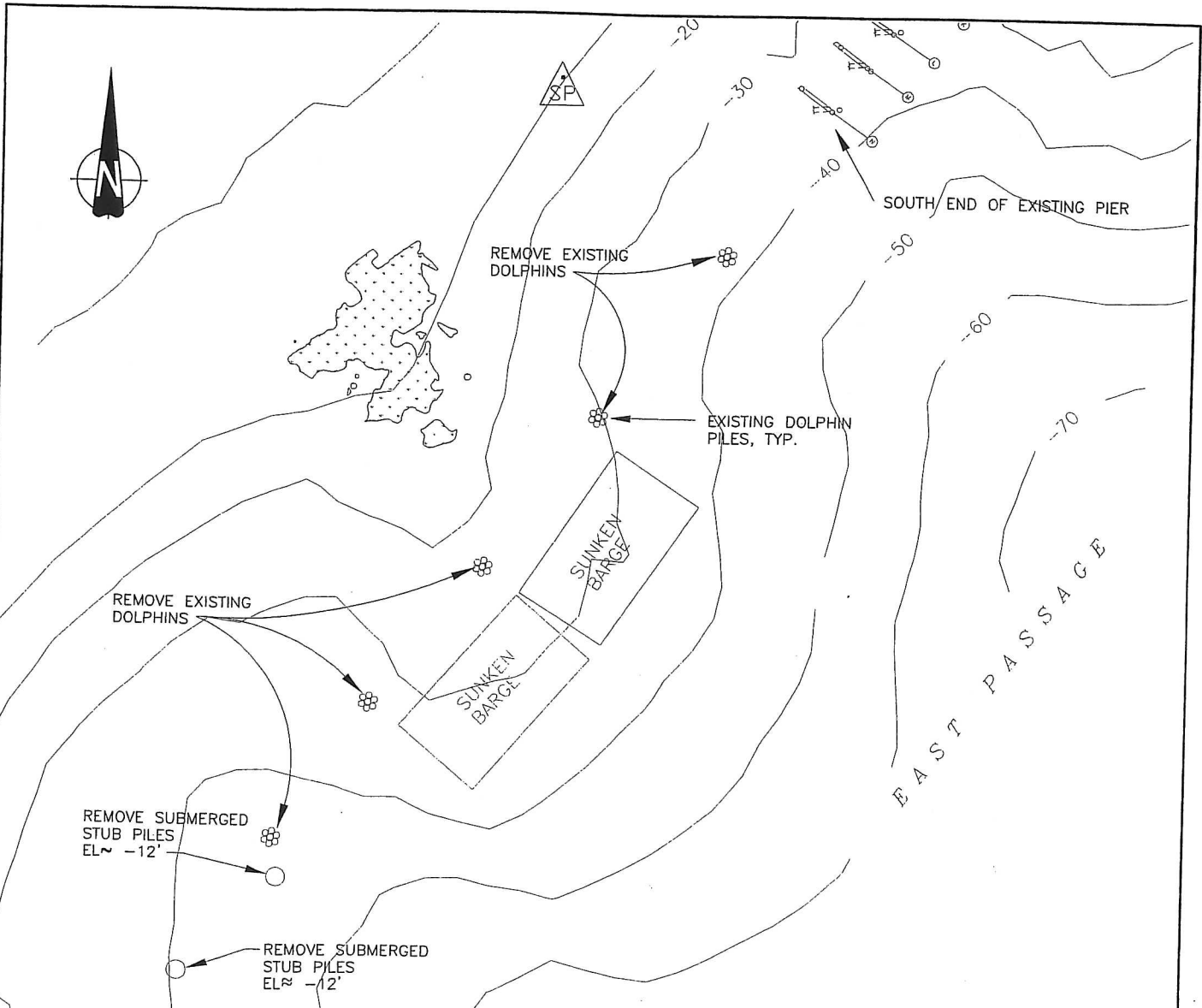

LEGEND:

- EELGRASS
- SMALL PATCH OF EELGRASS
- SINGLE SHOOT OF EELGRASS
- EXISTING ABOVE WATER TIMBER PILE DOLPHIN
- EXISTING SUBMERGED DOLPHINS

NOTE:

EELGRASS LOCATIONS TAKEN FROM PACIFIC INTERNATIONAL ENGINEERING SURVEY, JUL/AUG 2001.
 BATHYMETRY (BLUE WATER ENGINEERING, 1999)

EXISTING PIER & DOLPHIN LAYOUT - SOUTH

PURPOSE:
 PROVIDE MOORAGE FOR VESSELS TO RECEIVE SAND AND GRAVEL BEING TRANSFERRED OFF-SHORE

DATUM: MLLW

MAURY ISLAND PIER MODIFICATIONS

SCALE: 1"=50'

NAME: NORTHWEST AGGREGATES
ADDRESS: 5975 E. MARGINAL WAY S.
 P.O. BOX 1730
 SEATTLE, WA 98111

PROPOSED: REPLACEMENT BARGE LOADING STRUCTURE

IN: EAST PASSAGE
AT: MAURY ISLAND
COUNTY OF: KING
APPLICATION BY: NORTHWEST AGGREGATES

SHEET 6 OF 19 **DATE:** NOVEMBER 2003

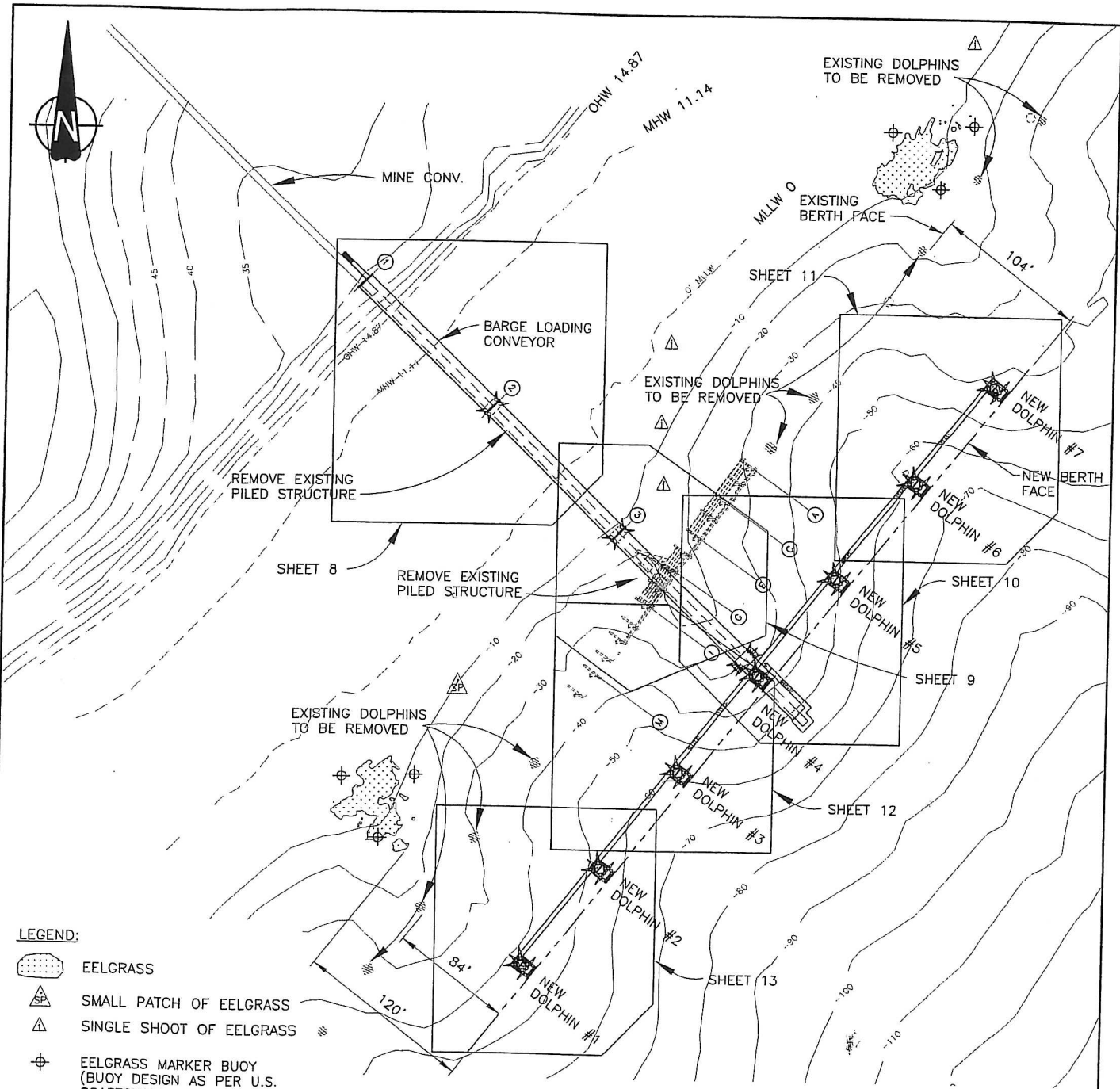

LEGEND:

- EELGRASS
- SMALL PATCH OF EELGRASS
- SINGLE SHOOT OF EELGRASS
- EELGRASS MARKER BUOY (BUOY DESIGN AS PER U.S. COASTGUARD REQUIREMENTS)

NOTE:

EELGRASS LOCATIONS TAKEN FROM PACIFIC INTERNATIONAL ENGINEERING SURVEY, JUL/AUG 2001.

NOTE:

FOR PILE SUMMARY TABLE & SURFACE AREA TABLE SEE SHEET 19

**PROPOSED NEW PIER AND
NEW ENCLOSED CONVEYOR**

KEY PLAN

PURPOSE:
PROVIDE MOORAGE FOR VESSELS TO RECEIVE SAND AND GRAVEL BEING TRANSFERRED OFF-SHORE

DATUM: MLLW

**MAURY ISLAND
PIER MODIFICATIONS**

SCALE: 1"=100'
NAME: NORTHWEST AGGREGATES
ADDRESS: 5975 E. MARGINAL WAY S.
P.O. BOX 1730
SEATTLE, WA 98111

PROPOSED: REPLACEMENT BARGE LOADING STRUCTURE

IN: EAST PASSAGE
AT: MAURY ISLAND
COUNTY OF: KING
APPLICATION BY: NORTHWEST AGGREGATES

SHEET 7 OF 19 DATE: NOVEMBER 2003

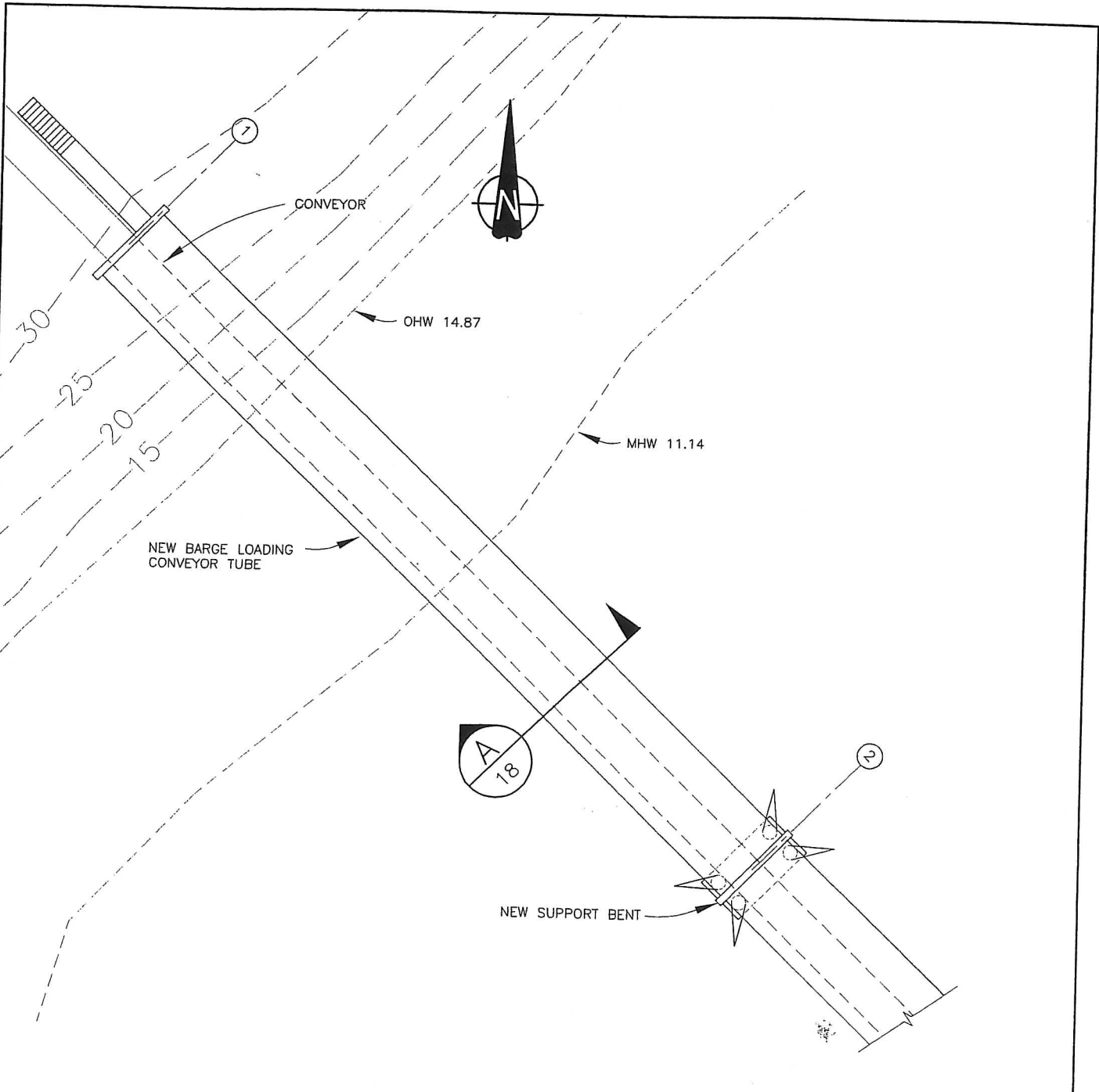

PROPOSED NEW CONVEYOR TUBE PLAN

PURPOSE:
 PROVIDE MOORAGE FOR VESSELS TO
 RECEIVE SAND AND GRAVEL BEING
 TRANSFERRED OFF-SHORE

DATUM: MLLW

**MAURY ISLAND
 PIER MODIFICATIONS**

SCALE: 1"=20'

NAME: NORTHWEST AGGREGATES
 ADDRESS: 5975 E. MARGINAL WAY S.
 P.O. BOX 1730
 SEATTLE, WA 98111

PROPOSED: REPLACEMENT BARGE
 LOADING STRUCTURE

IN: EAST PASSAGE
 AT: MAURY ISLAND
 COUNTY OF: KING
 APPLICATION BY: NORTHWEST AGGREGATES

SHEET 8 OF 19 DATE: NOVEMBER 2003

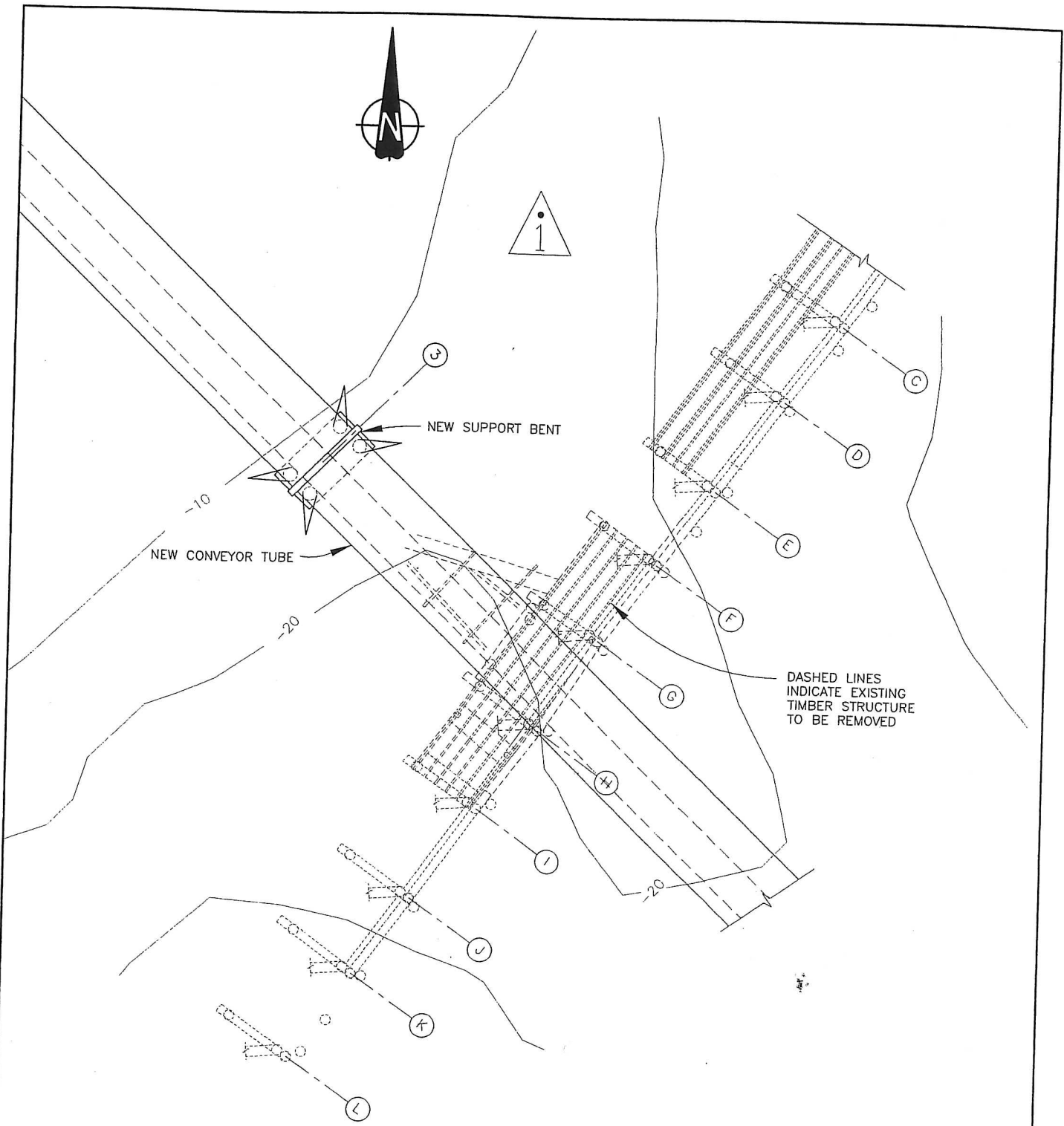

PROPOSED NEW CONVEYOR TUBE PLAN

PURPOSE:
 PROVIDE MOORAGE FOR VESSELS TO
 RECEIVE SAND AND GRAVEL BEING
 TRANSFERRED OFF-SHORE

DATUM: MLLW

**MAURY ISLAND
 PIER MODIFICATIONS**

SCALE: 1"=20'

NAME: NORTHWEST AGGREGATES
 ADDRESS: 5975 E. MARGINAL WAY S.
 P.O. BOX 1730
 SEATTLE, WA 98111

PROPOSED: REPLACEMENT BARGE
 LOADING STRUCTURE

IN: EAST PASSAGE
 AT: MAURY ISLAND
 COUNTY OF: KING
 APPLICATION BY: NORTHWEST AGGREGATES

SHEET 9 OF 19 DATE: NOVEMBER 2003

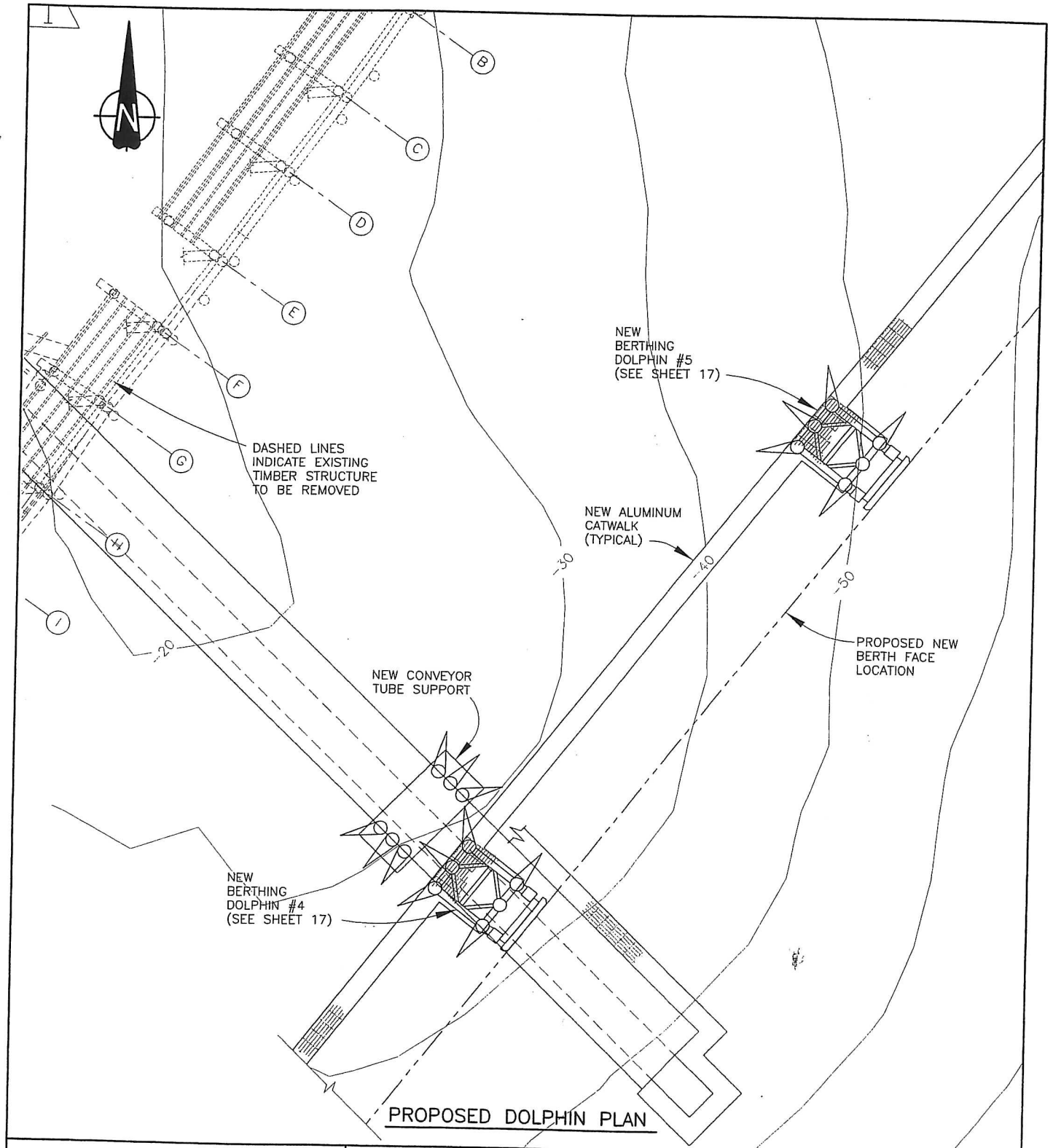

PURPOSE:
 PROVIDE MOORAGE FOR VESSELS TO
 RECEIVE SAND AND GRAVEL BEING
 TRANSFERRED OFF-SHORE

DATUM: MLLW

MAURY ISLAND PIER MODIFICATIONS

SCALE: 1"=20'
 NAME: NORTHWEST AGGREGATES
 ADDRESS: 5975 E. MARGINAL WAY S.
 P.O. BOX 1730
 SEATTLE, WA 98111

PROPOSED: REPLACEMENT BARGE
 LOADING STRUCTURE

IN: EAST PASSAGE
 AT: MAURY ISLAND
 COUNTY OF: KING
 APPLICATION BY: NORTHWEST AGGREGATES

SHEET 10 OF 19 DATE: NOVEMBER 2003

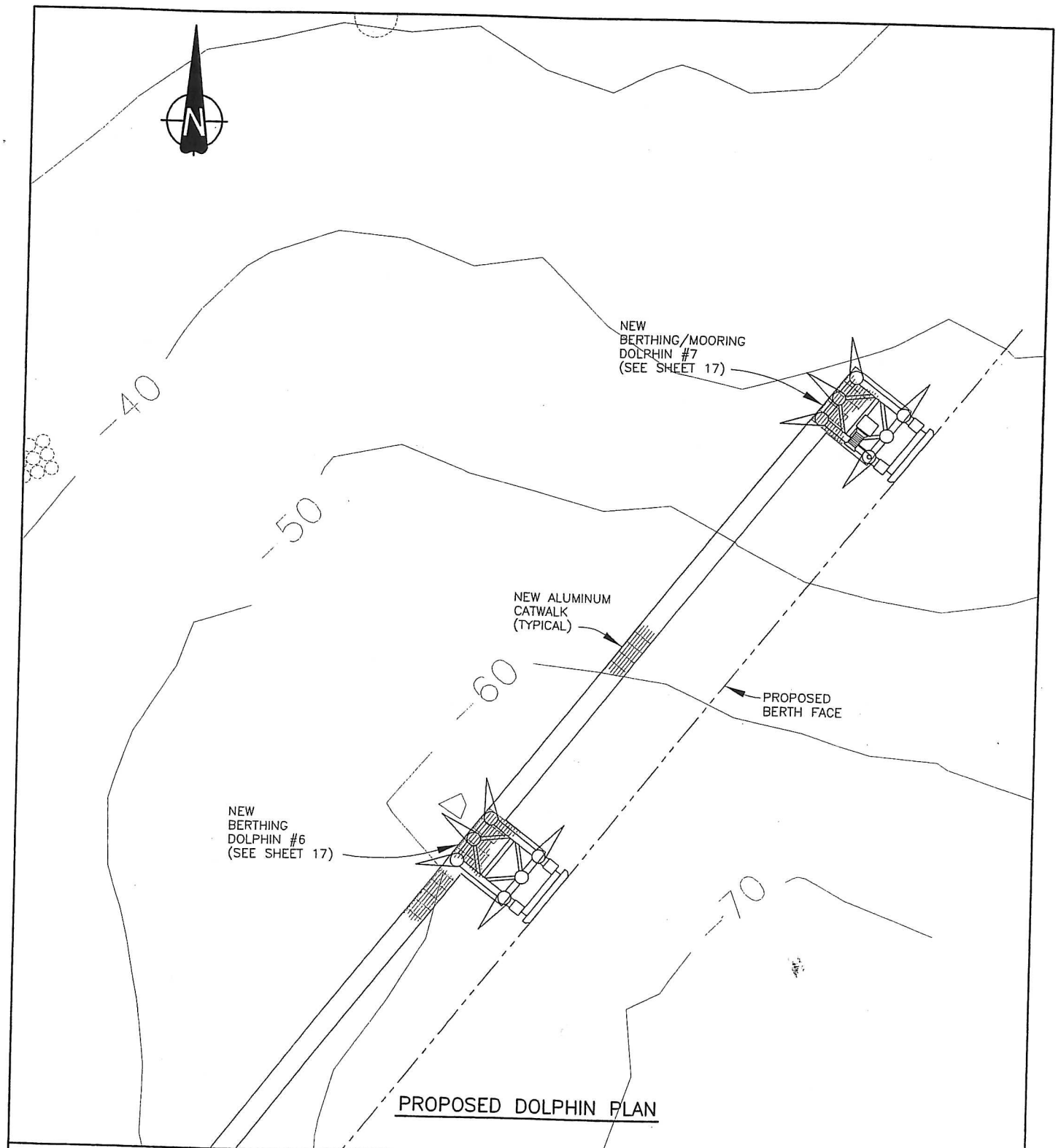

PURPOSE:
 PROVIDE MOORAGE FOR VESSELS TO
 RECEIVE SAND AND GRAVEL BEING
 TRANSFERRED OFF-SHORE

DATUM: MLLW

**MAURY ISLAND
 PIER MODIFICATIONS**

SCALE: 1"=20'

NAME: NORTHWEST AGGREGATES
 ADDRESS: 5975 E. MARGINAL WAY S.
 P.O. BOX 1730
 SEATTLE, WA 98111

PROPOSED: REPLACEMENT BARGE
 LOADING STRUCTURE

IN: EAST PASSAGE
 AT: MAURY ISLAND
 COUNTY OF: KING
 APPLICATION BY: NORTHWEST AGGREGATES

SHEET 11 OF 19 DATE: NOVEMBER 2003

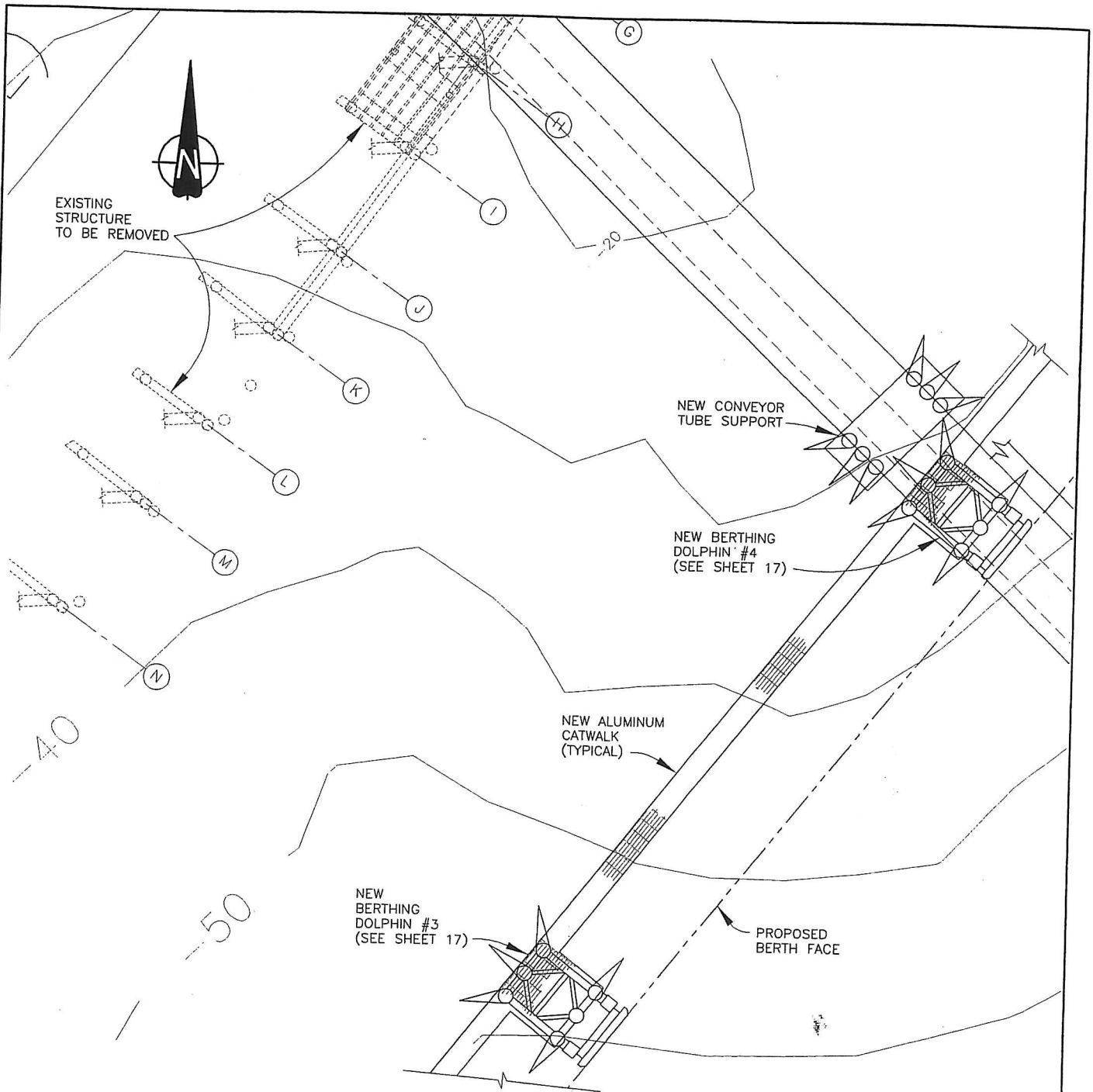

PROPOSED DOLPHIN PLAN

PURPOSE:
 PROVIDE MOORAGE FOR VESSELS TO
 RECEIVE SAND AND GRAVEL BEING
 TRANSFERRED OFF-SHORE

DATUM: MLLW

MAURY ISLAND
 PIER MODIFICATIONS

SCALE: 1"=20'
 NAME: NORTHWEST AGGREGATES
 ADDRESS: 5975 E. MARGINAL WAY S.
 P.O. BOX 1730
 SEATTLE, WA 98111

PROPOSED: REPLACEMENT BARGE
 LOADING STRUCTURE

IN: EAST PASSAGE
 AT: MAURY ISLAND
 COUNTY OF: KING
 APPLICATION BY: NORTHWEST AGGREGATES

SHEET 12 OF 19 DATE: NOVEMBER 2003

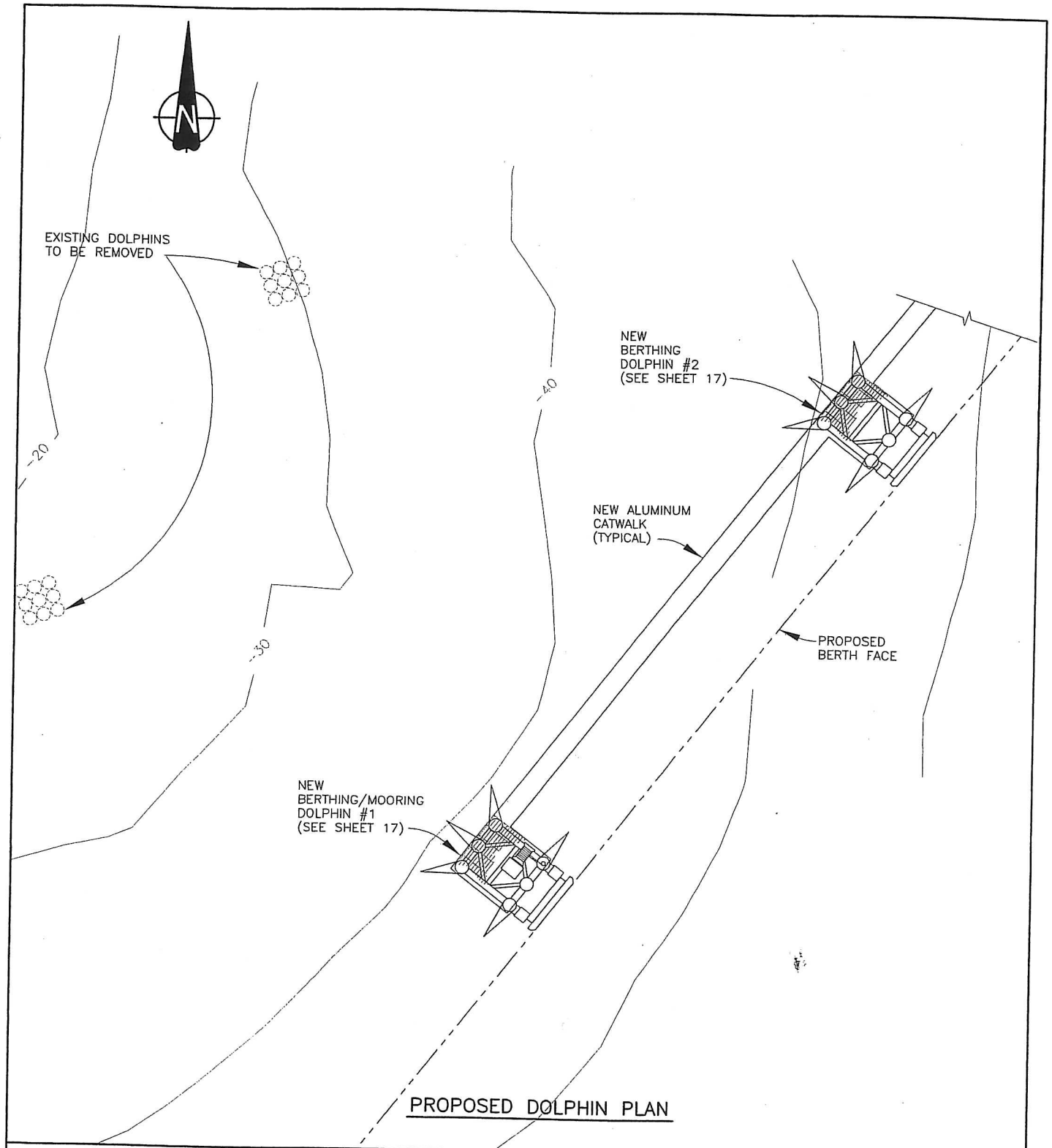

PROPOSED DOLPHIN PLAN

PURPOSE:
 PROVIDE MOORAGE FOR VESSELS TO
 RECEIVE SAND AND GRAVEL BEING
 TRANSFERRED OFF-SHORE

DATUM: MLLW

MAURY ISLAND PIER MODIFICATIONS

SCALE: 1"=20'
 NAME: NORTHWEST AGGREGATES
 ADDRESS: 5975 E. MARGINAL WAY S.
 P.O. BOX 1730
 SEATTLE, WA 98111

PROPOSED: REPLACEMENT BARGE
 LOADING STRUCTURE

IN: EAST PASSAGE
 AT: MAURY ISLAND
 COUNTY OF: KING
 APPLICATION BY: NORTHWEST AGGREGATES

SHEET 13 OF 19 DATE: NOVEMBER 2003

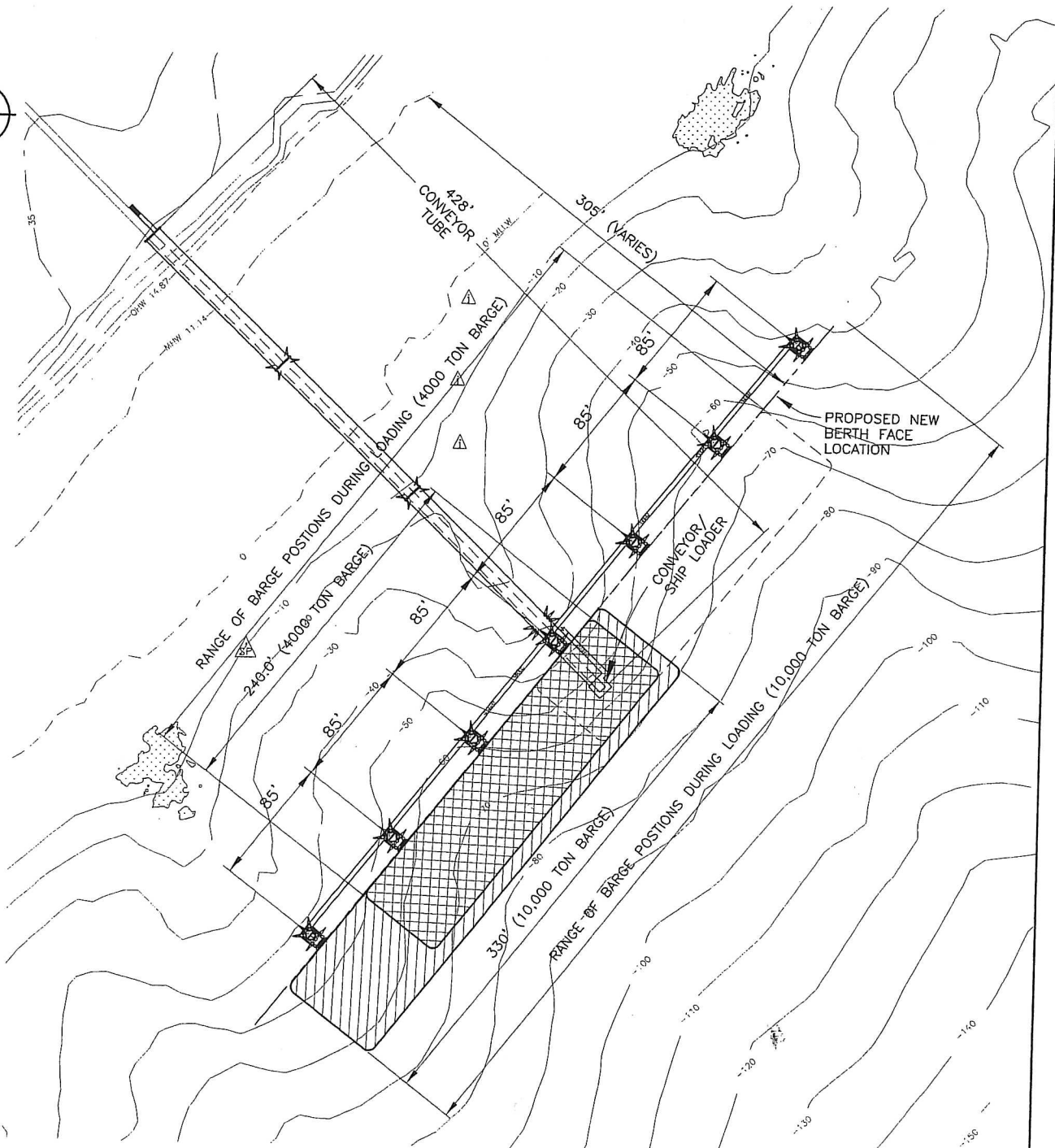

PROPOSED BARGE WARPING PLAN

PURPOSE:
PROVIDE MOORAGE FOR VESSELS TO
RECEIVE SAND AND GRAVEL BEING
TRANSFERRED OFF-SHORE

DATUM: MLLW

MAURY ISLAND PIER MODIFICATIONS

SCALE: 1"=100'
NAME: NORTHWEST AGGREGATES
ADDRESS: 5975 E. MARGINAL WAY S.
P.O. BOX 1730
SEATTLE, WA 98111

PROPOSED: REPLACEMENT BARGE
LOADING STRUCTURE

IN: EAST PASSAGE
AT: MAURY ISLAND
COUNTY OF: KING
APPLICATION BY: NORTHWEST AGGREGATES

SHEET 14 OF 19 DATE: NOVEMBER 2003

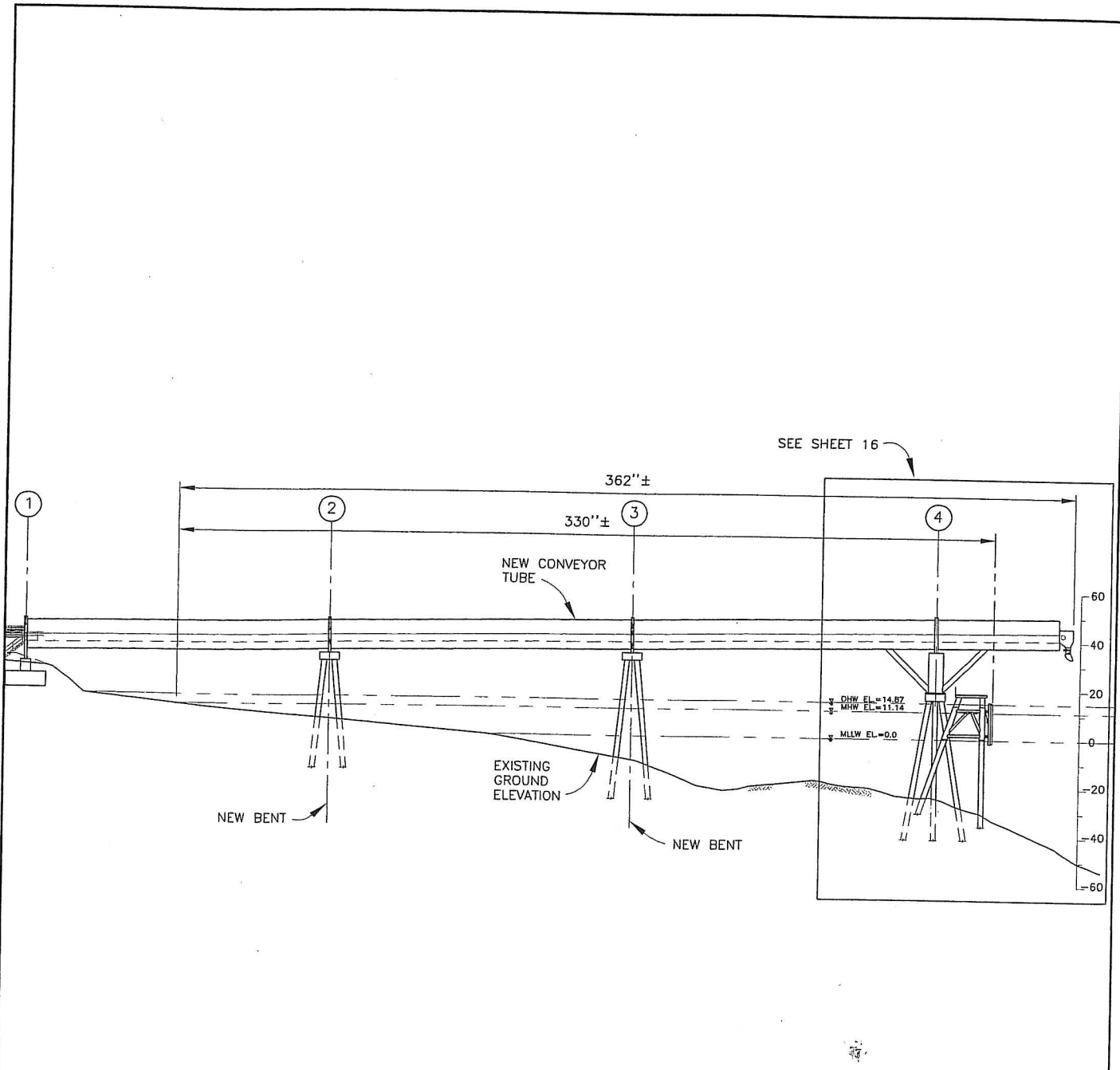

PROPOSED BARGE LOADING CONVEYOR ELEVATION

PURPOSE:
 PROVIDE MOORAGE FOR VESSELS TO
 RECEIVE SAND AND GRAVEL BEING
 TRANSFERRED OFF-SHORE

DATUM: MLLW

MAURY ISLAND PIER MODIFICATIONS

SCALE: 1"=60'
 NAME: NORTHWEST AGGREGATES
 ADDRESS: 5975 E. MARGINAL WAY S.
 P.O. BOX 1730
 SEATTLE, WA 98111

PROPOSED: REPLACEMENT BARGE
 LOADING STRUCTURE

IN: EAST PASSAGE
 AT: MAURY ISLAND
 COUNTY OF: KING
 APPLICATION BY: NORTHWEST AGGREGATES

SHEET 15 OF 19 DATE: NOVEMBER 2003

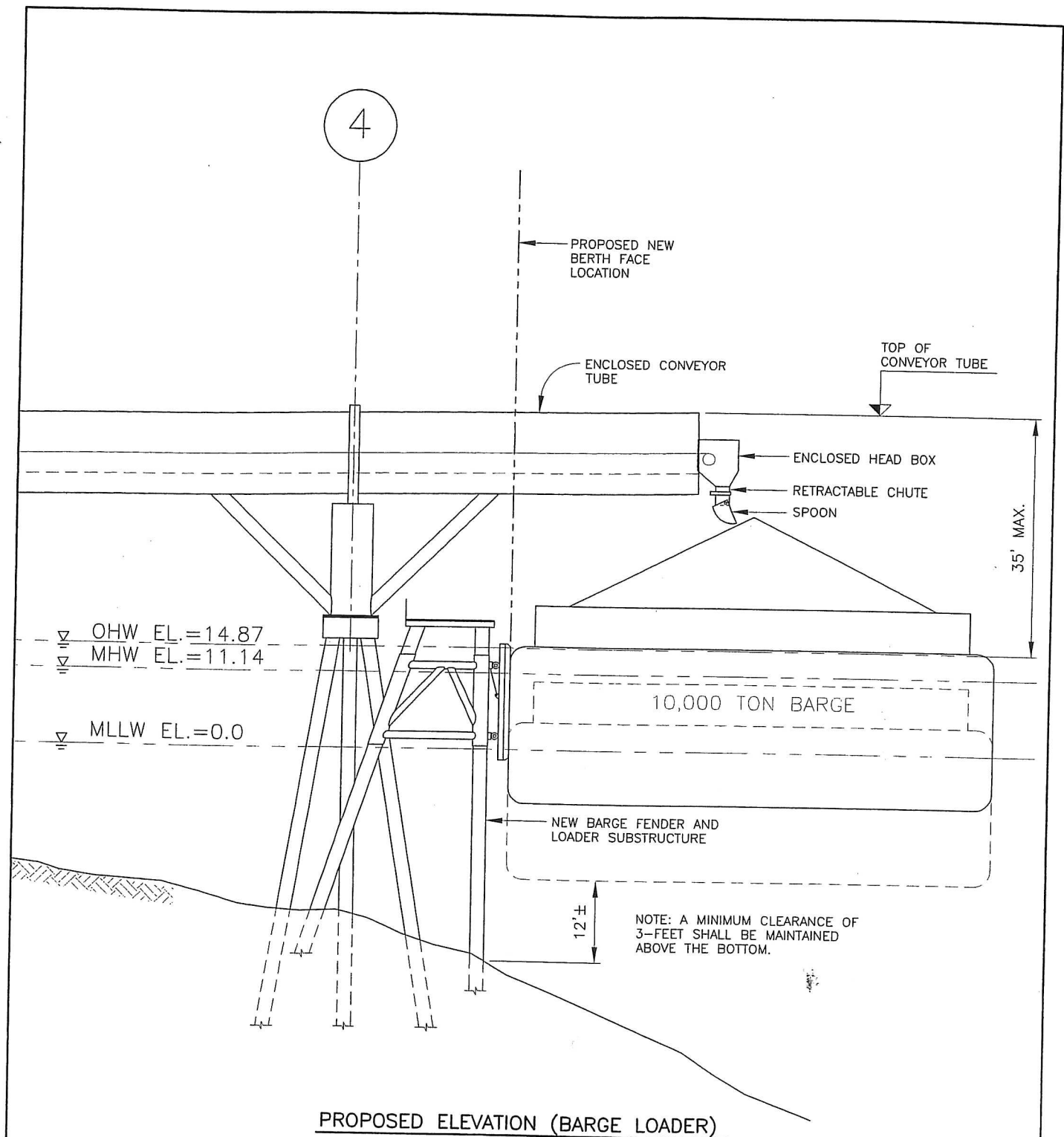

PURPOSE:
 PROVIDE MOORAGE FOR VESSELS TO
 RECEIVE SAND AND GRAVEL BEING
 TRANSFERRED OFF-SHORE

DATUM: MLLW

MAURY ISLAND PIER MODIFICATIONS

SCALE: 1"=20'
 NAME: NORTHWEST AGGREGATES
 ADDRESS: 5975 E. MARGINAL WAY S.
 P.O. BOX 1730
 SEATTLE, WA 98111

PROPOSED: REPLACEMENT BARGE
 LOADING STRUCTURE

IN: EAST PASSAGE
 AT: MAURY ISLAND
 COUNTY OF: KING
 APPLICATION BY: NORTHWEST AGGREGATES

SHEET 16 OF 19 DATE: NOVEMBER 2003

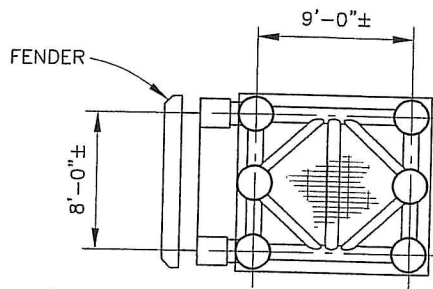

PLAN

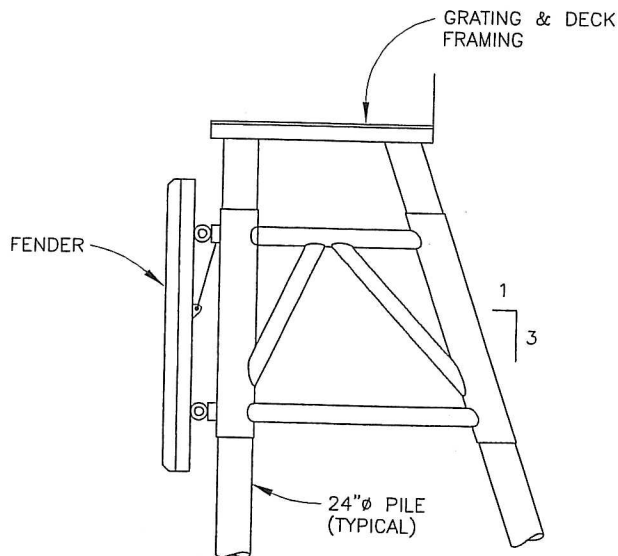

ELEVATION
(DOLPHINS #1 TO #7)

PURPOSE:
PROVIDE MOORAGE FOR VESSELS TO
RECEIVE SAND AND GRAVEL BEING
TRANSFERRED OFF-SHORE

MAURY ISLAND PIER MODIFICATIONS

SCALE: 3/32"=1'-0"
NAME: NORTHWEST AGGREGATES
ADDRESS: 5975 E. MARGINAL WAY S.
P.O. BOX 1730
SEATTLE, WA 98111

PROPOSED: REPLACEMENT BARGE
LOADING STRUCTURE

IN: EAST PASSAGE
AT: MAURY ISLAND
COUNTY OF: KING
APPLICATION BY: NORTHWEST AGGREGATES

SHEET 17 OF 19 DATE: NOVEMBER 2003

NEW CONVEYOR

12'-0" DIAMETER
CONVEYOR TUBE

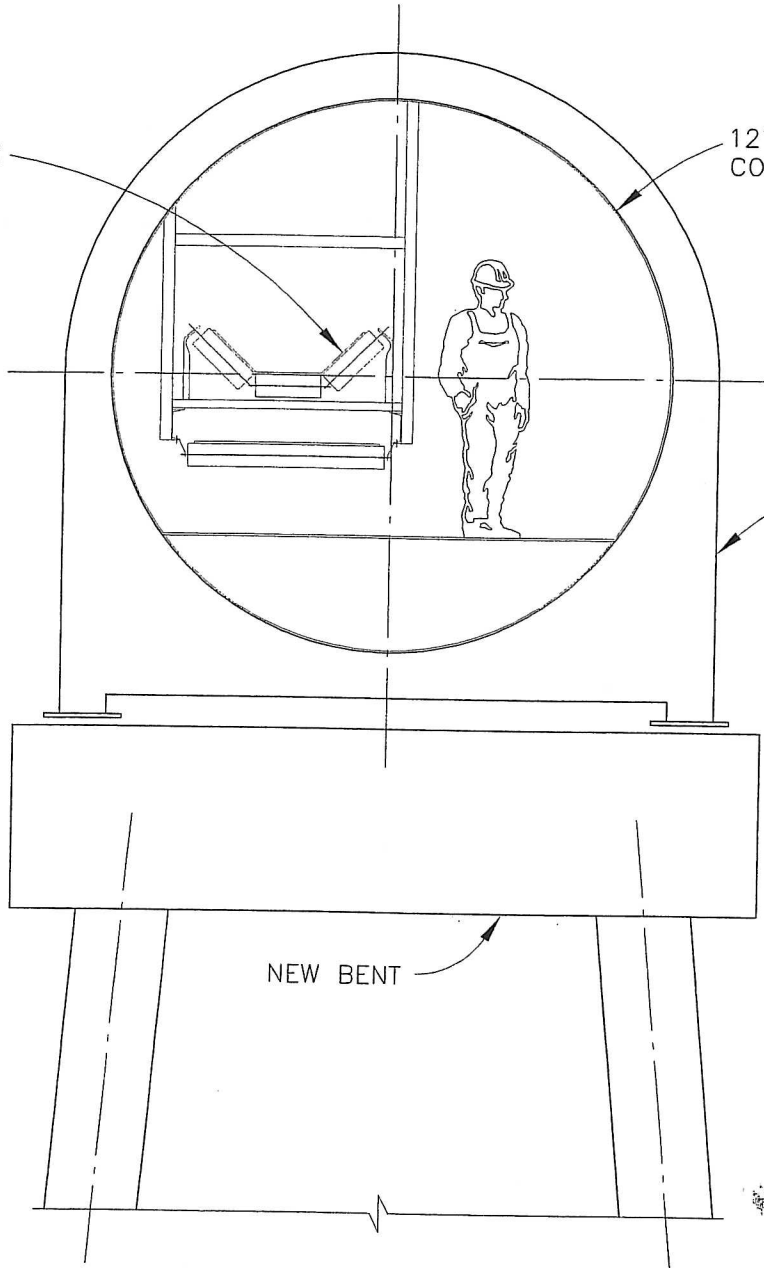

EXTERNAL TUBE
STIFFENER AT
BENT SUPPORTS

NEW BENT

SECTION

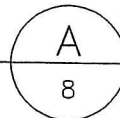

PURPOSE:
PROVIDE MOORAGE FOR VESSELS TO
RECEIVE SAND AND GRAVEL BEING
TRANSFERRED OFF-SHORE

MAURY ISLAND PIER MODIFICATIONS

SCALE: NOT TO SCALE
NAME: NORTHWEST AGGREGATES
ADDRESS: 5975 E. MARGINAL WAY S.
P.O. BOX 1730
SEATTLE, WA 98111

PROPOSED: REPLACEMENT BARGE
LOADING STRUCTURE

IN: EAST PASSAGE
AT: MAURY ISLAND
COUNTY OF: KING
APPLICATION BY: NORTHWEST AGGREGATES

SHEET 18 OF 19 DATE: NOVEMBER 2003

PILE SUMMARY TABLE					
STRUCTURE	PILE TYPE	TOTAL NUMBER OF EXISTING PILES	NUMBER OF TIMBER PILES TO BE REMOVED	NUMBER OF STEEL REPLACEMENT PILES **	TOTAL NUMBER OF PILES AFTER REPAIRS **
CONVEYOR TRESTLE	VERTICAL	26	26	8 TO 14	8 TO 14
PIER	VERTICAL	32	32	0	0
	BATTER	18	18	0	0
FENDER SYSTEM	FENDER	21	21	0	0
DOLPHINS	VERTICAL	105	105	28 TO 42	28 TO 42
SUBMERGED DOLPHINS	CLUSTER	26	26	0	0
TOTAL		228 PILES	228 PILES	36 TO 56 PILES	36 TO 56 PILES

GROSS SURFACE AREA TABLE (TOTAL SF)								
STRUCTURE	EXISTING PILES	REMOVED PILES	**ADDED PILES	** AFTER MODIFICATIONS	EXISTING TIMBER DECK/WALKWAY	REMOVED TIMBER DECK/WALKWAY	ADDED STRUCTURE	FINAL STRUCTURE
CONVEYOR TRESTLE (LOWER LEVEL)	27.1	27.1	25.1 TO 44.0	25.1 TO 44.0	2640	2640	0	0
PIER (LOWER LEVEL)	62.2	62.2	0	0	2520	2520	0	0
FENDER SYSTEM	23.5	23.5	0	0			0	0
DOLPHIN	127.4	127.4	88 TO 131.9	88 TO 131.9			0	0
SUBMERGED DOLPHINS	33.2	33.2	0	0			980	980
CONVEYOR TRESTLE (UPPER LEVEL)					3410	3410	0	0
PIER					370	370	5136	5136
TOTALS	273.4	273.4	113.1 TO 175.9	113.1 TO 175.9	8940	8940	1680*	1680*

** THE FINAL NUMBER OF PILES AND THE CORRESPONDING PILE AREA WILL BE DETERMINED DURING FINAL DESIGN AFTER DETAILED GEOTECHNICAL INFORMATION HAS BEEN OBTAINED BY SOIL BORINGS OR TEST PILES.

* OPEN-GRATED STEEL WITH 75% OPEN AREA

PURPOSE:
PROVIDE MOORAGE FOR VESSELS TO RECEIVE SAND AND GRAVEL BEING TRANSFERRED OFF-SHORE

MAURY ISLAND PIER MODIFICATIONS

SCALE: NOT TO SCALE
NAME: NORTHWEST AGGREGATES
ADDRESS: 5975 E. MARGINAL WAY S.
P.O. BOX 1730
SEATTLE, WA 98111

PROPOSED: REPLACEMENT BARGE
LOADING STRUCTURE

IN: EAST PASSAGE
AT: MAURY ISLAND
COUNTY OF: KING
APPLICATION BY: NORTHWEST AGGREGATES

SHEET 19 OF 19 DATE: NOVEMBER 2003



STATE OF WASHINGTON

DEPARTMENT OF ECOLOGY

P.O. Box 47600 • Olympia, Washington 98504-7600
(360) 407-6000 • TDD Only (Hearing Impaired) (360) 407-6006

STATE OF WASHINGTON
DEPARTMENT OF ECOLOGY

Notice of Application for
Certification of Consistency with the
Washington Coastal Zone Management Program

Date: December 13, 2004

Notice is hereby given that a request has been filed with the Department of Ecology, pursuant to the requirements of Section 307© of the federal Coastal Zone Management Act of 1972(16 U.S.C. 1451), to certify that the project described in the U.S. Army Corps of Engineers Public Notice No. 200001094 will comply with the Washington State Coastal Zone Management Program and that the project will be conducted in a manner consistent with that Program.

Any person desiring to present views on the project pertaining to the project's compliance or consistency with the Washington State Coastal Zone Management Program may do so by providing written comments within 30 days of the above publication date to:

Federal Permit Coordinator
Department of Ecology
SEA Program
Post Office Box 47600
Olympia, Washington 98504-7600

Adjacent Property Owners

1. Dr. Gordon C. Newton
16020 7th Ave. SW
Seattle, WA 98166
2. Earle W. Lovering
7819 SW 259th PL
Vashon, WA 98070
3. Lovering Earle W.
C/O Johnson Sarah
7 Drum Road
Rowayton, CT 06853
4. Brian E. Stroop
7823 SW 259th
Vashon, WA 98070
5. Richard H. Belland
26415 7th Ave S.
Des Moines, WA 98198
6. Celi G. Nendoza
2 Hannah Court
Midland Michigan 48642
7. John B. Stygar
314 NE 91st Street
Seattle, WA 98115
8. Joice Fox
P.O. Box 978
Vashon, WA 98070
9. Val Knight
2246 S. 116th
Seattle, WA 98168
10. Geanne Anglin
27725 156 Ave. SE
Kent, WA 98042
11. Paul Dest
1545 N. Cyrpress
Ontario, CA 91762
12. David Long
25734 79th Ave. SW
Vashon, WA 98070
13. Richard Dixon
P.O. Box 1446
Vashon, WA 98070
14. August Sestrap
P.O. Box 614
Vashon, WA 98070
15. Peter Saunders
8225 SW Van Ounda Rd.
Vashon, WA 98070
16. Joeseoph Zimmer
27410 Sandy Shores Dr. SW
Vashon, WA 98070
17. Stephen Andrus
8901 SW 274th Street
Vashon, WA 98070



US Army Corps
of Engineers
Seattle District

Public Notice For Public Hearing

Regulatory Branch
Post Office Box 3755
Seattle, Washington 98124-3755
Telephone (206) 764-3495
ATTN: Olivia Romano, Project Manager

Public Notice and Erratum Date: April 14, 2004
Expiration Date: May 31, 2005
Reference: 200001094
Name: Northwest Aggregates

PUBLIC HEARING AND ERRATUM – The U.S. Army Corps of Engineers, Seattle District, will hold a public hearing to record public comments related to the Northwest Aggregates' application for a Department of the Army permit under the authorities of Section 10 of the Rivers and Harbors Act of March 3, 1899, and Section 404 of the Clean Water Act.

Northwest Aggregates' proposed project was the subject of Public Notice issued December 13, 2004 under the same reference number listed above. The public notice describing the project are available at the following website: [http://www.nws.usace.army.mil/PublicMenu/Menu.cfm?sitename=REG&pagename=Public Notices Archive](http://www.nws.usace.army.mil/PublicMenu/Menu.cfm?sitename=REG&pagename=Public%20Notices%20Archive)

Date and Time: May 17, 2005, 7:00 p.m. to 9:00 p.m.

Location: Vashon High School Commons
20120 Vashon Highway SW
Vashon Island, Washington, 98070

Hearing Purpose: The purpose of the hearing is to obtain public views and opinions on the proposed project that are relevant for consideration in making a permit decision for the proposed project.

HEARING FORMAT – The forum will be one formal hearing with verbatim recording. Oral and/or written comments can be presented. The hearing will be conducted in accordance with procedures set forth in 33 CFR, Part 327 (see Federal Register, Volume 51, Number 219, dated November 13, 1986, page 41249 et. Seq.). A brief description of the proposal will be presented. Following this, interested parties may present specific information on the project proposal, potential impacts, alternatives, and other related concerns.

All interested parties are invited to be present or to be represented at this public hearing. Oral statements will be heard, but for accuracy of the administrative record, important testimony should be submitted in writing. Oral statements should be brief (if necessary, a specific time limit may be applied per speaker), and the speaker should summarize any extensive written material so that there will be time for all interested persons to be heard.

COMMENT AND REVIEW PERIOD – The Corps will accept written comments on the proposed project following the hearing, until May 31, 2005. Written comments should be provided at the hearing, e-mailed to Olivia.H.Romano@usace.army.mil, subject line; 200001094 Public Hearing Comment or mailed to: (Comments mailed must be postmarked not later than May 31, 2005; comments e-mailed must be received not later than May 31, 2005)

200001094

U.S. Army Corps of Engineers
Seattle District, Regulatory Branch
Post Office Box 3755
Seattle, Washington 98124-3755
ATTN: CENWS-OD-RG, Olivia Romano, Project Manager

ERRATUM: This erratum adds Section 404 of the Clean Water Act authority for the proposed placement of clean pea gravel or sand in any depressions or holes caused by the removal of 228 timber piles. The placement of clean pea gravel or sand is a conservation measure provided by the applicant as part of the Endangered Species Act Section 7 consultation.

and proposed listing of critical habitat for Pacific salmon species and bull trout, the U.S. Army Corps of Engineers will evaluate the potential impacts to killer whales and critical habitat for Pacific salmon and bull trout.

The above information was not presented in the Public Notice dated December 13, 2004.

The proposed discharge will be evaluated for compliance with guidelines promulgated by the Environmental Protection Agency under authority of Section 404 (b) (1) of the Clean Water Act. These guidelines require an alternatives analysis for any proposed discharge of dredged or fill material into waters of the United States.

All other information shown on Public Notice No. 200001094 remains unchanged.