

National Park Service
U.S. Department of the Interior

Submerged Resources Center



Yellowstone National Park

Submerged Resources Survey



James E. Bradford, Matthew A. Russell,
Larry E. Murphy and Timothy G. Smith

YELLOWSTONE NATIONAL PARK

a product of the

NATIONAL PARK SERVICE

SYSTEMWIDE ARCHEOLOGICAL INVENTORY PROGRAM



YELLOWSTONE NATIONAL PARK

Submerged Resources Survey

James E. Bradford
Archeologist

Matthew A. Russell
Archeologist

Larry E. Murphy
Archeologist

Timothy G. Smith
GPS Coordinator

Submerged Resources Center
Professional Reports
Number 16

Cultural Resources Management
Professional Paper
Number 65

Submerged Resources Center
Intermountain Region
National Park Service

Santa Fe, New Mexico
2003

Submerged Resources Center
Cultural Resources Management
Intermountain Region
National **Park** Service
US Department of the Interior

TABLE OF CONTENTS

LIST OF FIGURES	ix
FOREWORD	xiii
ACKNOWLEDGEMENTS	xv
PART I: REMOTE SENSING SURVEY	1
Matthew A. Russell, Larry E. Murphy and Timothy G. Smith	
INTRODUCTION	2
PROBLEM STATEMENT	3
SURVEY DESIGN AND RATIONALE	4
Geographic Information Systems (GIS)	5
GIS Data Archiving	6
Survey Blocks and Sample Intervals	6
Positioning	6
SURVEY INSTRUMENTATION	7
Positioning	8
RoxAnn Bottom Classification Device	8
Depth Sounder	9
Side Scan Sonar	9
Magnetometer	10
SURVEY METHODOLOGY	10
Objectives	10
Digitizing	10
Survey Planning	12
Survey Positioning	12
RoxAnn Survey	13
Side Scan Sonar Survey	14
Magnetometer Survey	15
SURVEY OPERATIONS	15
Geodetic Positioning	15
Hydrographic Survey	16
ROXANN TRAINING SITES	17
RoxAnn Bottom Type Classifications	17
RoxAnn Classification Boxes	19

SURVEY RESULTS	22
RoxAnn Survey	22
Side Scan Sonar Survey	23
Depth Sounder	23
CONCLUSIONS AND RECOMMENDATIONS	23
PART II: CULTURAL RESOURCES INVESTIGATIONS	45
James E. Bradford and Matthew A. Russell	
1 INTRODUCTION	46
2 ENVIRONMENTAL CONTEXT	49
Geology	49
Volcanism	49
Glaciation	52
Climate	53
Biology	53
Flora and Fauna	54
3 HISTORICAL CONTEXT	57
Brief History of Yellowstone National Park	58
Yellowstone Lake Use	61
American Indian Lake Use	61
Euro-american Lake Use	63
4 PREVIOUS ARCHEOLOGICAL WORK	85
Fishing Bridge/Mary Bay	85
Lake/Bridge Bay	87
West Thumb	87
Southeast Arm	88
1995 SCRU Reconnaissance	88
5 SURVEY RESULTS	91
Frank Island	91
Dot Island	93
Pumice Point	94
Little Thumb Creek	94
West Thumb Geyer Basin	94
Lake Boat Docks	100
Small Craft	103
<i>Zillah</i> and <i>Jean D</i>	108
<i>E. C. Waters</i>	108

	Hull Remains	117
	Propulsion System and Related Features	126
	Disarticulated Machinery and Other Features	132
	Analysis and Discussion	140
6	CONCLUSIONS AND RECOMMENDATIONS	145
	Recommendations	146
	Management	146
	Future Research	147
	REFERENCES	149

LIST OF FIGURES

PART I

1.	Planned survey blocks and side scan sonar coverage	11
2.	Category 1: Cobble and rubble with sand	18
3.	Category 2: Rubble and sand on hard bottom.....	18
4.	Category 3: Mud and fine sand	21
5.	Category 5: Dispersed rubble with sand	21
6.	Category 7: Sand with dispersed rubble	?
7.	RoxAnn boxes generated during the YELL Submerged Resources Survey, August 1996	21
8.	Raw RoxAnn data, survey block YELL001	25
9.	Raw RoxAnn data, survey block YELL005	27
10.	Raw RoxAnn data, survey block YELL006	29
11.	Raw RoxAnn data, survey blocks YELL009 and 010	31
12.	Sonograph of single small boat located offshore Lake Hotel	33
13.	Sonograph of two small boats located offshore Lake Hotel	33
14.	Three small boats in close proximity offshore Lake Hotel	34
15.	Sonograph of unusual geological feature on lake floor	34
16.	Sonograph of <i>E. C. Waters</i> ' site showing hull features and surrounding bottom areas	35
17.	Sonograph of West Thumb dock supports (cribbing)	36
18.	Two-meter bathymetric contours, survey block YELL001	37
19.	Two-meter bathymetric contours, survey block YELL005	39
20.	Two-meter bathymetric contours, survey block YELL006	41
21.	Two-meter bathymetric contours, survey blocks YELL009 and 010 ...	42

PART II

1.1	Yellowstone National Park	47
2.1	Major geological features in Yellowstone National Park	50
3.1	Anna, the first boat launched on Yellowstone Lake	65
3.2	Zillah, possibly at West Thumb, after 1889	68
3.3	Zillah, about 1896	69
3.4	<i>Zillah</i> at Lake dock, 1896	69
3.5	<i>Zillah</i> at Lake dock	70
3.6	Postcard photograph of <i>E. C. Waters</i> at Lake dock, about 1905	73
3.7	<i>E. C. Waters</i> ' anchor at Lake dock in 1961	74
3.8	Jean <i>D</i> , about 1910	75
3.9	Jean <i>D</i> , about 1912	75
3.10	Jean <i>D</i> , about 1910	76
3.11	Jean <i>D</i> and Zillah on shore at Lake, about 1922	76
3.12	Rental boats at Lake	77
3.13	Passenger launch at Lake, September 1934	77

3.14	Gas-powered launches at West Thumb	79
3.15	Gas-powered launch at West Thumb	79
3.16	US Fisheries vessel, 1930s	80
3.17	NPS speedboat at Lake dock, about 1915	80
3.18	NPS speedboat, October 1938	81
3.19	Eleven-passenger speedboat Adelaide postcard during the 1920s	81
3.20	NPS 28-foot Chris Craft, 1930s	82
3.21	Deckhouse cruiser NPS No. 2 at Lake dock, 1938	82
3.22	Deckhouse cruiser NPS No. 1 on Yellowstone Lake	83
3.23	Former US Coast Guard lifeboat Arena Cove on marine railway at Lake, 1936	83
3.24	Arena Cove being launched at Lake boathouse, 1936	84
4.1	Yellowstone Lake	86
5.1	Areas and sites investigated by SCRUI in 1996	92
5.2	Frank Island boat dock, about 1950	93
5.3	Algae covered dock crib at West Thumb	95
5.4	Wagon wheel at West Thumb	96
5.5	Close-up of West Thumb wagon wheel	97
5.6	<i>Jean D</i> docked at West Thumb	97
5.7	Plan view site map of West Thumb dock cribs	98
5.8	West Thumb dock crib	99
5.9	West Thumb dock	100
5.10	<i>Zillah</i> docked at West Thumb, about 1900	101
5.11	<i>E. C. Waters</i> at the Lake dock, about 1905	101
5.12	Lake dock rental boats	102
5.13	Lake boathouse	102
5.14	Small launch off Lake Hotel	104
5.15	Hotel launch stern	104
5.16	Field sketch of four small rental boats off Lake Hotel	105
5.17	Small boat bow	106
5.18	Small boat bow	106
5.19	Small boat stern	107
5.20	Small boat stern	107
5.21	Yellowstone Park Company rental boat #78	109
5.22	Yellowstone Park Company rental boat #78	109
5.23	<i>Zillah</i> at the Lake dock, 1889	110
5.24	<i>Jean D</i> docked, probably at West Thumb, about 1910	110
5.25	View southeast of <i>E. C. Waters</i> ' remains on Stevenson Island's eastern shore	111
5.26	View northeast of <i>E. C. Waters</i> remains	111
5.27	Plan view of <i>E. C. Waters</i> ' site (48YE13)	113
5.28	Plan view of <i>E. C. Waters</i> hull remains	115
5.29	<i>E. C. Waters</i> ' frames. View aft of paired frames with butt joints in the wreck's forward port section	118

5.30	Different styles of framing a wooden vessel	120
5.31	Plan and elevation of engine bed and thrust bearing showing additional frames to support engine weight	123
5.32	Side and end views of boiler saddle	127
5.33	Boiler saddle	127
5.34.	View west of <i>E. C. Waters</i> ' propulsion system	128
5.35	Starboard side of thrust bearing	128
5.36	Plan, elevation and end view of forward propeller shaft bearing	130
5.37	Top view of propeller shaft bearing	131
5.38	View southeast of after bulkhead stuffing box and gland, and propeller shaft coupling	131
5.39	View southwest of forward end of stern tube stuffing box and gland	132
5.40	Plan, starboard elevation, fore and aft views of adjustable stem bearing assembly ...	133
5.41	View north, starboard side of adjustable stern bearing assembly and propeller	134
5.42	View northeast of propeller	134
5.43	Plan view and aft elevation of the globe valve with intake pipes	135
5.44	View aft along port midships showing feed water intake piping and globe valve	136
5.45	Close-up view of globe valve	136
5.46	Scale drawing of <i>E. C. Waters</i> capstan	137
5.47	Partially buried capstan	137
5.48	Scale drawing of life boat davit and support bracket	138
5.49	Davit and support bracket within <i>E. C. Waters</i> ' wreckage	139
5.50	Metal rod handle wedged between frames on the port side turn of the bilge	139
5.51	Plan and profile views of flat metal plate, "V"-shaped brace and boat davit brace.....	141
5.52	Iron or steel strap near <i>E. C. Waters</i> stem	142
5.53	Thick glass fragments between <i>E. C. Waters</i> frames	142

FOREWORD

It is surprising to most that one of the largest water bodies in National Park Service (NPS) jurisdiction is in Wyoming, in Yellowstone National Park (YELL). Those most familiar with parks on the Atlantic, Pacific and Gulf of Mexico coasts are often astonished to learn Yellowstone Lake encompasses a water surface rivaling Biscayne National Park and larger than that of Dry Tortugas National Park. Yellowstone Lake is not just large — it is deep. Average Yellowstone Lake depths exceed all other NPS areas, with the possible exception of Lake Superior's Isle Royale National Park.

Beyond physical dimensions, NPS Submerged Resources Center (SRC, formerly Submerged Cultural Resource Unit or SCRUC) divers were greeted by geological features unique to YELL and remarkable vestiges of human occupation that stretch from prehistory through the stagecoach era to steam-powered tour boats. Underwater, we observed hot springs emerging in the lake and, with side-scan sonar, strange mineral formations resembling volcano cones and tall, thin spires rising high from the lakebed. The long procession of human visitors to this extraordinary landscape is well represented by material remains in and around the lake. We recorded many submerged structures and small boats and documented a well-preserved tour boat. These archeological features are material evidence of adaptations developed to address the challenges of navigating this large, isolated, high mountain lake and material remains of America's diverse and long-standing involvement with this park. The body of water upon which watercraft operate influences their design, and we are among the few to have the opportunity to investigate rare mountain lake vessels of the West.

Initially, park managers contacted SRC regarding natural resource issues arising from exotic lake trout introduction and visitor use issues surrounding the growth of YELL as a destination for sport divers. Several team members made a reconnaissance visit in 1995, which formed the basis for the park's request for a field operation devoted to both sets of issues in 1996.

The project reported here represents an approach to park-based research that is unusual to the normal divisions of labor in our agency. Ordinarily, NPS projects are either natural or cultural, each approached with separate lines of inquiry with different methodologies. Effective submerged cultural resources investigation and management requires consideration and incorporation of natural resources in a multidisciplinary approach. Natural resource investigation is core to all SRC research, whether to characterize archeological site formation processes or environmental context. In some instances, park management has requested SRC to conduct submerged natural resource investigations. In these cases, we combine cultural-oriented research to the extent practical. This approach, which utilizes a single team and mobilization, is effective and cost-efficient, as demonstrated here. SRC projects are often designed to serve as models and to test and refine methodology to accommodate NPS' particular needs. The Yellowstone Lake project demonstrated benefits to be gained from seabed classification applied to lake biology, which the park has pursued.

This *Yellowstone National Park Submerged Resources Study* is an example of combined natural and cultural resource approach to Yellowstone Lake research. In consultation with park staff, System-wide Archeological Inventory

Program (SAIP) funds from SRC were combined with park natural resource funds to accomplish this project. The 1996 fieldwork generated most of the information reported here. Part One of the report discusses hydrographic survey and remote sensing operations aimed at simultaneously generating data for delineating surficial lake-bed classifications in areas park biologists deemed important to determining lake trout habitat and obtaining high-resolution side scan sonar coverage of selected cultural and natural features in the lake. Part Two is a comprehensive discussion of the submerged cultural resources of Yellowstone Lake that places human activities in and around the lake in the context of regional prehistory and history.

Although this report is the finished document required of NPS research, other project results with immediate relevance to ongoing management concerns were forwarded to the park within three months of fieldwork completion. Deliverables included all processed survey data for inclusion into the YELL GIS database so as to be immediately available to fisheries biologists. At the park's request, we conducted a survey to establish coordinates for their park's GPS base station, which was completed during the fieldwork. This was provided at no cost to the park and represents the efficiency of combining multiple tasks. A draft report was forwarded to the park for review in March 1997. Personnel attrition, reduced

funding and other field obligations delayed printing the final report. We acknowledge and appreciate the patience and continuing support of Sue Consolo-Murphy, Laura Joss, John Varley, John Lounsbury and Ann Johnson while bringing this report to press.

Partly in association with the work at YELL, SRC conducted an assessment of submerged cultural resources at Glacier National Park, Yellowstone's northern cousin (another example of combining tasks to minimize costs). Perhaps the most important observation we made during our involvement in these two magnificent parks is that submerged resources are all too easy to ignore when there is such scenic magnificence and pressing visitation problems that confront managers every day on land. Both parks have wonders that extend beneath the surface into realms that are often out of sight and out of mind. We commend the resource managers and rangers of Yellowstone for having the vision to begin addressing submerged resource issues proactively as concerns rather than waiting until, through some unfortunate circumstance, they become crises.

Larry E. Murphy, Chief
Submerged Resources Center

ACKNOWLEDGEMENTS

Many people contributed to the success of the Yellowstone National Park (YELL) Submerged Resources Survey. The park staffs foresight in dealing with submerged cultural resources on equal footing with terrestrial cultural resources made this project possible. Superintendent Michael Finley; Chief Ranger Rick Obernesser; Dr. John Varley, Director, Yellowstone Center for Resources; Laura Joss, Chief, Branch of Cultural Resources; and Lake District Ranger John Lounsbury all played key roles in project planning and execution and supporting an innovative, cost-effective approach to combining natural and cultural resource survey and evaluation that may serve as a model for other areas. YELL Dive Officer Wesley Miles and Rangers Rick Fey and Gary Nelson worked with us on a daily basis and were crucial in providing logistical support. Fisheries biologists and natural resource specialists Dan Mahoney, Jack McIntyre and James Ruzycki were integral in planning the RoxAnn survey. In particular, James Ruzycki came out on the survey boat when we collected RoxAnn training sites for lakebed sediments and identified primary RoxAnn lakebed classifications of primary biological interest. Geographic Information System (GIS) Specialist Eric Compas worked closely with National Park Service (NPS) Global Positioning System (GPS) Coordinator Tim Smith integrating SCRUI's data with the YELL GIS database. Cultural resources staff members particularly helpful with archival research include: Supervisory Museum Curator Susan Kraft, Lead Museum Technician Vanessa Christopher, Museum Aide Linnaea Despain and Historian/

Archivist Lee Whittlesey. Retired park historian Aubrey Haines provided much insight into Yellowstone Lake's maritime history and particularly regarding lake tour boat *Zillah*. Other park staff and volunteers who worked with us on the project include: Travis Wyman, Bill Archer, Bob Ryan, and Frank and Beverly Ford. In addition, Midwest Archeological Center Archeologist Ann Vawser provided background on archeological work conducted in the park and a draft manuscript was reviewed by YELL Archeologist Ann Johnson, Scott Harris and Dan Lenihan.

Many specialists and volunteers contributed directly to the project. Marty Wilcox of Marine Sonic Technology, Ltd. generously donated use of a side scan sonar and operator. We thank him for making the side scan sonar survey possible. Ian Ablett, steam engineering consultant; Stan Liddiard, marine surveyor; and VIPs Greg and Linda LaLonde helped with analysis of the *E. C. Waters* site. Field personnel included: Principal Investigators Dan Lenihan and Larry Murphy, Field Director Matt Russell, Archeologist Jim Bradford, Photographer Brett Seymour and NPS GPS Coordinator Tim Smith.

This publication would not have been possible without the active support of IMR Regional Director Karen Wade, Deputy Director Mike Snyder and Support Office Superintendent Hal Grovert on the regional level and Sue Consolo Murphy at Yellowstone National Park.

Finally, we thank SCRUI Visual Information Specialist Fran Day, who corrected and revised the manuscript and designed and produced the final publication during a time when reduced staff greatly increased her workload.

PART I

REMOTE SENSING SURVEY

by

Matthew A. Russell
Larry E. Murphy
and
Timothy G. Smith

PART I

Remote Sensing Survey

INTRODUCTION

During August 1996, the National Park Service's (NPS) Submerged Cultural Resources Unit (SCRU) conducted a multiresource remote-sensing survey in Yellowstone Lake, Yellowstone National Park (YELL). This survey was initiated through discussions among Dan Lenihan, Program Manager, SCRU; John Lounsbury, Lake District Ranger, YELL; Laura Joss, Chief of Cultural Resources, YELL; and John Varley, Director, Yellowstone Center for Resources during a 1995 reconnaissance visit to the park by Lenihan and others.

The general strategy was to apply methodology developed by SCRU for marine resource hydrographic survey to specific management issues at Yellowstone Lake. The first submerged resources surveys designed specifically for Geographic Information System (GIS) applications were conducted several years earlier by SCRU in areas of the National Park System in Florida. The Dry Tortugas National Park Survey, begun in 1993, was funded through the Systemwide Archeological Inventory Program (SAIP) to generate an NPS model for

underwater remote-sensing of cultural resources. The Biscayne National Park Survey, funded through post-Hurricane Andrew mitigation funds, focused on natural resources and seabed classification but included cultural resources survey. Methodology developed for these two projects was to be tested during the Yellowstone National Park Submerged Resources Survey.

SCRU methodology was designed to produce high-resolution, concurrent data on both natural and cultural resources as a cost-efficient approach to survey and inventory of marine park areas. Basic methodology incorporates a Differential Global Positioning System (DGPS) to position digital data derived from remote sensing instruments for addition to the park GIS database. GIS data sets are cumulative, integrated, comparative and readily accessible. This technology provides the infrastructure for data collection, storage, manipulation and presentation necessary for long-term park management and research applications. Yellowstone Lake management concerns provided a test case for the SCRU survey system in a freshwater environment with

a priority focus on natural resource issues. Specific methodological refinements were made for the YELL Submerged Resources Survey to address particular management problems and are discussed below.

Information gathered by Lenihan in 1995 indicated a high potential for historically significant submerged cultural remains in some areas of Yellowstone Lake (Lenihan 1996). Cultural resources remote-sensing survey planning for the 1996 survey was directed toward locating exposed cultural materials and documenting known sites. Site documentation utilized minimum-impact techniques; no test excavation, artifact collection or site disturbance of any kind was planned. Additional historical research was conducted to refine site location models and enhance interpretative uses of field data. Principal study areas included: West Thumb dock area, where activity took place between 1890 and 1960; Lake Hotel dock area, where depositional activity and small watercraft use may have left cultural materials and which was also the primary search area for the passenger steamer *Zillah*; Pumice Point, where divers have reported wagon and stagecoach parts; Frank Island dock area; Dot Island dock area; and Stevenson Island, particularly the grounded vessel *E. C. Waters* site area. SCRU was granted a *Special Use Collecting and Research Permit* June 24, 1996, for the project titled: Underwater Investigations of Selected Localities in Yellowstone Lake.

Natural resource issues focused on lake bed surficial sediment classification to locate and map substrate that might include lake trout spawning habitat. Although primary lake trout spawning substrate has been identified for the Great Lakes, there is currently no corollary model for Yellowstone Lake. To date, lake trout biological data for Yellowstone Lake depends upon shore-based gill net capture numbers and sport fishermen capture reports.

Exotic lake trout control is critical to continued viability of native trout species in Yellowstone Lake. Currently, control consists of gill net capture and evaluation of lake trout. Based upon gill net results, certain shorelines were identified by YELL natural resource specialists as productive lake trout areas, with no assumption of relation between gill net production and breeding habitat. Primary among productive gill net areas were the West Thumb north shore and the "Neck" area between West Thumb and the main lake. The Neck area was specified as the first priority for lake bed classification, with West Thumb second.

Past work utilizing remote sensing (side scan sonar), remotely operated vehicles (ROVs) equipped with video, and submarines has successfully demonstrated potential of these approaches for determining ideal lake trout breeding substrate in Great Lakes areas (Manny and Edsall 1989; Edsall, Brown, Kennedy and Poe 1992; Edsall, Brown, Kennedy and French 1992; Edsall et al. 1995). SCRU has experience with another surficial sediment classification device, RoxAnn, which has recently been used for marine seabed classification in NPS areas, particularly Biscayne National Park (Murphy et al. 1995). The RoxAnn device would be the principal remote sensing instrument for this experimental Yellowstone Lake natural resource application, and its efficacy would be evaluated.

PROBLEM STATEMENT

1. Natural Resources: Exotic lake trout introduced into Yellowstone Lake compromise viability of native trout species. Identification and delineation of optimum lake trout breeding substrate could increase control method effectiveness. Primary objective was to develop an appropriate survey methodology and conduct a lake bed classification survey to

ascertain lake bed sediments, and in particular, presence of potential lake trout breeding substrate in the priority areas delineated by natural resource specialists based on gill net capture numbers.

2. Cultural Resources: Historical documents indicate several long-term activities directly associated with Yellowstone Lake. Submerged components of these activities have not been investigated, and their extent and significance level is currently unknown to managers. A secondary objective was to delineate high-priority areas based upon historical documents, oral histories and diver reports, and to conduct a remote sensing survey designed to locate cultural materials on or above the lake bed.

SURVEY DESIGN AND RATIONALE

For the natural resources survey, the general investigative approach was to systematically survey specific areas for lake trout habitat using RoxAnn, depth sounder and positioning system to generate water depth and bottom classification data and to develop signatures for specific bottom-type classifications for use in post-processing analysis. Because no excavation was anticipated, cultural resource survey would utilize positioned side scan sonar survey of high probability areas for shipwrecks, small watercraft and discarded materials lying exposed on the lake bed. A proton-precession magnetometer would be tested to determine effectiveness in a volcanic environment. The stranded and wrecked passenger steamer *E. C. Waters* on Stevenson Island would be documented and surrounding area surveyed for related materials. Planned products included digital and analog information appropriate for park GIS applications, research and interpretation. Maps of the survey area were delivered to the park soon after completion of the fieldwork and before report completion.

SCRU designed the YELL survey to produce a comprehensive data set that would be accessible to YELL managers for planning and interpretation. The survey design was based upon wide-area archeological survey methodology developed by SCRUC during the NPS SAIP survey of Dry Tortugas National Park beginning in 1993 (Murphy 1997a; Murphy and Smith 1995; Shope et al. 1995).

Data collection, post-plotting, analysis and presentation were designed to be utilized in a GIS database to facilitate their use by managers and incorporation into permanent archives. This approach results in an electronic product that can incorporate available digital data, such as aerial imagery and digitized historical maps, so they can be combined with project-specific results and be analytically manipulated to examine relationships that would otherwise be extremely difficult to observe. The project GIS data set was generated to provide a standardized, permanent, cumulative, computer-accessible product for multiple applications by managers, interpreters, researchers, the public and those involved in planning and conducting future submerged resource operations within the park.

This survey approach, which combines natural and cultural resource survey, reduces overall park costs for resource evaluation. NPS equipment was deployed, so no equipment rental or procurement was necessary. Because NPS does not possess a side scan sonar, a cooperative partnership was established with Marine Sonic Technology, Ltd. of White Marsh, Virginia, manufacturers of a high-resolution, PC-based, digital side scan sonar that easily interfaces with SCRUC equipment. Marine Sonic provided a state-of-the-art instrument and operator for this survey at no cost to the park.

GEOGRAPHIC INFORMATION SYSTEM (GIS)

GIS is the use of multiple, spatially referenced databases to produce maps that graphically depict user generated combinations of variables presented as themes, layers or coverages. Spatially referenced data are basic to archeological inquiry, but it has only been in the last few years that technological advances in software and hardware have overcome difficulties in collecting, collating, storing, editing, querying, depicting and manipulating the large amount of data generated by marine remote sensing survey. YELL Submerged Resources Survey results were formulated to be incorporated into a GIS product easily transferrable to park managers.

GIS provides a methodology to compare variables among many sets of spatial data, such as artifact categories, remote sensing results and natural environmental characterizations, to examine distribution and change over space, and, if sufficient data are available, over time. Rapid manipulation of scale and variables can allow pattern recognition that may not be apparent at other levels. Examination of combined variables is instantaneous because they are presented graphically, greatly simplifying analysis by precluding the necessity of generating mathematical and statistical models to characterize patterned relationships. Current computer and software speed allow rapid manipulation of multiple variable combinations, which allows generation of associations and relationships that might otherwise be unanticipated. Hypotheses can be quickly generated and tested through seamless graphical display. Data manipulation can easily be done by researchers or managers with basic GIS software familiarity, which does not require sophisticated mathematical ability.

GIS data sets can be presented as tabular database files or themes that can be generated, analyzed, scaled, combined, superimposed and displayed through direct user access in unlimited variations. Data themes are presentations of nonspatial data referenced to a common location expressed as geographic coordinates. One way of looking at themes is to consider them x - y horizontal locations that share a category of variable z values, which represent discrete, quantifiable attributes. Analytical techniques include statistical and spatial analysis, measurement and comparisons that can be used to create additional themes reflecting analytical results useful for additional hypothesis testing.

GIS can be contrasted with computer-assisted design (CAD) systems that are generally limited to graphic output such as drawings, pictures and maps, and contain no relational database capability nor the ability to generate new data sets based upon analytic functions. CAD systems generally contain no interrogative capability and are unable to manipulate *nonspatial* database attributes (see Murphy 1997b).

Two problems make creation of GIS data sets expensive and time consuming: accuracy determination and conversion of various data sets to an appropriate format. Mixing different accuracy levels among data sets degrades overall GIS accuracy and gives a false sense of comparability that can lead to serious analytical problems in data interpretation. Data set conversions must consider fundamental geodetic concepts such as geoid, ellipsoid, datum, coordinate system and projection. Geodesy factors vary over time and space, and each variation is critical to conversion accuracy (Smith 1997). Few archeologists record a chart's datum and projection when generating coordinates. For example, latitude/longitude

coordinates in North American Datum 1927 (NAD 27) and those in World Geodetic System 1984 (WGS 84) can vary from tens to hundreds of meters—confusing these datums introduces serious error. Being given coordinates in NAD 27 and trying to relocate the point with an instrument reading in WGS 84 is an easy and common mistake to make. All data generated during the YELL Submerged Resources Survey were based on the WGS 84 datum. Other data not collected by SCRUC during the project and not already in WGS 84 datum were converted from their original datum before incorporation into the YELL survey GIS database.

GIS DATA ARCHIVING

Raw and processed hydrographic survey field data and GIS information archiving is as much a concern as any archeological data archiving, and it must be planned in advance. YELL remote sensing survey electronic data archiving is in a nonproprietary format, primarily DOS ASCII text, which ensures long-term data accessibility by many scientific disciplines, managers, archeologists and other researchers. All results are stored in latitude/longitude and Universal Transverse Mercator (UTM), WGS 84. SCRUC stores archive data in latitude/longitude coordinates so that the database can be easily converted if future alterations or corrections are made to WGS 84; it is more difficult to convert grid coordinates after a datum revision. Most current computer programs require grid coordinates, so GIS themes are also archived in this form. Upon report completion, YELL staff will be provided a CD-ROM (some media now have 100-year archival quality) containing all pertinent field data and GIS coverages. This CD-ROM will be directly accessible through ArcView, a readily available PC-based GIS program that is the current NPS standard.

SURVEY BLOCKS AND SAMPLE INTERVALS

Hydrographic survey is conducted in area blocks through which the survey vessel travels along preplotted transects, or lanes, at investigator-defined intervals selected to ensure complete instrumental coverage of the study area. Lane spacing depends upon the survey questions and remote sensing instrument attributes. The YELL survey was conducted with a preplotted block to maximize remote sensing coverage. Standard SCRUC practice is to label survey blocks with the four-letter park acronym followed by a numerical designation, such as “YELL001.”

Standard SCRUC methodology for wide area survey requires 30-m transects, which have been demonstrated to provide cost-effective magnetic coverage for discovering most colonial period shipwrecks (Murphy 1984:90–95; Murphy and Saltus 1990:93–95). Because magnetometry was not the primary survey objective, however, the survey blocks designed for RoxAnn and bathymetric survey (YELL001–010) were created with first 20-m, and later 40-m transects (see discussion below). Side scan sonar can produce high-resolution imagery in 100-m swaths, so the side scan portion of the survey was run on 100-m transects.

GPS provides a position every second, and all instrument data were collected at intervals of 1% seconds or less and collated with the appropriate DGPS position. At a typical boat speed of 6 knots, a sample is collected about every 4–6 m along the transect.

POSITIONING

Hydrographic survey requires real-time positions with very rapid updates (1–2 seconds) for accurate vessel navigation to ensure complete, systematic coverage at the desired

sample interval. GIS accuracy requirements are a 2–3 m circle-of-error or less. Unlike terrestrial archeological survey and mapping, hydrographic survey usually has no landmarks; simply, on the water, it is very difficult to occupy and then reoccupy the same point and to continually know where you are without real-time positioning.

Accuracy is usually expressed as parts-per-unit (e.g., 1:10,000); plottable accuracy, the accuracy that a point can be plotted, less important now because of GIS digital entry and zoom capability; or circle of error, which is an ellipse whose largest radius represents the root mean square error of a set of measurements, and whose orientation shows directional uncertainty. The ellipse, centered on the true position, is typically at the 95% statistical confidence level.

Although several positioning systems are presently available, GPS offers several advantages over most others. GPS has become the state-of-the-art and will likely ultimately replace other systems for survey applications. The US Department of Defense (DOD) developed the GPS system for military purposes. This system uses trilateration of satellite-transmitted signals to determine position. GPS provides 1-second updates with global coverage from 24 satellites, meaning four or more space vehicles are continuously in view anywhere on the globe. The satellites produce two signals, known as C/A code and P code frequency, the latter encrypted and available only to military or government users. The GPS is close to an ideal positioning system; it is accurate and continuously available on demand anywhere in the world under any weather conditions.

The GPS and GIS combination has provided a solution for accurate positioning and analysis in hydrographic remote sensing. However, some additions to the basic GPS system are necessary to achieve acceptable accuracy levels.

Autonomous civilian GPS receivers produce circles-of-error of about 10–30 m. Unfortunately, GPS instrumental accuracy is further reduced by “selective availability” (SA), which is intentional, random dithering of the C/A code GPS signals by DOD as a security measure that degrades the signal to a guaranteed accuracy of no more than 100m. However, real-time accuracy of 2–3 m is possible by deploying a base station to compensate for SA through differential GPS (DGPS) correction. Ionospheric variables alter the satellite signal propagation times through the atmosphere and are an additional error source, which are also correctable with a differential base station. The base station, which is set up on a control point whose position is known to a very high accuracy, generates corrections for SA and transmits them via a radio modem datalink to the mobile survey instrument. Broadcast differential corrections are currently available in most coastal areas through the US Coast Guard navigational beacons and commercial suppliers, which provide differential corrections at various accuracy levels. Because correction services were not available in the study area, the YELL survey utilized SCRUs’ proprietary, self-contained base station

SURVEY INSTRUMENTATION

SCRUs’ GPS-based Archeological Data Acquisition Platform (ADAP) survey system, built in 1992 by Sandia Research Corporation of Albuquerque, New Mexico, to SCRUs specifications, was used during the YELL Submerged Resources Survey. The ADAP system automates and integrates field data collected with a variety of remote sensing instruments, and accurately tags each data point with real-time differential GPS position and time references (Shope et al. 1995; Murphy and Smith 1995). Generating survey blocks, navigating preplotted lanes, and collecting and

post-processing data were done with Coastal Oceanographic's "Hypack" hydrographic survey software. This program time tags and collates incoming multiple sensor data for post-processing into standard database formats. Standardized post-processed data are easily incorporated into a PC-based GIS, in this case, ESRI's ArcView, which YELL also uses. Consultation with Eric Compas, YELL GIS coordinator, ensured data compatibility between the SCRU data sets and park GIS.

POSITIONING

Accurate, real-time vessel positioning is fundamental to systematic hydrographic survey. The YELL Submerged Resources Survey relied upon GPS for geodetic survey, vessel positioning during survey, target relocation and shore survey.

Geodetic survey during the project used two Trimble Navigation 4000SE geodetic receivers. Positioning aboard the survey vessel relied on a Trimble Accutime II GPS receiver and VHF radio datalink. Differential corrections were provided to the survey vessel by SCRU's self-contained, shore-based GPS base station, which uses a Trimble 4000SE geodetic receiver and VHF radio datalink to generate and transmit a data stream of real-time RTCM-104 differential corrections. This base station allows independent differential correction generation for remote park areas, which makes SCRU's ADAP system completely self-contained. The ADAP base station supplied Yellowstone Lake survey corrections sufficient for a 1–2-m-circle-of-error at 95% confidence, required for SCRU survey parameters developed for GIS applications.

ROXANN BOTTOM CLASSIFICATION DEVICE

The basic natural resource survey sensor is RoxAnn, manufactured by Marine Micro Systems of Aberdeen, Scotland. RoxAnn, basically a hydroacoustic "black box" with no user-manipulated controls, is easily deployed and adaptable to various survey systems (see discussion in Murphy et al. 1995). The model used for the YELL survey is called a "Groundmaster," which incorporates a depth sounder and is designed to give absolute, rather than relative, numerical bottom characterizations. These characterizations, based on comparative analysis of multiple depth-sounder returns, give two numerical values for surficial sediment roughness and hardness, called E1 and E2 values. Bottom sediments can be characterized and differentiated by these two values, and subtle changes in bottom types can be reliably detected by RoxAnn.

The demonstrated strength of the RoxAnn device is that it produces unambiguous, nonintrusive, reproducible sediment classifications. The instrument derives its information from the first and second echo reflections from a single-beam depth sounder. An index, E1, is derived from the initial bottom reflection and its characteristics are related to sediment roughness. The second index, E2, is produced by the second echo, which is reflected twice from the bottom and once from the water surface, and its characteristics are related to sediment hardness.

Every surficial sediment has a particular signature that is a combination of the two variables E1 and E2, which are displayed as x-

y coordinates on a Cartesian grid (see Figure 7). The range of x - y coordinates for a bottom type are represented as a “RoxAnn square or box,” to which a user-selected color is attributed by the survey software. The RoxAnn boxes can be adjusted for specific bottom types whose presence is indicated in the raw data by the color pixel representing each unique bottom type. In post-plotting, the color pixel is plotted in its geographic location and combined with others to form GIS thematic layers. Polygons depicting geographic extension of bottom types, as defined by similar colored pixels, can be hand drawn or produced through various GIS analytical procedures. These multiple polygons are displayed as a map or thematic layer in a large-scale GIS to provide bottom classification information on lake bed bottom types.

DEPTH SOUNDER

Bathymetric information was collected using a Furuno Model LS-6000 LCD Video Sounder, which is integrated into the RoxAnn “Groundmaster” bottom classification device. Sounding area, and consequently bottom sample area for RoxAnn lake bed classification, is a function of transducer beam width, which is generally a function of frequency. Usually, the higher the frequency, the narrower the beam width. Most depth sounders use a frequency of about 50 khz, which has a beam width of approximately 46° and samples a circular area with a 42-m diameter at a depth of 50 m. The Furuno depth sounder uses a 200 khz transducer, which provides a high-resolution sample area and reduces bubble-derived noise. The 200 khz beam width is about 10° , which provides bottom coverage equal to about 17% of the water depth. For example, the area covered in 50 m of water is a circle with a diameter of 9 m, or an area of 64 m^2 . In shallower depths, the sample area is

reduced accordingly. The RoxAnn reading is basically an average of the area within the depth sounder transducer sample area.

The Furuno video depth sounder supplies the signal source for RoxAnn. The RoxAnn produces a digital depth from the sounder signal that is recorded and collated with position and collected as part of the survey data set at each 1–2-second sample interval.

SIDE SCAN SONAR

Side scan sonar is one of the principal remote sensing instruments used in submerged archeological survey. Side scan sonar uses sound waves to image the sea floor and objects laying on or above it. Normally a towed system, a side scan sonar transmits a microsecond, pulsed and shaped acoustic beam to each side of the tow vessel’s path at multiple times per second. The beam propagates through the water and across the sea floor, reflecting incident sound energy back to the sonar. A sonar data processor converts the reflections’ intensity and time delays to a visual image for display. The end result is a sea floor (or lake bed) image of near photographic quality showing areas of light (strong reflection) and dark (areas of lower reflectivity or shadow areas).

For the YELL Submerged Resources Survey, a Marine Sonic Technology Sea Scan PC Side Scan Sonar was used. The Sea Scan PC is a digital, high-resolution side scan sonar system that uses a Windows-based personal computer for all control, display, analysis and storage functions. The reflected signal is digitized within the sonar data processor and stored as digital information. Digital imagery is preferred because it allows images to be filtered and enhanced for improved analysis and target recognition, and it can be processed into mosaics and incorporated into GIS as an image

layer, much like aerial photography. The digital format facilitates archival data storage and retrieval.

The Sea Scan PC includes an integrated navigational plotter, using standard DGPS input, that allows all parts of the acoustic image to be automatically correlated with correct geographic position. During the YELL survey, a 600-khz towfish was used. Like the depth sounder, the higher the sonar signal frequency, the higher its resolution. This instrument was selected for the YELL survey because prior deployment by SCRUI proved it was a reliable instrument that produced very high resolution images in a digital format appropriate for inclusion into a GIS database.

MAGNETOMETER

In addition to side scan sonar, submerged cultural resource surveys are primarily accomplished with a vessel-towed magnetometer, which measures the earth's magnetic field. Some objects, primarily ferrous (iron) materials, distort the earth's magnetic field and show up as anomalies in ambient magnetic readings. The primary anomaly source in hydrographic survey is typically ferrous cultural materials associated with shipwrecks or other submerged archeological sites. The magnetometer's strength is that its readings are generally unaffected by burial; it easily locates buried ferrous cultural materials.

A Geometrics model G-876 proton-precession magnetometer was used as part of SCRUI's ADAP system. The output of this magnetometer is proportional to the total magnetic field intensity and independent of sensor coil orientation. Because data processing is done in-water with a separate, towed computer connected in-line with the sensor, typical noise levels are 0.5–1.0 gammas (nanoteslas) in the earth's field of approximately

50,000 gammas. Current industry standards for proton-precession magnetometers allows ± 3 gammas of noise, a level that SCRUI experience has demonstrated to be too high for discriminating some cultural materials on a cost-effective transect spacing. The G-876 generates a sensor depth and height over bottom, which are displayed during the survey and are important for quality control of data collection and anomaly interpretation. These data are collected and collated with DGPS positions as part of the ADAP data set at each sample position at a rate of less than 2 seconds. Unlike most NPS cultural resource surveys, magnetometer deployment was secondary to side scan sonar during the YELL survey. Only visible remains were to be examined during this project.

SURVEY METHODOLOGY

OBJECTIVES

Survey objectives included several goals: cover specific areas of Yellowstone Lake defined by park natural resource managers with the RoxAnn bottom classification device to identify and delineate lake bed sediments, in particular possible lake trout spawning habitat; survey high probability areas with a side scan sonar to identify submerged cultural resources related to historical use of Yellowstone Lake; characterize lake-bottom surficial sediments concurrently with RoxAnn and the high-resolution side scan sonar for direct comparison to determine the most effective methodology; and test effectiveness of a proton-precession magnetometer in the volcanic geological environment of Yellowstone Lake.

DIGITIZING

As a normal part of survey planning, the most current Yellowstone Lake bathymetric

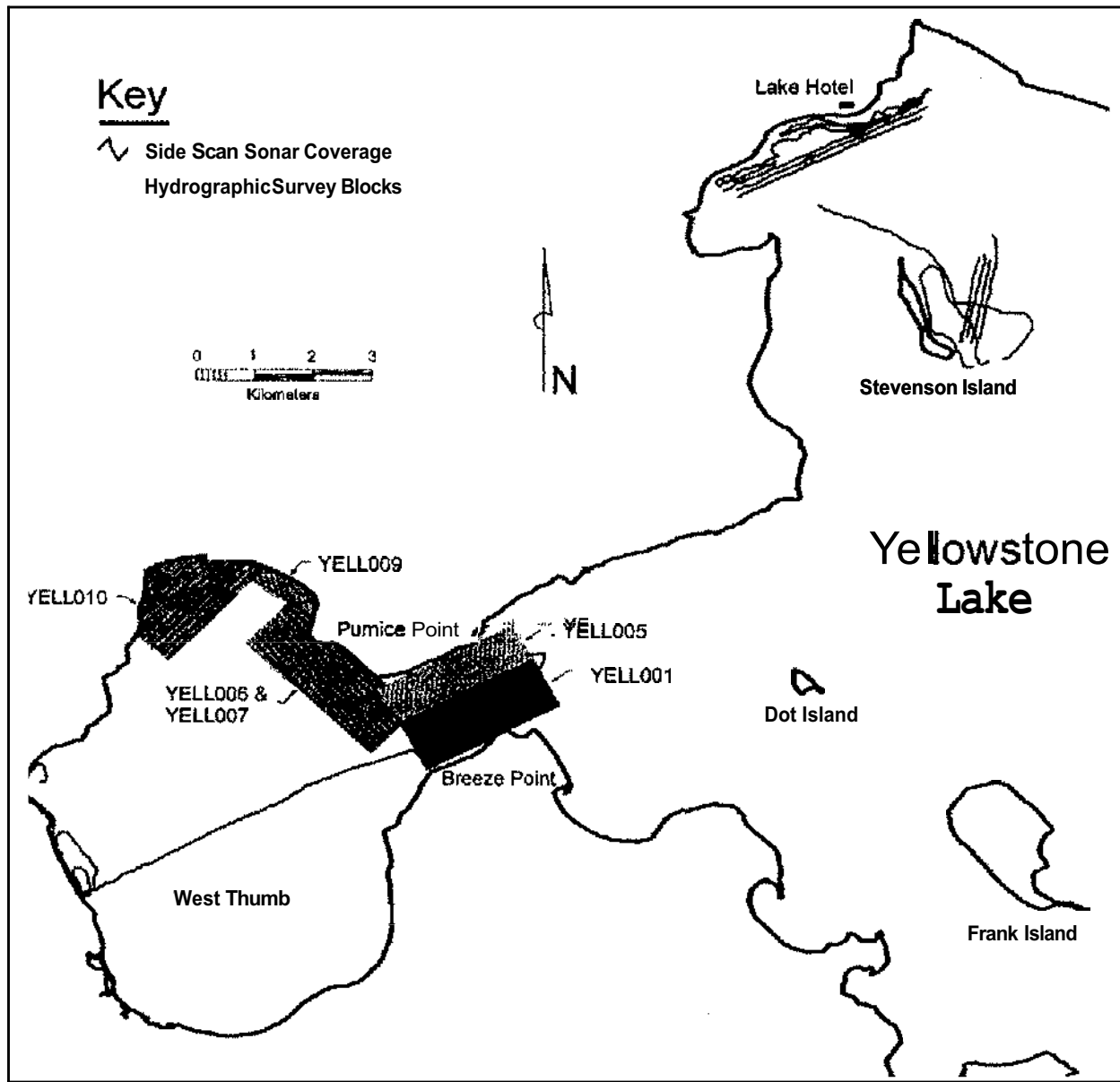

Figure 1. Planned survey blocks and side scan sonar coverage.

chart was digitized for survey design, execution and incorporation into GIS. This chart (and its digitized format) is problematic, however, and should not be used for navigation until corrected through additional high-resolution survey. Chart contours only generally represent bottom features, and the shoreline had to be georectified with very few control points. This chart was

supplied to Eric Compass, YELL GIS coordinator.

During field operations, a brief pedestrian survey was conducted along the lake shore adjacent to surveyed areas to provide positions for correcting the north lake shoreline. Figure 1 incorporates changes made to the original digitized chart to correct shoreline inaccuracies

in the study area, and these corrections have been incorporated into the GIS survey results.

SURVEY PLANNING

Dividing the study area into rectangular-shaped blocks provides an easily controlled and executable methodology to ensure full survey coverage at the desired sample interval. Survey blocks covering lake bed classification areas were established using the digital lake map. These blocks are depicted in Figure 1.

Survey blocks were first laid out in the primary survey area, as defined by YELL natural resource managers. This survey area is based on productive gill net locations, which may not be directly related to spawning loci. There is not yet a model for lake trout spawning loci, but the primary survey area represents an estimate of high lake trout populations by natural resource researchers. The desired survey coverage was in two areas: the restriction between the main lake and West Thumb, known as the "Neck"; and the north part of West Thumb, from Pumice Point to Carrington Island, from the shoreline to a depth of 120 ft. Thermal features, such as in the vicinity of the West Thumb Geyser Basin, were the lowest priority. Six survey blocks were laid out to cover the area specified by park biologists: YELL001, YELL005, YELL006, YELL007, YELL009 and YELL010.

Initial survey transects or lanes in block YELL001 were designed with 20-m lane spacing to evaluate survey interval adequacy for RoxAnn coverage in Yellowstone Lake. These data were post-plotted and discussed with Yellowstone natural resource personnel. Evaluation of survey transects indicated that 40-m lane spacing would be adequate for habitat location purposes and allow maximum coverage of desired target areas.

SURVEY POSITIONING

Positioning was provided by on-board GPS and real-time differential corrections from SCRU's shore-based GPS base station, placed at either the Lake District or Grants location. Survey data points were collected approximately every 1.5 seconds, with DGPS positioning accuracy within a 1–2 m circle-of-error (95% confidence level) throughout the survey area. Real-time positions with rapid updates (1–2 seconds) are necessary in hydrographic surveys for accurate vessel navigation to ensure complete, systematic coverage at the desired sample interval. A Trimble Navigation Accutime II GPS receiver and radio datalink were used aboard the survey boat for navigation and data collection. Typically, about 10,000 points per km² are collected with all data collated and tied to DGPS position. Survey positions and sensor data were stored to the hard drive of an on-board computer as it was collected, and backed-up nightly via modem to a computer at the SCRU office in Santa Fe.

Preplotted survey lanes were followed using navigation information provided by the GPS and displayed in Hypack, a commercial hydrographic software package. A computer monitor mounted near the helm provided the boat pilot with current position as well as navigation information such as cross-track error, speed, course, distance to end-of-line and bearing to end-of-line to ensure complete, systematic survey block coverage. In addition to tabular information, a graphical display showed real-time boat position and movement and survey lanes superimposed over a geo-referenced, digitized lake chart.

Three geodetic surveys were conducted to establish extremely accurate survey points during the project, two for SCRU base station

positions at Lake District Ranger Station and Grants, and one at Mammoth Hot Springs to establish a YELL community base station for park operations (see discussion below).

ROXANN SURVEY

Sample Interval

National Park Service submerged resource survey standards utilize 30-m transects for general survey. The spacing represents NPS experience regarding optimal cost-effective magnetic coverage for most colonial-period shipwrecks and related materials (Murphy 1984:90–95; Murphy and Saltus 1990:93–95). In block YELL001, the survey transect distance was reduced to 20 m for RoxAnn performance evaluation in Yellowstone Lake. The initial survey block data were examined and a decision was made in consultation with Yellowstone fisheries biologists that halving the resolution would be adequate for their purposes. In all later blocks, transect interval was 40 m, which appears to provide acceptable RoxAnn data resolution for the rather patchy environment of Yellowstone Lake.

RoxAnn Signature Generation

To map potential trout habitat, a signature for the target substrate had to be developed for the RoxAnn data. Increased knowledge about lake trout spawning habitat has resulted from attempts in the Great Lakes to re-establish lake trout populations decimated by lamprey predation and overfishing (Edsall et al. 1995:418). Although complete lake trout habitat utilization studies have not been conducted (Edsall, Brown, Kennedy and Poe 1992:84), generally, the optimum lake trout spawning habitat is believed to be rounded or angular rubble and cobble-sized rocks, 5–50 cm in diameter (Edsall, Brown, Kennedy and Poe

1992:86), with 10–30 cm interstitial depths (Edsall et al. 1995:424), which is sufficient to prevent mechanical damage and predation of eggs and *fry*. This environment often appears as cobble patches or piles on bedrock. Trout breeding apparently occurs in a range of water depths, from 1–36 m, with most in the 4–25-m-depth range, but reportedly as deep as 46 m (Edsall et al. 1989:277; Edsall, Brown, Kennedy and Poe 1992:85; Edsall et al. 1996:87). Spawning lake trout in Lake Superior were often found in water deeper than 10 m, and they are abundant on reefs deeper than 15 m, with one researcher stating that 36 m is the maximum lake trout spawning depth (Edsall, Brown, Kennedy and Poe 1992:86–87). YELL Submerged Resources Survey bottom classification was designed to isolate this bottom type should it later prove to be a spawning ground in Yellowstone Lake as it is in the Great Lakes.

There are two ways to develop seabed categories based on RoxAnn classification data. First, post-processed data sets can be grouped into discrete value ranges of E1 (a numerical quantification of sediment roughness) and E2 (sediment hardness), which are each attributed a specific color. Correlation of RoxAnn ranges and bottom types requires diver investigation. Diver examination and ground truthing in past RoxAnn surveys revealed a 1:1 congruence between RoxAnn data and bottom type. There was also a very high correlation between bathymetry, aerial imagery and RoxAnn data. In one case at Gulf Islands National Seashore, a sandy area of about 1.5 km² was classified into six categories derived solely from mathematical data set analysis. Diver observations and grab samples verified that the range of classifications developed mathematically directly reflected subtle variations of sediment size and constituents that correlated very well with submerged dune formation. This test and diver evaluation has provided compelling empirical verification of RoxAnn's resolution.

The second method of seabed categorization requires specific software capabilities. Recent modifications to Hypack, a Windows-based survey software used by SCRU, allow RoxAnn data color boxes to be manipulated in real time and also allow static data collection into a reference file. This particular combination allows generation of seabed classifications based on existing bottom classifications as developed by sedimentologists, biologists and other natural resource scientists. For this procedure, the survey vessel is positioned above the type location for the seabed classification and a reference (training) file is collected. The RoxAnn color box is altered to fit the data range, resulting in a tight classification capability. This procedure, which was used for bottom classification of Yellowstone Lake, combined with the RoxAnn Groundmaster instrument, results in a standardized bottom classification capability for specific areas that can be compared over long periods of time. This new seabed classification tool coupled with GIS should provide comparable databases over wide areas appropriate for long-term monitoring and management needs and be entirely compatible with existing YELL GIS data sets and layers.

Based on the Great Lakes experience and the reported lake trout literature, the target depths and lake bed sediment would be concentrations of cobble-sized material on hard bottom in depths between 4–40 m. Several training sites for RoxAnn data collection were developed to represent bottom-type classifications of interest to natural science researchers for post-processing the RoxAnn data. James Ruzycki, a fisheries biologist, assisted SCRU in locating and evaluating RoxAnn training sites specific to Yellowstone Lake. Lake bed sediment signature generation methodology is discussed in detail below in the “RoxAnn Training Sites” section.

SIDE SCAN SONAR SURVEY

A corporate-partnership with Marine Sonic Technology of White Marsh, Virginia, allowed use of a side scan sonar and operator for four days. There were three basic goals for the use of this instrument: to characterize the lake bottom concurrently with RoxAnn for direct comparison to high resolution side scan imagery; to survey high-probability lake areas for submerged cultural remains above the lake bottom; and to image areas surrounding known submerged archeological sites to locate further material.

The principal areas chosen for the cultural resources survey and termed “high-probability” are locations near the Lake Hotel likely to contain cultural remains associated with hotel activities, the vicinity of *E. C. Waters* on the east side of Stevenson Island and the West Thumb Geyser Basin docks. One specific target was the passenger steamer *Zillah*, which may have been scuttled for disposal in the early twentieth century. According to former YELL Historian Aubrey Haines, if *Zillah* was scuttled, the most likely location would have been just west of the former Lake Hotel docks, offshore the old boathouse and marine railway. In addition to *Zillah*, one known site, a small steam launch associated with the Lake Hotel, is located in the same area. This site was briefly visited during Lenihan’s reconnaissance in 1995 (Lenihan 1995a). The Lake Hotel offshore areas became top priority for sonar survey for cultural remains based on possible presence of *Zillah*, heavy use of the Lake Hotel area and presence of known sites. Secondary priorities were offshore Stevenson Island to locate materials potentially associated with *E. C. Waters* and other wrecks, and the West Thumb Geyser Basin dock area.

Three survey blocks were established in two of the high-probability areas. One block, YELL002, was constructed offshore of the Lake Hotel, and two smaller blocks, YELL003 and YELL004, were created on Stevenson Island's east side. These blocks defined the general survey area for simultaneous side scan sonar and RoxAnn coverage. These blocks, maximized for sonar coverage, were surveyed on 100 m transects at 3 knots or less to maximize sonar record quality. The bottom topography was extremely irregular in these survey areas, so preplotted lanes could not always be followed. No block was created for the West Thumb Geyser Basin dock area because dock remnants are visible from the shore, and the shoreline affords a navigation guide.

MAGNETOMETER SURVEY

SCRU's magnetometer was deployed to test the instrument's effectiveness in the volcanic Yellowstone Lake geological environment. As a cultural resource discovery tool, the magnetometer's effectiveness is considerably reduced in an environment with excessive background noise; subtle anomalies generated by cultural remains can be masked by the greater fluctuations of the earth's magnetic field caused by the geological environment. Deployment and tuning of the instrument on the first day of survey proved this was the case and was sufficient to determine that it would be ineffective to use it on subsequent days.

SURVEY OPERATIONS

SCRU members arrived in YELL on July 28, 1996, and began survey preparations. From July 29 to August 1, the SCRU survey team installed and readied the survey system for operations. This included setting up a mobile GPS base station to provide real-time differential corrections to the survey boat,

installing survey gear on the park's 25-ft. Bertram and testing the system.

Survey operations began August 2 and continued through August 14, totaling 12 days of survey; survey operations were not conducted August 12. RoxAnn coverage was completed in six survey blocks (YELL001, 005, 006, 007, 009, 010), totaling approximately 4 mi.², in addition to side scan sonar coverage depicted in Figure 1.

GEODETIC POSITIONING

Three geodetic surveys were conducted during the August field operations: to position DGPS base stations at Lake District Ranger headquarters and Grants, and to establish a park DGPS base station at Mammoth.

For a base station to supply accurate corrections, its position must be surveyed accurately, which is done using geodetic-capable GPS receivers. A static geodetic survey was conducted to establish control coordinates for the GPS base station at a point on the old "air quality shack" near the Lake District Ranger Station. The base station control point was triangulated from two "Order B" horizontal control monuments, "Yellowstone" and "CVO 84 23."

The YELL Submerged Resources Survey study areas included both the Lake Hotel shoreline and the far shore of West Thumb. A water test of the Lake District base station indicated the radio link could not reach the West Thumb area, which was the primary survey area for trout-habitat bottom classification. The base station was moved to Grants, where a geodetic survey was conducted to locate the new base station position and tie it to the Lake District position. Subsequent tests of the new base station location proved it easily covered the primary survey area. Full study area coverage required repositioning the base station between Lake District and Grants.

During the project, geodetic positioning was conducted at the park's request to aid YELL's Spatial Analysis Center in establishing a community GPS base station. The base station was designed to continuously collect GPS base station information for differential corrections of remotely-collected GPS data in the park and surrounding areas, up to 300 miles distant. A basic requirement for a community base station is the GPS antenna be geodetically positioned to a circle-of-error of no more than a few centimeters. An antenna location was selected by YELL GIS Coordinator Eric Compas on the Mammoth Village Fire Cache roof, which provides a secure, unobstructed position.

On July 30, 1996, SCRU Geodesist Tim Smith, assisted by YELL personnel, conducted a GPS geodetic-control survey to establish coordinates for the Mammoth permanent GPS base station. This station was named "Mam-Base." Two National Geodetic Survey (NCS) Control monuments were used for this survey: "F-Mammoth", a third-order horizontal control and "C157", a B-order horizontal and vertical control monument. "F-Mammoth" NAD 83 horizontal coordinates are: $44^{\circ} 58' 54.761666''$ N, $110^{\circ} 42' 16.47553''$ W; Mean Sea Level (MSL) height for this monument was scaled from an existing topographic map by the NGS, and geoidal height (-8.37 m) obtained using the Geoid 90 program. Coordinates for "C157" are, $44^{\circ} 58' 12.29096''$ N, $110^{\circ} 42' 06.93849''$ W. Height is 1937.218 m MSL and 1928.757 m Height Above the Ellipsoid (HAE). Vertical height for this monument was established though differential leveling and geodetic separation (-8.35 m) by the Geoid 90 program.

The first baseline observation was conducted from "F-Mammoth" to "C157" to verify the coordinates on both monuments. The observed ground distance was 1328.0253 m. The second baseline was established from "F-Mammoth" to the YELL base point

("Mam-Base"), which is an "X" scratched in the fire cache building roof peak just north of a raised roof portion. The third observation was made from "C157" to "Mam-Base." All observed data were processed and baselines adjusted according to the strengths of the monuments. Horizontal control was used from both "F-Mammoth" and "C157"; vertical control was used from "C157" only.

Statistical analysis of the resulting horizontal coordinates for "Mam-Base" establish it to within a few millimeters. Confidence in the geodetic coordinates for this point is high, within a few centimeters. Established WGS 84 datum coordinates for "Mam-Base" are: $44^{\circ} 58' 31.388351''$ N, $110^{\circ} 41' 51.094834''$ W, HAE = 1901.0199 m.

HYDROGRAPHIC SURVEY

Weather was frequently a limiting factor during Yellowstone Lake survey operations. Inclement weather could appear with very little warning, quickly making conditions unacceptable for accurate survey and unsafe for boating. Surveying had to be terminated early on several occasions because of strong winds and seas. The weather patterns generally deteriorated in the afternoon; consequently, the survey team began work early when the wind was still calm, often leaving the dock before 0600.

The first four survey days, August 2-5, were spent on block YELL001 in the southern part of the "Neck." On the first day, the survey team deployed the G-876 magnetometer. This instrument, which is extremely sensitive, typically has internal noise of 0.5-1.0 gammas. In Yellowstone Lake, readings fluctuated more than 20 gammas. Extensive attempts to tune the instrument were unsuccessful; the background noise in the earth's magnetic field was simply too much for reliable recording of small anomalies. Magnetometer operations

were terminated. Inclement weather on several of these first days forced survey operations to terminate midday.

The Marine Sonics Technology side scan sonar and operator arrived August 5, and on August 6 the instrument was mobilized and tested. The next two days were spent covering high-probability areas offshore the Lake Hotel and east of Stevenson Island, including imaging *E. C. Wafers* and the surrounding areas. For these survey days, three blocks, YELL002, YELL003 and YELL004, were created, and they defined the general survey area covered simultaneously by side scan sonar and RoxAnn. The fourth and last day of side scan sonar survey, August 9, covered the area around West Thumb Geyser Basin, including imaging the submerged dock structures and vicinity. Finally, an attempt was made to cover block YELLO01 with side scan sonar to generate data for comparison with RoxAnn in the high priority area. Unfortunately, the towfish struck a vertical underwater cliff on the first lane and was disabled beyond field repair. Side scan operations were terminated, and no direct comparisons between side scan sonar data and RoxAnn data could be accomplished.

Block YELLO01 was completed with RoxAnn coverage only during the afternoon of August 9. The next day, block YELL005, which is adjacent to YELLO01 to the north, was completed on 40-m lane spacing. Completing this block finished RoxAnn coverage in the restriction between West Thumb and the main lake.

Final RoxAnn coverage was completed August 13 and 14. Blocks YELL006, YELL007, YELL009 and YELL010 encompassing the area in the north part of West Thumb from Pumice Point to Carrington Island, from the shoreline to a water depth of 120 ft. were surveyed, completing all primary RoxAnn survey areas defined by YELL natural resource managers.

ROXANN TRAINING SITES

On August 11, training site data files were collected for RoxAnn post-processing. Nine homogenous bottom types were selected based on raw RoxAnn data to produce RoxAnn identification signatures. These categories are presented in the software as RoxAnn Classification Boxes, which are user defined. Each box was based on a particular bottom type found in Yellowstone Lake. Each site was visited and divers were sent down to visually inspect the bottom and videotape the location as a permanent record. These sites varied in bottom type from fine, deep, fluff-type mud to hard rock surfaces. Each data file was completed successfully, and a good classification model with seven distinct bottom types was produced from these training files for the entire surveyed area. Identified bottom classifications were based visually on Wentworth Scale definitions: sand = less than 2 mm in diameter (0.07 in.); gravel = 2-64 mm (0.07-2.5 in.); rubble = 65-256 mm (2.5-10 in.); cobble = 257-999 mm (10-39 in.); and boulders = greater than 999 mm (39 in.).

ROXANN BOTTOM TYPE CLASSIFICATIONS

The following categories were developed for Yellowstone Lake surficial bottom type analysis and display. Bottom classifications 1, 2, 3, 5 and 7 were developed from training sites; 4 and 6 were judgmentally determined from data set categorization. The classification nomenclature indicates predominate sediment type first, followed by lesser sediment types; i.e., “dispersed rubble with sand” consists of more rubble than “sand with dispersed rubble.” Yellowstone Lake classifications are:

1. Cobble and rubble with sand (Figure 2)
2. Rubble and sand on hard bottom (Figure 3)

3. Mud and fine sand (Figure 4)
4. Hard bottom with sand
5. Dispersed rubble with sand (Figure 5)
6. Large cobble and boulders
7. Sand with dispersed rubble (Figure 6)

ROXANN CLASSIFICATION BOXES

RoxAnn classification boxes are generated as a normal part of data collection and post-processing, and are the method of converting raw RoxAnn data into bottom categories for display purposes and GIS integration. Basically, digital values collected from field data representing bottom sediment characteristics are attributed a color indicating presence of a particular bottom type that is collated with position to produce a map showing bottom type distribution. The RoxAnn classification boxes are developed and designed based on two basic types of information: homogeneous bottom type files or “training sites” and the overall field data set.

RoxAnn data are displayed as E1 (roughness) and E2 (hardness) values with each data point presented on a Cartesian grid as an x - y position representing roughness and hardness. The range of RoxAnn values can theoretically portray thousands of bottom types, and it is capable of extremely high-resolution discrimination. Similar bottom types produce similar E1 and E2 values and appear clustered on the grid. A RoxAnn box is simply a square or rectangle formed on the grid around a cluster area that defines a particular range of E1 and E2 values, which indicates a similar bottom type (Figure 7). The software attributes a color (actually a color value number) to each point based on its position within the grid in relation to described RoxAnn boxes. Any survey point producing E1 and E2 values falling within the range as defined by the RoxAnn box will be attributed the box color and appear on the map as the bottom category represented by that box’s

color. The boxes can be made any size and attributed any color, and the data set can be re-evaluated after the survey to produce additional or different categories. In practical applications, we have found that only a few bottom types have been necessary to categorize survey areas for most research purposes, although more could be added at any time as scientific questions about the lake bed are developed.

To produce a RoxAnn box from a training site, the survey boat and transducer are positioned over a homogenous bottom type desired as a bottom category. A training site file is recorded and displayed on the RoxAnn grid. A box is constructed around the scatter of sample points. (The variation in plots is a result of boat movement, bottom variation and other factors. A stable transducer generally produces a fairly small point-cluster spread.) If it is necessary to isolate that particular bottom type to a very high degree of accuracy, a small RoxAnn box is constructed in the software on the grid. Generally, a larger box is constructed to incorporate the range of variability a particular category encompasses. The process is repeated for each bottom category in the desired classification series.

It is unlikely that all bottom variations will be represented by desired categories. Our experience has shown that RoxAnn’s ability to discriminate variations in bottom sediment exceeds researchers’ ability to discriminate categories. For example, variable percentages of sand versus gravel, rubble or cobble can be discriminated by RoxAnn, but are difficult, and often unnecessary, to categorize into separate bottom types through on-site observation.

The second way of generating RoxAnn classification boxes is by using the whole hydrographic survey data set. Typically, the data over a large area will more or less cluster into areas of dense sample points on the graph, which represent similar bottom types. Training sites can be selected in an area where nothing may

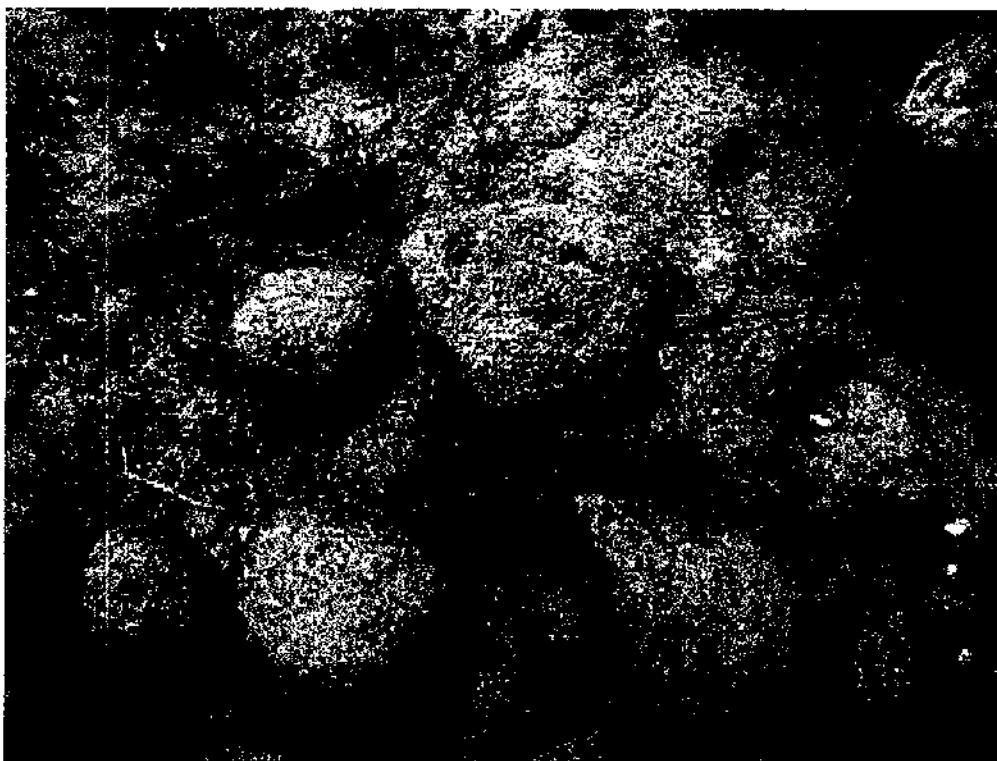

Figure 2. Category 1: Cobble and rubble with sand.

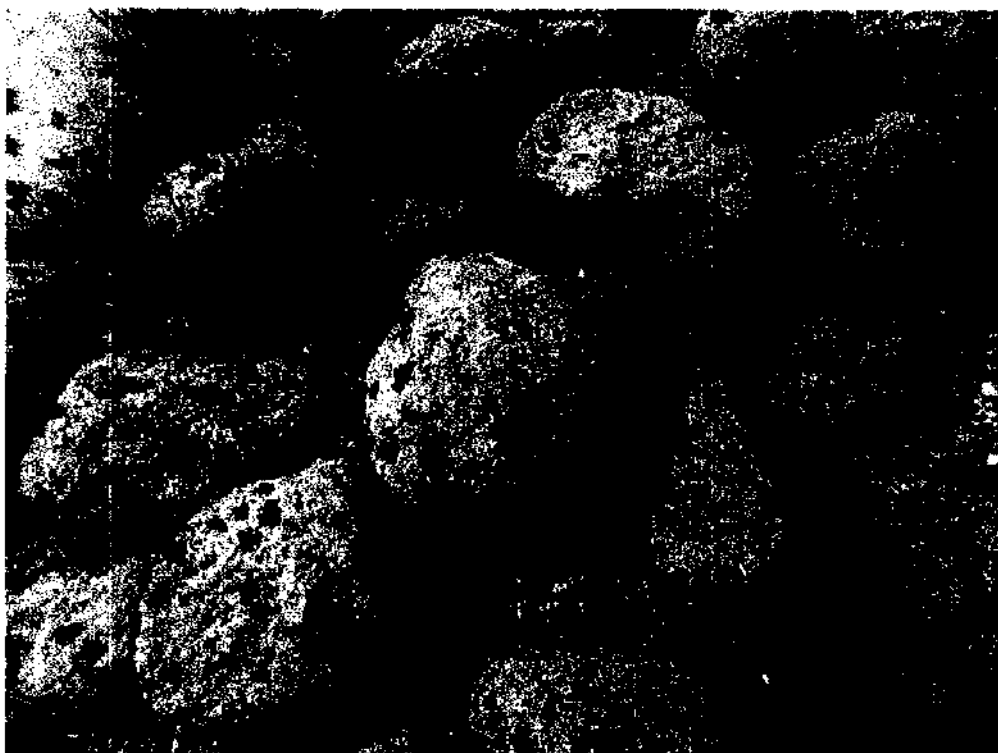

Figure 3. Category 2: Rubble and sand on hard bottom.

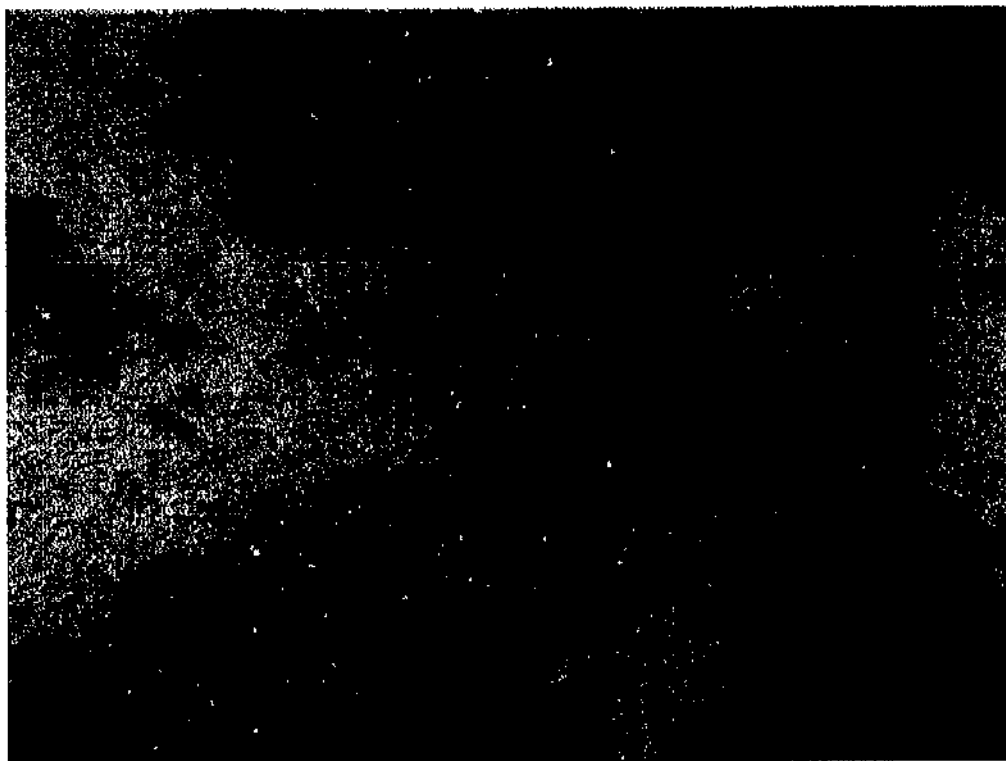

Figure 4. Category 3: Mud and fine sand.



Figure 5. Category 5: Dispersed rubble with sand.

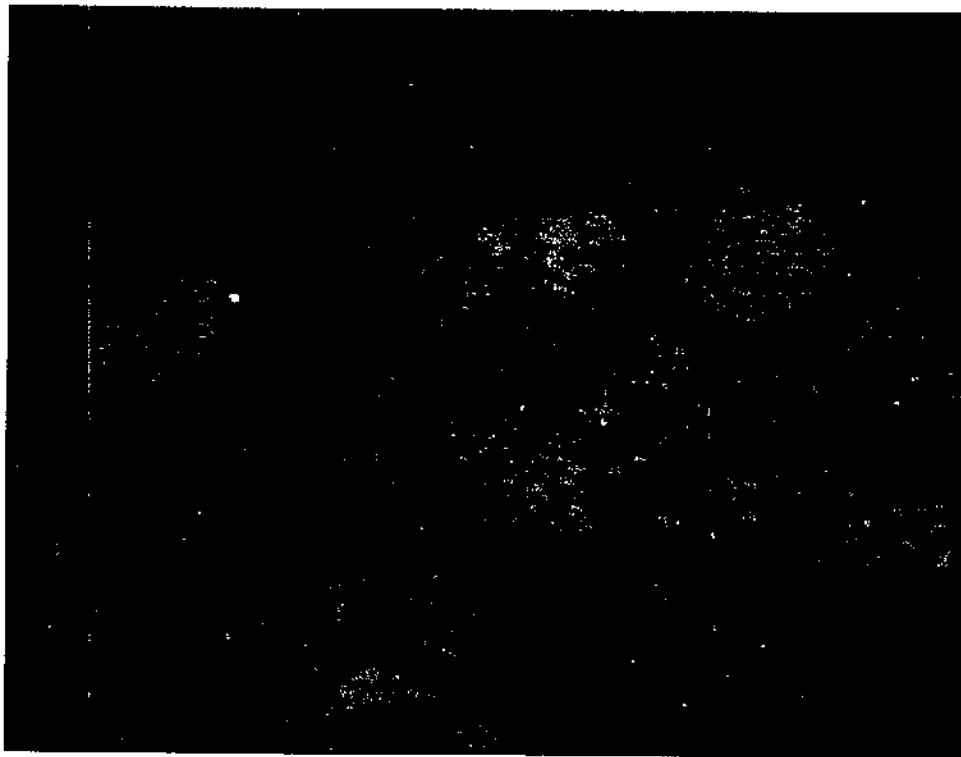

Figure 6. Category 7: Sand with dispersed rubble,

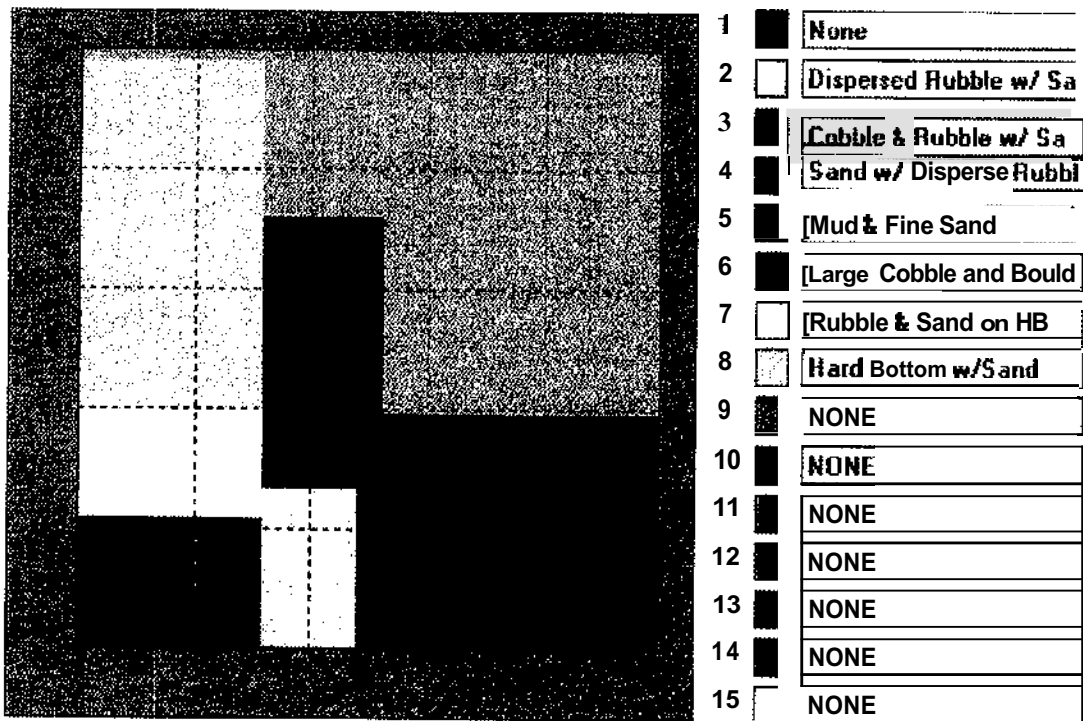

Figure 7. RoxAnn boxes generated during the YELL Submerged Resources Survey, August 1996. The center box is shown with the points generated during collection of a training site file over an area of cobble and rubble with sand.

be known about the bottom sediments based on the data clustering alone. A central point in the graph is selected and the survey boat proceeds to that area and collects a training site. Diver observations provide the category descriptions. Box size and number are judgmentally selected, with the results fairly reliably providing categorization of the predominate sediment types present in the survey area. Both procedures require judgmental determination of box boundaries, and they incorporate some assumptions about bottom variability during post-processing operations. Categories are easily tested by conducting diver investigations of areas on the post-processed map to determine homogeneity of bottom types depicted. SCRUI has conducted several tests of this nature in marine areas.

In practice, SCRUI uses a combination of these two approaches with the methodology varying according to research questions and general conditions. For example, a question might involve one particular sediment type. A training site generated from that sediment could be developed, and the survey data divided into two categories: the desired sediment and everything else. Typically, a more comprehensive bottom classification is desired for management purposes. Some classifications are developed from particular bottom types of research interest that are combined with types generated from survey data clusters. Classification boxes based solely on training sites will, generally, be too narrow to cover all the bottom variations in the survey area. Adjustments to existing ground-truthed bottom classification boxes is usually desirable for comprehensive coverage and to eliminate undescribed areas. Typically, one assumes there is a range of E1, E2 values within any bottom type category. For example, a classification box for fine mud assigned from training data may incorporate coarser grained bottom types such as fine sand so that the identified bottom type

classification is “Mud and Fine Sand,” by enlarging the classification box along the E1 (roughness) axis, which was done for the Yellowstone data. Classifications #4, “hard bottom with sand,” and #6 “large cobble and boulders,” were judgmentally developed by extending the RoxAnn data range to encompass data sets outside the training site categories.

Bottom type categories can range from several to many, their number and ranges determined by research questions and the natural range of variability. Any bottom characterization necessarily creates boundaries between arbitrary abstract categories that are in reality gradations of sediment types and percentages. Distinct boundaries between polygons representing similar types are useful in GIS, but they mask the natural range and complexity of the surficial sediments depicted. Any set of categorizations incorporate combinations of empirical observation, judgmental determinations and assumptions about sediment characteristics. However, all depictions are based on reproducible, quantified attributes of bottom sediment that can be reanalyzed to incorporate additional information, training sites or different assumptions.

SURVEY RESULTS

ROXANN SURVEY

Training sites from August 11 provided a bottom classification model for the Yellowstone Lake bottom as discussed above. Data collection was skewed toward areas most likely to include lake trout habitation, so more training sites may be required for future work in other lake areas. Indications are, however, that most bottom types will probably fall between the variations found in the bottom classification model developed during this survey. Bottom classification maps for each survey block were

produced, and this information was sent to YELL shortly after the project's completion for use in developing lake trout control methods. Survey block maps for surveyed areas are presented in Figures 8–11.

SIDE SCAN SONAR SURVEY

Yellowstone Lake side scan sonar coverage is presented in Figure 1. High-probability areas near the Lake Hotel revealed several interesting cultural and natural features. Although no trace of *Zillah* was observed, eight small, wooden rowboats associated with the Lake Hotel were located; three were briefly visited and documented (Figures 12–14 and Part II). In addition, unique bottom topography and geological features were also observed. For example, the probable hot water vent in Figure 15. Side scan sonar images (sonographs) of *E. C. Waters* (Figure 16) and the West Thumb docks (Figure 17) did not reveal any additional remains associated with these sites. However, the sonographs have proved useful for analytical and documentation purposes. Because the sonar towfish was damaged, no comparative data were collected in the primary RoxAnn coverage areas.

DEPTH SOUNDER

A 2-m-contour surface model of the lake bottom was produced from the bathymetric data, and is presented in Figures 18–21.

CONCLUSIONS AND RECOMMENDATIONS

The project surveyed approximately 4 mi² with a DGPS-positioned RoxAnn bottom classification device and depth sounder for lake trout habitat location. The instrument appears effective and of sufficient resolution to distinguish lake bed sediment for estimation of fish breeding and other habitats. Survey data incorporation into the park's GIS database provides a permanent record that can be used for future lake trout control and research operations. Side scan sonar survey of about 4.8 mi.² located eight small watercraft and eliminated the highest potential areas for *Zillah*'s location.

Should further bottom classification be desired, additional training sites need to be developed to refine bottom classification typology. Survey data generated during this project is ultimately useful for the management issues for which it was conducted only if it is collated with gill net locations and fish catch numbers in the GIS.

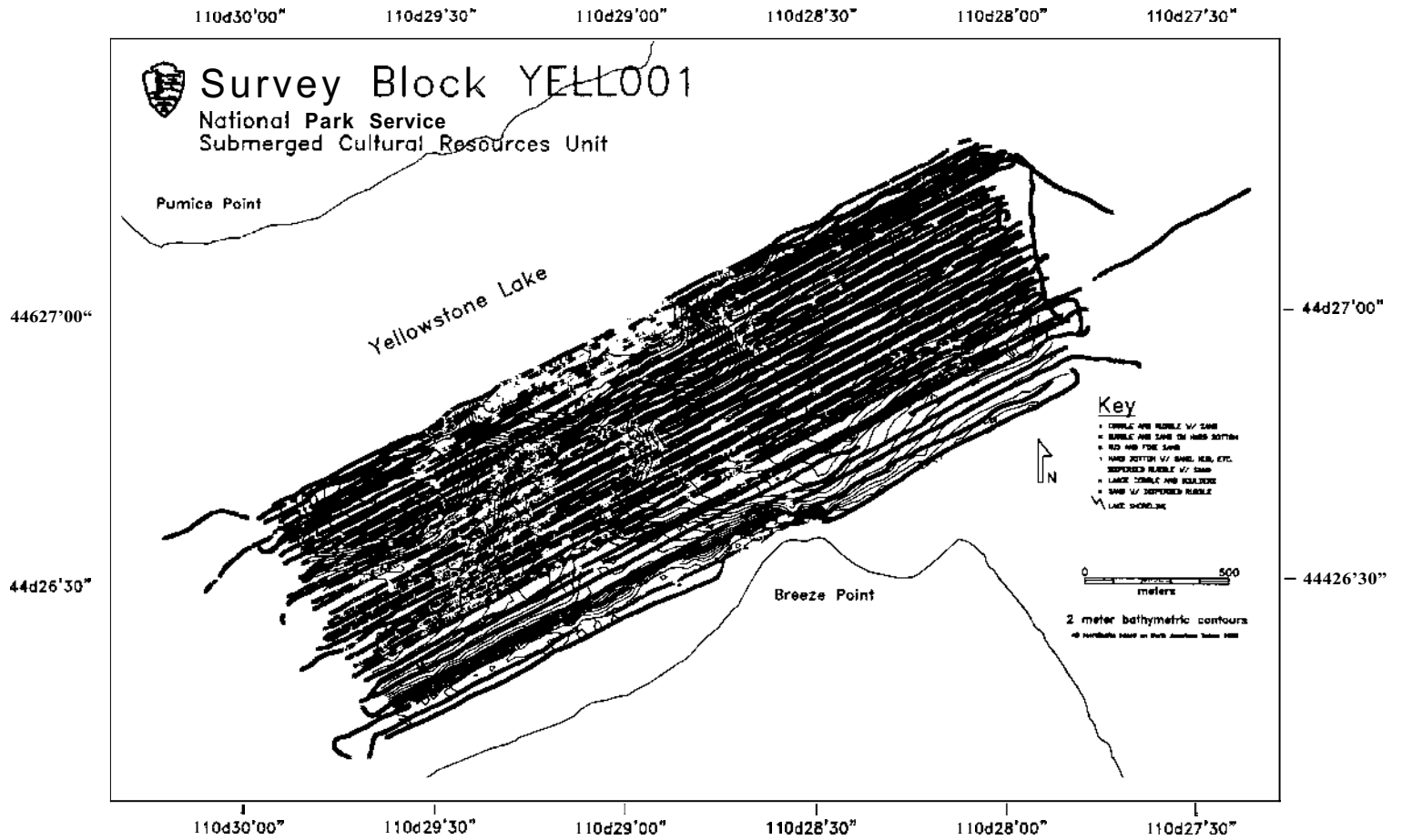

Figure 8. Raw RoxAnn data, survey block YELL001.

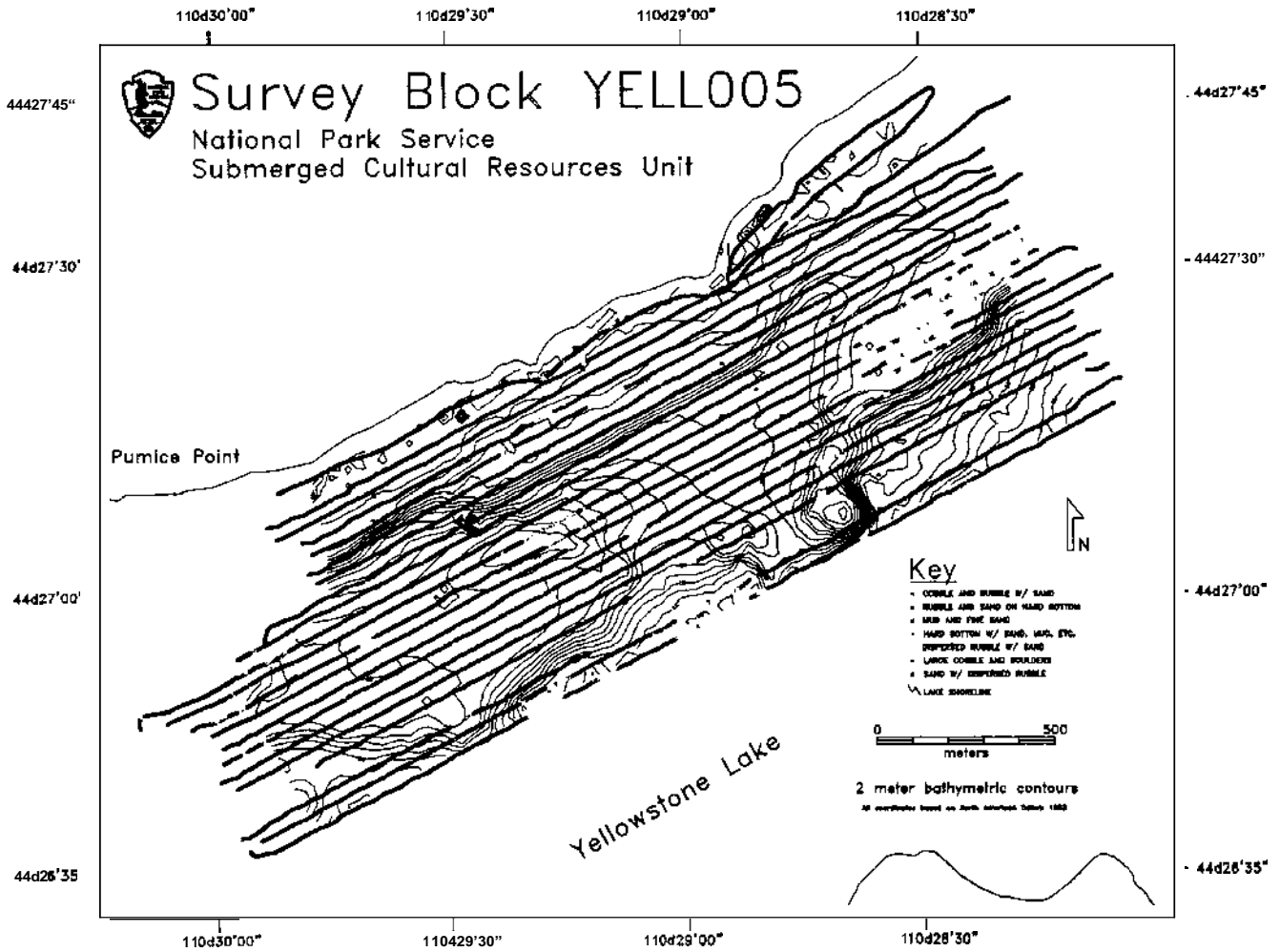

Figure 9. Raw RoxAnn data, survey block YELL005.

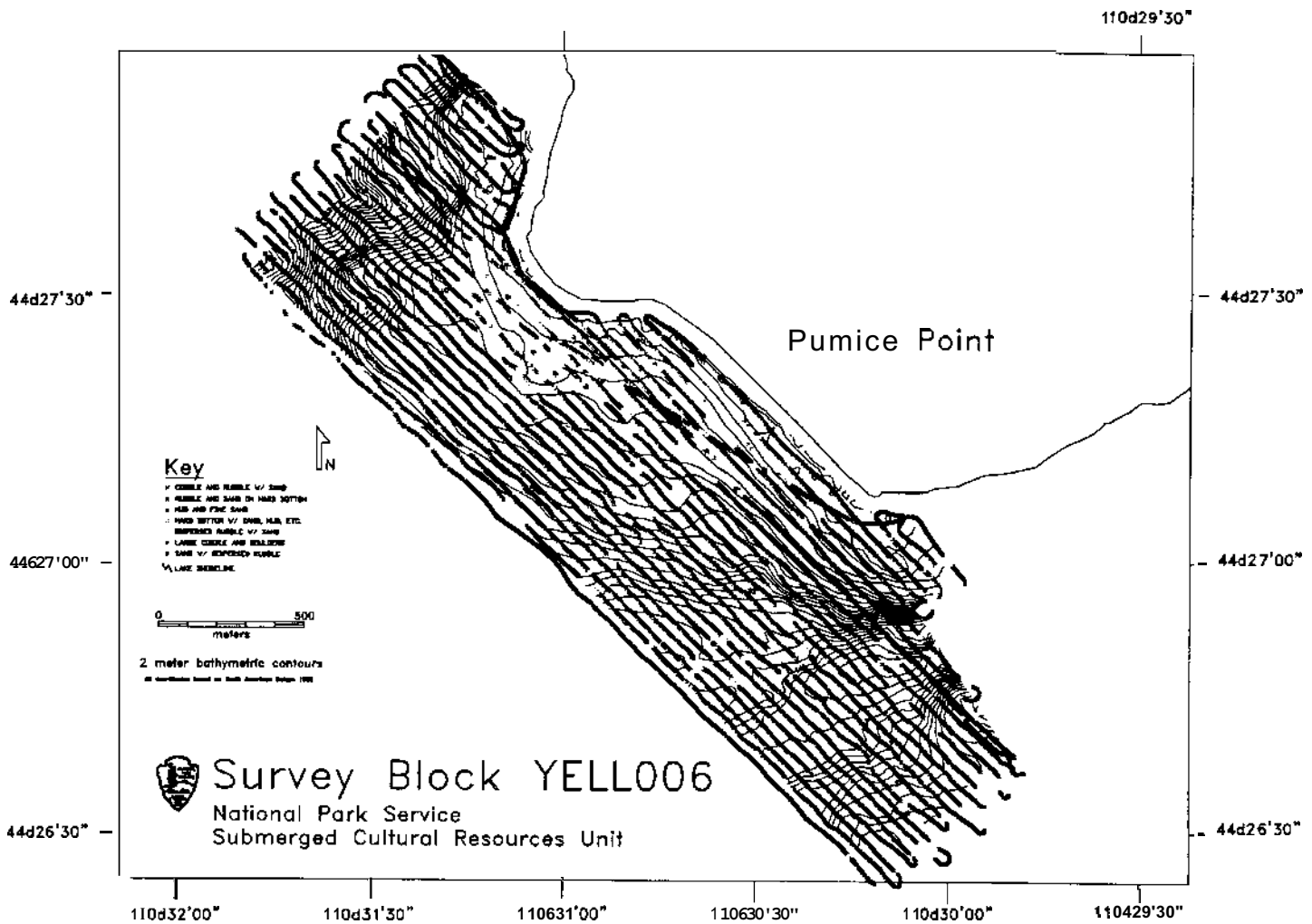

Figure 10. Raw RoxAnn data, survey block YELL006.

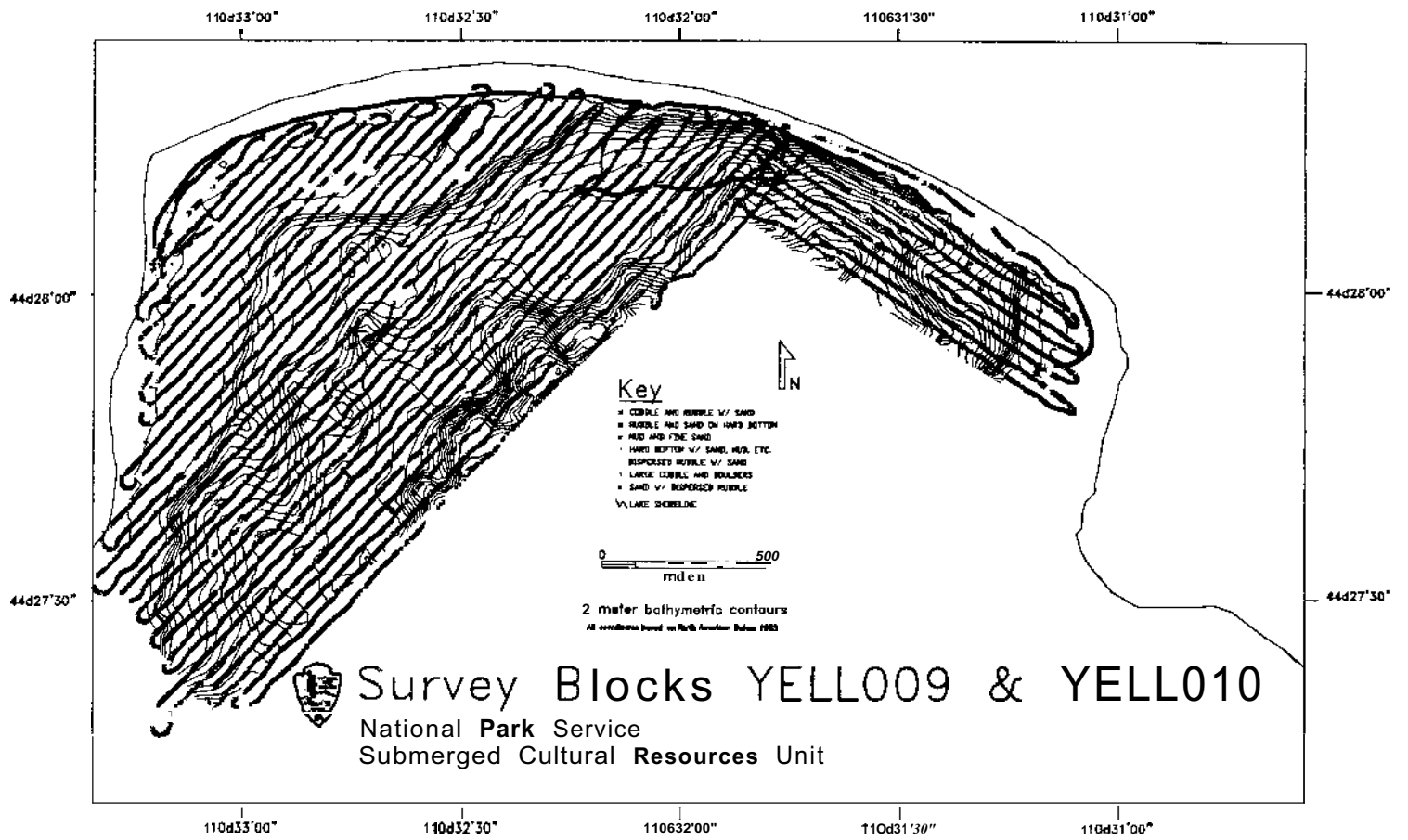

Figure 11. Raw RoxAnn data, survey blocks YELLO04 and YELLO10.

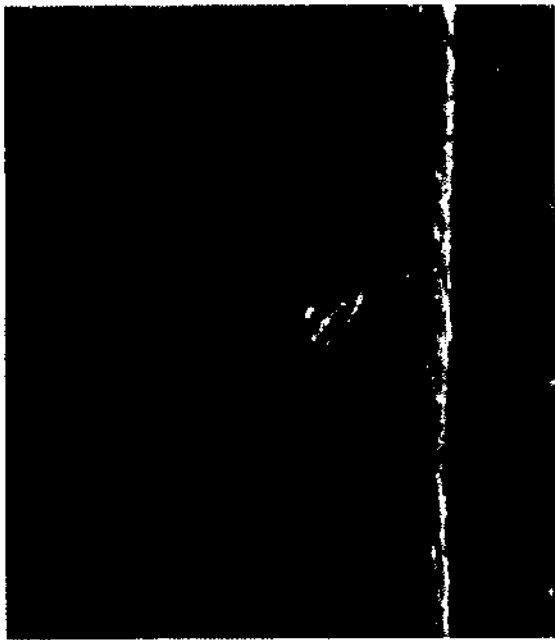

Figure 12. Sonograph of single small boat located offshore Lake Hotel.

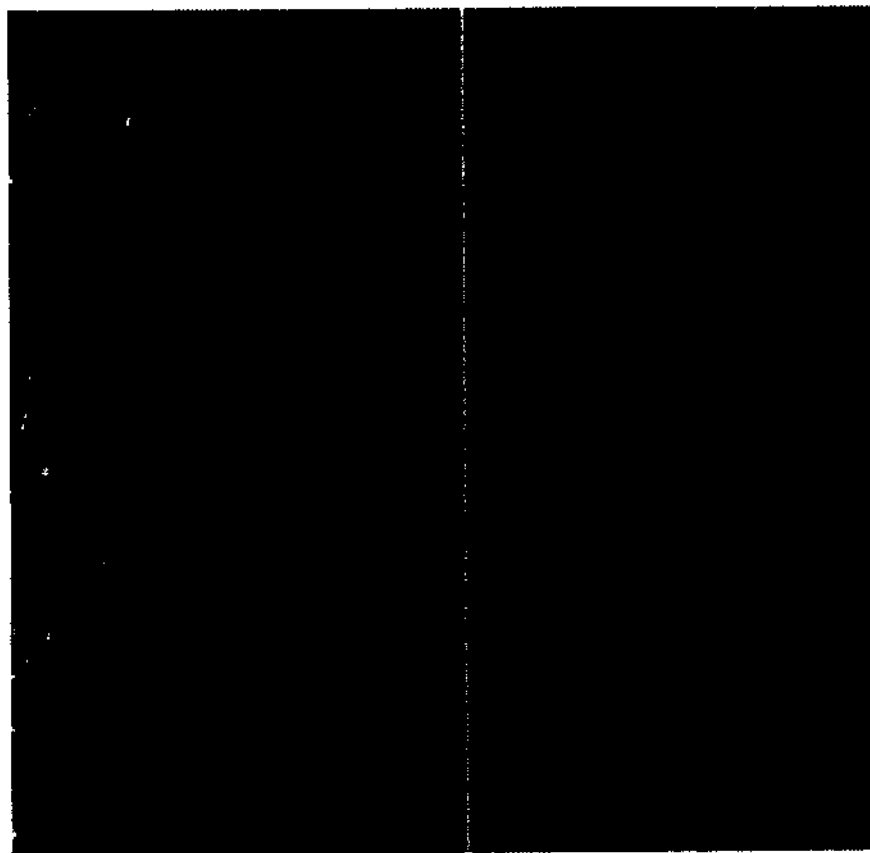

Figure 13. Sonograph of two small boats located offshore Lake Hotel.

Figure 14. Three small boats in close proximity offshore Lake Hotel

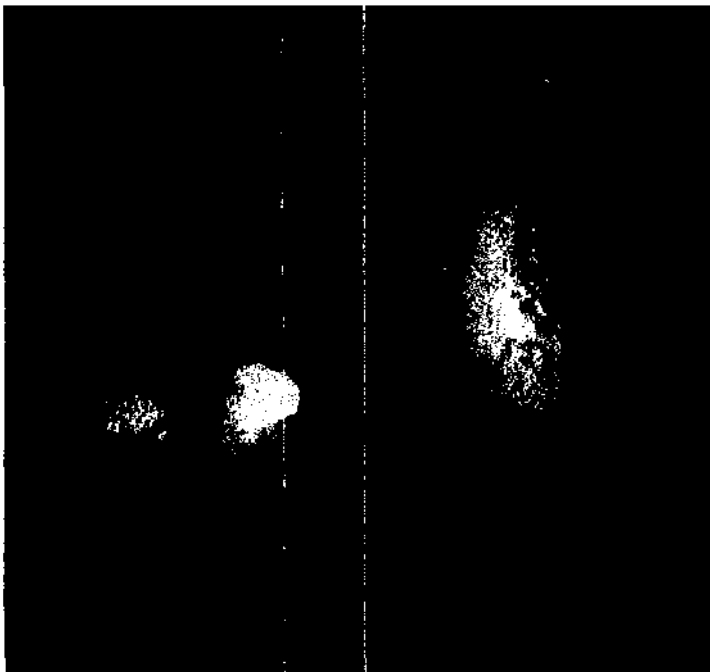

Figure 15. Sonograph of unusual geological feature on lake floor. Most likely this is a hot water vent surrounded by mineral deposition.



Figure 16. Sonograph of *E. C. Waters*' site showing hull features and surrounding bottom areas. Curvature is the result of the survey vessel's path. *E. C. Waters*' bow is at the bottom of the image.



Figure 17. Sonograph of the West Thumb dock supports (cribbing).

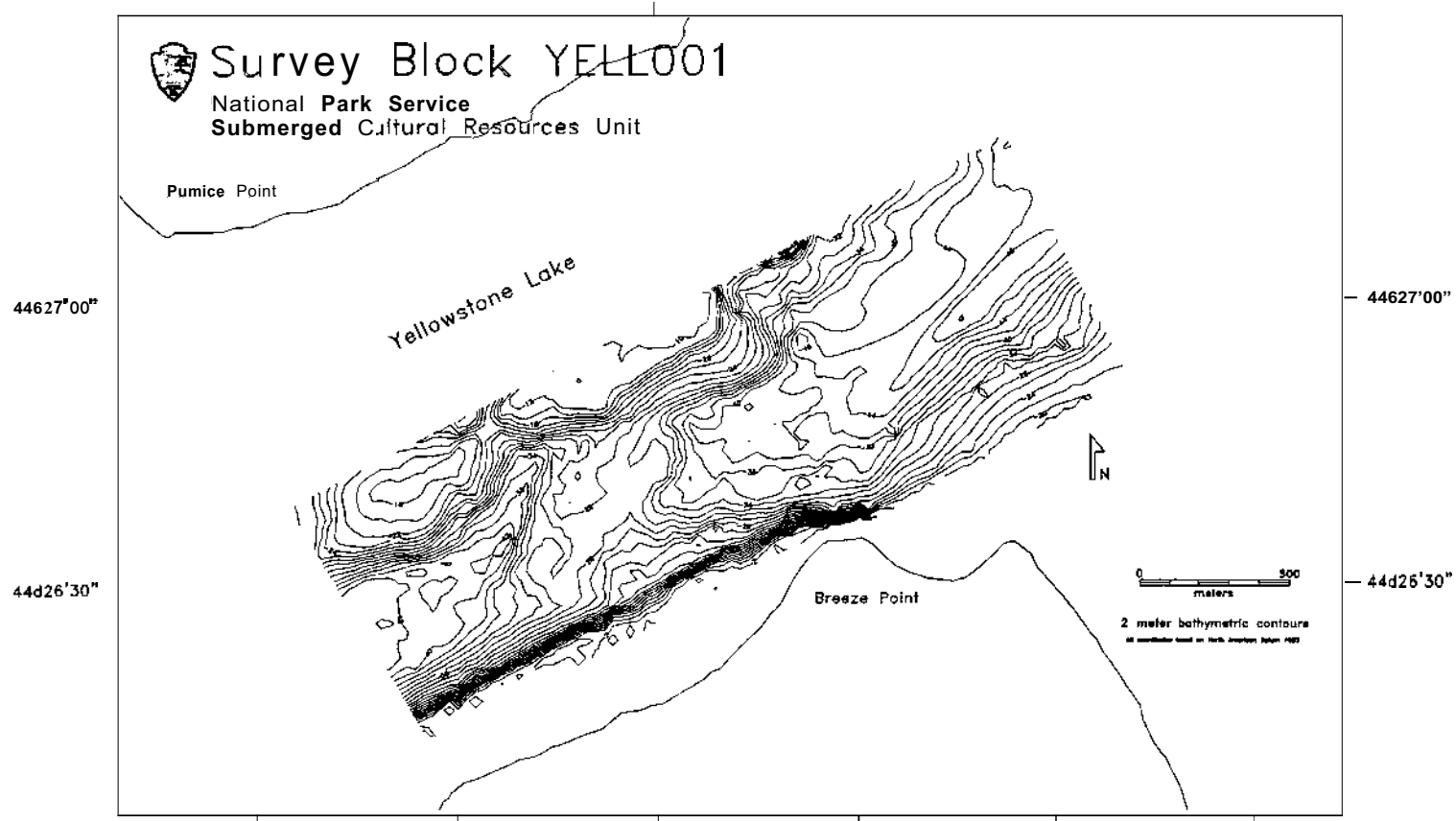

Figure 18. Two meter bathymetric contours, survey block YELL001.

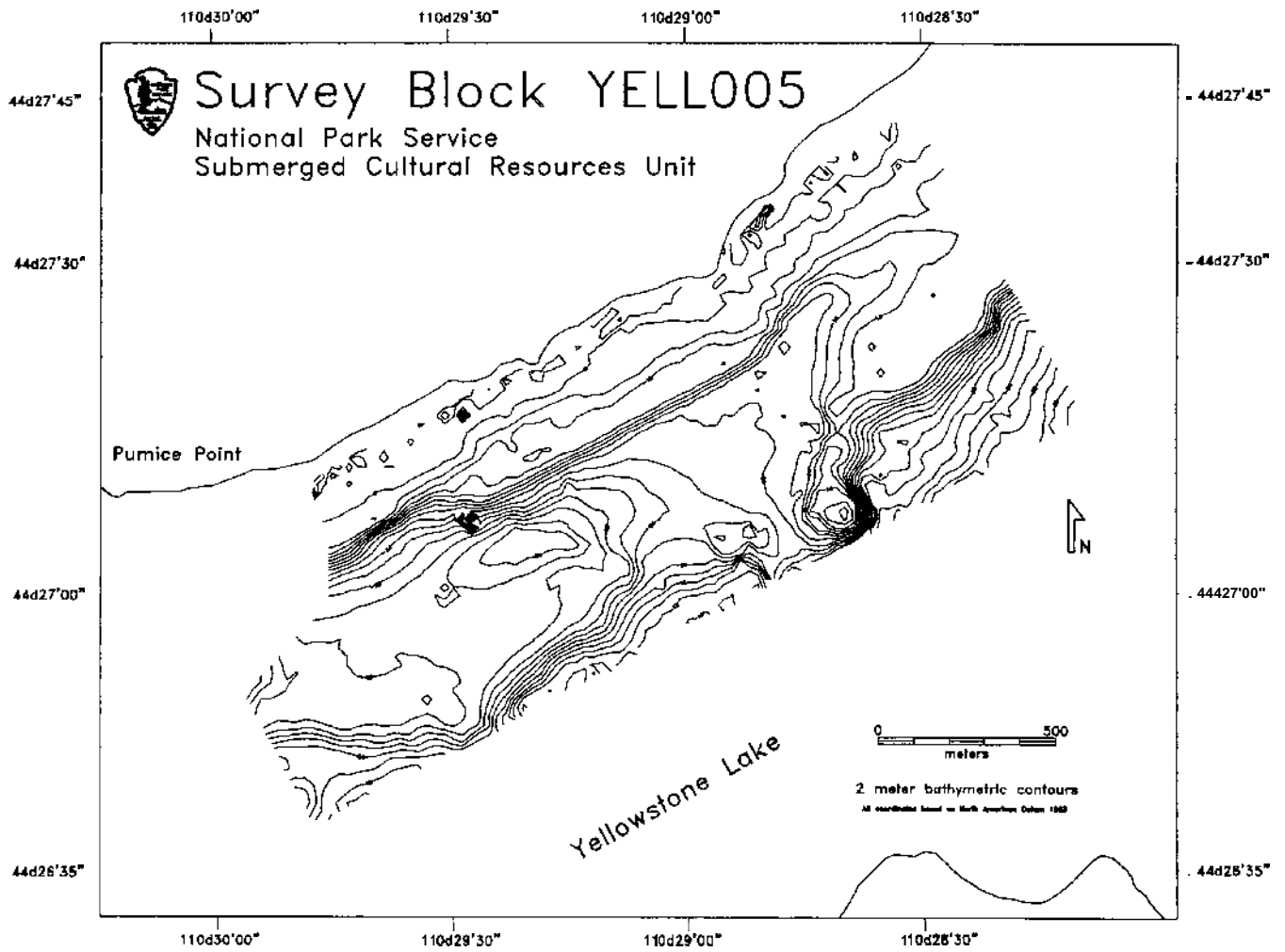

Figure 19. Two meter bathymetric contours, survey block YELL005.

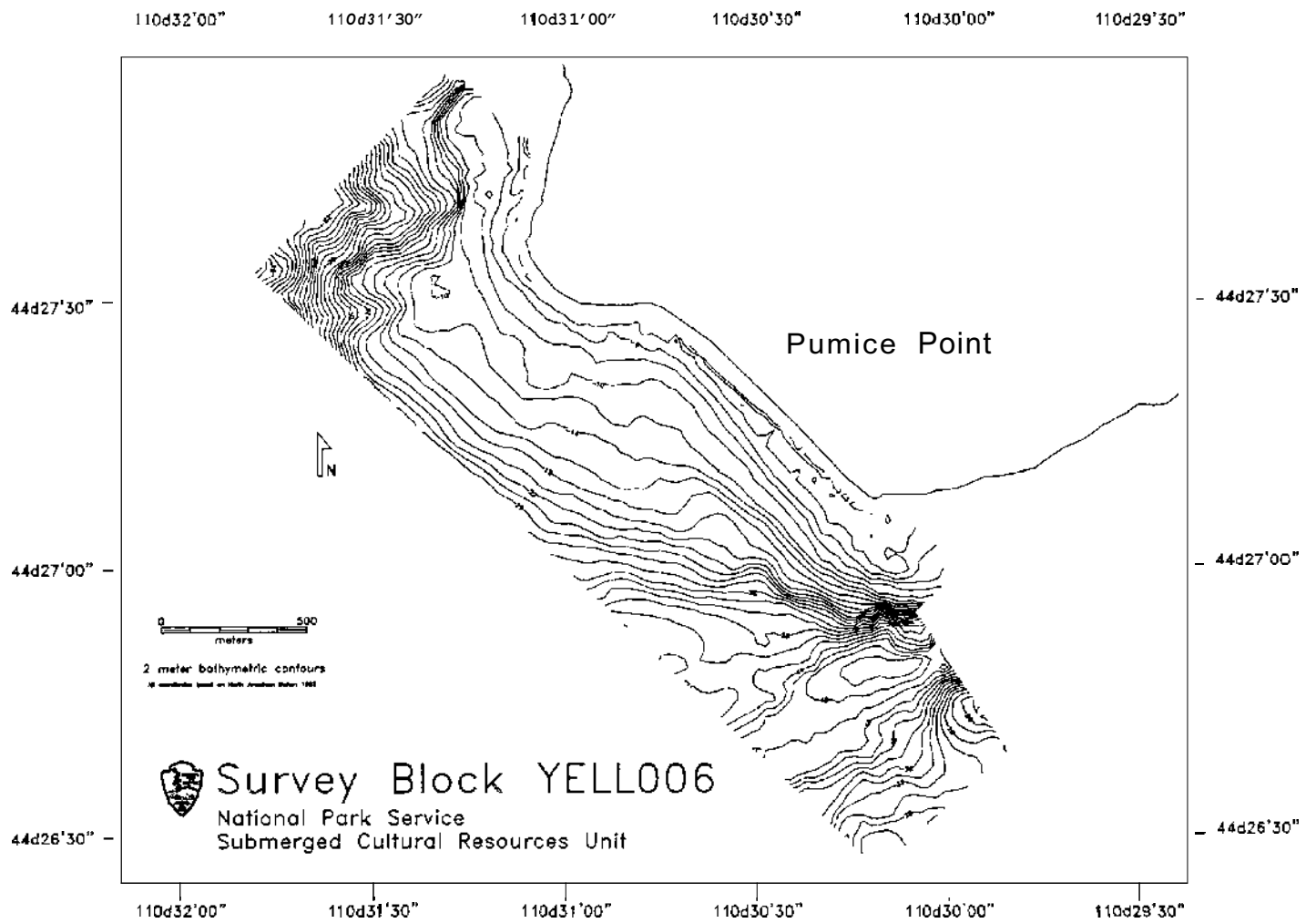

Figure 20. Two meter bathymetric contours, survey block YELL006.

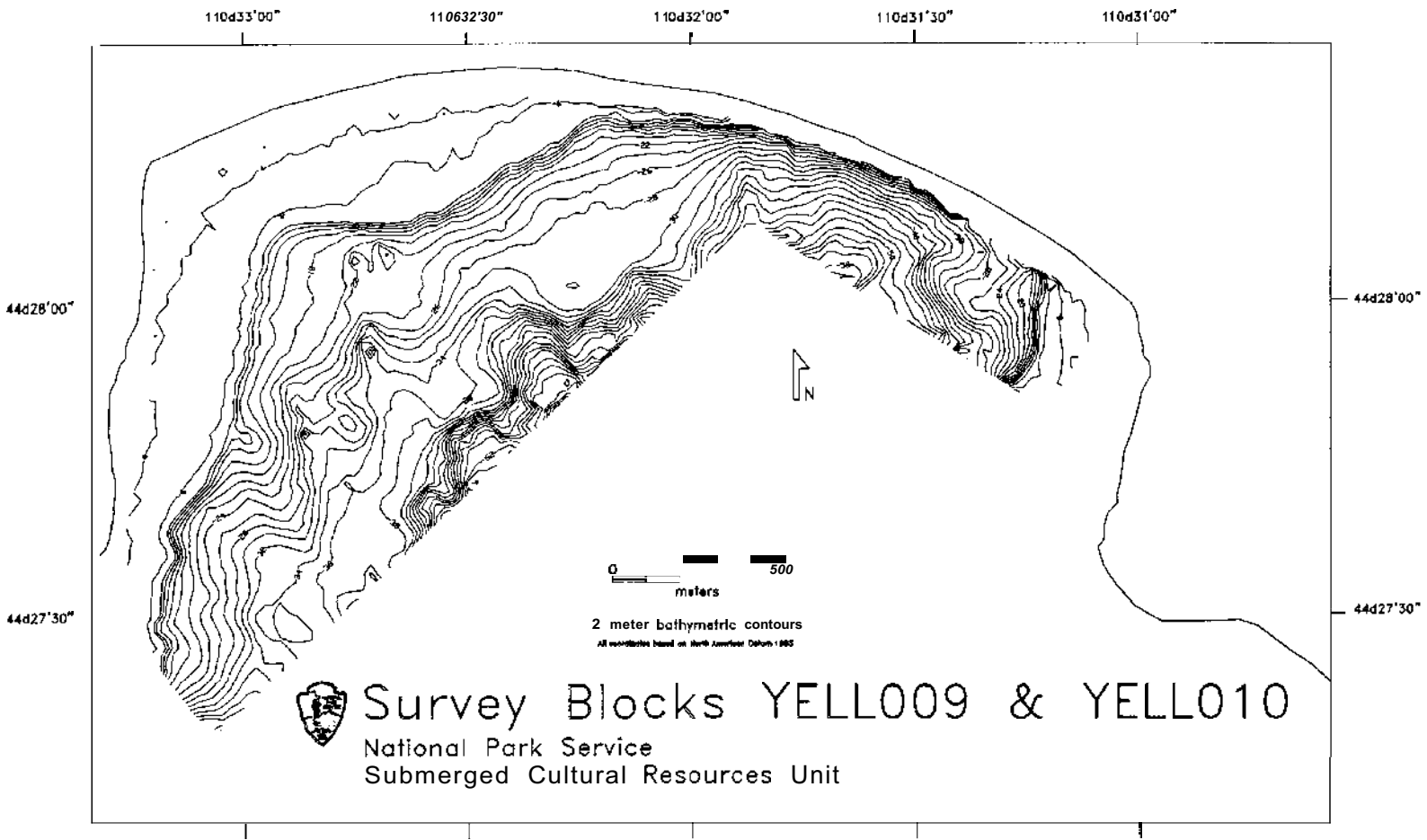

Figure 21. Two meter bathymetric contours, survey blocks YELL009 and YELL010.

PART II

CULTURAL RESOURCES INVESTIGATIONS

by
James E. Bradford
and
Matthew A. Russell

CHAPTER 1

Introduction

Yellowstone Lake, with more than 100mi.² of surface area, dwarfs the other 75 ponds and lakes in Yellowstone National Park (YELL) (Figure 1.1). Centuries before the idea of the world's first national park was discussed around a frontier campfire, Yellowstone Lake was the focus of much human activity. American Indian groups had long been moving through the area, hunting and living along the shores of this high-altitude, volcanic lake. How many aboriginal sites occur along the lake shores is unknown, but evidence indicates a long history of human occupation and use of the unusual area associated with Yellowstone Lake.

The earliest Euroamerican activities in the area mirrored those of American Indians. However, these activities shifted toward scientific studies by the 1870s and, before the end of the century, included recreation, with heavy influence from concessionaires catering to the growing tourist trade. Euroamerican sites, many of which are integral to the park's history, are numerous around Yellowstone Lake, although the number and full range of these sites are not yet known. Park management has recognized the importance of these archeological

sites and begun a program to survey, inventory and evaluate them in a manner necessary for their management, protection and interpretation. Terrestrial archeological surveys and excavations have been conducted in many park areas, including some portions of the Yellowstone Lake shoreline.

As a result of discussions with park management in 1995 during an archeological reconnaissance, the Submerged Cultural Resources Unit (SCRU) was asked to provide technical information on lake physiography for natural resource issues. YELL scientists had become aware of SCRU's systematic remote sensing of natural resources in other park areas, particularly Biscayne National Park and Dry Tortugas National Park. An important question facing YELL natural resource scientists was how to control proliferation of exotic lake trout that compete with native trout in Yellowstone Lake. These scientists wished to determine if the methods developed by SCRU for seabed classification would be appropriate for classifying lake-bed sediments in order to understand their relationship to lake trout breeding. Recognizing the cost-effective

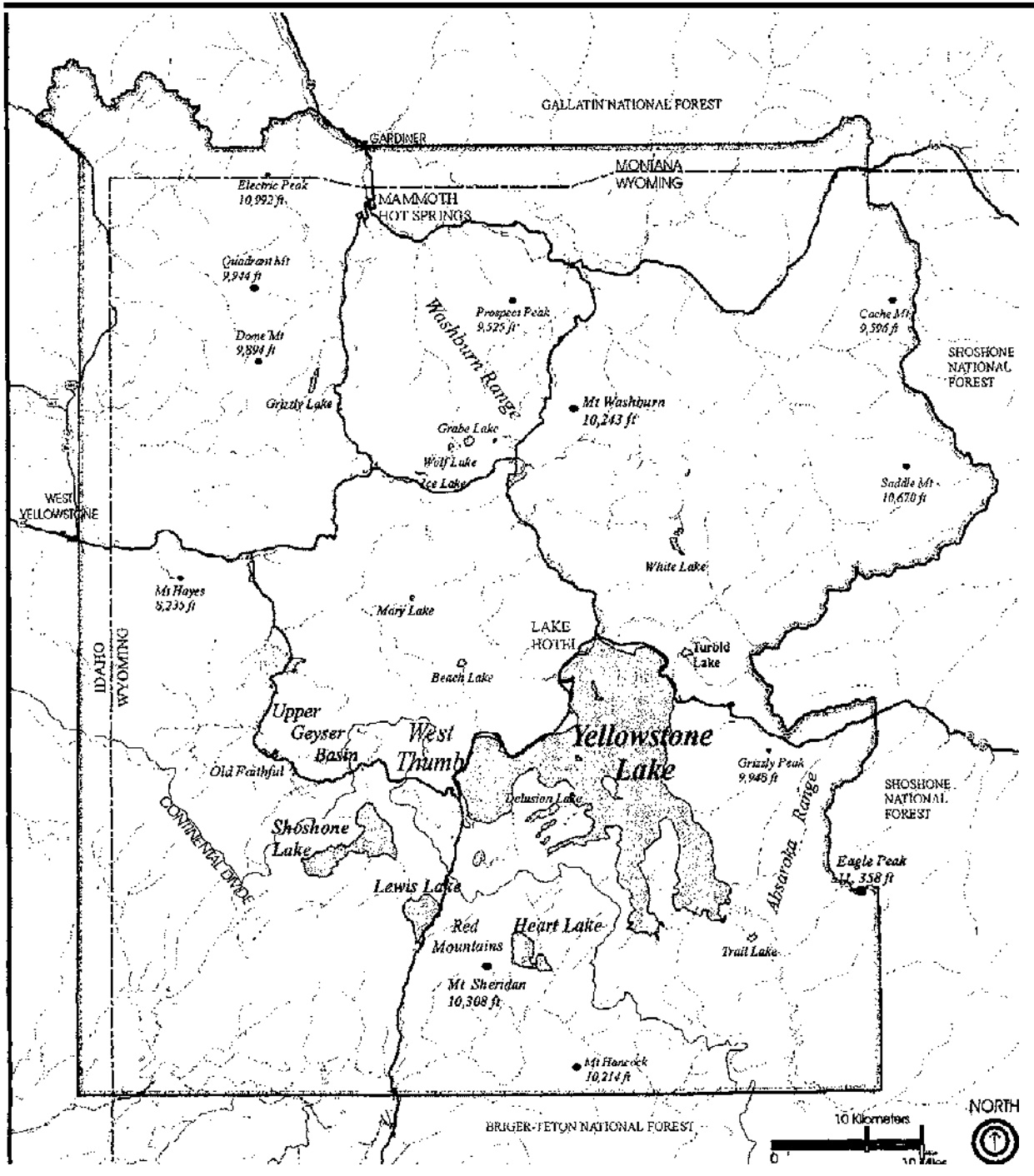

Figure 1.1. Yellowstone National Park.

benefits of multiresource investigations, SCRUI accepted the opportunity afforded by this natural resource investigation to collect information on submerged cultural resources at the same time.

The 1996 SCRUI investigations of Yellowstone Lake were a follow-up to the 1995 reconnaissance-level study. This second, more intensive project was designed to acquire substantial information on cultural resources in the lake in areas selected by park managers. The cultural resources survey and documentation phases were opportunistically "piggy-backed" on the primary field objective of testing the efficacy of SCRUI's remote-sensing survey methodology for lake sediment classification to assist resolution of the park's lake trout issue.

The cultural resource component of the 1996 project was designed to accomplish two goals: 1) investigate selected shoreline archeological sites and submerged near-shore features related to the history of Yellowstone Lake, including precontact and postcontact American Indian sites, and historical Euroamerican features such as boat docks, watercraft remains and other material culture scatters; and 2) conduct side scan sonar survey to locate submerged watercraft remains,

including small boats near the old Lake Hotel dock and *Zillah*, the first large lake tour boat, reported to have been sunk near the lake's northern end. Although park divers have observed submerged near-shore features near the Lake Hotel and West Thumb Geyser Basin, no systematic archeological survey of these areas has been conducted. Lake District Ranger John Lounsbury provided the background information and historical context for these areas.

Fieldwork began July 30, 1996, and was completed August 15, 1996. Daniel J. Lenihan was overall SCRUI project director and Larry E. Murphy was field director. Murphy and Timothy G. Smith were principal remote sensing surveyors; Lenihan, Matthew A. Russell, Brett T. Seymour and James E. Bradford conducted the in-water investigations; John D. Brooks and Seymour documented cultural and natural features with photography and video. Park rangers provided logistical support, with John Lounsbury, Rick Fey, Wesley Miles and Gary Nelson directly involved in field operations.

This report presents the methodology and results of the 1996 field investigations in Yellowstone Lake. Recommendations for future work are included in the last chapter.

CHAPTER 2

Environmental Context

This chapter presents a brief discussion of specific Greater Yellowstone Ecosystem aspects that have particular relevance to the environmental context of archeological sites presented in this report. Its purpose is to briefly describe how Yellowstone Lake was formed, discuss the bio-diversity that evolved along its shores, and explain why these factors attracted people to Yellowstone Lake, the largest high-altitude lake in the intermountain west.

GEOLOGY

Situated in the northwest corner of Wyoming, Yellowstone National Park is at the juncture of three physiographic provinces: the southeasternmost extension of the Northern Rockies; the northern lobe of the Middle Rockies; and the easternmost extension of the Columbia Plateau. This location, in the heart of the youngest and largest mountain chain in North America, affords one of the most geologically complex and fascinating settings in the world. Although pioneering geological studies were conducted in the Yellowstone area as early as 1871 by the western geologist F. V.

Hayden (1872, 1873, 1883) and followed by A. Hague's classic studies done between 1883 and 1902 (Hague 1899, 1904), the area's complexity was not well understood until the work of Boyd (1957), when the vast age difference between the older and younger rocks was recognized. Since Boyd's work, studies by Pierce (1979), Christensen (1984) and others have increased and refined knowledge of Yellowstone's complex geology.

VOLCANISM

The Yellowstone Plateau has been destroyed, altered and reshaped often through geologic time. The oldest rocks in Yellowstone National Park are volcanic, dating to perhaps 50 million years ago when countless mud flows cooled into breccia deposits forming a nearly 65-km (40-mi.)-long mountain range between Mt. Washburn, 26 km (16 mi.) north of Yellowstone Lake, and Mt. Sheridan in the Red Mountains, 13 km (8 mi.) south of the lake's West Thumb (Figure 2.1). Connecting these two high peaks and running along Yellowstone Lake's eastern edge is the Absaroka Range

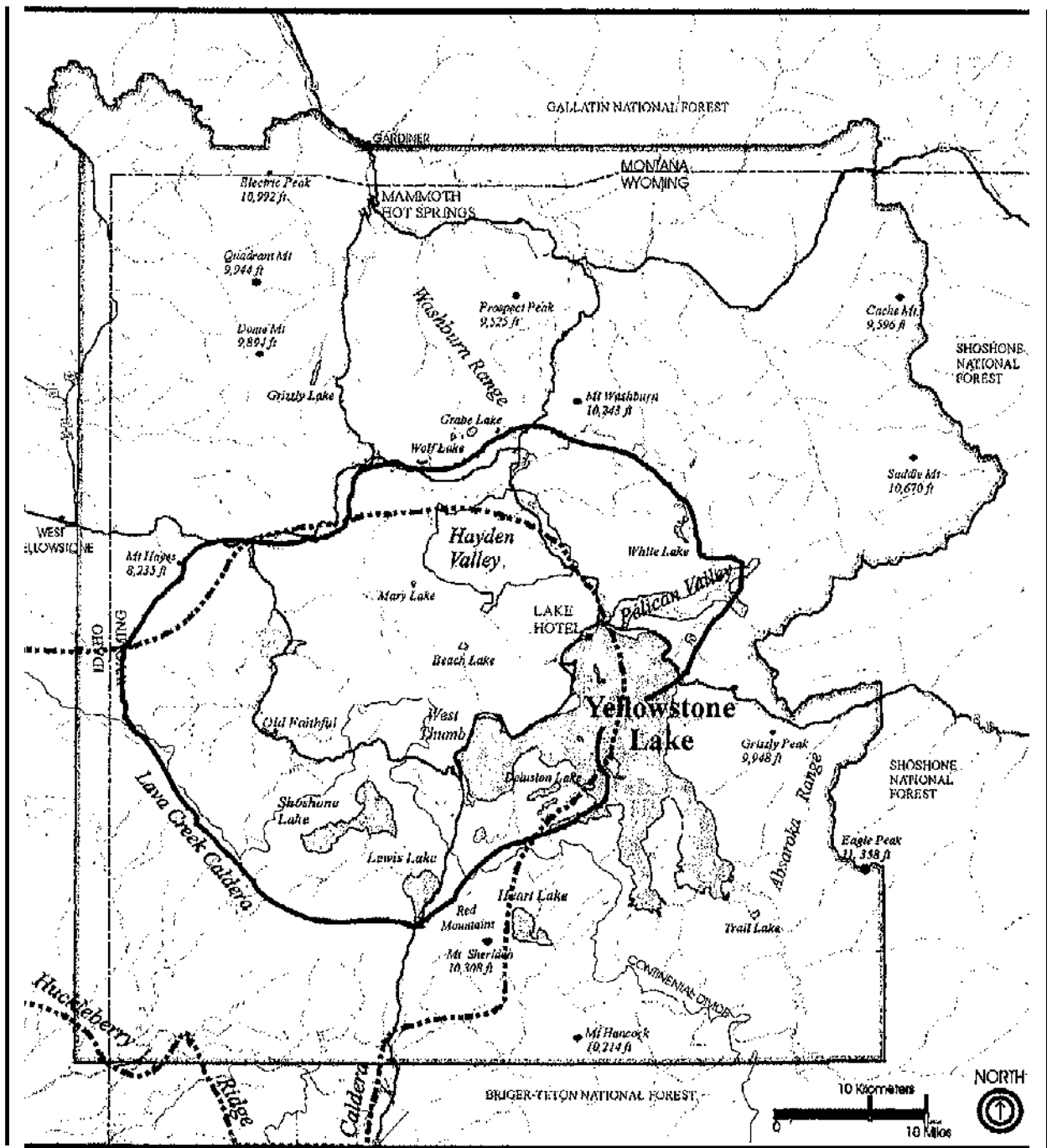

Figure 2.1. Major geological features in Yellowstone National Park.

which, together with the Washburn Range and the Red Mountains, form a “sort of geologic horseshoe open to the southwest” (Good and Pierce 1996:6). The original size of these mountainous deposits will likely never be known because later geologic events have destroyed many of them.

Beginning about two million years ago, a series of volcanic eruptions occurred in the general Yellowstone area creating four large calderas, three of which directly affect park topography (Figure 2.1). Calderas are “large basin-shaped volcanic depressions more or less circular in form” (Good and Pierce 1996:8). The first caldera eruption, about 2.1 million years ago, produced 965 km³ (600 mi³) of volcanic rock—2,400 times more than the recent Mt. St. Helens eruption. This caldera is centered in west Yellowstone, extending westward into Idaho and eastward to include the area now containing the western half of Yellowstone Lake. A second explosion, the island park caldera, occurred 1.3 million years ago outside the current park boundaries but within the westernmost extension of the earlier caldera. The third and most relevant caldera to the study area erupted about 650,000 years ago in much the same place as the first, overlapping it and extending the newly formed Yellowstone Caldera 16 km (10 mi.) northeast. This third caldera encompassed all of what would become Yellowstone Lake except for the two southern fingers (Southeast and South arms). It may have been this explosion that destroyed the southern part of the much older Washburn Range (Good and Pierce 1996:10). More recently, about 160,000 years ago, an eruption, minor by comparison to the earlier ones, formed the West Thumb Caldera within the southeast portion of the much larger Yellowstone Caldera (Taylor et al. 1989).

The Yellowstone Caldera was created when a huge magma chamber beneath the earth’s crust began rising and arching the overlying crust into a huge dome, resulting in a series of concentric

or ring fractures around the dome and allowing rising magma to vent to the surface. The venting triggered a sudden release of tremendous pressure in the form of gasses and molten rock that erupted almost immediately and, upon exposure, began cooling and solidifying into pumice, ash and dust across the surrounding landscape. Vast ash flows quickly covered thousands of square miles, obliterating a complex ecosystem of plant and animal life and replacing everything with a barren, black moonscape (Good and Pierce 1996:13). With relief of underlying pressure, the dome collapsed several thousand feet into the underlying magma chamber forming a giant caldera 77 km (48 mi.) long by 45 km (28 mi.) wide, ultimately creating the depression for what is now most of Yellowstone Lake.

Even with these eruptions, the magma chamber still contained most of its material and began rising again, creating two resurgent domes within the caldera floor and causing a series of rhyolite flows through the fractures. These flows spread across the caldera floor and completely buried the caldera’s western rim (Good and Pierce 1996:12). This young rhyolite along the caldera floor shaped the foundation of much Yellowstone topography seen today. This process created many streams, waterfalls and lakes. For example, Shoshone and Lewis lakes’ fill basins are located between adjacent flows, and “Yellowstone Lake [eventually came to fill] a basin in the southeast part of the 600,000-year-old caldera between the east rim of the caldera and the rhyolite flows of the west” (Good and Pierce 1996:14).

This formative geologic activity is caused by what geologists now believe to be the slow, southwestern movement of the North American tectonic plate passing over a stationary thermal mantle plume—a bulbous mass of magma that has risen from the earth’s core toward the crust, which is slowly being flattened by crustal plate movement (Good and Pierce 1996:21). This

tectonic movement over the mantle plume also uplifted much of northwest Wyoming, southwest Montana and southern Idaho, resulting in Yellowstone's 2,450 m (8,000 ft.) average elevation (Good and Pierce 1996:21). Subsequent volcanism, glaciation and erosion have caused elevation differences within the park ranging from 1,620 m (5,315 ft.) near the park's north entrance to 3,462 m (11,360 ft.) on Eagle Peak near the southeastern corner boundary (Haynes 1946:15).

GLACIATION

Concurrent with Yellowstone Plateau's volcanic history is glaciation. Although one does not usually think of fire and ice coexistence, Yellowstone's geologic history often encompassed both simultaneously, much as the Kamchatka Peninsula of eastern Russia does today. A combination of factors caused glaciation, the second major geologic influence on park terrain: the upward thrust of the plateau to its current elevations and a cooler global climate. Glaciation requires "considerable snowfall [and] summer temperatures . . . cool enough for some of the winter snow to survive into the succeeding winter, year after year" (Good and Pierce 1996:27).

Glacial conditions existed during the past two million years over 26 million km² (10 million mi.²) of Canada and the United States that are now almost ice-free, extending as far south as St. Louis, Missouri (Good and Pierce 1996:27). This Quaternary-age glaciation was cyclical, alternating between periods of glaciation and glacial melting about every 100,000 years, which was influenced by two factors: 1) eccentricity of the earth's movement around the sun; and 2) effects on global weather patterns created by plateau and mountain uplift, as in the western United States, that created barriers to west-east storm tracks (Good and Pierce 1996:28).

Yellowstone Plateau's glacial history is as complex as its volcanic history. In the Yellowstone region, there were at least 10 glacial periods; the last began around 70,000 years ago, reached its maximum size about 25,000 years ago, and all but vanished 15,000 years ago. The Yellowstone Plateau ice shield was separate from the North American ice shield and covered the entire area in an almost flat ice mantle for miles in all directions. During this last glacial period, the ice mantle was 1,200 m (4,000 ft.) thick above the Yellowstone Lake area (Good and Pierce 1996:31). Because of Yellowstone Plateau's modest elevation, early warming significantly affected the area when the Yellowstone ice field began to shrink about 20,000 years ago. The snow line rose 900 m (2,953 ft.) to its current position, which resulted in the plateau being in the initial melt zone.

As the plateau ice field melted, the Yellowstone valley glacier retreated up valley and thinned . . . [but the major valleys] were still full of moving ice. Meltwater streams from the plateau ice field drained toward the ice-filled major valleys and ran along the margins of the valley glaciers [Good and Pierce 1996:43].

As the ice thinned, the underlying volcanism was uncovered, and interactions between stagnant ice and hydrothermal features were abundant (Good and Pierce 1996:44). Moving ice often blocked the valley streams creating large lakes that, in turn, eventually rose to overpower the ice dams and create violent, massive glacial outburst floods (Good and Pierce 1996:46). Such wasting of the massive ice cover caused a 61 m (200 ft.) drop in the level of Yellowstone Lake, resulting in the explosion of superheated water from below that created the 1.6 m long (1 mi.) by 49 m deep

(160 ft.) Mary Bay on the lake's northern end. Similar, smaller explosions between 5,500 and 3,500 years ago created Indian Pond and Turbid and Fern lakes (Hirschmann 1982:83). With the lake level currently stabilized, we are left today with numerous, but much less violent, hydrothermal features that characterize the Yellowstone Plateau: an estimated 150 geysers and more than 5,000 hot springs, hot pools, and steam vents. These geothermal features, particularly geyser basins, are concentrated along streams and on lake shores because it is here that the necessary concurrence of heat and water is found. These remarkable features have no peers, and they have made "Yellowstone" synonymous with geothermal activity (Haines 1996a:xix).

Today, glaciers, along with a few remnant ice fields, are all but gone within the contiguous United States remaining only in the highest Rocky Mountain elevations within classic glacial erosion topography. These features include mud, sand, gravel and boulders reduced and redeposited by glacial action. This lithic debris forms much of the lake shore and islands within Yellowstone Lake. Aside from minor exposures of late Tertiary and Quaternary-age volcanic flows and a few hydrothermal deposits along the shoreline, almost the entire lake shore is composed of Quaternary-age glacial sediments and subsequent lake deposits (Taylor et al. 1989). Also left over from the last Yellowstone glacial retreat was a large amount of melt water that originally filled low areas within the calderas, creating the many lakes that are replenished each spring with snow melt. This cycle created the ancestral Yellowstone Lake, which once covered the Hayden and Pelican Creek valleys. Many features of the present Yellowstone Lake reflect its complex formation.

CLIMATE

Yellowstone's climate is affected primarily by its latitude, Yellowstone Plateau elevation, and its location within the Rocky Mountains. The climate is considered severe along the lake shore, with a mean annual temperature of 0° C (32° F). Daytime summer temperatures are generally mild, in the 15.5° C (60° F) range, but winter temperatures can plunge to 10–15.5° C (50–60° F) below zero. Winters are long with snow commonly occurring from September to June, but snow can also occur in limited amounts during summer months. Annual precipitation varies from 30–200 cm (12–80 in.) across the park with a mean precipitation of 76 cm (30 in.), most of it snow. Yellowstone Lake is often icebound by late December and stays frozen all winter, though the ice is rarely more than 60 cm (2 ft.) thick (John Lounsbury, personal communication 1996). Winter generally lasts 7–8 months, and it usually snows every few days. Winds can reach 160 kph (100 mph) on the region's higher peaks, and dangerous winds come up on the lake most summer afternoons. These climatic conditions have a major influence on the region's floral and faunal populations.

BIOLOGY

Volcanism produced enormous amounts of silica sediments that cover the landscape, creating a relatively sterile soil environment. Certain plants have adapted to this environment, including lodgepole pine, pine grasses and fireweed (Good and Pierce 1996:14). These adaptations eventually led to plant and animal associations that add to the area's uniqueness and include wildlife that, along with the

geologic wonders, has drawn people to Yellowstone for centuries.

FLORA AND FAUNA

As described by Good and Pierce (1996:47–50), the postglacial Yellowstone Plateau history is one of a succession of plant communities and their attendant animal populations. As temperatures rose and the glaciers retreated, new deposits of glacial till supported a series of plant communities. Toward the glacial-period terminus, the plateau was a tundra containing a mixture of grasslands, stunted sagebrush, and other tundra vegetation, with dwarf willows lining meltwater streams. Pleistocene animals from south of the continental ice sheets moved northward with the ice shield's retreat. Many tundra-related animals, such as musk oxen, woolly mammoths, dire wolves and elk, were present. About 14,000 years ago, the Yellowstone Plateau became ice-free and episodic changes in vegetation began to occur. With *lake* and pond formation, hardier plants became established through pollination by trees and shrubs from areas south of the plateau. With these new plant communities may have come such animals as American lions, bison, ground sloths, camels, horses and, by late Holocene times (about 10,000 years ago), beaver. Two animals not previously recorded in North America, humans and grizzly bears, also entered during this period (Good and Pierce 1996:49).

The tundra-like vegetation was replaced by Engelmann spruce that spread through the region over a 500-year period, indicating rising summer temperatures and moist conditions. As the temperatures continued to rise, whitebark, limber and lodgepole pine formed open forests that were eventually succeeded by the present closed forests of lodgepole pine (Good and Pierce 1996:48). Deer and black bear probably entered the region at this time.

During the period from 10,000–6,000 years ago, the earth was at its perihelion, the closest approach to the sun. Lodgepole pine flourished in this period of higher solar radiation, probably also due in part to the natural fires that swept the area. These pines occupied areas that today support primarily spruce and fir, while Douglas fir predominated around Yellowstone Lake's shore. Today, these pines are restricted to dry southern exposures.

Cooler temperatures followed the warm early Holocene period, allowing four minor glacial advances in the last 6,000 years. The last of these cooler periods, dubbed the "Little Ice Age," began around A.D. 1250 and lasted until about 1900. During this period, the snow line dropped 90–180 m (300–600 ft.). This cooler, 650-year period was the last major environmental influence on plateau vegetative communities, and is evident in the local plant communities and distribution patterns seen today. Of the 13 arboreal species found in the park, eight are conifers that cover almost 80% of the park terrain. Along the lake shore, lodgepole pine dominates and herbaceous plant communities are principal understory types. Lakeshore glacial sediments support sagebrush communities, including silver sage, big sagebrush, and a variety of forbs and grasses. Stream banks and marshy areas produce stands of willows, sedges and rushes, important food for elk and moose.

Just as plant communities are dependent on the region's geology, native animals are dependent on the vegetation. As described by Haines, Yellowstone today is not only a:

...hot-water extravaganza [but also]
...an unusual wildlife habitat, a great outdoor zoo preserving a more representative sample of the primeval fauna of the American West than is now found anywhere else. Here,

living under conditions very nearly those existing when white men first entered the area, are elk, buffalo, mule deer, moose, antelope, bighorn sheep, black and grizzly bear, cougar, coyotes, wolves, beaver and a number of smaller animals, as well as many species of resident and migratory birds [Haines 1996a:xix].

To briefly summarize the environmental history of Yellowstone:

. . . we have learned that . . . Yellowstone [is a] very active part of our planet. . . . The hotspot (the thermal mantle plume) produced repeated volcanic eruptions and still produces prodigious amounts of heat energy that drive the largest natural hydrothermal system in the world. In the greater Yellowstone region,

doming above the hot spot fostered Pleistocene glaciation that sculptured stunning scenery — mountains, canyons, and lakes, large and small. Pleistocene glacial and interglacial cycles also produced cyclical advances and retreats of forests and wildlife over the millennia [Good and Pierce 1996:51].

Similar to human migration into the western hemisphere that followed Pleistocene herd animals, it was the promise of animal furs, particularly beaver, that brought the first Euro-americans to the Yellowstone region in the early 1800s. But the lure of profits from pelts quickly gave way to the fantastic geologic sights these early explorers and trappers encountered. Tales of these wonders soon brought public interest to Yellowstone, which began the exploitation of its less tangible resources: its scenic beauty.

CHAPTER 3

Historical Context

Yellowstone National Park (YELL), established by Congress March 1, 1872, as a “pleasuring ground for the benefit and enjoyment of the people” (Tilden 1951:98), was the world’s first national park. The idea of preserving a vast territory in its natural state for the general public was a novel concept, particularly in a young country where extractive exploitation of the seemingly limitless resources was considered a right. To actually preserve this large area is even more astounding, although it took almost a half-century of experimentation to learn how to manage such an unparalleled undertaking. Although the congressional concept of natural preservation did have precedent in the 1864 Yosemite Grant that provided state protection for that area, the unique wonders of Yellowstone so impressed explorers and scientists that the idea of a national park originated early in its exploration. Perhaps the earliest recorded comment on the matter, which was made in 1865 by then Acting Territorial Governor Thomas F. Meagher, who upon hearing first-hand stories from trapper François Vielle and Father Francis X. Kuppens, declared that such a place of wonders “should

be reserved for public use as a park” (Haines 1996a:90). Meagher soon led his own group to explore Yellowstone, the 1867 Curtis-Dunlevy expedition. Unfortunately, he died suddenly, and the expedition only reached Mammoth Hot Springs before turning back. This expedition elevated interest in Yellowstone exploration and was soon followed by another futile attempt in 1868, as well as the successful, three-man expedition of David Folsom, Charles Cook and William Peterson in 1869 (Haines 1996a:91). David Folsom was later credited by an expedition partner as proposing that the “government ought not to allow anyone to locate here at all,” to which Cook responded, “it ought to be kept for the public some way” (Haines 1996a:103).

The successful Folsom team was followed the next year by the Washburn expedition, the first to collect important information about the area. Washburn expedition member Cornelius Hedges, present in 1865 when Meagher made his prophetic comment, was the only member to suggest in print that the area should be preserved for public use (*Helena Herald*, November 9, 1870). N. P. Langford credited

Hedges with the idea of “. . . a great National Park . . .” when Langford compiled his 1870 Washburn expedition diary more than 30 years after Congress created the park (Haines 1996a:130). Cramton (1932:28–35) provides a good discussion of this facet of Yellowstone history, and Haines (1996a:130, 134–140), with the benefit of Father Kuppens’ 1865 information, expands upon who may have first proposed the national park wording: Hedges, Langford or even F. V. Hayden, who led three expeditions into Yellowstone in 1871. Haines’ (1996a:156–173) chapter on this early Yellowstone history is particularly good. Historians may someday settle the question of who first proposed the idea of a “great national park,” but whoever is finally credited, it is clear that the idea’s seed had been planted, germinated and taken root in the Montana Territory by 1870.

The 1870 Washburn expedition resulted in several articles written by various expedition members and Langford’s speaking tour in the eastern United States. These presentations initiated a rapidly growing interest in Yellowstone and spurred many others to bring Yellowstone’s remarkable natural wonders to the American public’s attention.

BRIEF HISTORY OF YELLOWSTONE NATIONAL PARK

In 1864, the Montana Territory was carved from the vast Idaho Territory, which had been created in 1863. YELL is located within the Wyoming Territory, which was established in 1868 from the Montana Territory. Although Yellowstone could be reached from either the Montana or Wyoming side, it was much easier from the Montana Territory, particularly through the Gallatin and Yellowstone River drainages, and, to a lesser extent, from eastern Idaho via the Snake River. Consequently, impetus for creating a Yellowstone park came from Montana, principally through people educated

in current affairs and influential in the national capitol. By early December 1871, a memorial (Joint Memorial. 5 earlier adopted by the Montana Legislative Council), was submitted to Congress, calling for granting the Yellowstone region to the Territory of Montana (Cramton 1932:25). This memorial was based on two premises: 1) the precedent set when the federal government transferred Yosemite Valley and Mariposa Big Trees to California in 1864; and 2) that Montana’s claim to the region was justified by its exploration of the area and settlement of Yellowstone Valley north of the proposed grant (Haines 1996a:165–166). The memorial was not supported because Congress determined the government could not grant public lands to territories (Montana was not yet a state), although it could to states, as in the California precedent. However, the national park idea rapidly gathered support, and a draft bill establishing a national park was introduced into both houses of Congress on December 18, 1871. The bill passed within ten weeks and was signed into law by President Grant March 1, 1872.

The fledgling park was an exciting, new experiment, but it had a nearly disastrous beginning. Congress failed to define basic guidelines and appropriate funds, which were limited in the post-Civil War recovery era. Park management and protection responsibilities were given, by law, to the Secretary of the Interior, initiating federal land management policies. Although there was pressure for a local person as the park’s first superintendent, on May 10, 1872, the secretary selected N. P. Langford, a member of the Washburn expedition visiting Washington at the time. Langford promptly selected David Folsom as assistant superintendent—both men served without salary. The managers believed lack of park operational funds would be ameliorated by growth of a tourist economy resulting from the Northern Pacific Railroad, a major park

supporter, reaching Montana. This certain tourist growth from easy, dependable transportation to Yellowstone would encourage concessionaires from whom fees would be collected to offset park costs. Unfortunately, these plans collapsed with the failure of Jay Cooke & Company, which started the Panic of 1873. No railroads were built for the next six years, which meant no tourist growth, no concessionaires, no fees, and ultimately, no money for park operations (Haines 1996a:179).

Langford, for all his efforts to explore Yellowstone and establish the park, proved to be an ineffectual manager. In five years as superintendent, he visited the park only twice: once in 1872 to accompany the second Hayden survey; and again to evict squatter Matthew McGuirk from his Mammoth Hot Springs homestead (Haines 1996a:212). Langford had some good ideas for managing the new park, and portended the major park roads. But his reluctance to select concessionaires, perhaps influenced by his close association with the railroad and its eventual recovery, damaged his relationship with the Secretary of the Interior. Growing criticism of Langford's unresponsiveness to increasing vandalism of thermal formations, setting of wildfires and, particularly, rampant slaughter of park animals led to his dismissal in early 1877 (Haines 1996a:200, 212–216).

Langford was replaced in April 1877 by the dynamic P. W. Noms, a highly energetic person critical of Langford. Norris' management difficulties began upon his arrival. During two weeks of warfare, the US Army chased Chief Joseph's band of 600 Nez Perce Indians through the park, and several tourists were killed (Haines 1996a:219–237). Norris received some funding for salary and park improvements, and he constructed many park facilities, including the famous Mammoth Hot Springs blockhouse headquarters. He also began the basic park road system, hired the first gamekeeper, and waged

a ceaseless war against poachers and vandals. Norris was tireless in exploring the park, mapping its physical features, and adding immensely to geographic knowledge about the park, but he was criticized by some for applying his own name to several landmarks, including Norris Geyser Basin, Norris Valley and Norris Pass (Clary 1972:36).

Despite his best efforts, Norris got caught in the politics of big business and was replaced after nearly five years as superintendent.

The removal of Norris was indicative of Yellowstone's plight. During its formative years, the park was fought over by interests that for political or financial reasons hoped to claim it as a prize and control it totally. Without legal protection against such exploitation or against poaching and vandalism, the park suffered greatly during its first two decades. An active and conscientious, if abrasive, superintendent like Norris was unable to fully protect the park. After his dismissal, promoters of schemes to build railroads and toll roads in the park and to monopolize accommodations usually blocked the appointment of capable superintendents and harassed any who showed signs of honestly striving for the benefit of the park. A succession of powerless and mediocre superintendents took office [Clary 1972:37].

The government attempted to bring law and order to the park in the 1880s. In addition to the superintendent, ten assistant superintendents were hired to patrol the park and enforce regulations. These measures failed, and they were described as "notoriously inefficient if not positively corrupt" (Clary 1972:42). Because

of this failure, Wyoming Territory laws were extended into the park in 1884. But this situation only created a different brand of corruption—it allowed magistrates and informers to split fines. Consequently, no money went to the park. In 1886, Congress repealed the act allowing territorial law enforcement in Yellowstone. The park soon fell victim to a new onslaught of poachers, wood cutters, vandals, squatters and pyromaniacs. Failure of superintendents to protect the park gave Congress reason to refuse appropriations for their ineffective administration. At this point, no one could be found to serve as YELL superintendent.

The Secretary of the Interior, lacking both park funding and a superintendent, enlisted the aid of the Secretary of War, which was allowed under the act establishing the park. Beginning in 1886, the US Army had jurisdiction of Yellowstone, which proved a positive management step for the park. The Army had sufficient manpower for mounted patrols and law enforcement. They posted new regulations in the park, and constant military patrols enforced them. Military detachments were stationed around heavily visited areas and, although no specific law denoted offenses, the Army had authority to evict troublemakers and keep them out of the park (Clary 1972:43). Congressional appropriations increased, and the Corps of Engineers began a series of improvements that included completion of the road system begun by Norris. Army Engineer H. Chittenden, who also wrote the first history of YELL, left a tangible mark on the park with these improvements, including the great arch at the park's north entrance. The Army's Yellowstone legacy is most obvious at their Mammoth Hot Springs headquarters, initially at Camp Sheridan, and, later, at Fort Yellowstone, which houses park headquarters today (Clary 1972:43).

Continued poaching in Yellowstone eventually forced Congress to correct the lack of enforceable laws. In 1894, poacher E. Howell's arrest for slaughtering park bison led to the National Park Protective Act (Lacey Act) that finally put teeth in protecting Yellowstone's treasures. Although the Army's record over the next 30 years was admirable, something more was clearly needed. The Army was not in the business of running parks, and they could not meet requirements of the rapidly increasing tourists who wanted more information about the park. During this period, 14 other national parks had been established, and each was managed independently. This situation caused uneven management, inefficiency and a general lack of direction. By 1916, it was obvious that a government agency was needed to provide coordinated national park administration by professionals able to meet protection responsibilities and other special park needs, including a new concept called interpretation (Clary 1972:44). On August 25, 1916, President Woodrow Wilson signed into law a bill creating the National Park Service (NPS).

Yellowstone management and protection responsibilities passed from the Army to the NPS in 1918, and C. A. Lindsley became the first NPS superintendent. Many early park rangers were Army veterans already familiar with Yellowstone's issues and territory. But by this time, tourism, particularly automobile traffic, was becoming a major issue for park management. The growing influx of people and cars required more time spent on traffic control and protection of the park's fragile natural features. More sophisticated management techniques were clearly required.

This growing challenge was met by Horace M. Albright, who became superintendent in June 1919. Albright is legendary for innovative park management during this period of rapid park

visitation growth. He laid the foundation for Yellowstone's management, which became a model for the whole park system. Albright emphasized public interpretation and portrayed parks, important in themselves, as part of an intricate interrelationship of humans and their environment. During his tenure, Albright extended Yellowstone's boundaries to encompass related natural topographic features, protect petrified tree deposits, and increase elk winter grazing range. Developers' attempts to impound the Yellowstone River were successfully defeated, and solid research into the park's natural resources provided a foundation for more sophisticated wildlife and forest management policies. A better understanding of park ecology led to better ways of allowing public access to the park's natural wonders without inflicting severe environmental impact (Clary 1972:44–45). Albright's pioneering Yellowstone management style continues today throughout the National Park System.

YELLOWSTONE LAKE USE

Yellowstone Lake occupies the central Yellowstone Plateau. By the time ancient humans arrived on the plateau, there were many lakes, ponds and streams created by melting glacial ice. Yellowstone Lake was the region's largest, and its present size of 139 mi.² makes it the United States' largest natural, high-elevation lake (Whittlesey 1988:167–168). Yellowstone Lake, like most fresh water sources, was a focal point for human activity.

AMERICAN INDIAN LAKE USE

Archeological evidence from YELL reflects more than 10,000 years of human utilization, beginning at the end of the last ice age with seasonal occupation by highly mobile hunting bands possessing limited material culture. The

scant material evidence indicates only rare and brief sojourns onto the plateau to hunt modern species and now-extinct Pleistocene herd animals such as mammoth, horse and giant bison, and to gather supplemental wild food plants.

Artifacts from Fishing Bridge peninsula on the lake's east shore indicate Yellowstone Lake shores were probably used as early as 10,000 years before present (B.P.), and certainly by about 9000 B.P. (Reeve 1989; Cannon 1993:9). Sometime around 8500 B.P., many Pleistocene megafauna species died off as the climate changed to a warmer, drier regime. Rainfall remained abundant in the mountains, and succeeding human occupations continued into Late Prehistoric times. The most intensive lake use appears to have been during either Middle to Late Archaic times (5000–2000 B.P.) or during the Late Prehistoric period (up to A.D. 1500). Many precontact sites, some quite large, from both periods have been located around the lake (Taylor et al. 1964; Reeve 1989; Cannon 1993).

Yellowstone's aboriginal occupation is often referred to as limited or transient, but the archeological evidence indicates a long history of American Indian use. This archeological evidence supports American Indian origin stories and ethnohistorical accounts from several tribes that describe the Yellowstone Lake region as their ancestral homeland or place of origin. Groups claiming ties to Yellowstone Lake include the Kiowa (Mooney 1979), Shoshone (Dominick 1964; Wright 1978) and Apache groups (Perry 1980), particularly the Kiowa-Apache (Gunnerson and Gunnerson 1971:14).

By the late 1600s, introduction of the modern horse into the northern plains drastically changed subsistence patterns of indigenous cultures. Pedestrian bands became more mobile and much faster with the horse, so groups hunted plains bison more and used the mountains less

(Haines 1996a:8). By the time Euro-Americans first penetrated the Yellowstone Plateau in the early 1800s, the plateau was largely abandoned except for occasional trips through the area by the Shoshone, Piegan (Blackfeet), Crow and Bannocks, and the more distant Flatheads and Nez Perce to the north and west along established trails. These trails:

though indistinct, were found by the early explorers, generally on lines since occupied by the tourist routes. One . . . followed the Yellowstone Valley across the Park from north to south [branching] at Yellowstone Lake, the principal branch following the east shore [to] a great trail which connected the Snake and Wind River Valleys. The other branch passed along the west shore of the lake and over the divide to the valley of the Snake River and Jackson Lake. Other intersecting trails connected the Yellowstone River trail with the Madison and Firehole Basins on the west and the Bighorn Valley on the east. The most important trail. . . was that known as the Great Bannock Trail. It extended from Henry Lake across the Gallatin Range to Mammoth Hot Springs, where it was joined by another coming up the valley of the Gardiner. Thence it led across the plateau to the ford above Tower Falls; and thence up the Lamar Valley, forking at Soda Butte, and reaching the Bighorn Valley. . . . This trail was an ancient and much-traveled one. . . [But] with one or two exceptions the old trails were indistinct. . . [and] their undeveloped condition indicated infrequent use [Chittenden 1924:7-9].

The Great Bannock Trail through the park's northern section was the major east-west thoroughfare with other trails forming minor connecting routes in other directions. Yellowstone Lake appears to have been a major landmark in north-south travel, and sites associated with these movements are likely to be found along its shores.

One exception to general plateau abandonment was an American Indian group referred to as "Sheepeaters." This group has been described as:

. . . Shoshonis who had 'retained the old way of living from the time before horses were introduced and who established a specialized mountain culture.' [They are described] as living in very small groups, often of family size; traveling on foot, accompanied by large dogs which were used for hunting and as beasts of burden (they were sometimes packed, and sometimes pulled V-shaped dog travois); and living on berries, herbs, fish, small animals, elk, deer, and bighorn sheep.

. . . As a people, they were timid but not unfriendly, and their philosophical outlook was animistic. Altogether, their lifestyle was a holdover from the Late Prehistoric period [Haines 1996a:24].

The first recorded Euro-American observation of Sheepeaters is from 1835 when a party of Lamar Valley trappers led by Osborne Russell encountered them (Haines 1996a:49). Early Euro-American explorer accounts of the region suggest that most Indian groups, including Sheepeaters, were generally unfamiliar with the area beyond specific areas they frequented.

Apparently, they were unaware of the main geyser basins' thermal features (Chittenden 1924:9–12). Sheepeater diet included fish, which indicates they probably utilized, and perhaps seasonally occupied, Yellowstone Lake shores. Euro-American encounters occurred until the Sheepeaters were dispossessed of their lands in 1851. Their lands were ceded by treaty with the United States to the Piegan and Crow, who, in turn, lost them in an 1868 treaty (Haines 1996a:27; Hodge 1910:378).

Archeological evidence of Yellowstone Lake fishing is scant, although some has been observed. A submerged feature just offshore an occupation site northeast of Bridge Bay has been suggested as a fish weir (John Lounsbury, personal communication 1996; Johnson and Lippencott 1989:41). Net-weight sinkers have been found in archeological sites south of the lake and along the Yellowstone River. Fish bones were recovered from a roasting pit at site 24YE3 (Ann Johnson, personal communication 1997). There is only a single mention of Indian watercraft in the ethnohistorical literature—an entry by Norris (1880:37) who “. . . saw a rude canoe at the lower rapids of the Upper Yellowstone, and probably others have been used by both Indians and white men, . . .”

EURO-AMERICAN LAKE USE

It is generally agreed that John Colter, a member of the 1803–1806 Lewis and Clark expedition, was the first Euro-American to view Yellowstone Lake. In his 500-mi. solo trek through the Northern Rockies in the winter of 1807–1808, Colter walked along the lake's west side during his return to the Bighorn River (Haines 1996a:35–38). In 1827, trapper Daniel Potts described Yellowstone Lake as “a large fresh water *Lake* . . . on the very top of the Mountain. . . and as clear as crystal. . .” (Haines 1996a:41). Many trapping parties probably camped by the lake after 1826, and Osborne

Russell made five trips into the Yellowstone country between 1835 and 1839. Although Yellowstone Lake was the original objective of his 1835 trip, (its location had been drawn for him by a Sheepeater on a hide map), he instead trapped in the surrounding mountains (Haines 1996a:48). Russell returned in summer 1836, trapping in the lake's marshy south shore area where the Yellowstone River enters. From there, he traveled up the lake's east side to Pelican Creek, exiting the region to the north at summer's end (Haines 1996a:50). Russell returned to the area twice in 1839. During the second trip while camping at Pelican Creek, Piegan Indians attacked his party, and he escaped along Yellowstone Lake's west shore to the Snake River (Haines 1996a:51–52). Also in 1839, Indians attacked a group of 40 trappers traveling the lake's east shore near Mary Bay just south of Pelican Creek (Haines 1996a:52). Trappers were only interested in beaver; their association with Yellowstone Lake was trapping where the Yellowstone River connects and using established shore trails. Warren Angus Ferris, an American Fur Company clerk, was probably the first “tourist” to visit Yellowstone. Ferris traveled to Yellowstone specifically to see the geological wonders, rather than for solely commercial reasons (Haines 1996a:46–47).

For the next 20 years, few Euro-Americans visited Yellowstone territory, but gold strikes in the early 1860s brought an incursion of miners to the Idaho-Montana region. By the end of this period, miners had explored most parts of the future park, and many undoubtedly saw Yellowstone Lake. At least nine mining expeditions entered park territory between 1863 and 1870. The 1864 Phelps-Davis party skirted the lake's eastern edge, and, in 1866, George Huston mentioned a “horse-thief trail” along the west side of Yellowstone Lake (Haines 1996a:75). Both mining groups and horse thieves were apparently taking advantage of earlier Indian and trapper trails through the area.

Like the trappers, miners' interest was commercial, and their association with the lake was incidental. Before 1869, when the first expedition was organized to specifically inspect and record Yellowstone's unique natural features, Yellowstone Lake's importance was likely limited to providing fish for American Indians, trappers and miners.

The 1870s were a decade of scientific study for Yellowstone. Although visitors to the area continued to mention Yellowstone Lake's productive fishing, it is during this period that direct use of Yellowstone Lake for transportation is first mentioned.

Yellowstone Lake's Early Watercraft

The First Rafts

The first recorded Yellowstone Lake watercraft was a small raft built September 4, 1870, by the Washburn expedition. The builders assumed lake islands had "doubtless . . . never been trodden by human footsteps" (*Helena Herald*, November 9, 1870). In a single sentence of his 1870 official report, Washburn expedition member Lt. G. C. Doane noted the raft's fate and characterized Yellowstone Lake navigation: "We built a raft for the purpose of attempting to visit them [the islands], but the strong waves of the lake dashed it to pieces in an hour" (Cramton 1932:130). Fellow expedition member C. Hedges provided more detail:

The wonderful beauty of the lake had wrought a charm over almost the entire party, and around the evening camp fire we voted to traverse the entire lake shore. . . . We would build a raft, raise a blanket sail, and visit the wooded islands; we would visit every nook and corner. . . . Our attempt at raft building was such an

utter and ignominious failure that the subject was dropped by mutual consent. The wind was always from the wrong direction, the waves rolled unnecessarily high, the water was evidently deep and unmistakably cold, the islands distant, and the logs altogether too much inclined to slip their cables and strike out in their individual capacity. The toil of a day was the wreck of a few moments, and we hushed our disgust with the glad reflection that we had never got away on it, and quit the subject by promising ourselves to bring an India-rubber boat when we came again" [*Helena Herald*, November 9, 1870; see also Cramton 1932:108–109].

The combined Hayden/Barlow-Heap expedition rafted the Yellowstone River near Mud Volcano in July 1871. On July 30, Captain Barlow built another raft to cross the Yellowstone River lake outlet, and with it explored east of the river to Pelican Creek (Haines 1996a:146, 148).

In 1873, another raft was launched on the Yellowstone River at its lake outlet. Two members of the Corps of Engineers had only slightly more success than their predecessors. Near the river outlet

. . . two topographers (Paul LeHardy and his partner, Gabbet) decided to abandon their horses temporarily for a float trip down the Yellowstone River. . . [which] they expected to be a pleasant voyage of a day or so to the falls. . . . The first three miles were delightful, but, on approaching some cascades . . . the raft went out of control in the swift rapids, straddled a conical rock, and the rear end pulled under and stuck [Haines 1996a:201].

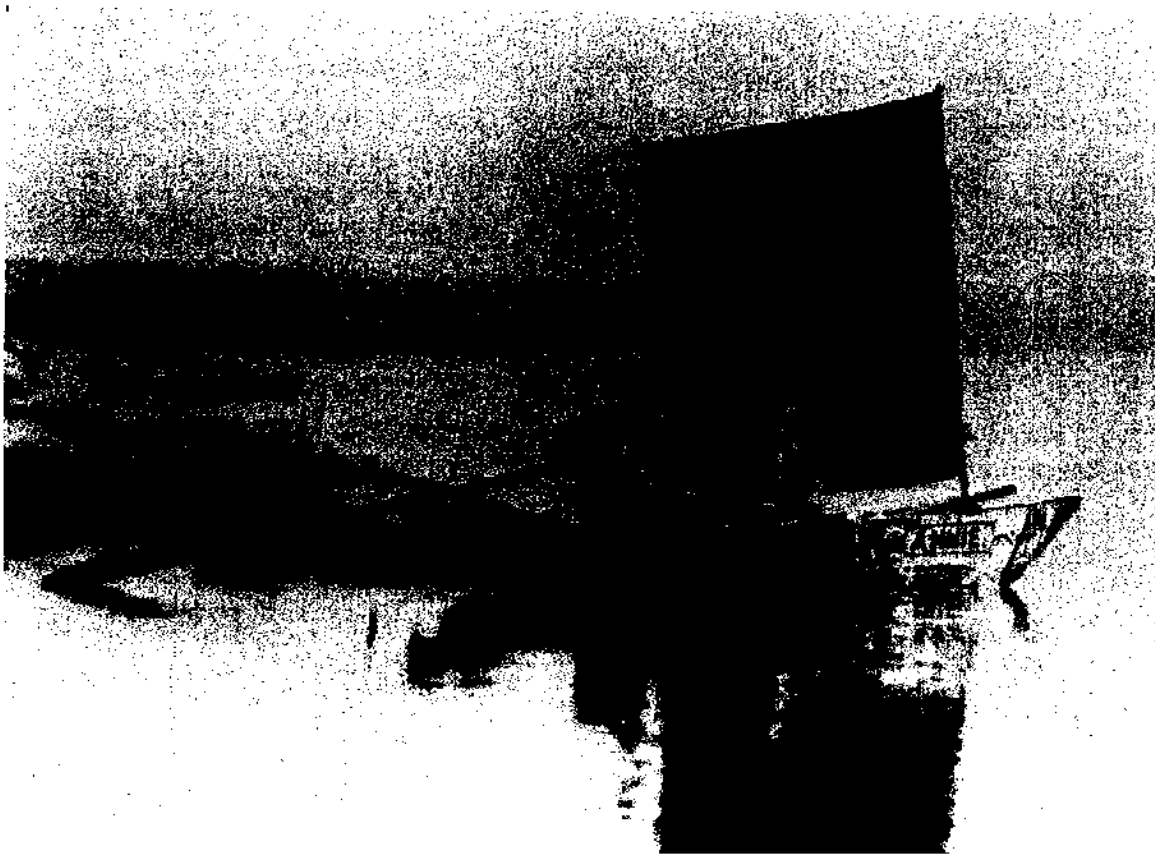

Figure 3.1. The canvas-and-frame boat *Anna*, the first boat on Yellowstone Lake, 1871 (W. H. Jackson photograph 273). Haines (1996a:147) attributes the misspelled name to the photographer altering the negative.

The men survived, and LeHardy Rapids gained its name.

Whittlesey (1988:167) mentions that in the same year (1874) US Government surveyors constructed a raft to conduct their business around the lake, but no other information is offered.

Early Boats

The first successful lake navigation in a boat occurred during the 1871 Hayden expedition. Hayden's group brought a collapsible, canvas-and-wood-frame sail boat for lake exploration (Figure 3.1). The craft was named *Anna* in honor of Anna Dawes, an early and effective proponent of the national park. She was also

daughter of H. D. Dawes of Massachusetts, then Chairman of the House Committee on Appropriations, which helped fund the expedition, and sister to Henry Dawes, the expedition's general assistant. The boat was quite effective for exploring both Yellowstone and Shoshone lakes in 1871 (Norris 1880:11, 37). Haines describes the lake's first boat trip:

That evening [July 28] Hayden's party assembled the framework of a twelve-foot boat and covered it with a 'skin' of well-tarred canvas, and the next morning were able to launch the *Anna*. . . . In it, Henry Elliott and James Stevenson sailed over to the island which Hayden proceeded to

name for his assistant, whom he considered ‘undoubtedly the first white man that ever placed foot upon it.’ Having proved its seaworthiness by that voyage, the *Anna* was put to work sounding the lake [Haines 1996a:148].

In 1874, E. S. Topping, 1872 Hayden Expedition member and one of the early park tour guides, along with Frank Williams, built a row boat and a small sail boat of green whipsawed timber at his cabin (later named Topping Point) near the foot of Yellowstone Lake. Topping described the boat and its maiden voyage:

... furnished with a whipsaw, canvas, and rigging, (they) went up the Yellowstone to its lake. There they sawed out lumber to build a row boat, and a yacht, which they rigged in sloop form. They launched the latter on the twentieth of July. On the trial trip the two ran into a flock of geese which were moulting and could not fly, and secured enough to make feather beds and pillows [Topping 1968:123].

The yacht, referred to as *Topping* by Whittlesey (1988:155) after its builder, but as *Sallie* by Topping (1968:124), had a short life and after “perilous service during a small portion of the seasons of 1875 and 1876, was dismantled, abandoned and finally lost” (Norris 1880:37; Whittlesey 1988:155). This was the earliest boat on the lake to provide some tourist services.

Lt. Doane, who led the military escort for the 1870 Washburn expedition, conducted a military reconnaissance of the park in the winter of 1876. Doane’s equipment included a small boat, and one of his enlisted men had operated

Hayden’s canvas boat *Anna* on Yellowstone Lake in 1871.

The boat had been built in the post carpentry shop before the expedition was authorized. It was a 22-foot double-ender with a beam of 46 inches and a depth of 26 inches, strongly up-curved fore and aft. After construction the boat was taken apart and packaged in two bundles convenient for mule transportation. It would be reassembled with wood screws upon reaching the launch site [Haines 1996a:210].

When the party reached the Yellowstone Lake outlet, it took two days to assemble the boat. When ready, the party used the boat to transport supplies by towing it with a mule around the west shore. This worked well for about 15 miles, but “at Pumice Point, where it was necessary to cast off the line and row around the rocks, a large wave swamped the loaded boat, and it sank instantly. Everything was saved, but time was lost drying the cargo and repairing the damaged hull” (Haines 1996a:211). Three soldiers took the boat across West Thumb, but it was slow going against the wind, and the boat and men were coated with ice when they reunited with the others. They found the boat would not bear a cross-sea, and their only choice was put the bow into the wind and row as hard as possible, bailing the boat each time a freezing wave caught them. The boat was transported overland to Heart Lake where it was used, again with great difficulty, to transport the group’s supplies down the outlet stream to the Snake River, where it was eventually lost and the expedition abandoned (Haines 1996a:211–212).

In the summer of 1880 at Topping Point, P. W. Norris, second superintendent of YELL, had T. E. “Billy” Hofer and his brother construct a

small sail boat, also of green, whipsawed lumber, measuring 20 ft. long by 6 ft. wide by 2½ ft. deep, dubbed *Explorer*. Norris and two companions, Captain Jack Davis and W. H. Parker, made a 10–12-day voyage in *Explorer* during which they circumnavigated Yellowstone Lake and most of its bays and fingers and ascended Pelican Creek, the Upper Yellowstone and other streams to their rapids. These investigations did not result in any major discoveries, but they did confirm Stevenson’s 1871 lake soundings. The boat, described as loggy and clumsy, proved to be very unseaworthy and was maneuverable only with great effort. “After encountering many mishaps and dangers,” *Explorer* eventually wrecked near the point where it was built and was abandoned to the elements (Norris 1880:11–12).

At least two other boats operated on Yellowstone Lake in 1880. T. E. Hofer “built a boat [in 1880] and tried to make some money with it in catering to the tourist trade, but did not succeed, and the boat later drifted over the Falls” (Chittenden 1924:345). Another “boat piloted by Billy Hofer and William D. Pickett made at least one trip in 1880” (Whittlesey 1988:167).

Two government vessels were operating on Yellowstone Lake in 1885. The first, a US Geological Survey (USGS) boat, was destroyed by lightning (Whittlesey 1988:167). John H. Renshawe, geographer-in-charge of a USGS surveying team on the lake, provided the following details:

Three members of the party were making observations, also in the northeast part of Yellowstone Lake, in a rowboat fitted with a mast and sail. The sky was clear yet the mast was struck by a bolt of lightning, accompanied by a clap of thunder. The oarsman next to the mast was killed and the other men in the boat,

including Mr. Renshawe, were rendered unconscious but soon revived and brought their lifeless companion to shore, where other members of the party stated that they heard the thunder [Haynes 1946:104].

This incident likely occurred during the Hague geological survey. Hague’s park field studies spanned 20 years (1883–1902), and he continued work for another 14 years after formal fieldwork ended. Although his studies concentrated on hydrothermal features, his influence pervaded all aspects of the park, and his works are still primary in park literature. Hague was one of the most eloquent tour guides in park history (Whittlesey 1988:120). The second government boat was *US Pinafore*, a small craft tested on Swan Lake by Dan C. King of the US Army Corps of Engineers before being used on Yellowstone Lake (Whittlesey 1988:153). This boat, built by Road Foreman Lamartine, was the first Corps of Engineers vessel on Yellowstone Lake (Haines 1996b:408, n15). *US Pinafore* is not mentioned again after its trial voyage that year (*Livingston Enterprise*, August 22, 1885).

Another Corps of Engineer boat operated on Yellowstone Lake in July 1891: “the U. S. Army Engineer Corps put on [the lake] a small boat which they use in supplying their road camps with forage and provisions and in hauling lumber from the mill to the various points where it is to be used” (Anderson 1891:7–8). Lt. Grayhill, in charge of park road construction in early 1891, hauled a 40-ft. steam launch to the lake to supply road crews working on the east end of the West Thumb-Lower Geyser Basin road (Haines 1996b:217).

The idea of launching a passenger boat on Yellowstone Lake to service the growing tourist trade was mentioned several times in the 1880s. As early as 1880, P. W. Norris observed that Yellowstone Lake, though very dangerous for

sailing craft, “. . . even a small steamer, well built and managed . . . would be [in] little danger attending regular trips around the fingers, thumb and palm of the lake. . . .” Norris continued his visionary statement: “. . . with a suitable steamer making regular excursions. . . it is safe to predict that a hotel on some one of the many charming terraces near the foot of the lake would ultimately prove a profitable investment in this region of wonders” (Norris 1880:12–13).

In 1889, park administration granted a permit to the Yellowstone Park Association for a naphtha launch on Yellowstone Lake, but the plan was never executed (Harris 1889:5). In the same year, the Yellowstone Park Association Board of Directors voted to put a steamboat, to be operated by Ella C. Waters, on the lake under the company’s franchise (Haines 1996b:18).

Captain Ella C. Waters’ Boats

Ella C. Waters, born 1849 in New York, spent his early years in Fond du Lac, Wisconsin.

When 14, he enlisted in the Union army and received praise from his commanding officer for bravely in Civil War action. On July 26, 1865, he mustered out of service and began a series of endeavors that eventually led him to Yellowstone, including stints as a gold prospector, tea merchant, hotel operator, cattleman and representative in the Montana Territorial Legislature. By the mid-1880s, after watching his fortunes rise and fall several times, he found himself in Yellowstone country. In 1887, he was appointed general manager of the Yellowstone Park Association (*TRW Newsletter*, 1995:5–7).

Zillah

In the summer of 1889, the Yellowstone Park Association acquired a steel-hulled, 40-ton steamer to provide tourist transportation on Yellowstone Lake (Figures 3.2–3.5). *Zillah*, 81 ft. long with a 14-ft. beam, was brought from Michigan to Yellowstone in segments (Haines

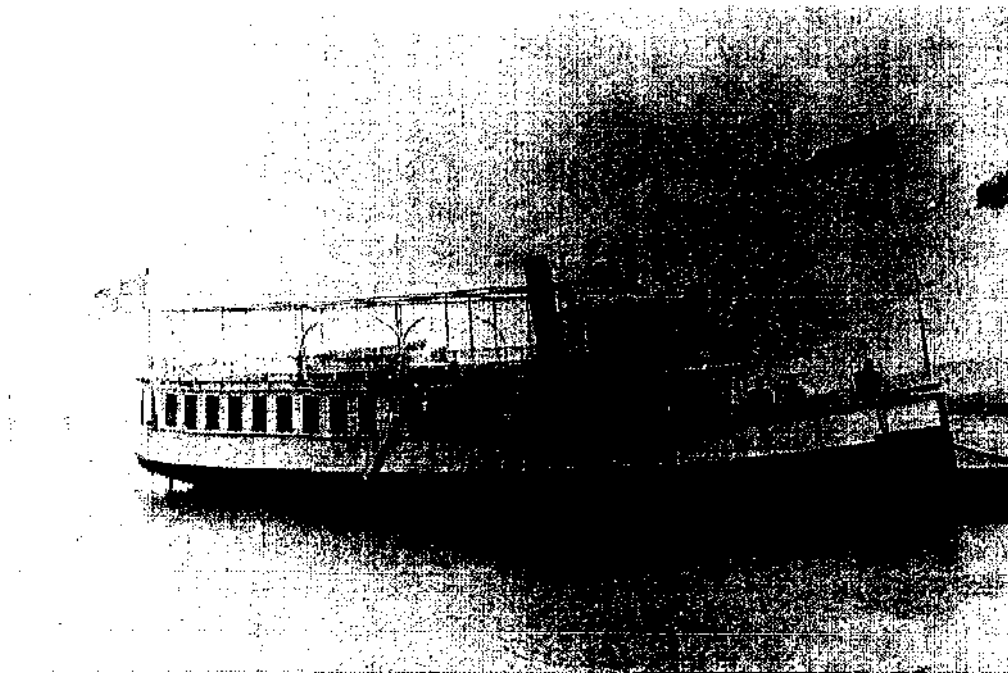

Figure 3.2. *Zillah*, possibly at West Thumb, after 1889 (YELI Archives).

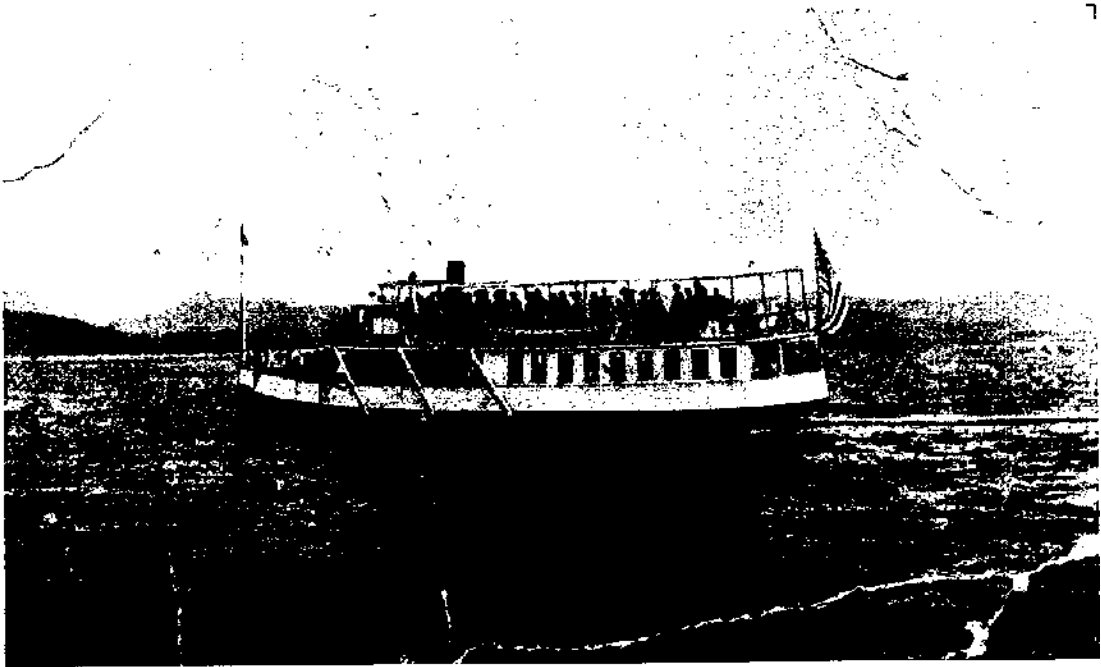

Figure 3.3. *Zillah*, about 1896 (YELL Archives).

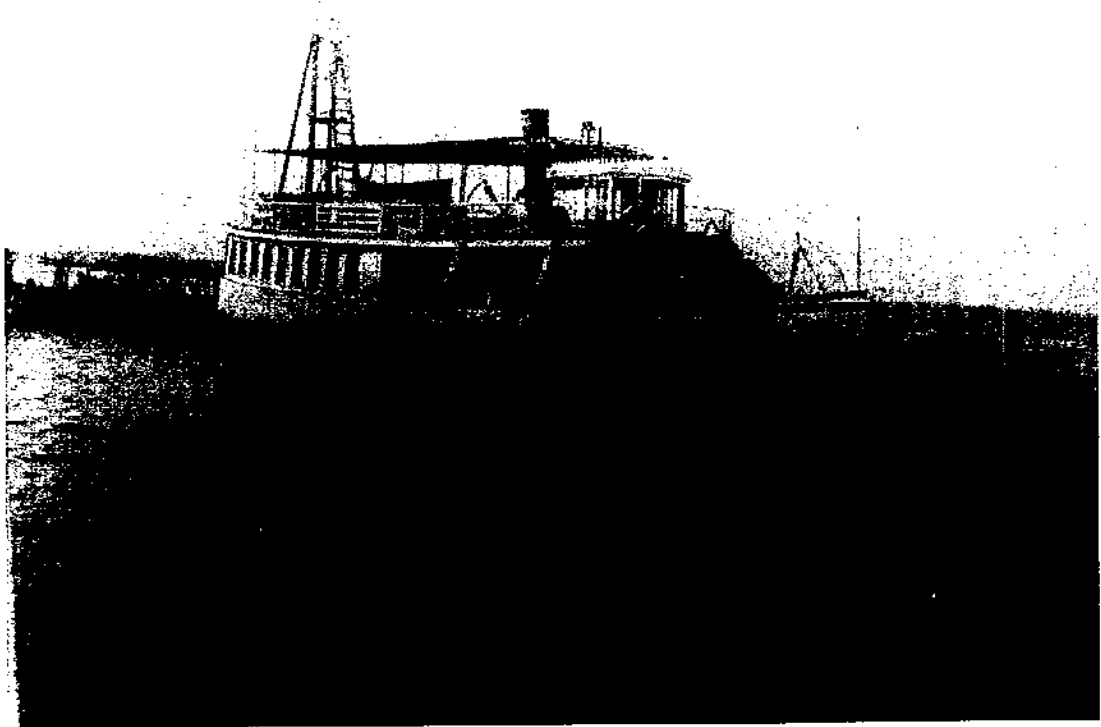

Figure 3.4. *Zillah* at Lake dock, 1896 (YELL Archives).



Figure 3.5. *Zillah* at Lake dock (YELL Archives).

1996b:18–19). During winter 1889–1890, a crew reassembled and fitted out the vessel. *Zillah*, originally launched on the Great Lakes in 1884, had *sunk* in Lake Michigan and was raised before its disassembly and trip west (Haines 1996b:401 n53). *Zillah* was working on Lake Minnetonka in eastern Minnesota when purchased by Charles Gibson, owner of Yellowstone Park Association (Bartlett 1989:190–191). The “Certificate of Inspection of the *Zillah*,” from the firm of Douglas and Douglas dated September 5, 1906, provides additional information about the vessel:

An inspector’s report in 1905 described the vessel, dubbed the ‘Zillah,’ as having been built in Dubuque, Iowa, in 1884. It had a steel hull, was of forty gross tons displacement, had staterooms and berths, could carry up to 120 passengers, and was required to carry

a full complement of six or seven officers and crew. It was powered by one steam engine and one boiler ‘made of lawful steel, in the year 1890’ [Bartlett 1989:207].

Haines (1996b:18–19) states *Zillah* was on Yellowstone Lake by 1890, but the 1891 Superintendent’s Report indicates the boat was actually licensed a year later:

The proposition to put a small steamer on the *lake* for the accommodation of tourists has been agitated for a good many years, but was only recently accomplished. Early in July, an inspector came and gave the boat a license to carry 125 passengers. It is a smooth-running, seaworthy little vessel and will add much to the attractiveness of the lake as a resort. I hope to see it made a part of the Park

transportation, and used in ferrying tourists from the Lake Hotel to the West Thumb in their journey around the circuit [Anderson 1891:7-8].

Zillah, captained by E. C. Waters, provided an alternative to the laborious stagecoach that brought tourists through the park to the Lake Hotel. Because Waters was not in business with the coach transportation companies, he charged an additional fee for lake transportation. Many tourists complained to the superintendent about Waters' extra fee. Despite this and other questionable acts, Waters received favorable comments in the park annual reports, for example, Acting Superintendent Anderson's 1892 report:

The steamer on the lake has been running successfully for a year or more, and adds much to the pleasure of a trip through the park. It is commodious and comfortable, and I believe perfectly safe. It is now made a part of the park transportation, and carries passengers, at their option, from the Thumb to the Lake Hotel, thus relieving them of 18 miles of tedious staging. I believe the boat company has enough small boats for the demands of fishing parties, but I think prices might be lowered where boats are used continuously for several hours [Anderson 1892:7].

The pattern continued into the following year with the description that "The steamer continues to be satisfactorily run, and is greatly enjoyed by all tourists who make the trip on it" (Anderson 1893:10). However, labor problems affected lake business in 1894. Because of close association between Yellowstone tourism and the railroad companies, the 1894 railroad strike resulted in losses to all park operations.

Superintendent Anderson commented in his Annual Report:

The boat company has suffered quite as much as other industries in the Park from lack of patronage. The boat has been put in excellent condition, and it furnishes one of the most delightful bits of travel on the tour. The proposition to put a few small steam or naphtha launches on the lake has not been carried out, but I believe it would prove remunerative and certainly would be a great accommodation to tourists [Anderson 1894:8].

By the following year, business returned to normal. E. C. Waters obtained a large percentage of the tourist travel and, as company general manager, was granted a license to expand his business to include selling small groceries, providing blacksmithing to campers and taking parties on small side trips, a niche not filled by larger concessionaires (Anderson 1895:10). He also expanded his business to include renting tourists small boats and fishing tackle. In 1896, Waters placed bison and elk on Dot Island as an added attraction to *Zillah* customers, a move that contributed to his eventual undoing in the park.

Waters received permission to construct small landings at several points on the lake shore, including Dot Island and at his operations center near the Lake Hotel (Anderson 1896:10). Satisfactory reports of the boat operation continued through the remainder of the decade and into the early years of the twentieth century. *Zillah* was popular with tourists, and it carried 2,589 passengers during the 1897 season (Young 1897:6) and 3,050 in 1900 (Goode 1900:4). At the turn of the century, the strong Yellowstone Lake tourist business prompted Acting Superintendent Pitcher (1901:7) to suggest it

would be desirable to have “some competition be introduced in this business.” The following year Pitcher (1902:12) suggested a larger boat, or several smaller ones, be placed on the lake to accommodate increased tourist traffic.

Within a few years, E. C. Waters, likely in an effort to thwart competition, followed Pitcher’s suggestion of a larger boat. Meantime, however, the first few years of the new century continued to be successful for Waters. *Zillah* carried 3,826 passengers in 1904 (Pitcher 1904:10) and a record 5,275 passengers in 1907 (Young 1907:10). Despite these successes, Waters’ Yellowstone Lake Boat Company fell into financial trouble due to “his unscrupulous activities” (Haines 1996b:50). Because tourists’ complaints continued about the “exorbitant” \$3.00 charge for passage, Pitcher pushed his suggestion for lake excursion boat competition, which was likely fueled by *Zillah*’s deteriorating condition. As early as 1902, *Zillah*’s declining condition was commented upon by one traveler who, when seeing the moored vessel, said: “It was such an old rattletrap that I would not risk passage on it” (Bartlett 1989:192). E. C. Waters, in an apparent effort to shore up his operation, acquired a new larger vessel in 1905.

E. C. Waters

Increasing tourist trade after the turn of the century and comments by park management suggesting competition prompted E. C. Waters to expand his tour boat operations. As president of the Tacoma-based Pacific Launch Company, Waters brought plans and materials for a “140’ by 30’ wooden hulled steamship” to Yellowstone Lake in 1904 (Anonymous 1995:6). The new vessel, larger than *Zillah*, was constructed and launched on the marine railway at the Lake docks boathouse in 1905 (Aubrey Haines, personal communication 1996). Christened *E. C. Waters* after its owner and captain, the new steamer, reportedly costing \$60,000

(Anonymous 1995:7), was expected to carry Waters’ business into the next decades.

E. C. Waters, 125 ft. in length and 26 ft. in beam and the largest Yellowstone Lake passenger steamer, was designed to carry 500 passengers (Haines 1996b:127) (Figure 3.6). Bartlett (1989:208) quoting from the *Montana Standard*, Butte, Montana, gives different information on both *E. C. Waters* size and launch date:

In 1902, Waters brought into the park from Tacoma, Washington, and floated in time for the 1903 season, a larger vessel dubbed the ‘Eli C. Waters.’ It was, if a newspaper article can be accepted as accurate, 140 feet long and 30 feet wide and could carry 600 passengers. Trouble was, the authorities refused to allow him to place it in service on the grounds that it was unsafe. Waters eventually sailed it to Dot Island where he moored it; it became an ugly hulk and was finally burned.

Several parts of this account do not match other information in the literature: 1) the date *E. C. Waters* arrived in the park is given as 1902 instead of 1905; 2) the vessel is called “*Eli C. Waters*” (*Eli vs Ella*) instead of *E. C. Waters*; 3) the length is given as 140 ft. instead of 125 ft.; 4) the beam is given as 30 ft. instead of 26 ft.; 5) the number of passengers indicated is 600 instead of 500; and 6) it states the vessel was sailed to Dot Island instead of Stevenson Island. Given the number of discrepancies in this newspaper article, it is doubtful that it represents first-hand knowledge at the time of publication.

After launching the vessel, Waters requested a permit to carry 500 passengers, but park administration refused it. Because of difficulties with the park, Waters apparently never made more than test runs with his new steamer



Figure 3.6. Postcard photograph of *E. C. Waters* at Lake dock, about 1905 (YELL Archives photo no. 14871).

(Whittlesey 1988:167). Waters refused to agree to a permit to carry fewer than 500 passengers, so the new steamer sat idle at its Stevenson Island anchorage (Haines 1996b:127).

Because of disagreements with park administration over the 500-passenger *E. C. Waters* permit and other problems he created through the years, Waters was run out of the park in 1907 (Haines 1996b:77). After Waters left the park, the T. E. Hofer Boat Company was given a permit to operate Yellowstone Lake concessions, and they bought Waters' park assets in 1910. T. E. Hofer Boat Company was reorganized into the Yellowstone Park Boat Company in 1911 with Harry Child as director (Bartlett 1989:193). By this time, *Zillah* had deteriorated beyond repair, and its tour boat career had ended. The vessel was either sold for scrap or scuttled (Anonymous 1995:6). At least one other tour boat of comparable size was running on the lake, but not *E. C. Waters*.

E. C. Waters was secured in a cove on Stevenson Island's east side. The "ship was wintered in that cove for many years because it was thought safe from the lake ice, which normally went out with a southwestwind in the spring. But the ice broke up with an easterly wind in 1921, pushing the vessel onto the beach where it remained. The machinery was removed in 1926" (Haines 1996b:415 n67).

After removal of *E. C. Waters*' machinery, the boiler, "a typical scotch marine boiler" (Aubrey Haines, personal communication 1996), was used to heat the Lake Hotel for 46 years. The boiler was converted from wood to oil in 1937 (Dittl and Mallman 1987:19) and, at some point, coated with asbestos insulation. In 1972, it was sold as scrap to a junkyard near Three Forks, Montana (Aubrey Haines, personal communication 1996). Some of *E. C. Waters*' original steam gauges are reportedly still in use in the hotel heating system (John Lounsbury,



Figure 3.7. *E. C. Waters'* anchor at Lake dock in 1961 (photo by A. L. Haines, YELL Archives).

personal communication 1996). No record of what became of the vessel's engine could be located. The steamer's anchor is at the Bridge Bay marina and serves as a signpost (Figure 3.7). *E. C. Wafers* was never removed from the Stevenson Island beach:

On the longer crossings of the lake . . . skiers could stop on Stevenson Island to warm up in the shelter of the abandoned steamboat, *E. C. Waters*. The hulk had lain aground in the cove on the east side of the island throughout the twenties; its engine and boilers had been removed through a gaping hole which left the boat a useless derelict. Beyond the shelter it gave skiers, the *E.C. Wafers* was useful as a prop for Jack Croney's fish-fry business and as a retreat for brawls fueled with moonshine. On the other hand, the hulk was an eyesore, and, since the rangers were under pressure to clean up the debris of more than fifty years of indiscriminate use of the

Park, the boys at Lake decided to do something about the boat—burn it!

So in the spring of 1930 a little party consisting of Albert Elliot and Skeet Dart, both rangers, with winter keeper "Boots" Chenard, skied over to Stevenson Island, poured a can of kerosene on the bow of the boat and torched it [Haines 1996b:316].

1910-1930

After the Yellowstone Park Boat Company (formerly Hofer Boat Company) transition from E. C. Waters' Yellowstone Lake Boat Company, little information is available about the lake tour business. Visitation apparently remained fairly constant. For example, from 1912 to 1915, passengers ranged from 3,305 to 4,277 per season (Brett 1912:7; Brett 1913:4; Brett 1914:6; Brett 1915:6), similar to E. C. Waters' business during the late 1890s. The new company operated *Jean D* (Figure 3.8-3.11), a boat similar to *Zillah*, but fishing boat rentals (Figures 3.12 and 3.13) and tackle sales were more profitable (Bartlett 1989:193).

In 1916, passenger numbers dropped to 2,558 (Anonymous 1916:3). A prophetic note in the superintendent's 1917 Annual Report provides a clue for Yellowstone Lake passenger decline—touring cars had supplanted the old stagecoach for park travel (Anonymous 1917:6). More visitors were using their own car to visit YELL. Auto camping became popular after World War I, as indicated by a comment in the superintendent's 1918 Annual Report:

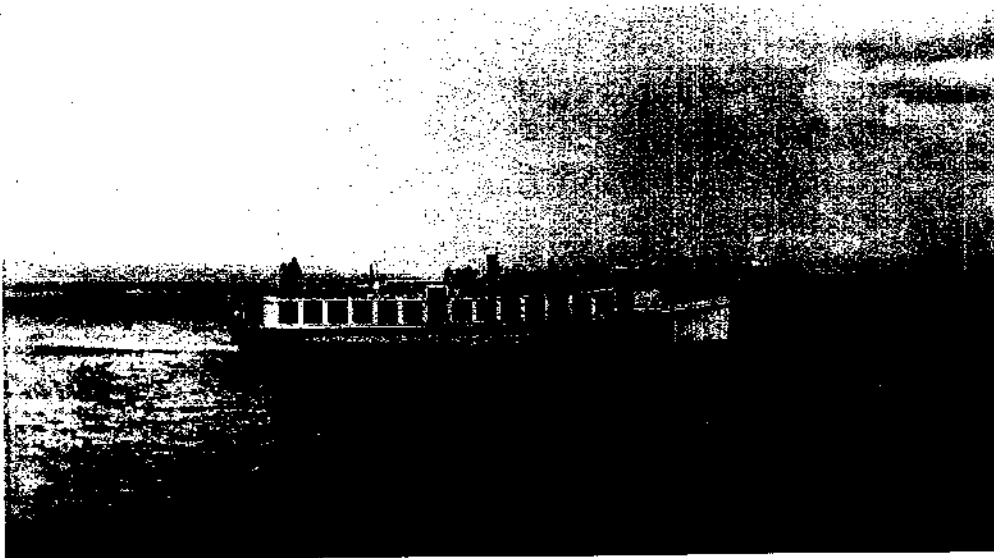

Figure 3.8. *Jean D*, about 1910(YELL Archives photo no. 36373-3).

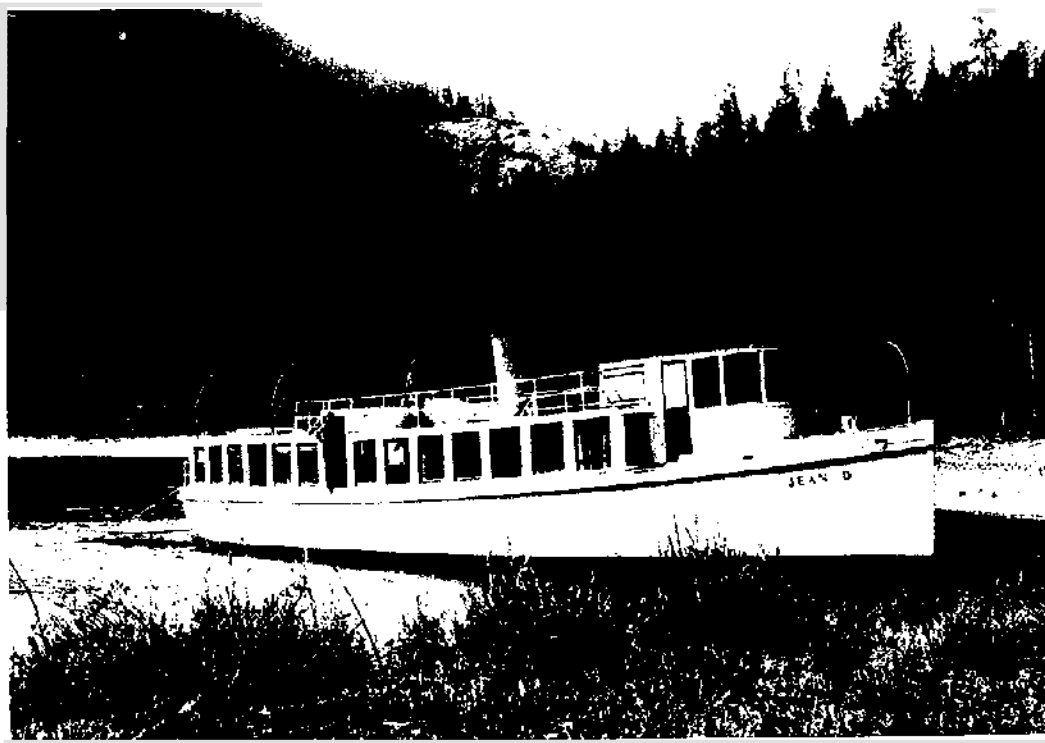

Figure 3.9. *Jean D*, about 1912(YELL Archives photo no. 36362).

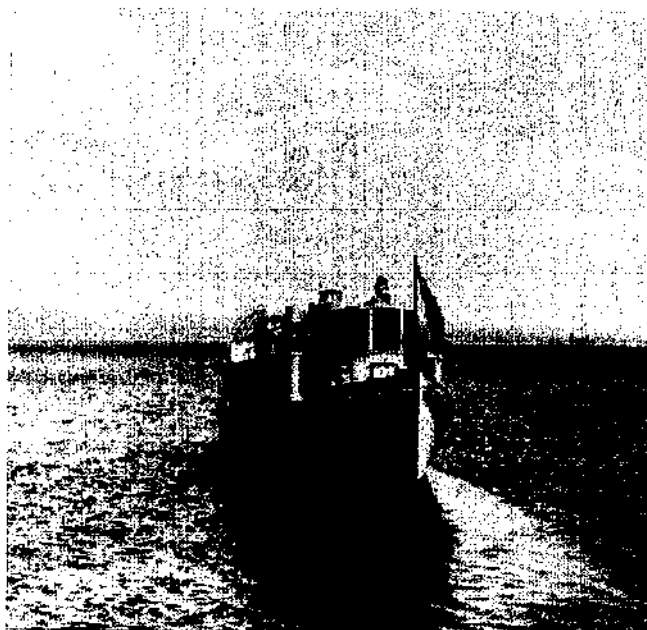

Figure 3.10. *Jean D*, about 1910 (YELL Archives photo no. 36373-1).



Figure 3.11. *Jean D* (left) and *Zillah* (right) on shore at Lake, about 1922 (YELL Archives photo no. 36372-1).



Figure 3.12. Rental boats at Lake (YELL Archives photo no. 18771).

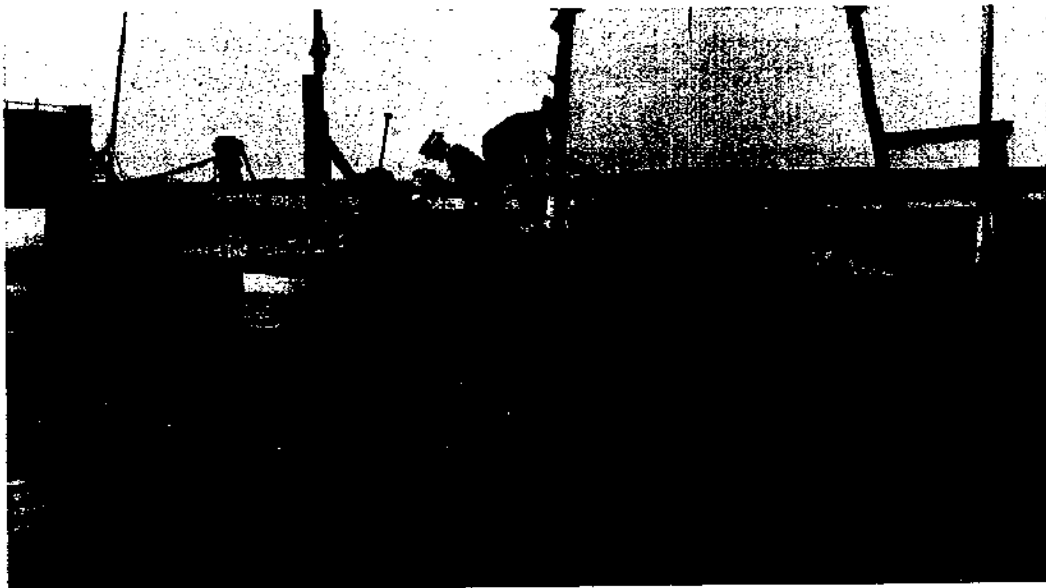

Figure 3.13. Passenger launch at Lake in September 1934 (YELL Archives photo no. 29091/12120).

The Yellowstone Park Boat Co. rendered little service to the public this season. This company has very little useful boat equipment. Its big boats are in poor condition and will not meet present demands on service on the lake, and its small boats, except two 45-foot gasoline boats and a few launches [Figures 3.14 and 3.15], are old, dilapidated, and unsafe. This company has not furnished satisfactory equipment for the boat service since 1916 [Anonymous 1918:81].

Park archival photographs depict several small watercraft operating on Yellowstone Lake during 1910–1930, but no supplemental information was found during this project’s limited search in these archives. The photographs include: a US Fish and Wildlife Service boat (Figure 3.16) from around 1910; what appears to be an NPS speedboat (Figures 3.17 and 3.18) dating to the 1920s; and another NPS boat named Marion. Several commercial speedboats operated on the lake in the 1920s. One, Adelaide (Figure 3.19), used between West Thumb and the Lake Hotel, may be the boat “added in 1922 which carried 11 passengers and was propelled by a 185 hp Sterling engine at a speed of 35–40 mph . . .” (Anonymous 1976:5).

1930–1950

NPS purchased a 28-ft. Chris Craft (Figure 3.20) in 1930 for lake service, and the Bureau of Fisheries operated several boats in 1930–31. In 1936, the Department of the Interior provided three lake boats to the NPS: two cabin cruisers (Figures 3.21 and 3.22) and a Coast Guard boat (Figures 3.23 and 3.24). These boats were

bought to Gardiner, Wyoming, by rail and trucked to the Lake Hotel dock boathouse, where they were reconditioned and launched as NPS Boats 1, 2 and 3. These boats were used into the 1940s and 1950s. Another NPS boat, named *Lollipop*, is reported as *sunk* in the lake in 1940 (Dan Lenihan, personal communication 1996). No additional information on *Lollipop* has been located.

1950s

Photographs depicting three NPS boats dating to the 1950s were found in the archives: Pelican 1957, *Mojave* 1958 and *Gull* 1959. No other information was found on these boats. Mention of another boat, Tender, was located in the archives. No photographs of this appear in the files but a photograph caption of a window weight and a small propellor found in shallow water attribute them to Tender.

Yellowstone Lake has a rich navigation history, and many watercraft undoubtedly remain underwater. So far, no aboriginal craft have been located, but their submerged remains are likely preserved in the lake. At least three tour boats more than 50 ft. in length operated on Yellowstone Lake between 1890 and 1930. Only *E. C. Waters’* remains have been located. Many small craft were operated by both concessionaires and government agencies, including cabin cruisers; steam, naphtha and gas-powered launches; and small Fisheries Bureau boats. Based on archival sources, about 25 watercraft operated on Yellowstone Lake before 1950. Added to these are many nonmotorized rental boats and canoes, which make an impressive material record of lake navigation history. The history of these watercraft is incomplete, but it could easily compete with the park’s history of stagecoach and motorcar use for transportation and recreation.



Figure 3.14. Gas-powered launches at West Thumb (YELL Archives photo no. 43549).

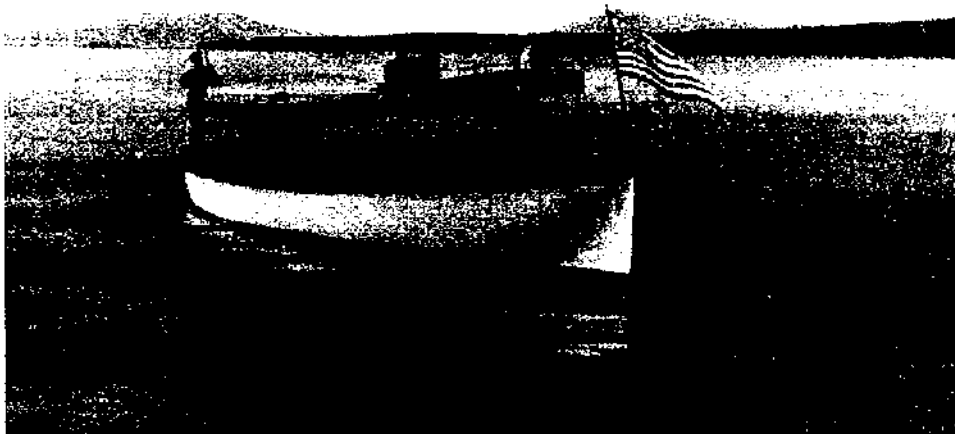

Figure 3.15. Gas-powered launch at West Thumb (YELL Archives photo no. 43575).

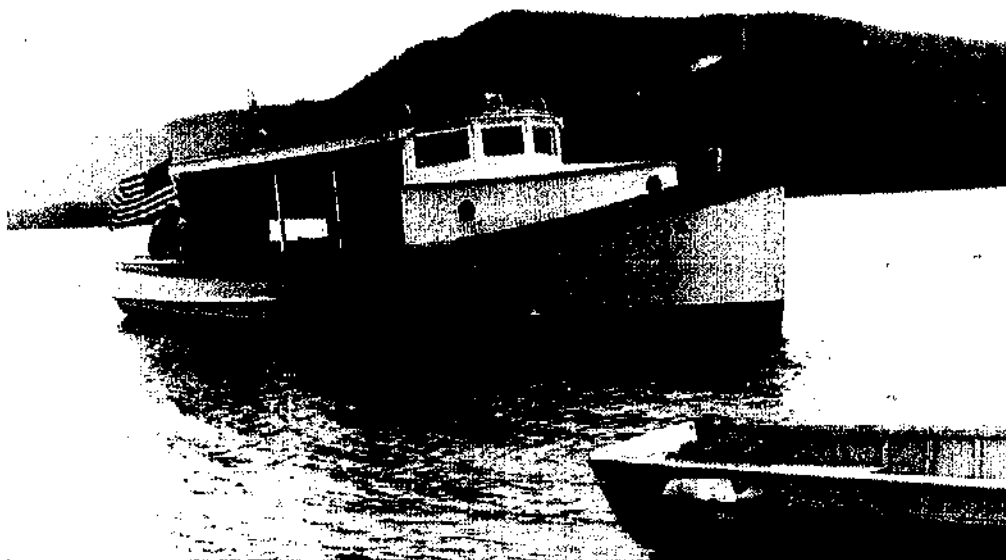

Figure 3.16. US Fisheries vessel, 1930s (YELL Archives photo no. 9254-6).

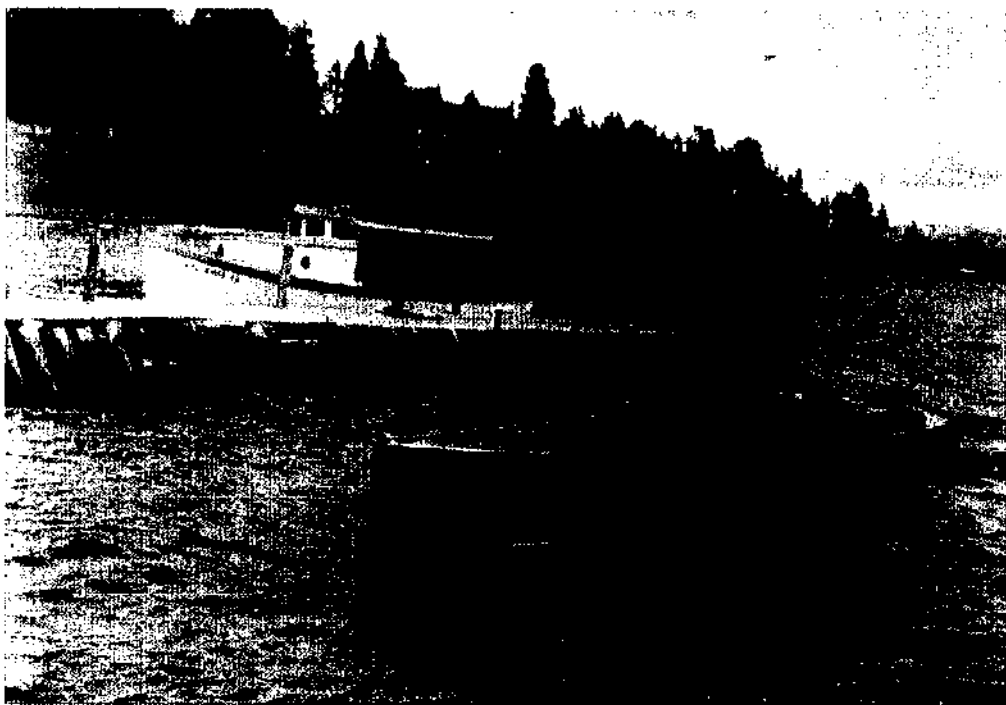

Figure 3.17. NPS speedboat (runabout) at Lake dock, about 1915 (YELL Archives photo no. 29038/12004).

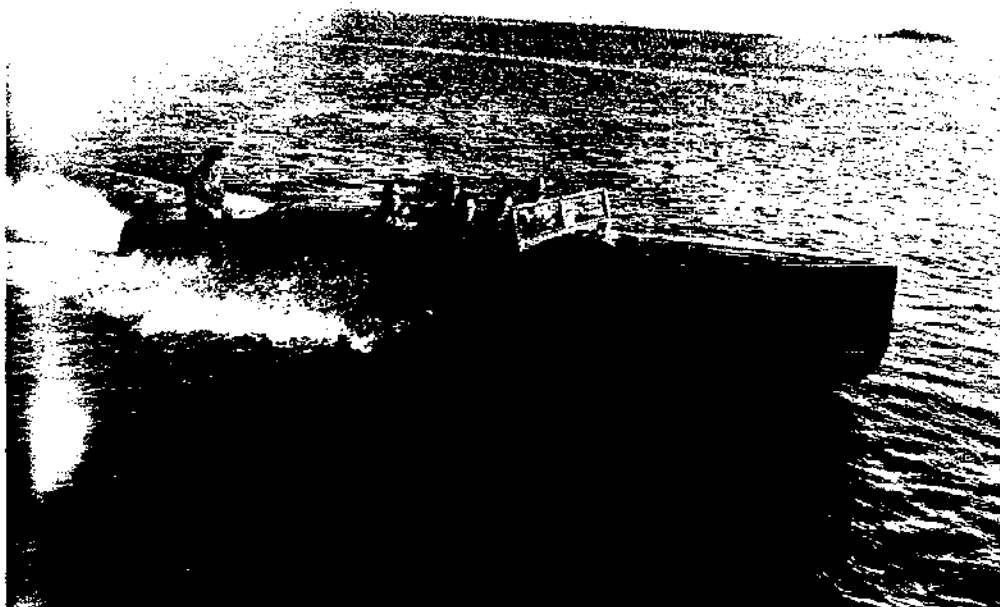

Figure 3.18. NPS speedboat (runabout), October 1938 (YELL Archives photo no. 29069/12069).



Figure 3.19. Eleven-passenger speedboat (runabout) *Adelaide* postcard during the 1920s (YELL Archives photo no. 87423).



Figure 3.20. National Park Service 28-foot Chris Craft, 1930s (YELL Archives photo no. 29079-1).

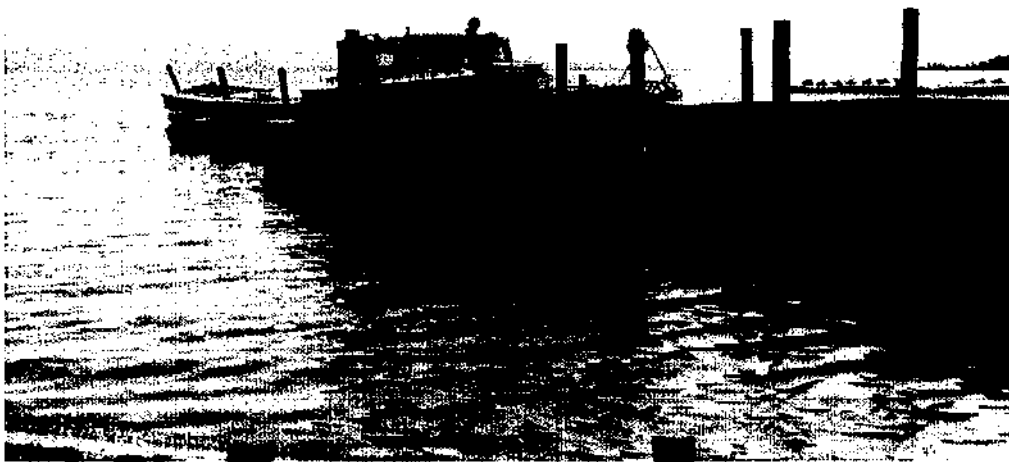

Figure 3.21. Deckhouse cruiser National Park Service No. 2 at Lake dock, 1938 (YELL Archives photo no. 29055-2/12044).

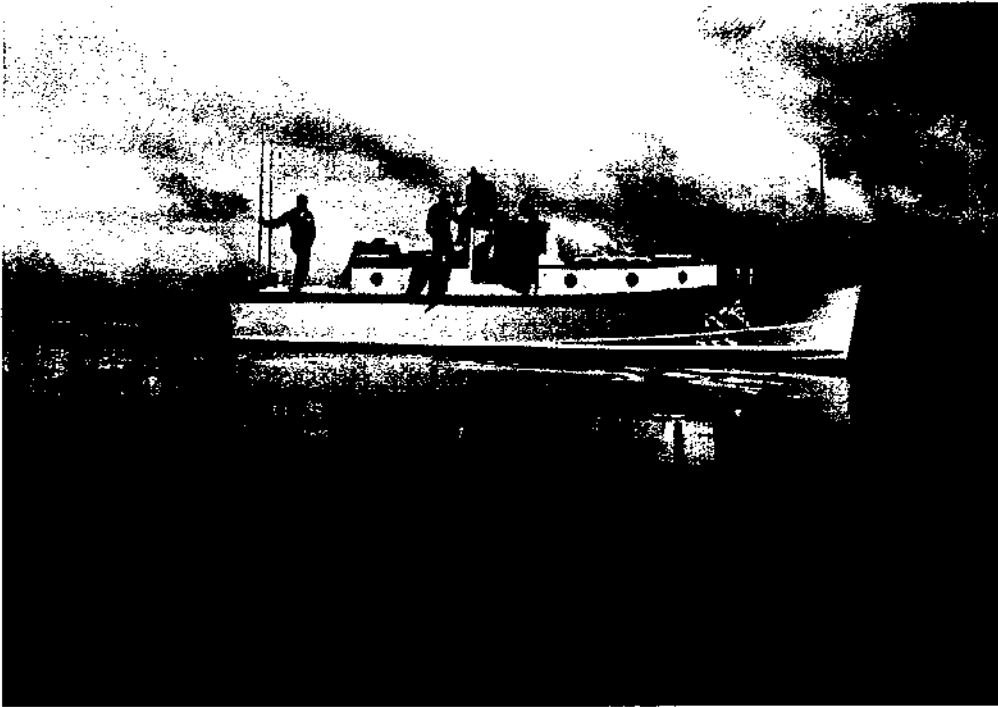

Figure 3.22. Deckhouse cruiser National Park Service No. 1 on Yellowstone Lake (YELLArchives photo no. 29077/12077).



Figure 3.23. Former US Coast Guard lifeboat *Arena Cove* on marine railway at Lake, 1936 (YELLArchives photo no. 29046-1/12016).



Figure 3.24. *Arena Cove* being launched at Lake boathouse, 1936 (YELL Archives photo no. 29044-3/12012).

CHAPTER 4

Previous Archeological Work

Archeologists have conducted a variety of investigations in Yellowstone National Park (YELL) through the years. The National Park Service Midwest Archeological Center (MWAC) contains about 221 references relating to YELL archeological investigations, including trip reports, cultural resource management (CRM) investigations, and more traditional archeological survey, inventory, evaluation and excavation studies. National Register of Historic Places documentation, post-fire surveys and park development projects produced many of these archeological investigations. Most park archeology has focused on prehistoric sites; however, there has been some on sites related to early park history. About 30 archeological studies have been done near Yellowstone Lake, most on the north and west shores (Figure 4.1).

FISHING BRIDGE/MARY BAY

The Mary Bay north shore, just east of Pelican Creek between Indian Pond and Yellowstone Lake, has long been noted for its human activity. As early as 1880, observers described this area as having “abundant

evidence of frequent occupancy by Sheepeater aborigines” in the form of “decaying brush corrals, wickiups, and lodge-poles . . . [as well as] rude stone heaps of wickiup sweathouses” (Norris 1880:587).

One of the park’s largest and oldest sites, 48YE1, is located at Fishing Bridge between the lake outlet (Yellowstone River) and Pelican Creek, covering nearly the entire peninsula. Work began on this site in the 1940s when two human burials, with associated grave goods and dogs, were removed from the area during construction activities (Condon 1948; Wright et al. 1982:2–26; Cannon 1993:15). Montana State University (now University of Montana) archeological survey crew members recorded the site and five others in the northern lake area during a 1960s park-wide inventory survey (Taylor et al. 1964). According to Cannon (1993:7–9), lack of diagnostic artifacts prevented the Montana survey crew from determining site age. However, related components and Reeve’s (1989) later work indicate 48YE1 may have been occupied from the Paleo-Indian period (about 9000 B.P.) to Late Prehistoric times. Reeve (1989), who

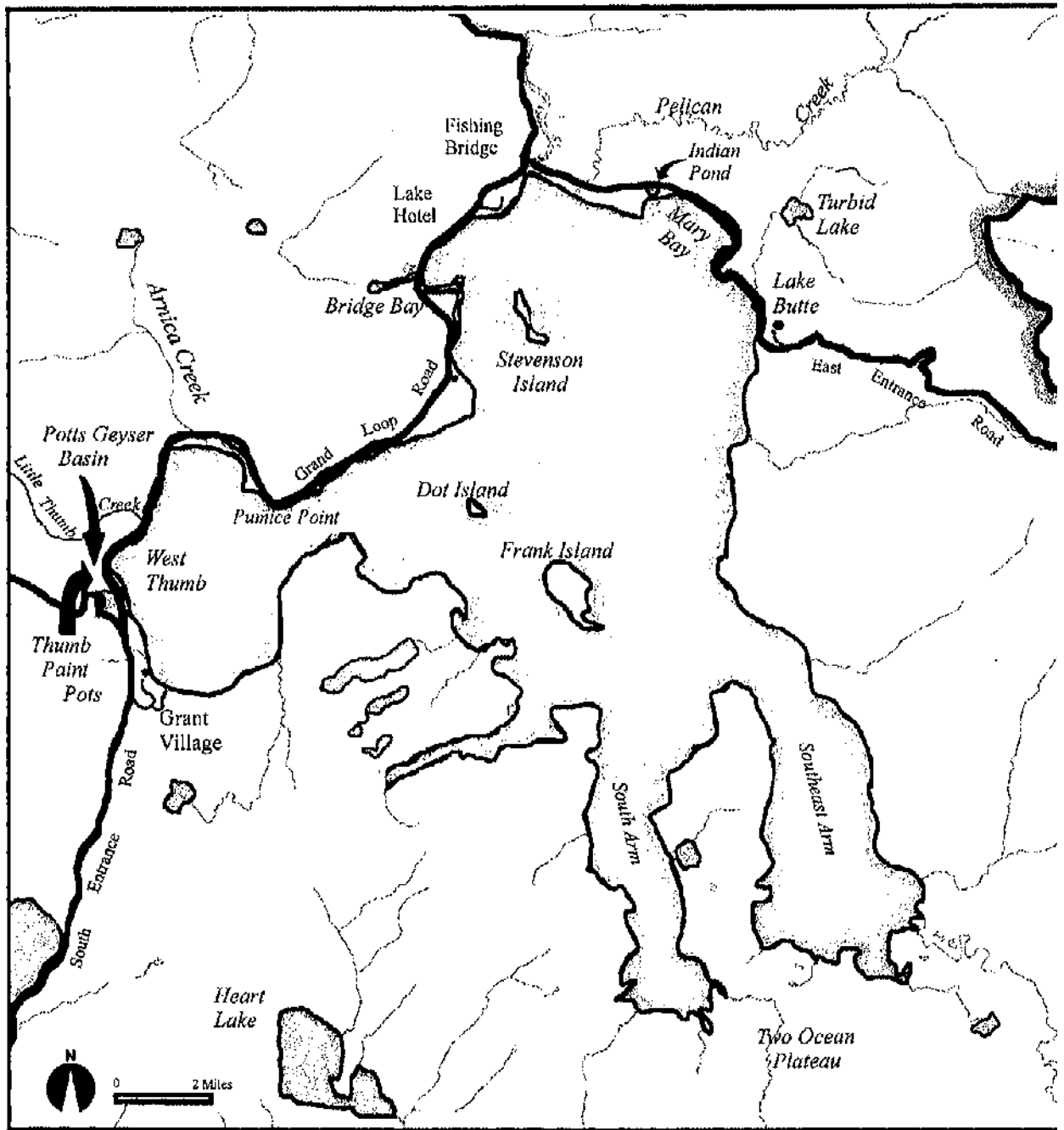

Figure 4.1. Yellowstone Lake.

recovered 8,560 lithic artifacts, fire-cracked rock, bone, shell and ground stone, concluded aboriginal subsistence may have centered on fishing. Work on other sites in the area has been conducted by Cannon (1991), including a site dating to 7000 B.P. on Mary Bay's south shore. Historical activity has also centered on Fishing Bridge. Recent evidence supports this location as one of Hayden's 1872 Expedition campsites (Cannon 1995:40). Other work in the immediate area, conducted ahead of road development or facility improvements, includes that of Williams and Wright (1980), Baumann (1984), Cannon (1990, 1992 and 1995) and Connor (1994).

Three NPS-related sites have been reported in the Lake Butte area south of Mary Bay (Hunt 1989:3-4, 21-22). Because the Fishing Bridge/Mary Bay area was a primary camping place for both Euro-American expeditions and American Indian groups traveling through the area, there may be many more significant sites in this area. Historical documentation supports this possibility. Haines (1996a:50-52) cites several references to the lake outlet/Pelican Creek/Mary Bay vicinity as a camping area for trappers as early as 1836, when a two-day battle between a 40-person trapping party and Piegans occurred near Indian Pond (Haines 1996a:52). Five prospecting parties camped in this vicinity between 1864-67 (Haines 1996a:68-69, 75, 79), and later exploring expeditions made the area a regular camping place between 1869 and 1871 (Haines 1996a:110). A large Nez Perce squaw camp was located at Indian Pond in 1877 (Haines 1996a:227).

LAKE/BRIDGE BAY

The area between the lake outlet at the Yellowstone River and Bridge Bay is the most extensively developed part of the lake shore (Figure 4.1). Several archeological projects have been conducted in this area resulting in

few aboriginal sites being located, but several Euro-American sites, related mostly to hotel and park activities, being recorded. With one notable exception, aboriginal sites along this shoreline tend to be small and contain limited materials. The exception is a large site located just northeast of Bridge Bay, with a purported fish weir located just offshore. Reports of numerous artifacts encountered during road construction through this site attest to its size. Haynes (1946:104) noted: "In building the road along the lake, the workmen found many arrowheads, spearheads, skinning knives and other Indian artifacts." Johnson (1986, 1989), Daron (1992a, 1992b, 1992c, 1992d, 1995), Cannon and Phillips (1993), and Cannon (1995) have conducted development-related surveys and archeological testing projects in the Lake/Bridge Bay area.

Hunt (1989) located 11 Euro-American sites between Lake Junction and Bridge Bay, including some associated with road construction, NPS maintenance activities, hotel trash dumps, and, on Stevenson Island, the exposed *E. C. Waters* shipwreck. Johnson and Lippencott (1989:31) first recorded this shipwreck as an archeological site (48YE13) during their post-fire assessment work. Underwater sites are present in the area, particularly features related to the Lake Hotel, Lake boathouse and dock, and the former fish hatchery.

WEST THUMB

West Thumb (Figure 4.1) history is similar to that of Lake. Archeologists from Montana State University recorded the first 12 archeological sites along the West Thumb shoreline in 1958-1959 (Taylor et al. 1964). Most sites range from Grant Village on the west shore to Arnica Creek on West Thumb's north shore. These sites date from Paleo-Indian period (about 10,000 B.P.) to Late Prehistoric (Taylor

et al. 1964:108, 179). In 1980, Samuelson (1981) discovered two more sites, which she concluded represent winter hunting and spring fishing activities. Little work was done in this area until 1992 when MWAC archeologists surveyed and tested several sites between Arnica Creek and Little Thumb Creek near the Potts Geyser Basin north of West Thumb (Cannon 1993). Archeological testing exposed hearths on an old occupation surface. Researchers also recovered sherds from 48YE449—the only site to yield such artifacts in the park. Some older sites, deeply buried and dating back 5,000 years, provide important information on aboriginal lakeshore use relative to changing lake levels through time. Most sites in this area, like Lake, are small with few stone artifacts. Johnson (1989), Daron (1992e), Cannon (1992), Cannon and Phillips (1993), Deaver (1993) and Johnson et al. (1993) have all conducted archeological investigations here as a result of park improvements in Grant Village and Potts Geyser Basin.

West Thumb, protected from prevailing winds, was apparently heavily utilized and likely contains many more aboriginal sites. This area was also the center for much Euro-American activity in the park. For example, in 1839, trapper Osborne Russell camped at West Thumb Geyser Basin as did George Huston in 1866 (Haines 1996a:49, 72), and probably several unrecorded prospectors during the 1860s. Most later expeditions camped at the Geyser Basin: the 1869 Cook-Folsom party; the 1870 Washburn expedition; the 1871 Hayden expedition twice (along with his military escort); the 1873 military reconnaissance by Lt. Jones' troops; and Lt. Doane's winter expedition of 1876 (Haines 1996a:99, 125, 127, 148, 203, 210–211).

By 1879, there was a rough trail from the Upper Geyser Basin to West Thumb and, in 1882, General Sheridan cut a rough road from the park's south entrance to West Thumb

(Haines 1996a:245, 263). The Upper Geyser Basin road to West Thumb was improved and opened to the public in 1892 (Haines 1996b:217–219), leading to increased visitation, which, in turn, led to development of Army (and later NPS) visitor facilities. With the road's opening and its extension to Lake, tourists were rerouted through West Thumb as they passed through the park. As a result, many structures have been built, removed, and maintained near the geysers, all contributing to the archeological record of the West Thumb Geyser Basin. Of particular interest to this study, the West Thumb area was a terminus for the passenger steamer *Zillah* between 1891 and 1907, which had its dock near the Thumb Paint Pots.

SOUTHEAST ARM

Very little archeological work has been conducted along Yellowstone Lake's Southeast Arm (Figure 4.1). However, three archeological sites were briefly visited during this study. One of two sites reported in the vicinity of the south shore patrol cabin was located. The "YCC Camp Site" could not be relocated. A site on shoreline due south of Molly Island was located, but not formally recorded. Site 48YE707 on Terrace Point on the arm's east shore was briefly visited. This site consists of several lean-tos and was first recorded in 1989 by Cannon (1993:48–49, 140–141).

1995 SCRU RECONNAISSANCE

In August 1995, after discussions with park management, the Submerged Cultural Resources Unit (SCRU) staff spent nine days in the park conducting reconnaissance-level underwater investigations at several Yellowstone Lake locations (Lenihan 1995a, 1995b, 1996).

The 1995 SCRU Yellowstone Lake investigation was initiated, in part, by the impending visit of a large group of scuba divers.

Later, a scuba diving club asked permission to conduct an instrument survey to locate the shipwreck *Zillah*, purported to have been scuttled in deep water offshore the Lake Hotel. Park management became concerned about potential impacts to underwater archeological sites from large dive groups and they requested advice from SCRU about the park response to the dive club survey request. The 1995 SCRU investigations included dives in particular areas to determine site location, character, integrity and archeological significance. Investigations were conducted at the Lake Hotel dock area,

West Thumb Geyser Basin and *E. C. Waters* site on Stevenson Island. Dives were made at other locations to document some of the park's natural underwater features. Recommendations by Lenihan (1995a:9–10) led to the subsequent work in 1996, as reported in this document.

In conclusion, although much archeological research has been conducted around Yellowstone Lake, the 1995–1996 SCRU investigations were the first time submerged cultural resources have been intensively investigated in the lake. Chapter 5 discusses these investigations' results.

CHAPTER 5

Survey Results

The Submerged Cultural Resources Unit (SCRU) cultural resource survey and documentation conducted August 1996 generated archeological data on several sites in and around Yellowstone Lake. Yellowstone National Park (YELL) staff selected and prioritized sites investigated by SCRU. Although some information was obtained on aboriginal shoreline sites along Yellowstone Lake's Southeast Arm, the primary fieldwork focus was to locate and document Euro-American sites, in particular sites associated with lake passenger vessels that served the growing turn-of-the-century tourist industry. Project results are provided below by geographic areas and major sites (Figure 5.1).

FRANK ISLAND

Frank Island, the largest Yellowstone Lake island (see Figure 5.1), was named in 1871 for the brother of Hayden expedition member Henry Elliot. During the expedition, Elliot conducted several excursions around the lake in the boat *Anna* (Whittlesey 1988:58).

Currently, there are no structures on Frank Island, but plans were apparently made in the late 1890s for a dock to accommodate the steamer *Zillah*. Park archives contain a document labeled "Frank Island - East Side Dock," which is one of eight blueprints submitted to the park superintendent by E. C. Waters requesting permission to construct facilities for the Yellowstone Lake Boat Company around the lake. This assumption is based on the remark by Acting Superintendent Anderson (1896: 10) that "last autumn Mr. Waters, the manager, applied for authority to construct small landing places at several points on the shore of the Lake, one on Dot Island and one for 'ways' near the site of his present landing in front of the hotel. All of these have my approval." The various planned facilities were for Dot Island, the Southeast Arm, near Lower Lake Hotel, Stevenson Island and West Thumb, all intended to enhance E. C. Waters' enterprises. Although some of these facilities were built, it is currently not known if all structures planned by Waters, including the Frank Island dock, were completed.

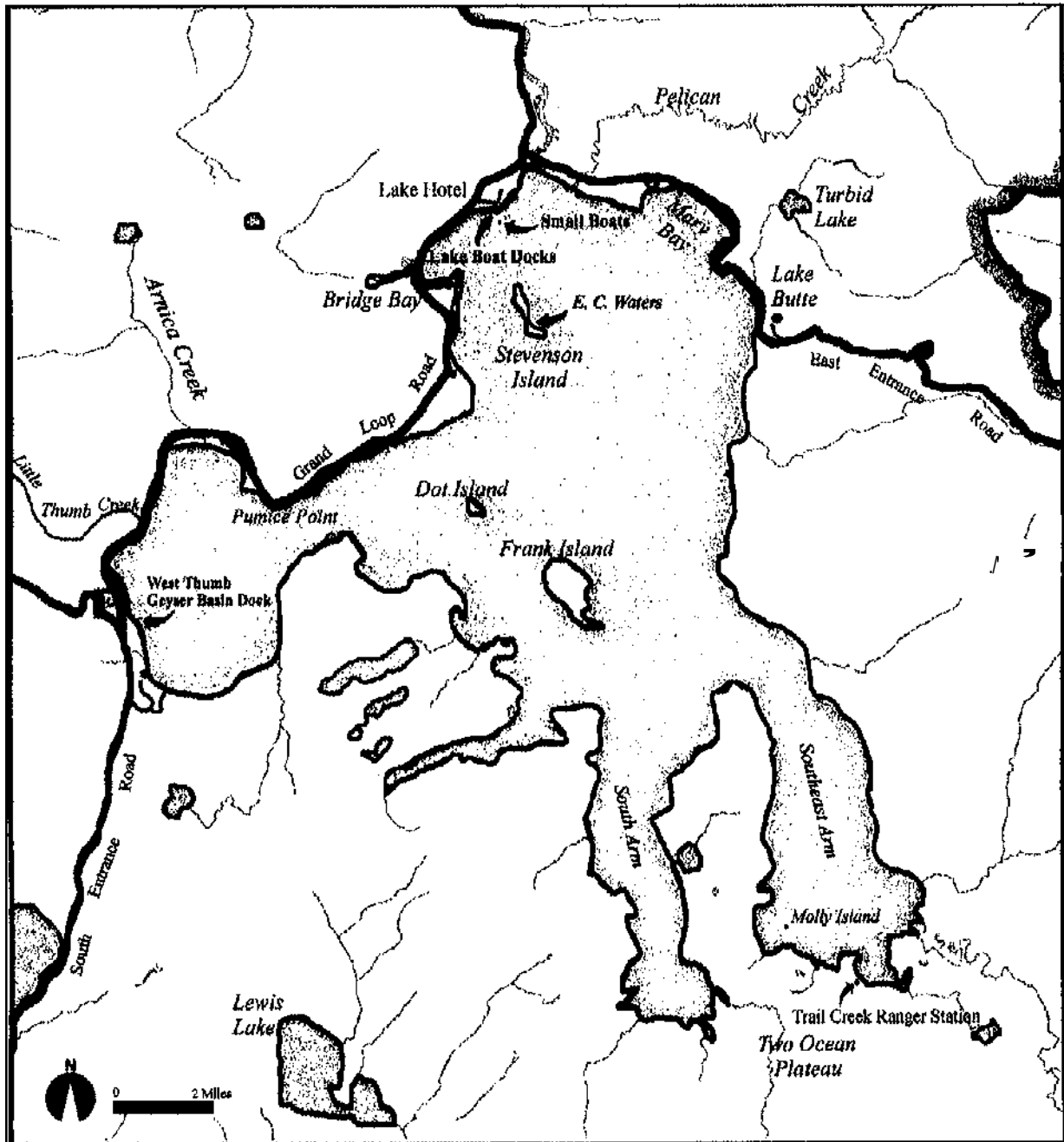

Figure 5.1. Areas and sites investigated by SCRUI in 1996.

In an attempt to locate dock remains, Jim Bradford conducted a diver tow visual survey from the island's southeast tip along the entire east shoreline to the northernmost point, a distance of about 3 mi. This is the island's lee side, which contains two small bays that appear ideal locations for a dock. Water depth ranged from 3 to 20 ft., and visibility was fair to good in this area. Numerous tree trunks were observed on the lake bottom, but none were modified or appear associated with dock pilings or cribbing. Despite the record of a dock on Frank Island as late as the 1950s (Figure 5.2), no cultural features were observed during this visual search.

DOT ISLAND

Dot Island, located due east of West Thumb (see Figure 5.1), was named by 1871 Hayden

survey members "because it was a mere dot on the map" (Whittlesey 1988:47). E. C. Waters "kept buffalo and elk in pens to show tourists who stopped there on the boat trip from West Thumb to Lake Hotel. Because the animals were mistreated, park officials forced Waters to release the animals in 1907" (Whittlesey 1988:47). Plans for a dock on Dot Island's northeast side were submitted to the park superintendent in 1895. Several references mention both dock facilities and a "Game Corral"; apparently Waters requested one-acre plots for both. "Game Corral" remnants can still be seen on the island, however, an archeological assessment of the remains has not been made (Hunt 1989:14; Ann Johnson, personal communication 1997).

John Brooks conducted a diver tow visual survey for dock remains on the island's lee side from the northwest point to the southeast point.



Figure 5.2. Frank Island boat dock, about 1950 (YELL Archives photo no. 44141).

Visibility was good to a depth of 25 ft. A concentration of logs was found near the starting point, where oral tradition suggest there may have been a navigation beacon consisting of a wooden platform with a kerosene lamp (Lenihan 1996). Close inspection of the logs revealed no cultural features, nor was there any indication of dock structures observed along the shore.

Two possibilities could explain absence of dock-associated features on Dot and Frank Islands: 1) the windward side of these islands are eroding, while the leeward sides are building, burying any indications of structures under migratory sediments (Rick Fey, personal communication 1996); or 2) the National Park Service (NPS) has removed all traces of the docks during one of several cleanup efforts (see *E. C. Waters*' burning in Chapter 3).

PUMICE POINT

The area directly off Pumice Point (see Figure 5.1) is reported to have wagon wheels and other stagecoach parts on the lake bottom in shallow water (John Lounsbury, personal communication 1996) and was considered a priority area for investigation by park resource management staff. John Brooks conducted a diver tow visual survey in an area about 600 ft. long on either side of the point, except in the north side where gill nets prevented boat passage. Depth and visibility varied from 8 to 20 ft. No cultural material was located during this survey.

LITTLE THUMB CREEK

Yellowstone Lake's first fish hatchery was located in this area about 1½ mi. north of West Thumb Geyser Basin (see Figure 5.1):

A fish hatchery was suggested for the Park by Captain J. B. Erwin in 1898, but nothing was done about it until

1902, when a fish egg collection station was authorized for Thumb. The station was put into operation the following year, greatly facilitating the taking of trout eggs which had been started at that place in 1901 By 1909, the Thumb station was recognized as the most successful collecting point for blackspotted trout eggs in the United States. From then on [1911] the fishery activity in the Park increased rapidly: the Thumb station was enlarged and three boats were put into operation in 1912; a hatchery was constructed near Lake Hotel. . . . [Haines 1996b:92-93].

The first hatchery was located at the confluence of Yellowstone Lake and Little Thumb Creek about 2 mi. north of the West Thumb Junction, an area Haynes (1946:101) called "Fisheries Creek Crossing." Fish stocking in YELL ceased in the 1950s, and the last fishery, at Lake, was closed in 1958.

SCRU investigators expected that both boats and docks associated with Fisheries Commission activities would be present underwater near Little Thumb Creek. Brooks conducted a diver tow in this area from the creek confluence south for a distance of about ½ mi., visually searching the lake bottom to a depth of 20 ft. Thermal features and a steep drop off were observed, but no cultural resources of any kind were located.

WEST THUMB GEYSER BASIN

In 1995, SCRUI examined an area east of the West Thumb Geyser Basin boardwalk. The task was to observe lake bed artifact density and assess potential for scuba divers removing artifacts from the shallow lake bottom. NPS divers noted several scattered wood pieces and

automobile engine blocks, one chained to a concrete block. Two engine blocks were removed at park request. The engine blocks were most likely placed as small boat mooring anchors. Other artifacts observed included old and recent bottles, and several historical West Thumb dock crib remnants. SCRUC conducted general documentation of the dock remains using videography and photography, and they acquired five Differential Global Positioning System (DGPS) points to delineate the general dock outline and precisely position the cribbing. Water conditions here promote a thick growth of filamentous algae that covers the bottom (Figure 5.3) making visual survey difficult. However, a wagon wheel was located and removed to Bridge Bay for curation at the park's request because of potential for theft (Lenihan 1995a:4–5). The wheel (Figure 5.4) is 4 ft. 7 in. in diameter, has tapered spokes and a metal

tire 2¼-in. wide x 1/8-in. thick. The rim is composed of two felloes with a metal wedge or shim inserted at one seam to increase the diameter and tighten the fit. Other than some natural deterioration from years in the lake, the wheel is in good condition and shows little damage or wear (Figure 5.5). According to District Ranger John Lounsbury, an historical wagon aficionado, the wheel size and construction suggest a small stagecoach because it appears too big for a buggy and too small for a freight wagon. Park Archeologist Ann Johnson (personal communication 1997) confirmed the wheel diameter matches those of the smaller stagecoaches in the park vehicle collection. There were perhaps five park stagecoach lines, and each stagecoach had a distinct paint scheme, which may have been useful for determining an association for this wheel. Unfortunately, no paint remained on the

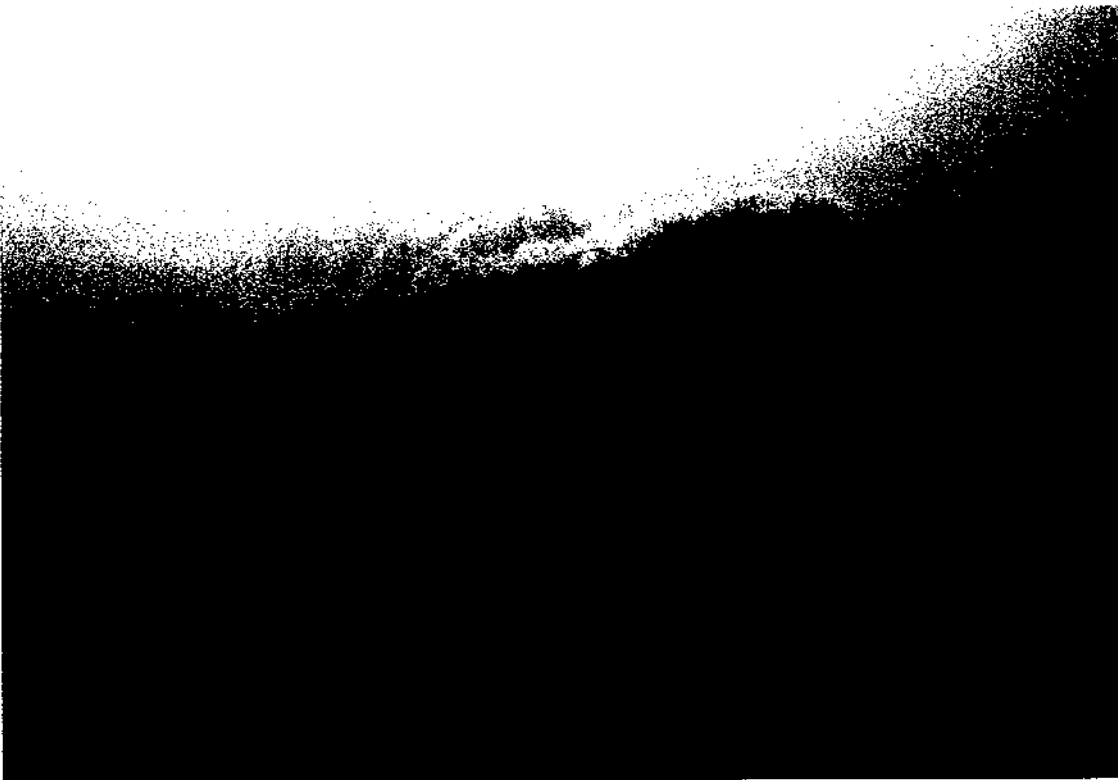

Figure 5.3. Algae covered dock crib at West Thumb. NPS photo by Brett Seymour.



Figure 5.4. Wagon wheel at West Thumb. NPS photo by Brett Seymour.

wheel. As a possible *terminus ante quem*, the last horse-drawn lines operated in the 1916 season after which motorized tours were conducted (Chittenden 1924:344), which indicates this wheel is at least 80 years old.

One 1995 recommendation (Lenihan 1995a) was to document the West Thumb dock remains, which was completed during the 1996 project. Sinter deposits from the active geysers coat the lakeshore in the vicinity and form an underwater shelf immediately offshore the thermal features. A high portion of the shelf extends above water line about 11 ft. west of the dock remains and was incorporated into the original dock (Figure 5.6). The dock remains consist of basal portions of six log cribs set three to a side to form an L-shape. All six cribs, spaced a consistent 22 ft.

apart, have spilled rock out all sides (Figure 5.7). The east-west portion is a linear rock pile extending along the lake bottom for a distance of 85 ft.; the top of the rocks varies in depth below the surface from 3 to 7 ft., while the bottom of the rocks ranges in depth from 5 to 12 ft. Cribs 1 and 2 are less intact than other cribs; their rocks have spilled outward into mixed piles presenting the appearance of a jetty rather than discrete cribs. Numerous logs, cable, iron I-beams and a terra cotta pipe segment were observed in the rock piles. Crib 3, at the easternmost end of this dock section, is mostly intact and forms an acute angle; the alignment of cribs 4 to 6 extends about 115 ft. to the south. Cribs 4 and 5 have distinct crib remnants and less rock spillage to their sides (see Figures 5.7 and 5.8). Crib 6 is a distinct pile of rocks, but shows very little original crib form. Several automobile tires, crib logs, miscellaneous cable and concrete slabs were observed between cribs 3 to 6. As depicted in Part I, Figure 17 and Figure 5.7 in this chapter, the crib alignment is not a true L-shape, but instead angles more to the west following the submerged shallow slope. One explanation for this alignment is that the builders were likely taking advantage of the shallow shelf slope edge, which reduced construction materials and allowed access to the deep water directly offshore.

The cribs are about 12 ft. on a side, with what appears to be an interior wall of logs dividing each crib into two parts. The cribs are made of logs ranging from 7 to 11 in. in diameter, with the majority about 8 in. in diameter. Almost solid algae growth and spilled rocks prevent complete documentation of the crib corners. Logs on all sides about those above and below, creating a solid wall. The lower logs are shortened to accommodate the lake bottom slope, with those higher in the wall being the full 12 ft. in length or, in some cases, two logs with ends abutting to achieve the total length of a side. The crib corners are fastened with a



Figure 5.5. Close-up of West Thumb wagon wheel. NPS photo by John Brooks.



Figure 5.6. *Jean D* docked at West Thumb. Note the cribbing and walkway (YELL Archives photo no. 88438).

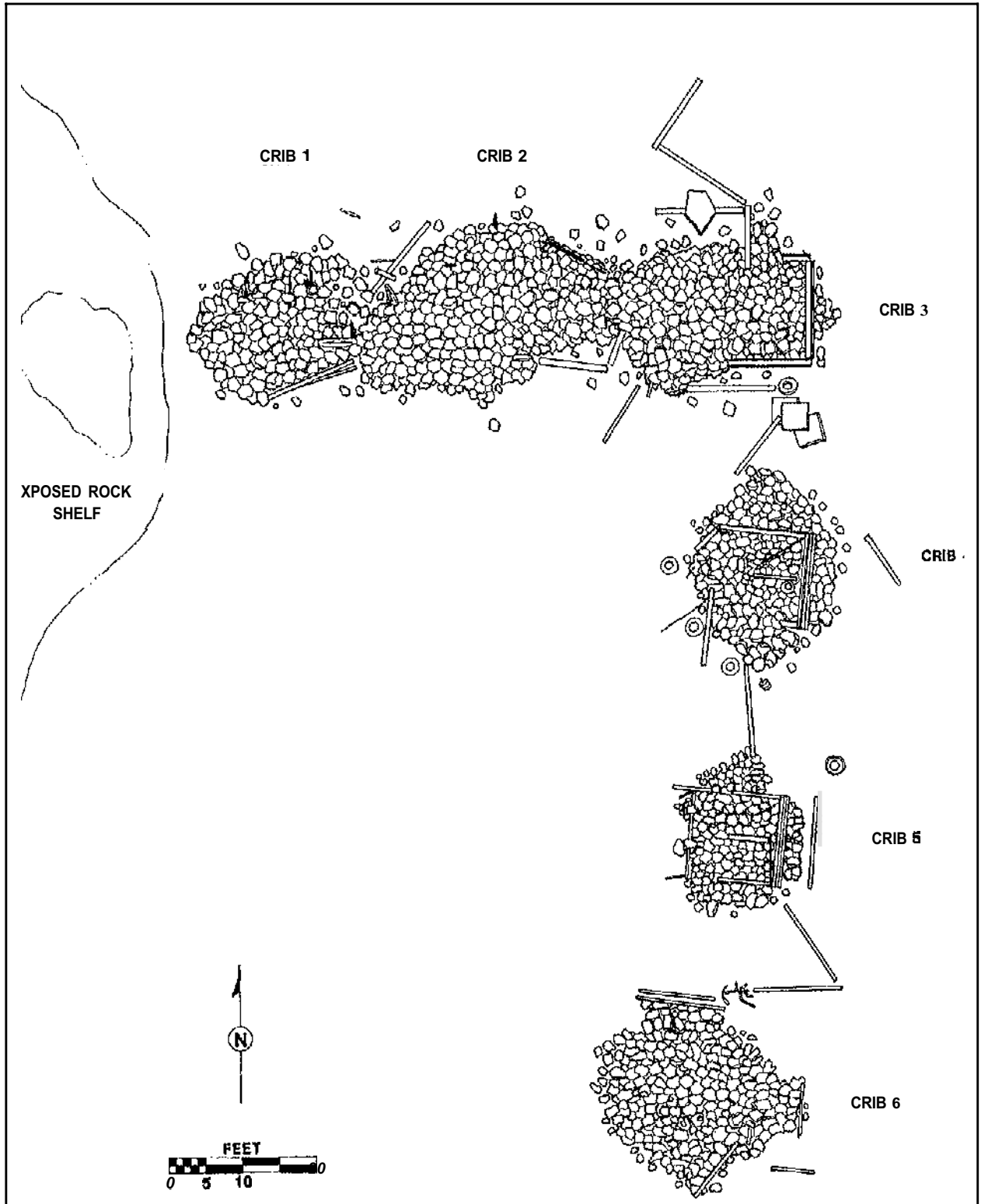

Figure 5.7. Plan view site map of the West Thumb dock cribs. Drawing by Jim Bradford and Matt Russell.



Figure 5.8. West Thumb dock crib. NPS photo by Brett Seymour.

single 1-in. iron or steel rod driven through the entire height of the crib side. The only evidence of overlap is in Crib 5, where the top course of logs has a single log overlap at each corner, with the corresponding next-side log abutting the overlap and tied at the next corner. This appears to leave a weak corner at the crib bottom, which might allow separation unless other fasteners were driven through the courses of logs at other locations. No evidence of fasteners other than at the corners was observed, nor were any horizontal ties (dogs) between logs. Algal growth may have obscured these detail features.

Crib 5 is a typical example and will be discussed in detail. The east wall is 7 ft. high, while the west wall, because of lake bed slope, is 4 ft. high. Two bent corner fasteners at the crib top have exposed lengths of about 8 ft. 6 in. Typical depth below surface at the crib tops is 6 ft. Subtracting the 6 ft. depth below surface

from the 8 ft. exposed fastener length indicates the crib extended 2 ft. above water level. With the dock structure attached, the dock height above lake level would have been about 3 ft. (see Figures 5.6 and 5.9), sufficient to stay above lake ice in this protected area of the Thumb, which receives little ice shelving.

As shown in Figure 5.6, the exposed shelf rock was used as a dock support. The original dock extended eastward from shore approximately 80 ft. to the exposed rock (with some small supports in very shallow water), incorporated the exposed rock as a support, then utilized cribs 1 and 2 in about 5 ft. of water, and continued to the end of this segment at Crib 3 in about 12 ft. of water. Here the dock turned south, using cribs 4 to 6, for a distance of about 115 ft. to the end of the L. This configuration produced 12 to 13 ft. of depth on the dock's offshore side at current lake level.



Figure 5.9. West Thumb dock (YELL Archives photo no. 94212).

Crib dimensions indicate each would encase about 1,656 ft.³ of rock fill to the lake surface, or about 1,800 ft.³ to the bottom of the dock. The four north-south cribs (cribs 3 to 6) contained about 6,624 ft.³ of rock. Cribs 1 and 2 contained about 2,160 ft.³, which gives an estimated total dock fill volume of about 8,784 ft.³, or about 325 yd.³ of broken rock ranging from fist size to 1 x 2 x 2 ft. Rock type and origin are unknown, but acquisition, transportation and handling of that much material involved considerable effort.

The uniformity of the depth of Cribs 3 to 6 at 6 ft. below the surface (a similar depth as the single crib located at the former Lake Hotel dock), suggests the cribs were deliberately razed to this level when the dock structure was removed. This may have been done to reduce them as navigation hazards. Intentional razing to a uniform depth seems more likely than it being the result of ice action, because ice rarely gets more than 2 ft. thick in the winter (John Lounsbury, personal communication 1996). Dock construction date and builder(s) are unknown, but the docks probably went through several periods of rebuilding since first constructed. E. C. Waters undoubtedly

constructed the original dock. *Zillah* docked at West Thumb from the 1890s through the 1910s (Figure 5.10), as did other *lake* boats (see Figure 5.6). A photograph shows a dock in this area as late as the mid-1930s (Allen and Day 1935:130). It is not known when the dock was removed, but it was likely present until the early 1960s when many older West Thumb facilities were removed and relocated or replaced by Mission 66 developments. The West Thumb Geyser Basin docks have not been given a site number.

LAKE BOAT DOCKS (48YE247)

Despite the rich Lake Hotel dock area history, little material evidence of the various facilities remains today. Before the turn of the century, E. C. Waters proposed and built a dock at Lake, which included the boat management concession headquarters. Shore facilities at Lake included the largest Yellowstone Lake docks (Figure 5.11), the primary rental boat operation (Figure 5.12), the main dock for *Zillah* and other lake boats, a boathouse (Figure 5.13), a marine railway for launching and dry docking boats (see Figure 3.23), and a fish hatchery. Waters built the original dock in the 1890s, and



Figure 5.10. *Zillah* docked at West Thumb, about 1900 (YELL Archives).



Figure 5.11. *Jean D* at the Lake dock, about 1905. Stevenson Island is in the background (YELL Archives photo no. 88090).



Figure 5.12. Lake dock rental boats (YELL Archives photo no. 36371).



Figure 5.13. Lake boathouse (YELL Archives photo no. 61-699).

completed a long dock extending south from shore with a short east leg by the turn of the century. This dock configuration was used until major extension and revisions were completed between August and October 1936. These revisions employed a pile driver, as in the original construction. The dock was extended, a launch ramp constructed and a trestle track added from the road to the water providing a means of *dry* docking large boats, and a small boat ramp was built. All are well documented in the park photograph archives. In spring 1937, the docks were severely damaged by ice, which resulted in additional ice protection measures in October 1938. The fish hatchery was added to the facilities in the 1910s, and all vestiges of these structures, with exception of the boathouse, were removed around 1962.

Underwater features noted during the 1995–1996 investigations include a single crib remnant from the dock and a short marine railway section still on the lake bottom. The dock crib contains only three courses of logs and has a spike projecting out of the top, the upper end of which is at a depth of 6 ft.

The bottom is sand, some of it very well packed into a hardpan. Cobbles from the cribbing have in many places been spread along the bottom through natural site formation processes in a manner resembling paving blocks. They are evenly distributed over the bottom rather than helter-skelter in piles. Some of the wooden members utilized in cribs that are now lying loose on the bottom seem to have formed a slight furrow or depression about them in the hardpan; in some cases the depression is longer than the spar itself. There is also the remains of docking and some smaller artifacts of a modern vintage protruding through

the smooth, hard bottom between the rocks [Lenihan 1995a: 1].

Park resource managers and divers conducted a more extensive investigation of the Lake docks in October 1998. They officially recorded the site and issued it an archeological site number, 48YE247. At that time, they observed a large scatter of rocks 15 ft. wide extending in an arc for 900 ft.; a second scatter, also 15 ft. wide, extending for 170 ft.; and four intact rock-filled cribs (Dave Price, personal communication 1999). The 1998 work done by park staff indicates more Lake docks remains than observed by SCRUC during the 1995–1996 field work.

The marine railway section was located by SCRUC in 1996 in shallow water and consists of a short segment of ties and rails still in place (John Brooks, personal communication 1996). The railway, located just west of the later fisheries dock, was used to launch the *E. C. Waters* in 1905 (Aubrey Haines, personal communication 1996) and three NPS boats brought to the park in 1936.

SMALL CRAFT

A launch located on the lake bottom near the Lake Hotel dock was dived in 1995 (Figures 5.14–5.15). The launch's rudder was removed by park divers sometime in 1994–1995, and it is currently in the Bridge Bay Marina Ranger Station.

In 1996, side scan sonar revealed a clear sonogram of a cluster of small boats about 0.2 mi. southeast of Lake Hotel. A single dive on these craft confirmed four boats sitting in 23 ft. of water (Figures 5.16). All four are of similar design and oriented in the same direction (Figures 5.17–5.20). Rough measurements give a length range from 13% to 14 ft., and a width from 3 ft. 7 in. to 3 ft. 9 in. All four have small seats fore and aft, two have a single center seat,

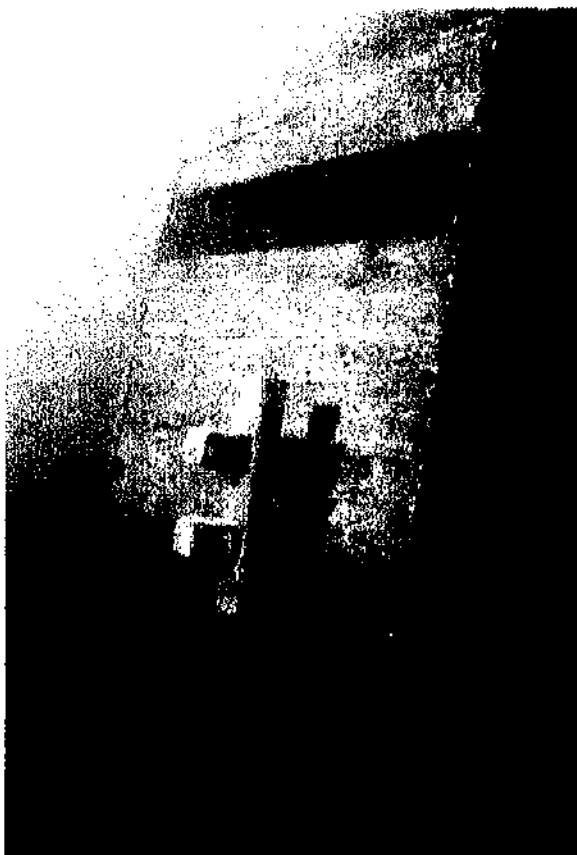

Figure 5.14. Small launch off Lake Hotel. NPS photo by John Brooks.

Figure 5.15. Hotel launch stem. NPS photo by John Brooks.



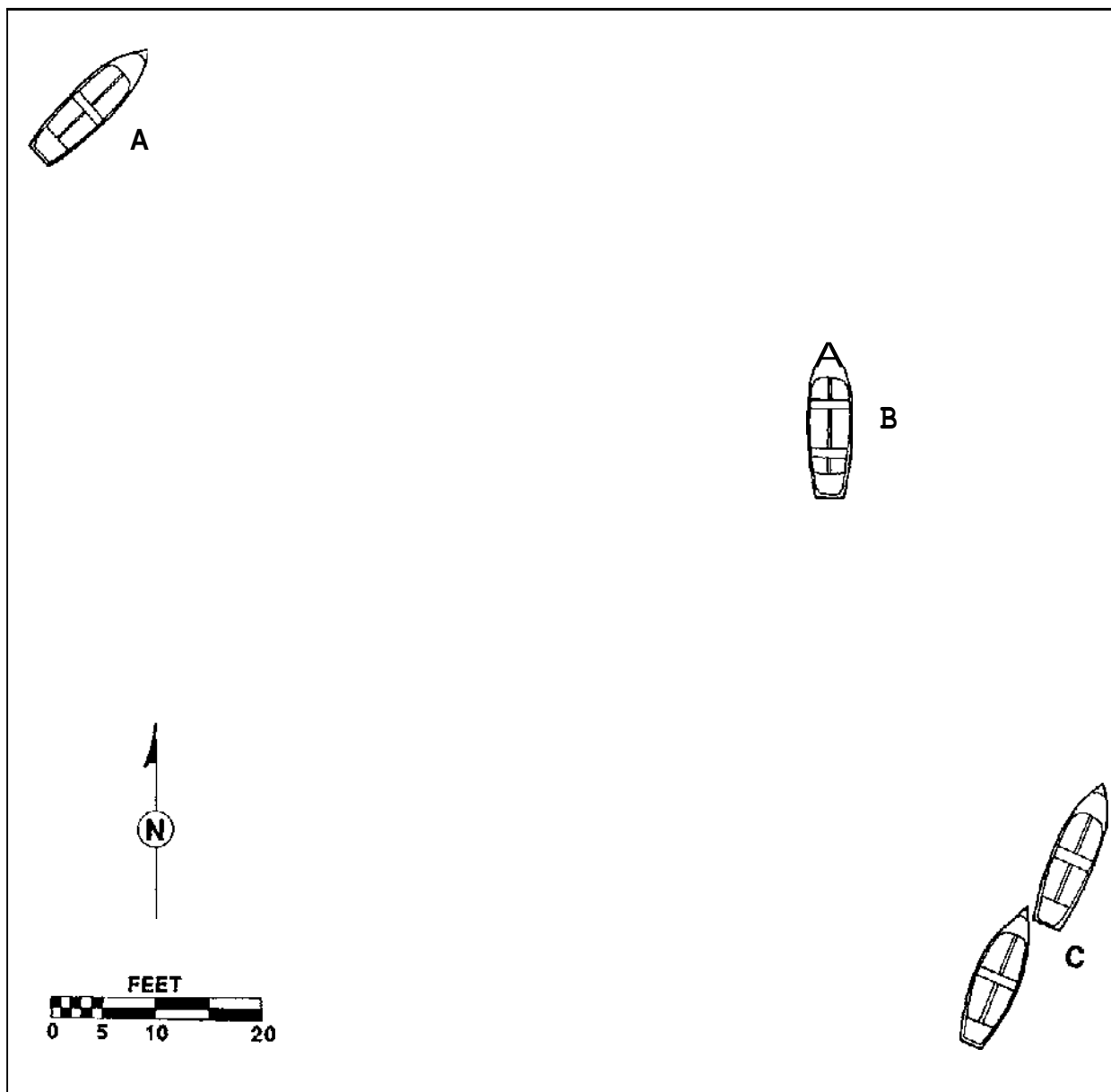

Figure 5.16. Field sketch of four small rental boats off Lake Hotel. Drawing by Paul Neidinger.



Figure 5.17. Small boat bow. NPS photo by John Brooks.

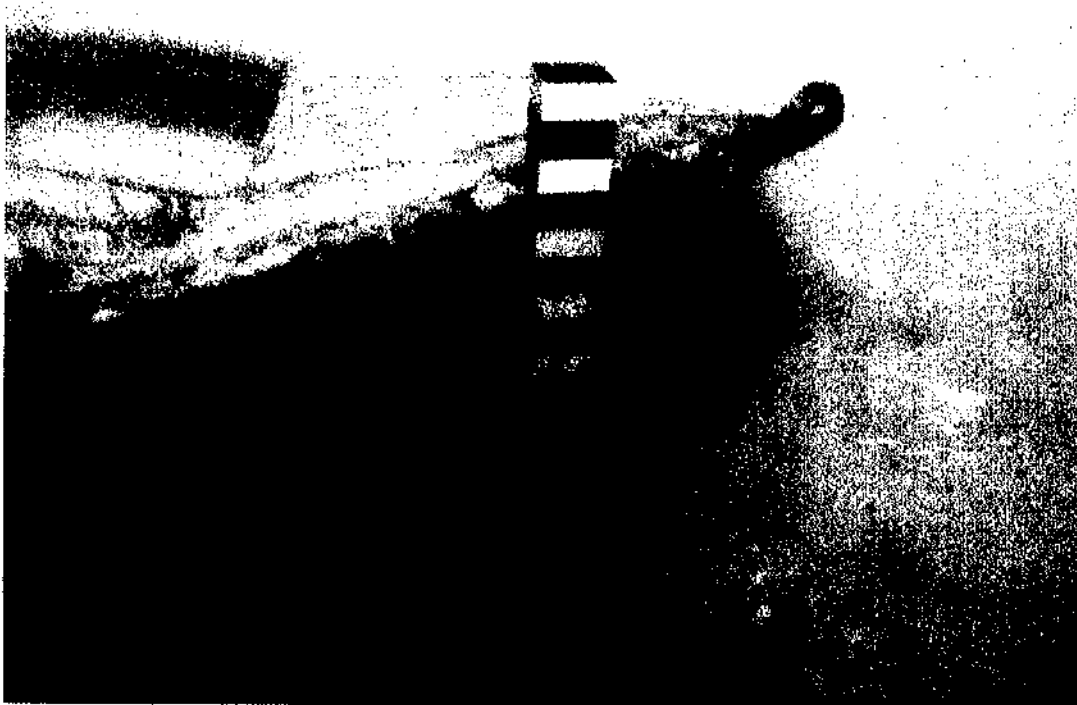

Figure 5.18. Small boat bow. Scale in inches. NPS photo by John Brooks.

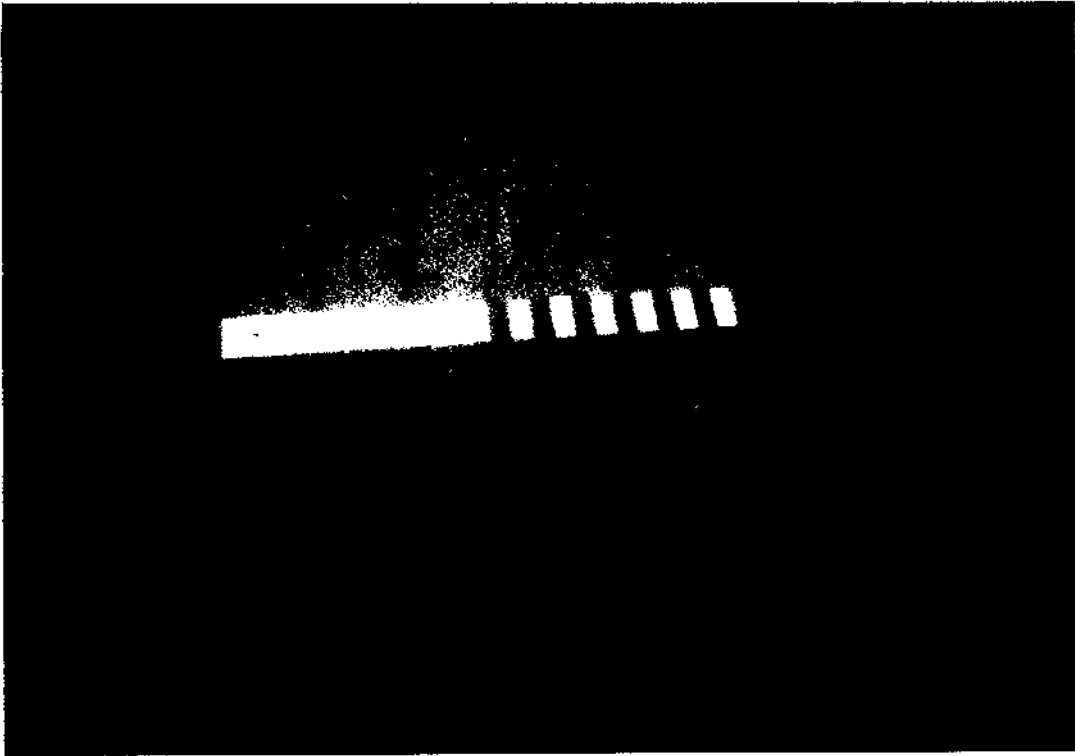

Figure 5.19. Small boat stem. Scale in feet and inches. NPS photo by John Brooks.



Figure 5.20. Small boat stem. Scale in feet and inches. NPS photo by John Brooks

one has two such seats and the fourth lacks center seats. As noted by Lenihan (1996), “these craft are all approximately the same size with enough variations to suggest nonassembly-line production. They seem fragile as if they have been there quite some time.” They compare exactly with the rental boats shown in Figures 5.21 and 5.22, which date to 1941 and were apparently scuttled after becoming obsolete. Neither the launch nor the small boats have been formally recorded and given site numbers.

ZILLAH AND JEAN D

Several *Zilluh* photographs are in the park archives (Figures 5.23 and see Figures 3.2–3.5). According to Aubrey Haines (personal communication 1996), *Zillah’s* linen construction drawings were in the Maintenance Division hanging files until 1968. He also stated that reproductions of these drawings were used by Harpers Ferry Center as part of an interpretive kiosk on “Steam Boating on the Lake” that was in front of the Lake Hotel until the late 1970s. The kiosk has since been removed, and neither of these leads could be confirmed while at the park, nor later in the Technical Information Center in Denver.

Despite local lore that *Zilluh* was taken from the old fisheries dock, towed out to deep water and scuttled, no evidence of it in that area was noted during extensive side scan sonar survey of the area to a depth of 200 ft. This area was selected based on information that *Zilluh* rested on the bottom in the general area southwest of the old docks. Archival information on *Zillah’s* fate is contradictory. *Zilluh* is described as making “her last voyage out into Yellowstone Lake, where her hull was opened and she came to rest on the bottom where she remains today” (Anonymous 1995:7). In another article, reference is made that the Yellowstone Park Boat Company dismantled it in 1929 (Anonymous 1976:5). In a telephone

conversation with Aubrey Haines after the 1996 fieldwork, he commented that he had found a reference to *Zilluh* having been cut up and sold for scrap, perhaps a confirmation of its being dismantled. Haines also stated that there is a reference to the “destruction of the *Zilluh*” in his 1961 taped interview with Mr. Hallin. This has not yet been confirmed. Definitive references to *Zillah’s* final disposition have yet to be found.

The *Jean D* (Figure 5.24 and see Figures 3.8–3.11), along with *Zilluh*, was owned and operated by the Yellowstone Park Boat Company during the 1910s (Aubrey Haines, personal communication 1996). Unfortunately, no other information on this vessel was located in a brief search of park archives.

E. C. WATERS (48YE13)

E. C. Waters, the largest vessel ever operated on Yellowstone Lake, was a 125-ft.-long, wooden-hulled, single-screw passenger steamer with a 26-ft. beam (Haines 1996b:127). Although depth of hold and tonnage are not documented for this vessel, they are estimated to have been a 10-ft. depth of hold and between 200 and 250 tons. Today, *E. C. Waters’s* remains lie partially exposed and awash on Stevenson Island’s east shore (Figures 5.25 and 5.26). Initial field observations of site 48YE13 were that the wreckage consists of the largely intact lower hull below the turn of the bilge, much of the drive train (excluding engine and boiler), and many scattered features and artifacts (Figure 5.27). Major structural features include the keel, main keelson, sister keelsons, floors, the first and second futtocks of most frame-pairs, engine bed, propeller shaft and bearings, thrust bearing, propeller, hull planking, ceiling planking and deck machinery, along with numerous scattered fittings (Figure 5.28). The hull, listing 27° to port, is 121 ft. 7 in. long from propeller to the forward-most attached hull plank, and the bow points due east.



Figure 5.21. Yellowstone Park Company rental boat #78 (YELL Archives photo no. 29078/12078).



Figure 5.22. Yellowstone Park Company rental boat #78 (YELL Archives photo no. 29078-2).

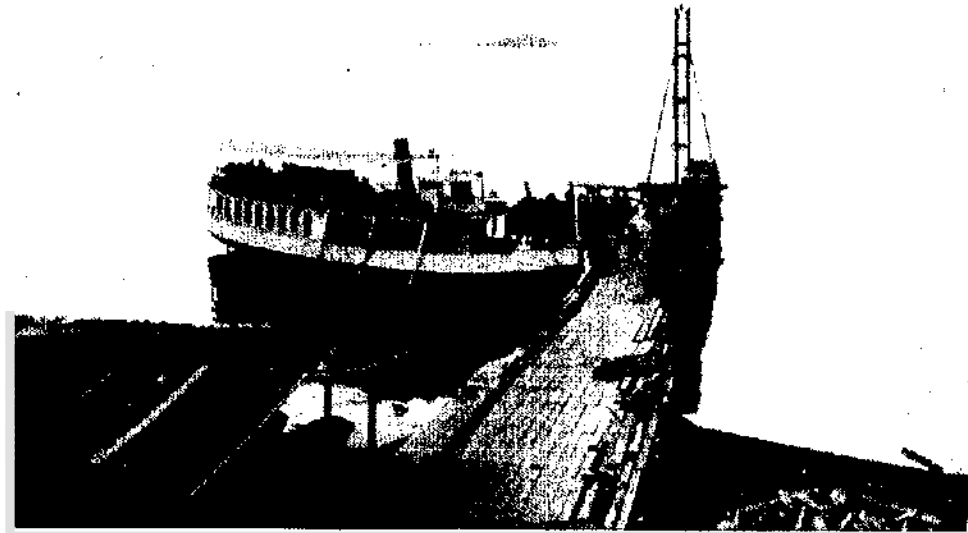

Figure 5.23. *Zillah* at the Lake dock, 1889(YELLArchives photo no. 88853).

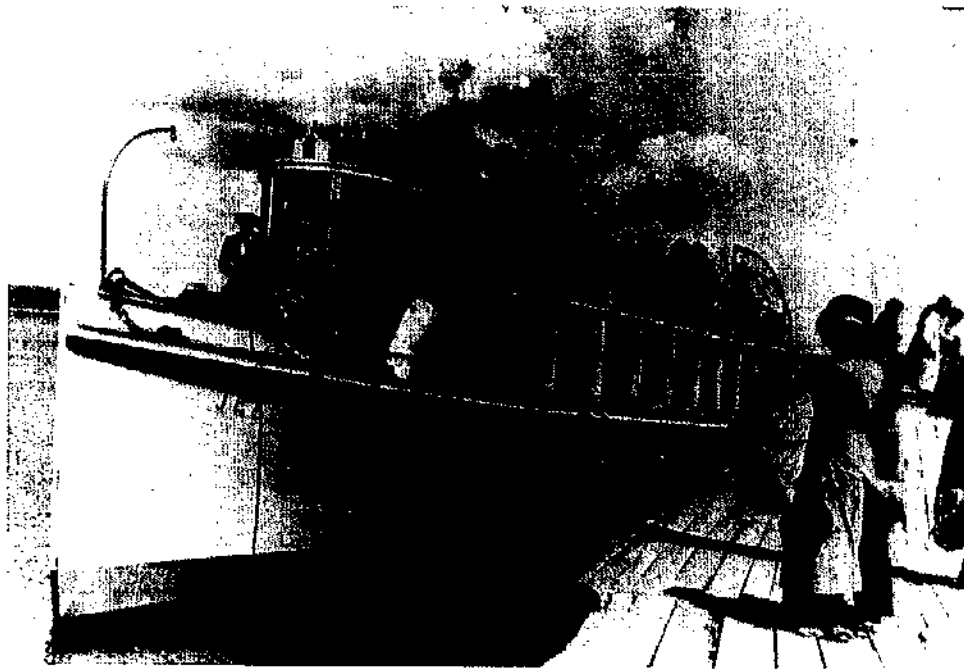

Figure 5.24. *Jean D* docked, probably at West Thumb, about 1910 (YELL Archives photo no. 40348).



Figure 5.25. View southeast of *E. C. Waters*' remains on Stevenson Island's eastern shore. NPS photo by John Brooks.



Figure 5.26. View northeast of *E. C. Waters*' remains. NPS photo by John Brooks.

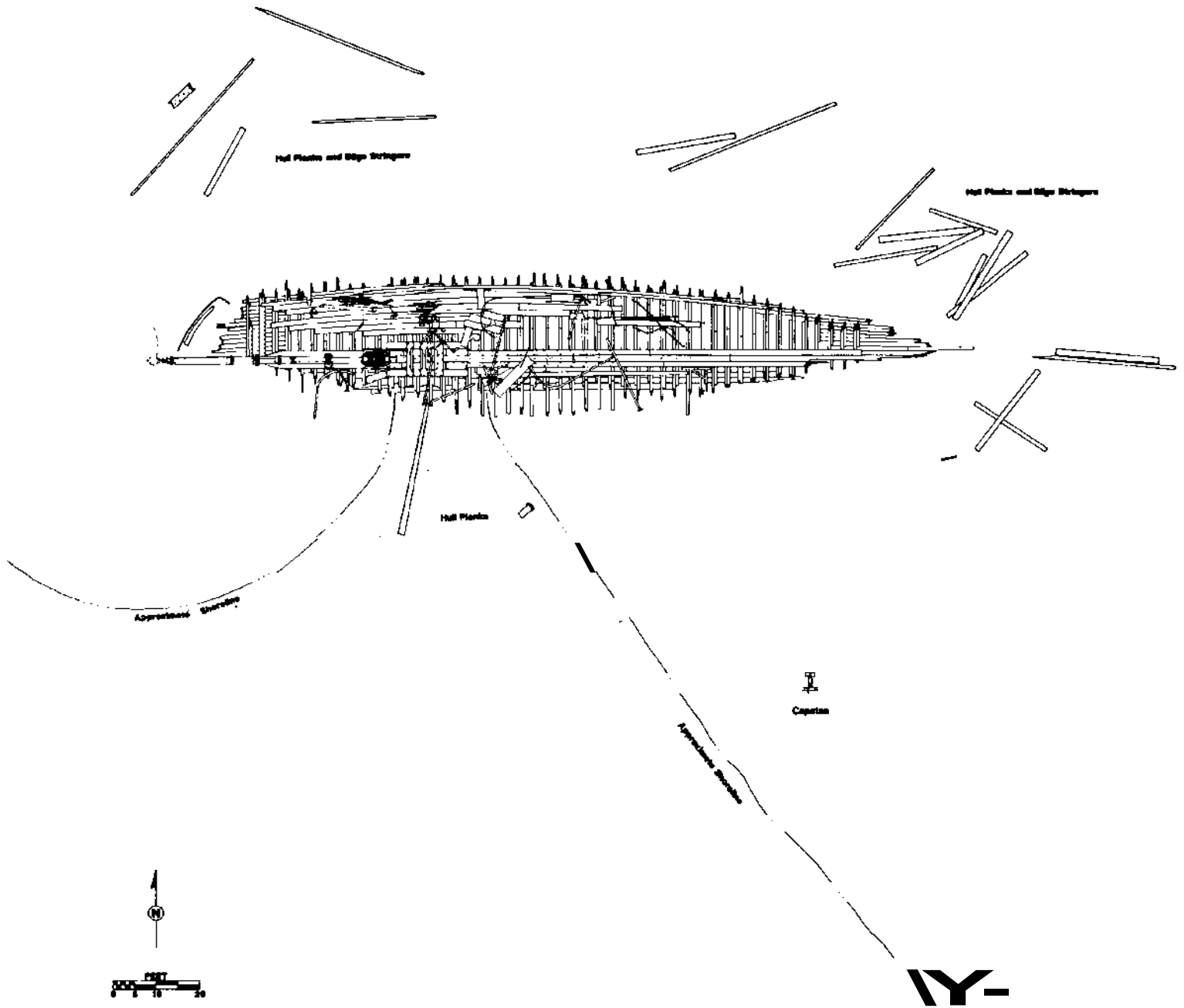

Figure 5.27. Plan view of *E. C. Waters*' site (48YE13). Drawing by Jim Bradford and Matt Russell.

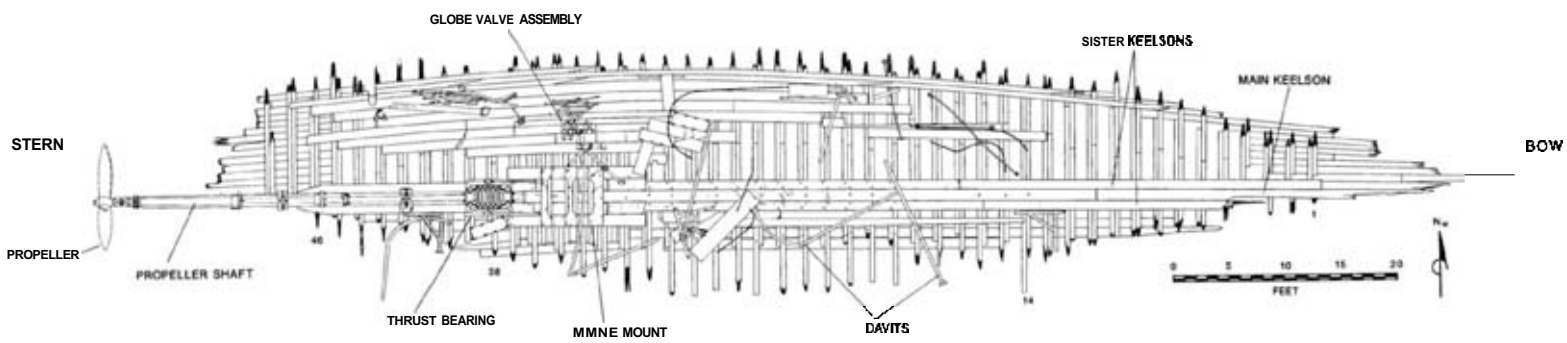

Figure 5.28. Plan view of *E. C. Roers'* hull remains. Numbers along the lower edge are frame pair numbers. Drawing by Jim Bradford and Man Russell.

The SCRUI field team, consisting of two archeologists and a photographer, documented the site during a six-day period in August 1996. This preliminary site assessment employed a nondestructive, noninvasive approach; no artifacts were collected and only exposed features were documented. The one exception was the capstan, buried in the sand 75 ft. south of the hull, which was exposed by hand fanning the sediments for documentation and photography and then reburied. The documentation team established a baseline along the wreck's centerline structure and mapped site features using baseline trilateration and direct measurements. The main features, including *E. C. Waters'* hull, remaining propulsion system, and scattered site features were also drawn to scale. Unfortunately, limited time for this assessment did not allow complete documentation of all site details. For example, the many small, portable artifacts located between the vessel frames could not be completely documented, and other details, such as the hull fastening patterns, were documented through recording only a representative sample. No wood samples were taken during this noninvasive site assessment.

HULL REMAINS

At August 1996 lake levels, the *E. C. Waters'* centerline (keelson and propeller shaft) was just at the lake's surface. Because of the 27° port list, the submerged port side is better preserved than the starboard side, which is mostly exposed above water level. Port-side hull remains are extant to the turn of the bilge, while the starboard-side hull consists of burnt stubs of several floors and futtocks (frames or "ribs"), and a few hull (outer) and ceiling (inner) planks. Overall, *E. C. Waters'* preserved lower hull remains represent a unique opportunity to study turn-of-the-century, high-altitude, western lake-steamer construction.

The keel is a vessel's main centerline structural member, running the length of the vessel to provide longitudinal support. In wooden vessels it is composed of long timbers, scarfed (joined) together at their ends (Kerchove 1961:418). *E. C. Waters'* keel dimensions are 10 in. sided (width), 11 in. molded (height) and approximately 117 ft. long. Only 30 ft. 6 in. of the keel's forward part is exposed, and the forward end is splintered and worn with an eroded upward slant on its lower face that has removed any evidence of the keel and stempost joint. The keel's aft end, where it meets the propeller post, or sternpost, is buried, obscuring that joint and making it impossible to determine if the keel had an aft extension to the rudder post, or if the rudder was supported by a rudder shoe, or skeg. Because the keel is buried here, an exact keel length measurement is impossible. One horizontal hook scarf is visible in the keel, beginning 18 ft. 6 in. aft of the keel's forward end. The scarf, which angles up toward the bow, is 4 ft. 5 in. long horizontally, 5 ft. 2 in. long diagonally, with a hook offset of 1% in. The scarf extends over only three frame pairs, less than the four recommended in the following decade (Desmond 1984:46 [1919]), but long enough to meet required specifications of the more contemporaneous *Great Lakes Register* (1908:180), which states keel scarf length should be four and one-half times the keel's sided dimension. To meet this requirement, *E. C. Waters'* 10-in.-sided keel required a minimum scarf length of 3 ft. 9 in. Because longer scarf lengths are stronger than shorter ones, *E. C. Waters* was built more conservatively in this regard than required by contemporary Great Lakes practice. There are likely other scarfs along the keel's length, but the rest of the keel is buried and could not be examined.

Other than the worn, splintered forward end, the only other keel damage noted was that the aft end of the forward keel section, below the scarf, was broken-off and missing. This damage

is unusual, and there is no evidence of how it occurred. Keel rabbets (for securing hull planks) could not be observed, and no false keel (an expendable plank placed on the keel bottom to protect the keel) was present on the keel's exposed end.

None of *E. C. Waters'* stem assembly remain on-site, and nothing related was located in the surrounding area during a side scan sonar search. The forward-most wreckage consists of the keel, keelson, filler deadwood between the keel and keelson, and outer hull planking. No deadwood was present on top of the forward end of the main keelson.

The vessel's sternpost, or propeller post, is present and is sided 8 in. and molded 11 in. The sternpost heel, where it joins the keel, and the keel extension or rudder shoe that supports the rudder post and rudder are buried and were not observed. The sternpost protrudes 2 ft. 11 in. above the sediment, to a point just below the propeller shaft, where it is broken off inside the

iron bushing assembly that encases it. The stem bearing and other features associated with the sternpost will be described below with the propulsion system.

E. C. Waters' frames are constructed from horizontal pairs of timbers that cross the keel perpendicularly, and are located between the underlying keel and the overlying keelson (Figure 5.29). These pairs of timbers, made up of floors and futtocks, extended from the keel amidships to the turn of the bilge and continued up the hull side. The frames on *E. C. Waters'* port side are now broken at the turn of the bilge; those on the starboard are broken near the keel. Individual floor and futtock timbers are joined end to end with butt joints that are staggered so that one half of each frame pair overlaps the butt joints of the other half to maximize strength. This paired frame arrangement with staggered butt joints is known as "double framing."

E. C. Waters' framing was constructed using a peculiar combination of the long-and-short-



Figure 5.29. *E. C. Waters'* frames. View aft of paired frames with butt joints in the wreck's forward port section. The main and sister keelsons overlay the frames in the upper left. Scale = 1 foot. NPS photo by Brett Seymour.

arm method through its midsection (which was the preferred construction method by the turn-of-the-century), and an older style of framing near the bow and stem. The long-and-short-arm method uses two staggered floors of the same length crossing the keel, so that the long arm of one timber is on the same side of the keel as the short arm of the other (Figure 5.30). The first futtock on each side of the vessel butt-joins the floor's short arm, while the second futtock butts the long arm. In this way the futtocks are carried up the vessel's side. The older style of framing uses just one floor, centered over the keel, for one half of the frame pair, with the two first futtocks butt-joined over the keel forming the other half. Second futtocks are attached to either end of the floor and third futtocks are attached to the end of each first futtock. This pattern is repeated up the vessel's side (Figure 5.30).

The practice of long-and-short-arm framing was introduced before the Civil War and became the preferable construction technique by the 1870s (Record of American *and* Foreign *Shipping* 1879:21). The historical shift to long-and-short-arm frame techniques occurred for several reasons, including availability of material and this framing technique's superior strength

The practice of placing two sets of floors across the keel having a long and a short arm on **alternate** sides is of recent origin, and is consequent upon the great difficulty in obtaining first futtocks of sufficient length, size and crook for ships of the largest classes. It is regarded **as** a great improvement, inasmuch as it rids the keel of the range of butts with which it was covered under the old system . . . [Wilson 1873:197].

Specifications for both the "old system" and the long-and-short-arm framing method were included in the Rules for the Construction of *Wooden Vessels*, published annually by the American Shipmasters' Association through at least 1900. Several standard early-twentieth century ship construction manuals do not even mention the older framing style (Estep 1918; Curtis 1919; Desmond 1984[1919]), indicating standardization on the long-and-short-arm frame method. No examples of mixing the early and later framing styles in a single vessel were located in either historical or archeological literature.

Forty-eight frame pairs are present in *E. C. Waters'* hull remains (see Figure 5.28); all floors and futtocks measure 5 in. sided and 9 in. molded, while room and space (distance from the center of one frame pair to the center of the next) is 24 in. As recorded, Frame Pair #1 is the first square frame, which crosses the keel perpendicularly. Forward of this square frame were half or cant frames that butted into the deadwood. Half frames remained perpendicular to the keel and became increasingly steep as they formed the pointed ship bow, whereas cant frames rotated forward in a radial pattern. Because no bow framing remains, there is no way to determine if *E. C. Waters'* builders used half or cant frames. The bow filler deadwood exhibits heel notches for the frames and fastener patterns in the outer hull planking indicates several half or cant frames were present. In the stem, two half or cant frames (#47 and #48) notched into the deadwood are still in place on the port side and a notch for a third half or cant frame is present. Fastener patterns on the starboard stem deadwood indicate at least three half or cant frames were used but are no longer present. Frame pairs #1–14, as recorded, were constructed using the older framing style, with a single floor and the port and starboard first

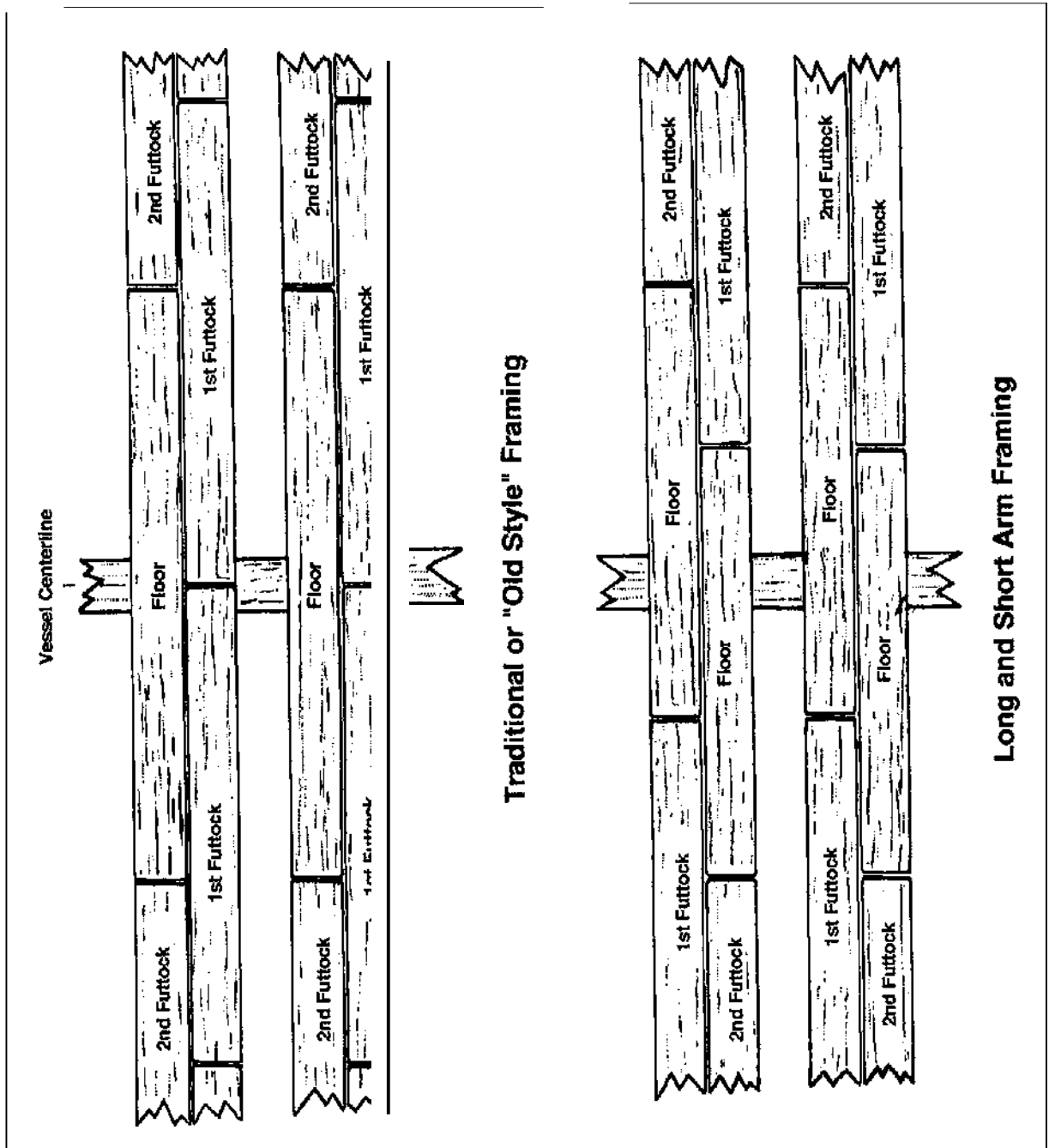

Figure 5.30. Different styles of framing a wooden vessel. Drawing by Matt Russell.

futtocks butting under the keelson. Each futtock was fastened horizontally to its mated floor with $\frac{3}{4}$ -in.-diameter fasteners, creating the frame pair. These 14 frame pairs are constructed with the floors forward of the futtocks. *E. C. Waters'* midship section (frame pairs #15–38) is constructed using the long-and-short-arm method, with two staggered floors. Near the stem, frame pairs #39–46 (the last square frame) revert back to the older style of framing, with a single floor and two first futtocks butted under the keelson, though in these the floors are aft of the futtocks. The last two frame pairs (#47–48), are either half or cant frames, which are mortised into the stem filler deadwood. These frames are perpendicular to the keel, but it could not be determined if they are half or cant frames. Only first futtocks are present on *E. C. Waters'* starboard side due to the vessel listing to port when it burned (many futtocks showed evidence of burning on their top ends). There is probably also deterioration from ice, water, wave impact and vandalism. Several port-side frame pairs' second futtocks are present.

All frame pairs have two limber holes, each hole offset 9% in. from centerline, allowing for bilge water drainage down the vessel length to the pump wells. The limber holes are roughly rectangular, $1\frac{1}{2}$ in. high, and varying between 3 and 4 in. long. Amidships, beneath the engine mounts, 14 additional floors are present, creating a solid block of athwartship supports that add strength to the vessel's machinery spaces, which bore the combined weight of engines and boilers (Figure 5.31). Space for two other floors is present in the mount's forward section, but the floors are missing. They may have been purposefully omitted to allow bilge water to pass from one side of the vessel to the other.

Typical of late-nineteenth and early-twentieth century wooden ship construction, *E. C. Waters* was built with multiple keelsons. Keelsons are fore-and-aft centerline timbers extending the vessel's length, located on top of,

and fastened through, the floors into the keel, tying the main centerline structures together into a solid unit. *E. C. Waters* has a main keelson and two sister keelsons, the latter being slightly smaller timbers flanking the main keelson on either side. The forward end of the main keelson is broken and splintered, but is the same length as the keel, suggesting it is almost fully intact. With the exception of the port garboard strake (the outer hull plank closest to the keel), which extends another 1 ft. 6 in. forward of the keelson and keel, the keel/keelson structure is the forward-most articulated hull structure. A single outer hull plank extends further forward on the port side, but it is loose and not fastened to other timbers. The main keelson extends aft to the stempost. Its total length is 116 ft. 4 in., and its dimensions are 11 in. sided and 10 in. molded. Like the keel, a single horizontal scarf is visible on the main keelson, beginning 30 ft. 8 in. aft of its forward-most end. Because the main keelson is flanked on both sides by sister keelsons, no details of this scarf could be observed. It could not be determined if the scarf is angling forward or aft, or what type of scarf it is. Because the keel and both sister keelsons used hook scarfs, however, it is reasonable to expect the builder used this scarf when assembling the main keelson. Given the main keelson length, at least one additional scarf would be expected, probably hidden by the engine bed aft of midship.

E. C. Waters' sister keelsons flank the main keelson, but are slightly shorter. The port sister keelson appears to be complete, its forward end cut straight 10 ft. 1 in. aft of the main keelson's forward end, just forward of Frame Pair #1. In the stern, the port sister keelson ends 13 ft. 11 in. forward of the main keelson's aft end. This gives the port sister keelson a total length of 92 ft. 2 in.; both sister keelsons measure 10 in. sided and 8 in. molded. The starboard sister keelson's forward end is broken off 8 ft. 7 in. aft of the port sister keelson's forward end. The starboard

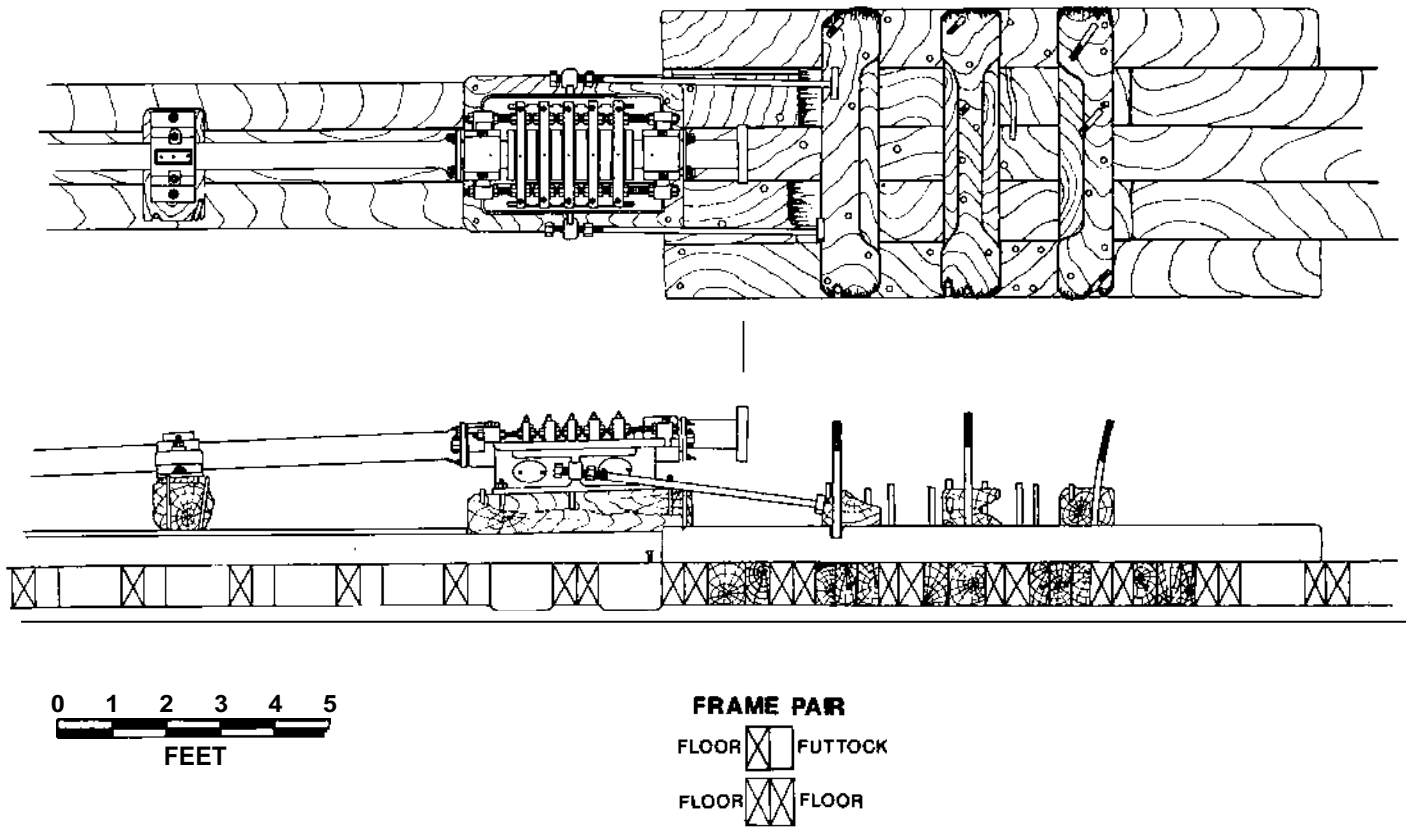

Figure 5.31. Plan and elevation of engine bed and thrust bearing showing additional frames to support engine weight. Drawing by Jim Bradford.

sister keelson ends in the same place as the port sister, giving it a total length of 83 ft. 8 in. The aft ends of both sister keelsons taper from their full sided dimension of 10 in. to 2 in. over the aft 2 ft. 8 in. The port sister keelson was notched over the frames from the engine bed forward. The notches are ½ in. deep at the engine bed and get progressively deeper moving forward so they are notched 5 in. over Frame Pair #1. Like the keel and main keelson, each sister keelson has a single visible horizontal hook scarf. The scarfs are offset by several feet, are slightly different lengths, and angle in opposite directions. The port sister keelson scarf begins 32 ft. 1 in. aft of the port sister keelson's forward end and is 5 ft. 10 in. long horizontally. Its nibs (ends) are 1½ in., the hook is 1 in., and it angles up towards the bow. The starboard sister keelson scarf begins 1 ft. 4 in. forward of the port sister keelson scarf, is 5 ft. 2 in. long horizontally, has 1½-in. nibs and hook, and angles up towards the stern. Most likely, the slight offset and opposite angles were intentionally designed to increase the centerline structural strength. As with the main keelson, though no other scarfs are visible in either sister keelson, it is likely they are present and probably obscured by the engine bed.

Both outer hull and ceiling planking are present across the *E. C. Waters* site. The vessel's outer hull planking is 3 in. thick and 7 to 11 in. wide, depending on where tapering is required by the hull form. The **garboard strake**, or first hull plank butting the keel, is 4 to 5 in. thick. Hull plank lengths vary, but the longest one measured, a starboard hull plank, is 30 ft. 1 in. long. Hull planking is attached to each frame with two or three ¾-in.-square spikes. Ceiling, or interior, planking, 2 in. thick and 10 to 12 in. wide, is fastened to each frame with two ¾-in.-diameter spikes. The starboard limber board (longitudinal planks lying atop the floors) butts the starboard sister keelson and is fastened with spikes, but the port limber board shows no

evidence of fasteners. Portions of three bilge strakes (thick planks) are in place on the starboard side. Bilge strakes are thick timbers at the turn of the bilge that add additional longitudinal hull support. On this vessel these *strakes* are 5 in. wide x 4 in. thick, made of multiple lengths joined with 3-ft.-long plain scarfs, and fastened to the frames with ¾- or 1-in.-diameter clinch bolts.

In addition to the frames, main keelson and sister keelsons described above, the engine bed or foundation incorporates several other elements (see Figure 5.28 and 5.31) to strengthen the hull in the machinery spaces. As mentioned above, additional floors were placed between the regularly spaced frames, creating a nearly solid block of timbers under the engine bed. The sided dimensions of these added floors vary between 3 in. and 7 in. Two timbers measuring 12 ft. 6 in. long, 1 ft. 1 in. sided, and 10 in. molded were placed outside each sister keelson to help support the engine. Because the molded dimension of the sister keelsons is 2 in. less than the main keelson and the engine bed timbers, a 2-in.-thick cover board was fastened over each sister keelson, between the main keelson and the outside timber, making a flush surface to fasten the engine bed frames. The engine bed frames are three transverse timbers fastened to the platform with four to seven ¾-in.-diameter fasteners plus three to four 2-in.-diameter threaded bolts that also secured the engine to the three timbers. The bed frames vary in their sided dimensions; the aft timber is sided 1 ft., the middle timber is sided 1 ft. 1 in., and the forward timber is sided 1 ft. 4 in. They are all 5 ft. 4 in. long and measure 10 in. molded. The timbers are shaped to accept the underside of the engine and allow clearance to the engine crankshaft.

In addition to the intact hull bottom and associated features, there are many scattered hull planks, ceiling planks, bilge stringers, and frames across the lake bottom to the north, east

and southeast of *E. C. Waters*. Most of these are included on the site map (see Figure 5.27). Several of the scattered timbers show evidence of burning. A complete, systematic survey of areas beyond the main wreck concentration was not conducted.

PROPULSION SYSTEM AND RELATED FEATURES

As noted in Chapter 3, the engine and boiler were salvaged from *E. C. Waters* sometime after abandonment on Stevenson Island. The boiler was used for many years to heat the Lake Hotel and later sold for scrap; there is no record of what happened to the engine. Historical research did not locate any specifications on engine or boiler types and sizes, other than a note that the boiler was a Scotch-type marine boiler (Aubrey Haines, personal communication 1996). Although *E. C. Waters* was built for use in a unique environment, reasonable speculation can be made about the engine and boiler based on parallels from contemporary vessels.

The first compound reciprocating steam engines were developed during the 1850s and saw widespread service beginning in the 1860s (Gardiner 1993:106). The idea of compounding, in which high pressure steam entered a small, high pressure cylinder and was then recycled to a larger, lower pressure cylinder before being vented or condensed, greatly improved marine steam engine efficiency. This idea was improved upon even further with the triple expansion engine, which added a third cylinder to the basic compound design. Triple expansion engines were first developed during the 1870s and became popular during the 1880s and 1890s; they continued to be built well into the twentieth century. At the turn of the century marine steam technology branched into two distinct lines: 1) the reciprocating engine, which reached its pinnacle with the quadruple

expansion engine, and 2) the steam turbine, which became more widespread and eventually eclipsed the reciprocating engine (Gardiner 1994:152–154). As with the introduction of the compound engine 50 years earlier and the triple expansion engine 30 years earlier, the most technologically advanced machinery was initially only used in the most profitable trades, such as in Atlantic passenger steamers. It is unlikely *E. C. Waters* carried the most modern steam engine available.

As asserted by Haines (personal communication 1996), there is no question *E. C. Waters* would have been equipped with a cylindrical, or Scotch, boiler. The Scotch boiler was developed during the 1860s and was a great improvement over the firebox boiler, which used many flat surfaces, because it could withstand much greater steam pressures. Scotch boilers were fitted in ships until the mid-twentieth century (Gardiner 1993:106–107). Although there is no historical documentation on *E. C. Waters*' steam engine, configuration of the bed frames and the size of the thrust bearing indicate either a compound engine (most likely), or a double simple engine, of about 80–100 hp was used in combination with a single Scotch boiler (Ian Ablett, personal communication 1999).

The only evidence remaining of *E. C. Waters*' engine is the wooden engine bed and the bolts that secured the engine to the bed. The boiler is represented by four iron or steel saddles (Figures 5.32 and 5.33) that supported the boiler and served to distribute the concentrated weight of the boiler and its water over a larger area through the main keelson and other wooden members of the hull. These four saddles are scattered in the general debris within the vessel's hull, a pattern most likely the result of salvage activity. Each saddle is triangular with one concave side to accept the rounded boiler shell, and is notched on one edge for mounting in the hull. There is no evidence of direct fastening

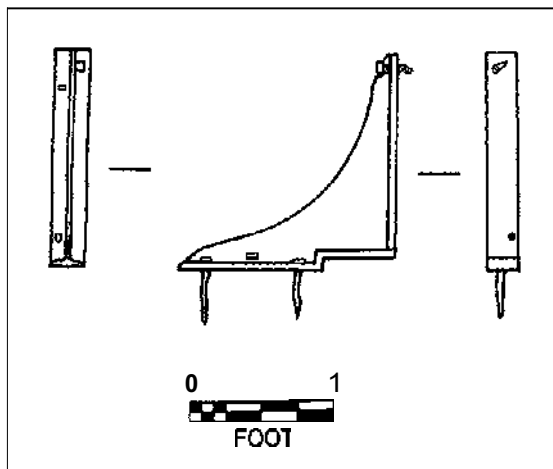

Figure 5.32. Side and end views of boiler saddle. Drawing by Jim Bradford.

of the boiler to the saddles, indicating metal straps or stays with turnbuckles may have been used to secure the boiler to the vessel.

With the exception of the engine and boiler, the rest of *E. C. Wafers'* propulsion system is intact within the wreck (Figure 5.34). This includes the thrust bearing; propeller shaft with two shaft bearings, the after bulkhead stuffing box and gland, a single shaft coupling, and the stern tube with stuffing box and gland; an adjustable stern bearing assembly; and the propeller. Total length from crankshaft coupling forward of the thrust bearing to the aft end of propeller hub is 37 ft. 10 in.

E. C. Waters' thrust bearing (Figures 5.31 and 5.35) is a multiple-collar block developed during the 1850s and in near-universal use by the later part of the nineteenth century (Gardiner 1993:100). The purpose of the thrust bearing, or thrust block, is “to receive and to transmit to

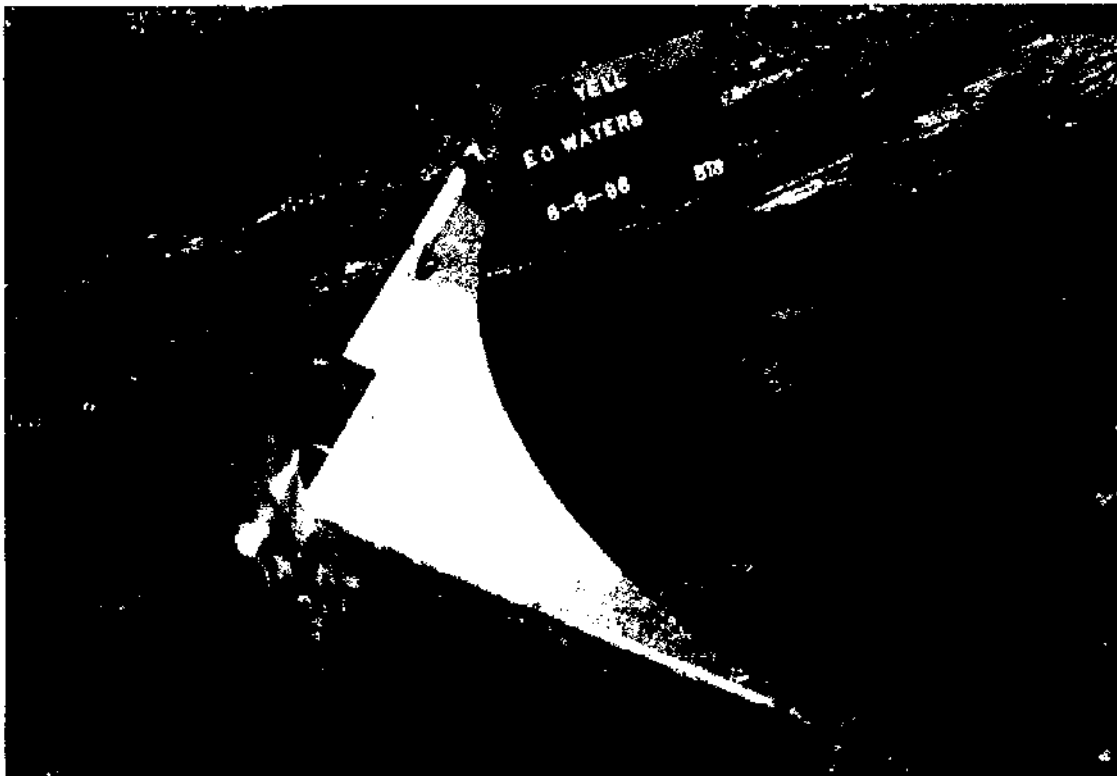

Figure 5.33. Boiler saddle. Scale = 1 foot. NPS photo by Brett Seymour.



Figure 5.34. View west of *E. C. Waters'* propulsion system. The engine bed is in the foreground, the thrust bearing is in the middle foreground and the propeller shaft and the propeller is in the background. NPS photo by John Brooks.

the ship the thrust produced along the line of shafting by the revolution of the screw" (Yeo 1894:83). The thrust bearing is generally positioned near the forward end of the propeller shaft, just aft of the engine, and consists of a block with removable cap. The shaft, at this part of the drive train, is composed of a number of collars while the thrust bearing has a corresponding set of internal collars; in this case, six thrust collars separated by five horseshoe bearings. When the thrust of the propeller is transferred up the propeller shaft, the shaft collars press upon either the forward or aft faces of the thrust bearing collars, depending on which direction the vessel is going. In either direction, the screw tends to force the shaft slightly forward or aft, but that pressure is taken by the block and, through the strong support on which it is fixed, transferred to the hull.

Adjustment of the thrust block is made with large set screws on either side of the block, while the forward end has a shaft coupling to accept the engine crankshaft. *E. C. Waters'* thrust bearing measures 3 ft. 4 $\frac{1}{2}$ in. long x 2 ft. 2 in. wide, and is 1 ft. 6 in. high. It is mounted on a pillow, or plwnmer, block solidly attached to

Figure 5.35. Starboard side of thrust bearing. NPS photo by Jim Bradford.



the main and sister keelsons; the pillow block measures 4 ft. long, 2 ft. 10 $\frac{1}{2}$ in. wide, and 10 in. high.

E. C. Waters' propeller shaft is intact aft of the thrust bearing (see Figure 5.34). The forward part of the propeller shaft, or line shaft, is 6 in. in diameter and articulates with an 8-in.-diameter stem tube in which the aft part of the propeller shaft, or tail shaft, spun. Typically, propeller shafts are hollow, with internal diameter about half the external diameter. The tail shaft within the stem tube is usually larger in diameter than the line shaft, about the same size as the crankshaft attached to the engine. In this case, the tail shaft, where it exits the stem tube and stem post, is 7 $\frac{1}{2}$ in. in diameter (1 $\frac{1}{2}$ in. larger than the line shaft) and tapers aft through the propeller hub, or boss.

There are two shaft bearings on *E. C. Waters'* propeller shaft (Figures 5.36 and 5.37). Their purpose is to support the weight of the shaft and provide lubrication through the oil boxes atop the cap covering. They rest on wooden blocks called pedestals, which are secured to the main keelson.

Located midway between the two shaft bearings, just forward of the shaft coupling, is the after bulkhead stuffing box and gland (Figure 5.38). It consists of two flanges of two halves each. The upper and lower half of each flange is clamped around the propeller shaft and the two flanges are bolted together, connected by a liner that surrounds the portion of the shaft between the two flanges. This liner, connected to the smaller forward flange, serves as the gland while the larger aft flange serves as the stuffing box, resulting in a watertight connection bolted to the after bulkhead. This feature did not carry the weight of the shaft, but provided a watertight opening through the bulkhead. The bulkhead created an aft compartment that held the shaft coupling and aft shaft bearing.

The shaft coupling (see Figure 5.38) is a typical design and connected the two propeller

shaft sections between the thrust bearing and the propeller. Flanges are forged to the end of each shaft and bolted together with 1-in.-diameter bolts. The aft flange has a 10-in.-diameter neck, 5 $\frac{1}{2}$ in. long, that steps down to the 6-in. diameter propeller shaft. Three feet aft of the coupling is the second shaft bearing (see Figures 5.37 and 5.38).

Three feet aft of the second shaft bearing is the stuffing box and gland on the forward end of the stem tube. The stem tube stuffing box (Figure 5.39) consists of a flared end of the stem tube with a square flange formerly bolted to deadwood through which the stern tube presumably passed. The gland is a circular flanged tube inserted into the stuffing box and compressed against a fibrous material to make the seal watertight (McEwen and Lewis 1953:201; see Paasch 1890:104, 118).

The stem bearing and bushing assembly is located outboard between the sternpost and propeller, where the propeller shaft exits the sternpost (Figures 5.40 and 5.41). It consists of a vertical plate bolted to either side of the sternpost and a two-piece iron casting that clamps over the propeller shaft and is bolted to the stempost. In addition, a wide band, bolted together below the iron casting, wraps around the latter and bolts together above the assembly where a 3 ft. 3 in.-long, threaded, bolt connected through the hom timber. This assembly tied the shaft, stempost, stern hearing, and hom timber together and provided stability against vibration at the propeller shaft's aft-most end. Similar assemblies have been documented archeologically on *Chisholm* at Isle Royale National Park (Lenihan 1987:224) and *Ottawa* in Red Cliff Bay, near Apostle Islands National Lakeshore (Cooper et al. 1991:114), both in *Lake Superior*.

E. C. Waters' propeller is typical of lake steamers. It is cast iron with four blades, though two blades are broken off about 1 ft. from the hub, or boss (Figures 5.41 and 5.42). The two

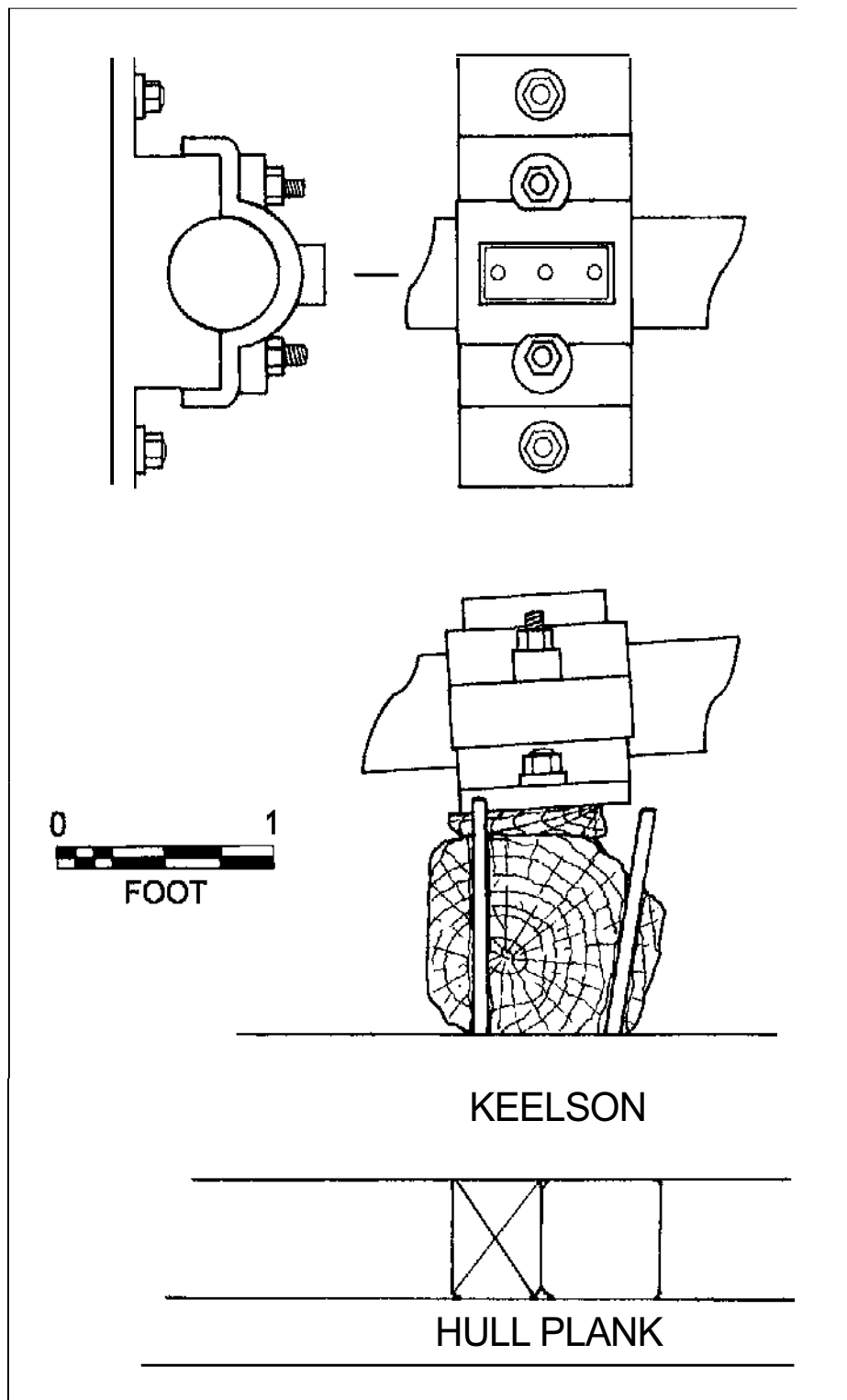

Figure 5.36. Plan, elevation and end view of forward propeller shaft bearing. Drawing by Jim Bradford.

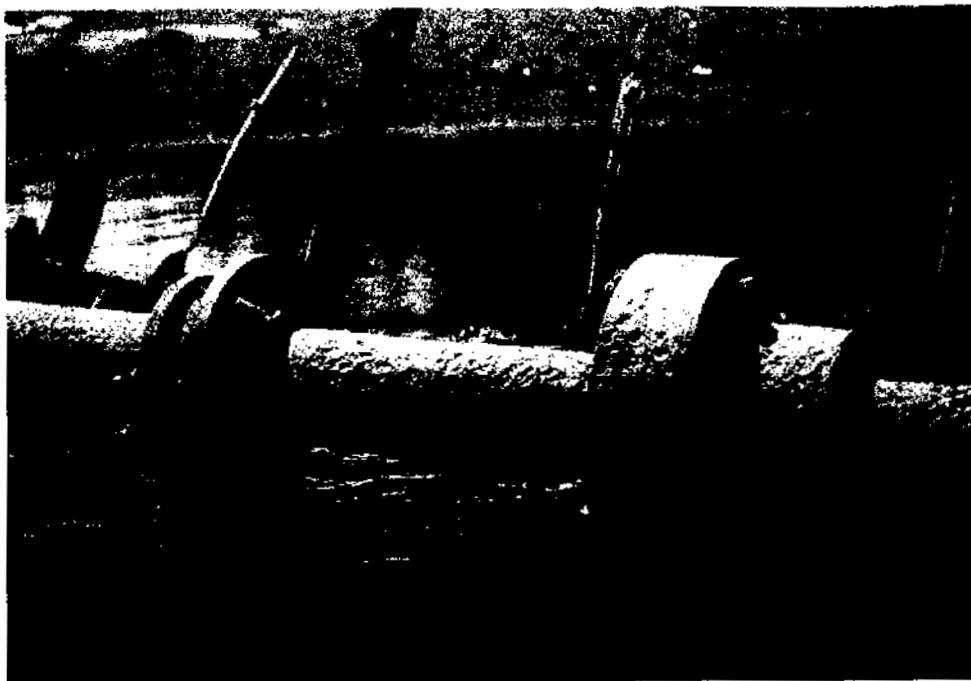

Figure 5.37. Top view of propeller shaft bearing. Scale = 1 foot. NPS photo by Brett Seymour.

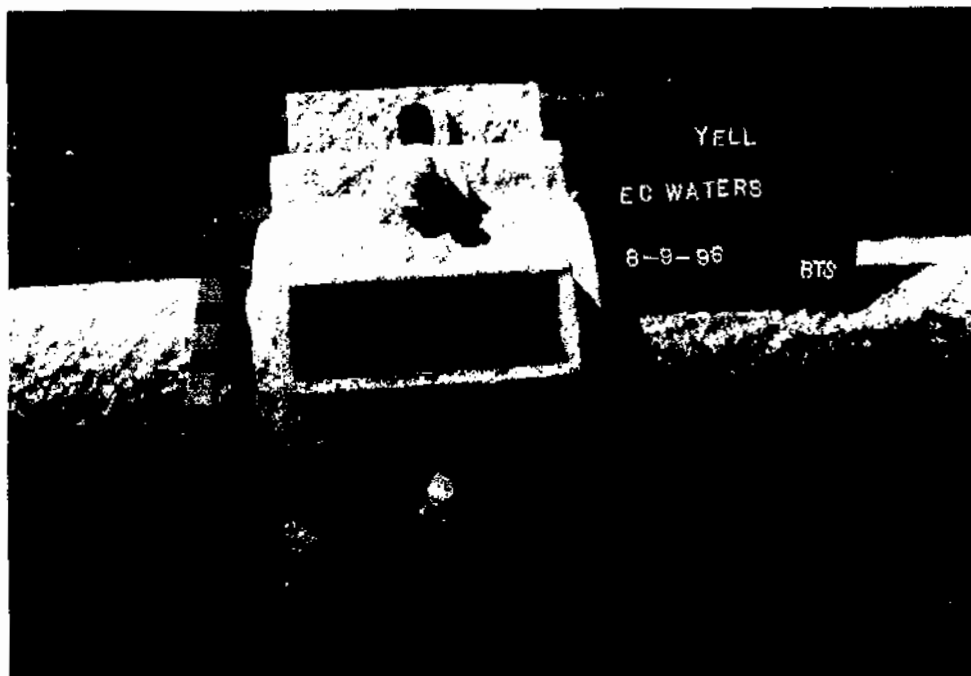

Figure 5.38. View southeast of after bulkhead stuffing box and gland (left), and propeller shaft coupling (right). NPS photo by Brett Seymour.



Figure 5.39. View southwest of forward end of stern tube stuffing box and gland. Note large bolt on top that secured the shaft to the stern deadwood (now missing) through which it passed. Marked section of scale = 6 inches. NPS photo by Brett Seymour.

complete blades are elliptical in shape, 3 ft. 8 in. long x 2 ft. 5 in. wide and varying in thickness from base to tip. The boss, 1 ft. 2 $\frac{1}{2}$ in. long, is circular in cross-section and has convex sides in profile. It has a diameter of 9 in. at each end and is 1 ft. 3 in. in diameter in the middle. The boss and blades are cast as one piece and are keyed to the shaft end and secured with a large hexagonal, keyed nut.

DISARTICULATED MACHINERY AND OTHER FEATURES

Several features associated with *E. C. Waters'* machinery are located within the hull or near the vessel remains. One of the most prominent is a globe valve mounted in the hull bottom on the engine bed's port side (Figures 5.43–5.45). This valve was the main lake water inlet for supplying water to the boiler and auxiliaries. The valve contains all of the features

of an ordinary stop valve as shown in Lyon and Hines (1915:76–77), but is an angle rather than a straight-through valve. The intake is through a feed water pipe fitted in the wooden block on which the valve is secured.

E. C. Waters' capstan is located 75 ft. south of the engine bed, buried in the sand in about 1 $\frac{1}{2}$ ft. of water (Figures 5.46 and 5.47). Before 1995, the capstan was located on the beach about 30 ft. south-southwest of the wreck. During SCRU's 1995 visit, the capstan was not located and thought by park rangers to be missing. A depression on the beach marked the location where park rangers remembered it (Lenihan 1995b:5). During the present site documentation, the capstan was found in its current location, apparently moved by would-be looters in a failed attempt to remove it. The capstan is 1 ft. 3 in. high, 1 ft. 4 in. across the drumhead, and its base is 2 ft. 2 in. in diameter. The base plate, spindle, and drumhead are intact,

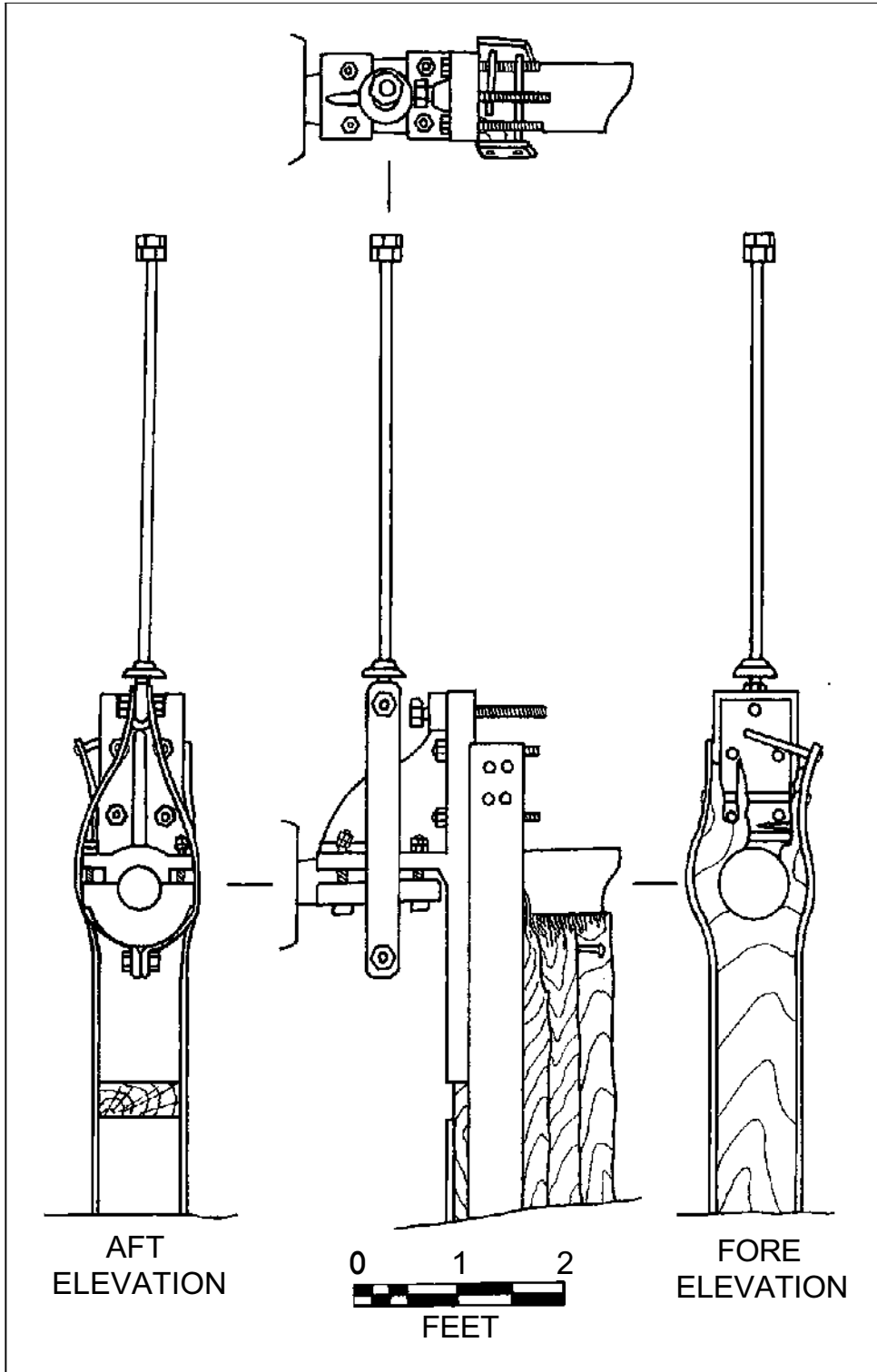

Figure 5.40. Plan, starboard elevation, fore and aft views of adjustable stem bearing assembly. Drawing by Jim Bradford.



Figure 5.41. View north, starboard side of adjustable stern bearing assembly (center) and propeller (left). NPS photo by John Brooks.



Figure 5.42. View northeast of propeller. NPS photo by John Brooks.

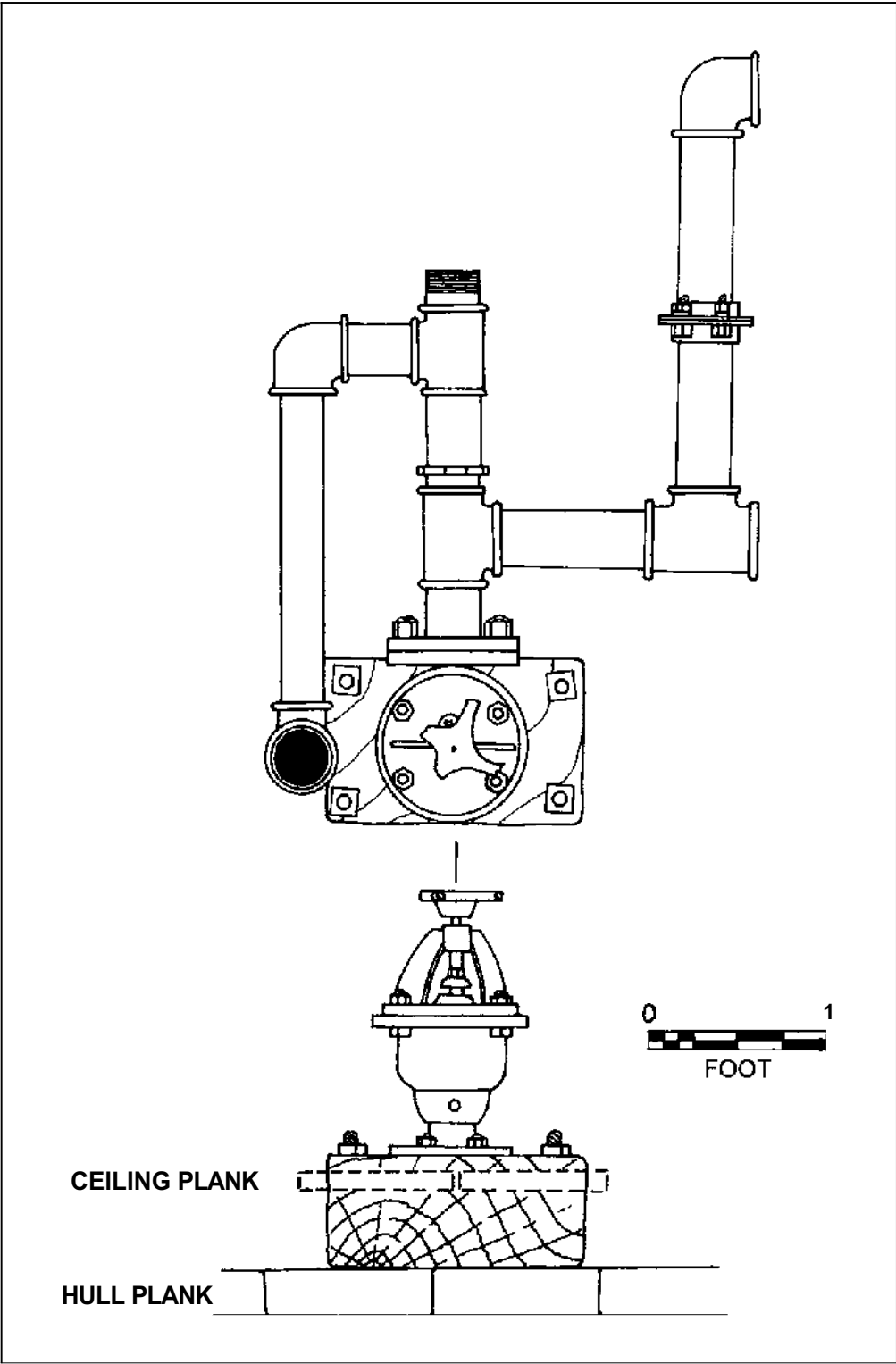

Figure 5.43. Plan view and aft elevation of the globe valve with intake pipes. Drawing by Jim Bradford.

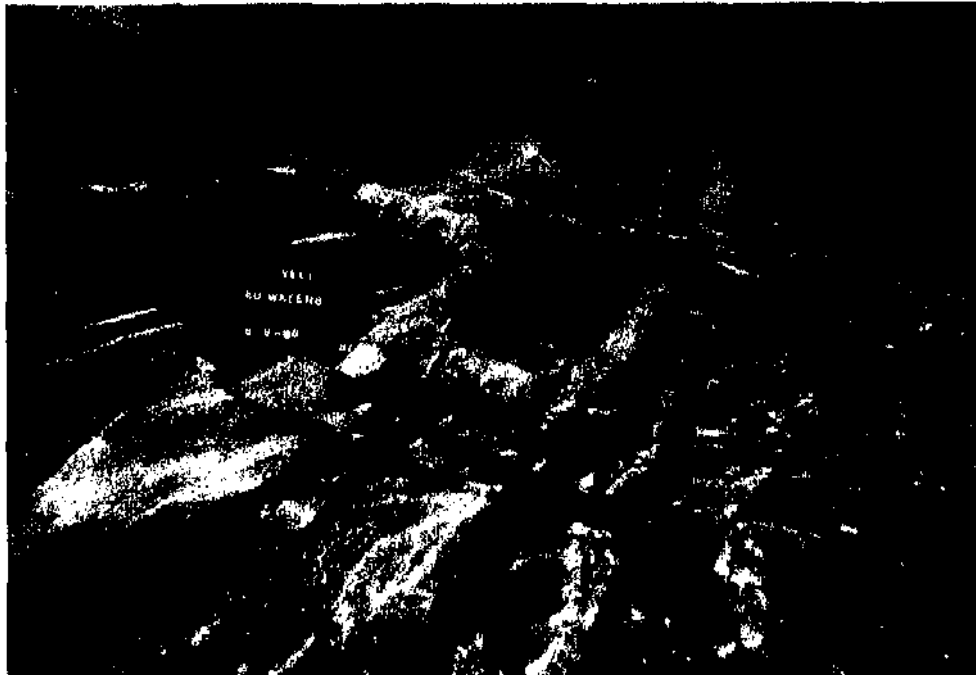

Figure 5.44. View aft along port midships showing feed water intake piping (foreground) and globe valve (background). Scale = 1 foot. NPS photo by Brett Seymour.



Figure 5.45. Close-up view of globe valve. NPS photo by Brett Seymour.

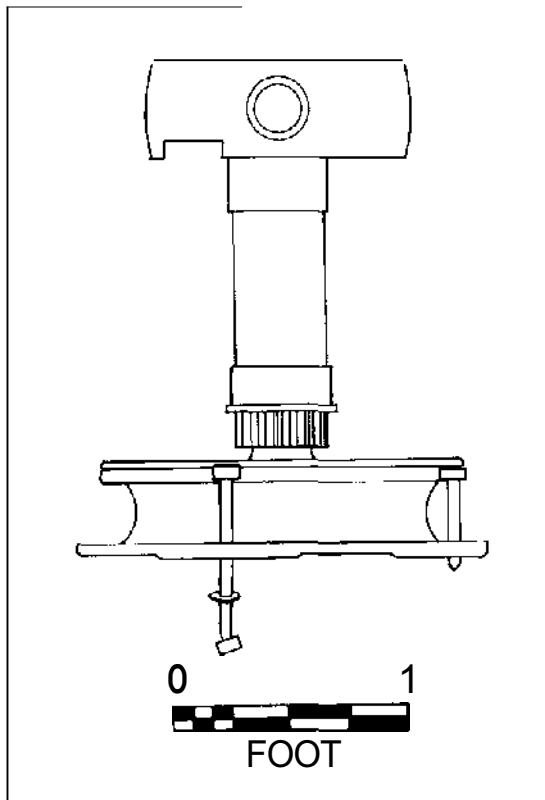

Figure 5.46. Scale drawing of *E. C. Waters'* capstan. Drawing by Matt Russell.

but the barrel is missing. The capstan is geared, indicating it was probably operated with an auxiliary steam engine.

Seven davits are present within the *E. C. Waters'* wreck (Figures 5.48 and 5.49). Davits are small derricks of various designs used for hoisting boats, ladders, loads, etc. They are often made of forged ingot steel bent to shape, steel tubing, or built-up welded shapes (Kerchov 1961:199). All seven are 3-in.-diameter steel tubing, welded at the bend. A davit collar bolted to the deck secured each base, and each davit was braced below the bend. Figure 3.6 shows three sets of davits holding lifeboats on *E. C. Waters'* port side in about 1906.

Three flat iron or steel brackets are present on the wreck, all loose and not in their original location (see Figures 5.28 and 5.49). These brackets are made from $\frac{3}{8}$ -in. flat iron or steel in a modified L-shape, with a diagonal brace connecting the *arm* and leg. A base plate measuring 10 in. long, 4 in. wide, and $\frac{1}{2}$ in. thick is attached to the bottom of the leg. A 1-in.-diameter tab projects through the plate, which

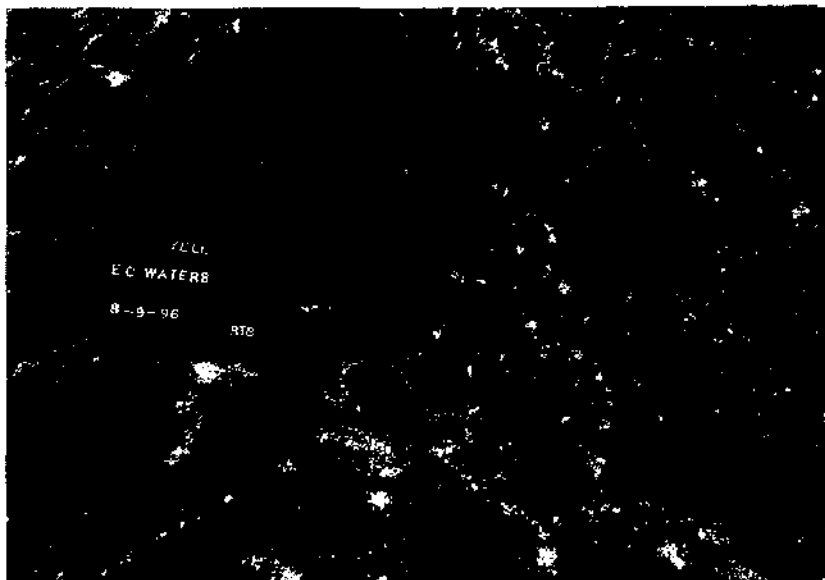

Figure 5.47. Partially buried capstan. Scale = 1 foot. NPS photo by Brett Seymour.

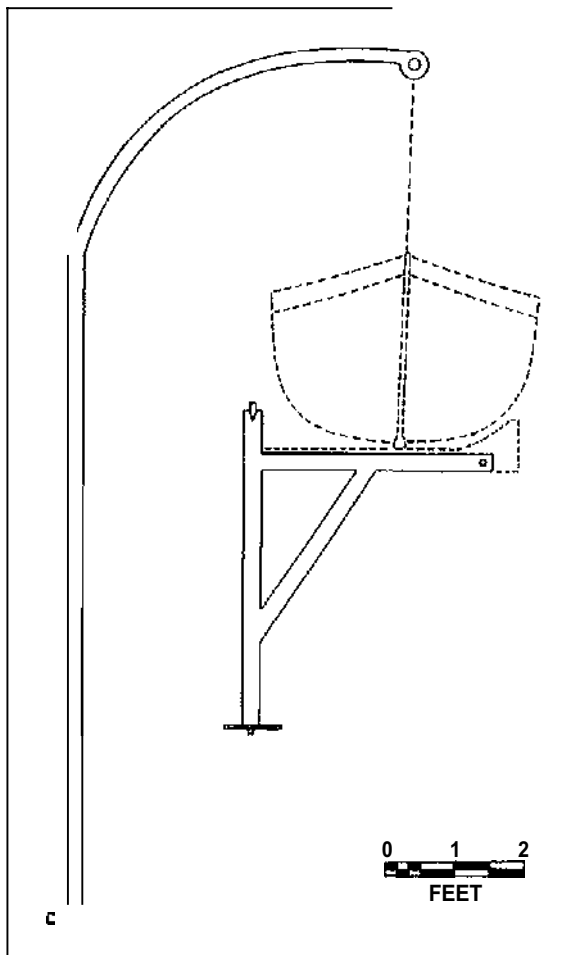

Figure 5.48. Scale drawing of life boat davit and support bracket showing their relative positions in securing a life boat. Drawing by Jim Bradford.

allowed the bracket to swivel on the base plate. A similar tab is also present on the top of the bracket. The plates were secured to the vessel with 3-in. lag bolts. Holes drilled through the arms are not identically placed in each piece but are probably evidence of where wooden chocks were attached. These brackets were supports for the lifeboats (see Figure 3.6) when stowed. They were rigged so as to swing against the cabin and out of the way when the lifeboats were hoisted or lowered.

Various lengths of 1-in.-diameter iron or steel rod are scattered across the site. All are bent, and two exhibit particular attributes. One segment, 7 $\frac{1}{2}$ ft. long, has the rod curved around to form a symmetrical handle (Figure 5.50), while the opposite end has a steel plate attached. The plate measures 6 in. x 10 in. x 1/16 in. and, on the opposite side of the attached rod, has a 1 $\frac{1}{4}$ -in.-square nut welded to the plate as reinforcement. Its purpose is unknown but it appears to have been a long handle. The second piece was intentionally bent into a “J” hook at one end and has an “eye” on the other end through which an “eye” from a second segment of rod is joined, giving both pieces an articulated connection. Its function is unknown but it could have served as a connecting rod of some kind.

Numerous segments and fragments of iron pipe are scattered throughout the wreck. Lengths vary from a few inches up to 8 ft.; most are threaded. Diameters include $\frac{3}{4}$ in., 1 in., 1 $\frac{1}{2}$ in., 2 in., 2 $\frac{1}{2}$ in., 3 in., 3 $\frac{1}{2}$ in. and 6 in. Many examples of pipe tees, elbows and plugs are also scattered around the hull. Many pipes are corroded through their walls. Most were probably part of the main and auxiliary steam systems, and several are still attached to the globe valve described above.

Thirteen small iron or steel plates are located within the wreck, most concentrated in two clusters just forward of the engine bed. Each plate (Figure 5.51a) measures 3 ft. 2 $\frac{1}{2}$ in. long x 11 in. wide x $\frac{1}{4}$ in. thick. Two 2 $\frac{1}{2}$ -in. holes are present on each plate’s centerline near each end and were used to either fasten the plate down or lift it. The tops are patterned with uniform squares raised from the plate’s surface, two squares per inch. These provided traction on the plate’s surface. On the underside, each plate has eight 2-in.-long, $\frac{1}{4}$ -in.-wide, $\frac{1}{2}$ -in.-thick tabs, four along each side. These tabs may have served as small legs upon which the plates rested

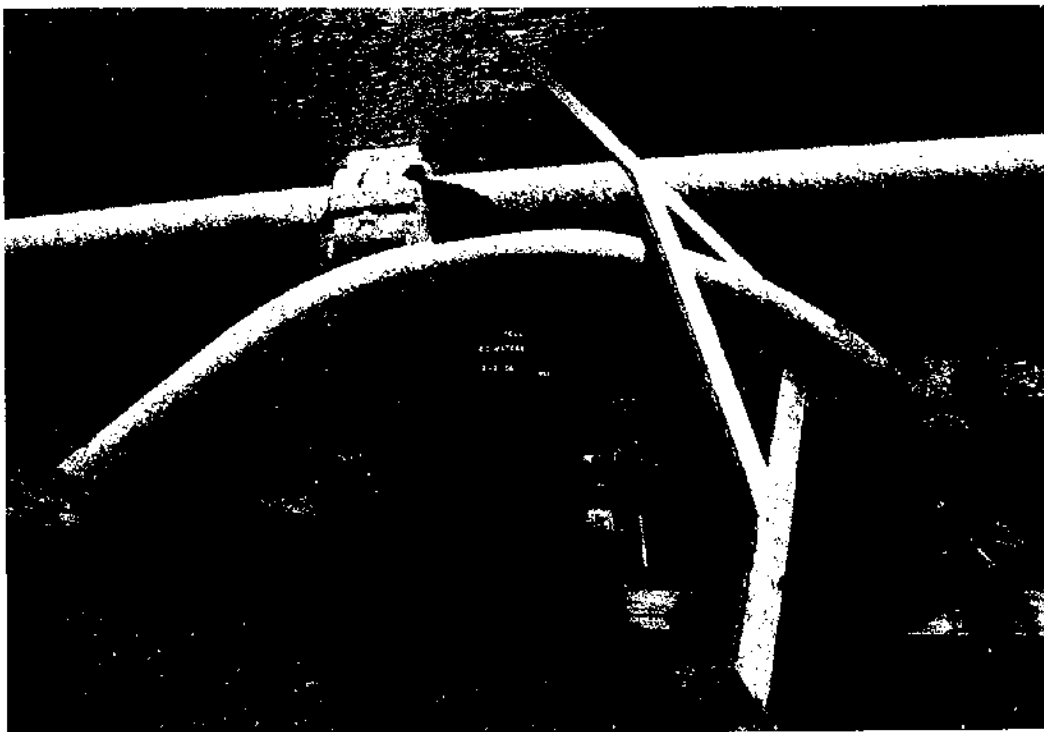

Figure 5.49. Davit (left) and support bracket (right) within *E. C. Waters'* wreckage. NPS photo by Brett Seymour.

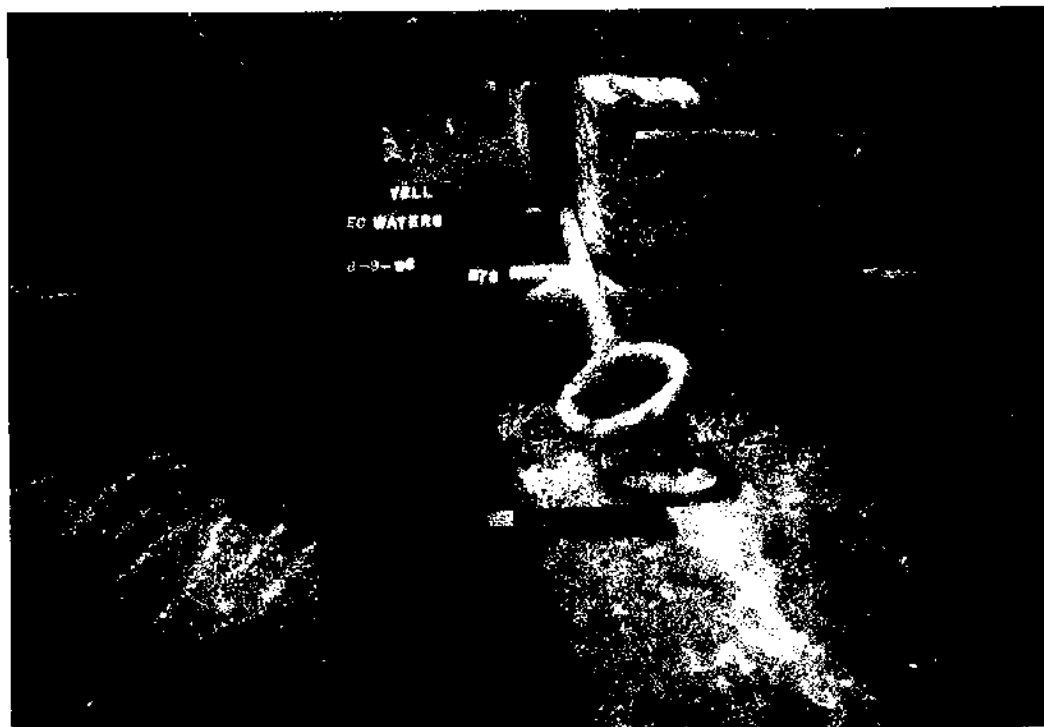

Figure 5.50. Metal rod handle wedged between frames on the port side turn of the bilge. Scale = 1 foot. NPS photo by Brett Seymour.

or, more likely, secured the plates from movement once installed. These plates were probably flooring around the engine or boiler.

A single large iron or steel sheet is present forward of the engine bed (see Figure 5.28), although it is not secured in its original location. The sheet is 7 ft. 5 $\frac{1}{2}$ in. long, 2 ft. wide and $\frac{1}{4}$ in. thick. It is notched on one end and three $\frac{1}{2}$ -in.-square holes are present along one end, each with a 1-in.-long square nail in place. Two $\frac{1}{2}$ -in.-square holes are present along each side, with an additional $\frac{1}{4}$ -in.-diameter hole on one side, while the fourth side has a crudely cut $1\frac{1}{2}$ -in.-diameter hole near the edge with a 1-in.-diameter bent steel rod through it. Function is unknown, but it may have been a heat shield on top of the keelsons, below the boiler.

A single, uniquely shaped, iron or steel brace is also located within the wreckage (Figure 5.51b). It is roughly V-shaped and twisted to accommodate whatever it secured with $\frac{1}{2}$ -in. x 4-in. carriage bolts. It is very similar to the boat davit braces (Figure 5.51c) but is shaped to fit a wooden board rather than a metal pole. Its association is unknown.

Three examples of iron or steel strapping are present; one at the wreck's stern (Figure 5.52), a second in shallow water about 100 ft. south of the wreck's bow, and the third on shore about 200 ft. southeast of the wreck. All are at least 6 in. wide and $\frac{1}{4}$ in. thick, and partially buried in the sand. The one on shore is square in shape, the one near the stern is about 12 ft. long and L-shaped, while the third is long with a one end curved into around. None are in their original location, and their functions are unknown.

Many small, portable artifacts are located between *E. C. Waters*' frames, including two pieces of 1-in.-thick glass (Figure 5.53). Small slivers of windowpane glass were also noted on the site, probably from the cabin windows. Three small pieces of hardware were also

observed. One is a small cabinet door hinge, one is a brass keyhole plate, and the third is part of a door lock jamb. All would have been located in *E. C. Waters*' pilothouse or cabins. These are only the most noteworthy of the many artifacts on the site.

A variety of fasteners is located across the wreck. These range from small wire nails to hull spikes and clinch pins. Many of the items described above were fastened to the vessel with common nails, screws and bolts. Numerous nails are present along the keelsons and appear to mark locations where blocks of wood supports were, or are, located. These are common nails varying in size from 2d to 10d. Equipment bases, brackets and braces were fastened with 1-in.-square nails and various sized carriage bolts and lag screws. Smaller wooden members and frame pairs were fastened with $\frac{1}{2}$ -in. pins, while hull planking was fastened with $\frac{1}{2}$ -in.-square spikes. The larger wooden elements of the vessel were fastened with $\frac{3}{4}$ -in.- and 1-in.-diameter fasteners, some threaded to receive nuts to secure metal components.

ANALYSIS AND DISCUSSION

The *E. C. Waters* site is unique not only in YELL, but to the entire National Park System. No other high-altitude lake passenger steamer as large as *E. C. Waters* is known to exist in any other park waters. Smaller passenger vessels still exist, in use and as archeological sites, in Glacier National Park (see Russell 1997) and possibly other mountain parks. By studying the *E. C. Waters*' site, archeologists have a unique opportunity to learn about tourist economy development in the world's first national park. After documentation of *E. C. Waters*, several aspects of the material remains offer the opportunity to study behavior associated with the lake tourist trade. Analysis of *E. C. Waters* gives

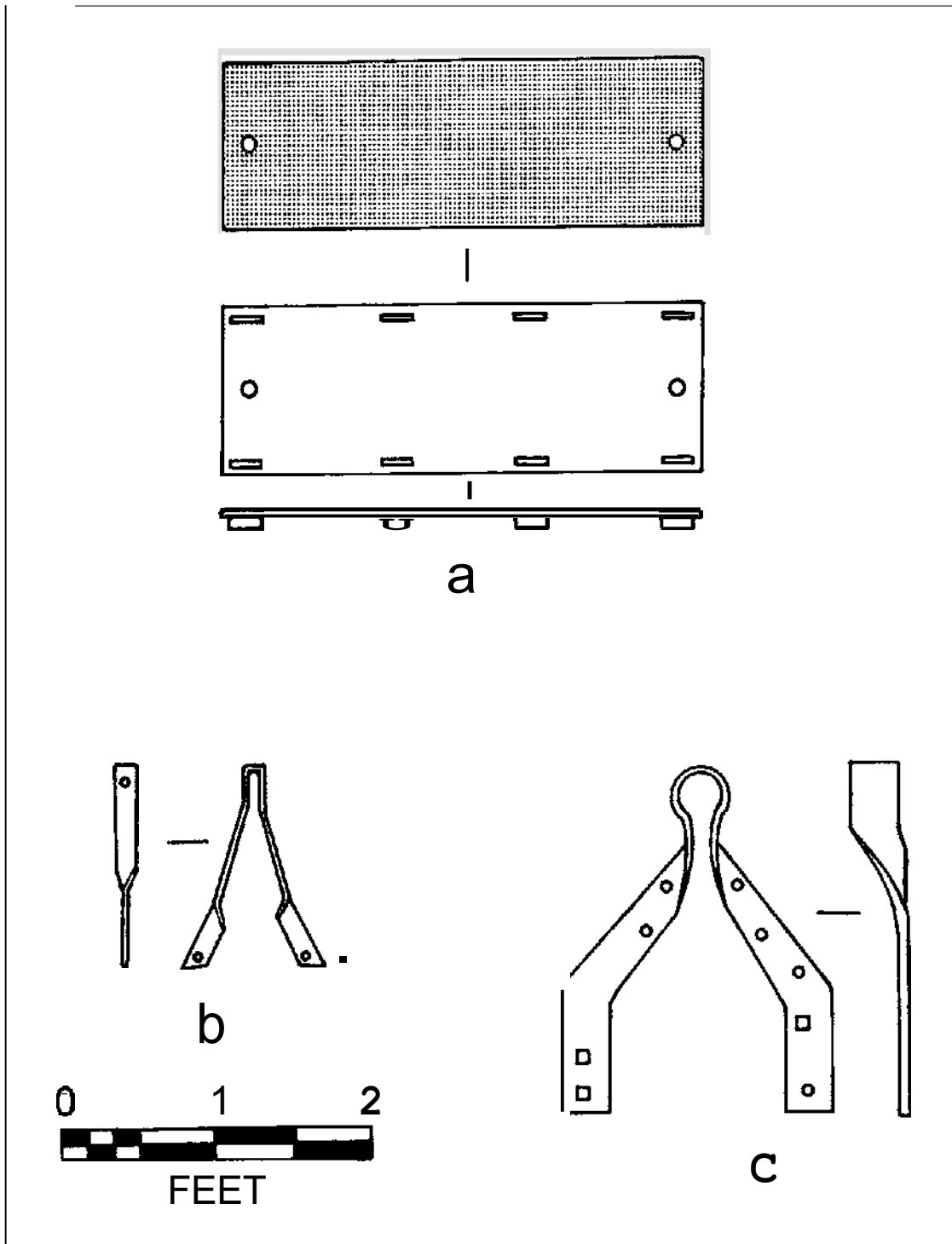

Figure 5.51. Plan and profile views of flat metal plate (a), "V"-shaped brace (b) and boat davit brace (c). Drawing by Jim Bradford.



Figure 5.52. Iron or steel strap near *E. C. Waters'* stern. Scale = 1 foot. NPS photo by Brett Seymour.

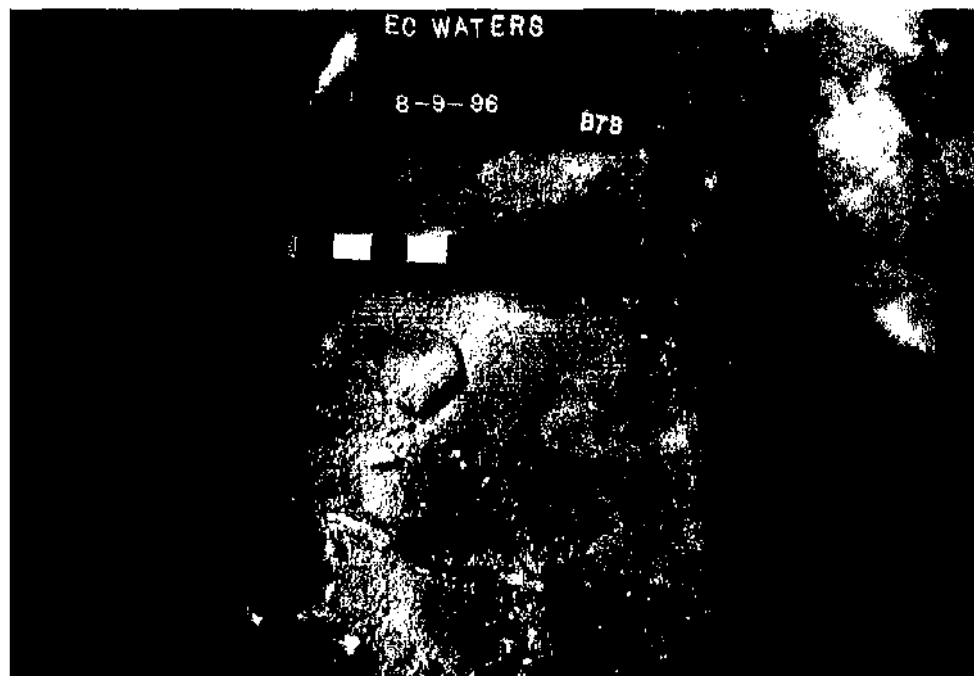

Figure 5.53. Thick glass fragments between *E. C. Waters'* frames. Scale = 1 foot. NPS photo by Brett Seymour.

insight into such diverse topics as vernacular versus traditional ship construction techniques and maritime salvage activity.

Hull construction is mostly typical of wooden-hulled steamer construction. Scantlings, scarfs, machinery, and general construction style is comparable to contemporary Great Lakes practices. Even the odd stem bearing arrangement has corollaries in the Great Lakes. *E. C. Waters'* mixed-style of framing, however, is an anomaly; no analogous examples were located in the historical or archeological literature. The obvious question, then, is why did the builders use this framing pattern? By the turn-of-the-century, it had been clearly demonstrated that the long-and-short-arm framing method provided greater hull strength than the older framing style because it eliminated butted first futtocks over the keel. Yet *E. C. Waters'* builders created an unusual hybrid of the two framing styles. A functional explanation can be dismissed: mixing framing styles is not a better way to build a ship. So a cultural explanation needs to be addressed. It could indicate multiple builders: one who directed the project during midship construction, and a different one involved in bow and stem framing. Another possibility is that the bow and stem timbers were reused from some other shipbuilding project, and brought to Yellowstone Lake prefabricated for use in *E. C. Waters*. The unusual framing pattern, then, may reflect recycling and reuse behavior. The real surprise, however, in spite of the framing hybrid, is that the vessel is as well-constructed as it is. Many small details, such as the keel and keelson horizontal hook scarfs, indicate a seaworthy vessel constructed by competent shipbuilders. At 8,000 ft. above sea level in the Wyoming mountains, more evidence of expedience was expected, which was not the case.

Salvage activity on *E. C. Waters* was similar to typical salvage practice in the Great Lakes, but differed in one notable way: although the engine and boiler were recycled and reused, the vessel's thrust bearing was left in place on the

wreck. Typically, in coastal and Great Lake environments, if the engines and boilers are accessible enough to be salvaged, then other high-cost, reusable items such as the thrust bearing are also removed. This is the case on several sites documented in Lake Superior, for example the *Monarch* wreck at Isle Royale National Park (Lenihan 1987:264). When the engine and boilers are inaccessible, such as on Isle Royale's *Glenlyon*, then the thrust bearing is also left in place. On *E. C. Waters*, however, even though the engine and boilers were removed and the thrust bearing was easily accessible, it was not salvaged. This reflects the unique environment that in which the steamer operated. The engine and boiler were easily put to nonmaritime use: the boiler was used to heat the Lake Hotel, and although it is unknown where the engine was used, it could easily have been used locally, for example, in a lumber mill. The thrust bearing, on the other hand, had no other use than on another screw steamer. In the Great Lakes or coastal locations, an object like a thrust bearing could easily be sold for reuse. This was not the case in Yellowstone.

Documentation of *E. C. Waters* and other sites in Yellowstone Lake give researchers a tangible link to Yellowstone's turn-of-the-century tourist trade. Few maritime material remains are left in the park representing the new century's burgeoning tourist economy, and several of those, such as the West Thumb docks, the Lake Hotel docks, the small boats off the Lake Hotel, and *E. C. Waters*, are submerged in Yellowstone Lake. Analysis of these important archeological remains provides insight into aspects of these commercial enterprises not recorded in the historical record. Baseline documentation of archeological resources allows researchers to pose particular questions relating to Yellowstone Lake's maritime history and creates the opportunity to study a little-documented facet of YELL's economic development as a tourist destination.

CHAPTER 6

Conclusions and Recommendations

The 1996 SCRUYellowstone National Park Submerged Resources Survey expanded the initial 1995 submerged site reconnaissance requested by park management. In 1996, park *staff* prioritized particular areas in and around Yellowstone Lake for SCRUY to examine with remote sensing and direct observation to determine how many and what kind of cultural resources were present, their condition, and what concerns for their protection and management should be considered. The second investigation accomplished variable documentation levels of these areas, and variable results were obtained. For example, archeological sites along the lakeshore were photographically documented, small watercraft were located on the lake bottom and drawn, and *E. C. Waters* and the West Thumb dock remains were recorded to a high level of detail in photographs and measured drawings.

The 1996 investigations were designed to accomplish a great deal of fieldwork in a very short time; consequently, park archival research was necessarily limited. Investigators were not able to completely trace many of the intriguing leads located within park archives, photographs

and library. Other complementary regional records and those in Aubrey Haines' possession were not examined. However, researchers were able to obtain sufficient information to describe cultural resources located during fieldwork and evaluate their potential significance.

Some study produced negative evidence. For example, we did not locate the reported stagecoach parts near Pumice Point or submerged features associated with the Little Thumb Creek facilities. Limited material evidence in some areas, such as the Lake Hotel dock area and West Thumb Geyser Basin, suggests a very efficient effort at removing buildings, docks, etc. from those locales. Additional archival research and oral history collection with former and present park employees would likely augment the history and observations presented in this report.

Confirmation of the lake steamer *Zillah's* fate is one of the most intriguing questions. Data from the remote sensing survey suggest *Zillah* is not on the lake bottom, at least in the primary area identified by local lore. Additional historical research is necessary before continuing a search for its remains. Little is

known about the lake vessel *Jean D*, and more research is required here, too. More is known about *E. C. Waters*, a vessel that may have never carried a paying passenger on the lake.

The West Thumb Geyser Basin dock remains are unquestionably an archeological site that has significant association with park development, particularly regarding lake transportation and tourism. These remains, one of the earliest lake docks, represent a lakeshore tourist destination second only to the Lake Hotel dock. The Lake Hotel docks present very little archeological evidence of its past. The West Thumb Geyser Basin dock remains should be preserved and protected, and they may offer an interpretive potential for both land and diving visitors. Documentation produced by SCRUC during these investigations should be useful to park management in forming any decisions required about the long-term development and preservation of this resource.

E. C. Waters' remains, along with the Lake boathouse, are the most obvious surviving cultural resources associated with Yellowstone Lake boating history. The wreckage is a destination for current lake boat tours, as well as pleasure boaters and fishermen. Site documentation resulting from this study can serve interpretive purposes and as a baseline against which evaluation of future impact can be measured. Interpretation and monitoring of this site is warranted.

RECOMMENDATIONS

Based on information and results presented in the preceding chapters, the following management and research recommendations are offered.

MANAGEMENT

This study was, in part, initiated by park management's concern about effects of the

diving public on Yellowstone Lake submerged cultural resources and in response to a dive club proposal to search for remains of *Zillah*. Given these concerns, and this study's results, the following management recommendations are suggested:

1. Diving visitors are on the increase in most parks containing diveable waters. The park should present a higher park dive management profile to accommodate growing diver interest, including the option of diving on submerged cultural resources in the lake, but cultural resource preservation must be stressed. Specific interpretive devices including pamphlets, brochures, permitting and exhibits have proved useful in other areas.

2. Park divers should monitor the condition of small craft and other cultural features off the Lake Hotel to assess diving visitor impact and general natural deterioration rates of these resources. Should diver impact be observed, diving these resources can be curtailed or redirected to other areas.

3. Monitoring the West Thumb dock remains for signs of deterioration from visitor access should also be done, for the same reasons.

4. The *E. C. Waters*' remains off Stevenson Island should be both monitored and regularly patrolled to determine and minimize visitor impact to this important archeological site. Documentation generated by this study can be used as baseline information for a monitoring program.

5. The West Thumb dock remains, the steam launch examined in 1995 and the small boats located in 1996 should be officially recorded as archeological sites and given site numbers, like Lake dock and *E. C. Waters*. In addition, the steam launch and small boats should be recorded in detail.

6. Sites determined to be eligible should be nominated to the National Register of Historic Places. Although individual sites such as the

historic dock remains and small boats may not be eligible individually, nominating all the maritime archeological sites as district, thematic or possibly cultural landscape listings should be considered.

Currently, there appears to be no need for restrictions for divers or boaters to these resources, but a systematic monitoring program should be initiated and maintained to make informed management decisions should they become necessary through loss of resource integrity.

FUTURE RESEARCH

This initial study of Yellowstone Lake submerged cultural resources revealed many discrepancies in the current and historical literature about the resources and pointed out many areas where information about the resources is lacking. The following recommendations address this issue.

1. Personnel should conduct research on *Zillah's* history. There are many discrepancies in the vessel's early history, and its final disposition needs to be confirmed. *Zillah*, as the lake's first tourist steamer, is a primary historical subject for the park, and more complete information is needed to accurately interpret this subject. An accurate history is important to decide whether to expend additional resources to locate this site.

2. Like, *Zillah*, *E. C. Waters* needs further historical research. Its construction by the Pacific Launch Company in Tacoma is poorly documented. An attempt should be made to locate construction plans, which could clarify discrepancies between reported vessel dimensions and those observed on site. Another question is why was this vessel anchored off Stevenson Island unused for so many years after its owner/builder was removed from the park and his assets sold to Billy Hofer? Historical research may reveal the final disposition of *E.*

C Waters' engine, which may still be extant. Comparative analyses among *E. C. Waters*, *Zillah* and other lake tour boats of the northwestern United States are important to understanding the regional archeological significance of this poorly documented facet of Western history. Historical research is also important for interpretive purposes.

3. *Jean D* also requires further historical research. Other than a few archival photographs, no information was found on this vessel, which had a lake history as long as *Zillah's*. Very little is known about this vessel, which may also be in the lake.

4. A definitive history of the lake docks is important to Yellowstone Lake interpretation. Historical documents indicate several docks were proposed, some were constructed and expanded. However, very few material remains attest to this aspect of lake history.

5. Lake fisheries facilities should be researched. As with the dock facilities, fisheries have an important place in lake history, but little is known about them.

6. National Park Service removal of earlier lake facilities should be documented, including fisheries, docks, marine railway, etc. Based on lack of archeological evidence observed in historically developed areas, NPS efforts were apparently extremely effective. Records and oral histories should be researched to complete this gap in lake history.

Much of the information discussed above can be found in various archives and collections. Historical research conducted as part of this report has indicated some repositories that may be particularly productive: the Yellowstone Park archives at Mammoth; Aubrey Haines' personal files located in Tucson, Arizona; the Haynes photographic collection at the Montana Historical Society; Museum of the Rockies archives; the Northern Pacific Railroad archives at the Minnesota History Center in St. Paul; and perhaps the Pacific Launch Company archives

in Tacoma, Washington. Other leads should be sought to acquire additional information on these issues.

7. One research domain that may prove particularly fruitful regarding aboriginal sites is how Yellowstone Lake sites and life ways were affected by changing lake levels and the length of human occupation around the lake.

This report provides background information relating to the creation and evolution of Yellowstone Lake; its plant and animal communities; associated natural

resources, particularly those along its shores; human history associated with the lake; and, particularly, a history of exploration, exploitation and tourism of this unique lake resource within a park full of unique resources. It provides results of investigations in areas around the lake, provides documentation of cultural resources encountered, compiles some of the history of those resources, and provides recommendations for future studies, management, protection and preservation of those cultural resources.

REFERENCES

Allen, E. T. and A. L. Day

1935 Hot Springs of the Yellowstone National Park. *Carnegie Institution of Washington Publication* No. 466. Waverly Press, Baltimore.

American Shipmasters' Association

1879 Rules for the Construction of Wooden Vessels. In *Record of American and Foreign Shipping*, New York.

Anderson, G. S.

1891 Annual Report of the Superintendent of the Yellowstone National Park to the Secretary of the Interior. US Government Printing Office, Washington, D.C.

1892 Annual Report of the Superintendent of the Yellowstone National Park to the Secretary of the Interior. US Government Printing Office, Washington, D.C.

1893 Annual Report of the Superintendent of the Yellowstone National Park to the Secretary of the Interior. US Government Printing Office, Washington, D.C.

1894 Annual Report of the Acting Superintendent of the Yellowstone National Park to the Secretary of the Interior. US Government Printing Office, Washington, D.C.

1895 Annual Report of the Acting Superintendent of the Yellowstone

National Park to the Secretary of the Interior. US Government Printing Office, Washington, D.C.

1896 Annual Report of the Acting Superintendent of the Yellowstone National Park to the Secretary of the Interior. US Government Printing Office, Washington, D.C.

Anonymous

1916 Annual Report for Yellowstone National Park. Ms. on file at Yellowstone National Park archives, Yellowstone.

1917 Annual Report for Yellowstone National Park. Ms. on file at Yellowstone National Park archives, Yellowstone.

1918 Annual Report for Yellowstone National Park. Ms. on file at Yellowstone National Park archives, Yellowstone.

1976 Boats on Yellowstone Lake. *Commentary Newsletter*, Yellowstone Park Company, Vol. 4, No. 3 (August).

1995 E. C. Waters. *Commentary Newsletter*, Yellowstone Park Company, Vol. 10, No. 4 (June).

Bartlett, R. A.

1989 *Yellowstone: A Wilderness Besieged*. University of Arizona Press, Tucson.

- Baumann, S.**
1984 Ground Disturbance and Construction Monitoring at site 48YE304, Fishing Lake Junction. Ms. on file, National Park Service, Midwest Archeological Center, Lincoln.
- Boyd, F. R.**
1957 *The Geology of the Yellowstone Rhyolite Plateau*. Ph.D. dissertation. Harvard University, Cambridge.
- Brett, L. M.**
1912 Annual Report of the Acting Superintendent of the Yellowstone National Park to the Secretary of the Interior. US Government Printing Office, Washington, D.C.
1913 Annual Report of the Acting Superintendent of the Yellowstone National Park to the Secretary of the Interior. US Government Printing Office, Washington, D.C.
1914 Annual Report of the Acting Superintendent of the Yellowstone National Park to the Secretary of the Interior. US Government Printing Office, Washington, D.C.
1915 Annual Report of the Acting Superintendent of the Yellowstone National Park to the Secretary of the Interior. US Government Printing Office, Washington, D.C.
- Cannon, K. P.**
1990 Report of an Archeological Survey of the East Entrance Highway, Yellowstone National Park, Wyoming. Ms. on file, National Park Service, Midwest Archeological Center, Lincoln.
- 1991 Site Testing Along the North Shore of Yellowstone Lake, Yellowstone National Park, Wyoming. Ms. on file, National Park Service, Midwest Archeological Center, Lincoln.
- 1992 Limited Testing at Sites 48YE1 and 48YE304 within the Proposed East Entrance Road Corridor. Ms. on file, National Park Service, Midwest Archeological Center, Lincoln.
- 1993 A Preliminary Appraisal of Archeological Resources Along Yellowstone Lake, Yellowstone National Park, Wyoming. Ms. on file, National Park Service, Midwest Archeological Center, Lincoln.
- 1995 *Archeological Inventory and Testing of Selected Areas for Campground Relocation, HUDAT and Lake YPSS Service Station Development Projects, Yellowstone National Park, Wyoming*. National Park Service, Midwest Archeological Center, Technical Report No. 34, Lincoln.
- Cannon, K. P. and P. Phillips**
1993 *Post-Fire Inventory and Evaluation in Yellowstone National Park, Wyoming: The 1989 Field Season*. National Park Service, Midwest Archeological Center, Technical Report No. 24, Lincoln.
- Chittenden, H. M.**
1924 *The Yellowstone National Park: Historical and Descriptive*. J. E. Haynes, Saint Paul.
- Christensen, R. L.**
1984 Yellowstone Magmatic Evolution: Its Bearing on Understanding Large-

volume Explosive Volcanism. In *Explosive Volcanism, Inception, Evolution, and Hazards*, National Academy Press, Studies in Geophysics, pp. 84–95. Washington, D.C.

Clary, D. A.

1972 “*The Place Where Hell Bubbled Up*”: *A History of the First National Park*. National Park Service Office of Publications, US Government Printing Office, Washington, D.C.

Condon, D.

1948 American Indian Burial Giving Evidence of Antiquity Discovered in Yellowstone National Park. *Yellowstone Nature Notes* 22(4). Yellowstone National Park, Wyoming. Reprinted in *Plains Archeological Conference News Letter* 1(5):87–91.

Connor, M. A.

1994 Archeological Inventory of Lake Butte Overlook Road, Yellowstone National Park, Rocky Mountain Region Archeological Project Report, March 9, 1994. Ms. on file, National Park Service, Midwest Archeological Center, Lincoln.

Cooper, D. J., M. A. Partlow, B. A. Rodgers, G T. Smith and G P. Watts, Jr.

1991 *By Fire, Storm, and Ice: Underwater Investigations in the Apostle Islands*. Underwater Archeology Program, Division of History Preservation, State Historical Society of Wisconsin, Madison.

Cramton, L. C.

1932 *Early History of Yellowstone National*

Park and Its Relation to National Park Policies. National Park Service, US Government Printing Office, Washington, D.C.

Curtis, W. H.

1919 *The Elements of Wood Ship Construction*. McGraw-Hill, London.

Daron, S. E.

1992a Archeological Investigations in the Bridge Bay Area in Association with US West Cable Replacement. Rocky Mountain Region, Archeological Project Report, August 4, 1992. Ms. on file, National Park Service, Midwest Archeological Center, Lincoln.

1992b Archeological Investigation along the Power Line Corridor from Lake to Bridge Bay in Association with US West Cable Replacement. Rocky Mountain Region, Archeological Project Report, August 25, 1992. Ms. on file, National Park Service, Midwest Archeological Center, Lincoln.

1992c Archeological Investigations in the Lake Development Area in Association with US West Cable Replacement. Rocky Mountain Region Archeological Project Report, September 23, 1992. Ms. on file, National Park Service, Midwest Archeological Center, Lincoln.

1992d Archeological Investigations at the Lake Post Office Dump Site in Association with US West Cable Replacement. Rocky Mountain Region, Archeological Project Report, September 28, 1992. Ms. on file,

- National Park Service, Midwest Archeological Center, Lincoln.
- 1992e Archeological Investigations in the Grant Village Area in Association with US West Cable Replacement. Rocky Mountain Region, Archeological Project Report, June 24, 1992. Ms. on file, National Park Service, Midwest Archeological Center, Lincoln.
- 1995 Archeological Investigations and Testing for Montana Power Near Lake Junction, Yellowstone National Park. Rocky Mountain Region Archeological Project Report, January 1995. Ms. on file, National Park Service, Midwest Archeological Center, Lincoln.
- Deaver, S.**
1993 Cultural Resource Monitoring of the Yellowstone National Park 50 kv Transmission Line. Montana Power Company, Butte. Ms. on file, National Park Service, Midwest Archeological Center, Lincoln.
- Desmond, C.**
1984 *Wooden Ship-Building*. Rudder [1919] Publishing Co., New York. 1984 facsimile ed. Vestal [1919] Press, Lanham, Maryland.
- Dittl, B. and J. Mallman**
1987 *Plain to Fancy: The Story of the Lake Hotel*. Roberts Rinehart, Boulder.
- Doane, G. C.**
1877 Expedition of Lt. G. C. Doane, 1876-77. Ms. on file, Yellowstone National Park, archives, Yellowstone.
- Dominick, D.**
1964 The Sheepeater. *Annals of Wyoming* 36:131-168.
- Edsall, T. A., T. P. Poe, R. T. Nester and C. L. Brown**
1989 Side-Scan Sonar Mapping of Lake Trout Spawning Habitat in Northern Lake Michigan. *North American Journal of Fisheries Management* 9:269-279.
- Edsall, T., C. L. Brown, G. W. Kennedy and T. P. Poe**
1992 Lake Trout Spawning Habitat in the Six Fathom Bank-Yankee Reef Lake Trout Sanctuary, Lake Huron. *Journal of Great Lakes Research* 18(1):70-90.
- Edsall, T., C. L. Brown, G. W. Kennedy and J. R. P. French**
1992 *Surficial Substrates and Bathymetry of Five Historical Lake Trout Spawning Reefs in Near-Shore Waters of the Great Lakes*. Great Lakes Fishery Commission Technical Report 58. Ann Arbor.
- Edsall, T. A., M. E. Holey, B. A. Manny and G. W. Kennedy**
1995 An Evaluation of Lake Trout Reproductive Habitat on Clay Banks Reef, Northwestern Lake Michigan. *Journal of Great Lakes Research* 21 (Supplement 1):418-432.
- Edsall, T., G. W. Kennedy and W. H. Horns**
1996 Potential Spawning Habitat for Lake Trout on Julian's Reef, Lake Michigan. *Journal of Great Lakes Research* 22(1):83-88.

Estep, H. C.

1918 *How Wooden Ships are Built*. W. W. Norton, New York.

Gardiner, R. (editor)

1993 *The Advent of Steam: The Merchant Steamship Before 1900*. Conway Maritime Press, London.

1994 *The Golden Age of Shipping: The Classic Merchant Ship 1900–1960*. Conway Maritime Press, London.

Good, J. M. and K. L. Pierce

1996 *Interpreting the Landscapes of Grand Teton & Yellowstone National Parks: Recent and Ongoing Geology*. Grand Teton Natural History Association, Moose, Wyoming.

Goode, G. W.

1900 Annual Report of the Acting Superintendent of the Yellowstone National Park to the Secretary of the Interior. US Government Printing Office, Washington, D.C.

Great Lakes Register

1908 *Rules and Regulations for the Classification and Building of Metal and Wooden Vessels*. Lakeside Press, R. R. Connelley & Sons, Chicago.

Greenhill, B.

1988 *The Evolution of the Wooden Ship*. Facts On File. New York.

Gunnerson, J. H. and D. A. Gunnerson

1971 Apachean Culture: A Study in Utility and Diversity. In *Apachean Culture History and Ethnology*, edited by K. H. Basso and M. E. Opler, pp. 7–27. *University of Arizona Anthropological Papers* 21, Tucson.

Hague, A.

1899 Geology of the Yellowstone National Park. *Monographs XXXII, Part I*. US Government Printing Office, Washington, D.C.

1904 *Atlas to Accompany Monograph XXXII on the Geology of the Yellowstone National Park*. US Government Printing Office, Washington, D.C.

Haines, A. L.

1996a *The Yellowstone Story: A History of Our First National Park, Volume One*. The Yellowstone Association for Natural Science, History & Education, in association with University Press of Colorado.

1996b *The Yellowstone Story: A History of Our First National Park, Volume Two*. The Yellowstone Association for Natural Science, History & Education, in association with University Press of Colorado.

Harris, M.

1889 Annual Report of the Superintendent of the Yellowstone National Park to the Secretary of the Interior. US Government Printing Office, Washington, D.C.

Hayden, F. V.

1872 Preliminary Report of the US Geological Survey of Montana and Portions of Adjacent Territories; Being a Fifth Annual Report of Progress. US Government Printing Office, Washington, D.C.

- 1873 Sixth Annual Report of the United States Geological Survey of the Territories for the Year 1872. US Government Printing Office, Washington, D.C.
- 1883 Twelfth Annual Report of the United States Geological and Geographical Survey of the Territories: A Report of Progress for the Year 1878, two parts. Part II, Yellowstone National Park. Geology—Thermal Springs—Topography. US Government Printing Office, Washington, D.C.
- Haynes, J. E.**
1946 *Haynes Guide: Handbook of Yellowstone National Park*. 48th ed. Haynes, Yellowstone Park and Bozeman.
- Helena Herald**
1870 November 9.
- Hirschmann, F.**
1982 *Yellowstone*. Graphic Arts Center, Portland, Oregon.
- Hodge, F. W.**
1910 Handbook of North American Indians, part 2. Smithsonian Institution, *Bureau of American Ethnology Bulletin* 30, Washington, D.C.
- Hultkrantz, Å.**
1961 Shoshones in the Rocky Mountains. *Annals of Wyoming* 33(1):19-41.
- Hunt, W. J., Jr.**
1989 Trip Report, Yellowstone National Park, June 13 to June 22, 1989. Ms. on file, National Park Service, Midwest Archeological Center, Lincoln.
- Johnson, A. M.**
1986 Five Small Scale Inventories in Yellowstone National Park. Rocky Mountain Region Archeological Project Report, December 17, 1986. Ms. on file, National Park Service, Midwest Archeological Center, Lincoln.
- 1989 Archeological Inventories for New Housing at Lower Mammoth and Grant Village. Rocky Mountain Region Archeological Project Report, June 27, 1989. Ms. on file, National Park Service, Midwest Archeological Center, Lincoln.
- Johnson, A. M. and K. A. Lippencott**
1989 1988 Post-Fire Archeological Assessment, Yellowstone National Park. Ms. on file, National Park Service, Midwest Archeological Center, Lincoln.
- Johnson, D. E., A. D. Gardner and K. W. Thompson**
1993 Assessment of Abandoned Mine Lands in Yellowstone National Park. Rocky Mountain Region Archeological Project Report, November 11, 1993. Ms. on file, National Park Service, Midwest Archeological Center, Lincoln.
- Kerchove, R. de**
1961 *International Maritime Dictionary*. 2nd ed. Van Nostrand Reinhold, New York.
- Lenihan, D. J.**
1995a Submerged Cultural Resources Reconnaissance Report, Yellowstone National Park 1995. Ms. on file, National Park Service, Submerged

- Cultural Resources Unit,
Intermountain Cultural Resources
Center, Santa Fe.
- 1995b Trip Report Covering Activities of
SCRU at Yellowstone, August 9–17,
1995. On file, National Park Service,
Submerged Cultural Resources
Center, Santa Fe.
- 1996 Field Notes. On file, National Park
Service, Submerged Cultural
Resources Unit, Santa Fe.
- Lenihan, D. J. (editor)**
1987 *Submerged Cultural Resources Study:
Isle Royale National Park*. National
Park Service, Southwest Cultural
Resources Center Professional Papers
No. 8. Santa Fe.
- Livingston Enterprise**
1885 August 22.
- Lyon, F. and A. W. Hinds**
1915 *Marine and Naval Boilers*. United
States Naval Institute, Annapolis.
- Manny, B. A. and T. A. Edsall**
1989 Assessment of Lake Trout spawning
Habitat Quality in Central Lake
Huron by Submarine. *Journal of
Great Lakes Research* 15(1):164–
173.
- McEwen, W. A. and A. H. Lewis**
1953 *Encyclopedia of Nautical Knowledge*.
Cornell Maritime Press, Cambridge.
- Mooney, J.**
1979 *Calendar History of the Kiowa
Indians*. Smithsonian University
Press, Washington, D.C.
- Murphy, L. E. (editor)**
1984 *Submerged Cultural Resources
Survey: Portions of Point Reyes
National Seashore and Point Reyes-
Farallon Islands National Marine
Sanctuary, Phase I - Reconnaissance
Survey*. Southwest Cultural Resources
Center Professional Papers No. 1.
National Park Service, Santa Fe.
- Murphy, L. E.**
1997a Shipwrecks, Satellites, and
Computers: An Underwater Inventory
of Our National Parks. *Common
Ground* 1(3/4):47–51.
- 1997b Geographical Information System
(GIS). In *Encyclopaedia of
Underwater and Maritime
Archaeology*, edited by James P.
Delgado, pp. 340-344. British
Museum Press, London.
- Murphy, L. E., T. Leary and A. Williamson**
1995 Standardizing Seabed Classification
Techniques. *Sea Technology*
36(7):15-19.
- Murphy, L. E. and T. G. Smith**
1995 Submerged in the Past: Mapping the
Beguiling Waters of Florida's
Biscayne and Dry Tortugas National
Parks. *Geo Info Systems* 5(10):26–
33.
- Murphy, L. E. and A. Saltus**
1990 Consideration of Remote Sensing
Limitations to Submerged Historical
Site Survey. In *Underwater
Archaeology Proceedings from the
SIA Conference*, edited by Toni L.
Carrell pp. 93–95. Tucson.

National Park Service

- 1996 Project Scope and Project Design, Yellowstone National Park. On file, June 24, 1996, National Park Service, Submerged Cultural Resources Unit, Santa Fe.

Norris, P. W.

- 1880 Annual Report of the Superintendent of the Yellowstone National Park to the Secretary of the Interior. US Government Printing Office, Washington, D.C.

Paasch, H.

- 1997 *Paasch's Illustrated Marine Dictionary*. By the author as From Keel to Truck, Antwerp. [1885] 1997 facsimile ed. Conway Maritime Press, Lyons & Buford Publishers, New York.

Perry, R. J.

- 1980 The Apachean Transition from the Subarctic to the Southwest. *Plains Anthropologist* 25(90):279–296.

Pierce, K. L.

- 1979 History and Dynamics of Glaciation in the Northern Yellowstone National Park Area. *U.S. Geological Survey Professional Paper* 729-F. US Government Printing Office, Washington, D.C.

Pitcher, J.

- 1901 Annual Report of the Acting Superintendent of the Yellowstone National Park to the Secretary of the Interior. US Government Printing Office, Washington, D.C.
- 1902 Annual Report of the Acting Superintendent of the Yellowstone

National Park to the Secretary of the Interior. US Government Printing Office, Washington, D.C.

- 1904 **Annual Report of the Acting Superintendent of the Yellowstone National Park to the Secretary of the Interior.** US Government Printing Office, Washington, D.C.

Reeve, S. A.

- 1989 Prehistoric Settlements at the Yellowstone Lake Outlet, Yellowstone National Park, Wyoming. Ms. on file, National Park Service, Midwest Archeological Center, Lincoln.

Russell, M. A.

- 1997 *Glacier National Park, Submerged Cultural Resources Assessment*. National Park Service, Santa Fe.

Samuelson, A. E.

- 1981 *Archaeological Investigations in the Grant Village—West Thumb Area of Yellowstone National Park, Wyoming*. Unpublished Master's thesis, State University of New York, Albany.

Shope, S. M., L. E. Murphy and T. G. Smith

- 1995 Found at Sea: Charting Florida's Sunken Treasures. *GPS World* 6(5):22–34.

Smith, T. G.

- 1997 Geodesy. In *Encyclopaedia of Underwater and Maritime Archaeology*, edited by James P. Delgado, p. 166. British Museum Press, London.

- Taylor, D. C., K. Wood and J. J. Hoffman**
1964 Preliminary Archaeological Investigations in Yellowstone National Park. Ms. on file, National Park Service, Midwest Archeological Center, Lincoln.
- Taylor, R. L., J. M. Ashley, W. W. Locke, III, W. L. Hamilton and J. B. Erickson**
1989 *Geological Map of Yellowstone National Park*. Department of Earth Sciences, Montana State University, Bozeman.
- Tilden, Freeman**
1951 *The Natural Parks*. Alfred A. Knopf, New York.
- Topping, E. S.**
1968 *The Chronicles of the Yellowstone*. Ross and Haines, Minneapolis.
- Whittlesey, L. H.**
1988 *Yellowstone Place Names*. Montana Historical Society Press, Helena.
- Williams, L. and G. A. Wright**
1980 Preliminary Archeological Survey of the East Shore of Yellowstone Lake. Ms. on file, Department of Anthropology, State University of New York, Albany.
- Wilson, T. D.**
1873 *An Outline of Ship Building, Theoretical and Practical*. John Wiley and Son, New York.
- Wright, G. A.**
1978 The Shoshonean Migration Problem. *Plains Anthropologist* 23:113-137.
- Wright, G. A., R Proulx and T. Keonig**
1982 A Native American Burial from 48YE1, Fishing Bridge Peninsula, Yellowstone National Park. *Wyoming Archaeologist*, pp. 2-26.
- Yeo, J.**
1894 *Steam and the Marine Steam-Engine*. MacMillan, London.
- Young, S. B. M.**
1897 Annual Report of the Acting Superintendent of the Yellowstone National Park to the Secretary of the Interior. US Government Printing Office, Washington, D.C.
- 1907 Annual Report of the Superintendent of the Yellowstone National Park to the Secretary of the Interior. US Government Printing Office, Washington, D.C.

SUBMERGED RESOURCES CENTER REPORT AND PUBLICATION SERIES

The Submerged Cultural Resources Unit was established in 1980 to conduct research on submerged cultural resources throughout the National Park System with an emphasis on historic shipwrecks. One of the unit's primary responsibilities is to disseminate the results of research to National Park Service managers, as well as the professional community. A report series has been initiated in order to fulfill this responsibility. It has been incorporated into an umbrella series entitled Southwest Cultural Resources Center and Intermountain Cultural Resource Centers Professional Papers. The following are the categories:

SUBMERGED CULTURAL RESOURCES ASSESSMENT

First line document that consists of a brief literature search, an overview of the maritime history and the known or potential underwater sites in the park, and preliminary recommendations for long-term management. It is designed to have immediate application to protection and interpretation needs and to become a source document for a park's Submerged Cultural Resources Management Plan.

SUBMERGED CULTURAL RESOURCES SURVEY

Comprehensive examination of blocks of park lands for the purpose of locating and identifying as much of the submerged cultural resources base as possible. A comprehensive literature

search would most likely be apart of the Phase I report but, in some cases, may be postponed until Phase II.

Phase I — Reconnaissance of target areas with remote sensing and visual survey techniques to establish location of any archeological sites or anomalous features that may suggest the presence of archeological sites.

Phase II — Evaluation of archeological sites or anomalous features derived from remote-sensing instruments to confirm their nature, and if possible, their significance. This may involve exploratory removal of overburden.

SUBMERGED CULTURAL RESOURCES STUDY

A document that discusses, in detail, all known underwater archeological sites in a given park. This may involve test excavations. The intended audience is managerial and professional, not the general public.

SUBMERGED CULTURAL RESOURCES SITE REPORT

Exhaustive documentation of one archeological site which may involve a partial or complete site excavation. The intended audience is primarily professional and incidentally managerial. Although the document may be useful to a park's interpretive specialists because of its information content, it would probably not be suitable for general distribution to park visitors.

SUBMERGED CULTURAL RESOURCES SPECIAL REPORT

These may be in published or photocopy format. Included are special commentaries, papers on methodological or technical issues pertinent to underwater archeology, or any miscellaneous report that does not appropriately fit into one of the other categories.

SUBMERGED RESOURCES CENTER PROFESSIONAL REPORTS

1. Daniel J. Lenihan, Toni L. Carrell, Stephen Fosberg, Larry Murphy, Sandra L. Rayl and John A. Ware. *Final Report of the National Reservoir Inundation Study*. Two volumes. Submerged Cultural Resources Unit, 1981.
2. Larry E. Murphy, Editor. *Submerged Cultural Resources Survey: Portions of Point Reyes National Seashore and Point Reyes-Farallon Islands National Marine Sanctuary*. Submerged Cultural Resources Unit, 1984. Originally published as Southwest Cultural Resources Center Professional Papers #1.
3. Toni Carrell. *Submerged Cultural Resources Inventory: Portions of Point Reyes National Seashore and Point Reyes-Farallon Islands National Marine Sanctuary*. Submerged Cultural Resources Unit, 1984. Originally published as Southwest Cultural Resources Center Professional Papers #2.
4. Toni Carrell. *Submerged Cultural Resources Site Report: NOQUEBAY, Apostle Islands National Lakeshore*. Submerged Cultural Resources Unit, 1985. Originally published as Southwest Cultural Resources Center Professional Papers #7.
5. Daniel J. Lenihan, Editor. *Submerged Cultural Resources Study: Isle Royale National Park*. Submerged Cultural Resources Unit, 1987. Originally published as Southwest Cultural Resources Center Professional Papers #8.
6. Toni Carrell, Editor. *Submerged Cultural Resources Site Report: Charles H. Spencer Mining Operation and Paddle Wheel Steamboat, Glen Canyon National Recreation Area*. Submerged Cultural Resources Unit, 1987. Originally published as Southwest Cultural Resources Center Professional Papers #13.
7. James P. Delgado and Stephen A. Haller. *Submerged Cultural Resources Assessment: Golden Gate National Recreation Area, Gulf of the Farallones National Marine Sanctuary and Point Reyes National Seashore*. Submerged Cultural Resources Unit, 1989. Originally published as Southwest Cultural Resources Center Professional Papers #18.
8. C. Patrick Labadie. *Submerged Cultural Resources Study: Pictured Rocks National Lakeshore*. Submerged Cultural Resources Unit, 1989. Originally published as Southwest Cultural Resources Center Professional Papers #22.
9. Daniel J. Lenihan, Editor. *Submerged Cultural Resources Study: USS Arizona Memorial and Pearl Harbor National Historic Landmark*. Submerged Cultural Resources Unit, 1989. Originally published as Southwest Cultural Resources Center Professional Papers #23.
10. Toni L. Carrell, Editor. *Submerged Cultural Resources Assessment of Micronesia*.

Submerged Cultural Resources Unit, 1991. Originally published as Southwest Cultural Resources Center Professional Papers #36.

11. James P. Delgado, Daniel J. Lenihan and Larry Murphy. *The Archeology of the Atomic Bomb: A Submerged Cultural Resources Assessment of the Sunken Fleet of Operation Crossroads at Bikini and Kwajalein Atoll Lagoons, Republic of the Marshall Islands*. Submerged Cultural Resources Unit, 1991. Originally published as Southwest Cultural Resources Center Professional Papers #37.

12. Larry E. Murphy. *SSL17: Natural Site-Formation Processes of a Multiple-Component Underwater Site in Florida*. Submerged Cultural Resources Unit, 1990. Originally published as Southwest Cultural Resources Center Professional Papers #39.

13. Larry Murphy, Editor. *Dry Tortugas National Park, Submerged Cultural Resources Assessment*. Submerged Cultural Resources,

1993. Originally published as Southwest Cultural Resources Center Professional Papers #45.

14. Don Morris. *Channel Islands National Park and Channel Islands National Marine Sanctuary, Submerged Cultural Resources Assessment*. Submerged Cultural Resources Unit, 1996. Originally published as Intermountain Cultural Resource Centers Professional Papers #56.

15. Larry E. Murphy, Editor. *H.L. Hunley Site Assessment*. Submerged Cultural Resources Unit, 1998. Originally published as Cultural Resources Management Professional Papers #62.

16. James E. Bradford, Matthew A. Russell, Larry E. Murphy and Timothy G. Smith. *Yellowstone National Park Submerged Resources Survey*. Submerged Resources Center, 2002. Cultural Resources Management Professional Papers #65.

Mission: **As** the Nation's principal conservation agency, the Department of the Interior has responsibility for most of our nationally-owned public lands and natural and cultural resources. This includes fostering wise use of our land and water resources, protecting our fish and wildlife, preserving the environmental and cultural values of our national parks and historical places, and providing for the enjoyment of life through outdoor recreation. The Department assesses our energy and mineral resources and work to assure that their development is in the best interests of all our people. The Department also promotes the goals of the Take Pride in America campaign by encouraging stewardship and citizen responsibility for the public lands and promoting citizen participation in their care. The Department also has a major responsibility for American Indian reservation communities and for people who live in Island Territories under US Administration.