

SECTION 25

EXCAVATIONS

25.A GENERAL

25.A.01 Planning.

- a. Prior to opening an excavation, underground installations (e.g., sewer, communication lines, water, fuel, electric lines) shall be located and protected from damage or displacement. Utility companies and other responsible authorities shall be contacted to locate and mark the locations and, if they so desire, direct or assist with protecting the underground installations. When required, the Contractor shall obtain a "Digging Permit" (excavation permit) from Base Civil Engineers or other authority having jurisdiction prior the initiation of any excavation work. Requests for the permits will be processed through the GDA.
- b. Where excavations are to be performed in areas known or suspected to be contaminated with explosives, unexploded munitions, or military ordnance, surface and subsurface clearance by qualified explosive ordnance disposal (EOD) personnel shall be accomplished prior to excavation work.

25.A.02 Excavation inspection and testing.

- a. When persons will be in or around an excavation, a competent person shall inspect the excavation, the adjacent areas, and protective systems daily, as needed throughout the work shifts, and after every rainstorm or other hazard-increasing occurrence.
- b. If evidence of a situation that could result in possible cave-ins, slides, failure of protective systems, hazardous atmospheres, or other hazardous condition is identified, exposed workers shall be removed from the hazard and all work

EM 385-1-1

3 Nov 03

in the excavation stopped until all necessary safety precautions have been implemented.

c. In locations where oxygen deficiency or gaseous conditions are known or suspected, air in the excavation shall be tested prior to the start of each shift or more often if directed by the GDA. A log of all test results shall be maintained at the work site. > **See Sections 5 and 6.**

25.A.03 Protective systems.

a. The sides of all excavations in which employees are exposed to danger from moving ground shall be guarded by a support system, sloping or benching of the ground, or other equivalent means.

b. Excavations less than 5 ft (1.5 m) in depth and which a competent person examines and determines there to be no potential for cave-in do not require protective systems.

c. Sloping or benching of the ground shall be in accordance with 25.C.

d. Support systems shall be in accordance with 25.D.

e. Protective systems shall have the capacity to resist without failure all loads that are intended or could reasonably be expected to be applied to the system.

f. Shoring shall be used for unstable soil or depths >5 ft (>1.5 m) unless benching, lay-back, or other acceptable plan is implemented by the Contractor.

25.A.04 Stability of adjacent structures.

a. Except in stable rock, excavations below the level of the base of footing of any foundation or retaining wall shall not be permitted unless:

(1) A support system, such as underpinning, is provided to ensure the stability of the structure and to protect employees involved in the excavation work or in the vicinity thereof; or

(2) A registered professional engineer has approved the determination that the structure is sufficiently removed from the excavation so as to be unaffected by the excavation and that the excavation will not pose a hazard to employees.

b. If the stability of adjoining buildings or walls is endangered by excavations, shoring, bracing, or underpinning designed by a qualified person shall be provided to ensure the stability of the structure and to protect employees.

c. Sidewalks, pavements, and related structures shall not be undermined unless a support system is provided to protect employees and the sidewalk, pavement, or related structure.

25.A.05 Where it is necessary to undercut the side of an excavation, overhanging material shall be safely supported.

25.A.06 Protection from water.

a. Diversion ditches, dikes, or other means shall be used to prevent surface water entering an excavation and to provide good drainage of the area adjacent to the excavation.

b. Employees shall not work in excavations in which there is accumulated water or in which water is accumulating unless the water hazards posed by accumulation is controlled.

(1) Freezing, pumping, drainage, and similar control measures shall be planned and directed by a registered engineer. Consideration shall be given to the existing moisture balances in surrounding soils and the effects on foundations and structures if it is disturbed.

(2) When continuous operation of ground water control equipment is necessary, an emergency power source shall

EM 385-1-1

3 Nov 03

be provided. Water control equipment and operations shall be monitored by a competent person to ensure proper operation.

25.A.07 Protection from falling material.

a. Employees shall be protected (by scaling, ice removal, benching, barricading, rock bolting, wire mesh, or other means) from loose rock or soil that could create a hazard by falling from the excavation wall: special attention shall be given to slopes that may be adversely affected by weather, moisture content, or vibration.

b. Materials, such as boulders or stumps, that may slide or roll into the excavation shall be removed or made safe.

c. Excavated material shall be placed at least 2 ft (0.6 m) from the edge of an excavation or shall be retained by devices that are sufficient to prevent the materials from falling into the excavation. In any case, material shall be placed at a distance to prevent excessive loading on the face of the excavation.

25.A.08 Mobile equipment and motor vehicle precautions.

a. When vehicles or mobile equipment are used or allowed adjacent to an excavation, substantial stop logs or barricades shall be installed. The use of a ground guide is recommended.

b. Workers shall stand away from vehicles being loaded or unloaded to avoid being struck by spillage or falling materials.

c. Excavating or hoisting equipment shall not be allowed to raise, lower, or swing loads over personnel in the excavation without substantial overhead protection.

25.A.09 Employees shall not be permitted to work on the faces of sloped or benched excavations at levels above other employees except when employees at lower levels are adequately protected from the hazard of falling material or equipment.

25.A.10 When operations approach the location of underground utilities, excavation shall progress with caution until the exact location of the utility is determined. Workers shall be protected from the utility and the utility shall be protected from damage or displacement.

25.A.11 Employees shall wear a harness with a lifeline securely attached to it when entering excavations classified as confined spaces or that otherwise present the potential for emergency rescue. > **See 5.F.**

25.B SAFE ACCESS

25.B.01 Protection shall be provided to prevent personnel, vehicles, and equipment from falling into excavations. Protection shall be provided according to the following hierarchy. > **See Appendix Q for definitions of Class I, Class II, and Class III perimeter protection.**

- a. If the excavation is exposed to members of the public (e.g., other than those individuals engaged in project-specific work at the site) or vehicles or equipment, then Class I perimeter protection is required;
- b. If the excavation does not meet the requirements for Class I perimeter protection but is (1) routinely exposed to employees, and (2) either is deeper than 6 ft (1.8 m) or contains hazards (e.g., impalement hazards, hazardous substances), then Class II perimeter protection is the minimum protection required. When workers are in the zone between the warning barricades/flagging and the excavation, they shall be provided with fall protection as specified in Section 21;
- c. If the excavation does not meet the requirements for either Class I or Class II perimeter protection, then Class III perimeter protection is the minimum protection required.

25.B.02 All wells, calyx holes, pits, shafts, etc., shall be barricaded or covered.

EM 385-1-1
3 Nov 03

25.B.03 Excavations shall be backfilled as soon as possible. Upon completion of exploration and similar operations, test pits, temporary wells, calyx holes, etc., shall be backfilled immediately.

25.B.04 Walkways or bridges with standard guardrails shall be provided where people or equipment are required or permitted to cross over excavations.

25.B.05 Where personnel are required to enter excavations over 4 ft (1.2 m) in depth, sufficient stairs, ramps, or ladders shall be provided to require no more than 25 ft (7.6 m) of lateral travel.

a. At least two means of exit shall be provided for personnel working in excavations. Where the width of the excavation exceeds 100 ft (30.4 m), two or more means of exit shall be provided on each side of the excavation.

b. When access to excavations in excess of 20 ft (6 m) in depth is required, ramps, stairs, or mechanical personnel hoists shall be provided.

25.B.06 Ramps. > **See 21.B and 21.F**

a. Ramps used solely for personnel access shall be a minimum width of 4 ft (1.2 m) and provided with standard guardrails.

b. Ramps used for equipment access shall be a minimum width of 12 ft (3.6 m). Curbs not less than 8-in x 8-in (20.3-cm x 20.3-cm) timbers, or equivalent protection, shall be provided. Equipment ramps shall be designed and constructed in accordance with accepted engineering practice.

25.B.07 Ladders used as accessways shall extend from the bottom of the excavation to not less than 3 ft (0.9 m) above the surface.

25.C SLOPING AND BENCHING

25.C.01 Sloping or benching of the ground shall be in accordance with one of the systems outlined in a through c below:

> See Figure 25-1 for Examples from 29 CFR 1926, Subpart P, Appendix B.

a. For excavations less than 20 ft (6 m) in height, the maximum slope shall be 34° measured from the horizontal (1-1/2 horizontal to 1 vertical).

b. The design shall be selected from and be in accordance with written tabulated data, such as charts and tables. At least one copy of the tabulated data shall be maintained at the job site during excavation. The tabulated data shall include:

(1) Identification of the parameters that affect the selection of a sloping or benching system drawn from the data,

(2) Identification of the limits of use of the data, to include the magnitude and configuration of slopes determined to be safe,

(3) Explanatory information as may be necessary to aid the user in correctly selecting a protective system from the data, and

(4) The identity of the registered professional engineer who approved the data.

c. The sloping or benching system shall be designed by a registered engineer. At least one copy of the design shall be maintained at the job site during excavation. Designs shall be in writing and include:

(1) The magnitudes and configurations of the slopes that were determined to be safe for the particular excavation, and

EM 385-1-1
3 Nov 03

(2) The identity of the registered engineer who approved the design.

25.D SUPPORT SYSTEMS

25.D.01 Support systems shall be in accordance with one of the systems outlined in a through c below:

a. Designs drawn from manufacturer's tabulated data shall be in accordance with all specifications, limitations, and recommendations issued or made by the manufacturer.

(1) Deviation from the specifications, recommendations, and limitations are only allowed after the manufacturer issues specific written approval.

(2) A copy of the manufacturer's specifications, recommendations, and limitations (and the manufacturer's approval to deviate from these, if required) shall be in written form and maintained at the job site during excavation.

b. Designs shall be selected from and be in accordance with tabulated data (such as tables and charts). At least one copy of the tabulated data shall be maintained at the job site during excavation. The tabulated data shall include:

(1) Identification of the parameters that affect the selection of the protective system drawn from such data,

(2) Identification of the limits of use of the data, and

(3) Explanatory information as may be necessary to aid the user in correctly selecting a protective system from the data, and

(4) The identity of the registered professional engineer who approved the data.

c. Designed by a registered engineer. At least one copy of the design shall be maintained at the job site during excavation. Designs shall be in writing and include:

(1) A plan indicating the sizes, types, and configurations of the materials to be used in the protective system, and

(2) The identity of the registered engineer who approved the design.

25.D.02 Materials and equipment used for protective systems.

a. Materials and equipment shall be free from damage or defects that might impair their proper function.

b. Manufactured materials and equipment shall be used and maintained in a manner consistent with the recommendations of the manufacturer and in a manner that will prevent employee exposure to hazards.

c. When material or equipment is damaged, a competent person shall examine the material or equipment and evaluate its suitability for continued use.

25.D.03 Installation and removal of support systems. **> See Examples of Support Systems at Figures 25-2 and 25-3.**

a. Members of support systems shall be securely connected together to prevent sliding, falling, kickouts, or other predictable failure.

b. Support systems shall be installed and removed in manners that protect employees from cave-ins, structural collapses, or from being struck by members of the support system.

c. Individual members of a support system shall not be subjected to loads exceeding those for which they were designed to withstand.

EM 385-1-1
3 Nov 03

- d. Before temporary removal of individual members, additional precautions shall be taken to ensure the safety of employees, such as installing other structural members to carry the loads imposed on the support system.
- e. Removal shall begin at and progress from the bottom of the excavation. Members shall be released slowly as to note any indication of possible failure of the remaining members or possible cave-in of the sides of the excavation.
- f. Backfilling shall progress together with the removal of support systems from excavations.

25.D.04 Shield systems.

- a. Shields shall be installed in a manner to restrict lateral or other hazardous movement of the shield in the event of the application of sudden lateral loads.
- b. Employees shall be protected from the hazard of cave-ins when entering or exiting the area protected by shields.
- c. Employees shall not be allowed in shields when shields are being installed, removed, or moved vertically.

25.D.05 Additional requirements for trenching.

- a. Installation of support systems shall be closely coordinated with excavations of trenches.
- b. Bracing or shoring of trenches shall be carried along with the excavation.
- c. Backfilling and removal of trench supports should progress together from the bottom of the trench. Jacks or braces shall be released slowly and, in unstable soil, ropes shall be used to pull out the jacks or braces from above after personnel have cleared the trench. **> See Examples of Jacks at Figure 25-3.**

d. Excavation of material to a level no greater than 2 ft (0.6 m) below the bottom of the members of a trench support system (including a shield) shall be permitted, but only if the system is designed to resist the forces calculated for the full depth of the trench and there are no indications while the trench is open of a possible loss of soil from behind or below the bottom of the support system.

25.E COFFERDAMS

25.E.01 If overtopping of the cofferdams by high water is possible, design shall include provisions for controlled flooding of the work area.

25.E.02 If personnel or equipment are required or permitted on cofferdams, standard railings, or equivalent protection, shall be provided.

25.E.03 At least two means of access shall be provided for personnel and equipment working on cofferdams.

25.E.04 A plan (including warning signals) for evacuation of personnel and equipment in case of emergency and for controlled flooding shall be developed and posted.

25.E.05 Cofferdams located close to navigable shipping channels shall be protected from vessels in transit.

FIGURE 25-1

SLOPING AND BENCHING

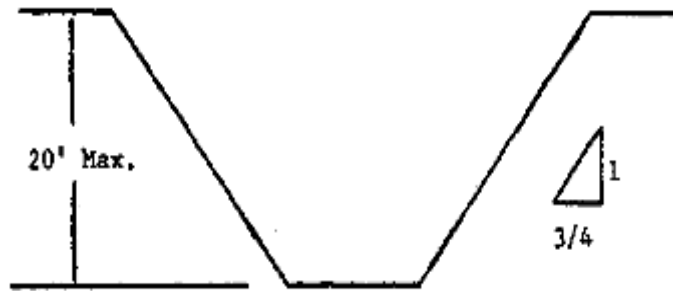

SIMPLE SLOPE - GENERAL - TYPE A SOIL

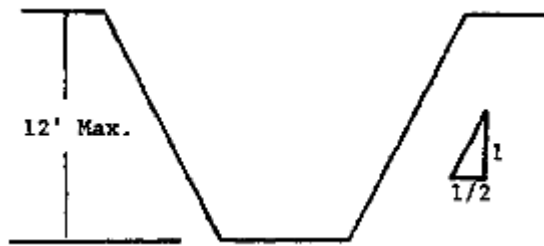

SIMPLE SLOPE - SHORT TERM - TYPE A SOIL

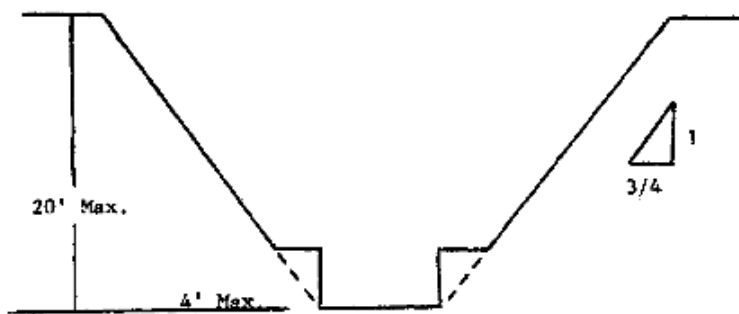

SIMPLE BENCH - TYPE A SOIL

FIGURE 25-1 (CONTINUED)

SLOPING AND BENCHING

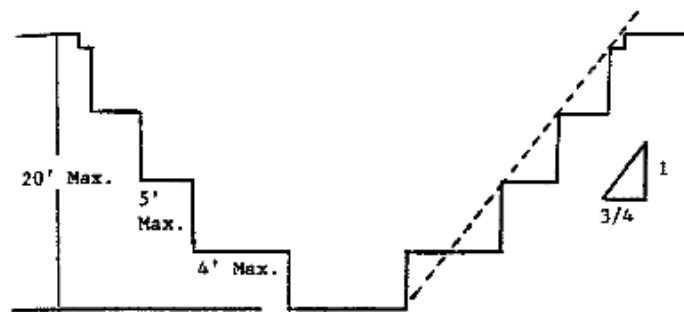

MULTIPLE BENCH - TYPE A SOIL

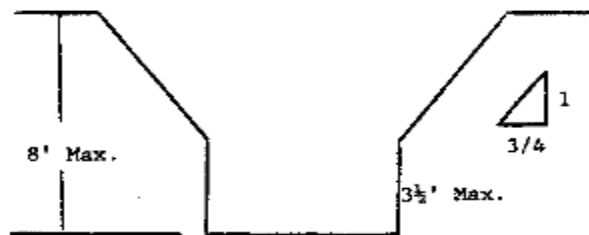

UNSUPPORTED VERTICALLY SIDED LOWER PORTION -
MAXIMUM 8 FEET IN DEPTH - TYPE A SOIL

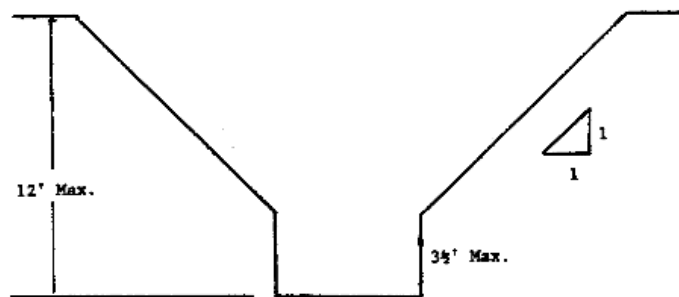

UNSUPPORTED VERTICALLY SIDED LOWER PORTION -
MAXIMUM 12 FEET IN DEPTH) - TYPE A SOIL

FIGURE 25-1 (CONTINUED)

SLOPING AND BENCHING

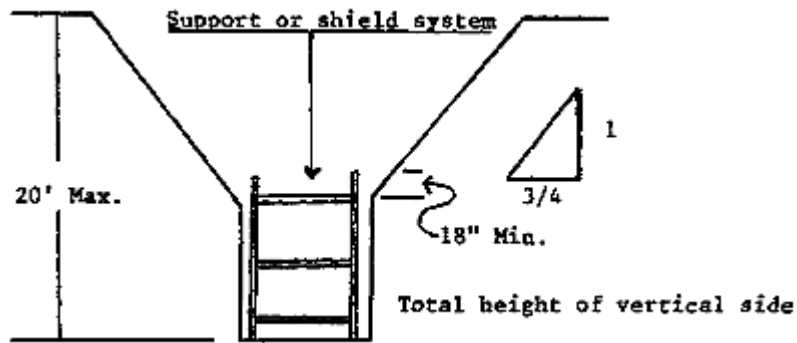

SUPPORTED OR SHIELDED VERTICALLY SIDED LOWER PORTION) - TYPE A SOIL

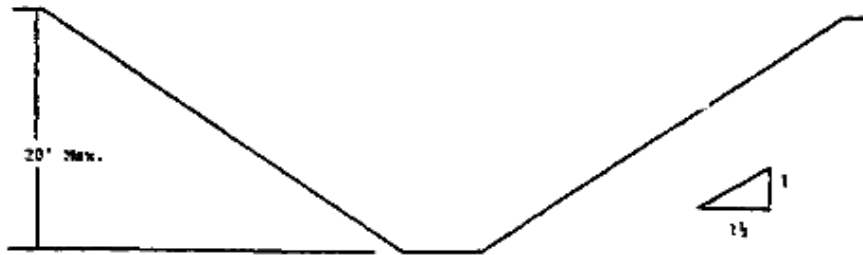

SIMPLE SLOPE - TYPE C SOIL

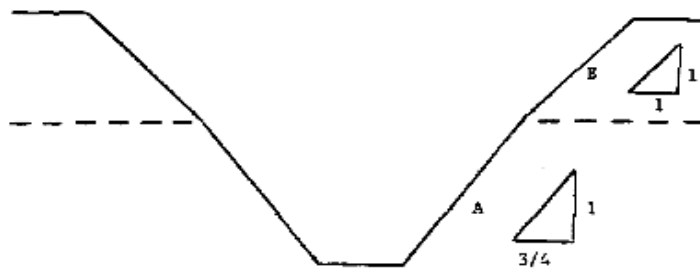

EXCAVATIONS MADE IN LAYERED SOILS - B OVER A

FIGURE 25-1 (CONTINUED)

SLOPING AND BENCHING

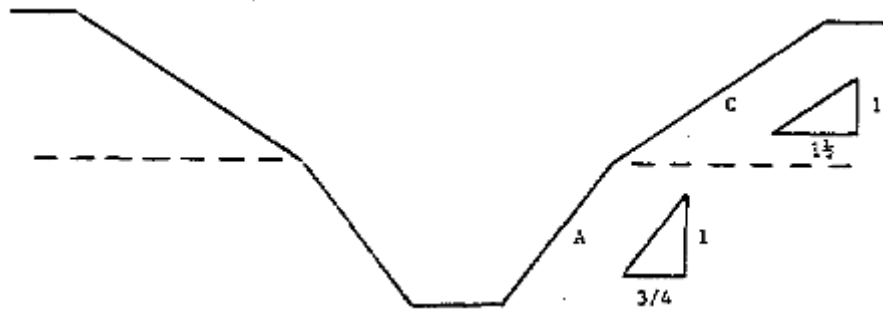

EXCAVATIONS MADE IN LAYERED SOILS - C OVER A

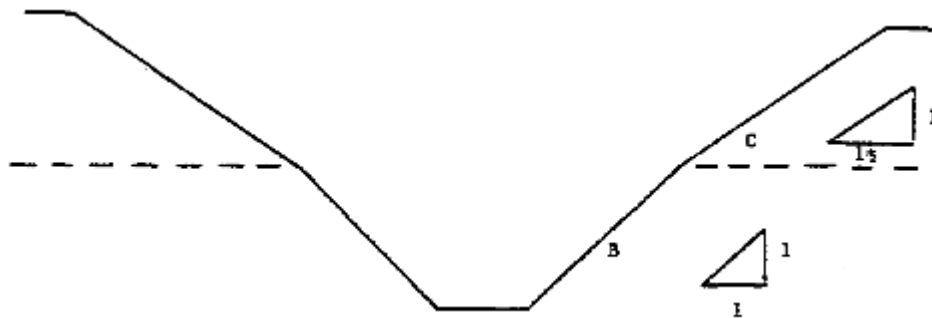

EXCAVATIONS MADE IN LAYERED SOILS - C OVER B

FIGURE 25-3
TRENCH JACKS

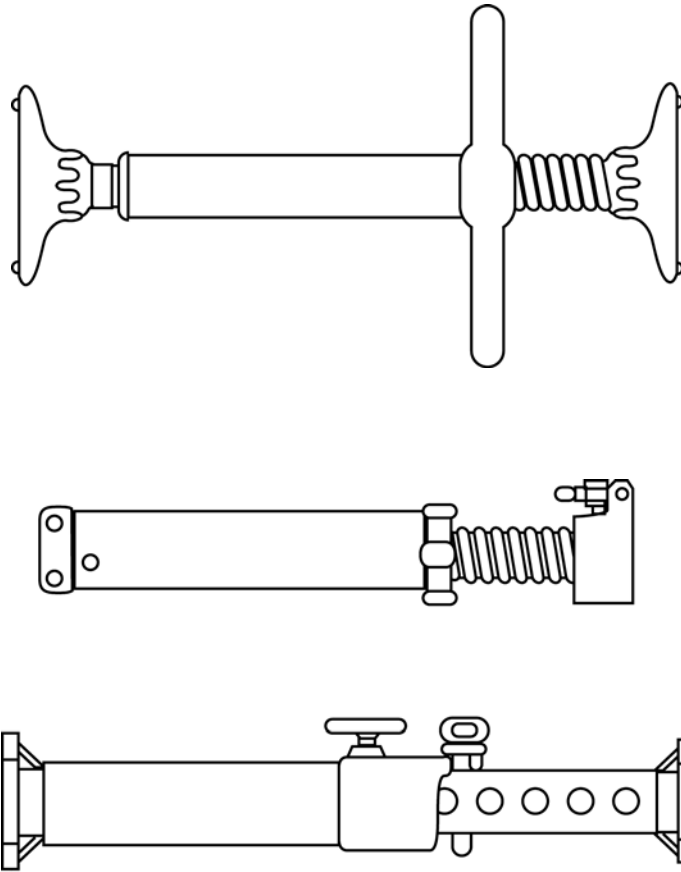

Pneumatic/hydraulic Shoring