

## **4.1 INTRODUCTION**

**T**his chapter outlines the earthquake risk to schools and the processes and methods that can be used to reduce it. An explanation of the nature and probability of earthquakes is provided, together with procedures for determining the earthquake threat to specific locations. An assessment of the scope and effectiveness of seismic building codes is followed by an explanation of how to evaluate the vulnerability of a school building. Current methods of designing for seismic resistance in new buildings and upgrading existing buildings lead to a discussion on determining acceptable risk and the use of performance-based design to achieve community objectives in providing for seismic safety.

## **4.2 THE NATURE AND PROBABILITY OF EARTHQUAKES**

Although earthquakes cannot be prevented, modern science and engineering provide tools that can be used to reduce their effects. Science can now identify, with considerable accuracy, where earthquakes are likely to occur and what forces they will generate. This information is readily available and can be obtained for local geographic regions (see Section 4.2.3).

### **4.2.1 Earthquakes and Other Geologic Hazards**

Earthquakes have long been feared as one of nature's most terrifying phenomena. Early in human history, the sudden shaking of the earth and the death and destruction that resulted were seen as mysterious and uncontrollable. We now understand the origin of earthquakes and know that they must be accepted as a natural environmental process. Scientific explanations, however, have not lessened the terrifying nature of the earthquake experience. Earthquakes continue to remind us that nature can, without

warning, in a few seconds create a level of death and destruction that can only be equaled by the most extreme weapons of war.

This uncertainty, together with the terrifying sensation of earth movement, creates our fundamental fear of earthquakes. Beyond the threat to life is the possibility of the destruction of public and private property. Jobs, services, and business revenues can disappear instantly and, for many, homelessness can suddenly be very real. The aftermath of a great earthquake can endure for years or even decades.

Other types of phenomena sometimes accompany earthquake-caused ground shaking and are generally identified as geologic hazards:

- **Liquefaction** occurs when loose granular soils and sand in the presence of water change temporarily from a solid to a liquid state when subjected to ground shaking. This condition occurs mainly at sites located near rivers, lakes, and bays.
- **Landslides**, which involve the slipping of soil and rock on sloping ground, can be triggered by earthquake ground motion (see Figure 4-1).
- **Tsunamis** are earthquake-caused wave movements in the ocean that travel at high speed and may result in large coastal waves of 30 feet or more. They are sometimes, and incorrectly, called tidal waves.
- **Seiches** are similar to tsunamis, but take the form of sloshing in closed lakes or bays; they have the potential to cause serious damage, although such occurrences have been very rare.

For all of the above geologic hazards, the only truly effective defense is the application of good land-use practices that limit development in hazard-prone locations. Seismic design and construction is aimed at reducing the consequences of earthquake-caused ground shaking, which is by far the main cause of damage and casualties.



Figure 4-1  
School, Anchorage, AK,  
1964, severely damaged  
by earthquake-induced  
landslide

SOURCE: NATIONAL INFORMATION  
SERVICE FOR EARTHQUAKE  
ENGINEERING, UNIVERSITY OF  
CALIFORNIA, BERKELEY



#### 4.2.2 Earthquakes: A National Problem

Earthquakes in the United States are a national problem. This was recognized by the U.S. Congress in 1977 when it passed legislation authorizing the National Earthquake Hazards Reduction Program (NEHRP), which has supported considerable research and hazard mitigation implementation since that time.

Most people now know that earthquakes are not restricted to just a few areas in the United States, most notably California and Alaska, and that two of the greatest earthquakes known occurred not in California, but near New Madrid, Missouri, in 1811 and 1812. As shown on a map of earthquake probability in the U.S., more than 40 of the 50 states are at risk from earthquake-caused damage, life loss, injuries, and economic impacts (see Figure 4-2). Certainly the likelihood of a damaging earthquake occurring west of the Rocky Mountains, and particularly in California, the states of Oregon and Washington, and Salt Lake City, is much greater than it is in the East, Midwest, or South. However, the New Madrid, Missouri, and Charleston, South Carolina, regions are subject to the possibility of severe earthquakes, although with a lesser probability than the western U.S.

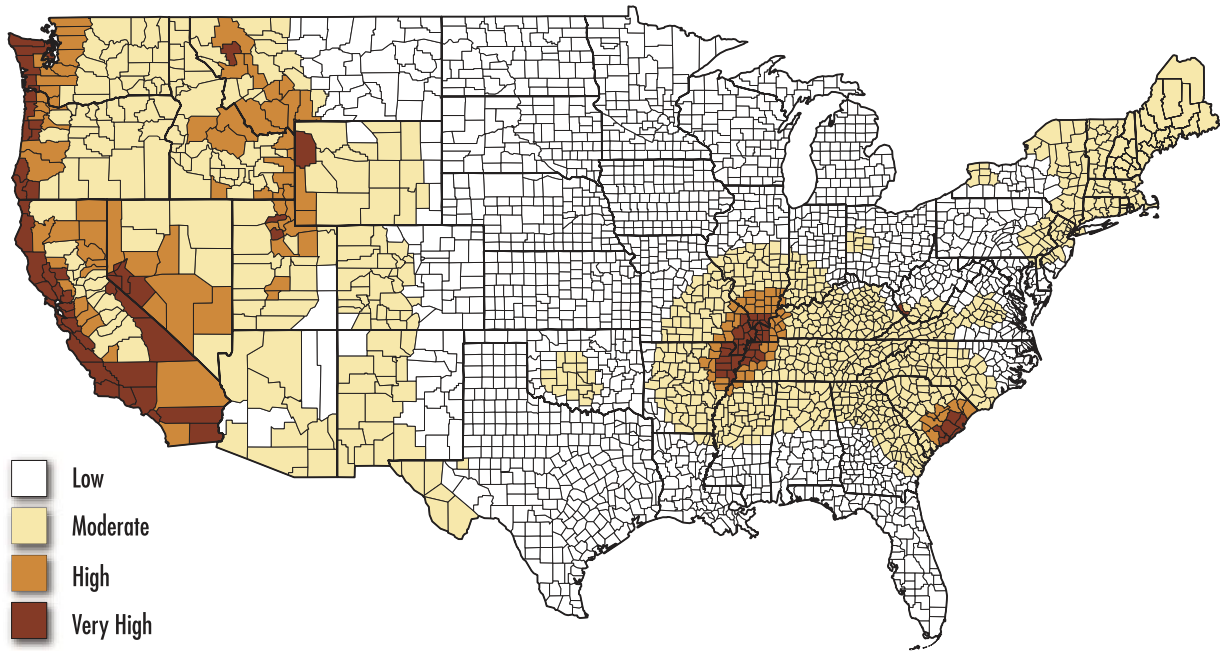

Figure 4-2 Map of the continental United States that shows counties and probabilities of earthquakes of varying magnitude

SOURCE: USGS

There are several common measures of earthquakes. Perhaps the most familiar is the Richter Magnitude, devised by Professor Charles Richter of the California Institute of Technology in 1935. Richter’s scale is based on the maximum amplitude of certain seismic waves recorded on a standard seismograph at a distance of 100 kilometers (km) from the earthquake epicenter. Because the instruments are unlikely to be exactly 100 km from the source, Richter devised a method to allow for the diminishing of wave amplitude with increased distance. The Richter scale is logarithmic, and each unit of magnitude indicates a ten-fold increase in wave amplitude. The energy increase represented by each unit of scale is approximately 31 times. The scale is open-ended, but a magnitude of about 9.5 represents the largest possible earthquake.

Table 4-1 shows significant earthquakes (Magnitude 6 or over) that occurred in 47 of the 50 U.S. states between 1568 and 1989.

Table 4-1: Known Historic (1568-1989) Earthquakes in 47 U.S. States

Number of Quakes with Reported Maximum Modified Mercali Intensity (MMI) of:			
State	VI	VII	VII+
Alabama	5	7	—
Alaska	41	21	13
Arizona	11	3	1
Arkansas	8	3	2
California	329	131	66
Colorado	19	1	—
Connecticut	2	1	—
Delaware	—	1	—
Florida	2	—	—
Georgia	5	—	—
Hawaii	30	13	10
Idaho	12	4	2
Illinois	18	12	—
Indiana	5	2	—
Kansas	4	2	—
Kentucky	8	1	—
Louisiana	1	—	—
Maine	7	2	—
Massachusetts	8	7	3
Michigan	1	1	1
Minnesota	3	—	—
Mississippi	2	—	—
Missouri	14	2	3
Montana	35	4	5
Nebraska	4	2	—
Nevada	28	10	8
New Hampshire	7	2	—
New Jersey	5	1	—
New Mexico	29	10	8
New York	16	6	2
North Carolina	5	2	—
North Dakota	1	—	—
Ohio	9	5	1

Table 4-1: Known Historic (1568-1989) Earthquakes in 47 U.S. States (continued)

State	Number of Quakes with Reported Maximum Modified Mercalli Intensity (MMI) of:		
	VI	VII	VII+
Oklahoma	9	2	—
Oregon	10	1	—
Pennsylvania	7	1	—
Rhode Island	1	—	—
South Carolina	17	2	1
South Dakota	6	—	—
Tennessee	12	2	—
Texas	7	1	—
Utah	31	8	5
Vermont	1	—	—
Virginia	12	1	1
Washington	37	6	3
West Virginia	1	—	—
Wyoming	8	1	—

SOURCE: U.S. GEOLOGICAL SURVEY, PROFESSIONAL PAPER 1527, 1993

NOTE: This list includes only earthquakes that affected human settlements.

Records show that some seismic zones in the United States experience moderate to major earthquakes approximately every 50 to 70 years, while other areas have “recurrence intervals” for the same size earthquake of about 200 to 400 years. These frequencies of occurrence are simply statistical probabilities and one or several earthquakes could occur in a much shorter than average period. With current knowledge, there is no practical alternative for those responsible for schools located in earthquake-prone regions but for them to assume that a large earthquake is likely to occur at any time and that appropriate action should be taken.

Moderate and even very large earthquakes are inevitable, although very infrequent, in areas of normally low seismicity. Consequently, in these regions, buildings are very seldom designed

to deal with an earthquake threat; therefore, they are extremely vulnerable. In other places, however, the earthquake threat is quite familiar. Schools in many areas of California and Alaska will be shaken by an earthquake perhaps two or three times a year and some level of “earthquake-resistant” design has been accepted as a way of life since the early 20th century.

Although, on a national basis, the areas where earthquakes are likely to occur and the potential size or “magnitude” of these earthquakes are well identified and scientists have a broad statistical knowledge of the likelihood of their occurrence, it is not yet possible to predict the near-term occurrence of a damaging earthquake. Therefore, lacking useful predictions, it makes sense in any seismic region to take at least the minimum affordable prudent actions directed at saving lives. Because most lives are lost in earthquakes when buildings collapse, U.S. seismic building code provisions focus on requiring that the minimum measures necessary to prevent building collapse are taken.

In California, schools are further protected by the Field Act of 1933, which mandated additional requirements relating to design qualifications, plan checking, and site inspection. (The Field Act is discussed in more detail in Section 4.3.2.)

The following graphics explain some earthquake terminology and characteristics of ground motion.

## WHAT EARTHQUAKES DO

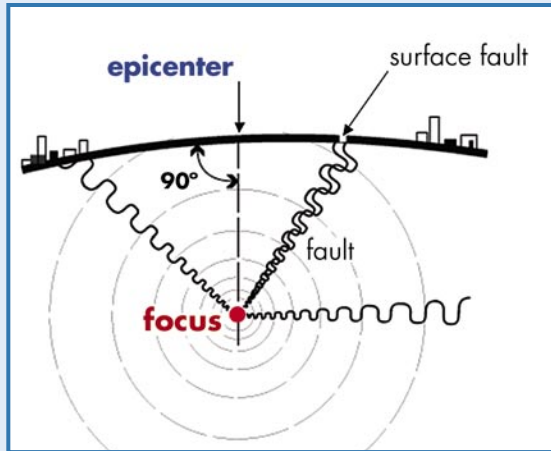

### The Origin of Earthquakes

This diagram explains some of the common terms used in talking about earthquakes. Waves of vibration radiate out from the fault break.

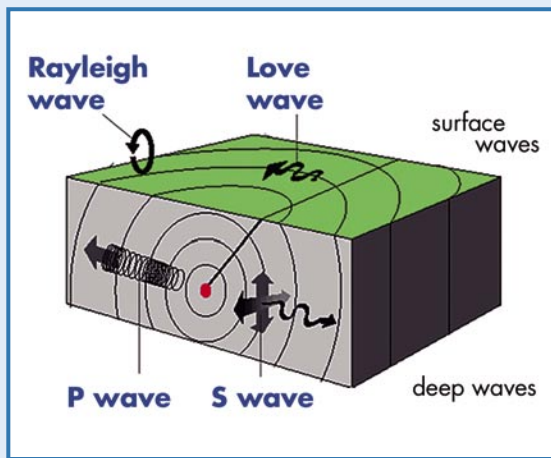

### Types of Seismic Waves

Four main types of waves radiate from a fault break. The P or Primary wave, a back-and-forth motion, arrives first, followed by the S wave (secondary or shear) that is more of a rolling motion. These are deep waves that travel through the earth to the surface. The Love and Rayleigh waves, named after their discoverers, travel along the earth's surface.

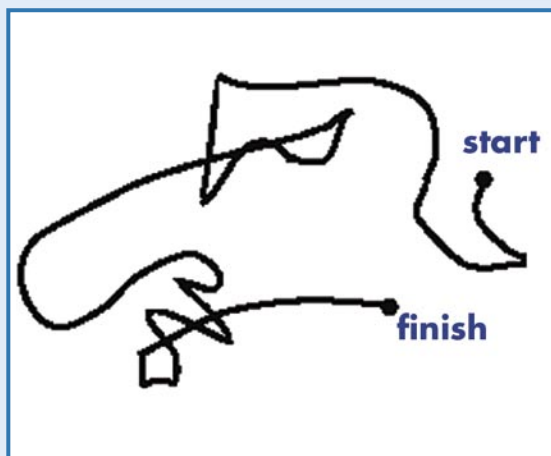

### Motion at Site

Scratch left on a floor by a kitchen range in the 1933 Long Beach earthquake that shows the random nature of earthquake motion.



## ACCELERATION FORCES

... NEWTON'S SECOND LAW OF MOTION

$$\mathbf{F} = \mathbf{MA}$$

force

mass acceleration

### Forces and Gravity

Because ground motion waves produce inertial forces within structures, these forces obey Newton's Second Law of Motion. This fundamental equation establishes the forces for which buildings must be designed to resist earthquakes.



**NEWTON'S APPLE**

acceleration is measured in "gs".

one **g** is the acceleration due to gravity

**1.0 g = 32 feet/second**

### Acceleration

The acceleration, or the rate of change of the velocity of the waves that set the building in motion, is used in an equation, derived from Newton's Second Law of Motion to estimate the percentage of the building mass or weight that must be dealt with as a horizontal force.



one "g" parachute team



four "g" roller coaster



nine "g" airforce display team



0.0001 "g" human perception

### Acceleration

Some common examples of acceleration. The skydivers are falling under the action of gravity, 1g.

## PERIOD AND RESONANCE

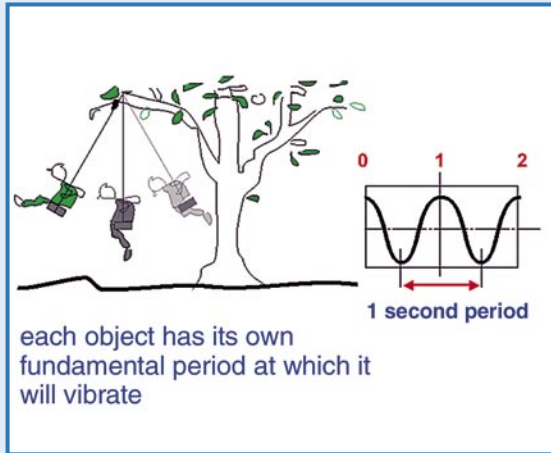

### Fundamental Period and Resonance

Every object has a fundamental period at which it vibrates if it is set in motion. It cannot vibrate at another period unless it is dragged back and forth. The ground also has a fundamental period. If an object is set in motion by an external force such as ground shaking, which is at the fundamental period of the object, the result will be "resonance" and the motion of the object will tend to increase. When you push a child on a swing, you instinctively give it a push at its fundamental period, which results in an enjoyable increase in the motion with very little force applied.

Similarly, if the ground pushes a building with the same period as the motion, the accelerations in the building will increase, perhaps four or five times.

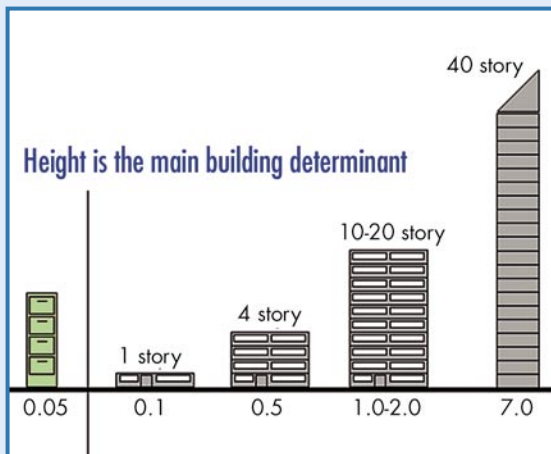

### Fundamental Period in Seconds

This shows typical periods for structures. The main determinant of period is building height and proportion; thus, a tall slender object will have a long period and sway back and forth quite slowly. So the 40-story building will sway gently back and forth once every 7 seconds.

SOURCE: BSSC: PRESENTATIONS TO THE ARCHITECTURAL COMMUNITY, 2001, CHRIS ARNOLD AND TONY ALEXANDER

### **4.2.3 Determination of Local Earthquake Hazards**

Until quite recently, the United States was divided into a number of seismic zones, which were shown on the maps in the model codes. Zones ranged from Zone 0 (indicating no seismicity) to Zones 1, 2A, 2B, 3, and 4. Zone 4 indicates the highest level of seismicity (see Figure 4-3; only Zones 0, 1, 2A, and 3 are shown). Each zone was allocated a factor, or coefficient, from 0.075 to 0.40; this value was a multiplier representing the acceleration value for which the building was to be designed. These values indicate a four-fold range in acceleration values between Zones 1 and 4. Within a zone, all buildings must be designed to the same acceleration value (or greater); contour lines show the boundaries between zones.

Current codes, such as the International Building Code, define site seismicity in a different way. The United States is still divided into zones by contour lines, but their areas are much smaller. Numerical values are also shown on the maps and also represent the acceleration value to be used for design, but they are calculated in a different way, and many more values are shown that reflect greater precision of knowledge. Also, acceleration values for both long and short period buildings are shown in a separate series of maps. Figure 4-4 shows a portion of the earthquake ground motion map in the International Building Code 2003 corresponding to the region shown in Figure 4-3. The simplicity of the old seismic zones is lost, but the design information is much more detailed.

If the school district or community desires to obtain more detailed information on the seismic hazard than is shown on the code maps, or if the location does not enforce a seismic code, but there is concern about seismicity, the U.S. Geological Survey (USGS) web page at [www.USGS.gov](http://www.USGS.gov), Earthquake Hazards Program, is an excellent resource. The USGS provides more detailed earthquake hazard maps for general regions such as the Western, Central, and Eastern U.S.

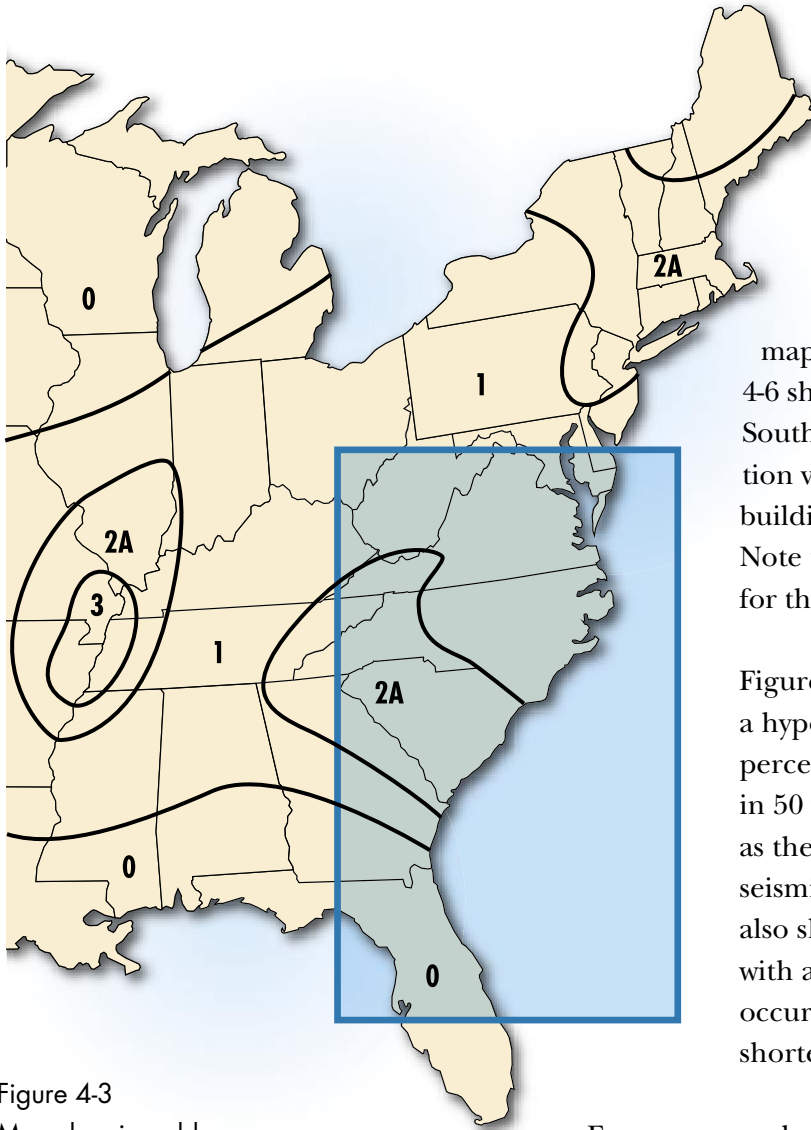

Figure 4-3  
Map showing older seismic zones in part of the United States, from the 1997 Uniform Building Code. The area in the box corresponds to the area in Figure 4-4.

SOURCE: INTERNATIONAL CONFERENCE OF BUILDING OFFICIALS, WHITTIER, CA

Figure 4-5 shows a comparison between the Southeast U.S. and California. The larger acceleration values for the latter are symbolized by the darker colors. These maps are used as the basis for the maps shown in the IBC. Figure 4-6 shows a comparison, for the Southeast U.S., between acceleration values for a 1.0-second period building and a 0.2-second building. Note the larger acceleration values for the shorter period building.

Figures 4-5 and 4-6 show values for a hypothetical earthquake with a 2-percent probability of exceedance in 50 years. This can be visualized as the odds of occurrence. The seismic code section of the IBC also shows values for earthquakes with a 10-percent probability of occurrence in 50 years (i.e., much shorter odds).

For even more localized information, the USGS provides seismicity information for any location in the United States on the basis of latitude and longitude, or Zip Code. This information can be obtained by opening the Seismic Hazard listings on the USGS web page, and opening Hazards by Latitude and Longitude, or Hazards by Zip Code. These listings show information on the expected maximum shaking that is estimated for the location. The information and terminology are quite technical and may need to be interpreted by qualified staff at the responsible local code office, a structural engineer, or perhaps a knowledgeable seismic professional.

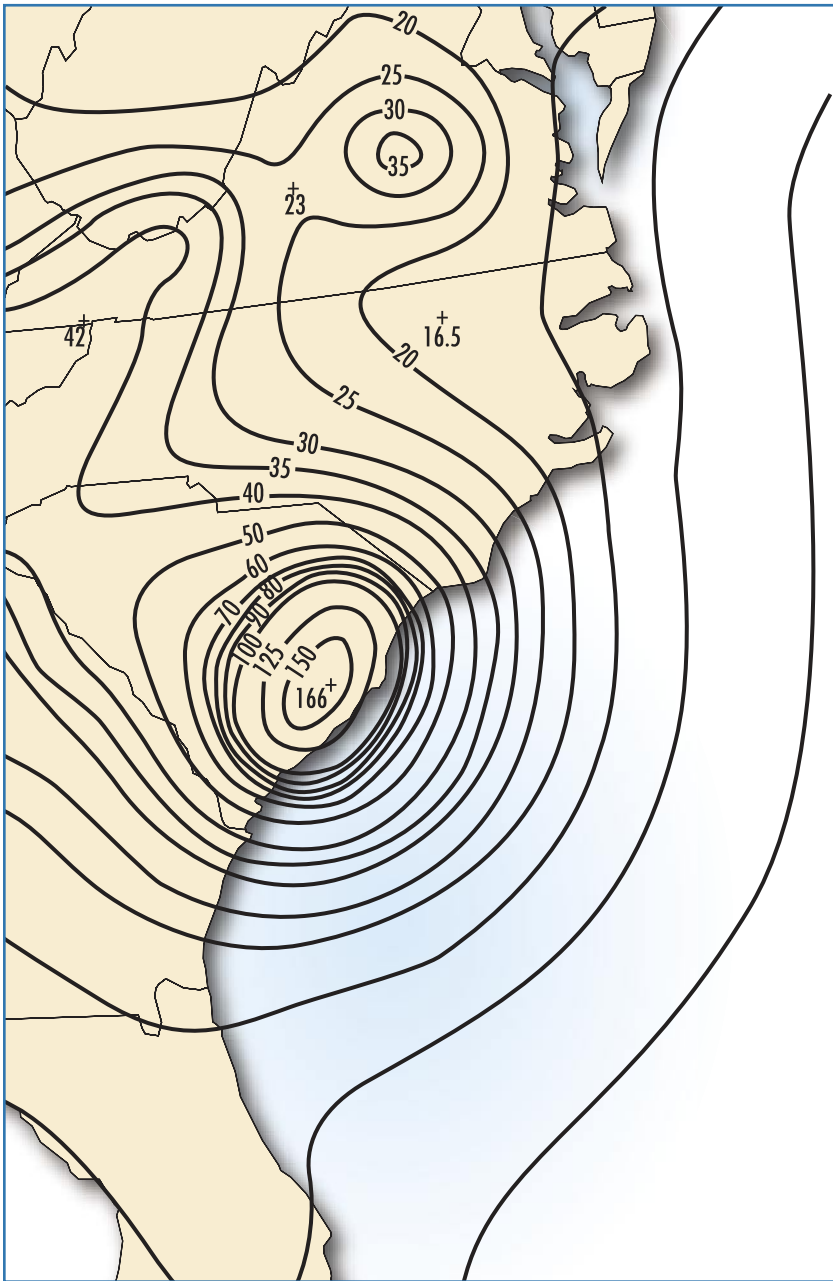

Figure 4-4  
 Portion of an earthquake ground motion map used in the International Building Code 2003 that shows contours that identify regions of similar spectral response accelerations to be used for seismic design. Spectral response acceleration includes both ground acceleration and effect of building period. This area corresponds to the area in the box in Figure 4-3. Many more acceleration values are shown in the newer map.

SOURCE: USGS/BSSC PROJECT 97 BY BUILDING SEISMIC SAFETY COUNCIL, FEDERAL EMERGENCY MANAGEMENT AGENCY

**0.2 sec Spectral Acceleration (%g) with 2% Probability of Exceedance in 50 Years**

site: NEHRP B-C boundary

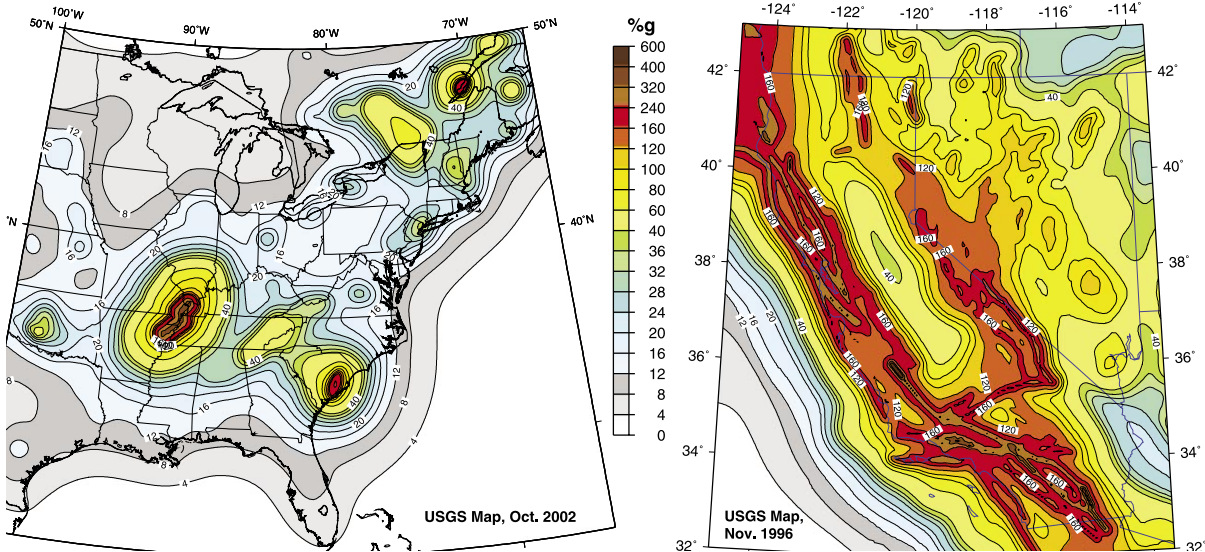

Figure 4-5

These maps compare the seismicity of the Southeast U.S. and California. The larger acceleration values for the latter are symbolized by the darker colors.

SOURCE: USGS

**1.0 sec Spectral Acceleration (%g) with 2% Probability of Exceedance in 50 Years**

site: NEHRP B-C boundary

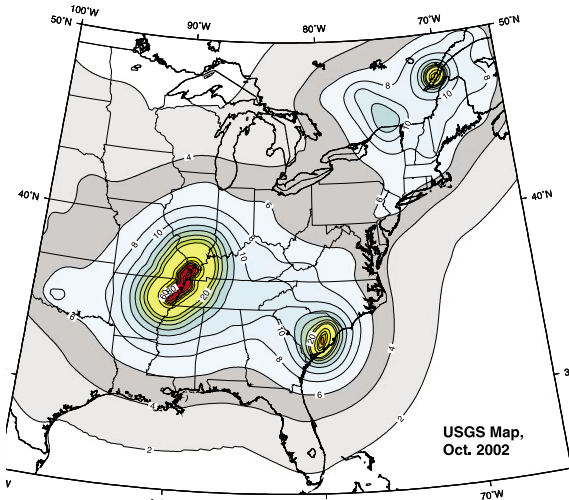

**0.2 sec Spectral Acceleration (%g) with 2% Probability of Exceedance in 50 Years**

site: NEHRP B-C boundary

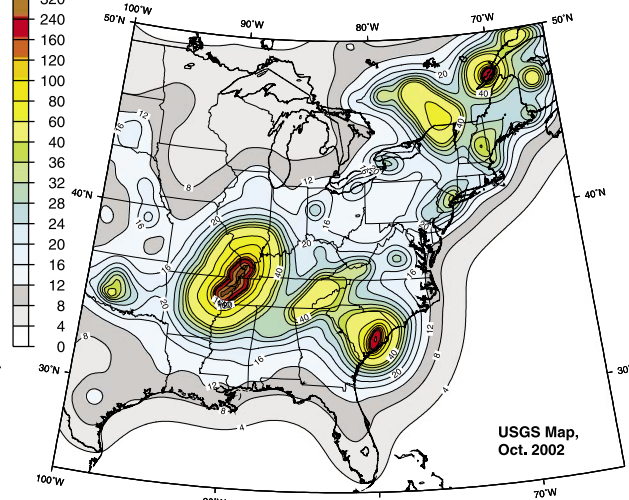

Figure 4-6

These maps show a comparison for the Southeast U.S. between the acceleration values for a 1-second (long) and a 0.2-second (short) building period.

SOURCE: USGS

## 4.3 VULNERABILITY: WHAT EARTHQUAKES CAN DO TO SCHOOLS

This section reviews the experience of schools in earthquakes. Much of the information presented comes from California, because of the prevalence of earthquakes in that state. In general, the seismic performance of newer buildings has been good, although considerable costly and dangerous nonstructural damage still occurs. California public school design and construction has been subject to strict regulation since 1933 which undoubtedly contributes to good performance. Many of the damage examples shown in this section are of older buildings: this is relevant because schools are long-lived buildings and many schools constructed in the early decades of the 20th century are still in use.

### 4.3.1 Vulnerability of Schools

Older unreinforced masonry school buildings present a very high risk, and this type of structure has been prohibited by law in California since the mid-1930s, following severe damage to schools of this type in the 1933 Long Beach earthquake.

A structural type that poses perhaps an even greater risk than unreinforced masonry is that of the mid-rise nonductile reinforced concrete frame. “Nonductile” refers to the frame’s lack of ductility (flexibility), or ability to deform considerably before breaking (see Figure 4-7).

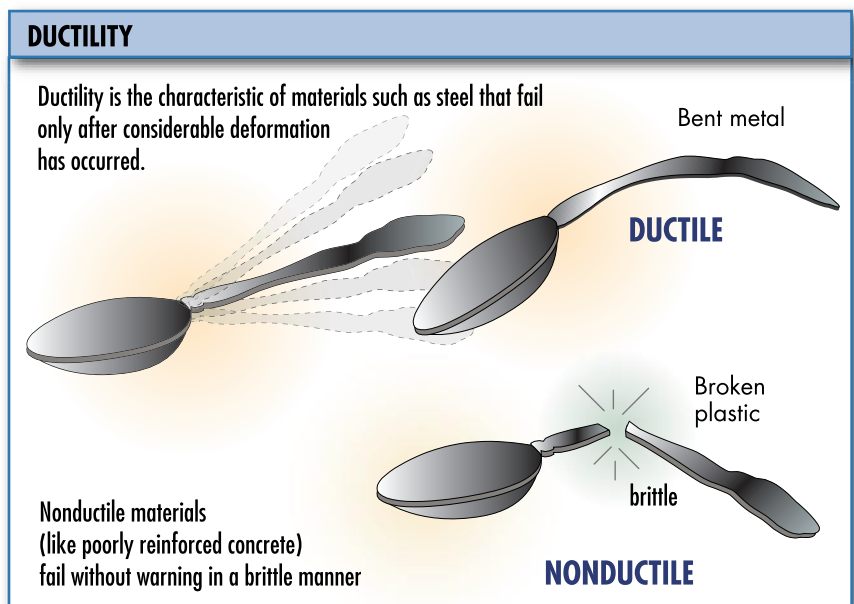

Figure 4-7 Ductility

SOURCE: BSSC: PRESENTATIONS TO THE ARCHITECTURAL COMMUNITY, 2001, CHRIS ARNOLD AND TONY ALEXANDER

Reinforced concrete frames are made ductile by introducing an appropriate, code-specified amount of specifically designed steel reinforcing; unfortunately, the need for this was not recognized in seismic codes until the mid-1970s and so a large inventory of these types of structure exists (see Figure 4-8).

Figure 4-8  
Collapse of portion of  
nonductile concrete frame  
school structure, Helena,  
MT, 1935

SOURCE: NATIONAL INFORMATION  
SERVICE FOR EARTHQUAKE  
ENGINEERING, UNIVERSITY OF  
CALIFORNIA, BERKELEY



Wood frame structures perform effectively, provided that they are well constructed, particularly with respect to correct nailing of shear walls as specified in the code and properly detailed roof-to-wall connections. Good maintenance, ensuring continued protection against moisture and wood attacking insects, is also critical for wood frames.

Newer structures, employing frames and fewer walls, also perform effectively if well designed and constructed; however, their response differs from that of shear wall structures, which are stiff and resistant to lateral forces. Frame structures are more flexible, which reduces the forces on the structural members and enables a light and safe structure to be designed.

Modular classrooms are liable to topple off their foundations unless securely attached and braced. This damage is not life-threatening, but makes the building unusable; fractured power, gas, and waste lines may be a hazard (see Figure 4-9).





Figure 4-9  
Modular classrooms  
pushed off their  
foundations; note stairs  
at left, Northridge, CA,  
1994.

SOURCE: GARY MCGAVIN,  
REDLANDS, CA

If long-span roof and floor members are employed, however, there may be excessive drift, or sway, which causes damage to nonstructural components such as hung ceilings, light fixtures, light partitions, and contents. Piping, ductwork, electrical conduits, and communication pathways (cable trays) may also be damaged. Storage units, filing cabinets, and library shelving in any type of structure may be hazardous if not properly braced (see Figure 4-10). Broken pipes can create an additional hazard in the form of flooding, lack of fire protection water, and, with heating piping or domestic hot water piping, this could result in a flood of hot water.

School occupants are particularly vulnerable to nonstructural damage. Although students and staff may duck under desks and be safe from falling objects such as lighting fixtures and ceiling tiles, ceiling components that fall in hallways and stairs can make movement difficult, particularly if combined with power failure and loss of lights. Additional falling



Figure 4-10  
Fallen filing cabinets and shelves, Northridge,  
CA, 1994

SOURCE: GARY MCGAVIN, REDLANDS, CA

hazards that are common in schools are large wall-mounted televisions (TVs) or ceiling mounted liquid crystal display (LCD) projectors. Heavy equipment can be hazardous and falling debris can also cause panic (see Figure 4-11).

Figure 4-11  
Fallen shop equipment,  
Coalinga, CA, 1983

SOURCE: GARY MCGAVIN,  
REDLANDS, CA

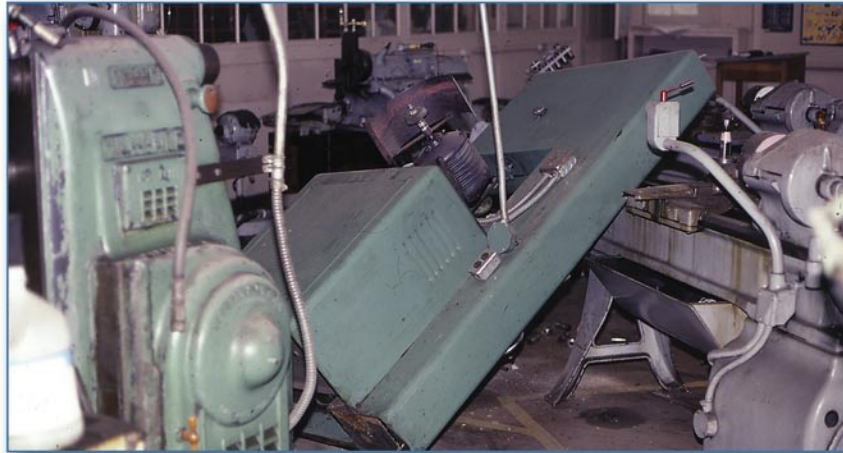

Pendant light fixtures have sometimes fallen if they are insecurely attached and not designed to swing freely (see Figure 4-12). Sudden breakage of large glass areas is a specific hazard because of the dense occupancy in many school rooms; design of glazing to resist wind-borne debris and physical attack may also assist in protecting it from earthquake motion. This kind of damage has been significant in California schools that have suffered recent earthquakes.

Heavy hung lath and plaster ceilings in older auditoriums (and assembly buildings) can be dangerous and need careful inspection of their attachment and materials. If deficient in safety, replacement is the only acceptable solution (see Figure 4-13).



Figure 4-12  
Fallen light fixtures, library, Coalinga, CA, 1983  
SOURCE: GARY MCGAVIN, REDLANDS, CA



Figure 4-13  
Fallen heavy lath and  
plaster ceiling across  
auditorium seating,  
Northridge, CA, 1994  
SOURCE: GARY MCGAVIN,  
REDLANDS, CA

### 4.3.2 Earthquake Damage to Schools

Most information on earthquake damage to schools comes from California. Its high incidence of earthquake activity has also resulted in sophisticated seismic building codes for all buildings and special plan checking and inspection requirements, enforced by the state, for school buildings.

Considering the number of significant earthquakes in California since the early years of the 20th century, there has been remarkably little severe structural damage to schools, except in the Long Beach earthquake of 1933, and there have been very few casualties. In California, no school child has been killed or seriously injured since 1933. This good fortune has been primarily because all major California earthquakes since 1925 have occurred outside school hours (see Figure 4-14).

Figure 4-14  
Damage to the John Muir  
School, Long Beach, CA,  
1933

SOURCE: NATIONAL INFORMATION  
SERVICE FOR EARTHQUAKE  
ENGINEERING, UNIVERSITY OF  
CALIFORNIA, BERKELEY



In the Long Beach earthquake that occurred at 5:55 p.m. on March 10, 1933, damage to unreinforced masonry school buildings was so severe that there would have been many casualties had they been occupied. As a result, the state passed the Field Act within a month of the earthquake (see Figures 4-15 and 4-16).



Figure 4-15  
Damage to shop building,  
Compton Junior High  
School, Long Beach, CA,  
1933

SOURCE: NATIONAL INFORMATION  
SERVICE FOR EARTHQUAKE  
ENGINEERING, UNIVERSITY OF  
CALIFORNIA, BERKELEY



Figure 4-16  
A dangerous passage way between two  
buildings, Polytechnic High School, Long  
Beach, CA, 1933

SOURCE: NATIONAL INFORMATION SERVICE FOR  
EARTHQUAKE ENGINEERING, UNIVERSITY OF  
CALIFORNIA, BERKELEY

The Field Act required that all public school buildings be designed by a California licensed architect or structural engineer; all plans were to be checked by the then Department of General Services and construction was to be continuously inspected by qualified independent inspectors retained by the local school board. The Department of General Services set up a special division, staffed by structural engineers, to administer the provisions of the Act. The Field Act, which is still enforced today, has greatly reduced structural damage to California schools.

The earthquake also resulted in the passage of the Riley Act, which governed all buildings, with a few exceptions. The Riley Act required all buildings in the state to be designed to a specified lateral force, and effectively outlawed unreinforced masonry construction.

In 1952, a series of earthquakes occurred in Kern County, in the Bakersfield region, some 70 miles north of Los Angeles. Two groups of earthquakes occurred; the first, in the last week of July, included one with a magnitude of 7.6 on the Richter scale. The second group occurred in late August, and one earthquake, near the city of Bakersfield, had a magnitude of 5.9 on the Richter scale. There were 10 deaths in the July earthquake and 2 in the August earthquake.

This earthquake was of particular interest because the incidence of school damage might represent that of comparable earthquakes striking in regions today where seismic codes have not been adopted and enforced due to the rarity of seismic events (see Figures 4-17, 4-18, and 4-19).

There were no casualties in schools in 1952, because these earthquakes also occurred outside school hours. At that time, the Field Act had been in force for nearly 20 years, and the newer schools had been constructed to conform to its requirements. Of the 58 masonry schools in the region, 18 had been constructed after the Field Act. Of these, one suffered moderate damage; this school was constructed of grouted reinforced brick masonry and in-



Figure 4-17  
A heavy corridor lintel  
ready to fall, Emerson  
School, Bakersfield, Kern  
County, CA, 1952

SOURCE: NATIONAL INFORMATION  
SERVICE FOR EARTHQUAKE  
ENGINEERING, UNIVERSITY OF  
CALIFORNIA, BERKELEY



Figure 4-18  
Overturned shop equipment and failed  
light fixtures, Kern County, CA, 1952

SOURCE: NATIONAL INFORMATION SERVICE FOR  
EARTHQUAKE ENGINEERING, UNIVERSITY OF  
CALIFORNIA, BERKELEY

Figure 4-19  
Destroyed exit corridor,  
Bakersfield, Kern County,  
CA, 1952

SOURCE: NATIONAL INFORMATION  
SERVICE FOR EARTHQUAKE  
ENGINEERING, UNIVERSITY OF  
CALIFORNIA, BERKELEY



curred approximately 1 percent damage. Of the 40 non-Field Act schools, 1 collapsed, 15 suffered severe damage, and 14 suffered moderate damage. In the Bakersfield City School District, 175 classrooms and 6,500 students were displaced and only about 10 classrooms could quickly be put back in service. There was considerable nonstructural damage to ceilings and light fixtures.

In other states, similar damage to unreinforced masonry (URM) and early reinforced concrete structures occurred. Considerable damage to schools occurred in Helena, Montana, in 1935 (see Figure 4-20). In 1949, severe damage was inflicted on several URM schools, resulting in one fatality, in Seattle (see Figures 4-21 and 4-22). At Puyallup High School, three boys on the stage just managed to escape when the roof collapsed (see Figure 4-23). Widespread damage to furniture and contents also occurred (see Figure 4-24).





Figure 4-20  
Typical school damage,  
Helena, MT, 1935

SOURCE: NATIONAL INFORMATION  
SERVICE FOR EARTHQUAKE  
ENGINEERING, UNIVERSITY OF  
CALIFORNIA, BERKELEY

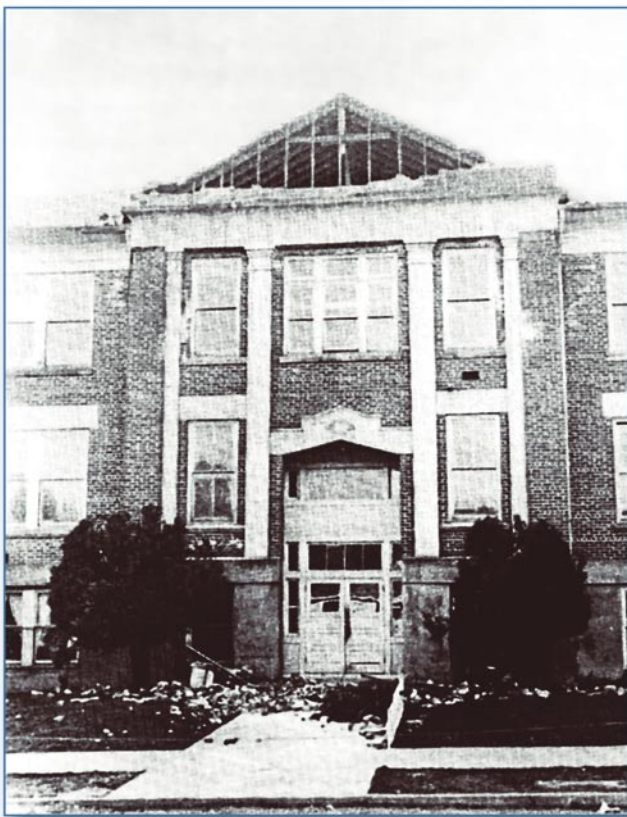

Figure 4-21  
The student body president was killed here by  
falling brickwork, Seattle, WA, 1949.

SOURCE: EARTHQUAKE ENGINEERING RESEARCH INSTITUTE,  
OAKLAND, CA. PHOTO FROM A.E. MILLER COLLECTION,  
UNIVERSITY OF WASHINGTON ARCHIVES

Figure 4-22  
Another dangerous entry  
collapse, Seattle, WA,  
1949

SOURCE: EARTHQUAKE  
ENGINEERING RESEARCH  
INSTITUTE, OAKLAND, CA. PHOTO  
FROM SEATTLE SCHOOL ARCHIVES



Figure 4-23  
Collapse of roof over stage, Seattle, WA,  
1949

SOURCE: NATIONAL INFORMATION SERVICE FOR  
EARTHQUAKE ENGINEERING, UNIVERSITY OF CALIFORNIA,  
BERKELEY





Figure 4-24  
Damage to library shelving,  
Seattle, WA, 1949

SOURCE: NATIONAL INFORMATION  
SERVICE FOR EARTHQUAKE  
ENGINEERING, UNIVERSITY OF  
CALIFORNIA, BERKELEY

### 4.3.3 Significant School Damage in Recent U.S. Earthquakes

In the Anchorage, Alaska, earthquake of 1964, which registered 8.4 on the Richter scale, a number of public schools were damaged, but there were no collapses. The earthquake occurred on Good Friday at 5:36 p.m., when the schools were unoccupied. The most seriously damaged school was that shown previously in Figure 4-1; the school was subsequently demolished. At the West Anchorage High School (see Figures 4-25 and 4-26), a two-story nonductile concrete frame and shear wall classroom wing suffered severe structural damage and near total failure in a number of columns. Structural distortion also created a number of severe glass breakages. The second floor was removed during reconstruction and the first floor was repaired and retained.

In the San Fernando, CA, earthquake of 1971, there were no injuries and no schools collapsed; however, the earthquake caused \$13.2 million in damages (in 1971 dollars), and 100 pre-Field Act schools were demolished within 1½ years after the earthquake.

Figure 4-25  
Severe structural damage to  
the West Anchorage High  
School, Anchorage, AK,  
1964

SOURCE: NATIONAL INFORMATION  
SERVICE FOR EARTHQUAKE  
ENGINEERING, UNIVERSITY OF  
CALIFORNIA, BERKELEY



Figure 4-26  
Brittle failure at nonductile concrete column,  
West Anchorage High School, 1964

SOURCE: NATIONAL INFORMATION SERVICE FOR  
EARTHQUAKE ENGINEERING, UNIVERSITY OF CALIFORNIA,  
BERKELEY



A survey of 1,544 public school buildings showed that only three schools sustained severe damage as a result of the Loma Prieta (San Francisco Bay area) earthquake of 1989. A portable classroom near Santa Cruz was rocked off its unbraced and unanchored supports. An elementary school in Los Gatos was subjected to severe shaking, but damage was limited to non-structural and contents shifting, except in one classroom wing, where ground heaving raised and cracked the floor slab, jamming a door and window shut.

A San Francisco High School suffered severe structural cracking. This school was constructed in 1920 as an automobile manufacturing building and was structurally upgraded in 1947. Restoration costs were estimated at \$10 million. Total restorations for the San Francisco school district were estimated to be \$30 million; for Oakland, the district losses were \$1.5 million. Though undamaged, an elementary school in San Francisco was closed because of the potential collapse of a nearby elevated freeway structure, which was considered a hazard to the building and its occupants. Hazards from unbraced and unanchored nonstructural items were evident in many buildings, including pendant-mounted light fixtures, suspended acoustical ceilings, and unanchored furniture and contents such as filing cabinets and shelving.

In the Northridge, California, earthquake of 1994, state inspectors red-tagged 24 school buildings and yellow-tagged 82 school buildings, although this was later considered

### TAGGING

A post-earthquake evaluation procedure has been developed in California that employs colored placards, or "tags," affixed to buildings, that show that the building has been inspected and indicate the level of safety. The colors of the tags and their safety level classification follow:



A red tag indicates **UNSAFE**: Extreme hazard, may collapse. Imminent danger of collapse from an aftershock. Unsafe for occupancy or entry, except by authorities.



A yellow tag indicates **LIMITED ENTRY**: Dangerous condition believed to be present. Entry by owner permitted only for emergency purposes and only at own risk. No usage on continuous basis. Entry by public not permitted. Possible major aftershock hazard.



A green tag indicates **INSPECTED**: No apparent hazard found, although repairs may be required. Original lateral load capacity not significantly decreased. No restriction on use or occupancy.

over-conservative. No structural elements collapsed. There was, however, considerable nonstructural damage that was costly to repair, resulting in the closure of a number of schools and, if the schools had been in session, would have caused casualties. The Field Act focused on structural design and construction, and only recently were nonstructural elements included in the scope of the Act (see Figures 4-27, 4-28, and 4-29).

Figure 4-27  
Ceiling damage,  
Northridge, CA, 1994

SOURCE: GARY MCGAVIN,  
REDLANDS, CA





Figure 4-28  
Damage to ceramic kiln, including fractured gas  
line, Northridge, CA, 1994

SOURCE: GARY MCGAVIN, REDLANDS, CA

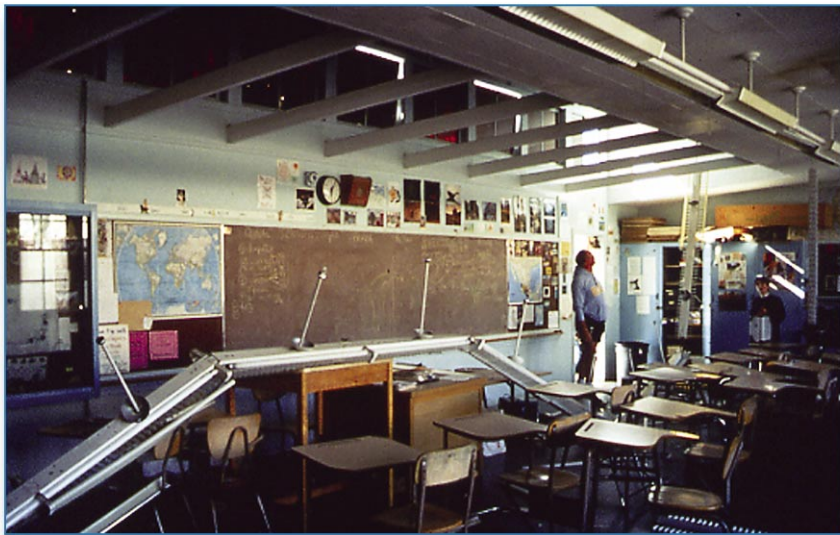

Figure 4-29  
Line of suspended light  
fixtures fallen on teacher's  
station, Northridge, CA,  
1994

SOURCE: EARTHQUAKE  
ENGINEERING RESEARCH INSTITUTE,  
OAKLAND, CA, AND GARY  
MCGAVIN, REDLANDS, CA

#### **4.3.4 Consequences: Casualties, Financial Loss, and Operational Disruption**

Casualties in California schools have been few and minor, primarily due to regulation by the Field Act and by chance. Significant Alaskan and California earthquakes, from Santa Barbara (1925) to Northridge (1984) have all occurred outside of school hours: therefore, the effects of a major earthquake when schools are fully occupied have not been experienced. In other regions, casualties have been few; in the Seattle earthquake of 1949, two school children died in Tacoma when bricks cascaded onto exit ways. The closure of Seattle schools for spring vacation had averted fatalities and serious injuries in similar building failures at a number of sites in the city.

The impact of school closure as a result of damage is the loss of public service and severe disruption for students, faculty, and staff. Ultimately, the taxpayer will pay the costs, but this is spread over the whole community, the state, and the Federal Government. Typically, schools are self-insured and do not purchase insurance on the private market. For a private school, closure means a serious loss of revenue; in addition to the costs of repair, the students may not return if the school is closed for a long period of time. Therefore, obtaining insurance may be a prudent measure.

As with any of the natural hazards reviewed in this manual, an earthquake can close a school, keeping the school district from doing its main job (i.e., teaching students). The length of the closure will depend on the severity and types of damage. It may also depend on whether the building was fully insured or whether disaster assistance will be available quickly enough to allow speedy repairs and reconstruction. Sometimes repairs are put on hold, pending a decision on whether the building should be repaired or condemned.

There are also social and psychological factors, such as difficulties imposed on students, parents, faculty, staff, and the administration during the time the school is not usable. This is illustrated by the following quotation that, although it refers directly to hurricanes, also applies to earthquakes and other disasters.



- “From the standpoint of children and families, after an impact is a particularly bad time for schools to be closed. Damaged homes and neighborhoods are dangerous and depressing places. Children are often left with no safe place to play when yards, playgrounds and recreational programs are lost, no one to play with when playmates and friends are forced to dislocate and parents are too busy dealing with survival and rebuilding issues to have much time for them.”
- “The closing of a local school is highly disruptive to social networks and, if it becomes permanent, can rob a neighborhood of its identity and cohesion. One of the most dramatic effects that can occur to a severely impacted community is when a school is closed for a long time, maybe even permanently, due to regional depopulation after homes are destroyed.”
- “Getting schools reopened quickly has been found to be an important step toward rebuilding the community as a whole.”
- “An understudied area is the long-term effect of major disasters on the education and development of children.”
- “The shock of being uprooted and moved to a new school, even temporarily, can be very difficult for children. The effects can be particularly traumatic if they occur at a critical developmental time, such as the senior year with its preparation for college and graduation festivities.”

SOURCE: THE HEINZ CENTER, *HUMAN LINKS TO COASTAL DISASTERS*, H. JOHN HEINZ III CENTER FOR SCIENCE, ECONOMICS AND THE ENVIRONMENT, WASHINGTON, DC, 2002

#### **4.4 SCOPE, EFFECTIVENESS, AND LIMITATIONS OF CODES**

Building design in the United States has typically been regulated by the provisions of one of three model building codes: the National Building Code (NBC), published by Building Officials and Code Administrators International (BOCA); the Standard Building Code (SBC), published by Southern Building Code Congress International (SBCCI); and the Uniform Building Code (UBC), published by International Conference of Building Officials (ICBO). The UBC tended to be most commonly adopted in the Western U.S., the NBC was used predominantly in the Northeast and Midwest, and the SBC was most commonly used in the South and Southeast.

#### 4.4.1 The Background of Seismic Codes

Seismic codes currently in use in the United States have been very highly developed since the initial regulations for the protection of buildings against earthquakes first appeared in the UBC in California in 1927. Beginning in the 1950s, the earthquake-resistant design provisions of the three model codes used as the basis for building regulation in the U.S. were based on recommendations developed by the seismology committee of the Structural Engineers Association of California (SEAOC) and contained in their publication known as the “*Blue Book*.”

FEMA, one of the lead agencies in NEHRP, provided support for updating and continued development of a seminal document, ATC-3-06, produced by the Applied Technology Council (ATC), a non-profit research foundation set up after the San Fernando earthquake of 1978 to work on recommended improvements in the seismic building code. The ATC-3-06 document, now titled the *NEHRP Recommended Provisions for Seismic Regulations for New Buildings and Other Structures*, has been updated every 3 years since 1985. These provisions were adopted by the SBC in 1992 and, in 1997, the seismic provisions of the UBC and NEHRP were combined.

Depending on which code regulated the structural design, seismic design was conducted in accordance with one of two significantly different sets of provisions. Seismic design of structures under the UBC is governed by provisions developed by the SEAOC and structures designed under the NBC and the SBC are governed by somewhat different provisions developed by the Building Seismic Safety Council (BSSC) of the National Institute of Building Sciences (NIBS). Following a major effort by both groups, the 1997 editions of both the UBC and NEHRP *Provisions* resulted in a unification of these design approaches.

Meanwhile, after years of negotiation, all three model code entities have now consolidated their services, products, and operations into one member service operation, the International

Code Council. The ICC first published a unified model building code, the International Building Code (IBC) in 2000, with revisions planned on a 3-year basis. The seismic provisions of the IBC are based primarily on the unified UBC/NEHRP provisions. Subsequently, however, the National Fire Protection Association has also developed a model building code, the NFPA 5000, *Building Construction and Safety Code*, first issued in 2002. The American Society of Civil Engineers (ASCE) published ASCE 7 *Minimum Design Loads for Buildings and Other Structures*, which gives requirements for dead, live, soil, flood, wind, snow, rain, ice, and earthquake loads. ASCE 7 is referenced in the UBC, IBC, and NFPA model codes.

Thus the seismic codes are in a state of transition, and the intent of developing a single, nationally applicable model code has not yet been realized. Currently, jurisdictions are faced with continuing with one of the three original model codes, which will become increasingly out of date because they will no longer be revised and published, or adopting the IBC or NFPA 5000 model codes. Some large municipal jurisdictions will continue to produce their own codes, which will be derived from some combination of the model codes.

As noted above, seismic codes have the primary purpose of establishing the minimum lateral forces for which buildings must be designed. To do this, the code provides an equation, in which the vibrating seismic forces are represented by a single static force, called the “base shear,” applied at the base of a building. Variables in the equation enable the designer to adjust the design force for varying site seismicity, alternative soil conditions, different structural and nonstructural systems and materials, different building heights, and occupancies of varying importance.

In addition, the codes have a number of provisions that deal with the detailed design of some building components, such as reinforcing steel in concrete structures and welding in steel structures. Because the actual forces on the building are

estimated in a very simplified manner, a large safety factor is introduced, so that the design forces tend to be over-estimated.

#### **4.4.2 Seismic Codes and Schools**

Seismic codes are concerned primarily with types of structures and there are a few provisions that relate to specific occupancies. The IBC categorizes school buildings as Type II: "...buildings and other structures that represent a substantial hazard to human life in the event of failure..." Type II buildings are assigned an Importance Factor of 1.25. This means that the seismic force calculated by use of the Equivalent Lateral Force procedure would be multiplied by 1.25 so that schools are designed to a higher standard than ordinary buildings.

As previously mentioned, in California, K-12 schools are regulated by the Field Act, which is the only significant legislation that singles out the design and construction of schools to resist earthquakes and is an important model. However, the Field Act is not a code; it requires that schools be designed by a licensed architect or structural engineer, that plans and specifications be checked by a special office of the Department of the State Architect, and that independent testing and inspection be conducted during construction. The Greene/Garrison Act of 1976 made the Field Act provisions retroactive and required that all non-conforming schools be brought up to the current code level.

Implementing the nonstructural provisions of the seismic code will significantly reduce damage to the nonstructural components and reduce the possibility of closing the school because of ceiling and lighting damage, partition failures, and loss of essential utilities. In this instance, the code goes somewhat beyond the structural objective of only reducing the risk of casualties. However, this is an important issue for schools, for recent experience in earthquakes has shown that nonstructural damage to schools is dangerous to the occupants, costly to repair, and operationally disruptive.

### 4.4.3 The Effectiveness of Seismic Codes

Building codes originated in the effort to reduce risk to health and safety, rather than reducing property loss, but, as they evolved, they indirectly and directly assisted in reducing building damage. They establish the minimum standards for safety commensurate with affordability and other impacts such as measures that might create extreme inconvenience to occupants or seriously reduce the building's functional efficiency.

Among engineers, there is general agreement that, based on California's earthquake experience, regulation through a properly enforced seismic code has largely fulfilled the intent of ensuring an acceptable level of safety against death and injury. The performance of school buildings in recent California earthquakes substantiates this; structural damage has been minimal in the more recently designed schools. Application of the Field Act ensures that schools are designed and constructed to more rigorous standards than most other buildings.

Some qualifications, however, follow:

- Even in California, the standards of code enforcement vary considerably, and smaller jurisdictions may not have trained engineering staff to conduct effective plan checks and inspections.
- The nonstructural provisions of the seismic codes are often not adopted at the local level. Even in California, nonstructural components have not been regulated to the same level of care as structural components, and have been the cause of considerable economic loss and disruption of operation.
- In regions of moderate earthquake risk that have recently introduced seismic design regulation, the code may be misinterpreted and design errors made due to inexperience of both designers and building officials.

## **4.5 EVALUATING EXISTING SCHOOLS FOR SEISMIC RISK AND SPECIFIC RISK REDUCTION METHODS**

A set of well developed procedures exists for the seismic evaluation of buildings, and a number of FEMA-sponsored publications are available to assist in the evaluation process. These guides have been developed since the 1980s and have been used extensively. However, this section also provides a simple seismic evaluation checklist that focuses specifically on schools.

The procedures are listed below in the order in which they would be used, starting with a simple screening process.

### **4.5.1 Rapid Visual Screening**

The Rapid Screening Procedure (RSP) was published in FEMA 154, *Rapid Visual Screening of Buildings for Potential Seismic Hazards: a Handbook*. The procedure is intended as an initial step in identifying hazardous buildings and their deficiencies. Buildings identified by this procedure to be potentially hazardous must be examined in more detail by a professional engineer experienced in seismic design. Because this screening is aimed at providing a low cost method of identifying large inventories of potentially hazardous buildings for public and private owners, and thus reducing the number of buildings that should be subject to a more detailed evaluation, it is designed to be performed from the street without benefit of entry into a building.

The screening process can be completed in 20-30 minutes for each building. In some cases, hazardous details may not be visible, and seismically hazardous structures will not be identified as such. Nonstructural interior components are not evaluated. Conversely, buildings identified as potentially hazardous may prove to be adequate.

Typically, a school district will not be faced with the problem of lack of building access and the RSP procedure is most useful for

large school districts, municipalities, or even states that wish to get an economical preliminary evaluation of the seismic risks faced by their school inventory. The procedure is not intended to provide a definitive evaluation of the individual buildings.

The methodology is based on a visual survey of the building and a data collection form used to provide critical information. The collection form includes space for sketches and a photo of the building as well as pertinent earthquake-safety related data. The FEMA handbook for the procedure provides the inspector with background information and data required to complete the form (see Figure 4-30). The procedure is designed to be usable by people with some knowledge of buildings who are not necessarily professional architects or engineers or familiar with seismic design. It has been successfully applied by architectural and engineering students. The methodology enables the inspector to identify significant seismic-related defects and to arrive at a numerical score, with a hazard ranking of 1-6 (see Figure 4-30).

The ranking of surveyed buildings can be divided into two categories: those acceptable as to risk to life safety or those that may be seismically hazardous and should be studied further. A score of 2 is suggested as a “cut-off” based on current seismic knowledge (i.e., if a building has a structural “score” of 2 or less, it should be investigated by a structural engineer experienced in seismic design).

<b>ATC-21/</b> (NEHRP Map Areas 5, 6, 7 High)		<b>NUMBER</b> <u>123</u>												
<b>Rapid Visual Screening of Seismically Hazardous Buildings</b>		<b>NAME</b> <u>EAST SANDY ELEMENTARY</u> <b>ADDRESS</b> <u>SANDY, UT</u> <b>ZIP</b> <u>84089</u> <b>USE</b> <u>SCHOOL</u> <b>YEAR OCCUPIED</b> <u>1969</u> <b>NO. STORIES</b> <u>1</u> <b>U.B.C. YEAR</b> <u>1967</u> <b>TOTAL FLOOR AREA (sq. ft.)</b> <u>60,540</u> <b>INSPECTOR</b> <u>J.M.</u> <b>DATE</b> <u>10/4/90</u>												
		<b>SEISMIC RATING:</b> <b>GOOD</b> <input checked="" type="checkbox"/> <b>FAIR</b> <input type="checkbox"/> <b>POOR</b> <input type="checkbox"/> <b>VERY POOR</b> <input type="checkbox"/>												
<b>SCALE</b>		<b>COMMENTS:</b> <u>ROOF DIAPHRAGM NOT CONNECTED TO WALLS AT JOIST BEARING ENDS (PERPENDICULAR TO JOISTS). DIAPHRAGM IS CONNECTED TO WALLS PARALLEL TO JOISTS. ROOF DECK WELDED AND BUTTON PUNCHED TO PROVIDE DIAPHRAGM.</u>												
<b>PHOTO</b>														
<b>OCCUPANCY</b>		<b>STRUCTURAL SCORES AND MODIFIES</b>												
Residential	No. Persons	<b>BUILDING TYPE</b>	<b>W</b>	<b>S1</b>	<b>S2</b>	<b>S3</b>	<b>S4</b>	<b>C1</b>	<b>C2</b>	<b>CS/C5</b>	<b>PC1</b>	<b>PC2</b>	<b>RM</b>	<b>URM</b>
Commercial	0-10	Basic Score	4.5	4.5	3.0	5.5	3.5	2.0	3.0	1.5	2.0	1.5	3.0	1.0
Office	11-100	High Rise	N/A	-2.0	-1.0	N/A	-1.0	-1.0	-1.0	-0.5	-N/A	-0.5	-1.0	-0.5
Industrial	100+	Poor Condition	-0.5	-0.5	-0.5	-0.5	-0.5	-0.5	-0.5	-0.5	-0.5	-0.5	-0.5	-0.5
Pub. Assem.		Vect. Irregularity	-0.5	-0.5	-0.5	-0.5	-0.5	-1.0	-0.5	-0.5	-1.0	-1.0	-0.5	-0.5
School		Soft Story	-1.0	-2.5	-2.0	-1.0	-2.0	-2.0	-2.0	-1.0	-1.0	-2.0	-2.0	-1.0
Govt. Bldg.		Torsion	-1.0	-2.0	-1.0	-1.0	-1.0	-1.0	-1.0	-1.0	-1.0	-1.0	-1.0	-1.0
Emer. Serv.		Plan Irregularity	-1.0	-0.5	-0.5	-0.5	-0.5	-0.5	-0.5	-0.5	-1.0	-1.0	-1.0	-1.0
Historic Bldg.		Pounding	N/A	-0.5	-0.5	N/A	-0.5	-0.5	N/A	N/A	N/A	-0.5	N/A	N/A
Non Structural	<input type="checkbox"/>	Large Heavy Cladding	N/A	-2.0	N/A	N/A	N/A	-1.0	N/A	N/A	N/A	-1.0	N/A	N/A
Falling Hazard		Short Columns	N/A	N/A	N/A	N/A	N/A	-1.0	-1.0	-1.0	-N/A	-1.0	N/A	N/A
		Post Benchmark Year	+2.0	+2.0	+2.0	+2.0	+2.0	+2.0	+2.0	N/A	+2.0	+2.0	+2.0	N/A
<b>DATA CONFIDENCE</b>		SL2	-0.3	-0.3	-0.3	-0.3	-0.3	-0.3	-0.3	-0.3	-0.3	-0.3	-0.3	-0.3
* - Estimated, Subjective, or Unreliable Data		SL3	-0.6	-0.6	-0.6	-0.6	-0.6	-0.6	-0.6	-0.6	-0.6	-0.6	-0.6	-0.6
DNK - Do Not Know		SL3 & 8 to 20 stories	N/A	-0.8	-0.8	N/A	-0.8	-0.8	-0.8	-0.8	N/A	-0.8	-0.8	-0.8
		<b>FINAL SCORE</b>												<b>3.0</b>
<b>COMMENTS</b>													<b>Detailed Evaluation Required?</b> <b>YES</b> <b>NO</b>	

Figure 4-30 Example of rapid visual screening information form

SOURCE: JORDAN SCHOOL DISTRICT, SANDY, UT, RANDY HASLAM

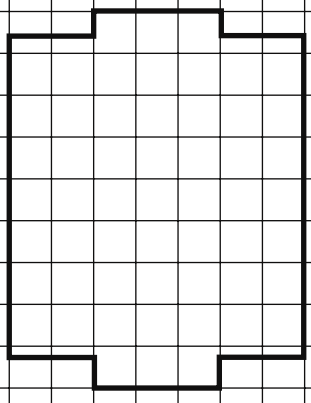

## **4.5.2 Systems Checklist for School Seismic Safety Evaluation**

Table 4-2 represents a simplified version of the FEMA 178/310 Evaluation Procedure; also see Section 4.5.3. This version focuses on structural and nonstructural systems and components that will be found in schools. The data are organized on a systems basis and are designed to establish whether the building is a potential seismic hazard and, if so, what its specific vulnerabilities are. Use of the checklist requires some seismic engineering knowledge, but the information can be obtained by inspection and no engineering calculations are necessary. The checklist can be used in conjunction with the RSP procedure, and will augment the RSP analysis because it assumes that the building will be accessible and design drawings are available. Both of these conditions are likely to be met in evaluating a public school building.

The checklist can also be useful in interdisciplinary discussions between consultants and school district personnel, and can assist in fee negotiation with the client.

Table 4-2: School Seismic Safety Evaluation Checklist

System Identifier	Evaluation Question	Evaluation Y or N or comment	Guidance	Data References
<b>1</b>	<b>Site</b>			
	Is there is an active fault on or adjacent to the site?		If suspected, site-specific geologic investigations should be performed.	Local building department, state geologist, local university, or local geotechnical consultant
	Does the site consist of stiff or dense soil or rock?		If softer soils that can lead to force amplification are suspected, site-specific geologic investigations should be performed.	Local building department, state geologist, local university, or local geotechnical consultant
	Are post-earthquake site egress and access secured?		Alternative routes, unlikely to be blocked by falling buildings, power lines, etc., are desirable.	Inspection by district personnel/architect
	Are utility and communications lifelines vulnerable to disruption and failure?		Security of the entire utility and communications network is the issue: the school may be impacted by off-site failures.	Inspection on site by district personnel and Mechanical/Electrical/Plumbing (M/E/P) consultants. For off site, contact local power and communications providers.
	Are there alternate or backup sources for vital utilities?		Increase the probability of the school remaining functional after an event, particularly if the school is used for post-earthquake shelter.	Inspection and district personnel, M/E/P consultants, and local utility suppliers
	Are building setbacks adequate to prevent battering from adjacent buildings?		Inadequate spaces between building walls may occur in dense urban settings.	FEMA 178, Section 3.4 FEMA 273, Section 2.11.10
	Is there adequate space on the site for a safe and "defensible" area of refuge from hazards for building occupants?		Outside spaces can be used as safe post-earthquake assembly areas for school occupants and possibly the community.	Inspection district personnel/architect/local emergency staff
<b>2</b>	<b>Architectural</b>			
	<b>Configuration</b>			
	Is the architectural/structural configuration regular?		Irregular vertical and horizontal configurations, such as re-entrant corners and soft first stories, may lead to significant stress concentrations.	FEMA 178, Section 3.7 FEMA 273, Section 2.7.1

Table 4-2: School Seismic Safety Evaluation Checklist (continued)

System Identifier	Evaluation Question	Evaluation Y or N or comment	Guidance	Data References
<b>Planning and Function</b>				
	Are exit routes, including stairs, protected from damage and clear from nonstructural elements or contents that might fall and block exit ways?		Schools sometimes have large unbraced lockers in hallways, or store other materials, such as tall filing cabinets or bookcases, that may block exits.	Inspection by district personnel FEMA 274, Section C11.94.4
<b>Ceilings</b>				
	Are light suspended grid ceilings braced and correctly attached at walls?		Grid ceilings easily distort (particularly in light and flexible frame structures), thus causing ceiling panels to fall.	FEMA 274, Section C11.9.4
	Are heavy plaster suspended ceilings securely supported and braced?		Heavy lath and plaster ceilings in older schools are very dangerous if poorly supported.	FEMA 274, Section C11.9.4.4
<b>Partitions and Space Division</b>				
	Are partitions that terminate at a hung ceiling braced to the structure above?		Partitions need support for out-of-plane forces and attachment to a suspended ceiling grid is inadequate.	FEMA 178, Section 10.5.2 FEMA 273, Section 11.9.2.4
	Are masonry or hollow tile partitions reinforced, particularly those surrounding exit stairs?		Heavy partitions attract strong earthquake forces because of their stiffness and mass, and are prone to damage. They are particularly dangerous around stairs and exit ways.	FEMA 273, Section 11.9.2.4
<b>Other Elements</b>				
	Are exterior entrance canopies and walkways engineered to ensure no collapse?		Post-earthquake safety of these structures is critical to ensure safe exiting after an event. Also, at certain times they may be used as gathering places and be densely occupied.	FEMA 273, Section 11.9.6
	Are parapets, appendages, etc., securely attached and braced to the building structure?		Unreinforced masonry parapets are especially vulnerable. Also include items such as cornices, signs, large satellite communication "dishes."	FEMA 273, Section 1.9.5
	Are heavy lockers, library shelves, and vertical filing cabinets that could fall on people braced to the structure?		These can topple and injure occupants, and also block exit ways.	FEMA 178, Section 10.9.5

Table 4-2: School Seismic Safety Evaluation Checklist (continued)

System Identifier	Evaluation Question	Evaluation Y or N or comment	Guidance	Data References
<b>3</b>	<b>Structural System</b>			
	Is there a continuous load path from the foundation to the roof?		This is an important characteristic to ensure good seismic performance. This also sometimes relates to irregularity in configuration.	Engineer to check design of school structure
	Does the structure provide adequate redundancy in the event of the loss of some structural supports?		Short spans with many vertical supports are desirable, but long spans are sometimes necessary and require special care in design.	FEMA 178, Section 3.1
	Is all load-bearing structural masonry reinforced according to code?		Unreinforced masonry has limited ductility and therefore cannot withstand large earthquake-induced repetitive displacements.	Engineer to check against local code requirements
	Is the structure's reinforced concrete designed to seismic code later than 1976?		The reinforced concrete codes changed in 1976, and structures designed before these codes were adopted may be inadequate.	Check date of design, and edition of code used
	Is the structure's wood frame well maintained, with little or no deterioration?		Wood framing is subject to attack by termites and water damage, which may seriously weaken the structure.	School district personnel to inspect
	Are horizontal structural members securely connected to walls and columns?		Good connections between all structural members are very important for structural integrity.	Structural engineer to check FEMA 178, Chapter 8
	Are horizontal diaphragms correctly designed and constructed with necessary chords and collectors?		Large diaphragm openings and the edges of diaphragms need careful design to ensure forces are properly transmitted to walls and frames.	Structural engineer to check FEMA 178, Chapter 7
<b>4</b>	<b>Building Envelope</b>			
	<b>Wall Cladding</b>			
	Is the building cladding attached to structural frames so that it can accommodate drift?		Frames are flexible and cladding must be detailed to accommodate calculated drifts and deformations.	FEMA 273, Section 11.1.9.4

Table 4-2: School Seismic Safety Evaluation Checklist (continued)

System Identifier	Evaluation Question	Evaluation Y or N or comment	Guidance	Data References
	Are heavy veneer facing materials such as brick or stone securely attached to the structural walls?		Shear wall structures are very stiff and carry large earthquake forces; heavy attachments must be securely attached.	Structural engineer to check design and field condition
	Are heavy roofing materials such as tile and slate securely attached to the structure?		Installation of these materials over points of egress may be dangerous.	IBC Table 1507.3.7
<b>Glazing</b>				
	Are glazing and other panels attached so that they can accommodate drift?		Glazing must be installed with sufficient bite, and adequate space between glass and metal.	FEMA 274, Section C11.9.1.5
	Is the glazing material inserted into a surrounding structure that limits drift and racking?		Glazing is dependent on the surrounding structure to limit racking.	Structural engineer to inspect framing and structural conditions
<b>5</b>	<b>Utilities</b>			
	Are building utility distribution systems well supported and adequately braced?		Flexible connections may be necessary where utilities enter the building.	FEMA 273, Section 11.10.8
<b>6</b>	<b>Mechanical</b>			
	Is heavy mechanical equipment adequately secured and isolators provided with snubbers?		Spring isolated equipment must be restrained from jumping off isolators.	FEMA 174, Section 11.10.1
	Is the heating piping properly braced and provided with expansion joints?		Increase likelihood of continued post-event function.	Inspection by school district personnel and M/E/P consultants
	Is ductwork properly supported and braced?		Increase likelihood of continued post-event function.	Inspection by school district personnel and M/E/P consultants
	Are water heaters and other tanks securely braced?		Gas heaters or tanks with flammable or hazardous materials must be secured against toppling.	FEMA 174

Table 4-2: School Seismic Safety Evaluation Checklist (continued)

System Identifier	Evaluation Question	Evaluation Y or N or comment	Guidance	Data References
<b>7</b>	<b>Plumbing</b>			
	Are plumbing lines adequately supported and braced?		Protection of joints is especially important.	FEMA 174, Section 11.10.3
	Is fire protection piping correctly installed and braced?		Increase likelihood of continued post-event function.	Inspection by school district personnel and M/E/P consultants
	Are ducts and piping that pass through seismic joints minimized and provided with flexible connections?		Differential movement between sections of the building can cause breakage and leaks in pipes and ducts if no provision is made for movement. If walls at joint are firewalls, penetrations should be fireproofed.	FEMA 174
<b>8</b>	<b>Electrical</b>			
	Are suspended lighting fixtures securely attached, braced, or designed to sway safely?		Older suspended lighting fixtures have performed badly in earthquakes and are an injury hazard.	FEMA 174 FEMA 273, Section 11.10.9.1
	Are light fixtures supported in an integrated ceiling, braced, and provided with safety wires?		Light fixtures within a grid often fall when the grid is distorted, unless the fixtures are secured with safety wires.	FEMA 174 FEMA 273, Section 11.10.4.1
	Is heavy electrical equipment adequately secured?		Switch gear and transformers are heavy and failure can shut down the electrical system.	FEMA 273, Section 11.10.7
<b>9</b>	<b>Fire Alarm</b>			
	Is the fire alarm system connected to a secondary power supply?		This is also necessary to support daily operational needs, including lighting, heating, communications, etc., and also if the building is used as a post-earthquake shelter.	Inspection by district maintenance personnel and M/E/P consultants
	Is the fire alarm system provided with a battery backup system capable of operating the system for 24 hours after power loss?		Required by code even if the building will not be used after an event, so that the school can be evacuated.	Inspection by district maintenance personnel and M/E/P consultants

Table 4-2: School Seismic Safety Evaluation Checklist (continued)

System Identifier	Evaluation Question	Evaluation Y or N or comment	Guidance	Data References
<b>10</b>	<b>Communications and IT Systems</b>			
	Are communications components adequately braced and supported?		Post-event communications are vital for issuing instructions to school administrators, students, faculty, and staff. Some components, such as large satellite dish antennas, are easily damaged if not properly supported.	FEMA 273, Section 11.10.8
	Are building intercom systems connected to a standby generator?		Necessary to enable continued use of utility power, whether earthquake-caused or not.	Inspection by maintenance personnel and M/E/P consultants
<b>11</b>	<b>Equipment Operations and Maintenance</b>			
<b>12</b>	<b>Security Systems</b>			
<b>13</b>	<b>Security Master Plan</b>			

### 4.5.3 The NEHRP Handbook for the Seismic Evaluation of Existing Buildings (FEMA 178/310)

For those buildings that, as the result of a preliminary screening, are candidates for a more detailed investigation, the BSSC developed a procedure for the systematic evaluation of any type of building (FEMA 178 and 310, *The NEHRP Handbook for the Seismic Evaluation of Existing Buildings*). This procedure can be used to evaluate the structural and nonstructural systems and components for any type or size of individual school building. However, the procedure focuses on evaluating whether the building is a potential earthquake-related risk to human life posed by the building

or a building component. The procedure does not address code compliance, damage control, or other aspects of seismic performance not related to life safety.

The handbook methodology involves the use of two sets of questions: one set addresses the characteristics of 15 common structural types and the other, instead of addressing complete structural systems, deals with structural elements, foundations, geologic site hazards, and nonstructural components and systems. These questions are designed to uncover the flaws and weaknesses of a building, and are in the form of positive evaluation statements describing building characteristics that are essential if the failures observed in past earthquakes are to be avoided. The evaluating architect or engineer should address each statement and determine whether it is true or false. True statements identify conditions that are acceptable and false statements identify conditions in need of further investigation. The handbook also specifies a process for dealing with statements that are found to be false.

The evaluation requires some basic structural calculations and a site visit and follow-up field work will be necessary. The primary product of the evaluation is the identification of weak links in the building that could precipitate structural or component failure. Although the procedure will provide guidance on structural deficiencies, it is not intended to identify appropriate seismic retrofit options. The design engineer needs to understand the overall deficiencies of the building before attempting to identify retrofit design approaches. The overall deficiencies may be due to a combination of component deficiencies, inherent adverse design, construction failures, deterioration, or a serious weak link.

## **4.6 EARTHQUAKE RISK REDUCTION METHODS**

Although the general principles of design are similar for new or existing schools, there are differences in code requirements and



overall project delivery processes that reflect the design freedoms of new buildings and the constraints of existing ones.

Engineering of structural and nonstructural risk reduction methods is similar for new and existing schools. New school design offers the possibility of construction on a site subject to less ground motion because of better soil conditions or further proximity to a fault. It can be designed with the most appropriate structural system, using known and tested materials and a good building configuration. These possibilities are not available when retrofitting an existing school; the building may have been designed to an obsolete seismic code or no code at all, its materials may be questionable, and the building configuration and structural system may be inappropriate. Therefore, the protection of an existing school must start with a careful evaluation of its vulnerability. Seismic retrofitting is expensive and time-consuming; however, the adoption of an incremental retrofit procedure, as described in Section 4.6.2, can help to keep time and cost within reasonable limits.

#### **4.6.1 Risk Reduction for New Schools**

Methods of design for earthquake protection involve three main aspects of the school: its site, its structure, and its nonstructural components.

In terms of risk reduction, the first priority is the implementation of measures that will reduce the risk of casualties to students, staff, and visitors. The second priority is the reduction of damage that leads to downtime and disruption. The third priority is the reduction of damage and repair costs.

Alternative measures to achieve these objectives are as follows, in ascending order of cost:

- New Schools Regulated by Seismic Codes
  - Provide personal protection training.

- Evaluate code provisions against risk priorities. Evaluate whether design to current code will meet acceptable risk objectives for damage costs and reduction of downtime.
  - Consider adopting California’s Field Act model for quality control of design and construction; can be administered by a single district with specification provisions for inspection in contract documents.
  - Use performance-based design procedures if code-based design does not meet acceptable risk objectives.
- New Schools Not Regulated by Seismic Codes
- Provide personal protection training.
  - Design to appropriate code standards on a voluntary basis.
  - Use performance-based design procedures to meet acceptable risk objectives.
  - Consider adoption of seismic code; requires community-wide cooperation.

Damage reduction is common to all the objectives. The following sections give an overview of the design strategies that are used to achieve acceptable levels of protection in new schools.

**School Sites.** Protection of schools and their occupants from earthquakes depends on correct seismic design and construction to resist the estimated earthquake forces that the building could encounter at its site. Because ground motion from a single earthquake may vary considerably, depending on the nature of the soil and the distance of the building from known earthquake faults, careful site selection is a critical first step in reducing the forces on the building, although a single school site or a small district will rarely have this option. School sites are generally selected based on factors such as availability, served student population, cost, convenience of access for the school students and staff, and general demographic concerns rather than seismicity. However, a large district that is developing a multi-school plan of new facilities

should include recognition of any natural hazard vulnerabilities as a factor in the evaluation of alternative sites. A school district can reduce its seismic vulnerability by reducing the intensity of earthquake shaking to be expected at a site over the life of the building. There are several ways in which this can be accomplished:

- Locate the building in an area of lower seismicity, where earthquakes occur less frequently or with typically smaller intensities. Although it would be very rare for a school district to make a site selection decision based solely on seismic risk, moving a school even a few miles in some cases can make a big difference to its seismic hazard, such as locating a school within 1 mile of a major fault versus being 5 to 10 miles away from it.
- Locate the building on a soil type that reduces the hazard. Local soil profiles can be highly variable, especially near water, on sloped surfaces, or close to faults. In an extreme case, siting on poor soils can lead to liquefaction, land sliding, or lateral spreading of the soil. Frequently, similar buildings located less than 1 mile apart have performed in dramatically different ways because of differing soil conditions in earthquakes. Even when soil-related geologic hazards are not present, earthquake motions that have to travel through softer soils will be amplified more than those traveling through firm soils or rock. If general knowledge of site conditions is a concern, the effects of soil hazard on risk should be determined by the use of geotechnical and structural engineers to assess the potential vulnerabilities associated with differing site conditions. Variables in vulnerabilities should be weighed against the costs, both direct and indirect, of locating the facility on soils that will result in better performance.
- Engineer the building site to increase building performance and reduce vulnerability. If building relocation to an area of lower seismicity or to an area with a better natural soil profile

In the late 1960s, the small school district of Portola Valley, California, was faced with declining enrollment for its intermediate school, which was also outdated. In addition, the school was located very close to the San Andreas Fault. Concerned about seismic risk, the district deemed the site unsuitable for school purposes and sold the site to the city for 1 dollar, which used it for recreational purposes.

is not a cost-effective option, the soil at the designated site can sometimes be treated to reduce the hazard. For example, on a liquefiable site, the soil can be grouted or otherwise treated to reduce the likelihood of liquefaction occurring. Soft soils can be excavated and replaced, or combined with foreign materials to make them stiffer. Alternatively, the building foundation itself can be modified to account for the potential effects of the soil, reducing the building's susceptibility to damage even if liquefaction or limited land sliding does occur. The school board should weigh the additional costs of modifying the soil characteristics or the building foundation with the expected reduction in damage and loss. However, because most schools are one or two stories in height, site area usage is considerable, and site treatment is likely to be costly.

In most cases, it is probable that a designated school site will be accepted. Proposed construction directly over a fault is probably the only location characteristic that would lead to rejection of an otherwise suitable site. The forces for which the school must be designed

The ELF equation in the IBC is  $V=C_s W$ , where  $V$ = the shear, or pushing, force at the base of the building, which represents the total earthquake force on the building,  $C_s$  is a coefficient representing the estimated site acceleration (derived from maps provided in the code), modified by factors related to the characteristics of the structure, the importance of the building, and the nature of the soil.  $W$  is the weight of the building. This equation is the same as Sir Isaac Newton's equation in his second law of motion,  $F=MA$  (Force = Mass times Acceleration), with some added modifiers.

are also increased if it is in close proximity of a fault, which will increase the structural cost. Sites are assigned to one of six categories, from A, which represents hard rock, to F, which represents soils vulnerable to potential failure or collapse such as liquefiable soils, sensitive clays, and weak soils and clays. Variations in soil type are covered by increasing or decreasing the design forces by application of a coefficient within the calculation of the Equivalent Lateral Force (ELF) equation, which is used to establish the design lateral forces on the building.

The ELF procedure assumes a soil type B. For categories A through E, design forces must be modified by application of a coefficient, or multiplier. For Category A soils, the multiplier is 0.8 (i.e., the values are reduced). For Category E soils, the multiplier can be as high as 2.5 for short-period buildings such as schools. For buildings located on

type F soils, a site-specific geotechnical investigation must be performed to establish design values.

**Reducing Damage to School Structures.** Minimum standards and criteria for structural design are defined in the seismic codes. The codes provide maps that show whether the location is subject to earthquakes and, if so, the probability of occurrence, expressed by varying levels of seismic forces for which a building must be designed. Seismic codes are adopted by state or local authorities, so it is possible for a seismically-prone region to be exempt from seismic code regulations if the local community feels that the adoption of a seismic building code is not desired. Based on historic and scientific data, although the seismic hazard exists, some communities may choose to ignore the risk, because no one has experienced an earthquake in their lifetime. Such a policy should be of serious concern to school district officials, the local school board, and parents.

This is a difficult issue because, although the risk may appear to be minimal, the effects could be catastrophic if a significant event were to occur. The very fact that such an event is rare means that the community may have no history of design for earthquakes and the building stock will be especially vulnerable. School buildings are an important community resource (along with other essential buildings such as hospitals, and fire and police stations) that should not gamble on the avoidance of a rare event.

Because of systematic observation of earthquake damage to buildings and extensive analytical and experimental research, seismic design in the 20th century has become a highly developed technology.

Reducing structural damage in earthquakes depends on:

- The correct application of code criteria and analytical methods. Seismic codes have become increasingly complex and a high standard of care and engineering judgment is necessary to ensure correct application.

- The correct selection and application of structural systems and materials. Different structural systems have varied characteristics that must be matched to the nature and purpose of the school. Flexible planning, for example, implies the use of a frame structure rather than relying on shear walls that may impact planning freedom.

The following two graphics show the basic types of structural lateral force resisting systems.

## HOW BUILDINGS RESIST EARTHQUAKES

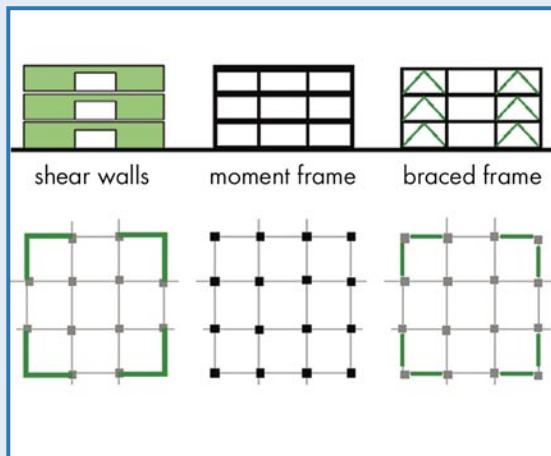

### Lateral Force Resisting Systems – Basic Types

This figure shows the basic types of lateral force resisting structural systems. They tend to be mutually exclusive (i.e., it is desirable not to mix the systems in a single building because of the different strength and stiffness characteristics of the systems). Shear walls are very stiff while moment-resistant frames are flexible. Braced systems are in between.

The systems have major architectural implications. Shear walls, which should run uninterrupted from foundation to roof, may impose major planning constraints on a building. Moment frames create unobstructed floors, but, because of their special connection requirements, are expensive. They are subject to more deformation that may result in costly damage to nonstructural components and systems. Braced frames are a common compromise.

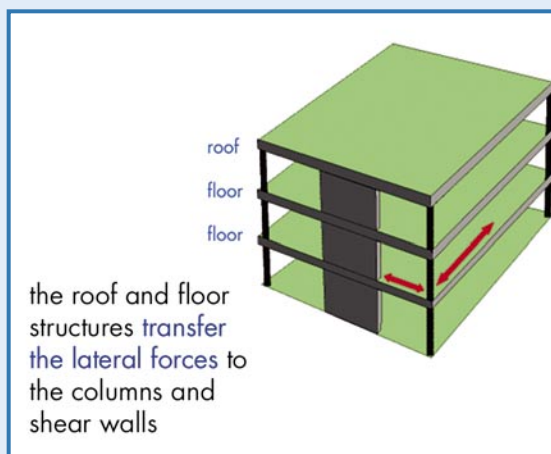

### Diaphragms

Together with the lateral force resisting system, diaphragms form a horizontal system that connects the vertical elements and carries their loads down to the foundation. Large openings in the diaphragm may limit its ability to be effective in transferring forces.

SOURCE: BSSC: PRESENTATIONS TO THE ARCHITECTURAL COMMUNITY, 2001, CHRIS ARNOLD AND TONY ALEXANDER

- The correct design of critical elements such as frames, shear walls, and diaphragms and their connections to one another: earthquake forces search out the weak links between structural members. Serious damage and collapse is often initiated by connection failure. These are the critical elements that provide seismic resistance; they must be correctly sized, located, and detailed.
- Careful attention to key structural design principles such as provision of a direct load path and structural redundancy.
- The correct design of the connections between structural elements and nonstructural components.
- Configuration of the building (its size and shape) to be as simple and regular as planning and aesthetic requirements permit. Experience has shown that certain building shapes and architectural design elements contribute to bad seismic performance and need expensive structural design methods to make them achievable.
- A high level of quality control to ensure that the building is properly constructed. Careful seismic design is valueless if not properly executed.
- A high level of maintenance to ensure that the building retains its integrity over time. Corrosion of steel and termite infestation or dry rot in wood can seriously affect structural integrity.

The following graphics show some problems caused by irregular building configurations.

## SOME TYPICAL DESIGN PROBLEMS

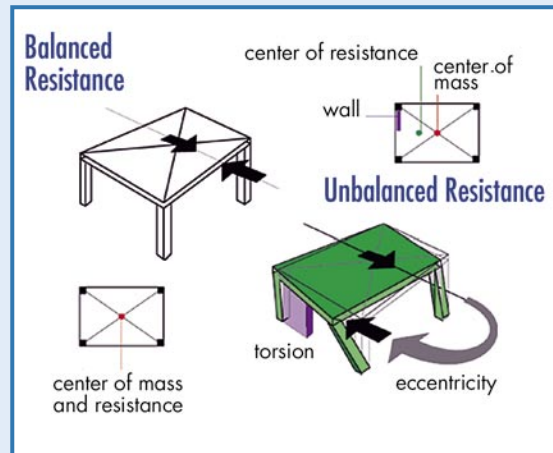

### Torsional Forces

This figure shows how torsion occurs. If the center of mass and center of resistance do not coincide, the building tends to rotate around the center of resistance.

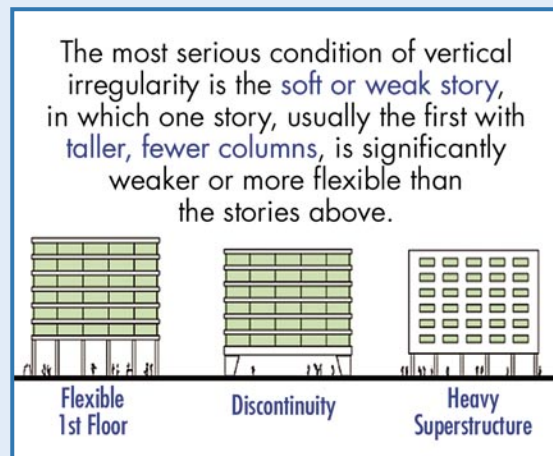

### Stress Concentrations

Stress concentration means that an undue proportion of the overall forces is concentrated at one or a few points of the building such as a particular set of beams, columns, or walls. These few members may fail and, by a chain reaction, bring down the whole building.

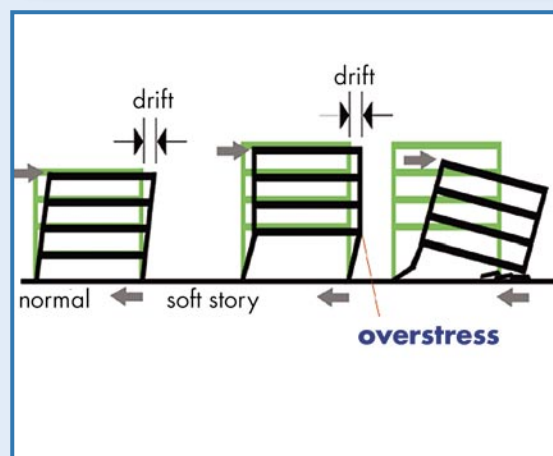

### Soft Stories

This figure shows the failure mechanism of a soft or weak story. A regular building with equal floor heights will distribute its drift equally to each floor so that each is subjected to manageable drift. In the soft story building, the overall drift is the same, but the second floor connections are subject to all, or almost all, the drift and a failure mechanism is created.

SOURCE: BSSC: PRESENTATIONS TO THE ARCHITECTURAL COMMUNITY, 2001, CHRIS ARNOLD AND TONY ALEXANDER



## TORSIONAL FORCES AND STRESS CONCENTRATION



### Soft Stories

Typical examples of soft story-induced damage.

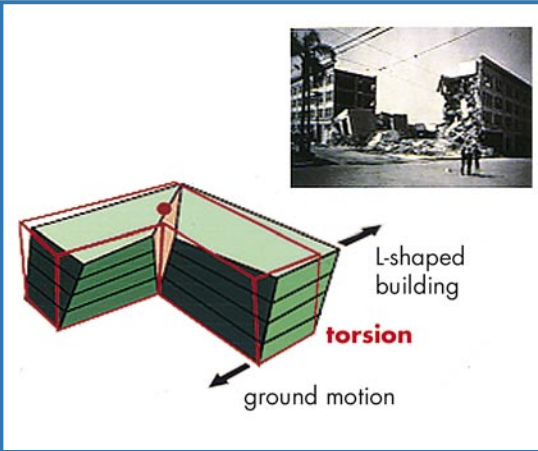

### Re-entrant Corners

Buildings with re-entrant corners (L-shape, U-shape, etc.) are subject to torsion and stress concentrations. Special design measures are necessary to counteract these tendencies.

SOURCE: BSSC: PRESENTATIONS TO THE ARCHITECTURAL COMMUNITY, 2001, CHRIS ARNOLD AND TONY ALEXANDER

### Reducing Damage to Nonstructural Components and Systems.

Nonstructural components and systems are defined as those elements that do not contribute to the seismic resistance of the building (see Figure 4-31). They typically comprise from 75 to 80 percent of the total school building by value, and they transform the structure into a working environment that provides weather protection, heating, cooling, lighting, and acoustic control. Damage to these components can be costly and render the building functionally useless even if the building structure

performs in accordance with the intent of the seismic code. Non-structural components are generally broadly classified as:

- Architectural
  - Exterior envelope - opaque or glazed, roof and wall coverings
  - Veneers
  - Interior partitions
  - Ceilings
  - Parapets and appendages (e.g., signs and decorative elements)
  - Canopies and marquees
  - Chimneys and stacks
- Mechanical
  - Boilers and furnaces
  - HVAC source equipment and distribution components
- Electrical and Electronic
  - Source power equipment and distribution components
  - Source communications equipment and distribution components
  - Light fixtures
- Plumbing
  - Storage vessels and tanks
  - Piping systems
  - Hazardous materials distribution
- Furnishings and Interior Equipment
  - Bookcases, filing cabinets, and other storage
  - Shop and art equipment
  - Hazardous materials (HazMat) storage

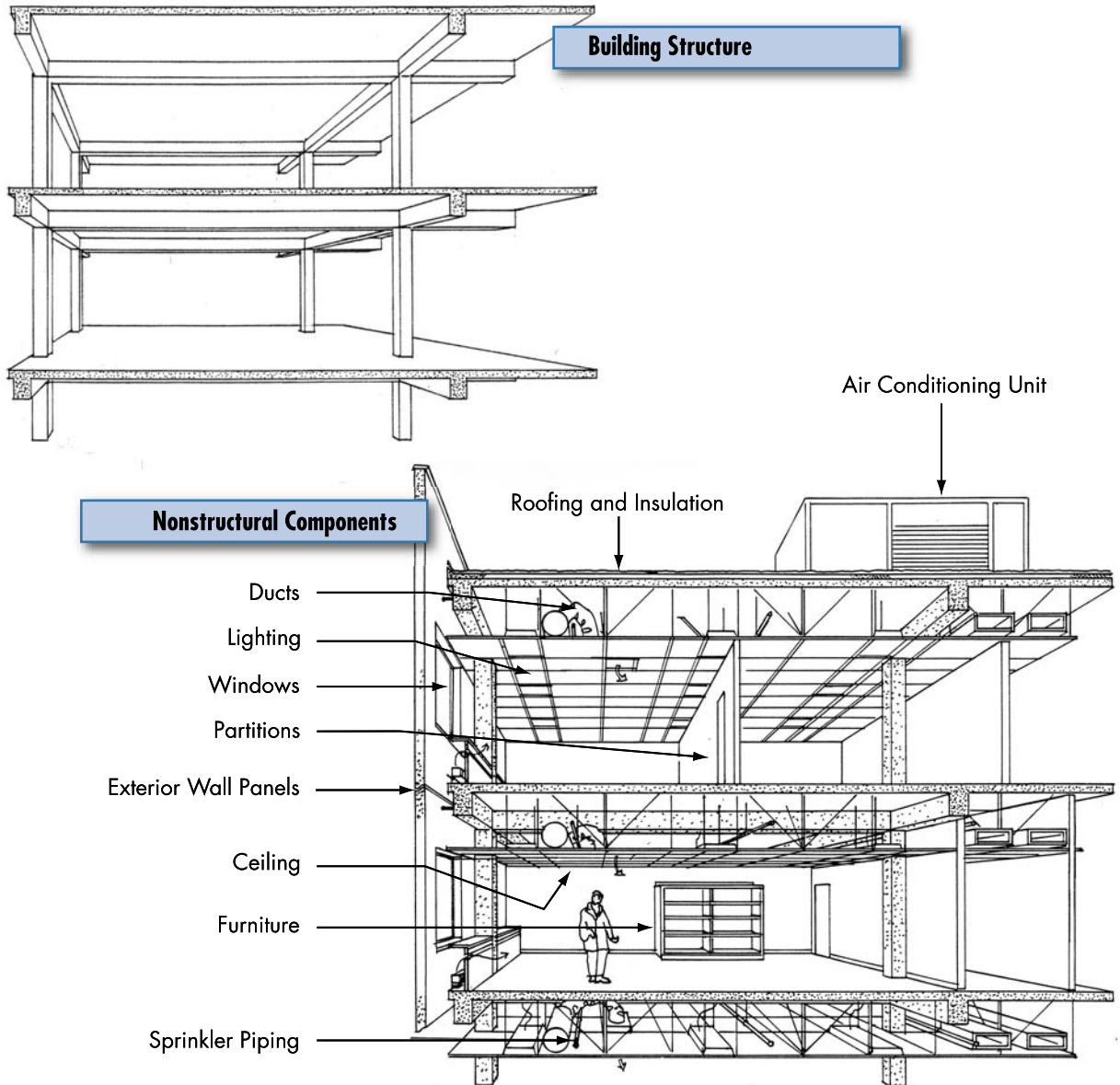

Figure 4-31  
 The structural and nonstructural components. The upper graphic shows the building structure. The lower graphic shows the addition of the main nonstructural components.

Reduction of damage to nonstructural components depends on using methods of supporting and bracing the components to prevent failure (see examples in Figures 4-32, 4-33, 4-34, and 4-35). Seismic codes provide the design force for which the above components must be designed, together with a number of specific design requirements that must be followed.

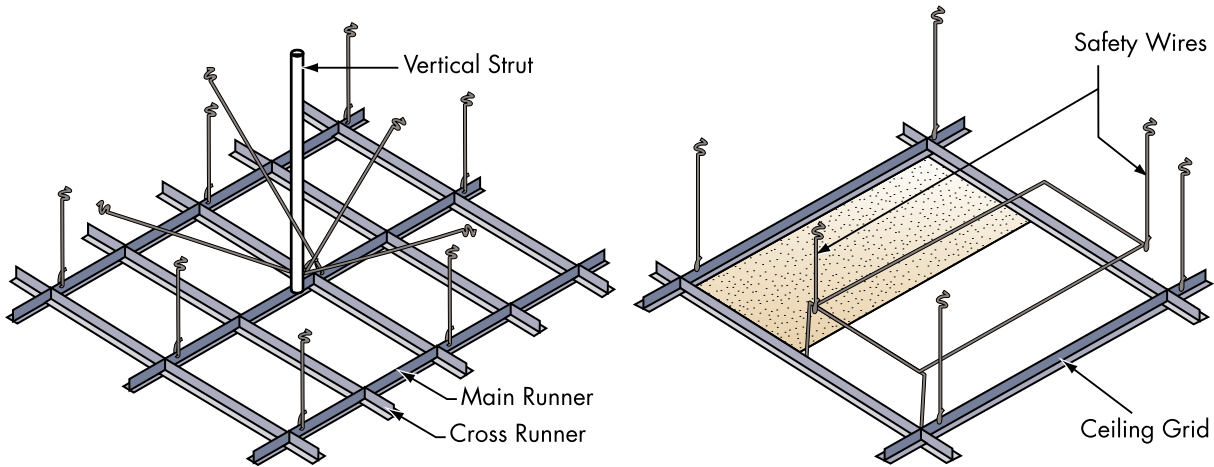

Figure 4-32 Suspended ceiling and light fixture bracing and support

Figure 4-33  
Bracing tall shelving to the structure

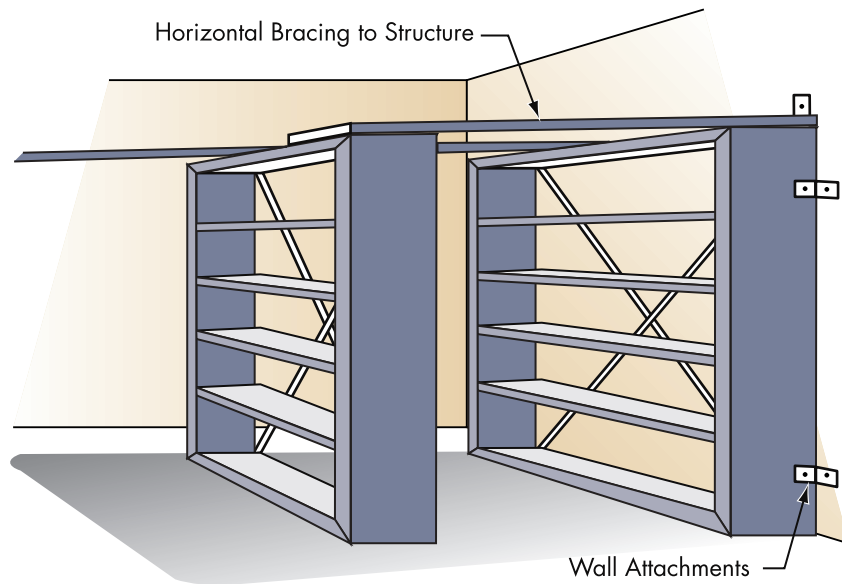
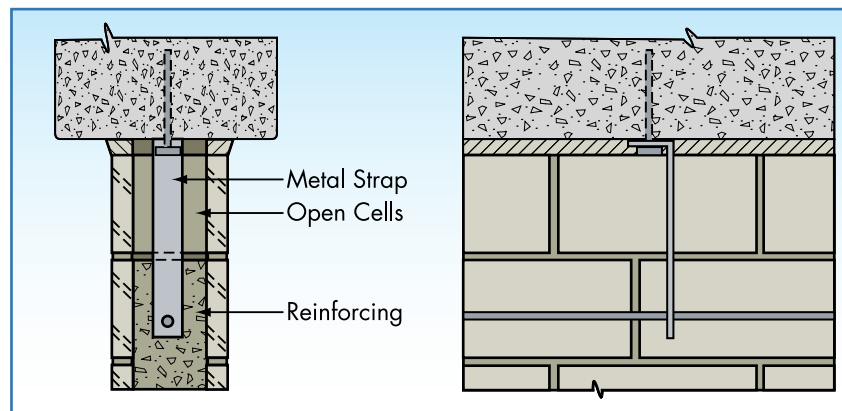

Figure 4-34  
Connection of nonstructural masonry wall to structure to permit independent movement



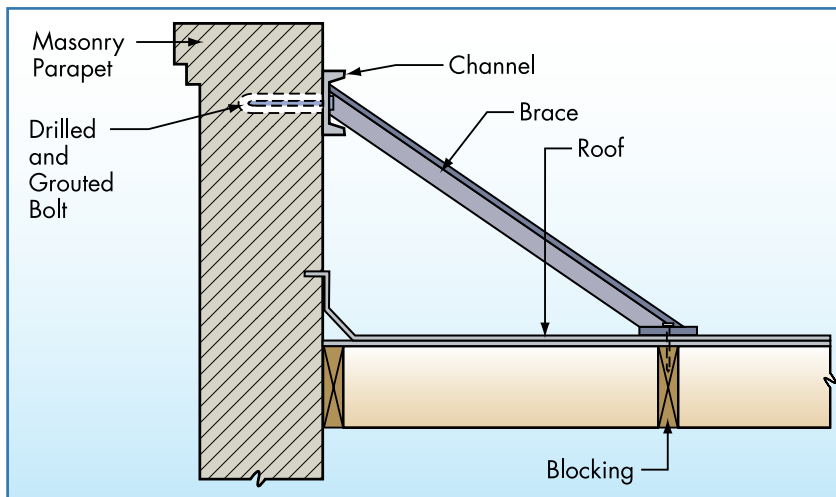

Figure 4-35  
Bracing for existing  
unreinforced masonry  
parapet wall

#### 4.6.2 Risk Reduction for Existing Schools

**Procedures and Design Strategies.** Additions to an existing school must meet all of the code requirements for a new building. There is currently no seismic code that applies to the retrofit of existing schools. Typically, the standards to be applied are derived from the code for new buildings and negotiated with the applicable building department. It is generally recognized that it is difficult or almost impossible to bring an existing structure up to full compliance with a current code and so some compromises have to be made; there is, however, no general agreement as to how the code for new buildings is applied to the retrofit design of existing ones.

Reducing the seismic risk for an existing building requires the same general design principles as those necessary for a new building, but the architect and engineer are faced with existing structural and nonstructural systems and materials that may be far from ideal and, as previously stated, to bring them up to the standard of a new building could be difficult or almost impossible.

The process should begin with an evaluation procedure similar to those outlined in Section 4.5. If the result of these evaluations is the need to retrofit an existing school or schools, the *NEHRP*

*Guidelines for the Seismic Rehabilitation of Buildings* (FEMA 273) is the authoritative source document and can be used to help a school district select seismic protection criteria. The architect and engineer can also use the document for the design and analysis of seismic retrofit projects.

FEMA 273 adopted the approach of providing methods and design criteria to achieve several different levels and ranges of seismic performance (unlike a conventional code that implies, but does not define, a single performance level). In doing this, the document shows that there is always the possibility of damage in a seismic event and the term “seismic performance” refers to the nature and extent of damage that the building exhibits. FEMA 273 provides a thorough and systematic procedure for performance-based seismic design, intended to result in the development of a design that targets achieving the owner’s level of acceptable risk within the owner’s available resources.

The performance-based design approach outlined in FEMA 273 provides uniform criteria by which existing buildings may be retrofitted to attain a wide range of performance levels, when subjected to earthquakes of varying severities and probabilities of occurrence. The process starts by requiring that the user select specific performance goals as a basis for design. In this way, users can directly determine the effect of different performance goals on the design requirements, including their complexity and cost.

Typical design strategies for improving the protection of an existing school include (see Figure 4-36):

- Modifying and improving local components or materials, such as beam/column connections. This involves retrofitting connections and strengthening structural members by such methods as adding reinforcing or replacing them with new components.

**Strengthening Solution**

**Result**

**Infill walls**

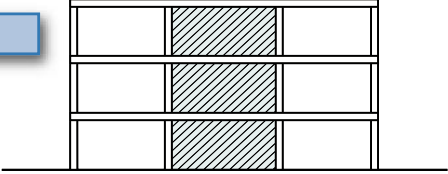

Increased strength and drift limitation

**Add braces**

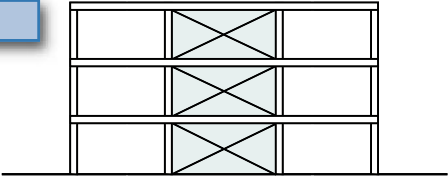

Increased strength and drift limitation

**Add buttresses**

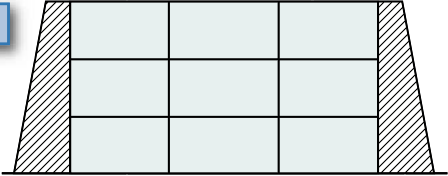

Containment and drift limitation

**Add frame; interior or exterior**

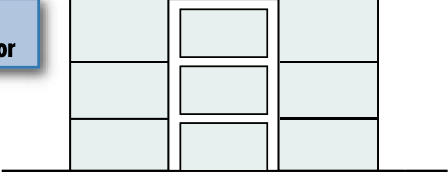

Containment and drift limitation

**Completely rebuild**

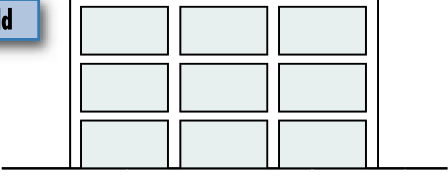

High seismic capacity  
conventional damage control

**Isolate building**

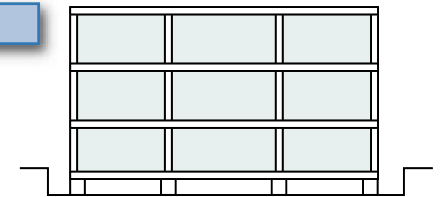

High seismic capacity  
conventional damage control

Figure 4-36  
Design strategies for seismic retrofit of existing buildings

SOURCE: *BUILDINGS AT RISK: SEISMIC DESIGN BASICS FOR PRACTICING ARCHITECTS*, AIA/ACSA COUNCIL ON ARCHITECTURAL RESEARCH, WASHINGTON, DC, 1994, ERIC ELSESSER

- Removing or reducing configuration irregularities. This involves providing seismic separations in irregular configurations or adding shear walls or bracing to reduce torsional effects, thereby strengthening and/or stiffening the entire structural system. This is a major retrofit that involves adding bracing or shear walls, replacing many structural members.
- Reducing the mass of the building (to reduce forces). This involves changing the location of heavy items (e.g., bookcases) within the building, but would not apply to a one-story building, except where a tile or slate roof covering might be replaced with a lightweight material.

**Retrofit Methods.** Seismic (base) isolation (to reduce force on the building superstructure) is a new technique that has been successfully used in the retrofit of large buildings, but it is not appropriate to the scale and nature of school buildings unless the school building is considered a historical building. A newer technique is passive energy dissipation, the insertion of supplemental energy devices (to reduce movement), which might be applicable to certain types of school structures (e.g., large gymnasiums, multiuse buildings, or auditoriums).

Seismic retrofit at any large scale is expensive, both in design and construction, because of the more complex analyses that must be conducted and the construction constraints that must be overcome. In addition, closure of a school for an extended period (beyond that of the normal summer break) is usually unacceptable. Major seismic retrofit is rare, although some successful projects have been done, primarily with the goal of saving a building that is not only a place of learning, but a historic community resource as well. The retrofitting of the B.F. Day School in Seattle was one such project (see Figures 4-37 and 4-38).





Figure 4-37  
Retrofit of B.F. Day  
Elementary School, Seattle,  
WA

SOURCE: EARTHQUAKE  
ENGINEERING RESEARCH  
INSTITUTE, OAKLAND, CA; B.F. DAY  
ELEMENTARY SCHOOL, SEATTLE,  
TODD W. PERBIX AND LINDA L.  
NOSON, 1996

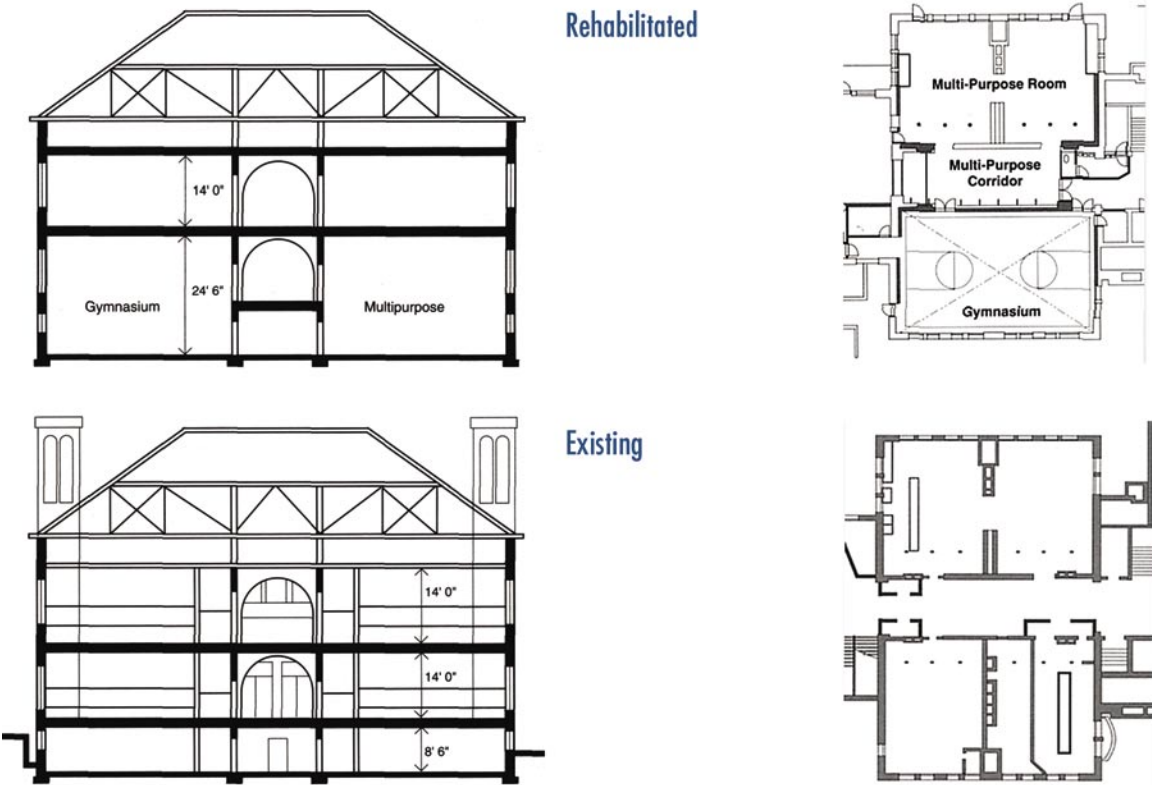

Figure 4-38  
Sections and plans of the B.F. Day School: existing at bottom, retrofitted at top. Note that the retrofit has also opened up the basement and first floor to provide large spaces suitable for today's educational needs.

SOURCE: EARTHQUAKE ENGINEERING RESEARCH INSTITUTE, OAKLAND, CA; B.F. DAY ELEMENTARY SCHOOL, SEATTLE, TODD W. PERBIX AND LINDA L. NOSON, 1996

**Incremental Seismic Rehabilitation.** An approach that greatly improves the feasibility of retrofitting a school is that of “Incremental Seismic Rehabilitation.” A full description of this procedure is presented in *Incremental Seismic Rehabilitation of School Buildings (K-12)* (FEMA 395). The principles of this process follow.

Whereas extensive single-stage seismic retrofitting of an existing school represents a significant cost, retrofit actions can be divided into increments and integrated into normal repairs and capital improvement projects. Implementation of incremental seismic retrofit requires assessing the buildings, establishing retrofit priorities, and planning integration with other projects. Integration will reduce the cost of the seismic work by sharing engineering design costs and some aspects of construction costs. An “integration opportunity” occurs when a seismic retrofit measure can be paired with other repair or replacement tasks or categories. Integration opportunities are a key consideration in determining the sequence of operations that will be conducted.

School districts often categorize maintenance and capital improvement projects in the following eight categories;

- Re-roofing
- Exterior wall and window replacement
- Fire and life safety improvements
- Modernization/remodeling/new technology accommodation
- Under floor and basement maintenance and repair
- Energy conservation/weatherizing/air conditioning
- Hazardous materials abatement
- Accessibility improvements

FEMA 395 provides five matrices that show possible combinations of seismic improvement measures with typical work categories. A typical matrix from FEMA 395, showing possible seismic improvements relating to roof maintenance and repair is shown in Table 4-3.

Table 4-3: Roofing Maintenance and Repair/Re-roofing

Rank*	Level of Seismicity			Building Structural Element	Structural Subsystem	Seismic Performance Improvement	Vertical Load Carrying Structure						
	L	M	H				Wood	Masonry <sup>1</sup>		Concrete		Steel	
							Unreinforced Masonry	Reinforced Masonry	Wood Diaphragm	Concrete Diaphragm	Wood Diaphragm	Concrete Diaphragm	
<b>Nonstructural</b>													
1	✓	✓	✓	n/a	n/a	Bracing of Parapets, Gables, Ornamentation, and Appendages		■		■	■	■	■
2	✓	✓	✓	n/a	n/a	Anchorage of Canopies at Exits	■	■	■	■	■	■	■
3		✓	✓	n/a	n/a	Bracing or Removal of Chimneys	■	■	■	■	■	■	■
10		✓	✓	n/a	n/a	Anchorage and Detailing of Rooftop Equipment	■	■	■	■	■	■	■
<b>Structural</b>													
n/a		✓	✓	All Elements		Load Path and Collectors	□	□	□	□	□	□	□
n/a		✓	✓	Horizontal Elements	Diaphragms	Attachment and Strengthening at Boundaries	■	■	■	■	□	■	□
n/a		✓	✓	Horizontal Elements	Diaphragms	Strength/Stiffness	■	■	■	■	□	■	□
n/a		✓	✓	Horizontal Elements	Diaphragms	Strengthening at Openings	□	□	□	□		□	
n/a		✓	✓	Horizontal Elements	Diaphragms	Strengthening at Re-entrant Corners	□	□	□	□	□	□	□

Table 4-3: Roofing Maintenance and Repair/Re-roofing (continued)

Rank*	Level of Seismicity			Building Structural Element	Structural Subsystem	Seismic Performance Improvement	Vertical Load Carrying Structure						
	L	M	H				Wood	Masonry <sup>1</sup>		Concrete		Steel	
								Unreinforced Masonry	Reinforced Masonry	Wood Diaphragm	Concrete Diaphragm	Wood Diaphragm	Concrete Diaphragm
n/a		✓	✓	Horizontal Elements	Diaphragms	Topping Slab for Precast Concrete		☐	☐		☐		☐
n/a	✓	✓	✓	Vertical Elements	Load Path	Lateral Resisting System to Diaphragm Connection		■	■	■	⊗	■	⊗
n/a	✓	✓	✓	Vertical Elements		Out-of-Plane Anchorage of Concrete or Masonry Wall		■	■	■	☐	■	☐

\* Nonstructural improvements are ranked on the basis of engineering judgment of their relative impact on improving life safety in schools.

Structural improvements are not ranked, but are organized by structural element and subsystem.

- Work that may be included in the building rehabilitation/maintenance/repair project using little or no engineering.
- ☐ Work requiring detailed engineering design to be included in the project.
- ⊗ Work requiring detailed engineering design and evaluation of sequencing requirements. The “x” designates work that could redistribute loads, overstressing some elements.

Note 1: Masonry buildings with a concrete roof should use the concrete building, concrete diaphragm for integration opportunities.

n/a = Not Applicable.

Incremental seismic retrofit is an effective, affordable, and non-disruptive strategy to achieve responsible seismic risk mitigation.

At the lower levels of protection, some effective construction measures (e.g., bracing nonstructural bookcases and filing cabinets, and anchoring key desktop equipment such as computers) can be

implemented by school district maintenance personnel. As a last resort in cases of extreme risk and badly antiquated school buildings, demolition is the only solution.

## **4.7 THE SCHOOL AS A POST-EARTHQUAKE SHELTER**

In the aftermath of any damaging earthquake, there is an immediate need of shelter for people who have been displaced from their homes. There are three kinds of shelters:

- First is the immediate need for shelter on the day or night of the earthquake. The American Red Cross has a congressional mandate to provide this after any disaster, with the intent that this will be available only for a few weeks.
- Following the immediate need, there is a need for longer-term housing, while homes and apartments are being repaired. This is generally accomplished by governmental subsidies that enable people to move into vacant hotel rooms or apartments. This kind of shelter depends, to some extent, on the availability of these forms of housing on the market in the local area. This is sometimes augmented by temporary housing; where the season and climate allow, this can be provided by tents and FEMA has, in the past, maintained a stock of modular housing that can be moved to a local site within a month or two, depending on the availability of land. This housing may be occupied for a year or so, depending on the scale of the disaster.
- Finally, there is permanent replacement housing that is typically provided by the home building industry and non-profit housing organizations, with possible financial aid programs from the Federal Government.

It is common in earthquake-prone regions for school sites to provide the first kind of immediate shelter. There are several good reasons for this. First, schools are conveniently located in every community, with easy and known access to the local population

that they serve. Second, schools have suitable space (e.g., gymnasiums or multiuse rooms) where large numbers of people can be accommodated for a few days. Food services are often available and there is ample space for assembly, processing, and delivery of goods and equipment. Third, because schools are public property, the financial costs of making use of the facilities for a few weeks are minimal, and arrangements can be worked out in advance. Finally, particularly in California, where schools are subject to the Field Act, schools are well constructed and probably among the most likely of all the community's buildings to survive intact and in a usable condition.

The only problem that has been encountered is that of ensuring that the time of use is limited; no school district wishes for its schools to be used as shelters for weeks, unless it is during the summer break. However, improvisation can generally ensure that some semblance of a normal school teaching program can be reinstated within a day or so of a moderate event.

No specific design decisions are necessary for this use, nor is it necessary to stockpile emergency supplies, because they could use up valuable storage space for years and then be useless if needed. The exact circumstances of the event and the number and types of people to be accommodated will determine the supplies that are necessary. Experience has shown that local and even regional manufacturers and suppliers are very effective in providing services after an event. Following the Coalinga 1983 earthquake, temporary shelter was provided in the high school gymnasium. A regional beer canning plant substituted drinking water for beer for a few shifts and rapidly delivered the chilled cans to the site.

However, pre-event planning should be undertaken between the school district and the local emergency services agency to anticipate key issues that will need quick solutions if an event occurs. This includes determining what spaces will be available and how many people can be accommodated, signing a pre-contract with a local engineer or architect for immediate post-earthquake in-

spection to determine safety, looking at strategies for continued operation in the event some spaces are occupied by refugees, and the possible provision of food and sanitary supplies by the district.

Possible use of school buildings as a safe haven for the community in the event of chemical, biological, radiological, or explosive attack involves complex design and construction issues. This use of school property is discussed in FEMA 428, Chapter 6, and FEMA 453.

## **4.8 REFERENCES AND SOURCES OF ADDITIONAL INFORMATION**

*ASCE, 2000, Prestandard and Commentary for the Seismic Rehabilitation of Buildings*, American Society of Civil Engineers, FEMA Publication 356, Washington, DC (FEMA 273 published as a standard).

*Building Construction and Safety Code NFPA 5000*, National Fire Protection Association, Quincy, MA, 2002 .

*Incremental Seismic Rehabilitation of School Buildings (K-12)* (FEMA 395), Virginia Polytechnic Institute/Building Technology Incorporated, Silver Spring, MD/Melvyn Green & Associates, Inc., Torrance, CA, Federal Emergency Management Agency, Washington, DC, 2002.

*International Building Code 2003*, International Code Council, Birmingham, AL, 2003.

*Minimum Design Loads for Buildings and Other Structures*, ASCE 7-02, American Society of Civil Engineers, Reston, VA, 2002.

*NEHRP Commentary on the Guidelines for the Seismic Rehabilitation of Buildings* (FEMA 274), Building Seismic Safety Council, Washington, DC, 1997.

*NEHRP Guidelines for the Seismic Rehabilitation of Buildings* (FEMA 273), Building Seismic Safety Council, Washington, DC, 1997.

*NEHRP Handbook for the Seismic Evaluation of Existing Buildings* (FEMA 178), Building Seismic Safety Council, Washington, DC, 1992.

*The NEHRP Recommended Provisions for Seismic Regulation for New Buildings*, 2000 Edition, 2 volumes and maps (FEMA 368) and Commentary (FEMA 369).

*Primer to Design Safe School Projects in Case of Terrorist Attacks* (FEMA 428), Federal Emergency Management Agency, U.S Department of Homeland Security, Washington, DC, 2003.

*Rapid Visual Screening of Buildings for Potential Seismic Hazards* (FEMA 154), Applied Technology Council, FEMA, Washington, DC, 1988.

*Reducing the Risks of Nonstructural Earthquake Damage: a Practical Guide* (FEMA 74), Wiss, Janney, Elstner Associates, Inc., Washington, DC, 1994.

*Seismic Design Criteria of Nonstructural Systems for New School Facilities*, EQE International/Salt Lake City School District, Salt Lake City, UT, 2001.

## **4.9 GLOSSARY OF EARTHQUAKE TERMS**

**Acceleration.** Rate of change of velocity with time.

**Amplification.** A relative increase in ground motion between one type of soil and another or an increase in building response as a result of resonance.

**Amplitude.** Maximum deviation from mean of the center line of a wave.

**Architectural Components.** Components such as exterior cladding, ceilings, partitions, and finishes.



**Building.** Any structure whose use could include shelter of human occupants.

**Component (also Element).** Part of an architectural, structural, electrical, or mechanical system.

**Configuration.** The size, shape, and geometrical proportions of a building.

**Connection.** A method by which different materials or components are joined to each other.

**Damage.** Any physical destruction caused by earthquakes.

**Deflection.** The state of being turned aside from a straight line, generally used in the horizontal sense; see also “Drift.”

**Design Earthquake.** In the IBC, the earthquake that produces ground motions at the site under consideration that are two-thirds those of the “Maximum Considered Earthquake.”

**Design Ground Motion.** See “Design Earthquake.”

**Diaphragm.** A horizontal or nearly horizontal structural element designed to transmit lateral forces to the vertical elements of the seismic force resisting system.

**Drift.** Vertical deflection of a building or structure caused by lateral forces; see also “Story Drift.”

**Ductility.** Property of some materials, such as steel, to distort when subjected to forces while still retaining considerable strength.

**Earthquake.** A sudden motion or vibration in the earth caused by the abrupt release of energy in the earth’s lithosphere.

**Effective Peak Acceleration and Effective Peak Velocity-Related Acceleration.** Coefficients shown on maps in the IBC for determining prescribed seismic forces.

**Elastic.** Capable of recovering size and shape after deformation.

**Epicenter.** A point on the earth's surface that is directly above the focus of an earthquake.

**Exceedance Probability.** The probability that a specified level of ground motion or specified social or economic consequences of earthquakes will be exceeded at a site or in a region during a specified exposure time.

**Exposure.** The potential economic loss to all or certain subsets of the built environment as a result of one or more earthquakes in an area; this term usually refers to the insured value of structures carried by one or more insurers.

**Fault.** A fracture in the earth's crust accompanied by displacement of one side of the fracture with respect to the other in a direction parallel to the fracture.

**Focus.** The location of a fault break where an earthquake originates; also termed "Hypocenter."

**Force.** Agency or influence that tries to deform an object or overcome its resistance to motion.

**Frame, Braced.** Diagonal members connecting together components of a structural frame in such a way as to resist lateral forces.

**Frame, Space.** A structural system composed of interconnected members, other than bearing walls, that is capable of supporting vertical loads and that also may provide resistance to seismic forces.

**Frame System, Building.** A structural system with an essentially complete space frame providing support for vertical loads; seismic forces are resisted by shear walls or braced frames.

**Frame System, Moment.** A space frame in which members and joints are capable of resisting lateral forces by bending as well as along the axis of the members; varying levels of resistance are provided by ordinary, intermediate, and special moment frames as defined in the IBC with special frames providing the most resistance.

“g”. The acceleration due to gravity or 32 feet per second.

**Ground Failure.** Physical changes to the ground surface produced by an earthquake such as lateral spreading, landslides, or liquefaction.

**Hypocenter.** See “Focus.”

**Intensity.** The apparent effect that an earthquake produces at a given location; in the United States, intensity generally is measured by the modified Mercalli intensity (MMI) scale.

**Irregular.** Deviation of a building configuration from a simple symmetrical shape.

**Joint.** Location of connections between structural or nonstructural members and components.

**Liquefaction.** The conversion of a solid into a liquid by heat, pressure, or violent motion; sometimes occurs to the ground in earthquakes.

**Load, Dead.** The gravity load created by the weight of all permanent structural and nonstructural building components such as walls, floors, roofs, and fixed service equipment.

**Load, Live.** Moving or movable external loading on a structure; it includes the weight of people, furnishings, equipment, and other items not permanently attached to the structure.

**Loss.** Any adverse economic or social consequences caused by earthquakes.

**Mass.** A constant quantity or aggregate of matter; the inertia or sluggishness that an object, when frictionlessly mounted, exhibits in response to any effort made to start it or stop it or to change in any way its state of motion.

**Maximum Considered Earthquake Ground Motion.** The most severe earthquakes effects considered in the IBC. These are represented by the mapped spectral response accelerations at short and long periods, obtained from maps reproduced in the IBC, adjusted for Site Class effects using site coefficients.

**Mercalli Scale (or Index).** A measure of earthquake intensity named after Giuseppe Mercalli, an Italian priest and geologist.

**Nonbuilding Structure.** A structure, other than a building, constructed of a type included in Chapter 14 of the IBC.

**Occupancy Importance Factor.** A factor, between 1.0 - 1.5, assigned to each structure according to its Seismic Use Group (SUG).

**Partition.** See “Wall, Nonbearing.”

**Period.** The elapsed time (generally in seconds) of a single cycle of a vibratory motion or oscillation; the inverse of frequency.

**P-Wave.** The primary or fastest waves traveling away from a fault rupture through the earth’s crust and consisting of a series of compressions and dilations of the ground material.

**Quality Assurance Plan.** A detailed written procedure that establishes the systems and components subject to special inspection and testing.

**Recurrence Interval.** See “Return Period.”

**Resonance.** The amplification of a vibratory motion occurring when the period of an impulse or periodic stimulus coincides with the period of the oscillating body.

**Return Period.** The time period in years in which the probability is 63 percent that an earthquake of a certain magnitude will recur.

**Richter Magnitude (or Scale).** A logarithmic scale expressing the magnitude of a seismic (earthquake) disturbance in terms of the maximum amplitude of the seismic waves at a standard distance from their focus named after its creator, the American seismologist Charles R. Richter.

**Rigidity.** Relative stiffness of a structure or element; in numerical terms, equal to the reciprocal of displacement caused by unit force.

**Seismic.** Of, subject to, or caused by an earthquake or an earth vibration.

**Seismic Event.** The abrupt release of energy in the earth’s lithosphere causing an earth vibration; an earthquake.

**Seismic Force Resisting System.** The part of the structural system that is designed to provide required resistance to prescribed seismic forces.

**Seismic Forces.** The actual forces created by earthquake motion; assumed forces prescribed in the IBC that are used in the seismic design of a building and its components.

**Seismic Hazard.** Any physical phenomenon such as ground shaking or ground failure associated with an earthquake that may

produce adverse effects on the built environment and human activities; also the probability of earthquakes of defined magnitude or intensity affecting a given location.

**Seismic Risk.** The probability that the social or economic consequences of an earthquake will equal or exceed specified values at a site during a specified exposure time; in general, seismic risk is vulnerability multiplied by the seismic hazard.

**Seismic Use Group.** A classification assigned in the Provisions to a structure based on its occupancy and use as defined in the IBC.

**Seismic Waves.** See “Waves, Seismic.”

**Seismic Zone.** Generally, areas defined on a map within which seismic design requirements are constant; in the IBC, seismic zones are defined both by contour lines and county boundaries.

**Shear.** A force that acts by attempting to cause the fibers or planes of an object to slide over one another.

**Shear Panel.** See “Wall, Shear.”

**Shear Wall.** See “Wall, Shear.”

**Speed.** Rate of change of distance traveled with time irrespective of direction.

**Stiffness.** Resistance to deflection or drift of a structural component or system.

**Story Drift.** Vertical deflection of a single story of a building caused by lateral forces.

**Strain.** Deformation of a material per unit of the original dimension.

**Strength.** The capability of a material or structural member to resist or withstand applied forces.

**Stress.** Applied load per unit area or internal resistance within a material that opposes a force's attempts to deform it.

**S-Wave.** Shear or secondary wave produced essentially by the shearing or tearing motions of earthquakes at right angles to the direction of wave propagation.

**System.** An assembly of components or elements designed to perform a specific function such as a structural system.

**Torque.** The action of force that tends to produce torsion; the product of a force and lever arm as in the action of using a wrench to tighten a nut.

**Torsion.** The twisting of a structural member about its longitudinal axis.

**Velocity.** Rate of change of distance traveled with time in a given direction; in earthquakes, it usually refers to seismic waves and is expressed in inches or centimeters per second.

**Vulnerability.** The degree of loss to a given element at risk, or set of such elements, resulting from an earthquake of a given intensity or magnitude; expressed in a scale ranging from no damage to total loss; a measure of the probability of damage to a structure or a number of structures.

**Wall, Bearing.** An interior or exterior wall providing support for vertical loads.

**Wall, Cripple.** A framed stud wall, less than 8 feet in height, extending from the top of the foundation to the underside of the lowest floor framing.

**Wall, Nonbearing.** An interior or exterior wall that does not provide support for vertical loads other than its own weight as permitted by the building code; see also “Partition.”

**Wall, Shear.** A wall, bearing or nonbearing, designed to resist lateral forces parallel to the plane of the wall.

**Wall System, Bearing.** A structural system with bearing walls providing support for all or major portions of the vertical loads; seismic resistance may be provided by shear walls or braced frames.

**Waves, Seismic.** Vibrations in the form of waves created in the earth by an earthquake.

**Weight.** Name given to the mutual gravitational force between the earth and an object under consideration; varies depending on location of the object at the surface of the earth.