

Design and Construction Guidance for Community Safe Rooms

FEMA 361, *Second Edition* / August 2008



FEMA

Any opinions, findings, conclusions, or recommendations expressed in this publication do not necessarily reflect the views of FEMA. Additionally, neither FEMA nor any of its employees makes any warrantee, expressed or implied, or assumes any legal liability or responsibility for the accuracy, completeness, or usefulness of any information, product, or process included in this publication. Users of information contained in this publication assume all liability arising from such use.

Design and Construction Guidance for Community Safe Rooms

FEMA 361, Second Edition / August 2008



FEMA

Preface

Federal Emergency Management Agency (FEMA) publications presenting design and construction guidance for both residential and community safe rooms have been available since 1998. Since that time, thousands of safe rooms have been built using FEMA's Hazard Mitigation Assistance Program. A growing number of these safe rooms have already saved lives in actual events. There has not been a single reported failure of a safe room constructed to FEMA criteria. This Second Edition of FEMA 361 presents updated and refined design criteria for safe rooms when compared to the First Edition's 2000 criteria. The changes to the design criteria are the result of post-disaster investigations into the performance of safe rooms and shelters after tornadoes and hurricanes. Further, the changes also consider the new consensus standard from the International Code Council® (ICC®) and the National Storm Shelter Association (NSSA) released in August 2008, the *ICC/NSSA Standard for the Design and Construction of Storm Shelters* (ICC-500). The criteria presented in this publication address how to design and construct a safe room that provides near-absolute protection for groups of individuals sent to a building or structure expecting it to be capable of providing them life-safety protection from wind, windborne debris, and flooding.

FEMA continues to support the development of consensus codes and standards that provide minimum acceptable requirements for the design and construction of hazard-resistant buildings; and FEMA supported and participated in the development of the ICC-500. Although the ICC-500 took much of what was presented in the First Edition of this publication and updated and codified it through the consensus standard process, some design criteria remain different between the two documents. The technical differences related to wind design criteria for both tornado and hurricane hazards, the design missile criteria for hurricane safe rooms, peer review requirements for the safe room designs, and siting requirements with respect to flood hazards are presented at the beginning of Chapter 3 of this publication. FEMA has maintained different criteria than what is provided in the ICC-500 in the same way FEMA continues to provide best-practices and design guidance on all types of hazard resistance construction (from residential buildings to critical facilities). Should safe room designers, operators, and emergency managers implement the FEMA criteria in their projects, they can feel confident knowing that they used the best-available information to guide the design and construction of a safe room (public or private) that provides near-absolute protection from the deadly winds and debris associated with extreme-wind events.

Design and Construction Guidance for Community Safe Rooms

Table of Contents

Preface	i
1 Introduction	1-1
1.1 Purpose	1-1
1.2 Safe Rooms vs. Shelters	1-2
1.3 Background	1-5
1.3.1 Tornado Events	1-5
1.3.2 Hurricane Events	1-8
1.3.3 Post-Disaster Assessments, Research, and Design Development	1-10
1.4 Organization of the Publication	1-13
2 Protection Objectives	2-1
2.1 What is a Safe Room?	2-2
2.1.1 Structural and Building Envelope Characteristics of Safe Rooms	2-4
2.1.2 Design Criteria for Different Types of Safe Rooms and Shelters	2-5
2.1.3 Occupant Safety	2-6
2.2 Safe Room Design Process	2-7
2.2.1 The Threat From Extreme-Wind Events	2-7
2.2.2 Vulnerability Assessment	2-16
2.2.3 Population at Risk	2-17
2.2.4 Risk Analysis	2-18
2.2.5 Types of Safe Rooms	2-19
2.3 Safe Room Costs	2-21
2.3.1 Design Parameters Affecting Safe Room Costs	2-21
2.3.2 Recent Safe Room Cost Data	2-22

2.3.3	Other Factors Impacting Cost	2-23
2.3.4	Additional Factors to Consider When Constructing a Safe Room.....	2-26
2.4	Benefit-Cost Analysis	2-26
2.4.1	Existing Shelter BCA Software.....	2-27
2.4.2	New Tornado Safe Room BCA Software.....	2-28
3	Design Criteria for Tornado and Hurricane Safe Rooms.....	3-1
3.1	General Approach to the Design of Safe Rooms.....	3-1
3.2	Load Combinations	3-3
3.2.1	Load Combinations Using Strength Design.....	3-4
3.2.2	Load Combinations Using Allowable Stress Design.....	3-5
3.2.3	Other Loads and Load Combination Considerations.....	3-6
3.3	Tornado Community Safe Room Design Criteria	3-7
3.3.1	Wind Design Parameters for Tornado Community Safe Rooms.....	3-7
3.3.2	Debris Impact Criteria for Tornado Community Safe Rooms	3-12
3.4	Hurricane Community Safe Room Design Criteria.....	3-14
3.4.1	Wind Design Parameters for Hurricane Community Safe Rooms.....	3-15
3.4.2	Debris Impact Criteria for Hurricane Community Safe Rooms	3-20
3.5	Residential Safe Room Design Criteria	3-23
3.5.1	Wind Design Parameters for Residential Safe Rooms.....	3-24
3.5.2	Debris Impact Criteria for Residential Safe Rooms	3-26
3.6	Flood Hazard Design Criteria for Safe Rooms	3-28
3.6.1	Flood Design Criteria for Community Safe Rooms.....	3-29
3.6.2	Flood Design Criteria for Residential Safe Rooms	3-31
3.7	Product Testing	3-33
3.8	Permitting, Code Compliance, Professional Design Oversight, and Peer Review	3-34
3.8.1	Permitting and Code Compliance	3-34
3.8.2	Professional Design Oversight	3-35
3.8.3	Peer Review	3-36
3.9	Construction Documents, Signage Criteria, and Labeling	3-36
3.9.1	Construction Documents.....	3-36
3.9.2	Signage Criteria and Labeling.....	3-38

3.10 Quality Assurance/Quality Control and Special Inspections	3-38
3.10.1 Detailed Quality Assurance/Quality Control Recommendations.....	3-38
3.10.2 Quality Assurance Plan Preparation	3-39
3.10.3 Contractor’s Responsibility.....	3-40
3.10.4 Special Inspections and Acceptance	3-40
4 Characteristics of Tornadoes and Hurricanes	4-1
4.1 General Wind Effects on Buildings	4-1
4.2 Wind-Induced Forces – Tornadoes and Hurricanes.....	4-2
4.2.1 Tornadoes	4-2
4.2.2 Hurricanes and Typhoons.....	4-7
4.3 Effects of Extreme-Wind Forces	4-8
4.3.1 Effects of Tornado and Hurricane Wind Forces.....	4-10
4.3.2 Forces Generated by the Safe Room Design Wind Speed.....	4-10
4.3.3 Building Failure Modes – Elements, Connections, and Materials	4-13
4.3.4 Cyclic Loading	4-14
4.3.5 Windborne Debris and the Selection of the Representative Missile.....	4-15
4.4 Multi-Hazard Considerations.....	4-16
4.4.1 Multi-Hazard Risk Assessment	4-16
4.4.2 Multi-Hazard Design	4-16
4.4.3 Flood Hazards	4-17
4.4.4 Seismic Hazards	4-18
4.5 Other Hazards	4-21
4.6 Fire Protection and Life Safety	4-22
5 Types, Location, and Siting of Safe Rooms	5-1
5.1 Safe Room Types	5-1
5.1.1 Stand-Alone Safe Rooms.....	5-2
5.1.2 Internal Safe Rooms.....	5-3
5.2 Single-Use and Multi-Use Safe Rooms	5-3
5.2.1 Single-Use Safe Rooms.....	5-4
5.2.2 Multi-Use Safe Rooms	5-5
5.3 Modifying and Retrofitting Existing Spaces.....	5-6
5.3.1 General Retrofitting Issues.....	5-6
5.3.2 Specific Retrofitting Issues.....	5-7

5.4	Community Safe Rooms for Neighborhoods	5-9
5.5	Community Safe Rooms at Public Facilities	5-11
5.6	Safe Room Site Selection	5-13
5.6.1	Site Function and Use Considerations.....	5-13
5.6.2	Site Safety and Accessibility Considerations	5-13
5.6.3	Other Criteria to Consider	5-14
5.7	Locating Safe Rooms on Building Sites	5-14
6	Commentary on Load Determination and Structural Design Criteria	6-1
6.1	Commentary on the General Approach	6-1
6.1.1	Design Wind Speeds.....	6-2
6.1.2	Design Wind Speeds for Tornado Safe Rooms.....	6-3
6.1.3	Design Wind Speeds for Hurricane Safe Rooms.....	6-5
6.1.4	Wind Speeds for Alaska.....	6-8
6.1.5	Probability of Exceeding the Design Wind Speed	6-8
6.2	Commentary on Load Combinations	6-9
6.2.1	Strength Design.....	6-9
6.2.2	Allowable Stress Design (ASD).....	6-11
6.2.3	Combination of Loads – MWFRS and C&C	6-13
6.3	Commentary on Tornado Community Safe Room Design Criteria	6-16
6.3.1	Wind Design Parameters Using ASCE 7-05.....	6-16
6.4	Commentary on Hurricane Community Safe Room Design Criteria	6-21
6.5	Commentary on Residential Safe Room Design Criteria.....	6-23
6.6	Commentary on Continuous Load Path Concepts.....	6-24
6.7	Anchorage and Connections	6-25
6.7.1	Roof Connections and Roof-to-Wall Connections	6-25
6.7.2	Foundation-to-Wall Connections and Connections Within Wall Systems	6-27
7	Commentary on Debris Impact Performance Criteria for Safe Rooms	7-1
7.1	Windborne Debris in Tornadoes and Hurricanes	7-2
7.1.1	Debris Potential at Safe Room Sites.....	7-3
7.1.2	Representative Missiles for Debris Impact Testing.....	7-5
7.2	Commentary on Resistance to Missile Loads and Successful Testing Criteria	7-8

7.2.1	Debris Impact Test Speeds for Representative Missiles	7-10
7.2.2	Induced Loads From the Design Missile and Other Debris	7-12
7.3	Commentary on Performance of Wall and Roof Assemblies During Debris Impact Tests.....	7-16
7.3.1	Impact Resistance of Wood Systems	7-16
7.3.2	Impact Resistance of Sheet Metal	7-17
7.3.3	Impact Resistance of Composite Wall Systems	7-18
7.3.4	Impact Resistance of Concrete Masonry Units.....	7-18
7.3.5	Impact Resistance of Reinforced Concrete	7-19
7.4	Commentary on General Performance of Doors, Door Frames, and Windows During Debris Impact Tests.....	7-20
7.4.1	Door Construction	7-21
7.4.2	Door Frames	7-23
7.4.3	Door Hardware	7-23
7.4.4	Doors and Egress Recommendations	7-25
7.4.5	Performance of Windows During Debris Impact Tests	7-27
7.5	Commentary on Soil Protection From Debris Impact	7-28
7.6	Commentary on Large Falling Debris	7-28
8	Human Factors Criteria.....	8-1
8.1	Protection of Critical Support Systems	8-1
8.2	Occupancy Duration	8-2
8.2.1	Tornado Safe Rooms	8-2
8.2.2	Hurricane Safe Rooms.....	8-2
8.3	Ventilation	8-2
8.3.1	Ventilation for Tornado Community Safe Rooms	8-3
8.3.2	Ventilation for Hurricane Community Safe Rooms	8-4
8.4	Square Footage, Occupancy, and Egress Recommendations	8-5
8.4.1	Tornado and Hurricane Community Safe Room Square Footage Criteria.....	8-5
8.4.2	Tornado and Hurricane Residential Safe Room Square Footage Criteria	8-7
8.5	Distance and Travel Time	8-7
8.6	Americans with Disabilities Act (ADA).....	8-8
8.7	Special Needs	8-9
8.8	Lighting.....	8-9

8.9	Emergency Provisions	8-10
8.9.1	Food and Water.....	8-10
8.9.2	Sanitation Management	8-10
8.9.3	Emergency Supplies	8-11
8.9.4	Communications Equipment	8-11
8.10	Standby Power	8-12
9	Emergency Management Considerations	9-1
9.1	Community Safe Room Operations Plan	9-2
9.1.1	Community Safe Room Manager.....	9-3
9.1.2	Building Manager	9-4
9.1.3	Shift Supervisor	9-4
9.1.4	Registration Unit Leader.....	9-5
9.1.5	Health Services Unit Leader	9-5
9.1.6	Communications Unit Leader.....	9-6
9.1.7	Food Unit Leader.....	9-6
9.1.8	Equipment and Supplies	9-7
9.2	Community Safe Room Maintenance Plan	9-7
9.3	Commercial or Public Building Safe Room Operations Plan	9-8
9.3.1	Emergency Assignments	9-8
9.3.2	Emergency Call List	9-9
9.3.3	Tornado/Hurricane Procedures for Safety of Employees	9-10
9.4	Signage	9-10
9.4.1	Community Signage.....	9-11
9.4.2	Building Signage at Schools and Places of Work.....	9-11
10	References	10-1

Appendices

APPENDIX A Acknowledgments

APPENDIX B Safe Room Assessment and Design Tools

APPENDIX C Case Study I – Stand-Alone Community Safe Room (North Carolina)

APPENDIX D Case Study II – School Community Safe Room (Kansas)

APPENDIX E Wall Sections That Passed Previous Missile Impact Tests

APPENDIX F Doors and Hardware That Passed Previous Missile Impact Tests**APPENDIX G Design Guidance on Missile Impact Protection Levels for Wood Sheathing****APPENDIX H Acronyms and Abbreviations****Tables****Chapter 1**

Table 1-1. Past FEMA Safe Room and Shelter Publications and Guidance	1-13
--	------

Chapter 2

Table 2-1. Wind Safe Room and Shelter Design Codes, Standards, and Guidance Comparison.....	2-8
Table 2-2. Wind Safe Room and Shelter Design Values Comparison	2-10
Table 2-3. Risk Analysis Matrix	2-18
Table 2-4. Cost Data From Recent Community Safe Room Projects.....	2-22

Chapter 3

Table 3-1. Occupant Density for Tornado Community Safe Rooms.....	3-11
Table 3-2. Tornado Missile Impact Criteria	3-13
Table 3-3. Occupant Density for Hurricane Community Safe Rooms	3-19
Table 3-4. Hurricane Missile Impact Criteria	3-22
Table 3-5. Occupant Density for Residential Safe Rooms.....	3-26
Table 3-6. Residential Safe Room Missile Impact Criteria.....	3-27

Chapter 4

Table 4-1. Comparison Table for the Fujita and Enhanced Fujita Scales	4-5
Table 4-2. The Saffir-Simpson Hurricane Scale Wind Speeds and Pressures	4-7

Chapter 6

Table 6-1. Tornado Frequencies in the United States (1950-2006)	6-4
Table 6-2. Saffir-Simpson Hurricane Scale	6-6

Chapter 7

Table 7-1. Windborne Debris (Missiles) Classifications for Tornadoes and Hurricanes...	7-3
Table 7-2. Debris Impact Test Requirements for Tornadoes and Hurricanes	7-8
Table 7-3. Missile Speed as a Function of Exposure and Distance Traveled	7-11
Table 7-4. Missile Speed and Distance Traveled Relationships.....	7-12

Chapter 8

Table 8-1. Venting Area Requirements for Tornado Safe Rooms	8-4
Table 8-2. Venting Area Requirements for Hurricane Safe Rooms	8-5

Figures**Chapter 1**

Figure 1-1. Destroyed tornado refuge area at an elementary school	1-6
Figure 1-2. Destroyed tornado refuge area at a high school	1-7
Figure 1-3. Severely damaged hurricane shelter	1-10

Chapter 2

Figure 2-1. Process for risk and needs assessments for safe rooms	2-12
Figure 2-2. Tornado occurrence map	2-14
Figure 2-3. Flowchart for the existing benefit-cost model	2-27

Chapter 3

Figure 3-1. Tornado Safe Room Design Wind Speed Map (consistent with ICC-500 Tornado Hazard Map)	3-8
Figure 3-2. Hurricane Safe Room Design Wind Speed Map	3-16
Figure 3-2a. Western Gulf of Mexico Detail	3-17
Figure 3-2b. Eastern Gulf of Mexico Detail	3-17
Figure 3-2c. Mid-Atlantic and Northeast Detail.....	3-18
Figure 3-3. Storm surge.....	3-30

Chapter 4

Figure 4-1. Typical tornado damage	4-6
Figure 4-2. Typical hurricane damage.....	4-9
Figure 4-3. Calculated pressures acting on a typical safe room	4-12
Figure 4-4. Internal pressurization and resulting building failure	4-13
Figure 4-5. Forces on a building due to wind moving around the structure.....	4-14
Figure 4-6. Examples of buildings with regular and irregular shapes	4-19
Figure 4-7. Time response of ground during a seismic event.....	4-19
Figure 4-8. Example of a single-degree-of-freedom system.....	4-19
Figure 4-9. Acceleration vs. period of structure.....	4-20

Chapter 5

Figure 5-1. Signs at an airport showing the best available areas of refuge	5-6
--	-----

Figure 5-2. Illustration of properly and improperly sited community and residential safe rooms in a coastal environment.....	5-15
Figure 5-3a. Elevation details for sample community safe rooms presented in Figure 5-2.	5-16
Figure 5-3b. Elevation details for sample residential safe rooms presented in Figure 5-2.	5-17
Chapter 6	
Figure 6-1. MWFRS and C&C loads acting on a structural member.....	6-15
Figure 6-2. Tributary and effective wind areas for a roof	6-21
Figure 6-3. Critical connections important for providing a continuous load path	6-25
Figure 6-4. Continuous load path in a reinforced masonry building	6-26
Figure 6-5. Load path failure between bond beam and top of URM wall	6-26
Figure 6-6. Steel columns that failed at their connection to the foundation	6-27
Chapter 7	
Figure 7-1. Examples of large debris generated by tornadoes and hurricanes.....	7-4
Figure 7-2. School bus lifted atop a section of a high school.....	7-5
Figure 7-3. Refrigerator pierced by windborne missile	7-6
Figure 7-4. Variations of impact impulse as a function of impact angle.....	7-14
Figure 7-5. Measured raw and filtered forcing functions	7-15
Figure 7-6. Impulse as a function of initial missile momentum for 2x4	7-15
Figure 7-7. Plywood/masonry infill and plywood/metal wall sections.....	7-16
Figure 7-8. Uses of expanded metal and sheet metal in wall sections.....	7-17
Figure 7-9. Composite wall section	7-18
Figure 7-10. Concrete masonry unit (CMU) wall sections	7-18
Figure 7-11. Reinforced concrete wall sections	7-19
Figure 7-12. Safe room door protected by a missile-resistant barrier.....	7-26
Figure 7-13. Soil cover over a safe room	7-29
Chapter 9	
Figure 9-1. Example of a wind safe room sign.....	9-10

1 Introduction

This publication provides guidance for architects, engineers, building officials, local officials and emergency managers, and prospective safe room owners and operators about the design, construction, and operation of safe rooms and storm shelters, and for extreme-wind events. It presents important information about the design and construction of community safe rooms that will provide protection during tornado and hurricane events.

1.1 Purpose

This publication presents the design and construction guidance that the Federal Emergency Management Agency (FEMA) believes is necessary to provide life-safety protection during extreme-wind events. This guidance interprets the new International Code Council® (ICC®) *ICC/NSSA Standard for the Design and Construction of Storm Shelters* [(ICC-500, produced in consensus with the National Storm Shelter Association (NSSA)] design criteria and provides technical design guidance and emergency management considerations to individuals who are looking for “best-practices” that are above minimums in the codes and standards. FEMA continues to advocate the design and construction of safe rooms as evident by its continuing support of safe room initiatives through several grant programs. Since the initiation of its safe room program, FEMA has provided federal funds totaling over \$200,000,000 for the design and construction of more than 500 community safe rooms. Through residential safe room initiatives over the same time, FEMA has provided support for the design and construction of nearly 20,000 residential safe rooms with federal funds totaling more than \$50,000,000. These projects were completed in both tornado-prone and hurricane-prone regions of the country.¹ Although this publication provides technical information that must be adhered to as part of the funding requirements of the FEMA safe room policy,² this is not its primary purpose. Rather, the most important aspect of this publication is that it provides the criteria necessary for any safe room, private or public, to be constructed so that it is capable of providing “near-absolute protection” for its occupants during extreme-wind events.

The first edition of FEMA 361, released in July 2000, set forth design and construction criteria for tornado and hurricane shelters where none had been provided. These criteria were the basis of many community safe rooms that have been designed, constructed, and funded by FEMA since 2000. This second edition of FEMA 361 continues to provide guidance in the design and construction of tornado and hurricane safe rooms, but now references much of the ICC-500

¹ FEMA safe room program statistics are current through March 2008. The dollar figures provided are the estimated federal share obligated towards the design and construction of the safe rooms.

² FEMA's policy on the eligibility of the design and construction of safe rooms for federal funding is provided in FEMA Mitigation Interim Policy MRR-2-07-1, *Hazard Mitigation Assistance for Safe Rooms*, dated March 7, 2008.

Storm Shelter Standard. FEMA supports the development of hazard-resistant codes and standards through the monitoring of, and participation in the process of creating these documents, including the ICC-500.

Codes and standards are typically produced by consensus committees through open, public forums and there are always topics and subject areas where compromises are made in the preparation of the design criteria. As such, FEMA has identified specific design criteria in this publication to be more conservative than what is presented in the ICC-500 in large part due to emergency management considerations and maintaining near-absolute protection. FEMA believes the criteria in this updated publication should be incorporated into safe room design and construction projects to best protect individuals from wind and debris during wind storms. This second edition of FEMA 361 relies upon much of the ICC-500, but also identifies the specific technical criteria where the FEMA guidance meets or exceeds the minimum requirements of the ICC-500. This approach is consistent with past publications produced by FEMA. FEMA guidance publications have provided, and will continue to provide, “best-practices” guidance above and beyond the minimum criteria and scope of the consensus codes and standards for design and construction of buildings and structures to resist natural and manmade hazards.

1.2 Safe Rooms vs. Shelters

“Safe room” and “shelter” are two terms that have been used interchangeably in past publications, guidance documents, and other shelter-related materials. However, with the release of the ICC-500 standard, there is a need to identify or describe shelters that meet the FEMA criteria for life-safety protection and those that meet the ICC-500 standard. To help clarify the difference between shelters designed to the ICC-500 standard and the FEMA 320 and 361 guidance, this publication will refer to all shelters constructed to meet the FEMA criteria (whether for individuals, residences, small businesses, schools, or communities) as safe rooms. All safe room criteria in this publication meet or exceed the shelter requirements of the ICC-500.

Safe rooms designed and constructed in accordance with the guidance presented in this publication provide “near-absolute protection” from extreme-wind events. Near-absolute protection means that, based on our current knowledge of tornadoes and hurricanes, the occupants of a safe room built according to this guidance will have a very high probability of being protected from injury or death. Our knowledge of tornadoes and hurricanes is based on substantial meteorological records as well as extensive investigations of damage from extreme winds. However, since extreme-wind events may occur or have hypothetically occurred in the past, to date a wind event exceeding the maximum design criteria in this publication has not been observed. For this reason, the protection provided by these safe rooms is called near-absolute rather than absolute.

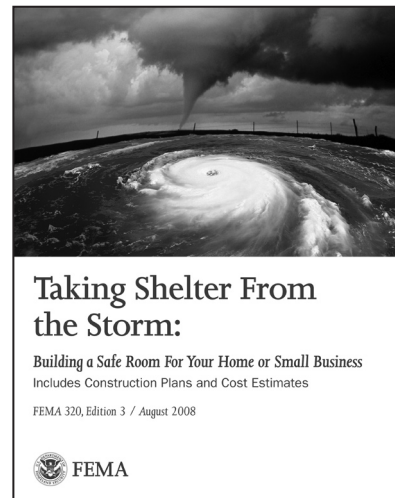

TORNADO OCCURRENCE AND RESULTANT LOSSES ARE INCREASING

In 1950, the National Weather Service (NWS) started keeping organized records of tornadoes occurring in the United States (U.S.). Since that time, 1953 was the deadliest year (519 deaths). The average in recent years has been 62 deaths per year. Deaths caused by tornadoes were 38, 67, and 81 for 2005, 2006, and 2007, respectively. As of May of this year, 110 deaths have been caused by tornadoes.

In addition to deaths, tornadoes cause injuries and devastating losses of personal property. Insurance claim losses from a single tornadic event of \$1 billion and higher are becoming more frequent. So far in 2008, tornadoes have resulted in insured losses of more than \$1 billion (almost \$850 million from the mid-South outbreaks on February 5 and 6; in March, Atlanta and its surrounding counties were struck by a tornado that caused \$349 million in losses).

Although hurricanes and earthquakes generally generate higher losses per event, since 1953, tornadoes (and related weather events) have caused an average of 57 percent of all U.S. insured catastrophic losses. In 2007, that number increased to 69 percent.



This photograph from FEMA's photo library shows the vivid reality of how lives are impacted by tornadoes. (Lafayette, TN – February 5, 2008)

SOURCE: JOCELYN AUGUSTINO/FEMA

SOURCE: A.M. BEST, CNN

For the purpose of this publication, a community safe room is defined as a shelter that is designed and constructed to protect a large number of people from a natural hazard event. The number of persons taking refuge in the safe room will typically be more than 16 and could be up to several hundred or more. These numbers exceed the maximum occupancy of small, in-residence safe rooms recommended in the second edition of FEMA 320, *Taking Shelter From the Storm: Building a Safe Room Inside Your House*. It should be noted that a third edition of FEMA 320 is being prepared and will be released in conjunction with this update of FEMA 361.

The two types of community safe rooms covered by the guidance in this publication include:

- Stand-alone safe room – a separate building (i.e., not within or attached to any other building) that is designed and constructed or retrofitted to withstand extreme winds and the impact of windborne debris (missiles) during tornadoes, hurricanes, or other extreme-wind events.
- Internal safe room – a specially designed and constructed room or area within or attached to a larger building; the safe room (room or area) that may be designed and constructed or retrofitted to be structurally independent of the larger building, but provides the same wind and missile protection as a stand-alone safe room.

These safe rooms are intended to provide protection during a short-term extreme-wind event (i.e., an event that normally lasts no more than 24 hours) such as a tornado or hurricane. (Minimum safe room occupancy times are 2 and 24 hours for tornadoes and hurricanes, respectively.) They are **not** recovery shelters intended to provide services and housing for people whose homes have been damaged or destroyed by fires, disasters, or catastrophes.

Both stand-alone and internal community safe rooms may be constructed near or within school buildings, hospitals and other critical facilities, nursing homes, commercial buildings, disaster recovery shelters, and other buildings or facilities occupied by large numbers of people. Stand-alone community safe rooms may be constructed in neighborhoods where existing homes lack shelters or where the homes are subject to damage from extreme-wind events. Community safe rooms may be intended for use by the occupants of buildings they are constructed within or near, or they may be intended for use by the residents of surrounding or nearby neighborhoods or designated areas.

This publication provides detailed guidance concerning the design and construction of both stand-alone and internal community safe rooms for extreme-wind events – guidance that is currently not available in other design guides or in building codes or standards. It is a compilation of the best information available at the time of publication. Safe room location, design loads, performance criteria, and human factor criteria that should be considered for the design and construction of such safe rooms are discussed herein. Case studies (one for a stand-alone safe room and one for an internal safe room) are presented in Appendices C and D, respectively, and illustrate how to evaluate existing shelter areas and make safe room selections, and provide construction drawings, emergency operations plans, and cost estimates. Many factors may influence the decision to construct a community safe room. They include the following:

- The likelihood of an area being threatened by an extreme-wind event
- The consequences (deaths and injuries) of an extreme-wind event
- The cost of constructing a safe room

Therefore, this publication also provides decision-making tools that include safe room hazard evaluation checklists and information about economic analysis software. These tools provide

an effective means of addressing all or many of the considerations that can affect the decision either to build or to not build a community safe room.

1.3 Background

Tornadoes and hurricanes are among the most destructive forces of nature. Unfortunately, these types of wind storms continue to cause injury and death to people who are unable to safely evacuate or find shelter from these events. This section provides background information about recent tornadoes and hurricanes, post-disaster assessments, research activities, and design criteria development carried out by FEMA and other organizations in an attempt to improve the guidance for safe room design and construction.

1.3.1 Tornado Events

On average, more than 1,275 tornadoes have been reported nationwide each year since 1997. From 1950 through 2006, tornadoes have caused 5,506 deaths and 93,287 injuries,³ as well as devastating personal and property losses. According to the *Glossary of Meteorology* (AMS 2000), a tornado is “a violently rotating column of air, pendant from a cumuliform cloud or underneath a cumuliform cloud, and often (but not always) visible as a funnel cloud.” The most violent tornadoes are capable of tremendous destruction with wind speeds of up to 250 miles per hour (mph) near ground level. Damage paths over 50 miles long and over 1 mile wide have been reported. During the Great Plains Tornado Outbreak of May 3, 1999, 67 tornadoes struck Oklahoma and Kansas, including numerous EF4 and EF5 tornadoes (EF4 and EF5 are classifications based on the Enhanced Fujita (EF) Tornado Scale – see Table 4-1 in Chapter 4). This tornado outbreak resulted in 49 deaths and leveled neighborhoods. Additional information about the Oklahoma and Kansas tornadoes is available in the FEMA Mitigation Assessment Team (MAT) report *Midwest Tornadoes of May 3, 1999*, FEMA 342. These events had a great influence on FEMA and the decision to develop the first edition of FEMA 361 in June 2000. Figure 1-1 shows Kelley Elementary School in Moore, Oklahoma, and the central corridor of the school, which was the designated tornado refuge area. When the tornado hit, classes were over for the day. However, had this tornado occurred earlier in the day, the effect on individuals taking shelter would have been disastrous.

Similar deadly storm outbreaks have occurred since that time. Almost 4 years to the day after the May 3, 1999, tornadoes, 80 tornadoes were reported across eight states, including Kansas, Oklahoma, and Missouri. The tornadoes struck on May 8, 2003, causing 37 deaths and destroying hundreds of homes and businesses. Again in May, but in 2007, a smaller tornado outbreak occurred. On May 4th, 12 tornadoes were spawned by an intense supercell.

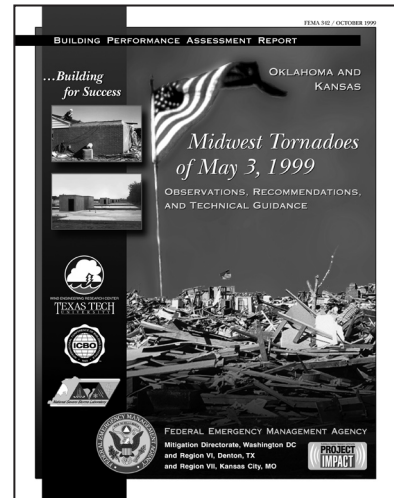

³ Tornado occurrence data obtained from the NOAA Storm Prediction Center records at <http://www.spc.noaa.gov/climo/historical.html>.

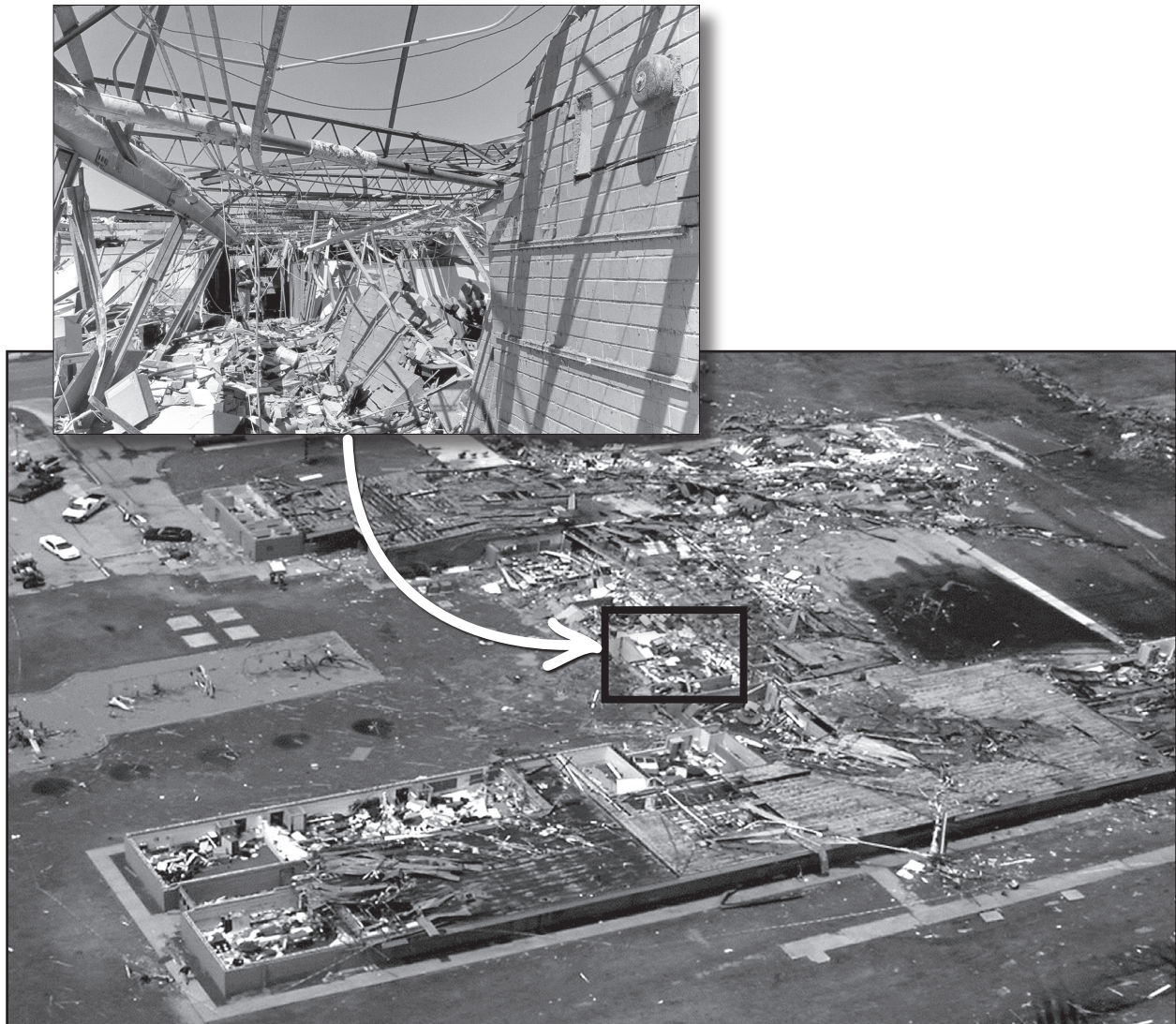

Figure 1-1. Destroyed tornado refuge area at Kelley Elementary School, Moore, Oklahoma (1999)

One of these tornadoes was rated an EF5. Wind speeds from this tornado were estimated to be greater than 205 mph (3-second gust). The tornado had a reported swath of 1.7 miles, and destroyed approximately 95 percent of Greensburg, Kansas, causing 11 deaths in the town.

Prior to the Greensburg tornado, Florida was impacted by a tornado outbreak in February 2007. A small, but deadly outbreak of three tornadoes struck northeast Florida from the Lady Lake area to New Smyrna Beach on the coast. These three tornadoes killed 21 people and injured dozens of others. Of the three tornadoes, two were rated EF3 and one was rated EF1. Because these tornadoes struck in the middle of the night, almost all of the fatalities were to individuals who were in their homes. The unfortunate events of February 2007 remind us that, even in hurricane-prone areas where many homes are considered to be more “hazard-resistant,” they

are not designed to provide life-safety protection. The two EF3 tornadoes, in the middle of the EF Scale, were not the large EF4 and EF5 tornadoes typically associated with major storm fatalities. These lower intensity, and more common tornadoes, highlight the tornado hazard that exists in hurricane-prone regions and calls attention to the threat posed to homeowners by smaller tornadoes because residential construction is typically not designed to provide near-absolute protection for their occupants.

Also in 2007, a significant tornado developed near Enterprise, Alabama on March 1st, again with deadly results. The tornado was categorized as a lower-end EF4 and produced enough force to damage a significant portion of the town, including directly impacting Enterprise High School (see Figure 1-2). Eight students perished at the high school as they were sheltering-in-place. The school had identified a best-available area for refuge during a tornado, but no portion of the building had been hardened for tornado resistance to provide the level of protection consistent with a FEMA 361 safe room. After the event, the following statement was released by the investigators from the National Oceanic and Atmospheric Administration (NOAA – *Tornadoes in Southern Alabama and Georgia, March 1, 2007*; NOAA tornado assessment):



Figure 1-2. Destroyed tornado refuge area at Enterprise High School, Enterprise, Alabama (2007)

“The high school in Enterprise followed proper protocol in terms of maximizing student safety. The eight fatalities at the high school appear to have been due to structural failure of the roof and walls, which collapsed on the students. Previous events have shown that hardened safe rooms provide better shelter from tornadoes than other permanent structures, especially during EF3 or greater tornadoes, and may be a critical component of adequate tornado safety plans, especially in mobile home parks, homes with standard grade construction, and non-residential buildings in which many people normally gather (schools, office buildings, etc.).”

The events in Moore, Oklahoma, Greensburg, Kansas, and Enterprise, Alabama, as well as other events not detailed here, show the deadly and destructive potential of tornadoes. Such events continue to illustrate the compelling need for shelters and safe rooms capable of protecting human lives against the risk of tornadoes. This publication provides design criteria for the design and construction of community safe rooms that should provide the level of protection needed to protect lives from tornadic events.

**NOTE**

FEMA 320, *Taking Shelter From the Storm: Building a Safe Room For Your Home or Small Business*, is another FEMA publication that provides guidance on safe rooms for tornado and hurricane protection. FEMA 320 presents a summary of storm hazards and prescriptive designs of both above- and in-ground safe rooms that meet the design criteria of FEMA 361 and the ICC-500 for residential and small community shelters.

1.3.2 Hurricane Events

A hurricane, as defined by NOAA, is a tropical cyclone in which the maximum sustained surface wind (using the U.S. 1-minute average) is 74 mph. The term hurricane is used for Northern Hemisphere tropical cyclones east of the International Dateline to the Greenwich Meridian. Around its core, winds can grow with great velocity, generating violent seas. As the storm moves ashore, it can push ocean waters inland (this effect is known as storm surge) while spawning tornadoes and producing torrential rains and floods. In this publication, the term storm surge means an abnormal rise in sea level accompanying a hurricane or other intense storm, whose height is the difference between the observed level of the sea surface and the level that would have occurred in the absence of the cyclone. Storm surge is usually estimated by subtracting the normal or astronomic high tide from the observed storm tide (see Figure 3-3 of Chapter 3).

On average, 10 tropical storms (6 of which become hurricanes) develop each year in the Atlantic Ocean.⁴ Approximately five hurricanes strike the United States mainland every 3 years; two of those storms will be major hurricanes (Category 3 or greater on the Saffir-Simpson Hurricane Scale – see Table 4-2 in Chapter 4). The loss of life and property from hurricane-generated winds and floodwaters can be staggering. Although these storms do not make landfall in the U.S. every year, from 1900 through 2006, hurricanes caused 17,832 deaths and substantial numbers of injuries, as well as extensive personal and property losses. Tornadoes of weak to moderate intensity (typically EF0 to EF2) occasionally accompany tropical storms and hurricanes that move over land. These tornadoes are usually to the right and ahead of the path of the storm center as it comes onshore.

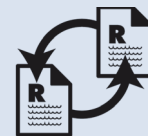
**CROSS-REFERENCE**

The Saffir-Simpson Hurricane Scale is discussed in Chapter 4.

In the western Pacific, hurricanes are called “typhoons.” The term typhoon is used for Pacific tropical cyclones north of the Equator and west of the International Dateline [(i.e., the Pacific Islands, including Guam and American Samoa)]. In the Indian Ocean, similar storms are called “cyclones.” Like hurricanes and tornadoes, typhoons and cyclones can generate extreme winds, flooding, high-velocity flows, damaging waves, significant erosion, and heavy rainfall. Historically,

⁴ Hurricane occurrence data obtained from NOAA historical records. Note: Although the statistical set goes back to 1851, data records older than 1900 may underreport occurrences since many coastal communities had not yet been established.

typhoons have been classified by strength as either typhoons (storms with less than 150 mph winds) or super typhoons (storms with wind speeds of 150 mph or greater), rather than by the Saffir-Simpson Hurricane Scale.

In recent years, multiple hurricanes have caused severe damage to coastal areas in the southern Atlantic and Gulf coast regions of the United States. One hurricane that had significant effects on not only the people and the community impacted, but also on design and construction requirements for all building types (residential, non-residential, and essential facilities) was Hurricane Andrew. The storm made landfall in southeastern Florida on August 24, 1992, generated strong winds and heavy rains over a vast portion of southern Dade County. This Category 4/5 hurricane (which is defined as having sustained wind speeds of approximately 155 mph) produced extreme winds and high storm surge, but the most extensive damage was caused by winds and not the storm surge. The storm caused unprecedented economic devastation; damage in the United States was estimated to be \$21 billion dollars in insured losses (adjusted for inflation to 2006 dollars). In Dade County, the storm forces caused 15 deaths and left almost one-quarter million people temporarily homeless. Additional information about Hurricane Andrew was documented in the FEMA report *Building Performance: Hurricane Andrew in Florida*, FIA-22.

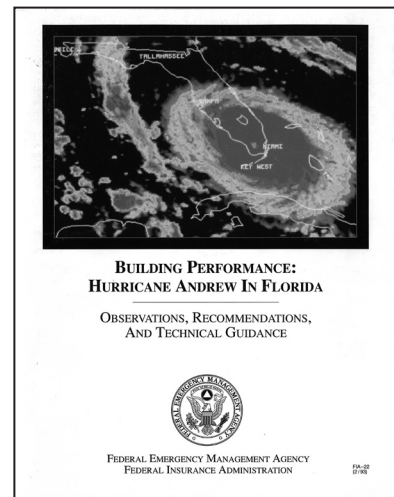

Facilities designated as shelters are given the responsibility of protecting the lives of those taking refuge within them. Yet damage to these “shelters” or “hardened areas” continues to be observed, which undermines public confidence. Often, there is a general lack of understanding of effects of exposing buildings not designed to provide life-safety protection from extreme-wind events. A variety of different types of “shelters” that are used before, during, and after storm events, provide different levels of protection. If the building or structure selected for use as a shelter cannot withstand the effects of hurricane winds, the results can be devastating. In 2004, Hurricane Charley moved over Florida as a Category 4 hurricane. In an inland county, a facility had recently been constructed to design wind speeds above the 110 to 120 mph (3-second gust) wind speeds that were actually experienced. The building met minimum requirements established by the state for shelter facilities. The building was sheltering approximately 1,200 people when roof panels began lifting off and one end wall of the facility partially collapsed (see Figure 1-3). Shelter performance such as this prompts scrutiny of the different protection levels that have been developed over the years and again reinforces the need for better shelter design and construction guidance such as FEMA 361 and the ICC-500, which address the entire design and construction life-cycle from planning through design and construction of the facility, and provide a level of protection associated with life-safety of shelter occupants.

The most devastating hurricane in recent years, however, was Hurricane Katrina, the third strongest hurricane to make landfall in the history of the United States. Though crossing Florida as only a moderate Category 1 hurricane, it moved into the Gulf of Mexico where it rapidly

increased to a Category 5 hurricane. After weakening just 24 hours prior to landfall, Katrina came ashore as a Category 3 storm in Louisiana and Mississippi. Hurricane Katrina went on to cause over 1,800 deaths and \$81.2 billion in insured losses (making it the largest natural disaster in U.S. history). The storm caused the levees to break in New Orleans, pushing floodwaters throughout much of the city, and caused tremendous damage to many cities and towns all along the Mississippi coast. After the storm, FEMA dispatched a MAT to assess the performance of buildings impacted by the storm (see FEMA 549, *Hurricane Katrina in the Gulf Coast*). Among the many findings and conclusions made by the MAT, it was determined that buildings functioning as critical and essential facilities (which were often used as shelters during the storm) did not perform better than their commercial counterparts. The same construction issues that affected residential and commercial buildings were observed in critical and essential facilities, the very facilities that the public regularly assumes have to be hardened to resist hurricane winds and floodwaters.



Figure 1-3. Severely damaged hurricane shelter at Turner Agri-Civic Center, Arcadia, Florida (2004)

As with the tornado events discussed in the previous section, the events in Florida, Louisiana, and Mississippi represent just a small sampling of the deadly and destructive potential of hurricanes and continue to illustrate the compelling need for shelters and safe rooms capable of protecting human lives. FEMA 361 provides design criteria for the design and construction of community safe rooms for facilities that can resist such wind forces.

1.3.3 Post-Disaster Assessments, Research, and Design Development

When a hurricane, tornado, earthquake, or terrorist attack results in a catastrophic natural or manmade disaster in the United States or one of its territories, FEMA frequently deploys a technical building sciences team to document the performance of the built environment during the event. These teams are referred to as Mitigation Assessment Teams. The objectives of a MAT are to inspect damage to buildings, assess the performance of the buildings, evaluate design and construction practices, and evaluate building code requirements and enforcement. The MAT then makes recommendations for improving building performance in future storm events. The MAT consists of representatives from FEMA Headquarters, the FEMA Regional Offices, state and

local governments, and public and private sector experts in design, construction, and building code development and enforcement.

The findings from MATs outline building science issues of national significance that warrant further study. Since Hurricane Opal in 1989, MATs (and building science teams from preceding programs, such as the Building Performance Assessment Team [BPAT] program) have studied and reported on over 10 major hurricane or tornado events. In addition, FEMA uses smaller technical field assessment teams to support the MAT and other post-disaster activities to further document the performance of buildings and shelters during these events. For example, in 2007, in response to numerous outbreaks of tornadoes, FEMA ordered several teams into the field to assess building performance, damages, and associated issues. These teams produced a series of technical safe room and building improvement documents: the five February 2007 Tornado Recovery Advisories (RAs) (FEMA DR-1679, <http://www.fema.gov/library/viewRecord.do?id=2631>) and the three May 2007 Tornado RAs (FEMA DR-1699, <http://www.fema.gov/library/viewRecord.do?id=2972>, 2973, and 2974) prepared for public release to aid in post-disaster reconstruction. The RAs contain informative facts about tornadoes, their effects on various types of construction from manufactured housing to community safe rooms, the risk of tornado events associated with regions of the country, and potential mitigation actions that can be taken to reduce damages to older and new manufactured homes.

The MAT Process: In response to catastrophic hurricanes, floods, tornadoes, earthquakes, and other disasters, FEMA often deploys Mitigation Assessment Teams (MATs) to conduct field investigations at disaster sites. More information about the MAT program can be found at http://www.fema.gov/rebuild/mat/mat_faqs.shtml.

Additionally, studies have been conducted since the early 1970s to determine design parameters for safe rooms intended to provide protection from tornadoes, hurricanes, and other extreme-wind events. In 1998, using the results of research conducted by Texas Tech University's (TTU's) Wind Science and Engineering (WISE) Research Center, formerly the Wind Engineering Research Center (WERC), FEMA developed design guidance and construction plans for in-home safe rooms and prepared the booklet *Taking Shelter From the Storm: Building a Safe Room Inside Your House* (FEMA 320). As the title suggests, the guidance presented in FEMA 320 is specific to small safe rooms built inside individual houses.

Since the original guidance was published, several significant tornado and hurricane events have occurred. Considerable engineering and scientific research and investigations have been conducted that have resulted in various important findings. Also, using the original FEMA 361 publication as guidance, the International Code Council in partnership with FEMA and the National Storm Shelter Association (NSSA), formed a national committee that developed and released a new consensus standard to codify the design and construction requirements of extreme-wind storm shelters. This new standard, the *ICC/NSSA Standard for the Design and Construction of Storm Shelters* (ICC-500), was completed in the summer of 2008 and will be incorporated by reference into the 2009 International Building Code® (IBC®) and the International

Residential Code® (IRC®). This second edition of FEMA 361 updates the original guidance and takes into consideration the new ICC-500 standard, along with the additional research and studies that have been conducted since 2000.

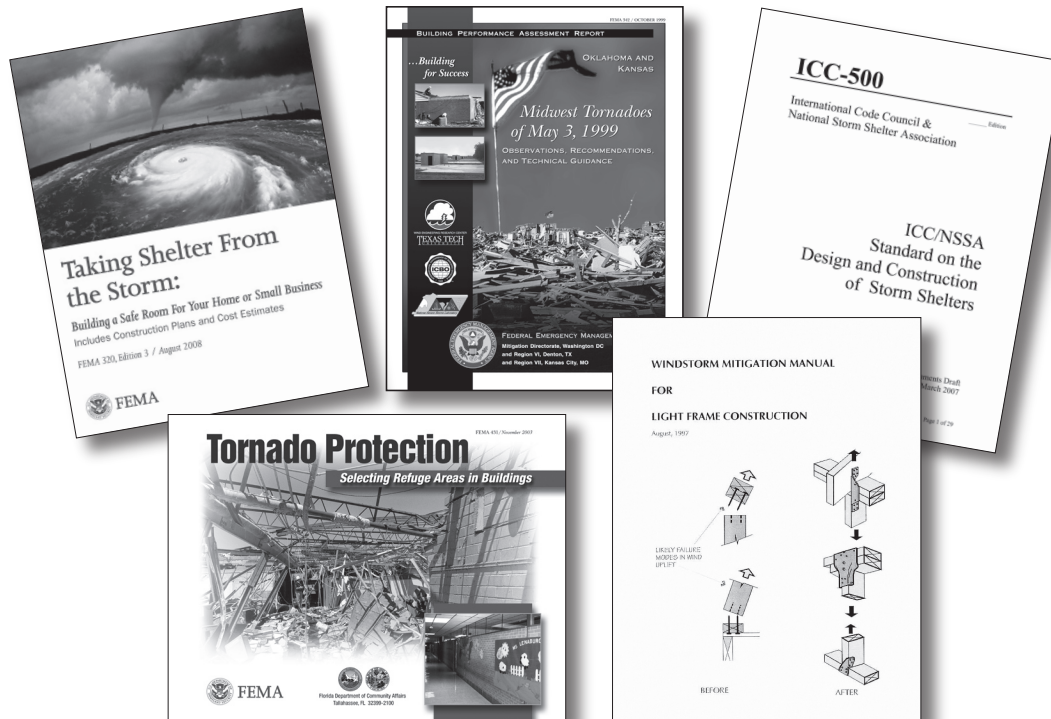

This publication builds on the knowledge of field investigations, research, and technical reports and publications prepared by FEMA and other national and state agencies that have studied and researched the performance of the built environment during tornadoes and hurricanes. FEMA remains committed to the development of design and construction criteria and guidance for safe rooms capable of providing the highest quality of life-safety protection from extreme-wind events. Table 1-1 provides a listing of safe room and shelter publications and guidance documents that have been produced by FEMA over the past 32 years.

For questions related to safe room design criteria presented in FEMA 320 or FEMA 361, call the FEMA Building Science helpline at (866) 222-3580 or email saferoom@dhs.gov for technical assistance.

Table 1-1. Past FEMA Safe Room and Shelter Publications and Guidance

Date	Publication
April 1976	FEMA TR-83B, <i>Tornado Protection: Selecting and Designing Safe Areas in Buildings</i>
September 1980	FEMA TR-83A, <i>Interim Guidelines for Building Occupant Protection From Tornadoes and Extreme Winds</i>
September 1998	FEMA 320, <i>Taking Shelter From the Storm</i> (First Edition)
May 1999	FEMA <i>National Performance Criteria for Tornado Shelters</i>
August 1999	FEMA 320, <i>Taking Shelter From the Storm</i> (Second Edition)
July 2000	FEMA 361, <i>Design and Construction Guidance for Community Shelters</i>
October 2001	FEMA 388, <i>Safe Room and Shelter Resource</i> – CD
November 2003	FEMA 431, <i>Tornado Protection – Selecting Refuge Areas in Buildings</i> (in cooperation with the Florida Department of Community Affairs)
March 2007	2007 <i>Florida Tornado Outbreak – Tornado Recovery Advisories</i>
September 2007	<i>Greensburg, KS Tornado – Tornado Recovery Advisories</i>

1.4 Organization of the Publication

This publication consists of 10 chapters and 8 appendices. This first chapter is the introduction and provides the purpose and background for the publication. The following is a list of the other chapters herein:

Chapter 2 describes the objectives of designing community safe rooms (the primary objective is the safety of the occupants within the safe rooms), and discusses risk assessment tools and compares FEMA safe room criteria with other shelter criteria.

Chapter 3 presents the FEMA design criteria for both tornado and hurricane safe rooms. Details include applicable ICC-500 design requirements, code compliance, peer review, and design documentation.

Chapter 4 discusses the characteristics of tornadoes and hurricanes, and their effects on structures.

Chapter 5 provides commentary on some of the design criteria given in Chapter 3, safe room location concepts (including safe rooms accessed from the interior or exterior of a building),

modifying and upgrading existing interior space, safe room location and accessibility, and types of safe rooms.

Chapter 6 presents commentary on the wind and flood load design criteria for safe room structures (e.g., determination of wind loads, protection against penetration by windborne missiles, and proper anchorage and connection).

Chapter 7 provides commentary on the performance criteria for windborne missile impacts, doors and door frames, windows, and roofs.

Chapter 8 presents the human factors criteria for safe rooms (e.g., proper ventilation, square footage per safe room occupant, accessibility, lighting, occupancy durations, emergency food and water, sanitary management, emergency supplies, and emergency power).

Chapter 9 discusses emergency management considerations, including parameters for developing a plan of action to respond to an extreme-wind event for both community safe rooms and safe rooms in commercial buildings, and preparation of a safe room maintenance plan.

Chapter 10 provides a list of references used in the preparation of this publication.

Appendix A presents a list of the key people involved in preparation of both the first and second editions of the publication. This includes the Project Team, the Review Committee, and a list of individuals and agencies that FEMA would like to acknowledge.

Appendix B contains checklists for use in assessing wind, flood, and seismic hazards at a potential safe room site and for refuge areas. It also contains checklists for designers and planners to use when planning and establishing the design criteria for a new tornado or hurricane community safe room.

Appendices C and D each present a case study in which a community safe room was designed. The case studies include wind load analyses, conceptual safe room design plans, and cost estimates. Appendix C contains conceptual design plans for a community safe room for a community in North Carolina. Appendix D contains conceptual design plans for a safe room for a school building in Wichita, Kansas.

Appendices E and F provide the results of missile impact tests on a variety of different safe room wall sections, and safe room doors and door hardware, respectively.

Appendix G presents design guidance regarding impact protection for wood sheathing.

Appendix H contains the list of acronyms and abbreviations used in this publication.

2 Protection Objectives

As noted in Chapter 1, FEMA has developed prescriptive designs for residential and small community safe rooms (for 16 or fewer occupants) designed to near-absolute protection for the occupants of a home or small business during extreme-wind events. The May 1999 MAT investigation of the tornadoes in Oklahoma and Kansas made it clear that an extreme-wind event can cause a large loss of life or a large number of injuries in high-occupancy buildings (e.g., schools, hospitals and other critical care facilities, nursing homes, day care centers, and commercial buildings). Extreme-wind events can also cause a large loss of life or a large number of injuries in residential neighborhoods where people do not have access to either in-residence or community safe rooms. Based on the concepts for the residential safe rooms, the first edition of FEMA 361 was developed to provide design professionals with guidance on the design of community safe rooms that can accommodate large groups of people for protection from extreme-wind events for larger, at-risk populations.

This publication provides guidance addressing the design and engineering issues for design and construction of “stand-alone” community safe room buildings, constructing safe rooms within or as a part of a new building, and adding a safe room to an existing building. Guidance is also provided by identifying wall and roof sections capable of withstanding impacts from windborne debris (missiles). Although arguably not required for life-safety protection from extreme-wind events, the criteria on reconciling non-structural design criteria with the model building, fire, and life-safety codes are also included, along with a discussion of emergency considerations such as evacuation and operations plans.

This publication provides guidelines for the design and construction of safe rooms with the objective of near-absolute protection. This level of life-safety protection, and the criteria upon which it is based, distinguish this manual from other design standards and model codes, including the ICC-500. To better understand these differences, Table 2-1, presented later in this chapter, gives a detailed review of basic criteria and provisions of all major design standards, codes, and guidelines related to safe room and shelter design and construction.

The design and planning necessary for high-capacity safe rooms that may be required for use in large,



WARNING

A safe room designed according to the guidance presented in this manual provides near-absolute protection from death and injury, even though the building itself may be damaged during a design event. (A design event is determined by design wind speeds for tornadoes and hurricanes from the maps in Figures 3-1 and 3-2, respectively, of Chapter 3.)

public venues such as stadiums or amphitheaters are beyond the scope of this manual. An owner or operator of such a venue may be guided by concepts presented in this publication, but detailed guidance concerning extremely high-capacity safe rooms is not provided. The design of such safe rooms requires attention to behavioral and other non-engineering issues that affect the life safety of a large number of people. Egress timing for thousands of people in a stadium, how to manage a large group of individuals in a safe room or shelter, and security within a shelter or safe room are examples of behavioral and other non-engineering issues that should be addressed when protecting a large group of people. However, these issues are also beyond the scope of this publication.

2.1 What is a Safe Room?

A safe room is typically an interior room, a space within a building, or an entirely separate building, designed and constructed to provide life-safety protection for its occupants from tornadoes or hurricanes. Safe rooms constructed to the criteria in this publication will provide protection against both wind forces and the impact of windborne debris. The level of occupant protection provided by a space specifically designed as a safe room is intended to be much greater than the protection provided by buildings that comply with the minimum requirements of most model building codes. Model building codes usually are developed not for life-safety protection, but rather for property loss protection. The model building codes currently do not provide design and construction criteria for life safety for sheltering nor do they provide design criteria for tornadoes, but this will change in 2009. In 2008, the ICC will release for adoption the ICC-500 Storm Shelter Standard. This document will provide the basis for the design and construction of shelters that was produced through the consensus standard process. The ICC-500 will be incorporated by reference into the 2009 IBC and IRC codes to regulate the design and construction of buildings, or portions thereof, that have been designed as safe rooms to provide life-safety protection from extreme-wind events. The purpose and scope of the ICC-500 are presented below:



NOTE

Neither FEMA 361 nor the ICC-500 mandates the design and construction of residential or community safe rooms or shelters within a jurisdiction. Rather, these documents provide criteria or requirements for regulating and enforcing the proper design and construction of safe rooms and shelters.

ICC-500, Section 101.1 Purpose. *The purpose of this standard is to establish minimum requirements to safeguard the public health, safety, and general welfare relative to the design, construction, and installation of storm shelters constructed for protection from high winds associated with tornadoes and hurricanes. This standard is intended for adoption by government agencies and organizations for use in conjunction with model codes to achieve uniformity in the technical design and construction of storm shelters.*

ICC-500, Section 101.2 Scope. *This standard applies to design, construction, installation, and inspection of storm shelters constructed as separate detached buildings or constructed as safe rooms within buildings for the purpose of providing safe refuge from storms that produce high winds, such as tornadoes and hurricanes. Shelters designed and constructed to this standard shall be designated to be hurricane shelters, tornado shelters, or combined hurricane and tornado shelters.*

These statements are very similar to the purpose and scope identified in FEMA 361, but important differences between the two documents do exist. From a technical standpoint, the ICC-500 has successfully standardized and codified a good deal of the original design guidance provided in the first edition of FEMA 361. However, some of the criteria originally proposed in FEMA 361 were modified during the consensus process that produced the ICC-500. FEMA acknowledged the rationale behind some of the changes and has accepted the new criteria. This second edition of FEMA 361 incorporates these changes by referring to sections of the ICC-500 for the design and construction requirements of a community safe room.

FEMA continually reviews its safe room design criteria and has interpreted the available research differently from the consensus standard committee. In FEMA's view, many wind design, windborne debris hazards, flood hazards, and operational issues should be addressed from a more conservative standpoint than the one agreed upon in the consensus standard process. From a procedural standpoint, FEMA's criteria have been, and will remain, guidance; they are not code or standard enforceable in a jurisdiction unless they have been adopted to act as a standard for extreme-wind protection. The same applies to the ICC-500 from its release in late 2008 until the release of the 2009 Editions of the IBC and IRC. Upon the release of the 2009 codes, the ICC-500 will not only be a stand-alone consensus standard document, it will be a part of the building code (incorporated by reference) as a readily enforceable design standard. This will be the case for any jurisdiction that adopts the 2009 IBC and IRC and that does not eliminate or delete the reference language in the code that invokes the use of the ICC-500 to govern how shelters should be constructed.

FEMA safe rooms may be classified into two categories: residential and community (non-residential) safe rooms.

- **A residential safe room** is intended to provide protection for a small number of people (16 or less). There are two general types of residential safe rooms: in-residence safe rooms and safe rooms located adjacent to, or near, a residence. An in-residence safe room is a small, specially designed ("hardened") room, such as a bathroom or closet, which is intended to provide a place of refuge for the people who live in the home. An external residential safe room is similar in function and design, but it is a separate structure installed outside the home, either above or below ground. The residential safe room criteria presented by FEMA are for the combined tornado and hurricane hazards and are capable of providing life-safety protection as defined in Section 3.5 of this publication.

- **A community safe room** is intended to provide protection for a large number of people, anywhere from approximately 16 to as many as several hundred individuals. These safe rooms include not only public but also private safe rooms for business and other types of organizations. Tornado and hurricane community safe rooms are buildings or portions thereof that have been designed and constructed to the criteria set forth in Sections 3.3 and 3.4, respectively.

The term “hardened” refers to specialized design and construction applied to a room or building to allow it to resist wind pressures and windborne debris impacts during an extreme-wind event and are capable of providing life-safety protection as defined in Sections 3.3, 3.4, and 3.5 of this publication.

2.1.1 Structural and Building Envelope Characteristics of Safe Rooms

The primary difference in a building’s structural system designed for use as a safe room, rather than for conventional use, is the magnitude of the wind forces that it is designed to withstand. Conventional (normal) buildings are designed to withstand forces associated with a certain wind speed (termed “design [basic] wind speed”) based on historic wind speeds and probabilistic wind events documented for different areas of the country and presented in design standards such as the American Society of Civil Engineers (ASCE) 7-05, *Minimum Design Loads for Buildings and Other Structures*. The highest design wind speed used in conventional construction is near the coastal areas of the Atlantic and Gulf coasts and is in the range of 140 to 150 mph for a 3-second gust. By contrast, the design wind speed recommended by FEMA for safe rooms in these same areas is in the range of 200 to 225 mph for a 3-second gust and is intended to build safe rooms that can provide “near-absolute protection” for occupants.

For envelope or cladding systems, the governing design criterion is windborne debris, commonly referred to as missiles, which causes many of the injuries and much of the damage from tornadoes and hurricanes. Windows and the glazing in exterior doors of conventional buildings are not required to resist windborne debris, except when the buildings are located within windborne debris regions. Buildings located in windborne debris regions must have impact-resistant glazing systems or protection systems to protect the glazing. These systems can be laminated glass, polycarbonate glazing, or shutters. The ASCE 7-05 missile criteria were developed to minimize property damage and improve building performance; they were not developed to protect occupants and notably do not require walls and roof surfaces to be debris impact-resistant. To provide occupant protection for a life-safety level of protection, the criteria used in designing safe rooms include substantially greater resistance to penetration from windborne debris. Sections 3.3.2, 3.4.2, and 3.5.2 present the debris impact-resistance performance criteria for the tornado, hurricane, and residential safe rooms, respectively.



DEFINITION

ASCE 7-05 defines hurricane prone regions and windborne debris regions as follows:

Hurricane Prone Regions: Areas vulnerable to hurricanes; in the United States and its territories defined as:

1. The U.S. Atlantic Ocean and Gulf of Mexico coasts where the basic wind speed is greater than 90 mi/h, and
2. Hawaii, Puerto Rico, Guam, Virgin Islands, and American Samoa.

Windborne Debris Regions: Areas within hurricane prone regions located:

1. Within 1 mile of the coastal mean high water line where the basic wind speed is equal to or greater than 110 mi/h and in Hawaii, or
2. In areas where the basic wind speed is equal to or greater than 120 mi/h.

* ASCE 7-05 uses mi/h, which equates to mph.

The roof deck, walls, and doors in conventional construction systems are not required by the model building codes to resist windborne debris.¹ However, if the space defined as a safe room is to provide adequate life-safety occupant protection, the roof deck and walls that define the protected area and the doors leading into it all must resist windborne debris impacts. Additional information regarding criteria for the different levels of windborne debris resistance is provided in Sections 3.3.2, 3.4.2, and 3.5.2.

2.1.2 Design Criteria for Different Types of Safe Rooms and Shelters

Safe rooms, shelters, and refuge areas all provide different levels of protection depending on the design criteria used. The level of protection provided by a safe room or shelter is a function of the design wind speed (and resulting wind pressures) and of the windborne debris load criteria used in designing the facility.

The required design strength of the safe room, shelter, or refuge area, is dictated by wind pressure criteria given by different guides, codes, and standards. FEMA recommends design wind speeds for safe rooms that range from 130 to 250 mph for tornado hazards and from 160 to 255 mph for hurricane hazards.

¹ The last several editions of the Florida Building Code (FBC) have a requirement for protecting the walls, roofs, doors, and non-opening portions of certain buildings. Critical and essential facilities designed in special regions as High Velocity Hurricane Zones (HVHZs) are required by Chapter 16 of the FBC to provide debris impact-resistance per the windborne debris requirements of the American Society for Testing and Materials (ASTM) E 1996.

By contrast, the 2006 IRC and the 2006 IBC, which establish the minimum requirements for residential and other building construction, define a design wind speed as 90 mph in the Midwest (where a corresponding safe room design wind speed is 250 mph). Table 2-1 compares shelter design criteria and levels of protection with different guidance manuals, codes, regulations, standards, and shelter programs. The last row is provided to address the issue of selection of the area within existing buildings to be used as a refuge of last resort. Several publications related to identifying refuge areas from hurricane and other storm events exist. A good example is FEMA 431, *Tornado Protection: Selecting Refuge Areas in Buildings*. This publication, as well as others, does not set minimum criteria for improving buildings to resist wind loads and debris. Rather, FEMA 431 provides information about how buildings are damaged by wind and windborne debris so individuals who do not have access to a safe room or shelter, but are exposed to extreme-wind hazards, may identify the best available spaces within a building or structure in which to take refuge. This guidance in the publication is based on lessons learned and field observations of buildings and structures that have experienced extreme-wind events. However, individuals seeking protection in “refuges or areas of last resort” should understand that these portions of buildings have not been designed to resist extreme-wind loads or debris impacts and may not protect the individuals inside from being killed or injured during an extreme-wind event.

Table 2-2 presents comparative data for three locations using these design criteria for the different safe room and shelter documents. “N/A” (not applicable) is used to indicate that no guidance is provided for sheltering or basic construction., “Not required” indicates that there are no requirements.

2.1.3 Occupant Safety

This publication presents guidance for the design of engineered safe rooms that will protect large numbers of people during an extreme-wind event. Safe rooms designed by a professional according to the criteria outlined in this publication (including the safe room design wind speed selected in Chapter 3) are intended to minimize the probability of death and injury during an extreme-wind event by providing their occupants with near-absolute protection.

The risk of death or injury from tornadoes or hurricanes is not evenly distributed throughout the United States. This publication guides the reader through the process of identifying the risk of extreme winds in a particular location and mitigating that risk. The intent is not to mandate the construction requirements for safe rooms for extreme-wind events, but rather to provide design guidance for persons who wish to design and build such facilities. Levels of risk, and tools for determining the levels of risk, are presented in this chapter.

The intent of this publication is not to override or replace current codes and standards, but rather to continue to provide important guidance where none has been available before. Until the development of the ICC-500 Storm Shelter Standard, no building, fire, or life-safety code or engineering standard had provided detailed design criteria for the design of tornado or other extreme-wind shelters. FEMA 361 remains unique in that its goal is not just to help provide a safe space for individuals to take shelter from extreme-wind events, but it also presents guidance

on how to achieve near-absolute protection. The information provided in this document is the best available at the time of publication. This information will support the design of a safe room that provides near-absolute protection during an event with a specified design wind speed that has been determined to define the wind threat for a given geographic area. Designing and constructing a safe room according to the criteria in this publication does not mean that the shelter will be capable of withstanding every possible extreme-wind event. The design professional who ultimately designs a safe room should state what the design parameters are and describe them in detail in the project documents as required by Sections 3.8 and 3.9. Examples of actual safe rooms that have been designed to the criteria presented in this publication are contained in Appendices C and D.

2.2 Safe Room Design Process

The decision to design and construct a safe room can be based on a single factor or on a collection of factors. Single factors are often related to the potential for loss of life or injury (e.g., officials at a hospital that cannot move patients housed in an intensive care unit, officials at a school that takes care of a large number of small children, etc.). Other factors that are considered in the risk assessment process should include the type of hazard event, probability of event occurrence and severity, vulnerability of buildings in the community, size of the population at risk, and probable single and aggregate annual event casualties.

The flowchart in Figure 2-1 presents the decision-making process that should take place when the construction of a community safe room is being considered. The major steps of this process are discussed in Sections 2.2.1 through 2.2.5.

2.2.1 The Threat From Extreme-Wind Events

The assessment of the level of threat from extreme winds is a first step in quantifying the risk to which a community is exposed. The exposure to extreme-wind hazards differs greatly in various parts of the country. Although the level of exposure to wind hazards is not easy to quantify accurately, areas exposed to stronger or more frequent tornadoes or hurricanes have been identified and mapped.

The assessment of the level of threat, or the exposure to wind hazards, is determined on the basis of probability of occurrence of a hazard event of specific magnitude at a specific location. The probabilities of occurrence are statistical estimates drawn from historical records of previous hazard events that describe not only the time and place, but also the details related to the intensity, size, duration, general circumstances, and effects of the event. Much of this information has been compiled into a number of risk assessment tools such as wind speed maps and frequency maps and tables.

Table 2-1. Wind Safe Room and Shelter Design Codes, Standards, and Guidance Comparison

Title or Name of Document ¹	Code, Regulation, Standard, or Publication	Wind Hazard	Wind Map
<p>FEMA Safe Room Publications:</p> <p>FEMA 320, <i>Taking Shelter From the Storm: Building a Safe Room For Your Home or Small Business</i> (2008)</p> <p>FEMA 361, <i>Design and Construction Guidance for Community Safe Rooms</i> (2008)</p>	<p>FEMA guidance document, not a code or standard. “Best Practice” for extreme-wind safe rooms.</p>	<p>Tornado and Hurricane</p>	<p>FEMA 320: Hazard map, maximum wind hazard speed of 250 mph used for design.</p> <p>FEMA 361, Tornado: Map with four wind speed zones for design (wind MRI² is 10,000–100,000 years). This map is often referred to as the “FEMA 361 map.”</p> <p>FEMA 361, Hurricane: Uses ICC-500 hurricane map.</p>
<p>International Code Council/National Storm Shelter Association (ICC/NSSA) <i>Standard for the Design and Construction of Storm Shelters</i> (ICC-500, August 2008)</p>	<p>Consensus standard for shelter design and construction, tentatively available for adoption in 2008. To be incorporated by reference into the 2009 IBC and IRC.</p>	<p>Tornado and Hurricane</p>	<p>Tornado: Uses FEMA 361 map.</p> <p>Hurricane: Uses revised ASCE 7-05 map with contours at 10,000-year MRI² with minimum shelter design wind speed of 160 mph, maximum approximately 255 mph.</p>
<p>Florida State Emergency Shelter Program (SESP) – Florida Interpretation of the American Red Cross (ARC) 4496 Guidance. Note: shelters in this category will range from Enhanced Hurricane Protection Area (EHPA) recommended design levels, shown in this row, to the code requirement levels (next row), to the ARC 4496 requirements (see below).</p>	<p>Guidance in the FBC “recommending” above-code requirements for EHPAs. See also Appendix G of the SESP report for the detailed design guidance.</p>	<p>Tornado and Hurricane</p>	<p>Florida Building Code (FBC) map +40 mph recommended, based on ASCE 7-05 (maps basically equivalent); MRI is 50–100 years in coastal areas and adjusted with importance factor.</p>
<p>Florida Building Code EHPAs – code requirements for public “shelters” (FBC Section 423.25)</p>	<p>Statewide code requirements for EHPAs</p>	<p>Hurricane</p>	<p>FBC map, based on ASCE 7-05 (maps basically equivalent); MRI is 50–100 years in coastal areas and adjusted with importance factor.</p>
<p>FBC 2000 and later International Building Code (IBC)/International Residential Code (IRC 2000) and later/ASCE 7-98 and later.</p>	<p>Building code and design standards for regular (non-shelter) buildings. Some additional guidance is provided in the commentary.</p>	<p>Hurricane</p>	<p>ASCE has its own wind speed map based on historical and probabilistic data; MRI is 50–100 years in coastal areas and adjusted with importance factor.</p>
<p>American Red Cross (ARC 4496) <i>Standards for Hurricane Evacuation Shelter Selection</i></p>	<p>Guidance for identifying buildings to use as hurricane evacuation shelters</p>	<p>Hurricane</p>	<p>None</p>
<p>Pre-2000 Building Codes</p>	<p>Building code and design standards for regular (non-shelter) buildings</p>	<p>Hurricane</p>	<p>Each of the older codes used their own published wind contour maps.</p>
<p>Refuge Areas of Last Resort</p>	<p>Guidance from FEMA and others for selecting best-available refuge areas</p>	<p>Tornado and Hurricane</p>	<p>None</p>

Table 2-1. Wind Safe Room and Shelter Design Codes, Standards, and Guidance Comparison (continued)

Wind Design Coefficient Considerations ^{3,4}	Debris Impact Criteria ⁵	Remarks
<p>FEMA 320: Use 250 mph and calculate pressures using ASCE 7-05 methods and use $I=1.0$, $K_d=1.0$, Exposure C, no topographic effects, $GC_{pi}=\pm 0.55$ (this will account for atmospheric pressure change [APC]).</p> <p>FEMA 361, Tornado: Use FEMA 361 wind speed map with four zones. Calculate pressures using ASCE 7-05 methods and use $I=1.0$, $K_d=1.0$, Exposure C, no topographic effects, $GC_{pi}=\pm 0.55$ (this will account for APC).</p> <p>FEMA 361, Hurricane: Use ICC-500 process, but also must use Exposure C and design building using $GC_{pi}=\pm 0.55$.</p>	<p>FEMA 320: Test all safe rooms with the representative missile: a 15-lb 2x4 at 100 mph (horizontal) and 67 mph (vertical).</p> <p>FEMA 361: Test safe rooms with representative missile (missile speed dependent on site design wind speed).</p> <p>Tornado: 15-lb 2x4 at 80–100 mph (horizontal) and 2/3 of this speed (vertical). Hurricane: 9-lb 2x4 at 80–128 mph (horizontal) and 16–26 mph (vertical).</p>	<p>FEMA 320: Intent is to provide “near-absolute protection” with prescriptive designs that meet the highest hazard design criteria for both tornadoes and hurricanes.</p> <p>FEMA 361: Intent is to provide “near-absolute protection” through appropriate design and construction guidance. Design criteria for features such as debris impact-resistance, flood hazard-resistance, and operational criteria are more conservative than criteria in the ICC-500. Safe room operations guidance is provided. Occupancy issues addressed. Wall section details provided. Building evaluation checklist provided.</p> <p>Notes: (1) Does not require the design and construction of safe rooms, but provides criteria for doing so. (2) FEMA does not provide safe room certification or product approvals.</p>
<p>Tornado: Use FEMA 361 wind speed map. Calculate pressures using ASCE 7-05 methods and use $I=1.0$, $K_d=1.0$, Exposure as appropriate, no topographic effects, $GC_{pi}=\pm 0.55$ or $\pm 0.18+APC$.</p> <p>Hurricane: Use revised ASCE 7-05 map and methods and use $I=1.0$, special definitions for enclosure classification, all other items as per ASCE 7-05, no APC consideration required.</p>	<p>Test safe rooms with representative missile (missile speed dependent on site design wind speed):</p> <p>Tornado: 15-lb 2x4 at 80–100 mph (horizontal) and 2/3 of this speed (vertical). Hurricane: 9-lb 2x4 at 64–102 mph (horizontal) and 16–26 mph (vertical)</p>	<p>Intent is to provide a standard for the design and construction of extreme-wind shelters. Will not use term “near-absolute protection.” Occupancy, ventilation, and use issues are also addressed.</p> <p>Notes: (1) The standard does not require the design and construction of shelters, but provides criteria for doing so. (2) The ICC-500 does not provide shelter or shelter component certifications, but rather defines the procedure by which testing must be performed to be certified and define what type of laboratory certification is required.</p>
<p>Recommends that designer add 40 mph to basic wind speed from map, Exposure C, $I=1.15$, $K_d=0.85$, GC_{pi} as required by design (typically ± 0.18), but recommends ± 0.55 for tornado shelter uses.</p>	<p>In windborne debris region (120 mph+): Small – pea gravel; Large – 9-lb 2x4 at 34 mph (horizontal), up to 60 feet above grade, but recommends 15-lb 2x4 at 50 mph (horizontal).</p>	<p>The building, or a portion of a building, is defined as an essential facility and as a shelter. Designer is required to submit a signed/sealed statement to building department and state offices stating the structure has been designed as a shelter (EHPA plus added recommended criteria).</p>
<p>Use basic wind speed at site as identified on FBC wind speed map, use exposure at site, use $I=1.15$, $K_d=0.85$, GC_{pi} as required by design (typically ± 0.18).</p>	<p>In windborne debris region: Small – pea gravel; Large – 9-lb 2x4 at 34 mph (horizontal), up to 60 feet above grade.</p>	<p>The building or a portion of a building is defined as an essential facility and as an EHPA. Designer is required to submit a signed/sealed statement to building department and state offices stating the structure has been designed as an EHPA.</p>
<p>Method is the basis of most wind pressure calculation methods. All items in design process are site-specific. Use $I=1.15$ for critical and essential facilities.</p>	<p>In windborne debris region: Small – pea gravel; Large – 9-lb 2x4 at 34 mph (horizontal), up to 60 feet above grade.</p> <p>Note: FBC, IBC, and ASCE 7-05 require the 9-lb 2x4 (large) missile to be tested at 55 mph for critical and essential facilities.</p>	<p>Code requires increased design parameters only for buildings designated as critical or essential facilities. For improved performance of residential buildings (but not life-safety protection), design criteria and prescriptive solutions can be found in ICC-6, <i>Standard for Residential Construction in High Wind Regions</i> (Fall 2008)</p>
<p>None</p>	<p>None</p>	<p>Provides guidance on how to select buildings and areas of a building for use as a wind shelter or refuge area during wind events. Does not provide or require a technical assessment of the proposed shelter facility.</p>
<p>Typically these older codes provided a hurricane regional factor for design wind speeds, but little attention was paid to components and cladding.</p>	<p>Not required for all buildings. Where required, the Standard Building Code (SBC)⁶ developed and recommended debris impact standards for use in hurricane-prone regions.</p>	<p>These codes specified limited hazard-resistant requirements. Some guidance was provided with SSTD 10 from SBCCI for the design and construction of buildings in extreme-wind and hurricane-prone regions. Buildings constructed to these early codes were not required to have structural systems capable of resisting wind loads.</p>
<p>None</p>	<p>None</p>	<p>Best available refuge areas should be identified in all buildings without shelters. FEMA 431, <i>Tornado Protection: Selecting Refuge Areas in Buildings</i>, provides guidance to help identify the best available refuge areas in existing buildings. Because best available refuge areas are not specifically designed as shelters, their occupants may be injured or killed during a tornado or hurricane.</p>

Notes:

1. The wind shelter guidance and requirements shown here are presented from highest to least amount of protection provided.
2. Mean recurrence intervals (MRIs) for wind speeds maps are identified by the code or standard that developed the map. Typically, the MRI for non-shelter construction in non-hurricane-prone areas is 50 years and in hurricane-prone regions, approximately 100 years.
3. ASCE 7-05 *Minimum Design Loads for Buildings and Other Structures* (2005) is the load determination standard referenced by the model building codes. The wind design procedures used for any shelter type in this table use one of the wind design methods as specified in ASCE 7-05, but with changes to certain design coefficients that are identified by the different codes, standards, or guidance summarized in this table.
4. From ASCE 7-05 method: I = importance factor; K_d = wind directionality factor; GC_{pi} = internal pressure coefficient.
5. Roof deck, walls, doors, openings, and opening protectives must all be tested to show resistance to the design missile for the FEMA, ICC, and FL EHPA criteria.
6. From the Southern Building Code Congress International, Inc. (SBCCI).

Table 2-2. Wind Safe Room and Shelter Design Values Comparison

Shelter Design Standard, Code, or Document	Data ¹	Example Location #1: Miami, Florida Tornado and Hurricane Hazards	Example Location #2: Galveston, Texas Tornado and Hurricane Hazards	Example Location #3: Greenburg, Kansas Tornado Hazards
FEMA 361	Design wind speed	200 mph (tornado) 225 mph (hurricane)	200 mph (tornado) 160 mph (hurricane)	250 mph (tornado)
	Pressure on windward wall ²	107 psf (tornado) 136 psf (hurricane)	107 psf (tornado) 69 psf (hurricane)	167 psf (tornado)
	Pressure on roof section ²	257 psf (tornado, suction) 325 psf (hurricane, suction)	257 psf (tornado, suction) 202 psf (hurricane, suction)	401 psf (tornado, suction)
	Test missile momentum at impact ²	62 lb _f -s (tornado) 46 lb _f -s (hurricane)	62 lb _f -s (tornado) 33 lb _f -s (hurricane)	68 lb _f -s (tornado)
ICC-500 ³	Design wind speed	200 mph (tornado) 225 mph (hurricane)	200 mph (tornado) 160 mph (hurricane)	250 mph (tornado)
	Pressure on windward wall ²	107 psf (tornado) 136 psf (hurricane)	107 psf (tornado) 69 psf (hurricane)	167 psf (tornado)
	Pressure on roof section ²	257 psf (tornado, suction) 325 psf (hurricane, suction)	257 psf (tornado, suction) 202 psf (hurricane, suction)	401 psf (tornado, suction)
	Test missile momentum at impact ²	62 lb _f -s (tornado) 36 lb _f -s (hurricane)	62 lb _f -s (tornado) 26 lb _f -s (hurricane)	68 lb _f -s (tornado)
FBC EHPA/ SESP Recommend Criteria (using basic wind speed + 40 mph)	Design wind speed	186 mph	130 mph	N/A
	Pressure on windward wall ²	91 psf	44 psf	N/A
	Pressure on roof section ²	217 psf (suction)	106 psf (suction)	N/A
	Test missile momentum at impact ²	34 lb _f -s	14 lb _f -s	N/A

Table 2-2. Wind Safe Room and Shelter Design Values Comparison (continued)

Shelter Design Standard, Code, or Document	Data ¹	Example Location #1: Miami, Florida Tornado and Hurricane Hazards	Example Location #2: Galveston, Texas Tornado and Hurricane Hazards	Example Location #3: Greensburg, Kansas Tornado Hazards
FBC EHPA (Required per FBC Section 423.25)	Design wind speed	146 mph	N/A	N/A
	Pressure on windward wall ²	39 psf	N/A	N/A
	Pressure on roof section ²	117 psf (suction)	N/A	N/A
	Test missile momentum at impact ²	14 lb _f -s	N/A	N/A
ASCE 7-05/IBC 2006 (ASTM E 1996)	Design wind speed	150 mph	105 mph	90 mph
	Pressure on windward wall ²	41 psf	18 psf	15 psf
	Pressure on roof section ²	124 psf (suction)	52 psf (suction)	44 psf (suction)
	Test missile momentum at impact ²	14 lb _f -s	Not required	Not required
ARC 4496	Design wind speed	Not specified	Not specified	Not specified
	Pressure on windward wall ²	Not specified	Not specified	Not specified
	Pressure on roof section ²	Not specified	Not specified	Not specified
	Test missile momentum at impact ²	Not specified	Not specified	Not specified
Pre-2000 Building Codes	Design wind speed	140 mph and less	90 mph and less	90 mph and less
	Pressure on windward wall ²	< 40 psf (varies)	< 15 psf (varies)	< 15 psf (varies)
	Pressure on roof section ²	< 120 psf (varies)	< 45 psf (varies)	< 45 psf (varies)
	Test missile momentum at impact ²	Not required by all codes	Not required	Not required
Refuge Areas of Last Resort	Design wind speed	Unknown	Unknown	Unknown
	Pressure on windward wall ²	Unknown	Unknown	Unknown
	Pressure on roof section ²	Unknown	Unknown	Unknown
	Test missile momentum at impact ²	Not required	Not required	Not required

Notes:

1. Wind pressures were calculated based on a 40-foot x 40-foot building, with a 10-foot eave height and a 10-degree roof pitch.
2. psf – pounds per square foot; lb_f-s – pounds (force) seconds.
3. ICC-500 Hurricane design criteria used the most restrictive case that may be appropriate, which results in the use of $GC_{pi} = +/-0.55$ and Exposure Category C at the site.

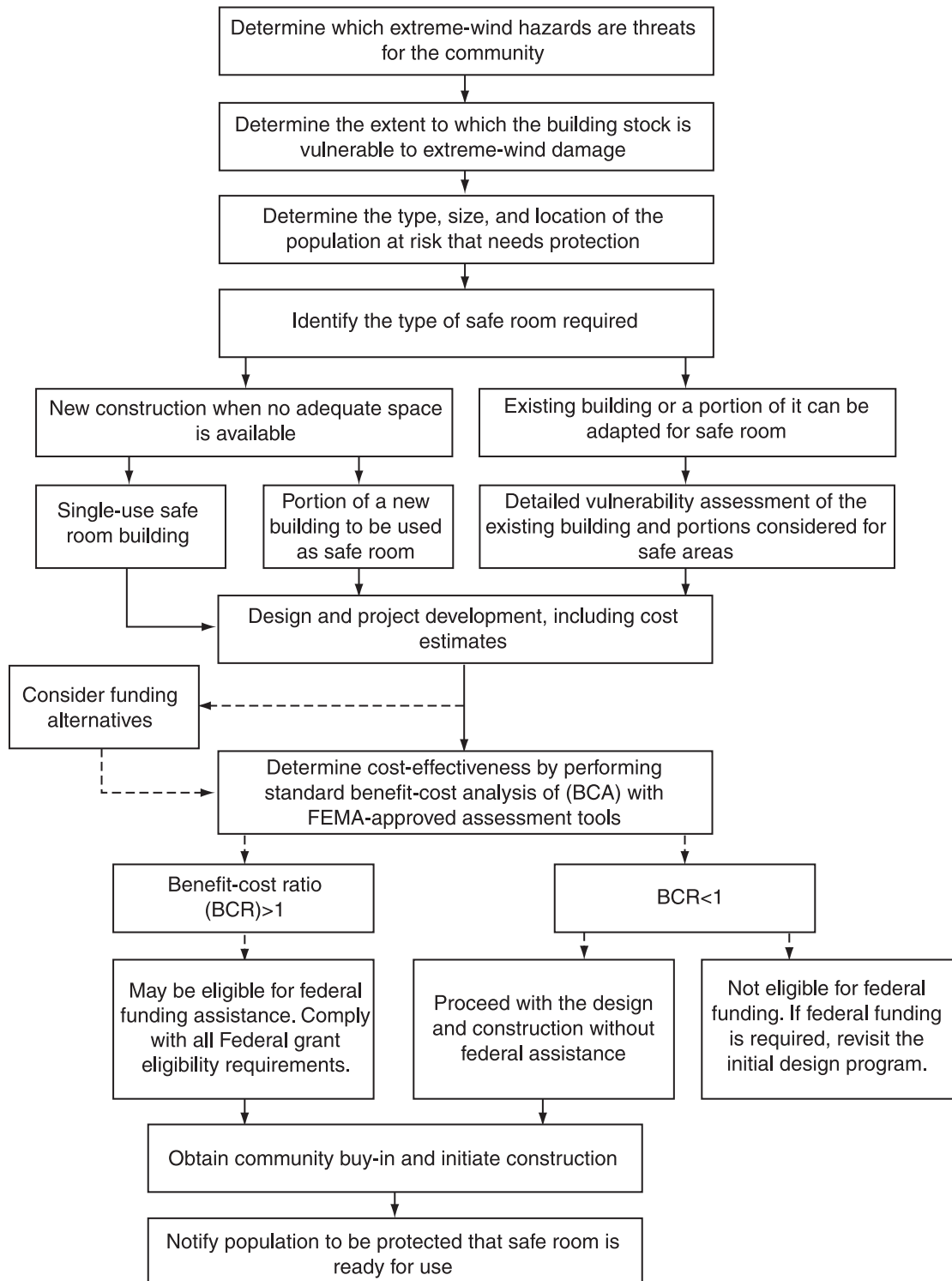

Figure 2-1. Process for risk and needs assessments for safe rooms

Frequency or Probability of Occurrence Maps

Researchers have compiled data that illustrate the frequency of extreme-wind events. These frequency maps show the number of extreme-wind hazard events, such as tornadoes, that occurred in various parts of the country. Although tornadoes were recorded as far back as 1700s, the systematic gathering of data related to tornado events did not start until the early 1950s. Therefore, the historical records used for statistical analysis of frequencies span only slightly more than 50 years. Figure 2-2 shows the areas of the United States with the greatest incidence of strong tornadoes, those that were designated as EF3, EF4, or EF5. The historical information on past windstorms is used to calculate their statistical frequency or the probability of occurrence of a wind event of certain magnitude. The probability of occurrence therefore describes a wind event of specific intensity irrespective of the place of occurrence. This wind event characteristic is known as the mean recurrence interval (MRI). The mean recurrence interval represents the frequency with which large or small hazard events take place. For example, most buildings are designed and constructed to resist wind pressures resulting from a wind event with a 50-year MRI or 2 percent annual probability of exceedence.

Most wind speed maps in use today reflect a specific MRI that was adopted as a risk indicator for that design standard. ASCE 7-05 wind maps, for example, use a 50-year MRI to determine the basic wind speeds for non-hurricane-prone areas. Some occupancies categorized by ASCE 7-05 as Category III and IV buildings are required to be designed for 100-year wind events, which necessarily involves higher wind speeds. This adjustment in the MRI is accomplished through the use of an importance factor (*I*) in the wind load calculations. The FEMA 361 map for tornado hazards, which is identical to the ICC-500 tornado map, uses 10,000 to 100,000 MRI wind events to determine the wind speed zones for tornado safe rooms. The low probability of occurrence or the mean recurrence interval of 10,000 to 100,000 years is used in order to make sure that safe rooms are protected even against the rarest of wind storms with extreme-wind speeds of 250 mph (3-second gust).

For the hurricane hazard, NOAA and other meteorological groups have more readily available tracking maps to illustrate the occurrence of hurricanes. Furthermore, the ASCE 7-05 basic wind speed map was developed from a combination of historical and probabilistic storm events (which include hurricanes, but not tornadoes). As a result, for the hurricane-prone regions the mapped speeds reflect the hurricane influence and hazard and should be considered to be 100-year MRI basic wind speeds.² The FEMA 361 map uses the ICC-500 Shelter Design Wind Speeds for Hurricanes Map (ICC-500, Figure 304.2.2), which has been developed using the same modeling approach and inputs as the ASCE 7-05 basic wind speed map. However, it has been developed for an ultimate wind event of 10,000 MRI (based on both historical and probabilistic storm data). As a result, appropriate maximum hazard wind speeds associated with the hurricane event alone (tornadoes are not included in this model) are 225 mph for the mainland U.S. and 255 mph for certain U.S. island territories (3-second gust).

² For a complete discussion on the MRI use for hurricane and non-hurricane wind speeds depicted in the ASCE 7-05 Basic Wind Speed Map, see the commentary for Chapter 6 of ASCE 7-05.

TORNADO ACTIVITY IN THE UNITED STATES*

Summary of Recorded EF3, EF4, and EF5 Tornadoes Per 2,470 Square Miles (1950-2006)

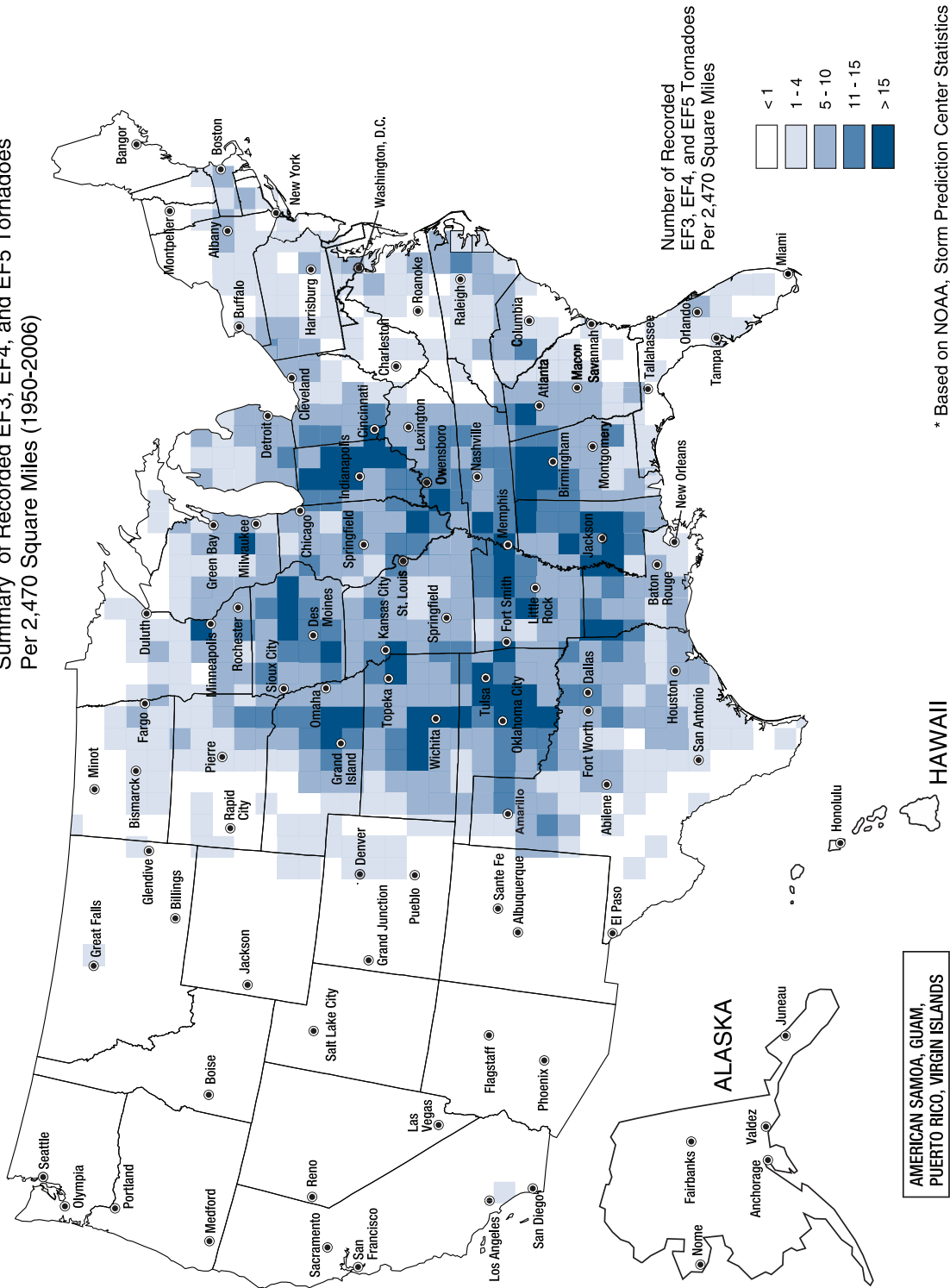

* Based on NOAA, Storm Prediction Center Statistics

Figure 2-2. Tornado occurrence map

Wind Speed Maps

Safe rooms are designed to protect the occupants from windstorms such as tornadoes, hurricanes, or thunderstorms. The prevailing wind hazard along the Gulf of Mexico and Atlantic coasts and in the Caribbean and some Pacific Islands is a hurricane, although some regions of the Pacific and Alaska refer to the extra-tropical cyclones as typhoons. Interior areas in the United States are mainly threatened by tornadoes or thunderstorms.

The wind speed maps in Figures 3-1 and 3-2 consider tornado and hurricane hazards separately and present safe room design wind speed maps for each hazard. For the tornado hazard, this map is primarily based on historical data. Since 1997, almost 1,300 tornadoes, on average, have been reported nationwide each year. Most tornadoes are short-lived, average less than 500 feet wide, and traverse less than 2,000 feet. Some large tornadoes have been known to cause damage along paths that are 1-mile wide and many miles long; however, tornadoes such as these occur only a few times each year. The land area directly impacted by all tornadoes in a year is relatively small. At present, it is not possible to directly measure wind speeds in a tornado because of its short life. Thus, the data available for tornadoes, intensity, and area of damage are relatively sparse and require special consideration in the probability assessment of wind speeds.

For hurricane wind speeds along the Gulf of Mexico and Atlantic coasts, ASCE 7-05 uses the Monte Carlo numerical simulation procedure to establish design wind speeds. The numerical simulation procedure provides reasonable wind speeds for an annual probability of exceedance of 0.02 (50-year MRI). For wind speeds with an extremely low probability of occurrence, the current numerical procedure, according to some critics, gives unusual answers (e.g., wind speed estimates in Maine are higher than those in Florida). The ICC-500 Review Committee, which prepared the new map for the hurricane hazard, considered these issues in its work with the ASCE modelers who developed a set of maps that the committee believed appropriately represented the hurricane wind hazards along the coastal U.S.

The measure (or units) used to identify tornadic and hurricane safe room design wind speeds are unified to one averaging time: a 3-second gust wind speed. The resulting 3-second gust speeds are consistent with the reference wind speeds used in ASCE 7-05. Consequently, they can be used in the wind pressure calculation formulas from ASCE 7-05 to determine wind loads as discussed in Chapters 3 and 6. Further, unless otherwise noted, all wind speeds presented in this publication are 3-second gust wind speeds, for Exposure C, over land, at 33 feet (height) above the ground.

The safe room design wind speeds shown in Figures 3-1 and 3-2 are valid for most regions of the country. However, the Special Wind Regions (e.g., mountainous terrain, river gorges, ocean promontories) shown on the ASCE 7-05 basic wind speed map are susceptible to local effects that may cause substantially higher wind speeds at safe room sites. Mountainous areas often experience localized winds of considerable magnitude. For instance, mountain-induced windstorms in the lee of the Colorado Front Range (generally the eastern side of the range) have been documented at speeds approaching 120 mph. In Boulder, Colorado, straight-line winds

in excess of 60 mph are observed about once a year. The frequency and maximum intensity of such extreme-wind events at higher elevations within Special Wind Regions are likely to be more frequent and even stronger. When the desired shelter location is within one of these regions, or there is reason to believe that the wind speeds on the map do not reflect the local wind climate, the design professional should seek expert advice from a wind engineer or meteorologist.

Based on this information as well as a community's own historical records, it is possible to determine to what extent the area is susceptible to extreme-wind hazards. The information within this section was provided to help better understand the risk associated with the jurisdiction in which a safe room may be designed or constructed.

2.2.2 Vulnerability Assessment

When a community is exposed to extreme-wind hazards, the level of threat is determined using the historical information described in the previous section. This represents a first step in determining the actual risks to the community from extreme-wind events. Community safe rooms are built to provide safe areas for a local, at-risk population that may be exposed to extreme-wind hazards. Life safety depends on the ability of people to reach a hardened, safe location in a timely manner and remain inside unharmed during the wind storm. Since not all buildings and structures can be considered a safe room in a wind storm, it is necessary to evaluate the building stock in the community in order to identify their potential vulnerability to wind damage that could cause casualties. This is a critical step for all high-occupancy buildings or buildings that house highly vulnerable populations. (See Appendix B for a checklist to assist in the performance of the assessments discussed below.)

1. Vulnerability of buildings

An inventory of vulnerable buildings based on architectural/engineering (A/E) review of building-specific factors such as structural integrity, age, condition, building materials, design, quality of construction, etc., should be conducted. It is recommended that a building vulnerability assessment be performed in two stages. The first stage should comprise a general survey of the building stock in the community to identify the buildings that could potentially pose the greatest risk of serious damage or collapse in an extreme-wind event. The buildings that would need to be identified in advance comprise older manufactured housing units, old wood-frame and unreinforced masonry (URM) buildings, and especially any potentially hazardous high-occupancy structures that might require a more detailed inspection. The second stage would need to be performed by a well-qualified and experienced professional. It is recommended that the second stage should identify all high-occupancy buildings that are prone to wind damage and rank them according to the level of potentially harmful wind effects. This stage is an especially important component of the risk analysis that will assist communities in prioritizing their safe room needs. It is also recommended that the second stage of the vulnerability assessment identify the interior areas of high-occupancy buildings that may serve as the safest refuge areas in the event of an extreme-wind event. These areas should not be confused with safe rooms or other types of wind shelters because they would not be

able to offer the near-absolute level of life-safety protection. The occupants of buildings, however, should be aware of the best places in the building in which to seek refuge in an emergency.

2. Identify buildings or structures that could be used as safe rooms

During the second stage of the vulnerability assessment, special attention should be made to identify stand-alone buildings, portions of existing buildings, or the interior areas of high-occupancy buildings that could be used as safe rooms after the structural hardening and other recommended improvements are completed. The main criteria for selection of structures as potential safe rooms are related to their suitability for a retrofit according to the design and construction recommendations described in Chapter 3. Other criteria that outline how the space should be used and how the occupants should be provided for are no less important and should also be considered. The accessibility of such places should be evaluated along with their size or their everyday functions with respect to their availability for safe room usage in an emergency.

3. Potential losses as a result of identified weaknesses of buildings

Physical vulnerability of the built environment to wind damage represents only one component of the vulnerability assessment. It must be combined with the level of exposure of building occupants to potential wind damage in order to calculate the potential losses in the event of an extreme-wind event. Potential losses should therefore be estimated on the basis of identified weaknesses in the buildings and their occupancy type (see Section 2.2.3). Occupancy types such as hospitals, long-term care centers (nursing homes), or elementary schools and day care centers are likely to suffer greater losses than other types of occupancies with the same level of a building's physical vulnerability to wind damage.

4. Identify areas with high concentration of vulnerable structures

The above-mentioned first stage of the vulnerability assessment of the community's building inventory serves another important purpose. By identifying the areas of high concentrations of vulnerable structures and occupancies based on area-specific factors such as the presence of manufactured housing parks, old residential neighborhoods, blighted areas, topography, and others, local communities can easily map and plan their safe room needs. This can be an invaluable tool in selecting the most appropriate and most effective sites for new and retrofitted safe rooms.

2.2.3 Population at Risk

Community safe rooms have a single purpose - to protect the life safety of the population at risk during the storm event. The population at risk is understood to encompass only those people who are unable to evacuate ahead of the storm for any reason. The community safe rooms are different from other types of shelters in that they are designed to safeguard people only during a relatively short period of time when the extreme winds are the strongest and able to cause the greatest damage. FEMA considers this period to be a minimum of approximately 2 hours for tornadoes and a minimum of approximately 24 hours for hurricanes.

Since the warning times for approaching hurricanes are considerably longer than for tornadoes, the at-risk population for hurricane safe rooms might include those who must remain in the area (like emergency response personnel) and those who are unable to evacuate on time either because of their frailty, lack of transport, a suitable place to go, or other reasons. In the case of approaching tornadoes, the definition of special population that cannot evacuate on time is extended to include practically all the people in buildings deemed vulnerable to damage and failure from extreme-wind events.

Identifying the population at risk is required not only for risk assessment (determining potential losses as a result of possible building damage), but also for effective mitigation, by determining the location and optimal size/capacity of a community safe room. The intent of the guidance in this section on the at-risk population is to start the thought process necessary to determine the size of the safe room that may be needed. The design criteria in this document have been defined using a minimum floor area per occupant approach, in order to ensure that adequate hardened space is provided for the safe room population, irrespective of who comprises that population. However, state and local agencies responsible for emergency management and developing and executing evacuation plans should be consulted when identifying a population in need of protection. FEMA safe room guidance should also be reviewed for detailed recommendations for determining the population at risk.

2.2.4 Risk Analysis

Risk analysis is the final step in the risk assessment process in which all components are brought together to estimate the risk and help prioritize the mitigation activities. In the case of the safe room risk assessment process, risk analysis should be performed for each proposed safe room project to make sure that the safe room will serve those most at risk. The potential losses determined on the basis of the vulnerability of a building and its occupants to damage and resultant death and injury from an extreme-wind event of a certain magnitude are compared with the probability of occurrence of such an event at that location. Table 2-3 below proposes a basic matrix for categorizing or quantifying the risk into three general risk levels: low (L), moderate (M), and high (H). Once a moderate level of risk can be identified, a safe room should be considered for the community. Communities are, however, encouraged to devise their own methods and risk levels that are best suited to local conditions.

Table 2-3. Risk Analysis Matrix

Potential Losses	Probability of Occurrence of an Extreme-Wind Event			
	Low	Moderate	High	Very High
Minor	L	L	L	M
Moderate	L	M	M	H
Severe	M	M	H	H
Catastrophic	M	H	H	H

2.2.5 Types of Safe Rooms

In inspecting areas of existing buildings that are used as safe room areas, FEMA has found that owners may overlook the safest area of a building. In addition, the safety of a hallway or other potential safe room area may be overestimated. Evaluating safe room areas in an existing building helps the owner:

- Determine whether the safest part of the building is being used as a safe room
- Identify possible ways to make existing areas safer
- Decide whether to design and build a safe room according to the guidance in this publication

A preliminary evaluation may be performed by a design professional or by a potential safe room owner, property owner, emergency manager, building maintenance person, or other interested party. This person must have a basic knowledge of building sciences and be able to read and understand building design plans and specifications.

The wind hazard evaluation checklists in Appendix B will help the user assess a building's susceptibility to damage from extreme-wind events such as tornadoes and severe hurricanes. Although the threat of damage from extreme-wind events is the predominant focus of the evaluation, additional threats may exist from flood and seismic events. Therefore, flood and seismic hazard evaluations should be performed in conjunction with the wind hazard evaluation to assess the multi-hazard threats at the site. Checklists for flood and seismic hazard evaluations are also provided in Appendix B. However, the checklists are designed to support only a generalized evaluation (the wind hazard section includes detailed screening processes for the building structure).

The wind, flood, and seismic hazard evaluation checklists in Appendix B may be used for the preliminary assessment. Prior to the design and construction of a safe room, a design professional should perform a more thorough assessment

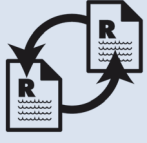

CROSS-REFERENCE

For improved flood hazard assessment checklists and criteria, see FEMA 543. For improved seismic hazard assessment checklists and criteria, see ASCE 31-03.

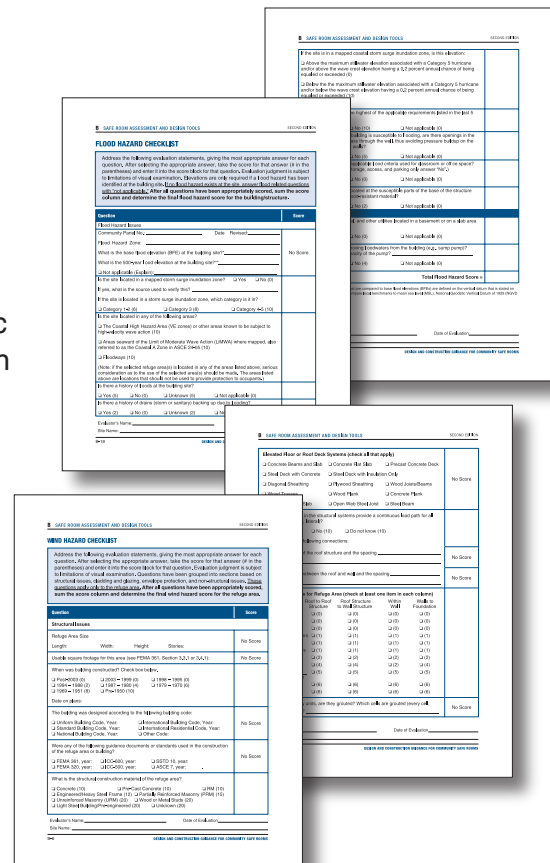

The image shows several overlapping checklists. The most prominent ones are the 'FLOOD HAZARD CHECKLIST' and the 'WIND HAZARD CHECKLIST'. Both checklists include sections for 'General Information', 'Screening Questions', and 'Detailed Evaluation'. The 'FLOOD HAZARD CHECKLIST' includes questions about flood hazard maps, FEMA Flood Insurance Rate Maps (FIRMs), and Flood Hazard Analysis (FHA) studies. The 'WIND HAZARD CHECKLIST' includes questions about wind speed maps, ASCE 7-10 wind speed maps, and wind tunnel studies. Both checklists also include a 'Total Hazard Score' section at the bottom.

in order to confirm or, as necessary, modify the findings of a preliminary assessment. The checklists in Appendix B can provide a starting point for the more thorough assessment.

An entire building or a section of a building may be designated a potential safe room area. If an existing building is selected for use as a community safe room, the hazard evaluation checklists will help the user identify potential safe room areas within the building and evaluate their vulnerability to natural hazards. The intent of the checklist evaluation process is to guide the user through the selection of the best safe room areas within the building and focus the evaluation on the critical sections of the building. For example, an evaluator who inspects a portion of a building being considered for use as a safe room should determine whether that portion is structurally independent of the rest of the building, easily accessible, and of sufficient size.

The checklists consist of questions pertaining to structural and non-structural characteristics of the area being considered. The questions are designed to identify structural and non-structural vulnerabilities to wind hazards based on typical failure modes. Structural or non-structural deficiencies may be remedied with retrofit designs (structural and non-structural mitigation); however, depending on the type and degree of deficiency, the evaluation may indicate that the existing structure is unsuitable for use as a safe room area. The checklists are not a substitute for a detailed engineering analysis, but they can assist the decision-makers involved with hazard mitigation and emergency management to determine whether a building or section of a building has the potential to serve as a safe room.

The checklists are also used to comparatively rank multiple facilities within a given geographic region that are considered potential safe room sites. A scoring system is included to enable the user to compare performance characteristics at various potential safe room sites and to highlight vulnerabilities. For each question on the checklist, deficiencies and vulnerabilities are assessed penalty points. Therefore, a high score reflects higher hazard vulnerability and a low score reflects lower hazard vulnerability, but only relative to the other buildings considered in the scoring system. There is a minimum possible score for the checklists, but this minimum score will vary, depending on the design wind speed selected from Figures 3-1 and 3-2. Therefore, although a low score is desired, there is no “passing score” or “minimum acceptable score for protection.” Again, these checklists help a user determine which area of a building is likely to perform best during an extreme-wind event and which areas require engineering and retrofit design if they are to provide protection from a tornado, a hurricane, or both.

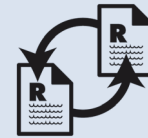

CROSS-REFERENCE

Guidance concerning the siting of safe rooms is presented in Chapter 5 of this publication.

2.3 Safe Room Costs

Costs for the design, construction, and maintenance of community safe rooms will vary by location and construction type. This section presents information related to safe room costs and the relative impact of different aspects of the design and construction on the cost of a safe room.

2.3.1 Design Parameters Affecting Safe Room Costs

As part of the risk assessment plan discussed earlier in this chapter, budgetary cost estimates (estimates that will be ± 30 percent accurate) should be prepared by the design professional for each proposed safe room alternative. Key design parameters that drive the cost of community safe rooms are:

- Safe room use. Single or dual-use of the safe room (multi-purpose space within a building) will affect the cost of many building components, finishes, furnishings, and other occupancy-driven design parameters.
- Simplicity of design. The simpler the safe room construction system (short walls, short roof spans, and minimal interior finishes), the lower the cost. Safe rooms with large, open spaces that require more elaborate construction systems will undoubtedly cost more than an ordinary building. The choices made during the initial planning and design stage will have a direct impact on cost.
- Safe room design wind speed. The safe room design wind speed will affect the strength criteria, which both the structural system and exterior components and cladding of the safe room need to satisfy in order to resist the design wind loads.
- Safe room debris impact-resistance criteria. These design criteria arguably have the most significant influence over cost. Common building materials are readily available to harden wall and roof systems to be debris impact-resistant. However, opening protection systems and devices for doors, windows, vents, and other elements that may protrude through the safe room are much less common. Costs for these systems range from \$50 (basic code compliance for building protection) to \$400 per square foot of opening (for life-safety protection that meets FEMA 361 safe room criteria). Thus, the more openings desired by the safe room owner/operator/designer, the greater the cost of the safe room. The decision to include more windows or openings in a safe room, because it has uses other than sheltering, will have a significant impact on the safe room cost.
- Exterior walls and roof materials. The materials selected by designers may be readily available common building materials or newer technologies that may improve the safe room performance, but at a premium cost.
- Location of the safe room – impact on foundation type. The foundation of a safe room may be a simple, slab-on-grade with minimal footings and a relatively low cost. A basement safe room will cost more to excavate, but these increased costs are offset by higher levels of debris impact protection afforded by the surrounding soils in addition to debris impact-resistant walls. A safe room needed to protect at risk population located

in an area subject to flooding may require elevated foundations that are more expensive than other options, but are inevitable for this type of a safe room.

- Location of the safe room – other hazards. A safe room constructed in an open field may not be exposed to any additional hazards such as falling objects and building debris. However, safe rooms located on the lower floors of small buildings that have not been designed to resist high winds, or those located near trees or large power, telephone, light, or cellular towers and poles, are usually exposed to falling debris hazards. The safe rooms that cannot avoid these additional risks can be designed to resist them, but often at a premium cost. Additionally, the location of a safe room with respect to local seismic risk must also be considered. When constructing safe rooms in areas subject to seismic activity, these loads may govern some aspects of the design, resulting in an increase to the cost of the safe room.

2.3.2 Recent Safe Room Cost Data

Community shelters and safe rooms have been designed long before the first edition of FEMA 361 was released in July 2000. However, since that time there have been hundreds of extreme-wind hazard community safe rooms designed and constructed across the country. Since 2000, over 500 community safe rooms have been constructed around the country with some federal funding being provided through FEMA grant programs. For the update to this publication, FEMA reviewed a more recent series of cost estimates from 2005 to 2008 (including the 2008 Pre-Disaster Mitigation [PDM] Grant Program cycle, which included 36 safe room grant applications from 12 states). Table 2-4 presents cost metrics that have been developed to assist groups planning to design and construct safe rooms. These data were compiled from extreme-wind-hazard safe room projects.

Table 2-4. Cost Data From Recent Community Safe Room Projects

Description	Cost Metric	Comments
General Safe Room and Shelter Data		
Safe room average cost per square foot	\$150 – \$240 per square foot (sf)	Single use community safe rooms consistently had the lowest associated (estimated or actual) per square foot cost. Safe rooms in the lower range of this cost had low walls and short roof spans. Average costs at the higher end were typically for larger safe rooms (by square footage and occupancy) with much of the protected areas designed as large, open spaces with long roof spans.
Percent increase in building cost to harden a portion of a new building to resist 250-mph winds from a 140-mph basic wind speed	5% – 7%	Percent increase in cost per square foot associated with the structural and envelope hardening to meet 250-mph safe room design wind speed versus 140-mph basic wind speed from the building code. This is a cost increase per square foot of the safe room area being hardened.
Percent increase in building cost to harden a portion of a new building to resist 250-mph winds from a 90-mph basic wind speed	15% – 20%	Percent increase in cost per square foot associated with the structural and envelope hardening to meet 250-mph safe room design wind speed versus 90-mph basic wind speed from the building code. This is a cost increase per square foot of the safe room area being hardened.

Table 2-4. Cost Data From Recent Community Safe Room Projects (continued)

Description	Cost Metric	Comments
General Safe Room and Shelter Data (continued)		
Percent increase in building cost to harden a portion of a new building to resist debris impact from a 15-lb 2x4 board missile traveling horizontally at 100 mph and impacting vertical surfaces and the same missile traveling vertically at 67 mph and impacting horizontal surfaces	5% – 27%	Percent increase in cost per square foot associated with the hardening of all portions of the safe room exterior walls, roofs, and opening protective devices versus providing no debris impact protection at all (debris impact resistance only, wind pressure resistance not considered). This is an increase to the cost per square foot of the safe room area being hardened. The percent increase for hardening the safe room exterior components to resist debris impact is highly dependent on a number of factors including, but not limited to: size of the safe room, materials used, strength in wall and roof systems already provided by designing to resist wind loads from the safe room design wind speed, the percentage of openings in the safe room exterior, the number of egress points to be protected, and several others. For the purposes of this comparison, the safe room projects considered had minimal doors and building exteriors requiring protection for openings (windows) that ranged from 0% to 10% of the total building exterior.
Percent increase in building cost to harden a portion of a new building to resist 250-mph winds and associated debris impacts from a 90-mph basic wind speed	20% – 32%	Percent increase in cost per square foot associated with the structural and envelope hardening to meet 250-mph safe room design wind speed versus 100-mph basic wind speed and provide debris impact protection from a 15-lb missile traveling at 90 mph. This is a cost increase per square foot of the safe room area being hardened.
2008 PDM Grant Application Sample Cost Data (36 safe room projects)		
Safe room sizes proposed	Max = 32,000 sf Min = 700 sf Avg = 6,500 sf	Most projects associated with the submittals for this cycle proposed an entire building as the safe room (78% of projects). In most instances, 85% of the usable space within the proposed protected area was considered available for occupants; see Chapter 3 for appropriate occupant loads per square foot of available space.
Range of safe room average cost per square foot for projects considered technically feasible and effective for providing protection	Max = \$480/sf Min = \$90/sf Avg = \$188/sf	These cost figures are as proposed. Their incorporation here is for informational purposes only. These numbers were separately evaluated on a project by project basis for cost-effectiveness.

Notes:

1. Costs were based on safe room and shelter projects meeting the criteria of FEMA 361 (July 2000).
2. Safe room sizes for the General Safe Room and Shelter Data sections of the table varied from 5,000 square feet to 32,000 square feet.
3. Data in this table are from several sources including, but not limited to: cost estimates prepared by designers/architects/engineers on behalf of prospective and actual safe room owners, FEMA analyses, FEMA grant applications, and state and local emergency management agencies.

2.3.3 Other Factors Impacting Cost

The most cost-effective means of constructing a safe room at a site is to incorporate the safe room into a new building design in the initial planning stage. The cost to design and construct hardened safe room areas within new buildings is much lower than the cost of retrofit (i.e., when the existing buildings or portions of existing buildings need to be hardened). For example, in recent FEMA-funded mitigation projects in many midwestern and southeastern states, the construction costs (per square foot) for retrofitting safe rooms have been (at a minimum) approximately 10 to 15 percent higher than construction costs for safe rooms in new buildings. It

is important to remember, however, that this increase in cost applies only to a small area of the building (i.e., the area being hardened and not the entire building).

Also, Table 2-4 shows how the relative cost per square foot for safe rooms included as a part of a building project increases when life-safety protection is provided. For large new building projects, however, the percent increase in the overall project cost is quite small. For example, many safe rooms protecting 200 to 300 occupants being constructed as part of a new school have added only 1 to 2 percent to the total project cost when the safe room was included in the design process at the beginning of the project.

The level of protection afforded by a safe room also impacts the cost of the safe room; however, that does not always mean that a safe room constructed for a higher level of protection will cost more than one that has been constructed for a lower level of protection. Table 2-1 provides a comparison of different levels of protection offered by FEMA safe rooms and shelters designed and constructed to other criteria or code requirements. For example, a simplified design for a single-use, tornado community safe room may cost less than a large, multi-use hurricane community safe room that has multiple uses and a long-span roof system. Similarly, constructing a shelter or safe room to comply with ICC-500 flood criteria in a V zone may cost upwards of 10 percent more (per square foot of the entire project cost) than the same safe room constructed to meet the FEMA 361 community safe room flood design criteria that does not permit safe room construction in V zones. Although a higher level of protection is provided by the FEMA compliant safe room because it has been removed from the velocity zone, the elevation of the shelter to the ICC criteria (which allows placement in the V zone) results in a more expensive solution because of the elevated foundation required even though the hazard is still present.

Table 2-4 shows relative incremental cost increases for constructing safe rooms to FEMA 361 criteria in comparison to building code required construction, even in hurricane-prone regions where the design of buildings is more robust. In these cases, buildings such as critical or essential facilities constructed in coastal areas called “wind-borne debris regions” are required to be designed and constructed to resist wind speeds up to 145 to 150 mph (3-second gust) and also have debris impact-resistance for a 9-lb missile traveling at 55 mph. This improved level of protection is required for these areas by the building code to reduce damage to these facilities by known hazards; however, they do not provide a level of protection that can be considered near-absolute for life-safety of occupants within the building. Further, Table 2-4 presents data from recent projects indicating that safe rooms constructed to the FEMA 361 criteria for 250 mph (to resist both wind pressures and debris impacts) where the protected areas provide near-absolute protection for its occupants have been constructed for as little as 5 percent more (on a cost per square foot basis) than critical and essential facilities designed to a 140-mph basic wind speed.

Intuitively, it may be stated that when two safe rooms are constructed of the same materials, but one is designed to the level of protection being offered by a FEMA 361 tornado community safe room while the second is designed to the level of protection offered by a FEMA 361 hurricane community safe room (where the safe room design wind speed and the design missile impact is based on a smaller and slower missile), the cost of the hurricane community safe room may

be even closer to that of the critical facility designed to resist 140 mph (and associated debris impacts) per ASCE 7-05. This is based on the assumption that smaller quantities of the building materials are required and thus the safe room will cost less. The same may be said when comparing differences in costs associated with the level of protection offered by a FEMA 361 safe room and an ICC-500 shelter (for either hazard or for the combined tornado and hurricane hazards) constructed of the same materials. But such a comparison needs to be completed carefully. Factors such as single-use versus multi-use shelters or safe rooms and optional features that result from the selection of a multi-use safe room (such as taller walls, more windows, more doors/egress points, etc.) must be identified when comparing the cost estimates for two protected areas designed to different criteria. No two safe rooms or shelters were able to be identified with matching building materials and design assumptions, thus specific cost comparisons could not be made at the time this publication was prepared.

Both the new FEMA 361 hurricane community safe room design criteria presented in Chapter 3 and the new ICC-500 hurricane community shelter criteria specify new wind speed ranges and new debris impact-resistance criteria. Because these criteria are new, no products other than those that satisfy the existing FEMA 361 life-safety criteria (250 mph and a 15-lb 2x4 board missile traveling at 100 mph) are available in the market for a number of the components. Thus, specific wall systems, opening protection devices and systems, and glazing or glazing protection systems that satisfy the new criteria do not yet exist. Since no products have been developed at this time, no cost comparisons can be made.

Depending upon the “features” included in the design of a safe room or shelter, arguments may be made that a combined hazard safe room can likely be constructed for nearly the same cost as a hurricane-specific hazard safe room (depending upon size, number of openings, building materials selected, etc.), but it is difficult to quantify for many of the reasons discussed above. As such, it is also difficult to state or prove that a hurricane-specific safe room will cost significantly less to construct than a combined-hazard safe room with minimal doors and openings. At this time, the percent cost difference between a FEMA 361 hurricane community safe room and a FEMA 361 combined tornado and hurricane community safe room cannot be specifically provided, but is assumed to be less than 5 percent. This statement is based on the project data in Table 2-4 that showed cost per square foot increases as small as 5 to 7 percent to improve building wind resistance from the level of a critical facility constructed to the building code in a hurricane-prone region with 140-mph design wind speed criteria and the 250-mph safe room design wind speed criteria presented in Chapter 3. It would follow that, to reduce the design parameters to a slightly lower wind speed (250 to 200 mph) and to reduce the debris impact resistance requirements for the lighter missile of the FEMA 361 hurricane safe room criteria, because the magnitude of the design criteria is not as significant as to drop back to code-level requirements, the cost impact would also not be as dramatic.

Similarly, the cost differences between a FEMA 361 safe room and an ICC-500 shelter cannot be quantified at this time. Even though the differences in design criteria exist, FEMA criteria are mostly equivalent to or slightly more restrictive than the ICC-500 requirements. The wind speeds are the same and the missiles are the same. The small differences in design parameters and

missile impact speeds (for FEMA hurricane safe rooms versus the ICC-500 shelters) are less in magnitude than the design parameters for essential facilities that are constructed at protection levels based on 140 mph 3-second gust at costs of 5 to 7 percent less than the costs associated with a FEMA 361 safe room. As such, the cost differential to construct an ICC-500 shelter should be between these two costs since the design criteria required for compliance are between the FEMA 361 and the essential facility criteria of the building code.

2.3.4 Additional Factors to Consider When Constructing a Safe Room

A number of factors can influence the decision-making process in addition to cost considerations. The potential for death or injury may be a sufficient reason to build a safe room at a given building site. The benefit-cost ratio of constructing a safe room discussed in Section 2.4 may be a contributing factor or a requirement of the safe room design process, depending upon the funding source. However, additional factors may be involved in the decision-making process:

- Do the residents feel safe without a safe room?
- Does a business want to provide the protection for its workers?
- Does a safe room allow for faster business recovery after an extreme-wind event?
- Is the building in question a government-owned building that is required to have a safe room?
- Do zoning ordinances require it?
- Are there insurance benefits?

2.4 Benefit-Cost Analysis

Benefit-cost analysis (BCA) is a method used to determine the cost-effectiveness of proposed projects. FEMA regulations require mitigation projects funded under Hazard Mitigation Assistance (HMA) programs to have benefits (avoided losses) that exceed costs, usually expressed as a benefit-cost ratio (BCR) greater than 1.0.

The July 2000 Edition of FEMA 361, Design and Construction Guidance for Community Shelters, included BCA software for tornado and hurricane shelters, which will be referred to below as the “existing shelter BCA software.” This software focused exclusively on the reduction of injuries and deaths (life-safety benefits) from shelters as the basis for benefits. Beginning in 2007, in parallel with revisions to FEMA 361, FEMA undertook to redesign all BCA software associated with their mitigation grant programs for flood, earthquake, hurricane, and tornado hazards. As the new Tornado Safe Room BCA and Hurricane Safe Room BCA software are finalized, they will be used in place of the existing shelter BCA software. The new Tornado Safe Room BCA software will be included in release 4.0 of the new Benefit-Cost Analysis software, with an anticipated release date of fall 2008. The Hurricane Safe Room BCA software requires more extensive revisions and is planned to be included in release 5.0 of the Benefit-Cost Analysis software, with an anticipated release in 2009. Copies of the existing and new BCA software and information on

the final releases of the new software can be found at the FEMA BCA website, <http://www.fema.gov/government/grant/bca.shtm>.

2.4.1 Existing Shelter BCA Software

The existing shelter BCA software was designed based on the presumed need to provide community safe rooms that were either retrofits of existing structures, such as schools, or retrofits of designs for new structures (e.g., adding a hardened hallway to the design of a new town hall). Figure 2-3 is a flowchart of the existing benefit-cost model. The project costs to be inputted should be based on the costs of building construction and any additional maintenance costs incurred by the project. Benefits, or avoided damages, are based on the reduction of casualties (injuries and deaths) resulting from the construction of the proposed shelter. The four main factors used to calculate these benefits are:

- Losses associated with injury or death
- Safe room occupancy
- Probability of injury and death due to tornado or hurricane winds
- Probability of tornado or hurricane wind events

Original default loss values are based on values from the 1990s used by the Federal Aviation Administration (FAA) for insurance purposes. These defaults include a single injury level estimated to cost \$12,500 per person and a death is estimated as \$2,200,000 per person. Safe room occupancy is based on average hourly occupancy counts throughout a 24-hour period. The software was developed with the assumption that these occupants would only include the people who would have already been in the structure, which eliminates the consideration of issues such as warning response time and travel time to the safe room. These values are entered by the user.

The probability of an injury or death is represented by casualty rate tables giving estimated death and injury percentages for five building types (with two window covering categories) over nine wind speed ranges. Building types represent before-mitigation (pre-safe room) conditions. To represent the safe room, the before-mitigation death and injury values are reduced by a certain percentage based on safe room design. These tables were developed by FEMA tornado experts and consultants on the basis of professional experience and judgment.

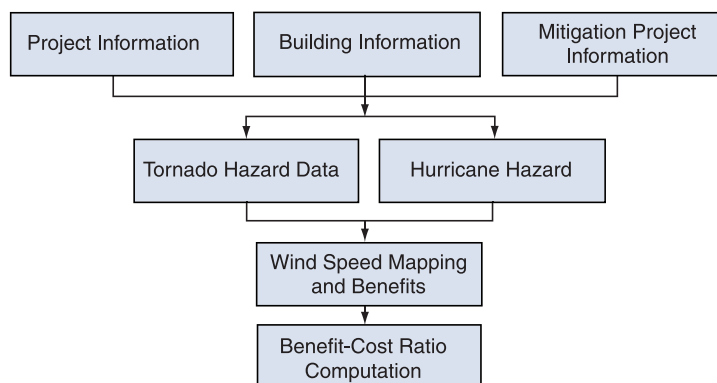

Figure 2-3. Flowchart for the existing benefit-cost model

The probability of a tornado hitting a safe room is based on the NOAA Storm Prediction Center's Historical Tornado Data Archive from 1950-2006. County-based tornado statistics were calculated directly from this archive for Fujita (F) and now Enhanced Fujita (EF) class, time of day, and tornado length and width. Because tornado occurrence is infrequent for certain Fujita classes, especially F3 (and EF3) and greater, the current software used a geographic information system (GIS)-based approach that has the user select a region of counties surrounding the county of the safe room until a significant number of tornadoes has been reached. Probability of tornado occurrence is then calculated for this region of counties based on NOAA data and the shelter footprint area. The probability of hurricane events is based on the ASCE 7-98 map of 50-year MRI wind speeds and adjustment equations for other recurrence intervals compared against maximum anticipated wind speeds from storms.

The final benefit calculation compares the before- and after-mitigation expected deaths and injuries. This calculation is performed separately for tornadoes and hurricanes and then added for the total benefits.

2.4.2 New Tornado Safe Room BCA Software

The use of the existing shelter BCA software for grant programs like PDM has highlighted a number of issues. The New Tornado Safe Room BCA software addresses many of these issues and allows users to choose between the following safe room projects:

- New vs. retrofit safe room
- Stand-alone vs. internal safe room
- Community vs. residential safe room

The benefits (losses avoided) are calculated as a difference between losses that would occur before the safe room is built and the losses that would occur after the safe room is fully operational. The losses before mitigation (safe room construction) are determined on the basis of potential damage to different types of buildings where potential safe room occupants would be taking shelter during the storm.

In many cases, a new safe room, especially a stand-alone one, will serve a population that would not necessarily be on site. The potential safe room occupants would need to travel to the safe room from the surrounding area within the minimum allowed time period. This approach now requires the new methodology to take into account warning response times and travel times to the safe room.

The four main factors used to calculate the benefits remain the same:

- Costs associated with injury and death
- Shelter occupancy

- Probability of injury and death due to tornado winds
- Probability of tornado wind events

However, the way that each of these factors is calculated has changed. In 2007, FEMA convened an outside panel of building performance experts (with significant knowledge in tornado and hurricane building damage assessments) and life-safety experts from consulting firms, research organizations, and academia. This expert panel evaluated the existing methods for calculating benefits and provided guidance on updated methods. The costs associated with casualties are now divided between three injury levels (self-treat, treat and release, hospitalized) and death, based on updated tables from the FAA (2007 dollars).

The occupancy load is counted for three intervals during a 24-hour period: day, evening, and night. Since the majority of the potential occupants of the community safe room will come from the surrounding areas, the new methodology allows the user to select up to two before-mitigation structure types to represent the level of risk to which the potential occupants would be exposed in conditions without a safe room. These two types can be selected from eight pre-defined structure types provided in the model, based on the categories used in the development of the Enhanced Fujita Scale. The casualty rates for each damage state were defined on the basis of damage indicators and degree of damage tables published in the Enhanced Fujita Scale report (TTU 2006).³

The probability of a tornado striking a safe room is still based on NOAA tornado historical records, but employs a regional analysis method to eliminate the need for user-selected regions. Tornado records with recorded paths or start points were expanded and updated to cover the period from 1950 to 2006. This information was used as part of a geospatial analysis method, based on tornado probability research, to produce tornado occurrence maps for each Enhanced Fujita class. Tornado probability is then calculated using published average national tornado length and width values. When the user selects the county where the safe room will be located, the pre-calculated tornado probabilities are accessed from the software database.

The basis for project costs (initial project costs and maintenance) has remained the same as in the existing model; however, new cost estimation tools have been developed. As a result of all of these changes and overall changes to the BCA software platform, the new Tornado Safe Room BCA provides an updated, defensible, and more user-friendly tool to calculate life-safety benefits for tornado safe rooms, for both the community and residential units.

³ *A Recommendation for an Enhanced Fujita Scale (EF-Scale)*, Revision 2, October 2006, prepared by the Wind Science and Engineering Research Center, Texas Tech University.

3 Design Criteria for Tornado and Hurricane Safe Rooms

This chapter provides the design and performance criteria for the structural systems and envelope systems (including openings and protection systems for openings and windows) for tornado and hurricane safe rooms. The performance criteria includes detailed guidance on debris impact-resistance criteria. Other engineering factors and concepts involved in the design of a safe room are also identified in this chapter, but will be discussed in detail in later chapters. This chapter presents the information in the following order (and each section provides cross-references as to which criteria are the same or different from the criteria presented in the ICC-500 Storm Shelter Standard):

- General approach to the design of safe rooms.
- Load combinations.
- Tornado community safe room wind design and debris impact performance criteria (including the Tornado Safe Room Design Wind Speed Map).
- Hurricane community safe room wind design and debris impact performance criteria (including the Hurricane Safe Room Design Wind Speed Map).
- Residential safe room wind design and debris impact performance criteria.
- Guidance on flood hazard design criteria.
- Guidance on product testing, permitting, code compliance, professional design oversight, peer review, construction documents, signage, labeling, and quality assurance/quality control, and special inspections issues are addressed at the end of the chapter.

3.1 General Approach to the Design of Safe Rooms

The design criteria presented in this chapter are based on the best information available at the time this manual was published and rely heavily on the ICC-500 Storm Shelter Standard. However, FEMA has identified a few design and performance criteria that are consistent with the previous FEMA guidance on safe room design and construction that remain more restrictive than some of the requirements found in the ICC-500. Chapters 5 to 9 of this publication provide a detailed commentary on these criteria and are intended to provide supplemental guidance to the design professional for the safe room criteria set forth in this chapter. The key differences

affecting design of the FEMA safe room and the ICC shelter, by hazard and classification, are as follows:

- Tornado community safe rooms per FEMA 361 (see Sections 3.3.1, 3.3.2, and 3.6.1):
 - Should be designed for all cases as partially enclosed buildings, for Exposure C
 - Should be sited out of specific flood hazard areas and designed to the flood design criteria of this chapter
 - Should have life-safety protection elements of the design peer reviewed when safe room occupancy is 50 persons or more
- Hurricane community safe rooms per FEMA 361 (see Sections 3.4.1, 3.4.2, and 3.6.1):
 - Should be designed using Exposure C (may not use Exposure B as with ICC-500)
 - Should be designed as partially enclosed buildings (to account for uncontrolled openings of doors and windows)
 - Should be designed to resist the 9-lb 2x4 wood board missile traveling horizontally at 0.5 x hurricane safe room design wind speed (may not use 0.4 x hurricane safe room design wind speed)
 - Should be sited out of specific flood hazard areas and designed to the flood design criteria of this chapter
 - Should have life-safety protection elements of the design peer reviewed when safe room occupancy is 50 persons or more
- Residential safe rooms per FEMA 361/320 (see Sections 3.5.1, 3.5.2, and 3.6.2):
 - Should be designed using 250 mph as the safe room design wind speed
 - Should be designed to resist the 15-lb 2x4 wood board missile traveling horizontally at 100 mph and vertically at 67 mph
 - Should be sited out of specific flood hazard areas and designed to the flood design criteria of this chapter

The design of a safe room to resist wind loads relies on the approach to wind load determination taken in ASCE 7-05, Chapter 6, Section 6.5, Method 2 – Analytical Procedure. The International Building Code (IBC) 2006 and International Residential Code (IRC) 2006 also reference ASCE 7-05 for determining wind loads. For consistency, the designer may wish to use ASCE 7-05 to determine other loads such as dead, live, seismic, flood, and snow loads that may act on the safe room. Note: The ICC-500 provides rain and

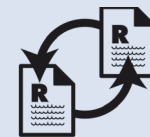

ICC-500 CROSS-REFERENCE

As part of the ICC-500, rain and roof live loads for safe room designs are different and higher than as prescribed by ASCE 7-05 and the IBC and IRC.

roof live loads for safe room design that are above the requirements of ASCE 7-05 and the IBC. Wind loads should be combined with the gravity loads and the code-prescribed loads acting on the safe room in load combinations presented in Sections 3.2.1 and 3.2.2. When wind loads are considered in the design of a building, lateral and uplift loads must be properly applied to the building elements along with all other loads.

The FEMA safe room design and construction criteria are presented in this chapter without detailed discussion or guidance. The remaining chapters of this publication provide both discussion and guidance on the design and construction criteria presented in this chapter. These criteria are based on codes and standards available for adoption by any jurisdiction. Specifically, the criteria are based on the ICC-500, ASCE 7-05 and ACSE 24-05, and the 2006 IBC and IRC unless otherwise noted. For design and construction criteria not provided in this publication, or in the ICC-500, the 2006 IBC and IRC (as appropriate) should be used to determine the required criteria to complete the safe room. Should a designer, builder, or manager have any questions regarding design criteria presented in this standard, the following approach should be taken:

1. When questions arise pertaining to the difference between FEMA 361 criteria and another code or standard (such as the ICC-500), the criteria in FEMA 361 should govern. If not, the safe room cannot be considered to be a FEMA safe room.
2. When questions arise pertaining to design and construction criteria not presented in FEMA 361, but provided in the ICC-500, the criteria of the ICC-500 should be used.
3. Where the purpose of a safe room is to provide life-safety protection from both tornadoes and hurricanes, the entire safe room should be designed and constructed using the most restrictive of the two sets of criteria.
4. When a questions arise pertaining to a criteria or requirements not addressed by this publication or the ICC-500, the 2006 IBC and 2006 IRC (with references to ASCE 7-05 and ASCE 24-05) should be used to provide the necessary design and construction criteria. When these codes or standards provide conflicting criteria, the most conservative criteria should apply.

3.2 Load Combinations

Model building codes and engineering standards are the best available guidance for identifying the basic load combinations that should be used to design buildings. The design professional should determine the loads acting on the safe room using the load combinations and conditions for normal building use as defined in the building code in effect or as presented in Section 2 of ASCE 7-05.

The designer should then calculate the ultimate-wind loads that will act on the safe room using the design coefficients and criteria from this chapter and in the design method from Section 6.5 of ASCE 7-05. For an extreme (“ultimate”) wind load (W_x) for a tornado, hurricane, or combined hazard, the designer should use the design parameters presented later in this chapter. However, it is important to remember that the safe room design wind speed selected from this guidance

manual is for an extreme-wind event and the load combinations from ASCE 7-05 are based on design level wind events (with velocity, V). Therefore, the wind coefficients in the load combinations from ASCE 7-05 for design level wind events should be modified for the ultimate wind load. The load combinations provided in Sections 3.2.1 and 3.2.2 are for Strength Design (also termed Load and Resistance Factor Design [LRFD]) and Allowable Stress Design (ASD), respectively. These load combinations are the load combinations from ASCE 7-05 for the design level event, except where bolded. The bolded load combinations have been revised to appropriately account for the use of ultimate wind load (W_x) in safe room design that must be calculated using the wind design parameters specified in Sections 3.3.1, 3.4.1, and 3.5.1. The revisions are based on the guidance given in the Commentary of ASCE 7-05 for extreme-wind events and, as such, incorporate different load multipliers (specifically the wind load, W_x) from those used in either the model codes or ASCE 7-05 (Section 2). These load combinations should be used for the safe room design and construction.

Flood hazard design criteria for safe room design are provided in Section 3.6. Note that these criteria define where a safe room may be placed and how to design a safe room if portions of the structure are subject to flood loads. It is possible, and preferred, that there may be no flood loads to consider because a safe room has been sited outside areas subject to flooding.

The load combinations presented in Sections 3.2.1 and 3.2.2 for Strength Design and Allowable Stress Design, respectively, are the same as those presented in the ICC-500. They have been peer reviewed by the Project Team and the Review Committee. It is important to note that these load combinations are different from those presented in the first edition of FEMA 361.

3.2.1 Load Combinations Using Strength Design

For the design of a safe room using Strength Design Methods, the designer should use the load combinations of Section 2.3.2 of ASCE 7-05 to ensure that a complete set of load cases is considered. For the main wind force resisting system (MWFRS), components and cladding (C&C), and foundations of safe rooms designed for extreme- (ultimate-) wind loads, designers should also consider the following load cases (using W_x) so that the design strength equals or exceeds the effects of the factored loads in the following combinations (LRFD):

- a) In load combination 3, replace $0.8W$ with $0.5W_x$.
- b) In load combinations 4 and 6, replace $1.6W$ with $1.0W_x$.
- c) Exception 1 from ASCE 7-05, Section 2.3.2 should not apply.

Implementing these modifications of the Strength Design Load Cases from ASCE 7-05 results in the following cases to be used for ultimate wind loads in FEMA 361 (see ASCE 7-05 for definitions of all terms, but note that W_x = ultimate wind load is based on wind speed selected from the appropriate safe room design wind speed map in Sections 3.3 or 3.4):

Load Combination 1: $1.4(D + F)$

Load Combination 2: $1.2(D + F + T) + 1.6(L + H) + 0.5(L_r \text{ or } S \text{ or } R)$

Load Combination 3: $1.2D + 1.6(L_r \text{ or } S \text{ or } R) + (L \text{ or } 0.5 W_x)$

Load Combination 4: $1.2D + 1.0W_x + L + 0.5(L_r \text{ or } S \text{ or } R)$

Load Combination 5: $1.2D + 1.0E + L + 0.2S$

Load Combination 6: $0.9D + 1.0W_x + 1.6H$

Load Combination 7: $0.9D + 1.0E + 1.6H$

Exceptions:

1. N.A.
2. The load factor on H shall be set equal to zero in load combinations 6 and 7 if the structural action due to H counteracts that due to W or E .
3. In combinations 2, 4, and 5, the combination load S shall be taken as either the flat roof snow load or the sloped roof snow load.

The designer should also consider the appropriate seismic load combinations from Section 2.3.2 of ASCE 7-05. Where appropriate, the most unfavorable effects from both wind and seismic loads should be investigated. Wind and seismic loads should not be considered to act simultaneously (refer to Section 9.2 of ASCE 7-05 for the specific definition of earthquake load, E). From the load cases of Section 2.3.2 of ASCE 7-05 and the load cases listed above, the combination that produces the most unfavorable effect in the building, safe room, building component, or foundation should be used.



NOTE

When a safe room is located in a flood zone, the following load combinations in Section 3.2.1 should be considered:

- In V zones and coastal A zones, the $1.0W_x$ in combinations 4 and 6 should be replaced by $1.0W_x + 2.0F_a$.
- In non-coastal A zones, the W_x in combinations 4 and 6 should be replaced by $1.0W_x + 1.0F_a$.

3.2.2 Load Combinations Using Allowable Stress Design

For the design of a safe room using Allowable Stress Design Methods, the designer should use the load combinations of Section 2.4.1 of ASCE 7-05 to ensure that a complete set of load cases is considered. For the MWFRS, C&C, and foundations of extreme-wind safe rooms, designers should also consider the following load cases (using W_x) so that the design strength equals or exceeds the effects of the factored loads in the following ASD load combinations:

- a) In load combinations 5, 6, and 7, replace W with $0.6W_x$.

Implementing these modifications of the Allowable Stress Design Load Cases from ASCE 7-05 results in the following cases to be used for ultimate wind loads in FEMA 361 (see ASCE 7-05 for definitions of all terms, but that W_x = ultimate wind load is based on wind speed selected from the appropriate safe room design wind speed map in Sections 3.3 or 3.4):

Load Combination 1: $D + F$

Load Combination 2: $D + H + F + L + T$

Load Combination 3: $D + H + F + (L_r \text{ or } S \text{ or } R)$

Load Combination 4: $D + H + F + 0.75(L + T) + 0.75(L_r \text{ or } S \text{ or } R)$

Load Combination 5: $D + H + F + (0.6W_x \text{ or } 0.7E)$

Load Combination 6: $D + H + F + 0.75(0.6W_x \text{ or } 0.7E) + 0.75L + 0.75(L_r \text{ or } S \text{ or } R)$

Load Combination 7: $0.6D + 0.6W_x + H$

Load Combination 8: $0.6D + 0.7E + H$

The designer should also consider the appropriate seismic load combinations from Section 2.4.1 of ASCE 7-05. Where appropriate, the most unfavorable effects from both wind and seismic loads should be investigated. Wind and seismic loads should not be considered to act simultaneously (refer to Section 9.2 of ASCE 7-05 for the specific definition of earthquake load, E). From the load cases of Section 2.4.1 of ASCE 7-05 and the load cases listed above, the combination that produces the most unfavorable effect in the building, safe room, building component, or foundation should be used.



NOTE

When a safe room is located in a flood zone, the following load combinations in Section 3.2.2 should be considered:

- In V zones and coastal A zones, $1.5F_a$ should be added to load combinations 5, 6, and 7.
- In non-coastal A zones, $0.75F_a$ should be added to load combinations 5, 6, and 7.

3.2.3 Other Loads and Load Combination Considerations

The ICC-500 provides specific guidance on loads in addition to wind loads. The rain (R) and roof live load (L_r) guidance provided in the ICC-500 applies to the design and construction of safe rooms.

Concrete and masonry design guidance is provided by the American Concrete Institute International (ACI), American Society of Civil Engineers (ASCE), and The Masonry Society (TMS). *Building Code Requirements for Structural Concrete* (ACI 318-08) and *Building Code Requirements and Specifications for Masonry Structures* (ACI 530-08/ASCE 5-08/TMS 402-08, and ACI 530.1-08/ASCE 6-08/TMS 602-08) are the most recent versions of the concrete and masonry design codes. The load combinations for these codes may differ from the load combinations in ASCE 7-05, the IBC, and other model building codes.

When designing a safe room using concrete or masonry, the designer should use load combinations specified in the concrete or masonry codes, except when the safe room design wind speed is taken from Sections 3.3, 3.4, or 3.5 of this manual. For the safe room design wind speed, the ultimate wind load (W_x) should be determined from the wind pressures acting on the building, calculated according to ASCE 7-05 and the provisions and assumptions stated in Sections 3.3, 3.4, or 3.5.

3.3 Tornado Community Safe Room Design Criteria

The first step in designing and constructing a safe room is the identification of the hazard. If there is a need for the design and construction of a safe room to protect lives during a tornado or if tornado hazards have been identified, the following design criteria are recommended. The next step in the design process is to identify the appropriate tornado safe room design wind speed from the map presented in Figure 3-1.

In this map, four zones have corresponding safe room design wind speeds of 250 mph, 200 mph, 160 mph, and 130 mph. These wind speeds should be used to determine the wind forces that act on either the structural frame (i.e., the load-bearing elements – MWFRS) of a building to be used as a safe room, the exterior coverings of the safe room (C&C), and openings or opening protectives (such as doors and windows). Additional discussion on the origin and content of this map is provided in Chapter 6 of this publication.

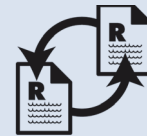

ICC-500 CROSS-REFERENCE

The tornado community safe room design criteria presented in this section of FEMA 361 are the same as the tornado community shelter design criteria presented in the ICC-500 Storm Shelter Standard unless otherwise noted.

3.3.1 Wind Design Parameters for Tornado Community Safe Rooms

As previously mentioned, the wind loads on the safe room should be calculated using the wind load provisions in Section 6.5 of ASCE 7-05, Method 2 – Analytical Procedure (except when modified by this guidance). The design recommendations for tornado safe rooms do not meet the requirements for using Method 1 – Simplified Procedure. In addition, all doors, windows, and openings should be protected with devices that comply with the design wind pressures as calculated by ASCE 7-05. The safe room provides life-safety protection from wind events and therefore should be capable of resisting ultimate wind loads without failure, although some damage may occur and serviceability of the safe room may be an issue after an event.

The coefficients and parameters used in the ASCE 7-05 pressure calculations in the design of a safe room are different from those listed for regular buildings or even essential facilities. This is because detailed wind characteristics in tornadoes are not well understood and the wind event

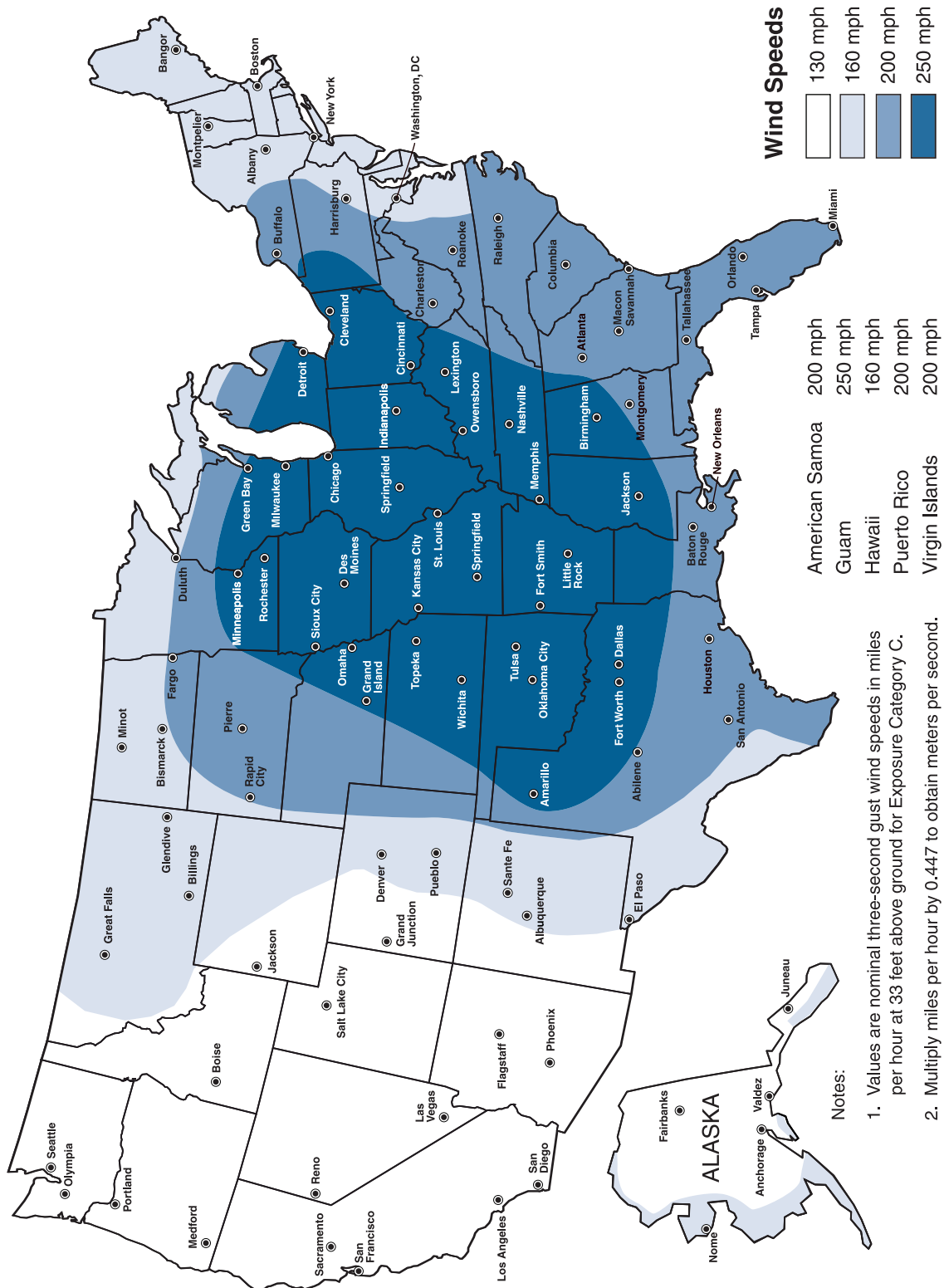

Figure 3-1. Tornado Safe Room Design Wind Speed Map (consistent with ICC-500 Tornado Hazard Map)

should be considered an “ultimate-level” event and not a “design-level” event. After selecting the tornado community safe room design wind speed from Figure 3-1, the following wind design parameters should be used when calculating wind pressures acting on tornado safe rooms:

- a) **Select Safe Room Design Wind Speed.** This is the first component of the safe room design process. Select either $V_x = 250, 200, 160, 130$ mph (3-second gust).
- b) **Importance Factor (I)** $I = 1.0$
- c) **Exposure Category** C
- d) **Directionality Factor** $K_d = 1.0$
- e) **Topographic Effects** K_{zt} need not exceed 1.0.
- f) **Enclosure Classifications.** Enclosure classifications for safe rooms should be determined in accordance with ASCE 7-05, Section 6.2. For determining the enclosure classification for community safe rooms, the largest door or window on a wall that receives positive external pressure should be considered as an opening. As such, the internal pressure coefficient may be appropriate for either an enclosed or partially enclosed building, depending upon the openings in the safe room and whether the atmospheric pressure change (APC) has been calculated or estimated.
- g) **Atmospheric Pressure Change.** The potential for APC should be considered in the design of tornado community safe rooms. For tornado community safe rooms, the internal pressure coefficient, GC_{pi} , may be taken as ± 0.18 when a venting area of 1 square foot per 1,000 cubic feet of interior safe room volume is provided to account for the effect of APC. The APC venting should consist of openings in the safe room roof having a pitch not greater than 10 degrees from the horizontal or openings divided equally (within 10 percent of one another) on opposite walls. A combination of APC venting meeting the above criteria is permitted (see ICC-500, Section 304.8).

As an alternative to calculating the effects of APC, and designing an appropriate venting system for the safe room, the design may be completed using an internal pressure coefficient of $GC_{pi} = \pm 0.55$ as a conservative means to account for the APC.



The design criteria discussed in this chapter pertain to the protection of the safe room space via the structural system, wall and roof assemblies, and doors and windows (and opening protectives). The design of architectural treatments on the exterior of safe room that do not provide protection of occupants within the safe room are not required to meet the design criteria presented in this publication. Should such elements or assemblies be used to improve the aesthetics of the safe room, the loads acting on those elements or assemblies should comply with requirements of the ICC-500 as applicable and, where not addressed by the ICC-500, as identified by model building code in effect or ASCE 7-05. See Chapter 7 for additional information on this topic.

- h) **Maximum Safe Room Height.** The height of a safe room is not restricted or limited.
- i) **Duration of Protection.** The tornado community safe rooms are designed to provide occupants life-safety protection for storm durations of at least 2 hours.
- j) **Ventilation, Sanitation, Power, and Other Non-structural Design Criteria.** Ventilation, sanitation, power, and other recommendations for tornado community safe rooms should be incorporated into the design of the safe room in accordance with ICC-500, Chapter 7. In addition, the safe room should be equipped with an electrical system with an emergency power backup system for lighting and other needs in accordance with ICC-500, Chapter 7. Additional information on these recommendations is also provided in Chapters 4 and 8 of FEMA 361.
- k) **Weather Protection.** All exposed components and cladding assemblies and roof coverings of tornado community safe rooms should be designed to resist rainwater penetration during the design windstorm event, and should be designed and installed to meet the wind load requirements as prescribed by ASCE 7-05 for non-safe room wind loads at the site.
- l) **Occupancy Classifications for Safe Rooms.** If a safe room is a single-use safe room, the occupancy classification per the IBC should be A-3 for the protected space. If a safe room is a multi-use safe room area, the occupancy classification for the primary use of the protected space (when not in use as a safe room) should be used.
- m) **Maximum Allowable Tornado Community Safe Room Population.** From a design and construction standpoint, there is no limitation on the maximum population that a safe room may be designed to protect. However, applicants and sub-applicants who request funding support from FEMA for safe room projects should be aware that limitations do apply to the size of the safe room. Refer to FEMA safe room and benefit-cost analysis tools for guidance and criteria that can be used to define the maximum population. Any group involved in the design and construction of a tornado community safe room should obtain the latest guidance from their FEMA regional office.
- n) **Maximum Population Density of a Tornado Community Safe Room.** The minimum recommended safe room floor area per occupant is provided in Table 3-1. The number of standing, seated (wheelchair-bound), or bedridden spaces should be determined based upon the needs of the safe room calculated by the designer and the applicable authority having jurisdiction. However, each community safe room should be sized to accommodate a minimum of one wheelchair space for every 200 occupants. It is also important to note that floor areas within community safe rooms should provide an access route in accordance with ICC/American National Standards Institute (ANSI) A117.1, *Standard on Accessible and Usable Buildings and Facilities*.

Table 3-1. Occupant Density for Tornado Community Safe Rooms

Tornado Safe Room Occupant	Minimum Recommended Usable Floor Area ¹ in Square Feet per Safe Room Occupant
Standing or Seated	5
Wheelchair-bound	10
Bedridden	30

¹ See below for recommendations for minimum recommended usable safe room floor area.

- o) **Calculation of Usable Floor Area.** The usable safe room floor area should be determined by subtracting the floor area of excluded spaces, partitions and walls, columns, fixed or movable objects, furniture, equipment, or other features that, under probable conditions, cannot be removed, or stored, during use as a safe room from the gross floor area.

An alternative method for determining the usable safe room floor area is to use the following percentages:

1. Reducing the gross floor area of safe rooms with concentrated furnishings or fixed seating by a minimum of 50 percent.
 2. Reducing the gross floor area of safe rooms with unconcentrated furnishings and without fixed seating by a minimum of 35 percent.
 3. Reducing the gross floor area of safe rooms with open plan furnishings and without fixed seating by a minimum of 15 percent.
- p) **Number of Doors.** The number of doors as means of egress from the safe room should be determined based upon the occupant load for the normal occupancy of the space in accordance with the applicable building code. For facilities used solely for safe rooms, the number of doors should be determined in accordance with the applicable building code based upon the occupant load as calculated above in Part n). The direction of the swing of doors should be as required by the applicable building code for the normal occupancy of the space and the egress doors should be operable from the inside without the use of keys or special knowledge or effort.

Where the applicable building code requires only one means of egress door, an emergency escape opening should be provided. The emergency escape opening should be an additional door or an opening that is a minimum of 5.7 square feet in area. Such openings should have a minimum height of 24 inches and a minimum width of 20 inches. The emergency escape opening should be operable from the inside without the use of tools or special knowledge. The emergency escape opening should be located away from the means of egress door by a minimum distance of 1/3 of the length of the maximum overall diagonal dimension of the area to be served.

3.3.2 Debris Impact Criteria for Tornado Community Safe Rooms

The elements of the safe room structure and its components (including windows, doors, and opening protective systems) that separate the individuals therein from the event outside should resist failure from wind pressures and debris impacts. For tornado community safe rooms, the structural elements, the building envelope, and openings in the building envelope should be designed to resist wind-induced loads as well as impacts from debris.

Providing windborne debris protection for safe rooms is different from the debris impact requirements in the IBC, IRC, and ASCE 7-05. All building elements that make up the portion of the safe room that protects the occupants should resist impacts from windborne debris. As mentioned above, these include not only the openings into and out of the safe room, but the walls and roof of the safe room. No portion of the envelope (roof, wall, opening, door, window, etc.) should fail by wind pressure or be breached by the specified windborne debris (at the appropriate debris impact wind speed). The only exceptions are roof or wall coverings that provide code-compliant performance for non-safe room design features, but are not needed for the protection of the occupants within the safe room. In addition, openings for ventilation into and out of the safe room should be hardened to resist both wind loads and debris impact.

For tornado hazards, the debris impact criteria for large missiles vary with the safe room design wind speed. Specifically, the representative missile for the debris impact test for all components of the building envelope of a safe room should be a 15-lb 2x4. The speed of the test missile impacting vertical envelope surfaces varies from 100 mph to 80 mph and the speed of the test missile impacting horizontal surfaces varies from 67 mph down to 53 mph. Table 3-2 presents the missile impact speeds for the different wind speeds applicable for tornado safe room designs. This debris impact test is recommended above any other debris impact criteria that may be applicable in the local jurisdiction in which the safe room is being constructed. If the tornado safe room is located in an area that already requires debris impact protection for openings to minimize damage to buildings and contents, it is important to note that the code mandated requirements for property protection must still be adhered to and that the debris impact protection criteria which provide life-safety protection from tornadoes are additional criteria. A more detailed discussion of the debris impact recommendations is provided in Chapter 7 of this publication.

Debris impact and extreme winds result from the same storm. However, each debris impact affects the structure for an extremely short duration, probably less than 1 second. For this reason, the highest wind load and the highest impact load are not considered likely to occur at precisely the same time.

Table 3-2. Tornado Missile Impact Criteria

Safe Room Design Wind Speed	Missile Speed (of 15 lb 2x4 board member) and Safe Room Impact Surface
250 mph	Vertical Surfaces: 100 mph Horizontal Surfaces: 67 mph
200 mph	Vertical Surfaces: 90 mph Horizontal Surfaces: 60 mph
160 mph	Vertical Surfaces: 84 mph Horizontal Surfaces: 56 mph
130 mph	Vertical Surfaces: 80 mph Horizontal Surfaces: 53 mph

Note: Walls, doors, and other safe room envelope surfaces inclined 30 degrees or more from the horizontal should be considered vertical surfaces. Surfaces inclined less than 30 degrees from the horizontal should be treated as horizontal surfaces.

To show compliance with the criteria to provide life-safety protection from windborne debris, the following guidance is provided:

- a) **Testing for Missile Impacts.** Missile impact resistance of all components of the safe room envelope (including doors and opening protectives) should be tested in accordance with ICC-500, Section 305.
- b) **Wall and Roof Assemblies.** All wall assemblies, roof assemblies, window assemblies, door assemblies, and protective devices used to cover openings and penetrations in the wall/roof that are recommended to protect occupants should be tested as identified in Part a) above and ICC-500, Section 306. The testing procedures that are used to comply with these criteria are provided in ICC-500, Section 804.
- c) **Openings and Opening Protectives in Tornado Safe Rooms.** The openings in the safe room envelope should be protected by doors complying with ICC-500, Section 306.3.1; windows complying with ICC-500, Section 306.3.2; other opening protectives complying with ICC-500, Section 306.4; or baffled to prevent windborne debris from entering the safe room protected occupant area in accordance with ICC-500, Section 306.5. The testing procedures that are used to show compliance with these criteria are provided in ICC-500, Section 804; this also includes skylight assemblies and other glazed openings. Opening protectives in tornado safe rooms should be permanently affixed, and manually operable from inside the safe room.

Also, window assemblies (operable and non-operable) and other glazed openings (including skylights, side lights, and transoms) should be tested using the procedures for missile impact resistance in accordance with ICC-500, Section 804; pressure in accordance with ICC-500, Section 805; and cyclic pressures in accordance with ASTM E 1996.

Exceptions:

1. Missile impact testing for the life-safety missile impact criteria is not necessary for window assemblies and other glazed openings where the opening is protected by a device located on the exterior or interior sides of the opening and meeting the criteria of Part a) above.
 2. Missile impact and pressure testing for life-safety missile impact criteria is not necessary for window assemblies and other glazed openings where the opening is protected by a device located on the interior side of the opening and meeting the criteria of Part a) above.
- d) **Soil-covered Portions of Safe Rooms.** Should all or portions of safe rooms be below ground or covered by soil, missile impact resistance criteria may not need to be addressed. Safe rooms with at least 12 inches of soil cover protecting horizontal surfaces, or with at least 36 inches of soil cover protecting vertical surfaces, do not need to be tested for resistance to missile impact as though the surfaces were exposed. Soil in place around the safe room as specified above can be considered to provide appropriate protection from the representative, tornado safe room missile impact.
- e) **Alcove or Baffled Entry Systems.** All protective elements of alcove or baffled entry systems to safe rooms (when used) should be designed to meet the wind load criteria of Section 3.3.1 and the debris impact test criteria of Section 3.3.2 of this publication. Where a door is employed as part of the protection in such an entry system, the door should meet the debris impact test requirements of ICC-500, Section 804.9.7 and the pressure testing requirements of ICC-500, Sections 805 and 806.6. The enclosure classification for safe rooms with alcove or baffled entries should be determined in accordance with Section 3.3.1 of this publication.
- f) **Other Debris Hazards.** Lay down, rollover, and collapse hazards (i.e., trees, other structures, rooftop equipment, etc., that have a reasonable chance of adversely impacting the safe room) should be considered by the design professional when determining the location of safe rooms on the site.
- g) **Other Hazards.** Fuel tanks, fueling systems, fuel pipes, or any other known hazards near the safe room should be taken into account in the siting and design of the safe room.

3.4 Hurricane Community Safe Room Design Criteria

The first step in designing and constructing a safe room is the identification of the hazard. If there is a need for the design and construction of a safe room to protect lives during a hurricane or from hurricane hazards, the following design criteria are recommended. The next step in the design process is to identify the appropriate hurricane safe room design wind speed from the map presented in Figure 3-2 (including 3-2a through 3-2c).

In these maps, hurricane safe room design wind speeds are not provided by wind zones, but by wind contours and range from 160 mph to 255 mph. These wind speed contours were developed

using the same model used to develop the wind speed contours for ASCE 7-05 and represent an “ultimate” design wind speed for the hurricane hazards in these areas. These wind speeds should be used to determine the wind-generated forces that act on either the structural frame (i.e., the load-bearing elements) of a building or shelter to be used as a safe room (MWFRS),

the exterior coverings of the safe room (C&C), and openings or opening protectives (such as doors and windows). Additional discussions on the origins and contents of these maps are provided later in Chapters 5 and 6 of this publication.

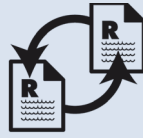

ICC-500 CROSS-REFERENCE

The hurricane community safe room design criteria presented in this section of FEMA 361 differ from the tornado community safe room design criteria presented in the ICC-500 Storm Shelter Standard in several key areas. These areas are exposure classification, debris impact criteria, and flood protection. Flood design criteria are presented in Section 3.6.

The difference between the hurricane safe room wind design speed map presented in Figure 3-2 (including 3-2a through 3-2c) and the hurricane shelter design wind speed map in the ICC-500 is the landward limit line for hurricane safe rooms. The FEMA 361 map contains an additional contour line that depicts the inland geographic boundary of the area in which FEMA hurricane community safe room design criteria are deemed appropriate. Should a safe room be constructed landward of this line, the tornado community safe room recommendations presented in Section 3.3 should be used. This inland boundary is defined as the extent of the hurricane-prone region, as mapped by ASCE 7-05.

3.4.1 Wind Design Parameters for Hurricane Community Safe Rooms

As previously mentioned, the wind loads on the portions of the safe room that experience wind pressures (including MWFRS, C&C, and openings) should be calculated using the wind load provisions in Section 6.5 of ASCE 7-05, Method 2 – Analytical Procedure (except as modified by this section). The design recommendations for hurricane safe rooms do not meet the requirements for using Method 1 – Simplified Procedure. In addition, all doors, windows, and openings should be protected with devices that comply with the design wind pressures as calculated by ASCE 7-05. The safe room provides life-safety protection from wind events and therefore should be capable of resisting ultimate-wind loads without failure, although some damage may occur and serviceability of the safe room may be an issue after an event.



For additional information on the definition of “hurricane-prone regions,” see Chapters 6 and C6 of ASCE 7-05, *Minimum Design Loads for Buildings and Other Structures*.

The coefficients and parameters used in the ASCE 7-05 pressure calculations in the design of a safe room should be different from those listed for regular buildings or even essential facilities

because detailed wind characteristics in hurricanes are complex and the wind event should be considered an “ultimate-level” event and not a “design-level” event. Based on the wind speed selected from Figure 3-2, the following wind design parameters should be used when calculating wind pressures acting on hurricane safe rooms:

- a) **Select Safe Room Design Wind Speed.** This is the first component of the safe room design process. Select $V_x = 255-160$ mph (3-second gust).
- b) **Importance Factor (I)** $I = 1.0$
- c) **Exposure Category** C
- d) **Directionality Factor** $K_d = 1.0$
- e) **Topographic Effects** K_{zt} need not exceed 1.0.

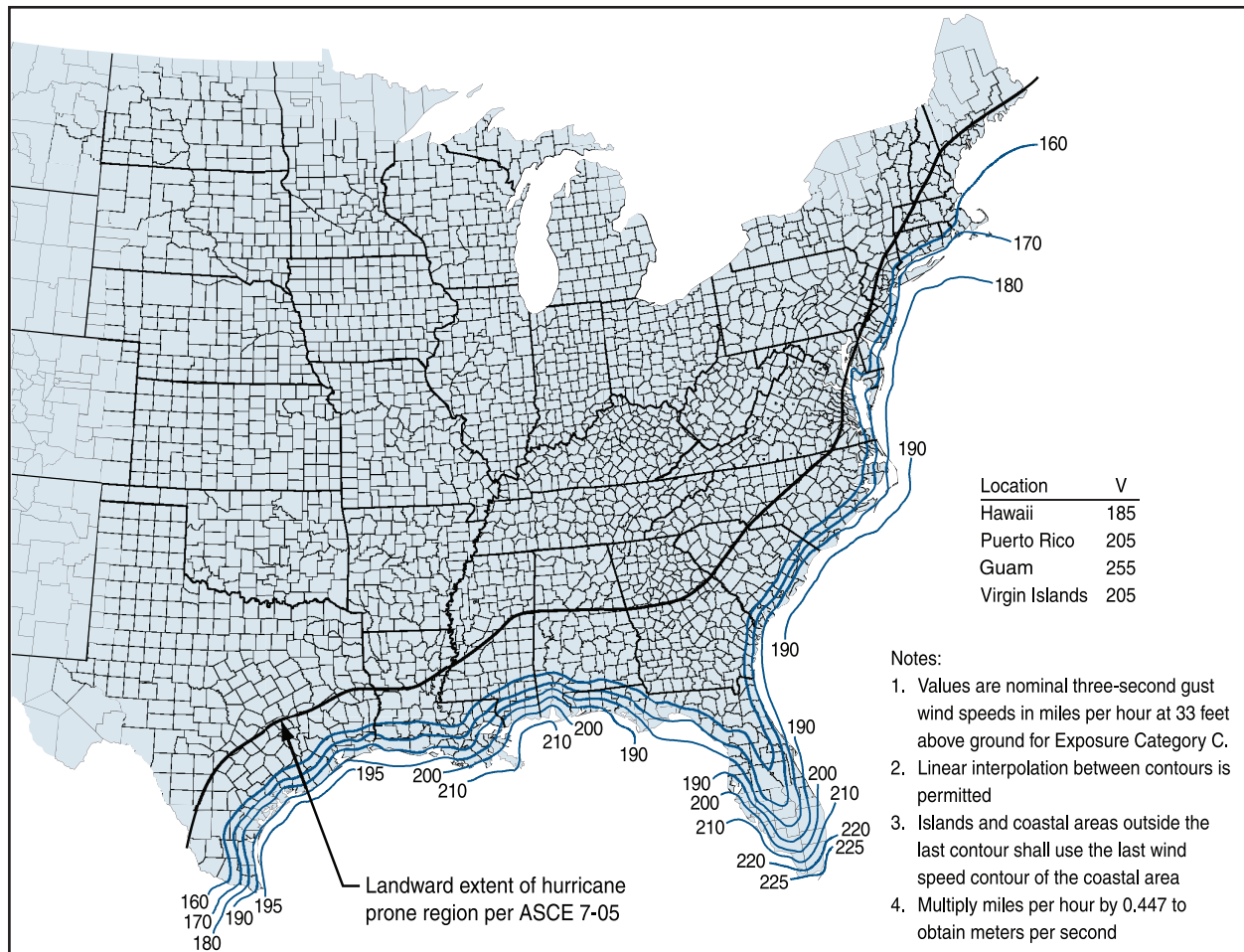

Figure 3-2. Hurricane Safe Room Design Wind Speed Map from the ICC-500

SOURCE: ICC/NSSA STANDARD FOR THE DESIGN AND CONSTRUCTION OF STORM SHELTERS (ICC-500). COPYRIGHT 2008, WASHINGTON, DC: INTERNATIONAL CODE COUNCIL. REPRODUCED WITH PERMISSION. ALL RIGHTS RESERVED. WWW.ICCSAFE.ORG < HTTP://WWW.ICCSAFE.ORG >.

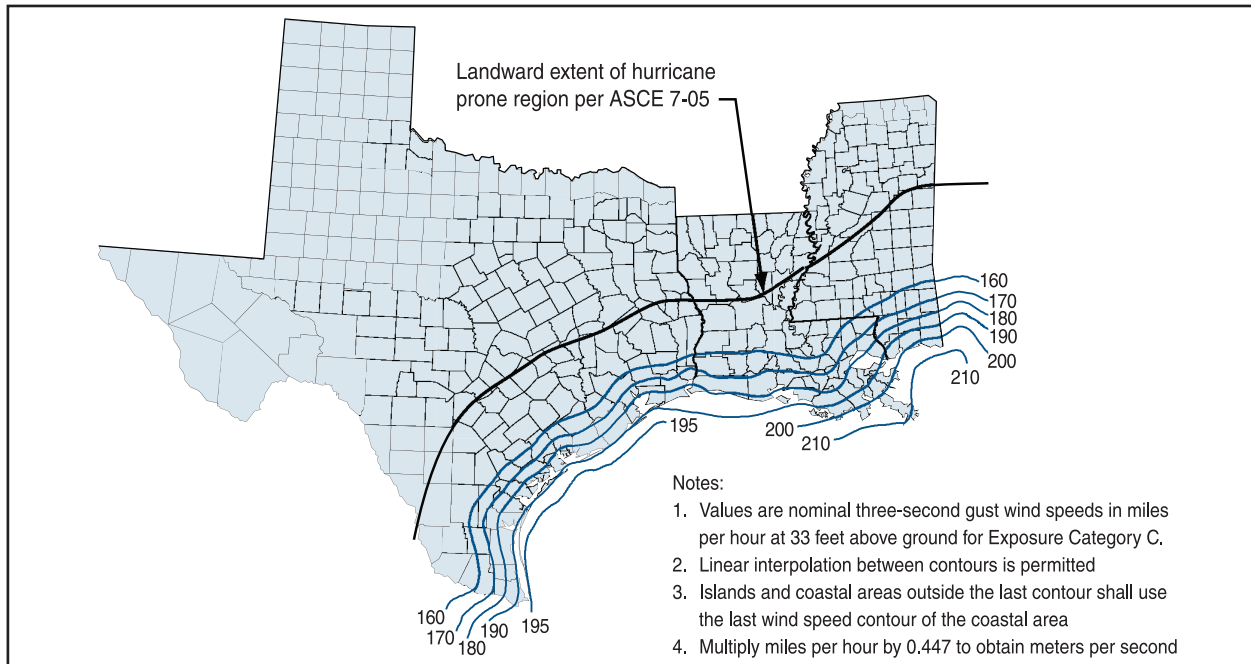

Figure 3-2a. Hurricane Safe Room Design Wind Speed Map from the ICC-500 – Western Gulf of Mexico Detail

SOURCE: ICC/NSSA STANDARD FOR THE DESIGN AND CONSTRUCTION OF STORM SHELTERS (ICC-500). COPYRIGHT 2008, WASHINGTON, DC: INTERNATIONAL CODE COUNCIL. REPRODUCED WITH PERMISSION. ALL RIGHTS RESERVED. WWW.ICCSAFE.ORG < HTTP://WWW.ICCSAFE.ORG >.

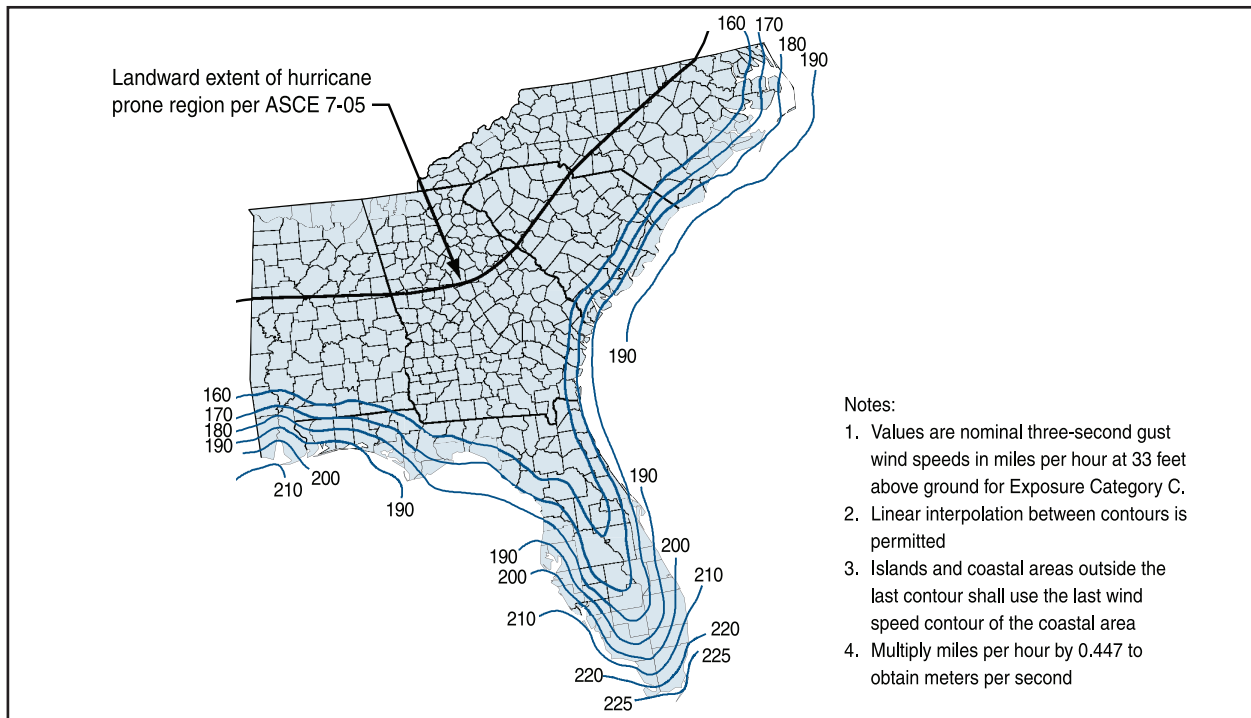

Figure 3-2b. Hurricane Safe Room Design Wind Speed Map from the ICC-500 – Eastern Gulf of Mexico Detail

SOURCE: ICC/NSSA STANDARD FOR THE DESIGN AND CONSTRUCTION OF STORM SHELTERS (ICC-500). COPYRIGHT 2008, WASHINGTON, DC: INTERNATIONAL CODE COUNCIL. REPRODUCED WITH PERMISSION. ALL RIGHTS RESERVED. WWW.ICCSAFE.ORG < HTTP://WWW.ICCSAFE.ORG >.

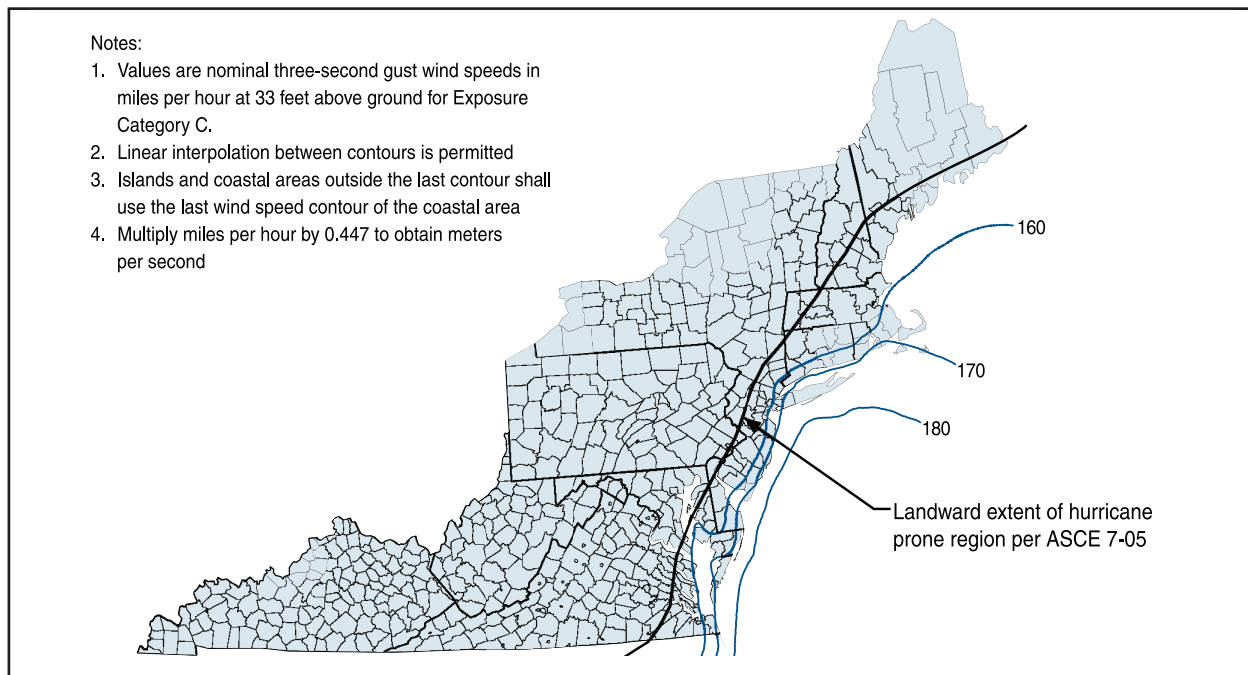

Figure 3-2c. Hurricane Safe Room Design Wind Speed Map from the ICC-500 – Mid-Atlantic and Northeast Detail

SOURCE: ICC/NSSA STANDARD FOR THE DESIGN AND CONSTRUCTION OF STORM SHELTERS (ICC-500). COPYRIGHT 2008, WASHINGTON, DC: INTERNATIONAL CODE COUNCIL. REPRODUCED WITH PERMISSION. ALL RIGHTS RESERVED. WWW.ICCSAFE.ORG < HTTP://WWW.ICCSAFE.ORG >.

- f) **Enclosure Classifications.** Enclosure classifications for safe rooms should be determined in accordance with ASCE 7-05, Section 6.2. For determining the enclosure classification for hurricane community safe rooms, the largest door or window on a wall that receives positive external pressure should be considered as an opening. As such, the internal pressure coefficient may be appropriately taken for either enclosed or partially enclosed buildings, depending upon the openings in the safe room.
- g) **Atmospheric Pressure Change.** The potential for APC is considered negligible for hurricane hazards and therefore need not be considered in the design of hurricane community safe rooms.
- h) **Maximum Safe Room Height.** The height of a safe room is not restricted or limited.
- i) **Duration of Protection.** The hurricane community safe rooms are designed to provide occupants life-safety protection for storm durations of at least 24 hours.
- j) **Ventilation, Sanitation, Power, and Other Non-structural Design Criteria.** Ventilation, sanitation, and other recommendations for hurricane community safe rooms should be incorporated into the design of the safe room in accordance with ICC-500, Chapter 7. In addition, the safe room should be equipped with an electrical system with an emergency power system for lighting and other needs in accordance with ICC-500, Chapter 7.

Emergency lighting recommendations may be met through means other than generators (i.e., flashlights may be used to meet this recommendation). Additional information is also provided in Chapters 4 and 8 of FEMA 361.

- k) **Weather Protection.** All exposed C&C assemblies and roof coverings of hurricane safe rooms should be designed to resist rainwater penetration during the design windstorm and should be designed and installed to meet the wind load criteria of Section 3.4.1.
- l) **Occupancy Classifications for Safe Rooms.** If a safe room is a single-use safe room, the occupancy classification per the IBC should be A-3 for the protected space. If a safe room is a multi-use safe room area, the occupancy classification for the primary use of the protected space (when not in use as a safe room) should be used.
- m) **Maximum Allowable Hurricane Community Safe Room Population.** From a design and construction standpoint, there is no limitation on the maximum population that a safe room may be designed to protect. However, applicants and sub-applicants who request funding support from FEMA for safe room projects should be aware that limitations do apply to the size of the safe room. Refer to FEMA safe room and benefit-cost analysis tools for guidance and criteria that can be used to define the maximum population. Any group involved in the design and construction of a hurricane community safe room should obtain the latest guidance from their FEMA regional office.
- n) **Maximum Population Density of a Hurricane Community Safe Room.** The minimum recommended safe room floor area per occupant is provided in Table 3-3. The number of standing, seated, or bedridden spaces should be determined based upon the needs of the safe room determined by the designer and the applicable authority having jurisdiction. However, each community safe room should be sized to accommodate a minimum of one wheelchair space for every 200 occupants or portion thereof. It is also important to note that floor space (areas) within community safe rooms should provide an accessible route in accordance with ICC/ANSI A117.1.

Table 3-3. Occupant Density for Hurricane Community Safe Rooms

Hurricane Safe Room Occupant	Minimum Recommended Usable Floor Area ¹ in Square Feet per Safe Room Occupant
Standing or Seated	20
Wheelchair-bound	20
Bedridden	40

¹See below for recommendations for minimum recommended usable safe room floor area.

- o) **Calculation of Usable Floor Area.** The usable safe room floor area should be determined by subtracting the floor area of excluded spaces, partitions and walls, columns, fixed or movable objects, furniture, equipment or other features that under probable conditions can not be removed or stored during use as a safe room from the gross floor area.

An alternative for determining the usable safe room floor area is to use the following percentages:

1. Reducing the gross floor area of safe room areas with concentrated furnishings or fixed seating by a minimum of 50 percent
 2. Reducing the gross floor area of safe room areas with unconcentrated furnishings and without fixed seating by a minimum of 35 percent
 3. Reducing the gross floor area of safe room areas with open plan furnishings and without fixed seating by a minimum of 15 percent
- p) **Number of Doors.** The number of doors as means of egress from the safe room should be determined based upon the occupant load for the normal occupancy of the space in accordance with the applicable building code. For facilities used solely for safe rooms, the number of doors should be determined in accordance with the applicable building code based upon the occupant load as calculated above in Part n). The direction of the swing of doors should be as required by the applicable building code for the normal occupancy of the space and the egress doors should be operable from the inside without the use of keys or special knowledge or effort.

Where the applicable building code requires only one means of egress door, an emergency escape opening should be provided. The emergency escape opening should be an additional door or an opening that is a minimum of 5.7 square feet in area. Such openings should have a minimum height of 24 inches and a minimum width of 20 inches. The emergency escape opening should be operable from the inside without the use of tools or special knowledge. The emergency escape opening should be located away from the means of egress door by a minimum distance of 1/3 of the length of the maximum overall diagonal dimension of the area to be served.

3.4.2 Debris Impact Criteria for Hurricane Community Safe Rooms

The elements of the safe room structure and its components (including windows, doors, and opening protectives) that separate the individuals inside from the event outside should resist failure from wind pressures and debris impacts. For hurricane community safe rooms, the structural elements, the building envelope, and openings in the building envelope should be designed to resist wind-induced loads as well as impacts from debris.

Providing windborne debris protection for safe rooms is different from the debris impact requirements in the IBC, IRC, and ASCE 7-05. All building elements that make up the portion of the safe room that protects the occupants should resist impacts from windborne debris. As mentioned above, these include not only the openings into and out of the safe room, but the walls and roof of the safe room. No portion of the envelope (roof, wall, opening, door, window, etc.) should fail by wind pressure or be breached by the specified windborne debris (at the appropriate debris impact wind speed). The only exceptions are roof or wall coverings that provide code-compliant performance for non-safe room design features, but are not needed for the protection of the occupants within the safe room. In addition, openings for ventilation into and out of the safe

room should be hardened to resist both wind loads and debris impact.

For hurricane hazards, the debris impact criteria for large missiles are a function of the hurricane safe room design wind speed. Specifically, the representative missile for the debris impact test for all components of the building envelope of hurricane safe rooms should be a 9-lb 2x4. The speed of the test missile impacting vertical safe room surfaces should be a minimum of 0.50 times the safe room design wind speed. The speed of the test missile impacting horizontal surfaces should be 0.10 times the safe room design wind speed. Table 3-4 presents the missile impact speeds for the different wind speeds applicable for hurricane safe room designs. This debris impact test is recommended above any other debris impact criteria that may be applicable in the local jurisdiction in which the safe room is being constructed. If the hurricane safe room is located in an area that already requires debris impact protection for openings to minimize damage to buildings and contents, it is important to note that life-safety debris impact-resistance criteria identified here should be applied in addition to the code mandated requirements because the protected area must be designed to provide near-absolute protection from hurricanes. A more detailed discussion of the debris impact criteria is provided in Chapter 7 of this publication.

To show compliance with criteria for providing life-safety protection from windborne debris, the following guidance is provided:

- a) **Testing for Missile Impacts.** Testing for missile impact resistance of all components of the safe room envelope (including doors and opening protectives) should be in accordance with ICC-500, Section 305, with the exception of the missile impact speed, which should be that specified in Table 3-4.
- b) **Wall and Roof Assemblies.** All wall assemblies, roof assemblies, window assemblies, door assemblies, and protective devices used to cover openings and penetrations in the wall/roof that are recommended to protect occupants should be tested as identified in Part a) above and ICC-500, Section 306. The testing procedures that are used to comply with these criteria are provided in ICC-500, Section 804.

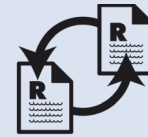

ICC-500 CROSS-REFERENCE

The hurricane community safe room missile impact criteria in this section of FEMA 361 differ from the hurricane community shelter design criteria presented in the ICC-500 Storm Shelter Standard. The ICC-500 Standard Committee considered several factors in determining the horizontal missile speed to be used for testing with the 9-lb 2x4 board member. FEMA, however, reviewed the same data, research, and post-storm assessments, but took a position that it is more appropriate to recommend a high impact speed for the representative missile (for the debris impact criteria) when providing near-absolute level of protection of occupants that FEMA has promulgated since the first safe room and shelter guidance in FEMA 320 and FEMA 361.

Table 3-4. Hurricane Missile Impact Criteria

Hurricane Design Missile is a 9-lb 2x4 board member impacting the safe room at the following missile impact speed (as a function of safe room design wind speed [V])				
Hurricane Design Wind Speed (V)	FEMA 361 Horizontal Missile Speed – Hurricane (0.5xV)	FEMA 361 Vertical Missile Speed – Hurricane (0.1xV)	ICC-500 Horizontal Missile Speed – Hurricane (0.4xV)	ICC-500 Vertical Missile Speed – Hurricane (0.1xV)
255 mph	128 mph	26 mph	102 mph	26 mph
250 mph	125 mph	25 mph	100 mph	25 mph
240 mph	120 mph	24 mph	96 mph	24 mph
230 mph	115 mph	23 mph	92 mph	23 mph
220 mph	110 mph	22 mph	88 mph	22 mph
210 mph	105 mph	21 mph	84 mph	21 mph
200 mph	100 mph	20 mph	80 mph	20 mph
190 mph	95 mph	19 mph	76 mph	19 mph
180 mph	90 mph	18 mph	72 mph	18 mph
170 mph	85 mph	17 mph	68 mph	17 mph
160 mph	80 mph	16 mph	64 mph	16 mph

Note: Walls, doors, and other safe room envelope surfaces inclined 30 degrees or more from the horizontal should be considered vertical surfaces. Surfaces inclined less than 30 degrees from the horizontal should be treated as horizontal surfaces.

- c) **Openings and Opening Protectives in Tornado Safe Rooms.** The openings in the safe room envelope should be protected by doors complying with ICC-500, Section 306.3.1; windows complying with ICC-500, Section 306.3.2; other opening protectives complying with ICC-500, Section 306.4; or baffled to prevent windborne debris from entering the safe room protected occupant area in accordance with ICC-500, Section 306.5. The testing procedures that are used to show compliance with these criteria are provided in ICC-500, Section 804; this also includes skylight assemblies and other glazed openings. Opening protectives in tornado safe rooms should be permanently affixed, and manually operable from inside the safe room.

Also, window assemblies (operable and non-operable) and other glazed openings (including skylights, side lights, and transoms) should be tested using the procedures for missile impact resistance in accordance with ICC-500, Section 804; pressure in accordance with ICC-500, Section 805; and cyclic pressures in accordance with ASTM E 1996.

Exceptions:

- Missile impact testing for the life-safety missile impact criteria is not necessary for window assemblies and other glazed openings where the opening is protected by a device that is located on the exterior or interior side of the opening, and meets the criteria of Part a) above.

2. Missile impact and pressure testing for the life-safety wind design criteria are not necessary for window assemblies and other glazed openings where the opening is protected by a device that is located on the interior side of the opening and meets the criteria of Part a) above.
- d) **Soil-covered Portions of Safe Rooms.** Should all or portions of safe rooms be below ground or covered by soil, missile impact resistance criteria may not need to be addressed. Safe rooms with at least 12 inches of soil cover protecting safe room horizontal surfaces, or with at least 36 inches of soil cover protecting safe room vertical surfaces, do not need to be tested for resistance to missile impact as though the surfaces were exposed. Soil in place around the safe room as specified above can be considered to provide appropriate protection from the representative hurricane safe room missile impact.
 - e) **Alcove or Baffled Entry Systems.** All protective elements of alcove or baffled entry systems to safe rooms (when used) should be designed to meet the wind load recommendations of Section 3.4.1 of this publication and the debris impact test recommendations of this section. When a door is employed as part of the protection in such an entry system, the door should meet the debris impact test requirements of ICC-500, Section 804.9.7 and the pressure testing requirements of ICC-500, Sections 805 and 806.6. The enclosure classification for safe rooms with baffled or alcove entries should be determined in accordance with Section 3.4.1 of this publication.
 - f) **Other Debris Hazards.** Lay down, rollover, and collapse hazards (i.e., trees, other structures, rooftop equipment, etc., that have a reasonable chance of adversely impacting the safe room) should be considered by the design professional when determining the location of safe rooms on the site.
 - g) **Other Hazards.** Fuel tanks, fueling systems, fuel pipes, or any other known hazards near the safe room should be taken into account in the siting and design of the safe room.
 - h) **Safe Rooms Meeting Hurricane Impact Test Recommendations.** Safe room envelope components meeting missile impact test recommendations for tornado safe rooms should be considered acceptable for hurricane safe rooms provided they meet structural design load recommendations for hurricane safe rooms.

3.5 Residential Safe Room Design Criteria

This section provides the residential safe room design criteria for both tornado and hurricane safe rooms. FEMA supports the ICC-500 Storm Shelter Standard design and construction requirements for residential tornado and hurricane shelters. However, FEMA safe room guidance on the use of safe rooms in residential applications takes a different approach from the ICC-500. FEMA 320 designs are combination tornado and hurricane safe rooms that meet the most stringent criteria for each hazard. The original FEMA 320, *Taking Shelter From the Storm: Building a Safe Room Inside Your House* (1998, and revised in 1999) provided prescriptive solutions for homeowners for below- and above-ground safe rooms that could provide “near-absolute protection” without the need to obtain and hire professional design services, provided

the design plans in the publication are used properly. Therefore, the intent of FEMA in the original publication, and in any revisions to FEMA 320, remains the same, to continue to provide the prescriptive solutions for sheltering from extreme-wind events for life-safety protection. As such, the FEMA 320 designs provide FEMA's interpretation of how to implement the combined tornado and hurricane residential safe room criteria based on the design criteria included in this section.

Along with these revisions and updates to FEMA 361, FEMA has updated and expanded the guidance provided in FEMA 320. The updated FEMA 320 guidance and prescriptive design plans comply not only with the residential shelter requirements of the ICC-500, but also with the community shelter requirements for small shelters (less than 16 occupants) to support the use of these safe rooms in buildings other than residences. Since FEMA 320 does not present detailed design information, this section of FEMA 361 provides designers with the criteria used for the development of the revised, prescriptive safe room plans in FEMA 320. Therefore, the revised FEMA 320, *Taking Shelter From the Storm: Building a Safe Room for Your Home or Small Business* publication (August 2008) presents simple and conservative prescriptive approaches to safe room designs that are considered compliant with both FEMA 361 criteria and the ICC-500 requirements for the design and construction of combined, residential tornado and hurricane safe rooms.

3.5.1 Wind Design Parameters for Residential Safe Rooms

Calculate the wind loads on the residential safe room for all sections that experience wind pressures (including MWFRS and C&C) using the wind load provisions in Section 6.5 of ASCE 7-05, Method 2 – Analytical Procedure (except as modified by this section). The design recommendations for residential safe rooms do not meet the requirements for using Method 1 – Simplified Procedure. In addition, all doors, windows, and openings should be protected with devices that comply with the design wind pressures as calculated by ASCE 7-05. The safe room provides life-safety protection from wind events and therefore should be capable of resisting ultimate wind loads without failure, although some damage may occur and serviceability of the safe room may be an issue after an event. The following wind design parameters should be used when calculating wind pressures acting on residential safe rooms:

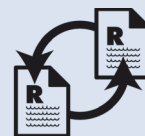

ICC-500 CROSS-REFERENCE

The residential safe room design criteria presented in FEMA 361 meet the design criteria presented in the ICC-500 for combined, residential tornado and hurricane shelters. The FEMA safe room criteria presented here also meet the requirements for combined, small tornado and hurricane community safe rooms (with maximum occupancies of 16 persons or less). The criteria presented here are the basis for the safe room designs presented in FEMA 320, *Taking Shelter From the Storm: Building a Safe Room For Your Home or Small Business*.

- a) **Select Safe Room Design Wind Speed.** The design wind speed for residential safe rooms should be taken as $V_x = 250$ mph (3-second gust).
- b) **Importance Factor (I)** $I = 1.0$
- c) **Exposure Category** C
- d) **Directionality Factor** $K_d = 1.0$
- e) **Topographic Effects** K_{zt} need not exceed 1.0.
- f) **Enclosure Classifications.** Enclosure classifications for small community safe rooms should be that used for a partially enclosed building as defined by ASCE 7-05, Section 6.2. For residential safe rooms serving one- and two-family dwellings only, the partially enclosed building classification is recommended, but the enclosed building classification may be used for the design of the safe room.
- g) **Atmospheric Pressure Change (APC).** When the safe room is being designed as a partially enclosed building, it meets the alternative design criteria for considering APC in the design of the safe room. Therefore, the designer should use $GC_{pi} = \pm 0.55$.
- h) **Maximum Safe Room Height.** The height of the residential safe room is restricted to 8 feet of vertical wall.
- i) **Duration of Protection.** The residential safe rooms are designed to provide occupants life-safety protection for storm durations of at least 24 hours.
- j) **Ventilation, Sanitation, Power and Other Non-structural Design Criteria.** Ventilation, sanitation, power, and other services for tornado community safe rooms should be incorporated into the design of the safe room in accordance with ICC-500, Chapter 7. In addition, the safe room should be equipped with an electrical system with an emergency power backup system for lighting and other needs in accordance with ICC-500, Chapter 7. Emergency lighting recommendations may be met through means other than generators (i.e., flashlights may be used to meet this recommendation). Additional information is also provided in Chapters 4 and 8 of FEMA 361.
- k) **Weather Protection.** All exposed C&C assemblies and roof coverings of hurricane safe rooms should be designed to resist rainwater penetration during the design windstorm and should be designed and installed to meet the wind load recommendations of Section 3.3.1.
- l) **Occupancy Classifications for Safe Rooms.** A safe room serves occupants of dwelling units as defined in Section 310 of the IBC and having an occupant load not exceeding 16 persons.
- m) **Maximum Allowable Residential Safe Room Population.** The maximum allowable population for the prescriptive designs provided is 16 persons (only when the design selected provides at least 80 square feet of net, usable floor space within the safe room).

- n) **Maximum Population Density of a Residential Safe Room.** The minimum safe room floor area per occupant in a residential safe room is provided in Table 3-5.

Table 3-5. Occupant Density for Residential Safe Rooms

Type of Safe Room	Minimum Recommended Usable Safe Room Floor Area in Square Feet Per Occupant
Tornado	
One- and Two-Family Dwelling	3
Other Residential	5
Hurricane	
One- and Two- Family Dwelling	7
Other Residential	10

For this table, the usable tornado safe room floor area should be the gross floor area, minus the area of sanitary facilities, if any, and should include the protected occupant area between the safe room walls at the level of fixed seating, where fixed seating exists.

- o) **Number of Doors.** The number of doors as means of egress from the safe room should be determined based upon the occupant load for the normal occupancy of the space in accordance with the applicable building code. A minimum of one door is recommended and an emergency escape opening, in addition to the egress door is not required.



It is important to note that use and occupancy of a residential safe room is at the discretion of the safe room occupant. Compliance with FEMA residential safe room design recommendations should not be seen as a waiver or variance from the Federal Government of disregard or to not comply with a mandatory evacuation order issued by local emergency management officials or the authority having jurisdiction (AHJ).

3.5.2 Debris Impact Criteria for Residential Safe Rooms

The entire safe room structure, and especially the components that separate the individuals inside from the event outside, should resist failure from wind pressures and debris impacts. For residential safe rooms, the structural elements and the building envelope should be designed to resist wind-induced loads as well as impacts from debris.

Providing windborne debris protection for safe rooms is different from the debris impact requirements in the IBC, IRC, and ASCE 7-05. All building elements that make up the portion of the safe room that protects the occupants should resist impacts from windborne debris. As mentioned above, these include not only the openings into and out of the safe room, but the walls and roof of the safe room. No portion of the envelope (roof, wall, opening, door, window, etc.) should fail by wind pressure or be breached by the specified windborne debris (at the appropriate

debris impact wind speed). The only exceptions are roof or wall coverings that provide code-compliant performance for non-safe room design features, but are not needed for the protection of the occupants within the safe room. In addition, openings for ventilation into and out of the safe room should be hardened to resist both wind loads and debris impact.

For the residential safe room, the representative missile for the debris impact test for all components of the safe room envelope should be a 15-lb 2x4. The speeds of the test missile impacting vertical and horizontal safe room surfaces are presented in Table 3-6. This debris impact test is recommended above and beyond any other debris impact criteria that may be applicable in the local jurisdiction in which the safe room is being constructed. If the residential safe room is located in an area that already requires debris impact protection for openings to minimize damage to buildings and contents, it is important to note that the code mandated requirements for property protection must still be adhered to and that the debris impact protection criteria that provide life-safety protection from tornadoes and hurricanes are the additional criteria. A more detailed discussion of the debris impact criteria is provided in Chapter 7 of this publication.

Table 3-6. Residential Safe Room Missile Impact Criteria

Safe Room Design Wind Speed	Missile Speed (of 15-lb 2x4 board member) and Safe Room Impact Surface
250 mph	Vertical Surfaces: 100 mph Horizontal Surfaces: 67 mph

Note: Walls, doors, and other safe room envelope surfaces inclined 30 degrees or more from the horizontal should be considered vertical surfaces. Surfaces inclined less than 30 degrees from the horizontal should be treated as horizontal surfaces.

To show compliance with criteria pertaining to life-safety protection from windborne debris, the following guidance is provided:

- a) **Testing for Missile Impacts.** Testing for missile impact resistance of all components of the safe room envelope (including doors and opening protectives) should be in accordance with ICC-500, Section 305, with the exception of the missile impact speed, which should be that specified in Table 3-6.
- b) **Wall and Roof Assemblies.** All wall assemblies, roof assemblies, window assemblies, door assemblies, and protective devices used to cover openings and penetrations in the wall/roof that are recommended to protect occupants should be tested as identified in Part a) above and ICC-500, Section 306. The testing procedures that are used to comply with these criteria are provided in ICC-500, Section 804.
- c) **Openings and Opening Protectives in Tornado Safe Rooms.** The openings in the safe room envelope should be protected by doors complying with ICC-500, Section 306.3.1; windows complying with ICC-500, Section 306.3.2; other opening protectives complying with ICC-500, Section 306.4; or baffled to prevent windborne debris from entering the safe room protected occupant area in accordance with ICC-500, Section 306.5. The testing procedures that are used to show compliance with these criteria are

provided in ICC-500, Section 804; this also includes skylight assemblies and other glazed openings. Opening protectives in residential safe rooms should be permanently affixed and manually operable from inside the safe room.

Also, window assemblies (operable and non-operable) and other glazed openings (including skylights, side lights, and transoms) should be tested using the procedures for missile impact resistance in accordance with ICC-500, Section 804; pressure in accordance with ICC-500, Section 805; and cyclic pressures in accordance with ASTM E 1996.

Exceptions:

1. Missile impact testing for the life-safety missile impact criteria is not necessary for window assemblies and other glazed openings where the opening is protected by a device located on the exterior or interior sides of the opening and meeting the criteria of Part a) above.
 2. Missile impact testing and pressure testing for the life-safety missile impact criteria are not necessary for window assemblies and other glazed openings where the opening is protected by a device located on the interior side of the opening and meeting the criteria of Part a) above.
- d) **Soil-covered Portions of Safe Rooms.** Should all or portions of a safe room be below ground or covered by soil, missile impact resistance criteria may not be to be addressed. Safe rooms with at least 12 inches of soil cover protecting horizontal surfaces, or with at least 36 inches of soil cover protecting vertical surfaces, do not need to be tested for resistance to missile impact as though the surfaces were exposed. Soil in place around the safe room as specified above can be considered to provide appropriate protection from the representative residential safe room missile impact.
- e) **Alcove or Baffled Entry Systems.** All protective elements of alcove or baffled entry systems to safe rooms (when used) should be designed to meet the wind load recommendations of Section 3.5.1 of this publication and the debris impact test recommendations of Section 3.5.2 of this publication. Where a door is employed as part of the protection in such an entry system, the door should meet the debris impact test requirements of ICC-500, Section 804.9.7 and the pressure testing requirements of ICC-500, Sections 805 and 806.6. The enclosure classification for safe rooms with alcove or baffled entries should be determined in accordance with Section 3.5.1 of this publication.
- f) **Other Debris Hazards.** Lay down, rollover, and collapse hazards (i.e., trees, other structures, equipment, etc., that have a reasonable chance of adversely impacting the safe room) should be considered by the design professional when determining the location of safe rooms on the site.

3.6 Flood Hazard Design Criteria for Safe Rooms

The design of safe rooms to resist wind forces and wind loads was identified in the previous section. It is also important to address the flood hazards that may exist at a safe room site. This

section outlines the flood design criteria for community and residential safe rooms. This process, like the wind design, can be accomplished and completed by a design professional using the processes presented in ASCE 7-05 as modified in this publication for the flood hazard (if it exists). If the flood hazard does not exist at the site, a statement identifying that there is not a flood hazard should be included on the project plans.

SAFE ROOMS AND TSUNAMI HAZARDS

Tsunami hazards may exist in some jurisdictions where safe rooms are designed and constructed to provide protection from hurricanes. Flood Insurance Rate Maps (FIRMs) will exist for these areas, but tsunami inundation maps may or may not.

The tsunami hazard in the U.S. is the greatest along the coasts in Washington, Oregon, California, Alaska, and Hawaii, and along the coasts of the U.S. territories in the Caribbean. Most areas considered to have a high tsunami risk have been studied, and tsunami inundation areas associated with the credible worst-case scenario have been mapped. These maps were prepared as part of the National Tsunami Hazard Mitigation Program (NTHMP) in cooperation with affected states and communities. FEMA has also recently started to evaluate tsunami hazards through its Map Modernization Program, by performing Probabilistic Tsunami Hazard Assessments (PTHAs). Currently, FEMA's Tsunami Pilot Study Working Group is developing a methodology that identifies relevant tsunami events and then maps the corresponding 500-year inundation area and tsunami elevations.

Until a unified set of tsunami hazard maps is available, FEMA recommends that the existing maps be used to identify the extents of the tsunami hazard in a given jurisdiction. Once a tsunami hazard has been identified to exist, FEMA recommends that both community and residential safe rooms be constructed outside of tsunami inundation areas. This is similar to the approach used for the flood design criteria in this Section 3.6, which recommends that safe rooms not be sited in Velocity (V) Zones shown on FIRMs or in storm surge inundation zones shown on Sea, Lake, and Overland Surges from Hurricanes (SLOSH) maps.

For additional information on the mapping of tsunami inundation zones, see the NTHMP web site at <http://nthmp.tsunami.gov/>. For additional information on the design and construction of structures in tsunami inundation areas, see FEMA P646, *Guidelines for the Design of Structures for Vertical Evacuation from Tsunamis* (June 2008), available at <http://www.atccouncil.org/atc64.shtml>.

3.6.1 Flood Design Criteria for Community Safe Rooms

Flood hazards should be considered when designing a community safe room. Flood loads acting on a structure containing a safe room will be strongly influenced by the location of the structure relative to the flood source. It is for this reason that safe rooms should be located *outside* of the following high-risk flood hazard areas:

- a. The Coastal High Hazard Area (VE zones) or other areas known to be subject to high-velocity wave action; or
- b. Areas seaward of the Limit of Moderate Wave Action (LiMWA) where mapped, also referred to as the Coastal A Zone in ASCE 24-05; or
- c. Floodways.

Structures containing community safe rooms should be located in areas at low risk to flooding and mapped as unshaded Zone X or Zone C (outside the 500-year [0.2 percent annual chance] floodplain) wherever possible. Where not possible, the structures should be located in the least hazardous portion of the area subject to flooding during the 0.2 percent annual chance flood (shaded Zone X or Zone B), or if that is not possible, then in the least hazardous portions of the 1 percent annual chance floodplain (i.e., within SFHA, Zones AO or AH, or Zones AE or A1-30). Siting of structures containing safe rooms in SFHAs is not a desirable option, and should be avoided except in special circumstances where consultation with local and state emergency management officials and with FEMA concludes there is no other feasible option.

For the purposes of this guidance, the lowest floor used for safe room space and/or safe room support areas should be elevated to the higher of the following elevations, which should be used as the design flood elevation (DFE) for flood load calculations:

1. Two feet above the base flood elevation (BFE), i.e., 2 feet above the flood elevation having a 1 percent annual chance of being equaled or exceeded in any given year (100-year event); or
2. The stillwater flood elevation associated with the 0.2 percent annual chance of being equaled or exceeded in any given year (500-year event); or
3. The lowest floor elevation required by the community's floodplain ordinance, if such ordinance exists; or
4. Two feet above the highest recorded flood elevation in an area, if the area is designated as Zone D on a FIRM or Flood Hazard Boundary Map, or if the area has not been evaluated as part of a NFIP flood study (or equivalent flood study); or
5. If the community safe room is in an area subject to coastal storm surge inundation:
 - a. The maximum stillwater inundation elevation associated with a Category 5 hurricane
 - b. The wave crest elevation having a 0.2 percent annual chance of being equaled or exceeded in any given year.

In areas where Category 5 storm surges are not mapped, references in this document to "Category 5" storm surge inundation area should be taken to mean the area inundated by the highest storm surge category mapped. See Chapter 10, References, for a list of some web sites that provide state-specific storm surge inundation maps.



DEFINITION

In this publication, the term **storm surge** means an abnormal rise in sea level accompanying a hurricane or other intense storm, and whose height is the difference between the observed level of the sea surface and the level that would have occurred in the absence of the cyclone. Storm surge (see Figure 3-3) is usually estimated by subtracting the normal or astronomic high tide from the observed storm tide.

Safe rooms subject to flooding, including any foundation or building component supporting the safe room, should be designed in accordance with the provisions of this chapter, ASCE 7-05, Section 5, and ASCE 24-05.

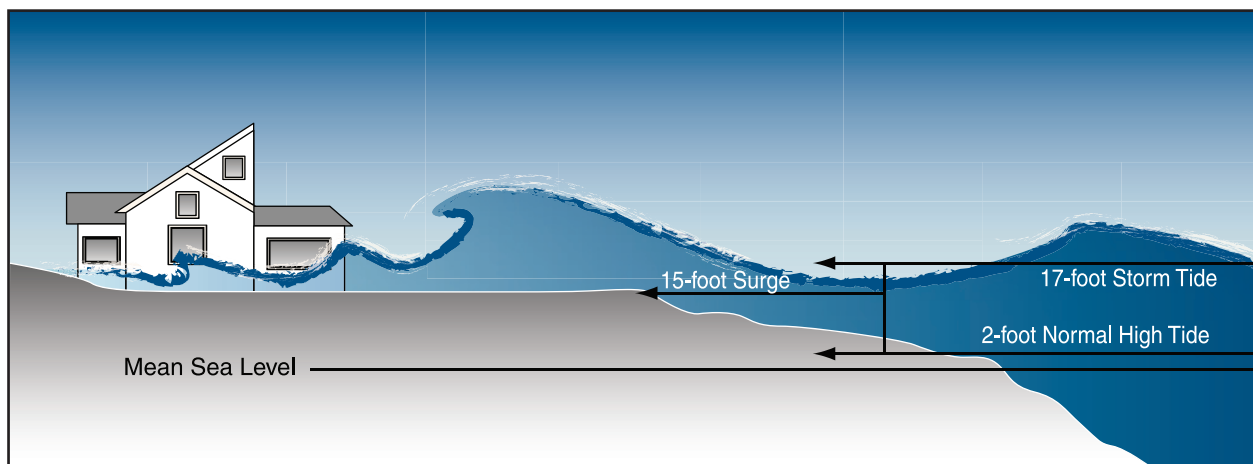

Figure 3-3. Storm surge



When at all possible, a community safe room should be located outside the influence of coastal storm surge and outside of any areas subject to flooding. When a safe room is installed in a Special Flood Hazard Area (SFHA) or other flood-prone area, the top of lowest floor for the safe room should be elevated at or above the highest flood elevation defined in Section 3.6.1.

3.6.2 Flood Design Criteria for Residential Safe Rooms

Flood hazards should be considered when designing and constructing a residential safe room. A tornado or hurricane residential safe room should be located outside of the high-risk flood hazard areas listed in this section. If the safe room needs to be located within the SFHA, the lowest floor of the safe room should be elevated to the highest of flood hazard elevations identified in this section.

Flood loads and conditions acting on a structure containing a safe room will be strongly influenced by the location of the structure relative to the flood source. It is for this reason that residential safe rooms should be located outside of the following high-risk flood hazard areas:

- a. The Coastal High Hazard Area (VE zones) or other areas known to be subject to high-velocity wave action; or
- b. Areas seaward of the LiMWA where mapped, also referred to as the Coastal A Zone in ASCE 24-05; or
- c. Floodways; or
- d. Areas subject to coastal storm surge inundation associated with a Category 5 hurricane (where applicable, these areas should be mapped areas studied by the U.S. Army Corps of Engineers [USACE], NOAA, or other qualified source).

In areas where Category 5 storm surges are not mapped, references in this document to “Category 5” storm surge inundation area should be taken to mean the area inundated by the highest storm surge category mapped. See Chapter 10, References, for a list of some web sites that provide state-specific storm surge inundation maps.

A residential safe room, as prescribed in FEMA 320 or designed to the criteria presented in Section 3.5.2, should not be located within the SFHA if at all possible. If it is not possible to install or place a residential safe room outside the SFHA, the residential safe room should be placed outside of the high hazard areas identified above and the top of the elevated floor of the safe room should be design and constructed to the highest of the elevations specified below based on the Flood Insurance Study (FIS) or FIRM. It is important to note, if the residential safe room plans from FEMA 320 are used, the designs are restricted by a maximum allowable height above grade as specified on the drawing sheets; for a maximum elevation above existing grade of 3 to 5 feet. The elevations that should be considered when designing the safe room are the highest of:

1. The minimum elevation of the lowest floor required by the floodplain ordinance of the community (if such ordinance exists); or
2. Two feet above the BFE, (i.e., 2 feet above the flood elevation having a 1 percent annual chance of being equaled or exceeded in any given year [100-year event]); or
3. The stillwater flood elevation associated with the 0.2 percent annual chance of being equaled or exceed in any given year (500-year event).

Residential Tornado Safe Room Exception: Where a residential tornado safe room is located outside of the hurricane-prone region as identified on Figure 3-2, and the community participates in the NFIP, the safe room need only be elevated to the minimum lowest floor elevation identified by the floodplain ordinance of the community.

Note, when installing a residential safe room in an area that has not been mapped or studied as part of a NFIP flood study (or equivalent flood study), the top of the safe room floor should be elevated such that it is 2 feet above the flood elevation corresponding to the highest recorded

flood elevation in the area that has not been evaluated. Should no historical flood elevation data be available for the area, the elevation of the safe room floor should be set at the elevation identified by the local authority having jurisdiction.

3.7 Product Testing

The design of safe rooms to resist wind forces and wind loads can be accomplished and completed by a design professional using the processes presented in ASCE 7-05 as modified in this publication or approved through laboratory testing. However, to show that the safe room provides life-safety protection against flying debris, all wall and roof assemblies, window and door assemblies, and exterior cladding (envelope) systems should successfully pass the debris impact-resistance product testing. In addition, since all openings in the safe room envelope should be protected by doors, windows, opening protective devices complying with wind pressure and debris impact-resistant criteria described in Sections 3.3, 3.4, and 3.5, these systems should also be tested and approved. Alternatively, baffles or walls to prevent windborne debris from entering the protected occupant area of the safe room complying with the design criteria of Sections 3.3, 3.4, and 3.5 should also be considered acceptable if testing shows they meet the design criteria specified in this document.

All safe rooms and components that protect the occupants from wind and windborne debris should be designed and tested to resist wind pressures and a breach from debris impact in accordance with the Test Method for Impact and Pressure Testing in Chapter 8 of the ICC-500. The hazard criteria specified for the impact and pressure testing of safe room components have been described in the tornado community safe room debris impact criteria of Section 3.3.2, the hurricane community safe room debris impact criteria of Section 3.4.2, and the residential safe room debris impact criteria of Section 3.5.2.

Once testing has been completed, documentation should be maintained and provided to the AHJ where the safe room is being constructed. It is important to note that DHS and FEMA are not product testing agencies and do not “certify” or lend their authority to any group to produce or provide “FEMA approved” or “FEMA certified” products. The means by which product testing and compliance with the FEMA criteria is documented and presented will be addressed later in this chapter. FEMA supports the statement in Section 306.1 of ICC-500 not to require additional testing of assemblies and products for different levels of debris impact, if the most stringent criteria of missile size and speed are met. The ICC-500 states:

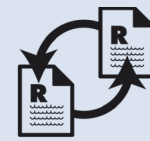

ICC-500 CROSS-REFERENCE

The safe room performance criteria for debris impact-resistance and product testing presented in this section of FEMA 361 are the same as the shelter design criteria presented in the ICC-500 Storm Shelter Standard Sections 305, 306, and Chapter 8, Test Method for Impact and Pressure Testing.

306.1 Shelters meeting tornado impact test requirements. Shelter envelope components meeting missile impact test requirements for tornado shelters shall be considered acceptable for hurricane shelters provided they meet structural design load requirements for hurricane shelters.

3.8 Permitting, Code Compliance, Professional Design Oversight, and Peer Review

This section clarifies the permitting, compliance, and involvement of the design professional in the safe room permitting design process. Where safe rooms are designated areas normally occupied for other purposes, the requirements of the applicable construction codes for the occupancy of the building should apply unless otherwise stated in this publication.

However, where a facility is designed to be occupied solely as a safe room, the designated occupancy should be Assembly 3 (A-3) as defined by the IBC for purposes of determination of applicable requirements that are not included in this publication or the ICC-500. Where the construction of a safe room is to take place in jurisdictions where no applicable codes exist, the provisions of the International Code Council 2006 *International Building Code* should apply.

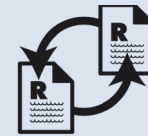

ICC-500 CROSS-REFERENCE

The safe room recommendations for permitting, code compliance, and design oversight presented in this section of FEMA 361 are the same as the requirements for permitting, code compliance, and design oversight presented in the ICC-500 Storm Shelter Standard.

3.8.1 Permitting and Code Compliance

Before construction begins, all necessary state and local building and other permits should be obtained. The design professional should meet with the local code official to discuss any concerns the building official may have regarding the design of the safe room. This meeting will help ensure that the safe room is properly designed and constructed to local ordinances or codes. As of 2008, no model building codes address the design of a tornado or hurricane safe room. The only way the design and construction of safe rooms or shelters is addressed is if the AHJ has adopted FEMA 361 or the ICC-500 as a design standard for shelters. This will change if jurisdictions adopt the 2009 Editions of the IBC and IRC that will incorporate the ICC-500 standard by reference, unless the AHJ explicitly removes the referencing text from the code language during the code adoption process.

Complete detailed plans and specifications should be provided to the building official for each safe room design. The design parameters used in the structural design of the safe room, as well as all life-safety, Americans with Disabilities Act (ADA), mechanical, electrical, and plumbing recommendations that were addressed, should be presented on the project plans

and in the project specifications (see Section 3.8 for additional information on documentation of safe room information on project plans).

Egress recommendations should be based on the maximum occupancy of the safe room as defined by Sections 3.3.1, 3.4.1, and 3.5.1, depending upon the hazard and use of the safe room. This will likely occur when the designer calculates the occupancy load based on the 5 square feet or 10 square feet per person recommended in Sections 3.3.1 and 3.4.1 for tornado and hurricane safe rooms, respectively. For multi-use safe rooms, reaching the maximum occupancy may be a rare event. For life-safety considerations, egress points for the safe room area should be designed to the maximum possible occupancy until the criteria in this publication or in the ICC-500 governing the design of safe rooms or shelters have been adopted to govern safe room design in that particular jurisdiction. As a result, the design professional will likely have difficulty providing doors and egress points with hardware (specifically latching mechanisms) that comply with code and resist the design missile impact criteria presented earlier in this chapter. Design professionals who are limited to door hardware that is acceptable to the building official but that does not meet the impact-resistance criteria should refer to Table 7-2 and also Section 7.4 for guidance on the use of missile-resistant barriers to protect doors from debris impact.

Regarding code requirements not related to life-safety or structural requirements (typically those for mechanical, electrical, and plumbing systems), the designer should design for the normal use of a multi-use safe room unless otherwise directed by the AHJ. It would not be reasonable to consider the additional cost of and need for providing additional mechanical, electrical, and plumbing equipment and facilities for the high-occupancy load that would occur only when the safe room is providing protection from a tornado or hurricane. Safe rooms designed to the criteria in this manual are for short-duration use, and the probability of their use at maximum occupancy is low.

3.8.2 Professional Design Oversight

The building owner should employ a registered design professional during the construction of a community safe room. The task for the design professional, is to conduct visual observations of the construction of the structural system for general conformance to the approved construction documents at significant construction stages and at completion of the construction of the structural system. Structural observation should not obviate the need for other inspections or testing as specified by this publication, the ICC-500, or the applicable building code.



The reader should be aware of descriptors and modifiers in the text of both this publication and the ICC-500 that state the code and standard requirements are applicable to the design of community safe rooms meeting FEMA's design criteria. The omission of the residential safe room is not an oversight but rather an exception to these requirements such that these items are not required for the residential safe room or the construction documents associated with the residential safe room.

Deficiencies should be reported in writing to the owner and to the authority having jurisdiction. At the conclusion of the work, the registered design professional who made the structural observations should submit to the AHJ a written statement that the site visits have been made and identify any reported deficiencies that, to the best of the structural observer's knowledge, have not been resolved.

3.8.3 Peer Review

Construction documents for community safe rooms designed for more than 50 occupants should undergo a peer review by an independent registered design professional for conformance with the design criteria of this chapter. This peer review should focus on the structural and non-structural design of elements that provide life-safety protection for the occupants of the safe room. The design professional performing the peer review may be the same design professional who provides design oversight as recommended in Section 3.8.2.

3.9 Construction Documents, Signage Criteria, and Labeling

This section provides the criteria that should be adhered to when documenting the design criteria on project plans or within the safe room itself. The location of the safe room, the design criteria for the safe room, the product testing information, and similar information should be clearly identified on the project plans or construction documents. In addition, all safe rooms should have a label clearly identifying it as a safe room designed to provide life-safety protection to its occupants at a specified performance level; this is referred to as signage.

3.9.1 Construction Documents

Although not all jurisdictions require detailed construction documents, compliance with the FEMA criteria presented in this publication requires that construction documents should be prepared and maintained. Such documents should contain information as required by the applicable building code, the authority having jurisdiction, and this section.

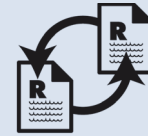

ICC-500 CROSS-REFERENCE

The safe room criteria for Peer Review of Safe Room Designs in this section of FEMA 361 are more stringent than the Peer Review criteria presented in the ICC-500 Storm Shelter Standard Sections 305, 306, and Chapter 8, Test Method for Impact and Pressure Testing.

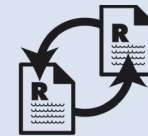

ICC-500 CROSS-REFERENCE

The safe room recommendations for construction documents, signage, and labeling presented in this section of FEMA 361 are the same as the construction documents, signage, and labeling presented in the ICC-500 Storm Shelter Standard.

The following information applicable to construction and operation of the safe room should be supplied on the construction documents:

- a) **Safe Room Design Information.** The area being designated for use as a safe room should be clearly identified on the construction documents. In addition, the following information should be provided for these areas, as part of the construction documentation:
1. A floor plan drawing or image representing the entire facility indicating the location of the safe room on a site or within a building or facility.
 2. A statement that the wind design conforms to the provisions of the FEMA 361, *Design and Construction Guidance for Community Safe Rooms*, with the edition year specified.
 3. The safe room design wind speed, mph.
 4. The importance factor, I .
 5. The wind exposure *category* (*indicate all if more than one is used*).
 6. The internal pressure coefficient, GC_{pi} .
 7. The topographic factor K_{zt} .
 8. The directionality factor K_d .
 9. A statement that the safe room has/has not been constructed within an area susceptible to flooding in accordance with Chapter 3 of this publication.
 10. Documentation showing that components of the safe room envelope will meet the missile impact and pressure test recommendations identified in Chapter 3 of this publication and Chapter 8 of the ICC-500 Storm Shelter Standard.
 11. The occupancy load of the safe room.
 12. The usable safe room floor area.
 13. Venting area (sq. in.) provided locations in the safe room.
 14. If applicable, the designer should document the flood hazard at the site and the design elevation used for the safe room (per Section 3.6).
 15. The lowest floor elevation (and corresponding datum) of the structure containing the safe room, the lowest floor elevation of the safe room floor, and the lowest floor or a room or space that houses any mechanical, electrical, or support equipment that is needed for the operation of the safe room.
- b) **Enclosure.** When a safe room is to be constructed as a portion of a host building, the walls and floors enclosing the safe room should be clearly indicated on the drawings.
- c) **Signage.** The type and location of signs recommendations by this publication should be indicated on the floor plans.

- d) **Inspections.** Where any special details are utilized in the design of the structure, or where any special investigations are recommended that are in addition to those required by the applicable building code, the construction documents should contain a schedule of the inspections recommended and the criteria for the special installation.
- e) **Special Details.** The construction documents should provide any special manufacturer's details or installation instructions for systems or equipment designed for the safe room.
- f) **Special Instructions.** The construction documents should contain details of special instructions recommended for the specified functional operation of the safe room, such as:
 - 1. Type and location of equipment and amenities provided within the safe room, including water supply, sanitary facilities, fire extinguishers, batteries, flashlights, special emergency lighting equipment, or any other equipment recommended to be installed in the safe room.
 - 2. Specifications for any alarm system to be installed.
 - 3. Instructions for the installation or deployment of any special protection equipment, such as shutters, screens, special latching of doors or windows, any equipment or switching for mechanical, electrical and plumbing equipment.

3.9.2 Signage Criteria and Labeling

All safe rooms should have a sign outside or inside the safe room with the name of the manufacturer or builder of the safe room, its purpose (i.e., the storm type), and safe room design wind speed. The sign should remain legible and visible. Further, any products, materials, or systems specified for occupant protection should be labeled by the agency that approved them when called for by the applicable publication (such as this document), standard (such as the ICC-500), or the local building code.

3.10 Quality Assurance/Quality Control and Special Inspections

Because a tornado or hurricane safe room should perform well during extreme conditions, quality assurance and quality control (QA/QC) for the design and construction of the safe room should be at a level above that for normal building construction. Design calculations and shop drawings should be thoroughly scrutinized for accuracy. When the design team is satisfied that the design of the safe room is acceptable, a registered design professional should prepare the quality assurance plan for the construction of the safe room. The construction documents for any tornado or hurricane community safe room should contain a quality assurance plan as defined in Sections 3.10.1 through 3.10.3.

3.10.1 Detailed Quality Assurance/Quality Control Recommendations

The quality assurance plan should be based on the Special Inspection Requirements listed in Sections 1704, 1705, and 1706 of the IBC; however, because of the design wind speeds

involved, exceptions that waive the need for quality assurance when elements are prefabricated should not be allowed. The IBC recommends using these special inspections and quality assurance program when the design wind speeds are in excess of 110 to 120 mph (3-second gust), depending on exposure or if the building is in a high seismic hazard area. Sufficient information to ensure that the safe room is built in accordance with the design and performance criteria of this manual should be provided by the design professional. The quality of both construction materials and methods should be ensured through the development and application of a quality control program.

A quality assurance plan should be provided for the following:

- a) Roof cladding and roof framing connections
- b) Wall connections to roof and floor diaphragms and framing
- c) Roof and floor diaphragm systems, including connectors, drag struts, and boundary elements
- d) Main wind force resisting systems, including braced frames, moment frames, and shear walls
- e) Main wind force resisting system connections to the foundation
- f) Fabrication and installation of components and assemblies of the safe room envelope recommended to meet missile impact test recommendations of this chapter
- g) Recommendations for components and cladding, including soffits
- h) Corrosion resistance or protection of metal connectors exposed to the elements that provide load path continuity
- i) Recommendations for critical support systems connections and debris impact-protection of the components and connections

3.10.2 Quality Assurance Plan Preparation

The design of each main wind force resisting system and each wind-resisting component should include a quality assurance plan prepared by a registered design professional. The quality assurance plan should identify the following:

- a) The main wind force resisting systems and wind-resisting components
- b) The special inspections and testing to be required in accordance with Section 106.2 of the ICC-500
- c) The type and frequency of testing to be performed
- d) The type and frequency of special inspections to be performed
- e) The structural observations to be performed in accordance with Section 106.4 of the ICC-500

- f) The distribution, type, and frequency of reports of test, inspections, and structural observations to be prepared and maintained

3.10.3 Contractor's Responsibility

Each contractor responsible for the construction of a MWFRS or any component listed in the quality assurance plan should submit a written statement of responsibility to the authority having jurisdiction, the responsible design professional, and owner prior to the commencement of work on the system or component. The contractor's statement of responsibility should contain:

- a) Acknowledgement of awareness of the special criteria contained in the quality assurance plan
- b) Acknowledgement that control will be exercised to obtain conformance with the construction documents
- c) Procedures for exercising control within the contractor's organization, and the method and frequency of reporting and the distribution of reports
- d) Identification and qualifications of the person(s) exercising such control and their position(s) in the organization

Exception: Prefabricated or panelized safe room components that have been inspected and labeled by an approved agency meeting the requirements of the applicable building code.

3.10.4 Special Inspections and Acceptance

The construction of safe rooms and installation of all equipment should be subject to inspections in accordance with the applicable building code. Special inspections should be provided for construction and installation of materials as required by the applicable building code, and when the proposed work comprises:

- a) Construction materials and systems that are alternatives to traditional materials and systems prescribed by the applicable code
- b) Unusual design and construction applications

In addition, where fabrication of structural load-bearing and debris impact-resistant components and assemblies is being performed on the premises of a fabricator, a special inspection of the fabricator's shop should be performed. However, this inspection may be waived if the prefabricated or panelized safe room components have been inspected and labeled by an approved agency that meets the requirements of the applicable building code.

4 Characteristics of Tornadoes and Hurricanes

This chapter provides basic information about tornadoes and hurricanes and their effects on the built environment. This information will help the reader better understand both how extreme winds damage buildings and the specific guidance provided in Chapter 3.

4.1 General Wind Effects on Buildings

Building failures occur when winds produce forces on buildings that they were not designed or constructed to withstand. Failures also occur when the breaching of a window or door creates a relatively large opening in the building envelope. These openings allow wind to enter buildings, where it again produces forces that the buildings were not designed to withstand. Other failures may be attributed to poor construction, inadequate structural systems, older building codes that provided little to no hazard-resistance provisions, and poor selection of building materials.

Past history and post-disaster investigations have shown that, to a large extent, (1) wind-induced structural damage to both residential and non-residential buildings can be minimized and (2) wind- and debris-induced damage to the building exterior (envelope) can be reduced. Experience shows that mitigation opportunities for building protection exist for properties that may be exposed to wind hazards along the periphery of strong and violent tornadoes, in the path of the vortex of weak tornadoes, and within the wind fields of most hurricanes. In these areas, damage to property was investigated to determine whether losses could have been minimized through compliance with up-to-date model building codes and engineering standards, and whether construction techniques proven to minimize damage in other wind-prone areas were used. Buildings designed and constructed above basic code requirements (i.e., “hardened” buildings), and newer structures designed and constructed to modern, hazard-resistant codes have been found to be able to resist the wind load forces from weak tornadoes



NOTE

If a standard-size window is broken by windborne debris on the wall of a typical single-story home, an opening in the building envelope can be formed that is large enough (4 to 5 percent of the wall area) that the building may experience internal pressurization. In addition to exposing the interior of the building to wind-driven rain, an increase in wind loads may result in a partial or complete structural failure.

(EF1 or weaker). Furthermore, during stronger tornado strikes, not all damage is from the rotating vortex of the tornado. Much of the damage is from straight-line winds rushing toward and being pulled into the tornado itself. Many newer homes designed and constructed to modern codes, such as the *International Residential Codes* (IRC 2000 Edition and newer), with a continuous load path to resist extreme-wind forces may survive without structural failure. The primary damage to these newer homes is to the building envelope (i.e., cladding and other exterior systems: roof covering, roof deck, exterior walls, and windows). Even this type of damage may be reduced on buildings that are designed and constructed according to the IRC 2000 (or newer) when the building experiences weaker tornadoes and the outermost winds from stronger tornadoes. This is an important consideration for building owners who are contemplating mitigation because these are the most frequent wind hazards. Based on NOAA tornado data from 1997 to 2006, EF0, EF1, and EF2 tornadoes account for approximately 80 to 95 percent of reported tornadoes in any given year.

However, for tornadoes classified EF3 and larger (see Table 4-1), larger buildings and large areas of buildings cannot be economically strengthened to resist the wind loads and debris impacts. If the building cannot resist the wind loads acting on it, it will fail. However, if the occupants of the building have retreated to a safe, specially designed and constructed safe room area, injuries and deaths will be avoided. Safe rooms designed and constructed according to the principles in this publication provide a near-absolute level of protection for their occupants.

4.2 Wind-Induced Forces – Tornadoes and Hurricanes

Tornadoes and hurricanes are complex wind events that cause damage ranging from minimal or minor to extensive devastation. It is not the intent of this section to provide a complete and thorough explanation or definition of tornadoes, hurricanes, and the damage associated with each event. Rather, this section defines basic concepts concerning tornadoes, hurricanes, and their associated damages.

4.2.1 Tornadoes

Tornadoes are one of nature's most violent storms. According to the *Glossary of Meteorology* (AMS 2000), a tornado is "a violently rotating column of air, pendant from a cumuliform cloud or underneath a cumuliform cloud, and often (but not always) visible as a funnel cloud." From 1997 to 2006, in an average year, approximately 1,300 tornadoes have been reported across the United States, resulting in 67 deaths and over 1,100 injuries annually. The most violent tornadoes, with wind speeds of 250 mph or more, are capable of tremendous destruction. Damage paths can be more than 1 mile wide and up to 50 miles long. Tornadoes can occur anywhere in the United States. The states along the Atlantic and Gulf coasts have some of the highest occurrence rates of smaller tornadoes (EF0-EF2), while the Great Plains region of the country (which includes parts of Texas, Oklahoma, Kansas, and Nebraska) consistently has the highest occurrence rates of larger tornadoes (EF3-EF5). Tornadoes are responsible for the greatest number of wind-related deaths each year in the United States.

Tornadoes come in all shapes and sizes. In the southern states, peak tornado season is March through May; peak months in the northern states are during the summer. Tornadoes can also occur in thunderstorms that develop in warm, moist air masses in advance of eastward-moving cold fronts. These thunderstorms often produce large hail and strong winds, in addition to tornadoes. During the spring in the central plains, thunderstorms frequently develop along a “dryline,” which separates warm, moist air to the east from hot, dry air to the west. Tornado-producing thunderstorms may form as the dryline moves east during the afternoon hours. Along the front range of the Rocky Mountains, in the Texas panhandle, and in the southern high plains, thunderstorms frequently form as air near the ground flows “upslope” toward higher terrain. If other favorable conditions exist, these thunderstorms can produce tornadoes. Tornadoes occasionally accompany tropical storms and hurricanes that move over land. They are most common to the right and ahead of the path (in the right front quadrant) of the storm center as it comes onshore.

In a simplified tornado “model,” there are three regions of tornadic winds:

- Near the surface, close to the core or vortex of the tornado. In this region, the winds are complicated and include the peak at-ground wind speeds, but are dominated by the tornado’s strong rotation. It is in this region that strong upward motions occur that carry debris upward, as well as around the tornado.
- Near the surface, away from the tornado’s vortex. In this region, the flow is a combination of the tornado’s rotation, inflow into the tornado, and the background wind. The importance of the rotational winds as compared to the inflow winds decreases with distance from the tornado’s vortex. The flow in this region is extremely complicated. The strongest winds are typically concentrated into relatively narrow swaths of strong spiraling inflow rather than a uniform flow into the tornado’s vortex circulation.
- Above the surface, typically above the tops of most buildings. In this region, the flow tends to become nearly circular.

In a tornado, the diameter of the core or vortex circulation can change with time, so it is impossible to say precisely where one region of the tornado’s flow ends and another begins. Also, the visible funnel cloud associated with and typically labeled the vortex of a tornado is not always the edge of the strong, high winds. Rather, the visible funnel cloud boundary is determined by the temperature and moisture content of the tornado’s inflowing air. The highest wind speeds in a tornado occur at a radius measured from the tornado vortex center that can be larger than the edge of the visible funnel cloud’s radius. It is important to remember that a tornado’s wind speeds cannot be determined solely from its appearance.

From 1971 until February 2007, tornadoes were typically categorized according to the Fujita Scale (F Scale), which was created by the late Dr. Tetsuya Theodore Fujita, University of Chicago. The Fujita Scale¹ categorized tornado severity by damage observed, not by recorded

¹ The text describing the Fujita Scale and the Enhanced Fujita Scale was primarily taken from the report titled: *A Recommendation for an Enhanced Fujita Scale (EF-Scale)*, October 17, 2006, by the Wind Science and Engineering Research Center, Texas Tech University.

wind speeds. Ranges of wind speeds have been associated with the damage descriptions of the Fujita Scale, but their accuracy has been called into question by both the wind engineering and meteorological communities, especially the ranges for the higher end (F4 and F5) of the scale. The wind speeds were estimates intended to represent the observed damage. They were not calibrated, nor did they account for variability in the design and construction of buildings.

As a result, the Wind Science and Engineering (WISE) Research Center at TTU and other researchers from the wind engineering and meteorological communities worked together to revise and update the Fujita Scale over the past several years. The resulting tornado classification scale is called the Enhanced Fujita Scale (EF Scale). The primary limitations of the Fujita Scale were a lack of damage indicators, no account of construction quality and variability, and no definitive correlation between damage and wind speed. These limitations have led to inconsistent ratings of tornadoes.

Based on its vast experience in tornado damage and investigation, the TTU team assigned to the project proposed 28 damage indicators that consisted of buildings, structures, and trees. For each damage indicator (DI), several degrees of damage (DODs) are identified. The DODs are sequenced so each one requires a higher expected wind speed than the previous one. Damage ranges from the initiation of visible damage to complete destruction of the particular DI.

The strategy of damage indicators requires that an expected, upper and lower bound wind speed be defined for each DOD. The range of wind speed defined by the upper and lower bound wind speeds accounts for circumstances that cause the actual wind speed associated with the damage to deviate from the expected value. The expected value of wind speed to cause a given DOD is based on a set of “normal” conditions. A weak link is a discontinuity in the load path, which runs from the building surface through the structural system to the foundation.

The EF scale addresses the major limitations of the original Fujita Scale. Additional DIs are proposed along with DODs. Through an expert elicitation process, wind speeds corresponding to the described damage for each DOD are estimated. The estimated wind speed then determines the EF Scale category appropriate for the observed damage. The categories range from EF0 to EF5. The wind speed ranges in each category are related to Fujita Scale ranges by a correlation function (see the 2006 WISE paper) and are shown in Table 4-1. This correlation between Fujita Scale and EF Scale wind speeds provides a link between the two scales and thus makes it

**NOTE**

Dr. Fujita’s group at the University of Chicago and personnel at the National Severe Storms Forecast Center (NSSFC) independently assigned Fujita Scale ratings to tornadoes in the historical records based on written descriptions of the damage. However, the primary recordkeeper of the NSSFC data became the Storm Prediction Center (SPC), which maintained the tornado track data through 1995. Tornado records since that time are kept at the National Climatic Data Center (NCDC) in Asheville, North Carolina.

possible to express a Fujita Scale rating in terms of an EF Scale rating. The only difference is the wind speed ranges in each scale. Thus, the historical tornado database is preserved and can be easily converted to the criteria of the EF Scale. Figure 4-1 presents a description of the damage states of the EF Scale and provides photos to assist with understanding.

Table 4-1. Comparison Table for the Fujita and Enhanced Fujita Scales

Fujita Scale		EF Scale	
Fujita Scale	3-Second Gust Speed (mph)	EF Scale	3-Second Gust Speed (mph)
F0	45-78	EF0	65-85
F1	79-117	EF1	86-109
F2	118-161	EF2	110-137
F3	162-209	EF3	138-167
F4	210-261	EF4	168-199
F5	262-317	EF5	200-234

The Fujita Scale categorizes tornado severity based on observed damage. The six-step scale ranges from F0 (light damage) to F5 (incredible damage). Since February 2007, the National Weather Service has used the Enhanced Fujita Scale (EF Scale). This new scale ranges from EF0 to EF5. See <http://www.spc.noaa.gov/efscale> for further information on the EF Scale.

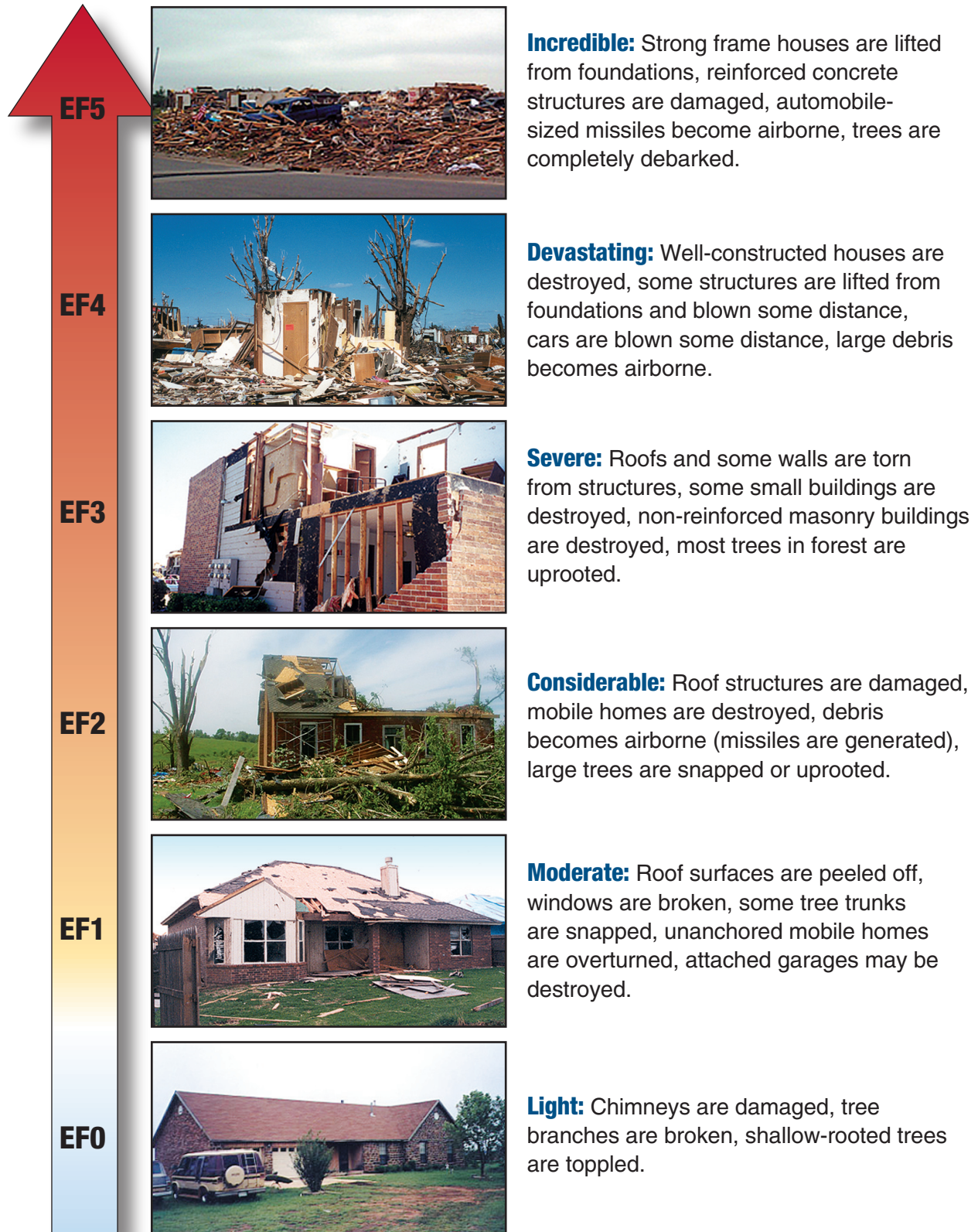

Figure 4-1. Typical tornado damage

4.2.2 Hurricanes and Typhoons

A hurricane, as defined by NOAA, is a tropical cyclone in which the maximum sustained surface wind (using the U.S. 1-minute average) is 74 mph or greater. The term hurricane is used for Northern Hemisphere tropical cyclones east of the International Dateline to the Greenwich Meridian. Tropical cyclones are classified as follows:

- Tropical Depression – An organized system of clouds and thunderstorms with a defined circulation and maximum sustained winds of 38 mph or less.
- Tropical Storm – An organized system of strong thunderstorms with a defined circulation and maximum sustained winds of 39 to 73 mph.
- Hurricane – An intense tropical weather system with a well-defined circulation and sustained winds of 74 mph or higher. In the western Pacific, hurricanes are called “typhoons,” and similar storms in the Indian Ocean are called “cyclones.”

Hurricanes that affect the U.S. mainland are products of the Tropical Ocean (Atlantic Ocean, Caribbean Sea, or Gulf of Mexico) and the atmosphere. Powered by heat from the sea, they are steered by the easterly trade winds and the temperate westerly trade winds, as well as by their own intense energy. Around their core, winds grow with great velocity, generating violent seas. Moving ashore, they sweep the ocean inward (storm surge) while spawning tornadoes, downbursts, and straight-line winds, and producing torrential rains and floods. A comparison of the sustained wind speed measure of the Saffir-Simpson Hurricane Scale and the 3-second gust measure now used by ASCE 7-05, the ICC-500, and this publication for their respective wind speed maps is presented in Table 4-2.

Table 4-2. The Saffir-Simpson Hurricane Scale Wind Speeds and Pressures

Strength	Sustained Wind Speed (mph)*	Gust Wind Speed (mph)**	Pressure (millibars)
Category 1	74-95	89-116	>980
Category 2	96-110	117-134	965-979
Category 3	111-130	135-159	945-964
Category 4	131-155	160-189	920-944
Category 5	>155	>189	<920

* 1-minute sustained over open water

** 3-second gust over open water

Hurricanes are categorized according to the Saffir-Simpson Hurricane Scale (see Table 4-2 and Figure 4-2), which is used by the National Weather Service (NWS) to estimate the potential property damage and flooding expected along the coast from a hurricane landfall. The scale is a 1 to 5 rating based on the hurricane’s intensity. Wind speed and barometric pressure are the determining factors in the scale. Storm surge is not a determining factor, because storm surge values are highly dependent on the slope of the continental shelf in the landfall region.

Recently, there has been an increased recognition of the fact that wind speed, storm surge, and inland rainfall are not necessarily related. There is growing interest in classifying hurricanes by separate scales according to the risks associated with each of these threats.

In terms of wind interaction with buildings, hurricanes create both positive and negative (i.e., suction) pressures. A particular building should have sufficient strength to resist both the applied wind loads and windborne missile impact loads in order to prevent wind-induced building failure or damage. The magnitude of the pressure is a function of many factors, such as the wind speed, exposure, topography, and building height and shape.

Typhoons affect the Pacific Islands (e.g., Guam and American Samoa) and, like hurricanes, can generate high winds, flooding, high-velocity flows, damaging waves, significant erosion, and heavy rainfall. Historically, typhoons have been classified according to strength as either typhoons (storms with less than 150 mph winds) or super typhoons (storms with wind speeds of 150 mph or greater) rather than by the Saffir-Simpson Hurricane Scale. For the purposes of this publication, the guidance provided for hurricanes applies to areas threatened by typhoons.

4.3 Effects of Extreme-Wind Forces

Wind-induced damage to residential and commercial buildings indicates that extreme winds moving around buildings generate loads on building surfaces that can lead to the total failure of a building, especially if that building was not designed to modern, hazard-resistant building codes. In addition, internal pressurization due to a sudden breach of the building envelope (the failure of the building exterior) is also a major contributor to poor building performance under ultimate-wind loading conditions. These loads should be transferred in an identifiable path from the building exterior or, in case of envelope breach, interior surfaces to the structural system and through the foundations into the ground. If a building is constructed with such a path (called a continuous load path), the building's ability to survive during a design event will be improved, even if a portion of the building envelope fails. This section discusses topics related to wind and wind pressures acting on buildings. The importance of a continuous load path within a building or structure is discussed in Chapter 6.

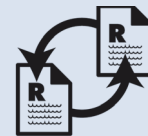

CROSS-REFERENCE

Section 6.6 presents detailed information about continuous load paths. A continuous load path is required in a safe room in order for it to resist the wind and wind pressures described in this section.

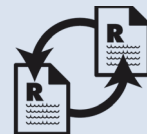

CROSS-REFERENCE

The design wind speed for a safe room designed to the criteria set forth in this publication is selected from either Figure 3-1 or Figure 3-2, depending upon the hazard or combined hazards. If the safe room is being designed as a combined hazard safe room, the highest wind speed should be selected for the proposed location on each map.

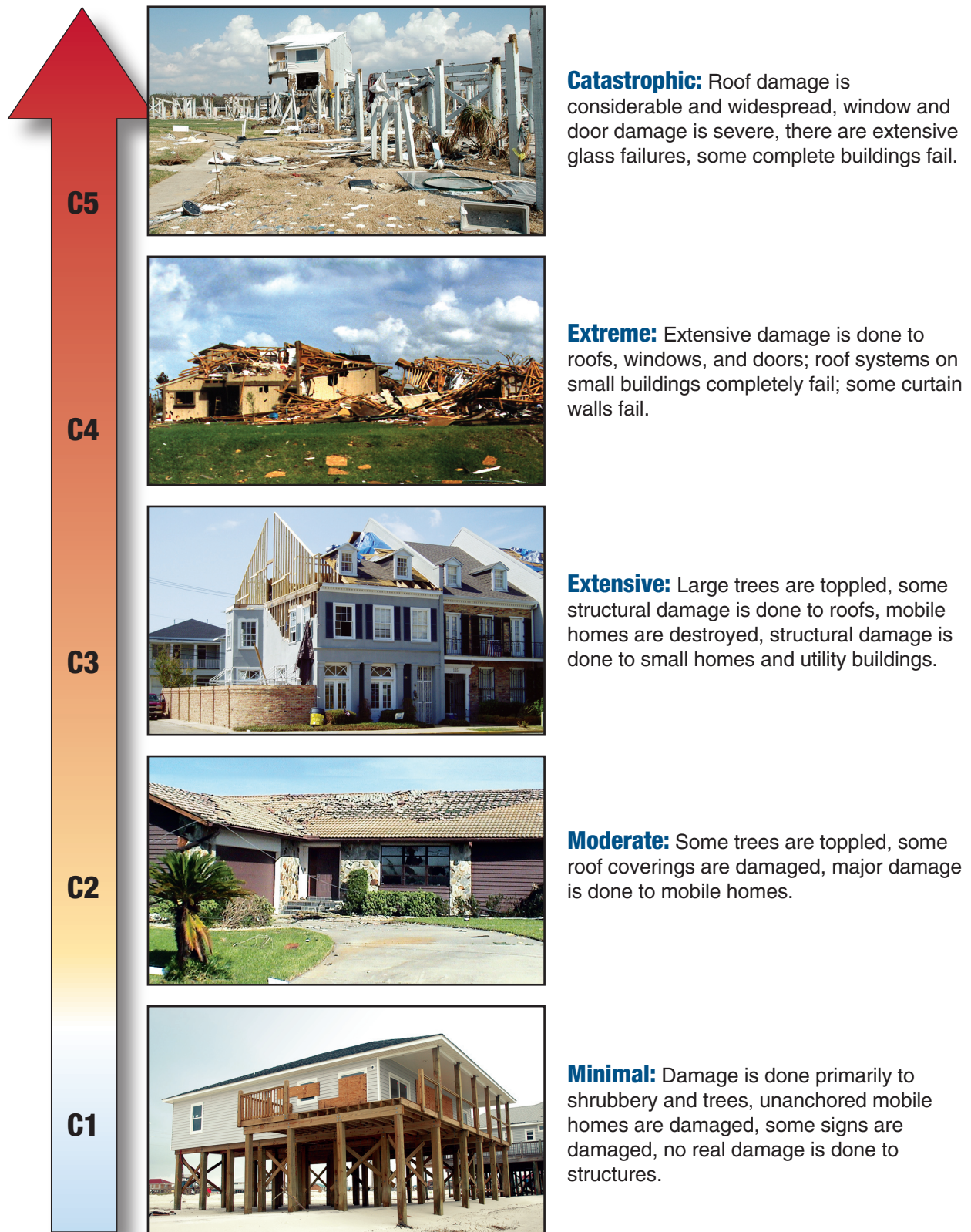

Figure 4-2. Typical hurricane damage

4.3.1 Effects of Tornado and Hurricane Wind Forces

Damage to buildings from tornadoes and hurricanes can occur as a result of three types of forces:

- Forces induced by changes in atmospheric pressure (for tornadoes only)
- Wind-induced forces
- Forces induced by debris impact

The atmospheric pressure in the center of the tornado vortex is lower than the ambient atmospheric pressure. When a tornado vortex passes over a building, the outside pressure is lower than the ambient pressure inside the building. This atmospheric pressure change (APC) in a tornado may cause outward-acting pressures on all surfaces of the building. If there are sufficient openings in the building, air flowing through the openings will equalize the inside and outside atmospheric pressures, and the APC-induced forces will not be a problem. However, it should be noted that openings in the building envelope also allow wind to enter the building and cause internal pressures in addition to wind-induced aerodynamic external pressures (see Section 6.3.1).

Maximum APC occurs in the center of a tornado vortex where winds are assumed to be zero. A simple tornado vortex model suggests that, at the radius of the maximum winds, APC is one-half of the maximum value. Thus, for tornado loadings, two situations of the state of the building should be considered: (1) sealed building or (2) vented building (i.e., a building with openings). For a sealed building, the maximum design pressure occurs when wind-induced aerodynamic pressure is combined with one-half APC-induced pressure. For a vented building, the maximum design pressure occurs when wind-induced aerodynamic pressure is combined with wind-induced internal pressure. See Chapter 6 for design guidance regarding the effects of APC.

Forces from tornadic and hurricane winds are discussed in the next few sections and guidance on the calculation of these forces is provided in Chapter 6. Forces due to debris impact are discussed later in this chapter and guidance on the evaluation of how to address these forces is provided in Chapter 7.

4.3.2 Forces Generated by the Safe Room Design Wind Speed

The design wind speed for construction of a community safe room should be determined from Figures 3-1 or 3-2 for tornado and hurricane hazards, respectively. When calculating the wind pressures based on the safe room design wind speed, the designer should not consider the effects of the other parts of the building that may normally reduce wind pressures on the safe room. The designer should also consider that the collapse of the non-safe room parts of the building may or may not impart additional loads on the safe room and verify that the safe room is designed for these additional loads.

The design wind speed is used to predict forces on both the main wind force resisting system and on the exterior surfaces of the buildings – components and cladding. The MWFRS is the

structural system of the building or safe room that works to transfer wind loads to the ground and includes structural members such as roof systems (including diaphragms), frames, cross bracing, and load-bearing walls. C&C elements include wall and roof members (e.g., joists, purlins, studs), windows, doors, fascia, fasteners, siding, soffits, parapets, chimneys, and roof overhangs. C&C elements receive wind loads directly and transfer the loads to other components or to the MWFRS.

The effects of wind on buildings can be summarized as follows:

- Inward-acting, or positive, pressures act on windward walls and windward surfaces of steep-sloped roofs.
- Outward-acting, or negative pressures act on leeward walls, side walls, leeward surfaces of steep-sloped roofs, and all roof surfaces for low-sloped roofs or steep-sloped roofs when winds are parallel to the ridge.
- Airflow separates from building surfaces at sharp building edges and at points where the building geometry changes.
- Localized suction or negative pressures at eaves, ridges, edges, and the corners of roofs and walls are caused by turbulence and flow separation. These pressures affect loads on C&C.
- Windows, doors, and other openings are subjected to wind pressures and the impact of windborne debris (missiles). If these openings fail (are breached) either because of wind pressure or windborne debris impact, the entire structure becomes subject to wind pressures that can be twice as great as those that would result if the building remained fully enclosed. Further, some or all of the occupants within the safe room would become exposed to wind and windborne debris impact hazards.

Extreme winds associated with tornadoes and hurricanes are capable of imposing large lateral (horizontal) and uplift (vertical) forces on buildings. The strength of the building's structural frame, connections, and envelope determines the ability of the building to withstand the effects of these forces.

Wind loads are influenced by the location of the building site (the general roughness of the surrounding terrain, including open, built-up, and forested areas, can affect wind speed), height of the building (wind pressures increase with height above ground, or the building may be higher than surrounding vegetation and structures and, therefore, more exposed), surrounding topography (abrupt changes in land surface elevations can create a wind speedup effect), and the configuration of the building (roof geometry and building shape).

Roof shape plays a significant role in roof performance, both structurally and with respect to the magnitude of the wind loads. Compared to other types of roofs, hip roofs generally perform better in extreme winds because they have fewer sharp corners and their construction makes them inherently more structurally stable. Gable-end roofs require extensive detailing to properly transfer lateral loads acting against the gable-end wall into the structure. Steeply pitched roofs

(roofs angled to the horizontal at 30 degrees or more) usually perform better than flat roofs because uplift on the windward roof slopes is either reduced or eliminated.

Figure 4-3 illustrates the effects of roof geometry on wind loads. Notice that the roof with the 3-foot parapet around the edges does not have elevated roof pressures at the corners. By comparison, the flat roof without parapet has corner roof wind loads more than 1.5 times the edge pressures of the roof with parapet. Also, the gable-end and hip roofs with a roof pitch of greater than 30 degrees produces the lowest leeward and corner pressures. The highest roof pitches tested are 45 degrees (12 on 12 pitch) because few roofs have steeper pitches than 45 degrees and few data are available for higher slopes.

Wind loads and the impact of windborne debris are both capable of damaging a building envelope. Post-disaster investigations of wind-damaged buildings have shown that many building failures begin because a component or a segment of cladding is blown off, allowing wind and rain to rapidly enter the building. An opening on the windward face of the building can also lead to a failure by allowing positive pressures to build up inside, which, in conjunction with negative external pressures, can “blow the building apart.” Figure 4-4 depicts the forces that act on a structure when an opening exists in the windward wall.

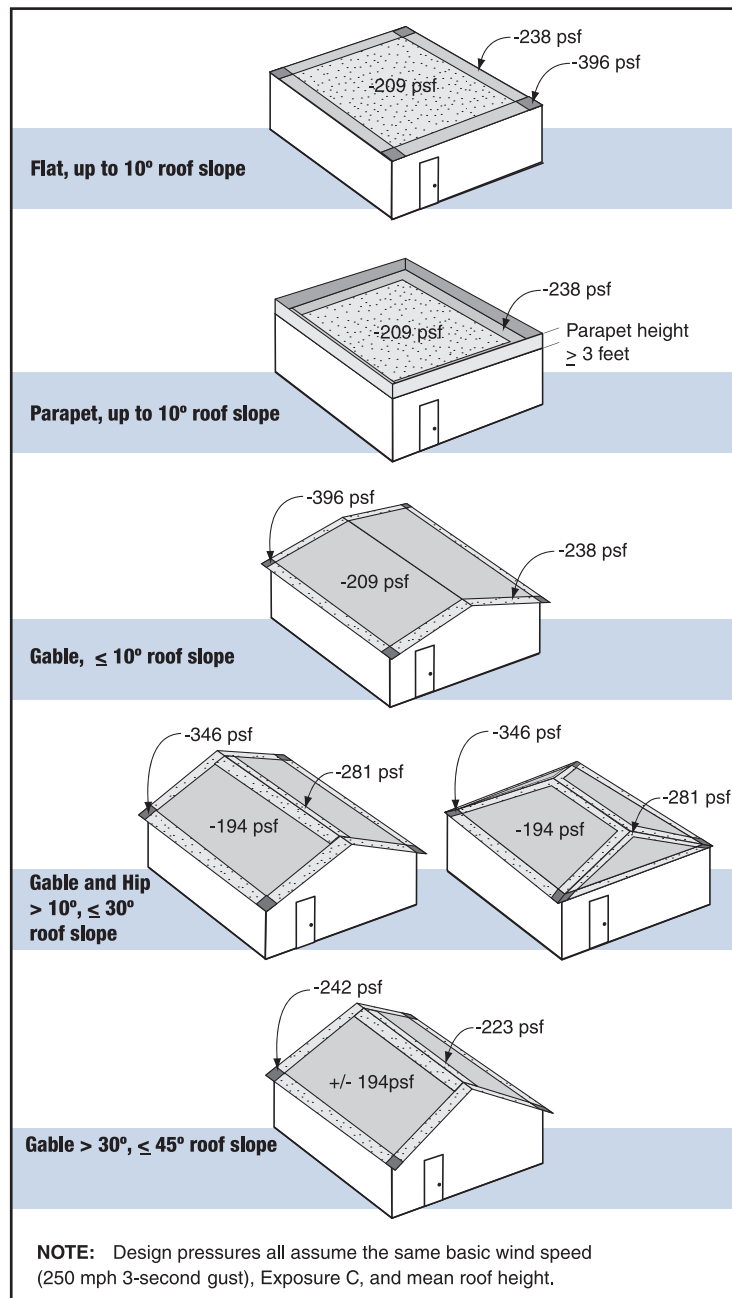

Figure 4-3. Calculated pressures (based on ASCE 7-05 C&C equations) acting on a typical safe room. This figure illustrates the different roof pressures that result for the same building and wind speed as the roof shape is varied. For the calculation of the loads from these pressures, the safe room was assumed to be a 50-foot x 75-foot rectangular building with a constant mean roof height of 12 feet. Note: These loads do not include any additional loads from internal pressurization resulting from either a vented or breached building envelope.

The magnitude of internal pressures depends on whether the building is “enclosed,” “partially enclosed,” or “open” as defined by ASCE 7-05. The internal pressures in a building are increased when a building changes from an “enclosed” to a “partially enclosed” building (e.g., when a building envelope is breached). The design criteria presented in Chapter 3 (and discussed in detail in Chapters 5, 6, and 7) state that safe room designs to provide occupants with life-safety protection be based on the partially enclosed internal pressures or on enclosure classifications outlined in the ICC-500, Chapter 3. The walls and the roof of the safe room and connections between the components should be designed for the largest possible combination of internal and external pressures. This design concept is in keeping with a conservative approach because of the life-safety issues involved in safe room design.

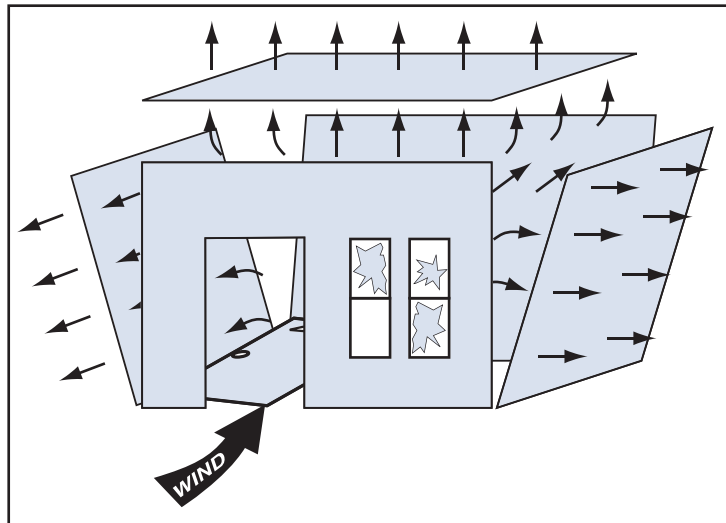

Figure 4-4. Internal pressurization and resulting building failure due to design winds entering an opening in the windward wall

4.3.3 Building Failure Modes – Elements, Connections, and Materials

The wind forces described in the previous section will act on a building as both inward-acting and outward-acting forces. The direction and magnitude of the forces are governed by the direction of the wind, location of the building, height and shape of the building, and other conditions that are based on the terrain surrounding the building. Chapter 6 of this publication and Section 6 of ASCE 7-05 provide information on calculating the direction and magnitude of the wind forces acting on a building once the design wind speed and types of openings in the building envelope have been determined.

Building failures can be independently categorized by one or a combination of the four failure modes illustrated in Figure 4-5. Winds moving around a building or structure may cause sliding, overturning, racking, and component failures. A sliding failure occurs when wind forces move a building laterally off its foundation. An overturning failure occurs when a combination of the lateral and vertical wind forces cause the entire building to rotate about one of its sides. A racking failure occurs when the building’s structural system fails laterally, but the building typically remains connected to the foundation system. A component failure, the most common failure seen during extreme-wind events (and typically a contributing factor to the first three failure modes listed), may be caused by wind pressures or windborne debris (missile) impacts. Component failures may be either full-system failures or individual element failures.

Most buildings are designed as enclosed structures with no large or dominant openings that allow the inside of the building to experience internal pressurization from a wind event. The beginning of this chapter identified the concept that, under extreme-wind conditions, a breach in the building envelope due to broken windows, failed entry doors, or failed large overhead doors may cause a significant increase in the net wind loads acting on building components such as walls and the roof structure. In such cases, the increase in wind loads may cause a partial failure or propagate into a total failure of the primary structural system. Uplift or downward forces (depending on roof pitch and wind direction) may act upon the roof of the building and cause overturning, racking, or failure of components.

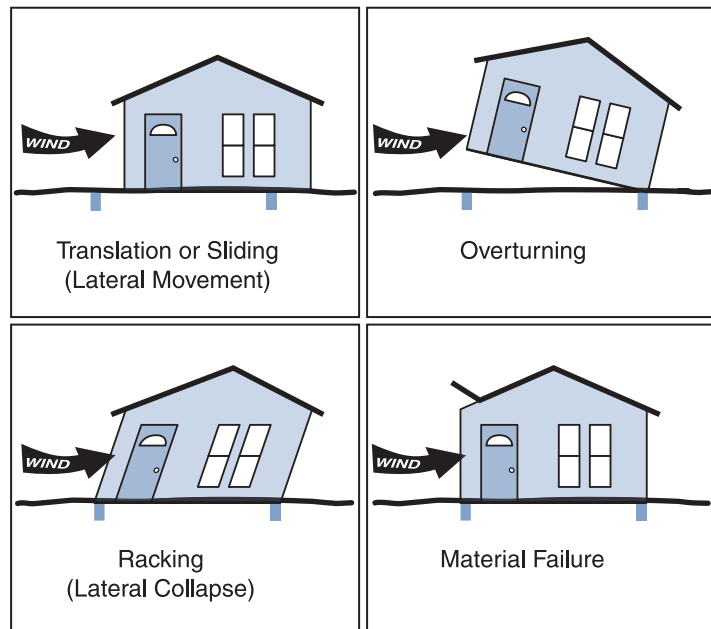

Figure 4-5. Forces on a building due to wind moving around the structure

4.3.4 Cyclic Loading

Both tornadoes and hurricanes have unsteady wind patterns within their circular wind fields. These effects cause cyclic loading on buildings. Tornadoes, however, generally pass over a site in a very short time. Wind experts believe that the cyclic periods of wind loads in tornadoes are short and less frequent than those in hurricanes. Thus, designing tornado safe rooms for cyclic loads is not required.

Hurricane winds typically affect a site for a much longer period of time, which can result in many repetitive cycles close to the peak loads. Failures in the roof system itself and of roof-to-wall, wall-to-wall, wall-to-floor, and wall/floor to foundation connections are precipitated under such repetitive loads. Cyclic loads become particularly important when either the structure or a component is flexible or when the fastening system receives repetitive loading. When cyclic loads are to be considered, designers are advised to review loading cycles given in the ICC-500, Chapter 8 (Protocols for Testing) for shelters and ASTM Standard E 1996, or to use allowable stresses below the endurance limit of materials or connections. Structural connections of heavy steel and reinforced concrete and masonry construction, where the structural system is rigid, are more likely to resist hurricane cyclic loads.

4.3.5 Windborne Debris and the Selection of the Representative Missile

Tornadoes and hurricanes produce large amounts of debris that become airborne. This windborne debris (missiles) may kill or injure persons unable to take refuge and may also perforate the envelope and other components of any conventional building in the path of the debris. The actual size, mass, and speed of missiles in tornadoes or hurricanes vary widely by storm type and event. Only a few direct measurements of debris velocity have been made; such measurements require the use of photogrammetric techniques to analyze videos of tornadoes that contain identifiable debris. For this reason, the choice of the missile, the impact of which a safe room should withstand, is somewhat subjective and relies upon the selection of a “representative” missile traveling at an assumed speed related to the safe room design wind speed. Tornado winds tend to lift and accelerate debris (missiles) consisting of roof gravel, sheet metal, tree branches, broken building components, and other items. Large debris, such as cars, tends to tumble along the ground. The impact of this debris can cause significant damage to wall and roof components. The speed at which the representative missile travels is a function of the shelter design wind speed and was presented in Section 3.3.2.



2x6 missile penetrating a refrigerator, Midwest tornadoes of May 3, 1999



A plywood missile lodged in a palm tree, Hurricane Andrew

From over 38 years of post-disaster investigations after tornadoes and hurricanes, the WISE Research Center at TTU concluded that the missile most likely to perforate building components during a hurricane event is a 2x4 wood member, weighing up to 15 pounds. Other, larger airborne missiles do occur; for example, cars can be moved across the ground or, in extreme winds, they can be tumbled, but they are less likely than smaller missiles to perforate building elements. Following the Oklahoma and Kansas tornado outbreaks of May 3, 1999, both FEMA and TTU investigated tornado damage and debris fields and concluded that resistance to the impact of a 15-lb 2x4 missile was a reasonable criterion for tornado safe room design.

The ICC-500 Shelter Standard Committee worked to define the appropriate representative missile and speed for hurricane hazards although the data and research on windborne debris associated with both hurricanes and tornadoes are limited at best. As a result, little data are

available from the field, wind tunnel tests, or empirical studies to discuss this topic in detail. The committee concluded that, based on construction in coastal areas, it was appropriate that the representative, large missile need not be larger than the 9-lb 2x4 board member. However, a notable point is that the FEMA safe room publications review committee examined the ICC-500 proposed debris impact criteria and testing methods and supporting data, and ended with a different determination as to the appropriate speed at which the representative missile travels during a hurricane. As a result, the FEMA criteria will utilize the same 9-lb 2x4 board member as the large, representative missile, but will test the impact resistance of a safe room at a higher speed than the ICC-500. The speed at which the representative missile travels is a function of the shelter design wind speed and was presented in Section 3.3.2. More detail on this topic is provided in Chapter 7.

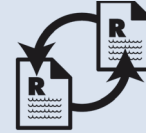

CROSS-REFERENCE

Chapter 7 presents additional information about cyclic loading for missile impact protection and for code compliance in specific regions of the country.

4.4 Multi-Hazard Considerations

Most safe rooms are built with a single purpose in mind: to protect the local population against the dangers inherent to extreme-wind events. This singular objective, however, should not divert the designers' and local decision-makers' attention from the all too real presence of other hazards, both natural and manmade. For this reason, designers and local officials alike should adopt a multi-hazard approach from the very beginning of their safe room deliberations. Multi-hazard approach to building design has gained prominence and the support of FEMA and other government agencies and professional associations that have long promoted this approach. This is not only because a multi-hazard approach ensures a comprehensive risk analysis and appropriate mitigation responses, but because it is able to optimize building design and produce the most cost-effective design solutions over a life-cycle of a building.

4.4.1 Multi-Hazard Risk Assessment

Once it is established that extreme winds represent a sufficient threat to the community, it is recommended that a multi-hazard approach be used in assessing the multitude of risks. The potential adverse effects of other hazards on the functionality of safe rooms should be identified, evaluated, and documented. The final risk analysis should include these multi-hazard considerations in order to produce as comprehensive a list of design requirements as possible.

4.4.2 Multi-Hazard Design

Multi-hazard design (i.e., the design of buildings that may be exposed to more than one hazard) can be both an advantage and a disadvantage for the designer. This is because, on the one hand, two or more hazards may pose design requirements that reinforce each other,

thus reducing costs and improving protection. On the other hand, design requirements for some hazards may be conflicting, thereby making them extremely difficult to reconcile. Many recommended features of wind-resistant design, for example, are detrimental for earthquake-resistant design and vice versa. In such circumstances, it is extremely important to conduct a careful risk analysis and identify all design constraints and prioritize all design parameters.

4.4.3 Flood Hazards

The designer should investigate all sources of flooding that could affect the use of the safe room. It should be remembered that the functionality of the safe room can be affected by flooding in many different ways. The building itself may be under water or surrounded by water, but it can also be affected indirectly when access to the safe room is disrupted or blocked as a result of flooding in the area.

The sources of flooding include floods up to and including the 500-year flood, any flood of record, flooding from storm surge (in coastal areas), and flooding from local drainage. If it is not possible to locate a community safe room on a site outside an area subject to the flooding defined in the hazard design criteria provided in Chapter 3, special precautions should be taken to ensure the safety and well-being of anyone using the safe room. The lowest floor of the safe room should be elevated above the flood elevation from any of the flooding sources described. All utilities or services provided to the safe room should be protected from flooding as well. Additionally, the planning and design of the proposed safe room should be conducted according to the 8-step process mandated by the Executive Order 11988, Floodplain Management.

A safe room in a flood-prone area should be properly equipped to meet any emergency medical, food, and sanitation needs during the time the occupants could be isolated by flooding. Access to the safe room should be maintained during flooding conditions. If access is not possible by ground transportation during flooding, alternative access should be provided. An example of how alternative access can be achieved is the installation of a helicopter pad that is above the flood levels. In all cases, both the designer and the owner will need to work with local and state emergency managers to ensure that these special requirements are met, both in the safe room design and construction and in emergency operation procedures.

For residential safe rooms, the design criteria are more stringent than for the community safe rooms (and also when compared to the ICC-500). Residential safe rooms cannot be placed in any area that may be affected or inundated by coastal storm surge for any category hurricane. Potential safe room owners should be aware that flood design criteria for residential safe rooms is provided to guide the appropriate design and construction of safe rooms that may be exposed to these hazards.

Whether constructing a community or residential safe room, the safe room developer should remember that FEMA provides policy statements and guidance separate from the design criteria in this publication for both wind and flood hazards associated with extreme-wind shelter projects. The FEMA HMA Safe Room Policy, and associated guidance, should be consulted for the latest

information from FEMA regarding implementation of safe room design criteria and how much of the design criteria may be eligible for federal funding.

4.4.4 Seismic Hazards

When a safe room is in a seismically active area as defined by the IBC, ASCE 7-05, or FEMA's National Earthquake Hazards Reduction Program (NEHRP) provisions, a seismic risk assessment of the structure should be conducted. New facilities will also require the assessment of risks for the selected site conditions. Seismic design requirements should be reviewed for compatibility with other design parameters and prioritized according to the design program.

As mentioned earlier, wind and earthquake (seismic) loads differ in the mechanics of loading (i.e., the way the load is applied). In a wind event, the load is applied to the exterior of the envelope of the structure. Typically, internal building elements that are not part of the MWFRS of the building will not receive loads unless there is a breach of the building envelope. Earthquakes induce loads based on force acceleration relationships. These relationships require that all objects of mass develop loads. Therefore, all structural elements and all non-structural components within, and attached to, the structure will be loaded. As a result, seismic loading requires both exterior building elements and internal building elements (including non-load-bearing elements and fixtures) to be designed for the seismically-induced forces.

Another important seismic consideration for the designer is the assumed response of the structure during an event. Buildings are designed to remain elastic during a wind event – elastic in the sense that no permanent deformation of any of the structural members will occur. For earthquakes, this is not the case. Design for earthquakes is based on a two-earthquake scenario. The first earthquake is the common earthquake that can occur many times in the life of a structure and the second is the larger, rare earthquake. The design process requires that the structure remain elastic for the common earthquake. But, for the rare earthquake, permanent deformation is allowed as long as it does not result in structural collapse of the building. Building elements that can “stretch and bend” give a structure the ability to withstand a large earthquake without the economic penalty of having to accommodate the rare earthquake without any permanent deformation.

Design Methods

After earthquakes in the 1920s and 1930s in California, engineers began to recognize the need to account for the lateral seismic-induced loads on structures. The first seismic codes calculated lateral seismic-induced loads using a percentage of the weight of the structure. This allowed common analysis procedures to be used. This method has been retained and is seen in today's building codes. It is commonly called the equivalent static force method. Over the years, this percentage coefficient has been refined and put on a more rational basis derived from the dynamic analysis of structures.

There are cases in which a more complicated dynamic analysis procedure is required. This dynamic analysis is common in the design and construction of very tall, irregular structures. The structures are considered irregular if they are not cube-like or do not have a rectangular footprint. They may have wings or appendages like an “L” or they may be “cross-shaped” structures. Figure 4-6 shows examples of buildings with regular and irregular shapes.

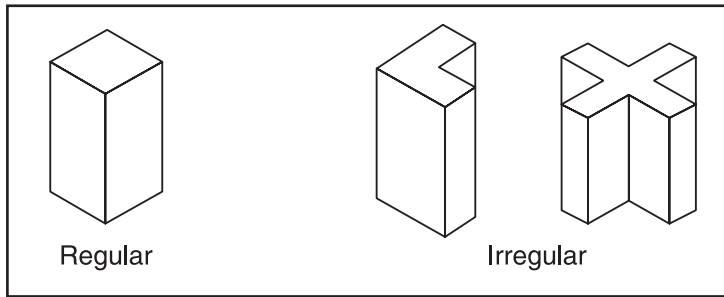

Figure 4-6. Examples of buildings with regular and irregular shapes

The dynamic analysis procedure for these types of structures consists of three parts:

1. A time history analysis is conducted.
2. A response spectrum is developed.
3. A modal analysis of the final structure is performed.

Unless a seismic event has occurred and is documented at the exact building site, some sort of computed ground movement should be developed. This can be done in several ways. One is to use the existing earthquake records and average several of them to produce a composite ground motion. Figure 4-7 is an actual graphical representation of a time response of the ground during a seismic event.

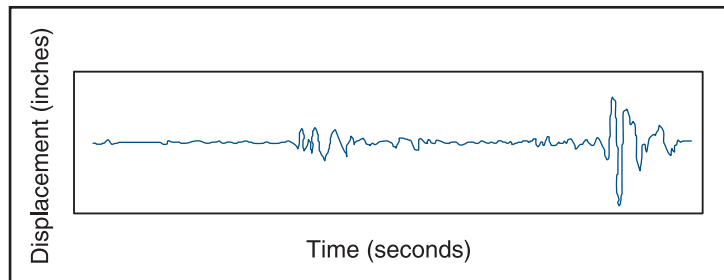

Figure 4-7. Time response of ground during a seismic event

Another way is to synthetically generate this motion using models of geologic phenomena and soil conditions. In either case, the result is a description of the movement and acceleration of the ground. Once this acceleration is defined, the acceleration is used as input in a single-degree-of-freedom system, illustrated in Figure 4-8. The single-degree-of-freedom system is a model of the building system with mass from floors and roof systems consolidated together to represent the building as a mass (M) supported by vertical building elements, with stiffness (k), acted upon by a lateral force (F) representative of the ground acceleration.

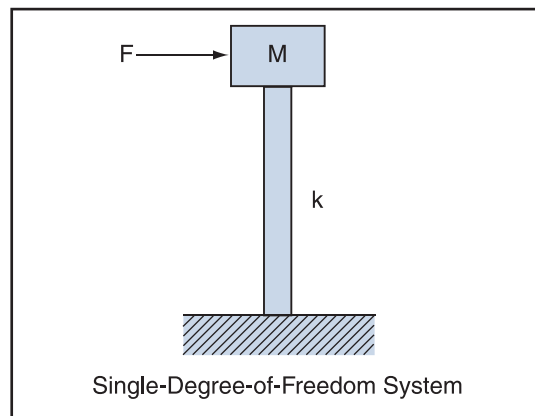

Figure 4-8. Example of a single-degree-of-freedom system

The stiffness (k) of the system can be varied to change the period of the building response to the applied lateral force. When this is done, a plot is made of the acceleration versus the period of the structure (see Figure 4-9). This type of plot is known as a Response Spectrum for the induced earthquake motion and illustrates the elastic structural system response to a particular earthquake motion.

The last step in the dynamic analysis is to perform a modal analysis on the actual building. This type of analysis provides the motion of the building in terms of a single-degree-of-freedom system. Therefore, the response spectrum can be input into the modal analysis to give the building's response to the earthquake.

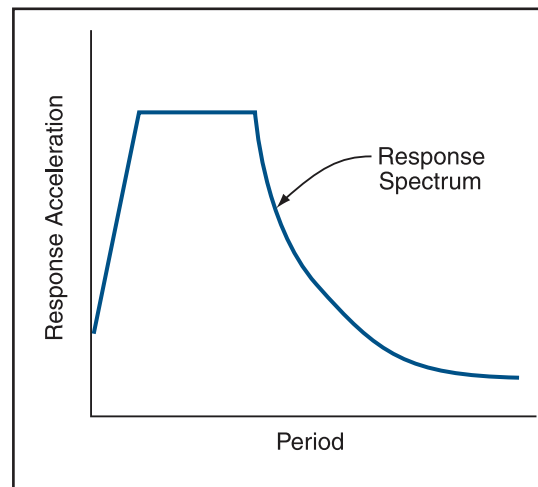

Figure 4-9. Acceleration vs. period of structure

Both the static method and the dynamic method determine the lateral forces acting on the structure. The geographic region of the country in which the safe room is located will dictate which analysis should be used. Once the forces are calculated, they can be input into the load combinations (as seismic load E) used for the design of the safe room.

Code Development

Earthquake codes are under continual refinement as new data become available. This continual refinement attempts to give more accurate models of how a structure responds to ground motion. Seismic events, like wind events, are constantly occurring and continue to test buildings constructed to recently improved codes and standards. An earthquake provides a test for the current procedures; after every event, those procedures are reviewed to ensure they are acting as intended.

An example of code development is the recent acknowledgment that seismic events occurring on the west and east coasts are not expected to be the same type of seismic event. On the west coast, the difference between the common earthquake and the rare earthquake is small. Design codes assume that the rare earthquake is only 50 percent larger than the common earthquake. On the east coast, this is not the case. In this region, the rare earthquake can be as much as 400 percent larger than the common earthquake. Therefore, prior to the release of the 2000 IBC, western U.S. design codes did not fit well to eastern U.S. earthquake requirements.

This poor fit has led to refinements in seismic design procedures. The new procedures attempt to provide a process for evaluating the response of a building when it begins to deform from seismic loads. This approach is needed to ensure that the structure can stretch and bend to resist the rare earthquake. In the western U.S., this is ensured because of the minimal difference between the two different earthquakes; however, this cannot also be assumed in the eastern U.S.

Other Design Considerations

All the elements of the structure should be evaluated for earthquake forces. Not only are the exterior walls loaded, but the interior walls can also receive substantial out-of-place loads. For wind loading, these interior building components are not usually considered, although most codes require interior walls to be designed for some lateral pressures. Seismically-induced forces may be larger than the code-specified lateral wind pressures and, as a result, govern the design in seismically active areas. For areas that may have both wind and seismic activity, the careful evaluation of which forces may govern the design is an important step in the design process. Therefore, the design of these elements and their connections to the main structure are essential to a complete design – one in which both structural and non-structural elements are considered.

Earthquake requirements considered in the design of a safe room can enhance the lateral resistance of the structure to wind loads. For example, seismic loads tend to govern the designs of “heavy” structures constructed with concrete or masonry walls and concrete slab or roofs. In “lighter” structures constructed from framing and light structural systems supporting lightweight (metal or wood) roof systems, wind loads tend to govern. But even if wind loads govern, consideration should be given to the calculated seismic loads to allow the structure to deform without immediate failure. This ability gives the structure reserve capacity that can be useful in extreme-wind events.

Earthquake requirements will also govern the design of all interior non-structural building components, fixtures, and equipment. For exterior-mounted equipment, both seismic and wind loads must be considered, as either may govern the design of the exterior component.

4.5 Other Hazards

It is important that the designer consider other hazards at the building site, in addition to the wind, flood, and seismic hazards already mentioned. One such consideration is the location of a safe room on a building site with possible physical hazards (e.g., other building collapses or heavy falling debris). These siting and location issues are discussed in Chapter 5.

Another consideration is the presence of a hazardous material (HAZMAT) on a site. Older buildings that are retrofitted for safe room use should be inspected for hazardous materials that may be stored near the safe room (e.g., gasoline, chlorine, or other chemicals) or that may have been used in the construction of the surrounding building (e.g., lead paint or asbestos). For example, asbestos may become airborne if portions of the surrounding building are damaged, resulting in the chemical contamination of breathable air. Live power lines, fire, and gas leaks are also safe room design concerns that may need to be addressed at some safe room sites. For example, the case study in Appendix D (Sheet P-1) shows how a gas line, required for gas service to the safe room area when in normal daily use, was fitted with an automatic shutoff valve. This precaution greatly reduces the risk of a gas-induced fire occurring while the safe room is occupied.

4.6 Fire Protection and Life Safety

The safe room should comply with the fire protection and life-safety requirements of the model building code, the state code, or the local code governing construction in the jurisdiction where the safe room is constructed. For single-use extreme-wind safe rooms, the model building codes, life-safety codes, and engineering standards do not indicate square footage requirements or occupancy classifications. For multi-use extreme-wind safe rooms, the codes and standards address occupancy classifications and square footage requirements for the normal use of the safe room. The designer is advised to comply with all fire and life-safety code requirements for the safe room occupant load and not the normal use load; the safe room occupancy load is typically the controlling occupancy load. Chapter 3 presented the recommended square footage requirements for tornado and hurricane safe rooms.

Guidance and requirements concerning fire protection systems may be found in the model building codes and the life-safety codes. Depending on the occupancy classification of the safe room (in normal use), automatic sprinkler systems may or may not be required. For many safe rooms, an automatic sprinkler system will not be required. However, when automatic sprinkler systems are not required and fire extinguishers are used, all extinguishers should be mounted on the surface of the safe room wall. In no case should a fire extinguisher cabinet or enclosure be recessed into the interior face of the exterior wall of the safe room. This requirement is necessary to ensure that the integrity of the safe room walls is not compromised by the installation of fire extinguishers. Finally, any fire suppression system specified for use within safe rooms should be appropriate for use in an enclosed environment with human occupancy. If a fire occurs during a tornado or hurricane, it may not be possible for occupants of the safe room to ventilate the building immediately after the discharge of the fire suppression system.

5 Types, Locations, and Siting of Safe Rooms

A community safe room will either be used solely for sheltering or will have multiple purposes, uses, or occupancies. This chapter discusses community safe room design concepts that relate to the type and location of safe rooms. How safe room uses (either single or multiple¹) may affect the type of safe room selected and its location is also discussed.

5.1 Safe Room Types

This publication provides design guidance on two types of safe rooms:

- Stand-alone safe rooms
- Internal safe rooms: shelter areas that are located inside, or are part of a larger building, but have been designed to be structurally independent

This is not meant to imply that these are the only two types of safe rooms that should be considered. Other safe room options, such as groups of smaller, often proprietary shelter systems, may be appropriate for residential communities, hospitals, schools, or at places of business. It is not possible to provide guidance concerning all sheltering options for all locations. The guidance provided in this publication for stand-alone and internal safe rooms, including the design criteria, may be applied to other safe room options. If other shelter systems and types of safe rooms are designed to meet the criteria in this publication, they should be capable of providing near-absolute protection as well.

The guidance provided in this publication is intended for the design and construction of new safe rooms, as well as for the addition of safe rooms to existing buildings by hardening the existing room (i.e.,



NOTE

This publication provides guidance for the design and construction of new safe rooms. The design professional performing retrofit work on existing buildings should apply the new design guidance presented in this publication to the retrofit design.

¹ FEMA HMA Safe Room Policy MRR-2-07-1 uses slightly different terminology for multi-use safe rooms. The policy document refers to multi-use safe rooms as “dual use” safe rooms. Although the terminology is different, the intent is that the safe rooms are of the same type; that is, safe rooms that have a primary use other than being used as a safe room. Contact your FEMA regional office for the latest FEMA policy on safe rooms.

retrofitting). The variety of structural systems and the number of different configurations of existing buildings preclude a comprehensive look at various retrofit options, so that only a limited extent of guidance is provided on modifying existing buildings to create a safe room where none existed previously. However, a design professional engaged in a safe room retrofitting project should be able to use the guidance in this publication to identify the appropriate hazards at the site, determine the risk, and calculate the loads acting on the building that is the subject of the safe room retrofit. Additionally, the checklists in Appendix B and information presented in the case studies in Appendices C and D may be helpful in a safe room retrofitting project.

5.1.1 Stand-Alone Safe Rooms

The results of the risk and site assessments discussed in Chapter 2 may show that the best solution to providing protection for large numbers of people is to build a new, separate (i.e., stand-alone) building specifically designed and constructed to serve as a tornado or hurricane safe room.

Potential advantages of a stand-alone safe room include the following:

- The safe room may be located away from potential debris hazards.
- The safe room will be structurally separate from any building and therefore not vulnerable to being weakened if part of an adjacent structure collapses.
- The safe room does not need to be integrated into an existing building design.
- The size of the safe room may be determined according to the needs rather than be limited by available space in the existing building.

Case Study I (see Appendix C) shows the calculated wind loads for a safe room design as a combined hazard safe room and the manner in which the design criteria were met for a stand-alone safe room for both tornado and hurricane hazards. According to Figure 3-1, the safe room was located in an area with a 200-mph safe room design wind speed for the tornado hazard. By comparison, Figure 3-2 shows the range of hurricane speeds for the state of North Carolina as having a highest mapped design wind speed of 190 mph. As the tornado design wind speed is greater, this safe room would be designed to that wind speed to fulfill the requirements of a combined hazard safe room. This safe room was designed to serve communities in North Carolina that housed families displaced by flooding caused by Hurricane Floyd.

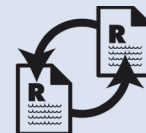

CROSS-REFERENCE

Site Assessment Checklists are discussed in Chapter 2 and presented in Appendix B. A risk assessment plan that uses these checklists can help determine which type of safe room is best suited to a given site.

5.1.2 Internal Safe Rooms

The results of the risk analysis presented in Chapter 2 may show that a specifically designed and constructed safe room area within or connected to a building is a more attractive alternative than a stand-alone safe room, especially when the safe room is to be used mainly by the occupants of the building. Potential advantages of an internal safe room include the following:

- A safe room that is partially shielded by the surrounding building may not experience the full force of the tornado or hurricane wind. (Note, however, that any protection provided by the surrounding building cannot be considered in the determination of wind loads and debris impact for safe room design.)
- A safe room designed to be within a new building may be located in an area of the building that the building occupants can reach quickly, easily, and without having to go outside during the storm.
- Incorporating the safe room into a planned renovation or building project may reduce the safe room cost.

Case Study II (see Appendix D) shows the calculated wind loads for a safe room located in an area with a 250-mph design wind speed for the tornado hazard according to Figure 3-1 and the manner in which the design requirements were met for a safe room connected to an existing building. This safe room was designed for a school in Wichita, Kansas, and replaced a portion of the school building that was damaged by the tornadoes of May 3, 1999. There is a risk of building debris collapsing on a safe room that has been constructed within another building. When this risk is properly considered by the design professional, a community safe room constructed within a building is an acceptable application of the safe room concept.

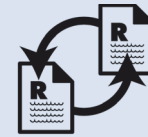

ICC-500 CROSS-REFERENCE

The ICC-500 does not explicitly address the use or application of shelters as stand-alone or internal shelters. Section 309 of the ICC-500, Shelters Enclosed or Partially Enclosed in a Host Building, provides specific design criteria for shelters that are connected to existing structures or new structures surrounding the shelter to specify the interaction between the two structures (the shelter and the non-shelter). FEMA 361 recommends that the structural and non-structural connections between internal safe rooms and the buildings surrounding them comply with Section 309 of the ICC-500.

5.2 Single-Use and Multi-Use Safe Rooms

A stand-alone (internal or external) safe room may be used for sheltering only, or it may have multiple uses. For example, a multi-use safe room at a school could also function as a classroom, a lunchroom, a laboratory, or an assembly room; a multi-use safe room intended to serve a manufactured housing community or single-family-home subdivision could also function

as a community center. The decision to design and construct a single-use or a multi-use safe room will likely be made by the prospective client or the owner of the safe room. To help the designer respond to non-engineering and non-architectural needs of property owners, this section discusses how safe room use may affect the type of safe room selected.

5.2.1 Single-Use Safe Rooms

Single-use safe rooms are, as the name implies, used only in the event of a natural hazard event. One advantage of single-use safe rooms is a potentially simplified design that may be readily accepted by a local building official or fire marshal. Single-use safe rooms typically have simplified electrical and mechanical systems because they are not required to accommodate the normal daily needs of occupants. Single-use safe rooms are always ready for occupants and will not be cluttered with furnishings and storage items, which is a concern with multi-use safe rooms. Simplified, single-use safe rooms may have a lower total cost of construction than multi-use safe rooms. Examples of single-use safe rooms were observed during the BPAT investigation of the May 3, 1999, tornadoes, primarily in residential communities (FEMA 1999a). Small, single-use safe rooms were used in residential areas with a shelter-to-house ratio of 1:1 or ratios of up to 1:4. One example of a large, single-use community safe room was observed in a manufactured housing park in Wichita, Kansas. Since then many more community safe rooms have been designed according to the design requirements presented in this publication.

The advantage of ready availability of a single-use safe room in an emergency may easily turn to a disadvantage if a proper operations and maintenance plan is not followed diligently. In the absence of regular usage, the safe room may soon acquire other unintended functions (e.g., for temporary storage or similar uses) that could seriously impede its primary function. This issue can be addressed by the Safe Room Operations and Maintenance Plans.

The cost of building a single-use safe room may be the same as the cost of designing and constructing a multi-use safe room, or possibly lower due to the simplicity of the design requirements for a single function. However, the safe room project may result in the perception that a single-use safe room has a much higher cost than a multi-use facility because no other benefit is being provided with the construction of a new building. This perception may also be related to the fact that the operations and maintenance plans for multi-use facilities can be incorporated into operations and maintenance plans for the multi-use structure (for a small

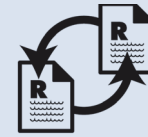

ICC-500 CROSS-REFERENCE

This section of FEMA 361 and Section 104 of the ICC-500 provide the same design criteria for single-use and multi-use safe rooms with respect to occupancy requirements of the IBC and IRC. For single-use community safe rooms, the occupancy type should be A-3 (assembly). For multi-use safe rooms, the occupancy type should be that of the primary use of the protected space when not in use as a safe room.

increase in overall plan costs), while in the case of single-use safe rooms, the costs of these plans would not be incurred if the safe room itself did not exist.

5.2.2 Multi-Use Safe Rooms

The ability to use a safe room for more than one purpose often makes a multi-use stand-alone or internal safe room appealing to a shelter owner or operator. Multi-use safe rooms also allow immediate return on investment for owners/operators; the safe room space is used for daily business when the safe room is not being used during a tornado or hurricane. Hospitals, assisted living facilities, and special needs centers are examples of building uses that may benefit from constructing multi-use, internal safe rooms. For these facilities, constructing multi-use safe rooms in building areas such as intensive care units or surgical suites, from which the occupants cannot be evacuated rapidly, is an example of a multi-use application that provides immediate return on investment for the safe room space. But, in addition to these safe room spaces, the hospitals may also need additional community safe rooms for staff, patients, and visitors who may not be allowed into these specially controlled facilities. Internal multi-use safe rooms in these types of facilities allow optimization of space while providing near-absolute protection with easy access for non-ambulatory persons.

It is important to note that multi-use safe rooms frequently require permanent fixtures and furnishings that reduce the effective area for safe room usage. Auditoriums, laboratories, and libraries have such fixtures or furniture that reduce the available safe room area and therefore the maximum safe room population that can be protected in that space. Sections 3.3.1 and 3.4.1 (Part n in both sections) provide criteria for calculating usable square footage for safe room areas.

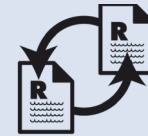

CROSS-REFERENCE

Sections 3.3.1 and 3.4.1 (Part n in both sections) provide criteria for calculating usable square footage for safe room areas. Auditoriums, laboratories, and libraries have permanent fixtures or furniture that reduce the available safe room area and must be accounted for when determining the maximum safe room population.

Recent FEMA-sponsored projects have evaluated the construction cost of hardening a small area or room during the design and construction of a new building. The FEMA projects indicate that, although the cost to construct this portion of a building may be 25 to 50 percent higher than the construction cost for a non-hardened version of the same area or room, the entire impact to the total project cost is often less than 5 to 10 percent of the entire building construction project.

The MAT investigations of the May 3, 1999, tornadoes, as well as investigations conducted after numerous hurricanes in the 1990s, found many examples of multi-use areas designed or retrofitted for use as safe rooms. They include multi-use safe rooms constructed as:

- Cafeterias, classrooms, hallways, music rooms, and laboratories in school buildings

- Cafeterias/lunchrooms, hallways, and bathrooms (see Figure 5-1) in public and private buildings
- Lunchrooms, hallways, and surgical suites in hospitals

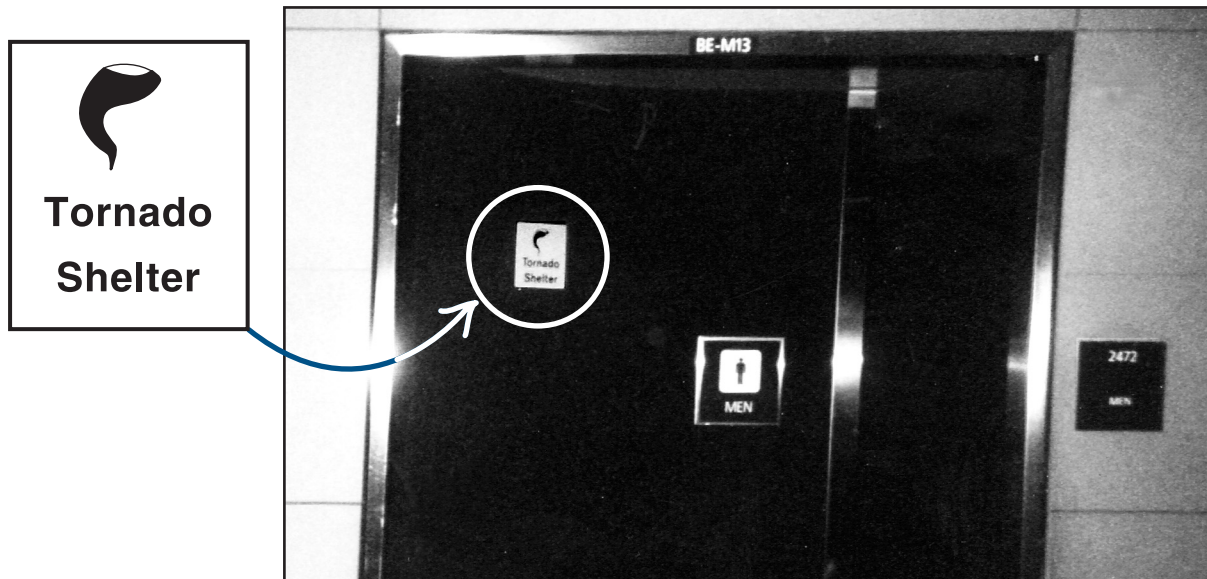

Figure 5-1. The Denver International Airport (a public-use facility) evaluated the tornado risk at the airport site and identified the best available areas of refuge. Signs were placed at these areas to clearly identify the refuge areas to the public.

5.3 Modifying and Retrofitting Existing Spaces

If a tornado or hurricane safe room is designed and constructed to the criteria presented in this publication, it will provide its occupants with near-absolute protection during an extreme-wind event. However, it may be difficult to meet the structural and envelope design criteria of this publication in a cost-effective manner when modifying an existing building. A retrofit project that modifies a space in a building for safe room use but that does not meet the design criteria of Chapter 3 will improve the ability of the space to function as a shelter or refuge area from extreme-wind events, but it cannot be relied upon to provide near-absolute protection as defined by FEMA 361.

5.3.1 General Retrofitting Issues

Although retrofitting existing buildings to include a safe room can be expensive and disruptive to users of that space, it frequently is the only available option. When retrofitting an existing space within a building is considered, corridors are often designated as the safest areas because of their short roof spans and the obstruction-free areas they provide. Recent safe room evaluation projects, however, have indicated that, although hallways may provide the best refuge in an existing building, retrofitting hallways to provide a near-absolute level of protection may be

extremely difficult. Hallways usually have a large number of doors that would need to be upgraded or replaced before near-absolute protection can be achieved based on the criteria outlined in Sections 3.3.2 or 3.4.2 for tornadoes and hurricanes, respectively. Designers should be aware that an area of a building usually used for refuge may not necessarily be the best candidate for retrofitting when the goal is to provide near-absolute protection.

Examples of interior spaces within buildings designed or retrofitted as safe rooms for life-safety protection from tornadoes and hurricanes were listed in Section 5.2.2; additional examples include interior offices, workrooms, and lounges. Guidelines for building vulnerability assessments that can help in the selection of the best available space for a safe room are discussed in Chapter 2. The design modifications that might be required should follow the recommendations of this publication for new construction (see Appendices E and F for examples of wall sections, doors, and door hardware that are capable of withstanding the impact of a 15-lb design missile at 100 mph – the most restrictive debris impact requirement for the tornado and hurricane hazards).

Upgrades to improve levels of protection to create refuge areas in rooms, hallways, and other spaces (until a safe room can be designed and constructed) may include the following retrofits:

- Replacing existing doors (and door hardware) vulnerable to failures from wind pressures or missile impacts with metal door systems meeting the criteria described in Chapters 3 and 7
- Removing all glazing or wall sections vulnerable to failure from wind pressures or missile impacts and replacing with wall sections that meet impact criteria defined in Chapters 3 and 7
- Protecting glazing, doors, or openings with metal doors, shutter systems, or impact-resistant glazing systems, meeting the criteria described in Chapters 3 and 7 to replace glazing that is vulnerable to failure from wind pressures or missile impacts
- Adding alcoves and walls to protect existing doors from the direct impact of windborne debris, as described in Chapters 3 and 7

5.3.2 Specific Retrofitting Issues

An existing area that has been retrofitted to serve as a shelter or refuge area is unlikely to provide the same level of protection as a safe room designed according to the criteria presented in this publication. MAT investigations and FEMA-funded building science investigative projects have indicated that, when existing space is retrofitted for safe room use, issues have arisen that have challenged both designers and shelter operators. These issues occur when attempts are made to improve the level of protection in areas not originally designed for use as safe

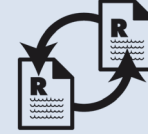

CROSS-REFERENCE

The checklists in Appendix B may be used to identify refuge areas as candidates for retrofit projects.

rooms or refuge areas. Frequently, this cannot be accomplished within the constraints of the project scope or budget. Additional problems may arise when retrofit projects call for improving the levels of protection by implementing specific mitigation measures that address only a specific set of building vulnerabilities without consideration for other potential vulnerabilities of the designated space. For example, before retrofitting doors, windows, and other openings to meet the missile impact criteria identified in Chapter 3 (using Chapter 8 of the ICC-500), the structural characteristics of the area being retrofitted should be carefully analyzed.

Most structural and wall systems of existing buildings will not be able to resist the wind forces and debris associated with the safe room design wind speed. If this is the case, retrofitting windows and doors without improving the structural system is not recommended for life-safety protection.

Issues related to the retrofitting of existing refuge areas (e.g., hallways/corridors, bathrooms, workrooms, laboratory areas, kitchens, and mechanical rooms) that should be considered include the following:

- **The roof system (roof deck and structural supporting members).** Are the roof deck and structural supporting members over the proposed refuge area structurally independent of the remainder of the building? If not, is it possible to strengthen the existing roof to resist the expected wind and debris loads? Can the openings in the roof system for mechanical equipment or lighting be protected during an extreme-wind event? It may not be reasonable to retrofit the rest of the proposed safe room if the roof system is part of a building-wide system that was not designed for ultimate-wind load requirements.
- **The wall system.** Can the wall systems be accessed so that they can be retrofitted for improved resistance to wind pressure and missile impact? It may not be reasonable to retrofit a proposed safe room area to protect the roof or the openings if the wall systems



NOTE

It is difficult to retrofit an existing area of a building to serve as a shelter or refuge area and meet the level of protection of a safe room designed according to the guidance presented in this publication. Designers of safe rooms should also consider comparing costs for a new, multi-purpose room with the costs for retrofitting an existing space for safe room use. However, limited space at the proposed safe room site or other constraints may make retrofitting a practical alternative in some situations.

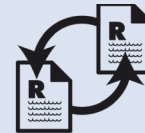

CROSS-REFERENCE

Design criteria for safe room envelope systems are provided in Chapters 3, 6, and 7. Examples of wall and door systems that have passed missile impact tests are presented in Appendixes E and F, respectively.

(load-bearing or non-load-bearing) cannot withstand wind pressures or cannot be retrofitted in a reasonable manner to withstand wind pressures and missile impacts.

- **Openings.** Windows and doors are extremely vulnerable to wind pressures and debris impact. Shutter systems and doors rated to meet FEMA 320 and 361 debris impact criteria may be used as shutters over windows for tornado protection. There is often only minimal warning time before a tornado; therefore, a shelter design that relies on manually installed shutters is impractical. Automated shutter systems may be considered, but they would require a protected backup power system to ensure that the shutters are closed before an event. Doors should be constructed of impact-resistant materials (e.g., steel) and secured with six points of connection (typically three hinges and three latching mechanisms); regardless of the number of hinges and latches, all doors should be tested to meet the debris impact testing requirements of ICC-500, Chapter 8. Door frames should be constructed of at least 16-gauge metal and adequately secured to the walls to prevent the complete failure of the door/frame assemblies.
- **The existing functions and conditions in the refuge area.** For example, bathrooms have been used as refuge areas during tornadoes and hurricanes since they often have minimal numbers of openings to protect. However, emergency managers may find it difficult to persuade people to sit on the floor of a bathroom when the sanitary condition of the floor cannot be guaranteed. Also, mechanical rooms that are noisy and may contain hot or dangerous machinery should be avoided as refuge areas whenever possible. The permanent fixtures and furnishings in a proposed safe room area (e.g., permanent tables, cabinets, sinks, and large furniture) occupy some of the available space within the safe room, and may make the safe room uncomfortable for its occupants, or may pose a hazard to the occupants. These types of safe room areas should be used only when a better option is not available.

5.4 Community Safe Rooms for Neighborhoods

Community safe rooms intended to provide protection in the residential neighborhoods require designers to focus on a number of issues in addition to structural design. These include ownership, rules for admission, pets, parking, ensuring user access while preventing unauthorized use, and liability issues. All of the structural, envelope, and additional issues are typically collected into a set of criteria called a “design program” that should be provided to designers by safe room owners to govern the safe room design process. In addition to being identified in the safe room design program, these issues should also be addressed by the Safe Room Operations Plan. It is therefore of utmost importance that the development of a design program and the Safe Room Operations Plan be coordinated from the very beginning of the planning and design process. FEMA post-disaster investigations have revealed many issues that need to be addressed in the planning of such community safe rooms. Many of these issues are addressed in the sample Safe Room Operations Plans in Chapter 9 and Appendix C for community safe rooms. The following are additional considerations:

- **Access and entry.** Confusion has occurred during past tornado events when residents evacuated their homes to go to a community shelter, but could not get in. During the

Midwest tornadoes of May 3, 1999, residents in a Wichita community went to their assigned shelter only to find it locked. Eventually, the shelter was opened prior to the event, but had there been less warning time for the residents, loss of life could have occurred. The Safe Room Operations Plan should clearly state who is to open the safe room and should identify the backup personnel necessary to respond during every possible emergency.

- **Signage.** Signage is critical for users to be able to readily find and enter the safe room, especially when a safe room is located inside a larger building. In addition to directing users to the safe room, signs can also identify the area the safe room is intended to serve. Confusion about who may use the safe room could result in overcrowding, or worse, people being turned away from the safe room. Signs can also inform the residents of the neighborhood served by the safe room about the occupancy limitations during any given event. Examples of tornado safe room signage are presented in Chapter 9 and the North Carolina safe room case study in Appendix C. It should be noted, however, that signage is the tool of last resort to direct safe room occupants. Potential users in the neighborhood should be informed well in advance of the community's emergency plans and should be prepared to seek refuge in their pre-assigned safe room or best-available refuge space. Communities and neighborhoods that operate community safe rooms are encouraged to conduct regular exercises in order to test their operational preparedness.

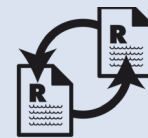

ICC-500 CROSS-REFERENCE

The ICC-500 addresses signage requirements for community shelters in Section 108. The guidance for signage provided here and in Chapter 9 is meant to meet or exceed the criteria specified in the ICC-500.

- **Warning signals.** It is extremely important that safe room users know the warning signal that calls for them to proceed to the safe room. The owners/operators of safe rooms should conduct public information efforts (e.g., mass mailings, meetings, flyer distribution, and actual exercises) to help ensure that the residents of the neighborhood served by the safe room know the meaning of any warning signals to be used.
- **Parking.** Parking at community safe rooms can be a problem if neighborhood residents, who are expected to walk, drive to the safe room instead. Residents returning home from work may drive directly to the safe room. Parking problems can adversely affect access, thereby preventing occupants from getting to the safe room before a tornado or hurricane strikes. The sample Safe Room Operations Plan in Appendix C discusses approaches to addressing parking limitations.
- **Pets.** Many people do not want to leave their pets during a storm. However, tornado and hurricane safe rooms are typically not prepared to accommodate pets. The policy regarding pets in a community safe room should be clearly stated in the Safe Room

Operations Plan by the AHJ and posted to avoid misunderstandings and hostility when residents arrive at the safe room. There are many different types of pets that people may want protected with a safe room, including cats, dogs, snakes and other reptiles, ferrets, horses, birds, etc. The requirements for their care can be very different, such as separation distances, food, cleaning, and space. If a safe room owner, operator, or AHJ chooses to provide protected space for pets, operational plans should be developed and coordinated with designers so they can address these needs (e.g., readily cleanable animal areas having drainage and materials capable of being washed down, areas for quarantining animals that may be sick, etc.).

- **Maximum recommended occupancy.** In determining the maximum recommended number of people who will use the safe room, the design professional should assume that the safe room will be used at the time of day when the maximum number of occupants is expected. A community may also wish to consider increasing the maximum recommended occupancy to accommodate additional occupants such as visitors to the community who may be looking for a refuge during a wind event. However, any safe room owner, operator, or designer should request from the FEMA regional office the most current safe room policy addressing the safe room population issue, since that may be different from safe room design requirements in this publication. Regardless of the means by which the appropriate safe room population has been identified, the maximum recommended occupancy should be posted within the safe room area.

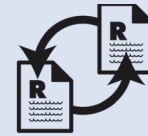

ICC-500 CROSS-REFERENCE

Sample community Safe Room Operations Plans are presented in Chapter 9 and the case study in Appendix C.

5.5 Community Safe Rooms at Public Facilities

Community safe rooms at public facilities also require designers to focus on issues other than structural design requirements for extreme winds. Similar to the process of planning and design of neighborhood community safe rooms, these issues should also be addressed in a design program for public safe rooms and in the Safe Room Operations Plan. It is of utmost importance that the development of the design program and the Safe Room Operations Plan be coordinated from the very beginning of the planning and design process. Some issues that have arisen from post-disaster investigations include:

- **Protecting additional areas.** If the safe room is at a special needs facility such as a nursing home or hospital, additional areas within the facility may need to be protected. These include medical and pharmaceutical supply storage areas and intensive/critical care areas that house non-ambulatory patients. A safe room should address the needs of all of its users.

- **Signage.** Signage is critical for users of public facilities to be able to readily find and enter the safe room. However, signage can be confusing. For example, tornado safe rooms in schools in the Midwest are often designed for use only by the school population, but aggressive signage on the outside of the school may cause surrounding residents to assume that they may use the safe room as well. This may cause overcrowding, or worse, people being turned away. Similar problems may occur at hospitals, where the public may seek refuge from a tornado or hurricane. The owners/operators of safe rooms in public-use facilities such as these should inform all users of the facility about the occupancy limitations of the safe room during any given event. The potential safe room occupants in the facility should be informed well in advance of the community's emergency plans and should be prepared to seek refuge in their pre-assigned safe room or best-available shelter space. Examples of tornado safe room signage may be found in Chapter 9 and the North Carolina safe room case study in Appendix C. Without performing this critical coordination, the shelter will not function as well as it could and it may be expensive to modify years after the initial construction if use requirements change.
- **Warning signals.** It is extremely important that safe room users know the warning signal that calls for them to proceed to the safe room. In schools, work places, and hospitals, storm refuge drills and fire drills should be conducted to ensure that all persons know when to seek refuge in the safe room and when to evacuate the building during a fire or other hazard.
- **Pets.** Many people do not want to leave their pets during a wind storm. The same problem was identified for the community safe rooms in neighborhoods. Tornado and hurricane safe rooms are typically not prepared to accommodate pets. The policy regarding pets in a public facility safe room should be clearly stated in the Safe Room Operations Plan and posted to avoid misunderstandings and hostility when residents arrive at the safe room.
- **Off-hours safe room expectations.** It is important for safe room owners and operators to clearly indicate to the potential safe room users when the facility will be open. For example, will the safe room at a school be accessible after the regular school hours? At places of business, will the safe room be accessible after normal work hours? At hospitals, can employees bring their families to the hospital safe room? These types of questions should be anticipated in the design and operational planning for a community safe room.

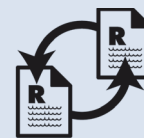

ICC-500 CROSS-REFERENCE

Additional human factors criteria are presented in Chapter 8. In addition, sample community Safe Room Operations Plans are presented in Chapter 9 and Appendix C.

5.6 Safe Room Site Selection

Safe rooms by their very function are exceptionally site-specific facilities (i.e., their effectiveness is dependent on their location). Safe rooms must be located in the closest proximity to their potential users – the population at risk from extreme-wind hazards. In addition to the functional factors, the location of the safe room is determined by other considerations, such as safety, accessibility, and a whole series of environmental factors. This section examines the most important factors that determine the location of the safe room.

5.6.1 Site Function and Use Considerations

Community safe rooms may be designed and constructed to serve a single property or facility, such as a school or hospital campus or a manufactured housing park, or as true community oriented public facilities, to serve multiple properties such as a neighborhood.

The site selection criteria that pertain to the functionality of a safe room are closely associated with the risk assessment criteria mentioned in Chapter 2. They include among others, the size and the geographic distribution of the population at risk and the relative vulnerability of that population both with respect to the physical vulnerability of the buildings they normally occupy and to their own ability to reach the safe room in a timely manner during an emergency. Examples for the latter include public facilities like hospitals, assisted living facilities, and special needs centers, as well as schools and child care centers that house large populations that may not be able to reach a remote safe room quickly enough. That is why such facilities are commonly served by safe rooms that are inside the facility or are attached to it, which minimizes the evacuation problems. When the physical vulnerability of the buildings is considered, residents of manufactured housing parks must be regarded as highly vulnerable because of the frequent failures of these structures during wind storms. Neighborhoods with predominantly older homes, either wood-frame or unreinforced masonry, are also extremely vulnerable to extreme winds.

5.6.2 Site Safety and Accessibility Considerations

The safety of the site is evaluated on the basis of its exposure to any kind of hazard. Sites exposed to flooding are not suitable for safe rooms, not only because of the dangers flooding may pose for the occupants, but also because flooding can isolate the facility and its occupants, or make it inaccessible in an emergency. Other hazards that must be considered are seismic hazards, landslides, and fires (especially the exposure of the site to wildfire hazards).

The accessibility of the site is directly related to safe room service area and the proximity of the potential users. All safe room owners, operators, or designers should request from the FEMA regional office the most current safe room policy addressing the safe room population issue, to verify the most up-to-date safe room requirements regarding the maximum travel time/distance allowed. The potential users should be able to reach the safe room within the required time period using a designated pedestrian pathway. This pathway should not have restrictions or obstructions such as multi-lane highways, railroad tracks, bridges, or similar facilities and topographic features.

5.6.3 Other Criteria to Consider

Environmental and historic preservation, economic, zoning, and other administrative factors may also play an important part in site selection and should be considered from the very start of the process.

5.7 Locating Safe Rooms on Building Sites

The location of a safe room on a building site is an important part of the design process for any safe room. The safe room should be located such that all persons designated to take refuge may reach the safe room with minimal travel time; this is of particular importance for tornado safe rooms. Safe rooms located at one end of a building or one end of a community, office complex, or school may be difficult for some users at a site to reach in a timely fashion. Routes to the safe room should be easily accessible and well marked.

Safe rooms should be located outside areas known to be flood-prone, including areas within the 500-year floodplain and susceptible to storm surge inundation as defined in Chapter 3. Safe rooms in flood-prone areas will be susceptible to damage from hydrostatic and hydrodynamic forces associated with rising floodwaters. Damage may also be caused by debris floating in the water. Most importantly, flooding of occupied safe rooms may well result in injuries or deaths. Furthermore, safe rooms located in Special Flood Hazard Areas (SFHAs), with flood depths of 3 feet and higher or within the 500-year floodplain may become isolated if access routes are flooded. As a result, emergency services would not be available if some safe room occupants are injured.



WARNING

Safe rooms should be located outside known flood-prone areas, including the 500-year floodplain, and away from any potential large debris sources.

When possible, the safe room should be located away from large objects and multi-story buildings. Light towers, antennas, satellite dishes, and roof-mounted mechanical equipment could topple or become airborne during tornadoes or hurricanes. Multi-story buildings adjacent to a safe room could be damaged or could fail structurally during tornadoes and hurricanes and may damage the safe room by collapsing onto it or exposing it to large debris impact. The impact forces associated with these objects are well outside the design parameters of any building code. Only limited debris impact testing was performed in the preparation of this publication and is discussed in Chapter 7.

Examples of improper and proper locations of tornado or hurricane safe rooms on residential sites are presented in Figures 5-2 and 5-3. Figure 5-2 is an example of a community that has several residential and community safe rooms. The figure shows which safe rooms are properly sited with respect to the mapped flood hazards. Figure 5-3 shows a series of building section details illustrating elevation criteria for the different safe rooms as a function of their location in different areas of flood risk.

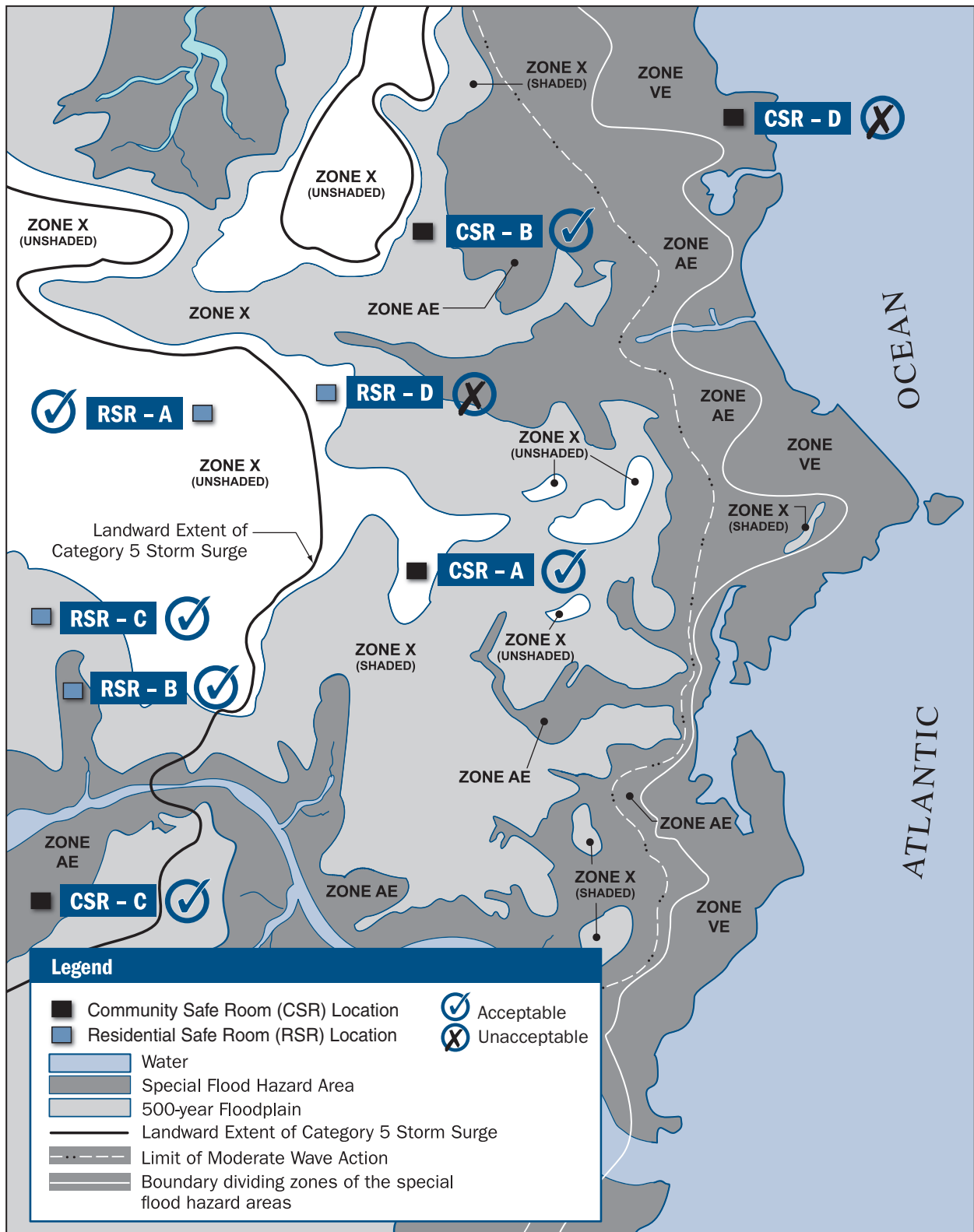

Figure 5-2. Illustration of properly and improperly sited community and residential safe rooms in a coastal environment.

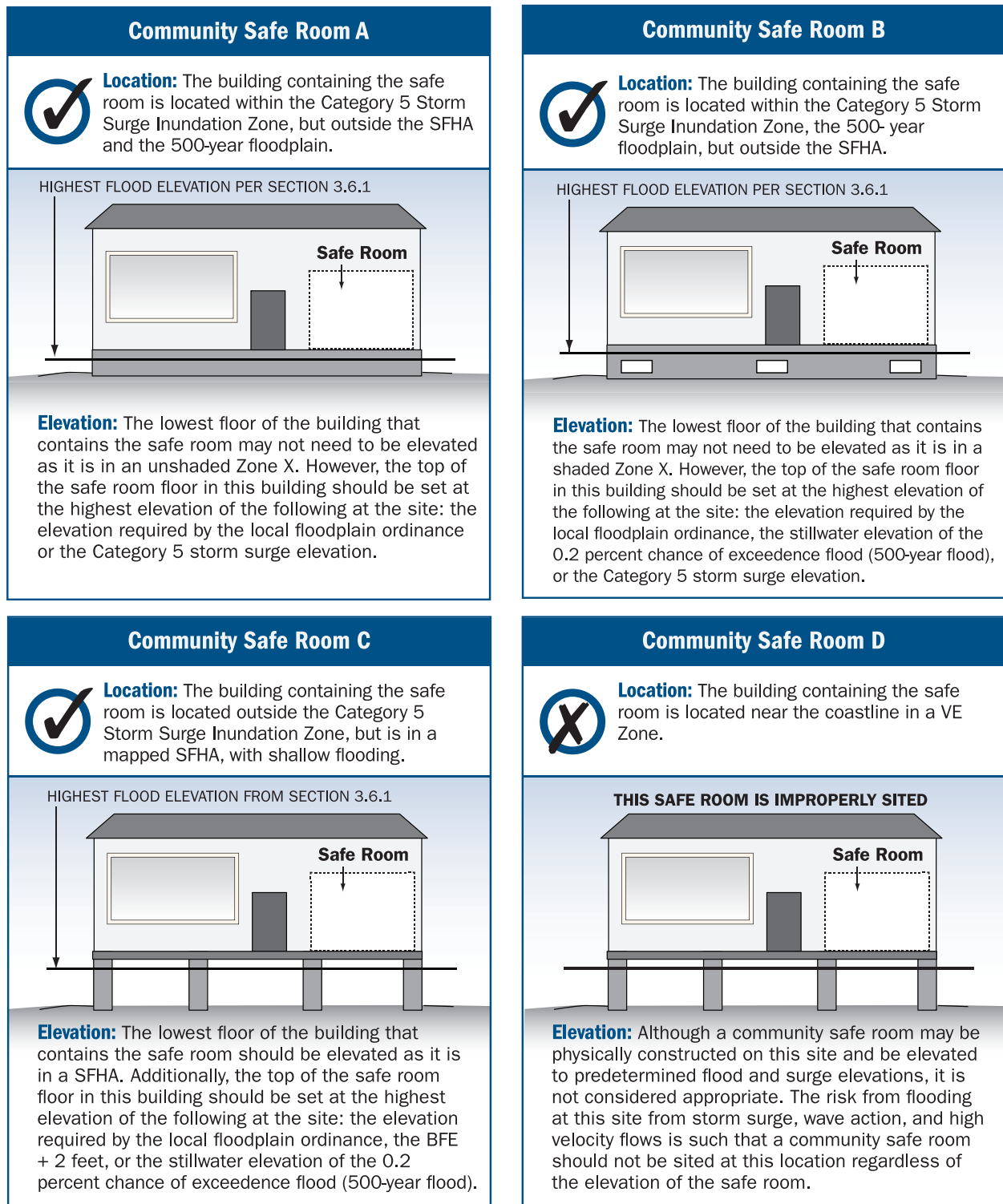
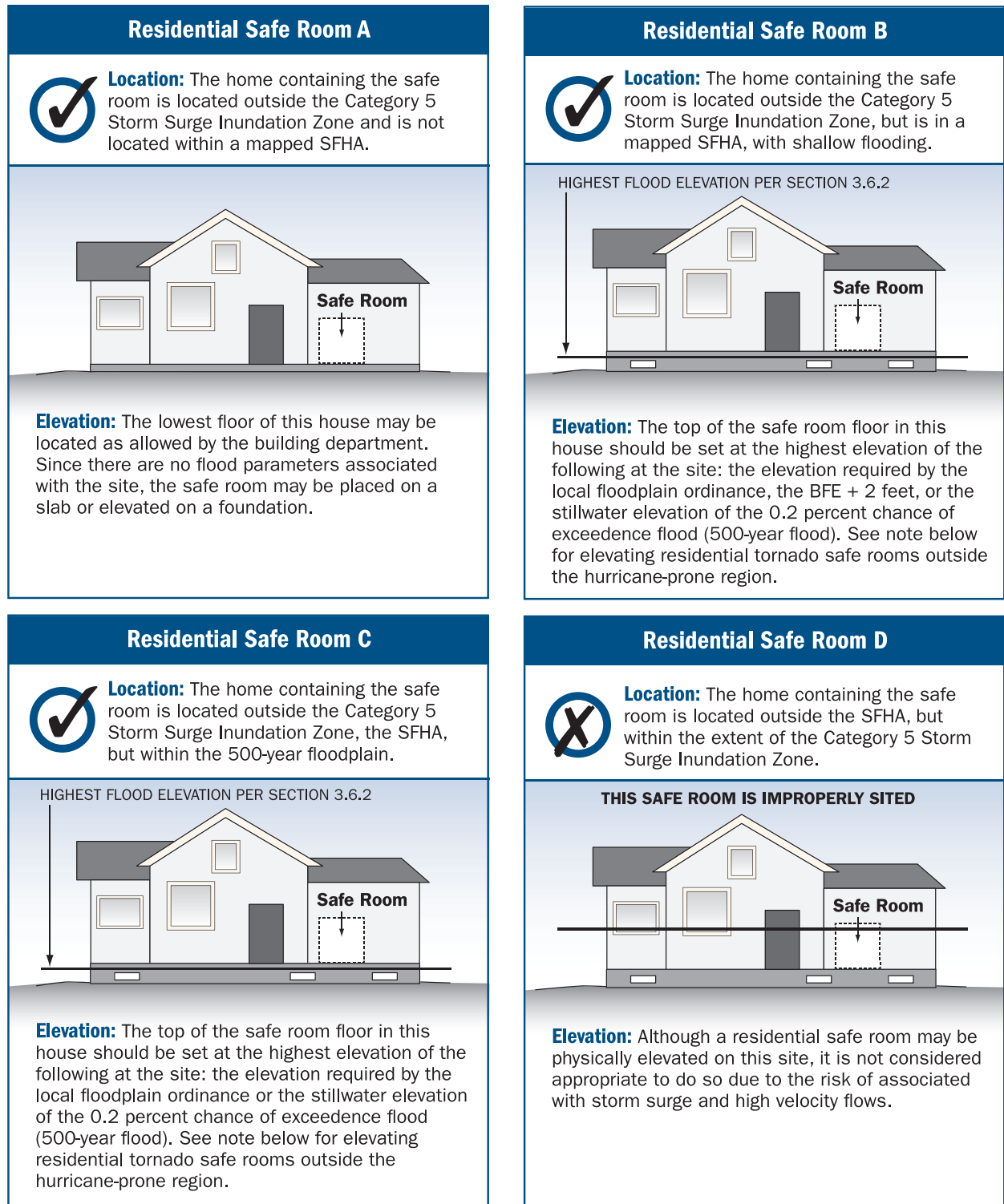

Figure 5-3a. Elevation details for sample community safe rooms presented in Figure 5-2.



Note: When a residential tornado safe room is located outside the hurricane-prone region identified on Figure 3-2, the top of the safe room floor need only be elevated to the lowest floor elevation identified by the floodplain ordinance of the community for that location. See Section 3.6.2 for additional information.

Figure 5-3b. Elevation details for sample residential safe rooms presented in Figure 5-2.

6 Commentary on Load Determination and Structural Design Criteria

This chapter provides a discussion of the technical and design criteria information presented in Chapter 3. The intent of this chapter is to present commentary and background information on the “how and why” of the design criteria, including where appropriate, the discussion of how the criteria presented in this publication differ from the new ICC-500 Storm Shelter Standard. Commentary related to performance criteria for debris impact is presented in Chapter 7. The design criteria presented in this chapter are based on the best information available at the time this document was published.

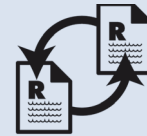

CROSS-REFERENCE

See Chapter 10 for a list of the FEMA publications and other reference documents cited here.

6.1 Commentary on the General Approach

Considerable and significant development of safe room design criteria and standards has taken place since the original FEMA 361 was first published in July 2000. Several extreme-wind events have tested buildings specifically designed and used as safe rooms. This has provided an opportunity to assess the performance of these buildings in extreme events and evaluate the criteria and standards used in their design. Additionally, testing laboratories and universities have been evaluating the acceptability of building envelope components such as wall and roof assemblies, window and door units, and glazing systems for both wind pressure and debris impact resistance design criteria. Since FEMA 361 first appeared, storm shelters have become a manufactured commodity with installations occurring in many markets, especially those where tornadoes are a frequent threat. All of this has considerably extended our knowledge and experience in safe room design.

Much of this knowledge has found expression in new building codes and standards, especially the ICC-500 storm shelter standard. However, following the design requirements of the ICC-500, the IBC, the IRC, or ASCE 7-05 alone might not satisfy the safe room design requirements that FEMA has established. Table 2-1 in Chapter 2 is intended to provide a roadmap to the appropriate use of the standards or design guidance documents, so users of these standards

can be assured that, depending on the ultimate use and completion strategy chosen for a safe room project, the appropriate guidance has been followed. Following FEMA safe room criteria will provide “near-absolute protection” for individuals seeking safety from a tornado or hurricane. This level of protection, as defined in Chapter 2, is meant to protect safe room occupants from injury or death during an extreme-wind event.

6.1.1 Design Wind Speeds

The development of design wind speeds used in ASCE 7-05 is discussed in the commentary of ASCE 7-05, Section C6.5.4. An excerpt from that commentary about the use of basic wind speeds shown in Figure 6-1 of that standard states:

The design-level speed map has several advantages. First, a design using the map results in an ultimate load (loads inducing the design strength after use of the load factor) that has a more uniform risk for buildings than occurred with earlier versions of the map. Second, there is no need for a designer to use and interpolate a hurricane coast importance factor. It is not likely that the 500-yr event is the actual speed at which engineered structures are expected to fail, due to resistance factors in materials, due to conservative design procedures that do not always analyze all load capacity, and due to a lack of a precise definition of “failure.”

The wind speed map of Fig. 6-1 presents basic wind speeds for the contiguous United States, Alaska, and other selected locations. The wind speeds correspond to 3-s gust speeds at 33 ft (10 m) above ground for exposure category C. Because the National Weather Service (NWS) has phased out the measurement of fastest-mile wind speeds, the basic wind speed has been redefined as the peak gust that is recorded and archived for most NWS stations. Given the response characteristics of the instrumentation used, the peak gust is associated with an averaging time of approximately 3 s. Because the wind speeds of Fig. 6-1 reflect conditions at airports and similar open-country exposures, they do not account for the effects of significant topographic features such as those described in Section 6.5.7. Note that the wind speeds shown in Fig. 6-1 are not representative of speeds at which ultimate limit states are expected to occur. Allowable stresses or load factors used in the design equation(s) lead to structural resistances and corresponding wind loads and speeds that are substantially higher than the speeds shown in Fig. 6-1.

Until more research on the gust structure of tornadoes is conducted, wind engineers must use the same ASCE 7-05 provisions to calculate wind pressures from tornado-induced winds as they do for other types of extreme winds, but with the modifications provided in this manual or the ICC-500. It is imperative that engineers exercise good judgment in the design of a building to resist tornadoes and hurricanes so that actual building performance falls within expected or desired ranges. It is important to note that other effects such as debris impact may control the design of an element rather than the direct wind pressure.

The design methodology presented in this publication is based on the wind load provisions of ASCE 7-05 - Method 2, modified only to the extent that the values of some factors have been specifically recommended because of the extreme nature of tornado and hurricane winds. If the values of all coefficients and factors used in determining wind pressures are selected by the user, the results would likely be overly conservative and not representative of the expected building behavior during an ultimate level event (extreme-wind event).

6.1.2 Design Wind Speeds for Tornado Safe Rooms

Historical data were the key tool used to establish wind speeds and zones associated with areas susceptible to tornado occurrence. The Storm Prediction Center (SPC) archives were searched for data on historical tornadoes, including the time, location, and path of tornado occurrence and the intensity of the tornado.

The National Weather Service assigns an intensity F scale measurement to each tornado occurrence. The F Scale was developed by Dr. T.T. Fujita in 1971 (Fujita 1971). The intensity F Scale is based on the appearance of damage to buildings and other structures. Dr. Fujita assigned a wind speed range to each F Scale level of damage and determined that the ranges represent the fastest ¼-mile wind speeds. A modified version of the F Scale was developed by Texas Tech University and a panel of wind engineering experts in 2007. This modified version, called the Enhanced Fujita (EF) Scale, was shown in Table 4-1 along with the original F Scale. The wind speed ranges associated with both scales are based on subjective evaluation of tornado damage that is used to associate tornado intensity and estimated wind speeds with observed damage. The new EF Scale, which was implemented for use in February 2007, has refined damage evaluation methods that consider improvements in the built environment when tornado damage is viewed and used to categorize the tornado and estimate a maximum wind speed associated with the event.

Engineering analyses of damage since 1970 have shown that observed damage to buildings can be caused by storms with wind speeds of less than 200 mph (Mehta 1970, Mehta et al. 1976, Mehta and Carter 1999, Phan and Simiu 1998). Prior to 1970, engineers associated wind speeds above 300 mph with F4 and F5 tornadoes. Although F4 and F5 tornadoes are intense and can cause devastating damage, the wind speeds traditionally assigned to these Fujita categories may well be too high (Minor et al. 1982). Some evidence suggests that wind speeds in tornadoes at ground level can be higher than 200 mph, but the limited engineering assessment of EF4 and EF5 tornado damage presents very few examples that can be definitively attributed to winds with speeds above 225 to 230 mph. There is also a debate over the wind speeds from tornadoes just above the ground and in the first 60 feet above grade and the maximum wind speed that can be produced when close to the ground. Research meteorologists mostly agree with the conclusion that the maximum possible wind speed may be above 200 mph, but cannot agree on the highest predicted wind speed. Therefore, the wind speed zones are based on the occurrence of intense tornadoes, but the specified wind speeds are not necessarily related to the EF scale. These observations and conclusions are partially confirmed by the EF Scale shown in Table 4-1.

Data used for the development of wind speed zones consist of tornado statistics assembled by the NOAA SPC. The statistics used are for the years 1950 through 2006, almost 60 years of data. Tornado occurrence statistics prior to 1950 are available, but they are considered to be of lesser quality. From 1950 to 2006, a total of 50,096 tornadoes were recorded in the contiguous United States. Each of these tornadoes was assigned an F Scale level. Table 6-1 shows the number of recorded tornadoes and percentages for each F Scale level, as well as the cumulative percentages. As noted in Table 6-1, less than 2 percent of the tornadoes are in the F4 category and less than 1 percent of the tornadoes are in the F5 category.

Table 6-1. Tornado Frequencies in the United States (1950-2006)

Fujita Scale	Number of Tornadoes	Percentage	Cumulative Percentage
F0	20,728	43.68	43.68
F1	16,145	34.03	77.71
F2	7,944	16.74	94.45
F3	2,091	4.41	98.86
F4	491	1.03	99.89
F5	50	0.11	100
Totals	47,449	100	

To develop wind speed zones, the occurrences of tornadoes over the 1950-2006 period were tallied for all 80 km x 80 km squares (correlating to weather forecasting and monitoring measuring limitations) and plotted on a geographic information system (GIS) grid map. The number of EF5 tornado occurrences and combined EF3, EF4, and EF5 tornado occurrences within the 80 km x 80 km (2,470 square miles) squares were tabulated for the whole country and presented in Figure 2-2. These frequencies of occurrence data were used as a key factor to produce the wind speed map in Figure 3-1. Tornado damage paths are less than 5 square miles on the average; thus, the area covered by a tornado on the ground is quite small compared to the size of a 2,470-square mile GIS grid map square.

A 250-mph wind speed zone includes all 2,470-square mile GIS grid squares with two or more F5 tornadoes recorded in the last 56 years. The 250-mph zone also includes areas with 10 or more F4 and F5 tornado occurrences combined during this same period. In Figure 2-2, the darkest zone covers the middle part of the United States, where the most intense tornado damage has occurred. It also includes large metropolitan areas of the midwestern and southwestern United States (e.g., Chicago, St. Louis, Dallas-Fort Worth). This area should use tornado safe room design wind speeds of 250 mph (and was previously designated as Zone IV in the 2000 Edition of FEMA 361).

A 200-mph wind speed area (previously designated as Zone III in the 2000 Edition of FEMA 361) was developed using the statistics of EF3 tornado occurrences. EF3 tornadoes are less intense and are generally smaller (cover less area on the ground). Most areas with 20 to 30 F3 tornado occurrences in a 2,470-square mile GIS grid square also had a sufficient number of EF4 and EF5 tornado occurrences to be included in the 250-mph tornado safe room design wind speed zone identified above. To be conservative, the tornado safe room design wind speed zone for 200 mph is extended to cover areas where more than five F3 tornadoes were identified within a single square. This zone extends along the Gulf and lower Atlantic coastal areas to include hurricane winds. There are a couple of GIS grid squares in New York and Massachusetts that fall outside of this zone even though they have more than five F3 tornado occurrences. They are considered outliers and have had less than 10 F3 occurrences.

A 160-mph tornado safe room design wind speed (previously designated as Zone II in the 2000 Edition of FEMA 361) has been identified for the remaining areas east of the Rocky Mountains. The western border for this 160-mph zone approximately follows the Continental Divide. The wind speed of 160 mph covers all tornadoes of EF2 or lower intensity and is 75 percent higher than the speed specified in ASCE 7-05.

In the areas west of the Rocky Mountains, there are relatively few tornado occurrences, and none have been assigned an intensity scale of EF5. Over the past 56 years, only two tornadoes were assigned an intensity of EF4 and only 10 were assigned an intensity of EF3 over the entire region. Further revisions of the NWS data set between 1998 and 2006 resulted in the reclassification of a number of the tornado events west of the Rocky Mountains and caused the elimination of historical data points; this is apparent when comparing the new occurrence map in the revised edition of FEMA 361 with the occurrence map (Figure 2-3) in the original FEMA 361 publication (2000). It was determined that a tornado safe room design wind speed of 130 mph is sufficient for this zone. This safe room design wind speed is about 50 percent higher than the basic wind speeds specified in ASCE 7-05 for the west coast states.

6.1.3 Design Wind Speeds for Hurricane Safe Rooms

Hurricane intensity is assessed using the Saffir-Simpson Scale comprising five categories, C1 through C5; hurricane category C5 is the most intense, with decreasing intensity for each of the lower categories of storms. There are, on the average, five hurricanes recorded annually in the Atlantic, with the average of 1.7 landfalling hurricanes. NOAA's National Hurricane Center has archived data on hurricanes since 1900. Hurricane data include track, central barometric pressure, diameter of the eye, distance to hurricane force winds, maximum wind speeds, and storm surge height. The hurricane classification system has a range of wind speeds assigned to each category of storm as shown in Table 6-2. This table also illustrates the relationship between the 1-minute sustained wind speeds of the Saffir-Simpson scale and the 3-second gust speeds shown in Figure 3-2.

Table 6-2. Saffir-Simpson Hurricane Scale

Saffir-Simpson Scale	1-Minute Sustained Wind Speed (mph)*	3-Second Gust Wind Speed (mph)**
C1	74-95	90-116
C2	96-110	117-134
C3	111-130	135-159
C4	131-154	160-188
C5	155+	189+

Conversion: 1 mph = 0.447 m/s

* Powell 1993

** Durst 1960 (ASCE 7-98)

The wind speeds associated with each category of storm are considered to be 1-minute sustained wind speeds (Powell et al. 1994). These wind speeds are converted to equivalent 3-second gust speeds using Figure C6-1 in the Commentary of ASCE 7-05 (Durst 1960). The 3-second gust speed permits the development of a unified map for wind speed, as well as use of ASCE 7-05 for determining wind loads. The total number of hurricanes rated category C3, C4, or C5 that struck each U.S. Gulf and Atlantic coast state during the period of 1900 to 2006 were also identified and included in the preparation of Figure 3-2. The data show that no hurricanes of intensity C4 and C5 have made landfall north of the North Carolina coast. Also, during the last 100 years, only three category C5 storms have made landfall – an unnamed hurricane struck Florida in 1935, Hurricane Camille made landfall in Mississippi and Louisiana in 1969, and Hurricane Andrew in September 1992 (although Andrew has been classified both a C4 and a C5, it is currently categorized a C5 by NOAA).

Based on those historical data, and hurricane simulation models, a hurricane hazard map was developed to identify appropriate hurricane design wind speeds for shelters for the ICC-500. Simulation model results for the development of design wind speed maps have been incorporated in the United States wind loading standards since 1982. The ICC-500 standard committee recognized that using computer-based simulation models is the accepted method for developing hurricane hazard curves, where “hazard curves” are wind speed contours representing the expected maximum hurricane-induced wind speed for a location as it makes landfall and moves inward away from the water.

The hurricane hazard curves or wind speed contours were generated using the hurricane simulation models as described in Vickery et al. 2000¹ and Vickery et al. 2006.² The version

¹ Vickery, P.J., P.F. Skerlj, and L.A. Twisdale Jr., “Simulation of hurricane risk in the U.S. using an empirical track model,” *Journal of Structural Engineering*, ASCE, Vol. 126, No. 10, October 2000.

² Vickery, P.J., J.X. Lin, P.F. Skerlj, and L.A. Twisdale Jr., “The HAZUS-MH hurricane model methodology part I: Hurricane hazard, terrain and wind load modeling”, *Natural Hazards Review*, ASCE, Vol. 7, No. 2, May 2006.

of the model described in Vickery et al. 2000 forms the basis of the wind speeds given in the Basic Wind Speed Map (Figure 6-1) in ASCE 7-98 through ASCE 7-05. The version of the model described in Vickery et al. 2006 is a refinement to the model discussed in Vickery et al. 2000 and forms the basis of the hurricane hazard model which is used by FEMA's HAZUS-MH software. Further, the Vickery et al. 2006 model was used to develop the wind speed contours, and thus the shelter design wind speeds, for the hurricane hazard in the ICC-500. It should be noted that the model from Vickery et al. 2006 yields slightly lower wind speeds in the Florida panhandle as compared to the model described in Vickery et al. 2000.³

As part of the preparation of the ICC-500, the ICC-500 committee had several wind speed maps prepared using the Vickery et al. 2006 model. The maps that were prepared and considered by the ICC-500 committee had mean recurrence intervals of 1,000, 2,000, 5,000, and 10,000 years. In order to develop the wind speed contours presented on the maps, the model was run where wind speeds associated with 100,000 years of simulated hurricanes were recorded at a number of grid point locations near the hurricane coast. At each location, a hurricane hazard curve was constructed using the methodology outlined in Vickery et al. (2000) and the 1,000-, 2,000-, 5,000, and 10,000-year mean recurrence interval (MRI) values were extracted from the curves and used to develop the contour maps. Each of the maps was then reviewed by the committee to determine if the appropriate ultimate wind speed from the hurricane event was being identified.

After considering the historical nature of landfalling hurricanes, their decay (or weakening) as these storms move inland, and the frequency at which these storms have and may occur, the ICC-500 committee selected maps to represent the ultimate hazard from the hurricane hazard. The map, the *Shelter Design Wind Speeds for Hurricanes Map*, Figure 304.2.2 of ICC-500 has wind speeds ranging from a minimum of 160 mph to 225 mph for the contiguous United States (see map for island and U.S. territory wind speeds) and is associated with the 10,000-year MRI.

The FEMA review committee responsible for the safe room publications update reviewed the work used to prepare the ICC-500 hurricane hazard map. The work of the ICC-500 committee was the best information regarding hurricane hazard mapping that was available for consideration. After a thorough review of the information and coordination with several members of the ICC-500 standard committee, the FEMA review committee concurred with the findings of the ICC-500 committee and agreed to move forward with the hurricane hazard map developed as part of the ICC-500 standard development because it provided defensible, scientific data to revise the previous wind hazard data used in the hurricane-prone regions. The hurricane safe room design wind speed map presented in Figure 3-2 (and the additional, enlarged regional maps) have been included here with permission from the ICC-500 standard committee. This map should be used to select the appropriate hurricane safe room design wind speed to be used in the design calculations presented in Chapter 3.

³ A revised version of the model discussed in the Vickery et al. 2006 paper is being proposed to determine new maps for upcoming editions of ACSE 7-10. However, since the revisions were not accepted at the time this map was produced for the ICC-500, the proposed updates to the model were not used.

6.1.4 Wind Speeds for Alaska

The State of Alaska does not experience hurricanes and is not prone to a significant number of tornadoes, but it does experience extra tropical cyclone winds and thunderstorms. Since there are no specific records of extreme storms in Alaska, the safe room design wind speeds are based on contours shown on the map in ASCE 7-05. It is recommended that wind speeds of 160 mph be used for areas shown on the ASCE 7-05 basic wind speed map with wind speeds of 110 mph or higher. For the interior areas where the ASCE 7-05 basic wind speeds are less than 110 mph, the safe room design wind speed of 130 mph is recommended; these safe room design wind speeds are shown in Figure 3-1.

6.1.5 Probability of Exceeding the Design Wind Speed

The design wind speeds chosen for safe room guidance were determined with the intent of specifying “near-absolute protection” with an emphasis on life safety. Historically, most tornado deaths have occurred in storms that have been classified as either F4 or F5 (now EF4 or EF5). For hurricanes, the largest storms have typically been the deadliest; however, it should be noted that most of these deaths are associated with storm surge inundation. For either hazard, such intense storms are very rare. Even in the areas of the middle of the country where the risk of EF4 and EF5 tornadoes is greatest, the annual probabilities that a particular structure will be impacted by an EF4 or EF5 tornado are no more than 0.00002 (a 50,000-year MRI). For the purpose of “near-absolute protection,” the safe room design guidance must address these extremely rare events.

Tornado probabilities have typically been based on historical records of tornado observations and classifications within large areas surrounding the site. These areas have ranged from 80 km by 80 km squares to 1 degree latitude and longitude squares. Consequently, they are subject to considerable uncertainty, particularly for the rare EF4 and EF5 storms. The annual probability of 0.00002 was selected as the nominal return period for addressing the tornado wind risk. However, it should be pointed out that the safe room design wind speed contours on the maps have been smoothed and rounded upwards, which reflects the limited number of observations and the large variability that occurs when 40 or 50 years of tornado experience are used to extrapolate very long return periods for these very low probability events. The reanalysis of tornado wind speeds required to produce observed damage has resulted in a decrease in wind speeds assigned to EF Scale-rated events as opposed to F Scale-rated events. The 250-mph 3-second gust design wind speed chosen for the areas with greatest risk from the most intense tornadoes corresponds to a value near the upper end of the old F4 Scale and is actually above the upper end of the current EF5 Scale, so annual probability of 0.000001 may be provided by the maps in some instances. This provides a conservative design wind speed for the riskiest region and allows reductions in wind speeds for other east coast zones based on relative risks while maintaining the lowest tornado design wind speed for that region close to the bottom of the EF4 range.

Selection of an annual probability of 0.00002 (50,000-year MRI) for the hurricane risk was considered unreasonable and the extrapolation methodology based on available data was

considered unreliable. The most credible estimates of 3-second gust wind speeds in the intense Category 5 hurricanes that have occurred in this century are slightly above 200 mph. A 2,000-year return period produced 3-second gust design wind speeds for “near-absolute protection” that were on the order of 190 mph in the areas of the country most prone to intense hurricanes. Maps showing annual probability of 0.0001 (10,000-year) for hurricanes produced 3-second gust wind speeds on the order of 210 mph to 225 mph in the most hurricane-prone regions, with a maximum of 255 mph for some Pacific islands. This probability of exceeding the design wind speed was selected for the hurricane design wind speeds in the ICC-500 standard. It produces higher values in the areas most prone to hurricanes than those given in the earlier version of FEMA 361 and provides a consistent risk-based design approach for hurricane shelters and safe rooms. The lower limit of the hurricane safe room and shelter design wind speed was set at 160 mph, which is close to the upper limit of the EF3 Scale and at the upper limit of the old F2 Scale. Since nearly all observed tornadoes spawned by hurricanes have been classified as F3 or lower, this lower limit provides reasonable and conservative design criteria for safe rooms that are intended for use during a hurricane.

6.2 Commentary on Load Combinations

This section presents discussion on the load combinations used in safe room design. Strength Design load combinations are presented first, followed by those for Allowable Stress Design.

6.2.1 Strength Design

The concept used in the development of design methodology for safe rooms is that the designers must use wind loads for extreme events, with mean recurrence intervals as high as 20,000 to 1,000,000 years. Section C2.5 in ASCE 7-05 describes how ASCE has treated the load combinations for extraordinary events and a similar approach is being used in this design guidance. The current load combinations for strength design are (new/revised values are in bold):

Load Combination 1: $1.4(D + F)$

Load Combination 2: $1.2(D + F + T) + 1.6(L + H) + 0.5(Lr \text{ or } S \text{ or } R)$

Load Combination 3: $1.2D + 1.6(Lr \text{ or } S \text{ or } R) + (L \text{ or } \mathbf{0.5 W_x})$

Load Combination 4: $1.2D + \mathbf{1.0W_x} + L + 0.5(Lr \text{ or } S \text{ or } R)$

Load Combination 5: $1.2D + 1.0E + L + 0.2S$

Load Combination 6: $0.9D + \mathbf{1.0W_x} + 1.6H$

Load Combination 7: $0.9D + 1.0E + 1.6H$

Exceptions (from ASCE 7-05):

1. N.A.

2. The load factor on H shall be set equal to zero in load combinations 6 and 7 if the structural action due to H counteracts that due to W or E .
3. In combinations 2, 4, and 5, the combination load S shall be taken as either the flat roof snow load or the sloped roof snow load.

The recommended changes are as follows:

In load combination 3, replace $0.8W$ with $0.5 W_x$

In load combinations 4 and 6, replace $1.6W$ with $1.0 W_x$

Exception 1 shall not apply, and Exception 3 is added per ASCE 7-05.

The primary reason for the reduction of load factors for extreme events is that the use of load factors for standard design wind speeds is not justified because the proposed wind speeds used in safe room design are considered to be very low probability events. The level of adjustment that the load factors provide for load combinations using the standard design wind speeds is not necessary for load combinations with extreme-wind speeds. It should be noted that the section on load combinations for extraordinary events in ASCE 7-05, Section C2.5 indicates that the extraordinary load be taken as A_k with no load factor applied, because such loads encompass the uncertainty of extraordinary events and are necessarily very conservative; therefore, no adjustment is needed. These are basically the cases presented above as load combinations 4 and 6. Load combinations 3 and 4 are both for vertical forces. Except for the dead load, the other components of these two combinations are reversed. The reduction of the load factor on W_x in the vertical or uplift direction means that uplift loads are being reduced for extremely high wind speeds. Load combination 6 is used for lateral loads and the reduction in load factor in this case reduces the overturning effect caused by wind.

In all load combinations, the W symbol is used to indicate standard design wind pressures from ASCE 7-05. The W_x symbol is used in load combinations for extreme events (safe room design) to indicate extreme wind pressures.

For example, if all of the loads were 1,000 pounds and the basic wind speed was 130 mph, but the safe room design wind speed was 200 mph (and all other wind design parameters were as proposed), then W from 130 mph speed is based on velocity pressure (q). So, designating q_{130} as the velocity pressure, we can calculate the following: $q_{130} = 0.00256 \times K_d \times K_{zt} \times I \times V^2$. Then, from ASCE we know $W = q_{130}(p=q) \times$ (area of the building – assumed to be 1,000 square feet for this simple example). For simplicity, assume there is no difference between the design coefficients.

For 130-mph “basic” wind speed:

$$\text{Load Combination 3: } 1.2(1,000) + 1.6(1,000 \text{ or } 1,000 \text{ or } 1,000) + (1,000 \text{ or } 0.8 * 42.29 * [-1,000]) = -31,032 \text{ lbs}$$

$$\text{Load Combination 4: } 1.2(1,000) + 1.6 * 42.29 * (-1,000) + 1,000 + 0.5(1,000 \text{ or } 1,000 \text{ or } 1,000) = -64,964 \text{ lbs}$$

Load Combination 6: $0.9(1,000) + 1.6 \cdot 42.29 \cdot 1,000 + 1.6(1,000) = 70,164$ lbs

For a safe room design wind speed of 200 mph, the velocity pressure q_{200} is calculated in the same way except that the K_d (directionality factor) is now 1.0 instead of a value specified for 'basic' wind design in ASCE 7-05 Table 6-4. Therefore, for 200-mph "safe room" wind speed:

Load Combination 3: $1.2(1,000) + 1.6(1,000 \text{ or } 1,000 \text{ or } 1,000) + (1,000 \text{ or } 0.5 \cdot 102.4 \cdot [-1,000]) = -48,400$ lbs

Load Combination 4: $1.2(1,000) + 1.0 \cdot 102.4 \cdot (-1,000) + 1,000 + 0.5(1,000 \text{ or } 1,000 \text{ or } 1,000) = -99,700$ lbs

Load Combination 6: $0.9(1,000) + 1.0 \cdot 102.4 \cdot 1,000 + 1.6(1,000) = 104,900$ lbs

This example illustrates the increase in loads on the building only by the increase in the wind speed and the modification of wind parameter K_d from that used in 'basic' hurricane wind design to that used in tornado safe room design. It should be borne in mind that the load increase resulting from the increase in wind speed for safe room design is tempered by the revised (reduced) load factors, thereby providing much more realistic design loads.

The designer should also consider the appropriate seismic load combinations in Section 2.3.2 of ASCE 7-05. Where appropriate, the most unfavorable effects from both wind and seismic loads should be investigated. Wind and seismic loads should not be considered to act simultaneously (refer to Section 9.2.2 of ASCE 7-05 for the specific definition of earthquake load, E). From the load cases of Section 2.3.2 of ASCE 7-05 and the load cases listed above, the combination that produces the most unfavorable effect in the building, safe room, building component, or foundation shall be used.



NOTE

When a safe room is located in a flood zone, the following load combinations in Section 3.2.1 should be considered:

In V zones and coastal A zones, the $1.0W_x$ in combinations 4 and 6 should be replaced by $1.0W_x + 2.0F_a$.

In non-coastal A zones, the $1.0W_x$ in combinations 4 and 6 should be replaced by $1.0W_x + 1.0F_a$.

6.2.2 Allowable Stress Design (ASD)

The building code in effect should indicate the load combinations to be considered for the design of a building. In the absence of a building code, the designer should use the load combinations of Section 2.4.1 of ASCE 7-05 to ensure that a complete set of load cases is considered. For the MWFRS, C&C, and foundations of extreme-wind safe rooms, designers should also consider the current load cases for ASD (new/revised values are in bold):

Load Combination 1: $D + F$

Load Combination 2: $D + H + F + L + T$

Load Combination 3: $D + H + F + (L_r \text{ or } S \text{ or } R)$

Load Combination 4: $D + H + F + 0.75(L + T) + 0.75(L_r \text{ or } S \text{ or } R)$

Load Combination 5: $D + H + F + (0.6W_x \text{ or } 0.7E)$

Load Combination 6: $D + H + F + 0.75(0.6W_x \text{ or } 0.7E) + 0.75L + 0.75(L_r \text{ or } S \text{ or } R)$

Load Combination 7: $0.6D + 0.6W_x + H$

Load Combination 8: $0.6D + 0.7E + H$

The recommended changes for use in FEMA 361 are as follows:

In load combinations 5, 6, and 7, replace W with $0.6W_x$.

As illustrated for the strength design load combinations, the ASD combinations will yield the same approximate relationships, so if all terms of the equations are 1,000 pounds except the wind speed is varied from 130 mph to 200 mph and the wind tributary area is 1,000 square feet, the results follow:

For 130-mph wind speed:

Load Combination 5: $D + W_x + L = 1,000 + 42,290 + 1,000 = 44,290 \text{ lbs}$

Load Combination 6: $D + H + F + 0.75W_x + 0.75L + 0.75(L_r \text{ or } S \text{ or } R) = 1,000 + 1,000 + 1,000 + 0.75*42,290 + 0.75*1,000 + 0.75*1,000 = 36,218 \text{ lbs}$

Load Combination 7: $0.6D + W_x + H = 0.6*1,000 + 42,290 + 1,000 = 0.6*1,000 + 42,290 + 1,000 = 43,890 \text{ lbs}$

where D = dead load, L = live load, and W_x = extreme-wind load based on wind speed selected from Figure 2-2.



NOTE

When a safe room is located in a flood zone, the following load combinations in Section 6.2.2 should be considered per ASCE 7-05:

In V zones and coastal A zones, $1.5F_a$ should be added to load combinations 1 and 2.

In non-coastal A zones, $0.75F_a$ should be added to load combinations 1 and 2.

For 200-mph safe room wind speed:

$$\text{Load Combination 5: } D + 0.6W_x + L = 1,000 + 0.6*102,400 + 1,000 = 63,440 \text{ lbs}$$

$$\text{Load Combination 6: } D + H + F + 0.6W_x + 0.75L + 0.75(L_r \text{ or } S \text{ or } R) = 1,000 + 1,000 \\ + 1,000 + 0.6*102,400 + 0.75*1000 + 0.75*1,000 = 65,940 \text{ lbs}$$

$$\text{Load Combination 7: } 0.6D + 0.6W_x + H = 0.6*1,000 + 0.6*102,400 + 1,000 = 63,040 \text{ lbs}$$

As mentioned in Section 6.2.1, wind loads determined from the safe room design wind speed maps presented in Figures 3-1 and 3-2 are considered extreme loads. Safe rooms are required to protect their occupants during extreme windstorms. When live load (transient load) is to be combined with wind load, live load is multiplied by a factor of 0.5, but no reduction should be taken for wind loads except as specifically shown above for the extreme-wind event being considered. In addition, allowable stress should not be increased for designs based on the wind loads specified in this document.

Finally, the designer should consider the appropriate seismic load combinations in Section 2.4.1 of ASCE 7-05. Where appropriate, the most unfavorable effects from both wind and seismic loads should be investigated. Wind and seismic loads should not be considered to act simultaneously (refer to Section 9.2.2 of ASCE 7-05 for the specific definition of earthquake load, E). From the load cases of Section 2.4.1 of ASCE 7-05 and the load cases listed above, the combination that produces the most unfavorable effect in the building, safe room, building component, or foundation should be used.

The determination of which load combination method should be used is dictated in part by the materials of construction chosen for the safe room. The masonry, concrete, and steel trade organizations have strength requirements in their respective codes that have been used for several years and there has been research and testing done for these ultimate loads situations. The wood industry has strength requirements in part of the wood design codes, but the use of these requirements is not widespread. Many mechanical connectors still do not give ultimate loads, but rather specify the allowable load with a stress increase to be used for high load but short duration, such as wind and seismic events.

6.2.3 Combination of Loads – MWFRS and C&C

According to ASCE 7-05, the MWFRS is an assemblage of structural elements assigned to provide support and stability for the overall structure and, as a consequence, generally receives wind loading from all surfaces of the building. Elements of the building envelope that do not qualify as part of the MWFRS are identified as C&C and are designed using C&C wind loads. The elements of low-rise buildings are considered part of the building envelope (C&C) or the MWFRS, depending upon the wind load being considered. For example, MWFRS provisions are used to determine the in-plane shear forces for the design of exterior masonry walls, while C&C provisions are used to determine the out-of-plane design bending loads.

The pressure (positive/inward or negative/outward suction) exerted by the wind flowing over and around a building varies with time and location on the building. The highest pressures occur over small areas for a very short time in the regions of a building where the wind flow separation is quite significant. This flow separation can cause small vortices to form that can cause much higher pressures in small localized areas. These flow separation regions generally occur along the edges of the roof and corners of the exterior walls. Therefore, the design wind pressures for the design of the C&C are higher when the tributary area for the element is small and located in a wind flow separation region. The design pressure for a C&C element can be over twice the pressure used to design the structural framing of the building. Proper assessment of the design wind pressures is critical to developing the design of a building's structural frame and the selection of appropriate exterior cladding.

The majority of the wind load provisions are based on wind tunnel modeling of buildings considering non-cyclonic, straight-line winds. Most wind engineers believe that the results from these wind tunnel tests can be used to determine wind pressure from hurricanes. Tornado wind fields are believed to be more complex than the winds modeled in wind tunnel tests that form the basis for the wind loads calculated in ASCE 7-05. However, in investigations of buildings damaged by tornadic winds, the damage is consistent with damage caused by the forces calculated by ASCE 7-05. For this reason, use of ASCE 7-05 provides a reasonable approach to calculating wind loads for tornadoes, even though it is known that these winds are more complex than the wind fields used in the models.

Design wind loads can cause axial, in-plane, and out-of-plane forces to act on the same building element. The combination of these loads should be considered in the design of building walls. For example, consider the exterior reinforced masonry wall shown in Figure 6-1. Depending on wind direction, the building walls carry different combined loads. For wind direction 1, the wall element shown acts as a shearwall and may experience axial, shear, and bending effects (from wind suction pressures) or axial and shear effects only. When either of these conditions exists, the designer should calculate and combine these loads using MWFRS loads. For wind direction 2, however, the loads on the wall are from axial and out-of-plane bending effects. For this condition, the designer should use MWFRS loads to calculate axial loads and C&C loads to calculate the bending loads when combining loads that affect the design of the wall.

It has been previously stated that, when wind blows over a building, a myriad of forces act on the structure. These forces may cause the building to overturn, deform by racking or bending of components, or collapse and fail at the component junctions or joints. Chapter 3 describes how these wind loads affect

**NOTE**

C&C elements include wall and roof members (e.g., joists, purlins, studs), windows, doors, fascia, fasteners, siding, soffits, parapets, chimneys, and roof overhangs. C&C elements receive wind loads directly and transfer the loads to other components or to the MWFRS.

a building or safe room. To calculate the loads corresponding to the design wind, the design professional should refer to ASCE 7-05 when calculating the wind pressures on the safe room.

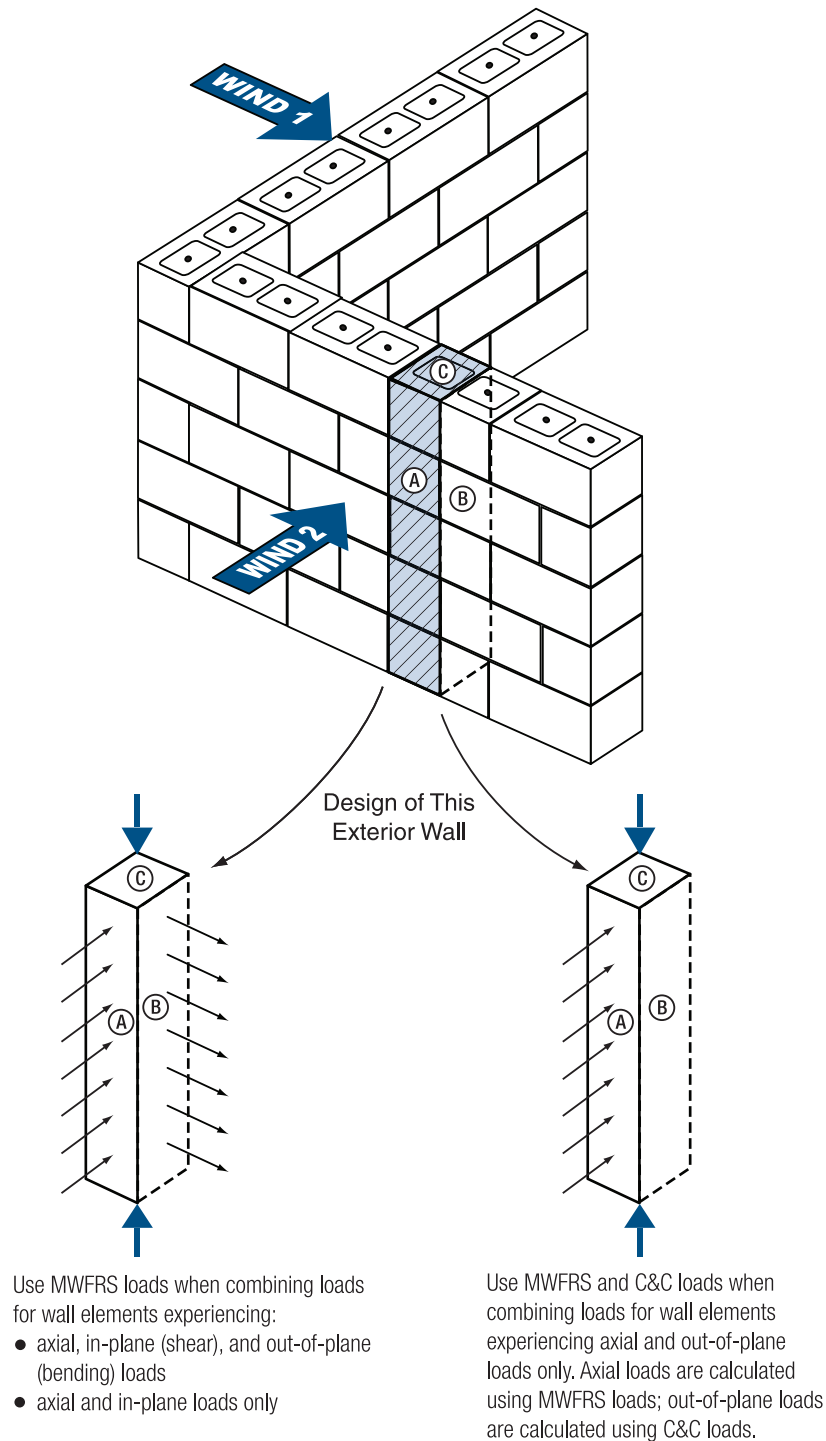

Figure 6-1. MWFRS combined loads and C&C loads acting on a structural member

6.3 Commentary on Tornado Community Safe Room Design Criteria

When wind loads are considered in the design of a building, lateral and uplift loads (discussed in Chapter 3) must be properly applied to the building elements along with all other loads. The design of the safe room relies on the approach taken in ASCE 7-05 for wind loads. For consistency, the designer may wish to use ASCE 7-05 to determine other loads that may act on the safe room. The IBC 2006 and IRC 2006 also reference ASCE 7-05 for determining wind loads. These wind loads should then be combined with the gravity loads and the code-prescribed loads acting on the safe room in load combinations that are presented in Sections 6.2.1 and 6.2.2.

Design wind loads for buildings are generally treated separately for the design of the structural system and the design of the cladding and its attachment to the structural system. Design loads for the structural system of a safe room start with the basic loads from the applicable building code governing the non-refuge use of the safe room. The determination of design wind loads acting on the safe room is based on standard provisions and formulas (equations) for the MWFRS as defined in ASCE 7-05. The design of cladding and its attachment to the structural system is based on standard provisions and formulas for the C&C. Wall and roof panels should also be checked for out-of-plane loading associated with C&C loads for the appropriate tributary areas.

6.3.1 Wind Design Parameters Using ASCE 7-05

After it has been determined that a safe room is needed, the next step in the design process is to select the safe room design wind speed from the maps in Figures 3-1 and 3-2, or the highest of either (for a combined hazard safe room). The four zones on the map in Figure 3-1 have corresponding design wind speeds of 130 mph, 160 mph, 200 mph, and 250 mph. Similarly, the wind contours on the map on Figure 3-2 represent the hurricane hazard as wind speed isobars that range from 160 to 225 mph for the mainland U.S. and increase to up to 255 mph for specific island territories. Depending upon the hazard, one wind speed should be selected as the safe room design wind speed. The safe room design wind speed should be used to determine the wind-generated forces from tornadoes that act on either the structural frame or load-bearing elements of a building or safe room (MWFRS) and the exterior coverings of a building or safe room (C&C).

It is recommended that all wind loads, both MWFRS and C&C, be calculated using the wind load provisions in Section 6 of ASCE 7-05. When ASCE 7-05 is used for the design of tornado or hurricane safe rooms, only *Method 2 – Analytical Procedure* should be used. The design requirements for tornado and hurricane safe rooms do not meet the requirements for using *Method 1 – Simplified Procedure*. In addition, some of the pressure calculation parameters used in the design of a safe room should be different from those listed in ASCE 7-05 because detailed wind characteristics in tornadoes and hurricanes are not well understood. Based on the wind speed selected from Figure 3-1, the following parameters are recommended for the calculation of wind pressures with Method 2 of ASCE 7-05:

Importance Factor (I)	$I = 1.0$
Site Exposure	C
Directionality Factor (K_d)	$K_d = 1.0$
Internal Pressure Coefficient (GC_{pi})	$GC_{pi} = +/- 0.55$
Height of the safe room is not restricted	

The importance factor (I) is set to 1.0. The importance factor for wind loads in ASCE 7-05 is designed to adjust the velocity pressure to different annual probabilities of it being exceeded (different MRIs). Since the wind speeds in Figure 3-1 are already based on very large MRIs (i.e., low exceedence probabilities), they do not need to be adjusted with the importance factor.

It is recommended that site Exposure C, associated with open terrain, be used to determine design wind forces for safe rooms. In severe tornadoes and hurricanes, ordinary structures and trees in wooded areas are flattened, exposing safe rooms to winds coming over open terrain. Also, very little is known about the variation of winds with height in hurricanes and tornadoes. Use of Exposure C is appropriate until the knowledge of localized winds, turbulence characteristics, and boundary layer effects of winds in hurricanes and tornadoes improves.

The directionality factor (K_d) is conservatively set at 1.0. This is done because wind directions may change considerably during a tornado or higher intensity hurricane and a building may be exposed to intense winds from its most vulnerable direction. Therefore, the reduction of this factor allowed in ASCE for normal building design is not recommended for the design of a safe room.

The ASCE 7-05 equations for determining wind loads also include the topographic factor K_{zt} . Damage documentation in hurricane disasters suggests that buildings on escarpments experience higher forces than buildings otherwise situated. No specific observations on topographic effects in tornadic events are available. The designer is advised to avoid siting safe rooms in locations that are likely to experience topographic effects. If it is necessary to locate a safe room on top of a hill or an escarpment, requirements given in ASCE 7-05 for the topographic factor can be used when calculating wind pressures on safe rooms that are being designed for hurricane winds only.

The design wind loads/pressures for the MWFRS or the C&C of a building are based on the following factors: velocity pressure, an external gust/pressure coefficient, and an internal gust/pressure coefficient. These coefficients are derived from several factors related to the wind field, the wind/structure interaction, and the building characteristics.

The velocity pressure equation (Equation 6-15, ASCE 7-05) is shown in Formula 6-1. The equation for pressure on a building surface for MWFRS for buildings of all heights (Equation 6-17, ASCE 7-05) is shown in Formula 6-2.

√ formula

Formula 6-1 Velocity Pressure*

$$q_z = (0.00256)(K_z)(K_{zt})(K_d)(V^2)(I)$$

where: q_z = velocity pressure (psf) calculated at height z above ground
 K_z = velocity pressure exposure coefficient at height z above ground
 K_{zt} = topographic factor
 K_d = directionality factor = 1.0
 V = safe room design wind speed (mph) (from Figure 3-1 or 3-2)
 I = importance factor = 1.0

*From ASCE 7-05

√ formula

Formula 6-2 Pressure on MWFRS for Low-Rise Buildings*

$$p = (q)(G)(C_p) - (q_i)(GC_{pi})$$

where: p = pressure (psf)
 q = q_z for windward walls calculated at height z above ground
 q = q_h for roof surfaces and all other walls
 G = gust effect factor
 C_p = external pressure coefficients
 q_i = q_h = velocity pressure calculated at mean roof height
 GC_{pi} = internal pressure coefficients = ± 0.55

*From ASCE 7-05

The velocity pressure is related to height above ground, exposure, wind directionality, wind speed, and importance factor. Several of these factors account for the boundary layer effects of wind flowing close to the surface of the earth where it interacts with the terrain, buildings, and vegetation.

Values of the exposure factor (K_z) are presented in tabular form in ASCE 7-05. The value of K_z selected should be based on the height of the safe room above grade and the building exposure (Exposure C). The terrain speedup factor (K_{zt}) is based on the acceleration of straight winds over hills, ridges, or escarpments. As previously mentioned, the ASCE provisions for K_{zt} should be followed.

For the MWFRS, the gust effect factor (G) depends on wind turbulence and building dimensions. The gust effect factor can be calculated, or, for a rigid building, $G = 0.85$ is permitted by ASCE 7-05. The external pressure coefficient (C_p) for the design of the MWFRS is based on the

physical dimensions and shape of the building and the surface of the building in relation to a given wind direction.

The equation for pressures on C&C and attachments (Equation 6-22, ASCE 7-05) is shown in Formula 6-3.

formula

Formula 6-3 Pressures on C&C and Attachments*

$$p = (q_h)[(GC_p) - (GC_{pi})]$$

where: **p** = pressure (psf)
q_h = velocity pressure calculated at mean roof height
GC_p = external pressure coefficients
GC_{pi} = internal pressure coefficients = ±0.55

*From ASCE 7-05

The internal pressure coefficient (GC_{pi}), which incorporates the gust factor (G), accounts for the leakage of air entering or exiting the building where the building envelope has been breached. This leakage creates a pressure increase or a decrease within the building. The recommended value of GC_{pi} is ±0.55. This value, associated with partially enclosed buildings and applicable to both the MWFRS and C&C components, was selected for the following reasons:

1. In tornadic events, as discussed in Section 3.3.1, maximum wind pressures should be combined with pressures induced by atmospheric pressure change (APC) if the building is sealed or, like most safe rooms, nearly sealed. Although most buildings have enough air leakage in their envelopes that they are not affected by APC, safe rooms are very “tight” buildings with few doors and typically no windows. A building designed to nullify APC-induced pressures, which usually qualifies as a partially enclosed building as defined by ASCE 7-05, would require a significant number of openings in the safe room to allow pressures to equalize. Allowing wind to flow through the safe room through large openings to reduce internal pressures (venting) could create an unsatisfactory environment for the occupants, possibly leading to panic, injury, or even death. It is important to note that ventilation is needed to ensure that safe room occupants have sufficient airflow to remain safe, but that code-compliant ventilation is not sufficient to nullify APC-induced pressures. Designers who wish to eliminate the need for venting to alleviate APC-induced pressures should use higher values of GC_{pi} (in safe room design, $GC_{pi} = \pm 0.55$ is recommended). Design pressures determined using wind-induced internal and external pressure coefficients are comparable to the pressures determined using a combination of wind-induced external pressure coefficients and APC-induced pressures. Thus, the resulting design will be able to resist APC-induced pressures, should they occur.
2. In hurricane events, tornadic vortices are often embedded in the overall storm structure. These tornadoes are considered small and less intense than tornadoes occurring in the interior

of the country. However, swaths of damage reminiscent of tornado damage have been noted in several hurricanes. It has not been confirmed whether these swaths are caused by localized gusts or unstable small-scale vortices. As a conservative approach, to design safe rooms better able to resist long-duration wind forces associated with landfalling hurricanes, designers should use high values of GC_{pi} . This approach will provide reliable and safe designs. It is particularly important that none of the C&C elements (e.g., doors, windows) fail during a windstorm and allow winds to blow through the safe room. The consequences could be the same as those described above for tornadoes.

Additionally, the value of GC_p for C&C elements is related to the location on the building surface and the effective wind area of the element. For systems with repetitive members, adjustments can be taken during the design to gain benefit from the systems. These systems are allowed to use the effective wind area, and not the tributary area, to select the external wind coefficient (which typically results in the designer being able to use a coefficient with smaller value and, therefore, the wind area may be taken as the effective width multiplied by the span length); in these instances, the effective width may be determined by taking 1/3 of the member span. It is not uncommon for the effective wind area for a C&C element to be different from the tributary area for the same element (see Figure 6-2). The effective wind area is applied to select the coefficient used to calculate the magnitude of the design wind pressure, while the tributary area is the area over which the calculated wind pressure is applied for that specific C&C-designed element.

It should be noted that the external gust/pressure coefficient is constant and maximum for effective wind areas less than 10 ft² and constant and minimum for effective wind areas greater than 500 ft². If the tributary area of a component element exceeds 700 ft², the design wind pressure acting on that component may be based on the main MWFRS provisions.

Once the appropriate MWFRS and C&C wind pressures are calculated for the safe room, they should be applied to the exterior wall and roof surfaces of the safe room to determine design wind loads for the structural and non-structural elements of the safe room. After these wind loads are identified, the designer should assemble the relevant load combinations for the safe room.

Finally, the designer should not reduce the calculated wind pressures or assume a lower potential for missile impacts on the exterior walls and roof surfaces of an internal safe room. Although a safe room inside a larger building, or otherwise shielded from the wind, is less likely to experience the full wind pressures and missile impacts, it should still be designed for the design wind pressures and potential missile impacts that would apply to a stand-alone safe room. This is required because it must be assumed that the structure surrounding the internal safe room may sustain substantial damage or collapse in extreme-wind events, offering no protection whatsoever. There is no conclusive research that can quantify allowable marginal reductions in design wind pressure for safe rooms within buildings or otherwise shielded from wind. Likewise, there is no conclusive research that can quantify the marginal increase in debris impact loads as a result of the progressive collapse of the structure surrounding the safe room. For this reason, the designers are cautioned to avoid building areas where an internal safe room may be exposed

to an impact of a collapsing large or heavy building component that cannot be quantified and designed for as part of the design process.

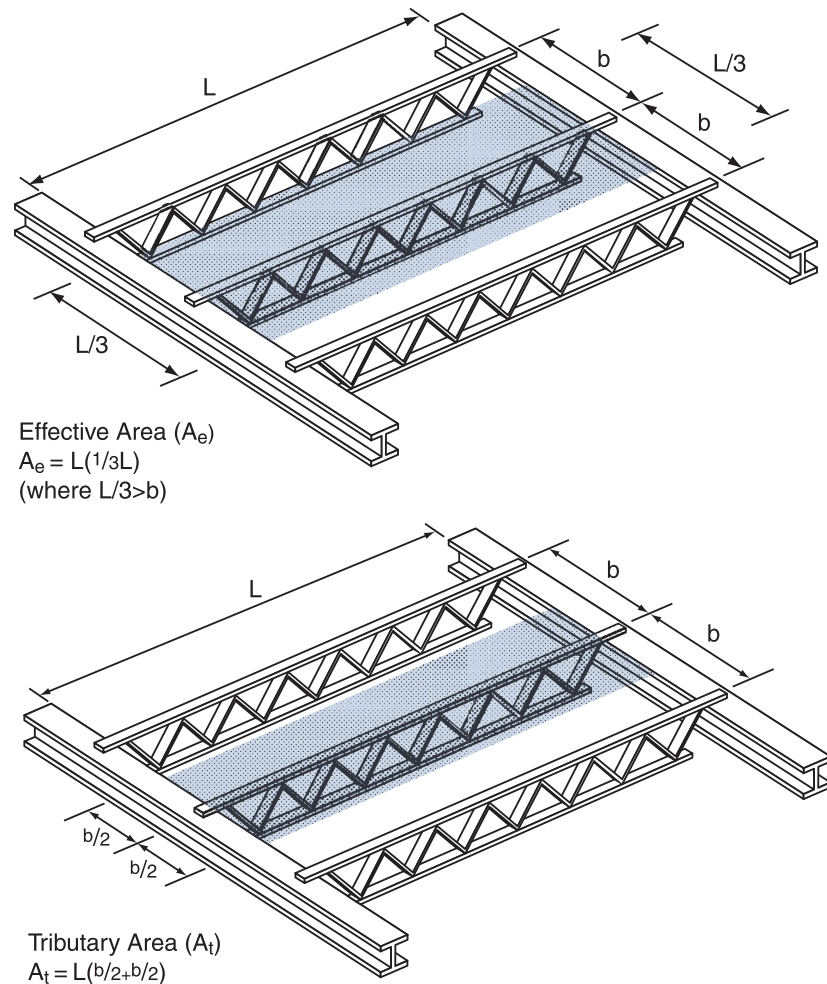

Figure 6-2. Comparison of tributary and effective wind areas for a roof supported by open-web steel joists

6.4 Commentary on Hurricane Community Safe Room Design Criteria

The design methodology used for hurricane community safe rooms is the same as for tornado community safe rooms. The design premise is to provide a building that affords the safe room occupant “near-absolute protection.” The only difference in the design procedure is that hurricane safe room design wind speeds are obtained from the wind speed contours shown in Figure 3-2. These wind speeds represent ultimate design wind speeds.

Site exposure for hurricane safe rooms should be a C exposure unless a B exposure exists on all four sides of the safe room. Since the wind can come in any direction, and the wind is rotating during a hurricane, it is believed if any part of the site exposure is open terrain (Exposure C), that exposure should govern the design. The urban, suburban exposure would need to be present on all four sides in order to ensure that the exposure could effectively reduce the velocity pressure experienced by the safe room area.

The flood design criteria for hurricane safe rooms stipulate that the safe room should be located outside the floodway, the 500-year floodplain, and the 100-year floodplains in coastal areas designated as velocity (V) zones. The safe room should not be located so that access to the safe room can be cut off by flooding. The lowest floor of the safe room area should either be 2 feet above the 100-year flood elevation or at the 500-year flood elevation, whichever is higher. Should the safe room be located in an area subject to storm surge, the safe room must be elevated so that the floor of the protected area is located at or above the storm surge inundation elevation predicted for a Category 5 storm surge.

It is extremely important to conduct a thorough flood hazard analysis on the proposed site or building for a hurricane community safe room. The possibility of flooding from a hurricane event is very high, and since occupants might be in the safe room for some extended period of time (perhaps longer than 24 hours), the scenario of saving people from death or injury caused by extreme winds only to cause them harm by flooding or drowning must be avoided.

The minimum space requirements for hurricane community safe room occupants were shown in Table 3-3 of this publication.

The determination of usable space for any particular building might not be straightforward because of the configuration of the interior. The calculation methodology below is intended to provide guidance on how to determine the usable space. For almost all spaces, the usable space is less than the building footprint because of interior walls or partitions; bathroom or kitchen fixtures; permanently mounted desks, chairs, or tables; or the storage area required to store portable desks, chairs, and tables. The maximum usable space is 85 percent of the footprint as calculated using the parameters below.

Calculation of Usable Floor Area. The usable safe room floor area should be determined by subtracting the floor area of excluded spaces, partitions and walls, columns, fixed or movable objects, furniture, equipment, or other features that under probable conditions can not be removed or stored during use as a safe room from the gross floor area.

An alternative method for determining the usable safe room floor area is to use the following percentages:

- Reducing the gross floor area of safe room areas with concentrated furnishings or fixed seating by a minimum of 50 percent.

- Reducing the gross floor area of safe room areas without concentrated furnishings or fixed seating by a minimum of 35 percent.
- Reducing the gross floor area of safe room areas with open plan furnishings and without fixed seating by a minimum of 15 percent.

6.5 Commentary on Residential Safe Room Design Criteria

The design methodology used for residential safe rooms is the same as for tornado community safe rooms. The design premise is to provide a building that affords the safe room occupant “near- absolute protection.” The only difference in the design procedure is for hurricane safe room design; wind speeds are obtained from the wind speed contours shown in Figure 3-2. These wind speeds represent ultimate design wind speeds.

Site exposure for residential safe rooms should be a C exposure in all cases. The safe room should also be designed as a partially enclosed building in all cases. While conservative, it follows the design premise of providing “near-absolute protection.”

It is extremely important to conduct a thorough flood hazard analysis on the proposed site or building for a residential safe room. The possibility of flooding from a hurricane event is very high, and since occupants might be in the safe room for some extended period of time (perhaps longer than 24 hours), the scenario of saving people from death or injury caused by extreme winds only to cause them harm by flooding or drowning must be avoided.

It is also important to remember that FEMA does not support placing safe rooms offering protection against extreme-wind events where floodwaters have the potential to endanger occupants within the safe room. Although the ICC-500 allows the placement of residential shelters in areas subject to flooding, FEMA safe room design criteria for residential safe rooms significantly limits the placement of safe rooms in Special Flood Hazard Areas (SFHAs). A residential safe room may only be sited in a mapped SFHA where no wave action or high-velocity water flow is anticipated. Therefore, the installation of a safe room in a home supported by piles, piers, or columns should be scrutinized for its location with respect to flood hazards. With building connectors commercially available, it is extremely difficult to economically and structurally separate the safe room from the elevated floor framing and ensure that the safe room will withstand the forces of extreme winds.

If your safe room is located where coastal or riverine flooding may occur during hurricanes, it should not be occupied during a hurricane. Further, a residential safe room should not be located in an area subject to storm surge inundation. Although occupying such a safe room during a tornado may be acceptable provided that the safe room is located where it will not be flooded by rains associated with other storm and tornado events, it should not be used during a hurricane. A residential safe room sited in the SFHA should meet the flood-specific FEMA safe room design criteria presented in Section 3.6. Consult your local building official or local NFIP representative to determine whether your home or small business, or a proposed stand-alone safe room site, is susceptible to coastal or riverine flooding. In any case, the installation of any safe room in

a hurricane-prone area should be coordinated with local emergency management and law enforcement to ensure that its use during extreme-wind events is not a violation of any local or state evacuation plan.

6.6 Commentary on Continuous Load Path Concepts

Structural systems that provide a continuous load path are those that support all loads acting on a building: laterally and vertically (inward and outward, upward and downward). Many buildings have structural systems capable of providing a continuous load path for gravity (downward) loads, but they are unable to provide a continuous load path for the lateral and uplift forces generated by tornadic and hurricane winds.

A continuous load path can be thought of as a “chain” running through a building. The “links” of the chain are structural members, connections between members, and any fasteners used in the connections (e.g., nails, screws, bolts, welds, or reinforcing steel). To be effective, each “link” in the continuous load path must be strong enough to transfer loads without permanently deforming or breaking. Because all applied loads (e.g., gravity, dead, live, uplift, lateral) must be transferred into the ground, the load path must continue unbroken from the uppermost building element through the foundation and into the ground.

In general, the continuous load path that carries wind forces acting on a building’s exterior starts with the non-load-bearing walls, roof covering and decks, and windows or doors. These items are classified as C&C in ASCE 7-05. Roof loads transfer to the supporting roof deck or sheathing and then to the roof structure made up of rafters, joists, beams, trusses, and girders. The structural members and elements of the roof must be adequately connected to each other and to the walls or columns that support them. The walls and columns must be continuous and connected properly to the foundation, which, in turn, must be capable of transferring the loads to the ground.

Figure 6-3 illustrates typical connections important to continuous load paths in masonry, concrete, or metal-frame buildings (e.g., residential multi-family or non-residential buildings); Figure 6-4 illustrates a continuous load path in a typical commercial building. Figure 6-3 also illustrates the lateral and uplift wind forces that act on the structural members and connections. A deficiency in any of the connections depicted in these figures may lead to structural damage or collapse.

In a tornado or hurricane safe room, this continuous load path is essential and must be present for the safe room to resist wind forces. The designers of safe rooms must be careful to ensure that all connections within the load path have been checked for adequate capacity. Again, designers should refer to ASCE 7-05 and the design wind speed and parameters specified in this manual when determining the loads on the building elements and ensure that the proper pressures are being used for either MWFRS or C&C building elements.

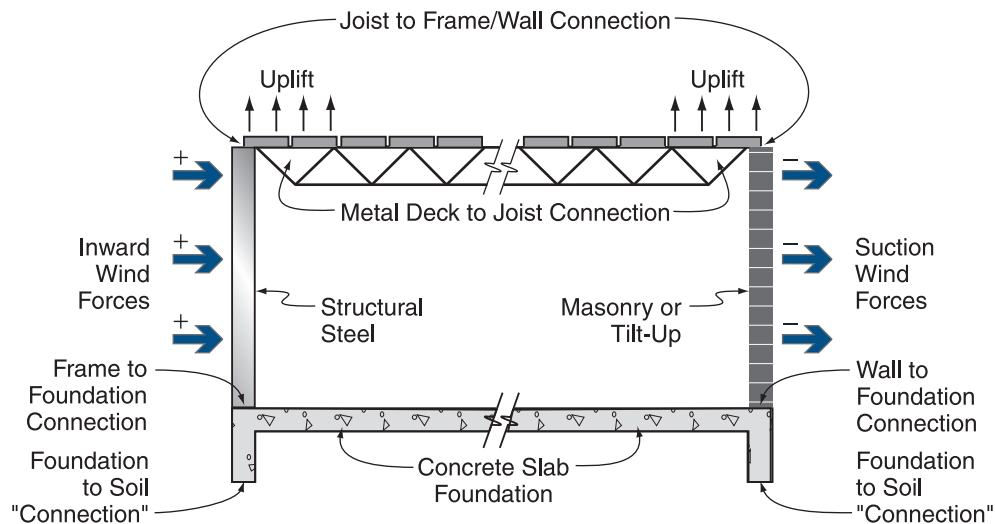

Figure 6-3. Critical connections important for providing a continuous load path in a typical masonry, concrete, or metal-frame building wall. (For clarity, concrete roof deck is not shown.)

6.7 Anchorages and Connections

A common failure of buildings during extreme-wind events is the failure of connections between building elements. This failure is often initiated by a breach in the building envelope, such as broken doors and windows or partial roof failure, which allows internal pressures within the building to increase rapidly. This phenomenon is discussed in Chapter 3 and the schematic in Figure 4-4 illustrates the forces acting on buildings when a breach occurs.

Anchorage and connection failures can lead to the failure of the entire safe room and loss of life. Therefore, the design of all anchorages and connections should be based on the C&C loads calculated from ASCE 7-05 and on the specified design assumption stated in Section 6.7.2. All effects of shear and bending loads at the connections should be considered.

6.7.1 Roof Connections and Roof-to-Wall Connections

Adequate connections must be provided between the roof sheathing and roof structural support, steel joists, and other structural roofing members and walls or structural columns. These are the connections at the top of the continuous load path and are required to keep the roof system attached to the safe room.

Reinforcing steel, bolts, steel studs, welds, screws, and nails are used to connect roof decking to supporting members. The size and number of these connections required for a safe room depend on the wind pressures that act on the roof systems. Examples of connection details that have been designed for some of these conditions may be found in Appendices C and D for cast-in-place and pre-cast concrete safe room designs.

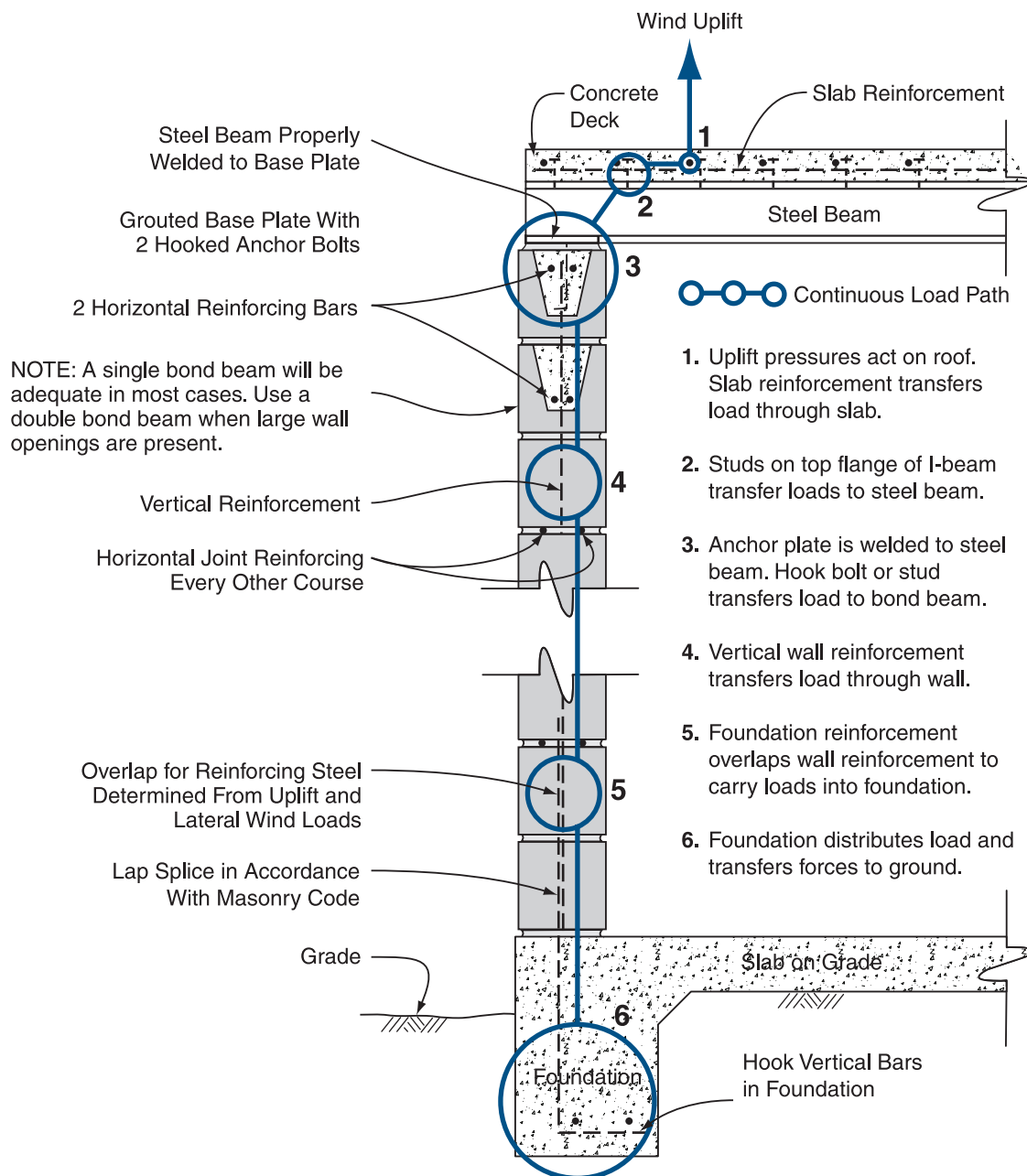

Figure 6-4. Continuous load path in a reinforced masonry building with a concrete roof deck

Figure 6-5 shows damage to a school in Oklahoma that was struck by a tornado. The school used a combination of construction types: steel frame with masonry infill walls and load-bearing unreinforced masonry walls. Both structural systems support open-web steel joists with a lightweight roof system composed of light steel decking, insulation, and a built-up roof covering with aggregate ballast.

The figure highlights a connection failure between a bond beam and its supporting unreinforced masonry wall as well as the separation of the bond beam from roof bar joists. See Figure 6-4 for an illustration of connections in a reinforced masonry wall that are likely to resist wind forces from a tornado or hurricane. Note that four connection points – between the roof decking and joists, the joist and the bond beam, the bond beam and the wall, and the wall to the foundation – are critical to a sound continuous load path.

6.7.2 Foundation-to-Wall Connections and Connections Within Wall Systems

Anchor bolts, reinforcing steel, imbedded plate systems properly welded together, and nailed mechanical fasteners for wood construction are typical connection methods used to establish a load path from foundation systems into wall systems. These connections are the last connections in the load path that bring the forces acting on the building into the foundation and, ultimately, into the ground. The designer should check the ability of both the connector and the material into which the connector is anchored to withstand the design forces.

Figure 6-6 shows two columns from a building that collapsed when it was struck by the vortex of a weak tornado. Numerous failures at the connection between the columns and the foundation were observed. Anchor bolt failures were observed to be either ductile material failures or, when ductile failure did not occur, embedment failures.



Figure 6-5. Failure in this load path occurred between the bond beam and the top of the unreinforced masonry wall. This school building was in the path of an F4 tornado vortex.

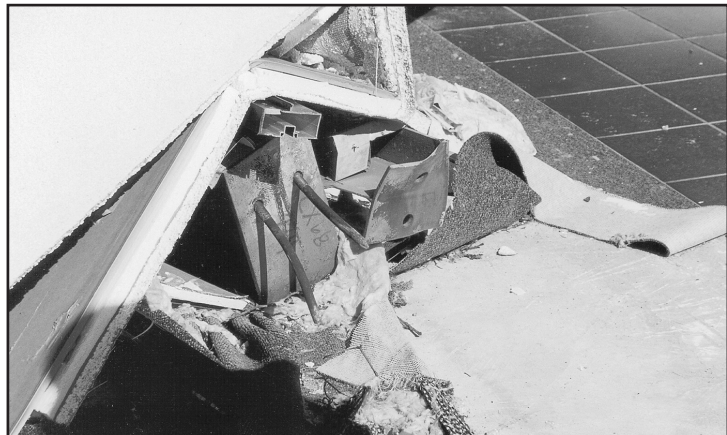

Figure 6-6. These two steel columns failed at their connection to the foundation. The anchor bolts that secured the column released from the concrete (embedment failure) while the anchor bolts that secured the column on the right experienced a ductile failure.

7 Commentary on Debris Impact Performance Criteria for Safe Rooms

Recommended performance criteria for tornado and hurricane safe rooms are provided in Chapter 3 of this manual. A listing of the existing guidance for community and residential safe rooms (early editions of FEMA 320 and 361), the ICC-500 *Standard for the Design and Construction of Storm Shelters* (2008), and other standards, manuals, and publications referenced in this chapter are listed in Chapter 10. The most recent of these documents are the ICC-500, ASCE 7-05, and FEMA 320. Although these documents do not address all factors and elements of the design of extreme-wind safe rooms, they provide the basis for the criteria presented in this chapter.

Chapter 3 of this manual, and referenced standards ICC-500 and ASCE 7-05, provide the information necessary for the computation of wind pressures and the loads imposed by winds on the walls, roof, windows, and doors of a safe room. The walls, ceiling, floor, foundation, and all connections joining these elements should be designed to resist the pressures and loads calculated from the design wind speed without localized element failure and without separating from one another; the commentary on these criteria was presented in Chapter 6.

For a safe room to be effective and considered as having met the criteria presented in this document, the external surfaces of the safe room (including the structural elements, the building envelope, and openings in the building envelope) should be designed to resist wind-induced loads as well as impacts from debris. For the residential and small commercial safe room designs presented in FEMA 320, the original designs called for ceiling spans and wall lengths no greater than 8 feet. The design of the wall and ceiling systems were governed by the criteria specified for resistance to the impacts of windborne debris. For the 2008 edition of FEMA 320, additional testing and design analyses were performed to expand the maximum safe room size such that they now have maximum wall and roof spans of 12 to 14 feet. However, it is important to note that debris impact still governs much of the design. For larger community safe rooms, this broad statement cannot be made. The structural elements and the building envelope should be designed to resist wind-induced loads as well as impacts from debris.

This chapter discusses what research was performed to identify the representative (large) missiles used for the tornado and hurricane hazards and the speeds at which these

representative missiles should be tested. It provides direction as to how to test building components to resist the wind loads using the new test protocols outlined in Chapter 3 for both tornado and hurricane hazards using the ICC-500. This chapter also gives insight into the performance characteristics of different wall, roof, window, door, and other protective systems. The systems have been tested to meet the most restrictive design criteria (a horizontally traveling large missile represented with a 15-lb 2x4 wood board member traveling at 100 mph).

Due to the limited research and testing that has been performed with regard to debris impact testing of buildings and building components to provide life-safety protection, much of what is presented at the end of this chapter is based on the testing and use of a 15-lb 2x4 wood board member traveling horizontally at 100 mph. A significant amount of products have been tested and approved to meet lower debris impact design criteria (i.e., a 9-lb 2x4 wood member traveling horizontally at 34 mph). However, those systems are not presented here since they do not meet the protection criteria for life safety nor can they provide similar levels of protection at impact (when compared with either momentum or energy). This chapter provides information to assist with the understanding of the performance of safe rooms, safe room envelope components, and opening protective assemblies in resisting debris impact. It links that performance to testing that has been performed at research universities on this topic. It is important to note, however, that any products described here or mentioned via internet link still need to be verified to comply with the new ICC-500, Chapter 8 (Test Method for Impact and Pressure Testing) before they can be said to meet the debris impact protection criteria presented in this manual.



WARNING

ICC-500, Chapter 8 (Test Method for Impact and Pressure Testing) is a new testing protocol for building systems and components that are to provide life-safety protection. It combines and uses several existing ASTM tests and test methods (such as ASTM E1886 and E1996), and addresses issues related to product acceptance, performance for life-safety acceptance, and large missiles that are above basic code designs promulgated prior to the release of the ICC-500. As such, no product can be said to meet the ICC-500 criteria if the report on it is dated prior to the 2008 release date of ICC-500 since the criteria were not available. Product certifications and claims by manufacturers to meet the criteria of FEMA 320 (2008), FEMA 361 (2008), and the ICC-500 (2008) that pre-date the release of these three documents should be scrutinized as to how they could have product approval prior to the release of the standard (or public comment drafts of the standard).

7.1 Windborne Debris in Tornadoes and Hurricanes

The quantity, size, and force of windborne debris (missiles) generated by tornadoes and large hurricanes are unequalled by those of other windstorm debris. Missiles are a danger to buildings because the debris can damage the structural elements themselves or breach the building envelope. Although there is a substantial body of knowledge on penetration and perforation of small, high-speed projectiles (such as bullets and other ammunitions, etc.), by comparison,

relatively little testing has been performed on lower-speed missiles such as windborne debris impacting buildings. In the design of community safe rooms, wind loads are likely to control the structural design. However, components and cladding (C&C) and building envelope issues may be governed by missile impact requirements. Nonetheless, after the safe room has been designed to withstand wind forces from the design wind speed, the proposed wall and roof sections should be tested for impact resistance from missiles. Windborne debris may kill or injure people who cannot find adequate shelter or refuge during a tornado or hurricane.

If the missile breaches the building envelope, wind may enter the building, resulting in an over-pressurization of the building that often leads to structural failures. This high potential for missiles capable of breaching a building's exterior supports the recommended use of the internal pressure coefficient for partially enclosed buildings in the design criteria presented in Chapter 3. Most experts group missiles and debris into three classifications. Table 7-1 lists the classifications, presents examples of debris, and describes expected damage.

Table 7-1. Windborne Debris (Missiles) and Debris Classifications for Tornadoes and Hurricanes

Missile Size	Typical Debris	Associated Damage Observed
Small (Light Weight)	Aggregate roof surfacing, pieces of trees, pieces of wood framing members, bricks	Broken doors, windows, and other glazing; some light roof covering damage
Medium (Medium Weight)	Appliances, HVAC units, long wood framing members, steel decking, trash containers, furniture	Considerable damage to walls, roof coverings, and roof structures
Large (Heavy Weight)	Structural columns, beams, joists, roof trusses, large tanks, automobiles, trees	Damage to wall and roof framing members and structural systems

Wind events have been modeled to show that the selected 15-lb missile will have different speeds and trajectories, depending on the event. However, to be conservative, it is recommended that test criteria for missile impact resistance be as stated in this section and Chapter 3.

Comparisons of results from missile impact tests for missiles other than the 15-lb wood 2x4 traveling at the design missile speed are discussed in Appendix G.

7.1.1 Debris Potential at Safe Room Sites

Debris impacting buildings during extreme-wind events can originate from both the surrounding area and from the building itself. During the development of a safe room design, the design professional should review the site to assess potential missiles and other debris sources in the area.

In addition to the wood 2x4 members identified as the representative large missile, roof coverings are a very common source of windborne debris (missiles) or falling debris (ranging from roof aggregate or shingles to heavy clay tiles, slate roof coverings, and roof pavers; see Figure 7-1).

Other sources of debris include roof sheathing (decking) materials, wall coverings, roof-mounted mechanical equipment, parapets, garbage cans, lawn furniture, missiles originating from trees and vegetation in the area, vehicles, and small accessory buildings. Missiles originating from loose pavement and road gravel have also been observed in intense windstorms. In one area impacted by Hurricane Andrew, mailboxes were filled with rocks and asphalt from surrounding roadways.

As buildings break apart during extreme-wind events, the failures progress from the exterior building elements inward to the structural members (e.g., trusses, masonry units, beams, and columns). The literature on tornadoes and hurricanes contains numerous examples of large structural members that have been transported by winds for significant distances by the wind field when a portion of exterior sheathing remains connected and provides an aerodynamic sail area on which the wind can act.



Figure 7-1. Examples of large debris generated by tornadoes and hurricanes

Rooftop mechanical equipment that is kept in place only by gravity connections is a source of heavy deformable debris when displaced during extreme-wind events. Additional vulnerabilities to missiles and winds are created when rooftop equipment is displaced from the roof, leaving large openings in the roof surface. Cars, busses, and trucks can also be moved by strong winds (see Figure 7-2). Lightweight vehicles can be moved around in parking lots in winds with gust speeds approaching 100 mph. Although pieces of debris larger than the test missiles (a wood board 2x4 that is either 15 or 9 pounds in weight) have been observed, the speed of these missiles is considerably less. From post-disaster investigations, the 2x4 test missile appears most representative of the high-energy missile most likely to penetrate conventional construction. However, a safe room that has been designed to provide punching shear resistance from a 15-lb wood 2x4 and the capacity to resist the large wind forces associated with an extreme-wind

event will likely provide protection for some level of impact from larger debris items. Additional design guidance concerning large falling debris is presented in Section 7.6.

7.1.2 Representative Missiles for Debris Impact Testing

The size, mass, and speed of missiles in tornadoes and hurricanes varies widely. Only a few direct measurements of debris velocity have been made. Such measurements require using photogrammetric techniques to analyze videos of tornadoes that contain identifiable debris. Unfortunately, very little studies (in the field or using photogrammetry) have occurred in the past 20 years to help produce a more technically documented choice for the representative missile. For this reason, the choice of the missiles that a safe room should be designed to withstand is somewhat subjective. From over 30 years of post-disaster investigations after tornadoes and hurricanes, the Wind Science and Engineering (WISE) Research Center at Texas Tech University (TTU) concluded that the missile that best represents windborne debris that is likely to perforate building components is a wood 2x4 member, weighing up to 15 pounds.



Figure 7-2. A school bus was lifted atop a section of Caledonia High School, Caledonia, Mississippi (January 2008)

The trajectories of windborne debris of all shapes have been the subject of research in recent years (particularly at TTU, University of Florida, and Louisiana State University). This work includes trajectory trials on wind-tunnel models and validated numerical models. As part of this work, debris is categorized by its shape and flying characteristics into ‘compact,’ ‘rod,’ and ‘plate/sheet’ types. ‘Compact’ objects, usually generalized as cubes or spheres, are driven by wind drag forces, and have downward directed trajectories from their initial point of flight and often hit the ground before hitting a downwind building. On the other hand, the ‘rod’ and ‘plate’ types are subjected to significant lift forces, and can fly up before eventually attaining a downward trajectory under the influence of gravity. Therefore, these types have more potential to stay in flight and accelerate to damaging horizontal speeds before impacting a downwind building. These characteristics are consistent with the observed distances traveled, and damage observed after tornadoes and hurricanes have occurred.

The design missile chosen for much of the work done in protective structures and in storm shelters is a nominal, 2x4 wood board. It is very likely that much of the debris generated by extreme winds consists of boards and sawn lumber that came from buildings being torn apart by wind-induced pressures or other windborne debris. The 2x4 member is a representative test missile for the variety of damaging ‘plate/sheet’ and ‘rod’ type objects that have been observed during hurricanes. These include roof tiles, panels from billboards, and metal roof panels and flashing, etc., as well as timber roofing members. Furthermore, the 2x4 board has been shown

to have more perforation potential than other common types of debris, including 2x6 boards (see Figure 7-3) of the same length and traveling at the same speed. Therefore, a 2x4 board has been chosen as the design missile for safe room design. The speed with which the missile travels is a function of the type of wind – straight-line, tornado, or hurricane – as well as the wind speed. The speed of the missile will be discussed more in Section 7.2.



Figure 7-3. Refrigerator pierced by windborne missile (a 2x6 wood board), Moore, Oklahoma

Although large pieces of debris are sometimes found in the aftermath of extreme-wind events, heavy pieces of debris are not likely to become airborne and be carried at high speeds. Other, larger airborne missiles do occur; larger objects, such as cars, can be moved across the ground or, in extreme winds, can be tumbled, but they are less likely than smaller missiles to perforate building elements. Following the Oklahoma and Kansas tornado outbreaks of May 3, 1999, both FEMA and TTU investigated tornado damage and debris fields and concluded that the 15-lb 2x4 missile was reasonable for safe room design. Therefore, from research in the field, as well as the results of research at TTU studying windborne debris in various wind fields, the representative tornado missile has been selected as a 15-lb 2x4 (12 to 14 feet long) wood board; a larger, representative missile does not appear justified at this time. This approach is consistent with the representative missile used for the impact tests discussed in FEMA 320, the first edition of FEMA 361, and those specified in FEMA's *National Performance Criteria for Tornado Shelters* (May 1999).

For hurricanes, damage investigations have provided varying results with respect to documenting the distances that debris has traveled for the reported wind speeds of the storm events. While arguments might be made to use 15-lb 2x4 wood boards as the design missile for hurricane testing, conclusive field data in post-storm inspections supported such criteria (and were used as the basis for debris impact criteria by the Department of Energy¹ and the Florida Emergency Operations Center Design Criteria²), but still have not successfully resulted in a single, representative missile to be used for both tornado and hurricane hazards by the wind code community. Legacy codes and standards have had a significant impact on the desire to use a smaller missile in hurricane-prone regions. The first use of the 9-lb 2x4 as a design missile dates back to 1976 in the Darwin Area (Australia) Building Manual, which first used a design missile in

¹ The Department of Energy (DOE) promulgates a design standard for their facilities titled *Natural Phenomena Hazards Design and Evaluation Criteria For Department of Energy Facilities* (DOE-STD-1020-2002), dated January 2002. This DOE Standard ranks levels of protection from natural hazard events. Levels of protection from windborne debris use the following representative missiles for debris impact testing (presented from highest to lowest level of protection): a 3,000-lb automobile, a 3-inch steel pipe, and a 15-lb 2x4 wood board. See Table 7-2 for additional information).

² The Florida Department of Community Affairs, Division of Emergency Management design criteria for Emergency Operations Centers is presented in the 2003 document titled *Guide Publication: Emergency Operations Center Project Development and Capabilities Assessment*.

the building code in response to the devastation caused to the city by Tropical Cyclone Tracy in 1974. In the United States, despite documented research from the 1970s supporting the 15-lb missile, the devastation of Hurricane Andrew in Florida in 1992 eventually led to the use of the 9-lb 2x4 as a design missile in a domestic building code as early as 1994 in the South Florida Building Code and 1995 in ASCE 7-95. Since that time, considerable testing using a 9-lb 2x4 board (approximately 9 feet long) has been completed on building envelope materials in Florida, and other coastal states, following the ASTM test procedures using this lighter missile.

Based on the acceptance of the 9-lb 2x4 wood board as a representative missile, and the information provided earlier in this section, these considerations led to the selection of the 9-lb 2x4 as the test missile for hurricanes for a variety of wind speeds (associated with the safe room design wind speed for the site). It is important to note that the Florida windborne debris standards and past Standard Building Code (SBC) as well as the current ASCE 7-05 windborne debris requirements were all developed and promulgated to minimize damage to buildings, and not to provide for life safety or the protections of occupants within those buildings. As such, Section 7.2 discusses the test speeds from Chapter 5 that the debris is to be moving when impacting a test specimen. For several criteria, this test missile speed is notably higher than that used for building envelope protection in the model building codes.

Table 7-2 compares the debris impact criteria used in the design and construction of safe rooms, shelters, and typical buildings. These criteria were first presented in Chapter 2 in Table 2-2, which compares the different levels of protection provided by safe rooms and other buildings.

Table 7-2. Comparison of Debris Impact Test Requirements for Tornadoes and Hurricanes

Guidance, Code, or Standard Criteria for the Design Missile	Horizontal Debris Impact Test Speed (mph)	Large Missile Specimen	Momentum at Impact (lb _f -s) ⁺	Energy at Impact (ft-lb _f) ⁺
Tornado Safe Room Missile Testing Requirements				
DOE-STD-1020-2002	25 mph 75 mph 150 mph (maximum) 100 mph (minimum)	3,000-lb auto 75-lb pipe 15-lb 2x4 15-lb 2x4	3,240 257 103 68	67,710 14,110 11,288 5,017
FEMA 320/FEMA 361	100 (maximum) 80 (minimum)	15-lb 2x4 15-lb 2x4	68 55	5,017 3,210
ICC-500 Storm Shelter Standard	100 (maximum) 80 (minimum)	15-lb 2x4 15-lb 2x4	68 55	5,017 3,210
IBC/IRC 2006, ASCE 7-05, Florida and North Carolina State Building Codes, ASTM E 1886/ E 1996	N/A	None	N/A	N/A

Table 7-2. Comparison of Debris Impact Test Requirements for Tornadoes and Hurricanes (continued)

Guidance, Code, or Standard Criteria for the Design Missile	Horizontal Debris Impact Test Speed (mph)	Large Missile Specimen	Momentum at Impact (lb _f -s) ⁺	Energy at Impact (ft-lb _f) ⁺
Hurricane Safe Room Missile Testing Requirements*				
DOE-STD-1020-2002	50	15-lb 2x4	34	1,254
FEMA 320/FEMA 361	128 (maximum) 80 (minimum)	9-lb 2x4 9-lb 2x4	53 33	4,932 1,926
ICC-500 Storm Shelter Standard	102 (maximum) 64 (minimum)	9-lb 2x4 9-lb 2x4	42 26	3,132 1,233
Florida State Emergency Shelter Program (SESP) Criteria and EOC Design Criteria	50 (EOC recommended) 55 (EHPA recommended) 34 (EHPA minimum)	15-lb 2x4 9-lb 2x4 9-lb 2x4	34 23 14	1,254 911 348
IBC/IRC 2006, ASCE 7-05, Florida and North Carolina State Building Codes, ASTM E 1886/ E 1996*	55 34	9-lb 2x4 9-lb 2x4	23 14	910 348

Notes:

+ lb_f-s = pounds (force) seconds and ft-lb_f = foot pounds (force).

* Hurricane missile testing requirements in these codes and standards only apply in the windborne debris regions (defined in the code/standard) and not throughout the hurricane-prone region.

N/A = Not applicable.

7.2 Commentary on Resistance to Missile Loads and Successful Testing Criteria

After a structure is designed to meet wind load requirements, its roof, walls, doors, windows, and opening protective systems should be checked for resistance to missile impacts. The structural integrity necessary to withstand wind forces for small residential safe rooms can be provided with materials common to both commercial and residential construction. For safe room design, the major challenge in designing small safe rooms is to protect against missile perforation as discussed in Chapter 3. A number of designs for safe rooms capable of withstanding a 250-mph design wind are presented in FEMA 320. For larger safe rooms, the design challenge shifts to providing the structural integrity necessary to resist wind loads. Walls designed with reinforced concrete or reinforced masonry to carry extreme-wind loads will normally prevent perforation by flying debris.

Relationships between wind speeds and missile speeds have been the subject of limited study over the past 30 years. For a 250-mph wind speed, the highest design wind speed considered

necessary for safe room design, the horizontal speed of a 15-lb missile is calculated to be 100 mph based on a simulation program developed at TTU. The vertical speed of a falling wood 2x4 is considered to be two-thirds the horizontal missile speed. Although the probability is small that the missile will travel without rotation, pitch, or yaw and strike perpendicular to the surface, these worst case conditions are assumed in design and testing for missile perforation resistance.

While it is recognized that this is not the only type of debris that is carried by extreme winds, it is considered a reasonable representative missile to be used for design and testing purposes. In considering perforation of a structure or wall section, worst case conditions are assumed. Testing at TTU determined that blunt (square-faced) boards are more likely than pointed ones to perforate shelter surfaces. Furthermore, in numerous post-storm damage documentation studies, it was observed that 2x4 boards are the missiles most often found to have perforated building surfaces. While beams, bar joists, concrete blocks, and heavier objects are sometimes found, they are most often found on the ground close to the point of origin.

The horizontal wind speeds of all types of windborne missiles progressively increase with distance traveled and the duration of flight, since the horizontal wind forces continue to act in the direction of the wind until the missile speed reaches the wind speed. However, this equality never occurs as the missile will invariably strike the ground or another building well before this situation is reached. Thus, the horizontal speed at which a given missile strikes a building wall depends on several factors: the gust wind speed (most missile flights occur in less than 3 seconds), the weight and shape of the object, the initial angle at release, and the distance it has traveled before impact. A discussion on the basis for which horizontal and vertical speeds of the debris propelled during impact testing identified in Chapter 3 is presented in Section 7.2.1.

The roof, wall sections, and coverings that protect any openings in a safe room should be able to resist



DEFINITION

Perforation is the term used to describe the failure of a safe room component from windborne debris. When a missile impacts a safe room component and passes through it and into the protected space of the safe room, this is called **perforation**. This is different than **penetration**. Penetration is when a component is impacted by debris and the debris enters the component but not to the extent that it enters the protected space. A missile may penetrate a door, wall section, etc., and remain lodged within the component, but the component does not allow the missile to completely perforate the component and enter into the safe room protected space.



NOTE

Few window or glazing systems tested for resistance to missile impact have met the missile impact criteria recommended in this manual.

missile impacts. Doors, and sometimes windows, are required for some safe rooms for egress and by the building code. However, doors and other openings are vulnerable to damage and failure from missile impact. Large doors with quick-release hardware (required in public buildings) and windows present challenges to the designer. Design guidance for doors and windows is given in Section 7.4.

7.2.1 Debris Impact Test Speeds for Representative Missiles

Chapter 3 provided debris impact test speeds for each missile for each hazard. The speeds at which the representative missiles are propelled for the tests are representative of the safe room design wind speed at the safe room site. For tornadoes, the debris impact test speeds for the horizontal missile range from a maximum of 100 mph to a minimum of 80 mph, varying from 0.4 to 0.6 times the safe room design wind speed. For hurricanes, the debris impact test speeds range from 128 mph to 80 mph, simply 0.5 times the safe room design wind speed. This section discusses how these speeds were selected.

During the development of the ICC-500, some new research was completed. These experimental and numerical studies of windborne debris of the ‘rod’-type (Holmes, Letchford, and Lin 2005)³ concluded how long it takes for the debris to speed up while being propelled through the wind field. The results were that a 2x4 board accelerates to about:

- 0.5 times the local gust 3-second gust wind speed at a distance of 33 feet downwind from the source,
- 0.6 times the gust speed at a distance of 66 feet, and
- 0.8 times the gust speed at about 197 feet.

When considering the speed of the missile, an assumption has to be made at what height the missile is released into the wind field. A simplistic approach suggests taking the missile release point to be 33 feet above grade, the same elevation used to define and select the safe room design wind speed. However, many will argue that the maximum height of a safe room (typically located on the ground level of a facility) will be less than 33 feet. Therefore, the closer to the ground a missile is during flight, the slower the missile speed is because the surface roughness has reduced the safe room design wind speed; this is accounted for in the wind load design process through the use of K_z when calculating wind loads on building surfaces at heights other than 33 feet.

Instead of considering the increases and decreases in elevation of the debris in the wind field depending on whether or not the debris is released above or below 33 feet, the missile speed can be assumed to be constant if a conservative and simplistic approach is taken. To establish a minimum bound on the missile wind speed, it is assumed the representative debris is introduced into the wind field at the same height in which it strikes another building or object (heights of

³ The remainder of this section has taken text from the J.D. Holmes, C.W. Letchford, and N. Lin paper (“Investigations of plate type windborne debris, Parts I and II.” *Journal of Wind Engineering and Industrial Aerodynamics*) and consolidated it for shortness of presentation and inclusion in this manual.

0-15 feet). This is a minimum bound since this is the lowest elevation at which debris may be introduced into the wind field. Next, the designer should consider the reduced speed of the wind, using K_z ; for low-rise buildings in urban areas, the gust wind speed is approximately equal to 0.75 times the reference gust speed at 33 feet (height above grade) in open terrain used for design (i.e., K_z in ASCE-7 of $0.57 \cong 0.75^2$). Assuming that the horizontal distances between buildings in the vicinity of a safe room are typically in the range of 30 to 60 feet, it is reasonable to assume horizontal missile speeds of 0.5 to 0.6 times the maximum, *local* gust speed. This is equivalent to a speed of 0.375 (0.5×0.75) with 30 feet of travel, 0.45 (0.6×0.75) with 65 feet of travel, and 0.6 (0.8×0.75) with 200 feet of travel times the basic design gust speed for Exposure B. Table 7-3 presents these data along with the same calculation made for Exposure C.

Table 7-3. Missile Speed as a Function of Exposure and Distance Traveled (expressed as a percentage of the safe room design wind speed)

Exposure Considerations			V Missile / V Safe Room Design		
	K_z	% 33 ft speed	with 33 ft travel	with 65 ft travel	with 200 ft travel
Exp C (33ft)	1.00	1.00	0.50	0.60	0.80
Exp C (15ft)	0.85	0.92	0.46	0.55	0.74
Exp B (15ft)	0.57	0.75	0.38	0.45	0.60

V = velocity (mph)

Selection of the appropriate velocity ratio of the missile to the safe room design wind speed also considered the horizontal distance that the missile could travel in the wind. Again, this assumes the missile impacts a building or structure at the same height it was introduced into the wind field (because assuming a higher point of release would increase the distance traveled, thus increasing missile wind speed). Table 7-4 shows the horizontal distances traveled by 4.5-lb and 15-lb missiles as predicted by Holmes et al. for various wind speeds.

Table 7-4. Missile Speed and Distance Traveled Relationships

	Distance Traveled	
	4.5 lb	15 lb
90 mph	26.4 ft	49.5 ft
134 mph	99 ft	214.5 ft
avg =	62.7 ft	132 ft

Based on the above table, it is reasonable to assume that, for safe room design wind speeds of 160 mph and greater, debris generated within 15 feet of the ground can be transported over 65 feet. For both Exposure B and Exposure C situations, many examples can be provided in which buildings and structures would be separated by 65 feet or more. When debris is provided with

65 feet or more, it can be shown to accelerate to at least 0.45 times the safe room design wind speed for Exposure B and 0.55 times the safe room design wind speed for Exposure C.

Hurricane winds are considered straight-line winds without an upward component of velocity (which is a discriminating difference when comparing tornado and hurricane wind fields). Hurricane winds increase to their maximum speed more slowly than in tornadoes. There is no sudden atmospheric pressure change in hurricanes. Windborne debris is arguably released faster in tornadoes than in hurricanes and, therefore, can be said to travel farther. For the hurricane safe room, this has led to the choice of the ratio of 0.50 times the basic design wind speed as the horizontal missile speed for the 9-lb 2x4 in this guidance for the design of hurricane safe rooms.

Note that the probability of a missile like a 2x4 being released at the critical distance and angle of attack upstream and then actually striking a vulnerable part of a safe room during any given storm is quite small and to use the 'worst case' missile would be considered conservative. For the tornado safe room, this has led to the choice of acknowledging the gradation of missile speed with a design speed that was presented in the first edition of FEMA 361 in Table 3-3, but not allowed in the performance criteria. For this edition, the speed of the tornado missile varies from 0.40 to 0.65 times the safe room design wind speed.



NOTE

For additional information on windborne debris research and testing, the following internet sites provide links to FEMA, State of Florida Division of Emergency Management, and Texas Tech University, web pages containing reports on this subject area:

- <http://www.fema.gov/plan/prevent/saferoom/index.shtm>
- http://floridadisaster.org/Response/engineers/Wind_Missile_Impact.htm
- <http://www.wind.ttu.edu/Research/DebrisImpact/TestingLab.php>

7.2.2 Induced Loads From the Design Missile and Other Debris

The static force equivalent of the dynamic impact of a missile into a component of the safe room envelope is difficult to calculate, and a direct conversion to a static load often results in extremely large loads. The actual impact force of the missile varies with the material used for the wall or roof section and will be a function of the stiffness of the material itself as well as the overall stiffness of the wall section in which it is used. Therefore, no formula for the determination of impact load is provided in this manual, but the following discussion is provided for background and understanding of the impact loads.

Determining static design loads from a propelled missile or a piece of free-falling debris is a complex computation that depends on a number of factors, including the following:

- Material that makes up the missile or falling debris
- Material of the wall, door, window, or roof section being impacted
- Stiffness of the individual elements being impacted
- Stiffness of the structural system supporting them
- Angle of impact between the missile and the structure

Because of the complex nature of missile and debris impacts, this manual does not provide design criteria that can be used to calculate the static force of a missile impact on any part of the safe room. To determine adequate missile impact resistance for a safe room, the designer should use the performance criteria presented in this chapter and the results of successful wall, door, window, and roof tests that are presented in Appendices E and F of this manual.

Windborne debris and falling objects are two of the risks that safe rooms are designed to mitigate against and can be described in terms of their mass, shape, impact velocity, angle of impact, and motion at impact (i.e., linear motion or tumbling). The mass and impact velocity can be used to calculate a simple upper bound on the impact momentum (I_m) and impact energy (I_e) by assuming linear motion of the debris striking perpendicular to the surface. In this instance, the impact momentum is calculated using Formula 7-1, where W is the weight of the debris, g is the acceleration of gravity, and V is the impact velocity. For similar conditions, the impact energy can be calculated from Formula 7-2. I_m and I_e are the impact momentum and impact energy, respectively, for simple linear impacts perpendicular to the surface.

These equations provide reasonable estimates of impact momentum and impact energy for compact debris, where the length-to-diameter ratio is less than about 2, striking perpendicular to the surface. They also provide reasonable estimates for slender rigid body missiles striking on end, perpendicular to the surface when there is very little rotation of the missile. For off-angle impacts of compact debris (impacts at some angle to the surface), the normal component of the impact momentum and impact energy can be estimated with Formulas 7-1 and 7-2 if the velocity V is replaced by an effective velocity V' , where $V' = V \cos(\Theta)$ and the angle Θ is measured relative to the axis normal to the surface.



Formula 7-1 Impact Momentum

$$I_m = (W/g)(V)$$

where: I_m = impact momentum
 W = weight of debris
 g = acceleration of gravity
 V = impact velocity

Formula

Formula 7-2 Impact Energy

$$I_e = (1/2)(W/g)(V^2)$$

where: I_e = impact energy
 W = weight of debris
 g = acceleration of gravity
 V = impact velocity

For slender, rigid-body missiles such as wood structural members, pipes, or rods, where the length-to-diameter ratio is greater than about 4, the angle of impact and the motion characteristics at impact become very important. Research has shown that the normal component of the impact drops off more rapidly than a simple cosine function for linear impact of long objects because the missile begins to rotate at impact (Pietras 1997). Figure 7-4, based on data from Pietras 1997, shows the reduction in normal force as a function of angle as compared to a cosine function reduction. For tumbling missiles, the equivalent impact velocity has been estimated using a complex equation (Twisdale and Dunn 1981, Twisdale 1985).

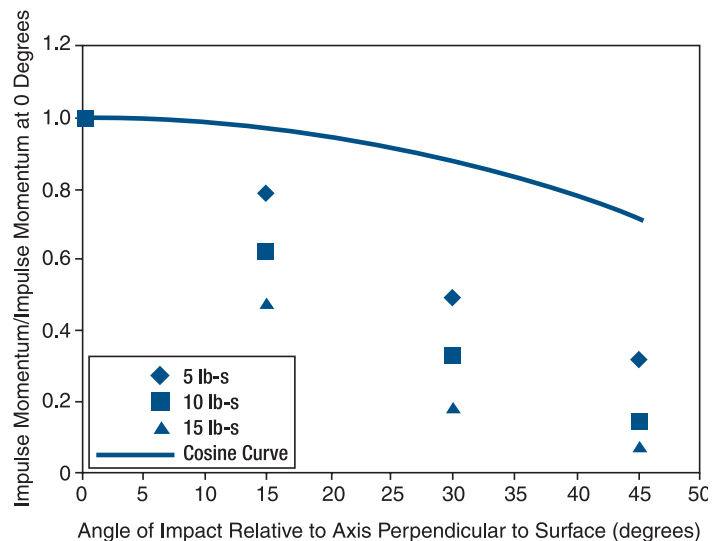

Figure 7-4. Variations of impact impulse as a function of impact angle

The impact of windborne debris can apply extremely large forces to the structure and its components over a very short period of time. The magnitude of the force is related to the mass of the object and the time of the deceleration as the missile impacts a surface of the safe room. The magnitudes of the forces also depend on the mechanics involved in the collision. For example, inelastic crushing of the wall or the missile will absorb some of the impact energy and reduce the force level applied to the structure. Similarly, large elastic or inelastic deformation of the structure in response to the impact can increase the duration of the deceleration period and therefore reduce the magnitude of the impact forces. For a perfectly elastic impact, the impulse force exerted on the structure is equal to twice the impact momentum since the missile rebounds with a speed of equal magnitude to the impact velocity but in the opposite direction. For a perfectly plastic impact, the missile would not rebound and the impulse force would be equal to the impact momentum.

Figure 7-5 illustrates the impulse loading applied by a 4.1-lb Southern Yellow Pine 2x4 (nominal) missile striking a rigid impact plate at a velocity of 21 mph (42.3 feet per second [fps]). Note that the entire impulse force is applied over a period of 1.5 milliseconds and the peak force approaches 10,000 pounds. Similar tests with a 9-lb wood 2x4 at 34 mph (50 fps) generated peak forces of around 25,000 pounds. The dotted (raw) line represents the measured impulse force and includes some high-frequency response of the impact plate. The signal has been “filtered” to remove the high-frequency response of the impact plate and illustrate the expected impulse forces time history.

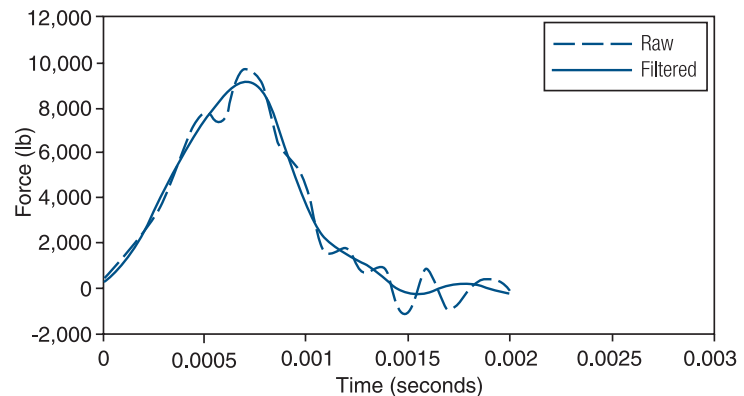

Figure 7-5. Raw and filtered forcing functions measured using impact plate for impact from a 4.1-lb 2x4 moving at 42.3 fps (Sciaudone 1996)

Impact test results for Southern Yellow Pine 2x4 members of various masses striking the impact plate at different velocities illustrate the complex nature of the impact phenomenon (Sciaudone 1996). Figure 7-6 compares the impulse force measured with the impact plate against the initial momentum of the missile. At low velocities, the impulse is characteristic of an inelastic impact where the impulse is equal to the initial momentum. This is likely due to the localized crushing of the wood fibers at the end of the missile. As the missile speed increases (initial momentum increases), the impulse increases toward a more elastic impact response because the impulse force increases to a value, which is substantially greater than initial momentum.

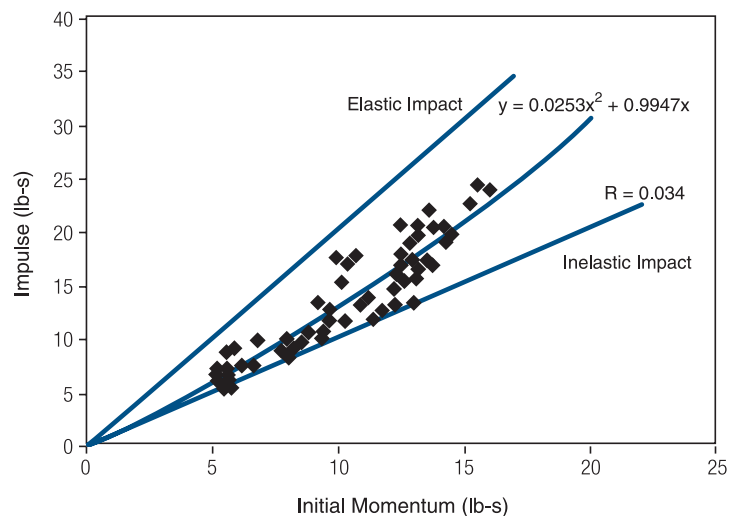

Figure 7-6. Impulse as a function of initial missile momentum for 2x4

Design considerations should include local failures associated with missile perforation or penetration, as well as global structural failure. Sections 7.3 and 7.4 provide discussions that center on local failures. Global failures are usually related to overall wind loading of the structure or the very rare impact of an extremely large missile. Falling debris such as elevated mechanical equipment could cause a buckling failure of a roof structure if it impacted near the middle of the roof.

7.3 Commentary on Performance of Wall and Roof Assemblies During Debris Impact Tests

Various wall and roof sections tested at the WERC at TTU have performed successfully during years of testing. To provide an understanding of what type of systems have performed well, this section presents a summary of information on wall assemblies of common materials that have successfully passed missile impacts for the largest missile at the highest test speed (the 15-lb 2x4 traveling horizontally at 100 mph) as discussed in Chapter 3. For more detail on these assemblies, see Appendices E and G.

7.3.1 Impact Resistance of Wood Systems

TTU conducted extensive testing of wall systems that use plywood sheathing. The most effective designs, in terms of limiting the number of layers of plywood necessary, incorporate masonry infill of the wall cavities or integration of 14-gauge steel panels as the final layer in the system.

Appendix E shows wall sections that have been tested with the design missile without failing (i.e., provide adequate missile impact resistance). Examples are shown in Figure 7-7.

For conventional light-frame construction, the side of the wall where the sheathing or protective material is attached and the method of attachment can affect the performance of the wall in resisting damage from the impact of windborne debris. The impact of debris on material attached to the outside (i.e., harm side) of a wall pushes the material against the wall studs. Material attached to the inside of the wall (i.e., safe or safe room side) can be knocked loose from the studs if it is not adequately attached to the studs. Similarly, material on the harm side would be susceptible to being pulled off the studs by wind suction pressures if it was not adequately attached to the studs.

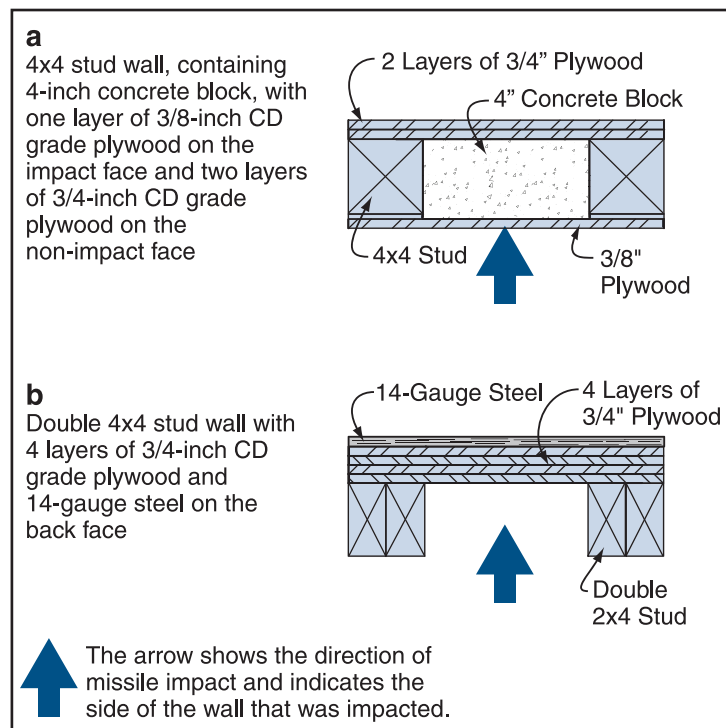

Figure 7-7. Wall sections constructed of plywood and masonry infill (a) and plywood and metal (b)

Consequently, sheathing materials bearing on the framing members should be securely attached to the framing members. Tests have shown that sheathing attached using an AFG-01 approved wood adhesive and code-approved #8 screws (not drywall screws) penetrating at least 1½

inches into the framing members and spaced not more than 6 inches apart provides sufficient capacity to withstand expected wind loads if the sheathing is attached to the exterior surfaces of the wall studs. These criteria are also sufficient to keep the sheathing attached under impact loads when the sheathing is attached to the interior surfaces of the studs. For information about oriented strand board (OSB) or particleboard sheathing, see Appendix G.



DEFINITION

AFG-01 is an American Plywood Association (APA) specification for adhesives for field gluing plywood to wood framing.

7.3.2 Impact Resistance of Sheet Metal

Various gauges of cold rolled A569 and A570 Grade 33 steel sheets have been tested in different configurations (see Appendix E for examples of representative wall sections that have been previously tested to resist the 15-lb 2x4 traveling at 100 mph). The steel sheets stop the missile by deflecting and spreading the impact load to the structure. Testing has shown that, if the metal is 14 gauge or lighter and is backed by any substrate that prevents deflection of the steel, the missile will perforate the steel. If the 14-gauge or lighter steel sheets are placed between plywood layers or between plywood and studs, the steel does not have the ability to deflect and is perforated by the missile. Therefore, on a wood stud wall, a 14-gauge steel sheet can resist perforation only when it is used as the last layer on the non-impact face on the interior (safe room side) of the wall, as shown in Figure 7-8.

In laboratory tests at Texas Tech University, 12-gauge or heavier steel sheets have never been perforated with the 15-lb wood 2x4 traveling at 100 mph. The 12-gauge steel has been mounted directly to studs and mounted over solid plywood. Test samples have used the standard stud spacing of 16 inches on center (o.c.). Increased spacing between supports affects the permanent deformation of the steel sheet. Permanent deformation of 3 inches or more into the safe room area after impact is deemed unacceptable. Tests have not been performed to determine the maximum support spacing that would control the 3-inch permanent deformation limit.

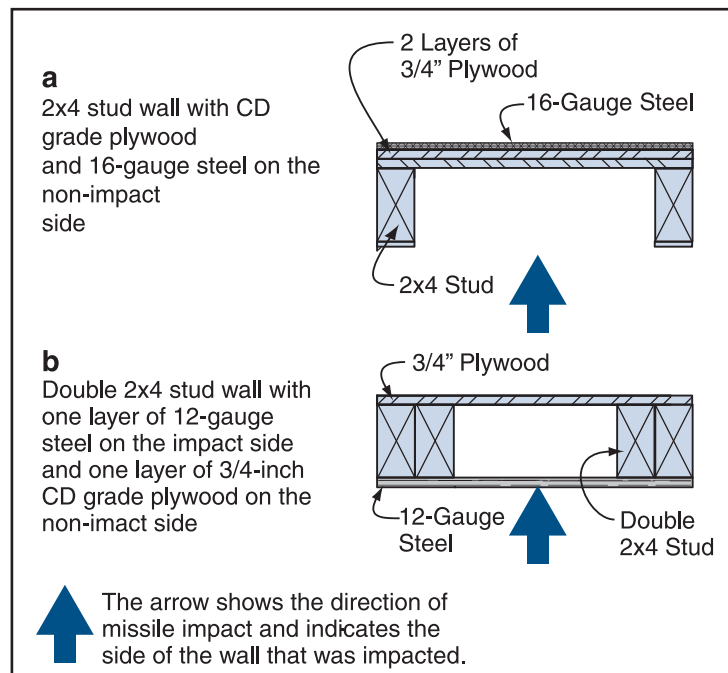

Figure 7-8 Uses of expanded metal (a) and sheet metal (b) in wall sections

Designs provided in FEMA 320 include the use of sheet metal in safe room roof construction. If sheet metal alone is relied on for missile impact protection, it should be 12 gauge or heavier.

7.3.3 Impact Resistance of Composite Wall Systems

Composite wall systems need rigorous testing because there is no adequate method to model the complex interactions of materials during impact. Tests have shown that impacting a panel next to a support can cause perforation while impacting midway between supports results in permanent deformations but not perforation. Seams between materials are the weak links in the tested systems. The locations and lengths of seams between different materials are critical. Currently the best way to determine the missile shielding ability of a composite wall system is to build and test a full-scale panel that consists of all the materials and structural connections to be used in constructing the panel. See Figure 7-9 for an illustration of a representative composite wall section.

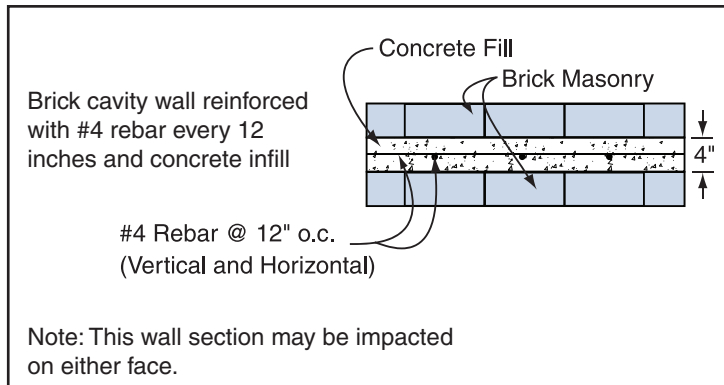

Figure 7-9. Composite wall section

7.3.4 Impact Resistance of Concrete Masonry Units

Texas Tech research has demonstrated that both 6- and 8-inch-thick concrete masonry units (CMUs) can resist the large missile impact. Six-inch CMU walls that are fully grouted with concrete and reinforced with #4 reinforcing steel (rebar) in every cell (see Figure 7-10) can withstand the impact of a 15-lb 2x4 wood member striking perpendicular to the wall with speeds in excess of 100 mph. Eight-inch CMU walls should be fully grouted but need only be reinforced with #5 reinforcing steel (rebar) in every fifth cell (40 inches o.c.) for debris impact-resistance; however, more reinforcing steel may be required in the masonry wall to carry wind loads, depending upon the design and geometry of the masonry wall.

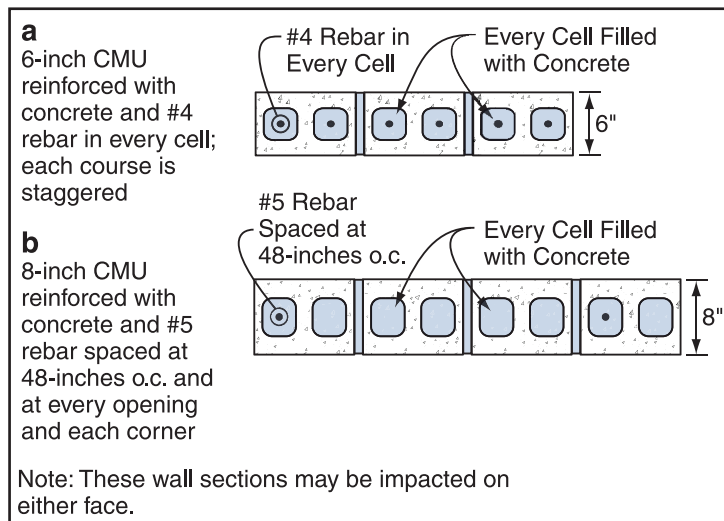

Figure 7-10. Concrete masonry unit (CMU) wall sections

7.3.5 Impact Resistance of Reinforced Concrete

Research related to the design of nuclear power facilities has produced a relatively large body of information and design guides for predicting the response of reinforced concrete walls and roofs to the impact of windborne debris. The failure modes have been identified as penetration, threshold spalling, spalling, barrier perforation, and complete missile perforation (Twisdale and Dunn 1981). From a sheltering standpoint, penetration of the missile into, but not through, the wall surface is of no consequence unless it creates spalling where concrete is ejected from the inside surface of the wall or roof. Spalling occurs when the shock wave produced by the impact creates tensile stresses in the concrete on the interior surface that are large enough to cause a segment of concrete to burst away from the wall surface. Threshold spalling refers to conditions in which spalling is just being initiated and is usually characterized by small fragments of concrete being ejected. When threshold spalling occurs, a person directly behind the impact point might be injured, but is not likely to be killed.

However, as the size of the spalling increases, so does the velocity with which it is ejected from the wall or roof surface. When spalling occurs, injury is likely for people directly behind the impact point and death is a possibility. In barrier perforation, a hole occurs in the wall, but the missile still bounces off the wall or becomes stuck in the hole. A plug of concrete about the size of the missile is knocked into the room and can injure or kill occupants. Complete missile perforation can cause injury or death to people hit by the primary missile or wall fragments. Design for missile impact protection with reinforced concrete barriers should focus on establishing the minimum wall thickness to prevent threshold spalling under the design missile impact. Twisdale and Dunn (1981) provide an overview of some of the design equations developed for nuclear power plant safety analysis.

It should be noted that the missiles used to develop the analytical models for the nuclear industry, which are most nearly suitable for wood structural member missiles, are steel pipes and rods. Consequently,

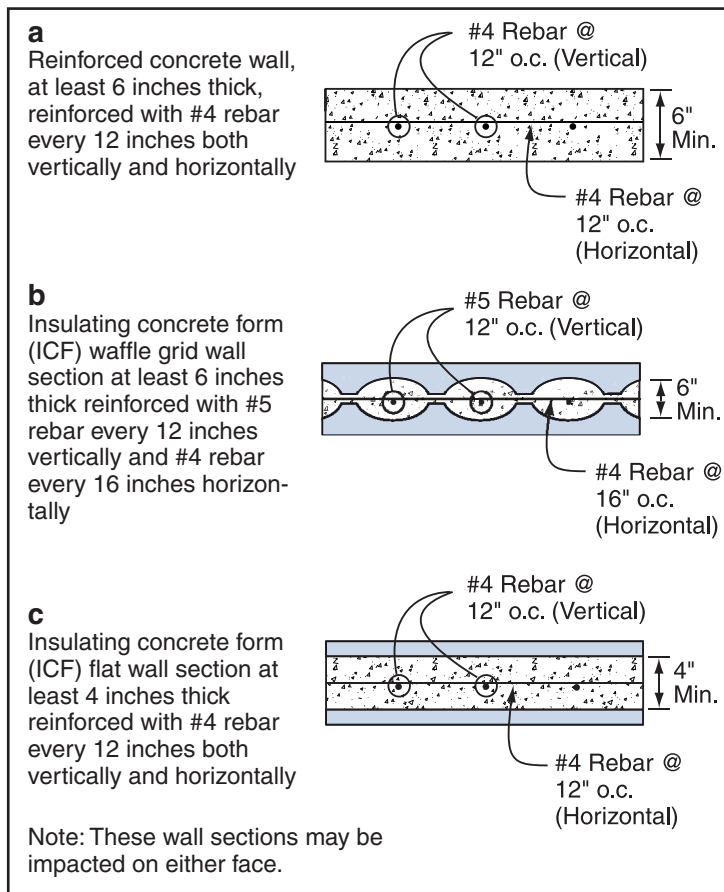

Figure 7-11. Reinforced concrete wall section (a), reinforced concrete “waffle” wall constructed with insulating concrete forms (b), and reinforced concrete “flat” wall constructed with insulating concrete forms (c)

the models are expected to provide conservative estimates of performance when a “softer” missile, such as a wood structural member, impacts the walls. A summary of test results from a number of investigations (Twisdale and Dunn 1981) suggests that 6-inch-thick reinforced concrete barriers are needed to stop a 15-lb wood 2x4 missile impacting at 100 mph without threshold spalling. TTU research indicates that a 6-inch reinforced concrete wall (see Figure 7-11, illustrations a and b) provides sufficient protection from the 15-lb wood 2x4 missile impacting at 100 mph. Reinforced concrete walls constructed with insulating concrete forms (ICFs) with a concrete section 4 inches thick (see Figure 7-11, illustration c) also provide sufficient protection. The TTU research also shows that a 4-inch-thick reinforced concrete roof provides sufficient protection from a 15-lb wood 2x4 missile impacting at 67 mph (the free-falling missile impact speed recommended in this document).

7.4 Commentary on General Performance of Doors, Door Frames, and Windows During Debris Impact Tests

Door failures are typically related to door construction and door hardware. To provide an understanding of what type of systems have performed well, this section presents a summary of information on doors and door hardware that have successfully passed missile impacts for the largest missile at the highest test speed (the 15-lb 2x4 traveling horizontally at 100 mph) as discussed in Chapter 3. For more detail on door assemblies, see Appendix F.

Previous research and testing has determined that steel doors with 14-gauge or heavier skins prevent perforation by the design missile traveling horizontally at 100 mph. Furthermore, such doors in widths up to 3 feet are capable of withstanding wind loads associated with wind speeds up to 250 mph when they are latched with three hinges and three deadbolts. Because community safe rooms may have doors larger than those previously tested for use in in-home safe rooms, testing was performed for doors up to 44 inches wide. Double-door systems with center mullions and different types of closure hardware were also tested. The information presented here and in Appendix F is a compilation of the test information available to date.

Critical wind loads on doors and door frames are calculated according to the guidance presented in Chapter 3 of this manual and ASCE 7-05 for C&C loading. Calculations indicate that the maximum wind



NOTE

The design pressure for a 250-mph wind on doors in wall corner regions of a community safe room is 1.75 psi for C&C elements with an area of 21 ft². Locating the door outside the corner region reduces the design pressure for the door to approximately 217 psf or 1.5 psi (corner regions are defined as the first 3 feet from the corner, 10 percent of the least wall dimension, or 4 percent of the wall height). These pressures are different from the 1.37-psi maximum door pressure used for the small, flat-roofed safe rooms in FEMA 320 that were assumed to be designed for “enclosed building” conditions (as defined in ASCE 7-05).

load expected on a door system (due to external suction wind forces combined with internal pressures for a 250-mph design wind) is 250 psf or 1.75 pounds per square inch (psi). Doors have been tested at these pressures through laboratory pressure tests. The doors were tested with positive pressure. The doors and frames were mounted as swing-in or swing-out doors to simulate either positive or negative pressures acting on the door. The doors were tested from both sides with positive pressure because the door and frame could not be sealed properly to pull a vacuum on the door to simulate negative pressures. Sliding door systems have been tested in the same manner.

7.4.1 Door Construction

Door construction (primarily the exterior skin) has been found to be a limiting element in the ability of a door to withstand missile impacts, regardless of the direction of door swing (inward or outward). Both steel and wood doors have been tested for missile impact resistance. Previous research and testing have determined that steel doors with 14-gauge or heavier skins that are specially constructed prevent perforation by the design missile. Furthermore, such doors in widths up to 3 feet are capable of withstanding forces associated with wind speeds up to 250 mph when they are latched with three hinges and three points of locking. At this time, no wood door, with or without metal sheathing, has successfully passed either the pressure or missile impact tests using the design criteria for 250-mph winds.

Single-Door Systems Less Than 36 Inches Wide

The following is a list of single-door systems less than 36 inches wide that have successfully withstood the missile impact criteria of this publication:

- Steel doors with exterior skins of 14 gauge or thicker. These doors can be used without modification of the exterior skin. The internal construction of the doors should consist of continuous 14-gauge steel channels as the hinge and lock rails and 16-gauge channels at the top and bottom. The minimum hardware reinforcement should be 12 gauge. The skin should be welded the full height of the door. The weld spacing on the lock and hinge rails should be a maximum of 5 inches o.c. The skin should be welded to the 14-gauge channel at the top and bottom of the door with a maximum weld spacing of 2½ inches o.c. The interior construction of doors must include



NOTE

The weak link of door systems when resisting wind pressures and debris impact is the door hardware. Testing was performed on a limited number of door and door hardware systems that represented off-the-shelf products to indicate their expected performance in safe rooms. Although these systems passed the wind pressure tests, they did not pass the missile impact tests. The maximum wind pressures on any safe room occur at building corners. Therefore, any safe room door system that is not specially constructed for 250-mph wind speeds (of Figure 3-1) should be protected by an alcove or debris barrier. See Appendix F for more detailed guidance.

internal 20-gauge steel ribs. The door may include fill consisting of polystyrene infill or a honeycomb core between the stiffeners.

- Lighter-skinned steel doors may be used with modification. The modification is the addition of a 14-gauge steel sheet to either side of the door. The installation of the steel should be with ¼-inch x 1¼-inch self-tapping screws with hexagon washer heads attached at 6 inches o.c. along the perimeter of the sheathing and 12 inches o.c. in the field. The edge of the internal door construction should meet the specifications listed above.
- Site-built sliding doors constructed of two layers of ¾-inch plywood and an 11-gauge steel plate attached to the exterior face of the door with ¼-inch x 1¼-inch self-tapping screws with hexagon washer heads attached at 6 inches o.c. along the perimeter of the sheathing and 12 inches o.c. in the field. These doors should be supported by “pockets” capable of transferring loads on the door to the safe room wall. The doors should be suspended by an overhead track system capable of carrying the door weight. Locking can be accomplished by a simple ½-inch diameter pin through the supporting door pocket jamb and the door.

Single-Door Systems Greater Than 36 Inches Wide

Successful pressure and debris impact tests (for 250-mph winds and the 15-lb 2x4 missile traveling at 100 mph) have been conducted on numerous doors up to 48 inches in width and 86 inches in height. These doors were specially constructed similarly to the first bullet of the previous section. For the testing, the door was installed in a 12-gauge frame constructed within an 8-inch reinforced CMU wall and connected to the CMU with steel T-anchors (5 per jamb and 4 per head); note that the void between the frame and the masonry wall was grouted solid. The door was connected to the frame with five 4½-inch heavyweight hinges. The latching hardware on the door tested was the single-lever-operated hardware with two and three points of locking (described in Section 7.4.3).

Double-Door Systems (with Center Mullions)

Double-door systems (with fixed, removable, or no center mullions) were tested for resistance to damage from wind pressures and missile impact. For the test, both doors were equipped with panic bar mechanisms. The door configuration for these tests used two doors arranged in a swing-out configuration (a typical requirement for code-compliant egress). Each door was 3 feet wide and 7 feet tall and was constructed as described in the first bullet under Single-Door Systems Less Than 36 Inches Wide (presented earlier in this section). The doors were mounted in a 12-gauge steel frame with a 4¾-inch-



NOTE

Heavy-gauge steel doors have been successfully tested for resistance to wind and blast pressures. Testing has shown that the weak link in available door products is the door hardware. Testing has shown that the weak link in available door products is resistance to debris impacts and failure of the door hardware. See Section 7.4.3 for testing of door hardware systems.

deep frame. Doors with removable mullions were bolted to the frame at the top and the sill and were either a structural steel tube section or contained a structural steel reinforcement within the mullion. Non-removable mullions were similarly constructed but were fixed at the head and the sill. Finally, the frame was attached to an 8-inch, fully reinforced, CMU wall with steel T-anchors, a minimum of five in each jamb and three in each head opening, and the void between the frame and masonry wall was grouted solid. No grout was placed in the center mullion.

The double-door systems were tested with pressures associated with the 250-mph design wind and for the 15-lb design missile. Also, for some door missile impact tests, it was not uncommon for one door to withstand the impacts and remain closed, but the hardware on that particular door (with the panic bar hardware) was no longer operational. For life-safety considerations, these results meet the missile impact criteria since the missile did not enter the safe room area. However, when functionality is a requirement (such as in the Dade County Florida impact test criteria), this result does not meet those impact requirements.

7.4.2 Door Frames

Fourteen-gauge steel door frames in either a welded or knockdown style are known to be adequate to carry design wind and impact loads on a single door. Care should be taken in the installation of the frame so that it works properly and does not hinder the rest of the safe room construction. Frames used in stud construction should be attached to the main wind force resisting system (MWFRS). This attachment is achieved with five 3/8-inch lag screws in the jamb and three 3/8-inch lag screws in the head, installed into the studs that make the rough opening of the door. Frames used in masonry construction are connected to the structure with T-anchors. It is critical that the T-anchors be bent at the internal edge of the masonry so that the tail of the anchor does not interfere with the placement of reinforcing steel and pea-gravel concrete. A minimum of five T-anchors in the jamb and three T-anchors in the head are typically needed to secure the jamb effectively.

Frames for large single doors should be constructed of at least 12-gauge steel. Frames for double-door systems should be constructed of at least 14-gauge steel frames and use a 14-gauge, steel center mullion as described in Double-Door Systems (with Center Mullions) in the previous section.

7.4.3 Door Hardware

Door hardware consists of latching and locking mechanisms, hinges, door coordinators, door closers, view windows, and "peep" sights. In all cases, following pressure and impact tests, the door should remain closed and locked and none of the hardware mechanisms should have been disassociated from their attachment to the door and frame. Two points of locking should remain engaged following the conclusion of the pressure or impact tests. Three points of locking are recommended so that, if a debris impact close to one destroys it, two latches will be left to carry the loads. Latching and locking hardware is further described in this section. Hinges should be heavy duty 5-knuckle types that are attached with American-made, "fullhead" screws. Some

doors with heavy duty hinges have been successfully tested to 250-mph standards. Door closers and coordinators must remain attached to the door and frame following the tests. View windows and “peep” sights have not been successfully tested in any assemblies and should not be included in the door.

Single-Latch Mechanisms

Previous testing of latching and locking mechanisms consisted of testing an individual latch/lock cylinder or a mortised latch with a throw bolt locking function. In each case, tests proved that these locks, when used alone (without supplemental locks) did not pass the wind pressure and missile impact tests. Further testing proved that doors with these latching Grade 1 mechanisms and two additional Grade 1 mortised, cylindrical deadbolts (with solid ½-inch-thick steel throw bolts with a 1-inch throw into the door jamb) above and below the original latch would meet the criteria of the wind pressure and missile impact tests. It is important to note, however, that hollow deadbolts containing rod inserts, and residential grade deadbolts, failed the pressure and impact tests.

However, it is important to note that the use of a door with three individually operated latching mechanisms may conflict with code requirements for egress for areas with large occupancies. Additional information on appropriate door hardware for larger occupancies is presented later in this section. Further guidance on door and egress recommendations is provided in Section 7.4.4.

Latching Mechanisms Operated with Panic Hardware

An extensive search was performed to locate three-point latching systems operated from a single panic bar capable of resisting the wind pressures and missile impacts specified in this chapter. Two systems were selected and tested. These systems consisted of a panic-bar-activated headbolt, footbolt, and mortised deadbolt. The headbolt and footbolt are 5/8-inch stainless steel bolts with a 1-inch projection (throw)



WARNING

Maintenance problems have been encountered with some three-point latching systems currently in use. If the door system uses a latch that engages a floor mounted catch mechanism, proper maintenance is needed if the latch is to function properly. Lack of maintenance may lead to premature failure of the door hardware during an extreme-wind event. Some tested manufacturers now offer a low jamb bolt in lieu of a sill bolt to solve these maintenance issues.



NOTE

Most doors evaluated by FEMA prior to January 2000 were equipped with latching mechanisms composed of three individually activated deadbolt closures. Since that time, multiple latching mechanisms activated by a single lever or by a panic bar release mechanism have been tested and shown to resist the wind loads and debris impacts of the most stringent criteria in this publication (pressures associated with the 250-mph safe room design wind speed and impacts from a 15-lb 2x4 traveling horizontally at 100 mph).

at the top and bottom encased in stainless steel channels. Each channel is attached to the door with a mounting bracket. The headbolt and footbolt assembly can be mounted inside the door or on the exterior of the door, but only the externally mounted assembly was tested. The mortised lock complies with ANSI/BHMA 115.1 standard mortise lock and frame preparation (1 ¼-inch x 8-inch edge mortise opening with mounting tabs). All three locking points were operated by a single action on the panic bar.

This hardware was used for the double-door tests discussed previously. Each of the doors was fitted with the panic bar hardware and three-point latches. This system was tested to 1.75 psi without failure. The system also passed the missile impact test, and the door remained closed; however, the hardware was not operational after the test.

7.4.4 Doors and Egress Recommendations

All doors should have sufficient points of connection to their frame to resist design wind pressure and impact loads. Each door should be attached to its frame with six points of connection (three connections on the hinge side and three connections on the latch side). Model building codes and life-safety codes often include strict requirements for securing doors in public areas (areas with assembly classifications). These codes often require panic bar hardware, single-release mechanisms, or other hardware requirements. For example, the IBC and the NFPA life-safety codes require panic bar hardware on doors for assembly occupancies of 100 persons or more. The design professional will need to establish what door hardware is required and what hardware is permitted.

Furthermore, most codes will not permit primary or supplemental locking mechanisms that require more than one action to achieve egress, such as deadbolts, to be placed on the door of any area with an assembly occupancy classification, even if the intended use would only be during an extreme-wind event. This restriction is also common for school occupancy classifications.

These door hardware requirements affect not only safe room areas, but also rooms and areas adjacent the safe room. For example, in a recent project in North Carolina, a school design was modified to create a safe room area in the main hallway. Structurally, this was not a problem; the walls and roof systems were designed to meet the wind pressure and missile impact criteria presented in this manual. The doors at the ends of the hallway also were easily designed to meet these criteria. However, the doors leading from the classrooms to the hallway were designed as rapid-closing solid doors without panic hardware in order to meet the wind pressure and missile impact criteria. This configuration was considered not to be a problem when the students were in the hallway that functioned as a safe room, but it was a violation of the code for the normal use of the classrooms by the local building department. The designer was able to meet the door and door hardware requirements of the code for the classrooms by installing an additional door in each classroom that did not lead to the safe room area, thereby providing egress that met the requirements of the code. Currently, one manufacturer has been identified that offers a single action three-point locking hardware with a “Classroom Function” that has been successfully

tested to resist pressures associated with a 250-mph safe room design wind speed and impacts from a 15-lb 2x4 traveling horizontally at 100 mph.

Another option for protecting doors from missile impacts and meeting the criteria of this manual is to provide missile-resistant barriers. The safe room designs presented in Appendices C and D of this manual use alcoves to protect doors from missile impacts. A protective missile-resistant barrier and roof system should be designed to meet the design wind speed and missile impact criteria for the safe room and maintain the egress width provided by the door itself. If this is done, the missile impact criteria for the door and code egress requirements for the door are satisfied. Although the wind pressures at the door should be reduced by the presence of the alcove, significant research to quantify the reduction has not been performed. Therefore, the door should be designed to resist wind pressures from the design wind. See Figure 7-12.

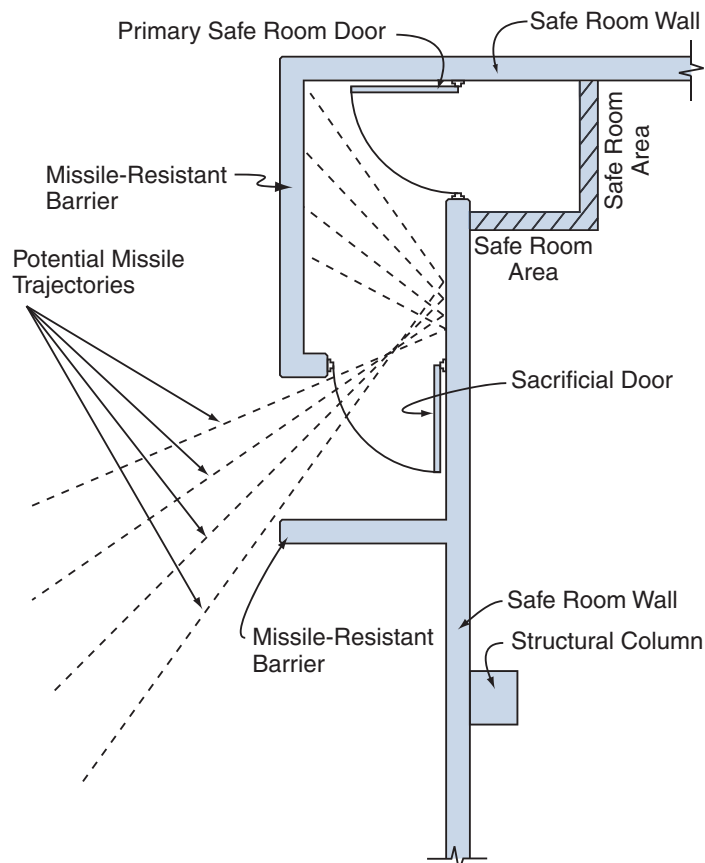

Figure 7-12. The door of the safe room in Case Study I (Appendix C) is protected by a missile-resistant barrier. Note: the safe room roof extends past the safe room wall and connects to the top of the missile-resistant barrier to prevent the intrusion of missiles traveling vertically.

Finally, the size and number of safe room doors should be determined in accordance with applicable fire safety and building codes. If the community or governing body where the

safe room is to be located has not adopted current fire safety or model building codes, the requirements of the most recent edition of a model fire safety and model building code should be used.

7.4.5 Performance of Windows During Debris Impact Tests

Natural lighting is not required in small residential safe rooms; therefore, little testing has been performed to determine the ability of windows to withstand the debris impacts and wind pressures currently prescribed. However, for non-residential construction, some occupancy classifications require natural lighting. Furthermore, design professionals attempting to create aesthetically pleasing buildings are often requested to include windows and glazing in building designs. Glazing units can be easily designed to resist extreme-wind pressures and are routinely installed in high-rise buildings. However, the controlling factor in extreme-wind events, such as tornadoes and hurricanes, is protection of the glazing from missile perforation (the passing of the missile through the window section and into a building or safe room area).

Polycarbonate sheets in thicknesses of 3/8 inch or greater have proven capable of preventing missile perforation. However, this material is highly elastic and extremely difficult to attach to a supporting window frame. When these systems were impacted with the representative missile, the deflections observed were large, and the glazing often popped out of the frame in which they were mounted.

For this manual, window test sections included Glass Clad Polycarbonate (2-ply 3/16-inch PC with 2-ply 1/8-inch heat-strengthened glass) and four-layer and five-layer laminated glass (3/8-inch annealed glass and 0.090 polyvinylbutyral (PVB) laminate). Test sheets were 4 feet x 4 feet and were dry-mounted on neoprene in a heavy steel frame with bolted stops. All glazing units were impact-tested with the representative missile, a 15-lb wood 2x4 traveling at 100 mph.

Summarizing the test results, the impact of the test missile produced glass shards, which were propelled great distances and at speeds considered dangerous to safe room occupants. Although shielding systems can contain glass spall, their reliability is believed to degrade over time. Further testing of the previously impacted specimen caused the glass unit to pull away from the frame.

Testing indicates that glass windows in any configuration are undesirable for use in tornado safe rooms. The thickness and weight of the glass systems needed to resist penetration and control glass spall, coupled with the associated expense of these systems, make them impractical for inclusion in safe room designs. To date, FEMA is aware of only one product that has been tested to meet the large missile criteria of this publication, a 15-lb wood 2x4 traveling at 100 mph.

It is therefore recommended that glazing units subject to debris impacts not be included in safe rooms until products are proven to meet the design criteria. Should the safe room design specify windows, the designer should have a test performed consistent with the impact criteria. The test should be performed on the window system with the type and size of glass specified in the

design and mounted in the actual frame as specified in the design. A “PASS” on the test should be as identified in Chapter 8 of the ICC-500. In general, this means that a “PASS” should show the following: 1) the missile did not perforate the glazing, 2) the glazing remained attached to the glazing frame, and 3) glass fragments or shards remained within the glazing unit. It is important to note that glass block is also not acceptable. Glass block, set in beds of unreinforced lime-rich mortar, offers little missile protection.



NOTE

Few window or glazing systems tested for resistance to missile impact have met the missile impact criteria recommended in this manual.

7.5 Commentary on Soil Protection From Debris Impact

As discussed in Chapter 3, soil cover on or around safe rooms can help to protect the safe room from debris impact. Should all or portions of safe rooms be below-ground or covered by soil, missile impact resistance may not be required. Safe rooms with at least 12 inches of soil cover protecting horizontal surfaces, or with at least 36 inches of soil cover protecting vertical surfaces, do not need to be tested for resistance to missile impact as though the surfaces were exposed. Soil in place around the safe room as specified above can be considered to provide appropriate protection from the representative tornado safe room missile impact. Figure 7-13 (based on ICC-500 Figure 305.2.2) presents this information graphically.

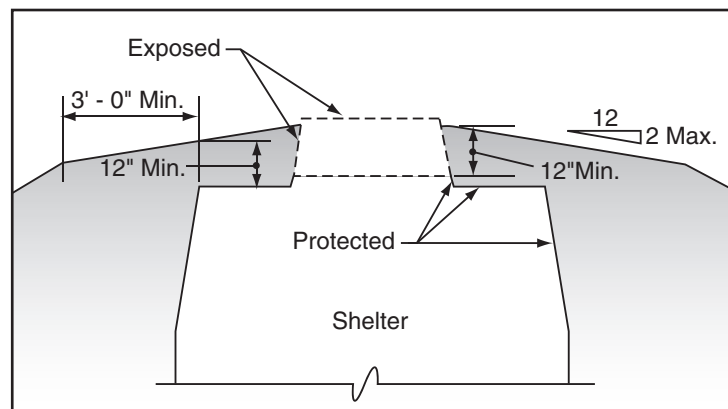

Figure 7-13. ICC-500 Figure 305.2.2 Soil cover over a safe room relieving the requirement for debris impact-resistance

It is also important to note that the soil conditions described above assume the soil is compactable fill. When fill is placed on top of or around a safe room, the soil should be compacted to achieve 95 percent compaction of the dry density of the soil as defined by a Modified Proctor Test. The fill cannot be the soil type used in “green buildings” on the roof or sides of the safe room unless it can be shown to be compactable fill.

7.6 Commentary on Large Falling Debris

The design recommendations for the wind speed selected from Figures 3-2 and 3-3 and the representative missile impact criteria outlined in Sections 3.3.2 and 3.4.2 provide most safe room designs with roof and wall sections capable of withstanding some impacts from slow-moving, large (or heavy) falling debris. The residual capacity that can be provided in safe room designs

was the subject of limited large debris impact testing at Clemson University. The purpose of this testing was to provide guidance on the residual capacity of roof systems when the safe room is located where falling debris may be a hazard. In this testing, two types of safe room roofs were subjected to impacts from deformable, semi-deformable, and non-deformable debris released from heights up to 100 feet and allowed to impact the roofs by free-fall.

Non-deformable debris included barrels filled with concrete weighing between 200 and 1,000 pounds. Semi-deformable debris included barrels filled with sand weighing between 200 and 600 pounds, while deformable debris included heating/ventilation/and air conditioning (HVAC) components and larger objects weighing from 50 to 2,000 pounds. Impact speeds for the falling debris were calculated from the drop height of the debris. The speed of the objects at impact ranged from approximately 17 to 60 mph. Impacts were conducted in the centers of the roof spans and close to the slab supports to observe bending, shear, and overall roof system reactions.

Cast-in-place and pre-cast concrete roof sections were constructed from the design plans in Case Studies I and II in Appendices C and D, respectively. The heavily reinforced, cast-in-place concrete roof performed quite well during the impact testing. Threshold spalling, light cracking, to no visible damage was observed from impacts by deformable missiles, including the large 2,000-lb deformable object that impacted the slab at approximately 60 mph. Impacts from the 1,000-lb concrete barrel did cause spalling of concrete from the bottom surface of the roof near the center of the slab that would pose a significant hazard to the occupants directly below the point of impact. However, significant spalling required relatively high missile drops (high impact speeds).

Spalling of the slab extended into the slab from the bottom surface to the middle of the slab during impacts from the 1,000-lb concrete barrel impacting at approximately 39 mph. During this heavy spalling, the largest fragments of concrete were retained in the roof by the steel reinforcing. Metal decking (22 gauge) was successfully used as cast-in-place formwork on one of the test samples to retain concrete spalls created by the falling debris. The metal decking, however, should be connected to reinforcing within the slab or secured to the concrete to contain the spalling concrete.

The 1,000-lb concrete barrel completely perforated the flange of the double-tee beam in one drop from 50 feet (impacting at 39 mph) and caused significant damage to the stem in a second drop from the same height. Little damage occurred when the deformable debris materials (HVAC units, the 300-lb sand barrels, and a 1,500-lb deformable object) were dropped on the double-tee beams. Only light cracking and threshold spalling were observed from impacts from these deformable objects.

Based on the observed behavior of these roof specimens, it is believed that roof designs that incorporate a uniform thickness (i.e., flat slab) provide a more uniform level of protection from large debris impacts, anywhere on the roof, than a waffle slab, ribbed slab, or other designs that incorporate a thin slab supported by secondary beams. This approach is the best means of

protecting safe room occupants from large impacts on safe room roof systems if siting the safe room away from potential falling debris sources is not a viable solution. Future research may yield information that will result in a more refined approach to designing safe rooms to resist the forces created by large falling debris.

Falling debris also creates structural damage, the magnitude of which is a function of the debris size and distance the debris falls. Falling debris generally consists of building materials and equipment that have significant mass and fall short distances from taller structures nearby. When siting the safe room, the designer should consider placing the safe room away from a taller building or structure so that, if the structure collapses, it will not directly impact the safe room. When this cannot be done, the next best alternative would be to site the safe room in such a way that no large structure is within a zone around the safe room defined by a plane that is 1:1 (vertical to horizontal) for the first 200 feet from the edge of the safe room.

If it is not possible to site the safe room away from all the potential falling debris hazards, the designer should consider strengthening the roof and wall systems of the safe room for the potential dynamic load that may result from these large objects impacting the safe room.

The location of the safe room has an influence on the type of debris that may impact or fall on the safe room. For residential structures, the largest debris generally consists of wood framing members. In larger buildings, other failed building components, such as steel joists, pre-cast concrete members, or rooftop-mounted equipment, may fall on or impact the safe room. Chapter 5 discusses how to minimize the effects of falling debris and other large object impacts by choosing the most appropriate location for a safe room at any given site.

When using the designs provided in FEMA 320 for residential and small, community safe rooms, the safe room user/operator should be aware that falling debris was considered during the design of these prescriptive design solutions. As such, it should be noted that the use of the FEMA 320 safe room within low-rise buildings (typically 60 feet in height and less), even though it may collapse upon the safe room during an extreme-wind event, is considered appropriate.

8 Human Factors Criteria

Human factors criteria for the community safe rooms are based on the design criteria set forth in Chapter 3 and the guidance expanding on those criteria presented in Chapter 6. When the first edition of this manual was published, existing documents did not address all the human factors involved in the design of extreme-wind safe rooms, but they did provide the basis for the criteria summarized in this chapter. Many documents now provide improved guidance with respect to human factors criteria that should be included in safe room design and construction. Unless otherwise noted, the criteria in this section are the same as those provided in the ICC-500, which standardized and correlated much of the existing FEMA guidance in this area with the current 2006 IBC and IRC requirements. These criteria were addressed without explanation in Chapter 3 and are discussed here in more detail to provide clarification of their use. If safe rooms are designed to provide protection from both tornadoes and hurricanes, the design should incorporate the human factor criteria for the most conservative criteria (i.e., the criteria that are appropriate for the larger population, the longer time, etc.).

Human factors design criteria are necessary in safe room design criteria to ensure a safe and comfortable environment for the safe room. Minimum criteria for the items in this chapter were presented in Chapter 3 for the tornado and hurricane community safe rooms as well as for the residential safe rooms. However, this chapter provides additional detail on the criteria or discussions to clarify their use. If criteria are not addressed in Chapter 3 or herein, the design requirements of the ICC-500 should be used. Should the ICC-500 also not address the criteria in question, consult the latest edition of the IBC or IRC.

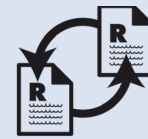

ICC-500 CROSS-REFERENCE

The community and residential safe room design criteria presented in this chapter were addressed in Chapter 3 of this publication, but were not expanded upon in detail. This chapter provides additional information on these topics that governs aspects related to the use of the safe room beyond structural wind design criteria or debris impact criteria. The criteria in this chapter are the same as the community tornado shelter design criteria presented in the ICC-500 Storm Shelter Standard unless otherwise noted.

8.1 Protection of Critical Support Systems

A safe room may depend upon equipment or support systems to provide habitable safe room space. If this is the case, any equipment or critical support systems should remain functional

for the design wind event and the period of occupancy for the safe room (typically 2 hours for tornado safe rooms and 24 hours for hurricane safe rooms). Critical support systems located outside of the protected area of the safe room should be protected by a means that meets the wind pressure and missile impact criteria and, as applicable, the flood-resistance criteria presented in Chapter 3.

8.2 Occupancy Duration

The duration of occupancy of a safe room will vary, depending on the intended event or hazard for which the safe room has been designed. Occupancy duration is an important factor that influences many aspects of the design process. Safe rooms designed to the criteria in this manual are intended to provide life-safety protection to a specific population facing the immediate threat of impact from a landfalling hurricane or from a tornado.

In the interest of developing cost-effective designs, some items that would have increased occupant comfort were not included in the recommended design criteria. However, examples of items that might help to make safe rooms more comfortable and functional during an event are discussed in this chapter and are also listed in the sample operations plans described in Chapter 9 and presented in Appendices C and D.

8.2.1 Tornado Safe Rooms

Historical data indicate that tornado safe rooms will typically have a maximum occupancy time of 2 hours. Because the occupancy time is so short, many items that are needed for the comfort of occupants for longer durations (in hurricane safe rooms) are not recommended for a tornado safe room.

8.2.2 Hurricane Safe Rooms

Historical data indicate that hurricane safe rooms will typically have a maximum occupancy time of 24 hours (when the safe room is exposed to extreme winds). For this reason, the occupants of a hurricane safe room need more space and comforts than the occupants of a tornado safe room.

8.3 Ventilation

Ventilation for a safe room should comply with the building codes or ordinances adopted by the local jurisdiction; the designer should use the 2006 IBC and IRC if the AHJ has not adopted a building code. Ventilation should be provided either through the floor or the ceiling. Although horizontal ventilation openings may be easier to design and construct, vertical ventilation openings have a smaller probability of being damaged by a missile. Nevertheless, a protective shroud or cowling that meets the missile impact criteria of Chapters 3 and 6 should be provided to protect any ventilation openings in the safe room that are exposed to possible missile impacts,

such as the point where ductwork for a normal-use ventilation system penetrates the wall or roof of the safe room. Occupied space in safe rooms should be ventilated by natural or mechanical means as discussed in Sections 8.3.1 and 8.3.2.

Air exhaust or intake openings that terminate outside of safe room and support system areas should comply with the provisions of Sections 3.3, 3.4, or 3.5 for exterior wall and roof opening protective devices for the appropriate hazard and safe room use. Configuration of natural ventilation openings recommended for the safe rooms should be such that a minimum of 25 percent of the recommended area is located within 46 inches of the floor, or in the lower half of the height of the safe room, whichever is less, with the balance, but not less than 50 percent of the recommended area, located a minimum of 72 inches above the floor, or in the upper quarter of the height of the safe room, whichever is greater. Additionally, outside air intake openings located in the same wall should be located a minimum of 10 feet horizontally. The intake should be separated from any hazardous or noxious contaminant, such as emergency or backup generator vents or exhausts, fuel storage tank vents and containers, and maintenance or custodial storage facilities.

Although a mechanical ventilation system may be overwhelmed in a rare event when the area is used as a safe room, air exchange will still take place. The designer should confirm with the local building official that the ventilation system may be designed for the normal-use occupancy. In the event the community where the safe room is to be located has not adopted a model building and/or mechanical code, the requirements of the most recent edition of the IBC are recommended.

Mechanical systems that provide ventilation are typically part of larger systems that also provide air conditioning and heating. For safe rooms, ventilation and fresh air criteria are driven by the code requirements of the IBC and IRC. Air conditioning and heating systems are not considered part of the design criteria for safe rooms and, therefore, are not addressed by this publication (or the ICC-500). Although air conditioning and heating may increase occupant comfort, they are not necessary for life-safety protection from wind and windborne debris.

However, any buildings that support hospitals or other life-critical operations should consider appropriate design, maintenance, and operations plans that ensure continuous operation of all mechanical equipment during and after a tornado or hurricane. In these instances, a failure of the air-handling system may have a severe effect on life safety. For these types of facilities, protecting the backup power supply to the ventilation system of the safe room is recommended.

8.3.1 Ventilation for Tornado Community Safe Rooms

Tornado community and residential safe rooms should be ventilated by natural means or by mechanical ventilation in accordance with this section. Further, either type of ventilation openings used for atmospheric pressure change (APC) is permitted to be counted as ventilation for the purposes of this section.

If mechanical ventilation is provided, the ventilation system for both single- and multi-use tornado safe rooms (community and residential) should be capable of providing the minimum mechanical ventilation rate of required outdoor air in accordance with the applicable building code provisions for the normal use of the space for the safe room's occupancy classification. The mechanical ventilation system should also be connected to a standby power system. For single-use safe rooms, 15 cubic feet (ft³) per person per minute is the minimum air exchange recommended; this recommendation is based on guidance outlined in the International Mechanical Code (IMC). For multi-use safe rooms, the design of mechanical ventilation systems is recommended to accommodate the air exchange requirements of the IMC for the occupancy classification of the normal use of the safe room.

Tornado safe rooms (community and residential) that rely on natural ventilation should provide the minimum ventilation area in accordance with Table 8-1.

Table 8-1. Venting Area Requirements for Tornado Safe Rooms (from ICC-500, Table 702.1.1)

Tornado Safe Room Type	Venting Area (per Occupant)
Residential	2 square inches*
Community (≤ 50 persons)	5 square inches
Community (> 50 persons)	6 square inches

* However, air intake openings for residential tornado safe rooms should be permitted to be located entirely in the upper half of the safe room if the venting area provided is increased to 4 square inches per safe room occupant.

8.3.2 Ventilation for Hurricane Community Safe Rooms

Hurricane community and residential safe rooms should be ventilated by natural means or by mechanical ventilation in accordance with this section. For hurricane safe rooms with an occupant load greater than 50, every occupied space in a hurricane community safe room should be ventilated by mechanical means. The minimum mechanical ventilation rate of required outdoor air should be determined in accordance with the applicable building code provisions for the normal use of the space. If less than 50 persons occupy the safe room, mechanical ventilation may be used but is not required.

All hurricane safe rooms should be provided with openings to facilitate minimum natural ventilation. The area of ventilation openings should comply with Table 8-2 and the location of openings should be in accordance with the provisions presented earlier in this section. When hurricane safe rooms are also designed as tornado safe rooms, openings provided to relieve internal pressure for APC per Sections 3.3.1 or 3.5.1 should be permitted to be counted as natural ventilation openings.

Table 8-2. Venting Area Requirements for Hurricane Safe Rooms (from ICC-500, Table 703.1)

Hurricane Safe Room Type	Venting Area (per Occupant)
Residential	4 square inches
Community (≤ 50 persons)	8 square inches
Community (> 50 persons)	12 square inches

8.4 Square Footage, Occupancy, and Egress Recommendations

The criteria for occupancy and egress were presented in Chapter 3 for all safe rooms and were intended to mirror those requirements set out in the applicable building code (IBC being the default if no code is available), where for multi-use safe rooms, the normal occupancy of the safe room is used and for single-use safe rooms occupancy Assembly 3 (A-3) is used. Additional criteria, based on the specific type of safe room, are added to the conditions associated with the normal occupancy of the space. The minimum area criteria for safe rooms presented in this section are based on the use of the space during a storm event and are not intended to address the space recommended for a safe room that might be used for recovery purposes.

Further, a fundamental concept in life safety is that a means of egress, of adequate size to accommodate all occupants, should be available at all times. Since most community safe rooms will be located in spaces normally used for other purposes, such as a gymnasium or cafeteria, the number of egress elements present will often be adequate for those who occupy the space as a safe room.

8.4.1 Tornado and Hurricane Community Safe Room Square Footage Criteria

Occupancy recommendations for tornado and hurricane community safe room design are provided in this section. Additional criteria for seated, bedridden, and disabled occupants were provided in Sections 3.3.1 and 3.4.1.

Section 3.3.1 recommended a minimum of 5 square feet per person for tornado community safe rooms. These recommendations are the same as those provided in the FEMA 1999 *National Performance Criteria for Tornado Shelters* and the first edition of FEMA 361, and are considered to be an appropriate minimum for the tornado community safe room.

The designer, however, should be aware of the occupancy requirements of the building code governing the construction of the safe room. The occupancy loads in the building codes have historically been developed for life-safety considerations. Most building codes will require the maximum occupancy of the safe room to be clearly posted. Multi-use occupancy classifications are provided in the IBC and state and local building codes. Conflicts may arise between the code-specified occupancy classifications for normal use and the occupancy needed for sheltering. The following is an example for a tornado community safe room:

According to the IBC, the occupancy classification for educational use is 20 ft² per person; however, the recommendation for a tornado safe room is 5 ft² per person (per FEMA 361 and ICC-500). Without proper signage and posted occupancy requirements, using an area in a school as a safe room can create a potential conflict regarding the allowed numbers of persons in the safe room. If both the normal and safe room maximum occupancies are posted, and the safe room occupancy is not based on a minimum less than the recommended 5 ft² per person, the safe room design should be acceptable to the building official. The IBC and the model building codes all have provisions that allow occupancies as concentrated as 5 ft² per person and, in some cases, 3 ft² per person.

Section 3.4.1 recommended a minimum of 20 square feet per person for hurricane community safe rooms. This square footage requirement is an increase over the original FEMA 361 hurricane community safe room criteria as a result of discussions among the Project Team, the Review Committee, the ICC-500 Standard Committee, and data from the use of shelters after hurricanes in 2004 and 2005. This increase brings the minimum requirements in line with the recommendations of American Red Cross Publication No. 4496. The ARC publication recommends the following minimum floor areas (Note: the ARC square footage criteria are based on long-term use of the safe room [i.e., use of the safe room both as a refuge area during the event and as a recovery center after the event] and are presented here for informational purposes only):

- 20 ft² per person for a short-term stay (i.e., a few hours to a few days)
- 40 ft² per person for a long-term stay (i.e., a day to weeks)

As with the tornado community safe room, conflicts may arise between the code-specified occupancy classifications for normal use and the occupancy needed for sheltering for hurricane community safe rooms. Below is an example for a hurricane community safe room; in this example, the occupancy conflict can directly affect egress requirements for the safe room set forth in the building code:

According to the IBC, for a 5,000-ft² proposed safe room, the normal occupancy load is $5,100/20 = 255$ people, while the safe room occupancy load is $5,100/10 = 510$ people. For both educational and safe room uses, the IBC requires 0.20 inch of egress per person for buildings not equipped with a sprinkler system. For normal (educational) use, this calculates to 51 inches of required egress and, because of code, a minimum of two doors (exits). Therefore, two 32-inch doors (64-inch total net egress) should be provided. For safe room use, the requirement is for 102 inches and a minimum of three doors (exits). Therefore, three 36-inch doors (108-inch total net egress) should be provided. Although guidance concerning code compliance is provided in Chapter 3 of this publication, the conflicts between these two occupancy requirements for egress must be resolved with state and/or local officials. Future code requirements concerning occupancies and egress may address extreme events and temporary circumstances.

8.4.2 Tornado and Hurricane Residential Safe Room Square Footage Criteria

Occupancy recommendations for tornado and hurricane residential safe room design are provided in this section. Section 3.5.1 recommended a minimum of 3 square feet per person and 7 square feet per person for tornado and hurricane residential safe rooms servicing one- and two-family dwellings, respectively. Similarly, for residential safe rooms servicing more than one- and two-family dwellings, a minimum of 5 square feet per person and 10 square feet per person for tornado and hurricane safe rooms, respectively, is recommended.

These recommendations provide for a more dense residential safe room population than previously recommended in the first edition of FEMA 361. However, these more dense occupancies have been determined to be appropriate for the smaller population residential safe rooms where the maximum occupancy is 16 persons.

8.5 Distance and Travel Time

The safe room designer should consider the time needed for all occupants of a building or facility to reach the safe room. The National Weather Service has made great strides in predicting tornadoes and hurricanes and providing warnings that allow time to seek shelter. For tornadoes, the time span is often short between the NWS warning and the onset of the tornado. Refer to FEMA Hazard Mitigation Assistance (HMA) safe room policy for guidance on how to address the issues of travel time and distance of the at risk population to the safe rooms for tornado hazards. For hurricane safe rooms, a different set of criteria apply. Other hazard-specific constraints that may be governed by local emergency management or law enforcement requirements, mandatory evacuations, and other plans that affect the movement of at risk populations out the way of landfalling hurricanes should be considered for hurricane community safe rooms. To obtain the current FEMA policy on safe rooms, contact your FEMA regional office.

Travel time may be especially important when safe room users have disabilities that impair their mobility and may need assistance from others to reach the safe room. In addition, wheelchair users may need a particular route that accommodates wheelchairs. The designer should consider these factors in order to provide the shortest possible access time and most accessible route for all potential safe room occupants.

Access is an important element of safe room design. If obstructions exist along the travel route, or if the safe room is cluttered with non-essential equipment and storage items, access

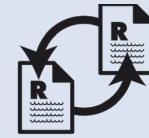

ICC-500 CROSS-REFERENCE

Design criteria and code compliance requirements for the number of doors (exits), door orientation and swing, and door hardware are addressed in detail in Chapter 5 of the ICC-500 and are correlated with the egress and life-safety requirements of the IBC, IRC, and National Fire Protection Association (NFPA) 101. Further, guidance for constraints that apply to vertical egress into and out of safe rooms that require the use of stairs and ladders has also been provided and should be enforced as appropriate.

to the safe room will be impeded. It is essential that the path remain unencumbered to allow orderly access to the safe room. Hindering access in any way can lead to chaos and panic. In addition, siting factors that affect access should be considered (see Chapter 5). For example, at a community safe room built to serve a residential neighborhood, parking at the site may complicate access to the safe room; at a non-residential safe room, such as a facility at a manufacturing plant, mechanical equipment could impede access.

Unstable or poorly secured structural or exterior envelope elements could potentially block access if a collapse occurs that creates debris piles along the access route or at entrances. A likely scenario is an overhead canopy or large overhang that lacks the capacity to withstand extreme-wind forces and collapses over the entranceway. Prior to collapse, these entranceways and canopies may reduce wind pressures and protect openings from windborne debris impacts. However, if they are not designed to withstand the design wind forces acting on the building, they may be damaged during a wind event and may prevent access to and egress from the safe room. If canopies and overhangs are not designed for the design wind speed, they should either be retrofitted and reinforced or be removed.

8.6 Americans with Disabilities Act (ADA)

The needs of persons with disabilities requiring safe room space should be considered. The appropriate access for persons with disabilities should be provided in accordance with all federal, state, and local ADA requirements and ordinances. If the minimum requirements dictate only one ADA-compliant access point for the safe room, the design professional should consider providing a second ADA-compliant access point for use in the event that the primary access point is blocked or inoperable. Additional guidance for compliance with the ADA can be found in many privately produced publications.

The design professional can help safe room operators understand ADA requirements and assist the owner/operator of the safe room in the development of the plan. All safe rooms should be managed with an operations and maintenance plan. Guidelines for the development of safe room operations plans are provided in Chapter 9 for community safe rooms intended to serve residential areas and for non-residential community safe rooms. Developing a sound operations plan is extremely important if compliance with ADA at the safe room site requires the use of lifts, elevators, ramps, or other considerations for safe rooms that are not directly accessible to non-ambulatory persons.



NOTE

For more information about providing for the needs of disabled persons during emergencies, refer to FEMA's United States Fire Administration publication *Emergency Procedures for Employees with Disabilities in Office Occupancies*.

8.7 Special Needs

The use of the safe room also needs to be considered in the design of special needs facilities. The design of special needs safe rooms is beyond the scope of this publication; however, it is important for the design professional to be aware of the need of specific users for whom a safe room is or may be constructed. Occupancy classifications, life-safety codes, and ADA requirements may dictate the design of such elements as door opening sizes and number of doors, but use of the safe room by hospitals, nursing homes, assisted living facilities, and other special needs groups may affect access requirements to the safe room. For example, strict requirements are outlined in the IBC and the model codes regarding the provision of uninterruptible power supplies for life support equipment (e.g., oxygen) for patients in hospitals and other health care facilities.

In addition, strict requirements concerning issues such as egress, emergency lighting, and detection-alarm-communication systems are presented in Chapter 10 of the IBC and in the NFPA Life Safety Code (NFPA 101, 1997 Edition, Chapter 12) for health care occupancies. The egress requirements for egress distances, door widths, and locking devices on doors for health care occupancies are more restrictive than those for an assembly occupancy classification in non-health care facilities based on one of the model building codes for non-health care facilities. Additional requirements also exist for health care facilities that address automatic fire doors, maximum allowable room sizes, and maximum allowable distances to egress points. The combination of all these requirements could lead to the construction of multiple small safe rooms in a health care facility rather than one large safe room.

8.8 Lighting

A standby power source for lighting is essential during a disaster because the main power source is often disrupted. For the regular (i.e., non-safe room) use of multi-use safe rooms, lighting, including emergency lighting for assembly occupancies, is required by all model building codes. Emergency lighting is recommended for community safe rooms. Natural lighting provided by windows and doors is often a local design requirement but is not required by the IBC for assembly occupancies. At this time, very few glazing systems proposed to provide natural lighting for safe rooms meet the missile impact requirements presented in Chapters 3 and 7.

When a standby light system is required, the lighting system should provide an average of 1 foot-candle of illumination in occupied safe room areas, occupant support areas, required corridors, passageways, and means of egress. Standby lighting systems are recommended as follows:

- Tornado community safe rooms should be provided with an emergency lighting system.
- Hurricane community safe rooms with a safe room occupant load greater than 50 should be provided with a standby lighting system.
- Personal-use flashlights should be permitted as satisfying the emergency lighting system criteria for tornado community safe rooms with an occupant load of less than or equal to

50, when provided at a quantity not less than one flashlight per 10 occupants. Personal-use flashlights should be a minimum of two “D” cell batteries size or equivalent light output, and readily accessible from within the occupied safe room areas or immediately adjacent occupant support areas.

In addition to the above criteria, a battery-powered system is recommended as the standby power source because it can be located, and fully protected, within the safe room, although for hurricane safe rooms, a more significant standby power supply may be necessary. Flashlights stored in cabinets are useful as secondary lighting provisions, but should not be used as the primary backup lighting system with the exception of tornado residential safe rooms and community safe rooms with less than 50 occupants (see ICC-500, Chapter 7). A reliable lighting system will help calm safe room occupants during a disaster. Failing to provide proper illumination in a safe room may make it difficult for the owners/operators to minimize the agitation and stress of the safe room occupants during the event. If the backup power supply for the lighting system is not contained within the safe room, it should be protected with a structure designed to the same criteria as the safe room itself.

8.9 Emergency Provisions

Emergency provisions will also vary for different wind events. In general, emergency provisions will include food and water, sanitation management, emergency supplies, and communications equipment. A summary of these issues is presented in the following sections.

8.9.1 Food and Water

For tornado safe rooms, because of the short duration of occupancy, stored food is not a primary concern; however, water should be provided. For hurricane safe rooms, providing and storing food and water are an important concern. As noted previously, the duration of occupancy in a hurricane safe room could be as long as 24 hours or more. Food and water will be needed, and storage areas for them should be included in the design of the safe room. These issues should be addressed in the operations plan for the safe room. FEMA and ARC publications concerning food and water storage in safe rooms may be found at <http://www.fema.gov> and <http://www.redcross.org>.

8.9.2 Sanitation Management

A minimum of two toilets are recommended for both tornado and hurricane community safe rooms. Although the short duration of a tornado might suggest that toilets are not essential for a tornado safe room, the safe room owner/operator is advised to provide two toilets or at least two self-contained, chemical-type receptacles/toilets (and a room or private area where they may be used) for safe room occupants. Meeting this criterion will provide separate facilities for men and women, but is in excess of the ICC-500 requirements, which only specify one toilet when occupancy is less than 50 persons.

ICC-500 also requires a minimum of two toilets for community safe rooms that serve more than 50 occupants, but allows a single toilet for smaller facilities. Larger tornado safe rooms would need to add only one additional toilet per 500 occupants, while the hurricane safe rooms would need one additional toilet per 50 occupants.

Additional toilets will be needed by the occupants of hurricane safe rooms because of the long duration of hurricanes. The toilets will need to function without power, water supply, and possibly waste disposal. Sanitation facilities may be damaged during a hurricane; therefore, designers should consider siting the safe room above a pump station (if appropriate at a safe room site), which would allow the system to have some capacity during the event.

8.9.3 Emergency Supplies

Community safe rooms should contain, at a minimum, the following safety equipment:

- Flashlights with continuously charging batteries (one flashlight per 10 safe room occupants)
- Fire extinguishers (number based on occupancy type) appropriate for use in a closed environment with human occupancy, surface mounted on the safe room wall
- First aid kits rated for the safe room occupancy
- NOAA weather radio with continuously charging batteries
- Radios with continuously charging batteries for receiving commercial radio broadcasts
- A supply of extra batteries to operate radios and flashlights
- An audible sounding device that continuously charges or operates without a power source (e.g., canned air horn) to signal rescue workers if safe room egress is blocked

The above list shows a number of important items to keep in a safe room for the safety and well-being of the occupants. The list should, however, also be cross-checked with the list of items shown in Case Study I, Attachment 11 (Community Safe Room Manager's Kit) contained in the Community Safe Room Sample Standard Operating Procedures, in Appendix C of this publication, which also includes key supplies to have ready for use, such as detailed first-aid equipment, toiletries, and other basic supplies.

8.9.4 Communications Equipment

A means of communication other than a landline telephone is recommended for all safe rooms. Both tornadoes and hurricanes are likely to cause a disruption in telephone service. At least one means of backup communication should be stored in or brought to the safe room. This could be a handheld amateur (HAM) radio, cellular telephone, citizens' band radio, or emergency radios capable of reaching police, fire, or other emergency services. If cellular telephones are relied upon for communications, the owners/operators of the safe room should install a signal amplifier

to send/receive cellular signals from within the safe room. It should be noted that cellular systems may be completely saturated in the hours immediately after an event if regular telephone service has been interrupted.

Finally, the safe room should contain either a battery-powered radio transmitter or a signal-emitting device that can be used to signal the location of the safe room to local emergency personnel should occupants in the safe room become trapped by debris blocking the access door. The safe room owner/operator is also encouraged to inform police, fire, and rescue organizations of the safe room location before an event occurs. These recommendations apply to both above-ground and in-ground safe rooms.

8.10 Standby Power

Safe rooms designed for tornadoes and hurricanes will have different standby (emergency) power needs. These needs are based upon the length of time that people will stay in the safe rooms (i.e., shorter duration for tornadoes and longer duration for hurricanes). In addition to the essential requirements that should be provided in the design of the safe room, comfort and convenience should be addressed.

For tornado safe rooms, the most critical use of standby power is for lighting. Emergency power may also be required in order to meet the ventilation recommendations described in Section 8.3. The user of the safe room should set this requirement for special needs facilities, but most tornado community safe rooms would not require additional emergency power. The ICC-500 standard requires standby power systems to be designed to provide the required output capacity for a minimum of 2 hours and to support the mechanical ventilation system, when applicable.

For hurricane community safe rooms, standby or emergency power may be required for both lighting and ventilation by the local building code. This is particularly important for safe rooms in hospitals and other special needs facilities. Therefore, a backup generator is recommended. Any generator relied on for standby or emergency power should be protected with an enclosure designed to the same criteria as the safe room. The ICC-500 requires the standby backup electrical system to have sufficient capacity to power all the required (critical support) systems and circuits at the same time continuously for a minimum period of 24 hours.

9 Emergency Management Considerations

Disaster preparedness is crucial to quick and effective responses to emergency situations. Potential owners and managers of tornado and hurricane shelters should be ready and able to open a safe room for immediate use in response to an extreme-wind event. The best way to accomplish this is to create a Community Safe Room Plan tailored to the needs of the intended users of the facility. To help emergency managers and facility owners and operators prepare Community Safe Room Plans, this chapter presents guidelines for two types of plans: a Community Safe Room Operations Plan with an accompanying Community Safe Room Maintenance Plan in Sections 9.1 and 9.2, respectively, and a Commercial or Public Building Safe Room Operations Plan in Section 9.3.

Typically, a plan is developed by a Community Safe Room Plan Coordinator whose responsibility is to develop, organize, and coordinate the Community Safe Room Operations Plan. The following guidelines are designed to help the Plan Coordinator organize the process of plan development, which should occur well in advance of any emergency event. While the Plan Coordinator primarily serves a planning role, he or she may also have a role during the activation and operation of the community safe room during an actual emergency. Specifically, the Community Safe Room Plan Coordinator's responsibilities include the following:

- Planning, organizing, and coordinating the development and maintenance of the Community Safe Room Operations Plan
- Ensuring that personnel are assigned roles to facilitate all aspects of the Community Safe Room Operations Plan
- Developing education and training programs relative to the Community Safe Room Operations Plan
- Coordinating practice drills and exercises to test the Community Safe Room Operations Plan
- Conducting regular community meetings to discuss emergency planning
- Preparing and distributing newsletters, as needed
- Distributing phone numbers of key personnel to appropriate individuals and agencies
- Ensuring that the Community Safe Room Operations Plan is periodically reviewed and updated as necessary

The plans described in this chapter should be considered as baseline plans that present the minimum information that should be contained in Community Safe Room Operations Plans. A sample Community Safe Room Operations Plan outlining the many of the recommended procedures that should be part of a Community Safe Room Operations Plan is presented in Appendix C. In addition, an actual tornado safe room operations plan from a FEMA-sponsored safe room project has been included in Appendix D. Although the plan in Appendix D was developed prior to this guidance, it is a good example of a safe room operations plan for tornado hazards and is provided for informational purposes. Designers and operators of safe rooms should review these documents to improve their understanding of how the safe room will be relied upon during an event.

9.1 Community Safe Room Operations Plan

Each community safe room designed according to the guidance in this publication should have a Community Safe Room Operations Plan. The plan should describe the difference between tornado watches and warnings, and hurricane watches and warnings, and clearly define the actions to be taken for each type of weather-related emergency. A Community Safe Room Management Team composed of members committed to performing various duties should be designated. The following is a list of action items for the Community Safe Room Operations Plan:

- The names and all contact information for the managers/leaders detailed in Sections 9.1.1 through 9.1.7 should be presented in the beginning of the plan.
- A tornado or hurricane watch is issued by the National Weather Service (NWS) when a tornado or a hurricane is possible in a given area. When a watch is issued, the Community Safe Room Management Team should be placed on alert. Depending on the type of the safe room and the impending emergency, the timing of the watch announcement, and the availability of personnel responsible for safe room operations, the plan should specify the types of activities to be performed for each contingency. For example, a stand-alone community safe room in a residential neighborhood may need to be opened and prepared for a possible emergency at this early stage.
- A tornado or hurricane warning is issued when a tornado or hurricane has been sighted or indicated by weather radar. When a warning is issued, the Community Safe Room Management Team should be activated and should begin performing the following tasks:
 - Sending the warning signal to the community, alerting them to go to the community safe room
 - Evacuating the residents who need assistance to reach the community safe room
 - Taking a head count in the community safe room
 - Securing the community safe room
 - Notifying and maintaining contact with the local Emergency Operations Center (EOC)
 - Monitoring the storm from within the community safe room

- After the storm is over, determining when conditions warrant allowing community safe room occupants to leave and return to their homes
- After the storm is over, cleaning the community safe room and restocking emergency supplies

A member of the Community Safe Room Management Team can take on multiple assignments or roles as long as all assigned tasks can be performed effectively by the team member before and during an extreme-wind event. Readiness and availability of the Community Safe Room Management Team is of special importance for stand-alone community safe rooms in residential neighborhoods and the Community Safe Room Operations Plan should specify the duties and responsibilities of the team for each type of emergency.

The following team members would be responsible for overseeing the implementation of the Community Safe Room Operations Plan:

- Community Safe Room Manager
- Building Manager (for safe rooms in public or commercial facilities)
- Shift Supervisor
- Registration Unit Leader
- Health Services Unit Leader
- Communications Unit Leader
- Food Unit Leader

Full contact information (i.e., home and work telephone, cell phone, and pager numbers) should be provided for all team members and their designated backups. The responsibilities of each of these team members are detailed in Sections 9.1.1 through 9.1.7. Appendix C provides an example of a Community Safe Room Standard Operating Procedure (SOP). Appendix C also includes a suggested list of equipment and supplies for community safe rooms in Attachment 11.

9.1.1 Community Safe Room Manager

The Community Safe Room Manager provides overall supervision and management of the community safe room's operations both during its activation and in between the emergency events. The Community Safe Room Manager ensures that the needs of the community safe room occupants are being met. The Community Safe Room Manager's responsibilities include the following:

- Establishing contact with the local EOC and the facility's representative(s)
- Conducting a pre-event safe room walkthrough
- Ensuring that adequate personnel are in place and appropriately assigned to manage and operate the community safe room

- Ensuring that all aspects of the Community Safe Room SOP are implemented
- Ensuring that the community safe room occupants receive accurate and updated information
- Ensuring that health and safety standards are met
- Coordinating the closure of the community safe room

9.1.2 Building Manager

The Building Manager serves as the building owner's representative (i.e., facility owner, school principal, etc.) and provides security, maintenance, housekeeping, and logistical support for sheltering responsibilities within the facility. The Building Manager is responsible for the overall building/facility operations and works closely with the Community Safe Room Manager, who ensures that the needs of community safe room occupants are being met. The Building Manager's responsibilities include:

- Establishing contact with the Community Safe Room Manager and activating the facility when ready
- Conducting a pre-occupancy inspection in collaboration with the Community Safe Room Manager
- Surveying and laying out the space plan for the occupants and the Food Unit in collaboration with the Community Safe Room Manager and Food Unit Leader
- Assigning appropriate staff to implement the extreme-wind protocol and ensure the integrity of the facility; making regular rounds of the interior and exterior portions of the building on a regular basis, weather permitting
- Understanding the operation of all facility equipment (including communications, lighting, and safety equipment, and closures for building openings)
- Routinely inspecting the safety and sanitation of the facility, including the kitchen, occupant areas, bathrooms, exterior, and registration area and ensuring that health standards and occupants' needs are being met
- Completing an inventory of all supplies owned by the facility that were used in the community safe room

9.1.3 Shift Supervisor

The Shift Supervisors are responsible for the operational elements of the community safe room during their shift, including staffing, ordering food/snacks, water, and supplies, monitoring occupants, etc. The Shift Supervisor reports directly to the Community Safe Room Manager. The Shift Supervisor's responsibilities include the following:

- Surveying and laying out the space plan for the occupants
- Posting signage throughout the community safe room
- Recruiting and training personnel and volunteers
- Assisting the Community Safe Room Manager in keeping occupants informed
- Monitoring community safe room occupants to ensure their needs are being met
- Coordinating the completion of an inventory of all supplies
- Performing duties of the Community Safe Room Manager when he/she is off site or unable to carry out his/her responsibilities

9.1.4 Registration Unit Leader

The Registration Unit Leader and his/her staff ensure that persons entering and leaving the community safe room go through the registration process so that there is an accurate tracking mechanism for all occupants. In cases of extreme urgency, the registration process should not impede the occupants' admission to the safe room and may be conducted after the safe room has been secured. The Registration Unit Leader's responsibilities include the following:

- Surveying and laying out the space plan for the Registration Unit near the entrance to the community safe room
- Posting signage in strategic areas that directs evacuees to the registration area of the community safe room
- Recruiting and training personnel and volunteers, especially multi-lingual registrars
- Assisting the Community Safe Room Manager in keeping occupants informed
- Referring appropriate persons to the Health Services Unit (e.g., ill or injured persons, or those on special medications or diets, etc.)
- Maintaining a community safe room census and reporting it to the Community Safe Room Manager as required
- Ensuring that all community safe room occupants have been accounted for during closure procedures

9.1.5 Health Services Unit Leader

The Health Services Unit Leader ensures the provision of quality health services and that applicable public health standards (state, county, or municipal) are met. Health Services Unit personnel should be appropriately credentialed personnel recruited from local health, medical and Emergency Management Service (EMS) agencies (e.g., nurses, paramedics, Emergency Medical Technicians [EMTs], etc.). The Health Services Unit Leader's responsibilities include the following:

- Determining the needs of the community safe room occupants and arranging to meet those needs by referring the ill or injured to other health care providers and treating minor illnesses or injuries
- Being available at the registration desk to help screen arriving evacuees for communicable diseases, major medical conditions, etc.
- Arranging for the care of those occupants requiring assistance (e.g., infants, elderly, those with disabilities)
- Arranging for the inspection of the community safe room facilities to ensure that all health and safety standards are met, including food handling procedures
- Maintaining appropriate records and ensuring the confidentiality of all medical information
- Ensuring that all community safe room occupants have been accounted for during closure procedures, especially those with any medical needs (to the extent possible), ensuring continuity of care
- Transferring medical records to appropriate authorities, as needed

9.1.6 Communications Unit Leader

The Communications Unit Leader is usually a full-time, 24-hour position required to provide communications between the community safe room, the EOC, and other components of the disaster relief operation when telephones are out of order or anticipated to be out of order. It is recommended that local amateur radio operators (HAM) and/or Radio Amateur Civil Emergency Service (RACES) members be recruited to fulfill this function. The Communications Unit Leader's responsibilities include the following:

- Establishing contact with facility representatives and/or Building Manager to determine the appropriate location for radio and communications equipment
- Determining, in collaboration with the Community Safe Room Manager, which people have the authority to transmit messages
- Establishing initial (pre-event) contact with the local EOC and other components of the disaster relief operation
- Establishing and maintaining a communications log
- Arranging for the return of any equipment once the community safe room is closed or communications are restored to normal

9.1.7 Food Unit Leader

The feeding responsibilities in a community safe room include supervising on-site food preparation and service for community safe room occupants and staff. The Food Unit Leader advises the Community Safe Room Manager of supplies that are needed, ensures that safe food

handling procedures are followed, and sees that menus are planned. The Food Unit Leader may prepare and monitor the food service staff work schedule and record the hours of personnel as requested. The Food Unit Leader's responsibilities include the following:

- Surveying and laying out the space plan for the Food Unit (e.g., food preparation, food storage, disposal, and dining areas)
- Coordinating meal times with the Community Safe Room Manager
- Identifying supply sources for utilities, food, water, and supplies
- Completing an inventory of food supplies on hand
- Overseeing the preparation of meals with the assistance of occupant volunteers
- Restocking food, water, and supplies as needed
- Cleaning food service and preparation areas, including a final clean prior to closure
- Maintaining records for documentation purposes

9.1.8 Equipment and Supplies

Safe rooms designed and constructed to the criteria in this publication are intended to provide safe refuge from an extreme-wind event. These safe rooms serve a different function from shelters designed for use as long-term recovery shelters after an event; however, Community Safe Room Managers may elect to provide supplies that increase the comfort level within the short-term safe rooms. Appendix C, Attachment 11, lists suggested equipment and supplies for community safe rooms.

9.2 Community Safe Room Maintenance Plan

Each community safe room should have a maintenance plan that includes the following:

- An inventory checklist of the emergency supplies (see Appendix C, Attachment 11)
- Information concerning the availability of emergency generators to be used to provide power for lighting and ventilation
- A schedule of regular maintenance of the safe room to be performed by a designated party

Such plans will help to ensure that the community safe room equipment and supplies are fully functional during and after tornadoes and hurricanes. The Community Safe Room Maintenance Plan should be included as part of a Community, Commercial, or other Safe Room Operations Plan.

9.3 Commercial or Public Building Safe Room Operations Plan

A safe room designed to the criteria of this manual may be used by a group other than a residential community (e.g., the safe room may have been provided by a commercial business for its workers or by a school for its students). Guidance for preparing a Commercial or Public Building Safe Room Operations Plan is presented in this section. Please note that, although the sample operating procedures outlined in Appendix C are more tailored to residential safe rooms, there are many elements within the sample procedures that are applicable to preparing a Commercial or Public Building Safe Room Operations Plan.

9.3.1 Emergency Assignments

It is important to have personnel assigned to various tasks and responsibilities for emergency situations before they occur. An Emergency Committee, consisting of a Site Emergency Coordinator, a Safety Manager, and an Emergency Security Coordinator (and backups), should be formed, and additional personnel should be assigned to serve on the committee.

The Site Emergency Coordinator's responsibilities include the following:

- Maintaining a current Safe Room Operations Plan
- Overseeing the activation of the Safe Room Operations Plan
- Providing signage
- Notifying local authorities
- Implementing emergency procedures
- As necessary, providing for emergency housing and feeding needs of personnel isolated at the site because of an emergency situation
- Maintaining a log of events

The Safety Manager's responsibilities include the following:

- Ensuring that all personnel are thoroughly familiar with the Safe Room Operations Plan
- Conducting training programs that, at a minimum, include the following:
 - The various warning signals used, what they mean, and what responses are required
 - What to do in an emergency (e.g., where to report)
 - The identification, location, and use of common emergency equipment (e.g., fire extinguishers)
 - Shutdown and startup procedures
 - Evacuation and sheltering procedures (e.g., routes, locations of safe areas)
- Conducting drills and exercises (at a minimum, twice annually) to evaluate the Safe Room Operations Plan and to test the effectiveness of the emergency procedures

- Ensuring that employees with special needs have been consulted about their specific disabilities and then determining how best to provide them with assistance during an emergency (FEMA's United States Fire Administration's publication *Emergency Procedures for Employees with Disabilities in Office Occupancies* is an excellent source of information on this topic.)
- Conducting an evaluation after a drill, exercise, or actual occurrence of an emergency situation, in order to determine the adequacy and effectiveness of the Community Safe Room Operations Plan and the appropriateness of the response by the site emergency personnel

The Emergency Security Coordinator's responsibilities include the following:

- Opening the safe room for occupancy
- Controlling the movement of people and vehicles at the site and maintaining access lanes for emergency vehicles and personnel
- "Locking down" the community safe room
- Assisting with the care and handling of injured persons
- Preventing unauthorized entry into hazardous or secured areas
- Assisting with fire suppression, if necessary

In addition, the Emergency Committee's responsibilities include the following:

- Informing employees in their assigned areas when to shut down work or equipment and evacuate the area
- Accounting for all employees in their assigned areas
- Turning off all equipment

9.3.2 Emergency Call List

A Community Safe Room Operations Plan for a commercial or public building should include a list of all current emergency contact numbers. A copy of the list should be kept in the designated community safe room area. The following is a suggested list of what agencies/numbers should be included:

- Office emergency management contacts for the building
- Local fire department (both emergency and non-emergency numbers)
- Local police department (both emergency and non-emergency numbers)
- Local ambulance
- Local EOC

- Local emergency utilities (e.g., gas, electric, water, telephone)
- Emergency contractors (e.g., electrical, mechanical, plumbing, fire alarm and sprinkler service, window replacement, temporary emergency windows, general building repairs)
- Any regional office services pertinent to the company or companies occupying the building (e.g., catastrophe preparedness unit, company cars, communications, mail center, maintenance, records management, purchasing/supply, data processing)
- Local services (e.g., cleaning, grounds maintenance, waste disposal, vending machines, snow removal, post office, postage equipment, copy machine repair, elevator music supplier)

9.3.3 Tornado/Hurricane Procedures for Safety of Employees

The following procedures should be followed in the event of a tornado or a hurricane:

- The person first aware of the onset of severe weather should notify the switchboard operator or receptionist, or management immediately.
- If the switchboard operator or receptionist is notified, he or she should notify the management immediately.
- Radios or televisions should be tuned to a local news or weather station, and the weather conditions should be monitored closely.
- If conditions warrant, the management should notify the employees to proceed to and assemble in a designated safe area(s). A suggested announcement would be “The area is experiencing severe weather conditions. Please proceed immediately to the designated safe area and stay away from all windows.”
- Employees should sit on the floor in the designated safe area(s) and remain there until the Site Emergency Coordinator announces that conditions are safe for returning to work.

9.4 Signage

The Community or Commercial Safe Room Management Plan should summarize all activities and strongly encourage community involvement. Potential area community safe room occupants should be given a list of all key personnel and associated contact information. The plan should also describe the type of signage occupants are to follow to reach the safe room. The signs should be illuminated, luminescent, and obvious.

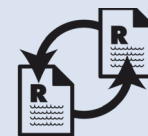

ICC-500 CROSS-REFERENCE

Signage for a FEMA 361 community safe room should be installed as described in Section 3.9 of this publication and as defined in Section 108 of the ICC-500.

9.4.1 Community Signage

It is very important that community safe room occupants can reach the facility quickly and without chaos. Parking is often a problem at community shelters and safe rooms; therefore, a Community Safe Room Operations Plan should instruct occupants to proceed to a community safe room on foot if time permits. Main pathways should be determined and laid out for the community. Pathways should be marked to direct users to the community safe room. Finally, the interior or exterior of the community safe room should have a sign that clearly identifies the building as a community safe room, indicating whether it is a tornado, hurricane, or combined community safe room.

9.4.2 Building Signage at Schools and Places of Work

Signage for safe rooms at schools and places of work should be clearly posted and should direct occupants through the building or from building to building. If the safe room is in a government-funded or public-funded facility, a placard should be placed on the outside of the building designating it an emergency safe room (see Figure 9-1). It is recommended that signage be posted on the outside of all other types of safe rooms as well. The sign should indicate whether the facility is a tornado, hurricane, or combined community safe room.

It is important to note, however, that once a public building has been identified as a tornado or hurricane community safe room, people who live or work in the area around the safe room may expect it to be open during an event. Safe room owners should be aware of this and make it clear that the times when a safe room will be open may be limited. For example, a community safe room in an elementary school or commercial building may not be accessible at night.

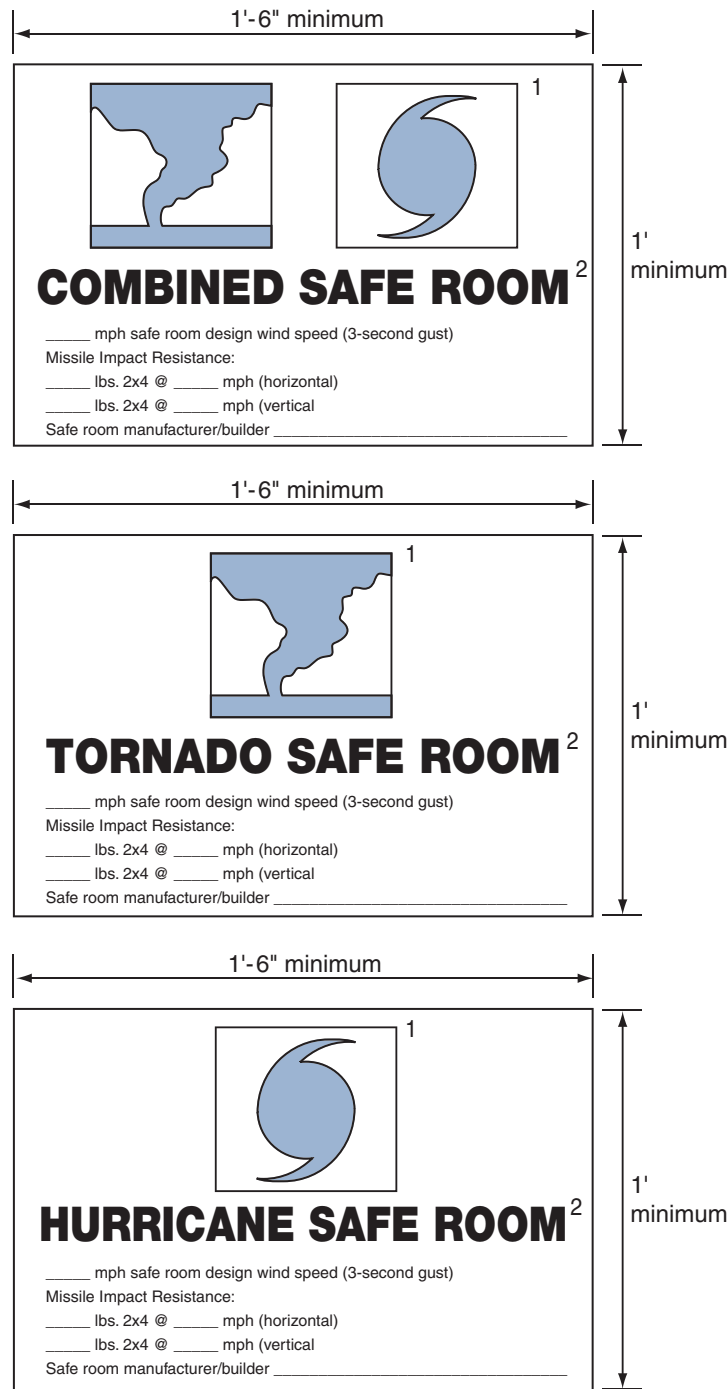

“SAFE ROOM” and logos shall be reflective, using 3M Scotchlite Diamond-Grade reflective sheeting or an equivalent product. Yellow in color. Verify with manufacturer that the sign will glow for a minimum of 6 hours, in the event of power loss.

¹ The applicable picture should be shown for the hazard(s) the safe room has been designed to resist – tornado, hurricane, or combined (show both pictures).

² The applicable hazard should be shown here. For a safe room designed to resist both hurricanes and tornadoes, use the term “combined.”

Figure 9-1. Example of a wind safe room sign (see Detail 201, Sheet A2, Schedules and Details, in the drawing titled Community Shelter, Hurricane Floyd Housing Initiative, North Carolina – Appendix C of this manual)

10 References

American Concrete Institute (ACI). 2008. *Building Code Requirements for Structural Concrete*, ACI 318-08. 2008 Edition. Farmington Hills, MI.

American Concrete Institute and the Masonry Society. 2008. *Building Code Requirements and Specifications for Masonry Structures*, ACI 530-08/ASCE 5-08/TMS 402-08, ACI 530.1-08/ASCE 5-08, and TMS 602-08. Boston, MA.

American Meteorological Society. 2000. *Glossary of Meteorology*.

American Society of Civil Engineers (ASCE), 1998. *Minimum Design Loads for Buildings and Other Structures*, ASCE 7-98, 05 Public Ballot Copy, American Society of Civil Engineers. Reston, VA.

American Society of Civil Engineers, *Minimum Design Loads for Buildings and Other Structures*, ASCE/SEI 7-05, 2006, American Society of Civil Engineers. Reston, VA.

American National Standards Institute and the American Forest & Paper Association. 2005. *National Design Specification® for Wood Construction*. NDS-2005.

Batts, M.E., Cordes, M.R., Russell, L.R., Shaver, J.R. and Simiu, E. 1980. *Hurricane Wind Speeds in the United States*. NBS Building Science Series 124. National Bureau of Standards, Washington, DC. pp. 41.

Carter, R. R. 1998. *Wind-Generated Missile Impact on Composite Wall Systems*. MS Thesis. Department of Civil Engineering, Texas Tech University, Lubbock, TX. May.

Clemson University Department of Civil Engineering. 2000. *Enhanced Protection from Severe Wind Storms*. Clemson University, Clemson, SC. January.

Coats, D. W., and Murray, R. C. 1985. *Natural Phenomena Hazards Modeling Project: Extreme Wind/Tornado Hazard Models for Department of Energy Sites*. UCRL-53526. Rev. 1. Lawrence Livermore National Laboratory, University of California, Livermore, CA. August.

Durst, C.S. 1960. "Wind Speeds Over Short Periods of Time," *Meteorology Magazine*, 89. pp.181-187.

Federal Emergency Management Agency. 1976. *Tornado Protection: Selecting and Designing Safe Areas in Buildings*. TR-83B. April.

Federal Emergency Management Agency. 1980. *Interim Guidelines for Building Occupant Protection From Tornadoes and Extreme Winds*. TR-83A. September.

Federal Emergency Management Agency. 1999a. *Midwest Tornadoes of May 3, 1999: Observations, Recommendations, and Technical Guidance*. FEMA 342. October.

Federal Emergency Management Agency. 1999b. *National Performance Criteria for Tornado Shelters*. May 28.

Federal Emergency Management Agency. 2000. *NEHRP Recommended Provisions for Seismic Regulations for New Buildings and Other Structures*. 2000 Edition. Part 1: Provisions. FEMA 302.

Federal Emergency Management Agency. 2000. *Design and Construction Guidance for Community Shelters*. FEMA 361. July.

Federal Emergency Management Agency. 2002. *Rapid Visual Screening of Building for Potential Seismic Hazards: A Handbook. Second Edition*. FEMA 154. March.

Federal Emergency Management Agency. 2003. *Tornado Protection: Selecting Refuge Areas in Buildings*. November.

Federal Emergency Management Agency. 2004. *Taking Shelter From the Storm: Building a Safe Room Inside Your House*. FEMA 320. Second Edition. March.

Federal Emergency Management Agency and U.S. Fire Administration. Undated. *Emergency Procedures for Employees with Disabilities in Office Occupancies*.

Fujita, T.T. 1971. *Proposed Characterization of Tornadoes and Hurricanes by Area and Intensity*. SMRP No. 91. University of Chicago, Chicago, IL.

Holmes, J.D., Letchford, C.W., and N. Lin. 2005. "Investigations of plate-type windborne debris, Parts I and II." *Journal of Wind Engineering and Industrial Aerodynamics*, Volume 94.

HQ AFCESA/CES. *Structural Evaluation of Existing Buildings for Seismic and Wind Loads*. Engineering Technical Letter (ETL) 97-10.

International Code Council & National Storm Shelter Association. (Scheduled for release in 2008.) *Standard on the Design and Construction of Storm Shelters*. ICC-500. Country Club Hills, IL.

- Kelly, D.L., J.T. Schaefer, R.P. McNulty, C.A. Doswell III, and R.F. Abbey, Jr. 1978. "An Augmented Tornado Climatology." *Monthly Weather Review*, Vol. 106, pp. 1172-1183.
- Krayer, W.R. and Marshall, R.D. 1992. *Gust Factors Applied to Hurricane Winds*. Bulletin of the American Meteorology Society, Vol. 73, pp. 613-617.
- Masonry Standards Joint Committee. 2002. *Building Code Requirements for Masonry Structures and Specifications for Masonry Structures*. ASCE Standard No. 5-08 / No. 6-08.
- Mehta, K.C. 1970. "Windspeed Estimates: Engineering Analyses." I. 22-24 June 1970, Lubbock, TX. pp. 89-103.
- Mehta, K.C., and Carter, R.R. 1999. "Assessment of Tornado Wind Speed From Damage to Jefferson County, Alabama." *Wind Engineering into the 21st Century: Proceedings, 10th International Conference on Wind Engineering*, A. Larsen, G.L. Larose, and F.M. Livesey, Eds. Copenhagen, Denmark. June 21-24. pp. 265-271.
- Mehta, K.C., Minor, J.E., and McDonald, J.R. 1976. "Wind Speed Analysis of April 3-4, 1974 Tornadoes." *Journal of the Structural Division*, ASCE, 102(ST9). pp. 1709-1724.
- Minor, J.E., McDonald, J.R., and Peterson, R.E. 1982. "Analysis of Near-Ground Windfields." *Proceedings of the Twelfth Conference on Severe Local Storms* (San Antonio, Texas, 11-15 January 1982). American Meteorological Society, Boston, MA.
- National Concrete Masonry Association. 1972. *Design of Concrete Masonry Warehouse Walls*. TEK 37. Herndon, VA.
- National Concrete Masonry Association. 2003. *Investigation of Wind Projectile Resistance of Concrete Masonry Walls and Ceiling Panels with Wide Spaced Reinforcement for Above Ground Shelters*.
- O'Neil, S., and Pinelli, J.P. 1998. *Recommendations for the Mitigation of Tornado Induced Damages on Masonry Structures*. Report No. 1998-1. Wind & Hurricane Impact Research Laboratory, Florida Institute of Technology. December.
- Phan, L.T., and Simiu, E. 1998. *The Fujita Tornado Intensity Scale: A Critique Based on Observations of the Jarrell Tornado of May 27, 1997*. NIST Technical Note 1426. U.S. Department of Commerce Technology Administration, National Institute of Standards and Technology, Washington, DC. July.
- Pietras, B. K. 1997. "Analysis of Angular Wind Borne Debris Impact Loads." Senior Independent Study Report. Department of Civil Engineering, Clemson University, Clemson, SC. May.

Powell, M.D. 1993. *Wind Measurement and Archival Under the Automated Surface Observing System (ASOS)*. Bulletin of American Meteorological Society, Vol. 74, 615-623.

Powell, M.D., Houston, S.H., and Reinhold, T.A. 1994. "Standardizing Wind Measurements for Documentation of Surface Wind Fields in Hurricane Andrew." *Proceedings of the Symposium: Hurricanes of 1992* (Miami, Florida, December 1-3, 1993). ASCE, New York. pp. 52-69.

Sciaudone, J.C. 1996. *Analysis of Wind Borne Debris Impact Loads*. MS Thesis. Department of Civil Engineering, Clemson University, Clemson, SC, August.

Steel Joist Institute. *Steel Joist Institute 75-Year Manual 1928-2003*.

Texas Tech University Wind Engineering Research Center. 1998. *Design of Residential Shelters From Extreme Winds*. Texas Tech University, Lubbock, TX. July.

Texas Tech University Wind Science and Engineering Center. 2006. *A Recommendation for an Enhanced Fujita Scale (EF-Scale)*. Lubbock, TX.

Twisdale, L.A. 1985. "Analysis of Random Impact Loading Conditions." *Proceedings of the Second Symposium on the Interaction of Non-Nuclear Munitions with Structures*. Panama City Beach, FL. April 15-18.

Twisdale, L.A., and Dunn, W.L. 1981. *Tornado Missile Simulation and Design Methodology*. EPRI NP-2005 (Volumes I and II). Technical Report. Electric Power Research Institute, Palo Alto, CA. August.

Vickery, P.J., Skerlj, P.F., and L.A. Twisdale, Jr. 2000. "Simulation of hurricane risk in the U.S. using an empirical track model," *Journal of Structural Engineering*, ASCE, Vol. 126, No. 10, October 2000.

Vickery, P.J., Lin, J.X., Skerlj, P.F., and L.A. Twisdale Jr. 2000. "The HAZUS-MH hurricane model methodology part I: Hurricane hazard, terrain and wind load modeling", *Natural Hazards Review*, ASCE, Vol. 7, No. 2, May 2006.

U.S. Department of Energy. 2002. *Natural Phenomena Hazards Design and Evaluation Criteria for Department of Energy Facilities*. DOE-STD-1020-2002. Washington, DC. January.

Zain, Mohammed, Budek, Andrew, and Kiesling, Ernst. *Size Limits for Above-Ground Safe Rooms*. Lubbock, TX.

Storm Surge Inundation Data

Storm surge inundation data mapped for different storm levels (such as Category 1, 3, and 5 hurricanes) needed to evaluate the flood hazard as identified in Section 3.6 of FEMA 361

may not be easily obtainable in your jurisdiction. If your jurisdiction is having difficulty obtaining storm surge inundation data, you may wish to contact the National Oceanic and Atmospheric Administration (NOAA) to talk about how local governments could get a copy of the Sea, Lake, and Overland Surges from Hurricanes (SLOSH) Display Program, which would show the storm surge inundation from different types of hurricanes. For this information, contact Dr. Wil Shaffer (301-713-1613 or wilson.shaffer@noaa.gov).

Below is a list of states and communities that provide storm surge inundation data on the internet. This list is not exhaustive, nor is it meant to be. It has been provided to allow the reader to see how these data may be collected and provided for use.

North Carolina:

These maps show fast moving and slow moving Category 1-5 hurricanes, but no elevations are listed. These were produced from the SLOSH model.

<http://www.hurricanetrack.com/ncstormsurge/comaps.html>

New Jersey:

These maps show the potential flooding from Category 1-4 hurricanes from SLOSH model results. Surge elevations are printed on the maps.

<http://www.nap.usace.army.mil/HES/nj/index.html>

Virginia:

These maps show the areas affected by each storm, but do not show the storm surge elevations associated with those storms. More details about specific properties can be obtained by contacting the emergency management office for that locality. The study was done with the Virginia Department of Emergency Management, FEMA, and the Army Corps of Engineers.

<http://www.vaemergency.com/threats/hurricane/stormsurge.cfm>

Louisiana and Mississippi:

FEMA also has some limited storm surge inundation maps available for the states of Louisiana and Mississippi. The website below provides a link to the FEMA Flood Recovery Map sites for these two Gulf Coast states, which include storm surge inundation data.

<http://www.fema.gov/hazard/flood/recoverydata/katrina>

Appendix A

Acknowledgments

SECOND EDITION TEAM MEMBERS

The Federal Emergency Management Agency would like to acknowledge the significant contributions made by following individuals in developing the second edition of this publication.

FEMA

John Ingargiola – FEMA Headquarters
Jack Anderson – FEMA Headquarters
Marcus Barnes – FEMA Headquarters
Kent Baxter – FEMA Region VI
Daniel Catlett – FEMA Headquarters
Robert Franke – FEMA Region VII
Edward Laatsch – FEMA Headquarters
John Plisich – FEMA Region IV
Shabbar Saifee – FEMA Headquarters
Jonathan Smith – FEMA Headquarters
Jody Springer – FEMA Headquarters
Keith Turi – FEMA Headquarters
Zachary Usher – FEMA Headquarters
Brian Willsey – FEMA Headquarters

CONSULTANTS

Scott Tezak, PE, URS
William Coulbourne, PE, URS
Bill Johnson, URS
Omar Kapur, URS
Shane Parson, PhD, URS
Bogdan Srdanovic, URS
Deb Daly, Greenhorne & O'Mara

Julie Liptak, Greenhorne & O'Mara
Jimmy Yeung, PhD, PE, Greenhorne & O'Mara
John Squerciati, PE, Dewberry
Wanda Rizer, Consultant

PROJECT TEAM AND REVIEW COMMITTEE

Robert Boteler, MEMA (Mississippi)
David Bowman, International Code Council
Ronald Cook, University of Florida
Kenneth Ford, National Association of Home Builders
Dennis Graber, National Concrete Masonry Association
Christopher P. Jones, PE
Ernst Kiesling, PhD, PE, Texas Tech University
Danny Kilcollins, Florida Division of Emergency Management
Philip Line, American Forestry and Paper Association
Marc Madden, American Red Cross
Joseph J. Messersmith, PCA
Sam Nelson, Texas Department of Insurance
Tim Reinhold, PhD, Institute for Business and Home Safety
William Rutherford, Clemons-Rutherford
Corey Schultz, PBA Architects, P.A.
Larry Tanner, RA, PE, Wind Science and Engineering Center, Texas Tech University
Cliff Vaughn, FlatSafe Tornado Shelters

FIRST EDITION TEAM MEMBERS

FEMA would also like to acknowledge the members of the Project Team for the first edition of this manual. The team comprised engineers from FEMA's Mitigation Directorate, consulting design engineering firms, and university research institutions. All engineering and testing efforts required to complete this project were performed by the team. (Note: All affiliations and titles were current at the time of publication of the first edition in July 2000.)

FEMA

James L. Witt, Director, FEMA
Clifford Oliver, CEM, CBCP, FEMA Mitigation Directorate
Paul Tertell, PE, FEMA Mitigation Directorate

CONSULTANTS

William Coulbourne, PE, Greenhorne & O'Mara

Ernst Kiesling, PhD, PE, Wind Engineering Research Center, Texas Tech University

Daniel Medina, PhD, PE, Dewberry & Davis, LLC

Kishor Mehta, PhD, PE, Wind Engineering Research Center, Texas Tech University

Shane Parson, PhD, Dewberry & Davis, LLC

Robert Pendley, Greenhorne & O'Mara

Scott Schiff, PhD, Clemson University

Scott Tezak, PE, Greenhorne & O'Mara

The American Red Cross, Clemson University, the International Code Council® (ICC®), Texas Tech University, and the U.S. Department of Education assisted FEMA in the preparation of the first edition of the manual by providing invaluable guidance and participating on the project Review Committee.

The following individuals made significant contributions to the first edition of the manual. (Note: All affiliations and titles were current at the time of publication of the first edition in July 2000.)

Eugene Brislin, Jr., PE, Structural Engineer

Wes Britson, PE, Professional Engineering Consultants

Russell Carter, EIT, Wind Engineering Research Center, Texas Tech University

Gene Corley, PhD, SE, PE, Construction Technology Laboratories

David Low, PE, Greenhorne & O'Mara

Norland Plastics, Haysville, KS

Timothy Reinhold, PhD, Clemson University

Joseph T. Schaefer, PhD, Storm Prediction Center, National Oceanic and Atmospheric Association

Emil Simiu, PhD, National Institute of Standards and Technology

Larry Tanner, RA, PE, Wind Engineering Research Center, Texas Tech University

In addition to the individuals listed directly above, the following individuals also served on the Review Committee of the first edition of the manual. The committee was composed of design professionals; representatives of federal, state, and local governments; and members of public and private sector groups that represent the potential owners and operators of community shelters. (Note: All affiliations and titles were current at the time of publication of the first edition in July 2000.)

Kent Baxter, FEMA Region VI

Larry K. Blackledge, Blackledge and Associates Architects

John Cochran, FEMA, United States Fire Administration
Doug Cole, Manufactured Home Park Owner
Glenn Fiedelholz, FEMA Preparedness, Training, and Exercise Directorate
Robert Franke, FEMA Region VII
John Gambel, FEMA Mitigation Directorate
Louis Garcia, American Red Cross
Michael Gaus, University of Buffalo
Danny Ghorbani, Manufactured Housing Association for Regulatory Reform
Dirk Haire, Associated General Contractors of America
Dave Hattis, Building Technology Incorporated
E. Jackson, Jr., American Institute of Architects
Aziz Khondker, ESG, Inc.
Danny Kilcollins, National Emergency Management Association
Fred Krimgold, Virginia Tech, Northern Virginia Center
Edward Laatsch, FEMA Mitigation Directorate
Randolph Langenbach, FEMA Infrastructure Division
Emmanuel Levy, Manufactured Housing Research Alliance
John Lyons, U.S. Department of Education, Office of the Director
Robert McCluer, Building Officials and Code Administrators International
Rick Mendlen, U.S. Department of Housing and Urban Development, Office of Consumer Affairs
Charles Moore, Kansas Department on Aging
Peggy Mott, American Red Cross, Planning and Evaluation Directorate
Mark Nunn, Manufactured Housing Institute
Steven Pardue, FEMA Mitigation Directorate
Jim Rossberg, American Society of Civil Engineers
Corey Schultz, PBA Architects, P.A.
Robert Solomon, National Fire Protection Association
Eric Stafford, Southern Building Code Congress International, Inc.
Dan Summers, International Association of Emergency Managers
S. Shyam Sunder, Structures Division, National Institute of Standards and Technology
Carol W. Thiel, Maryland Emergency Management Agency
William Wall, International Conference of Building Officials
Jarrell Williams, Manufactured Home Park Owner
Soy Williams, International Code Council

The following individuals were corresponding members of the Review Committee of the first edition of the manual. (Note: All affiliations and titles were current at the time of publication of the first edition in July 2000.)

Deborah Chapman, National Foundation of Manufactured Housing Owners, Inc.

Jim Fearing, Fearing & Hagenauer Architects, Inc.

Daniel Gallucci, New Necessities, Inc.

Robert Hull, Olathe School District, Kansas

Larry Karch, State Farm Insurance Companies, Facilities Management Division

Mark Levitan, Civil and Environmental Engineering, Louisiana State University

Jerry McHale, Federation of Manufactured Housing Owners of Florida, Inc.

Dick Nystrom, State Farm Insurance Companies, Facilities Management Division

Janet Potter, National Foundation of Manufactured Housing Owners, Inc.

Audrey Staight, American Association of Retired Persons, Public Policy Institute

Lynn White, National Child Care Association

Appendix B Safe Room Assessment and Design Tools

Appendix B.1 Extreme-Wind Refuge Area Evaluation Checklists

Appendix B.2 Designer Checklists

B.1 Extreme-Wind Refuge Area Evaluation Checklists

Wind hazard evaluation checklists were developed by FEMA for the First Edition of FEMA 361 for use in assessing building's susceptibility to damage from high-wind events such as tornadoes and hurricanes. The checklist evaluation process will guide the user in identifying potential refuge areas at a site with one or more buildings. If the refuge area selected is to be considered for use as a "safe room," it must be structurally independent, easily accessible, and of sufficient size for the intended occupant load. Most importantly, the refuge area must be sufficiently resistant to wind forces or be made resistant with mitigation retrofits identified in FEMA 361. If it cannot meet the design criteria for near-absolute protection, the designated space should not be considered a safe room. Rather, it may be the best available space within the building, but use of this space during an extreme-wind event should only occur as a last resort.

An agency or individual can use the checklists to assess the ability of the refuge area to resist forces generated by a tornadic or hurricane event. The checklists consist of questions pertaining to structural and non-structural characteristics of a facility. The questions are designed to identify structural and non-structural vulnerabilities to wind-induced damage based on typical building failures. Structural or non-structural deficiencies may be remedied with retrofit designs but, depending on the type and degree of deficiency, the evaluation may indicate that the structure is unsuitable to serve as a safe room or even as a refuge area. The checklists are not a substitute for a detailed engineering analysis, but can assist the decision-makers involved in hazard mitigation and emergency management to make a preliminary selection of areas of a building that are best suited to serve as refuge areas, or are the best candidates for retrofitting to meet FEMA 361 safe room criteria.

The checklists can also be used to rank a group of facilities within a given geographic region. A scoring system was developed to be used in conjunction with the checklists. Each building deficiency is assigned penalty points according to the level of its vulnerability. Therefore, a high score reflects higher hazard vulnerability and a low score reflects higher hazard resistance, but only relative to other buildings considered in the scoring system. This evaluation process helps determine which building will perform best under natural hazard conditions in the least subjective manner possible. The checklists help identify the areas within buildings that are least vulnerable to damage from extreme winds and would likely require the least mitigation effort to achieve near-absolute protection. The scoring tool does not provide a "passing" or "acceptable" score. To determine the actual level of protection provided by the refuge area, a more detailed assessment is required.

The checklist has five sections: General Building Information, Wind Hazard Checklist, Flood Hazard Checklist, Structural Seismic Hazard Checklist, and Selecting the Refuge Area.

A summary score sheet has been provided with the evaluation checklists to compile the evaluation scores for each natural hazard when multiple sites or areas are being considered. A description of common building types and a glossary of terms are presented following the checklists.

Checklist Instructions

The checklists are designed to walk the user through a step-by-step process and should be filled out in sequence. This process is based on a rapid visual screening methodology and does not involve any destructive testing or detailed engineering calculations. A large portion of the checklists can be filled out using data obtained from design or construction plans. It is important to verify these data during a field inspection and note upgrades (i.e., expect roof replacements on older buildings). If building plans are not available for this evaluation, the accuracy of the checklist may be compromised; worst case scenarios should be assumed for information that cannot be verified. Additional information can be acquired from building specifications, site visits, and interviews with building personnel who can provide historical information on specific problems, repairs, upgrades, and procedures.

Low scores on the checklists indicate structural features that provide considerable levels of protection. Higher scores indicate that a refuge area is more vulnerable to wind damage and less able to provide adequate life-safety protection. The lowest possible cumulative score for Zone IV (region most vulnerable to tornado hazards) is 20 and a safe room or refuge area with this score would likely provide significant protection from an extreme-wind event; however, it is very unlikely that any building would have this score. A pilot study of 10 schools in Wichita (located in Zone IV) resulted in scores ranging from 56 to 161.

General Building Information: This section is for collecting information for reference purposes. All questions relate to the entire building or buildings at the site. The user may need to refer back to the General Building Information section to answer hazard related questions in other sections. This section is not scored.

Wind Hazard Checklist: This checklist applies only to the refuge area(s). If more than one area is selected, a separate checklist should be filled out for each area. A glossary is provided (starting on page 28) to help the user with unfamiliar terminology. Answer the questions and determine a score for this hazard.

Flood Hazard Checklist: This section applies to both the refuge area and to the entire building. A Flood Insurance Rate Map (FIRM) is required to answer most of the questions in this section. Answer the questions and determine a score for this hazard.

Structural Seismic Hazard Checklist: The checklist for the seismic threat pertains to the entire building. A Uniform Building Code (UBC) Seismic Zone Map is provided to help assess the seismic threat. Answer the questions and determine a score for this hazard.

Selecting the Refuge Area: The purpose of the evaluation is to select appropriate refuge areas that provide the best protection from tornado and hurricane events in the absence of a dedicated safe room. The criteria contained in this section will guide the user on how to select good refuge areas. Several refuge areas may be needed to provide enough usable space for the entire population that requires protection. A separate checklist should be filled out for each potential refuge area. This section is not scored.

Summary Score Sheet: After answering and scoring all of the questions in the checklists, the Summary Score Sheet should be filled out. The score sheet is used to compile all the scores for each refuge area for comparison. The total scores will then enable the user to rank each building and its potential as a suitable refuge area.

Transfer checklist scores to the Summary Score Sheet to include subscores from the wind section for each refuge area evaluated. The highest Area Total Wind Hazard Score should be placed in the Highest Wind Hazard Score block. The Total Score is the sum of the Highest Wind Hazard Score, Flood Hazard Score, and Seismic Hazard Score. The Total Scores will reflect the expected performance ranking of the buildings when placed in order from lowest to highest score (i.e., least vulnerable to most vulnerable structure).

GENERAL BUILDING INFORMATION

CONTACT INFORMATION

Site Name: _____

Street Address: _____

City, State, Zip: _____

Contact Person: _____

Contact Phone #: _____

Potential Refuge Population: _____

Typical hours the building is occupied: _____

Is the building locked at any time? _____

BUILDING DATA

Size/Square Footage: _____ Number of Stories: _____

Describe the building configuration: _____

General description of surrounding area: _____

Are there any portable/temporary units: _____ How many: _____

Describe the condition of the building (are there cracks in the walls, signs of deterioration, rusting, peeling paint, or other repair needs): _____

What are the power or fuel sources for the following utilities (natural gas, oil, electric, LP, etc.)?

Heating: _____ Cooling: _____ Cooking: _____

Is there a refuge area or safe room already identified within the building? _____

From which hazard(s) is the refuge area supposed to protect?

Tornado Hurricane Combined (Tornado and Hurricane)

If an existing safe room was designed for extreme winds, indicate the design professional and all relevant design parameters, specifically design wind speed: _____

Evaluator's Name: _____

Date of Evaluation _____

Site Name: _____

WIND HAZARD CHECKLIST

Address the following evaluation statements, giving the most appropriate answer for each question. After selecting the appropriate answer, take the score for that answer (# in the parentheses) and enter it into the score block for that question. Evaluation judgment is subject to limitations of visual examination. Questions have been grouped into sections based on structural issues, cladding and glazing, envelope protection, and non-structural issues. These questions apply only to the refuge area. **After all questions have been appropriately scored, sum the score column and determine the final wind hazard score for the refuge area.**

Question	Score
Structural Issues	
Refuge Area Size Length: Width: Height: Stories:	No Score
Usable square footage for this area (see FEMA 361, Section 3.3.1 or 3.4.1):	No Score
When was building constructed? Check box below. <input type="checkbox"/> Post-2003 (0) <input type="checkbox"/> 2003 – 1999 (0) <input type="checkbox"/> 1998 – 1995 (0) <input type="checkbox"/> 1994 – 1988 (2) <input type="checkbox"/> 1987 – 1980 (4) <input type="checkbox"/> 1979 – 1970 (6) <input type="checkbox"/> 1969 – 1951 (8) <input type="checkbox"/> Pre-1950 (10) Date on plans:	
The building was designed according to the following building code: <input type="checkbox"/> Uniform Building Code, Year: <input type="checkbox"/> International Building Code, Year: <input type="checkbox"/> Standard Building Code, Year: <input type="checkbox"/> International Residential Code, Year: <input type="checkbox"/> National Building Code, Year: <input type="checkbox"/> Other Code:	No Score
Were any of the following guidance documents or standards used in the construction of the refuge area or building? <input type="checkbox"/> FEMA 361, year: <input type="checkbox"/> ICC-600, year: <input type="checkbox"/> SSTD 10, year: <input type="checkbox"/> FEMA 320, year: <input type="checkbox"/> ICC-500, year: <input type="checkbox"/> ASCE 7, year: .	No Score
What is the structural construction material of the refuge area? <input type="checkbox"/> Concrete (10) <input type="checkbox"/> Pre-Cast Concrete (10) <input type="checkbox"/> RM (10) <input type="checkbox"/> Engineered/Heavy Steel Frame (12) <input type="checkbox"/> Partially Reinforced Masonry (PRM) (15) <input type="checkbox"/> Unreinforced Masonry (URM) (20) <input type="checkbox"/> Wood or Metal Studs (20) <input type="checkbox"/> Light Steel Building/Pre-engineered (20) <input type="checkbox"/> Unknown (20)	

Evaluator's Name: _____ Date of Evaluation _____

Site Name: _____

<p>What building plans are available for the inspection?</p> <p><input type="checkbox"/> As-built Plans (including full architectural and structural plans) (0)</p> <p><input type="checkbox"/> Design/Construction Plans (including full architectural and structural plans) (2)</p> <p><input type="checkbox"/> Structural Plans only (3)</p> <p><input type="checkbox"/> Architectural Plans only (5)</p> <p><input type="checkbox"/> Partial set of plans (8)</p> <p><input type="checkbox"/> No plans are available (12)</p>	
<p>Vertical and Lateral Load Resisting Systems (select the system that applies)</p> <p><input type="checkbox"/> <u>Moment Resisting Frame</u> or <u>Braced Frame</u> (identify infill wall below) (0)</p> <p style="padding-left: 20px;"> <input type="checkbox"/> Concrete Beams/Columns <input type="checkbox"/> Precast Concrete Beams/Columns <input type="checkbox"/> Steel Beams/Columns (heavy) <input type="checkbox"/> Wood Beams/Columns <input type="checkbox"/> Steel Beams/Columns (light) <input type="checkbox"/> Steel Bar Joist and Concrete or RM Columns </p>	
<p>Shear Wall of Braced Frame; bracing or support is provided by:</p> <p style="padding-left: 20px;"> <input type="checkbox"/> Concrete Shear Wall (0) <input type="checkbox"/> RM Shear Wall (0) <input type="checkbox"/> PRM Shear Wall (2) <input type="checkbox"/> URM Shear Wall (5) <input type="checkbox"/> Plywood Shear Wall (5) <input type="checkbox"/> Other: _____ (5) </p>	
<p><input type="checkbox"/> Solid Load-Bearing Wall System</p> <p style="padding-left: 20px;"> <input type="checkbox"/> Concrete Walls (0) <input type="checkbox"/> RM Walls (0) <input type="checkbox"/> PRM Walls (4) <input type="checkbox"/> URM Walls (10) <input type="checkbox"/> Framed Walls (wood or metal stud) (6) <input type="checkbox"/> Other: _____ (6) </p>	

Evaluator's Name: _____

Date of Evaluation _____

Site Name: _____

<p>Elevated Floor or Roof Deck Systems (check all that apply)</p> <p> <input type="checkbox"/> Concrete Beams and Slab <input type="checkbox"/> Concrete Flat Slab <input type="checkbox"/> Precast Concrete Deck <input type="checkbox"/> Steel Deck with Concrete <input type="checkbox"/> Steel Deck with Insulation Only <input type="checkbox"/> Diagonal Sheathing <input type="checkbox"/> Plywood Sheathing <input type="checkbox"/> Wood Joists/Beams <input type="checkbox"/> Wood Trusses <input type="checkbox"/> Wood Plank <input type="checkbox"/> Concrete Plank <input type="checkbox"/> Concrete Waffle Slab <input type="checkbox"/> Open Web Steel Joist <input type="checkbox"/> Steel Beam </p>	No Score																																																												
<p>Do the connections in the structural systems provide a continuous load path for all loads (gravity, uplift, lateral)?</p> <p> <input type="checkbox"/> Yes (0) <input type="checkbox"/> No (10) <input type="checkbox"/> Do not know (10) </p> <p>If YES, identify the following connections:</p> <p>Actual connectors of the roof structure and the spacing _____</p> <p>_____</p> <p>Actual connectors between the roof and wall and the spacing _____</p> <p>_____</p>	No Score																																																												
<p>Connection Details for Refuge Area (check at least one item in each column)</p> <table style="width: 100%; border-collapse: collapse;"> <thead> <tr> <th style="width: 25%;"></th> <th style="width: 12.5%; text-align: center;">Roof to Roof Structure</th> <th style="width: 12.5%; text-align: center;">Roof Structure to Wall Structure</th> <th style="width: 12.5%; text-align: center;">Within Wall</th> <th style="width: 12.5%; text-align: center;">Walls to Foundation</th> </tr> </thead> <tbody> <tr> <td>Reinforcing Steel</td> <td style="text-align: center;"><input type="checkbox"/> (0)</td> <td style="text-align: center;"><input type="checkbox"/> (0)</td> <td style="text-align: center;"><input type="checkbox"/> (0)</td> <td style="text-align: center;"><input type="checkbox"/> (0)</td> </tr> <tr> <td>Welded (not tack)</td> <td style="text-align: center;"><input type="checkbox"/> (0)</td> <td style="text-align: center;"><input type="checkbox"/> (0)</td> <td style="text-align: center;"><input type="checkbox"/> (0)</td> <td style="text-align: center;"><input type="checkbox"/> (0)</td> </tr> <tr> <td>Bolted</td> <td style="text-align: center;"><input type="checkbox"/> (0)</td> <td style="text-align: center;"><input type="checkbox"/> (0)</td> <td style="text-align: center;"><input type="checkbox"/> (0)</td> <td style="text-align: center;"><input type="checkbox"/> (0)</td> </tr> <tr> <td>Metal Clips/Fasteners</td> <td style="text-align: center;"><input type="checkbox"/> (1)</td> <td style="text-align: center;"><input type="checkbox"/> (1)</td> <td style="text-align: center;"><input type="checkbox"/> (1)</td> <td style="text-align: center;"><input type="checkbox"/> (1)</td> </tr> <tr> <td>Metal Hangers</td> <td style="text-align: center;"><input type="checkbox"/> (1)</td> <td style="text-align: center;"><input type="checkbox"/> (1)</td> <td style="text-align: center;"><input type="checkbox"/> (1)</td> <td style="text-align: center;"><input type="checkbox"/> (1)</td> </tr> <tr> <td>Self Tapping Screws</td> <td style="text-align: center;"><input type="checkbox"/> (1)</td> <td style="text-align: center;"><input type="checkbox"/> (1)</td> <td style="text-align: center;"><input type="checkbox"/> (1)</td> <td style="text-align: center;"><input type="checkbox"/> (1)</td> </tr> <tr> <td>Wire Fastener</td> <td style="text-align: center;"><input type="checkbox"/> (2)</td> <td style="text-align: center;"><input type="checkbox"/> (2)</td> <td style="text-align: center;"><input type="checkbox"/> (2)</td> <td style="text-align: center;"><input type="checkbox"/> (2)</td> </tr> <tr> <td>Nailed</td> <td style="text-align: center;"><input type="checkbox"/> (4)</td> <td style="text-align: center;"><input type="checkbox"/> (4)</td> <td style="text-align: center;"><input type="checkbox"/> (2)</td> <td style="text-align: center;"><input type="checkbox"/> (4)</td> </tr> <tr> <td>Other: _____ (possible tack weld)</td> <td style="text-align: center;"><input type="checkbox"/> (5)</td> <td style="text-align: center;"><input type="checkbox"/> (5)</td> <td style="text-align: center;"><input type="checkbox"/> (5)</td> <td style="text-align: center;"><input type="checkbox"/> (5)</td> </tr> <tr> <td>Gravity Connection</td> <td style="text-align: center;"><input type="checkbox"/> (6)</td> <td style="text-align: center;"><input type="checkbox"/> (6)</td> <td style="text-align: center;"><input type="checkbox"/> (6)</td> <td style="text-align: center;"><input type="checkbox"/> (6)</td> </tr> <tr> <td>Unknown</td> <td style="text-align: center;"><input type="checkbox"/> (6)</td> <td style="text-align: center;"><input type="checkbox"/> (6)</td> <td style="text-align: center;"><input type="checkbox"/> (6)</td> <td style="text-align: center;"><input type="checkbox"/> (6)</td> </tr> </tbody> </table>		Roof to Roof Structure	Roof Structure to Wall Structure	Within Wall	Walls to Foundation	Reinforcing Steel	<input type="checkbox"/> (0)	<input type="checkbox"/> (0)	<input type="checkbox"/> (0)	<input type="checkbox"/> (0)	Welded (not tack)	<input type="checkbox"/> (0)	<input type="checkbox"/> (0)	<input type="checkbox"/> (0)	<input type="checkbox"/> (0)	Bolted	<input type="checkbox"/> (0)	<input type="checkbox"/> (0)	<input type="checkbox"/> (0)	<input type="checkbox"/> (0)	Metal Clips/Fasteners	<input type="checkbox"/> (1)	<input type="checkbox"/> (1)	<input type="checkbox"/> (1)	<input type="checkbox"/> (1)	Metal Hangers	<input type="checkbox"/> (1)	<input type="checkbox"/> (1)	<input type="checkbox"/> (1)	<input type="checkbox"/> (1)	Self Tapping Screws	<input type="checkbox"/> (1)	<input type="checkbox"/> (1)	<input type="checkbox"/> (1)	<input type="checkbox"/> (1)	Wire Fastener	<input type="checkbox"/> (2)	<input type="checkbox"/> (2)	<input type="checkbox"/> (2)	<input type="checkbox"/> (2)	Nailed	<input type="checkbox"/> (4)	<input type="checkbox"/> (4)	<input type="checkbox"/> (2)	<input type="checkbox"/> (4)	Other: _____ (possible tack weld)	<input type="checkbox"/> (5)	<input type="checkbox"/> (5)	<input type="checkbox"/> (5)	<input type="checkbox"/> (5)	Gravity Connection	<input type="checkbox"/> (6)	<input type="checkbox"/> (6)	<input type="checkbox"/> (6)	<input type="checkbox"/> (6)	Unknown	<input type="checkbox"/> (6)	<input type="checkbox"/> (6)	<input type="checkbox"/> (6)	<input type="checkbox"/> (6)	No Score
	Roof to Roof Structure	Roof Structure to Wall Structure	Within Wall	Walls to Foundation																																																									
Reinforcing Steel	<input type="checkbox"/> (0)	<input type="checkbox"/> (0)	<input type="checkbox"/> (0)	<input type="checkbox"/> (0)																																																									
Welded (not tack)	<input type="checkbox"/> (0)	<input type="checkbox"/> (0)	<input type="checkbox"/> (0)	<input type="checkbox"/> (0)																																																									
Bolted	<input type="checkbox"/> (0)	<input type="checkbox"/> (0)	<input type="checkbox"/> (0)	<input type="checkbox"/> (0)																																																									
Metal Clips/Fasteners	<input type="checkbox"/> (1)	<input type="checkbox"/> (1)	<input type="checkbox"/> (1)	<input type="checkbox"/> (1)																																																									
Metal Hangers	<input type="checkbox"/> (1)	<input type="checkbox"/> (1)	<input type="checkbox"/> (1)	<input type="checkbox"/> (1)																																																									
Self Tapping Screws	<input type="checkbox"/> (1)	<input type="checkbox"/> (1)	<input type="checkbox"/> (1)	<input type="checkbox"/> (1)																																																									
Wire Fastener	<input type="checkbox"/> (2)	<input type="checkbox"/> (2)	<input type="checkbox"/> (2)	<input type="checkbox"/> (2)																																																									
Nailed	<input type="checkbox"/> (4)	<input type="checkbox"/> (4)	<input type="checkbox"/> (2)	<input type="checkbox"/> (4)																																																									
Other: _____ (possible tack weld)	<input type="checkbox"/> (5)	<input type="checkbox"/> (5)	<input type="checkbox"/> (5)	<input type="checkbox"/> (5)																																																									
Gravity Connection	<input type="checkbox"/> (6)	<input type="checkbox"/> (6)	<input type="checkbox"/> (6)	<input type="checkbox"/> (6)																																																									
Unknown	<input type="checkbox"/> (6)	<input type="checkbox"/> (6)	<input type="checkbox"/> (6)	<input type="checkbox"/> (6)																																																									
<p>If walls are masonry units, are they grouted? Which cells are grouted (every cell, every 4th cell, etc.)? _____</p>	No Score																																																												

Evaluator's Name: _____

Date of Evaluation _____

Site Name: _____

For all URM, both load-bearing and non-load-bearing, fill in the blanks and answer the following two questions. Maximum height: _____ Longest span: _____ Thickness: _____	No Score
Is the maximum wall height/wall thickness (h/t) ratios for URM in excess of those noted in AFM 32-1095, page G-63 (see chart below). <input type="checkbox"/> Yes (5) <input type="checkbox"/> No (0) <input type="checkbox"/> Not applicable (0)	
Is the maximum wall length/wall thickness (l/t) ratios for URM in excess of those noted in AFM 32-1095, page G-63 (see chart below). (Measure longest span between column or pilaster supports or from end wall to wall opening). <input type="checkbox"/> Yes (5) <input type="checkbox"/> No (0) <input type="checkbox"/> Not applicable (0)	

Allowable Value of Height-to-Thickness Ratio of URM Walls in High Wind Regions

Wall Types	Maximum l/t to h/t	
	Solid or Solid Grouted	All Other
Bearing Walls		
Walls of one-story buildings	16	13
First-story wall of multistory building	18	15
Walls in top story of multistory building	13	9
All other walls	16	13
Nonbearing Walls (Exterior and Interior ¹)	15	13
Cantilever Walls	3	2
Parapets	2	1 1/2

¹ Interior wall ratio should be the same as the exterior wall ratio due to the risk of internal pressure through breached openings.

Chart from Air Force Manual (AFM) 32-1095: *Structural Evaluation of Existing Buildings for Seismic and Wind Loads*, page G-63.

Does the location of the refuge area require occupants to go outdoors to get to it? <input type="checkbox"/> No (0) <input type="checkbox"/> Yes (2)	
If the refuge area is a section of a building, are the wall systems separated from the remainder of the building structure with expansion joints? <input type="checkbox"/> Yes (0) <input type="checkbox"/> No (3)	
Does the refuge area have its own roof system (i.e., the roof does not extend over other sections of the building outside the refuge area or is separated by joints)? <input type="checkbox"/> Yes (0) <input type="checkbox"/> No (5)	

Evaluator's Name: _____

Date of Evaluation _____

Site Name: _____

Is the height of the refuge area roof less than 30 feet above ground level? <input type="checkbox"/> Yes (0) <input type="checkbox"/> No (2)	
Is there a roof span in the refuge area longer than 40 feet from support to support? <input type="checkbox"/> Yes (10) <input type="checkbox"/> No (0)	
Is the pitch of the roof less than 30° (less than 6/12 pitch)? <input type="checkbox"/> Yes (4) <input type="checkbox"/> No (0)	
If the building has parapet walls, are they taller than 3 feet (as compared to the adjacent roof level)? Check any of the following that apply. <input type="checkbox"/> Structurally attached to the refuge area (2) <input type="checkbox"/> Adjacent to egress routes (2) (if parapet walls collapse, egress routes to the refuge area may be blocked)	
Is there a roof overhang that is more than 2 feet wide? <input type="checkbox"/> Yes (2) <input type="checkbox"/> No (0)	
Structural Issues Subtotal =	

Evaluator's Name: _____

Date of Evaluation _____

Site Name: _____

Cladding and Glazing Issues	
<p>What is the percentage of the exterior wall surface covered by windows and doors on the outer perimeter of the refuge area?</p> <p> <input type="checkbox"/> No windows/protected doors (0) <input type="checkbox"/> No windows/unprotected doors (1) <input type="checkbox"/> 0% – 1% (1) <input type="checkbox"/> 2% (2) <input type="checkbox"/> 3% – 4% (4) <input type="checkbox"/> 5% – 6% (6) <input type="checkbox"/> 7% or more (10) </p>	
<p>Are the ALL windows, doors, and openings protected from impacts from windborne debris? If no, enter a score of 10 in the column to the right. If so, identify the level of protection offered by the system.</p> <p>The windows, doors, or openings of this space are protected from debris impact by systems that have been tested to resist the appropriate missile at the site as defined by:</p> <p> <input type="checkbox"/> The FEMA 361 or ICC-500 Tornado Missile Criteria (15-lb 2x4 board @ at 100-80 mph) (0) <input type="checkbox"/> The FEMA 361 Hurricane Missile Criteria (9-lb 2x4 board @ at 128-80 mph) (2) <input type="checkbox"/> The ICC-500 Hurricane Missile Criteria (9-lb 2x4 board @ at 102-64 mph) (4) <input type="checkbox"/> ASTM E 1996 for Critical Facilities Criteria (9-lb 2x4 board @ at 55 mph) (6) <input type="checkbox"/> ASTM E 1996 for Critical Facilities Criteria (9-lb 2x4 board @ at 34 mph) (7) <input type="checkbox"/> No criteria or a level of protection that does not meet any of the above criteria (10) </p>	
<p>Are doors to the refuge area secured at top and bottom with connections to resist suction effects that may pull the doors open (3-point latches)?</p> <p> <input type="checkbox"/> Yes (0) <input type="checkbox"/> No (10) </p>	
<p>Are there skylights or overhead atrium glass or plastic?</p> <p> <input type="checkbox"/> Yes (5) <input type="checkbox"/> No (0) </p>	
<p>What is the roof covering on the refuge area? NOTE: If more than one material type is used on the roof, choose the one with the highest penalty.</p> <p> <input type="checkbox"/> Storm-resistant shingles (0) <input type="checkbox"/> Wood shingles and shakes (2) (greater than 100 mph rating) <input type="checkbox"/> Clay tile (2) <input type="checkbox"/> Built-up roof, with stone ballast (2) <input type="checkbox"/> Single-ply membrane with ballast (2) <input type="checkbox"/> Built-up roof, without ballast (1) <input type="checkbox"/> Single-ply membrane without ballast (1) <input type="checkbox"/> Traditional metal roofing (1) <input type="checkbox"/> Asphalt/metal shingles (1) <input type="checkbox"/> Material other than those listed above (2) <input type="checkbox"/> No roof covering (0) </p>	
Cladding and Glazing Issues Subtotal =	

Evaluator's Name: _____ Date of Evaluation _____
 Site Name: _____

Envelope Protection	
<p>What are the debris hazards (choose all that apply):</p> <p><input type="checkbox"/> Large light towers (such as for an athletic field) and/or antennas within 300 feet of the structure? (2)</p> <p><input type="checkbox"/> Portable classrooms/trailers, small light frame buildings, HVAC units within 300 feet of the structure? (4)</p> <p><input type="checkbox"/> Unanchored fuel tanks within 300 feet of the structure? (5)</p>	
<p><input type="checkbox"/> Are there buildings with roof gravel within 300 feet of the structure? (including the building site itself) (2)</p> <p><input type="checkbox"/> Are there debris generating sources (e.g., lumber yards, nurseries, and junk yards) within 300 feet of the structure? (4)</p> <p><input type="checkbox"/> Is the refuge area vulnerable to trees, telephone poles, light poles, and other potential missiles? (4)</p>	
<p>What is the material on the exterior walls of the refuge area (excluding window and door systems)?</p> <p><input type="checkbox"/> Concrete (0) <input type="checkbox"/> RM (0) <input type="checkbox"/> PRM (4)</p> <p><input type="checkbox"/> Brick and block composite wall with reinforcing steel @4 feet on center (o.c.) (6)</p> <p><input type="checkbox"/> 3-wythes of solid masonry brick (6)</p> <p><input type="checkbox"/> URM (8) <input type="checkbox"/> Metal/vinyl siding (10)</p> <p><input type="checkbox"/> Metal panels (pre-engineered metal building) (10)</p> <p><input type="checkbox"/> Combination (other than EIFS) (12)</p> <p><input type="checkbox"/> EIFS (on substrate other than concrete or RM) (15)</p>	
<p>What is the material of the roof deck/elevated floor at the refuge area?</p> <p><input type="checkbox"/> Reinforced concrete at least 6 inches thick (0)</p> <p><input type="checkbox"/> Metal deck at least 14 gauge (0)</p> <p><input type="checkbox"/> Reinforced concrete at least 3-inches thick (2)</p> <p><input type="checkbox"/> Metal deck at least 20 gauge (4)</p> <p><input type="checkbox"/> Wood panels at least 1-inch thick (4)</p> <p><input type="checkbox"/> Cement fiber board/deck (tectum) (6)</p> <p><input type="checkbox"/> Metal deck 22 gauge or higher (8)</p> <p><input type="checkbox"/> Wood panels at least ½-inch thick (8)</p> <p><input type="checkbox"/> Other _____ (10)</p>	

Evaluator's Name: _____

Date of Evaluation _____

Site Name: _____

<p>Will the structure adjacent to the refuge area or surrounding it pose a threat if subject to collapse (structural components become debris that creates impact loads on the refuge area)? Specify: _____</p> <p><input type="checkbox"/> Yes (5) <input type="checkbox"/> No (0)</p>	
<p>Are there large, roll-down or garage type doors (metal, wood, plastic) on the exterior of the refuge area?</p> <p><input type="checkbox"/> Yes (5) <input type="checkbox"/> No (0)</p>	
<p>For tornado and combined hazard safe rooms, identify what wind zone region the building is located in based on the Wind Zones Map provided in Figure 1.</p> <p><input type="checkbox"/> Zone I [130 mph] (4) <input type="checkbox"/> Zone II [160 mph] (6)</p> <p><input type="checkbox"/> Zone III [200 mph] (8) <input type="checkbox"/> Zone IV [250 mph] (10)</p> <p>Or</p> <p>For hurricane hazard safe rooms, identify the wind speed contour for the site (if the site is between contour lines, select the highest wind speed contour) provided in Figure 2.</p> <p><input type="checkbox"/> 160-170 (6)</p> <p><input type="checkbox"/> 180-190 (7)</p> <p><input type="checkbox"/> 200-225 (8)</p> <p><input type="checkbox"/> 225 + (10)</p>	
<p>Envelope Protection Subtotal =</p>	

Evaluator's Name: _____

Date of Evaluation _____

Site Name: _____

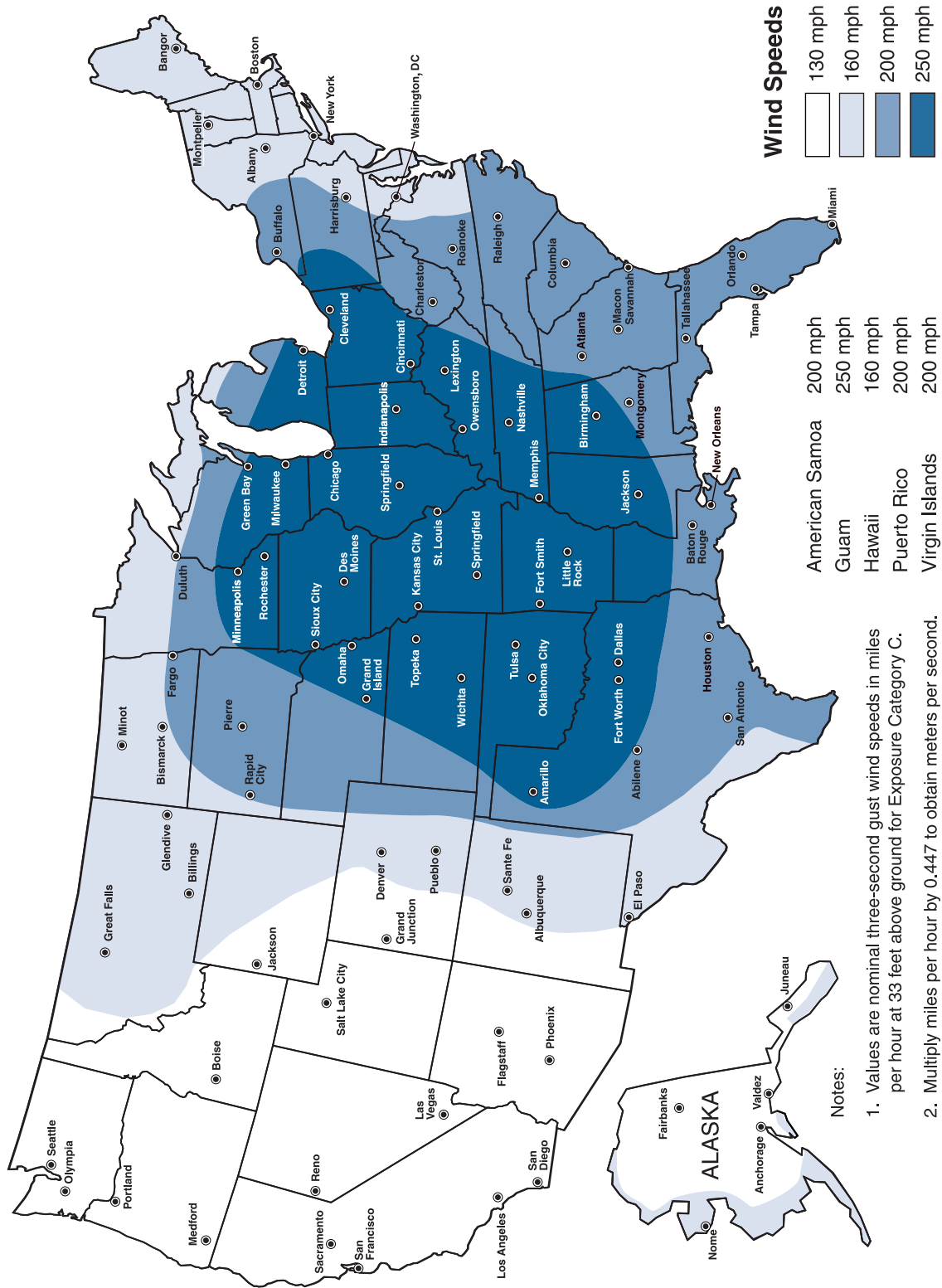

Figure 1: Wind Zones in the United States (Federal Emergency Management Agency) previously printed in FEMA 320, Taking Shelter From the Storm.

Evaluator's Name: _____

Date of Evaluation _____

Site Name: _____

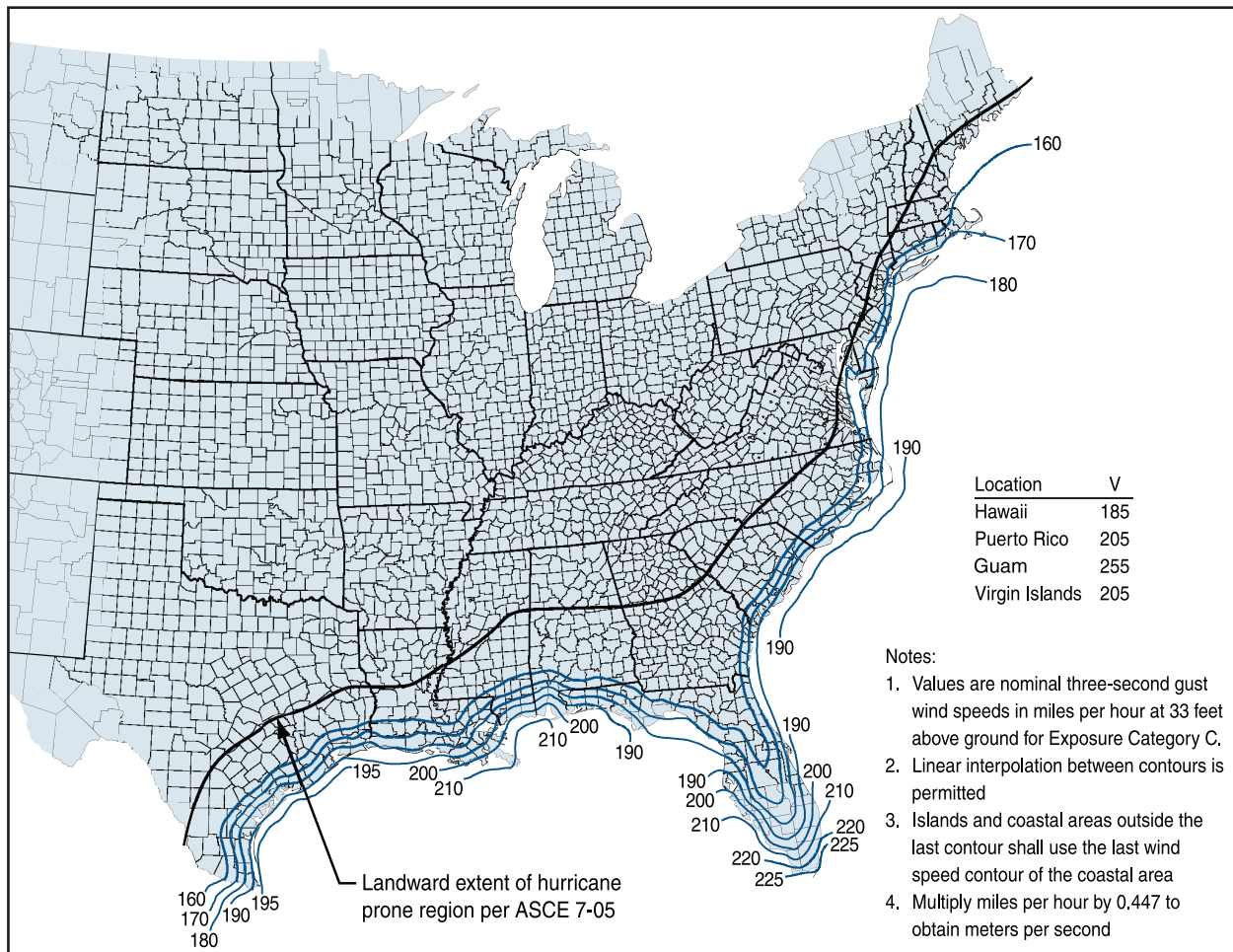

Figure 2: Hurricane Safe Room Design Wind Speed Map from the ICC-500

SOURCE: ICC/NSSA STANDARD FOR THE DESIGN AND CONSTRUCTION OF STORM SHELTERS (ICC-500). COPYRIGHT 2008, WASHINGTON, DC: INTERNATIONAL CODE COUNCIL. REPRODUCED WITH PERMISSION. ALL RIGHTS RESERVED. WWW.ICCSAFE.ORG < HTTP://WWW.ICCSAFE.ORG >.

Non-structural Issues	
Does a combustible gas line run through the refuge area? <input type="checkbox"/> Yes (10) <input type="checkbox"/> No (0) <input type="checkbox"/> Unknown (10)	
Is there a stand-by power source/generator? <input type="checkbox"/> Yes (0) <input type="checkbox"/> No (8)	
If yes, what is the power source: <input type="checkbox"/> Battery powered (0) <input type="checkbox"/> Other power (indicate fuel type) _____(2)	
Is there an automatic transfer switch? <input type="checkbox"/> Yes (0) <input type="checkbox"/> No (2)	
What is the duration of lighting under the back-up power source? <input type="checkbox"/> 0-2 hours (2) <input type="checkbox"/> 3-6 hours (1) <input type="checkbox"/> 7 or more hours (0)	
If the stand-by power supply is not within the refuge area, is it in a place where it will be protected during an extreme-wind event (in an interior room, or below grade)? <input type="checkbox"/> Yes (0) <input type="checkbox"/> No (5) <input type="checkbox"/> Not Applicable (0)	
Is there a back-up communications system (if yes, list type)? <input type="checkbox"/> Yes (0) <input type="checkbox"/> No (2)	
Are bathrooms accessible within the refuge area? <input type="checkbox"/> Yes (0) <input type="checkbox"/> No (2)	
Is the refuge area ADA accessible? <input type="checkbox"/> Yes (0) <input type="checkbox"/> No (2)	

Evaluator's Name: _____

Date of Evaluation _____

Site Name: _____

<p>Is an operations plan in place for evacuation to a refuge area during an extreme-wind event?</p> <p><input type="checkbox"/> Yes (0) <input type="checkbox"/> No (8)</p>	
<p>If yes, answer the following questions:</p> <p>Does the evacuation plan include practice drills?</p> <p><input type="checkbox"/> Yes (0) <input type="checkbox"/> No (2)</p>	
<p>What type of warning signal is used to indicate a tornado drill?: _____</p> <p>Does it differ from a fire drill alarm?</p> <p><input type="checkbox"/> Yes (0) <input type="checkbox"/> No (1)</p>	
<p>Can all occupants reach the candidate refuge area within 5 minutes?</p> <p><input type="checkbox"/> Yes (0) <input type="checkbox"/> No (2) <input type="checkbox"/> Unknown (2)</p> <p>List time: _____</p>	
<p>Non-structural Subtotal =</p>	
<p>Total Wind Hazard Score =</p>	

Evaluator's Name: _____

Date of Evaluation _____

Site Name: _____

FLOOD HAZARD CHECKLIST

Address the following evaluation statements, giving the most appropriate answer for each question. After selecting the appropriate answer, take the score for that answer (# in the parentheses) and enter it into the score block for that question. Evaluation judgment is subject to limitations of visual examination. Elevations are only required if a flood hazard has been identified at the building site. If no flood hazard exists at the site, answer flood related questions with “not applicable.” **After all questions have been appropriately scored, sum the score column and determine the final flood hazard score for the building/structure.**

Question	Score
Flood Hazard Issues	
Community Panel No.: _____ Date Revised: _____ Flood Hazard Zone: _____ What is the base flood elevation (BFE) at the building site?* _____ What is the 500-year flood elevation at the building site?** _____ <input type="checkbox"/> Not applicable (Explain): _____	No Score
Is the site located in a mapped storm surge inundation zone? <input type="checkbox"/> Yes <input type="checkbox"/> No (0) If yes, what is the source used to verify this? _____ If the site is located in a storm surge inundation zone, which category is it in? <input type="checkbox"/> Category 1-2 (6) <input type="checkbox"/> Category 3 (8) <input type="checkbox"/> Category 4-5 (10)	
Is the site located in any of the following areas? <input type="checkbox"/> The Coastal High Hazard Area (VE zones) or other areas known to be subject to high-velocity wave action (10) <input type="checkbox"/> Areas seaward of the Limit of Moderate Wave Action (LiMWA) where mapped, also referred to as the Coastal A Zone in ASCE 24-05 (10) <input type="checkbox"/> Floodways (10) (Note: if the selected refuge area(s) is located in any of the areas listed above, serious consideration as to the use of the selected area(s) should be made. The areas listed above are locations that should not be used to provide protection to occupants.)	
Is there a history of floods at the building site? <input type="checkbox"/> Yes (5) <input type="checkbox"/> No (0) <input type="checkbox"/> Unknown (5) <input type="checkbox"/> Not applicable (0)	
Is there a history of drains (storm or sanitary) backing up due to flooding? <input type="checkbox"/> Yes (2) <input type="checkbox"/> No (0) <input type="checkbox"/> Unknown (2) <input type="checkbox"/> Not applicable (0)	

Evaluator's Name: _____ Date of Evaluation _____

Site Name: _____

Does the surrounding topography contribute to flooding in low-lying areas? Are there poor drainage patterns, basement stairwells, etc.? <input type="checkbox"/> Yes (5) <input type="checkbox"/> No (0)	
Are access roads to the building site sufficiently elevated and expected to be accessible during periods of high water (based on local flooding history and/or FIRM panel information)? <input type="checkbox"/> Yes (0) <input type="checkbox"/> No (2)	
If the building is within a 500-year floodplain or storm surge inundation zone, complete the following. If not, STOP HERE and skip to page 21 for THE STRUCTURAL SEISMIC HAZARD CHECKLIST.	

* BFEs are shown on the Flood Insurance Rate Map (FIRM) for the community.

** 500-year flood elevations are not shown on the FIRM; they are provided in the Flood Insurance Study (FIS) report for the community

Structural Issues***	
What is the building/structure type? <input type="checkbox"/> Concrete (0) <input type="checkbox"/> RM (2) <input type="checkbox"/> Steel (2) <input type="checkbox"/> PRM (5) <input type="checkbox"/> URM (8) <input type="checkbox"/> Wood (10) <input type="checkbox"/> Unknown (10)	
What is the elevation of the lowest floor/level of the building being used for refuge? _____	
Is this elevation: <input type="checkbox"/> Above the 100-year flood elevation + 2 feet (0) <input type="checkbox"/> Less than 2 feet above the BFE (4) <input type="checkbox"/> Below the BFE or unknown (8) <input type="checkbox"/> Not applicable (0)	
Is this elevation: <input type="checkbox"/> Above the 500-year stillwater flood elevation (0) <input type="checkbox"/> Less than the 500-year stillwater flood elevation (10) <input type="checkbox"/> Not applicable (0)	
Is this elevation: <input type="checkbox"/> Above the lowest floor elevation required by the community's floodplain ordinance (0) <input type="checkbox"/> Below the lowest floor elevation required by the community's floodplain ordinance (10) <input type="checkbox"/> Not applicable (0)	
If the site is in a mapped Zone D (or has not been evaluated as part of a NFIP flood study), is this elevation: <input type="checkbox"/> Above the highest recorded flood elevation in the area + 2 feet (0) <input type="checkbox"/> Below the highest recorded flood elevation in the area + 2 feet (10) <input type="checkbox"/> Not applicable (0)	

Evaluator's Name: _____

Date of Evaluation _____

Site Name: _____

<p>If the site is in a mapped coastal storm surge inundation zone, is this elevation:</p> <p><input type="checkbox"/> Above the maximum stillwater elevation associated with a Category 5 hurricane and/or above the wave crest elevation having a 0.2 percent annual chance of being equaled or exceeded (0)</p> <p><input type="checkbox"/> Below the the maximum stillwater elevation associated with a Category 5 hurricane and/or below the wave crest elevation having a 0.2 percent annual chance of being equaled or exceeded (10)</p> <p><input type="checkbox"/> Not applicable (0)</p>	
<p>Is the elevation above the highest of the applicable requirements listed in the last 5 questions?</p> <p><input type="checkbox"/> Yes (0) <input type="checkbox"/> No (10) <input type="checkbox"/> Not applicable (0)</p>	
<p>If the lowest floor of the building is susceptible to flooding, are there openings in the walls to allow water to pass through the wall, thus avoiding pressure buildup on the foundation and first floor walls?</p> <p><input type="checkbox"/> Yes (0) <input type="checkbox"/> No (5) <input type="checkbox"/> Not applicable (0)</p>	
<p>Is any space below the applicable flood criteria used for classroom or office space? (If this area is used for storage, access, and parking only answer "No").</p> <p><input type="checkbox"/> Yes (2) <input type="checkbox"/> No (0) <input type="checkbox"/> Not applicable (0)</p>	
<p>Is the building material located at the susceptible parts of the base of the structure constructed of entirely flood-resistant material?</p> <p><input type="checkbox"/> Yes (0) <input type="checkbox"/> No (2) <input type="checkbox"/> Not applicable (0)</p>	
Facility and Utility Issues	
<p>Are the heating, electrical, and other utilities located in a basement or on a slab area that is below the BFE?</p> <p><input type="checkbox"/> Yes (4) <input type="checkbox"/> No (0) <input type="checkbox"/> Not applicable (0)</p>	
<p>Is there a method of removing floodwaters from the building (e.g., sump pump)? What is the size and capacity of the pump? _____</p> <p><input type="checkbox"/> Yes (0) <input type="checkbox"/> No (4) <input type="checkbox"/> Not applicable (0)</p>	
Total Flood Hazard Score =	

*** Ensure that all elevations that are compared to base flood elevations (BFEs) are defined on the vertical datum that is stated on the FIRM panel. (Do not compare local benchmarks to mean sea level (MSL), National Geodetic Vertical Datum of 1929 (NGVD '29), etc.)

Evaluator's Name: _____ Date of Evaluation _____
 Site Name: _____

STRUCTURAL SEISMIC HAZARD CHECKLIST

Address the following evaluation statements, giving the most appropriate answer for each question. After selecting the appropriate answer, take the score for that answer (# in the parentheses) and enter it into the score block for that question. Evaluation judgment is subject to limitations of visual examination and availability of plans. (NOTE: This checklist is based upon the guidelines set forth in the FEMA 154 publication, *Rapid Visual Screening of Buildings for Potential Seismic Hazards: A Handbook* (2nd Edition, March 2002). One significant difference is the scoring procedure used herein. Do not compare a building scored on this checklist system with a building scored from FEMA 154. The comparison will not be valid.) After all questions have been appropriately scored, sum the structural seismic hazard score column and determine the final score for the building/structure.

For additional guidance on the design and construction of buildings subject to seismic hazards see FEMA 454, *Designing for Earthquakes: A Manual for Architects* (December 2006), and FEMA 232, *Homebuilder's Guide to Earthquake-Resistant Design and Construction* (June 2006).

Question	Score
See the Seismic Zone Map of the United States (Figure 3 on page B-23) to determine the region of seismicity (low, medium, or high) of the building locale.	
<p>Is the building located in a low region of seismicity and was it designed by a design professional?</p> <p><input type="checkbox"/> Yes (0)</p> <p>If yes, further inspection within the seismic checklist is not necessary. STOP HERE.</p> <p>Is the building located in a medium or high region of seismicity?</p> <p><input type="checkbox"/> Yes (0)</p> <p>If yes, complete all remaining questions on this checklist.</p>	
<p>What is the building/structure type?</p> <p><input type="checkbox"/> Wood (10) <input type="checkbox"/> RM and PRM (12) <input type="checkbox"/> Steel (12)</p> <p><input type="checkbox"/> Concrete (14) <input type="checkbox"/> Pre-cast " Tilt-up" Concrete (15) <input type="checkbox"/> URM (17)</p> <p><input type="checkbox"/> Unknown (20)</p>	

Evaluator's Name: _____

Date of Evaluation _____

Site Name: _____

Add penalty points for deficiencies as noted during the inspection. Select one column based on the building type determined in the previous question. Under each column, circle the penalty points if they apply for the criteria listed. (Use descriptions provided on the following page when filling out the matrix below.) When complete, sum the penalties that have been circled and place that total in the score box at right.

Building Characteristic	RM and PRM	URM	Steel	Wood	Concrete	Pre-cast	Unknown
High Rise	1.0	0.5	1.0	N/A	1.0	0.5	1.0
Poor Condition	0.5	0.5	0.5	0.5	0.5	0.5	0.5
Vertical Irregularity	0.5	0.5	0.5	0.5	1.0	1.0	1.0
Soft Story	2.0	2.0	2.0	1.0	2.0	2.0	2.0
Plan Irregularity	2.0	2.0	1.5	2.0	1.5	2.0	2.0
Pounding	N/A	N/A	0.5	N/A	0.5	0.5	0.5
Large (and Heavy) Cladding	N/A	N/A	N/A	N/A	1.0	1.0	1.0
Post Benchmark	2.0	N/A	2.0	2.0	2.0	2.0	2.0
Total Structural Seismic Hazard Score =							

Evaluator's Name: _____

Date of Evaluation _____

Site Name: _____

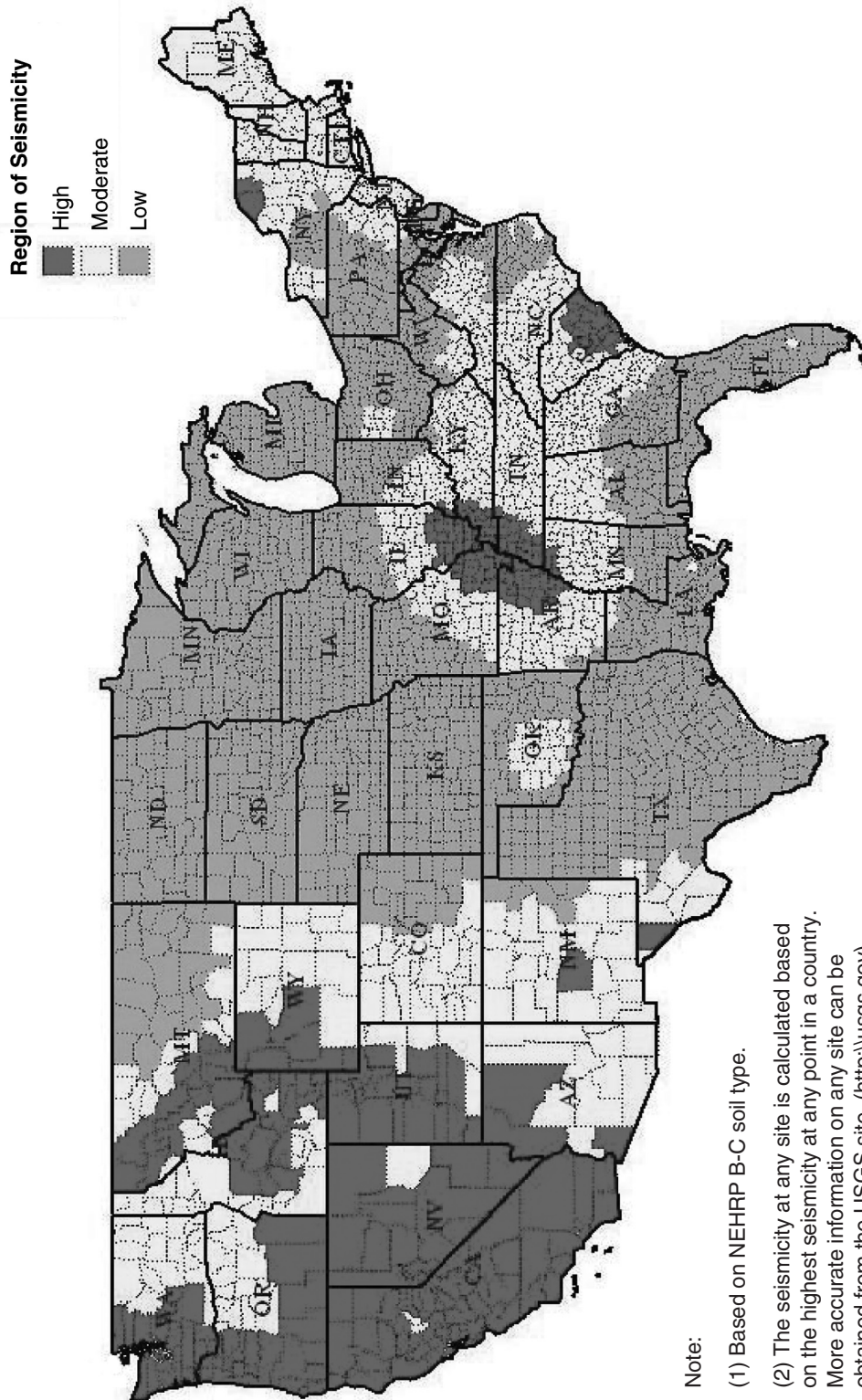

Figure 3: Seismic Zone Map of the United States (FEMA 154, March 2002)

Explanation of Building Characteristics

High-Rise:

For the purposes of this checklist, a wood-frame structure will not be considered a high-rise building. For buildings constructed of masonry units (i.e., brick, block, etc.), if the building is five stories and taller, it is considered a high-rise. For all remaining building types, the building must be eight stories or taller to be considered a high-rise building. If the building is determined to be a high-rise, assess penalty.

Poor Condition:

A building will be considered to be in poor condition if the building condition for the appropriate building type has been observed. Assess penalty if:

- **Masonry Joints:** The mortar can be easily scraped away from the joints by hand with a metal tool, and/or there are significant areas of eroded mortar.
- **Masonry Units:** There is visible deterioration of large areas of masonry units (i.e., significant cracking in the mortar joints, cracks through the masonry blocks themselves, voids or missing blocks or units, etc.).
- **Deterioration of Steel:** Significant visible rusting, corrosion, tearing, or other deterioration in any of the steel elements in the vertical or lateral force-resisting system.
- **Deterioration of Wood:** Wood members show signs of decay, shrinkage, splitting, fire damage, or sagging, or the metal accessories are deteriorated, broken, or loose. Wood members also showing signs or “tracks” from insect infestation.
- **Deterioration of Concrete:** Visible deterioration of concrete (i.e., cracking, spalling, crumbling, etc.) or significant exposure of reinforcing steel in any of the frame elements.
- **Concrete Wall Cracks:** Diagonal cracks in the wall element that are ¼ inch or greater in width are found in numerous locations, and/or form an X pattern.
- **Cracks in Boundary Columns:** Diagonal cracks wider than 1/8 inch in concrete columns on any level of the structure.

Vertical Irregularity:

Are there “steps” in elevation of the building? Are some floors set-back or do they extend outward from the footprint of the building? Are all of the walls of the building vertical or are there walls that slope inward or outward as viewed from the base of the building? Is the building located atop a small hill? If so, there are vertical irregularities; assess penalty.

Soft Story:

Does one story in a building have substantially less shear resistance (resistance to lateral deformation or story drift) than other stories above or below it? This condition usually occurs on the ground-floor level between a rigid foundation system and a stiff upper level system. Tall open ground floors are common architectural features in many large buildings. If the presence of a soft story is suspected (open floor plan, extensive glazing, taller ceilings, etc.) check whether

that story has sufficient peripheral bracing (larger number or stiffer columns, moment frames or similar) or a rigid braced interior core. Assess penalty points according to the level and adequacy of story shear resistance (bracing).

Plan Irregularity:

Does the building have a highly irregular floorplan? Is the floorplan of the building an “L,” “E,” “H,” “+,” “T,” or other such irregular configuration? Is the building long and narrow; length/width ratio greater than 2:1? If so, there are plan irregularities; assess penalty.

Pounding:

How close is the next adjacent building? Are the floors of two adjacent buildings at different elevations? An adjacent building presents a threat of pounding if the lateral distance between the two buildings is less than 4 feet times the number of stories of the smallest building. For example, if a ten-story building and a four-story building are adjacent to one another, there is a potential pounding problem if the buildings are not more than 16 inches apart. (4” x 4 stories = 16” of separation required); assess penalty.

Large (and Heavy) Cladding:

Is the exterior of the building covered in large concrete, or stone panels? If large panels exist, were the connections that secure these panels designed for seismic requirements? If it cannot be positively determined that the connections were designed for seismic requirements, assume that they were not. If large panels are present and they have been determined to be connected with non-seismic connectors, cladding deficiencies exist; assess penalty.

Post Benchmark:

A building is considered to be “post benchmark” if it was designed after modern seismic provisions were accepted by the local building code or the code that has been specified by the local jurisdiction. If the building was not designed for seismic requirements or it is not known if the building was designed for seismic requirements, it is not post benchmark; assess penalty.

Selecting the Refuge Area

Identify potential refuge areas and answer the following questions for each one.

On basis of this information, select the best potential refuge areas (interior spaces that provide the best protection). Explain the selection and rank the refuge areas from most desirable to least desirable.

The recommended square footage (RSF) used for refuge must be calculated depending on the hazard type.

(For Tornado Use, $RSF = \text{Total Population} \times 5 \text{ square feet}$)

(For Hurricane Use, $RSF = \text{Total Population} \times 20 \text{ square feet}$)

Does the potential refuge area have excessive glazing (greater than 6% of exterior wall surface covered by windows) or long unsupported walls and roof spans (greater than 40 feet)?

Is the potential refuge area susceptible to damage from collapsing nearby heavy structures or other objects (e.g., concrete towers, telephone or power poles, antenna towers, chimneys, trees, etc.)?

Is the potential refuge area accessible to all building occupants, including the disabled?

If a potential refuge area is cluttered, can materials be easily moved to create additional usable space?

How much usable space exists (see Part o of FEMA 361, Sections 3.3.1 and 3.4.1)?

recommended square footage (RSF, calculated above) =

available square footage (ASF) =

usable square footage (USF) =

Is $USF \geq$ to RSF? _____

The USF is determined by subtracting the floor area of excluded spaces, partitions and walls, columns, fixed or movable objects, furniture, equipment or other features that cannot be removed, or stored, during use as a safe room from the ASF.

[Note: as an alternate method, the following values can be used to calculate USF – for safe room areas with concentrated furnishings or fixed seating, reduce by a minimum of 50%; for safe room areas with unconcentrated furnishings (removable tables, etc.) and without fixed seating, reduce by a minimum of 35%; for safe room areas with open space, reduce by a minimum of 15%.]

Evaluator's Name: _____ Date of Evaluation _____

Site Name: _____

Sketch refuge areas within building layout and show access routes (an existing floorplan may be marked up and attached in lieu of the sketch):

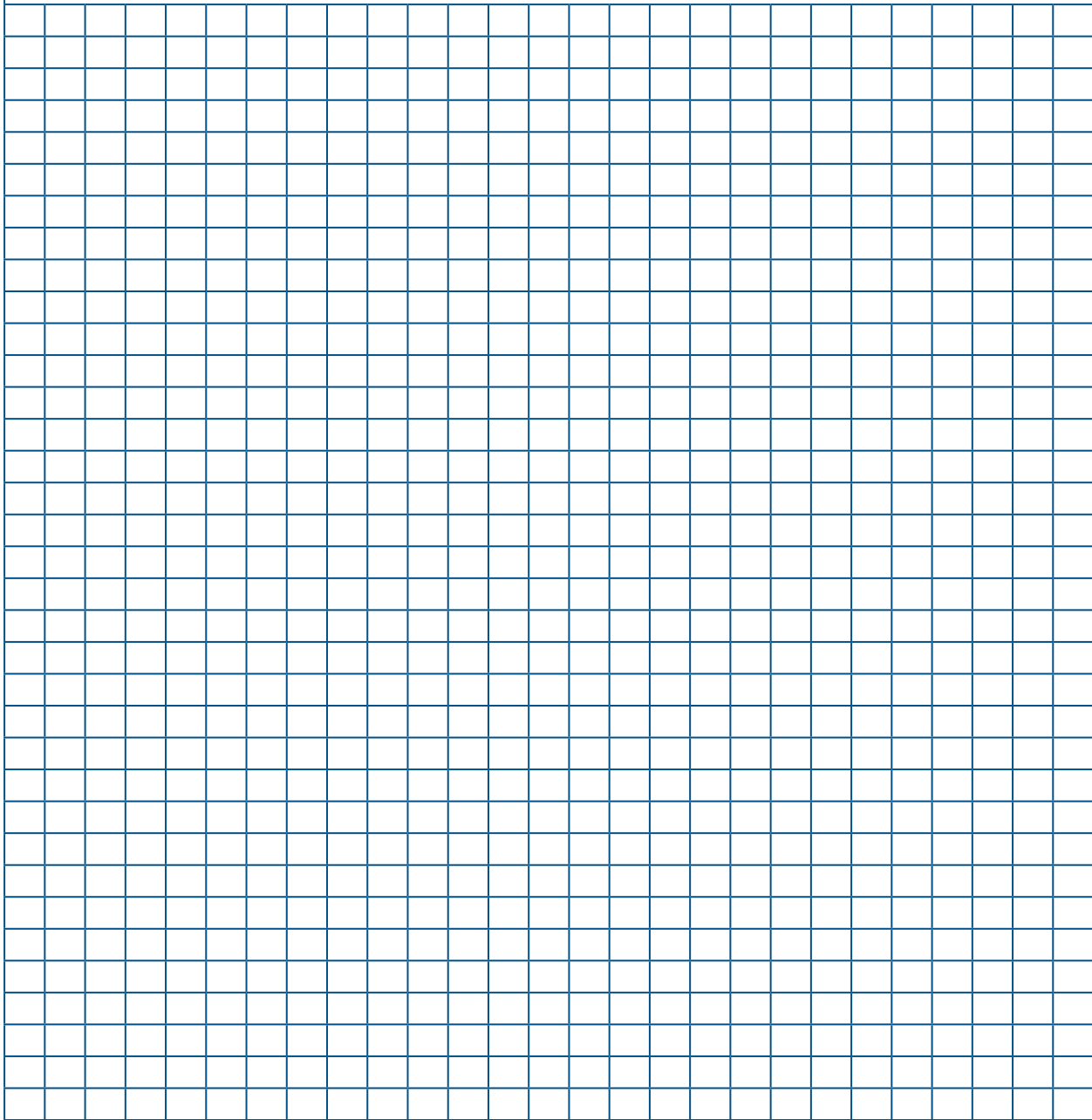

Additional Comments:

Evaluator's Name: _____

Date of Evaluation _____

Site Name: _____

Common Building Types and Glossary of Terms

The following is a guide for selecting the type of building/type of construction of the building evaluated. The primary designations that the building types are divided into are Wood, Steel, Concrete, Pre-Cast Concrete, Reinforced Masonry, Partially Reinforced Masonry, and Unreinforced Masonry.

Braced Frame

A building frame system in which all vertical and lateral forces are resisted by shear and flexure in the members, joints of the frame itself, and walls or bracing systems between the beams and columns. A braced frame is dependent on bracing, infill walls between the columns, or shear walls between the columns to resist lateral loads.

Concrete

These buildings have walls and/or frames constructed of reinforced concrete columns and beams. Walls will be seen as smooth surfaces of finished concrete. If this is a concrete frame, concrete masonry units (CMUs) are often used as shear (internal) walls placed between the columns and the beams.

Engineered Steel (Heavy)

These buildings are constructed of steel beams and columns and use either moment or braced frame systems. These buildings are designed specifically for that site and are not a “pre-engineered” or “pre-fabricated” building.

Load-Bearing Wall System

A building structural system in which all vertical and lateral forces are resisted by the walls of the building. The roof structure will be attached to the walls of the building and any forces in the roof system will be transferred to the walls through this roof/wall connection.

Moment Frame

A building frame system in which all vertical and lateral forces are resisted by shear and flexure in members and joints of the frame itself. A moment frame will not utilize bracing, infill walls between the columns, or shear walls between the columns to resist lateral loads.

Partially Reinforced Masonry (PRM)

These buildings have perimeter, bearing walls of reinforced brick or CMU and the vertical wall reinforcement is spaced at more than 8 inches apart and a maximum spacing of 72 inches apart. Reinforcing for these walls will not be evident when viewing the walls; this information may be attained by using reinforcement locating devices or from reviewing project plans. Roof systems will typically be constructed of wood members, steel frames and trusses, or concrete. They may also have roofs and floors composed of precast concrete.

Pre-cast (Including Tilt-up Construction) Concrete

These buildings typically have pre-cast and tilt-up concrete that will run vertically from floor to ceiling/roof. These buildings often have pre-cast or cast-in-place concrete roof systems, but may have very large wood or metal deck roof systems. These buildings could also be pre-cast concrete frames with concrete shear walls, containing floor and roof diaphragms typically composed of pre-cast concrete.

Reinforced Masonry (RM)

These buildings have perimeter bearing walls of reinforced brick or CMU and the vertical wall reinforcement is spaced at a maximum spacing of 8 inches apart; if the reinforcement is in CMU walls, every cell must contain reinforcing steel and grout. Reinforcing for these walls will not be evident when viewing the walls; this information may be attained by using reinforcement locating devices or from reviewing project plans. Roof systems will typically be constructed of wood members, steel frames and trusses, or concrete. They may also have roofs and floors composed of pre-cast concrete.

Steel (Light/Pre-engineered)

These buildings, at a minimum, will have a frame of steel columns and beams. These buildings may be constructed with braced frames. These buildings may be “pre-engineered” and/or “prefabricated” with transverse rigid frames. Interior shear walls may exist between the columns and beams of the frame. In addition, exterior walls may be offset from the exterior frame members, wrap around them, and present a smooth masonry exterior with no indication of the steel frame.

Unreinforced Masonry (URM)

These buildings have perimeter bearing walls of unreinforced brick or concrete-block masonry. Roof systems will typically be constructed of wood members, steel frames and trusses, or concrete. They may also have roofs and floors composed of pre-cast concrete. Most masonry wall systems that were constructed prior to the 1970s are unreinforced masonry.

Wood

These buildings are typically single or multiple family dwellings of one or more stories. Wood structures may also be commercial or industrial buildings with a large floor area and with few, if any, interior walls. Typically, all walls and roof systems are constructed of timber frames.

The following is a glossary of terms that has been provided to ensure clarity and provide definitions for terminology used in these checklists.

Base Flood

The flood having a 1-percent probability of being equaled or exceeded in any given year; also referred to as the 100-year flood.

Base Flood Elevation (BFE)

This height of the base flood in relation to the National Geodetic Vertical Datum of 1929 (or other vertical datum as specified). These elevations can be found on a Flood Insurance Rate Map (FIRM). The elevation of the lowest floor of a structure must be above the BFE to qualify for most forms of federal flood insurance.

Continuous Load Path

A continuous load path can be thought of as a “chain” running through a building. The “links” of the chain are structural members, connections between members, and any fasteners used in the connections (such as nails, screws, bolts, welds, etc.). To be effective, each “link” in the continuous load path must be strong enough to transfer loads without breaking. Because all applied loads (gravity, dead, live, uplift, lateral, etc.) must be transferred to the foundation, the load path must connect to the foundation.

An exterior insulation finishing system (EIFS) is a multi-layered exterior wall system used on both commercial buildings and homes (see Figure 4). It comprises an insulation board mounted to a substrate. The insulation is protected by a plastic finish coat. Mesh reinforcing may be used to strengthen the system. Mesh reinforcing is located in a base coat that is between the insulation board and the finish coat.

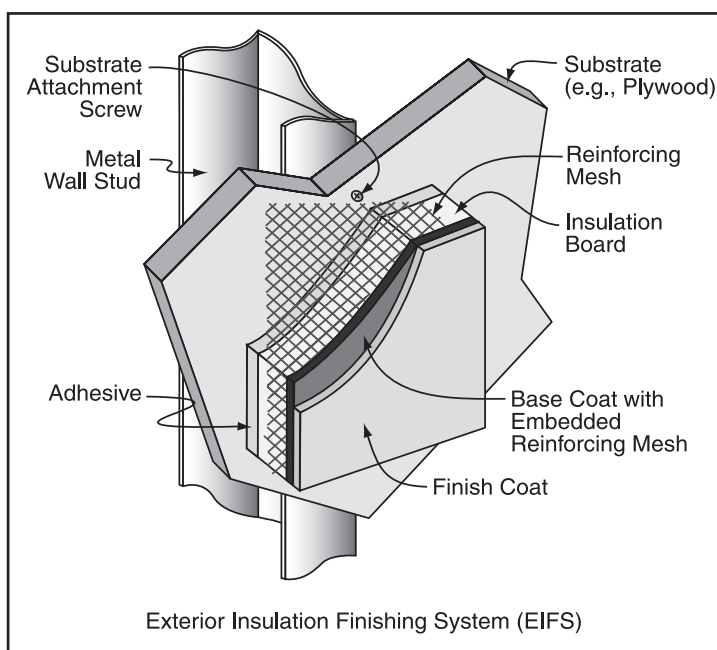

Figure 4. EIFS wall construction

Flood Insurance Rate Map (FIRM)

An insurance and floodplain management map issued by FEMA that identifies areas of a 100-year flood hazard in a community. In areas studied by detailed analyses, the FIRM also shows BFEs and 500-year floodplain boundaries and, occasionally, floodway boundaries.

Flood-Resistant Material

Any building material capable of withstanding direct and prolonged contact with floodwaters without sustaining significant damage. The term “prolonged contact” means at least 72 hours, and the term “significant damage” means any damage requiring more than low-cost cosmetic repair (such as painting).

Masonry Wall: Height to Thickness Ratio (H/T)

Height to thickness refers to the height of a masonry wall compared to the thickness of the wall. The height of the wall should be measured from the foundation up to the point at which the wall is laterally supported. In a one-story building, the maximum height will typically be found at the point at which a wall extends to the highest roof support. In a multi-story building, the tallest floor height will indicate the height of the wall. Inspection of a doorway section in a masonry wall will allow an evaluator to determine the thickness of the wall. The largest ratio that is found is the most critical.

Masonry Wall: Length to Thickness Ratio (L/T)

Length to thickness refers to the length of a masonry wall compared to the thickness of the wall. The length of the wall is typically measured from a wall corner to the next adjacent wall corner. Wall spans, however, can be quite long. If there are any vertical columns in a wall, the length will then be measured from column to column or from vertical support to vertical support. Inspection of a doorway section in a masonry wall will allow an evaluator to determine the thickness of the wall. The largest ratio that is found is the most critical.

Parapet

A parapet is a small wall located atop a building that extends above the roof level. Parapets are typically located along a wall face at the top of the roof. They are most commonly seen on flat roofs and are usually a few feet tall and will be a minimum of 8 inches thick. They are often constructed of unreinforced masonry and are susceptible to damage by lateral forces caused by wind and seismic forces.

Tack Weld

A small weld intended only to secure a building element (i.e., roof deck) in place during construction. If the type of weld cannot be determined, it should be considered no better than a tack weld and “Other” should be selected.

B.2 Designer Checklists

 FEMA		Checklist <i>for</i> Design and Construction Guidance for Community Safe Rooms using FEMA 361, Edition 2 (2008)			
Blue - User Input		Gray - Program generate		Date:	
Project Name:					
Location:					
Designer/Lead Authority:		Completed by:			
1 General Design and Drawings					
2	Type of [community] safe room	Tornado/ Hurricane/ Both			
3	Do the structural drawings include a statement that the safe room was designed to FEMA 361?	Yes/No			
4	Is the design wind speed stated on the drawings?	Yes/No			Wind speed should be obtained from Sections 3.3 or 3.4 of FEMA 361
5	Are other structural and envelope design parameters identified on the drawings?	Yes/No			See Section 3.9 of FEMA 361
6	Has the safe room (s) to be incorporated been identified on the drawings?	Yes/No			See Section 3.9 of FEMA 361
7	Is space provided for safe room supplies within each safe room area?	Yes/No			
8 Wind Loading - Identify Appropriate Safe Room Hazard Criteria					
9 Tornado Safe Room - Go to Line 16 if this is not a Tornado Safe Room					
10	What wind zone is the safe room located in?	I, II, III, IV			
11	What is the design wind speed for the tornado safe room?			mph	Wind speed should be obtained from Figure 3-1 of FEMA 361
12	What is the state's site exposure category?	ASCE 7-05			See Section 3.3.1 of FEMA 361
13	Building enclosure classification - how was Atmospheric Pressure Change (APC) considered? - Designed at a partially enclosed building - Designed as an enclosed building with APC value added	FEMA 361/ ICC-500/ ASCE 7-05/ Other			
14	What standard was used in calculating wind pressures?	ASCE 7-05/ ICC-500/ Other/ None			
15 Go to Line 31 (Walls / Openings / Door Assemblies / Window and Window Assemblies)					
16 Hurricane Safe Room - Go to Line 23 if this is a Tornado/Hurricane (Combined Hazard) Safe Room					
17	What is the design wind speed for the hurricane safe room?			mph	
18	How is this design wind speed determined? From FEMA 361 Chapter 3?	Yes/No			Wind speed should be obtained from Figure 3-2 of FEMA 361
19	What is the State's site exposure category?	ASCE 7-05			
20	Building enclosure classification? - Designed at a partially enclosed building - Designed as an enclosed building	FEMA 361/ ICC-500/ ASCE 7-05 /Other			

21	What standard was used in calculating wind pressures?	ASCE 7-05/ ICC-500/ Other/ None			
22	Go to Line 31 (Walls / Openings / Door Assemblies / Window and Window Assemblies)				
23	Tornado/Hurricane (Combined Hazard) Safe Room				
24	What wind zone is the safe room located in?	I, II, III, IV			
25	What is the design wind speed if designed as a tornado safe room?			mph	
26	What is the design wind speed if designed as a hurricane safe room?			mph	
27	How was this hurricane design wind speed determined from FEMA 361 Chapter 3?	Yes/No			Wind speed should be obtained from Figure 3-2 of FEMA 361
28	What is the state's site exposure category?	ASCE 7-05			
29	Building enclosure classification - how was Atmospheric Pressure Change (APC) considered? - Designed at a partially enclosed building - Designed as an enclosed building with APC value added	FEMA 361/ ICC-500/ ASCE 7-05/ Other			
30	What standard was used in calculating wind pressures?	ASCE 7-05/ ICC-500/ Other/ None			
31	Walls / Openings / Door Assemblies / Window and Window Assemblies				
32	Have the walls of the safe room area been successfully tested for the identified hazard criteria for tornadoes, hurricanes, or both? Identify hazard and criteria.	Yes/No			
33	Have the roof deck systems of the safe room area been successfully tested for the identified hazard criteria for tornadoes, hurricanes, or both? Identify hazard and criteria.	Yes/No			
34	Have any openings or opening protection systems of the safe room area been successfully tested for the identified hazard criteria for tornadoes, hurricanes, or both? Identify hazard and criteria.	Yes/No			
35	Have any glazing or glazing systems of the safe room area been successfully tested for the identified hazard criteria for tornadoes, hurricanes, or both? Identify hazard and criteria.	Yes/No			
36	Have any door or door systems of the safe room area been successfully tested for the identified hazard criteria for tornadoes, hurricanes, or both? Identify hazard and criteria.	Yes/No			
37	Are windows or openings protected by shutter systems? If yes, and for tornado safe rooms, are these shutter systems readily available?	Yes/No			Openings should be protected to resist wind pressures and debris impacts
38	Flood Hazards (FEMA 361)				
39	Is the safe room located on a FIRM in a mapped A, B, or shaded X zone?	Yes/No			
40	Is the safe room located on a FIRM in a mapped V or VE zone?	Yes/No			
41	Is the safe room located in a mapped floodway?				
42	Is the safe room located behind a non-certified levee?				
43	Is the safe room located in an area subject to Category 5 storm surge inundation?	Yes/No			
44	What is the mapped BFE (100-year flood elevation) at the site, if applicable?				

45	What is the mapped 500-year flood elevation at the site, if applicable?				
46	What is the (proposed) elevation of the top of the safe room floor?				
47	Was Section 3.6 of FEMA 361 used to select this elevation?				
48	If the surrounding area is flooded, is access to the safe room possible?	Yes/No			
49	Other Hazards (FEMA 361)				
50	Is the safe room designed to resist damage from the collapse of adjoining or adjacent structures?	Yes/No			
51	If non-safe room portions of adjoining structures are attached to the safe room, would collapse cause damage to the safe room?	Yes/No			
52	Is the safe room designed in accordance with the latest National Earthquake Hazards Reduction Program (NEHRP) seismic recommendations?	Yes/No			
53	Ventilation (FEMA 361)				
54	Is ventilation provided by passive (P) or mechanical (M) methods?	(P/M)			
55	Are ventilation openings protected?	Yes/No			
56	Is the ventilation equipment protected from wind forces and debris impacts?	Yes/No			
57	Air exchanges per hour provided				
58	Square Footage/Occupancy Criteria (FEMA 361)				
59	Maximum expected occupancy (number of people)				
60	Net available square footage (ASF) - Open areas			sf	Refer to FEMA 361 Chapter 3 on how to calculate usable floor areas.
61	Net available square footage (ASF) - Restrooms, kitchens, storage areas, etc.			sf	Refer to FEMA 361 Chapter 3 on how to calculate usable floor areas.
62	Total usable square footage			sf	
63	Recommended Square Footage (RSF) Calculations				
64	Expected number of standing or seated occupants				
65	Expected number of wheelchair-bound occupants				
66	Expected number of bedridden occupants				
67	Total number of occupants described for the safe room				
68	Total number of recommended square footage (RSF) based on number of occupants listed above			sf	
69	ADA Requirements (FEMA 361)				
70	Is the safe room accessible to individuals with disabilities? (Assume a power-off condition, where the elevator is not functioning, unless a protected generator or standby power source is present.)	Yes/No			
71	Toilets				
72	Number of toilets provided				
73	Are appropriate toilets available in each separate safe room area?	Yes/No			
74	Special Inspection				
75	Has or will a Special Inspection Program and a QA/QC plan been/be developed?	Yes/No			See Section 3.10, FEMA 361

Appendix C

Case Study I – Stand-Alone Community Safe Room (North Carolina)

Introduction

This appendix presents an example of a combined safe room that meets the most restrictive design requirements for both tornado and hurricane hazards. This example was from the FEMA response to Hurricane Floyd in North Carolina and background information on the project is included in the “Overview” section. Several additional items related to this project have been included in this appendix, including:

- Initial wind load calculations for the safe room.
- The initial budgetary cost estimate (which was originally prepared in 1999 and has been updated to 2008 dollars).
- A sample of the original conceptual design drawings for the North Carolina safe room project.
- A sample Community Safe Room Operations Plan (with attachments). The plan is provided as a template listing responsibilities and procedures for the operation of a safe room that may be used during a tornado or hurricane. The procedures shown in these attachments can be adapted to any safe room in the United States designed for the same hazards.

Overview

The severe flooding in the state of North Carolina produced by Hurricane Floyd caused substantial property damage, leaving many residents homeless. Temporary housing was provided by FEMA for the victims of the floods. Temporary manufactured home communities were set up to house those left homeless until such time that permanent homes would be available.

Conventional stick-built houses and manufactured homes are typically not designed to resist design wind speeds associated with tornadoes. In areas where extreme winds are common,

community safe rooms are needed to protect the great numbers of people living in FEMA-provided housing. A project for the design of dual-use safe rooms intended to function as both community centers and safe rooms for residential neighborhoods was initiated to meet this need. The safe room design drawings and specifications for this project were also intended for use as case studies to provide guidance for design professionals.

Efforts were made to involve design professionals from areas that experience extreme-wind events and require community safe rooms to protect the population from extreme-wind events. The safe rooms were required to provide near-absolute protection from extreme winds, comply with local building codes, and serve as a community center. Community safe rooms in hurricane-prone regions do not have to be designed for a tornado hazard as well, but it is recommended as hurricanes can spawn tornadoes upon landfall. This project was designed as a combined hazard safe room. Design guidance from ASCE 7-98 was used for the original structural design; however, calculations of wind loads used in the original design have been checked using the design criteria stated in Chapter 3 of this publication and ASCE 7-05, which yielded the same values for wind loads as the original calculations. Equations, figures, and tables from ASCE 7 have been referenced from both ASCE 7-98 and ASCE 7-05. Site evaluations were performed to assess natural hazard risks and parking capacity, and to ensure proper access. In addition, an operations plan was developed specifying procedures, public education, and signage. The wind load analysis on which the designs were based, the operations plan, and the design drawings are provided in this appendix. A summary of design parameters is presented on Sheet S1 of the plans.

**NOTE**

To design reinforced concrete safe rooms, designers may use either the main body of ACI 318, Building Code Requirements for Structural Concrete or the Alternate Design Method, Appendix A of ACI 318. For this case study, the designer chose to use the Alternate Design Method.

ASCE 7-98/7-05 Wind Load Analysis for Community Safe Room in North Carolina

Using Exposure C

General Data

$K_z = 0.85$	Velocity Pressure Exposure Coefficient (Table 6-5 of ASCE 7-98; Table 6-3 of ASCE 7-05)
$I = 1.00$	Importance Factor (see Chapter 6 of this publication)
$V = 200$	Wind Speed (mph) (Figure 3-2 in this publication). Note that the wind speed selected is for the tornado hazard, which has greater requirements of the two

hazards that the safe room is designed for (hurricane and tornado). For reference, the hurricane design wind speed for the state of North Carolina varies from 160 to 190 mph.

$K_{zt} = 1$	Topographic Factor (Figure 6-2 of ASCE 7-98; Figure 6-4 of ASCE 7-05)
$K_d = 1.00$	Wind Directionality Factor (see Chapter 3 of this publication)
$h = 11.75$	Building Height (ft)
$L = 72$	Building Length (ft)
$B = 50$	Building Width (ft)

Velocity Pressure (Section 6.5.10 of ASCE 7-98 and ASCE 7-05)

$$q_z = (0.00256)(K_z)(K_{zt})(K_d)(V^2I) \quad q_z = 87.04 \text{ psf}$$

$$q_h = q_z$$

$$q_h = 87.04 \text{ psf}$$

External Pressure Coefficients for Walls (Figure 6-3 of ASCE 7-98; Figure 6-6 of ASCE 7-05)

$L/B = 1.44$	$C_{p1} = 0.8$ windward wall	$B/L = 0.69$	$C_{p1} = 0.8$ windward wall
	$C_{p2a} = -0.412$ leeward wall		$C_{p2b} = -0.5$ leeward wall
	$C_{p3} = -0.7$ side wall		$C_{p3} = -0.7$ side wall

Roof Pressure Coefficients (Figure 6-3 of ASCE 7-98; Figure 6-6 of ASCE 7-05)

$h/L = 0.16$	$C_{p4a} = -0.9$ from 0 – 5.9 ft from windward edge
	$C_{p4b} = -0.9$ from 5.9 – 11.75 ft from windward edge
	$C_{p5} = -0.5$ from 11.75 – 23.5 ft from windward edge
	$C_{p6} = -0.3$ more than 23.5 ft from windward edge

(Note: Let $C_{p4} = C_{p4a} = C_{p4b}$ due to roof geometry)

Gust Factor

$$G = 0.85$$

Internal Pressure Coefficients for Buildings (Table 6-7 of ASCE 7-98; Figure 6-5 of ASCE 7-05)

$$GC_{pi\text{pos}} = 0.55 \text{ for partially enclosed buildings}$$

$$GC_{pi\text{neg}} = -0.55 \text{ for partially enclosed buildings}$$

ATMOSPHERIC PRESSURE CHANGE (APC)

The internal pressure coefficient, GC_{pi} , may be taken as ± 0.18 (for fully enclosed buildings) when venting area of 1 square foot per 1,000 cubic feet of interior safe room volume is provided to account for APC. As an alternative to calculating the effects of APC, and designing an appropriate venting system for the safe room, the design may be completed using an internal pressure coefficient $GC_{pi} = \pm 0.55$ as a conservative means to account for APC.

Design Wind Pressure for Rigid Buildings of All Heights (Section 6.5.12.2.1 of ASCE 7-98 and ASCE 7-05)

(for positive internal pressures)

$$p_{wi} = (q_z)(G)(C_{p1}) - (q_h)(GC_{pi\text{pos}})$$

$$p_{wi} = 11.32 \text{ windward wall}$$

$$p_{lee2a} = (q_z)(G)(C_{p2a}) - (q_h)(GC_{pi\text{pos}})$$

$$p_{lee2a} = -78.35 \text{ leeward wall (wind parallel to ridge)}$$

$$p_{lee2b} = (q_z)(G)(C_{p2b}) - (q_h)(GC_{pi\text{pos}})$$

$$p_{lee2b} = -84.86 \text{ leeward wall (perpendicular to ridge)}$$

$$p_{side} = (q_z)(G)(C_{p3}) - (q_h)(GC_{pi\text{pos}})$$

$$p_{side} = -99.66 \text{ side wall}$$

$$p_{roof1} = (q_z)(G)(C_{p4}) - (q_h)(GC_{pi\text{pos}})$$

$$p_{roof1} = -114.46 \text{ roof pressures (0 – 11.75 ft from windward edge)}$$

$$p_{roof2} = (q_z)(G)(C_{p5}) - (q_h)(GC_{pi\text{pos}})$$

$$p_{roof2} = -84.86 \text{ roof pressures (11.75 – 23.5 ft from windward edge)}$$

$$p_{roof3} = (q_z)(G)(C_{p6}) - (q_h)(GC_{pi\text{pos}})$$

$$p_{roof3} = -70.07 \text{ roof pressures (more than 23.5 ft from windward edge)}$$

(for negative internal pressures)

$$p_{wi} = (q_z)(G)(C_{p1}) - (q_h)(GC_{pineg})$$

$$p_{wi} = 107.06 \text{ windward wall}$$

$$p_{lee2a} = (q_z)(G)(C_{p2a}) - (q_h)(GC_{pineg})$$

$$p_{lee2a} = 17.39 \text{ leeward wall (wind parallel to ridge)}$$

$$p_{lee2b} = (q_z)(G)(C_{p2b}) - (q_h)(GC_{pineg})$$

$$p_{lee2b} = 10.88 \text{ leeward wall (perpendicular to ridge)}$$

$$p_{side} = (q_z)(G)(C_{p3}) - (q_h)(GC_{pineg})$$

$$p_{side} = -3.92 \text{ side wall}$$

$$p_{roof1} = (q_z)(G)(C_{p4}) - (q_h)(GC_{pineg})$$

$$p_{roof1} = -18.71 \text{ roof pressures (0 – 11.75 ft from windward edge)}$$

$$p_{roof2} = (q_z)(G)(C_{p5}) - (q_h)(GC_{pineg})$$

$$p_{roof2} = 10.88 \text{ roof pressures (11.75 – 23.5 ft from windward edge)}$$

$$p_{roof3} = (q_z)(G)(C_{p6}) - (q_h)(GC_{pineg})$$

$$p_{roof3} = 25.68 \text{ roof pressures (more than 23.5 ft from windward edge)}$$

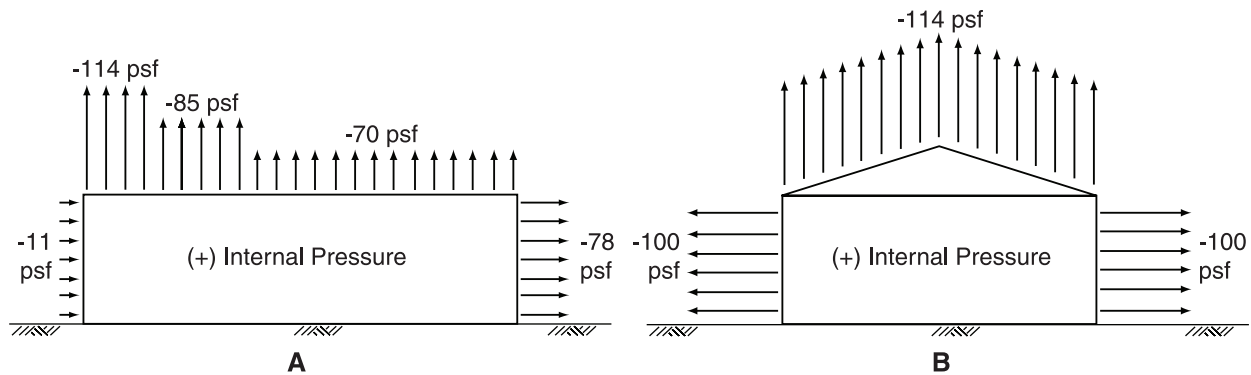

Notes:

1. Positive pressure values act against the building surface.
2. Negative pressure values act away from the building surface.
3. Wind direction is from left to right in figure A, and going into the page in figure B.

Figure C-1 Design wind pressures when wind is parallel to ridge with positive internal pressures (community safe room in North Carolina)

BUDGETARY COST ESTIMATE FOR THE NORTH CAROLINA SAFE ROOM (IN 2008 DOLLARS)

**ESTIMATED CONSTRUCTION COSTS (+/- 20%)
(SAFE ROOM AREA = 3,600 Square Feet)**

Construction Item	Cost
Site work and general requirements	\$47,000
Major structural system: footings, floors, columns, pilasters, beams, roof	\$206,000
Interior partitions	\$25,700
Doors and hardware	\$12,000
Painting, floor seal, exterior waterproofing	\$55,000
Roofing (EPDM) single ply	\$22,000
Toilet partitions and accessories (ADA)	\$6,600
Plumbing	\$8,800
Electrical	\$46,300
Mechanical	\$44,000
Total Construction Costs	\$473,400
Profit and Fees	\$47,300
Total Estimated Construction Costs	\$520,700
Unit Cost (per square foot [sf])	\$145.00/sf

COMMUNITY SAFE ROOM

HURRICANE FLOYD HOUSING INITIATIVE

NORTH CAROLINA

COMMUNITY SAFE ROOM
 HURRICANE FLOYD HOUSING INITIATIVE
 NORTH CAROLINA

DRAWING INDEX	
COVER SHEET	
FUTURE SITE PLAN (FURNISHED BY OTHERS)	C1
FLOOR PLAN	A1
BUILDING DETAILS	A2
ELEVATIONS	A3
STRUCTURAL NOTES	S1
FOUNDATION PLAN	S2
SLAB REINFORCING & JOINT LAYOUT	S3
ROOF REINFORCING	S4
SECTIONS & DETAILS	S5
SECTIONS & DETAILS	S6
MECHANICAL PLAN & SCHEDULES	M1
POWER PLAN & SCHEDULES	E1
LIGHTING PLAN & SCHEDULES	E2
PLUMBING PLAN & SCHEDULES	P1

ACCESSIBILITY NOTES: ADA/ANSI A117.1

THE INTERNATIONAL SYMBOL OF ACCESSIBILITY SIGN SHALL BE DISPLAYED AT ALL ACCESSIBLE RESTROOM FACILITIES AND AT ACCESSIBLE BUILDING ENTRANCES UNLESS ALL ENTRANCES ARE ACCESSIBLE. INACCESSIBLE ENTRANCES SHALL HAVE DIRECTIONAL SIGNS INDICATING THE ROUTE TO THE NEAREST ACCESSIBLE ENTRANCE.

RECEPTACLES ON WALLS SHALL BE MOUNTED NO LESS THAN 15" ABOVE THE FLOOR. EXCEPTION: HEIGHT LIMITATIONS DO NOT APPLY WHERE THE USE OF SPECIAL EQUIPMENT DICTATES OTHERWISE OR WHERE ELECTRICAL RECEPTACLES ARE NOT NORMALLY INTENDED FOR USE BY BUILDING OCCUPANTS.

WHERE EMERGENCY WARNING SYSTEMS ARE PROVIDED, THEY SHALL INCLUDE BOTH AUDIBLE AND VISUAL ALARMS. THE VISUAL ALARMS SHALL BE LOCATED THROUGHOUT, INCLUDING RESTROOMS, AND PLACED 80" ABOVE THE FLOOR OR 6" BELOW CEILING, WHICHEVER IS LOWER.

DOORS TO ALL ACCESSIBLE SPACES SHALL HAVE ACCESSIBLE HARDWARE (i.e. LEVER-OPERATED, PUSH-TYPE, U-SHAPED) MOUNTED NO HIGHER THAN 48" ABOVE THE FLOOR.

FLOOR SURFACES SHALL BE STABLE, FIRM, AND SLIP-RESISTANT. CHANGES IN LEVEL BETWEEN 0.25" AND 0.5" SHALL BE BEVELED WITH A SLOPE NO GREATER THAN 1:2". CHANGES IN LEVEL GREATER THAN 0.5" REQUIRE RAMPS. CARPET PILE THICKNESS SHALL BE 0.5" MAX. GRATINGS IN FLOOR SHALL HAVE SPACES NO GREATER THAN 0.5" WIDE IN ONE DIRECTION. DOORWAY THRESHOLDS SHALL NOT EXCEED 0.5" IN HEIGHT.

GRAB BARS REQUIRED OF ACCESSIBILITY SHALL BE 1.25"-1.50" IN DIAMETER WITH 1.5" CLEAR SPACE BETWEEN THE BAR AND THE WALL.

ACCESSIBLE WATER CLOSETS SHALL BE 17"-19" FROM FLOOR TO THE TOP OF THE SEAT. GRAB BARS SHALL BE 36" LONG MINIMUM WHEN LOCATED BEHIND WATER CLOSET AND 42" MINIMUM WHEN LOCATED ALONG SIDE OF WATER CLOSET, AND SHALL BE MOUNTED 33"-36" ABOVE THE FLOOR.

ACCESSIBLE URINALS SHALL BE STALL-TYPE OR WALL HUNG WITH ELONGATED RIMS AT A MAXIMUM OF 17" ABOVE THE FLOOR.

ACCESSIBLE LAVATORIES SHALL BE MOUNTED WITH THE RIM NO HIGHER THAN 34" ABOVE THE FLOOR AND A CLEARANCE OF AT LEAST 29" ABOVE THE FLOOR TO THE BOTTOM OF THE APRON.

ACCESSIBLE SINKS SHALL BE MOUNTED WITH THE RIM NO HIGHER THAN 34" ABOVE THE FLOOR AND A CLEARANCE OF AT LEAST 27" HIGH, 30" WIDE, AND 19" DEEP UNDERNEATH SINK. THE SINK DEPTH SHALL BE 6.5" MAXIMUM.

HOT WATER AND DRAIN PIPES UNDER ACCESSIBLE LAVATORIES AND SINKS SHALL BE INSULATED OR OTHERWISE CONFIGURED TO PROTECT AGAINST CONTACT. THERE SHALL BE NO SHARP OR ABRASIVE SURFACES UNDER ACCESSIBLE LAVATORIES AND SINKS.

ACCESSIBLE LAVATORIES AND SINKS SHALL HAVE ACCESSIBLE FAUCETS (i.e. LEVER-OPERATED, PUSH-TYPE, ELECTRONICALLY CONTROLLED.)

WHERE MIRRORS ARE PROVIDED IN RESTROOM, AT LEAST ONE SHALL BE PROVIDED WITH ITS BOTTOM EDGE NO HIGHER THAN 40" ABOVE THE FLOOR.

LIMIT OF LIABILITY:

The designs included herein are based on extensive research of the causes and effects of windstorm damage to buildings.

Safe Rooms designed and built to these designs should provide a high degree of occupant protection during tornadoes.

Any substitution of either materials or design concepts may decrease the level of occupant protection and/or increase the possibility of personal injury during a severe wind event.

Because it is not possible to predict or test all conditions that may occur during severe windstorms, or control the quality of construction, among other things, the designer does not warrant the design.

The designer neither manufactures nor sells safe rooms built from this design. The designers have not made and do not make any representation, warranty, or covenant, express or implied, with respect to the design, condition, quality, durability, operation, fitness for use, or suitability of the safe room in any respect whatsoever. Designers shall not be obligated or liable for actual, incidental, consequential, or other damages of or to users of safe rooms or any other person or entity arising out of or in connection with the use, condition, and/or performance of safe rooms built from this design or from the maintenance thereof.

COVER SHEET

SHEET No.:

DATE: 7 MARCH 2000

REVISED: AUGUST 2008

REV. NO.



FEMA

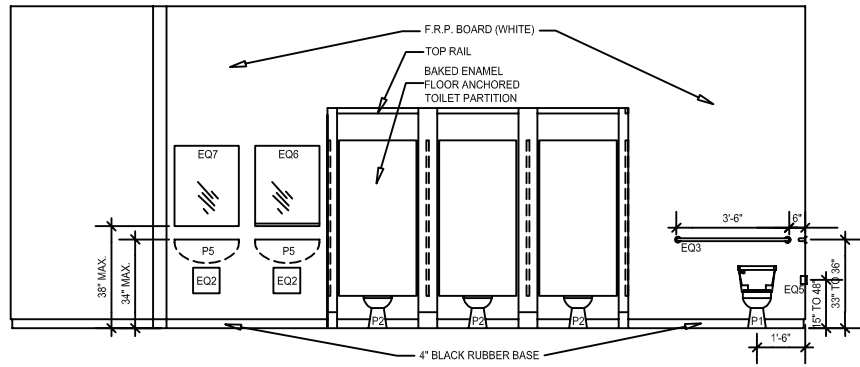

102 WOMENS RESTROOM
SCALE: 3/8" = 1'-0"

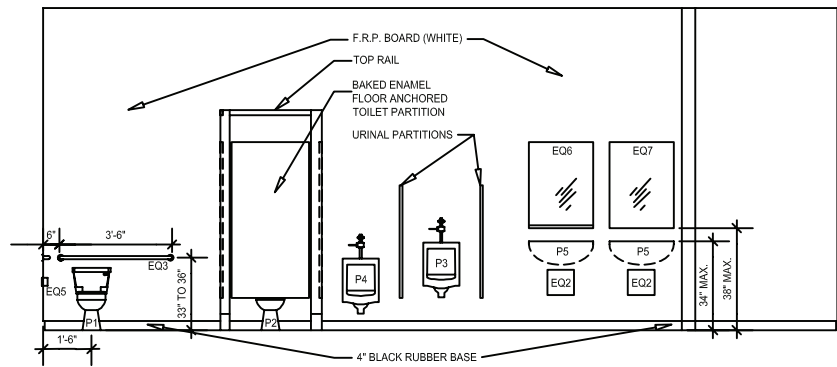

103 MENS RESTROOM
SCALE: 3/8" = 1'-0"

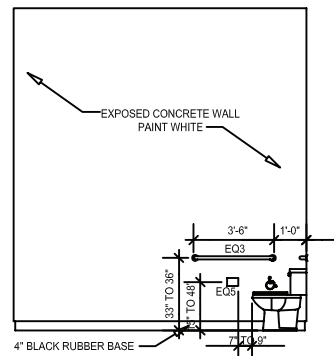

104 RESTROOM
SCALE: 3/8" = 1'-0"

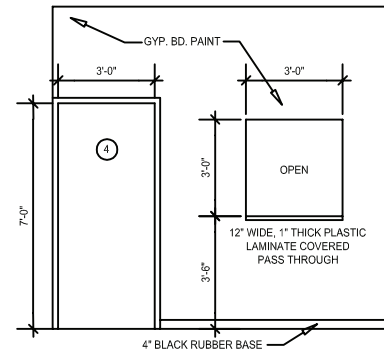

105 CORRIDOR
SCALE: 3/8" = 1'-0"

GENERAL NOTES:

1. ALL GYP. BOARD WALLS 1/2" THICK.
2. CONTRACTOR SHALL PROVIDE SOLID WOOD BLOCKING IN WALLS FOR ANCHORAGE OF SINKS, MIRRORS, PARTITIONS, ETC.
3. INTERIOR WALL CONSTRUCTION SHALL BE METAL FRAMING 25 GAUGE AT 16" ON CENTER.
4. F.R.P. BOARD SHALL BE INSTALLED USING ALL EDGE, CORNER & JOINT MATERIALS OF THE SAME COLOR.

EQUIPMENT SCHEDULE				
ITEM	DESCRIPTION	MANUFACTURER	MODEL	REMARKS
EQ1	MOP HANGER	ELGER	24" LONG x 3"	STAINLESS STEEL WITH 3 RUBBER TOOL GRIPS
EQ2	DRAIN COVERS	PLUMBEREX	3011	
	VALVE AND SUPPLY COVERS	PLUMBEREX	3021	
	TAILPIECE COVERS	PLUMBEREX	3041	
EQ3	42" GRAB BARS	BRADLEY	MODEL 812 TYPE 304 001-42-2	
EQ4	TOWEL DISPENSER WASTE RECEPTACLE	BRADLEY	MODEL 2017-11 TYPE 304	30" DROP-IN, UP-FRONT CONTROLS, WHITE
EQ5	TISSUE DISPENSER	BRADLEY	MODEL 508	
EQ6	MIRROR	BRADLEY	7815-2430-2 24" x 30"	MIRROR WITH SHELF
EQ7	MIRROR	BRADLEY	782-2436-2	TILT MIRROR
EQ8	FIRE EXTINGUISHER	ANY		10LB. ABC WALL MOUNTED

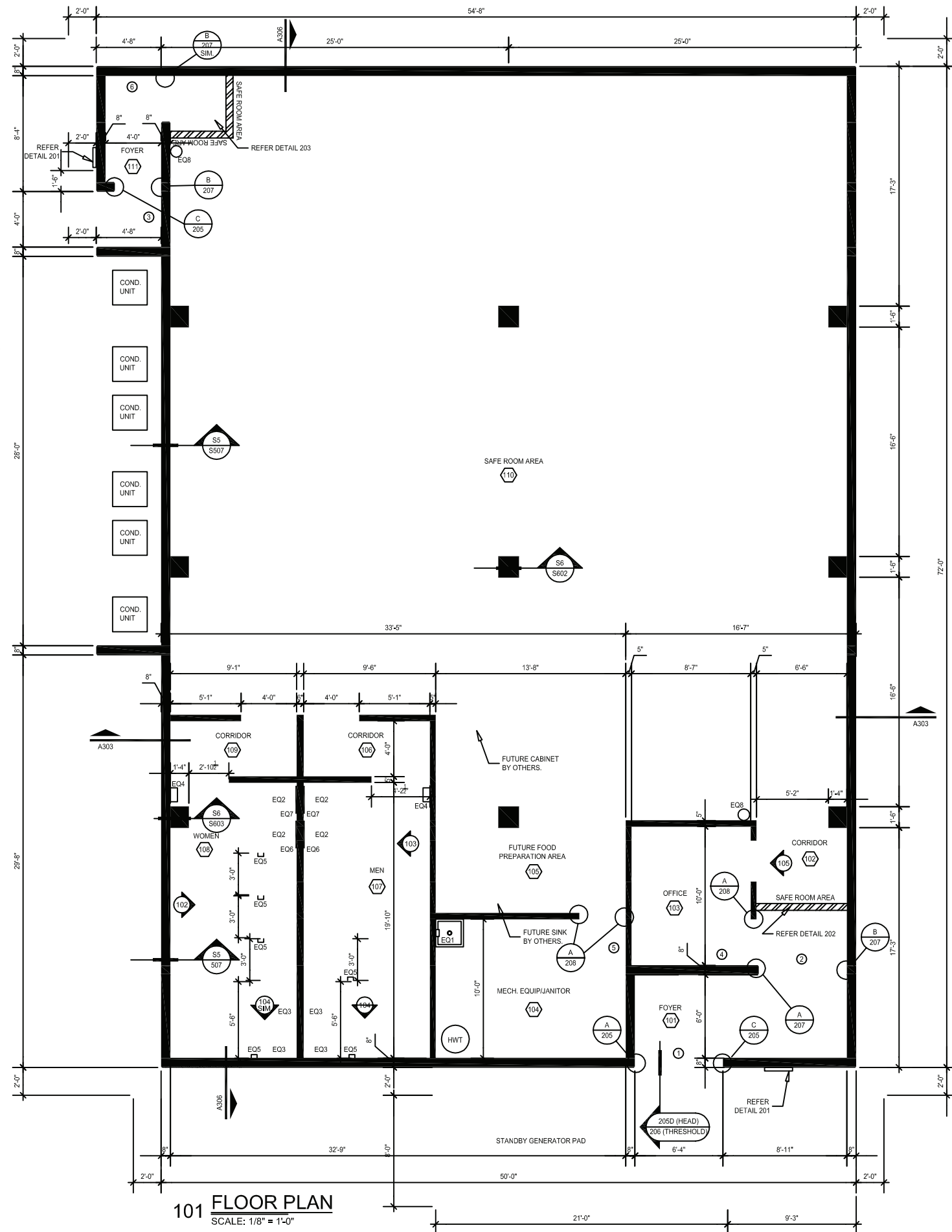

101 FLOOR PLAN
SCALE: 1/8" = 1'-0"

COMMUNITY SAFE ROOM
HURICANE FLOYD HOUSING INITIATIVE
NORTH CAROLINA

LIMIT OF LIABILITY:

The designs included herein are based on extensive research of the causes and effects of windstorm damage to buildings. Safe Rooms designed and built to these designs should provide a high degree of occupant protection during tornadoes. Any substitution of either materials or design concepts may decrease the level of occupant protection and/or increase the possibility of personal injury during a severe wind event.

Because it is not possible to predict or test all conditions that may occur during severe windstorms, or control the quality of construction, among other things, the designer does not warrant the design.

The designer neither manufactures nor sells safe rooms built from this design. The designers have not made and do not make any representation, warranty, or covenant, express or implied, with respect to the design, condition, quality, durability, operation, fitness for use, or suitability of the safe room in any respect whatsoever. Designers shall not be obligated or liable for actual, incidental, consequential, or other damages or to users of safe rooms or any other person or entity arising out of or in connection with the use, condition, and/or performance of safe rooms built from this design or from the maintenance thereof.

FLOOR PLAN

SHEET No.: A1
DATE: 7 MARCH 2000
REVISED: _____ REV. NO. _____



ROOM FINISH SCHEDULE										
MK	DESCRIPTION	FLOOR	BASE	WALL 1	WALL 2	WALL 3	WALL 4	CEILING	HEIGHT	REMARKS
101	FOYER	SEALED CONC.	NONE	EXPOSED CONCRETE PAINT	EXPOSED CONCRETE PAINTED	EXPOSED CONCRETE PAINTED	EXPOSED CONCRETE PAINTED	EXPOSED CONCRETE PAINTED	VARIES	
102	CORRIDOR	SEALED CONC.	NONE	-----	EXPOSED CONCRETE PAINTED	EXPOSED CONCRETE PAINTED	GYP. BOARD PAINTED	EXPOSED CONCRETE PAINTED	VARIES	4" RUBBER BASE WALL 4
103	OFFICE	SEALED CONC.	4" RUBBER ALL WALLS	GYP. BOARD PAINTED	GYP. BOARD PAINTED	EXPOSED CONCRETE PAINTED	GYP. BOARD PAINTED	EXPOSED CONCRETE PAINTED	VARIES	
104	MEC. JANITORIAL EQUIP.	SEALED CONC.	4" RUBBER WALL (1, 2 & 4)	FRP BOARD	FRP BOARD & EXPOSED CONCRETE, PAINTED	EXPOSED CONCRETE PAINTED	FRP BOARD	EXPOSED CONCRETE PAINTED	VARIES	
105	FUTURE FOOD PREP. AREA	SEALED CONC.	4" RUBBER ALL WALLS	-----	FRP BOARD	FRP BOARD	FRP BOARD	EXPOSED CONCRETE PAINTED	VARIES	
106	CORRIDOR	SEALED CONC.	4" RUBBER	FRP BOARD	FRP BOARD	FRP BOARD	FRP BOARD	EXPOSED CONCRETE PAINTED	VARIES	
107	MEN'S RESTROOM	SEALED CONC.	4" RUBBER	FRP BOARD	FRP BOARD	EXPOSED CONCRETE PAINTED	FRP BOARD	EXPOSED CONCRETE PAINTED	VARIES	
108	WOMEN'S RESTROOM	SEALED CONC.	4" RUBBER	FRP BOARD	FRP BOARD	EXPOSED CONCRETE PAINTED	EXPOSED CONCRETE PAINTED	EXPOSED CONCRETE PAINTED	VARIES	
109	CORRIDOR	SEALED CONC.	4" RUBBER	FRP BOARD	FRP BOARD	FRP BOARD	EXPOSED CONCRETE PAINTED	EXPOSED CONCRETE PAINTED	VARIES	
110	SAFE ROOM AREA	SEALED CONC.	NONE 4" RUBBER WALL 3	EXPOSED CONCRETE PAINT	EXPOSED CONCRETE PAINT	GYP. BOARD PAINT	EXPOSED CONCRETE PAINT	EXPOSED CONCRETE PAINTED	VARIES	
111	FOYER	SEALED CONC.	NONE	EXPOSED CONCRETE PAINT	EXPOSED CONCRETE PAINTED	EXPOSED CONCRETE PAINTED	EXPOSED CONCRETE PAINTED	EXPOSED CONCRETE PAINTED	VARIES	

DOOR FINISH SCHEDULE												
MK	TYPE	SIZE	MATERIAL	FINISH	FRAME	FINISH	GLAZING	HEAD	JAMB	TRESH	REMARKS	
1	A	CECO MEDALLION PR 3'-0"x7'-0"x1 3/4" LEVEL 4	14 ga. STEEL	PAINT	12 ga. STEEL	PAINT	NONE	205 D	205 A,B,C	206	14 ga. STEEL DOOR WITH 20 ga. RIBS.	
2	A	CECO MEDALLION PR 3'-0"x7'-0"x1 3/4" LEVEL 4	14 ga. STEEL	PAINT	12 ga. STEEL	PAINT	NONE	205 D	207 A & B	NONE	14 ga. STEEL DOOR WITH 20 ga. RIBS.	
3	B	CECO MEDALLION PR 3'-0"x7'-0"x1 3/4" LEVEL 4	14 ga. STEEL	PAINT	12 ga. STEEL	PAINT	NONE	205 D	205 B (SIM)	206 (SIM)	14 ga. STEEL DOOR WITH 20 ga. RIBS.	
4	B	CECO MEDALLION 3'-0" x 7'-0" x 1 1/2" LEVEL 1	20 ga. STEEL	PAINT	16 ga. STEEL	PAINT	NONE	208 B	207 A	NONE		
5	B	CECO MEDALLION 3'-0" x 7'-0" x 1 1/2" LEVEL 1	20 ga. STEEL	PAINT	16 ga. STEEL	PAINT	NONE	208 B	208 B (SIM)	NONE		
6	B	CECO MEDALLION PR 3'-0"x7'-0"x1 3/4" LEVEL 4	14 ga. STEEL	PAINT	12 ga. STEEL	PAINT	NONE	205 D	207 A & B	NONE	14 ga. STEEL DOOR WITH 20 ga. RIBS.	

ALUMINUM SIGN BACKGROUND NON-REFLECTIVE. "HURICANE - SAFE ROOM" AND LOGO SHALL BE REFLECTIVE USING 3M SCOTCHLITE DIAMOND GRADE REFLECTIVE SHEETING. YELLOW IN COLOR. VERIFY WITH MANUFACTURER THAT SIGN WILL GLOW FOR A MIN OF 6 HOURS, IN THE EVENT OF POWER LOSS.

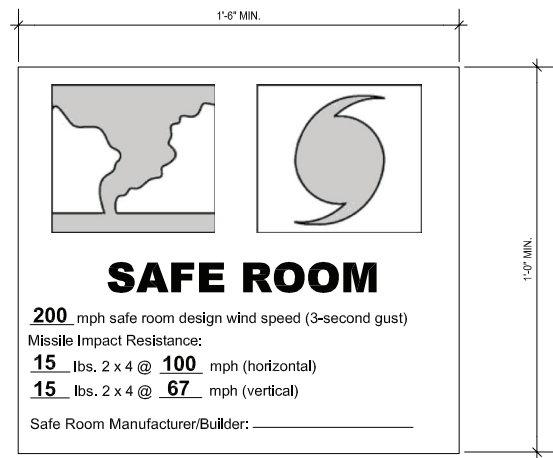

201 BUILDING I.D. SIGN
N.T.S.

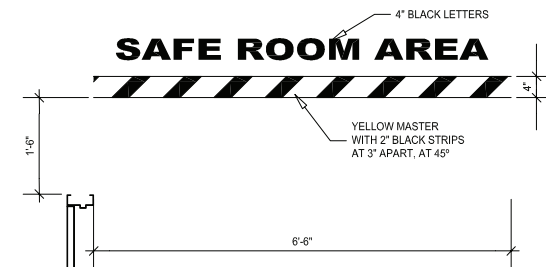

202 FLOOR SIGNAGE
SCALE: 3/4" = 1'-0"

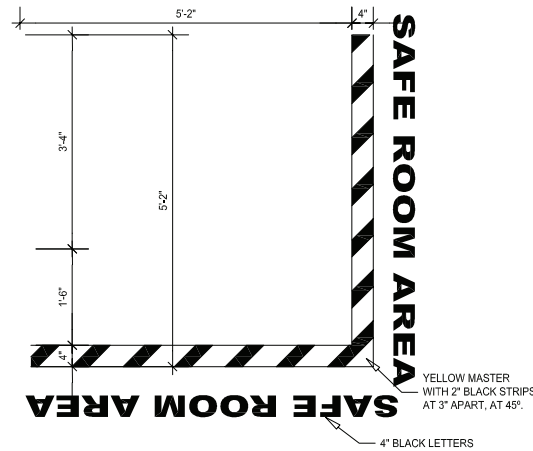

203 FLOOR SIGNAGE
SCALE: 3/4" = 1'-0"

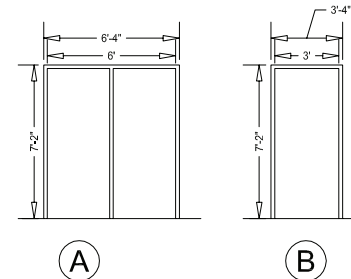

204 DOOR TYPE
SCALE: 3/4" = 1'-0"

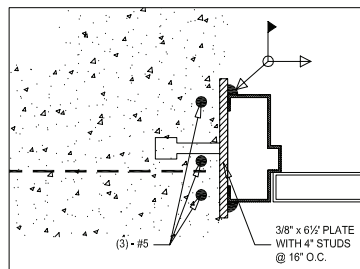

A JAMB

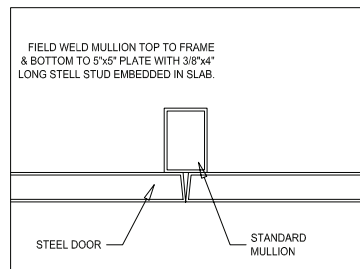

B MULLION

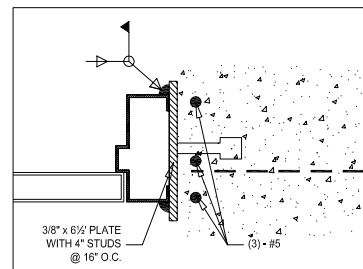

C JAMB

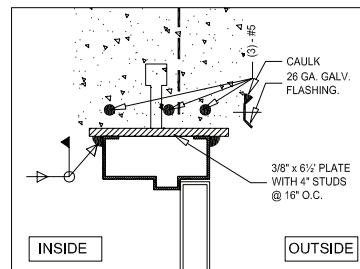

D HEAD

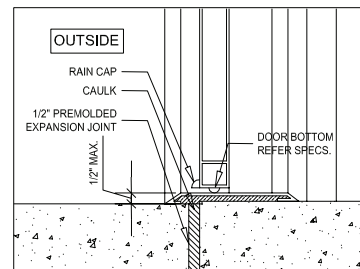

206 THRESHOLD DETAIL
SCALE: 3" = 1'-0"

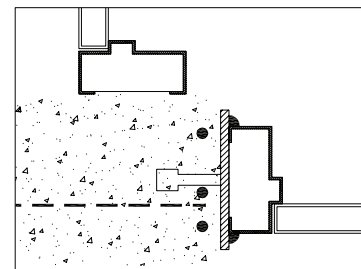

A JAMB

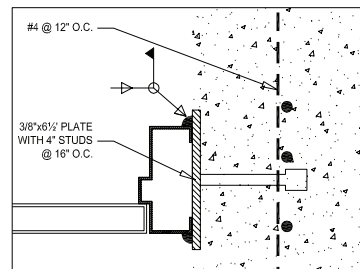

B JAMB

205 DOUBLE DOOR ENTRY DETAILS
SCALE: 3" = 1'-0"

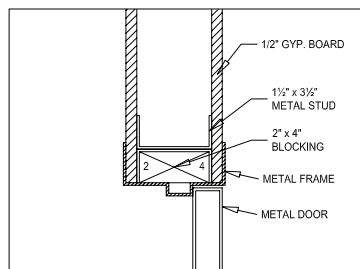

A JAMB

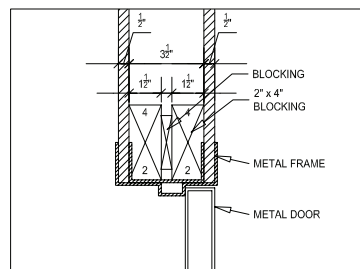

B HEAD

208 DETAILS AT DRYWALL
SCALE: 3" = 1'-0"

COMMUNITY SAFE ROOM
HURICANE FLOYD HOUSING INITIATIVE
NORTH CAROLINA

LIMIT OF LIABILITY:
The designs included herein are based on extensive research of the causes and effects of windstorm damage to buildings. Safe Rooms designed and built to these designs should provide a high degree of occupant protection during tornadoes. Any substitution of either materials or design concepts may decrease the level of occupant protection and/or increase the possibility of personal injury during a severe wind event.

Because it is not possible to predict or test all conditions that may occur during severe windstorms, or control the quality of construction, among other things, the designer does not warrant the design.
The designer neither manufactures nor sells safe rooms built from this design. The designers have not made and do not make any representation, warranty, or covenant, express or implied, with respect to the design, condition, quality, durability, operation, fitness for use, or suitability of the safe room in any respect whatsoever. Designers shall not be obligated or liable for actual, incidental, consequential, or other damages of or to users of safe rooms or any other person or entity arising out of or in connection with the use, condition, and/or performance of safe rooms built from this design or from the maintenance thereof.

SCHEDULES & DETAILS

SHEET No.: A2
DATE: 7 MARCH 2000
REVISED: AUGUST 2008 | REV. NO.



COMMUNITY SAFE ROOM

HURICANE FLOYD HOUSING INITIATIVE
NORTH CAROLINA

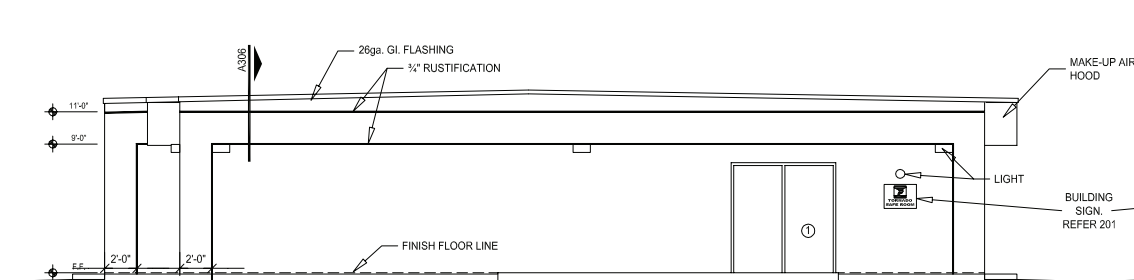

301 FRONT ELEVATION
SCALE: 3/16" = 1'-0"

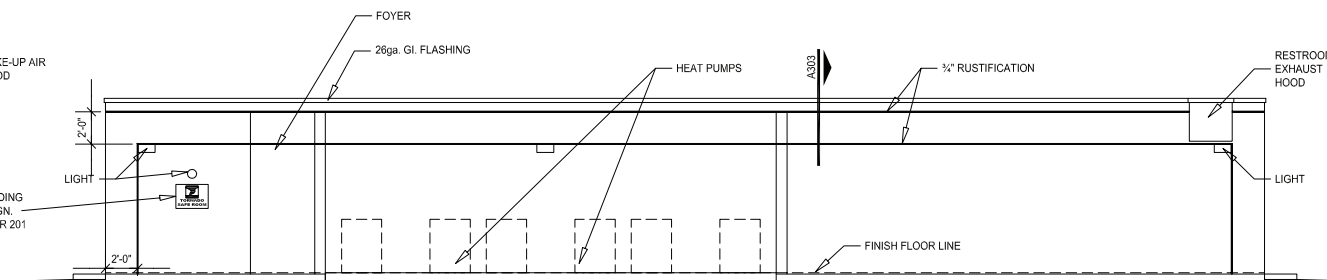

304 SIDE ELEVATION
SCALE: 3/16" = 1'-0"

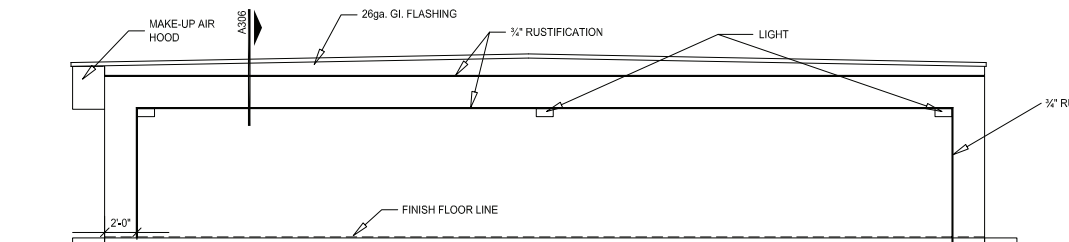

302 REAR ELEVATION
SCALE: 3/16" = 1'-0"

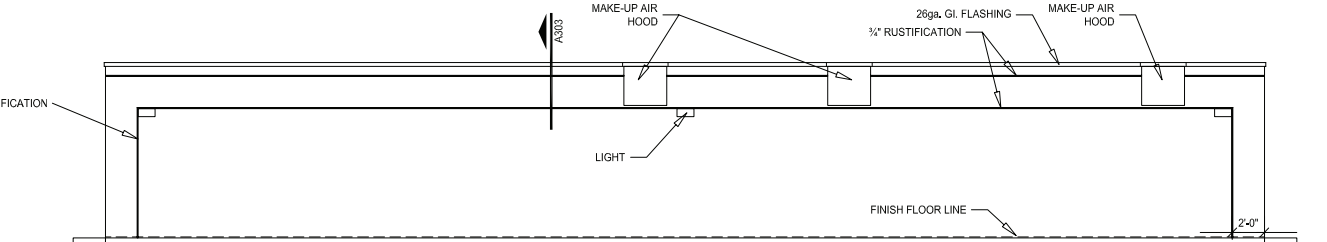

305 SIDE ELEVATION
SCALE: 3/16" = 1'-0"

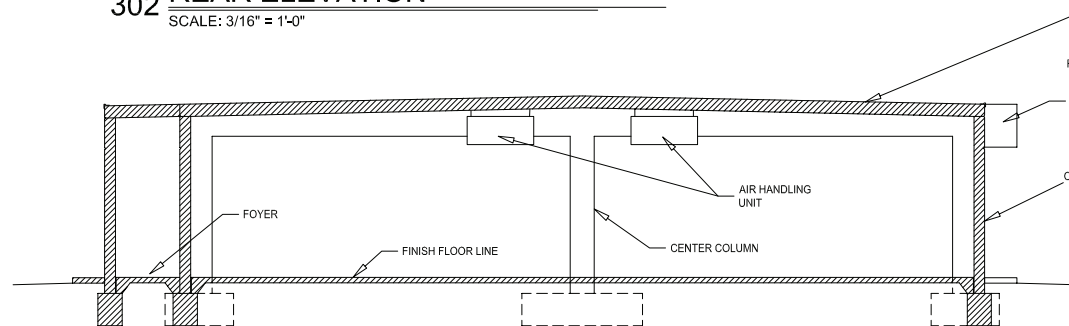

303 CROSS SECTION
SCALE: 3/16" = 1'-0"

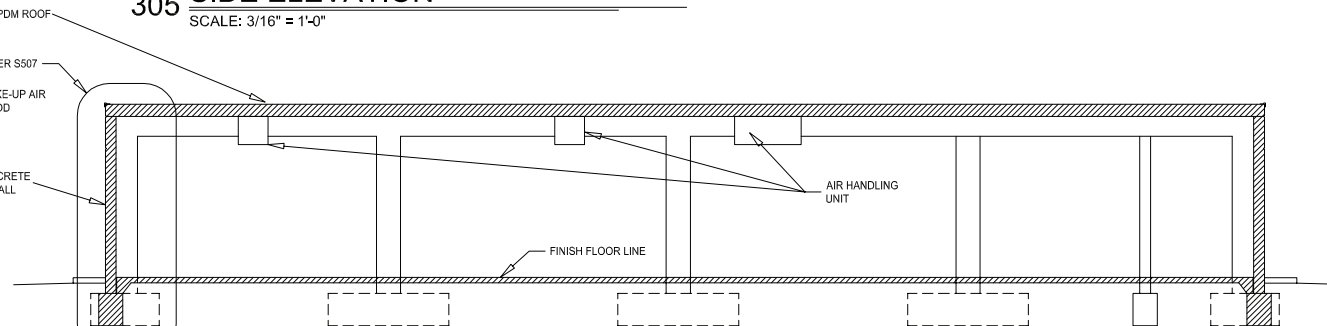

306 CROSS SECTION
SCALE: 3/16" = 1'-0"

LIMIT OF LIABILITY:

The designs included herein are based on extensive research of the causes and effects of windstorm damage to buildings. Safe Rooms designed and built to these designs should provide a high degree of occupant protection during tornadoes. Any substitution of either materials or design concepts may decrease the level of occupant protection and/or increase the possibility of personal injury during a severe wind event.

Because it is not possible to predict or test all conditions that may occur during severe windstorms, or control the quality of construction, among other things, the designer does not warrant the design.

The designer neither manufactures nor sells safe rooms built from this design. The designers have not made and do not make any representation, warranty, or covenant, express or implied, with respect to the design, condition, quality, durability, operation, fitness for use, or suitability of the safe room in any respect whatsoever. Designers shall not be obligated or liable for actual, incidental, consequential, or other damages of or to users of safe rooms or any other person or entity arising out of or in connection with the use, condition, and/or performance of safe rooms built from this design or from the maintenance thereof.

ELEVATIONS

SHEET No.: A3
DATE: 7 MARCH 2000
REVISED: _____ REV. NO. _____



GENERAL NOTES

1. NOTES AND DETAILS ON DRAWINGS SHALL TAKE PRECEDENCE OVER THESE GENERAL NOTES.
2. THE DESIGN ADEQUACY AND SAFETY OF ERECTION BRACING, SHORING, TEMPORARY SUPPORTS, ETC., IS THE SOLE RESPONSIBILITY OF THE CONTRACTOR, AND HAS NOT BEEN CONSIDERED BY THE STRUCTURAL ENGINEER. THE CONTRACTOR IS RESPONSIBLE FOR THE STABILITY OF THE STRUCTURE PRIOR TO THE APPLICATION OF ROOF DIAPHRAGMS AND FINISH MATERIALS. HE SHALL PROVIDE THE NECESSARY BRACING TO PROVIDE STABILITY PRIOR TO THE APPLICATION OF THE AFOREMENTIONED MATERIALS.
3. REFER TO PROJECT SPECIFICATIONS FOR MATERIAL SPECIFICATIONS AND PERFORMANCE REQUIREMENTS NOT COVERED BY THE STRUCTURAL DRAWINGS.
4. ALL DETAILS, SECTIONS AND NOTES SHOWN ON THE DRAWINGS ARE INTENDED TO BE TYPICAL AND SHALL APPLY TO SIMILAR CONDITIONS UNLESS OTHERWISE NOTED.
5. REFER TO DRAWINGS OF OTHER SECTIONS FOR ALL NON-STRUCTURAL INFORMATION INCLUDING EXACT LOCATION OF DOORS, WINDOWS, NONBEARING WALLS, PIPES, CONDUITS, DEPRESSIONS, DRAINS, INSULATION, FINISHES, ETC.
6. NO CONCRETE WORK SHALL BE PERFORMED DURING HEAVY RAIN, SNOW, OR HAIL, OR WHEN THE TEMPERATURE OF THE OUTSIDE AIR IS BELOW 40°F UNLESS APPROVED METHODS ARE USED TO PREVENT FREEZING OF CONCRETE. SUCH METHODS SHALL PREVENT THE MATERIALS FROM FREEZING FOR AT LEAST 48 HOURS. ALL MATERIALS USED AND MATERIALS BUILT UPON SHALL BE FREE FROM ICE AND SNOW. ALL MATERIALS ALLOWED TO FREEZE SHALL BE REMOVED AND REPLACED WITH NEW WORK ALL AT THE EXPENSE OF THE CONTRACTOR.

CONSTRUCTION JOINTS DESIGNATED TO HAVE ROUGHENED SURFACE SHALL BE PREPARED AS FOLLOWS: ALL OF THE CONSTRUCTION JOINT AREA EXCEPT 1" AROUND ALL EDGES SHALL BE ROUGHENED WITH A MIN. 1/8" WIDE x 1/8" DEEP GROOVE WITH A MINIMUM OF 1/2" CLEAR BETWEEN GROOVES. GROOVES SHALL BE MADE IN TWO DIRECTIONS THAT ARE AT RIGHT ANGLES TO EACH OTHER.

FOUNDATION NOTES

1. ALL FOOTINGS SHALL BE COMPLETELY FREE OF ANY LOOSE DIRT AND DEBRIS PRIOR TO PLACEMENT OF ANY CONCRETE.
2. ALL REINFORCING STEEL SHALL BE TIED AND SUPPORTED IN SUCH A MANNER TO INSURE THEY MAINTAIN THEIR PROPER LOCATION DURING THE PLACING OF THE CONCRETE. REINFORCING STEEL SHALL BE SUPPORTED ON APPROVED METAL CHAIRS OR BY SUSPENDING FROM ABOVE WITH ADEQUATE TIE WIRES DURING PLACEMENT OF CONCRETE. NO STEEL BARS DRIVEN INTO THE GROUND OR CONCRETE BRICKS WILL BE ALLOWED FOR SUPPORT OF THE REINFORCING STEEL.
3. THERE SHALL BE A VIBRATOR IN USE BY A QUALIFIED OPERATOR DURING THE PLACEMENT OF ALL CONCRETE. FAILURE TO USE A VIBRATOR BY A PERSON EXPERIENCED IN THE OPERATION THEREOF WILL BE CAUSE FOR REFUSAL TO ALLOW ANY CONCRETE PLACEMENT.
4. IF THE CONTRACTOR PLANS TO POUR THE GRADE BEAMS IN PHASES HE MUST SUBMIT A PLAN OF THE PHASES TO THE ENGINEER FOR APPROVAL PRIOR TO STARTING THE FOUNDATIONS. INCLUDED WITH THE PLAN SHALL BE DETAILS OF THE METHOD OF MAKING THE CONSTRUCTION JOINTS BETWEEN THE PHASES.
5. PROVIDE CORNER BARS IN BOTH FACES OF ALL GRADE BEAMS. NUMBER SIZE AND SPACING TO MATCH HORIZONTAL REINFORCEMENT WITH WHICH THEY LAP AND SHALL EXTEND 2'-6" IN EACH DIRECTION.

CONCRETE NOTES

1. CONCRETE FOR FOOTINGS, SIDEWALKS, FLOOR SLAB & PADS SHALL HAVE A MINIMUM COMPRESSIVE STRENGTH AT 28 DAYS OF 3000 PSI, A MINIMUM SLUMP OF 2" AND A MAXIMUM SLUMP OF 4"
2. CONCRETE FOR WALLS AND ROOF STRUCTURE SHALL HAVE A MINIMUM COMPRESSIVE STRENGTH AT 28 DAYS OF 4000 PSI, A MINIMUM SLUMP OF 2" AND A MAXIMUM SLUMP OF 4". CONCRETE SHALL HAVE AIR ENTRAINMENT OF 5% ±1%
3. CEMENT SHALL CONFORM TO A.S.T.M C-150M TYPE I.
4. ALL # 3 AND SMALLER REINFORCEMENT STEEL SHALL CONFORM TO A.S.T.M. A-615, GRADE 40 AND ALL #4 AND LARGER REINFORCEMENT STEEL SHALL CONFORM TO A.S.T.M. A-615, GRADE 60.
5. MINIMUM LAP FOR ALL REINFORCEMENT IS 30 BAR DIAMETERS BUT NOT LESS THAN 2'-0".
6. CONCRETE SHALL BE MIXED AND DELIVERED IN ACCORDANCE WITH A.S.T.M C-94.
7. BEFORE PLACEMENT OF CONCRETE, THE CONTRACTOR SHALL VERIFY PROPER PLACEMENT OF ALL ITEMS OF WORK WHICH ARE EMBEDDED IN THE CONCRETE.
8. THE CONCRETE WORK SHALL BE IN ACCORDANCE WITH ACI 318 AND 347.
9. CONCRETE FINISHES AND CURING SHALL CONFORM TO THE PROJECT SPECIFICATIONS.
10. REFER TO MECHANICAL, ELECTRICAL, ARCHITECTURAL, ETC. DRAWINGS FOR LOCATIONS OF ALL PIPES, CONDUITS, ETC.
11. THE STRENGTH LEVEL OF THE CONCRETE WILL BE CONSIDERED SATISFACTORY IF THE AVERAGE OF THE STRENGTH TESTS OF A GIVEN AREA OR PANEL EQUALS OR EXCEEDS THE SPECIFIED STRENGTH AT 28 DAYS, WITH NO INDIVIDUAL STRENGTH TEST OF SUCH AREA OR PANEL MORE THAN 5% BELOW THAT SPECIFIED. CONCRETE THAT DOES NOT MEET OR EXCEED THESE CRITERIA SHALL BE REMOVED BY THE CONTRACTOR AND BE REPLACED WITH CONCRETE, WHICH CONFORMS TO THESE CRITERIA, AT THE CONTRACTORS EXPENSE.
12. ALL CONCRETE CORNERS 10'-0" ABOVE F.F. ELEVATION SHALL BE 3/4" CHAMFERED AT CORNERS, UNLESS OTHERWISE NOTED ON PLANS. (DOES NOT APPLY TO CONCRETE FLOOR PLAN)
13. PROVIDE CORNER BARS IN CENTER OF ALL WALLS. NUMBER SIDE AND SPACING TO MATCH HORIZONTAL REINFORCEMENT WITH WHICH THEY LAP AND SHALL EXTEND 2'-6" IN EACH DIRECTION.

DESIGN SPECIFICATIONS

ACI 318-95 (ALTERNATE DESIGN METHOD)
ASCE 7-98 (MINIMUM DESIGN LOADS)

FOUNDATION PRESSURE

ASSUMED BEARING ALLOWABLE OF 2100 PSF.
CONTRACTOR SHALL FURNISH SOIL REPORT AS PER SPECIFICATION

DESIGN LOADS:

WIND LOAD : 200 MPH (3 SECOND PEAK GUST @ 33') EXPOSURE "C", I=1.15
IMPACT LOAD : BASED ON A 15lb MISSILE (A NOMINAL 2"x4" WOOD MEMBER) TRAVELLING HORIZONTALLY AT 100 MPH OR VERTICALLY AT 67 MPH AND IMPACTING THE SURFACE @ 90°

ROOFING COLLATERAL ROOF D.L. : 6 psf
ROOF L.L. : 20 psf

COMMUNITY SAFE ROOM
HURICANE FLOYD HOUSING INITIATIVE
NORTH CAROLINA

LIMIT OF LIABILITY:

The designs included herein are based on extensive research of the causes and effects of windstorm damage to buildings. Safe Rooms designed and built to these designs should provide a high degree of occupant protection during tornadoes. Any substitution of either materials or design concepts may decrease the level of occupant protection and/or increase the possibility of personal injury during a severe wind event.

Because it is not possible to predict or test all conditions that may occur during severe windstorms, or control the quality of construction, among other things, the designer does not warrant the design.

The designer neither manufactures nor sells safe rooms built from this design. The designers have not made and do not make any representation, warranty, or covenant, express or implied, with respect to the design, condition, quality, durability, operation, fitness for use, or suitability of the safe room in any respect whatsoever. Designers shall not be obligated or liable for actual, incidental, consequential, or other damages of or to users of safe rooms or any other person or entity arising out of or in connection with the use, condition, and/or performance of safe rooms built from this design or from the maintenance thereof.

STRUCTURAL NOTES

SHEET No.: S1
DATE: 7 MARCH 2000
REVISED: REV. NO.



COMMUNITY SAFE ROOM

HURICANE FLOYD HOUSING INITIATIVE

NORTH CAROLINA

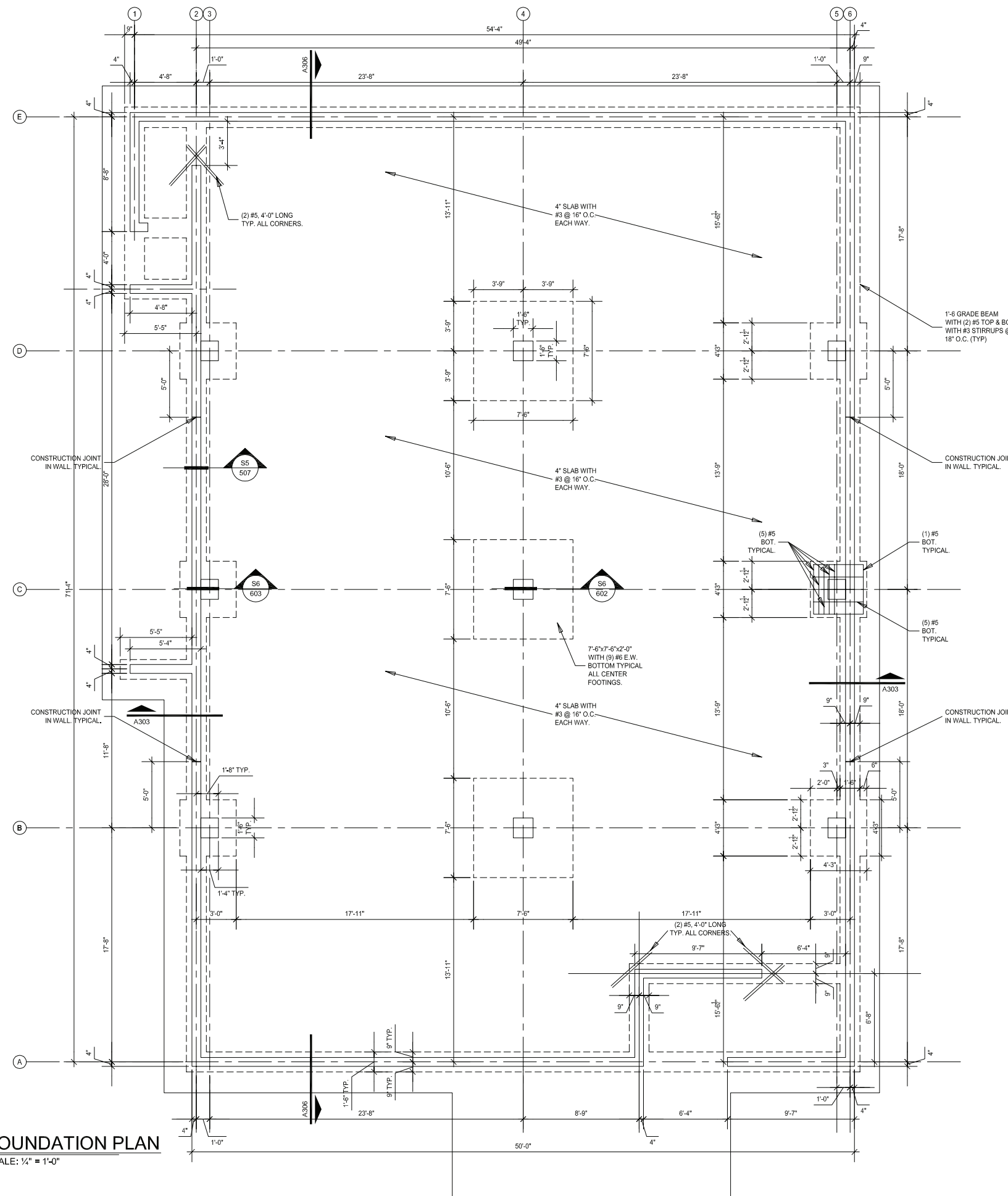

S201 FOUNDATION PLAN
SCALE: 1/4" = 1'-0"

LIMIT OF LIABILITY:

The designs included herein are based on extensive research of the causes and effects of windstorm damage to buildings.

Safe Rooms designed and built to these designs should provide a high degree of occupant protection during tornadoes.

Any substitution of either materials or design concepts may decrease the level of occupant protection and/or increase the possibility of personal injury during a severe wind event.

Because it is not possible to predict or test all conditions that may occur during severe windstorms, or control the quality of construction, among other things, the designer does not warrant the design.

The designer neither manufactures nor sells safe rooms built from this design. The designers have not made and do not make any representation, warranty, or covenant, express or implied, with respect to the design, condition, quality, durability, operation, fitness for use, or suitability of the safe room in any respect whatsoever. Designers shall not be obligated or liable for actual, incidental, consequential, or other damages of or to users of safe rooms or any other person or entity arising out of or in connection with the use, condition, and/or performance of safe rooms built from this design or from the maintenance thereof.

FOUNDATION PLAN

SHEET No.: S2

DATE: 7 MARCH 2000

REVISED: _____ REV. NO. _____



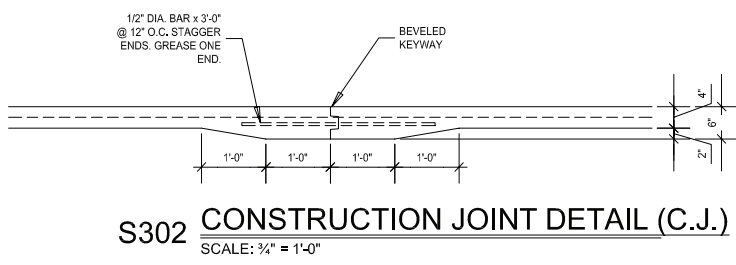
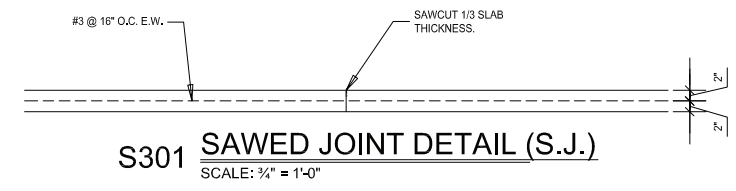

- SLAB JOINT NOTES:**
1. BLOCKOUT AROUND ALL COLUMNS AND PILASTERS.
 2. CONTRACTOR MAY USE EITHER CONSTRUCTION JOINT OR SAWED JOINTS AT LOCATIONS SHOWN.
 3. FILL ALL BLOCKOUTS WITH 3000 PSI CONCRETE AFTER ALL THE SLAB HAS BEEN PLACED AND ALL SAWING HAS BEEN COMPLETED.

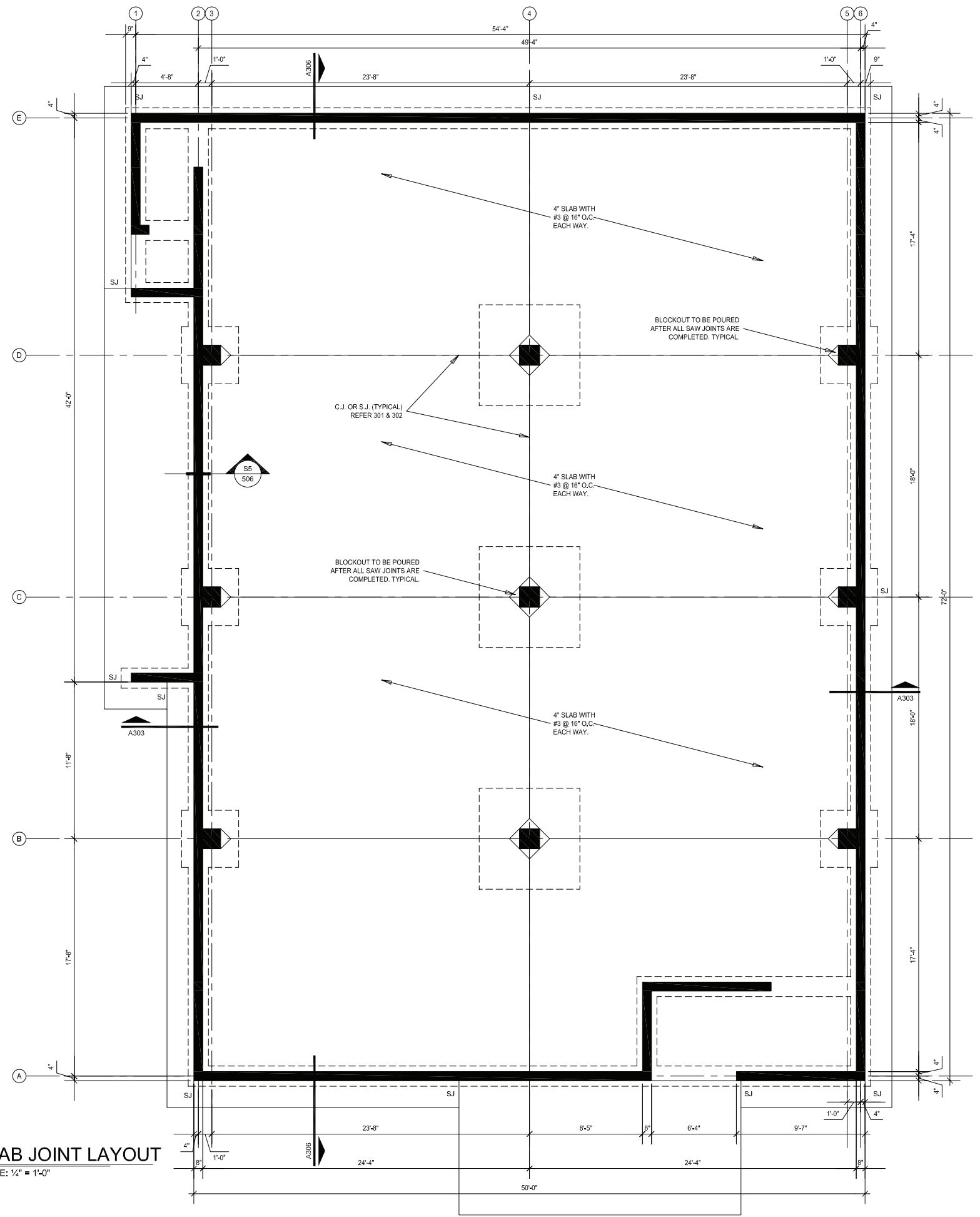

COMMUNITY SAFE ROOM
HURICANE FLOYD HOUSING INITIATIVE
NORTH CAROLINA

LIMIT OF LIABILITY:
The designs included herein are based on extensive research of the causes and effects of windstorm damage to buildings. Safe Rooms designed and built to these designs should provide a high degree of occupant protection during tornadoes. Any substitution of either materials or design concepts may decrease the level of occupant protection and/or increase the possibility of personal injury during a severe wind event.

Because it is not possible to predict or test all conditions that may occur during severe windstorms, or control the quality of construction, among other things, the designer does not warrant the design.

The designer neither manufactures nor sells safe rooms built from this design. The designers have not made and do not make any representation, warranty, or covenant, express or implied, with respect to the design, condition, quality, durability, operation, fitness for use, or suitability of the safe room in any respect whatsoever. Designers shall not be obligated or liable for actual, incidental, consequential, or other damages or to users of safe rooms or any other person or entity arising out of or in connection with the use, condition, and/or performance of safe rooms built from this design or from the maintenance thereof.

SLAB JOINT LAYOUT

SHEET No.:	S3
DATE:	7 MARCH 2000
REVISED:	REV. NO.



COMMUNITY SAFE ROOM

HURICANE FLOYD HOUSING INITIATIVE

NORTH CAROLINA

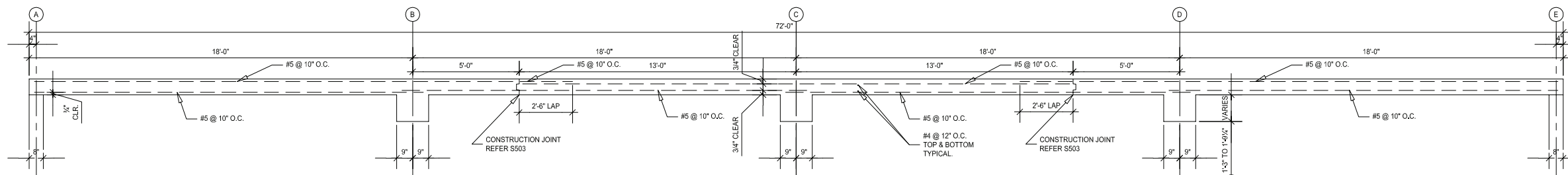

S501 SECTION THRU ROOF
SCALE: 3/8" = 1'-0"

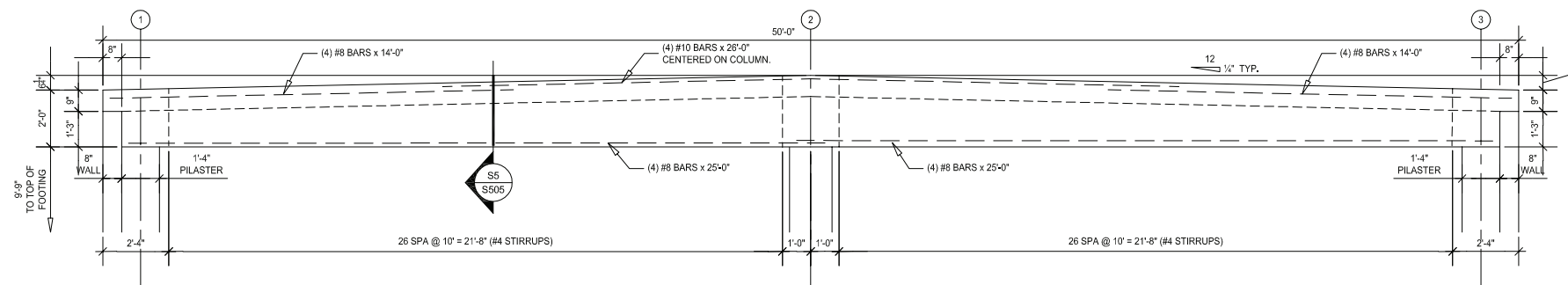

S502 SECTION THRU ROOF BEAM
SCALE: 3/8" = 1'-0"

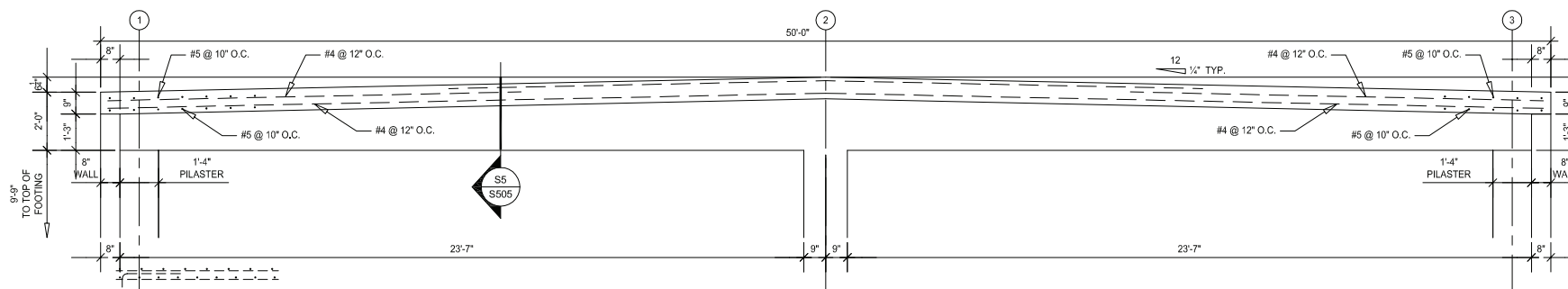

S503 SECTION THRU ROOF
SCALE: 3/8" = 1'-0"

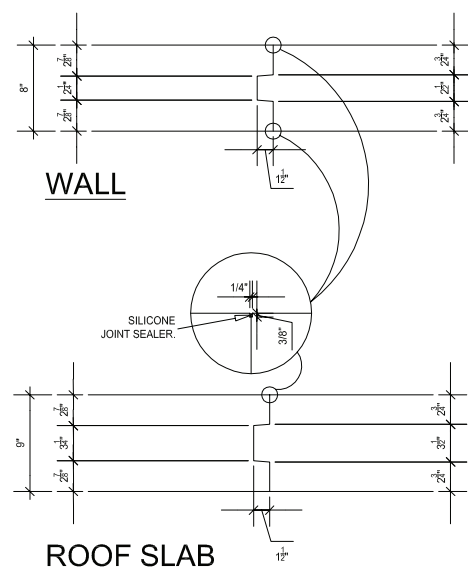

S504 CONSTRUCTION JOINT DETAIL
SCALE: 1 1/2" = 1'-0"

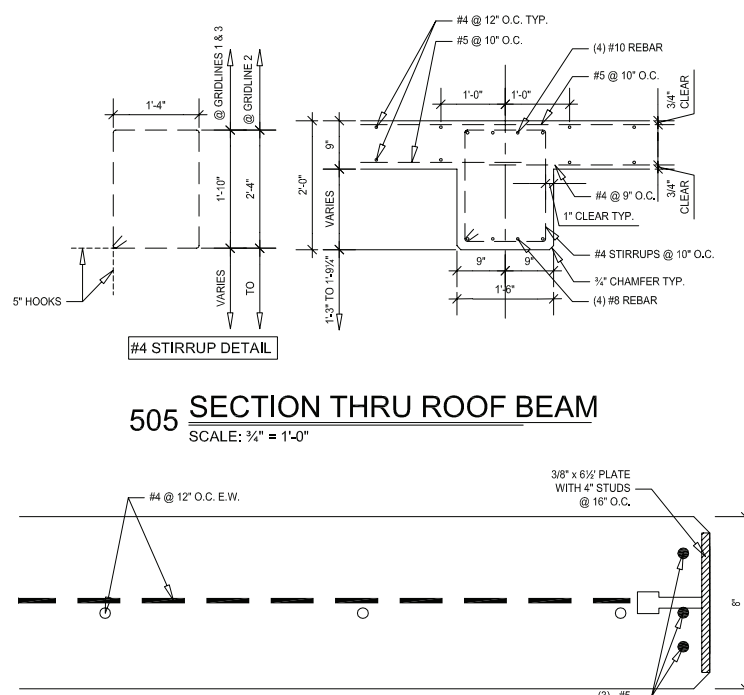

S505 SECTION THRU ROOF BEAM
SCALE: 1/4" = 1'-0"

S506 WALL DETAIL AT OPENNING
SCALE: 3" = 1'-0"

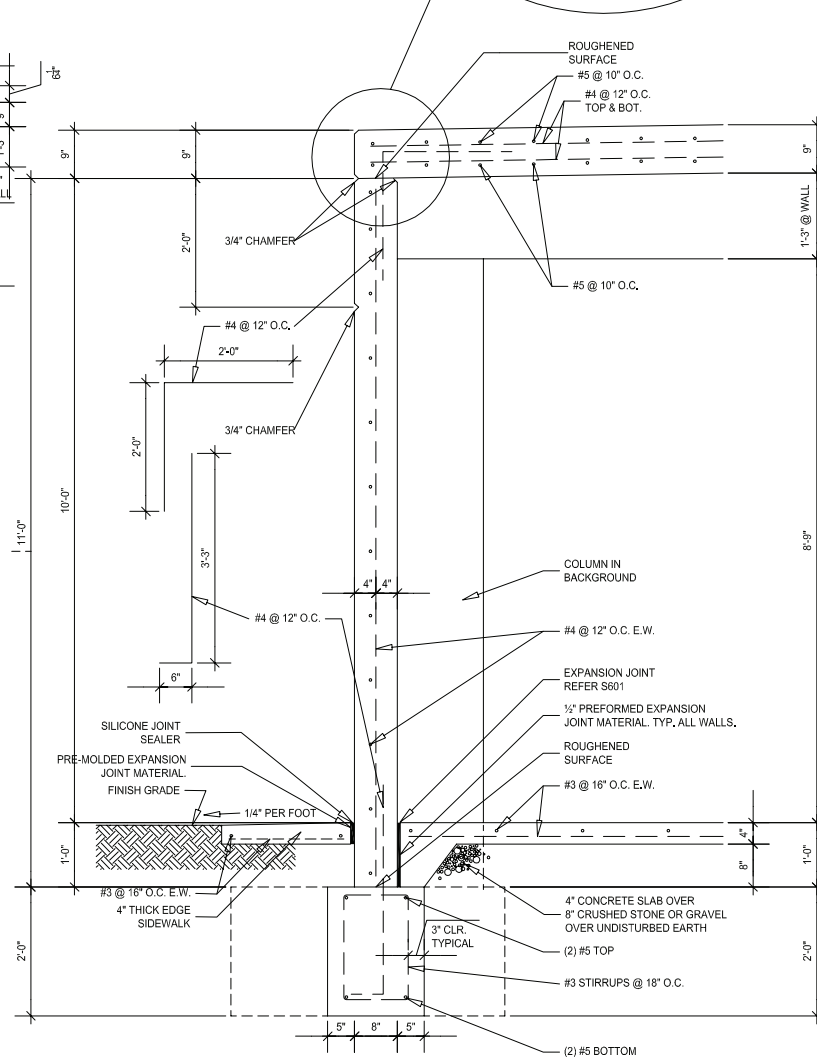

S507 SECTION THROUGH WALL
SCALE: 1/4" = 1'-0"

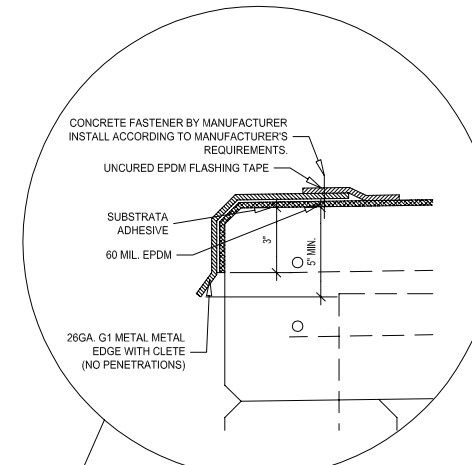

LIMIT OF LIABILITY:

The designs included herein are based on extensive research of the causes and effects of windstorm damage to buildings. Safe Rooms designed and built to these designs should provide a high degree of occupant protection during tornadoes. Any substitution of either materials or design concepts may decrease the level of occupant protection and/or increase the possibility of personal injury during a severe wind event.

Because it is not possible to predict or test all conditions that may occur during severe windstorms, or control the quality of construction, among other things, the designer does not warrant the design.

The designer neither manufactures nor sells safe rooms built from this design. The designers have not made and do not make any representation, warranty, or covenant, express or implied, with respect to the design, condition, quality, durability, operation, fitness for use, or suitability of the safe room in any respect whatsoever. Designers shall not be obligated or liable for actual, incidental, consequential, or other damages of or to users of safe rooms or any other person or entity arising out of or in connection with the use, condition, and/or performance of safe rooms built from this design or from the maintenance thereof.

STRUCTURAL DETAILS

SHEET No.: S5
DATE: 7 MARCH 2000
REVISED: REV. NO.



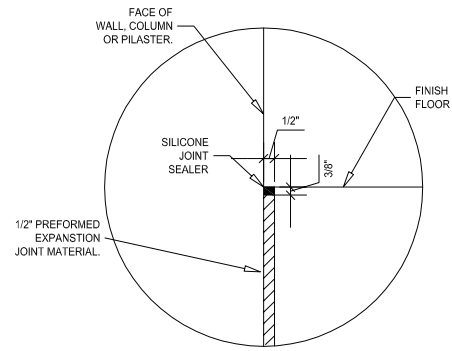

S601 SEALANT DETAIL
SCALE: 3" = 1'-0"

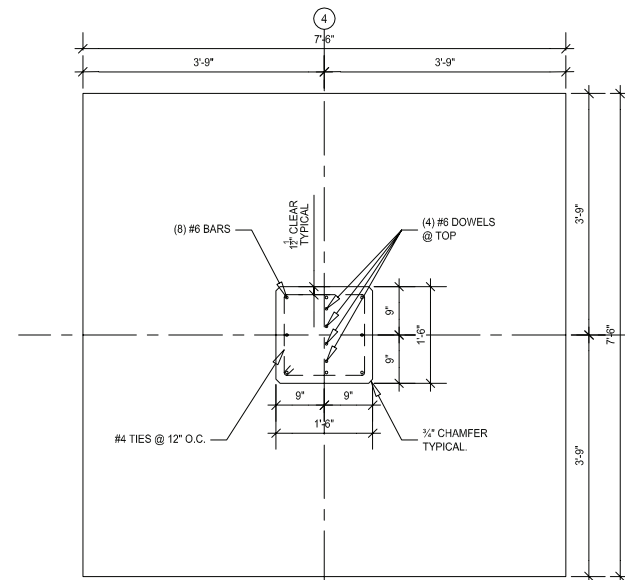

PLAN

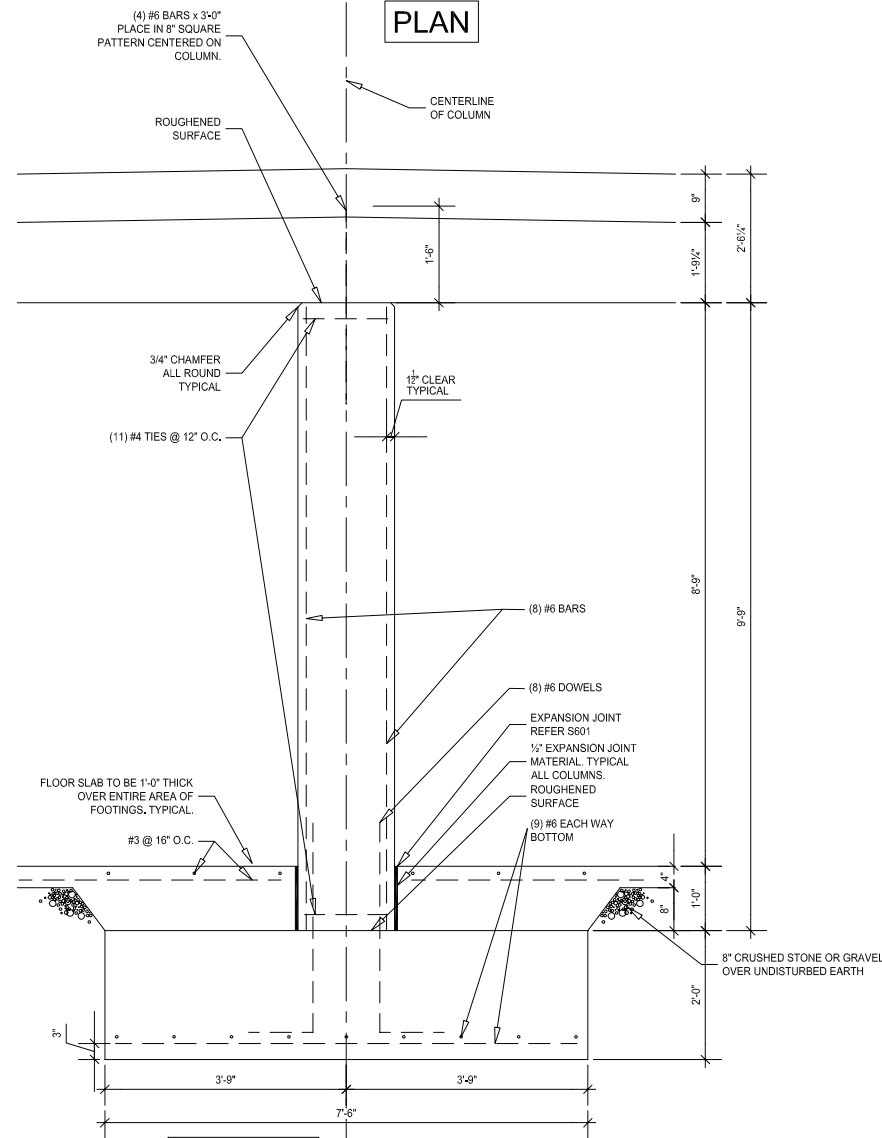

SECTION

S602 DETAILS THRU CENTER COLUMN
SCALE: 3/4" = 1'-0"

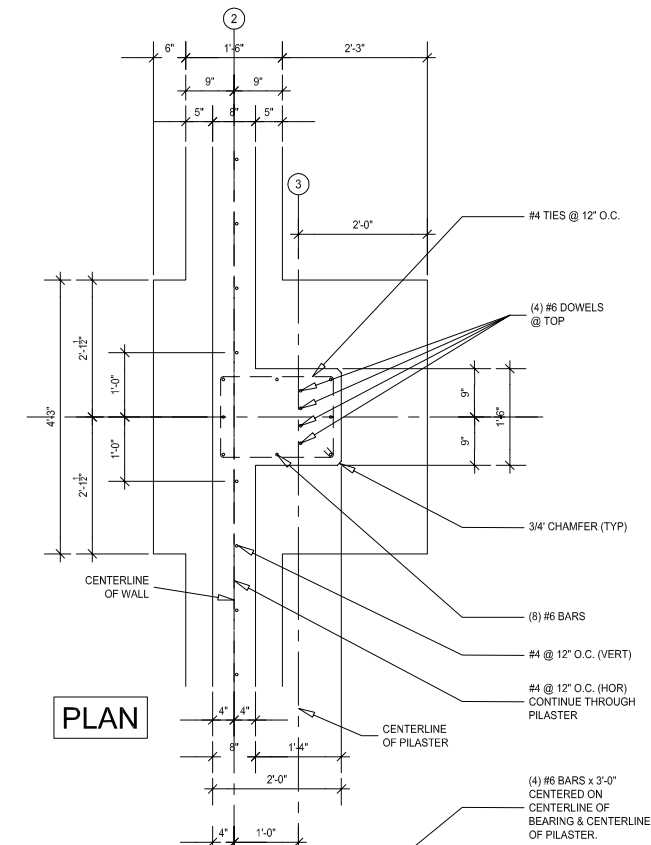

PLAN

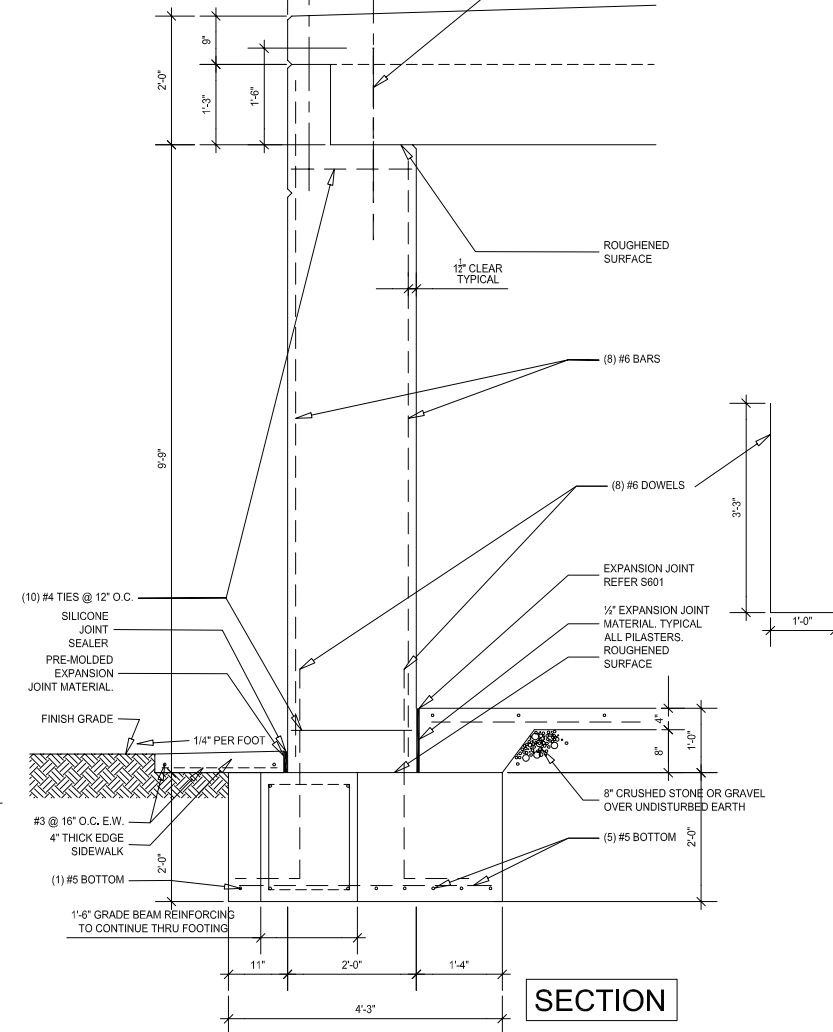

SECTION

S603 DETAILS THRU PILASTER
SCALE: 3/4" = 1'-0"

COMMUNITY SAFE ROOM

HURICANE FLOYD HOUSING INITIATIVE

NORTH CAROLINA

LIMIT OF LIABILITY:

The designs included herein are based on extensive research of the causes and effects of windstorm damage to buildings. Safe Rooms designed and built to these designs should provide a high degree of occupant protection during tornadoes. Any substitution of either materials or design concepts may decrease the level of occupant protection and/or increase the possibility of personal injury during a severe wind event.

Because it is not possible to predict or test all conditions that may occur during severe windstorms, or control the quality of construction, among other things, the designer does not warrant the design.

The designer neither manufactures nor sells safe rooms built from this design. The designers have not made and do not make any representation, warranty, or covenant, express or implied, with respect to the design, condition, quality, durability, operation, fitness for use, or suitability of the safe room in any respect whatsoever. Designers shall not be obligated or liable for actual, incidental, consequential, or other damages or to users of safe rooms or any other person or entity arising out of or in connection with the use, condition, and/or performance of safe rooms built from this design or from the maintenance thereof.

STRUCTURAL DETAILS

SHEET No.: S6
DATE: 7 MARCH 2000
REVISED: _____ REV. NO. _____



Heating & Cooling Load Calculations:
 BASED ON RALEIGH NORTH CAROLINA LOCATION

Heat Loss- 246,341 BTUH
 Heat Gain- 259,057 BTUH

Equipment Schedule- Carrier- Electric Air Handler & Heat Pump

- 6- Air Handlers- FC4BNF048- 1700 CFM- 208-230/60/1- 3/4 H.P.- 4.3 FLA- Factory installed TXV metering device
 Length- 49 5/8", Width- 22 1/16", Height- 21 1/8"
 Weight- 150 Lbs.
- 6- Auxiliary Heat Strips- KFAEH0401N10- 10 KW@- 31,400 BTUH@
 Fuse Size- 60 Amps.
- 6- Heat Pumps- 38YCC048301- 46,000 BTUH Cooling@- 10.00 SEER- 208-230/60/1
 47,000 BTUH@47 Degree DB- 3.20 COP- 7.20 HSPF
 29,600 BTUH@13 Degree DB- 2.24 COP
 Compressor- 24.4 RLA- MCA- 31.9 Amps.- Max. Fuse
 Size- 50 Amps.- Condenser Fan- 1/4 H.P.- 1.4 FLA
 Width- 29 1/8", Depth- 29 9/16", Height- 39 15/16"
 Weight- 219 Lbs.
- 6- Thermostats- TSTATCCNHP01-A- Auto Changeover, Non-Programmable,
 2 Stage Heat-1 Stage Cool- Auto/Manual Fan
- 6- Start Assist- KSAHS1601AAA
- 6- Outdoor Thermostats- KHAOT0301FST

Refrigeration Lines

From each air handler coil, install properly sized refrigeration lines to heat pumps. Secure refrigeration lines to concrete ceiling with proper fasteners.

Condensate Drains.

From air handlers hanging close together, bring 3/4" PVC from each and tee together. Run 3/4" PVC across and out thru wall.

SUPPLY AIR

Each horizontal air handler will have short 12" supply plenum on supply side of unit. Will install one supply diffuser on front to supply air to areas. On one unit near office, will install starting collar with air scoop. Will run 8" sheetmetal duct from plenum to supply box at office wall. Will elbow below concrete beam to high sidewall supply box. Duct will be secured to concrete ceiling with proper fasteners.

Return Air

Each horizontal air handler will have short 12" return air plenum on return air end of unit. Will install filter rack inside of return air so that filter can be easily changed.

Ventilation Air (885 CFM Fresh Air)

Each horizontal air handler will have 8" round sheetmetal fresh air duct coming off of return air plenum. Each 8" duct will run into 10" x 8" x 8" tee. 10" round sheetmetal duct will then be ran to wall mounted filter box at wall. This box will have 12" x 12" metal filter in box. On outside of wall there will be 12" x 12" Louvered Grille. All duct will be secured to concrete ceiling with proper fasteners. Install manual damper in 10" duct near filter box.

Air Devices AirMate

Supply Diffusers

- 20" X 18"- #220-V- Multi-Shutter Damper - White
- 14" X 6"- #220-V- Multi-Shutter Damper - White

Return Air

None- Open return plenums with filter rack inside.

Exhaust Fan Tjernlund

- 1- #EF-10- 10" In-line exhaust fan. 115/60/1- 0.46 Amps.- 10" Duct connection.
 Width- 15 1/2", Diam.- 10", Weight- 10 Lbs.

Attach 10" x 10" exhaust air box in each restroom. Run 8" sheetmetal from each to sheetmetal tee, then run 10" duct to inline exhaust fan. From fan, run 10" duct to 12" x 12" wall box. Mount 12" x 12" Louvered Grille W/Backdraft damper on outside of wall. Secure duct to concrete ceiling with proper fasteners.

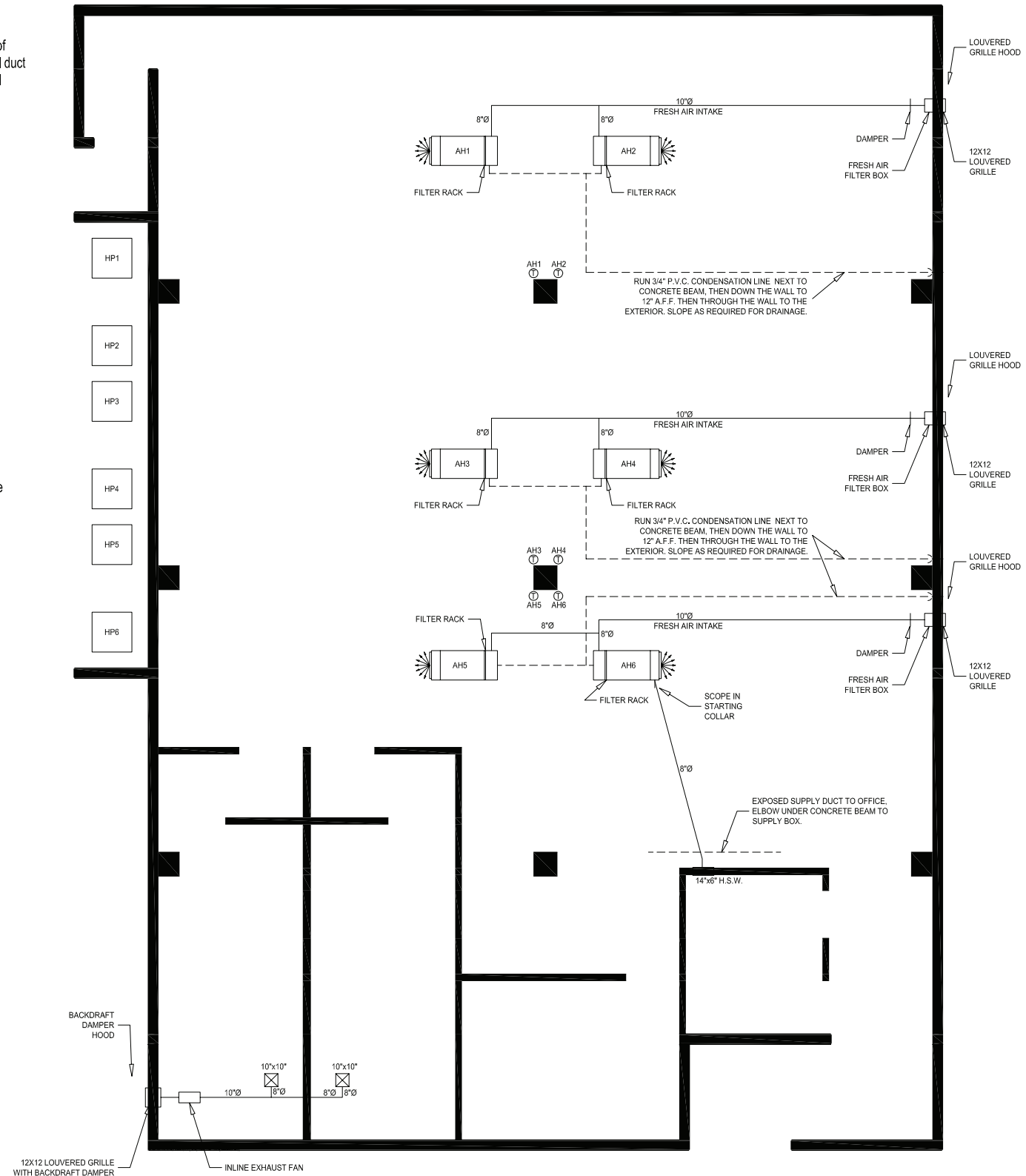

M101 MECHANICAL PLAN
 SCALE: 1/4" = 1'-0"

COMMUNITY SAFE ROOM
 HURICANE FLOYD HOUSING INITIATIVE
 NORTH CAROLINA

LIMIT OF LIABILITY:

The designs included herein are based on extensive research of the causes and effects of windstorm damage to buildings. Safe Rooms designed and built to these designs should provide a high degree of occupant protection during tornadoes. Any substitution of either materials or design concepts may decrease the level of occupant protection and/or increase the possibility of personal injury during a severe wind event.

Because it is not possible to predict or test all conditions that may occur during severe windstorms, or control the quality of construction, among other things, the designer does not warrant the design.

The designer neither manufactures nor sells safe rooms built from this design. The designers have not made and do not make any representation, warranty, or covenant, express or implied, with respect to the design, condition, quality, durability, operation, fitness for use, or suitability of the safe room in any respect whatsoever. Designers shall not be obligated or liable for actual, incidental, consequential, or other damages of or to users of safe rooms or any other person or entity arising out of or in connection with the use, condition, and/or performance of safe rooms built from this design or from the maintenance thereof.

MECHANICAL PLAN

SHEET No.: M1
 DATE: 7 MARCH 2000
 REVISED: _____ REV. NO. _____



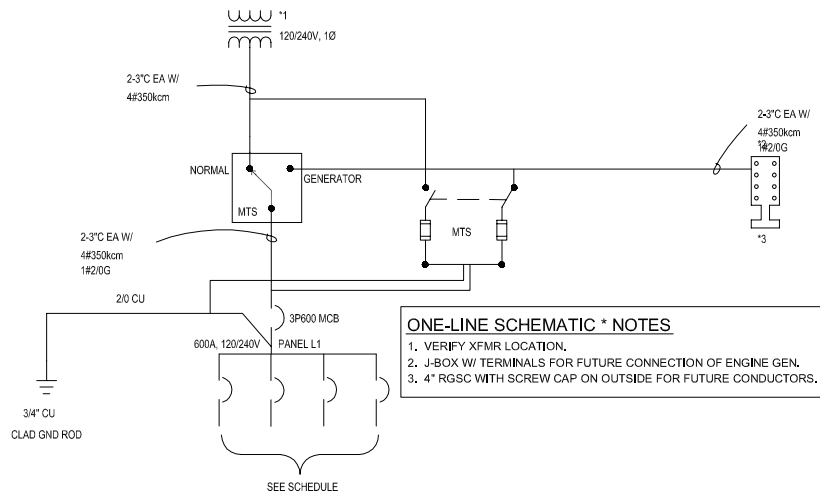

E101 ONE LINE SCHEMATIC

ELECTRICAL SPECIFICATIONS

1. SECTION 16010 - BASIC ELECTRICAL REQUIREMENTS

- A. All material shall be UL approved where standards are established.
- B. Materials and equipment shall be of current production by recognized manufacturers with spare parts available. All units of the same class shall be of the same manufacturer.
- C. Materials shall be installed as indicated and meet requirements of the NFPA, including NEC.

2. SECTION 16110 - RACEWAYS

- A. Install according to NEC. Minimum size to be 1/2". Provide a complete assembly with all fittings and accessories.
- B. All conduit shall be surface mounted. No imbedded conduit.
- C. EMT for all other interior applications. EMT couplings and connectors shall be compression type. Rigid galvanized steel conduit for all outside conduit. Seal tight for connection to motors.
- D. Seal all fire wall penetrations with fire retardant silicone foam, CTC PR-855, Chase Technology.

3. SECTION 16120 - WIRE, CABLE AND CONNECTORS

- A. Wire and Cable
 1. Copper conductors.
 2. Minimum size No. 12 AWG, No. 8 and larger shall be stranded.
 3. Insulation shall be type THHN/THWN.

- B. Connectors
 1. No. 10 AWG and smaller, solderless, screw-on pressure type.
 2. Larger than No. 10 AWG bolt clamp-type.
 3. 250 kcm or larger shall have at least two clamping elements.

- C. Control Wiring
 1. No. 16 AWG minimum.
 2. Refer to Division 15 for control wiring of mechanical equipment.
- D. Signal Wiring as recommended by system manufacturer.

4. SECTION 16135 - ELECTRICAL BOXES AND FITTINGS

Interior boxes shall be sheet steel with knockouts. Exterior boxes shall be gasketed cast metal.

5. SECTION 16143 - WIRING DEVICES

- A. Receptacles shall be 15 ampere, 125 volt AC, duplex, NEMA 15-5R.
- B. Switches shall be rated 20 amperes at 277 volts AC.
- C. All switches and receptacles shall be quiet-type, specification grade.
- D. Device plates shall be stainless steel in finished areas and zinc coated steel for unfinished areas.
- E. Photo electric control cell shall be rated 3000W, similar and equal to Tork #35403.

6. SECTION 16441 - ENCLOSED SWITCHES

- A. Disconnect switches shall be fusible, NEMA KS 1, Type GD load break.
- B. Enclosures: NEMA KS1. Interior dry locations; Type 1, Exterior locations; Type 3R.
- C. Neutral and ground buses required.
- D. Manual transfer switch shall be Double throw type similar and equal to Cutler Hammer #DT326FGK In NEMA1 enclosure.

E. Fuses:

Fuses protecting motors or transformers shall be Bussmann type FRN-R. Fuses for MTS to be Type T.

7. SECTION 16470 - PANELBOARDS

- A. Circuit breaker type for branch ckt. Lighting and Power equal to GE, Square D or Cutler Hammer, complete with protective devices and accessories as required.
- B. Shall be dead-front safety type, enclosed in a sheet steel cabinet.
- C. Neutral and ground buses required.
- D. Molded case circuit breakers shall meet NEMA and UL standards.

1. Breakers shall be one, two, or three-pole units as indicated and shall operate both manually and automatically.
2. All poles shall operate simultaneously and mechanism shall be trip free
3. Minimum interrupting capacity shall be 14,000 amps at 120/208 volts and 22,000 amps at 277/480 volts.

8. SECTION 16452 - GROUNDING

- A. Ground buses and neutral buses shall be isolated except in main switchgear and transformer terminal compartments.
- B. All branch and feeder circuits shall include green grounding conductors.

9. SECTION 16515 - INTERIOR LIGHTING FIXTURES AND ACCESSORIES

Furnish as scheduled.

10. SECTION 16722 - FIRE ALARM SYSTEM

- A. Shall be self contained, 120V, similar and equal to BRK #1839W1-2.
- B. Comply with all local Codes.

POWER PLAN NOTES

- §1. JUNCTION BOX WITH TERMINALS FOR FUTURE CONNECTION.
- §2. RGSC STUBED THROUGH WALL WITH SCREW CAP.
- §3. UNDERGROUND SERVICE FEEDER TO SERVICE TRANSFORMER.

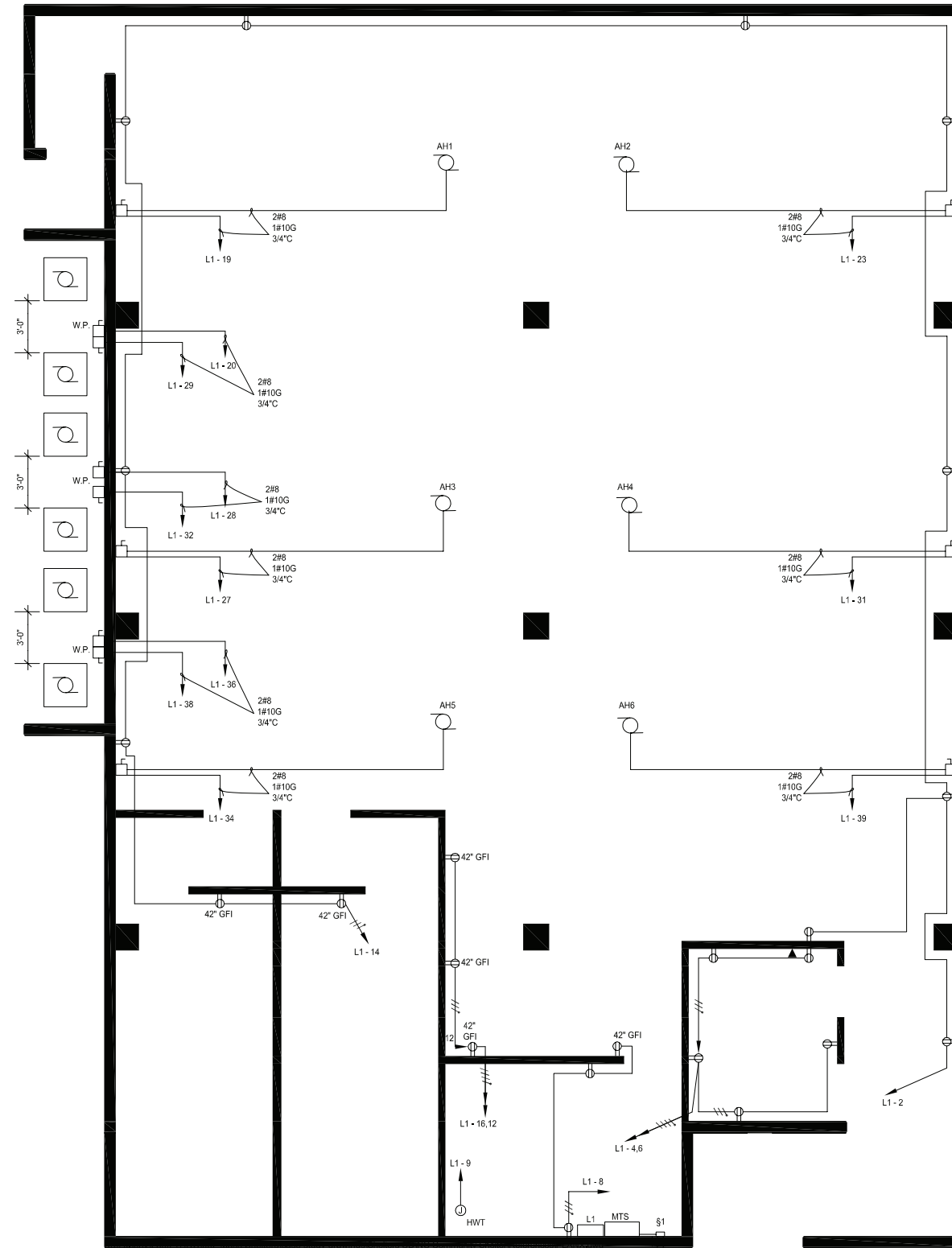

E102 POWER PLAN
SCALE: 1/4" = 1'-0"

COMMUNITY SAFE ROOM
HURICANE FLOYD HOUSING INITIATIVE
NORTH CAROLINA

LIMIT OF LIABILITY:

The designs included herein are based on extensive research of the causes and effects of windstorm damage to buildings. Safe Rooms designed and built to these designs should provide a high degree of occupant protection during tornadoes. Any substitution of either materials or design concepts may decrease the level of occupant protection and/or increase the possibility of personal injury during a severe wind event.

Because it is not possible to predict or test all conditions that may occur during severe windstorms, or control the quality of construction, among other things, the designer does not warrant the design.

The designer neither manufactures nor sells safe rooms built from this design. The designers have not made and do not make any representation, warranty, or covenant, express or implied, with respect to the design, condition, quality, durability, operation, fitness for use, or suitability of the safe room in any respect whatsoever. Designers shall not be obligated or liable for actual, incidental, consequential, or other damages of or to users of safe rooms or any other person or entity arising out of or in connection with the use, condition, and/or performance of safe rooms built from this design or from the maintenance thereof.

POWER PLAN

SHEET No.: E1
DATE: 7 MARCH 2000
REVISED: REV. NO.



ELECTRICAL SYMBOLS

SYMBOL	DESCRIPTION
□	FLUORESCENT LIGHTING FIXTURE, TYPE NO. INDICATED
○	INCANDESCENT LIGHTING FIXTURE, CEILING OR WALL MOUNTED
⊙	EXIT LIGHTING FIXTURE, CEILING OR WALL MOUNTED
⊕	EXIT LIGHTING FIXTURE WITH EMERGENCY LIGHTS
○	JUNCTION BOX
○	JUNCTION BOX FOR FUTURE SPEAKER
○	UTILITY OUTLET BOX, SEE DETAIL
⊕	DUPLEX RECEPTACLE
⊕	DUPLEX RECEPT MNT'D IN HORIZ POSITION, 6" ABOVE COUNTER
⊕	DOUBLE DUPLEX RECEPTACLE
⊕	SIMPLEX RECEPTACLE WITH DEDICATED CKT
⊕	POLARIZED RECEPTACLE, STYLE AS NOTED
⊕	COMPUTER RECEPTACLE, WALL OR FLOOR BOX
⊕	LOW VOLTAGE RELAY
⊕	SWITCH AND RECEPTACLE MOUNTED IN SINGLE OUTLET BOX
⊕	MASTER CLOCK
⊕	SECONDARY CLOCK
⊕	CLOCK OUTLET
⊕	DOUBLE FACE CLOCK
⊕	FLOOR BOX WITH DOUBLE DUPLEX RECEPTACLE
⊕	FLOOR BOX WITH RECEPTACLE OUTLET
⊕	FLOOR BOX WITH TELEPHONE OUTLET
⊕	MICROPHONE OUTLET
⊕	TELEVISION OUTLET
⊕	INTERCOM OUTLET
⊕	"PHONO" OUTLET FLOOR MOUNTED
⊕	"PHONO" OUTLET WALL MOUNTED
⊕	SPEAKER
⊕	SOUND SYSTEM VOLUME CONTROL
⊕	TELEPHONE OUTLET, 12" AFF
⊕	TELEPHONE OUTLET MNT'D IN HORIZ POSITION 6" ABOVE COUNTER
⊕	TELEPHONE OUTLET MNT'D AT 42" AFF
⊕	SPECIAL CONDITIONS, SEE DETAIL
⊕	KITCHEN ITEMS, SEE KITCHEN PLANS FOR DESCRIPTION
*1, *2, *3	SEE NOTES
⊕	THERMOSTAT
⊕	AQUASTAT
⊕	TRANSFORMER
⊕	FIRE ALARM VISUAL INDICATOR ONLY
⊕	FIRE ALARM PULL STATION
⊕	FIRE ALARM AUDIBLE-VISUAL INDICATOR
⊕	FIRE ALARM HORN
⊕	FIRE ALARM BELL
⊕	FIRE ALARM SMOKE DETECTOR
⊕	FIRE ALARM HEAT DETECTOR
⊕	FIRE ALARM FLAME DETECTOR
⊕	FIRE ALARM DUCT DETECTOR
⊕	SINGLE POLE WALL SWITCH
⊕	TWO POLE WALL SWITCH
⊕	THREE-WAY WALL SWITCH
⊕	FOUR-WAY WALL SWITCH
⊕	SINGLE POLE WALL SWITCH WITH PILOT LIGHT
⊕	SINGLE POLE WALL SWITCH, KEY OPERATED
⊕	SINGLE POLE WALL SWITCH, LOW VOLTAGE
⊕	PLUG IN STRIP
⊕	MANUAL MOTOR STARTER, SINGLE PHASE
⊕	MOTOR DISCONNECT SWITCH
⊕	MAGNETIC MOTOR STARTER
⊕	MAGNETIC CONTACTOR
⊕	COMBINATION MOTOR DISCONNECT SWITCH
⊕	MOTOR WITH HORSEPOWER RATING
⊕	ELECTRIC PANEL
⊕	TELEPHONE TERMINAL CABINET
⊕	TELEPHONE TERMINAL BOARD
⊕	CIRCUIT HOME RUN, TWO WIRES & GREEN GROUND INDICATED
⊕	CONDUIT EXPOSED ON WALL OR AT CEILING
WP	DENOTES WEATHERPROOF
(E)	DENOTES EXISTING TO BE RETAINED
EDF	ELECTRIC DRINKING FOUNTAIN
EG	EQUIPMENT GROUND
MD	MOTION DETECTOR
PC	PART CIRCUIT
GFCI	GROUND FAULT CIRCUIT INTERRUPTER

NOTE: NOT ALL SYMBOLS USED

LIGHTING FIXTURE SCHEDULE					
FIXT. I.D.	TYPE	MANUFACTURER & CATALOG NUMBER	NO.	WATTS	REMARKS
A	STRIP	LITHONIA #UN432120GEB	4	32	F32T8/SP35 SURFACE *1
B	STRIP	LITHONIA #UN232120GEB	2	32	F32T8/SP35 SURFACE
C	EMERGENCY LT	LITHONIA #ELT125SSBH1212	2	12	FURNISHED WALL SURFACE @ #AFF
D	WALL PACK	LITHONIA #TWH175M120LPI	1	175	175MVR175/U WALL SURFACE @ 10' AFF
E	SIGN LT	GE #SBN03MOH	1	35	MH35/U *2
X	EXIT	LITHONIA #LESB1R120ELN	-	-	FURNISHED SURFACE ABOVE DOOR

LIGHTING FIX NOTES: *1 FURNISH W/ 2 BALLASTS FOR INSIDE & OUTER LAMPS.
*2 MOUNT JUST ABOVE SIGN, USE RGSC TO EXTEND FIX 24" FROM WALL, AIM FIX TOWARD SIGN.

PANEL L1, SINGLE Ø, 3 WIRE, 120/240 V, 600 A MCB.					
14,000 RMS SYM. A.I.C., ENCLOSURE: NEMA 1, MOUNTING: ELECT/MECH ROOM.					
MLO-MAIN LUGS ONLY, MCB-MAIN CIRCUIT BREAKER, MCS-MOLDED CASE SWITCH, HCAR-AIR CONDITIONING BREAKER					
CIRCUIT USE	CCT. BKR.	NO.	CONNECTED LOAD VA @ A @ C	CCT. BKR.	CIRCUIT USE
BACK LTS	1P20	1	1650	2	RECPT
FRONT LTS	1P20	3	1750	4	RECPT OFFICE
EMG LTS	1P20	5	650	6	RECPT OFFICE
OUTSIDE LTS	1P20	7	2850	8	RECPT MECH RM
HOT WATER TANK	2P30	9	1200	10	RECPT KIT
HOT WATER TANK	2P30	11	200	12	RECPT KIT
SPACE	--	13	1200	14	RECPT
SPACE	--	15	--	16	SPARE
SPACE	--	17	--	18	SPARE
AH1	2P60	19	5500	20	HP1 (HACR)
..	--	21	5500	22	..
AH2	2P60	23	5500	24	HP2 (HACR)
..	--	25	5500	26	..
AH3	2P60	27	5500	28	HP3 (HACR)
..	--	29	5500	30	..
AH4	2P60	31	5500	32	HP4 (HACR)
..	--	33	5500	34	..
AH5	2P60	35	5500	36	HP5 (HACR)
..	--	37	5500	38	..
AH6	2P60	39	5500	40	HP6 (HACR)
..	--	41	5500	42	..
			57,400	58,100	

NOTES:
CONNECTED LOAD = 115.5 kVA
ESTIMATED DEMAND LOAD = 80.0 kVA

LIGHTING PLAN NOTES

- §1. 2 LAMPS ON ALL THE TIME.
- §2. ROUTE THROUGH PE CELL. MOUNTED ON ROOF FACING NORTH.
- §3. SMOKE DETECTOR CONNECTED TO EMG. CKT. L1-5.

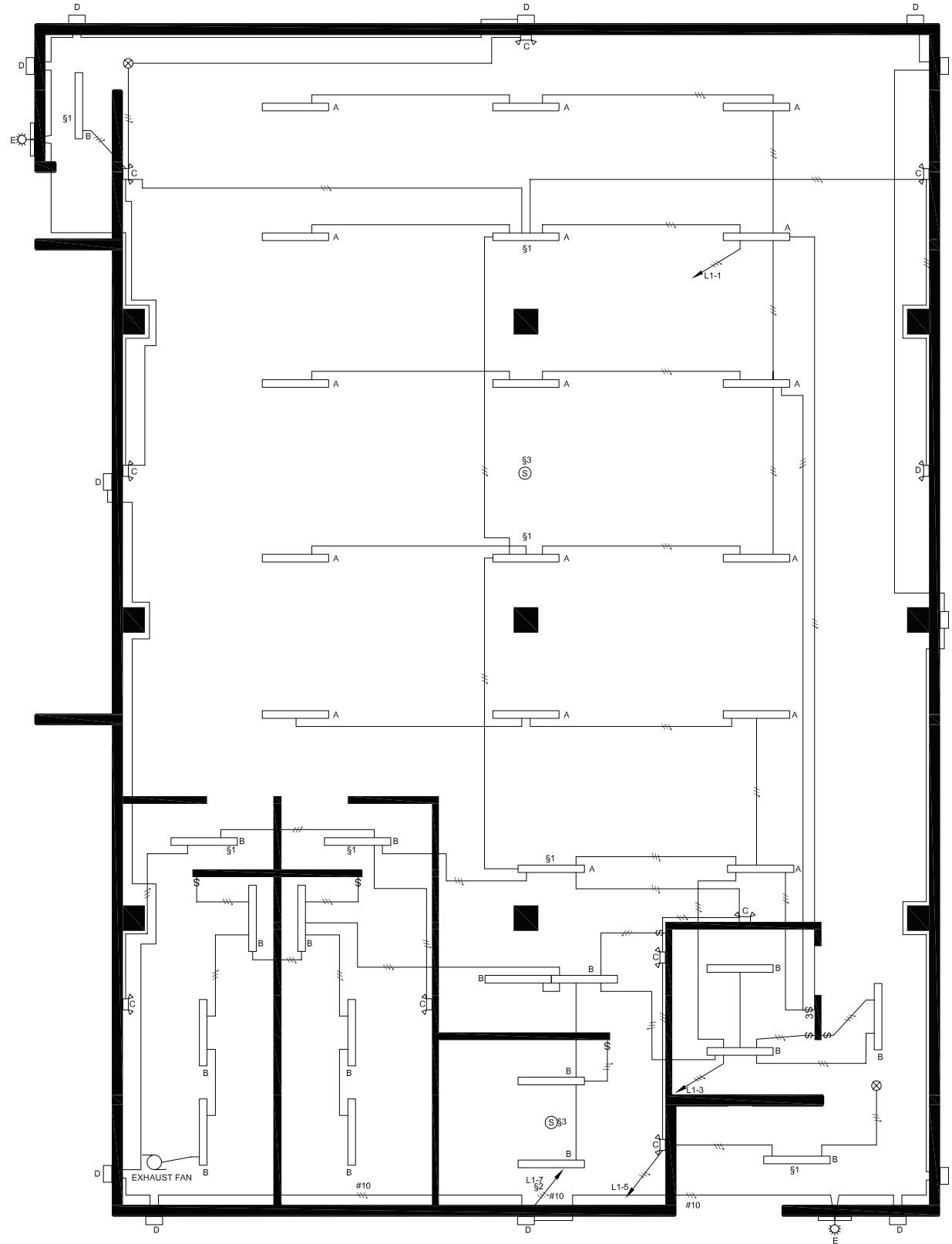

E201 LIGHTING PLAN
SCALE: 1/4" = 1'-0"

COMMUNITY SAFE ROOM

HURICANE FLOYD HOUSING INITIATIVE
NORTH CAROLINA

LIMIT OF LIABILITY:

The designs included herein are based on extensive research of the causes and effects of windstorm damage to buildings. Safe Rooms designed and built to these designs should provide a high degree of occupant protection during tornadoes. Any substitution of either materials or design concepts may decrease the level of occupant protection and/or increase the possibility of personal injury during a severe wind event.

Because it is not possible to predict or test all conditions that may occur during severe windstorms, or control the quality of construction, among other things, the designer does not warrant the design.

The designer neither manufactures nor sells safe rooms built from this design. The designers have not made and do not make any representation, warranty, or covenant, express or implied, with respect to the design, condition, quality, durability, operation, fitness for use, or suitability of the safe room in any respect whatsoever. Designers shall not be obligated or liable for actual, incidental, consequential, or other damages of or to users of safe rooms or any other person or entity arising out of or in connection with the use, condition, and/or performance of safe rooms built from this design or from the maintenance thereof.

LIGHTING PLAN

SHEET No.: E2
DATE: 7 MARCH 2000
REVISED: REV. NO.



PLUMBING SPECIFICATIONS

GENERAL PROVISIONS

1. SCOPE: PROVIDE ALL LABOR, MATERIAL, AND EQUIPMENT IN ACCORDANCE WITH THESE SPECIFICATIONS AND THE ACCOMPANYING DRAWINGS TO PROVIDE A COMPLETE AND PROPERLY OPERATING PLUMBING SYSTEM FOR THE BUILDING.

OBTAIN WATER & SEWER, GAS TAPS, AND ANY OTHER REQUIRED UTILITIES AND EXTEND SERVICE FROM SAME TO BUILDING AS SHOWN ON DRAWINGS. VISIT THE SITE FOR UNDERSTANDING OF THE WORK TO BE DONE BEFORE SUBMITTING BID.

COORDINATE THIS WORK WITH THE WORK OF THE OTHER TRADES ON THE PROJECT. ALL PLUMBING IS TO BE ROUGHED IN WHILE THE BUILDING IS BEING CONSTRUCTED AT SUCH TIMES AS NOT TO DELAY THE GENERAL CONTRACTOR ON THE BUILDING.

2. GENERAL REQUIREMENTS: COMPLY WITH ALL FEDERAL, STATE, AND LOCAL REQUIREMENTS, CODES, RULES, AND ORDINANCES GOVERNING WORK ON THIS CHARACTER. PAY FOR AND OBTAIN NECESSARY CONSTRUCTION PERMITS AND CERTIFICATES OF INSPECTION.

A. DRAWINGS: THE LOCATION OF THE PIPING RUNS ARE APPROXIMATE AND THE CONTRACTOR MUST MAKE ANY NECESSARY CHANGES IN THE PIPING RUNS, ETC., AND AT NO ADDITIONAL COST TO THE OWNER. OUTLET LOCATIONS ARE CRITICAL AND MUST BE LOCATED EXACTLY ACCORDING TO THE PLUMBING PLAN. COORDINATE THIS WORK WITH THE INSTALLERS OF EQUIPMENT FURNISHED AND INSTALLED BY OTHERS. REFER TO THE OTHER DRAWINGS FOR DETAILS OF THE BUILDING CONSTRUCTION AND THE OTHER MECHANICAL, ELECTRICAL, AND EQUIPMENT FEATURES.

B. COORDINATION AND WORKMANSHIP: SCHEDULE THIS WORK SO THAT IT WILL BE PROPERLY COORDINATED WITH ALL OTHER TRADES. WORKMANSHIP SHALL BE IN ACCORDANCE WITH THE BEST PRACTICE FOR THE CLASS OF WORK INVOLVED. WORKMANSHIP SHALL ALLOW THE APPLIANCE TO OPERATE AS INTENDED AND BE INSTALLED TO BEST PROTECT THE PUBLIC AND OPERATORS FROM INJURY OR DAMAGE, AND TO PRESENT A NEAT, PLEASING, AND ORDERLY APPEARANCE.

MATERIALS AND PERFORMANCE

1. MATERIALS: ALL MATERIALS SHALL BE NEW AND OF THE QUALITY INDICATED BY THE SPECIFIED BRAND NAMES. SUBSTITUTIONS OF MATERIAL OF EQUAL QUALITY BY OTHER FIRST-LINE MANUFACTURERS MAY BE ACCEPTABLE PROVIDED A LIST OF SUCH SUBSTITUTIONS IS APPROVED IN WRITING BY FEMA REPRESENTATIVE. A SUBSTITUTIONS LIST SHALL BE SUBMITTED IN TRIPLICATE WITHIN FIVE (5) DAYS AFTER THE CONTRACT IS LET.

2. BACKFILLING: PERFORM ALL NECESSARY EXCAVATING AND BACKFILLING REQUIRED FOR THIS INSTALLATION. PREPARE A PROPER BED OF SAND OR GRAVEL OR EQUIVALENT IN ROCK SCREENINGS SO AS TO ELIMINATE SHIMMING AND VOID SPACE UNDER ANY OF THE UTILITY SERVICE PIPES. BENDING OF ANY HARD PIPE WILL NOT BE PERMITTED. WHERE A CHANGE IN DIRECTION IS NECESSARY ON PRESSURE PIPES, "COMPATIBLE" COUPLINGS OR EQUAL SHALL BE USED AND BENDS MAY NOT EXCEED 90 DEGREES. ALL EXCAVATION BELOW THE BOTTOM OF FOOTINGS SHALL BE BACKFILLED WITH 2000 PSI CONCRETE. OTHER BACKFILL SHALL CONSIST OF 2-3" OF SAND OR ROCK SCREENINGS AND EARTH TO A FINAL LEVEL EQUAL TO ITS ORIGINAL CONDITION. IN THE EVENT THE BACKFILL SHOULD SETTLE BEFORE THE FINAL TOP SURFACE IS APPLIED, APPLY THE BACKFILL SHOULD SETTLE BEFORE THE FINAL TOP SURFACE IS APPLIED, APPLY ADDITIONAL BACKFILL TO SUSTAIN THE ORIGINAL LEVEL. CARE SHOULD BE TAKEN TO ADDITIONAL BACKFILL TO SUSTAIN THE ORIGINAL LEVEL. CARE SHOULD BE TAKEN TO MINIMIZE THE DUST LEVEL WHEN EXCAVATING AND BACKFILLING SO AS TO COMPLY WITH FEDERAL AND STATE E.P.A. REGULATIONS RELATING TO THIS TYPE OF WORK (FUGITIVE DUST).

3. PIPING INSTALLATION: CLEANOUTS MUST BE INSTALLED ON MINIMUM DROP LINES EVEN THOUGH NOT SHOWN ON THE BLUEPRINTS. USE REDUCING FITTINGS IN MAKING REDUCTIONS IN SIZE OF PIPE. REAM ALL PIPE AFTER CUTTING. THEN TURN PIPES ON END AND KNOCK OUT ALL LOOSE DIRT AND SCALE BEFORE INSTALLING. MAKE CHANGES IN HORIZONTAL DIRECTION OF SOIL AND WASTE PIPES WITH LONG RADIUS FITTINGS OR WITH "Y" BRANCHES AND 1/8" OR 1/16" BENDS. CONNECT SOIL STACKS AT BASE TO HORIZONTAL RUNS WITH "Y" CONNECTIONS.

WATER SUPPLY PIPES TO FIXTURES AND WASTE PIPES FROM FIXTURES SHALL BE CENTERED IN THE PROPER PLACE RELATIVE TO THE CENTER LINE OF THE FIXTURE. NO OFFSETS WILL BE ALLOWED. ALL PIPES SHALL BE RUN MECHANICALLY STRAIGHT AND SQUARE WITH BUILDING LINES, EXCEPT FOR REQUIRED PITCH ON HORIZONTAL LINES, AND ALL CHANGES IN DIRECTION SHALL BE MADE WITH FITTINGS. WATER PIPING TO BE ROUTED IN WALLS, UNDER THE FLOOR SLAB, AND ON CEILINGS AS NOTED. WHERE WATER LINES ARE ROUTED UNDER THE FLOOR SLAB, NO MECHANICAL JOINTS SHALL BE MADE UNDER THE SLAB EXCEPT AS LISTED BELOW. WATER PIPING SHALL BE INSTALLED NOT TO EXERT VERTICAL NOR HORIZONTAL STRESSES ON THE SEATING OF UNIONS, UNIONS SHALL BE COPPER TYPE NIBCO #733 OR EQUAL.

NO WAX, PUTTY, OR VARNISH WILL BE PERMITTED. CRACKED FITTINGS SHALL BE REMOVED AND REPLACED WITH NEW FITTINGS. MAKE THREADED JOINTS IN BRASS PIPE AND FITTING WITH PIPE THREADING TO THE SHOULDER OF THE FITTINGS. NO SLIP JOINTS OR COUPLING JOINTS IN BRASS PIPE WILL BE PERMITTED, EXCEPT ON THE FIXTURE SIDE OF THE TRAP.

4. WATER PIPE:

JOINTS SHALL BE CLEANED AND DEBURRED AS RECOMMENDED BY THE MANUFACTURER AND FEDERAL, STATE AND LOCAL CODES AND SOLDERED AS LISTED BELOW. FLUX SHALL BE NON-CORROSIVE.

ABOVE GRADE - WHERE FITTINGS ARE SOLDERED BOTH FITTINGS AND TUBING SHALL BE CLEANED AS DESCRIBED ABOVE. UNDER NO CIRCUMSTANCES SHALL DISSIMILAR METALS COME INTO DIRECT CONTACT WITH COPPER TUBING, E.G., GALVANIZED STRAPPING, HANGERS, OR CLAMPS TO SECURE THE TUBING.

BELOW GRADE, OR FLOOR SLAB ON EARTH OR STONE FILL - HIGH TEMPERATURE, SOLDER, 1200 DEG. F. OR GREATER MELTING POINT. NOTE: WATER PIPE TO BE PROPERLY SECURED AND ALIGNED SO AS NOT TO EXERT VERTICAL OR HORIZONTAL STRESSES ON THE SEATING OF THE MATING (MALE AND FEMALE) SURFACES OF THE UNIONS.

A. MATERIALS - UNDERGROUND: TYPE "K" COPPER TUBE, SOFT TEMPER

B. MATERIALS - ABOVEGROUND: TYPE "L" COPPER TUBE, HARD DRAWN, OR CPVC

C. INSULATION: INSULATION FOR HOT AND COLD WATER PIPING SHALL BE 1/2" THICK ARMAFLEX UL LABELED OR FIBERGLASS 25 WITH ASJ/SSL FOIL/VINYL JACKET OR EQUAL. INSULATE ALL PIPING AND FITTINGS.

5. WASTE PIPING: INSTALL HORIZONTAL DRAIN AND WASTE PIPES WITH 1/4" FT. SLOPE.

MATERIALS: PVC SCH. 40 OR CAST IRON - HUB TYPE WITH NEOPRENE JOINTS.

6. PIPE SLEEVES/ESCUTCHEONS: PROVIDE CHROME-PLATED ESCUTCHEONS ON ALL PIPES PASSING THROUGH WALLS, FLOORS, OR CEILINGS OF FINISHED ROOMS. ESCUTCHEONS TO BE BEATON & CADWELL, #10, 40, 6A OR EQUIVALENT WITH SET-SCREWS. PROVIDE ESCUTCHEONS ON ALL WASTE LINES FROM PLUMBING FIXTURES, WHETHER THROUGH WALLS, FLOORS, AND WHETHER CONCEALED BEHIND COUNTERS OR EXPOSED. PIPE SLEEVES SHALL BE PROVIDED WHEN PIPES PENETRATE FOUNDATION AND SHALL BE 1" LARGER THAN PIPE. SEAL SLEEVE WITH CAULKING.

7. PLUMBING FIXTURES: FURNISH AND INSTALL PLUMBING FIXTURES AS SHOWN ON DRAWINGS WITH ALL ACCESSORIES AND TRIM AS LISTED. ALL FIXTURES SHALL BE PROTECTED THROUGH THE COURSE OF THE CONSTRUCTION. ANY FIXTURE DAMAGED SHALL BE REPLACED WITHOUT ADDITIONAL EXPENSE TO THE OWNER.

8. CONNECTION TO OTHER FIXTURES: CONNECT BUILDING SERVICE PIPING, INCLUDING BUT NOT LIMITED TO WATER & DRAIN.

9. TESTS:

A. DRAINAGE AND VENT PIPING - DRAINAGE AND VENT PIPING SHALL BE TESTED BEFORE THE PLUMBING FIXTURES ARE INSTALLED BY CAPPING THE OPENINGS AND FILLING THE ENTIRE SYSTEM WITH WATER AND ALLOWING IT TO STAND THUS FILLED NOT LESS THAN ONE (1) HOUR. INSPECT WATER LEVEL TO DETERMINE IF PIPING IS TIGHT.

B. WATER PIPING - THE WATER SUPPLY PIPING LINES SHALL BE TESTED BEFORE THE PLUMBING FIXTURES ARE CONNECTED BY FILLING THE ENTIRE SYSTEM WITH POTABLE WATER AND APPLYING HYDROSTATIC PRESSURE OF 100 PSI AND ALLOWING TO STAND FOR NOT LESS THAN FOUR (4) HOURS AT THIS PRESSURE TO PROVE PLUMBING INTEGRITY.

10. DISINFECTION OF POTABLE WATER SYSTEM: UPON COMPLETION OF INSTALLATION DISINFECT THE WATER SYSTEM BY FILLING IT WITH SOLUTION CONTAINING 50 PARTS PER MILLION OF CHLORINE AND ALLOW IT TO STAND FOR NOT LESS THAN SIX (6) HOURS BEFORE FLUSHING THOROUGHLY AND RETURNING TO SERVICE. FURNISH CLEAN WATER SAMPLES TO THE LOCAL AUTHORITY FOR TESTING AFTER THE LINES HAVE BEEN DISINFECTED. THIS PROCEDURE TO BE IN ACCORDANCE WITH STATE PLUMBING CODE.

11. CLEANUP: CLEAN ALL PLUMBING FIXTURES AND EQUIPMENT THOROUGHLY BEFORE FINAL INSPECTION, LEAVING ALL READY FOR USE.

12. EXTENDED WARRANTY: WARRANT IN WRITING ANY EQUIPMENT OR MATERIALS USED IN THE INSTALLATION HAVING AN EXTENDED WARRANTY AS OFFERED BY THE MANUFACTURER, PROVIDE NEW OR REBUILT ASSEMBLIES TO THE SITE FOR ANY SUCH EQUIPMENT OR MATERIALS WHICH FAIL DURING THIS PERIOD, AND INSTALL AT NO ADDITIONAL COST TO THE OWNER.

PLUMBING SCHEDULE				
ITEM	DESCRIPTION	MANUFACTURER	MODEL	REMARKS
P1	H.C. WATER CLOSET	MANSFIELD	137-160	WHITE C965 12" R.L. 18" HIGH H.C. W/ WHITE SEAT & LID. USE STANDARD COMPONENTS
P2	WATER CLOSET	MANSFIELD	135-160	WHITE C938 12" R.L. W/ WHITE SEAT & LID. USE STANDARD COMPONENTS
P3	URINAL	MANSFIELD	410	ADA URINAL - SIPHON - JET
P4	URINAL	MANSFIELD	475 SUBURBAN	WHITE URINAL W/ FLUSH VALVE C199
P5	LAVATORIES	ELJER	051-2964	20 1/2"x27" VITREOUS CHINA 4" CENTERS - WHITE W/ Z1231-79 LAVATORY CARRIER W/ DELTA 2773834 FAUCETS
P6	FLOOR DRAIN	WADE	W1102-STD6	
P7	JANITOR SINK	ELJER	24"x24"x10"	MOLDED STONE NO. 231 DRIFT WHITE W/ DELTA 289 8" WALL MOUNTED SINK FAUCET
P8	HOT WATER TANK	A. O. SMITH	DLE/DRE-52	50 GAL. SINGLE PHASE 1 1/4" INLET/OUTLET W/ 26" P.V.C. OVERFLOW PAN PIPED TO FLOOR DRAIN

PLUMBING FIXTURE RUN OUT SCHEDULE					
NO.	DESCRIPTION	WATER		WASTE	VENT
		COLD	HOT		
P1	H.C. WATER CLOSET	1/2"		3"	4"
P2	WATER CLOSET	1/2"		3"	4"
P3	URINAL	1/2"		3"	4"
P4	URINAL	1/2"		3"	4"
P5	LAVATORIES	1/2"	1/2"	1 1/2"	1 1/2"
P6	FLOOR DRAIN			1 1/2"	
P7	JANITOR SINK	1/2"	1/2"	3"	4"
	SINK ROUGH-IN	1/2"	1/2"	1 1/2"	1 1/2"

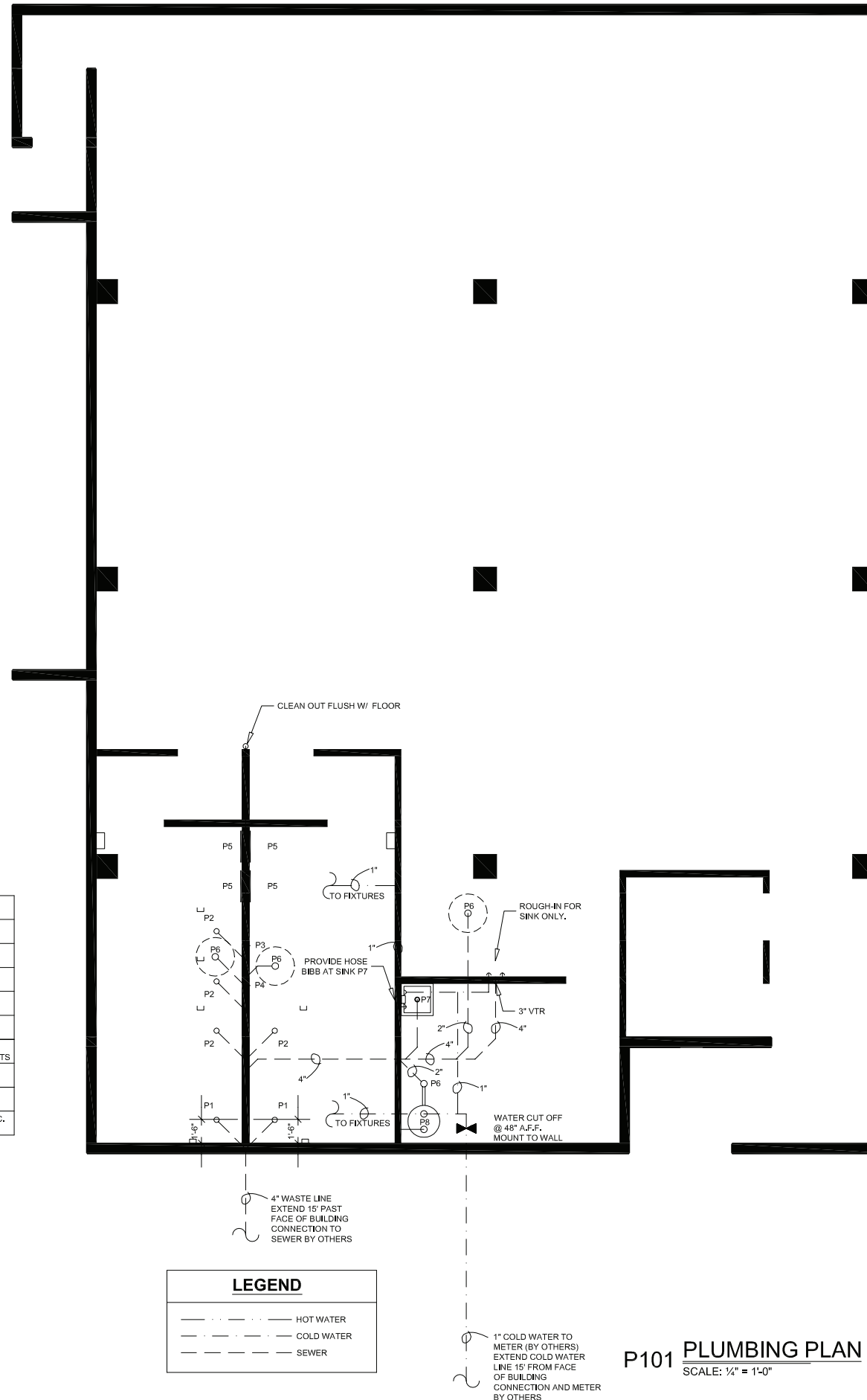

COMMUNITY SAFE ROOM
HURICANE FLOYD HOUSING INITIATIVE
NORTH CAROLINA

LIMIT OF LIABILITY:
The designs included herein are based on extensive research of the causes and effects of windstorm damage to buildings. Safe Rooms designed and built to these designs should provide a high degree of occupant protection during tornadoes. Any substitution of either materials or design concepts may decrease the level of occupant protection and/or increase the possibility of personal injury during a severe wind event.

Because it is not possible to predict or test all conditions that may occur during severe windstorms, or control the quality of construction, among other things, the designer does not warrant the design.

The designer neither manufactures nor sells safe rooms built from this design. The designers have not made and do not make any representation, warranty, or covenant, express or implied, with respect to the design, condition, quality, durability, operation, fitness for use, or suitability of the safe room in any respect whatsoever. Designers shall not be obligated or liable for actual, incidental, consequential, or other damages of or to users of safe rooms or any other person or entity arising out of or in connection with the use, condition, and/or performance of safe rooms built from this design or from the maintenance thereof.

PLUMBING PLAN

SHEET No.: P1
DATE: 7 MARCH 2000
REVISED: _____ REV. NO. _____



P101 **PLUMBING PLAN**
SCALE: 1/4" = 1'-0"

Community Safe Room (CSR) Sample Standard Operating Procedures (SOP)

TABLE OF CONTENTS

1 Introduction	C-9
1.1 Purpose of Community Safe Rooms.....	C-9
1.2 Scope.....	C-10
1.3 How to Use This SOP.....	C-11
2 Procedures	C-11
2.1 Direction and Control.....	C-11
2.2 Alert and Notification.....	C-12
2.3 Response.....	C-13
2.3.1 Opening the Community Safe Room.....	C-13
2.3.2 Securing the Facility.....	C-14
2.3.3 Set-up of Supplies.....	C-14
2.3.4 Functional Stations within the Community Safe Room.....	C-14
2.3.5 Arrival of Staff.....	C-16
2.3.6 Arrival of Volunteers.....	C-16
2.3.7 Arrival of Supplies.....	C-16
2.3.8 Arrival of Evacuees.....	C-17
2.3.9 Ongoing Operations.....	C-17
2.4 Recovery.....	C-21
2.4.1 Demobilization.....	C-21
2.4.2 “All-Clear”.....	C-21
2.4.3 Transportation.....	C-21
2.4.4 Placement of Evacuees Who Are Unable to Return Home.....	C-22
2.4.5 Debriefing.....	C-22
2.4.6 Packing Up Supplies.....	C-22
2.4.7 Restoration of Facility.....	C-22
2.4.8 Post-Event Facility Survey.....	C-22
2.4.9 After Action Report.....	C-22
3 Attachments (Job Aids)	C-22
Attachment 1: Quick Start-Up Checklist for Community Safe Room Manager.....	C-23
Attachment 2: Community Safe Room Manager Job Aid.....	C-25
Attachment 3: Building Manager Job Aid.....	C-27
Attachment 4: Shift Supervisor Job Aid.....	C-29
Attachment 5: Registration Unit Leader Job Aid.....	C-31
Attachment 6: Health Services Unit Leader Job Aid.....	C-33
Attachment 7: Communications Unit Leader Job Aid.....	C-37
Attachment 8: Food Unit Leader Job Aid.....	C-39
Attachment 9: EOC Liaison Job Description.....	C-43
Attachment 10: Sample Floor Plan of a Community Safe Room.....	C-45
Attachment 11: Community Safe Room Manager’s Kit.....	C-47

1 INTRODUCTION

The term “safe room” is used by many emergency response and disaster assistance agencies and organizations to describe a place where assistance is provided before, during, and after a catastrophic event. What is most important to note is that few, if any safe rooms to where people are evacuating have been designed or constructed to provide life-safety protection during an extreme-wind event such as a tornado or hurricane. This sample Standard Operating Procedures (SOP) is being developed for a building, structure, or portion thereof that has been designed and constructed to function as a community safe room as defined by FEMA 361 *Design and Construction Guidance for Community Safe Rooms* (2008 Edition). For the purposes of this sample SOP, a “community safe room” is a building, structure, or portion thereof that has been designed and constructed to provide life-safety protection of its occupants in compliance with the design and construction criteria for community safe rooms as defined by FEMA 361. All other safe rooms are considered refuges of last resort intended to provide a place of refuge for the general population who live in an evacuation zone or in an unsafe structure, but only after the storm has passed or without the security of having been evaluated, certified, designed, or constructed to meet design criteria that provide “near-absolute protection” for the occupants. The focus of this SOP is to provide procedures for opening, managing, and closing down (or handing off) a community safe room in response to a hurricane; most aspects of this SOP are also relevant to the opening, managing, and closing down of a tornado community safe room.

1.1 Purpose of Community Safe Rooms

Community safe rooms are opened when an evacuation order has been issued in the community due to an impending hurricane, tornado, or other potential emergency. Community safe rooms are intended to save lives by providing a safe space that has been designed and constructed to resist the wind forces, wind-driven rain, and debris impacts from a storm or event; they are equipped to provide only the basic essentials in order to protect their occupants and to support their intended purpose (e.g., potable water, minimal food [snacks], basic sanitation, basic first aid, and some electricity). Since the purpose is life safety for a minimum specified duration, community safe rooms do not provide beyond these essentials.

As stated above, community safe rooms are generally intended to operate for a very limited time. In a scenario involving a tornado, a community safe room may function for only a matter of hours, whereas in a scenario of an approaching hurricane, a community safe room may function longer, typically up to 1 to 2 days (readers should be advised that the design criteria minimum safe room specifications are built around only 24-hour occupancy for hurricane safe rooms and 2 hours for tornado safe rooms). In most instances, evacuees should be able to return to their homes within a short time or relocate to other housing. If the community sustains damage from a hurricane or tornado and families cannot return home, then some community safe rooms may transition into more long-term safe rooms, providing more considerable mass care – more substantial meals, showers, and cots to displaced families. This publication is not intended to address long-term sheltering needs or issues.

Often, area public school districts permit the American Red Cross, faith-based organizations, homeowners associations, or other civic groups to use public schools or facilities as safe rooms prior to a potential emergency or post-disaster as mass care safe rooms. Local municipal law enforcement is often expected to maintain and safe guard these facilities. Safe room management staff typically receives support from the local Emergency Operations Center (EOC) in the form of supplemental equipment, supplies, and/or staff. The American Red Cross routinely makes arrangements for snacks and other supplies with local vendors for the operation of each safe room and, in some cases, the local EOC may augment these efforts by providing additional comfort supplies such as floor pads and blankets. However, it is very important to note that, although these safe rooms are the best-available building stock open to provide a refuge from an impending event, they have most likely not been designed or constructed to meet the design criteria of FEMA 361 or the ICC/NSSA *Standard on the Design and Construction of Storm Shelters* (ICC-500). Again, only buildings, structures, or portions thereof that have been designed and constructed to the FEMA 361 criteria may be considered FEMA “community safe rooms.”

1.2 Scope

This publication is a guide, with tools such as checklists, for individuals responsible for opening and operating a school, public building, church, or other facility to be used as a community safe room for the reception and care of general population evacuees or displaced residents prior to, during, and immediately after a storm. The community safe rooms will most likely become operational under the directive of the local EOC and the facility owner (e.g., local school board superintendent) in the event an evacuation of certain populations becomes necessary. Community safe rooms are generally intended to operate for a limited time – 1 to 2 days. Due to the variation of needs for different types of disasters, these procedures may vary slightly. **Clearly, not every component of this manual needs to be fully implemented for every situation.** This publication was developed by compiling best practices, which may not be applicable in every situation. For example, in a situation with an impending storm with a short notice (e.g., a rapidly approaching tornado), it may not be feasible to register community safe room occupants, yet it is important to consider many of the other aspects of this publication such as alert and notification, security, and recovery (see Attachment 1: Quick Start-up Checklist for the Community Safe Room Manager). On the other hand, in situations where more advanced notice is likely (such as a hurricane), many, if not all, of the components of this manual can be fully implemented.

Individuals requiring specialized care due to health and medical concerns should be evacuated to special needs community safe rooms or hospitals, nursing homes, or other specially-equipped and staffed facilities. Additionally, to the degree possible, consideration should be given to evacuees with pets. Details of these facilities will not be covered in this document, but can be found in a variety of sources on the web or by contacting your local office of emergency management.

1.3 How to Use This SOP

This plan is divided into three sections: Introduction, Procedures, and Attachments. The Procedures Section will list the agencies tasked with either a lead role or supportive role and provide guidance for procedures ranging from preparation to recovery. This SOP is used to orient and familiarize agencies on the procedures and guidelines that govern operations at a hurricane community safe room.

2 PROCEDURES

2.1 Direction and Control

Table 1 illustrates a suggested staffing structure and chain of command once a community safe room has been opened:

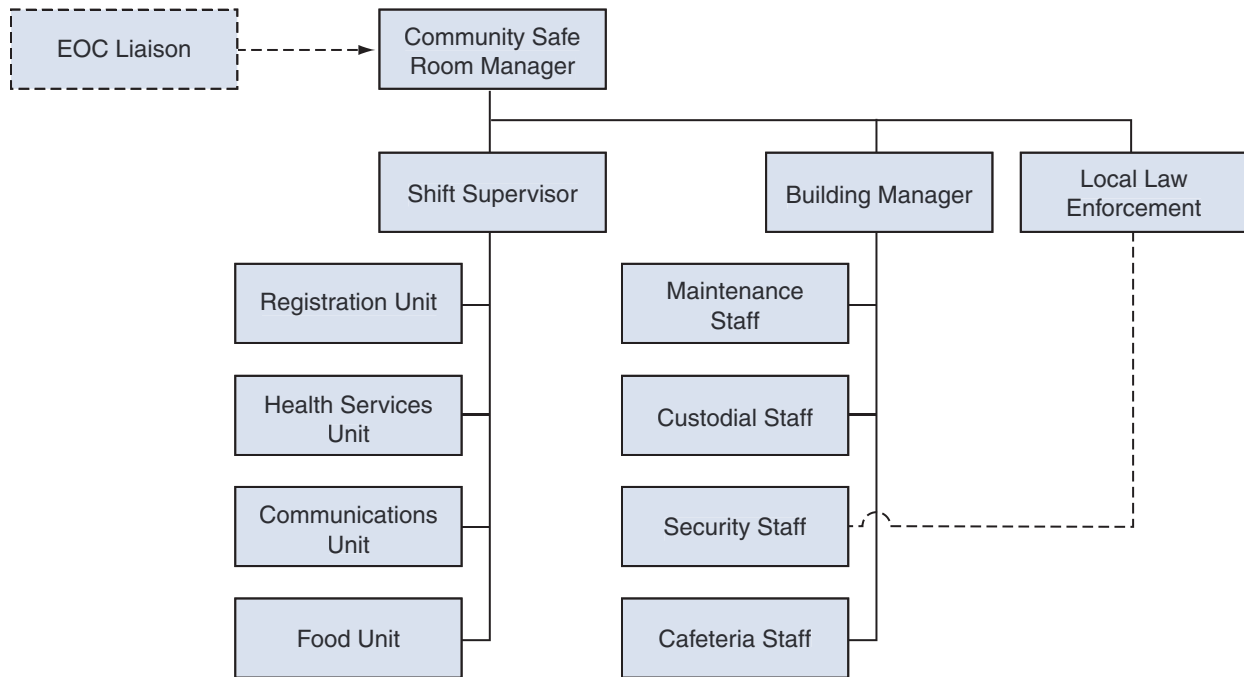

Table 1. Staff Organization for a Community Safe Room

Due to the variation of needs and availability of resources for different types of disasters, these positions may vary. **Clearly, not every position needs to be fully implemented for every situation.** Should staffing resources be limited, roles and responsibilities may be combined. This staffing structure was developed by compiling best practices, which may not be applicable in every situation. The Community Safe Room Manager is responsible for the overall community safe room operations and works closely with the Building Manager (i.e., facility owner, school principal, etc.). The Building Manager makes final decisions concerning the use of space or

equipment, and oversees the repair of any appliances, equipment, etc., while the community safe room is operational. The Building Manager also collaborates with local law enforcement officials to ensure a secure facility. The Shift Supervisor is responsible for the operational elements of the safe room for his/her assigned shift, including staffing, ordering food and supplies, monitoring community safe room occupants, etc. The EOC Liaison assigned to each community safe room works as a trouble-shooter for the EOC and will work with the EOC to try to solve problems or issues that the Community Safe Room Manager or Building Manager is having difficulty resolving. The EOC Liaison can provide an “extra pair of hands” for the safe room management staff, especially for issues that are difficult to resolve.

2.2 Alert and Notification

Depending on the nature of the disaster, there may or may not be advance warning of an event. In situations where advanced warning is given, preparation for the event will begin with as much lead-time as possible. The local emergency management agency or EOC will send information for hurricane evacuations to agencies well in advance of the projected landfall. The local emergency management agency will provide information on the storm and a projected schedule to support agencies. A timetable of when the local EOC will activate should also be provided.

Roles during the Alert and Notification Phase:

The local emergency management agency will:

- Notify community agencies that will have representatives in the EOC, and all agencies involved in the operations and support of the community safe rooms in the possible threat area of an event
- Identify possible evacuation zones and affected populations
- Keep agencies updated on the status of the event, by phone calls, faxes, or meetings
- Determine which community safe room(s) will open
- Notify support agencies and personnel with estimated opening time and locations

Agencies that are notified by the local emergency management agency will:

- Notify their staff of the possible threat of an event
- Inspect, dispense, and/or relocate equipment and/or supplies
- Mobilize available resources
- Notify the local emergency management agency of any problems/deficiencies
- Provide representative, if designated, at the EOC at designated time

Staff that is expected to report to work during activation will implement their Personal Emergency Preparedness Plan by:

- Securing their homes
- Making arrangements for family members and pets
- Locating personal supplies
- Ensuring that they have supplied up-to-date emergency contact numbers to their agency or the person who will be notifying them
- Ensuring that any vehicles and/or equipment that they will need are operational and that needed supplies are on hand
- Reviewing the SOP manual and being aware of their roles

2.3 Response

2.3.1 Opening the Community Safe Room

The designated personnel from the facility (i.e., school, church, etc.) will meet the community safe room personnel at the facility to unlock it and prepare for the opening to the evacuees. Ideally, the Community Safe Room Manager and staff should arrive at the facility at least 2 hours prior to the opening time for the safe room (as applicable and appropriate) to perform a walkthrough and set up operations. Each facility or school should already be stocked with an existing Community Safe Room Manager’s Kit (see Attachment 11 of this plan). Community Safe Room Managers should also be given an inventory of food items that should be on hand at the school or facility, if available, and a sample floor plan of the space that has been designated as safe and usable for occupants (see Attachment 10 of this plan).

Upon arriving at the facility/school, the Community Safe Room Manager should make contact with the Building Manager and do a walkthrough of the areas designated as safe and usable for community safe room occupants. Report any usable space disagreements with the Building Manager to the EOC immediately.

The survey should document the condition of the facility at the time of the opening and any equipment that will be utilized during the community safe room’s operation. The survey should also address which areas of the school may be used and which will be off-limits while the community safe room is operational. Finally, the walkthrough should identify safety issues such as the location of all emergency exits, fire extinguishers, fire alarm pull boxes, etc.

The Community Safe Room Manager should work with the Building Manager to identify a location that has a telephone, which can be used as the community safe room’s “Command Center.” Once this is established, the Community Safe Room Manager should call the EOC and provide the telephone number to the Command Center so that the EOC can reach the Community Safe Room Manager, as needed.

After walking through the entire facility with the Building Manager, the Community Safe Room Manager should meet with the cafeteria staff, if applicable, to inventory the on-hand emergency

food and water stock. If the emergency food stock is not in place, the Community Safe Room Manager should notify the EOC immediately. While this is happening, the Shift Supervisor and assisting staff can make signs to label bathrooms, exit doors, feeding areas, and the registration desk. The community safe room areas should be subdivided into areas usable for: families with children, single males, single females, elderly and ill occupants – signs should be placed in the respective areas. Community safe room staff should also set up the registration desk near the entrance to the community safe room to ensure that all occupants are identified upon arrival. If possible, signs should be placed on the community safe room grounds and at nearby intersections to assist those driving toward the facility. Just prior to opening, the Community Safe Room Manager should brief the staff and make work assignments.

2.3.2 Securing the Facility

In order to maintain the flow of personnel and evacuees, it is important to establish one main entranceway. Security personnel and local police will ensure that the areas that are not to be used during the community safe room operation are secured and identified as off-limits. Appropriate signage should be placed on the door to identify the main entranceway and exterior signs with directional arrows should be placed on access routes to direct traffic to the appropriate entrance. Interior spaces of the building that are not to be utilized should be identified with “Do Not Enter” signs.

For hurricane safe room activities, building maintenance personnel should ensure that the windows and doors of the facility are closed properly to protect the integrity of the building. Shutters, screens, or other opening protective devices should also be secured into place over openings and glazing (windows) prior to the storm impacting the facility.

2.3.3 Set-up of Supplies

After the site has been surveyed and secured properly, the staff should begin setting up to receive evacuees and supplies. Supplies should be distributed to the appropriate area of the facility. Refer to the facility map for location of supplies. A sample floor plan is provided as Attachment 10. The Food Unit Leader should work with the cafeteria manager (if applicable) for the placement of food and snacks. The EOC Liaison will coordinate the set-up and distribution of comfort items such as floor pads and blankets, if available.

2.3.4 Functional Stations within the Community Safe Room

Command Center

This station will serve as the location for the main flow of internal and external communications. This station should ideally be located in or near the main office of the facility, depending on the layout. The Command Center should have the following equipment readily accessible:

- Telephone

- Fax machine
- Intercom system
- Local school board radio communications capability (if a school site)
- Handheld amateur (HAM) radio and antennae
- AM/FM radio - must have capability to operate on batteries in case of power outage
- NOAA weather radio
- Television

The key personnel who will be located in or have access to this area will be the:

- Community Safe Room Manager and Shift Supervisor
- Building Manager
- Communications Unit Leader (Radio Operator)
- Security Staff
- Any other personnel authorized by the Community Safe Room Manager

Access to the Command Center should be limited. All general information to be provided to the evacuees should be posted and disseminated through information stations.

Registration/Information Area

The registration area should be set up near the main entranceway to ensure that all persons coming into the facility are screened and registered. Several tables or desk areas should be set up to handle large crowds of evacuees that may arrive at the same time. The information area should be close to the Command Center and include a large board where updates can be posted. The community safe room rules, meal times, and a map of the facility should be displayed in this area. Personnel should remain at the information area to provide updates to the people in the community safe room. An information board should also be set up in the cafeteria.

First Aid Station

The Health Services Unit should staff the first aid station. The first aid station should be located near the registration area. The Registration Unit Leader will work with the Health Services Unit personnel to screen any evacuees that may need to be rerouted to a special needs community safe room or a medical facility.

General Supply Area

The general supplies for the facility should be stored in an area away from the general congregation area.

Staff Sleeping Area

This area should be located in a quiet area of the facility, preferably away from the main traffic. The ideal area would be an area where there is limited or no natural light to allow for people to sleep during the day.

2.3.5 Arrival of Staff

Staff assigned to the community safe room will be notified by their corresponding agency. All staff reporting to the community safe room must sign in at registration in their appropriate sign-in sheet. EOC Liaisons should report to the Community Safe Room Manager. All staff should wear identification badges and maintain an accurate log of the hours they work while the community safe room is open.

Staff is expected to report to the site under the agreements made by each agency. Shift changes should be taken into consideration with reporting times. Depending on the nature of the emergency, it may be impossible for staff to report during and immediately after the event. This could lead to shortages in staff and exhaustion of staff on duty. Agencies providing staff should consider two 12-hour shifts for personnel to relieve one another.

2.3.6 Arrival of Volunteers

All volunteers must sign in at the Registration desk, complete a Volunteer Registration Form, and log all hours worked. Volunteer assignments are the responsibility of the Community Safe Room Manager or Shift Supervisor. If the Building Manager or EOC Liaison needs volunteers for a task, he/she should make a request to the Community Safe Room Manager. Volunteers should be assigned to an area of the community safe room where they will feel comfortable. Evacuees may be asked to help out with community safe room operations. All volunteers should be oriented and supervised by the appropriate staff member. All volunteers should be issued and wear identification badges.

2.3.7 Arrival of Supplies

The Food Unit Leader will coordinate the delivery of food, water, juices, and snacks to the community safe room. The Shift Supervisor will coordinate the delivery of other supplies such as forms, signage, first aid, and, possibly, comfort items (e.g., floor pads and blankets if ordered and available¹). All supplies that arrive at the community safe room must be inventoried and then kept in a secure area. The management personnel in charge of each area will track their supplies and report the receipt of supplies to the Community Safe Room Manager. Supplies are to be disbursed to the appropriate area within the facility. Due to the space constraints, supplies may have to be stored in a centralized secure area.

¹ Typically, comfort items are not provided at American Red Cross general population safe rooms.

2.3.8 Arrival of Evacuees

Arrival

Security personnel are tasked with traffic control. Posted signs will direct traffic to the designated parking areas. Parking should be in designated areas, away from the building's main entrance in order to foster efficient loading/unloading at the entrance area pre- and post-event. Evacuees should be permitted to unload their personal items at the drop-off area so they do not have to carry them a long distance. Posted signs should also direct pedestrian traffic to the entranceway of the facility and the registration area.

Registration

Upon entering the community safe room, Registration Unit personnel will register all evacuees and volunteers. The Registration Unit Leader may request that the Health Services Unit personnel assess certain evacuees for appropriateness based on the level of care available. The Health Services Unit personnel should perform a quick assessment of the clients arriving at the site to determine if they are appropriate for the community safe room. Those evacuees whose care or medical needs exceed the level of care that can be provided in a community safe room must be transferred to a special needs community safe room or hospital. Health Services Unit personnel will consult with the Emergency Management Services (EMS) EOC Representative at the EOC to reroute these evacuees in an expeditious manner. The Community Safe Room Manager will be notified of problematic transfers; the EOC Liaison may be asked to assist in facilitating in these situations, if needed.

2.3.9 Ongoing Operations

This section includes all activities that take place once the community safe room is up and running. Ongoing operations include:

Updates to EOC

It is the responsibility of the Community Safe Room Manager or the EOC Liaison to keep the EOC apprised of the events in the community safe room. The following must be reported to the EOC immediately:

- Staff shortages
- Supply shortages

The EOC Logistics Section should attempt to secure needed supplies. Only essential supplies should be requested.

Population Count

The Registration Unit Leader will update the Community Safe Room Manager and Building Manager on the population count every 2 hours. The population count should be separated into two categories: evacuees and staff. When community safe rooms reach 80 percent capacity, every attempt will be made to start rerouting traffic to other safe rooms or open additional sites. Regular reports must be given on the population count to update agencies providing food and other resources. Problems that cannot be resolved by the safe room staff should be reported to their corresponding EOC Liaison. Emergency situations that require immediate action should be reported to 911.

Updates to Evacuees

It is the responsibility of the Community Safe Room Manager to assign someone to provide updates and announcements to evacuees on events occurring outside the facility. The HAM radio operator (Communications Unit Leader) and Shift Supervisors should listen to the radio or television for updates when possible and post updates on information bulletin boards in the cafeteria and in the registration area. The Community Safe Room Manager may request that the Building Manager broadcast updates on the overhead public address/intercom system.

Develop Maintenance Plans

Community safe room management staff should assess the staffing and supply needs that may need to be available for the anticipated length of the operation of the safe room. Concerns about shortages should be reported to the EOC Liaison immediately.

Shift Changes

It is the responsibility of the safe room management team to ensure that the staff they are supervising is rotated to prevent exhaustion. Agencies providing staff may rotate their staff as they choose as long as they provide an acceptable level of coverage. A “buddy system” should be developed to ensure that staff members have someone looking out for them to prevent exhaustion. Staff members who refuse to rest and appear to be exhausted or stressed should be identified, and the Community Safe Room Manager should be notified.

It is the responsibility of the Community Safe Room Manager, Building Manager, and EOC Liaison to ensure that the new shift coming on is given a briefing from the outgoing shift. In addition to area briefings, the Community Safe Room Manager should have a safe room management team briefing or “staff meeting” on a regular basis with the Building Manager and EOC Liaison. Dissemination of information is extremely important.

Maintaining Security of the Building

During occupation of the community safe room, it is the responsibility of the Community Safe Room Manager, Building Manager, security personnel, and local law enforcement personnel to ensure that the building is secure. During the storm, doors and windows to the facility must remain closed to ensure the integrity of the building. Shutters, screens, and other systems installed for the protection of the building must also be checked to ensure they are closed and secured. Security personnel should make regular rounds of the interior and exterior portions of the building on a regular basis, weather permitting. Exterior areas should only be surveyed when conditions are safe to do so. Emergency situations should be reported to 911. Non-emergency situations should be reported to the Building Manager and the Community Safe Room Manager.

Community safe room occupants are expected to adhere to some basic rules and conduct themselves in an orderly fashion. Basic community safe room rules include:

- No weapons
- No alcohol or drugs (other than those prescribed by a doctor)

Community safe room occupants who cannot adhere to the community safe room rules or are disruptive to the orderly functioning of the community safe room will be referred to security or local law enforcement personnel and may have to be removed from the facility.

Maintaining Health and Safety Conditions of the Facility

It is the responsibility of the Health Services Unit, in collaboration with other personnel working in the community safe room areas, to maintain the health and safety conditions of their area. The facility should be regularly inspected by the Community Safe Room Manager and Health Services Unit Leader to ensure the kitchen, bathrooms, areas usable for occupants, registration, and exterior areas of the building are meeting the basic needs of the evacuees and staff, and are maintained at an appropriate health standard. Problems with running water and sewer that cannot be resolved by the Building Manager and staff should be reported to the EOC for resolution.

Population Control

The Registration Unit is responsible for maintaining an accurate count of the number of evacuees and staff members who are in the community safe room at all times. They should keep the Community Safe Room Manager and Building Manager apprised of the number of evacuees in the facility on a regular basis and report to the Community Safe Room Manager when the capacity of the facility is about 80 percent full.

The Registration Unit personnel are responsible for updating records once the major influx of people has ceased. Information must be compiled for the cafeteria personnel (special dietary

needs). Data collection completed using the American Red Cross Disaster Welfare Inquiry is recommended as it will help with the smooth transfer of information to post-disaster assistance groups.

Registration Unit personnel are responsible for ensuring that evacuees sign out and in when leaving and re-entering the community safe room. It is understood that once the “all clear” is given, evacuees will leave in large groups, making it difficult to sign evacuees out. An accurate census on how many people are in the community safe room needs to be maintained to ensure that the proper supplies and staff are available to continue operations.

Media Relations

It is highly likely that the media will visit the community safe room. Often they will arrive without warning. The Community Safe Room Manager and/or Building Manager should handle all media relations. The Community Safe Room Manager should be familiar with public affairs protocol and procedures. Media should be greeted at the front door and wait in an area that does not interfere with the community safe room operations. If the weather or conditions permit, the media may be asked to wait outside. Members of the media must be escorted at all times.

The Community Safe Room Manager should respond to the media’s request as soon as he/she is able. The privacy rights of the staff and evacuees in the facility should be observed and media personnel should only be allowed to access areas of the facility that do not interfere with anyone’s rights or with community safe room operations. If the media wish to interview anyone in the center, the Community Safe Room Manager may ask for volunteers. Community safe room personnel should only comment on areas of the operation with which they have knowledge and only with the consent of the Community Safe Room Manager.

Lock-down for Storms

In the case of a tornado, the Community Safe Room Manager should monitor weather conditions and, when conditions deteriorate and become unsafe outside, the Community Safe Room Manager should “lock-down” the facility – all doors and windows need to be secured. All occupants must be gathered in the appropriate interior areas to await impact of the storm. Community safe room staff must make sure that no one attempts to exit the facility during lock-down because this may threaten the safety of the other evacuees.

In the case of a hurricane, the EOC will likely notify each community safe room staff of when they should lock-down their facility. Here again, all doors and windows need to be secured. All occupants must be gathered in the appropriate areas to await impact of the storm. Community safe room staff must make sure that no one attempts to exit the facility during lock-down because this may threaten the safety of the other evacuees. If the community safe room is located near the eye of the storm, there may be a time when the winds will decrease or even cease, temporarily. No one may exit the facility at this time because errant gusts may still be possible, and the winds will intensify once the eye passes. Staff will be notified by the EOC when the local weather office has made the “all clear” announcement.

2.4 Recovery

2.4.1 Demobilization

The EOC will work with the Building Manager and the Community Safe Room Manager to return the facility to normal operations as soon as possible. In cases where evacuees are unable to return to their homes, attempts will be made to identify alternate facilities, whether they are family, friends, or other accommodations.

Consolidation of community safe room populations may be considered in an effort to reduce the number of sites that are to remain open. This decision will be made by the EOC and depend on the current community safe room populations and on the duration of sheltering needs. If consolidation is implemented, evacuees will be moved to the other site according to regular transportation guidelines. The EOC will notify staff at each community safe room to coordinate this process.

The decision of when to close sites will include the following factors:

- Weather conditions
- Impact of the event on evacuees' homes
- Urgency of need to return the facility to normal conditions
- Availability of transportation resources
- Time of day

2.4.2 "All-Clear"

Evacuees may be anxious to return to their homes and should be advised to wait for the "all-clear" indicator to be given by the EOC to avoid placing themselves in harm's way if weather conditions remain unfavorable. The EOC will receive the "all-clear" indicator from the local Weather Service Office and local law enforcement authorities once inspected areas are deemed "safe."

2.4.3 Transportation

Safe room staff will alert evacuees when it is time to close the community safe room. Local transportation departments will likely dispatch vehicles to each community safe room to return evacuees who were picked up at evacuation bus stops. The Community Safe Room Manager will collaborate with the EOC Liaison to report evacuees remaining at the community safe room with no means of transportation. The EOC Liaison will work with the EOC to address any transportation issues.

2.4.4 Placement of Evacuees Who Are Unable to Return Home

It is the responsibility of community safe room staff to ensure that evacuees have a place to go. Evacuees who are unable to return home should be encouraged to identify friends, family, or civic agencies where they may be able to stay. If other community safe rooms remain open, evacuees may be moved to an alternate site.

2.4.5 Debriefing

The Community Safe Room Manager should make every attempt to have a short debriefing period to wrap up all center business before the staff leaves. Agencies should schedule a debriefing session with their staff within a short timeframe after the event to allow them to discuss their actions and suggest improvements for future activations.

2.4.6 Packing Up Supplies

Community safe room personnel will inventory used and unused supplies. Food items that are perishable should either be stored or discarded appropriately. Cafeteria staff should note all food supplies that were provided by the facility and give the written report to the Community Safe Room Manager. In most cases, if requested, the American Red Cross will collect all unopened snacks and drinks provided by their agency.

2.4.7 Restoration of Facility

Arrangements must be made for the facility to be cleaned and restored to its original condition as soon as possible. The Community Safe Room Manager should work closely with the Building Manager to ensure that the facility is restored to a usable condition. Community safe room personnel and volunteers should be enlisted to assist building custodial staff in returning the facility to its original condition.

2.4.8 Post-event Facility Survey

After the evacuees have left, the Building Manager and the Community Safe Room Manager must complete a post-event facility survey. The survey should document the conditions of the facility at the closing and document any damages or losses to equipment that was utilized during the community safe room operation.

2.4.9 After Action Report

Following the event, the Community Safe Room Manager, building representatives (including the Building Manager), EOC Liaisons, and local emergency management staff should meet to prepare an after action report on the operation.

3 Attachments (Job Aids)

Attachment 1: Quick Start-Up Checklist for Community Safe Room Manager

If residents are already waiting at the community safe room when you arrive, the building may already be open and clients inside. It is also possible that facility representatives or government authorities have already assumed leadership of the community safe room. Do the following critical tasks:

- Identify yourself to any leadership at the site, such as facility staff, governmental authorities, or spontaneous leadership. Introduce yourself; identify your role and responsibilities. Offer your assistance and support in getting the community safe room up and running.
- Identify the building owner and/or Building Manager.
- Identify a Shift Supervisor.
- Ask for volunteers to help get things running more quickly.
- Immediately assign people to the following tasks:
 - Get people to safety and out of the weather. Set aside an area for people to wait comfortably.
 - Set up registration area to more or less “triage” community safe room residents and direct them to appropriate areas of the building.
 - Provide residents with a registration form to fill out on their own; collect it later when things settle down.
 - Establish crowd control and traffic patterns both inside and outside.
 - Post appropriate signs and community safe room rules.
 - Guide media (if present) to waiting area, and brief them as soon as possible.
- Contact the local Emergency Operations Center (EOC) and confirm your arrival and the situation.
- Once tasks are assigned, conduct a pre-inspection with the facility representative or Building Manager. Assess the general condition of the facility, citing pre-existing damage. During or immediately following the walkthrough, the Community Safe Room Manager and Shift Supervisor should determine how the space will be allocated.
- Once these tasks are completed, regroup the community safe room team and assign more formal roles and responsibilities.

Attachment 2: Community Safe Room Manager Job Aid

The Community Safe Room Manager provides supervision and administrative support for sheltering responsibilities within the facility. The Community Safe Room Manager is responsible for the overall community safe room operations and works closely with the Building Manager (i.e., facility owner, school principal, etc.). This person ensures that the needs of community safe room occupants are being met. The Shift Supervisors assist the Community Safe Room Manager with the responsibilities in this checklist.

✓ Done	Task
	Obtain the following information: <ul style="list-style-type: none"> • Nature of disaster • Safe room assignment location • Estimated community safe room population • Facility contact person and/or Building Manager • What other staff are being recruited? <ul style="list-style-type: none"> – Shift Supervisor(s) – Registration Unit Leader(s) – Health Services Unit Leader(s) – Communications Unit Leader(s) – Food Unit Leader(s)
	Notify your family and work supervisor.
	Pack personal items: clothes, toilet items, medications, blankets, and phone numbers.
	Pick up Community Safe Room Manager’s Kit (see Attachment 11).
Initial Actions	
	Establish contact with facility representative(s) and/or Building Manager and activate the building when ready. If clients are waiting, the facility may need to be partially activated immediately.
	Conduct the pre-occupancy inspection; assess the general condition of the facility, citing pre-existing damage.
	Survey and lay out the space plan for residents.
	Organize and brief staff.
	Assign staff to perform the tasks on the following job aid lists: <ul style="list-style-type: none"> • Shift Supervisor(s) • Registration Unit Leader(s) • Health Services Unit Leader(s) • Communications Unit Leader(s) • Food Unit Leader(s)
	Coordinate recruitment of additional personnel. Encourage the involvement of community safe room residents as workers.
	Assess feeding options and discuss recommended solutions with on-site cafeteria personnel (if available). Otherwise, meet with Food Unit Leader.
	Establish a community safe room log reporting process.
	Put up community safe room identification signs both inside and out.

✓ Done	Task
Ongoing Actions	
	Ensure that community safe room residents are receiving updated information about the disaster, the recovery process, and all of the resources available to them.
	Establish standard shift schedules for staff.
	Conduct staff meetings. Include updates on disaster response and community safe room operations, direction and advice from the local EOC Liaison, and status of problems and resolutions. Identify needs for clients, staff supplies, and systems. Address rumors.
	Monitor disaster and response efforts, and plan for closing of the community safe room.
	Ensure that the proper systems are in place to track expenditures, bills and invoices, materials, and local volunteer records.
	Routinely inspect the safety and sanitation of the facility, including the kitchen, resident areas, bathrooms, exterior, and registration area, and ensure that health standards and residents' needs are being met.
	Meet regularly with the Building Manager and/or facility representative to share concerns and resolve potential problems.
Closing Actions	
	Coordinate plans to close the community safe room with the local EOC well in advance of the actual closing.
	Coordinate with the EOC Liaison to ensure timely and appropriate placement of all remaining community safe room occupants.
	Complete an inventory of all supplies owned by the facility that were used in the community safe room, and forward it to the Building Manager.
	Return all rented or borrowed equipment to the owners. Send signed receipts for such equipment to the EOC Liaison.
	Arrange for the cleaning of the facility and have it returned to the pre-occupancy condition or as close a condition as possible.
	Remove all signage materials from the facility.
	Prepare a list of other voluntary organizations, vendors, and staff to be thanked or recognized. Submit to the EOC Liaison.
	Forward all volunteer staff lists to the EOC Liaison for recognition.
	Prepare a narrative report on the community safe room operation and submit it to local EOC or emergency management agency. Include the community safe room location and dates of operation, summary of services provided, problems, and recommendations.

Attachment 3: Building Manager Job Aid

The Building Manager serves as the building owner’s representative (i.e., facility owner, school principal, etc.) and provides security, maintenance, housekeeping, and logistical support for sheltering responsibilities within the facility. The Building Manager is responsible for the overall building/facility operations and works closely with the Community Safe Room Manager. This person ensures that the needs of community safe room occupants are being met. The Shift Supervisors assist the Building Manager with the responsibilities in this checklist.

✓ Done	Task
	Obtain the following information: <ul style="list-style-type: none"> • Nature of disaster • Estimated community safe room population • Name and contact information of the Community Safe Room Manager • What other staff are being recruited? <ul style="list-style-type: none"> – Shift Supervisor(s) – Registration Unit Leader(s) – Health Services Unit Leader(s) – Communications Unit Leader(s) – Food Unit Leader(s)
	Notify your family and work supervisor/building owner.
	Pack personal items: clothes, toilet items, medications, blankets, and phone numbers.
	Notify building staff (i.e., maintenance, custodial, security, and/or cafeteria staff) of the location and time to report to duty. Remind them to implement their personal preparedness plan.
Initial Actions	
	Establish contact with the Community Safe Room Manager and activate the building when ready. If clients are waiting, the facility may need to be partially activated immediately.
	Conduct pre-occupancy inspection – assess the general condition of the facility, citing pre-existing damage.
	In collaboration with the Community Safe Room Manager, survey and lay out the space plan for residents.
	Organize and brief staff (i.e., maintenance, custodial, security, and/or cafeteria staff).
	Coordinate recruitment of additional personnel. Encourage the involvement of community safe room residents as workers, if needed.
	Assign maintenance personnel in implementing the extreme-wind protocol and beginning installation of window and door protection, securing outdoor movable items (e.g., garbage cans, chairs, etc.), and otherwise securing the facility.
	Assign the Cafeteria Manager to meet with the Food Unit Leader in order to assess feeding options and discuss recommended solutions.
	Establish a community safe room log reporting process.
	Assist the Community Safe Room Manager in posting community safe room identification both inside and out, if necessary.

✓ Done	Task
Ongoing Actions	
	During the storm, confirm that doors and windows to the facility remain closed to ensure the integrity of the building. Security personnel should make regular rounds of the interior and exterior portions of the building on a regular basis, weather permitting.
	Coordinate activities with law enforcement officials or security personnel to ensure that routine patrols circulate throughout the community safe room and surrounding areas.
	Establish standard shift schedules for staff.
	Conduct building staff meetings. Include updates on disaster response and community safe room operations, direction and advice from the local EOC, and status of problems and resolutions. Identify needs for clients, staff supplies, and systems. Address rumors.
	Monitor disaster and response efforts, and plan for closing of the community safe room.
	Ensure that the proper systems are in place to track expenditures, bills and invoices, materials, and local volunteer records.
	Routinely inspect the safety and sanitation of the facility, including the kitchen, resident areas, bathrooms, exterior, and registration area, and ensure that health standards and residents’ needs are being met.
	Meet regularly with the Community Safe Room Manager to share concerns and resolve potential problems.
Closing Actions	
	Complete an inventory of all supplies owned by the facility that were used in the community safe room, and forward this to the Community Safe Room Manager.
	Return all rented or borrowed equipment to the owners. Send signed receipts for such equipment to the EOC Liaison.
	Work with the Community Safe Room Manager to arrange for staff and volunteers to assist custodial staff in the cleaning of the facility and have it returned to the pre-occupancy condition or as close a condition as possible.
	Remove all signage materials from the facility.
	Prepare a narrative report on the community safe room operation and submit it to local EOC or emergency management agency. Include the community safe room location and dates of operation, summary of services provided, problems, and recommendations.

Attachment 4: Shift Supervisor Job Aid

The Shift Supervisor is responsible for the operational elements of the community safe room for his/her assigned shift, including staffing, ordering food and supplies, monitoring community safe room residents, etc. The Shift Supervisor reports directly to the Community Safe Room Manager.

✓ Done	Task
	Obtain an update from the Community Safe Room Manager regarding the following information: <ul style="list-style-type: none"> • Nature of disaster • Safe room assignment location • Estimated community safe room population • Building Manager • What other staff are being recruited? <ul style="list-style-type: none"> – Shift Supervisor(s) – Registration Unit Leader(s) – Health Services Unit Leader(s) – Communications Unit Leader(s) – Food Unit Leader(s)
	Notify your family and work supervisor.
	Pack personal items: clothes, toilet items, medications, blankets, and phone numbers.
Initial Actions	
	Establish contact with the Community Safe Room Manager and assist the Community Safe Room Manager to activate the building when ready. If clients are waiting, the facility may need to be partially activated immediately.
	Assist the Community Safe Room Manager in conducting the pre-occupancy inspection – assess the general condition of the facility, citing pre-existing damage.
	Survey and lay out the space plan for residents. When designating space within the community safe room, consider allocating separate space for families with small children, the elderly, night workers who sleep during the day, and other unique situations. Consider that community safe room residents will likely be placed into confined areas of less than 10 square feet per person until the storm is over. Ensure that planning includes access to movement within the building for persons with disabilities and other forms of support for people with particular needs.
	Organize and brief staff: <ul style="list-style-type: none"> • Shift Supervisor(s) • Registration Unit Leader(s) • Health Services Unit Leader(s) • Communications Unit Leader(s) • Food Unit Leader(s)
	Put up community safe room identification/signage both inside and out: <ul style="list-style-type: none"> • Post community safe room directional signs from main roads, so that clients can locate the community safe room. • Post signs on the outside of building, indicating which entrance to use. • Post internal signage to label and provide directions to registration, the Health Services Unit, and restroom areas. A good rule of thumb is about one (1) sign per wall.

✓ Done	Task
	Assist in the recruitment of additional personnel – encourage the involvement of community safe room residents as workers. Recruit volunteers to help keep the resident areas of the community safe room clean. Recruit volunteers to provide recreational activities for community safe room residents, especially children and young adults, particularly during waiting periods.
	Assist the Community Safe Room Manager in assessing feeding options – meet with Food Unit Leader.
	Work with Building Manager to arrange for a television or radio so that residents and workers can get information about current disaster conditions. If possible, have copies of the daily newspaper available.
	Establish bulletin boards in central locations where messages, information, and community safe room rules and routines, such as lights-out time, will be posted (e.g., near registration and in the cafeteria).
Ongoing Actions	
	Work with the Community Safe Room Manager in ensuring that community safe room residents are receiving updated information about the disaster, the recovery process, and all of the resources available to them.
	Routinely monitor and communicate with community safe room residents to ensure their needs are being met. Regularly inspect resident areas of the community safe room to ensure an optimal distribution of clients. Routinely inspect the safety and sanitation of the facility, including the kitchen, resident areas, bathrooms, exterior, and registration area and ensure that health standards and residents’ needs are being met.
	Coordinate activities with law enforcement officials or security to ensure that routine patrols circulate throughout the community safe room and surrounding areas.
	Enter appropriate information on the community safe room log.
	Keep accurate and updated information on all of the community safe room bulletin boards.
	Participate in community safe room staff meetings.
	Assist the Community Safe Room Manager in monitoring disaster and response efforts, and planning for closing of the community safe room.
	Assist the Community Safe Room Manager in ensuring that expenditures, bills and invoices, materials, and local volunteer records are tracked.
Closing Actions	
	Coordinate the completion of an inventory of all supplies owned by the facility that were used in the community safe room, and forward this to the Community Safe Room Manager.
	Assist the Community Safe Room Manager in coordinating personnel for the cleaning of the facility and have it returned to the pre-occupancy condition or as close a condition as possible.
	Assist the Community Safe Room Manager in removing all signage materials from the facility.
	Assist the Community Safe Room Manager in preparing a list of other voluntary organizations, vendors, and staff to be thanked or recognized.

Attachment 5: Registration Unit Leader Job Aid

The Registration Unit Leader and workers are responsible for ensuring that persons entering or leaving the community safe room go through the registration process. The Registration Unit supports Disaster Health Services staff by identifying community safe room residents with illnesses or other medical needs and alerting the nursing staff. Disaster welfare information depends on the community safe room registration forms to provide information to families outside the area (through the American Red Cross). Without complete, legible, and accurate information about the residents of the community safe room, the ability to provide needed services is impaired.

✓ Done	Task
Initial Actions	
	Obtain an update from the Community Safe Room Manager regarding the following information: <ul style="list-style-type: none"> • Nature of disaster • Safe room assignment location • Estimated community safe room population • Estimated [maximum] community safe room capacity
	Notify your family and work supervisor.
	Pack personal items: clothes, toilet items, medications, blankets, and phone numbers.
	Survey and lay out the space plan for the Registration Unit.
	Place the reception desk near the entrance to welcome those entering the community safe room, to answer their questions, and to direct them toward the registration tables and registrars. Allow enough space for a waiting area.
	Use a sufficient number of tables to ensure that everyone entering is registered within a reasonable period of time.
	Post signs directing persons to the registration area, and post signs clearly marking the registration desk or tables.
	Recruit volunteers to translate and prepare signs for community safe room residents who are non-English-speaking.
	Use only one entrance to the building, if possible, to support effective registration efforts and provide a secure environment. Position signs and/or community safe room staff at other entrances to direct community safe room residents to appropriate areas. However, make sure fire exits are not blocked.
	Use the American Red Cross Disaster Shelter Registration (Form 5972) to record information about families entering the community safe room; use index cards (3" x 5", 4" x 6", etc.) or pads of lined paper, if Form 5972 is not available. <ul style="list-style-type: none"> • Use one form, one card, or one sheet of paper for each family. A family usually consists of all persons living in a household. Provide a Safe Room Resident information sheet to each family as they register.
	Recruit community safe room residents or local volunteers to do registration, if registration workers are not available.

✓ Done	Task
	Indicate in the margin of the registration form those community safe room residents who would like to volunteer for specific community safe room jobs or have a specific skill that can be utilized in the community safe room.
	Refer the following persons to the Health Services Unit staff: <ul style="list-style-type: none"> • ill or injured persons • those on special medications or diets • those who claim to have medical training
	The Health Services staff should be available at the registration desk to help screen arrivals at the community safe room who require medical attention.
Ongoing Actions	
	Work with the Community Safe Room Manager to ensure that community safe room residents are receiving updated information about the disaster, the recovery process, and all of the resources available to them.
	Enter appropriate information on the community safe room log.
	Participate in community safe room staff meetings.
	Assist the Community Safe Room Manager in monitoring disaster and response efforts, and plan for closing of the community safe room.
	Assist the Community Safe Room Manager in ensuring that expenditures, bills and invoices, materials, and local volunteer records are tracked.
	Place a sign at each community safe room exit reminding those leaving the community safe room to go to the registration desk for “out-processing.” (Those leaving the community safe room temporarily will have their registration cards flagged in some way to indicate their status.) For those families leaving the community safe room permanently, the registrar should complete the information below the dotted line on the registration form and forward the form to the Community Safe Room Manager.
	Maintain a log for visitors to sign in and out.
	Escort official visitors, including the media, to the Community Safe Room Manager.
	Maintain an community safe room census and, as required, report this information to the Community Safe Room Manager.
	Provide a job induction for new or newly arriving registrars.
Closing Actions	
	Assemble all registration forms and visitor logs, and forward them to the Community Safe Room Manager.
	Ensure that all safe room residents have been accounted for.
	Assist the Community Safe Room Manager in removing all signage materials from the facility.
	Assist the Community Safe Room Manager in cleaning the facility and have it returned to the pre-occupancy condition or as close a condition as possible.

Attachment 6: Health Services Unit Leader Job Aid

The Health Services Unit Leader is responsible for providing quality health services and for seeing that applicable public health standards (state, county, or municipal) are met. Health Services Unit personnel and volunteers working in community safe rooms strive to meet the health needs of clients and workers. Health Services Unit workers do this in part by acting as advisors to the Community Safe Room Manager and the Food Unit Leader on general health and safety issues. Health Services Unit personnel should be appropriately credentialed personnel recruited from local health, medical and Emergency Medical Services (EMS) agencies (e.g., nurses, paramedics, Emergency Medical Technicians (EMTs), etc.).

When a nursing home or a hospital evacuates patients to a community safe room, separate space should be provided to accommodate their clients, supplies, and equipment. The responsibility for the care of the clients rests with the staff of the evacuating institution. The community safe room Health Services Unit Leader will serve as a liaison between the community safe room and the institution's staff. The staff of those institutions must continue to be present and provide the usual care that they give to their clients.

When the community safe room population has many medical cases or many people with special problems requiring more than the usual care that the Health Services Unit personnel can provide, the Health Services Unit Leader, in consultation with the Community Safe Room Manager, should contact local EMS and/or public health authorities and inform them that medical intervention is needed, or request that they establish a temporary infirmary. Community safe rooms cannot operate a facility during a disaster that would require licensure during non-disaster times. It is important to keep in mind that the health of the community is the responsibility of the local public health authority, not the American Red Cross or the community safe room. As with temporary infirmaries set up by evacuated institutions, temporary infirmaries set up by the local public health authority are to be operated under the medical supervision of that authority. If the authority requests assistance, the community safe room or American Red Cross may supplement with staff who are under the supervision and control of the local public health officer. The community safe room staff may also help with food and in procuring supplies and equipment. However, the responsibility for providing medical and nursing care rests solely with the local public health department.

Temporary infirmaries remain open only until residents of the institutions can return to the institution or until disaster victims can return to their homes, or are referred by the local public health authorities to other health care providers.

✓ Done	Task
Initial Actions	
	<p>Obtain an update from the Community Safe Room Manager regarding the following information:</p> <ul style="list-style-type: none"> • Nature of disaster • Safe room assignment location • Estimated community safe room population • Anticipated medical needs of the community safe room population, if known
	Notify your family and work supervisor.
	Pack personal items: clothes, toilet items, medications, blankets, and phone numbers.
	Survey and lay out the space plan for the Registration Unit.
	<p>Determine the health needs of all community safe room occupants and arrange to meet those needs. This work includes:</p> <ul style="list-style-type: none"> • Assessing and referring the seriously ill and injured for health care. • Treating minor illnesses and injuries. • Looking for unreported health problems of community safe room occupants and taking necessary action to care for these problems. • Assisting with arrangements for lost prescriptions or other essential health items.
	The Health Services staff should be available at the registration desk to help screen arrivals at the community safe room who require medical attention. Be aware of any persons who have a communicable disease. Isolate them from the rest of the community safe room occupants as needed, and report noticeable trends in illness to the local health department.
	Work with registration staff to enlist their help in referring people who may have health problems to the Health Services Unit.
Ongoing Actions	
	Arrange for health care for infants, the elderly, or persons with disabilities.
	Determine any needs for special diets (including formula and baby food for infants) and ensure that these needs are communicated to the Food Unit Leader.
	Participate in community safe room staff meetings.
	Assess the number and type of injuries and the age of the population affected and plan preventive interventions. Prevent pre-existing health problems from getting worse.
	Assist the Community Safe Room Manager in ensuring that expenditures, bills and invoices, materials, and local volunteer records are tracked.
	In coordination with the Community Safe Room Manager and Food Unit Leader, arrange for inspections of the community safe room by public health officials, including inspections of food storage, food preparation, and food serving areas, restrooms, and health care areas.
	Ensure that conditions are sanitary in the community safe room. The Community Safe Room Manager should be kept advised about these conditions.
	Work with the Community Safe Room Manager or Building Manager in ensuring the security of all medical supplies and equipment.
	Provide 24-hour medical coverage for the community safe room occupants. Report medical issues and emergency situations to the Community Safe Room Manager.

✓ Done	Task
	Maintain appropriate Health Services Unit records; maintain appropriate confidentiality of all medical information.
	Provide a job induction for new or newly arriving registrars.
Closing Actions	
	Transfer medical records as determined by the Community Safe Room Manager and Health Services Unit Leader.
	Ensure that all safe room residents have been accounted for, especially those with medical needs. To the degree possible, ensure continuity of care. Consult with the Community Safe Room Manager and Health Services Unit Leader to identify residents who may need special services.
	Assist the Health Services Unit Leader in cleaning the facility and have it returned to the pre-occupancy condition or as close a condition as possible.

Attachment 7: Communications Unit Leader Job Aid

The Communications Unit Leader is usually a full-time, 24-hour position at community safe rooms when telephones are out of order or anticipated to be out of order. Consequently, it is recommended to recruit local amateur radio operators (handheld amateur (HAM) radio and/or Radio Amateur Civil Emergency Service (RACES) members) to provide initial communications between the community safe room, the EOC, and other parts of the disaster relief operation.

✓ Done	Task
	Obtain an update from the Community Safe Room Manager regarding the following information: <ul style="list-style-type: none"> • Nature of disaster • Safe room assignment location • Estimated community safe room population • Facility contact person and/or Building Manager • What other staff are being recruited? <ul style="list-style-type: none"> – Shift Supervisor(s) – Registration Unit Leader(s) – Health Services Unit Leader(s) – Food Unit Leader(s)
	Notify your family and work supervisor.
	Pack personal items: clothes, toilet items, medications, blankets, and phone numbers.
Initial Actions	
	Establish contact with facility representative(s) and/or Building Manager and determine the appropriate location for radios. The location should be suitable for optimal reception, have access to generator-powered outlet(s), and isolated from the general community safe room residents.
	Meet with the Community Safe Room Manager and identify which people will have the authority to transmit messages.
	Establish contact with the local EOC.
	Brief staff who will have the authority to send messages via the radio.
	Coordinate recruitment of additional personnel. Encourage the involvement of community safe room residents as workers, if applicable.
	Establish a community safe room communications log.
Ongoing Actions	
	Receive and send messages as requested.
	Establish standard shift schedules for staff.
	To the extent possible, convey messages to the appropriate individual. If needed, recruit runners.
	Maintain the communications log.
	Identify additional communication needs for staff and clients.
	Meet regularly with the Building Manager and/or facility representative to share concerns and resolve potential problems.

✓ Done	Task
Closing Actions	
	At the direction of the Community Safe Room Manager, notify the local EOC of estimated closure date/time.
	Return equipment to owners.
	Arrange for the cleaning of the facility and have it returned to the pre-occupancy condition or as close a condition as possible.
	Prepare a thank-you list of volunteers (runners) to be thanked or recognized. Submit to the EOC Liaison.
	Prepare a narrative report on the community safe room operation and submit it to the local EOC or emergency management agency. Include the community safe room location and dates of operation, summary of services provided, problems, and recommendations.

Attachment 8: Food Unit Leader Job Aid

The feeding responsibilities in a community safe room include supervising on-site food preparation and service for safe room residents and workers. The Food Unit Leader advises the Community Safe Room Manager of supplies that are needed, ensures that safe food handling procedures are followed, and oversees menu planning. The Food Unit Leader may prepare and monitor the food service staff work schedule and record the hours of personnel as requested. The Food Unit Leader must keep accurate records of food and supplies received and expended.

✓ Done	Task
Initial Actions	
	Obtain an update from the Community Safe Room Manager regarding the following information: <ul style="list-style-type: none"> • Nature of disaster • Safe room assignment location • Estimated community safe room population • Time/day of first meal for community safe room residents
	Notify your family and work supervisor.
	Pack personal items: clothes, toilet items, medications, blanket, and phone numbers.
	Survey and lay out the space plan for the Food Unit.
	In your initial briefing with the Community Safe Room Manager, discuss the best options for feeding at the safe room. These may include the following: <ul style="list-style-type: none"> • Fast food or restaurant-prepared meals (particularly during the first 24 hours) • Red Cross-managed kitchen • School cafeteria workers • Staff from church or other organization • Establish a beverage and snack canteen service as soon as possible.
	Meet with a representative of the facility, preferably with the kitchen or cafeteria supervisor. Identify supply sources for food, water, and supplies. Identify food storage, food preparation, serving, dining, and garbage disposal areas within the community safe room.
	Take inventory of food supplies on hand at the facility before preparing any meals, or designate a specific, secured area for those items available for use by the community safe room food service staff. Make sure the receiving area is close to a road and that there is enough room to maneuver delivery vehicles.
	Locate the storage area between the receiving area and the food preparation area. Make sure the area can be secured. Equip the areas with tables, shelves, and off-the-floor racks for storage of dry food and staples. Provide refrigeration if available.
	If all food is canned or ready-to-cook, the preparation area can be small. For fresh food, you will need work tables, cutting boards, sinks, utensils, cookware, and garbage containers. The serving area should be near the preparation area. It should be arranged for cafeteria-style service or line feeding and should be equipped with several counters or tables for speedier service. If the community safe room is serving as a fixed feeding site, be prepared to feed members of the community in addition to community safe room residents. The serving rate for cafeteria-type systems is about eight people per minute.

✓ Done	Task
	Set up the dining area near the serving area. Set up enough tables and chairs to accommodate the maximum number of persons expected to be served. If tables and chairs are scarce, plan for two or more seatings.
	Locate the disposal area away from the preparation, serving, and dining areas. Provide containers for disposal of trash, liquid waste, and garbage and an appropriate area for cleaning trash receptacles. Provide cleaning and disinfectant supplies.
	Identify available utilities. If no utilities are currently available, find out when supplemental power will be supplied or when utilities may be restored.
	Estimate staffing needs on the basis of whether food is to be prepared on site or delivered. Try to project these needs for the immediate future. Identify any facility personnel who will be working in the feeding function. You will probably be able to use community safe room residents for most food service tasks. A general ratio is 1 kitchen staff per 100 meals prepared.
	Determine the initial menu plan. Review with the Community Safe Room Manager and, when possible, community safe room resident representatives to ensure cultural sensitivity and needs for feeding babies and young children.
Ongoing Actions	
	Establish a work schedule and assign shifts. Oversee preparation of meals.
	Enter appropriate information on the community safe room log.
	Participate in community safe room staff meetings. Report food service statistics and any accomplishments, problems, or recommendations.
	Ensure that your staff are assigned to and briefed on their specific duties. Document hours worked daily by local volunteers and facility personnel.
	<p>When the safe room first opens, there may be limited stocks of food available. If this is the case, do what you can with food stocks within the facility and with supplies you are able to acquire from the community. If necessary, ration food. Once you are receiving food supplies regularly, consider the following:</p> <ul style="list-style-type: none"> • Do not duplicate primary (entree) menu items more than once every 5 days, if possible. • Keep menus simple. • Use U.S. Department of Agriculture (USDA) foods when available. Purchase at wholesale. Observe purchasing procedures such as authorization limits. • If staffing levels are low, order convenience-packaged items, such as ready-made cole slaw, beef stew, etc., to save work. • Plan menus around the equipment you have on hand for preparation. • Listen to your community safe room residents and staff. If you are serving items that are not liked, change them as soon as possible. • Be aware of weather conditions. If it's hot, serve colder or chilled foods; if it's cold, serve more hot items. • Plan for 2,500 calories per day per person, three meals per day, and at least one hot meal per day. Try to serve nutritious snacks between meals and have beverages available throughout the day. • Coordinate special diet requirements with the Health Services Unit. Usually, products low in sodium and sugar will meet most needs.

✓ Done	Task
	<ul style="list-style-type: none"> • Determine how many servings should be prepared. Add 10 percent to the number of persons expected to be served. • If water is in short supply, use it only for drinking and cooking. Plan on a minimum of 1 gallon of water per day per person for drinking. • Use perishable food first; rotate stock.
	<p>Assist the Community Safe Room Manager in ensuring that expenditures, bills and invoices, materials, and local volunteer records are tracked:</p> <ul style="list-style-type: none"> • Keep a record of all food and supplies obtained and/or received, including amounts and sources. • Keep receipts for all food and supplies that your unit acquires locally. • Record any food supplies belonging to the facility that were used. • Record any breakage of facility-owned equipment. • Ensure invoices are processed promptly for payment; keep copies.
	<p>Ensure restocking orders are based on need by doing regular inventories. Watch inventory level and the numbers of meals served. Adjust orders as needed. Reduce orders as safe room feeding winds down.</p>
	<p>Ensure that food areas are kept clean and sanitary, and that food holding times and other safety procedures are followed. Arrange for the local public health inspector to visit and advise you on local codes and health laws. Coordinate this with the Health Services Unit Leader.</p>
	<p>Provide the Community Safe Room Manager with daily statistics on the number of meals and snacks served:</p> <ul style="list-style-type: none"> • A meal usually equals an entree, vegetable, fruit, starch, and beverage. • Snacks are counted individually. • Drinks are counted individually but are reported as a snack.
	<p>Maintain an community safe room census and, as required, report this information to the Community Safe Room Manager.</p>
	<p>Provide a job induction for new or newly arriving registrars.</p>
Closing Actions	
	<p>Coordinate with the Community Safe Room Manager regarding when the last meal will be served.</p>
	<p>A goal is to end up with no excess supplies. If there are any, however, consult with the Community Safe Room Manager about how excess supplies will be disposed of. Return supplies according to plan, including the following:</p> <ul style="list-style-type: none"> • Inventory all remaining facility supplies. • Restock food, water, and supplies that were taken from the facility's stores, including USDA food. • Inventory remaining supplies received from vendors. Make arrangements for the return of excess supplies.
	<p>Thoroughly clean food service and food preparation areas.</p>
	<p>Provide worker evaluation and debriefing.</p>
	<p>Turn in all records and other documentation to the Community Safe Room Manager.</p>
	<p>Prepare and submit a narrative report of the Food Unit's activities, noting accomplishments, problems and how they were solved, and recommendations for future operations.</p>

Attachment 9: EOC Liaison Job Description

The EOC Liaison is designated by the local EOC to act as a liaison between the Community Safe Room Manager and the EOC. An EOC Liaison is assigned to each community safe room to work as a troubleshooter for the local EOC. The EOC Liaison will work with the local EOC to try to solve problems or issues that the Community Safe Room Manager or Building Manager is having difficulty resolving. EOC Liaisons can be an invaluable resource since they can provide an “extra pair of hands” for the safe room management staff, especially in difficult-to-resolve issues.

The EOC Liaison will work to resolve concerns and disputes between participating agencies, evacuees, and the EOC. This person must communicate effectively, demonstrate strong supervisory skills, and be completely knowledgeable about the operations within the community safe room.

At least one EOC Liaison should be assigned to each community safe room at all times. Duties of EOC Liaisons include:

Work collaboratively with the Community Safe Room Manager and school principal to ensure that operations run in a smooth and effective manner.

- Coordinate distribution of blankets and floor pads to appropriate evacuees.
- Maintain inventory of supplies distributed to evacuees.
- Tour the community safe room and its exterior on a regular basis.
- Apprise the Community Safe Room Manager of any problems that arise.
- Coordinate with the Building Manager in regards to building operations and ensuring that the facility is being used properly.
- Report status of the community safe room operations to the local EOC on a frequent basis.
- Notify the EOC whenever support is needed to handle unresolved issues.
- Provide operational updates to the incoming EOC Liaison.

Attachment 10: Sample Floor Plan of a Community Safe Room

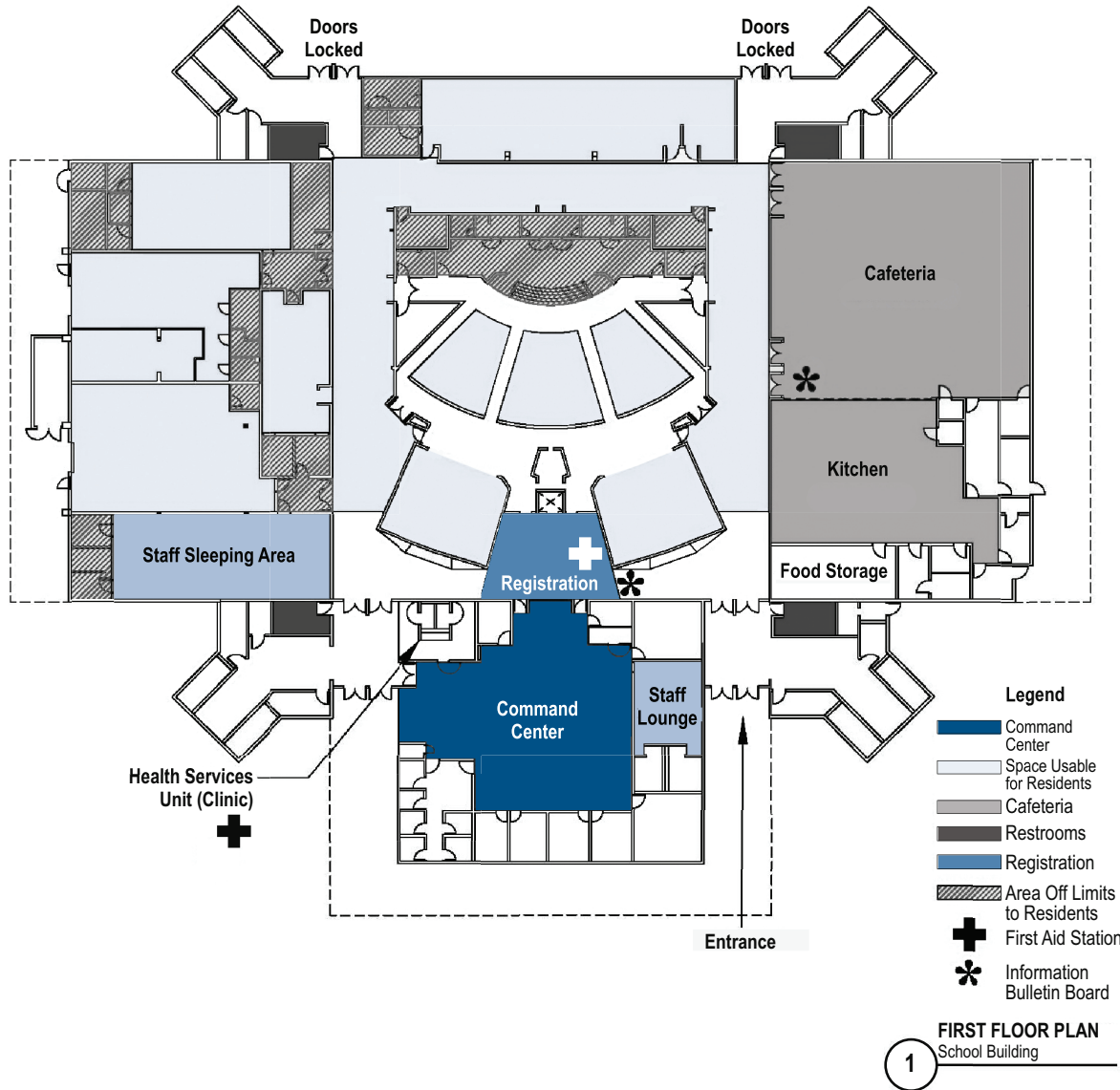

Attachment 11: Community Safe Room Manager's Kit

As part of its disaster preparedness, a community should keep on hand one or more pre-packed Community Safe Room Manager's kits for each anticipated community safe room. The list below shows the contents of a kit adequate for a community safe room housing 100 persons. However, this list is meant to be a sample only. Communities should adapt it to meet local needs. A footlocker or large insulated plastic ice chest makes a good container for the kit. Only items that have an indefinite shelf life should be placed in pre-packed kits. Other items such as batteries should be readily available for insertion in kits before use. Pre-packed safe room kits should be inventoried annually to ensure that forms are current and that items are in good condition.

Quantity	Item Description
Basic Supplies	
2	pk/50 community safe room registration forms
1	pk/5 sign strips
1	pk/5 directional arrows
1	pk/5 utility pole signs
20	temporary name badges and holders
8	vests or other identification/apparel
Office Supplies	
12	pencils
12	ballpoint pens
1	package 3" x 5" cards
2	clipboards
4	paper tablets
1	pencil sharpener
2	staplers
1	box staples
2	boxes paper clips
1	package carbon paper
1	manual hole punch
2	large black magic markers
1	box thumbtacks
2	rolls masking tape
1	roll Scotch tape
1	package rubber bands
1	pair scissors
24	file folders
24	file folder labels
1	pad of easel paper
1	3-ring binder with tab dividers
1	whistle

Quantity	Item Description
1	roll orange/yellow tape for traffic control
Other Supplies	
1	box large trash bags
2	rolls paper towels
1	package paper napkins
1	box safety pins
1	bottle of all-purpose cleaner
1	flashlight
1	electric lantern
1	package flashlight batteries
1	package lantern battery
1	battery-operated radio w/batteries
Toiletries	
1	package disposable diapers
1	box sanitary napkins
2	boxes facial tissue
6	rolls toilet tissue
1	package antiseptic pre-moistened towelettes (40)
First Aid Kits	
1	2" x 2" sterile gauze pads (box of 100)
1	3" x 3" sterile gauze pads (box of 100)
1	4" x 4" sterile gauze pads (box of 50)
10	5" x 9" sterile dressings
300	adhesive bandages, various sizes (¾" to 1" sizes)
2	adhesive tape, 2" x 5 yds
2	adhesive tape, 1" x 5 yds
10	2" conforming roller gauze bandages
6	advanced antimicrobial elastic (Ace) bandages 3" x 5 yds.
4	multi-trauma dressings 12" x 30"
3	triangle bandages 38" x 52"
1	2" non sterile cling gauze rolls (12 pack)
1	Cardiopulmonary Resuscitation (CPR) breathing barrier, such as a face shield.
1	medical grade non-latex gloves (box of 100, large)
1	medical grade non-latex gloves (box of 100, small)
2	penlights
3	bandage shears
1	cotton-tipped applicators (box of 100)
1	ammonia inhalant ampules (box of 10)

Quantity	Item Description
4	instant ice packs
4	instant heat packs
4	cervical collars (1 each: child, and S, M, L adult sizes)
1	eye wash 4 oz. bottle
2	eye pads
1	hydrogen peroxide 4 oz. bottle
100	towelettes, antiseptic (100 count)
1	alcohol prep pads (box of 100)
10	safety pins
10	tongue depressors
1	triple antibiotic (anti-bacterial) ointment (box of 10 or 1 oz. tube)
1	tweezers
1	waterless alcohol-based hand sanitizer 12 oz. bottle

Appendix D

Case Study II – School Community Safe Room (Kansas)

Introduction

This appendix presents an example of a tornado safe room that meets tornado hazards and design criteria set forth in this publication. This example was from the reconstruction of a damaged school after the May 1999 Midwest tornado outbreaks and background information on the project is included in the “Overview” section. Several additional items related to this project have been included in this appendix, including:

- Initial wind load calculations for the safe room.
- The initial budgetary cost estimate (which was originally prepared in 1999 and has been updated to 2008 dollars).
- A sample tornado Community Shelter Operations Plan (without attachments). The plan provided is a reference document for a tornado safe room plan. The plan is not from the Wichita Safe Room Project presented in this appendix because one was not required when the safe room was constructed. The plan attached, however, was a recent plan developed for a community tornado safe room in Missouri. Although it was developed prior to the update of the guidance provided in Chapter 3 of this publication, it is presented here for reference and use by the reader. The plan provides a good representation of an operations plan and, with the guidance provided in Chapter 3, can be adapted to any tornado safe room in the United States.
- A sample of the original conceptual design drawings for the Wichita safe room project.

Overview

On May 3, 1999, an outbreak of tornadoes tore through parts of Oklahoma and Kansas, leveling entire neighborhoods and killing 49 people in Oklahoma and 6 in Kansas. Chisholm Life Skills Center in Wichita, Kansas, sustained heavy damage from these storm systems. A double portable classroom was demolished and the roof system for the southwest classroom section of

the school was destroyed. A mechanical room chimney collapsed onto an adjacent roof, causing roof and wall failure. The roof membrane was damaged at several locations over the entire building.

PBA, an A/E firm in Wichita, was commissioned by the Unified School District No. 259 to assess damages and provide retrofit options, including proposed locations for safe areas at Chisholm Center. Advantages and disadvantages for each proposal were listed, along with a recommendation and a cost estimate.

PBA recommended a centrally located classroom addition to replace the portable classrooms. The new addition would replace the lost facilities and also function as a community safe room to protect the population from extreme-wind events. It would provide 840 square feet of usable floor space and be constructed with pre-cast concrete wall panels, a pre-cast double tee concrete roof structure, and roof mounted mechanical equipment. The design would meet the requirements of the newest local building codes for normal building use and technical guidelines in FEMA documents for tornado community safe room use, including a design wind speed of 250 mph. Calculations of wind loads used in the original design (using ASCE 7-98) have been checked using the design criteria stated in Chapter 3 of this publication and ASCE 7-05, which yielded the same values for wind loads as the original calculations. Equations, figures, and tables have been referenced from both ASCE 7-98 and ASCE 7-05.

A major advantage of the design plan is that it could be implemented without disrupting school activities. Design plans for the new addition at the Chisholm Life Skills Center are provided in this appendix. The plans are preceded by the wind load analysis on which the design is based.

ASCE 7-98/7-05 Wind Load Analysis for Chisholm Life Skills Center Shop Addition

Using Exposure C

General Data

$K_z = 0.85$ Velocity Pressure Exposure Coefficient (Table 6-5 of ASCE 7-98; Table 6-3 of ASCE 7-05)

$I = 1.00$ Importance Factor (see Chapter 6 of this manual)

$V = 250$ Wind Speed (mph) from FEMA Wind Zone Map (Figure 3-1 of this publication)

$K_{zt} = 1$ Topographic Factor (Figure 6-2 of ASCE 7-98; Figure 6-4 of ASCE 7-05)

$K_d = 1.00$ Wind Directionality Factor (see Chapter 3 of this publication)

$h = 14$ Building Height (ft)

$L = 56$ Building Length (ft)

$B = 35$ Building Width (ft)

Velocity Pressure (Section 6.5.10 of ASCE 7-98 and ASCE 7-05)

$$q_z = (0.00256)(K_z)(K_{zt})(K_d)(V^2) \quad q_z = 136.00 \text{ psf}$$

$$q_h = q_z$$

$$q_h = 136.00 \text{ psf}$$

External Pressure Coefficients for Walls (Figure 6-3 of ASCE 7-98; Figure 6-6 of ASCE 7-05)

$$L/B = 1.60 \quad C_{p1} = 0.8 \text{ windward wall} \quad B/L = 0.63 \quad C_{p1} = 0.8 \text{ windward wall}$$

$$C_{p2a} = -0.38 \text{ leeward wall} \quad C_{p2b} = -0.5 \text{ leeward wall}$$

$$C_{p3} = -0.7 \text{ side wall} \quad C_{p3} = -0.7 \text{ side wall}$$

Roof Pressure Coefficients (Figure 6-3 of ASCE 7-98; Figure 6-6 of ASCE 7-05)

$$h/L = 0.25 \quad C_{p4a} = -0.9 \text{ from 0–7 ft from windward edge}$$

$$C_{p4b} = -0.9 \text{ from 7–14 ft from windward edge}$$

$$C_{p5} = -0.5 \text{ from 14–28 ft from windward edge}$$

$$C_{p6} = -0.3 \text{ more than 28 ft from windward edge}$$

(Note: Let $C_{p4} = C_{p4a} = C_{p4b}$ due to roof geometry)

Gust Factor

$$G = 0.85$$

Internal Pressure Coefficients for Buildings (Table 6-7 of ASCE 7-98; Figure 6-5 of ASCE 7-05)

$GC_{pi\text{pos}} = 0.55$ for partially enclosed buildings

$GC_{pi\text{neg}} = -0.55$ for partially enclosed buildings

ATMOSPHERIC PRESSURE CHANGE (APC)

The internal pressure coefficient, GC_{pi} , may be taken as ± 0.18 when venting area of 1 square foot per 1,000 cubic feet of interior safe room volume is provided to account for APC. As an alternative to calculating the effects of APC, and designing an appropriate venting system for the safe room, the design may be completed using an internal pressure coefficient $GC_{pi} = \pm 0.55$ as a conservative means to account for APC.

Design Wind Pressure for Rigid Buildings of All Heights (Section 6.5.12.2.1 of ASCE 7-98 and ASCE 7-05)

(for positive internal pressures)

$$p_{wi} = (q_z)(G)(C_{p1}) - (q_h)(GC_{pi\text{pos}}) \quad p_{wi} = 17.68 \text{ windward wall}$$

$$p_{lee2a} = (q_z)(G)(C_{p2a}) - (q_h)(GC_{pi\text{pos}}) \quad p_{lee2a} = -118.73 \text{ leeward wall (wind parallel to ridge)}$$

$$p_{lee2b} = (q_z)(G)(C_{p2b}) - (q_h)(GC_{pi\text{pos}}) \quad p_{lee2b} = -132.60 \text{ leeward wall (perpendicular to ridge)}$$

$$p_{side} = (q_z)(G)(C_{p3}) - (q_h)(GC_{pi\text{pos}}) \quad p_{side} = -155.72 \text{ side wall}$$

$$p_{roof1} = (q_z)(G)(C_{p4}) - (q_h)(GC_{pi\text{pos}}) \quad p_{roof1} = -178.84 \text{ roof pressures (0 – 14 ft from windward edge)}$$

$$p_{roof2} = (q_z)(G)(C_{p5}) - (q_h)(GC_{pi\text{pos}}) \quad p_{roof2} = -132.60 \text{ roof pressures (14 – 28 ft from windward edge)}$$

$$p_{roof3} = (q_z)(G)(C_{p6}) - (q_h)(GC_{pi\text{pos}}) \quad p_{roof3} = -109.48 \text{ roof pressures (more than 28 ft from windward edge)}$$

(for negative internal pressures)

$$p_{wi} = (q_z)(G)(C_{p1}) - (q_h)(GC_{pi\text{neg}}) \quad p_{wi} = 167.28 \text{ windward wall}$$

$$p_{lee2a} = (q_z)(G)(C_{p2a}) - (q_h)(GC_{pi\text{neg}}) \quad p_{lee2a} = 30.87 \text{ leeward wall (wind parallel to ridge)}$$

$$p_{lee2b} = (q_z)(G)(C_{p2b}) - (q_h)(GC_{pi\text{neg}}) \quad p_{lee2b} = 17.00 \text{ leeward wall (perpendicular to ridge)}$$

$p_{side} = (q_z)(G)(C_{p3}) - (q_h)(GC_{pineg})$	$p_{side} = -6.12$ side wall
$p_{roof1} = (q_z)(G)(C_{p4}) - (q_h)(GC_{pineg})$	$p_{roof1} = -29.24$ roof pressures (0 –14 ft from windward edge)
$p_{roof2} = (q_z)(G)(C_{p5}) - (q_h)(GC_{pineg})$	$p_{roof2} = 17.00$ roof pressures (14 – 28 ft from windward edge)
$p_{roof3} = (q_z)(G)(C_{p6}) - (q_h)(GC_{pineg})$	$p_{roof3} = 40.12$ roof pressures (more than 28 ft from windward edge)

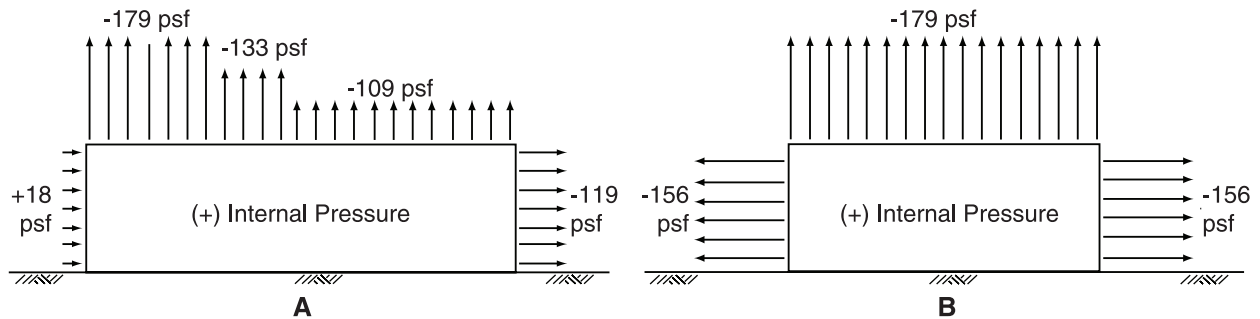

Notes:

1. Positive pressure values act against the building surface.
2. Negative pressure values act away from the building surface.
3. Wind direction is from left to right in figure A, and going into the page in figure B.

Figure D-1. Design wind pressures when wind is parallel to ridge with positive internal pressures (Chisholm Life Skills Center Shop Addition)

Budgetary Cost Estimate For The Wichita, Kansas, Safe Room (In 2008 Dollars)

**Estimated Construction Costs (+/- 20%)
(Safe Room Area = 2,133 Square Feet)**

Construction Item	Cost
Site work and general requirements	\$25,500
Utilities	\$3,300
Cast-in-place concrete	\$36,000
Pre-cast concrete structure	\$90,500
Metals	\$13,700
Woods and plastics	\$33,000
Thermal and moisture protection	\$25,100
Doors and hardware	\$9,400
Finishes	\$9,400
Specialties	\$9,400
Special equipment/technology	\$9,400
Electrical	\$35,500
Mechanical	\$69,200
Total Construction Costs	\$369,400
Profit and Fees	\$36,900
Total Estimated Construction Costs	\$406,300
Unit Cost (Per Square Foot [sf])	\$190.00/sf

NOTE: Currently, in this area of Kansas, school projects consisting of exterior load-bearing walls of CMU with brick veneer, interior non-load-bearing CMU walls, and open-web steel joist roof systems with metal decks are budgeted at \$95.00–\$100.00/ft².

WITCHITA SCHOOL TORNADO SAFE ROOM WITCHITA, KANSAS

**WITCHITA SCHOOL
TORNADO SAFE ROOM**
 WICHITA, KANSAS

DRAWING INDEX	
COVER SHEET	
SITE & FLOOR PLAN	A1
ELEVATIONS & SECTIONS	A2
STRUCTURAL GENERAL NOTES	S1
STRUCTURAL GENERAL NOTES (CONT.)	S2
FOUNDATION DETAILS	S3
ROOF DETAILS	S4
ELECTRICAL PLAN & SCHEDULES	E1
PLUMBING PLAN & SCHEDULES	P1

LIMIT OF LIABILITY:

The designs included herein are based on extensive research of the causes and effects of windstorm damage to buildings. Safe Rooms designed and built to these designs should provide a high degree of occupant protection during tornadoes. Any substitution of either materials or design concepts may decrease the level of occupant protection and/or increase the possibility of personal injury during a severe wind event.

Because it is not possible to predict or test all conditions that may occur during severe windstorms, or control the quality of construction, among other things, the designer does not warrant the design.

The designer neither manufactures nor sells safe rooms built from this design. The designers have not made and do not make any representation, warranty, or covenant, express or implied, with respect to the design, condition, quality, durability, operation, fitness for use, or suitability of the safe room in any respect whatsoever. Designers shall not be obligated or liable for actual, incidental, consequential, or other damages of or to users of safe rooms or any other person or entity arising out of or in connection with the use, condition, and/or performance of safe rooms built from this design or from the maintenance thereof.

COVER SHEET

SHEET No.:
 DATE: 7 MARCH 2000
 REVISED: AUGUST 2008 REV. NO.



WITCHITA SCHOOL TORNADO SAFE ROOM

WICHITA, KANSAS

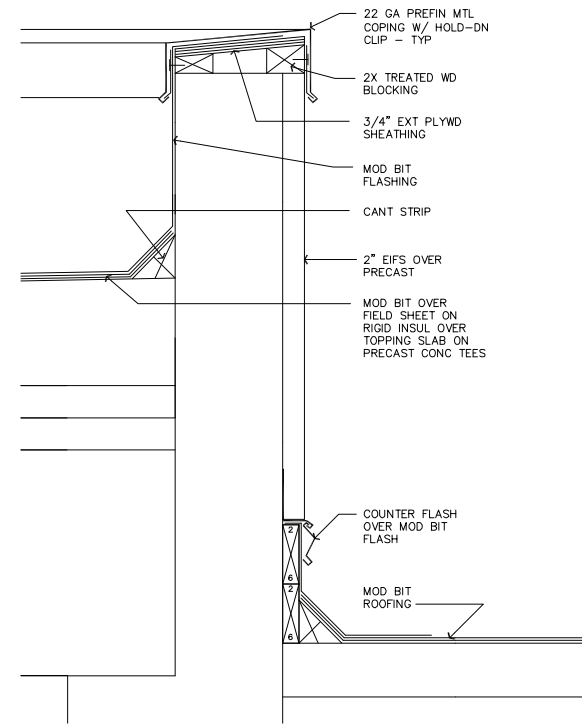
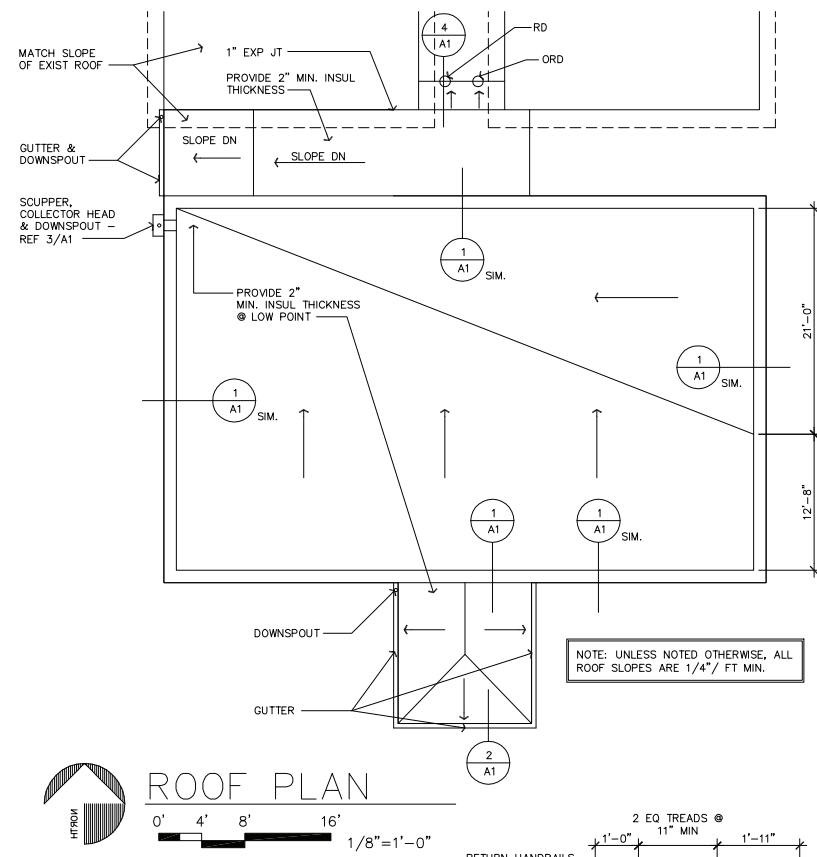
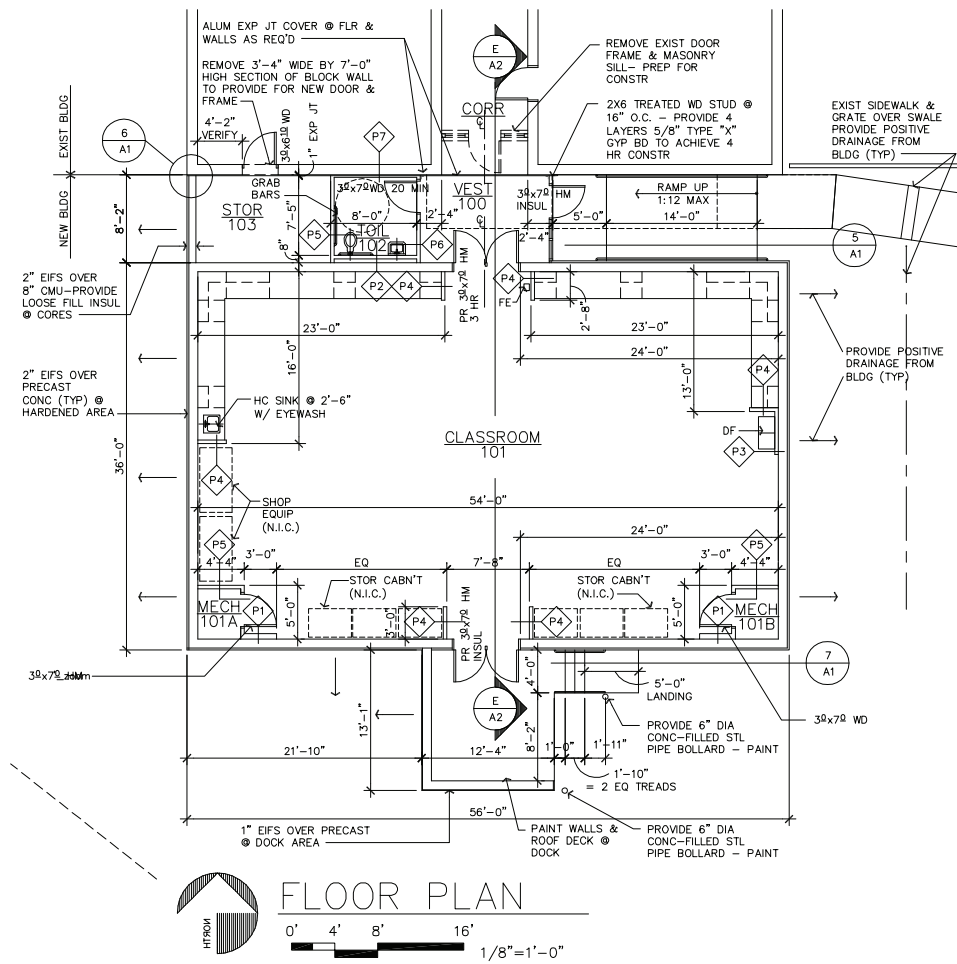

GENERAL NOTES:

- FINISHES-
-VEST 100 - MATCH EXIST. SAT CLG
-SHOP/SAFE ROOM 101 - NO FINISHES, SEAL CONC FLR, PAINT GYP BD, BASE @ GYP BD
-TOIL 102 - SEALED CONCRETE FLOOR, 48"H FRP ON WALLS
-STOR 103 - NO FINISHES
- PROVIDE SPACE IN NEW CABINET FOR THE FOLLOWING PER FEMA REGULATIONS:
1. FLASH LIGHTS
2. FIRST-AID KIT
3. NOAA WEATHER RADIO
- ALL COLOR SELECTIONS BY OWNER
- TORNADO SAFER AREA SHALL BE CONSTRUCTED PER THE NATIONAL PERFORMANCE CRITERIA FOR TORNADO SAFE ROOMS DATED 5/28/99

SPECIFICATION NOTES:

- ROOF MEMBRANE: TAMKO 102FR AWAPLAN PREMIUM FR
- ROOF INSULATION: EPS 1.50 PCF DENSITY W/ 1/2" COVER BOARD HOT MOPPED TO ROOF DECK - MAX 4'X4' SHEETS
- EIFS: DRYVIT SYSTEMS, 2" EPS INSUL, 1.0 PCF, PANZER 20 MESH, SAND FINISH, COLOR AS SELECTED BY OWNER
- METAL STUDS: 25 GAUGE
- HM DOORS: STEELDRIFT MFG, CO. 14 GA FACES, 14 GA FRAMES - ANCHOR FRAMES W/ (4) 3/8" X 6" EXP ANCHORS PER JAMB
- WOOD DOORS: WEYERHAEUSER 1 3/4" SOLID CORE W/ HARDWOOD VENEER FACES - STAIN, CLEAR FINISH IN 16 GA HM FRAME W/ STUD ANCHORS
- SUSP ACOUST CLG: ARMSTRONG NATURAL FISSURED 2'X4'
- MILLWORK: AWW CUSTOM GRADE - LAMINATE FACED, LAMINATE COUNTERTOPS & BACKSPASHES, LAMINATE COLOR SELECTIONS BY OWNER

DOOR HARDWARE:

- (2) PR HM DOOR @ CLASSRM ENTRY/EXIT
-1 1/2 PR HINGES
-REMOVABLE MULLION
-CLOSER
-PANIC DEVICE
-THRESHOLD
-WEATHERSTRIPPING
- TOILET 102 WOOD DOOR
-1 1/2 PR HINGES
-CLOSER
-LEVER LOCKSET (PRIVACY FUNCTION)
-WALL MOUNTED DOOR STOP
- VEST 100 HM ENTRY DOOR
-1 1/2 PR HINGES
-CLOSER
-PANIC DEVICE
-PULL HANDLE
-THRESHOLD - CLEAR ANOD
-WEATHERSTRIPPING
NOTE: UNLESS NOTED OTHERWISE, FIN TO BE DARK BRONZE ANOD.
- (2) WOOD DOORS @ MECH ROOMS
-1 1/2 PR HINGES
-LEVER LOCKSET (STOREROOM FUNCTION)
-DOOR STOP
-HOLD OPEN
- STORAGE 103 WOOD DOOR
-1 1/2 PR HINGES
-LEVER LOCKSET (STOREROOM FUNCTION)
-DOOR STOP

PARTITION SCHEDULE

- P1 8" MTL STUD @ 16" O.C. W/ 5/8" GYP BD ON EXPOSED SIDE OF STUD - EXTEND TO 10'-0" AFF
- P2 3 5/8" MTL STUD @ 16" O.C. W/ 5/8" GYP BD ON EXPOSED SIDE OF STUD - EXTEND TO 4" ABV FIN CLG
- P3 3 5/8" MTL STUD @ 16" O.C. W/ 5/8" GYP BD EA SIDE OF STUD W/ SOUND BATTS - EXTEND TO STRUCT ABV
- P4 3 5/8" MTL STUD @ 16" O.C. W/ 5/8" GYP BD EA SIDE OF STUD - EXTEND TO 10'-0" AFF
- P5 3 5/8" MTL STUD @ 16" O.C. W/ 5/8" GYP BD EA SIDE OF STUD W/ SOUND BATTS - EXTEND TO STRUCT ABV
- P6 3 5/8" MTL STUD @ 16" O.C. W/ 5/8" TYPE "X" GYP BD EA SIDE OF STUD W/ SOUND BATTS - EXTEND TO 4" ABV FIN CLG
- P7 1 5/8" MTL STUD @ 16" O.C. W/ 5/8" TYPE "X" GYP BD OVER STRUCT

7 SECT @ DOCK STAIR
1/2" = 1'-0"

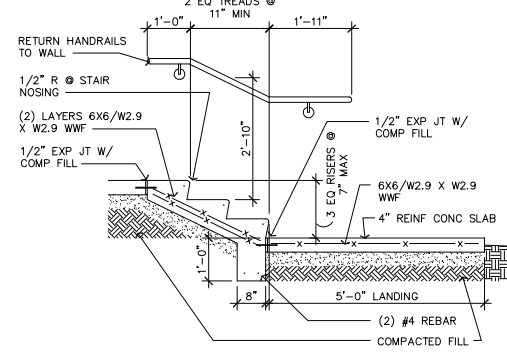

2 ROOF DETAIL @ DOCK
1 1/2" = 1'-0"

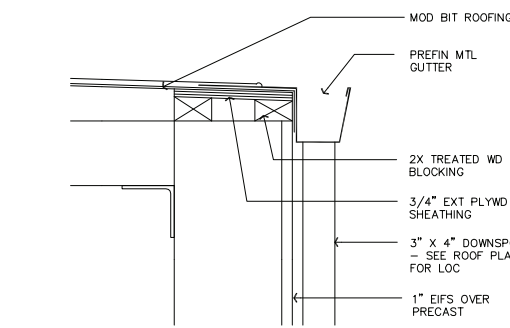

6 DETAIL @ EIFS JT
3" = 1'-0"

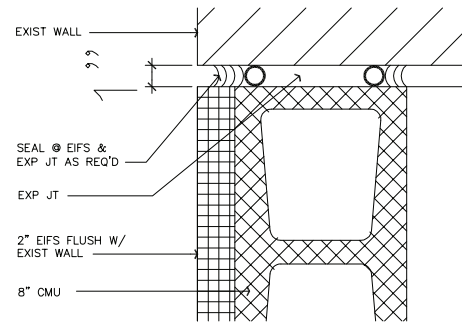

5 DETAIL @ RAMP
1/2" = 1'-0"

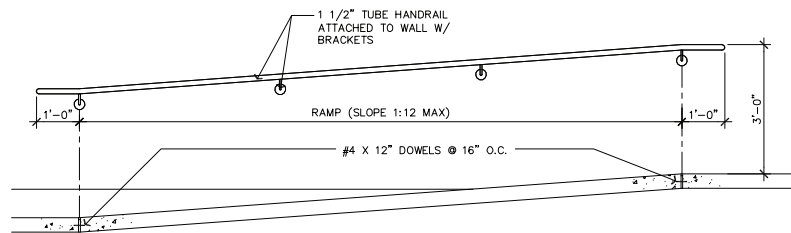

4 ROOF DETAIL @ EXP JT
1 1/2" = 1'-0"

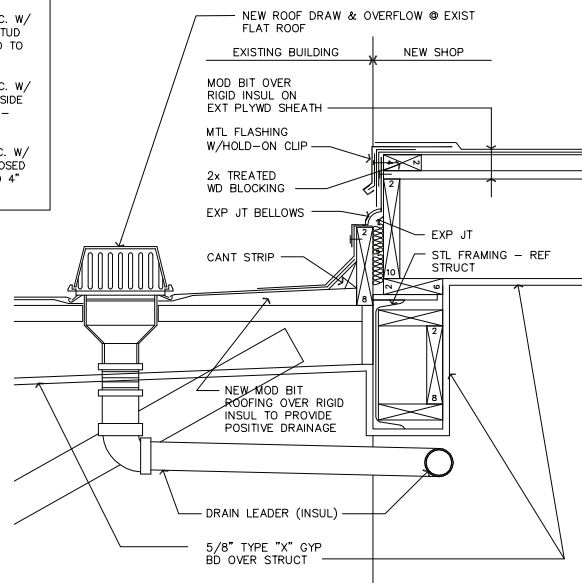

3 SCUPPER DETAIL
1 1/2" = 1'-0"

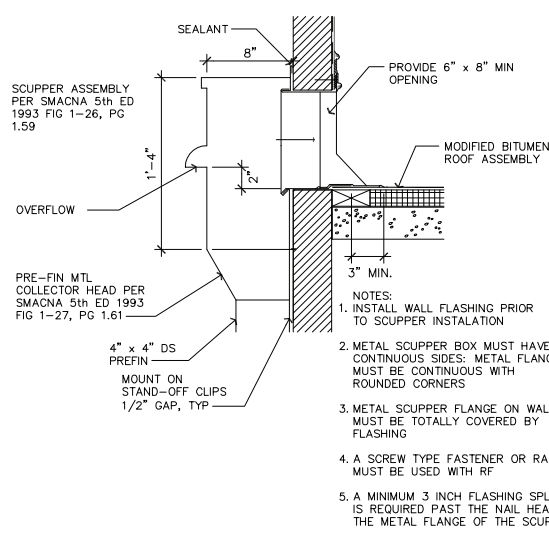

LIMIT OF LIABILITY:

The designs included herein are based on extensive research of the causes and effects of windstorm damage to buildings. Safe Rooms designed and built to these designs should provide a high degree of occupant protection during tornadoes. Any substitution of either materials or design concepts may decrease the level of occupant protection and/or increase the possibility of personal injury during a severe wind event.

Because it is not possible to predict or test all conditions that may occur during severe windstorms, or control the quality of construction, among other things, the designer does not warrant the design.

The designer neither manufactures nor sells safe rooms built from this design. The designers have not made and do not make any representation, warranty, or covenant, express or implied, with respect to the design, condition, quality, durability, operation, fitness for use, or suitability of the safe room in any respect whatsoever. Designers shall not be obligated or liable for actual, incidental, consequential, or other damages of or to users of safe rooms or any other person or entity arising out of or in connection with the use, condition, and/or performance of safe rooms built from this design or from the maintenance thereof.

SITE & FLOOR PLAN

SHEET No.: A1
DATE: 7 MARCH 2000
REVISED: REV. NO.



WITCHITA SCHOOL TORNADO SAFE ROOM

WICHITA, KANSAS

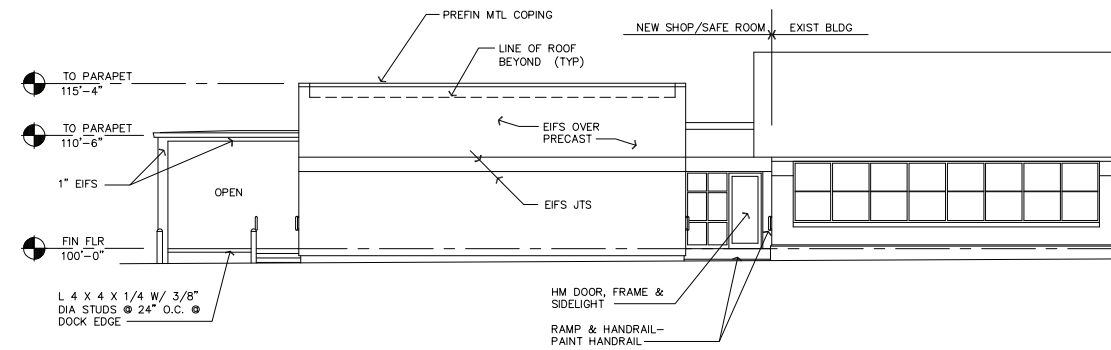

A BUILDING SECTION - EAST
1/8"=1'-0"

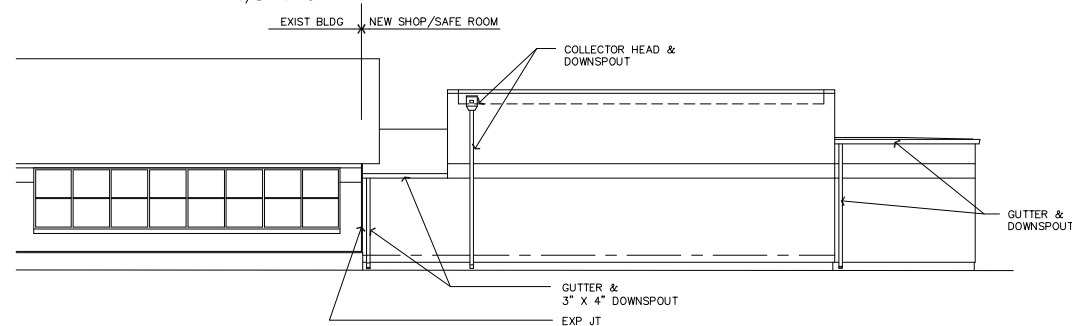

C BUILDING SECTION - WEST
1/8"=1'-0"

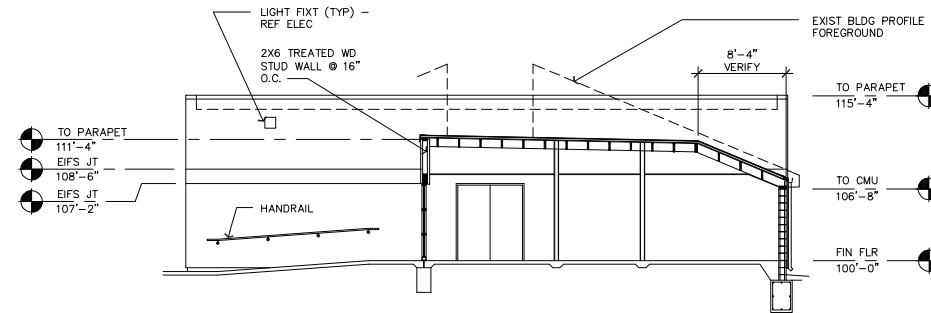

B BUILDING SECTION - NORTH
1/8"=1'-0"

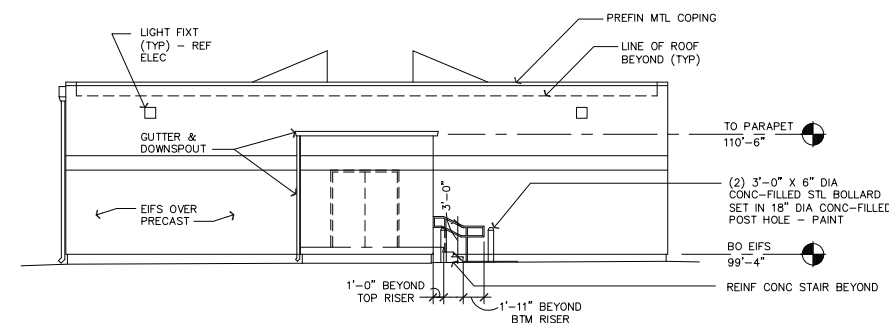

D BUILDING SECTION - SOUTH
1/8"=1'-0"

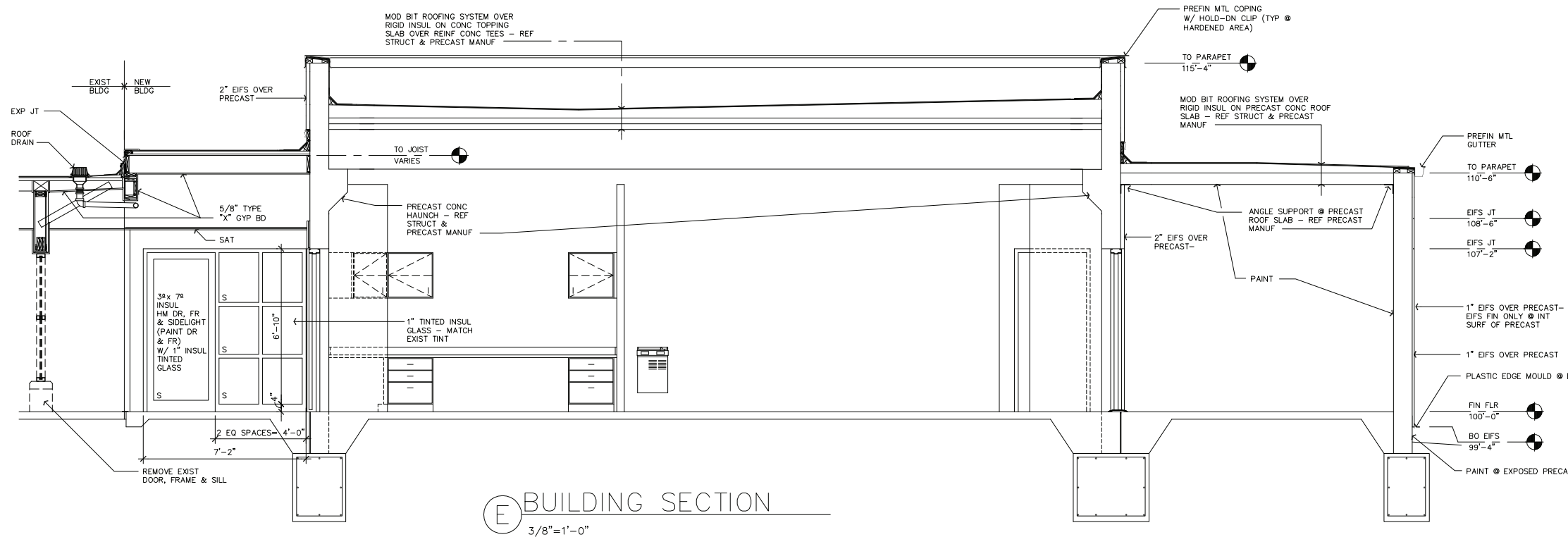

E BUILDING SECTION
3/8"=1'-0"

LIMIT OF LIABILITY:

The designs included herein are based on extensive research of the causes and effects of windstorm damage to buildings. Safe Rooms designed and built to these designs should provide a high degree of occupant protection during tornadoes. Any substitution of either materials or design concepts may decrease the level of occupant protection and/or increase the possibility of personal injury during a severe wind event.

Because it is not possible to predict or test all conditions that may occur during severe windstorms, or control the quality of construction, among other things, the designer does not warrant the design.

The designer neither manufactures nor sells safe rooms built from this design. The designers have not made and do not make any representation, warranty, or covenant, express or implied, with respect to the design, condition, quality, durability, operation, fitness for use, or suitability of the safe room in any respect whatsoever. Designers shall not be obligated or liable for actual, incidental, consequential, or other damages of or to users of safe rooms or any other person or entity arising out of or in connection with the use, condition, and/or performance of safe rooms built from this design or from the maintenance thereof.

ELEVATIONS & SECTIONS

SHEET No.: A2
DATE: 7 MARCH 2000
REVISED: REV. NO.



STRUCTURAL GENERAL NOTES

A. DESIGN CRITERIA

1. BUILDING CODE: UNIFORM BUILDING CODE (UBC), 1997 EDITION, INCLUDING LOCAL SUPPLEMENTS, ASCE 7-95, & FEMA TORNADO PERFORMANCE CRITERIA.

2. GRAVITY LOADS:

LOCATION	UNIFORM LIVE LOAD	CONCENTRATED LIVE LOAD	UNIFORM DEAD LOAD
ROOF	20 PSF	-----	16 PSF
GROUND SNOW	15 PSF	-----	-----
SLAB ON GRADE	100 PSF	2000 LB	-----

LIVE LOAD REDUCTION ON SUPPORTING ELEMENTS SHALL BE IN ACCORDANCE WITH THE UNIFORM BUILDING CODE (UBC), 1997 EDITION. NO LIVE LOAD REDUCTION OF ROOF LOADING IS PERMITTED. DRIFTING OF SNOW IN ACCORDANCE WITH CODE. UNIFORM DEAD LOAD IS ADDITIVE TO ACTUAL STRUCTURAL WEIGHTS.

3. LATERAL LOADS:

A. BASIC WIND SPEED SHALL BE 250 MPH, EXPOSURE C, I=1.0.

B. SEISMIC LOAD SHALL BE FOR ZONE 1.

Z=0.075 I=1.00 RW=8 Co=0.19 Cv=0.26 SOIL PROFILE TYPE=SE

B. SOIL PREPARATION AND FOUNDATIONS

1. A COPY OF THE SUBSURFACE GEOTECHNICAL REPORT IS AVAILABLE FOR INSPECTION AT THE ARCHITECT'S PLACE OF BUSINESS.

2. SOIL SUPPORTED FOUNDATIONS:

A. DESIGN BEARING PRESSURE (NET) IS 2,500 PSF FOR FOUNDATIONS BEARING ON UNDISTURBED SOIL OR 1,500 PSF ON APPROVED ENGINEERED FILL MATERIAL. BEARING MATERIALS SHALL BE VERIFIED BY A LICENSED SOIL ENGINEER.

B. ALL FOUNDATIONS ARE DESIGNED WITH FORMED SIDES. IF EARTH FORMED SIDES ARE APPROVED BY THE ENGINEER, THE TOP 7 1/4" SHALL BE FORMED TO THE DESIGN DIMENSION AND ONE INCH SHALL BE ADDED TO EACH SIDE OF THE EARTH FORMED AREA TO PROVIDE ADEQUATE COVER OVER THE REINFORCING AT THE CONTRACTOR'S EXPENSE.

C. REINFORCING SHALL BE SUPPORTED FROM ABOVE OR WITH 3" SBP (WITH BOTTOM PLATE) AT 4'-0" CENTERS MAXIMUM FOR ALL FOUNDATION REINFORCING.

3. DO NOT BACKFILL FOUNDATION WALLS UNTIL THE RESTRAINING SLABS OR ADEQUATE BRACING ARE IN PLACE. ALL BACKFILL SHALL BE PLACED AND COMPACTED IN ACCORDANCE WITH THE SPECIFICATION.

4. EXTERIOR SLABS SHALL SLOPE AWAY FROM THE STRUCTURE A MINIMUM OF 1/4" PER FOOT UNLESS NOTED OTHERWISE.

C. CAST-IN-PLACE CONCRETE

1. ALL STRUCTURAL CONCRETE HAS BEEN DESIGNED IN ACCORDANCE WITH THE ACI 318-95 AND THE BUILDING CODE.

2. THE CONCRETE REQUIREMENTS ARE:

A. CEMENT SHALL BE TYPE I OR II CONFORMING TO ASTM C150.

B. FINE AND COURSE AGGREGATES SHALL CONFORM TO ASTM C33.

C. MIX REQUIREMENTS ARE:

LOCATION	MIN. F' C	MIN. F' CI	MIN. CEM. PSI	MAX. W/C ENT.	AIR PCY	RATIO
FOUNDATIONS	4000	N/A	470	0.50	5%+/-1%	
GRADE BEAMS	4000	N/A	470	0.50	5%+/-1%	
INTERIOR SLAB*	4000	N/A	564	0.50	NR	

* SLAB ON GRADE SHALL HAVE A FLEXURAL STRENGTH OF 650 PSI.

D. CONCRETE CLEAR COVER OVER REINFORCING SHALL BE IN ACCORDANCE WITH ACI 318-95, AS LISTED BELOW, UNLESS NOTED OTHERWISE.

LOCATION	CLEAR COVER INCHES
CAST AGAINST EARTH	3
EXPOSED TO EARTH OR WEATHER #6 AND LARGER	2
EXPOSED TO EARTH OR WEATHER #5 AND SMALLER	1 1/2
SLABS AND WALLS NOT EXPOSED TO WEATHER	3/4
BEAMS AND COLUMNS NOT EXPOSED TO WEATHER	1 1/2
SLABS ON GRADE (COVER FROM TOP OF SLAB)	1 1/2

3. CONCRETE REINFORCING SHALL MEET THE FOLLOWING:

A. REINFORCING BARS SHALL CONFORM TO THE REQUIREMENTS OF ASTM A615 GRADE 60. REINFORCING BARS REQUIRED TO BE WELDED SHALL CONFORM TO THE REQUIREMENTS OF ASTM A706 GRADE 60. WELDING OF REINFORCING OTHER THAN SPECIFIED IS PROHIBITED.

B. WELDED WIRE FABRIC SHALL CONFORM TO THE REQUIREMENTS OF ASTM A185.

C. ALL REINFORCING SHALL BE CONTINUOUS. CONTINUOUS BARS SHALL LAP IN ACCORDANCE WITH TABLE A UNLESS NOTED OTHERWISE. PROVIDE BENT BARS AT ALL CORNERS.

D. WELDED WIRE FABRIC SHALL LAP ONE FULL SQUARE PLUS 2".

E. SHOP DRAWINGS SHALL BE SUBMITTED WITH REINFORCING STEEL DETAILED IN ACCORDANCE WITH ACI 315.

4. FORMING AND EMBEDMENTS SHALL MEET THE FOLLOWING:

A. ALL EXPOSED EDGES OF CONCRETE SHALL BE CHAMFERED 3/4" INSIDE FORMS OR TOOLED TO 3/4" RAD., UNLESS NOTED OTHERWISE.

B. SLABS ON GRADE SHALL HAVE CONSTRUCTION JOINTS AND CONTROL JOINTS (SAWN JOINTS), LOCATED AS SHOWN ON THE DRAWINGS. CONTRACTOR SHALL LOCATE SLAB JOINTS ON SHOP DRAWINGS.

C. WHERE NECESSARY, VERTICAL CONSTRUCTION JOINTS SHALL BE LOCATED AT MIDSPAN. ALL JOINTS SHALL BE THOROUGHLY CLEANED AND PURPOSELY ROUGHENED TO 1/4" PRIOR TO PLACING ADJACENT CONCRETE.

D. THE CONTRACTOR SHALL BE RESPONSIBLE FOR THE DESIGN OF ALL FORMING, TEMPORARY BRACING AND SHORING.

E. NO ALUMINUM SHALL BE EMBEDDED IN CONCRETE. CONDUITS AND PIPING EMBEDDED IN CONCRETE SHALL BE SPACED A MINIMUM OF FOUR DIAMETERS AND THE OUTSIDE DIAMETER SHALL BE LESS THAN 30% OF THE MEMBER THICKNESS PLACED BETWEEN LAYERS OF REINFORCING.

D. PRECAST CONCRETE

1. ALL PRECAST CONCRETE PRODUCTS SHALL BE DESIGNED IN ACCORDANCE WITH THE BUILDING CODE, ACI 318-95 AND PCI DESIGN HANDBOOK FIFTH EDITION. SHOP DRAWINGS AND CALCULATIONS OF PRECAST PRODUCTS AND CONNECTIONS SHALL BE SUBMITTED BEARING THE SEAL OF AN ENGINEER REGISTERED IN THE STATE WHERE THE PROJECT IS LOCATED. PRECAST SUPPLIER SHALL BE CERTIFIED BY PCI.

2. ADDITIONAL DESIGN REQUIREMENTS ARE:

A. BEARING PADS SHALL BE DESIGNED AND SUPPLIED BY THE PRECAST MANUFACTURER TO ABSORB ALL REQUIRED MOVEMENT WITHOUT SLIPPAGE. THE MINIMUM THICKNESS OF BEARING PADS SHALL BE 1/4" UNLESS NOTED OTHERWISE. BEARING PADS SHALL BE LOCATED A MINIMUM OF 1/2" AWAY FROM THE FACE OF THE SUPPORT.

B. MEMBERS SHALL NOT BE REMOVED FROM THE FORMS UNTIL THE CONCRETE HAS REACHED SUFFICIENT STRENGTH TO RESIST REMOVAL WITHOUT DAMAGE. IN NO CASE, SHALL PRECAST MEMBERS BE REMOVED PRIOR TO ATTAINING A MINIMUM COMPRESSIVE STRENGTH OF 2,500 PSI.

C. PRECAST MEMBERS AND THEIR CONNECTIONS SHALL BE DESIGNED FOR THE LOADS SHOWN ON THE DRAWINGS, IN ADDITION TO THE SELF WEIGHT OF THE MEMBER AND FOR ALL THE CONDITIONS NOTED IN ACI 318-95. CONNECTIONS SHALL BE DESIGNED FOR FORCES AND MOVEMENTS DUE TO VOLUMETRIC CHANGES RESULTING FROM TEMPERATURE CHANGE, ELASTIC DEFORMATIONS, CREEP AND SHRINKAGE. BEAM TO BEAM AND BEAM TO COLUMN CONNECTIONS SHALL BE DESIGNED FOR A MINIMUM ULTIMATE FORCE (HORIZONTAL SHEAR OR TENSION) OF 6 KIPS.

D. ALL COLUMNS AND WALL PANELS, SUPPORTED ON FOUNDATIONS, SHALL HAVE THE HORIZONTAL JOINT GROUDED WITH A NON-SHRINK GROUT WHICH HAS A COMPRESSIVE STRENGTH AT 28 DAYS EQUAL TO OR GREATER THAN THAT OF THE SUPPORTED MEMBER.

E. FLOOR AND ROOF MEMBERS SHALL BE CONNECTED TO ADJACENT MEMBERS WITH WELDED SIDE ANCHORS SPACED AT 10'-0" CENTERS MAXIMUM, AND A MINIMUM OF TWO ANCHORS PER MEMBER ON EACH SIDE UNLESS NOTED OTHERWISE.

3. MATERIALS SHALL MEET THE FOLLOWING REQUIREMENTS:

CONCRETE	MIN. F' C	MIN. F' CI	MIN. CEM. PSI	MAX. W/C ENT.	AIR PCY	RATIO
EXT. WALL PANELS	5000	470	0.50	4%+/-1%		
ROOF TEES*	5000	470	0.50	NR		

REINFORCING

REINFORCING BARS	ASTM	GRADE
WELDED WIRE FABRIC	A185	60
WELDED WIRE FABRIC	A706	60
WELDED WIRE FABRIC	A615	60

E. MASONRY

1. ALL MASONRY HAS BEEN DESIGNED BASED ON ALL MASONRY RECEIVING SPECIAL FIELD INSPECTION.

2. CONCRETE MASONRY UNITS (CMU) MATERIALS SHALL BE:

A. ALL CONCRETE MASONRY UNITS (CMU) SHALL BE TWO CELL LIGHTWEIGHT AGGREGATE UNITS WITH A SPECIFIED MINIMUM COMPRESSIVE STRENGTH OF 2000 PSI ON NET AREA (1000 PSI ON GROSS AREA) AT 28 DAYS CONFORMING TO ASTM C90. CMU LOCATED BELOW GRADE, SHALL BE NORMAL WEIGHT AGGREGATE UNITS.

B. ALL MORTAR SHALL BE TYPE "S" OR "M" WITH A MINIMUM MORTAR COMPRESSIVE STRENGTH OF 1800 PSI AT 28 DAYS CONFORMING TO ASTM C270. THE MINIMUM COMPRESSIVE STRENGTH (FM) OF A PRISM ASSEMBLED OF CMU AND MORTAR SHALL BE 1350 PSI AT 28 DAYS ON THE NET AREA.

C. GROUT SHALL CONFORM TO ASTM C476 WITH 3/8" AGGREGATE WITH THE FOLLOWING REQUIREMENTS:

MIN. F' C	MIN. PSI	MAX. CMT	AIR W/C ENT. RATIO
3000	611	0.65	NR

D. REINFORCING STEEL SHALL MEET THE REQUIREMENTS OF ASTM A615, OR 60.

E. JOINT REINFORCING STEEL SHALL MEET THE REQUIREMENTS OF ASTM A82 WIRE WITH A MINIMUM YIELD GREATER THAN 70 KSI. LONGITUDINAL WIRES SHALL BE 9 GA (0.1483" DIA) WITH TRUSS TYPE WIRES CONNECTED AT 16" CENTERS. REINFORCING SHALL BE MILL GALVANIZED PER ASTM A641, CLASS 3.

3. HORIZONTAL WALL REINFORCING

A. PROVIDE BOND BEAM COURSES IN ALL WALLS AT THE TOP OF WALL OR PARAPET, AT FLOOR LEVELS (ABOVE GRADE), AT TOP OF OPENINGS OR IMMEDIATELY ABOVE LINTELS, BELOW OPENINGS AND AT BEARING LOCATIONS. BOND BEAMS SHALL BE REINFORCED AS FOLLOWS:

WALL TYPE	BOND BEAM REINF.
8" CMU	2-#5

ALL INTERIOR STRUCTURAL WALLS (SHEAR AND/OR BEARING) SHALL HAVE INTERMEDIATE BOND BEAMS LOCATED AT THE SAME LEVELS AS EXTERIOR BOND BEAMS.

B. PROVIDE BOND BEAMS AT INTERMEDIATE LOCATIONS IN EVERY SIXTH COURSE (IE: 4'-0" CENTERS).

4. VERTICAL REINFORCING

A. PROVIDE VERTICAL REINFORCING (NORMAL REINFORCING) IN GROUT FILLED CELLS IN ALL WALLS AS FOLLOWS, UNLESS NOTED OTHERWISE:

WALL TYPE	REINF. IN FILLED CELLS	MAXIMUM SPACING OF FILLED CELLS
8" CMU	1-#5	32"

B. PROVIDE AN ADDITIONAL VERTICAL REINFORCING BAR WITH DOWELS INTO SUPPORTING MEMBERS, WITH SAME SIZE AND LENGTH AS THE NORMAL REINFORCING BAR, AT THE FOLLOWING LOCATIONS:

- ON EACH SIDE OF A CONTROL OR ISOLATION JOINT
- AT INTERSECTION OF WALLS
- EACH SIDE OF A WALL OPENING
- AT EACH END OF WALL
- AT EACH BEAM BEARING

C. VERTICAL REINFORCING SHALL EXTEND CONTINUOUSLY FROM THE TOP OF THE SUPPORTING MEMBER TO EMBED AT LEAST 6" INTO THE TOP BOND BEAM. THERE SHALL BE A DOWEL, CAST INTEGRAL WITH THE SUPPORTING MEMBER, FOR EACH VERTICAL REINFORCING BAR EXCEPT AS NOTED.

5. REINFORCING SHALL MEET THE FOLLOWING LAP, SPLICE AND EMBEDMENT REQUIREMENTS:

REINF. BAR SIZE	LAP OR SPLICE LENGTH IN WALL	FOUNDATION EMBEDMENT WITH HOOK INTO FOUND.	DOWELS STRAIGHT EMBEDMENT INTO FOUND.
JOINT	16"	N/A	N/A
4	24"	8"	15"
5	25"	10"	19"

HOOKS IF USED SHALL BE ACI STANDARD HOOKS.

6. CELLS WHICH CONTAIN REINFORCING STEEL (VERTICAL CELLS, BOND BEAMS AND LINTELS) SHALL BE FILLED SOLIDLY WITH GROUT.

7. VERTICAL CELLS TO BE FILLED SHALL HAVE VERTICAL ALIGNMENT SUFFICIENT TO MAINTAIN A CLEAR UNOBSTRUCTED CONTINUOUS VERTICAL CELL.

8. BOND BEAM AND JOINT REINFORCING FOR INTERIOR AND EXTERIOR WALLS SHALL BE CONTINUOUS THROUGHOUT, EXCEPT AT CONTROL AND ISOLATION JOINTS, IT SHALL BE AS FOLLOWS:

A. INTERMEDIATE REINFORCING SHALL BE DISCONTINUOUS AT CONTROL JOINTS. REINFORCEMENT IN BOND BEAMS AT FLOOR AND ROOF DIAPHRAGM LEVELS SHALL BE CONTINUOUS.

B. AT ISOLATION JOINTS, ALL REINFORCING SHALL BE DISCONTINUOUS.

9. BARS AROUND PERIMETER OF OPENINGS SHALL EXTEND NOT LESS THAN 40 BAR DIAMETERS OR 24", WHICHEVER IS LARGER, BEYOND THE CORNER OF THE OPENING. VERTICAL JAMB BARS SHALL BE THE SAME SIZE AND NUMBER AS THE NORMAL VERTICAL REINFORCING. FOUNDATION DOWELS ARE ONLY

10. LINTELS OVER OPENINGS, UNLESS NOTED OTHERWISE, SHALL BE:

OPENING	LINTEL
< 4'-0"	8"x8" CMU BOND BEAM W/ 2-#5 & 8" BEARING
> 4'-0", < 8'-0"	8"x16" CMU BOND BEAM W/ 2-#5 T&B & 16" BEARING
> 8'-0"	SEE PLANS

11. ALL MASONRY IN CONTACT WITH SOIL SHALL BE NORMAL WEIGHT UNITS AND HAVE ALL VOIDS FILLED WITH GROUT.

F. STRUCTURAL WOOD

1. ALL WOOD STRUCTURES HAVE BEEN DESIGNED IN ACCORDANCE WITH THE BUILDING CODE.

2. THE DESIGN OF THE STRUCTURE IS BASED UPON THE USE OF THE FOLLOWING PRODUCTS:

A. WOOD

USE	WOOD TYPE	GRADE	Fb PSI	Fcp PSI	E PSI
JOISTS	SOUTHERN PINE	#2	1,050	1,450	1,600,000
STUDS (2 X 4) (2 X 6)	DOUGLAS FIR	#1	1,000	1,450	1,700,000
	DOUGLAS FIR	#2	875	1,300	1,600,000

ALL MEMBERS SHALL BE SURFACED DRY AND HAVE A MAXIMUM MOISTURE CONTENT OF 19 PERCENT. STRESS INCREASE SHALL BE 15% FOR LIVE LOAD ONLY.

B. ROOF SHEATHING SHALL BE 1/2", 7/16" OR 15/32" APA RATED PLYWOOD OR PARTICLE BOARD, 24/0 SPAN RATING, EXPOSURE 1, LAID IN A STAGGERED PATTERN, WITH EDGE CLIPS BETWEEN SUPPORTS, AND CONTINUOUS OVER A MINIMUM OF THREE SUPPORTS.

C. ALL WOOD PRODUCTS IN DIRECT CONTACT WITH THE FOUNDATION SHALL BE PRESSURE TREATED PER SPECIFICATION.

3. CONNECTIONS SHALL MEET THE FOLLOWING REQUIREMENTS:

A. ALL BOLTS SHALL BE ASTM A307. OVERSIZED WASHERS SHALL BE USED BETWEEN THE HEAD OR NUT AND THE WOOD MEMBER.

B. WOOD MEMBERS SHALL BE CONNECTED TOGETHER USING THE NAILING SCHEDULE UNLESS NOTED OTHERWISE. NO STAPLES ARE ALLOWED UNLESS NOTED OTHERWISE.

LOCATION	NAILING
TOP PLATE TO STUD, END-NAIL	2-16d
SOLE PLATE TO STUD, END-NAIL	2-16d, 4-8d TOE-NAIL
BUILT-UP STUDS	16d @ 24" CENTERS
DOUBLE TOP PLATE	16d @ 16" CENTERS
DOUBLE TOP PLATE SPLICE	8-16d
TRUSS TO NON-LOAD TOP PLATE	4-8d TOE-NAIL
DOUBLE HEADERS W/ 1/2" SPACER	16d @ 16" CENTERS EDGES
HEADER TO STUD, TOE-NAIL	4-8d EACH SIDE

C. ANCHORS TO FOUNDATION SHALL BE 1/2" DIA. ANCHOR BOLTS @ 48" CENTERS MAXIMUM. MINIMUM TWO ANCHOR BOLTS PER SILL BOARD WITH ONE ANCHOR BOLT WITHIN 12" OF EACH END OF EACH PIECE.

D. PLYWOOD DIAPHRAGMS AND SHEAR WALLS SHALL BE NAILED USING COMMON NAILS, SIZE AND SPACING SHOWN ON PLANS. SPECIAL PLYWOOD NAILS MAY BE SUBSTITUTED AS FOLLOWS:

10 GA. X 2" PLYWOOD NAILS FOR 8d COMMONS
9 GA. X 2 1/2" PLYWOOD NAILS FOR 10d COMMONS

4. PROVIDE BRIDGING AT 8'-0" CENTERS MAXIMUM FOR JOISTS AND RAFTERS USING 2X3 CROSS-BRIDGING OR SOLID BLOCKING.

6. WOOD HEADERS AND LINTELS SHALL BEAR ON TOP OF A SINGLE STUD AT EACH END FOR OPENINGS LESS THAN 3'-8". BEAR ON TOP OF DOUBLE STUDS FOR OPENINGS GREATER THAN 3'-8" AND LESS THAN 8'-0", AND TRIPLE STUDS FOR OPENINGS GREATER THAN 8'-0", UNLESS NOTED OTHERWISE. SUPPORT STUDS SHALL BE CONNECTED TO AN ADJACENT FULL LENGTH STUD.

(CONTINUED ON SHEET S2)

WITCHITA SCHOOL TORNADO SAFE ROOM WICHITA, KANSAS

LIMIT OF LIABILITY:

The designs included herein are based on extensive research of the causes and effects of windstorm damage to buildings.

Shelters designed and built to these designs should provide a high degree of occupant protection during tornadoes.

Any substitutions of either materials or design concepts may decrease the level of occupant protection and/or increase the possibility of personal injury during a severe wind event.

Because it is not possible to predict or test all conditions that may occur during severe windstorms, or control the quality of construction, among other things, the designer does not warrant the design.

The designer neither manufactures nor sells shelters built from this design. The designers have not made and do not make any representation, warranty, or covenant, express or implied, with respect to the design, condition, quality, durability, operation, fitness for use, or suitability of the shelter in any respect whatsoever.

Designers shall not be obligated or liable for actual, incidental, consequential, or other damages of or to users of shelters or any other person or entity arising out of or in connection with the use, condition, quality, performance of shelters built from this design or from the maintenance thereof.

STRUCTURAL NOTES

SHEET No.: S-1

DATE: 7 MARCH 2000

REVISED: _____ REV. NO. _____



G. MISCELLANEOUS

- CONCRETE PADS FOR MECHANICAL AND ELECTRICAL EQUIPMENT ON FLOORS SHALL BE 3 1/2" HIGH UNLESS OTHERWISE NOTED AND REINFORCED WITH #3 BARS ON 12" CENTERS, EACH WAY, 1 1/2" FROM TOP OF SLAB. WHEN THE PAD EXCEEDS 10" IN THICKNESS, REINFORCE WITH #3 BARS ON 12" CENTERS EACH WAY, TOP AND BOTTOM. ANCHOR PAD TO SLAB WITH #4 DOWELS AT 24" CENTERS, EACH WAY, CAST OR EPOXIED INTO SUPPORTING SLAB.
- CONTRACTOR SHALL SUPPLY ALL ITEMS FOR ATTACHING MECHANICAL AND ELECTRICAL EQUIPMENT TO THE BUILDING STRUCTURE TO RESIST ALL LOADS INCLUDING SEISMIC FORCES. ATTACHMENT SHALL BE MADE SO AS NOT TO OVERSTRESS STRUCTURAL MEMBERS. COORDINATE THE ATTACHMENTS AND LOCATIONS OF THE EQUIPMENT WITH THE STRUCTURAL SHOP DRAWINGS. REFER TO THE MECHANICAL AND ELECTRICAL DRAWINGS FOR ADDITIONAL REQUIREMENTS.
- SUBSTITUTION OF EXPANSION ANCHORS FOR ADHESIVE ANCHORS, EPOXY ANCHORS OR EMBEDDED ANCHORS SHOWN ON THE DRAWINGS WILL NOT BE PERMITTED UNLESS APPROVED BY THE ENGINEER IN ADVANCE.
- THE CONTRACTOR SHALL PROVIDE THE FOLLOWING ADDITIONAL SERVICES:
 - VERIFICATION OF ALL DIMENSIONS, ELEVATIONS, OPENING SIZES, AND MECHANICAL EQUIPMENT WEIGHTS PRIOR TO STARTING WORK.
 - REMOVE ALL ABANDONED FOUNDATIONS, UTILITIES, PIPELINES, ETC. THAT INTERFERE WITH NEW CONSTRUCTION.
 - REVIEW AND APPROVE ALL SHOP DRAWINGS PRIOR TO SUBMITTAL, NOTING CHANGES MADE WHICH DO NOT COMPLY WITH DESIGN DRAWINGS.
 - PROVIDE TEMPORARY BRACING AND SHORING TO PREVENT EXCESSIVE DEFLECTIONS AND DAMAGE DURING CONSTRUCTION. DESIGN OF TEMPORARY BRACING AND SHORING SHALL BE THE RESPONSIBILITY OF THE CONTRACTOR.

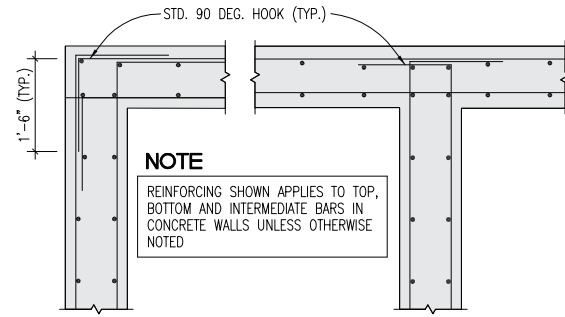

1 TYP. CORNER AND INTERSECTION REINF. NO SCALE

H. REQUIRED STRUCTURAL INSPECTIONS

- INSPECTIONS BY THE BUILDING OFFICIAL.
 - FOUNDATION INSPECTION AFTER EXCAVATION AND SOIL PREPARATION, BUT PRIOR TO PLACING REINFORCING. AGAIN, AFTER REINFORCING PLACEMENT AND PRIOR TO CONCRETE PLACEMENT.
 - CONCRETE SLAB ON GRADE/UNDERFLOOR INSPECTION SHALL BE MADE AFTER ALL UNDERFLOOR EQUIPMENT IS IN PLACE, BUT PRIOR TO CONCRETE PLACEMENT OR OTHER FLOORING PLACEMENT.
 - FRAMING INSPECTION SHALL BE MADE AFTER ALL ROUGH MECHANICAL, ELECTRICAL, AND PLUMBING EQUIPMENT IS IN PLACE, BUT PRIOR TO FIREPROOFING OR WALL COVERING IS INSTALLED.
 - FINAL INSPECTION SHALL BE MADE WHEN THE CONTRACTOR HAS COMPLETED THE BUILDING AND IT IS READY FOR OCCUPANCY.
- IN ACCORDANCE WITH THE REQUIREMENTS OF THE BUILDING CODE, THE OWNER WILL PROVIDE QUALIFIED PERSONNEL TO PERFORM THE FOLLOWING SPECIAL INSPECTIONS AND REPORT THE FINDINGS TO THE ENGINEER. THIS DOES NOT RELIEVE THE CONTRACTOR OF ANY RESPONSIBILITY TO PERFORM THE WORK IN ACCORDANCE WITH THE DESIGN DRAWINGS. THE CONTRACTOR SHALL NOTIFY THE INSPECTOR 24 HOURS IN ADVANCE OF ALL INSPECTIONS.
 - EXCAVATIONS, GRADING AND EARTH FILL SHALL BE INSPECTED IN ACCORDANCE WITH THE CODE.
 - FOUNDATION INSPECTION DURING THE PLACEMENT OF PILING, DRILLED PIERS, GRADE BEAMS, FOOTINGS, RETAINING WALLS, AND SLABS ON GRADE. ALL EMBEDDED BOLTS SHALL BE INSPECTED.
 - FRAMING INSPECTIONS DURING THE ERECTION OF ALL STEEL FRAMING MEMBERS. INSPECTIONS OF ALL DECKING PLACEMENT AND ATTACHMENTS.
 - DUCTILE-MOMENT RESISTING STEEL FRAMES SHALL HAVE WELDS INSPECTED IN ACCORDANCE WITH THE CODE.
 - HIGH-STRENGTH BOLTS SHALL BE INSPECTED DURING INSTALLATION AND TIGHTENING IN ACCORDANCE WITH THE CODE.
 - ALL REINFORCING STEEL SHALL BE INSPECTED PRIOR TO CONCRETE PLACEMENT. ALL PRESTRESSING SHALL BE INSPECTED DURING STRESSING AND DURING GROUTING.
 - DUCTILE MOMENT-RESISTING CONCRETE FRAMES AS REQUIRED IN THE CONCRETE CODE.
 - STRUCTURAL MASONRY SHALL BE INSPECTED DURING PLACEMENT IN ACCORDANCE WITH THE CODE.
 - SPRAY-APPLIED FIREPROOFING INSPECTIONS SHALL BE MADE IN ACCORDANCE WITH THE CODE.

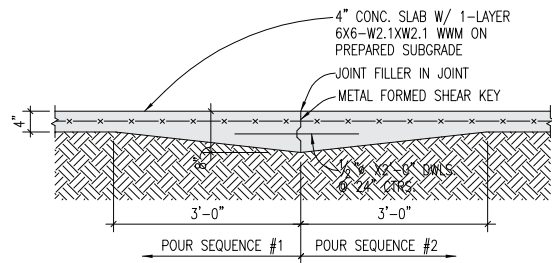

2 SLAB CONSTRUCTION JOINT (CJ) 3/4" = 1'-0"

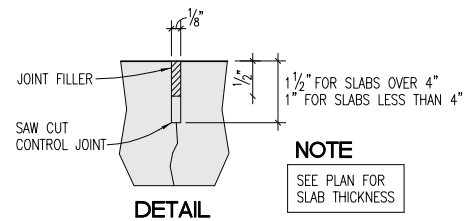

3 TYPICAL SLAB SAWN JOINT (SJ) NO SCALE

TABLE A - REINFORCEMENT TENSION LAPS, EMBEDMENT AND HOOK LENGTHS ①

$f_y = 60000 \text{ psi}$ $f'_c = 3000 \text{ psi}$ ② ③

BAR SIZE (d)	CLEAR SPACING (S) (in) ④			EMBEDMENT & CLASS A LAP (in) ⑤ ⑥ ⑦			CLASS B LAP (in) ⑧ ⑨			HOOK (in) ⑩						
	2d	3d	5d	TOP BAR ⑩		OTHER BARS	TOP BAR ⑩		OTHER BARS							
				$2d < S < 3d$	$S \geq 3d$ ⑪	$S \geq 5d$ ⑫	$2d < S < 3d$	$S \geq 3d$ ⑪	$S \geq 5d$ ⑫							
3	3/4	1 1/8	1 7/8	16	16	16	13	13	13	21	21	21	16	16	16	9
4	1	1 1/2	2 1/2	22	22	22	17	17	17	28	28	28	22	22	22	11
5	1 1/4	1 7/8	3 1/8	27	27	27	21	21	21	35	35	35	27	27	27	14
6	1 1/2	2 1/4	3 3/4	35	32	32	27	25	25	46	42	42	35	32	32	17
7	1 3/4	2 3/8	4 3/8	48	38	38	37	29	29	63	49	49	48	38	38	20
8	2	3	5	63	45	43	49	35	33	82	59	56	63	45	43	22
9	2 1/4	3 3/8	5 5/8	80	57	48	62	44	37	104	74	63	80	57	48	25
10	2.54	3.81	6.35	102	73	58	78	56	45	132	94	76	102	73	58	28
11	2.82	4.23	7.05	125	89	71	96	69	55	162	116	93	125	89	71	31

NOTES FOR USE WITH TABLE A

- LENGTHS SHOWN CONFORM WITH NON-SEISMIC PROVISIONS OF ACI 318-89 FOR UNCOATED BARS NOT ENCLOSED BY CLOSELY SPACED SPIRALS OR TIES. DEVELOPMENT OF REINFORCEMENT NOT COVERED BY THE TABLE SHALL CONFORM WITH ACI 218-89.
- MULTIPLY LENGTHS SHOWN BY 0.87 FOR 4000 PSI CONCRETE, BUT LENGTH OF LAP SHALL NOT BE LESS THAN 12 INCHES.
- MULTIPLY LENGTHS SHOWN BY 1.3 FOR LIGHTWEIGHT AGGREGATE CONCRETE.
- BAR CLEAR SPACING IS THE CENTER TO CENTER BAR SPACING MINUS TWO BAR DIAMETERS WHEN ALL BARS ARE LAPPED AT THE SAME LOCATION. WHEN BAR LAPS ARE STAGGERED TO LAP HALF THE BARS AT THE SAME LOCATION, THE BAR CLEAR SPACING IS TWICE THE CENTER TO CENTER BAR SPACING MINUS TWO BAR DIAMETERS. WHEN ALL BARS ARE EMBEDDED AT THE SAME LOCATION, THE BAR CLEAR SPACING IS THE CENTER TO CENTER BAR SPACING MINUS ONE BAR DIAMETER.
- CLASS A LAP LENGTHS APPLY WHEN BAR LAPS ARE STAGGERED TO LAP HALF THE BARS AT THE SAME LOCATION OR WHEN BARS ARE LAPPED AT A LOCATION OF MINIMUM STRESS IN THE BARS.
- LAP AND EMBEDMENT LENGTHS SHOWN APPLY WHEN BAR MINIMUM CONCRETE COVER OVER BARS CONFORMS WITH VALUES GIVEN IN THE TABLE FOR "CONCRETE COVER". THESE COVER VALUES CONFORM WITH ACI 318-89.
- CLASS A LAP AND EMBEDMENT LENGTH HAVE SAME VALUE.
- CLASS B LAP LENGTHS APPLY WHEN ALL BARS ARE SPLICED AT A LOCATION OF MAXIMUM STRESS IN THE BARS.
- HOOK LENGTH GIVEN IS THE STRAIGHT LINE DISTANCE FROM THE LOCATION OF MAXIMUM STRESS IN THE BAR TO THE OUTSIDE END OF THE HOOK. MULTIPLY LENGTHS GIVEN BY 0.7 FOR HOOKS WITH SIDE COVER NORMAL TO THE HOOK NOT LESS THAN 2 1/2 INCHES AND FOR 90 DEGREE HOOKS COVER ON BAR EXTENSION BEYOND HOOK NOT LESS THAN 2 INCHES.
- TOP BARS ARE HORIZONTAL REINFORCEMENT PLACED SO THAT MORE THAN 12 INCHES OF CONCRETE IS CAST BELOW THE REINFORCEMENT.
- MULTIPLY LAP AND EMBEDMENT LENGTHS GIVEN BY 2.0 FOR BARS WITH CLEAR SPACING OF TWO BAR DIAMETERS OR LESS, OR CONCRETE COVER OF ONE BAR DIAMETER OR LESS.
- MINIMUM CONCRETE COVER FROM FACE OF MEMBER TO EDGE BAR SHALL NOT BE LESS THAN TWO AND ONE HALF BAR DIAMETERS.

WICHITA SCHOOL
TORNADO SAFE ROOM
WICHITA, KANSAS

LIMIT OF LIABILITY:

The designs included herein are based on extensive research of the causes and effects of windstorm damage to buildings.

Shelters designed and built to these designs should provide a high degree of occupant protection during tornadoes.

Any substitutions of either materials or design concepts may decrease the level of occupant protection and/or increase the possibility of personal injury during a severe wind event.

Because it is not possible to predict or test all conditions that may occur during severe windstorms, or control the quality of construction, among other things, the designer does not warrant the design.

The designer neither manufactures nor sells shelters built from this design. The designers have not made and do not make any representation, warranty, or covenant, express or implied, with respect to the design, condition, quality, durability, operation, fitness for use, or suitability of the shelter in any respect whatsoever.

Designers shall not be obligated or liable for actual, incidental, consequential, or other damages of or to users of shelters or any other person or entity arising out of or in connection with the use, condition, and/or performance of shelters built from this design or from the maintenance thereof.

STRUCTURAL NOTES

SHEET No.: S-2

DATE: 7 MARCH 2000

REVISED: REV. NO.



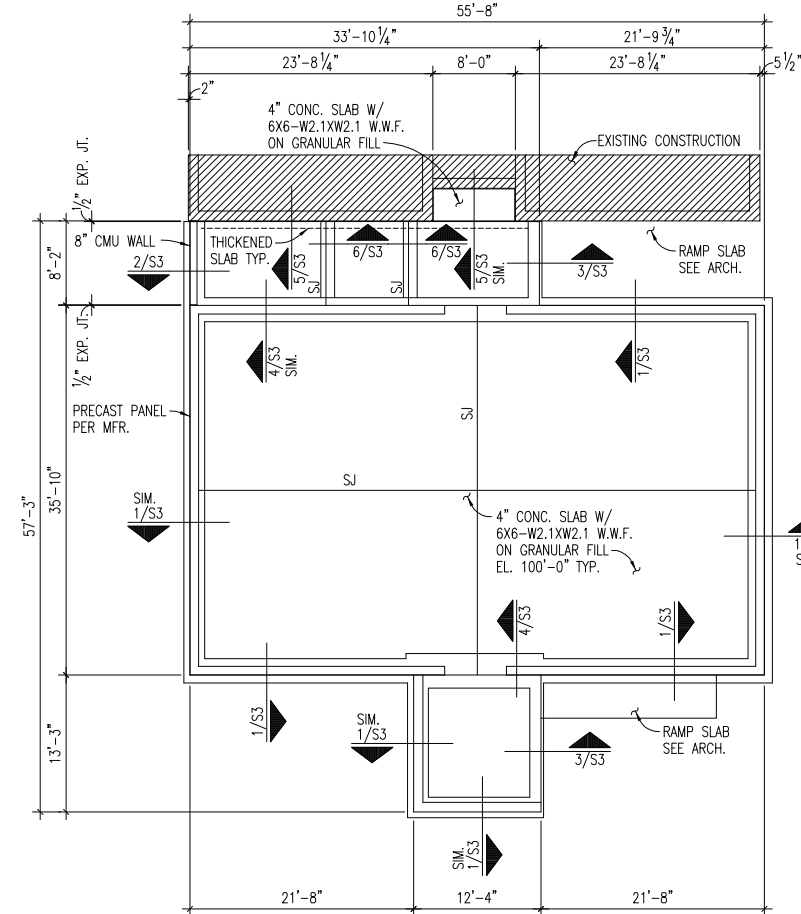
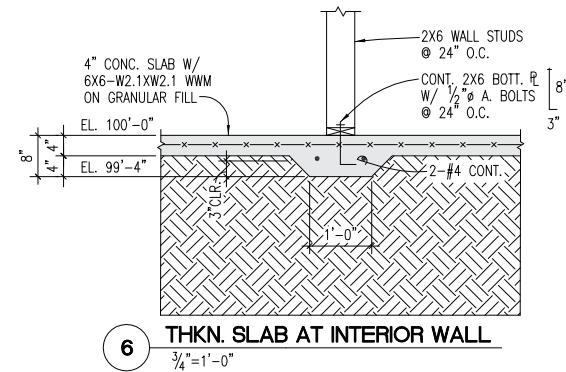
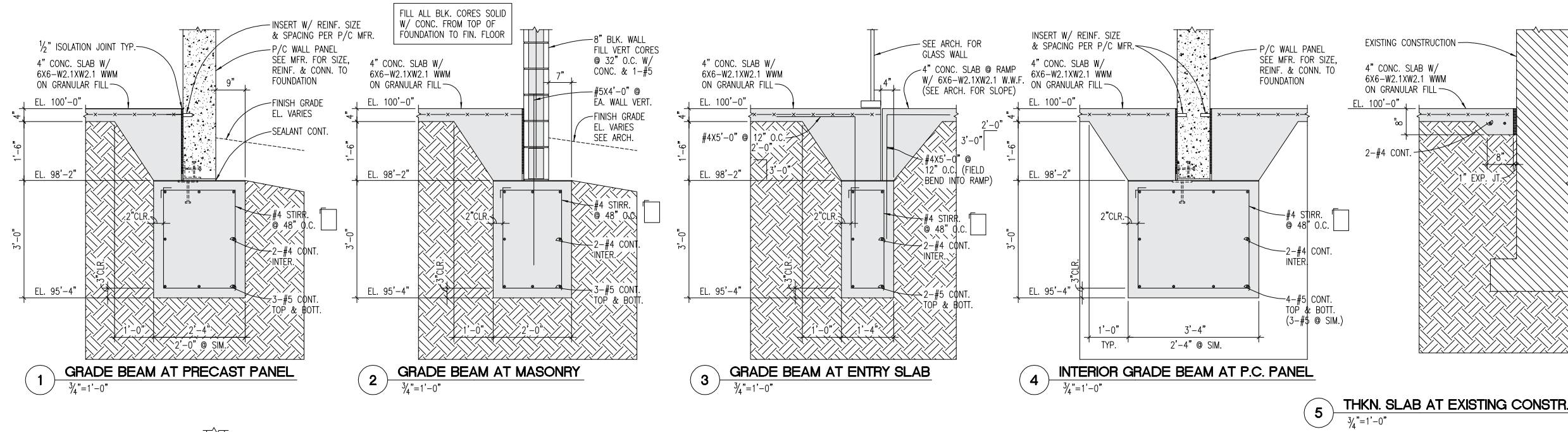

WICHITA SCHOOL TORNADO SAFE ROOM

WICHITA, KANSAS

LIMIT OF LIABILITY:

The designs included herein are based on extensive research of the causes and effects of windstorm damage to buildings.

Shelters designed and built to these designs should provide a high degree of occupant protection during tornadoes.

Any substitutions of either materials or design concepts may decrease the level of occupant protection and/or increase the possibility of personal injury during a severe wind event.

Because it is not possible to predict or test all conditions that may occur during severe windstorms, or control the quality of construction, among other things, the designer does not warrant the design.

The designer neither manufactures nor sells shelters built from this design. The designers have not made and do not make any representation, warranty, or covenant, express or implied, with respect to the design, condition, quality, durability, operation, fitness for use, or suitability of the shelter in any respect whatsoever.

Designers shall not be obligated or liable for actual, incidental, consequential, or other damages of or to users of shelters or any other person or entity arising out of or in connection with the use, condition, and/or performance of shelters built from this design or from the maintenance thereof.

FOUNDATION DETAILS

SHEET No.: S-3
 DATE: 7 MARCH 2000
 REVISED: _____ REV. NO. _____



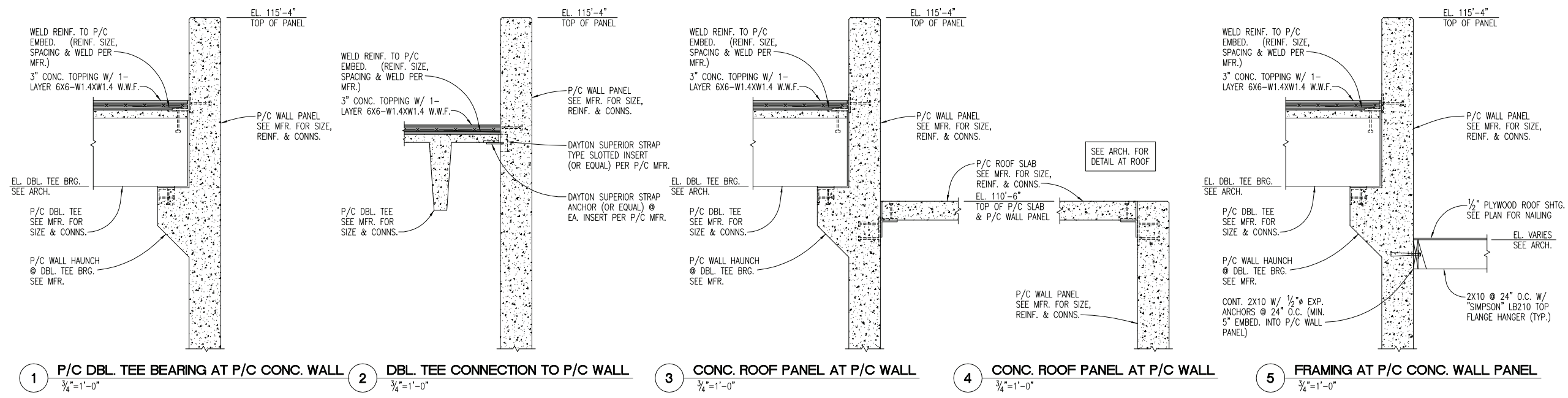

1 P/C DBL. TEE BEARING AT P/C CONC. WALL 3/4"=1'-0"
 2 DBL. TEE CONNECTION TO P/C WALL 3/4"=1'-0"
 3 CONC. ROOF PANEL AT P/C WALL 3/4"=1'-0"
 4 CONC. ROOF PANEL AT P/C WALL 3/4"=1'-0"
 5 FRAMING AT P/C CONC. WALL PANEL 3/4"=1'-0"

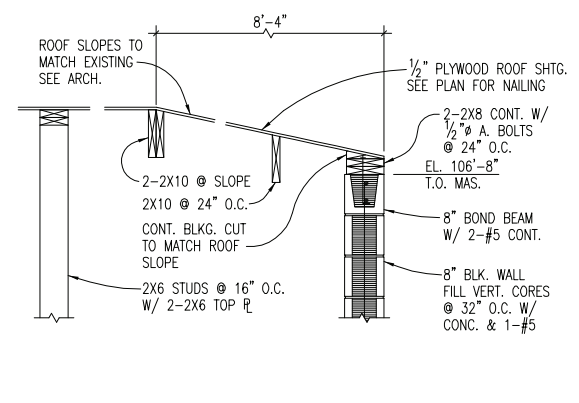

6 ROOF FRAMING AT BLOCK WALL 3/4"=1'-0"

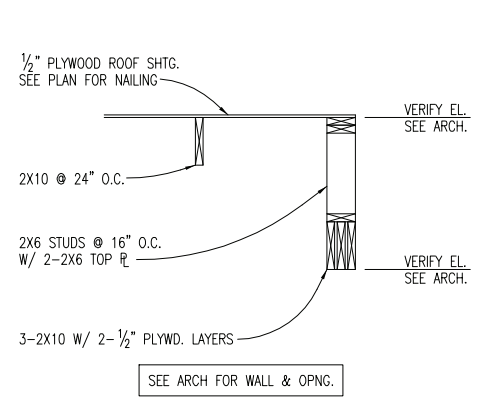

7 BEAM ABOVE GLASS FRAMING 3/4"=1'-0"

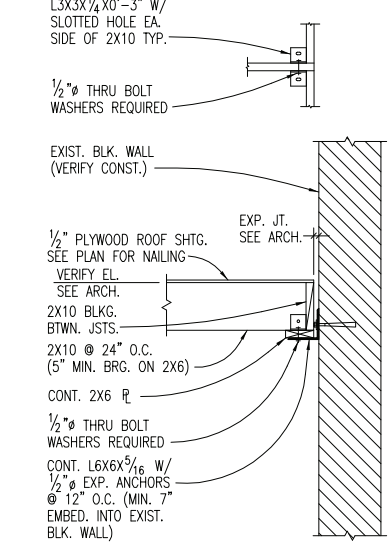

8 FRAMING AT EXIST. MAS. WALL 3/4"=1'-0"

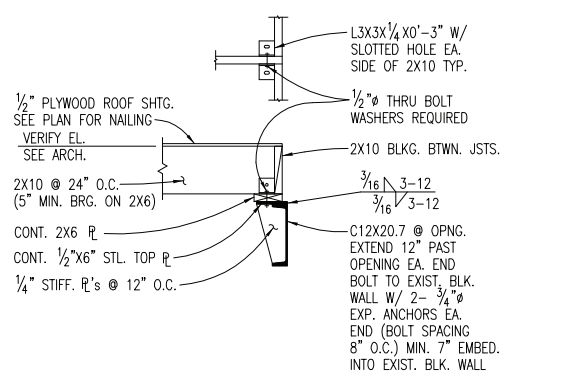

9 FRAMING AT STEEL BEAM 3/4"=1'-0"

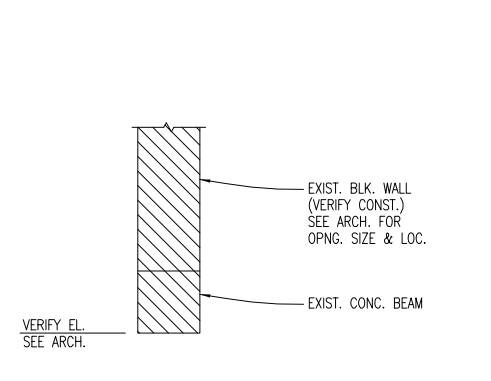

10 STEEL OPNG. FRAMING AT EXIST. BLK. 3/4"=1'-0"

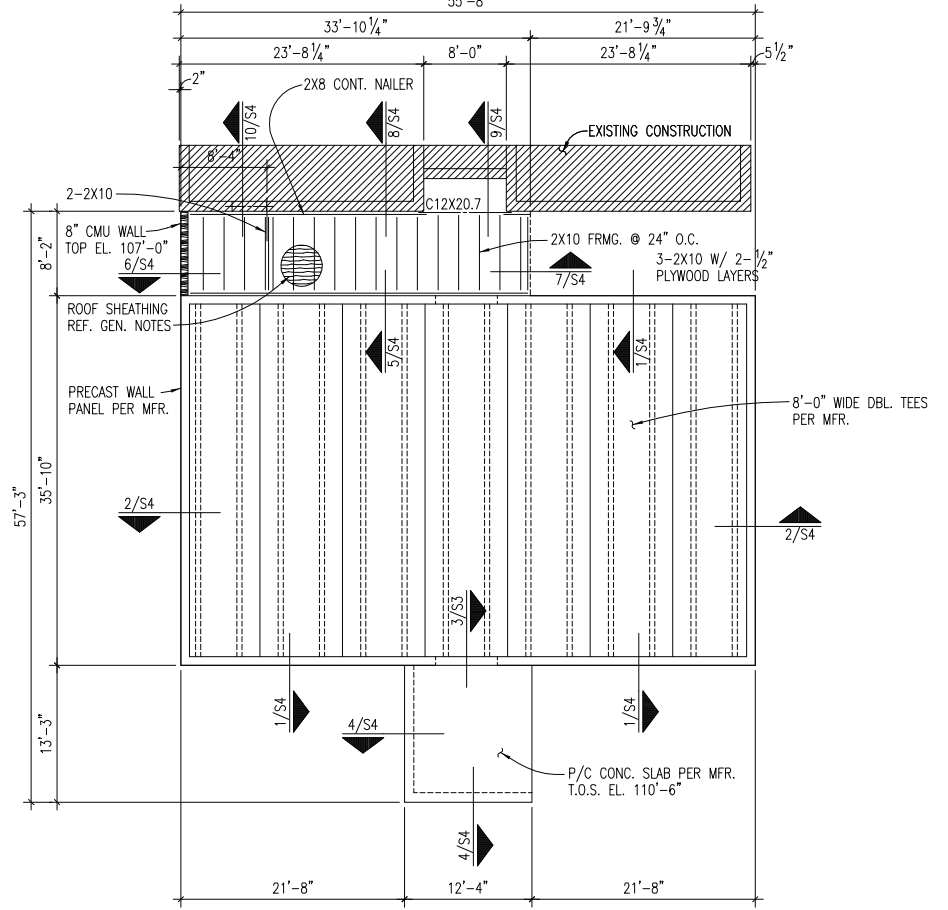

ROOF FRAMING PLAN 1/8"=1'-0"
 ROOF PLYWOOD DIAPHRAGM NAILING
 8d NAILS @ 6" O.C. @ PANEL EDGES
 8d NAILS @ 12" O.C. @ INTER. SUPPORTS

WICHITA SCHOOL TORNADO SAFE ROOM

WICHITA, KANSAS

LIMIT OF LIABILITY:
 The designs included herein are based on extensive research of the causes and effects of windstorm damage to buildings.
 Shelters designed and built to these designs should provide a high degree of occupant protection during tornadoes.
 Any substitutions of either materials or design concepts may decrease the level of occupant protection and/or increase the possibility of personal injury during a severe wind event.
 Because it is not possible to predict or test all conditions that may occur during severe windstorms, or control the quality of construction, among other things, the designer does not warrant the design.
 The designer neither manufactures nor sells shelters built from this design. The designers have not made and do not make any representation, warranty, or covenant, express or implied, with respect to the design, condition, quality, durability, operation, fitness for use, or suitability of the shelter in any respect whatsoever.
 Designers shall not be obligated or liable for actual, incidental, consequential, or other damages of or to users of shelters or any other person or entity arising out of or in connection with the use, condition, and/or performance of shelters built from this design or from the maintenance thereof.

GENERAL NOTES

- ALL WORK SHALL COMPLY WITH LOCAL, STATE AND NATIONAL CODES.
- THE ELECTRICAL CONTRACTOR SHALL SECURE AND PAY FOR ALL PERMITS, FEES, INSPECTIONS AND CERTIFICATES REQUIRED.
- THE ELECTRICAL CONTRACTOR SHALL FURNISH ALL LABOR, MATERIAL, TOOLS, TRANSPORTATION, AND EQUIPMENT REQUIRED FOR THE COMPLETE, PROPER AND SUBSTANTIAL INSTALLATION OF ALL ELECTRICAL WORK INDICATED OR REQUIRED FOR A COMPLETE WORKING INSTALLATION OF ALL ELECTRICAL SYSTEMS.
- REFER TO ARCHITECTURAL, STRUCTURAL AND MECHANICAL PLANS FOR RELATED INFORMATION.
- REFER TO MECHANICAL PLANS AND SPECIFICATIONS FOR EXACT LOCATION OF MECHANICAL EQUIPMENT AND T-STAT LOCATIONS. FUSING OF MECHANICAL EQUIPMENT AS PER NAME PLATE DATA ON EQUIPMENT.
- ALL LINE VOLTAGE WIRING SHALL BE COPPER IN STEEL CONDUIT & STEEL BOXES, UNLESS SPECIFICALLY NOTED OTHERWISE. EACH CONDUIT CONTAINING LINE VOLTAGE SHALL CONTAIN A GREEN, INSULATED GROUND CONDUCTOR. ALL CONDUITS ROUTING SHALL BE INSTALLED PARALLEL AND PERPENDICULAR. ALL CONDUIT PENETRATIONS OF FIRE RATED WALLS SHALL BE SEALED WITH AN APPROPRIATELY RATED FIRE STOP MATERIAL.
- STRAIGHT RUNS UNDERGROUND / IN SLAB CONDUIT MAY BE SCHEDULE 40 PVC, 3/4" MINIMUM WITH STEEL ELLS, BENDS AND RISERS. ALL RISERS PENETRATING SLAB OR EXTING FROM EARTH SHALL BE RIGID STEEL. NO EXCEPTIONS.
- ALL CONDUITS STUBBED OUT OF BUILDING, SHALL BE CAPPED AND MARKED.
- ALL CONDUITS STUBBED INTO THE CEILING CAVITY FOR MECHANICAL CONTROLS, FIRE ALARM, DATA, COMMUNICATIONS, TELEVISION, CLOCKS, INTERCOM, ETC. SHALL BE PROVIDED WITH A PRESS ON, INSULATING BUSHING. ARLINGTON INDUSTRIES # 8MT SERIES OR EQUAL.
- VERIFY ALL OUTLET LOCATIONS ON JOB, PRIOR TO ROUGH-IN.
- EXTERIOR EXPOSED CONDUIT RUNS WILL NOT BE PERMITTED. (EXCEPT FOR SERVICE ENTRANCES POWER/TELEPHONE OR NOTED OTHERWISE ON PLAN.)
- REFER TO ARCHITECTURAL PLANS/SPECIFICATIONS FOR A DETAILED DESCRIPTION OF ALL ALTERNATES. ELECTRICAL WORK MAY BE INVOLVED THAT DOES NOT SHOW ON THE ELECTRICAL PLANS.
- ALL NEW CONDUIT SHALL BE INSTALLED CONCEALED INSIDE CONSTRUCTION. ANY NEW SURFACE MOUNTED RACEWAYS, IN FINISHED AREAS, SHALL BE APPROVED IN WRITING BY THE ARCHITECT PRIOR TO INSTALLATION. NO EXCEPTIONS. SURFACE MOUNTED RACEWAY IN NON-SHOP FINISHED AREAS SHALL BE WIREMOLD #500/700 RACEWAY. RUNS SHALL BE PARALLEL/PERPENDICULAR TO STRUCTURE. FASTEN TO WALLS (ANCHORS IN SOLID WALLS / TOGGLE ANCHORS IN HOLLOW WALLS) EVERY 36". E.C. RESPONSIBLE FOR PAINTING RACEWAYS TO MATCH SURROUNDINGS, EITHER FOR EXISTING AREAS AND/OR NEW CONSTRUCTION. EMT CONDUIT IS ACCEPTABLE INSIDE NEW SHOP/CLASS ROOM AREA.
- E.C. SHALL VISIT SITE TO DETERMINE : 1.) EXISTING CONDITIONS. 2.) THE EXTENT OF DEMOLITION. ANY CONFLICTS BETWEEN PLANS/SPECIFICATIONS AND ACTUAL EXISTING CONDITIONS THAT AFFECT CONSTRUCTABILITY, SHALL BE BROUGHT TO THE ATTENTION OF THE ENGINEER PRIOR TO BID. NO EXCEPTIONS.
- ALL PANELS SHALL BE PANELBOARD CONSTRUCTION WITH BOLT-IN CIRCUIT BREAKERS, COPPER BUS AND COPPER GROUND BUS.
- TELEPHONE OUTLETS: EMPTY 4" SQUARE BOX WITH A SINGLE GANG PLASTER RING AND BLANK PLATE. PROVIDE 3/4" C. WITH PULL WIRE FROM OUTLET TO ABOVE ACCESSIBLE CEILING. CONDUCTORS, CONDUIT INSTALLATION AND TERMINATIONS NOT IN CONTRACT.
- CRT/DATA OUTLETS: EMPTY 4" SQUARE BOX WITH A SINGLE GANG PLASTER RING AND BLANK PLATE. PROVIDE 3/4" C. WITH PULL WIRE FROM OUTLET TO ABOVE ACCESSIBLE CEILING. CONDUCTORS, CONDUIT INSTALLATION AND TERMINATIONS NOT IN CONTRACT.
- COLOR OF DEVICES/PLATES: MATCH EXISTING TYPE OF PLATES: MATCH EXISTING
- MECHANICAL/TEMPERATURE CONTROL WIRING NEED NOT BE INSTALLED IN CONDUIT ABOVE ACCESSIBLE CEILINGS, UNLESS SPECIFICALLY NOTED OTHERWISE. REFER TO THE MECHANICAL PLANS AND SPECIFICATIONS. CONDUIT IS REQUIRED FOR VERTICAL RUNS IN WALLS AND WHERE EXPOSED. ALL CONDUIT REQUIRED, SHALL BE PROVIDED AND INSTALLED BY THE E.C. REQUIRED CONDUCTORS AS FOLLOWS:
 - ALL LINE VOLTAGE SUPPLY (CONSTANT) POWER WIRING SHALL BE PROVIDED AND INSTALLED, IN CONDUIT, BY THE E.C.
 - ALL LOW LINE VOLTAGE CONTROL (SWITCHED) WIRING, WIRING INSTALLATION AND TERMINATIONS SHALL BE PROVIDED AND INSTALLED BY THE M.C./T.C.C. (LINE VOLTAGE CONTROL WIRING SHALL BE INSTALLED IN CONDUIT. CONDUIT FOR LINE VOLTAGE CONTROL WIRING - BY E.C.)
- "BACK TO BACK" MOUNTING OF DEVICES IN WALLS IS NOT ALLOWED. MINIMUM OF ONE STUD SPACE BETWEEN DEVICES.
- E.C. IS RESPONSIBLE FOR THE RELOCATION OF ALL ELECTRICAL DEVICES, EXISTING OR NEW, DUE TO ANY ARCHITECTURAL MODIFICATIONS. REFER TO THE ARCHITECTURAL PLANS, SPECIFICATIONS AND ADDENDA FOR: NEW DOOR LOCATIONS, WALL REMOVAL, WALL ADDITIONS, CEILING MODIFICATIONS, ETC.
- REFER TO THE ARCHITECTURAL PLANS/SPECIFICATIONS FOR A COMPLETE, DETAILED LIST OF ALL ALTERNATES.
- THE MOUNTING HEIGHTS OF THE ELECTRICAL DEVICES ARE TO THE CENTER OF THE DEVICE. REFER TO THE SYMBOL LIST. SPECIAL MOUNTING HEIGHTS ARE SHOWN ADJACENT TO THE DEVICE. ALL MOUNTING HEIGHTS LISTED ARE FROM ABOVE FINISHED FLOOR. (AFF) EXCEPTION: E.C. SHALL COORDINATE THE MOUNTING OF FLUSH MOUNTED DEVICES IN MASONRY BLOCK WALLS WITH THE MASONRY CONTRACTOR. MOUNTING HEIGHTS WILL BE DETERMINED BY ACTUAL BLOCK CONFIGURATION. MOUNT DEVICES SUCH THAT THE EDGE OF THE COVER PLATE IS EVEN WITH THE TOP OR BOTTOM OF THE BLOCK. DO NOT OVERLAP JOINT. MOUNT DEVICES IN A SINGLE BLOCK.
- E.C. SHALL PROVIDE AND INSTALL A SINGLE GANG BOX, 48" AFF WITH 1/2" CONDUIT TO ABOVE ACCESSIBLE CEILING FOR T-STATS. REFER TO THE MECHANICAL PLANS FOR PLACEMENT OF T-STATS.
- REFER TO THE MECHANICAL ADDENDA FOR THE ADDITION, DELETION OR REVISION OF MECHANICAL EQUIPMENT.
- DO NOT MOUNT DISCONNECT SWITCHES ON ACCESSIBLE PANELS FOR RTU'S, AHU'S, ETC. E.C. SHALL PROVIDE AND INSTALL PROPER SUPPORTS TO MOUNT SWITCH, CLEAR OF ALL ACCESSIBLE PANELS.
- REFER TO THE ARCHITECTURAL PLANS FOR THE EXTENT OF ALL DEMOLITION.
- E.C. IS RESPONSIBLE FOR RETAINING THE CONTINUITY OF EACH EXISTING BRANCH CIRCUIT. SPECIAL ATTENTION SHALL BE GIVEN TO THOSE CIRCUITS WHICH WILL BE ALTERED DUE TO THE DEMOLITION AND/OR NEW CONSTRUCTION.
- E.C. SHALL COORDINATE ANY "DOWN TIME" OF ANY SYSTEM WITH THE OWNER. THIS INCLUDES BUT NOT LIMITED TO: EMERGENCY LIGHTING, FIRE ALARM SYSTEM, COMMUNICATION SYSTEM, DATA SYSTEM, NORMAL POWER, ETC. E.C. SHALL INFORM OWNER, IN WRITING, 5 WORKING DAYS PRIOR TO "SCHEDULED SHUT-DOWNS". LIFE SAFETY SYSTEMS SUCH AS FIRE ALARM AND EMERGENCY LIGHTING MUST REMAIN ACTIVE AT ALL TIMES WHEN THE SPACE IS OCCUPIED.
- EACH BRANCH CIRCUIT SHALL HAVE IT'S OWN SEPARATE NEUTRAL. DO NOT COMBINE MULTIPLE BRANCH CIRCUITS WITH A COMMON NEUTRAL.

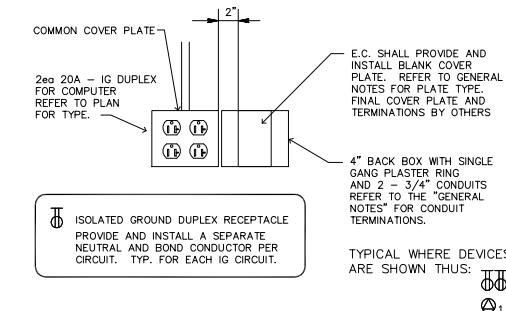

WORK STATION DETAIL

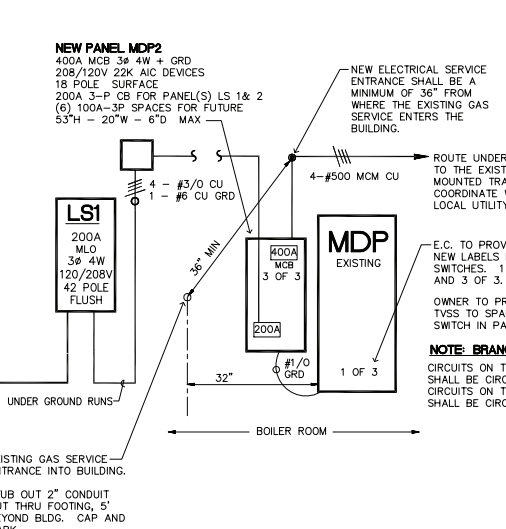

DISTRIBUTION DIAGRAM

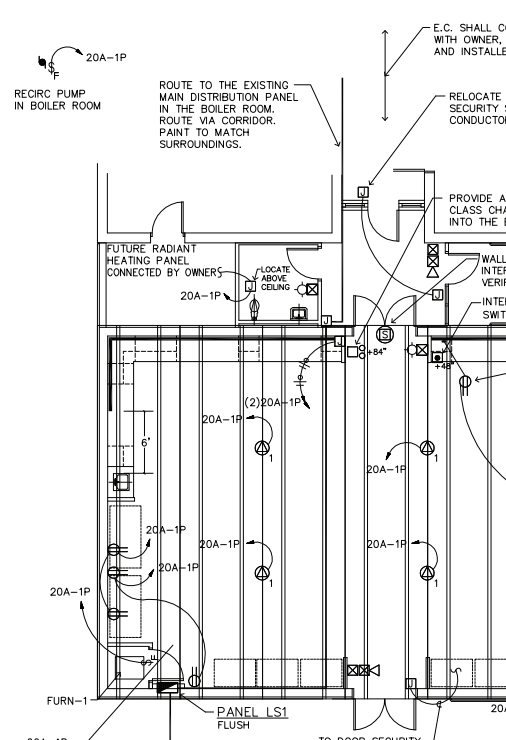

POWER PLAN

SCALE: 1/8" = 1'-0"

LIGHT FIXTURE SCHEDULE

SYMBOL	MFG. & CATALOG NUMBER	VOLT	LAMPS	MOUNTING
A	LITHONIA # 8TLB332-120ES	120	3 - F032/741	18" STEM SET
B	WILLIAMS # 50G-S24-2320C-SWKA125-ET8	120	2 - F032/741	TROFFER
C	LITHONIA # TWH-70S-120	120	1 - LU70	WALL @ 12'
D	LITHONIA # TWH-100S-120	120	1 - LU100	WALL @ 12'
F	PATTON # 989W WHITE 3 SPEED/REVERSIBLE	120	NONE	36" PENDANT
	SURE-LITE # CAX-7-1/2-70-R-120/277	120	FURNISHED W/UNIT	CEILING
	SURE-LITE # CAX-7-1/2-70-R-120/277	120	FURNISHED W/UNIT	WALL
	SURE-LITE # RD-3 (MINI HEADS)	120	FURNISHED W/UNIT	RECESSED CLG
	SURE-LITE # XR11-215 (WG = WIRE GUARD)	120	FURNISHED W/UNIT	WALL

- SPECIFICATION GRADE TROFFER EQUALS: WILLIAMS SERIES 50, LITHONIA SERIES 2SP-APAF, METALUX SERIES 20C, COLUMBIA SERIES 4000-PAF. ENTIRE FIXTURE SHALL BE POST PAINTED INCLUDING SOCKET RAILS, BALLAST COVER, END PLATES, DOOR FRAME, ETC. LENS: .125 NOMINAL THICK EQUAL TO KSH-12.
- EXIT SIGN EQUALS: PRESCOLITE "COMPASS" SERIES LITHONIA "SIGNATURE" SERIES
- ALL SUBSTITUTIONS SHALL BE REVIEWED AT SHOP DRAWINGS FOR ACCEPTANCE OR REJECTION. ATTENTION SHALL BE GIVEN TO LAMPS, VOLTAGE, MOUNTING, PHYSICAL DIMENSIONS, FINISHES, PHOTOMETRICS, ETC.
- SURFACE MOUNTED FIXTURES MOUNTED TO A "T" BAR CEILING GRID SHALL BE FASTENED TO THE GRID IN FOUR PLACES TO INSURE RIGID SUPPORT.
- CONNECT TO UNSWITCHED LEG OF LOCAL AREA LIGHTING CIRCUIT. REFER TO THE LIGHTING PLANS FOR EXIT SIGN FACE AND ARROW DIRECTIONS. PROVIDE BATTERY FOR EXITS AND EGRESS FIXTURES.
- ALL HID FIXTURES SHALL BE "BURNED-IN" AS PER LAMP MANUFACTURER'S RECOMMENDATIONS TO INSURE PROPER LAMP LIFE.
- ALL FLUORESCENT FIXTURES SHALL BE SUPPLIED WITH INSTANT START, 20K HZ ELECTRONIC BALLAST(S). ACCEPTED BALLASTS: MOTOROLA/GE G-IN SERIES, ADVANCE REL/VEL P SERIES, EQUAL BY PENNSYLVANIA AND UNIVERSAL. BALLASTS SHALL BE COMPATIBLE WITH LAMPS.
- FIXTURES DESIGNATED "d.b." SHALL BE SWITCHED FOR DUAL LEVEL ILLUMINATION. OUTBOARD LAMPS SEPARATE FROM INBOARD LAMPS. E.C. OPTION: MASTER / SLAVE FIXTURES (CONSIDER ODD NUMBER OF FIXTURES WITHIN AN AREA) OR PROVIDE EACH FIXTURE WITH 2 BALLASTS.

SCOPE OF WORK

- INTERCOM SYSTEM: E.C. SHALL PROVIDE CONDUIT, BOXES AND WIRING FOR THE NEW INTERCOM EQUIPMENT. DEEP WIREMOLD BOX FOR THE CALL-IN SWITCH. SHALLOW WIREMOLD BOX FOR THE SPEAKER. WIRING FROM THE NEW CLASSROOM TO THE EXISTING MASTER INTERCOM IN THE OFFICE AREA. USE EXISTING INTERCOM RACEWAYS WHERE POSSIBLE. ALLOW 36" OF CONDUCTORS AT TERMINATION POINTS FOR OWNER CONNECTIONS. OWNER SHALL PROVIDE AND INSTALL: CALL-IN/PRIVACY SWITCH, SURFACE SPEAKER, AND CONNECTIONS TO MASTER.
- SECURITY SYSTEM: E.C. SHALL RELOCATE DOOR SWITCH FROM THE EXISTING SOUTH EXTERIOR DOOR TO THE NEW EAST EXTERIOR DOOR (APPROX 10' TO THE S.E.). E.C. TO PROVIDE AND INSTALL -BOX, CONDUIT/WIREMOLD, AND CONDUCTORS FROM THE NEW SET OF DOUBLE DOORS (SOUTH) TO THE EXISTING SECURITY PANEL IN THE BOILER ROOM. ALLOW 36" OF CONDUCTORS AT TERMINATION POINTS FOR OWNER CONNECTIONS. VERIFY CONDUCTOR TYPE W/ OWNER. OWNER SHALL PROVIDE AND INSTALL: SECURITY DEVICES AND CONNECTIONS.
- FIRE ALARM: PROVIDE AND INSTALL A NEW SIMPLEX 4010 FACP AND NECESSARY NEW DEVICES AS SHOWN ON PLAN. PROVIDE AND INSTALL NECESSARY WIRING AND CONNECTIONS AS REQUIRED FOR A COMPLETE AND OPERATIONAL SYSTEM. CONNECT THE NEW AND EXISTING FIRE ALARM SYSTEMS TOGETHER. EITHER SYSTEM SHALL ACTIVATE THE OTHER. LOCATE FACP AND SMOKE DETECTOR IN THE PRINCIPALS OFFICE ON NORTH WALL, EAST OF DOOR.

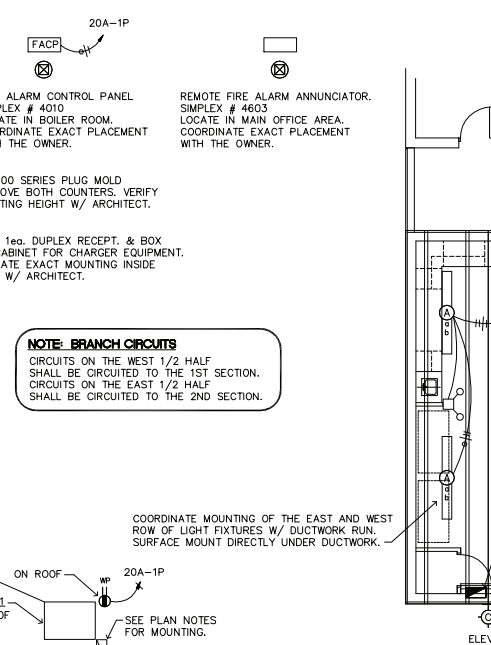

LIGHTING PLAN

SCALE: 1/8" = 1'-0"

SYMBOL LIST

SYMBOL	DESCRIPTION	MOUNTING
AFF	ABOVE FINISHED FLOOR	
CT	MOUNTED ABOVE COUNTER TOP	VERIFY HT.
EM	CONNECTED TO EMERGENCY POWER	
NL	NIGHTLIGHT, WIRE FOR CONTINUOUS OPERATION	
WP	WEATHER PROOF	
3R	NEMA 3R ENCLOSURE	
TB	TELEPHONE TERMINAL BOARD	
a,b,c,d	SWITCH DESIGNATION (LIGHTS, FANS ETC.)	
E.C. M.C. G.C. T.C.C.	ELECTRICAL CONTRACTOR, MECHANICAL CONTRACTOR, GENERAL CONTRACTOR, TEMP. CONTROL CONTRACTOR	
	SWITCHES (2-POLE, 3-WAY, 4-WAY, PILOT, KEY)	4'-0" AFF ON EQUIPMENT
	FUSTAT IN BUSS FUSETRON BOX COVER UNIT W/ SW. MOTOR SPEED CONTROL, SIZE AS INDICATED	4'-0" AFF
	WIRE STATION - SEE DETAIL	1'-4" AFF
	20 A. 125 V. IG DUPLEX RECEPTACLE FOR COMPUTER HUBBELL # IG 5362 ORANGE. SEPARATE NEUTRAL AND BOND CONDUCTORS PER CIRCUIT. IG CONDUCTORS IN SEPARATE RACEWAY SYSTEM.	1'-4" AFF
	20 A. 125 V. DUPLEX GROUNDED RECEPTACLE	1'-4" AFF
	20 A. 125 V. DUPLEX GFI RECEPTACLE - 5 mA FEED THRU PROTECTION TO NORMAL RECEPTACLES IS NOT ACCEPTABLE.	1'-4" AFF
	20 A. 125V. 1/2 SWITCHED DUPLEX RECEPTACLE	1'-4" AFF
	20 A. 125 V. DOUBLE DUPLEX GROUNDED RECEPTACLE	1'-4" AFF
	20 A. 125 V. SINGLE DUPLEX GROUNDED RECEPTACLE FOR DRINKING FOUNTAIN. CONCEAL BEHIND FOUNTAIN	HORIZONTAL
	15 A. 125 V. CLOCK RECEPTACLE	6'-6" AFF
	MOTOR JUNCTION BOX	
	SPECIAL DEVICE AS NOTED	
	CONDUIT RUN 1/2" CONDUIT	WALL, CEILING
	CONDUIT RUN 3/4" CONDUIT MINIMUM	FLOOR, EARTH
	CONDUIT RUN W/ 3 HOTS, 1 NEUTRAL, & 1 GROUND	
	TO PANEL - CIRCUIT AS INDICATED (20A-1P. BREAKER UNLESS OTHERWISE INDICATED)	
	PARTIAL CIRCUIT	
	120/208 V. 3φ 4W. CIRCUIT BREAKER PANELBOARD	6'-0" TO TOP
	FUSED DISCONNECT SWITCH - HEAVY DUTY	
	MAGNETIC MOTOR STARTER	6'-0" TO TOP
	FLUORESCENT FIXTURE - AND FIXTURE DESIGNATION	CEILING
	SEE WORKSTATION DETAIL, THIS SHEET.	
	FIRE ALARM MANUAL PULL STATION	4'-0" AFF
	FIRE ALARM UNIT - COMBINATION AUDIO/VISUAL 80" AFF OR 6" BELOW THE CEILING WHICHEVER IS LOWER. 30/110 cd	AS PER ADA
	FIRE ALARM UNIT - STROBE ONLY 80" AFF OR 6" BELOW THE CEILING WHICHEVER IS LOWER. 30/110 cd	AS PER ADA
	FIRE ALARM CONTROL PANEL - SIMPLEX 4010	

WITCHITA SCHOOL TORNADO SAFE ROOM

WICHITA, KANSAS

LIMIT OF LIABILITY:

The designs included herein are based on extensive research of the causes and effects of windstorm damage to buildings. Safe Rooms designed and built to these designs should provide a high degree of occupant protection during tornadoes. Any substitution of either materials or design concepts may decrease the level of occupant protection and/or increase the possibility of personal injury during a severe wind event.

Because It is not possible to predict or test all conditions that may occur during severe windstorms, or control the quality of construction, among other things, the designer does not warrant the design.

The designer neither manufactures nor sells safe rooms built from this design. The designers have not made and do not make any representation, warranty, or covenant, express or implied, with respect to the design, condition, quality, durability, operation, fitness for use, or suitability of the safe room in any respect whatsoever. Designers shall not be obligated or liable for actual, incidental, consequential, or other damages of or to users of safe rooms or any other person or entity arising out of or in connection with the use, condition, and/or performance of safe rooms built from this design or from the maintenance thereof.

ELECTRICAL PLAN

SHEET No.: E-1
DATE: 7 MARCH 2000
REVISED: _____ REV. NO. _____



SYMBOL SCHEDULE

MARK	DESCRIPTION	MARK	DESCRIPTION	MARK	DESCRIPTION
W	WASTE PIPING (W)	AV	AIR VENT	FSD	FIRE & SMOKE DPR
CD	CONDENSATE DRAIN (CD)	BV	BALL VALVE	CRD	CEILING RADIATION DAMPER
RLP	RAIN LEADER PIPING	F.D.	FLOOR DRAIN	RAG	RETURN AIR GRILLE
CW	COLD WATER PIPING (CW)	VR	VENT THRU ROOF	WPL	WEATHERPROOF LOUVER
HW	HOT WATER PIPING (HW)			SR	SUPPLY REGISTER
HRP	HOT WATER RECIRCULATING PIPING			ER	EXHAUST REGISTER
VP	PLUMBING VENT (V)	M.C.	MECHANICAL CONTRACTOR	EG	EXHAUST GRILLE
G	GAS PIPING	G.C.	GENERAL CONTRACTOR	CD	CEILING DIFFUSER
GV	GATE VALVE	E.C.	ELECTRICAL CONTRACTOR	T	THERMOSTAT
CV	CHECK VALVE			ST	SUPPLY AIR DUCT
BV	BALANCING VALVE			RT	RETURN AIR DUCT
GC	GAS COCK			FA	FRESH AIR DUCT
UN	UNION			EA	EXHAUST AIR DUCT
WH	WALL HYDRANT			FD	FIRE DAMPER (F.D.R.)
CO	CLEANOUT			MD	MANUAL DAMPER (MD)

NOTE:

PLUMBING FIXTURE SCHEDULE

MARK	FIXTURE	COLD WATER	HOT WATER	WASTE	VENT
P-1	HC WATER CLOSET	2"	--	4"	2"
P-2	HC LAVATORY	2"	2"	1 1/2"	1 1/2"
P-3	SINK	2"	2"	1 1/2"	1 1/2"
P-4	HC DRINKING FOUNTAIN	2"	--	1 1/2"	1 1/2"

NOTE:

EVAPORATOR COIL SCHEDULE

MARK	CFM	COOLING BTUH @ ARI	MIN. ROWS	FACE AREA	REFRIG. SUCTION	REFRIG. LIQUID	CONDENSATE DRAIN	USED WITH	MAX. S.P.	REMARKS
EC-1	1450	43,500	3	5.50	1" OD	2" OD	1"	FURN-1	0.25"	

NOTE: MUST BE ARI LISTED W/ACCU FURNISHED

FURNACE SCHEDULE

MARK	CFM	EXT. S.P.	BTUH @ ARI	REC'D MIN	BLOWER MOTOR	FLUE SIZE	FILTERS	GAS CONN.	O.A. CFM	REMARKS			
FURN-1	1450	0.5"	80,000	75,000	65,000	1/3 1075	115/60/1#	2" PVC	TA	20x25x2	3/4"	225	

NOTE: * OUTPUT

AIR COOLED CONDENSING UNIT SCHEDULE

MARK	TOTAL BTUH @ ARI	REC'D MIN	TOTAL CLG @ ARI	COMPRESSOR	CONDENSER FAN AMPS	SEER	MIN. CIRCUIT AMPS	REC. FUSE SIZE	REMARKS
ACCU-1	43,500	43,000	14.9	208/60/3#	1.7	10.05	20	30	

NOTE:

EXHAUST FAN SCHEDULE

MARK	CFM	S.P.	H.P.	FAN R.P.M.	TIP SPEED	CURRENT	DRIVE	REMARKS
EF-1	100	1/4"	60W	1100	--	115/60/1#	DIRECT	COOK LITTLE SEM

NOTE:

DIFFUSER & GRILLE SCHEDULE

MARK	STYLE	DAMPER	REMARKS
A	SR	OSD	
B	RAG	---	
C	TDC	OSD	KRUEGER SH SERIES

MARK SIZE CFM #WAYS

CD-CEILING DIFF
CBD-CURVED BLADE DIFF
RAG-RETURN AIR GR
ER-EXHAUST REG
SR-SUPPLY REG
EG-EXHAUST GR
FR-FLOOR REG
FRAG-FLOOR GR
TG-TRANSFER GR

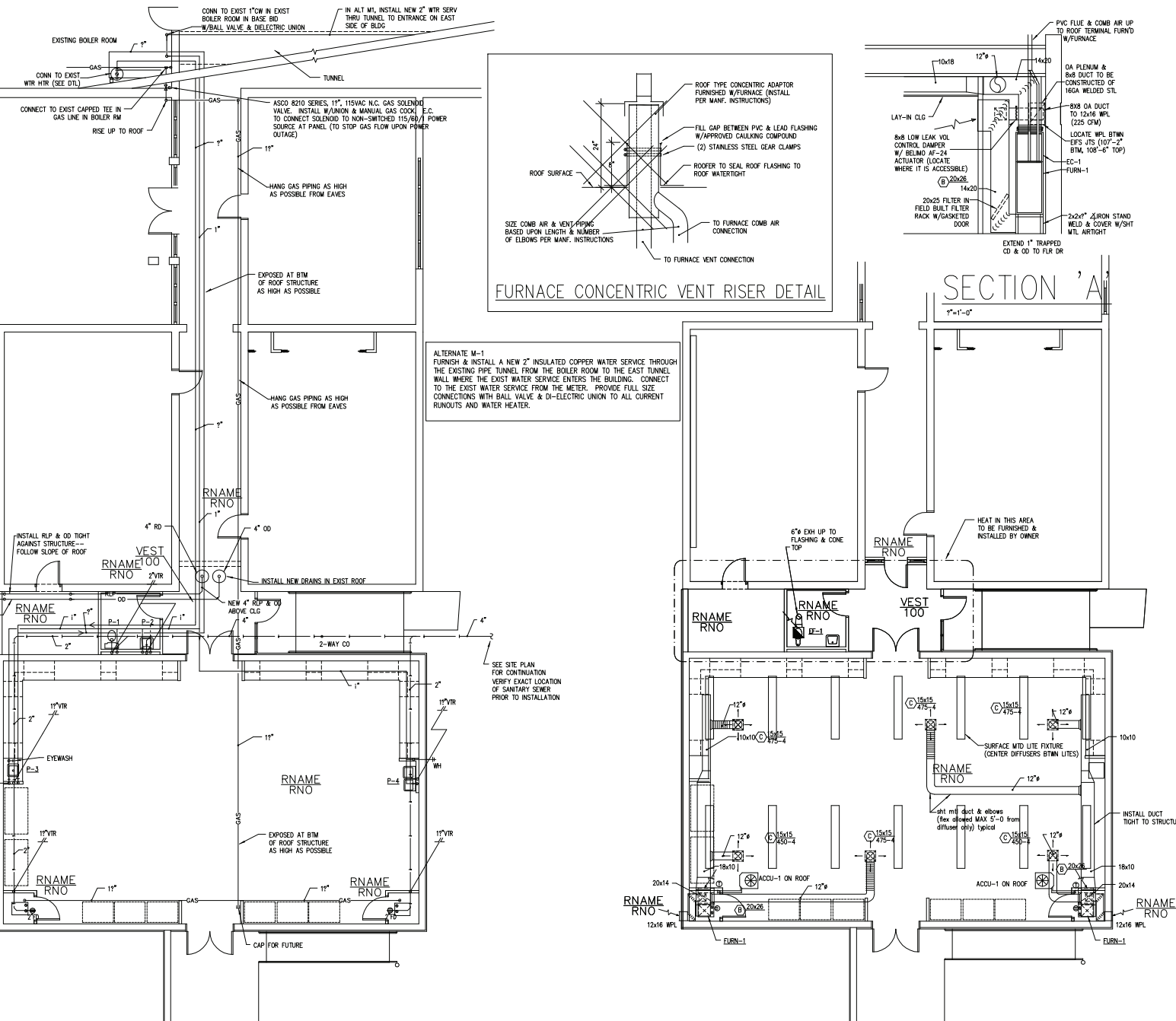
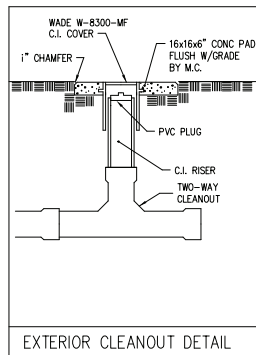
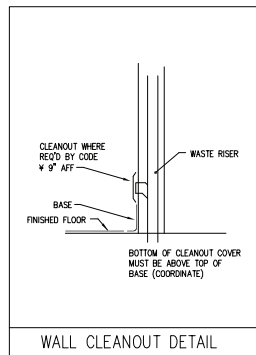

PLUMBING PLAN



HVAC PLAN

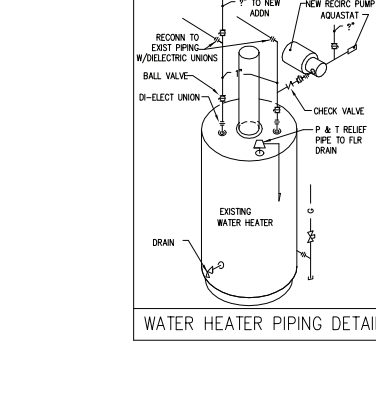
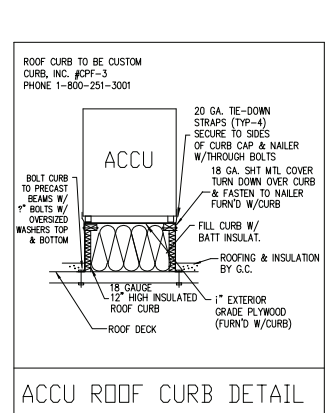
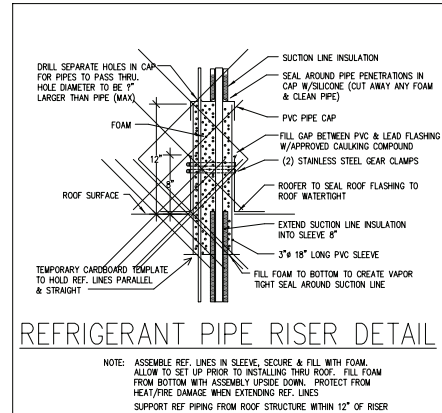
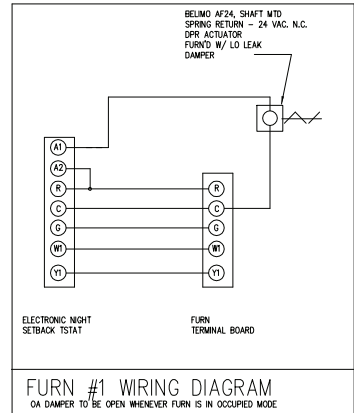

WITCHITA SCHOOL TORNADO SAFE ROOM

WICHITA, KANSAS

LIMIT OF LIABILITY:

The designs included herein are based on extensive research of the causes and effects of windstorm damage to buildings. Safe Rooms designed and built to these designs should provide a high degree of occupant protection during tornadoes. Any substitution of either materials or design concepts may decrease the level of occupant protection and/or increase the possibility of personal injury during a severe wind event.

Because it is not possible to predict or test all conditions that may occur during severe windstorms, or control the quality of construction, among other things, the designer does not warrant the design.

The designer neither manufactures nor sells safe rooms built from this design. The designers have not made and do not make any representation, warranty, or covenant, express or implied, with respect to the design, condition, quality, durability, operation, fitness for use, or suitability of the safe room in any respect whatsoever. Designers shall not be obligated or liable for actual, incidental, consequential, or other damages of or to users of safe rooms or of any other person or entity arising out of or in connection with the use, condition, and/or performance of safe rooms built from this design or from the maintenance thereof.

PLUMBING PLAN



SHEET No.: P-1
DATE: 7 MARCH 2000
REVISED: _____ REV. NO. _____







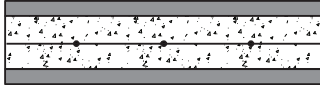
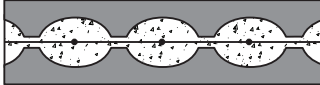
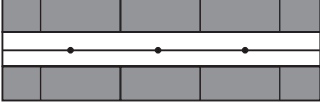
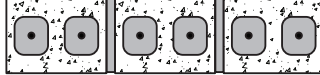

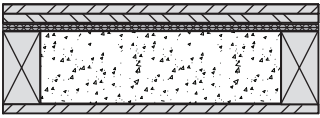
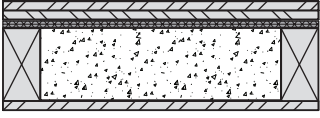

Appendix E

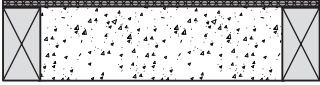

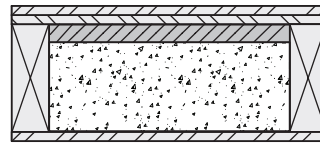
Wall Sections That Passed Previous Missile Impact Tests

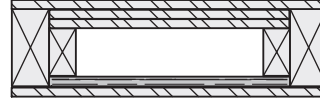
The following sheets document the performance of wall sections that passed previous missile impact tests (standards held by the first edition of FEMA 361). Information is provided for each wall section and contains a description of the wall construction (e.g., stud wall with plywood and/or metal sheathing, stud wall with concrete infill, reinforced CMU wall, insulating concrete form [ICF] wall), cross-section illustration, test missile speed, and description of damage. It is important to note that the inclusion of a wall section here does not signify that the section will necessarily pass the current missile impact standard tests, or give the wall sections listed as passing previous tests certification to the more recent standards upheld by this publication and the ICC-500. However, these sections have passed tests held to previous standards that, in some cases, may have been more stringent than current standards. This section is to be used merely as a method of determining which wall sections could be considered for use in a safe room application from the knowledge gained from previous testing performed.

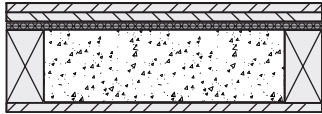
Type of Wall Section (Target)	Description of Wall Section	Missile Speed (mph)	Description of Damage
Reinforced concrete wall, at least 6 inches thick, reinforced with #4 rebar every 12 inches (both vertically and horizontally)		100+	This target has been proven successful in previous tests.
Insulating concrete form (ICF) flat wall section at least 4 inches thick reinforced with #4 rebar every 12 inches (both vertically and horizontally)		100+	This target has been proven successful in previous tests.
Insulating concrete form (ICF) waffle grid wall section at least 6 inches thick reinforced with #5 rebar every 12 inches vertically and #4 rebar every 16 inches horizontally		100+	This target has been proven successful in previous tests.
Brick cavity wall reinforced with #4 rebar every 12 inches and concrete infill		100+	This target has been proven successful in previous tests.
8-inch CMU reinforced with concrete and #4 rebar in every cell		100+	The target was impacted over 30 times with the design missile. This was done for demonstration purposes. Only the first (verification) test was conducted as part of FEMA 320.
6-inch CMU reinforced with concrete and #4 rebar in every cell		103.4	The missile impacted the target at a mortar joint. The target was cracked from the point of impact to the top of the target both in the front and in the back. The mortar spalled out of the joint on the back of the target.
6-inch CMU reinforced with concrete and #4 rebar in every cell		111.3	The target was impacted at a vertical mortar joint. There was a 1/16-inch indentation on the impact face, but no visible damage to either side of the target.

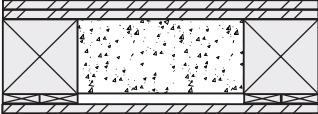
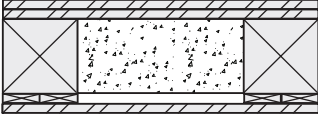
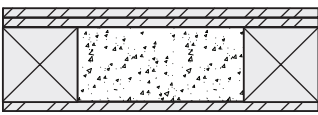
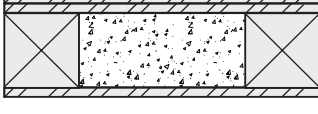
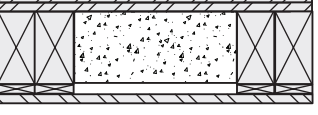
Type of Wall Section (Target)	Description of Wall Section	Missile Speed (mph)	Description of Damage
2x4 stud wall with CD grade plywood, 14-gauge ½-inch expanded metal, and concrete infill		105.0	The missile impacted 4 inches to the left of a stud. No damage was visible on the back of the target.
2x4 stud wall with CD grade plywood, 14-gauge ½-inch expanded metal, and concrete infill		106.1	The missile impacted 1½ inches to the left of a stud. No damage was visible on the back of the target.
2x4 stud wall filled with concrete with no plywood and 14-gauge ½-inch expanded metal on the non-impact face		107.7	The missile made partial contact with the stud. The concrete was cracked around the impact area.
2x4 stud wall filled with concrete with no plywood and 14-gauge ½-inch expanded metal on the non-impact face		107.2	The missile made partial contact with the stud. The concrete was severely damaged, and a 4-inch deflection on the back of the target was observed.
2x4 stud wall filled with concrete with no plywood and 14-gauge ½-inch expanded metal on the non-impact face		107.1	The missile impacted the concrete. No damage was visible.
4-inch concrete block in a 2x6 stud wall with 1½ inches polystyrene between block and two layers of ¾-inch CD grade plywood		111.3	The missile penetrated the target. There was no visible damage to the back side of the target.
Double 2x4 stud wall with 4 layers of ¾-inch CD grade plywood and 14-gauge steel on the back face		106.6	The target was impacted next to a stud. Several heads of screws were popped off the back of the target. The steel had 1 inch of deformation.
Double 2x4 stud wall with 4 layers of ¾-inch CD grade plywood and 14-gauge steel on the back face		104.9	The target was impacted on the stud line. The stud was cut in two. No deformation was visible on the back side.
4 layers of ¾-inch plywood with 14-gauge steel insert with spacers between the insert and the back face		109.4	The missile penetrated the target 1½-2 inches. A crack in the plywood on the back face caused bending, but total separation did not occur.

Type of Wall Section (Target)	Description of Wall Section	Missile Speed (mph)	Description of Damage
4-inch concrete block in a 2x4 stud wall with two layers of 3/4-inch CD grade plywood, and one layer of 14-gauge 1/2-inch expanded metal on the non-impact side and one layer of plywood on the impact side		106.7	3/4 inch of penetration. There was no visible damage to the non-impact side.
2x4 stud wall with 3 layers of 3/4-inch CD grade plywood inserts with 14-gauge metal on the non-impact side		105.7	The first insert of plywood failed in shear while the interior two failed in bending. The studs started to be torn in half, and there were 3 inches of deformation of the 14-gauge metal.
4x4 stud wall with 1x4s on the studs, containing 4-inch concrete block, gypsum board infill, and one layer of 3/4-inch CD grade plywood on the impact face and two layers on the non-impact face		111.2	The missile impacted the stud and 1/2 inch of deflection occurred on the non-impact side.
4x4 stud wall with 1x4s on the studs, containing 4-inch concrete block, gypsum board infill, and one layer of 3/4-inch CD grade plywood on the impact face and two layers on the non-impact face		106.5	Missile penetrated the target, but did not perforate the target when it impacted at the interface between the block and the 4x4 stud.
4x4 stud wall with 4-inch concrete block, with one layer of 3/8-inch CD grade plywood on the impact face and two layers of 3/4-inch CD grade plywood on the non-impact face		115.7	There was no missile penetration.
4x4 stud wall with 4-inch concrete block, with one layer of 3/8-inch CD grade plywood on the impact face and two layers of 3/4-inch CD grade plywood on the non-impact face		109.0	The missile impacted the interface between the block and the 4x4 stud, perforating the target 3 feet.
Double 2x4 stud wall with furring, containing 4-inch block, with two layers of 3/4-inch CD grade plywood on the non-impact face, one layer on the impact face, and a layer of 3/8-inch gypsum board on the impact face		100.7	The missile impacted next to the stud. There was 1/2 inch of deformation and cracking on the non-impact side.

Type of Wall Section (Target)	Description of Wall Section	Missile Speed (mph)	Description of Damage
Double 2x4 stud wall with one layer of 12-gauge steel on the impact side and one layer of 3/4-inch CD grade plywood on the non-impact side		105.2	The missile impacted next to the stud and was destroyed.
Double 2x4 stud wall with one layer of 12-gauge steel on the impact side and one layer of 3/4-inch CD grade plywood on the non-impact side		103.6	The missile impacted next to the stud and was destroyed.

Appendix F

Doors and Hardware That Passed Previous Missile Impact Tests

The tables on the following pages document the performance of some available doors and door hardware that passed wind pressure and impact requirements contained in previous editions of FEMA 320, *Taking Shelter From the Storm*. The inclusion of door systems in this appendix does not signify that the systems will necessarily pass the current missile impact and pressure criteria. The doors and door hardware included herein provide only a starting point to see what type of doors could withstand the old standards. However, the testing program focused on a variety of doors and hardware systems rather than multiple tests of a single type of door system. The data presented are single-test results, which are intended to be used as indicators of expected performance and not a certification that the door will pass the requirements in this publication and the ICC-500, which are, in some areas, more stringent.

A residential shelter in FEMA 320 is considered a partially enclosed structure (“enclosed” and “partially enclosed” buildings are defined by ASCE 7-05) that uses an internal pressure coefficient of $GCP_i = \pm 0.55$ for components and cladding (C&C) design. The previous edition of FEMA 320 (the standard to which these door systems were tested) used an enclosed structure in the design of the safe rooms that used $GCP_i = \pm 0.18$. This reduced value for the internal pressure coefficient resulted in lower loads, to which these door systems were tested. It is important that any door and door hardware to be used in a safe room application be tested to the current requirements.

The change in pressure coefficients has increased the design wind pressures for doors and windows in community safe rooms. Most of the door systems discussed in this publication and presented in this appendix have been successfully tested to wind pressure values associated with a 200-mph wind speed (Figure 2-2). However, many safe rooms will be located in areas with 250-mph speeds. The maximum wind pressures on a safe room occur at building corners.

This appendix attempts to provide information on door/door hardware systems that are readily available from manufacturers. All doors in this appendix have passed the 15-lb 2x4 at 100 mph missile impact criteria. Chapter 7 discussed wide single-door systems (greater than 36 inches wide, specifically 44-inch widths) and double-door systems.

It is important to note that the size of the door that is being tested will affect the design wind pressure to which a door should be designed. Specifically, the external pressure coefficient (GC_p) will vary with location along the wall (proximity to the building corner) and with the area of the door when calculating C&C loads using ASCE 7-05.

The testing of standard doors and door hardware will continue after the publication of this manual. The goal of this testing is to determine whether available doors and door hardware will be capable of resisting the highest of wind pressures associated with 250-mph wind speeds. Updates on tested door systems will be posted on the Texas Tech University (TTU) web page at <http://www.wind.ttu.edu>.

The information presented in this appendix includes the internal pressure coefficient used, dimensions, lock details and other factors of door construction, and whether it passed the missile impact and pressure tests from the previous editions of FEMA 361 and 320. Due to proprietary concerns and federal policy, door, window, and lock manufacturers are not listed by name in the table. The designer should note that these test results were derived from door systems that used door hardware systems that may not be acceptable for egress under some occupancy classifications.

Results of Wind Pressure Tests on Doors with Individually Activated Latching Mechanisms

Date	Test Type	Door Description	Lock Description	Failure Pressure	Pressurization Results
3/31/98	Pressure	14-gauge steel door with 20-gauge metal ribs. The door was installed and tested as a swing-out door.	Sargent mortise lock with deadbolt function.	0.97 psi	Lock held to 0.97psi. The lock failed internally when the bar connecting the deadbolt bent, allowing the door to swing open.
3/6/98	Pressure	14-gauge steel door with polystyrene infill. The door was installed and tested as a swing-out door.		1.37 psi	The door failed at a pressure of 1.37 psi. The door failure was due to the failure of the lock set; also, the door did open due to the pressure.
3/26/98	Pressure	14-gauge door with a polystyrene infill. The door was mounted and tested as a swing-in door.	Yale mortise lock set with deadbolt function.	1.2 psi	The door failed at a pressure of 1.2 psi. The door failure was due to the failure of the lock set; also, the door did open due to the pressure.
3/31/98	Pressure	20-gauge door, a honeycomb infill, with a 14-gauge steel plate mounted on the non-impact side. The door was mounted and tested as a swing-in door.	Standard heavy-duty lock with three 1.2-inch slide bolts mounted opposite the hinges.	1.36 psi	The modified door held a pressure of 1.36 psi for 5 seconds.
4/1/98	Pressure	20-gauge door, a honeycomb infill, with a 14-gauge steel plate mounted on the non-impact side. The door was mounted and tested as a swing-in door.	Standard heavy-duty lock with three 1.2-inch slide bolts mounted opposite the hinges.	1.46 psi	The modified door held a pressure of 1.46 psi for 5 seconds.
5/98	Pressure	Six-panel metal-covered wood-frame door with a sheet of 14-gauge steel attached.	Standard off-the-shelf doorknob with three deadbolt locks placed opposite the hinges.	1.21 psi	The modified door failed at the location of the deadbolts at 1.21 psi. The hardware appeared to cause the door to fail.
5/98	Pressure	Solid-core wood door with a sheet of 14-gauge steel attached.	Standard off-the-shelf doorknob with three deadbolt locks placed opposite the hinges.	1.13 psi	The modified door failed at the location of the deadbolts at 1.13 psi. The hardware appeared to cause the door to fail.
5/98	Pressure	Six-panel solid-wood door with a sheet of 14-gauge steel attached.	Standard off-the-shelf doorknob with three deadbolt locks placed opposite the hinges.	1.12 psi	The modified door failed at the location of the deadbolts at 1.12 psi. The hardware appeared to cause the door to fail.

Results of Missile Impact Tests on Doors with Individually Activated Latching Mechanisms

Date	Test Type	Door Description	Lock Description	Missile Threshold (mph)	Impact Results	Impact Speed (mph)
	Missile	14-gauge steel door with 20-gauge metal ribs. The door was installed and tested as a swing-out door.	Sargent mortise lock with deadbolt function.	> 100	The door withstood several impacts at the midpoint of the door next to the hardware and at the upper and lower corners next to the hinges and on the lock side, respectively.	82.35 81.99 104.83 106.57
3/26/98	Missile	14-gauge door with a polystyrene infill. The door was mounted and tested as a swing-in door.	Yale mortise lock with deadbolt function.	81	Door failed the impact test due to hardware failure. When modified with three slide bolt locks mounted opposite the hinges, the door was successful.	81.3
3/31/98	Missile	20-gauge door, a honeycomb infill, with a 14-gauge steel plate mounted on the non-impact side. The door was mounted and tested as a swing-in door.	Standard heavy duty lock with three 1/2-inch slide bolts mounted opposite the hinges.	104	There was a local failure of the hardware, but the redundancies in the hardware held the door in place. The missile penetrated the impact skin, but did not perforate the non-impact side or the 14-gauge steel plate. There was permanent deformation.	103.88
4/1/98	Missile	20-gauge door, a honeycomb infill, with a 14-gauge steel plate mounted on the non-impact side. The door was mounted and tested as a swing-in door.		104	The missile did not penetrate the door, but it caused permanent deformation in the internal door frame. (The door buckled around the standard lock set.)	104.09

Results of Wind Pressure and Missile Impact Tests on Double-Door Set with Panic Bar Hardware and Single-Action Lever Hardware

Date	Test Type	Door Description	Hardware Description	Test Results
5/00	Pressure and Missile	3-foot x 7-foot steel 14-gauge door with 14-gauge steel channels as hinge and lock rails and 16-gauge channels at top and bottom. Polystyrene infill or honeycomb core. 14-gauge steel frame with 14-gauge center steel mullion.	Externally mounted three-point latching mechanism with panic bar release, 5/8-inch headbolt and footbolt with 1-inch throw, and mortised center deadbolt.	Pressure reached 1.37 psi without failure. Missile impact at 100 mph did not perforate.
5/00	Pressure and Missile	3-foot x 7-foot steel 14-gauge door with 14-gauge steel channels as hinge and lock rails and 16-gauge channels at top and bottom. Polystyrene infill or honeycomb core. 14-gauge steel frame with 14-gauge center steel mullion.	Externally mounted three-point latching mechanism with single-action lever release, 1-inch solid mortised center deadbolt with 1-inch throw, and two 1-inch x 3/8-inch solid hookbolts, one below and one above the deadbolt.	Pressure reached 1.37 psi without failure of door, although top hookbolt failed. Missile impact at 100 mph pushed door through frame, causing center mullion to rotate. Testing inconclusive; further testing required.

Door/Widow- Manufacturer (D/W Mfr)	Internal Pressure Coefficient	Pressure Test?	Impact Test?	Size w x h	Center Mullion	Lock Manufacturer (L Mfr)	Locking Mechanism	Push Bar?	Latch (3/4")	Deadbolts (1")	Hinges	Door Swing	Remarks
D Mfr 1	enclosed	yes	yes	3' x 7'	no	L Mfr 1	3-point	no	yes	yes	1 1/2 pair	Out	
D Mfr 2	enclosed	yes	yes	3' x 7'	no	L Mfr 2	3-point	no	yes	yes	1 1/2 pair	In	
D Mfr 3	enclosed	yes	yes	3' x 7'	no	L Mfr 1	3-point	no	yes	yes	1 1/2 pair	In	
D Mfr 3	enclosed	yes	yes	3' x 7'	no	L Mfr 2	3-point	no	yes	yes	1 1/2 pair	In	
D Mfr 4	enclosed	yes	yes	3' x 7'	no	L Mfr 3	M.P. ¹	no	yes	no	1 1/2 pair	In	14 Lock Points, M. Security Frame
D Mfr 5	enclosed	yes	yes	3' x 7'	no	L Mfr 4	3-point	no	yes	yes	1 1/2 pair	In	
D Mfr 6	enclosed	yes	yes	32" x 83"	no	L Mfr 5	M.P. ¹	no	yes	no	1 pair	In	10 Lock Points
D Mfr 6	enclosed	yes	yes	32" x 81"	no	L Mfr 5	M.P. ¹	no	yes	no	1 1/2 pair	In	6 Lock Points
D Mfr 6	enclosed	yes	yes	36" x 80"	no	L Mfr 5	M.P. ¹	no	yes	no	1 1/2 pair	In	6 Lock Points
D Mfr 7	enclosed	yes	yes	3' x 7'	no	L Mfr 6	3-point	no	yes	no	1 1/2 pair	In	
D Mfr 8	enclosed	yes	yes	3' x 7'	no	L Mfr 6	3-point	no	yes	no	1 1/2 pair	In	
D Mfr 9	partially enclosed	yes	yes	3' x 7' pair	Removable	L Mfr 6	3-point	yes	no	no	1 1/2 pair	Out	
D Mfr 9	partially enclosed	yes	yes	4' x 8' pair	Removable	L Mfr 6	3-point	yes	no	no	2 pair	Out	
D Mfr 2	partially enclosed	yes	yes	3' x 7'	no	L Mfr 6	3-point	yes	no	no	1 1/2 pair	Out	
D Mfr 2	partially enclosed	yes	yes	3' x 7' pair	Removable	L Mfr 7 ²	3-point	yes	no	no	1 1/2 pair	Out	16-gauge hollow metal frame
D Mfr 10	partially enclosed	yes	no	10' x 10'	no	L Mfr 8		no	no	no		N/A	Colling Overhead Door
D Mfr 3	partially enclosed	yes	yes	3' x 7'	no	L Mfr 9	3-point	yes	no	no	1 1/2 pair	Out	2.55 psi max. pressure
D Mfr 3	partially enclosed	yes	yes	3' x 7'	no	L Mfr 9	3-point	yes	no	no	1 1/2 pair	Out	5.00 psi max. pressure
D Mfr 4	partially enclosed	yes	yes	3' x 7'	no	L Mfr 3	M.P. ¹	yes	no	no	1 pair	Out	14 Lock Points, M. Security Frame
D Mfr 5	partially enclosed	yes	yes	3' x 7'	no	L Mfr 6	3-point	yes	no	no	1 1/2 pair	Out	
D Mfr 7	partially enclosed	yes	yes	3' x 7'	no	L Mfr 6	3-point	yes	no	no	1 1/2 pair	Out	
D Mfr 7	partially enclosed	yes	yes	3' x 7' pair	no	L Mfr 6	2-point	yes	no	no	1 1/2 pair	Out	
D Mfr 7	partially enclosed	yes	yes	3' x 7' pair	no	L Mfr 10	2-point	yes	no	no	1 1/2 pair	Out	Exit Only Hardware
D Mfr 7	partially enclosed	yes	yes	3' x 7' pair	Removable	L Mfr 6	3-point	yes	no	no	1 1/2 pair	Out	
W Mfr 3	partially enclosed	yes	no	40" x 60"		N/A	N/A	N/A	N/A	N/A	N/A	N/A	Window - 5.00 psi pressure
W Mfr 3	partially enclosed	yes	no	36" x 36"		N/A	N/A	N/A	N/A	N/A	N/A	N/A	Window - 5.00 psi pressure
W Mfr 3	partially enclosed	yes	no	40" x 60"		N/A	N/A	N/A	N/A	N/A	N/A	N/A	Window - 9.50 psi pressure
W Mfr 3	partially enclosed	yes	no	36" x 36"		N/A	N/A	N/A	N/A	N/A	N/A	N/A	Window - 8.98 psi pressure
W Mfr 11	partially enclosed	yes	yes	100" x 88"	yes	N/A	N/A	N/A	N/A	N/A	N/A	N/A	2-50"x44" openings, special glass and frame

Testing Details refer to: <http://www.wind.ttu.edu/Research/DebrisImpact/TestingLab.php>
 Except where noted, all door frames are 14-gauge hollow metal.

¹ Multi-point Locking Device

² Rim Type Exit Device

Appendix G

Design Guidance on Missile Impact Protection Levels for Wood Sheathing

Reinforced concrete and reinforced masonry have been the most common wall and roof materials used with success in non-residential safe rooms. The use of wood panels for exterior wall sheathing in non-residential safe room applications had been limited. This appendix provides limited information on wood panel testing that has been performed for both hurricane and tornado safe room applications.

Data from the missile impact tests on walls with plywood and oriented strand board (OSB) sheathing conducted at Texas Tech University (Carter 1998) and at Clemson University (Clemson 2000) have been combined to determine the variation of missile perforation resistance with thickness of the sheathing. In order to put all the data on a consistent basis, missile weights and lowest impact velocities for perforation of the sheathing have been extracted from previous test results. The weight and impact velocity information were used to calculate the impact momentum {weight (lb) x velocity (ft/sec)/acceleration of gravity (32.2 ft/sec²) = momentum (lb/sec)} and the impact energy {weight (lb) x velocity squared (ft/sec)²/acceleration of gravity (32.2 ft/sec²) = energy (ft/lb)}. The resulting impact momentum and impact energy for perforation of the sheathing are plotted as a function of sheathing thickness (in 1/32 inch) in Figures G-1 and G-2.

The momentum required for a wood 2x4 missile to cause perforation varies essentially linearly with thickness of the sheathing material for both plywood and OSB. This suggests, at least for this type of missile and common sheathing materials, that a desired target penetration resistance (ability to resist a certain impact momentum) can be achieved by simply adding up the contributions of the various layers of sheathing. For example, in Figure G-1, sheathing with a 30/32-inch thickness represents two layers of 15/32-inch material.

Figure G-3 provides information on the relative resistance of various common sheathing materials, in terms of impact momentum absorption, for a compact impact area such as that associated with a wood 2x4 missile impacting perpendicular to the sheathing material. Summing the momentum resistance of the various layers of common sheathing materials is permissible when developing initial design criteria for walls that provide adequate protection. However, this

process may not work for other types of missiles or for wall materials that absorb impact energy by undergoing large deformations (i.e., corrugated metal panels).

For the large design missile of this publication (a 15-lb wood 2x4 missile), the maximum horizontal impact speed designated in the criteria is 100 mph, and the corresponding momentum is approximately 68 lb/sec. For vertical impacts, the maximum impact velocity designated is reduced to 67 mph; the corresponding momentum to the maximum vertical impact speed is approximately 46 lb/sec.

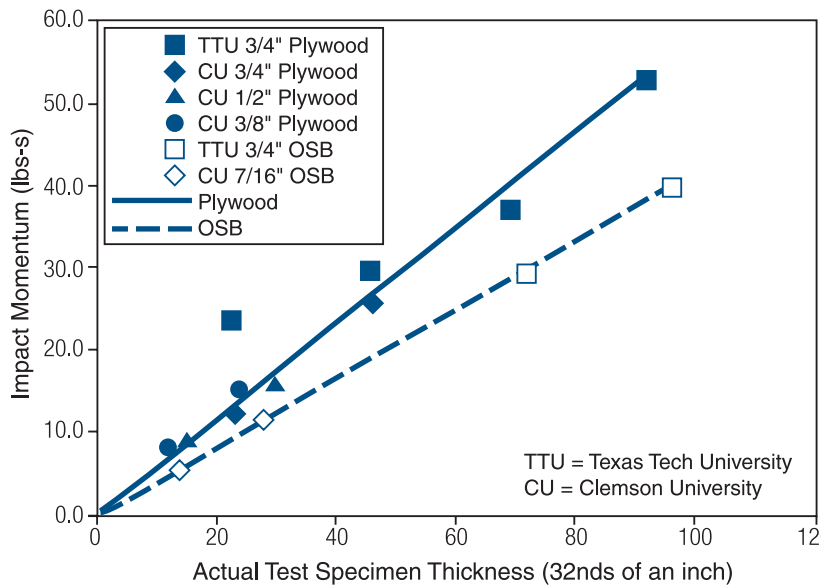

Figure G-1. Variation of impact momentum required for missile penetration vs. wall sheathing thickness

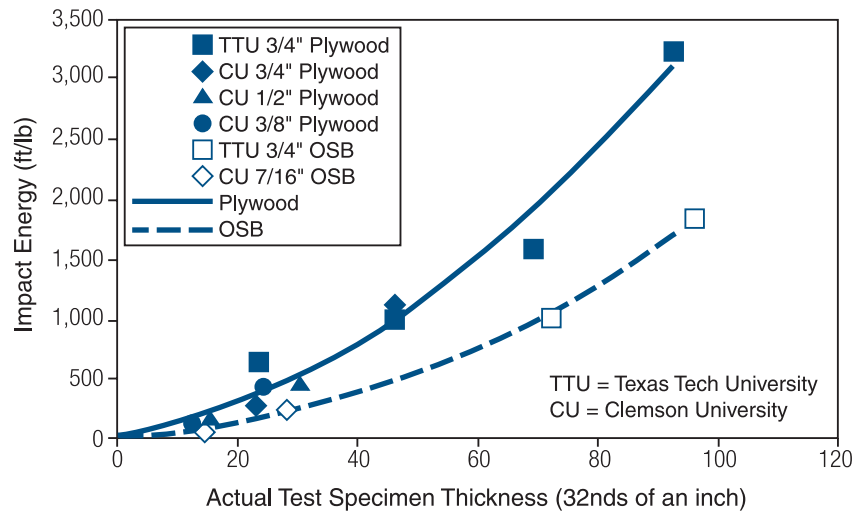

Figure G-2. Variation of impact energy required for missile penetration vs. wall sheathing thickness

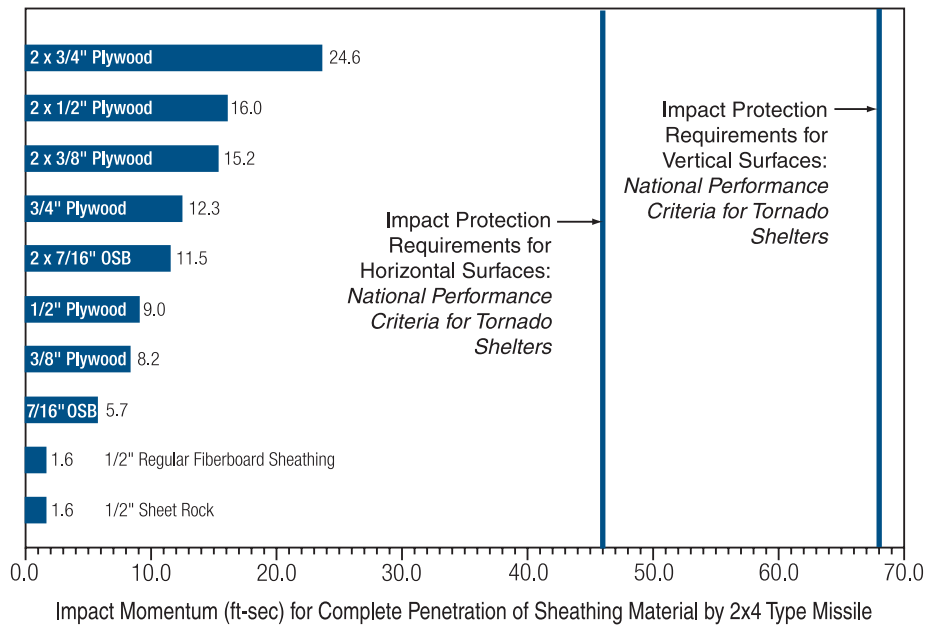

Figure G-3. Impact momentum required for a 2x4 wood missile to penetrate various common sheathing materials (impact perpendicular to sheathing surface). Note: All wood products provide less than half the required impact momentum resistance needed to meet the horizontal surface impact resistance required by the *National Performance Criteria for Tornado Shelters*.

Appendix H

Acronyms and Abbreviations

A

ACE	Advanced antimicrobial elastic
ACI	American Concrete Institute International
ADA	Americans with Disabilities Act
A/E	architectural/engineering
AFM	Air Force manual
AHJ	authority having jurisdiction
AMS	American Meteorological Society
ANSI	American National Standards Institute
APA	American Plywood Association
APC	atmospheric pressure change
ARC	American Red Cross
ASCE	American Society of Civil Engineers
ASD	Allowable Stress Design
ASF	available square footage
ASTM	American Society for Testing and Materials

B

B/C	benefit-cost
BCA	benefit-cost analysis
BCR	benefit-cost ratio
BFE	base flood elevation

BHMA Builders Hardware Manufacturers Association

BPAT Building Performance Assessment Team

C

C&C components and cladding

CMU concrete masonry unit

CPR Cardiopulmonary Resuscitation

CU Clemson University

D

DFE design flood elevation

DI damage indicator

DOD degree of damage

DOE Department of Energy

E

EF Enhanced Fujita (Scale)

EHPA Enhanced Hurricane Protection Area

EIFS Exterior Insulation Finishing System

EMS Emergency Management Services

EMT Emergency Management Technician

EOC Emergency Operations Center

EPDM ethylene propylene diene monomer

F

F Fujita (Scale)

F lateral force

FAA Federal Aviation Administration

FBC Florida Building Code

FEMA Federal Emergency Management Agency

FIRM Flood Insurance Rate Map

FIS Flood Insurance Study

fps feet per second

ft feet, foot

G

GIS geographic information system

H

HAM handheld amateur (radio operator)

HAZMAT hazardous material

HAZUS-MH Hazards U.S. – Multi-Hazard

HMA Hazard Mitigation Assistance

HVAC heating, ventilation, and air conditioning

HVHZ High Velocity Hurricane Zone

I

IBC International Building Code

ICC International Code Council

ICF insulating concrete form

IMC International Mechanical Code

IRC International Residential Code

K

kg kilogram

L

LimWA Limit of Moderate Wave Action

LRFD Load and Resistance Factor Design

M

MAT	Mitigation Assessment Team
mi/h	miles per hour (ASCE)
m²	square foot, feet
m³	cubic foot, feet
mph	miles per hour
MRI	mean recurrence interval
MSL	mean sea level
MWFRS	main wind force resisting system

N

N/A	not applicable
NCDC	National Climatic Data Center
NEHRP	National Earthquake Hazards Reduction Program
NFPA	National Fire Protection Association
NGVD '29	National Geodetic Vertical Datum of 1929
NOAA	National Oceanic and Atmospheric Administration
NSSA	National Storm Shelter Association
NSSFC	National Severe Storms Forecast Center
NWS	National Weather Service

O

o.c.	on center
OSB	oriented strand board

P

PC	polycarbonate
PDM	Pre-Disaster Mitigation

PFR	police, fire, and rescue
PRM	partially reinforced masonry
psf	pounds per square foot
psi	pounds per square inch
PUB	polyvinylbutyral

Q

QA/QC	Quality Assurance/Quality Control
--------------	-----------------------------------

R

RA	Recovery Advisory
RACES	Radio Amateur Civil Emergency Service
RSF	recommended square footage

S

SBC	Standard Building Code
SBCCI	Southern Building Code Congress International
SESP	State Emergency Shelter Program (Florida)
SFHA	Special Flood Hazard Area
SOP	Standard Operating Procedures
SPC	Storm Prediction Center
STD	Standard

T

TMS	The Masonry Society
TTU	Texas Tech University

U

UBC	Uniform Building Code
UPS	uninterrupted power supply

URM	unreinforced masonry
U.S.	United States
USACE	United States Army Corps of Engineers
USDA	U.S. Department of Agriculture
USF	usable square footage

V

V	velocity
WERC	Wind Engineering Research Center (TTU)
WISE	Wind Science and Engineering Research Center (TTU)