

Before the
COPYRIGHT ROYALTY BOARD
LIBRARY OF CONGRESS
Washington, D.C.

In the Matter of)	
)	
Adjustment of Rates and Terms for)	Docket No. 2006-1 CRB DSTR A
Preexisting Subscription and Satellite)	
Digital Audio Radio Services)	

**WRITTEN DIRECT STATEMENT
OF SIRIUS SATELLITE RADIO INC.**

EXHIBITS

VOLUME 3 OF 4

Bruce G. Joseph (D.C. Bar No. 338236)
Michael L. Sturm (D.C. Bar No. 422338)
Thomas W. Kirby (D.C. Bar No. 915231)
Karyn K. Ablin (D.C. Bar No. 454473)
Matthew J. Astle (D.C. Bar No. 488084)
WILEY REIN & FIELDING LLP
1776 K St NW
Washington, DC 20006
tel.: (202) 719-7258
fax (202) 719-7049
bjoseph@wrf.com, tkirby@wrf.com,
msturm@wrf.com, kablin@wrf.com
mastle@wrf.com

Counsel for Sirius Satellite Radio Inc.

January 11, 2007

UNITED STATES
SECURITIES AND EXCHANGE COMMISSION
WASHINGTON, D.C. 20549

F O R M 10-K

ANNUAL REPORT PURSUANT TO SECTION 13 OR 15(d) OF
THE SECURITIES EXCHANGE ACT OF 1934
FOR FISCAL YEAR ENDED DECEMBER 31, 2005
OR
TRANSITION REPORT PURSUANT TO SECTION 13 OR 15(d) OF
THE SECURITIES EXCHANGE ACT OF 1934
FOR THE TRANSITION PERIOD FROM TO
COMMISSION FILE NUMBER 0-24710

SIRIUS SATELLITE RADIO INC.
(Exact name of registrant in its charter)

Delaware
(State or other jurisdiction of
incorporation of organization)

52-1700207
(I.R.S. Employer Identification Number)

1221 Avenue of the Americas, 36th Floor
New York, New York 10020
(Address of principal executive offices)

Registrant's telephone number, including area code: (212) 584-5100

Securities registered pursuant to Section 12(b) of the Act:

Title of each class:

Name of each exchange
on which registered:

None

Securities registered pursuant to Section 12(g) of the Act:

Common Stock, par value \$0.001 per share
(Title of class)

Indicate by check mark if the registrant is a well-known seasoned issuer, as defined in Rule 405 of the Securities Act. Yes S No £

Indicate by check mark if the registrant is not required to file reports pursuant to Section 13 or 15(d) of the Act. Yes £ No S

Indicate by check mark whether the registrant (1) has filed all reports required to be filed by Section 13 or 15(d) of the Securities Exchange Act of 1934 during the preceding 12 months (or for such shorter period that the registrant was required to file such reports) and (2) has been subject to such filing requirements for the past 90 days. Yes S No £

Additional information regarding the compensation for Messrs. Karmazin, Greenstein, Meyer, Donnelly and Frear will be included in our definitive proxy statement for our 2006 annual meeting of stockholders to be held on Tuesday, May 23, 2006.

Item 1A. Risk Factors

In addition to the other information in this Annual Report on Form 10-K, the following risk factors should be considered carefully in evaluating us and our business. This Annual Report on Form 10-K contains forward-looking statements within the meaning of the federal securities laws. Actual results and the timing of events could differ materially from those projected in forward-looking statements due to a number of factors, including those set forth below and elsewhere in this Annual Report on Form 10-K. See "Special Note Regarding Forward-Looking Statements."

Failure of our satellites would significantly damage our business.

Our three satellites were launched in 2000. We do not maintain in-orbit insurance policies covering our satellites. Our operating results would be materially adversely affected if the useful life of our satellites is significantly shorter than we expect, whether as a result of a satellite failure or technical obsolescence, and we fail to launch replacement satellites in a timely manner.

The useful lives of our satellites will vary and depend on a number of factors, including:

- degradation and durability of solar panels;
- quality of construction;
- random failure of satellite components, which could result in significant damage to or loss of a satellite;
- amount of fuel our satellites consume; and
- damage or destruction by electrostatic storms or collisions with other objects in space, which occur only in rare cases.

Our satellites have experienced circuit failures on their solar arrays. The circuit failures our satellites have experienced to date do not limit the power of our broadcast signal or otherwise affect our current operations. Additional circuit failures could reduce the useful life of our existing in-orbit satellites.

In the ordinary course of operation, satellites experience failures of component parts and operational and performance anomalies. Components on our in-orbit satellites have failed, and from time to time we have experienced anomalies in the operation and performance of our satellites. These failures and anomalies are expected to continue in the ordinary course, and it is impossible to predict if any of these future events will have a material adverse effect on our operations or the useful life of our existing in-orbit satellites.

If one of our three satellites fails in orbit, our service would be impaired until such time as we successfully launch and commission our spare satellite, which would take six months or more. If two or more of our satellites fail in orbit in close proximity in time, our service could be suspended for at least 24 months. In such event, our business would be materially impacted and we could default on our commitments.

We may from time to time modify our business plan, and these changes could adversely affect us and our financial condition.

We regularly evaluate our plans and strategy. These evaluations often result in changes to our plans and strategy, some of which may be material and significantly change our cash requirements or cause us to achieve cash flow breakeven at a later date. These changes in our plans or strategy may include: the acquisition of unique or compelling programming; the introduction of new features or services; significant new or enhanced distribution arrangements; investments in infrastructure, such as satellites, equipment or radio spectrum; and acquisitions of third parties that own programming, distribution, infrastructure, assets, or any combination of the foregoing.

To fund incremental cash requirements, or as market opportunities arise, we may choose to raise additional funds through the sale of additional debt securities, equity securities or a combination of debt and equity securities. The incurrence of indebtedness would result in increased fiscal obligations and could contain additional restrictive covenants. The sale of additional equity or convertible debt securities would result in dilution to our stockholders. These additional sources of funds may not be available or, if available, may not be available on terms favorable to us.

Our business might never become profitable.

As of December 31, 2005, we had an accumulated deficit of approximately \$2.7 billion. We expect our cumulative net losses to grow as we make payments under various contracts, incur marketing and subscriber acquisition costs and make interest payments on our debt. If we are unable ultimately to generate sufficient revenues to become profitable, we could default on our commitments and may have to discontinue operations or seek a purchaser for our business or assets.

Programming is an important part of our service, and the costs to renew our programming arrangements may be more than anticipated.

Third-party content is an important part of our service, and we compete with many parties, including XM Radio, for content. We have entered into a number of important content arrangements, including agreements with the NFL, Howard Stern and NASCAR, which require us to pay substantial sums. Our agreement with the NFL expires at the end of the 2010-2011 NFL season; our agreement with Howard Stern expires in December 2010; and our agreement with NASCAR expires in 2011. As these agreements expire, we may not be able to negotiate renewals of one or more of these agreements, or renew such agreements at costs we believe are attractive.

Our financial obligations under our agreement with Howard Stern consist of both fixed and incentive payments in cash and common stock, and are substantial. In October 2004 we disclosed that the aggregate fixed obligations under our agreement with Stern would be approximately \$100 million per year commencing in 2006. The 34,375,000 shares issued in January 2006 for the benefit of Howard Stern and Don Buchwald, his agent, were valued in October 2004 at approximately \$110 million and were included as part of the aggregate fixed obligations under the agreement. At issuance, these shares were valued at approximately \$225 million, which will be recorded to equity granted to third parties and employees expense in the first quarter of 2006.

In addition, we may not be able to obtain additional third-party content within the costs contemplated by our business plan. We also must negotiate and enter into final music programming royalty arrangements with BMI and our existing arrangements with the ASCAP, SESAC and SoundExchange will expire at the end of 2006. Such royalty arrangements may be more costly than anticipated.

Certain copyright holders have stated concerns regarding features in SIRIUS radios that allow subscribers to listen to SIRIUS programming after the initial broadcast. We believe these devices comply with applicable copyright law. We cannot assure that our royalty fees will remain at current levels or that arbitration or litigation will not arise in connection with royalty arrangements or SIRIUS radios that include certain recording capabilities and we cannot predict what the costs to us of a proceeding or a settlement of such a dispute or disputes might be.

Higher than expected costs of attracting new subscribers could adversely affect our financial performance and operating results.

We are spending substantial funds on advertising and marketing and in transactions with automakers, radio manufacturers, retailers and others to obtain and attract subscribers. If the costs of attracting subscribers are greater than expected or if our competitor, XM Radio, substantially increases equipment subsidies or reduces hardware prices, our financial performance and operating results could be adversely affected.

Higher subscriber turnover could adversely affect our financial performance and operating results.

We are experiencing, and expect to continue to experience in the future, some subscriber turnover, or churn. We cannot predict the amount of churn we will experience. High subscriber turnover, or our inability to attract customers to our service, would adversely affect our financial performance and operating results.

Competition from XM Radio and traditional and emerging audio entertainment providers could adversely affect our ability to generate revenues.

We compete with many entertainment providers for both listeners and advertising revenues, including XM Radio, the other satellite radio provider in North America; traditional AM/FM and digital radio; Internet-based audio providers; direct broadcast satellite television audio services; and cable systems that carry audio services. In addition, other technologies in the mobile audio environment, such as Apple iPod® and MP3 devices, wireless broadband services and next generation cellular telephones, have emerged to compete with our service.

If consumers or other third parties perceive that XM Radio offers more attractive service, enhanced features or superior equipment alternatives, or has stronger marketing or distribution channels, it may gain a long-term competitive advantage over us. As of December 31, 2005, we had 3,316,560 subscribers, while XM Radio reported 5,932,957 subscribers as of the same date.

In July 2005, XM Radio announced an agreement to acquire WCS Wireless, the principal assets of which are wireless spectrum licenses in geographic areas covering a significant portion of the continental United States. While XM Radio has not announced a plan for the use of this spectrum, XM Radio's acquisition of this spectrum, other radio spectrum or technologies not available to us, may enable it to offer more services, produce entertainment products of greater interest to consumers or operate at a more competitive cost.

We compete vigorously with XM Radio for subscribers and in all other aspects of our business, including the pricing of our service and our radios, retail and automotive distribution arrangements, programming acquisitions and technology. Competition with XM Radio may increase our operating expenses as we seek arrangements with third parties, such as programming providers, and may cause us to reach cash flow breakeven with more subscribers or later than we estimate.

Unlike satellite radio, traditional AM/FM radio has a well established and dominant market presence for its services and offers free broadcasts supported by commercial advertising rather than by a subscription fee. Many radio stations also offer consumers well known on-air personalities and information programming of a local nature, which we do not offer as broadly as local radio. To the extent that consumers place a high value on these features of traditional AM/FM radio, we are at a competitive disadvantage. Some radio stations have begun reducing the number of commercials per hour, expanding the range of music played on the air and experimenting with new formats in order to compete more directly with our service. Several major radio companies recently banded together to launch an advertising campaign designed to assert that traditional AM/FM radio, like satellite radio, is innovative and features new artists.

Digital radio broadcast services have been expanding, and an increasing number of radio stations in the U.S. have begun digital broadcasting or are in the process of converting to digital broadcasting. The technology permits broadcasters to transmit as many as five stations per frequency. To the extent that traditional AM/FM radio stations adopt digital transmission technology and to the extent such technology allows signal quality that rivals our own, any competitive advantage that we enjoy over traditional radio because of our digital signal would be lessened.

Internet radio broadcasts have no geographic limitations and can provide listeners with radio programming from around the world. According to an Arbitron study, approximately 20 million Americans listened to Internet radio each week in January 2005. We expect that improvements from higher bandwidths, faster modems and wider programming selection will make Internet radio increasingly competitive.

The Apple iPod ® , a portable digital music player that stores up to 15,000 songs, allows users to download and purchase music through Apple's iTunes ® Music Store, which offers for sale over two million songs. The iPod ® is also compatible with certain car stereos and various home speaker systems. Our SIRIUS S50 portable satellite radio player competes with the iPod ® and other portable music devices.

A number of wireless telephone providers now offer, or have announced plans to offer, music services. These music services may provide a variety of live music channels as well as the ability to download selected songs. Although many of these services have just been launched, are dependent upon the adoption of next generation cell phone technology and are not yet widely accepted in the market, music services from wireless telephone providers could become increasingly competitive with our service.

Weaker than expected market and advertiser acceptance of our service could adversely affect our advertising revenue and results of operations.

Our ability to generate advertising revenues will be directly affected by the number of subscribers to our service and the amount of time subscribers spend listening to our talk and entertainment channels or our traffic and weather service. Our ability to generate advertising revenues will also depend on several factors, including the level and type of market penetration of our service, competition for advertising dollars from other media, and changes in the advertising industry and economy generally. We directly compete for audiences and advertising revenues with XM Radio and traditional AM/FM radio stations, some of which maintain longstanding relationships with advertisers and possess greater resources than we do.

We attract a substantial number of our new subscribers during the fourth quarter and our inability to deliver competitive products during the fourth quarter could have a material adverse affect on our operations.

We attract a disproportionate share of our new subscribers each year during the fourth quarter because of the holiday season. For example, in 2005 we attracted approximately 53% of our new subscribers during the fourth quarter. As a result, our failure to properly manage radio inventory, respond to changing technology and competitive pressures or deliver a competitive product during the fourth quarter could significantly reduce our number of new subscribers and have an adverse affect on our operations. We also depend on third parties to manufacture, distribute, market and sell SIRIUS radios, and their failure to perform during the fourth quarter could have an adverse affect on our operations.

Failure of third parties to perform could adversely affect our business.

Our business depends in part on the efforts of third parties, especially the efforts of:

- automakers that manufacture, market and sell vehicles capable of receiving our service, but in many cases have no obligations to do so;
- consumer electronics manufacturers that manufacture and distribute SIRIUS radios;
- companies that manufacture and sell integrated circuits for SIRIUS radios;
- programming providers and on-air talent, including Howard Stern;
- retailers that market and sell SIRIUS radios and promote subscriptions to our service; and
- third party vendors that have designed, built, support or operate important elements of our system, such as our customer service facilities.

If one or more of these third parties does not perform in a sufficient or timely manner, our business will be adversely affected and we could be placed at a long-term disadvantage.

The sale of vehicles with SIRIUS radios is an important source of subscribers for us. To the extent sales of vehicles by our distribution partners slow, our subscriber growth could be adversely impacted. In addition, we do not manufacture satellite radios or accessories, and we depend on

manufacturers and others for the production of SIRIUS radios and their component parts. If one or more manufacturers does not produce radios in a sufficient quantity to meet demand, or if such radios were not to perform as advertised or were to be defective, sales of our service and our reputation could be adversely affected.

Failure to comply with FCC requirements could damage our business.

As the holder of one of two FCC licenses to operate a satellite radio service in the United States, we are subject to FCC rules and regulations. The terms of our license require us to meet certain conditions, including designing a receiver that will permit end users to access XM Radio's system; coordination of our satellite radio service with radio systems operating in the same range of frequencies in neighboring countries; and coordination of our communications links to our satellites with other systems that operate in the same frequency band.

Non-compliance by us with these conditions could result in fines, additional license conditions, license revocation or other detrimental FCC actions. We may also be subject to interference from adjacent radio frequency users if the FCC does not adequately protect us against such interference in its rulemaking process, including interference that could result from XM Radio's use of the spectrum it is seeking to acquire from WCS Wireless.

The FCC has not yet issued final rules permitting us to operate and deploy terrestrial repeaters to fill gaps in our satellite coverage. We are operating our terrestrial repeaters on a "non-interference" basis pursuant to a grant of special temporary authority from the FCC. The FCC's final terrestrial repeater rules may require us to reduce the power of our terrestrial repeaters and limit our ability to deploy additional repeaters. If the FCC requires us to reduce significantly the power of our terrestrial repeaters, this would have an adverse effect on the quality of our service in certain markets and/or cause us to alter our terrestrial repeater infrastructure at a substantial cost. If the FCC limits our ability to deploy additional terrestrial repeaters, our ability to improve any deficiencies in our service quality that may be identified in the future would be adversely affected.

Rapid technological and industry changes could make our service obsolete.

The satellite industry and the audio entertainment industry are both characterized by rapid technological change, frequent new product innovations, changes in customer requirements and expectations, and evolving industry standards. If we are unable to keep pace with these changes, our business may be unsuccessful. Products using new technologies, or emerging industry standards, could make our technologies obsolete or less competitive in the marketplace.

Our substantial indebtedness could adversely affect our financial health.

As of December 31, 2005, we had approximately \$1.1 billion of indebtedness. We may incur more debt if we believe we can raise money on favorable terms. A significant portion of our indebtedness contains restrictive covenants. Our indebtedness could:

- limit our flexibility in planning for, or reacting to, changes in our business and industry;
- limit our ability to borrow additional funds;
- increase our vulnerability to general adverse economic and industry conditions;
- require us to dedicate a substantial portion of our cash flow from operations to payments on our indebtedness, possibly reducing the availability of our cash flow to fund working capital, capital expenditures, and other general corporate purposes; and
- place us at a competitive disadvantage compared to competitors that have less debt.

Failure to comply with the covenants contained in the indentures governing our debt could result in an event of default, which, if not cured or waived, could cause us to discontinue operations or seek a purchaser for our business or assets.

Our national broadcast studio, terrestrial repeater network, satellite uplink facility or other ground facilities could be damaged by natural catastrophes or terrorist activities.

An earthquake, tornado, flood, terrorist attack or other catastrophic event could damage our national broadcast studio, terrestrial repeater network or satellite uplink facility, interrupt our service and harm our business. We do not have replacement or redundant facilities that can be used to assume the functions of our terrestrial repeater network, national broadcast studio or satellite uplink facility in the event of a catastrophic event.

Any damage to the satellite that transmits to our terrestrial repeater network would likely result in degradation of our service for some subscribers and could result in complete loss of service in certain areas. Damage to our national broadcast studio would restrict our programming production and require us to obtain programming from third parties to continue our service. Damage to our satellite uplink facility could result in a complete loss of service until we could identify a suitable replacement facility and transfer our operations to that site.

Consumers could pirate our service.

Individuals who engage in piracy may be able to obtain or rebroadcast our satellite radio service without paying the subscription fee. Although we use encryption technology to mitigate the risk of signal theft, such technology may not be adequate to prevent theft of our signal. If signal theft becomes widespread, it could harm our business.

Item 1B. Unresolved Staff Comments

None.

Item 2. Properties

We lease space in an office building in New York, New York, to house our headquarters and national broadcast studio. We use certain space as office, studio and display space; and we use portions for satellite transmission equipment. We also lease office or studio space in Lawrenceville, New Jersey; Farmington Hills, Michigan; Peekskill, New York; Nashville, Tennessee; Memphis, Tennessee; Los Angeles, California; and Houston, Texas. The aggregate annual rent for these properties was approximately \$6,853,000 for the year ended December 31, 2005.

We own property that we use for technical and engineering facilities in New Jersey. We also lease properties in Panama and Ecuador that we use as earth stations to command and control our satellites.

Item 3. Legal Proceedings

In September 2001, a purported class action lawsuit, entitled *Sternbeck v. Sirius Satellite Radio, Inc.*, 2:01-CV-295, was filed against us and certain of our current and former executive officers in the United States District Court for the District of Vermont. Subsequently, additional purported class action lawsuits were filed. These actions were consolidated in a single purported class action, entitled *In re: Sirius Satellite Radio Securities Litigation*, No. 01-CV-10863, pending in the United States District Court for the Southern District of New York. This action was brought on behalf of all persons who acquired our common stock on the open market between February 16, 2000 and April 2, 2001. The complaint alleged violations of Sections 10(b) and 20(a) of the Securities Exchange Act of 1934 and Rule 10b-5 promulgated thereunder. The complaint alleged, among other things, that the defendants issued materially false and misleading statements and press releases concerning when our service would be commercially available, which caused the market price of our common stock to be artificially inflated.

In January 2006, we and certain of our current and former executive officers who are also defendants agreed in principle to settle this action for \$8 million in cash. Our insurer will fund the entire amount of the settlement payment. We do not anticipate incurring any additional significant expenses in connection with this action and we will not seek recovery of any unreimbursed

**CERTIFICATION PURSUANT TO
18 U.S.C. SECTION 1350,
AS ADOPTED PURSUANT TO
SECTION 906 OF THE SARBANES-OXLEY
ACT OF 2002**

In connection with the Annual Report of Sirius Satellite Radio Inc. (the "Company") on Form 10-K for the period ended December 31, 2005 as filed with the Securities and Exchange Commission on the date hereof (the "Report"), I, David J. Frear, Executive Vice President and Chief Financial Officer of the Company, certify, pursuant to 18 U.S.C. Section 1350, as adopted pursuant to Section 906 of the Sarbanes-Oxley Act of 2002, that:

(1) The Report fully complies with the requirements of Section 13(a) or 15(d) of the Securities Exchange Act of 1934; and

(2) The information contained in the Report fairly presents, in all material respects, the financial condition and results of operations of the Company.

By: /s/ D AVID J. F REAR
David J. Frear
Executive Vice President and
Chief Financial Officer
(Principal Financial Officer)

March 13, 2006

A signed original of this written statement required by Section 906, or other document authenticating, acknowledging, or otherwise adopting the signature that appears in typed form within the electronic version of this written statement required by Section 906, has been provided to the Company and will be retained by the Company and furnished to the Securities and Exchange Commission or its staff upon request.

SIR Ex. 2

A



It's the most significant advancement in radio broadcasting since the introduction of FM stereo more than 50 years ago. HD Radio technology enables AM and FM radio stations to broadcast their programs digitally – a tremendous technological leap from the analog broadcasts of the past.

The Same Unmatched Fidelity as Your Digital Music

FM stations now with CD-quality sound
AM stations now with FM-quality sound
Crystal-clear reception with no audio distortion
[Hear the Difference](#)

More of What You're Listening to Now

New channels to play more of what you like to hear
More talk and music from the stations you're plugged into
More complete sets and more full albums
More in-depth interviews
More lengthy talk and more detailed news

Be the First to Get New HD Radio Gear

Receives and plays digital HD2 Multicast programming
Available in tabletop systems and shelf units
Also available in car and marine stereo units
[Available Products](#)
[HD Radio Buyer's Guide](#)

New Music, New Sounds with No Subscription Fee

- New artists and new personalities
- New genres, new music from abroad
- New kinds of programs you've never listened to before
- New experimental formats that no one has ever heard

[View the HD format list](#)
[Find stations ON THE AIR](#)

[View the HD format list](#)
[Find stations ON THE AIR](#)

More of What You Want

- More info on your dial, such as traffic data and stock info
- Real-time artist and song IDs
- Free of charge** like radio should be
- No subscription costs, no plans and no monthly bills

Expect More From Your Radio

- All digital, all the time
- No hiss, distortion or station drop off
- Reception is free, with no subscription costs

Since HD Radio is a free broadcast, all you have to do is get a new HD Radio receiver for your home or car. Prices are plummeting as more and more people are discovering what HD Radio is all about. So check out the products on this site for the most up-to-date info.



HD Radio
Pure Digital, Clear Radio.

Available with Free Shipping at
amazon.com



CRUTCHFIELD
The place to get HD Radio gear

HD Radio
Pure Digital, Clear Radio.

1-800-319-6752
crutchfield.com

Free shipping on most HD Radio® gear



Isonic™ entertainment system



FREE shipping from **polkaudio**®

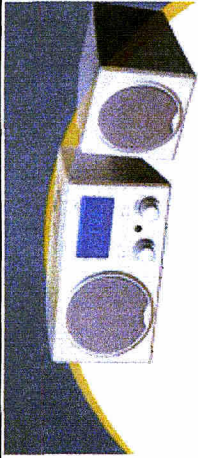

Boston
 Quality Sound with
 Digital Technology

Digital Radio

- Free shipping
- Customer reviews
- Buy online, pick up in store

circuits city

CONSUMER NEWS IBIQUNITY PRESS ROOM FAQ CONTACT CLUB HD

Privacy Statement Trademark www.ibiquity.com

© 2006 HD DIGITAL RADIO™. ALL RIGHTS RESERVED.

Información en español



B



Radio Companies Kick Off First Phase of \$200 Million Ad Campaign for HD Digital Radio

*Unprecedented national campaign will air on more than 250 stations in the first 28 markets
Boston Acoustics' early support pays off – 25% of the spots will highlight the Receptor Radio HD
Ads showcasing automakers, retailers in the works*

ORLANDO, Florida – February 21, 2006 – As promised and ahead of schedule, 12 leading radio companies are this week kicking off the first phase of a massive, \$200 million advertising campaign to accelerate the adoption of HD digital radio. In a powerful demonstration that they are making good on their commitment to this groundbreaking new technology, broadcasters will air specially created ads nationwide on more than 250 stations in the first 28 markets where HD Radio has been launched. The campaign is spearheaded by the HD Digital Radio Alliance and includes spots developed by longtime radio advertising specialists Dick Orkin and the Radio Ranch.

The campaign also builds on strong momentum for the emerging sector in recent months. More than 700 radio stations are currently broadcasting primary signals in HD digital radio. And last month, a number of leading radio companies announced HD2 multicast channels and, collectively, more than 250 entirely new music formats. The additions dramatically increase both the quality and choice of broadcasts for radio listeners.

"We're moving much faster than originally expected," said Peter Ferrara, president and CEO of the HD Digital Radio Alliance. "The support from radio companies has been unwavering, and since we've launched in the first 28 markets, response from receiver manufacturers, retailers and automakers has been extremely encouraging."

In an unconventional approach, radio companies will devote a portion of the ad time to promoting the receiver makers, retailers and automakers who make early commitments to HD digital radio. In this first wave, some 25% of the spots highlight Boston Acoustics' Receptor Radio™ HD. Citing expanding popularity of HD digital radio broadcasts and the launch of HD2 multicast channels, Boston Acoustics lowered the price on its Receptor Radio HD model to \$299, effective February 1st.

***Fun, entertaining and informative**

"The creative on these spots is fun, entertaining and informative," added Peter Ferrara. "With the industry and listener momentum we're seeing, we're able to showcase what radio does best – engage and inform."

The first wave – some 16 ads in both 30- and 15-second versions – introduce "Jake and Josh", Jake's new girlfriend, and "Big Announcer" in interrelated segments that highlight HD digital radio's crystal-clear, CD-quality sound and dramatically increased local entertainment choices. Listeners are referred to <http://www.hdradio.com/index.php> for more information.

The spots also reinforce that HD digital radio is free to the consumer and never requires a subscription fee. Samples of the spots can be heard at www.hdradio.com/press_room.php.

Links to online retailers selling HD digital radios are at <http://www.hdradio.com/index.php>. HD digital radio receivers are currently manufactured by more than 15 companies, including Audio Design Associates, Kenwood, Alpine, Panasonic, Boston Acoustics, Polk, Day Sequeira, Radiosophy, Delphi, Rotel, DICE, Sanyo, Eclipse (Fujitsu), Yamaha, JVC and Visteon.

About the HD Digital Radio™ Alliance

The HD Digital Radio Alliance is a joint initiative of leading radio broadcasters to accelerate the successful rollout of HD digital radio. Current members include major radio groups and independent station owners: ABC Radio (in Los Angeles and Minneapolis), Beasley Broadcast Group, Bonneville International, CBS Radio, Citadel Broadcasting, Clear Channel Radio, Cumulus, Emmis Communications, Entercom, Greater Media, and Susquehanna and independent owner Jerry Lee with WBEB Philadelphia. For more information on HD digital radio, visit <http://www.hdradio.com/index.php>.

All Spots

»Download Instructions«

All files are in .mp3 format. To save a file to your computer:
»right click and select "Save As" (PC)
»option + click (MAC)

- Spot #1 - What's HD - Jake & Josh (:30)** **Spot #5 - Big Announcer - So Sue Me (:30)**
- Spot #2 - Married a Tattoo Artist (:30)** **Spot #6 - Big Announcer - Pretty Darn Clever (:30)**
- Spot #3 - Perfect Relationship (:30)** **Spot #7 - Boston - Jake & Josh (:30)**
- Spot #4 - Naughty Chat Room (:15)** **Spot #8 - Big Announcer - Hot Diggity (:15)**

« [View all Press Releases](#)

Press Inquiries

Michelle Radvansky / Michele Clarke
Brainerd Communicators, Inc.
(212) 986-6667
radvansky@braincomm.com
clarke@braincomm.com

Diane Warren
HD Digital Radio Alliance
(210) 832-3509
diane@hdradioalliance.com



HD Radio
Pure Digital. Clear Radio.

Available with Free Shipping at
amazon.com

CRUTCHFIELD
The place to get HD Radio gear

HD Radio
Pure Digital. Clear Radio.

1-800-319-6752
crutchfield.com

Free shipping on most HD Radio® gear

I.Sonic™ entertainment system



FREE shipping from **polkaudio**™

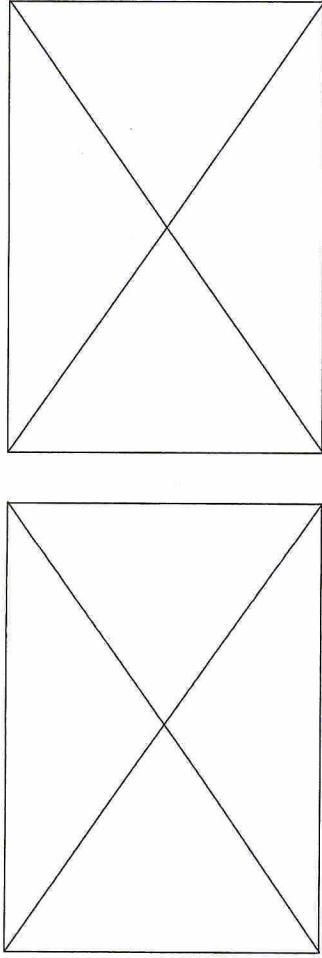

Digital Radio

- Free shipping
- Customer reviews
- Buy online, pick up in store

[CONSUMER NEWS](#) [IBIQUITY](#) [PRESS ROOM](#) [FAQ](#) [CONTACT](#) [CLUB HD](#)

Privacy Statement [Trademark http://www.ibiquity.com/](http://www.ibiquity.com/)

© 2006 HD DIGITAL RADIO™. ALL RIGHTS RESERVED.

Información en español



SIR Ex. 3

A



SIRIUS BROADCASTING NEW POLITICAL TALK AND NEWS SHOWS

Nation's First 24/7 Forum Dedicated Exclusively To Right and Left Wing Content

CES, LAS VEGAS, NV -- January 8, 2003 --SIRIUS (NASDAQ: SIRI), the only satellite radio service delivering uncompromised coast-to-coast music and entertainment for your car and home, announced today it will broadcast two new streams dedicated exclusively for right and left wing political programming. The new programming is scheduled to debut on February 3rd, and will be dubbed "SIRIUS Right" (stream #144) and "SIRIUS Left" (stream #145).

SIRIUS Right will focus on conservative leaning issues with debate and perspective offered from a hard-hitting lineup led by such prominent voices as Oliver North and Bob Dornan. SIRIUS listeners can tune in for strong opinions on national and international issues from well known names and up and comers on shows including Common Sense Radio with Oliver North, Dateline Washington, anchored by Greg Corombos, and The Jason Jarvis Show.

On the other end of the political spectrum, SIRIUS Left launches its new talk lineup reflecting all degrees of liberal ideology. With a focus on progressive issues and commentary, SIRIUS Left provides listeners with opinions, analysis, and perspective, including commentary on political and social issues from personalities such as Peter Werbe, Ernie Brown, Mike Malloy, consumer advocate Davide Horowitz, and SIRIUS' own John McMullen. Listeners can tune in to hear the John McMullen Show, Battle Line with Alan Nathan, and FIGHT BACK with David Horowitz.

"One of the exciting things about creating new content for SIRIUS is being able to offer listeners their choice of diverse programming that covers many different viewpoints," said Larry Rebich, Vice President, Programming & Market Development. "We offer both ends of the spectrum of alternative talk and progressive talk programming. So, if you have a more conservative viewpoint, you can listen to SIRIUS Right all day long, but listeners also have the chance to hear another point of view by tuning over to SIRIUS Left."

About SIRIUS

SIRIUS is the only satellite radio service bringing listeners 100 streams of the best music and entertainment coast-to-coast. SIRIUS offers 60 music streams with no commercials, along with 40 world-class sports, news, and entertainment streams for a monthly subscription fee of \$12.95. Stream Designers create and deliver uncompromised music in virtually every genre to our listeners 24 hours a day. Satellite radio products bringing SIRIUS to listeners in the car, truck, home, RV, and boat are manufactured by Kenwood, Panasonic, Clarion, Audiovox, and Jensen, and are available at major retailers including Circuit City, Best Buy, Sears, Good Guys, Tweeter, Ultimate Electronics, and Crutchfield. SIRIUS is the leading OEM satellite radio provider, with exclusive partnerships with DaimlerChrysler, Ford, and BMW. Automotive companies that have announced plans to offer SIRIUS radios in select new car models include Chrysler, Dodge, Jeep®, Ford, Lincoln, Mercury, Mazda, Land Rover, Jaguar, Volvo, Aston Martin, Nissan, Infiniti, BMW, MINI, Audi, and Volkswagen.

Click on www.SIRIUS.com to listen to SIRIUS live, or to find a SIRIUS retailer or car dealer in your area.

Any statements that express, or involve discussions as to, expectations, beliefs, plans, objectives, assumptions, future events, or performance with respect to SIRIUS Satellite Radio Inc. are not historical facts and may be forward-looking and, accordingly, such statements involve estimates, assumptions, and uncertainties which could cause actual results to differ materially from those expressed in any forward-looking statements. Accordingly, any such statements are qualified in their entirety by reference to the factors discussed in our Registration Statement on Form S-4 (File No. 333-101317) filed with the Securities and Exchange Commission on November 20, 2002. Among the key factors that have a direct bearing on our results of operations are: our need for substantial additional financing in the first half of this year; our dependence upon third parties to manufacture, distribute, market and sell SIRIUS

SIR Ex. 3-A

radios and components for those radios; the unproven market for our service; our competitive position and any events which affect the useful life of our satellites.

B



SIRIUS AND NBA TEAM UP TO OFFER NBA GAMES NATIONWIDE THROUGH SATELLITE RADIO

NEW YORK, NY--January 21, 2003-- The National Basketball Association and SIRIUS (NASDAQ: SIRI) announced today that SIRIUS will carry live audio broadcasts of NBA regular season games, playoffs and NBA Finals, as part of its standard programming package.

Beginning in mid-February, basketball fans can hear up to 40 NBA games each week as part of SIRIUS' standard programming package consisting of 100 music and entertainment streams. A complete schedule of NBA games is available on NBA.com and www.SIRIUS.com.

In addition to the play-by-play coverage, SIRIUS will implement media and marketing initiatives with various NBA properties.

"The NBA is excited to provide our fans with another innovative way to follow their favorite NBA teams and players through the SIRIUS satellite radio service," said Gregg Winik, Executive Vice President of Programming and Executive Producer, NBA Entertainment. "We want to be where our fans are and continue to make it easy for them to experience the excitement of our game."

"Adding NBA games immensely enhances our service for our valued subscribers," said Larry Rebich, SIRIUS Vice President, Programming and Market Development. "SIRIUS is proud to offer the best in sports programming at no extra charge."

About the NBA

Since its founding in 1946, the NBA has become a global phenomenon that transcends national boundaries. With 29 teams in the United States and Canada, NBA games and related programming are broadcast to 212 countries in 42 languages. The NBA is one of the largest suppliers of sports television and Internet programming in the world. Through NBA Entertainment, the league's award-winning production and programming division, the league produces NBA TV, a 24-hour television network, weekly television shows, and exclusive content for each of the NBA's team web sites, and the league's official sites, NBA.com, WNBA.com and NBDL.com. The league has also continued its partnerships with the leading Internet content and technology providers to bring the game experience even closer to its fans worldwide. For more information on the NBA, visit www.nba.com.

About SIRIUS

SIRIUS is the only satellite radio service bringing listeners 100 streams of the best music and entertainment coast-to-coast. SIRIUS offers 60 music streams with no commercials, along with 40 world-class sports, news and entertainment streams for a monthly subscription fee of \$12.95. Stream Designers create and deliver uncompromised music in virtually every genre to our listeners 24 hours a day. Satellite radio products bringing SIRIUS to listeners in the car, truck, home, RV and boat are manufactured by Kenwood, Panasonic, Clarion, Audiovox and Jensen, and are available at major retailers including Circuit City, Best Buy, Sears, Good Guys, Tweeter, Ultimate Electronics and Crutchfield. SIRIUS is the leading OEM satellite radio provider, with exclusive partnerships with DaimlerChrysler, Ford and BMW. Automotive companies that have announced plans to offer SIRIUS radios in select new car models include Chrysler, Dodge, Jeep®, Ford, Lincoln, Mercury, Mazda, Land Rover, Jaguar, Volvo, Aston Martin, Nissan, Infiniti, BMW, MINI, Audi and Volkswagen.

Click on www.SIRIUS.com to listen to SIRIUS live, or to find a SIRIUS retailer or car dealer in your area.

Any statements that express, or involve discussions as to, expectations, beliefs, plans, objectives, assumptions, future events or performance with respect to SIRIUS Satellite Radio Inc. are not historical facts and may be forward-looking and, accordingly, such statements involve estimates, assumptions and uncertainties which could cause actual results to differ

SIR Ex. 3-B

materially from those expressed in any forward-looking statements. Accordingly, any such statements are qualified in their entirety by reference to the factors discussed in our Registration Statement on Form S-4 (File No. 333-101317), and amendments thereto, filed with the Securities and Exchange Commission. Among the key factors that have a direct bearing on our results of operations are: our need for substantial additional financing in the first half of this year; our dependence upon third parties to manufacture, distribute, market and sell SIRIUS radios and components for those radios; the unproven market for our service; our competitive position and any events which affect the useful life of our satellites.

C



SIRIUS HITS ONE OUT OF THE PARK WITH 2003 MAJOR LEAGUE BASEBALL PLAYOFF AND WORLD SERIES COVERAGE

NEW YORK – September 22, 2003 – SIRIUS (NASDAQ: SIRI), known for delivering the very best in commercial-free music and premium broadcast entertainment to cars and homes across the country, today announced that SIRIUS subscribers will have access to complete play-by-play coverage of Major League Baseball's Divisional Series, League Championship Series and World Series on ESPN Radio, stream 120, throughout the 2003 post-season. Coverage will begin September 30.

"SIRIUS is committed to bringing subscribers closer to the playing field with our sports programming," said Jay Clark, Executive Vice President of Programming, SIRIUS. "Partners such as ESPN Radio allow us to provide our listeners with a front row seat to the best in sports programming."

"ESPN Radio on SIRIUS provides subscribers with expert play-by-play coverage of some of the most exciting games in baseball, no matter where they are," said ESPN Radio Vice President T.J. Lambert. "We're excited to provide this kind of access to sports fans nationwide."

For a complete schedule of all MLB coverage on SIRIUS and ESPN Radio, please visit www.sirius.com or www.espnradio.com for updates.

SIRIUS is committed to offering depth of choice in sports programming. Coupled with ESPN Radio, ESPNEWS and Sports Byline USA, SIRIUS offers live coverage of more than 40 games a week of the National Basketball Association. SIRIUS also broadcasts live play-by-play coverage of the NCAA College Football Bowl Championship Series via ESPN Radio.

About SIRIUS

SIRIUS is the only satellite radio service bringing listeners more than 100 streams of the best music and entertainment coast-to-coast. SIRIUS offers 60 music streams with no commercials, along with over 40 world-class sports, news and entertainment streams for a monthly subscription fee of only \$12.95, with greater savings for upfront payments of multiple months or a year or more. Stream Jockeys create and deliver uncompromised music in virtually every genre to our listeners 24 hours a day. Satellite radio products bringing SIRIUS to listeners in the car, truck, home, RV and boat are manufactured by Kenwood, Panasonic, Clarion and Audiovox, and are available at major retailers including Circuit City, Best Buy, Car Toys, Good Guys, Tweeter, Ultimate Electronics, Sears and Crutchfield. SIRIUS is the leading OEM satellite radio provider, with exclusive partnerships with DaimlerChrysler, Ford and BMW. Automotive brands currently offering SIRIUS radios in select new car models include BMW, MINI, Chrysler, Dodge, Jeep®, Nissan, Infiniti, Mazda, Audi, Ford and Lincoln-Mercury. Automotive brands that have announced plans to offer SIRIUS in select models include Mercedes-Benz, Jaguar, Volvo, Volkswagen, Land Rover and Aston Martin. Genmar Holdings, the world's largest manufacturer of recreational boats, Formula Boats and Winnebago, the leading supplier of recreational vehicles and motor homes, have also announced plans to offer SIRIUS.

Click on www.SIRIUS.com to listen to SIRIUS live, or to find a SIRIUS retailer or car dealer in your area.

Any statements that express, or involve discussions as to, expectations, beliefs, plans, objectives, assumptions, future events or performance with respect to SIRIUS Satellite Radio Inc. are not historical facts and may be forward-looking and, accordingly, such statements involve estimates, assumptions and uncertainties which could cause actual results to differ materially from those expressed in any forward-looking statements. Accordingly, any such statements are qualified in their entirety by reference to the factors discussed in our Annual Report on Form 10-K for the year ended December 31, 2002 filed with the Securities and Exchange Commission. Among the key factors that have a direct bearing on our results of operations are: our dependence upon third parties to manufacture, distribute, market and sell SIRIUS radios and components for those radios; the unproven market for our service; our

SIR Ex. 3-C

competitive position and any events which affect the useful life of our satellites.

D



SIRIUS SCORES WITH DELIVERY OF NHL GAMES AND NHL CORPORATE PARTNERSHIP

Satellite Radio Broadcaster to Air Daily NHL Talk Show, NHL LIVE!

NEW YORK – October 2, 2003 – SIRIUS (NASDAQ: SIRI), known for delivering the very best in commercial-free music and premium broadcast entertainment to cars and homes across the country, announced today it will air up to 40 National Hockey League games each week throughout the NHL season, beginning Oct. 8 and continuing through the Stanley Cup Finals. The broadcasts will be available to all SIRIUS subscribers at no additional cost. SIRIUS also has signed on as an official corporate marketing partner of the League.

The NHL and SIRIUS will produce a live, daily, two-hour call-in talk show originating from the SIRIUS studios in Rockefeller Center in New York City. NHL Live! will feature NHL players, coaches and celebrity hockey fans, expert commentary and fan participation. The show debuts Monday, Oct. 6 from 2-4 pm ET (with a replay at 4 pm ET), and will air on SIRIUS Sports Play-By-Play, stream 124.

"This partnership between the NHL and SIRIUS continues our commitment to delivering world class sports to our subscribers," said Joseph P. Clayton, President and CEO of SIRIUS. "I'm thrilled that hockey fans will be able to follow their favorite team no matter where they are in the continental U.S. This is a real power play for SIRIUS."

NHL Executive VP and COO Jon Litner said, "NHL fans are the most tech-savvy in all of sports, and our new marketing partnership with SIRIUS will not only allow our fans to follow NHL action across the League through satellite radio but also provide the NHL with another vehicle to grow the game of hockey."

The play-by-play hockey broadcasts will be carried live across a variety of SIRIUS streams including 124, 125 and 126. A complete schedule of games will be available at www.nhl.com and www.sirius.com.

As "The Official Satellite Radio Sponsor of the NHL," SIRIUS can include the NHL shield and related trademarks in its advertising and promotions, and will be featured in a number of NHL publications and marketing materials, and at NHL events.

About SIRIUS

SIRIUS is the only satellite radio service bringing listeners more than 100 streams of the best music and entertainment coast-to-coast. SIRIUS offers 60 music streams with no commercials, along with over 40 world-class sports, news and entertainment streams for a monthly subscription fee of only \$12.95, with greater savings for upfront payments of multiple months or a year or more. Stream Jockeys create and deliver uncompromised music in virtually every genre to our listeners 24 hours a day. Satellite radio products bringing SIRIUS to listeners in the car, truck, home, RV and boat are manufactured by Kenwood, Panasonic, Clarion and Audiovox, and are available at major retailers including Circuit City, Best Buy, Car Toys, Good Guys, Tweeter, Ultimate Electronics, Sears and Crutchfield. SIRIUS is the leading OEM satellite radio provider, with exclusive partnerships with DaimlerChrysler, Ford and BMW. Automotive brands currently offering SIRIUS radios in select new car models include BMW, MINI, Chrysler, Dodge, Jeep®, Nissan, Infiniti, Mazda, Audi, Ford and Lincoln-Mercury. Automotive brands that have announced plans to offer SIRIUS in select models include Mercedes-Benz, Jaguar, Volvo, Volkswagen, Land Rover and Aston Martin. Genmar Holdings, the world's largest manufacturer of recreational boats, Formula Boats and Winnebago, the leading supplier of recreational vehicles and motor homes, have also announced plans to offer SIRIUS.

Click on www.SIRIUS.com to listen to SIRIUS live, or to find a SIRIUS retailer or car dealer in your area.

SIR Ex. 3-D

Any statements that express, or involve discussions as to, expectations, beliefs, plans, objectives, assumptions, future events or performance with respect to SIRIUS Satellite Radio Inc. are not historical facts and may be forward-looking and, accordingly, such statements involve estimates, assumptions and uncertainties which could cause actual results to differ materially from those expressed in any forward-looking statements. Accordingly, any such statements are qualified in their entirety by reference to the factors discussed in our Annual Report on Form 10-K for the year ended December 31, 2002 filed with the Securities and Exchange Commission. Among the key factors that have a direct bearing on our results of operations are: our dependence upon third parties to manufacture, distribute, market and sell SIRIUS radios and components for those radios; the unproven market for our service; our competitive position and any events which affect the useful life of our satellites.

NHL, the NHL Shield and the word mark and image of the Stanley Cup are registered trademarks of the National Hockey League. NHL and team marks are the property of the NHL and its teams. All Rights Reserved.

SIR EX. 4

A



SIRIUS AND NFL ANNOUNCE MULTI-YEAR BROADCAST AND MARKETING AGREEMENT

SIRIUS Becomes The Official Satellite Radio Partner of the National Football League; Will Create 'The NFL Radio Network'

NEW YORK - December 16, 2003 - The National Football League and SIRIUS Satellite Radio (NASDAQ: SIRI) today announced a seven-year agreement for SIRIUS to broadcast all NFL games live nationwide, and for SIRIUS to become the Official Satellite Radio Partner of the National Football League, with exclusive rights to use the NFL "shield" logo and collective NFL team trademarks.

Beginning with the NFL's 2004 season, SIRIUS will carry the entire NFL regular season as well as select pre-season contests and playoff games.

As part of the agreement, SIRIUS will create "The NFL Radio Network," an around-the-clock exclusive stream of NFL content for SIRIUS subscribers. The radio channel will provide news, features, and a wide-range of other programming highlighting the NFL and its teams. The NFL Radio Network will also include programs from The NFL Network television channel, the first television network dedicated to the NFL which launched in November.

SIRIUS will offer all of the NFL programming at no additional cost to its subscribers.

NFL Commissioner Paul Tagliabue said, "SIRIUS has a strong commitment to sports broadcasting. We look forward to the great new programming that will be available to NFL fans on Sirius. Our partnership with SIRIUS provides all fans nationwide with another way to stay in touch with their favorite teams."

"The NFL is the most powerful name in sports, and SIRIUS is elated to be working with this world-class organization," said Joseph P. Clayton, President and CEO, SIRIUS. "For the first time ever, football fans will have the opportunity to hear radio play-by-play of their favorite NFL team - called by their favorite local announcers - no matter where they are in North America. This agreement represents a major enhancement to our superior programming lineup and it underscores our ongoing commitment to enrich the SIRIUS subscriber experience."

Scott Greenstein of The Greenstein Group, an entertainment industry consulting firm that brought SIRIUS and the NFL together, commented, "This is much more than a simple broadcast license. The NFL programming provides SIRIUS with compelling content that is unavailable anywhere else while allowing the teams to connect with their out-of-market fans across the country."

The agreement between the NFL and SIRIUS has been approved by the owners of NFL-member clubs and is subject to customary documentation. Further information regarding SIRIUS' agreement with the NFL is contained in a Current Report on Form 8-K filed by Sirius Satellite Radio Inc. with the United States Securities and Exchange Commission.

A complete schedule of games will be available at www.sirius.com and www.nfl.com. SIRIUS radios for the car and home, starting at \$149, are available at thousands of retailers nationwide. The monthly subscription fee is \$12.95, or less with prepaid subscription plans.

About SIRIUS

SIRIUS is the only satellite radio service bringing listeners more than 100 streams of the best music and entertainment coast-to-coast. SIRIUS offers 60 music streams with no commercials, along with over 40 world-class sports, news and entertainment streams for a monthly subscription fee of only \$12.95, with greater savings for upfront payments of multiple months or a year or more. Stream Jockeys create and deliver uncompromised music in virtually every

SIR Ex. 4-A

genre to our listeners 24 hours a day. Satellite radio products bringing SIRIUS to listeners in the car, truck, home, RV and boat are manufactured by Kenwood, Panasonic, Clarion and Audiovox, and are available at major retailers including Circuit City, Best Buy, Car Toys, Good Guys, Tweeter, Ultimate Electronics, Sears and Crutchfield. SIRIUS is the leading OEM satellite radio provider, with exclusive partnerships with DaimlerChrysler, Ford and BMW. Automotive brands currently offering SIRIUS radios in select new car models include BMW, MINI, Chrysler, Dodge, Jeep[®], Nissan, Infiniti, Mazda, Audi, Ford and Lincoln-Mercury. Automotive brands that have announced plans to offer SIRIUS in select models include Mercedes-Benz, Jaguar, Volvo, Volkswagen, Land Rover and Aston Martin. Genmar Holdings, the world's largest manufacturer of recreational boats, Formula Boats and Winnebago, the leading supplier of recreational vehicles and motor homes, have also announced plans to offer SIRIUS.

Click on www.SIRIUS.com to listen to SIRIUS live, or to find a SIRIUS retailer or car dealer in your area.

Any statements that express, or involve discussions as to, expectations, beliefs, plans, objectives, assumptions, future events or performance with respect to SIRIUS Satellite Radio Inc. are not historical facts and may be forward-looking and, accordingly, such statements involve estimates, assumptions and uncertainties which could cause actual results to differ materially from those expressed in any forward-looking statements. Accordingly, any such statements are qualified in their entirety by reference to the factors discussed in our Annual Report on Form 10-K for the year ended December 31, 2002 filed with the Securities and Exchange Commission. Among the key factors that have a direct bearing on our results of operations are: our dependence upon third parties to manufacture, distribute, market and sell SIRIUS radios and components for those radios; the unproven market for our service; our competitive position and any events which affect the useful life of our satellites.

B



SIRIUS And National Football League Execute Definitive Multi-Year Broadcast And Marketing Agreement

SIRIUS Becomes The Official Satellite Radio Partner of the NFL; 'The NFL Satellite Radio Network' to Debut This Year

NEW YORK – February 4, 2004 – The National Football League and SIRIUS Satellite Radio (NASDAQ: SIRI) today announced they have completed a definitive seven-year agreement – announced in December 2003 – for SIRIUS to broadcast all NFL games live nationwide and for SIRIUS to become the Official Satellite Radio Partner of the NFL.

Beginning with the NFL's 2004 season, SIRIUS plans to carry all NFL regular-season contests as well as select pre-season and playoff games. Starting with the 2005 season, SIRIUS will also broadcast the Conference Championships and the Super Bowl. SIRIUS will also create "The NFL Satellite Radio Network," an around-the-clock, year-round stream of NFL content on SIRIUS. All of the programming will be available at no additional cost to SIRIUS subscribers. As Official Satellite Radio Partner of the NFL, SIRIUS now has the right to use the NFL "shield" logo and collective NFL team trademarks for consumer promotion.

"Our announcement that SIRIUS would carry NFL play-by-play games has been met with great enthusiasm by out-of-market football fans, our automotive partners and consumer electronics retailers," said Joseph P. Clayton, President and CEO, SIRIUS. "We look forward to providing nationwide game coverage of every regular-season NFL game beginning this year as well as comprehensive coverage from The NFL Satellite Radio Network."

A complete schedule of games will be available at sirius.com. SIRIUS radios for the car and home, starting at \$149, are available at thousands of retailers nationwide. The monthly subscription fee is \$12.95, or less with prepaid subscription plans.

About SIRIUS

SIRIUS is the only satellite radio service bringing listeners more than 100 streams of the best music and entertainment coast-to-coast. SIRIUS offers 61 music streams with no commercials, along with over 44 world-class sports, news and entertainment streams for a monthly subscription fee of only \$12.95, with greater savings for upfront payments of multiple months or a year or more. SIRIUS is also the official satellite radio partner of the NFL. Stream Jockeys create and deliver uncompromised music in virtually every genre to our listeners 24 hours a day. Satellite radio products bringing SIRIUS to listeners in the car, truck, home, RV and boat are manufactured by Kenwood, Panasonic, Clarion and Audiovox, and are available at major retailers including Circuit City, Best Buy, Car Toys, Good Guys, Tweeter, Ultimate Electronics, Sears and Crutchfield. SIRIUS is the leading OEM satellite radio provider, with exclusive partnerships with DaimlerChrysler, Ford and BMW. Automotive brands currently offering SIRIUS radios in select new car models include BMW, MINI, Chrysler, Dodge, Jeep[®], Nissan, Infiniti, Mazda, Audi, Ford and Lincoln-Mercury. Automotive brands that have announced plans to offer SIRIUS in select models include Mercedes-Benz, Jaguar, Volvo, Volkswagen, Land Rover and Aston Martin. Genmar Holdings, the world's largest manufacturer of recreational boats, Formula Boats and Winnebago, the leading supplier of recreational vehicles and motor homes, also offer SIRIUS. Hertz currently offers SIRIUS in 29 vehicle models at 53 major locations around the country.

Click on sirius.com to listen to SIRIUS live, or to find a SIRIUS retailer or car dealer in your area.

Any statements that express, or involve discussions as to, expectations, beliefs, plans, objectives, assumptions, future events or performance with respect to SIRIUS Satellite Radio Inc. are not historical facts and may be forward-looking and, accordingly, such statements involve estimates, assumptions and uncertainties which could cause actual results to differ materially from those expressed in any forward-looking statements. Accordingly, any such statements are qualified in their entirety by reference to the factors discussed in our Annual Report on Form 10-K for the year ended December 31, 2002 filed with the Securities and Exchange Commission. Among the key factors that have a direct bearing on our results of operations are: our dependence upon third parties to manufacture, distribute, market and sell SIRIUS radios and components for those radios; the unproven market for our service; our

SIR Ex. 4-B

competitive position and any events which affect the useful life of our satellites.

C



SIRIUS NFL Radio Goes Live August 2, Marking Launch Of First 24/7 Radio Channel Dedicated To The NFL

Programming Lineup Includes In-Studio Talk Shows Hosted by Chris Carter, Dan Reeves, John Riggins, Shannon Sharpe and others.

NEW YORK, August 2, 2004 – SIRIUS (NASDAQ: SIRI), the premium satellite radio provider known for delivering the very best in commercial-free music and sports programming to homes and cars across the country, today announced that SIRIUS NFL Radio, the first 24/7 year-round radio channel devoted entirely to the National Football League, will go live on Monday, August 2. SIRIUS also announced the programming lineup for its inaugural season.

SIRIUS NFL Radio will provide the most comprehensive, in-depth radio coverage of the NFL, including daily live shows hosted by legendary NFL figures, including Cris Carter, Dan Reeves, John Riggins and Shannon Sharpe. Each show will feature team-by-team reports, expert analysis, exclusive conversations with team personnel and sports insiders – and best of all, phone calls from football fans from around the country. The channel will also cater to fantasy football fans with a show dedicated to fantasy leagues every Friday.

SIRIUS NFL Radio complements SIRIUS NFL Sunday Drive, the new programming package that lets subscribers choose from a full slate of live radio game broadcasts from all around the NFL each Sunday.

"Football fans – real football fans – will get the best coverage of the NFL, every day of the year on SIRIUS NFL Radio," remarked Steve Cohen, SIRIUS Director of NFL Programming. "We have spared no effort in assembling the wisest, smartest names in pro football for our on-air lineup. SIRIUS subscribers will be the best-informed football fans around!"

"SIRIUS NFL Sunday Drive will enhance football fans' fall Sunday rituals, because wherever they are – at the beach, in the car or on the patio – they can now follow every play of their favorite teams and players with SIRIUS," said Scott Greenstein, President of Entertainment and Sports, SIRIUS. "We've got something for every fan, including the opportunity to choose from either the home or away broadcast of the same game. SIRIUS NFL Sunday Drive and SIRIUS NFL Radio are two great ways to enjoy the NFL season this fall."

SIRIUS NFL Radio kicks off at 8 am ET Monday, August 2 with "The Opening Drive" show hosted by Dan Reeves and Chris Moore. The complete weekday lineup:

Live talk shows: hosted by current and future NFL Hall of Famers, NFL and media experts. A look at the opening day schedule:

- 8-10am "The Opening Drive" with Chris Moore and Dan Reeves
- 10am-1pm "Movin' The Chains" with Bob Papa, Shannon Sharpe and Tim Ryan
- 1-3pm "The Red Zone" with Steve Cohen, Cris Carter, Glenn Parker, Gil Brandt and Carl Banks
- 3pm-7pm "The Afternoon Blitz" with Adam Schein, John Riggins and Pat Kirwan.

Fantasy Show: A weekly show throughout the season, updating fans on statistics, injuries and all the players hosted by Adam Caplan and John Hansen.

SIRIUS NFL Radio and SIRIUS NFL Sunday Drive are provided to SIRIUS customers at no additional cost over SIRIUS' basic monthly subscription price of \$12.95 per month (an annual subscription lowers the monthly cost to \$9.95). SIRIUS radios that can be used in both the car and home are available for \$149 at Best Buy, Circuit City, Radio Shack, Wal-Mart and other electronics retailers across America.

About SIRIUS

SIR Ex. 4-C

SIRIUS, now available to over 10 million DISH Network satellite TV and SIRIUS Satellite Radio subscribers, provides listeners with over 120 channels of the best commercial-free music, sports, information and entertainment, with digital quality sound coast-to-coast, broadcast daily from New York City, Los Angeles, Nashville, New Orleans, Houston and Daytona. SIRIUS offers 65 channels of 100% commercial-free music, featuring multiple categories of pop, rock, country, hip-hop, R&B, dance, jazz, classical and Latin music, along with more than 50 channels of world-class sports, news, talk entertainment, traffic and weather for a monthly subscription fee of only \$12.95, with greater savings for upfront payments of multiple months or a year or more. SIRIUS also broadcasts live play-by-play games of the NHL and the NFL, and is the Official Satellite Radio partner of the NFL.

SIRIUS Satellite Radio products for the car, truck, home, RV and boat are manufactured by Alpine, Audiovox, Blaupunkt, Clarion, Eclipse, Jensen, JVC, Kenwood, Panasonic and U.S. Electronics, and can be purchased at major retailers including Advance Auto Parts, Best Buy, Car Toys, Circuit City, Crutchfield, Good Guys, Wal-Mart, Sears, Tweeter and Ultimate Electronics, along with RadioShack and DISH Network outlets.

SIRIUS' exclusive automotive partners DaimlerChrysler, Ford and BMW represent over 40% of new cars and light trucks sold annually in the United States. Automotive brands currently offering SIRIUS radios in select new car models include BMW, MINI, Chrysler, Dodge, Jeep®, Nissan, Infiniti, Mazda, Audi, Ford, Lincoln-Mercury, Mercedes-Benz, Porsche and Volkswagen. Automotive brands that have announced plans to offer SIRIUS radios in select models include Jaguar, Volvo, Land Rover and Aston Martin. In 2004, SIRIUS radios are expected to be available in over 80 different car models, with more than 50 of them factory programs. Also, Hertz currently offers SIRIUS in 29 vehicle models at 53 major locations around the country. In addition, the Penske companies – Penske Auto Group, United Auto Group and Penske Trucking – are offering SIRIUS radios as a factory installed option, where available, in their cars and trucks through their dealerships.

Genmar Holdings, the world's largest manufacturer of recreational boats, Formula Boats and Winnebago, the leading supplier of recreational vehicles and motor homes, also offer SIRIUS.

Click on sirius.com to listen to SIRIUS live, or to find a SIRIUS retailer or car dealer in your area.

Any statements that express, or involve discussions as to, expectations, beliefs, plans, objectives, assumptions, future events or performance with respect to SIRIUS Satellite Radio Inc. are not historical facts and may be forward-looking and, accordingly, such statements involve estimates, assumptions and uncertainties which could cause actual results to differ materially from those expressed in any forward-looking statements. Accordingly, any such statements are qualified in their entirety by reference to the factors discussed in our Annual Report on Form 10-K for the year ended December 31, 2003 filed with the Securities and Exchange Commission. Among the key factors that have a direct bearing on our results of operations are: our dependence upon third parties to manufacture, distribute, market and sell SIRIUS radios and components for those radios; the unproven market for our service; our competitive position and any events which affect the useful life of our satellites.

SIR Ex. 5

A



SIRIUS Satellite Radio Adds EWTN Global Catholic Radio To Programming Lineup

World-renowned Religious Networks to Air in English and in Spanish

NEW YORK - January 5, 2004 - SIRIUS Satellite Radio (NASDAQ: SIRI), known for delivering the very best in 100% commercial-free music and premium sports programming to cars and homes across the country, announced today that EWTN Global Catholic Network has joined the SIRIUS lineup on two streams serving English- and Spanish-speaking subscribers.

EWTN Global Catholic Network is in its 22nd year and is in more than 85 million television households in 110 countries. With its worldwide short wave radio station, Internet site (www.ewtn.com), publishing arm and now its affiliation with SIRIUS, EWTN is the largest religious media network in the world.

EWTN began its English and Spanish short wave radio services in 1992. Four years later, using the satellite reach of its television network, EWTN's radio service was made available to AM & FM radio stations around the world. EWTN Global Catholic Radio offers listeners live call-in talk shows, informative teaching series, daily devotions, Church events and musical presentations in English and Spanish.

Michael P. Warsaw, the Network's President, said, "We are delighted to be the first Catholic programmer to be included in a U.S. satellite radio service. This new digital technology will enable people across the country, particularly those who are not served by terrestrial Catholic radio stations, to have access to EWTN's radio programming. "We are grateful to SIRIUS for recognizing the need for Catholic programming to be included in their line-up. We thank God for this development."

Joseph P. Clayton, President & CEO, SIRIUS, said, "The addition of EWTN Global Catholic Radio helps to fulfill our ongoing commitment to provide popular radio programming that can't be found in large portions of the country. EWTN is a household name by virtue of its wide distribution around the world and SIRIUS is delighted to be able to answer our subscribers requests by adding this programming."

Beginning on January 19, EWTN Global Catholic Radio will be found on SIRIUS stream 160 and EWTN Radio Católica Mundial will be on SIRIUS stream 158.

About SIRIUS

SIRIUS is the only satellite radio service bringing listeners more than 100 streams of the best music and entertainment coast-to-coast. SIRIUS offers 60 music streams with no commercials, along with over 40 world-class sports, news and entertainment streams for a monthly subscription fee of only \$12.95, with greater savings for upfront payments of multiple months or a year or more. SIRIUS is also the official satellite radio partner of the NFL. Stream Jockeys create and deliver uncompromised music in virtually every genre to our listeners 24 hours a day. Satellite radio products bringing SIRIUS to listeners in the car, truck, home, RV and boat are manufactured by Kenwood, Panasonic, Clarion and Audiovox, and are available at major retailers including Circuit City, Best Buy, Car Toys, Good Guys, Tweeter, Ultimate Electronics, Sears and Crutchfield. SIRIUS is the leading OEM satellite radio provider, with exclusive partnerships with DaimlerChrysler, Ford and BMW. Automotive brands currently offering SIRIUS radios in select new car models include BMW, MINI, Chrysler, Dodge, Jeep[®], Nissan, Infiniti, Mazda, Audi, Ford and Lincoln-Mercury. Automotive brands that have announced plans to offer SIRIUS in select models include Mercedes-Benz, Jaguar, Volvo, Volkswagen, Land Rover and Aston Martin. Genmar Holdings, the world's largest manufacturer of recreational boats, Formula Boats and Winnebago, the leading supplier of recreational vehicles and motor homes, also offer SIRIUS. Hertz currently offers SIRIUS in 29 vehicle models at 53 major locations around the country.

Click on www.SIRIUS.com to listen to SIRIUS live, or to find a SIRIUS retailer or car dealer in your area.

SIR Ex. 5-A

Any statements that express, or involve discussions as to, expectations, beliefs, plans, objectives, assumptions, future events or performance with respect to SIRIUS Satellite Radio Inc. are not historical facts and may be forward-looking and, accordingly, such statements involve estimates, assumptions and uncertainties which could cause actual results to differ materially from those expressed in any forward-looking statements. Accordingly, any such statements are qualified in their entirety by reference to the factors discussed in our Annual Report on Form 10-K for the year ended December 31, 2002 filed with the Securities and Exchange Commission. Among the key factors that have a direct bearing on our results of operations are: our dependence upon third parties to manufacture, distribute, market and sell SIRIUS radios and components for those radios; the unproven market for our service; our competitive position and any events which affect the useful life of our satellites.

B



SIRIUS Satellite Radio To Provide Traffic And Weather Information For Top 20 Markets

- **Reports Begin This Weekend In New York and Los Angeles Areas**
- **SIRIUS Subscribers in All 20 Markets Will be Within Four Minutes of a Traffic Report for Their Area**

NEW YORK - February 27, 2004 - SIRIUS Satellite Radio (NASDAQ: SIRI), known for delivering the very best in commercial-free music and premium sports programming to cars and homes across the country, announced today that it will provide around-the-clock traffic and weather reports for the top 20 traffic markets, beginning with New York and Los Angeles on Sunday, February 29 on SIRIUS stream 150.

SIRIUS FIRST TRAFFIC will be the only satellite radio service that will broadcast traffic conditions from monitoring centers located around the country. The SIRIUS resources include a fleet of helicopters, fixed-wing aircraft, ground monitors, traffic cameras and other state-of-the-art technologies. SIRIUS FIRST TRAFFIC will be presented in conjunction with SmartRoute Systems Inc., a Westwood One company and America's most trusted source of traffic reporting news. Weather information will come from The Weather Channel, the nation's premier provider of weather information.

"SIRIUS FIRST TRAFFIC sets itself apart from other national traffic reporting services because it has 'eyes' on problem traffic areas, right where they are happening," said Jay Clark, Executive Vice President of Programming, SIRIUS. "Unlike other services, which attempt to monitor road conditions from as far as 2,500 miles away, SIRIUS FIRST TRAFFIC uses veteran on-the-scene reporters who know their roadways and can even suggest little-known shortcuts and re-routes."

By the end of March 2004, traffic and weather for Chicago, Philadelphia, San Francisco-San Jose, Boston, Dallas-Ft. Worth, Washington, DC, Atlanta, Detroit, Houston, Seattle, Tampa-St. Petersburg, Phoenix, Miami-Ft. Lauderdale, Orlando, Pittsburgh, St. Louis, Baltimore and San Diego will be added to the SIRIUS lineup. Subscribers in these areas will always be within minutes of their market-specific traffic and weather report.

Reports for all markets will be available to all SIRIUS subscribers via the SIRIUS national satellite broadcasting system, which uses three high-elliptical orbit satellites to beam more than 100 streams of programming to North America.

SIRIUS FIRST TRAFFIC will be provided to SIRIUS customers at no additional cost over the basic monthly subscription of \$12.95 per month (an annual subscription lowers the monthly cost to about \$10). This value-packed subscription also includes programming that you will only find on SIRIUS, including play-by-play from the NBA, NHL and NFL, two channels of NPR, and BBC World Service News. SIRIUS radio systems that can be used in both the car and home are available for \$149 at electronics retailers including Best Buy, Circuit City and other retailers across America.

About SIRIUS

SIRIUS is the only satellite radio service bringing listeners more than 100 streams of the best music and entertainment coast-to-coast. SIRIUS offers 61 music streams with no commercials, along with over 40 world-class sports, news and entertainment streams for a monthly subscription fee of only \$12.95, with greater savings for upfront payments of multiple months or a year or more. SIRIUS is also the official satellite radio partner of the NFL. Stream Jockeys create and deliver uncompromised music in virtually every genre to our listeners 24 hours a day. Satellite radio products bringing SIRIUS to listeners in the car, truck, home, RV and boat are manufactured by Kenwood, Panasonic, Clarion and Audiovox, and are available at major retailers including RadioShack, Circuit City, Best Buy, Car Toys, Good Guys, Tweeter, Ultimate Electronics, Sears and Crutchfield. SIRIUS is the leading OEM satellite radio provider, with exclusive partnerships with DaimlerChrysler, Ford and BMW. Automotive brands currently offering SIRIUS radios in select new car models include BMW, MINI, Chrysler, Dodge, Jeep[®], Nissan, Infiniti, Mazda, Audi, Ford and Lincoln-Mercury. Automotive brands that have announced plans to offer SIRIUS in select models include Mercedes-Benz, Jaguar, Volvo, Volkswagen, Land

SIR Ex. 5-B

Rover and Aston Martin. Genmar Holdings, the world's largest manufacturer of recreational boats, Formula Boats and Winnebago, the leading supplier of recreational vehicles and motor homes, also offer SIRIUS. Hertz currently offers SIRIUS in 29 vehicle models at 53 major locations around the country.

Click on www.sirius.com to listen to SIRIUS live, or to find a SIRIUS retailer or car dealer in your area.

Any statements that express, or involve discussions as to, expectations, beliefs, plans, objectives, assumptions, future events or performance with respect to SIRIUS Satellite Radio Inc. are not historical facts and may be forward-looking and, accordingly, such statements involve estimates, assumptions and uncertainties which could cause actual results to differ materially from those expressed in any forward-looking statements. Accordingly, any such statements are qualified in their entirety by reference to the factors discussed in our Annual Report on Form 10-K for the year ended December 31, 2002 filed with the Securities and Exchange Commission. Among the key factors that have a direct bearing on our results of operations are: our dependence upon third parties to manufacture, distribute, market and sell SIRIUS radios and components for those radios; the unproven market for our service; our competitive position and any events which affect the useful life of our satellites.

C



SIRIUS Satellite Radio Provides The Ultimate Choice: Three Full-Time Channels Of Liberal And Conservative Talk Programming

SIRIUS LEFT Lineup Includes Alan Colmes, Ed Schultz, Lynn Samuels, Alex Bennett. ***SIRIUS RIGHT*** Adds Michael Savage, Laura Ingraham, Tony Snow. ***Air America Radio*** includes Best-Selling Author Al Franken and actor Janeane Garofalo.

NEW YORK – April 5, 2004 - This election year, citizens with liberal, progressive and conservative viewpoints – no matter where they are in America – can find a home on one of three politically-charged radio channels.

SIRIUS Satellite Radio (NASDAQ: SIRI), known for delivering the very best in commercial-free music and premium sports programming to cars and homes across the country, today announced that it will add *Air America Radio* to its lineup of programming that already includes the first radio channel dedicated to liberal viewpoints, SIRIUS LEFT. The two channels complement SIRIUS RIGHT, the talk radio channel dedicated to conservative viewpoints, which today announced the additions of such hard-hitting national stars as Michael Savage, Laura Ingraham and Tony Snow.

SIRIUS LEFT begins its second year as America's first voice for liberals by adding seasoned radio hosts including Fox News Channel personality Alan Colmes, nationally-known liberal Midwesterner Ed Schultz, fiery New Yorker Lynn Samuels, San Francisco radio legend Alex Bennett and SIRIUS originals The Young Turks.

SIRIUS RIGHT promises the fiery, unyielding opinions of national talk sensation Michael Savage; the biting conservative views of Laura Ingraham; and the unmatched knowledge and insights of Fox News Commentator Tony Snow and accomplished talk show hosts Rusty Humphries and Michael Reagan.

Air America Radio will feature on-air personalities who represent today's top political and popular satirists, commentators and activists. Comedian and best-selling author Al Franken, whose books include *Lies, and the Lying Liars Who Tell Them: A Fair and Balanced Look at the Right* and *Rush Limbaugh is a Big Fat Idiot*, will host a weekday show called *The O'Franken Factor*.

"This new lineup is the Tiffany of conservative and liberal talk radio," said Jay Clark, Executive Vice President of Programming, SIRIUS. "These hosts are intelligent, humorous and sharp-tongued. They don't hold back on their opinions, and they know how to bring the best out of their callers. While we are not in the business of telling people where to stand, we make it our business to ensure every viewpoint is represented."

Jones Radio Networks' Ed Schultz, the award-winning liberal talker who has generated boxcar ratings for over seventeen years in the Midwest, says of his place in the SIRIUS LEFT lineup, "I've always been the lone lefty – and the No. 1 program – on right-leaning stations. To be 'all-left' is all right with me. I'm sure we'll have a lot of listeners from SIRIUS RIGHT click over to hear what Big Eddie has to say."

"To be able to do a talk radio show is an unbelievable blessing," Tony Snow said. "There is a way to talk about all the issues and have a sense of confidence rather than a sense of fear, anger, or rage. I'm certainly going to be making my political views known, and from time to time I'll get into fights with people, but the idea here is to have fun with it."

"We are delighted that SIRIUS Satellite Radio will bring our important message directly into the cars, homes and minds of Americans," said Mark Walsh, CEO of Progress Media. "There is a great audience of Americans who want to hear compelling and funny talk voices expressing viewpoints long absent from the radio airwaves. Now they'll get to hear the full *Air America Radio* line-up on SIRIUS."

Full programming schedules and a complete list of hosts will be posted to sirius.com.

SIR Ex. 5-C

About SIRIUS

SIRIUS provides listeners with over 110 channels of the best commercial-free music, sports, information and entertainment, with digital quality sound coast-to-coast, broadcast daily from New York City, Los Angeles, Nashville, New Orleans, Houston and Daytona. SIRIUS offers over 60, 100% commercial-free music channels featuring multiple categories of Pop, Rock, Country, Hip-Hop, R&B, Dance, Jazz, Classical and Latin music, along with over 50 channels of world-class sports, news, talk entertainment, traffic and weather for a monthly subscription fee of only \$12.95, with greater savings for upfront payments of multiple months or a year or more. SIRIUS also broadcasts live play-by-play games of the NHL, NBA and NFL, and is the official satellite radio partner of the NFL.

SIRIUS Satellite Radio products for the car, truck, home, RV and boat are manufactured by Alpine, Audiovox, Blaupunkt, Clarion, Eclipse, Jensen, JVC, Kenwood, Panasonic, Tivoli and U.S. Electronics, and can be purchased at major retailers including Best Buy, Car Toys, Circuit City, Good Guys, Sears, Tweeter and Ultimate Electronics, along with RadioShack and DISH Network outlets in mid-2004.

SIRIUS' exclusive automotive partners DaimlerChrysler, Ford and BMW represent over 40% of new cars and light trucks sold annually in the United States. Automotive brands currently offering SIRIUS radios in select new car models include BMW, MINI, Chrysler, Dodge, Jeep®, Nissan, Infiniti, Mazda, Audi, Ford, Lincoln-Mercury, Mercedes-Benz and Volkswagen. Automotive brands that have announced plans to offer SIRIUS radios in select models include Jaguar, Volvo, Land Rover and Aston Martin. In 2004, SIRIUS radios are expected to be available in nearly 80 different car models, with over 50 of them factory programs. Also Hertz currently offers SIRIUS in 29 vehicle models at 53 major locations around the country. In addition, Penske Companies – Penske Auto Group, United Auto Group and Penske Trucking – are offering SIRIUS radios as a factory installed option, where available, in their cars and trucks through their dealerships.

Genmar Holdings, the world's largest manufacturer of recreational boats, Formula Boats and Winnebago, the leading supplier of recreational vehicles and motor homes, also offer SIRIUS.

Click on sirius.com to listen to SIRIUS live, or to find a SIRIUS retailer or car dealer in your area.

Any statements that express, or involve discussions as to, expectations, beliefs, plans, objectives, assumptions, future events or performance with respect to SIRIUS Satellite Radio Inc. are not historical facts and may be forward-looking and, accordingly, such statements involve estimates, assumptions and uncertainties which could cause actual results to differ materially from those expressed in any forward-looking statements. Accordingly, any such statements are qualified in their entirety by reference to the factors discussed in our Annual Report on Form 10-K for the year ended December 31, 2003 filed with the Securities and Exchange Commission. Among the key factors that have a direct bearing on our results of operations are: our dependence upon third parties to manufacture, distribute, market and sell SIRIUS radios and components for those radios; the unproven market for our service; our competitive position and any events which affect the useful life of our satellites.

D



SIRIUS Satellite Radio Expands Lineup Of Talk Programming With New Conservative Channel, Sirius Patriot

SIRIUS Talk Radio Lineup Now Features Two Left-Liberal Channels and Two Right-Conservative Channels

NEW YORK – July 7, 2004 - SIRIUS (NASDAQ: SIRI), the premium satellite radio provider known for delivering the very best in commercial-free music and sports programming to cars and homes across the country, today announced the debut of SIRIUS Patriot, a call-in talk radio channel dedicated to conservative American values. SIRIUS Patriot brings to 12 the number of SIRIUS channels that feature call-in talk radio programming, far more than what a listener could hear on any other radio service. SIRIUS Patriot is also the second channel dedicated to conservative viewpoints on SIRIUS.

"SIRIUS is all about variety, selection and choice," said Jeremy Coleman, SIRIUS Vice President of Talk, Information and Entertainment Programming. "Earlier this year, SIRIUS added a second liberal channel with Air America Radio. We felt it was not only fair, but essential that in this crucial election year we add a second conservative channel for our subscribers. Our offering the greatest number of talk radio viewpoints is key to the SIRIUS promise of unique and compelling programming that listeners cannot get anywhere else."

Among the unique offerings of the SIRIUS Patriot lineup is an overnight feed of The Pentagon Channel. This program, produced by the Department of Defense, broadcasts military news and information for the 2.6 million members of the U.S. Armed Forces, including Defense Department news briefings, military news, interviews with top defense officials and short stories about the work of the U.S. military.

The SIRIUS Patriot lineup features (weekdays):

6 am - 9 am ET - Geoff Metcalf
 9 am - 12 pm ET - Laura Ingraham
 12 pm - 2 pm ET - Bob Dornan
 2 pm - 5 pm ET - Cam & Company from NRA News
 5 pm - 6 pm ET - Joseph Farah's Worldnet Daily
 6 pm - 10 pm ET - Michael Reagan
 10 pm - 1 am ET - Joseph Farah's Worldnet Daily
 1 am - 6 am ET - The Pentagon Channel

Also, SIRIUS Right, the original satellite radio channel devoted exclusively to conservative talk, will add Jerry Doyle to its lineup from 10 pm - 1 am ET weeknights.

About SIRIUS

SIRIUS, now available to over 10 million DISH Network satellite TV and SIRIUS Satellite Radio subscribers, provides listeners with over 120 channels of the best commercial-free music, sports, information and entertainment, with digital quality sound coast-to-coast, broadcast daily from New York City, Los Angeles, Nashville, New Orleans, Houston and Daytona. SIRIUS offers 65 channels of 100% commercial-free music, featuring multiple categories of pop, rock, country, hip-hop, R&B, dance, jazz, classical and Latin music, along with more than 50 channels of world-class sports, news, talk entertainment, traffic and weather for a monthly subscription fee of only \$12.95, with greater savings for upfront payments of multiple months or a year or more. SIRIUS also broadcasts live play-by-play games of the NHL and the NFL, and is the official satellite radio partner of the NFL.

SIRIUS Satellite Radio products for the car, truck, home, RV and boat are manufactured by Alpine, Audiovox, Blaupunkt, Clarion, Eclipse, Jensen, JVC, Kenwood, Panasonic and U.S. Electronics, and can be purchased at major retailers including Best Buy, Car Toys, Circuit City, Good Guys, Wal-Mart, Sears, Tweeter and Ultimate Electronics, along with RadioShack and DISH Network outlets.

SIR Ex. 5-D

SIRIUS' exclusive automotive partners DaimlerChrysler, Ford and BMW represent over 40% of new cars and light trucks sold annually in the United States. Automotive brands currently offering SIRIUS radios in select new car models include BMW, MINI, Chrysler, Dodge, Jeep, Nissan, Infiniti, Mazda, Audi, Ford, Lincoln-Mercury, Mercedes-Benz and Volkswagen. Automotive brands that have announced plans to offer SIRIUS radios in select models include Jaguar, Volvo, Land Rover and Aston Martin. In 2004, SIRIUS radios are expected to be available in over 80 different car models, with more than 50 of them factory programs. Also, Hertz currently offers SIRIUS in 29 vehicle models at 53 major locations around the country. In addition, the Penske companies – Penske Auto Group, United Auto Group and Penske Trucking – are offering SIRIUS radios as a factory installed option, where available, in their cars and trucks through their dealerships.

Genmar Holdings, the world's largest manufacturer of recreational boats, Formula Boats and Winnebago, the leading supplier of recreational vehicles and motor homes, also offer SIRIUS.

Click on sirius.com to listen to SIRIUS live, or to find a SIRIUS retailer or car dealer in your area.

Any statements that express, or involve discussions as to, expectations, beliefs, plans, objectives, assumptions, future events or performance with respect to SIRIUS Satellite Radio Inc. are not historical facts and may be forward-looking and, accordingly, such statements involve estimates, assumptions and uncertainties which could cause actual results to differ materially from those expressed in any forward-looking statements. Accordingly, any such statements are qualified in their entirety by reference to the factors discussed in our Annual Report on Form 10-K for the year ended December 31, 2003 filed with the Securities and Exchange Commission. Among the key factors that have a direct bearing on our results of operations are: our dependence upon third parties to manufacture, distribute, market and sell SIRIUS radios and components for those radios; the unproven market for our service; our competitive position and any events which affect the useful life of our satellites.

E



SIRIUS Satellite Radio Kicks Off College Football Season With Broadcast Of Usc-Virginia Tech Game

The Leader In Satellite Radio Sports To Deliver Exciting Matchup Between Pac-10, ACC Teams; Sets Stage For More College Football Programming

NEW YORK – August 24, 2004 - SIRIUS (NASDAQ: SIRI), the premium satellite radio provider known for delivering the very best in commercial-free music and sports programming to cars and homes across the country, today announced the first of an extensive package of college football games with a live play-by-play broadcast featuring the No. 1-ranked University of Southern California Trojans of the Pac-10 vs. the Virginia Tech Hokies of the Atlantic Coast Conference on Saturday, August 28.

SIRIUS, the Official Satellite Radio Partner of the USC Trojans, will carry the game at 7:45pm on SIRIUS channel 123, featuring USC announcers Pete Arbogast and Paul McDonald. More details regarding SIRIUS' exciting package of college football programming will be announced shortly.

USC head football coach Pete Carroll said, "I've seen how well SIRIUS has approached their NFL coverage and I've enjoyed being on their broadcasts, and I look forward to them bringing USC football to the whole country. SIRIUS Satellite Radio is the state of the art in the media today."

SIRIUS also is the Official Satellite Radio Partner of the NFL and features SIRIUS NFL Sunday Drive, the only satellite radio programming package that lets subscribers choose from a full slate of live radio game broadcasts from around the NFL each Sunday.

SIRIUS radios for the car and home are available at leading retailers nationwide. More information is available at sirius.com.

About SIRIUS

SIRIUS, now available to over 10 million DISH Network satellite TV and SIRIUS Satellite Radio subscribers, provides listeners with over 120 channels of the best commercial-free music, sports, information and entertainment, with digital quality sound coast-to-coast, broadcast daily from New York City, Los Angeles, Nashville, New Orleans, Houston and Daytona. SIRIUS offers 65 channels of 100% commercial-free music, featuring multiple categories of pop, rock, country, hip-hop, R&B, dance, jazz, classical and Latin music, along with more than 50 channels of world-class sports, news, talk entertainment, traffic and weather for a monthly subscription fee of only \$12.95, with greater savings for upfront payments of multiple months or a year or more. SIRIUS also broadcasts live play-by-play games of the NHL and the NFL, and is the Official Satellite Radio partner of the NFL.

SIRIUS Satellite Radio products for the car, truck, home, RV and boat are manufactured by Alpine, Audiovox, Blaupunkt, Clarion, Eclipse, Jensen, JVC, Kenwood, Panasonic and U.S. Electronics, and can be purchased at major retailers including Advance Auto Parts, Best Buy, Car Toys, Circuit City, Crutchfield, Good Guys, Wal-Mart, Sears, Tweeter and Ultimate Electronics, along with RadioShack and DISH Network outlets.

SIRIUS' exclusive automotive partners DaimlerChrysler, Ford and BMW represent over 40% of new cars and light trucks sold annually in the United States. Automotive brands currently offering SIRIUS radios in select new car models include BMW, MINI, Chrysler, Dodge, Jeep, Nissan, Infiniti, Mazda, Audi, Ford, Lincoln-Mercury, Mercedes-Benz, Porsche and Volkswagen. Automotive brands that have announced plans to offer SIRIUS radios in select models include Jaguar, Volvo, Land Rover and Aston Martin. In 2004, SIRIUS radios are expected to be available in over 80 different car models, with more than 50 of them factory programs. Also, Hertz currently offers SIRIUS in 29 vehicle models at 53 major locations around the country. In addition, the Penske companies – Penske Auto Group, United Auto Group and Penske Trucking – are offering SIRIUS radios as a factory installed option, where available, in their cars and trucks through their dealerships.

SIR Ex. 5-E

Genmar Holdings, the world's largest manufacturer of recreational boats, Formula Boats and Winnebago, the leading supplier of recreational vehicles and motor homes, also offer SIRIUS.

Click on sirius.com to listen to SIRIUS live, or to find a SIRIUS retailer or car dealer in your area.

Any statements that express, or involve discussions as to, expectations, beliefs, plans, objectives, assumptions, future events or performance with respect to SIRIUS Satellite Radio Inc. are not historical facts and may be forward-looking and, accordingly, such statements involve estimates, assumptions and uncertainties which could cause actual results to differ materially from those expressed in any forward-looking statements. Accordingly, any such statements are qualified in their entirety by reference to the factors discussed in our Annual Report on Form 10-K for the year ended December 31, 2003 filed with the Securities and Exchange Commission. Among the key factors that have a direct bearing on our results of operations are: our dependence upon third parties to manufacture, distribute, market and sell SIRIUS radios and components for those radios; the unproven market for our service; our competitive position and any events which affect the useful life of our satellites.

F



SIRIUS Satellite Radio And CSTV: College Sports Television Launch 'SIRIUS College Sports Radio' SIRIUS To Broadcast Sports From 23 Universities

Lineup Includes Notre Dame, USC, UCLA, LSU, Oklahoma, Michigan, Nebraska, Texas, Ohio State, Florida, Tennessee, Missouri, Alabama, Auburn, Colorado, Iowa State, Kansas, Kentucky, Oklahoma State, South Carolina, Syracuse, Texas A&M and Vanderbilt

Sirius Satellite Radio And Cstv: College Sports Television Launch 'Sirius College Sports Radio' Sirius To Broadcast Sports From 23 Universities

NEW YORK - August 31, 2004 - SIRIUS (NASDAQ: SIRI), the premium satellite radio provider known for delivering the very best in commercial-free music and sports programming to cars and homes across the country, and CSTV: College Sports Television, the leader in college sports coverage on-air and on-line, today announced the launch of SIRIUS College Sports Radio. SIRIUS will broadcast a comprehensive package of play-by-play sports programming representing top-ranked colleges from the greatest conferences around the country.

As part of a wide-ranging advertising, marketing and promotional partnership between the companies, CSTV will provide college sports programming to SIRIUS and will create marketing and promotion programs that strengthen SIRIUS' position as the premier satellite radio sports broadcaster.

SIRIUS will broadcast football, basketball and other events for, and become the Official Satellite Radio Partner of, the Alabama Crimson Tide, Auburn Tigers, Colorado Buffaloes, Florida Gators, Iowa State Cyclones, Kansas Jayhawks, Kentucky Wildcats, Louisiana State University Tigers, Michigan Wolverines, Nebraska Cornhuskers, Missouri Tigers, Notre Dame Fighting Irish, Ohio State Buckeyes, Oklahoma Sooners, Oklahoma State Cowboys, South Carolina Gamecocks, Syracuse Orange, Tennessee Volunteers, Texas Longhorns, Texas A&M Aggies, UCLA Bruins, USC Trojans and Vanderbilt Commodores.

The schools are from college sports' most storied conferences, including the SEC, Big 10, Big 12, Big East and Pac-10. SIRIUS College Sports Radio will offer such highly anticipated matchups as Texas-Oklahoma, Michigan-Ohio State, Tennessee-Georgia, LSU-Florida, USC-Notre Dame and many others.

Mac Brown, University of Texas head coach said, "The University is excited to be a part of SIRIUS College Sports Radio. Texas has a huge fan constituency and their passion is Longhorns football. In keeping with the times and technology, Texas students, fans and alumni across the nation, regardless of where they are, will now be able to follow the Longhorns throughout the season."

"The University of Michigan is excited about kicking off the new season and building on last year's Big Ten Championship," said Michigan head coach Lloyd Carr. "This new initiative with SIRIUS Satellite Radio and CSTV will continue to bolster the fan base of one of the most popular football programs in the country. Now, Michigan students, fans and alumni across the nation will be able to follow the Wolverines."

"College athletics is a huge passion for many of our subscribers, and it is my pleasure to announce relationships with many of the nation's most respected universities," said Joseph P. Clayton, SIRIUS CEO. "These schools boast millions of currently enrolled students and alumni located around the country. They'll be glad to know that they can stay connected to the school no matter where they are. Once again SIRIUS has asserted itself as the leader in satellite radio sports."

"SIRIUS College Sports Radio creates another platform for CSTV to connect to the millions of college sports fans across the country," said Brian Bedol, President and CEO, CSTV. "Through our relationships with the top schools, conferences and alumni associations across the country, CSTV

SIR Ex. 5-F

will provide SIRIUS with the same outstanding programming we offer on our network, on-line and through video-on-demand."

"More than 120 million people attended college in the U.S., and college sports played an important role for many of those students," said Scott Greenstein, SIRIUS President of Entertainment and Sports. "Our agreement with CSTV and the most selective colleges in the US opens the doors for millions of students and alumni to follow their alma maters throughout the season."

"Our mission at CSTV is to connect college sports fans with more games, from more sports, across more platforms, than anyone else," added Chris Bevilacqua, Executive Vice President and co-Founder, CSTV. "With SIRIUS College Sports Radio, fans from coast to coast will have the opportunity to enjoy games all season from the top athletic programs in the country, whether they're in their cars, their dorm rooms or at home."

SIRIUS is also the Official Satellite Radio Partner of the NFL, featuring a programming package that brings subscribers live broadcasts of every NFL game. SIRIUS radios for the car and home are available at major retailers nationwide. For more information, go to www.sirius.com.

About SIRIUS

SIRIUS, now available to over 10 million DISH Network satellite TV and SIRIUS Satellite Radio subscribers, provides listeners with over 120 channels of the best commercial-free music, sports, information and entertainment, with digital quality sound coast-to-coast, broadcast daily from New York City, Los Angeles, Nashville, New Orleans, Houston and Daytona. SIRIUS offers 65 channels of 100% commercial-free music, featuring multiple categories of pop, rock, country, hip-hop, R&B, dance, jazz, classical and Latin music, along with more than 50 channels of world-class sports, news, talk entertainment, traffic and weather for a monthly subscription fee of only \$12.95, with greater savings for upfront payments of multiple months or a year or more. SIRIUS also broadcasts live play-by-play games of the NHL and the NFL, and is the official satellite radio partner of the NFL.

SIRIUS Satellite Radio products for the car, truck, home, RV and boat are manufactured by Alpine, Audiovox, Blaupunkt, Clarion, Eclipse, Jensen, JVC, Kenwood, Panasonic and U.S. Electronics, and can be purchased at major retailers including Advanced Auto Parts, Best Buy, Car Toys, Circuit City, Crutchfield, Good Guys, Wal-Mart, Sears, Tweeter and Ultimate Electronics, along with RadioShack and DISH Network outlets.

SIRIUS' exclusive automotive partners DaimlerChrysler, Ford and BMW represent over 40% of new cars and light trucks sold annually in the United States. Automotive brands currently offering SIRIUS radios in select new car models include BMW, MINI, Chrysler, Dodge, Jeep, Nissan, Infiniti, Mazda, Audi, Ford, Lincoln-Mercury, Mercedes-Benz, Porsche and Volkswagen. Automotive brands that have announced plans to offer SIRIUS radios in select models include Jaguar, Volvo, Land Rover and Aston Martin. In 2004, SIRIUS radios are expected to be available in over 80 different car models, with more than 50 of them factory programs. Also, Hertz currently offers SIRIUS in 29 vehicle models at 53 major locations around the country. In addition, the Penske companies - Penske Auto Group, United Auto Group and Penske Trucking - are offering SIRIUS radios as a factory installed option, where available, in their cars and trucks through their dealerships.

Genmar Holdings, the world's largest manufacturer of recreational boats, Formula Boats and Winnebago, the leading supplier of recreational vehicles and motor homes, also offer SIRIUS.

Click on sirius.com to listen to SIRIUS live, or to find a SIRIUS retailer or car dealer in your area.

About College Sports TV

CSTV is a multi-media company that consists of the first-ever 24-hour college sports television network, College Sports TV; the leading college sports online network, CollegeSports.com; and the first ever 24-hour college sports radio network, SIRIUS College Sports Radio. Through its numerous platforms, CSTV provides more live college sports games, events, news, information, analysis and broadband content, and reaches more college sports fans, than any other company.

College Sports TV, voted the #1 emerging cable network in the 2003 Beta research study, televises regular season and championship event coverage from over 35 men's and women's sports across every major collegiate athletic conference as well as many select NCAA Championships. CSTV and the Mountain West Conference recently announced a fully integrated multi-media partnership, beginning in Fall 2006 that will deliver more games to more people in more homes across more sports than any other Conference partnership. College Sports TV currently has agreements with the top three national distributors - Comcast, DirecTV and Time Warner Cable, among others.

CollegeSports.com, the most-trafficked college sports Web site, and its network of nearly 160 official athletic sites are the number one online source for college sports broadband content, news, information, scores and analysis. SIRIUS College Sports Radio will broadcast a comprehensive package of college football and basketball games from teams in the Big 10, Big 12, Big East, Pac 10, and SEC conferences, as well as from Notre Dame.

CSTV was co-founded by President and CEO Brian Bedol, Chairman Steve Greenberg and Executive Vice President Chris Bevilacqua. Bedol and Greenberg co-founded Classic Sports Network, which they sold to ESPN. It is now ESPN Classic. Bevilacqua is a former senior executive with Nike Inc., where he headed the company's successful foray into the college market.

Any statements that express, or involve discussions as to, expectations, beliefs, plans, objectives, assumptions, future events or performance with respect to SIRIUS Satellite Radio Inc. are not historical facts and may be forward-looking and, accordingly, such statements involve estimates, assumptions and uncertainties which could cause actual results to differ materially from those expressed in any forward-looking statements. Accordingly, any such statements are qualified in their entirety by reference to the factors discussed in our Annual Report on Form 10-K for the year ended December 31, 2003 filed with the Securities and Exchange Commission. Among the key factors that have a direct bearing on our results of operations are: our dependence upon third parties to manufacture, distribute, market and sell SIRIUS radios and components for those radios; the unproven market for our service; our competitive position and any events which affect the useful life of our satellites.

SIR Ex. 6

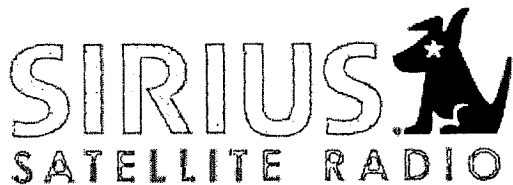

Howard Stern And SIRIUS Announce The Most Important Deal In Radio History

- Radio Innovator Signs Five Year Agreement to Broadcast on SIRIUS Beginning in 2006
- Landmark Deal for SIRIUS and Satellite Radio Industry, With Significant Potential to Accelerate Growth for SIRIUS

NEW YORK – October, 6, 2004 – "King of All Media" Howard Stern and SIRIUS (NASDAQ: SIRI) announced today an epic agreement whereby Stern will move to SIRIUS beginning January 1, 2006. SIRIUS is the premium satellite radio provider known for delivering the very best in commercial-free music and sports programming to cars and homes across the country.

The world-renowned Stern is credited with revolutionizing the talk radio format. He is the No. 1 national radio host among males 18-49 years of age and ranks No. 1 in many of the 46 major markets where his show is broadcast, including New York and Los Angeles.

"It has been my dream to have the top-rated show in radio since I was five years old," said Stern. "SIRIUS - the future of radio - will take this dream to a whole new level as I bring my fans my show my way. It will be the best radio they will ever hear."

Known for his extremely loyal fan base and for his unequalled ability to migrate fans to other media, Stern has embarked on numerous highly successful ventures over the years while maintaining dominant ratings in his demographic. Stern has written two best-selling books - Private Parts, which was Simon & Schuster's fastest selling book ever, and Miss America, the fastest selling book in publishing history. He later starred in the highly successful motion picture adaptation of Private Parts, orchestrated the fastest-selling soundtrack in motion picture history and starred in the most watched entertainment pay-per-view special of all time. "The Howard Stern Show" is the E! television network's most successful show.

"Signing Howard Stern is, without a doubt, the most exciting and transformational event in the history of radio," said Joseph P. Clayton, CEO of SIRIUS. "He is an entertainment force of unprecedented recognition and popularity in the broadcast world, who is capable of changing the face of satellite radio and generating huge numbers of subscribers for SIRIUS."

"Howard is an incredible creative and comedic icon, and we are thrilled that he chose SIRIUS to broadcast what everyone believes will be the most exciting part of his career," said Scott Greenstein, SIRIUS President of Entertainment and Sports. "There is absolutely no one like Howard Stern, and I'm excited that, for the first time, his show will be heard across the entire country as it was always meant to be heard."

Greenstein negotiated the five-year, multi-million dollar agreement with Don Buchwald, who represents Stern.

Buchwald said: "An important new industry is being developed and Howard wants to be its leader. He is truly excited to be working with SIRIUS, which will not only provide a new and innovative platform for his broadcast talents, but will draw on his skills as a businessman. SIRIUS has offered Howard and his fans a great opportunity to be a part of something truly remarkable, and we look forward to a spectacular future."

Through SIRIUS' nationwide broadcast system, Stern will be heard in every market across the country. Moreover, Stern's tremendous popularity among males 18 - 49 matches perfectly with SIRIUS' target demographic.

SIRIUS estimates that Stern only would need to generate approximately 1 million subscribers in order to cover the costs of the deal. Total production and operating costs for the Stern show, including compensation of the show cast and staff, overhead, construction costs for a dedicated studio, and a budget for the development of additional programming and marketing concepts, is estimated to be approximately \$100 million per year.

"When you look at his enormous existing fan base, all we need is for Howard to bring in a small fraction of his weekly audience for this agreement to pay for itself," said Clayton. "Anyone who knows Howard, and who understands how loyal his fan base is, will not have a hard time seeing the incredible potential for growth that he will represent for SIRIUS. We are absolutely delighted

SIR Ex. 6

that he will be joining our company, and we look forward to expanding the scope and diversity of SIRIUS programming with him."

Additional information regarding the agreement is available in a Current Report on Form 8-K filed by SIRIUS with the Securities and Exchange Commission.

SIRIUS will host a conference call today at 9:15 am ET to brief analysts on the agreement. The audio portion of the call will be webcast at www.sirius.com.

About SIRIUS

SIRIUS, now available to over 10 million DISH Network satellite TV and SIRIUS Satellite Radio subscribers, provides listeners with over 120 channels of the best commercial-free music, sports, information and entertainment, with digital quality sound coast-to-coast, broadcast daily from New York City, Los Angeles, Nashville, New Orleans, Houston and Daytona. SIRIUS offers 65 channels of 100% commercial-free music, and features 55 channels of world-class sports, news, talk, entertainment, traffic and weather for a monthly subscription fee of only \$12.95, with greater savings for upfront payments of multiple months or a year or more. SIRIUS also broadcasts live play-by-play games of the NHL and the NFL, and is the Official Satellite Radio partner of the NFL.

SIRIUS Satellite Radio products for the car, truck, home, RV and boat are manufactured by Alpine, Audiovox, Blaupunkt, Clarion, Eclipse, Jensen, JVC, Kenwood, Panasonic, Sanyo and U.S. Electronics, and can be purchased at major retailers including Advance Auto Parts, Best Buy, Car Toys, Circuit City, Crutchfield, Good Guys, Wal-Mart, Sears, Tweeter and Ultimate Electronics, along with RadioShack and DISH Network outlets.

SIRIUS' exclusive automotive partners DaimlerChrysler, Ford and BMW represent over 40% of new cars and light trucks sold annually in the United States. Automotive brands currently offering SIRIUS radios in select new car models include BMW, MINI, Chrysler, Dodge, Jeep®, Nissan, Infiniti, Mazda, Audi, Ford, Lincoln-Mercury, Mercedes-Benz, Porsche and Volkswagen. Automotive brands that have announced plans to offer SIRIUS radios in select models include Jaguar, Volvo, Land Rover and Aston Martin. In 2004, SIRIUS radios are expected to be available in over 80 different car models, with more than 50 of them factory programs. Also, Hertz currently offers SIRIUS in 29 vehicle models at 53 major locations around the country. In addition, the Penske companies - Penske Auto Group, United Auto Group and Penske Trucking - are offering SIRIUS radios as a factory installed option, where available, in their cars and trucks through their dealerships.

Genmar Holdings, the world's largest manufacturer of recreational boats, Formula Boats and Winnebago, the leading supplier of recreational vehicles and motor homes, also offer SIRIUS.

Click on www.sirius.com to listen to SIRIUS live, or to find a SIRIUS retailer or car dealer in your area.

Any statements that express, or involve discussions as to, expectations, beliefs, plans, objectives, assumptions, future events or performance with respect to SIRIUS Satellite Radio Inc. are not historical facts and may be forward-looking and, accordingly, such statements involve estimates, assumptions and uncertainties which could cause actual results to differ materially from those expressed in any forward-looking statements. Accordingly, any such statements are qualified in their entirety by reference to the factors discussed in our Annual Report on Form 10-K for the year ended December 31, 2003 filed with the Securities and Exchange Commission. Among the key factors that have a direct bearing on our results of operations are: our dependence upon third parties to manufacture, distribute, market and sell SIRIUS radios and components for those radios; the unproven market for our service; our competitive position and any events which affect the useful life of our satellites.

SIR Ex. 7

A



SIRIUS Satellite Radio Brings NCAA March Madness® To College Hoops Fans Nationwide

Unprecedented Multiyear Radio Deal to Broadcast Every Game of NCAA® Division I Men's Basketball Championship To SIRIUS Subscribers

NEW YORK – November 29, 2004 - SIRIUS (NASDAQ: SIRI), the premium satellite radio provider known for delivering the most compelling commercial-free music and sports programming to cars and homes across the country, today announced a multi-year agreement to broadcast every game of the 2005, 2006 and 2007 NCAA Division I Men's Basketball Championships.

Only SIRIUS will carry a live play-by-play radio broadcast of every NCAA Division I Men's Basketball Championship game. The 2005 championship begins with the opening round game on March 15 and concludes with the championship game on April 4. NCAA basketball fans throughout the country can follow their favorite teams, all the way to the Edward Jones Dome in St. Louis, Missouri, site of the 2005 Men's Final Four®. All games from every round will be offered to SIRIUS subscribers in their entirety, with no blackouts and at no extra charge over the basic monthly subscription price of \$12.95.

"There is no more exciting sporting event in college sports than NCAA March Madness, and this deal will allow college hoops fans everywhere to follow their team, from the opening tip to the Men's Final Four," said Scott Greenstein, President of Entertainment and Sports, SIRIUS. "Our non-stop coverage will make basketball fans feel like they are a part of every game."

Westwood One, through an agreement with CBS Sports and the NCAA, owns the national radio broadcast rights to all 88 NCAA championships, including the Division I Men's Basketball Championship.

SIRIUS Satellite Radio features the most comprehensive play-by-play and sports talk coverage on satellite radio. SIRIUS is the Official Satellite Radio Partner of the NFL and NHL, and its Sirius College Sports Radio package features the top three ranked schools in the current BCS rankings; the USC Trojans, Oklahoma Sooners and Auburn Tigers, as well as the Alabama Crimson Tide, Colorado Buffaloes, Florida Gators, Iowa State Cyclones, Kansas Jayhawks, Kentucky Wildcats, Louisiana State University Tigers, Michigan Wolverines, Navy Midshipmen, Nebraska Cornhuskers, Missouri Tigers, Notre Dame Fighting Irish, Ohio State Buckeyes, Oklahoma State Cowboys, South Carolina Gamecocks, Syracuse Orange, Tennessee Volunteers, Texas Longhorns, Texas A&M Aggies, Texas Tech Red Raiders, UCLA Bruins, Vanderbilt Commodores and West Virginia Mountaineers.

SIRIUS radios for the car and home are available at retailers nationwide. More information: sirius.com.

About SIRIUS

SIRIUS, now available to over 10 million DISH Network satellite TV and SIRIUS Satellite Radio subscribers, provides listeners with over 120 channels of the best commercial-free music, sports, information and entertainment, with digital quality sound coast-to-coast, broadcast daily from New York City, Los Angeles, Nashville, New Orleans, Houston and Daytona. SIRIUS offers 65 channels of 100% commercial-free music, and features over 55 channels of world-class sports, news, talk, entertainment, traffic and weather for a monthly subscription fee of only \$12.95, with greater savings for upfront payments of multiple months or a year or more. SIRIUS also broadcasts live play-by-play games of the NFL, NBA, and NHL, and is the Official Satellite Radio partner of the NFL.

SIRIUS Satellite Radio products for the car, truck, home, RV and boat are manufactured by Alpine, Audiovox, Blaupunkt, Brix Labs, Clarion, Delphi, Eclipse, Jensen, JVC, Kenwood, Sanyo and XACT Communications and can be purchased at major retailers including Advance Auto Parts, Audio Express, Best Buy, Car Toys, Circuit City, Crutchfield, Good Guys, Office Depot,

SIR Ex. 7-A

Sears, Target, Tweeter, Ultimate Electronics and Wal-Mart, along with RadioShack and DISH Network outlets. SIRIUS is also available at heavy truck dealers and truck stops nationwide.

SIRIUS' exclusive automotive partners DaimlerChrysler, Ford and BMW represent over 40% of new cars and light trucks sold annually in the United States. Automotive brands currently offering SIRIUS radios in select new car models include BMW, MINI, Chrysler, Dodge, Jeep, Nissan, Infiniti, Mazda, Audi, Ford, Lincoln-Mercury, Mercedes-Benz, Porsche and Volkswagen. Automotive brands that have announced plans to offer SIRIUS radios in select models include Jaguar, Volvo, Land Rover and Aston Martin. In 2004, SIRIUS radios are expected to be available in over 80 different car models, with more than 50 of them factory programs. SIRIUS is also available as a factory option on select Freightliner, Kenworth and Peterbilt Class 8 trucks. Also, Hertz currently offers SIRIUS in over 30 vehicle models at 53 major locations around the country. In addition, the Penske companies - Penske Auto Group and United Auto Group - are offering SIRIUS radios as a factory installed option, where available, in their cars and trucks through their dealerships.

Some of the best names in boating and recreational vehicles also offer SIRIUS including Carver, Formula, Four Winns, Glastron, Godfrey, Hydra Sports, Larson, Lowe, Mastercraft, Monterey, Ranger, Regal, Sea Ray, Skier's Choice and Wellcraft, as well as RV and coach builders Winnebago, Fleetwood, American Coach, Starcraft and Alfa Leisure.

Click on sirius.com to listen to SIRIUS live, or to find a SIRIUS retailer or car dealer in your area.

Any statements that express, or involve discussions as to, expectations, beliefs, plans, objectives, assumptions, future events or performance with respect to SIRIUS Satellite Radio Inc. are not historical facts and may be forward-looking and, accordingly, such statements involve estimates, assumptions and uncertainties which could cause actual results to differ materially from those expressed in any forward-looking statements. Accordingly, any such statements are qualified in their entirety by reference to the factors discussed in our Annual Report on Form 10-K for the year ended December 31, 2003 filed with the Securities and Exchange Commission. Among the key factors that have a direct bearing on our results of operations are: our dependence upon third parties to manufacture, distribute, market and sell SIRIUS radios and components for those radios; the unproven market for our service; our competitive position and any events which affect the useful life of our satellites.

B



The NBA And SIRIUS Satellite Radio Score With Extension Of Multi-Year Programming And Marketing Agreement

NEW YORK – January 21, 2005 – The National Basketball Association and SIRIUS Satellite Radio (NASDAQ: SIRI) today announced that SIRIUS will broadcast NBA regular season games, Playoffs and The Finals nationwide to subscribers as part of a non-exclusive multi-year extension agreement.

SIRIUS currently broadcasts up to 40 NBA games each week at no extra charge over the basic monthly \$12.95 programming fee. A complete schedule of NBA games is available on sirius.com and NBA.com. The new agreement provides SIRIUS with expanded trademark and promotional rights, and SIRIUS and the NBA are expected to conduct joint marketing efforts targeted at NBA fans. And for the first time, SIRIUS subscribers will receive live official courtside game stats on their SIRIUS displays.

"With millions of sports fans across the country, the NBA ranks among the world's premier sports franchises and we're delighted to expand our relationship with them," said Scott Greenstein, SIRIUS President of Entertainment and Sports. "When you look at the variety and choice that's available on SIRIUS, including the NFL, college sports, 100% commercial-free music, original programming, such as Eminem's 'Shade 45', Howard Stern beginning next January, and with the extension of our NBA relationship, there's no question who has the best programming in satellite radio."

"We are pleased to extend our relationship with SIRIUS satellite radio service which provides our fans with another innovative way to follow their favorite NBA teams and players," said Ed Desser, NBA Executive Vice President of Strategic Planning and Business Development.

SIRIUS radios are available at retail outlets around the country. More information: sirius.com.

C



NASCAR Selects SIRIUS As New Home On Satellite Radio

- **Live Races Move to SIRIUS Starting in 2007**
- **Five Year Broadcast and Marketing Agreement Includes 24/7 NASCAR Channel**

NEW YORK and DAYTONA BEACH, FL - February 22, 2005 - SIRIUS Satellite Radio (NASDAQ: SIRI) today announced an agreement to give SIRIUS North American satellite radio rights to broadcast NASCAR racing and events that will bring unprecedented programming and marketing opportunities to NASCAR fans. Beginning in 2007, SIRIUS will broadcast all NASCAR Nextel Cup Series, NASCAR Busch Series and NASCAR Craftsman Truck Series races live on a specially created, 24/7 NASCAR channel, and SIRIUS will be the only place on satellite radio to listen to NASCAR.

As part of the agreement, SIRIUS will become the Official Satellite Radio Partner of NASCAR, with exclusive trademark and marketing rights, and the right to sell all advertising time on its NASCAR channel and during the race broadcasts. SIRIUS will pay NASCAR rights fees totaling \$107.5 million over the term of the agreement, with the highest payments in the final years of the term.

"We're thrilled that NASCAR has chosen to move to SIRIUS," said Mel Karmazin, CEO of SIRIUS. "Without question, SIRIUS is the content leader in satellite radio. This decision places SIRIUS on track to become the content leader in all of radio, and we believe it will be an important driver of subscriber growth and advertising revenue. Our 24/7 NASCAR channel will super-serve NASCAR's 75 million fans nationwide in a way that's never been done before. In addition to the races, SIRIUS will take fans behind the scenes for inside news and bring them exclusive shows featuring their favorite drivers. It will be the ultimate NASCAR lifestyle experience."

"SIRIUS is the sports leader on satellite radio, and sports programming is a leading reason subscribers choose SIRIUS," said Brian France, Chairman and CEO of NASCAR. "When you combine NASCAR's growing popularity with SIRIUS' commitment to bringing the best in sports to its subscribers, it's easy to understand why we made this move. We believe that our partnership with SIRIUS will offer the best possible experience to NASCAR fans nationwide."

SIRIUS and NASCAR will work together to develop an extensive consumer marketing and outreach campaign for NASCAR fans. This effort could include advertising, cross-channel promotion throughout SIRIUS programming, officially licensed products, extensive at-track activation and ways for current NASCAR fans to switch to SIRIUS.

NASCAR is the number 2 rated sport on television, second only to the NFL. Its 75 million fans nationwide are a testament to the sport's overall growth and broad appeal. NASCAR has the most brand loyal fans in all sports. Plus, with a 10-month season, the longest in U.S. pro sports, sponsors and advertisers are visible to NASCAR's fan base for most of the year.

"This agreement with NASCAR clearly reinforces SIRIUS' leadership position in sports programming," said Scott Greenstein, SIRIUS President of Entertainment and Sports. "With NASCAR, we will be able to develop endless creative programming and marketing opportunities, as we have with our SIRIUS NFL Radio channel, to benefit NASCAR fans and SIRIUS subscribers throughout the country."

"NASCAR and SIRIUS share a vision and passion for the future, and today's announcement sets the stage for a very unique partnership within our industry," said NASCAR Digital Entertainment President Paul Brooks. "For the first time ever, NASCAR is combining a national programming and content partnership with multi-channel branding opportunities and a major national marketing commitment. This is a new type of national media partnership that will have the resources to build amazing content every day from our drivers, teams, events and industry, and package that together with the NASCAR brand like never before to reach NASCAR fans and new audiences."

SIR Ex. 7-C

NASCAR adds another exciting element to SIRIUS' sports programming that includes live, play-by-play broadcast of all NFL games, up to 40 NBA games each week and college sports from the top schools in the country. For example, SIRIUS College Sports Radio will broadcast more than 200 college basketball games in February alone, as well as the entire NCAA Division I Men's Basketball Tournament. No single broadcast source can give you this level of comprehensive sports coverage, according to SIRIUS.

In addition to NASCAR, SIRIUS is the Official Satellite Radio Partner of the NFL, the NHL and Barclays English Premier League Soccer.

Conference Call Information:

SIRIUS will hold a conference call for news media today at 2:15pm ET to discuss this announcement. Investors and the public will have live access to the media conference call via the company's website sirius.com, COMPANY INFO, Investor Relations page. A replay of the call will also be available on the SIRIUS website.

About SIRIUS

SIRIUS delivers more than 120 channels of the best commercial-free music, compelling talk shows, news and information, and the most exciting sports programming to listeners across the country in digital quality sound. SIRIUS offers 65 channels of 100% commercial-free music, and features over 55 channels of sports, news, talk, entertainment, traffic and weather for a monthly subscription fee of only \$12.95. SIRIUS also broadcasts live play-by-play games of the NFL and NBA, and is the Official Satellite Radio partner of the NFL.

SIRIUS radios for the car, truck, home, RV and boat are manufactured by Alpine, Audiovox, Blaupunkt, Clarion, Delphi, Jensen, JVC, Kenwood, Sanyo and XACT Communications. Available in more than 25,000 retail locations, SIRIUS radios can be purchased at major retailers including Best Buy, Circuit City, Crutchfield, Office Depot, Sears, Target, Wal-Mart and RadioShack. SIRIUS is also available at heavy truck dealers and truck stops nationwide.

SIRIUS radios are currently offered in vehicles from Audi, BMW, Chrysler, Dodge, Ford, Infiniti, Jeep®, Lincoln-Mercury, Lexus, Mazda, Mercedes-Benz, MINI, Nissan, Porsche, Scion, Toyota, Volkswagen and Volvo. Hertz currently offers SIRIUS at 53 major locations around the country.

Click on sirius.com to listen to SIRIUS live, or to find a SIRIUS retailer or car dealer in your area.

Any statements that express, or involve discussions as to, expectations, beliefs, plans, objectives, assumptions, future events or performance with respect to SIRIUS Satellite Radio Inc. are not historical facts and may be forward-looking and, accordingly, such statements involve estimates, assumptions and uncertainties which could cause actual results to differ materially from those expressed in any forward-looking statements. Accordingly, any such statements are qualified in their entirety by reference to the factors discussed in our Annual Report on Form 10-K for the year ended December 31, 2003 filed with the Securities and Exchange Commission. Among the key factors that have a direct bearing on our results of operations are: our dependence upon third parties to manufacture, distribute, market and sell SIRIUS radios and components for those radios; the unproven market for our service; our competitive position and any events which affect the useful life of our satellites.

About NASCAR

The National Association for Stock Car Auto Racing, Inc. (NASCAR), which began in 1948, is the sanctioning body for one of America's premier sports. NASCAR is the #1 spectator sport - holding 17 of the top 20 attended sporting events in the U.S., the #2 rated regular season sport on network TV with broadcasts in 150 countries and has 75 million fans who purchase over \$2 billion in annual licensed product sales. These fans are the most brand loyal in all of sports and as a result, more Fortune 500 companies participate in NASCAR than any other sport.

NASCAR consists of three major national series (NASCAR NEXTEL Cup Series, NASCAR Busch Series and the NASCAR Craftsman Truck Series) as well as seven Regional Tours and one Local grassroots series. NASCAR sanctions 1,500 races at over 100 tracks in 38 states, Canada and Mexico. Based in Daytona Beach, NASCAR has offices in Charlotte, Concord (NC), Conover (NC), Los Angeles, New York, Mexico City and Toronto.

D



Sirius Satellite Radio to Launch Exclusive Martha Stewart Channel

Martha Stewart Living Radio to Provide Lifestyle and How-To Information Radio's First Home Dedicated to Women's Lifestyles

NEW YORK, April 18, 2005 /PRNewswire-FirstCall via COMTEX/ -- SIRIUS Satellite Radio (Nasdaq: SIRI) and Martha Stewart Living Omnimedia, Inc. (NYSE: MSO) today announced an exclusive four-year agreement to create and launch a Martha Stewart-branded satellite radio channel. The channel, the first of its kind, will provide original programming specifically designed for women listeners and their families, 24-hours-a-day, seven days-a-week.

Martha Stewart Living Radio will leverage the company's expertise in the lifestyle arena to create programming focused on topics such as cooking, entertaining, gardening, home-keeping, decorating, holidays, collecting, health and whole living, crafts, and weddings, as well as how-to projects for parents and children, and information and tips for owners and their pets. Martha Stewart will be a regular presence on the channel and will be actively involved with program development. Martha Stewart Living Omnimedia's team of experts will also contribute. Martha Stewart Living Radio is expected to begin on SIRIUS later this year. Terms of the agreement were not disclosed.

"Martha Stewart Living is the premier brand in lifestyle and how-to programming for women and their families. Martha Stewart Living Radio on SIRIUS will have tremendous appeal to women, who are completely underserved by traditional radio programming," said Mel Karmazin, Chief Executive Officer of SIRIUS. "We expect our partnership with Martha Stewart Living Omnimedia to generate both significant subscriber growth and substantial advertising revenue, as sponsors will rush to embrace this huge, brand-loyal audience."

"This will be the first 'around the clock' channel devoted entirely to areas of interest for women in particular. It has been our dream to bring our expertise in the life-style arena, and our vast library of how-to ideas, to radio programming. Just as we pioneered in the creation of the how-to lifestyle magazine and how-to television media categories, our new partnership with SIRIUS is breaking new ground in satellite radio," said Martha Stewart, founder Martha Stewart Living Omnimedia. "The combined strength of our two companies will enable our customers, as well as current and future SIRIUS subscribers to benefit from our company's unique approach to how-to content. We are all about information and inspiration that is pertinent to every family's everyday living, and we know that our new partnership will enable an even broader audience to partake of our brand of practical, useful, sensible and nurturing information."

"Martha Stewart has an incredibly vibrant and active community of loyal readers and viewers who look for every opportunity to connect and learn from her. This new channel will deliver ideas and information, conversations and expert advice, whenever and wherever their busy lives take them," said Susan Lyne, Martha Stewart Living Omnimedia President and CEO. "We also see a tremendous opportunity to reach a new audience with programming that will be relevant, useful, and entertaining. SIRIUS is a true innovator in this uniquely personal and interactive medium, and the company's strong brand and phenomenal growth rate make them a perfect partner for this new venture."

Editors and producers at Martha Stewart Living Omnimedia have been regularly recognized for their work: the company has received 60 Emmy nominations for the daytime Martha Stewart Living television show, including three this year. Last week, Martha Stewart Living won two National Magazine Awards; Martha Stewart Weddings won in the general excellence category for magazines with circulation of 250,000 to 500,000. Kids: Fun Stuff To Do Together, won for best magazine design amongst all national magazines

"Through magazines, books, television, Internet, and merchandising, Martha Stewart Living has become the leader in women's lifestyle as a brand that stands for quality and expertise around the world," said Scott Greenstein, President of Entertainment and Sports Programming. "SIRIUS and Martha Stewart Living together create a one-of-a-kind combination that will provide women with the definitive complement to their lives and lifestyle."

For those who want to subscribe to Martha Stewart Living Radio on SIRIUS, information is available at <http://www.SIRIUS.com> and <http://www.marthastewart.com> or by calling 800-869-5059 or 800-869-5547.

###

SIR Ex. 7-D

About SIRIUS:

SIRIUS delivers more than 120 channels of the best commercial-free music, compelling talk shows, news and information, and the most exciting sports programming to listeners across the country in digital quality sound. SIRIUS offers 65 channels of 100% commercial-free music, and features over 55 channels of sports, news, talk, entertainment, traffic and weather for a monthly subscription fee of only \$12.95. SIRIUS also broadcasts live play-by-play games of the NFL and NBA, and is the Official Satellite Radio partner of the NFL.

SIRIUS radios for the car, truck, home, RV and boat are manufactured by Alpine, Audiovox, Blaupunkt, Clarion, Delphi, Jensen, JVC, Kenwood, Pioneer, Sanyo and XACT Communications. Available in more than 25,000 retail locations, SIRIUS radios can be purchased at major retailers including Best Buy, Circuit City, Crutchfield, Office Depot, Sears, Target, Wal-Mart and RadioShack. SIRIUS is also available at heavy truck dealers and truck stops nationwide.

SIRIUS radios are currently offered in vehicles from Audi, BMW, Chrysler, Dodge, Ford, Infiniti, Jeep(R), Lincoln-Mercury, Mazda, Mercedes-Benz, MINI, Nissan, Porsche, Volkswagen and Volvo. Hertz currently offers SIRIUS at 53 major locations around the country.

Click on <http://www.sirius.com> to listen to SIRIUS live, or to find a SIRIUS retailer or car dealer in your area.

Any statements that express, or involve discussions as to, expectations, beliefs, plans, objectives, assumptions, future events or performance with respect to SIRIUS Satellite Radio Inc. are not historical facts and may be forward-looking and, accordingly, such statements involve estimates, assumptions and uncertainties which could cause actual results to differ materially from those expressed in any forward-looking statements. Accordingly, any such statements are qualified in their entirety by reference to the factors discussed in our Annual Report on Form 10-K for the year ended December 31, 2004 filed with the Securities and Exchange Commission. Among the key factors that have a direct bearing on our operational results are: our dependence upon third parties, including manufacturers of SIRIUS radios, retailers, automakers and programming partners, our competitive position and any events which affect the useful life of our satellites.

P-SIRI**About MSO:**

Martha Stewart Living Omnimedia, Inc. (MSO) is a leading provider of original "how-to" information, inspiring and engaging consumers with unique lifestyle content and high-quality products. MSO is organized into four business segments: Publishing, Television, Merchandising, and Internet/Direct Commerce. Martha Stewart Living Omnimedia, Inc. is listed on the New York Stock Exchange under the ticker symbol MSO.

This press release contains certain "forward-looking statements," as that term is defined in the Private Securities Litigation Reform Act of 1995. These forward-looking statements are not historical facts but instead represent only our current beliefs regarding future events, many of which, by their nature, are inherently uncertain and outside of our control. These statements can be identified by terminology such as "may," "will," "should," "could," "expects," "intends," "plans," "anticipates," "believes," "estimates," "potential" or "continue" or the negative of these terms or other comparable terminology. The Company's actual results may differ materially from those projected in these statements, and factors that could cause such differences include further adverse reaction to the prolonged and continued negative publicity relating to Martha Stewart by consumers, advertisers and business partners; further adverse reaction by the Company's consumers, advertisers and business partners to the outcome of Ms. Stewart's trial and related sentencing arising from a sale of non-Company stock by Ms. Stewart; a loss of the services of Ms. Stewart; a loss of the services of other key personnel; an adverse resolution to the SEC enforcement proceeding currently underway against Ms. Stewart arising from her personal sale of non-Company stock; adverse resolution of some or all of the Company's ongoing litigation; downturns in national and/or local economies; shifts in our business strategies; a softening of the domestic advertising market; changes in consumer reading, purchasing and/or television viewing patterns; unanticipated increases in paper, postage or printing costs; operational or financial problems at any of our contractual business partners; the receptivity of consumers to our new product introductions; and changes in government regulations affecting the Company's industries. Certain of these and other factors are discussed in more detail in the Company's filings with the Securities and Exchange Commission, especially under the heading "Management's Discussion and Analysis of Financial Condition and Results of Operations", which may be accessed through the SEC's World Wide Web site at <http://www.sec.gov>. The Company is under no obligation to update any forward-looking statements after the date of this release.

SOURCE SIRIUS Satellite Radio

Contacts SIRIUS: Patrick Reilly, Media, +1-212-901-6646, preilly@siriusradio.com; Ji Collins, Media, +1-212-901-6422, jcollins@siriusradio.com; Michelle McKinnon,

Investor Relations, +1-212-584-5285, mmckinnon@siriusradio.com; Contacts MSO: Media Elizabeth Estroff, AVP, Corporate Communications, +1-212-827-8281; Media - Allyn Magrino, Samantha Schabel, Susan Magrino Agency (For MSO), +1-212-957-3005; Investor - Howard Hochhauser, VP, Finance and Investor Relations, +1-212-827-8530

<http://www.prnewswire.com>

Copyright (C) 2005 PR Newswire. All rights reserved.

News Provided by COMTEX

E



SIRIUS Satellite Radio to Launch Cosmopolitan-Branded Women's Channel

NEW YORK, Sept. 2 /PRNewswire-FirstCall/ -- It was announced today that SIRIUS Satellite Radio (Nasdaq: SIRI - News) and Cosmopolitan, the best-selling young women's magazine in the world, will launch a full time channel early next year.

The talk shows on "Cosmopolitan Radio" will feature a diverse array of topics of interest to women including: love, relationships, beauty, style, health, entertainment and fashion and will cater to the Cosmopolitan reader - "fun, fearless, female." Guests on the programs will include Cosmopolitan Editor-in-Chief Kate White, as well as the magazine's editors and writers.

In addition to talk shows, the channel will feature thematic music programming, which will include the best in pop music and will appeal to the tastes of Cosmopolitan's audience. The music will be specifically programmed to mirror the activities in a "Cosmopolitan" woman's day including songs for: waking up, exercising, bringing to the beach, a cocktail party or a romantic evening at home.

"Cosmopolitan Radio will be the preeminent place to hear the latest on the topics and music that most interest young women," said Scott Greenstein, SIRIUS President of Entertainment and Sports. "This new channel once again demonstrates how we are consistently reinventing the radio format so that women have a place on radio that is truly their own."

"Our readers are constantly asking for more Cosmo and that is exactly what this new channel will give them," said White. "Moving beyond the magazine into radio for the first time, even more women will be able to get the fun, informative and interesting information that Cosmopolitan has provided for 40 years. It's a perfect way to extend our reach and connect with a new audience."

About SIRIUS

SIRIUS delivers more than 120 channels of the best commercial-free music, compelling talk shows, news and information, and the most exciting sports programming to listeners across the country in digital quality sound. SIRIUS offers 65 channels of 100% commercial-free music, and features over 55 channels of sports, news, talk, entertainment, traffic and weather for a monthly subscription fee of only \$12.95. SIRIUS also broadcasts live play-by-play games of the NFL and NBA, and is the Official Satellite Radio partner of the NFL.

SIRIUS radios for the car, truck, home, RV and boat are manufactured by Alpine, Audiovox, Blaupunkt, Clarion, Delphi, Jensen, JVC, Kenwood, Pioneer, Sanyo and XACT Communications. Available in more than 25,000 retail locations, SIRIUS radios can be purchased at major retailers including Best Buy, Circuit City, Crutchfield, Costco, Office Depot, Sears, Target, Wal-Mart and RadioShack. SIRIUS is also available at heavy truck dealers and truck stops nationwide.

SIRIUS radios are currently offered in vehicles from Audi, BMW, Chrysler, Dodge, Ford, Infiniti, Jaguar, Jeep®, Land Rover, Lexus, Lincoln-Mercury, Mazda, Mercedes-Benz, MINI, Nissan, Scion, Toyota, Porsche, Volkswagen and Volvo. Hertz currently offers SIRIUS at major locations around the country.

Click on <http://www.sirius.com> to listen to SIRIUS live, or to find a SIRIUS retailer or car dealer in your area.

About Cosmopolitan

Cosmopolitan is the largest selling young women's monthly magazine worldwide with 51 international editions (55 with brand extensions) that are published in 32 languages and sold in more than 100 countries.

SIR Ex. 7-E

Cosmopolitan is published by Hearst Magazines, a unit of The Hearst Corporation (<http://www.hearst.com>). Hearst is one of the biggest publishers of monthly magazines, with a total of 19 U.S. titles and 142 international editions. The company also publishes 19 magazines in the United Kingdom through its wholly owned subsidiary, The National Magazine Company Limited.

Any statements that express, or involve discussions as to, expectations, beliefs, plans, objectives, assumptions, future events or performance with respect to SIRIUS Satellite Radio Inc. are not historical facts and may be forward-looking and, accordingly, such statements involve estimates, assumptions and uncertainties which could cause actual results to differ materially from those expressed in any forward-looking statements. Accordingly, any such statements are qualified in their entirety by reference to the factors discussed in our Annual Report on Form 10-K for the year ended December 31, 2004 filed with the Securities and Exchange Commission. Among the key factors that have a direct bearing on our operational results are: our dependence upon third parties, including manufacturers of SIRIUS radios, retailers, automakers and programming partners, our competitive position and any events which affect the useful life of our satellites.

Media Contacts:

Patrick Reilly
SIRIUS
212.901.6646
preilly@siriusradio.com

Liz Berger
SIRIUS
212.901.6726
lberger@siriusradio.com

Paul Luthringer
The Hearst Corporation
212.649.2540
pluthringer@hearst.com

F



SIRIUS Satellite Radio and the NBA Announce Multi-Year Broadcast and Marketing Agreement

- SIRIUS Becomes the Official Satellite Radio Partner of the NBA - - SIRIUS Delivers More Than 1000 Live Games Per Season - - SIRIUS Launches NBA Radio on SIRIUS, the First 24/7 Year-Round NBA Radio Channel -

NEW YORK, Dec 13, 2005 /PRNewswire-FirstCall via COMTEX News Network/ -- The National Basketball Association and SIRIUS Satellite Radio (Nasdaq: SIRI) announced today a multi-year agreement which expands upon their current broadcast arrangement and makes SIRIUS an official NBA marketing partner.

(Logo: <http://www.newscom.com/cgi-bin/prnh/19991118/NYTH125>)

The partnership makes SIRIUS the broadcaster of more live NBA games than any other radio outlet. As part of their original agreement, in February 2003, the NBA became the first major professional sports league to provide live games on SIRIUS.

SIRIUS and the NBA have launched NBA Radio on SIRIUS, the first 24/7, year-round radio channel devoted to the NBA. Airing on SIRIUS' channel 127, NBA Radio on SIRIUS features content from NBA TV -- including news, highlights and features on the league, its teams and players -- and will showcase specialized programming that will be heard exclusively on SIRIUS.

SIRIUS is the exclusive satellite radio provider of an extensive programming package that features more than 1,000 regular season games, plus every game of the NBA Playoffs and The Finals. SIRIUS has the exclusive national satellite radio rights to NBA team radio broadcasts and will air regular season games from every NBA team. Throughout the regular season, SIRIUS will, in most cases, air the home team's local radio broadcast. During the NBA Playoffs and The Finals, SIRIUS will offer the home team, visiting team and national radio broadcasts.

"SIRIUS is the content leader in satellite radio and this deal deepens our partnership by delivering more NBA games and programming to our fans and provides new marketing opportunities for SIRIUS to promote its product and brand," said NBA Commissioner David Stern. "Expanding our partnership with SIRIUS reinforces our belief in their continued growth and our commitment to embrace all forms of new media."

"The NBA is one of the most powerful names in sports and SIRIUS is excited to partner with this first-class organization," said Mel Karmazin, CEO, SIRIUS Satellite Radio. "The NBA draws an ever-larger audience of passionate fans from all across America and those fans will have access to more NBA basketball on SIRIUS than anywhere else on radio. This agreement is a significant enhancement to our superior sports lineup and underscores our ongoing commitment to bring the best sports programming to SIRIUS subscribers."

As the Official Satellite Radio Marketing Partner of the NBA, SIRIUS will conduct NBA-themed advertising and promotions with the NBA logo, NBA Radio on SIRIUS logo and 30 team logos through NBA media assets and at the NBA Store.

On NBA.com, the league's official Web site that generates more than 2.75 million visitors per day, SIRIUS will feature advertising, logo placement and a reciprocal link to SIRIUS.com. SIRIUS' NBA programming schedule and channel listings will be available on NBA.com.

SIRIUS will have a presence in the world's only NBA Store, located on Fifth Avenue in New York City, which receives approximately one million visitors per year. The NBA Store will feature a fully interactive SIRIUS display for the duration of each NBA season with a listening station that will allow customers to sample SIRIUS radios and programming. For select weeks, SIRIUS signage and products will be displayed in store windows and visitors to the NBA Store will receive a SIRIUS brochure/insert with every purchase.

SIRIUS ads will also appear on NBA TV and in other NBA media outlets. In addition, NBA promotions will run within SIRIUS and NBA media inventory.

SIR Ex. 7-F

SIRIUS also currently broadcasts exclusive NBA-themed talk shows on channel 123. Full Court Press, hosted by Kenny Smith and Ian Eagle, airs weekdays from 12-3 p.m. ET, and The Phil Jackson Show, featuring the renowned head coach of the Los Angeles Lakers, airs Mondays from 6-7 p.m. ET.

SIRIUS offers all NBA programming at no additional cost to its subscribers. For a schedule of upcoming NBA games on SIRIUS visit <http://www.sirius.com/nba> or NBA.com.

About SIRIUS

SIRIUS delivers more than 120 channels of the best commercial-free music, compelling talk shows, news and information, and the most extensive sports programming to listeners across the country in digital quality sound. SIRIUS offers 65 channels of 100% commercial-free music, and features over 55 channels of sports, news, talk, entertainment, traffic and weather for a monthly subscription fee of only \$12.95. SIRIUS is the Official Satellite Radio Partner of the NFL, NBA and NHL, broadcasting live play-by-play games of the NFL, NBA and NHL, plus college football and basketball, including the entire NCAA(R) Division I Men's Basketball Championship (March 14 - April 3, 2006).

SIRIUS radios for the car, truck, home, RV and boat are manufactured by Alpine, Audiovox, Blaupunkt, Clarion, Delphi, JBL, Jensen, JVC, Kenwood, Pioneer, Sanyo, Sony, XACT Communications and Visteon. Available in more than 25,000 retail locations, SIRIUS radios can be purchased at major retailers including Best Buy, Circuit City, Crutchfield, Costco, RadioShack, Sam's Club, Target and Wal-Mart. SIRIUS is also available at heavy truck dealers and truck stops nationwide.

SIRIUS radios are currently offered in vehicles from Audi, BMW, Chrysler, Dodge, Ford, Infiniti, Jaguar, Jeep, Land Rover, Lexus, Lincoln-Mercury, Mazda, Mercedes-Benz, MINI, Nissan, Scion, Toyota, Porsche, Volkswagen and Volvo. Hertz currently offers SIRIUS at major locations around the country.

Click on <http://www.sirius.com> to listen to SIRIUS live, or to find a SIRIUS retailer or car dealer in your area.

About the NBA

The NBA, founded in 1946, features 30 teams in the United States and Canada. The league distributes more than 800 NBA games and 44,000 hours of programming to 215 countries and territories in 43 languages. The 2005-06 NBA season features 142 games on network television -- ABC, TNT, ESPN and ESPN2. ABC's schedule, which tips off with the Christmas Day doubleheader of San Antonio-Detroit and LA Lakers-Miami, expands this season to 20 regular season game windows and will feature flexible scheduling throughout the regular season in order to provide the most compelling matchups to a national audience. NBA telecasts on all national and local networks in 2005-06 are expected to reach nearly 700 million viewers domestically. The NBA is on pace to eclipse the league's all-time attendance record for the third consecutive season.

Through NBA Cares, players and teams have committed to raise and contribute more than \$100 million for charity; donate more than one million hours of hands-on volunteer service to communities worldwide; and build more than 100 educational and athletic facilities where kids can learn and play.

Any statements that express, or involve discussions as to, expectations, beliefs, plans, objectives, assumptions, future events or performance with respect to SIRIUS Satellite Radio Inc. are not historical facts and may be forward-looking and, accordingly, such statements involve estimates, assumptions and uncertainties which could cause actual results to differ materially from those expressed in any forward-looking statements. Accordingly, any such statements are qualified in their entirety by reference to the factors discussed in our Annual Report on Form 10-K for the year ended December 31, 2004 filed with the Securities and Exchange Commission. Among the key factors that have a direct bearing on our operational results are: our dependence upon third parties, including manufacturers of SIRIUS radios, retailers, automakers and programming partners, our competitive position and any events which affect the useful life of our satellites.

P-SIRI

Media Contacts:

Andrew FitzPatrick, SIRIUS, 212.901.6693, afitzpatrick@siriusradio.com
Matt Bourne, NBA, 212-407-8093, mbourne@nba.com

SOURCE The National Basketball Association; SIRIUS Satellite Radio

Andrew FitzPatrick, of SIRIUS, +1-212-901-6693, fitzpatrick@siriusradio.com; or Matt Bourne, of NBA, +1-212-407-8093, mbourne@nba.com

<http://www.prnewswire.com>

Copyright (C) 2005 PR Newswire. All rights reserved.

News Provided by COMTEX

G



SIRIUS Satellite Radio to Launch New Playboy Channel

Expanded Playboy Radio - With New, Exclusive Content - Debuts on SIRIUS in First Quarter 2006 'Playboy Radio Morning Show' Features 'Ask Hef Anything' with Playboy Founder Hugh Hefner Answering Listeners' Questions

NEW YORK, Jan 05, 2006 /PRNewswire-FirstCall via COMTEX News Network/ -- SIRIUS Satellite Radio (Nasdaq: SIRI) and Playboy Enterprises, Inc. (NYSE: PLA, PLAA) today announced an agreement to launch a new 24-hour-a-day, seven day-a-week Playboy-branded radio channel in early 2006. The agreement with SIRIUS will leverage Playboy's vast array of entertainment assets and introduce listeners to the next generation of Playboy Radio.

(Logo: <http://www.newscom.com/cgi-bin/prnh/19991118/NYTH125>)

Playboy Radio will feature a full-range of new live programming originally created for SIRIUS, such as a new morning show that will include segments with Playboy founder Hugh Hefner, live call-in shows and broadcasts from the Playboy Mansion. Playboy Radio on SIRIUS will be Playboy's most extensive foray into radio, producing more than four times the content of previous radio ventures, to keep listeners entertained morning, noon and night.

"Playboy, one of the world's most recognizable brands in men's entertainment, joined SIRIUS so it could create compelling original programming that it hasn't been able to do anywhere else before," said Scott Greenstein, SIRIUS President of Entertainment and Sports. "With a lineup that includes the new morning show and other exciting programming to come, the Playboy Radio channel will give listeners unprecedented access into the world of Playboy."

"We are excited to announce the new home of Playboy Radio and chose SIRIUS because it is the clear leader in diverse and compelling radio programming," said Jim Griffiths, President of the Playboy Entertainment Group. "As the leading provider of lifestyle and entertainment programming for adults, we are in a unique position to bring the power of the Playboy brand to satellite radio and to offer an unparalleled program line-up to SIRIUS listeners who are interested in this type of sexy and sophisticated content."

Subscribers wishing to hear Playboy Radio will "opt-in" for the channel, either via the phone or Internet. SIRIUS also offers the ability to block Playboy Radio, and other channels, through its parental control system. The new Playboy Radio channel will be offered at no extra cost to subscribers.

The new channel will originate from Playboy's state-of-the-art Andrita Studio in Los Angeles with remotes from the Playboy Mansion, and will include a broad range of programming, leveraging personalities and elements from Playboy magazine, Playboy.com and Playboy TV. Hugh Hefner, Playboy Playmates, Playboy magazine editors and Playboy TV talent will all have a regular presence on the channel.

Previews of daily line-up:

The Playboy Radio Morning Show - the style and culture of Playboy magazine will come to life every morning in a sophisticated lifestyle-based show. Playboy editors will appear regularly on the morning show to report the latest buzz on everything from celebrities to music to sports. This program will also feature the segment "Ask Hef Anything," where legendary Playboy founder Hugh Hefner will answer listeners' questions.

The Playmate Hour - this daily show will give listeners a peek inside Hef's world and the Playboy Mansion through the eyes of Playboy's famous Playmates. The show will be hosted by a Playmate and will feature daily Playmate interviews and updates.

Afternoon Delight - a live call-in show that will blend sex, humor, information and entertainment. This

SIR Ex. 7-G

show will feature frank and honest discussions with guest experts and recurring segments such as "Sex in the News" and "The Playboy Advisor."

Sexy Stories - a daily hour of original sizzling fiction and erotic adventures hosted by the sultry Ginger Jones.

Night Calls Radio - Playboy TV's fiery red-head Tiffany Granath and legendary adult starlet Christy Canyon will steam-up the airwaves with this radio version of the immensely popular Playboy TV series.

About SIRIUS

SIRIUS delivers more than 125 channels of the best commercial-free music, compelling talk shows, news and information, and the most extensive sports programming to listeners across the country in digital quality sound. SIRIUS offers 68 channels of 100% commercial-free music, and features over 55 channels of sports, news, talk, entertainment, traffic and weather for a monthly subscription fee of only \$12.95. SIRIUS is the Official Satellite Radio Partner of the NFL, NBA and NHL and broadcasts live play-by-play games of the NFL, NBA and NHL.

SIRIUS products for the car, truck, home, RV and boat are distributed by Alpine, Audiovox, Brix Group, Clarion, Delphi, Directed Electronics, Eclipse, Jensen, JVC, Kenwood, Magnadyne, Monster Cable, Pioneer, Russound, Tivoli and XACT Communications. Available in more than 25,000 retail locations, SIRIUS radios can be purchased at major retailers including Best Buy, Circuit City, Crutchfield, Costco, Target, Wal-Mart, Sam's Club, RadioShack and at shop.sirius.com.

SIRIUS radios are currently offered in vehicles from Audi, BMW, Chrysler, Dodge, Ford, Infiniti, Jaguar, Jeep(R), Land Rover, Lexus, Lincoln-Mercury, Mazda, Mercedes-Benz, MINI, Nissan, Scion, Toyota, Porsche, Volkswagen and Volvo. Hertz currently offers SIRIUS at major locations around the country.

Click on www.sirius.com to listen to SIRIUS live, or to find a SIRIUS retailer or car dealer in your area.

Any statements that express, or involve discussions as to, expectations, beliefs, plans, objectives, assumptions, future events or performance with respect to SIRIUS Satellite Radio Inc. are not historical facts and may be forward-looking and, accordingly, such statements involve estimates, assumptions and uncertainties which could cause actual results to differ materially from those expressed in any forward-looking statements. Accordingly, any such statements are qualified in their entirety by reference to the factors discussed in our Annual Report on Form 10-K for the year ended December 31, 2004 filed with the Securities and Exchange Commission. Among the key factors that have a direct bearing on our operational results are: our dependence upon third parties, including manufacturers of SIRIUS radios, retailers, automakers and programming partners, our competitive position and any events which affect the useful life of our satellites.

P - SIRI

Media Contact:

Patrick Reilly
SIRIUS
212.901.6646
preilly@siriusradio.com

Jay Jay Nesheim
Playboy Enterprises
212-261-4933
jayjayn@playboy.com

SOURCE SIRIUS

Patrick Reilly of SIRIUS, +1-212-901-6646, preilly@siriusradio.com; or Jay Jay Nesheim of Playboy Enterprises, +1-212-261-4933, jayjayn@playboy.com

<http://www.prnewswire.com>

Copyright (C) 2006 PR Newswire. All rights reserved.

News Provided by COMTEX

H



SIRIUS Satellite Radio to Broadcast Every Game of the 2006 NCAA(R) Division I Men's Basketball Tournament

Uninterrupted Broadcast Lineup Will Allow SIRIUS Listeners to Hear Every Second of Every Tournament Game

NEW YORK, March 9, 2006 /PRNewswire-FirstCall via COMTEX News Network/ -- SIRIUS Satellite Radio (Nasdaq: SIRI), for the second straight year, will be the exclusive satellite radio provider of every game of the 2006 NCAA(R) Division I Men's Basketball Championship.

(Logo: <http://www.newscom.com/cgi-bin/prnh/19991118/NYTH125>)

SIRIUS will provide uninterrupted coverage of every match-up from the opening tip of the opening round game on March 14 through the final buzzer of the championship game on April 3. All games will be offered in their entirety with no blackouts and at no extra charge to subscribers. SIRIUS is the only radio broadcaster to broadcast every game of the NCAA(R) Division I Men's Basketball Tournament in its entirety.

Games will air on channels 121, 123, 125 and 181. Regular SIRIUS host Steve Torre will anchor SIRIUS' coverage, providing up-to-the-minute scores and highlights and directing listeners to games around the dial. Full SIRIUS tournament brackets, with match-ups and channel assignments, can be downloaded from <http://www.sirius.com> following Selection Sunday, March 12.

"For many fans, the NCAA tournament marks the most exciting three weeks on the sports calendar," said Steve Cohen, SIRIUS' Vice President of Sports Programming. "SIRIUS will air every second of action, every cinderella performance and every buzzer-beater to our national audience, making us a must-have for NCAA hoops fans."

SIRIUS airs more college sports than any other radio outlet, providing play-by-play from more than 150 college teams around the nation from conferences including the Pac 10, SEC, Big Ten, Big 12, Big East, Atlantic 10, Big West, Metro Atlantic, Mid-American, Missouri Valley, Ohio Valley, Southern, Sun Belt, West Coast, Mountain West, Western Athletic, Conference USA, Colonial Athletic Association, Horizon League and Ivy League.

SIRIUS is also the Official Satellite Radio Partner of Alabama, Army, Auburn, Colorado, Florida, Iowa State, Kansas, Kentucky, Louisville, LSU, Michigan, Ole Miss, Mississippi State, Missouri, Navy, Nebraska, Notre Dame, Ohio State, Oklahoma, Oklahoma State, Pittsburgh, South Carolina, Syracuse, Tennessee, Texas, Texas A&M, Texas Tech, UCLA, USC, Vanderbilt and West Virginia.

In addition to being the Official Satellite Radio Partner of the NFL, NBA, NHL, AFL, Wimbledon Championships and Barclays English Premier League soccer, SIRIUS provides sports news and talk and coverage of several of the year's top thoroughbred horse races. Starting in 2007, SIRIUS will be the official satellite radio home of NASCAR.

About SIRIUS

SIRIUS delivers more than 125 channels of the best commercial-free music, compelling talk shows, news and information, and the most extensive sports programming to listeners across the country in digital quality sound. SIRIUS offers 68 channels of 100% commercial-free music, and features over 55 channels of sports, news, talk, entertainment, traffic and weather for a monthly subscription fee of only \$12.95. SIRIUS is the Official Satellite Radio Partner of the NFL, NBA and NHL and broadcasts live play-by-play games of the NFL, NBA and NHL.

Click on <http://www.sirius.com> to listen to SIRIUS live, or to find a SIRIUS retailer or car dealer in your area.

About the NCAA

SIR Ex. 7-H

The NCAA is a membership-led nonprofit association of colleges and universities committed to supporting academic and athletic opportunities for more than 360,000 student-athletes at more than 1,000 member colleges and universities. Each year, more than 49,000 student-athletes compete in NCAA championships in Division I, II and III sports. For more information, go to <http://www.ncaa.org>.

Any statements that express, or involve discussions as to, expectations, beliefs, plans, objectives, assumptions, future events or performance with respect to SIRIUS Satellite Radio Inc. are not historical facts and may be forward-looking and, accordingly, such statements involve estimates, assumptions and uncertainties which could cause actual results to differ materially from those expressed in any forward-looking statements. Accordingly, any such statements are qualified in their entirety by reference to the factors discussed in our Annual Report on Form 10-K for the year ended December 31, 2004 filed with the Securities and Exchange Commission. Among the key factors that have a direct bearing on our operational results are: our dependence upon third parties, including manufacturers of SIRIUS radios, retailers, automakers and programming partners, our competitive position and any events which affect the useful life of our satellites.

P-SIRI

Media Contact:

Andrew FitzPatrick
SIRIUS
212-901-6693
afitzpatrick@siriusradio.com

SOURCE SIRIUS Satellite Radio

Media, Andrew FitzPatrick of SIRIUS, +1-212-901-6693, afitzpatrick@siriusradio.com

<http://www.prnewswire.com>

Copyright (C) 2006 PR Newswire. All rights reserved.

News Provided by COMTEX





COSMO Radio Channel Debuts Today Exclusively on SIRIUS Satellite Radio

From the Pages of Cosmopolitan - the Best-Selling Young Women's Magazine in the World

NEW YORK, March 14, 2006 /PRNewswire-FirstCall via COMTEX News Network/ -- SIRIUS Satellite Radio (Nasdaq: SIRI) and Cosmopolitan magazine today announced the launch of COSMO Radio, a 24-hour, 7-day-a-week channel. Geared toward Cosmopolitan's audience of fun, fearless females, COSMO Radio features the same smart relationship advice, beauty and fitness tips, health news and entertaining information that has given the magazine its iconic brand status.

(Logo: <http://www.newscom.com/cgi-bin/prnh/19991118/NYTH125>)

COSMO Radio can be heard on SIRIUS channel 111. Exploring stories and trends from the latest issue of Cosmopolitan with guests and live callers, and playing today's top music hits, COSMO Radio is the new destination for savvy, sophisticated young women. Programming includes interviews with Cosmopolitan's expert editors, including Editor in Chief Kate White, on everything from astrological predictions to snagging the man of your dreams. The show will also feature celebrity guests talking about their latest projects as well as readers sharing their own experiences. COSMO Radio joins an already powerful lineup of informative and entertaining talk programming for women at SIRIUS.

"COSMO Radio on SIRIUS will give women across the country a smart and humorous way to take the intimacy of a "girls' night out" to a much larger platform," said Scott Greenstein, SIRIUS president of sports and entertainment. "We welcome them and their legions of fans to satellite radio -- Cosmo style."

"Readers always tell us that they can't get enough of the magazine so we're delighted to offer them an around-the-clock Cosmo fix," said White. "We are bringing the pages of the magazine to life so expect fun, irreverent shows covering everything a girl loves."

WAKE UP WITH COSMO RADIO

Monday - Friday, 7:00 am - 11:00 am

Each day will start with celebrity gossip, the latest entertainment news, and stories from the current issue of Cosmopolitan while playing today's hottest hits. There will be interviews with experts, celebrities, other special guests and more. Hosted by Taylor Strecker and Tia Williams.

GO TO BED WITH COSMO RADIO

Monday - Friday, 7:00 pm - 11:00 pm

The talk at night turns to relationships and going out on the town. Listeners will be given the all-important "guy perspective" on Cosmo-related topics. Hosted by Patrick Meagher.

BEAUTY BEAT

Cosmopolitan's Beauty Director Rachel Hayes Gayle and Associate Beauty Editor Andrea Lavinthal give tips on how to look totally gorgeous.

BEAUTY BLOG

Cosmopolitan's Associate Beauty Editor Andrea Lavinthal takes COSMO Radio listeners behind the velvet ropes with her reports on special beauty events and parties.

BEDSIDE ASTROLOGER

SIR Ex. 7-1

Who cares about the weather--COSMO Radio listeners want to know what's in the stars! They'll find out with COSMO Radio's daily Bedside Astrologer horoscopes.

LOOK GOOD NAKED

COSMO Radio's fitness segments will give listeners tips on how to get awesome abs and a better butt without even leaving their bedroom or desk.

7 THINGS YOU NEED TO KNOW

A look at the biggest stories of the day that matter to the COSMO Radio listener, plus what happened on last night's hottest TV shows and the latest celebrity gossip.

ASK HIM ANYTHING

Cosmopolitan's resident guy guru Jonathan Small comes to COSMO Radio to answer listeners questions about why men do the things they do and give them a peek inside the male mind.

COSMO CONFESSIONS

Listeners share their most shocking stories and steamiest secrets in the COSMO Radio version of the magazine's popular Confessions column.

GUY SPY

Cosmo's Man on the Street gets the dirt from his buddies on decoded man-speak, and reports it all back to our listeners.

BEHIND THE SCENES AT COSMO RADIO

Cosmopolitan Editor in Chief Kate White takes listeners behind-the-scenes of Cosmo events and happenings and shares her insider view of features in the magazine.

COSMO FOR YOUR GUY

Don't know how to talk to him about sensitive stuff? Grab your man and listen as we tell him what you really want.

COSMO NEWS

A look at the biggest stories of the day that matter to the COSMO Radio listener, plus what happened on last night's hottest TV shows and the latest celebrity gossip. You'll be the most informed girl at the water cooler!

CONVERSATION STARTERS

Never be at a loss for words around that cute guy again. We not only give you the opening line, our COSMO Radio team road-tests it for you!

COSMO WEEKEND

Every Friday, tips on what else to do with your man this weekend

GUYS UNCENSORED

What do guys really think about sex, love and the way you look in those jeans? The most intimate questions are answered -- by guys themselves.

WORK IT

Is it okay to date a coworker? How do you stay professional when your boss is totally hot? And how do you handle a colleague who's a backstabber? Work questions get answers!

About SIRIUS

SIRIUS delivers more than 130 channels of the best commercial-free music, compelling talk shows, news and information, and the most extensive sports programming to listeners across the country in digital quality sound. SIRIUS currently offers 69 channels of 100% commercial-free music, and features 64 channels of sports, news, talk, entertainment, traffic, weather and data for a monthly subscription fee of only \$12.95. SIRIUS is the Official Satellite Radio Partner of the NFL, NBA and NHL and broadcasts live play-by-play games of the NFL, NBA and NHL.

SIRIUS products for the car, truck, home, RV and boat are distributed by Alpine, Audiovox, Brix Group, Clarion, Delphi, Directed Electronics, Eclipse, Jensen, JVC, Kenwood, Magnadyne, Monster Cable, Pioneer, Russound, Tivoli and XACT Communications. Available in more than 25,000 retail locations, SIRIUS radios can be purchased at major retailers including Best Buy, Circuit City, Crutchfield, Costco, Target, Wal-Mart, Sam's Club, RadioShack and at <http://shop.sirius.com>.

SIRIUS radios are currently offered in vehicles from Audi, BMW, Chrysler, Dodge, Ford, Infiniti, Jaguar, Jeep(R), Land Rover, Lexus, Lincoln-Mercury, Mazda, Mercedes-Benz, MINI, Nissan, Scion, Toyota, Porsche, Volkswagen and Volvo. Hertz currently offers SIRIUS at major locations around the country.

Click on <http://www.sirius.com> to listen to SIRIUS live, or to find a SIRIUS retailer or car dealer in your area.

Any statements that express, or involve discussions as to, expectations, beliefs, plans, objectives, assumptions, future events or performance with respect to SIRIUS Satellite Radio Inc. are not historical facts and may be forward-looking and, accordingly, such statements involve estimates, assumptions and uncertainties which could cause actual results to differ materially from those expressed in any forward-looking statements. Accordingly, any such statements are qualified in their entirety by reference to the factors discussed in our Annual Report on Form 10-K for the year ended December 31, 2005 filed with the Securities and Exchange Commission. Among the key factors that have a direct bearing on our operational results are: our dependence upon third parties, including manufacturers of SIRIUS radios, retailers, automakers and programming partners, our competitive position and any events which affect the useful life of our satellites.

About Cosmopolitan

Cosmopolitan is the best-selling young women's monthly magazine worldwide, reaching almost 18 million readers every month. With more than 50 international editions that are published in 32 languages and sold in more than 100 countries, Cosmopolitan is published by Hearst Magazines, a unit of The Hearst Corporation (<http://www.hearst.com>). Hearst is one of the biggest publishers of monthly magazines, with a total of 19 U.S. titles and 145 international editions. The company also publishes 19 magazines in the United Kingdom through its wholly owned subsidiary, The National Magazine Company Limited.

P-SIRI

Media Contacts:
Hillary Schupf
SIRIUS
212-901-6739
HSchupf@siriusradio.com

Elizabeth Dye
Cosmopolitan
212.649.2573
edye@hearst.com

SOURCE SIRIUS Satellite Radio

Hillary Schupf, SIRIUS, +1-212-901-6739, HSchupf@siriusradio.com; Elizabeth Dye, Cosmopolitan, +1-212-649-2573, edye@hearst.com

<http://www.prnewswire.com>

Copyright (C) 2006 PR Newswire. All rights reserved.

News Provided by COMTEX

J



SIRIUS Satellite Radio and Archdiocese of New York to Launch The Catholic Channel on September 26

24-Hour Catholic Radio Network to Air on Channel 159 Will Feature Exclusive Participation of His Eminence Edward Cardinal Egan, Call-in Talk Shows, and Notre Dame Football

NEW YORK, Sept 21, 2006 /PRNewswire-FirstCall via COMTEX News Network/ -- The Archdiocese of New York and SIRIUS Satellite Radio (Nasdaq: SIRI) announced today that The Catholic Channel will debut Tuesday, September 26th exclusively on SIRIUS channel 159. The lifestyle radio channel will air nationally 7 days a week/24 hours a day, and will feature contemporary talk and live daily Mass from Saint Patrick's Cathedral in New York.

(Logo: <http://www.newscom.com/cgi-bin/prnh/19991118/NYTH125>)

The Catholic Channel will feature a modern format with an open dialogue focused on Catholicism in the 21st century, especially as it is lived in today's world. Listeners will be encouraged to call in to talk about the issues that are on their mind and in the news -- everything from what's happening in the Church today, to the headline stories of current events, and the latest in the world of entertainment, the arts and sports. Daily program hosts and guests will include members of the clergy and distinguished laity from across America.

Programming on The Catholic Channel will also include human-interest stories and inspirational themes, reflections on Scripture, Church history, sacred music, shows offering spiritual guidance, and football and basketball games from the University of Notre Dame.

His Eminence Edward Cardinal Egan, Archbishop of New York, will be a prominent contributor to The Catholic Channel. The Cardinal will make frequent appearances on the channel and will be a regular guest of the various programs where he will address what is happening in the Archdiocese of New York and other significant issues in the Church. In addition, Cardinal Egan will be a regular celebrant and homilist for the Masses broadcast from Saint Patrick's Cathedral on The Catholic Channel.

"The Catholic Channel will engage listeners with exceptional Catholic programming delivered in a contemporary format," said Cardinal Egan. "This is a unique and unprecedented opportunity for the Catholic Church to combine its message and its teaching with the most modern communications medium available, in order to reach out to people wherever they are in life, and address what is on their minds and in their hearts."

"Together with the Archdiocese, we have assembled an exceptional cast of hosts whose talent and experience will produce some of the most compelling Catholic programming on the air," said Mel Karmazin, CEO of SIRIUS. "The Catholic Channel will be an important component in a SIRIUS lineup that offers listeners the best radio on radio."

Programming highlights: (All times ET)

- * The Catholic Guy, hosted by Lino Rulli (weekdays, 5-8pm). The 34-year-old Rulli is the Emmy award-winning host and executive producer of the popular TV show Generation Cross and a former TV reporter for the CBS affiliate in Minneapolis. With a master's degree in theology and a sometimes off-beat and humorous approach, Rulli has emerged a fan-favorite for younger generations of Catholics.
- * Speak Now with Dave and Sue Konig, hosted by Susan and David Konig (weekdays, 12-2pm). She is a former newspaper columnist. He is an award-winning actor and stand-up comedian. They are married with four children and together will focus on married life, parenting and the issues facing today's families.
- * Sleepless With SIRIUS, hosted by Father Paul Keenan (weekdays, 11pm-3am). Fr. Keenan, an experienced author and radio broadcaster,

SIR Ex. 7-J

will help those who are seeking to add more meaning and purpose to their lives, and will be a comforting and understanding companion to those who are facing life's daily struggles and concerns.

- * Live daily Mass from St. Patrick's Cathedral (weekdays, 8-8:30am).
Re-broadcast daily from 11-11:30am ET.
- * Notre Dame Athletics. SIRIUS is the Official Satellite Radio Partner of the University of Notre Dame and will air all Fighting Irish football and basketball broadcasts on The Catholic Channel // 159.

Other on-air talent will include: Gus Lloyd, a former host on Spirit FM in Tampa, FL, whose morning show on SIRIUS will set the tone for the day with an overview of news and current events with scripture reflection and compelling interviews; Father Edward Beck, a Passionist priest, native New Yorker and noted author; and Bob Dunning, a veteran broadcaster, journalist and attorney from Sacramento, CA, who will engage his listeners by zeroing in on the issues facing today's Catholics. These hosts will interact with leading figures in the Catholic Church, prominent people from the world of news, entertainment and the arts, as well as with their audience to provide high quality, dynamic Catholic programming.

The Catholic Channel will join other religious-themed programming on SIRIUS, including EWTN Global Catholic Radio Network // Ch. 160, which features talk shows, news, daily devotions and teaching series, and Christian Talk // Ch. 161, faith-based programming provided by FamilyNet, the broadcast arm of the North American Mission Board of the Southern Baptist Convention, which features programs such as Pat Robertson's "The 700 Club." SIRIUS also offers Christian and Gospel-themed music channels, including Spirit // Ch. 66, the best of contemporary Christian pop music, Revolution // Ch. 67, dedicated to Christian rock, and Praise // Ch. 68, featuring Gospel hits.

For information on SIRIUS Satellite Radio, log on to www.sirius.com.

About SIRIUS

SIRIUS delivers more than 125 channels of the best programming in all of radio. SIRIUS is the original and only home of 100% commercial free music channels in satellite radio, offering 67 music channels available nationwide. SIRIUS also delivers 61 channels of sports, news, talk, entertainment, traffic, weather and data. SIRIUS is the Official Satellite Radio Partner of the NFL, NBA and NHL and broadcasts live play-by-play games of the NFL, NBA and NHL. All SIRIUS programming is available for a monthly subscription fee of only \$12.95.

SIRIUS products for the car, truck, home, RV and boat are available in more than 25,000 retail locations, including Best Buy, Circuit City, Crutchfield, Costco, Target, Wal-Mart, Sam's Club, RadioShack and at shop.sirius.com.

SIRIUS radios are offered in vehicles from Audi, BMW, Chrysler, Dodge, Ford, Infiniti, Jaguar, Jeep(R), Land Rover, Lexus, Lincoln-Mercury, Mazda, Mercedes-Benz, MINI, Nissan, Rolls Royce, Scion, Toyota, Porsche, Volkswagen and Volvo. Hertz also offers SIRIUS in its rental cars at major locations around the country.

Click on <http://www.sirius.com> to listen to SIRIUS live, or to purchase a SIRIUS radio and subscription.

Any statements that express, or involve discussions as to, expectations, beliefs, plans, objectives, assumptions, future events or performance with respect to SIRIUS Satellite Radio Inc. are not historical facts and may be forward-looking and, accordingly, such statements involve estimates, assumptions and uncertainties which could cause actual results to differ materially from those expressed in any forward-looking statements. Accordingly, any such statements are qualified in their entirety by reference to the factors discussed in our Annual Report on Form 10-K for the year ended December 31, 2005 and Quarterly Report on Form 10-Q for the quarter ended June 30, 2006 filed with the Securities and Exchange Commission. Among the key factors that have a direct bearing on our operational results are: our dependence upon third parties, including manufacturers of SIRIUS radios, retailers, automakers and programming partners, our competitive position and any events which affect the useful life of our satellites.

P-SIRI

Media Contacts:

Patrick Reilly
SIRIUS
212.901.6646
preilly@siriusradio.com

Joseph Zwilling
Archdiocese of New York
212-371-1011 ext. 2997
joseph.zwilling@archny.org

Andrew FitzPatrick
SIRIUS
212.901.6693
afitzpatrick@siriusradio.com

SOURCE SIRIUS Satellite Radio

Patrick Reilly, +1-212-901-6646, preilly@siriusradio.com, or Andrew FitzPatrick, +1-212-901-6693, afitzpatrick@siriusradio.com, both of SIRIUS; or Joseph Zwilling of the Archdiocese of New York, +1-212-371-1011 ext. 2997, joseph.zwilling@archny.org

<http://www.prnewswire.com>

Copyright (C) 2006 PR Newswire. All rights reserved.

News Provided by COMTEX

SIR Ex. 8

A



SIRIUS Reports Strong Second Quarter 2006 Results

- Company Increases 2006 Revenue and Subscriber Guidance - Revenue Nearly Triples Year-Over-Year to More Than \$150 Million - Satellite Radio Market Share Leader For Third Consecutive Quarter

NEW YORK, Aug 01, 2006 /PRNewswire-FirstCall via COMTEX News Network/ -- SIRIUS Satellite Radio (Nasdaq: SIRI) today announced that its second quarter 2006 revenue nearly tripled from the year-ago second quarter to more than \$150 million. The company increased its 2006 guidance for total revenue to \$615 million and for year-end subscribers to 6.3 million.

SIRIUS ended the second quarter with 4,678,207 subscribers, 158% higher than second quarter 2005 ending subscribers of 1,814,626. During the second quarter of 2006, SIRIUS added 600,460 net subscribers, a 64% increase over second quarter 2005 net subscriber additions of 365,931. For the third consecutive quarter, SIRIUS led the satellite radio industry in net subscriber additions, capturing a record 60% share of industry net additions in the second quarter.

"Continued strong demand for SIRIUS' products and programming gives us confidence to increase our revenue and subscriber guidance," said Mel Karmazin, CEO of SIRIUS. "We continue to be excited about the growth prospects for satellite radio and remain pleased with our solid execution as we approach positive free cash flow."

Total revenue for the second quarter of 2006 increased to a record \$150.1 million, nearly triple last year's second quarter total revenue of \$52.2 million. Average monthly revenue per subscriber (or "ARPU") was \$11.16 in the second quarter of 2006, up from \$10.50 in the year-ago second quarter. ARPU for the second quarter of 2006 included a \$0.62 contribution from net advertising revenue, compared with a \$0.22 contribution from net advertising revenue in the second quarter of 2005. Average monthly churn was 1.8%, in line with the company's annual churn guidance, reflecting total churn from both retail and OEM channels. SAC per gross subscriber addition was \$131 for the second quarter of 2006, an 18% improvement over second quarter 2005 SAC per gross subscriber addition of \$160.

During the second quarter of 2006, SIRIUS added 276,294 net subscribers from its retail channel, a 13% increase over 244,985 retail net additions during the second quarter of 2005. The company also added 324,574 net subscribers from its automotive OEM channel, 167% more than second quarter 2005 OEM net subscriber additions of 121,664. Strong contributions by SIRIUS' exclusive automotive partners, DaimlerChrysler and Ford, fueled OEM growth during the quarter.

SIRIUS reported a net loss of (\$237.8) million, or (\$0.17) per share, for the second quarter of 2006. The net loss in the second quarter of 2006 included a (\$0.01) per share impact associated with the write-off of certain long-lead time parts purchased in 1999 that will no longer be needed in light of the company's new satellite contract.

Other Developments

In the second quarter of 2006, SIRIUS continued to augment "The Best Radio on Radio" by announcing a variety of new programming initiatives, including:

- The Catholic Channel, a 24x7 lifestyle channel in collaboration with The Archdiocese of New York, that will feature contemporary talk and music programming as well as live daily masses from St. Patrick's Cathedral in New York City.
- A radio news bureau with Variety, the "show business bible," originating from Variety's Los Angeles offices. Variety will provide the latest in entertainment news to SIRIUS' national radio audience multiple times per hour every day.
- A weekly two-hour series featuring dynamic and compelling interviews by broadcasting icon Barbara Walters from her 30-year archive of interviews with great entertainers and world leaders.

SIR Ex. 8-A

- A live, weekly three hour health and wellness call-in talk show on Saturday mornings hosted by Deepak Chopra, the best-selling author and leader in the field of mind and body medicine.
- An exclusive weekly talk show with Mark Cuban, the groundbreaking entrepreneur and outspoken owner of the NBA's Dallas Mavericks.
- New talk shows featuring leading sports personalities Jerry Rice, the legendary NFL receiver; Tiki Barber, the New York Giants running back; and Tony Stewart, the two-time and reigning NASCAR NEXTEL Cup Series champion.

During the second quarter of 2006, SIRIUS and Kia announced that Kia will exclusively offer SIRIUS as factory standard equipment in all of its vehicles through 2014, with an optional three-year extension to 2017. SIRIUS will become a standard feature in all 2009 model year Kia vehicles, beginning in 2008.

SIRIUS' Canadian affiliate, SIRIUS Canada, passed the 100,000 subscriber milestone in early May, less than six months after launching its Canadian service. SIRIUS Canada is Canada's leading satellite radio service and the number one choice among Canadian satellite radio subscribers. Ford of Canada and SIRIUS Canada recently announced an exclusive long-term agreement to make SIRIUS receivers factory-installed equipment in virtually all Ford vehicles sold in Canada by 2008.

In June 2006, SIRIUS announced that it had entered into an agreement with Space Systems/Loral for the design and construction of a new satellite. Construction of the satellite is expected to be completed in the fourth quarter of 2008. The satellite will be launched on a Proton rocket acquired by SIRIUS under a previously announced launch contract. The aggregate cost of designing, building and launching the satellite and insuring its launch will be approximately \$260 million.

SIRIUS has disclosed that the FCC is conducting a review of the company's products as well as products of other companies containing FM transmitters. SIRIUS believes the company's radios that are currently being produced comply with applicable FCC rules. SIRIUS and its manufacturers are cooperating with the FCC to obtain new equipment authorizations for the company's remaining affected products.

Guidance

SIRIUS today provided the following guidance for full year 2006:

- 6.3 million subscribers at year-end, increased from previous guidance of over 6.2 million
- Average monthly churn of approximately 1.8%, in line with previous guidance
- SAC per gross subscriber addition approaching \$110, in line with previous guidance
- Total revenue of \$615 million, up from previous guidance of over \$600 million
- Adjusted loss from operations of approximately (\$565) million, in line with previous guidance
- Free cash flow loss of approximately (\$500) million, reflecting the impact of the satellite agreement announced in June 2006 and changes to working capital assumptions, up from previous guidance of (\$480) million (5)
- SIRIUS' first quarter of positive free cash flow, after capital expenditures, could be reached as early as the fourth quarter of 2006

Previously issued longer term guidance remains unchanged.

RESULTS OF OPERATIONS

The discussion of operating expenses below excludes the effects of equity granted to third parties and employees. The company believes this presentation improves the transparency of disclosure and is consistent with the way operating results are evaluated.

SECOND QUARTER 2006 VERSUS SECOND QUARTER 2005

For the second quarter of 2006, SIRIUS recognized total revenue of \$150.1 million compared with \$52.2 million for the second quarter of 2005. This 188%, or \$97.9 million, increase in revenue was primarily driven by an \$88.0 million increase in subscriber revenue resulting from the net increase in subscribers of 2,863,581, or 158%, from June 30, 2005 to June 30, 2006, and a \$7.1 million increase in net advertising revenue.

The company's adjusted loss from operations increased (\$17.7) million to (\$126.5) million for the second

quarter of 2006 from (\$108.8) million for the second quarter of 2005 (refer to the reconciliation table of net loss to adjusted loss from operations). This increase was driven by a 58%, or \$40.0 million, increase in subscriber acquisition costs reflecting higher shipments of SIRIUS radios and chip sets and increased commissions to support a 92% increase in gross subscriber additions from 432,687 for the second quarter of 2005 to 830,571 for the second quarter of 2006. The increase in subscriber acquisition costs was more than offset by the 177%, or \$88.0 million, increase in subscriber revenue as a result of a 158% increase in the company's subscriber base.

Satellite and transmission expenses increased \$11.0 million to \$17.7 million for the second quarter of 2006 from \$6.7 million for the second quarter of 2005. The increase was primarily attributable to an impairment charge associated with certain satellite long-lead time parts that will no longer be needed in light of the company's new satellite contract.

Programming and content expenses increased \$37.2 million to \$53.0 million for the second quarter of 2006 from \$15.8 million for the second quarter of 2005. The increase was primarily attributable to license fees and consulting costs associated with new programming, and higher broadcast and webstreaming royalties as a result of the company's larger subscriber base.

Customer service and billing expenses increased \$6.0 million to \$13.7 million for the second quarter of 2006 from \$7.7 million for the second quarter of 2005. The increase was primarily attributable to call center operating costs necessary to accommodate the increase in the company's subscriber base and transaction fees due to the addition of new subscribers. Customer service and billing expenses per average subscriber per month declined 34% to \$1.05 for the second quarter of 2006 from \$1.60 for the second quarter of 2005.

Sales and marketing expenses increased \$22.4 million to \$56.6 million for the second quarter of 2006 from \$34.2 million for the second quarter of 2005. This 65% increase in sales and marketing expenses compared with a 92% increase in gross subscriber additions from 432,687 for the three months ended June 30, 2005 to 830,571 for the three months ended June 30, 2006. The increase was primarily attributable to less spending in second quarter 2005 in anticipation of the fourth quarter 2005 marketing campaign associated with the launch of Howard Stern; advertising costs for the new marketing campaign; cooperative marketing spend with the company's channel partners; and increased residuals and OEM revenue share as a result of a 158% increase in the company's subscriber base.

General and administrative expenses increased \$7.6 million to \$21.7 million for the second quarter of 2006 from \$14.1 million for the second quarter of 2005. The increase was primarily a result of legal fees, employment-related costs and bad debt expense to support the growth of the business.

SIRIUS reported a net loss of (\$237.8) million, or (\$0.17) per share, for the second quarter of 2006, including a (\$0.01) per share impact from the impairment loss and (\$0.05) per share impact from equity charges, compared with a net loss of (\$177.5) million, or (\$0.13) per share, in the year-ago quarter, including a (\$0.03) per share impact from equity charges. The adjusted net loss per share, or net loss per share excluding the impairment loss and equity charges, was (\$0.11) for the second quarter of 2006 compared with an adjusted net loss per share of (\$0.10) for the second quarter of 2005 (refer to the reconciliation table of net loss per share to adjusted net loss per share).

SIX MONTHS ENDED JUNE 30, 2006 VERSUS SIX MONTHS ENDED JUNE 30, 2005

For the six months ended June 30, 2006, SIRIUS recognized total revenue of \$276.7 million compared with \$95.4 million for the six months ended June 30, 2005. This 190%, or \$181.3 million, increase in revenue was primarily driven by a \$161.3 million increase in subscriber revenue resulting from the net increase in subscribers of 2,863,581, or 158%, from June 30, 2005 to June 30, 2006, and a \$13.9 million increase in net advertising revenue.

The company's adjusted loss from operations increased (\$27.4) million to (\$263.2) million for the six months ended June 30, 2006 from (\$235.8) million for the six months ended June 30, 2005 (refer to the reconciliation table of net loss to adjusted loss from operations). This increase was driven by a 60%, or \$82.0 million, increase in subscriber acquisition costs reflecting higher shipments of SIRIUS radios and chip sets and increased commissions to support a 127% increase in gross subscriber additions from 787,395 for the six months ended June 30, 2005 to 1,791,181 for the six months ended June 30, 2006. The increase in subscriber acquisition costs was more than offset by the 176%, or \$161.3 million, increase in subscriber revenue as a result of a 158% increase in the company's subscriber base.

Satellite and transmission expenses increased \$11.5 million to \$25.0 million for the six months ended June 30, 2006 from \$13.5 million for the six months ended June 30, 2005. The increase was primarily attributable to an impairment charge associated with certain satellite long-lead time parts that will no longer be needed in light of the company's new satellite contract.

Programming and content expenses increased \$69.5 million to \$109.5 million for the six months ended June 30, 2006 from \$40.0 million for the six months ended June 30, 2005. The increase was primarily attributable to license fees and consulting costs associated with new programming, and higher broadcast and webstreaming royalties as a result of the company's larger subscriber base.

Customer service and billing expenses increased \$12.3 million to \$29.5 million for the six months ended June 30, 2006 from \$17.2 million for the six months ended June 30, 2005. The increase was primarily attributable to call center operating costs necessary to accommodate the increase in the company's subscriber base and transaction fees due to the addition of new subscribers. Customer service and billing expenses per average subscriber per month declined 38% to \$1.21 for the six months ended June 30, 2006 from \$1.96 for the six months ended June 30, 2005.

Sales and marketing expenses increased \$26.5 million to \$95.9 million for the six months ended June 30, 2006 from \$69.4 million for the six months ended June 30, 2005. This 38% increase in sales and marketing expenses compared with a 127% increase in gross subscriber additions from 787,395 for the six months ended June 30, 2005 to 1,791,181 for the six months ended June 30, 2006. The increase was primarily attributable to increased residuals and OEM revenue share as a result of a 158% increase in the company's subscriber base, as well as increased cooperative marketing spend with the company's channel partners, advertising costs for the new marketing campaign and compensation related costs.

General and administrative expenses increased \$11.8 million to \$40.8 million for the six months ended June 30, 2006 from \$29.0 million for the six months ended June 30, 2005. The increase was primarily a result of legal fees, employment-related costs and bad debt expense to support the growth of the business.

For the six months ended June 30, 2006, the company recorded (\$4.4) million for its share of SIRIUS Canada, Inc.'s net loss.

SIRIUS reported a net loss of (\$696.4) million, or (\$0.50) per share, for the six months ended June 30, 2006, including a (\$0.01) per share impact from the impairment loss and (\$0.25) per share impact from equity charges, compared with a net loss of (\$371.2) million, or (\$0.28) per share, for the six months ended June 30, 2005, including a (\$0.06) per share impact from equity charges. The adjusted net loss per share, or net loss per share excluding the impairment loss and equity charges, was (\$0.24) for the six months ended June 30, 2006 compared with an adjusted net loss per share of (\$0.22) for the six months ended June 30, 2005 (refer to the reconciliation table of net loss per share to adjusted net loss per share).

Sirius Satellite Radio Inc. and Subsidiaries
Subscriber Data, Metrics and Other Non-GAAP Financial Measures
(Dollars in thousands, unless otherwise stated)
(Unaudited)

Subscribers:

	For the Three Months Ended June 30,		For the Six Months Ended June 30,	
	2006	2005	2006	2005
Beginning subscribers	4,077,747	1,448,695	3,316,560	1,143,258
Net additions	600,460	365,931	1,361,647	671,368
Ending subscribers	4,678,207	1,814,626	4,678,207	1,814,626
Retail	3,276,615	1,354,798	3,276,615	1,354,798
OEM	1,373,610	432,988	1,373,610	432,988
Hertz	27,982	26,840	27,982	26,840

Metrics:

	For the Three Months Ended June 30,		For the Six Months Ended June 30,	
	2006	2005	2006	2005
Gross subscriber additions	830,571	432,687	1,791,181	787,395
Deactivated subscribers	230,111	66,756	429,534	116,027
Average monthly churn (1) (6)	1.8%	1.4%	1.8%	1.3%
SAC per gross subscriber addition (2) (6)	\$131	\$160	\$122	\$173
Customer service and billing expenses				

per average subscriber (3) (6)	\$1.05	\$1.60	\$1.21	\$1.96
Monthly ARPU:				
Average monthly subscriber revenue per subscriber before effects of Hertz subscribers and mail-in rebates	\$10.64	\$10.60	\$10.66	\$10.61
Effects of Hertz subscribers	0.05	0.05	0.04	0.03
Effects of mail-in rebates	(0.15)	(0.37)	(0.35)	(0.23)
Average monthly subscriber revenue per subscriber	10.54	10.28	10.35	10.41
Average monthly net advertising revenue per subscriber	0.62	0.22	0.63	0.18
ARPU (4) (6)	\$11.16	\$10.50	\$10.98	\$10.59

Adjusted Loss from Operations:

	For the Three Months Ended June 30,		For the Six Months Ended June 30,	
	2006	2005	2006	2005
Net loss	\$(237,828)	\$(177,546)	\$(696,372)	\$(371,158)
Impairment loss	10,917	-	10,917	-
Depreciation	25,738	24,580	50,671	49,081
Equity granted to third parties and employees	67,289	41,230	351,875	79,936
Other income (expense)	6,778	2,404	18,400	5,197
Income tax expense	578	560	1,331	1,120
Adjusted loss from operations (7)	\$(126,528)	\$(108,772)	\$(263,178)	\$(235,824)

Adjusted Net Loss and Adjusted Net Loss per Share:

	For the Three Months Ended June 30,		For the Six Months Ended June 30,	
	2006	2005	2006	2005
Net loss	\$(237,828)	\$(177,546)	\$(696,372)	\$(371,158)
Impairment loss	10,917	-	10,917	-
Equity granted to third parties and employees	67,289	41,230	351,875	79,936
Adjusted net loss (8)	\$(159,622)	\$(136,316)	\$(333,580)	\$(291,222)
Net loss per share (basic and diluted)	\$(0.17)	\$(0.13)	\$(0.50)	\$(0.28)
Impairment loss	0.01	-	0.01	-
Equity granted to third parties and employees	0.05	0.03	0.25	0.06
Adjusted net loss per share (basic and diluted) (8)	\$(0.11)	\$(0.10)	\$(0.24)	\$(0.22)
Weighted average common shares outstanding (basic and diluted)	1,404,022	1,324,270	1,395,549	1,319,318

Condensed Consolidated Statements of Operations:

	For the Three Months Ended June 30,	For the Six Months Ended June 30,
--	-------------------------------------	-----------------------------------

	2006	2005	2006	2005
Total revenue	\$150,078	\$52,194	\$276,742	\$95,410
Operating expenses:				
Satellite and transmission	17,686	6,668	24,987	13,481
Programming and content	53,011	15,769	109,455	40,047
Customer service and billing	13,659	7,738	29,500	17,230
Cost of equipment	3,467	1,952	6,932	2,928
Sales and marketing	56,609	34,240	95,905	69,362
Subscriber acquisition costs	108,663	68,693	217,807	135,786
General and administrative	21,653	14,120	40,797	28,952
Engineering, design and development	12,775	11,786	25,454	23,448
Depreciation	25,738	24,580	50,671	49,081
Equity granted to third parties and employees	67,289	41,230	351,875	79,936
Total operating expenses	380,550	226,776	953,383	460,251
Loss from operations	(230,472)	(174,582)	(676,641)	(364,841)
Other income (expense)	(6,778)	(2,404)	(18,400)	(5,197)
Loss before income taxes	(237,250)	(176,986)	(695,041)	(370,038)
Income tax expense	(578)	(560)	(1,331)	(1,120)
Net loss	\$(237,828)	\$(177,546)	\$(696,372)	\$(371,158)

Sirius Satellite Radio Inc. and Subsidiaries
Consolidated Statements of Operations
(In thousands, except per share data)
(Unaudited)

	For the Three Months Ended June 30,		For the Six Months Ended June 30,	
	2006	2005	2006	2005
Revenue:				
Subscriber revenue, including effects of mail-in rebates	\$137,636	\$49,622	\$252,817	\$91,526
Advertising revenue, net of agency fees	8,125	1,052	15,463	1,586
Equipment revenue	3,096	1,503	6,788	2,270
Other revenue	1,221	17	1,674	28
Total revenue	150,078	52,194	276,742	95,410
Operating expenses (1):				
Cost of services (excludes depreciation shown separately below):				
Satellite and transmission	18,496	7,097	26,699	14,469
Programming and content	76,735	20,819	382,979	49,985
Customer service and billing	13,863	7,864	29,948	17,495
Cost of equipment	3,467	1,952	6,932	2,928
Sales and marketing	61,676	41,516	103,174	90,068
Subscriber acquisition costs	130,563	81,226	249,606	154,547
General and administrative	34,558	22,452	68,208	44,561
Engineering, design and development	15,454	19,270	35,166	37,117
Depreciation	25,738	24,580	50,671	49,081
Total operating				

expenses	380,550	226,776	953,383	460,251
Loss from operations	(230,472)	(174,582)	(676,641)	(364,841)
Other income (expense):				
Interest and investment income	8,873	4,790	18,810	9,277
Interest expense	(15,660)	(7,201)	(32,784)	(14,526)
Equity in net loss of affiliate	-	-	(4,445)	-
Other income	9	7	19	52
Total other income (expense)	(6,778)	(2,404)	(18,400)	(5,197)
Loss before income taxes	(237,250)	(176,986)	(695,041)	(370,038)
Income tax expense	(578)	(560)	(1,331)	(1,120)
Net loss	\$(237,828)	\$(177,546)	\$(696,372)	\$(371,158)
Net loss per share (basic and diluted)	\$(0.17)	\$(0.13)	\$(0.50)	\$(0.28)
Weighted average common shares outstanding (basic and diluted)	1,404,022	1,324,270	1,395,549	1,319,318

(1) Amounts related to equity granted to third parties and employees included in other operating expenses were as follows:

Satellite and transmission	\$810	\$429	\$1,712	\$988
Programming and content	23,724	5,050	273,524	9,938
Customer service and billing	204	126	448	265
Sales and marketing	5,067	7,276	7,269	20,706
Subscriber acquisition costs	21,900	12,533	31,799	18,761
General and administrative	12,905	8,332	27,411	15,609
Engineering, design and development	2,679	7,484	9,712	13,669
Total equity granted to third parties and employees	\$67,289	\$41,230	\$351,875	\$79,936

Sirius Satellite Radio Inc. and Subsidiaries
Balance Sheet Data
(In thousands)
(Unaudited)

	As of	
	June 30, 2006	December 31, 2005
Cash, cash equivalents and marketable securities	\$583,588	\$879,257
Restricted investments	108,315	107,615
Working capital	67,646	404,481
Total assets	1,811,396	2,085,362
Long-term debt	1,083,929	1,084,437
Total liabilities	1,868,519	1,760,394
Accumulated deficit	(3,425,225)	(2,728,853)
Stockholders' equity	(57,123)	324,968

Sirius Satellite Radio Inc. and Subsidiaries
Statements of Cash Flows
(In thousands)
(Unaudited)

For the Three Months Ended For the Six Months Ended

	June 30,		June 30,	
	2006	2005	2006	2005
Cash flows from operating activities:				
Net loss	\$ (237,828)	\$ (177,546)	\$ (696,372)	\$ (371,158)
Adjustments to reconcile net loss to net cash used in operating activities:				
Depreciation	25,738	24,580	50,671	49,081
Non-cash interest expense	786	761	1,547	1,523
Provision for doubtful accounts	2,003	882	3,780	2,282
Non-cash equity in net loss of affiliate	-	-	2,276	-
Loss on disposal of assets	320	125	541	252
Impairment loss	10,917	-	10,917	-
Equity granted to third parties and employees	67,289	41,230	351,875	79,936
Deferred income taxes	578	560	1,331	1,120
Changes in operating assets and liabilities:				
Marketable securities	-	-	-	16
Accounts receivable	(966)	(5,716)	8,986	(6,056)
Inventory	(9,656)	(4,449)	(10,854)	(4,433)
Prepaid expenses and other current assets	(13,724)	(4,373)	(35,482)	(7,554)
Other long-term assets	(25,667)	1,635	(25,088)	478
Accounts payable and accrued expenses	27,202	31,754	(18,018)	26,153
Accrued interest	11,620	(2,862)	1,160	(126)
Deferred revenue	29,389	30,800	73,847	50,223
Other long-term liabilities	1,052	(2,018)	8,595	(3,542)
Net cash used in operating activities	(110,947)	(64,637)	(270,288)	(181,805)
Cash flows from investing activities:				
Additions to property and equipment	(22,284)	(3,975)	(27,780)	(10,863)
Sales of property and equipment	71	47	123	59
Purchases of restricted investments	-	-	(700)	(6,291)
Release of restricted investments	-	10,997	-	10,997
Purchases of available-for-sale securities	(36,900)	-	(108,500)	-
Sales of available-for-sale securities	72,675	-	177,125	4,835
Net cash provided by (used in) investing activities	13,562	7,069	40,268	(1,263)
Cash flows from financing activities:				
Proceeds from exercise of stock options	1,517	5,111	2,976	6,104

Other	-	-	-	(8)
Net cash provided by financing activities	1,517	5,111	2,976	6,096
Net decrease in cash and cash equivalents	(95,868)	(52,457)	(227,044)	(176,972)
Cash and cash equivalents at the beginning of period	630,831	629,376	762,007	753,891
Cash and cash equivalents at the end of period	\$534,963	\$576,919	\$534,963	\$576,919

FOOTNOTES TO PRESS RELEASE AND TABLES FOR NON-GAAP FINANCIAL MEASURES

This press release, including the selected financial information above, includes the following non-GAAP financial measures: average monthly churn; SAC per gross subscriber addition; customer service and billing expenses per average subscriber; average monthly revenue per subscriber, or ARPU; adjusted loss from operations; adjusted net loss; adjusted net loss per share; and free cash flow. The definitions and usefulness of such non-GAAP financial measures are as follows (dollars in thousands, unless otherwise stated):

(1) SIRIUS defines average monthly churn as the number of deactivated subscribers divided by average quarterly subscribers.

(2) SIRIUS defines SAC per gross subscriber addition as subscriber acquisition costs, excluding equity granted to third parties and employees, and margins from the direct sale of SIRIUS radios and accessories divided by the number of gross subscriber additions for the period. SAC per gross subscriber addition is calculated as follows:

	For the Three Months Ended June 30,		For the Six Months Ended June 30,	
	2006	2005	2006	2005
Subscriber acquisition costs	\$130,563	\$81,226	\$249,606	\$154,547
Less: equity granted to third parties and employees	(21,900)	(12,533)	(31,799)	(18,761)
Add: negative margin from direct sale of SIRIUS radios and accessories	371	449	144	658
SAC	\$109,034	\$69,142	\$217,951	\$136,444
Gross subscriber additions	830,571	432,687	1,791,181	787,395
SAC per gross subscriber addition	\$131	\$160	\$122	\$173

(3) SIRIUS defines customer service and billing expenses per average subscriber as total customer service and billing expenses, excluding equity granted to third parties and employees, divided by the daily weighted average number of subscribers for the period.

(4) SIRIUS defines ARPU as the total earned subscriber revenue and net advertising revenue divided by the daily weighted average number of subscribers for the period. ARPU is calculated as follows:

	For the Three Months Ended June 30,		For the Six Months Ended June 30,	
	2006	2005	2006	2005
Subscriber revenue	\$137,636	\$49,622	\$252,817	\$91,526
Net advertising revenue	8,125	1,052	15,463	1,586
Total subscriber and net advertising				

revenue	\$145,761	\$50,674	\$268,280	\$93,112
Daily weighted average number of subscribers	4,354,447	1,609,521	4,070,075	1,465,106
ARPU	\$11.16	\$10.50	\$10.98	\$10.59

(5) SIRIUS defines free cash flow as cash flow from operating activities, capital expenditures and restricted investment activity.

(6) SIRIUS believes average monthly churn, SAC per gross subscriber addition, customer service and billing expenses per average subscriber, ARPU and free cash flow provide meaningful supplemental information regarding operating performance and liquidity and are used for internal management purposes, when publicly providing the business outlook, and as a means to evaluate period-to-period comparisons. These non-GAAP financial measures are used in addition to and in conjunction with results presented in accordance with GAAP. These non-GAAP financial measures may be susceptible to varying calculations; may not be comparable to other similarly titled measures of other companies; and should not be considered in isolation, as a substitute for, or superior to measures of financial performance prepared in accordance with GAAP.

(7) SIRIUS refers to net loss before taxes; other income (expense) - including interest and investment income, interest expense and equity in net loss of affiliate; depreciation; impairment charges; and equity granted to third parties and employees expense as adjusted loss from operations. Adjusted loss from operations is not a measure of financial performance under GAAP. The company believes adjusted loss from operations is a useful measure of its operating performance. The company uses adjusted loss from operations for budgetary and planning purposes; to assess the relative profitability and on-going performance of consolidated operations; to compare performance from period to period; and to compare performance to that of its primary competitor. The company also believes adjusted loss from operations is useful to investors to compare operating performance to the performance of other communications, entertainment and media companies. The company believes that investors use current and projected adjusted loss from operations to estimate the current or prospective enterprise value and make investment decisions.

Because the company funds and builds-out its satellite radio system through the periodic raising and expenditure of large amounts of capital, results of operations reflect significant charges for interest expense and depreciation, and charges for impairment of property and equipment when deemed necessary. The company believes adjusted loss from operations provides useful information about the operating performance of the business apart from the costs associated with the capital structure and physical plant. The exclusion of interest expense and depreciation is useful given fluctuations in interest rates and significant variation in depreciation expense that can result from the amount and timing of capital expenditures and potential variations in estimated useful lives, all of which can vary widely across different industries or among companies within the same industry. The company believes the exclusion of taxes is appropriate for comparability purposes as the tax positions of companies can vary because of their differing abilities to take advantage of tax benefits and because of the tax policies of the various jurisdictions in which they operate. The company also believes the exclusion of equity granted to third parties and employees expense is useful given the significant variation in expense that can result from changes in the fair market value of the company's common stock. Finally, the company believes that the exclusion of equity in net loss of affiliate (SIRIUS Canada Inc.) is useful to assess the performance of its core consolidated operations in the continental United States. To compensate for the exclusion of taxes, other income (expense), depreciation, impairment charges and equity granted to third parties and employees expense, the company separately measures and budgets for these items.

There are material limitations associated with the use of adjusted loss from operations in evaluating the company compared with net loss, which reflects overall financial performance, including the effects of taxes, other income (expense), depreciation, impairment charges and equity granted to third parties and employees expense. The company uses adjusted

loss from operations to supplement GAAP results to provide a more complete understanding of the factors and trends affecting the business than GAAP results alone. Investors that wish to compare and evaluate the operating results after giving effect for these costs, should refer to net loss as disclosed in the unaudited consolidated statements of operations. Since adjusted loss from operations is a non-GAAP financial measure, the calculation of adjusted loss from operations may be susceptible to varying calculations; may not be comparable to other similarly titled measures of other companies; and should not be considered in isolation, as a substitute for, or superior to measures of financial performance prepared in accordance with GAAP.

(8) SIRIUS refers to adjusted net loss and adjusted net loss per share as net loss and net loss per share excluding impairment charges and equity granted to third parties and employees expense. Adjusted net loss and adjusted net loss per share are not measures of financial performance under GAAP. The company believes adjusted net loss and adjusted net loss per share are useful to investors to compare its operating performance to the performance of other communications, entertainment and media companies. The company believes the exclusion of impairment charges is appropriate for comparability purposes as the existence, amount and timing of impairment charges can vary period to period and can vary widely across different industries or among companies within the same industry. The company also believes the exclusion of equity granted to third parties and employees expense is useful given the significant variation in expense that can result from changes in the fair market value of the company's common stock.

There are material limitations associated with the use of adjusted net loss and adjusted net loss per share in evaluating the company compared with net loss and net loss per share, which reflects overall financial performance, including the effects of impairment charges and equity granted to third parties and employees expense. The company uses adjusted net loss and adjusted net loss per share to supplement GAAP results to provide a more complete understanding of the factors and trends affecting the business than GAAP results alone. Investors that wish to compare and evaluate the operating results after giving effect for these costs, should refer to net loss and net loss per share as disclosed in the unaudited consolidated statements of operations. Since adjusted net loss and adjusted net loss per share are non-GAAP financial measures, the calculation of adjusted net loss and adjusted net loss per share may be susceptible to varying calculations; may not be comparable to other similarly titled measures of other companies; and should not be considered in isolation, as a substitute for, or superior to measures of financial performance prepared in accordance with GAAP.

About SIRIUS

SIRIUS delivers more than 125 channels of the best programming in all of radio. SIRIUS is the original and only home of 100% commercial free music channels in satellite radio, offering 67 music channels available nationwide. SIRIUS also delivers 61 channels of sports, news, talk, entertainment, traffic, weather and data. SIRIUS is the Official Satellite Radio Partner of the NFL, NBA and NHL and broadcasts live play-by-play games of the NFL, NBA and NHL. All SIRIUS programming is available for a monthly subscription fee of only \$12.95.

SIRIUS products for the car, truck, home, RV and boat are available in more than 25,000 retail locations, including Best Buy, Circuit City, Crutchfield, Costco, Target, Wal-Mart, Sam's Club, RadioShack and at shop.sirius.com.

SIRIUS radios are offered in vehicles from Audi, BMW, Chrysler, Dodge, Ford, Infiniti, Jaguar, Jeep(R), Land Rover, Lexus, Lincoln-Mercury, Mazda, Mercedes-Benz, MINI, Nissan, Rolls Royce, Scion, Toyota, Porsche, Volkswagen and Volvo. Hertz also offers SIRIUS in its rental cars at major locations around the country.

Click on www.sirius.com to listen to SIRIUS live, or to purchase a SIRIUS radio and subscription.

Any statements that express, or involve discussions as to, expectations, beliefs, plans, objectives, assumptions, future events or performance with respect to SIRIUS Satellite Radio Inc. are not historical facts and may be forward-looking and, accordingly, such statements involve estimates, assumptions and

uncertainties which could cause actual results to differ materially from those expressed in any forward-looking statements. Accordingly, any such statements are qualified in their entirety by reference to the factors discussed in the company's Annual Report on Form 10-K for the year ended December 31, 2005 filed with the Securities and Exchange Commission. Among the key factors that have a direct bearing on the company's operational results are: its dependence upon third parties, including manufacturers of SIRIUS radios, retailers, automakers and programming partners, its competitive position and any events which affect the useful life of its satellites.

E-SIRI

Contacts:

Media

Patrick Reilly

SIRIUS

212-901-6646

preilly@siriusradio.com

Analysts

Paul Blalock

SIRIUS

212-584-5174

pblalock@siriusradio.com

Michelle McKinnon

SIRIUS

212-584-5285

mmckinnon@siriusradio.com

SOURCE SIRIUS Satellite Radio

media, Patrick Reilly, +1-212-901-6646, preilly@siriusradio.com, or analysts, Paul Blalock, +1-212-584-5174, pblalock@siriusradio.com, or Michelle McKinnon, +1-212-584-5285, mmckinnon@siriusradio.com, all for SIRIUS Satellite Radio

<http://www.prnewswire.com>

Copyright (C) 2006 PR Newswire. All rights reserved.

News Provided by COMTEX

B



SIRIUS Satellite Radio Reports Strong First Quarter 2006 Results

- Company Increases Year-End Subscriber Guidance to Over 6.2 Million - Revenue Nearly Triples to Over \$126 Million - Satellite Radio Leader with 57% of Net Subscriber Additions

NEW YORK, May 2, 2006 /PRNewswire-FirstCall via COMTEX News Network/ -- SIRIUS Satellite Radio (Nasdaq: SIRI) today announced strong first quarter 2006 results including record market share of satellite radio net subscriber additions.

(Logo: <http://www.newscom.com/cgi-bin/prnh/19991118/NYTH125>)

SIRIUS ended the first quarter with 4,077,747 subscribers, reflecting net subscriber additions of 761,187, a 149% increase in net additions from the year-ago quarter. For the second consecutive quarter, SIRIUS led the satellite radio industry in net subscriber additions.

First quarter 2006 revenue grew to \$126.7 million, up 193% from \$43.2 million in the year-ago quarter. Advertising revenue increased to a record \$7.3 million, representing 53% of total satellite radio industry advertising revenue in the first quarter. Average monthly churn was 1.8%, in line with guidance. Subscriber acquisition costs (SAC) per gross addition were \$113 for the first quarter, a 41% improvement over the year-ago quarter.

"SIRIUS led the industry in the first quarter with the majority of satellite radio net additions, while achieving 64% share at retail and strong growth in our OEM channel. Based upon our growth we are pleased to be raising our subscriber guidance for 2006 to over 6.2 million and we continue to believe we could be free cash flow positive as early as the fourth quarter of 2006 and for the full year 2007," said Mel Karmazin, CEO of SIRIUS. "We are also very excited about the launch of our first live wearable radio this summer and our plans to stream The Howard Stern Show via the Internet to SIRIUS subscribers by Father's Day."

During the first quarter, SIRIUS added 534,958 net subscribers from the company's retail channel, a 169% increase from 198,558 net retail subscriber additions in the year-ago quarter. The company also added 225,343 net subscribers from its automotive OEM channel, 109% more than the 107,855 net automotive OEM subscriber additions in the year-ago quarter.

SIRIUS reported a net loss of (\$458.5) million, or (\$0.33) per share, for the first quarter of 2006, including a (\$0.20) per share impact from equity charges, compared to a net loss of (\$193.6) million, or (\$0.15) per share, in the year-ago quarter, including a (\$0.03) per share impact from equity charges. The adjusted net loss per share, or net loss per share excluding equity charges, was (\$0.13) in the first quarter 2006 as compared to an adjusted net loss per share of (\$0.12) in the first quarter of 2005. (Refer to the reconciliation table of GAAP net loss per share to the adjusted net loss per share).

"This was a great quarter on every front for SIRIUS," added Mel Karmazin. "Non-cash equity charges were the primary reasons for our widening loss over last year and do not impact our free cash flow guidance or our very bright short and long term prospects."

Other Developments

During 2006, SIRIUS reached new exclusive agreements with Kia, Volkswagen, Audi, and Rolls-Royce. SIRIUS will be a standard feature in all 2009 model year Kia vehicles. In the 2007 model year, Volkswagen is expected to include SIRIUS in 80% of its production. SIRIUS is now a standard feature in all Rolls-Royce vehicles sold in the United States.

SIRIUS enhanced its strong programming line-up during the first quarter with new additions including the Howard Stern channels, Playboy Radio, Cosmo Radio, Blue Collar Comedy Radio, FOX News Channels, and a new morning call-in show from Court TV. SIRIUS is the original and only home of 100% commercial free music.

Guidance

SIRIUS provided the following guidance for full year 2006 and beyond:

SIR Ex. 8-B

Full Year 2006:

- * Over 6.2 million subscribers at year-end
- * Average monthly churn of approximately 1.8%
- * SAC per gross addition approaching \$110
- * Total revenue to exceed \$600 million
- * Adjusted loss from operations of approximately (\$565) million, reflecting the impact on total SAC of more robust subscriber growth than previously expected
- * SIRIUS' first quarter of positive free cash flow, after capital expenditures, could be reached as early as the fourth quarter of 2006

Longer Term:

- * Total revenue for 2007 of approximately \$1 billion
- * SAC per gross addition for 2007 to decline further from the 2006 level
- * Positive free cash flow, after capital expenditures, for full-year 2007
- * Total revenue for 2010 of approximately \$3 billion
- * Free cash flow for 2010, after capital expenditures, of approximately \$1 billion

Conference Call Information:

SIRIUS will hold a conference call today at 8 am ET to discuss operating and financial results. The public, members of the investment community and the press will have live access to the conference call via the company's website, www.sirius.com, and on the SIRIUS service by tuning to SIRIUS Channel 125. A replay of the call will also be available on the SIRIUS website.

FIRST QUARTER 2006 VERSUS FIRST QUARTER 2005

For the first quarter of 2006, SIRIUS recognized total revenue of \$126.7 million compared with \$43.2 million for the first quarter of 2005. This 193%, or \$83.5 million, increase in revenue was primarily driven by a \$73.3 million increase in subscriber revenue resulting from the net increase in subscribers of 2,629,052, or 181%, from March 31, 2005 to March 31, 2006, and a \$6.8 million increase in advertising revenue.

The company's adjusted loss from operations increased by (\$9.6) million to (\$136.7) million for the first quarter of 2006 from (\$127.1) million for the first quarter of 2005 (refer to the reconciliation table of GAAP loss from operations to adjusted loss from operations). This increase was driven by a 63%, or \$42.1 million, increase in subscriber acquisition costs reflecting higher shipments of SIRIUS radios and chip sets and increased commissions to support a 171% increase in gross subscriber additions from 354,708 for the first quarter of 2005 to 960,610 for the first quarter of 2006. This increase was offset by reductions in hardware subsidy rates as the company continued to reduce manufacturing and chip set costs. The increase in subscriber acquisition costs was more than offset by a 175%, or \$73.3 million, increase in subscriber revenue as a result of a 181% increase in the company's subscriber base.

Programming and content expenses increased by \$32.1 million to \$56.4 million for the first quarter of 2006 from \$24.3 million for the first quarter of 2005. The increase was primarily attributable to license fees and consulting costs associated with new programming, and broadcast royalties.

Customer service and billing expenses increased by \$6.3 million to \$15.8 million for the first quarter of 2006, from \$9.5 million for the first quarter of 2005. The increase was primarily attributable to call center operating costs necessary to accommodate the increase in the company's subscriber base. Customer service and billing expenses per average subscriber per month declined 42% to \$1.40 for the first quarter of 2006 from \$2.40 for the first quarter of 2005.

Sales and marketing expenses increased by \$4.2 million to \$39.3 million for the first quarter of 2006 from \$35.1 million for the first quarter of 2005. The increase was primarily attributable to higher distribution and compensation related costs, offset by decreases in advertising costs.

During the first quarter of 2006, the company also had increases in general and administrative expenses and engineering, design and development expenses. General and administrative expenses increased \$4.3 million to \$19.1 million for the first quarter of 2006 from \$14.8 million for the first quarter of 2005 primarily as a result of overhead expansion to support the growth of the business. Engineering, design and development expenses increased \$1.0 million to \$12.7 million for the first quarter of 2006 from \$11.7 million for the first quarter of 2005 primarily as a result of costs associated OEM tooling and manufacturing upgrades for SIRIUS factory installations.

For the first quarter of 2006, the company recorded (\$4.4) million for its share of SIRIUS Canada, Inc.'s net loss.

SIRIUS reported a net loss of (\$458.5) million, or (\$0.33) per share, for the first quarter of 2006, including a (\$0.20) per share impact from equity charges, compared to a net loss of (\$193.6) million, or (\$0.15) per share, in the year-ago quarter, including a (\$0.03) per share impact from equity charges. The adjusted net loss per share, or net loss per share excluding equity charges, was (\$0.13) in the first quarter 2006 as compared to an adjusted net loss per share of (\$0.12) in the first quarter of 2005. (Refer to the reconciliation table of GAAP net loss per share to the adjusted net loss per share).

(Selected financial information follows).

This press release, including the selected financial information to follow, includes the following financial measures defined as non-GAAP financial measures by the Securities and Exchange Commission: average monthly churn; subscriber acquisition costs, or SAC, per gross subscriber addition; customer service and billing expenses per average subscriber; average monthly revenue per subscriber, or ARPU; adjusted loss from operations; adjusted net loss; adjusted net loss per share; and free cash flow. SIRIUS believes these non-GAAP financial measures provide meaningful supplemental information regarding operating performance and liquidity and are used for internal management purposes, when publicly providing the business outlook, and as a means to evaluate period-to-period comparisons. These non-GAAP financial measures are used in addition to and in conjunction with results presented in accordance with GAAP. These non-GAAP financial measures may be susceptible to varying calculations; may not be comparable to other similarly titled measures of other companies; and should not be considered in isolation or as a substitute for measures of financial performance prepared in accordance with GAAP.

SIRIUS defines average monthly churn as the number of deactivated subscribers divided by average quarterly subscribers.

SIRIUS defines SAC per gross subscriber addition as SAC and margins from the direct sale of SIRIUS radios and accessories divided by the number of gross subscriber additions for the period.

SIRIUS defines customer service and billing expenses per average subscriber as total customer service and billing expenses divided by the daily weighted average number of subscribers for the period.

SIRIUS defines ARPU as the total earned subscriber revenue and net advertising revenue divided by the daily weighted average number of subscribers for the period.

SIRIUS defines adjusted loss from operations as GAAP loss from operations before charges for depreciation and equity, reported as equity granted to third parties and employees. SIRIUS defines adjusted net loss as GAAP net loss before charges for equity granted to third parties and employees. SIRIUS defines adjusted net loss per share as adjusted net loss divided by the actual weighted average common shares outstanding (basic and diluted).

SIRIUS defines free cash flow as cash flow from operating activities, capital expenditures and restricted investments activity.

Sirius Satellite Radio Inc.
Subscriber Data and Metrics
(Unaudited)

	For the Three Months Ended March 31,	
	2006	2005
Subscribers:		
Beginning subscribers	3,316,560	1,143,258
Net additions	761,187	305,437
Ending subscribers	4,077,747	1,448,695
Retail	3,000,321	1,109,813
OEM	1,049,036	311,324
Hertz	28,390	27,558
	For the Three Months Ended March 31,	
	2006	2005
Metrics:		
Gross subscriber additions	960,610	354,708
Deactivated subscribers	199,423	49,271

Average monthly churn	1.8%	1.3%
SAC per gross subscriber addition	\$113	\$190
Customer service and billing expenses per average subscriber	\$1.40	\$2.40

Monthly ARPU:

Average monthly subscriber revenue per subscriber before effects of Hertz subscribers and mail-in rebates	\$10.70	\$10.64
Effects of Hertz subscribers	0.03	0.01
Effects of mail-in rebates	(0.58)	(0.06)
Average monthly subscriber revenue per subscriber	10.15	10.59
Average monthly net advertising revenue per subscriber	0.65	0.13
ARPU	\$10.80	\$10.72

Sirius Satellite Radio Inc.
 Financial Highlights
 (In thousands, except per share data)
 (Unaudited)

For the Three Months
 Ended March 31,
 2006 2005

Revenue:

Subscriber revenue, including effects of mail-in rebates	\$115,181	\$41,904
Advertising revenue, net of agency fees	7,338	534
Equipment revenue	3,692	767
Other revenue	453	11
Total revenue	126,664	43,216

Operating expenses:

Cost of services (excludes depreciation shown separately below):		
Satellite and transmission	7,301	6,813
Programming and content	56,444	24,278
Customer service and billing	15,841	9,492
Cost of equipment	3,465	976
Sales and marketing	39,296	35,122
Subscriber acquisition costs	109,144	67,093
General and administrative	19,144	14,832
Engineering, design and development	12,679	11,662
Depreciation	24,933	24,501
Equity granted to third parties and employees (1)	284,586	38,706
Total operating expenses	572,833	233,475
Loss from operations	(446,169)	(190,259)
Other income (expense):		
Interest and investment income	9,937	4,487
Interest expense	(17,124)	(7,325)
Income (expense) from affiliate	(4,445)	-
Other income	10	45
Total other income (expense)	(11,622)	(2,793)
Loss before income taxes	(457,791)	(193,052)
Income tax expense	(753)	(560)
Net loss	\$(458,544)	\$(193,612)
Net loss per share (basic and diluted)	\$(0.33)	\$(0.15)
Weighted average common shares outstanding (basic and diluted)	1,386,982	1,314,312

(1) Allocation of equity granted to third parties and employees to other operating expenses:

Satellite and transmission	\$902	\$559
Programming and content	249,800	4,888
Customer service and billing	244	139
Sales and marketing	2,202	13,430
Subscriber acquisition costs	9,899	6,228
General and administrative	14,506	7,277
Engineering, design and development	7,033	6,185
Total equity granted to third parties and		

employees	\$284,586	\$38,706
	For the Three Months Ended March 31,	
	2006	2005
Adjusted loss from operations:		
GAAP loss from operations, as reported	\$(446,169)	\$(190,259)
Depreciation	24,933	24,501
Equity granted to third parties and employees	284,586	38,706
Adjusted loss from operations	\$(136,650)	\$(127,052)
Adjusted net loss:		
GAAP net loss, as reported	\$(458,544)	\$(193,612)
Equity granted to third parties and employees	284,586	38,706
Adjusted net loss	\$(173,958)	\$(154,906)
GAAP net loss per share (basic and diluted), as reported	\$ (0.33)	\$ (0.15)
Equity granted to third parties and employees, per share	0.20	0.03
Adjusted net loss per share (basic and diluted)	\$ (0.13)	\$ (0.12)
Weighted average common shares outstanding (basic and diluted), as reported	1,386,982	1,314,312
	As of	
	March 31, 2006	Dec. 31, 2005
Balance sheet data:		
Cash, cash equivalents and marketable securities	\$715,231	\$879,257
Restricted investments	108,315	107,615
Working capital	266,656	404,481
Total assets	1,908,104	2,085,362
Long-term debt	1,083,929	1,084,437
Total liabilities	1,773,401	1,760,394
Accumulated deficit	(3,187,397)	(2,728,853)
Stockholders' equity	134,703	324,968
	For the Three Months Ended March 31,	
	2006	2005
Cash flows from operating activities:		
Net loss	\$(458,544)	\$(193,612)
Adjustments to reconcile net loss to net cash used in operating activities:		
Depreciation	24,933	24,501
Non-cash interest expense	761	762
Provision for doubtful accounts	1,777	1,400
Non-cash income (expense) from affiliate	2,276	-
Loss on disposal of assets	221	127
Equity granted to third parties and employees	284,586	38,706
Deferred income taxes	753	560
Changes in operating assets and liabilities:		
Marketable securities	-	16
Accounts receivable	9,952	(340)
Inventory	(1,198)	16
Prepaid expenses and other current assets	(21,758)	(3,181)
Other long-term assets	579	(1,157)
Accounts payable and accrued expenses	(45,220)	(5,601)
Accrued interest	(10,460)	2,736
Deferred revenue	44,458	19,423
Other long-term liabilities	7,543	(1,524)
Net cash used in operating activities	(159,341)	(117,168)
Cash flows from investing activities:		
Additions to property and equipment	(5,496)	(6,888)
Sales of property and equipment	52	12

Purchases of restricted investments	(700)	(6,291)
Purchases of available-for-sale securities	(71,600)	-
Sales of available-for-sale securities	104,450	-
Maturities of available-for-sale securities	-	4,835
Net cash provided by/(used in) investing activities	26,706	(8,332)
Cash flows from financing activities:		
Proceeds from exercise of stock options	1,459	993
Other	-	(8)
Net cash provided by financing activities	1,459	985
Net decrease in cash and cash equivalents	(131,176)	(124,515)
Cash and cash equivalents at the beginning of period	762,007	753,891
Cash and cash equivalents at the end of period	\$630,831	\$629,376

About SIRIUS

SIRIUS delivers more than 125 channels of the best programming in all of radio. SIRIUS is the original and only home of 100% commercial free music channels in satellite radio, offering 67 music channels available nationwide. SIRIUS also delivers 61 channels of sports, news, talk, entertainment, traffic, weather and data. SIRIUS is the Official Satellite Radio Partner of the NFL, NBA and NHL and broadcasts live play-by-play games of the NFL, NBA and NHL. All SIRIUS programming is available for a monthly subscription fee of only \$12.95.

SIRIUS products for the car, truck, home, RV and boat are available in more than 25,000 retail locations, including Best Buy, Circuit City, Crutchfield, Costco, Target, Wal-Mart, Sam's Club, RadioShack and at shop.sirius.com.

SIRIUS radios are offered in vehicles from Audi, BMW, Chrysler, Dodge, Ford, Infiniti, Jaguar, Jeep(R), Land Rover, Lexus, Lincoln-Mercury, Mazda, Mercedes-Benz, MINI, Nissan, Rolls-Royce, Scion, Toyota, Porsche, Volkswagen and Volvo. Kia will provide SIRIUS as a standard feature in its 2009 vehicles, beginning in 2008. Hertz also offers SIRIUS in its rental cars at major locations around the country.

Click on www.sirius.com to listen to SIRIUS live, or to purchase a SIRIUS radio and subscription.

Any statements that express, or involve discussions as to, expectations, beliefs, plans, objectives, assumptions, future events or performance with respect to SIRIUS Satellite Radio Inc. are not historical facts and may be forward-looking and, accordingly, such statements involve estimates, assumptions and uncertainties which could cause actual results to differ materially from those expressed in any forward-looking statements. Accordingly, any such statements are qualified in their entirety by reference to the factors discussed in our Annual Report on Form 10-K for the year ended December 31, 2005 filed with the Securities and Exchange Commission. Among the key factors that have a direct bearing on our operational results are: our dependence upon third parties, including manufacturers of SIRIUS radios, retailers, automakers and programming partners, our competitive position and any events which affect the useful life of our satellites.

E-SIRI

Media Contact:

Jim Collins
SIRIUS
212-901-6422
jcollins@siriusradio.com

Analyst Contacts:

Paul Blalock
SIRIUS
212-584-5174
pblalock@siriusradio.com

Michelle McKinnon
SIRIUS
212-584-5285
mmckinnon@siriusradio.com

SOURCE SIRIUS Satellite Radio

Media: Jim Collins, +1-212-901-6422, jcollins@siriusradio.com, Analyst: Paul Blalock, +1-212-584-5174, pblalock@siriusradio.com, or Michelle McKinnon, +1-212-584-5285,

mmckinnon@siriusradio.com, all of SIRIUS

<http://www.prnewswire.com>

Copyright (C) 2006 PR Newswire. All rights reserved.

News Provided by COMTEX

C



Deepak Chopra, World Renowned Mind and Body Expert and Author, to Host Weekly Show on SIRIUS Satellite Radio

'Deepak Chopra's Wellness Radio' will take calls on health, spirituality, relationships and success Saturday mornings on SIRIUS Stars, channel 102.

NEW YORK, May 4, 2006 /PRNewswire-FirstCall via COMTEX News Network/ -- SIRIUS Satellite Radio (Nasdaq: SIRI), announced today that Deepak Chopra, best-selling author and leader in the field of mind and body medicine, will host a live, weekly three hour health and wellness call-in talk show, Saturday mornings on SIRIUS.

(Logo: <http://www.newscom.com/cgi-bin/prnh/19991118/NYTH125>)

Deepak Chopra's Wellness Radio will debut in Summer 2006 exclusively on SIRIUS. Each week Chopra will discuss the areas of health, spirituality, relationships and success. Often putting today's news in the context of mind and body wellness, Chopra will teach, explain, inform, nurture and advise his listeners nationwide. Listeners will be able to call in for personal one-on-one conversations. Deepak Chopra's Wellness Radio will air every Saturday morning on SIRIUS Stars, channel 102.

"With SIRIUS I hope to reach a critical mass of people with a message of self development and personal and social transformation," said Chopra. "I will be focusing on four areas -- success; love, sexuality and relationships; well being; and spirituality. My hope is to develop a more personal relationship with a back and forth communication, something that I haven't been able to do with my books."

"Deepak Chopra's exceptional success as a doctor, author and teacher has touched the lives of millions of people. Deepak is leading the field of mind and body medicine and is changing the way we look at our health," said Scott Greenstein, SIRIUS' President, Entertainment and Sports. "We are excited to add Deepak Chopra's Wellness Radio to our already strong line-up of lifestyle programming."

Deepak Chopra has written over 42 books and released more than 100 audio, video and CD-ROM titles. They have been translated into 35 languages with over 20 million copies sold worldwide. In 1999 Time magazine selected Dr. Chopra as one of the Top 100 Icons and Heroes of the Century, describing him as "the poet prophet of alternative medicine."

His latest book, *Peace Is the Way* (Harmony Books) won the Quill Awards and *The Book of Secrets: Unlocking the Hidden Dimensions of your Life* was awarded the Nautilus Award. Some of his NY Times best-sellers include *Ageless Body, Timeless Mind*; *The Seven Spiritual Laws of Success*; *Grow Younger, Live Longer: 10 Steps to Reverse Aging*; and *The Path to Love*.

In 1995 the Chopra Center for Well Being was established in California, and has since become a leading institution for advancements in melding traditional western medicine and alternative healing practices. Deepak serves as an adjunct professor at the Kellogg School of Management, and regularly mentors corporate and political leaders through his *Soul of Leadership* workshops. He's the recipient of the Einstein award through Albert Einstein College of Medicine, in collaboration with the American Journal of Psychotherapy, and the recipient of the 2006 Ellis Island Medal of Honor from the National Ethnic Coalition of Organizations. Along with Nobel Peace laureates Oscar Arias, Betty Williams, and others, Chopra is a founding director of the Alliance for the New Humanity. Chopra joined the Gallup Organization as a senior scientist in 2005.

For more information on Deepak Chopra please go to <http://www.chopra.com> .

SIRIUS has an extensive commitment to lifestyle programming, featuring related shows on its Martha Stewart Living Radio and LIME Radio channels.

SIR Ex. 8-C

About SIRIUS

SIRIUS delivers more than 125 channels of the best programming in all of radio. SIRIUS is the original and only home of 100% commercial free music channels in satellite radio, offering 67 music channels available nationwide. SIRIUS also delivers 61 channels of sports, news, talk, entertainment, traffic, weather and data. SIRIUS is the Official Satellite Radio Partner of the NFL, NBA and NHL and broadcasts live play-by-play games of the NFL, NBA and NHL. All SIRIUS programming is available for a monthly subscription fee of only \$12.95.

SIRIUS products for the car, truck, home, RV and boat are available in more than 25,000 retail locations, including Best Buy, Circuit City, Crutchfield, Costco, Target, Wal-Mart, Sam's Club, RadioShack and at shop.sirius.com.

SIRIUS radios are offered in vehicles from Audi, BMW, Chrysler, Dodge, Ford, Infiniti, Jaguar, Jeep(R), Land Rover, Lexus, Lincoln-Mercury, Mazda, Mercedes-Benz, MINI, Nissan, Scion, Toyota, Porsche, Volkswagen and Volvo. Hertz also offers SIRIUS in its rental cars at major locations around the country.

Click on <http://www.sirius.com> to listen to SIRIUS live, or to purchase a SIRIUS radio and subscription.

Any statements that express, or involve discussions as to, expectations, beliefs, plans, objectives, assumptions, future events or performance with respect to SIRIUS Satellite Radio Inc. are not historical facts and may be forward-looking and, accordingly, such statements involve estimates, assumptions and uncertainties which could cause actual results to differ materially from those expressed in any forward-looking statements. Accordingly, any such statements are qualified in their entirety by reference to the factors discussed in our Annual Report on Form 10-K for the year ended December 31, 2005 filed with the Securities and Exchange Commission. Among the key factors that have a direct bearing on our operational results are: our dependence upon third parties, including manufacturers of SIRIUS radios, retailers, automakers and programming partners, our competitive position and any events which affect the useful life of our satellites.

P-SIRI

Media Contact:

Hillary Schupf
SIRIUS
212.901.6739
hschupf@siriusradio.com

SOURCE SIRIUS Satellite Radio

Hillary Schupf of SIRIUS, +1-212-901-6739, hschupf@siriusradio.com

<http://www.prnewswire.com>

Copyright (C) 2006 PR Newswire. All rights reserved.

News Provided by COMTEX

D



NASCAR Driver Tony Stewart to Host Live Talk Show Exclusively on SIRIUS Satellite Radio

'Tony Stewart Live' will air weekly on SIRIUS' upcoming 24/7 NASCAR Channel SIRIUS will be the Official Satellite Radio Partner of NASCAR starting in 2007

NEW YORK, May 19, 2006 /PRNewswire via COMTEX News Network/ -- SIRIUS Satellite Radio, the Official Satellite Radio Partner of NASCAR starting in 2007, announced today that two-time and reigning NASCAR NEXTEL Cup Series champion Tony Stewart -- one of the sport's most exciting and outspoken drivers -- will host a live weekly talk show exclusively on SIRIUS.

(Logo: <http://www.newscom.com/cgi-bin/prnh/19991118/NYTH125>)

Debuting in January, Tony Stewart Live will air exclusively on SIRIUS' upcoming 24/7 NASCAR channel, providing SIRIUS listeners with the ultimate insider's perspective on auto racing. The weekly, two-hour show will feature Stewart -- who has never been shy about expressing his opinions in 27 years of racing -- taking calls from listeners, talking with prominent guests and covering the spectrum of motorsports -- from NASCAR to open-wheel racing and beyond. Matt Yocum, who is a pit reporter for the NASCAR broadcasts on FOX/FX and NBC/TNT, will be Stewart's co-host on Tony Stewart Live.

Preview editions of Tony Stewart Live, hosted by Stewart, will begin airing exclusively on SIRIUS in October 2006. Stewart will also be featured in SIRIUS' NASCAR related marketing and advertising.

Beginning next year, SIRIUS will be the Official Satellite Radio Partner of NASCAR, broadcasting all NASCAR NEXTEL Cup Series, NASCAR Busch Series and NASCAR Craftsman Truck Series races live on a specially created, 24/7 NASCAR channel.

"It's an honor to be a part of SIRIUS and its commitment to NASCAR," said Stewart. "Our show will allow us to speak with the fans on our terms, where we're free to talk about anything and everything, from racing and rock-and-roll to our travels across America. It's a unique opportunity, and we plan to make the most of it."

"NASCAR will be one of the cornerstones of SIRIUS' programming, and with Tony anchoring our NASCAR channel, we will provide the most expert and compelling coverage of the sport," said Scott Greenstein, SIRIUS' President, Entertainment and Sports. "Tony will have the freedom to run this show the same way he runs the track in his #20 car -- fast, aggressive and willing to trade a little paint with our listeners."

Stewart is a two-time NASCAR NEXTEL Cup Series champion, having won the title in 2002 and 2005, and with his second championship, he became one of only 14 drivers in the history of NASCAR to win multiple Cup Series titles. In addition to his achievements on the NASCAR circuit, Stewart is the first and only driver to have won championships in stock cars, Indy cars and in USAC's Midget, Sprint and Silver Crown divisions.

In 1980 at the age of eight, Stewart won his first championship -- a 4-cycle rookie junior class championship in his hometown of Columbus, Ind. By 1989, after two more national karting championships, Stewart had moved on to open-wheeled machines, racing Three-Quarter Midgets. He turned his attention to the USAC ranks in 1991, where he was named Rookie of the Year. Stewart won his first USAC championship in the National Midget category in 1994, and in 1995, he made USAC history by achieving the sport's Triple Crown -- winning the National Midget, Sprint and Silver Crown titles all in the same year -- a feat that had never been accomplished before. In 1996, he moved to the IRL IndyCar Series where he won Rookie of the Year honors before capturing the IndyCar Series championship in 1997.

While racing Indy cars, Stewart also began dabbling in stock cars. He ran nine NASCAR Busch Series races in 1996. There, his versatility was noticed by Joe Gibbs -- the three-time Super Bowl-winning coach of the Washington Redskins and the owner of Joe Gibbs Racing. By 1997, Stewart was a member of Joe Gibbs Racing, running five Busch Series races before a 22-race Busch Series slate in 1998. In 1999, Stewart moved to the pinnacle of motorsports -- the Nextel Cup Series. During an extraordinary rookie campaign, Stewart won three races, was crowned Rookie of the Year and became the first driver to complete both the Indianapolis 500 and the Coca-Cola 600 on the same day. Currently, Stewart has 25 Nextel Cup wins, 10 poles, 100 top-fives and 156 top-10s in 259 career starts.

SIR Ex. 8-D

Outside of his driving duties, Stewart is both a car owner and a track owner. Tony Stewart Motorsports fields a World of Outlaws team that won the series championship in 2001, a USAC team that fields entries in the Sprint, Midget and Silver Crown divisions, and a USAR Hooters Pro Cup Series team. Eldora Speedway, the premier grassroots motorsports venue in the country, is also Stewart's, as he purchased the 52-year-old half-mile, clay oval in late 2004.

While Stewart is passionate about racing, he is equally passionate about philanthropy. In 2003, he formed "The Tony Stewart Foundation," through which he raises funds that are distributed to organizations that actively support children's organizations, animal rescue groups and injured race car drivers.

Stewart, single, still calls Columbus home, where he lives in the house he grew up in. He has a sister Natalie, who helps run the Tony Stewart Fan Club, along with their mom, Pam Boas, who also runs the Foundation. His father, Nelson, oversees Stewart's portfolio of properties while assisting the race teams on a day-to-day basis.

About SIRIUS

SIRIUS delivers more than 125 channels of the best programming in all of radio. SIRIUS is the original and only home of 100% commercial free music channels in satellite radio, offering 67 music channels available nationwide. SIRIUS also delivers 61 channels of sports, news, talk, entertainment, traffic, weather and data. SIRIUS is the Official Satellite Radio Partner of the NFL, NBA and NHL, and broadcasts live play-by-play games of the NFL, NBA and NHL. All SIRIUS programming is available for a monthly subscription fee of only \$12.95.

SIRIUS products for the car, truck, home, RV and boat are available in more than 25,000 retail locations, including Best Buy, Circuit City, Crutchfield, Costco, Target, Wal-Mart, Sam's Club, RadioShack and at shop.sirius.com.

SIRIUS radios are offered in Land(R) vehicles from Audi, BMW, Chrysler, Dodge, Ford, Infiniti, Jaguar, Jeep, Rover, Lexus, Lincoln-Mercury, Mazda, Mercedes-Benz, MINI, Nissan, Rolls Royce, Scion, Toyota, Porsche, Volkswagen and Volvo. Hertz also offers SIRIUS in its rental cars at major locations around the country.

Click on <http://www.sirius.com> to listen to SIRIUS live, or to purchase a SIRIUS radio and subscription.

Any statements that express, or involve discussions as to, expectations, beliefs, plans, objectives, assumptions, future events or performance with respect to SIRIUS Satellite Radio Inc. are not historical facts and may be forward-looking and, accordingly, such statements involve estimates, assumptions and uncertainties which could cause actual results to differ materially from those expressed in any forward-looking statements. Accordingly, any such statements are qualified in their entirety by reference to the factors discussed in our Annual Report on Form 10-K for the year ended December 31, 2005 filed with the Securities and Exchange Commission. Among the key factors that have a direct bearing on our operational results are: our dependence upon third parties, including manufacturers of SIRIUS radios, retailers, automakers and programming partners, our competitive position and any events which affect the useful life of our satellites.

P-SIRI

Media Contacts:

Andrew FitzPatrick
SIRIUS
201.901.6693
afitzpatrick@siriusradio.com

Mike Arning
True Speed Communication
770.579.1970
mikearning@aol.com

SOURCE SIRIUS Satellite Radio

Andrew FitzPatrick of SIRIUS, +1-201-901-6693, afitzpatrick@siriusradio.com; or Mike Arning of True Speed Communication, +1-770-579-1970, mikearning@aol.com

<http://www.prnewswire.com>

Copyright (C) 2006 PR Newswire. All rights reserved.

E



NFL Legend Jerry Rice to Host Exclusive Show on SIRIUS Satellite Radio

Future Hall-of-Famer to Join the SIRIUS NFL Radio Roster

NEW YORK, June 12, 2006 /PRNewswire-FirstCall via COMTEX News Network/ -- SIRIUS Satellite Radio (Nasdaq: SIRI), the Official Satellite Radio Partner of the NFL, has added legendary NFL receiver Jerry Rice to the roster of expert hosts on SIRIUS NFL Radio, channel 124, the only 24/7 year-round radio channel devoted to the NFL.

(Logo: <http://www.newscom.com/cgi-bin/prnh/19991118/NYTH125>)

Rice will begin hosting on SIRIUS NFL Radio on Tuesday, June 13th when he co-hosts "The Afternoon Blitz" with Adam Schein from 3-7 pm ET. He will be heard three days a week on SIRIUS every week throughout the year.

"I'm thrilled to be joining the SIRIUS NFL Radio team. SIRIUS is the Super Bowl Champion of satellite radio companies," said Rice. "I'm going to approach my broadcasting career with the same energy and enthusiasm I had during my playing career and we'll put on a fun and informative show for all the listeners out there."

"Very few athletes in professional sports can claim that they were the absolute best at what they did -- Jerry Rice is one of those few," said Scott Greenstein, SIRIUS' President, Entertainment and Sports. "Now he will share his incredible wealth of knowledge and experience with SIRIUS' nationwide audience. Our listeners will be able to interact with him all year long, talking directly to one of the greatest players to ever put on a uniform."

After being drafted in 1985 by coach Bill Walsh and the San Francisco 49ers out of Division I-AA Mississippi Valley State, Jerry Rice went on to become the greatest receiver in NFL history. When he retired in 2005, his #80 had become a symbol of excellence.

Over an astonishing and highlight-filled 20-year career, Rice re-wrote the NFL record books with 208 career touchdowns, 22,895 career receiving yards and 1,549 career receptions. He represented one half of two of the most famously successful quarterback-receiver tandems in league history when he teamed up with Hall-of-Famers Joe Montana and Steve Young. He was selected to 13 Pro Bowls, won three Super Bowls and was named MVP of Super Bowl XXIII.

On SIRIUS NFL Radio, Rice joins a lineup of NFL experts that includes Cris Carter, Randy Cross, Gil Brandt, Tim Ryan, Pat Kirwan, Solomon Wilcotts and Adam Schein. NFL fans can tune in to SIRIUS NFL Radio throughout the calendar year for the only 24/7 radio channel dedicated entirely to pro football talk.

As the Official Satellite Radio Partner of the NFL, SIRIUS is the home of NFL Sunday Drive, the broadcasting package that offers live nationwide every regular and post-season NFL game, including the Super Bowl and Pro Bowl. Listeners can hear home and visiting team broadcasts, national radio broadcasts and Spanish-language broadcasts for select games.

More information on SIRIUS programming is available at <http://www.SIRIUS.com> .

About SIRIUS

SIRIUS delivers more than 125 channels of the best programming in all of radio. SIRIUS is the original and only home of 100% commercial free music channels in satellite radio, offering 67 music channels available nationwide. SIRIUS also delivers 61 channels of sports, news, talk, entertainment, traffic, weather and data. SIRIUS is the Official Satellite Radio Partner of the NFL, NBA and NHL and broadcasts live play-by-play games of the NFL, NBA and NHL. All SIRIUS programming is available for a monthly subscription fee of only \$12.95.

SIR Ex. 8-E

SIRIUS products for the car, truck, home, RV and boat are available in more than 25,000 retail locations, including Best Buy, Circuit City, Crutchfield, Costco, Target, Wal-Mart, Sam's Club, RadioShack and at shop.sirius.com.

SIRIUS radios are offered in vehicles from Audi, BMW, Chrysler, Dodge, Ford, Infiniti, Jaguar, Jeep (R), Land Rover, Lexus, Lincoln-Mercury, Mazda, Mercedes-Benz, MINI, Nissan, Rolls Royce, Scion, Toyota, Porsche, Volkswagen and Volvo. Hertz also offers SIRIUS in its rental cars at major locations around the country.

Click on <http://www.sirius.com> to listen to SIRIUS live, or to purchase a SIRIUS radio and subscription.

Any statements that express, or involve discussions as to, expectations, beliefs, plans, objectives, assumptions, future events or performance with respect to SIRIUS Satellite Radio Inc. are not historical facts and may be forward-looking and, accordingly, such statements involve estimates, assumptions and uncertainties which could cause actual results to differ materially from those expressed in any forward-looking statements. Accordingly, any such statements are qualified in their entirety by reference to the factors discussed in our Annual Report on Form 10-K for the year ended December 31, 2005 filed with the Securities and Exchange Commission. Among the key factors that have a direct bearing on our operational results are: our dependence upon third parties, including manufacturers of SIRIUS radios, retailers, automakers and programming partners, our competitive position and any events which affect the useful life of our satellites.

P-SIRI

Media Contact:
Andrew FitzPatrick
SIRIUS
212-901-6693
afitzpatrick@siriusradio.com

SOURCE SIRIUS Satellite Radio

Andrew FitzPatrick of SIRIUS, +1-212-901-6693, afitzpatrick@siriusradio.com

<http://www.prnewswire.com>

Copyright (C) 2006 PR Newswire. All rights reserved.

News Provided by COMTEX

F



Barbara Walters to Launch 'Best of the Very Best' on SIRIUS Satellite Radio Early Next Year

Four Times a Year, Walters To Do 'Ask Barbara Anything' Live Call-in Show Exclusively On SIRIUS

NEW YORK, June 26, 2006 /PRNewswire-FirstCall via COMTEX News Network/ -- SIRIUS Satellite Radio (Nasdaq: SIRI) announced today that broadcasting icon Barbara Walters' interviews will be featured in an exclusive weekly SIRIUS show, entitled Barbara Walters' Best of the Very Best, presenting a selection of her compelling interviews over the past 30 years with great entertainers and world leaders. Walters will also host four times a year a new, live call-in show, entitled Ask Barbara Anything, exclusively on SIRIUS.

(Logo: <http://www.newscom.com/cgi-bin/prnh/19991118/NYTH125>)

The weekly two-hour series, Barbara Walters' Best of the Very Best, will take the best from a vast archive of diverse interview subjects that have captivated millions. Barbara Walters' Best of the Very Best will debut early next year exclusively on SIRIUS Stars, channel 102. The show will include dynamic interviews with famous people ranging from Hillary Clinton to Muhammad Ali to Tom Hanks to Lance Armstrong, to name only a few.

Walters will also host a periodic new show created just for SIRIUS. The satellite radio show, Ask Barbara Anything, will focus on varied compelling topics and major cultural events spanning the worlds of entertainment and politics. The show, beginning this fall, will include Walters taking calls directly from listeners.

"I am delighted to be part of the SIRIUS Satellite Radio family," said Walters. "It is an exciting new venture for me, and I am glad that my interviews will have this new exposure."

"Barbara Walters is a pioneer in the world of broadcasting. Her intelligence, honesty and integrity have broken ground in television and opened many doors for women in journalism," said Scott Greenstein, President of Entertainment and Sports, SIRIUS Satellite Radio. "We are honored and excited to showcase her candid interviews with the world's biggest newsmakers, and offer Barbara a platform for exclusive new specials."

Considered one of the most recognizable faces on television, Walters was the first female to anchor a news broadcast, when she co-anchored ABC Evening News with Harry Reasoner in 1976. Since then she has interviewed more statesmen and stars than any other journalist in history, including every American President and First Lady since Richard Nixon. She was also the first female co-anchor of the Today show. Walters is currently co-executive producer and co-host of the Emmy Award winning daytime talk show, The View.

The Barbara Walters Specials are continuously the top-rated specials of the year and have included such entertainment legends as Sir Laurence Olivier, Bing Crosby, John Wayne, Bette Davis and Audrey Hepburn. More recent interviews of superstars have included George Clooney, Matthew McConaughey, Mariah Carey, Julianne Moore, and Renee Zellweger. Walters' The 10 Most Fascinating People special broadcast, launched in 1993, offers a year-end review of the most prominent newsmakers of the year.

In September 2004, after 25 years as co-host and chief correspondent of ABC News' 20/20, Walters left the show to begin a new phase in her career at the network. She remains an active member of the news division and network, substantially increasing the number of primetime ABC News specials, in addition to her Barbara Walters Specials.

About SIRIUS

SIRIUS delivers more than 125 channels of the best programming in all of radio. SIRIUS is the original and only home of 100% commercial free music channels in satellite radio, offering 67 music channels available nationwide. SIRIUS also delivers 61 channels of sports, news, talk, entertainment, traffic,

SIR Ex. 8-F

weather and data. SIRIUS is the Official Satellite Radio Partner of the NFL, NBA and NHL and broadcasts live play-by-play games of the NFL, NBA and NHL. All SIRIUS programming is available for a monthly subscription fee of only \$12.95.

SIRIUS products for the car, truck, home, RV and boat are available in more than 25,000 retail locations, including Best Buy, Circuit City, Crutchfield, Costco, Target, Wal-Mart, Sam's Club, RadioShack and at shop.sirius.com.

SIRIUS radios are offered in vehicles from Audi, BMW, Chrysler, Dodge, Ford, Infiniti, Jaguar, Jeep(R), Land Rover, Lexus, Lincoln-Mercury, Mazda, Mercedes-Benz, MINI, Nissan, Rolls Royce, Scion, Toyota, Porsche, Volkswagen and Volvo. Hertz also offers SIRIUS in its rental cars at major locations around the country.

Click on www.sirius.com to listen to SIRIUS live, or to purchase a SIRIUS radio and subscription.

Any statements that express, or involve discussions as to, expectations, beliefs, plans, objectives, assumptions, future events or performance with respect to SIRIUS Satellite Radio Inc. are not historical facts and may be forward-looking and, accordingly, such statements involve estimates, assumptions and uncertainties which could cause actual results to differ materially from those expressed in any forward-looking statements. Accordingly, any such statements are qualified in their entirety by reference to the factors discussed in our Annual Report on Form 10-K for the year ended December 31, 2005 filed with the Securities and Exchange Commission. Among the key factors that have a direct bearing on our operational results are: our dependence upon third parties, including manufacturers of SIRIUS radios, retailers, automakers and programming partners, our competitive position and any events which affect the useful life of our satellites.

P-SIRI

Media Contact:

Hillary Schupf
SIRIUS
212.901.6739
hschupf@siriusradio.com

Patrick Reilly
SIRIUS
212.901.6646
preilly@siriusradio.com

SOURCE SIRIUS Satellite Radio

Hillary Schupf, SIRIUS, +1-212-901-6739, hschupf@siriusradio.com; Patrick Reilly, SIRIUS, +1-212-901-6646, preilly@siriusradio.com

<http://www.prnewswire.com>

Copyright (C) 2006 PR Newswire. All rights reserved.

News Provided by COMTEX

G



SIRIUS and Variety Will Launch Radio News Bureau

Up-to-the-minute box office reports and breaking news and views on movies, TV, and entertainment SIRIUS to air Variety Radio News multiple times each hour every day

NEW YORK, June 29, 2006 /PRNewswire-FirstCall via COMTEX News Network/ -- SIRIUS Satellite Radio (Nasdaq: SIRI) and Variety, the "show business bible," today announced the launch of a radio news bureau, based in Variety's Los Angeles offices, that will provide the latest in entertainment news to SIRIUS' national radio audience multiple times each hour of every day.

(Logo: <http://www.newscom.com/cgi-bin/prnh/19991118/NYTH125>)

Launching this fall, Variety Radio News will broadcast regular reports on SIRIUS' Los Angeles channel 150. With contributions from veteran Variety reporters and editors and SIRIUS' national reach, listeners will now be able to hear the latest from the worlds of film, TV, publishing and online media, as well as industry gossip, anywhere they are, including as they drive to and from work and industry functions.

Variety is recognized throughout the world as the entertainment industry's newspaper of record, covering the global media and entertainment marketplace in 84 countries. With its seasoned editorial team and the largest newsgathering staff in the industry, Variety delivers breaking news, exclusive "scoops," box office reports, plus film and TV production charts.

"Variety delivers an insider's view on film, TV, music, the internet, and publishing with concise and provocative insight," said Scott Greenstein, SIRIUS President, Entertainment and Sports. "Variety Radio News will become as indispensable to the industry as the magazine itself, and also make it possible for anyone in the country to be as up-to-date as any movie insider. Whether it's on the way to work, a screening, or anywhere life takes them, SIRIUS will put Variety right there with them."

Peter Bart, Variety Editor-in-Chief, said: "Variety chose SIRIUS as our partner because of its already strong credibility in the entertainment world and SIRIUS' unrivaled ability to reach a national audience. There is clearly an appetite for news from the world of media and entertainment that is both timely and credible. It is our intention to get it first and also get it right."

About SIRIUS

SIRIUS delivers more than 125 channels of the best programming in all of radio. SIRIUS is the original and only home of 100% commercial free music channels in satellite radio, offering 67 music channels available nationwide. SIRIUS also delivers 61 channels of sports, news, talk, entertainment, traffic, weather and data. SIRIUS is the Official Satellite Radio Partner of the NFL, NBA and NHL and broadcasts live play-by-play games of the NFL, NBA and NHL. All SIRIUS programming is available for a monthly subscription fee of only \$12.95.

SIRIUS products for the car, truck, home, RV and boat are available in more than 25,000 retail locations, including Best Buy, Circuit City,

Crutchfield, Costco, Target, Wal-Mart, Sam's Club, RadioShack and at shop.sirius.com.

SIRIUS radios are offered in vehicles from Audi, BMW, Chrysler, Dodge, Ford, Infiniti, Jaguar, Jeep(R), Land Rover, Lexus, Lincoln-Mercury, Mazda, Mercedes-Benz, MINI, Nissan, Rolls Royce, Scion, Toyota, Porsche, Volkswagen and Volvo. Hertz also offers SIRIUS in its rental cars at major locations around the country.

Click on <http://www.sirius.com> to listen to SIRIUS live, or to purchase a SIRIUS radio and

SIR Ex. 8-G

subscription.

Any statements that express, or involve discussions as to, expectations, beliefs, plans, objectives, assumptions, future events or performance with respect to SIRIUS Satellite Radio Inc. are not historical facts and may be forward-looking and, accordingly, such statements involve estimates, assumptions and uncertainties which could cause actual results to differ materially from those expressed in any forward-looking statements. Accordingly, any such statements are qualified in their entirety by reference to the factors discussed in our Annual Report on Form 10-K for the year ended December 31, 2005 filed with the Securities and Exchange Commission. Among the key factors that have a direct bearing on our operational results are: our dependence upon third parties, including manufacturers of SIRIUS radios, retailers, automakers and programming partners, our competitive position and any events which affect the useful life of our satellites.

About The Variety Group/Reed Business Information (RBI)

The Variety Group, Daily Variety, Daily Variety Gotham, Weekly Variety, Variety China, and Variety.com, are all owned by Reed Business Information (RBI), the largest business publisher in the U.S. RBI and is a member of the Reed Elsevier Group plc (NYSE: RUK and ENL) -- a leading publisher and information provider operating in the science and medical, legal, education and business-to-business industry sectors.

P-SIRI

Media Contact:

Patrick Reilly
SIRIUS
preilly@siriusradio.com

SOURCE SIRIUS Satellite Radio

Patrick Reilly of SIRIUS, preilly@siriusradio.com

<http://www.prnewswire.com>

Copyright (C) 2006 PR Newswire. All rights reserved.

News Provided by COMTEX

SIR Ex. 9

A



Eminem, Shady Records, Interscope And SIRIUS Satellite Radio To Launch Exclusive Radio Channel

Groundbreaking Channel to be Executive Produced by Eminem and Record Executives Jimmy Iovine and Paul Rosenberg

NEW YORK - July 12, 2004 - SIRIUS (NASDAQ: SIRI), the premium satellite radio provider known for delivering the very best in commercial-free music and sports programming to cars and homes across the country, today announced a partnership with multi-platinum recording artist Eminem, Shady Records and Interscope Records to create a cutting-edge hip-hop music and lifestyle channel exclusively for SIRIUS Satellite Radio.

The new channel will feature music from across the hip-hop landscape along with programming specially created by leading artists and DJs. A weekly show by Eminem's DJ Green Lantern will spotlight the freshest mixes, while specialty shows hosted by Eminem and acts from the Shady Records roster will offer fans the opportunity to talk directly to their favorite artists. The channel is on tap to debut this fall and will be included with every SIRIUS subscription at no extra charge.

Eminem, Interscope Records Chairman Jimmy Iovine and Shady Records Vice President/Eminem manager Paul Rosenberg will serve as co-executive producers of the channel.

Eminem has been described as "the biggest star in the music world" by The Wall Street Journal and "the most compelling music icon of his generation" by the San Francisco Chronicle. Under Eminem and Rosenberg, Shady Records has quickly grown into one of the leading labels in urban music, featuring gold and platinum artists including 50 Cent, D-12, Obie Trice and Stat Quo, as well as the multi-platinum soundtrack to the film 8 Mile.

"Once upon a time not too long ago, the feds wanted all my music off the air," Eminem said. "Now we'll be on SIRIUS 24 hours a day, playing the best hip-hop...not just from Shady Records, but from everywhere. We'll deliver an uncut hip-hop radio station like never before. I can't wait to start dropping new material, exclusive tracks and uncensored hip-hop featuring me and everyone else, freely saying whatever the hell we want."

"Few artists in the history of music have had the kind of performance, songwriting and producing impact that Eminem has," said Scott Greenstein, SIRIUS President of Entertainment and Sports. "This is a perfect example of artistic and commercial forces coming together to create something truly unique, and we're proud to launch yet another innovative new channel for SIRIUS subscribers."

Paul Rosenberg, Eminem's manager and VP of Shady Records, remarked: "Our partnership with SIRIUS gives us the unique opportunity for nationwide exposure of our new and existing artist roster. While our channel will not be solely limited to Shady artists, we plan on delivering exclusive, obscure and/or hard to find music from our acts. Also, the channel will give fans further access into our world with live show broadcasts, unique remote interviews and on-air artist segments. We are thrilled to be the first nationwide label-driven 24-hour music radio station."

"Eminem and Paul Rosenberg have the insight to see the value in building a direct connection to their audience," said Iovine. "These guys are two of the most innovative people in our industry and what they develop with SIRIUS will influence the future of our business and the way artists and labels connect with their fans. This is the new music business at work, and once again, Shady is at the forefront."

About SIRIUS

SIRIUS, now available to over 10 million DISH Network satellite TV and SIRIUS Satellite Radio subscribers, provides listeners with over 120 channels of the best commercial-free music, sports, information and entertainment, with digital quality sound coast-to-coast, broadcast daily from

New York City, Los Angeles, Nashville, New Orleans, Houston and Daytona. SIRIUS offers 65 channels of 100% commercial-free music, featuring multiple categories of pop, rock, country, hip-hop, R&B, dance, jazz, classical and Latin music, along with more than 50 channels of world-class sports, news, talk entertainment, traffic and weather for a monthly subscription fee of only \$12.95, with greater savings for upfront payments of multiple months or a year or more. SIRIUS also broadcasts live play-by-play games of the NHL and the NFL, and is the official satellite radio partner of the NFL.

SIRIUS Satellite Radio products for the car, truck, home, RV and boat are manufactured by Alpine, Audiovox, Blaupunkt, Clarion, Eclipse, Jensen, JVC, Kenwood, Panasonic and U.S. Electronics, and can be purchased at major retailers including Best Buy, Car Toys, Circuit City, Good Guys, Wal-Mart, Sears, Tweeter and Ultimate Electronics, along with RadioShack and DISH Network outlets.

SIRIUS' exclusive automotive partners DaimlerChrysler, Ford and BMW represent over 40% of new cars and light trucks sold annually in the United States. Automotive brands currently offering SIRIUS radios in select new car models include BMW, MINI, Chrysler, Dodge, Jeep, Nissan, Infiniti, Mazda, Audi, Ford, Lincoln-Mercury, Mercedes-Benz and Volkswagen. Automotive brands that have announced plans to offer SIRIUS radios in select models include Jaguar, Volvo, Land Rover and Aston Martin. In 2004, SIRIUS radios are expected to be available in over 80 different car models, with more than 50 of them factory programs. Also, Hertz currently offers SIRIUS in 29 vehicle models at 53 major locations around the country. In addition, the Penske companies - Penske Auto Group, United Auto Group and Penske Trucking - are offering SIRIUS radios as a factory installed option, where available, in their cars and trucks through their dealerships.

Genmar Holdings, the world's largest manufacturer of recreational boats, Formula Boats and Winnebago, the leading supplier of recreational vehicles and motor homes, also offer SIRIUS.

Click on sirius.com to listen to SIRIUS live, or to find a SIRIUS retailer or car dealer in your area.

Any statements that express, or involve discussions as to, expectations, beliefs, plans, objectives, assumptions, future events or performance with respect to SIRIUS Satellite Radio Inc. are not historical facts and may be forward-looking and, accordingly, such statements involve estimates, assumptions and uncertainties which could cause actual results to differ materially from those expressed in any forward-looking statements. Accordingly, any such statements are qualified in their entirety by reference to the factors discussed in our Annual Report on Form 10-K for the year ended December 31, 2003 filed with the Securities and Exchange Commission. Among the key factors that have a direct bearing on our results of operations are: our dependence upon third parties to manufacture, distribute, market and sell SIRIUS radios and components for those radios; the unproven market for our service; our competitive position and any events which affect the useful life of our satellites.

B



Skateboarding Icon Tony Hawk To Host New Radio Show On SIRIUS Satellite Radio

Tony Hawk's Demolition Radio to Debut July 20

NEW YORK – July 16, 2004- SIRIUS (NASDAQ: SIRI), the premium satellite radio provider known for delivering the very best in commercial-free music and sports programming to cars and homes across the country, today announced a partnership with record-breaking skateboard champion Tony Hawk. Hawk will become the first host on SIRIUS Faction, the innovative music channel created by SIRIUS especially for action sports enthusiasts.

Tony Hawk's Demolition Radio will broadcast from a custom-designed SIRIUS studio at Hawk's new practice facility in California. Hawk will deliver his personal slant on the action sports lifestyle that he is largely responsible for bringing to the public consciousness. The show will launch Tuesday, July 20 at 6:00pm ET and will be uncensored and commercial-free.

According to Forbes Magazine, Tony Hawk's brand generated \$300 million in retail sales in 2003. The Tony Hawk's Pro Skater video games have become one of the most successful game series in the world. Hawk also enjoyed success with his 32-city US Boom Boom HuckJam action sports tour, which has successfully played to sold-out arenas for the past two years.

"I am very excited about doing a show on SIRIUS Satellite Radio," said Hawk. "Music has always been a huge part of what I do, and now I can share my influences and experiences with the world. It will also fit in perfectly with SIRIUS Faction's diverse format. Expect to hear interviews with interesting guests and a wide range of music from my world." Scott Greenstein, President of Entertainment and Sports at SIRIUS, commented, "Tony is the world's most visible action sport athlete and he's perfectly suited to become Faction's first on-air host. Tony Hawk's Demolition Radio is yet another example of the cutting-edge programming available only on SIRIUS." Over the next few months, SIRIUS will roll out additional star athletes who are slated to have their own shows on Faction. Tony Hawk's Demolition Radio is available with every SIRIUS subscription at no extra charge. SIRIUS radios for the car and home are available at Radio Shack, Best Buy, Wal-Mart, Circuit City and other electronics retailers around the country. To learn more, listen to SIRIUS live or find a SIRIUS retailer in your area, click on sirius.com.

About SIRIUS

SIRIUS, now available to over 10 million DISH Network satellite TV and SIRIUS Satellite Radio subscribers, provides listeners with over 120 channels of the best commercial-free music, sports, information and entertainment, with digital quality sound coast-to-coast, broadcast daily from New York City, Los Angeles, Nashville, New Orleans, Houston and Daytona. SIRIUS offers 65 channels of 100% commercial-free music, featuring multiple categories of pop, rock, country, hip-hop, R&B, dance, jazz, classical and Latin music, along with more than 50 channels of world-class sports, news, talk entertainment, traffic and weather for a monthly subscription fee of only \$12.95, with greater savings for upfront payments of multiple months or a year or more. SIRIUS also broadcasts live play-by-play games of the NHL and the NFL, and is the official satellite radio partner of the NFL.

SIRIUS Satellite Radio products for the car, truck, home, RV and boat are manufactured by Alpine, Audiovox, Blaupunkt, Clarion, Eclipse, Jensen, JVC, Kenwood, Panasonic and U.S. Electronics, and can be purchased at major retailers including Advance Auto Parts, Best Buy, Car Toys, Circuit City, Good Guys, Wal-Mart, Sears, Tweeter and Ultimate Electronics, along with RadioShack and DISH Network outlets.

SIRIUS' exclusive automotive partners DaimlerChrysler, Ford and BMW represent over 40% of new cars and light trucks sold annually in the United States. Automotive brands currently offering SIRIUS radios in select new car models include BMW, MINI, Chrysler, Dodge, Jeep, Nissan, Infiniti, Mazda, Audi, Ford, Lincoln-Mercury, Mercedes-Benz, Porsche and Volkswagen. Automotive brands that have announced plans to offer SIRIUS radios in select models include Jaguar, Volvo, Land Rover and Aston Martin. In 2004, SIRIUS radios are expected to be available in over 80 different car models, with more than 50 of them factory programs. Also, Hertz currently offers SIRIUS in 29 vehicle models at 53 major locations around the country. In

SIR Ex. 9-B

addition, the Penske companies – Penske Auto Group, United Auto Group and Penske Trucking – are offering SIRIUS radios as a factory installed option, where available, in their cars and trucks through their dealerships.

Genmar Holdings, the world's largest manufacturer of recreational boats, Formula Boats and Winnebago, the leading supplier of recreational vehicles and motor homes, also offer SIRIUS.

Any statements that express, or involve discussions as to, expectations, beliefs, plans, objectives, assumptions, future events or performance with respect to SIRIUS Satellite Radio Inc. are not historical facts and may be forward-looking and, accordingly, such statements involve estimates, assumptions and uncertainties which could cause actual results to differ materially from those expressed in any forward-looking statements. Accordingly, any such statements are qualified in their entirety by reference to the factors discussed in our Annual Report on Form 10-K for the year ended December 31, 2003 filed with the Securities and Exchange Commission. Among the key factors that have a direct bearing on our results of operations are: our dependence upon third parties to manufacture, distribute, market and sell SIRIUS radios and components for those radios; the unproven market for our service; our competitive position and any events which affect the useful life of our satellites.

C



Champion Surfer Kelly Slater's "Radio K-Os" To Debut August 22 On SIRIUS Satellite Radio

Kelly Slater Hosts Weekly Program on Groundbreaking Lifestyle Music Channel, SIRIUS Faction

Champion Surfer Kelly Slater's 'Radio K-Os' To Debut August 22 On Sirius Satellite Radio

NEW YORK – August 2, 2004- SIRIUS (NASDAQ: SIRI), the premium satellite radio provider known for delivering the very best in commercial-free music and sports programming to cars and homes across the country, today announced that surfing legend Kelly Slater will launch his own radio show on SIRIUS Faction, the innovative music channel created especially for action sports enthusiasts.

Slater is a six-time world champion and holds more surfing titles than anyone in the world. Often referred to as the "Michael Jordan of surfing," Slater also has recorded an album with Sony Music, developed his own video game and penned an autobiography, *Pipe Dreams: A Surfer's Journey*, a recent *New York Times* best seller.

On his new SIRIUS show, *Kelly Slater's Radio K-OS*, Slater will play music from Jack Johnson, G. Love and other artists who inspire him. Slater will also interview musicians and the surfing world's biggest names. The show will air on SIRIUS Faction, channel 28, starting Sunday, August 22 at 9pm ET.

Slater says, "Are you SIRIUS? *Radio K-OS* is getting set to take over the world ... or at least one hour a week on Faction."

"Kelly Slater is a unique athlete, musician and soulful human being," said Scott Greenstein, SIRIUS' President of Entertainment and Sports. "His varied talents are a perfect match for Faction, which also combines music and action sports, blended with humanity for a powerful listening experience."

Slater becomes SIRIUS Faction's second celebrity host, joining skateboarding legend Tony Hawk. Hawk recently launched his weekly show *Tony Hawk's Demolition Radio* heard exclusively on SIRIUS. Over the next few months SIRIUS will roll out additional star athletes who will join Faction's on-air team.

To get SIRIUS, visit www.sirius.com or visit Radio Shack, Best Buy, Wal-Mart, Circuit City or your favorite electronics retailer.

About SIRIUS

SIRIUS, now available to over 10 million DISH Network satellite TV and SIRIUS Satellite Radio subscribers, provides listeners with over 120 channels of the best commercial-free music, sports, information and entertainment, with digital quality sound coast-to-coast, broadcast daily from New York City, Los Angeles, Nashville, New Orleans, Houston and Daytona. SIRIUS offers 65 channels of 100% commercial-free music, featuring multiple categories of pop, rock, country, hip-hop, R&B, dance, jazz, classical and Latin music, along with more than 50 channels of world-class sports, news, talk entertainment, traffic and weather for a monthly subscription fee of only \$12.95, with greater savings for upfront payments of multiple months or a year or more. SIRIUS also broadcasts live play-by-play games of the NHL and the NFL, and is the official satellite radio partner of the NFL.

SIRIUS Satellite Radio products for the car, truck, home, RV and boat are manufactured by Alpine, Audiovox, Blaupunkt, Clarion, Eclipse, Jensen, JVC, Kenwood, Panasonic and U.S. Electronics, and can be purchased at major retailers including Advance Auto Parts, Best Buy, Car

SIR Ex. 9-C

Toys, Circuit City, Crutchfield, Good Guys, Wal-Mart, Sears, Tweeter and Ultimate Electronics, along with RadioShack and DISH Network outlets.

SIRIUS' exclusive automotive partners DaimlerChrysler, Ford and BMW represent over 40% of new cars and light trucks sold annually in the United States. Automotive brands currently offering SIRIUS radios in select new car models include BMW, MINI, Chrysler, Dodge, Jeep, Nissan, Infiniti, Mazda, Audi, Ford, Lincoln-Mercury, Mercedes-Benz, Porsche and Volkswagen. Automotive brands that have announced plans to offer SIRIUS radios in select models include Jaguar, Volvo, Land Rover and Aston Martin. In 2004, SIRIUS radios are expected to be available in over 80 different car models, with more than 50 of them factory programs. Also, Hertz currently offers SIRIUS in 29 vehicle models at 53 major locations around the country. In addition, the Penske companies – Penske Auto Group, United Auto Group and Penske Trucking – are offering SIRIUS radios as a factory installed option, where available, in their cars and trucks through their dealerships.

Genmar Holdings, the world's largest manufacturer of recreational boats, Formula Boats and Winnebago, the leading supplier of recreational vehicles and motor homes, also offer SIRIUS.

Click on www.sirius.com to listen to SIRIUS live, or to find a SIRIUS retailer or car dealer in your area.

Any statements that express, or involve discussions as to, expectations, beliefs, plans, objectives, assumptions, future events or performance with respect to SIRIUS Satellite Radio Inc. are not historical facts and may be forward-looking and, accordingly, such statements involve estimates, assumptions and uncertainties which could cause actual results to differ materially from those expressed in any forward-looking statements. Accordingly, any such statements are qualified in their entirety by reference to the factors discussed in our Annual Report on Form 10-K for the year ended December 31, 2003 filed with the Securities and Exchange Commission. Among the key factors that have a direct bearing on our results of operations are: our dependence upon third parties to manufacture, distribute, market and sell SIRIUS radios and components for those radios; the unproven market for our service; our competitive position and any events which affect the useful life of our satellites.

D



Olympic Athlete Kerri Walsh To Provide Reports From Athens For SIRIUS Satellite Radio

Beach Volleyball Champion Joins Tony Hawk and Kelly Slater as Third Celebrity Athlete on SIRIUS Faction Sports & Music Channel

NEW YORK, NY (August 11, 2004) – SIRIUS (NASDAQ: SIRI), the premium satellite radio provider, known for delivering the very best in commercial-free music and sports programming to cars and homes across the country, announced today that champion beach volleyball player Kerri Walsh, who is competing for the U.S. in the 2004 Summer Olympic Games in Athens, Greece, will provide exclusive reports from the games for SIRIUS Satellite Radio.

The "behind-the-scenes" reports will be heard on commercial-free SIRIUS music channel Faction. Following the Olympics, Walsh will become a regular on Faction, joining star athletes Tony Hawk and Kelly Slater, who have their own shows on the innovative music channel created especially for action sports enthusiasts.

Walsh rocketed to the No. 1 ranking in the world in competition on the 2003 AVP and FIVB tours and now seeks Olympic gold in Athens with her partner, Misty May. Walsh and May set a world record this year with their 89th consecutive match victory and were the 2003 World Champions. Walsh was named the AVP's Most Valuable Player and Best Offensive Player in 2003.

In a July, 2004 *New York Times* article, beach volleyball legend Karch Kiraly stated that Walsh is considered by many to be the finest female player in beach volleyball history – even more impressive considering that Walsh has competed in outdoor volleyball for just three years. Walsh is also recognized by many Americans from the VISA television spots she appeared in which first aired during the 2004 Super Bowl.

"Rather than keeping a diary or blog like other athletes, I have the unique opportunity to share my Olympic experiences on SIRIUS Faction," said Walsh. "The competition, life in the Olympic village and everything else going on in Athens ... it's all very exciting and it will only be on SIRIUS!"

Scott Greenstein, SIRIUS President of Entertainment and Sports said, "In a very short period, Kerri Walsh has emerged as the top female volleyball player and Olympic contender, inspiring young women who strive to become action and outdoor athletes. Kerri's Olympic reporting will be consistent with Faction's unique vision for delivering great music and lifestyle programming for action sports fans. We look forward to Kerri bringing the same spirit to Faction this fall."

Over the next few months, SIRIUS will announce additional star athletes who will join Faction's on-air team.

For more information about SIRIUS, and to get SIRIUS today, go to sirius.com.

About SIRIUS

SIRIUS, now available to over 10 million DISH Network satellite TV and SIRIUS Satellite Radio subscribers, provides listeners with over 120 channels of the best commercial-free music, sports, information and entertainment, with digital quality sound coast-to-coast, broadcast daily from New York City, Los Angeles, Nashville, New Orleans, Houston and Daytona. SIRIUS offers 65 channels of 100% commercial-free music, featuring multiple categories of pop, rock, country, hip-hop, R&B, dance, jazz, classical and Latin music, along with more than 50 channels of world-class sports, news, talk entertainment, traffic and weather for a monthly subscription fee of only \$12.95, with greater savings for upfront payments of multiple months or a year or more. SIRIUS also broadcasts live play-by-play games of the NHL and the NFL, and is the official satellite radio partner of the NFL. SIRIUS Satellite Radio products for the car, truck, home, RV and boat are manufactured by Alpine, Audiovox, Blaupunkt, Clarion, Eclipse, Jensen, JVC, Kenwood, Panasonic and U.S. Electronics, and can be purchased at major retailers including Advanced Auto Parts, Best Buy, Car Toys, Circuit City, Crutchfield, Good Guys, Wal-Mart, Sears, Tweeter and Ultimate

SIR Ex. 9-D

Electronics, along with RadioShack and DISH Network outlets.

SIRIUS' exclusive automotive partners DaimlerChrysler, Ford and BMW represent over 40% of new cars and light trucks sold annually in the United States. Automotive brands currently offering SIRIUS radios in select new car models include BMW, MINI, Chrysler, Dodge, Jeep, Nissan, Infiniti, Mazda, Audi, Ford, Lincoln-Mercury, Mercedes-Benz, Porsche and Volkswagen. Automotive brands that have announced plans to offer SIRIUS radios in select models include Jaguar, Volvo, Land Rover and Aston Martin. In 2004, SIRIUS radios are expected to be available in over 80 different car models, with more than 50 of them factory programs. Also, Hertz currently offers SIRIUS in 29 vehicle models at 53 major locations around the country. In addition, the Penske companies – Penske Auto Group, United Auto Group and Penske Trucking – are offering SIRIUS radios as a factory installed option, where available, in their cars and trucks through their dealerships.

Genmar Holdings, the world's largest manufacturer of recreational boats, Formula Boats and Winnebago, the leading supplier of recreational vehicles and motor homes, also offer SIRIUS.

Click on sirius.com to listen to SIRIUS live, or to find a SIRIUS retailer or car dealer in your area.

Any statements that express, or involve discussions as to, expectations, beliefs, plans, objectives, assumptions, future events or performance with respect to SIRIUS Satellite Radio Inc. are not historical facts and may be forward-looking and, accordingly, such statements involve estimates, assumptions and uncertainties which could cause actual results to differ materially from those expressed in any forward-looking statements. Accordingly, any such statements are qualified in their entirety by reference to the factors discussed in our Annual Report on Form 10-K for the year ended December 31, 2003 filed with the Securities and Exchange Commission. Among the key factors that have a direct bearing on our results of operations are: our dependence upon third parties to manufacture, distribute, market and sell SIRIUS radios and components for those radios; the unproven market for our service; our competitive position and any events which affect the useful life of our satellites.

E



Professional Skateboarder And "Viva La Bam" Host Bam Margera To Host Show On SIRIUS Satellite Radio

Margera Made Announcement on Tony Hawk's Demolition Radio Show On SIRIUS

Professional Skateboarder And 'Viva La Bam' Host Bam Margera To Host Show On Sirius Satellite Radio

NEW YORK - August 17, 2004 - SIRIUS (NASDAQ: SIRI), the premium satellite radio provider known for delivering the very best in commercial-free music and sports programming to cars and homes across the country, welcomes skateboarder and TV personality Bam Margera as the latest celebrity athlete to host his own show exclusively on SIRIUS Faction, the innovative new music channel created especially for action sports enthusiasts.

Margera announced his new show during a guest appearance this evening on *Tony Hawk's Demolition Radio* program, heard each Tuesday exclusively on SIRIUS.

Margera is the creator, producer, director and star of *Viva La Bam*, which enters its third season in October. He's also the co-creator and co-star of *Jackass* and *Jackass: The Movie*, which has grossed over \$100 million. Margera has been featured in several of the nation's top publications, including *Rolling Stone*, *People*, *ESPN the Magazine*, *Sports Illustrated*, *Details* and *Revolver*.

"There couldn't be a more appropriate radio host for SIRIUS Faction than Bam Margera," said Scott Greenstein, SIRIUS President of Entertainment and Sports. "Bam is as wickedly entertaining as he is unpredictable, and that's exactly what Faction is all about. We love giving our hosts the opportunity to share their eclectic tastes in music with their fans."

"I'm psyched to be joining Tony Hawk and the Faction team," Margera said. "Now we are finally going to be able to play some serious Scandinavian rock!"

Margera joins skateboarding legend Tony Hawk, world champion surfer Kelly Slater and Olympic competitor and beach volleyball champion Kerri Walsh as a host on SIRIUS Faction. Over the next few months, SIRIUS will announce additional star athletes who will join Faction's on-air team.

The yet-to-be-titled Margera radio show will launch this fall, exclusively on SIRIUS.

To get SIRIUS, visit sirius.com or visit Radio Shack, Best Buy, Wal-Mart, Circuit City or your favorite electronics retailer.

About SIRIUS

SIRIUS, now available to over 10 million DISH Network satellite TV and SIRIUS Satellite Radio subscribers, provides listeners with over 120 channels of the best commercial-free music, sports, information and entertainment, with digital quality sound coast-to-coast, broadcast daily from New York City, Los Angeles, Nashville, New Orleans, Houston and Daytona. SIRIUS offers 65 channels of 100% commercial-free music, featuring multiple categories of pop, rock, country, hip-hop, R&B, dance, jazz, classical and Latin music, along with more than 50 channels of world-class sports, news, talk entertainment, traffic and weather for a monthly subscription fee of only \$12.95, with greater savings for upfront payments of multiple months or a year or more. SIRIUS also broadcasts live play-by-play games of the NHL and the NFL, and is the Official Satellite Radio partner of the NFL.

SIRIUS Satellite Radio products for the car, truck, home, RV and boat are manufactured by Alpine, Audiovox, Blaupunkt, Clarion, Eclipse, Jensen, JVC, Kenwood, Panasonic and U.S. Electronics, and can be purchased at major retailers including Advance Auto Parts, Best Buy, Car Toys, Circuit City, Crutchfield, Good Guys, Wal-Mart, Sears, Tweeter and Ultimate Electronics,

SIR Ex. 9-E

along with RadioShack and DISH Network outlets.

SIRIUS' exclusive automotive partners DaimlerChrysler, Ford and BMW represent over 40% of new cars and light trucks sold annually in the United States. Automotive brands currently offering SIRIUS radios in select new car models include BMW, MINI, Chrysler, Dodge, Jeep, Nissan, Infiniti, Mazda, Audi, Ford, Lincoln-Mercury, Mercedes-Benz, Porsche and Volkswagen. Automotive brands that have announced plans to offer SIRIUS radios in select models include Jaguar, Volvo, Land Rover and Aston Martin. In 2004, SIRIUS radios are expected to be available in over 80 different car models, with more than 50 of them factory programs. Also, Hertz currently offers SIRIUS in 29 vehicle models at 53 major locations around the country. In addition, the Penske companies – Penske Auto Group, United Auto Group and Penske Trucking – are offering SIRIUS radios as a factory installed option, where available, in their cars and trucks through their dealerships.

Genmar Holdings, the world's largest manufacturer of recreational boats, Formula Boats and Winnebago, the leading supplier of recreational vehicles and motor homes, also offer SIRIUS.

Click on sirius.com to listen to SIRIUS live, or to find a SIRIUS retailer or car dealer in your area.

Any statements that express, or involve discussions as to, expectations, beliefs, plans, objectives, assumptions, future events or performance with respect to SIRIUS Satellite Radio Inc. are not historical facts and may be forward-looking and, accordingly, such statements involve estimates, assumptions and uncertainties which could cause actual results to differ materially from those expressed in any forward-looking statements. Accordingly, any such statements are qualified in their entirety by reference to the factors discussed in our Annual Report on Form 10-K for the year ended December 31, 2003 filed with the Securities and Exchange Commission. Among the key factors that have a direct bearing on our results of operations are: our dependence upon third parties to manufacture, distribute, market and sell SIRIUS radios and components for those radios; the unproven market for our service; our competitive position and any events which affect the useful life of our satellites.

F



Beach Volleyball Icon Sinjin Smith Added To SIRIUS Satellite Radio Lineup

NEW YORK – October 1, 2004 - SIRIUS (NASDAQ: SIRI), the premium satellite radio provider known for delivering the very best in commercial-free music and sports programming to cars and homes across the country, has added beach volleyball ambassador Sinjin Smith to the roster of superstars who will have a presence on SIRIUS Faction, the innovative new music channel created especially for action sports enthusiasts.

Smith is regarded as the world's greatest beach volleyball player and is often referred to as the "King of the Beach." His accomplishments in the sport are unparalleled and his contributions to beach volleyball have helped put the sport on the map and at the Summer Olympics. Together with partner Randy Stoklos, Smith finished his 25-year career with a record of 147 victories. He is currently President of the FIVB Beach Volleyball World Council that oversees world and Olympic competition.

"Volleyball players and fans everywhere look up to Sinjin Smith as one of the sporting world's most inspired and durable athletes," said Scott Greenstein, SIRIUS President of Entertainment and Sports. "Sinjin is in the top-tier of the sporting world and we're proud to have him as part of the SIRIUS Faction lineup."

"SIRIUS Faction plays the kind of music that was part of my professional life on the beach volleyball circuit," said Smith. "I can't wait to join the SIRIUS staff and take part in this cutting-edge radio."

Smith joins skateboarding legend Tony Hawk, world champion surfer Kelly Slater, professional skateboarder and "Viva La Bam" host Bam Margera and fellow Olympic competitor and beach volleyball champion Kerri Walsh as a host on SIRIUS Faction. SIRIUS will announce additional star athletes who will join Faction's on-air team.

To get SIRIUS, visit sirius.com or visit Radio Shack, Best Buy, Wal-Mart, Circuit City or your favorite electronics retailer.

About SIRIUS

SIRIUS, now available to over 10 million DISH Network satellite TV and SIRIUS Satellite Radio subscribers, provides listeners with over 120 channels of the best commercial-free music, sports, information and entertainment, with digital quality sound coast-to-coast, broadcast daily from New York City, Los Angeles, Nashville, New Orleans, Houston and Daytona. SIRIUS offers 65 channels of 100% commercial-free music, featuring multiple categories of pop, rock, country, hip-hop, R&B, dance, jazz, classical and Latin music, along with more than 50 channels of world-class sports, news, talk entertainment, traffic and weather for a monthly subscription fee of only \$12.95, with greater savings for upfront payments of multiple months or a year or more. SIRIUS also broadcasts live play-by-play games of the NHL and the NFL, and is the Official Satellite Radio partner of the NFL.

SIRIUS Satellite Radio products for the car, truck, home, RV and boat are manufactured by Alpine, Audiovox, Blaupunkt, Clarion, Eclipse, Jensen, JVC, Kenwood, Panasonic and U.S. Electronics, and can be purchased at major retailers including Advance Auto Parts, Best Buy, Car Toys, Circuit City, Crutchfield, Good Guys, Wal-Mart, Sears, Tweeter and Ultimate Electronics, along with RadioShack and DISH Network outlets.

SIRIUS' exclusive automotive partners DaimlerChrysler, Ford and BMW represent over 40% of new cars and light trucks sold annually in the United States. Automotive brands currently offering SIRIUS radios in select new car models include BMW, MINI, Chrysler, Dodge, Jeep, Nissan, Infiniti, Mazda, Audi, Ford, Lincoln-Mercury, Mercedes-Benz, Porsche and Volkswagen. Automotive brands that have announced plans to offer SIRIUS radios in select models include Jaguar, Volvo, Land Rover and Aston Martin. In 2004, SIRIUS radios are expected to be available in over 80 different car models, with more than 50 of them factory programs. Also, Hertz currently offers SIRIUS in 29 vehicle models at 53 major locations around the country. In addition, the Penske companies – Penske Auto Group, United Auto Group and Penske Trucking –

SIR Ex. 9-F

are offering SIRIUS radios as a factory installed option, where available, in their cars and trucks through their dealerships.

Genmar Holdings, the world's largest manufacturer of recreational boats, Formula Boats and Winnebago, the leading supplier of recreational vehicles and motor homes, also offer SIRIUS.

Click on sirius.com to listen to SIRIUS live, or to find a SIRIUS retailer or car dealer in your area.

Any statements that express, or involve discussions as to, expectations, beliefs, plans, objectives, assumptions, future events or performance with respect to SIRIUS Satellite Radio Inc. are not historical facts and may be forward-looking and, accordingly, such statements involve estimates, assumptions and uncertainties which could cause actual results to differ materially from those expressed in any forward-looking statements. Accordingly, any such statements are qualified in their entirety by reference to the factors discussed in our Annual Report on Form 10-K for the year ended December 31, 2003 filed with the Securities and Exchange Commission. Among the key factors that have a direct bearing on our results of operations are: our dependence upon third parties to manufacture, distribute, market and sell SIRIUS radios and components for those radios; the unproven market for our service; our competitive position and any events which affect the useful life of our satellites.

G



The Hype Is Real: Eminem's 'Shade 45' Radio Channel To Debut October 28 On SIRIUS Satellite Radio

Groundbreaking Hip-Hop Channel To Premier With Exclusive Broadcast of Shady National Convention

NEW YORK – October 14, 2004 – SIRIUS (NASDAQ: SIRI), the premium satellite radio provider known for delivering the very best in commercial-free music and sports programming to cars and homes across the country, today announced that Shade 45, the new uncensored hip-hop radio channel created by Eminem, Shady Records, Interscope Records and SIRIUS, will debut on Thursday, October 28.

Shade 45 will be heard on SIRIUS channel 45 and will hit the air with a live broadcast of the Shady National Convention from New York's Roseland Ballroom. Shade 45 will feature a full lineup of on-air hosts and mixers, including Eminem's DJ, Green Lantern.

"SIRIUS, Interscope, Shady and Eminem have assembled the definitive hip-hop radio channel," said Scott Greenstein, President of Entertainment and Sports, SIRIUS. "Shade 45 will be a radio channel that for the first time directly connects the artists with their fans. It will be originality of the highest order, with no filters and no commercial restrictions."

Paul Rosenberg, Eminem's manager and VP of Shady Records, remarked, "We're pleased to have Shade 45 launch live from the Convention. The station's mix of uncensored hip-hop music and on-air personalities who can say whatever they want is the kind of thing we at the SNC have fought for and will continue to support."

Shade 45 will be available to all SIRIUS subscribers at no extra charge over the standard monthly subscription fee of \$12.95. SIRIUS radios are available at retail outlets around the country. More information: sirius.com.

About SIRIUS SIRIUS, now available to over 10 million DISH Network satellite TV and SIRIUS Satellite Radio subscribers, provides listeners with over 120 channels of the best commercial-free music, sports, information and entertainment, with digital quality sound coast-to-coast, broadcast daily from New York City, Los Angeles, Nashville, New Orleans, Houston and Daytona. SIRIUS offers 65 channels of 100% commercial-free music, and features 55 channels of world-class sports, news, talk, entertainment, traffic and weather for a monthly subscription fee of only \$12.95, with greater savings for upfront payments of multiple months or a year or more. SIRIUS also broadcasts live play-by-play games of the NHL and the NFL, and is the Official Satellite Radio partner of the NFL.

SIRIUS Satellite Radio products for the car, truck, home, RV and boat are manufactured by Alpine, Audiovox, Blaupunkt, Clarion, Eclipse, Jensen, JVC, Kenwood, Panasonic, Sanyo and U.S. Electronics, and can be purchased at major retailers including Advance Auto Parts, Best Buy, Car Toys, Circuit City, Crutchfield, Good Guys, Wal-Mart, Sears, Tweeter and Ultimate Electronics, along with RadioShack and DISH Network outlets.

SIRIUS' exclusive automotive partners DaimlerChrysler, Ford and BMW represent over 40% of new cars and light trucks sold annually in the United States. Automotive brands currently offering SIRIUS radios in select new car models include BMW, MINI, Chrysler, Dodge, Jeep, Nissan, Infiniti, Mazda, Audi, Ford, Lincoln-Mercury, Mercedes-Benz, Porsche and Volkswagen. Automotive brands that have announced plans to offer SIRIUS radios in select models include Jaguar, Volvo, Land Rover and Aston Martin. In 2004, SIRIUS radios are expected to be available in over 80 different car models, with more than 50 of them factory programs. Also, Hertz currently offers SIRIUS in 29 vehicle models at 53 major locations around the country. In addition, the Penske companies – Penske Auto Group, United Auto Group and Penske Trucking – are offering SIRIUS radios as a factory installed option, where available, in their cars and trucks through their dealerships.

SIR Ex. 9-G

Genmar Holdings, the world's largest manufacturer of recreational boats, Formula Boats and Winnebago, the leading supplier of recreational vehicles and motor homes, also offer SIRIUS.

Click on sirius.com to listen to SIRIUS live, or to find a SIRIUS retailer or car dealer in your area.

Any statements that express, or involve discussions as to, expectations, beliefs, plans, objectives, assumptions, future events or performance with respect to SIRIUS Satellite Radio Inc. are not historical facts and may be forward-looking and, accordingly, such statements involve estimates, assumptions and uncertainties which could cause actual results to differ materially from those expressed in any forward-looking statements. Accordingly, any such statements are qualified in their entirety by reference to the factors discussed in our Annual Report on Form 10-K for the year ended December 31, 2003 filed with the Securities and Exchange Commission. Among the key factors that have a direct bearing on our results of operations are: our dependence upon third parties to manufacture, distribute, market and sell SIRIUS radios and components for those radios; the unproven market for our service; our competitive position and any events which affect the useful life of our satellites.

H



Lance Armstrong Joins SIRIUS Satellite Radio

Six-Time Tour de France Champion To Host Own Show On SIRIUS Faction

NEW YORK - October 25, 2004 - SIRIUS (NASDAQ: SIRI), the premium satellite radio provider known for delivering the very best in commercial-free music and sports programming to cars and homes across the country, today announced that Lance Armstrong is the latest celebrity athlete to host his own show on SIRIUS Faction, the innovative music channel created especially for action and outdoor sports enthusiasts.

Few athletes on the world stage can rival Lance Armstrong's accomplishments. Over the summer he won an unprecedented sixth Tour de France, with all six earned following his successful battle with cancer. Armstrong has been awarded virtually every sporting honor including Best Male Athlete at the 2003 ESPY awards; Sports Illustrated labeled him "one of the greatest athletes of all time." As founder of the Lance Armstrong Foundation, he has helped to fight cancer through education programs, government advocacy, public health initiatives, research and survivorship initiatives. The foundation has sold more than 18 million yellow LIVESTRONG bracelets at a dollar apiece.

"Lance Armstrong is arguably the greatest, most inspirational athlete and humanitarian in the sporting world," said Scott Greenstein, President of Entertainment and Sports, SIRIUS. "His accomplishments both as a cyclist, a two-time best-selling author and as founder of the Lance Armstrong Foundation are unparalleled. But Lance also likes to have fun - he takes advantage of all that his hometown of Austin, Texas has to offer in the form of great music. Lance will bring his life's experiences, interests and lifestyle to the SIRIUS microphone every week."

"SIRIUS has already gathered an amazing group of sports heroes for the Faction channel, and I'm honored to be included among them," said Armstrong. "Each week, I'll share some of my experiences, speak with listeners, bring on special guests, and most importantly play some of my favorite music."

SIRIUS Faction also features *Tony Hawk's Demolition Radio*, hosted by the legendary skateboarder; world champion surfer Kelly Slater's Radio KA-OS; *Sixty Minute Set with Kerri Walsh*, hosted by the Olympic Gold Medalist, and upcoming programs featuring *Viva La Bam* host Bam Margera and beach volleyball icon Sinjin Smith.

Armstrong's yet-to-be-titled show will launch later this year and will be heard exclusively on SIRIUS.

About SIRIUS

SIRIUS, now available to over 10 million DISH Network satellite TV and SIRIUS Satellite Radio subscribers, provides listeners with over 120 channels of the best commercial-free music, sports, information and entertainment, with digital quality sound coast-to-coast, broadcast daily from New York City, Los Angeles, Nashville, New Orleans, Houston and Daytona. SIRIUS offers 65 channels of 100% commercial-free music, and features 55 channels of world-class sports, news, talk, entertainment, traffic and weather for a monthly subscription fee of only \$12.95, with greater savings for upfront payments of multiple months or a year or more. SIRIUS also broadcasts live play-by-play games of the NHL and the NFL, and is the Official Satellite Radio partner of the NFL.

SIRIUS Satellite Radio products for the car, truck, home, RV and boat are manufactured by Alpine, Audiovox, Blaupunkt, Clarion, Eclipse, Jensen, JVC, Kenwood, Panasonic, Sanyo and U.S. Electronics, and can be purchased at major retailers including Advance Auto Parts, Best Buy, Car Toys, Circuit City, Crutchfield, Good Guys, Wal-Mart, Sears, Tweeter and Ultimate Electronics, along with RadioShack and DISH Network outlets.

SIRIUS' exclusive automotive partners DaimlerChrysler, Ford and BMW represent over 40% of new cars and light trucks sold annually in the United States. Automotive brands currently offering SIRIUS radios in select new car models include BMW, MINI, Chrysler, Dodge, Jeep[®],

SIR Ex. 9-H

Nissan, Infiniti, Mazda, Audi, Ford, Lincoln-Mercury, Mercedes-Benz, Porsche and Volkswagen. Automotive brands that have announced plans to offer SIRIUS radios in select models include Jaguar, Volvo, Land Rover and Aston Martin. In 2004, SIRIUS radios are expected to be available in over 80 different car models, with more than 50 of them factory programs. Also, Hertz currently offers SIRIUS in 29 vehicle models at 53 major locations around the country. In addition, the Penske companies - Penske Auto Group, United Auto Group and Penske Trucking - are offering SIRIUS radios as a factory installed option, where available, in their cars and trucks through their dealerships.

Genmar Holdings, the world's largest manufacturer of recreational boats, Formula Boats and Winnebago, the leading supplier of recreational vehicles and motor homes, also offer SIRIUS.

Click on sirius.com to listen to SIRIUS live, or to find a SIRIUS retailer or car dealer in your area.

Any statements that express, or involve discussions as to, expectations, beliefs, plans, objectives, assumptions, future events or performance with respect to SIRIUS Satellite Radio Inc. are not historical facts and may be forward-looking and, accordingly, such statements involve estimates, assumptions and uncertainties which could cause actual results to differ materially from those expressed in any forward-looking statements. Accordingly, any such statements are qualified in their entirety by reference to the factors discussed in our Annual Report on Form 10-K for the year ended December 31, 2003 filed with the Securities and Exchange Commission. Among the key factors that have a direct bearing on our results of operations are: our dependence upon third parties to manufacture, distribute, market and sell SIRIUS radios and components for those radios; the unproven market for our service; our competitive position and any events which affect the useful life of our satellites.

Armstrong's yet-to-be-titled show will launch later this year and will be heard exclusively on SIRIUS.

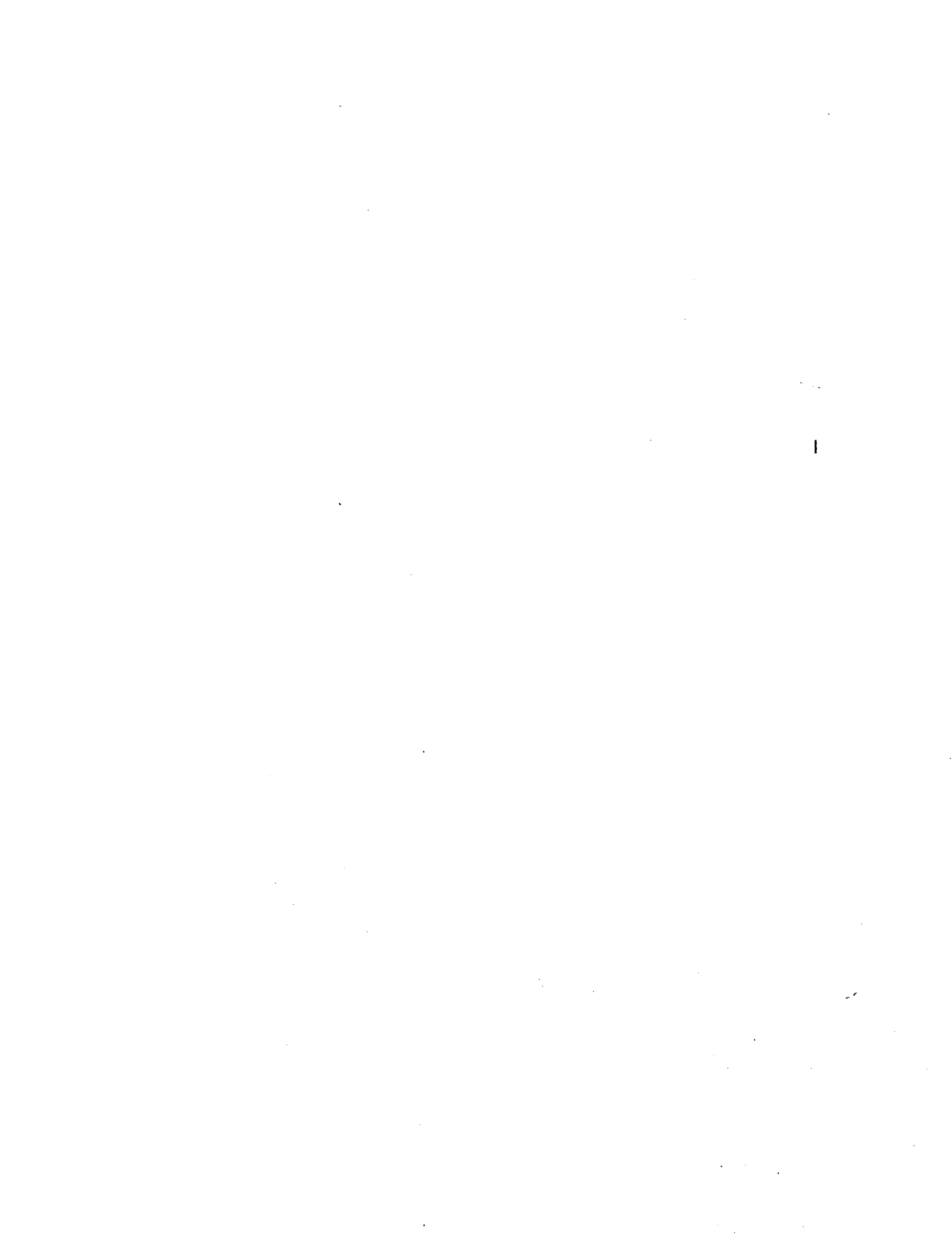



Double World Champion Skier Bode Miller to Host New Radio Show on SIRIUS Satellite Radio

World Cup Giant Slalom Champion Joins Celebrity Athletes Tony Hawk, Kelly Slater, Kerri Walsh and Bam Margera on SIRIUS Faction Channel

NEW YORK – December 2, 2004 - SIRIUS (NASDAQ: SIRI), the premium satellite radio provider known for delivering the most compelling commercial-free music and sports programming to cars and homes across the country, today announced that double World Champion and double Olympic medalist Bode Miller will host his own radio show on SIRIUS Faction, the innovative music channel created especially for action sports enthusiasts.

On *The Bode Show*, Miller will take listeners along as he, his friends and other racers talk about their experiences on and off the Alpine circuit. Bode will talk about and play his music. Starting December 9th, the show will air on SIRIUS Faction // Channel 28, every Thursday at 9 pm ET.

Miller will kick things off with a special broadcast from the Ice Rink in Beaver Creek, Colorado around 6:15pm MT on Thursday, December 2. Teammate Erik Schlopy and four-time Olympic medalist Summer Sanders will join Miller for a brief snapshot of what can be expected musically and topically on *The Bode Show*.

Miller has burst from the starting gate, making history by winning the first three races of the World Cup season - adding to his previous 12 World Cup wins. He sits in 1st place in the overall World Cup downhill, Super G and giant slalom standings. By winning his first career Super G, Bode became just the fifth racer ever to win a World Cup event in all five Alpine disciplines.

Bode says, "I'm psyched to get out with SIRIUS in front of ski and music fans - to have a little party and talk some skiing and play some tunes."

"Bode Miller is redefining the world of skiing with his charisma and athletic achievements," said Scott Greenstein, SIRIUS President of Entertainment and Sports. "Bode will treat his fans to an entertaining and fun weekly show that will also provide an inside view to his world of accomplishments."

Miller joins skateboarding legend Tony Hawk, world champion surfer Kelly Slater, Olympic beach volleyball gold medalist Kerri Walsh, and professional skateboarder/and host of *Viva La Bam* Bam Margera as a host on SIRIUS Faction. Champion cyclists Lance Armstrong and volleyball legend Sinjin Smith will debut with their own shows on SIRIUS Faction soon.

To get SIRIUS, go to sirius.com or visit Radio Shack, Best Buy, Wal-Mart, Circuit City or your favorite electronics retailer.

About SIRIUS

SIRIUS, now available to over 10 million DISH Network satellite TV and SIRIUS Satellite Radio subscribers, provides listeners with over 120 channels of the best commercial-free music, sports, information and entertainment, with digital quality sound coast-to-coast, broadcast daily from New York City, Los Angeles, Nashville, New Orleans, Houston and Daytona. SIRIUS offers 65 channels of 100% commercial-free music, featuring multiple categories of pop, rock, country, hip-hop, R&B, dance, jazz, classical and Latin music, along with more than 50 channels of world-class sports, news, talk entertainment, traffic and weather for a monthly subscription fee of only \$12.95, with greater savings for upfront payments of multiple months or a year or more. SIRIUS also broadcasts live play-by-play games of the NHL and the NFL, and is the official satellite radio partner of the NFL.

J



Jimmy Buffett to Bring Radio Margaritaville Exclusively to SIRIUS Satellite Radio

NEW YORK, May 10, 2005 /PRNewswire-FirstCall via COMTEX/ -- Singer/songwriter/author Jimmy Buffett and SIRIUS Satellite Radio (Nasdaq: SIRI) today announced an agreement to present a Radio Margaritaville music channel exclusively for SIRIUS subscribers. The new 24-hour channel, featuring a wide variety of music, live broadcasts of Buffett's concerts and other unique programs, will debut this summer.

(Logo: <http://www.newscom.com/cgi-bin/prnh/19991118/NYTH125>)

"I first listened to SIRIUS' incredible programming in my car and my boat," said Jimmy Buffett. "We designed Radio Margaritaville after the old pirate radio stations that sat offshore and played what they wanted. When I saw how SIRIUS is changing the way radio is being heard, I welcomed the opportunity for Radio Margaritaville to join them."

"Margaritaville is more than just great music -- it's a lifestyle," said Scott Greenstein, SIRIUS President of Entertainment and Sports. "Our subscribers requested more of Jimmy Buffett. With this new channel, we'll bring them not just his tunes, but the music Jimmy listens to himself. Jimmy's impeccable sense of what his audiences love and enjoy will now come to life for SIRIUS subscribers, who will be able to enjoy it wherever and whenever they want."

Jimmy Buffett launched Radio Margaritaville in 1998 as an Internet-only channel, which will still be available at www.radiomargaritaville.com. Now, for the first time, Jimmy Buffett fans across America can hear the channel in their cars, on their boats and on the go by becoming SIRIUS subscribers.

SIRIUS will also broadcast Radio Margaritaville live on a regular basis from a studio located at Buffett's Margaritaville restaurant at Universal City Walk in Orlando, Florida. The channel is expected to broadcast from its other Margaritaville Cafes and Restaurants currently located in Key West, New Orleans, Las Vegas, Jamaica and Cancun.

As one of today's most successful artists, Jimmy Buffett performs sold-out concerts worldwide and has recorded forty records, most of which have gone gold, platinum or multi-platinum. Jimmy's newest CD, License To Chill, which debuted at #1 on both the Pop and Country charts, was the first number one record of his career, spent 15 weeks in the Top 10 of the Billboard Country Albums Chart, and has been certified platinum by the RIAA.

Also an author, Jimmy's new novel, A Salty Piece Of Land, was released and immediately entered the New York Times Bestseller List. The New York Times said it "is very possibly Buffett's best work to date." With Jimmy's three previous No. 1 bestsellers, he is one of only six authors in the history of the New York Times Bestseller List to have reached No. 1 on both their fiction and non-fiction lists.

The arrangement with Jimmy Buffett is the latest SIRIUS endeavor to provide its subscribers with unique, proprietary content featuring some of the most popular and intriguing personalities in entertainment.

About SIRIUS

SIRIUS delivers more than 120 channels of the best commercial-free music, compelling talk shows, news and information, and the most exciting sports programming to listeners across the country in digital quality sound. SIRIUS offers 65 channels of 100% commercial-free music, and features over 55 channels of sports, news, talk, entertainment, traffic and weather for a monthly subscription fee of only \$12.95. SIRIUS also broadcasts live play-by-play games of the NFL and NBA, and is the Official Satellite Radio partner of the NFL.

SIRIUS radios for the car, truck, home, RV and boat are manufactured by Alpine, Audiovox, Blaupunkt, Clarion, Delphi, Jensen, JVC, Kenwood, Pioneer, Sanyo and XACT Communications. Available in more than 25,000 retail locations, SIRIUS radios can be purchased at major retailers including Best Buy, Circuit City, Crutchfield, Office Depot, Sears, Target, Wal-Mart and RadioShack. SIRIUS is also available

SIR Ex. 9-J

at heavy truck dealers and truck stops nationwide.

SIRIUS radios are currently offered in vehicles from Audi, BMW, Chrysler, Dodge, Ford, Infiniti, Jeep(R), Lincoln-Mercury, Mazda, Mercedes-Benz, MINI, Nissan, Porsche, Volkswagen and Volvo. Hertz currently offers SIRIUS at major locations around the country.

Click on www.sirius.com to listen to SIRIUS live, or to find a SIRIUS retailer or car dealer in your area.

Any statements that express, or involve discussions as to, expectations, beliefs, plans, objectives, assumptions, future events or performance with respect to SIRIUS Satellite Radio Inc. are not historical facts and may be forward-looking and, accordingly, such statements involve estimates, assumptions and uncertainties which could cause actual results to differ materially from those expressed in any forward-looking statements. Accordingly, any such statements are qualified in their entirety by reference to the factors discussed in our Annual Report on Form 10-K for the year ended December 31, 2004 filed with the Securities and Exchange Commission. Among the key factors that have a direct bearing on our operational results are: our dependence upon third parties, including manufacturers of SIRIUS radios, retailers, automakers and programming partners, our competitive position and any events which affect the useful life of our satellites.

P-SIRI

SOURCE SIRIUS Satellite Radio

Media Contact, Elise Brown of SIRIUS, +1-212-584-5290, or ebrown@siriusradio.com

<http://www.prnewswire.com>

Copyright (C) 2005 PR Newswire. All rights reserved.

News Provided by COMTEX

K



Rolling Stones Take Over SIRIUS Satellite Radio Music Channel

Features Exclusive Interviews with the Stones, Nightly Concert Playbacks and More

NEW YORK, Aug 22, 2005 /PRNewswire-FirstCall via COMTEX/ -- SIRIUS Satellite Radio (Nasdaq: SIRI) will launch an all-Rolling Stones music channel dedicated to the rock music icons. The legendary band will help program the channel, which will feature five decades of Rolling Stones music, rare tracks, live cuts and previews from A Bigger Bang, their first studio album since 1997.

(Logo: <http://www.newscom.com/cgi-bin/prnh/19991118/NYTH125>)

Rolling Stones Radio will be available on SIRIUS starting tomorrow, August 23 at 9 am ET through September 29. The channel will also air nightly concert playbacks whereby SIRIUS will play album versions of the Stones' songs in the order they were performed following each US tour date, among many other surprises.

Scott Greenstein, President of Entertainment and Sports for SIRIUS, said, "The Rolling Stones are the essence of the spirit of rock n' roll, and with this partnership, SIRIUS is truly giving the Rolling Stones and all SIRIUS subscribers 'a bigger bang.'"

SIRIUS will also present exclusive track-by-track stories and introductions to each of A Bigger Bang's 16 all-new songs, as told exclusively to SIRIUS by Mick Jagger, Keith Richards, Charlie Watts and Ron Wood. "Rolling Stones Weekends" will be featured during Labor Day weekend across eight SIRIUS commercial-free music channels.

Rolling Stones Radio will be heard on SIRIUS channel 99. For more information, visit <http://www.sirius.com>.

About SIRIUS

SIRIUS delivers more than 120 channels of the best commercial-free music, compelling talk shows, news and information, and the most exciting sports programming to listeners across the country in digital quality sound. SIRIUS offers 65 channels of 100% commercial-free music, and features over 55 channels of sports, news, talk, entertainment, traffic and weather for a monthly subscription fee of only \$12.95. SIRIUS also broadcasts live play-by-play games of the NFL and NBA, and is the Official Satellite Radio partner of the NFL.

SIRIUS radios for the car, truck, home, RV and boat are manufactured by Alpine, Audiovox, Blaupunkt, Clarion, Delphi, Jensen, JVC, Kenwood, Pioneer, Sanyo and XACT Communications. Available in more than 25,000 retail locations, SIRIUS radios can be purchased at major retailers including Best Buy, Circuit City, Crutchfield, Costco, Office Depot, Sears, Target, Wal-Mart and RadioShack. SIRIUS is also available at heavy truck dealers and truck stops nationwide.

SIRIUS radios are currently offered in vehicles from Audi, BMW, Chrysler, Dodge, Ford, Infiniti, Jaguar, Jeep(R), Land Rover, Lexus, Lincoln-Mercury, Mazda, Mercedes-Benz, MINI, Nissan, Scion, Toyota, Porsche, Volkswagen and Volvo. Hertz currently offers SIRIUS at major locations around the country.

Click on <http://www.sirius.com> to listen to SIRIUS live, or to find a SIRIUS retailer or car dealer in your area.

Any statements that express, or involve discussions as to, expectations, beliefs, plans, objectives, assumptions, future events or performance with respect to SIRIUS Satellite Radio Inc. are not historical facts and may be forward-looking and, accordingly, such statements involve estimates, assumptions and uncertainties which could cause actual results to differ

SIR Ex. 9-K

materially from those expressed in any forward-looking statements. Accordingly, any such statements are qualified in their entirety by reference to the factors discussed in our Annual Report on Form 10-K for the year ended December 31, 2004 filed with the Securities and Exchange Commission. Among the key factors that have a direct bearing on our operational results are: our dependence upon third parties, including manufacturers of SIRIUS radios, retailers, automakers and programming partners, our competitive position and any events which affect the useful life of our satellites.

P-SIRI

Media Contact:
Elise Brown
SIRIUS
212.584.5290
ebrown@siriusradio.com

SOURCE SIRIUS Satellite Radio

Media, Elise Brown of SIRIUS, +1-212-584-5290, ebrown@siriusradio.com

<http://www.prnewswire.com>

Copyright (C) 2005 PR Newswire. All rights reserved.

News Provided by COMTEX

L



SIRIUS Satellite Radio to Launch 'E Street Radio' - World's First 24/7 Bruce Springsteen Music Channel

Exclusive SIRIUS channel launches Nov. 1 and features rare tracks, special programs and exclusive Bruce Springsteen interview with Dave Marsh

NEW YORK, Oct 25, 2005 /PRNewswire-FirstCall via COMTEX News Network/ -- SIRIUS Satellite Radio (Nasdaq: SIRI) will break new ground and delight fans of Bruce Springsteen across the U.S. when it launches E Street Radio, its exclusive new commercial-free channel devoted to the music of Bruce Springsteen and the E Street Band, on Tuesday, November 1.

(Logo: <http://www.newscom.com/cgi-bin/prnh/19991118/NYTH125>)

E Street Radio on SIRIUS coincides with the 30th anniversary of the release of Springsteen's album Born To Run, which is being remastered and reissued for release on Columbia Records on November 15.

In addition to rarities such as recordings of Bruce Springsteen and the E Street Band dating from early 1973, E Street Radio will feature track-by-track album discussions, behind-the-scenes insights, and conversations with E Street Band members and others associated with Springsteen throughout his career.

E Street Radio will also feature an exclusive SIRIUS interview with Bruce Springsteen conducted by Dave Marsh, the author of two books on Springsteen and host of the weekly SIRIUS program Kick Out The Jams With Dave Marsh.

"E Street Radio will offer SIRIUS subscribers a unique perspective on 30 years of socially conscious music, and set the background for even more relevant songs to come in the future," said Scott Greenstein, SIRIUS President of Entertainment and Sports. "It will be the most comprehensive presentation ever of Bruce's music and a true inside look at the work and artistry of an American icon."

E Street Radio is due to run on SIRIUS through January 31, 2006.

SIRIUS, the content leader in radio, is the first to dedicate entire 24-hour, commercial-free music channels to some of the music world's greatest artists. SIRIUS launched Elvis Radio (channel 13), the world's only official, all-Elvis Presley radio channel broadcasting live from Graceland in Memphis, in June 2004. In September 2005, SIRIUS premiered Rolling Stones Radio, devoted to the music of the Rolling Stones, which featured an exclusive interview with the band and other unique special programs. SIRIUS is also the exclusive satellite radio home of Shade 45 (channel 45), the uncut hip-hop channel co-created with Eminem, and Jimmy Buffett's Radio Margaritaville (channel 31).

For more about SIRIUS, visit <http://www.sirius.com>.

About SIRIUS

SIRIUS delivers more than 120 channels of the best commercial-free music, compelling talk shows, news and information, and the most extensive sports programming to listeners across the country in digital quality sound. SIRIUS offers 65 channels of 100% commercial-free music, and features over 55 channels of sports, news, talk, entertainment, traffic and weather for a monthly subscription fee of only \$12.95. SIRIUS also broadcasts live play-by-play games of the NFL, NHL and NBA and is the Official Satellite Radio Partner of the NFL and NHL.

SIRIUS products for the car, truck, home, RV and boat are distributed by Alpine, Audiovox, Brix Group, Clarion, Delphi, Directed Electronics, Eclipse, Jensen, JVC, Kenwood, Magnadyne, Monster Cable, Pioneer, Russound, Tivoli and XACT Communications. Available in more than 25,000 retail

SIR Ex. 9-L

locations, SIRIUS radios can be purchased at major retailers including Best Buy, Circuit City, Crutchfield, Costco, Target, Wal-Mart, Sam's Club and RadioShack. SIRIUS is also available at heavy truck dealers, truck stops and travel centers nationwide.

SIRIUS radios are currently offered in vehicles from Audi, BMW, Chrysler, Dodge, Ford, Infiniti, Jaguar, Jeep(R), Land Rover, Lexus, Lincoln-Mercury, Mazda, Mercedes-Benz, MINI, Nissan, Scion, Toyota, Porsche, Volkswagen and Volvo. Hertz currently offers SIRIUS at major locations around the country.

Click on <http://www.sirius.com> to listen to SIRIUS live, or to find a SIRIUS retailer or car dealer in your area.

Any statements that express, or involve discussions as to, expectations, beliefs, plans, objectives, assumptions, future events or performance with respect to SIRIUS Satellite Radio Inc. are not historical facts and may be forward-looking and, accordingly, such statements involve estimates, assumptions and uncertainties which could cause actual results to differ materially from those expressed in any forward-looking statements. Accordingly, any such statements are qualified in their entirety by reference to the factors discussed in our Annual Report on Form 10-K for the year ended December 31, 2004 filed with the Securities and Exchange Commission. Among the key factors that have a direct bearing on our operational results are: our dependence upon third parties, including manufacturers of SIRIUS radios, retailers, automakers and programming partners, our competitive position and any events which affect the useful life of our satellites.

P-SIRI

Media Contact:

Elise Brown
SIRIUS
212.584.5290
ebrown@siriusradio.com

SOURCE SIRIUS Satellite Radio

Elise Brown, SIRIUS, +1-212-584-5290, or ebrown@siriusradio.com

<http://www.prnewswire.com>

Copyright (C) 2005 PR Newswire. All rights reserved.

News Provided by COMTEX

M



'The Who Channel' to Launch September 21 Exclusively on SIRIUS Satellite Radio

*** New 24-hour channel dedicated to legendary band * Pete Townshend and Roger Daltrey to produce channel * Exclusive interviews with band members * Broadcasts of current US tour dates and past concerts * Backstage tour reports from musician Rachel Fuller**

NEW YORK, Sept 14, 2006 /PRNewswire-FirstCall via COMTEX News Network/ -- SIRIUS Satellite Radio (Nasdaq: SIRI) announced today that it will launch a commercial-free music channel dedicated to legendary rock band The Who. The company made the announcement during a press event attended by all current members of The Who at SIRIUS' New York City headquarters.

(Logo: <http://www.newscom.com/cgi-bin/prnh/19991118/NYTH125>)

The Who Channel will debut on SIRIUS on Thursday, September 21. The limited-run channel will feature five decades of music by The Who, including rare tracks and live cuts, and SIRIUS-exclusive interviews with band members. Also featured will be nightly broadcasts of concerts on the band's current tour of the US and Canada, featuring commentary and backstage reports hosted by musician Rachel Fuller.

SIRIUS will also broadcast selected shows from The Who's massive archives, including some never before-heard shows and backstage conversations with the band, some with the late Keith Moon and John Entwistle.

Said The Who's Pete Townshend, "This is the most exciting thing I can imagine -- our own radio channel, straight to our fans. I'm completely revved about this. Who's serious about SIRIUS? You bet."

Scott Greenstein, SIRIUS President of Sports and Entertainment, said, "The band that revolutionized rock and roll as we know it will continue to make history by partnering with SIRIUS Satellite Radio for this groundbreaking channel. Our subscribers will be connected to all aspects of the band with an 'all access' pass granted to them by Pete Townshend and Roger Daltrey in a unique and unprecedented way, including, with the advent of technology, the return of Keith Moon and John Entwistle."

The pioneering British rock band has reached a new level in its storied career. Endless Wire, The Who's first studio album in 24 years, will be released by Universal on October 31. The 19-track album features extended versions of the various sections that formed their Wire & Glass mini-opera (released in July 2006) as well as exploring other themes from Pete Townshend's novella, The Boy Who Heard Music.

Surviving original Who band members Pete Townshend and Roger Daltrey are joined by bassist Pino Palladino, drummer Zak Starkey, guitarist Simon Townshend and keyboardist John "Rabbit" Bundrick on the new album as well as in their live performances. The Who launched their first world tour in more than 20 years on September 12 in Philadelphia, PA. More tour and ticket info is available at <http://www.thewhotour.com>.

SIRIUS, the content leader in radio, is the first to dedicate entire 24-hour, commercial-free music channels to some of the world's greatest artists. For three months in 2005, SIRIUS broadcast the E Street Radio channel, devoted to the music of Bruce Springsteen and the E Street Band, which featured exclusive interviews with Springsteen and band members, among other special programs. In September 2005, SIRIUS premiered Rolling Stones Radio (channel 98), devoted to the music of the Rolling Stones, and in March 2006, dedicated a channel for a limited time to the music of David Gilmour and Pink Floyd. SIRIUS launched Elvis Radio (channel 13), the world's only official, all-Elvis Presley radio channel broadcasting live from Graceland in Memphis, in June 2004. SIRIUS is also the exclusive satellite radio home of Shade 45 (channel

SIR Ex. 9-M

45), the uncut hip-hop channel co-created with Eminem, "Little Steven" Van Zandt's Underground Garage (channel 25) and Jimmy Buffett's Radio Margaritaville (channel 31).

For more information about SIRIUS, visit <http://www.sirius.com>.

About SIRIUS

SIRIUS delivers more than 125 channels of the best programming in all of radio. SIRIUS is the original and only home of 100% commercial free music channels in satellite radio, offering 67 music channels available nationwide. SIRIUS also delivers 61 channels of sports, news, talk, entertainment, traffic, weather and data. SIRIUS is the Official Satellite Radio Partner of the NFL, NBA and NHL and broadcasts live play-by-play games of the NFL, NBA and NHL. All SIRIUS programming is available for a monthly subscription fee of only \$12.95.

SIRIUS products for the car, truck, home, RV and boat are available in more than 25,000 retail locations, including Best Buy, Circuit City, Crutchfield, Costco, Target, Wal-Mart, Sam's Club, RadioShack and at shop.sirius.com.

SIRIUS radios are offered in vehicles from Audi, BMW, Chrysler, Dodge, Ford, Infiniti, Jaguar, Jeep(R), Land Rover, Lexus, Lincoln-Mercury, Mazda, Mercedes-Benz, MINI, Nissan, Rolls Royce, Scion, Toyota, Porsche, Volkswagen and Volvo. Hertz also offers SIRIUS in its rental cars at major locations around the country.

Click on <http://www.sirius.com> to listen to SIRIUS live, or to purchase a SIRIUS radio and subscription.

Any statements that express, or involve discussions as to, expectations, beliefs, plans, objectives, assumptions, future events or performance with respect to SIRIUS Satellite Radio Inc. are not historical facts and may be forward-looking and, accordingly, such statements involve estimates, assumptions and uncertainties which could cause actual results to differ materially from those expressed in any forward-looking statements. Accordingly, any such statements are qualified in their entirety by reference to the factors discussed in our Annual Report on Form 10-K for the year ended December 31, 2005 and Quarterly Report on Form 10-Q for the quarter ended June 30, 2006 filed with the Securities and Exchange Commission. Among the key factors that have a direct bearing on our operational results are: our dependence upon third parties, including manufacturers of SIRIUS radios, retailers, automakers and programming partners, our competitive position and any events which affect the useful life of our satellites.

P-SIRI

PHOTOS available from WireImage

Media Contact:

Elise Brown
SIRIUS
212.584.5290
ebrown@siriusradio.com

SOURCE SIRIUS Satellite Radio

Elise Brown of SIRIUS, +1-212-584-5290, ebrown@siriusradio.com

<http://www.prnewswire.com>

Copyright (C) 2006 PR Newswire. All rights reserved.

News Provided by COMTEX

N



The Metropolitan Opera and SIRIUS Satellite Radio to Create Historic New Radio Channel

'Metropolitan Opera Radio' to be Heard on SIRIUS Starting on September 25th 24/7 Channel Will Feature Archival Performances From the Met's 75-Year History, as Well as Hundreds of New Performances Live From the Met

NEW YORK, Sept 20, 2006 /PRNewswire-FirstCall via COMTEX News Network/ -- The Metropolitan Opera and SIRIUS Satellite Radio (Nasdaq: SIRI) today announced a multi-year agreement to create Metropolitan Opera Radio, the definitive radio channel for opera lovers. The channel will debut on SIRIUS this Monday, September 25th, with a live broadcast of the Met's opening night gala performance of Puccini's *Madama Butterfly*, conducted by Music Director James Levine and directed by Anthony Minghella.

(Logo: <http://www.newscom.com/cgi-bin/prnh/19991118/NYTH125>)

The exclusive new SIRIUS satellite radio music channel will broadcast an unprecedented number of live Metropolitan Opera performances each week throughout the Met's entire season, in addition to hundreds of archival performances from throughout the Met's 75-year history. Metropolitan Opera Radio will be heard on SIRIUS channel 85.

"This is a significant step in our plans to use digital technology to relay our extraordinary content," said Peter Gelb, the Met's new General Manager. "I look forward to working with SIRIUS to expand their listenership to include opera lovers throughout the US and Canada."

"With Metropolitan Opera Radio, we will bring opera lovers the best performances of our day and an unparalleled and definitive collection of historic broadcasts," said Scott Greenstein, SIRIUS President, Entertainment and Sports. "SIRIUS' broad reach and superb digital quality sound make us the perfect vehicle to help Peter Gelb and the Met fulfill their mission to both superserve existing opera lovers and create new opera fans nationwide."

The full-time channel will feature an average of four live broadcasts each week throughout the Met's 2006-07 performance season, with Saturday matinee performances enhanced with live interviews and dynamic intermission programs. The channel will also feature hundreds of re-mastered historic broadcasts culled from the Met's illustrious 75-year history. Additional vocal content will complement the Metropolitan Opera broadcasts.

Margaret Juntwait, the host of the Saturday matinee Metropolitan Opera Radio broadcasts, will be the announcer for the new channel's programs. She joins the Met full-time later this month, having hosted its nationally syndicated Saturday matinee broadcasts since 2004.

Highlights of the Met's 2006-07 season include Academy Award-winning film director Anthony Minghella's new production of Puccini's *Madama Butterfly* to open the season, and the world premiere of Tan Dun's *The First Emperor* on December 21, directed by Zhang Yimou with Placido Domingo in the title role. An abridged, English-language version of Julie Taymor's hit production of Mozart's *The Magic Flute* will inaugurate a new annual series of winter holiday family entertainment beginning December 29.

Today's announcement comes on the heels of the Metropolitan Opera's landmark union negotiations that provide new opportunities for distribution to larger audiences via digital media. In an historic first, this season the Met will use advanced distribution platforms and state-of-the-art technology to attract new audiences and reach millions of opera fans around the world. Beginning on December 30, the Met will transmit six of its performances live in high definition into movie theaters in the US, Canada and Europe that have been equipped with high-definition projection systems and satellite dishes.

For more information, visit <http://www.sirius.com> and <http://www.metopera.org>.

About SIRIUS

SIR Ex. 9-N

SIRIUS delivers more than 125 channels of the best programming in all of radio. SIRIUS is the original and only home of 100% commercial free music channels in satellite radio, offering 67 music channels available nationwide. SIRIUS also delivers 61 channels of sports, news, talk, entertainment, traffic, weather and data. SIRIUS is the Official Satellite Radio Partner of the NFL, NBA and NHL and broadcasts live play-by-play games of the NFL, NBA and NHL. All SIRIUS programming is available for a monthly subscription fee of only \$12.95.

SIRIUS products for the car, truck, home, RV and boat are available in more than 25,000 retail locations, including Best Buy, Circuit City, Crutchfield, Costco, Target, Wal-Mart, Sam's Club, RadioShack and at shop.sirius.com.

SIRIUS radios are offered in vehicles from Audi, BMW, Chrysler, Dodge, Ford, Infiniti, Jaguar, Jeep(R), Land Rover, Lexus, Lincoln-Mercury, Mazda, Mercedes-Benz, MINI, Nissan, Rolls Royce, Scion, Toyota, Porsche, Volkswagen and Volvo. Hertz also offers SIRIUS in its rental cars at major locations around the country.

Click on <http://www.sirius.com> to listen to SIRIUS live, or to purchase a SIRIUS radio and subscription.

Any statements that express, or involve discussions as to, expectations, beliefs, plans, objectives, assumptions, future events or performance with respect to SIRIUS Satellite Radio Inc. are not historical facts and may be forward-looking and, accordingly, such statements involve estimates, assumptions and uncertainties which could cause actual results to differ materially from those expressed in any forward-looking statements. Accordingly, any such statements are qualified in their entirety by reference to the factors discussed in our Annual Report on Form 10-K for the year ended December 31, 2005 and Quarterly Report on Form 10-Q for the quarter ended June 30, 2006 filed with the Securities and Exchange Commission. Among the key factors that have a direct bearing on our operational results are: our dependence upon third parties, including manufacturers of SIRIUS radios, retailers, automakers and programming partners, our competitive position and any events which affect the useful life of our satellites.

About the Metropolitan Opera

Under the leadership of new General Manager Peter Gelb, the Metropolitan Opera has launched many initiatives to connect the company with a larger audience. They include: a first-ever free open house that offers the public an opportunity to attend the final dress rehearsal of *Madama Butterfly*; an extensive *Madama Butterfly* transit advertising campaign in New York City during the month of September; \$15 tickets (formerly \$26) in the Family Circle section; the new Arnold and Marie Schwartz Gallery Met exhibiting contemporary art; a groundbreaking commissioning program in partnership with the Lincoln Center Theater that provides renowned composers and playwrights the resources to create and develop new works at the Met and Lincoln Center's Vivian Beaumont Theater; and dynamic new content on the web site, the house program, and the Saturday matinee terrestrial radio broadcasts, which are sponsored by Toll Brothers, America's luxury home builder(TM), with generous long-term support from the Annenberg Foundation and the Vincent A. Stabile Foundation.

P-SIRI

Media Contacts:

Elise Brown
SIRIUS
212.584.5290
ebrown@siriusradio.com

Sommer Hixson/Peter Clark
Metropolitan Opera
(212) 870-7457
shixson@metopera.org
pclark@metopera.org

Andrew Shearer
Rubenstein Associates
(212) 843-8061
ashearer@rubenstein.com

SOURCE SIRIUS Satellite Radio

Media, Elise Brown of SIRIUS Satellite Radio, +1-212-584-5290, ebrown@siriusradio.com; or Sommer Hixson, shixson@metopera.org, or Peter Clark, pclark@metopera.org, both of Metropolitan Opera, +1-212-870-7457; or Andrew Shearer

of Rubenstein Associates, +1-212-843-8061, ashearer@rubenstein.com, for SIRIUS
Satellite Radio

<http://www.prnewswire.com>

Copyright (C) 2006 PR Newswire. All rights reserved.

News Provided by COMTEX

SIR Ex. 10

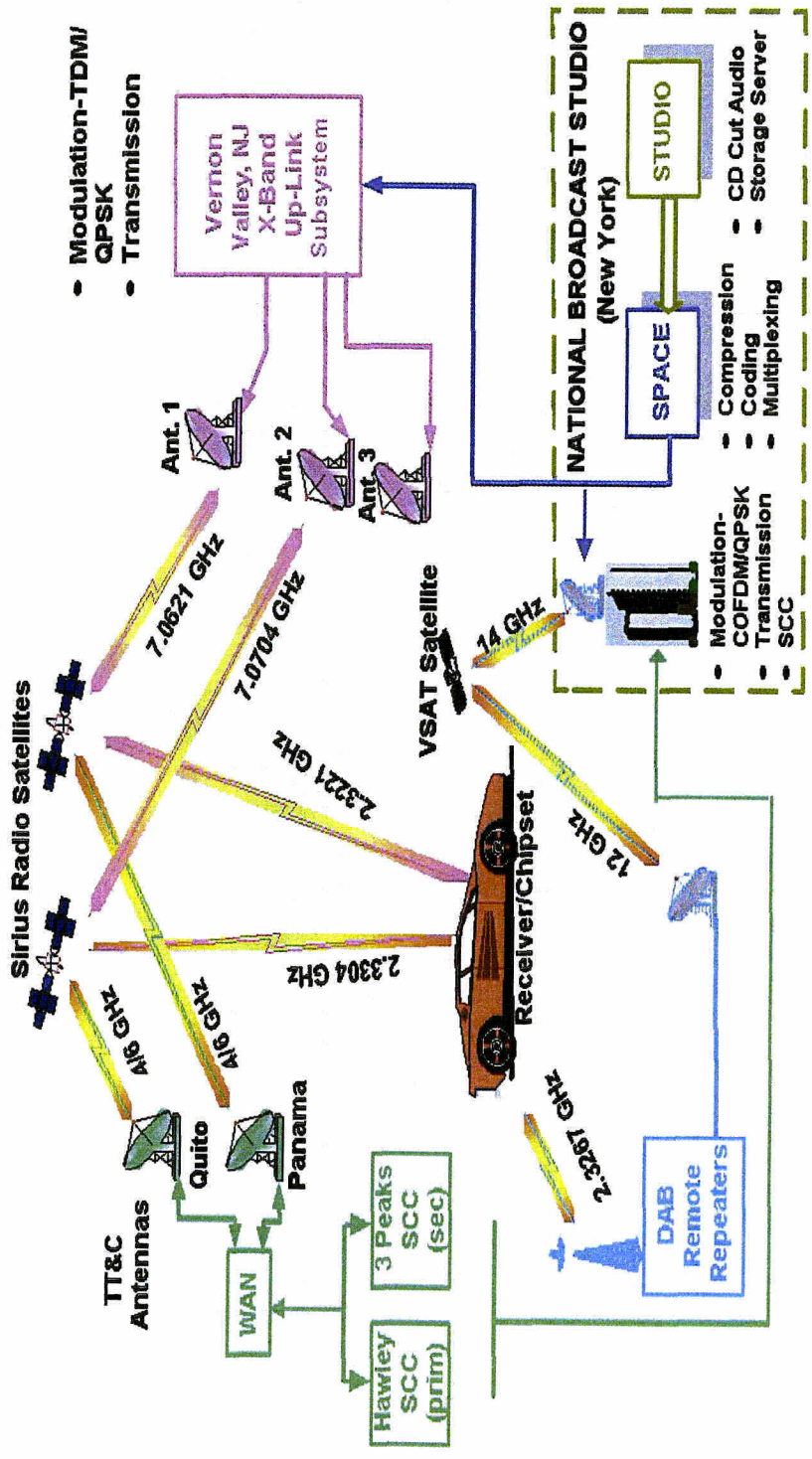

SIR Éx. 11

A

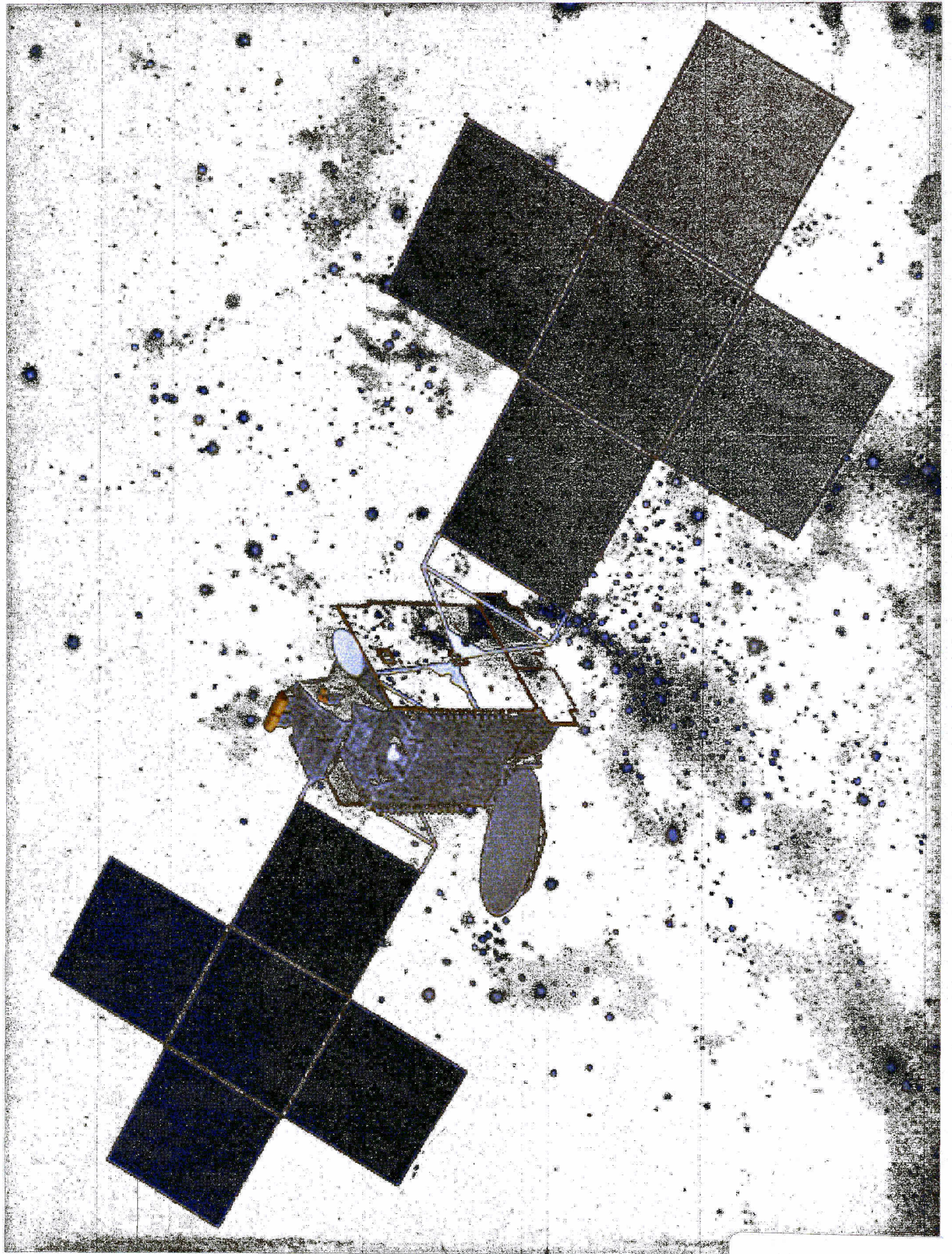

B

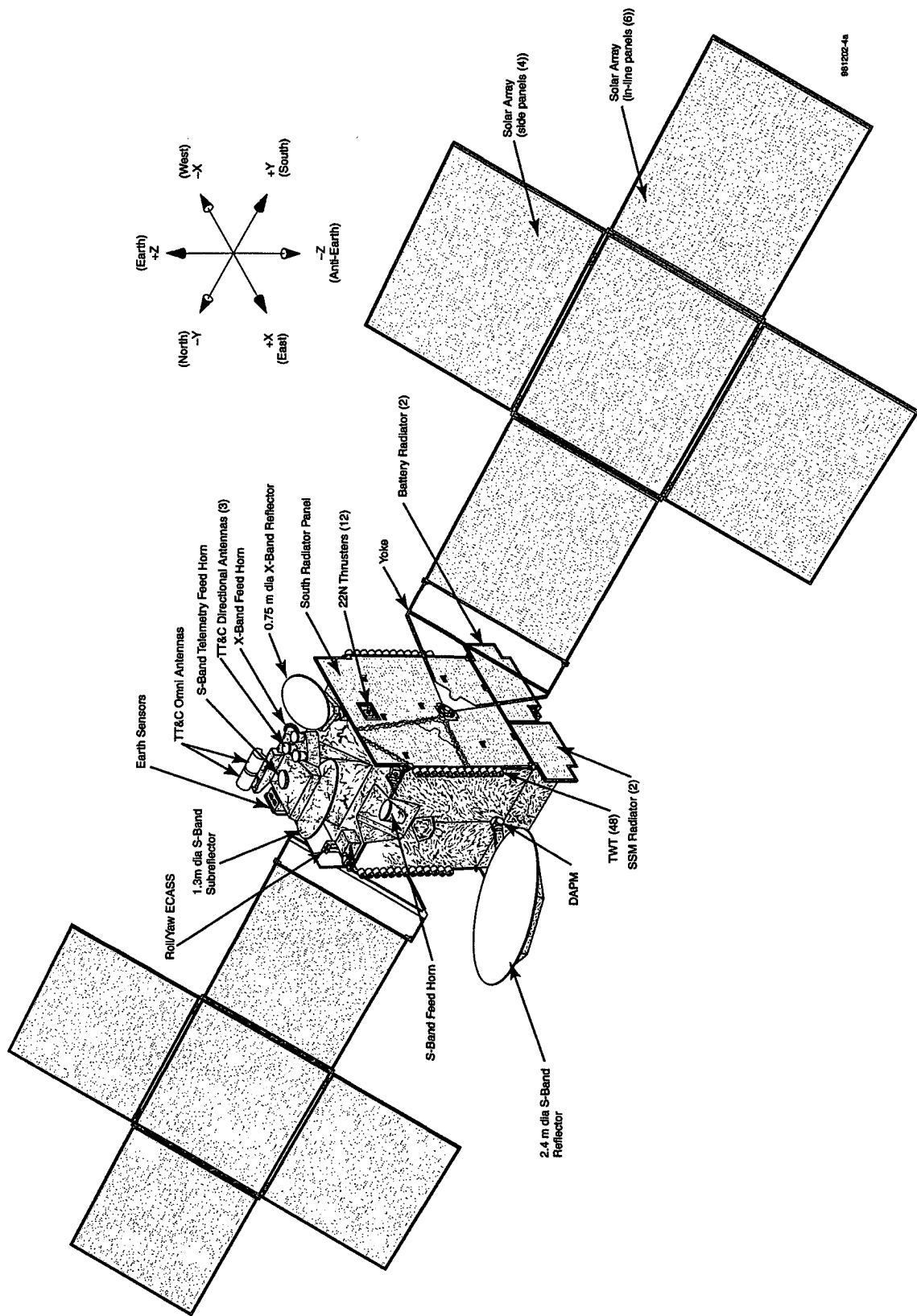

901202-4a

c

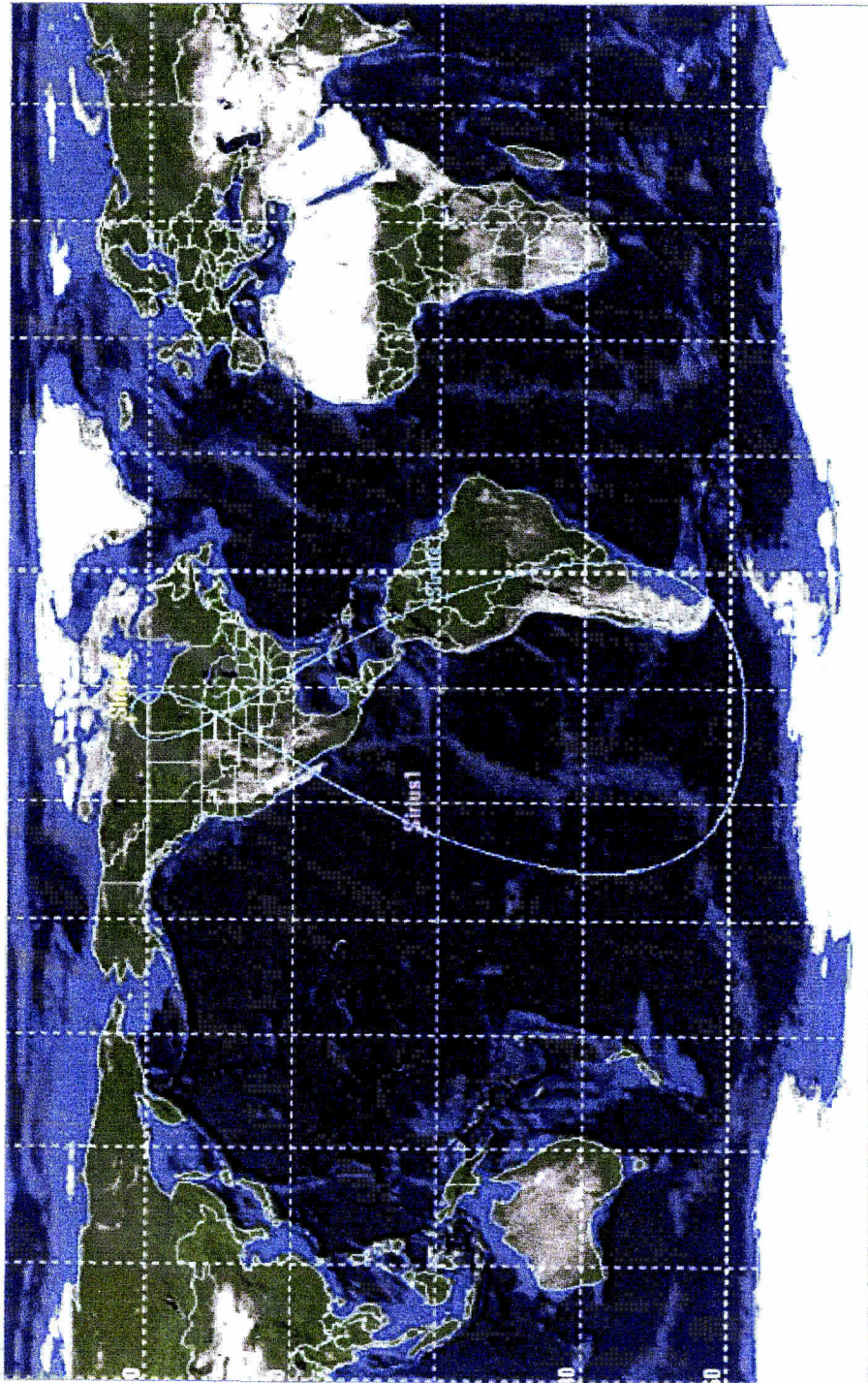

D

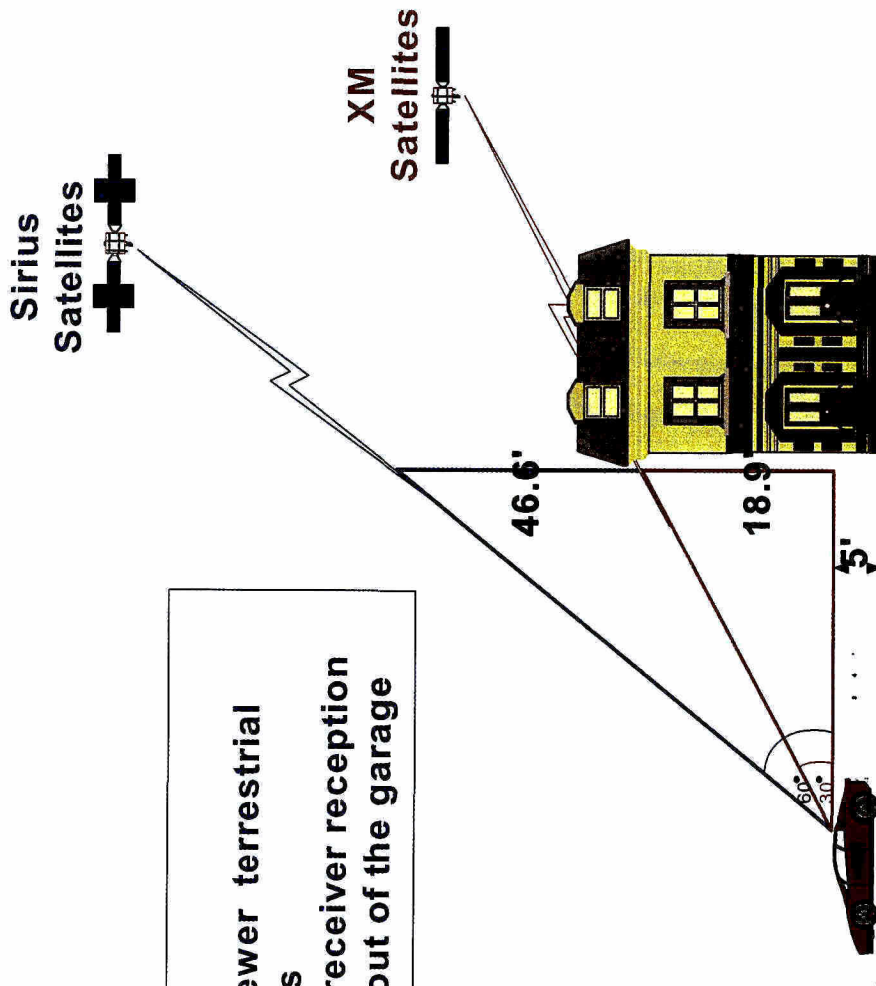

E

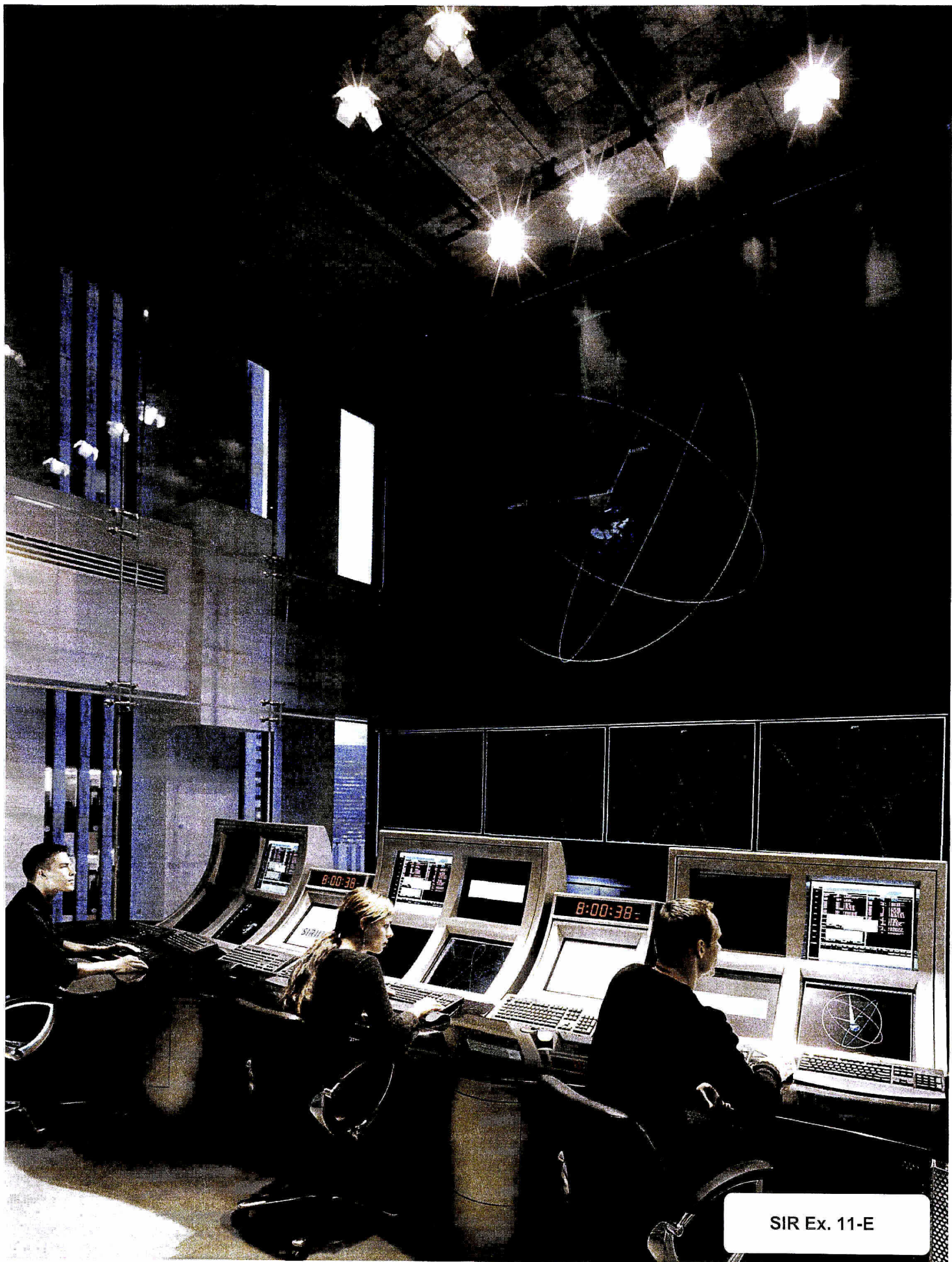

SIR Ex. 11-E

SIR Ex. 12

Gen 1 (2002)

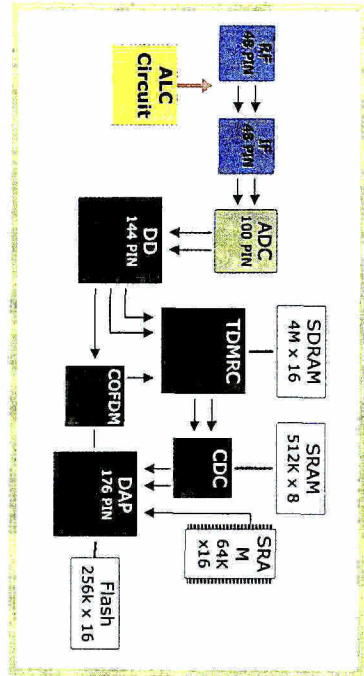

Gen 2 (2003)

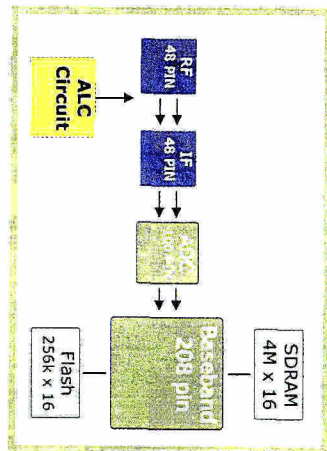

Gen 2.5 (2004)

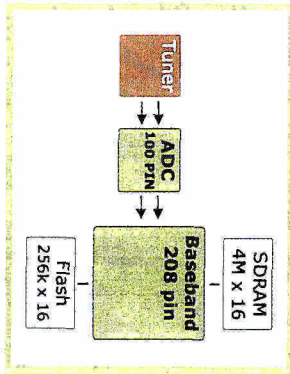

Gen 3 (2005)

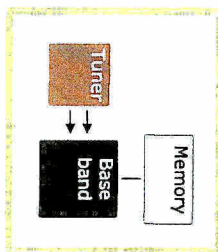

SIR EX. 13

A



STORE LOGIN
MY ACCOUNT
VIEW MY CART 0 ITEM(S) GO

ORDER STATUS
STORE HELP

HOME ALL RADIOS RADIO PACKAGES ACCESSORIES MERCHANDISE CLEARANCE

- Home Units
- Plug and Play Radios
- Portable Radios

Home > All Radios

SORT BY: - Sort -

1.888.GET.SIRIUS

LEARN MORE ABOUT HOW TO GET A FREE SIRIUS RADIO!



CLICK HERE >

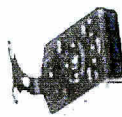

SIRIUS One Radio with Car Kit

Price: \$49.99

SEE DETAILS

ADD TO CART



Stratus Plug and Play Satellite Radio and Vehicle Kit (Ship...

Price: \$59.99

SEE DETAILS

ADD TO CART

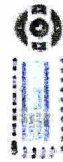

SIRIUS Starmate Replay Radio with Car Kit

Price: \$99.99

SEE DETAILS

ADD TO CART



SIRIUS Starmate 3 with Car Kit

Price: \$99.99

SEE DETAILS

ADD TO CART

SIRIUS Sportster 3 with Car Kit

SIRIUS Sportster Replay Radio and Car Kit





Price: \$119.99

SEE DETAILS

ADD TO CART



Price: \$129.99

SEE DETAILS

ADD TO CART



SIRIUS Sportster 4 with Car Kit

Price: \$149.99

SEE DETAILS

ADD TO CART

SIRIUS SRH550 home tuner with antenna

Price: \$269.99

SEE DETAILS

ADD TO CART



Tivoli's SIRIUS table radio

Price: \$299.99

SEE DETAILS

ADD TO CART

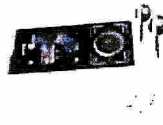

STILETTO 100 SL100 (Ships Week Of 11/06)

Price: \$349.99

SEE DETAILS

ADD TO CART

Contact Us | Returns | Activate | Rebates | Terms and Conditions | Privacy Policy | STORE SEARCH

Shipping | Payment | Store Help



B

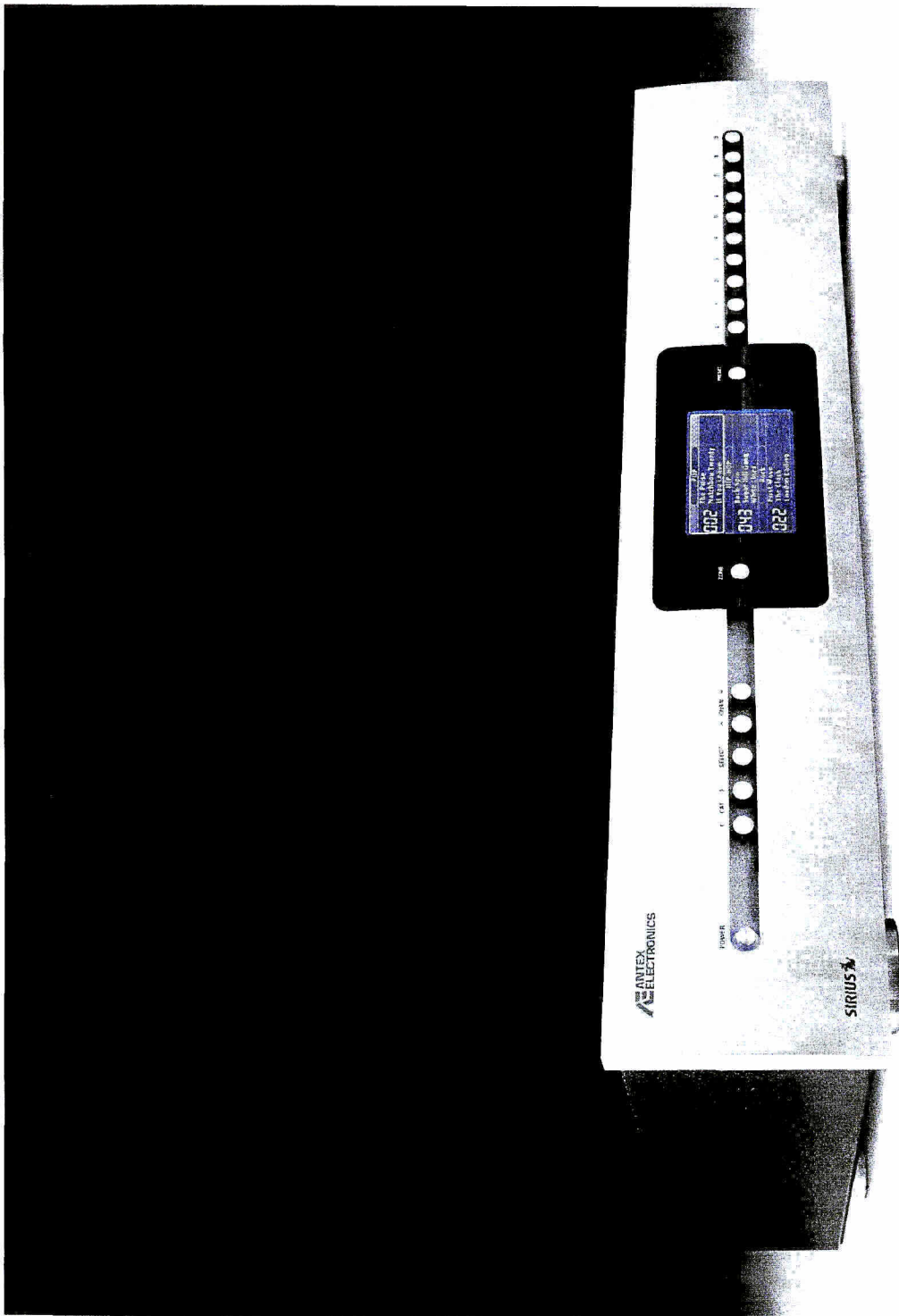



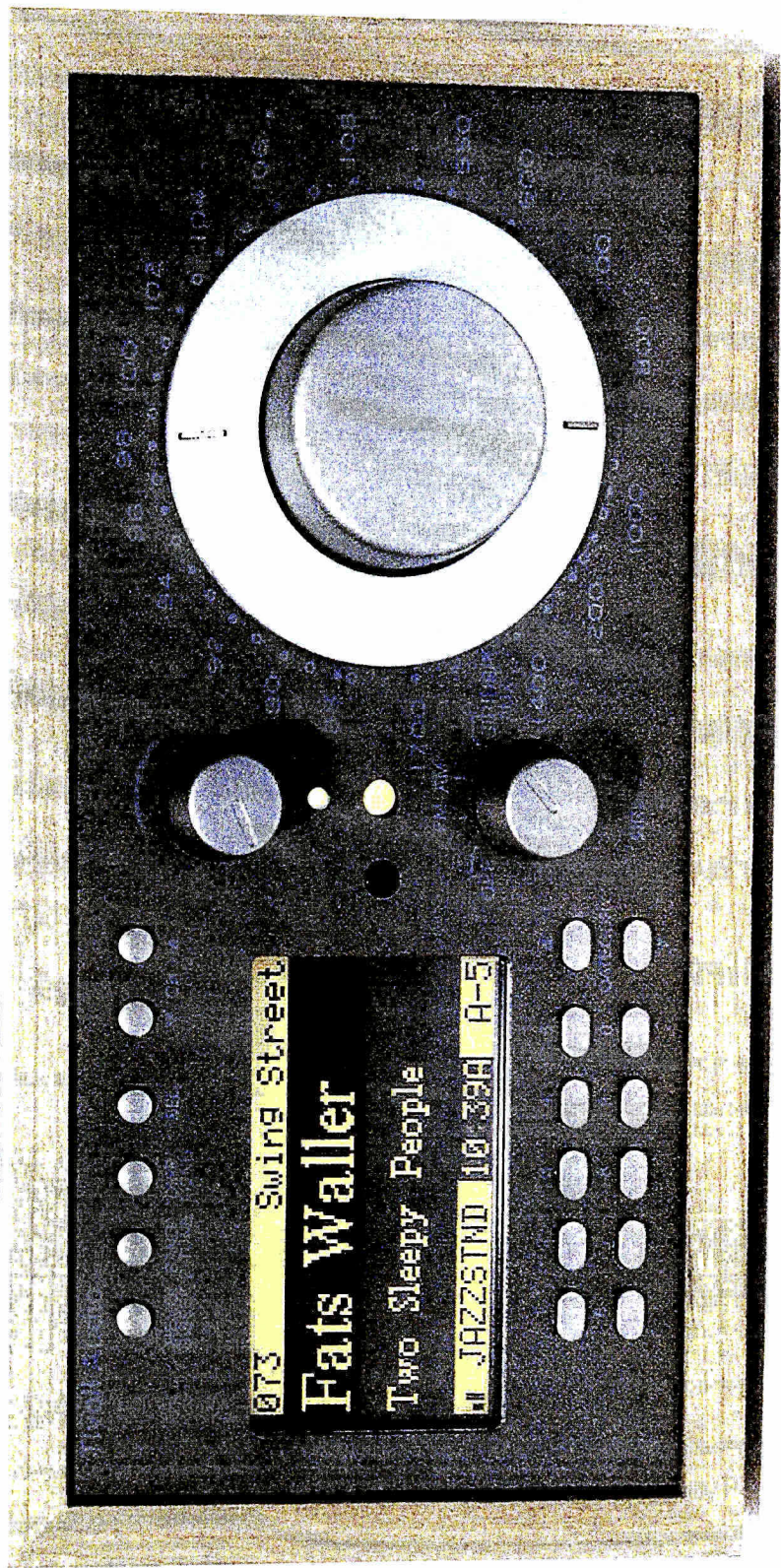

073 Swing Street
Fats Waller
Two Sleepy People
41 JAZZSTND 10 39A A-5



DISP

MEMO

S-SEEK



60
New Country
Tim McGraw
Back When
NEW COUNTRY 03:46P

SIRIUS XM STREAMER *GTTR*



MENU



BAND

P. TUNE



SIRIUSXM

14

Classic vinyl

Rolling Stones

Start Me Up



10.35



SIRIUSXM

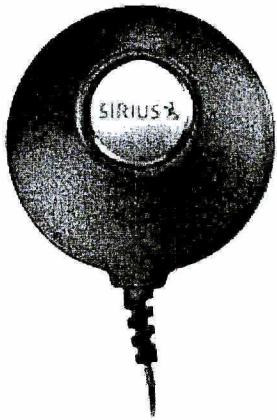

SIR Ex. 14



SIRIUS Satellite Radio Recognized for Call Center Customer Satisfaction Excellence by J.D. Power and Associates

SIRIUS' Call Center Operation is First in Satellite and Broadcast Radio Industry to be Certified by J.D. Power and Associates Certified Call Center Program

NEW YORK and WESTLAKE VILLAGE, Calif., Oct 13, 2005 /PRNewswire-FirstCall via COMTEX/ -- SIRIUS Satellite Radio (Nasdaq: SIRI) today announced that it has been recognized for call center operation customer satisfaction excellence under the J.D. Power and Associates Certified Call Center Program. This distinction acknowledges a strong commitment by SIRIUS' call center operation to provide an outstanding customer service experience.

(Logo: <http://www.newscom.com/cgi-bin/prnh/19991118/NYTH125>)

SIRIUS' call centers handled more than three million telephone, e-mail and fax interactions in 2004, and expects to handle approximately six million in 2005. The call center operation successfully passed a detailed audit of its recruiting, training, employee incentives, management roles and responsibilities, and quality assurance capabilities. In addition, J.D. Power and Associates conducted a random survey of SIRIUS customers who recently contacted its call centers. For certification status, a call center must perform within the top 20 percent of customer service, based on J.D. Power and Associates' cross-industry customer satisfaction research.

According to J.D. Power and Associates, SIRIUS is always working toward understanding what service excellence means to the customer. Furthermore, SIRIUS' call centers have created strong operational practices to support an infrastructure of service excellence.

"We are extremely pleased and honored to receive this recognition from such a prestigious organization as J.D. Power and Associates," said Jim Meyer, President of Operations and Sales for SIRIUS. "Customer service is a high priority for SIRIUS, and directly impacts our growth and subscriber retention. We dedicate much of our time to proper training and motivation of our personnel in order to make the customer experience as positive as it can be, and it is most rewarding to be recognized for our success in this all- important area."

The evaluation criteria used during the survey include: courtesy of the customer service representative (CSR); knowledge of the CSR; the CSR's concern for the customer questions and/or problem; usefulness of the information provided; convenience of customer service operating hours; ease of getting through to a CSR; and timely resolution of the customer's problem, question or request. Certification is valid for one year.

The Call Center Certification Program was launched by J.D. Power and Associates in 2004 to evaluate overall customer satisfaction and to help call centers in various industries increase their efficiency and effectiveness by establishing best practices for handling service calls.

There are more than 75,000 call centers in North America and an estimated 125,000 worldwide that help customers with product and service questions across a multitude of industries, ranging from credit cards, financial services, investment services, utilities, service warranty and insurance to telecommunications, healthcare and office products.

J.D. Power and Associates is currently evaluating call centers across a variety of industries to determine if they are eligible for certification.

About J.D. Power and Associates

Headquartered in Westlake Village, CA; J.D. Power and Associates is an ISO 9001 registered global marketing information services firm operating in key business sectors including market research, forecasting, consulting, training and customer satisfaction.

SIR Ex. 14

Media email contact: michael.greywitt@jdpa.com or john.tews@jdpa.com

No advertising or other promotional use can be made of the information in this release without the express prior written consent of J.D. Power and Associates. <http://www.jdpower.com>

About SIRIUS

SIRIUS delivers more than 120 channels of the best commercial-free music, compelling talk shows, news and information, and the most extensive sports programming to listeners across the country in digital quality sound. SIRIUS offers 65 channels of 100% commercial-free music, and features over 55 channels of sports, news, talk, entertainment, traffic and weather for a monthly subscription fee of only \$12.95. SIRIUS also broadcasts live play-by-play games of the NFL, NHL and NBA and is the Official Satellite Radio Partner of the NFL and NHL.

SIRIUS products for the car, truck, home, RV and boat are distributed by Alpine, Audiovox, Brix Group, Clarion, Delphi, Directed Electronics, Eclipse, Jensen, JVC, Kenwood, Magnadyne, Monster Cable, Pioneer, Russound, Tivoli and XACT Communications. Available in more than 25,000 retail locations, SIRIUS radios can be purchased at major retailers including Best Buy, Circuit City, Crutchfield, Costco, Target, Wal-Mart, Sam's Club and RadioShack. SIRIUS is also available at heavy truck dealers, truck stops and travel centers nationwide.

SIRIUS radios are currently offered in vehicles from Audi, BMW, Chrysler, Dodge, Ford, Infiniti, Jaguar, Jeep(R), Land Rover, Lexus, Lincoln-Mercury, Mazda, Mercedes-Benz, MINI, Nissan, Scion, Toyota, Porsche, Volkswagen and Volvo. Hertz currently offers SIRIUS at major locations around the country.

Click on <http://www.sirius.com> to listen to SIRIUS live, or to find a SIRIUS retailer or car dealer in your area.

Any statements that express, or involve discussions as to, expectations, beliefs, plans, objectives, assumptions, future events or performance with respect to SIRIUS Satellite Radio Inc. are not historical facts and may be forward-looking and, accordingly, such statements involve estimates, assumptions and uncertainties which could cause actual results to differ materially from those expressed in any forward-looking statements. Accordingly, any such statements are qualified in their entirety by reference to the factors discussed in our Annual Report on Form 10-K for the year ended December 31, 2004 filed with the Securities and Exchange Commission. Among the key factors that have a direct bearing on our operational results are: our dependence upon third parties, including manufacturers of SIRIUS radios, retailers, automakers and programming partners, our competitive position and any events which affect the useful life of our satellites.

G-SIRI

Media Contact:
Jim Collins
SIRIUS
212-901-6422
jcollins@siriusradio.com

SOURCE SIRIUS Satellite Radio

Media, Jim Collins of SIRIUS, +1-212-901-6422, jcollins@siriusradio.com

<http://www.prnewswire.com>

Copyright (C) 2005 PR Newswire. All rights reserved.

News Provided by COMTEX

SIR EX. 15



100% COMMERCIAL-FREE MUSIC
THE BEST RADIO ON RADIO.



ALL CHANNELS / HELP / MY ACCOUNT

SUNDAY, OCTOBER 29, 11:02 AM



SHOP SIRIUS

About Us

Auto Dealers

Partners

Retailers

Affiliates

Careers

CONTACT US

SIRIUS Customer Care

We appreciate feedback of all kinds. Comments, questions and suggestions may be sent to SIRIUS Customer Care by completing this **form** or by calling 1-888-539-SIRIUS (7474). NOTE: Please be sure to provide your account number when you call.

Record Labels and Recording Artists

Do you have a recording that you would like played on SIRIUS? Please submit your recording to:

Attn: Music Programming Department
SIRIUS
1221 Avenue of the Americas
New York, NY 10020

Song Requests

To make a song request, please go to the specific channel web page and fill out the "Request a Song" form.

Sponsorships

Are you interested in discussing media events, partnership opportunity, or sponsorships with us? Email us your proposal at sponsorships@sirius-radio.com, and be sure to include your contact information and details about the opportunity.

Advertising

SIRIUS Satellite Radio... Radio delivered in a whole new way:

- National reach - 100% coverage, coast-to-coast
- Exclusive content - Star personalities and power brands
- Creative ideas - Innovative messages and sponsorships
- Niche targeted - Reach your audience by demo, format, or lifestyle

Are you interested in discussing advertising with Sirius? Email us at [advertising@sirius-](mailto:advertising@sirius-radio.com)

radio.com, and be sure to include your contact information, including your phone number. You can also call Stephen Smith, Vice President, Advertising Sales at (212)584-5100.

News Media

Are you a member of the news media looking for information on SIRIUS? Email your questions to Lauren Kruk Winokur, Media Relations, at lkruk@siriusradio.com.

Investor Relations

Interested in investment information for SIRIUS? Email your questions to Jaymie Van Valkenburgh, Investor Relations, at jvanvalkenburgh@siriusradio.com.

Jobs

Interested in working for SIRIUS? Please see our [Careers](#) section.

Mailing Address

SIRIUS Satellite Radio
1221 Avenue of the Americas
New York, NY 10020

[About Us](#) | [Auto Dealers](#) | [Partners](#) | [Retailers](#) | [Affiliates](#) | [Careers](#)

[GET OUR NEWSLETTERS](#)

[FAQs](#) | [Manage Account](#) | [Contact Us](#) | [Site Map](#) | [Terms and Conditions](#) | [Privacy Policy](#) | [Canada](#)

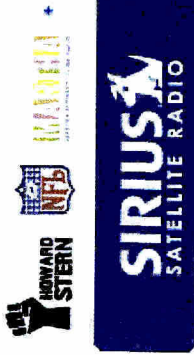

100% COMMERCIAL-FREE MUSIC
THE BEST RADIO ON RADIO.™

ALL CHANNELS / HELP / MY ACCOUNT

SUNDAY, OCTOBER 29, 11:03 AM



[About Us](#)

[Auto Dealers](#)

[Partners](#)

[Retailers](#)

[Affiliates](#)

[Careers](#)

CUSTOMER CARE

So that we can better assist you, please provide **all of the following information** when submitting a question or comment. All fields that appear are required.

First Name: _____

Last Name: _____

Email Address: _____

Re-enter Email Address: _____

Pick a Category: [Pick a category](#)

Are you a subscriber?

No

Yes

Please enter a question.

SUBMIT >

[About Us](#) | [Auto Dealers](#) | [Partners](#) | [Retailers](#) | [Affiliates](#) | [Careers](#)

[GET OUR NEWSLETTERS](#)

[FAQs](#) | [Manage Account](#) | [Contact Us](#) | [Site Map](#) | [Terms and Conditions](#) | [Privacy Policy](#) | [Canada](#)



100% COMMERCIAL-FREE MUSIC
THE BEST RADIO ON RADIO™



GET SIRIUS
INSTALL + ACTIVATE
WHAT'S ON SIRIUS
LISTEN ONLINE



ALL CHANNELS / HELP / MY ACCOUNT
MONDAY, OCTOBER 30, 2:52 AM

HOME ANTENNA TIPS CAR INSTALLATION TIPS PRODUCT MANUALS

INSTALL & ACTIVATE

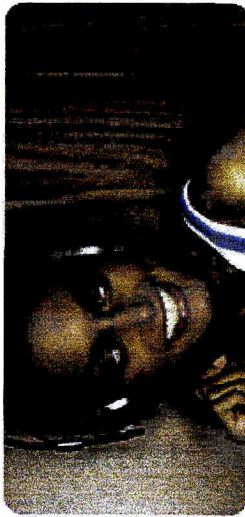

Need a radio? **GO HERE** ▶

Already have your radio?
You're in the right place.

INSTALL

There are two options you have when it comes to installing your new SIRIUS gear:

- option 1** **Install SIRIUS yourself.** If installation is the sort of thing you want to do yourself, go for it. Your installation can vary depending on the type of unit you own. *We strongly recommend following the directions included in your owner's manual.*
- option 2** **Have SIRIUS professionally installed.** If you choose professional installation, you get the benefit of having someone else take care of it for you. An authorized SIRIUS retailer can direct you towards a reliable professional installation option.

And if you have any questions during the course of installation, contact SIRIUS Customer Care by completing this **form** or calling **1-888-539-SIRIUS (7474)**. You may also want to contact the manufacturer directly for assistance.

Listen Now
TRY SIRIUS for free ▶



Car Installation Tips. Get the most out of your Plug-n-Play radio. [get tips](#)
Home Antenna Tips. Find the optimum placement to receive the best reception. [get tips](#)
Product Manuals. If you've lost your manual, you can view it here. [view manuals](#)



See Martha Stewart & Richard Simmons install SIRIUS

LAUNCH VIDEO ▶

ACTIVATE

Activating your Sirius-Ready hardware is an exciting part of the whole process - within minutes you'll be up and running and enjoying the best 100% commercial-free music from SIRIUS.

what you will need:

- Yes, I've got my gear. (If not, check out [what we've got](#))
- Yes, I've got my gear installed.
- Yes, I've picked a subscription plan. (If not, take a look at [your options](#))

be prepared with the following:

- 1** The ID/ESN number from your SIRIUS receiver.
- 2** A major credit card.
- 3** Have your SIRIUS tuner installed with the antenna facing skyward.
- 4** Turn your SIRIUS tuner on and tune it to channel 184.



SID: 123456789123

ACTIVATE ONLINE (and save money)

Save \$5 off our standard activation fee of \$15 by choosing to activate online (for plans of one year or greater).

ACTIVATE HERE ▶

To activate by phone call **1.888.539.SIRIUS(7474)**

Subscription is supplied in accordance with Sirius' standard Terms and Conditions.

[GET OUR NEWSLETTERS](#)

[About Us](#) | [Auto Dealers](#) | [Partners](#) | [Retailers](#) | [Affiliates](#) | [Careers](#)
[FAQs](#) | [Manage Account](#) | [Contact Us](#) | [Site Map](#) | [Terms and Conditions](#) | [Privacy Policy](#) | [Canada](#)



100% COMMERCIAL-FREE MUSIC

ALL CHANNELS / HELP / MY ACCOUNT

MONDAY, OCTOBER 30, 2:53 AM



GET SIRIUS

INSTALL & ACTIVATE

WHAT'S ON SIRIUS

LISTEN ONLINE



NEW ACCOUNTS

New accounts are for people who are not currently subscribers to SIRIUS Satellite Radio. This path will take you through setting up your account with SIRIUS and activating your radio.

Would you like to:

- Activate a **new SIRIUS** account?
- Set-up an activation date and time for your SIRIUS system?
- Register as a SIRIUS customer?

To make your activation a snap, be prepared with the following:

- The ID/ESN number from your SIRIUS receiver.
- A major credit card.
- Have your SIRIUS tuner installed with the antenna facing skyward.
- Turn your SIRIUS tuner on and tune it to channel 184.



EXISTING ACCOUNTS

Existing accounts are people who are already subscribers to SIRIUS Satellite Radio. Login below to manage your account information or to add a new receiver to your account.

Would you like to:

- Activate a new receiver on an **existing account**?
- View and edit your account information? Please login below.

*Login:

*Password:

[Forgot your password?](#)

NEXT ▶

GET OUR NEWSLETTERS

[About Us](#) | [Auto Dealers](#) | [Partners](#) | [Retailers](#) | [Affiliates](#) | [Careers](#)
[FAQs](#) | [Manage Account](#) | [Contact Us](#) | [Site Map](#) | [Terms and Conditions](#) | [Privacy Policy](#) | [Canada](#)

SIR Ex. 16

October 11, 2006

THE BEST RADIO ON RADIO™



Dear Arden,

Welcome to SIRIUS Satellite Radio, where you experience over 120 channels of the best entertainment satellite radio has to offer. We know...sometimes it's tough to decide which channel to listen to. But that's one of the reasons you chose SIRIUS, right?

Enjoy the revolutionary, original, 100% commercial-free music channels. News directly from the top sources, including CNN, CNBC, NPR and the BBC World Service. Complete and exclusive NFL coverage, along with NBA, NHL® and college sports. Uncensored talk and entertainment featuring the "King of All Media" Howard Stern. Satellite radio's most in-depth and frequent traffic and weather reports. And more. Broadcast nationwide via satellite from New York City in clear digital-quality sound. All day. Every day.

Take a look at the enclosed SIRIUS channel guide. It will help you find your favorite music, sports, news, talk and entertainment channels, which you can preset on your SIRIUS radio for easy access.

And did you know that you can listen to the SIRIUS music channels on your computer at no additional cost? To access the SIRIUS Player online, just visit sirius.com, click on "Listen" in the upper right corner of the website, and log in with your SIRIUS Account Username and Password (listed below).

Watch for our monthly e-newsletter, *Behind the Mic*, in your email inbox soon. It's filled with behind-the-scenes info about the music, artists and events you'll hear on SIRIUS. And don't forget to sign up for our *SIRIUS Music Weekly* and *SIRIUS Sports Weekly* e-newsletters, which deliver timely updates on SIRIUS music and sports programming. Sign up to receive them now by visiting sirius.com/newsletters.

You can also personalize your Username and Password or update your email address and account information online to ensure that you receive all the latest SIRIUS news. Just click on the "Manage Your Account" link found at the bottom of every page of sirius.com.

And let us know if there's anything we can do to add to your SIRIUS Satellite Radio listening experience. To ensure you get the most enjoyment from SIRIUS, we are here 24/7 to assist you should you need us. You can reach us at 1-888-539-SIRIUS (7474), our Customer Care line, or send us an email at customercare@sirius-radio.com and refer to the account information listed below.

Account Information

Yours truly,

Michael Moore
Vice President, SIRIUS Customer Care

P.S. Remember, SIRIUS offers channel access solutions. With SIRIUS Plug & Play radios you can customize the channel selection and control what channels are available for listening. To learn more, consult the User Manual that came with your radio or call Customer Care for additional information.

THE BEST RADIO™

SIRIUS E-NEWSLETTERS
Rely on SIRIUS e-newsletters to keep you on top of the variety of SIRIUS' original and exclusive programming, including

- ▶ Artists performing live in our NYC studios or stopping by to chat.
- ▶ Debuts of new SIRIUS on-air hosts and shows.
- ▶ Newsmakers and entertainment's biggest names on SIRIUS.
- ▶ Upcoming sports action from the NFL, NHL* and NBA plus the top college sports and much, much more.

Sign up for the SIRIUS e-newsletters at sirius.com/newsletters.

Behind the Mic Your guide to the best of SIRIUS programming, *Behind the Mic* shines a spotlight on SIRIUS music, sports, events, new products and artist visits.

SIRIUS Music Weekly Sneak previews of exclusive SIRIUS programming, including live performances in our NYC studios by your favorite artists.

SIRIUS Sports Weekly A weekly guide to the channels that carry all your favorite games from the NFL, college sports, NBA, NHL* and Barclays English Premier League—and much more.

SUB-WK-09-06



INFORMATION GUIDE

SIRIUSSM

SATELLITE RADIO™

THE BEST RADIO ON RADIO™



100% COMMERCIAL-FREE

MUSIC

NEWS



TALK

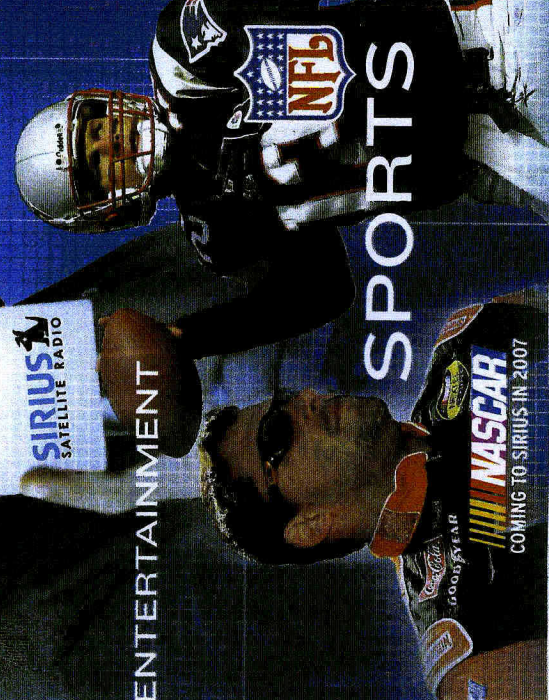

ENTERTAINMENT

SPORTS

ENJOY SIRIUS TO THE FULLEST
SIRIUS Satellite Radio offers you the variety of quality programming that will change the way you listen to radio forever.



Please take the time to review our channel lineup. It represents the best in satellite radio and will be your doorway to an unmatched listening experience. You'll find more of what you want and discover soon-to-be favorites. From the 100% commercial-free music to the heart-pumping sports action, with leading talk personalities and channels for women and family, SIRIUS is the best programming in all of radio.

To make it easy to navigate through the wide variety of channels, we have categorized them by genre. Take a look at the SIRIUS channel guide on the reverse side for a listing of the genres and their channels. Program the presets of your SIRIUS radio for quick access to your favorite channels. Consult the User Manual that came with your radio for easy step-by-step instructions.

To make a song request, record a dedication or song introduction, or just tell us what you like best about SIRIUS, call the SIRIUS Listener Line at 877-33-SIRIUS (7-4748). Call toll-free anytime. You can also email a song request to our on-air hosts by filling out the "Request a Song" form located on each music page on sirius.com.

Get SIRIUS in more than one vehicle or home. You get a discount for multiple subscriptions! Being a SIRIUS subscriber means you can activate a second subscription for only \$6.99 a month. For your shopping convenience, take advantage of the savings at sirius.com/shop or call SIRIUS Customer Care at 888-539-SIRIUS (7474).

It's easy to personalize your SIRIUS listening experience. All of our portable Plug & Play radios offer you the choice to limit access to just the channels you want. Consult the User Manual or you can call SIRIUS Customer Care at 888-539-SIRIUS (7474) and we help you choose an option that's right for you.

Go to sirius.com for the most extensive information about SIRIUS. It's the ultimate SIRIUS information resource. It's the place to get the most up-to-date information about our service, programming and new products.

Manage your account. Personalize your Username and Password or update your email address and account information to ensure you receive all the latest SIRIUS news. Just click on the "Manage Your Account" link found at the bottom of every page of sirius.com.

Don't miss out! Listen to SIRIUS online for FREE!

And now we'd like you to enjoy 100% commercial-free music at home and in the office with online access absolutely FREE from SIRIUS! Just click on the "Listen Online" link found at the top of any page of sirius.com. All you need is your SIRIUS Username and Password found in your welcome letter.



Get better online sound quality for your subscription. Add CD-quality audio to your existing subscription with SIRIUS Internet Radio. You'll never want to stop listening. Hear your favorite music the way it was meant to be heard. You continue to use your current Username when you choose this option.

Let us know if there's anything we can do to add to your SIRIUS Satellite Radio listening experience. To ensure you get the most enjoyment from SIRIUS, we are here 24/7 to assist you should you need us.

You can reach us at 1-888-539-SIRIUS (7474), our Customer Care line, or send us an email at customer@sirius-radio.com.



"An Outstanding Customer Service Experience"
For J.D. Power and Associates Certified Program™ information, visit www.jdpower.com or call 1-866-842-7548

SIRIUS SATELLITE RADIO

THE BEST RADIO ON RADIO

100% COMMERCIAL-FREE MUSIC

POP	01 Top 40 Hits	02 Live Pop	03 Love Songs	04 Easy Listening	05 The '80s	06 The '90s with Cousin Bruce	07 70s Pop	08 BIG80S
	09 '90s Pop	10 Mellow Rock	11 New Music from the U.K.	12 SUPERHITS	13 Radio	14 ROCK	15 CHRISTIAN	16 ELECTRONIC & DANCE
	17 ROCK	18 CHRISTIAN	19 JAZZ & BLUES	20 HIP-HOP	21 SHADE 45	22 STANDARDS	23 CLASSICAL	24 LATIN & INTERNATIONAL
	25 CLASSICAL	26 LATIN & INTERNATIONAL	27 CLASSICAL	28 LATIN & INTERNATIONAL	29 CLASSICAL	30 LATIN & INTERNATIONAL	31 CLASSICAL	32 LATIN & INTERNATIONAL
	33 CLASSICAL	34 LATIN & INTERNATIONAL	35 CLASSICAL	36 LATIN & INTERNATIONAL	37 CLASSICAL	38 LATIN & INTERNATIONAL	39 CLASSICAL	40 LATIN & INTERNATIONAL

Subscribers can listen to our 100% commercial-free music channels, Howard Stern, and more online for FREE at sirius.com

SIRIUS MUSIC STAR POWER. THE HOTTEST STARS. THE BIGGEST SHOWS.

Marky Ramone
Grandmaster Flash
Jimmy Fallon
Cousin Bruce

David Johansen
Paul van Dyk
Bam Margera
Kelly Slater
Hawk

FACTION
Music that defines the action sports lifestyle is on Faction.

TONY HAWK'S DEMOLITION RADIO

© 2006 Sirius Satellite Radio, Inc. "Sirius" and the Satellite 100 logo are trademarks of Sirius Satellite Radio, Inc. "Shade 100" and the NFL logo are trademarks of Sirius Satellite Radio, Inc. "NASCAR" and the NASCAR logo are trademarks of NASCAR Properties, Inc. The NFL, NFL logo, and the NFL shield are registered trademarks of the National Football League. "NASCAR" and the NASCAR logo are registered trademarks of NASCAR Properties, Inc. The NFL, NFL logo, and the NFL shield are registered trademarks of the National Football League. "NASCAR" and the NASCAR logo are registered trademarks of NASCAR Properties, Inc. The NFL, NFL logo, and the NFL shield are registered trademarks of the National Football League.

THE LEADER IN SPORTS RADIO PROGRAMMING

120	ESPN Radio	125	Play-by-Play
121	ESPN NEWS	127	NBA Radio on SIRIUS
122	Sports Talk & Play-by-Play	128	NASCAR
123	Sports Talk & Play-by-Play	181	ESPN Deportes Radio
124	Nonstop NFL Talk	186	Hardcore Sports Radio

NASCAR
COMING TO SIRIUS IN 2007

Tony Stewart brings you the ultimate on-air racing with his own exclusive talk show live on SIRIUS.

Get the most in-depth NASCAR coverage available. Hear every race and everything in between, with the hottest news, interviews and behind-the-scenes coverage. It's all on SIRIUS. All the time.

NFL
Live coverage of over 350 pro and college teams

Every game. Every week. Everywhere.

Hear in-depth analysis and talk across the leagues with the biggest names including John Madden, Tom Brady, Archie Manning, Tom Brady, Tom Brady.

SIRIUS NFL RADIO:
Where there is never an off-season

Hours of expert talk from these 124 channels:

John Madden, Tom Brady, Archie Manning, Tom Brady, Tom Brady.

SIRIUS COLLEGE RADIO
Live game play-by-play action including:

150 Football, Basketball, Hockey

The most college play-by-play action including:

SO MUCH SPORTS COVERAGE

We often have to use these channels: 107, 110, 118, 121, 122, 123, 124, 125, 127, 128, 130, 143, 144, 146, 147, 152, 153, 158, 181

HOWARD STERN

Howard Stern Show

- 20 years of the Stern library
- Howard: 100 News
- Bubs: The Love Sponge Show
- Super: an Roundtable
- The Scott Ferrall Show
- 2 dedicated channels, 24/7

HOWARD STERN - Hear The Revolution

COURTY
Fun, Fearless, Female

OUTQ
Gay & Lesbian Radio

PLAYBOY RADIO
Just for Truckers

KIDS
Kids Music 100% Commercial-free

CLASSIC
Classic Radio Shows

DISNEY
Radio Disney

FAMILY & KIDS

HEALTHY LIVING
Healthy Living with a Twist

RADIO DISNEY
Radio Disney

SIRIUS STAR POWER

Barbara Walters
Deepak Chopra
Richard Simmons
Jay Thomas
Senator Bill Bradley
Judith Regan

COMEDY

Blue Collar Comedy
Blue Collar Comedy features comedians Larry the Cable Guy, Bill Engvall, Ralphie May and many more.

RAW
Comedy

MARTHA STEWART
How-To For Living

"On SIRIUS, you can talk with me and my full team of lifestyle experts all day, every day."

RELIGION

CATHOLIC
The Catholic Channel

EWTN
EWTN Radio Catholic Network

TALK, NEWS & NPR

NPR
NPR Talk

NATIONAL
National/International News

SIRIUS NEWS STAR POWER

Larry King
Anderson Cooper
Greta Van Susteren
Paula Zahn

© 2006 Sirius Satellite Radio, Inc. "Sirius" and the Satellite 100 logo are trademarks of Sirius Satellite Radio, Inc. "Shade 100" and the NFL logo are trademarks of Sirius Satellite Radio, Inc. "NASCAR" and the NASCAR logo are trademarks of NASCAR Properties, Inc. The NFL, NFL logo, and the NFL shield are registered trademarks of the National Football League.

SIR Ex. 17

A

HOWARD STERN
100% COMMERCIAL-FREE MUSIC
THE BEST RADIO ON RADIO.

ALL CHANNELS / HELP / MY ACCOUNT
SATURDAY, OCTOBER 28, 5:58 PM

SIRIUS SATELLITE RADIO
GET SIRIUS
INSTALL & ACTIVATE
WHAT'S ON SIRIUS
LISTEN ONLINE
SHOP SIRIUS

MUSIC SPORTS NEWS/TALK ENTERTAINMENT OUR STARS
TALK US NEWS FINANCIAL NEWS PUBLIC RADIO INTERNATIONAL NEWS TRAFFIC & WEATHER

FOX NEWS CHANNEL
Powerful, hard-hitting coverage of the news that affect Americans most. Tune in to FNC for expert analysis, interviews and debate with the biggest names in news.
SEE MORE

TALK
Informative, inspiring, incendiary... here's the full spectrum of talk radio, as diverse and opinionated as its listeners.
ALL TALK GO
Today
COMING UP SIRIUS Left
The Bill Press Show
SIRIUS Stars Saturday 1 pm & 4 pm ET
Judith Regan Questions John Ashcroft on Justice and the Bush Administration

U.S. NEWS
Familiar names and voices you can trust report the news you need most.
ALL US NEWS GO
Today
COMING UP Fox News Talk Channel

Listen Now
Try SIRIUS for free
Get SIRIUS
Buy Online Now
Find a Retailer
Automotive Partners

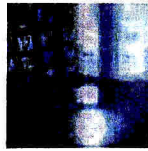

On the Next *Brian & The Judge*...on Fox News Talk

FINANCIAL NEWS



Up-to-the-minute business news, insight and analysis from reporters in the world's top financial markets.

ALL FINANCIAL NEWS  [GO](#)

PUBLIC RADIO



Your passion for public radio has a home on SIRIUS. Hear your favorite NPR news, features & personalities, plus news from around the world.

ALL PUBLIC RADIO  [GO](#)

COMING UP

BBC World Service News Sat 9:32 PM; Sun 3:32 AM, 1:32 PM ET

CLOSE UP

BBC World Service News Sat 10/28 3:06 am & 11:06 am ET

Sun 10/29 12:06 pm ET

The Ticket

INTERNATIONAL NEWS



Worldwide teams of reporters bring you on-the-spot, round-the-clock coverage of news from around the globe.

ALL INTERNATIONAL NEWS  [GO](#)

TRAFFIC & WEATHER

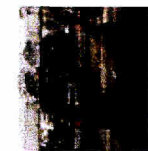

News you can truly use: Coast-to-coast weather forecasts & information, plus traffic reports for the top 20 most traffic congested metropolitan areas.

ALL TRAFFIC & WEATHER  [GO](#)

[About Us](#) | [Auto Dealers](#) | [Partners](#) | [Retailers](#) | [Affiliates](#) | [Careers](#) **GET OUR NEWSLETTERS**

[FAQs](#) | [Manage Account](#) | [Contact Us](#) | [Site Map](#) | [Terms and Conditions](#) | [Privacy Policy](#) | [Canada](#)



B

HOWARD STERN + 100% COMMERCIAL-FREE MUSIC
THE BEST RADIO ON RADIO.

ALL CHANNELS / HELP / MY ACCOUNT
SATURDAY, OCTOBER 28, 5:58 PM

SIRIUS SATELLITE RADIO

CALL SIRIUS | INSTALL & ACTIVATE | WHAT'S ON SIRIUS | LISTEN ONLINE

SHOP SIRIUS

MUSIC | SPORTS | NEWS/TALK | ENTERTAINMENT | OUR STARS

TALK | US NEWS | FINANCIAL NEWS | PUBLIC RADIO | INTERNATIONAL NEWS | TRAFFIC & WEATHER

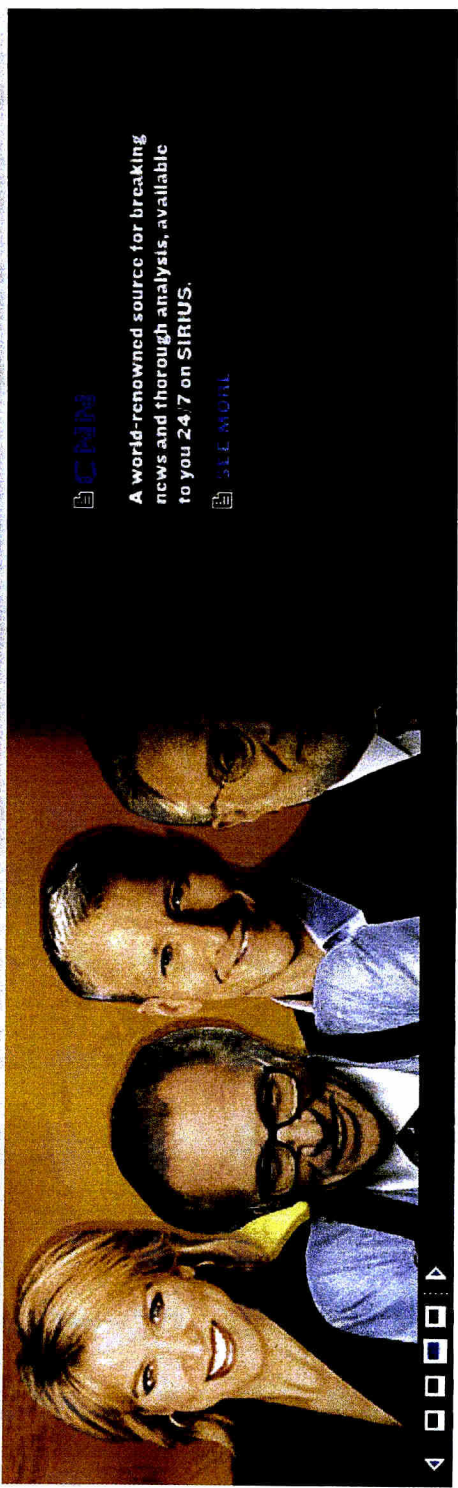

CNN

A world-renowned source for breaking news and thorough analysis, available to you 24/7 on SIRIUS.

[SEE MORE](#)

TALK



Informative, inspiring, incendiary... here's the full spectrum of talk radio, as diverse and opinionated as its listeners.

ALL TALK **GO**

COMING UP SIRIUS Left

The Bill Press Show

SIRIUS Stars Saturday 1 pm & 4 pm ET

Judith Regan Questions John Ashcroft on Justice and the Bush Administration

Today

Listen Now

Try SIRIUS for free

Get SIRIUS

Buy Online Now

Find a Retailer

Automotive Partners

U.S. NEWS

Familiar names and voices you can trust report the news you need most.

ALL US NEWS **GO**

COMING UP

Fox News Talk Channel

Today

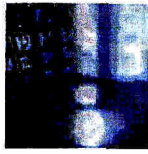

On the Next *Brian & The Judge*...on Fox News Talk

FINANCIAL NEWS



Up-to-the-minute business news, insight and analysis from reporters in the world's top financial markets.

ALL FINANCIAL NEWS  [GO](#)

PUBLIC RADIO



Your passion for public radio has a home on SIRIUS. Hear your favorite NPR news, features & personalities, plus news from around the world.

ALL PUBLIC RADIO  [GO](#)

COMING UP

BBC World Service News Sat 9:32 PM; Sun 3:32 AM, 1:32 PM ET

CLOSE UP

BBC World Service News Sat 10/28 3:06 am & 11:06 am ET

Sun 10/29 12:06 pm ET

The Ticket

INTERNATIONAL NEWS



Worldwide teams of reporters bring you on-the-spot, round-the-clock coverage of news from around the globe.

ALL INTERNATIONAL NEWS  [GO](#)

TRAFFIC & WEATHER



News you can truly use: Coast-to-coast weather forecasts & information, plus traffic reports for the top 20 most traffic congested metropolitan areas.

ALL TRAFFIC & WEATHER  [GO](#)

[GET OUR NEWSLETTERS](#)

[About Us](#) | [Auto Dealers](#) | [Partners](#) | [Retailers](#) | [Affiliates](#) | [Careers](#)

[FAQs](#) | [Manage Account](#) | [Contact Us](#) | [Site Map](#) | [Terms and Conditions](#) | [Privacy Policy](#) | [Canada](#)

C

SIR EX. 17-C

ALL CHANNELS / HELP / MY ACCOUNT
SATURDAY OCTOBER 28, 5:50 PM

100% COMMERCIAL-FREE MUSIC
THE BEST RADIO ON RADIO.



SHOP SIRIUS
Free Shipping

GET SIRIUS
INSTALL & ACTIVATE
WHAT'S ON SIRIUS
LISTEN ONLINE

- MUSIC
- SPORTS
- NEWS/TALK
- ENTERTAINMENT
- OUR STARS
- TALK
- US NEWS
- FINANCIAL NEWS
- PUBLIC RADIO
- INTERNATIONAL NEWS
- TRAFFIC & WEATHER

NPR NOW & NPR TALK

Voices you trust for thoughtful reporting and intelligent discussion. Find your favorite NPR shows on NPR Now // Ch. 134 and top-notch conversation on NPR Talk // Ch. 135.

[SEE NPR NOW](#)
[SEE NPR TALK](#)

Listen Now
Try SIRIUS for free ▶

Get SIRIUS
Buy Online Now ▶
Find a Retailer ▶
Automotive Partners ▶

COMING UP
SIRIUS Left
The Bill Press Show
SIRIUS Stars
Judith Regan Questions John Ashcroft on Justice and the Bush Administration

Today

GO ▶
Saturday 1 pm & 4 pm ET

U.S. NEWS
Familiar names and voices you can trust report the news you need most.
GO ▶
Fox News Talk Channel
Today

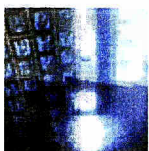

On the Next *Brian & The Judge*...on Fox News Talk

FINANCIAL NEWS



Up-to-the-minute business news, insight and analysis from reporters in the world's top financial markets.

[ALL FINANCIAL NEWS](#) **GO**

PUBLIC RADIO



Your passion for public radio has a home on SIRIUS. Hear your favorite NPR news, features & personalities, plus news from around the world.

[ALL PUBLIC RADIO](#) **GO**

COMING UP

BBC World Service News Sat 9:32 PM; Sun 3:32 AM, 1:32 PM ET

CLOSE UP

BBC World Service News Sat 10/28 3:06 am & 11:06 am ET

Sun 10/29 12:06 pm ET

The Ticket

INTERNATIONAL NEWS



Worldwide teams of reporters bring you on-the-spot, round-the-clock coverage of news from around the globe.

[ALL INTERNATIONAL NEWS](#) **GO**

TRAFFIC & WEATHER

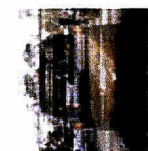

News you can truly use: Coast-to-coast weather forecasts & information, plus traffic reports for the top 20 most traffic congested metropolitan areas.

[ALL TRAFFIC & WEATHER](#) **GO**

[GET OUR NEWSLETTERS](#)

[About Us](#) | [Auto Dealers](#) | [Partners](#) | [Retailers](#) | [Affiliates](#) | [Careers](#)

[FAQs](#) | [Manage Account](#) | [Contact Us](#) | [Site Map](#) | [Terms and Conditions](#) | [Privacy Policy](#) | [Canada](#)



D



100% COMMERCIAL-FREE MUSIC
THE BEST RADIO ON RADIO.



GET SIRIUS

INSTALL & ACTIVATE

WHAT'S ON SIRIUS

LISTEN ONLINE

SHOP SIRIUS



ALL CHANNELS / HELP / MY ACCOUNT
SATURDAY, OCTOBER 28, 6:00 PM

ABOUT SIRIUS COMPARE US RADIOS PLANS/SERVICES BUY NOW

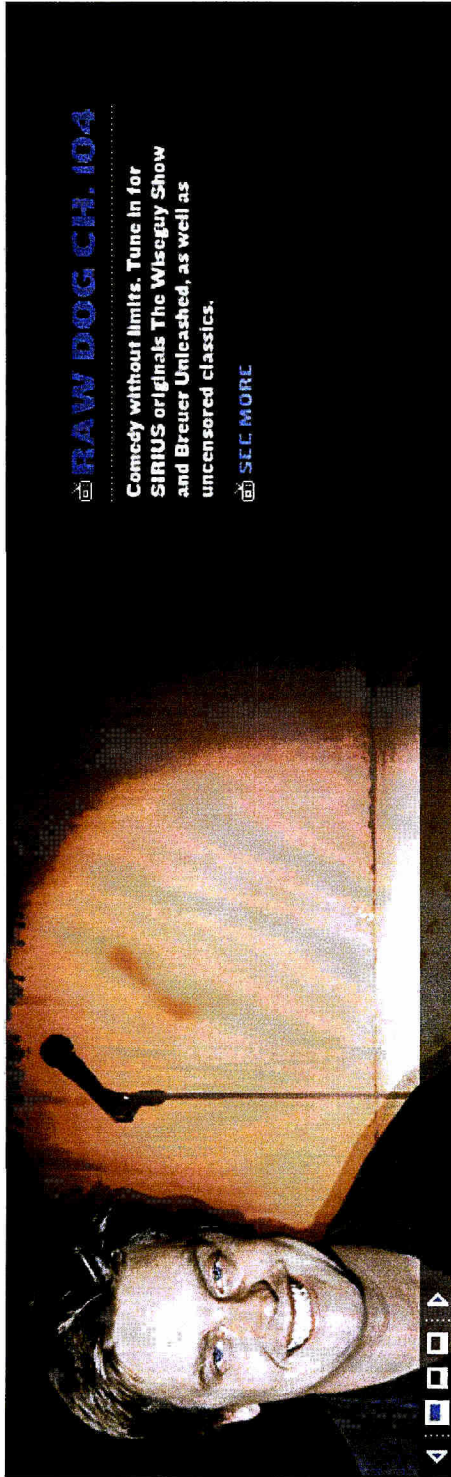

RAW DOG CH. 104

Comedy without limits. Tune in for SIRIUS originals The Wiseguy Show and Breuer Unleashed, as well as uncensored classics.

SEE MORE

COMEDY



Want to laugh? Look no further. We've got family-friendly favorites, uncensored comedy and Blue Collar Radio--all guaranteed to tickle your ribs.

ALL COMEDY

GO

COMING UP

Raw Dog

Saw III on the The Alternative Comedy Show

Mon 10/30

ENTERTAINMENT



Distinctive voices, diverse opinions, definitely entertaining - informative and inspiring radio you'll hear nowhere else.

ALL ENTERTAINMENT

GO

HOWARD STERN

Listen Now

TRY SIRIUS for free





Be part of the revolution exclusively on SIRIUS with 2 channels, all Howard, all the time, 30 hours a day.

ALL HOWARD STERN **GO**

MARTHA STEWART



Martha Stewart and her team of lifestyle experts will teach, advise, and inspire you. Get ready for round-the-clock shows covering cooking, gardening, collecting, crafts, weddings and much more.

ALL MARTHA STEWART **GO**

FAMILY & KIDS



Looking for radio that's fun for everyone? Look no further than our variety of family- and kid-friendly shows.

ALL FAMILY & KIDS **GO**

COMING UP

Kids Stuff 10/28 - 10/31

Kids Stuff's Treats and Tricks Halloween Weekend!

Kids Stuff All Halloween

SCARIOUS -- SIRIUS Halloween Radio

RELIGION

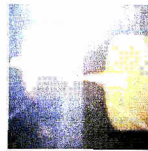

Improve your life, awaken your spirit, find a higher meaning... radio for the soul is broadcast daily on SIRIUS.

ALL RELIGION **GO**

GET OUR NEWSLETTERS

About Us | Auto Dealers | Partners | Retailers | Affiliates | Careers
FAQs | Manage Account | Contact Us | Site Map | Terms and Conditions | Privacy Policy | Canada

SIR Ex. 18









[GET SIRIUS](#)
[INSTALL & ACTIVATE](#)
[WHAT'S ON SIRIUS](#)
[LISTEN ONLINE](#)

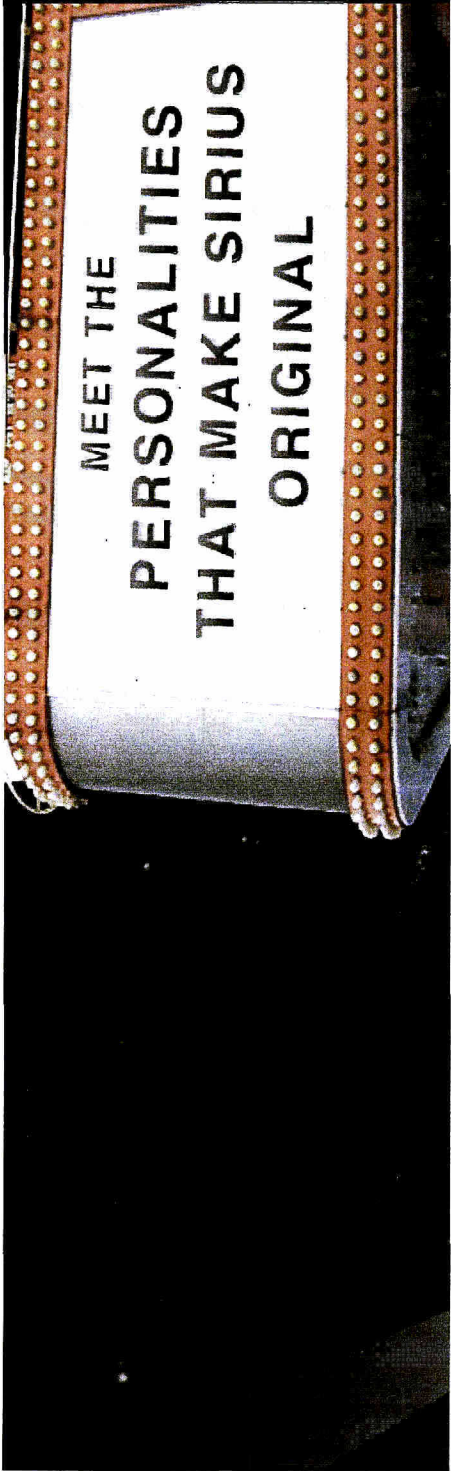

[MUSIC](#)
[SPORTS](#)
[NEWS/TALK](#)
[ENTERTAINMENT](#)
[OUR STARS](#)
[JAZZ/BLUES](#)
[STANDARDS](#)
[CLASSICAL](#)
[LATIN/INT'L](#)



THE HOWARD STERN SHOW



The King of All Media holds court with Robin, Artie, Fred and Gary, as well as a cast of Wackpackers, Farters, Strippers and Porn Stars. Hear the show like it's never been heard before - uncensored.

Ch. 100 >

WORLD CLASS SOCCER



Don't wait four years—SIRIUS has World Class Soccer right now! UEFA Champions League, Barclays English Premier League, every Chelsea Premier League match, plus exclusive programs hosted by legendary Italian striker Giorgio Chanaglia and soccer insider Charlie Stillitano.

More >

HEADLINES

HOWARD STERN TWO-DAY, FREE WORLDWIDE EVENT TO LAUNCH SIRIUS INTERNET RADIO

JANE PRATT, Media Pioneer, to Launch Weekly Show on SIRIUS Satellite Radio

ch85 THE METROPOLITAN OPERA AND SIRIUS SATELLITE RADIO TO CREATE HISTORIC NEW RADIO CHANNEL

"THE WHO CHANNEL" TO LAUNCH SEPTEMBER 21 EXCLUSIVELY ON SIRIUS SATELLITE RADIO

BARBARA WALTERS to Launch



DEDICATED TO GREAT LIVING

Get ready for round-the-clock shows covering cooking, gardening, collecting, crafts, pets, weddings and much more, as Martha Stewart and her team of lifestyle experts teach, advise and inspire you.

Ch. 112 >

'Best of the Very Best' on SIRIUS Satellite Radio Early Next Year
 Ch.124 SIRIUS Signs NFL Legend Jerry Rice

TONY STEWART LIVE - NASCAR driver to host exclusive new talk show on SIRIUS

ch.26 BLOG RADIO -- The most influential music bloggers, weeknights on Left Of Center

ch.102 MARK CUBAN'S Radio Maverick - outspoken owner of the Dallas Mavericks to host weekly show, from the NEA to an MBA.



THE WHO CHANNEL

The Who Channel is dedicated to the music of one of the greatest rock and roll bands of all time, featuring their hits, interviews with the band, rare recordings, behind the scenes access, historic performances, fan-based recordings and broadcasts of the shows on their current tour.

Ch. 10 >

ONLY ON SIRIUS



50 CENT
 Shade 45 // Ch. 45



ALEXIS & JENNIFER
 Martha Stewart Living Radio // Ch. 112



LANCE ARMSTRONG
 Faction // Ch. 28



THE BARBER SHOP
 NFL Radio // Ch. 124



ALEX BENNETT
 SIRIUS Left // Ch. 146



NINA BLACKWOOD
 Big 80s // Ch. 8



SEN. BILL BRADLEY
 SIRIUS Stars // Ch. 102



JIM BREUER
 Raw Dog // Ch. 104



BUBBA THE LOVE SPONGE
 Howard 101 // Ch. 101



CANDACE BUSHNELL
 SIRIUS Stars // Ch. 102



DEEPAK CHOPRA
 SIRIUS Stars // Ch. 102



MIKE CHURCH
 SIRIUS Patriot // Ch. 144



COUSIN BRUCIE
 '60s Vibrations // Ch. 6



MARK CUBAN
 SIRIUS Stars // Ch. 102



ADAM CURRY
 SIRIUS Stars // Ch. 102



































DJ WHOO KID
 Shade 45 // Ch. 45



EMINEM
 Shade 45 // Ch. 45



THE FERRALL SHOW
 Howard 101 // Ch. 101

	GINGER LYNN & CHRISTIE CANYON Playboy Radio // Ch. 198		MARK GOODMAN Big 80s // Ch. 8		GRANDMASTER FLASH Boombox // Ch. 30
	TONY HAWK Faction // Ch. 28		HILLBILLY JIM Outlaw Country // Ch. 63		ALAN HUNTER Big 80s // Ch. 8
	FRED IMUS Outlaw Country // Ch. 63		PHIL JACKSON SIRIUS Sports Action // Ch. 123		SHOOTER JENNINGS Outlaw Country // Ch. 63
	JOAN JETT Underground Garage // Ch. 25		SUE JOHANSON SIRIUS Stars // Ch. 102		BAM MARGERA Faction // Ch. 28
	DAVE MARSH SIRIUS Stars // Ch. 102		CARL P. MAYFIELD Road Dog Trucking // Ch. 147		Metropolitan Opera Radio // Ch. 85
	MOJO NIXON Outlaw Country // Ch. 63		SIRIUS OutQ // Ch. 106		PATRICK & VICTORIA Cosmo Radio // Ch. 111
	VINCENT PASTORE Raw Dog // Ch. 104		VINNIE POLITAN Court TV Radio // Ch. 110		ELVIS PRESLEY Elvis Radio // Ch. 13
	MARTHA QUINN Big 80s // Ch. 8		MARKY RAMONE Faction // Ch. 28		JUDITH REGAN SIRIUS Stars // Ch. 102
	JERRY RICE SIRIUS NFL Radio // Ch. 124		MO ROCCA Discovery Channel Radio // Ch. 119		LYNN SAMUELS SIRIUS Left // Ch. 146
	FRED SCHNEIDER First Wave // Ch. 22		DANNY SEO LIME // Ch. 114		RICHARD SIMMONS SIRIUS Stars // Ch. 102
	KELLY SLATER		KENNY SMITH		HOWARD STERN

<p>Faction // Ch. 28</p>	<p>SIRIUS Sports Action // Ch. 123</p>	<p>Howard Stern // Ch. 100</p>
		
<p>MARTHA STEWART Martha Stewart Living Radio // Ch. 112</p>	<p>TONY STEWART NASCAR</p>	<p>TAYLOR & TIA Cosmo Radio // Ch. 111</p>
		
<p>DENEY TERRIO The Strobe // Ch. 37</p>	<p>JAY THOMAS SIRIUS Stars // Ch. 102</p>	<p>LITTLE STEVEN Underground Garage // Ch. 25</p>
		
<p>P.J. WALSH Blue Collar Radio // Ch. 103</p>	<p>BARBARA WALTERS SIRIUS Stars // Ch. 102</p>	<p>ANDREW WILKOW SIRIUS Patriot // Ch. 144</p>
		
<p>The Who Channel // Ch. 10</p>	<p>BARRY WILLIAMS Totally 70s // Ch. 7</p>	

[GET OUR NEWSLETTERS](#)

[About Us](#) | [Auto Dealers](#) | [Partners](#) | [Retailers](#) | [Affiliates](#) | [Careers](#)
[FAQs](#) | [Manage Account](#) | [Contact Us](#) | [Site Map](#) | [Terms and Conditions](#) | [Privacy Policy](#) | [Canada](#)

SIR Ex. 19

JAY-Z

SHOW ME WHAT YOU GOT

R&R/BDS Urban: D39*-14*! +1415! - #1 Most Increased!

M.Base Urban: D # 16*! +1156 - #1 Great. Gainer!

R&R/BDS Rhythmic: D29*! +586 - #1 Most Increased!

M.Base Rhythmic: D31*! +941 - #1 Great. Gainer!

**#1 Most Added at Rhythm for 2 Weeks!!!
Most Added at Pop Again!!!**

Over 40 Total Pop Stations Including:

**KIIS, WKSC, KHKS, WIOQ, KZZP, KHTS, KSLZ, WKST, KDND, WNOU,
WKFS, WPRO, WEZB, WKSS, CKEY, XM20, Sirius XM & More!**

On 60 Total Rhythm Stations Including:

**KPWR, WBBM, KYLD, KMEL, WPGC, WPHI, WRDW, WBTS, KBXX, KPTY, WJMN,
WLLD, KQKS, KVEG, KLUC, KBMB, WPYO, XHTZ, XMOR, KUBE and more!**

ADDED TO  **playing every hour**



Jams



MySpace Stats: Over 1 Million Profile Views!

KINGDOM COME 11.21.06



SIR Ex. 19

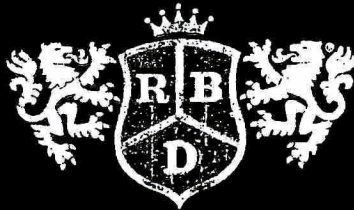

TU AMOR



IMMEDIATE ACTION AT POP & RHYTHM RADIO INCLUDING

- | | | | |
|----------------------------|-------------------------|---------------------------|-----------------------|
| Z100 New York | KIIS Los Angeles | WPOW Miami | XHTZ San Diego |
| KHKS Dallas | WKSC Chicago | KXJM Portland | KWIE Riverside |
| WIHT Wash. DC | KHTS San Diego | KLUC Las Vegas | KVEG Las Vegas |
| KXXM San Antonio | KELZ San Antonio | KKWD Oklahoma City | KSEQ Fresno |
| KZHT Salt Lake City | WEZB New Orleans | KPRR El Paso | |
| KRQQ Tucson | SIRIUS HITS 1 | | |

AND MANY MORE!

OVER 1.5 MILLION ALBUMS SOLD IN THE U.S. (OVER 5 MILLION WORLDWIDE)

FIRST ENGLISH LANGUAGE ALBUM IN STORES 12/26

WWW.RBDUS.COM WWW.MYSPACE.COM/RBD WWW.VIRGINRECORDS.COM

© & © 2006 Televisa S.A. de C.V. Bajo Licencia Exclusiva a EMI Music México, S.A. de C.V., in the United States to Virgin Records America, Inc. All rights reserved. RBD® Televisa, S.A. de C.V. © All rights reserved 2006.



and all rights reserved are property of Yair Dozi International GmbH and Cris Morena Group S.A. De C.V. All rights reserved 2006 under sublicense of Televisa S.A. de C.V.

GUEST OPINION: OPEN THE PLAYLIST

LAST WEEK, FARSHID ARSHID, HONCHO AT ATTICA SOUND, WAS ASKING WHY A STATION WOULD DROP ONE OF ITS MOST REQUESTED SONGS, AND ALSO WONDERING WHY REACTIVE SONGS DON'T BECOME FULL-TIME ADDS. HIS ANSWER...?

It's the result of a disconnect between the people in charge (their personal tastes and opinion) and the listenership! The results of this disconnect, I believe, can be seen in the low ratings of Alternative in Arbitron numbers in almost every market in the country, and in their dwindling profits. Rather than a bitch session on "Why My Single Didn't Get Added," this an observation on Alternative radio in the U.S., which is going through its most confused time—but not because the music doesn't exist. The reason is that the gatekeepers are not heeding the signs of changing times.

What we hear on Alternative radio today reminds us of what used to be alternative. But the musical tastes of the demographic targeted by Alternative stations are changing: take a lesson from your Urban competitors in the radio market. Their advertising profits have skyrocketed NOT because they cater to an urban demographic. On the contrary, their listenership consists largely of suburban whites, and their profit comes from the middle-American beer money your GMs fight so hard to capture. Why? How? The answer is they play what these kids want to hear, what they're engulfed in at school, and the stars they emulate: Hip-Hop artists, the rock stars of the new generation. The Mash-up of Hip-Hop and Rock is the self expression of new white America. Specialty shows like "Skratch N' Sniff" are in the forefront of this trend. It's the new sound we've all been waiting for. It's not dated.

A most reactive and requested song that is dropped to "make room for a song" or other similar reasons doesn't make sense. Doesn't playing what people react to and want to hear ultimately increase listenership, drive up revenues, and ratings? My point is simple: just pay attention to your listenership and where you are in this great country we call America. Open the playlist. Give younger and new bands that make sense and work hard a chance! Your listeners will tell you who that is—and don't be surprised if it's not the bands that hearken back to the Brit-pop and new wave or the grunge era you associate with "Alternative."

I hope that my epiphany triggers action that might return the format we call Alternative back to its former glory—both musically and economically. And feel free to send me your thoughts and hate email at farshid@arshident.com. ■



ALT DOGGIE CORNER

Just in time for Halloween, meet Dread Pirate Sadie... a.k.a. Doggie Barko. She's the adopted sweetheart of Kris Gillespie of Domino Records, who says Sadie is all bark and no bite. "If you scratch her belly, she's your friend for life."

Send your photo to dawg@thesandsreport.com

Mailing Address: The Sands Report • 401-F Miller Avenue, Suite 147 • Mill Valley, CA 94941

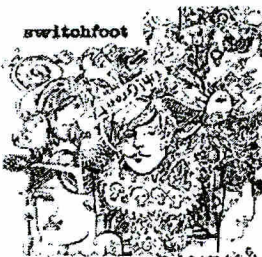

switchfoot

Oh! Gravity..

switchfoot.com
MySpace.com/switchfoot



On Early: KTBZ, DC101, 91X, KNRK, KWOD, KVGs, WLUM, WEND, WROX, WRAX, KUCD, WGRD, KQXR, SIRIUS

US HEADLINING TOUR NOW

COLUMBIA



STREET TALK

by **KEVIN CARTER**
 kcarter@radioandrecords.com

DAILY

If you experienced transmission problems, please call our Circulation Department at 310-789-1625

INSIDE

First, The Atom. Now, Scientists Successfully Split Universal Motown In Two

Derrick Brown Escapes Denver Snow For DC, Where, Oops, Never Mind

Mancow Featured On America's Most Wanted. No, It's Not About Him, Stupid

Please Call 98 Rock And Say Something Clever; They Can't Do This Alone

Tonight, On Coast To Coast AM: 'Those Damn Aliens Stole My Pants, Honey!'

Universal Motown Meets Universal Republic

After weeks of rumors and speculation, ST Daily has learned that Universal Motown Records Group will indeed be splitting into two separate, fully functioning entities: Motown Records President **Sylvia Rhone**, who was also Exec. VP of Universal Records, will now be President of Universal Motown, and current Universal President **Monte Lipman** will be President of the new Universal Republic Records. Until 2000, Lipman had been President of Republic Records (Chumbawumba, anyone?), which he started with his brother, Avery. Republic was later sold to Universal, and Monte was elevated to President of Universal.

The extensive roster of multi-genre UMRG artists will now be divided between these newly formed labels: Universal Republic will now be home to many of the acts Lipman has been personally involved with, such as **Jack Johnson, Godsmack, 3 Doors Down, Damian Marley, Don Omar, Elton John and 10 Years**, as well as **Nina Sky, Tamar** and the recently signed **Prince**.

Universal Motown's artists will also span multiple genres: **Nelly, Stevie Wonder, Lindsay Lohan, Michael McDonald, Blue October, Jojo, Chamillionaire, Erykah Badu, India.Arie, Akon, Lil' Wayne, David Banner** and **The Mars Volta**, as well as the **Cash Money** and **Blackground** imprints.

Both labels will operate with separate, dedicated promotion, A&R, marketing and publicity staffs, but will continue to share back-office functions such as legal and finance. Rhone and Lipman will continue to report to UMRG Chairman/CEO **Mel Lewinter**.

Mr. Brown Goes To Washington

Man, that headline never gets old, does it? Veteran PD **Derrick Brown** is back in the game as the new PD of Radio One Urban **WKYS/Washington**. Brown most recently programmed Infinity Urban Oldies **KDJM/Denver** until it flipped to Country as **KWLI** on Dec. 15. After that, things got weird. Brown is best known for his stint as PD of Cox Urban AC **WHQT (Hot 105)/Miami**, which he took to No. 1. Brown fills the gap created

R&R & NAB: Together Again For The First Time, Dallas, Sept. 20-22, 2006

© 2006 Radio & Records. All Rights Reserved. No part of this material may be reproduced in any form or incorporated in any information retrieval system without written permission of the Publisher.



SHAKIRA



FEATURING WYCLEF JEAN

#1 Phones:

**Impacting POP
and Rhythm NOW**

**KIIS/Los Angeles 60x WXKS/Boston 40x (#2 Phones!)
 KRBE/Houston 40x (Top 10 Phones) Y100/Miami 50x (#2 Phones!)
 KHTS/San Diego 25x KZHT/Salt Lake 40x SIRIUS HITS 1 40x**

ALREADY COMMITTED:
KZZA/Dallas WIOQ/Philadelphia WABB/Mobile

SHE GAVE YOU THE
#1 BILLBOARD HOT R&B SINGLE
DEJA VU

NOW SHE'S BACK WITH THE FOLLOW-UP...

Beyoncé
RING THE ALARM

**MOST ADDED
AT RHYTHM!**

TOP 15 AT URBAN RADIO!
ON OVER 70 STATIONS WITH OVER 2,300 SPINS (+720)
AUDIENCE OVER 29.2 MILLION!

BUILDING AT RHYTHM: **DEBUT 31***
ON OVER 30 STATIONS...
APPROACHING 1,000 SPINS!

AND REACTING AT POP!
LEADERS INCLUDE:

WKCI CKEY WKRZ
WWHT WZNR WAKZ
WKSC WEZB KRQQ
SIRIUS HITS 1 AND MORE!

MUSIC WORLD  COLUMBIA

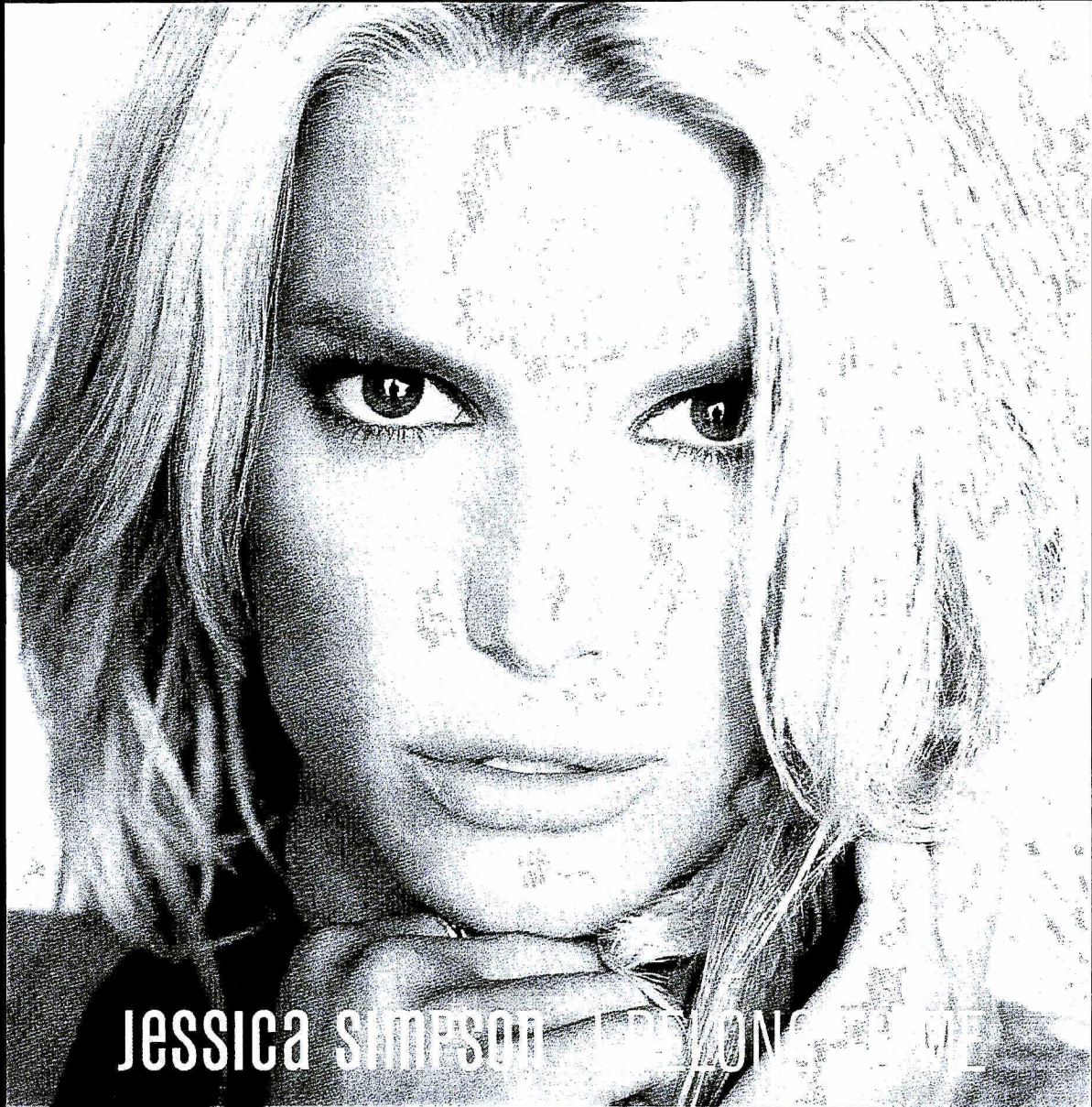

JESSICA SIMPSON I'M A ONE-TRICK HORSE

The New Single
Impacting September 26th

KHKS/Dallas, Sirius Hits 1, WZNR/Norfolk,
WDKF/Dayton, WJIM/Lansing, WSSX/Charleston

PHOTO CREDIT: BRETT RATNER



FMOB

FRIDAY MORNING CHARIEBAG
September 2005

CHR

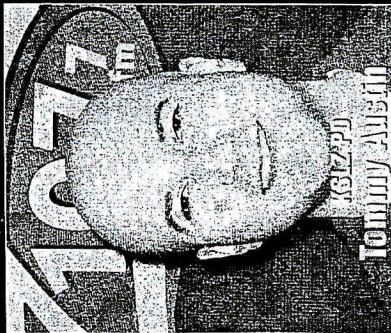

KSZZ PD
Tommy Allison

Rhythm

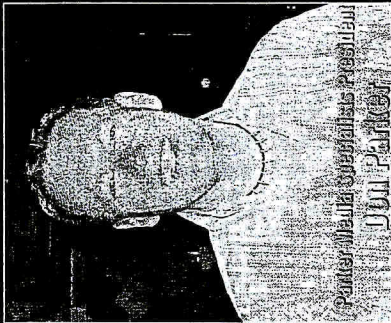

Painter, Media Specialist, President
JIM PARKER

Modern Rock



WLDN PD
Jacob Jackson

Rock



MEDI PD
Jim Kozlowski

ALSO
INSIDE

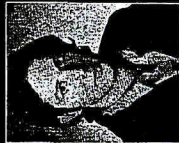

Cover Story
EPIC'S
LEE LEIPSNER



WSPK APD
SkyWalker



KIMBY PD
Byron Cooke

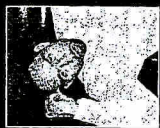

Rhythm Artist To Watch
Johna Austin

**NICK LACHEY
I CAN'T HATE
YOU ANYMORE**

On Over 70 Pop Stations Including:
Z100 WPRO WINGI KBND WKSS WKFS WKXS KHHS KDWB Sirius Hits 1
KMXV WFAW KBKS WLHT WSTR WVVQ KHKS KZZP KELZ XM 20on20

Follow Up Single To The Top 5 Multi-Format Smash, "What's Left Of Me"
EP *What's Left Of Me* Certified Gold
Tour Kicks Off This Fall
BDS: 40*-37 Mediabase 40*-36

nicklachey.com
liverrecords.com

MTV Add
TRL
iVY

SIR Ex. 20

**THIS EXHIBIT CONTAINS
CONFIDENTIAL INFORMATION AND
THEREFORE WAS NOT INCLUDED.**

SIR Ex. 21

**THIS EXHIBIT CONTAINS
CONFIDENTIAL INFORMATION AND
THEREFORE WAS NOT INCLUDED.**

SIR Ex. 22

**THIS EXHIBIT CONTAINS
CONFIDENTIAL INFORMATION AND
THEREFORE WAS NOT INCLUDED.**

SIR Ex. 23

**THIS EXHIBIT CONTAINS
CONFIDENTIAL INFORMATION AND
THEREFORE WAS NOT INCLUDED.**