

Copyright Office fees are subject to change.
For copyright Office
web site Copy-

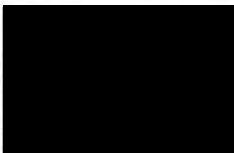

REGISTRATION NUMBER

DVH 0394

DATE OF REGISTRATION/PUBLICATION

10 **07** **08**
Month Day Year

DO NOT WRITE ABOVE THIS LINE. IF YOU NEED MORE SPACE, USE A SEPARATE CONTINUATION SHEET. (Form D-VH/CON)

1
TITLE

Please give the make and model of the vessel that embodies the design.

Stratos 1750DV

2
DESIGN

(a) What is the type or style of the design for which registration is sought?

Fishing Boat

(b) Provide a brief general statement setting forth the salient features of the design.

The features relate to the design of the deck and the configuration of the vessel hull.

Check here if this is a single design.

Check here if registering more than one design. Use Form D-VH/CON for additional designs.

(c) If this design is derived from an earlier design, describe how that design has been revised, adapted, or rearranged.

The design of the hull and the deck are new.

3
DESIGNER(S)

Provide the name and address of the designer(s). The name of the employer may be given instead of the designer(s) if, (1) the design was made within the regular scope of employment of the designer(s) and (2) the individual authorship of the design is difficult or impossible to ascribe.

Please check here if those conditions are satisfied and you are providing the employer's name.

Name: Stratos Boats, Inc.

Name:

Address: 880 Butler Road

Address:

Murfreesboro, TN 37127

4
OWNER,
IF NOT
DESIGNER(S)

If the owner is different from the designer(s) or employer named above, provide the name and address of the owner:

Name:

Address:

5
PRIORITY
CLAIM

(a) Was an application for registration of this design identified in an application filed in a foreign country that extends to designs of owners who are citizens of the United States, or to persons filing applications in the United States, similar protection to that afforded in 17 U.S.C. chapter 13?

Yes No

(b) If yes, identify the country and date of application:

Country:

Date of application:

Serial No:

6
DATE MADE
PUBLIC

Was this design made public before the date of application? Yes No

If yes, on what date?

February 1 2008
Month Day Year

DO NOT WRITE HERE
OFFICE USE ONLY

APPLICATION RECEIVED

DESIGN COPIES RECEIVED

FUNDS RECEIVED

JUL 01 2008
7/01/08
7/01/08

EXAMINED BY

FORM D-VH

CHECKED BY

CORRESPONDENCE

 YesFOR
COPYRIGHT
OFFICE
USE
ONLY

DO NOT WRITE ABOVE THIS LINE. IF YOU NEED MORE SPACE, USE A SEPARATE CONTINUATION SHEET. (Form D-VH/CON)

7

CONTACT
PERSON

Please provide the name and address of the person to whom correspondence regarding this application may be directed:

Name: Alpaslan SapmazAddress: 3200 IDS Center, 80 South Eighth Street, Minneapolis, Minnesota 55402Email address: asapmaz@merchant-gould.comFAX number: 612-332-9081Daytime phone: (612) 766-6093

8

DEPOSIT
ACCOUNT

Give the name and account number if the registration fee is to be charged to a Deposit Account established in the Copyright Office:

Name of Account: _____

Account number: _____

9

CERTIFICATION AND
SWORN STATEMENTS**DECLARATION:** The undersigned, as the applicant or the applicant's duly appointed agent or representative, being hereby warned that willful false statements are punishable by fine or imprisonment, or both, under 18 U.S.C. §1001, and that such willful false statements may jeopardize the validity of this application or any resulting registration, hereby declares to the best of his or her knowledge and belief:

- (1) that the design has been fixed in a useful article;
- (2) that the design is original and was created by the designer(s), or employer if applicable, named in the application;
- (3) that those aspects of the design for which registration is sought are not protected by a design patent;
- (4) that the design has not previously been registered on behalf of the applicant or applicant's predecessor in title; and
- (5) that the applicant is the person entitled to protection and to registration under chapter 13 of title 17, United States Code.

Complete if applicable:

The design has been made public with a design notice as prescribed by 17 U.S.C. §1306.

Following is the exact form of the design notice:

Protected Design Stratos Boats, 2008

Where on the useful article is the design notice located?

Transom

If the undersigned is not the applicant, he or she is properly authorized to execute this application on behalf of the applicant.

Signature

Alpaslan Sapmaz

Print or type name

612-766-6083

Telephone number

612-332-9081

FAX number

Date

5/22/08

Attorney

Position or Title

asapmaz@merchant-gould.com

Email address

Copyright Office fees are subject to change. For current fees, check the Copyright Office website at www.copyright.gov, write the Copyright Office, or call (202) 707-3000.Certificate
will be
mailed in
window
envelope
to this
address:

Name ▼

Alpaslan Sapmaz

Number/Street/Apt ▼

3200 IDS Center, 80 South Eighth Street

City/State/ZIP ▼

Minneapolis, Minnesota 55402**YOU MUST:**

- Complete all necessary spaces
- Sign your application in space 9

**SEND ALL 3 ELEMENTS
IN THE SAME PACKAGE:**

1. Application form
2. Nonrefundable filing fee in check or money order payable to Register of Copyrights
3. Design material

MAIL TO:

Dept. D-VH
Vessel Hull Registration
P.O. Box 71380
Washington, D.C. 20024-1380

17 U.S.C. §1327. Penalty for false representation. "Whoever knowingly makes a false representation materially affecting the rights obtainable under this chapter for the purpose of obtaining registration of a design under this chapter shall pay a penalty of not less than \$500 and not more than \$1,000, and any rights or privileges that individual may have in the design under this chapter shall be forfeited."

FIG.

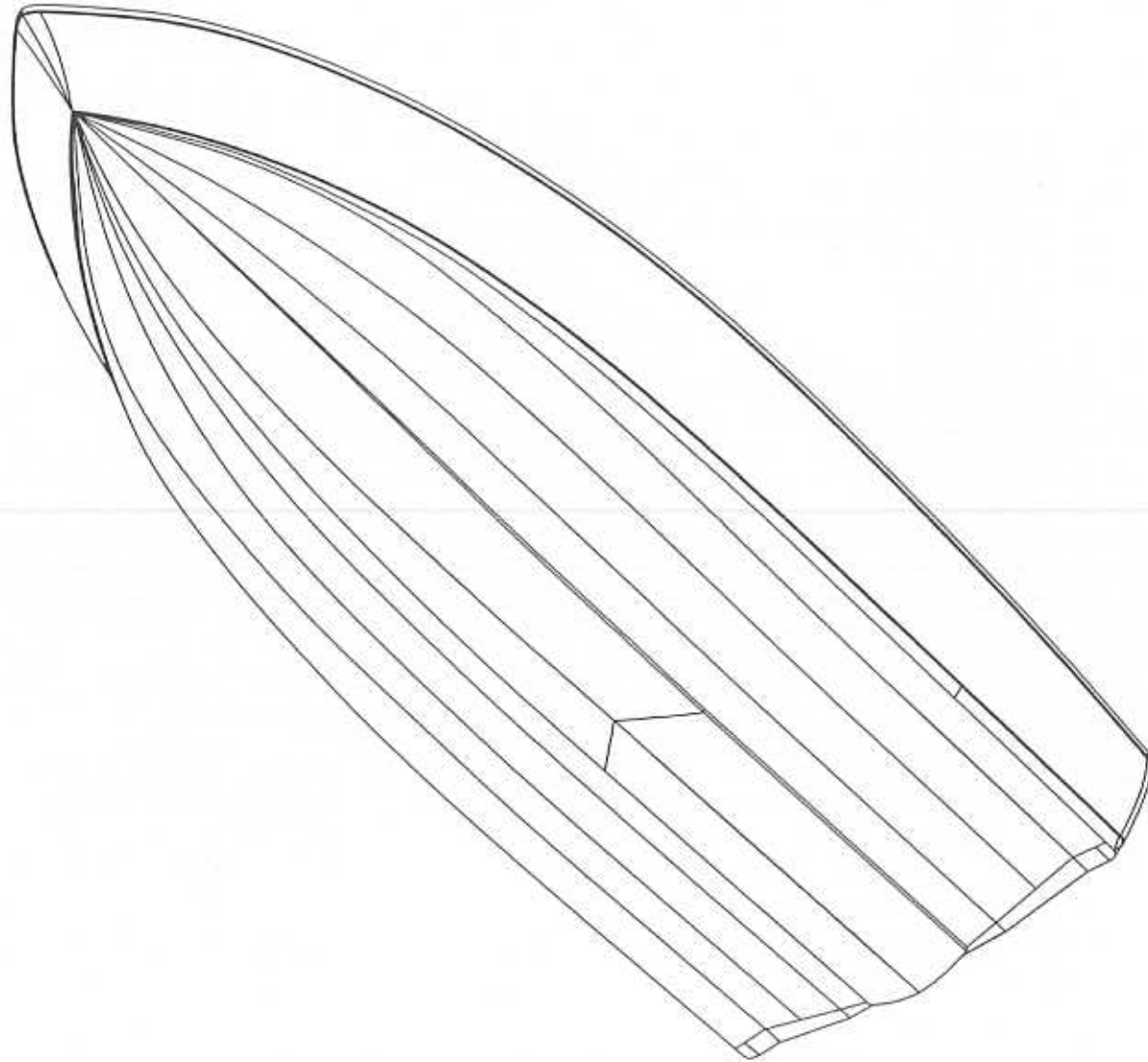

DVH 0394



FIG.

DVH-0394

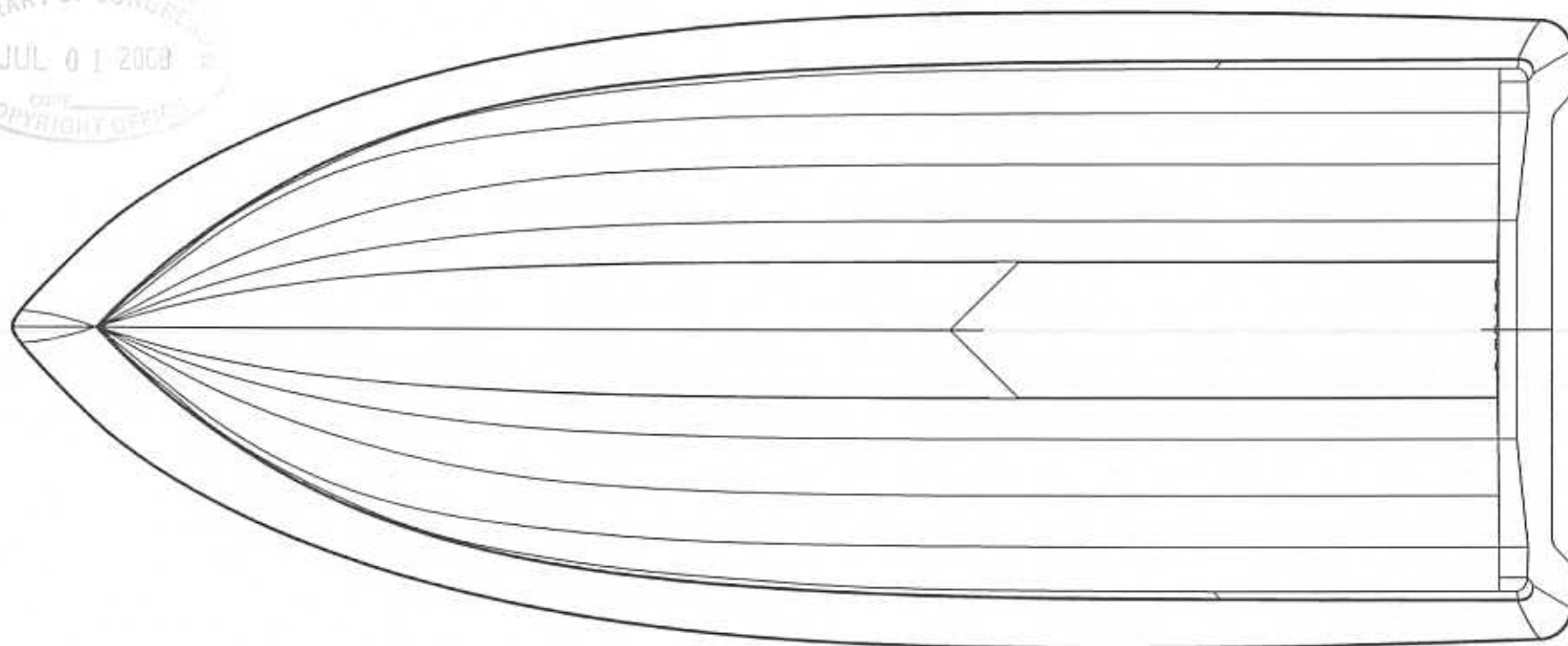

FIG.

DVH 0394

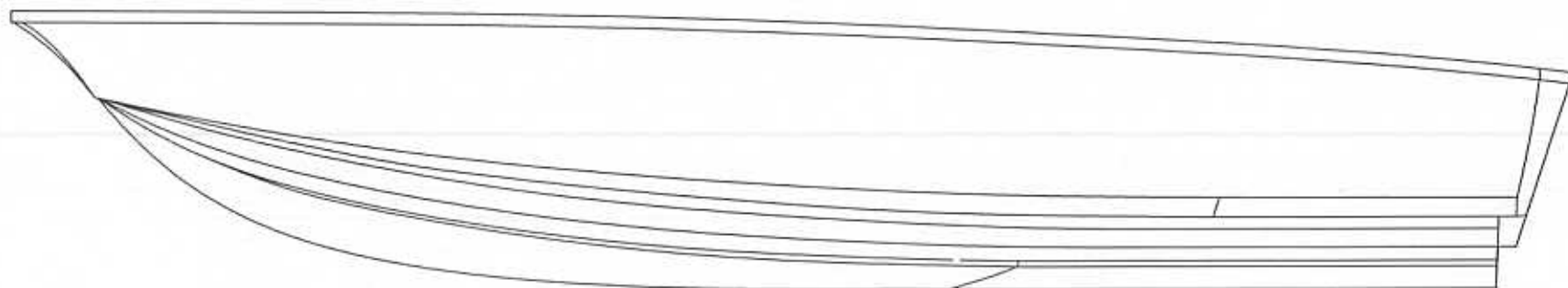

FIG.

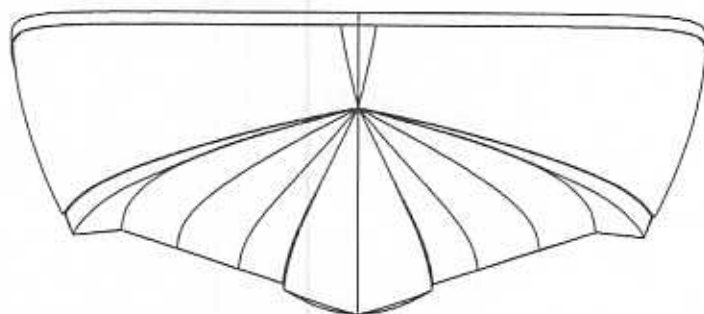

FIG.

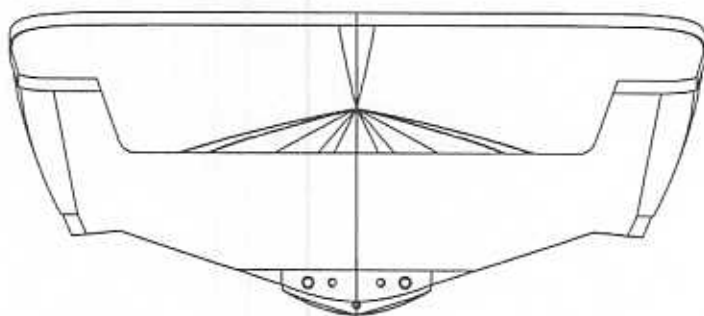
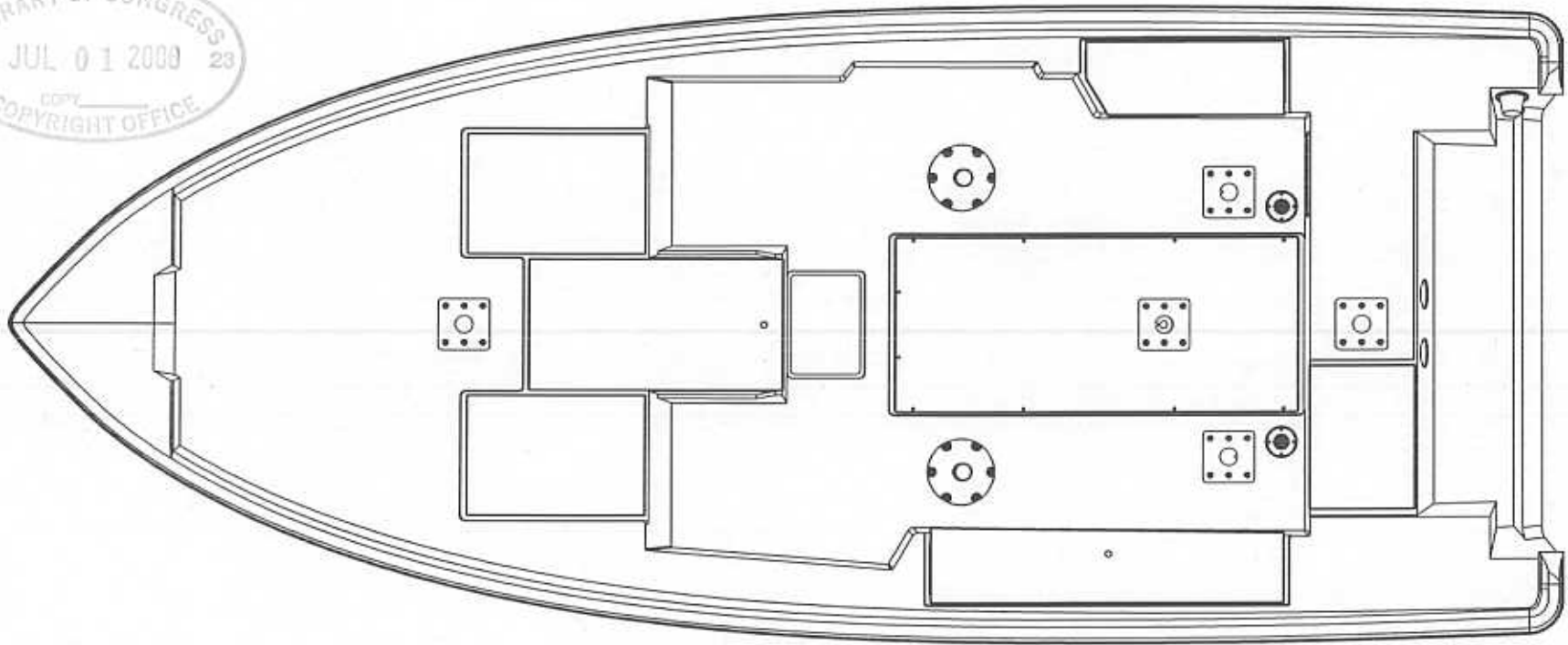

FIG.

DVH 0394





DVH 0394
LIBRARY OF CONGRESS
JUL 01 2008 23
COPYRIGHT OFFICE

DVH 0394

LIBRARY OF CONGRESS

JUL 01 2008

OFFICE
COPYRIGHT



DVH 0394

LIBRARY OF CONGRESS

JUL 01 2008

COPY
RIGHT OFFICE



DVH 0394

LIBRARY OF CONGRESS
JUL 01 2008
COPY
COPYRIGHT OFFICE



CAPACITIES**ROD BOX LENGTH****CAPACITIES/SPECIFICATIONS**

Overall Hull Length 17' 6"
Beam 92"
Inside Depth 20.5"

Transom Height 20"
Total Persons, Motor, Gear (lbs.) 1480
Approximate Boat Weight (lbs.) - Single Console 1490
Approximate Length on Trailer With Swing-Away Tongue Open 20'



DVH 0394



DVH 0394

LIBRARY OF CONGRESS
JUL 01 2009
COPYRIGHT OFFICE

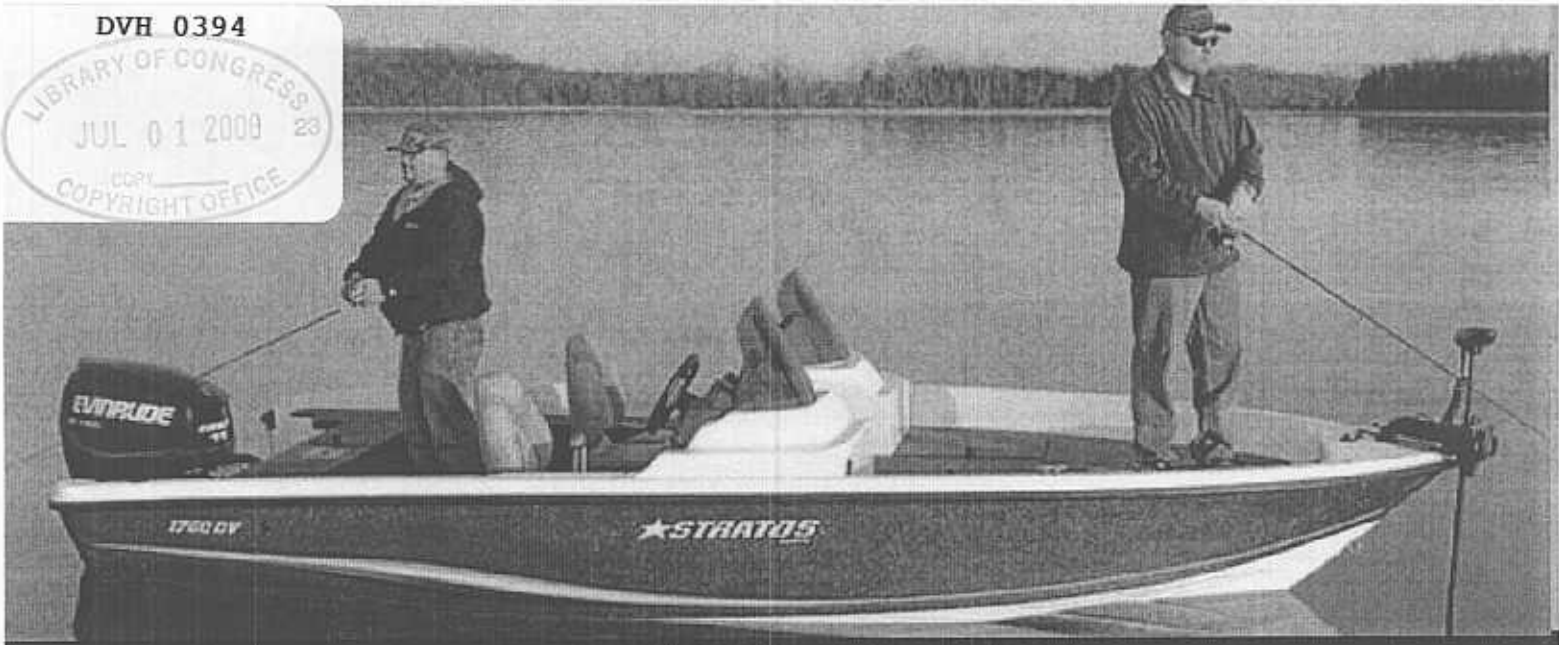

DVH-0394

LIBRARY OF CONGRESS

JUL 01 2009

COPYRIGHT OFFICE

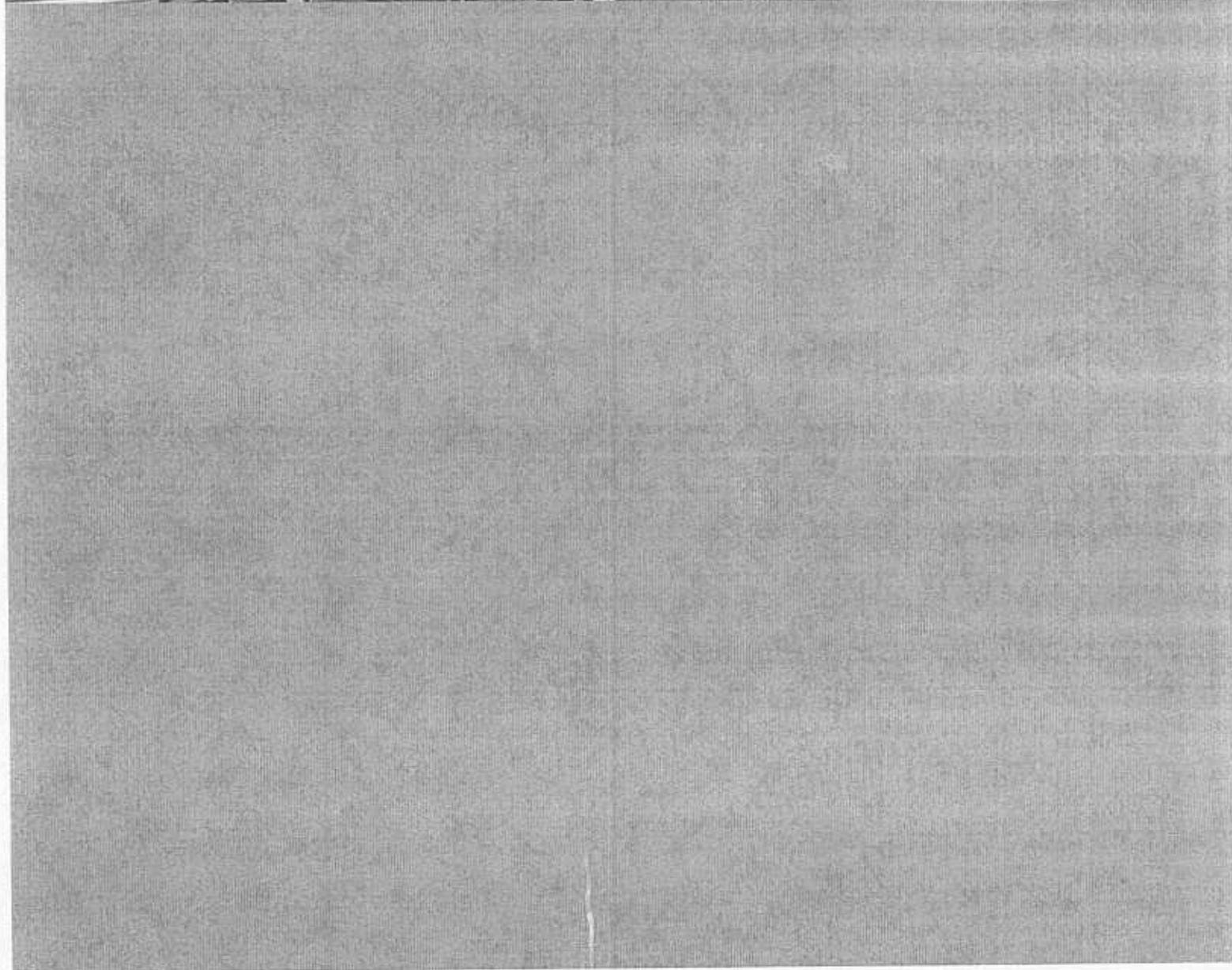



DVH 0394



03/10/2008



DVH 0394

LIBRARY OF CONGRESS
JUL 01 2009 23
COPYRIGHT OFFICE

03/10/2008



DVH 0394

LIBRARY OF CONGRESS

JUL 01 2008

COPYRIGHT OFFICE

03/10/2008

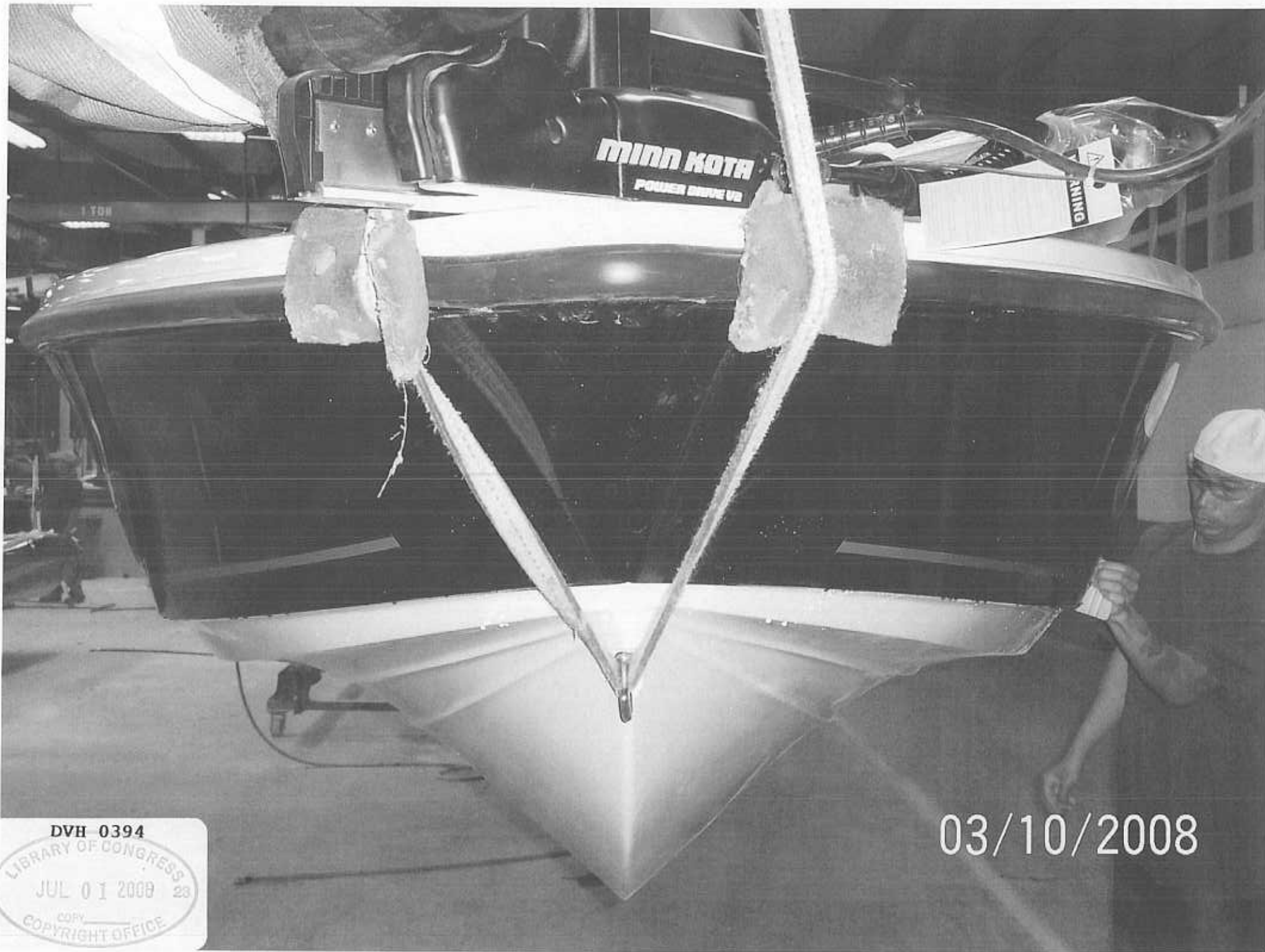

MINN KOTA
POWER DRIVE VR

MINN

DVH 0394

LIBRARY OF CONGRESS
JUL 01 2008 23
COPYRIGHT OFFICE

03/10/2008



DVH 0394

LIBRARY OF CONGRESS
JUL 01 2008
COPYRIGHT OFFICE

03/10/2008



DVH 0394



03/10/2008