

REGISTRATION NUMBER

DVH 0289

DATE OF REGISTRATION/PUBLICATION

Month 04 Day 05 Year 06

DO NOT WRITE ABOVE THIS LINE. IF YOU NEED MORE SPACE, USE A SEPARATE CONTINUATION SHEET. (Form D-VH/CON)

Please give the make and model of the vessel that embodies the design.

AZURE

TITLE

What is the type or style of the design for which registration is sought?

Fiberglass deckboat

DESIGN

Provide a brief general statement setting forth the salient features of the design.

Overall appearance including hull configuration and deck layout

Check here if this is a single design.

Check here if registering more than one design. Use Form D-VH/CON for additional designs.

If this design is derived from an earlier design, describe how that design has been revised, adapted, or rearranged.

Provide the name and address of the designer(s). The name of the employer may be given instead of the designer(s) if, (1) the design was made within the regular scope of employment of the designer(s) and (2) the individual authorship of the design is difficult or impossible to ascribe.

Please check here if those conditions are satisfied and you are providing the employer's name.

DESIGNER(S)

Name: Anthony Kalil

Name: _____

Address: 408 West University Avenue

Address: _____

Gainesville, Florida 32061

If the owner is different from the designer(s) or employer named above, provide the name and address of the owner:

Name: Bennington-Marine Corporation

Address: 52791 C.R. 113

Elkhart, Indiana 46514

OWNER, IF NOT DESIGNER(S)

Was an application for registration of this design identified in an application filed in a foreign country that extends to designs of owners who are citizens of the United States, or to persons filing applications in the United States, similar protection to that afforded in 17 U.S.C. chapter 13?

Yes No

If yes, identify the country and date of application:

Country: _____

Date of application: _____

Serial No: _____

Was this design made public before the date of application? Yes No

If yes, on what date? August 20 2004
Month Day Year

DO NOT WRITE HERE
OFFICE USE ONLY

APPLICATION RECEIVED **SEP 01 2005**
DESIGN COPIES RECEIVED **SEP 01 2005**
FUNDS RECEIVED **SEP 01 2005**

PRIORITY CLAIM

DATE MADE PUBLIC

MORE ON BACK

• Complete all applicable spaces (numbers 7 -9) on the reverse side of this page.
• See detailed instructions. • Sign the form at section 9.

DO NOT WRITE HERE
Page 1 of pages

DVH 0289

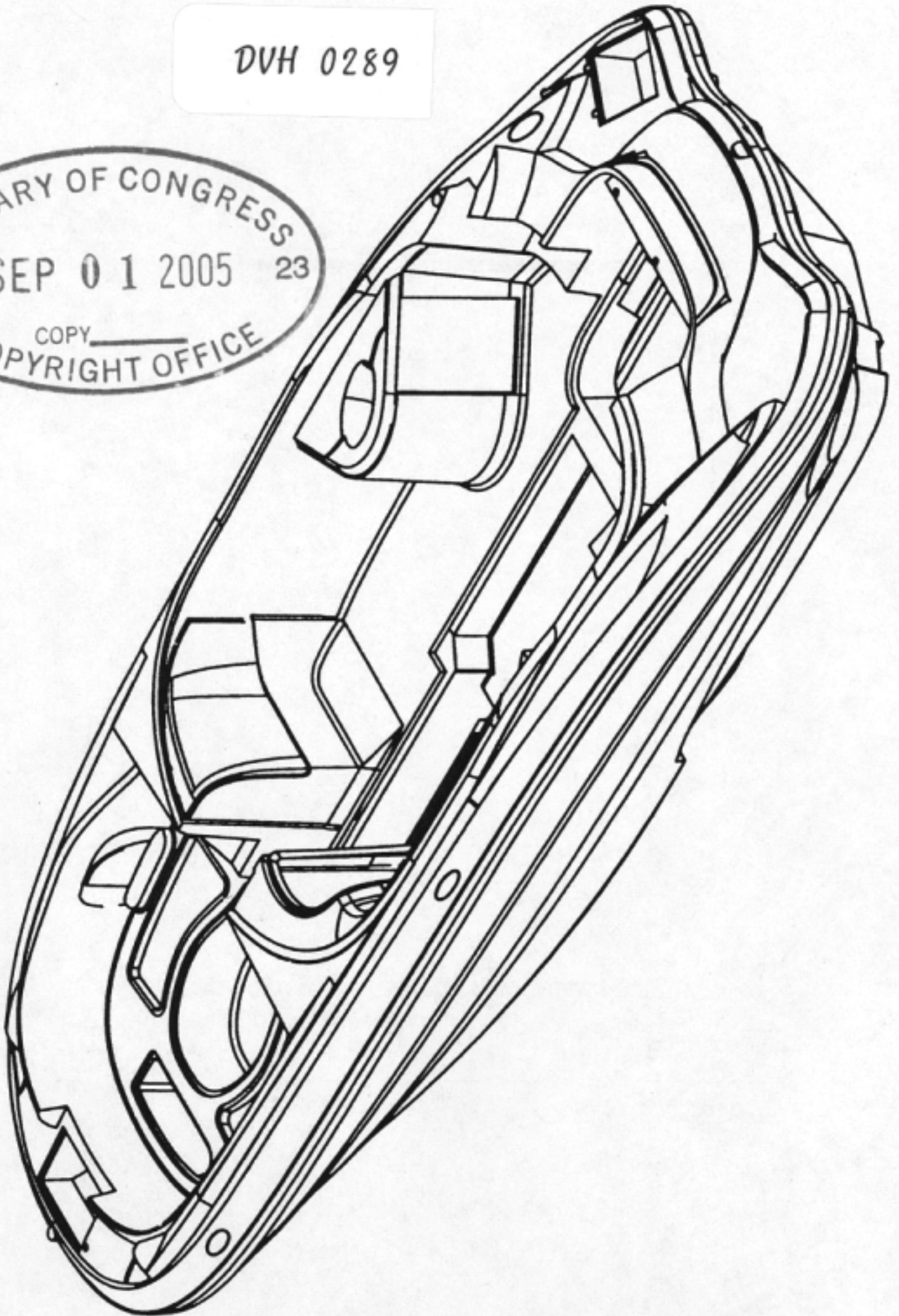
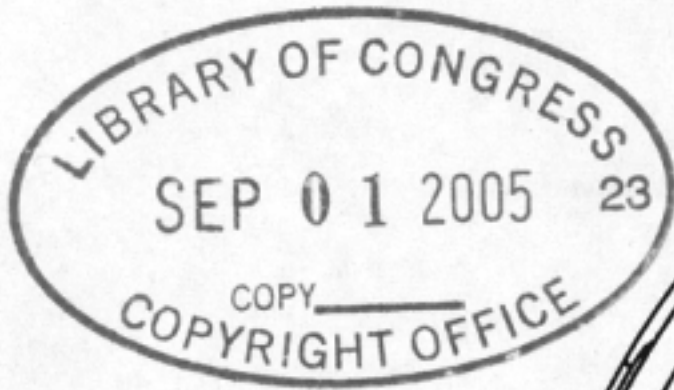

DVH 0289

LIBRARY OF CONGRESS
SEP 01 2005 23
COPY _____
COPYRIGHT OFFICE

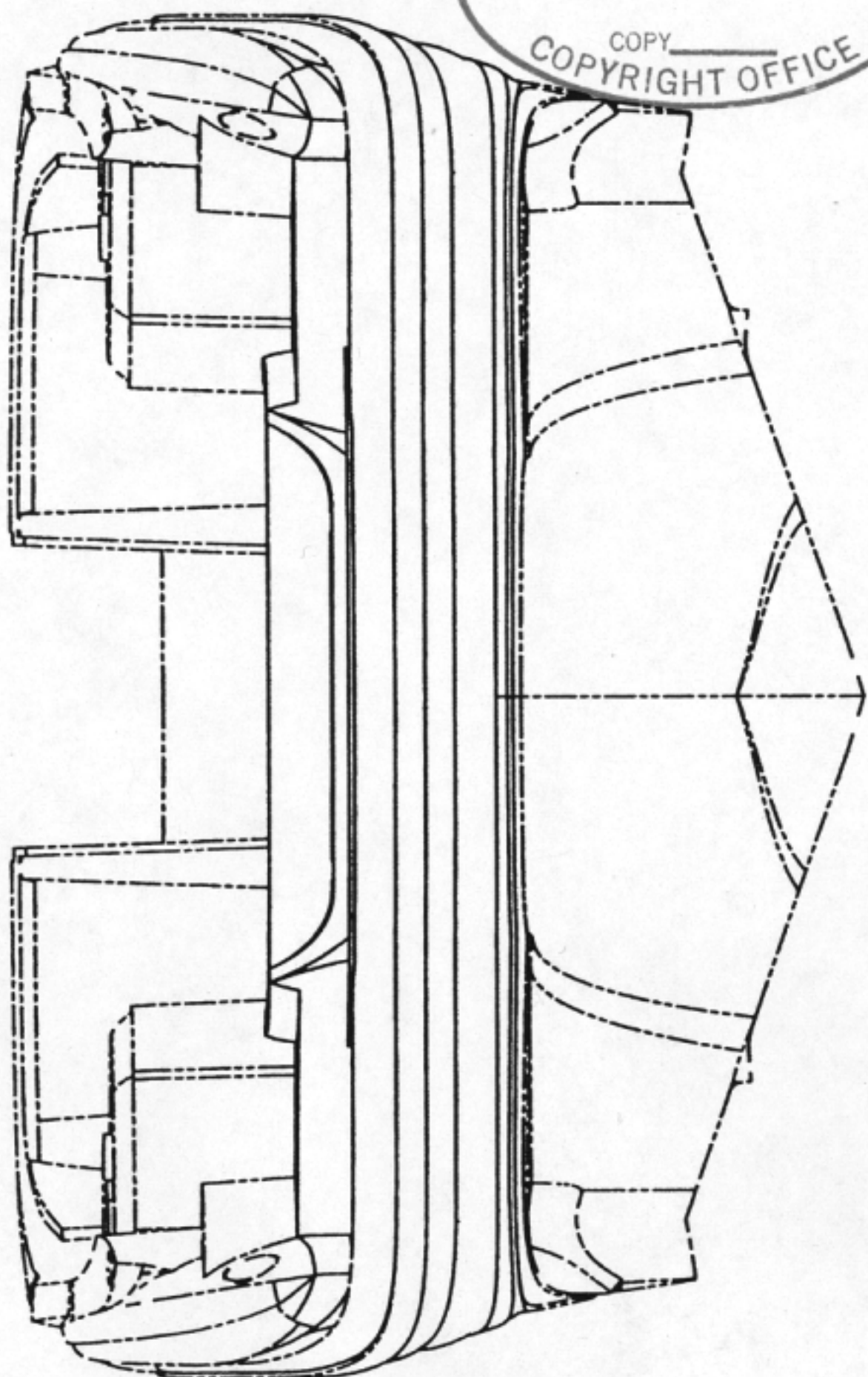

LIBRARY OF CONGRESS
SEP 01 2005 23
COPYRIGHT OFFICE

DVH 0289

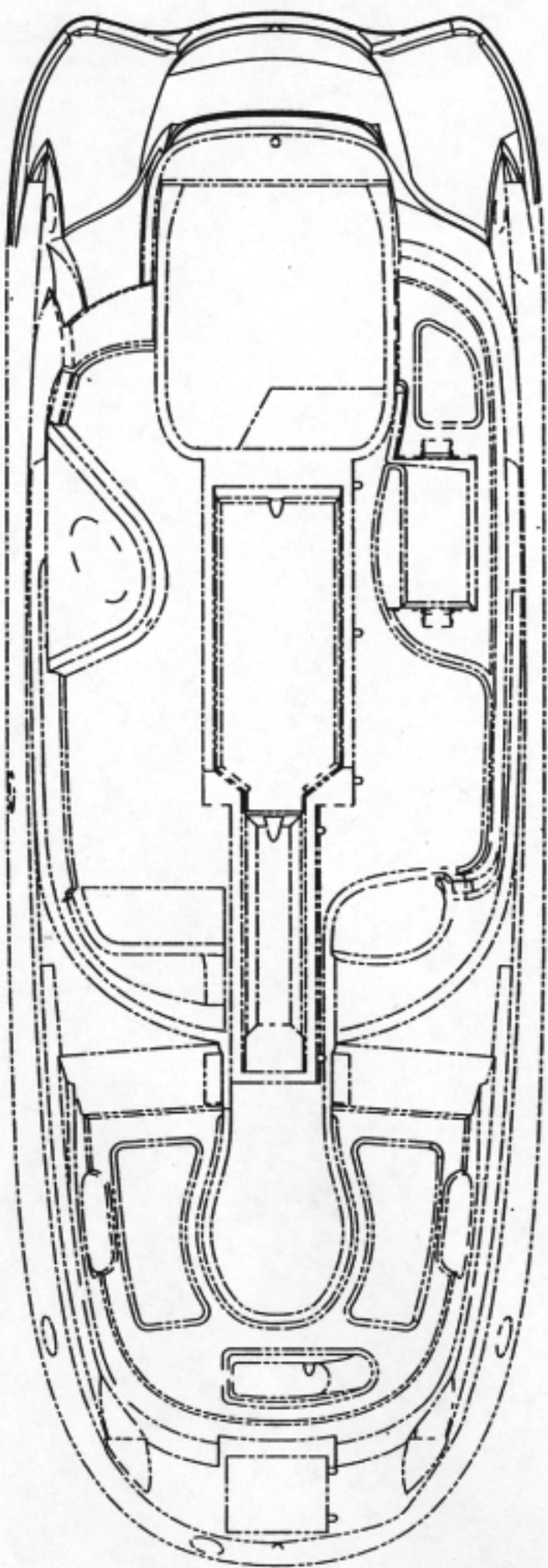

LIBRARY OF CONGRESS
SEP 01 2005 23
COPYRIGHT OFFICE

DVH 0289

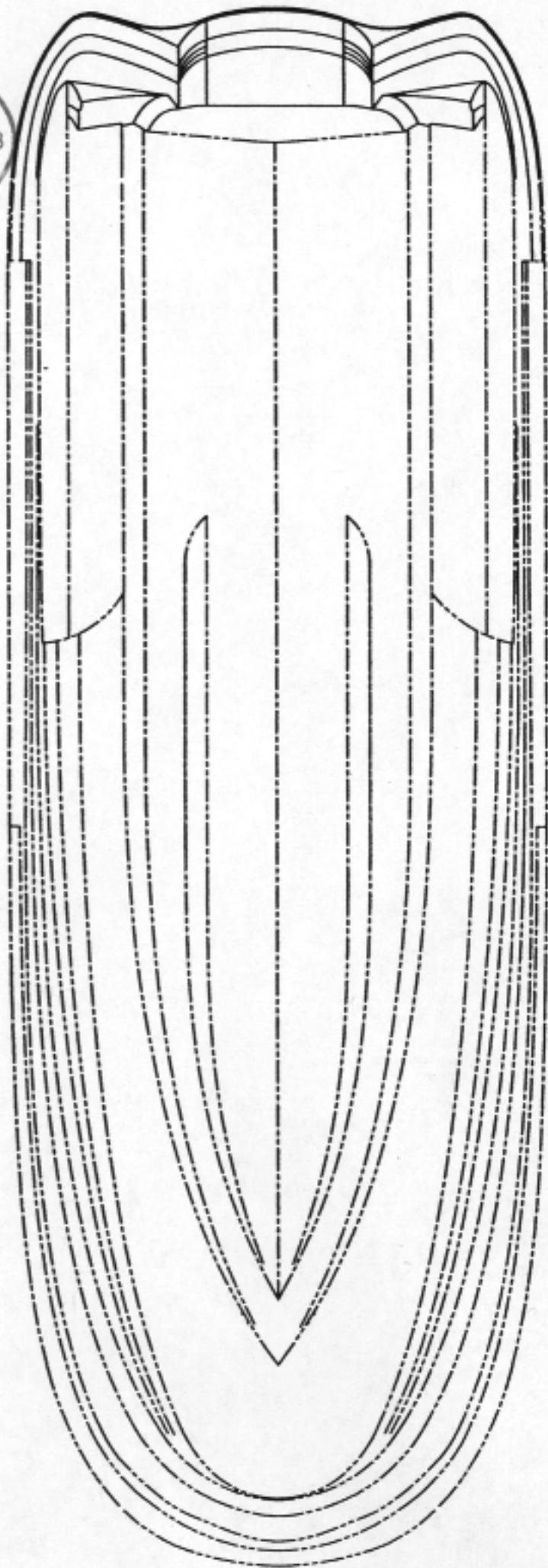

DVH 0289

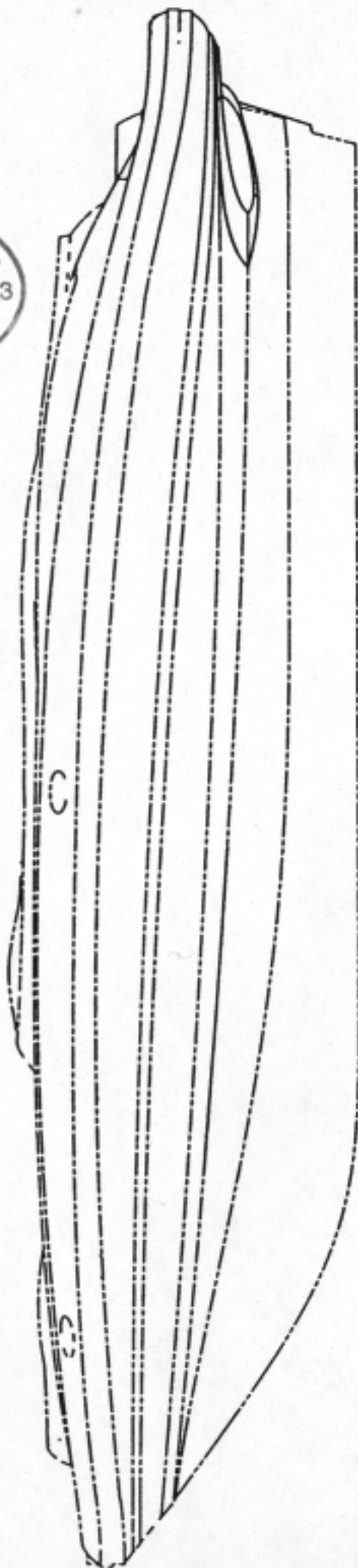
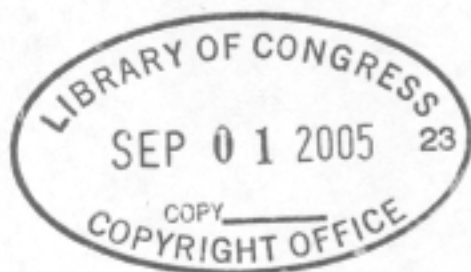

DVH 0289

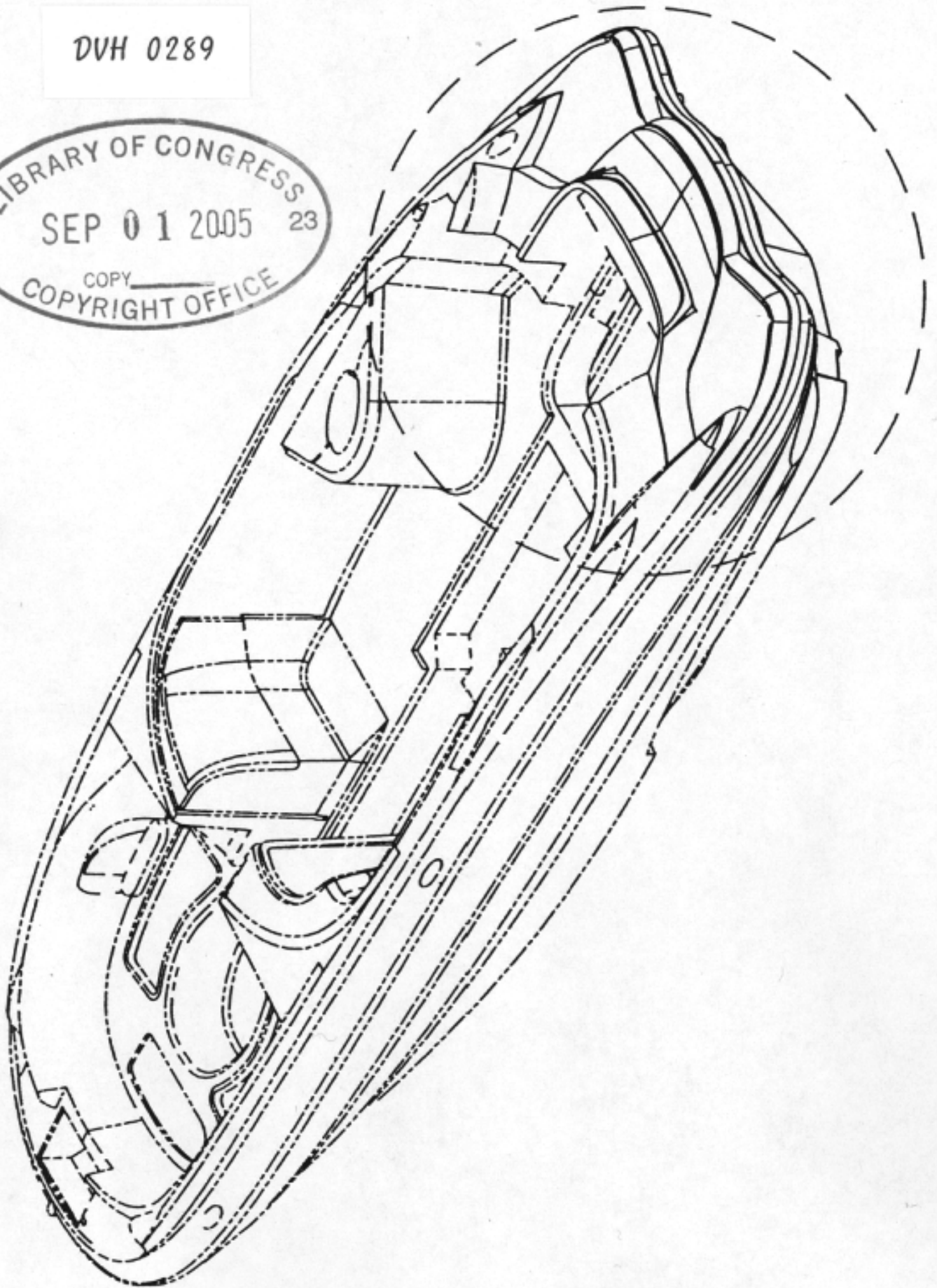
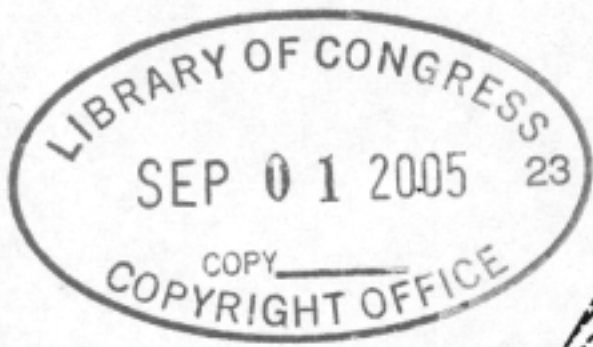

LIBRARY OF CONGRESS
SEP 01 2005 23
COPY _____
COPYRIGHT OFFICE

DVH 0289

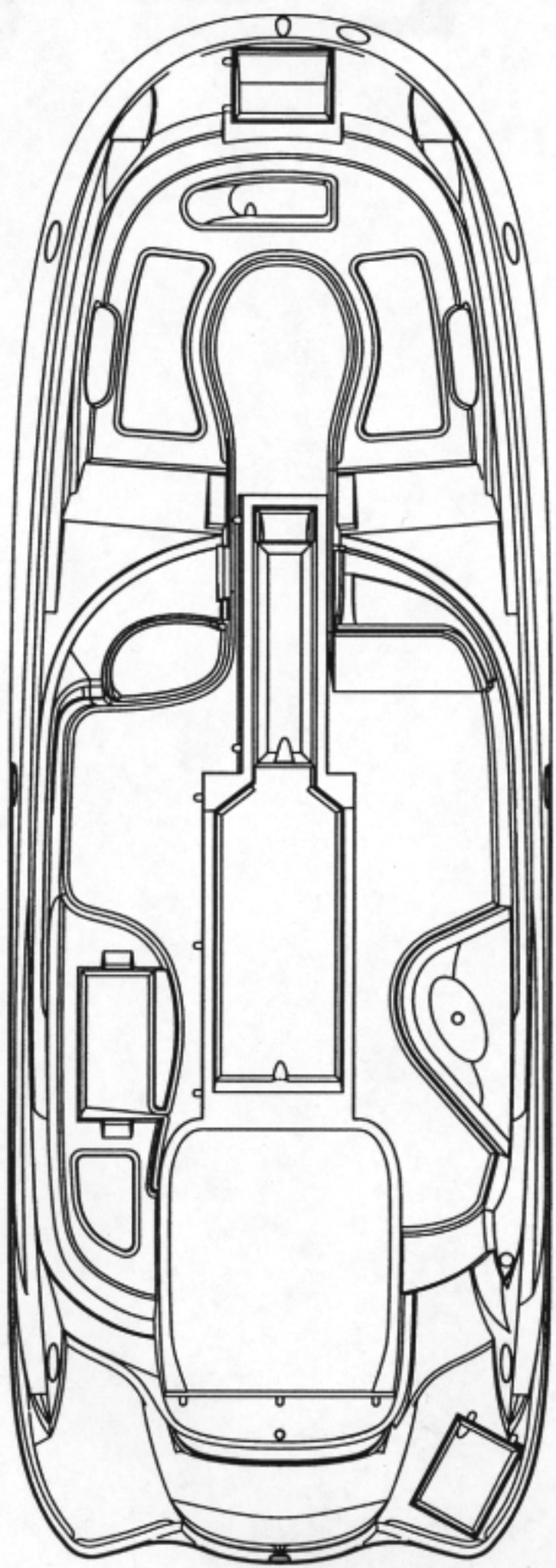

DVH 0289

LIBRARY OF CONGRESS
SEP 01 2005 23
COPY _____
COPYRIGHT OFFICE

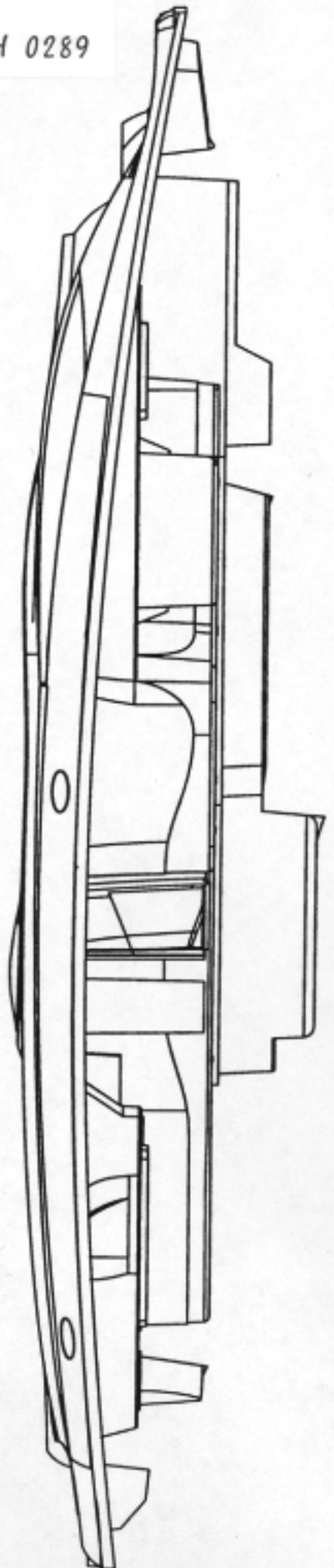
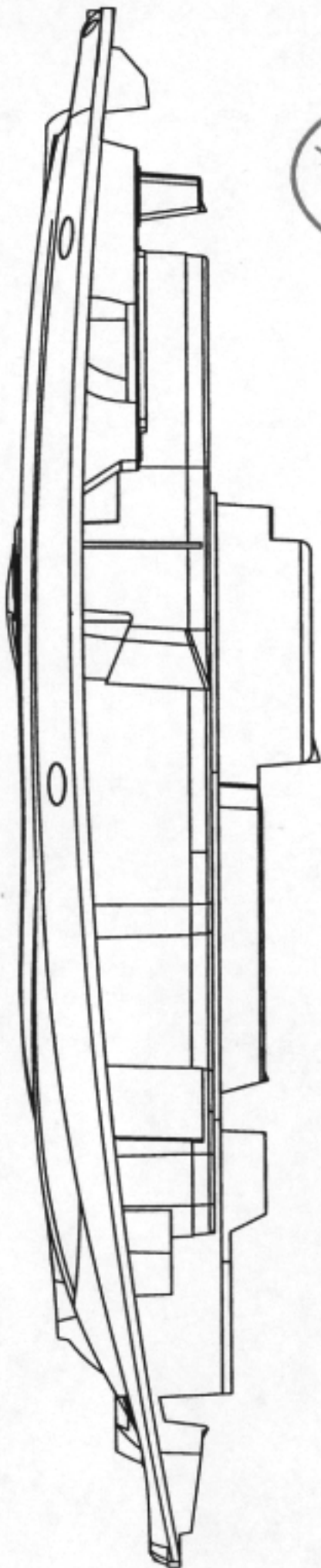

LIBRARY OF CONGRESS
SEP 01 2005 23
COPYRIGHT OFFICE

DVH 0289

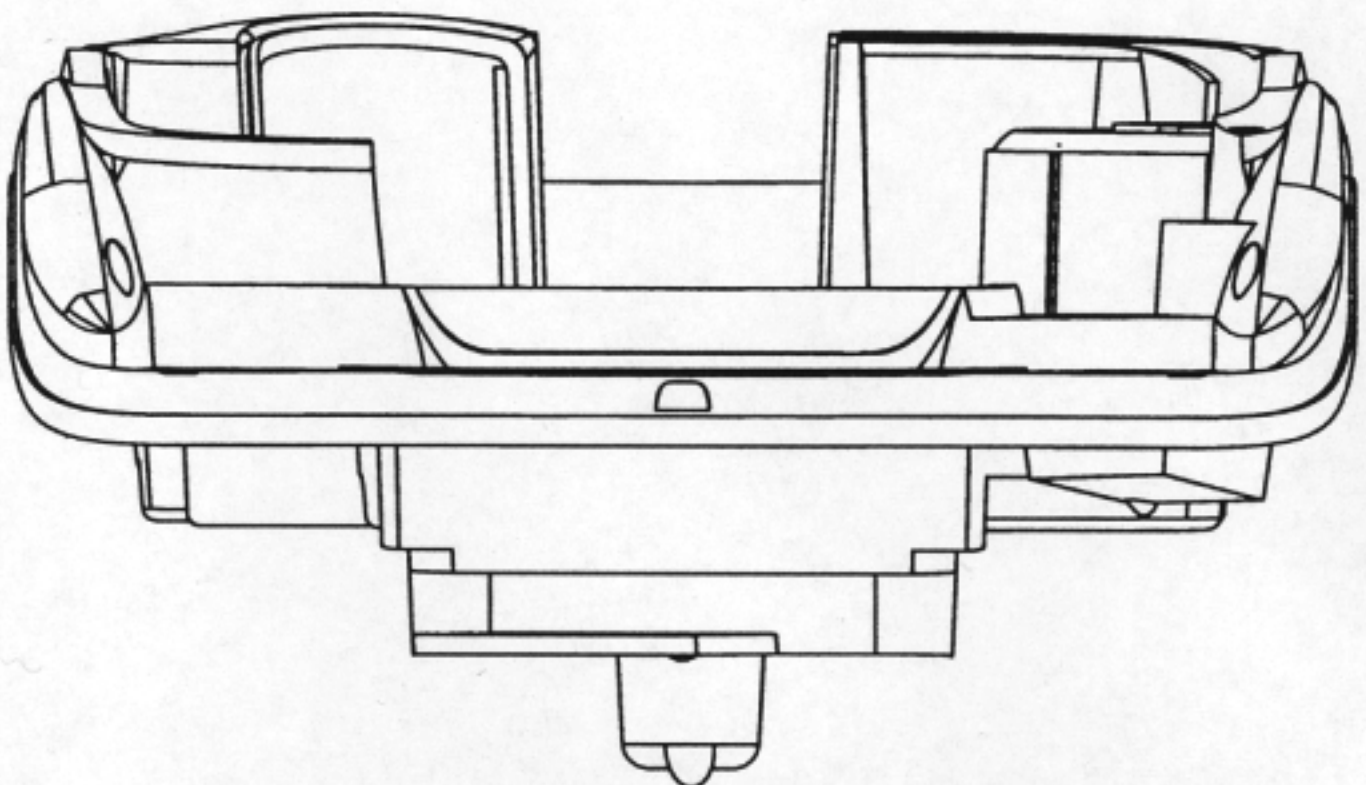
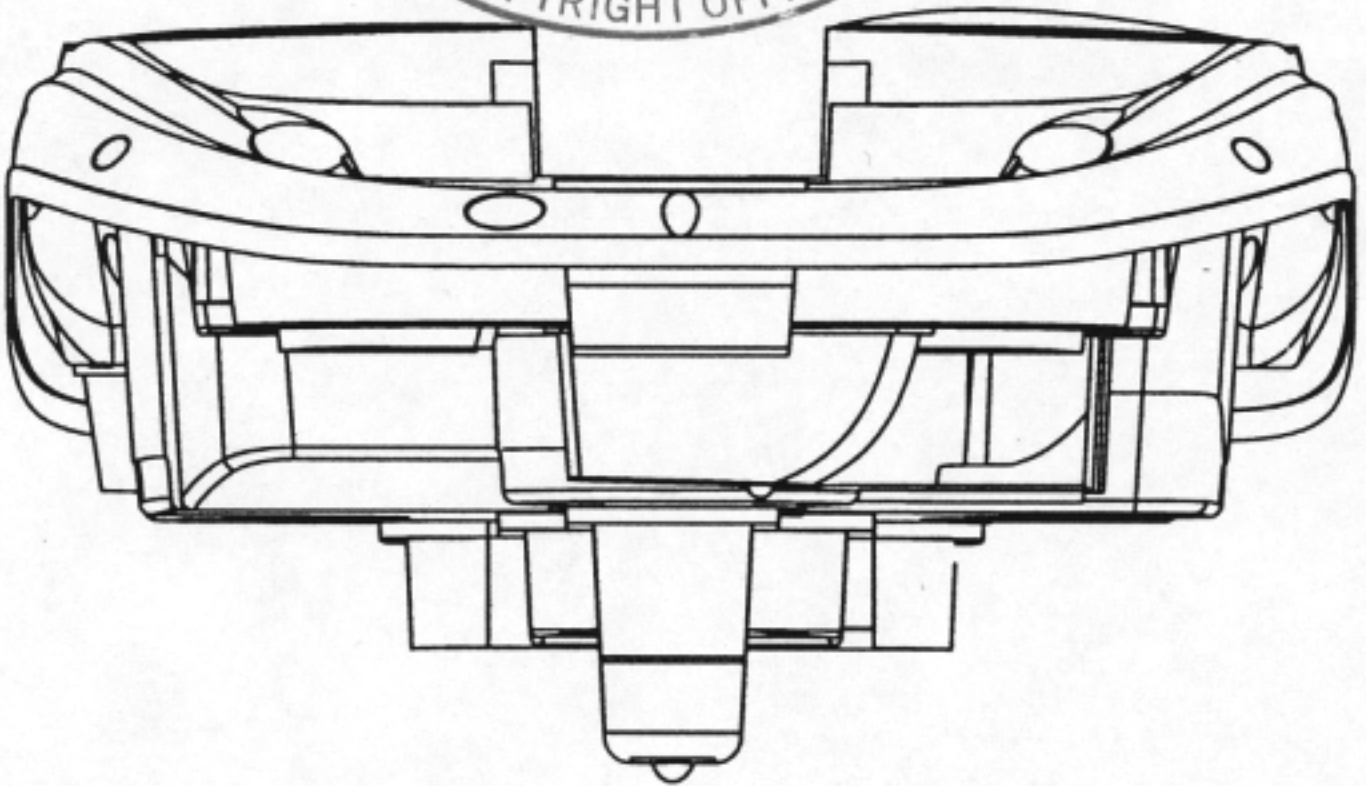

DVH 0289

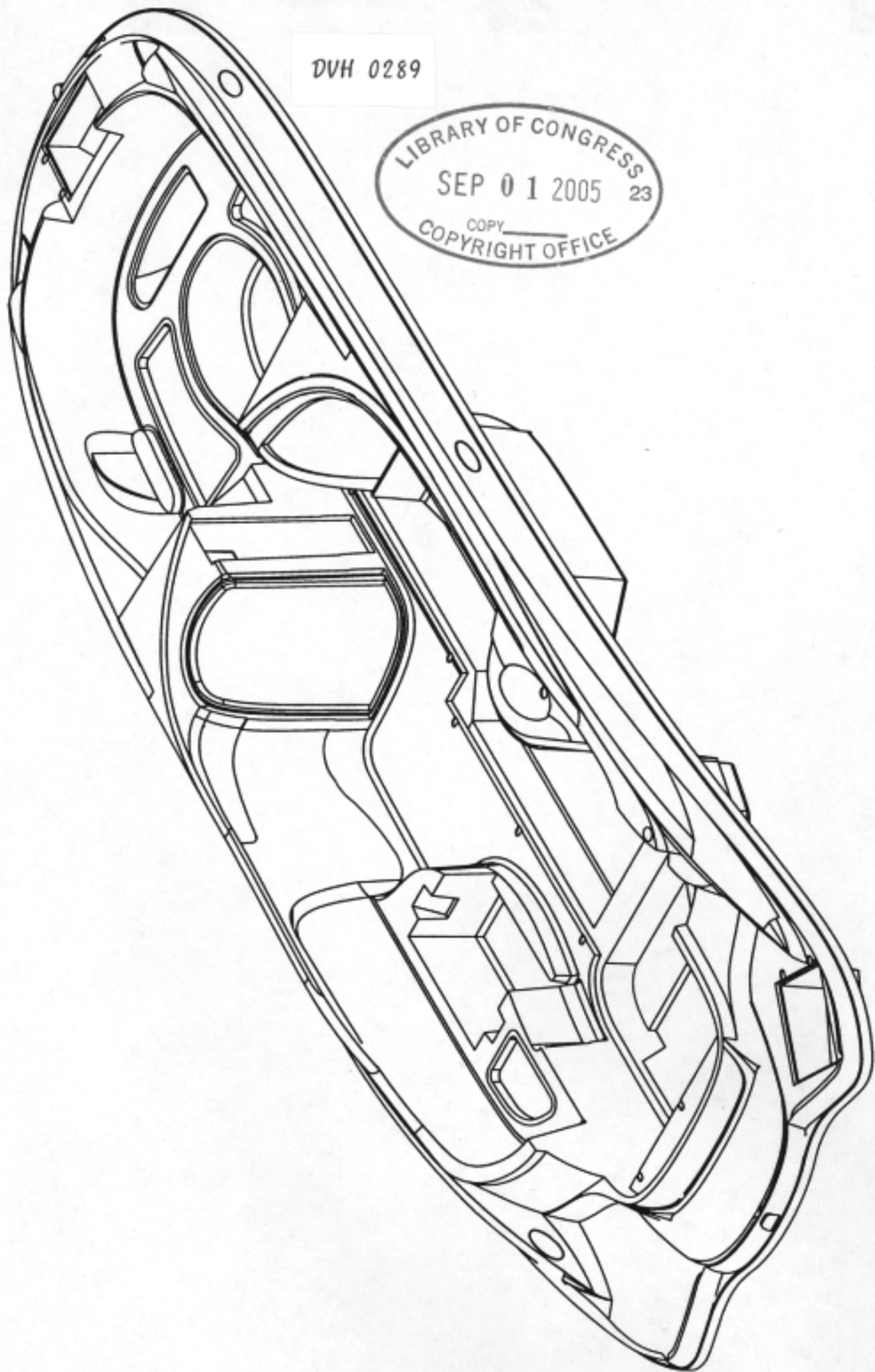

LIBRARY OF CONGRESS
SEP 01 2005 23
COPY _____
COPYRIGHT OFFICE

DVH 0289

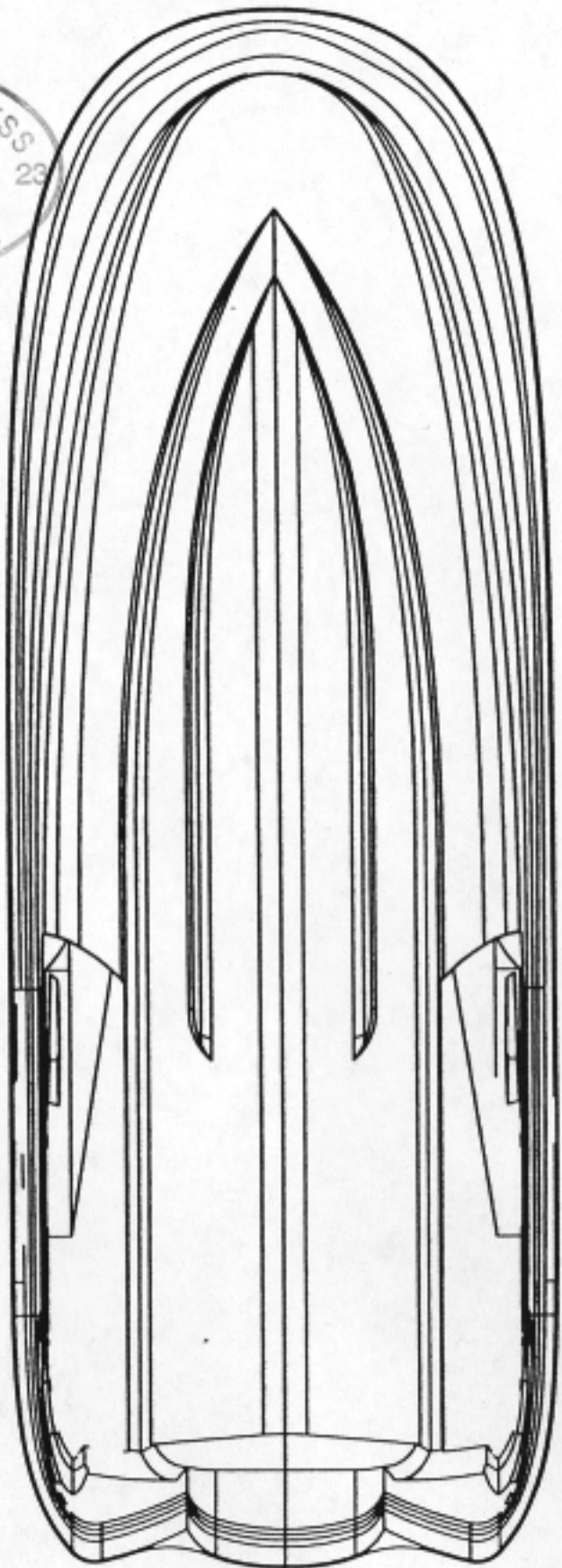
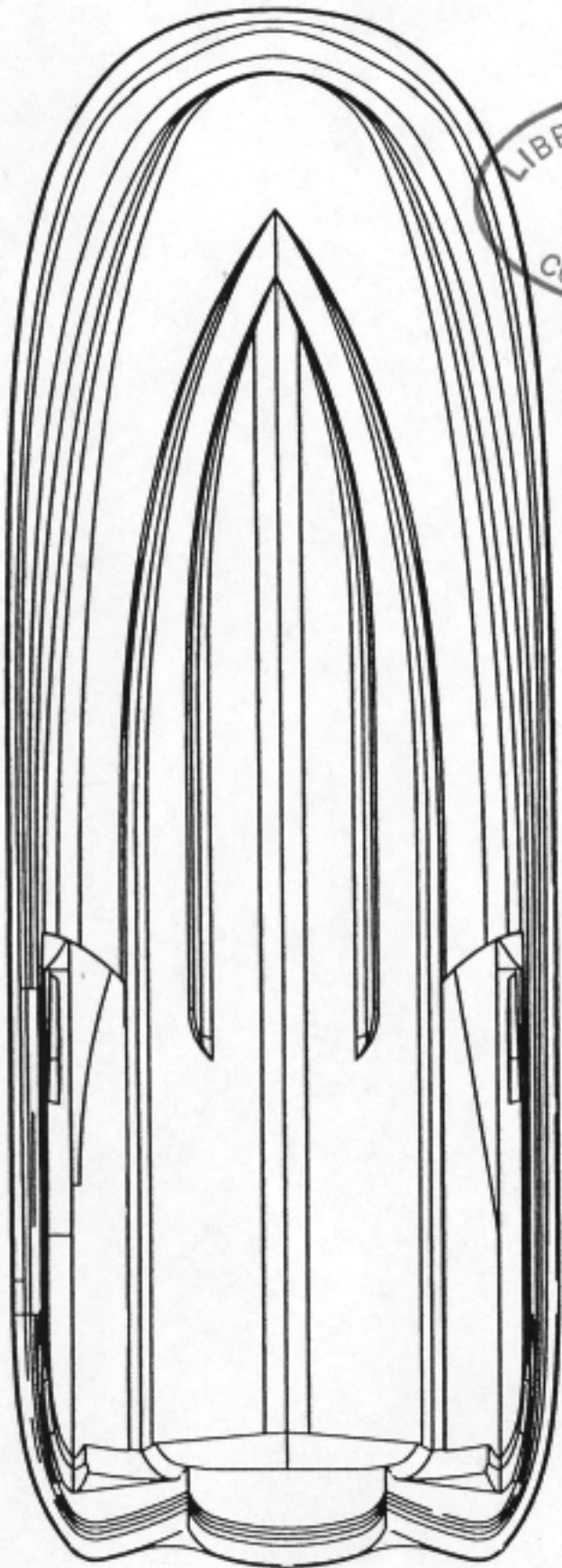

LIBRARY OF CONGRESS
SEP 01 2005 23
COPY _____
COPYRIGHT OFFICE

DVH 0289

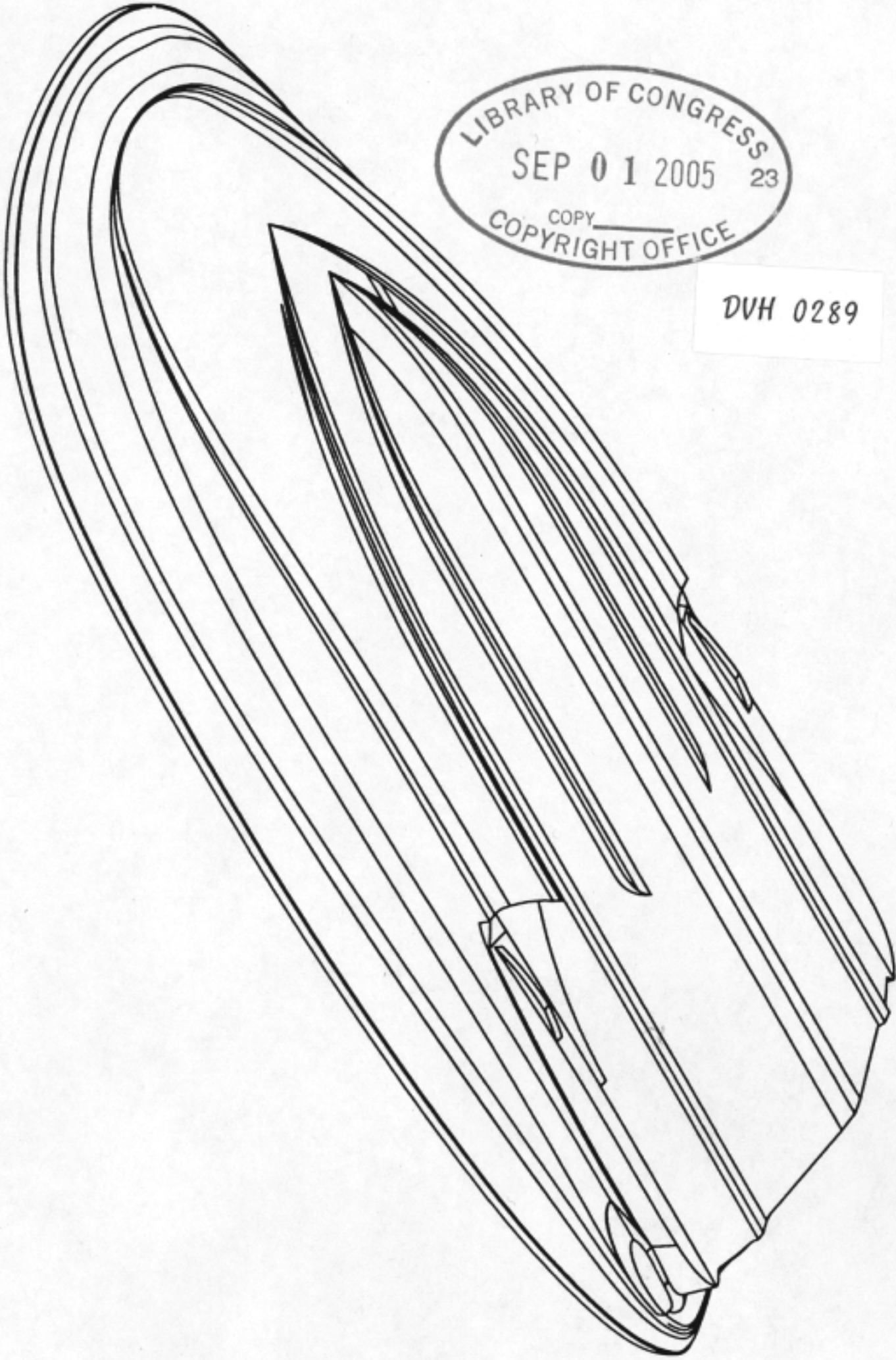

DVH 0289

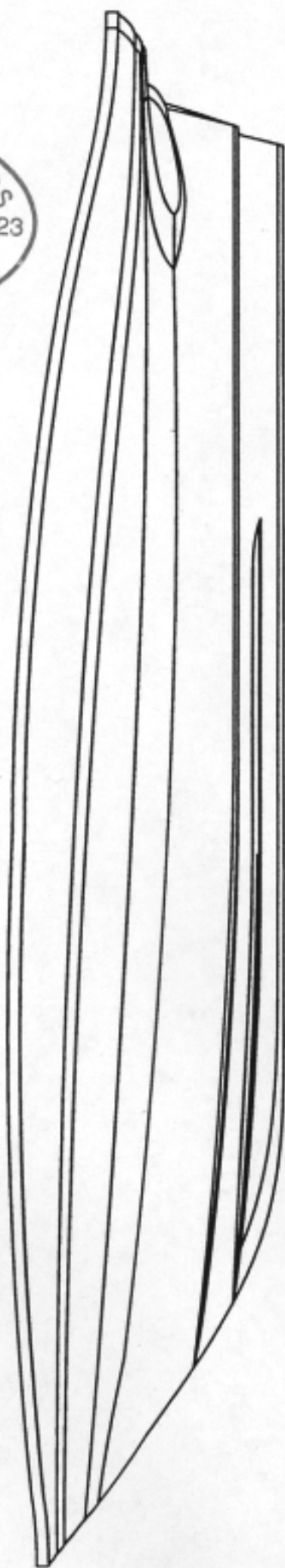
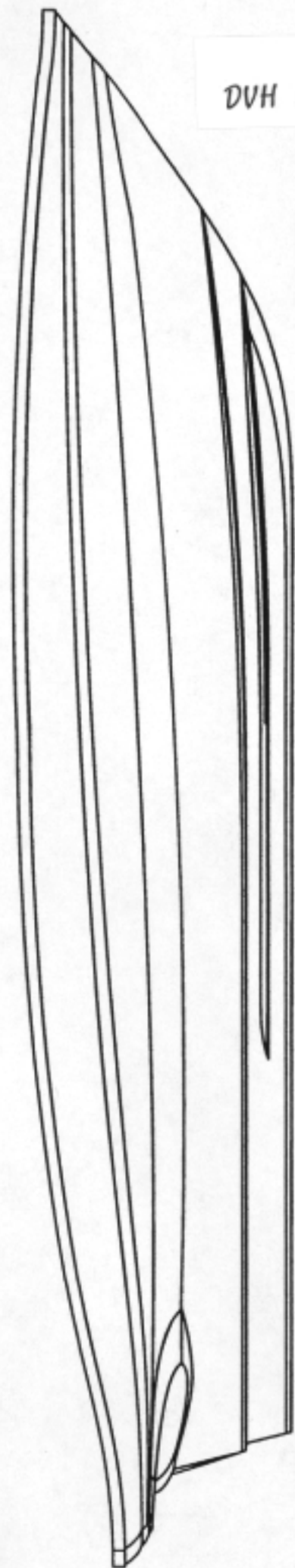

DVH 0289

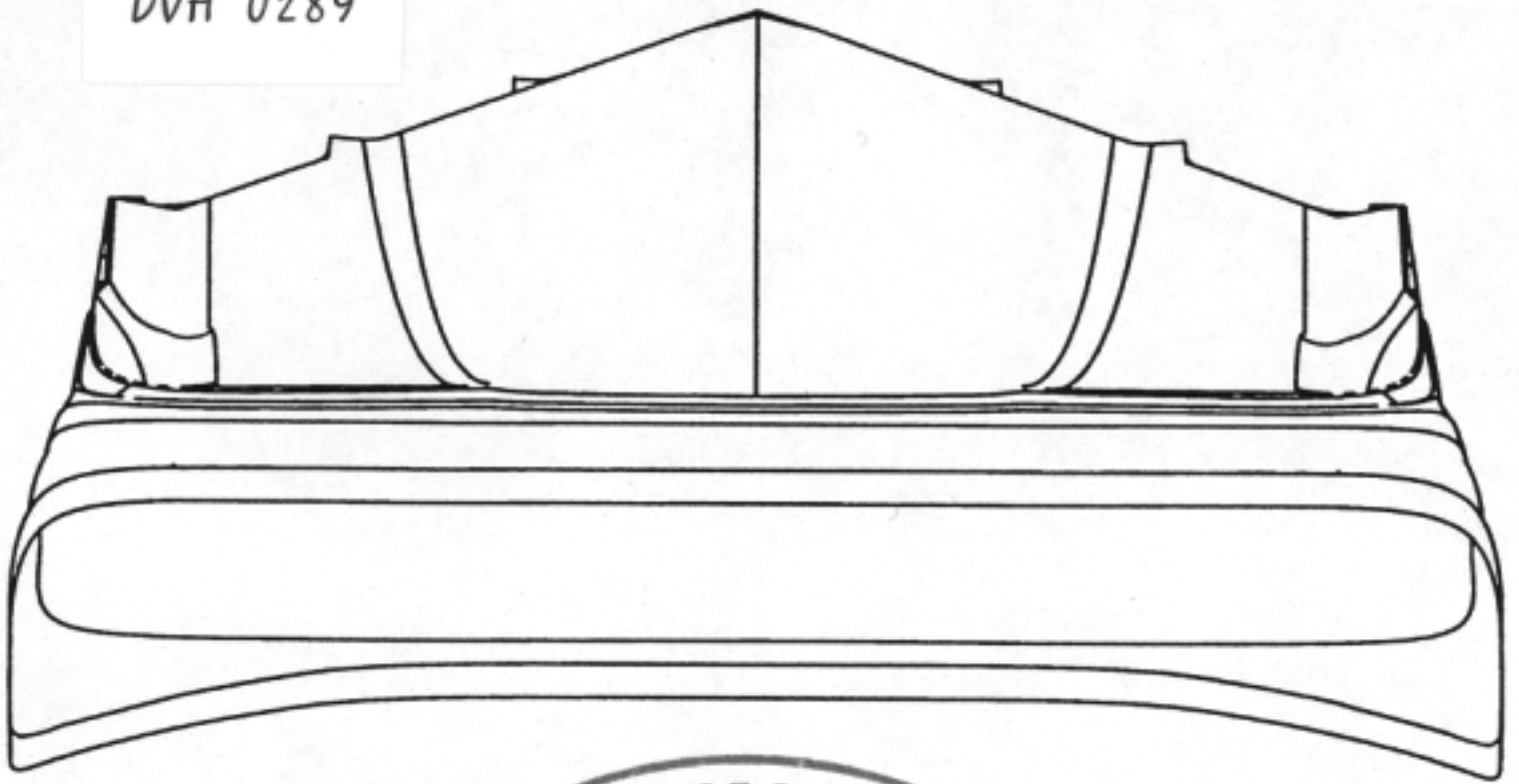

LIBRARY OF CONGRESS
SEP 01 2005 23
COPY _____
COPYRIGHT OFFICE

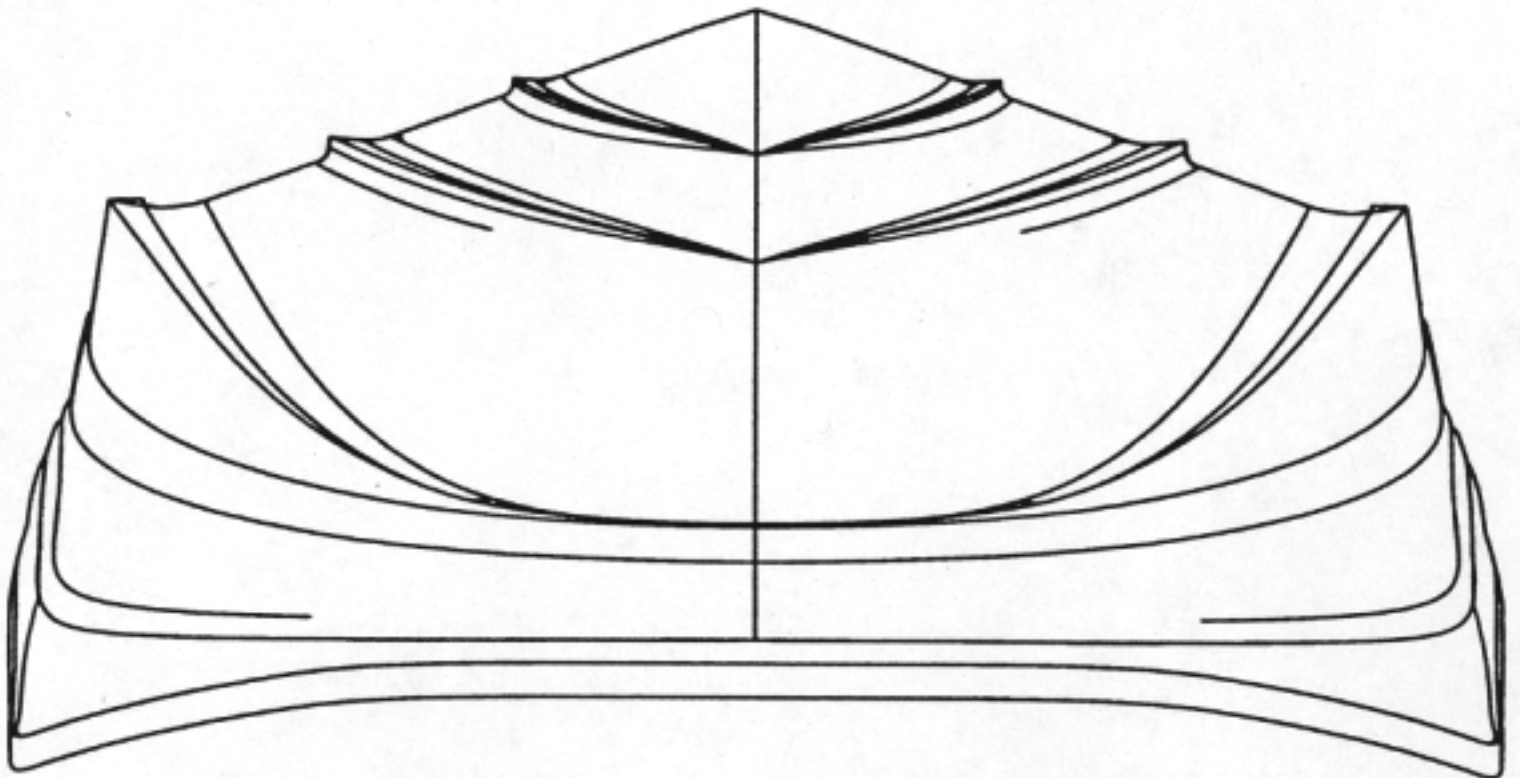

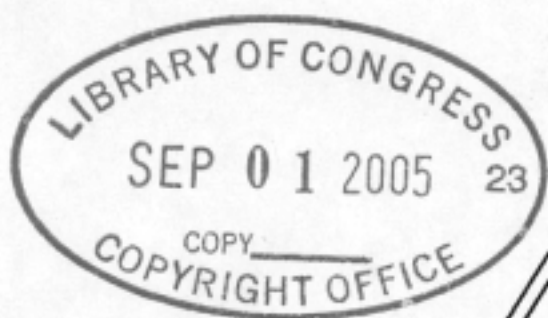

DVH 0289

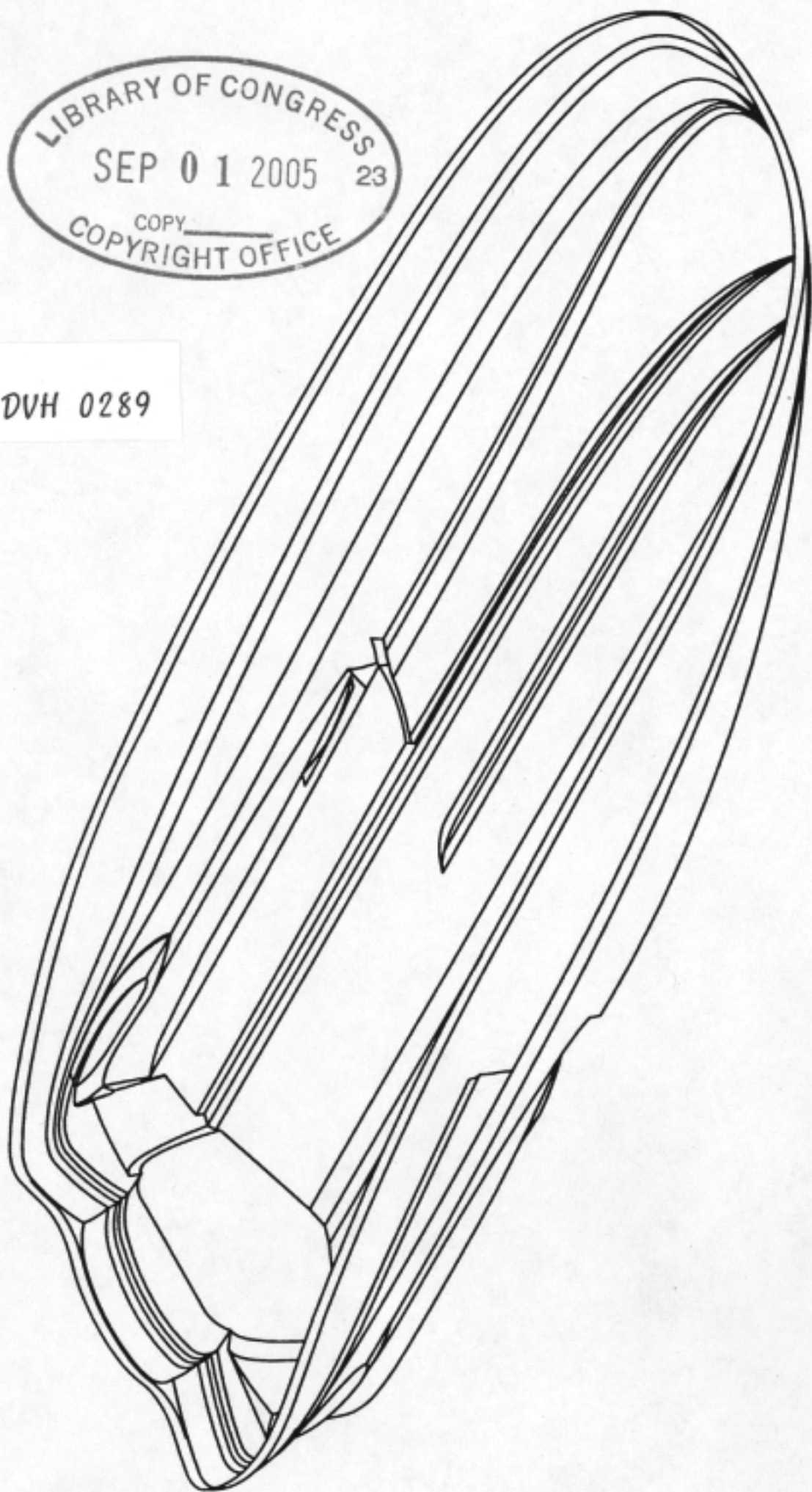

DVH 0289

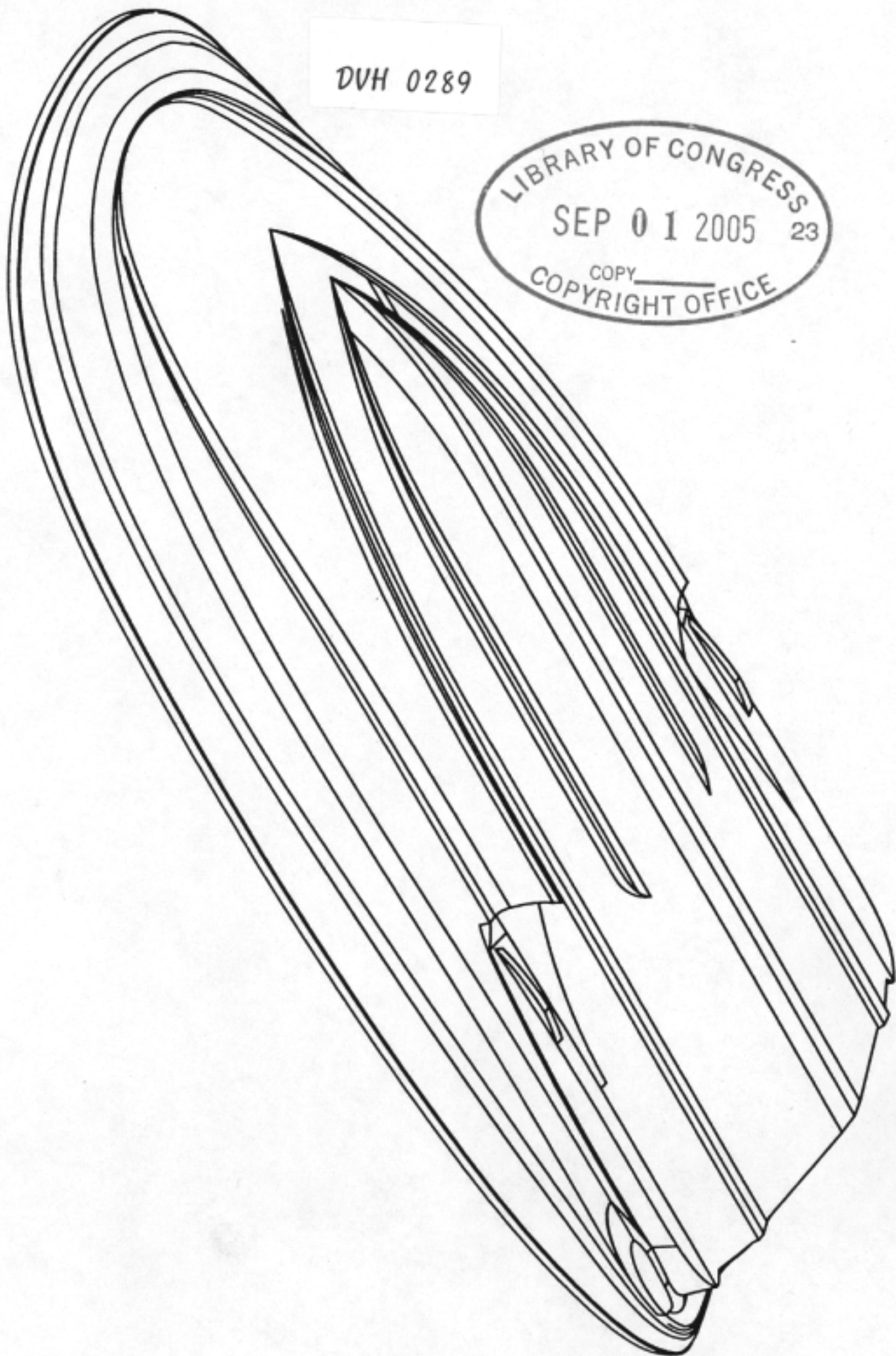

DVH 0289

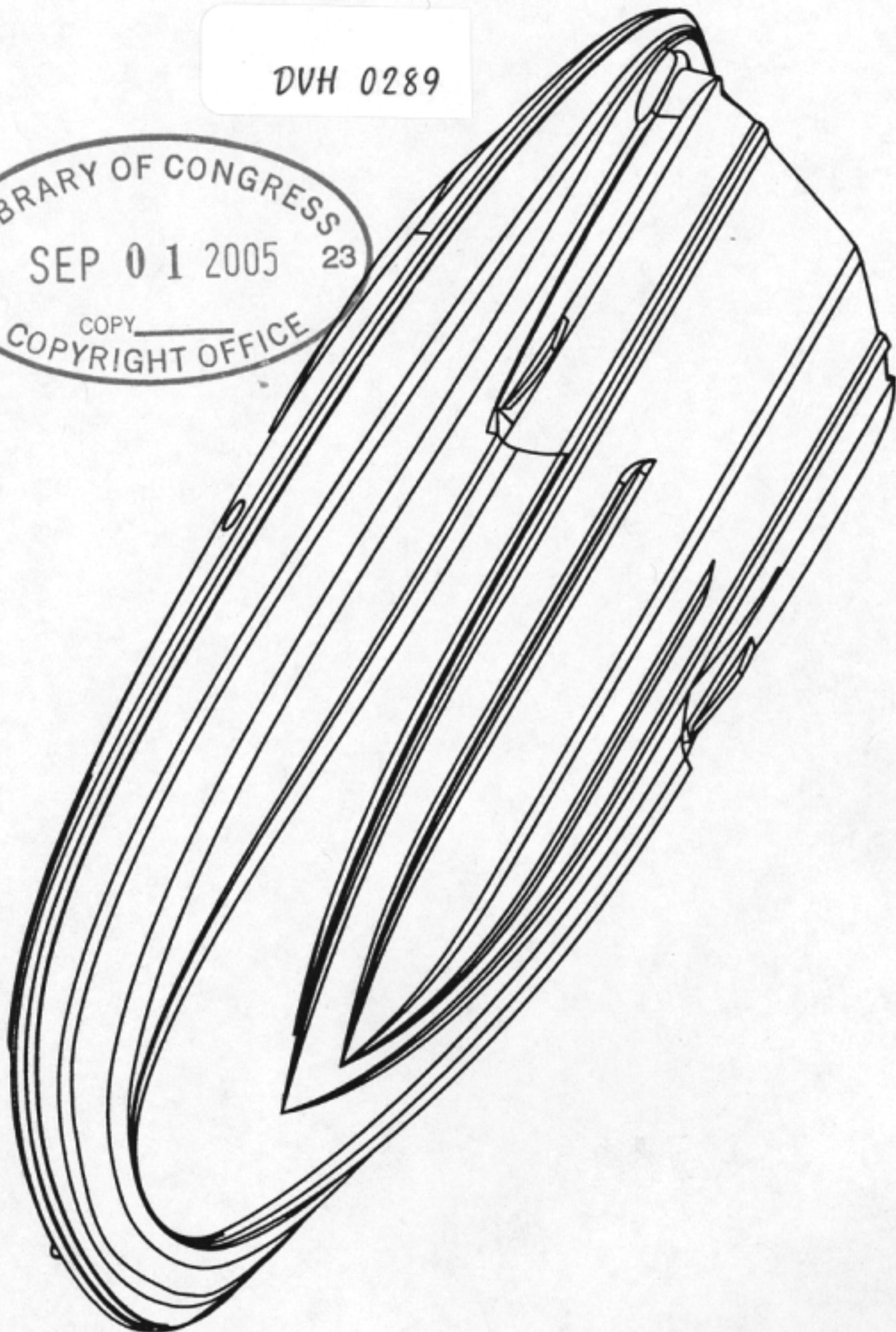
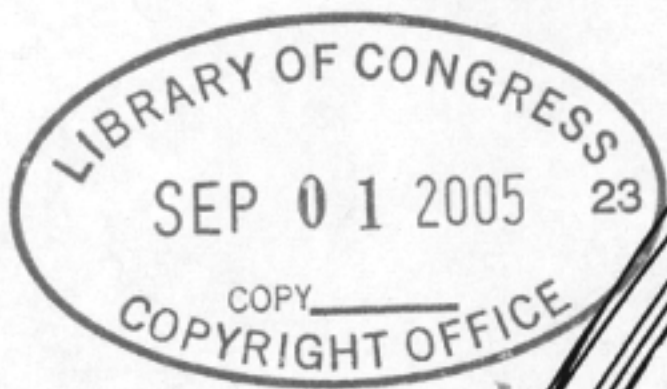

LIBRARY OF CONGRESS
SEP 01 2005 23
COPY _____
COPYRIGHT OFFICE

DVH 0289

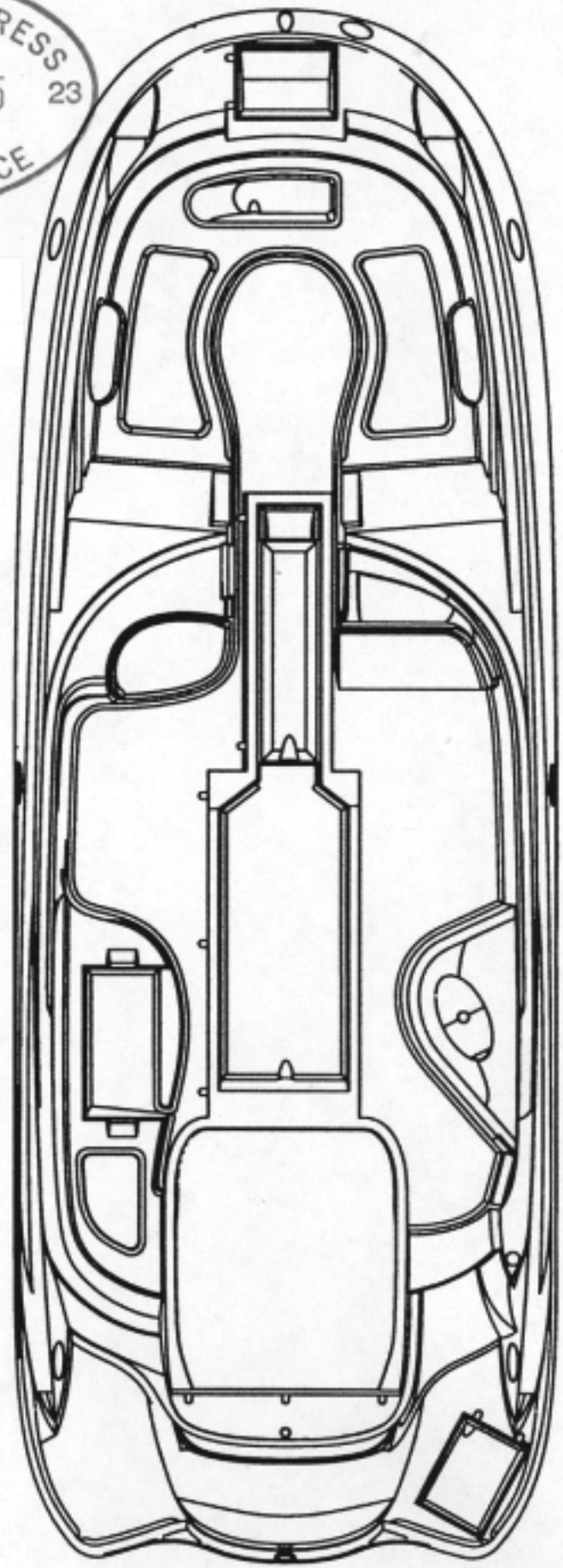
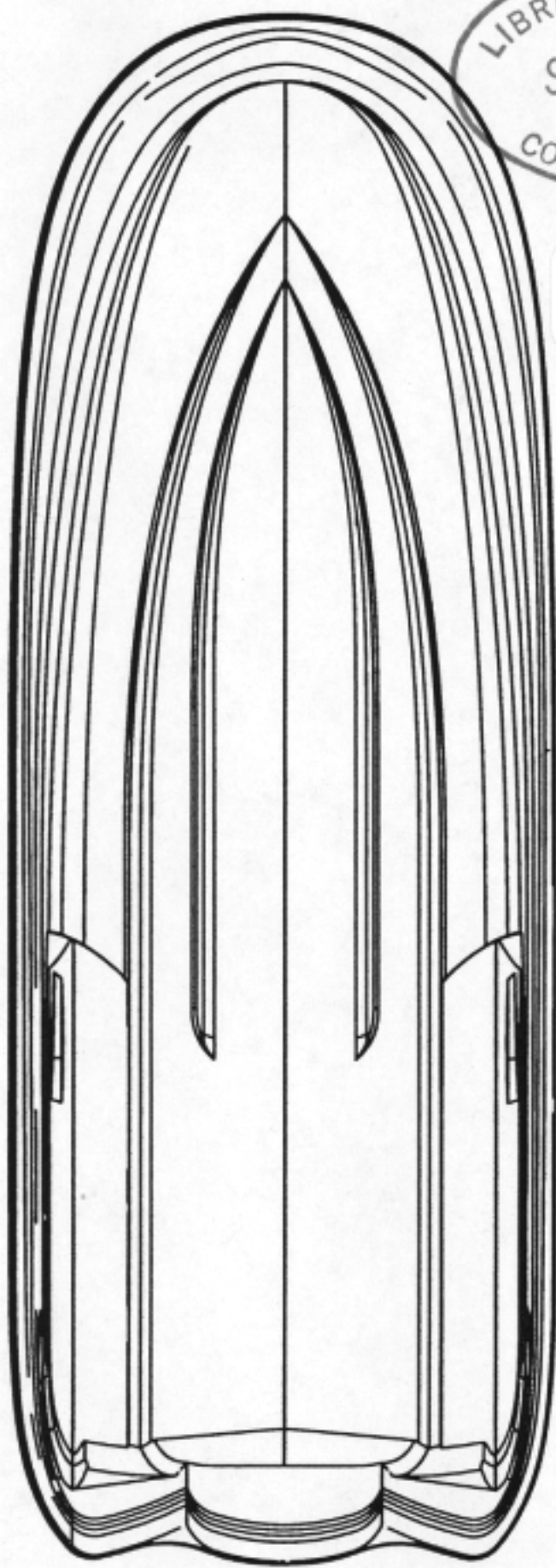

DVH 0289

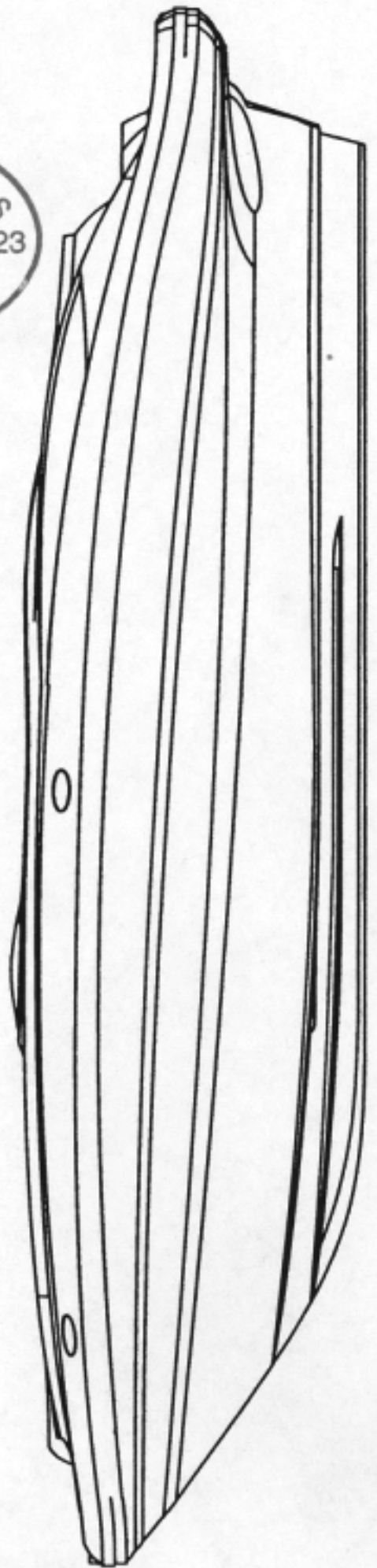
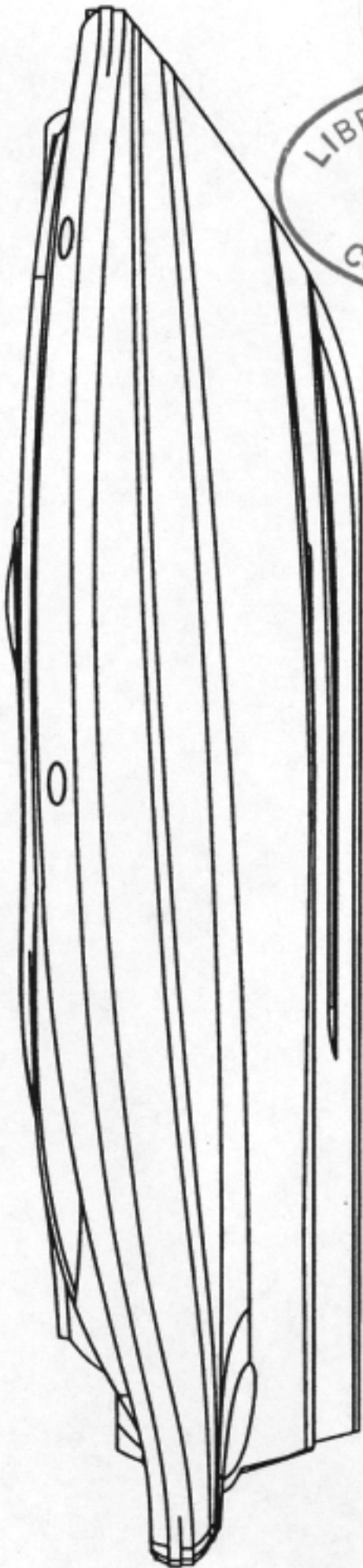
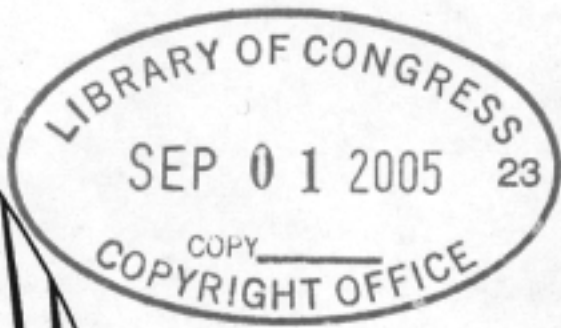

DVH 0289

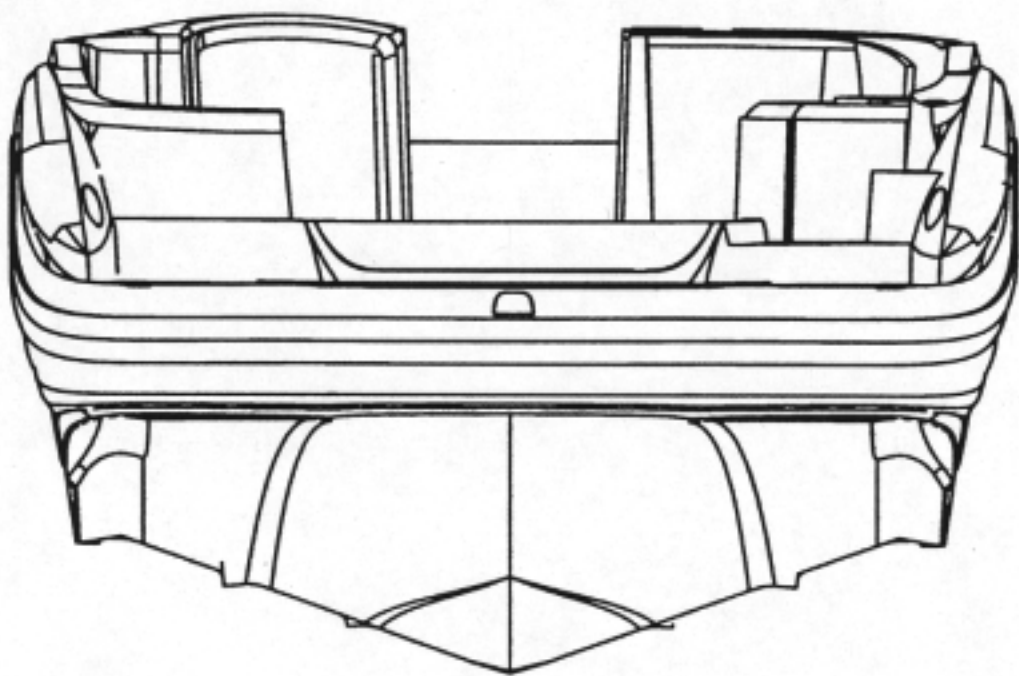

LIBRARY OF CONGRESS
SEP 01 2005 23
COPYRIGHT OFFICE

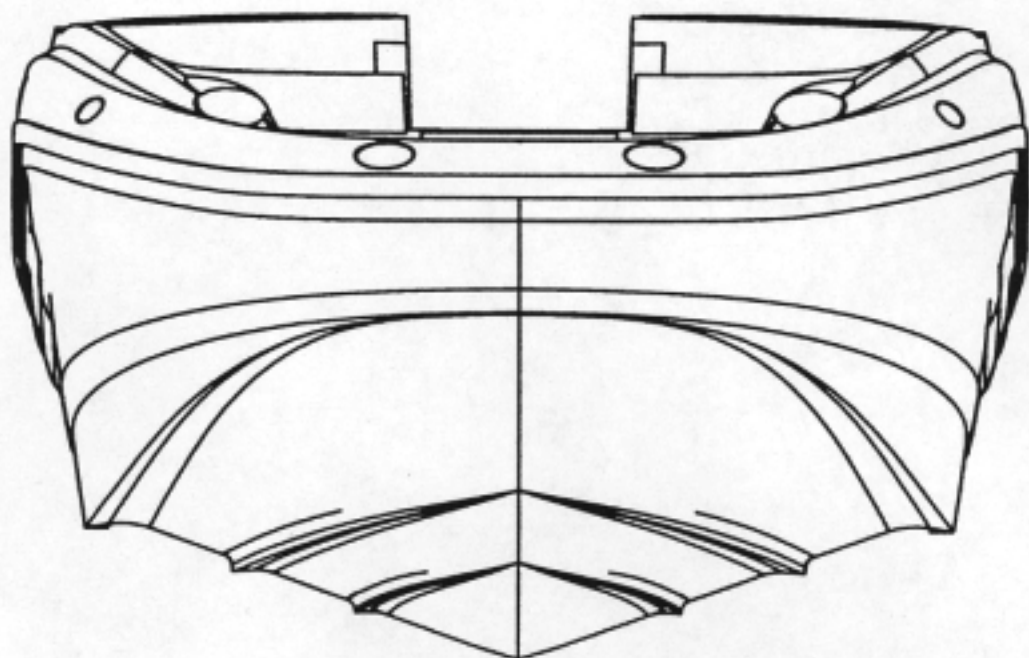

LIBRARY OF CONGRESS
SEP 01 2005 23
COPYRIGHT OFFICE

DVH 0289

