

Full Useful Life (120,000 miles) Exhaust Emission Performance of a NO_x Adsorber and Diesel Particle Filter Equipped Passenger Car and Medium-duty Engine in Conjunction with Ultra Low Sulfur Fuel

Diesel Engine Emissions Reduction Conference
August 25th, 2005

Matthew Thornton, National Renewable Energy Laboratory
Marek Tatur, Heather Tyrer, Dean Tomazic, FEV Engine Technology
Phil Weber and Cynthia Webb, SwRI

NREL/PR-540-38639

Presented at 2005 Diesel Engine Emissions Reduction (DEER) Conference, August 21-25, 2005 in Chicago, IL.

Disclaimer and Government License





This work has been authored by Midwest Research Institute (MRI) under Contract No. DE-AC36-99GO10337 with the U.S. Department of Energy (the “DOE”). The United States Government (the “Government”) retains and the publisher, by accepting the work for publication, acknowledges that the Government retains a non-exclusive, paid-up, irrevocable, worldwide license to publish or reproduce the published form of this work, or allow others to do so, for Government purposes.

Neither MRI, the DOE, the Government, nor any other agency thereof, nor any of their employees, makes any warranty, express or implied, or assumes any liability or responsibility for the accuracy, completeness, or usefulness of any information, apparatus, product, or process disclosed, or represents that its use would not infringe any privately owned rights. Reference herein to any specific commercial product, process, or service by trade name, trademark, manufacturer, or otherwise does not constitute or imply its endorsement, recommendation, or favoring by the Government or any agency thereof. The views and opinions of the authors and/or presenters expressed herein do not necessarily state or reflect those of MRI, the DOE, the Government, or any agency thereof.

Outline

- Project Overview
- Program goals and objectives
- Hardware overview
- Test procedures
- Test results
- Summary and outlook

APBF-DEC Projects

| NO _x Adsorber/DPF | | SCR/DPF | | Lubes |
|--|---|--|---|---|
|  |  |  |  |  |
| FEV | SwRI | Ricardo | SwRI | AEI |
| 1.9L TDI | 6.6L Isuzu Duramax | 15L Cummins ISX | Caterpillar C12 | Cummins ISB |
| Audi A4 Avant | Chevrolet Silverado | <i>No vehicle</i> | | |

APBF-DEC Organization

DOE, EPA, additive companies,
automobile manufacturers, engine
manufacturers, energy companies,
emission control mfrs., Calif. agencies

**APBF-DEC
Steering Committee**

**Unregulated
emissions**

**Experimental design
and data analysis**

**Fuel and lubricant
provision**

**Fuels, engines,
NO_x adsorbers,
and diesel
particle filters**

**Fuels, engines,
selective
catalytic
reduction and
diesel particle
filters**

Lubricants

Communications

Project Objectives for LD NO_x Adsorber Projects : Examine fuel property effects on NAC/DPF systems

Approach:

- Demonstrate low emissions potential of diesel engines equipped with advanced fuel, NO_x adsorbers, DPFs, EGR, double-wall exhaust
 - Goal: Tier 2 Bin 5 (0.07 g/mi NO_x 0.01 g/mi PM)
- Age systems with Ultra Low S fuel for up to 2200 hrs
 - Periodic emissions evaluations during aging (before and after NO_x adsorber desulfation)
 - Periodic unregulated emissions measurement with 15-ppm S refinery product
 - NO_x adsorber desulfation performed on time based schedule

Project Outline

Project divided into three Tasks:

- Hardware procurement and operational strategy development
- System integration and optimization
- Performance and aging evaluation
 - Age ECS to 2000-2200 hours with 15-ppm S Fuel
 - 2,200 hours equal full useful lifetime of 120,000 miles
 - Emissions evaluation procedures performed every 100-200 hrs
 - Desulfations performed every 150-200 hours to start then 100 hours (and every 50 hours at the end for the Passenger Car platform)

Project Hardware Overview

Passenger Car

Engine Specification

Arrangement: In-Line 4-Cylinder

Displacement: 1.9 L

Rated Power: 100 kW @ 4000 rpm

Max. Torque: 330 Nm @ 2000 rpm

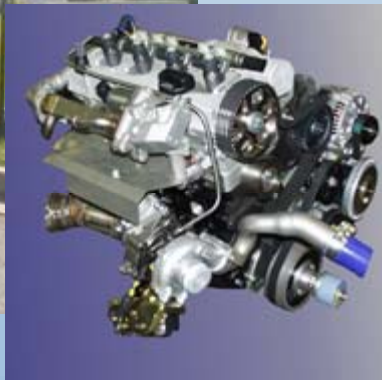

Medium-Duty Engine



Engine Specification

Arrangement: 8-Cylinder V

Displacement: 6.6 L

Rated Power: 224 kW @ 3100 rpm

Max. Torque: 705 Nm @ 1800 rpm

Passenger Car Project In-Line Emission Control System

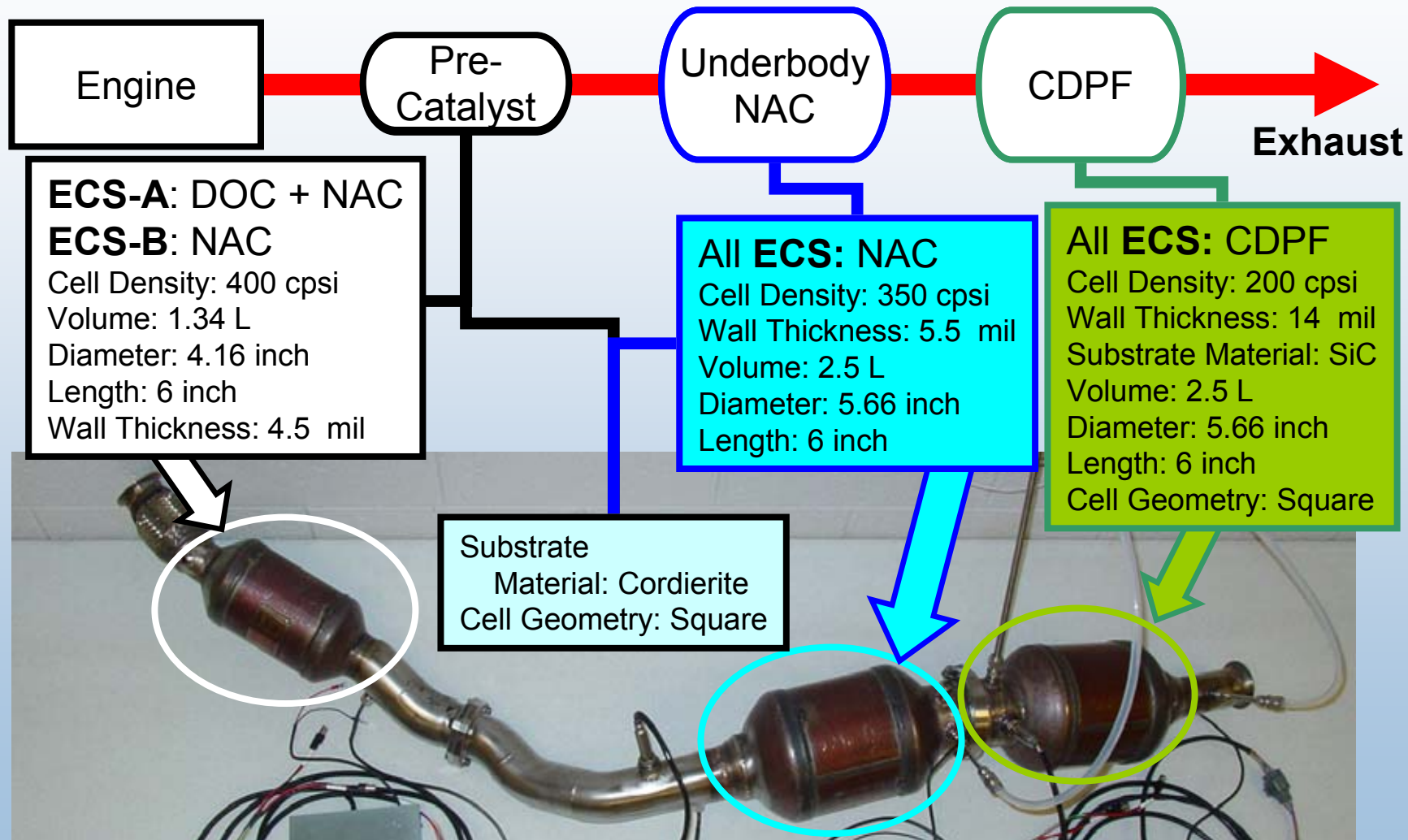

Medium-Duty Engine Project Dual Leg Emission Control System

NAC

Cell Density: 300 cpsi
Wall Thickness: 8 mil
Substrate Material: Cordierite
Volume: 7 L x 2
Diameter: 9.5 inch
Length: 6 inch

CDPF

Cell Density: 200 cpsi
Wall Thickness: 12 mil
Substrate Material: Cordierite
Volume: 12.5 L
Diameter: 9 inch
Length: 12 inch

DOC Front

Cell Density: 300 cpsi
Wall Thickness: 8 mil
Substrate Material: Cordierite
Volume: 3.5 L x 2
Diameter: 9.5 inch
Length: 3 inch

DOC Back

Cell Density: 300 cpsi
Wall Thickness: 8 mil
Substrate Material: Cordierite
Volume: 3.5 L x 2
Diameter: 9.5 inch
Length: 3 inch

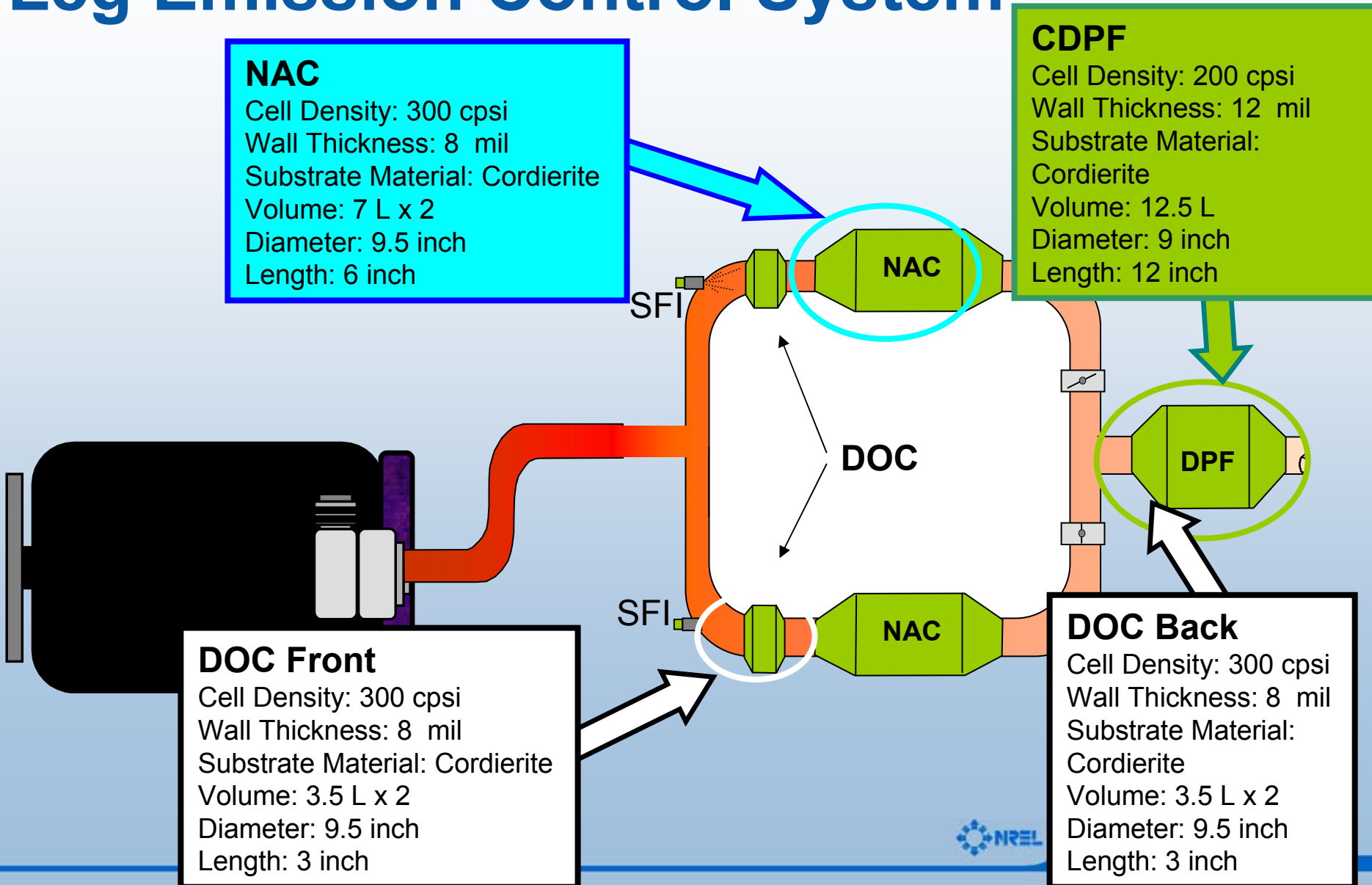

Test Procedures

Engine Dynamometer Test Cell:

Pre-Desulfation Procedure

| | | | | | |
|--------|---|------|---------------|-------------|-------------|
| Run 3x | 1 | CLA4 | HLA4 | US06 | HFET |
| | 2 | | HLA4 | US06 | HFET |
| | 3 | | HLA4 | US06 | HFET |
| | | | 1/3 PM sample | 1 PM sample | 1 PM sample |

1 test cycle = 1 gas sample = 30 gas samples
1 set of cycles = 1 PM sample = 10 PM samples

Post-Desulfation Procedure

| | | | | | |
|--------|---|------|---------------|-------------|-------------|
| Run 2x | 1 | CLA4 | HLA4 | US06 | HFET |
| | 2 | | HLA4 | US06 | HFET |
| | 3 | | HLA4 | US06 | HFET |
| | | | 1/2 PM sample | 1 PM sample | 1 PM sample |

1 test cycle = 1 gas sample = 20 samples
1 set of cycles = 1 PM sample = 7 PM samples

Passenger Car Project Test Results

NOx Emission Trends

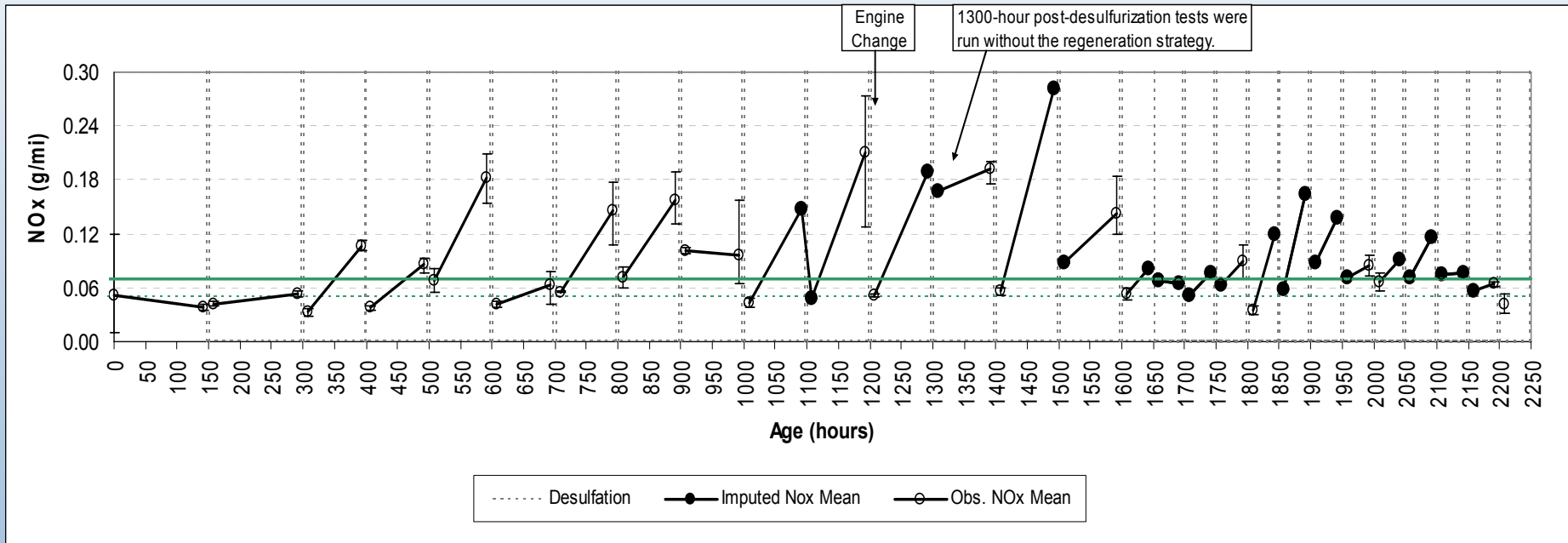

Passenger Car Project Test Results

NOx Adsorber Conversion Efficiency

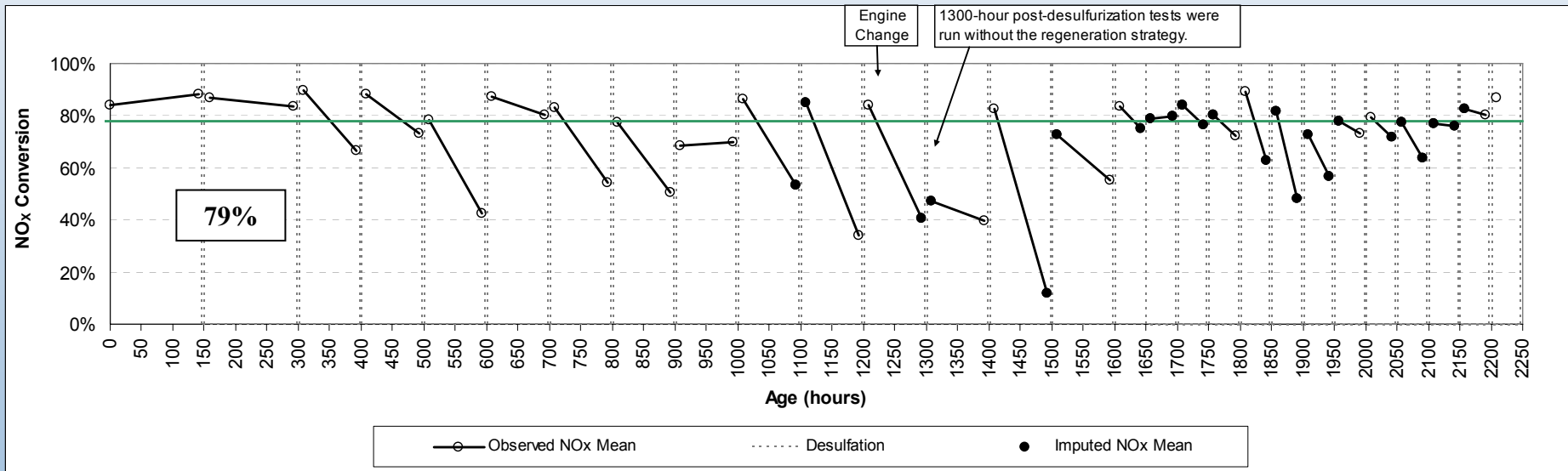

Passenger Car Project Test Results

NO_x Adsorber Deterioration

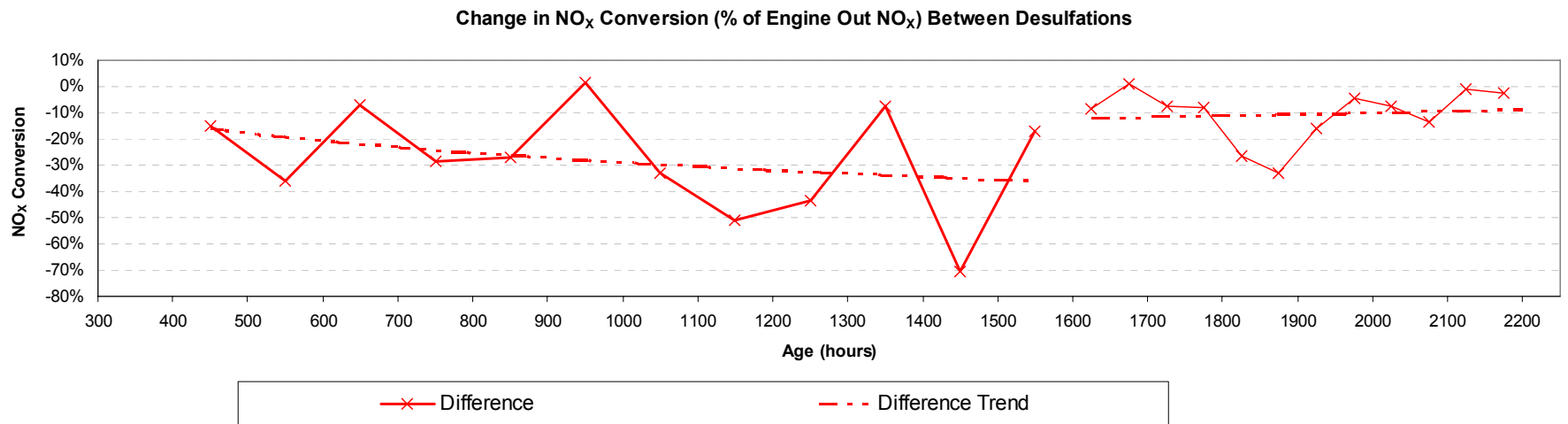

Passenger Car Project Test Results

Desulfation Effectiveness

Increase in NO_x Conversion (% of Engine Out NO_x) at Each Desulfation

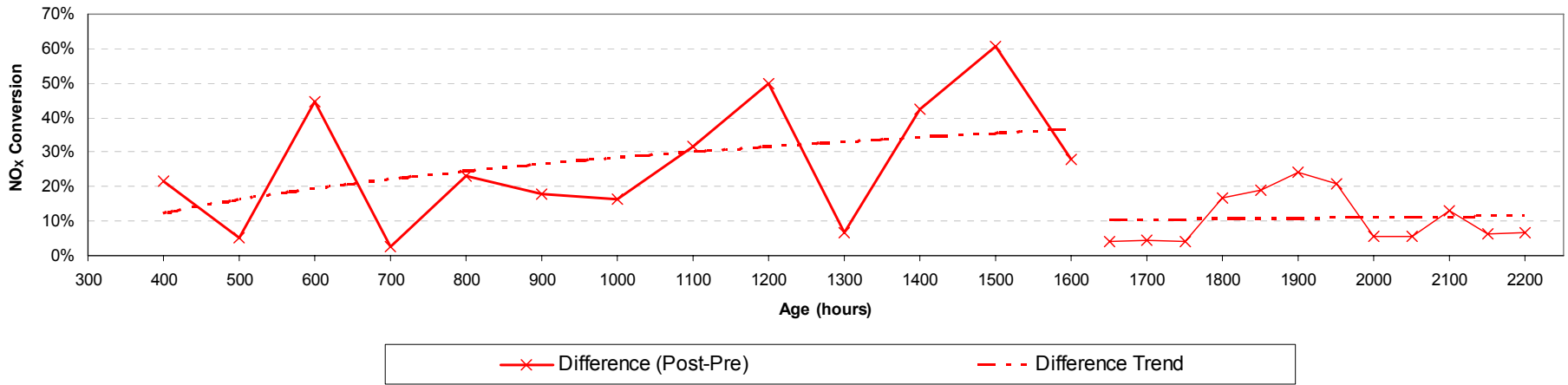

Passenger Car Project Test Results

PM Emission Trends

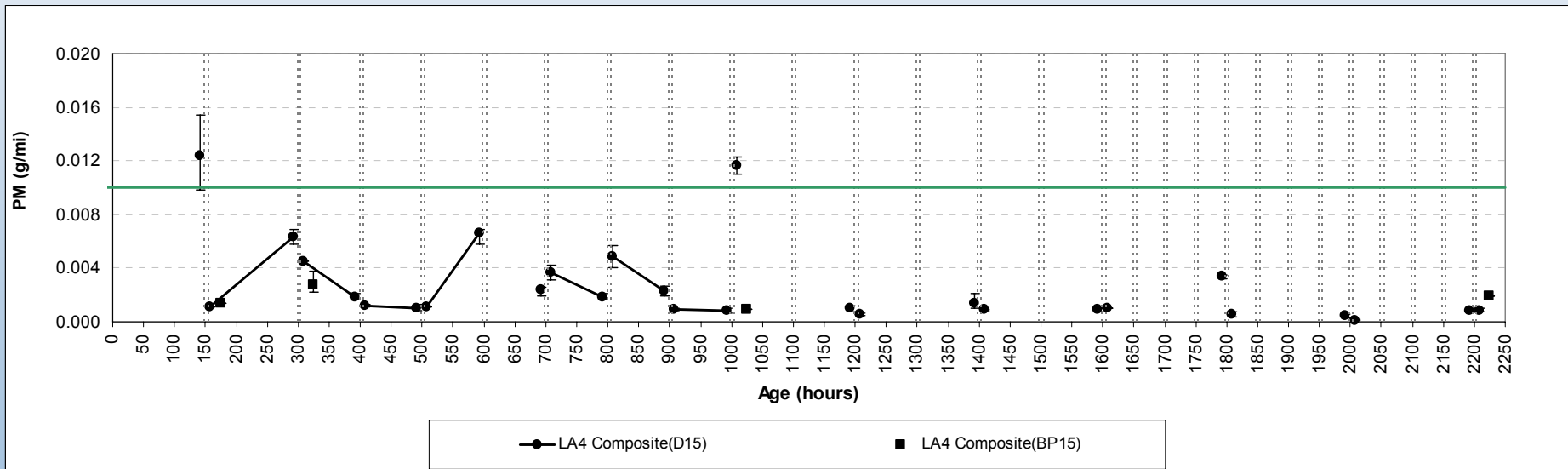

Medium-Duty Engine Project Test Results

NOx Emission Trends

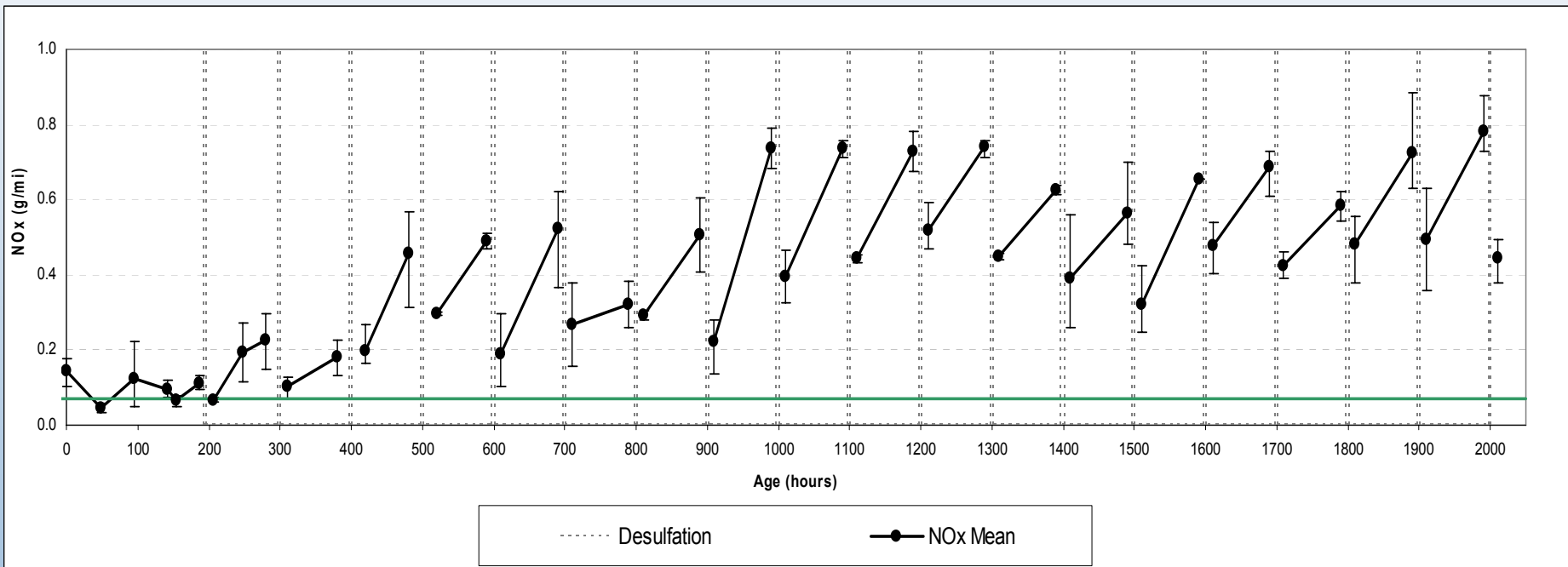

Medium-Duty Engine Project Test Results

NOx Adsorber Conversion Efficiency

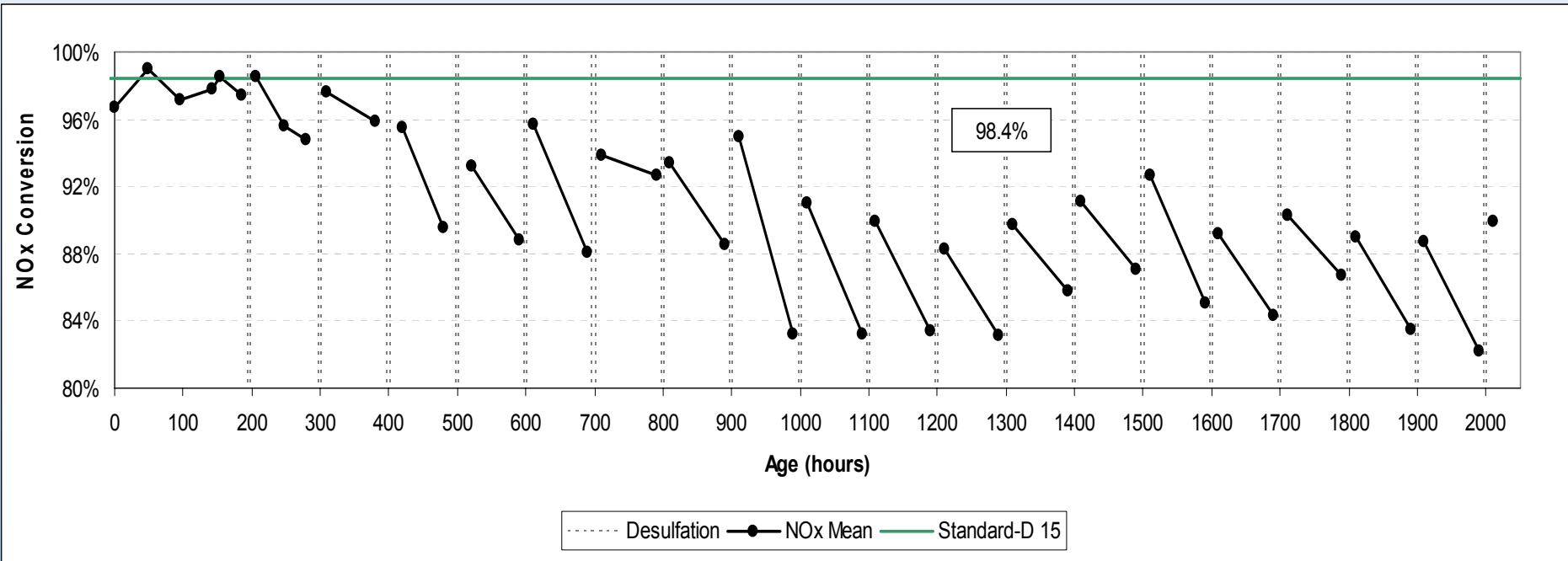

Medium-Duty Engine Project Test Results

NO_x Adsorber Deterioration

Change in NO_x Conversion (% of Engine Out NO_x) Between Desulfations

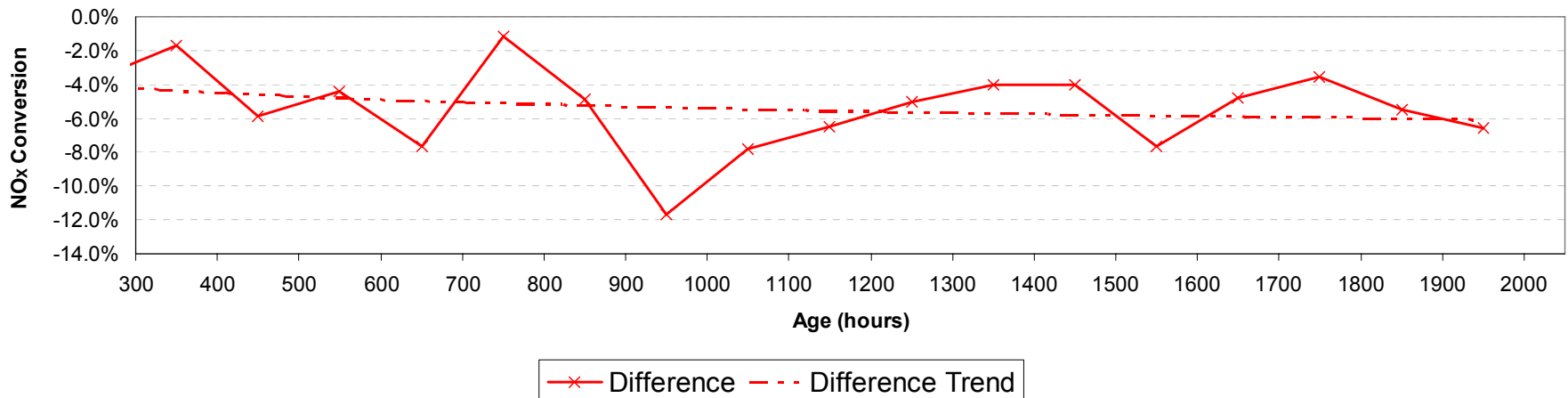

Medium-Duty Engine Project Test Results

Desulfation Effectiveness

Increase in NO_x Conversion (% of Engine Out NO_x) at Each Desulfation

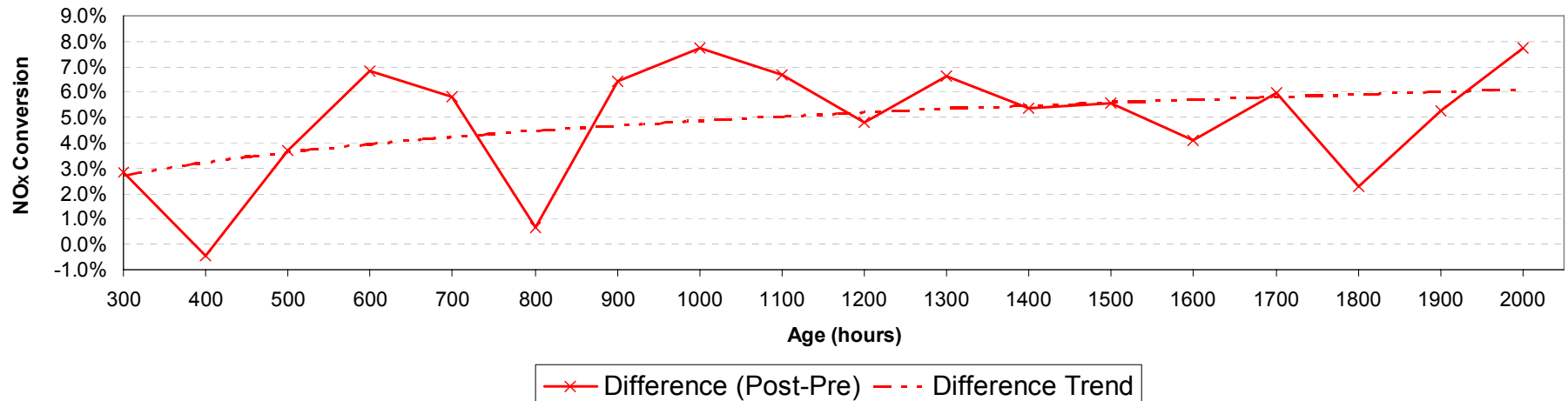

Medium-Duty Engine Project Test Results

PM Emission Trends

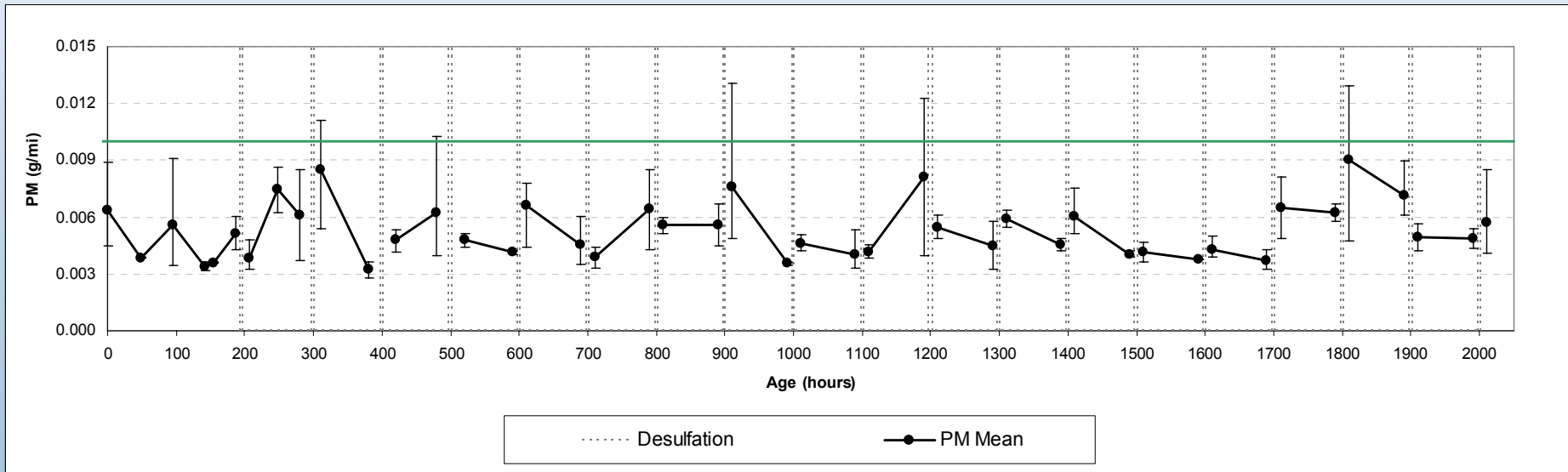

Summary

- Fresh NOx adsorber system in conjunction with 15ppm sulfur fuel can achieve Tier 2 Bin 5 NOx emission levels for both platforms
- Desulfation strategies are effective in recovering NOx adsorber performance with some deterioration through 2000 hours for both platforms
- Aged and desulfurized NOx adsorber system in conjunction with 15ppm sulfur fuel achieved Tier 2 Bin 5 NOx emission levels for the passenger car platform, achieved 85-90% NOx conversion for the MD Engine platform
- DPF in conjunction with 15ppm sulfur fuel can achieve Tier 2 Bin 5 PM emission levels throughout aging for both platforms
- Detailed emissions information (e.g. CO, HC, and Unregulated species) are included in final report

Program Participants

Automobile:

DaimlerChrysler
Ford
GM
Toyota

Government:

CARB/SCAQMD
DOE
EPA
NREL
ORNL

Emission Control:

Argillon
ArvinMeritor
Benteler
Clean Diesel Tech.
Corning
Delphi
Donaldson Co.
Engelhard
Johnson Matthey
MECA
NGK
Rhodia
Robert Bosch Corp.
STT Emtec AB
Tenneco Automotive
3M
Umicore

Energy/ Additives:

American Chemistry
Council
API
BP
Castrol
Chevron Oronite
Chevron
Ciba
Conoco-Phillips
Crompton
Ergon
Ethyl
ExxonMobil
Infineum
Lubrizol
Marathon Ashland
Motiva
NPRA
Pennzoil-Quaker State
Shell Global Solutions
Valvoline

Engines:

Caterpillar
Cummins
Detroit Diesel
EMA
International Truck
& Engine
John Deere
Mack Trucks

Technology:

Battelle

Acknowledgements

- Department of Energy, Office of FreedomCAR and Vehicle Technologies
- ORNL
- Battelle
- MECA
- APBF-DEC Industry partners for financial and in-kind support
- Technical Team members and their companies for their support and contributions