

DOT/FAA/AM-02/11

Office of Aerospace Medicine
Washington, DC 20591

Human Factors Associated With the Certification of Airplane Passenger Seats: Seat Belt Adjustment and Release

Richard DeWeese
Van Gowdy
Civil Aerospace Medical Institute
Federal Aviation Administration
Oklahoma City, OK 73125

June 2002

Final Report

This document is available to the public
through the National Technical Information
Service, Springfield, VA 22161.



U.S. Department
of Transportation
**Federal Aviation
Administration**

N O T I C E

This document is disseminated under the sponsorship of the U.S. Department of Transportation in the interest of information exchange. The United States Government assumes no liability for the contents thereof.

Technical Report Documentation Page

1. Report No. DOT/FAA/AM-02/11	2. Government Accession No.	3. Recipient's Catalog No.	
4. Title and Subtitle Human Factors Associated With the Certification of Airplane Passenger Seats: Seat Belt Adjustment and Release		5. Report Date June 2002	
		6. Performing Organization Code	
7. Author(s) DeWeese, R., and Gowdy, R.V.		8. Performing Organization Report No.	
9. Performing Organization Name and Address FAA Civil Aerospace Medical Institute P.O. Box 25082, Oklahoma City, OK 73125		10. Work Unit No. (TRAIS)	
		11. Contract or Grant No.	
12. Sponsoring Agency name and Address Office of Aerospace Medicine Federal Aviation Administration 800 Independence Ave., S.W. Washington, DC 20591		13. Type of Report and Period Covered	
		14. Sponsoring Agency Code	
15. Supplemental Notes Work was accomplished under approved task AM-B-02-PRS-96.			
16. Abstract <p>Two separate studies were accomplished to investigate human factors issues related to the use of lap belts. Human performance trials were conducted under two protocols to measure and assess: (1) seat belt tension adjustment during normal flight and emergency landing conditions, and (2) the effects on passenger emergency egress performance related to the lift-latch release angle of typical lap belts.</p> <p>In the lap belt tension adjustment study, subjects were asked to sit in a typical passenger seat and adjust the lap belts as they normally would for take-off or landing during a commercial flight. Participants were then asked to adjust the lap belts as if they were anticipating an emergency landing. The airplane seat used in this study was instrumented to measure the tension in the lap belt, which was recorded for both the normal and emergency conditions. A total of 1182 subjects participated in this study. An analysis of results indicate that most passengers (90%) tighten the lap belt to a tension less than 7 lb. during normal flight conditions and less than 10 lb. for an anticipated emergency. These data indicate that the tension adjustment of lap belts restraining anthropomorphic test dummies in airplane seat certification tests should not exceed 10 lbs. to be representative of belt tension applied by a typical passenger. The current standard practice for adjusting the belt tension prior to these tests was evaluated and found to be adequate in light of these findings.</p> <p>The lift-latch release angle experiments were designed to study lap belt restrained human subjects as they released the belt buckle and proceeded to egress from a typical passenger seat. Some foreign regulatory authorities require the release angle to be between 70° and 95°, whereas, typical U.S. buckles release between 45° and 60°. Three lap belts with latch release angles of 30°, 60°, and 90° were installed on a triple passenger seat. Subjects were observed and timed as they tried to release the belts and exit from the seat. Each was instructed to perform the exercise quickly. A total of 201 subjects participated in this study. No significant differences in human performance factors related to the lift-latch angle were detected from an analysis of the data.</p>			
17. Key Words Lift Latch Buckles, Seat Belts, Transport Airplanes		18. Distribution Statement Document is available to the public through the National Technical Information Service, Springfield, VA 22161	
19. Security Classif. (of this report) Unclassified	20. Security Classif. (of this page) Unclassified	21. No. of Pages 11	22. Price

HUMAN FACTORS ASSOCIATED WITH THE CERTIFICATION OF AIRPLANE PASSENGER SEATS: SEAT BELT ADJUSTMENT AND RELEASE

INTRODUCTION

This report presents the results from two human subject studies regarding the use of lap belt restraints on transport airplane passenger seats. The first study involved the assessment of the belt tension that results when passengers manually adjust their lap belts. The second study examined the lift-latch buckle release angle for lap belts, focusing primarily on the effect it has on egress from the seat.

Lap Belt Adjustment. The certification requirements for transport airplane passenger seats can include impact tests using anthropomorphic test dummies (ATDs) restrained by lap belts in the seat. The amount of pre-test tension in the belts is commonly affected by the judgment, experience, technique, and strength of the technician preparing the test. This study addressed two questions related to pre-test belt tension. First, what belt tension is produced when a typical passenger adjusts his or her lap belt? Second, what is the relationship between the parameters that are involved when tightening a lap belt over an ATD in a passenger seat? The parameters studied were: load applied to the free end of the webbing, tension produced in the belt, ATD position, cushion stiffness, and perceived belt tension.

Buckle Release Angle. Although the lap belt buckle release angle is not specifically addressed by FAA regulations, it has been recognized as a feature that varies widely, with no documented rationale for its effects on passenger safety. Discussions with major aircraft belt manufacturers revealed that while no guidance exists, the buckles they supply for US aircraft have traditionally been designed to release when the lever is raised between 30 and 45 degrees. The UK Civil Aviation Authority requires that lift latches used on their aircraft release between 70 and 95 degrees (1). The presumed intent of the larger angle is to prevent inadvertent release during turbulence or emergency landing scenarios. Thus, for the purposes of commonality of lap belt operation and harmonization of international policies, an understanding of how buckle release angle affects occupant egress is necessary.

These two studies were conducted concurrently using human subjects participating in an aircraft evacuation study at the FAA Civil Aerospace Medical

Institute's (CAMI's) Protection and Survival Laboratory. Anthropometric data such as age, height, weight, stature, and girth were gathered from each subject. Also, experience in commercial air travel as a passenger was obtained from many of the participants.

The following presents the methods, observations, and results from these two studies.

LAP BELT TENSION STUDY

Trial Setup. As shown in Figure 1, a typical economy class passenger seat was trimmed down to a single place and was instrumented with a load cell placed in line with the fixed length side of the lap belt. The belt used was a typical lift latch type with a fixed length segment of 16.5 inches, including the load cell. The overall length of the belt path was 29.5 inches when tightened to 10 lb. of tension over the lap of a 50% ATD. The armrests were tied up out of the way to



Figure 1. Tension Study Seat

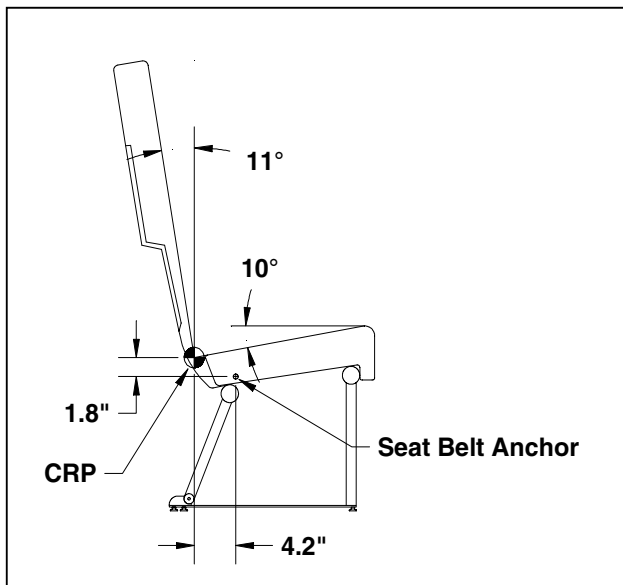

Figure 2. Tension Study Seat Dimensions

simplify belt donning and tightening. Figure 2 shows the pertinent dimensions of the trial seat, and Figure 3 shows the nominal position of a seated 50% ATD.

Instrumentation. A uni-axial load cell of 100 lb. capacity was installed between the belt hook and the seat anchor point, as shown in Figure 4. Since the tension reading tended to vary with time due to subject motion and settling, the load cell output was processed by a computer program that reported the average value over a three-second period.

Protocol. To acquire the tension readings, the subjects were instructed to:

- Fasten the seat belt, and tighten it the way they normally would for takeoff or landing.
- Sit still and stop breathing for a few seconds. (The trial conductor records the load cell three-second averaged measurement of normal belt tension.)
- Adjust the belt in anticipation of an emergency landing.
- Sit still and stop breathing for a few seconds. (The trial conductor records the load cell three-second averaged measurement of anticipated emergency belt tension.)

This procedure provided tension readings for two conditions. The first reading was recorded after the subject was told to adjust the belts as if expecting a normal takeoff or landing. The other tension measurement was recorded after the subject was told to re-adjust the belts as he/she would in anticipation of an emergency landing. To reduce the effects of slight movements by the subject during measurement of the

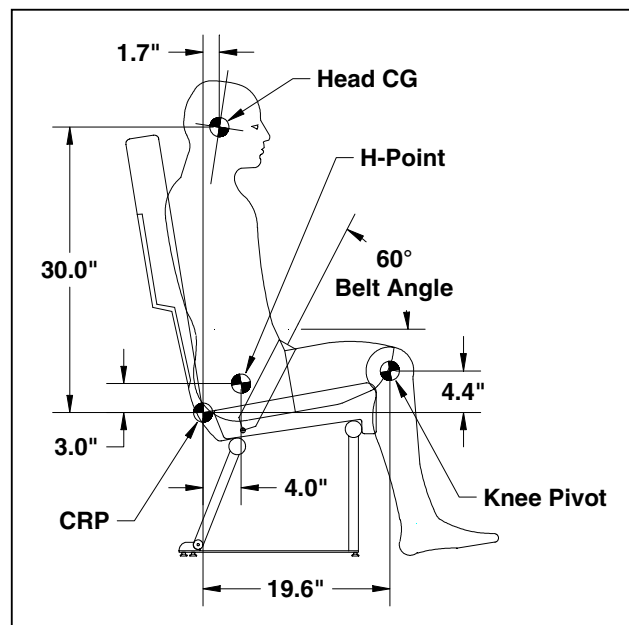

Figure 3. ATD Position in Tension Study Seat



Figure 4. Tension Load Cell

belt tension, the subjects were told to sit still and not breathe while the computer was recording the tension reading. The time history of a few subjects was recorded throughout the trial to verify that the protocol was producing consistent data. As can be seen in Figure 5, the instructions for the subjects to stop breathing had the desired result of producing a constant belt tension during the three-second averaging period.

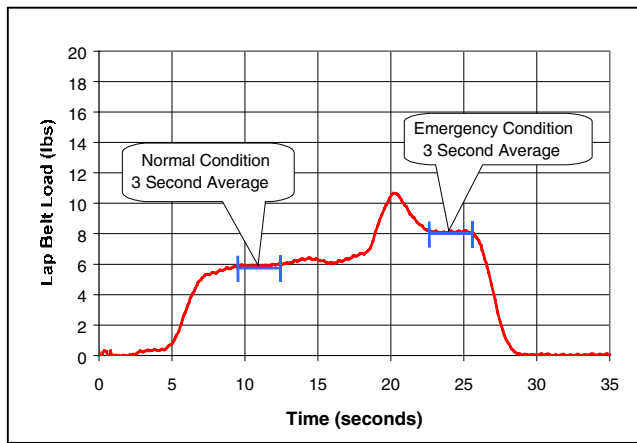

Figure 5. Typical Lap Belt Adjustment Time History

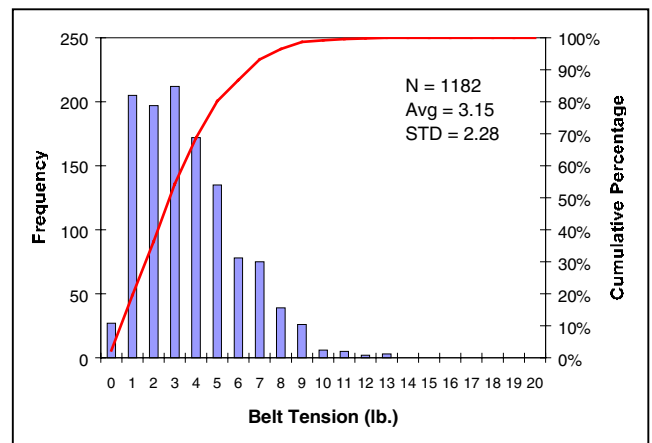

Figure 6. Normal Lap Belt Tension

Subject Anthropometry. Data were collected from 1182 subjects during this study, 587 males and 595 females. Their anthropometric statistics are summarized in Table 1. As seen in the Table, all average measurements are larger than the US average (3)(4). This difference is somewhat explained by the fact that, unlike the thinly clad subjects from which the national statistics were gathered, all measurements of these subjects were taken over street clothing, which added weight and increased the girth and height. The girth measurement, in particular, is considered to be only an estimate, since it was not possible to precisely locate the subject's waist (at omphalion) due to heavy clothing.

Human Subject Belt Tension Results. All subjects were able to apply enough force to the free end of the webbing to remove slack from the belt. The average normal condition tension measured was 3.2 lb., with 90% of all readings less than 7 lb. Figure 6 shows the distribution of tension measurements recorded for the normal flight condition. The average emergency landing tension measured was 5.6 lb., with 90% of all

readings less than 10 lb. Figure 7 shows the distribution of tension measurements recorded for the anticipated emergency condition.

If only experienced airplane passengers (more than 1 flight) are considered, the belt tension results from both the normal and emergency conditions are not significantly different from the entire group results. Also, there does not appear to be a difference between the results gathered from male and female subjects.

When the subjects were asked to adjust the belt as if expecting an emergency, 14% elected not to adjust the tension at all, 77% adjusted the belts tighter than the normal tension, and 9% actually loosened the belt (inadvertently in most cases). Some subjects indicated they would need to loosen the belt so they could assume the brace for impact position. The most intriguing result was that some subjects stated they would unlatch the belt if they thought a crash was imminent, so they could get out quickly afterwards.

ATD Belt Tension Results. To relate the human subject belt tension data to initial tension used in sled tests, measurements were also taken with a 50% H-2

Table 1. Tension Subject Anthropometry

	Males				Females			
	Age	Height	Weight	Waist	Age	Height	Weight	Waist
Average	37.7	70.6	192.3	38.3	37.9	65.6	168.3	35.8
Max	65.0	79.7	359.0	60.2	65.0	74.8	322.7	53.9
Min	18.0	61.6	89.1	26.0	18.0	57.8	81.4	24.4
US Average	-	69.0 (3)	170.0 (3)	33.7 (4)	-	63.7 (3)	137.0 (3)	30.8 (4)

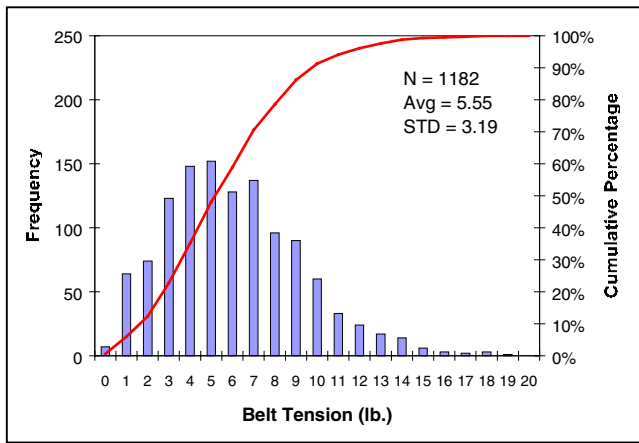

Figure 7. Emergency Lap Belt Tension



Figure 8. Lap Belt Adjustment Force Measurement

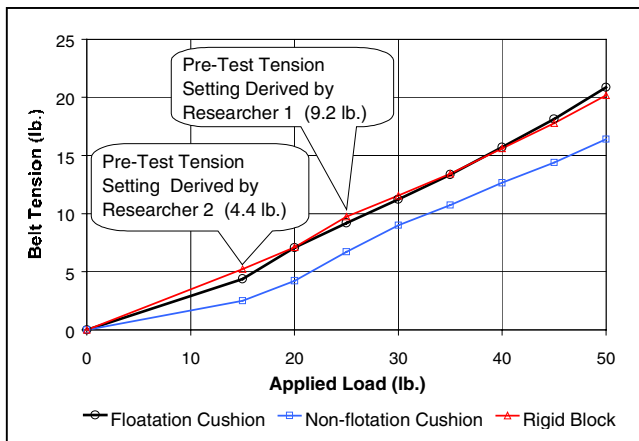

Figure 9. Lap Belt Tension vs. Applied Adjustment Force

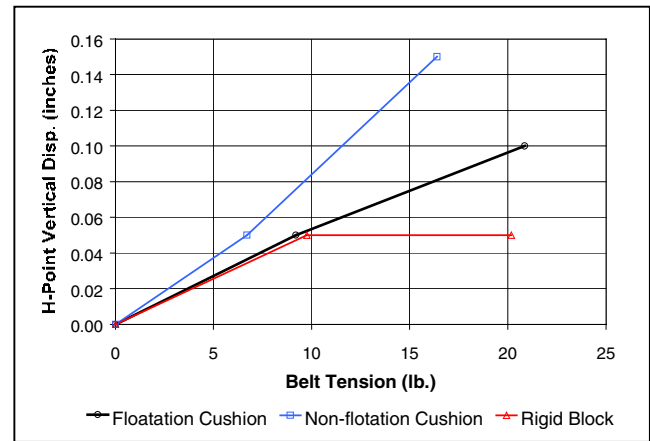

Figure 10. Lap Belt Tension vs. ATD Pelvis Displacement



Figure 11. Lift Latch Study Seat



Figure 12. Lift Latch Study Target Markers

ATD placed in the same seat used with the human subjects. The purpose was to measure the relationship between the force applied to the end of the webbing, the amount of tension produced in the belt, and the effect on the position of the ATD. Three cushions were used for this measurement: 1) the firm flotation cushion used with the human subjects trials, 2) a soft non-flotation cushion, and 3) a rigid wood block. The dimensions of the soft cushion and the rigid block were such that the ATD's hip joint (H-Point) was in the same initial position as when sitting on the flotation cushion.

Load was applied with a force gage to the free end of the webbing in a direction parallel to the entrance of the webbing from the buckle, as shown in Figure 8. The tension produced and the position of the ATD's hip joint was noted as the load applied was increased in 5-lb. increments. Fifteen pounds of force was required to overcome static friction in the buckle before slack could be removed from the belt. As can be seen in Figure 9, after the initial compliance of the ATD and seat cushion, the relationship between applied load and tension produced is linear.

The standard practice for setting the belt tension prior to a sled test is to tighten the belt until two fingers can be comfortably placed between the belt and the ATD's abdomen. (2) As part of this study, the belt tension was adjusted by two experienced CAMI laboratory personnel using the standard practice. Shown in Figure 9, the resulting tension differed by almost 5 lb (4.4 vs. 9.2 lb). Clearly, consistency is not a hallmark of this method.

The relationship between the ATD compression into the seat cushion and the belt tension is shown in Figure 10. The total compression into the seat cushion is affected by the combination of the stiffness of the cushion and the foam that makes up the ATD's pelvic flesh. When the belts are tightened with the ATD seated on the rigid block, the soft foam flesh under the ATD's ischial tuberosities compresses until it bottoms out. Increasing the tension does not further vertically displace the ATD.

When the ATD is seated on the firm flotation cushion and the belt tension is increased, the vertical displacement of the ATD mimics the load-displacement characteristic of the rigid block, up to the bottoming point of the pelvic flesh. Increasing the belt tension results in further vertical displacement of the ATD as the pelvis continues to compress the seat cushion, which has a stiffness characteristic slightly higher than the ATD pelvic flesh compliance.

When the belts are tightened with the ATD seated on the soft non-flotation cushion, the cushion begins to compress prior to the point at which the pelvic flesh bottoms out, indicating that the cushion foam is less stiff than the pelvis flesh.

These measurements indicate that the differences between the belt tension – ATD displacement characteristics for the rigid block, soft cushion, and firm cushion are small in the normal tension range. From Figure 10, the difference in the ATD's H-Point displacement is less than 0.02 inch when the belt tension is 7 lb. Although adjustment of the pre-test belt tension using the “two fingers” method may not provide consistency in the resulting tension, differences in ATD displacement from the nominal +1-Gz seated location are insignificant.

Discussion of Results

In general, the short answer to “How tight do passengers tighten their lap belt?” is “not very tight.” This conclusion, while not surprising, is important to seat and restraint designers, as well as those conducting dynamic sled tests. Data from human subjects in this study indicate that the tension passengers typically produce when adjusting their lap belts in non-emergency situations is less than 7 lb.

The general guidance suggested by this study is that the belt tension prior to a horizontal dynamic test should be high enough to remove all slack but should not disturb the initial position of the seated ATD. Although the person executing the procedure affects the lap belt tension arrived at using the “two fingers” method, the resulting pre-test tension may be considered sufficiently representative for the purpose of conducting sled tests. Considering that lap belt tension during a 16-G sled test may exceed 2000 lb., the pre-test tension produced by this method is unlikely to affect the test results.

LIFT LATCH ANGLE STUDY

Trial Setup. As shown in Figure 11, a typical economy class triple-place passenger seat was used in this study. The seat width, belt anchor location, and arm rest placement at each of the three seat positions were identical. Lap belts with lift latch type buckles were installed at all three seat locations. The belts had buckles that released at 30, 60, and 90 degrees. The seat was secured to the floor, facing a table in front of the seat. A push button switch was placed on the table directly in front of each seat place, 48 inches forward of the front edge of the

seat and 30 inches above the floor. To reach the switch, a subject had to release the lap belt buckle, stand up, and step forward towards the table.

Instrumentation. Two red light-emitting diodes (LEDs), one mounted on the table in front of the subject, and one mounted on the back of the seat, served as “START” indicators. The trial conductor controlled the illumination of the START LEDs. The lap belts were instrumented to detect when the buckle and tang physically separated, i.e. buckle release. This provided an electronic measurement of the time interval between the START LED illumination and the release of the buckle by the trial subject. Also, the time interval between the START LED illumination and the activation of the table-mounted push button switch by the subject was measured during this study.

Video Coverage. A normal speed video camera was placed in front of the trial setup. All three seat positions and the seat back START LED were in the field of view of the camera. The trial conductor initiated each trial by pressing a switch that simultaneously illuminated the two START LEDs, one prompting the subject to release the seat belt and the other visible on the video tape for timing synchronization.

Protocol. Each subject performed a trial with each of the three lift latch configurations. A repeated-measures counterbalanced design was chosen for economy of subjects and to control for the effects of trial sequence. Three buckle release angles (30, 60, and 90) were compared in the study; therefore, subjects were assigned to one of six possible experimental sequences (30-60-90, 30-90-60, 60-30-90, 60-90-30, 90-30-60, and 90-60-30).

In addition to the normal anthropometry gathered from each subject, the fore/aft and lateral position of the belt buckle was also measured after each subject had tightened the belt. A still photo was taken of each subject when seated with the belt tightened. As illustrated in Figure 12, calibration targets were placed on the seat and belt to allow other dimensional data to be derived from these still photos as necessary.

The human performance factors measured in this study were: 1) time to release the belt, and 2) time to egress from the seat and press a button located four feet from the seat. Any obvious difficulties encountered by the subject were also noted. The same directions were repeated to each subject. For each belt position, the subjects were instructed to:

- Sit in the seat, fasten the belt, and tighten the belt snugly.
- When the START LED illuminates, release the belt, stand, and press the button on the table *as fast as possible*.

Subject Anthropometry. Data were collected from a total of 201 subjects during this study (107 males, 94 females). The subjects’ anthropometric statistics are summarized in Table 2. As discussed previously, the average measurements of height, weight, and waist girth for this subject pool are larger than the US population average. Figure 13 shows the relationship between the measured buckle location and occupant girth. For reference, Figure 13 includes these dimensions measured with a 50% ATD.

Results. Figures 14 and 15 show a comparison of results by trial sequence. These figures do not indicate a learning effect during the three trials with each subject. When the average release time and average egress time is compared between the three belt configurations for all three experience levels, there is no significant difference between them.

This is not to say some subjects did not have some degree of difficulty. The maximum release time was 2.85 seconds. Fifteen subjects (7% of the total subject pool) had to try at least twice to get the buckle to release. Of the 15 subjects with double attempts, 9 occurred with the 90° lift latch configuration. In each case but one, the second attempt was successful in releasing the buckle. One subject repeatedly tried to push, rather than pull, on the release lever, as normally would be done in an automobile.

Table 2. Lift Latch Subject Anthropometry

	Males				Females			
	Age	Height	Weight	Waist	Age	Height	Weight	Waist
Average	37.2	70.4	188.8	37.2	35.4	65.9	165.0	34.9
Max	63.0	77.2	308.4	54.7	65.0	74.8	322.7	49.6
Min	18.0	64.5	120.3	27.2	18.0	60.3	99.4	26.0
US Average	-	69.0 (3)	170.0 (3)	33.7 (4)	-	63.7 (3)	137.0 (3)	30.8 (4)

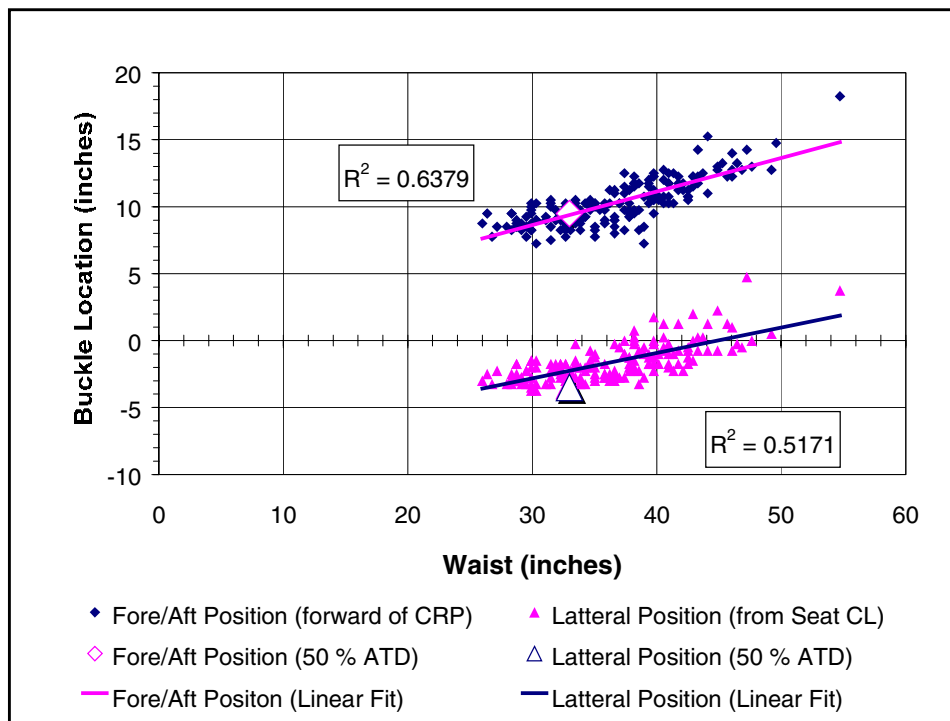

Figure 13. Belt Buckle Location vs. Occupant Girth

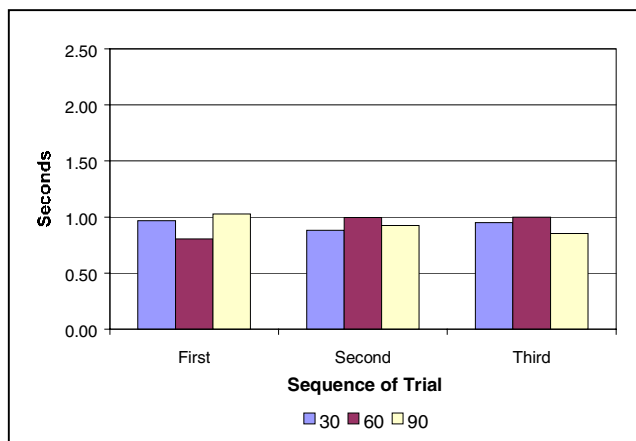

Figure 14. Average Latch Release Time

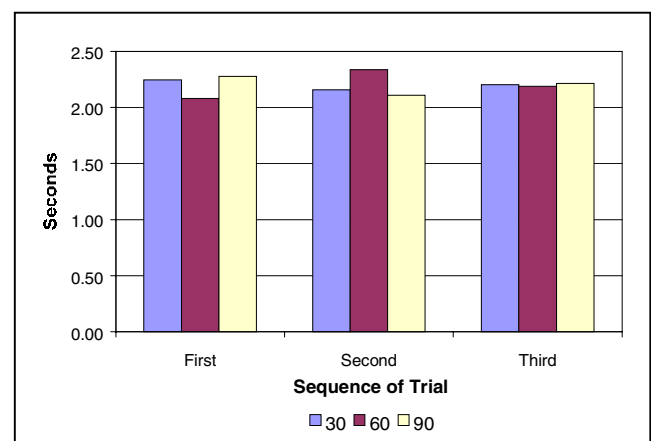

Figure 15. Average Egress Time

Discussion of Results. Most of the subjects in this study pulled the lift lever over 90 degrees when attempting to release the buckle in a rapid manner. Therefore, the effects on seat egress time due to differences in the lift latch release angles were negligible. It is important to note that this study did not address the difficulty in releasing the belt if the occupant was in a folded posture due to post crash injuries,

debris, or aircraft inversion. These scenarios could make it difficult to release a high-angle buckle due to interference with the abdomen.

Selection of an optimum range for the buckle release angle requires striking a balance between the need for easy release, while precluding inadvertent release during those situations where the lap belts are necessary for the safety of the passenger.

REFERENCES

1. British Civil Aviation Authority. Specification No. 1.
2. SAE International. Performance Standard for Seats in Civil Rotorcraft, Transport Aircraft, and General Aviation Aircraft. Warrendale, PA: SAE; 1997. Aerospace Standard: AS 8049A.
3. Schneider DH, et al. Development of Anthropometrically Based Design Specifications for an Advanced Adult Anthropomorphic Dummy Family, Volume 1. The University of Michigan, MI; 1983; Transportation Research Institute Report No. UMTRI-83-53-1.
4. Gordon CC, et al. 1988 Anthropometric Survey of U.S Army Personnel: Methods and Summary Statistics. Alexandria, Virginia: Defense Technical Information Center; 1989; Technical Report No. NATICK/TR-89/044.