

GAO

Report to the Chairman, Committee on
Education and Labor, House of
Representatives

April 2008

MINE SAFETY

Additional Guidance and Oversight of Mines' Emergency Response Plans Would Improve the Safety of Underground Coal Miners





Highlights of [GAO-08-424](#), a report to the Chairman, Committee on Education and Labor, House of Representatives

Why GAO Did This Study

In 2006, several mining tragedies led the Congress to pass the Mine Improvement and New Emergency Response Act of 2006 (MINER Act). The law required underground coal mine operators to develop emergency response plans that contain several components designed to improve accident preparedness and response, including providing a refuge of air to miners trapped underground after an accident and wireless communications systems. The Mine Safety and Health Administration (MSHA) is responsible for approving the plans and ensuring their implementation. GAO examined (1) the effectiveness of the approval process, (2) the status of implementation of the plans, and (3) MSHA's efforts to enforce and oversee implementation. To address these questions, GAO reviewed a nonprobability sample of emergency response plans, analyzed MSHA data, and interviewed MSHA officials and members of the mining community.

What GAO Recommends

GAO is recommending that MSHA clarify its guidance on the requirements for key components of emergency response plans; develop guidance on how mines can meet the June 2009 requirement for wireless communications systems; and take steps to analyze information on plans and their enforcement. MSHA agreed with the recommendations and noted several actions it is taking or plans to take to implement them.

To view the full product, including the scope and methodology, click on [GAO-08-424](#). For more information, contact Anne-Marie Lasowski at (202) 512-7215 or lasowskia@gao.gov.

MINE SAFETY

Additional Guidance and Oversight of Mines' Emergency Response Plans Would Improve the Safety of Underground Coal Miners

What GAO Found

The effectiveness of MSHA's process for approving underground coal mines' emergency response plans was hampered by several factors, including revisions and delays by MSHA in developing guidance for mine operators on the required components of the plans and the lack of specificity of its guidance, which delayed approval of the plans. MSHA revised its guidance several times and did not issue guidance on one key requirement—providing a refuge of air to miners trapped underground—until 6 months after the initial plans were due. In addition, while the content of the plans may differ because of the unique characteristics of the mines, GAO found that some plans did not specify the protections to be provided and information about these protections varied. For example, some of the plans did not specify whether refuges of air would be provided to miners working in certain areas of the mine to help them survive if they are trapped in the mine after an accident. As a result, it is uncertain whether all of the plans will help ensure that miners will be adequately protected in the event of an accident.

Most of the components of the mines' emergency response plans have been implemented but, as of January 2008, two key components remain. First, many mines have not implemented methods of providing air to trapped miners because needed equipment is not available. Second, mines have not begun to implement wireless communications systems or comparable alternatives to meet the June 2009 requirement in the MINER Act because fully wireless technology is not available and MSHA has not determined what technology it will allow mines to use to meet the requirement. The act provides that, where wireless systems are not available, alternatives to wireless communications systems are acceptable. While alternatives are currently available, MSHA headquarters officials told us they had no immediate plans to issue guidance detailing what technology would be acceptable in meeting the June 2009 requirement because they wanted to wait and see how new technologies developed by then. Given the delay, it is uncertain whether mine operators will be able to plan for and order the appropriate technology to meet the deadline, thereby missing opportunities to improve the chances of miners trapped in an underground coal mine after an accident to survive until they are able to be rescued.

MSHA's district offices have inspected many of the mines for compliance with their emergency response plans and have issued citations to enforce immediate implementation of the plans, but MSHA headquarters officials have not systematically evaluated the data on citations to identify potential problems with implementation or enforcement. For example, MSHA headquarters has not analyzed or compared citations issued under the statute or related regulations, which may lead to inconsistent enforcement and assessment of penalties. In addition, MSHA has provided insufficient oversight to ensure the quality of emergency response plans or to identify whether corrective actions are needed.

Contents

Letter		1
	Results in Brief	3
	Background	5
	The Effectiveness of MSHA's Approval Process Was Hampered by Several Factors that Delayed Approval and Resulted in Variations in the Plans	14
	While Most Plan Components Have Been Implemented, Two Key Components Have Not	22
	While MSHA's District Offices Have Enforced Mines' Implementation of Emergency Response Plans, MSHA Headquarters Has Provided Limited Oversight of Enforcement and Plan Quality	30
	Conclusions	38
	Recommendations for Executive Action	39
	Agency Comments and Our Evaluation	40
Appendix I	Scope and Methodology	43
Appendix II	Citations Issued by MSHA Related to the Requirements of Mines' Emergency Response Plans	48
Appendix III	Comments from the Department of Labor	51
Appendix IV	Comments from the Department of Health and Human Services	57
Appendix V	GAO Contact and Staff Acknowledgments	59
Tables		
	Table 1: Components of Emergency Response Plans Required by the MINER Act of 2006	12
	Table 2: Examples of Partially Wireless Communications Systems for Use in Underground Coal Mines	28

Table 3: Examples of Conditions Cited by Inspectors for Noncompliance with Mines' Emergency Response Plans	33
Table 4: Correction Time Frames for Citations Issued under the MINER Act to Mines for Failing to Submit or for Not Complying with Their Emergency Response Plans	35
Table 5: Number of Emergency Response Plans, by District	45
Table 6: Number of Citations Issued under the MINER Act to Active Mines for Violating Components of Emergency Response Plans, August 15, 2006, to December 11, 2007	48
Table 7: Citations Issued under the MINER Act for Violations of Multiple Components of Mines' Emergency Response Plans as of December 11, 2007	49
Table 8: Number and Percentage of Mines Cited per District under the MINER Act as of December 11, 2007	50

Figures

Figure 1: MSHA's Coal Mine Safety and Health District Offices and Number of Underground Coal Mines Located in Each District as of June 2007	7
Figure 2: Number of Workers in U.S. Underground Coal Mines, 1996 to 2006	9
Figure 3: Example of Self-Contained Self-Rescuer That Provides Supplemental Air in Case of an Emergency	11
Figure 4: Lifeline and Cache of Self-Contained Self-Rescuers in a Mine Tunnel	12
Figure 5: Timeline of Guidance and Key Events Related to Emergency Response Plans	16
Figure 6: Illustrations of Technologies Used to Meet the Current Requirement for Redundant Communication Systems	24
Figure 7: Methods for Providing Long-Term Postaccident Breathable Air for Trapped Miners and Percentages of Mines Planning to Use Each Method	25
Figure 8: Citations MSHA Issued to Mines under the MINER Act for Noncompliance with Each Emergency Response Plan Component, by Component, August 15, 2006, to December 11, 2007	32
Figure 9: Number of Citations Issued under the MINER Act Each Month, August 15, 2006, to December 11, 2007	34

Abbreviations

MINER Act	Mine Improvement and New Emergency Response Act of 2006
MSHA	Mine Safety and Health Administration
NIOSH	National Institute for Occupational Safety and Health

This is a work of the U.S. government and is not subject to copyright protection in the United States. This published product may be reproduced and distributed in its entirety without further permission from GAO. However, because this work may contain copyrighted images or other material, permission from the copyright holder may be necessary if you wish to reproduce this material separately.



United States Government Accountability Office
Washington, DC 20548

April 8, 2008

The Honorable George Miller
Chairman
Committee on Education and Labor
House of Representatives

Dear Mr. Chairman:

In January 2006, at the Sago mine in West Virginia, 12 men lost their lives after an explosion prompted them to barricade themselves in the mine to await rescue, an effort that took almost 2 days to complete. They died hours after the explosion from the poisonous carbon monoxide gases produced by the explosion. In the wake of this and other fatal mine disasters in the United States, the Congress enacted the Mine Improvement and New Emergency Response Act of 2006 (MINER Act) in an effort to improve the safety of the nation's underground coal mines.¹ As part of this act, mine operators were required to develop emergency response plans that detail how they will ensure the safety of underground coal miners immediately following any future disasters, such as how they plan to communicate with trapped miners after an accident. The act required mine operators to submit their plans to the Department of Labor's Mine Safety and Health Administration (MSHA) for approval by August 14, 2006—2 months after the law was enacted. MSHA issued guidance to mine operators on plan development and assigned responsibility for reviewing and approving the plans to its 11 district offices. After approving the emergency response plans, MSHA inspectors in its district offices enforce mine operators' compliance with the requirements described in their plans as part of regular inspections of underground coal mines.

The plans must contain several components designed to help ensure the safety of miners trapped in a mine after an accident, such as providing breathable air—air that has not been contaminated by carbon monoxide or other deadly gases released during an explosion or fire. Generally, mine operators must implement each component of the plan as soon as the component is approved by MSHA, rather than waiting for approval of the entire plan. In addition, by June 2009, the plans must provide for wireless

¹Pub. L. No. 109-236.

communications and electronic tracking systems or alternatives to these systems. The MINER Act also required the National Institute for Occupational Safety and Health (NIOSH), a research agency within the Department of Health and Human Services' Centers for Disease Control and Prevention, to study options for providing refuge to miners trapped underground after an accident.²

To learn about MSHA's efforts to approve and enforce implementation of the emergency response plans, you asked us to examine 1) the effectiveness of MSHA's process for approving mines' emergency response plans, 2) the status of implementation of underground coal mines' emergency response plans, and 3) the efforts MSHA has made to enforce implementation of the plans and oversee enforcement and plan quality.

To address these topics, we reviewed relevant federal laws, regulations, and agency guidance. We reviewed data provided by MSHA on the approval and implementation status of the emergency response plans for all underground coal mines categorized by MSHA as active, producing mines as of June 21, 2007. Using MSHA's data on the approval status of the plans, we selected a nonprobability sample of plans from each of MSHA's 11 district offices for review.³ Our sample included both plans that had been fully approved and those that had only been partially approved. Because there were so few, we selected many of the partially approved plans to identify the factors delaying their approval. We also reviewed data on citations issued by MSHA's district offices to mine operators for noncompliance with their plans. To assess the reliability of the data obtained from MSHA, we reviewed related documentation to corroborate the data, including the sample of emergency response plans and completed citation forms, evaluated the data for obvious errors in accuracy and completeness, and interviewed agency officials knowledgeable about the data. We determined that the data were sufficiently reliable for the purposes of our review. In addition, we interviewed officials at MSHA's headquarters and 11 district offices to learn about the plan approval process, implementation of the plans, and MSHA's inspection efforts. We visited two of MSHA's district offices, located in West Virginia and Kentucky—the two states with the largest number of underground coal mines in the United States—and visited

²NIOSH is responsible for developing or adapting new technologies for use in the mining industry and may make recommendations to MSHA based on its research findings.

³A nonprobability sample cannot be generalized to the population from which it was drawn.

underground coal mines in those states to learn about the equipment and technologies they used to implement their emergency response plans. In addition, we consulted with individuals knowledgeable about the field of mine safety, mine company officials, and union and industry representatives. We conducted this audit from April 2007 through April 2008 in accordance with generally accepted government auditing standards. Those standards require that we plan and perform the audit to obtain sufficient, appropriate evidence to provide a reasonable basis for our findings and conclusions based on our audit objectives. We believe that the evidence obtained provides a reasonable basis for our findings and conclusions based on our audit objectives. See appendix I for further information on our scope and methodology.

Results in Brief

The effectiveness of MSHA's process for approving underground coal mines' emergency response plans was hampered by several factors, including revisions and delays in developing the guidance and the lack of specificity of the guidance, which delayed approval of the plans. While MSHA headquarters issued initial guidance to its district offices and mine operators in July 2006, the agency continued to refine and revise the guidance for several months and did not issue guidance on one key component of the plans—providing postaccident breathable air to miners—until 6 months after the plans were due. These revisions and delays caused mine operators to revise and resubmit the plans and district officials to review the changes, delaying their approval, and ultimately, the preparedness of mine operators to respond in the event of an accident. MSHA headquarters officials attributed the revisions to not having enough time to interpret the law and obtain input from the mining community given the 2-month period between the enactment of the MINER Act and the deadline for submitting plans to MSHA. In addition, the lack of specificity in MSHA's guidance compelled headquarters and district staff to spend time resolving questions about the guidance after it was issued. Further, while the content of the plans may differ because of differences in the characteristics of each mine, we found that some of the plans did not specify the protections to be provided, and information about these protections varied. For example, some of the plans did not specify whether postaccident breathable air would be provided to miners working in certain areas of the mine, while other plans did. As a result, it is uncertain whether all miners will be adequately protected in the event of an accident.

As of January 2008, the operators of all active, producing underground coal mines had implemented most components of their emergency

response plans, but many had not implemented two key components. Many mine operators could not implement one of the components—providing postaccident breathable air to trapped miners in the event of an accident—because all of the needed equipment was not yet available. For example, about one-fifth of the mines had not received breathing devices on order from manufacturers, and nearly three-quarters of the mines were waiting for refuge chambers—one of the methods operators may use to provide breathable air to trapped miners. In addition, mine operators have not yet begun to implement another key component of their plans—upgrading mines’ communication systems to wireless or approved alternatives—because completely wireless systems are not available for underground mine use and MSHA has not determined what technologies it will allow mine operators to use to meet the June 2009 statutory requirement. The MINER Act provides that, where wireless systems are not available, alternatives to wireless communication systems are acceptable. Some companies have developed and begun marketing partially wireless systems that, according to NIOSH, could enhance communications and the safety of miners. However, MSHA headquarters officials told us they had no immediate plans to issue guidance detailing what technologies will be acceptable in meeting the June 2009 requirement because they wanted to wait and see how new technologies develop by then. Given the delay, it is uncertain whether mine operators will be able to plan for and order the appropriate technology to meet the deadline, thereby missing opportunities to improve the chances of miners trapped in an underground coal mine after an accident to survive until they are able to be rescued.

MSHA’s district offices have conducted inspections and issued citations to enforce implementation of mines’ emergency response plans, but MSHA headquarters has provided limited oversight of the districts’ enforcement efforts and the overall quality of the plans. MSHA’s districts have inspected many mines for compliance with their plans and issued citations to ensure immediate implementation of all components of the plans. Since late 2006, inspectors have issued over 350 citations to mine operators who had not properly implemented the approved components of their plans. However, while its district offices have taken steps to enforce implementation of the plans, MSHA headquarters has not systematically evaluated the data on citations to identify potential problems with implementation or enforcement. We reviewed the citations issued by MSHA’s 11 district offices for violations of mines’ emergency response plans from August 15, 2006, through December 11, 2007, and found large differences in the number of citations issued across districts. For example, one district had cited one of its 18 mines for noncompliance, while three districts had each

issued citations to over two-thirds of their mines. While there may be valid explanations for these differences, MSHA headquarters officials have not reviewed the data to identify why they occurred and, when asked about these differences, they said they were not aware of them. Similarly, MSHA headquarters has not analyzed whether inspectors are issuing citations under the statute or regulations when both apply, which could prevent MSHA from adequately tracking compliance and lead to inconsistent penalty assessments. In addition, MSHA has provided insufficient oversight to ensure the content of underground coal mines' emergency response plans meets a consistent agency-wide standard and determine whether corrective actions are needed.

To help ensure that underground coal mines' emergency response plans and their implementation improve the safety of underground coal miners in the event of an accident, we are recommending that the Secretary of Labor direct MSHA to develop additional guidance to clarify what is required for key components of the emergency response plans, such as providing postaccident breathable air for the maintenance of trapped miners; work with NIOSH to develop guidance for mine operators on how to meet the June 2009 requirement to provide postaccident wireless communications systems; and take steps to ensure that district offices are consistently applying MSHA's guidance on approving and enforcing emergency response plans. In commenting on a draft of our report, the Department of Labor agreed with the recommendations and noted several actions that MSHA has begun or is planning to take to provide additional guidance and oversight for emergency response plans. In its comments, the Department of Health and Human Services concurred with our recommendation that NIOSH and MSHA work together to develop guidance on postaccident wireless communications systems.

Background

Under the Federal Mine Safety and Health Act of 1977 (the "Mine Act"), Congress created MSHA and gave it primary responsibility for ensuring the safety and health of mine workers. MSHA's Coal Mine Safety and Health program office in headquarters is responsible for carrying out enforcement activities related to surface and underground coal mines, managing agency operations, and monitoring the activities of its 11 district offices. MSHA's district offices have day-to-day responsibility for activities such as reviewing and approving mine plans, including emergency response plans, and for conducting inspections, issuing citations for violations of health

and safety standards, and investigating mine accidents. As of December 2007, MSHA employed 460 underground coal mine inspectors in its 11 district offices.⁴ MSHA's principal enforcement responsibility for underground coal mines is fulfilled by conducting a minimum of four comprehensive inspections of every underground coal mine in the United States each year.⁵ When MSHA inspectors observe violations of mandatory federal health and safety standards, they are required to issue citations, or in some cases withdrawal orders,⁶ to mine operators. The mine operators generally are required by law to correct the hazardous situation on which the violation was based within the time frame set by the inspector, even if the mine operator contests the violation or penalty.

As of June 2007, there were approximately 470 U.S. underground coal mines categorized by MSHA as active, producing mines. As shown in figure 1, the number of active, producing mines varies among districts.

⁴These offices also employed approximately 76 inspectors who are authorized to inspect surface coal mines but not underground mines.

⁵Mines that are recognized as being especially dangerous, such as those containing high levels of methane gas, are required to be inspected more frequently.

⁶Withdrawal orders compel mine operators to remove miners from the affected work areas until the hazardous situation cited is corrected, which could halt production in those areas of the mine.

Figure 1: MSHA's Coal Mine Safety and Health District Offices and Number of Underground Coal Mines Located in Each District as of June 2007^a

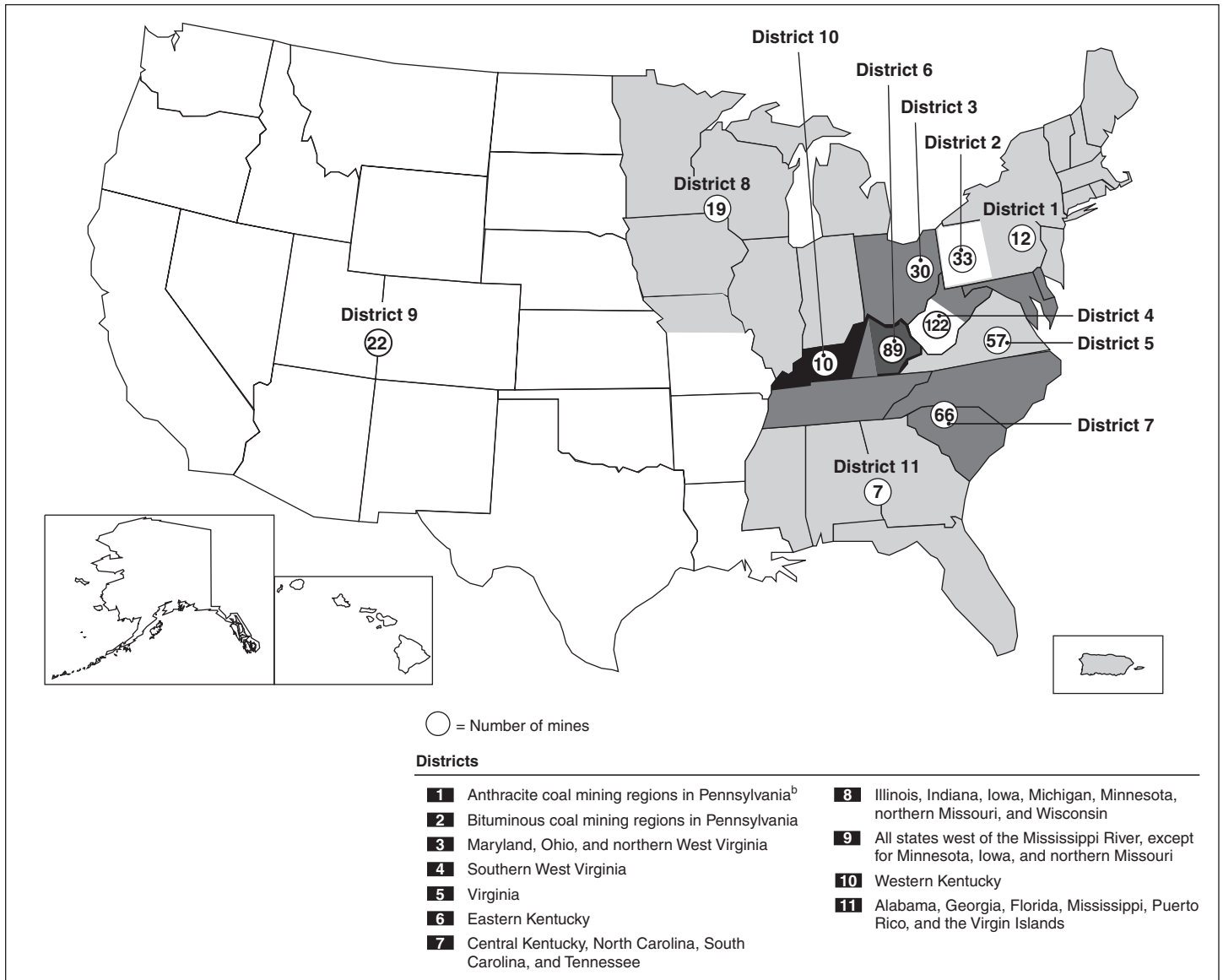

Sources: MSHA (information); Art Explosion (map).

^aWe included all underground coal mines categorized by MSHA as active, producing mines as of June 2007. MSHA defines active mines as those that operate on a full-time basis to produce coal.

^bWhile the map indicates that District 1 includes states north of Pennsylvania, there currently is no coal mining in those states.

The number of active, producing coal mines changes frequently as new mines open, active mines are temporarily idled, or mines are abandoned.⁷ Some underground mines do not actively produce coal all year; some are only operated seasonally because of local weather conditions; and operations at smaller, less cost-effective mines are often suspended when the price of coal drops below a certain level.

Underground coal mining is a dangerous industry for several reasons. For example, the presence of methane gas, which is highly explosive and is often produced in large quantities when coal is extracted, contributes to the hazardous working conditions. Additional risks include geological conditions in many areas of the country that make the roofs of mines unstable, the danger posed by a fire in an underground mine, and flooding from nearby abandoned mines. The danger posed by these factors has increased in recent years as miners dig deeper to reach remaining coal reserves. Further, while the number of underground coal miners was on the decline in the last half of the 1990s, as shown in figure 2, this trend has reversed in recent years, exposing more workers to the dangers of underground coal mining.

⁷MSHA categorizes mines that have ceased production but anticipate reopening in the future as temporarily idled; mines that are closed for the foreseeable future as being abandoned; and mines that have been abandoned with their underground openings sealed as being abandoned and sealed.

Figure 2: Number of Workers in U.S. Underground Coal Mines, 1996 to 2006

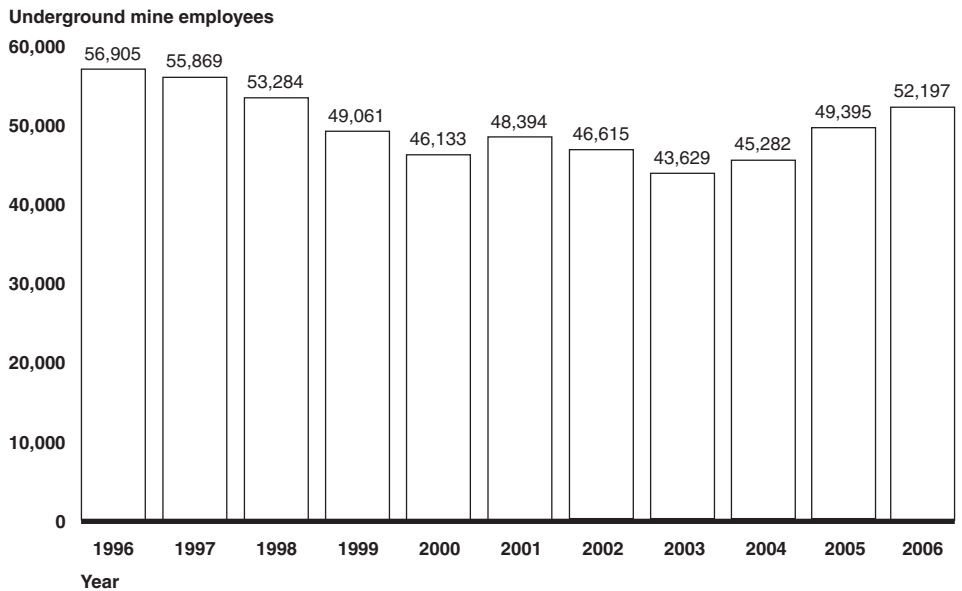

Source: GAO analysis of MSHA data.

In March 2006, a few months after the Sago mine accident, MSHA issued an Emergency Temporary Standard that required mine operators to immediately implement certain health and safety improvements designed to enhance protections for underground coal miners.⁸ MSHA issued a final rule revising the standard in December 2006. In June 2006, the Congress passed the MINER Act, which required mine operators and MSHA to undertake reforms, including developing and adopting emergency response plans, enhancing mine rescue teams, and instituting higher penalties for the most serious violations.

The MINER Act required that, within 60 days of enactment, underground mine operators develop and adopt written emergency response plans.⁹ The act also required MSHA to review and approve emergency response plans.

⁸MSHA has the authority to issue an Emergency Temporary Standard when it determines that miners are exposed to grave danger from exposure to substances or agents determined to be toxic or physically harmful, or to other hazards, and that an emergency standard is needed to protect miners from such danger. The standard becomes effective upon publication in the *Federal Register* and remains in effect until replaced by final regulations subject to the rulemaking process, but for no longer than 9 months.

⁹30 U.S.C. § 876(b)(2)(A).

The agency implemented this requirement by issuing guidance for mine operators to use in developing their plans and by having its district offices review the plans submitted by mines under their jurisdiction to ensure that they conformed with the guidance.¹⁰ MSHA is also required to review approved plans at least every 6 months to ensure that they are updated to reflect changes in mine operations and advances in technology.¹¹ The MINER Act specified several components that mine operators must include in their emergency response plans, including providing uncontaminated or “breathable” air for miners after an accident.¹² The postaccident breathable air component includes two parts: (1) emergency supplies of air sufficient to maintain trapped miners for extended (long-term) periods and (2) caches of portable breathing devices—known as self-contained self-rescuers (see fig. 3)—positioned along mine tunnels leading to the mine entrance to aid in the miners’ escape.¹³ Another component required by the act is postaccident lifelines—ropes that miners can use after an accident to find their way out of the mine and to find the caches of portable breathing devices stored in the mine¹⁴ (see fig. 4).

¹⁰30 U.S.C. § 876(b)(2)(C).

¹¹30 U.S.C. § 876(b)(2)(D).

¹²30 U.S.C. § 876(b)(2)(E)(iii).

¹³According to MSHA’s guidance, self-contained self-rescuers are not an acceptable method of providing emergency supplies of air for the long-term maintenance of trapped miners.

¹⁴30 U.S.C. § 876(b)(2)(E)(iv).

Figure 3: Example of Self-Contained Self-Rescuer That Provides Supplemental Air in Case of an Emergency



Source: CSE Corporation.

Figure 4: Lifeline and Cache of Self-Contained Self-Rescuers in a Mine Tunnel

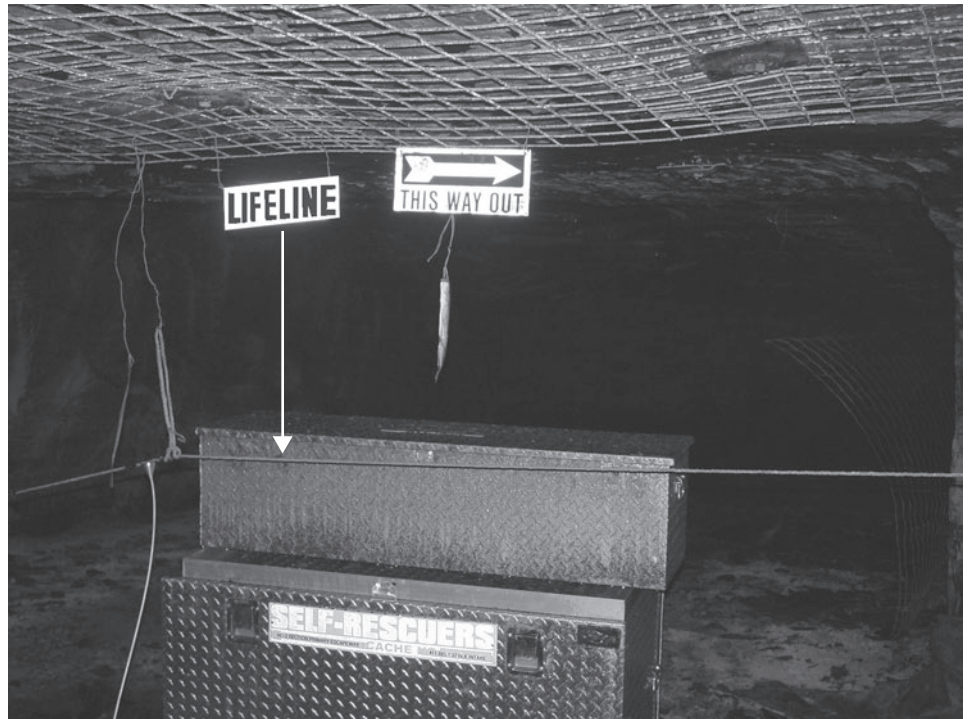

Source: MSHA.

Table 1 describes all of the components of mines' emergency response plans required by the MINER Act.

Table 1: Components of Emergency Response Plans Required by the MINER Act of 2006

Component	Description of requirement
Postaccident communications	Redundant (backup) means of two-way communication with the surface for persons underground. Plans must require wireless two-way systems or alternatives by June 2009.
Postaccident tracking	System to enable above ground personnel to determine the current or immediately preaccident location of all underground personnel. Plans must require an electronic tracking system or alternative by June 2009.
Postaccident breathable air	Emergency supplies of breathable air sufficient to maintain trapped miners for a "sustained period of time." Caches of self-contained self-rescuers providing, in total, not less than 2 hours per miner to be kept in escapeways (tunnels that lead to the mine entrance) from the deepest work area to the surface at intervals no farther than a miner could walk in 30 minutes and a schedule for checking the reliability of self-rescuers to ensure that the units will function properly in an emergency.

Component	Description of requirement
Training	<p>Training for proper donning of self-contained self-rescuers, switching from one self-contained self-rescuer to another, and ensuring proper fit of self-contained self-rescuers.</p> <p>Training program for emergency procedures described in the plan.</p>
Postaccident lifelines	<p>Directional lifelines (ropes with cones or other devices to indicate the direction of the mine entrance) used during an evacuation that are installed along mine tunnels leading from the areas where miners are extracting coal to the entrance of the mine (escapeways).</p> <p>Plans must require lifelines that meet MSHA's flame resistant standards by June 2009 or sooner, as existing lifelines are replaced.</p>
Local coordination	<p>Procedures for coordination and communication between the mine operator, mine rescue teams, and local emergency personnel; and provisions for familiarizing local rescue personnel with surface functions that may be required in the course of mine rescue work.</p>

Source: GAO analysis of the MINER Act.

MSHA's headquarters allowed district offices to separately approve each component of a mine's emergency response plan so that the mine could begin implementing each component once it was approved, rather than waiting for approval of the entire plan. Most of the required components were to be implemented immediately upon approval or within the time frames set in the approved plan. However, the act gave operators additional time to implement certain components, including wireless communications and electronic tracking systems, or their alternatives, and flame-resistant lifelines, which generally are not required to be implemented until June 15, 2009.

In addition, the MINER Act required NIOSH to study the utility, practicality, survivability, and cost of providing various refuge alternatives in underground coal mines and to report its findings, which it did, by December 2007.¹⁵ Under its Mining Safety and Health Research program, NIOSH conducts research on mine safety technology, including research on advancements in self-contained self-rescuers, communications equipment, and tracking devices. In 2006, the Congress provided NIOSH with \$10 million in emergency supplemental appropriations for research to develop mine safety technology.

MSHA and NIOSH are both responsible for getting new safety technology into the mines. For certain types of mining products, MSHA's technical experts conduct evaluations and tests to ensure that they will not cause a fire or an explosion in a mine before they approve the use of such

¹⁵NIOSH, *Research Report on Refuge Alternatives for Underground Coal Mines* (Washington, D.C., Dec. 2007).

products. NIOSH is responsible for developing and adapting new technologies for use in the mining industry. Based on research findings, NIOSH may recommend that MSHA issue new safety and health standards. However, NIOSH does not have the authority to compel MSHA to take action on its recommendations. In our 2007 report on MSHA, we stated that coordination between MSHA and NIOSH was primarily informal and inconsistent and recommended that they develop a formal memorandum of understanding to guide their agencywide coordination efforts.¹⁶ However, at the time of our review, such a memorandum had not been finalized.

The Effectiveness of MSHA's Approval Process Was Hampered by Several Factors that Delayed Approval and Resulted in Variations in the Plans

The effectiveness of MSHA's approval process for underground coal mines' emergency response plans was hampered by several factors that delayed approval of the plans. Specifically, MSHA issued its guidance multiple times and did not issue guidance on one key requirement until 6 months after the initial plans were due. Once issued, MSHA's guidance lacked specificity and, as a result, MSHA district staff we interviewed said that they had to spend time resolving mine operators' questions about the guidance after it was issued. In addition, actions taken by some mine operators, such as their reluctance to submit adequate plans, further delayed the approval process. We also found that the plans we reviewed varied in content and did not always specify the protections to be provided for miners.

MSHA's Revisions and Delays in Issuing Its Guidance Delayed Plan Approvals

Both MSHA district staff and mine operators we interviewed stated that MSHA's revisions of its guidance and delays in issuing the guidance caused mine operators to revise their mines' plans several times, delaying plan approvals. The MINER Act required underground coal mine operators to develop and adopt written emergency response plans by August 14, 2006. (See fig. 5 for a timeline of MSHA's guidance and key events related to the emergency response plans.) MSHA issued general guidance on the requirements for the emergency response plan components in July 2006 and revised it twice—in August and October of that year. According to district officials, by the time MSHA headquarters issued its revised guidance in October—2 months after mine operators were required to

¹⁶GAO, *Mine Safety: Better Oversight and Coordination by MSHA and Other Federal Agencies Could Improve Safety for Underground Coal Miners*, GAO-07-622 (Washington, D.C.: May 16, 2007).

submit their plans for approval—the districts were in the process of reviewing and approving the plans. As a result, mine operators had to revise and resubmit their plans to reflect the revised guidance, and the districts had to review them to ensure that changes were incorporated.

Figure 5: Timeline of Guidance and Key Events Related to Emergency Response Plans

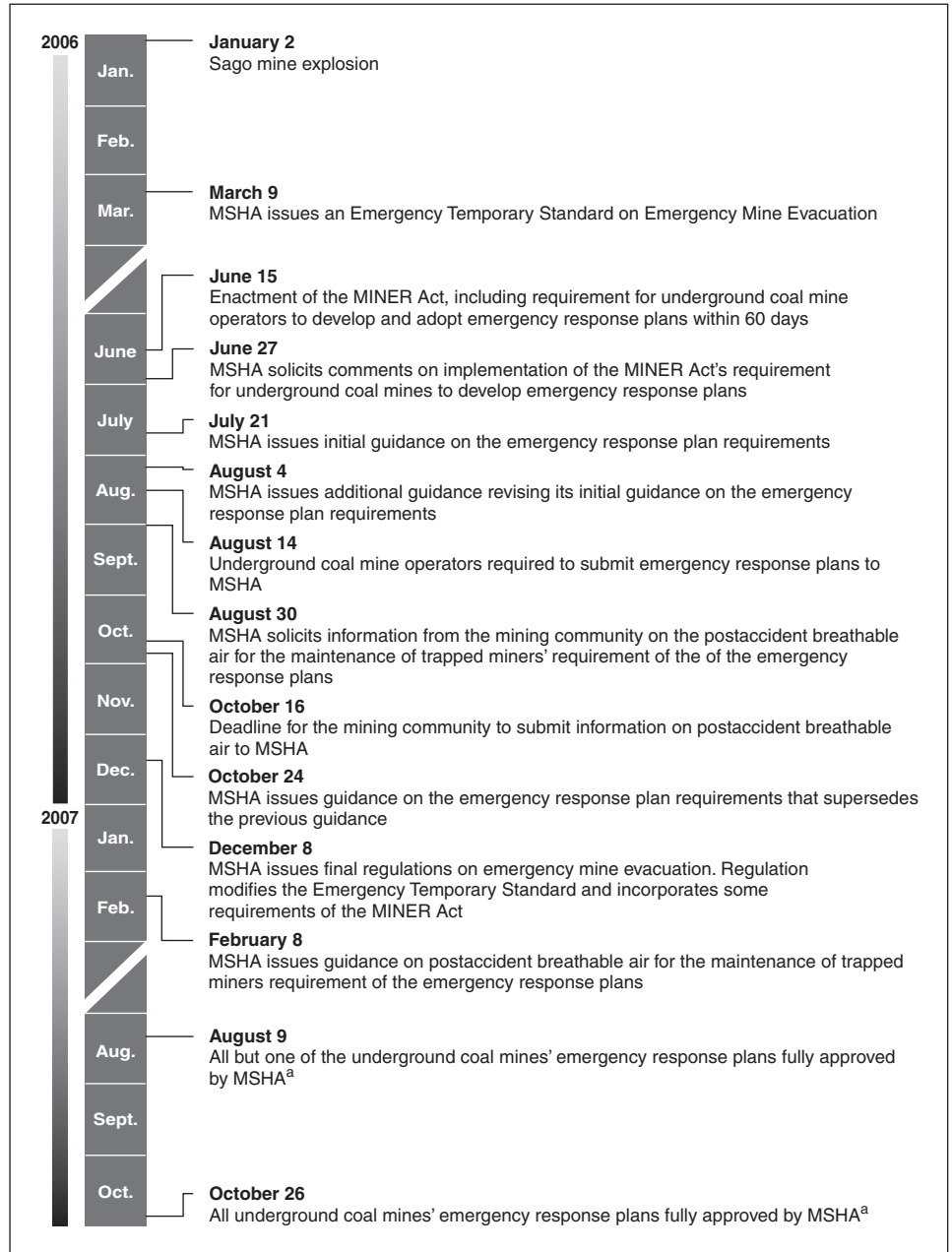

Sources: MSHA and GAO analysis of applicable laws, regulations, guidance, and *Federal Register* notices.

^aThis includes only mines categorized by MSHA as active, producing as of June 2007.

In addition, in February 2007, 6 months after mines were required to submit their emergency response plans to MSHA for approval, the agency issued new guidance on the MINER Act's requirement that the plans provide long-term postaccident breathable air for miners trapped underground. MSHA sought input from the mining community on this requirement, requesting comments on methods for providing safe and reliable supplies of postaccident breathable air in the summer of 2006. However, while MSHA received 11 comments from mine operators or their representatives during the comment period that closed on October 16, 2006, it did little to act on these comments for several months. One senior level MSHA official told us that a working group established to develop this guidance did not begin to do so until January 2007 and that the agency did not finalize the guidance until February 2007, 4 months after the comment deadline and 6 months after the deadline for mine operators to submit their plans to MSHA for approval.

In the absence of written guidance, some district officials we interviewed said that they provided mine operators with verbal guidance that was inconsistent with written guidance later issued by MSHA headquarters. For example, officials in one district told us that they had informed mine operators, based on discussions with headquarters officials, that they would be required to provide 48 hours of long-term postaccident breathable air. However, when headquarters later issued written guidance requiring mine operators to provide 96 hours of postaccident breathable air, the district officials had to meet with mine operators to explain the new guidance and ask them to revise their plans, which delayed approval.

According to MSHA officials, some of the revisions and delays in developing guidance resulted from the tight time frames specified in the MINER Act for developing and adopting the plans. MSHA headquarters and district officials told us that, between the enactment of the MINER Act in mid-June 2006 and the deadline for submitting emergency response plans to MSHA for approval in mid-August, there was not enough time to develop complete guidance outlining what mine operators should include in their plans. At the same time, MSHA headquarters officials said that they were also trying to meet the December 2006 deadline for finalizing the Emergency Temporary Standard the agency issued in March. MSHA headquarters officials said they needed additional time to interpret the law, discuss it with key stakeholders from the mining community, and incorporate the results of these discussions in the guidance. Similarly, MSHA headquarters officials stated that they needed time to review and evaluate acceptable methods for meeting the MINER Act's requirement for postaccident breathable air before making decisions about the type,

amount, and location of breathable air mines would be required to provide. However, because of the revisions and delays in issuing the guidance, mine operators' ability to provide the equipment and information needed to protect miners' safety in the event of an accident, as intended by the MINER Act, was also delayed.

The Lack of Specificity of MSHA's Guidance Also Hampered Approval of the Plans

The effectiveness of the approval process was also hampered by the lack of specificity of MSHA's guidance on the emergency response plans' components, including its guidance on the postaccident tracking, lifelines, and postaccident breathable air requirements of the MINER Act. As a result, MSHA's district staff had to spend time resolving mine operators' questions about the guidance after it was issued, which further delayed approval of the plans and the preparedness of mine operators to respond to an accident. To resolve some of the questions posed by mine operators, some district officials told us that they asked headquarters staff for additional guidance but did not always receive a response, and sometimes the response was not timely. Staff in a few districts said that, if they did not receive a response from headquarters officials, they made their own decisions about how to interpret the guidance. In some instances, they said that headquarters officials later made decisions about the requirements of the plans that differed from those made by the districts. As a result, the districts had to ask mine operators to revise their plans to comply with headquarters' revised interpretations of the requirements, further delaying approval of the plans. The following examples illustrate the impact of MSHA's guidance:

- Although MSHA's guidance indicated that operators could satisfy the postaccident tracking requirement by using a dispatcher system, it did not specify certain aspects of what should be included in the plans. A few of the district officials we interviewed said that some mine operators stated in their plans that they intended to divide their mines into large zones to minimize the number of phones they had to provide and make it easier for miners to move around the mine without having to report their location to staff working above ground.¹⁷ However, because MSHA's guidance did not specify the allowable sizes of the zones or provide criteria for determining their appropriate sizes, the district officials said they had to spend time negotiating with mine

¹⁷Generally, underground areas of the mine are divided into zones. Miners are required to contact mine staff working above ground when they move from one zone to another to let them know in which zone they are located in case of an accident.

operators to establish smaller zone sizes, which would improve the chances of identifying the location of trapped miners after an accident.

- MSHA's guidance did not specify the materials mine operators needed to use to meet the requirement for postaccident lifelines. One district official told us some of the mine operators in his district wanted to use existing water lines as lifelines, rather than providing new, flame resistant lifelines. As a result, the official had to negotiate with them to resolve this issue. MSHA headquarters later specified in writing that some water lines were not a suitable option for meeting this requirement of the MINER Act.
- Further, MSHA's guidance did not specify what methods mine operators could use or what methods they were prohibited from using to provide oxygen to and remove hazardous gas from refuge areas. A few of the district officials we interviewed said that they had many discussions with mine operators and headquarters officials about whether MSHA would consider chemically-generated oxygen an acceptable method for supplying long-term breathable air. Similarly, some officials were seeking guidance from MSHA headquarters on acceptable methods of removing hazardous gas from refuge areas several months after the initial guidance was issued. MSHA's technical support division provided additional guidance after researching the technical issues involved. District officials then had to notify the mine operators who intended to use these methods that their plans had to be revised, which delayed their approval.

Approval of Plans Sometimes Delayed by Mine Operators' Actions

In addition to the delays caused by issues related to MSHA's guidance, actions taken by some mine operators delayed plan approval. While district officials said that most mine operators were cooperative and responsive during the approval process, some district officials said some mine operators submitted initial plans that did not meet all of the requirements, which contributed to delays in the review process. For example, a few district officials said that some mine operators used vague language in their plans. In addition, a few district officials responsible for reviewing the plans told us that it was difficult to reach some of the mine operators to discuss deficiencies in their plans or ask them to resubmit their plans when revisions were needed, further delaying the approval process. One official added that, once MSHA gave mine operators deadlines for submitting revisions, the process for reviewing the revisions moved more quickly.

Some mine operators proposed methods for meeting the requirements of the MINER Act that took time for MSHA to evaluate because they were unfamiliar with these methods. For example, a company that owned nine mines in one district proposed an alternative method of meeting the postaccident tracking requirement: using telephone answering machines to track the locations of miners working underground. Since this method differed from the typical dispatcher system used by other mines, district staff sought input from headquarters on whether the proposed system was an acceptable method of complying with the postaccident tracking requirement for emergency response plans. MSHA's technical support division observed the system before making a decision and determined that it was not sufficient. The process of reviewing such alternative methods prolonged the approval of some mines' plans.

By June 2007, MSHA had resolved most of the issues with the mine operators and approved their plans, but the approval of a few plans was delayed for several months. After discussion with the mine operators, two districts reached an impasse with three mines on the postaccident breathable air component of their plans.¹⁸ However, MSHA subsequently reached agreement with these mines on their emergency response plans. As of October 26, 2007, more than a year after the initial deadline for submitting plans, MSHA had approved all underground coal mines' emergency response plans that were part of our analysis.¹⁹

¹⁸Under the MINER Act, if MSHA and a mine operator reach an impasse on the approval of the mine's emergency response plan, MSHA must issue the mine a citation. Such a citation is immediately referred to the Federal Mine Safety and Health Review Commission, where an administrative law judge must render an expedited decision to resolve the dispute. That decision is reviewable by the Commission.

¹⁹This included all underground coal mines that were categorized by MSHA as active, producing mines as of June 2007.

Mines' Approved
Emergency Response
Plans Vary in the
Information Provided on
Certain Plan Components,
Raising Uncertainties
about the Protections
Provided to Miners

The approved emergency response plans we reviewed varied in the information provided and, therefore, it is uncertain whether certain protections will be afforded to all miners. It is understandable that the content of the plans may differ because there are differences in the specific characteristics of mines. However, in our review of the plans we sampled, we found that some plans did not specify the protections to be provided and the amount of information about these protections varied from plan to plan. The following examples illustrate the variations in the plans we reviewed.

Postaccident breathable air. Some of the plans we reviewed specified the materials that the mine needed to provide long-term postaccident breathable air for trapped miners, but other plans did not. For example, the plans we reviewed in three districts included worksheets for mine operators to complete that specified the quantity of oxygen, number of compressed air cylinders, and materials needed to remove contaminants from the air. An official in one of the districts said the district also required mines that chose refuge chambers as a method of providing long-term postaccident breathable air to trapped miners to indicate the size and type of refuge chambers they purchased. The official said they asked for this information to help ensure that the locations in the mines where the chambers would be placed were large enough to accommodate the inflated chambers without puncturing them. In contrast, some of the plans we reviewed in other districts only indicated the possible options or combinations of methods of providing breathable air that the mine might choose; the plans did not indicate the specific methods that the mines chose for meeting the breathable air requirement or specify the amount of oxygen, air, or materials needed to remove contaminants from the air. As a result, it was unclear how the districts determined that the methods identified in the plans will be sufficient for those mines.

Postaccident breathable air in certain locations of the mine. The plans we reviewed varied in whether they specified that the mine operator would provide long-term postaccident breathable air in locations between the working section of the mine where coal was being extracted and the entrance of the mine, known as outby locations.²⁰ For 6 of the 10 districts

²⁰MSHA's guidance on long-term postaccident breathable air issued in February 2007 did not clearly specify whether the plans must require postaccident breathable air in these locations. It was later, in April 2007, in a questions and answers document, that MSHA headquarters clarified that the plans should require breathable air in outby locations.

with approved plans,²¹ all of the approved plans we reviewed either specified that postaccident breathable air would be provided in these locations and the method to be used to provide air, or they indicated that air was not required in these locations and explained why.²² However, for 4 of the 10 districts with approved plans, some plans did not specify whether postaccident breathable air was required for miners working in outby locations or the methods for providing it. As a result, in some mines, miners working in these locations may not have access to postaccident breathable air if they become trapped in the mine after an accident.

Postaccident tracking. We also found large differences in the information contained in the plans we reviewed for the postaccident tracking component. All of the plans we reviewed for one district detailed the responsibilities of surface and underground personnel for this component and described the underground areas or zones to be used in identifying the location of miners. In contrast, in another district, none of the plans we reviewed described the responsibilities of the mine personnel or the zones to be used to identify the location of miners. Without providing specific information about how to track miners, it was not clear how the districts determined that the methods identified in the plans will be sufficient for those mines and how mine operators will identify where trapped miners are located in the event of an accident.

While Most Plan Components Have Been Implemented, Two Key Components Have Not

Most of the components of mines' emergency response plans have been implemented, but two key components remain. As of January 2008, all underground coal mines had implemented all or most components of their emergency response plans. However, few of the mines had implemented one key component—postaccident breathable air—because needed equipment was not available. In addition, mines had not begun to implement another component—wireless communications systems or a comparable alternative—because fully wireless technology is not available and MSHA had not determined what alternative technologies mine operators will be allowed to use to meet this requirement of the MINER Act, which mines must implement by June 2009.

²¹One of MSHA's districts did not have any fully approved plans when we collected the sample of plans to be reviewed and, therefore, was not included in this analysis.

²²According to MSHA's guidance, some mines are not required to provide postaccident breathable air if the working section of the mine (the area where the coal is being removed) is less than 2,000 feet from the mine entrance.

Mines Had Implemented All or Most Components of Their Emergency Response Plans

As of January 2008, all underground coal mines had implemented all or most of the components of their emergency response plans²³ that were required to be implemented immediately after approval. Twenty percent of all underground coal mines had fully implemented all components of their emergency response plans. The remaining mines had implemented all of the components, except the requirement for postaccident breathable air. Specifically, according to MSHA district officials, all mines had implemented the redundant communication and tracking systems required by their plans, had provided training on emergency procedures and the use of self-contained self-rescuers, and had developed procedures for coordinating and communicating with local emergency responders, as required. In addition, many mines had installed flame-resistant lifelines, although the MINER Act generally does not require their installation until June 2009.

Generally, as with most plan components, mines are using widely accepted methods to implement the current postaccident communications and tracking requirements of their emergency response plans and are moving toward using electronic tracking systems to meet the June 2009 requirement of the MINER Act. To meet the redundant communications requirement, according to NIOSH, most mines are using hardwired mine phones and leaky feeder cable systems with handheld radios²⁴ (see fig. 6). To meet the postaccident tracking requirement, nearly 90 percent of the plans we reviewed specified that a dispatcher or equivalent system would be used to track miners.²⁵ At the time of our review, according to the manufacturers we interviewed, approximately 13 mines were installing electronic tracking systems.²⁶

²³This includes 449 mines characterized by MSHA as active, producing mines as of October 30, 2007.

²⁴These are systems that use feeder cables that allow radio signals to “leak” into and out of the cable, radiating a signal throughout most areas of a mine and allowing miners working underground and personnel above ground to communicate using these signals.

²⁵Miners report their changes in location to a dispatcher on the surface, who notes their new location on a map of the mine.

²⁶Identifying tags attached to miners’ helmets or belts are read by electronic readers when the miners pass by the readers. The tags transmit each miner’s location to electronic equipment on the surface. The system provides each miner’s location on an electronic map of the mine.

Figure 6: Illustrations of Technologies Used to Meet the Current Requirement for Redundant Communication Systems

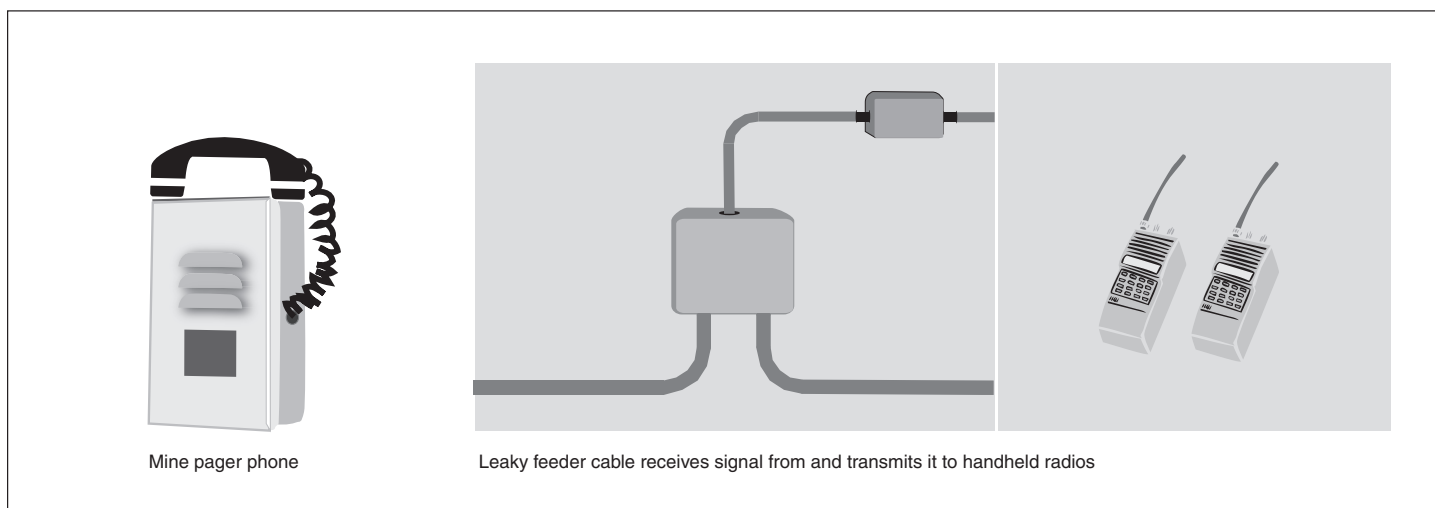

Sources: GAO presentation of miner's equipment used to summon help; images partially from Art Explosion.

One Key Component Had Not Been Fully Implemented Because Equipment Was Not Available

As of January 2008, because needed equipment was not available, more than three-quarters of the mines had not been able to fully implement the requirement to provide long-term postaccident breathable air for trapped miners, and one-fifth of the mines had not been able to provide all of the required self-contained self-rescuers to aid in miners' escape.²⁷ According to MSHA's guidance, mines can use several alternative methods to provide long-term postaccident breathable air for trapped miners. These methods include providing a premanufactured refuge chamber, either hard-sided or inflatable, that can be easily moved around the mine; building a protected room in the mine—called a prebuilt safe haven—where breathable air and survival supplies will be available; and providing a skid that contains materials for constructing an airtight barricade after an accident, equipment to provide breathable air, as well as water, food, and other supplies. As shown in figure 7, most mines planned to use at least one refuge chamber to provide long-term postaccident breathable air to trapped miners.

²⁷The postaccident breathable air component includes two parts: (1) emergency supplies of air sufficient for the long-term maintenance of trapped miners and (2) caches of self-contained self-rescuers positioned along mine tunnels leading to the mine entrance to aid in the miners' escape. According to MSHA guidance, self-contained self-rescuers are not an acceptable method for providing emergency supplies of air sufficient for the long-term maintenance of trapped miners.

Figure 7: Methods for Providing Long-Term Postaccident Breathable Air for Trapped Miners and Percentages of Mines Planning to Use Each Method^a

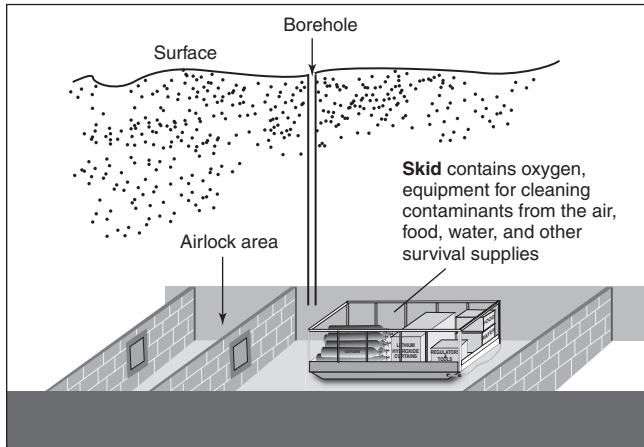

Prebuilt safe haven (14% of mines)

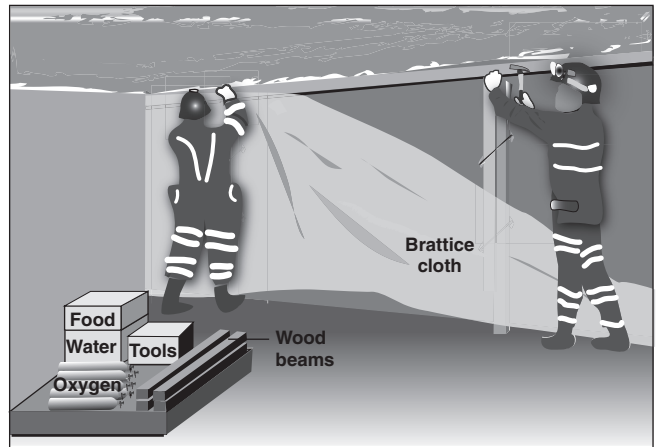

Miners using barricading materials from a skid to erect a safe haven after an accident (27% of mines)

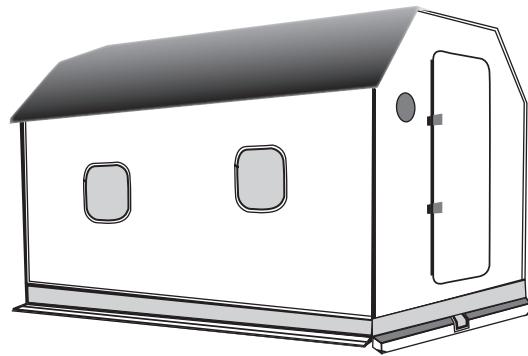
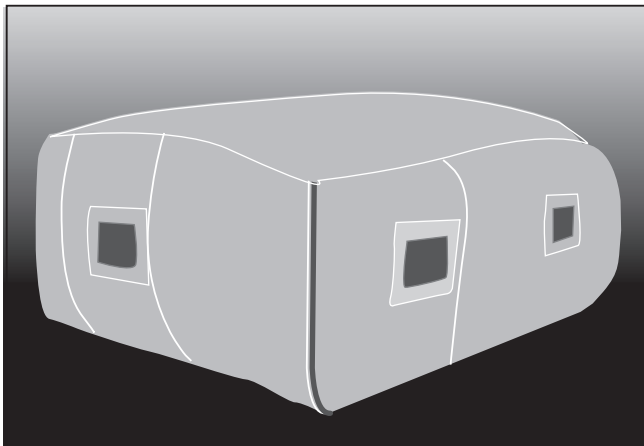

Inflatable (left) and hard-sided (right) refuge chambers (69% of mines)

Source: GAO's illustration of miner's refuge in an emergency.

^aMines may use more than one method to provide breathable air to trapped miners. For example, a mine may choose to use a refuge chamber at the working section of the mine (i.e., where the coal is being removed) and a prebuilt safe haven at locations nearer the mine entrance along an exit route.

Note: District officials reported that 7 percent of mines were using something other than the above alternatives to provide postaccident breathable air, such as forcing air into the mine through preinstalled pipes or through a borehole or shaft drilled from the surface into the mine.

Refuge chambers. Although, according to MSHA, 69 percent of all underground coal mines had ordered either inflatable or hard-sided refuge chambers, only 4 percent of these mines had received the chambers as of January 2008. Manufacturers had difficulty increasing production to meet the demand from mine operators prompted by enactment of the MINER Act, and they encountered shortages of needed materials and equipment. According to the MSHA officials and manufacturers we interviewed, manufacturing limitations may delay delivery of some refuge chambers until 2009. In light of these delays, senior MSHA headquarters officials told us that they were considering requiring mine operators who had not yet received refuge chambers to make interim arrangements, such as providing prebuilt safe havens or barricading materials to allow miners to construct safe havens. In addition, mine operators we interviewed said they were concerned that, based on NIOSH's evaluation of the chambers, MSHA might develop guidance that requires modification or replacement of the chambers they have ordered, which might further delay their delivery or increase the costs.²⁸

Prebuilt safe havens and skids with barricading materials. Fourteen percent of the mines opted to build their own safe havens, and 27 percent opted to provide skids with supplies needed for breathable air, barricades, and other survival necessities. However, as of January 2008, only 12 percent of the mines using safe havens and 50 percent of the mines using skids had fully implemented these methods. Unavailable equipment prevented full implementation for many mines, often because manufacturers were not able to meet the increased demand for items such as oxygen tanks, airlock doors, and equipment needed to eliminate carbon dioxide from refuge areas.

Self-contained self-rescuers. At the time of our review, manufacturers of self-contained self-rescuers were beginning to catch up with the sudden increased demand created by the requirements of the MINER Act. However, as of January 2008, 20 percent of the mines were waiting for delivery of some of the self-contained self-rescuers required by their plans.

²⁸In April 2007, MSHA specified in a questions and answers document that state-approved refuge chambers were an acceptable alternative for providing postaccident breathable air for trapped miners. NIOSH released its research report on refuge alternatives in December 2007, which identified shortcomings in selected refuge chambers that must be corrected before they are installed in mines. As of February 2008, MSHA had not responded to the NIOSH report with specific guidance on the use of refuge alternatives. Its response is required by June 2008.

The manufacturers we interviewed told us that they did not expect this large increase in demand to continue into the foreseeable future and, therefore, did not greatly increase their production capacity, which limited the number of units they could produce in the short term.

MSHA Has Not Determined What Technologies Will Be Acceptable in Meeting the MINER Act Requirement for Wireless Communications Systems

Although the MINER Act requires mines to provide postaccident wireless two-way communications systems or approved alternatives by June 2009, MSHA has not determined what technology mine operators will be allowed to use to meet this requirement. The MINER Act does not define wireless communications systems, except to state that mines' emergency response plans must include provisions for postaccident communications between underground and surface personnel via a "wireless two-way medium." However, the act also states that, if such components cannot be adopted by mine operators, their plans may instead include alternative methods that "approximate, as closely as possible, the degree of functional utility and safety protection" that would be provided by a wireless system.²⁹ The Senate committee report on the act stated that the intent of this requirement is for mine operators to use the most advanced technology available that works best in their particular mine. The report also noted that the intent is to avoid interpreting the law so narrowly as to stifle innovation and delay implementation of methods or equipment that would have significant safety benefits.³⁰

According to NIOSH, the term "wireless," as used by the global telecommunications industry, has come to mean that the end user device, such as a cell phone, is not connected locally by a wire. However, these systems require a hardwired infrastructure to support communications. In its research, NIOSH has found that infrastructure-free systems that can provide wireless two-way communications—which we refer to in this report as fully wireless systems—do not exist for most underground coal mines due to operational constraints. According to NIOSH officials, their research has demonstrated that, for wearable and portable two-way communications devices to work in most underground coal mines, infrastructure will be required to support any postaccident communications systems that will be available in the foreseeable future.

²⁹30 U.S.C. § 876(b)(2)(F).

³⁰S. Rep. No. 109-365 (2006).

Although researchers and manufacturers have developed fully wireless communications systems, there are concerns about the viability and practicality of these systems, and there are significant limitations for their use in underground coal mines. For example, according to NIOSH, systems that use antennae placed underground and on the surface above the mine (referred to as through-the-earth systems) have a very limited range and most provide only one-way text communication from individuals on the surface to miners underground. Individuals we interviewed who were knowledgeable about the mine industry—including representatives of NIOSH, MSHA’s technical support division, and companies that develop new technology for use in underground coal mines—and the research we reviewed indicated that fully wireless two-way communications systems may not be available for many years because the conditions in the mines make it extremely difficult for communication signals to cover significant distances.

According to NIOSH, MSHA’s technical support division staff, and manufacturers, some partially wireless systems in which the coal miner is not tethered to the infrastructure are available now, and other alternatives that could enhance communications and the safety of miners in underground coal mines are nearly ready for use. The use of these partially wireless communications systems—such as leaky feeder or fiber optic cable systems—is becoming more widespread in mines. In addition, NIOSH and manufacturers are developing other options for providing partially wireless communications in mines, including ethernet networks and wireless mesh networks. Examples of some of these systems are shown in table 2.

Table 2: Examples of Partially Wireless Communications Systems for Use in Underground Coal Mines

Type of system	Description
Leaky feeder	Signal “leaks” to and from a feeder cable, radiating a signal that allows communication throughout much of the mine.
Ethernet	Ethernet local area network that uses a special data communications protocol transmitted over coaxial cable or twisted-pair wires to permit voice communications in mines.
Wireless mesh	Wireless mesh networks use wireless modems (called nodes) placed throughout a mine. The signal “hops” from node to node, permitting two-way voice, data and video to be sent and received. If some nodes fail in a mine accident, the network can reconfigure itself and create a new path for communication signals using nodes that are still functional.
Parasitic signal propagation	A signal is transmitted along existing mine infrastructure, such as wires, rails, and cabling, and can “jump” from one medium to another, such as traveling from a wire to a rail. In some instances, the signal can bypass a damaged section of cable by traveling along an alternate medium until it is past the damaged section.

Source: NIOSH.

Although some of these systems are currently available, others are still being developed, and some components have not yet been approved by MSHA as being safe for use in underground coal mines.³¹ In early 2008, MSHA approved the first wireless mesh network for tracking miners and is reviewing the manufacturer's application for approval of a modification that would enable two-way text messaging using this network. An MSHA official responsible for approving equipment for use in underground coal mines told us that the agency is working with a number of other manufacturers seeking MSHA's approval of wireless mesh systems that would allow two-way voice communications.

NIOSH has developed plans for ensuring that advanced and survivable communications systems are provided in the mines. Given the progress that has been made in developing alternatives to fully wireless technology, NIOSH has developed a phased approach in which underground coal mines would install systems using partially wireless technology. Mines could install these improved communications systems alongside traditional systems, such as mine pager phones, or combine systems that use one type of technology, such as leaky feeder cable, with those that use other technologies, such as wireless mesh, to create communications systems more likely to survive a mine accident. NIOSH officials told us that their approach is focused on ensuring that mine operators can make use of existing technologies as they upgrade to more survivable communications systems.

Similar to NIOSH's approach, West Virginia requires mines to use wireless communications systems but defines them as systems that allow individual communications by a miner through a mine communication and tracking system without a physical connection. West Virginia allows mines to use leaky feeder cable and WiFi communications systems to meet this requirement, both of which are partially, rather than fully, wireless systems. West Virginia's state mining office has approved communications and tracking technologies developed by several manufacturers, but not all of them have been approved by MSHA for use in underground coal mines. West Virginia officials said that they expect their mines to have operational systems to meet this requirement by late 2008.

³¹Equipment installed in an underground coal mine must have prior approval from MSHA as being either intrinsically safe for use in an underground coal mine or explosion-proof.

Despite these advances in partially wireless technology, MSHA had not yet determined what types of technology will be acceptable for mines to use to meet the June 2009 requirement for wireless communications. In its guidance on emergency response plans issued in October 2006, MSHA defined the term wireless to mean systems with no underground wires that might be damaged by fire or explosion. As previously noted, according to NIOSH, such infrastructure-free systems will not be possible for most mines. MSHA's guidance noted that specific conditions in each mine would be taken into account in determining whether the system was likely to withstand an accident intact. At the time of our review, MSHA officials told us they had no immediate plans to issue guidance detailing what technology will be acceptable in meeting the June 2009 requirement for wireless communications because they wanted to wait and see what technology is available closer to the deadline. As a result, it is uncertain whether mine operators will be able to plan for and order enhanced communications systems to meet the deadline. In justifying the delay, one official expressed concern that manufacturers would stop trying to develop fully wireless technology if MSHA announced that partially wireless technology is acceptable. However, some manufacturers told us that, because MSHA has not determined what technology will be acceptable, they are concerned that they are investing time and money in developing technology that may not ultimately be acceptable to MSHA.

While MSHA's District Offices Have Enforced Mines' Implementation of Emergency Response Plans, MSHA Headquarters Has Provided Limited Oversight of Enforcement and Plan Quality

MSHA's district offices have conducted inspections and issued citations to enforce implementation of mines' emergency response plans, but MSHA headquarters has provided limited oversight of the districts' enforcement efforts and the overall quality of the plans. MSHA's districts have inspected many mines for compliance and issued citations to enforce implementation of their emergency response plans, but MSHA headquarters officials have not systematically evaluated the data on citations related to emergency response plans to identify potential problems with implementation or enforcement. In addition, MSHA headquarters has provided insufficient oversight to ensure the quality of underground coal mines' emergency response plans or to identify whether corrective actions might be needed.

District Offices Have Used Inspections and Citations to Enforce Implementation of Plans

In October 2006, MSHA headquarters provided the districts with guidance stating that inspectors should begin checking for compliance with approved emergency response plan components during the regular inspection process. If an inspector finds a mine operator has not implemented a component of its approved plan, MSHA can cite the mine for noncompliance with its plan. According to district officials, all of MSHA's districts began incorporating individual components of mines' plans into their regular inspections as soon as the components were approved. Inspectors were notified of the approval of individual components of the mines' plans through updates of the mines' uniform mine files, which contain all of the mines' plans and must be reviewed by inspectors prior to each inspection.³²

As of December 2007, inspectors had issued over 350 citations to mine operators who had not properly implemented the approved components of their emergency response plans. MSHA inspectors began issuing citations for noncompliance in November 2006, shortly after MSHA headquarters issued its guidance.³³ Prior to November 2006, MSHA district offices only issued citations to mines that had failed to submit or revise their emergency response plans for approval. From November 2006 through mid-December 2007, the most frequently issued citations were related to postaccident communications, postaccident tracking, postaccident breathable air, and additional plan content.³⁴ The citations for noncompliance with the postaccident breathable air component of mines' plans included violations for not having the required self-contained self-rescuers and supplies for providing oxygen to miners trapped underground for a long period of time. Figure 8 indicates the percentage

³²Each district office maintains all of the plans that each mine is required to have approved by MSHA, including its emergency response plan, in a uniform mine file for that mine. In addition to the emergency response plans, mines are required to have many other plans approved by MSHA, including ventilation plans and roof control plans.

³³Unless otherwise specified, the citations referred to in this report are citations written under the MINER Act, in which the inspector cites either § 316(b) or § 316 as the section of the act that was violated. We analyzed the citations MSHA issued from August 15, 2006, through December 11, 2007, to mines that were categorized by MSHA as active, producing mines, as of October 30, 2007.

³⁴The MINER Act does not specify the requirements for additional plan content; however, the requirements for this component of the plans are detailed in MSHA's guidance to underground coal mine operators on the content of emergency response plans. The guidance specifies provisions that the plan should include for the maintenance of miners trapped underground, including barricading materials, food and water, and emergency supplies.

and number of citations issued for noncompliance with each component of the mines' emergency response plans.

Figure 8: Citations MSHA Issued to Mines under the MINER Act for Noncompliance with Each Emergency Response Plan Component, by Component, August 15, 2006, to December 11, 2007

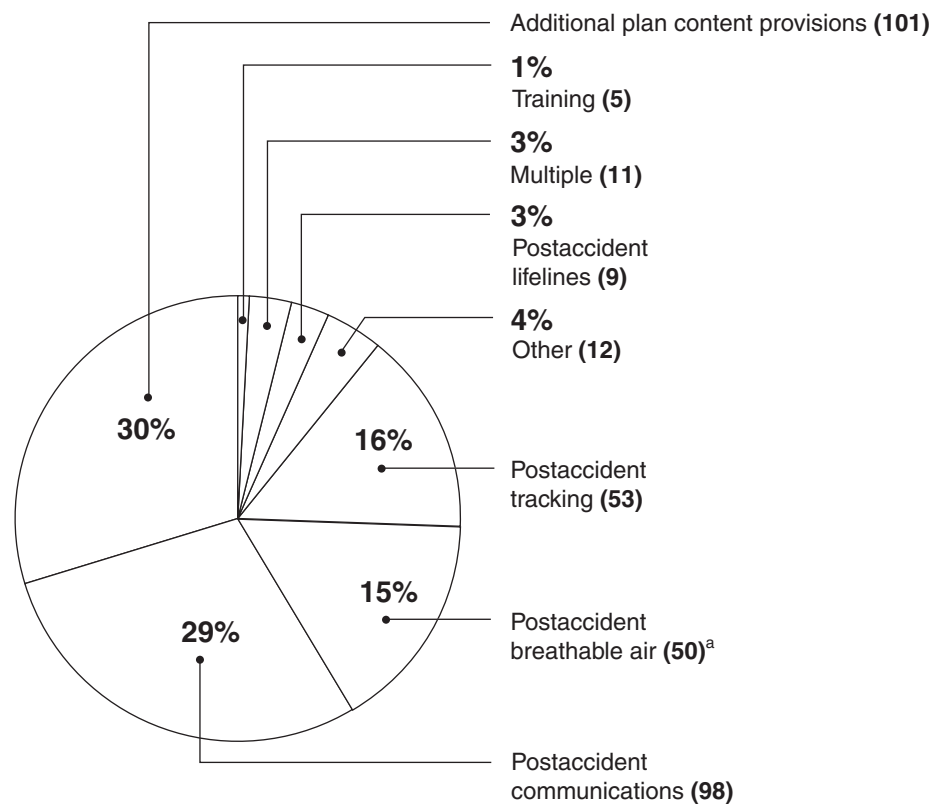

Source: GAO analysis of MSHA data.

^aThe 50 citations for noncompliance with the postaccident breathable air component include 42 violations of plans' provisions for the long-term maintenance of miners trapped underground, 7 violations of plans' provisions for self-contained self-rescuers, and 1 violation of both provisions for both.

The reasons for the citations varied; instances of noncompliance cited included, among other things, mines not installing required equipment or equipment not functioning properly. Table 3 includes examples of the conditions cited by inspectors.

Table 3: Examples of Conditions Cited by Inspectors for Noncompliance with Mines' Emergency Response Plans

Emergency response plan component	Summary of violation
Postaccident communications	The plan stated that a second and separate communications system would be installed in the primary escapeway. The plan also stated that the second system would be a telephone line that would extend with the lifeline as mining progressed. This second line was to be installed within 30 days of the approval of the plan. No secondary communications system had been installed.
Postaccident tracking	The mine operator failed to comply with the tracking plan in the mine's emergency response plan. The tracking plan was not effective in that one miner was recorded as being in two different working sections of the mine at the same time and two miners were recorded as being underground when they were actually both on the surface.
Postaccident breathable air: long-term maintenance of miners trapped underground	The operator's emergency response plan required that arrangements be made to provide breathable air for the active section of the mine within 60 days after the plan was approved. The plan had been approved and 60 days had elapsed, but the operator had not made arrangements to provide breathable air.
Postaccident breathable air: self-contained self-rescuers	A self-contained self-rescuer storage container was not being maintained. The container had been damaged; the lids were badly bent and hanging; and the self-contained self-rescuers were exposed to dirt, dust, and water.
Training	Discussions with seven miners indicated that they were not adequately trained in transferring from one self-contained self-rescuer to another, as required by the approved emergency response plan.
Postaccident lifelines	The lifeline installed in the alternate escapeway along the conveyor belt was broken in several locations. A section of the lifeline was wrapped around other equipment.
Additional plan content	The following items were not available on the working section: claw hammer, protective gloves, eight roof jacks, four brattice boards, nails, and food and water in sufficient amounts.
Multiple	The operator had not installed a lifeline in the primary escapeway from the surface to the working section. Also, the mine operator had not installed an additional means of communication from the surface to the working section of the mine.
	The mine operator was not keeping a written record of the location of miners underground, as required by the mine's emergency response plan. In addition, the items listed in the plan's section for additional plan contents were not provided on the working section for the maintenance of miners trapped underground.

Source: GAO summary of MSHA data.

MSHA issued more citations to mines beginning in May 2007 when more plans had been fully approved. Citations issued for failure to submit or revise a plan were generally issued earlier in light of the August 2006 deadline, and citations issued for long-term postaccident breathable air for miners trapped underground tended to be issued later, since MSHA did not provide guidance on this issue until February 2007. Excluding these two categories, the number of monthly citations increased from 9 in April 2007 to 30 in May 2007 and had increased to nearly 60 by October 2007 (see fig. 9). According to MSHA's Administrator for Coal Mine Safety and Health, the number of citations increased as more approved plans became

eligible for inspection, and will likely decrease as more mines successfully implement their plans and properly maintain their equipment.

Figure 9: Number of Citations Issued under the MINER Act Each Month, August 15, 2006, to December 11, 2007

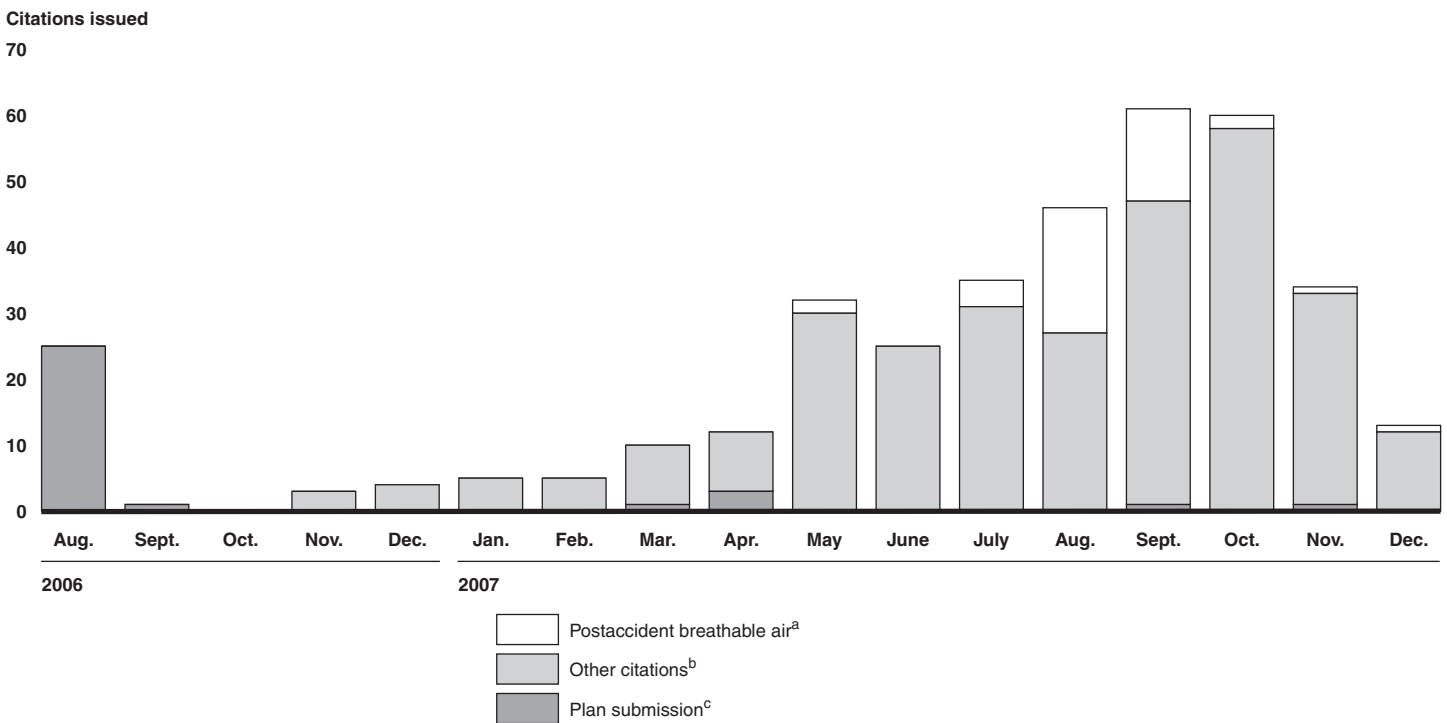

Source: GAO analysis of MSHA data.

^a“Postaccident breathable air” includes citations issued for not providing supplies for the long-term maintenance of miners trapped underground. These citations were related to MSHA’s February 2007 guidance on providing postaccident breathable air for the maintenance of miners trapped underground. Citations issued for failure to comply with the requirement for providing caches of self-contained self-rescuers, which MSHA addressed in its general guidance in the summer and fall of 2006, are included in “other citations.” We categorized the citations this way to demonstrate the increase in citations related to postaccident breathable air that occurred after MSHA issued the guidance on this component. One citation that was issued for both the maintenance of trapped miners and for self-contained self-rescuers is included in this category.

^b“Other citations” includes citations issued for multiple components, including one from August 2007 that cited a mine for, among other things, not providing postaccident breathable air for the long-term maintenance of miners trapped underground. The category also includes citations issued regarding self-contained self-rescuers, which were addressed in MSHA’s general guidance on emergency response plans issued in the summer and fall of 2006.

^c“Plan submission” includes failure to submit a plan or revise a plan. For example, after MSHA released its February 2007 guidance on postaccident breathable air for the long-term maintenance of trapped miners, MSHA required mine operators to resubmit their plans to show how the mine would address this component.

Most citations MSHA issued for violations of mines' emergency response plans were promptly addressed by the mine operators. Upon issuing a citation, the MSHA inspector is required to establish a deadline for correction of the safety or health hazard identified in the citation. More than half of the hazards identified in citations issued to underground coal mines through December 11, 2007, were corrected within a week of being issued, and one-quarter were corrected on the same day that the citations were issued (see table 4). About 7 percent of the citations reviewed were still outstanding at the end of 2007 and pertained to mines' failure to comply with their plans' requirement to provide long-term postaccident breathable air to trapped miners. Half of these outstanding citations have not been terminated because the equipment the mine operators planned to use to meet the requirement was unavailable.

Table 4: Correction Time Frames for Citations Issued under the MINER Act to Mines for Failing to Submit or for Not Complying with Their Emergency Response Plans

Correction time frame	Number of violations	Percent of total violations
Same day	94	25.3%
Within 1 week	134	36.1
Within 2 weeks	39	10.5
Within 3 weeks	39	10.5
Within 4 weeks	18	4.9
Greater than 4 weeks	20	5.4
Not corrected ^a	27	7.3
Total	371	100%

Source: GAO analysis of MSHA data.

^aThese citations were still outstanding, as of January 1, 2008.

In a November 2007 report, the Department of Labor's Office of Inspector General indicated that decreasing inspection resources has made it difficult for MSHA to complete all required inspections of underground coal mines.³⁵ Management officials we interviewed in 4 of the 11 district offices indicated that they did not have an adequate number of inspectors to complete the required emergency response plan inspections. However, several managers also said that this situation will be remedied when newly

³⁵U.S. Department of Labor, Office of Inspector General, *Underground Coal Mine Inspection Mandate Not Fulfilled Due to Resource Limitations and Lack of Management Emphasis*, 05-08-001-06-001 (Washington, D.C., Nov. 2007).

hired inspectors become fully qualified to conduct inspections. One former district manager said that inspectors were able to complete the required inspections of mines' emergency response plans but may not have had time to proactively recommend improved safety practices to mine operators during these inspections.

MSHA Has Not Systematically Evaluated Citation Data to Identify Potential Problems with Implementation or Enforcement

MSHA headquarters has not examined the available data on citations to assess the extent to which each emergency response plan component has been violated or whether enforcement of the plans may differ across districts. Senior officials at MSHA headquarters told us that they had not analyzed the citations related to emergency response plans, apart from totaling the number of citations issued under the MINER Act. The MSHA specialist responsible for reviewing the citation data said that MSHA headquarters analyzes the citation data more to oversee the compliance of individual mine operators and mines, rather than to oversee districts' enforcement efforts. As a result, MSHA headquarters officials were not aware that the number of citations related to emergency response plans varies across districts. We reviewed the citations issued by MSHA's 11 district offices for violations of mines' emergency response plans from August 15, 2006, through December 11, 2007, and found large differences in the number of citations issued across districts. For example, as of December 11, 2007, one district had cited one of its 18 mines for failing to comply with its emergency response plan; in contrast, three districts had cited over two-thirds of their mines for noncompliance with their plans. (See app. II for details on the number of citations issued and the number of mines cited per district.) When we informed a senior MSHA official of these differences, he said he was not aware of them or the reasons for these differences. While some differences can be expected, MSHA has not identified the causes of these differences or whether they are the result of inconsistent enforcement, which may warrant corrective actions.

MSHA headquarters also has not analyzed and compared citations issued under the MINER Act with citations issued under related agency regulations.³⁶ Some of the emergency response plan requirements of the MINER Act are also contained in MSHA's regulations. For example, both the MINER Act and MSHA regulations require mines to have lifelines or equivalent devices.³⁷ MSHA has not established a clear policy for when

³⁶30 C.F.R. Part 75 contains regulations relating to mandatory safety standards for underground coal mines.

³⁷See 30 U.S.C. § 876(b)(2)(E)(iv) and 30 C.F.R. § 75.380(d)(7) and § 75.381(c)(5).

inspectors should cite the emergency response plan requirement of the MINER Act or the regulations when both apply. We found that both types of citations have been issued for the same requirement, indicating that it would not be possible to assess mines' compliance with a requirement by evaluating either type of citation in isolation. Specifically, based on our analysis of MSHA's citation data, we found that, while inspectors issued only 14 citations for noncompliance with the lifeline requirements of the MINER Act, they issued over 150 citations for noncompliance with regulations regarding lifelines over the same period.³⁸ One assistant district manager said that inspectors use the regulations as the basis for citations because they are more specific than the language of the MINER Act; therefore, the regulations allow the inspector to better specify the nature of the violation and defend the citation if it is contested.³⁹ While data on citations for noncompliance with the MINER Act and the regulations are available, MSHA headquarters does not review both data sources and, as a result, may not have accurate information to reflect the full extent of operator compliance with emergency response plan requirements.

The option to cite either the emergency response plan requirement of the MINER Act or regulations for certain kinds of violations could also prevent MSHA from appropriately considering one of the statutory factors that is used to calculate penalty assessments. Specifically, MSHA is required to consider the mine operator's history of previous violations in assessing penalties. The formula it uses to assess penalties results in a higher penalty if the mine has been cited previously five or more times for violating the same statutory provision or regulation in the preceding 15 months. However, if citations for repeat violations by the same mine are not issued consistently under the same provision—either the applicable statute or the regulations—MSHA's penalty assessment system will not identify them as repeat violations, even though the nature of the violation is the same. Therefore, if an inspector issued five citations to a mine operator for failing to maintain the mine's lifelines under the emergency response plan requirement of the MINER Act and subsequently issued a sixth citation under the regulations, rather than the MINER Act, MSHA's penalty assessment system would not flag the violation as a repeat violation, and the higher penalty assessment would not apply. For example,

³⁸Lifeline citations included in this analysis were those issued under 30 C.F.R. §75.380(d)(7)(i)-(ii) and 30 C.F.R. §75.381(c)(5)(i).

³⁹For example, MSHA's regulations contain more specific requirements regarding the spacing between directional indicators and the use of reflective material to mark the location of lifelines.

MSHA issued two citations to one mine under the MINER Act and assessed the minimum penalty amount. Between the dates that these two citations were issued, however, the mine received at least four citations for violations of regulations that overlapped with the requirements of the MINER Act. Had these four citations been issued under the MINER Act per MSHA headquarters' guidance to its districts, rather than under MSHA's regulations, the penalties assessed would have been higher to reflect the mine's repeated violations of the emergency response plan requirements of the MINER Act.

MSHA Has Not Provided Sufficient Oversight to Ensure Plan Quality

Although MSHA headquarters has reviewed some of the mines' emergency response plans, it has not provided sufficient oversight of the district offices to ensure that the levels of safety protection required by the plans are adequate across all of its district offices. Internal control standards for the federal government advise that internal controls should be designed so that monitoring is ongoing and ingrained in agency operations.⁴⁰ During mine inspections, inspectors must ensure that the mines are adhering to the requirements described in the content of their emergency response plans. However, as discussed earlier in this report, the plans we reviewed varied in the information provided for certain plan components, such as postaccident breathable air and postaccident tracking, raising uncertainties about the protections provided to miners. One senior MSHA headquarters official said that the district offices have submitted samples of mines' approved plans to headquarters but the review of such plans has not been systematic or comprehensive. He further indicated that such a review would be time-consuming and resource intensive. MSHA headquarters officials said they plan to review the emergency response plans as part of the agency's peer review process, but each district office only undergoes a peer review once every 2 years. Without monitoring the quality of the plans across all districts, it is unclear how MSHA headquarters can ensure that its guidance and the requirements of the MINER Act are applied consistently and that mines are held to the same standards.

Conclusions

At the Sago mine, 12 miners died hours after an explosion in the mine after being exposed to the carbon monoxide that accumulated in the mine. The MINER Act now requires underground coal mines to develop emergency response plans to ensure that miners have the tools and technology needed to protect them in the event of future mine accidents. However, because of

⁴⁰GAO, *Standards for Internal Control in the Federal Government*, [GAO/AIMD-00-21.3.1](#) (Washington, D.C.: Nov. 1999).

differences in the mines' emergency response plans, it is not clear that all mines are being held to the same standards for providing these tools to trapped miners and, ultimately, for providing the protections needed to ensure the safety of miners. We understand that not all of the mines' emergency response plans will be exactly the same because they must take into account the specific characteristics of each mine. However, the differences in the plans we reviewed seemed to reflect a lack of specific guidance, rather than the unique characteristics of each mine. MSHA's current guidance will continue to be a problem as districts approve emergency response plans for new mines and review compliance with emergency response plans as part of their inspections of all mines. In addition, despite advances in technology, MSHA has not developed guidance indicating what technologies it will allow mine operators to use to meet the June 2009 wireless communications requirement of the MINER Act because they want to wait and see what will be available. However, if MSHA does not act soon to determine what will be acceptable, it is not clear that manufacturers and mine operators will be able to plan and prepare for the implementation of new technologies before the deadline, thereby missing opportunities to improve trapped miners' chances of survival after an accident. Finally, by not monitoring district offices to determine the quality of the emergency response plans and district enforcement efforts, MSHA headquarters officials will not be aware that the district offices may be holding mines to different standards. As a result, all mines may not be prepared to adequately protect their miners in the event of an accident.

Recommendations for Executive Action

To ensure that new and existing mines are held to the same agencywide standards in preparing for future accidents, we recommend that the Secretary of Labor direct the Assistant Secretary for Mine Safety and Health to develop and issue additional guidance to district offices to clarify what is required for key components of the emergency response plans, such as providing postaccident breathable air for the maintenance of trapped miners.

To improve trapped miners' chances of survival after future accidents through the use of advanced technology, we recommend that the Secretary of Labor direct the Assistant Secretary for Mine Safety and Health to work with NIOSH to develop guidance for mine operators on how to meet the June 2009 requirement to provide postaccident wireless communications systems.

To improve oversight of the enforcement and approval of emergency response plans, we recommend that the Secretary of Labor direct the Assistant Secretary for Mine Safety and Health to take steps to ensure that

district offices are consistently applying MSHA's guidance on approving and enforcing emergency response plans, such as:

- analyzing its citation data by district offices and using the information to clarify policies across districts if these analyses reveal discrepancies in policies;
- analyzing violations of the MINER Act and related regulations to identify trends and ensure that the appropriate penalties are being assessed, particularly for repeat violations; and
- reviewing a sample of plans across districts to ensure that the content of the plans meets a consistent agencywide standard and, if not, take corrective action by clarifying the guidance.

Agency Comments and Our Evaluation

We obtained written comments on a draft of this report from the Departments of Labor and Health and Human Services, which are reproduced in their entirety in appendixes III and IV. Both agencies concurred with our recommendations and the Department of Health and Human Services provided technical comments and clarification, which we incorporated in the report as appropriate.

In response to our recommendation that MSHA issue additional guidance to its district offices clarifying the requirements for key components of emergency response plans, the Department of Labor agreed and stated that MSHA will issue more detailed guidance to district managers, including checklists that clarify what must be included in reviewing new emergency response plans and 6-month reviews of the plans. The agency also noted that, in developing guidance on the breathable air component of the plans, MSHA needed time to evaluate all available technology to ensure that breathable air was provided safely in an underground mine environment. We understand that the safety issues involved warranted careful consideration and that MSHA needed to obtain input from the mining community as it developed the guidance. However, as stated in our report, MSHA, for several months, did little to act on the comments it received on the draft guidance which made it difficult for its district offices and mine operators to move forward in providing miners with the protections intended by the MINER Act.

In response to our recommendation that MSHA work with NIOSH to develop guidance for mine operators on meeting the June 2009 requirement to provide postaccident wireless communications systems, both the Departments of Labor and Health and Human Services agreed

with the recommendation. The Department of Labor stated that it expects MSHA to develop guidelines at least 6 months prior to the June 2009 deadline. In its comments, the Department of Health and Human Services emphasized the need for MSHA to issue its guidance in time for mine operators to respond quickly, indicating that at least 10 months would be needed for them to develop plans, order equipment, and install the new systems. Given the upcoming June 2009 deadline and steps mine operators and manufacturers must take, the Departments of Labor and Health and Human Services should work quickly to develop the needed guidance. The Department of Labor also indicated that our report omitted the fact that MSHA maintains up-to-date lists of approved equipment on its website. However, while these lists indicate which equipment has been approved as safe for use in underground coal mines, they do not address what equipment will be sufficient to meet the postaccident wireless communications requirement in the MINER Act.

In response to our recommendation that MSHA provide additional oversight to ensure that district offices are consistently applying the agency's guidance on approving and enforcing emergency response plans, the Department of Labor agreed. It stated that MSHA plans to review citations issued by its district offices; provide inspectors with guidance to help ensure that consistent methods are used in citing statutory provisions of the MINER Act or regulations violated by mine operators; and formalize headquarters' reviews of emergency response plans to ensure consistency in their content, implementation, and enforcement.

As agreed with your office, unless you publicly announce its contents earlier, we plan no further distribution of this report until 30 days after its issue date. At that time, we will send copies of this report to the Secretaries of Labor and Health and Human Services, interested congressional committees, and other interested parties. We will also make copies available to others on request. In addition, the report will be available at no charge on GAO's Web site at <http://www.gao.gov>.

If you or your staff have any questions about this report, please contact me at (202) 512-7215 or lasowskia@gao.gov. Contact points for our Offices of Congressional Relations and Public Affairs may be found on the last page of this report. GAO staff who made major contributions to this report are listed in appendix V.

Sincerely yours,

A handwritten signature in black ink that reads "Anne-Marie Lasowski". The signature is written in a cursive style with a large initial "A" and a long horizontal stroke at the bottom.

Anne-Marie Lasowski
Acting Director, Education, Workforce,
and Income Security Issues

Appendix I: Scope and Methodology

To conduct this work, we interviewed officials at the Mine Safety and Health Administration's (MSHA) Coal Mine Safety and Health headquarters and its 11 district offices to learn about MSHA's guidance for approving the emergency response plans, the status of implementation of the plans, and MSHA's inspection efforts. In each district, we interviewed the district manager or assistant district manager,¹ the specialist responsible for reviewing and approving emergency response plans, and an underground coal mine inspector. We visited two of MSHA's district offices located in West Virginia and Kentucky—the two states with the largest number of underground coal mines in the United States. We selected District 3 in West Virginia because of the state's stringent mine safety laws. During this visit, we accompanied MSHA officials to observe conditions in an underground coal mine. We selected District 7 in Kentucky because of the unique and hazardous conditions in some of its mines, such as mines that release high amounts of methane. During this site visit, we accompanied an MSHA inspector to observe a system used by one mine that incorporated relatively new technology to meet the requirement for a postaccident tracking system. We also interviewed officials from the National Institute for Occupational Safety and Health (NIOSH); MSHA's Approval and Certification Center; and manufacturers of refuge chambers, breathing devices, and communications and tracking technologies to learn about the status of mine safety technology research and development. In addition, we interviewed the director of MSHA's penalty assessment office to determine how citations for violations related to mines' emergency response plans are processed.

We examined relevant federal laws and regulations that govern MSHA, the Federal Mine Safety and Health Review Commission, and NIOSH, as they applied to our research. Further, we reviewed the decisions that resolved the cases in which MSHA reached an impasse with mine operators on the requirements of their emergency response plans mentioned in our report. Finally, we consulted with outside individuals knowledgeable about the field of mine safety; mine company officials; and other representatives of the mining community, including the United Mine Workers of America, the National Mining Association, and the Bituminous Coal Operators' Association to obtain their views on mine safety efforts and the new

¹Due to changes in MSHA's staffing that occurred during our review, we interviewed the former managers of some of the district offices who oversaw the approval process, rather than the current managers who were not knowledgeable about the process because they were not in the district at the time that the approval process was being developed.

requirements of the Mine Improvement and New Emergency Response Act of 2006 (MINER Act) for emergency response plans.

We also obtained and analyzed data provided by MSHA on the approval, implementation, and enforcement of the emergency response plans that all underground coal mines were required to submit to MSHA as part of the MINER Act. Our review included all mines that MSHA categorized as active, producing mines, which MSHA defines as those mines that operate on a full-time basis to produce coal.

Data on the Approval Status of Mines' Emergency Response Plans

To determine the approval status of mines' emergency response plans, we obtained copies of the tracking reports from each district office used by MSHA headquarters officials to track the approval status of each component of the mines' plans. The reports indicate which components of each mine's plan had been approved, as of June 21, 2007. MSHA's district offices updated these tracking reports weekly and provided them to MSHA headquarters. To assess the accuracy and reliability of the data recorded on the tracking reports, we (1) reviewed a nonprobability sample of emergency response plans and the supporting approval and deficiency letters sent by MSHA's district offices to mine operators that corroborated the reports provided to us by MSHA's district offices; (2) ensured that the data included all mines that became active, producing mines prior to June 21, 2007; and (3) interviewed agency officials knowledgeable about the data. We worked with district officials to correct any discrepancies we found before conducting our analyses. MSHA's tracking reports contained data for 462 of 467 mines; for the 5 mines that were omitted, we obtained the mines' emergency response plans and supplemented MSHA's tracking reports with information for these mines. We verified our assessment of the approval status of these plans with MSHA. After completing these steps, we determined that the data were sufficiently reliable for the purposes of our review.

We selected the nonprobability sample of mines' emergency response plans from mines that were included in the data provided by MSHA. Our sample included 77 of the plans submitted to MSHA by the 462 mines for which MSHA was tracking the approval status of their plans as of June 21, 2007. As of June 21, 2007, with the exception of District 1, all of MSHA's district offices had fully approved most of their mines' emergency

response plans.² Districts 2 through 11 had fewer than five plans that had only been partially approved. Therefore, we included all of the partially approved plans from these districts in our sample to determine why they had not been fully approved and what factors were delaying their approval. We also randomly selected a minimum of five fully approved plans for the mines in these districts and 10 percent of the plans in the four districts with over 50 mines. Because none of the emergency response plans for the 12 mines in District 1 had been fully approved as of that date, we randomly selected a sample of 5 of these 12 partially approved plans for review. As shown in Table 5, our sample included 63 of the 441 plans that had been fully approved and 14 of the 21 plans that had been partially approved as of June 21, 2007.

Table 5: Number of Emergency Response Plans, by District

District office	1	2	3	4	5	6	7	8	9	10	11	Total
Underground coal mines' emergency response plans tracked for approval, as of June 21, 2007	12	33	29	120	57	89	64	19	22	10	7	462
Partially approved plans, as of June 21, 2007	12	2	0	0	2	0	0	4	1	0	0	21
Partially approved plans selected for review	5	2	0	0	2	0	0	4	1	0	0	14
Fully approved plans, as of June 21, 2007	0	31	29	120	55	89	64	15	21	10	7	441
Fully approved plans selected for review	0	5	5	12	6	9	6	5	5	5	5	63
Total number of plans selected for review	5	7	5	12	8	9	6	9	6	5	5	77

Source: GAO analysis of MSHA data.

We also used the 77 plans that we sampled to review the content of the plans and analyze the differences in the plans. We developed a data collection instrument to record information on each component contained in the plans. We used this data collection instrument to analyze and compare differences across the plans we reviewed.

Because, at the time of our review, MSHA had only recently approved most of the mines' emergency response plans, we did not include in the scope of our work the 6-month reviews of approved plans that the MINER Act requires MSHA to conduct.

²None of the emergency response plans for the 12 underground coal mines in District 1 had been fully approved because, at the time, the mine operators were contesting the MINER Act's requirements for some components of their plans.

Data on the Implementation Status of Mines' Emergency Response Plans

To determine the status of mines' implementation of the components of their emergency response plans, we obtained data as of September 2007 from MSHA headquarters detailing whether the mines' plans had been partially or fully implemented and what supplies mines had on order. We obtained these data for 439 of the 449 mines categorized by MSHA as active, producing mines as of October 30, 2007. We used this more recent date, rather than the June 2007 date, because it better reflected the implementation status of the emergency response plans of mines categorized as active, producing mines.³ We could not obtain information on the implementation status of 10 mines' emergency response plans because MSHA did not track the status of their plans.

The September 2007 data on the implementation status of the mines' emergency response plans were compiled by MSHA's district offices as part of a one-time request from MSHA headquarters for this information. In January 2008, we asked the district offices to provide updated information on the implementation status of the emergency response plans for each of the 449 mines that were still active, producing mines. We used the January 2008 data to assess the extent to which mines had implemented their emergency response plans and the extent to which they were using certain methods to implement the requirements of their plans, such as whether they were using refuge chambers to meet the requirement to provide postaccident breathable air to trapped miners.

We did not independently verify the information provided by MSHA on the implementation status of each mine's emergency response plan, but we assessed its reliability. To assess the reliability of the data provided by MSHA on the implementation status of each mine's emergency response plan, we (1) reviewed MSHA's citation data to corroborate the data on implementation of the mines' emergency response plans and (2) interviewed agency officials knowledgeable about the data. We determined that the data were sufficiently reliable for the purposes of our review.

³MSHA was in the process of collecting the implementation data throughout the month of September 2007 and provided it to us in late October 2007. In order to examine only active, producing mines, we requested mine status information, and MSHA was able to accommodate this request on October 30, 2007.

Data on MSHA's Citations

To analyze MSHA's enforcement efforts, we obtained data from MSHA's headquarters office on citations issued by its inspectors for violations of the emergency response plan section of the MINER Act. The data represent citations issued from August 15, 2006, through December 11, 2007. We analyzed citations issued to underground coal mines that were among the 449 categorized by MSHA as active, producing mines as of October 30, 2007. Many mines may have changed status during that time frame; therefore, we used the data on the status of each mine as of October 30, 2007 that we obtained in conjunction with the data on the status of the implementation of the mines' plans because obtaining data on the status of each mine on the date that it received a citation would have been too cumbersome. We also obtained data on citations issued for violations of 30 C.F.R. Part 75 during this same general period because some of the provisions it contains overlap with requirements of the MINER Act. We reviewed these citations, as well as those issued for violations of the of the emergency response plan section of the MINER Act, to obtain a complete picture of MSHA's enforcement efforts. We also analyzed whether some of these overlapping requirements posed a problem for inspectors in deciding how to issue the citations and for MSHA in assessing accurate penalties. We did not, however, review the extent to which mine operators contested citations issued by MSHA.

To assess the reliability of MSHA's citation data, we (1) reviewed a sample of completed citation forms to corroborate the data provided by MSHA, (2) performed electronic testing for obvious errors in accuracy and completeness, and (3) interviewed agency officials knowledgeable about the data. We determined that the data were sufficiently reliable for the purposes of our review.

We conducted this audit from April 2007 through April 2008 in accordance with generally accepted government auditing standards. Those standards require that we plan and perform the audit to obtain sufficient, appropriate evidence to provide a reasonable basis for our findings and conclusions based on our audit objectives. We believe that the evidence obtained provides a reasonable basis for our findings and conclusions based on our audit objectives.

Appendix II: Citations Issued by MSHA Related to the Requirements of Mines' Emergency Response Plans

The following tables summarize MSHA's citations of the MINER Act, by district, from August 15, 2006, through December 11, 2007. Table 6 shows the number of citations issued by each district for each component of mines' emergency response plans. Table 7 provides additional detail on citations issued for violations of multiple components of the mines' plans. Table 8 indicates the number of mines per district that have been issued citations under the MINER Act.

Table 6: Number of Citations Issued under the MINER Act to Active Mines for Violating Components of Emergency Response Plans, August 15, 2006, to December 11, 2007

Violation	District											Totals
	1	2	3	4	5	6	7	8	9	10	11	
Failure to submit	2	2	5	3	-	-	17	-	-	-	3	32
Failure to comply												
Postaccident communications	3	7	10	24	23	3	14	1	3	1	9	98
Postaccident tracking	-	9	8	8	20	-	4	-	1	3	-	53
Postaccident breathable air												
Maintenance of miners trapped underground	-	2	-	-	26	8	4	-	2	-	-	42
Self-contained self-rescuers	-	-	5	-	-	2	-	-	-	-	-	7
Maintenance of miners trapped underground and self-contained self-rescuers	-	-	-	-	1	-	-	-	-	-	-	1
Training	-	-	1	2	-	-	-	-	-	-	2	5
Postaccident lifelines	-	-	-	1	1	-	6	-	1	-	-	9
Local coordination	-	-	-	-	-	-	-	-	-	-	-	-
Additional plan content provisions	3	4	3	44	15	3	25	-	-	-	4	101
Multiple ^a	-	-	3	3	1	-	4	-	-	-	-	11
Other	-	-	2	7	1	-	1	-	-	-	1	12
Total number of citations issued	8	24	37	92	88	16	75	1	7	4	19	371
Number of active, producing mines, as of October 30, 2007	11	33	30	119	54	85	61	18	21	10	7	449

Source: GAO analysis of MSHA data.

^aSee table 7 for a breakdown of citations issued for multiple violations.

**Appendix II: Citations Issued by MSHA
Related to the Requirements of Mines'
Emergency Response Plans**

Table 7: Citations Issued under the MINER Act for Violations of Multiple Components of Mines' Emergency Response Plans as of December 11, 2007

Emergency response plan components violated	Number of instances in which a mine in a district was issued one citation for violating multiple components
District 3	
Additional plan content provisions, postaccident communications, postaccident lifelines, postaccident tracking, training	1
Postaccident communications, postaccident lifelines	1
Postaccident communications, postaccident tracking	1
District 4	
Additional plan content provisions, postaccident communications	2
Additional plan content provisions, postaccident lifelines	1
District 5	
Additional plan content provisions, postaccident tracking	1
District 7	
Additional plan content provisions, postaccident tracking	1
Postaccident communications, postaccident lifelines	2
Additional plan content provisions, postaccident breathable air: maintenance of miners trapped underground	1

Source: GAO analysis of MSHA data.

**Appendix II: Citations Issued by MSHA
Related to the Requirements of Mines'
Emergency Response Plans**

Table 8: Number and Percentage of Mines Cited per District under the MINER Act as of December 11, 2007

District	Number of mines in district	Number of mines cited	Percentage of mines cited by district
District 1	11	5	36%
District 2	33	15	45
District 3	30	17	57
District 4	119	50	42
District 5	54	39	72
District 6	85	11	13
District 7	61	41	67
District 8	18	1	6
District 9	21	5	24
District 10	10	3	30
District 11	7	6	86

Source: GAO analysis of MSHA data.

Appendix III: Comments from the Department of Labor

U.S. Department of Labor

Mine Safety and Health Administration
1100 Wilson Boulevard
Arlington, Virginia 22209-3939



MAR 31 2008

Ms. Anne-Marie Lasowski
Acting Director
Education, Workforce, and
Income Security Issues
Government Accountability Office
441 G Street, NW
Washington, DC 20548

Dear Ms. Lasowski:

Thank you for the opportunity to comment on your draft report titled "*Additional Guidance and Oversight of Mines' Emergency Response Plans Would Improve the Safety of Underground Coal Miners*" (GAO-08-424). As you note in your report, MSHA has been diligent in taking actions to enhance mine safety since passage of the MINER Act in June 2006. As of March 17, 2008, 552 Emergency Response Plans (ERPs) for all active producing underground coal mines have been fully approved and implemented except where technology or products are not yet available.

MSHA continues to improve mine safety and values GAO's input in its efforts. A more detailed response to each of your agency's recommendation is enclosed. Also included is a summary of the MSHA actions taken to date to improve coal miner health and safety following enactment of the MINER Act.

We look forward to continued dialogue with your staff regarding any additional improvements that will benefit our nation's miners.

If you have any questions, please contact Ken Bullock at (202) 693-9778.

Sincerely,

A handwritten signature in black ink that reads "Richard E. Stickler". The signature is written in a cursive style.

Richard E. Stickler
Acting Assistant Secretary for
Mine Safety and Health

Enclosures

You can now file your MSHA forms online at www.MSHA.gov. It's easy, it's fast, and it saves you money!

Mine Safety and Health Administration (MSHA) Responses to GAO Report

GAO Recommendation

To ensure that new and existing mines are held to the same agency-wide standards in preparing for future accidents, we recommend that the Secretary of Labor direct the Assistant Secretary for Mine Safety and Health to develop and issue additional guidance to district offices to clarify what is required for key components of the emergency response plans, such as providing post-accident breathable air for the maintenance of trapped miners.

MSHA Response

MSHA continually reviews Emergency Response Plans (ERPs) every six months to ensure consistency and constant improvement. MSHA is pleased that GAO determined that MSHA has successfully implemented all technologically feasible Emergency Response Plan (ERP) requirements of the MINER Act in all active, producing underground coal mines. We also appreciate that GAO acknowledged that the two exceptions to full implementation are outside the control of MSHA and the coal mining industry due to supply constraints and technological feasibility.

To address the specific GAO recommendation, MSHA will issue updated guidance from the Administrator for Coal Mine Safety and Health (CMS&H) to the District Managers with more detailed information on the content and reviews of ERPs. This will include a national checklist and guidance on what must be included in a new emergency response plan review and a 6-month review. Each ERP will be different because of the unique conditions of the mine; however, as mine specific ERP implementation experience is gained and additional knowledge is learned, providing further guidance on the specific protections required will help to ensure that operators "(i) provide for the evacuation of all individuals endangered by an emergency; and (ii) provide for the maintenance of individuals trapped underground in the event that miners are not able to evacuate the mine."

One concern we have with the report, however, is GAO's criticism of MSHA's implementation schedule for the breathable air component of ERPs. The MINER Act required that ERPs must:

2

- a. Afford miners a level of safety protection at least consistent with the existing standards, including standards mandated by law and regulation;
- b. Reflect the most recent credible scientific research;
- c. Be technologically feasible, make use of current commercially available technology, and account for the specific physical characteristics of the mine; and
- d. Reflect the improvements in mine safety gained from experience under the [MINER] Act and other worker safety and health laws.

Stockpiling large amounts of oxygen for breathable air underground could create a significant safety issue. Thus, in requiring breathable air underground, MSHA had to evaluate all available technology to determine how breathable air could be most safely provided. Without careful consideration, premature implementation could have actually increased the danger to miners in the event of a mine accident, rather than improving their chances of survival, which is the overarching goal of MSHA.

GAO Recommendation

To improve trapped miners' chance of survival after future accidents through the use of advanced technology, we recommend that the Secretary of Labor direct the Assistant Secretary for Mine Safety and Health to work with NIOSH to develop guidance for mine operators on how to meet the June 2009 requirement to provide post accident wireless communications systems.

MSHA Response

MSHA concurs with the recommendation and has been working diligently with the National Institute for Occupational Safety and Health (NIOSH) to evaluate all communication and tracking technologies since the MINER Act was signed in June 2006. For example, NIOSH has a number of research and development contracts that have completion dates later this year that may develop new technology to meet the goals of the MINER Act. MSHA has also been working with NIOSH on guidance for mine operators on how to meet the June 2009 requirement to provide post accident wireless communications systems, and expects to implement guidelines well in advance of the required deadline -- at least six months prior to June 2009.

As GAO's report notes, currently available communication systems are not truly wireless. In the event of a significant accident underground, the infrastructure that these systems rely upon is almost certainly going to be damaged or destroyed - exactly when communications are needed most. Moreover, MSHA believes that mandating technologies that do not ensure communications in the event of an accident, could actually hinder the development of truly wireless technologies and thereby preclude an important safety improvement.

Should technology take longer to develop, the MINER Act allows for alternative means of compliance if the necessary, completely wireless technologies are not fully developed by June 2009. As noted, MSHA currently plans to provide guidance on a performance-based criteria for acceptable technological alternatives by January 2009, and later provide performance-based criteria for completely wireless solutions when such systems become commercially available.

Also, while we share GAO's concern that operators be given formal guidance as soon as possible, we believe GAO's report omits the important fact that MSHA maintains an up-to-date listing of MSHA-approved technologies and evaluation results of such technologies on its website at <http://www.msha.gov/techsupp/commoandtracking.asp>, which can be easily referenced by operators in evaluating systems for their mines.

GAO Recommendation

To improve oversight of the enforcement and approval of emergency response plans, we recommend that the Secretary of Labor direct the Assistant Secretary for Mine Safety and Health to take steps to ensure that district offices are consistently applying MSHA's guidance on approving and enforcing emergency response plans, such as:

- **analyzing its citation data by district offices and using the information to clarify policies across districts if these analyses reveal discrepancies in policies;**

MSHA Response

MSHA is pleased that GAO found that MSHA's diligent enforcement of ERP requirements has resulted in mine operators promptly improving safety - the majority "within a week" when cited -- and that any ongoing problems with ERP implementation are due to manufacturing back orders of breathable air components and technological limitations, which are outside the control of mine operators and MSHA. As noted above, MSHA is constantly seeking to improve

the ERP review process for the benefit of miners in the course of it twice annual reviews of each ERP. To specifically address GAO's recommendation, the Administrator for CMS&H will issue a memo to District Managers requesting that all citations issued for ERP violations be scanned and transmitted to Headquarters for review and analysis. Internal guidance will be issued to underground coal mine inspectors to cite the statutory provision of the MINER Act applicable to emergency response plans when inspectors find a violation of the plan, unless there is a more specific regulation that applies to the violation. Headquarters staff will evaluate the issued violations and determine if any policy clarifications are necessary to improve consistency in issuances, and as MSHA does in all other areas, it will hold regular discussions with District Managers to receive input and develop best practices and improvements for ERPs.

- **analyzing violations of the MINER Act and related regulations to identify trends and ensure that the appropriate penalties are being assessed, particularly for repeat violations;**

MSHA Response

Penalties are an essential part of the Mine Act's enforcement scheme and deter mine operators from committing violations. When operators ignore their responsibilities, repeat violations rightfully incur a much higher penalty. Currently, there are only some specific safety regulations, such as those for lifelines, that apply to the components of the required ERPs; other requirements are covered by the statute and are more general. As GAO notes in its report, to ensure the fullest protection of miners, MSHA prefers to issue citations under the more protective regulations it has developed in cooperation with miners, operators and scientific experts through the rulemaking process, as opposed to more general statutory provisions. As a legal matter, we note that a violation of the regulations may not also violate the MINER Act and vice versa.

MSHA, however, appreciates the importance of requiring that repeat violations under either the statute or the regulation are deterred. Accordingly, MSHA will issue guidance to its inspectors to cite the statutory provision of the MINER Act where it is applicable unless there is a more protective regulation that applies to the violation. This policy will ensure that repeat violations are accurately captured in a mine's violation history and that the resulting assessment amount will reflect that history and ensure that the most protective standard for miners is met by operators.

- reviewing a sample of plans across districts to ensure that the content of the plans meets a consistent agency-wide standard and, if not, take corrective action by clarifying the guidance.

MSHA Response

As noted in GAO's report, MSHA headquarters personnel have been reviewing ERPs from mines throughout the country and working to ensure consistency of ERPs. In order to formalize that effort, MSHA will issue a memo to the Director, Office of Accountability (OA) and the Administrator, CMS&H, requiring the review of ERPs during any national OA review and CMS&H headquarters accountability review and district peer reviews to ensure consistency in plan provisions, operator implementation of the ERPs, and enforcement efforts.

CMS&H headquarters has already developed a list of mines, encompassing an appropriate cross-section of coal mine types and operators, for ERP review. The national ERP checklist and guidance, described previously, will be used to ensure that the content and approval of the ERPs meet the applicable agency-wide guidance. Based on a recurring review of sample ERPs from the districts, corrective action will be taken to update and clarify headquarters' guidance to address discrepancies and inconsistencies from established policy on the approval of these emergency response plans.

Conclusion

MSHA concurs with all of the GAO's recommendations for additional guidance and oversight of the approval and enforcement of mine operators' emergency response plans, and had already been working on improvements that address a number of GAO's recommendations. We will continue our efforts in that regard and expect these actions will further improve the consistency in ERPs approved and enforced nationwide for the benefit of our nation's miners.

Appendix IV: Comments from the Department of Health and Human Services



DEPARTMENT OF HEALTH & HUMAN SERVICES

Office of the Assistant Secretary
for Legislation

Washington, D.C. 20201

APR 2 2008

Aine-Marie Lasowski
Acting Director
Education, Workforce, and
Income Security Issues
U.S. Government Accountability Office
Washington, DC 20548

Dear Ms. Lasowski:

Enclosed are the Department's comments on the U.S. Government Accountability Office's (GAO) draft report entitled: *Mine Safety: Additional Guidance and Oversight of Mines' Emergency Response Plans Would Improve the Safety of Underground Coal Miners* (GAO 08-424).

The attached comments serve as the final comments for publication.

The Department appreciates the opportunity to review and comment on this report.

Sincerely,

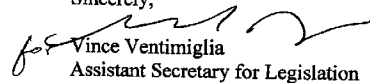
Vince Ventimiglia
Assistant Secretary for Legislation

GENERAL COMMENTS OF THE DEPARTMENT OF HEALTH AND HUMAN SERVICES (HHS) ON THE GOVERNMENT ACCOUNTABILITY OFFICE'S (GAO) DRAFT REPORT ENTITLED: MINE SAFETY: ADDITIONAL GUIDANCE AND OVERSIGHT OF MINES' EMERGENCY RESPONSE PLANS (GAO 08-424)

We have reviewed the report with particular attention to the issues, findings, and recommendations that relate to NIOSH's research activities. Overall we concur with those aspects of the report.

Below is an explanation/clarification of the timeline and excel spreadsheet sent with our earlier comments, which makes reference to the 10 month timeframe.

- We especially want to emphasize the importance of GAO's finding on page 28 that fully wireless systems may not be available for many years.
- As GAO correctly observed on page 27, the MINER Act itself does not define "wireless" communication, but as noted in the Senate HELP Committee Report on the Act, the intent is for mine operators to use the most advanced technology available for a particular mine, and to avoid interpretation of the law so narrowly as to stifle innovation and delay implementation of methods or equipment that would have significant safety benefits.
- These are critical points. NIOSH has informed MSHA that its policy statement on wireless communication is too narrowly defined.
- Moreover, we have estimated that it will take many operators at least 10 months after MSHA issues policy guidance to develop a post-accident communication plan, place equipment orders, and begin in-mine installation.
- Therefore, this guidance should be issued as soon as practicable, if the goal is to meet the June 2009 target established by the MINER Act.
- For this reason, we fully support GAO's recommendation that MSHA work with NIOSH to develop this guidance.
- It should be noted that MSHA has made a commitment to work with us on this issue.

Appendix V: GAO Contact and Staff Acknowledgments

GAO Contact

Anne-Marie Lasowski, (202) 512-7215 or lasowskia@gao.gov.

Staff Acknowledgments

Revae Moran, Assistant Director, and Cady Panetta, Analyst-in-Charge, managed this report. Other staff who made key contributions to the report include Alana Finley and Jill Yost. Sheila McCoy provided legal assistance. Cindy Gilbert and Shana Wallace assisted with the methodology and statistical analysis. Susanna Compton and Mimi Nguyen helped prepare the final report and the graphics.

GAO's Mission

The Government Accountability Office, the audit, evaluation, and investigative arm of Congress, exists to support Congress in meeting its constitutional responsibilities and to help improve the performance and accountability of the federal government for the American people. GAO examines the use of public funds; evaluates federal programs and policies; and provides analyses, recommendations, and other assistance to help Congress make informed oversight, policy, and funding decisions. GAO's commitment to good government is reflected in its core values of accountability, integrity, and reliability.

Obtaining Copies of GAO Reports and Testimony

The fastest and easiest way to obtain copies of GAO documents at no cost is through GAO's Web site (www.gao.gov). Each weekday, GAO posts newly released reports, testimony, and correspondence on its Web site. To have GAO e-mail you a list of newly posted products every afternoon, go to www.gao.gov and select "E-mail Updates."

Order by Mail or Phone

The first copy of each printed report is free. Additional copies are \$2 each. A check or money order should be made out to the Superintendent of Documents. GAO also accepts VISA and Mastercard. Orders for 100 or more copies mailed to a single address are discounted 25 percent. Orders should be sent to:

U.S. Government Accountability Office
441 G Street NW, Room LM
Washington, DC 20548

To order by Phone: Voice: (202) 512-6000
TDD: (202) 512-2537
Fax: (202) 512-6061

To Report Fraud, Waste, and Abuse in Federal Programs

Contact:

Web site: www.gao.gov/fraudnet/fraudnet.htm

E-mail: fraudnet@gao.gov

Automated answering system: (800) 424-5454 or (202) 512-7470

Congressional Relations

Ralph Dawn, Managing Director, dawnr@gao.gov, (202) 512-4400
U.S. Government Accountability Office, 441 G Street NW, Room 7125
Washington, DC 20548

Public Affairs

Chuck Young, Managing Director, youngc1@gao.gov, (202) 512-4800
U.S. Government Accountability Office, 441 G Street NW, Room 7149
Washington, DC 20548